

1954-5

19th EDITION

Radio's MASTER[®]

OFFICIAL
BUYING GUIDE
OF THE INDUSTRY
•
ELECTRONIC-TV PARTS
AND EQUIPMENT



UNITED CATALOG PUBLISHERS, INC.
106-110 LAFAYETTE STREET
NEW YORK 13, N. Y., U. S. A.

NOV 14 1955

U. S. PATENT OFFICE

RADIO'S MASTER®

NINETEENTH EDITION

301

3/21

OFFICIAL

PARTS and EQUIPMENT MANUAL

of the

RADIO, TELEVISION & ELECTRONIC INDUSTRY

DIRECTORY OF ADVERTISERS

ADDRESSES

TELEPHONE NUMBERS

BRANCH OFFICES

U. S. Patent Office

NOV 15 1955

Design Division

Published by

UNITED CATALOG PUBLISHERS, INC.

106-110 Lafayette Street



New York 13, N. Y.

TK
6560
Z5R3

1954

Des. Div.

RADIO'S MASTER

NINETEENTH EDITION

U. S. Patent Office

NOV 15 1955

Design Division

Copyright 1954

United Catalog Publishers, Inc.

Printed in U.S.A.

— A —

ACRO PRODUCTS COMPANY
369 Shurs Lane
Philadelphia 28, Pa.
Tel. Ivy Ridge 3-5969

ADVANCE ELECTRIC & RELAY CO.
2435 No. Naomi Street
Burbank, Calif.
Tel. THornwall 2-8191
Victoria 9-1146

AERO INSTRUMENT COMPANY
11423 Vanowen Street
N. Hollywood, Calif.
Tel. STanley 7-5433

AEROVOX CORPORATION
740 Belleville Avenue
New Bedford, Mass.
Tel. NEw Bedford 4-9661

AKRO-MILS, INC.
P.O. Box 989RM
Akron 9, Ohio
Tel. BLackstone 3-7100

ALL CHANNEL ANTENNA CORP.
47-39 49th Street
Woodside 77, N. Y.
Tel. EXeter 2-1336

ALLIANCE MANUFACTURING CO.
Alliance, Ohio
Tel. ALliance 1-5361

ALPHA WIRE CORPORATION
430 Broadway
New York 13, N. Y.
Tel. CANal 6-6800

Branch Office & Warehouse
2419 S. Grand Avenue
Los Angeles 7, Calif.
Tel. RIchmond 7-4321

ALTEC LANSING CORPORATION
9356 Santa Monica Blvd.
Beverly Hills, Calif.
Tel. BRAdshaw 2-6356
CRestview 5-5101

New York Office
161 Sixth Avenue
New York 13, N. Y.
Tel. ALgonquin 5-3636

AMERICAN ELECTRICAL HEATER CO.
("American Beauty")
6110 Cass Avenue
Detroit 2, Mich.
Tel. TRinity 5-2505

AMERICAN MICROPHONE COMPANY
370 South Fair Oaks Avenue
Pasadena 1, Calif.
Tel. RYan 1-7444

AMERICAN PHENOLIC CORP. (Amphenol)
1830 South 54th Avenue
Chicago 50, Ill.
Tel. Bfshop 2-1000

AMERICAN RADIO RELAY LEAGUE, INC.
(ARRL)
38 La Salle Road
West Hartford 7, Conn.
Tel. ADams 3-6268

AMERICAN TELEVISION & RADIO CO.
300 East Fourth Street
St. Paul 1, Minn.
Tel. CApitol 2-3791

Sales Offices
ATLANTA 6, GEORGIA
1426 High Point Pl. N.E.
Tel. EMerson 3979

BALTIMORE 29, MARYLAND
1204 W. Wildwood Parkway
Tel. WIlkins 4-1572

BOSTON 16, MASSACHUSETTS
739 Boylston St.
Tel. COpley 7-0061

BOULDER, COLORADO
1003 Grandview Ave.
Tel. HIlcrest 2-7899

CHICAGO 10, ILLINOIS
227 W. Chicago Ave.
Tel. SUperior 7-8181

CINCINNATI, OHIO
6225 Joyce Lane
Tel. JEFFerson 3998

CLEVELAND 20, OHIO
16201 Shaker Blvd.
Tel. WYoming 1-2624

DALLAS 1, TEXAS
4411 Maple Avenue
Tel. LOGan 8329

DETROIT 23, MICHIGAN
18925 Grand River Ave.
Tel. VERmont 7-5310

DE WITT, NEW YORK
P.O. Box 222
Tel. SYracuse 72-5198

EAST POINT, GEORGIA
704 Lumpkin
Tel. CAIhou 3160

HAVERTOWN, PENNSYLVANIA
230 Mill Road
Tel. HIltop 6-6892

INDIANAPOLIS, INDIANA
18 N. Bolton St.
Tel. BLackstone 6176

LOS ANGELES, CALIF.
2837 W. Pico Blvd.
Tel. REpublic 3-9111

MERRIAM, KANSAS
6359 Antioch Ave.
Tel. VAlient 7523

MINNEAPOLIS, MINNESOTA
9 E. 22nd Street
Tel. GE 4078

NEW HAVEN, CONNECTICUT
42 Church Street
Tel. UNiversity 5-2147

NEW ORLEANS, LOUISIANA
727 Ursuline Street
Tel. CANal 0403

NEW YORK 16, NEW YORK
6 E. 39th Street
Tel. LEXington 2-7372

NORTH VANCOUVER, B. C.
3093 Woodbine Drive
Tel. York 2597

PITTSBURGH 21, PENNSYLVANIA
409 Todd Street
Tel. PENnhurst 1-1210

SAN FRANCISCO, CALIFORNIA
154 Eighth Street
Tel. HEMlock 1-0692, 1-5127

SEATTLE 1, WASHINGTON
2321 2nd Avenue
Tel. MAIn 8811

SILVER SPRING, MARYLAND
9431 Georgia Avenue
Tel. JUNiper 9-4002

WILLOWDALE, ONTARIO
P.O. Box 99
Tel. BA 1-7755

WINTER HAVEN, FLORIDA
940 Lake Elbert Drive
Tel. WInter Haven 4-6671

AMPEREX ELECTRONIC CORPORATION
P.O. Box 418
230 Duffy Avenue
Hicksville, L. I., N. Y.
Tel. HICKsville 3-6200

AMPERITE COMPANY, INC.
561 Broadway
New York 12, N. Y.
Tel. CANal 6-1446

AMPHENOL
(See American Phenolic Corp.)

ARCO ELECTRONICS, INC. (El-Menco)
103 Lafayette Street
New York 13, N. Y.
Tel. WORTH 6-0530

ARGOS PRODUCTS CO.
310 Main Street
Genoa, Ill.

Executive Offices
4753 N. Broadway
Chicago 40, Ill.
Tel. Longbeach 1-7611

U. S. PATENT OFFICE

ASTATIC CORPORATION
Conneaut, Ohio
Tel. 22-656

ASTRON CORPORATION
255 Grant Avenue
E. Newark, N. J.
Tel. HUMBoldt 2-7800

ATLAS RESISTOR CO.
24 E. Coulter Street
Philadelphia 44, Pa.
Tel. VICTor 4-5174

ATLAS SOUND CORPORATION
1449 - 39th Street
Brooklyn 18, N. Y.
Tel. GEdney 8-5500

AUDAK COMPANY, INC. (Audax)
500 Fifth Avenue
New York 36, N. Y.
Tel. LACKawanna 4-3723

AUDIO DEVELOPMENT COMPANY
2833 - 13th Avenue South
Minneapolis 7, Minn.
Tel. Dupont 7386

AUDIO DEVICES, INC.
444 Madison Avenue
New York 22, N. Y.
Tel. PLaza 3-0973

Hollywood Office
1006 North Fairfax Ave.
Hollywood 46, Calif.
Tel. HOllywood 9-8902

AURORA EQUIPMENT CO.
Equipto Division
Aurora, Ill.
Tel. Aurora 9231

— B —

BAKER MANUFACTURING CO.
133 Enterprise Street
Evansville, Wis.
Tel. 400

BELDEN MANUFACTURING CO.
4647 West Van Buren Street
Chicago 44, Ill.
Tel. ESTerbrook 8-1000

BELL SOUND SYSTEMS, INC.
555 Marion Road
Columbus 7, Ohio
Tel. HICKory 4-1193

BERKSHIRE LABORATORIES
810 Beaver Pond Road
Lincoln, Mass.
Tel. WALTHam 5-7000

BIRNBACH RADIO CO., INC.
145 Hudson Street
New York 13, N. Y.
Tel. WALKer 5-6980

BLACO MANUFACTURING CO.
6541 Euclid Avenue
Cleveland 3, Ohio
Tel. EXpress 1-0497

BLILEY ELECTRIC COMPANY
Union Station Building
Erie, Pa.
Tel. ERIE 2-2287

BLONDER-TONGUE LABS., INC.
526-536 North Ave.
Westfield, N. J.
Tel. WEstfield 2-7032-3

BLUM & CO., INC., JULIUS
Carlstadt, N. J.
Tel. GENEva 8-4600

RADIO'S MASTER • 1954 • NINETEENTH EDITION

BOGEN COMPANY, INC., DAVID
29 Ninth Avenue
New York 14, N. Y.
Tel. ORegon 5-6565

Branch Offices

AMSTERDAM, NEW YORK
R. D. 4
Tel. 531J1

ATLANTA 3, GEORGIA
407 Whitehead Bldg.
Tel. MAIn 5878

BOSTON 82, MASSACHUSETTS
Wellesley Hills
90 Edmunds Road
Tel. WELlesley 5-0102

CHICAGO 31, ILLINOIS
6571 N. Olmstead Avenue
Tel. ROdney 3-4154

COLUMBUS 15, OHIO
150 E. Broad Street
Tel. Main 3363

COLORADO SPRINGS, COLORADO
1501 N. Weber Street
Tel. MElose 4-3401

DALLAS 6, TEXAS
5004 Ross Avenue
Tel. Tenison 6735

DETROIT 19, MICHIGAN
Suite 207
22128 Grand River Avenue
Tel. KENwood 3-7700

INDIANAPOLIS 20, INDIANA
P.O. Box 5971
909 E. Westfield Blvd.
Tel. Broadway 6770

KANSAS CITY II, MISSOURI
510 Porter Bldg.
Broadway at 34th
Tel. Jefferson 5236

***LOS ANGELES 5, CALIFORNIA**
672 S. Lafayette Park Place
Tel. DUNkirk 7-8235

MINNEAPOLIS 5, MINNESOTA
1711 Hawthorne Avenue
Tel. MAine 5457

PHELPS, NEW YORK
R. D. 1
Tel. 228

PITTSBURGH 19, PENNSYLVANIA
600 Grant Street
Tel. COurt 1-0131

PORTLAND 10, OREGON
2941 N. W. Quimby
Tel. Broadway 5004

***SAN FRANCISCO 3, CALIF.**
758 Natoma Street
Tel. UNderhill 3-0317

***SEATTLE 4, WASHINGTON**
4130 First Avenue, S.
Tel. ELiot 8882

TORONTO 14, ONTARIO, CANADA
Long Branch
1166A Lakeshore Road
Tel. CLifford 9-5464

* Stocking warehouse

BOYCE BOOKS
(See Howard W. Sams, Inc.)

BRACH MFG. CORP.
Div. General Bronze Corp.
200 Central Avenue
Newark 4, N. J.
Tel. HUmboldt 2-1500

BRADLEY LABORATORIES, INC.
168 Columbus Avenue
New Haven 11, Conn.
Tel. MAIn 4-3123

BRAND & CO., INC., WILLIAM
North & Valley Streets
Willimantic, Conn.
Tel. HArrison 3-1661

Regional Sales Office

CHICAGO, ILLINOIS
3959 North Lincoln Avenue
Tel. LAKeview 5-8225

Branch Offices

BRIDGEPORT 5, CONNECTICUT
E. A. Taylor
505 Bostwick Avenue
Tel. BRidgeport 6-4489

BROCKTON 27, MASSACHUSETTS
Warren Stedman
225 Plain Street

CHICAGO 22, ILLINOIS
R. W. Brinson
767 N. Milwaukee Avenue
Tel. TAylor 9-1888

CLEVELAND 22, OHIO
J. H. Clark
Box 708--Warrenville Br.
Tel. TErrace 1-8369

DECATUR, GEORGIA
V. Avis McCorvey Co.
307 Church Street
Tel. CREScent 6167

DETROIT 24, MICHIGAN
Nelson J. Clark
3850 Kensington Road
Tel. TUredo 5-1723

EAST ORANGE, NEW JERSEY
R. T. and W. A. Murray
604 Central Avenue
Tel. ORange 5-9038

ELM GROVE, WISCONSIN
Albert H. Dorsch
13395 Watertown Plank Road
Tel. SUNset 2-7150

FAYETTEVILLE, NEW YORK
M. P. Andrews
Mott Road
Tel. 65-B405

LOS ANGELES 15, CALIF.
Thomas L. Stevens Co.
1151 So. Broadway
Tel. RICHmond 7-5691

MINNEAPOLIS 17, MINNESOTA
A. J. Warner Co.
5022 29th Ave. S.
Tel. DRexel 1895

PHILADELPHIA 6, PENNSYLVANIA
J. A. Maguire & Co.
5th and Chestnut Sts.
Tel. MARket 7-1670

PITTSFIELD, MASSACHUSETTS
McKenzie & Shugg, Inc.
Box 604
Tel. 8618

PITTSBURGH 35, PENNSYLVANIA
W. P. Jones
164 Crescent Hill Road
Tel. SYcamore 3-1973

ST. LOUIS 9, MISSOURI
Fred R. Hearn Co.
5761a Chippewa Street
Tel. HUDson 1-8135

SAN FRANCISCO 3, CALIF.
William J. Purdy Co.
312 Seventh Street
Tel. UNderhill 3-4321

SEATTLE 44, WASHINGTON
Associated Industries
1752 Rainier Avenue

TOWSON 4, MARYLAND
R. L. Gibson
c/o J. A. Maguire & Co.
29 Allegheny Avenue
Tel. VAIlley 5-3836

BRITISH INDUSTRIES CORPORATION
164 Duane Street
New York 13, N. Y.
Tel. WALKer 5-0900

BRUSH ELECTRONICS COMPANY
Unit of Clevite Corporation
3405 Parklins Avenue
Cleveland 14, Ohio
Tel. ENdicott 1-3315

BUD RADIO, INC.
2118 East 55th Street
Cleveland 3, Ohio
Tel. HENDERSON 1-7166

BURGESS BATTERY COMPANY
Freeport, Ill.
Tel. MAIn 3300

Branch Offices

ATLANTA, GEORGIA
450 Thurman St., N.W.
Tel. ALPine 2092

BOSTON 29, MASSACHUSETTS
55 Terminal Street
Tel. CHArlestown 2-0880

CHICAGO, ILLINOIS
6 South Crawford
Tel. NEVada 2-2771

GREENSBORO, N. C.
810 Hunt Street
Tel. 6420

KANSAS CITY 6, MISSOURI
228-236 W. Fourth Street
Tel. VICTor 0225

LOS ANGELES 21, CALIF.
1855 Industrial Street
Tel. VANDYke 1776

NEW YORK 11, NEW YORK
76 Ninth Avenue
Tel. CHelsee 2-2270

SAN FRANCISCO 7, CALIF.
625 Third Street
Tel. SUTter 1-3461

SEATTLE, WASHINGTON
1016 First Avenue, South
Tel. ELiot 5007

TOLEDO, OHIO
1510 Elm Street
Tel. ADams 2251

BURLINGTON INSTRUMENT COMPANY
Burlington, Iowa
Tel. 7241

BURNELL & CO., INC.
45 Warburton Avenue
Yonkers, N. Y.
Tel. YONkers 5-6800
Pacific Division
726 Mission Street
S. Pasadena, Calif.

BURTON-ROGERS COMPANY
Sales Div. of
Hoyt Electrical Instrument Works, Inc.
42 Carleton Street
Cambridge 42, Mass.
Tel. ELiot 4-1643

BUSSMANN MANUFACTURING CO.
University at Jefferson
St. Louis 7, Mo.
Tel. GARfield 1-1740

Branch Offices

CHICAGO 6, ILL.
9 S. Clinton Street
Tel. DEarborn 2-1893

NEW YORK 7, N. Y.
53 Park Place
Tel. COrtlandt 7-1466

SAN FRANCISCO 9, CALIF.
574 Eddy Street
Tel. ORdway 3-2822

— C —

CANNON COMPANY, C. F.
Springwater, N. Y.
Tel. 531

CANNON ELECTRIC CO.
3209 Humboldt Street
Los Angeles 31, Calif.
Tel. CApitol 5-1251

Eastern Division
191 Kimberly Avenue
P.O. Box 218
East Haven 12, Conn.
Tel. HObart 7-6329

Canadian Factory
Cannon Electric (Canada) Ltd.
2451 Danforth Avenue
Toronto, Ontario

Branch Office
Montreal Airport
Dorval, Quebec

Directory of Advertisers, Branch Offices, Addresses, Telephone Numbers

- CAPPS & CO., INC., FRANK L.**
20 Addison Place
Valley Stream, N. Y.
Tel. Valley Stream 5-4413
- CARDWELL ELECTRONICS PRODUCTIONS CORP., ALLEN D.**
97 Whiting Street
Plainville, Conn.
Tel. SHerwood 7-2741
- CARLING ELECTRIC INC.**
505 New Park Avenue
West Hartford 10, Conn.
Tel. ADams 2-4461
- CARTER MOTOR COMPANY**
2644 North Maplewood Avenue
Chicago 47, Ill.
Tel. HUmboldt 6-4700
- CARTER PARTS COMPANY**
213 Institute Place
Chicago 10, Ill.
Tel. Superior 7-4885
- CBS-HYTRON**
(Div. of Columbia Broadcasting System, Inc.)
100 Endicott Street
Danvers, Mass.
Tel. Danvers 2360
- Sales Offices
Newark 2, N. J.
32 Green St.
Tel. Market 3-5832
- Chicago 39, Ill.
5637 W. Diversey Ave.
Tel. NATIONAL 2-1425-6-7
- CENTRALAB DIV.**
Globe-Union Inc.,
900 E. Keefe Avenue
Milwaukee 1, Wis.
Tel. Woodruff 2-9200
and
CENTRALAB CANADA LTD.
804 Mt. Pleasant Road
Toronto, Ont., Canada
Tel. HUDson 1-2291
- Branch Office
5359 W. Fullerton Avenue
Chicago 39, Ill.
Tel. BERkshire 39, Ill.
- CETRON**
(See Continental Electric Co.)
- CHALLENGER AMPLIFIER CO.**
29 Ninth Ave.
New York 14, N. Y.
Tel. OREGon 5-6565
(For Branch Offices
see Bogen Co., Inc., David)
- CHANNEL MASTER CORPORATION**
Ellenville, N. Y.
Tel. Ellenville 1300
- CHATHAM ELECTRONICS CORP.**
630 W. Mt. Pleasant Ave.
Livingston, N. J.
Tel. LI. 6-1100
- CHICAGO INDUSTRIAL INSTRUMENT CO.**
536 West Elm Street
Chicago 10, Ill.
Tel. SUperior 7-5055-56
- Sales Offices
CHICAGO 26, ILLINOIS
Victoria Sales
7522 N. Sheridan Road
KANSAS CITY 6, MISSOURI
A. R. Thibau Co.
402 Mrs. Exchange Bldg.
SAN FRANCISCO 3, CALIF.
Meyer & Ross
113 10th Street
- CHICAGO STANDARD TRANSFORMER CORP.**
Chicago Division
Addison and Elston
Chicago 18, Ill.
Tel. INdependence 3-7400
- CHICAGO STANDARD TRANSFORMER CORP.**
Standard Division (Stancor)
Addison & Elston
Chicago 18, Ill.
Tel. INdependence 3-7400
- CHISHOLM-RYDER CO., INC.**
(See Premax Products)
- CINAUDAGRAPH COMPANY**
7334 N. Clark Street
Chicago 26, Ill.
Tel. SHeldrake 3-7010
- CINCH-JONES SALES**
Div. Cinch Mfg. Co.
1026 South Homan Ave.
Chicago 24, Ill.
Tel. NEvada 2-2000
- Branch Offices
LOS ANGELES 14, CALIF.
1709 West 8th Street
Tel. DUnkirk 7-5371
- DETROIT 11, MICHIGAN**
2832 E. Grand Blvd.
Tel. TRinity 3-9500
- BUFFALO, NEW YORK**
463 Huxley Drive
Tel. Parkside 0984
- NEW YORK 10, N. Y.**
15 East 26th Street
Tel. MURray Hill 3-9356
- CLARKSTAN**
(See Pacific Transducer Corp.)
- CLAROSTAT MFG. CO., INC.**
Dover, N. H.
Tel. 975-6-7-8-9
TWX 275 U
- CLIFTON CONDUIT CO. (TENNESSEE) INC.**
(See Pierceway Division)
- COLUMBIA BROADCASTING SYSTEM, INC.**
(See CBS-Hytron)
- COLUMBIA PRODUCTS COMPANY**
Div. of The Shakespeare Co.
P.O. Box 5207
Columbia 5, S. C.
Tel. 3-7032
LD 84
- COLUMBIA WIRE AND SUPPLY CO.**
2850 West Irving Park Road
Chicago 18, Ill.
Tel. CORnellia 7-3160
- CONANT LABORATORIES**
6500 "O" Street
Lincoln 5, Nebraska
Tel. 6-2210
- CONDENSER PRODUCTS CO., INC.**
Div. New Haven Clock & Watch Co.
133 Hamilton Street
New Haven, Conn.
Tel. MAIn 4-1174
- Branch
7517 N. Clark Street
Chicago 26, Ill.
Tel. AMBassador 2-3727
- CONRAC, INC.**
19217 E. Foothill Blvd.
Glendora, Calif.
Tel. EDGewood 5-1241
- CONSOLIDATED RADIO PRODUCTS CO.**
(Smith-Baldwin Speakers)
350 W. Erie Street
Chicago 10, Ill.
Tel. DElaware 7-6900
- CONSOLIDATED WIRE & ASSOCIATED COS.**
1635 S. Clinton Street
Chicago 16, Ill.
Tel. HAYmarket 1-4441
- CONTINENTAL CARBON, INC.**
13900 Lorain Avenue
Cleveland 11, Ohio
Tel. Clearwater 1-6500
- CONTINENTAL ELECTRIC CO. (Cetron)**
715 Hamilton Street
Geneva, Ill.
Tel. COLUMbus 1-1216
- Branch Office
310 South Orange Avenue
South Orange, N. J.
Tel. SOuth Orange 3-3373
- COPPERWELD STEEL CO.**
Wire and Cable Div.
Glassport, Pa.
Tel. GLassport 4-7131
- CORNELL-DUBILIER ELECTRIC CORP.**
333 Hamilton Blvd.
South Plainfield, N. J.
Tel. PLainfield 6-9000
- Branch Offices
INDIANAPOLIS, IND.
2900 Columbia Avenue
Tel. Talbot 2442
- CHICAGO 6, ILL.**
605 West Washington St.
Tel. Financial 6-4586
- CLEVELAND, OHIO**
3455 Vega Ave.
Tel. Melrose 1-3408
- CORNISH WIRE COMPANY, INC.**
50 Church Street
New York 7, N. Y.
Tel. BRa clay 7-5140
- COYNE TECHNICAL BOOKS**
(See Howard W. Sams, Inc.)
- CREST LABORATORIES, INC.**
Affiliate of Microtran Company
84-11 Rockaway Beach Blvd.
Rockaway Beach 93, N. Y.
Tel. NEptune 4-3328
- CRONAME**
(See Waldom Electronics, Inc.)
- CROWN CONTROLS COMPANY, INC.**
124 South Washington St.
New Bremen, Ohio
Tel. 17 or 19
- CUTLER-HAMMER, INC.**
1465 St. Paul Ave.
Milwaukee 1, Wis.
- Sales Offices:
Albany 7, N. Y.
91 State St.
Atlanta, Ga.
714 Spring St. N.W.
Tel. ATwood 9746
Baltimore 18, Md.
1119 E. 30th St.
Tel. HOPkins 9001
Boston 15, Mass.
784 Commonwealth Ave.
Tel. BEacon 2-7900
Buffalo 3, N. Y.
295 Main St.
Tel. WASHINGTON 2518, 9
Charlotte 2, N. C.
237 S. Tryon St.
Tel. 6-8481
Chicago 6, Ill.
400 W. Madison St.
Tel. STATE 2-4960
Cincinnati 2, Ohio
804 Plum St.
Tel. CHerry 5111, 2, 3, 4
Cleveland 3, Ohio
2010 E. 46th St.
Tel. UTAh 1-0300, 1, 2, 3
Columbus 9, Ohio
2700 E. Main St.
Tel. DOUGLAS 6110
Dallas 2, Tex.
1331 Dragon St.
Tel. STerling 2101
Davenport, Iowa
220 Main St.
Tel. 3-8057

RADIO'S MASTER • 1954 • NINETEENTH EDITION

CUTLER-HAMMER Sales Offices (Cont.)

Dayton 2, Ohio
410 W. First St.
Tel. Hemlock 7483, 4

Denver 4, Colo.
126 W. 5th Ave.
Tel. Sherman 2495

Detroit 38, Mich.
15427 Woodrow Wilson Ave.
Tel. TULSA 3-1600, 1, 2, 3, 4, 5

Fresno, Calif.
2946 Michigan Ave.
Tel. FResno 7-1209

Grand Rapids 2, Mich.
407 Bldg. & Loan Bldg.
Tel. Glendale 68529

Houston 3, Texas
1605 Jefferson St.
Tel. Charter 1854-5

Indianapolis 5, Ind.
644 E. 38th St., Rm. 208
Tel. Hickory 6475

Los Angeles 31, Calif.
1795 Pasadena Ave.
Tel. Capitol 28191

Midland, Texas
508 N. Main St.
Tel. Midland 3-3421

Milwaukee 3, Wis.
536 W. Wisconsin Ave.
Tel. BR 1-7800

Minneapolis 15, Minn.
523 S. 7th St.
Tel. Bridgeport 7849

Newark 2, N. J.
155 Washington St.
Tel. Mitchell 2-8600

New Orleans 12, La.
833 Howard Ave.
Tel. Magnolia 5050

New York 18, N. Y.
8 W. 40th St.
Tel. PENNSYLVANIA 6-8400

Omaha, Neb.
320 W.O.W. Bldg.
Tel. Harney 8600

Philadelphia 7, Pa.
112 No. 12th St.
Tel. Locust 4-2131

Pittsburgh 22, Pa.
355 Fifth Ave.
Tel. Atlantic 1-4840

Portland 4, Ore.
208 S.W. Stark St.
Tel. Broadway 2405

Rockford, Ill.
1404 N. Main St.
Tel. 5-9469

Sacramento 17, Calif.
1331 T St.
Tel. Hillcrest 6-1984

Saginaw, Mich.
107 N. Franklin St.
Tel. 2-1617

St. Louis 3, Mo.
1914 Washington St.
Tel. Central 9974

Salt Lake City 1, Utah
165 S. First, West
Tel. 3-5013

San Francisco 7, Calif.
2130 Third St.
Tel. Hemlock 1-3835

Seattle 4, Wash.
619 Eighth Ave. So.
Tel. Elliot 4032

Silver Spring, Md.
8055 13th St.

South Bend 5, Ind.
108 N. Main St.
Tel. Cassopolis 112F5

Spokane 14, Wash.
W. 3013 Princeton Ave.
Tel. Empire 4624

Syracuse 2, N. Y.
109 S. Warren St.
Tel. 2-2769

Tulsa 14, Okla.
1632 S. Main St.
Tel. 34533

Youngstown 3, Ohio
25 E. Boardman St.
Tel. 4-5359

— D —

DAGE ELECTRIC COMPANY, INC.
67 North Second Street
Beech Grove, Ind.
Tel. Idlewood 1494

Branch Office
Dage Corporation
(Foreign Representative)
40 Hudson Street
New York, N. Y.

DALE PRODUCTS, INC.
P.O. Box 136
1356—28th Ave.
Columbus, Nebr.
Tel. 2139

DAVIES MOLDING CO., HARRY
1428 North Wells Street
Chicago 10, Ill.
Tel. Michigan 2-7240

DAVIS ELECTRONICS
4002 Burbank Boulevard
Burbank, Calif.
Tel. Thornwall 2-3032

DIALIGHT CORPORATION
(Dialco)
60 Stewart Ave.
Brooklyn 37, N. Y.
Tel. Hyacinth 7-7600

Jobber Sales
SIGNAL INDICATOR CORP.
42 Stewart Ave.
Brooklyn 37, N. Y.
Tel. Hyacinth 7-5020

DOLLAR, THE ROBERT DOLLAR CO.
Communications Equipment Division
Fifty Drumm Street
San Francisco 11, Calif.
Tel. Yukon 2-4479
Exbrook 2-8454

DRAKE COMPANY, R. L.
18 E. Central Avenue
Miamisburg, Ohio
Tel. 6-2479
MO 6-2479

DRAKE MANUFACTURING CO.
1713 W. Hubbard Street
Chicago 22, Ill.
Tel. CHesapeake 3-4462

DUOTONE COMPANY, INC.
Locust Street
Keyport, N. J.
Tel. Keyport 7-1501

— E —

EAGLE ELECTRONICS, INC.
43 Lispenard Street
New York 13, N. Y.
Tel. CAnal 6-2357

EBY SALES COMPANY
130 Lafayette Street
New York 13, N. Y.
Tel. WORTH 2-7766

EDITORS & ENGINEERS, LTD.
P.O. Box 689
880 Coast Highway
Santa Barbara, Calif.
Tel. Woodland 9-4201

EICO
(See Electronic Instrument Co.)

EITEL-McCULLOUGH, INC. (EIMAC)
798 San Mateo Avenue
San Bruno, Calif.
Tel. Juno 8-1212

ELCO SALES COMPANY
"M" Street below Erie Avenue
Philadelphia 24, Pa.
Tel. CUMBERLAND 9-5500

ELECTRIC SOLDERING IRON CO., INC. (ESICO)
W. Elm Street
Deep River, Conn.
Tel. 5-5975

ELECTRO-MECHANICAL INSTRUMENT CO. (EMICO)
812 Chestnut Street
Parkside, Penn.
Tel. Parkside 2840

ELECTRO-MOTIVE MFG. CO. (EL-MENCO)
(See Arco Electronics, Inc.)

ELECTRO PRODUCTS LABORATORIES
4501 No. Ravenswood Avenue
Chicago 40, Ill.
Tel. UPTown 8-1141

ELECTRONIC DEVICES, INC.
429 Twelfth St.
Brooklyn 15, N. Y.
Tel. SOUTH 8-3530

ELECTRONIC FABRICATORS, INC. (Efcon)
682 Broadway
New York 12, N. Y.
Tel. ALgonquin 4-6424

ELECTRONIC INSTRUMENT CO., INC. (EICO)
84 Withers Street
Brooklyn 11, N. Y.
Tel. Stagg 2-2700

ELECTRONIC MEASUREMENT CORP. (EMC)
280 Lafayette Street
New York 12, N. Y.
Tel. WORTH 4-5214

ELECTRONS, INC.
127 Sussex Avenue
Newark 3, N. J.
Tel. HUMBOLDT 2-5977

San Francisco Office
Wm. C. Grabau
354 Pine Street
Room 704

Export Office
E. B. Latham Co.
250 Fourth Ave.
New York 3, N. Y.
Tel. ALgonquin 4-2200

ELECTRO-SONIC LABORATORIES, INC.
35-54 36th Street
Long Island City 6, N. Y.
Tel. RAVenswood 8-6887

ELECTRO-VOICE, INC.
Buchanan, Mich.
Tel. Buchanan 1000

Branch Offices
Carduner Sales Company
164 Duane Street
New York 13, N. Y.
Tel. WALKER 5-0900

Radio Mfg. Engineers
Div. of Electro-Voice, Inc.
300 First Avenue
Peoria 6, Ill.
Tel. 6-6501

Roburn Agencies, Inc.
39 Warren Street
New York 7, N. Y.
Tel. Digby 9-2260

Rocke International Corp.
13 East 40th Street
New York 16, N. Y.
Tel. Murray Hill 9-0200

ELECTROVOX CO., INC.
(See Walco Products Co., Inc.)

ELECTROX
(See Schauer Mfg. Corp.)

EL-MENCO CAPACITORS
(See Arco Electronics, Inc.)

Directory of Advertisers, Branch Offices, Addresses, Telephone Numbers

ELMENCO PRODUCTS CO.
103 Lafayette Street
New York 13, N. Y.
Tel. WOrth 6-0396

EMICO
(See Electro Mechanical Instrument Co.)

EQUIPTO
Div. Aurora Equipment Co.
Aurora, Ill.
Tel. Aurora 9231

ERIE RESISTOR CORP.
644 W. 12th Street
Erie, Pa.
Tel. 21481

ERSIN MULTICORE SOLDER
(See British Industries Corp.)

ESICO
(See Electric Soldering Iron Co.)

EVEREADY BATTERIES
(See National Carbon Company)

— F —

FEDERAL TELEPHONE & RADIO CORP.
(Selenium-Intellin Division)
100 Kingsland Road
Clifton, N. J.
Tel. Nutley 2-3600

Branch Offices
WASHINGTON 6, D. C.
1025 Connecticut Ave., N.W.
Tel. Executive 1697

MONTREAL 14, P.Q., CANADA
Federal Elec. Mfg. Co., Ltd.
9600 St. Lawrence Blvd.
Tel. Dupont 5785

Export Office
NEW YORK 4, N. Y.
International Standard Elec. Corp.
67 Broad Street
Tel. BOWling Green 9-3800

FENTON COMPANY
15 Moore Street
New York 4, N. Y.
Tel. BOWling Green 9-3445-6

FERRANTI ELECTRIC, INC.
30 Rockefeller Plaza
New York 20, N. Y.
Tel. Circle 7-0911

FISHER RADIO CORPORATION
21-21 44th Drive
Long Island City 1, N. Y.
Tel. EX. 2-2500

FREED TRANSFORMER CO., INC.
1718-36 Weirfield Street
Brooklyn 27, N. Y.
Tel. Evergreen 6-1300

— G —

GALBRAITH & SON ELECTRIC CORP., C. C.
450 Ave. of the Americas
New York 11, N. Y.
Tel. ALgonquin 4-1922

GARRARD SALES CORPORATION
164 Duane Street
New York 13, N. Y.
Tel. WAlker 5-0900

GEE-LAR MFG. COMPANY
819 Elm Street
Rockford, Ill.
Tel. 5-9548

GENERAL BRONZE CORP.
(See Brach Mfg. Co.)

GENERAL CEMENT MFG. CO.
919 Taylor Avenue
Rockford, Ill.
Tel. 2-6695

GENERAL DRY BATTERIES, INC.
13000 Athens Avenue
Cleveland 7, Ohio
Tel. Boulevard 2-0030

Branch Offices
CHICAGO 6, ILL.
Rm. 1511 Engineers Bldg.
205 West Wacker Drive
Tel. RAndolph 1868

NEW YORK 17, N. Y.
521 Fifth Avenue
Tel. MURray Hill 2-3877

MEMPHIS, TENN.
745 Royal Street
Tel. 370418

LOS ANGELES, CALIF.
1807 E. Olympic Blvd.
Tel. VAn Dyke 8049

SAN FRANCISCO, CALIF.
200 Davis Street
Tel. Yukon 2-0520

PORTLAND, OREGON
234 Sherlock Bldg.
Tel. ATwater 5403

GENERAL ELECTRIC COMPANY
Apparatus Sales Division
Schenectady 5, N. Y.

Apparatus Sales Offices

ABILENE, TEXAS
220 Pender Bldg.

AKRON 8, OHIO
335 South Main Street

ALBANY 7, N. Y.
90 State Street

ALBUQUERQUE, N. M.
323 3rd Street, S.W.

Alexandria, La.
720 Murray St.

ALLENTOWN, PA.
1014 Hamilton Street

AMARILLO, TEXAS
719 Amarillo Bldg.

APPLETON, WISC.
531 W. College Ave.

ATLANTA 3, GA.
1860 Peachtree Rd., N.W.

AUGUSTA, GA.
423 Masonic Bldg.

AUGUSTA, ME.
15 Grove St.

BAKERSFIELD, CALIF.
211 E. 18th St.

BALTIMORE 1, MD.
111 Park Ave.

BANGOR, MAINE
77 Central St.

BATON ROUGE, LA.
3170 Florida Blvd.

BATTLE CREEK, MICH.
25 W. Michigan Ave.

BEAUMONT, TEXAS
1385 Calder Ave.

BILLINGS, MONT.
107½ N. 27th Street

BINGHAMTON, N. Y.
19 Chenango St.

BIRMINGHAM 3, ALA.
1804 Seventh Ave., N.

BISMARCK, N. D.
117½ Fifth St.

BLUEFIELD, W. VA.
704 Bland St.

BOISE, IDAHO
1524 Idaho St.

BOSTON 1, MASS.
140 Federal St.

BUFFALO 3, N. Y.
535 Washington St.

BUTTE, MONTANA
103 N. Wyoming St.

G. E. Apparatus Sales Offices (Cont.)

CANTON 2, OHIO
700 Tuscarawas St., W.

CEDAR RAPIDS, IOWA
210 Second St., S.E.

CHARLESTON 28, W. VA.
306 MacCorkle Ave., S.E.

CHARLOTTE 1, N. C.
112 S. Tryon St.

CHARLOTTESVILLE, VA.
123 E. Main St.

CHATTANOOGA 2, TENN.
832 Georgia Ave.

CHICAGO 80, ILL.
840 S. Canal St.

CINCINNATI 2, OHIO
215 W. Third St.

CLEVELAND 4, OHIO
4966 Woodland Ave.

COLUMBIA 1, S. C.
1420 Lady St.

COLUMBUS 15, OHIO
40 S. Third St.

CORPUS CHRISTI, TEXAS
205 No. Chaparral St.

DALLAS 2, TEXAS
1801 North Lamar St.

DAVENPORT, IOWA
511 Pershing Ave.

DAYTON 2, OHIO
11 W. Monument Bldg.

DENVER 2, COLO.
650 Seventeenth St.

DES MOINES 9, IOWA
505 W. Fifth Ave.

DETROIT 2, MICH.
700 Antoinette St.

DULUTH 2, MINN.
14 W. Superior St.

ELMIRA, N. Y.
Main & Woodlawn Aves.

EL PASO, TEXAS
109 N. Oregon St.

ERIE, PA.
1001 State St.

EUGENE, OREGON
610 High St.

EVANSVILLE 19, IND.
123 Northwest Fourth St.

FAIRMONT, W. VA.
310 Jacobs Bldg.

FERGUS FALLS, MINN.
108 N. Court Ave.

FLINT 3, MICH.
663 S. Saginaw St.

FORT WAYNE 2, IND.
127 W. Berry St.

FORT WORTH 2, TEXAS
406 W. Seventh St.

FRESNO 1, CALIF.
407 Patterson Bldg.

GRAND RAPIDS 2, MICH.
148 Monroe Ave., N.W.

GREENSBORO, N. C.
301 S. Elm St.

GREENVILLE, S. C.
108 W. Washington St.

GULFPORT, MISS.
20750 Fran Bldg.

HAGERSTOWN, MD.
Professional Arts Bldg.

HARRISBURG, PA.
300 N. 2nd Street

HARTFORD 3, CONN.
410 Asylum St.

HOUSTON 1, TEXAS
1312 Live Oak St.

HUNTSVILLE, ALA.
1107 Times Bldg.

RADIO'S MASTER • 1954 • NINETEENTH EDITION

G. E. Apparatus Sales Offices (Cont.)

INDIANAPOLIS 4, IND.
110 N. Illinois St.

JACKSON, MICH.
120 W. Michigan Ave.

JACKSON 1, MISS.
203 W. Capitol St.

JACKSONVILLE 2, FLA.
700 E. Union St.

JAMESTOWN, N. Y.
2 Second St.

JOHNSON CITY, TENN.
321 W. Walnut St.

JOHNSTOWN, PA.
841 Oak St.

JOPLIN, MO.
220½ W. Fourth St.

KALAMAZOO, MICH.
112 Parkway Ave.

KANSAS CITY 6, MO.
106 W. Fourteenth St.

KNOXVILLE 08, TENN.
602 S. Gay St.

LANSING 8, MICH.
306 Michigan Nat. Tower

LEXINGTON, KY.
First National Bank Bldg.

LINCOLN 8, NEBR.
206 S. 13th St.

LITTLE ROCK, ARK.
103 W. Capitol Ave.

LOS ANGELES 54, CALIF.
212 N. Vignes St.

LOUISVILLE 2, KY.
455 S. Fourth St.

MACON, GA.
714 Bankers' Ins. Bldg.

MADISON 3, WIS.
16 N. Carroll St.

MANCHESTER, N. H.
875 Elm St.

MEDFORD, ORE.
205 W. Main St.

MEMPHIS 3, TENN.
8 N. Third St.

MIAMI 32, FLA.
25 Southeast Second Ave.

MILWAUKEE 3, WIS.
940 W. St. Paul Ave.

MINNEAPOLIS 3, MINN.
12 S. Sixth St.

MOBILE 13, ALA.
54 St. Joseph St.

MONTGOMERY 4, ALA.
205 Montgomery St.

NASHVILLE 3, TENN.
234 Third Ave., N.

NEWARK 2, N. J.
744 Broad St.

NEW HAVEN 6, CONN.
129 Church St.

NEW ORLEANS 12, LA.
837 Gravier St.

NEW YORK 22, N. Y.
570 Lexington Ave.

NIAGARA FALLS, N. Y.
253 Second St.

NORFOLK 10, VA.
229 W. Bute St.

OAKLAND 12, CALIF.
409 Thirteenth St.

OKLAHOMA CITY 2, OKLA.
119 N. Robinson St.

OMAHA 2, NEBR.
409 S. Seventeenth St.

PASCO, WASH.
421 W. Clark St.

G. E. Apparatus Sales Offices (Cont.)

PEORIA 2, ILL.
309 Jefferson Bldg.

PHILADELPHIA 2, PA.
1405 Locust St.

PHOENIX, ARIZ.
303 Luhrs Tower

PITTSBURGH 22, PA.
535 Smithfield St.

PORTLAND 3, MAINE
477 Congress St.

PORTLAND 7, ORE.
920 S. Sixth Ave.

PORTSMOUTH, OHIO
721 Sixth St.

PROVIDENCE 3, R. 1.
Industrial Trust Bldg.

RALEIGH, N. C.
336 Fayetteville St.

READING, PA.
31 N. Sixth St.

RICHMOND 17, VA.
700 E. Franklin St.

RIVERSIDE, CALIF.
3808 Main St.

ROANOKE 16, VA.
920 S. Jefferson St.

ROCHESTER 4, N. Y.
89 East Avenue

ROCKFORD, ILL.
110 S. First St.

RUTLAND, VT.
38½ Center St.

SACRAMENTO 14, CALIF.
Forum Bldg.

SAGINAW, MICH.
Second Nat. Bk. Bldg.

ST. LOUIS 2, MO.
112 N. Fourth St.

SALT LAKE CITY 9, UTAH
200 S. Main St.

SAN ANTONIO 5, TEXAS
310 S. St. Mary's St.

SAN DIEGO 1, CALIF.
1240 Seventh Ave.

SAN FRANCISCO 6, CALIF.
235 Montgomery St.

SAN JOSE 10, CALIF.
460 Park Ave.

SAVANNAH, GA.
1104 Savannah Bk. & Trust Bldg.

SEATTLE 4, WASH.
710 Second Ave.

SHREVEPORT, LA.
910 Shelby Bldg.

SIoux CITY 13, IOWA
572 Orpheum Electric Bldg.

SIoux FALLS, S. D.
306 S. Phillips Ave.

SOUTH BEND 1, IND.
112 W. Jefferson Blvd.

SPOKANE 8, WASH.
South 162 Post St.

SPRINGFIELD, ILL.
607 E. Adams St.

SPRINGFIELD 3, MASS.
1387 Main St.

STOCKTON, CALIF.
11 S. San Joaquin St.

SYRACUSE 2, N. Y.
113 South Salina St.

TACOMA 1, WASH.
1019 Pacific Ave.

TAMPA 6, FLORIDA
1206 North "A" St.

TOLEDO 4, OHIO
420 Madison Ave.

G. E. Apparatus Sales Offices (Cont.)

TRENTON 8, N. J.
214 E. Hanover St.

TUCSON, ARIZ.
650 N. Sixth Ave.

TULSA 3, OKLA.
320 S. Boston Ave.

UTICA 2, N. Y.
258 Genesee St.

WASHINGTON 5, D. C.
777 Fourteenth St., N.W.

WATERBURY 89, CONN.
111 W. Main St.

WATERLOO, IOWA
206 W. Fourth St.

WENATCHEE, WASH.
328 N. Wenatchee Ave.

WHEELING, W. VA.
40 Fourteenth St.

WICHITA 2, KANS.
200 E. 1st St.

WILLIAMSTON, N. C.
115 E. Main St.

WILMINGTON 98, DEL.
1326 N. Market St.

WORCESTER 8, MASS.
507 Main St.

YORK, PA.
56 N. Harrison St.

YOUNGSTOWN 5, OHIO
272 E. Indianola Ave.

CANADA
Canadian General Elec. Co.
Toronto, Canada and Principal Cities

HAWAII
American Factors, Ltd.
Honolulu, T.H.

GENERAL ELECTRIC COMPANY
Electronics Division
Electronics Park
Syracuse, New York

District Offices

ATLANTA 3, GEORGIA
187 Spring St., N.W.
Tel. CYPRESS 2581

BIRMINGHAM, ALABAMA
Brown-Marx Building
Tel. 54-8356

BOSTON 15, MASS.
963 Commonwealth Avenue
Tel. Hubbard 2-1800

CHARLOTTE, N. C.
314 West Trade St.
Tel. 5-5244

CHICAGO 54, ILLINOIS
3800 N. Milwaukee Ave.
Tel. Spring 7-1600

CINCINNATI, OHIO
215 West 3rd St.
Tel. Main 5022

CLEVELAND 14, OHIO
710 Williamson Bldg.
Tel. Superior 1-6822

COLUMBUS, OHIO
8 E. Long St.
Tel. Adam 1847

DALLAS 2, TEXAS
3200 Maple Ave.
Tel. Prospect 7-4296

DENVER, COLORADO
1030 - 15th St.
Tel. Keystone 7171

DAYTONA BEACH, FLA.
710½ N. Ridgewood Ave.
Tel. 3-1890

DETROIT 26, MICH.
2511-13 Book Tower
Tel. Woodward 3-3601

HARTFORD, CONN.
410 Asylum Street
Tel. 7-6419

Directory of Advertisers, Branch Offices, Addresses, Telephone Numbers

HOUSTON, TEXAS
1100 E. Holcombe
Tel. Justin 0657

INDIANAPOLIS, IND.
110 N. Illinois St.
Tel. Lincoln 3426

KANSAS CITY 6, MO.
106 West 14th St.
Tel. Victor 9745

LOS ANGELES, CALIF.
11840 W. Olympic Blvd.
Tel. BR. 28566

MINNEAPOLIS, MINN.
12 - 6th St.
Tel. Main 2000

MONTGOMERY, ALA.
121 Molton St.
Tel. 4-7934

NEW ORLEANS 12, LA.
325 Intern'l Trade Mart
Tel. Tulane 5871

NEW YORK 22, N. Y.
570 Lexington Ave.
Tel. Plaza 5-1311

OKLAHOMA CITY, OKLA.
418 Terminal Bldg.
Tel. 79-1215

PHILADELPHIA 2, PA.
1405 Locust St.
Tel. Pennypacker 5-9000

SALT LAKE CITY, UTAH
200 So. Main St.
Tel. 4-1892

SAN FRANCISCO 6, CALIF.
235 Montgomery St.
Tel. Douglas 2-3740

SCHENECTADY, N. Y.
148 Clinton St.
Tel. 4-2211

SEATTLE 11, WASH.
710 Second Ave.
Tel. Seneca 8300

ST. LOUIS 8, MISSOURI
4227 Lindell Blvd.
Tel. Lucas 8873

SYRACUSE, N. Y.
Electronics Park
Tel. 76-4411

WASHINGTON, D. C.
777-14th St., N.W.
Tel. Executive 3600

GENERAL INDUSTRIES CO.
Olive & Taylor Streets
Elyria, Ohio
Tel. Elyria 2235

GERNSBACK PUBLICATIONS, INC.
25 West Broadway
New York 7, N. Y.
Tel. Rector 2-8630

GIRARD-HOPKINS
1000 40th Avenue
Oakland 1, Calif.
Tel. Kellogg 2-8477

GLOBE-UNION, INC.
(See Centralab Division)

GONSET COMPANY
801 South Main St.
Burbank, Calif.
Tel. Victoria 9-2222

GOTHARD MANUFACTURING CO.
2112 Clear Lake Avenue
Springfield, Ill.
Tel. Springfield 4-4861

GRAMER-HALLDORSON TRANSFORMER CORP.
2734 North Pulaski Road
Chicago 39, Ill.
Tel. Everglade 4-4400

GRANCO PRODUCTS, INC.
36-17 20th Avenue
Long Island City 5, N. Y.
Tel. Ravenswood 1-0400

GRAY RESEARCH & DEVELOPMENT CO., INC.
658 Hilliard Street
Manchester, Conn.
Tel. Mitchell 9-4506

GRAYHILL
561 Hillgrove Avenue
La Grange, Ill.
Tel. Fleetwood 4-1040

GREENLEE TOOL COMPANY
Rockford, Ill.
Tel. Rockford 3-4881

Export Offices
United Export Suppliers
9 So. Clinton St.
Chicago 6, Ill.
(Central and South America, Asia,
Africa, Australia)

Gaston E. Marbaix, Ltd.
Devonshire House
Vicarage Crescent
London S.W. 11, England
(British Isles, Continental Europe,
excl. U.S.S.R.)

GUARDIAN ELECTRIC MFG. CO.
1621 W. Walnut St.
Chicago 12, Ill.
Tel. Chesapeake 3-1100

— H —

HALLICRAFTERS CO.
4401 W. 5th Avenue
Chicago 24, Ill.
Tel. Van Buren 6-6300

HAMMARLUND MFG. CO., INC.
460 West 34th Street
New York 1, N. Y.
Tel. Longacre 5-1300

HARDWICK, HINDLE, INC.
40 Hermon Street
Newark 5, N. J.
Tel. Market 2-8200

HARVEY HUBBELL, INC.
Interlock Dept.
Bostwick Ave. & State St.
Bridgeport 2, Conn.
Tel. Edison 5-3151

HARVEY-WELLS ELECTRONICS, INC.
North Street
Southbridge, Mass.
Tel. Southbridge 44361

HETHERINGTON, INC.
1200 Elmwood Avenue
Sharon Hill, Pa.
Tel. Farragut 9-3500

West Coast Division
8568 W. Washington Blvd.
Culver City, Calif.
Tel. Texas 03979, 02823

HEXACON ELECTRIC CO.
161 West Clay Avenue
Roselle Park, N. J.
Tel. Chestnut 5-6200-1-2

HICKOK ELECTRICAL INSTRUMENT CO.
10514 Dupont Avenue
Cleveland 8, Ohio
Tel. Liberty 1-8060

HI-LO TV ANTENNA CORP.
3540 N. Ravenswood Avenue
Chicago 13, Ill.
Tel. Raceland 7-1890

HOYT ELECTRICAL INSTR. WORKS, INC.
42 Carleton Street
Cambridge 42, Mass.
Tel. Elliot 4-1643

HYCON MFG. COMPANY
2961 East Colorado Street
Pasadena 8, Calif.
Tel. Sycamore 5-4241
RYan 1-9381

Branch Offices
WASHINGTON 6, D. C.
Barr Bldg., Suite 206
910 17th Street, N.W.
Tel. Sterling 3-7070

DAYTON, OHIO
1904 Brown Street
Tel. HEmlock 2897

HY-LITE ANTENNAE, INC.
242 E. 137th St.
New York 51, N. Y.
Tel. CYPress 2-3402-3

HYTRON
(See CBS-Hytron)

— I —

I.D.E.A., INC.
(See Regency Division)

IMPERIAL RADAR AND WIRE CORP.
820 East 233rd St.
New York 66, N. Y.
Tel. FAirbanks 4-6307

INDUSTRIAL CONDENSER CORP.
3243-65 North California Avenue
Chicago 18, Ill.
Tel. Independence 3-2200

INDUSTRIAL INSTRUMENTS, INC.
Cedar Grove, N. J.
Tel. Verona 8-2500

INDUSTRIAL SAFETY BELT CO.
51 Chatham Street
Pittsburgh 19, Penna.
Tel. EXpress 1-1420-1

INSULINE CORPORATION OF AMERICA
186 Granite Street
Manchester, N. H.
Tel. MAnchester 5-8511

INTERELECTRONICS CORPORATION
2432 Grand Concourse
New York 58, N. Y.
Tel. LUdlow 4-6200 and 4-6201

Branch Offices
CHICAGO 44, ILL.
5049 Quincy Street
Tel. MAnfield 6-0499

ASPEN, COLORADO
c/o Charles V. Kettering

LOS ANGELES 46, CALIF.
7614 Melrosa Avenue
Tel. WHitney 1167

PHILADELPHIA 44, PENNA.
5919 Pulaski Avenue
Tel. GERMantown 8-3791

INTERNATIONAL RECTIFIER CORP.
1521 E. Grand Avenue
El Segundo, Calif.
Tel. Oregon 8-6281

Branch Offices
International Rectifier Corp.
501 Madison Ave.
New York 22, N. Y.
Tel. PLaza 5-8665

International Rectifier Corp.
205 W. Wacker Drive
Chicago 6, Ill.
Tel. FRanklin 2-3889

RADIO'S MASTER • 1954 • NINETEENTH EDITION

INTERNATIONAL REGISTER COMPANY
2620 W. Washington Blvd.
Chicago 12, Ill.
Tel. VAn Buren 6-4242

Sales Office
40-22 Main Street
Flushing 54, N. Y.

INTERNATIONAL RESISTANCE CO.
401 North Broad Street
Philadelphia 8, Pa.
Tel. WALnut 2-2166

Branch Offices
New York 6, N. Y.
165 Broadway, Room 1438
Tel. COrtlandt 7-5020

Chicago 41, Ill.
4013 N. Milwaukee Ave.
Tel. PEnsacola 6-3910

Syracuse 2, N. Y.
112 Montgomery St.
Tel. Syracuse 2-0274

— J —

JACKSON ELECTRICAL INSTRUMENT CO.
18 S. Patterson Boulevard
Dayton 2, Ohio
Tel. Michigan 0367

JAMES VIBRAPOWR CO.
4036 N. Rockwell Street
Chicago 18, Ill.
Tel. COrnella 7-6333

JAN HARDWARE MFG. CO., INC.
75 North 11th Street
Brooklyn 11, N. Y.
Tel. EVergreen 7-3300

J-B-T INSTRUMENTS, INC.
441 Chapel Street
New Haven 8, Conn.
Tel. STATE 7-5825

JENNINGS RADIO MFG. CORP.
970 McLaughlin Avenue
P.O. Box 1278
San Jose 8, Calif.
Tel. CYpress 2-4025

JENSEN INDUSTRIES, INC.
7333 W. Harrison Street
Forest Park, Ill.
Tel. FOrest 6-0180

JENSEN MANUFACTURING CO.
6601 South Laramie Avenue
Chicago 38, Ill.
Tel. PORTsmouth 7-7600

JERROLD ELECTRONICS CORP.
26th & Dickinson Sts.
Philadelphia 46, Pa.
Tel. Howard 8-9200

JOHNSON COMPANY, E. F.
242 Second Ave., S.W.
Waseca, Minn.
Tel. 990

JONTZ MANUFACTURING CO.
1101 E. McKinley
Mishawaka, Ind.
Tel. 9-2496, 7

— K —

KAY ELECTRIC COMPANY
14 Maple Avenue
Pine Brook, N. J.
Tel. CALdwell 6-4000

KENWOOD ENGINEERING CO., INC.
(Kenco)
265 Colfax Ave.
Kenilworth, N. J.
Tel. CHEstnut 5-0100

KENYON TRANSFORMER CO., INC.
840 Barry Street
New York 59, N. Y.
Tel. KILpatrick 2-4500

KESTER SOLDER COMPANY
4201 Wrightwood Avenue
Chicago 39, Ill.
Tel. BElmont 5-1601

Plants
88 Ferguson Street
Newark 5, N. J.
Tel. MITchell 2-0246
and
51 Bruce Street
Brantford, Ont., Canada

KEYSTONE ELECTRONICS CORP.
423 Broome Street
New York 13, N. Y.
Tel. WORTH 2-2789

KLEIN & SONS, MATHIAS
7200 McCormick Road
Chicago 54, Ill.
Tel. JUNiper 8-6820

KNIGHTS CO., JAMES
Sandwich, Ill.
Tel. 2141

KRAEUTER & COMPANY, INC.
563-585 - 18th Avenue
Newark 3, N. J.
Tel. Essex 3-4000

KWIKHEAT MFG. CO.
3732 San Fernando Road
Glendale 4, Calif.
Tel. CITrus 3-4221, Chapman 5-2376

— L —

LANSING SOUND, INC., JAMES B.
2439 Fletcher Drive
Los Angeles 39, Calif.
Tel. NOrmandy 3-3218

LARSON CO., CHAS. O.
P.O. Box 358
Sterling, Ill.
Tel. Main 503

LEAK AMPLIFIERS
(See British Industries Corp.)

LECTROHM, INC.
5560 Northwest Highway
Chicago 30, Ill.
Tel. RODney 3-1700

LENK MFG. COMPANY, THE
30-38 Cummington Street
Boston 15, Mass.
Tel. KENmore 6-9700

LEWIS AND KAUFMAN, LTD.
P.O. Box 337
17320 El Rancho Ave.
Los Gatos, Calif.
Tel. El Gato 4-3540

LINE MASTER SWITCH CORPORATION
Woodstock, Conn.
Tel. PUTnam 8-3051

LITTELFUSE, INC.
1865 Miner Street
Des Plaines, Ill.
Tel. VANDerbilt 4-1188

LOWELL MANUFACTURING CO.
3030 Leclde Station Road
St. Louis 17, Mo.
Tel. STerling 1-9058

— M —

MACMILLAN COMPANY
60 Fifth Ave.
New York 11, N. Y.
Tel. OREGon 5-4000

Sales Offices
CHICAGO 16, ILL.
2459 Prairie Avenue
DALLAS 21, TEXAS
Ross Ave. & Akard St.

MAGNECORD, INC.
1101 S. Kilbourn
Chicago 24, Ill.
Tel. WHIttehall 4-1889

MAGUIRE INDUSTRIES, INC.
Thordarson-Meissner Mfg. Div.
7th & Belmont Sts.
Mt. Carmel, Ill.
Tel. Mt. Carmel 1200

MALLORY & CO. INC., P. R.
Indianapolis 6, Ind.

District Offices
ATLANTA, GA.
1145 Peachtree St., N.E.
Tel. Atwood 6916

CHICAGO 6, ILL.
Civic Opera Bldg.
20 N. Wacker Drive
Tel. FranklIn 2-8110

CLEVELAND 23, OHIO
22700 Shore Center Ave.
Tel. Redwood 2-9200

DALLAS 14, TEXAS
P. O. Box 9644
Tel. Fairdale 4736

DAYTON 2, OHIO
705 Commercial Bldg.
44 South Ludlow St.
Tel. Hemlock 4033

DENVER 17, COLO.
P.O. Box 5502
Tel. KeyStone 6751

DETROIT 4, MICHIGAN
8631 Livernois Ave.
Tel. Webster 3-1696

KANSAS CITY 2, MO.
4528 Main St., Rm. 209
Tel. Logan 9035

LOS ANGELES 23, CALIF.
1338 S. Lorena St.
Tel. Angelus 1-5193

MILWAUKEE 3, WISC.
526 Empire Bldg.
710 N. Plankinton Ave.
Tel. Broadway 2-5997

MINNEAPOLIS 1, MINN.
60 So. Fourth St.
Tel. Filmore 1156

NEW YORK 17, N. Y.
41 E. 42nd St.
Tel. VANDerbilt 6-4434

PHILADELPHIA 7, PA.
1343 Arch St.
Tel. RITtenhouse 6-8062

PORTLAND 9, OREGON
510 N.W. 19th Ave.
Tel. Broadway 3830

ROCHESTER 14, N. Y.
Reynolds Arcade
16 East Main St.
Tel. Baker 9179

SAN FRANCISCO 3, CALIF.
1264 Folsom St.
Tel. Underhill 1-2367

ST. LOUIS 5, MO.
Room 214
7 No. Brentwood Blvd.
Tel. Parkview 8695

WASHINGTON 5, D. C.
312-313 Bond Bldg.
1404 New York Ave., N.W.
Tel. EXecutive 3-0090

TORONTO 12, ONTARIO, CANADA
A. C. Simmonds & Sons, Ltd.
100 Merton St.
Tel. Mayfair 9111

Directory of Advertisers, Branch Offices, Addresses, Telephone Numbers

MARION ELECTRICAL INSTRUMENT CO.
410 Canal Street
Manchester, N. H.
Tel. Manchester 5-6971

(MASCO) MARK SIMPSON MFG. CO., INC.
32-28 49th Street
Long Island City 3, N. Y.
Tel. Yellowstone 2-3400

MASTER MOBILE MOUNTS, INC.
P.O. Box 36317
Los Angeles 36, Calif.
Tel. Richmond 7-0638
Warehouse & Shipping Address
1306 Bond Street
Los Angeles 15, Calif.

MEASUREMENTS CORPORATION
Boonton, N. J.
Tel. Boonton 8-2131

MEISSNER Products
(See Thordarson-Meissner)

MERIT COIL & TRANSFORMER CORP.
4427 North Clark St.
Chicago 40, Ill.
Tel. Longbeach 1-6311

MICROTRAN COMPANY
Affiliate of Crest Laboratories, Inc.
84-11 Rockaway Beach Blvd.
Rockaway Beach 93, N. Y.
Tel. Neptune 4-3207

MIDDLETOWN MANUFACTURING CO., INC.
Stack Street
Middletown, Conn.
Tel. Middletown 6-8659

MILLEN MFG. CO., INC., JAMES
150 Exchange St.
Malden 48, Mass.
Tel. Malden 4-4108

MILLER COMPANY, J. W. (Coils)
5917 South Main Street
Los Angeles 3, California
Tel. Adams 3-4297

Branch Offices

ATLANTA, GA.
Post Office Box 116, Station "C"
Telephone: Elgin 0919

CHICAGO, ILL.
6518 West North Avenue
Telephone: Berkshire 7-2420

CINCINNATI, OHIO
6225 Joyce Lane
Tel. Jefferson 3998

CLEVELAND, OHIO
16201 Shaker Blvd.
Telephone: Academy 4932

DALLAS, TEXAS
3409 Oaklawn Avenue
Tel. Justin 2411

DENVER, COLO.
446 Broadway
Tel. Sherman 4-2501

DETROIT, MICH.
16267 James Couzens Hiway
Tel. University 3-1227

GLENSIDE, PA.
2 Roberts Block
Tel. Turner 1075

INDIANAPOLIS, IND.
4241 Melbourne Road
Tel. Humboldt 8800

KANSAS CITY, MISSOURI
Porter Building, Room 11
406 West 34th Street
Telephone: Logan 0772

LOS ANGELES, CALIF.
1044 S. Parkview
Tel. Dunkirk 8-1039

MANKATO, MINN.
721 S. Second Street

NEW YORK, N. Y.
164 Duane Street
Telephone: Barclay 7-0210

HELPS, N. Y.
R. D. 1
Telephone: 228

PHILADELPHIA, PA.
Reading Station Building
2601 North Broad Street
Telephone: Radcliff 5-1001

PHOENIX, ARIZ.
P.O. Box 7245
Telephone: AMherst 5-4662

PITTSBURGH, PENNSYLVANIA
2046 Brookfield Road
Telephone: Bridgeville 2083

SAN FRANCISCO, CALIF.
530 Gough Street
Telephone: Hemlock 1-5127

SCITUATE, MASSACHUSETTS
291 First Parish Road
Telephone: Scituate 652

SEATTLE, WASH.
3215 Western Avenue
Telephone: KE. 6042

TORONTO, CANADA
560 King Street West
Telephone: WA. 4761

MILLER CO., SANFORD (Rectifiers)
691 Bedford Avenue
Brooklyn 6, N. Y.
Tel. ULster 8-2817

MILLER MFG. CO., M. A. (Needles)
4th & Church Sts.
Libertyville, Ill.
Tel. Libertyville 2-7550

MILLER TELEVISION (Antennas)
2840 Naomi Street
Burbank, Calif.
Tel. Victoria 9-1659

MINNESOTA MINING & MFG. CO.
900 Fauquier Ave.
St. Paul 6, Minn.

Branch Offices

Atlanta 3, Ga.
732 Ashby St., N.W.

Buffalo 6, N. Y.
330 Greene St.

Chicago 8, Ill.
1500 So. Western Ave.

Cincinnati 2, Ohio
47 Central Ave.

Cleveland 11, Ohio
12430 Elmwood Ave.

Dallas 2, Tex.
1221 Dragon St.

Detroit 13, Mich.
8825 Grinnell Ave.

Grand Rapids 4, Mich.
815 Monroe Ave., N.W.

High Point 3, N. C.
1501 So. Main St.

Los Angeles 54, Calif.
6411 Randolph St.

Philadelphia 8, Pa.
401 N. Broad St.

Pittsburgh 19, Pa.
911 Plaza Bldg.

Newton Center 59, Mass.
1330 Centre St.

New York: Ridgefield, N. J.
700 Grand Ave.

San Francisco, Calif.
320 Shaw

St. Paul 1, Minn.
367 Grove St.

Seattle 4, Wash.
1242 - 6th Ave. So.

St. Louis 8, Mo.
3700 Forest Park

MODEL ENGINEERING & MFG., INC.
(See Tru-Ohm Products Div.)

MONITOR PRODUCTS CO.
815 Fremont Ave.
South Pasadena, Calif.
Tel. Pyramid 1-1174

MOODY MACHINE PRODUCTS CO., INC.
52 Dudley Street
Providence 5, R. I.
Tel. GAspee 1-3317

MORROW RADIO MFG. CO.
2794 Market St.
Salem, Ore.
Tel. Ph. 3-6952
Twx Salem

MOSLEY ELECTRONICS, INC.
8622 St. Charles Rock Road
St. Louis 14, Mo.
Tel. Winfield 6-7430
West Coast Branch Office
and Warehouse
1406-08 S. Grand Blvd.
Los Angeles, Calif.
Tel. Richmond 6191

MUELLER ELECTRIC CO.
1583 East 31st St.
Cleveland 14, Ohio
Tel. Prospect 1-5225

MULTICORE SALES CORP.
164 Duane Street
New York 13, N. Y.
Tel. WAlker 6-0900

— N —

NAJESCO, INC. (Jerrold)
26th and Dickinson Sts.
Philadelphia 46, Pa.
Tel. HHoward 5-9200

NATIONAL CARBON COMPANY
A Div'n of Union Carbide & Carbon Corp.
("Eveready")
30 East 42nd St.
New York 17, N. Y.
Tel. MURray Hill 7-8000

District Sales Offices

SOUTHEASTERN DISTRICT
41 Marietta St., N.W.
Atlanta 3, Georgia
Tel. Maine 7700

CENTRAL DISTRICT
230 N. Michigan Ave.
Chicago 1, Illinois
Tel. Financial 6-3300

SOUTHWESTERN DISTRICT
1511 Bryan St.
Dallas 1, Texas
Tel. Riverside 9176

MIDWESTERN DISTRICT
19th & Campbell Sts.
Kansas City 8, Mo.
Tel. Baltimore 2400

EASTERN DISTRICT
292 Madison Avenue
New York 17, N. Y.
Tel. MURray Hill 7-8000

MIDEASTERN DISTRICT
613 Oliver Bldg.
Pittsburgh 22, Pa.
Tel. EXpress 1-3800

PACIFIC DISTRICT
22 Battery Street
San Francisco 6, Calif.
Tel. Yukon 2-1360

NATIONAL COMPANY, INC.
61 Sherman St.
Malden 48, Mass.
Tel. Malden 2-7950

NATIONAL ELECTRONIC MFG. CORP.
186 Granite Street
Manchester, N. H.
Tel. 5-8511

NATIONAL ELECTRONICS, INC.
628 North Street
Geneva, Ill.
Tel. Geneva 702

NATIONAL UNION ELECTRIC CORP.
Jacksonville Road
Hatboro, Pa.
Tel. OSborne 5-5000

RADIO'S MASTER • 1954 • NINETEENTH EDITION

NATIONAL WIRE & CABLE CORP.
136 San Fernando Road
Los Angeles 31, Calif.
Tel. Capitol 1-2171

NEWCOMB AUDIO PRODUCTS CO.
6824 Lexington Ave.
Hollywood 38, Calif.
Tel. Hollywood 9-5381

— O —

OAK ELECTRONICS CO.
144-164 Oak Street
Buffalo 3, N. Y.
Tel. Mohawk 3607

OHMITE MANUFACTURING CO.
3601 W. Howard St.
Skokie, Ill.
Tel. Orchard 5-2600

OLIN INDUSTRIES, INC.
ELECTRICAL DIVISION
275 Winchester Ave.
New Haven, Conn.
Tel. MAin 4-0101

Field Warehouses

EAST ALTON, ILL.
Electrical Division
East Alton, Ill.
Tel. 4-7311

HOUSTON, TEXAS
Electrical Division
c/o Universal Terminal Warehouse Co.
1002 Washington Ave.
Houston, Texas
Tel. Preston 2381

SAN FRANCISCO, CALIF.
Electrical Division
c/o J. H. Coffman & Son
625 Folsom St.
San Francisco, Calif.
Tel. Exbrook 2-2516

ORRADIO INDUSTRIES, INC.
T-120 Marvyn Road
Opelika, Ala.
Tel. 976

Branch Office

458 Broadway
New York, N. Y.
Tel. WAiker 5-3535

OXFORD ELECTRIC CORP.
3911 S. Michigan Ave.
Chicago 15, Ill.
Tel. Atlantic 5-6161

— P —

PACIFIC TRANSDUCER CORP. (Clarkston)
11921 West Pico Blvd
Los Angeles 64, Calif.
Tel. ARizona 8-1134

PAR-METAL PRODUCTS CORP.
32-62 - 49th St.
Long Island City 3, N. Y.
Tel. AStoria 8-8905

PEERLESS ELECTRICAL PRODUCTS DIV.
(See Altec Lansing Corp.)

PENN TELEVISION PRODUCTS CO.
Allegheny & Trenton Aves.
Philadelphia 34, Pa.
Tel. Garfield 6-3031

PENTRON CORPORATION
777 South Tripp Avenue
Chicago 24, Ill.
Tel. SAcramento 2-3201

PERMA-POWER COMPANY
4727 N. Damen
Chicago 25, Ill.
Tel. Uptown 8-6121

PERMO, INC.
6415 Ravenswood Ave.
Chicago 26, Ill.
Tel. BRiargate 4-0075

PETERSEN RADIO CO., INC.
2800 W. Broadway
Council Bluffs, Iowa
Tel. 2-2760

PHAOSTRON CO.
151 Pasadena Ave.
South Pasadena, Calif.
Tel. CLEVELand 5-1471

PHILMORE MFG. CO., INC.
113-115 University Place
New York 3, N. Y.
Tel. ALgonquin 4-3363-4-5

PICKERING & CO., INC.
309 Woods Ave.
Oceanside, N. Y.
Tel. ROCKville Centre 4-3200

PIERCEWAY DIVISION
Clifton Conduit Co. (Tennessee) Inc.
Factory: 1278 Orgill Ave.
Memphis 6, Tenn.

Executive Offices

75 Montgomery Street
Jersey City 2, N. J.
Tel. DELaware 2-0324

PLANET MANUFACTURING CORP.
225 Belleville Ave.
Bloomfield, N. J.
Tel. B.L. 2-2874-5

PLASTIC CAPACITORS, INC.
2511 W. Moffat St.
Chicago 47, Ill.

PORCELAIN PRODUCTS, INC.
P.O. Box 300
Findlay, Ohio
Tel. Main 2920

POTTER & BRUMFIELD
Princeton, Indiana
Tel. Princeton 1596

PRECISE DEVELOPMENT CORP.
2 Neil Court
Oceanside, N. Y.
Tel. ROCKville Centre 6-0171

PRECISE MEASUREMENTS CO.
942 Kings Highway
Brooklyn 23, N. Y.
Tel. ESplanade 5-9435

PRECISION APPARATUS CO., INC.
92-27 Horace Harding Blvd.
Elmhurst, L. I., N. Y.
Tel. HAvemeyer 9-6262

PREMAX PRODUCTS
Div. of Chisholm-Ryder Co., Inc.
Niagara Falls, N. Y.
Tel. Niagara Falls 9186

PREMIER METAL PRODUCTS CO.
3160 Webster Ave.
Bronx 67, N. Y.
Tel. OLinville 4-4841

PRESTO RECORDING CORP.
Factory: Paramus, N. J.
Mall Address: P. O. Box 500
Paramus, N. J.
Tel. DIamond 3-5700

— Q —

QUAM-NICHOLS COMPANY
Marquette Road at Prairie Ave.
Chicago 37, Ill.
Tel. WEntworth 6-8150

QUIETROLE COMPANY
395 St. John Street
Spartanburg, S. C.
Tel. 8996

Branch Office

Sales Mgr. & Experimental
1414 Park Circle
Tampa 4, Fla.
Tel. 34-9331

— R —

RACON ELECTRIC CO., INC.
1261 Broadway
New York 1, N. Y.
Tel. MUrray Hill 4-6258

RADELCO MANUFACTURING CO.
7580 Garfield Blvd.
Cleveland 25, Ohio
Tel. VUican 3-8080

RADIART CORPORATION
3455 Vega Ave.
Cleveland 13, Ohio
Tel. MEIrose 1-6660

RADIO CITY PRODUCTS CO., INC.
Centre and Glendale Sts.
Easton, Pa.
Tel. EAston 9122

RADIO CORPORATION OF AMERICA
RCA TUBE DIVISION
415 South 5th St.
Harrison, N. J.
Tel. Humboldt 5-3900

RCA VICTOR DIVISION
Front and Cooper Streets
Camden, N. J.
Tel. WOODlawn 3-8000

Regional Offices

ATLANTA 3, GA.
522-523 Forsyth Bldg.
N.W. Cor. Forsyth & Luckie Sts.
Tel. Walnut 5948

BOSTON 16, MASS.
200 Berkeley St.
Tel. HUBbard 2-1700

CHICAGO, ILL.
666 North Lake Shore Drive
Tel. Delaware 7-0700

CLEVELAND 15, OHIO
718 Keith Building
1621 Euclid Ave.
Tel. Cherry 1-3450

DALLAS 1, TEXAS
1907-11 McKinney Ave.
Tel. RIVERSide 1371

HOLLYWOOD, CALIF.
RCA Bldg.
1560 N. Vine Street
Tel. HOLlywood 9-2154

KANSAS CITY 6, MO.
340 Dierks Bldg.
Harrison 6480

NEW YORK 20, N. Y.
36 W. 49th St.
Tel. Circle 6-4030

SAN FRANCISCO, CALIF.
1355 Market St.
Tel. Hemlock 1-8300

RADIO CRAFTSMEN, INC.
4401 N. Ravenswood Ave.
Chicago 40, Ill.
Tel. Uptown 8-4000

RADIO MERCHANDISE SALES, INC.
Offices and Electronics Plant
2016 Bronxdale Ave.
New York 62, N. Y.
Tel. TYrone 2-6700

Conical Antenna Plant
1165 Southern Blvd.
New York 59, N. Y.
Tel. TYrone 2-6700

Yagi Antenna Plant
1735 West Farms Rd.
New York 60, N. Y.
Tel. TYrone 2-6700

RADIO MFG. ENGINEERS
Div. of Electro-Voice, Inc.
300 First Ave.
Peoria 6, Ill.
Tel. 6-6051

RADIO RECEPTOR CO., INC.
Semiconductor Division
251 W. 19th St.
New York 11, N. Y.
Tel. WATkins 4-3633

Directory of Advertisers, Branch Offices, Addresses, Telephone Numbers

RADION CORPORATION, THE
1130 W. Wisconsin Ave.
Chicago 14, Ill.
Tel. MOhawk 4-4617

RAM ELECTRONICS SALES CO.
So. Buckhout Street
Irvington-on-Hudson, N. Y.
Tel. IRvington 9-5700

RAYTHEON MANUFACTURING CO.
Equipment Sales Division
Waltham 54, Mass.
Tel. Waltham 5-5860

Branch Sales Offices
CHICAGO, ILL.
5016 West Madison St.
Esterbrook 9-3277

CLEVELAND, OHIO
3076 West 117th St.
Tel. Winton 1-7005

NEW ORLEANS, LA.
4032 Thalia St.
Tel. Canal 7611

SAN FRANCISCO, CALIF.
49 California St.
Tel. Sutter 1-0475

SEATTLE, WASH.
3224 Western Ave.
Tel. Alder 4895

WILMINGTON, CALIF.
114 West B St.
Tel. Terminal 4-8575

Export Office
NEW YORK, N. Y.
589 Fifth Ave.
International Division
Tel. Plaza 9-3900

RAYTHEON MANUFACTURING CO.
Receiving & Cathode Ray Tube Operations
55 Chapel St.
Newton 58, Mass.
Tel. Bigelow 4-7500

Branch Offices
CHICAGO 11, ILL.
445 Lake Shore Drive
Tel. Delaware 7-4446

LOS ANGELES 7, CALIF.
2419 So. Grand Ave.
Tel. Richmond 7-5524

ATLANTA 6, GA.
901 Bernina Ave., N.E.
Tel. Lamar 6878

RECOTON CORPORATION
147 W. 22nd St.
New York 11, N. Y.
Tel. ORegon 5-7868-9

REEVES SOUNDCRAFT CORP.
10 E. 52nd St.
New York 22, N. Y.
Tel. PLaza 9-2644

REGENCY DIVISION I.D.E.A., INC.
7900 Pendleton Pike
Indianapolis 26, Ind.
Tel. CHerry 2466

REK-O-KUT COMPANY
38-01 Queens Blvd.
Long Island City 1, N. Y.
Tel. STilwell 4-7062

RIDER PUBLISHER, INC., JOHN F.
480 Canal St.
New York 13, N. Y.
Tel. WOrth 6-1740

RIPLEY COMPANY, INC.
Factory St.
Middletown, Conn.
Tel. DIamond 6-6679

R-J AUDIO PRODUCTS, INC.
164 Duane St.
New York 13, N. Y.
Tel. WAlker 5-0900

RME
(See Radio Mfg. Engineers)

ROGAN BROTHERS
8025-33 N. Monticello Ave.
Skokie, Ill.
Tel. Skokie 2665

ROGERS ELECTRONIC CORP.
43-49 Bleecker Street
New York 12, N. Y.
Tel. GRamercy 7-8820

San Francisco Warehouse
1061 Howard Street
San Francisco 3, Calif.
Tel. HEmlock 1-4738

**ROYAL TELEVISION SUPPLY
& MFG. CO., INC.**
126 — 10th Street
P. O. Box 1383
Modesto, Calif.
Tel. 3-4511

— S —

SAMS & CO., INC., HOWARD W.
2201 E. 46th St.
Indianapolis 5, Ind.
Tel. GLendale 4531

SANGAMO ELECTRIC CO.
Capacitor Division
Marion, Ill.
Tel. Ordill 231

SARKES TARZIAN, INC.
Rectifier Division

415 N. College Ave.
Bloomington, Ind.
Tel. Bloomington 2-1435

Tuner Division
E. Hillside Drive
Bloomington, Ind.
Tel. Bloomington 7251

Air Trimmer Division
E. Hillside Drive
Bloomington, Ind.
Tel. Bloomington 7251

SCALA RADIO CO.
2814 — 19th Street
San Francisco 10, Calif.
Tel. VAlerencia 6-2898

SCHAUER MFG. CORP. (Electro)
4513 Alpine Ave.
Cincinnati 36, Ohio
Tel. Sycamore 3030

SCOTT, INC., HERMON HOSMER
385 Putnam Ave.
Cambridge 39, Mass.
Tel. KI. 7-0646

SHALLCROSS MANUFACTURING CO.
Jackson & Pusey Aves.
Collingdale, Pa.
Tel. FArragut 9-5100
TWX Sharon Hill, Pa. 967-U

SHURE BROTHERS, INC.
225 West Huron St.
Chicago 10, Ill.
Tel. Delaware 7-4550

SHURITE METERS
61 Hamilton St.
New Haven 8, Conn.
Tel. STate 7-5826

SIGNAL INDICATOR CORP.
(See Dialight Corp.)

SIMPSON ELECTRIC COMPANY
5200-18 West Kinzie St.
Chicago 44, Ill.
Tel. ESTebrook 9-1121

**SIMPSON MFG. CO., INC., MARK
(Masco)**
32-28 — 49th Street
Long Island City 3, N. Y.
Tel. YELlowstone 2-3400

SMITH, INC., HERMAN H.
2326 Nostrand Ave.
Brooklyn 10, N. Y.
Tel. CLoverdale 3-7900

SMITH-BALDWIN
(See Consolidated Radio Products Co.)

SNAP-ON-DRAWER COMPANY
Morrow, Ohio
Tel. 38

SNC MANUFACTURING CO., INC.
P. O. Box 277
Oshkosh, Wis.
Tel. Stanley 187

SOLA ELECTRIC CO.
4633 West 16th St.
Chicago 50, Ill.
Tel. Bishop 2-1414

Branch Offices

Boston, Mass.
272 Centre St.
Newton 58, Mass.
Tel. Bigelow 4-3354

Cleveland 15, Ohio
1836 Euclid Ave.
Tel. Prospect 1-6400

Kansas City 2, Mo.
406 W. 34th Street
Tel. Jefferson 4382

Los Angeles 26, Calif.
2025 Sunset Blvd.
Tel. DUNkirk 7-1606

New York 35, N. Y.
103 East 125th Street
Tel. TRafalgar 6-6464

Philadelphia, Pa.
Commercial Trust Bldg.
15th & Market Streets
Tel. RITTEnhouse 6-4988

SONAR RADIO CORP.
3050 West 21st Street
Brooklyn 24, N. Y.
Tel. ESplanade 2-6000

SONOTONE CORPORATION
Elmsford, New York
Tel. ELMSford 6-6400

SOUTH RIVER METAL PRODUCTS CO., INC.
377-379 Turnpike
South River, N. J.
Tel. South River 6-2330

SPECIALTIES MFG. CO. (Spemco)
12830 Linwood
Detroit 38, Michigan
Tel. TR. 1-1862

SPECIFIC PRODUCTS
14515 Dickens Street
Sherman Oaks, Calif.
Tel. STANley 7-7882

SPELLMAN TELEVISION CO., INC.
3029 Webster Ave.
New York 67, N. Y.
Tel. KINGSbridge 7-0306

SPIRLING PRODUCTS CO., INC. (Spico)
Henrietta St. & Duffy Ave.
Hicksville, L. I., N. Y.
Tel. HICKsville 3-6650-1-2

SPRAGUE PRODUCTS CO.
North Adams, Mass.
Tel. MOhawk 3-6511

Branch Offices

LOS ANGELES, CALIF.
11325 Washington Blvd.
Culver City, Calif.
Tel. Texas 0-7491

CHICAGO, ILL.
5942 West Montrose Ave.
Tel. MULberry 5-6400

RADIO'S MASTER • 1954 • NINETEENTH EDITION

STANCOR
(See Chicago Standard Transformer Corp.)

STANDARD COIL PRODUCTS CO., INC.
2085 North Hawthorne Avenue
Melrose Park, Ill.
Tel. Filmore 4-5680
AUstin 7-3800

Sales Office
1919 Vineburn Avenue
Los Angeles, Calif.
Tel. CAPitol 2-8161
Export Agent
Rocke International
13 East 40th St.
New York 16, N. Y.

STANDARD ELECTRICAL PRODUCTS CO.
(Staco)
2240 E. Third St.
Dayton 3, Ohio
Tel. KE. 1191

STANWYCK WINDING CO., INC.
137-151 Walsh Ave.
Newburgh, N. Y.
Tel. Newburgh 3360
REctor 2-6282 (Direct N. Y. C. Line)

STEPHENS MANUFACTURING CORP.
("TruSonic")
8538 Warner Drive
Culver City, Calif.
Tel. Texas 0-3775; Vermont 9-7578

STERLING MANUFACTURING CO.
7201 Wentworth Ave.
Cleveland 2, Ohio
Tel. OLYmpic 1-5800

SUPERIOR ELECTRIC CO.
54 Clarke Avenue
Bristol, Conn.
Tel. Bristol 2-9561-2-3-4

Branch Offices
HOLLYWOOD, CALIF.
1436 N. Serrano Ave.
Tel. HOLlywood 2-7209

REDWOOD CITY, CALIF.
P. O. Box 946
1246 Junipero Ave.
Tel. EMerson 8-7094

OAK PARK, ILL.
P. O. Box 48
721 S. Boulevard
Tel. EUclid 3-5430

MEDINO, OHIO
P. O. Box 132
Tel. 3-3761

DALLAS, TEX.
4515 Prentice St.
Tel. EMerson 2174

MONTREAL, QUE., CANADA
4680 Barclay Ave.
Tel. REgent 8-6427

SUPERIOR INSTRUMENTS CO.
2435 White Plains Rd.
New York 67, N. Y.
Tel. TUlip 2-6880

SUPREME, INC.
1714-16 Carrollton Road
Greenwood, Miss.
Tel. 4102-3

SWITCHCRAFT, INC.
1328-30 North Halsted St.
Chicago 22, Ill.
Tel. Michigan 2-7136

SYLVANIA ELECTRIC PRODUCTS, INC.
1740 Broadway
New York 19, N. Y.
Tel. JUdson 6-2424

Branch Offices
LOS ANGELES 58, CALIF.
2936 E. 46th St.

SAN FRANCISCO, CALIF.
6450 Hollis St.
Emeryville, Calif.

ATLANTA, GA.
Fulwiler & Chapman, Inc.
702 Whitehall St., S.W.

NEW ORLEANS, LA.
Fulwiler & Chapman, Inc.
213 S. Front St.

GREENSBORO, N. C.
Fulwiler & Chapman, Inc.
445 English St.

CHICAGO 6, ILL.
2001 N. Cornell Ave.
Melrose Park, Ill.

CLEVELAND, OHIO
4848 W. 130th St.

SEATTLE 1, WASH.
3466 East Marginal Way

IPSWICH, MASS.
Estes Street

KANSAS CITY, KANS.
450 Funston Road

DALLAS, TEXAS
100 Fordyce St.

PHILADELPHIA 48, PA.
Cor. Ritner & Water Sts.

ST. LOUIS 9, MO.
5010 Kemper Ave.

WILLIAMSPORT, PA.
1621 Memorial Ave.

TEREBORO, N. J.
1000 Huyler St.

— T —

TALK-A-PHONE CO.
1512 South Pulaski Road
Chicago 23, Ill.
Tel. LAWndale 1-8414

TAYLOR TUBES, INC.
2312 W. Wabansia Ave.
Chicago 47, Ill.
Tel. ARmitage 6-1730

TECH LABORATORIES, INC.
Bergen & Edsall Bldgs.
Palsades Park, N. J.
Tel. LEonia 4-2221

TECH-MASTER CORP.
75 Front St.
Brooklyn 1, N. Y.
Tel. ULster 5-3535

TECHNICAL APPLIANCE CORP.
(Taco) (Tacoplex)
Sherburne, N. Y.
Tel. Sherburne 7-2211

TELEVISION HARDWARE MFG. CO.
(Telco)
919 Taylor Ave.
Rockford, Ill.
Tel. 2-6695

TELEX, INC.
Telex Park
St. Paul 1, Minn.
Tel. Nester 7211

Canadian Office
Atlas Radio Corp. Ltd.
560 King St. W.
Toronto 2-8, Ontario

TELREX, INC.
Asbury Park, N. J.
Tel. PProspect 5-7252

THORDARSON-MEISSNER MFG. DIV.
Maquire Industries, Inc.
7th & Belmont Streets
Mt. Carmel, Ill.
Tel. Mt. Carmel 1200

THORENS COMPANY
2020 Jericho Turnpike
New Hyde Park, N. Y.
Tel. FLoral Park 4-0123

TRIAD TRANSFORMER CORP.
Plant & General Offices:
4055 Redwood Ave.
Venice, Calif.
Tel. Texas 0-5381
EXbrook 7-2145

TRIMM, INC.
400 West Lake Street
P. O. Box 489
Libertyville, Ill.
Tel. Libertyville 2-3700

TRIPLETT ELECTRICAL INSTRUMENT CO.
Harmon Road
Bluffton, Ohio
Tel. 323W

TRU-OHM PRODUCTS DIVISION
Model Engineering & Mfg., Inc.
2800 N. Milwaukee Ave.
Chicago 18, Ill.
Tel. EVERglade 4-2646

Factory
Huntington, Ind.

TUNG-SOL ELECTRIC, INC.

General Offices
95 Eighth Ave.
Newark 4, N. J.
Tel. HUMBoldt 2-4200

Sales Offices
ATLANTA, GA.
Tung-Sol Sales Corporation
1349-51 Spring St., N.W.

CHICAGO 11, ILL.
Tung-Sol Sales Corporation
315 E. Grand Ave.

COLUMBUS 8, OHIO
Tung-Sol Sales Corporation
755 W. Goodale Blvd.

DALLAS 1, TEXAS
The Branum Company
310 Reserve Loan Life Bldg.

DENVER 4, COLO.
The James H. Bilnn Co.
1140 Speer Blvd.

LOS ANGELES 15, CALIF.
Tung-Sol Sales Corporation
8575 Washington Blvd.
Culver City, Calif.

NEWARK 4, N. J.
Tung-Sol Sales Corporation
95 Eighth Ave.

SEATTLE 9, WASH.
Ron Merritt Company
217 Ninth Avenue North

TURNER COMPANY
Cedar Rapids, Iowa
Tel. 3-8144

— U —

UNGAR ELECTRIC TOOLS, INC.
P.O. Box 312
4101 Redwood
Venice, Calif.
Tel. EXbrook 8-5718

UNION CARBIDE & CARBON CORP.
(See National Carbon Company)

UNITED TECHNICAL LABORATORIES
Box 425
Morristown, N. J.
Tel. MORristown 4-0711

UNITED TRANSFORMER COMPANY
150 Varick St.
New York 13, N. Y.
Tel. ALgonquin 5-3500

UNIVERSITY LOUDSPEAKERS, INC.
80 South Kensico Ave.
White Plains, N. Y.
Tel. WHite Plains 6-7700

U. S. ENGINEERING CO.
521 Commercial St.
Glendale 3, Calif.
Tel. CHApman 5-5777

Directory of Advertisers, Branch Offices, Addresses, Telephone Numbers

UTAH RADIO PRODUCTS, INC.
1123 East Franklin Street
Huntington, Ind.
Tel. 3100

UTICA DROP FORGE & TOOL CORP.
2415 Whitesboro St.
Utica 4, N. Y.
Tel. 3-2331

— V —

VACO PRODUCTS CO.
317 East Ontario St.
Chicago 11, Ill.
Tel. WHitehall 4-2340

VALPEY CRYSTAL CORPORATION
P. O. Box 325
Holliston, Mass.
Tel. 851

VAN CLEEF BROS., INC.
Division of Johns Manville
7800 Woodlawn Ave.
Chicago 19, Ill.
Tel. SAginaw 1-1000

Branch Office
250 E. 43rd St.
New York 17, N. Y.
Tel. LExington 2-0096

VECTOR ELECTRONIC COMPANY
3352 San Fernando Road
Los Angeles 65, Calif.
Tel. Cl. 7-8237

VIBROPLEX COMPANY, INC.
833 Broadway
New York 3, N. Y.
Tel. ALgonquin 4-4828

YIDAIRE ELECTRONICS MFG. CO.
576 W. Merrick Rd.
Lynbrook, N. Y.
Tel. LYnbrook 9-6544

VIKING LOUDSPEAKERS
(See Jensen Mfg. Co.)

V-M CORPORATION
280 Park Street
Benton Harbor, Mich.
Tel. WAInut 5-8841

VULCAN ELECTRIC CO.
88 Holten St.
Danvers, Mass.
Tel. Danvers 1730

Branch Office
420 Lexington Ave.
New York 17, N. Y.
Tel. LExington 2-0806

— W —

WALCO PRODUCTS, INC.
(also Electrovox Co., Inc.)
60 Franklin St.
East Orange, N. J.
Tel. ORange 4-1060

WALDOM ELECTRONICS, INC. (Croname)
911 North Larrabee Street
Chicago 10, Ill.
Tel. Superlor 7-1863

WALSCO ELECTRONICS CORP.
3602 Crenshaw Blvd.
Los Angeles 16, Calif.
Tel. Axminster 3-7201

Chicago Warehouse
315 West Walton
Chicago 10, Ill.
Tel. WHitehall 4-5996

WARD LEONARD ELECTRIC CO.
3100 N. Cicero Ave.
Chicago 41, Ill.
Tel. MUlberry 5-6450

Factory
115 MacQuesten Parkway So.
Mount Vernon, N. Y.

WARD PRODUCTS CORPORATION
Div. of the Gabriel Co.
1148 Euclid Ave.
Cleveland 15, Ohio
Tel. MA. 1-4610

WASSCO ELECTRIC PRODUCTS CORP.
126 W. Cass Street
Joliet, Ill.
Tel. 2-4714

WATERMAN PRODUCTS CO., INC.
2445-63 Emerald St.
Philadelphia 25, Pa.
Tel. GARfield 6-8600

WAVEFORMS, INC.
333 Ave. of the Americas
New York 14, N. Y.
Tel. WATkins 9-2795

WEBSTER ELECTRIC CO.
1900 Clark St.
Racine, Wisconsin
Tel. 3-3511

WEBSTER MFG. CO.
242 Shoreline Blvd.
Mill Valley, Calif.
Tel. Dunlap 8-5775
Dunlap 8-5224

WELLER ELECTRIC CORP.
890 Packer St.
Easton, Pa.
Tel. 7119

WESTINGHOUSE ELECTRIC CORPORATION
Electronic Tube Div.
P. O. Box 284
Elmira, N. Y.
Tel. ELMira 9-3611

District Offices
ATLANTA, GA.
1299 Northside Drive

BLOOMFIELD, N. J.
MacArthur Ave.

BOSTON 10, MASS.
10 High St.

CHICAGO 54, ILL.
Merchandise Mart Plaza

CINCINNATI, OHIO
207 West 3rd St.

DALLAS 1, TEXAS
1232 Fidelity Union Bldg.

DETROIT 31, MICHIGAN
5757 Trumbull Ave.

ELMIRA, N. Y.
Box 284

LOS ANGELES 14, CALIF.
600 St. Paul Ave.

PHILADELPHIA 4, PA.
3001 Walnut St.

PITTSBURGH 30, PA.
306-4th Ave.

For Canada
Canadian Westinghouse Co., Ltd.
Hamilton, Ont.

For Other Parts of the World

Westinghouse Electric International
40 Wail St.
New York 5, N. Y.
Tel. WHitehall 3-4321

WESTON ELECTRICAL INSTRUMENT CORP.
614 Frelinghuysen Ave.
Newark 5, N. J.
Tel. Blgelow 3-4700

District Offices
CHICAGO 6, ILL.
205 W. Wacker Drive

NEW YORK 7, N. Y.
50 Church Street

WASHINGTON 11, D. C.
6230 Third St., N.W.

WHARFEDEALE SPEAKERS
(See British Industries Corp.)

WILCOX-GAY CORPORATION
Charlotte, Mich.
Tel. Charlotte 485

Distributor Offices
BROOKLYN 1, N. Y.
79 Washington St.
Tel. ULster 2-6000

CHICAGO, ILL.
743 N. LaSalle St.
Tel. WHitehall 4-0077

BOSTON 20, MASS.
1103 Columbus Ave.
Tel. HIGHLand 2-1400

WIRT COMPANY
5221-27 Greene St.
Philadelphia 44, Pa.
Tel. GERMantown 8-1000

WORKMAN TV, INC.
309 Queen Anne Road
Teaneck, N. J.
Tel. TEaneck 6-0200

WORNER ELECTRONIC DEVICES
Rankin, Ill.
Tel. Rankin 55

WRIGHT, INC.
2233 University Ave.
St. Paul 14, Minn.
Tel. NE. 3553

— X —

Xcelite, Inc.
(Formerly Park Metalware Co.)
19-24 Bank Street
Orchard Park, N. Y.
Tel. Idlewood 4461-2

U. S. Patent Office
NOV 15 1965
Design Division

UNITED CATALOG PUBLISHERS, Inc.

106-110 Lafayette Street

New York 13, N. Y.

Affiliates

**UNITED PRICING SERVICE
UNITED FILE-O-MATIC, INC.**

RADIO'S MASTER

NINETEENTH EDITION

U. S. Patent Office

NOV 15 1955

Design Division

OFFICIAL
PARTS and EQUIPMENT MANUAL
of the
RADIO, TELEVISION & ELECTRONIC INDUSTRY

What to Buy and Where to Buy It

•
ILLUSTRATIONS

•
DESCRIPTIONS

•
SPECIFICATIONS

•
PRICES

Published by
UNITED CATALOG PUBLISHERS, INC.

106-110 Lafayette Street



New York 13, N. Y.

TK
6560.25
13
D-51

NINETEENTH EDITION

FOREWORD

RADIO'S MASTER® is the official buying guide and reference book of radio parts and electronic equipment for the industry.

The distribution of this buying guide is not a representation by the person or firm distributing the same that all of the lines and all of the products contained herein are necessarily carried by such person or firm.

•
Prices are furnished only for information—they are not offered as quotations.

•
WHERE LIST PRICES ARE SHOWN, TRADE DISCOUNTS APPLY IN MOST CASES. . . . PHONE OR WRITE FOR PRICES AND DELIVERY.

•
Enrolled manufacturers reserve the right to make mechanical changes in specifications necessitated by emergencies over which they have no control, and to change prices or withdraw items without notice.

•
Every precaution is taken to insure accuracy in the preparation of display pages and indexes, but the publishers cannot guarantee against the possibility of error or omission, nor can they be held responsible for price changes or withdrawal of items during or after publication.

IMPORTANT

When ordering, please mention RADIO'S MASTER, 19th EDITION, also page number on which the item appears and specific catalog or code number, if any. This will help to expedite the filling of your order and lessen the chance of error.

Copyright 1954

United Catalog Publishers, Inc.

No part of this book may be reproduced without express permission of the publishers.

Printed in U.S.A.

NOV 15 1955

RADIO'S MASTER
NINETEENTH EDITION

Design Division

ALPHABETICAL INDEX OF MANUFACTURERS

	Section	Page
— A —		
Acro Products Co.....	N	68
Advance Electric & Relay Co.....	L	48 to 51
Aero Instrument Co.....	G	48
Aerovox Corporation		
—Capacitors.....	P	102 to 124
—Resistors.....	R	70 to 73
Akro-Mils, Inc.....	U	36
All Channel Antenna Corp.....	S	116
Alliance Manufacturing Co.		
TV Antenna Rotators, Boosters.....	T	14, 15
Phono and Small Motors.....	E	34 to 37
Alpha Wire Corporation.....	S	1 to 16
Altec Lansing Corporation		
Amplifiers.....	B	1
Microphones.....	D	9
Speakers.....	C	3
Peerless Transformers.....	N	36 to 39
American Electrical Heater Co.		
(American Beauty).....	U	1
American Microphone Company.....	D	30 to 33
American Phenolic Corp. (Amphenol).....	F	1 to 12
American Radio Relay League, Inc. (ARRL).....	K	7
American Television & Radio Co.....	M	16 to 31
Amperex Electronic Corporation.....	A	32
Amperite Company, Inc.		
Ballasts (Resistor Tubes).....	R	76
Microphones.....	D	21
Relays.....	L	54
Amphenol (American Phenolic Corp.).....	F	1 to 12
Arco Electronics, Inc. (El-Menco).....	P	35 to 45
Argos Products Company.....	T	1
Astatic Corporation.....	D	10 to 15
Astron Corporation.....	P	130 to 141
Atlas Resistor Co.....	R	66, 67
Atlas Sound Corporation		
Microphone Stands.....	D	22, 23
Speakers.....	C	24, 25
Audax Company, Inc. (Audax).....	E	24, 25
Audio Development Co.....	L	41
Audio Devices, Inc.....	E	56, 57
Aurora Equipt. Co., Equipto Div.....	U	34, 35
— B —		
Baker Mfg. Co.....	S	126
Belden Manufacturing Co.....	S	17 to 27
Bell Sound Systems, Inc.....	B	2 to 5
Berkshire Laboratories.....	G	137
Birnbach Radio Co., Inc.....	S	31 to 47
Blaco Mfg. Co.....	S	121
Bliley Electric Company.....	T	42, 43
Blonder-Tongue Labs., Inc.....	T	5
Blum & Co., Inc., Julius.....	S	72
Bogen Company, Inc., David		
Amplifiers, Intercoms.....	B	14, 15
TV Boosters.....	T	6
Boyce Books (Sams).....	K	10
Brach Mfg. Corp., Div. General Bronze.....	S	83
Bradley Laboratories, Inc.....	H	22
Brand & Co., Inc., Wm.....	S	28 to 30
British Industries Corp.....	E	29

	Section	Page
Brush Electronics Co.....	D	35, 36
Bud Radio, Inc.		
Amateur Gear.....	J	42 to 52
Hardware.....	U	114, 115
Speaker Enclosures.....	C	40, 41
TV Accessories.....	T	34
Burgess Battery Company.....	M	6 to 9
Burlington Instrument Co.....	G	55
Burnell & Co., Inc.....	J	60, 61
Burton-Rogers Co. (Hoyt Meters).....	G	58, 59
Bussmann Mfg. Co. (Buss Fuses).....	H	14, 15
— C —		
Cannon Company, C. F.....	D	40
Cannon Electric Co.....	F	13 to 27
Capps & Co., Inc., Frank L.....	D	29
Cardwell Electronics Productions Corp.....	J	15 to 18
Carling Electric, Inc.....	L	16 to 23
Carter Motor Company.....	M	46 to 51
Carter Parts Co.....	L	34, 35
CBS-Hytron		
(Div. of Columbia Broadcasting System).....	A	1
Centralab Div. of Glove Union, Inc.		
Capacitors.....	P	71 to 77
Printed Circuits.....	P	71 to 77
Steatite Insulators.....	P	73
Switches.....	L	12 to 15
Volume Controls.....	R	40 to 43
Cetron (Continental Electric Co.).....	A	30, 31
Challenger Amplifier Co.....	B	15
Channel Master Corp.....	S	120
Chatham Electronics Corp.....	A	37
Chicago Industrial Instrument Co.....	G	11 to 14
Chicago Standard Transformer Corp.		
Chicago Division.....	N	86 to 93
Standard Division (Stancor).....	N	1 to 16
Chisholm-Ryder Co., Inc., Premax Div.....	S	124, 125
Cinaudagraph Company.....	C	36, 37
Cinch-Jones Sales Div., Cinch Mfg. Co.....	F	30 to 46
Clarkstan (Pacific Transducer Corp.).....	E	15
Clarostat Mfg. Co., Inc.....	R	28 to 36
Clifton Conduit Co., Inc., Pierceway Div.....	U	38
Columbia Broadcasting System, Inc.		
CBS-Hytron Division.....	A	1
Columbia Products Div., Shakespeare Co.....	S	112
Columbia Wire & Supply Co.....	S	48, 49
Conant Laboratories.....	H	23
Condenser Products Co., Inc.....	P	126 to 129
Conrac, Inc.....	B	26
Consolidated Radio Products Co.....	C	38
Consolidated Wire & Associated Cos.....	S	50 to 57
Continental Carbon, Inc.....	R	44 to 46
Continental Electric Co. (Cetron).....	A	30, 31
Copperweld Steel Co.....	S	62
Cornell-Dubilier Electric Corp.		
Antennas.....	S	94 to 96
Capacitors.....	P	50 to 70
Vibrators and Converters.....	M	36 to 38
Cornish Wire Co., Inc.....	S	58 to 61
Coyne Technical Books (Howard W. Sams).....	K	10

FOR SPECIFIC ITEMS AND THEIR PAGE NUMBERS, REFER TO GENERAL INDEX PAGES 9 TO 22 FOLLOWING

ALPHABETICAL INDEX OF MANUFACTURERS (Cont.)

	Section	Page		Section	Page
Crest Laboratories, Inc.			Gee-Lar Manufacturing Co.	U	120 to 123
Transformers, Voltage Boosters	N	121	Genalex Audio Tubes (British Industries)	U	15
TV Converters, Generators, etc.	T	20	General Bronze Corp., Brach Mfg. Div.	S	72
Croname (See Waldom Electronics, Inc.)			General Cement Mfg. Co.	U	41 to 75
Crown Controls Co., Inc.	S	117	General Dry Batteries, Inc.	M	10, 11
Cutler-Hammer, Inc.	L	24, 25	General Electric Company		
— D —			Capacitors	P	12 to 15
Dage Electric Co., Inc.	F	54, 55	Photoelectric Units	L	58, 59
Dale Products, Inc.	R	58 to 61	Rectifiers	H	20
Davies Molding Co., Harry	U	130, 131	Soldering Irons	UV	6, 7
Davis Electronics	S	118	Speakers	C	2
Dialight Corporation	H	1 to 10	Switches and Relays	L	1
Dollar Co., Robert	J	8, 9	Transformers and Reactors	N	124
Drake Co., R. L.	T	35	Tubes, Receiving & TV	A	2, 3
Drake Manufacturing Co.	H	11, 12	Tubes, Transmitting and Industrial	A	4, 5
Duotone Company, Inc.			General Industries Co.	E	30 to 33
Needles, Tape, Discs	E	54, 55	Gernsback Publications, Inc.	K	13
Speakers and Microphones	C	35	Girard-Hopkins	R	65
— E —			Globe-Union, Inc. (See Centralab Div.)		
Eagle Electronics, Inc.	B	37	Gon-Set Company	J	6, 7
Eby Sales Company	F	50 to 53	Gothard Manufacturing Co.	M	65
Editors & Engineers, Ltd. (Books)	K	12	Gramer-Halldorson Transformer Corp.	N	123
Eico (Electronic Instrument Co.)	G	84 to 88	Granco Products, Inc.	T	10, 11
Eitel-McCullough, Inc. (Eimac)	A	28, 29	Gray Research & Development Co., Inc.	E	1, 16
Elco Sales Company	F	47 to 49	Grayhill	L	36, 37
Electric Soldering Iron Co., Inc. (Esico)	U	5	Greenlee Tool Company	U	32, 33
Electro Mechanical Instrument Co. (Emico)	G	89	Guardian Electric Mfg. Co.	L	52, 53
Electro Products Laboratories	M	40	— H —		
Electronic Devices, Inc.	H	34	Hallicrafters Company	J	14
Electronic Fabricators, Inc. (Efcon)	P	142	Hammarlund Mfg. Co., Inc.	J	34 to 39
Electronic Instrument Co., Inc. (Eico)	G	84 to 88	Hardwick, Hindle, Inc.	R	62 to 64
Electronic Measurements Corp.	G	107 to 109	Harvey-Hubbell, Inc.	F	28, 29
Electrons, Inc.	A	35	Harvey-Wells Electronics, Inc.	J	10, 11
Electro-Sonic Laboratories	D	34	Hetherington, Inc.	L	38
Electro-Voice, Inc.			Hexacon Electric Co.	U	2 to 4
Microphones, Cartridges	D	24 to 27	Hickok Electrical Instrument Co.	G	60 to 79
Speakers, Horns, Enclosures	C	30 to 33	Hi-Lo TV Antenna Corporation	S	97
TV Boosters, Distribution Systems	T	4	Hoyt Electrical Instrument Works, Inc.	G	58, 59
Electrovox Co. (Walco Products Co., Inc.)	E	50 to 52	Hycon Mfg. Co.	G	138
Electrox (See Schauer Mfg. Corp.)			Hy-Lite Antennae, Inc.	S	92
Elmenco Products Co.	H	13	— I —		
Emico (Electro Mechanical Instrument Co.)	G	39	I.D.E.A., Inc. - Regency Division	T	7
Equipto Div. Aurora Equipment Co.	U	34, 35	Imperial Radar & Wire Corp.	S	65 to 67
Erie Resistor Corp.			Industrial Condenser Corp.	P	46 to 49
Capacitors, Printed Circuits, Resistors	P	90 to 98	Industrial Instruments, Inc.	G	133
Switches	L	31	Industrial Safety Belt Co.	U	39
Ersin Multicore (Multicore Sales Corp.)	U	15	Insuline Corporation of America		
Esico (Electric Soldering Iron Co.)	U	5	Cabinets, Racks, Panels	J	84 to 89
Eveready Batteries (National Carbon Co.)	M	1 to 4	Hardware, Tools, Service & Amateur Aids	U	132 to 150
Expanded Aluminum (British Industries)	U	15	Interelectronics Corp.	B	13
— F —			International Rectifier Corp.	H	32, 33
Federal Telephone & Radio Corp.			International Register Co.	L	39
Rectifiers	H	30, 31	International Resistance Co.	R	8 to 27
TV Lead-in Cables	S	63	— J —		
Fenton Company	S	64	Jackson Electrical Instrument Co.	G	80 to 83
Ferranti Electric, Inc.	N	69 to 71	James Vibrapowr Company	M	41
Fisher Radio Corp.	B	28 to 31	Jan Hardware Mfg. Co., Inc.	U	111 to 113
Freed Transformer Co., Inc.			J-B-T Instruments, Inc.		
Laboratory Test Equipment	G	114 to 124	Switches	L	2 to 5
Transformers, Toroidal Inductors	N	45 to 67	Test Equipment	G	98 to 102
— G —			Jennings Radio Mfg. Corp.	J	40, 41
Galbraith & Son Electric Corp., C. C.	C	48	Jensen Industries, Inc. (Needles)	E	40
Garrard Sales Corp.	E	29	Jensen Manufacturing Co. (Speakers)	C	42 to 47
			Jerrold Electronics Corp.	S	113
			Johnson Company, E. F.	J	62 to 81
			Jontz Manufacturing Co.	S	127

FOR SPECIFIC ITEMS AND THEIR PAGE NUMBERS, REFER TO GENERAL INDEX PAGES 9 TO 22 FOLLOWING

ALPHABETICAL INDEX OF MANUFACTURERS (Cont.)

NOV 14 1955

— K —		Section	Page
Kay Electric Company	G		134
Kenwood Engineering Co., Inc. (Kenco)	T		19
Kenyon Transformer Co., Inc.	N	40, 41	
Kester Solder Company	U		16
Keystone Electronics Corp.	U		89
Klein & Sons, Mathias	U		30
Knights Co., James	T		47
Kraeuter & Co., Inc.	U	26 to 29	
Kwikheat Mfg. Co.	U		8

— L —		Section	Page
Lansing Sound, Inc., James B.	C		34
Larson Co., Chas. O.	U	116, 117	
Leak Amplifiers (British Industries)	E		29
Lectrohm, Inc.	R	47 to 49	
Lenk Mfg. Co.	U		12
Lewis and Kaufman, Ltd.	A		36
Line Master Switch Corp.	L	26, 27	
Littelfuse, Inc.	H	16 to 19	
Lowell Mfg. Co.	C	26 to 29	

— M —		Section	Page
MacMillan Company	K		14
Magnecord, Inc.	E		15
Maguire Industries, Inc. (See Thordarson-Meissner Mfg. Divs.)			
Mallory & Co., Inc., P. R. Capacitors	P	1 to 11	
Controls, Rheostats, Resistors	R	1 to 7	
Switches, Jacks, Plugs	L	6 to 9	
Vibrators, Rectifiers, Battery Chargers	M	32 to 35	
UHF Converter, Tuning Unit, Grid Bias Cells	T	2, 3	
Marion Electrical Instrument Co.	G	40 to 43	
Masco (Mark Simpson Mfg. Co.)	B	16 to 25	
Master Mobile Mounts, Inc.	S	90, 91	
Measurements Corporation	G	125 to 132	
Meissner Products Div. Thordarson-Meissner	J	58, 59	
Merit Coil & Transformer Corp.	N	72 to 85	
Microtran Co. (Affiliate of Crest Labs)	N	122	
Middletown Mfg. Co., Inc.	J	108 to 110	
Millen Mfg. Co., Inc.	J	19 to 33	
Miller Co., J. W. (Coils)	J	54 to 57	
Miller Co., Sanford (Rectifiers)	H	35	
Miller Mfg. Co., M. A. (Needles)	E	38, 39	
Miller Television (Antennas)	S	98, 99	
Minnesota Mining & Mfg. Co.	E	53	
Model Engineering & Mfg., Inc. (Tru-Ohm Products Div.)	R	68, 69	
Monitor Products Co.	T	46	
Moody Machine Products Co., Inc.	U	31	
Morrow Radio Mfg. Co.	J	12	
Mosley Electronics, Inc.	T	22 to 24	
Mueller Electric Co.	M	14, 15	
Multicore Sales Corp.	U	15	

— N —		Section	Page
Najesco, Inc.	S		113
National Carbon Company (Eveready)	M	1 to 4	
National Company, Inc.	J	1 to 5	
National Electronic Mfg. Corp. (Nemco)	S	106 to 110	
National Electronics, Inc.	A		34
National Union Electric Corp.	A	22, 23	
National Wire & Cable Corp.	S	68 to 71	
Newcomb Audio Products Co.	B	6 to 11	

— O —		Section	Page
Oak Electronics Company	T		12
Ohmite Manufacturing Co.			
Rheostats and Resistors	R	52 to 56	
Switches	L	40	
Olin Industries, Inc.	M	12, 13	
Orradio Industries, Inc.	E	62	
Oxford Electric Corp.	C	49	

— P —		Section	Page
Pacific Transducer Corp. (Clarkstan)	E		17
Par-Metal Products Corp.	J	90 to 99	
Peerless Electrical Products Div. Altec Lansing Corp.	N	36 to 39	
Penn Television Products Co.	T	30 to 33	
Pentron Corporation	E	11	
Perma-Power Company	M	60, 61	
Permo, Inc.	E	41 to 49	
Peterson Radio Co., Inc.	T	44, 45	
Phaotron Company	G	56, 57	
Philmore Mfg. Co., Inc.	B	36	
Pickering & Co., Inc.	E	18 to 21	
Pierceway Div. Clifton Conduit Co., Inc.	U	38	
Planet Mfg. Corp.	P	125	
Plastic Capacitors, Inc.	P	99 to 101	
Porcelain Products, Inc.	S	73	
Potter & Brumfield	L	44 to 47	
Precise Development Corp.	G	110 to 113	
Precise Measurements Co.	G	140, 141	
Precision Apparatus Co., Inc.	G	90 to 97	
Premax Products Div. Chisholm-Ryder Co., Inc.	S	124, 125	
Premier Metal Products Co.	J	100 to 107	
Presto Recording Corp.	E	2 to 5	

— Q —		Section	Page
Quam-Nichols Company	C	4 to 6	
Quietrole Company	U	118	

— R —		Section	Page
Racon Electric Co., Inc.	C	7 to 9	
Radelco Manufacturing Co.	S	100 to 103	
Radiart Corporation Antennas	S	84 to 87	
Vibrators, Converters	M	42 to 45	
Radio City Products Co., Inc.	G	143 to 148	
Radio Corporation of America Batteries	M	5	
Crystal Pickups	C	1	
Speakers	C	1	
Television Components	T	16 to 18	
Test and Measurement Equipment	G	1 to 10	
Tube Manuals, Technical Literature	K	8, 9	
Tubes	A	6 to 9	
Radio Craftsmen, Inc.	B	27	
Radio Mfg. Engineers	J	13	
Radio Merchandise Sales, Inc.	S	114, 115	
Radio Receptor Co., Inc.	H	26 to 29	
Radion Corporation	S	93	
Ram Electronics Sales Co.	T	13	
Raytheon Mfg. Co., Equipt. Sales Div.	M	52, 53	
Raytheon Mfg. Co., Tube Operations	A	10 to 15	
Recoton Corporation	E	60, 61	
Reeves Soundcraft Corp.	E	58, 59	
Regency Division I.D.E.A., Inc.	T	7	
Rek-O-Kut Company	E	6 to 10	
Rider Publisher, Inc., John F.	K	1 to 6	
Ripley Company, Inc.	L	55	

FOR SPECIFIC ITEMS AND THEIR PAGE NUMBERS, REFER TO GENERAL INDEX PAGES 9 TO 22 FOLLOWING

ALPHABETICAL INDEX OF MANUFACTURERS (Cont.)

	<i>Section</i>	<i>Page</i>
R-J Audio Products, Inc.....	E	29
RME (Radio Mfg. Engineers).....	J	13
Rogan Brothers.....	U	128, 129
Rogers Electronic Corp.....	N	120
Royal Television Supply & Mfg. Co., Inc.....	S	122, 123

— S —

Sams & Co., Inc., Howard W.....	K	10, 11
Sangamo Electric Co.....	P	78 to 89
Sarkes Tarzian, Inc.....	H	24, 25
Scala Radio Co.....	G	139
Schauer Manufacturing Corp. (Electrox)		
Battery Chargers & Eliminators.....	M	39
Rectifier Units.....	H	21
Scott, Inc., Hermon Hosmer.....	B	12
Shallcross Manufacturing Co.....	R	50, 51
Shure Brothers, Inc.....	D	1 to 8
Shurite Meters.....	G	46, 47
Signal Indicator Corp. (Dialight Corp.).....	H	1 to 10
Simpson Electric Company.....	G	27 to 39
Simpson Mfg. Co., Inc., Mark (Masco).....	B	16 to 25
Smith, Inc., Herman H.....	U	76 to 88
Smith-Baldwin		
(Consolidated Radio Products Co.).....	C	38
Snap-on Drawer Company.....	U	37
SNC Manufacturing Co., Inc.....	N	32 to 35
Sola Electric Co.....	M	62 to 64
Sonar Radio Corp.....	J	111
Sonotone Corporation.....	E	22, 23
South River Metal Products Co., Inc.....	T	25 to 29
Specialties Manufacturing Co. (Spemco).....	L	32, 33
Specific Products.....	J	83
Spellman Television Co., Inc.....	M	58, 59
Spirling Products Co., Inc. (Spico).....	S	88, 89
Sprague Products Co.		
Capacitors.....	P	16 to 34
Resistors.....	R	57
Standard Coil Products Co., Inc.....	T	8, 9
Standard Division (Stancor)		
Chicago Standard Transformer Corp.....	N	1 to 16
Standard Electrical Products Co. (Staco)		
Relays.....	L	52
Transformers.....	N	42 to 44
Stanwyck Winding Co., Inc.....	J	53
Stephens Manufacturing Corp. (Tru Sonic).....	C	14, 15
Sterling Manufacturing Co.....	G	44, 45
Superior Electric Co.....	M	54 to 57
Superior Instruments Co.....	G	104, 105
Supreme, Inc.....	G	106
Switchcraft, Inc.....	L	28 to 30
Sylvania Electric Products, Inc.		
Tubes, Crystal Diodes, Rectifiers.....	A	19 to 21
Test Equipment.....	G	103

— T —

Talk-A-Phone Co.....	B	38, 39
Taylor Tubes, Inc.....	A	33
Tech Laboratories, Inc.....	L	10, 11
Tech-Master Corporation.....	B	32 to 35
Technical Appliance Corp. (Taco).....	S	104, 105
Television Hardware Mfg. Co. (Telco).....	T	37 to 41
Telex, Inc.....	D	37
Telrex, Inc.....	S	74 to 77
Thordarson-Meissner Mfg. Divs.		
Meissner Coils.....	J	58, 59
Thordarson Transformers.....	N	95 to 97
Thorens Company.....	E	27
Triad Transformer Corp.....	N	17 to 31
Trimm, Inc.		
Headphones.....	D	38, 39
Jacks and Plugs.....	L	42

	<i>Section</i>	<i>Page</i>
Triplett Electrical Instrument Co.....	G	15 to 26
Tru-Ohm Products Div.....	R	68, 69
Tung-Sol Electric, Inc.....	A	16 to 18
Turner Company.....	D	16 to 20

— U —

Ungar Electric Tools, Inc.....	U	13
Union Carbide & Carbon Corp.		
National Carbon Div. (Eveready).....	M	1 to 4
United Technical Laboratories.....	U	40
United Transformer Co.....	N	98 to 119
University Loudspeakers, Inc.....	C	16 to 23
U. S. Engineering Co.....	F	58 to 60
Utah Radio Products, Inc.		
Speakers.....	C	10 to 13
Transformers.....	N	94
Utica Drop Forge & Tool Corp.....	U	17

— V —

Vaco Products Co.....	U	18 to 21
Valpey Crystal Corp.....	T	48
Van Cleef Bros., Inc.....	U	119
Vector Electronic Company.....	F	56, 57
Vibroplex Company, Inc.....	J	82
Vidaire Electronics Mfg. Co.....	T	21
Viking Loudspeakers.....	C	43
V-M Corporation.....	E	28
Vulcan Electric Co.....	U	10, 11

— W —

Walco Products, Inc. (Electrovox Co.).....	E	50 to 52
Waldom Electronics, Inc. (Croname)		
TV Distribution Amplifier.....	S	119
Hardware, etc.....	U	124 to 127
Walco Electronics Corp.....	U	90 to 110
Ward Leonard Electric Co.....	R	37 to 39
Ward Products Corporation.....	S	78 to 82
Wassco Electric Products Corp.....	U	14
Waterman Products Co., Inc.....	G	136, 137
Waveforms, Inc.....	G	142
Webster Electric Co.....	E	26
Webster Manufacturing Co.....	S	111
Weller Electric Corp.....	U	9
Westinghouse Electric Corporation.....	A	24 to 27
Weston Electrical Instrument Corp.....	G	49 to 54
Wharfedale Speakers (British Industries).....	E	29
Wilcox-Gay Corporation.....	E	12 to 14
Wirt Co.....	R	74, 75
Workman TV, Inc.....	T	36
Worner Electronic Devices.....	L	56, 57
Wright, Inc.....	C	39

— X —

Xcelite, Inc.....	U	22 to 25
-------------------	---	----------

FOR SPECIFIC ITEMS AND THEIR PAGE NUMBERS, REFER TO GENERAL INDEX PAGES 9 TO 22 FOLLOWING

RADIO'S MASTER®

NINETEENTH EDITION

NUMERICAL INDEX OF MANUFACTURERS' DISPLAY PAGES

By Section and Folio

NOTE: This is a bare outline of the eighteen sections of RADIO'S MASTER. It will serve for speedy reference and for the purpose of familiarizing yourself quickly with its general contents. Regular use of the Master will reveal many additional items too numerous to list here—you may also discover an item in a section to which it does not directly relate. For more complete and precise information, consult the detailed General Index which follows (Index pages 9 through 22).

SECTION A

RECEIVING AND TELEVISION TUBES—
TRANSMITTING, INDUSTRIAL, SPECIAL TUBES—
DIODES, TRANSISTORS—DIAL & PANEL LAMPS
(See Section H for additional Germanium & Selenium Diodes)

<i>Section & Page</i>	<i>Name of Manufacturer</i>
A-1.....	CBS-Hytron
A-2 to 5.....	General Electric Co.
A-6 to 9.....	Radio Corporation of America
A-10 to 15.....	Raytheon Manufacturing Co.
A-16 to 18.....	Tung-Sol Electric, Inc.
A-19 to 21.....	Sylvania Electric Products, Inc.
A-22, 23.....	National Union Electric Corp.
A-24 to 27.....	Westinghouse Electric Corp.
A-28, 29.....	Eitel-McCullough, Inc.
A-30, 31.....	Continental Electric Co.
A-32.....	Amprex Electronic Corp.
A-33.....	Taylor Tubes, Inc.
A-34.....	National Electronics, Inc.
A-35.....	Electrons, Inc.
A-36.....	Lewis and Kaufman, Ltd.
A-37.....	Chatham Electronics Corp.

SECTION B

AUDIO EQUIPMENT — P. A.
TUNERS — AMPLIFIERS — HIGH FIDELITY UNITS
RADIO & TV RECEIVER CHASSIS, KITS
INTERCOM SYSTEMS

B-1.....	Altec Lansing Corporation
B-2 to 5.....	Bell Sound Systems, Inc.
B-6 to 11.....	Newcomb Audio Products Co.
B-12.....	Hermon Hosmer Scott, Inc.
B-13.....	Interelectronics Corp.
B-14, 15.....	David Bogen Co., Inc.
B-16 to 25.....	Mark Simpson Mfg. Co., Inc.
B-26.....	Conrac, Inc.
B-27.....	Radio Craftsmen, Inc.
B-28 to 31.....	Fisher Radio Corp.
B-32 to 35.....	Tech-Master Corporation
B-36.....	Philmore Mfg. Co., Inc.
B-37.....	Eagle Electronics, Inc.
B-38, 39.....	Talk-A-Phone Co.

SECTION C

SPEAKERS, PROJECTORS, HORNS, TRUMPETS
Section & Page *Name of Manufacturer*

C-1.....	Radio Corporation of America
C-2.....	General Electric Company
C-3.....	Altec Lansing Corporation
C-4 to 6.....	Quam-Nichols Company
C-7 to 9.....	Racon Electric Co., Inc.
C-10 to 13.....	Utah Radio Products, Inc.
C-14, 15.....	Stephens Manufacturing Corp.
C-16 to 23.....	University Loudspeakers, Inc.
C-24, 25.....	Atlas Sound Corporation
C-26 to 29.....	Lowell Manufacturing Co.
C-30 to 33.....	Electro-Voice, Inc.
C-34.....	James B. Lansing Sound, Inc.
C-35.....	Duotone Company, Inc.
C-36, 37.....	Cinaudagraph Company
C-38.....	Consolidated Radio Products Co.
C-39.....	Wright, Inc.
C-40, 41.....	Bud Radio, Inc.
C-42 to 47.....	Jensen Manufacturing Co.
C-48.....	C. C. Galbraith & Son Electric Corp.
C-49.....	Oxford Electric Corp.

SECTION D

MICROPHONES—MICROPHONE STANDS—
PICKUPS—CARTRIDGES
(See Section E for additional Pickups and Cartridges)

D-1 to 8.....	Shure Brothers, Inc.
D-9.....	Altec Lansing Corp.
D-10 to 15.....	Astatic Corporation
D-16 to 20.....	Turner Company
D-21.....	Amperite Co., Inc.
D-22, 23.....	Atlas Sound Corp.
D-24 to 27.....	Electro-Voice, Inc.
D-29.....	Frank L. Capps & Co., Inc.
D-30 to 33.....	American Microphone Co.
D-34.....	Electro-Sonic Laboratories
D-35.....	Brush Electronics Co.
HEADPHONES	
D-36.....	Brush Electronics Co.
D-37.....	Telex, Inc.
D-38, 39.....	Trim, Inc.
D-40.....	C. F. Cannon Co.

FOR SPECIFIC ITEMS AND THEIR PAGE NUMBERS, REFER TO GENERAL INDEX PAGES 9 TO 22 FOLLOWING

NUMERICAL INDEX OF DISPLAY PAGES (Cont.)

SECTION E

RECORDERS AND RECORDING EQUIPMENT—
TRANSCRIPTION UNITS—PICKUPS—CARTRIDGES—
PHONO MOTORS—TURNTABLES—RECORD
CHANGERS—DISCS—NEEDLES—TAPE
(See Section B for Amplifiers, Tuners, etc.)

Section & Page	Name of Manufacturer
E-1.....	Gray Research & Development Co.
E-2 to 5.....	Presto Recording Corporation
E-6 to 10.....	Rek-O-Kut Company
E-11.....	Pentron Corporation
E-12 to 14.....	Wilcox-Gay Corporation
E-15.....	Magnecord, Inc.
E-16.....	Gray Research & Development Co.
E-17.....	Pacific Transducer Corp.
E-18 to 21.....	Pickering & Co., Inc.
E-22, 23.....	Sonotone Corporation
E-24, 25.....	Audak Company, Inc.
E-26.....	Webster Electric Company
E-27.....	Thorens Company
E-28.....	V-M Corporation
E-29.....	Garrard Sales Corporation
E-30 to 33.....	General Industries Co.
E-34 to 37.....	Alliance Manufacturing Co.
E-38, 39.....	M. A. Miller Mfg. Co.
E-40.....	Jensen Industries Inc.
E-41 to 49.....	Permo, Inc.
E-50 to 52.....	Walco Products, Inc.
E-53.....	Minnesota Mining & Mfg. Co.
E-54, 55.....	Duotone Company, Inc.
E-56, 57.....	Audio Devices, Inc.
E-58, 59.....	Reeves Soundcraft Corp.
E-60, 61.....	Recoton Corporation
E-62.....	Orradio Industries, Inc.

SECTION F

CABLE & MICROPHONE CONNECTORS, FITTINGS—
PLUGS—SOCKETS—RECEPTACLES—
TERMINALS, TERMINAL STRIPS

F-1 to 12.....	American Phenolic Corp.
F-13 to 27.....	Cannon Electric Co.
F-28, 29.....	Harvey Hubbell, Inc.
F-30 to 46.....	Cinch-Jones Sales Div. Cinch Mfg. Co
F-47 to 49.....	Elco Corporation
F-50 to 53.....	Eby Sales Company
F-54, 55.....	Dage Electric Co., Inc.
F-56, 57.....	Vector Electronic Company
F-58 to 60.....	U. S. Engineering Co.

SECTION G

TESTING, MEASURING, INDICATING
INSTRUMENTS, ANALYZERS, PANEL METERS—
TEST EQUIPMENT

G-1 to 10.....	Radio Corporation of America
G-11 to 14.....	Chicago Industrial Instrument Co.
G-15 to 26.....	Triplett Electrical Instrument Co.
G-27 to 39.....	Simpson Electric Company
G-40 to 43.....	Marion Electrical Instrument Co.
G-44, 45.....	Sterling Manufacturing Co.
G-46, 47.....	Shurite Meters
G-48.....	Aero Instrument Co.
G-49 to 54.....	Weston Electrical Instrument Co.
G-55.....	Burlington Instrument Co.
G-56, 57.....	Phaotron Company

Section & Page Name of Manufacturer

G-58, 59.....	Hoyt Electrical Instrument Co.
G-60 to 79.....	Hickok Electrical Instrument Co.
G-80 to 83.....	Jackson Electrical Instrument Co.
G-84 to 88.....	Electronic Instrument Co., Inc.
G-89.....	Electro-Mechanical Instrument Co.
G-90 to 97.....	Precision Apparatus Co., Inc.
G-98 to 102.....	J-B-T Instruments, Inc.
G-103.....	Sylvania Electric Products, Inc.
G-104, 105.....	Superior Instruments Co.
G-106.....	Supreme, Inc.
G-107 to 109.....	Electronic Measurements Corp.
G-110 to 113.....	Precise Development Corp.
G-114 to 124.....	Freed Transformer Co., Inc.
G-125 to 132.....	Measurements Corporation
G-133.....	Industrial Instruments, Inc.
G-134.....	Kay Electric Co.
G-135.....	Berkshire Laboratories
G-136, 137.....	Waterman Products Co., Inc.
G-138.....	Hycon Mfg. Co.
G-139.....	Scala Radio Co.
G-140, 141.....	Precise Measurements Corp.
G-142.....	Waveforms, Inc.
G-143 to 148.....	Radio City Products Co., Inc.

SECTION H

PILOT AND DIAL LIGHTS—ASSEMBLIES

H-1 to 10.....	Dialight Corporation
H-11, 12.....	Drake Manufacturing Co.

INSTRUMENT FUSES

H-13.....	El-Menco Products Co.
H-14, 15.....	Bussmann Manufacturing Co.
H-16 to 19.....	Littelfuse, Inc.

RECTIFIERS: DRY DISC, SELENIUM, INSTRUMENT—
GERMANIUM & SELENIUM DIODES — TRANSISTORS
PHOTO ELECTRIC CELLS

(See Section A for additional Diodes & Transistors)

H-20.....	General Electric Co.
H-21.....	Schauer Mfg. Corp.
H-22.....	Bradley Laboratories, Inc.
H-23.....	Conant Laboratories
H-24, 25.....	Sarkes Tarzian, Inc.
H-26 to 29.....	Radio Receptor Co., Inc.
H-30, 31.....	Federal Telephone & Radio Corp.
H-32, 33.....	International Rectifier Corp.
H-34.....	Electronic Devices, Inc.
H-35.....	Sanford Miller Co.

SECTION J

COMMUNICATION RECEIVERS—TRANSMITTERS—
AMATEUR EQUIPMENT AND ACCESSORIES—
VARIABLE CAPACITORS—COILS—INSULATORS—
METAL RACKS, CABINETS, PANELS, ETC.

J-1 to 5.....	National Company, Inc.
J-6, 7.....	Gonset Company
J-8, 9.....	Robert Dollar Co.
J-10, 11.....	Harvey-Wells Electronics, Inc.
J-12.....	Morrow Radio Mfg. Co.
J-13.....	Radio Mfg. Engineers, Inc.
J-14.....	Hallicrafters Co.
J-15 to 18.....	Allen D. Cardwell Electronics Productions Corp.
J-19 to 33.....	James Millen Mfg. Co., Inc.
J-34 to 39.....	Hammarlund Mfg. Co., Inc.
J-40, 41.....	Jennings Radio Mfg. Co.
J-42 to 52.....	Bud Radio, Inc.
J-53.....	Stanwyck Winding Co.
J-54 to 57.....	J. W. Miller Co.
J-58, 59.....	Meissner Products, Div. Thordarson-Meissner

FOR SPECIFIC ITEMS AND THEIR PAGE NUMBERS, REFER TO GENERAL INDEX PAGES 9 TO 22 FOLLOWING

NUMERICAL INDEX OF DISPLAY PAGES (Cont.)

<i>Section & Page</i>	<i>Name of Manufacturer</i>
J-60, 61.....	Burnell & Co., Inc.
J-62 to 81.....	E. F. Johnson Co.
J-82.....	Vibroplex Co., Inc.
J-83.....	Specific Products
J-84 to 89.....	Insuline Corp. of America
J-90 to 99.....	Par-Metal Products Co.
J-100 to 107.....	Premier Metal Products Co.
J-108 to 110.....	Middletown Mfg. Co., Inc.
J-111.....	Sonar Radio Corp.

SECTION K

BOOKS—MANUALS—RADIO DATA SERVICES

K-1 to 6.....	John F. Rider Publisher, Inc.
K-7.....	American Radio Relay League
K-8, 9.....	Radio Corporation of America
K-10, 11.....	Howard W. Sams & Co., Inc.
K-12.....	Editors & Engineers, Ltd.
K-13.....	Gernsback Publications, Inc.
K-14.....	MacMillan Company

SECTION L

SWITCHES—JACKS—PLUGS

(See Section U for additional Jacks and Plugs)

L-1.....	General Electric Co.
L-2 to 5.....	J-B-T Instruments, Inc.
L-6 to 9.....	P. R. Mallory & Co., Inc.
L-10, 11.....	Tech Laboratories, Inc.
L-12 to 15.....	Centralab Div. Globe-Union, Inc.
L-16 to 23.....	Carling Electric, Inc.
L-24, 25.....	Cutler-Hammer, Inc.
L-26, 27.....	Line Master Switch Corp.
L-28 to 30.....	Switchcraft, Inc.
L-31.....	Erie Resistor Corp.
L-32, 33.....	Specialties Mfg. Co.
L-34, 35.....	Carter Parts Co.
L-36, 37.....	Grayhill
L-38.....	Hetherington, Inc.
L-39.....	International Register Co.
L-40.....	Ohmite Mfg. Co.
L-41.....	Audio Development Co.
L-42.....	Trimm, Inc.

RELAYS

L-43.....	Standard Electrical Products Co.
L-44 to 47.....	Potter & Brumfield
L-48 to 51.....	Advance Electric & Relay Co.
L-52, 53.....	Guardian Electric Mfg. Co.
L-54.....	Amperite Company, Inc.

PHOTO ELECTRIC UNITS

L-55.....	Ripley Co., Inc.
L-56, 57.....	Worner Electronic Devices
L-58, 59.....	General Electric Co.

SECTION M

DRY BATTERIES

M-1 to 4.....	National Carbon Company
M-5.....	Radio Corporation of America
M-6 to 9.....	Burgess Battery Company
M-10, 11.....	General Dry Batteries, Inc.
M-12, 13.....	Olin Industries, Inc.

BATTERY ELIMINATORS & CHARGERS— POWER CONVERSION EQUIPMENT— GENERATORS, INVERTERS, VIBRATORS, PACKS— VOLTAGE TRANSFORMERS & CONTROLS

M-14, 15.....	Mueller Electric Co.
M-16 to 31.....	American Television & Radio Co.
M-32 to 35.....	P. R. Mallory & Co., Inc.
M-36 to 38.....	Cornell-Dubilier Electric Corp.
M-39.....	Schauer Mfg. Corp.
M-40.....	Electro Products Labs.

<i>Section & Page</i>	<i>Name of Manufacturer</i>
M-41.....	James Vibrapowr Co.
M-42 to 45.....	Radiart Corporation
M-46 to 51.....	Carter Motor Company
M-52, 53.....	Raytheon Mfg. Co.
M-54 to 57.....	Superior Electric Co.
M-58, 59.....	Spellman Television Co.
M-60, 61.....	Perma-Power Company
M-62 to 64.....	Sola Electric Company
M-65.....	Gothard Manufacturing Co.

SECTION N

TRANSFORMERS, ALL TYPES— REACTORS—CHOKES—COILS—INDUCTORS (See Section J for additional Coils)

N-1 to 16.....	Chicago Standard Transformer Corp.
N-17 to 31.....	Triad Transformer Corp.
N-32 to 35.....	SNC Manufacturing Co., Inc.
N-36 to 39.....	Altec Lansing Corp., Peerless Div.
N-40, 41.....	Kenyon Transformer Co., Inc.
N-42 to 44.....	Standard Electrical Products Co.
N-45 to 67.....	Freed Transformer Co., Inc.
N-68.....	Acro Products Co.
N-69 to 71.....	Ferranti Electric, Inc.
N-72 to 85.....	Merit Coil & Transformer Corp.
N-86 to 93.....	Chicago Standard Transformer Corp.
N-94.....	Utah Radio Products, Inc.
N-95 to 97.....	Thordarson-Meissner Mfg. Div.
N-98 to 119.....	United Transformer Co.
N-120.....	Rogers Electronics Corp.
N-121.....	Crest Laboratories, Inc.
N-122.....	Microtran Co.
N-123.....	Gramer-Halldorson Transformer Corp.
N-124.....	General Electric Co.

SECTION P

FIXED CAPACITORS, ALL TYPES— NOISE & INTERFERENCE FILTERS— CAPACITOR TESTERS — PRINTED CIRCUITS (See Section J for Variable Capacitors)

P-1 to 11.....	P. R. Mallory & Co., Inc.
P-12 to 15.....	General Electric Co.
P-16 to 34.....	Sprague Products Company
P-35 to 45.....	Arco Electronics, Inc.
P-46 to 49.....	Industrial Condenser Corp.
P-50 to 70.....	Cornell-Dubilier Electric Corp.
P-71 to 77.....	Centralab Div. Globe-Union, Inc.
P-78 to 89.....	Sangamo Electric Co.
P-90 to 98.....	Erie Resistor Corporation
P-99 to 101.....	Plastic Capacitors, Inc.
P-102 to 124.....	Aerovox Corporation
P-125.....	Planet Manufacturing Corp.
P-126 to 129.....	Condenser Products Co., Inc.
P-130 to 141.....	Astron Corporation
P-142.....	Electronic Fabricators, Inc.

SECTION R

RESISTORS—VOLUME CONTROLS—BALLASTS— DECADES, BRIDGES—NOISE FILTERS & SUPPRESSORS RHEOSTATS, POTENTIOMETERS, ATTENUATORS

R-1 to 7.....	P. R. Mallory & Co., Inc.
R-8 to 27.....	International Resistance Co.
R-28 to 36.....	Clarostat Mfg. Co., Inc.
R-37 to 39.....	Ward Leonard Electric Co.
R-40 to 43.....	Centralab Div. Globe-Union, Inc.
R-44 to 46.....	Continental Carbon, Inc.
R-47 to 49.....	Lectrohm, Inc.
R-50, 51.....	Shallcross Mfg. Co.
R-52 to 56.....	Ohmite Manufacturing Co.

FOR SPECIFIC ITEMS AND THEIR PAGE NUMBERS, REFER TO GENERAL INDEX PAGES 9 TO 22 FOLLOWING

NUMERICAL INDEX OF DISPLAY PAGES (Cont.)

Section & Page	Name of Manufacturer
R-57.....	Sprague Products Co.
R-58 to 61.....	Dale Products, Inc.
R-62 to 64.....	Hardwick, Hindle, Inc.
R-65.....	Girard-Hopkins
R-66, 67.....	Atlas Resistor Co.
R-68, 69.....	Tru-Ohm Products
R-70 to 73.....	Aerovox Corporation
R-74, 75.....	Wirt Company
R-76.....	Amperite Co., Inc.

SECTION S

WIRE AND CABLE, ALL TYPES

S-1 to 16.....	Alpha Wire Corporation
S-17 to 27.....	Belden Manufacturing Co.
S-28 to 30.....	William Brand & Co., Inc.
S-31 to 47.....	Birnbach Radio Co., Inc.
S-48, 49.....	Columbia Wire & Supply Co.
S-50 to 57.....	Consolidated Wire & Associated Cos.
S-58 to 61.....	Cornish Wire Co., Inc.
S-62.....	Copperweld Steel Co.
S-63.....	Federal Telephone & Radio Corp.
S-64.....	Fenton Company
S-65 to 67.....	Imperial Radar & Wire Corp.
S-68 to 71.....	National Wire & Cable Corp.
S-72.....	Julius Blum & Co., Inc.

ANTENNAS & SYSTEMS FOR TV-FM-AM-AUTO- ANTENNA INSTALLATION ACCESSORIES

(See Section T for additional TV Accessories)

S-73.....	Porcelain Products, Inc.
S-74 to 77.....	Telrex, Inc.
S-78 to 82.....	Ward Products Corp.
S-83.....	Brach Manufacturing Corp.
S-84 to 87.....	Radiart Corporation
S-88, 89.....	Spirling Products Co., Inc.
S-90, 91.....	Master Mobile Mounts, Inc.
S-92.....	Hy-Lite Antennae, Inc.
S-93.....	Radion Corporation
S-94 to 96.....	Cornell-Dubilier Electric Corp.
S-97.....	Hi-Lo TV Antenna Corp.
S-98, 99.....	Miller Television
S-100 to 103.....	Radelco Mfg. Co.
S-104, 105.....	Technical Appliance Corp.
S-106 to 110.....	National Electronic Mfg. Corp.
S-111.....	Webster Manufacturing Co.
S-112.....	Columbia Products Co.
S-113.....	Najesco, Inc.
S-114, 115.....	Radio Merchandise Sales, Inc.
S-116.....	All Channel Antenna Corp.
S-117.....	Crown Controls, Inc.
S-118.....	Davis Electronics
S-119.....	Waldom Electronics, Inc.
S-120.....	Channel Master Corp.
S-121.....	Blaco Mfg. Co.
S-122, 123.....	Royal Television Supply & Mfg.
S-124, 125.....	Premax Products
S-126.....	Baker Manufacturing Co.
S-127.....	Jontz Manufacturing Co.

SECTION T

TV PARTS & ANTENNA ACCESSORIES — BOSTERS, CONVERTERS, TUNERS — CABINETS

(See Section S for Antennas and additional
Antenna Installation Accessories)

T-1.....	Argos Products Co.
T-2, 3.....	P. R. Mallory & Co., Inc.
T-4.....	Electro-Voice, Inc.
T-5.....	Blonder-Tongue Labs., Inc.
T-6.....	David Bogen Co., Inc.
T-7.....	Regency Div. I.D.E.A., Inc.
T-8, 9.....	Standard Coil Products Co., Inc.

Section & Page	Name of Manufacturer
T-10, 11.....	Granco Products, Inc.
T-12.....	Oak Electronics Co.
T-13.....	Ram Electronics Sales Co.
T-14, 15.....	Alliance Mfg. Co.
T-16 to 18.....	Radio Corporation of America
T-19.....	Kenwood Engineering Co., Inc.
T-20.....	Crest Laboratories, Inc.
T-21.....	Vidaire Electronics Mfg. Co.
T-22 to 24.....	Mosley Electronics, Inc.
T-25 to 29.....	South River Metal Products Co., Inc.
T-30 to 33.....	Penn Television Products Co.
T-34.....	Bud Radio, Inc.
T-35.....	R. L. Drake Co.
T-36.....	Workman TV, Inc.
T-37 to 41.....	Television Hardware Mfg. Co.

CRYSTALS — AMATEUR, COMMERCIAL, SPECIAL

T-42, 43.....	Bliley Electric Co.
T-44, 45.....	Petersen Radio Co., Inc.
T-46.....	Monitor Products Co.
T-47.....	James Knights Co.
T-48.....	Valpey Crystal Corp.

SECTION U

TOOLS: SOLDERING IRONS, PLIERS, WRENCHES,
SCREWDRIVERS, NUTDRIVERS, PUNCHES, CUTTING
TOOLS, NEUTRALIZING & ALIGNMENT TOOLS—
CONNECTORS — CHEMICALS, OILS, PAINTS, ETC. —
HARDWARE, SERVICE AIDS OF EVERY DESCRIPTION

U-1.....	American Electrical Heater Co.
U-2 to 4.....	Hexacon Electric Co.
U-5.....	Electric Soldering Iron Co., Inc.
U-6, 7.....	General Electric Co.
U-8.....	Kwikheat Mfg. Co.
U-9.....	Weller Electric Co.
U-10, 11.....	Vulcan Electric Co.
U-12.....	Lenk Manufacturing Co.
U-13.....	Ungar Electric Tools, Inc.
U-14.....	Wassco Electric Products Corp.
U-15.....	Multicore Sales Corp.
U-16.....	Kester Solder Company
U-17.....	Utica Drop Forge & Tool Corp.
U-18 to 21.....	Vaco Products Company
U-22 to 25.....	Xcelite, Inc.
U-26 to 29.....	Kraeuter & Co., Inc.
U-30.....	Mathias Klein & Sons
U-31.....	Moody Machine Products Co., Inc.
U-32, 33.....	Greenlee Tool Co.
U-34, 35.....	Equipto Div. Aurora Equipt. Co.
U-36.....	Akro-Mils, Inc.
U-37.....	Snap-on Drawer Co.
U-38.....	Pierceway Div. Clifton Conduit Co.
U-39.....	Industrial Safety Belt Co.
U-40.....	United Technical Laboratories
U-41 to 75.....	General Cement Mfg. Co.
U-76 to 88.....	Herman H. Smith, Inc.
U-89.....	Keystone Electronics Corp.
U-90 to 110.....	Walsco Electronics Corp.
U-111 to 113.....	Jan Hardware Mfg. Co.
U-114, 115.....	Bud Radio, Inc.
U-116, 117.....	Chas. O. Larson Co.
U-118.....	Quietrole Company
U-119.....	Van Cleef Bros., Inc.
U-120 to 123.....	Gee-Lar Mfg. Co.
U-124 to 127.....	Waldom Electronics, Inc.
U-128, 129.....	Rogan Brothers
U-130, 131.....	Harry Davies Molding Co.
U-132 to 150.....	Insuline Corporation of America

FOR SPECIFIC ITEMS AND THEIR PAGE NUMBERS, REFER TO GENERAL INDEX PAGES 9 TO 22 FOLLOWING

RADIO'S MASTER

Nineteenth Edition

GENERAL INDEX

— A —

	Section & Page
AC-DC Antenna Wire.....	S-14, 25; U-57
AC-DC Power Inverters.....	M-22 to 31, 38
AC-DC Resistance Cords.....	S-45, 57; U-150
Aero Products Company	N-68
Adaphone Remote Control Phone.....	S-64
Adapter, Drill.....	U-84
Adapters, Cable Connector.....	S-81
Adapters, Cathode Ray Tube Testing.....	G-14, 88, 96; M-60; T-21; U-57
Adapters, Crystal Holder.....	T-23
Adapters, Phone Plug.....	F-8; L-30; U-82, 134
Adapters—Plug-In.....	L-37
Adapters, RCA Record.....	E-54; U-60
Adapters, Tube Checker.....	A-13; F-5, 56
Adapters, Voltage Adjusters—Foreign.....	S-57
Adjust-A-Cone Speakers.....	C-4, 5
Adjust-A-Volt Variable Transformers.....	N-42, 43
Advance Electric & Relay Co.....	L-48 to 51
Aero Instrument Company.....	G-48
Aerocon Capacitors.....	P-110
Aerial Kit.....	B-36; S-45, 57, 106
Aerovox Corporation	
Capacitors.....	P-102 to 124
Resistors.....	R-70 to 73
Aircraft and Marine Crystals.....	T-42 to 48
Aircraft Receiver, Transmitter.....	J-7, 9, 111
Aircraft Dynamotors, Magmotors.....	M-46, 50, 65
Aircraft Fuses.....	H-17
Aircraft Wires and Shielding.....	S-13, 26, 32, 36, 68, 69
Akro-Milk, Inc.....	U-36
Alarms, Burglar.....	L-57
Alignment, Neutralizing Tools, Kits.....	F-3; U-47 to 50, 58, 59, 88, 98, 137 to 139
All Channel Antenna Corp.	S-116
Allen Hex Screws.....	U-66
Allen Wrenches.....	U-20, 59, 80, 96
Alliance Manufacturing Co.	
Antenna Rotators, TV Boosters, Converters.....	T-14, 15
Phono Motors.....	E-34 to 37
Alligator Clips.....	M-14, 15; S-39, 40; U-55, 79, 135
Alnico V Speakers.....	Section C
Alpha Wire Corporation.....	S-1 to 16
Altec Lansing Corporation	
Amplifiers.....	B-1
Microphones.....	D-9
Speakers.....	C-3
Transformers (Peerless Division).....	N-36 to 39
Amateur Equipment (see specific headings, such as <i>Communication Receivers, Transmitters, Oscillators, etc.</i>)	
Amateur Type Tubes.....	Section A
American Beauty Soldering Irons.....	U-1
American Electrical Heater Co.....	U-1
American Microphone Co.....	D-30 to 33
American Phenolic Corp. (Amphenol).....	F-1 to 12
American Radio Relay League (ARRL).....	K-7
American Television & Radio Co. (ATR).....	M-16 to 31
Ammeters.....	G-24 to 26, 36 to 38, 42, 44 to 46, 49, 51, 55, 58, 59, 76, 78, 79, 89
Amperex Electronic Corp.	A-32
Amperite Company, Inc.	
Ballast Tubes.....	R-76
Microphones and Stands.....	D-21
Thermostatic Delay Relays.....	L-54
Amphenol (American Phenolic Corp.).....	F-1 to 12
Amplifiers and Systems.....	Section B; also C-14; E-29, G-118, 141; J-6; N-22, 119; T-7 to 21
Amplifier-Power Supply.....	J-6
Cases, Cabinets, Racks.....	B-9; J-46, 47, 84, 85
Foundation Chassis.....	J-46, 47, 85, 97, 106, 109
Hi-Fidelity.....	B-1, 2, 11, 12, 13, 25, 27, 30, 35, 36; C-14; E-29; N-22, 119; T-7, 21
Industrial and School Systems.....	B-9, 14, 19
Kits.....	B-35 to 37; N-22, 119
Magnetic.....	H-22; N-55, 107
Mobile Amplifiers.....	B-4, 8, 9, 10, 14, 15, 18, 21
Musical Instrument Amplifiers.....	B-10
Noise Suppressors.....	B-12, 31; N-54, 84, 111, 112
Phono Amplifiers, Systems.....	B-5, 8, 9, 10, 14, 15; N-22
Portable Amplifiers.....	B-5 to 10, 14, 15, 16, 20, 21
Pre-amplifiers, Boosters.....	B-1, 12, 13, 14, 17, 18, 30, 31, 35; E-19, 20; J-7; N-22; T-7; P-24, 71 to 73, 95
Printed Electronic Circuits.....	E-2, 5, 7
Recording Amplifiers.....	B-1, 2, 11, 30
Remote Control Amplifiers and Boxes.....	J-20
Transmitter, Amateur Power Amplifiers.....	B-1, 27, 29, 33; E-11; J-6, 57
Tuners, AM-FM.....	A-13; F-5, 56
Analyzer Adapters.....	Section G
Analyzers (see also Testing Instruments).....	Section G
Angles and Brackets.....	S-41; U-75, 88, 89, 147, 149
Anode Connectors.....	F-33; S-45; T-21; U-57, 109, 126

Section & Page

Antenna Accessories (see also TV)	
AC-DC Antenna Wire.....	S-14, 25; U-57
Coils.....	J-12, 53, 54, 55, 57, 59; N-82, 83, 85; S-91; T-18
Insulators.....	F-10; J-75, 76; P-73; S-43, 44, 73, 94, 106, 110, 115, 124; T-22, 29, 32, 39, 41; U-114
Isonet.....	F-10
Lead-in Strips, Ground Clamps, Rods.....	M-15; S-38, 49, 62, 67, 106, 110, 121, 124; T-29, 41; U-108
Lightning Arresters.....	C-1; F-10; S-85, 93, 94, 102, 106, 110, 114, 115; T-38; U-58
Matching, Coupling Transformers, etc.....	C-1; J-63; S-80, 105, 110, 111, 113, 119, 120; T-5, 21 to 23, 41; U-40
Mobile Antenna Equipment.....	J-64; S-82, 90, 91, 103, 107, 108, 111, 112, 124, 125
Mounting Accessories, Bases, etc.....	F-10; S-43 to 45, 73, 80 to 127; T-19, 25 to 34, 40, 41
Nail-it Knobs.....	S-106
Roof Patching Compound.....	U-43, 109
Spring Wire Clips.....	S-43; U-55, 70, 85, 148
Switches, Changerover, etc.....	S-105; T-22, 33
Tuner.....	J-12; U-150
Turnbuckles.....	S-110; T-32, 41; U-108, 117
Wall Receptacles.....	F-36; T-22, 23; U-108
Wire and Cable.....	S-14, 25, 37, 38, 59, 62, 106
Antenna Changerover Relays.....	J-65; L-43, 48, 49, 50
Antenna Couplers.....	J-54, 63, 85, 110, 113, 120; S-80; T-5, 21, 33, 35, 41; U-40
Antenna Manuals.....	Section K
Antennas and Systems	
Amateur.....	S-77, 82, 90, 91, 103, 107, 111, 112, 124, 125
Auto Antennas.....	S-80, 81, 84, 96, 98, 102, 107, 108, 112; U-59
Indoor Antennas, TV.....	F-11; S-79, 83, 89, 93, 94, 97, 102, 109, 115; T-37, 38
Kits (Wire and Accessories).....	B-36; S-45, 57, 106
Loop Antennas, Sticks, Rods, etc.....	J-53, 55, 57; T-12; U-40, 57, 100, 150
Master Antenna Distribution Systems.....	S-105, 113; T-5
Masts, Radiators, Towers.....	F-10; S-80, 103, 122, 126, 127; T-28
Mobile, Transmitter, Police Antennas.....	S-82, 90, 91, 103, 107, 111, 112, 124, 125
Motorcycle Antennas.....	S-82
Rotating Antennas.....	J-65; S-86, 87, 95, 117; T-14
Television and FM Antennas.....	F-11, 12; S-74 to 120; T-33, 37, 38; U-105, 106
UHF Antennas.....	F-12; S-74 to 120; T-33, 37, 38; U-105, 106
Window Antennas and House Masts.....	S-105, 109; T-37
Appliance Noise Filters.....	J-57; P-8, 31; R-46; S-110; U-150
Appliance Switches.....	L-20 to 23; S-31; U-56
Appliance Testers.....	G-21, 98
Arc Electronics, Inc. (El-Menco Capacitors).....	P-35 to 45
Argos Products Co.....	T-1
Astale Corporation.....	D-10 to 15
Astron Corporation.....	P-130 to 141
Atlas Resistor Co.....	R-66, 67
Atlas Sound Corporation	
Speakers, Horns, etc.....	C-24, 25
Stands.....	D-22, 23
ATR (American Television & Radio Co.).....	M-16 to 31
Attenuators, Audio, etc.....	L-10, 11, 35; R-2, 14, 32, 51; T-5
Audax Co., Inc. (Audax).....	E-24, 25
Audio Chokes.....	Section N
Audio Curve Tracer.....	G-142
Audio Development Co.....	L-41
Audio Devices, Inc.....	E-56, 57
Audio Filters.....	B-12, 31; N-54, 84, 111, 112
Audio Oscillators.....	G-82, 86, 142; U-150
Audio Reactors.....	Section N
Audio Sweep Frequency Transcription.....	E-17
Audio Transformers.....	Section N; also C-6, 37
Audiodes, Audiopoints, Audiotape.....	E-56, 57
Aurora Equipment Co., Equipio Division.....	U-34, 35
Auto Radio Accessories:	
Antenna and Fuse Connectors.....	F-33; S-41, 108; U-54, 84, 145
Auto Antennas.....	S-80, 81, 84, 96, 98, 102, 107, 108, 112; U-59
Battery Eliminators.....	G-87; M-26, 31, 38, 39, 40, 53, 60; S-84
Capacitors, Filters.....	P-5, 30, 31, 49, 111, 120, 121; R-46; S-108; U-59
Knobs.....	U-61, 120
Panel Lamps.....	A-17; M-4
Pin Plug and Jack Sets.....	F-33; U-54, 84, 89, 145
Power Supplies, Packs.....	J-19, 111; M-26, 34, 35, 39, 40, 45 to 48, 51, 53, 65; N-16
Speaker Switch, 4-position.....	T-12
Speakers—Replacement, Rear Seat, etc.....	C-6, 11, 36, 38, 41, 49
Suppressors, Ignition.....	P-5, 8, 30, 31, 49, 116, 120; R-46; S-45, 108; U-59, 85
Tire Static Neutralizing Kits.....	U-59
Tuner Tool.....	U-50
Vibrators.....	M-16 to 21, 32, 36, 37, 41 to 44
Vibrator Transformers, Exact Duplicate.....	N-11, 28, 29
Volume and Tone Controls.....	Section R
Wheel and Hub Static Eliminators.....	S-108; U-59
Wire, Cable, Shielding.....	S-1, 3, 6, 8, 13, 26, 36, 54
Automatic Line Voltage Regulators, Plug-in.....	R-30; U-150

GENERAL INDEX (Continued)

	Section & Page
Automatic Voltage Regulators, Controls, Reducers	M-52 to 58, 60 to 64
Autotransformers, Autoformers	Section N
Line Adjusting	N-16, 112
Power Line	N-41
Step Down	N-63, 80, 97, 117, 121
Television	N-4, 78
Vertical Voltage	N-42, 43, 113
Vertical Deflection Output	N-4
Azimuth Dial	U-124

- B -

Baffles, Enclosures for Speakers	Section C; also B-28; E-29, 39 to 41, 46; J-85, 86, 106, 110; T-1
Baker Manufacturing Co.	S-126
Ballasts (Voltage Regulator Tubes)	A-4, 6, 7, 12, 13, 19, 27, 32, 37; R-30, 76
Banana Plugs, Jacks	J-79; S-39, 40; U-53, 55, 76 to 78, 114, 132 to 134
Band Switches and Assemblies	J-64
Bandmaster Transmitters	J-10, 11
Bar and Pattern Generators, TV	G-1, 32, 86, 107, 143; M-61; T-20
Barrier Type Terminal Strips	F-45, 76; J-25; S-41; U-86, 87
Bases, Bottom Plates for Metal Chassis	J-46, 88
Batteries, Dry	M-1 to 13; R-5
Battery and Test Clips	M-14, 15; S-39, 40; U-55, 79, 85
Battery Chargers, Boosters	G-87; M-34, 38, 39
Battery Connectors, Straps	F-53; U-84, 133
Battery Eliminators	G-87; M-26, 31, 38, 39, 40, 53, 60; S-84
Battery Mini-Max Strips	U-59, 84, 133
Batteries—Power-Pak	R-5
Battery Plugs	F-34
Battery Testers, Meters	G-9, 13, 14, 37, 45, 93, 94, 96, 109, 144
Beam Benders (Ion Traps) for TV Tubes	C-6; J-54; R-36; T-17; U-57
Belden Manufacturing Co.	S-17 to 27
Hell Sound Systems, Inc.	B-2 to 5
Berkshire Laboratories	G-135
Binding Posts	F-53, 59; M-57; U-53, 77, 134
Birnback Radio Co., Inc.	S-31 to 47
Blaco Mfg. Co.	S-121
Blast Filter for Microphones	D-26
Bliley Electric Co.	T-42, 43
Blonder-Tongue Laboratories, Inc.	T-5
Blowers, Motors	L-55
Blum & Co., Inc., Julius	S-72
Bogen Company, Inc., David	B-14, 15; T-6
Bolts, Nuts, Screws, Washers	F-60; J-5; L-9; S-42, 43, 49
Booding Rings	F-25
Books and Manuals	Section K; also C-23; E-56; G-92; J-13, 82; M-32; N-54; P-73
Boosters and Pre-amplifiers for Amplifiers	B-1, 12 to 14, 17, 18, 30, 31, 35; E-19, 20; J-7; N-27; T-7
Boosters for TV, FM Reception	D-10; S-113; T-3 to 7, 12, 15, 36
Box Shields, Metal	J-46
Brach Mfg. Corp., Div. General Bronze	S-83
Brackets and Angles	F-59; J-43, 48, 99; S-41; U-75, 88, 89, 149
Brackets, Chassis Mounting	J-43, 87, 93, 97, 99, 106 to 108
Bradley Laboratories, Inc.	H-22
Brand & Co., Inc., Wm.	S-28 to 30
Break-in Relays	L-43, 53
Bridges:	
Capacitor	G-33
Capacitor-Resistor	G-87
Comparison, Direct Reading	G-120
Comparison and Limit	G-116
Fault Location	R-50
Incremental Inductance	G-116, 117
Megohm	G-141
Standing Wave Ratio	J-20, 62
Universal	G-117
Wheatstone	G-133; R-50
British Industries Corporation	E-29; U-15
Broadcast Audio & TV Equipment	Section E; also N-111
Broadcast Audio Cable	S-1, 20, 70
Brush Electronics Co.	D-35, 36
Bud Radio, Inc.	C-40, 41; J-42 to 52; T-34; U-114, 115
Bulb Tester & Tube Socket	F-5
Burgess Battery Company	M-6 to 9
Burglar Alarms, Photo Electric	L-57
Burlington Instrument Co.	G-55
Burnell & Co., Inc.	J-60, 61
Bus Bar Wire	S-14, 25, 37
Bushings, Spacers	F-25, 35; J-23; R-5; S-43; U-59 to 61, 85, 89, 92, 120, 145, 149
Bussman Mfg. Co. (Buss Fuses)	H-14, 15
Buttons—Plug, Snap, Ventilating, etc.	F-35; U-70, 95
Buzzers for Telegraph Keys	J-67
Bypass (Bathtub) Capacitors	P-4, 13, 30, 81, 84, 85, 109, 111, 112, 115, 121, 134, 135, 139, 141

- C -

Cabinet Drawer Pulls, Hinges—Furniture	U-104
Cabinet Mouldings, Handles, etc.	J-43, 48, 89
Cabinet Patching & Finishing Materials, Kits	U-41, 45, 46, 102, 103
Cabinet Rack Dollies, Casters, etc.	J-48, 84, 106
Cabinets & Cases—Amplifier, Receiver, Instrument	C-13; J-43, 46 to 48, 84 to 87, 95, 97, 98, 99, 102 to 104, 106, 108 to 110; T-1; U-126, 131

Cabinets & Cases, Speaker	Section C; also B-28; E-29
J-85, 86, 106, 110; T-1	
Cabinets, Racks, Panels—Metal	J-43, 44, 47, 48, 84 to 110
Cabinets—Radio, Phonograph	C-13, 32
Cabinets, Sloping Front	J-46, 48, 85, 95 to 109
Cabinets, TV	T-1
Cabinets, Utility	J-47, 48, 84, 86, 95 to 110; U-35 to 37
Cable (see Wire)	
Cable Clans	F-25, 46; S-42; U-71, 81, 88, 95, 148
Cable Connectors	Section F; H-10; S-103, 113; U-81
Calculators	K-7
Calibrators—TV, Frequency, Signal, Sweep	G-4, 20, 22, 52, 64, 130, 142; J-33
Calibrators Soldering Irons	G-31, 72, 85, 89, 103
Calrad Soldering Irons	U-6, 7
Cannon Company, C. F.	D-40
Cannon Electric Company	F-13 to 27
Canopy Switches	L-33; S-31; U-32, 143
Capacitor Analyzers, Decades, Bridges	G-33, 70, 87, 113, 122; P-34
Capacitor Color Codes	P-10, 82
Capacitor Mounting Hardware	P-11, 57, 124
Capacitor Selector, Motor-Starting	P-11, 57, 124
Capacitors, Fixed	Section P; also J-40, 41; R-46, 65; S-108
Auto Radio	P-5, 30, 31, 49, 111, 120, 121; R-46; S-108
Bypass, Bathtub	P-4, 13, 30, 81, 84, 85, 109, 111, 112, 115, 121, 134, 135, 139, 141
Ceramic	P-6, 7, 22 to 25, 42, 67 to 70, 74 to 77, 90 to 94, 98, 121 to 124
Electrolytic, Dry	P-1 to 5, 12 to 21, 39, 47 to 62, 64, 65, 78 to 84, 105 to 109, 125, 130, 131, 132
Feed-thru, Stand-off, etc.	P-7, 27, 42, 75, 98, 124
Filters, Noise, Interference	P-5, 8, 30, 31, 49, 116, 120; R-46; S-108; U-59
Fluorescent Lighting	N-84; P-23, 31, 49, 116
High Voltage	F-13 to 27
Kits—Paper, Mica, Ceramic, JAN, etc.	P-25, 43, 44, 45, 74, 75
Metal Clad	Section P
Metallized-Paper	P-64, 65, 113 to 115, 138 to 141
Mica, Bakelite, etc.	P-9, 10, 32 to 41, 65, 66, 86 to 89, 117 to 119
Mica, Silvered	P-9, 22, 23, 32, 35 to 37, 66, 86, 96, 118, 119
Miniature, Subminiature	P-3, 5, 12, 13, 23, 35, 41, 65, 66 to 69, 77, 109, 110, 115, 117, 136 to 141
Motor Starting & Running	P-4, 82, 115
Oil Filled	P-10, 28, 29, 30, 46, 47, 63, 84, 85, 111, 126, 134
Photoflash, Energy Storage	P-3, 13, 28, 111
Plastic, Molded, Cased, Tubular	P-3, 4, 6, 26, 39, 69 to 61, 65, 66, 83, 99, 101, 110, 111, 133, 134, 142
Plug-in, Twist-Prong, etc.	P-12, 18, 19 to 21, 63 to 56, 79 to 81, 83, 105 to 107, 131
Printed Electronic Circuits & Kits	P-24, 71 to 73, 95
Resonant	P-27
Screw Base	P-3, 17, 29, 46, 48, 58, 83, 84, 102 to 104, 109, 132
Television	Section P
Television Yoke Capacitor Kit	P-25
Temperature Coefficient	P-23, 91 to 93, 123
Transmitting	P-9, 10, 29, 33, 38, 39, 63, 76, 88, 89, 112, 117, 118
Tubular	P-1 to 5, 7, 12, 16 to 21, 26 to 29, 39, 46 to 62, 64, 65, 74, 75, 78 to 85, 99, 102 to 108, 110 to 112, 114, 115, 123, 125, 130 to 134, 136 to 142
Vacuum Type Tubes, H.V.	A-29, 32; J-40, 41
Vibrator-Buffer	P-5, 31, 49, 74, 111, 120, 121
Wet Electrolytic Replacements	P-4, 5, 6, 83
Capacitors, Variable	A-29; J-15, 16, 23, 36 to 41, 50, 51, 57, 68 to 71; U-144
Neutralizing, Padding	J-16, 23, 37, 51, 71; P-40, 41; U-144
Receiving, Tuning	J-15, 36, 38, 39, 50, 51, 57, 68 to 71; U-144
Transmitting	J-16, 17, 23, 36 to 38, 50, 69 to 71
Trimmer	J-15, 36 to 39, 68; P-7, 25, 40 to 42, 76, 97; U-144
Vacuum Tube Type	A-29, 32; J-40, 41
Capps, Frank L. & Co.	D-29
Captive Nuts & Screws	F-60; J-5
Carbofilm Resistors	R-72, 73
Carbon Microphones	B-36; D-12, 19
Carbon Resistors	P-98; R-7, 8, 24, 25, 45, 56, 59, 60, 65, 71 to 73
Carbon Tetrachloride	U-43, 102
Cardioid Microphones	D-9, 21, 24, 26, 80
Cardwell Electronics Productions Corp., Allen D.	J-15 to 18
Carling Electric, Inc.	L-16 to 23
Carrying Cases	E-29; J-47; T-1
Cartier Motor Company	M-46 to 51
Cartier Parts Company	L-34, 35
Cartridges, Pickups, Arms	Sections D and E; also B-28; T-18
Casters, Truck	J-48
Cathode Ray Oscillographs, Oscilloscopes	Section G; also J-19, 28
Cathode Ray Tube Bezels	J-25; U-112
Cathode Ray Tube Mounting Accessories	J-25, 31; U-112
Cathode Ray Tube Reactivator	S-98
Cathode Ray Tube Shields	J-25, 31; U-113
Cathode Ray Tube Testers	G-62, 83, 88, 93, 104, 145; T-21
Cathode Ray Tube Testing Adapters	G-14, 88, 96
Cathode Ray Tubes	A-4, 6, 7, 19, 23; G-136
Caulking, Sealing Compound	U-119
CBS-Hytron, A Division of Columbia Broadcasting System, Inc.	A-1
Cements—Radio Repair, Coil, Speaker, etc.	F-9; U-41, 42, 101
Centralab Div. Globe Union, Inc.	
Capacitors	P-71 to 77
Printed Electronic Circuits	P-71 to 73
Steatite Insulators	P-73
Switches	L-12 to 15
Volume Controls	R-40 to 43
Ceramic Capacitors	P-6, 7, 22 to 24, 42, 67 to 70, 74 to 77, 90 to 94, 98, 121 to 124

GENERAL INDEX (Continued)

	Section & Page
Ceramic Coil Forms	J-4, 24, 26
Ceramic-Element Microphones, Pickups	C-31; D-7, 10 to 15, 25, 27; E-22
Ceramic Sockets	F-1, 2, 47, 48, 52; J-22, 72, 73, 76; S-43; U-142
Ceramic Capacitors	P-90 to 94, 98
Cetron Tubes	A-30, 31
Challenger Sound Equipment	B-15
Channel Master Corp.	S-120
Chassis and Kits—Receiver, TV, etc.	B-26, 32 to 34, 36, 37; J-57
Chassis, Brackets, Panels—Metal	J-42 to 46, 86 to 88, 97, 99, 104, 106 to 108, 110
Chassis Kit for Experimental Work	J-83
Chassis Mounts, Rubber	U-74, 91
Chassis Punches for Cutting Holes	F-2; U-32, 33, 136
Chassis Supports for Service Work	U-34, 35, 58
Chatham Electronics, Inc.	A-37
Chemical Kits, Chemicals, Compounds	F-9; U-41 to 45; 101, 102, 109, 110
Chicago Industrial Instrument Co.	G-11 to 14
Chicago Standard Transformer Corp.	
Chicago Division	N-86 to 93
Standard Division	N-1 to 16
Chisholm-Ryder Co., Inc. Premax Div.	S-124, 125
Chokes—Audio, Filter, Swinging, Smoothing, AC-DC	Section N
Chokes—R.F., Plate, Power Line, etc.	H-35; J-5, 24, 26, 52, 56, 76; N-64, 84; P-8; R-27, 56; U-144
Cinaudagraph Company	C-36, 37
Cinch Manufacturing Co.	
Cinch-Jones Sales Div.	F-30 to 46
Circle-Cutting Tools	G-140; U-136
Circuit and Industrial Control Relays	L-44, 45, 47, 49
Circuit Opening Switch	L-6
Circuit Symbol Stampers	G-140
Circuit Testers, Analyzers	Section J
Civil Defense Communication Equipment	J-3, 9, 14
Clamp Volt-Ammeter	G-51
Clarkstan (Pacific Transducer Corp.)	E-17
Clarasoft Mfg. Co., Inc.	R-28 to 36
Cleaning Fluids, Materials	U-42, 43, 101, 102, 109, 110, 118
Clifton Conduit Co., Inc., Piereway Div.	U-38
Clips:	
Alligator	M-14, 15; S-39, 40; U-55, 79, 135
Battery and Test	M-14, 15; S-39, 40; U-55, 79, 85
Cable and Wire	F-35, S-42, U-71, 81, 88, 95, 148
Dial Cord	U-70, 99
Fuse	H-14, 18, 19; U-70, 92, 148
Inductor	J-66
Lead-in Wire, for TV	F-10; S-21, 28, 48, 51, 52, 58, 63, 64, 66, 116; T-6
Spring Wire, Fahnestock	S-43; U-55, 70, 85, 148
Tube Grid and Cap	F-5, 35; J-4, 22, 25; M-60; S-42; U-57, 73, 95, 108, 114, 146
Coaxial Cable, RG, etc.	F-9; S-7, 21 to 23, 28, 34, 55, 63, 64, 71
Coaxial Relays	J-40; L-48, 51
Coaxial Speakers	C-3, 5, 14, 15, 21, 30, 31, 38, 44
Code Phono Records for Learners	U-150
Code Practice Oscillators	B-37; J-50; U-150
Coil Assemblies	J-24, 66
Coil Bobbin Kit	L-46
Coil Dope, Cement	F-9; U-42, 43, 101
Coil Forms and Mountings	F-9; J-4, 24, 26; U-144
Coil Shields	U-143
Coils:	
Antenna	J-12, 53 to 55, 57, 59; N-82, 83, 85; S-91; T-18
Broadcast, S. W., Transmitting	J-24, 52 to 56, 58, 59; U-144
Choke	J-5, 24, 26, 52 to 54, 56; N-3; U-144
Exciter, Inductor, Tank	J-24, 66; N-13, 20, 48 to 53, 108, 109
FM	J-53 to 55, 57, 58; N-81, 82, 84
Focus	N-4
High Voltage Step-Up	M-59; N-1
High Q, Low Frequency	N-110, S-91
Hybrid and Repeat	N-45, 100
I. F. Transformers	J-53 to 55, 58, 59; N-81, 82, 83; T-18
Oscillator, Phono, Test	J-53, 57, 59; N-81 to 84
R. F.	J-53, 56, 76; N-82 to 85; U-144
Television	J-52 to 55, 58; N-3, 4, 77, 78, 81, 120; T-16 to 18, 20; U-40
Toroidal	J-60, 61; N-20, 48 to 53, 108
Wave Traps	J-55; N-81; T-21
Cold Zone Temperature Testers	G-35, 98, 99
Color-Bar Generator	G-1
Color Codes	P-10, 82; R-8; S-10, 12
Color Coding Kit	U-43
Color TV Equipment	
Test Equipment	G-1, 67, 80, 81, 138, 139, 148
Tubes	A-9, 11
Books	Section K
Coloring Lacquer for Light Bulbs	U-43, 103
Columbia Broadcasting System, Inc. (CBS-Hytron Div.)	A-1
Columbia Products Co., Div. Shakespeare Co.	S-112
Columbia Wire & Supply Co.	S-48, 49
Communication Receivers and Equipment	J-1 to 3, 6 to 10, 12, 14, 20, 27, 35; L-57
Communo-Phones	B-15
Compression Springs	U-61, 72, 73, 85, 90, 96
Conant Laboratories	H-23
Condenser Microphones	D-9, 29
Condenser Products Company, Inc. (see Capacitors)	P-126 to 129
Conical Antennas	Section S; also F-11; T-37, 38; U-105, 106
Connector Caps and Chains	F-5, 7, 8, 16, 20, 21, 25 to 27; H-10; U-55, 82, 134
Connectors	Section F
Antenna Rotator Cable	S-20, 28, 49, 51, 58; T-23
Army-Navy	F-6, 7, 28 to 25, 64, 55; S-103, 113; U-8, 81
Auto Antenna, Fuse	F-35; S-54, 54, 145; U-54, 84, 145

	Section & Page
Cable	F-3 to 7; 13 to 29; 32, 36 to 44, 49, 54, 55; U-81
Chassis	F-3, 48; H-10; S-39, 40; U-55, 82, 89, 134
Cord	Section F; also L-33; U-54
Couplings, Extenders, Reducers	F-23, 33; U-54, 81, 84, 134
Heat Radiating for Transmitting Tubes	A-29; J-52
Heavy Duty Power and Radio	Section F
Interlock Self-Locking	F-28, 29
Microphone	D-12; F-7, 8, 16 to 18; H-10; L-30; S-39; U-55, 82, 134
Rack and Panel, Wall	F-3, 8, 13 to 44; U-55, 82, 89, 134
R. F.	F-6, 7, 54, 55; S-103, 113; U-81
Twin Lead, for T.V.	F-10; J-31; L-37; S-110; T-23; U-108
Conrac, Inc.	B-26
Consolidated Radio Products Co.	C-38
Consolidated Wire & Associated Cos.	S-50 to 57
Constant Impedance Controls, Attenuators	L-10, 11, 35; R-2, 14, 32, 51; T-5
Constant Voltage Transformers	M-52, 53, 56, 57, 62, 63
Contact Cleaning Fluids, Devices	U-42, 43, 101, 102, 109, 110, 118
Contact Finger Stock	A-29
Contact Pickups & Mikes for Musical Instruments	D-21, 26, 35
Continental Carbon, Inc.	R-44 to 46
Continental Electric Co. (Cetron)	A-30, 31
Controlled Reluctance Microphones, Cartridges	D-4
Controls—Volume, Tone, etc.—Section R; also L-9, 10, 35; T-16, 18	
Cabinets and Kits	R-11, 41
Carbon	R-1, 12, 28, 32, 33, 40 to 42, 56
Hardware	R-2, 5, 13 to 16, 30; U-88, 94
Speaker—Volume, Loudness, etc.	C-22, 31, 44; R-14, 42
Switches	R-2, 3, 13, 17, 30, 40, 42, 56
Television Replacement	T-16, 18
Wire Wound	L-35; R-3, 4, 15, 29, 31 to 33, 87, 41
Converters, Amateur Bandspread, etc.	J-6, 9, 12, 13
Converters, Power Packs	M-22 to 31, 38 to 40, 45 to 50, 65
Converters, Rotary Power	J-10, 64; M-46 to 50, 65
Converters, UHF	D-10; T-2, 5, 6, 7, 10, 11, 15, 20
Copper Oxide Rectifiers	H-21 to 23
Copper Sulfide Rectifiers	M-38
Copperwell Steel Company	S-62
Cord Connectors, Plugs, Switches	Section F; L-33; S-38; U-54
Cord Strain Reliefs	U-75, 90
Cornell-Dubilier Electric Corporation	
Antennas	S-94 to 96
Capacitors	P-50 to 70
Vibrators and Converters	M-36 to 38
Cornish Wire Co., Inc.	S-58 to 61
Corona Dope	U-42, 103
Corona Shields	F-33
Cotter and Hairpins	U-69, 94
Counters, Electronic Phototube	L-55, 58
Couplers, Antenna	J-54, 63, 85, 110, 113, 120; S-80, 110; T-5, 21, 22, 33, 35, 41; U-40
Couplings, Insulated, Flexible	J-4, 17, 22, 26, 36, 52, 77; U-111, 115, 145
Couplings, Insulated, Non-Flexible	J-4, 17, 22, 26, 36, 77; U-85
Coyne Books	K-10
Crest Laboratories, Inc.	N-121, 122; T-20
Crimping Tool	S-113; U-21
Croflex Tuners	U-124
Croname Products	U-124, 125
Crossover Networks, Speaker	B-12; C-9, 15, 22, 31, 34
Crown Controls Co., Inc.	S-117
Crystal Diodes—Germanium, Microwave	A-1, 3, 8, 12, 13, 15, 20, 22; H-26, 27, 31, 33; R-26
Crystal Holder Adapters	T-23
Crystal Microphones, Pickups, Cartridges	Section D; E-26; T-18
Crystal Oscillators, Calibrators, Markers	Section G; J-33, 50; T-42
Crystal Receiving Sets	B-36, 37
Crystal Sockets	F-4, 30, 48, 52; J-76; T-23, 45
Crystals	G-86, T-42 to 48
Cube Taps, Electrical	U-54
Cup Washers	U-69, 88, 93, 148, 149
Cutter-Hammer, Inc.	L-24, 25
Cutting Heads, Recording	D-6, 13, 35; E-25
Cutting Needles	E-4, 44, 52, 54, 56, 59, 60
Cutting Pliers	U-17, 18, 25 to 30, 50
Cutting Tools, Circle	G-140; U-136

— D —

DC-AC and DC-DC Power Converters	M-22 to 32, 38, 45 to 51; J-10
Dage Electric Co., Inc.	F-54, 55
Dale Products, Inc.	R-58 to 61
Dandees Capacitors	F-108
Davies Molding Company, Harry	U-130, 131
Davis Electronics	S-118
Decade Amplifier	G-120
Decade Inductors	G-123; J-83; N-110
Decades, Capacitance	G-88, 122, 133; J-83
Decades, Resistance	G-88, 133; J-83; R-36, 50
Decade Switch	L-7
Decals for Electronics, Receivers, etc.	U-110, 123
Decibel Meters	G-26, 38, 43, 55, 77
Deflection Yokes, TV	N-1, 27, 78, 120; T-13, 16, 18
Delay Lines, Standards, Networks	J-29, 30
Desk and Cabinet Assemblies, Metal	J-98
Detents and Switches for TV Tuners	T-9; U-57, 109
Dial Cable, Cords, Belts	S-14, 38; U-47, 51, 91, 99
Dial Cable Adjuster Tools	U-47
Dial Cable Clips	U-70, 99
Dial Cord Anti-Slip Compound	U-44, 45, 102
Dial Crystals, Replacement	U-100
Dial Drive Accessories	F-58 to 60; U-89, 124, 142
Dial Drive Cements, Compounds	U-41, 44, 45, 102
Dial Drive Springs	U-60, 72, 96

GENERAL INDEX (Continued)

	Section & Page
Dial Knob Springs	U-61, 72, 96, 121
Dial Knobs, Pointers	E-17; F-59; G-146; J-5, 21, 26, 74; L-9; U-47, 60, 61, 97, 111, 120 to 124, 129 to 131, 141
Dial Lamps, Bulbs	A-17
Dial Light Assemblies, Jewels	H-1 to 9, 11, 12; J-80, 81; L-38; U-55, 83
Dial Light Coloring Lacquers, Kits	U-43
Dial Light Installer and Remover Tools	H-9; U-55
Dial Light Sockets, Brackets	H-5, 6, 8, 9, 11, 12; J-80, 81; U-55, 83
Dial Locking Devices	F-59; J-21; U-89, 114
Dial Oil	U-44, 102
Dial Plates	L-2, 9; R-5; U-123 to 125, 129, 142, 143
Dial Pulleys	U-72, 145
Dialight Corporation	H-1 to 10
Dials, Accessory	U-124
Dials—Instrument, Tuning, Vernier, etc.	J-19, 21; U-124, 129
Diaphragms, Headphones	D-39
Diathermy Cable	S-7, 35
Diathermy Tubes	Section A
Dictating Machine Inverter, Accessories	M-23, 30
Differential Voltmeter	G-120
Diodes—Germanium, Crystal—Union, Point Contact, etc.	A-1, 3, 8, 12, 13, 15, 20, 22; H-26, 27, 31, 33; R-26
Diodes—Selenium, Cuprous Oxide, etc.	H-22, 33; R-26
Diode Mounts	U-89
Disc Ceramic Capacitors	P-6, 22, 42, 67 to 69, 74, 75, 77, 93, 94, 121 to 123
Disc Neutralizing Capacitors	J-23, 37, 51
Discs, Cavity Socket Contact	J-22
Discs, Recording	E-4, 13, 54, 59, 60
Distortion Meters	G-121
Distributor Suppressors, Auto	P-5, 30, 31, 49, 111, 120, 121; R-46; S-108; U-59
Dollar Co., Robert	J-8, 9
Dome Light Filter Capacitors, Auto	P-5
Dot-Bar Generator	G-1
Drake Manufacturing Co. (Pilot Light Assemblies)	H-11, 12
Drake Co., R. I.	T-35
Drawer Pulls and Knobs, Furniture	U-104
Drawer Slides for Metal Drawers	U-104
Drawers—Snap-on, Storage, etc.	U-35 to 37
Drill Adapter	U-84
Drives for Radio and Phono, Rubber	U-48, 90, 100
Dry Batteries	M-1 to 13; R-5
Duotone Company, Inc.	C-35; E-54, 55
Dust Cap-and-Chains for Connectors, etc.	F-5, 7, 8, 16, 20, 21, 25 to 27; H-10; U-55, 82, 134
Dust Felts for Speaker Voice Coils	U-74
Dutch Brand Tapes, etc.	U-119
Dynamol Capacitors	P-63
Dynamic Microphones	Section D
Dynamic Tube Testers	G-60 to 63, 80, 82, 83
Dynamotors	J-10, 64; M-46, 50, 65
Dynamometer Instrument	G-76

— E —

Eagle Electronics, Inc.	B-37
Earphones	B-36; D-35, 37 to 40; E-29
Diaphragms	D-39
Ear Cushions	D-38; U-150
Earphone Cords and Accessories	D-39; S-45
Eby Sales Company	F-50 to 53
Editors & Engineers, Ltd. (Books)	K-12
Eico Test Equipment	G-84 to 88
Eitel-McCullough, Inc. (Eimac Tubes)	A-28, 29
Elapsed Time Meters	G-42, 48, 55, 102
Elec Sales Company	F-47 to 49
Electrical Connecting Devices	Section F; also L-33; S-39, 40, 103; U-54, 55, 81, 82, 89, 104
Electrical Extension Cords, Sets	L-30; S-14, 61
Electric Eye Units	L-55 to 57, 59
Electric Soldering Iron Co., Inc. (Esico)	U-5
Electro Dynamic and Electro Magnetic Speakers	Section C
Electro-Mechanical Instrument Co. (Emico)	G-89
Electro Products Laboratories, Inc.	M-40
Electrodynamometers	G-26, 38, 50, 76, 79
Electrolytic Capacitors, Dry	Section P
Electromagnetic Test Equipment	G-93, 94
Electronic Devices, Inc.	H-34
Electronic Fabricators, Inc.	P-142
Electronic Instrument Co., Inc. (Eico)	G-84 to 88
Electronic Measurements Corp.	G-107 to 109
Electrons, Inc.	A-35
Electro-Sonic Laboratories, Inc.	D-34
Electro-Voice, Inc.	T-4
Boosters, TV, FM	J-13
Communications Equipment	D-24 to 27
Microphones, Phono Cartridges	C-30 to 33
Speakers, Cartridges	E-50 to 52
Electrovox Co., Inc. (Walco Products)	H-21; M-39
Electroz Rectifiers, Battery Eliminators	P-35 to 45
El-Menco Capacitors (Arco Electronics, Inc.)	H-13
Elmenco Products Company	G-89
Emico Panel and Test Meters	U-41 to 44, 46, 101 to 103, 109
Enamels, Lacquers, Paints, Varnishes	P-3, 13, 28, 111
Energy Storage, Photoflash Capacitors	B-12, 13, 30, 31, 35; N-22
Equalizer Amplifiers	B-12, 13, 30, 31, 35; E-1, 16, 19 to 21; N-111, 112
Equalizers, Tone, Pickup	U-84, 36
Equipto Div. Aurora Equipment Co.	L-31; P-90 to 98
Erie Resistor Corporation	U-15
Ervin Multicore Solder	U-75, 95
Escutcheon Pins	U-75, 95

	Section & Page
Esico Soldering Irons	U-5
Eveready Batteries, Flashlights	M-1 to 4
Exciter Coils, Tanks, Forms	J-24, 66; N-13, 20, 48 to 53, 108, 109
Expanded Aluminum (Expamet)	U-15
Expansion Shields, Lag Screws	T-19; U-117
Expansion Springs	U-47, 60, 72, 96
Extension Cord Sets	L-30; S-14, 61
Eyelets, Rivets	U-73, 94, 135, 148
Tools and Punches	F-28; U-135
Eye-Opener Standoff Tool	T-39

— F —

Fahnestock and Spring Wire Clips	S-43; U-55, 70, 85, 148
Fanning Strips	F-46
Fault Location Bridge	R-50
Federal Telephone & Radio Corp.	H-30, 31
Rectifiers	S-63
TV Lead-in Cables	J-76; P-73; S-43, 44
Feeder Line Spreader Insulators	U-75
Felt Feet, Pads	U-46, 102
Felt Flock Spray Kits and Materials	U-60, 74, 91
Felt Washers for Knobs, etc.	U-47, 100
Felts for Phono Turntables	S-64
Fenton Co.	N-69 to 71
Ferranti Electric, Inc.	U-62, 69, 70, 85, 91, 148, 149
Fibre Insulating Washers	Section C
Field-Coil Speakers	G-32, 68, 131; S-93
Field Strength Meters	J-54, 56; N-85
Filament Chokes	Section N
Filament Resistors	G-123
Filament Transformers	Section P
Filter Amplifier, Wide-Band	H-35; J-5, 24, 26, 52, 56, 76; N-64, 84; P-8; R-27, 56; U-144
Filter Capacitors	Section N
Filter Chokes—Line, R. F., etc.	G-121
Filter Chokes, Reactors—Audio	G-121
Filter, Null "T"	P-116
Filter Selector, Analyzer	N-111
Filter, Sound Effects	B-31
Filter System, High Fidelity	B-12; G-121; J-7, 54 to 57, 60, 62, 111; N-54, 81, 84, 91, 111, 112; P-5, 8, 27, 31, 49, 116, 120; R-46; S-45, 108, 110; T-7, 21, 33 to 35; U-40, 59, 85, 150
Filters—Interference, Noise	J-57; P-8, 31, 116; R-46; S-110
Appliance	B-12, 31; N-54, 84, 111, 112
Audio	J-7, 12; P-5, 8, 31, 116, 120; R-46; S-45, 108, U-59, 85
Automotive Noise Suppression	N-84; P-8, 49, 116
Fluorescent Lighting	P-8, 116
Industrial, Heavy Duty	G-121; J-60; N-54
Interstage, Band Pass	J-54, 62, 111; N-54, 81, 91; P-27; S-110; T-7, 21, 34, 35; U-40
Low Pass, High Pass	P-27
Resonant	J-54, 55, 57; N-81; P-27, 31, 116; T-21, 33; U-40
Television	J-55; N-81; T-21
Wave Traps	B-28 to 31
Fisher Radio Corporation	S-6, 14, 35, 36, 59 to 61
Fixture Wire, Lamp Cords	A-21
Flash Tubes	M-1 to 7, 11, 12
Flashlight and Lantern Batteries	M-4, 7, 8
Flashlights and Lanterns	M-4
Flashlight Lenses and Lamps	B-26
Fleetwood TV Receiver Chassis	J-4, 17, 22, 26, 36, 62, 77; U-111, 115, 145
Flexible Couplings, Insulated	R-36
Flexible Resistors (Glasohm)	U-135, 136
Flexible Screw-Drivers	J-77; S-43
Flexible Shafts	U-56, 104, 146
Flexible Varnished Tubing & Spaghetti	U-46, 102
Flock Finishing Spray Materials & Kits	N-84; P-8, 49, 116
Fluorescent Lighting Capacitors, Suppressors	F-11, 12; S-74 to 120; T-33, 37, 38; U-105, 106
FM and TV Antennas	Section K
FM Books, Manuals	J-53 to 55, 57, 58; N-81, 82, 84
FM Coils	B-1, 27, 29, 33; J-45, 57
FM-AM Tuners	C-6; N-4, 78; T-13, #7
Focus Coils, TV	L-26, 27
Foot Switches	J-46, 47, 85, 97, 106, 109
Foundation Chassis for Amplifiers	G-114 to 124
Freed Transformer Co., Inc.	N-45 to 67
Laboratory Test Equipment	G-4, 20, 22, 64, 142; J-33, 50
Transformers, Inductors, etc.	G-22, 48, 77, 78, 100 to 102; J-33, 50
Frequency Calibrators	E-17; U-100
Frequency Meters, Testers, Standards	J-9
Frequency Records to Check Response	U-56, 119
Frequency Shifter Equipment	U-42, 103
Friction Tape	U-42, 44, 45
Fungus Varnish, Lacquer	H-18; U-50
Furniture Polishes, Varnishes, Oils, Kits	H-13
Fuse Pullers, Extractor Posts	H-14 to 17, 19
Fused Plugs	H-14, 17 to 19; S-41, 108; U-54, 70, 84, 92, 145, 148
Fuses	H-14, 17; S-41; U-84, 145
Connectors, Clips, etc.	F-53; H-14; U-84, 145
Fuse Blocks	H-14, 17; S-41; U-84, 145
Holders	F-53; H-14; U-84, 145
Fusotron Fuses	H-14, 15
Gain and Fader Controls, P.A.	Section R; also L-10, 11, 35; T-5
Galbraith & Son Electric Corp., C. C.	C-48

— G —

GENERAL INDEX (Continued)

	Section & Page
Galvanometers	G-38
Garrard Sales Corporation	E-29
Gas and Oil Gauge Filter Capacitors, Auto	P-5, 120
Gas Pressure Measuring Tubes	A-21
Geo-Lar Mfg. Co.	U-120 to 123
Geiger-Mueller Tubes	A-12, 13, 32
Generators	M-46, 47
General Cement Mfg. Co.	U-41 to 75
General Dry Batteries, Inc.	M-10, 11
General Electric Company	
Capacitors	P-12 to 15
Photo Electric Units	L-58, 59
Selenium Rectifiers	H-20
Soldering Irons	U-6, 7
Speakers	C-2
Switches and Relays	L-1
Transformers and Reactors	N-124
Tubes, Receiving and TV	A-2, 3
Tubes, Transmitting and Industrial	A-4, 5
General Industries Company	E-30 to 33
General Purpose Relays	L-1, 43
General Purpose Switches	L-13, 31
Generator Capacitors, Suppressors—Auto	P-5, 8, 30, 31, 49, 116, 120; R-46; S-108; U-59
Generators, Rotary Power	J-10, 64; M-46 to 50, 65
Generators, Signal	Section G
Geoscope Signal-Generator-Oscilloscope	G-29
Germanium Crystal Diodes	A-1, 3, 8, 12, 13, 15, 20, 22; H-26, 27, 31, 33; R-26
Gernsback Publications, Inc.	K-13
Girard-Hopkins	R-65
Glassohm Insulated Flexible Resistors	R-36
Glass and Porcelain Insulators—Antenna	J-75, 76; P-73; S-43 to 45, 73, 106, 124; T-41
Glass and Plastic Jars for Hardware	U-60, 63, 65 to 75, 97, 123
Glassmike Capacitors	P-128, 129
Glow Modulator Tubes	A-4, 21
Glue—Cabinet Repair, Wood	U-41, 101
Conset Company	J-6, 7
Gothard Manufacturing Co.	M-65
Gramer-Haldorson Transformer Corp.	N-123
Cranco Products Inc.	T-10, 11
Grayhill	L-36, 37
Gray Research & Development Co., Inc.	E-1, 16
Greenlee Tool Company	U-32, 33
Greenohm Resistors	R-34, 35
Grid Bias Cells	T-3
Grid Caps and Clips, Tube	F-5, 35; J-4, 25; M-60; U-57, 73, 96, 108, 146
Grid Dip Meters	E-1, 16
Grille Cloth and Screening	C-39; J-86; U-15, 46, 104
Grommets, Rubber	G-132; J-19, 32
Ground and Lead-in Wire	U-74, 83, 90, 91, 148, 149
Ground and Pipe Clamps	M-15; S-38, 67, 106, 110, 121; U-108
Ground Rods	S-49, 62, 67, 110, 124; T-29, 41
Guardian Electric Mfg. Co.	L-52, 53
Guy Wire	S-49, 62, 64, 65, 123; T-28; U-108
Guy Wire Tightener	U-110
Guy Wire Eye Bolts	U-117

— H —

H-Pads (Printed Circuits) for TV Attenuator Switch	P-73
Hallerafters Company	J-14
Hammarlund Mfg. Co., Inc.	J-34 to 39
Hamswitches	L-7, 14
Hardware Assortments	U-60, 62, 97, 148, 149
Hardware, Small	F-35; L-9; T-41; U-55 to 62, 75, 87 to 97, 107, 108, 116, 117, 134, 147 to 149
Hardwick, Hindle Inc.	R-62 to 64
Harmonic Distortion Meter	G-121
Harvey Hubbell, Inc.	F-28, 29
Harvey-Wells Electronics, Inc.	J-10, 11
Haz-Bin Storage Cabinets	U-36
Headphones	B-36; D-35, 37 to 40; E-29; U-150
Diaphragms	D-39
Ear Cushions	D-38; U-150
Headphone Cords, Accessories	D-39; S-45
Outlet Boxes and Controls	D-39
Hearing Aid Accessories:	
Batteries	M-2, 5, 7
Battery Testers	G-9, 13, 14, 37, 45
Capacitors	P-5, 109, 110
Earphones and Headsets	D-37, 39, 40
Outlet Boxes and Controls	D-39
Plugs, Jacks, Sockets	F-5, 33; L-28
Printed Electronic Circuits	P-24, 71, 72, 73, 95
Transformers	N-17, 105, 106, 118
Heat Dissipating Connectors for Tubes	A-29; J-52
Hetherington, Inc.	L-38
Hexacon Electric Company	U-2 to 4
Hex and Spline Keys, Wrenches	U-20, 80, 96, 99
Hickok Electrical Instrument Co.	G-60 to 79
High Altitude Devices	A-5
High Fidelity:	
Amplifiers and Tuners	Section B; also C-14; E-29; N-22, 119; T-7, 21
Books, Manuals	K-3, 11, 13
Cabinets, Enclosures	B-28; C-3, 9, 12, 13, 14, 32, 46; E-29; T-1
Converters, Rotary	J-10, 64; M-46 to 50, 65
Headphones	E-29
Pickups, Arms, Cartridges	Section E; also B-28; C-31; D-34
Record Changers, Players	B-15; E-14

	Section & Page
Record Compensator	B-12, 30, 31, 35; E-20, 21
Speakers	Section C
System	B-27
Tape Recorders	E-5, 11 to 15
Transformers—Audio, Output, etc.	N-5, 21, 37, 38, 39, 45 to 47, 54, 58, 59, 68, 88, 90, 99 to 106
High Frequency Relays	L-43, 48 to 50, 53
High Frequency Speakers and Horns	Section C
High Q Reactors	N-56, 60, 87, 110
High Voltage Converter—Miniature	G-140
High Voltage & Current Power Supplies	G-141; M-58
High Voltage Probes—TV, etc.	G-10, 23, 30, 34, 72, 84, 95, 113, 139, 146; U-50, 139
High Voltage Wire	S-7, 13, 25, 26, 33, 34, 36, 54, 61
Hi-Lo TV Antenna Corporation	S-97
Hinges—Cabinet Door	U-104
Hookup Wire	S-6 to 13, 23 to 30, 32 to 34, 46, 50, 55, 59, 60, 68
Horns, Projectors, Trumpets	Section C
Adapters, Connectors	C-9, 15, 16, 17, 19, 22, 25
Driver Units	C-3, 7, 9, 15, 16, 24, 30, 43
Stands, Brackets, Mounting Fixtures	C-16, 25
Hoyt Electrical Instrument Works, Inc.	G-58, 59
Hushatone Pillow Speaker	D-35
Hybrid and Repeat Coils	N-45, 100
Iyeon Mfg. Company	G-138
Hydrometer, Electrical	G-78
Hy-Lite Antennae, Inc.	S-92
Hypex Speaker Projectors	C-42
Hytron (now CBS-Hytron)	A-1
Hyoval Capacitors	P-112

— I —

I.D.E.A., Inc.—Regency Division	T-7
Idler Pulleys	U-72, 145
I. F. Strip	J-18
I. F. Transformers	J-24, 54, 55, 58, 59; N-81 to 85
Ignition Batteries	M-2 to 8, 11
Ignition Cable, Shielded	S-4, 13, 26
Ignition Pliers	U-18, 25 to 27
Ignition Suppressors	P-5, 8, 30, 31, 49, 116, 120; R-46; S-45, 108; U-59, 85
Ignitrons (Pool-Cathode Tubes)	A-4, 6, 7, 25, 32, 34
Imperial Radar & Wire Corp.	S-5 to 67
Incremental Inductance Bridge	G-116, 117
Indicating Instruments, Meters	Section G
Indicators—Panel, Signal	H-1 to 12; J-80, 81; L-38; U-55, 83
Indicators, Temperature	G-14, 35, 98, 99
Indicators, Volume Level	G-26, 38, 50, 55
Indoor Antenna Wire, AC-DC	S-14, 25; U-57
Indoor TV Antennas	F-11; S-79, 83, 89, 93, 94, 97, 102, 109, 115; T-37, 38
Inductors—Coils	J-12, 24, 54, 60, 61, 66; N-20, 48 to 53, 108, 109
Clips for Inductors	J-6; J-12, 66; N-109
Inductors—Variable, Rotary	J-12, 66; N-109
Inductance Tuning Device, TV	T-2, 3
Industrial Circuit Testers	Section G
Industrial Communications Equipment	J-7 to 9, 14, 111
Industrial Condenser Corp.	P-46 to 49
Industrial Instruments, Inc.	G-133
Industrial Safety Belt Co.	U-39
Infra-Red Materials, Chemicals, Lamps, etc.	G-140
Input Transformers	Section N
Inspection Lites, Mirrors	U-49, 52, 99
Instrument Rectifiers	H-21 to 23
Instrument Switches	L-2
Instruments and Meters, Panel	G-24, 25, 38 to 50, 55, 56 to 59; 77 to 79, 100 to 102; J-19
Insulated Staples, Saddle Type	S-38; U-55
Insulated Tubing for Tool Handles	U-52, 97
Insulated Wiring Nails	U-95, 107
Insulating Fibre Washers	U-62, 69, 70, 85, 91, 148, 149
Insulating Materials, Sheets	S-72; U-56, 104
Insulating Tubing, Spaghetti	P-21; S-29, 30, 38, 45, 71; U-56, 104, 107, 146
Insulating Varnish	U-42, 103
Insulator for Test and Battery Clips; Flexible	M-15
Insulators—Steatite, Lucite, Ceramic, etc.	
Antenna	F-10; J-75, 76; P-73; S-43, 44, 73, 94, 106, 110, 115, 124; T-22, 29, 32, 39, 41; U-114, 142
Beads	P-73
Beehive, Standoff	J-75; P-73; S-43, 44
Bowls, Bushings	J-75; P-73; U-145
Feeder Spreader	J-76; P-73; S-44; U-114
Nail-it Knobs	S-106
Standoff, Cone Type	J-75; P-73; S-44, 124; U-142
Standoff, Screw Eye	F-10; S-73, 94, 110, 115; T-29, 32, 39, 41
Strain, Airplane	J-76; P-73; S-43 to 45; 73, 106
Threaded Brass and Steel Rods	J-75; S-43
Thru-panel, Feed-thru	J-75; P-73; S-43, 44, 73; T-22, 41; U-107, 114, 142
Tubes, Rods, Pillars	P-73; S-43, 44, 73; T-22, 41; U-149
Insuline Corporation of America	
Cabinets, Racks, Panels	J-84 to 89
Hardware, Tools, Service and Amateur Aids	U-132 to 148
Interchangeable Relays	L-52
Intercommunication Systems	B-15, 19, 22 to 25; 37 to 39; L-57
Intercom Speakers	C-5, 11, 36, 49
Intercom Wire	S-1, 4 to 6, 18, 19, 36, 48, 49, 52 to 54, 59, 70
Intarelectronics Corp.	B-13
Interference Filters	B-12; G-121; J-7, 54 to 57; 60, 62, 111; N-54, 81, 84, 91, 111, 112; P-5, 8, 27, 31, 49, 116; R-46; S-45, 108, 110; T-7, 21, 33 to 35; U-40, 59, 85, 150
Interference Filter Selector	P-116

GENERAL INDEX (Continued)

	Section & Page
Interlock Self-Locking Electrical Connectors	F-28, 29
Inter-Matic Time Switches	L-39
Intermodulation Meter	G-130
International Rectifier Corporation	H-32, 33
International Register Co.	L-39
International Resistance Co.	R-8 to 27
Interstage, Band-Pass Filters	G-121; J-60; N-54
Inverters, Power, Mobile	M-22 to 31, 38
Ion Traps	C-6; J-54; R-36; T-17; U-57
Ionization Gauges	A-5, 27, 29
Irish Magnetic Recording Tape	E-62
Iron Testers	G-98
Isolation Transformers	M-35; N-5, 16, 29, 35, 42 to 44; 63, 75, 80, 117
Isonet, TV	F-10
Isotap Testing Transformer	G-9

— J —

Jack Covers—Panel	U-111
Jack Panels	L-41, 42
Jack Switches	L-7
Jacks and Plugs—F-4 to 7, 28, 29, 53 to 55, J-78, 79; L-8, 28 to 30, 34, 35, 41, 42; S-31, 39, 40, 103, 113; U-53 to 55, 76 to 78, 81, 84, 95, 100, 114, 115, 126, 132 to 134	
Jacks and Plugs—Military, JAN, SC, etc.	F-6, 7, 54, 55; L-8, 28 to 30; S-103, 113; U-81, 132
Jacks, Circuit	L-8, 28, 34, 35, 41, 42; U-115
Jacks, Extension	F-33; L-8, 28, 30; S-39; U-84, 134
Jacks, Long and Short Frame	L-8, 28, 34, 35, 42
Jacks, Panel Mounting	F-28, 29, 53 to 55; J-78, 79; L-8, 28, 29, 34, 35, 41, 42; S-39; U-53, 115, 133
Jacks, Tip	F-4, 53; J-78; S-39, 40; U-53, 77, 78, 133, 134
Jackson Electrical Instrument Co.	G-80 to 83
James Vibrapowr	M-41
JAN Hardware Mfg. Co., Inc.	U-111 to 113
Jars, Glass and Plastic—for Hardware	U-60, 63, 65 to 75, 97, 123, 149
J-B-T Instruments, Inc.	
Switches	L-2 to 5
Test Equipment	G-98 to 102
Jennings Radio Mfg. Co.	J-40, 41
Jensen Industries, Inc. (Needles)	E-40
Jensen Manufacturing Co. (Speakers)	C-42 to 47
Jerold (Najenco, Inc.)	S-113
Jewel Lights and Assemblies	H-1 to 12; J-80, 81; L-38; U-55, 83
Jewelers Pliers and Screwdrivers	U-28, 31
Johnson Company, E. F.	J-62 to 81
Jontz Manufacturing Co.	S-127
Junction Shells	F-25

— K —

Kay Electric Company	G-134
Kenwood Engineering Co., Inc. (Kenco)	T-19
Kenotrons (Vacuum Rectifier Tubes)	A-5
Kenyon Transformer Co., Inc.	N-40, 41
Kester Solder Company	U-16
Keying Break-ins and Monitors	U-150
Keying Relays	J-40; L-43, 53
Keys and Practice Sets, Telegraph	J-67, 82
Kerstone Electronics Corp.	U-89
Kilovoltmeter	G-72, 141
Kinescopes (TV Tubes)	A-3, 9, 11, 18, 19, 23, 27
Kits and Chassis—AM, FM, TV, Audio, etc.	B-26, 32 to 37; J-57; N-76
Klein & Sons, Mathias	U-30
Klystrons (Tubes)	A-12, 13, 21, 28, 32
Knife-Throw Switches	S-31, 110; U-143
Knight Company, James	T-47
Knob Puller Tools	U-61
Knobs—Clutch	U-111
Knobs & Pointers—Dial, Instrument, etc.	E-17; F-59; G-146; J-5, 21, 26, 74; L-9; U-60, 61, 97, 111, 120 to 124, 128 to 131, 141
Knob Felt Washers	U-60, 74, 91
Knobs for Auto Radios	U-61, 120
Set Screws and Springs	U-61, 72, 96, 121, 123
Knockout Punches and Cutters	F-2; U-32, 33
Kon-Nec-Tor Mercury Switches	A-5
Kraeuter & Company, Inc.	U-26 to 29
Kwikheat Mfg. Co.	U-8

— L —

L-Pads (Attenuators)	L-35; R-2, 32
Laboratory and Industrial Test Equipment	Section G
Lacing Cord—Nylon, Linen	U-81
Lacquers, Enamels, Paints, Varnishes	U-41 to 44, 45, 46, 101 to 103, 109
Ladders, Magnesium	U-108
Lamp Cords and Fixture Wire	S-6, 14, 35, 36, 59, 60, 61
Lamps, Dial and Panel	A-17
Lansing Sound, Inc., James B.	C-34
Lapel Microphones	D-3, 12, 17, 20, 21, 32, 35
Larson Co., Chas. O.	U-116, 117
Latching Impulse Relays	L-43, 45, 46, 51
Lead-in and Ground Wire	S-6, 8, 9, 25, 49, 59, 62, 66, 106; U-108
Lead-in Strips	S-106
Leak Amplifier	E-29
Leetromh, Inc.	R-47 to 49

	Section & Page
Lenk Mfg. Co.	U-12
Lenses and Lamps—Flashlight	M-4
Lever-Action Switches	L-4, 6, 18, 29 to 31
Lewis and Kaufman, Ltd.	A-36
Light Control Switch—Automatic	L-55
Lightning Arresters	C-1; F-10; S-85, 93, 94, 102, 106, 110, 114, 115; T-38; U-58
Limit Switches	L-1
Line Cord Resistors	S-45, 57; U-150
Line Voltage Booster	N-117, 121
Line Voltage Regulators, Plug-in	R-30, 76; U-150
Line Voltage Regulator Transformers & Controls	M-35, 52 to 57, 60, 62 to 64; N-78, 113, 117; T-6; U-150
LineMaster Switch Corp.	L-26, 27
Link Coils, Inductors	J-60, 61, 66; N-20, 48 to 53, 108
Jack Bars and Assemblies	J-66
Plug-in Links	J-66
Littelfuse, Inc.	H-16 to 19
Litz Wire	S-25
Lock Washers	S-42; U-62, 68, 88, 91, 148
Locks for Dials	F-59; J-21; U-89, 114
Loop Antennas, Sticks, Rods, etc.	J-53, 55, 57; T-12; U-40, 57, 100, 150
Loudness Control	R-14
Lowell Manufacturing Co.	C-26 to 29
Low Pass, High Pass Filters	J-54, 62, 111; N-54, 81, 91; P-27; S-110; T-7, 21, 34, 35; U-40
Lubricants	U-42 to 44, 101, 102, 118
Lubricator, Syringe	U-42, 50, 102
Lugs—Terminal, Soldering, Tinned	F-58, 59; S-41; U-58, 71, 84, 87 to 89, 95, 114, 127, 147, 149
Lynn Solderless Terminals	U-21

— M —

MacMillan Company	K-14
Magic Eye Assemblies and Accessories	F-2
Magmotors	M-47
Magnecord, Inc.	E-15
Magnesium-Copper Sulfide Rectifiers	M-33
Magnesium Ladders	U-108
Magnet Wire	S-26, 37, 55
Magnetic Amplifiers	H-22; N-55, 107
Magnetic Tape Recorders	E-5, 11 to 15
Magnetrons (Tubes)	A-12, 13, 21, 82
Maguire Industries—Thordarson-Meissner Div.	J-58, 59; N-95 to 97
Mallory & Co., Inc., P. R.	
Capacitors	P-1 to 11
Controls, Rheostats, Resistors	P-1 to 7
Switches, Jacks, Plugs	L-6 to 9
Tuning Unit, UHF Converter, Grid Bias Cells	T-2, 3
Vibrators, Rectifiers, Power Supplies	M-32 to 35
Manuals, Service and Instruction	Section K; also C-23; E-56; G-92; J-13, 82; M-32; N-54; P-73
Marine Speakers, Horns	C-8, 20, 48
Marion Electrical Instrument Co.	G-40 to 43
Marker Generators	G-1, 4, 20, 22, 53, 65, 68, 80, 91, 92, 103, 107, 111, 134, 138, 143
Marker Injector	G-139
Masco (Mark Simpson Mfg. Co.)	B-16 to 25
Mast Clamps, Straps, Bases, Couplers	F-10; M-15; S-80 to 94, 103, 109, 110, 117, 121 to 127; T-19, 21 to 35, 39 to 41; U-40, 54, 107, 108, 110, 117
Master Mobile Mounts, Inc.	S-90, 91
Masts and Towers Antenna	F-10; S-80, 102, 103, 122, 126, 127; T-28
Measurements Corporation	G-125 to 132
Measuring Instruments	Section G
Megacycle Meters	G-132
Megohm Bridge	G-141
Megohmmeters	G-92, 115
Meissner Products, Thordarson-Meissner Div.	J-58, 59
Mercury "A" Batteries	R-5
Mercury Switch Relays	L-43
Mercury Switches	A-5
Merit Coil & Transformer Corp.	N-72 to 85
Metal Cabinets, Racks, Panels	J-43, 44, 47, 48, 84 to 110
Metal Grille—Ornamental	J-86; U-15, 104
Metal Trim, Moulding, Handles	J-89; U-104
Metalized Paper Capacitors	P-64, 65, 118 to 115, 138 to 141
Meter Cases	J-44, 48, 84, 85, 95, 107, 109; U-126, 131
Meter Tester	G-43
Metered Transformers	N-42, 44, 117
Meters and Instruments	Section G
Meters, Elapsed Time	G-42, 48, 55, 102
Meters, Frequency	G-22, 48, 77, 78, 100 to 102; J-33, 50
Meters, Grid Dip	G-132; J-19, 32
Meters, Intermodulation	G-130
Meters, Panel	G-24, 25, 38 to 50, 55 to 59, 77 to 79, 89, 100 to 102; J-19
Meters, Pocket	G-12, 17, 28, 34 to 37, 45 to 47, 50, 51, 79, 106, 108
Meters, Recording Level, Decibel, Noise	G-26, 38, 43, 55, 57
Meters, Resistance	G-44, 46
Meters, Vibrating Reed	G-48, 100, 101
Mica Capacitors	P-9, 10, 32 to 41, 65, 66, 86 to 89, 117 to 119
Mica Capacitors, Silvered	P-9, 10, 23, 32 to 41, 65, 66, 86 to 89, 96, 117 to 119
Microammeters	G-7, 24, 28, 36 to 42, 49, 50, 55, 65, 68, 79
Microphones—Carbon, Cardoid, Crystal, Dynamic, Velocity	Section D; also B-36; C-35
Contact, Lapel, Hand, etc.	D-9, 12, 28, 28
Adapters, Swivels, Fittings	D-23
Base Flanges, Extension Rods	Section S; also F-9; T-28; U-53
Cable and Wire	D-5, 12
Cartridge Replacements	D-5, 12
Coiled Cord Sets	D-5

GENERAL INDEX (Continued)

	Section & Page
Connectors.....	D-12; F-7, 8, 16 to 18; H-10; L-30; S-39; U-55, 58, 134
Mixer.....	B-17
Musical Instrument (Contact).....	D-21, 26, 35
Stands and Attachments.....	Section D
Switches.....	D-5, 12; F-8
Third Hand, Chest Plate, etc.....	D-17, 20, 24, 25, 32
Transformers.....	Section N; also D-5, 20, 21, 26
Microtran Co., Div. of Crest Laboratories, Inc.....	N-122
Microvolt Signal Generators.....	G-69
Microwave Tubes, Crystal Diodes.....	A-1, 3, 8, 12, 13, 15, 20, 22; H-26, 27, 31, 33; R-26
Middletown Manufacturing Co., Inc.....	J-108, 110
Midget Replays.....	L-43, 45 to 48, 50, 51
Millen Mfg. Co., Inc., James.....	J-19 to 33
Miller Company, J. W. (Coils).....	J-54 to 57
Miller Company, Sanford.....	H-35
Miller Mfg. Co., Inc., M. A. (Needles).....	E-38, 39
Miller Television Co.....	S-98, 99
Milliammeters, Millivoltmeters.....	G-24 to 26, 36 to 44, 46, 49, 50, 55, 56, 58, 59, 76, 77, 79, 89
Mini-Max Strips for Batteries.....	F-34; U-59, 84
Mini-Spring for Miniature Tubes.....	U-55
Minnesota Mining and Mfg. Co. (3M) (Scotch).....	E-58
Mirroscope Oscilloscope.....	G-31
Mobile & Police Transmitters, etc.....	J-6, 7, 9, 13, 64, 111
Model Engineering & Mfg., Inc., Tru-Ohm I lv.....	R-68, 69
Modulators for Communications Equipment.....	J-27, 111
Modulators, Variators, Balanced Bridges.....	H-22
Molded Plastic Tubular Capacitors.....	F-3, 4, 6, 26, 39, 59, 61, 65, 66, 83, 89 to 101, 110, 111, 133, 134, 142
Momentary Contact Switches.....	L-16, 21 to 25, 32, 33, 36 to 38; S-31; U-82, 107
Monitor, Short Wave.....	J-62
Monitor Products Co.....	T-46
Moody Machine Products Co., Inc.....	U-31
Morrow Radio Mfg. Co.....	J-12
Morse Code Learner's Phono Records.....	U-118
Mosley Electronics.....	T-22 to 24
Motorcycle Antennas.....	S-82
Motors, Small Power.....	E-33, 36, 37
Motors, Turntables for Phonos & Recorders.....	E-3, 6, 9, 10, 27, 31 to 37
Motor-Starting Capacitors.....	P-4, 82, 115
Motor-Starting Relays.....	L-44
Mueller Electric Company.....	M-14, 15
Multicore Sales Corporation.....	U-15
Multimeters, Multitesters.....	Section G
Multiple Conductor Cable.....	S-1, 2, 4 to 6, 17 to 19, 20, 35, 36, 48, 49, 53, 54, 59, 70, 71
Multiple Leaf Relays.....	L-45
Musical Instrument Amplifiers, Microphones.....	D-21, 26, 35
Mutual Conductance Tube Testers.....	G-19, 53, 60, 61 to 63, 109, 112
- N -	
Nail-it Knobs.....	S-106
Nails, Insulated Wiring.....	U-95, 107
Najesco, Inc. (Jerrold).....	S-113
Name Plates.....	U-125, 142, 143
National Carbon Company (Eveready).....	M-1 to 4
National Company, Inc.....	J-1 to 5
National Electronic Mfg. Corp. (Nemco).....	S-106 to 110
National Electronics, Inc.....	A-34
National Union Radio Corp.....	A-22, 23
National Wire & Cable Corp.....	S-68 to 71
Needle Nose Pliers.....	U-25 to 30
Needles—Cutting, Recording.....	E-4, 44, 52, 54, 56, 59, 60
Needles—Phono Pickup, Playing.....	Section E; also C-31; D-8, 12, 14, 27; T-18
Needle Tip and Chuck.....	U-78
Neon Indicator Lights.....	H-12; U-52
Neon Testers, Low and High Voltage.....	U-52
Networks, Crossover—for Speakers.....	B-12; C-9, 15, 22, 31, 34
Neutralizing, Aligning Tools.....	F-3; U-20, 22, 47 to 50, 58, 59, 88, 98, 137 to 139
Neutralizing Capacitors.....	J-16, 23, 37, 51, 71; P-40, 41; U-144
Newcomb Audio Products Co.....	B-6 to 11
Nobletoy Metallic Film Resistors.....	R-44
Noise Filters, Silencers.....	B-12; G-121; J-7, 54 to 57, 60, 62, 111; N-54, 81, 84, 91, 111, 112; P-5, 8, 27, 31, 49, 116; R-46; S-45, 108, 110; T-7, 21, 33 to 35; U-40, 59, 85, 150
Noise Level Indicators.....	G-26, 38, 43, 55, 77
Noise Suppressors, Auto Ignition.....	J-7, 12; P-5, 8, 31, 116, 120; R-46; S-45, 108; U-59, 85
Noise Suppressors, P.A.....	B-12; N-18, 87, 91, 111, 112
Null Indicators, Detectors.....	G-40, 56, 60, 118
Null "T" Filters.....	G-121
Nut Drivers, Wrenches.....	U-19, 20, 24, 31, 135, 136
Nuts, Bolts, Screws, Washers.....	F-60; J-5; L-9; S-42, 43; U-60 to 69, 88, 90 to 94, 127, 148, 149
- O -	
Oak Electronics Co.....	T-12
Ohmite Manufacturing Co.....	L-40; R-52 to 56
Ohmmeters and Megohmmeters.....	G-36, 43, 51, 83, 92, 115
Ohm's Law Calculator.....	R-56
Oil and Gas Gauge Filter Capacitors, Auto.....	P-5, 120
Oil Burner Suppressors.....	R-46
Olin Industries, Inc.....	M-12, 13
Orradio Industries, Inc.....	E-62

	Section & Page
Oscillator Coils.....	J-53, 57, 59; N-81 to 84
Oscillators, Audio.....	G-82, 86, 142; U-150
Oscillators, Code Practice.....	B-37; J-50; U-150
Oscillators, Phono.....	T-34
Oscillators, Signal Generators.....	Section G
Oscillators, UHF.....	G-5, 66, 81, 129, 143
Oscillators, Variable Frequency.....	J-7, 11, 20, 62, 63
Oscillographs, Oscilloscopes.....	Section G; also J-19, 28
Accessories, Amplifiers, Calibrators.....	G-31, 72, 91, 139; J-19, 28
Cathode Ray Tubes.....	A-4, 6, 7, 19, 23; G-136
Output Meters.....	G-26, 38, 43, 55, 77
Output Transformers.....	Section N; also C-6, 37
Oven Temperature Testers.....	G-98
Overload and Underload Relays.....	J-40; L-43, 50, 52, 53
Oxford Electric Corporation.....	C-49
- P -	
P.A. Controls.....	Section R; also L-10, 35
P.A. Systems, Units.....	Sections B and C; also E-8, 28
P.A. Wire and Cable.....	S-1, 3, 5, 6, 18 to 20, 38, 53
Pacific Transducer Corp. (formerly Clarkstan).....	E-17
Packaged Wiring Systems for Work Benches.....	U-38
Padding Capacitors.....	J-51; P-40, 41; U-144
Paging and Talk-Back Speakers.....	C-2, 5, 7 to 11, 17 to 19, 24, 25, 43, 49
Paints, Enamels, Lacquers, Varnishes.....	U-41 to 44, 45, 46, 101 to 103, 109
Panel Bearings, Assemblies.....	F-58, J-77; S-43; U-85, 111, 114, 145
Panel Boring Tools.....	F-2; G-140; U-32, 33, 136
Panel Indicators.....	H-1 to 12; J-80, 81; L-38; U-55, 83
Panel Lamps.....	A-17
Panel Marking Transfers.....	U-110, 123
Panel Meters.....	G-24, 25, 38 to 50, 55 to 59, 77 to 79, 89, 100 to 102; J-19
Panels, Aluminum.....	J-86 to 88, 96, 104
Panels, Bakelite.....	J-89; U-126
Panels—Desk, Door, Grille.....	J-86, 96, 99, 103, 105
Panels, Masonite.....	J-87, 88
Panels, Metal Rack, Jack, etc.....	J-44, 87, 88, 96, 104, 105, 109, 110; L-41, 42
Panels, Meter.....	J-44, 88, 105, 109; U-126
Paper Capacitors.....	Section P
Par-Metal Products Corp.....	J-90 to 99
Patch Cords.....	L-41, 42; U-79
Pattern and Bar Generators, TV.....	G-1, 32, 86, 107, 143; M-61; T-20
Peak-to-Peak Voltmeter.....	G-131
Peerless Electrical Products Div. Altec Lansing.....	N-35 to 39
Penn Television Products Co.....	T-30 to 33
Pentron Corporation.....	E-11
Perma-Power Company.....	M-60, 61
Permanent Magnet Speakers.....	Section C
Permo, Inc.....	E-41 to 49
Petersen Radio Co., Inc.....	T-44, 45
Phanotrons (Rectifier Tubes).....	A-5, 6, 13, 25, 32, 33
Phaotron Company.....	G-56, 57
Phasitrons (Tubes).....	A-5
Phillips Screw Drivers.....	U-19, 20, 23
Phillmore Mfg. Co., Inc.....	B-36
Phone Cords.....	D-39; S-45
Phone Headsets.....	B-36; D-35, 37 to 40
Phone Plug Adapters.....	F-8; L-30; U-82, 134
Phone Plugs, Connectors, Jacks.....	D-39; J-78; L-8, 28 to 30, 34, 41, 42; U-53, 76 to 78, 81; U-115, 132 to 134
Phone Tips, Jacks.....	F-4, 53; J-78; S-39, 40; U-53, 76 to 78, 95, 132 to 134, 147
Phono Drawer Assemblies, Metal.....	J-93, 99, 103
Phonographs, Record Players.....	B-10, 19; E-6, 7, 14, 27 to 29
Cabinets, Cases.....	E-29; T-1
Drives.....	U-48, 90, 100
Needles, Playback.....	Section E; also C-31; D-8, 12, 14, 27
Oscillator—Wireless.....	B-37; T-34
Phono Plugs, Jacks.....	F-33, 52; L-30; S-31; U-53, 54, 84, 95, 100, 126, 134
Phono Wire, Shielded.....	S-3, 23, 36, 53, 61; U-58
Pickups and Arms.....	Section D; Section E; also B-28; C-31
Record Changers.....	E-27 to 29
Springs and Set Screws, Pickup.....	U-47, 60, 66, 78, 90
Stroboscope Discs.....	G-137; U-97
Turntable Drives and Felts.....	U-47, 90, 100
Turntable Mounting Springs.....	U-73, 90
Turntables, Motors, Assemblies.....	E-3, 6, 9, 10, 27, 31 to 37
Phono Plugs & Sockets for Record Players, etc.....	F-33, 52; L-30; S-21; U-53, 54, 84, 95, 100, 135, 134
Phono Turntable Repair Stand.....	U-58
Phosphor Bronze Aerial Wire & Dial Cable.....	S-14, 38, 54; U-51
Photo Electric Cells.....	A-30; H-22, 23
Photo Electric Relays.....	L-55 to 57
Photo Electric Units, Alarms.....	L-55 to 57, 98
Photocell Cable.....	S-1, 3, 23, 55
Photofac Radio Data Service & Manuals.....	K-11
Photoflash Capacitors.....	P-3, 13, 38, 111
Photoflash Power Transformers.....	N-16, 21, 80, 117
Photoflash Relays.....	L-47
Phototubes.....	A-5 to 7, 21, 25, 84
Pick-a-Shaft Controls.....	R-28, 34
Pickering & Co., Inc.....	E-13 to 15
Pickups and Arms, Phono & Transcription.....	Section D; Section E; also F-15
Cartridges.....	Section D; Section E; also B-28; C-31; F-15
Springs, Set and Mounting Screws.....	U-47, 60, 66, 78, 90
Tone Equalizers.....	B-12, 13, 30, 31, 35; E-1, 15, 19 to 21; N-111, 112
Pickup Tool.....	U-47

GENERAL INDEX (Continued)

	Section & Page
Pierceway Div. Clifton Conduit Co., Inc.	U-38
Pillars, Steatite	S-44
Pillow Speakers	D-35, 37
Pilot Lamps, Bulbs	A-17
Pilot Light Installer & Remover Tools	H-9; U-55
Pilot Lights and Assemblies	H-1 to 9, 11, 12; J-80, 81; L-38; U-55, 83
Pin Plug and Jack Sets for Auto, Phono, etc.	F-33; U-54, 84, 89, 145
Pin Straightener Tools for Tubes	U-50, 99
Pipe and Ground Clamps	S-38; M-15; S-67, 106, 110, 121; U-108
Planet Manufacturing Corp.	P-125
Planetary Drives	U-124
Plastic Capacitors, Inc.	P-99 to 101
Plastic Cement for Repairs	F-9; U-41, 42, 101
Plastic Dial Crystals	U-100
Plastic Electrical Tape	U-119
Plastic Jars & Boxes for Hardware	U-60, 63, 65 to 75, 97, 123, 149
Plastic Molded, Paper Tubular Capacitors	P-3, 4, 6, 26, 39, 59 to 61, 65, 66, 83, 99 to 101, 110, 111
Plastic Pliers	U-50, 123
Plastic Spray	U-40
Plastic Tubing	S-29, 30, 38, 45, 71, 73; U-56, 104, 107
Plasticon Capacitors	P-126 to 129
Plate Caps	J-25
Plate Transformers	Section N
Pliers	U-17, 18, 25 to 30, 60
Pliotrons (High Vacuum Tubes)	A-4
Plug Caps and Shells	F-4, 32; U-54
Plug-in Network Adapter	G-135
Plug-in Resistors, Tube Type	A-4, 6, 7, 12, 13, 19, 27, 32, 37; R-30, 76
Plug-in, Twist-Prong Capacitors	P-12, 18, 19 to 21, 53 to 56; 79 to 81, 83, 105 to 107, 131
Plugs and Jacks	F-4, 5, 33; J-79; L-28, 29, 30, 34, 41, 42; S-31, 38 to 40; U-53, 54, 76, 77, 84, 89, 104, 114, 132, 134
Plugs and Jacks—Transmitting	U-134
Plugs, Battery	F-34
Plugs, Cord	F-13 to 27; 36 to 44; L-42; U-54
Plugs, Fused	H-13
Plugs, Receptacles, Sockets	Section F; U-64
Plugs, Snap Button	F-35; U-70, 95
Plugs, Soft Rubber	S-38
Plugs, Solderless	J-78; U-76, 78, 133
Plugs, Speaker	F-5, 52
Plugs, Ventilating Hole	F-35; U-70, 95
Plunger Switch	L-7, 11, 21, 34
Pocket Meters, Testers	G-12, 17, 28, 34 to 37, 45 to 47, 50, 51, 79, 106, 108
<i>Pocketscopes</i>	G-136
Police & Mobile Antennas	S-82, 90, 91, 103, 107, 111, 112, 124, 125
Police & Mobile Receivers, Transmitters & Equipment	J-6, 7, 9, 13, 64, 111
Polyphase Reproducers, Heads	E-24
Polystyrene Cement and Coil Dope	F-9, 11, 41, 42, 101
Polystyrene Rods, Tubing, Sheets	S-72
Porcelain Products, Inc.	S-73
Potentiometers, Rheostats	Section R; also L-10
Potter & Brumfield	L-44 to 47
Power Conversion Equipment	Section M; also J-10, 64
Power Cords for Radios, Lamps, etc.	S-6, 14, 35, 36, 57, 60, 61
Power Level Indicators	G-26, 38, 43, 55, 77
<i>Power-Pak</i> Batteries	R-5
Power Plugs, Connectors, Receptacles	Section F
Power Rectifiers	Section A; also H-20 to 34; T-18
Power Relays	L-44, 48 to 50
Power Resistors	Section R
Power Rheostats	R-4, 31, 37, 52, 53, 62, 68, 69
Power Speakers	Section C
<i>Powerstat</i> Variable Transformers	M-54, 55
Power Supplies, Packs	B-1; G-112, 117, 118, 141; J-6, 19, 20, 111, 30, 31, 35, 39, 40, 45 to 51, 53, 57, 58; P-127
Power Switches, Rotary	J-10, 64; M-46, 50, 65
Power Transformers	L-25, 33, 38, 40; S-31; U-56, 82, 143
Pre-amplifiers, Boosters—for Amplifiers	Section N
Pre-amplifiers, Boosters—for TV	B-1, 12, 13, 14, 17, 18, 30, 31, 35; E-19, 20; J-7; N-22; T-7, 12, 15, 36
Pre-amplifiers for Pickups, Cartridges	D-10; S-113; T-3, 4 to 7, E-19, 20
Pre-amplifiers for Receivers, Transmitters	B-1, 12, 13, 30, 31, 35
Precise Development Corp.	J-7, 11, 20
Precise Measurements Co.	G-110 to 113
Precision Apparatus Co., Inc.	G-140, 141
Precision Capacitors, Drive Units	G-90 to 97
Precision Resistors	J-5, 15, 23, 39, 74
Premax Products Div. Chisholm-Ryder Co., Inc.	R-22 to 25, 44, 59, 60, 61, 73
Premier Metal Products Co.	S-124, 125
P.r.e.-selectors, Boosters for Communication Receivers	J-100 to 107
<i>Pre-to Recording Corporation</i>	J-13, 20
Printed Electronic Circuits & Kits	E-2 to 5
Printer Print for Repairing Circuits	P-24, 71 to 73, 95
Probes, R. F.	U-42
Probes, TV, High-Voltage	G-10, 72, 84, 85, 113, 139, 113, 139, 146; U-50, 139
Projectors, Horns	Section C
Public Address Equipment	Sections B & C; also E-28; N-22
Pushes, Idler	U-72, 145
Push Generators, Markers	U-72, 145
<i>Pushscopes</i>	G-137
Punches, Dies—Chassis, Panel, Socket	G-137
Punches—Rivets, Eyelet	F-2; U-32, 33, 136
Push and Push-Button Switches	F-28; U-35
	L-7, 21, 22, 29, 32 to 38; S-31; U-56, 82, 107, 143

	Section & Page
Pushback, Hookup Wire	S-6 to 13, 23 to 30, 32 to 34, 46, 50, 55, 59, 60, 68
Push Button Tools, Wrenches, etc.	U-50
Pyranol Capacitors	P-12 to 14
Pyrometers	G-99

— Q —

Quam-Nichols Company	C-4 to 6
Q-Meters, Indicators	G-114
Quietrole Company	U-118

— R —

Racks—Relay, Cabinet	J-42 to 44, 84, 90 to 95, 100 to 102, 108, 110
Racon Electric Co., Inc.	C-7 to 9
Radeleo Manufacturing Co.	S-100 to 103
Radiart Corporation	
Antennas	S-84 to 87
Vibrators, Power Supplies, Converters	M-42 to 45
Radiation Counter Tubes	A-12, 13, 32
<i>Radio Amateur Handbook</i> (ARRL)	K-5
Radio City Products Co., Inc.	G-143 to 148
Radio Corporation of America	
Batteries	M-5
Diodes	A-8
Pickups, Crystal, Replacement	C-1
Speakers, Lightning Arresters	C-1
Technical Literature, Tube Manuals	K-8, 9
Television Components	T-16 to 18
Test and Measuring Equipment	G-1 to 10
Tubes—Amateur Type	A-6, 7
Tubes—Industry, Communications	A-6, 7
Tubes—Receiving and TV	A-8, 9
Transistors	A-8
Radio Craftmen, Inc.	B-27
<i>Radio Handbook</i> (Editors & Engineers Ltd.)	K-12
Radio Merchandise Sales, Inc. (RMS)	S-114, 115
Radio Mfg. Engineers, Inc.	J-13
Radio Receptor Co., Inc., Seletron & Germanium Div.	H-26 to 29
Radio-Telephone, Two-way	J-8, 14, 111
Radion Corporation	S-93
Ram Electronics Sales Co.	T-13
Raytheon Mfg. Co., Equipment Sales Div.	M-52, 53
Raytheon Mfg. Co., Receiving Tube Div.	A-10 to 15
Reactors—Audio, Filter	Section N
Reamers	U-23
Receivers, AM, FM, etc.	B-10, 33
Receivers, Communication	J-1 to 3, 6 to 9, 12, 35, 111
Receivers, Crystal	B-36, 37
Receiving Kits, Chassis—AM, FM, etc.	B-10, 33, 34, 36, 37; J-57
Receiving Kits, Chassis—TV	B-26, 32 to 34, 36
Receiving Tubes	Section A
Receptacles, Sockets, Plugs	Section F
<i>Recitalist</i> Hi-Fidelity Phonograph	E-6
Record Adapters, 45 rpm	U-60
Record Changer Bases, Cases	E-27, 29; J-87, 93; T-1
Record Changers, Attachments	E-27 to 29
Record Cleaners, Preservers	E-54, 60; U-44
Record Players	B-10, 19; E-6, 7, 14, 27 to 29, 33
Record Player-Phono Switch	U-150
Recorders and Playback Equipment	Section E
Audio Input System	B-1, 12, 13, 30, 33, 35; E-19
<i>Chip-Chaser</i>	E-56
Converters for Tape Recording	M-22 to 24, 30, 48, 49, 50
Disc Recorders	B-19; E-2, 3, 7, 13, 33
Discs and Styli	Section E
Equalizers and Filters	B-12, 13, 30, 31, 35; E-1, 16, 19 to 21; N-111, 112
Frequency Records for Checking Response	E-17; U-100
Head Demagnetizer	E-57
Heads	D-6, 13, 35; E-25
Labels for Disc and Tape Reels	E-53, 57
Lubricants, Cleaners	U-42, 44, 102
Mechanisms, Assemblies, Chassis	E-3, 8, 30, 33
Meters, Volume	G-26, 38, 43, 55, 77
Motors, Turntables	E-3, 9, 10, 27, 29, 30 to 35
Needle Force Gauges	E-29
Record Brushes	E-44, 60
Recording Amplifiers	E-2, 5, 7
Stroboscope Discs	G-137; U-97
Tape-Disc Recording Assembly	E-30
Tape Drive Mechanisms	E-3, 5, 11, 30
Tape for Recording	E-12, 42, 53, 54, 57, 58, 60, 62; U-58
Tape Recorders	E-5, 11 to 15
Tape Reproducer	E-5
Tape Splicing Block	J-111; L-11
Transcription Pickups, Arms	B-28; D-34; E-1, 16, 18, 21, 25
Transcription Players, Tables	B-10, 15; E-2, 6, 7, 9, 10, 27
Transformers, Crystal Recorder Output	N-8
Wire, Stainless Steel, for Recording	E-43; U-58
<i>Recordio</i> (Wilcox-Gay)	E-12 to 14
Reconon Corporation	E-60, 61
Rectangular Plugs and Sockets	F-3 to 5, 27 to 44, 49
Rectifier Tubes	Section A
Rectifiers, Battery Charging	H-32
Rectifiers, Copper Oxide, Instrument	H-21 to 23
Rectifiers, Magnesium-Copper Sulfide	M-33
Rectifiers, Power, High Voltage	H-20, 22, 24, 25, 32 to 34
Rectifiers, Selenium	A-3, 21; H-20, 22 to 25, 28 to 35; M-33; T-18
Re-entrant Speakers, Trumpets	Section C
Reeves Soundcraft Corporation	E-58, 59
Regency Division I.D.E.A., Inc.	T-7

GENERAL INDEX (Continued)

	Section & Page	Section & Page
Regulators, Line Voltage, Plug-in	R-30, 76; U-150	
Rek-O-Kut Company	E-6 to 10	G-139
Relay Dust Cover	L-45	Scale Printing Machine
Relay Racks, Panels, etc.	J-42 to 44, 84, 87, 90 to 95, 100 to 102, 108, 110	G-140
Relays	G-22; J-40, 41; L-1, 43 to 59	Schauer Manufacturing Corp.
Antenna Changeover for Transmitters	J-65; L-43, 48 to 50	Battery Eliminators, Vibrator Analyzer
Break-in	L-43, 53	Rectifiers
Circuit and Industrial Control	L-46, 49	Scotch Magnetic Recording Tape (JM)
Coaxial	J-40; L-48, 51	Scott, Inc., Hermon Hosmer
Electronically Operated	L-55 to 57	Scratch Removers, Polishes
Enclosed Plug-in Type	L-45, 46	Screw Drivers
General Purpose	L-1, 43	Flexible
High Frequency and R. F.	L-43, 48 to 50, 53	Neutralizing, Alignment
High Voltage	L-50	Screw-eye Insulators
Interchangeable	L-52	Screw Eyes
Keying	J-40; L-43, 53	Screw Hooks
Latching Impulse	L-43, 45, 46, 51	Screws, Nuts, Bolts, Washers
Mercury-Switch, Mercury Contact	L-43	Escutcheon Plate Screws
Midget	L-43, 45 to 48, 50, 51	Lag Screws
Motor-Starting and Control	L-44	Machine Screws
Multiple Leaf	L-45	Ornamental Head Screws
Overload and Underload	J-40; L-43, 50, 52, 53	Rack and Cabinet Screws
Photo Electric, Sensitive	L-46 to 48, 51, 56, 58, 59	Self-Tapping, Parker-Kalon Screws
Photoflash	L-47	Set Screws for Knobs, Pickups
Power, Heavy Duty, etc.	L-44, 48 to 50	Wood Screws
Remote Control	L-52	Scriber for Marking Metal
Shockproof	L-44	Selectohm
Telephone Type	L-43, 45, 49, 52	Select-O-Ject Tuner
Time Delay, Thermostatic Delay	L-43, 49, 52, 54	Selector Switches
Vacuum	J-40	Selenium Rectifier Capacitors
Very Sensitive Type	L-47, 48	Selenium Rectifiers
Relatron Tubes	A-25 to 27	Selenium Rectifier Transformers
Remote Control Audio Cutout—Radio, TV	D-39	Selenon Rectifiers
Remote Control Kit	B-36	Service Aids, Miscellaneous
Remote Control Relays	L-43, 53, 56 to 59	Service and Instruction Manuals
Repair Kits for Cabinets	U-41, 45, 46, 102, 103	Set Analyzers
Resharpener Service—Styll	E-56, 59	Shaft Couplings, Insulated Flexible
Resistance Analyzers, Indicators, Meters, Decades	G-87, 113; R-36, 50	Shaft Couplings, Insulated Non-Flexible
Resistor Cabinets and Kits	R-10, 45, 56	Shaft Extenders, Reducers, Couplings
Resistor Color Coding, etc.	R-8	Shaft Locks
Resistors, Fixed and Adjustable	Section R; also L-35; P-98	Shafts, Flexible
Carbon, Composition, etc.	P-98; R-7, 8, 24, 25, 45, 56, 59, 60, 65, 71 to 73	Shakespeare Co., Columbia Products Division
Filament	T-36	Shalleross Manufacturing Co.
Flexible	R-36	Shav-Paks
Line Cord	S-45, 57; U-150	Shellac Sticks, Scratch Fillers
Metal Film	R-44	Shielding, Copper Braid
Miniature Power	R-58, 61	Shields and Shield Cans
Precision	R-22 to 25, 44, 59, 60, 61, 73	Box Shields
Printed Electronic Circuits	P-24, 71 to 73, 95	Cathode Ray Tube Shields
Tube Type, Ballasts	A-4, 6, 7, 12, 13, 19, 27, 32, 37; R-30, 76	Coil Shields
Vitreous Enamel	R-6, 38, 39, 47 to 49, 54, 55, 63, 64, 68, 70, 71	Corona Shields
Wire Wound	L-35; R-5, 6, 9, 20, 21 to 23, 34 to 36, 38, 39, 45 to 47, 49, 54, 55, 57, 61, 63, 64, 66 to 68, 70, 71, 74, 75	Tube Shields
Retainer Ring Tools for Socket Assembly	F-2	Shims, Speaker
Retaining Rings and C Washers	F-30; U-69, 91	Shock Tester
R.F. Chokes, Coils	J-5, 24, 26, 52 to 54, 56 to 58, 76; N-82 to 85; P-8; R-47, 56	Shunts, Ammeter Switchboard
R.F. Connectors	F-6, 7, 54, 55; S-103, 113; U-81	Shure Brothers, Inc.
Rheostats—Potentiometers	Section R; also L-10	Shurite Meters
Rheostats—Power	R-4, 31, 37, 52, 53, 62, 68, 69	Signal Calibrators
Rhythm-master Hi-Fidelity Phonograph	E-6	Signal Generators
Rider Publisher, Inc., John F.	K-1 to 6	Signal Indicator Corp. (Dialight Corp.)
Right Angle Drives for Capacitors, Potentiometers, etc.	J-21, 26	Signal Indicators
Ripley Co., Inc.	L-55	Signal Tracer Testers
Rivets, Eyelets	U-73, 94, 135, 148	Silicone Compounds
Punches for Rivets, Eyelets	F-28; U-135	Silver Contact Cleaning Cloth
R-J Audio Products, Inc.	E-29	Silver Mica Capacitors
RMS (Radio Merchandise Sales)	S-114, 115	Silver Print for Printed Circuits
Rocket Tubes	A-21	Simpson Electric Company
Rods, Extension, Insulated, Brass	S-43; U-85, 145, 146	Simpson Mfg. Co., Mark (Masco)
Rods, Polystyrene	S-44, 72	Sine & Square Wave Audio Generators
Rogan Brothers	U-128, 129	Sleeving—Coated, Saturated, etc.
Rogers Electronic Corp.	N-120	Slide-Type Switches
Roll Around Dolly, for TV Set	U-58, 110	Sliding Cabinet Drawer Assemblies—Metal
Roof-Patching Compound	U-43, 109	Small Power Motors
Rotary Inductors	J-12, 66; N-100	Smith, Inc., Herman H.
Rotary Power Supplies	J-10, 64; M-46, 50, 65	Smith-Baldwin Speakers
Rotary Switches	L-2, 3, 6, 7, 10, 12, 13 to 15, 20, 29, 31, 32, 36, 38, 40; R-30, 50; S-31; U-56, 82, 107, 143	Snap-Action Switches
Rotator TV-FM Cable	S-20, 28, 49, 51, 58; T-23	Snap-on Drawer Company
Rotators and Rotary Beam Antennas	J-65; S-86, 87, 95, 117; T-14	SNC Manufacturing Co., Inc.
Roto Ranger Set Analyzer	G-30	Snips, Metal etc.
Royal Television Supply Co.	S-122, 123	Socket Punches
Rubber and Bakelite Plugs	S-38; U-54	Socket-Switches—TV Antenna
Rubber Cement	U-101	Socket-Turrets and Plug-in Units
Rubber Chassis Mounts	U-74, 91	Socket Wrenches
Rubber Drives for Radios, Phonos	U-48, 90, 100	
Rubber Feet, Bumpers, Washers	U-75, 83, 90	
Rubber Grommets, Gaskets	U-74, 83, 90, 91, 148, 149	
Rubber Insulating Tape	U-119	
Rubber Plugs, Unbreakable	S-38	
Running Time Meters	G-42, 48, 55, 102	
Sama & Co., Inc., Howard W.	K-10, 11	
Sangamo Electric Co.	P-78 to 89	
Sarkes Tarzian, Inc.	H-24, 25	

— S —

GENERAL INDEX (Continued)

	Section & Page
Sockets.....	Section F; A-29; H-8, 9, 12; J-22, 24, 72, 73, 76; M-60; S-43, 45; T-22, 23, U-54, 126, 142
For Air System.....	A-29
For Crystal Holders.....	F-4, 30, 43, 52; J-76; T-23, 45
For Dial Lights.....	H-5, 6, 8, 9, 11, 12; J-80, 81; L-38; U-55, 83
For High Voltage.....	F-51
For JAN Application.....	F-47, 48, 50; J-72, 73, 76
For Miniature Bulb Tester.....	F-5
For Plug-in Capacitors.....	F-30
For Printed Circuits.....	F-47, 51
For Receiving Tubes.....	F-1, 2, 5, 30, 31, 33, 47, 48, 50 to 52, 56, 57; J-22, 24; U-54, 126, 142
For TV and Cathode Ray Tubes.....	F-2, 33; M-60; S-45; U-126
For TV Transmission Line.....	T-22, 23
For Transistors.....	F-48, 51
For Transmitting, Acorn, Industrial and Special Purpose Tubes.....	F-1, 33, 48, 51; J-22, 72, 73; S-43; U-142
Sola Electric Company.....	M-62 to 64
Solder, Solder Flux, Solder Paste.....	U-15, 16, 44, 102
Soldering, Terminal Lugs.....	F-58, 59; S-41; U-58, 71, 84, 87 to 89, 95, 114, 127, 147, 149
Soldering Unit, Induction.....	G-41
Solderless Coaxial Connectors.....	S-113
Solderless Terminal Lugs, Tip Plugs, etc.....	J-78; S-39 to 41; U-21, 58, 76, 78, 133
Soldering Irons, Guns, Pencils.....	U-1 to 14, 135
Non-Stick Compound.....	U-8
Power Unit.....	U-14
Replacement Tips.....	L-9; U-1 to 14, 50, 135
Soldering Aid.....	U-99
Stands, Pots, Heat Controls.....	U-1, 5, 9
Transformers for Midget Irons.....	U-7
Solvents and Thinners.....	U-41, 42, 101
Sonar Radio Corp.....	J-111
Sonotone Corporation.....	E-22, 23
Sound Broadcaster.....	B-19
Soundcraft Discs and Tape.....	E-58, 59
Sound Level Indicators.....	G-26, 38, 43, 55, 77
Sound System Cable.....	S-1, 3, 5, 6, 18 to 20, 36, 53
Sound Systems.....	Section B; also E-6
South River Metal Products Co., Inc.....	T-25 to 29
Spacers and Bushings, Metal and Insulating.....	F-25, 35; J-23; R-5; S-43; U-59 to 61, 85, 89, 92, 120, 145, 149
Spade Lugs, Bolts.....	S-39; U-53, 64, 87, 88, 134
Spaghetti Tubing.....	S-29, 30, 38, 45, 71; U-56, 104, 107, 146
Spark Plug Suppressors, Auto.....	P-5, 8, 30, 31, 49, 116, 120; R-46; S-45, 108; U-59, 85
Speakers, Horns, Projectors, Trumpets.....	Section C; also E-29; J-12; T-18
Auto, Rear Seat, Replacement, etc.....	C-5, 11, 36, 38, 41, 49
Baffles, Cabinets, Enclosures.....	B-28; C-3, 13, 14, 23, 26 to 29, 32, 34, 39 to 41, 46; E-29; J-85, 86, 106, 110; T-1
Cable, Wire.....	S-1, 3, 4, 6, 35, 36, 45, 49, 53, 54
Carrying Cases.....	J-47; T-1
Cement, Repair.....	F-9; U-41, 42, 101
Cone Reconditioning Fluids.....	T-36; U-44
Controls, Volume, Loudness, etc.....	C-22, 31, 44; R-14, 42
Cords, Extension.....	L-30; S-14, 61
Crossover Networks.....	B-12; C-9, 15, 22, 31, 34
Driver Units.....	C-3, 7, 9, 15, 16, 24, 30, 34, 43
Dust Felt for Voice Coil.....	U-74
Field Substitute Choke.....	N-12
Grille Cloth and Screening.....	C-39; J-86; U-15, 46, 104
High Fidelity.....	C-2, 3, 5, 12 to 15, 21 to 23, 30 to 35, 37, 38, 44, 45, 47, 49
Outdoor Theater, Drive-In.....	C-5, 11, 36, 38, 49
Panels.....	J-105, 110
Plugs, Connectors.....	F-5, 52
Shims.....	U-54, 100
Stands, Supports, Brackets.....	C-25, 48
Switch, Auxiliary.....	T-12; U-56
Switch Plates.....	U-125
Transformers.....	C-6, 16, 25, 33, 37, 44; N-12, 16, 37 to 39, 58, 60, 93, 101, 112, 114
Specialties Manufacturing Co. (Spemco).....	L-32, 33
Specific Products.....	J-83
Speed-Chassis.....	J-83
Speed Nuts.....	S-43; U-67, 94
Spellman Television Co., Inc.....	M-58, 59
Sprinkle Products Co., Inc. (Spico).....	S-88, 89
Splatter Chokes.....	N-91
Sprague Products Company.....	
Capacitors.....	P-16 to 34
Resistors.....	R-57
Spring (Friction) Washers.....	U-69, 91
Springs, Expansion and Compression.....	U-47, 60, 72, 73, 85, 90, 96, 121
Square Wave Generator.....	G-131
Staco Relays and Transformers.....	L-43; N-44
Stanco Transformers.....	N-1 to 16
Standard Coil Products Co., Inc.....	T-8, 9
Standard Electrical Products Co. (Staco).....	L-43; N-42 to 44
Standard Div. Chicago Standard Transformer Corp.....	N-1 to 16
Standing Wave Ratio Bridge.....	J-20, 62
Standoff Insulators, TV Screw Eye, etc.....	F-10, 35; S-73, 110, 115; T-29, 32, 39, 41
Stands, Microphone.....	Section D
Stands and Supports, Speaker.....	C-25, 48
Stanwyk Winding Co.....	J-53
Staples, Insulated—Saddle Type.....	S-38
Static-Chaser.....	U-44, 102
Stepdown Line Cords.....	S-45, 57; U-150
Stepdown Transformers.....	N-16, 28, 44, 63, 80, 117, 121
Step-up Coils, High Voltage.....	M-59
Stephens Manufacturing Corp.....	C-14, 15
Sterling Manufacturing Co.....	C-44, 45
Stock Boxes, Storage Cabinets, Steel and Plastic.....	U-34 to 36, 37, 60, 97
"Stop-It" Commercial Eliminator.....	D-39
Strap Clamp—Copper.....	S-38
Stroboscopes for Phono Turntables, etc.....	G-137; U-97
Styli, Cutting.....	C-4, 44, 52, 54, 56, 59, 60
Styli, Phono.....	Section E; also C-31; D-8, 12
Stylus Pressure Gauge.....	E-29
Subminiature Radio Tubes.....	Section A
Superior Electric Co.....	M-54 to 57
Superior Instruments Co.....	G-104, 105
Suppressors, Noise.....	B-12; G-121; J-7, 54 to 57, 60, 62, 111; N-54, 81, 84, 91, 111, 112; P-5, 8, 27, 31, 49, 116; R-46; S-45, 108, 110; T-7, 21, 33 to 35; U-40, 59, 85, 150
Auto Ignition.....	P-5, 8, 30, 31, 49, 116, 120; R-46; S-45, 108; U-59, 85
Oil Burner.....	R-46
Supreme, Inc.....	G-106
Swaging Machine.....	F-60
Sweep Frequency Generators, TV, etc.....	G-4, 5, 29, 53, 66, 80, 86, 91, 92, 103, 134, 138, 148
Sweep-Marker Generators.....	G-1, 4, 20, 22, 53, 65, 68, 80, 91, 92, 103, 107, 111, 134, 138, 143
Swinging Input Chokes, Reactors.....	Section N
Switchcraft, Inc.....	L-28 to 30
Switch Knobs, Washers, Nuts, Dial Plates, etc.....	L-9, 13, 15; U-125
Switches.....	
Antenna, Coaxial, Changeover, etc.....	S-105; T-22, 28
Appliance.....	L-20 to 23; S-31; U-56
Canopy.....	L-33; S-31; U-82, 143
Circuit Opening.....	L-6
Control—For Volume, Tone Controls, etc.....	R-2, 3, 13, 17, 30, 40, 42, 56
Decade.....	L-7
Detent, TV.....	T-9; U-57, 109
Electronic Switch.....	G-85
Foot.....	L-26, 27
General Purpose.....	L-13, 31
Ham Type.....	L-7, 14
Instrument.....	L-2
Jack.....	L-7
JAN.....	L-5, 23, 25, 36
Kits.....	L-2, 4, 15
Knife-Throw.....	S-31, 110; U-143
Lever Action.....	L-4, 6, 13, 29 to 31
Limit.....	L-1
Mercury.....	A-5
Microphone.....	D-5, 12; F-8
Momentary Contact.....	L-16, 21 to 25, 32, 33, 36 to 38; S-31; U-82, 107
Plunger.....	L-7, 11, 21, 34
Power, Heavy Duty.....	L-25, 33, 38, 40; S-31; U-56, 82, 143
Push, Push-Button, Single.....	L-21, 22, 29, 32 to 38; S-31; U-56, 82, 107, 143
Push-Button, Multiple.....	L-7
Record-Player, Phono.....	U-150
Rotary Power, Tap.....	L-10, 15, 20, 36, 40
Rotary Selector.....	L-2, 3, 6, 7, 10, 12 to 15, 31, 32, 36, 38; R-30, 50
Rotary Snap, Toggle.....	L-29; S-31; U-56, 82, 107, 143
Roto-Lock.....	L-32
Slide Type.....	L-22, 32; S-31; U-56, 82, 107, 143
Snap-Action, Spring-Return.....	L-1, 4, 20
Socket—TV Antenna.....	T-22
Speaker, Auxiliary.....	T-12; U-56
Tap, Tap-Change.....	F-5; L-6, 10
Television, Attenuator.....	P-73
Test, etc.....	L-2, 3, 6; U-56
Timer—Automatic.....	L-39
Toggle, Bat Handle, etc.....	L-5, 16 to 19, 23 to 25, 32, 33, 38; S-31; U-56, 82, 107, 143
Tool-Handle.....	L-33
Vacuum.....	A-29; J-40, 41
Switch-Light Combinations.....	L-38
Sylvania Electric Products, Inc.....	
Test Equipment.....	G-103
Tubes, Crystal Diodes, Rectifiers.....	A-19 to 21
Synchrosopes.....	J-19

— T —

T-Pads (Attenuators).....	L-35; R-2, 32, 51
Taco Antenna Equipment.....	S-104, 105
Talk-A-Phone Company.....	B-38, 39
Tap Switches.....	F-5; L-6, 10
Tape for Recorders.....	E-12, 42, 53, 54, 57, 58, 60, 62; U-58
Tape—Friction, Plastic, Rubber.....	U-56, 119
Tape Recorders.....	E-5, 11 to 15
Tape Eraser.....	J-111
Inverters, Accessories for car, etc.....	M-22, 30, 49, 50
Tape Recording Heads.....	D-6
Tape Splicing Block.....	J-111; L-11
Taylor Tubes, Inc.....	A-33
Tech Laboratories, Inc.....	L-10, 11
Tech-Master Products Co.....	B-32 to 35
Technical Appliance Corp. (Taco).....	S-104, 105
Tek-File.....	K-1
Telegraph Keys and Practice Sets.....	J-67, 82
Accessories, Parts, Buzzers.....	J-67, 82; U-150
Monitors.....	J-50; U-150
Morse Code Learner's Records.....	U-150
Oscillators—Code Practice.....	J-50; U-150
Relays.....	J-40; L-43, 53
Telephone Type Relay Racks—Open Type.....	J-43, 84, 100, 110

GENERAL INDEX (Continued)

	Section & Page
Television Components, Accessories:	
Anode Connectors, Extension Cords, Harnesses.....	F-33; S-45; T-21; U-57, 109, 126
Antenna Crossover Network—UHF-VHF.....	U-40
Antenna, Mounts, and Accessories.....	F-11, 12; M-15; S-45, 73 to 80, 83, 85 to 89, 92 to 102, 104, 105, 109, 110, 114 to 124; T-14, 15, 19 to 29, 30 to 33, 34, 35, 37 to 41; U-40, 105 to 108, 110, 116, 117
Antenna Orientor.....	T-24
Antenna Rotators.....	S-86, 87, 117; T-4
Attenuator.....	R-14; S-113; T-21, 23
Attenuator Switch.....	P-73
Ballasts—Resistor Tubes.....	A-4, 6, 7, 12, 13, 19, 27, 32, 37; R-30, 76
Bar Generator.....	G-1, 32, 86, 107, 143; M-61; T-20
Beam Benders for CR Tubes (Ion Traps).....	C-6; J-54; R-36; T-17; U-57
B.O. Eliminators.....	U-57
Boosters, Pre-Amplifiers.....	D-10; S-113; T-3 to 7, 12, 15, 36
Broadcast Projectors, Equipment, etc.....	E-1
Cabinets.....	T-1
Calibrated Coil Kits.....	T-20; U-40
Cameras, Camera Tubes.....	E-1; A-5, 7
Capacitors.....	Section P
Changeover Antenna Switches.....	S-105; T-22, 23
Chassis Support for Servicing.....	U-58
Coils, Chokes.....	J-53 to 55, 57, 58; N-3, 4, 28, 77; T-13, 17, 18, 20; U-40
Commercial Eliminator.....	D-39
Controls—Volume, Focusing, etc.....	Section R; also T-16, 18
Conversion Kits for Larger Tubes.....	N-76
Converters, Inverters—Power.....	M-22 to 31, 38 to 40, 45 to 50, 65
Couplers—Antenna.....	C-1; J-54, 63, 85, 110, 113, 120; S-80, 110; T-5, 21, 22, 33, 35, 41; U-40
Detents, Detent Switches.....	U-57, 109
Escutcheon Plates.....	U-124
“Eye Opener” Standoff Tool.....	T-39
Field Strength Meters.....	G-32, 68, 131; S-93
Filters, Wave Traps, etc.....	J-54, 55, 57; N-81; P-27; S-85; T-7, 21, 33, 34, 35; U-40
Focus Coils.....	C-6; N-4, 78; T-17
Grid Caps, Clips—High Voltage.....	M-60; U-57, 73, 96, 108
Guy Wire Eye Bolts.....	U-117
I.F. Strips.....	J-18
Interlock Receptacles, Cords.....	S-25, 45, 61; U-57, 109, 126
Ion Traps.....	C-6; J-54; R-36; T-17; U-57
Iron Cores, Powdered.....	T-36
Kits, Chassis.....	B-26, 32 to 36
Knobs.....	U-61
Line Sealer, Acrylic.....	U-44
Loopsticks, etc.....	J-53, 55, 57; T-12; U-40, 57, 100, 150
Manuals.....	Section K
Masks.....	U-124
Master Antenna Distribution System.....	T-5
Mirrors for Adjusting TV Sets.....	U-57
Open Wire Transmission Line.....	S-66
Picture Centering Device.....	U-57
Picture Tube Coating Material.....	U-42, 109
Pin Cushions.....	U-57
Power Connector and Safety Cords.....	S-25, 45, 61; U-57, 109
Printed Circuits.....	P-24, 71 to 73, 95
Probes—High Voltage.....	G-10, 23, 30, 34, 72, 84, 95, 113, 139, 146; U-50, 139
Projector Equipment—Broadcast.....	E-1
Receiver Chassis.....	H-26, 32 to 34, 36
Remote Control.....	T-7
Resistors, Voltage Dividers.....	Section R
Retrace Line Eliminator.....	T-21
R.F. Attenuator Pad.....	S-113
Roll-Around Dolly.....	U-58, 110
Rotators, Antenna.....	S-86, 87, 117; T-14
Safety Cords—Cheaters.....	S-25, 45, 61; U-57, 109, 126
Service Lite.....	S-49
Speakers.....	Section C
Standoff Insulators, Clamps, etc.....	F-10; M-15; S-73, 94, 110, 115, 121; T-29, 32, 39
Testing Equipment, Sweep Generators, etc.....	Section G
Test Pattern Generator.....	U-40
Tool, Service Kits.....	F-3; T-1, 39; U-20, 22, 47 to 50, 58, 59, 88, 98, 137 to 139
Transformers.....	C-6; J-53 to 55, 58; N-1 to 4, 20, 26, 27, 28, 32 to 34, 75 to 78, 81, 96, 120, 121; T-13, 16, 17, 18
Transmission Line Clips.....	M-15; S-110; T-23, 41; U-57
Transmission Line Connectors.....	F-10; J-21; L-37; S-110; T-23; U-59, 108
Tube Brighteners.....	M-61; N-5, 78; T-20, 21, 36
Tube Extension.....	M-60; T-21; U-57
Tube Masks—Plastic.....	U-124
Tube Reactivator.....	S-98
Tube Testers—Cathode Ray.....	G-62, 83, 88, 93, 104, 145; T-21
Tube Sockets.....	F-23; M-60; S-45; U-126
Tubes—Camera.....	A-5, 7
Tubes—Color TV.....	A-9, 11
Tubes—Picture, Black and White.....	A-1, 3, 9, 11, 18, 19, 23, 27
Tuners.....	B-33; T-2, 3, 8, 9
Turnbuckles.....	S-110; T-32, 41; U-108, 117
Twin Lead 4-in-1 Tool.....	U-58
Twin Lead Wiring Nails & Connectors.....	F-10; L-37; S-110; T-23; U-95, 107
UHF Antenna Mast Adapter.....	U-110
UHF Antennas.....	F-12; S-74 to 120; T-33, 37, 38; U-105, 106
UHF Converters.....	D-10; T-2, 5, 6, 7, 10, 11, 15, 20
UHF Tuner.....	B-33
Voltage Regulators.....	M-52, 53, 56, 57, 60, 62, 63, 64; R-30; T-6; U-150

	Section & Page
Wall Plates—Antenna.....	F-13, 14, 16 to 21, 23, 36; T-22, 23; U-108
Wave Trap Meter.....	T-21
Wire and Cable.....	F-10; S-21, 28, 48, 51, 52, 58, 63, 64, 66, 116; T-6
Yoke Extension.....	T-21; U-57
Yokes—Deflection.....	N-1, 2, 7, 78, 120; T-13, 16, 18
Television Hardware Mfg. Co. (Telco).....	F-37 to 41
Telco, Inc.....	D-37
Telrex, Inc.....	S-74 to 77
Temperature Coefficient Capacitors.....	P-23, 91 to 93, 123
Temperature Indicators, Testers.....	G-14, 35, 98, 99
Terminal and Soldering Lugs.....	F-58, 59; S-41; U-21, 58, 71, 84, 87, 88, 89, 95, 114, 127, 147, 149
Terminal Plates Clips, Strips.....	U-54, 71, 84, 89, 96, 125, 147
Terminal Posts, Assemblies.....	F-35, 53, 58, 59, 60; J-25; U-86, 87
Terminal Strips—Barrier Type.....	F-45, 46; J-25; S-41; L-37; U-40
Test Adapters.....	L-37; M-14, 15; S-39, 40; U-40, 55, 79, 135
Test Clips.....	L-37; M-14, 15; S-39, 40; U-40, 55, 79, 135
Test Leads, Prods, Handles.....	F-29; G-34, 72, 84, 85, 113, 139, 146; S-40; U-40, 50, 52, 53, 80, 81, 83, 115, 140, 141
Test Lites.....	U-52
Test Prod Couplers.....	F-29
Test Prod Wire.....	S-7, 25, 34, 56, 59; U-53, 140
Test Records for Adjusting Pickups, etc.....	E-17, 25; U-100
Testing Instruments and Analyzers.....	Section G; also J-19, 29; M-34, 35; P-34; T-21, 24; U-40
Appliance Testers.....	G-21, 98
Audio Sweep Frequency Generator.....	E-17
Battery Testers, Meters.....	G-9, 13, 14, 37, 45, 93, 94, 96, 109, 144
Bench and Rack Units.....	G-8, 10
Capacitor Analyzers, Decades, Bridges.....	G-33, 70, 87, 113, 120; P-34
Capacitor Resistor Analyzers.....	G-33, 109; M-35; P-34
Carrying Cases.....	G-23
Color TV Test Equipment.....	G-1, 67, 80, 81, 138, 139, 148
Delay Line Standards.....	J-29, 30
Distortion Meters.....	G-121
Electronic Switches.....	G-85
Flyback Transformer and Yoke Testers.....	G-87, 144
Interstage Filter.....	G-121
Marker-Injector.....	G-139
Meter Testers.....	G-43, 130
Multimeters, Multitesters.....	G-43, 88, 95, 97, 103, 105 to 107, 109, 145, 147, 148
Neon Glow Testers.....	U-52
Noise Generator.....	G-67
Null “T” Filter.....	G-121
Oscillators, Signal Generators.....	Section G
Oscilloscope Probes.....	G-91, 139
Oscillographs, Oscilloscopes.....	G-1, 2, 3, 20, 31, 73 to 75, 81, 85, 91, 103, 108, 110, 136, 137, 138, 144; J-19, 28
Resistor Analyzers.....	G-87, 113; R-36, 50
Resistor Kit.....	G-43
Shock Testing Machine.....	U-111
Signal Tracers.....	G-87
Television Testers, Generators, etc.....	Section G; also T-21, 24
Temperature Testers.....	G-14, 35, 98, 99
Tube Testers, Checkers.....	G-14, 19, 33, 53, 60 to 63, 80, 82, 83, 88, 93, 94, 96, 103, 104, 109, 112, 138, 144, 145, 148; T-21
UHF Signal Gain Generator.....	T-11
Vibrator Analyzers, Testers.....	M-34
Wave Trap Meter—TV.....	T-21
Wide Band Amplifier.....	G-123
Test Switches.....	L-2, 3, 6; U-56
Tetrachloride Cleaning Fluids.....	U-43
Theater Speakers, Indoor and Outdoor.....	Section C
Thermo Ammeters.....	G-25, 49, 50, 76
Thermocouples.....	G-98
Thermostatic Delay Relays.....	L-43, 49, 52, 54
Thinner for Cement, Paint, etc.....	U-41, 42, 103
Thordarson-Meissner Division Maguire Industries.....	N-95 to 97
Thorns Company.....	E-27
Threaded Brass and Steel Rods.....	S-43; U-85
Thyatron (Rectifier Tubes).....	Section A
Time Delay Relays.....	L-43, 49, 52, 54
Timer Meters.....	G-42, 48, 55
Time Controls, Automatic.....	L-55
Time Switch—Automatic.....	L-39
Time Switches.....	L-39
Timers—Electronic.....	L-55, 59
Tip Jacks, Plugs.....	F-4, 33, 53; J-78; S-39, 40; U-76 to 78, 133, 134
Tire Static Neutralizing Kits.....	U-59
Titone Pickup Cartridges.....	E-22, 23
Toggle Switches.....	L-5, 16 to 19, 23 to 25, 32, 33, 38; S-31; U-56, 82, 107, 143
Tone Arms.....	Section D; Section E; also B-28; C-31
Tone Controls.....	Section R; also L-10, 35
Tone Equalizers—Pickup, Recording.....	B-12, 13, 30, 31, 35; E-1, 16, 19 to 21; N-111, 112
Tool Handle Switches.....	L-33
Tool Holders.....	U-116
Tool Holders, Belts, etc.....	U-39, 99
Tools and Tool Kits.....	Section U; also F-3; S-43
Neutralizing, Alignment.....	F-3; U-20, 22, 47 to 50, 58, 59, 88, 98, 137 to 139
Television.....	U-48 to 50, 58, 59, 98, 137 to 139
Toroidal Coils, Inductors.....	J-60, 61; N-20, 48 to 53, 108
Transcription Arms, Pickups.....	B-28; D-34; E-1, 16, 18, 21, 25
Transcription Players, Turntables.....	B-10, 15; E-2, 6, 7, 9, 10, 27

GENERAL INDEX (Continued)

	Section & Page		Section & Page
Transformers, Chokes, Reactors	Section N; also J-5, 24, 26, 52, 53 to 55; M-35; T-13	Tube Extractor Tools	A-29; U-50, 99, 135
Antenna Coupling, Matching	C-1; J-63; S-80, 105, 110, 111, 113, 119, 120; T-5, 21 to 23, 41	Tube Heat Radiating Connectors	A-29; J-52
Audio, Input, Output	Section N; also C-6, 37	Tube Manuals	K-4, 5, 8, 9, 11, 12
Auto Bias Supply	N-15, 113, 115	Tube Masks, Plastic, for TV	U-50, 99
Blocking Oscillator	M-53; N-3, 4, 20, 27, 28, 32, 56, 77, 121; T-13, 17, 18	Tube Pin Straightener Tools	U-124
Booster	N-4	Tube Shields	F-1, 31, 47, 48, 50, 51; J-22, 24, 25, 31, 72; U-85, 113, 126, 143
Bridging	N-18, 39, 100	Tube Sockets, Receiving	F-1, 2, 5, 30, 31, 33, 47, 48, 50 to 52, 56, 57; J-22, 24; U-54, 126, 142
Cathode Ray Tube	N-5, 16, 24, 78	Tube Sockets, TV and CR	F-2, 33; M-60; S-45; U-126
Condenser Tester Power	N-16	Tube Sockets, Transmitting, etc.	F-1, 33, 48, 51; J-22, 72, 73; S-43; U-142
Constant Voltage	M-52, 53, 56, 57, 62, 63	Tube Testers, Checkers	G-14, 19, 33, 53, 60 to 63, 80, 82, 83, 88, 93, 94, 96, 103, 104, 109, 112, 138, 144, 145, 148
Crystal Recorder Output	N-8	Tube Tester Roll Charts	G-62
Deflection Yokes	N-1, 27, 78, 120; T-13, 16, 18	Tubes	Section A; also U-15
Driver	N-6, 30, 32, 40, 47, 59, 78, 88, 91, 92, 95, 100, 113, 114	Cathode Ray	A-3, 4, 6, 7, 9, 11, 18, 19, 23, 27
Dry Disk Rectifier	N-25	Crystal Diodes, Germanium	A-1, 3, 8, 12, 13, 15, 20, 23
Filament	J-53; M-59; N-3, 4, 14, 19, 25, 35, 36, 40, 41, 62, 69, 75, 76, 84, 86, 89, 92, 94, 97, 102, 113, 115, 116	Geiger Counter	A-12, 13, 32
Filter, Audio, Swinging, Smoothing Chokes	Section N	High Altitude Device	A-5
Flyback, High Voltage	J-53; N-1, 77, 120; T-13, 16	High Vacuum Types	A-6, 7, 12, 13, 25, 29, 31, 32
High Fidelity Audio	N-5, 21, 37 to 39, 45 to 47, 54, 58, 59, 68, 88, 90, 99 to 106; J-53; N-1, 77, 81	Microwave, Radar, etc.	A-5, 13, 20, 27
High Impedance and Bridging to Line	N-100, 103, 104	Phototubes	A-5 to 7, 21, 25, 30
High Voltage	G-140	Receiving	A-1, 2, 3, 7, 8, 10, 16, 17, 22, 26; U-15
Hum Reducing	N-8	Rectifier and Control	A-4 to 7, 12, 13, 19, 21, 23, 25, 28 to 37
Interstage Audio	N-7, 17, 18, 30 to 32, 37, 39, 46, 57, 58, 70, 74, 90, 93 to 95, 100, 103, 104, 106, 112, 116, 118, 122	Special Purpose	A-1, 3, 4, 5 to 7, 12, 13, 17, 19, 21, 23, 27, 32, 35
Isolation	M-35; N-5, 16, 29, 35, 42 to 44, 63, 75, 80, 117	Subminiature	A-12, 13, 19, 23, 32
Intercommunication	N-7, 116	Television Camera	A-5, 7
Line	D-26; N-7, 40, 74, 78, 99 to 101, 103 to 106, 112, 114, 116, 122	Television Picture	A-1, 3, 9, 11, 18, 19, 23, 27
Magnetic Amplifier	H-22; N-55, 107	Transistors	A-1, 3, 8, 13, 14, 21, 23, 24
Miniature, Hearing Aid, etc.	N-105, 106, 118, 122, 123	Transmitting, Amateur	A-4 to 7, 12, 13, 19, 23, 25, 28, 33
Mixing	N-18, 46, 58, 59, 90, 100, 112	Voltage Regulator, Resistor	A-4, 6, 7, 12, 13, 19, 27, 32, 37; R-30, 76
Modulation	N-13, 30, 33, 40, 78, 79, 91, 93, 95, 96, 101, 113, 114	Tubing—Flexible, Varnished, Spaghetti, etc.	S-29, 30, 38, 45, 71; U-56, 104, 107, 146
Photoflash Power	N-16, 21, 80, 117	Tubing, Insulated—for Tool Handles	U-52, 97
Plate Supply	N-15, 23, 35, 41, 78, 79, 89, 91, 94, 97, 102, 115	Tubing—Vinyl	S-29, 30, 38, 45, 71; U-104, 107
Plate-Filament Combined	N-10, 19, 23, 26, 36, 41, 69, 86, 87, 94, 102, 115	Tubing—Polystyrene, Bakelite, Fibre	S-72; U-56, 146
Power	J-53; N-2, 3, 10, 11, 16, 23, 24, 26, 28, 34, 61, 62; N-65, 75, 76, 86, 89, 92, 96, 97, 102, 103, 113, 116; T-13, 16 to 18	Tubular Capacitors—Cardboard, Paper, Metal	Section P
Pre-amplifiers, VTVM, etc.	N-40	Tuner Kits—Crystal Diode, TRF	J-57
Pulse	G-137; M-53; N-20, 56, 94, 107	Tuner-Kleen'r Device	H-26
Reactors, Chokes—Audio	Section N	Tuners—FM, AM	B-1, 27, 29, 33; E-11; J-6, 57
Signalling and Control	N-117	Tuners—TV	B-33; T-2, 3, 8, 9
Saturable	N-55	Tung-Sol Electric, Inc.	A-16 to 18
Speaker Field Supply	N-12, 16	Tuning Belts	U-47
Speaker Impedance Matching	C-44; N-37, 38, 39, 58, 93, 101, 112, 114	Tuning Dials	J-19, 21; U-124, 129
Step-down, Step-up	N-16, 28, 44, 63, 80, 117, 121	Tuning Units, Assemblies	J-12, 15, 66, 76
Television	C-6; J-53 to 55, 58; N-1 to 4, 20, 26 to 28, 32 to 34, 75 to 78, 81, 96, 120, 121; T-13, 16 to 18	Tuning Wands	U-98, 138
Television Booster	N-30	Turbo Wire Products	S-28 to 30
Transceiver	N-7, 30	Turnbuckles for Guy Wires	S-110; T-32, 41; U-108, 117
Transistor	N-53, 88, 106, 118, 122, 123	Turner Company	D-16 to 20
Tube Checker	N-14	Turntable Felts	U-47, 100
Variable Matching Line to Voice Coil	N-112	Turntable Repair Stand	U-58
Variable Output	N-112	Turntables and Motors, Phono, Recording	E-3, 6, 9, 10, 27, 29, 30 to 37
Variable Voltage	M-54, 55, 57; N-42, 43, 113, 117	Turret Assemblies for Band-Switching	J-64
Vibrator—Power and Auto Radio	N-11, 28, 29, 77, 80, 96	Turret Sockets and Assemblies	F-48, 52, 56, 57
Voltage Adjuster, Control	M-35; N-42 to 44, 78, 117; T-7	Tweezer Speakers and Units	C-5, 9, 15, 22, 30, 34, 37, 38, 44
Voltage Booster—Line	N-117, 121	Tweezers and Tweezer Kits	U-52, 97
Transistor Kit	G-12	Twin Lead Wire for TV and FM	F-10; S-21, 28, 48, 51, 52, 58, 63, 64, 66, 116; T-6
Transistors—Junction, Point Contact	A-1, 3, 8, 13, 14, 21, 22, 24; H-27	Twin Lead Wiring Nails, Connectors	F-10; J-21; L-37; S-110; T-23; U-56, 107
Diffused, PNP, etc.	F-10; S-1, 6, 21 to 23, 25, 28, 36, 48, 51, 52, 58, 63, 66, 70, 116		
Transmission Line, Cable	F-10; J-2, 1; L-37		
Transmission Line Plugs, Sockets, Connectors	S-110; T-23; U-59, 108		
Transmitters	J-7 to 12, 20, 27, 62 to 64		
Kits	B-36, 37; J-62 to 64, 111		
Metal Racks, etc.	J-42, 43, 48, 84, 90 to 92, 94, 95, 100 to 102, 108, 110		
Power, Speech Amplifiers	J-6, 7, 9		
Power Supplies	J-6, 10, 27, 64		
Variable Frequency Oscillators, VFO	J-7, 11, 20, 62, 63		
Transmitting Capacitors, Fixed	P-9, 10, 29, 33, 38, 39, 63, 76, 88, 89, 112, 117, 118		
Transmitting Capacitors, Variable	J-16, 17, 23, 36 to 38, 50, 69 to 71		
Transmitting Chokes	J-5, 24, 26, 52, 56, 76; N-84, 85; P-8; R-56; U-144		
Transmitting Coils and Forms	F-9; J-4, 24, 26, 52 to 56, 58, 59; U-144		
Transmitting Relays	J-65; L-43, 48 to 50		
Transmitting Tubes	A-4 to 7, 12, 13, 19, 23, 25, 28, 33		
TRF Tuner Kit—Crystal Diode	J-57		
Triad Transformer Corp.	N-17 to 31		
Trimm, Inc.	D-38, 39; L-42		
Trimmer Capacitors	J-15, 36 to 39, 68; P-7, 25, 40 to 42, 76, 97; U-144		
Trimout Fasteners, Snap-in	U-62, 70, 94		
Triplett Electrical Instrument Co.	G-15 to 26		
Trumpets and Horns	Section C		
Tru-Ohm Div. Model Eng. & Mfg. Co.	R-68, 69		
Tru-Sonic Speakers	C-14, 15		
Tube Carrying Cases, "Caddies"	T-1		
Tube Checker Adapters	A-13; F-5, 56		
Tube Clips, Caps, Grips	F-5, 35; J-4, 22, 35; M-60; S-42, T-31; U-57, 73, 96, 108, 114, 146		

GENERAL INDEX (Continued)

	Section & Page
Variable Transmitting Capacitors	J-16, 17, 23, 36 to 38, 50, 69 to 71
Variable Voltage Transformers	M-54, 55, 57; N-42, 43, 113, 117
Varicon Miniature Connectors	F-49
Varnished Tubing, Spaghetti, etc.	S-29, 30, 38, 45, 71; U-56, 104, 107, 146
Varnishes, Lacquers, Paints, Enamels	U-41 to 46, 101 to 103, 109
Vector Electronic Co.	F-56, 57
Velocity Microphones	D-18, 21
Ventilating Louvres, Chrome	J-89
Vernier Dials	J-5, 19, 21, 74; U-124, 129
VFO Oscillators	J-7, 11, 20, 62, 63
Vibrapak Power Supplies	M-32
Vibrating Reed Frequency Meters	G-48, 100, 101
Vibration Isolators	F-34
Vibration Pickups, Microphones	D-21, 26, 35
Vibrator Analyzers, Testers	M-34, 39
Vibrator Buffer Capacitors, Auto	P-5, 31, 49, 74, 111, 120, 121
Vibrator Power Supplies, Packs	M-32, 45
Vibrator Transformers, Power and Auto Radio	N-11, 28, 29, 34, 77, 80, 96
Vibrators	M-16 to 21, 32, 36, 37, 41 to 44
Vibromike	D-35
Vibroplex Co., Inc.	J-82
Vidair Electronics Mfg. Co.	T-21
Video Generator	G-67
Video Multimarker	G-1
Viking Loudspeakers	C-42
Viking Transmitter	J-62 to 64
Vinyl Insulating Tape, Colored	U-119
V-M Corporation	E-28
Voice Coil Dust Felts	U-74
Voice Coil Lead Wire	S-25
Volometer Meters	G-107
Voltage Adapters, Foreign, Export	S-57
Voltage Booster Transformer	N-117; T-7, 36
Voltage Dividers, Resistors	Section R; also J-40, 41
Voltage Reducer Cord Sets	S-57
Voltage Regulator Transformers, Controls	M-35, 62 to 57, 60, 62 to 64; N-78, 113, 117; T-6; U-150
Voltage Regulator Tubes (Ballasts)	A-4, 6, 7, 12, 13, 19, 27, 32, 37; R-30, 76
Voltage Stabilizers and Regulators, Electronic	G-124; M-52, 53, 56, 57, 62 to 64; R-76
Voltage Testers	G-31, 72, 85, 89, 103; U-52
Voltage Transformers, Constant	M-52, 53, 56, 57, 62, 63
Voltage Transformers, Variable	M-54, 55, 57; N-42, 43, 113, 117
Voltmeters, Voltmeters	Section G
Volt-Ohm Micrometer	G-28
Volt-Ohm Milliammeters	G-7, 8, 12, 13, 15 to 18, 27, 28, 30, 34, 51, 53, 54, 70, 71, 88, 105 to 107
Voltmysts	G-7, 8
Volume and Tone Controls	Section R
Volume Control Hardware, Accessories	R-2, 5, 13 to 16, 30; S-42; U-88, 94
Volume Control Wrenches	R-5
Volume Level Indicators	G-26, 38, 50, 55
Vulean Electric Co.	U-10, 11
VU Meter	G-26, 38, 50, 55

— W —

Wafer Sockets	F-30, 31, 52; J-73; U-54, 126, 142
Wako Products, Inc. (Electrovox Co.)	E-50 to 52
Waldom Electronics, Inc. (Croname Products)	S-119; U-124 to 127
Wall Plates, Receptacles	F-13, 14, 16 to 21, 23, 36; T-22, 23; U-108
Wall Racks for Hardware, Chemicals, etc.	U-62, 97
Walseo Electronics Corp.	U-90 to 110
Ward Leonard Electric Co.	R-37 to 39
Ward Products Corporation	S-78 to 82
Washers, Nuts, Bolts, Screws	F-60; J-5; L-9; S-42, 43; U-60 to 69, 88, 90 to 94, 127, 148, 149
Wasseo Electric Products Corp.	U-14
Waterman Products Co., Inc.	G-136, 137
Wattmeters	G-21, 26, 35, 38, 50, 72, 77
Wave Meters	J-33
Wave Traps	J-55; N-81; T-21
Waveforms, Inc.	G-142
Webster Electric Company	E-26
Webster Manufacturing Co.	S-111
Weller Electric Corporation	U-9
Westinghouse Electric Corporation	A-24 to 27
Weston Electrical Instrument Corp.	G-49 to 54
Wet Electrolytic Capacitor Replacements	P-4 to 6, 83
Wharfedale Speakers	E-29
Wheatstone Bridges	G-133; R-50
Wheel & Hub Static Eliminators, Auto	S-108; U-59
White Band Oscilloscope	G-1
Wileox-Gay Corporation (Recordio)	E-12 to 14
Winch—Antenna Guy Wire	S-123
Window Antennas	S-105, 109; T-37
Wing Nuts	S-42; U-67, 94
Wire and Cable	Section S; also F-9; L-30; T-28; U-57, 108
Aircraft Cable	S-13, 26, 32, 36, 68, 69
Antenna Wire and Cable	S-14, 25, 37, 38, 59, 62, 106

	Section & Page
Antenna Wire for AC-DC Sets	S-14, 25; U-57
Army-Navy, MIL, JAN-Spec., etc.	F-9; S-10 to 13, 21, 22, 28, 29, 32, 33, 50, 68, 69, 71
Auto Radio Wire and Cable	S-1, 3, 6, 8, 13, 26, 36, 54
Battery Cable	S-7, 54
Broadcast Audio Cable	S-1, 20, 70
Bus-Bar Wire (Solid Tinned Copper)	S-14, 25, 37
Cathode Ray Tube Cable	S-7, 13, 25, 33, 54, 61
Coaxial Cable, RG, etc.	F-9; S-7, 21 to 23, 28, 34, 58, 63, 64, 71
Copper Aerial Wire, Bare	S-14, 25, 37, 56, 59
Dial Cable, Cords	S-14, 38
Diathermy Cable	S-17, 35
Electrical Extension Cords, Sets	L-30; S-7, 61
End Seal for Tubular Twin Lead	F-10
Fixture Wire, Lamp Cords	S-6, 14, 35, 36, 57, 60, 61
General Purpose Wire Assortment	S-15, 24, 34, 48
Guy Wire	S-49, 62, 64, 65, 123; T-28; U-108
Headphone Cords	D-39; S-45
High Voltage Wire	S-7, 13, 25, 26, 33, 34, 36, 54, 61
Hookup, Pushback Wire	S-6 to 13, 23 to 30, 32 to 34, 46, 50, 55, 59, 60, 68
Ignition Cable, Shielded	S-8, 13, 26
Indoor Aerial Wire	S-14, 25
Intercom System Cable	S-1, 4 to 6, 18, 19, 36, 48, 49, 52 to 54, 59, 37
Lead Covered Intercom, PA Cable	S-5, 52
Lead-in and Ground Wire	S-6, 8, 9, 25, 49, 59, 62, 66, 106; U-108
Litz Wire	S-25
Magnet Wire	S-26, 37, 55
Microphone Cable	S-2, 17, 35, 48, 53, 58, 64, 70
Multiple-Conductor Cable	S-1, 2, 4 to 6, 17 to 20, 35, 36, 48, 49, 53, 54, 59, 70, 71
P.A. Wire and Cable	S-1, 3, 5, 6, 18 to 20, 36, 53
Phono Pickup and Grid Wire, Shielded	S-3, 23, 86, 53, 61; U-53
Phono System Cable	S-54
Phosphor Bronze Aerial Wire & Dial Cable	S-14, 38, 54; U-51
Photo Electric Cell Cable	S-1, 3, 23, 36
Recording Wire, Stainless Steel	E-42, 53; U-58
Remote Control Cable	S-4
Resistance Cords, AC-DC	S-45, 57
Rotator TV-FM Cable	S-20, 28, 49, 51, 58; T-23
Service Cord—Rubber Sheathed, etc.	S-6, 14, 25, 35, 36, 45, 57, 60, 61
Shielded Wire and Cable	S-1 to 3, 8, 9, 11, 17, 18, 20 to 22, 24 to 26, 35, 36, 52 to 54, 70
Shielding—Copper, Braid	S-8, 26, 36, 59
Sound System Cable	S-1, 3, 5, 6, 18 to 20, 36, 53
Speaker Cable	S-1, 3, 4, 6, 35, 36, 45, 49, 53, 54
Speaker Extension Cords	S-45
Test Prod Wire	S-7, 25, 34, 56, 59; U-53, 140
Transmission Line, Cable	F-10; S-1, 6, 21 to 23, 25, 28, 36, 48, 51, 52, 58, 63, 66, 70, 116
Tubing, Spaghetti, etc.	S-29, 30, 38, 45, 71; U-56, 104, 107
Twin-Lead, for TV and FM	F-10; S-21, 28, 48, 51, 52, 58, 63, 64, 66, 116; T-6
Twinnax	F-9
Varnished Cambric, Shielded	S-34
Voice Coil Lead Wire	S-25
Wire Connectors	U-119
Wireless Intercom System	B-22
Wire Measuring and Winding Outfits	S-38
Wire Recording Heads	D-6
Wire Recording Wire	E-42, 53; U-58
Wire Spring Clips (Fahnestock)	S-43; U-55, 70, 85
Wire Stripping Tools and Pliers	U-50, 52, 58, 97
Wire Wound Resistors	Section R
Wiring Nails, Insulated, Twin Lead	U-95, 107
Wiring Systems, Packaged—for Work Benches	U-38
Wirt Co.	R-74, 75
Wood Glue	U-41, 101
Woofer Speakers and Units	C-15, 21, 30, 37, 38, 44
Workman T.V., Inc.	T-36
Worner Electronic Devices	L-56, 57
Wrenches	
Hex, Key, Spline, Socket	U-20, 59, 60, 80
Neutralizing, Alignment	F-3; U-47 to 50, 58, 59, 88, 98, 137 to 139
Nut	U-19, 20, 24, 31, 135, 136
Steel	U-25, 28
Volume Control	R-5
Wright, Inc.	C-39
Wrinkle Varnish	U-43, 103

— X —

Xcelite, Inc. (formerly Park Metalware Co.)	U-22 to 25
---	------------

— Y —

Yard-Ohm Resistance Kits	R-5
--------------------------	-----

Thank You!

When writing for additional
information or when ordering
from sources of supply listed
in this book, please mention

RADIO'S MASTER

G. E. ELECTRONIC TUBES—RECEIVING TYPES (Cont.)

Type	List Price	Type	List Price	Type	List Price	Type	List Price	Type	List Price	Type	List Price
14B8	\$2.20	25D8GT	\$4.80	36	\$2.75	56S	\$3.55	117Z4GT	\$2.90	42N44	\$15.85
14C5	2.90	*25L6	3.20	37	1.85	57	2.10	117Z6GT	2.95	42N45	11.90
14C7	2.40	25L6G	2.00	38	2.30	57AS	3.55	FM-1000	3.20	⊗G6	3.75
14E6	2.90	25L6GT	1.90	39/44	2.75	57S	3.55	GERMANIUM PRODUCTS			
14E7	3.20	25N6G	4.80	40	2.40	58	2.10				
14F7	2.45	25W4GT	2.05	40Z5	1.65	58AS	3.55				
14F8	3.25	25W6GT	2.55	41	2.00	58S	3.55				
14H7	2.40	25Y5	3.00	42	2.00	59	3.70				
14J7	3.50	25Z5	1.80	43	2.05	70A7GT	3.55				
14N7	2.65	*25Z6	2.20	45	2.20	70L7GT	6.60				
14Q7	2.60	25Z6G	1.50	45Z3	1.80	71A	2.50				
14R7	3.35	25Z6GT	1.95	45Z5GT	1.80	75	2.00				
14S7	3.25	26	2.25	46	3.00	75S	3.55				
14W7	3.35	27	1.80	46A1	2.00	76	1.70				
14X7	2.65	27S	3.55	46B1	2.00	77	2.20				
14Y4	2.40	30	2.25	47	3.00	78	2.20				
15	3.20	31	2.75	48	4.80	79	2.75				
18	2.90	32	3.70	49	2.75	80	1.55				
19	3.35	32L7GT	3.20	50	5.15	81	4.80				
19BG6G	6.00	33	3.35	50A5	2.20	82	2.75				
19J6	2.65	34	3.50	50B5	2.05	83	2.85				
19T8	3.10	35/51	2.35	50C5	2.05	83V	3.20				
20	4.80	35A5	2.20	50C6G	3.30	84/6Z4	1.80				
22	3.20	35B5	2.05	50L6GT	1.90	85	2.30				
24A	2.70	35C5	2.05	50X6	2.20	85AS	3.55				
24S	3.55	35L6G	2.00	50Y6G	1.80	89	2.30				
*25A6	3.40	35L6GT	1.90	50Y6GT	2.15	99V	3.55				
25A6G	2.75	35S/51S	3.55	50Y7GT	2.10	99X	3.55				
25A6GT	2.90	35W4	1.35	50Z7G	2.00	100-70	2.00				
25AC5G	4.80	35Y4	1.80	52	4.80	100-77	2.00				
25AC5GT	2.90	35Z3	1.80	53	2.65	100-79	2.00				
25A5GT	3.60	35Z4GT	1.50	55	2.30	117L/M7GT	6.60				
25BK5	2.75	35Z5G	2.00	55S	3.55	117N7GT	4.80				
25BQ6GA	3.90	35Z5GT	1.40	56	1.90	117P7GT	4.80				
25BQ6GT	3.90	35Z6G	2.65	56AS	3.55	117Z3	1.80				
								11N48	\$1.10	⊗G7A	1.67
								11N48MP	4.12	⊗G7B	2.00
								11N51	.85	⊗G7C	2.00
								11N52	2.34	⊗G7D	4.00
								11N52MP	7.35	⊗G7E	4.00
								11N63	5.11	⊗G7F	2.00
								11N63MP	12.70	⊗G7G	2.00
								11N64	.78	⊗G10A	3.25
								11N65	1.11	⊗G10B	4.85
								11N69	1.50	⊗G10C	6.50
								11N69MP	5.70	⊗G11	29.00
								11N70	4.00	⊗G11A	29.00
								11N72	1.67	SELENIUM RECTIFIERS	
								11N73	27.00	6RS5GH1A	\$1.60
								11N74	20.60	6RS5GH2	1.60
								11N75	4.45	SPECIAL TYPES	
								11N75MP	11.75	With Industrial Applications	Sugg. User Price
								11N81	3.25	*OZ4A	\$1.20
								*11N91	2.69	6A57G	6.75
								*11N92	4.75	6K4	2.85
								*11N93	6.35	7F8-TV	4.00
								11N94	8.80	25A7GT	5.50
								*11N151	4.30	25B8GT	4.95
								*11N152	6.35	28D7	2.75
								*11N153	7.95		
								*11N158	11.90		
								42N43	23.75		

*Metal types. †Welded Germanium Diodes. ‡Welded Germanium Quads. §Germanium Transistors. ¶Power Rectifiers.
 ‡Matched pair. ⊗UMF Germanium Diodes. †Junction Transistors. *Diffused Junction Rectifiers.

GENERAL ELECTRIC TELEVISION PICTURE TUBES

Type	List Price	Description		Type	List Price	Description	
		Envelope	Faceplate			Envelope	Faceplate
45TP4	\$60.00	Round, Glass	Clear	19AP4-A	\$58.75	Round, Metal	Filter
†7JP4	26.00	Round, Glass	Clear	19AP4-B	58.75	Round, Metal	Filter, Etched
8AP4-A	24.20	Round, Metal	Filter	20CP4	51.25	Rectangular, Glass	Filter
10BP4-A	27.50	Round, Glass	Filter	20CP4-A	51.25	Rectangular, Glass	Filter
10FP4-A	34.85	Round, Glass	Filter, Aluminized	20DP4-A	51.50	Rectangular, Glass	Filter
12KP4-A	39.40	Round, Glass	Filter, Aluminized	*20HP4-A/20LP4	53.00	Rectangular, Glass	Filter
12LP4-A	32.40	Round, Glass	Filter	21ACP4	50.00	Rectangular, Glass	Filter, 90° Sweep
12UP4-B	40.35	Round, Metal	Filter, Etched	21ACP4-A	54.00	Rectangular, Glass	Filter, Aluminized 90° Sweep
14CP4	34.85	Rectangular, Glass	Filter	21AP4	60.75	Rectangular, Metal	Filter, Etched
16AP4-A	45.75	Round, Metal	Filter	21ARP4	50.50	Rectangular, Glass	Filter, Spherical Face
16DP4-A	51.00	Rectangular, Glass	Filter	21ARP4-A	55.00	Rectangular, Glass	Filter, Aluminized Spherical Face
16GP4	45.75	Round, Metal	Filter	21EP4-A	55.00	Rectangular, Glass	Filter, Cylindrical Face
16GP4-B	45.75	Round, Metal	Filter, Etched	21EP4-B	60.75	Rectangular, Glass	Filter, Aluminized Cylindrical Face
16KP4	37.60	Rectangular, Glass	Filter	*21FP4-A	56.75	Rectangular, Glass	Filter, Cylindrical Face
16KPA-A	43.00	Rectangular, Glass	Filter	21JP4	59.50	Rectangular, Glass	Filter, Cylindrical Face
16LP4-A	40.00	Round, Glass	Filter	*21MP4	64.25	Rectangular, Metal	Filter, Etched
16RP4	37.60	Rectangular, Glass	Filter, Spherical	*21XP4-A	47.00	Rectangular, Glass	Filter
16TP4	37.60	Rectangular, Glass	Filter	*21YP4	55.00	Rectangular, Glass	Filter, Aluminized
16WP4-A	40.00	Round, Glass	Filter	*21YP4-A	60.75	Rectangular, Glass	Filter, Aluminized
17BP4-A	36.25	Rectangular, Glass	Filter	21ZP4-A	53.25	Rectangular, Glass	Filter
17BP4-B	43.50	Rectangular, Glass	Filter, Aluminized	21ZP4-B	57.25	Rectangular, Glass	Filter, Aluminized
17CP4	41.25	Rectangular, Metal	Filter, Etched	24AP4	121.00	Round, Metal	Filter
*17FP4-A	38.50	Rectangular, Glass	Filter	24CP4-A	84.25	Rectangular, Glass	Filter, Aluminized
*17GP4	50.25	Rectangular, Metal	Filter, Etched	24TP4	95.00	Rectangular, Glass	Filter, Aluminized
17MP4	39.25	Rectangular, Glass	Filter	27EP4	122.25	Rectangular, Glass	Filter, Aluminized
17QP4	36.25	Rectangular, Glass	Filter, Cylindrical Face	27RP4	122.25	Rectangular, Glass	Filter, Aluminized
*17RP4/17HP4	37.50	Rectangular, Glass	Filter				
*17VP4/17LP4	37.50	Rectangular, Glass	Filter, Cylindrical Face				

†Projection Type. *Electrostatic Focus. ‡Electrostatic Focus and Deflection. All unmarked types Electromagnetic Focus.

Prices and other data subject to change without notice.

There's a G-E Electronic Tube for Every Purpose:

<ul style="list-style-type: none"> • Pilotrons • Ignitrons • Phasitron • Glow Tubes • Thyratrons • Phototubes 	<ul style="list-style-type: none"> • Ballast Tubes • High Altitude Devices • Phanotrons • Lighthouse Tubes • Cathode-Ray Tubes 	<ul style="list-style-type: none"> • Microwave Radar Devices • Kenotrons • TV Camera Tubes • Kon-Nec-Tor Mercury Switches
---	---	---

Ask for—ETX-10
For complete Prices, Descriptions and Ratings.



INDUSTRIAL AND TRANSMITTING TYPES

BALLAST TUBES

Type No.	Sugg. User Price
GL-5620/FB-50	\$14.50
GL-5621/B-6	13.50
GL-5622/B-25	12.50
GL-5623/B-47	13.50
GL-5624/B-46	13.50

GLOW TUBES

Type No.	Sugg. User Price
GL-OA2	\$ 2.90
GL-OA3	2.65
GL-OB2	3.20
GL-OB3	1.20
GL-OC3	2.65
GL-OD3	2.65
GL-874	3.10
GL-5651	2.30

THYRATRONS

Type No.	Sugg. User Price
GL-CIJ	\$ 8.69
GL-2D21	2.00
GL-3C23	12.50
FG-27-A	26.00
FG-81-A	16.00
FG-97	25.00
FG-98-A	27.00
FG-105	48.00
FG-154	47.50
FG-172	65.00
GL-393-A	13.25
GL-414	120.00
GL-502-A	1.85
GL-627	22.00
GL-672-A	35.00
GL-678	47.00
GL-884	1.85
GL-885	2.00
GL-2050	1.85
GL-5544	27.00
GL-5545	35.00
GL-5557/FG-17	8.50
GL-5559/FG-57	19.50
GL-5560/FG-95	28.00
GL-5632	12.15
GL-5662	3.20
GL-5663	1.90
GL-5720/FG-33	23.00
GL-5728/FG-67	26.00
GL-5830/FG-41	200.00
GL-5855	70.00
GL-6011	13.00
GL-6044	56.00
GL-6130	18.00

IGNITRONS

Type No.	Sugg. User Price
GL-5550/GL-415	\$50.00
GL-5551/FG-271	72.00
GL-5552/FG-235-A	110.00
GL-5553/FG-258-A	240.00
GL-5554/FG-259-B	171.50
GL-5555/FG-238-B	333.50
GL-5564/GL-507	870.00
GL-5630	1,000.00
GL-5779	80.00
GL-5822	130.00
GL-6228/GL-506	3300.00

CATHODE-RAY TUBES

Type No.	Sugg. User Price
GL-2AP1-A	\$10.55
GL-2BP1	9.60
GL-3AP1-A	14.25
GL-3BP1-A	16.50
GL-3KP1	14.50
GL-3MP1	22.50
GL-3UP1	27.00
GL-5BP1-A	22.50
GL-5CP1-A	23.25
GL-5CP7-A	27.25
GL-5FP7-A	30.00
GL-5FP14	30.25
GL-5QP4	49.50
GL-5UP1	17.75
GL-7BP7-A	48.50
GL-7UP7	49.50
GL-10KP7	50.00
GL-12DP7A	72.50
GL-12SP7	47.40
GL-12SP7B	68.00
GL-17ADP7	160.00
GL-914-A	93.50

PLIOTRONS

Type No.	Sugg. User Price
GL-2C39-A	\$24.00
GL-2C40	24.00
GL-2C42	21.50
GL-2C43	21.50
GL-2C46	22.00
GL-2E24	4.65
GL-2E26	3.85
GL-2E30	2.60
3X2500A3	198.00
GL-4C21	15.75
GL-4D21/4-125A	30.25
GL-4X150A	48.00
GL-4-250A/5D22	41.25
4-1000A	132.00
GL-5C24	45.00
GL-7C29	130.00
GL-7D21	320.00
GL-8D21	1,300.00
GL-9C24	570.00
GL-12AY7	3.00
GL-35T	10.50
GL-100TH	18.25
GL-146	27.00
GL-152	30.00
GL-159	160.00
GL-169	135.00
GL-203-A	13.75
GL-207	240.00
GL-211	13.75
GL-242-C	15.50
FP-265	40.00
FP-285	22.00
GL-473	165.00
GL-592	30.25
GL-800	11.50
GL-801-A	4.85
GL-802	4.75
GL-803	24.25
GL-805	13.50
GL-806	34.25
GL-807	2.50
GL-809	4.00
GL-810	16.25

PLIOTRONS (Cont'd)

Type No.	Sugg. User Price
GL-811-A	\$ 5.00
GL-812-A	5.00
GL-813	18.00
GL-814	14.25
GL-815	8.20
GL-826	12.50
GL-828	13.75
GL-829-B	16.25
GL-830-B	11.50
GL-832-A	12.90
GL-833-A	49.50
GL-835	19.50
GL-837	5.80
GL-838	13.75
GL-842	4.05
GL-843	2.60
GL-845	13.75
GL-849	138.00
GL-851	340.00
GL-862-A	1,322.00
GL-880	510.00
GL-880-A	210.00
GL-891	237.00
GL-892	237.00
GL-893-A	664.00
GL-895	950.00
GL-898-A	1,322.00
GL-954	5.65
GL-955	3.60
GL-956	7.00
GL-957	3.75
GL-1000-T	137.50
GL-1612	2.70
GL-1613	2.45
GL-1614	2.00
GL-1619	2.50
GL-1620	6.25
GL-1621	1.95
GL-1622	2.50
GL-1623	4.05
GL-1624	4.00
GL-1625	2.65
GL-1629	1.40
GL-1633	1.95
GL-5513	275.00
GL-5516	7.95
GL-5518	525.00
GL-5549	370.00
GL-5556/PJ-8	13.50
GL-5588	120.00
GL-5610	2.25
GL-5674	100.00
GL-5680	214.00
GL-5681	1780.00
GL-5687	6.00
GL-5691	9.50
GL-5692	9.75
GL-5693	7.75
GL-5739/FP-62	49.50
GL-5740/FP-54	88.00
GL-5742/PJ-7	14.50
GL-5743/PJ-21	14.00
GL-5751	3.35
GL-5763	1.75
GL-5797	13.50
GL-5824	3.35
GL-5844	2.25
GL-5879	1.75



INDUSTRIAL AND TRANSMITTING TYPES

PILOTRONS (Cont'd)

Type No.	Sugg. User Price
GL-5894A	\$19.00
GL-5963	1.40
GL-6017	340.00
GL-6019	620.00
GL-6039	620.00
GL-6136	2.20
GL-6137	2.20
GL-6146	4.90
GL-6159	4.90
GL-6166	905.00
GL-6183	680.00
GL-6201	4.15
GL-8000	14.50
GL-8002	160.00
GL-8002-R	190.00
GL-8005	8.40
GL-8025-A	11.30
GL-9001	3.40
GL-9002	2.50
GL-9003	3.40

KENOTRONS

KC-1	\$350.00
GL-2B22	21.00
GL-2B23	23.50
2X2-A	2.17
KC-3	350.00
GL-3B24-W	11.75
5R4-CY	2.20
GL-217-C	21.17
GL-218	225.00
FP-400	41.20
GL-411	250.00
GL-836	9.00
GL-1616	8.65
GL-5625/KC-4	225.00
GL-5741/FP-85-A	85.00
GL-5973	310.00
GL-6215	3.00
GL-8013-A	10.30
GL-8020	24.00

TELEVISION CAMERA TUBES

GL-1850-A	\$ 540.00
GL-5820	1,200.00
GL-5826	1,300.00

PHANOTRONS

GL-4B32	\$ 12.00
FG-166	160.00
GL-266-B	218.50
FG-280	62.00
GL-575-A	21.00
GL-673	21.00
GL-816	1.65
GL-857-B	218.50
GL-866-A	2.10
GL-869-B	138.00
GL-870-A	1,475.00
GL-872-A/872	8.20
GL-5558/FG-32	15.50
GL-5561/FG-104	40.00
GL-8008	8.20

MICROWAVE RADAR DEVICES

GL-1B24-A	\$43.00
GL-1B35-A	11.10
GL-1B37A	15.00
GL-1B38	50.00

MICROWAVE (Cont'd)

Type No.	Sugg. User Price
GL-1B44	\$38.00
GL-1B56	38.00
GL-1B63-A	43.00
GL-1Q26	85.00
GL-1Q26-A	93.00
GL-5921	40.00
GL-5922	40.00

PHOTOTUBES

GL-1P21	\$50.00
GL-1P29/FJ-401	2.95
GL-1P37	2.85
GL-1P39	1.75
GL-1P40	1.95
PJ-22	2.50
GL-441	4.50
GL-868/PJ-23	2.50
GL-917	3.50
GL-918	3.10
GL-919	3.50
GL-920	4.15
GL-921	2.05
GL-922	1.95
GL-923	2.05
GL-927	2.50
GL-929	1.50
GL-930	1.65
GL-931-A	8.60
GL-935	7.80
GL-5581	2.25

PHASITRONS

GL-2H21	\$100.00
GL-5593	87.50

HIGH-ALTITUDE DEVICES

GL-1L21	\$14.00
GL-1L22	29.00
GL-1L23	29.00
GL-1L24	49.50
GL-1L25	15.75
GL-1L31	15.75
GL-1L32	14.00
GL-1L33	34.00
GL-1L36	14.00
GL-1L38	25.00
GL-5626/FA-15	22.50
GL-5627/FA-6	27.00

VACUUM GAGES

GL-5628/FA-13	\$26.00
GL-5629/FA-14	21.00

RADIATOR-TYPE FORCED-AIR-COOLED TUBES

Type No.	List Price
GL-889R-A	\$295.00
GL-891R	385.00
GL-892R	385.00
GL-893A-R	1212.00
GL-895R	1300.00

5-STAR TUBES

Type No.	Conventional	Prototype	List Price
GL-5654	6AK5		\$ 3.00
GL-5670	*2C51		9.85
GL-5686			3.30
GL-5718			5.95

5-STAR TUBES (Cont'd)

Type No.	Sugg. User Price	
GL-5719	\$5.85	
GL-5725	6AS6 3.25	
GL-5726	6AL5 1.45	
GL-5727	2D21 2.70	
GL-5749	6BA6 2.00	
GL-5750	6BE6 2.50	
GL-5751	*12AX7 3.35	
GL-5797		13.50
GL-5798		17.45
GL-5814A	*12AU7 3.25	
GL-5840		8.85
GL-5896		7.25
GL-5899		8.90
GL-5902		9.00
GL-6005	6AQ5 3.55	
GL-6021		9.10
GL-6072	*12AY7 4.55	
GL-6087	5Y3GT 5.25	
GL-6111		9.00
GL-6112		9.40
GL-6134	6AC7 5.45	
GL-6135	*6C4 1.90	
GL-6136	6AU6 2.20	
GL-6137	6SK7 2.20	
GL-6201	12AT7 4.15	
GL-6202	6K4 3.17	
GL-6203		3.97

KON-NEC-TOR MERCURY SWITCHES

Type No.	List Price
1-1KR0	\$2.60
1-1KR1	3.05
1-2KR0	2.60
1-2KR1	2.85
1-15KR0	1.40
1-15KR1	1.70
2-25KR0	1.75
2-25KR1	2.00
2-33KR0	1.35
2-33KR1	1.50
2-36KR0	4.20
2-36KR1	4.80
2-52KR0	.25
2-52KR1	.35
4-2KR1	2.60
4-19KR0	2.75
4-19KR1	3.25
4-21KR0	2.00
4-21KR1	2.40
4-24KR0	4.00
4-24KR1	9.30
4-40KR0	2.25
4-40KR1	2.75
7-19KR0	3.25
7-19KR1	3.75
7-21KR0	2.40
7-21KR1	2.90
7-24KR0	4.50
7-24KR1	5.00

MOUNTINGS

Type No.	List Price
4838	\$0.03
4839	.03
6601	.06
6602	.06

RCA ELECTRON TUBES REPLACEMENT DIRECTORY

for INDUSTRY and COMMUNICATIONS



Direct Replacement Types

RCA types shown below are direct replacements under all circumstances for corresponding types to be replaced. Tube types covered include: Vacuum Power

Tubes, Rectifier Tubes, Thyratrons, Ignitrons, Voltage Regulators, Phototubes, Cathode-Ray Tubes, and Special Types.

Type to be Replaced	Replace by RCA Type	Type to be Replaced	Replace by RCA Type	Type to be Replaced	Replace by RCA Type	Type to be Replaced	Replace by RCA Type
OA3/VR75	OA3	FG-104	5561	WT-261	6H6	UE-905	805
OC3/VR105	OC3	VR105-30	OC3	WE-261A	835	905	905-A
OD3/VR150	OD3	HF120	211	WT-262	866-A	906-P1	3AP1-A
CE-1(A-D)	868, 918	VR150-30	OD3	WT-263	6Z4	908	908-A
1P32	927	WT-210-0001	2D21	WT-269	OC3	914	914-A
2AP1	2AP1-A	WT-210-0003	884	WT-270	80	931	931-A
2B4	885	WT-210-0004	2050	WT-270X	5Z3	UE-938	838
2X2/879	2X2-A	WT-210-0006	6H6	FG-271	5551	UE-949	849
3AP1	3AP1-A	WT-210-0008	866-A	WT-272	5557	UE-966A	866-A
3BP1	3BP1-A	WT-210-0009	84/6Z4	WE-274B	5R4-GV	UE-967	5557
4D21	4-125A/4D21	WT-210-0011	OC3	WT-294	OD3	UE-972A	872-A
4-250A	4-250A/5D22	WT-210-0012	80	WE-295A	203-A	UE-975A	575-A
5BP1	5BP1-A	WT-210-0013	5Z3	WT-301	83	1642	2C21/1642
5CP1	5CP1-A	WT-210-0015	5557	UE-303A	203-A	1802-P1	5BP1-A
5CP7	5CP7-A	WT-210-0018	OD3	WE-304B	834	1803-P4	12A P4
5D22	4-250A/5D22	WT-210-0019	83	F-307A	207	1804-P4	9AP4
5FP7	5FP7-A	WT-210-0021	6X5	WT-308	6X5-GT	1811-P1	7CP1
5HP1-A	5BP1-A†	WT-210-0025	117Z6-GT	CE-309	5557	1849	1850-A
7BP7	7BP7-A	WT-210-0027	872-A	CE-311	3C23	1850	1850-A
PJ-8	5556	WT-210-0028	3Q5-GT	UE-311	211	2051	2050
G9	868	WT-210-0029	6C5	UE-311C	835	2525A5	5BP1-A
BW-11	834	WT-210-0031	902-A	UE-317C	217-C	5728/FG-67	1904
CE-11V(A-D)	917	WT-210-0037	1171.7/M7-GT	WE-322A	803	8001	4E27/8001
RK-11	1623	WT-210-0038	172	WE-350A	807	8016	1R3-GT
12DP7	12DP7-A	WT-210-0040	6X4	375-A	575-A	WTT-100	6X4
FG-17	5557	WT-210-0042	5Y3-GT	WT-377	117Z6-GT	WTT-102	5Y3-GT
CE-20A	927	WT-210-0044	575-A	WT-389	3Q5-GT	WTT-103	6H6
RK-20A	804	WT-210-0045	892	WT-390	6C5	WTT-104	575-A
CE-21(A-D)	920	WT-210-0048	5U4-G	FJ-401	1P29	WTT-105	892
CE-23(A-D)	923	WT-210-0052	2AP1-A	WE-403A	6AK5	WTT-111	5559
PJ-23	868	WT-210-0053	3AP1-A	GL-415	5550	WTT-112	5560
CE-25(A-D)	927	WT-210-0056	5559	GL-451	8020	WTT-113	676
RK-25	802	WT-210-0057	5560	WT-606	2D21	WTT-114	0Z4
RK-25B	802	WT-210-0058	676	WL-630	2050	WTT-115	117N7-GT
CE-28(A-D)	928	WT-210-0060	0Z4	WL-631	5559	WTT-117	5557
RK-28	803	WT-210-0061	117N7-GT	KU-634	677	WTT-118	105
RK-28A	803	WT-210-0062	5557	WL-651/656	5552	WTT-119	172
CE-29(A-D)	929, 1P39	WT-210-0069	5557	WL-652/657	5551	WTT-122	6SJ7
CE-30(A-D)	930, 1P40	WT-210-0070	5550	WL-653B	5555	WTT-123	6V6
CE-30V	925	WT-210-0071	5551	WL-655/658	5553	WTT-124	7K7
RK-30	800	WT-210-0072	5552	672	672-A	WTT-125	6N7-GT
FG-32	5558	WT-210-0073	5553	WL-679	5554	WTT-126	50B5
RK-33	2C21/1642	WT-210-0074	105	WL-681/686	5550	WTT-127	833-A
CE-34	934	WT-210-0078	172	NL-715	5557	WTT-128	6K8-GT
RK-39	807	WT-210-0079	105	WL-735	868	WTT-129	6J5-GT
CE-41	921	WT-210-0081	6SJ7	801	801-A	WTT-130	6G6-G
CE-42	922	WT-210-0082	6V6	811	811-A	WTT-131	6C6
RK-44	837	WT-210-0083	7K7	812	812-A	WTT-132	OA4-G
RK-47	814	WT-210-0084	6N7-GT	829	829-B	WTT-135	5U4-G
UH-50	834	WT-210-0085	50B5	829-A	829-B	WTT-136	2AP1-A
R51A	927	WT-210-0086	833-A	832	832-A	WTT-137	3AP1-A
CE-55	924	WT-210-0087	6K8-GT	833	833-A	WTT-149	172
FG-57	5559	WT-210-0088	6J5-GT	C-833	833-A		
RK-57	805	WT-210-0089	6G6-G	857	857-B		
RK-58	838	WT-210-0090	6C6	862	862-A		
CE-59	5581	WT-210-0091	OA4-G	866	866-A		
R59A	868, 918	211-D	211	866-A/866	866-A		
R60A	920	FG-235A	5552	869-A	869-B		
HY-61/807	807	FG-238B	5555	872	872-A		
R61A	930	242A	211	872-A/872	872-A		
CE-64	5583	242B	211	F-872B	872-A		
FG-67/5728	1904	WT-245	884	879	2X2-A		
VR75-30	OA3	WT-246	2050	889	889-A		
FG-95	5560	FG-258A	5553	893	893-A		
CE-98	5582	FG-259B	5554	902	902-A		

See next page for a complete listing and suggested user's prices of more than 340 RCA Non-Receiving Tube Types.

† Except in high-altitude service.

NOTE: For additional replacement data on RCA Tubes for Industry and Communications, refer to the 20-page RCA Interchangeability Directory (Form ID-1020) which lists 1600 tube type numbers used by 24 manufacturers.

For complete technical information on RCA Tubes, see your RCA Distributor or write: Commercial Engineering, RCA Tube Department, Harrison, New Jersey.



RCA ELECTRON TUBES

• ENTERTAINMENT RECEIVING TYPES
• SEMICONDUCTOR DEVICES



JUNE 22, 1954

RCA Type	Sug'd List Price	RCA Type	Sug'd List Price	RCA Type	Sug'd List Price	RCA Type	Sug'd List Price	RCA Type	Sug'd List Price	RCA Type	Sug'd List Price
OZ4	\$1.65	6AB7	\$3.60	6F6	\$2.45	7A5	\$2.50	12BF6	\$1.75	25Z6GT	\$1.80
OZ4G	1.65	6AC5GT	3.00	6F6G	2.00	7A6	2.10	12BH7	2.75	26	2.05
1A3	2.50	6AC7	3.35	6G6GT	2.00	7A7	2.20	12BY7	2.65	27	1.75
1A5GT	2.05	6AD7G	3.90	6F7	3.90	7A8	2.10	12C8	3.90	35A5	2.20
1A7GT	2.45	6AF4	3.65	6F8G	3.90	7AD7	4.60	12H6	2.00		
1AC5	3.00	6AF6G	3.15	6G6G	2.75	7AF7	2.40	12J5GT	1.80	35B5	2.10
1AD5	3.00	6AG5	2.25	6H6	2.00	7AG7	2.45	12J7GT	2.55	35C5	2.05
1B3GT	2.65	6AG7	3.75	6H6GT	2.10	7AH7	2.45	12K7GT	2.35	35L6GT	1.95
1C5GT	2.60	6AH4GT	2.60	6J5	1.70	7B4	2.00	12K8	3.15	35W4	1.35
1D8GT	4.05	6AH6	3.90	6J5GT	1.80	7B5	1.85	12Q7GT	2.10	35Y4	1.80
1E8	3.00	6AK5	4.35	6J6	2.50	7B6	2.00	12SA7	2.10	35Z3	1.80
1G6GT	3.00	6AK6	2.55	6J7	2.50	7B7	2.00	12SA7GT	2.10	35Z4GT	1.45
1H5GT	1.95	6AL5	1.75	6J7GT	2.55	7B8	2.25	12SC7	2.50	35Z5GT	1.40
1L4	2.25	6AL7GT	4.00	6J8G	3.70	7C5	2.15	12SF5	2.10	41	1.90
1L6	2.75	6AN8	3.00	6K6GT	1.80	7C6	1.85	12SF7	2.40	42	1.90
1LA4	2.80	6AQ5	2.10	6K7	2.10	7C7	2.15	12SG7	2.35	43	2.05
1LA6	2.65	6AQ6	1.85	6K7G	2.40	7E6	2.90	12SH7	2.00	45	2.10
1LB4	2.80	6AQ7GT	3.15	6K7GT	2.35	7E7	3.20	12SJ7	2.00	47	2.90
1LC5	2.65	6AR5	1.80	6K8	3.05	7F7	2.45	12SK7	2.00	50A5	2.20
1LC6	2.65	6AS5	2.10	6L6	4.60	7F8	3.25	12SK7GT	2.00	50B5	2.10
1LD5	2.65	6AS8	3.00	6L6G	3.35	7G7	3.00	12SL7GT	2.65	50C5	2.05
1LE3	2.65	6AT6	1.65	6L7	2.90	7H7	2.20	12SN7GT	2.30	50C6G	3.30
1LG5	2.65	6AT8	2.85	6N7	2.95	7J7	3.50	12SQ7	1.75	50L6GT	1.95
1LH4	2.65	6AU4GT	2.90	6N7GT	2.85	7K7	3.15	12SQ7GT	1.75	50X6	2.20
1LN5	2.65	6AU5GT	3.20	6Q7	2.40	7L7	3.00	12SR7	2.00	50Y6GT	2.15
1N5GT	2.40	6AU6	1.85	6Q7GT	2.10	7N7	2.35	12V6GT	2.00	50Y7GT	2.10
1Q5GT	3.05	6AV5GT	3.20	6R7	2.80	7Q7	2.60	12X4	1.50	56	1.85
1R5	2.35	6AV6	1.65	6S4	1.90	7R7	3.35	14A7	2.20	57	2.10
1S4	2.45	6AX4GT	2.55	6S7	3.25	7V7	3.35	14A7F	2.40	58	2.10
1S5	2.05	6AX5GT	2.00	6S8GT	2.65	7W7	3.35	14B6	2.20	70L7GT	6.60
1T4	2.25	6B4G	3.20	6SA7	2.10	7X7	3.30	14B8	2.20	71A	2.35
1T5GT	2.80	6B8	3.35	6SA7GT	2.10	7Y4	1.80	14C5	3.00	75	2.00
1T6	3.00	6BA6	1.95	6SB7Y	2.90	7Z4	1.80	14C7	2.40	76	1.70
1U4	2.25	6BA7	2.50	6SC7	2.35	12A8GT	2.75	14C7	2.40	77	2.15
1U5	2.00	6BC4	4.45	6SF5	1.95	12AH7GT	3.05	14F7	2.45	78	2.15
1V	2.55	6BC5	2.00	6SF5GT	1.95	12AL5	1.80	14F8	3.25	80	1.55
1V2	1.70	6BC7	3.20	6SF7	2.30	12AQ5	2.10	14H7	2.40	83	2.85
1X2A	2.65	6BD4A	14.25	6SG7	2.30	12AT6	1.65	14Q7	2.60	83V	3.40
1X2B	2.65	6BD6	2.00	6SH7	2.50	12AT7	2.85	14R7	3.35	84VZ4	1.80
2A3	4.15	6BE6	2.05	6SJ7	2.00	12AU6	1.85	19B6G6	6.00		
								19J6	2.65		
3A2	3.00	6BF5	2.20	6SJ7GT	1.65	12AU7	2.40	19T8	3.10		
3A3	3.10	6BF6	1.75	6SK7	2.00	12AV6	1.65	19X8	3.10		
3LF4	3.00	6BG6G	5.25	6SK7GT	2.00	12AV7	3.00	24A	2.70		
3Q4	2.25	6BH6	2.30	6SL7GT	2.65	12AW6	2.65	25A6	3.40		
3Q5GT	2.80	6BJ6	2.10	6SN7GT	2.35	12AX4GT	2.65	25B6GT	3.90		
3S4	2.20	6BK7A	3.35	6SQ7	1.75	12AX7	2.50	25L6	3.90	117L7GT/	6.60
3V4	2.20	6BL7GT	3.40	6SQ7GT	1.75	12BA6	1.95	25L6GT	1.95	117M7GT	4.80
5A24	1.55	6BQ6GT	3.80	6SR7	1.85	12BA7	2.50	25W4GT	2.05	117N7GT	4.80
5T4	5.00	6BQ7A	3.50	6SS7	2.40	12BD6	2.00	25Z5	1.80	117P7GT	4.80
5U4G	1.75	6BY6	2.00	6ST7	2.70	12BE6	2.05	25Z6	2.60	117Z3	1.80
										117Z6GT	2.95
5V4G	2.80	6BZ7	3.80	6SZ7	2.45						
5W4GT	1.75	6C4	1.65	6T8	3.05						
5X4G	2.00	6C5	1.95	6U5	2.25						
5Y3G	1.35	6C5GT	2.10	6U7G	2.40						
5Y3GT	1.35	6C6	2.50	6U8	3.00						
5Y4G	1.70	6C8G	3.90	6V6	3.40						
5Z3	2.00	6CB6	2.10	6V6GT	2.00						
5Z4	3.30	6CD6G	4.80	6W4GT	1.90						
6A3	3.90	6CF6	2.50	6W6GT	2.45						
6A7	2.75	6CL6	3.35	6X4	1.50						
6A8	2.70	6D6	2.50	6X5	3.10						
6A8G	2.75	6DC6	2.50	6X5GT	1.55						
6A8GT	2.75	6E5	2.55	6X8	2.95						
6AB4	1.80	6F5	2.25	6Y6G	2.55						
6AB5/6N5	3.15	6F5GT	1.85	7A4	2.00						

SEMICONDUCTOR DEVICES

TRANSISTORS

Type	Description	Suggested Distributor Resale Prices
2N32	Point-Contact Type for pulse or switching applications	\$12.25
2N33	Point-Contact Type for oscillator applications up to 50 Mc	12.25
2N34	Junction (p-n-p) Type for low-power, audio-frequency applications	10.75

CRYSTAL DIODES

Type	Description	Suggested Distributor Resale Price
Germanium Point-Contact Types Sealed-in-Glass Construction		
1N34-A	General-Purpose Type	\$.90
1N38-A	Large-Signal Type	2.00
1N54-A	High-Back Resistance Type	1.45
1N55-A	Large-Signal Type	4.70
1N56-A	High-Conduction Type	1.45
1N58-A	Large-Signal Type	1.80

Suggested list prices and suggested distributor resale prices include Federal Excise Tax where applicable. All prices subject to change without notice.



RCA PICTURE TUBES

DEALER PRICE SCHEDULE

FEBRUARY 1, 1954



Type	Suggested List Price	Suggested Dealer Price	DESCRIPTION				
			Shape	Material	Face	Focus	Deflection
3KP4	\$23.50	\$17.50	Round	Glass	Clear	Electrostatic	Electrostatic
5TP4	60.00	45.00	Round	Glass	Clear	Electrostatic	Magnetic
7DP4	31.50	26.20	Round	Glass	Clear	Electrostatic	Magnetic
7JP4	26.00	19.50	Round	Glass	Clear	Electrostatic	Electrostatic
10BP4-A	28.00	21.00	Round	Glass	Filter	Magnetic	Magnetic
10FP4-A	35.00	26.00	Round	Glass	Filter	Magnetic	Magnetic
12KP4-A	39.50	29.50	Round	Glass	Filter	Magnetic	Magnetic
12LP4-A	32.00	24.00	Round	Glass	Filter	Magnetic	Magnetic
14CP4	35.00	26.00	Rectangular	Glass	Filter	Magnetic	Magnetic
14EP4	35.00	26.00	Rectangular	Glass	Filter	Magnetic	Magnetic
16AP4-A	46.00	34.50	Round	Metal	Filter	Magnetic	Magnetic
16DP4-A	39.00	29.25	Round	Glass	Filter	Magnetic	Magnetic
16GP4	46.00	34.50	Round	Metal	Filter	Magnetic	Magnetic
16GP4-B	46.00	34.50	Round	Metal	Fil.-Fr.	Magnetic	Magnetic
16KP4	37.00	28.00	Rectangular	Glass	Filter	Magnetic	Magnetic
16LP4-A	40.00	30.00	Round	Glass	Filter	Magnetic	Magnetic
16RP4	37.00	28.00	Rectangular	Glass	Filter	Magnetic	Magnetic
16TP4	37.00	28.00	Rectangular	Glass	Filter	Magnetic	Magnetic
16WP4-A	40.00	30.00	Round	Glass	Filter	Magnetic	Magnetic
17BP4-A	36.00	27.00	Rectangular	Glass	Filter	Magnetic	Magnetic
17CP4	42.00	31.00	Rectangular	Metal	Fil.-Fr.	Magnetic	Magnetic
17GP4	51.00	38.00	Rectangular	Metal	Fil.-Fr.	Electrostatic	Magnetic
17HP4	36.00	27.00	Rectangular	Glass	Filter	Electrostatic*	Magnetic
17JP4	39.00	29.00	Rectangular	Glass	Filter	Magnetic	Magnetic
17LP4	36.00	27.00	Rectangular	Glass	Filter	Electrostatic*	Magnetic
17QP4	36.00	27.00	Rectangular	Glass	Filter	Magnetic	Magnetic
17TP4	42.00	31.00	Rectangular	Metal	Fil.-Fr.	Electrostatic*	Magnetic
19AP4-A	59.00	44.00	Round	Metal	Filter	Magnetic	Magnetic
19AP4-B	59.00	44.00	Round	Metal	Fil.-Fr.	Magnetic	Magnetic
20CP4	51.50	38.50	Rectangular	Glass	Filter	Magnetic	Magnetic
20MP4	54.00	40.50	Rectangular	Glass	Filter	Electrostatic*	Magnetic
21AP4	61.00	45.50	Rectangular	Metal	Fil.-Fr.	Magnetic	Magnetic
21EP4	55.00	41.50	Rectangular	Glass	Filter	Magnetic	Magnetic
21EP4-A	54.00	40.50	Rectangular	Glass	Filter	Magnetic	Magnetic
21FP4-A	56.00	42.00	Rectangular	Glass	Filter	Electrostatic	Magnetic
21MP4	64.00	48.00	Rectangular	Metal	Fil.-Fr.	Electrostatic*	Magnetic
21YP4	51.75	38.75	Rectangular	Glass	Filter†	Electrostatic	Magnetic
21ZP4-A	50.00	37.50	Rectangular	Glass	Filter	Magnetic	Magnetic
21ZP4-B	54.00	40.50	Rectangular	Glass	Filter†	Magnetic	Magnetic
24CP4-A	84.25	63.25	Rectangular	Glass	Filter†	Magnetic	Magnetic
27MP4	143.00	107.00	Rectangular	Metal	Fil.-Fr.†	Magnetic	Magnetic
Color Kinescopes 15GP22	265.00	235.00	Round	Glass	Clear	Electrostatic	Magnetic

*Low voltage. †Aluminized
Suggested List and Dealer Prices include Federal Excise Tax. All prices subject to change without notice.

For the latest Service Aids — for the Best Tubes . . .

ALWAYS KEEP IN TOUCH WITH YOUR RCA DISTRIBUTOR



RADIO and TV RECEIVING TUBES

SUGGESTED LIST PRICES Effective May 1, 1954

Type	Price	Type	Price	Type	Price	Type	Price	Type	Price	Type	Price		
OY4	\$5.00	2A6	\$2.80	686G	\$2.45	6L6GA	\$3.35	7AG7	\$2.50	12S8GT	\$2.75	33	\$3.50
OZ4	1.65	2A7	2.80	6B7	3.50	6L7	2.90	7AH7	2.50	12S A7	2.10	34	3.60
OZ4G	1.65	2B7	3.50	6B8	3.50	6L7G	3.40	7B4	2.00	12S A7GT	2.10	35/51	2.40
IA3	2.50	2E5	2.85	6B8G	3.60	6N7	2.90	7B5	1.85	12S C7	2.50	35A5	2.25
IA4P	4.05	3A8GT	5.00	6BA6	1.95	6N7GT	2.85	7B6	2.00	12S F5	2.10	35B5	2.10
IA5GT	2.10	3B7/1291	5.70	6BA7	2.60	6P5GT	2.45	7B7	2.00	12S F5GT	2.10	35C5	2.05
IA6	3.60	3C6/XXB	3.75	6BC5	2.00	6Q7	2.40	7B8	2.25	12S F7	2.40	35L6GT	1.95
IA7GT	2.45	3D6/1299	4.80	6BC7	2.75	6Q7G	2.10	7C4	3.60	12S G7	2.35	35W4	1.35
IA8A	2.85	3LF4	3.10	6BD5GT	3.60	6Q7GT	2.10	7C5	2.15	12S H7	2.50	35Y4	1.80
IAH4	2.85	3Q4	2.30	6BD6	2.00	6R7	2.80	7C6	1.85	12S J7	2.00	35Z3	1.80
IAJ5	2.70	3Q5GT	2.80	6BE6	2.05	6R7G	2.75	7C7	2.15	12S J7GT	2.00	35Z4GT	1.50
IAK4	6.00	3S4	2.20	6BF5	2.25	6R7GT	2.75	7E5	2.90	12S K7	2.00	35Z5GT	1.40
IAK5	6.00	3Y4	2.20	6BF6	1.75	6R8	3.35	7E6	2.90	12S K7GT	2.00	36	2.85
IAX2	2.70	5AZ4	1.55	6BG6G	5.25	6S4	1.95	7E7	3.35	12S L7GT	2.65	37	1.85
IB3GT/8016	2.70	5T4	5.00	6BH6	2.30	6S7	3.25	7F7	2.50	12S N7GT	2.35	38	2.30
IB4P	4.05	5U4G	1.75	6BJ6	2.10	6S7G	3.50	7F8	3.40	12S Q7	1.75	39/44	2.80
IB5/25S	3.60	5Y4G	2.80	6BJ7	2.45	6S8GT	2.75	7G7/1232	2.90	12S Q7GT	1.75	41	2.00
IB7GT	3.50	5W4GT	1.75	6BK5	2.70	6SA7	2.10	7H7	2.25	12S R7	2.00	42	2.00
IC5GT	2.60	5X4G	2.00	6BK7A	3.35	6SA7GT	2.10	7J7	3.60	12V6GT	2.10	43	2.10
IC6	3.50	5Y3G	1.35	6BL7GT	3.50	6S87Y	2.90	7K7	3.15	12Z3	2.65	45	2.25
IC7G	3.50	5Y3GT	1.35	6BN6	2.90	6SC7	2.35	7L7	2.90	14A4	2.75	45Z3	1.80
ID5GP	4.05	5Y4G	1.70	6BQ6GT	3.80	6SD7GT	3.35	7N7	2.35	14A5	3.90	45Z5GT	1.80
ID7G	3.60	5Y4GT	1.55	6BQ7A	3.50	6SF5	1.95	7Q7	2.60	14A7/12B7	2.25	46	2.90
ID8GT	4.05	5Z3	2.00	6BX7GT	3.60	6SF5GT	1.95	7R7	3.50	14AF7/XXD	2.45	47	2.90
IESGP	4.05	5Z4	3.30	6BY5G	3.25	6SF7	2.30	7S7	3.40	14B6	2.25	49	2.80
IE7GT	4.05	6A3	3.90	6BZ7	3.80	6SG7	2.30	7V7	3.50	14B8	2.25	50	5.25
IF4	2.80	6A6	2.85	6C4	1.65	6SH7	2.50	7W7	3.50	14C5	2.90	50A5	2.25
IF5G	2.80	6A7	2.75	6C5	1.95	6SH7GT	2.50	7X6	2.25	14C7	2.45	50B5	2.10
IF6	4.05	6A8	2.70	6CSGT	2.10	6SJ7	2.00	7X7/XXFM	2.75	14E6	2.90	50C5	2.05
IF7G	4.05	6ABG	2.75	6C6	2.50	6SJ7GT	1.95	7Y4	1.80	14E7	3.35	50C6G	3.30
IG4GT	2.55	6ABGT	2.75	6C8G	3.90	6SK7	2.00	7Z4	1.80	14F7	2.50	50CD6G	6.60
IG5G	3.25	6AB4	1.80	6CB6	2.15	6SK7GT	2.00	10Y	3.90	14F8	3.40	50L6GT	1.95
IG6GT	2.90	6AB5/6N5	3.15	6CD6G	5.00	6SL7GT	2.65	12A6	2.90	14H7	2.45	50X6	2.25
IH4G	2.35	6AB7/1853	3.60	6CF6	2.50	6SN7GT	2.35	12A6GT	2.90	14J7	3.60	50Y6GT	2.15
IH5GT	1.95	6ACS5GT	3.10	6CL6	3.35	6SN7GTA	2.35	12A7	3.90	14N7	2.75	50Y7GT	2.10
IH6G	3.50	6AC7/1852	3.35	6CS6	2.05	6SQ7	1.75	12A8GT	2.75	14Q7	2.60	53	3.60
IJ4G	3.35	6AD7G	3.90	6CU6	4.60	6SQ7GT	1.75	12AH7GT	3.05	14R7	3.50	55	2.30
IJ6GT	3.50	6AF4	3.90	6D6	2.50	6SR7	1.85	12AL5	1.80	14S7	3.40	56	1.90
IL4	2.25	6AF6G	3.15	6D8G	3.50	6SS7	2.40	12A55	2.15	14W7	3.50	57	2.10
IL6	2.85	6AG5	2.25	6E5	2.55	6S7	2.80	12AT6	1.65	14X7	2.75	58	2.10
ILA4	2.90	6AG7	3.75	6F5	1.90	6SV7	3.60	12AT7	2.90	14Y4	2.45	59	3.80
ILA6	2.75	6AH4GT	2.65	6F5GT	1.85	6T4	3.80	12AU6	1.85	19	3.50	70L7GT	6.60
ILB4	2.90	6AH6	3.90	6F6	2.45	6T7G/6Q6G	3.50	12AU7	2.45	19B6G6	6.00	71A	2.50
ILC5	2.75	6AH6V	3.90	6F6G	2.00	6T8	3.05	12AV6	1.65	19C8	3.35	75	2.00
ILC6	2.75	6AJ4	6.00	6F6GT	2.00	6U5/6G5	2.25	12AV7	2.90	19J8	2.75	76	1.70
ILD5	2.75	6AK5	4.05	6F7	3.90	6U6GT	2.45	12AW6	2.70	19T8	3.10	77	2.20
ILE3	2.75	6AK6	2.50	6F8G	3.90	6U7G	2.40	12AX4GT	2.65	19X8	3.10	78	2.25
ILG5	2.75	6AL5	1.75	6G6G	2.85	6U8	2.90	12AX7	2.55	22	3.35	79	2.90
ILH4	2.75	6AL7GT	3.90	6H6	2.00	6V3A	3.90	12AY7	6.00	24A	2.70	80	1.55
ILN5	2.75	6AM4	4.80	6H6GT	2.10	6V6	3.50	12AZ7	2.55	25A6	3.50	81	4.80
INSGT	2.40	6AM8	2.90	6J5	1.70	6V6GT	2.00	12B4	2.30	25A6G	2.85	82	2.80
IP5GT	2.90	6AN4	4.40	6J5GT	1.80	6V8	3.75	12BA6	1.95	25A7GT	6.60	83	2.85
IQ5GT	3.05	6AN8	2.90	6J6	2.55	6W4GT	1.90	12BA7	2.60	25AV5GT	3.20	83V	3.40
IR4/1294	2.85	6AQ5	2.10	6J7	2.50	6W6GT	2.40	12BD6	2.00	25AX4GT	2.75	84/6Z4	1.80
IRS	2.35	6AQ6	1.85	6J7G	2.50	6W7G	2.80	12BE6	2.05	25BQ6GT	3.90	85	2.30
IS4	2.50	6AQ7GT	3.15	6J7GT	2.50	6X4	1.50	12BF6	1.75	25C5	2.05	89Y	2.30
IS5	2.05	6AR5	1.65	6J8G	3.80	6X5GT	1.55	12BH7	2.75	25CD6G	6.60	V99	3.35
IT4	2.25	6AS5	2.15	6K5GT	2.45	6X8	2.90	12BY7	2.75	25L6GT	1.95	X99	3.35
IT5GT	2.80	6AT6	1.65	6K6GT	1.80	6Y6G	2.55	12BZ7	2.75	25W4GT	2.05	117L/M7GT	6.60
IU2	2.25	6AU4GT	2.90	6K7	2.10	6Z7G	4.05	12C8	3.90	25Y5	3.10	117N7GT	4.80
IU5	2.00	6AU5GT	3.20	6K7G	2.40	6ZY5G	2.55	12F5GT	1.90	25Z5	1.80	117P7GT	4.80
IV	2.55	6AU6	1.85	6K8GT	2.35	7A4/XXL	2.00	12H6	2.00	25Z6GT	1.80	117Z3	1.80
IV2	1.70	6AV5GT	3.20	6K8	3.05	7A5	2.55	12J5GT	1.80	26	2.25	117Z4GT	2.90
IV6	3.15	6AV6	1.65	6K8G	3.40	7A6	2.15	12J7GT	2.55	27	1.80	117Z6GT	2.90
IX2A	2.60	6AX4GT	2.55	6K8GT	2.75	7A7	2.20	12K7GT	2.35	30	2.30	CK705	1.70
IX2B	2.75	6AX5GT	2.00	6L5G	2.85	7A8	1.95	12K8	3.15	31	2.85	CK706A	.80
2A3	4.05	6B4G	3.35	6L6	4.60	7AD7	4.60	12K8GT	2.90	32	3.80	CK710	1.95
2A4G	5.00	6B5	3.50	6L6G	3.35	7AF7	2.40	12Q7GT	2.10	32L7GT	3.35	5642	2.65
2A5	2.30												

Tube prices listed above are for your convenience and do not necessarily indicate type availability.

ALL PRICES SUBJECT TO CHANGE OR WITHDRAWAL WITHOUT NOTICE.



TELEVISION PICTURE TUBES

SUGGESTED LIST PRICES — EFFECTIVE JUNE 10, 1954

COLOR TUBE TYPE	ALUMINIZED SCREEN	ENVELOPE	FACE	TYPE OF FOCUS	TYPE OF DEFLECTION	EXTERNAL CONDUCTIVE COATING	ION TRAP	SUGGESTED LIST PRICE
15GP22	Yes	Glass	Color Dot	Elect.	Mag.	Yes	None	265.00

BLACK AND WHITE TUBE TYPE	ALUMINIZED SCREEN	ENVELOPE	FACE	TYPE OF FOCUS	TYPE OF DEFLECTION	EXTERNAL CONDUCTIVE COATING	ION TRAP	SUGGESTED LIST PRICE
3KP4	No	Glass	Clear	Elect.	Elect.	No	None	\$25.00
7JP4	No	Glass	Clear	Elect.	Elect.	No	None	26.00
8BP4	No	Glass	Clear	Elect.	Elect.	No	None	30.50
10BP4A	No	Glass	Filter	Mag.	Mag.	Yes	Double	28.00
10FP4	Yes	Glass	Clear	Mag.	Mag.	Yes	None	35.00
10FP4A	Yes	Glass	Filter	Mag.	Mag.	Yes	None	35.00
12KP4A	Yes	Glass	Filter	Mag.	Mag.	Yes	None	39.50
12LP4A	No	Glass	Filter	Mag.	Mag.	Yes	Double	32.00
*14BP4	No	Glass	Filter	Mag.	Mag.	Yes	Double	35.00
*14CP4	No	Glass	Filter	Mag.	Mag.	Yes	Single	35.00
16AP4A	No	Metal	Filter	Mag.	Mag.	Double	42.00
16DP4A	No	Glass	Filter	Mag.	Mag.	No	Double	39.00
16GP4	No	Metal	Filter	Mag.	Mag.	Single	42.00
16GP4B	No	Metal	Filter	Mag.	Mag.	Single	42.00
*16KP4	No	Glass	Filter	Mag.	Mag.	Yes	Single	37.00
*16KP4A	Yes	Glass	Filter	Mag.	Mag.	Yes	Single	43.00
*16RP4	No	Glass	Filter	Mag.	Mag.	Yes	Double	37.00
*16TP4	No	Glass	Filter	Mag.	Mag.	Yes	Single	37.00
16ZP4	No	Glass	Filter	Mag.	Mag.	Yes	Double	40.00
*17AP4	No	Glass	Filter	Mag.	Mag.	Yes	Single	35.00
*17BP4A	Yes	Glass	Filter	Mag.	Mag.	Yes	Single	36.00
*17BP4B	No	Glass	Filter	Mag.	Mag.	Yes	Single	35.00
*17CP4	No	Metal	Filter	Mag.	Mag.	Single	42.00
*17GP4	No	Metal	Filter	Elect.	Mag.	Single	51.00
*17HP4	No	Glass	Filter	Elect.	Mag.	Yes	Single	36.00
*17JP4	No	Glass	Filter	Mag.	Mag.	Yes	Single	36.00
*17LP4	No	Glass	Filter	Elect.	Mag.	Yes	Single	36.00
†*17QP4	No	Glass	Filter	Mag.	Mag.	Yes	Single	36.00
19AP4A	No	Metal	Filter	Mag.	Mag.	Single	53.00
19AP4B	No	Metal	Filter	Mag.	Mag.	Single	53.00
*20CP4	No	Glass	Filter	Mag.	Mag.	No	Single	51.50
*20CP4A	No	Glass	Filter	Mag.	Mag.	Yes	Single	51.50
*20DP4A	No	Glass	Filter	Mag.	Mag.	Yes	Single	51.50
*21AP4	No	Metal	Filter	Mag.	Mag.	Single	61.00
†*21EP4A	No	Glass	Filter	Mag.	Mag.	Yes	Single	43.00
†*21FP4A	No	Glass	Filter	Elect.	Mag.	Yes	Single	45.00
*21MP4	No	Metal	Filter	Elect.	Mag.	Single	64.00
*21YP4	No	Glass	Filter	Elect.	Mag.	Yes	Single	54.00
*21YP4A	Yes	Glass	Filter	Elect.	Mag.	Yes	Single	54.00
*21ZP4A	No	Glass	Filter	Mag.	Mag.	Yes	Single	54.00
*21ZP4B	Yes	Glass	Filter	Mag.	Mag.	Yes	Single	54.00
*24CP4	No	Glass	Filter	Mag.	Mag.	Yes	Single	82.75
*24CP4A	Yes	Glass	Filter	Mag.	Mag.	Yes	Single	84.25
*24DP4	No	Glass	Filter	Elect.	Mag.	Yes	Single	82.75
*24DP4A	Yes	Glass	Filter	Elect.	Mag.	Yes	Single	84.25
*27EP4	Yes	Glass	Filter	Mag.	Mag.	No	Single	126.50
*27RP4	Yes	Glass	Filter	Mag.	Mag.	Yes	Single	126.50

*Rectangular face

†Cylindrical face to reduce reflections

ALL PRICES SUBJECT TO CHANGE OR WITHDRAWAL WITHOUT NOTICE.



ELECTRONIC TUBES

SUGGESTED RESALE PRICES Effective May 15, 1954

TYPE	SUGG. RESALE PRICE	TYPE	SUGG. RESALE PRICE	TYPE	SUGG. RESALE PRICE
BH	\$ 4.50	RK2K45	\$100.00	RK65 (Use 5D23/RK65)	—
OA2	1.45	RK2K56	98.75	RK72	\$ 11.25
OA3/VR75	1.32	2N63	11.15	RX120	29.00
OA4G	1.45	2N64	14.25	RX120A	30.50
OB2	1.60	2N65	20.50	QK140 (Use QK290)	—
OB2WA	4.75	2X2A	2.17	RX212	35.75
OB3/VR90	1.70	*3A4	1.20	RX215	24.30
OC3/VR105	1.32	3A5	1.25	QK217	320.00
OD3/VR15C	1.32	3B4	3.60	QK217P	353.00
*OZ4A/CK1003	1.00	RK3B24W	11.25	QK226 (Use QK293)	—
*1AD4	2.05	RK3B26	18.00	QK227 (Use QK294)	—
*1AE4	1.55	RK3B29	12.60	QK241	2310.00
*1AG5	1.90	RK4B31	35.25	QK253	577.00
1B90	14.25	4C35	28.75	QK254	2375.00
1N66	.65	RK4D22	27.50	QK288	513.00
1N67	2.00	RK4D32	27.50	QK289	384.00
1N67P	2.00	RK4J30	225.00	QK290	384.00
1N68	2.00	RK4J31	225.00	QK291	384.00
2C33/RX233A	5.00	RK4J32	225.00	QK292	384.00
2C34/RK34	3.50	RK4J33	225.00	QK293	384.00
2C52	11.30	RK4J34	225.00	QK294	384.00
2E24	4.19	RK4J35	225.00	QK295	513.00
2E26	3.47	RK4J36	353.00	QK306	384.00
2E30	2.60	RK4J37	353.00	310A	12.45
*2E31	2.12	RK4J38	353.00	QK312	385.00
*2E32	2.12	RK4J39	353.00	QK329	320.00
*2E35	2.17	RK4J40	353.00	QK357	1285.00
*2E36	2.17	RK4J41	353.00	QK366	577.00
2E41 (Use 1AG5)	—	RK4J53	256.00	QK367	192.50
2E42 (Use 1AG5)	—	RK4J57	270.00	QK381	150.00
*2G21	2.20	RK4J58	270.00	QK390	225.00
*2G22	2.20	RK4J59	270.00	QK404	67.85
RK2J23	192.50	RK4J61	385.00	QK414	98.50
RK2J24	192.50	RK4J62	385.00	CK501AX	2.55
RK2J25	192.00	RK4J63	385.00	CK502AX	2.10
RK2J26	192.50	RK4J64	385.00	CK503AX	2.05
RK2J27	192.50	5D23/RK65	45.00	CK506AX	1.50
RK2J28	192.50	RK5126	423.00	CK510AX	2.55
RK2J29	192.50	RK5J26	423.00	CK511X	2.38
RK2J30	147.45	*5R4GY	1.85	CK512AX	2.15
RK2J31	147.45	*6A4WG	7.25	CK518AX	2.15
RK2J32	147.45	*6A5	3.50	CK522AX (Use CK6088)	—
RK2J33	147.45	*6AK5W	3.05	CK525AX	3.60
RK2J34	147.45	*6AL5W	1.55	CK526AX	1.90
RK2J36	150.00	6AN5	3.65	CK527AX	2.55
RK2J42	123.50	6AN5WA	11.30	CK528AX	1.58
RK2J49	131.00	6AR6	5.75	CK529AX	1.98
RK2J50	131.00	*6AS6	3.25	CK531DX	2.55
RK2J51	317.00	*6AS6W	4.75	CK532DX	2.55
RK2J55	165.00	6AS7G	4.87	CK533AX	2.40
RK2J56	164.50	6BL6	69.75	CK534AX	2.45
RK2J66	507.00	*6C4W	8.05	CK535AX	2.15
RK2J67	507.00	*6C4WA	12.00	CK536AX	1.58
RK2J68	506.00	6D21	320.00	CK537AX	2.60
RK2J69	506.00	*6J4	8.05	CK539DX	2.55
RK2J70	145.00	*6J5WGT	4.85	CK541DX	2.55
RK2J71	320.00	*6J6W	3.05	CK542DX	2.55
RK2K22	56.50	*6J6WA	8.95	CK542DXS	2.65
RK2K25	41.00	*6SN7WGT	2.45	CK544DX	2.55
RK2K26	56.50	*6X4W	1.80	CK546DX	2.55
RK2K28	67.85	*6X5WGT	1.89	CK547DX	2.55
RK2K28A	68.00	*7AK7	10.50	CK548DX	2.55
RK2K29	61.00	*12J5WGT	4.85	CK549DX	2.05
RK2K33	384.00	RK38	19.50	CK556AX (Use CK5676)	—
		RK61	3.30	CK568AX (Use CK5677)	—

*Types subject to 10% Federal Excise Tax, which has been included.

CONTINUED ON NEXT PAGE

ALL PRICES SUBJECT TO CHANGE OR WITHDRAWAL WITHOUT NOTICE.



ELECTRONIC TUBES

SUGGESTED RETAIL PRICES (Continued)

TYPE	SUGG. RESALE PRICE	TYPE	SUGG. RESALE PRICE	TYPE	SUGG. RESALE PRICE
CK569AX (Use CK5678)	—	CK1021	\$ 11.50	*CK5814 (Use CK5814A)	—
CK570AX (Use CK5697)	—	CK1022	15.00	*CK5814A	\$ 3.25
CK571AX (Use CK5886)	—	CK1023	11.50	CK5814WA	5.50
CK573AX (Use CK6029)	—	CK1024	3.60	*CK5829	4.80
CK574AX	\$ 2.25	CK1026	3.35	*CK5829WA	12.40
CK605CX (Use CK5702)	—	CK1027 (Use CK6174)	—	CK5851	8.70
CK606BX (Use CK5704)	—	CK1028A	22.50	CK5854	2.05
CK608CX (Use CK5703)	—	CK1029	15.00	CK5875	2.10
CK619CX (Use CK5744)	—	CK1030	30.00	CK5876	14.00
CK628 (Use CK6247)	—	CK1031	30.00	CK5879	1.75
CK703 (Use CK716)	—	CK1032	3.35	CK5886	4.50
CK705	.85	CK1033	30.00	CK5889	11.30
CK705A	.70	CK1034	7.50	CK5893	16.50
CK705A-P	.70	CK1036	7.50	CK5910	.95
CK705P	.65	CK1037	7.50	CK5962	11.30
CK706 (Use CK706A)	—	CK1038	7.50	CK5967	15.00
CK706A	.40	CK1039	7.50	CK5969	15.00
CK707	1.60	CK1042	9.00	CK5971	5.25
RK707B	67.85	CK1043	12.00	CK5972	5.25
CK707P	2.00	CK1044	7.50	CK5975	3.75
CK708	2.00	CK1089	5.30	RK5976	68.00
CK708P	2.00	RK1625	2.65	RK5981	115.00
CK709	4.50	2050	1.85	RK5982	577.00
CK710	.97	2051	1.90	CK5995	7.50
CK711	16.50	CK5517	3.40	RK6002	577.00
CK713	.95	RK5551	72.00	*CK6005	3.55
CK713A	.95	RK5552	110.00	*CK6021	9.10
CK713A-P	.95	RK5586	417.00	CK6029	4.50
CK715	.65	CK5608A	3.15	RK6043	67.85
RK715C	63.00	RK5609	112.00	CK6050	3.70
CK716	18.00	CK5651	2.30	CK6088	2.60
CK721	7.90	CK5651WA	4.00	CK6096	8.25
CK722	4.50	*CK5654	3.15	*CK6111	9.00
CK723	6.00	*CK5656	20.55	*CK6112	9.40
CK725	9.50	RK5657	417.00	RK6115	98.50
RK725A	125.00	*CK5670	4.85	RK6116	449.00
RK726C	49.75	CK5670WA	8.70	RK6133 (Use 2K28A)	—
CK727	11.25	*CK5672	1.60	*CK6135	2.75
CK730	.95	CK5675	13.25	CK6146	4.15
CK731	.95	CK5676	1.90	CK6147	9.60
CK732	1.05	CK5677	3.70	CK6148 (Use CK5702WA)	—
CK739	2.00	*CK5678	1.60	CK6149 (Use CK5703WA)	—
CK742	2.80	*CK5686	3.30	CK6150 (Use CK5784WA)	—
RK807	2.50	CK5687	5.00	CK6151 (Use CK5744WA)	—
RK811A	5.00	CK5694	3.75	CK6152	8.70
RK812A	5.00	*CK5702	5.85	CK6174	3.40
RK813	18.00	CK5702WA	9.30	RK6178	577.00
RK814	14.25	CK5703	2.20	CK6213	7.50
RK816	1.65	CK5703WA	8.75	RK6229	603.00
RK829B	16.25	CK5704	2.85	RK6230	603.00
RK832A	12.90	RK5721	229.00	CK6245	11.85
RK837	5.80	CK5725	3.25	CK6247	14.65
RK866A	2.10	*CK5726	1.45	RK6254	385.00
RK872A	8.20	*CK5744	2.70	CK6286	1.90
884	1.85	*CK5744WA	8.75	RK6294	417.00
885	2.00	*CK5749	2.00	RK6295	417.00
*954	5.65	*CK5750	2.50	CK6397	8.50
*955	3.60	*CK5751	3.35	RK6406	2180.00
*956	7.00	CK5755	11.90	RK6410	2180.00
*957	3.75	CK5763	1.75	*9001	3.40
*CK1005	1.00	CK5783	5.60	*9002	2.50
*CK1006	5.85	CK5783WA	7.90	*9003	3.40
*CK1007	1.10	CK5784	7.50	*9005	3.45
CK1012	3.10	CK5784WA	11.85	*9006	1.60
CK1017	11.30	CK5785	2.35	Subminiature Tube Test Adapters	
CK1018	14.25	CK5787	7.50	5AX51 (For 5 Lead Tubes)	7.50
CK1019	14.25	CK5787WA	11.85	7AX51 (For 6 Lead Tubes)	9.80
CK1020	12.00	CK5794	10.25	8CV50 (For 8 Lead Tubes)	9.80

ALL PRICES SUBJECT TO CHANGE OR WITHDRAWAL WITHOUT NOTICE.



JUNCTION TRANSISTORS

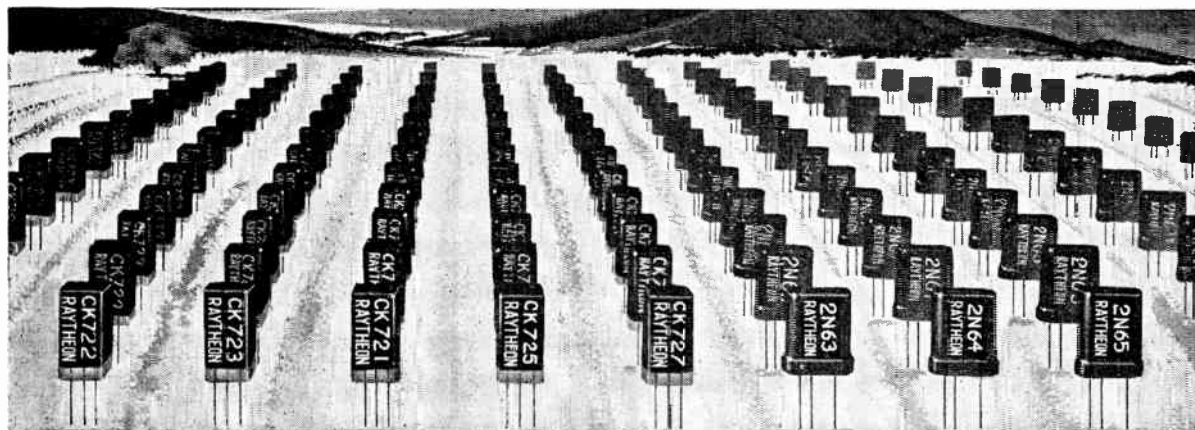

Foremost in the field

RAYTHEON TRANSISTORS lead the field in reliability. Over 1,000,000,000 operating hours of actual field performance in commercial equipment with only a fraction of 1% field returns. This proves their reliability to be

superior to that of vacuum tubes. Raytheon Transistors lead the field in number of units used in commercial equipment. Successful experimental, then pilot and now continuous mass production and inspection techniques are employed. Hundreds of thousands of Raytheon Transistors are in actual commercial use—many times more than all other makes combined.



GERMANIUM DIFFUSED JUNCTION PNP TRANSISTORS

RATINGS:—ABSOLUTE MAX. VALUES:	CK722	CK723	CK721	CK725	CK727	2N63*	2N64*	2N65*
Collector Voltage (volts)	—22	—22	—22	—22	—6	—22	—22	—22
Collector Current (ma)	10	10	10	10	10	10	10	10
Collector Dissipation (30°C) (mw)	33	33	33	33	30	33	33	33
Emitter Current (ma)	10	10	10	10	10	10	10	10
Ambient Temperature (°C)	50	50	50	50	50	50	50	50
AVERAGE CHARACTERISTICS (27°C)								
Collector Voltage (volts)	—6	—6	—6	—6	—1.5	—6	—6	—6
Emitter Current (ma)	1	1	1	1	0.5	1	1	1
Collector Resistance (meg)	2.0	2.0	2.0	2.0	2.0	2.0	2.0	2.0
Emitter Resistance (ohms)	25	25	25	25	50	25	25	25
Base Resistance (ohms)	250	350	700	1500	500	350	700	1500
Base Current Amplification Factor	12	22	45	90	35	22	45	90
Cutoff Current (approx.) (ua)	6	6	6	6	6	6	6	6
Noise Factor (max) (db)**	30†	25†	22†	20†	12††	25†	22†	20†

*Hermetically sealed in metal package
**In a one cycle band width at 1000 cycles

†Measured at $V_c = -2.5$ volts in common emitter circuit
††Measured at $V_c = -1.5$ volts; $I_c = 0.5$ ma in common emitter circuit

PRICES

CK721	\$ 7.90	CK727	\$11.25
CK722	4.50	2N63	11.15
CK723	6.00	2N64	14.25
CK725	9.50	2N65	20.50



GERMANIUM DIODES

NEW WEATHER CYCLED GERMANIUM DIODES



- Completely sealed against atmospheric conditions
- Every diode temperature-humidity cycled for 32 hours
- Samples of every production lot put through JAN-193 humidity test
- Available in both "plug-in" and "solder-in" design
- Extra rugged and shock resistant

- Coated with protective insulating lacquer
- Extremely small size

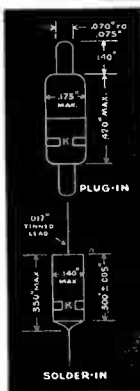

TYPE	TYPICAL APPLICATION	Max. DC Inverse Voltage	Max. Peak Anode Curr. ma.	Max. AVG DC Anode Curr. ma.	Min. Forward Current at +1V ma.	MAXIMUM INVERSE CURRENT				Min. Inverse Voltage	AVG Inverse Current —50V
						at —5V ma.	at —10V ma.	at —50V ma.	at —100V ma.		
IN67 IN67-P	50V DC Restorer	80	100	35	4.0	0.095		0.05		100	0.1
CK705 CK705-P	Gen. Purpose Diode	60	150	50	5.0		0.05	0.8		70	0.43
CK705A CK705A-P	Gen. Purpose Diode	60	150	50	5.0		0.01	0.8		70	0.43
CK707 CK707-P	50V DC Restorer	80	100	35	3.5	0.010		0.10		100	0.1
CK708 CK708-P	100V DC Restorer	100	100	35	3.0				0.625	120	0.15
CK713 CK713A CK713A-P CK713-P	Computer Diode	70	150	50	30 at +2V			0.25 at —40V	(DC characteristics at 50°C)		

P—Indicates plug-in type.

PRICES

IN67	\$2.00	CK707	\$1.60
IN67-P	2.00	CK707-P	2.00
CK70585	CK708	2.00
CK705-A70	CK708-P	2.00
CK705A-P70	CK713-A95
CK705-P65	CK713A-P95



TUNG-SOL ELECTRON TUBES

REVISED MAY 5, 1954

This Price List Is Supplied For Your Convenience By Tung-Sol Electric Inc.

All prices are subject to change without notice. The listing of price for any tubes does not necessarily indicate availability.

Type	Sugg'd Retail Price	Type	Sugg'd Retail Price	Type	Sugg'd Retail Price	Type	Sugg'd Retail Price
0Y4	\$4.80	1V	\$2.55	6AQ7GT	\$3.15	6J5GT	\$1.80
0Z4	1.65	1V2	1.70	6AR5	1.80	6J6	2.50
0Z4G	1.65	1V5	2.20	6AS5	2.10	6J7	2.50
01A	1.50	1V6	3.15	6AT6	1.65	6J7GT	2.55
1A3	2.50	1X2A	2.65	6AU5GT	3.20	6J8G	3.20
1A4P	4.05	1X2B	2.65	6AU6	1.85	6K5GT	2.65
1A5GT	2.05	1W5	2.20	6AV5GT	3.20	6K6GT	1.80
1A6	3.50	2A3	4.15	6AV6	1.65	6K7	2.10
1A7GT	2.45	2A4G	3.20	6AX4GT	2.55	6K7G	2.40
1AB5	5.70	2A5	2.30	6AX5GT	2.00	6K7GT	2.35
1AG4	2.85	2A6	2.80	6B4G	3.20	6K8	3.05
1AH4	2.85	2A7	2.75	6B5	3.35	6K8G	3.40
1AJ5	2.70	2B7	3.40	6B6G	2.45	6K8GT	2.75
1AK4	6.00	2E5	2.75	6B7	3.35	6L5G	2.75
1AK5	6.00	3A8GT	4.80	6B8	3.35	6L6	4.60
1B3GT	2.65	3B7/1291	5.70	6B8G	3.60	6L6G	3.35
1B4P (1B4/951)	4.05	3C6/XXB	3.75	6BA6	1.95	6L6GA	3.35
1B5/25S	3.35	3D6/1299	4.65	6BA7	2.50	6L7	2.90
1B7GT	3.50	3E6	4.05	6BC5	2.00	6L7G	3.30
1C5GT	2.60	3LF4	2.80	6BC7	3.20	6N6G	3.90
1C6	3.35	3Q4	2.25	6BD5GT	3.60	6N7	2.95
1C7G	3.35	3Q5GT	2.80	6BD6	2.00	6N7GT	2.85
1C8	2.40	3S4	2.20	6BE6	2.05	6P5GT	2.40
1D5GP	4.05	3V4	2.20	6BF5	2.20	6Q7	2.40
1D7G	3.50	5AW4	2.70	6BF6	1.75	6Q7G	2.10
1D8GT	4.05	5AX4GT	1.25	6BG6G	5.25	6Q7GT	2.10
1E5GP	4.05	5AZ4	1.55	6BH6	2.30	6R7	2.80
1E7GT	4.05	5T4	5.00	6BJ6	2.10	6R7GT	2.65
1F4	2.75	5U4G	1.75	6BK7	3.20	6R8	3.35
1F5G	2.75	5V4G	2.80	6BK78	3.35	6S4	1.90
1F6	4.05	5W4	1.65	6BL7GT	3.40	6S7	3.25
1F7G	4.05	5W4GT	1.75	6BN6	2.90	6S7G	3.35
1G4GT	2.55	5X4G	2.00	6BQ6GT	3.80	6S8GT	2.65
1G5G	3.15	5Y3G	1.35	6BQ7	3.50	6SA7	2.10
1G6GT	3.00	5Y3GT	1.35	6BQ7A	3.50	6SA7GT	2.10
1H4G	2.30	5Y4G	1.70	6BY5G	3.25	6SB7Y	2.90
1H5GT	1.95	5Z3	2.00	6BZ7	3.80	6SC7	2.35
1H6G	3.25	5Z4	3.30	6C4	1.65	6SC7GT	2.00
1J5G	2.65	6A3	3.35	6C5	1.95	6SD7GT	3.35
1J6G	3.20	6A4 (LA)	3.20	6C5GT	2.10	6SF5	1.95
1J6GT	3.35	6A5G	5.70	6C6	2.50	6SF5GT	1.95
1L4	2.25	6A6	2.75	6C8G	3.90	6SF7	2.30
1L6	2.75	6A7	2.75	6CB6	2.10	6SF7GT	1.80
1LA4	2.80	6A8	2.70	6CD6G	4.80	6SG7	2.30
1LA6	2.65	6A8G	2.75	6CF6	2.50	6SG7GT	2.20
1LB4	2.80	6A8GT	2.75	6CL6	3.35	6SH7	2.50
1LC5	2.65	6AB4	1.80	6CM6	2.25	6SH7GT	2.50
1LC6	2.65	6AB5/6N5	3.15	6CR6	2.05	6SJ7	2.00
1LD5	2.65	6AB7/1853	3.60	6CS6	2.05	6SJ7GT	1.75
1LE3	2.65	6AC5GT	3.00	6SU6	4.60	6SK7	2.00
1LG5	2.65	6ACT/1852	3.35	6D6	2.50	6SK7GT	2.00
1LH4	2.65	6AD7G	3.90	6D8G	3.35	6SL7GT	2.65
1LN5	2.65	6AF4	3.65	6E5	2.55	6SN7GT	2.35
1N5GT	2.40	6AF6G	3.15	6F5	2.25	6SQ7	1.75
1N6G	2.00	6AG5	2.25	6F5GT	1.85	6SQ7GT	1.75
1P5GT	2.65	6AG7	3.75	6F6	2.45	6SR7	1.85
1Q5GT	3.05	6AH4GT	2.60	6F6G	2.00	6ST7	2.40
1Q6	2.20	6AH6	3.90	6F6GT	2.00	6ST7	2.70
1R5	2.35	6AH6V	3.90	6F7	3.90	6SV7	3.60
1R4	2.45	6AK5	4.15	6F8G	3.90	6SZ7	2.45
1S5	2.05	6AK6	2.55	6G6G	2.75	6T7G (6Q6G)	3.35
1T4	2.25	6AL5	1.75	6H4GT	2.90	6T8	3.05
1T5GT	2.80	6AL7GT	4.00	6H6	2.00	6U4GT	2.55
1U4	2.25	6AQ5	2.10	6H6GT	2.10	6U5/6G5	2.25
1U5	2.00	6AQ6	1.85	6J5	1.70	6U6GT	2.45

ALL PRICES SUBJECT TO CHANGE WITHOUT NOTICE

TUNG-SOL ELECTRON TUBES (con.)

Type	Sugg'd Retail Price	Type	Sugg'd Retail Price	Type	Sugg'd Retail Price	Type	Sugg'd Retail Price
6U7G	\$2.40	12AQ6	\$2.10	14J7	\$3.25	50C8G	\$2.90
6U8	3.00	12AT6	1.65	14N7	2.65	50L6GT	1.95
6V8	3.55	12AT7	2.85	14Q7	2.60	50X6	2.20
6V8A	3.90	12AU6	1.85	14R7	3.35	50Y6GT	2.15
6V6	3.40	12AU7	2.40	14S7	3.25	50Y7GT	2.10
6V6GT	2.00	12AV6	1.65	14W7	3.35	53	2.75
6V7	3.55	12AV7	3.00	14X7	2.65	55	2.30
6V7G	2.00	12AW6	2.65	14Y4	2.40	56	1.90
6W4GT	1.90	12AX4GT	2.65	15	3.20	57	2.10
6W6GT	2.40	12AX7	2.50	19	3.35	58	2.10
6W7G	2.75	12AY7	6.00	19BQ6G	6.00	59	3.70
6X4	1.50	12AZ7	2.50	19C8	3.20	70L7GT	6.60
6X5	3.10	12BA6	1.95	19J6	2.65	71A	2.35
6X6GT	1.55	12BA7	2.50	19T8	3.10	75	2.00
6X8	2.95	12BD6	2.00	22	3.20	76	1.70
6Y6G	2.55	12BE6	2.05	24A	2.70	77	2.15
6Z7G	4.05	12BF6	1.75	25A6	3.40	78	2.15
6ZY6G	2.55	12BH7	2.75	25A6G	2.75	79	2.75
7A4/XXL	2.00	12BV7	2.65	25AC5GT	2.90	80	1.55
7A5	2.50	12BZ7	2.70	25BQ6GT	3.90	81	4.65
7A6	2.10	12C8	3.90	25C6G	3.00	82	2.75
7A7	2.20	12E6GT	2.20	25L6	3.90	83	2.85
7A8	\$2.10	12F5GT	1.90	25L6GT	1.95	83V	3.40
7AD7	4.60	12H6	2.00	25W4GT	2.05	84/6Z4	1.80
7AF7	2.40	12J5GT	1.80	25Y5	3.05	85	2.30
7AG7	2.45	12K7GT	2.35	25Z5	1.80	89	2.30
7AH7	2.45	12K8	3.15	25Z6	2.60	117L7/M7GT	6.60
7B4	2.00	12K8GT	2.80	25Z6GT	1.80	117N7GT	4.80
7B5	1.85	12Q7GT	2.10	26	2.25	117P7GT	4.80
7B6	2.00	12S8GT	2.65	27	1.75	117Z3	1.80
7B7	2.00	12SA7	2.10	30	2.25	117Z4GT	2.90
7B8	2.25	12SA7GT	2.10	31	2.75	117Z6GT	2.95
7C4/1208	3.50	12SC7	2.50	32	3.70	485	2.65
7C5	2.15	12SP5	2.10	32L7GT	3.20	FM1000	3.20
7C6	1.85	12SF5GT	2.10	33	3.35	XXD/14AF7	2.40
7C7	2.15	12SF7	2.40	34	3.50	XXFM/7X7	3.30
7E5/1201	2.80	12SF7GT	2.40	35/51	2.35	XXL/7A4	2.00
7E6	2.90	12SG7	2.35	35A5	2.20		
7E7	3.20	12SH7	2.50	35B5	2.10		
7F7	2.45	12SJ7	2.00	35C5	2.05		
7F8	3.25	12SJ7GT	2.00	35L6GT	1.95		
7G7/1282	3.00	12SK7	2.00	35W4	1.35		
7H7	2.20	12SK7GT	2.00	35Y4	1.80		
7J7	3.50	12SL7GT	2.65	35Z3	1.80		
7K7	3.15	12SN7GT	2.30	35Z4GT	1.45		
7L7	2.90	12SQ7	1.75	35Z5GT	1.40		
7N7	2.35	12SQ7GT	1.75	35Z6G	1.80		
7Q7	2.60	12SR7	2.00	36	2.75		
7R7	3.35	12SR7GT	2.20	37	1.85		
7S7	3.25	12V6GT	2.00	38	2.30		
7V7	3.35	12X4	1.50	39/44	2.75		
7W7	3.35	12Z3	2.60	41	1.90		
7X6	2.20	14A4	2.65	42	1.90		
7X7 (XXFM)	3.30	14A5	3.90	43	2.05		
7Y4	1.80	14A7/12B7	2.40	45	2.10		
7Z4	1.80	14AF7 (XXD)	2.40	45Z3	1.80		
9U8	3.00	14B6	2.20	45Z5GT (40Z5GT)	1.80		
10	3.90	14B8	2.20	46	2.90		
12A6	2.90	14C5	2.90	47	2.90		
12A6GT	2.90	14C7	2.40	48	4.80		
12A7	3.90	14E6	2.90	49	2.75		
12A8GT	2.75	14E7	3.20	50	5.15		
12AH6GT	2.20	14F7	2.45	50A5	2.20		
12AH7GT	3.05	14F8	3.25	50B5	2.10		
12AL5	1.80	14H7	2.40	50C5	2.05		

SPECIAL PURPOSE TUBES

1603	\$7.40
1AD4	2.05
2051	4.25
2E22*	6.00
3A4*	1.20
5A6*	5.50
5R4GY	1.89
6AJ5	3.50
6AR6*	5.75
6AS7G*	4.87
6SC7GTY*	3.25
6SU7GTY*	4.25
6X4W	1.80
25A7GT	4.00
26Z5W	4.00
5608A*	3.15
5636	12.85
5654/6AK5W	3.15
5672	1.60
5676*	1.90
5678	1.60
5687*	4.50
5726/6AL5W	1.45
5749/6BA6W	2.00
5751	3.35
5875*	2.10
5881*	3.50

(* Non-taxable type)

TUNG-SOL RADIO DIAL LAMPS

Tung-Sol Lamp No.	Bulb Type	Base	Bead Color	Volts	Amperes	List Price
40	T-8 1/4	Miniature Screw	Brown	6-8	.15	\$0.12
41	T-8 1/4	Miniature Screw	White	2.5	.50	.12
42	T-8 1/4	Miniature Screw	Green	3.2	.50	.13
43	T-8 1/4	Miniature Bayonet	White	2.5	.50	.12
44	T-8 1/4	Miniature Bayonet	Blue	6-8	.25	.12
45	T-8 1/4	Miniature Bayonet	Green	3.2	.50	.13
46	T-8 1/4	Miniature Screw	Blue	6-8	.25	.12
47	T-8 1/4	Miniature Bayonet	Brown	6-8	.15	.12
48	T-8 1/4	Miniature Screw	Pink	2.0	.06	.16
49	T-8 1/4	Miniature Bayonet	Pink	2.0	.06	.16
50	G-8 1/2	Miniature Screw	White	6-8	.20	.12
*51	G-8 1/2	Miniature Bayonet	White	6-8	.20	.11
*55	G-4 1/2	Miniature Bayonet	White	6-8	.40	.11
291	T-8 1/4	Miniature Bayonet	White	2.9	.17	.17
292	T-8 1/4	Miniature Screw	White	2.9	.17	.17
1490	T-8 1/4	Miniature Bayonet	White	3.2	.16	.12

*Taxable at 2.8% of list. All other taxable at 2.8% of list.

ALL PRICES SUBJECT TO CHANGE WITHOUT NOTICE



TUNG-SOL

PICTURE TUBES



ISSUED MAY 26, 1954

Type	Suggested List Price	Suggested Dealer Price	DESCRIPTION				
			Shape	Material	Face	Focus	Deflection
7JP4	26.00	19.50	Round	Glass	Clear	Electrostatic	Electrostatic
10BP4-A	28.00	15.00	Round	Glass	Filter	Magnetic	Magnetic
12LP4-A	32.00	18.10	Round	Glass	Filter	Magnetic	Magnetic
14BP4	34.75	19.70	Rectangular	Glass	Filter	Magnetic	Magnetic
14CP4	34.75	19.70	Rectangular	Glass	Filter	Magnetic	Magnetic
16AP4-A	46.00	31.00	Round	Metal	Filter	Magnetic	Magnetic
16GP4	46.00	31.00	Round	Metal	Filter	Magnetic	Magnetic
16GP4-B	46.00	31.00	Round	Metal	Fil.-Fr.	Magnetic	Magnetic
16KP4	37.00	23.00	Rectangular	Glass	Filter	Magnetic	Magnetic
16RP4	37.00	23.00	Rectangular	Glass	Filter	Magnetic	Magnetic
16TP4	37.00	23.00	Rectangular	Glass	Filter	Magnetic	Magnetic
17BP4-A	36.00	22.65	Rectangular	Glass	Filter	Magnetic	Magnetic
17CP4	42.00	31.00	Rectangular	Metal	Fil.-Fr.	Magnetic	Magnetic
17GP4	51.00	38.00	Rectangular	Metal	Fil.-Fr.	Electrostatic	Magnetic
17HP4	36.00	23.85	Rectangular	Glass	Filter	Electrostatic	Magnetic
17LP4	36.00	23.85	Rectangular	Glass	Filter	Electrostatic	Magnetic
17QP4	36.00	22.65	Rectangular	Glass	Filter	Magnetic	Magnetic
19AP4-A	59.00	39.60	Round	Metal	Filter	Magnetic	Magnetic
19AP4-B	59.00	39.60	Round	Metal	Fil.-Fr.	Magnetic	Magnetic
20CP4-A	51.50	28.15	Rectangular	Glass	Filter	Magnetic	Magnetic
20DP4-A	51.50	28.15	Rectangular	Glass	Filter	Magnetic	Magnetic
20HP4	54.00	33.00	Rectangular	Glass	Filter	Electrostatic	Magnetic
21AP4	61.00	45.50	Rectangular	Metal	Fil.-Fr.	Magnetic	Magnetic
21EP4-A	54.00	32.30	Rectangular	Glass	Filter	Magnetic	Magnetic
21FP4-A	57.00	33.70	Rectangular	Glass	Fil.-Cyl	Electrostatic	Magnetic
21MP4	64.00	48.00	Rectangular	Metal	Fil.-Fr.	Electrostatic	Magnetic
21YP4	51.75	33.00	Rectangular	Glass	Filter	Electrostatic	Magnetic
21ZP4	50.00	33.00	Rectangular	Glass	Filter	Magnetic	Magnetic

ALL PRICES SUBJECT TO CHANGE WITHOUT NOTICE

EQUIP YOUR SETS WITH THESE TUBES THAT HELP SALES!

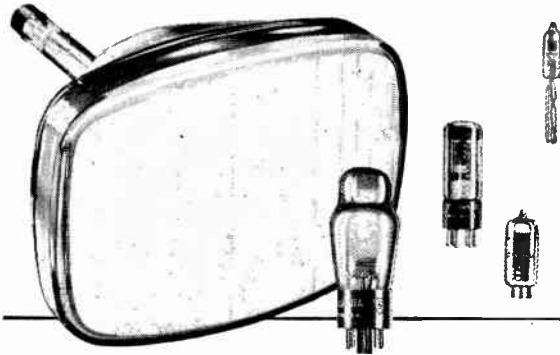

Sylvania's high-quality receiving tubes and picture tubes offer extra dependability ... extra fine performance.

Years of pioneering, research and development have established Sylvania as a world leader in the production of highest quality radio and television tubes. Today set builders and set owners alike know that Sylvania stands for the very highest quality and unbeatable dependability.

Moreover, the Sylvania tube line is a complete line providing tubes for every set and every circuit. Check this list of popular Sylvania tube types now available. For prices, specifications, and detailed data concerning any of these tubes, write a line on your letterhead to Dept. 4R-80 Sylvania.

TELEVISION PICTURE TUBES

7JP4	16ZP4	20MP4	21WP4
10BP4A	17BP4A	21ACP4	21WP4A
10HP4	17BP4B	21ACP4A	21XP4
10MP4	17CP4	21ALP4	21XP4A
12KP4A	17GP4	21ALP4A	21YP4
12LP4A	17HP4/17RP4	21AMP4	21YP4A
12VP4A	17JP4	21AMP4A	21ZP4
14BP4	17LP4/17VP4	21ANP4	21ZP4A
14CP4	17QP4	21ANP4A	21ZP4B
15GP22	17TP4	21AP4	24CP4
16AP4A	17YP4	21AQP4	24CP4A
16GP4	19AP4A	21AQP4A	24DP4A
16GP4B	19AP4B	21EP4	24VP4
16JP4A	20CP4	21EP4A	24VP4A
16KP4	20CP4A	21EP4B	27EP4
16LP4A	20DP4	21FP4	27GP4
16RP4	20DP4A	21FP4A	27LP4
16TP4	20HP4	21FP4C	27NP4
16WP4A	20HP4A/20LP4	21MP4	27RP4

Write for data and availability information on color television picture tubes.

GENERAL PURPOSE CATHODE RAY TUBES

2AP1A	3KP1	5FP7A	7JP1
3AP1A	5AP1	5FP14	7JP7
3BP1	5BP1	5GP1	10KP7
3FP7A	5CP1A	5HP1	10NP11
3JP12	5CP12	7BP7A	12SP7

SPECIAL PURPOSE TUBES

OA2	6AL5W	808	5644
OA3 (VR75)	6AN6	809	5645
OA4G	6AQ5W	810	5646
OB2	6AS6	811A	5647
OB3 (VR90)	6AS7G	812A	5654
OC3 (VR105)	6AU6WA	813	5679
OD3 (VR150)	6AZ5	815	5718
1AC5	6BA5	816	5719
1AD5	6BF7W	829B	5722
1C8	6D4	832A	5726
1D3	6J4	837	5749
1E8	6K4	841	5751
1S6	6L6GA/Y	866A	5763
1T6	6L6WGA/5932	872A	5814
1V5	6SJ7WGT	884	5840
1W5	6SK7GTY	885	5845
2A4G	6SL7WGT	1222	5896
2B5	6SN7WGT	1229	5899
2C4	6V6GTY	1236	5902
2D21	6X4W	1247	5906
2E22	6X5WGT	1265	5977
2E24	7AK7	1273	5987
2E26	7F8W	1274	6021
2E30	12AY7	1280	6110
2X2A	25A7GT	1616	6111
3A4	26D6	1625	6112
3A5	28D7	2050	6145
3D24	28D7W	5636	6146
5R4GY	801A	5637	6159
5Y3WGT	804	5638	6205
5U4WG/5931	805	5639	6206
6AD4	807	5641	9001
6AJ5	807W/5933	5642	9002
6AK4	807Y	5643	9003
			X6030



SYLVANIA



Sylvania Electric Products Inc., 1740 Broadway, New York 19, N. Y.

In Canada: Sylvania Electric (Canada) Ltd., University Tower Bldg., St. Catherine St., Montreal, P. Q.

LIGHTING • RADIO • ELECTRONICS • TELEVISION

FOR EFFICIENT DESIGN ... IMPROVED OPERATION

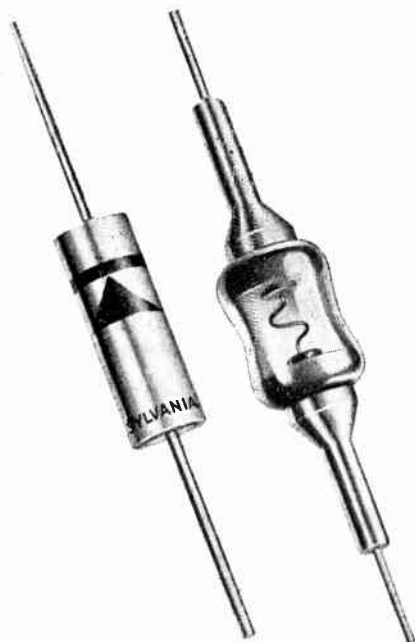

Use Sylvania Crystal Diodes and Electronic Components in your circuits!

Sylvania Crystal Diodes are lightweight, compact rugged circuit elements with low shunt capacity, no contact potential, and requiring no heater supply or mounting hardware. They have exceptional electrical stability and are strongly resistant to thermal shock. See how they will save space and improve the design and operation of your circuits.

Listed below are Sylvania's most popular crystal diodes with general descriptions and suggested re-sale prices. Also listed are Sylvania's most widely-used Electronic Components. For full details write to Dept. 4E-80 Sylvania.

MICROWAVE CRYSTAL DIODES

		Suggested Resale Price
1N21A	3000 mc Mixer	\$ 3.25
1N21B	3000 mc Mixer	3.65
1N21BM	3000 mc Mixer - Matched Pair	14.40
1N21C	3000 mc Mixer	15.15
1N23A	10,000 mc Mixer	3.25
1N23B	10,000 mc Mixer	3.65
1N23BM	10,000 mc Mixer - Matched Pair	9.00
1N23C	10,000 mc Mixer	5.75
1N25	1000 mc High Burnout Mixer	5.75
1N26	24,000 mc Mixer	10.80
1N31	10,000 mc Video Detector	7.20
1N32	3000 mc Video Detector	28.75
1N76	9000 mc Video Detector	5.05
1N78	16,000 mc Mixer	10.80
1N79	Meter Rectifier	3.95
1N155	Reverse Polarity 1N23B	12.95
1N155A	Reverse Polarity 1N23C	10.05
1N156	1N23B and 1N155 - Matched Pair	25.90
1N157	Reverse Polarity 1N21B	11.50

CRYSTAL DIODES

1N34	General Purpose Diode	.90
1N34A	General Purpose Diode (Glass)	1.00
1N35	Twin Matched Diode - 1N34's	2.20
1N38	100 Volt Diode	1.75
1N38A	100 Volt Diode (Glass)	2.55

		Suggested Resale Price
1N39	200 Volt Diode	\$ 5.05
1N40	Varistor - Plug In	12.25
1N41	Varistor - Lug Type	12.95
1N42	Varistor - Matched 1N38's	21.55
1N54	High Resistance Diode	1.05
1N54A	High Resistance Diode (Glass)	1.45
1N55	150 Volt Diode	2.90
1N55A	150 Volt Diode (Glass)	4.70
1N56	High Conduction Diode	1.05
1N56A	High Conduction Diode (Glass)	1.45
1N58	100 Volt Diode	1.45
1N58A	100 Volt Diode (Glass)	1.45
1N60	TV Video Detector Diode	.75
1N71	Varistor—Low Impedance—Plug In	7.20
1N77A	Photo Diode	18.00
1N82	700 mc Mixer	1.05
1N82A	700 mc Mixer	1.25
1N105	Type 1N60 without Pigtails	.75
1N109	Harmonic Generator	.65
1N111	Computer Diode	2.40
1N112	Computer Diode	1.90
1N113	Computer Diode	2.30
1N114	Computer Diode	1.80
1N115	Computer Diode	1.55
1N119	Computer Diode	3.30
1N120	Computer Diode	2.30
1N132	Video Detector	.65

GLOW MODULATOR TUBES

		Suggested Resale Price
R1130B	.055" Crater (1B59)	\$16.55
R1131C	.093" Crater	16.55

GAS PRESSURE MEASURING TUBES

R1111	Pirani Tube	6.30
R1111M	Matched Pair of R1111	15.15

TRANSISTORS

2N32	Point Contact—Switching Type	15.40
2N34	PNP Junction—Amplifier	13.40
2N35	NPN Junction—Amplifier	18.40
3N21	Tetrode	38.75

STROBOTRONS

1D21/SN4	240 PPS V Neon Duo Grid	5.65
SN5	60 PPS Neon Duo Grid	10.80
SA-309	Small Polychromatic Strobotron	3.40
S413	Straight Polychromatic Strobotron	12.95

FLASH TUBES

R4330	100 Watt Second Electroflash Tube	14.40
-------	-----------------------------------	-------

PHOTO TUBES

921	Gas Filled S1 Response	1.85
931A	Photomultiplier S4 Response	7.80

MISCELLANEOUS

OA5	Trigger Tube (Cold Cathode)	5.05
1237	Full Wave Argon Rectifier	4.75

MAGNETRONS

2J42	X-Band Frequency 9345 to 9405 (mc/sec.)	143.65
2J42A	X-Band Frequency 9345 to 9405 (mc/sec.)	231.85
4J50	X-Band Frequency 9345 to 9405 (mc/sec.)	341.30
4J52	X-Band Frequency 9345 to 9405 (mc/sec.)	450.80
4J78	X-Band Frequency 9003 to 9168 (mc/sec.)	933.80
6002	X-Band Frequency 9230 to 9404 (mc/sec.)	869.40

HYDROGEN THYRATRONS

4C35	8 KV, 90 Amp. Peak	33.05
5C22	15 KV, 325 Amp. Peak	61.45
HT-415	Non-Jitter 5C22	76.20
Hi-457	Industrial Type 4C35	21.55
HT-458	Industrial Type 5C22	28.75
HT-492	Non-Jitter 4C35	71.90

TR & ATR TUBES

1B24A	X-Band TR	33.05
1B35A	X-Band ATR	7.95
1B37	X-Band ATR	14.40
1B37A	X-Band ATR	18.00
1B40	L-Band TR	4.70
1B44	S-Band ATR	35.95

1855	S-Band TR	\$254.40
1856	S-Band ATR	35.95
1858	S-Band TR	115.90
1860	X-Band TR	93.45
1863	X-Band TR	44.55
1863A	X-Band TR	41.00
5792	S-Band ATR	28.75
5793	S-Band ATR	28.75
5853	S-Band TR	122.35
5863	X-Band TR (Restricted)	93.45
5864	ATR (Restricted)	20.15
5865	C-Band TR	212.50
5883	ATR (Restricted)	11.50
5921	ATR (Restricted)	27.30
5922	ATR (Restricted)	27.30
5927	TR (Restricted)	154.55
6214	X-Band ATR	71.90
6232	X-Band TR	115.90

KLYSTRONS

68L6	Broad Band, 1600-4500 mc	57.50
68M6	Broad Band, 550-2800 mc	71.90
68M6A	Broad Band Pulse Type 550-2800 mc	90.15
5836	Broad Band Pulse Type 1600-4500 mc	104.25
5837	Broad Band Pulse Type 550-2800 mc	104.25

ROCKET TUBES

2C36	Pulse-Modulated and C.W. Oscillator	46.75
2C37	C.W. Oscillator, Amplifier and Multiplier	46.75
5764	Pulse-Modulated Oscillator	71.90
5765	Broad Band C.W. Oscillator	71.90
5767	C.W. Oscillator	71.90
5768	C.W. Amplifier	71.90
RT-434	C.W. Oscillator, Amplifier and Multiplier	35.95

PENCIL TUBES

5876	UHF Triode For C.W. Oscillator	15.80
5794	UHF Triode Fixed Tuned Inside Cavity	11.45
6263	Med. mu Power Amplifier	18.35
6264	High mu Power Amplifier	18.35

SELENIUM RECTIFIERS

NA-5	65 ma.	.80
NB-5	75 ma.	.93
NC-5	100 ma.	1.14
ND-5	150 ma.	1.35
NE-5	200 ma.	1.62
NF-5	250 ma.	1.80
NH-5	400 ma.	2.07
NJ-5	450 ma.	2.58
NK-5	350 ma.	2.07
NL-5	400 ma.	2.55
NM-5	460 ma.	2.58



Sylvania Electric Products Inc., 1740 Broadway, New York 19, N. Y.

In Canada: Sylvania Electric (Canada) Ltd., University Tower Bldg., St. Catherine Street, Montreal, P. Q.

LIGHTING • RADIO • ELECTRONICS • TELEVISION

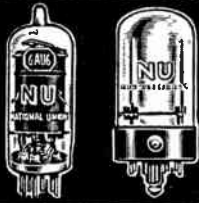

NATIONAL UNION



RADIO & TV RECEIVING TUBES

PRICE LIST EFFECTIVE MAY 15, 1954
ALL LIST PRICES INCLUDE TAX. PRICES & TYPES SUBJECT TO CHANGE OR WITHDRAWAL WITHOUT NOTICE.

TYPE	LIST	TYPE	LIST	TYPE	LIST	TYPE	LIST	TYPE	LIST	TYPE	LIST	TYPE	LIST	TYPE	LIST
0A2	\$3.20	1S4	2.45	6AG5	2.25	6F5GT	1.85	6SQ7GT	1.75	7X6	2.20	12SN7GT	2.30	35A5	2.20
0A3	2.65	1S5	2.05	6AG7	3.75	6F6	2.45	6SR7	1.85	7X7	2.65	12SQ7	1.75	35B5	2.10
0A4G	2.90	1S6	2.65	6AH4GT	2.65	6F6G	2.00	6SR7GT	2.00	7Y4	1.80	12SQ7GT	1.75	35C5	2.05
0B2	3.20	1T4	2.25	6AH6	3.90	6F6GT	2.00	6SS7	2.40	7Z4	1.80	12SR7	2.00	35L6GT	1.95
0B3	3.35	1T5GT	2.80	6AJ4	6.00	6F7	3.90	6SS7GT	2.00	10Y	3.90	12SR7GT	2.20	35W4	1.35
0C3	2.65	1T6	3.00	6AK5	4.35	6F8G	3.90	6ST7	2.70	12A	2.25	12V6GT	2.10	35Y4	1.80
0D3	2.65	1U4	2.25	6AK6	2.55	6G6G	2.75	6SV7	3.60	12A4	2.40	12Z3	2.60	35Z3	1.80
0Y4	4.80	1U5	2.00	6AL5	1.75	6H6	2.00	6T8	2.90	12A5	3.20	14A4	2.65	35Z4GT	1.50
0Z4	1.65	1U6	2.20	6AL7GT	3.75	6H6GT	2.10	6U5/6G5	2.25	12A6	2.90	14A5	3.90	35Z5GT	1.40
0Z4G	1.65	1V	2.55	6AN4	6.00	6J5	1.70	6U6GT	2.45	12A6GT	2.90	14A7/12B7		35Z6G	1.80
1A3	2.50	1V2	1.70	6AQ5	2.10	6J5GT	1.80	6U7G	2.40	12A7	3.90		2.20	36	2.75
1A4P	4.05	1V5	2.65	6AQ6	1.85	6J6	2.50	6U8	3.10	12A8G	2.75	14AF7/XXD		37	1.85
1A5GT	2.05	1W5	2.65	6AQ7GT	2.65	6J7	2.50	6V3	3.60	12A8GT	2.75		2.40	38	2.30
1A6	3.50	1X2B	2.65	6AR5	1.80	6J7G	2.50	6V3A	3.60	12AH6GT		14B6	2.20	39/44	2.75
1A7GT	2.45	2A3	4.15	6AS5	2.10	6J7GT	2.55	6V6	3.40	12AH7GT	3.05	14B8	2.20	40	2.20
1AB5	5.70	2A4G	3.20	6AT6	1.65	6J8G	3.20	6V6GT	2.00	12AL5	1.80	14C5	2.90	41	2.00
1AC5	3.00	2A5	2.30	6AU5GT	3.20	6K5GT	2.40	6V7G	1.80	12AT6	1.65	14C7	2.40	42	2.00
1AD5	3.00	2A6	2.80	6AU6	1.85	6K6GT	1.80	6V8	3.55	12AT7	2.90	14E6	2.90	43	2.05
1AX2	2.65	2A7	2.75	6AV5GT	2.90	6K7	2.10	6W4GT	1.90	12AU6	1.85	14E7	3.20	45	2.20
1B3GT	2.65	2B7	3.40	6AV6	1.65	6K7G	2.40	6W6GT	2.20	12AU7	2.40	14F7	2.45	45Z3	1.90
1B4P	4.05	2E5	2.75	6AX4GT	2.55	6K7GT	2.35	6W7G	2.75	12AV6	1.65	14F8	3.25	45Z5GT	1.80
1B5/25S	3.50	2X2A	4.35	6AX5GT	2.00	6K8	3.05	6X4	1.50	12AV7	2.90	14H7	2.40	46	2.90
1B7GT	3.35	3ABGT	4.80	6AX6G	2.40	6K8G	3.30	6X5	3.10	12AW6	2.65	14J7	3.25	47	2.90
1C5GT	2.60	3B7	5.70	6B4G	3.20	6K8GT	2.75	6X5GT	1.55	12AX4GT	2.65	14N7	2.65	49	2.75
1C6	3.35	3C6	3.70	6B5	3.35	6L5G	2.75	6X8	2.95	12AX7	2.50	14Q7	2.60	50	5.15
1C7G	3.35	3D6	4.65	6B6G	2.45	6L6	4.60	6Y6G	2.55	12AY7	6.00	14R7	3.35	50A5	2.20
1C8	2.65	3E5	2.20	6B7	3.35	6L6G	3.35	6Z7G	4.05	12AZ7	2.65	14S7	3.25	50B5	2.10
1D5GP	4.05	3E6	4.05	6B8	3.35	6L6GA	3.20	6ZY5G	2.55	12B4	2.90	14W7	3.35	50C5	2.05
1D7G	3.50	3LF4	2.80	6B8G	3.60	6L7	2.90	7A4	2.00	12BA6	1.95	14X7	2.65	50C6G	3.30
1D8GT	4.05	3Q4	2.25	6BA6	1.95	6L7G	3.30	7A5	2.35	12BA7	2.50	14Y4	2.40	50L6GT	1.95
1E5GP	4.05	3Q5GT	2.80	6BA7	2.50	6N6G	3.90	7A6	2.10	12BD6	2.00	19	3.35	50X6	2.20
1E7G	3.20	3S4	2.20	6BC5	2.00	6N7	2.95	7A7	2.00	12BE6	2.05	19B6G6	6.00	50Y6GT	2.15
1E7GT	4.05	3V4	2.20	6BC7	2.65	6N7GT	2.85	7A8	2.10	12BF6	1.75	19C8	3.20	50Y7GT	2.10
1E8	3.00	5AX4GT	1.25	6BD5GT	3.60	6P5GT	2.40	7AD7	4.60	12BH6	2.00	19J6	2.65	53	2.75
1F4	2.75	5A24	1.55	6BD6	2.00	6Q7	2.46	7AF7	2.10	12BH7	2.75	19T8	2.90	55	2.30
1F5G	2.75	5T4	5.00	6BE6	2.05	6Q7G	2.10	7AG7	2.45	12BY7	2.65	19V8	3.55	56	1.95
1F6	4.05	5U4G	1.75	6BF5	2.35	6Q7GT	2.10	7AH7	2.45	12BZ7	2.75	19X8	3.10	57	2.10
1F7G	4.05	5V4G	2.80	6BF6	1.75	6R7	2.80	7B4	1.80	12C8	3.90	20	3.90	58	2.10
1G4GT	2.55	5W4	1.65	6BG6G	5.25	6R7GT	2.65	7B5	1.85	12F5GT	1.90	22	3.20	59	3.70
1G5G	3.15	5W4GT	1.75	6BH6	2.30	6R8	3.20	7B6	2.00	12H6	2.00	24A	2.70	70L7GT	6.96
1G6GT	3.00	5X4G	2.00	6BJ6	2.10	6S4	1.90	7B7	2.00	12J5	1.50	25A6	3.40	71A	2.50
1H5GT	1.95	5X3	2.20	6BK5	2.55	6S7	3.25	7B8	2.25	12J5GT	1.80	25A6G	2.75	75	2.10
1H6G	3.35	5Y3G	1.40	6BK7	3.20	6S7G	3.35	7C4/1203A		12J7GT	2.55	25AC5GT	2.90	76	1.70
1H6GT	3.35	5Y3GT	1.35	6BK7A	3.20	6S8GT	2.65	7C5	2.15	12K7G	2.00	25AV5GT	2.90	77	2.20
1J6G	3.20	5Y4G	1.05	6BL7GT	3.20	6SA7	2.10	7C6	1.85	12K7GT	2.35	25BQ6GT	3.90	78	2.20
1J6GT	3.35	5Z3	2.00	6BN6	3.20	6SA7GT	2.10	7C7	2.15	12K8	3.15	25C6G	3.00	79	2.75
1L4	2.25	5Z4	3.30	6BQ6GT	3.80	6SB7Y	2.90	7E5/1201		12K8GT	2.80	25L6	3.90	80	1.55
1L6	2.75	6A3	3.35	6BQ7	3.50	6SC7	2.35	7E6	2.80	12Q7GT	2.10	25L6GT	1.95	81	4.65
1LA4	2.65	6A4/LA	3.20	6BQ7A	3.50	6SD7GT	3.35	7E7	2.90	12S8GT	2.65	25W4GT	2.05	82	2.75
1LA6	2.65	6A5G	5.70	6BX7GT	3.60	6SF5	1.95	7F7	3.20	12SA7	2.10	25W6GT	2.25	83	2.85
1LB4	2.65	6A6	2.75	6BY5G	3.00	6SF5GT	2.30	7F7	2.45	12SA7GT	2.10	25Y5	3.00	83V	3.40
1LC5	2.65	6A7	2.75	6BZ7	3.80	6SF7	2.30	7F8	3.25	12SC7	2.50	25Z5	1.80	84/6Z4	1.80
1LC6	2.65	6A8	2.70	6C4	1.65	6SG7	2.30	7G7	2.90	12SF5	2.10	25Z6	2.60	85	2.30
1LD5	2.65	6A8G	2.75	6C5	1.95	6SG7GT	2.20	7H7	2.20	12SF5GT	2.10	25Z6GT	1.80	89	2.30
1LE3	2.65	6A8GT	2.75	6C5GT	2.10	6SH7	2.50	7J7	3.25	12SF7	2.40	26	2.25	99V	3.20
1LG5	2.65	6AB4	2.00	6C6	2.50	6SH7GT	2.20	7K7	2.90	12SF7GT	2.00	27	1.80	117L7GT	3.90
1LH4	2.65	6AB5	3.15	6C8G	3.90	6SJ7	2.00	7L7	2.90	12SG7	2.35	30	2.25	117M7GT	3.90
1LN5	2.65	6AB7	3.60	6CB6	2.10	6SJ7GT	1.90	7N7	2.35	12SG7GT	2.20	31	2.75	117N7GT	4.80
1N5GT	2.40	6AC5GT	3.00	6CD6G	5.90	6SK7	2.00	7Q7	2.60	12SH7	2.50	32	3.70	117P7GT	4.80
1P5GT	2.75	6AC7	3.35	6CL6	3.35	6SK7GT	2.00	7R7	3.35	12SJ7	2.00	33	3.35	117Z3	1.80
1Q5GT	3.05	6AD7G	3.90	6D6	2.50	6SL7GT	2.65	7S7	3.25	12SJ7GT	2.00	34	3.50	117Z4GT	2.90
1Q6	2.20	6AE6G	1.80	6D8G	3.35	6SN7GT	2.35	7V7	3.35	12SK7	2.00	35/51	2.35	117Z6GT	2.95
1R4	2.75	6AF4	4.15	6E5	2.55	6SN7GTA	2.35	7W7	3.35	12SK7GT	2.00			1273	2.65
1R5	2.35	6AF6G	3.15	6F5	1.90	6SQ7	1.75			12SL7GT	2.65			1280	2.65
														5642	2.60
														FM1000	3.20

NATIONAL UNION ELECTRIC CORP.

MAIN OFFICE
HATBORO, PA.



NATIONAL UNION

see **BETTER**
hear **BETTER**

renew
with **N.U.**

PICTURE TUBES

TRANSISTORS and DIODES

PRICE LIST EFFECTIVE MAY 15, 1954
ALL LIST PRICES INCLUDE TAX. PRICES & TYPES SUBJECT TO CHANGE OR WITHDRAWAL WITHOUT NOTICE.

TELEVISION PICTURE and OSCILLOSCOPE TUBES

Type	Description	List Price
7JP4	Electrostatic deflection	\$26.00
8BP4	Electrostatic deflection	30.50
10BP4A	Electromagnetic focus — gray-face	19.75
12LP4A	Electromagnetic focus — gray-face	24.25
14C/BP4	Rectangular, magnetic focus, gray-face	26.75
16DP4A	Electromagnetic focus — gray-face	39.00
16JP4A	Electromagnetic focus — gray-face	39.00
16K/RP4	Rectangular, magnetic focus — gray-face	31.25
16TP4	Rectangular, magnetic focus — gray-face	31.25
17BP4A	Rectangular, magnetic focus — gray-face	31.00
17L/VP4	L-v. electrostatic focus, cylind. face	33.25
17QP4	Magnetic focus — cylindrical face	31.00
17R/HP4	L-v. electrostatic focus, gray-face	33.25
20C/DP4	Magnetic focus — gray-face	40.25
20C/DP4A	Magnetic focus — gray-face	40.25
20HP4	L-v. electrostatic focus — gray-face	42.75
20HP4A	L-v. electrostatic focus — gray-face	42.75
21EP4A	Magnetic focus — cylindrical face	46.25
21FP4A	L-v. electrostatic focus, cylind. face	48.00
21WP4	Magnetic focus — gray-face	43.25
21XP4	L-v. electrostatic focus — gray-face	44.00

Type	Description	List Price
21YP4	L-v. electrostatic focus — gray-face	\$46.00
21ZP4	Magnetic focus — gray-face	45.00
21ZP4A	Magnetic focus — gray-face	45.00
24C/VP4	Magnetic focus — gray-face	73.25

OSCILLOSCOPE C. R. TUBES

Type	Description	Users' Price
3BP1A	Electrostatic deflection	\$16.75
3JP1	Electrostatic deflection	18.00
3JP2	Electrostatic deflection	23.00
3JP7	Electrostatic deflection	23.00
5CP1A	Electrostatic deflection	23.25
5FP14	Magnetic deflection	31.00
5FP7A	Magnetic deflection	30.25
7BP7A	Magnetic deflection	48.50
7JP1	Electrostatic deflection	23.00
7JP7	Electrostatic deflection	30.25
8CP1	Electrostatic deflection	24.50
8CP7	Electrostatic deflection	35.00
10KP7	Magnetic deflection	61.75
12SP7	Magnetic deflection	47.75

TRANSISTORS and CRYSTAL DIODES

Type	Description	List Price
TRANSISTORS		
T18A	Amplifier Point Contact	\$25.00
2N39	PNP JUNCTION	15.00
2N40	PNP JUNCTION	11.00
T34D	PNP JUNCTION	15.50
T34E	PNP JUNCTION	11.45
T34F	PNP JUNCTION	7.00
UNION DIODES		
1N1D7	Small Area Bonded	6.50
1N1D8	Small Area Bonded	6.50
1N175	Small Area Bonded	6.50
POINT-CONTACT DIODES		
1N34A	Computer	1.60

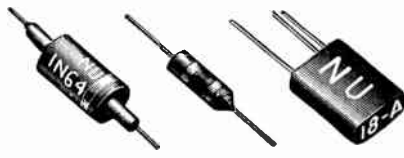

Type	Description	List Price
1N38A	Computer	\$ 3.80
1N40	Varistor	18.00
1N47	General purpose	1.90
1N48	General purpose	1.30
1N56A	High Conduction Diode	2.30
1N68A	General purpose	4.00

Type	Description	List Price
NU67	General purpose	\$ 4.25
1N51	General purpose	0.85
1N54A	General purpose	2.40
1N55A	General purpose	7.50
1N58A	General purpose	2.90
1N63	General purpose	5.10
1N64	Video detector	.95
1N65	General purpose	1.30
1N69	J.A.N. general purpose	1.80
1N70	J.A.N. general purpose	4.40
1N75	General purpose	4.60
1N81	J.A.N. general purpose	4.00
N.U.34	General purpose	1.50
N.U.38	General purpose	2.90
N.U.39	General purpose	8.45
N.U.58	General purpose	2.40

TRANSMITTING and SPECIAL PURPOSE TUBES

Type	Description	List Price
0Z4A	F-w. gas rectifier	\$ 1.30
2C53	High-mu triode amp.	15.00
2D21	Tetrode thyatron	2.00
2E24	V-h-f beam power amp.	4.65
2E26	V-h-f beam power amp.	3.85
3A4	Filamentary power pent.	1.20
5R4GY	F-w. vacuum rectifier	1.50
5R4WGY	Ruggedized f-w. vac. rectifier	6.80
6A5J	Pentode amplifier	3.50
6A57G	Power amp. double triode	6.75
6BL5GT/2160	Space charge power amp.	18.00
6D4	Triode thyatron	2.85
6J4	Triode, grounded grid	8.05
6L6GAY	Beam power amp.	3.10

Type	Description	List Price
6SA7GT	Pentagrid converter	\$ 1.22
6SK7GT	Pentode r-f. amp.	1.22
6V6GT	Beam power amp.	1.20
28D7	Beam power amp.	1.80
100TH	High-mu power amp. triode	16.65
371B	H-w. vacuum rectifier	14.50
811A	High-mu power amp. triode	5.00
812A	Med.-mu power amp. triode	5.00
813	Beam power amp.	18.00
884	Triode thyatron	1.85
885	Triode thyatron	2.00
955	U-h-f. triode, acorn	3.60

Type	Description	List Price
1621	Power amp. pentode	\$ 1.95
1622	Beam power amp.	2.10
1633	Triode amp.	1.95
2050	Tetrode thyatron	1.85
2051	Tetrode thyatron	1.90
5851	Sub. min. beam power amplifier	6.95
JAN5851	Sub. min. beam power amplifier	17.65
5857	Secondary emission amp.	65.00
6184/6AZ6	Sub. min. u-h-f double diode	18.00
9001	V-h-f. pentode amp.	3.10
9002	V-h-f. triode amp.	2.50
9003	V-h-f. pentode amp.	3.10
9006	V-h-f. diode	1.60

NATIONAL UNION ELECTRIC CORP. MAIN OFFICE HATBORO, PA.

WESTINGHOUSE RELIATRON[®] TUBES

WESTINGHOUSE TUBE FACILITIES

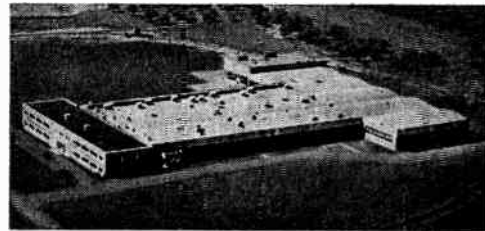
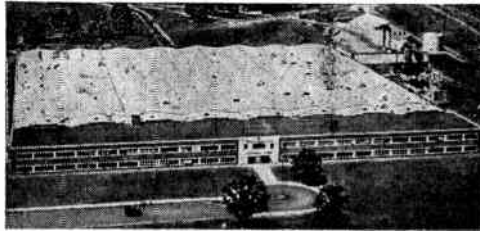

Westinghouse RELIATRON receiving tubes, picture tubes, and power tubes are manufactured in these two giant modern plants which comprise the new Electronic Tube Division of Westinghouse Electric Corporation. The Division offers manufacturers and distributors of electronic equipment the complete lines of tubes listed on the following pages. All are produced under rigid Westinghouse quality control standards. In addition Westinghouse is conducting long-range development programs on receiving and picture tubes for color television. For information concerning Westinghouse Electronic Tubes, contact one of the sales offices listed below:

Boston, Mass.
10 High Street
Liberty 2-0600

Providence, R. I.
51 Empire Street
GASper 1-0818

Bloomfield, New Jersey
MacArthur Avenue
BLoomfield 2-2200

Elmira, New York
Box 284
ELmira 9-3611

Atlanta, Ga.
1299 Northside Drive N.W.
ATwood 1642

Charlotte, N. C.
210 East 6th Street
CHarlotte 6-6461

Philadelphia, Pa.
3001 Walnut Street
EVergreen 2-1200

Pittsburgh, Pa.
306 Fourth Avenue
ATlantic 1-8400

Minneapolis 13, Minn.
2303 Kennedy Street, N.E.
GRanville 3545

Cincinnati, Ohio
207 W. 3rd Street
GARfield 2250

Chicago, Illinois
Merchandise Mart Plaza
WHitehall 4-3860

Detroit, Michigan
5757 Trumbull Avenue
TRinity 2-7010

Dallas, Texas
1232 Fidelity Union Building
RI-5231

Denver, Colorado
P. O. Box 614

Los Angeles, California
600 St. Paul
MADison 6-3881

TRANSISTORS

Engineering samples of germanium and silicon diodes and transistors of several types are available. Out-



standing additions to the Westinghouse line are three new Germanium PNP Junction Transistors for low power, low frequency amplifier applications, the 2N54, 2N55, and 2N56. These transistors are capable of dissipating more power than other transistors of comparable size. Operation within maximum ratings will permit stable function. These new junction transistors are designed for direct wiring. They are encapsulated in thermosetting resin which protects against deterioration due to penetration of any exterior agents.

MAXIMUM RATINGS

Emitter Current*	10 ma.
Collector:	
Current*	-10 ma.
Voltage*	-45 volts
Power*	200 mw.
Ambient Temperature	60°C.

* (at ambient temperature of 25°C.)

Average Characteristics with grounded base (at 25°C.) with:

Collector Volts	-20
Collector Current	-7.5x10 ³ amp.
Collector Dissipation	150 mw.

	2N54	2N55	2N56	
Input resistance with AC short-circuited output	10	15	20	ohms
Voltage Division Ratio with AC Open-circuited Input	40	75	150	X10 ⁵
Output Conductance with AC Open-Circuited Input	300	500	700	mhos X10 ⁸
Current Multiplication Ratio α with AC Short-Circuited Output	.97	.95	.92	

Westinghouse RELIATRON® TUBES

High-Vacuum Amplifiers, Modulators, Oscillators

Type Number	User Price	Type Number	User Price
WL-4D21/4-125A	\$30.25	WL-849	\$ 138.00
WL-4X150A	48.00	WL-862A	1,322.00
WL-4X500A	121.00	WL-880	510.00
WL-4-1000A	132.00	WL-889A	210.00
WL-5D22/4-250A	41.25	WL-889RA	295.00
WL-207	240.00	WL-891	237.00
WL-450TH	77.00	WL-891R	385.00
WL-473	165.00	WL-892	237.00
RJ-571	15.75	WL-892R	385.00
WL-801A	4.85	WL-893A	664.00
WL-802	4.75	WL-893AR	1,212.00
WL-803	24.25	WL-895	950.00
WL-805	13.50	WL-895R	1,300.00
WL-806	34.25	WL-1000T	137.50
WL-807	2.50	WL-1623	4.05
WL-808	10.75	WL-5604	540.00
WL-809	4.00	WL-5619	390.00
WL-810	16.25	WL-5668	263.00
WL-811A	5.00	WL-5669	406.00
WL-812A	5.00	WL-5671	1,250.00
WL-813	18.00	WL-5691	9.50
WL-814	14.25	WL-5692	9.75
WL-815	8.20	WL-5693	7.75
WL-826	12.50	WL-5736	160.00
WL-828	13.75	WL-5833	1,885.00
WL-829B	16.25	WL-5891	1,350.00
WL-832A	12.90	WL-5936	1,100.00
WL-833A	49.50	WL-5986	1,150.00
WL-837	5.80	WL-8000	14.50
WL-838	13.75	WL-8003	14.00
WL-845	13.75	WL-8005	8.40
		WL-8025A	11.30



WL-629



KU-627



WL-927

High-Vacuum Rectifiers

Type Number	User Price
WL-456	\$100.00
WL-481B	8.25
WL-579B	15.00
WL-616	225.00
WL-836	9.00
WL-5934	15.00
WL-5974	220.00
WL-6102	37.00
WL-6103	43.50
WL-8020	24.00

Gas and Mercury-Vapor Rectifiers

Type Number	User Price
WL-3B22/1C	\$ 7.52
WL-4B24/3C	8.90
WL-670A/6C	16.63
WL-575A	21.00
WL-816	1.65
WL-857B	218.00
WL-866A	2.10
WL-869B	138.00
WL-872A	8.20
WL-5558/32	14.00
WL-5561/104	37.90
WL-8008	8.20

IGNITRONS

New to the Westinghouse line are Ignitrons with detachable thermostats especially designed for welding service. They can save users up to 90% of normal cooling water requirements.

Type	Size	Recommended Applications	User Price
WL-5550/681	A	Welder Control	\$ 45.00
WL-5551/652	B	Welder Control	72.00
WL-5551-A/652	B	Welder Control	72.00
WL-5552/651	C	Welder Control	110.00
WL-5553/655	D	Welder Control	239.00
WL-5554/679		Welder Control	
		Power Rectification	171.50
WL-5555/653B	B	Welder Control	
		Power Rectification	333.50
WL-5822		Welder Control	130.00



WL-5552/651



WL-5555/653B



WL-5550/681

THYRATRONS

Type Number	User Price	Type Number	User Price
WL-2D21	\$ 2.00	KU-676	\$ 55.00
WL-3C23	12.50	WL-677	55.00
WL-33	See WL-5720/33	WL-678	47.00
WL-41	See WL-5830/41	WL-884	1.85
WL-81A	16.00	WL-885	2.00
WL-105	48.00	WL-2050	1.85
WL-172	65.00	WL-5557/17	8.50
WL-414	135.00	WL-5559/57	19.50
WL-502A	1.85	WL-5664	9.43
KU-610	22.00	WL-5665	56.67
WL-624	48.00	WL-5683	9.43
KU-627	22.00	WL-5684	15.04
KU-628	34.00	WL-5685	31.90
WL-629	13.00	WL-5720/33	23.00
WL-632B	29.00	WL-5796	13.75
WL-672A	35.00	WL-5830/41	200.00

PHOTO TUBES

Type Number	User Price	Type Number	User Price
WL-1P29	\$2.95	WL-923	\$2.00
WL-SR50Δ	7.35	WL-924	3.30
WL-SK60Δ	7.35	WL-925	2.40
WL-868	2.50	WL-926	2.90
WL-917	3.50	WL-927	2.50
WL-918	3.10	WL-928	2.85
WL-919	3.50	WL-929	1.50
WL-920	4.15	WL-930	1.65
WL-921	2.05	WL-931A	8.60
WL-922	1.95	WL-5581	2.25

Δ For replacement

Westinghouse RELIATRON® TUBES

RECEIVING TUBES



6AL5



35W4



6K6GT



6V3



12AV7

Reliatron Tube performance is assured by an exacting program of quality control. Every step in the manufacture of Reliatron Tubes from raw materials to finished product — must meet standards which are the toughest in the industry.

Complete data on these tubes is available on request. Write: Westinghouse Electronic Tube Division, Dept. RM 500, Elmira, New York.

Type Number	User Price	Type Number	User Price	Type Number	User Price
0Z4	\$1.65	6A7	\$2.75	6C5	\$1.95
0Z4-G	1.65	6A8	2.65	6C5-GT	2.10
1A5-GT	2.05	6A8-G	2.75	6C6	2.50
1A7-GT	2.45	6A8-GT	2.75	6C8-G	3.90
1AB5	5.70	6AB4	2.00	6CB6	2.10
1B3-GT	2.65	6AB7	3.60	6CD6-G	4.80
1C5-GT	2.60	6AC5-GT	3.00	6CL6	3.30
1D8-GT	4.05	6AC7	3.35	6CS6	2.05
1G4-GT	2.55	6AF4	4.05	6D6	2.50
1G6-GT	3.00	6AF6-G(n)	3.15	6DS-G	3.35
1H5-GT	1.95	6AG5	2.25	6DB6	2.00
1L4	2.25	6AG7	3.75	6E5 (n)	2.55
1L6	2.75	6AH4GT	2.65	6F5	1.90
1LA4	2.80	6AH6	3.90	6F5-GT	1.85
1LA6	2.65	6AK5	4.35	6F6	2.45
1LB4	2.80	6AK6	2.55	6F6-G	2.00
1LC5	2.65	6AL5	1.75	6F6-GT	2.00
1LC6	2.65	6AL7-GT(n)	4.00	6F7	3.90
1LD5	2.65	6AQ5	2.10	6F8-G	3.90
1LE3	2.65	6AQ6	1.85	6H6	2.00
1LH4	2.65	6AQ7-GT	3.15	6H6-GT	2.10
1LN5	2.65	6AS5	2.10	6J5	1.70
1N5-GT	2.40	6AS7-G	7.10	6J5-GT	1.80
1P5-GT	2.75	6AT6	1.65	6J6	2.50
1Q5-GT	3.05	6AU4GT	2.90	6J7	2.50
1R5	2.35	6AU5-GT	3.20	6J7-G	2.50
1S4	2.45	6AU6	1.85	6J7-GT	2.50
1S5	2.05	6AV5-GT	3.20	6J8-G	3.70
1T4	2.25	6AV6	1.65	6K6-GT	1.80
1U4	2.25	6AX4-GT	2.55	6K7	2.10
1U5	2.00	6AX5-GT	2.00	6K7-G	2.40
1-V	2.55	6B4-G	3.20	6K7-GT	2.35
1V2	1.70	6B8	3.35	6K8	3.05
1X2-B	2.65	6BA6	1.95	6L5-G	2.75
2A3	4.15	6BA7	2.50	6L6	4.60
3LF4	3.00	6BC5	2.00	6L6-G	3.35
3Q4	2.25	6BD6	2.00	6L6-GA	3.35
3Q5-GT	2.80	6BE6	2.05	6L7	2.90
3S4	2.20	6BF5	2.35	6N7	2.95
3V4	2.20	6BF6	1.75	6N7-GT	2.85
5AZ4	1.55	6BG6-G	5.25	6P5-GT	2.40
5R4-GY	1.85	6BH6	2.30	6Q7	2.40
5T4	5.00	6BJ6	2.10	6Q7-G	2.10
5U4-G	1.75	6BK5	2.65	6Q7-GT	2.10
5V4-G	2.80	6BK7-A	3.20	6R7	2.80
5W4-GT	1.75	6BL7-GT	3.40	6RT-GT	2.65
5X4-G	2.00	6BN6	3.00	6S4	1.90
5Y3-G	1.35	6BQ6-GT	3.80	6S7	3.25
5Y8-GT	1.35	6BQ7-A	3.50	6S8-GT	2.65
5Y4-G	1.70	6BY5-G	3.25	6SA7	2.10
5Z3	2.00	6BZ7	3.55	6SA7-GT	2.10
5Z4	3.30	6C4	1.65	6SB7-Y	2.90
6A3	3.35				
6A6	2.75				

PRICES SUBJECT TO CHANGE WITHOUT NOTICE

Type Number	User Price	Type Number	User Price
6SC7	\$2.35	12J5	\$1.80
6SD7-GT	3.35	12J5-GT	1.80
6SF5	1.95	12J7-GT	2.55
6SF5-GT	1.80	12K7-GT	2.35
6SF7	2.30	12KS	3.15
6NG7	2.30	12Q7-GT	2.10
6SH7	2.50	12SA7	2.10
6SJ7	2.00	12SA7-GT	2.10
6SJ7-GT	1.90	12SC7	2.50
6SK7	2.00	12SF7	2.40
6SK7-GT	2.00	12SG7	2.35
6SL7-GT	2.65	12SH7	2.50
6SN7-GT	2.35	12SJ7	2.00
6SN7-GTA	2.35	12SJ7-GT	2.00
6SQ7	1.75	12SK7	2.00
6SQ7-GT	1.75	12SK7-GT	2.00
6SR7	1.85	12SL7-GT	2.65
6SS7	2.40	12SN7-GT	2.30
6SV7	3.55	12SQ7	1.75
6TS	2.90	12SQ7-GT	1.75
6U5(n)	2.25	12SR7	2.00
6U7	2.40	12V6GT	2.10
6U8	3.10	12Z3	2.60
6V3	3.90	14A7	2.20
6V6	3.40	14B6	2.20
6V6-GT	2.00	14C7	2.40
6W4-GT	1.90	14F7	2.45
6W6-GT	2.40	14F8	3.25
6X4	1.50	14H7	2.40
6X5-GT	1.55	14Q7	2.60
6X8	2.95	14R7	3.35
6Y6-G	2.55	19BG6-G	6.00
6ZY5-G	2.55	19J6	2.65
7A4/XXL	2.00	19T8	2.90
7A5	2.50	24A	2.70
7A6	2.10	25AV5-GT	3.20
7A7	2.20	25BQ6-GT	3.90
7A8	2.10	25L6-GT	1.95
7AF7	2.40	25W4-GT	2.05
7AG7	2.45	25Z6-GT	1.80
7B4	2.00	26	2.25
7B5	1.85	27	1.80
7B6	2.00	32L7-GT	3.20
7B7	2.00	35A5	2.20
7B8	2.25	35B5	2.10
7C5	2.15	35C5	2.05
7C6	1.85	35L6-GT	1.95
7C7	2.15	35W4	1.35
7E6	2.90	35Y4	1.80
7E7	3.20	35Z3	1.80
7F7	2.45	35Z4-GT	1.50
7F8	3.25	35Z5-GT	1.40
7H7	2.20	36	2.75
7J7	3.50	41	2.00
7L7	2.90	42	2.00
7N7	2.35	43	2.05
7Q7	2.60	45	2.20
7R7	3.35	47	2.90
7S7	3.25	50A5	2.20
7V7	3.35	50B5	2.10
7W7	3.35	50C5	2.05
7X7/XXFM	2.65	50L6-GT	1.95
7Y4	1.80	50X6	2.20
7Z4	1.80	50Y6-GT	2.15
12A8-GT	2.75	50Y7-GT	2.10
12AH7-GT	3.05	56	1.85
12AL5	1.80	57	2.10
12AT6	1.65	58	2.10
12AT7	2.90	70L7-GT	3.90
12AU6	1.85	71A	2.40
12AU7	2.40	75	2.00
12AV6	1.65	76	1.70
12AV7	2.90	77	2.15
12AW6	2.65	78	2.15
12AX7	2.50	80	1.55
12AY7	6.00	83	2.85
12AZ7	2.55	84	1.80
12BA6	1.95	85	2.30
12BA7	2.50	117Z3	1.80
12BD6	2.00	117Z6-GT	2.95
12BE6	2.05		
12BH7	2.75		
12BY7	2.65		
12H6	2.00		

(n) Indicates types not subject to Federal Excise Tax.

Westinghouse RELIATRON® TUBES

PICTURE TUBES

Type	Face Plate		Envelope			Focus		User Price
	Spherical Cylindrical	Filter: Fil Frosted: Fr	Shape	Metal or Glass	External Cond. Coat.	Electrostatic Magnetic		
10BP4-A	spherical	Fil	round	glass	yes	Mag	\$23.00	
12KP4-A	spherical	Fil, Met.*	round	glass	yes	Mag	39.50	
12LP4-A	spherical	Fil	round	glass	yes	Mag	26.75	
14CP4	spherical	Fil	rectangular	glass	yes	Mag	28.25	
16AP4-A	spherical	Fil	round	metal	—	Mag	41.50	
16GP4-B	spherical	Fil, Fr	round	metal	—	Mag	41.50	
16KP4/16RP4	spherical	Fil	rectangular	glass	yes	Mag	33.00	
16LP4-A	spherical	Fil	round	glass	yes	Mag	35.75	
16TP4	spherical	Fil	rectangular	glass	yes	Mag	33.00	
16WP4-A	spherical	Fil	round	glass	yes	Mag	33.00	
17BP4-A	spherical	Fil	rectangular	glass	yes	Mag	35.75	
17CP4	spherical	Fil, Fr	rectangular	metal	—	Mag	42.00	
17GP4	spherical	Fil, Fr	rectangular	metal	—	Hi. V. Es	51.00	
17HP4/17RP4	spherical	Fil	rectangular	glass	yes	Low V. Es	34.75	
17JP4	spherical	Fil	rectangular	glass	yes	Mag	33.00	
17LP4	cylindrical	Fil	rectangular	glass	yes	Low V. Es	34.75	
17QP4	cylindrical	Fil	rectangular	glass	yes	Mag	33.00	
17TP4	spherical	Fil	rectangular	metal	—	Low V. Es	41.50	
17YP4	cylindrical	Fil	rectangular	glass	—	Mag	33.00	
19AP4-B	spherical	Fil, Fr	round	metal	—	Mag	53.50	
20CP4	spherical	Fil	rectangular	glass	none	Mag	42.00	
21AP4	spherical	Fil, Fr	rectangular	metal	yes	Low V. Es	61.00	
21ALP4	spherical	Fil	rectangular	glass	yes	Low V. Es	55.00	
21ALP4-A	spherical	Fil	rectangular	glass	yes	Mag	64.00	
21AMP4	spherical	Fil	rectangular	glass	yes	Mag	53.25	
21AMP4-A	spherical	Fil	rectangular	glass	—	Mag	62.00	
21EP4-A	cylindrical	Fil, Fr	rectangular	glass	yes	Mag	49.25	
21EP4-B	cylindrical	Fil	rectangular	glass	yes	Low V. Es	55.00	
21FP4-C	cylindrical	Fil	rectangular	glass	none	Mag	56.50	
21FP4-A	cylindrical	Fil	rectangular	glass	yes	Low V. Es	51.50	
21MP4	spherical	Fil, Fr	rectangular	metal	—	Low V. Es	64.00	
21YP4	spherical	Fil	rectangular	glass	yes	Low V. Es	47.25	
21YP4-A	spherical	Fil	rectangular	glass	yes	Low V. Es	52.50	
21ZP4-A	spherical	Fil	rectangular	glass	yes	Mag	45.25	
21ZP4-B	spherical	Fil	rectangular	glass	yes	Mag	50.75	
24AP4	spherical	Fil, Met.*	round	metal	—	Mag	117.00	
24CP4	spherical	Fil	rectangular	glass	yes	Mag	84.25	
27MP4	spherical	Fil	rectangular	metal	—	Mag	142.75	

Reliatron® Picture Tubes are available in both glass and metal construction, with either magnetic or electrostatic focusing. Every tube is produced under rigid Westinghouse quality control standards and is guaranteed for a full year. Write or phone the Westinghouse tube representative nearest you.

*Metal-backed fluorescent screen

MICROWAVE TUBES

Westinghouse Microwave Reference Cavities, Spark Gaps and Microwave Switching tubes are available for a broad variety of microwave equipment. T-R's have a long life, shorter recovery time and broad band characteristics. Write for complete specifications.

Prices subject to change without notice

REFERENCE CAVITIES

Type	Resonant Frequency (Megacycles)	Loaded Q	Insertion Loss at Resonant Frequency	User Price
WL-1Q22	9250±0.3	1900-2400	4-6 db	\$125.00
WL-1Q23	9280±0.3	1900-2400	4-6 db	125.00
WL-5846*	9280±0.3	1900-2400	4-6 db	130.00
WL-1Q24	9310±0.3	1900-2400	4-6 db	125.00
WL-1Q25	9375±0.6	1900-2400	4-6 db	125.00

*Interchangeable with 1Q23 except for attenuator card slot.

ATR & Pre-TR

Type	Class	Frequency (Megacycles)	User Price
WL-1B35	ATR	9000-9600	\$11.25
WL-1B37	ATR	8500-9000	15.00
WL-5939	Pre-TR (Gas Switching)	1280-1290	39.50

SERIES SPARK GAPS

Type	Breakdown Voltage (KV per Tube)	Nominal Peak Modulator Power for 2 Tubes (Megawatts)	User Price
WL-1B41	8.7-10.2	2	\$53.00
WL-1B45	13.1-15.1	4	53.00
WL-1B49	11.2-12.7	3	53.00

MISCELLANEOUS

VOLTAGE REGULATORS (Cold Cathode Type)

Type	DC Anode Supply Volts (min.)	DC Operating Current (ma.)	DC Operating Volts	Regulation Volts 5-40 (ma.)	User Price
WL-0A3	105	5-40	75	5	\$2.65
WL-0C3	133	5-40	105	2	2.65
WL-0D3	185	5-40	150	4	2.65

IONIZATION GAUGE

Type	Filament V. A.	Ion Coll. V.	Grid Volts	Sensitivity 1 amp. 10 ⁻⁵ mm Hg.	User Price
WL-5966	6.0 2.5	-30	150		\$25.00

PROTECTOR TUBE

Type	Volts, RMS		Current, Am		User Price
	Break-down	Max. Operating	Max. 2 Sec.	Max. 10 min.	
WL-KX642	800-500	230	50	7	\$12.60



EIMAC - 20 years



TETRODES

4-65A	4W20000A
4-125A	4X150A
4-250A	4X150D
4-400A	4X150G
4-1000A	4X500A
4PR60A	4X500F



TRIODES

2C39A	100TL
3W5000A3	152TH
3W5000F3	152TL
3W10000A3	250TH
3X2500A3	250TL
3X2500F3	304TH
3X3000A1	304TL
3X3000F1	450TH
6C21	450TL
25T	592/3-200A3
35T	750TL
35TG	1000T
75TH	1500T
75TL	2000T
100TH	

PENTODE

4E27A/5-125B



RECTIFIERS

2-01C	RX21A
2-25A	250R
2-50A	253
2-150D	866A
2-240A	872A
2-2000A	8020 (100R)
KY21A	



KLYSTRONS

3K20, 000LA
3K20, 000LF
3K20, 000LK
3K50, 000LA
3K50, 000LF
3K50, 000LK
1K015XA

TETRODES

TRIODES

PENTODE

KLYSTRONS

EIMAC TUBE TYPE	PRICE	MAXIMUM RATINGS						ELECTRICAL CHARACTERISTICS			
		Plate Dissipation Watts	Plate Voltage	Plate Current Milliamperes	Grid Dissipation Watts	Screen Voltage	Screen Dissipation Watts	Filament, Volts	Filament, Amperes	Amplification Factor	Transconductance umhos
4-65A	\$ 20.00	65	3000	150	5	400	10	6.0	3.5	5	4000
4-125A	30.25	125	3000	225	5	400	20	5.0	6.5	5.9	2450
4-250A	41.25	250	4000	350	10	600	35	5.0	14.5	5.1	4000
4-400A	60.50	400	4000	350	10	600	35	5.0	14.5	5.1	4000
4-1000A	132.00	1000	6000	700	25	1000	75	7.5	21	7.0	10,000
4PR60A*	90.00	60	20,000	†	†	1500	8	26	2.25	†	†
4W20,000A**	1850.00	20,000	8000	15,000	60	1500	200	10	30	5.5	75,000
4X150A*	48.00	150	1250	250	2	300	12	6.0	2.6	5	12,000
4X150D*	48.00	150	1250	250	2	300	12	26.5	5.7	5	12,000
4X150G*	54.00	150	1250	250	2	300	15	2.5	6.25	5.0	12,000
4X500A*	121.00	500	4000	350	10	500	30	5.0	13.5	6.2	5200
4X500F*	93.50	500	4000	350	10	500	30	5.0	13.5	6.2	5200
2C39A*	25.00	100	1000	125†	2	6.3	1.0	100	22,000
6C21	77.00	300	30,000	†	†	8.2	17.0	30	6100
3W5000A3**	198.00	5000	6000	2500	150	7.5	51	20	20,000
3W5000F3**	198.00	5000	6000	2500	150	7.5	51	20	20,000
3W10,000A3**	957.00	10,000	5000	10,000	100	10	30	20	55,000
3X2500A3*	198.00	2500	6000	2500	150	7.5	51	20	20,000
3X2500F3*	198.00	2500	6000	2500	150	7.5	51	20	20,000
3X3000A1*	198.00	3000	6000	2500	50	7.5	51	5	11,000
3X3000F1*	198.00	3000	6000	2500	50	7.5	51.0	5	11,000
25T	9.00	25	2000	75	7	6.3	3.0	24	2500
35T	10.50	50	2000	150	15	5.0	4.0	39	2850
35TG	11.00	50	2000	150	15	5.0	4.0	39	2850
75TH	13.25	75	3000	225	16	5.0	6.25	20	4150
75TL	13.25	75	3000	225	13	5.0	6.25	12	3350
100TH	18.25	100	3000	225	20	5.0	6.3	38	4500
100TL	18.25	100	3000	225	15	5.0	6.3	14	3000
152TH	28.75	150	3000	450	30	5 or 10	12.5 or 6.25	20	8300
152TL	28.75	150	3000	450	25	5 or 10	12.5 or 6.25	12	7150
250TH	33.00	250	4000	350	40	5.0	10.5	37	5600
250TL	33.00	250	4000	350	35	5.0	10.5	14	2650
304TH	60.50	300	3000	900	60	5 or 10	25 or 12.5	20	16,700
304TL	60.50	300	3000	900	50	5 or 10	25 or 12.5	12	16,700
450TH	77.00	450	6000	600	80	7.5	12.0	38	6650
450TL	77.00	450	6000	600	65	7.5	12.0	18	5000
592/3-200A3	30.25	200	3500	250	25	10.0	5.0	25	3600
750TL	137.50	750	10,000	1000	100	7.5	21.0	15	3500
1000T	137.50	1000	7500	750	80	7.5	15.5	35	9050
1500T	220.00	1500	8000	1250	125	7.5	24.0	24	10,000
2000T	275.00	2000	8000	1750	150	10.0	23.5	23	11,000
4E27A/5-125B	35.75	125	4000	200	5	750	20	5.0	7.5	5.0	2150
		Frequency Range Mc.	Collector Dissipation Watts	Beam Voltage	Beam Current Amperes	TV Peak Synchronizing Level	CW Power Amplifier				
3K20,000LA**	2975.00	470-580	20,000	14,000	1.7	5500	3000				
3K20,000LF**	2975.00	580-720	20,000	14,000	1.7	5500	3000				
3K20,000LK**	2975.00	720-890	20,000	14,000	1.7	5500	3000				
3K50,000LA**	4200.00	470-560	50,000	19,500	2.56	12,000	6000				
3K50,000LF**	4200.00	580-720	50,000	19,500	2.56	12,000	6000				
3K50,000LK**	4200.00	720-890	50,000	19,500	2.56	12,000	6000				
		D-C Resonator Voltage	Resonator Dissipation	D-C Cathode Current	D-C Repeller Voltage	Heater Voltage	Heater Current	Frequency Range			
1K015XA	235.00	350	15	45	0 to -500	6.3	0.80	8700-9400			

* Requires forced-air cooling
 ** Water-cooled
 † Cathode Current
 ‡ Pulse Modulator

ALL PRICES SUBJECT TO CHANGE WITHOUT NOTICE

SEE NEXT PAGE

EITEL-McCULLOUGH, INC.
 San Bruno, California

of Leadership!

Since 1934 Eimac electron-power tubes have been specified by leading engineers for all types of military and commercial application.

The incomparable performance, reliability and quality of Eimac tubes has enabled Eitel-McCullough, Inc. to become the world's largest manufacturer of transmitting tubes in just two decades.

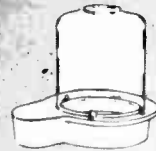

AIR SYSTEM SOCKETS

4-400A/4000 4-1000A/4006*
4-400A/4006* 4X150A/4000
4-1000A/4000 4X150A/4006*

4X150A/4010
4X150A/4011*

*Replacement Chimneys



ACCESSORIES

HR Heat dissipating connectors
Preformed Contact Finger Stock

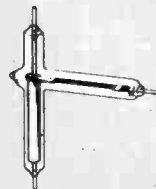

VACUUM SWITCH

VS-2

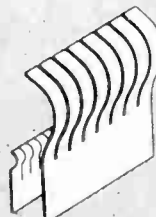

CONTACT FINGER STOCK

17/32"
31/32"
1-7/16"

VARIABLE VACUUM CAPACITORS

VVC60-20
VVC2-60-20
VVC4-60-20

ION GAUGE

100 IG ion gauge

VACUUM CAPACITORS

VC6-20 VC25-20
VC6-32 VC25-32
VC12-20 VC50-20
VC12-32 VC50-32

TUBE EXTRACTOR

4X150

RECTIFIERS

TYPE	PRICE	HIGH VACUUM TYPES		PEAK INVERSE VOLTAGE	CURRENT AMPS. PEAK PLATE	AVERAGE PLATE CURRENT MA.
		FILAMENT VOLTAGE	FILAMENT CURRENT AMPS.			
2-01C	\$ 15.25	6.3	0.4	1,000	0.010	—
2-25A	11.00	6.3	3.0	25,000	1.0	50
2-50A	13.75	5.0	4.0	30,000	1.0	75
2-150D	18.25	5.0	13.0	30,000	3.0	250
2-240A	66.00	7.5	12.0	40,000	4.0	500
2-2000A	214.50	10.0	25.0	75,000	12.0	750
250R	22.00	5.0	10.5	60,000	2.5	250
253	20.50	5.0	10.0	15,000	2.5	275
8020(100R)	15.00	5.0	6.5	40,000	1.5	100
MERCURY VAPOR TYPES						
*KY21A	13.25	2.5	10.0	11,000	3	750
RX21A	9.00	2.5	10.0	11,000	3	750
866A	2.10	2.5	5.0	10,000	1	250
872A	8.20	5.0	7.5	10,000	5	1250

VACUUM CAPACITORS

TYPE	PRICE	VARIABLE CAPACITY	RATING RF PEAK	FIXED		RATING RF PEAK	
				TYPE	PRICE		CAPACITY
VVC60-20	\$ 66.00	10-60 mmfd	20-KV	VC6-20	\$15.00	6 mmfd	20-KV
VVC2-60-20	147.50	Split Stator 5-30 mmfd	40-KV	VC6-32	17.25	6 mmfd	32-KV
				VC12-20	16.50	12 mmfd	20-KV
				VC12-32	20.00	12 mmfd	32-KV
VVC4-60-20	284.00	Split Stator 10-60 mmfd	40-KV	VC25-20	20.00	25 mmfd	20-KV
				VC25-32	23.25	25 mmfd	32-KV
				VC50-20	24.25	50 mmfd	20-KV
		Parallel 40-250 mmfd	20-KV	VC50-32	27.50	50 mmfd	32-KV

AIR SYSTEM SOCKETS

TYPE	COMPLETE ASSEMBLY PRICE	REPLACEMENT CHIMNEY PRICE	FOR USE WITH TUBE TYPE
4X150A/4000	\$18.00	\$0.60	4X150A or 4X150D
4X150A/4010	18.00	.60	4X150A or 4X150D
4-400A/4000	16.00	6.00	4-400A
4-1000A/4000	22.50	7.50	4-1000A

HEAT DISSIPATING CONNECTORS

TYPE	Price	HOLE DIA.
HR-1	\$.60	.052
HR-2	.60	.0625
HR-3	.60	.070
HR-4	.80	.1015
HR-5	.80	.125
HR-6	.80	.360
HR-7	1.60	.125
HR-8	1.60	.570
HR-9	3.00	.570
HR-10	1.60	.500

IONIZATION GAUGE

100 IG Price \$22.50
An electronic vacuum pressure gauge. Filament voltage 3.5 to 7.5 volts.

VACUUM SWITCH

VS-2 Price \$13.25
Single pole double throw switch within a high vacuum adaptable for high voltage switching. Contact spacing .015". Switch will handle R-F potentials as high as 20 Kv. In DC switching will handle approximately 1.5 Amps. at 5 Kv.

ALL PRICES SUBJECT TO CHANGE WITHOUT NOTICE

*Grid Controlled

PREFORMED CONTACT FINGER STOCK

WIDTH	PRICE
17/32"	\$1.65/ft.
31/32"	1.80/ft.
1-7/16"	2.00/ft.

A prepared strip of spring material slotted and formed into a series of fingers designed to make sliding contact.

Eimac
TUBES

EITEL-McCULLOUGH, INC.
San Bruno, California

Export Agents: Frazar & Hansen, 301 Clay St., San Francisco, Calif.

CETRON ELECTRONIC TUBES



Engineered and Manufactured by Continental Electric Co., Geneva, Illinois
Specialists in Photo Emissive and Photo Conductive Tubes

CETRON PHOTOTUBES

CETRON phototubes are either of the gas-filled or of the vacuum type. With the gas-filled type, greater effective response is obtained, particularly in low impedance circuits, while the vacuum type is recommended where maximum stability and signal to noise ratio are desired.

CETRON phototubes are selected as to their sensitivity and priced accordingly. Phototubes of the Super Class A/B or Q are generally used for experimental purposes where very high sensitivities are required; Class C or R mostly for motion picture equipment; Class D for relay work, etc.

CETRON RED SENSITIVE PHOTOTUBES (S1 Surface)

CETRON red sensitive phototubes are available in three sensitivity classes, A/B, C and D. The CETRON gas-filled and vacuum red sensitive tubes comprise a most complete line for sound reproduction. For complete engineering specifications, write for our PC 8/9.

CETRON BLUE SENSITIVE PHOTOTUBES (S4 Surface)

CETRON blue sensitive phototubes are available in two sensitivity classes, Q and R. The CETRON gas-filled and vacuum blue sensitive tubes comprise a most complete line for sound reproduction work from dye recorded film. For complete engineering specifications, write for our PC 8/9.

CETRON LEAD SULPHIDE PHOTOCELLS (Infra-red)

CETRON lead sulfide infra-red photoconductive cells are made in a variety of miniature types. They are also available in a variety of sensitive areas and resistances. CETRON lead sulfide photocells are available in three sensitivity classes, A, C and D. For complete engineering specifications, write for our lead sulfide literature.

CETRON SPECIAL PURPOSE PHOTOTUBES

Continental Electric also manufactures a complete line of special purpose photocells, such as the CE-5, CE-7, CE-8, CE-10, CE-12, CE-15, CE-18, CE-26, etc. We will be happy to work with you on design and development problems, also on any special phototubes your application may require. Full data, price, etc. on special phototubes will be forthcoming upon request.

PRICES

RED SENSITIVE TYPES, GAS-FILLED, RETMA SPECTRAL RESPONSE S1

Type	Class A/B	Class C	Class D
CE-1/918	\$6.20	\$4.10	\$2.50
CE-2/1P30	8.50	5.50	3.65
CE-3/1P31	8.50	5.50	3.30
CE-4/1P36	8.50	5.50	3.30
CE-21/920		5.60	3.60
CE-B22/1P41 End Type	8.00	4.00	2.40
CE-23/923	5.50	2.90	1.75
CE-B25/927 Shadowless Anode	12.00	5.50	2.50
CE-30/930	5.50	2.60	1.50
CE-36	12.00	5.50	2.50
CE-86 Bayonet Base	12.00	5.50	2.70

RED SENSITIVE TYPES, VACUUM, RETMA SPECTRAL RESPONSE S1

Type	Class A/B	Class C	Class D
CE-1V	\$8.50	\$4.20	\$2.60
CE-2V	10.00	6.00	3.30
CE-4V	10.00	6.00	3.65
CE-11V/917	12.00	5.00	3.00
CE-B22V End Type	8.50	4.25	2.50
CE-25V	12.00	5.50	3.00
CE-30V	8.50	2.80	1.85
CE-31V/919	12.00	5.00	3.00

BLUE SENSITIVE TYPES, GAS-FILLED, RETMA SPECTRAL RESPONSE S4

Type	Class Q	Class R
CE-59/5581	\$9.00	\$4.40
CE-64/5583	10.00	3.60
CE-74	12.00	6.50
CE-82 End Type	7.95	3.85
CE-83/5612	16.00	10.00
CE-84 Bayonet Base	12.00	4.60
CE-91/1P37	10.00	3.30
CE-97/5614	16.00	10.00

BLUE SENSITIVE TYPES, VACUUM, RETMA SPECTRAL RESPONSE S4

Type	Class Q	Class R
CE-29/929	\$9.00	\$2.00
CE-34	10.00	4.50
CE-61	10.00	6.60
CE-87 End Type	9.35	4.15
CE-99	16.00	6.50
CE-1645 2 Anodes Balanced Capacitance	10.95
CE-1645A 2 Anodes Balanced Capacitance	12.75

MINIATURE TYPES

LEAD SULFIDE TYPES

Type	Class A/B	Class C
CE-701 Side Type	\$16.00	\$10.00
CE-702 Side Type	16.00	10.00
CE-704 Double Side Type	22.50	15.00
CE-705 End Type	16.00	10.00
CE-706 Side Type	16.00	10.00
CE-711 Three-Pin Side Type	16.00	10.00
CE-712 Side Type, Flexible Leads	16.00	10.00



CE-B25



CE-1
CE-91

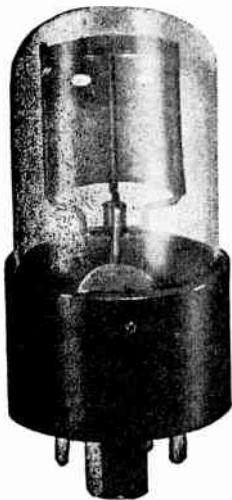

CE-30

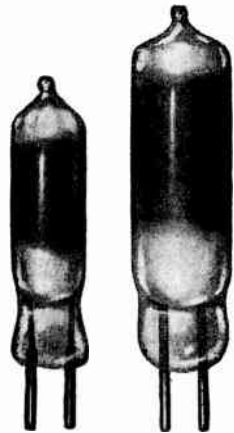

CE-702

CE-701

CETRON ELECTRONIC TUBES



Engineered and Manufactured by Continental Electric Co., Geneva, Illinois
Specialists in High Voltage and Inert Gas-Filled Rectifier and Grid Control Tubes

RECTIFIERS

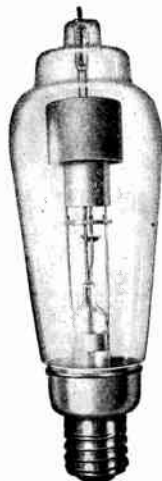

CE-202

Present Type No.	Ref. Type No.	Filament		Anode			Base	Notes	List Price
		Volts	Amps.	Volts Peak Inverse	Amps. Peak	Amps. Avg.			
CE-200A Mercury	200	2.5	6.5	900	4	2	A 4-10	Full Wave	\$ 7.75
CE-201A Mercury	201	2.5	6.5	900	4	2	Special	Full Wave	8.00
CE-202B Mercury	202	2.5	20.0	900	45	15	Mogul Screw	Half Wave	35.00
CE-203 Mercury		2.5	20.0	500	45	15	Mogul Screw	Half Wave	11.60
CE-205 Mercury	2-RA-5	2.0	12.0	900	15	5	Mogul Screw	Half Wave	12.60
CE-206 Mercury	2-RA-6	2.0	12.0	300	18	6	Mogul Screw	Half Wave	6.00
CE-207 Mercury		2.5	20.0	900	45	15	Mogul Screw	Half Wave	35.00
CE-201A Mercury	210	2.5	6.5	800	4	2	Stand. 4 Pin	Full Wave	7.75
CE-211A	211	2.5	6.5	800	4	2	Special	Full Wave	8.00
CE-213A Mercury		2.5	7.0	5000	10	2.5	A 4-10	Half Wave	7.50
CE-220/72 Vacuum	72	2.5	3.0	20000	.100	.020	A 4-10	Half Wave	7.72
CE-221 Xenon	4B25	2.5	17.0	725	25.6	6.4	Special	Full Wave	19.00
CE-224A	4B24	2.5	11.5	725	10.0	2.5	Special	Full Wave	10.90
CE-225 Argon	4B28	2.2	17.0	300	36.0	6.0	Mogul G2-3	Half Wave	5.00
CE-226 Argon	4B26, R6A	2.2	17.0	375	36.0	6.0	Mogul G2-3	Half Wave	5.00
CE-228 Xenon	3B28	2.5	5.0	10000	1.0	0.25	A 4-10	Half Wave	8.00
CE-229 Xenon		2.5	5.0	8000	1.0	0.25	A 4-10	Half Wave	7.00
CE-230A Vacuum	3B24W	5.0	3.0	20000	.300	.060	4 Pin A 4-10	Half Wave	13.20
CE-235 Argon	R-15-A	2.5	25	230	90	15	Mogul G2-3	Half Wave	10.75
CE-235A Argon		2.5	25	230	90	15	Mogul G2-3	Half Wave	10.75
CE-240 Xenon	2W2	2.5	5.0	2500	2.5	0.65	A 4-10	Half Wave	7.95
CE-243 Mercury		2.5	7.0	2000	10.0	2.5	A 4-10	Half Wave	8.50
CE-249C	249C	2.5	7.5	7500	2.5	0.65	A 4-10	Half Wave	9.00

GRID CONTROLLED RECTIFIERS THYRATRONS



CE-329

Present Type No.	Ref. Type No.	Filament		Anode			Base	List Price	
		Volts	Amps.	Volts Peak Inverse	Volts Peak FWD	Amps. Peak			Amps. Avg.
CE-303 Xenon	8C31, C1B	2.5	6.0	700	450	8.0	1.0	A 4-10	\$13.25
CE-304 Mercury		2.5	23	1000	1060	12.5	12.5	IND #4310	74.75
CE-305 Xenon		2.5	6.5	1700	850	12	2.0	A 4-10	28.00
CE-306 Xenon		2.5	18.0	1250	750	77.0	6.4	#412 (IND)	33.60
CE-309 Mercury	FG-17	2.5	5.0	5000	2500	3.0	0.5	A 4-10	7.90
CE-311 Mercury	3C23	2.5	7.0	1250	1250	6.0	1.5	A 4-10	15.75
CE-393A Mercury	393A	2.5	7.0	1250	1250	6.0	1.5	Octal B7-12	15.75
CE-329A Mercury	C3R14	14.0	2.5	500	500	30.0	3.0	Special A 4-81	42.50
CE-329C Xenon	C3P14	14.0	2.5	1250	1250	60.0	3.0	Special A 4-81	39.90
CE-330B Xenon	C5F14	14.0	2.5	1250	500	60.0	5.0	Special A 4-81	45.00
CE-394A Mercury	394A	2.5	3.8	1250	1250	2.5	0.65	Octal B7-12	7.90
CE-627 Mercury	627	2.5	5.0	5000	1250	2.5	0.65	IND. #411 A 4-15	15.75

Detailed engineering specifications on all tubes are available upon request. The extensive engineering and manufacturing facilities which we have, make possible the development and production of many types of special tubes to your specifications. If you have a problem involving the use of any CETRON tubes you are invited to consult us.

WARRANTY

We guarantee all products manufactured by us to be free from all material and manufacturing defects and to give satisfactory service when operated in accordance with instructions indicated for their use.

CONTINENTAL ELECTRIC CO.
Geneva, Illinois

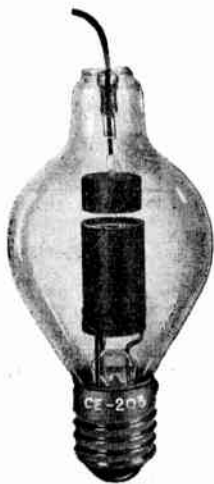

CE-203

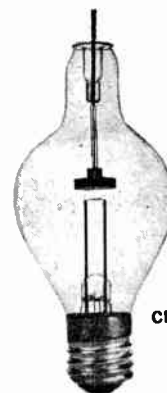

CE-226



AX-9902/5868



833A



857B



AX-5551



5870/AGR-9951



5894/AX-9903



VC25
VC50
VC100



6333



5924/AX-9904R

AMPEREX®

ELECTRONIC TUBES

COMMUNICATION — RECTIFICATION — INDUSTRIAL — ELECTRO-MEDICAL
— RADIATION DETECTION — SPECIAL PURPOSE

TYPE	PRICE	TYPE	PRICE	TYPE	PRICE	TYPE	PRICE	TYPE	PRICE
BEAM DEFLECTION TUBE		MAGNETRONS		SECONDARY EMISSION PENTODE		342A \$582.00		6445* 375.00	
EIT	\$16.50	2J48	\$250.00	EFP60 \$8.75		343A	350.00	6446	225.00
GEIGER COUNTERS		2J55	165.00	SUBMINIATURE PENTODES		343AA*	435.00	6447*	400.00
75N	\$10.00	2J56	165.00	SUBMINIATURE PENTODES		450TH	77.00	SUBMINIATURE TRIODE	
75N83	10.00	4J47	500.00	6007/5913 \$1.50		450TL	77.00	6375** \$.....	
90N8	20.00	4J52	350.00	6008/5911 1.50		498	500.00	TWIN TRIODES	
100C	35.00	4J57	270.00	REFLEX KLYSTRON		501R	160.00	E92CC‡ \$3.00	
100CB	37.50	4J58	270.00	2K25 \$55.00		502	150.00	5920 3.00	
100N	35.00	4J59	270.00	TETRODES		504R	175.00	6085‡ 6.00	
100NB	37.50	5586	417.00	AX-4-125A/6155 \$23.00		508/6246	500.00	TWIN TETRODES	
120C	75.00	5657	417.00	4X150A 48.00		750TL	137.50	832A \$12.90	
120N	75.00	MERCURY RECTIFIERS		AX-4-250A/6156 35.00		805	13.50	5894 24.95	
120NB	77.50	2498	\$9.00	807 2.40		810	16.25	6252/AX-9910 24.95	
150N	50.00	249C	9.00	813 18.00		833A	49.50	6360 3.00	
150NB	52.50	2558	145.00	6075/AX-9907 225.00		834	14.50	VACUUM CONDENSERS	
153C	65.00	2668	210.00	6076/AX-9907R 275.00		838	13.75	VC25/20 \$22.50	
200C	45.00	315A	38.60	6079/AX-9908 60.00		845	13.75	VC25/32 26.50	
200CB	47.50	575A	21.00	TRIODES		849	138.00	VC50/20 24.50	
200N	45.00	673	22.50	3X2500A3 \$198.00		849H	135.00	VC50/32 28.50	
200NB	47.50	857B	215.00	3X2500F3 198.00		851	335.00	VC100/20 30.00	
230N	30.00	866AX	2.10	6Q4 4.00		858	500.00	VC100/32 33.00	
240C	35.00	869B	132.00	6R4 3.00		859	500.00	VC250/32 70.00	
240N	35.00	872AX	8.20	EC55/5861 35.00		880	510.00	VACUUM DIODE	
HYDROGEN THYRATRONS		6508	80.00	HF-100 17.50		889A*	295.00	222A \$300.00	
4C35	\$28.75	8008	8.25	HF200 30.00		891	230.00	VOLTAGE REFERENCE & REGULATOR TUBES	
5C22	53.45	MERCURY THYRATRONS		HF201A/468 28.50		891R*	380.00	OA2 \$2.90	
6268/AX-9911†	28.75	FG17/1701/967/		203H 25.00		892R*	380.00	OB2 3.20	
6279/AX-9912†	53.45	5557	\$8.50	207 240.00		893A*	630.00	85A1/OE3 3.00	
IGNITRONS		5557	49.50	212E 104.00		HF-3000	500.00	85A2/OG3 3.00	
5550	\$45.00	5559	16.00	212F 104.00		ZB3200	350.00	90C1 3.00	
5551/652	72.00	5869/AGR-9950	25.00	220C 365.00		5604*	540.00	6354/15082 3.00	
5552/651	110.00	5870/AGR-9951	100.00	228A 325.00		5619	390.00	XENON RECTIFIERS	
5553/655	239.00	PENTODES		232C 560.00		5658	510.00	3B28 \$8.50	
5554/679	171.00	E81L‡	\$5.00	241B 115.00		5666	230.00	4B32 12.00	
5555/653B	333.50	E83F‡	5.00	250TH 33.00		5676*	310.00	XENON THYRATRONS	
5822	130.00	828	13.75	250TL 33.00		5736	160.00	5544 \$27.00	
INERT GAS THYRATRON		6083/AX-9909	13.50	251A 300.00		5771	510.00	5545 35.00	
2D21	\$2.00	6094‡	6.00	279A 355.00		5866/AX-9900	20.00	5685/C6J 31.90	
		6227‡	6.00	HF300 35.00		5867/AX-9901	30.00		
						5868/AX-9902	50.00		
						5923/AX-9904	150.00		
						5924/AX-9904R	210.00		
						6077/AX-9906	2000.00		
						6078/AX-9906R	2400.00		
						6333	230.00		

† 6268/AX-9911 and 6279/AX-9912 are improved, interchangeable versions of 4C35 and 5C22 respectively. Min. guaranteed life 1000 hrs.

RENEWAL PRICES* ON RADIATOR TYPE FORCED AIR-COOLED TUBES:

TUBE TYPE	USER'S NET	TUBE TYPE	USER'S NET
343AA	\$405.00	5604	510.00
889RA	275.00	5667	290.00
891R, 892R	360.00	6445	345.00
893AR	1,062.00	6447	370.00

*These prices currently apply when a new tube is purchased and the old tube radiator in original shipping container is returned prepaid in good condition with the replacement order.
HELPFUL CHARTS AND LITERATURE FREE: Write for CONDENSED TUBE CATALOG, information at a glance, rapid tube data reference tables. ** Price on request. ‡ 10,000 hour life tubes.



AMPEREX ELECTRONIC CORP.

230 DUFFY AVE., HICKSVILLE, L. I., N. Y.

Taylor

**CUSTOM
BUILT**

Tubes

2312-18 WABANSIA AVENUE, CHICAGO 47, ILLINOIS

TRANSMITTING TRIODES

Type	Filament		Dissipation Watts	Max. Plate		Max. Grid		Base	Max. Mc. for 100% Input	List Price
	Volts	Amps.		D.C. Volts	D.C. M.A.	Drive Watts	Amp. Factor			
UX-CV11	10.0	2.5	75	1500	165	8.0	14	Spec.	30	\$11.50
T-20	7.5	1.75	20	750	85	3.5	20	A4-10	60	4.00
TZ-20	7.5	1.75	20	750	85	3.5	62	A4-10	60	4.00
T-40	7.5	3.0	40	1500	150	9.0	25	A4-10	60	4.50
TZ-40	7.5	3.0	40	1500	150	9.0	62	A4-10	60	4.50
T-55	7.5	3.0	55	1500	150	7.0	20	A4-10	60	9.50
HF-60	10.0	3.0	60	1500	150	7.5	15	A4-10	60	12.50
T-60	10.0	3.0	60	1500	150	9.0	15	A4-10	60	11.50
T-200	10.0	5.75	200	2500	350	20.0	17	A4-29	30	25.00
T-300	10-11	6.0	300	3000	300	18.0	23	A4-30	30	30.00
468	10.0	4.5	150	2250	200	20.0	18	A4-30	30	29.50
805	10.0	3.25	125	1750	210	10.0	45 App.	A4-29	30	13.50
810	10.0	4.5	125	2250	275	15.0	36	A4-29	30	14.50
845	10.0	3.25	100	1230	175	10.0	5	A4-29	20	13.75
8000	10.0	4.5	125	2500	250	20.0	16.5	A4-29	30	14.50

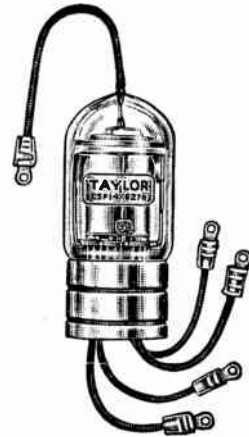

GRID-CONTROLLED RECTIFIERS

Type	Filament		Anode		Amps. Average	Base	List Price
	Volts	Amps.	Volts Peak Inverse	Amps. Peak			
*5557/TT-17	2.5	5.0	2500	2.0	0.5	A4-10	\$ 7.00
*873	5.0	6.75	3000	10.0	2.5	A4-29	17.25
C3A14	14.0	2.5	750	30.0	3.0	A4-81 Spec.	42.50
C3R14	14.0	2.5	500	30.0	3.0	A4-81 Spec.	42.50
6278/C5F14	14.0	2.5	500	60.0	5.0	A4-81 Spec.	45.50
C6A	2.5	17.5	600	77.0	6.4	G2-3	32.30
5685/C6J-A	2.5	21.0	1250	77.0	6.4	A4-81	31.90
C6M	2.5	21.0	1250	40.0	6.4	A4-81	32.20
*KY-21A	2.5	10.0	11000	3.0	0.750	A5-11	13.25

*Mercury Vapor—All others Inert Gas

RECTIFIERS

†3B28	2.5	5.0	10000	1.0	0.250	A4-10	\$ 8.85
†6B	2.5	21.0	920	40.0	6.4	A4-81	12.40
†16B	2.5	36.0	620	96.0	16.0	G2-3	24.30
TR-40M	5.0	10.5	60000	1.0	0.25	A4-29	20.00
*249-B	2.5	7.5	10000	1.5	0.375	A4-10	9.00
*249-C	2.5	7.5	10000	1.5	0.375	A4-10	9.00
*249-S	2.5	7.5	5000	0.5	0.125	A4-10	7.00
*258-B	2.5	7.5	10000	1.5	0.375	Spec.	11.00
*866-A	2.5	5.0	10000	0.5	0.250	A4-10	1.95
*866 Jr.	2.5	2.5	5000	0.5	0.125	A4-10	1.65
*872-A	5.0	6.75	10000	5.0	1.25	A4-29	8.20
*875-A	5.0	10.0	15000	6.0	1.5	A4-29	21.00
*8008	5.0	6.75	10000	5.0	1.25	A4-18	8.20
†6277/3B28A	2.5	5.0	10000	1.0	0.250	A4-10	8.85
†6288	2.5	2.0	7500	2.5	0.175	A4-5	—
8013-A	2.5	5.0	40000	0.15	0.02	A4-9	10.30
8020	5.0	6.0	40000	0.75	0.10	A4-10	22.00
*RX-21A	2.5	10.0	11000	3.0	0.750	A5-11	9.00

*Mercury Vapor

†Inert Gas

All others High Vacuum

In addition to its many lines of standard power tubes, Taylor designs and manufactures special tube types for industrial and commercial applications. Special purpose tubes can be economically produced to your exacting requirements. Contact our Application Engineering Department for information regarding standard or special tube types.

NATIONAL ELECTRONICS, INC.

GENEVA • ILLINOIS • U.S.A.

QUICK-HEATING INDUSTRIAL ELECTRONIC TUBES



NL-3C23 THYRATRON



NL-740 THYRATRON



NL-5552 IGNITRON

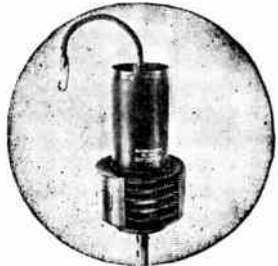

NL-1005 IGNITRON



NL-604 RECTIFIER

Prices and other data subject to change without notice.
WRITE FOR INDIVIDUAL TUBE DATA SHEETS FOR FULL DETAILS.

IGNITRONS

TYPE NUMBER	VOLTS	MAXIMUM RATINGS				PRICE
		Maximum Demand	Corresponding Current DC-Amps.	Maximum Current DC-Amps	Corresponding Demand	
NL-1001	250 - 600	150 Kva	4.9	9.0	50 Kva	\$37.50
NL-1005	250 - 600	600 Kva	30.2	56	200 Kva	\$72.00
NL-1051	250 - 600	600 Kva	30.2	56	200 Kva	\$73.00
NL-1052	250 - 600	1200 Kva	75.6	140	400 Kva	\$111.00
NL-5551	250 - 600	600 Kva	30.2	56	200 Kva	\$72.00
NL-5552	250 - 600	1200 Kva	75.6	140	400 Kva	\$110.00
NL-5822	1500 peak	1200 peak	20	70	420 peak	\$130.00

THYRATRONS

TYPE NUMBER	GAS FILLING	DC OUTPUT AMPERES	PEAK AMPS. RATING	PEAK INVERSE VOLTAGE	FILA-MENT VOLTS	FILA-MENT AMPERES	PRICE
NL-3C23	Arg. & Merc.	1.5	6	1250	2.5	7	\$12.50
NL-323B	Arg. & Merc.	1.5	6	1250	2.5	7	\$13.25
NL-393A	Arg. & Merc.	1.5	6	1250	2.5	7	\$13.25
NL-710/6011	Arg. & Merc.	2.5	30	1250	2.5	9	\$12.15
NL-714	Arg. & Merc.	1	3	1250	2.5	5	\$8.50
NL-715/5557	Mercury	1	3	5000	2.5	5	\$8.50
NL-740	Arg. & Merc.	4	50	1250	2.5	16	\$20.50
NL-741	Mercury	4	50	5000	2.5	16	\$20.50
NL-760	Arg. & Merc.	6.4	77	1250	2.5	21	\$30.90
NL-761	Mercury	4	40	5000	2.5	21	\$30.90
NL-5559/FG57	Mercury	2.5	15	1000	5	4.5	\$19.50
NL-5560/FG95	Mercury	2.5	15	1000	5	4.5	\$28.00
NL-5720/FG33	Mercury	2.5	15	1000	5	4.5	\$23.00

HALF-WAVE RECTIFIERS

NL-249C	Mercury	.64	2.5	7500	2.5	7.5	\$12.75
NL-614	Xenon	2.5	15	900	2.5	8.5	\$8.90
NL-615	Mercury	2.5	10	2000	2.5	7	\$7.50
NL-617	Mercury	5	20	1000	2	12	\$11.60
NL-618	Xenon	6.4	40	750	2.5	18	\$12.40
NL-623	Mercury	15	45	500	2.5	20	\$11.60
NL-625	Mercury	15	45	900	2.5	20	\$29.00
NL-627	Mercury	20	120	1000	2.5	26	\$35.00
NL-633	Mercury	30	225	900	2.5	50	\$52.00
NL-635	Mercury	6.4	40	1000	2.5	18	\$12.60
NL-643	Mercury	15	90	700	2.5	23	\$13.50
NL-649/5834	Mercury	2	10	900	2.5	7	\$7.50
NL-653/5835	Mercury	3	12	900	2.5	10	\$10.75
NL-5558/FG-32	Mercury	2.5	15	5000	5.0	4.5	\$14.00

FULL-WAVE RECTIFIERS

NL-600	Arg. & Merc.	1	4	900	2.5	6	\$8.20
NL-602	Arg. & Merc.	2	4	900	2.5	9	\$10.20
NL-604	Arg. & Merc.	2.5	10	900	2.5	12	\$8.90
NL-606	Arg. & Merc.	6.4	25.6	900	2.5	17	\$16.63

"EL" XENON GAS-FILLED TUBES

RECTIFIERS

FULL WAVE RECTIFIER EL 1C

D. C. Output (Amps.).... 1.0
Peak Anode Current.... 4.0
Peak Inverse Volts..... 725
Filament Volts 2.5
Filament Amperes 6.0
Overall Length 5½"

HALF WAVE RECTIFIER EL 3B

D. C. Output (Amps.).... 2.5
Peak Anode Current.... 20.0
Peak Inverse Volts..... 920
Filament Volts 2.5
Filament Amperes 9.0
Overall Length 5¼"

FULL WAVE RECTIFIER EL 3C

D. C. Output (Amps.).... 2.5
Peak Anode Current.... 10.0
Peak Inverse Volts..... 725
Filament Volts 2.5
Filament Amperes 11.5
Overall Length 7"

FULL WAVE RECTIFIER EL 6C

D. C. Output (Amps.).... 6.4
Peak Anode Current.... 25.6
Peak Inverse Volts..... 725
Filament Volts 2.5
Filament Amperes 17.0
Overall Length 7½"

HALF WAVE RECTIFIER EL 6B & EL 6F

D. C. Output (Amps.).... 6.4
Peak Anode Current.... 40.0
Peak Inverse Volts..... 920
Filament Volts 2.5
Filament Amperes 21
Overall Length (6B)..... 9"
Overall Length (6F)..... 8¼"
EL 6F (Panel Mounting)

HALF WAVE RECTIFIER EL 16F

D. C. Output (Amps.).... 16.0
Peak Anode Current.... 96.0
Peak Inverse Volts..... 620
Filament Volts 2.5
Filament Amperes 36
Overall Length 15½"
(Panel Mounting)

GRID CONTROL RECTIFIERS (THYRATRONS)

EL C1K

D. C. Output (Amps.).... 1.0
Peak Anode Current.... 8.0
Peak Forward Volts..... 1000
Peak Inverse Volts..... 1250
Filament Volts 2.5
Filament Amperes 6.3
Overall Length 4¼"

EL C1K/B

D. C. Output (Amps.).... 1.0
Peak Anode Current.... 8.0
Peak Forward Volts..... 2000
Peak Inverse Volts..... 2000
Filament Volts 2.5
Filament Amperes 6.3
Overall Length 4¼"

EL C3J

D. C. Output (Amps.).... 2.5
Peak Anode Current.... 30.0
Peak Forward Volts..... 750
Peak Inverse Volts..... 1250
Filament Volts 2.5
Filament Amperes 9.0
Overall Length 5¾"

EL C3J/A

D. C. Output (Amps.).... 2.5
Peak Anode Current.... 30.0
Peak Forward Volts..... 1000
Peak Inverse Volts..... 1250
Filament Volts 2.5
Filament Amperes 9.0
Overall Length 5¾"

EL C4J

D. C. Output (Amps.).... 4.0
Peak Anode Current.... 30.0
Peak Forward Volts..... 900
Peak Inverse Volts..... 900
Filament Volts 2.5
Filament Amperes 21.0
Overall Length 9"

EL C6J

D. C. Output (Amps.).... 6.4
Peak Anode Current.... 77.0
Peak Forward Volts..... 750
Peak Inverse Volts..... 1250
Filament Volts 2.5
Filament Amperes 21.0
Overall Length 9"

EL C6J/A & EL C6J/F

D. C. Output (Amps.).... 6.4
Peak Anode Current.... 77.0
Peak Forward Volts..... 1000
Peak Inverse Volts..... 1250
Filament Volts 2.5
Filament Amperes 21.0
Overall Length (C6J/A) 9"
Overall Length (C6J/F) 8½"
EL C6J/F (Panel Mounting)

EL C16J

D. C. Output (Amps.).... 16.0
Peak Anode Current.... 160.0
Peak Forward Volts..... 1000
Peak Inverse Volts..... 1250
Filament Volts 2.5
Filament Amperes 31.0
Overall Length 10"
(Panel Mounting)

EL C6C

D. C. Output (Amps.).... 6.4
Peak Anode Current.... 77.0
Peak Forward Volts..... 2000
Peak Inverse Volts..... 4000
Filament Volts 2.5
Filament Amperes 24.0
Overall Length 11"

FOR SPECIAL APPLICATIONS

EL C3H	EL C6J/K
EL C3J/K	EL C6J/KF
EL C3P14	EL C6M
EL C3R14	EL C6P
EL C5F14	EL C16J/A

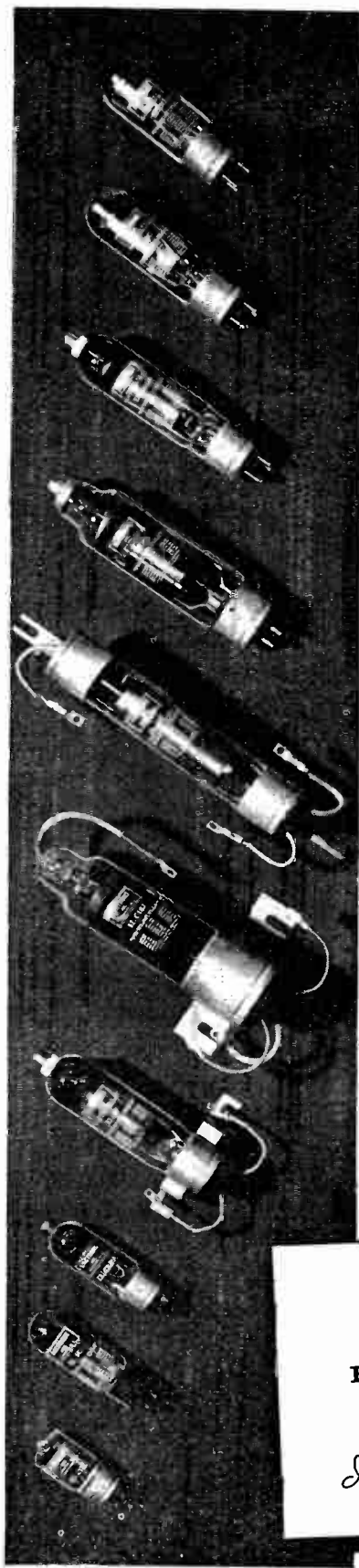

ELECTRONS, INCORPORATED

*Inert gas rectifier and thyristor
tube specialists since 1928.*

TUBES

with nine-plus
lives
built in

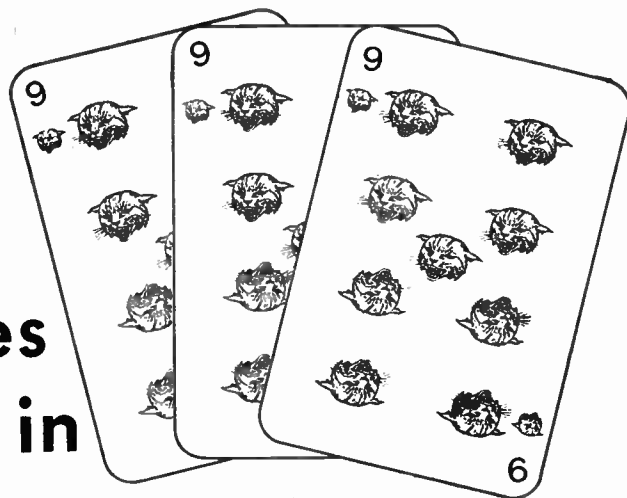

THE LOS GATOS LONG SUIT

LOS GATOS TYPE NUMBER	TUBE TYPE	USER PRICE	LOS GATOS TYPE NUMBER	TUBE TYPE	USER PRICE
3B24W	Rectifier	\$11.75	250R	Rectifier	\$20.00
3C24/24G	Triode	7.50	250TH	Triode	30.00
4D21/4-125A	Tetrode	30.25	250TL	Triode	30.00
4E27/8001	Pentode	24.50	253	Rectifier	19.50
4E27A/5-125B	Pentode	35.75	254	Triode	16.50
4E27TV	TV Pentode Special	27.50	332A	Pentode	32.00
UH50	Triode	22.00	705A	Rectifier	17.93
100R	Rectifier	13.50	715C	Tetrode	63.00
100TH	Triode	16.50	719A	Clipper Diode	32.00
100TL	Triode	16.50	8020	Rectifier	15.00

Los Gatos Brand Tubes in both JAN and commercial types are setting new performance records throughout the electronic field. Exclusive new SINTERCOTE® black-body surface on Molybdenum anodes improves

heat dissipation, keeps tubes hard during operation. Send for technical data bulletins.

Inquiries are welcomed for special tubes designed to your specifications.

LEWIS and KAUFMAN, Ltd.

LOS GATOS 3 CALIFORNIA



Export Representatives: MINTHORNE INTERNATIONAL CO., INC.
15 Moore Street, New York 4, N. Y. Cable Address "Minthorne"

In Canada: THE RADIO VALVE COMPANY OF CANADA, LTD.
189 Dufferin Street, Toronto 1, Ontario, Canada

CHATHAM ELECTRONICS

Electronic Tubes and Equipment

Tubes listed on this page can usually be supplied direct from stock. Many other types are available for immediate delivery — write for catalog. CHATHAM also designs, develops and manufactures special tubes to exact customer specifications — inquiries are invited.



● CHATHAM 1Z2 RECTIFIER

A small bulb high voltage vacuum rectifier. Low cathode heating power and low dielectric losses make tube suitable for radio frequency supply circuits. Filament 1.25 volts, .275 amps. . . Inverse peak anode voltage 15,000, average plate current 1.5 ma. peak anode plate current 8.5 ma.



● CHATHAM RUGGEDIZED 2D21W THYRATRON

A ruggedized Xenon filled shield grid thyratron for grid controlled rectifier service. Permits use of high resistance in the grid circuit. Heater 6.3 volts, .6 amp. . . inverse peak plate voltage 1300 volts, average plate current 100 ma.

● CHATHAM 3B28 RECTIFIER

This rugged half wave Xenon filled rectifier will operate in any position and throughout an ambient temperature range of -75°C to $+90^{\circ}\text{C}$ Fil. 2.5 volts, 5.0 amp. . . Inverse peak anode voltage 10,000 volts, .25 amp. average anode current.



● CHATHAM RUGGEDIZED 5R4WGY RECTIFIER

A ruggedized full wave high vacuum rectifier designed for high altitude operation. Heater voltage 5 volts, heater current 2 amps. Peak inverse voltage 2800 volts, peak plate current 650 ma.

● CHATHAM 4B32 RECTIFIER

A rugged half wave Xenon filled rectifier. Operates in any position throughout an ambient temperature range of -75°C to $+90^{\circ}\text{C}$ Fil. 5 volts, 7.5 amp. . . Inverse peak anode voltage 10,000 volts, 1.25 amp. average anode current.



● CHATHAM 6A57G TWIN POWER TRIODE

Features plate current and GM characteristics held to within $\pm 10\%$. Recommended for voltage regulation circuits. No grid current; greatly reduced plate current draft. Plate current 125 ma at 40 volts D.C. Amplification factor 2.

● CHATHAM 394A THYRATRON

A Mercury vapor and Argon filled thyratron for grid controlled rectifier service. Operates over a wide ambient temperature range. Heater 2.5 volts, 3.2 amps. . . Inverse peak anode voltage 1250, average anode current 640 ma.



● CHATHAM 6336 TWIN TRIODE

Specially suitable for voltage regulating applications. As a series tube will pass 150 ma per section at 40 volts D.C. Plate dissipation 30 watts; Amplification factor 2.7. Features hard glass envelope.

● CHATHAM 395A COLD CATHODE GAS TRIODE

Requires no filament supply and is used in many grid controlled rectifier and relay applications. Maximum DC anode current, 10 ma. Maximum DC anode voltage, 150 volts.



Custom-Built Electronic Equipment

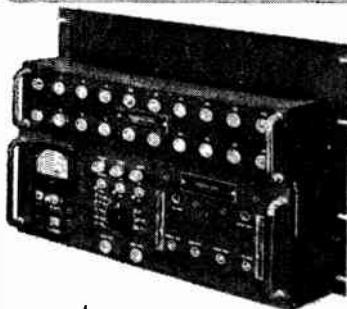

● Pulse life test equipment built by CHATHAM checks receiver type tubes under pulse operating conditions.

CHATHAM specializes in the development, design, and construction of custom-built electronic equipment to exactly meet customers' requirements. Our capable staff of engineers will furnish prompt estimates or, if desired, will call to discuss your problem personally. Call or write today for complete information.

Write today for the informative CHATHAM catalog. For free copy address requests on company letterhead — no obligation.

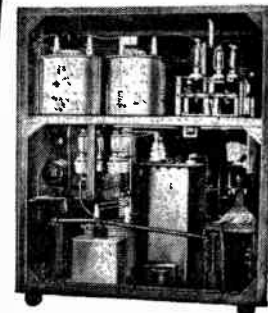

● 5 Megawatts radar modulator built by CHATHAM to rigid government standards.



CHATHAM ELECTRONICS • INC

LIVINGSTON, NEW JERSEY

PRICES

Prices of manufacturers and suppliers' products listed in **RADIO'S MASTER** are subject at all times to change without notice — they should not be considered final.

Get quick on-the-spot quotations from your distributor who subscribes to our perpetual up-to-the-minute **PRICING SERVICE**.



Official Pricing System of radio - electronic - television parts and equipment. Supported by the industry: distributors, manufacturers, and their sales representatives.

Loose-leaf, flexible binder. Contains over 1100 pages.

Published by
UNITED CATALOG PUBLISHERS, INC.
106-110 Lafayette Street
New York 13, N. Y.

DELIVERY

Delivery is often dependent on the availability of raw materials. So check with your distributor for delivery information.

amplifiers

ALTEC

LANSING CORPORATION

9356 Santa Monica Blvd.
Beverly Hills, Calif.

161 Sixth Avenue
New York 13, N.Y.



A-127 AMPLIFIER

Rack mounted power amplifier. POWER: 18 watts. GAIN: 66 db. IN: A-127—100,000 ohms; A-127A—30, 250, 500-600 ohms. OUT: A-127, A-127A—10-20 ohms; FREQUENCY: ± 1 db, 20-20,000 cycles. NOISE: ± 5 db. POWER SUPPLY: 105-130 V. at 50-60 cycles. EXT. VOLTAGES: 6.3 V. at 2.5 amp.; 350 V. at 20 Ma. DIM: 19" wide; 8 3/4" high; 7" deep. WT.: 18 lbs. COLOR: Blue Gray. NET PRICE: A-127 — \$234.00; A-127A \$267.00.

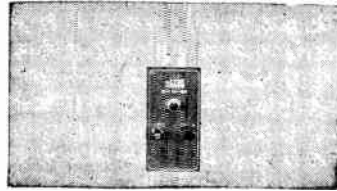

A-247B AMPLIFIER

Single stage (Class AB2 push-pull beam power amplifier. POWER: 75 watts. GAIN: 10 db. IN: 18 ohms. OUT: 4, 8 and 16 ohms. FREQUENCY: ± 1 db; 20-20,000 cycles. NOISE: ± 27 dbm. POWER SUPPLY: 105-125 V.; 50-60 cycles. DIM: 10 1/2" high; 19" wide; 8 1/2" deep. WT.: 56 lbs. COLOR: Blue gray. NET PRICE: \$276.00

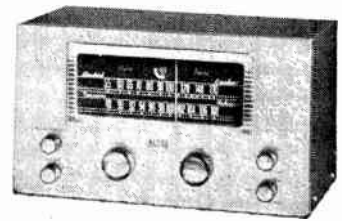

303C TUNER AND PHONOGRAPH CONTROL UNIT

AM-FM tuner includes a built-in power supply and multistage audio circuit. AM section is of the superhet type, designed to provide a broad band flat top curve. FM circuit has cascode type RF stage, separate oscillator and triode mixer stage and three stages of IF amplification in addition to a ratio detector. AFC assures drift free operation and simplifies tuning. Provision is made for switching off as desired. Both the AM and FM sections incorporate AVC and a magic eye. Multistage amplifier includes a preamp equalized for variable reluctance pickup and contains a five position selector switch for FM, FM with AFC, AM, phonograph and spare; three-step selection of record crossover frequencies; filter for 3 1/2 r.p.m. recording characteristic use; variable control of rise and drop in both treble and bass, and a continuously variable volume control. Cathode follower used in output stage enables the tuner to be connected to any power amplifier with a high impedance input. For best results the Altec A-333A power amplifier is recommended. NET PRICE: \$280.00

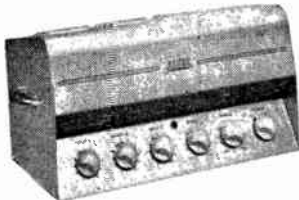

A-326 AMPLIFIER

Portable P.A. amplifier, 20 watts—2 microphone, 1 phono input. ± 1 db. 30-15,000 cycles. OUT: 4, 8, 16 ohms. POWER SUPPLY: 117 V. 50/60 cycle. DIM: 7 3/4" x 7 3/4" x 11 3/4". WT.: 21 lbs. COLOR: Aluminum hammetone. A-326A—IN: mic, 30, 150, 500 ohms; phono, 500,000 ohms. GAIN: mic, 104 db; phono, 74 db. NOISE: mic., ± 13 dbm; phono, ± 38 dbm. NET PRICE: \$198.00 A-326B—IN: mic, 100,000 ohms; phono, 500,000 ohms. GAIN: mic, 99 db; phono, 74 db. NOISE: mic., ± 15 dbm; phono, ± 38 dbm. NET PRICE: \$165.00



A-287WS AMPLIFIER

Class B power amplifier especially adaptable to installations where large audio power is required in package. POWER: 250 watts. GAIN: 12 db. IN: 8, 16, 250, 500 ohms. OUT: 2.25-20 ohms. FREQUENCY: ± 1 db, 100-10,000 cycles. NOISE: ± 27.8 db. POWER SUPPLY: 105-130 V.; 50-60 cycles. DIM: 23 3/4" high; 20 1/2" wide; 13" deep. in wall cabinet. WT.: 111 lbs. COLOR: Gray. NET PRICE: \$715.00

1500 SERIES AMPLIFIERS WITH 530A POWER SUPPLY*

A complete group of integrated amplifiers and pre-amplifiers adaptable to all high quality amplifying installations.

1510A PREAMPLIFIER—2 channels. GAIN: 47 db. IN: 50, 150, 300, 600 ohms. OUT: 10,000 ohms. DIM: 4 1/2" wide; 5 1/2" high; 5" deep. LIST PRICE: \$113.55

1511A AMPLIFIER—Equalized for VR pickup—has bass and treble controls for 1500 series system. GAIN: 34 db. BASS CONTROL: ± 10 db ± 14 db at 40 cps. TREBLE CONTROL: ± 10 db ± 20 db at 10,000 cps. INPUT: for VR pickup. OUT: 10,000 ohms. DIM: 4 1/2" wide; 5 1/2" high; 5" deep. LIST PRICE: \$92.95

1520A AMPLIFIER—Rack mounted. POWER: 35 watts. GAIN: 75 db. IN: 100,000 ohms. OUT: 4, 8, 16 ohms and 70 V line. EXT. VOLTAGES: (max.) 300 V. DC at 15 ma. 6.3 V. AC at 1.35 a. for 1510A and 1511A. DIM: 19" wide; 10 1/2" high; 9" deep. WT.: 55 lbs. LIST PRICE: \$253.20

1530A AMPLIFIER—Rack mounted. POWER: 70 watts. GAIN: 75 db. IN: 100,000 ohms. OUT: 4, 8, 16 ohms and 70 V line. EXT. VOLTAGES: (max.) 300 V. DC at 15 ma. 6.3 V. AC at 30 ma; 6.3 V. AC at 2.7 a. for 1510A and 1511A. DIM: 19" wide; 14" high; 9" deep. WT.: 60 lbs. LIST PRICE: \$327.15

1540A AMPLIFIER—GAIN: 65 db. IN: 100,000 ohms. OUT: 62.5, 125, 500 ohms. DIM: 3 1/2" wide; 5 1/2" high; 6 1/4" deep. LIST PRICE: \$104.35

1550A APPARATUS UNIT—Line level matching transformer. PRI: 30, 125, 250, 500 ohms. SEC: 17,500-70,000 ohms. DIM: 3 1/2" wide; 5 1/2" high; 4 1/2" deep. (Not Shown) LIST PRICE: \$38.25

530A POWER SUPPLY—300 V. DC 50 ma max.; 6.3 V. AC 3.2 a. max. DIM: 3 1/2" wide; 5 1/2" high; 6 3/4" deep. LIST PRICE: \$56.65

*Distributed by Graybar Electric Co.

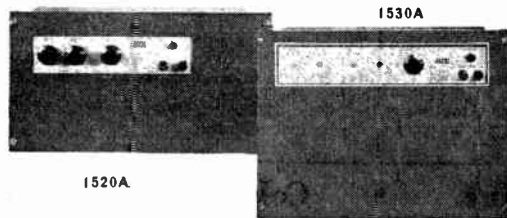

1530A

1520A

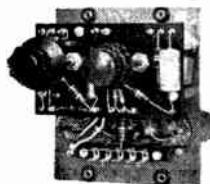

1511A

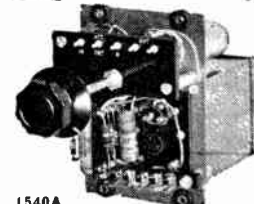

1540A

A-333A POWER AMPLIFIER A-433A REMOTE CONTROL PRE-AMPLIFIER

Designed especially for use in home music systems for the highly critical audiophile. Extremely versatile. Remote pre-amplifier contains controls for bass rise and drop; treble rise and drop; 3 selections for recording crossover frequencies; equalization for variable reluctance pickup; filter for 3 1/2 recording characteristic rise; 3 input selector switch and volume control. System frequency response flat to ± 0 ± 1 db from 20 cycles to 20,000 cycles and is within 3 db of flat response up to 100,000 cycles. Power amplifier will deliver full 27 watts of audio power at less than 5% total harmonic distortion; 20 watts at less than 2% total harmonic distortion; and 15 watts at less than 1/2% total harmonic distortion. NET PRICES: A-333A—\$111.00; A-433A—\$87.00

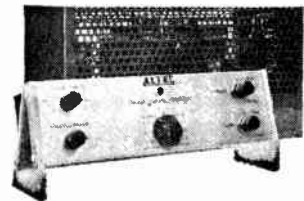

1510A

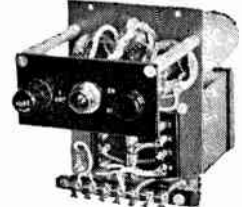
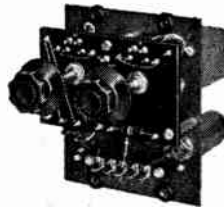

530A

BELL HIGH FIDELITY AMPLIFIERS

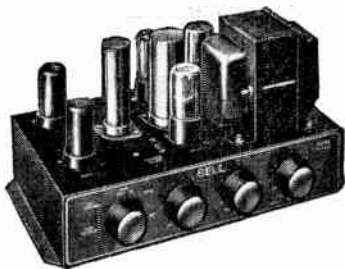

← **Model 2122C**
10-Watt
Amplifier

Power Output: 10 watts at 2% distortion. Peak 15 watts.
Frequency Response: 20 to 20,000 cycles plus or minus $\frac{3}{4}$ db with controls set for flat response.
Hum Level: 65 db below rated output.
Inputs: Radio; Tape, TV or Crystal; #1 Mag.; #2 Mag.
Controls: Selector switch with equalization (5 positions); Volume; Bass, minus 14 db to plus 13 db variation at 100 cycles; Treble w/AC switch, minus 13 db to plus 12 db variation at 10K cycles.
Outputs: 4, 8, 16 ohms, plus high imp. jack for disc or tape recorders.
Power Consumption: 75 watts; 117 volts; 50-60 cycles.
Tubes: (Six) 2-6SC7; 1-6SL7; 2-6V6GT; 1-5Y3GT.
Size & Weight: 8" deep; 11 $\frac{1}{2}$ " wide; 6" high. Net weight 10 $\frac{1}{2}$ lbs.

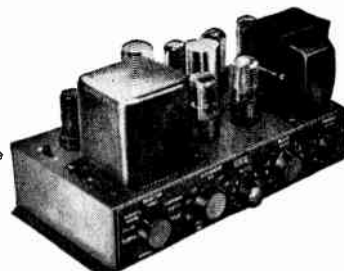

→ **Model 2199B**
12-Watt
Amplifier

Power Output: 12 watts at $\frac{1}{2}$ of 1%. Peak 20 watts.
Frequency Response: 20 to 20,000 cycles plus or minus $\frac{1}{2}$ db with controls set for flat response.
Hum Level: 70 db below rated output.
Inputs: Radio; Tape or TV; Crystal; 2 Mag.; plus a special input for frequency modulated and ceramic pickups.
Controls: 7-position Equalization and Selector switch; continuously variable compensated Loudness Control; Gain; Bass, minus 14 db to plus 13 db at 100 cycles; Treble w/AC switch, minus 13 db to plus 12 db at 10K cycles; Motor Bumble Suppressor switch on chassis deck.
Outputs: 4, 8, 16 ohms, plus high imp. jack for tape or disc recorders.
Power Consumption: 75 watts; 117 volts; 50-60 cycles.
Tubes: (Six) 1-6SC7; 2-6SL7; 2-6V6GT; 1-5Y3GT.
Size & Weight: 8 $\frac{3}{4}$ " deep; 13" wide; 6 $\frac{1}{4}$ " high. Net wt. 13 $\frac{1}{2}$ lbs.

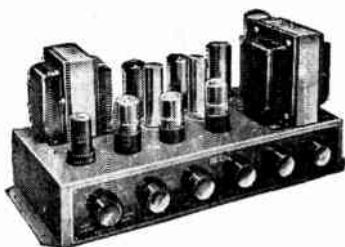

← **Model 2200B**
20-Watt
Amplifier

Power Output: 20 watts at less than .3%. Peak 35 watts.
Frequency Response: 20 to 20,000 cycles plus or minus .2 db with controls set for flat response.
Hum Level: 80 db below rated output.
Inputs: TV; 2 Mag.; Crystal; Radio; Tape; Micro.
Controls: 5-position Equalizer switch; 5-position Selector switch; Bass, minus 17 db to plus 15 db at 40 cycles; Treble, minus 28 db to plus 18 db at 15K cycles; Volume; Compensation and On-Off switch.
Outputs: 4, 8, 16 ohms, plus high imp. jack for tape or disc recorders.
Power Consumption: 150 watts; 117 volts; 50-60 cycles.
Tubes: (Seven) 1-12SC7; 1-6SN7GT; 2-6SL7GT; 2-5881; 1-5U4G.
Size & Weight: 8 $\frac{3}{4}$ " deep; 16" wide; 7 $\frac{1}{2}$ " high. Net weight 24 lbs.

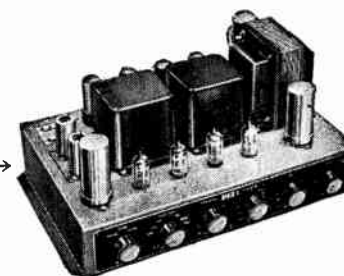

→ **Model 3-D**
BINAURAL
Amplifier

Power Output: 20 watts (10 watts each channel) at less than $\frac{1}{2}$ of 1% total distortion. Peak 35 watts.
Frequency Response: 20 to 20,000 cycles plus or minus $\frac{1}{2}$ db with tone controls set for flat response.
Hum Level: 70 db or more below rated output.
Dual Inputs: Tape, Radio, Phono.
Controls: 3-position Selector switch; 6-position Function switch (Binaural, Monaural or Reverse Binaural, each with or without loudness); Balance; Gain; Bass, minus 18 db to plus 17 db at 100 cycles; Treble w/AC switch, minus 17 db to plus 16 db at 10K cycles.
Dual Outputs: 4, 8, 16 ohms, plus high imp. jack for tape recorders.
Power Consumption: 135 watts; 117 volts; 50-60 cycles.
Tubes: (Eleven) 2-12AX7; 2-12AT7; 2-12AY7; 4-6V6GT; 1-5U4G.
Size & Weight: 11" deep; 16" wide; 8" high. Net weight 26 lbs.

Model 2145A Amplifier

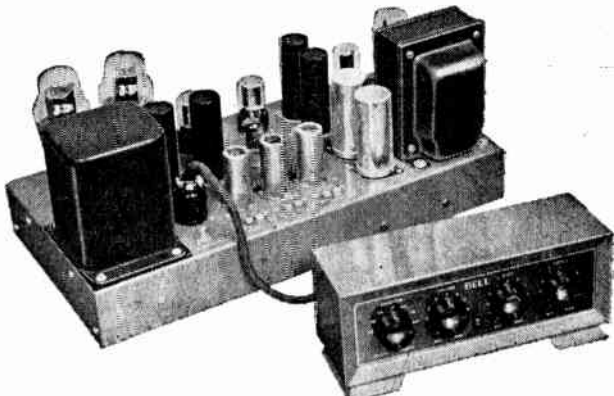

WITH REMOTE CONTROL

SPECIFICATIONS

Frequency Response: Within $\pm .25$ db 20 to 30,000 cycles.
Power-Distortion: (a) Distortion at normal listening levels is less than .2 of 1%.
(b) 20 watts at less than 2%. Peak output 30 watts.
(c) Less than .1 of 1% total distortion contributed by pre-amplifiers and control unit.
Hum and Noise Level: (a) 80 db below full output minimum.
(b) No audible hum with all controls at maximum, noise at least 10 db below surface noise of best record surface.
Inputs: Six: Hi-level mag; Lo-level mag; Crystal pickup; Microphone; Hi-level radio; Lo-level radio.
Controls: Remote Control Unit; Selector switch, 5 phono positions, 2 radio positions; Volume control (compensated); Bass control; Treble control. Power Amplifier: AC switch, provision for remote AC switch, Master gain control.
Output Impedance: 4, 8, 16 ohms.
Tubes: Eleven—3-12AU7; 3-12AX7; 2-6SN7GTA; 2-6B4G; 1-5V4G.
Power Consumption: 150 watts nominal at 117 Volts, 50-60 Cycles.
Dimensions and Weights: Remote Control Unit: 3 $\frac{1}{2}$ " deep, 10" wide, 4 $\frac{1}{4}$ " high—Weight: 3 $\frac{3}{4}$ Lbs.
Power Amplifier: 8 $\frac{1}{2}$ " deep, 17" wide, 7" high—Weight: 23 Lbs.

Mfg. by THE BELL SOUND SYSTEMS, Inc. • Columbus 7, Ohio
A Subsidiary of Thompson Products, Inc., Cleveland, Ohio

BELL SOUND EQUIPMENT

15 WATT BELL AMPLIFIER

Model 3715B



- Three Input Circuits
- Illuminated Control Panel
- Beam Power Output Tubes
- Exceptional Tone Quality
- Phono Tops Available

A fine performing, versatile, 15 watt amplifier. Utilizes push-pull beam power output tubes, and an inverse feedback to reduce total distortion. Three inputs with separate volume controls permit simultaneous mixing of two microphones and a phonograph. Standard top can be easily replaced with a phono top accessory, either single speed (Model 2196) or three speed (Model 2197), making the phonograph an integral part of the amplifier.

SPECIFICATIONS

Power Output: 15 Watts at Less Than 5% Peak Power: 18 Watts.
Frequency Response: 30 to 15,000 Cycles Plus or Minus 2 db.
Gain: Microphone Channels, 120 db; Phono Channel, 81 db.
Hum Level: 65 db Below Rated Output.
Inputs: 2 Microphone; 1 Phonograph.
Input Impedances: Micro Channels, 3 megs.; Phono Channel, ½ meg.
Controls: 2 Micro Volume; 1 Phono Volume; 1 Tone with AC Switch.

Output Impedances: 2.5; 4; 8; 16; 250; 500 Ohms and 70 V Constant Voltage Tap.

Power Consumption: 100 Watts; 117 Volts; 50-60 Cycles.

Tubes: 2-6AU6; 1-6SF5; 1-6N7; 2-6V6GT; 1-5U4G.

Dimensions: 11½" Deep; 8" High; 16½" Wide.

Shipping Weight: 32 lbs.

25 WATT BELL AMPLIFIER

Model 3725B

An eight tube version of one of Bell's most popular units, this model incorporates several new design features, including an additional microphone input. Each of the three microphone inputs and the phonograph input has a separate volume control. Bass and treble tone controls are also separate. Easy-to-read, sloping, lighted control panel. Wide range of output impedances permits matching to any speaker load.

Phono Tops: Standard top can be easily replaced with single or three speed (Models 2196 or 2197) turntable phono top.

SPECIFICATIONS

Power Output: 25 Watts at Less Than 5% Peak Power: 33 Watts.
Frequency Response: 30 to 18,000 cycles Plus or Minus 2 db.
Gain: Microphone Channels, 122 db; Phono Channel, 80 db.
Hum Level: 65 db Below Rated Output.
Inputs: 3 Microphone; 1 Phonograph.
Input Impedances: Micro Channels, 3 megs.; Phono Channel, ½ meg.
Controls: 3 Micro Volume; 1 Phono Volume; Bass; Treble, with AC Switch.

Output Impedances: 2.5; 4; 8; 16; 250; 500 Ohms; 70 V Constant Voltage Tap.

Power Consumption: 150 Watts, 117 Volts, 50-60 Cycles.

Tubes: 3-6AU6; 1-6SF5; 1-6N7; 2-6L6G; 1-5U4G.

Dimensions: 11½" Deep; 8" High; 16½" Wide.

Shipping Weight: 34 lbs.



- Attractive Modern Design
- Four Inputs: Three microphone, 1 Phonograph
- Separate Bass and Treble Controls
- Illuminated Control Panel
- Phono Tops Available

50 WATT BELL AMPLIFIER

Model 3750B



- Rugged Construction.
- Four Inputs.
- Bass and Treble Boost.
- Available for Remote Standby Operation.
- Excellent Frequency Response.

Sufficient wattage to cover 90 per cent of commercial sound requirements. Tone control circuits, operating in an inverse feedback network, provide wide tone adjustments with very low distortion.

Model 3750BR is the same basic amplifier with built-in stand-by relay for economical operation and prolonged life.

SPECIFICATIONS

Power Output: 50 Watts at Less Than 5% Peak Power: 80 Watts.
Frequency Response: 30 to 15,000 Cycles Plus or Minus 1 db.
Gain: Micro Channels, 125 db; Phono Channel, 85 db.
Hum Level: 67 db Below Rated Output.
Inputs: 3 Microphone; 1 Phonograph.
Input Impedances: Micro Channels, 10 megs.; Phono Channel, 1 meg.
Controls: 3 Microphone Volume; 1 Phono Volume; Bass; Treble, with AC Power Switch. Model 3750BR has Stand-by Relay.

Output Impedances: 2.5; 4; 8; 16; 250; and 500 Ohms and 70 V Constant Voltage Tap.

Power Consumption: 260 Watts at 117 Volts; 50-60 Cycles. Adjustable 105-117-128 Volts.

Tubes: 3-7C6; 3-6SC7; 1-6SN7GT; 2-6L6G; 1-5U4G; 1-5R4GY; 1-5V4G.

Dimensions: 16½" Deep; 8" High; 16½" Wide.

Shipping Weight: 60 lbs.

Mfg. by THE BELL SOUND SYSTEMS, Inc. • Columbus 7, Ohio
A Subsidiary of Thompson Products, Inc., Cleveland, Ohio

BELL SOUND EQUIPMENT

8 WATT BELL MOBILE AMPLIFIER

Model 3706-MB

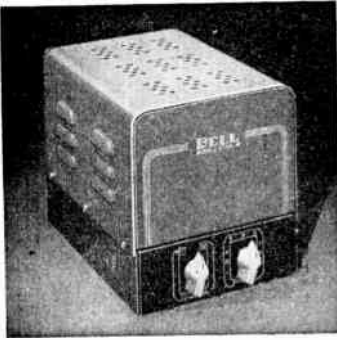

- Phono and Micro Inputs
- Fits under most dashboards
- Chassis Removable for Servicing
- Battery Stand-by Switch

SPECIFICATIONS Model 3706-MB

Power Output: 8 Watts at Less than 5%.
Peak Power: 12 Watts.
Frequency Response: 60 to 15,000 Cycles Plus or Minus 2 db.
Gain: Micro Channel, 112 db; Phono Channel, 75 db.
Hum Level: 60 db Below Rated Output.
Inputs: 1 Microphone; 1 Phonograph.
Input Impedances: Micro Channel, 3 megs; Phono Channel, ½ meg.

Controls: Volume with Power Switch; Battery Saver Stand-by Switch.
Output Impedances: 4; 8; 16 Ohms.
Power Consumption: 45 Watts, 117 Volts, 50-60 Cycles AC; 11 Amperes, 6 Volts DC.
Tubes: 1-6SJ7; 1-6SN7GT; 1-6L6; 1-6X5GT.
Dimensions: 10" Deep; 5½" Wide; 6½" High.
Shipping Weight: 15 lbs.

15 WATT BELL MOBILE AMPLIFIER

Model 3717-MB

Power Output: 15 Watts at Less than 5%.
Peak Power: 20 Watts.
Frequency Response: 50 to 15,000 Cycles Plus or Minus 2 db.
Gain: Micro Channel, 115 db; Phono Channel, 80 db.
Hum Level: 60 db Below Rated Output.
Inputs: 1 Microphone; 1 Phonograph (Built In).
Input Impedances: Micro Channel, 3.3 megs; Phono Channel, ½ meg.
Controls: Micro Volume; Phono Volume; Tone with AC Switch; Stand-by Switch; Phono Motor "Off-On" Switch.

Output Impedances: 2.5; 4; 8; 16; 250; 500 Ohms and 70 V Constant Voltage Tap.
Phono Motor: Single Speed, Rim Drive, 78 r.p.m.
Power Consumption: 110 Watts, 117 Volts, 60 Cycles AC; 15 Amperes (max.), 6 Volts DC.
Tubes: 1-6SC7; 1-6SL7GT; 2-6V6GT; 1-6AX5GT.
Dimensions: 10" Deep; 14½" Wide; 9" High.
Shipping Weight: 25 lbs.



Model 3717-MB3 — Three Speed Turntable

Has all the attractive features of Model 3717-MB, plus a three speed motor and turnover-type pickup for 33½, 45, and 78 r.p.m. records.

25 WATT BELL MOBILE AMPLIFIER

Model 3723-MB



Power Output: 25 Watts at Less than 5%. Peak Power: 38 Watts.
Frequency Response: 30 to 15,000 Cycles Plus or Minus 2 db.
Gain: Micro Channels, 120 db; Phono Channel, 76 db.
Hum Level: 60 db Below Rated Output.
Inputs: Two Microphone; One Phonograph.
Input Impedances: Micro Channels, 3.3 megs.; Phono Channel, ½ meg.
Controls: Two Micro Volume Controls; Phono Volume; Tone with Power Switch; Stand-by Switch; Phono Motor "Off-On" Switch.
Output Impedances: 2.5; 4; 8; 16; 250; 500 Ohms and 70 V Constant Voltage Tap.
Phono Motor: Single Speed, Rim Drive, 78 r.p.m.
Power Consumption: 115 Watts, 117 Volts, 60 Cycles AC; 24 Amperes, 6 Volts DC.
Tubes: 2-6AU6; 1-6J5; 1-6SN7GT; 2-6L6G; 2-6AX5GT.
Dimensions: 11½" Deep; 16½" Wide; 10" High.
Shipping Weight: 40 lbs.

Model 3723-MB3 — Three Speed Turntable

Has all the attractive features of Model 3723-MB, plus a three speed motor and turnover-type pickup for 33½, 45, and 78 r.p.m. records.

32 WATT BELL MOBILE AMPLIFIER

Model 3728-MB

SPECIFICATIONS

Power Output: 32 Watts at Less than 5%.
Peak Power: 45 Watts.
Frequency Response: 50 to 14,000 Cycles Plus or Minus 2 db.
Gain: Micro Channels, 120 db; Phono Channel, 84 db.
Hum Level: 60 db Below Rated Output.
Inputs: 2 Microphone; 1 Phonograph.
Input Impedances: Micro Channels, 10 megs; Phono Channel, 1 meg.
Controls: Two Micro Volume; Phono Volume; Bass Tone; Treble Tone with Power Switch; Stand-by Switch; Phono Motor "Off-On" Switch.

Output Impedances: 2.5; 4; 8; 16; 250; 500 Ohms and 70 V Constant Voltage Tap.
Phono Motor: Single Speed, Rim Drive, 78 r.p.m.
Power Consumption: 180 Watts, 117 Volts, 60 Cycles AC; 28 Amperes, 6 Volts DC.
Tubes: 1-6X5GT; 2-6AX5GT; 3-7B4; 1-6SL7GT; 2-6L6G.
Dimensions: 16½" Deep; 16½" Wide; 10" High.
Shipping Weight: 60 lbs.



Mfg. by THE BELL SOUND SYSTEMS, Inc. • Columbus 7, Ohio
A Subsidiary of Thompson Products, Inc., Cleveland, Ohio

BELL SOUND EQUIPMENT

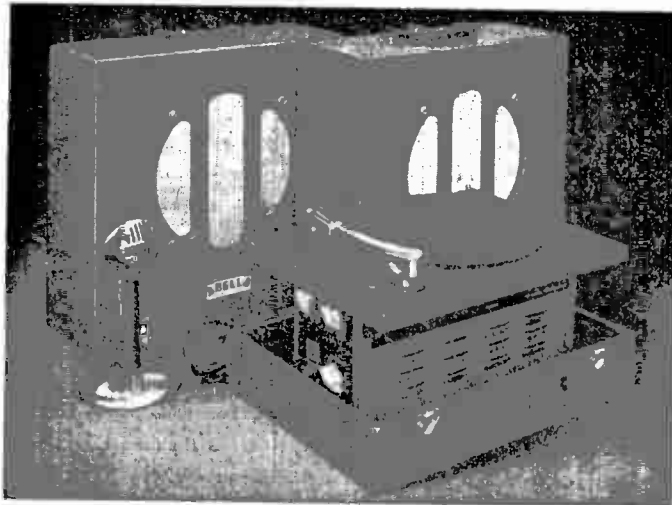

10 WATT BELL PHONO-PA SYSTEM

SPECIFICATIONS Model PA-3710B-P3

Amplifier: 3710B.

Speakers: 2-10" Heavy Duty P.M.

Cables: 2-25' Type SV with Plugs.

Phono Equipment: Three speed (33 $\frac{1}{3}$, 45, 78 RPM) motor and turntable and dual purpose turnover crystal pickup.

Microphone: JT-30 with desk type stand.

Microphone Cable: 15' Shielded Rubber with Connector.

Microphone Stand: Furnished with Micro.

Case: Model 3710B, 3 piece Portable.

Dimensions: 12" Deep; 18 $\frac{1}{2}$ " High; 15 $\frac{3}{4}$ " Wide.

Shipping Weight: 44 lbs.

15 WATT BELL SINGLE CASE PA SYSTEM

SPECIFICATIONS Model PA-3715B

Amplifier: 3715B (see page B-3)

Speakers: 2-10" Heavy Duty P.M.

Cables: 2-25' Type SV with Plugs.

Built-in Phono Equipment: None. Phono Tops (Models 2196 and 2197) are available as accessories.

Microphone: Not furnished with this system.

Case: Model 15 Three pc.

Dimensions: 13 $\frac{3}{4}$ " Deep; 20 $\frac{1}{4}$ " High; 18" Wide.

Shipping Weight: 62 lbs.

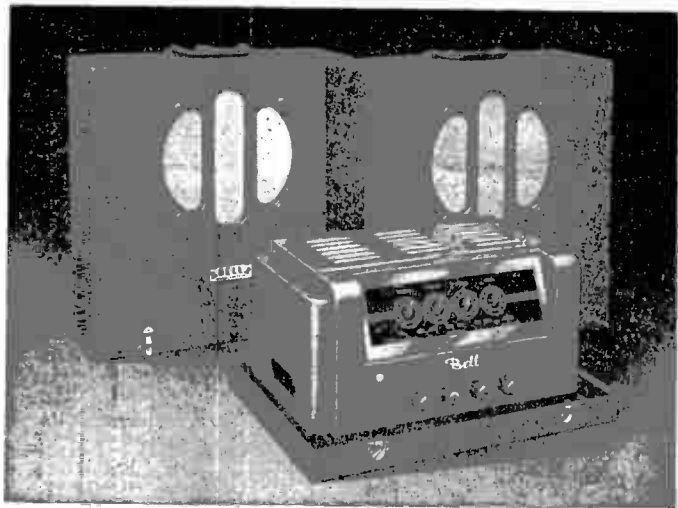

25 WATT BELL DUO-CASE PA SYSTEM

SPECIFICATIONS Model PA-3725B

Amplifier: 3725B (See page B-3).

Speakers: 2-12" Heavy Duty P.M. with Line Matching Trans.

Cables: 2-50' Type SV with Plugs.

Built-in Phono Equipment: None. Phono Tops (Models 2196 and 2197) are available as accessories.

Microphone: Not furnished with this system.

Case: 1 Model 95. 1 Model 14-A.

Dimensions: Model 14-A, 13 $\frac{3}{4}$ " Deep; 11 $\frac{1}{4}$ " High; 18" Wide.

Model 95, 13 $\frac{3}{4}$ " Deep; 20 $\frac{1}{2}$ " High; 18" Wide.

Shipping Weight: Complete System, 87 lbs.

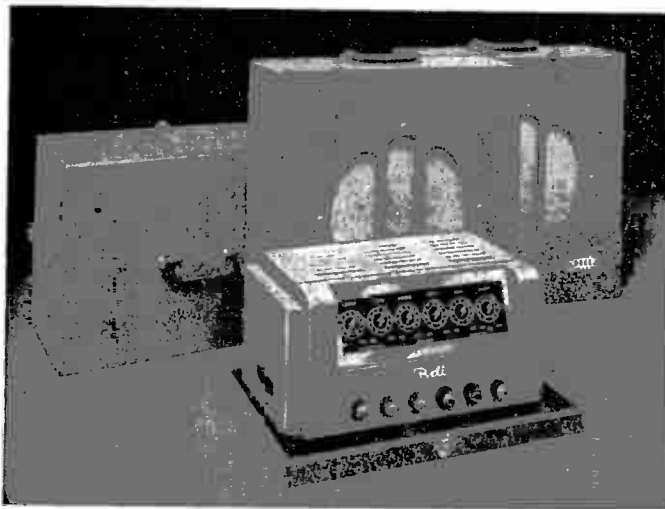

Mfg. by THE BELL SOUND SYSTEMS, Inc. • Columbus 7, Ohio
A Subsidiary of Thompson Products, Inc., Cleveland, Ohio

Newcomb

CUSTOM

K

SERIES AMPLIFIERS

Designed and Built To The Very Highest Standards of Quality In The Entire Industry



KX-25



KX-50



KX-6A



K-50B

Without equal at any price. The best examples why the name Newcomb is so revered by Engineers and Owners alike. Will improve any system. A must when using the new 2-way wide range speakers. Check these important features and specifications.

- ★ 20—20,000 cycles ± 1 db
- ★ Less than 3% distortion
- ★ 90% of rating at less than 1%
- ★ Full power any output tap
- ★ Audio bandwidth selectors
- ★ Hum and noise level—80 db.

- ★ Remote control provision—all inputs
- ★ U/L approved
- ★ Continuous duty—longer life parts
- ★ Key locked control cover
- ★ Sensitive volume and overload indicators
- ★ Wired for plug-in input transformers

Full audio power, 50 to 5000 cycles (region of all major power requirements) within ± 1/4 db, less than 5% distortion. Separate tone controls for Bass and Treble Boost or Attenuation of advanced design for better curve shape, greater range. Feedback controlled, 2 stage mike pre-amplifiers. Hum balancing control, all models but booster. Linear mixer frequency response. All but Pre-Amplifier have output impedance of 4, 8, 16, 250, 500 ohms, PLUS a 70 volt "constant voltage" tap, with convenient, simple, impedance selector. Multistage inverse feedback. Large, heavy duty power and output transformers thoroughly impregnated against moisture. Rear connections avoid unsightly wires, simplify rack installation. A. C. convenience outlet in rear, all models except booster. Cabinets: Heavy gauge welded steel beautifully styled. Finish: Silver Grey Hammertone Baked Enamel. Panels: Etched metal, illuminated. Knobs: Round, large, skirted type, for easy operation. Additional specifications given under specific model numbers.

KX-25: 25 watts power output design center rating, 30 watts max. at less than 3% distortion any output tap. PEAK POWER: 40 watts design center, 48 watts max. INPUTS (6): 5 mike (2 meg.), gain 123 db; 1 phono either Magnetic input gain 99 db based on 27,000 ohm input, bass equalization + 10 db or Crystal input 1/2 meg. gain 90 db REMOTE CONTROL: Use RC-6 remote control unit. BASS TONE CONTROL: Range -16 to +25 db. TREBLE TONE CONTROL: Range -30 to +20 db. HUM: -80 db controls off, -75 db crystal phono, -65 db mike

and magnetic pickup inputs (Referred to rated output). CONTROLS (15): 5 mike, 1 phono, 1 bass, 1 treble, 4 bandwidth, 1 master, 1 volume indicator (all under keylocked control cover) A.C. power switch. TUBES (15): 6-6SC7, 2-6J5, 1-6J7, 1-6SQ7, 1-6SN7, 2-6L6G, 1-6AF6G, 1-5U4G. POWER CONSUMPTION: 135 watts, 117 volts 60 cycles A.C. Max. Input 129 volts. DIMENSIONS: 9 3/8" x 17 3/4" x 14 3/4" WEIGHT: 38 1/2 lbs. LIST: (with tubes) \$450.00. Plug Kit: \$6.92.

KX-50: 50 watts power output design center rating, 60 watts max. at less than 3% distortion any output tap. PEAK POWER: 80 watts design center, 90 watts, max. BOOSTER COUPLING JACK for connecting K50B Boosters for 100 watts or more. All other characteristics identical with KX-25 except gains, which are all 3 db higher than KX-25.

TUBES (18): 6-6SC7, 2-6J5, 1-6SQ7, 1-6J7, 1-6SN7, 4-6L6G, 1-6AF6G, 2-5U4G. POWER CONSUMPTION: 235 watts, 117 volts 60 cycles A.C. Max. Input 129 volts. DIMENSIONS: 9 3/8" x 17 3/4" x 14 3/4". WEIGHT: 46 lbs. LIST: (with tubes) \$525.00. Plug kit: \$7.03.

KX-6A: A 6 channel mixer pre-amplifier designed to feed broadcast lines or boosters for finest quality. OUTPUT: +31 VU, less than 3% distortion, +30 VU at less than 1%. Has built in power supply and genuine VU meter with meter range extension switch. INPUTS for 5 mikes (2 meg.) gain 97 db and 1 phono either crystal (1/2 meg.) gain 64 db or magnetic (27,000 ohms) gain 73 db. Use RC-6 Unit for remote control. Includes Master Volume Control and same fine Dual Tone Controls and Audio Bandwidth Selectors as in KX-25 and KX-50. BASS TONE CONTROL: Range

-16 to +25 db, TREBLE TONE CONTROL: Range -30 to +20 db. HUM: -80 db controls off, -80 db crystal -75 db mike and magnetic. CONTROLS (12): 5 mike, 1 phono, 1 bass, 1 treble, 1 master, 1 four position bandwidth (all under key locked cover), 1 A.C. power switch, 1 VU meter range switch (in rear). TUBES (12): 6-6SC7, 4-6J5, 1-6J7, 1-6X5. POWER CONSUMPTION 35 WATTS, 117 volts 60 cycles A.C. Max. Input 129 volts. DIMENSIONS: 9 3/8" x 17 3/4" x 14 3/4". WEIGHT: 30 lbs. LIST: (with tubes) \$395.00. Plug Kit: \$5.29.

K50B: Booster Amplifier. Performance, power and output impedance same as KX-50 with but one input of 1/2 meg. impedance, gain 71 db. Provision for plug-in bridging or low impedance transformer. Built for continuous duty with long life parts, separate plate, and filament power transformers, individually fused, permits dependable plate power switching. Includes volume

and overload indicators as in KX-50. Ample multistage feedback to minimize effects of speaker load variations. Etched metal panel. TUBES (10): 1-6S17, 1-6SN7, 1-6SQ7, 4-6L6G, 1-6AF6G, 2-5U4G. POWER CONSTRUCTION: 230 watts 117 volts 60 cycles, 129 volts max. DIMENSIONS: 9 3/8" x 17 3/4" x 12 1/4". WEIGHT: 41 lbs. LIST: (with tubes) \$225.00. Plug Kit: \$2.50.

NEWCOMB CUSTOM PORTABLE SYSTEMS

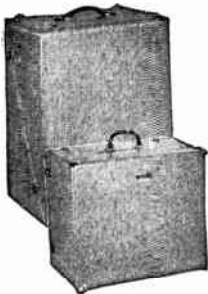

KX-2512X: Portable system with KX-25 amplifier and two heavy duty, extremely efficient speakers, each with 50' cable. System is carried in two cases: Model KA for the amplifier, size 19" x 11 3/4" x 16 7/8"; Model K-212X for two speakers, size 18 1/2" x 12 1/2" x 22 1/2". Speakers face inside for maximum protection when split case is closed. Mikes and mountings not included as requirements vary. LIST: (less mikes and stands) \$645.57.

KX-25R12X: Portable system identical to KX-2512X but with each speaker mounted in an individual portable reflex baffle, Model KR-112X, for utmost tone quality. Speaker cases size, 18 1/2" x 12 1/2" x 24 1/2". Mikes and mountings not included as requirements vary. LIST: (less mikes and stands) \$716.82.

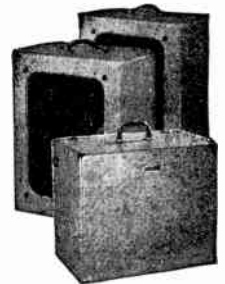

KA: Amplifier case fits all model K amplifiers. LIST: \$35.00.

All Prices and Specifications Subject to Change Without Notice.

Newcomb AUDIO PRODUCTS COMPANY

6824 LEXINGTON AVENUE • LOS ANGELES 38, CALIFORNIA



DELUXE

H

SERIES AMPLIFIERS

Compare These Deluxe Amplifiers with Any Other Brand at Any Price

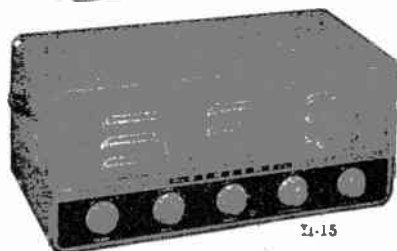

H-15

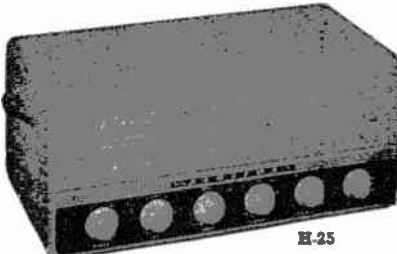

H-25

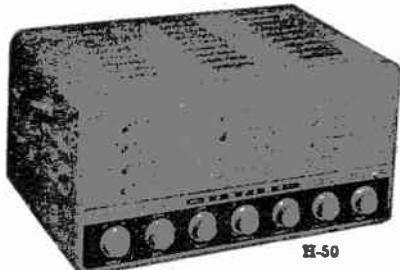

H-50



H-4VU

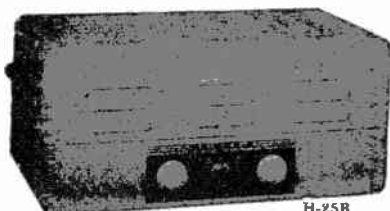

H-25B

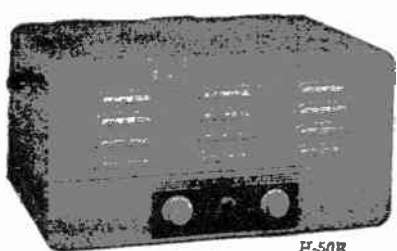

H-50B

For Performance, Dependability and Value check these features and specifications:

- ★ 20-20,000 cycles \pm 2 db
- ★ Full Power any output tap
- ★ Less than 5% distortion
- ★ 90% of rated power at less than 2%

- ★ Remote Control provision—all mikes
- ★ U/L c. proved
- ★ Continuous duty—longer life parts
- ★ Wired for plug-in input transformers

Full Audio Power, 50 to 5000 cycles (region of all major power requirements) within \pm 1/2 db, less than 5% distortion. Individual boost or attenuate type bass and treble tone controls in new distortion free circuit. Linear mixer frequency response. All models but pre-amplifier have output impedances of 4, 8, 16 250, and 500 ohms PLUS a 70 volt "constant voltage" tap, with easily-operated impedance selector. Multi-stage inverse feedback. Large heavy duty power and output transformer thoroughly impregnated against moisture. Rear connections avoid unsightly wires, simplify rack installations. A. C. convenience outlet in rear, all models except boosters. Cabinets: Heavy gauge welded steel beautifully styled in modern functional simplicity that endures. Finish: Silver Grey Hammertone Baked Enamel. Panel: Etched metal, illuminated. Knobs: large, round, skirted type, for ease of operation. Additional specifications under specific model numbers.

H-15: 17 watts power output design center rating, 20 watts max. at less than 5% distortion, any output tap. PEAK POWER: 25 watts design center, 31 watts max. INPUTS (3): 2 mike (2 meg.), gain 120 db; 1 phonograph (1/2 meg.), gain 80 db. BASS TONE CONTROL: Range -16 to +14 db. TREBLE TONE CONTROL: -34 to +13 db. HUM: -72 db phono input, -62 db mike inputs (referred to rated output). CONTROLS

(5): 1 mike-phonograph, 1 mike, 1 bass, 1 treble, 1 A.C. power switch. REMOTE CONTROL: Use RC-2 remote control unit. TUBES (7): 2-6SF5, 1-6SJ7, 1-6SN7, 2-6L6G, 1-5Z4. POWER CONSUMPTION: 85 watts, 117 volts 60 cycles A.C. Max. input 129 volts. DIMENSIONS: 8 1/4" x 19" x 10 1/8". WEIGHT: 20 lbs. LIST: (with tubes) \$179.50. Plug Kit: \$4.09.

H-25: 25 watts power output design center rating, 30 watts max. at less than 5% distortion, any output tap. PEAK POWER: 40 watts design center, 48 watts maximum. INPUTS (4): 3 mike (2 meg.), gain 124 db; 1 phonograph (1/2 meg.), gain 80 db. BASS TONE CONTROL: -18 to +15 db. TREBLE TONE CONTROL: Range -27 to +10 db. HUM: -72 db phono input, -62 db mike inputs (referred to rated output). CONTROLS

(6): 2 mike, 1 mike-phonograph, 1 bass, 1 treble, 1 A.C. power switch. REMOTE CONTROL: Use RC-3 remote control unit. TUBES (8): 3-6SF5, 1-6SJ7, 1-6SN7, 2-6L6G, 1-5U6G. POWER CONSUMPTION: 125 watts, 117 volts 60 cycles A.C. Max. input 129 volts. DIMENSIONS: 8 1/2" x 19" x 10 1/8". WEIGHT: 24 lbs. LIST: (with tubes) \$21.00. Plug Kit: \$5.03.

H-50: 50 watts power output design center rating, 60 watts max. at less than 5% distortion, any output tap. PEAK POWER: 80 watts design center, 90 watts max. INPUTS (5): 4 mike (2 meg.), gain 124 db. 1 phono (1/2 meg.), gain 81 db. BOOSTER COUPLING JACK for connecting H-25B or H-50B Boosters for 75 to 100 watts or more. BASS TONE CONTROL: Range -21 to +16 db. TREBLE TONE CONTROL: Range -27 to +10 db. HUM: -72 db phono input, -62

db mike inputs (referred to rated output). CONTROLS (7): 3 mike, 1 mike-phonograph, 1 bass, 1 treble, 1 A.C. power switch. REMOTE CONTROL: Use RC-4 remote control. TUBES (12): 4-6SF5, 1-6SJ7, 1-6SN7, 4-6L6G, 2-5U4G. POWER CONSUMPTION: 225 watts, 117 volts 60 cycles A.C. Max. input 129 volts. DIMENSIONS: 9 1/4" x 19" x 12 1/2". WEIGHT: 37 lbs. LIST: (with tubes) \$279.50. Plug Kit: \$6.10.

H-4VU Mixer Pre-Amp. with built-in power supply. Extremely low hum. Suitable for feeding telephone lines or booster amplifiers such as the H-25B or H-50B. Output +22 db at less than 5% distortion. +21 db at less than 2%. INPUTS for three mikes (2 meg.), gain 90 db. 1 phono (1/2 meg.), gain 51 db. HUM: Better than, -80 db from phono input or -75 db, mike inputs. Use RC-3 Unit for remote control. Includes master control and genuine VU meter with

meter range extension switch. BASS TONE CONTROL: Range -16 to +14 db. TREBLE TONE CONTROL: Range -27 to +13 db. TUBES (7): 3-6SF5, 1-6SJ7, 1-6SN7, 1-6J5, 1-6X5. POWER CONSUMPTION: 30 watts, 117 volts 60 cycles A.C. Max. input 129 volts. DIMENSIONS: 8 1/2" x 19" x 10 1/8". WEIGHT: 17 1/2 lbs. LIST: (with tubes) \$225.00. Without VU meter: \$179.50. Plug Kit: \$3.44.

H-25B Booster Amplifier — Performance Power and Output Impedances same as H-25 with but one input of 1/2 meg. impedance, gain 68 db. Provision for plug-in bridging or low impedance transformer. Etched metal panel with pilot light, A.C. power switch and volume control. Ideal for use

with H-4 Pre-amplifier. Built for long life. TUBES (5): 1-6SJ7, 1-6J5, 2-6L6G, 1-5U4G. POWER CONSUMPTION: 120 watts, 117 volts, 60 cycles A.C. Max. input 129 volts. DIMENSIONS: 8 1/8" x 19" x 10 1/8". WEIGHT: 22 lbs. LIST: (with tubes) \$149.50. Plug Kit: \$1.69.

H50B Booster Amplifier — Performance, Power and Output Impedances are same as H-50 with but one input of 1/2 meg. impedance, gain 71 db. Provision for plug-in bridging or low impedance transformer. Etched metal panel with pilot light, A.C. switch and volume control. Built for long

life. Ideal for use with H-4 Pre-Amp. TUBES (8) 1-6SJ7, 1-6J5, 4-6L6G, 2-5U4G. POWER CONSUMPTION: 220 watts, 117 volts, 60 cycles A.C. Max. input 129 volts. DIMENSIONS: 9 1/4" x 19" x 12 1/2". WEIGHT: 33 1/2 lbs. LIST: (with tubes) \$189.50. Plug Kit: \$1.69.

Newcomb Deluxe Portable Systems

H-1512R: Portable system with H-15 amp. and two 12" speakers, each with 25' cable, in split case Model EH-212R, size 11 1/8" x 20 1/2" x 21", covered in washable fabricoid. Kickproof metal grills protect speakers. Mikes and mountings not included as requirements vary. LIST: (less mikes and stands) \$283.09.

H-2512R: Portable system with H-25 amp. and two 12" speakers, each with 25' cable, in split case, Model EH-212R. Size, 20 1/2" x 11 1/8" x 21". Mikes and mountings not included as requirements vary. LIST: (less mikes and stands) \$314.53.

All Prices and Specifications Subject to Change Without Notice.

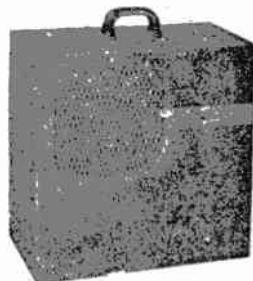

AUDIO PRODUCTS COMPANY

6824 LEXINGTON AVENUE • LOS ANGELES 38, CALIFORNIA

Copyright by U. C. P., Inc.

TRADE DISCOUNT APPLIES TO LIST PRICES ONLY

World Radio History

Radio's Master — 19th Edition

Page B-7

Newcomb

E

SERIES AMPLIFIERS

A Low Priced Line of Superior Utility Amplifiers

The same fine workmanship and materials as the incomparable KX- and H-Series. Designed to lead the low-price field. For performance, dependability and economy the E-Series is today's best combination of high quality and low cost. All models U/L approved.

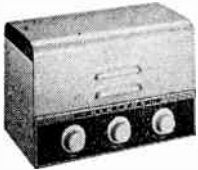

E-10A: Delivers 10 watts from push-pull 6V6 tubes. Separate mike and phono controls. Multistage inverse feedback circuit. POWER OUTPUT: 10 watts at less than 5%. FREQUENCY RESPONSE: 40 to 15,000 cycles \pm 2 db. INPUTS: (2) 1 mike (2 meg.) gain 116 db, 1 phono (1/2 meg.) gain 77 db. TONE CONTROL: Range 0 to -24 db. OUTPUT IMPEDANCES: 4, 8, 16 and 500 ohms to octal socket. TUBES: (5) 1-6SC7, 1-6SJ7, 2-6V6GT, 1-6X5GT. FINISH: Silvergrey hammer-tone baked enamel. PANEL: Genuine etched enamel. POWER CONSUMPTION: 60 watts at 117 volts, 60 cycles A.C. SIZE: 5 3/4" x 10 3/4" x 6 3/4". WT.: 9 1/2 lbs. Less cover, 7 1/2 lbs. LIST: (with tubes, without covers) \$69.50. Cover \$7.21. Plug Kit \$1.71.

1-6SC7, 1-6SJ7, 2-6V6GT, 1-6X5GT. FINISH: Silvergrey hammer-tone baked enamel. PANEL: Genuine etched enamel. POWER CONSUMPTION: 60 watts at 117 volts, 60 cycles A.C. SIZE: 5 3/4" x 10 3/4" x 6 3/4". WT.: 9 1/2 lbs. Less cover, 7 1/2 lbs. LIST: (with tubes, without covers) \$69.50. Cover \$7.21. Plug Kit \$1.71.

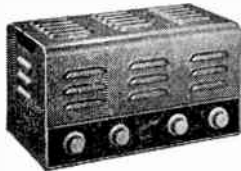

E-17P3: A conservative 17 watt model with 3 speed phono. Separate bass and treble controls, phono bass boost, multi-stage inverse feedback circuit. Input controls for mike and phono. POWER OUTPUT: 17 watts at less than 5%. FREQUENCY RESPONSE: \pm 2 db, 40 to 15,000 cycles. INPUTS: 1 mike (2 meg.) gain 115 db, 1 phono (1/2 meg.) gain 77 db. OUTPUT IMPEDANCES: 4, 8, 16 and 500 ohms. TUBES: (5) 1-12AX7, 1-6SJ7, 2-6L6G, 1-5V4G. FINISH: Silver-grey hammer-tone baked enamel. PANEL: Etched metal, lighted. POWER CONSUMPTION: 75 watts at 117 volts, 60 cycles A.C. SIZE: 8 3/4" x 14 1/8" x 8". WT.: 15 1/2 lbs. LIST: (with tubes) \$151.55. Plug Kit \$2.28.

E-17: A 17 watt amplifier without 3 speed phono. Otherwise identical to model E-17P3. LIST: (with tubes and cover) \$107.50. Plug Kit \$2.28.



E-25: A dependable, full 25 watts with inputs for 2 mikes and 1 phono, separate bass and treble controls, phono bass boost, multi-stage inverse feedback circuit. POWER OUTPUT: 25 watts at less than 5%. FREQUENCY RESPONSE: \pm 2 db, 40 to 15,000 cycles. INPUTS: (3) 2 mike (2 meg.) gain 117 db, 1 phono (1/2 meg.) gain 77 db. OUTPUT IMPEDANCES: 4, 8, 16 and 500 ohms. TUBES: (6) 1-12AX7, 1-6SC7, 1-6L5, 2-6L6G, 1-5V4G. FINISH: Silvergrey hammer-tone baked enamel. PANEL: Etched metal, lighted. POWER CONSUMPTION: 90 watts, 117 volts, 60 cycles A.C. SIZE: 8 3/4" x 14 1/8" x 8". WT.: 18 1/4 lbs. LIST: (with tubes and cover) \$139.50. Plug Kit \$3.24.

E-25P3: A 25 watt amplifier with 3 speed phono. Otherwise identical to model E-25. LIST: (with tubes) \$183.18. Plug Kit \$3.24.

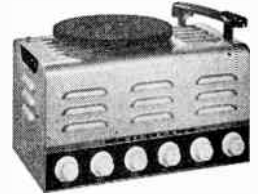

E-254P3: A highly versatile, yet economical 4 channel, 25 watt amplifier with 3 speed phono. Features: high gain, inputs for 3 mikes and 1 phono, separate bass and treble tone controls, phono bass boost, multi-stage inverse feedback circuit. Pickup is high-grade turnover crystal. POWER OUTPUT: 25 watts at less than 5% distortion. FREQUENCY RESPONSE: \pm 2 db, 40 to 15,000 cycles. 3 MIKE INPUTS: 2 meg., gain 123 db. PHONO INPUT: 1/2 meg., gain 83 db. OUTPUT IMPEDANCES: 4, 8, 16, and 500 ohms. TUBES (8): 3-6SF5, 1-6SJ7, 1-6SN7, 2-6L6G, 1-5V4G. FINISH: Silvergrey hammer-tone baked enamel. PANEL: Etched metal illuminated. CONTROLS: 3 mike, 1 phono, 1 bass, 1 treble and power switch. POWER CONSUMPTION: 105 watts at 117 volts, 60 cycles A.C. SIZE: 8 3/4" x 14 1/8" x 8". WT.: 18 1/4 lbs. LIST: (with tubes) \$213.18. Plug Kit \$3.90.

E-254: A 25 watt amplifier without 3 speed phono. Otherwise identical to model E-254P3. LIST: (with tubes and cover) \$169.50. Plug Kit \$3.90.



E-50: A distortion-free, conservatively rated 50 watts using push-pull parallel 6L6 tubes and multi-stage inverse feedback circuit. Has inputs for 2 mikes, 1 phono, separate bass and treble controls, phono bass boost. Same as E-25 except as follows: POWER OUTPUT: 50 watts at less than 5%. Mike gain 120 db, phono 79. OUTPUT IMPEDANCES: 4, 8, 16 and 250 ohms. TUBES: (9) 1-6SJ7, 1-12AX7, 1-6J5, 4-6L6G, 1-5V4G. POWER CONSUMPTION: 170 watts at 117 volts, 60 cycles A.C. SIZE: 11 1/4" x 14 3/4" x 8 1/2". WT.: 29 lbs. LIST: (with tubes and cover) \$196.50. Plug Kit \$3.24.

2-5V4G. POWER CONSUMPTION: 170 watts at 117 volts, 60 cycles A.C. SIZE: 11 1/4" x 14 3/4" x 8 1/2". WT.: 29 lbs. LIST: (with tubes and cover) \$196.50. Plug Kit \$3.24.

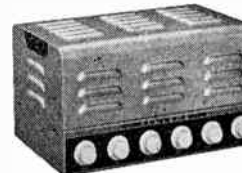

E-504: A 4 channel 50 watt amplifier featuring: high gain, inputs for 3 mikes and 1 phono, separate bass and treble tone controls, phono bass boost, multi-stage inverse feedback, push pull parallel output system for lowest distortion at all power levels. POWER OUTPUT: 50 watts at less than 5% distortion. FREQUENCY RESPONSE: \pm 2 db, 40 to 15,000 cycles. THREE MIKE INPUTS: 2 meg., gain 126 db. PHONO INPUT: 1/2 meg., gain 86 db. OUTPUT IMPEDANCES: 4, 8, 16 and 250 ohms. TUBES (11): 3-6SF5, 1-6SJ7, 1-6SN7, 4-6L6G, 2-5V4G. FINISH: Silvergrey hammer-tone baked enamel. PANEL: Etched metal illuminated. CONTROLS: 3 mike, 1 phono, 1 bass, 1 treble and power switch. POWER CONSUMPTION: 180 watts, 117 volts, 60 cycles A.C. SIZE: 11 1/4" x 14 3/4" x 8 1/2". WT.: 30 lbs. LIST: (with tubes and cover) \$239.50. Plug Kit \$3.90.

gain 86 db. OUTPUT IMPEDANCES: 4, 8, 16 and 250 ohms. TUBES (11): 3-6SF5, 1-6SJ7, 1-6SN7, 4-6L6G, 2-5V4G. FINISH: Silvergrey hammer-tone baked enamel. PANEL: Etched metal illuminated. CONTROLS: 3 mike, 1 phono, 1 bass, 1 treble and power switch. POWER CONSUMPTION: 180 watts, 117 volts, 60 cycles A.C. SIZE: 11 1/4" x 14 3/4" x 8 1/2". WT.: 30 lbs. LIST: (with tubes and cover) \$239.50. Plug Kit \$3.90.

NEW 2-CHANNEL STEREOPHONIC AMPLIFIER!



3D-12: Built for the future! Hollywood's 3-D reproduction now available for home enjoyment. For true Stereophonic or "Enhanced" 2-speaker Monaural reproduction from records, radio or tape. Channel Selector provides choice of stereophonic or "enhanced" monaural reproduction; reverses channels; gives choice of channel A or B separately; bass control range 0 to +18 db; treble control range -24 to +13 db. Phono Crossover Control selects program source and crossovers. Includes positions for Orthophonic, N.A.B., Columbia, AES and 78 RPM recording curves. Crossovers apply to both channels. New "Focus" control balances speakers for maximum stereophonic presence. Single knob control of duplicate functions in matched channels makes this 2 channel amplifier as easy to operate as a conventional one. Fletcher-Munson compensated volume control for utmost low level realism. RESPONSE: \pm 1 db, 20 to 20,000 cycles. Hum and noise 80 db, below 12 watts. POWER OUTPUT: Each channel, 12 watts at less than 2%; 10 watts at less than 1%. INPUTS to both channels provide for crystal pickups, high level magnetics (Pickering) .025 volts, low level magnetics (G.E.) .008 volts, radio 1 volt, tape 1 volt. OUTPUT IMPEDANCES: 8 and 16 ohms to speakers at each output strip. Special response for Cook Binaural recordings. 2 tape outputs, one from each channel, connect to owner's stereophonic tape recorder to produce stereophonic tapes. Average output using LP records: approximately 3 volts. Chassis provided with A.C. convenience outlet. Exclusive "Adjusta-Panel" feature. SIZE: 12 1/8" wide x 12 1/2" deep x 7 3/4" high. WT.: 19 lbs. Audiophile, NET: \$179.50.

All Prices and Specifications Subject to Change Without Notice.

E SERIES PORTABLES



E-1010S: A 10 watt basic portable consisting of one E-10 amplifier with plugs and one E-110S case assembly with efficient 10" P.M. speaker protected by a kick-proof metal grill. Speaker cable 25'. Overall size: 12 1/4" x 15 3/4" x 8 3/4". Weight: 19 lbs. LIST: (less mike and stand) \$126.82.

E-1712R. A 17 watt dual speaker portable system consisting of one EH-212R split speaker and amplifier case assembly with two 12" high quality P.M. speakers, each with 25' cable, protected by kick-proof grills, and one E-17 amplifier with plugs. Size: 11 1/8" x 20 1/2" x 21". Weight: 40 lbs. LIST: (less mike and stand) \$209.28.

E-2512R: A 25 watt dual speaker portable system with model E-25 amplifier. Weight 42 1/2 lbs. LIST: (less mikes and stands) \$242.24.

E-25412R: A 25 watt dual speaker portable system consisting of one EH-212R split case assembly with two 12" P.M. speakers each with 25' cable, and model E-254 four channel amplifier. LIST: (less mikes and stands) \$272.90.



E-17P312R: A 17 watt dual speaker portable system with 3 speed phono. Consists of model E-17P3 amplifier in EH-212R split case assembly. LIST: (less mike and stand) \$252.96.

E-25P312R: A 25 watt dual speaker portable system with 3 speed phono. Model E-25P3 amplifier in EH-212R split case assembly. LIST: (less mikes and stands) \$285.92.

E-254P312R: A 25 watt dual speaker portable system with 3 speed phono. Same as E-254P3.

25412R but with 3 speed phono top amplifier model E-254P3. LIST: (less mikes and stands) \$316.58.



E SERIES MOBILE AMPLIFIERS

E-25MP: A 25 watt mobile amplifier with 78 RPM phono. For use on 6 V. storage battery or 117 V.A.C. Consumes minimum current per watt output. Has standby switch, separate power and turntable switches, heavy duty Jones plugs and receptacles for dependable connections to battery or A.C. power. POWER OUTPUT: 25 watts at less than 5%. RESPONSE: ± 2 db, 50 to 15,000 cycles. INPUTS: 2 mikes (2 meg.) gain 119 db, 1 phono (1/2 meg.) gain 78 db. HIGH FREQ. ATTENUATOR: Range 28 db. CIRCUIT: Multi-stage inverse feed-back, resistance capacity coupling, phase correction for phono motor, 2000 V. hermetically sealed oil buffer condenser. OUTPUT IMPEDANCES: 4, 8, 16, and 500 ohms to 2 octal speaker sockets and impedance selector. PHONO: Constant speed 78 rpm. PICKUP: Crystal. TUBES: (7) 1-12AX7, 1-6SJ7, 1-6J5, 2-6L6, 2-6X5GT.



E-25M: Same as E-25MP without phono. POWER CONSUMPTION: 91 watts A.C. or 17 amps. from 6 V.D.C. SIZE: 8 3/4" x 14 1/8" x 8". WT.: 23 lbs. LIST: (with tubes) \$195.75. Plug Kit \$3.24.

E-25MP3: Same as model E-25MP except with 3 speed phono. LIST: (with tubes) \$239.43. Plug Kit \$3.24.

E-10M: A 10 watt mobile amplifier. For use on 6 V.D.C. or 117 V, 60 cycles A.C. Features push-pull beam power output tubes with inverse feedback for low distortion, standby battery saver switch, new freedom from vibrator hash, special mounting for easy removal of chassis, inputs for mike and phono, sturdy Jones connectors for battery and A.C. cables. POWER OUTPUT: 10 watts at less than 5%. FREQUENCY RESPONSE: ± 2 db, 50 to 15,000 cycles. INPUTS: Mike (2 meg.) gain 115 db, phono (1/2 meg.) gain 75 db. OUTPUT IMPEDANCES: 4, 8, 16 ohms. TUBES: (5) 1-6SC7, 1-6SF5, 2-6V6GT, 1-6X5GT. POWER CONSUMPTION: 88 watts, 117 volts, 8 amps. at 6 V.D.C. FINISH: Silvergrey hammertone baked enamel. PANEL: Etched metal with pilot lamp. SIZE: 6 1/8" x 6 3/4" x 8 1/4". WT.: 9 3/4 lbs. LIST: (with tubes) \$99.75. Plug Kit \$1.39.

ALL NEWCOMB EQUIPMENT U/L APPROVED

PRICES AND SPECIFICATIONS SUBJECT TO CHANGE WITHOUT NOTICE

Newcomb

AUDIO PRODUCTS COMPANY

6824 LEXINGTON AVENUE • LOS ANGELES 38, CALIFORNIA

Copyright by U. C. P., Inc.

TRADE DISCOUNT APPLIES TO LIST PRICES ONLY

Radio's Master — 19th Edition

Page B-9

RACK AND PANEL ASSEMBLIES



Any standard Newcomb amplifier may be obtained panel mounted on special order in 19" x 8 3/4" panels, thus giving the custom designer a wide choice of equipment to meet any need.

MODEL 595-19 CABINET: (Illustrated) Supplies a demand for a beautifully finished housing that is fully in keeping with the Newcomb tradition and reputation for quality. Panel space is 56". Design accepts standard 19" wide panels. Mounting holes are RMA standard 1 1/4" and 1/2" spacings. Panel mounting holes are tapped in 1/2" stock. Fully ventilated rear door provides easy accessibility. Entire cabinet is a complete welded assembly ready for use as you receive it. Finish is dark grey hammertone. Provision is made in the rear for nine 1/2" conduits. Included is a removable terminal strip mounting plate located near conduit inlets. Overall dimensions: 59 1/2" x 23" wide x 16" deep. Shipping weight: 92 lbs. LIST: \$189.50.

MODEL 385-19 CABINET: Provides 35" of panel space for standard 19" panels. Overall dimensions: 38 1/2" x 23" wide x 16" deep. Shipping weight: 72 lbs. LIST: \$149.50.

In addition to the panel mounted amplifiers Newcomb also provides a wide selection of other equipment designed for custom rack installations.

MODEL 1050-C PHONOGRAPH CHANGER PANEL is a practical solution to mounting a phono changer in cabinet 595-19. Ball bearing drawer with wood motor board is adaptable for mounting most popular changers. Panel size 19" x 10 1/2". All panels are finished in silver-grey hammertone baked enamel. **MODEL E2-525 PRE-AMPLIFIER** answers the need for a simple, dependable but economical pre-amp for rack use. **MODEL TB2-525 INTERCOM AMPLIFIER** has built-in power supply, speaker, talk-listen switch and separate talk and listen volume controls. **MODEL B-100-875 AM RADIO** is the Newcomb B-100 radio mounted on an 8 3/4" panel. (See listing page B-35.) **MODEL 700-MP MONITOR** is available for installation of one 6" speaker. **LEVER KEY PANELS** are provided for use with CRL keys, 3 1/2" deep with slots for 6, 8, 10 or 12 keys. **LOUVERED PANELS** for additional ventilation and **BLANK PANELS** are made in assorted sizes. **SPECIAL PANELS** are made to order to fit special equipment. Templates or suitable drawings must accompany order for any special sheet metal work. Full details of Newcomb rack and panel equipment available on request.

ACCESSORIES FOR H AND K SERIES AMPLIFIERS

REMOTE CONTROLS



For mixing and fading all H Series mike inputs. With K Series amplifiers all mikes and phono may be controlled. Up to 2000 feet of cable may be used. No inductive pickup.

RC-2 for H-15 amp. Requires ordinary 3 wire cable. 23 1/4" x 6" x 2 1/8". WT.: 1 lb. LIST: (less Cable) \$10.50.

RC-3 for H-25 or H-4 amp. Requires ordinary 4 wire cable. 23 1/4" x 6" x 2 1/8". WT.: 1 lb. LIST: (less Cable) \$15.50.

RC-4 for H-50 amp. Requires ordinary 5 wire cable. 23 1/4" x 7 5/8" x 2 1/8". WT.: 1 1/4 lbs. LIST: (less Cable) \$19.50.

RC-6 for KX-25, KX-50, KX-6 amps. Requires ordinary 7 wire cable. 23 1/4" x 11 1/4" x 2 1/8". WT.: 2 lbs. LIST: (less Cable) \$27.50.

PLUG-IN TRANSFORMERS



TR-91: Features sextuple alloy and copper shielding for quiet operation right in amp. proper. Alloy core and specially designed windings for extended frequency response from 20 to 20,000 cycles. Plug base for easy installation. For use between 30-50 or 200-250 ohm mikes and grid. WT.: 1 1/4 lbs. LIST: \$32.50.

TR-92: Input impedance 5,000 ohms to grid for bridging a 500-600 ohm line. When plugged into sockets on K50B, H50B, H25B it converts for use as bridging amps. WT.: 1 1/4 lbs. LIST: \$29.50.

TR-100: Identical to TR-91 but for use between 125-150 or 500-600 ohm mikes and grid. LIST: \$32.50.

NEWCOMB TRANSCRIPTION PLAYERS AND P.A. SYSTEMS

Newcomb transcription players also serve as excellent p.a. systems when mike is attached to input provided. Foolproof in operation with emphasis on dependability, tone quality and light weight. ALL U/L approved.

Variable control of tempo and pitch plus New Speed-O-Scope*

TR-25AM: 25 watt, 3 speed player and p.a. for all records up to 17 1/4". PICKUP: Twist type, dual needle G.E. variable reluctance. SCRATCH SUPPRESSOR: Controls surface noise. POWER OUTPUT: 25 watts at less than 5%. FREQUENCY RESPONSE: -2 db 40-15,000 cycles. INPUTS: 2 mikes, high impedance, gain 120 db. CONTROLS: (9) 1 phono bass, 1 phono treble, 1 phono vol., 2 mike vol., 1 mike bass (Second mike unaffected by either set of controls) 1 power, 1 scratch filter, 1 variable speed. MOTOR: 3 speed, 33 1/3, 45 and 78 rpm, with variable speed control. Two lb. 10" turntable contributes to wow-free performance. FLOATING SOUND: Eliminates needle skipping. SPEAKERS: 2 12" in separate split case, each with 25' cord. OUTPUT IMPEDANCES: 4, 8 ohms. TUBES: (10) 2-6SC7, 1-6SJ7, 1-6SN7, 4-6V6GT, 2-5Y3. POWER CONSUMPTION: 130 watts, 117 volts, 60 cycles A.C. including motor. SIZE: Amp-phono case, 16 1/4"x16 1/4"x7 7/8". WT.: 36 lbs. Dual speaker case, 16 1/4"x16 1/4"x12". WT.: 19 lbs. LIST: \$382.50.



TR-16AM: 10 watt, 3 speed player and p.a. system. All records to 17 1/4". PICKUP: Twist type, dual needle G.E. variable reluctance. SCRATCH SUPPRESSOR controls surface noise. POWER OUTPUT: 10 watts at less than 5%. FREQUENCY RESPONSE: ±2 db, 50-10,000 cycles. INPUTS: (2) 1 mike, 1 radio or phono changer. CONTROLS: (8) 1 treble, 1 base, 1 phono vol., 1 mike vol. (Circuit prevents phono bass from adding bass to mike.) 1 power, 1 scratch filter, 1 variable speed, 1 motor A.C. MOTOR: 3 speed, 33 1/3, 45 and 78 rpm with variable control. With 2 lb. turntable it achieves wow-free performance. FLOATING SOUND: Eliminates needle skipping. SPEAKER: 12" Alnico V PM dynamic, 25' cable. TUBES: (6) 2-6SC7, 1-6SJ7, 2-6V6GT, 1-6X5GT. POWER CONSUMPTION: 70 watts, 117 volts 60 cycles A.C. including motor. SIZE: 14 3/4"x15 3/4"x11 7/8". WT.: 33 lbs. LIST: \$257.50.



TR-16A: 10 watt, 3 speed player and p.a. PICKUP: Dual needle, featherweight crystal. Needles semi-permanent, easily replaced. Has all features of TR-16AM except scratch suppressor. TUBES: (5) 1-6SC7, 1-6SJ7, 2-6V6GT, 1-6X5GT. WT.: 33 lbs. LIST: \$233.25.



CR-11 MIKE: Newcomb-Shure mike for TR models and R-16. Combines good voice with ruggedness. Unaffected by high temps, and humidity. Has on-off switch. With mtg. bracket, 7' cable, plug. LIST: \$23.75.



T-112R EXTRA SPEAKER: For all TR models. 12" Alnico V PM dynamic, 25' cord, kickproof metal grill. Plywood case covered in fabricoid. SIZE: 16 1/4"x17 7/8". WT.: 12 lbs. LIST: \$65.85.

***SPEED-O-SCOPE:** A new strobe device to indicate exact 33 1/3, 45 or 78 speed that is practical for use around children. Completely concealed, it is protected from damage but is easily viewed by the polished metal mirror. It can even be read out of doors. A light intensifier switch improves readability in bright light. TR series only.

APPROVED

**BY LEADING SCHOOL AUTHORITIES
FROM COAST TO COAST**

ALL MODELS U/L APPROVED

PRICES AND SPECIFICATIONS SUBJECT TO CHANGE WITHOUT NOTICE

Newcomb

AUDIO PRODUCTS COMPANY

6824 LEXINGTON AVENUE • LOS ANGELES 38, CALIFORNIA

Radio's Master — 19th Edition

Copyright by U. C. P., Inc.

Page B-10

TRADE DISCOUNT APPLIES TO LIST PRICES ONLY

World Radio History

NEWCOMB PORTABLE PHONOGRAPHS AND RADIO

R-12 PORTABLE PHONOGRAPH

Plays all 3 speeds, 33 1/3, 45 and 78 rpm. Featherweight pickup for long record life. 100% A.C. construction. U/L approved. Big 6"x9" speaker. Kickproof grill. 5 watt, 3 speed portable plays all records up to 12". Floating sound construction eliminates groove skipping. Wonderfully rich, "console" tone quality and surprising full throated volume. Operating panel includes a tone control, volume control and pilot light. Sturdy case is plywood covered in fabricoid with metal corner guards. SIZE: 13 1/4"x14 1/8"x7 3/4". WT.: 20 lbs. LIST: \$89.95 (Plus Excise Tax where applicable).



RC-12A CHANGER PHONOGRAPH

Plays all 3 speeds, 33 1/3, 45 and 78 rpm. Featherweight pickup for long record life. 100% A.C. construction. U/L approved. Big 6"x9" oval speaker with kickproof grill. Slumber switch turns off entire machine automatically after last record if desired. 5 watt table model with 3 speed changer. Except for case design and record changer it is the same fine machine as R-12. Cabinet is plywood construction covered in rich, deep brown, sturdy leather-finished fabricoid. Kickproof speaker grill is finished in soft gold color. Panel, dark brown with golden trim, has tone control, volume control, pilot light and slumber switch. Size: 14 3/4"x9 5/8"x18 1/2". Wt.: 31 1/2 lbs. LIST: \$119.50 (Plus Excise Tax where applicable).



R-16 TRANSCRIPTION PLAYER

Shockproof Floating sound. 100% A.C. construction. Big 10" speaker. U/L approved. Plays all records to 17 1/4". Separate mike and phono volume. A practical P.A. system.



A 5 watt portable, 3 speed transcription player with mike input and mixing volume control. Speaker in removable section of case with 25' cable. Plays all records, 33 1/3, 45 and 78 rpm up to 17 1/4". Floating Sound construction eliminates needle skipping due to bumps and jars. Operating panel has tone control, mike volume, phono volume and pilot light. Sturdy carrying case is plywood covered in washable fabricoid material. Size: 14"x15"x8 1/2". WT.: 22 lbs. LIST: \$115.00.

B-100 TABLE RADIO

Big 6" speaker. Full A.C. construction. Built in loop. Extremely sensitive. Jack for added amplification or headphones. U/L approved.



AM radio that brings new quality and ruggedness to this field. Built in loop makes external antenna generally unnecessary. 3 gang design eliminates heterodyne squeals and assures adequate selectivity. Has jack connection to any TR-16 model for added volume, or may be used for headphones. 6" Alnico V PM dynamic speaker. Plywood cabinet is covered in two-tone fabricoid. Size: 7 5/8"x14 1/4"x8". TUBES: (6) 2-6SK7, 1-6SA7, 1-6SQ7, 1-6V6GT, 1-6X5GT. WT.: 13 1/4 lbs. LIST: \$85.95 (Plus Excise Tax where applicable).

NEWCOMB G-12 GUITAR AMP.



POWER OUTPUT: 12 watts at less than 5% distortion. Over 90% of output at less than 2% distortion. **FREQUENCY RESPONSE:** ±1 db 30-15,000 cycles. **INPUTS:** (4) 1 mike (2 meg.) gain 115 db; 3 musical instrument (1/2 meg.) gain 100 db. **CONTROLS:** (2) 1 volume, 1 bass with power. **TONE CONTROL:** 0 to -23db. **CASE:** Plywood construction with strength for constant traveling abuse, covered in washable fabricoid material. **SPEAKER:** 12" Alnico V permanent magnet. TUBES: (5) 1-6SC7, 1-6SF5, 2-6V6GT, 1-5Y3GT. SIZE: 9 1/4"x14 7/8"x18 3/8". WT.: 23 lbs. LIST: \$139.50 Protective Slip Cover. LIST: \$8.35.



PHONO AMPLIFIERS

For the Finest Phonograph Performance Ever Achieved

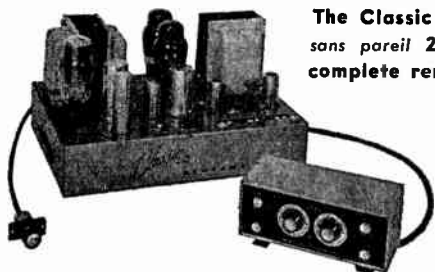

The Classic 25, Fidelity sans pareil 25 watts with complete remote control

An unexcelled combination of technical perfection, flexibility and listening pleasure. Average level distortion is reduced to vanishing point. "Audi-balance" achieves perfect balance of output tubes for lowest distortion in seconds. Here is fidelity with ample reserve power, hum eliminated by D.C. filament supply, a high damping factor reduces transient distortion to minimum without disregarding needs of speakers, new A.E.S. response position, a new output connection to tape recorder. Panel mounting simplified. "Adjusta-panel" extends control shafts to 3/4". Remote cable extends up to 100'.

POWER AMPLIFIER: Frequency response flat from 10 to 30,000 cycles with negligible deviation from 5 to 100,000 cycles. **Distortion:** As low as .005% at average listening levels; less than 15% at 20 watts. **Hum and Noise:** 95 db below 25 watts. **Six Inputs:** All at main amplifier, 1 low level magnetic pickup (.0092 volts), 1 high level magnetic pickup (.046 volts), 1 crystal (.61 volts), 1 radio (1 volt), 1 TV (1 volt), 1 tape (1 volt). **Pre-amp:** Shock mounted with full frequency compensation for various inputs. **Controls:** 1 master phono gain or "limit" control, 1 crystal-magnetic selector switch, 1 "Audi-balance" switch, 1 "Audi-balance" control, 1 A.C. power switch on 5' cable. **Outputs:** To speakers, 8 or 16 ohms at terminal strip. To tape recorder, up to 6 1/2 volts to high impedance "external amplifier" input of tape recorder. Auxiliary A.C. socket. **Fuse** for protection. **Tubes:** (power amp.) 2-12AX7, 1-12AU7, 2-6L6G, 1-5U4G. **Power Consumption:** 125 watts 117 volts 60 cycles A.C. **Finish:** Dove brown hammertone baked enamel. **Size:** 14" x 10" x 7 1/4".

REMOTE CONTROL: Cable length 5' (Model 2X, 20' extension cable available). **Panel Controls:** 1 bass, range -16 db to +23 db. (Special curve shape avoids overemphasis of mid-bass frequencies), 1 treble, range -25 to +23 db., 1 five position record condition compensator, 1 five position crossover control selects ideal playback characteristics and automatically equalizes for lower average level of microgroove records, 1 program selector, 1 volume control Fletcher-Munson compensated for both highs and lows for utmost low level realism, 1 petite pilot lamp. **Tubes:** (remote unit) 1-12AX7, 1-12AV6. **Finish:** Brushed brass. **Size:** 8 3/8" x 4 3/8" x 3 3/8" high. **Weight:** total 28 1/2 lbs. Audiophile, NET \$269.50.



Classic 15, Ultra-High Fidelity 15 watts with complete remote control

Low distortion, excellent reserve power, advanced circuitry, new features, superb reproduction, easy installation are characteristics. Remote

extends up to 50'. Design makes substantial savings possible in installation. Features new "Audi-balance" and "Adjusta-panel," excellent damping factor reduces speaker transient distortion, a new 5 position crossover selector includes A.E.S. and automatic level correction for microgroove recordings, and a new output connection to tape recorders.

POWER AMPLIFIER: Frequency response ± 1 db. 10-25,000 cycles with excellent response to 100,000 cycles. **Distortion:** Less than 1/10% at 12 watts, less than .2% at 15 watts. **Hum and Noise:** 85 db. below 15 watts. **Six Inputs:** All at main amp., 1 low level magnetic pickup (.008 volts), 1 high level magnetic pickup (.032 volts), 1 crystal pickup (.546 volts), 1 radio (1 volt), 1 TV (1 volt), 1 tape (1 volt). **Pre-amp:** Shock mounted and full frequency corrected for various inputs. **Controls:** 1 master phono gain or "limit" control, 1 crystal-magnetic selector switch, 1 "Audi-balance" control, 1 hum balance control, 1 A.C. power on 5' cord. **Outputs:** To speakers, 8 or 16 ohms at terminal strip. To tape recorder, up to 1.9 volts to high impedance "external amp." input of recorder. Auxiliary A.C. socket. **Fuse** for protection. **Tubes:** (in power amp) 2-12AX7, 1-6AV6, 2-6L6G, 1-5V4G. **Power Consumption:** 90 watts 117 volts 60 cycles A.C. **Finish:** Dove brown. **Size:** 14" x 10" x 7 1/4".

REMOTE CONTROL: Cable 5' (Model 2X, 20' extension available). **Panel Controls:** 1 bass, range -17 to +20 db., 1 treble, range -20 to +18 db., 1 five position crossover control, 1 program selector, 1 vol. control, Fletcher-Munson compensated for both highs and lows, 1 petite pilot lamp. **Tubes:** (remote) 1-6AV6, 1-12AX7. **Finish:** Brushed brass. **Size:** 8 3/8" x 4 3/8" x 3 3/8" high. **Weight:** (amp. and remote), 20 3/4 lbs. Audiophile, NET \$179.50.

A-15 HIGH FIDELITY 15 WATTS

Distortion: Less than .25% at 15 watts. 10 to 100,000 response within -1 db. from 20 to 20,000 cycles. Built-in pre-amp fully compensated for magnetic pickups. Distortion free individual bass and treble controls. Crossover selector with A.E.S. response position. Fletcher-Munson bass and treble compensation. "Adjusta-panel" shaft extension. High damping factor. Hum balance control. **Four Inputs:** 1 low level magnetic pickup (.0085 volts), 1 high level magnetic pickup (.037 volts), 1 crystal (.307 volts), 1 for radio, TV or tape (.975 volts). **Hum and Noise:** 82 db. below 15 watts. **Controls:** 1 bass, range to +19 db., 1 treble, range -20 to +19 db., 1 program and crossover selector, 1 vol. **Tubes:** 1-6AV6, 2-12AX7, 2-6L6G, 1-5V4G. **Output Impedances:** 8 and 16 ohms to terminal strip. Auxiliary A.C. socket for accessories. **Power Consumption:** 90 watts at 117 volts 60 cycles A.C. **Fuse** for protection. **Size:** 10" x 10" x 7 3/8". **Weight:** 15 lbs. Audiophile, NET \$99.50. Separate escutcheon, PT-67, NET \$1.80.



A-104R HIGH FIDELITY 12 WATTS

with remote control for easier installation

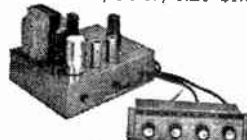

10 watts at less than 1%. ± 1 db. 20 to 20,000 cycles with good response to 100,000 cycles. Built-in pre-amp for magnetic pickups. Separate bass and treble tone controls. "Adjusta-panel" feature (Pat. applied for). Phono crossover selector with A.E.S. position. Fletcher-Munson bass and treble compensation. Hum balance control. Multi-stage inverse feedback. The A-104R offers listening pleasure, technical refinements, parts quality, workmanship and special features not heretofore offered in this price class. Specifications include: 12 watts at less than 2%. **Four Inputs:** Direct to main chassis, 1 low level magnetic pickup (.0115 volts), 1 high level magnetic pickup (.0515 volts), 1 crystal pickup (.58 volts), 1 radio, TV or tape (.98 volts). **Hum and Noise:** 70 db. below 12 watts. **Controls:** (on remote) 1 bass and power switch, range 0 db. to +19 db., 1 treble, range -24 db. to +13 db., 1 crossover and program selector, 1 vol. **Tubes:** 2-6AV6, 1-12AX7, 2-6V6G, 1-5Y3GT. **Output Impedances:** 8 and 16 ohms to terminal strip. Aux. A.C. socket for accessories. **Power Consumption:** 70 watts 117 volts 60 cycles A.C. **Fuse** for protection. **Finish:** Dove brown hammertone baked enamel. Remote panel finish, brushed brass. **Size:** (main amp.) 7 1/2" x 9" x 6 3/8" high. (remote) 8" x 2" x 2", (panel) 9 1/8" x 2 5/8". Remote cable 4'. **Weight:** (amp and remote) 11 lbs. Audiophile, NET \$79.50.

A-104 HIGH FIDELITY 12 WATTS

Identical to A-104R except no remote control. Controls are on main amp. "Adjusta-panel" permits control shafts to be lengthened up to 3/4". **Size:** 9" x 9" x 6 3/8". **Weight:** 9 1/2 lbs. U/L approved. Audiophile, NET \$69.50 Separate escutcheon, PT-66, NET \$1.65.

AM-10R HIGH FIDELITY 10 WATTS

with remote control for easy installation

10 watts at less than 3%. ± 1 db. 20 to 20,000 cycles with good response to 75,000 cycles. Built-in pre-amp compensated for magnetic pickup. New "interlocked" individual bass and treble controls. A.E.S. tone position. Hum balance control. Multi-stage inverse feedback. "Adjusta-panel."



Value packed with advanced features the AM-10R brings new listening pleasure and installation ease within everybody's reach. Never before has so much been offered for so little. Specifications include: **Four Inputs:** direct to main amp. chassis) 1 low level magnetic pickup (.0069 volts), 1 high level magnetic pickup (.039 volts), 1 crystal pickup (.485 volts), 1 radio, TV or tape input. **Hum and Noise:** 80 db. below 10 watts. **Controls:** (on remote) 1 bass with power switch, range 0 to +17 db., 1 treble, range -16 db. to +16 db., 1 vol. **Tubes:** 1-6SC7, 1-12AX7, 2-6V6GT, 1-6X5GT. **Output Impedances:** 8 and 16 ohms to terminal strip. Auxiliary A.C. socket for accessories. **Power Consumption:** 60 watts 117 volts 60 cycles A.C. **Fused** for protection. **Finish:** Dove brown hammertone baked enamel. Remote panel finish, brushed brass. Remote cable 4'. **Size:** (main amp.) 8" x 6 5/8" x 5 3/8", (remote) 2 1/8" x 2" x 5 3/4", (remote panel) 7" x 2 1/2". **Wt:** 8 1/2 lbs. Audiophile, NET \$59.50.

AM-10 HIGH FIDELITY 10 WATTS

Identical to AM-10R without remote. Controls on main amp. "Adjusta-panel" extends shafts up to 3/4". **Size:** 8" x 7 3/4" x 5 3/8". **Weight:** 7 3/4 lbs. Audiophile, NET \$49.75. Separate escutcheon, PT-65, NET \$1.50.



A-10 HIGH FIDELITY 10 WATTS

Similar to AM-10 but with lower gain for crystal pickups. Includes identical panel controls and "Adjusta-panel." **Inputs:** (2) Crystal, .55 volts. Radio, TV or tape, 1.15 volts. **Size:** 8" x 7 3/4" x 5 3/8". **Tubes:** (4) 1-12AX7, 2-6V6GT, 1-6X5GT. **Weight:** 7 1/2 lbs. Audiophile, NET \$44.75. Separate escutcheon, PT-65, NET \$1.50.

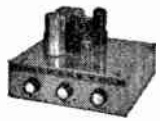

ALL MODELS U/L APPROVED

Copyright by U. C. P., Inc.

TRADE DISCOUNT APPLIES TO LIST PRICES ONLY

Radio's Master — 19th Edition

Page B-11



HERMON SCOTT, INC.

"PACKAGED ENGINEERING"

H. H. SCOTT TYPE 99-A TRANSCRIPTION AMPLIFIER

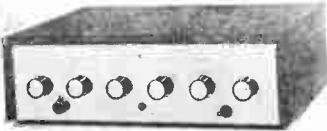

A complete wide-range control and power amplifier built as a single "front end" style unit. Outstanding performance equals amplifiers costing several times as much. Separate 3-position turnover and rolloff equalizers give 9 record equalization curves. Input selector switch with inputs for magnetic pickup, crystal or constant amplitude pickups such as Weathers, and three high level inputs: tuner, tape and TV. Automatic loudness control with adjustable loudness compensation and pickup level adjustment. Treble and bass tone controls. Frequency response flat 20 cps to 30 kc, sharp cutoff rumble filter below 20 cps. Hum better than 80 db below maximum output. Harmonic distortion less than 0.8% at full output. First-order beat-tone intermodulation less than 0.3% at full output. Power output 12 watts, with clean, symmetrical clipping permitting performance equal audibly to

much higher power ratings. Output terminals, 4, 8, 16, and 500 ohms Self balancing phase inverter automatically balances output tubes. Input provisions for DYNAURAL noise suppressor and for dubbing records on tape. Accessory AC outlet. Tubes 2-12AX7, 1-12AU7, 2-6V6GT, 1-5Y3. For 105-125 volts, 50-60 cycle operation, fused. Size 13 1/4 x 3 3/4 x 9 3/4". Shipping weight 15 lbs. Net Price \$99.95, West Coast \$104.95.

TYPE 121-A DYNAURAL EQUALIZER-PREAMPLIFIER

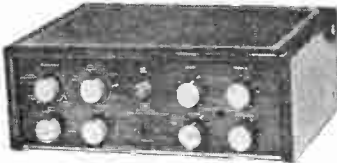

Rolloff frequency and both turnover frequency and extent of boost are continuously variable to compensate for any equalization curve. Amazing DYNAURAL noise suppressor virtually eliminates turntable rumble and record scratch without losing audible music. Record distortion filter (range switch) has 6, 12 and 20 kc high-frequency cutoffs, rumble suppression only and suppression-off positions. Listener-designed loudness control with separate switch for removing loudness compensation. Finished in durable hand-tooled leather with machined anodized aluminum knobs. Self-powered with low-flux density transformer for low hum radiation. DC on all filaments for low hum. Hum level better than 85 db below full output. Frequency response flat from 19 cps to 35 kc, sharp cutoff rumble filter below 19 cps. Two Cathode follower outputs, main and tape recorder. Maximum output voltage 15 volts. 3-channel treble and bass tone controls. Three AC outlets for accessories. Rear panel controls: Pickup load, pickup sensitivity, 5 high level input controls. For

105-125 volt 50-60 cps AC operation, fused. Tubes: 1-6AL5, 2-6BA6, 2-12AX7, 1-12AU7. Size 13 1/4 x 4 3/4 x 9 1/4". Shipping weight 12 lbs. Designed for use with H. H. Scott, Inc. 220-A Power Amplifier. Can be used with many other amplifiers. Net Price \$162.75, West Coast \$170.89.

TYPE 214-B REMOTE CONTROL AMPLIFIER

Rated FIRST CHOICE of all amplifiers in SATURDAY REVIEW HOME BOOK OF RECORDED MUSIC AND SOUND REPRODUCTION. Consists of 120-B Equalizer-Preamplifier and 220-A Power Amplifier. Net Price \$193.75, West Coast \$203.44.

TYPE 120-B EQUALIZER-PREAMPLIFIER

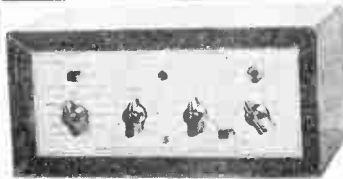

Eight-position record compensator equalizes virtually all records. Input selector for 3 high level inputs, Tuner, TV, Extra, 1 low level input for magnetic pickups. Loudness control with switch. Unique 3-channel treble and bass tone controls. DC operated filaments for low hum. Input level adjustment for matching any pickup. Switch and plug-in connections for accessory 114-A DYNAURAL Noise Suppressor. Provided with 6 ft. power-control cable. Mahogany cabinet. Tubes, 1-12AX7, 2-12AU7. Size 10 x 4 1/2 x 6 1/4". Shipping weight 10 lbs. Net Price \$76.25, West Coast \$80.06.

TYPE 220-A LABORATORY POWER AMPLIFIER

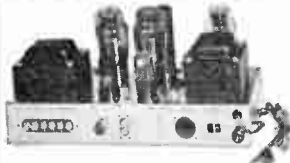

Undistorted power output 20 watts, maximum 25 watts. Frequency response flat 12 cycles to 55,000 cycles. Self-balancing phase inverter automatically balances output tubes. Hum 90 db below full output. Harmonic distortion less than 0.5% at full 20 watts. 1st-order beat-tone intermodulation less than 0.1% at full output. Hum control allows compensation for tube replacement. Input level adjustment. Two inputs. Class A operation throughout. Low output impedance for optimum speaker damping, less than 2 db regulation. Output terminals for speakers of 1 to 24 ohms impedance. Tubes, 2-6L6, 1-6J5, 1-6SN7, 1-5V4. For 110-120 v, 50-60 cycle AC. Size 14 x 6 1/2 x 7 3/4". Shipping weight 20 lb. Net Price \$117.50, West Coast \$123.37.

TYPE 210-B DYNAURAL LABORATORY AMPLIFIER

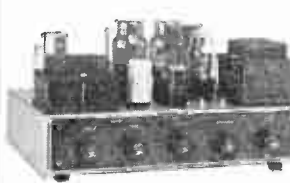

Patented DYNAURAL Noise Suppressor virtually eliminates rumble and record scratch from LP and shellac records without losing audible music. Adjustable record distortion filter limits response from full 22 kc range to 12 kc or 6 kc, particularly useful with older records. 20 watt undistorted power output, 25 watt maximum power. Harmonic distortion less than 0.5% at full 20 watts. 1st order beat-tone intermodulation less than 0.1% at full output. Hum level less than 84 db below full output, DC on filaments of low level tubes. Self-balancing phase inverter automatically balances output tubes. Flat frequency response 12 - 22000 cps. Automatic loudness control. Wide range, precise record equalization by adjusting basic equalization with unique 3-channel treble and bass tone controls, according to chart provided. Hum minimization control compensates for tube replacements. Input level adjustment for matching to any pickup. Output terminals for speakers from 1 - 24 ohms impedance. Tubes, 2-6L6, 2-12SL7, 1-6SN7, 1-6SQ7, 2-6SG7, 1-6J5, 1-5V4G. For 110-120 v, 50-60 cycles AC. Shipping weight 24 lbs. Size 8 1/2 x 14 1/2 x 10 1/4". Net Price \$224.00, West Coast \$235.20.

TYPE 114-A DYNAURAL NOISE SUPPRESSOR

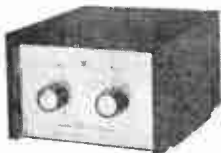

Virtually eliminates record scratch and turntable rumble from widerange music systems but without losing any audible music. For use with 120-B Equalizer-Preamplifier or 99-A Amplifier, simple plug-in connections after preamplifier stage. Obtains power from 99-A or 120-B units or by plugging under amplifier power output tubes such as 6L6, 6V6, 6K6, 6F6 beam-tetrode connected. DYNAURAL control and Record Distortion cutoff (range-switch), control degree of noise suppression, suppression-off, rumble, suppression only, and 20 kc, 12 kc and 6 kc high-frequency cutoffs. Tubes 3-12AU7, 1-6AL5. Size 4 x 6 1/4 x 8". Shipping weight 4 lbs. Net Price \$49.95, West Coast \$52.45.

TYPE 214-X8 VARIABLE SPEAKER CROSSOVER



Provides continuously adjustable speaker crossover from 175 to 3000 cycles. Balance control adjusts relative acoustical balance between high and low frequency speakers. For use between 120-B Equalizer-Preamplifier and two 220-A power amplifiers, one for high frequency "tweeter," other for low frequency "woofer." Allows speaker connections directly to amplifiers for best damping without interposing resonant L-C filters. Size 7 x 4 x 3 1/2". Shipping weight 2 lbs. Net Price \$29.95, West Coast \$31.45.

INTERELECTRONICS

FOR THE ULTIMATE IN HIGH FIDELITY

"THE CORONATION"



30 WATT CLASS A1 AMPLIFIER Advanced Williamson Supra-Linear Circuitry

HIGH OUTPUT: 60 watts peak, 30 watts continuous.

FULL FREQUENCY RESPONSE: 5 to 200,000 cycles.

POWER RESPONSE:

- AT 15 WATTS: 7 cycles to 60,000 cycles within 0.1 DB
- AT 25 WATTS: 15 cycles to 22,000 cycles within 0.1 DB
- 10 cycles to 50,000 cycles within 1.0 DB

LOW DISTORTION:

- Less than 0.05% harmonic distortion at 15 watts
- Less than 0.15% intermodulation distortion at 15 watts

HUM AND NOISE LEVEL:

Better than 96 DB below full output.

EXCELLENT TRANSIENT RESPONSE:

Completely non-ringing exclusive circuitry.

ULTRA-COMPACT: 4 3/4" wide, 15" long, 7 1/8" high, mounts on single 5 1/4" rack panel.

HIGH SENSITIVITY: 0.75 volt for full output.

OUTPUT IMPEDANCES: 8 and 16 ohms.

TUBE COMPLEMENT: two KT66, two 6SN7GTA, one 5U4G.

Superbly master crafted throughout.

Polished chromium chassis, matched sealed power and output transformers, 29 section output transformer, with interleaved windings and special oriented steel laminations.

Bakelite terminal board mounting for all components, plug-in electrolytic condenser. Pre-amplifier power socket provided for the Coronation Console Pre-amplifier and Equalizer and other pre-amps.

Two AC power receptacles, molded line cord. Heavy output to input loop negative feedback.

THREE NEGATIVE FEEDBACK LOOPS: Exclusive Inter-electronics circuitry.

USER NET, ONLY **99⁵⁰**

THE CORONATION Consolette

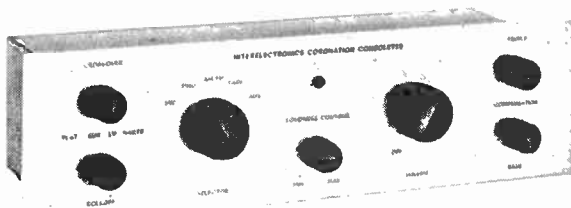

PREAMPLIFIER - EQUALIZER

ADVANCED EXCLUSIVE CIRCUITRY:

Unique new INTERELECTRONICS negative feedback circuitry. ALL controls operate through negative feedback. **OVER 50 DB FEEDBACK.**

REVOLUTIONARY NEW INPUT TUBE:

Features the unequalled lowest noise English preamplifier tube, Z-729. Finest available. **HUM INAUDIBLE** with volume on full.

DISTORTION VIRTUALLY ELIMINATED:

Harmonic and intermodulation distortion barely measurable. Less than 0.02% harmonic and 0.05% intermodulation distortion.

FULL FREQUENCY RESPONSE:

5 to 200,000 cycles.

NEW FUNCTIONAL CONTROLS:

Two major and five smaller control knobs permit simplified operation, provides the utmost in performance and flexibility.

SEVEN FULL FUNCTIONING CONTROLS:

1. Selector switch—five inputs
2. Volume control
3. Loudness contour—continuously variable
4. Bass control—boost and cut
5. Treble control—boost and cut
6. Playback equalization crossover—four positions
7. Playback equalization rolloff—four positions

SIXTEEN PRECISION PHONO PLAYBACK EQUALIZATION CURVES:

Separate crossover and rolloff switching for maximum precision.

POWERFUL BASS AND TREBLE COMPENSATION:

Full 20 DB distortion—free boost and cut compensation through feedback, at 20 and 20,000 cycles, with inflection frequencies variable with compensation. Insures full correction capabilities for loud-speaker, room acoustics and program deficiencies.

FIVE INPUT SELECTIONS:

TWO low level phonograph pickups or microphones, three high-level inputs for AM-FM tuner, tape recorder and Auxiliary. Necessary level controls are provided.

INDEPENDENT RECORDER OUTPUT:

Isolated from control circuit, allows feeding to tape, disc or other recorders.

LOUDNESS CONTOUR CONTROL:

Continuously variable, permits adjustment TO INDIVIDUAL TASTE for dynamic range compensation in accordance with Fletcher-Munson curves.

ULTRA COMPACT:

Panel 3 3/4" wide, 13 3/8" long, mounts from front into cabinet opening 3" x 12 1/8". Only 3 1/8" deep.

MASTER CRAFTED THROUGHOUT:

Finest molded sealed components. All critical control networks employ precision silver-mica condensers and deposited element resistors, lifetime potted in epoxy resin for lasting accuracy. **POLISHED CHROMIUM CABINET. BEAUTIFUL SATIN GOLD PANEL.** Hand-rubbed custom finished wood cabinet available for table use.

TUBE COMPLEMENT:

One Z-729, one 12AX7, one 12AX7.

USER NET:

Complete with all tubes, connecting cables and plugs, for operation with INTERELECTRONICS "CORONATION" amplifier or other amplifiers. Separate power supply for self-powered operation, \$9.95.

USER NET, ONLY **79⁵⁰**

INTERELECTRONICS CORPORATION • NEW YORK

Bogen SOUND SYSTEMS

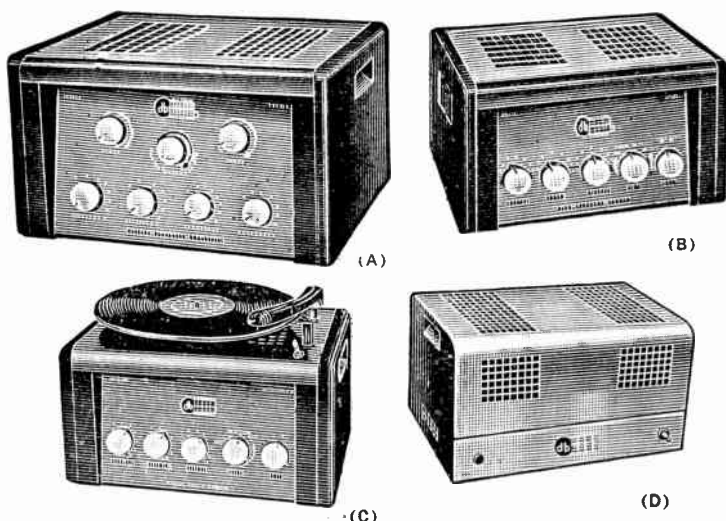

Public Address, Paging, Music Distribution, and Inter-communication Systems for every need—indoor, outdoor, portable or mobile—for the large factory, school, church, stadium, or the small office, auditorium, bus or store—designed and built by the country's largest manufacturer of sound systems.

Bogen amplifiers range in power from 6 watts to 125 watts and are available in a wide variety of "package" systems including different microphones and loudspeakers for different applications. In addition, if you have a special problem, the Bogen Custom Engineering Division will design and assemble a system for your particular installation, regardless of size.

The table below lists the Bogen P.A. amplifiers and package systems. All are conservatively rated in accordance with accepted engineering standards. Each has a frequency response carefully selected to insure optimum performance in the applications for which the model has been designed. Each amplifier marked with an asterisk (*) carries Underwriters' Laboratories approval. Each is finished in tasteful tones of green and buff or green and gray. All, except the mobile and phonograph top models, are available on panels for mounting in standard steel racks, if so ordered. (Panel mounting adds \$24.25 or \$30.75 to the list price, depending on the model.)

Amplifier	Rated Output (Watts, Distortion)	Illustration	Controls	Built-in Phonograph Top	Power Supply	Dimensions (W. x H. x D.)	Output Impedance Taps	Indoor System	Outdoor Systems	Portable System	Amplifier List Price	
(De Luxe)	JX50*	A	4 microphone channels, 1 phonograph channel, bass tone, treble tone, anti-feedback control	—	—	17"x9"x14"	4-8-16 ohms	JX50B	JX50TU	—	\$279.50	
	70-140 volts						JX30B	JX50TJ	—	219.50		
(Standard)	J50*	B, with vertical panel	2 microphone channels, 1 phonograph channel,	—	117 volts,	17"x9 1/4"x12 1/4"	4-8-16 ohms	J50B	J50TU	—	198.50	
	J30*	B	bass tone, treble tone,	—			70-140 volts	J30B	J30TU	J30P	132.75	
	J30Y*	C	plus phono speed control and power switch	3 speed			4-8-16-500 ohms	J30YB	J30YTU	J30YP	165.25	
	J15*	B	—	—	70 volts	J15B	—	J15P	114.00			
	J15Y*	C	—	3 speed	4-8-16 ohms	J15YB	—	J15YP	148.50			
	HE10*	Not shown	1 microphone channel, 1 phono channel, tone corrector, power switch	—	AC	11"x7 3/4"x7"	4-8-16-500 ohms (70 volts)	HE10B	—	HE10P	71.25	
(Mobile)	H623*	C	1 microphone channel, 1 phono channel, tone corrector, power switch, plus phono speed control on H623Y	1 speed	117 volts, AC or 6-volt, DC storage battery (automatic changeover)	15 1/2"x10 1/4"x10 1/4"	4-8-16 ohms 70 volts	H623B	H623TU	—	183.00	
	H623Y*			3 speed				H623YB	H623YTJ	—	196.00	
	E66			Not shown				1 mic channel, power switch, phono jack	—	6 1/4"x6 1/4"x9 1/4"	4-8-16 ohms	—
(Preamplifiers — Broadcast Quality)	JOH*	A	4 mic channels, 1 phono channel, master gain control, tone corrector	—	117 volts,	15 1/4"x8"x11"	10,000 ohms	—	—	—	132.75	
	JOL*	A, plus output meter	—	—				—	—	—	—	172.00
	RP-1 (less CAGVU cage and meter)	Not shown	1 microphone channel, 1 phono channel, power switch	—				AC	11"x6 1/2"x8 1/2"	10,000 ohms or 50-200-500 ohms (2" higher with cage)	—	—
(Boosters)	HO125*	D	Power switch	—	—	17 1/4"x9 3/4"x12 1/2"	90 ohms	—	—	—	215.75	
	HO50*			70-140 volts			—	—	—	167.50		
	JO30*			4-8-16 ohms 70-140 volts			—	—	—	108.75		
							4-8-16-500 ohms 70 volts	—	—	—		

Deluxe models JX50 and JX30 incorporate the exclusive Bogen ANTI-FEEDBACK CONTROL, which permits the tuning out of acoustic feedback and hence the use of more power in the system. These models also feature separate, continuously variable bass and treble tone controls, and provision for plug-in remote volume control of two input channels. (Order remote control unit separately—SCR50 [50' cable] at \$16.75 list price, or SCR100 [100' cable] at \$21.25 list price.)

All "J" models (except JO30) have provision for easy plug-in of low impedance input transformers, when it is desired to use low impedance microphones located at a considerable distance from the amplifier. (Order plug-in transformers separately for desired number of low impedance inputs: (T155, T156, T157, for 200, 500, 50 ohms, respectively.) In addition, models HE10, RP-1, HO125, HO50 and JO30 may be ordered as low impedance versions HE10L, RP-1L, HO125L, HO50L and JO30L, for \$18-\$25 additional to the list price. "J" models also feature broadcast-type microphone connectors, with positive lock and quick disconnect.

For simple, rapid impedance matching between amplifier and speakers, constant voltage output taps (70 volts, 140 volts) are provided on all Bogen amplifiers where there is likely to be need for them, in addition to conventional constant impedance taps. These eliminate the involved calculations previously required to determine the necessary speaker matching transformers, if any.

All indoor systems include a microphone and two or four speakers mounted in wall baffles, with connecting cables and plugs. Outdoor systems include a microphone with cable and plug and one, two or three trumpets. Portable systems include a microphone and two speakers mounted in a carrying case (E) with cables and plugs. The case, which also carries the amplifier, divides into two speaker baffles ready for instant use.

No matter what your requirement, you cannot buy a sound system of finer performance or greater dependability than a Bogen.



(E)

PRICES APPROXIMATELY 5% HIGHER WEST OF THE ROCKIES • ALL PRICES SUBJECT TO CHANGE WITHOUT NOTICE
For further information see your distributor, or write or telephone:

DAVID BOGEN CO., INC. • 29 Ninth Avenue • New York 14, N. Y. • Oregon 5-6565

Bogen SOUND SYSTEMS

PORTABLE 3-SPEED TRANSCRIPTION PLAYERS Equally Practical as Portable P.A. Systems

MODELS VP17 and VP17X are high-fidelity phonographs featuring variable speed control over the entire range from 29 to 86 r.p.m. Ideal for instruction, square dancing, and all other applications in business, school or recreation requiring speeds of 78, 45 and 33 1/2 r.p.m. plus variations from the three standard speeds. Incorporate 4-pole constant velocity motor, weighted and rubber-padded turntable, 10-watt high-fidelity amplifier and 12-inch speaker, all carefully matched and housed in an attractive and compact carrying case. These models will play all records up to 16" in diameter with splendid sound quality and minimum record wear. "Wow" is negligible. Separate bass and treble tone controls are provided. Scratch filter. Automatic start and shut-off. Shock mounting. A microphone input with separate volume control enables the units to serve also as 10-watt portable P.A. systems. U.L. Approved.

VP17 (with piezo electric cartridge).....List Price: \$215.00, plus excise tax
VP17X (with GE magnetic cartridge).....List Price: \$235.00, plus excise tax

MODELS FP17 and FP17X offer the three standard speeds, with the same amplifier (including tone controls and scratch filter) and same speaker and carrying case described above, for all applications where intermediate speed variations are not required.

FP17 (with piezo electric cartridge).....List Price: \$180.00, plus excise tax
FP17X (with GE magnetic cartridge).....List Price: \$195.00, plus excise tax



MODEL ET16 provides the three standard speeds, employing a 5-watt amplifier with tone corrector and a 10-inch speaker. Excellent performance at low cost.
ET16 (with piezo electric cartridge).....List Price: \$123.75, plus excise tax

NEW COMMUNO-PHONE SYSTEMS

Five Versatile Models to Solve Every Intercommunication Problem

SERIES "X"—Completely universal. Will serve installations requiring single master and several remote stations—installations requiring several masters—or installations requiring several masters and several remotes. Model X110 has ten selector buttons; Model X210 has twenty. Gray steel cabinets; typewriter keyboard action; automatic busy signal; provision for plug-in of handset; 117-volt, A.C., power supply; U.L. Approved.

SERIES "C"—Serves installations requiring either a single master and several remote stations or several master stations only. Will not serve installations requiring a combination of several masters and remotes. Operates on voice coil lines. A.C.-D.C.; no busy signal; similar to Series "X" in other respects.

MODEL "TWIN"—Complete 2-station wireless system, requiring no cable between stations. Simply plug stations into regular power line and talk. Additional stations available; all will receive when any one transmits. Any can be locked in "continuously transmitting" position. U.L. Approved. TWIN (2 stations).....List Price: \$95.00

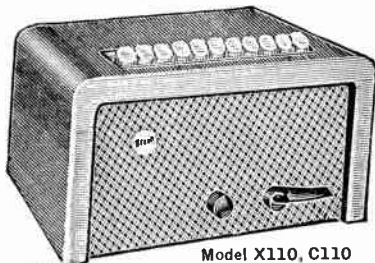

Model X110, C110

CHALLENGER SOUND EQUIPMENT by Bogen 30-WATT P.A. AMPLIFIER AND SYSTEMS

- Individual controls for two microphones, phonograph, tone control.
- Terminal strip and 2 speaker plug-in sockets for connection of speaker lines.
- Moulded bakelite sockets throughout.
- Inverse feedback for better response and regulation.
- Extractor type fuse. • Recessed carrying handles.
- Output Impedances: 4, 8, 16 ohms, 70 volts.
- Dimensions: CH30: 15" w. x 8" h. x 10" d.
- 117-volt, A.C., power supply.
- Underwriters' Lab. Approved.

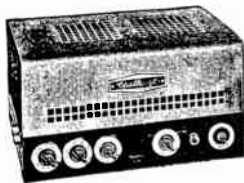

Model CH30



Model CH30X

MODEL CH30—30-watt amplifier, tubes and cage. List Price.....\$96.75

MODEL CH30P-1—Complete portable system containing 1-CH30 amplifier with tubes, cage; 2-12" Alnico V PM speakers, each with 25 ft. cable and plug, mounted in split portable case which also carries amplifier; 1 BOGEN-Shure 710 Crystal Microphone with Stand Adapter, 5 ft. cable and plug.

List Price.....\$171.80

Challenger 8-watt (CH8—L.Pr. \$54.50), 18-watt (CH18—L.Pr. \$81.50) and 60-watt (CH60—L.Pr. \$170.00) P.A. amplifiers also available, as well as indoor, outdoor and portable systems.

MODEL CH30X—30-watt amplifier, tubes and built-in 78 r.p.m. phonograph top. List Price.....\$118.75 (With 3-Speed Phono, \$129.25)

MODEL CH30XP-1—Complete portable system containing 1-CH30X amplifier with tubes; 2-12" Alnico V PM speakers, each with 25 ft. cable and plug, mounted in split portable case which also carries amplifier; 1 BOGEN-Shure 710 Crystal Microphone with Stand Adapter, 5 ft. cable and plug.

List Price.....\$194.30

MODEL CH618 18-WATT UNIVERSAL MOBILE AMPLIFIER For 117-Volt A.C. and 6-Volt D.C. Operation

Features individual controls for microphone, phono, tone; inverse feedback for better response and regulation; constant voltage output for easy speaker matching. Built-in 78 r.p.m. phonograph. Output Impedances: 4, 8, 16 ohms, 70 volts. Complete with tubes and cage. Dimensions: 15" wide x 10" high x 10" deep. Underwriters' Lab. Approved. List Price.....\$153.25 (With 3-Speed Phono.....\$163.75)

MODELS CD6, CD12

6-Watt mobile amplifiers for operation from 6-volt and 12-volt D.C. storage batteries. Complete with tubes, cage and D.C. cable.

CR6.....List Price: \$60.00

CD12.....List Price: \$64.50

CHALLENGER INTERCOM SYSTEMS



CHALLENGER 200 SYSTEM—Complete with 50 ft. of cable and plugs. List Price.....\$43.95

CHALLENGER 200 is a complete system—a master, a remote station and 50 ft. of cable. Operates 117v. AC-DC. Dual-Duty volume control keeps remote "alive" or permits master to silence it. Excellent for nursery, restaurant, business use. Underwriters' Lab. Approved.

CHALLENGER 600 & 1200 masters may be used in two types of systems: a single master with multiple remote stations or an all master system. 600 calls 5 other stations; 1200 calls 11. 117 v. A.C.-D.C. In sturdy beautiful polystyrene cabinets. Remotes can initiate calls also. Underwriters' Lab. Approved. CHALLENGER 600 MASTER with tubes. List Price: \$39.05

CHALLENGER 600 REMOTE STATION. List Price \$12.93
CHALLENGER 1200 MASTER with tubes. List Price: \$49.05



PRICES APPROXIMATELY 5% HIGHER WEST OF THE ROCKIES •
For further information see your distributor, or write or telephone:

ALL PRICES SUBJECT TO CHANGE WITHOUT NOTICE

DAVID BOGEN CO., INC. • 29 Ninth Avenue • New York 14, N. Y. • ORegon 5-6565

Copyright by U. C. P., Inc.

TRADE DISCOUNT APPLIES TO LIST PRICES ONLY

Radio's Master—19th Edition

Page B-15

Masco

AUDIO AMPLIFIERS

MA-8N 8 WATT AMPLIFIER and MAS-8N PORTABLE SYSTEM

MAS-8N



MA-8N



FEATURES: Microphone and phono input separately controlled • Bass-treble tone control • Light, compact, and sturdy • Hammertone-finish chassis • Carefully engineered circuit • Tapped line and voice coil impedances • U/L Approved.

APPLICATIONS: The ideal unit, because of its compactness and easy portability, for ballyhoo, store or street sales demonstrations and sales meetings. Also suitable for cab stands, garages, small warehouses and stockrooms, bingo calling, small taverns and clubs.

AMPLIFIER SPECIFICATIONS • MODEL MA-8N

POWER OUTPUT.....8 Watts, Class A, at less than 5% distortion
 PEAK POWER.....13 Watts
 INPUTS.....Two: 1-microphone, and 1-phono
 FREQUENCY RESPONSE.....± 2 DB 50 to 10,000 CPS
 POWER GAIN.....Microphone, 128.5 DB; Phono, 75 DB
 CONTROLS.....Three: Microphone, Phono, Tone (On-Off Switch)

TUBES.....1-6SF5, 1-6SJ7, 1-6L6G; 1-5Y3GT (Rectifier)
 OUTPUT IMPEDANCES...3.2, 8 and 500 Ohms
 70 Volt (Constant Voltage)
 HUM LEVEL.....60 DB below output level of 8 Watts
 POWER CONSUMPTION...75 Watts at 117 Volts
 VOLTAGE.....105-125 Volts, 60 CPS
 DIMENSIONS.....10" x 6" x 7 1/2" high

PRICES

MA-8N Amplifier less cover, with tubes. Shipping Weight: 14 lbs. \$ 65.00
 Cover for MA-8N..... 12.00
KIT OF MATCHED PLUGS AND CONNECTORS..... 1.73
MAS-8N Portable System Shipping Weight: 30 lbs. 132.50
 Consists of: 1—MA-8N Amplifier with Cover, with Tubes; 1—10" PM Speaker; 1—25-ft. Speaker Cable and Plug; 1—Model 303 Portable Carrying Case; 1—Astatic JT-30 Microphone with 15-ft. Cable and Connectors.

List Prices



MA-17N

MA-17N 17 WATT AMPLIFIER and MAS-17N 17 WATT PORTABLE SYSTEM

FEATURES: Two microphone inputs • One phono input • Individual volume controls • Separate bass and treble tone controls • Tapped line and voice-coil impedances • Dial Glo illumination • U/L Approved.

APPLICATIONS: Excellent for small orchestras, medium-sized paging systems, churches and Sunday Schools, lecturers, store demonstrations and night clubs. Suitable for groups of up to 500 people and areas of up to 400,000 cu. ft.

AMPLIFIER SPECIFICATIONS • MODEL MA-17N

POWER INPUT.....17 Watts, Class A, at less than 5% distortion
 PEAK POWER.....26 Watts
 INPUTS.....Three: 2-microphone, 1-phono
 FREQUENCY RESPONSE.....± 2 DB 50 to 12,000 CPS
 POWER GAIN.....Microphone, 132 DB; Phono, 78 DB
 CONTROLS.....Five: 2-Microphone, Phono, Bass, Treble, Separate Power On-Off Switch
 TUBES.....1-6SC7, 1-6SJ7, 1-6SL7GT, 2-6L6G; 1-5V4G (rectifier)

OUTPUT IMPEDANCES.....4, 8, 15, 250, 500 Ohms, 70 Volt (Constant Voltage)
 HUM LEVEL.....62 DB below output level of 17 Watts
 POWER CONSUMPTION.....125 Watts at 117 Volts
 VOLTAGE.....105-125 Volts, 60 CPS
 Has tapped primary to compensate for line voltage fluctuations.
 DIMENSIONS.....13" x 8" x 8 3/4" high

PRICES

MA-17N Amplifier with tubes. Shipping Weight: 20 lbs. \$116.00
KIT OF MATCHED PLUGS AND CONNECTORS..... 2.65
MAS-17N Portable System. Shipping Weight: 45 lbs. 211.00
 Consists of: 1—MA-17N Amplifier with tubes; 2—12" PM Speakers; 2—25-ft. Speaker Cables and Plugs; 1—Model 304 Portable Carrying Case; 1—Astatic JT-30 Microphone with 15-ft. Cable and Connectors.

List Prices

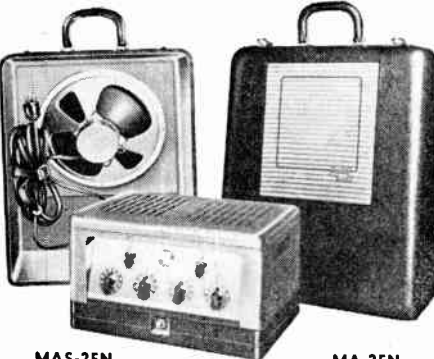

MAS-25N

MA-25N

MA-25N 25 WATT AMPLIFIER and MAS-25N 25 WATT PORTABLE SYSTEM

FEATURES: Four inputs • Four-Channel electronic mixing • Separate bass and treble controls • Tapped line and voice-coil impedances • Full 25-watts of undistorted output • Attractive blue-and-gray Hammertone finish • Over-all negative feedback • U/L Approved.

APPLICATIONS: For large groups and paging in large, noisy areas. Excellent for resorts, large auditoriums, churches, rodeos, carnivals, soft ball parks, institutions and large night clubs.

AMPLIFIER SPECIFICATIONS • MODEL MA-25N

POWER OUTPUT.....25 Watts, Class AB-1, at less than 5% distortion
 PEAK POWER.....40 Watts
 INPUTS.....Four: 3-microphone, 1-phono
 FREQUENCY RESPONSE.....± 2 DB 50 to 15,000 CPS
 POWER GAIN.....Microphone, 133.5 DB; Phono, 79 DB
 CONTROLS.....Six: 3-microphone, Phono, Bass, Treble, Separate Power On-Off Switch

TUBES...4-6J7, 2-6SC7, 2-6L6G; 1-5V4G (Rectifier)
 OUTPUT IMPEDANCES.....4, 8, 15, 250, 500 Ohms
 70 Volt (Constant Voltage)
 HUM LEVEL.....64 DB below output level of 25 Watts
 POWER CONSUMPTION.....145 Watts at 117 Volts
 VOLTAGE.....105-125 Volts, 60 CPS
 Has tapped primary to compensate for line voltage fluctuations.
 DIMENSIONS.....15" x 8 1/2" x 8 3/4" high.

PRICES

MA-25N Amplifier with tubes.....\$145.00
 Shipping Weight: 30 lbs.
KIT OF MATCHED PLUGS AND CONNECTORS..... 3.24
MAS-25N Portable System 240.00
 Shipping Weight: 60 lbs.
 Consists of: 1—MA-25N Amplifier with tubes; 2—12" PM Speakers; 2—25-ft. Speaker Cables and Plugs; 1—Model 305 Portable Carrying Case; 1—Astatic JT-50 Microphone with 15-ft. Cable and Connectors.

List Prices

MA-25PN-3 25 WATT PHONO TOP AMPLIFIER and MAS-25PN-3 PORTABLE SYSTEM

FEATURES: High-gain microphone inputs • Phono input (self contained) • High-quality crystal pick-up • Plays 12" and smaller records • All inputs separately controlled • Tapped line and voice-coil impedances • Individual bass and treble equalizers • Constant-speed motor • Lock-in Pickup Arm Rest • U/L Approved.

AMPLIFIER SPECIFICATIONS

MODEL MA-25PN-3

Same as Model MA-25N except for dimensions which are 14" x 11" x 8 3/4" high.

PRICES

MA-25PN-3 Amplifier with tubes, with three-speed motor. Shipping Weight: 32 lbs.....\$182.50
KIT OF MATCHED PLUGS AND CONNECTORS..... 2.27
MAS-25PN-3 Portable System 285.00
 Shipping Weight: 61 lbs.
 Consists of: 1—MA-25PN-3 Amplifier with tubes and same equipment as Model MAS-25N.

List Prices

OPTIONAL EQUIPMENT: Amplifiers can be supplied with photo cell inputs for theatre installation. Specify when ordering. For one input add \$10.00 to list price. For two inputs add \$8.00 list per input.
 Amplifiers also available with low impedance microphone input at \$37.50 per unit installed.
West of Rockies add 5% to list prices.



All specifications and prices subject to change without notice.



WRITE FOR COMPLETE CATALOG

MARK SIMPSON MFG. CO.

LONG ISLAND CITY 3, N. Y.

Masco

AUDIO AMPLIFIERS

MA-35N 35 WATT AMPLIFIER and MAS-35N 35 WATT PORTABLE SYSTEM

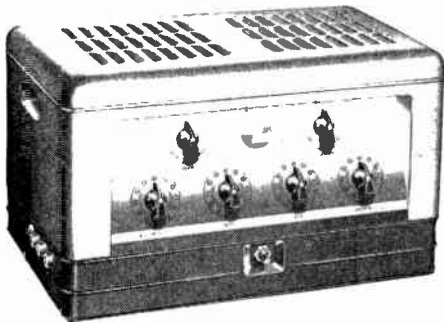

MA-35N

PRICES

MA-35N Amplifier with tubes. Shipping Weight: 32 lbs. \$180.00
 KIT OF MATCHED PLUGS and CONNECTORS 3.24
 MAS-35N Portable System. Shipping Weight: 63 lbs. 298.75
 Consists of: 1—MA-35N Amplifier with tubes; 2—EXTRA-HEAVY-DUTY 12" PM Speakers; 2—25-ft. Speaker Cables and Plugs; 1—Model 305 Portable Carrying Case; 1—Astatic JT-30 Microphone with 15-ft. Cable and Connectors.

List Prices

FEATURES: Four inputs • Three microphone and one phono input, each separately controlled • Electronic mixing overall • Individual bass and treble equalizers • Hum-free operation • Tapped output impedances of 4, 8, 15, 250 and 500 ohms and 70 volt constant voltage • U/L approved.

APPLICATIONS: Recommended for bathing beaches, county and state fairs, for paging and announce systems at airports and railroad terminals, for theatres, carnivals, hotels and motels.

AMPLIFIER SPECIFICATIONS • MODEL MA-35N

POWER OUTPUT.....35 Watts, Class AB-2, at less than 5% distortion
 PEAK POWER.....50 Watts
 INPUTS.....Four 3-Microphone, 1-Phono
 FREQUENCY RESPONSE.....±2 DB 50 to 15,000 CPS
 POWER GAIN.....Microphone, 135 DB; Phono, 80.5 DB
 CONTROLS.....Six: 3-Microphone, Phono, Bass, Treble, Separate Power On-Off Switch
 TUBES.....1-6SC7, 3-6J7, 3-6SN7GT, 2-6L6GT, 1-5U4G, 1-6X5GT (rectifiers)

OUTPUT IMPEDANCES.....4, 8, 15, 250, 500 Ohms, 70 Volt (Constant Voltage)
 HUM LEVEL.....65 DB below output level of 35 Watts
 POWER CONSUMPTION.....190 Watts at 117 Volts
 VOLTAGE.....105-125 Volts, 60 CPS
 Has tapped primary to compensate for line voltage fluctuations.
 DIMENSIONS MA-35N.....15" x 9 1/2" x 8 3/8" high

MA-77 75 WATT AMPLIFIER and MCO-77 75 WATT OUTDOOR SYSTEM

FEATURES: Full electronic mixing of all channels • Individual bass and treble equalizers • Seventy-five watts of undistorted power • Peak power output 90 watts • Negative feedback • Automatic safety interlock switch • Fully fused • U/L approved.

APPLICATIONS: For airports, railroad yards and terminals, factories, drydocks, hotel fire-alarm systems, and especially for church tower installations. Excellent for theatre sound re-inforcement, larger auditoriums and Civil Defense Warning systems.

AMPLIFIER SPECIFICATIONS • MODEL MA-77

POWER OUTPUT.....75 Watts, Class AB-1, at less than 5% distortion
 PEAK POWER.....90 Watts
 INPUTS.....Five: 4-Microphone, 1-Phono
 FREQUENCY RESPONSE.....±2 DB 50 to 15,000 CPS
 POWER GAIN.....Microphone, 136.5 DB; Phono, 82 DB
 CONTROLS.....Seven: 4-Microphone, Phono, Bass, Treble, Separate Power On-Off Switch

TUBES.....4-6J7, 1-6SC7, 1-6SJ7, 1-6SL7GT, 1-6SN7GT, 2-807; 3-5Y3GT (rectifiers)
 OUTPUT IMPEDANCES.....4, 8, 16 Ohms, 70 Volt, 140 Volt (Constant Voltage)
 HUM LEVEL.....67 DB below output level of 75 Watts
 POWER CONSUMPTION.....190 Watts at 117 Volts
 VOLTAGE.....105-125 Volts, 60 CPS
 Has tapped primary to compensate for line voltage fluctuations.
 DIMENSIONS.....16" x 11" x 8 3/8" high



MA-77

PRICES • List Price

MA-77 Amplifier with tubes.....\$280.00
 Shipping Weight: 45 lbs.
 KIT OF MATCHED PLUGS and CONNECTORS 3.67
 MCO-77 Outdoor System 490.00
 Shipping Weight: 100 lbs.
 Consists of: 1—MA-77 Amplifier with Tubes; 3—Masco-University PH Trumpets; 3—Masco-University MA-25 Driver Units; 3—25-ft. Speaker Cable and Plugs; 1—Astatic JT-30 Microphone with 15-ft. Cable and Connectors.

MA-125 125 WATT HI-POWER AMPLIFIER

FEATURES: 125 watts at less than 5% distortion—175 watts peak power • Four input channels • Separate controls for each input • Full electronic mixing • Stabilized inverse feedback • Constant voltage outputs • Oil-filled filters • Optional built-in press-to-talk relay for standby operation • Automatic safety interlock switch • Two-tone gray hammertone finish • Available for rack mounting • U/L approved.

APPLICATIONS: These are superior units designed for continuous heavy duty applications in very large installations such as shipyards, football stadia, sports arenas, large industrial plants, airports and race tracks. Especially recommended for Civil Defense Warning Systems, railroad yards, steel mills and for open-air theatres.

AMPLIFIER SPECIFICATIONS • MODEL MA-125

POWER OUTPUT.....125 Watts at less than 5% distortion
 PEAK POWER.....175 Watts
 INPUTS.....Four: 3-Microphone, 1-Phono
 INPUT SENSITIVITY.....Microphone .006 volts; Phono 0.3 volts for full power output
 CONTROLS.....Six: 3-Microphone, Phono, Bass, Treble, Separate Master Power Switch, Automatic Interlock Switch
 FREQUENCY RESPONSE.....80-10,000 CPS ±3db

TUBES.....3-6SJ7, 1-6SL7GT, 3-6SN7GT, 2-807; 1-5R4GY, 1-5Y3GT (rectifiers)
 OUTPUT IMPEDANCES.....70 Ohms; 70 Volts (40 Ohms), 140 Volts (200 Ohms) Constant Voltage taps. Separate high impedance output for MB-125 Booster Amplifier
 HUM LEVEL.....60 DB below full output
 POWER CONSUMPTION.....350 Watts, 117 Volts, 50-60 Cycles AC
 DIMENSIONS.....MA-125: 17" x 13" x 9" high



MA-125

PRICES

MA-125 Amplifier with tubes, with cover..\$312.50
 KIT OF MATCHED PLUGS and CONNECTORS 3.24
 Shipping Weight: 61 lbs.
 If desired with Press-to-Talk Relay, add to List Price 23.75

ELECTRONIC MICROPHONE MIXER AND PRE-AMPLIFIER

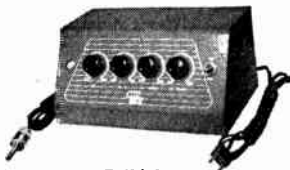

EMM-6

An all-electronic microphone mixer for up to 4 mikes and 2 radio-phonograph channels. 20 db gain on mike, 8 db on phonograph. Cathode follower output permits use up to 400 ft. from amplifier.

PRICES

EMM-6 Electronic Microphone Mixer and Pre-Amplifier, complete with 8-ft. Cable and Plug. Shipping Weight: 4 lbs.....\$65.00

List Price

MM-4 FOUR CHANNEL MICROPHONE MIXER

A 4-channel, high impedance, non-electronic microphone mixer for use with high impedance microphone input of any amplifier. Easiest and cheapest way to mix four microphones into one input.

PRICES

MM-4 Four Channel Mixer with 4-ft. Cable and Connector.....\$21.25
 Shipping Weight: 4 lbs.

List Price



West of Rockies, add 5% to list prices.

All specifications and prices subject to change without notice.



WRITE FOR COMPLETE CATALOG

MARK SIMPSON MFG. CO.

LONG ISLAND CITY 3, N. Y.

Masco

BOOSTER AMPLIFIERS

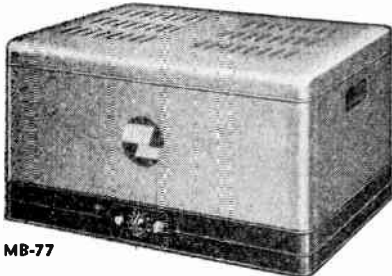

MB-77

PRICES

MB-77

Booster Amplifier with tubes, less cover.....\$190.00

MB-77P

Booster Amplifier with tubes, with 10 1/2" x 19" panel, less cover.... 207.50
Shipping Weight: Eizler model, 45 lbs.

List Price

MB-77 75 Watt Booster Amplifier and MB-77P 75 Watt Booster Amplifier with Standard Rack Panel

FEATURES: Zero-level input • For standard rack mounting • Designed for parallel operation • Oversize components • Tapped line and voice-coil impedances • Constant voltage outputs • Master gain control • U/L approved.

APPLICATION: For use with MA-77 or MA-125 Amplifiers where greater power is required.

AMPLIFIER SPECIFICATIONS

POWER OUTPUT.....75 Watts, Class AB-1, at less than 5% distortion	TUBES.....1-6SL7GT, 1-6SN7GT, 2-807; 3-5Y3GT (rectifiers)
PEAK POWER.....90 Watts	OUTPUT IMPEDANCES.....4, 8, 16 Ohms, 70 Volts, 140 Volts (Constant Voltage)
INPUTS.....500 Ohms balanced or unbalanced line	HUM LEVEL.....60 DB
FREQUENCY RESPONSE.....± 2 DB 50 to 15,000 CPS	POWER CONSUMPTION.....185 Watts at 117 Volts VOLTAGE.....105-125 Volts, 60 CPS
POWER GAIN.....46 DB	DIMENSIONS:
CONTROLS.....One: Master Gain, Separate On-Off Switch	(MB-77).....17" x 12" x 8 1/2" high (MB-77P).....Chassis: 17" x 12", Panel: 10 1/2" x 19"

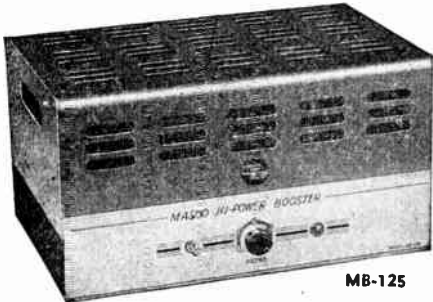

MB-125

MB-125 125 Watt Booster Amplifier and MB-125P 125 Watt Amplifier with Standard Rack Panel

FEATURES: High impedance input for bridging applications • May be driven by the special outputs of the MA-77 and MA-125 amplifiers • Optional 500 ohm balanced input transformer, 0 DB sensitivity • Automatic safety interlock switch • Optional press-to-talk relay • Oil-filled filters • U/L approved.

PRICES

List Price

MB-125 Booster Amplifier, with tubes, with cover.....	\$237.50
MB-125P Booster Amplifier, with tubes, with 10 1/2" x 19" panel, less cover.....	\$249.00
Shipping Weight, Either Model: 61 lbs.	

Optional Equipment: If above Models desired with Model IN-525, 500 Ohm Balanced Input Transformer, add to List Price.....\$37.50
For Optional Built-in Press-to-Talk Relay, add to List Price.....\$23.75

MOBILE AMPLIFIERS

12 Watt Power Output • 18 Watt Peak Output

Available with Three-Speed Motor and All Purpose Pickup with "Turnover" Cartridge

FEATURES: Two inputs, microphone and phono • Push-pull output • Separate microphone and phono control • Low battery drain • Ripple-free operation • Lightweight, rugged • U/L approved.

AMPLIFIER SPECIFICATIONS

POWER OUTPUT.....12 Watts, Class AB-1, at less than 5% distortion	TUBES.....1-6SF5, 1-6SL7G, 2-6V6GT; 1-7Z4 (Rectifier)
PEAK POWER.....18 Watts	OUTPUT IMPEDANCES.....3.2, 8, and 15 Ohms
INPUTS.....Two: 1-Microphone, 1-Phono	HUM LEVEL.....60 DB
FREQUENCY RESPONSE.....±3 DB, 100 to 8,000 CPS	POWER CONSUMPTION:
GAIN.....Mic., 110 DB; Phono, 75 DB	(MC-126P-3 and MC-126).....AC 60 Watts at 117 Volts; DC 8 Amps at 6 Volts (Bat.)
CONTROLS.....Microphone, Phono, Tone, On-Off	(MC-12P-3 and MC-12).....AC 60 Watts at 117 Volts; DC 4 Amps at 12 Volts (Bat.)
Stand-by-Operate (Battery-saver) Switch	DIMENSIONS.....12" x 6" x 8" high

AMPLIFIERS — 6 VOLT

List Prices

MC-126P-3 Phono Top Mobile Amplifier, 12 Watts (6 Volts DC, 117 Volts AC) with Tubes, with Cables.....	\$151.25
MC-126 Same as above with Plain Cover, less Phono Top Mechanism.....	100.00
Shipping Weight, all Models: 15 lbs.	

MOBILE PORTABLE SYSTEMS

MAC-126P-3 Phono Top Portable Mobile System (6 Volts) (Shipping Weight: 36 lbs.)..... 216.25
Consists of: 1—12 Watt Mobile Amplifier with Tubes; 1—10" PM Speaker; 1—25-ft. Speaker Cable and Plug; 1—Model 3D3 Portable Case; 1—Astatic JT-30 Microphone with 15-ft. Cable and Connectors.

MOBILE OUTDOOR SYSTEMS

MCO-126P-3 Mobile Outdoor Systems (6 Volts) (Shipping Weight: 36 lbs.).....\$216.25
Consists of: 1—12 Watt Mobile Amplifier with Tubes; 6 Volts DC and 117 Volts AC with Phono Top; 1—Masco-University Model 1B8 Loudspeaker; 1—25-ft. Cable and Plug; 1—Astatic JT-30 Microphone with 15-ft. Cable and Connectors.

WRITE TO FACTORY FOR PRICES OF 12 VOLT AMPLIFIERS AND SYSTEMS. OPTIONAL EQUIPMENT

If amplifiers in systems are desired with plain cover less phono top mechanism, deduct from above list price.....\$56.25

25 WATT MOBILE AMPLIFIERS

FEATURES: Inputs for 3 microphones and one phonograph, each with its own volume control • Microphone and phonograph may be mixed • Stand-by "battery-saver" switch • Extra-heavy duty vibrator • U/L approved.

MC-25PN-3 Phono-top Mobile Amplifier with Tubes. Shipping Weight: 44 lbs.....	\$250.00
Dimensions: 14" x 11" x 8 3/4" high.	
KIT OF MATCHED PLUGS AND CONNECTORS.....	3.24

MAC-25PN-3 Portable Mobile System. Shipping Weight: 72 lbs..... 345.00
Consists of: 1—MC-25PN-3 Phono-top Amplifier with Tubes; 2—12" PM Speakers; 2—25-ft. Speaker Cables and Plugs; 1—Model 305 Portable Carrying Case; 1—Astatic JT-30 Microphone with 15-ft. Cable and Connectors.

MCO-25PN-3 Outdoor Mobile System. Shipping Weight: 86 lbs.....\$409.25
Consists of: 1—MC-25PN-3 Phono-top Amplifier with Tubes; 2—Masco-University PH Trumpets; 2—Masco-University MA-25 Units; 2—25-ft. Cables and Connectors; 1—Astatic JT-30 Microphone with 15-ft. Cable and Connectors.



MC-126P-3

MC-12P-3



MC-25PN-3

West of the Rockies, Add 5% to Above List Prices. Prices and Specifications Subject to Change Without Notice.



MARK SIMPSON MFG. CO.

LONG ISLAND CITY 3, N. Y.

Radio's Master — 19th Edition

Page B-18

TRADE DISCOUNT APPLIES TO LIST PRICES ONLY

Copyright by U. C. P., Inc.

Masco

INDUSTRIAL AND INSTITUTIONAL EQUIPMENT

School and Institutional Control Amplifier
with Complete Program Facilities
MICROPHONE • RADIO • PHONOGRAPH

MS SERIES FOR 6 TO 36 STATIONS

28 Watts of Audio Power, 40 Watts Peak Power for 6, 12, 18, 24, 30 and 36 Stations with Built-in Intercommunication Channel.



MS-36

FEATURES: 28 Watt Amplifier • Built-in Intercommunication Channel • Two-way conversation • Simultaneous or selective paging • External phono provision • Volume-level indicator • Input selector switch • External microphone provision • Provision for external radio • U/L approved.

DESIGN AND CONSTRUCTION: Ample power for each speaker. Ample gain for external microphone and phonograph pickup. Group or selective paging. Calls may originate from any room to master when proper interconnecting cable is used. Separate volume controls for level adjustment of all calls. Volume-level indicator for correct level setting. Provision for connecting an external phonograph. Any standard radio may be adjusted for use. Two-way conversation feature permits easy communication. Balanced line for simplicity of installation. Use of more than 15 db of inverse feedback assures negligible change of volume level regardless of varying speaker loads.

PRICES

List Price

MODEL MS-6	Control Amplifier with tubes for 6 stations...	\$232.50
MODEL MS-12	Control Amplifier with tubes for 12 stations...	237.50
MODEL MS-18	Control Amplifier with tubes for 18 stations...	242.50
MODEL MS-24	Control Amplifier with tubes for 24 stations...	250.00
MODEL MS-30	Control Amplifier with tubes for 30 stations...	257.50
MODEL MS-36	Control Amplifier with tubes for 36 stations...	272.50

For Additional Stations, Write Factory.

School and Institutional Control Amplifier
with Self-Contained AM-FM Radio-
Webster Three Speed Automatic Record
Changer-Transcription Player
MPS SERIES FOR 10 TO 40 STATIONS



MPS-40

28 Watts Power Output 40 Watts Peak Power

Complete Program or Intercommunication Facilities
FEATURES: Built-in sensitive FM-AM tuner • Optional built-in three speed transcription player or Webster Model 114 three-speed record changer • Provides for 10 to 40 stations • Electronic Volume-level Indicator • Speaker switches provide for selective or group paging • Master switch allows for simultaneous paging • Built-in speaker is used for "talk" and "Listen" • Input is provided for external microphone • May be installed for private or non-private operation • Private operation prohibits the control operator from "listening in" unless switched in at the station location • Use of more than 15 db of inverse feedback assures negligible change of volume level regardless of varying speaker loads • U/L approved.

PRICES

List Price

MODEL MPS-10	(for 10 stations) Control Amplifier with tubes with AM-FM Tuner and Three Speed Manual Phonograph.....	\$628.75
MODEL MPS-20	(for 20 stations) Control Amplifier with tubes with AM-FM Tuner and Three Speed Manual Phonograph.....	650.00
MODEL MPS-30	(for 30 stations) Control Amplifier with tubes with AM-FM Tuner and Three Speed Manual Phonograph.....	666.25
MODEL MPS-40	(for 40 stations) Control Amplifier with tubes with AM-FM Tuner and Three Speed Manual Phonograph.....	685.00
To substitute Webster 114 three-speed record changer in above systems add		65.00

50 and 60 Station Units available on special order. Write factory for details.

BR-60 60 WATT SOUND BROADCASTER



BR-60

FEATURES: U/L approved • Six-position zone selector switch • 60-watt heavy-duty amplifier • Separate all-call switch • Constant voltage output • Oversized components assuring trouble-free service • Three inputs • Attractive Hammertone steel cabinet • Hinged rear door • AM-FM tuner • Webster Model 114 3-speed record changer.

APPLICATION: Offers performance to be had ONLY in custom-built equipment. Its all-in-one feature allows for Voice Paging, Phono and Radio Operation • For use in Airports • Hospitals • Institutions • Schools and Playgrounds.

PRICES

List Price

BR-60	Sound Broadcaster.....	\$900.00
No Federal Excise Tax Applies.		
Shipping Weight: 120 lbs.		

Consists of: Steel Cabinet with Hinged Rear Door; 60 Watt Amplifier; AM-FM Tuner; Webster Model 114 3-Speed Record Changer; Six-Position Zone Selector Switch; Separate "All-Call" Switch; Built-in Monitor Speaker.

MODEL RK-6 COMBINATION 3-SPEED DISC RECORDER RECORD PLAYER



PRICES

List Price

RK-6	Complete Portable Three-Speed Disc Recorder with Crystal Cutting Head and Tilt-type Dual Cartridge with Replaceable Stylus.....	\$187.50
Carrying Wt. 29 lbs.; Ship. Wt. 34 lbs. Plus F.E.T.		
RK-6R	Same as above but with Built-in AM Tuner.....	\$227.50
Carrying Wt. 30 lbs.; Ship. Wt. 35 lbs. Plus F.E.T.		



West of Rockies, add 5% to above list prices.
Prices and Specifications Subject to Change Without Notice.



WRITE FOR LATEST CATALOG

MARK SIMPSON MFG. CO.

LONG ISLAND CITY 3, N. Y.

Copyright by U. C. P., Inc.

TRADE DISCOUNT APPLIES TO LIST PRICES ONLY

Radio's Master — 19th Edition

Page B-19

The *Masco* Economy Line — 8 to 125 Watts

THE MOST COMPLETE LINE OF QUALITY SOUND EQUIPMENT IN THE U.S.A.



ME-8

8 WATT SOUND EQUIPMENT . . .

FEATURES: Inputs for one microphone and one phonograph, each with its own volume control • Microphone and phonograph may be mixed • Variable tone control • 70 volt output • Coppertone finish • U/L approved.

AMPLIFIER SPECIFICATIONS • MODEL ME-8

POWER OUTPUT.....8 Watts
 INPUTS.....Two: Microphone and Phono
 FREQUENCY RESPONSE.....50 to 10,000 CPS
 CONTROLS.....3-Microphone, Phono, Tone
 TUBES.....1-6SJ7, 1-6SF5, 1-6L6G, 1-5Y3GT (Rectifier)
 OUTPUT IMPEDANCES.....4, 8, and 500 Ohms.
 70 Volt (Constant Voltage)
 POWER CONSUMPTION.....63 Watts
 DIMENSIONS.....10" x 5 1/2" x 4 1/2" high

PRICES
 ME-8 Amplifier with Tubes, Shipping Weight: 14 lbs.....\$ 56.00
 MES-8 Portable System as described, Shipping Weight: 24 lbs..... 101.00
 3030 Portable Carrying Case, only 7" x 13" x 15 high, Shipping Weight: 13 lbs..... 26.48
 Portable System consists of: 1—8 Watt Amplifier, with Tubes; 1—10" PM Speaker; 1—25-ft. Cable and Plug; 1—Portable Carrying Case Model 3030; 1—Astatic JT-30 Microphone with 15-ft. Cable and Connectors.

18 WATT SOUND EQUIPMENT . . .

Available with Three-Speed Phono Top with Turnover Cartridge.
FEATURES: Inputs for one microphone and one phonograph, each with its own volume control • Microphone and phonograph may be mixed • 70 Volt constant voltage output • Finished in bronze and coppertone • U/L approved.

AMPLIFIER SPECIFICATIONS • MODELS ME-18 and ME-18P-3

POWER OUTPUT.....18 Watts
 CONTROLS.....Three: Microphone, Phono, Tone with On-Off Switch, Motor Switch
 INPUTS.....Two: Microphone and Phono
 TUBES.....1-6SJ7, 1-6SC7, 3-6L6G; 1-5Y3GT (Rectifier)
 OUTPUT.....Tapped 2, 4, 8, 15, 500 Ohms, 70 Volt (Constant Voltage)
 POWER CONSUMPTION: (ME-18).....93 Watts (ME-18P-3).....107 Watts
 FREQUENCY RESPONSE.....50 to 10,000 CPS ±2 DB
 DIMENSIONS:
 (ME-18P-3).....12" x 10" x 8" high
 (ME-18).....12" x 6 3/4" x 7 3/4" high

PRICES
 ME-18 Amplifier with tubes, with cover (Shipping Weight: 17 lbs.).....\$ 77.50
 ME-18P-3 Amplifier, with tubes, with 3-speed phono-top (Shipping Weight: 26 lbs.)..... 112.50
 MES-18 Complete portable system as described below (Shipping Weight: 38 lbs.)..... 152.50
 MES-18P-3 Complete portable system as described below (Shipping Weight: 47 lbs.)..... 187.50
 3040 Portable Carrying Case Only 14 1/2" x 13" x 21" High..... 33.48
 Portable System consists of: 1—ME-18 or ME-18P-3 Amplifier, with tubes; 2—12" PM Speakers; 2—25' Cables and plugs; 1—Portable carrying case Model 3040; 1—Astatic JT-30 microphone with 15' cable and connectors.

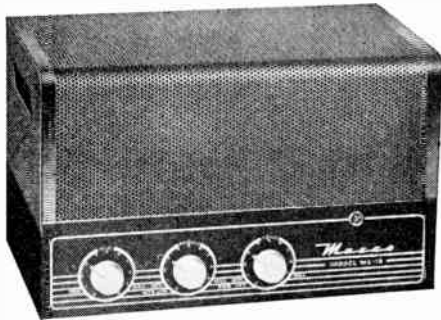

ME-18

27 WATT SOUND EQUIPMENT . . .

FEATURES: Inputs for two microphones and one phonograph, each separately controlled • Microphones and phonograph may be mixed • 70 volt output • Bronze and coppertone finish • U/L approved.

AMPLIFIER SPECIFICATIONS • MODEL ME-27

POWER OUTPUT.....27 Watts
 CONTROLS.....2-mic, phono, tone with AC switch
 INPUTSThree — Two microphones, one phono
 TUBES1-6SJ7, 2-6SC7, 2-6L6G, 1-5V4G (rectifier)
 OUTPUT.....Tapped 4, 8, 15, 500 ohms, 70 volt (constant voltage)
 POWER CONSUMPTION100 Watts,
 FREQUENCY RESPONSE50 to 10,000 cycles ±2 DB
 DIMENSIONS15" x 8" x 8"

PRICES
 ME-27 Amplifier with tubes, with cover (Shipping Weight: 30 lbs.).....\$ 96.25
 ME-27 Complete portable system as described (Shipping Weight: 54 lbs.)..... 176.25
 3050 Portable Carrying Case Only 15"x18 1/2"x23" high (Shipp'g Weight: 27 lbs.).... 38.34
 Portable System Consists of: 1—ME-27 Amplifier, with tubes; 2—12" PM Speakers; 2—25' Cables and Plugs; 1—Portable Carrying Case Model 3050; 1—Astatic JT-30 Microphone with 15' Cable and Connectors

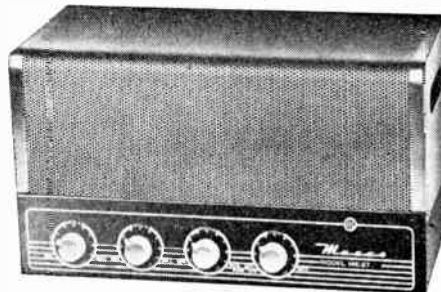

ME-27

36 WATT SOUND EQUIPMENT . . .

FEATURES: Inputs for 2 mikes and 1 phono, each with its own volume control • Mikes and phono may be mixed • Bass and treble tone controls • 70 volt tap • Bronze and coppertone finish • Available with Webster Model 114 automatic record changer • U/L approved.

AMPLIFIER SPECIFICATIONS • MODELS ME-36 and ME-36R

POWER OUTPUT36 Watts
 CONTROLS.....2-Mic., phono, bass, treble with AC switch
 INPUTS.....2 mic., one phono
 TUBES.....2-6SJ7, 1-6SC7, 1-6SN7GT, 2-6L6G; 1-5V4G (rectifier)
 OUTPUT4-8-15-250-500 ohms, 70 volt (constant voltage)
 POWER CONSUMPTIONME-36: 130 Watts; ME-36R: 150 watts,
 FREQUENCY RESPONSE50 to 10,000 cycles ±2 DB
 DIMENSIONS:
 (ME-36).....15" x 8" x 8" high
 (ME-36R).....15" x 9" high

PRICES
 ME-36 Amplifier with tubes, with streamline cover\$125.00
 Shipping Weight: 30 lbs.
 MES-36 Complete portable system as described 205.00
 Shipping Weight: 58 lbs.
 ME-36R Amplifier with tubes, with Webster Model 114..... 257.50
 Shipping Weight: 48 lbs.
 3050 Portable Carrying Case Only, 15" x 18 1/2" x 23" High 38.34
 Shipping Weight: 27 lbs.

Portable System consists of: 1—ME-36 Amplifier with Tubes; 2—12" PM Speakers; 2—25-ft. Cables and Plugs; 1—Astatic JT-30 Microphone with 15-ft. Cable and Connectors; 1—Portable Carrying Case Model 3050.

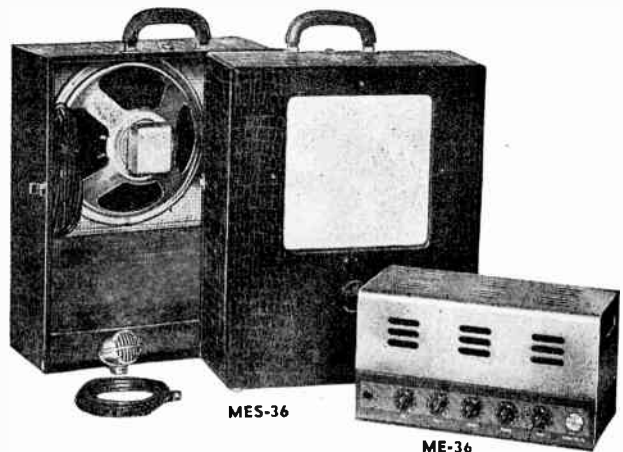

ME-36

ME-36

WEST OF ROCKIES, ADD 5% TO ABOVE LIST PRICES.
 Prices Subject to Change Without Notice.
 WRITE FOR CATALOG

MARK SIMPSON MFG. CO.

LONG ISLAND CITY 3, N. Y.

The Masco Economy Line — 8 to 125 Watts

The Most Complete Line of Quality Sound Equipment in the U.S.A.

HI-POWER 60 WATT AMPLIFIER

FEATURES: Inputs for two microphones and one phonograph, each with its own volume control • Microphones and phonograph may be mixed • Separate bass and treble tone controls • 70 volt and 140 volt constant voltage taps • Special output for driving booster amplifier • Optional built-in standby relay • Bronze and coppertone finish • U/L approved.

AMPLIFIER SPECIFICATIONS • MODEL ME-60

POWER OUTPUT	60 Watts	OUTPUTS	4, 8, 16 ohms, 70 volt, 140 volt (constant voltage)
PEAK POWER	80 Watts	POWER CONSUMPTION	190 watts, 117 volts, 60 cps AC
SENSITIVITY	Microphone .005v., Phono 0.1v.	HUM LEVEL	60 db below 60 watts
For full output		FREQUENCY RESPONSE	50 to 12,000 cps ±2 DB
CONTROLS	Five — Two microphone, phono, bass, treble (with on-off switch)	DIMENSIONS	17" x 10" x 8 1/2" High
TUBES	1 - 6SC7, 1 - 6SL7, 2 - 6SN7GT, 2 - 807, 3 - 5Y3GT (rectifiers)	List Price	\$197.50
INPUTS	Three — Two microphone, one phono		
PRICE			
ME-60	Amplifier with tubes — with streamline cover.....		
	Shipping Weight: 40 lbs.		

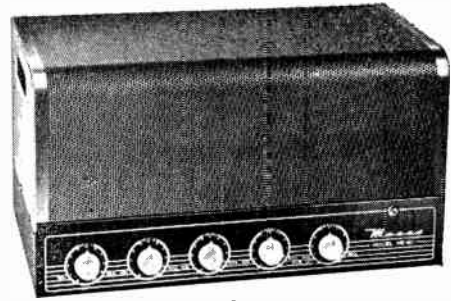

ME-60

15 WATT MOBILE AMPLIFIER

For 6 Volt Battery and 117 Volt AC

All Mobile Amplifiers Supplied Complete with Battery and AC Power Cables

APPLICATIONS: Suitable for religious revival meetings, lecturers, medicine shows, carnivals, service clubs and political street meetings. For groups of up to 500 people.

FEATURES: Very low "hash" level with DC operation • Inputs for one microphone and one phonograph (built-in), each with its own volume control • Microphone and phonograph may be mixed. • Variable tone control • 70 volt constant voltage output • Multi-tapped output • Standby "Battery-Saver" switch • Output impedance selector sockets and pin plug • Contrasting bronze and coppertone finish • U/L approved.

MM-15P-3 AMPLIFIER SPECIFICATIONS

POWER OUTPUT	15 Watts	OUTPUT TAPS	2, 4, 8, 15, 500 ohms and 70 volt constant voltage
PEAK POWER	20 Watts	POWER CONSUMPTION	80 watts at 117 volts, 60 cps AC; 15 amps. at 6 volts DC
INPUTS	1 — Mic.; 1 — Phono.	FREQUENCY RESPONSE	50-15,000 cps ±2 db
INPUT SENSITIVITY	Mic. .005V; Phono .25V	HUM AND NOISE	65 db below full output
CONTROLS	Mic. Volume, Phono Volume, Tone, Master Power Switch, Standby Battery-Saver Switch, Phono Motor On-Off Switch	DIMENSIONS	12" x 10" x 8" high
TUBES	6SC7, 6SL7GT, 2 - 6V6GT, 6AX5GT (Rectifier)		



MM-15P-3

PRICES

MM-15P-3 Mobile Phono Top Amplifier with tubes, with 3-speed Motor and Turnover Cartridge, Complete with 6-ft. AC and DC Power Cables. Shipping Weight: 22 lbs. **List Price \$156.25**

MMS-15P-3 Complete Portable Mobile System with 3-Speed Phono Top Amplifier. Shipping Weight: 43 lbs. **List Price 231.25**

Consists of 1—MM-15P-3 Amplifier, with tubes; 1—Acoustically designed carrying case (Model 3040) with two built-in 12" PM Speakers; 1—Model

PRICES

JT-30 Hand Microphone with 15-ft. Cable and Connectors; 2—25-ft. Speaker Cables and Connectors. **List Price**

MMO-15P-3 Complete Mobile Outdoor System..... **List Price \$251.00**

Shipping Weight: 57 lbs.

Consists of 1—MM-15P-3 Amplifier, with tubes; 2—1B8 Complete Paging Horns; 1—Model JT-30 Microphone with 15-ft. Cable and Connector; 2—25-ft. Speaker Cables and Connectors.

27 WATT MOBILE AMPLIFIER FOR 6 VOLT DC AND 115 VOLT AC OPERATION WITH THREE SPEED PHONO TOP

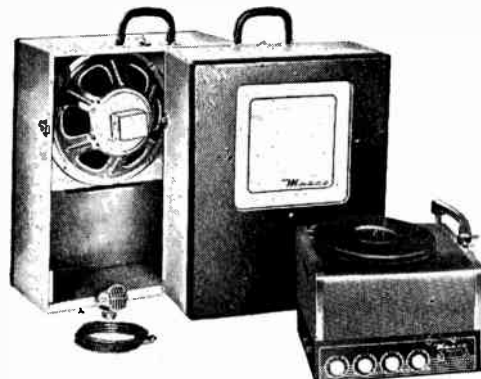

MMS-27P-3

FEATURES: Inputs for two microphones and one phonograph (built-in), each with its own volume control • Microphones and phonograph may be mixed • Variable tone control • 70 volt constant voltage output • Multi-tapped output • Standby "Battery-Saver" switch • Output selector socket and pin plug • Two-tone bronze and coppertone finish • Extra-Heavy duty vibrator • U/L approved.

AMPLIFIER SPECIFICATIONS • MODEL MM-27P-3

POWER OUTPUT	27 Watts	OUTPUT	Tapped 4, 8, 15, 250, 500 ohms
PEAK POWER	40 Watts		70 Volt (constant voltage)
GAIN Microphone	135 DB, Phono 78 DB	POWER CONSUMPTION	AC 130 Watts, 6 Volt DC 25 amps.
CONTROLS	Four — Two microphones, phono, tone, Switches — On-Off AC, On-Off phono motor on phono volume control, Stand-by battery-saver switch	HUM LEVEL	AC 55 DB below output of 27 Watts DC ripple-free
INPUTS	Three — Two microphones, one phono	FREQUENCY RESPONSE	50 to 10,000 cps ±2 DB
TUBES	2 - 6SC7, 1 - 6SJ7, 2 - 6L6G 1 - 5V4G (rectifier)	DIMENSIONS	12" x 11" x 8" high

PRICES

MM-27P-3 Mobile Phono-top Amplifier with tubes, with Three-Speed Motor and Turnover Cartridge. Shipping Weight: 39 lbs. **List Price \$190.00**

MMS-27P-3 Mobile Phono-top Complete Portable System, with Three-Speed Motor and Turnover Cartridge. Shipping Weight: 62 lbs. **List Price 270.00**

MMO-27-3 Mobile Phono-top, Complete Outdoor System, Shipping Weight: 90 lbs. **List Price 338.75**

3050 Portable Carrying Case only, 15" x 18 1/2" x 23" high. **List Price 38.34**

Portable System Consists of: 1—MM-27P-3 Phono-top Amplifier, with tubes; 2—12" PM Speakers; 2—25-ft. Cables and Plugs; 1—Portable Carrying Case, Model 3050; 1—Astatic JT-30 Microphone with 15-ft. Cable and Connectors.

Outdoor System Consists of: 1—MM-27P-3 Phono-top Amplifier, with tubes; 2—Masco-University Model MA-35 Driver Units; 2—Masco-University Model PH Reflex Trumpets; 2—25-ft. Cables and Plugs; 1—Astatic JT-30 Microphone with 15-ft. Cable and Connectors.

WEST OF ROCKIES, ADD 5% TO ABOVE LIST PRICES
Prices Subject to Change Without Notice.



WRITE FOR COMPLETE CATALOG

MARK SIMPSON MFG. CO.

LONG ISLAND CITY 3, N. Y.

Masco INTERCOMS

Complete Two-Station Intercoms for Every Need in Every Price Range

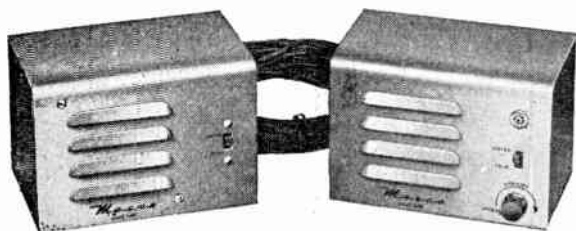

Small Talk

MASCO "Small Talk" TWO-STATION INTERCOM SYSTEM — Only \$29.95 List

COMPLETE WITH 50 Ft. CABLE • NOTHING MORE TO BUY • THE INTERCOM EVERYONE CAN AFFORD • For Homes, Nurseries, Restaurants, Offices, Stockrooms, Factories.

NOTE THESE EXTRA FEATURES: All-Metal Unbreakable Steel Cabinets • On-Off Pilot Light • Master has Volume Control with ON-OFF Switch and Separate Press-to-Talk Switch • Remote has Press-to-Talk Switch to originate calls to Master • Remote can be left "Open" for Baby-Sitting or Dictation, or closed for privacy, but still able to receive calls from Master • Sensitive and powerful • All stations finished in attractive brown hammertone • U/L and CSA approved.

Shipping Weight of System: 6 1/2 lbs.

"Small Talk" may be used with 1 additional Remote Station.

PRICES
 Extra Remote Station, Shipping Weight: 2 1/2 lbs. \$10.00
Model C-3 Three Conductor Cable for extending Small Talk System or adding one extra remote station.....\$.065 per foot

List Price

MASCO MIDGETALK VALUE-PACKED TWO-STATION INTERCOM SYSTEM

Your "Best Buy" in intercommunications!

DURABLE—Cast zinc unbreakable housing • QUALITY—U/L and CSA approved • COMPLETE—Master and Remote Station with 50 feet of cable . . . Nothing more to buy • UNMATCHED—For sensitivity, for clear and natural voice reproduction.

OTHER OUTSTANDING FEATURES: Cable can be extended to up to 2,000 feet • One extra remote station can be paralleled with the one supplied • Master station has volume control with on-off switch, separate talk-listen switch, and on-off pilot light • Remote station has talk-listen switch to permit originating calls to Master • Remote station can answer calls from a distance without operating a switch • Matching Master and Remote stations attractively finished in mahogany • Master and Remote cabinets designed to permit hanging units on wall • Rubber feet prevent marring polished surfaces • For 117 volts DC or AC • Extremely low power consumption.

PRICES
MASCO MIDGETALK 2-Station System, complete with 50 ft. cable, Shipping Weight: 7 1/2 lbs. \$43.15
Remote Station only, for Midgetalk, Shipping Weight: 3 lbs. each \$14.40
Model C-3 Three Conductor Cable for extending Small Talk System or adding one Remote station, Shipping Weight: 1/2 oz. per foot.....\$.065 per foot

List Price

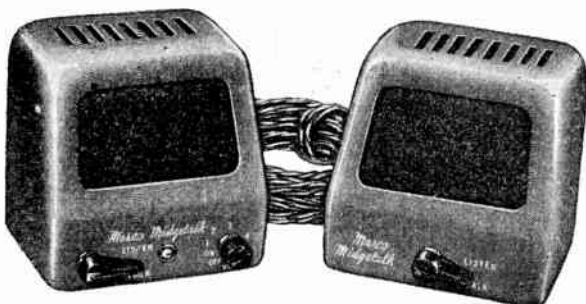

Midgetalk

MASCO MODEL JMR DE LUXE 2-STATION INTERCOM SYSTEM COMPLETE WITH 50 FOOT CABLE

U/L and CSA Approved

Acts as Baby-Sitter — Listens in Sick Room

FEATURES: Handsome, cast-aluminum deluxe cabinets • Cable can be extended up to 2,000 feet • An extra Remote station can be added, paralleling the one supplied • Highly sensitive • Remote can pick up sounds from up to 40 feet away • Natural voice reproduction • Matching Master and Remote stations, finished in attractive walnut hammertone • Pilot Light • Remote station can be used for two-way conversation without operating switch • Remote station can be installed for completely private operation.

PRICES
Model JMR Complete 2-Station Intercom, consisting of One Master and one Remote Station, Complete with 50 foot Cable.....\$56.70
 Shipping Weight: 9 1/4 lbs.
Model JR Extra Remote Station (less 3-Conductor Cable)..... 16.20
 Shipping Weight: 3 3/4 lbs.
Model C-3 Three Conductor Cable for extending JMR System or adding one JR Remote station, Shipping Weight: 1/2 oz. per foot....\$.065 per foot

List Price

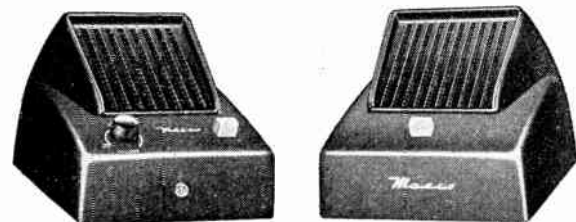

JMR

WIRELESSFONE

Two-Station Wireless Intercom System

FEATURING: A complete system ready to operate • No installation costs • To operate simply plug each station into any regular 105-125 volts electrical outlet • May be used on AC or DC current • Unbreakable cast aluminum housing . . . modern styling . . . finished in walnut hammertone . . . with pilot light on-off indicator • Assures distinct, clear voice reproduction with its powerful sound amplification of 2 1/2 watts • "Dictate" (lock) position of Talk-Listen Switch enables a secretary to take notes of a conference without actually being present and is ideal for baby-sitting • U/L approved.

AND THESE PLUS FEATURES: Noise silencing control • More than two Stations may be used in the same system and messages will be heard over the entire system • Selector switch permits use on either grounded or ungrounded electrical systems • Can be used between adjacent power circuits or on different sides of 220 volt lines without special "jumpers."

PRICES
Model WF-2 Wirelessfone Two-Station Intercom System, complete, per pair\$95.00
Model SSW Single Wirelessfone Stations, Each..... 47.50
 Shipping Weight: 11 1/2 lbs. (Two Units).

List Price

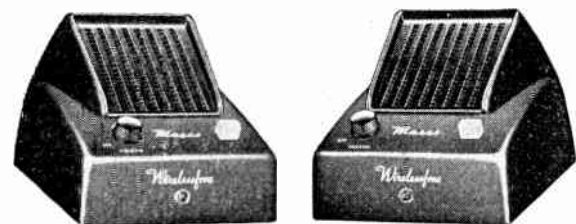

Wirelessfone

WEST OF ROCKIES, ADD 5% TO ABOVE LIST PRICES.
 Prices and Specifications subject to change without notice.

WRITE FOR LATEST CATALOG

MARK SIMPSON MFG. CO.

LONG ISLAND CITY 3, N. Y.

ECONOMY MULTIPLE STATION SYSTEMS ECONOFONE

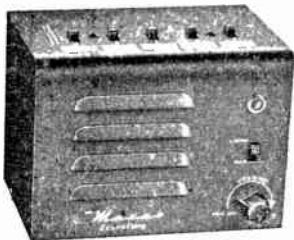

ST-5
Master

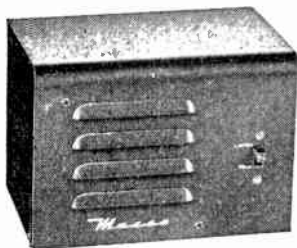

ST
Remote



MF-10 Master



CAM-10 Master

ECONOFONE Dual-Purpose System for one Master with up to five Remote Stations or up to six Masters in a fully-Intercommunicating All-Master System. The most economical multiple station intercom system available anywhere.

FEATURES: Master has volume control with on-off switch, talk-listen switch, pilot light, and 5 individual Station selector switches • Remote Stations have a talk-listen switch which provides complete privacy at the Remote or permits the Remote to be "open" for baby-sitting or for allowing calls to be answered from a distance without operating a switch • Easily-made modification changes the ECONOFONE to an All-Master system • Up to 6 Masters may be used in this system with up to 3 separate pairs of conversations or a conference of any group of Stations possible • Master and Remotes have unbreakable steel housings finished in attractive brown hammertone • U/L approved.

PRICES

ECONOFONE MASTER STATION, Model ST-5. Shipping Weight: 4 1/2 lbs.....\$26.50
Model ST REMOTE STATION. Shipping Weight: 2 lbs..... 10.00

List Price

For Cable Prices, See Below.

MULTIFONE

Economy Intermixed System of Masters and Remotes

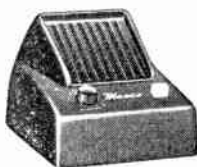

JS-6



JS



JL

FEATURES: Five-Station Master which can be connected to a combination of up to 5 other Masters and/or Remotes • Ten-Station Master for ten other Masters and/or Remotes • 2 1/2 Watts audio power output • Balanced input and output, input balancing adjustment, low impedance (13 ohms) line—for low hum and noise pickup. • New type Push-Bar, rugged talk-listen switch of advanced design on both Masters and Remotes • Switch on Masters has a lock-in position for "dictate" purposes • All units have newly styled unbreakable cast aluminum cabinets attractively finished in mahogany • AC-DC. • Low power consumption • Pilot Light • U/L approved.

PRICES

Model MF-5 5-Station Master\$57.50
Model MF-10 10-Station Master 65.50
Shipping Weight, Either Master: 6 lbs.

List Price

Model JS-6 Remote with 6 Position Selector Switch..... 32.40
Model JS Remote with Talk-Listen Switch 19.65
Model JL Remote Less Switch 15.20
Shipping Weight: 3 1/2 lbs.

For Cable Prices, See Below.

MASCOFONE

ECONOMY AC-POWERED INTERMIXED INTERCOM SYSTEM

For Master to Master, Master to Remote, or Master to Master to Remote
AC Powered for Quiet, Efficient Operation • 3 1/2 Watts Power • Can be used for paging with paging horn.

PRICES

Model CAM-5 5-Station Master with tubes.....\$74.00
Model CAM-10 10-Station Master with tubes..... 82.50
Shipping Weight, Either Master: 6 lbs.
ACS-6 Remote Station with 6-position Master selector switch and push-bar talk-listen switch... 33.13
ACS Remote Station with talk-listen switch..... 20.00
ACL Remote Station less talk-listen switch..... 16.65
Shipping Weight, Remotes: 3 1/2 lbs.

List Price

CABLE PRICES FOR ECONOFONE AND IJM DUAL PURPOSE INTERCOMS

	List Price Per 100 Ft.
C-3 Three Conductor Cable, for Master-to-Remote Hook-ups, per ft.....\$.065	
C-5 Five Conductor Cable, for All-Master Systems up to 4 Stations, per ft.....	.24
C-7 Seven Conductor Cable, for All-Master System up to 6 Stations, per ft.....	.29
C-12 Twelve Conductor Cable for All-Master System up to 11 Stations, per ft.....	.3125

WEST OF ROCK'IES, ADD 5% TO ABOVE LIST PRICES.
Prices Subject to Change Without Notice.

CABLE PRICES FOR MULTIFONE, MASCOFONE, CONFER-PHONE AND PRESIDENT INTERMIXED INTERCOMS

	List Price Per 100 Ft.
SCB One Shielded Twisted Pair	\$ 11.61
S One Twisted Pair, Unshielded.....	4.32
TW-4 Four pair Cable, each Pair Twisted.....	19.76
TW-7 Seven pair Cable, each Pair Twisted.....	32.94
TW-13 Thirteen pair Cable, each Pair Twisted.....	55.08
TW-25 Twenty-five pair Cable, each Pair Twisted.....	110.00
SW One Twisted Pair, Unshielded, Weatherproof, Water and Chemical Resistant Plastic Covering Overall.....	12.50
Shipping Weight, All Cables: 1 oz. per foot.	

WRITE FOR CATALOG

MARK SIMPSON MFG. CO.

LONG ISLAND CITY 3, N. Y.

Masco

INTERCOMS

MASCO CON-~~FER~~-PHONE — A Completely Flexible Master for any Combination System.

Build a system around any one Master to meet your requirements. Available in Six and Twelve Station Masters. Remote Available With or Without Call Switch and With 6 Position Master Station Selector.

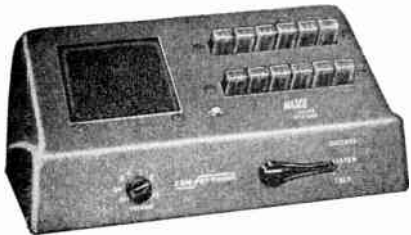

JMP-12 MASTER STATION

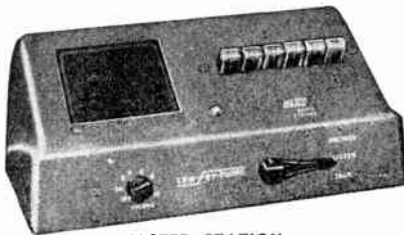

JMP-6 MASTER STATION



JS-6 REMOTE

FEATURES:

- For Master-to-Master-to-Remote Intermixed Installation.
- For Master-to-Master Installation.
- For Master-to-Remote Installation.
- Remote Station for two-way conversation with Masters.
- Remote Station can originate call to Masters.
- Masters may have personal remotes
- Push-Button station selection.
- Press-to-talk switch with dictate position on Master.
- Individual or group conversation.
- Volume control with on-off switch.
- On-Off indicating light.
- AC-DC operation.
- Finished in attractive walnut hammertone.
- Finish available in baked white enamel.
- U/L Approved.

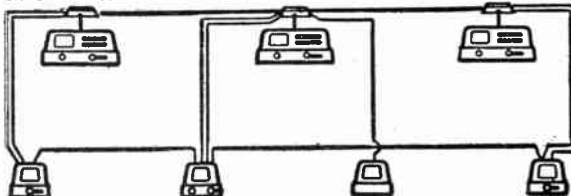

The above is an inter-mixed system using both Masters and Remotes. Masters may call selectively or to all masters and remotes in the circuit. Master stations can originate calls to any remote at will. Remotes can answer any master from a distance but cannot originate calls nor talk to other remotes. Remotes can originate calls to any master in the circuit, but cannot talk with other remotes. Model JS Remote may originate a call to only one master. Model JS-6 Remote may originate a call to as many as six masters. Remotes with switch can be installed for private or non-private use.

Each master can have his own private hook-up of remotes. The remotes may or may not originate calls to the individual master. Masters can call each other regardless of whether master being called has its power on or off.

Illustration shows less than the maximum number of units possible in installation.

A JMP-6 Master may be connected to a total of six other units and a JMP-12 Master to a total of twelve other units. These units may be other masters or the JL, JS, and JS-6 Remotes, or a Masco Paging Amplifier and/or Paging Horns. All of these units may be mixed.

Illustration of a Master-to-Master-to-Remote Inter-Mixed Installation

PRICES

		List Price
JMP-6	Six-Station Master with Tubes.....	\$71.28
JMP-12	Twelve-Station Master with Tubes.....	83.16
JL	Remote Less Call Switch.....	15.20
JS	Remote With Call Switch.....	19.65
JS-6	Remote with 6-Position Master Station Selector and Call Switch..	32.40

President Series

DE-LUXE 12 and 24 STATION AC POWERED INTERMIX INTERCOM SYSTEMS

This is a De Luxe Intermixed System performing all the services of any of the Masco Intermixing Systems described on these pages and also featuring a busy signal on Masters, incoming and outgoing volume controls; rugged, lifetime Station selector lever switches and talk-listen switches and sockets on all Masters permitting a telephone type handset to be readily plugged in; AC powered for extremely quiet operation and with an audio power output of 3 1/2 watts, these units can drive up to 3 parallel MIL-45 horns connected to any one Station position or a booster amplifier and horns for combining paging and intercom.



ACS Remote

AC-24 Master Station

All Masco President Series Master Stations are supplied complete with 6-foot cable and Junction Box, factory connected.

	List Price
AC-12	Twelve-Station DeLux AC Master, with Tubes.....\$140.00
AC-24	Twenty-four Station DeLux AC Master, with Tubes..... 174.00
	Shipping Weight, Master Station: 15 lbs.
ACL	Remote Station, Less Call Switch..... 16.65
ACS	Remote Station, With Call Switch..... 20.00
ACS-6	Remote Station with Six-Position Master Station Selector and Call Switch..... 33.13
	Shipping Weight, Remote Stations: 3 1/2 lbs.

WEST OF ROCKIES, ADD 5% TO ABOVE LIST PRICES.
Price and Specifications Subject to Change Without Notice.

WRITE FOR CATALOG

MARK SIMPSON MFG. CO.

LONG ISLAND CITY 3, N. Y.

Masco

INTERCOMS



IJM-10 Master



JR Remote

MASCO DUAL-PURPOSE MODELS

All Master Systems • Up to 11 Stations • MASTER-TO-REMOTE SYSTEMS • Single Master for Up to 10 Remotes

All-Master Systems: The IJM-5 Master may be connected to a maximum of 5 other Masters for a total of 6 in the system. The IJM-10 may be used with up to 10 other Masters, or 11 Stations in one system.

Master-to-Remote Systems: An IJM-5 Master may be connected to a maximum of 5 JR and JL Remotes. An IJM-10 Master may be connected to up to 10 JR and JL Remotes.

MODELS IJM-5 AND IJM-10 ALL-MASTER SYSTEMS

FEATURES: Any station can call and talk with any other station, without interference or cross-talk • A Master can always call another Master, even if the called station's power is off • Up to 5 pairs of conversations may be held (in an IJM-10 system) at the same time • Economical to operate—only uses 20 watts per Master • For AC or DC operation • Attractively styled unbreakable cast aluminum cabinets, finished in dark mahogany • Simple to install—easy to use • Clear instructions furnished

• Stations may be up to 2,000 feet apart • Heavy duty Push-Bar Talk-Listen Switch on all stations, designed for long-life operation. • Lock-in position of Talk-Listen Switch on Masters, for dictation, baby-sitting, sick-room and similar uses • Pilot light on-off indicator • "All" position on selector switch for calling all stations simultaneously • Masters can page directly through one or more horns or through paging amplifier and horns • Paging horns cannot reply in an All-Master System.

MODELS IJM-5 AND IJM-10 MASTER-TO-REMOTE SYSTEMS

Master can call any one or all Remotes at the same time • Stand-by position on Master's selector switch keeps Master silent until called by a Remote Station • Master has volume control with on-off switch and pilot light • System normally supplied for private operation of JR Remotes • Simple conversion enables wiring for non-private operation of Remotes and JR and JL Remotes can reply to calls without operating any switch • JR Remotes can always originate calls to Master • Master can page directly through paging horns, and when non-private you can reply to calls through the horn, without using any switch • Master can also page through paging amplifier and horns • ICS Switch permits reply to calls from horns and also allows horns to originate calls to the Master • Lock-In position of

Master's Talk-Listen Switch permits use for two-way baby-sitting, dictation, or sick-room use.

PRICES FOR MASTER AND REMOTES

List Price

IJM-5—Dual-Purpose Five Station Master, Complete with tubes	\$45.90
IJM-10—Dual-Purpose Ten Station Master, Complete with tubes	53.75
JR Remote Station, with Push-Bar Talk-Listen Switch for originating calls to either of above Masters	16.20
JL Remote Station, Less Switch	15.20
Shipping Weight Each 3 1/2 lbs.	

ABOVE MODELS AVAILABLE IN WHITE BAKED ENAMEL FINISH, ADD TO LIST PRICE PER UNIT 2.00

HIGH FIDELITY AMPLIFIERS

MASCO CUSTOM TEN 10 WATT HIGH FIDELITY AMPLIFIER

With Eight-Position Equalization Selector Plus Bass and Treble Compensated Volume Control — Removable Front Panel for Custom Installation.

FEATURES: Ten watts of low-distortion power • Free of internally-generated hum and noise • Separate Bass and Treble Tone Controls • Bass-and Treble-Compensated Volume Control automatically increases both low and high frequency response with reduction in volume in accordance with the characteristics of the human ear as described by Fletcher and Munson • Four inputs for Radio or TV Tuner or Tape Recorder, Crystal Phono Pickup, Magnetic Phono Pickup • Recorder Output Jack on the Custom Ten Amplifier permits instantaneous recording while listening. Suitable for any tape, disc or wire recorder • More than 15 db of feedback over three stages • Removable Front Panel designed for Easy Custom Installation • Beautifully styled black and gold panel and black chassis • Two internally fused Auxiliary AC Power Outlets • Can be used on 105-125 volts, 50 or 60 cycles AC • U/L Approved • Pilot light socket and plug provided • Extra-long control shafts supplied for custom cabinet installations.

MASCO CM-EIGHT

8 WATT HIGH FIDELITY AMPLIFIER

An **ECONOMICAL** Amplifier with Performance Usually Found Only in More Expensive Equipment. **FREQUENCY RESPONSE: 20 to 20,000 CYCLES PER SECOND ±1 DB.**
LESS THAN 1% HARMONIC DISTORTION AT 8 WATTS.
REMOVABLE FRONT PANEL FOR CUSTOM INSTALLATIONS.

Perfect for the **BUDGET** Custom Installation

An eight watt high fidelity unit complete with pre-amplifier and tone control equalization, with the fine performance usually expected only of more expensive amplifiers.

Now possible for **EVERYONE** to enjoy the satisfaction of high-fidelity music reproduction.

FEATURES: Three-Position Selector Switch permits simple choice of Radio, Crystal or Magnetic Phonograph, and Power-Off • Eight watts of power output • Very low hum and noise • Tone Control Equalization-wide variation of tone by the separate Bass and Treble Tone controls assures proper reproduction of all types of recordings • Three Inputs for Radio Tuner, Magnetic Phonograph Pickup, Crystal or Ceramic Phonograph Pickup • Front panel easily removed for custom cabinet installations • Beautifully styled black and gold chassis and panel • Auxiliary AC power outlet • Can be used on 105-125 volts, 50 or 60 cycles AC • Underwriters' Laboratories Approved • Extra-long control shafts supplied for custom cabinet installations.

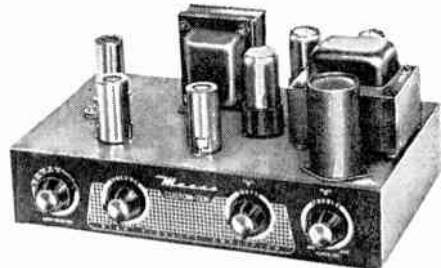

PRICES

List Price

CUSTOM 10 — 10 Watt Fidelity Amplifier, complete with tubes, removable panel, and pilot light plug\$106.25
Shipping Weight: 12 lbs.



PRICE

List Price

Model CM-8 Eight Watt High Fidelity Amplifier, complete with tubes\$59.75
Shipping Weight: 9 lbs.

WEST OF ROCKIES, ADD 5% TO ABOVE LIST PRICES.

Prices and Specifications Subject to Change Without Notice.

WRITE FOR CATALOG

MARK SIMPSON MFG. CO.

LONG ISLAND CITY 3, N. Y.

Copyright by U. C. P., Inc.

TRADE DISCOUNT APPLIES TO LIST PRICES ONLY

Radio's Master — 19th Edition

Page B-25

Fleetwood Remote TELEVISION RECEIVERS

CONRAC, INC., GLENDORA, CALIFORNIA

The Fleetwood Remote is a complete two chassis television system, built to professional standards. It employs 27 tubes in addition to the picture tube and provides audio power for a loudspeaker. The picture chassis is relay operated by the on-off switch of the Tuner, thus providing full remote control. Both Tuner and Picture Units and attractively finished in gray and black baked enamel. Each Fleetwood includes a gold finished, hinged escutcheon plate for easy access to the secondary controls.

The separate Tuner Unit, with edgelit dial and individual channel pilot lamps includes the off-on, picture, volume, channel selection and fine tuning controls. The illuminated channel numbers are readily replaceable and a full set of numerals, from 2 to 82, is provided. The tuner is of the Super Cascode type and is completely adaptable for Ultra High Frequency reception, by a simple interchange of strips and insertion of the correct channel identification number. (It also can be used with a color picture chassis, Model 400. Write factory for details.) The four video I.F. stages provide full four megacycle band-pass, and there are separate cathode followers for audio and video circuits. Three audio outputs are provided: (a) low level high impedance, and (b) low level cathode follower, both for connection to existing music systems, and (c) power amplifier to operate a loud speaker.

CHASSIS DIMENSIONS

Units	Height	Width	Depth
Tuner Chassis	7"	11½"	8½"
600 or 610 Chassis (21EP4 or 21ZP4 Mounted)	20¾"	21½"	24"
700 or 710 Chassis (24CP4A or 24TP4 Mounted)	24¾"	23½"	22½"
700 or 710 Chassis (27EP4 Mounted)	26½"	26¾"	22¾"

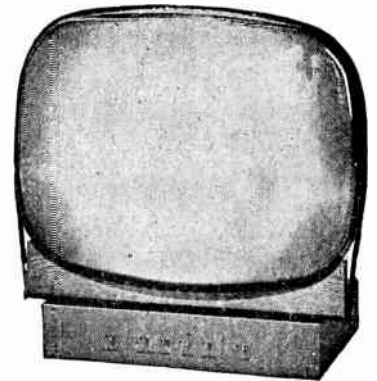
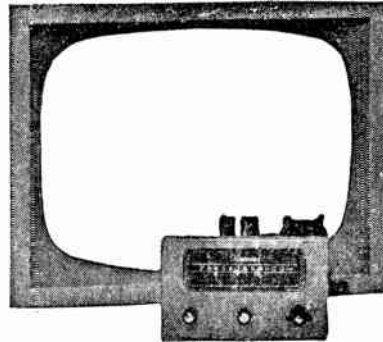

FLEETWOOD 600: Full Remote Control Receiver for 21" rectangular 70° picture tubes. Includes tuner chassis and picture chassis, supplied with 27 tubes, 14 pilot lamps, 40 feet of cable, ion trap, all knobs, and matching hinged cover for secondary controls. (Shipping Weight: 65 lbs.) **Users Net \$264.50**

FLEETWOOD 610: Complete Television Chassis for 21" rectangular 70° picture tubes. Non-remote control. Supplied with 23 tubes, ion trap, all knobs, and matching hinged cover for secondary controls. (Shipping Weight: 55 lbs.) **Users Net \$199.50**

FLEETWOOD 700: Full Remote Control Receiver for 24" rectangular and 27" rectangular 90° picture tubes. Includes tuner chassis and picture chassis. Supplied with 27 tubes, 14 pilot lamps, 40 feet of cable, ion trap, all knobs, and matching hinged cover for secondary controls. (Shipping Weight: 65 lbs.) **Users Net \$289.50**

FLEETWOOD 710: Complete Television Chassis for 24" rectangular and 27" rectangular 90° picture tubes. Non-remote control. Supplied with 23 tubes, ion trap, all knobs, and matching hinged cover for secondary controls. (Shipping Weight: 50 lbs.) **Users Net \$219.50**

All chassis less picture tube and mounting brackets.

Accessory Kits: Contains mounting frame, laminated safety glass, and royallite picture tube mask.

621B for 21" cylindrical face glass picture tubes, as 21EP4. (18" x 24") (Shipping Weight: 12 lbs.) **Users Net \$15.00**

621C for 21" spherical face glass picture tubes, as 21ZP4. (18" x 24") (Shipping Weight: 12 lbs.) **Users Net \$15.00**

724B for 24" rectangular glass 90° picture tubes, as 24CP4A or 24TP4. (20½" x 25") (Shipping Weight: 15 lbs.) **Users Net \$25.00**

727B for 27" glass 90° picture tubes as 27EP4. (24" x 30") (Shipping Weight: 22 lbs.) **Users Net \$25.00**

Mounting Kits: Includes tube supports, tie down straps, and all hardware for mounting picture tube on chassis.

601B mounts 21" glass tubes, as 21EP4, and 21ZP4, on Model 600 or 610. (Shipping Weight: 2 lbs.) **Users Net \$3.00**

704B mounts 24" rectangular glass tubes, as 24CP4A or 24TP4, on Model 700 or 710. (Shipping Weight: 3 lbs.) **Users Net \$6.00**

707B mounts 27" glass tubes, as 27EP4, on Model 700 or 710. (Shipping Weight: 5 lbs.) **Users Net \$6.00**

CONRAC, INC. • SINCE 1939 • GLENDORA, CALIFORNIA

craftsmen

HIGH-FIDELITY COMPONENTS

C800A FM-AM Tuner is Craftsmen's finest. Built-in phono pre-amplifier and record equalizer make the C800A extremely versatile for installations of all types. Front panel-selected phono equalization for AES, LP or EUROPEAN recording characteristics. Overall distortion: Less than 1/2% at 100% FM, 1/2% at 50% AM. Sensitivity: FM-4 μ v for 30db. quieting, AM-5 μ v for 1/2v audio output. Double-shadow tuning eye and AFC on FM simplifies tuning. Front panel AFC cutout for tuning weak stations. Has cathode follower audio output, continuously variable bass and treble controls provide up to 15 db. attenuation or boost. Size: 13 1/4 x 10 1/2 x 7 in. high. Shipping Weight 22 lbs. Net. \$159.50

C10 FM-AM Tuner. Choice of thousands for proven performance and dependability. Sensitivity: FM-5 μ v for 30db. quieting, AM-5 μ v for 1/2v output. Flywheel Tuning and Automatic Frequency Control: AFC simplifies tuning and assures freedom from FM drift. Distortion: Less than 1/2% at 100% FM, 1% at 50% AM. Frequency response: \pm 1db, 20 to 20,000 cps. Separate bass and treble tone controls provide up to 15 db. boost or attenuation. Phono pre-amplifier compensated for magnetic cartridges. Input: High impedance for TV or tape. Outputs: "Detector" and "Amplifier," both cathode followers permit remote control of power amplifier. FM-AM low-noise antenna, 11 tubes plus rectifier. Size: 13 1/2 x 9 1/2 x 7 in. high. Shipping Weight 17 lbs. Net. \$131.50

C500A Ultra-Fidelity Amplifier — finest made at any price. Based on famous Williamson all-triode circuit with 20db. inverse feedback. 10 watts output at less than 1/10% har. or 1/2% I.M. distortion; 1 watt at 1/10% har. or 1/20% I.M. distortion. Freq. response: 5 to 100,000 cps. \pm 2db. Hum: -90db. Damping factor 32:1. Matched push-pull KT66 output tubes provide lowest possible distortion. Size: 13 1/2 x 8 x 7 1/2 in. high. Shipping Weight 31 lbs. Net. \$99.50

C400 High-Fidelity Amplifier — Exceptional performance at low cost. Streamlined narrow chassis simplifies custom installations. 10 watts output at less than 1% harm. or 5% I.M. Distortion. Freq. response: 10 to 30,000 cps. \pm 1db. Hum: -70db. Damping factor: 4:1. Tubes: 6J5, 6SN7GTA, push-pull 6V6GT's, 5Y3GT rect. Size: 14 x 4 1/2 x 5 1/4 in. high. Shipping Weight 12 lbs. Net. \$42.90

C450 High-Fidelity Amplifier. Compact high-fidelity amplifier for the budget minded. Freq. response: \pm 1db. 20 to 20,000 cps. 6 watts at less than 1% harm. distortion. Push-pull 6W6GT beam-tetrode output tubes. Size: 8 1/2 x 6 x 6 in. high. Shipping Weight 8 lbs. Net. \$29.50

C900 FM Tuner. The ultimate in Stability, Sensitivity, and Minimum Distortion. Extreme Sensitivity: 1.0 μ v for 20 db. quieting provided by double-triode, cascode rf amplifier. Minimum Distortion: 0.1% I.M. distortion throughout entire receiver. Amplified AFC assures accurate tuning, essential for low distortion and eliminates FM drift. Maximum Stability: new photo-etched 20.6mc IF system coils guarantee life-long stability. Size: 13 1/2 x 8 3/4 x 7 in. high. Shipping Weight 12 lbs. Net. \$119.50

CA1 The complete High-Fidelity Home Music Assembly, ready to install. System includes C10 FM-AM Tuner, C400 High-Fidelity Amplifier, C20 Coaxial Dual Speaker, C30 3-Speed Record Player. With all connecting cables, hardware, escutcheons and detailed plans for installation. Shipping Weight 61 lbs. Net. Complete System. \$275.00

C20 Coaxial Dual Speaker, 12-inch "woofer" and horn "tweeter" coaxially mounted. Self-contained LC crossover network. Response: 40-16,000 cps. in recommended enclosure, construction details are included. Shipping Weight 10 lbs. Net. \$49.50

C30 3-Speed Record Player. Includes GE RPX-050 cartridge with dual sapphire styli. Finished in beautiful chrome and black. Complete with 16 x 16 precut mtg. board. Shipping Weight 18 lbs. Net. \$51.10

All chassis finished in polished chromium and shipped complete with all hardware and instructions necessary to complete a professional custom installation.

The Radio Craftsmen, Inc., Chicago

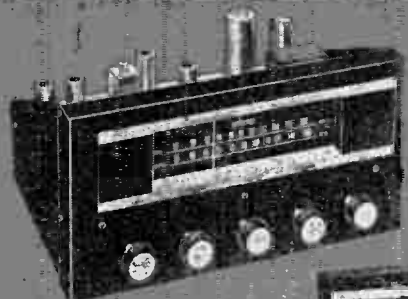

C800A
FM-AM
TUNER

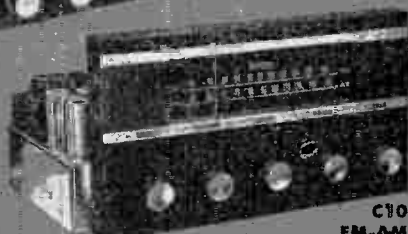

C10
FM-AM
TUNER

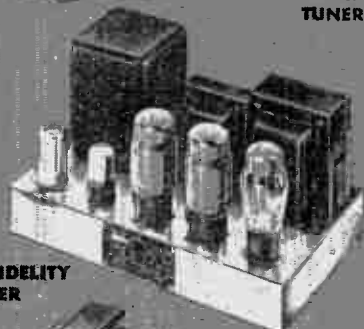

C500A
ULTRA-FIDELITY
AMPLIFIER



C400
HIGH-FIDELITY
AMPLIFIER



C900
FM-TUNER

THE COMPLETE "Assembly"
High Fidelity Home Music System



THE FISHER

WORLD'S FINEST CUSTOM AUDIO COMPONENTS

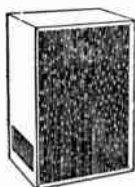

■ NEW! THE FISHER "50" HORN Loudspeaker Enclosure represents the results of an exhaustive survey in the field of enclosures, to determine the ONE perfect design. FISHER presents a new standard of acoustical satisfaction, engineering criteria, and product design.



■ THE FISHER FM-AM TUNERS, Model 50-R and Model 70-RT (with built-in tone controls)—unmatched in performance and beauty, with many features that are exclusive with FISHER. "A Kudo to FISHER design"—HIGH FIDELITY MAGAZINE.

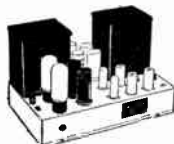

■ THE FISHER AUDIO AMPLIFIERS, Model 50-A (50 watts, 100 watts peak!) and Model 70-A (25 watts, 50 watts peak!), world's finest audio amplifiers. Highest quality design and construction for peak performance. "Of the very best"—HIGH FIDELITY MAGAZINE.



■ THE FISHER MASTER AUDIO CONTROL, Series 50-C, and THE FISHER PREAMPLIFIER-EQUALIZER, Model 50-PR, featuring professional equalization facilities.



■ THE FISHER HI-LO FILTER SYSTEM, Model 50-F—An all-electronic sharp cut-off filter for eliminating extraneous noise, with an absolute minimum loss of tonal range. Can be added to ANY sound system.



■ THE FISHER PHONO PREAMPLIFIER, Model PR-5—for use with magnetic cartridges or microphones. Exact, correct equalization for the pickup of your choice. Self-powered.

The FINEST equipment for the discriminating music lover in our 17 year history!

THE FISHER "50" — HORN SPEAKER ENCLOSURE . . . WITH BALANCED BASS

THE FISHER "50" Horn Speaker Enclosure meets all these requirements with flying colors: a. Conspicuously fine quality and over-all balance rather than an overpowering, and therefore unnatural bass response. b. Total flexibility; use with virtually any speaker system, and in any location in the room. c. Compactness, combined with simplicity of design and good taste. And it will outperform enclosures over twice its size!

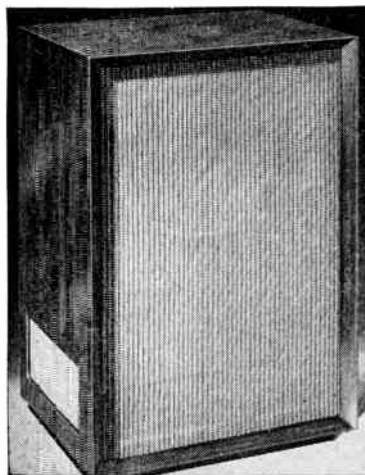

MODEL 50-HM
User's Net \$129.50

OUTSTANDING FEATURES

- 1) Smooth response to below 30 cycles per second.
- 2) Can be used with 12" or 15" single, coaxial, dual or triaxial speaker systems. For that reason you can change loudspeakers at any time in the future without obsoleting the speaker enclosure.
- 3) Does not require corner placement. Locate THE FISHER anywhere.
- 4) Air loading of the bass output is over four times that of an infinite baffle speaker enclosure.
- 5) Substantially extends the bottom bass range of any speaker.
- 6) Reduces the amplitude of the speaker's inherent bass resonant peak, assuring smoother bass response.
- 7) Special design eliminates synthetic or 'tuned' bass, with its characteristic 'boom' and barrel effect (particularly noticeable on the male speaking voice.)
- 8) There is no listener fatigue, regardless of volume level!
- 9) Additional tweeters, if desired, can be mounted at any time.

MODEL 50-HB
User's Net \$134.50

For 12" and 15" Speaker Systems

Prices slightly higher West of the Rockies.

Now Available . . .

THE FISHER

SERIES 50 Moving-Coil Phono Cartridge

Now, the quality of record reproduction with FISHER or other components no longer need be limited by the quality of the phonograph cartridge. THE FISHER Series 50 Moving Coil Phonograph Cartridges assure the finest reproduction of which the record is capable!

OUTSTANDING FEATURES

1. High compliance improves low frequency response, reduces record hiss and, most important of all, eliminates tracking distortion.
2. Can be used with virtually any tone arm.
3. Extremely low mass of stylus assembly (featuring a hollow aluminum stem) results in greatly reduced groove-side-wall wear, thus prolonging almost indefinitely the life of records and the stylus itself.
4. Supplied only with diamond stylus—the one acceptable material for the purpose.
5. Low impedance permits use of greatly varying cable length without loss of high frequency response and without its being subject to stray magnetic fields from nearby electronic equipment.
6. Rubber damping baffle protects moving parts from dust and suppresses needle talk.
7. Stylus suspension features shock-absorbing design to prevent accidental damage to both the stylus and the record.



THE FISHER Moving Coil Phonograph Cartridge,
Model 50-LP (33-45 RPM).....\$37.50

THE FISHER Moving Coil Phonograph Cartridge,
Model 50-ST (78 RPM).....\$37.50

THE FISHER Matching Transformer, Model MT-1
(for use with pre-amplifiers with insufficient gain) \$ 8.75

IMPORTANT NOTE: Transformer not required with FISHER Models 50-PR, 50-C, 70-RT.



SEE FOLLOWING
PAGES FOR
FULL DETAILS!

THE FISHER FM-AM TUNERS

THE FISHER FM-AM TUNER

Model 70-RT

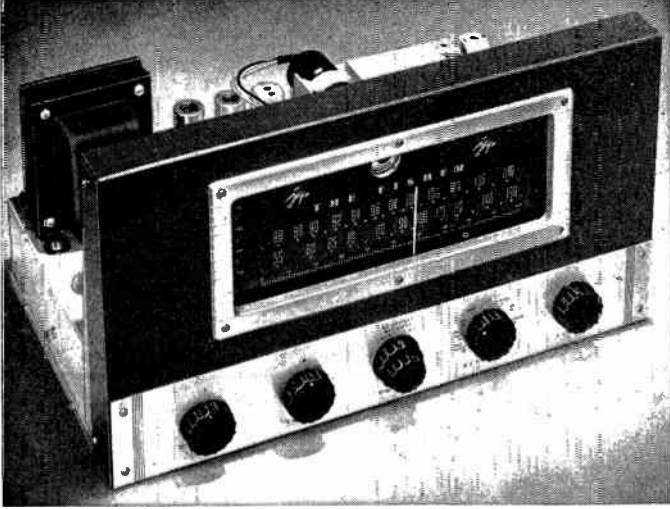

THE FISHER Model 70-RT has all the features of the Model 50-R, but includes within the one chassis many of the control facilities and flexibility normally found only in a separate Preamplifier-Equalizer such as THE FISHER Master Audio Control, Series 50-C. For basic features, see Model 50-R. Additional Features of the Model 70-RT: Loudness Balance Control Switch. Phonograph preamplification and equalization. Two cathode follower outputs. Six Controls: Bass Control, Line Switch, Treble, Volume, Loudness Balance, Channel and Equalization Selector Switch (Nine Positions: AM-Broad, AM-Sharp, FM, FM-AFC, AES, Ortho, LP, NARTB and TV), Station Selector. Tube Complement: Total of Fifteen, including 2-6BQ7A, 1-6CB6, 1-6BE6, 3-6BA6, 2-6AU6, 1-6AL5, 1-12AU7, 1-12AX7, 1-6AV6, 1-5Y3, 1-6U5. Size: 14 3/4" wide, 8 1/2" high, 9 1/4" deep. Shipping Weight: 19 pounds.

FM and AM sections are identical to 50-R, described below. Built-in preamplifier consists of two cascaded triode stages having adequate gain for even the lowest level magnetic pickups. Full choice of record equalization settings for proper acoustic balance of all makes of records.

Audio Section: Uniform response, ± 1 db, 20 to 20,000 cycles. Distortion less than 0.04% for 1 volt output; 0.8% for 10 volts output. Hum level on radio better than 90 db below 2 volts output with volume control at minimum (more than 86 db below 2 volts output with control at maximum.) Hum level on phono better than 62 db below output with 10 millivolts input signal. AM loop and FM dipole supplied.

Cables can be made any length up to 200 feet. The detector output is independent of the tone controls for use in recording applications or where a remote chassis is to be used. Bass and Treble Controls continuously variable, with 15 db of boost to 15 db of attenuation at 50 and 10,000 cycles respectively. Adjustable Loudness Balance Control; can be turned on or off, as desired, from front panel.

Model 70-RT User's Net \$184.50
Prices slightly higher West of the Rockies.

THE FISHER FM-AM TUNER

Model 50-R



THE FISHER Model 50-R, based on its performance in the field, is without question the finest unit of its type in the country. General Features: 14 tubes including rectifier and tuning eye. Self-powered. Completely shielded construction, including bottom plate. Six-gang variable capacitor. Flywheel tuning. Both main chassis and front-end sub-chassis are of etched aluminum and individually shock mounted. Beautiful hammertone front panel. Brushed brass control marker plate. AM loop and FM dipole antennas supplied. Two auxiliary AC outlets. Two high impedance inputs. Large tuning dial with logging scale. Channel indicator lights. Controls: On-Off, Volume; Selector Switch (AM-Broad, AM-Sharp, FM, FM-AFC, Phono, TV); Tuning. Tube Complement: 2-6BQ7A, 1-6CB6, 1-6BE6, 3-6BA6, 2-6AU6, 2-6AL5, 1-12AU7, 1-5Y3, 1-6U5. Size: 14 3/4" wide, 8 1/2" high, 9 1/4" deep. Shipping Weight: 19 pounds.

Incorporates a two-band superheterodyne circuit with separate front ends for FM and AM. Dual antenna inputs: 72 ohm or 300 ohm balanced. FM section is Armstrong system; Comprises cascade, tuned RF stage and two IF stages, followed by two cascaded limiters and a Foster-Seeley discriminator. Adjustable AFC; can be switched in and out of circuit from front panel. Sensitivity: 1/2 microvolts for 20 db of quieting on 72 ohm antenna input; 3 microvolts for 20 db of quieting on 300 ohm antenna input. Full limiting on signals as low as 1 microvolt. Frequency response: uniform from 20 to 20,000 cycles, ± 1 db.

AM section incorporates one tuned RF stage and two IF stages. IF band width adjustable from front panel. Frequency response: -3 db at 7,000 cycles in broad-tuning position. Band width in sharp-tuning position: 6 db down at 6 Kc. Sensitivity: less than 1 microvolt input for 1 volt output. Built-in 10 Kc heterodyne whistle filter. Dual antenna inputs. AM loop and FM dipole antennas supplied.

One triode stage of audio amplification. Frequency response: 20 to 20,000 cycles, ± 1 db. Distortion: less than 0.8% for 10 volts output, 0.04% for 1 volt output. Hum level with volume control at minimum: more than 100 db below 2 volts output (more than 90 db below 2 volts output with control at maximum.) Cathode follower output permits use of tuner at any desired distance, up to 200 feet from amplifier.

Model 50-R User's Net \$164.50
Prices slightly higher West of the Rockies.

"OF THE VERY BEST!"
—HIGH FIDELITY MAGAZINE



THE FISHER

AUDIO AMPLIFIERS and
MASTER AUDIO CONTROL



THE FISHER MASTER AUDIO CONTROL Series 50-C

5 inputs and 5 independent input level controls: 3 high-level, 1 low-level for magnetic cartridge, and 1 microphone input. PHONOGRAPH PREAMPLIFIER has two cascaded triode stages. Bass and Treble Controls produce up to 16 db of continuously variable boost or attenuation at 50 and 10,000 cycles respectively. MAXIMUM GAIN from high level input: 22.4 db; low level: 53 db. HARMONIC DISTORTION: 0.02% at 1 volt, 0.05% at 5 volts, 0.15% at 10 volts, 0.4% at 15 volts. INTERMODULATION DISTORTION: 0.08% at 1 volt, 0.2% at 5 volts, 0.5% at 10 volts, 1.6% at 15 volts. FREQUENCY RESPONSE: ± 0.5 db, 20 to 20,000 cycles with controls in uniform response position. HUM AND NOISE LEVEL: On radio input — better than 100 db below 2 volts output with control at zero; better than 90 db below signal with control at maximum. On phono input — 68 db below output with a 10 mv input signal. CATHODE FOLLOWER INPUT and two CATHODE FOLLOWER OUTPUTS permit leads up to 200 ft.

Model 50-CH (Chassis Only)User's Net \$89.50
Model 50-CM (Mahogany)User's Net \$97.50
Model 50-CB (Blonde)User's Net \$97.50
Prices slightly higher West of the Rockies.

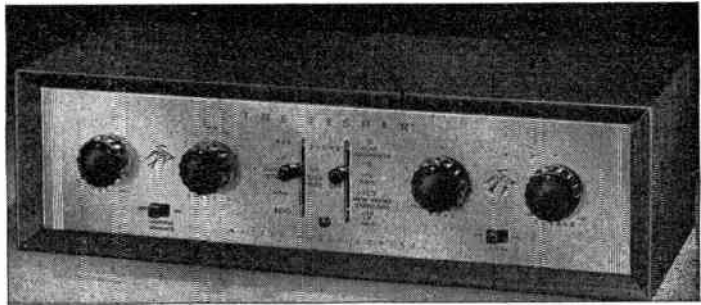

The performance of the 50-C will be limited only by the quality of the associated equipment. Features high gain with extreme reserve output voltage. Self-contained power supply, completely shielded, with DC for all filaments. 8 Controls: Volume, Loudness Balance, 5 position input Selector Switch. Two low and high frequency lever switches provide 25 combinations of record equalization. Bass and Treble controls. 3 spare AC receptacles. Tube complement: 2-12AX7, 1-12AU7. Size — in Cabinet: 15 1/4" wide, 4 1/2" high, 6 1/4" deep; Chassis only: 14 3/4" wide, 3 1/2" high, 6 1/2" deep. Shipping weight: 10 pounds.

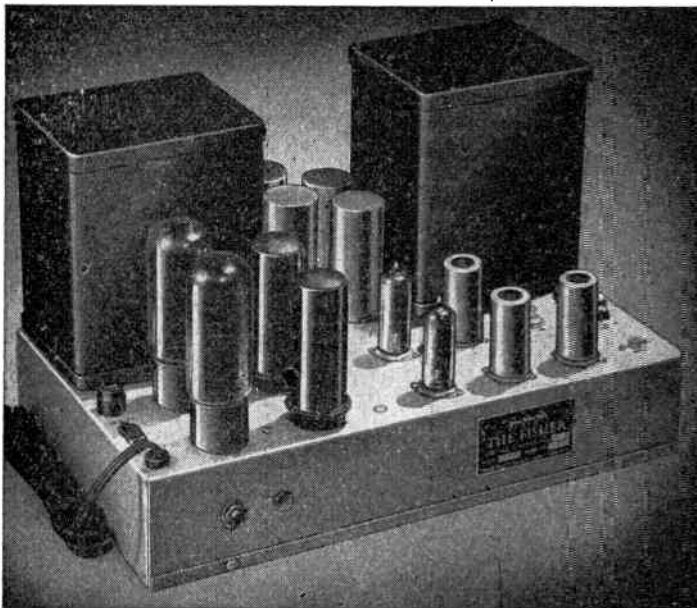

THE FISHER AUDIO AMPLIFIER Model 50-A

Expressly engineered to satisfy these criteria: low internal impedance, low harmonic and intermodulation distortion at all power levels, extremely low hum and noise level, unusual reserve power-handling capacity, high efficiency, good transient response, wide frequency response, good linearity (output versus input,) compactness, long component life, simple circuitry, complete accessibility for easy servicing and moderate cost.

HIGH OUTPUT, with less than 1% harmonic distortion at 50 watts. (.05% at 5 watts, .08% at 10 watts.) INTERMODULATION DISTORTION is below .4% at 10 watts, .8% at 40 watts and 2% at 45 watts (measured 40/7000 cycles at 4-1.) FREQUENCY RESPONSE is uniform within ± 1 db from 20 to 20,000 cycles and within 1 db from 5 to 100,000 cycles. POWER OUTPUT is constant within 1 db at 40 watts, 15 to 60,000 cycles. HUM AND NOISE is better than 92 db below full output. INTERNAL IMPEDANCE is .53 ohms at the 16-ohm tap, giving a damping factor of 31. EFFICIENCY is in excess of 55% at full output compared to 25%-30% of typical Class A circuits. Level Control. TUBE COMPLEMENT: 3-12AU7, 2-6CL6, 2-1614 and 2-5AW4. OUTPUT IMPEDANCES: 8 and 16 ohms. Jack in output tube circuit to measure plate current. Accessible bias control to adjust plate current. Accessible fuse. Auxiliary AC receptacle. SIZE: 8 3/4" x 14 1/2" x 9" high. SHIPPING WEIGHT: 41 pounds. — —

Model 50-AUser's Net \$159.50
Prices slightly higher West of the Rockies.

THE FISHER AUDIO AMPLIFIER Model 70-A

More clean watts per dollar! Extremely low harmonic and intermodulation distortion at all power levels, excellent transient response, wide frequency range and good linearity. Hum and noise are virtually non-measurable! HIGH OUTPUT, with less than 1/2% harmonic distortion at 25 watts (50 watts peak.) Less than 0.15% distortion at 20 watts; less than 0.05% at 10 watts. INTERMODULATION DISTORTION less than 1/2% at 20 watts and less than 0.2% at 10 watts. FREQUENCY RESPONSE is uniform within ± 0.1 db from 20 to 20,000 cycles and is within 1 db from 10 to 50,000 cycles. POWER OUTPUT is constant within 1 db at 25 watts from 15 to 35,000 cycles. HUM AND NOISE LEVEL is better than 95 db below full output. INTERNAL IMPEDANCE is 0.61 ohms at the 16-ohm tap, giving a damping factor of 26. PHASE SHIFT is less than 15° at 20 cycles and less than 18° at 20,000 cycles. THE FISHER Model 70-A has four separate feedback loops to achieve low internal impedance, extremely low distortion and excellent transient response. Two type 5881 tubes, connected as tetrodes, are employed in the power

stage. The use of a unique cathode and screen feed-back circuit provides all the advantages of triode performance together with the efficiency of tetrodes. The carefully designed output transformer consists of fifteen interleaved windings in conjunction with a grain-oriented steel core producing the finest in output transformer performance. The entire amplifier and power supply are built on one compact, steel chassis, simplifying installation. All transformers in drawn steel cans and sealed against moisture. TUBE COMPLEMENT: 1-12AT7, 1-12AU7, 2-5881, 1-5V4G. OUTPUT IMPEDANCES: 8 and 16 ohms. Fuse readily accessible. SIZE: 4 1/4" deep, 14 1/4" wide, 6 1/2" high. SHIPPING WEIGHT: 21 1/2 pounds.

Model 70-AUser's Net \$99.50
Prices slightly higher West of the Rockies.

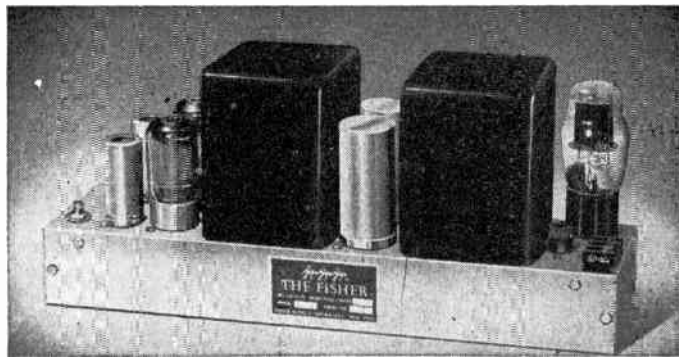

Net

Copyright by U. C. P., Inc.

Tomorrow's audio TODAY!

Radio's Master — 19th Edition
Page B-30



THE FISHER **Finest Audio Products**

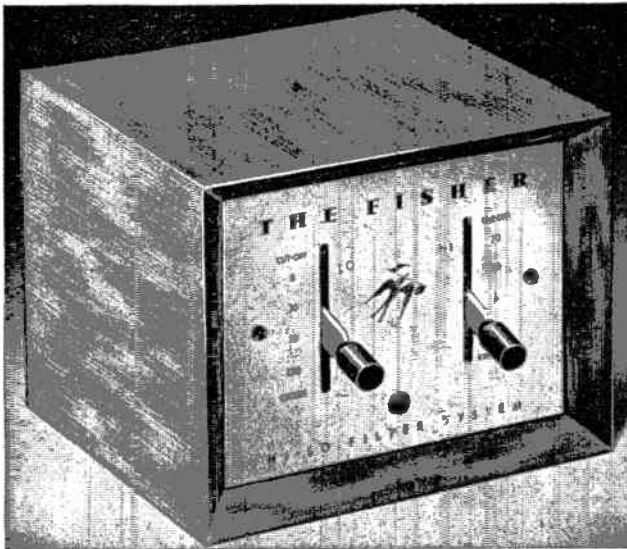

THE FISHER HI-LO FILTER SYSTEM Model 50-F

THE FISHER Hi-Lo Filter System, Model 50-F, does what conventional tone controls cannot do, for it suppresses all types of noise with an absolute minimum loss of tonal range. It can be readily connected to any tuner, amplifier, high fidelity system, radio-phonograph, preamplifier-equalizer, magnetic tape recorder, etc. High impedance input. Cathode follower output, permitting connecting cable up to 200 feet long, if desired. All-triode circuit, utilizing 1-12AX7, prevents insertion loss. Hum level more than 70 db below 1 volt output. Uniform response within 1/2 db, 20 to 20,000 cycles, with cut-off selector switches in neutral position. Distortion so low as to be virtually non-measurable. Two, independent lever switches. Low-Frequency Cut-Off Points: Zero, 30, 70 and 120 cycles at a slope of 10 db per octave. High-Frequency Cut-Off Points: 20 Kc (flat,) 10 Kc, 6 Kc and 3 Kc, at a slope of 20 db per octave. Self-powered. Built-in ON-OFF switch. Jewel pilot light. Completely shielded chassis, with bottom cover. Beautiful and durable plastic cabinet. Etched brass control panel. Size: 4 3/8" high, 5 1/2" wide, 5" deep. Chassis size: 3 7/8" high, 4 1/2" wide, 4 7/8" deep. (Add 1/8" to depths shown, for lever switches.) Shipping Weight: 3 3/4 pounds.

Model 50-F User's Net \$29.95
Prices slightly higher West of the Rockies.

THE FISHER PREAMPLIFIER-EQUALIZER

Model 50PR

THE FISHER Preamplifier-Equalizer, Model 50-PR, is the first high quality unit at low cost, bringing professional record equalization facilities within the reach of every record collector. Its voltage gain is ample for use with any low-level magnetic cartridge and it can be modified for constant amplitude or crystal pickups (a simple equalizer is required for the latter type.) Two stages of triode amplification (1-65C7). Exclusive feedback circuit assures full low-frequency equalization. Special circuit design permits output lead up to 50 feet in length. Two, independent lever switches. Low Frequency Turn-Over Points: AES, NART8 and ORTHO, LP, 800. High Frequency Roll-Off Positions: Zero (flat,) 8 db, 12 db AES (ORTHO), 16 db (NART8.) Over-all gain, 40 db (1 volt output from 10 millivolts input.) Hum level is 60 db below 10 millivolts input. Frequency response is uniform within 1 db of the published curve. Adjustable hum level control. Tube is shock-mounted to minimize possibility of microphonics. The 50-PR is self-powered and has a built-in AC switch. Jewel pilot light. Chassis is completely shielded. Bottom cover. Beautiful and durable plastic cabinet with attractive, etched brass control panel. Size: 4 3/8" high, 5 1/2" wide, 5" deep. Chassis Size: 3 7/8" high, 4 1/2" wide, 4 7/8" deep. (Add 1 3/8" to depths shown, for lever switches.) Shipping Weight: 3 3/4 pounds.

Model 50-PR User's Net \$22.95
Prices slightly higher West of the Rockies.

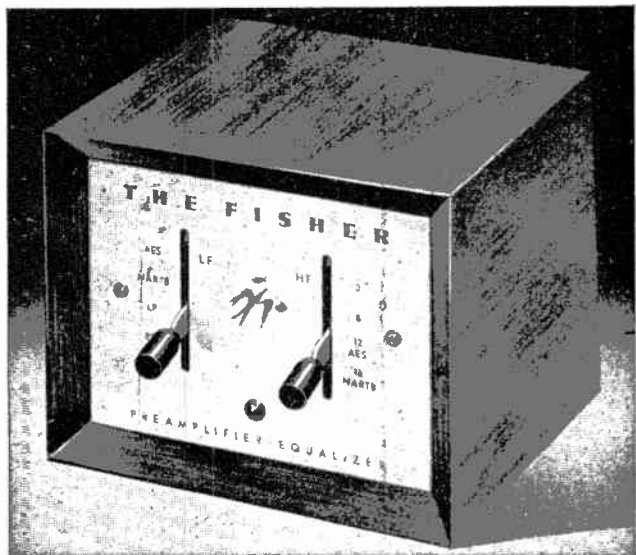

THE FISHER HIGH QUALITY PREAMPLIFIER

Model PR-5



Designed to meet the need for a self-powered unit of excellent quality, yet moderate cost. THE FISHER Model PR-5 can be used with low-level magnetic pickups of any make. In each case, exact and correct equalization is provided for the particular pickup of your choice. Can also be used as a microphone preamplifier. **OUTSTANDING FEATURES:** 1. Virtually inaudible hum level, better than 60 db below one volt output in both phonograph and microphone use. 2. Frequency response is uniform within 2 db from 30 to 20,000 cycles on all applications. 3. The unit is self-powered, using components of a type that assure long, trouble-free service. 4. Chassis is completely enclosed, with bottom cover. Latter is readily removable. 5. Two stages of triode amplification are utilized. 6. High Gain. On Phonograph: 10 millivolts (.01 volts) input to produce one volt output, a voltage gain of 100. On Microphone: 1 millivolt (.001 volts) input to produce one volt output, a voltage gain of 1,000. 7. An exclusive feedback circuit has been incorporated to produce full low frequency equalization. The latter has been designed for turn-over at 500 cycles (ORTHO.) 8. Circuit design permits the use of output cable up to fifty feet. 9. Complete installation and service manual, as well as all necessary connecting plugs supplied. 10. Overall size: 3 3/4" x 5 5/8" x 3 3/8" high. Shipping weight: 2 pounds.

Model PR-5 User's Net \$12.57

ALWAYS *the standard of comparison!*



TECH-MASTER

Custom Built TV Chassis

The World's Most Powerful, Most Dependable TV Receivers

Gold Medal Series

CUSTOM BUILT DELUXE TV CHASSIS

Tech-Master design and construction are as fine as human hands and technical know-how can produce. The most advanced engineering methods, the finest components, the rigid alignment and test standards and the pledged determination to produce the OPTIMUM in Television adds up to the finest TV Chassis that the industry has to offer. In fringe areas as well as normal range areas, The Gold Medal Series brings modern motion picture brilliance and clarity to the TV screen.

A NEW SYSTEM OF PICTURE-SOUND SYNCHRONIZATION guarantees highest picture resolution with drift-free, undistorted sound under all signal conditions.

Compare These Features

- ★ **TECH-MASTER 630 TYPE CIRCUIT:** Of all the circuits known to the TV industry, the RCA-630 type is still acclaimed the finest. But, even the 630 is only as good as the Engineering, the Components and the Workmanship that go into it. These three factors are inherent in every Tech-Master Custom-Built Chassis.
- ★ **ADVANCED CASCODE TURRET TUNER, Adaptable to UHF Without Tools:** Employs a Cascode RF amplifying stage, affords a high signal-to-noise output resulting in a sharper picture, with a minimum of "snow," even in weak signal areas. UHF channel strips may be inserted at any time, without the use of tools.
- ★ Full 4 Mc Band Width for better picture definition.
- ★ Quick-Action Keyed AGC Circuit assures stabilized control.
- ★ New Hi-Sweep Auto Transformer System for outstanding brilliance.
- ★ 3 Microvolt Sensitivity . . . Excellent for Fringe Areas.
- ★ Full Horizontal and Vertical blanking.
- ★ Area Control Switch (on front panel) for local or distant setting.
- ★ Picture-Expander: Variable control for extra width under low line voltage conditions.
- ★ Chassis are beautifully plated in gleaming nickel finish . . . come completely wired, aligned and tested, with all tubes (less kine).

FOR NEW 90° PICTURE TUBES UP TO 27"

Model 2430-9. Tech-Master's Latest Addition to the Gold Medal Series. Designed to drive 24", 27" picture tubes and others requiring 90° deflection. The size and quality of this ruggedly built chassis makes it ideal for school and commercial installations. The most advanced designs are embodied in the latest type high voltage and sweep circuits which feature 22KV second anode voltage, polyethelene enclosed HV socket, quick retrace auto-transformer, full horizontal and vertical sweep even under low voltage line conditions, variable vertical linearity and height controls, edge to edge focus and the latest 90° ferrite casine yoke.

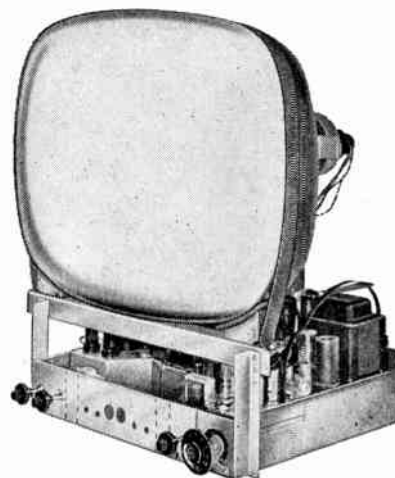

FOR CUSTOM INSTALLATION

Model 2430:—Designed specifically for all picture tubes requiring 60 to 70 degrees horizontal deflection (21EP4—24AP4, etc.). Has quality 12" PM speaker, Universal picture tube mounting brackets, Phono-input. Equipped with audio take-off to feed sound thru hi-fi system, if desired. Jack mounted on rear of chassis for easy connection.

\$189.50

Model 2431:—Same as Model 2430 (less sound take-off), but with true fidelity Push-Pull audio output.....\$199.95

Model 2430-9:—For all 90° picture tubes up to 27". Features similar to 2430, but incorporates new high voltage horizontal and vertical sweep circuits.....\$262.50

DIMENSIONS: 23 1/4" wide, 16 1/4" deep.
SHIPPING WEIGHT: 70 lbs.

----- All chassis now available with built-in U H F -----

Blue Ribbon

CUSTOM DESIGNED, CUSTOM-BUILT TV CHASSIS

Combining High Quality with Low Price

For Picture Tubes Up to 24"

MODEL C-30 has been engineered for the utmost in economy, retaining every important feature necessary for quality of image and sound.

Here again is Top TV Performance attained through skilled engineering and finest set-tested components, embodied in a completely factory-wired chassis, pre-aligned, pre-adjusted and ready for use.

- ★ **Basic 630-Type Circuit Features Include:**
 - Full 4 mc bandwidth
 - 4-Stage Video IF
 - 2-Stage Video Amplifier
- ★ **NEW, AUTOMATIC SOUND-PICTURE SYNCHRONIZATION.**
- ★ 29 Tubes, including rectifiers.
- ★ **Advanced, Cascode 12 channel turret tuner, adaptable to UHF without tools.**
- ★ 4-Stage Synchronizing Amplifier and Separator.
- ★ 5 Microvolt Sensitivity.
- ★ 16 kv 2nd Anode Voltage
- ★ New, Automatic Horizontal Stabilizer.
- ★ Automatic Background Control.
- ★ Retrace Blanking Circuit.
- ★ Double-time Constant AGC.

AUTOMATIC FOCUS

Designed for use with new, low-voltage E.S. self-focus tubes (17TP4, 21MP4, 24BP4, etc.)

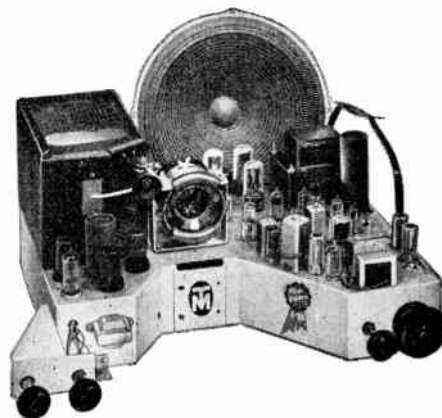

MODEL C-30: completely wired, aligned and tested . . . with quality PM speaker, and all tubes (less picture tube).....\$149.50
Dimensions: 21 3/4" wide x 16 1/4" deep.
Shipping Weight: 55 lbs.

New Horizons

OF TV ENJOYMENT
with Built-in 82-Channel
UHF/VHF Coverage

ALL TECH-MASTER TV RECEIVERS
ARE AVAILABLE WITH BUILT-IN
UHF—FACTORY ASSEMBLED,
ALIGNED AND TESTED.

Model No.	Price
★ 2430 UHF	\$249.50
★ 2431 UHF	259.59
★ 2430-9 UHF	299.50
★ C-30 UHF	209.95*

* Less mounting bracket

GENERAL FEATURES — UHF SECTION

- ★ Uniform bandwidth plus high selectivity.
- ★ 3-point tracking for optimum reception over entire band.
- ★ High oscillator stability.
- ★ Single knob continuous tuning.

TUBE COMPLEMENT — UHF SECTION

6AF4	Oscillator
6BQ7	Cascade I.F.
1N82 Crystal Diode	Mixer

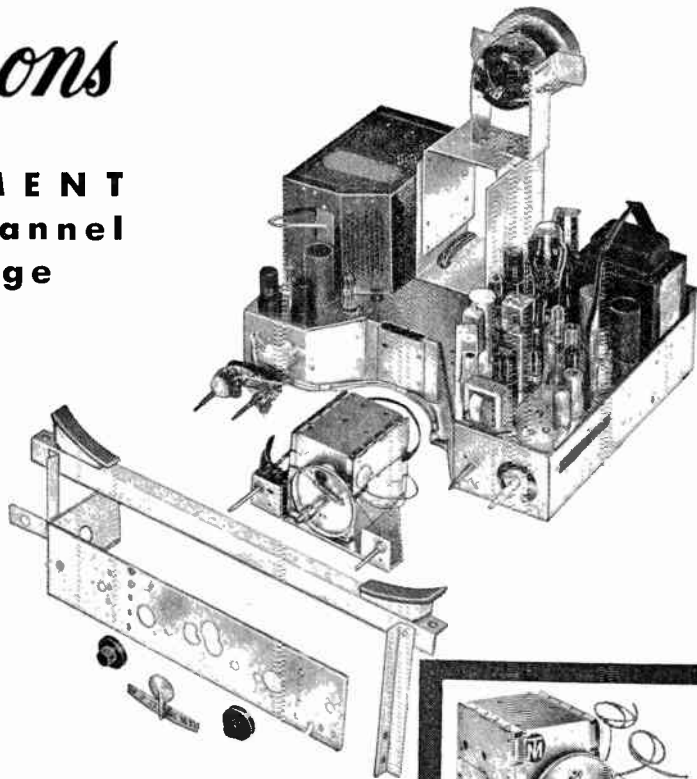

MODEL TV-101-U: 70-channel UHF Selector fits into front recess of all Tech-Master and other 630-type chassis. Factory wired and aligned. Complete with bracket, m't'g hardware, dial, escutcheon plate and knobs. 2-position selector switches VHF to UHF\$36.95

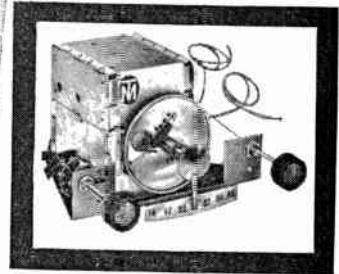

New TECH-MASTER 'REMOTUNER'

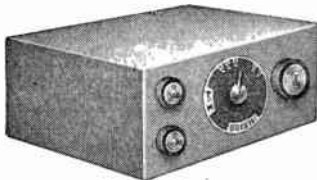

- ★ Covers all VHF channels as well as 88-108 mc FM band.
- ★ Quickly attaches to all Tech-Master and other 630-type TV chassis.
- ★ Readily adaptable to majority of standard commercial receivers.
- ★ Plug-in adaptors supplied.
- ★ No internal wiring.
- ★ 25-foot cable supplied with 'REMOTUNER.'

Affords convenience of TUNING - PICTURE CONTROL - VOLUME at your finger tips in any part of the room. Also, ideal for commercial installations, such as restaurants and bars.

Tuning unit has high sensitivity for fringe as well as local operation. Quiet, smooth, trouble-free mechanical construction. Can be used as far as 50 feet from the receiver (with additional extension.)

MODEL 154: Completely assembled, ready to operate. Shipping weight: 5½ pounds.

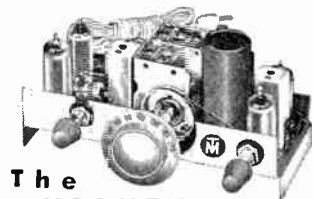

The MIGHTY VERSATILE MIDGET

3-Instruments-in-1

- (1)—A Complete AM Superhet Receiver which connects to any speaker system.
- (2)—A Sensitive AM Tuner with output connections for external amplifier.
- (3)—A Complete Audio Amplifier with input connections for high-impedance microphone or phonopickup.

This compact, versatile chassis affords most economical method of adding radio or phono to all TV receivers. Fits into 630-type chassis. Wired and aligned. All tubes included. Shipping weight: 2½ lbs. Dimensions: L-7½"; H-3¾"; D-3¼".
\$19.95



TECH-MASTER

QUALITY KITS

TELEVISION and RADIO

America's Finest TV Kit—Model 630-D

Tech-Master engineers have again demonstrated their skill by developing new and better features for the world famous RCA-630 type circuit. All components used are the best available . . . rigid factory test standards are your assurance of years of trouble-free performance.

With a minimum of tools you will have a TV receiver with unsurpassed picture quality . . . at a cost considerably less than a manufactured set. Special Tech-Master schematic and pictorial diagrams guide every move and make assembly utterly simple and enjoyable!

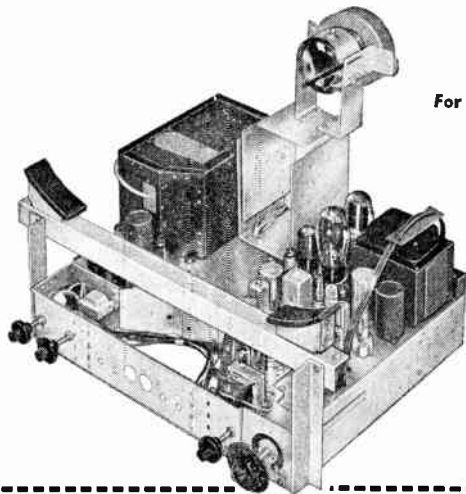

For All Picture Tubes up to 24"

- ★ Adjacent Channel Traps.
- ★ 2 Stage Video Amplifier.
- ★ Direct Coupling Used for Keyed AGC Circuit.
- ★ Improved Picture Brilliance — Due to New "Hi-Sweep" Voltage Multiplier System.
- ★ 5 microvolt sensitivity.
- ★ Complete front panel controls allow simple individual adjustments: Brightness, Horizontal and Vertical hold, Volume, -Contrast-On/Off, Channel Selector and Fine Tuning.

CHASSIS DIMENSIONS: 21 $\frac{3}{4}$ " wide x 15 $\frac{3}{4}$ " deep.

SHIPPING WEIGHT: Approximately 70 lbs.

DELUXE KIT—MODEL 630D24: Supplied complete with all components, mounting brackets, speaker, and all tubes (less kine, wire and solder).

\$159.50

UNIVERSAL TELEVISION KIT

Tech-Master brings high quality television within reach of the most economy-minded customer, with the lowest price ever for a top-performing, precision-engineered, AC/DC kit.

Tech-Master's development of the IF "Synchro-Strip" cuts in half the amount of work required to assemble and wire the kit! It comes mounted in place, on the main chassis, together with the tuner, and is completely wired, aligned and tested. The newest engineering advancements have been utilized in the design of the horizontal and vertical sync circuits to assure excellent stability and noise immunity characteristics. Complete step by step instructions and diagrams (both pictorial and schematic) permit complete wiring over a week-end!

IDEAL FOR SCHOOLS: Requires minimum bench equipment; affords maximum opportunities for comprehensive TV training.

- ★ Compact, light-weight easily portable unit, operates on both AC and DC, for use with picture tubes up to 17" rectangular.
- ★ Advanced and improved 12 channel turret tuner, adaptable to UHF without tools!
- ★ Latest type hi-gain stagger-tuned IF system incorporating bi-filar coils — for excellent picture definition.
- ★ New AGC system, utilizing special delay network — for steady pictures regardless of varying transmission conditions.
- ★ High efficiency beam power amplifier and ceramic core horizontal output transformer provide clear, bright pictures and full horizontal deflection.
- ★ Two-knob control on front panel provides automatically synchronized picture and sound.

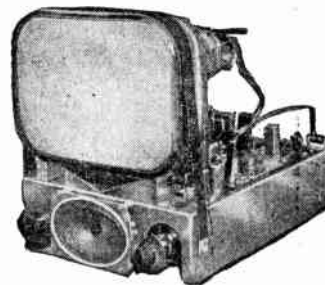

MODEL 5116: "UNIVERSAL" Kit complete with set of 16 Circuit Tested Tubes, all hardware, instructions and picture tube mounting brackets, (less kine, wire and solder)\$99.95
Dimensions: 17" deep x 14" wide.
Shipping Weight: Approx. 30 lbs.

NEW DELUXE SUPERHET AC-DC RADIO KIT

Highest quality, easy-to-build Superhet Receiver Kit, consisting of quality components throughout, die-stamped plated chassis and wide range speaker.

Kit is furnished complete with modernly styled, handsome Bakelite cabinet (10"x5 $\frac{1}{2}$ "x5 $\frac{1}{2}$ "), attractive station selector and control knob.

Only the finest components are furnished with this kit. Tunes all standard AM broadcasts from 550-1720 KC. Super-sensitive, high gain circuit assures outstanding reception with built-in loop antenna. Automatic volume control circuit to eliminate blasting or fading.

Tube Complement: 12SA7, 12SK7, 12SQ7, 50L6 and 35Z5 rectifier.

Detailed schematic and pictorial diagrams with clearly illustrated assembly instructions provide easy-to-follow directions for quick assembly. Operates 115-125 volts, 50-60 cycles, AC or DC. Shipping Weight: 6 lbs.

MODEL 3B5-K: Complete with tubes and cabinet.....\$19.95
(Wire and solder not included)

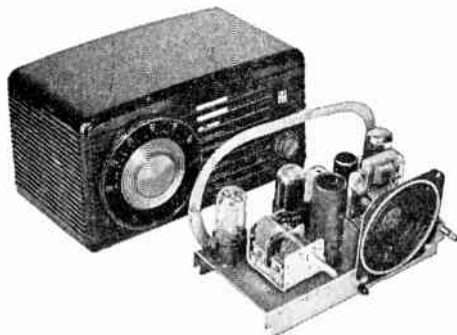

TECH-MASTER HIGH FIDELITY AUDIO AMPLIFIER KITS

Wherever quality custom television installations are desired, Tech-Master chassis are the overwhelming favorites. Tech-Master products are built to a standard, not to a price. They are the result of advanced engineering coupled with an honest determination to obtain the optimum in reception, performance and value. Tech-Master . . . first name in custom-built TV receivers . . . is rapidly earning a similar reputation in the high fidelity audio field. The Tech-Master Williamson Amplifier Kit and the Tech-Master Pre-Amplifier Kit are made with the same "custom-quality" attention that is given to our TV receivers. We have cut no corners, components are the finest, workmanship is meticulous. When you buy a Tech-Master Amplifier and Pre-Amplifier Kit, you get a world of pleasure, years of satisfaction.

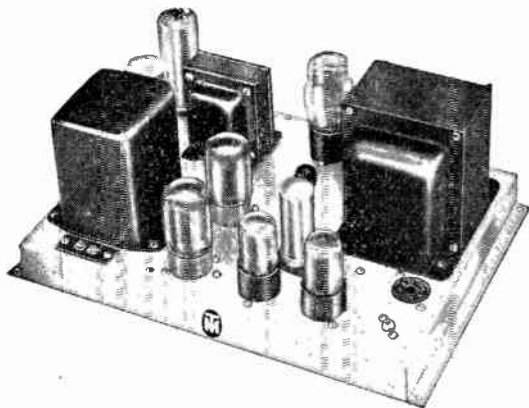

NEW DELUXE TECH-MASTER TM-15A U.L.* WILLIAMSON TYPE 20 WATT AMPLIFIER KIT

*Ultra linear

Uses the famous WILLIAMSON circuit with unique modification for true high fidelity reproduction at increased power output. Only top quality products are used — specially wound famous-make, high fidelity audio output transformer** — ruggedly constructed power transformer. A few hours of assembly, and the builder will be repaid with the finest listening quality he has ever heard. Frequency response flat and smooth beyond the two extremes of the audible range, and distortion is less than .0025 at normal listening levels, with excellent transient characteristics. The kit is furnished complete with punched chassis, transformers, tubes and all other components, together with full detailed wiring and assembly instructions.

Power Output.....20 watts undistorted
 Output Impedance.....4-8-16 ohms
 Input Impedance.....High for crystal pickups, tuners pre-amps, etc.
 Input Voltage.....1.1 VRMS (for 20W out)

Intermodulation and Harmonic Distortion25% at 10 W .5% at 15 W
 Hum and Noise Level..... 70 db below rated output
 Feedback 20 db
 Response at 5 Watts..... 8 cps to 100,000 cps ± 1 db
 Response at 15 Watts..... 10 cps to 70,000 cps ± 1 db
 Tube Complement..... 2 6SN7 2 5881 1 5V4G
 Power Requirements..... 105-125V, 50-60 cycles, 120 W
 Dimensions.....9"x13"x6 1/2" • Shipping Weight.....27 pounds

DELUXE AMPLIFIER KIT, Model TM-15A, factory assembled, all sockets, terminal strips and connectors riveted on chassis, ready to wire..... \$49.95

*Ultra linear operation through use of screen-tapped primary output transformer.

**Altec Lansing PEERLESS or Chicago Transformer audio output transformers will be furnished depending upon availability.

TRANSFORMER: Audio output transformer only, as used in Model TM-15A amplifier kit.

Part No. AT-15..... **\$17.95**

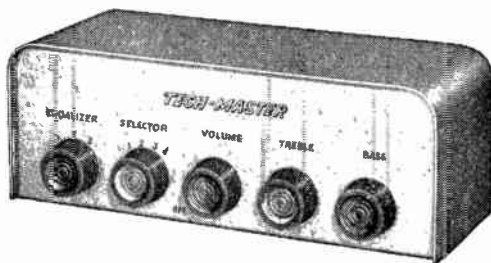

NEW DELUXE TECH-MASTER TM-15P FOUR CHANNEL PRE-AMPLIFIER KIT

TECH-MASTER design and TECH-MASTER quality — for discriminating listening. Has four input channels and selector switch for: FM-AM or TV Tuner, crystal pickup, reluctance style pickup, tape or wire recorder, or other signal source. 3 position equalizer switch in high gain input circuit permits selection of turnover and roll-off characteristics to match most types of recordings. Two independent, continuous controls provide full base and treble boost and attenuation. Power is obtained from main amplifier. AC outlet on chassis permits main amplifier and associated equipment to be controlled by master switch.

The Kit is furnished complete with punched chassis (pre-printed with pictorial diagram for easy assembly), all components, tubes, cabinet and detailed instruction.

Input Selector — Phono Pre-Amp — Tone Control

Input channels.....One low level — high gain
 Three hi-impedance
 Bass Frequency control ± 15 db boost or attenuation at 20 cycles
 Treble frequency control ± 15 db boost or attenuation at 20 KC

EQUALIZATION CONTROL

Position	Turnover	Roll-off	
1	300 Cps	none-flat	} for 78 RPM
2	500 Cps	none-flat	
3	400 Cps	12 db at 10 KC	for 33-1/3 and 45 RPM

Tube Complement.....1 — 12AX7, 1 — 12AU7
 Power Requirement.....125 volts DC at 6 ma, 6.3 volts at 600 ma
 Dimensions.....10 3/4" x 4" x 4" • Shipping Weight.....4 pounds

DELUXE PRE-AMPLIFIER KIT, Model TM-15P, factory assembled, all sockets, terminal strips and connectors riveted on chassis, ready to wire..... \$19.95

Philmore GUARANTEED Electronic PRODUCTS

CUSTOM-BUILT 31-TUBE* TELEVISION KIT

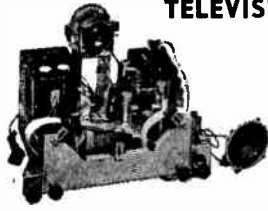

These kits utilize the popular RCA 630 basic circuit, and feature the famous Philmore High Fidelity 70° Deflection System, with more than enough power to operate up to 24-inch Picture Tubes! No. UP731-DL Kit, including 30 Tubes, less Pix Tube, wire and solder.....Dealer's Net Price \$157.50 *Including rectifiers and Video Tube.

HI-FIDELITY 20-WATT SOUND AMPLIFIER KIT



Including Preampifier 20-30,000 Cycles Flat Response ±0.5 db.

Features "Clean-Sound — Crisp Tone." Up to date circuiting, embodying simplicity, economy, ease of construction. Famous Peerless High Fidelity Output Transformer. Pictorial wiring diagrams, detailed step-by-step instructions, including tubes.

DeLuxe Model AA620DL.....Dealer's Net Price \$51.95 Standard Model, with standard hi-fi Output Transf., 30 to 20,000 cycles. Flat response ±1.0 db. Standard Model AA620S.....Dealer's Net Price \$44.95 Model MC620—Matching Cover.....Net Price \$3.50

RADIO Remote Control KITS

TRANSMITTER - RECEIVER

Perfect for Hobbyists! Easy to build... Economical... Fool-proof and Stable in Operation... No License Required.

The TRANSMITTER

Operates on 27.255 Mc. Uses one 3A4 tube. Surprisingly wide control with only 2.75 watts power input. Metal cabinet 9"x6"x5". 3 1/2 lbs. less batteries. No. RC222T (less batteries). List Price \$33.50

JR. TRANSMITTER

Model RC333T—Similar to above. Cabinet: 6x6x3 3/4". Wt. less batts.: 2 lb. 6 oz. Less batteries.....List \$26.00



THE RECEIVER

Compact, only 3 1/2 oz. 1 2 7/8" x 1 1/8" x 1 3/4". Complete instructions, pictorial, schematic diagrams. Includes 3-element Thyatron Tube. No. RC222R (less batteries). List Price \$26.50

ESCAPEMENT UNIT

Optional for receiver. Wired. List \$5.50

COMBINATION OFFERS (less escapement unit)

No. 1—RC-222T transmitter & RC-222R Receiver kits...\$57.95
No. 2—RC-333T transmitter & RC-222R Receiver kits...\$50.75

For PLANES BOATS TRAINS



NOVICE TRANSMITTER AND POWER SUPPLY KIT Including Key

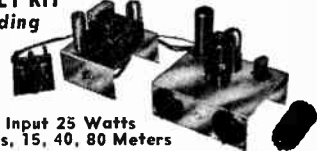

Power Input 25 Watts 3 Bands, 15, 40, 80 Meters

Easy to assemble, easy to operate. Untuned Pierce type Xtal Osc., uses 6V6 tube tuned output Amp., uses 6L6 tube. Power supply uses 5Y3 tube, 370 V DC at 100 Ma. With tubes and standard key. Foolproof instructions.

Model NT-200.....Amateur Net Price \$29.40

NOVICE RECEIVER KIT

Companion for above or other popular models. Plug-in coils for 40-80 meter bands. Coil winding data for 15, 40, 80 meters. Includes GSN7GT Tube.

Model NR-300.....List \$24.50

5-TUBE AC-DC RADIO KITS



Latest model compact hi-fi quality radios. Single Band: 550-1600 Kc. Two Band: 550-1600 Kc. and 5.5-16 Mc. Two-tone cabinets, loop antenna, punched chassis. Tubes included: 12SA7GT, 12SK7GT, 12SQ7GT, 50L6GT, 35Z5GT. Sizes: 8 3/4" x 5 7/8" x 5 1/2".

CABINET	SINGLE BAND		TWO BAND	
	Model	List	Model	List
Ivory & Green	100-1A	\$35.70	100-2A	\$41.45
Ivory & Red	100-1B	\$35.70	100-2B	\$41.45
Walnut & Ebony	100-1C	\$34.10	100-2C	\$39.90

Wire and Solder not included

2-TUBE (Incl. Rectifier Tube) AC-DC RADIO KIT



Designed purposely for easy construction yet uses the most efficient type of circuit. Kits are replicas of parts and circuits used and thoroughly tested in master models and standardized. Simple instructions and diagrams. Uses 1 each 35Z5GT and 12SJ7 tubes. Supplied with punched and formed chassis. Silk screen panel and gray hammertone finish. Attractively packaged in sturdy box.

No. 7001B—Complete, less tubes and headset.....List Price \$12.50

3-TUBE (Incl. Rectifier Tube) AC-DC RADIO KIT



More elaborate than the one-tube and much greater in signal strength—permitting use of a 4" P.M. speaker. Simple instructions with pictorial, schematic diagrams. Silk screen panel and gray hammertone finish. Superior in tone and selectivity to many manufactured radios! Uses 1 each 35Z5GT, 50L6GT and 12SJ7 tubes. Completely assembled, you have a TWO-BAND set, covering standard broadcast (550-1700 Kc) and SHORT WAVE (6-18 Mc).

Cat. No. 7001C—Complete with Speaker, less tubes.....List Price \$20.00 (NOTE: Wire and Solder not included with 7001B and 7001C).

"Supertone" Crystal Radio Receiver KIT



Includes all necessary components, ready wound tuning coil, single phone, with headband, hardware, instructions.

No. 7001A.....List \$4.90* *Plus Fed. Excise Tax

NEW ECONOMY MODEL "LITTLE WONDER" Radio Receiver KIT



Outstanding value! Includes molded bakelite base, precision-wound coil.

crystal, all hardware. Less phone and aerial wire. No. 7000K.....List \$2.00 Plus Fed. Excise Tax

NEW "SELECTIVE" GERMANIUM DIODE Radio Receiver KIT



Features Variable Capacity Tuning, High "Q" Coil, permanently fixed crystal. Plywood baseboard, with template label. Easy to assemble. All hardware, step-by-step instructions included.

No. VC-1000.....List \$5.00 Plus Fed. Excise Tax

"Supertone" RADIO RECEIVING SET



Built to give everlasting service. Brings in broadcasting loud and clear without distortion or noises. Equipped with a Philmore Super-sensitive crystal which will give excellent results.

Cat. No. 7001.....List Price \$2.25 Plus Federal Excise Tax

"LITTLE WONDER" RADIO RECEIVING SET

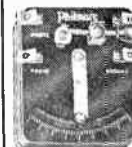

Compact in size but big in results. The open type detector permits fine adjustment. Includes Philmore Super-sensitive Crystal.

Cat. No. 7000.....List Price \$1.75 Plus Federal Excise Tax

PHILMORE AERIAL KIT

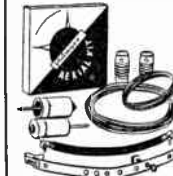

A complete kit of parts for assembly of a professional antenna. Attractively packaged in a multi-colored display box.

1 coil 50 ft. stranded copper aerial wire.
1 coil 25 ft. lead-in wire.
1 Ground clamp. 2 Nail-it knobs.
1 Lead-in strip. 1 Instruction sheet.
2 Porcelain insulators.
Cat. No. 2103.....List Price \$1.50

HAND MICROPHONE Carbon Type



Talk or sing through the radio speaker. Button switch cuts mike in and out of broadcast. Simple to install. Equipped with 9 ft. cord.

Cat. No. 500H.....List Price \$3.15

Junior MICROPHONE Carbon Type



For home broadcasting. Push button switch cuts off radio programs and brings in the home broadcaster's voice very clearly. Sensitive, with excellent volume, shock-proof. Easily attached to any set without rewiring and can remain attached without interfering with regular broadcasting.

Cat. No. 500.....List Price \$2.15

PHILMORE DOUBLE HEADPHONES



Accurately matched. Each unit consists of "double high flux" magnets. Ruggedly constructed of light-weight metal. Polished bakelite ear cups. Concealed terminal type. Braid covered adjustable headband and cord 4 1/2 feet long. 2000 ohm impedance.

Cat. No. 2260.....List Price \$4.75

SINGLE HEADPHONES

Same construction, head band is of spring steel. 1000 ohm impedance. Cat. No. 2261.....List Price \$2.65

Complete Line of Crystals, including: Open Type, Fixed Crystal, Glass Enclosed, Meter Tested; Unmounted Detector, Catswhiskers, etc. Write for Catalog RM-19.

CRYSTAL ACCESSORIES

PHILMORE MFG. CO. INC. • 113 University Place • New York 3, N. Y.

EAGLE *Pict-O-Graph* RADIO KITS

MGFD. BY EAGLE ELECTRONICS, INC., NEW YORK, N. Y.



QUADRUCATIONAL 4 IN 1 KIT

A complete electronic laboratory for learning. Combined on one chassis are: 1—Amplifier, 2—Code oscillator, 3—Receiver, 4—Transmitter. Uses 5 tubes (included), 12SA7, 12SK7, 12SL7, 50L6 and 35Z5 rectifier. For use on 110 volts AC or DC.

KIT NO. Q-5NET \$23.40
CODE KEY NO. Q-201NET \$.90
HEADPHONE NO. Q-207NET \$ 1.50
CABINET NO. Q-206NET \$ 3.00

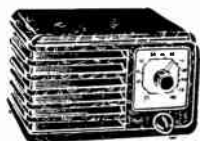

3 TUBE RADIO plus SELENIUM RECTIFIER

POWERFUL! Designed for maximum stability, selectivity and high output. Uses three tubes; 2—12SJ7, 1—50L6 plus selenium rectifier. Includes tubes, parts, loop antenna, alnico PM speaker, plastic cabinet and instructions. For use on 110 volts AC-DC.

KIT NO. RT-3NET \$16.20



25 WATT 'CUSTOM' AMPLIFIER KIT

A deluxe hi-fi amplifier for custom ensembles or auditoriums seating to 1500 persons. 25 watts, 28 on peaks. 30-20,000 CPS. Separate mike and phono channels. Xtal or dynamic input. Tubes: 2—6SN7, 2—6L6, 1—5Y3. 110 V. 60 cycles. (Less tubes).

KIT NO. AMP-25NET \$27.00

10 WATT 'SUPER' AMPLIFIER KIT

High gain P.A. amplifier for home or auditoriums seating up to 800 persons. Separate mike and phono inputs. Full 10 watts from 40 to 16,000 CPS. Tubes: 2—6SJ7, 1—6L6, 1—5Y3. Includes all parts, hardware, instructions, etc. 110 V. 60 cycles only. (Less tubes).

KIT NO. AMP-10NET \$15.00

CRYSTAL RADIO KIT

The first step in electronic education. Screwdriver construction (no soldering). Operates without batteries or power. Prefabricated tuning slide coil. Complete with all parts and instructions. (Less headphone).

KIT NO. CX-1NET \$1.11
HEADPHONE NO. Q-207NET \$1.50



2 TUBE AC-DC 'BC' RADIO

Four tube performance with two tubes. Features iron core permeability tuner, calibrated face plate, two hi-mu 6SL7 twin triodes. Kit includes tubes, all parts and simple PICT-O-GRAPH instructions.

KIT NO. RT-20NET \$9.60

'PAL' ONE TUBE AC-DC RADIO

Designed for the radio newcomer. Engineered for easy construction and efficient operation. No skill or knowledge required. Uses one 6SL7 dual triode (two tubes in one). Complete with tube, parts and PICT-O-GRAPH instructions.

KIT NO. T-10NET \$7.20

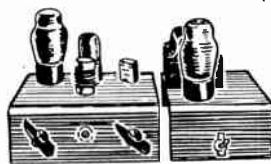

NOVICE TRANSMITTER

35 watts from 10-160 Mtrs. 6F6 tri-tet oscillator. 6L6 final. Pi-network. Resonance indicator. (Less tubes, coils, xtal).

KIT NO. X-30NET \$9.60
COIL C-3 (per band)NET \$1.11

X-30 POWER SUPPLY

Supplies full power for X-30. Matching chassis.

KIT PS-30 (Less 80 tube)\$9.60

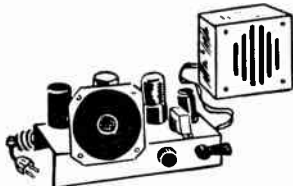

TWO STATION CALL SYSTEM KITS

Ideal for store, office, etc. Separate master and remote kits. Any remote may call master. Master calls all remotes. Tubes: 12SJ7, 50L6 and 35Z5. (Less tubes). PM speaker included in all kits. MASTER MASA (less cabinet)\$10.20
REMOTE CS-7 (incl. cabinet)\$ 4.05
CABINET (for MASA) C-6\$ 3.00

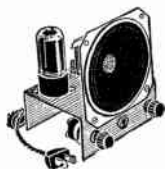

CODE OSCILLATOR KIT

Clear rich tone variable from 600 to 1,500 cycles. Full room volume. Speaker, headphone or both may be used. Includes parts, tube (117L7), speaker and instructions.

KIT NO. CP-12NET \$9.60
CODE KEY NO. Q-201NET \$.90
HEADPHONE NO. Q-207NET \$1.50

EAGLE PICT-O-GRAPHS

are a series of pictures faithfully reproduced from actual working models, showing the step-by-step procedure. They are simple and self-explanatory. EAGLE PICT-O-GRAPH KITS have been wired successfully without any knowledge of radio, and without the use of symbolic schematic diagrams.



4 TUBE AC-DC AMPLIFIER KIT

Exceptionally fine, compact amplifier. Similar to AM-30A (below) with added preamplifier to operate crystal or dynamic mike as well as crystal phono pickup. Tubes: 12SJ7, 12SQ7, 50L6 and 35Z5. Complete with all parts and instructions. (Less tubes).

KIT NO. AM-40ANET \$7.20

3 TUBE AC-DC AMPLIFIER KIT

Complete beam powered amplifier. Operates through phono crystal pickup or carbon mike. Excellent tone. Controlled speaker volume. Uses 3 tubes: 12SQ7, 50L6 & 35Z5 rectifier. Kit comes complete with parts and instructions. (Less tubes).

KIT NO. AM-30ANET \$5.40

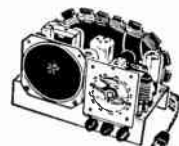

5 TUBE AC-DC 1 & 2 BAND SUPERHET RECEIVER KITS

For the advanced student. Sensitive and selective. Tunes from 6.9 to 17 Mcs. (20 and 40 Mtrs.) plus the BC range 540-1600 Kcs. Tubes: (not incl.) 12SA7, 12SK7, 12SQ7, 50L6 and 35Z5. Includes loop, speaker, etc.

KIT S520A (2 BANDS)NET \$16.20
MATCHED CABINET C5ANET \$ 3.00
KIT S500A (BC ONLY)NET \$14.40
MATCHED CABINET C5NET \$ 3.00



'MYSTERY' AC-DC PHONO OSCILLATOR KIT

Absolutely amazing! Talk or play records thru your own radio, without wires, up to 100 ft. away. No license required to operate. Uses 2 tubes: 6SA7 and 6SK7. Complete with all parts, tubes, hardware and easy PICT-O-GRAPH instructions.

KIT NO. PH-20NET \$5.40



TALK-A-PHONE

A System for Every Purpose

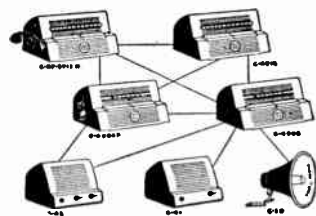
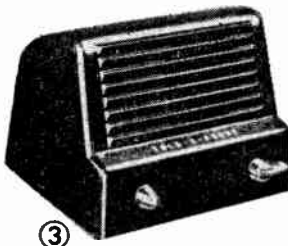
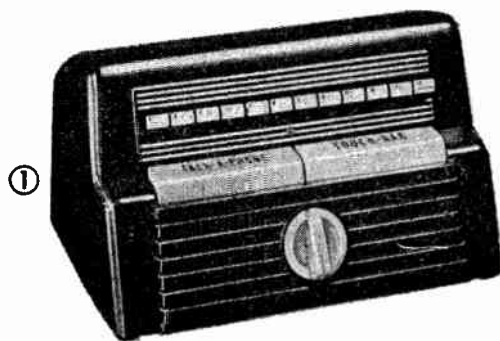

New "CHIEF" Talk-A-Phone
THE ONE MODEL THAT MEETS EVERY REQUIREMENT
The Answer to Your Intercommunication Problem



Setting a new standard in versatility and flexibility, the Talk-A-Phone "CHIEF" meets every intercommunication need of office, factory, institution or home. A touch of a button gives you instant, direct two-way Communication with every department. Saves time, increases efficiency, reduces loads on busy switchboards and enables executives and key personnel to cover more ground. It pays for itself many times over. Beautifully styled in streamlined impact bakelite cabinets. Walnut-finish.

"Chief" Universal Master Stations (Figure 1)

The "Chief" with its exclusive Dynasonic Design can be used in any combination—with all Master Stations—one Master and Staff Stations—or a number of Masters combined with Staff Stations. Six, 12, 20, 30, 40, 50, and 60, Station Masters, together with Staff Stations can be intermixed in same system. Masters can talk with any other Master, as well as with Staffs. Staff Stations can answer all Masters and can originate calls to as many as six Masters, depending upon Staff's capacity. Staff Stations are not connected to electrical outlet.

Exclusive Features: (1) **DYNASONIC DESIGN**—permits intermixing of units, variation of performance, and additions to system at any time. Some Staff Stations can be "private," others "non-private." Any Staff Station can be "non-private" to one or more Masters and "private" to others. (2) **MULTI-MAGIC SELECTOR**—enables selection of up to 40 stations with 12 push buttons (50 and 60 stations with 14 push buttons). (3) **UNI-TRANS**—for dictation... with no operation of controls necessary while speaking.

Optional: LD "Long Distance" (Figure 8)—for use between Master Stations over cables 2,000 ft., 5,000 ft., 10,000 ft. or even greater distances without loss of volume. Built-in at factory. At slight additional cost.

BUSY SIGNAL—on Master Stations. (Figure 7.) Visual indication when Master Station called is busy. Built-in at factory. At slight additional cost.

"CHIEF" (Figure 1) Master Stations are complete with tubes, junction box with 6-foot cable and instructions. Universal operation, 110-120 volts A.C. With push button selector and talk-listen control. Volume control with translucent light indicating when unit is on. Beautifully styled in streamlined impact bakelite cabinets. Walnut finish. Size 12" wide, 7" high and 9" deep.

- C-4906 Master 6 station capacity. Wt. 13 lbs. List Price per station \$ 89.50... Net **\$52.50**
- C-4912 Master 12 station capacity. Wt. 14 lbs. List Price per station \$106.00... Net **62.25**
- C-4920 Master 20 station capacity. Wt. 17 lbs. List Price per station \$125.00... Net **73.50**
- C-4930 Master 30 station capacity. Wt. 20 lbs. List Price per station \$144.00... Net **84.50**
- C-4940 Master 40 station capacity. Wt. 23 lbs. List Price per station \$163.00... Net **95.50**
- C-4950 Master 50 station capacity. Wt. 26 lbs. List Price per station \$182.00... Net **107.00**

"Chief" Redi-Power Master Stations (Figure 2)

"Chief" Redi-Power Master Stations have all the operational features listed above, plus the additional feature of built-in extra power for use when needed. This added power (up to 20 watts), gives you the additional volume needed, for example, when calling a number of stations at one time or calling noisy locations. Return speech from called stations is received at normal volume. Needs no separate power booster which would eliminate return speech. "Chief" Redi-Power has self-compensating volume, whether you call 2, 10 or 20 stations simultaneously. Each station receives its pre-determined volume with no division of output when you call more stations at one time. One or more Redi-Power Masters can be combined with regular Chief Masters and Staff Stations in same system. 110-120 volts. A.C. only.

Redi-Power Master Stations are also available with the added feature of pre-selected paging for each master unit as Model C-RP-5911. Provides 11-station capacity with one selector button for paging. Each Master may page its own pre-selected stations without any external paging equipment. 110-120 volts. A.C. only.

- C-RP-5912 Redi-Power Master 12 station capacity. Wt. 18 lbs. List Price per station \$160.00... Net **\$94.00**
- C-RP-5911 Redi-Power Master. 11 station capacity with pre-selective paging button. Wt. 18 lbs. List Price per station \$190.00... Net **112.00**
- C-RP-5920 Redi-Power Master 20 station capacity. Wt. 21 lbs. List Price per station \$179.00... Net **105.25**

"Chief" Models Available in Executive Gray Cabinets

For C-41 and C-42 Staff Stations. List Price each add \$2.50... Net add **\$1.50**
 For all Master Stations and C-46 Staff Station List Price each add \$4.00... Net add **\$2.50**

How to Determine Cable Requirements

To inter-connect Master Stations, measure from first Master to second Master only, from second to third Master only, etc., until the last unit in the system is reached, and total. For C-4920 and C-RP-5920, use two lengths of 6924 Cable; for C-4930 use three lengths of 6924 Cable, etc. To connect C-41, C-20, HP-2 or HP-3 Staff Stations, measure from Staff Station to the one Master to which Staff Station originates calls. To connect C-42 and C-46 Staff Stations measure a separate length of cable from Staff Station to each Master Station to which Staff originates calls (for each C-42 or C-46), follow same procedure.)

"Chief" Staff Stations (Figure 3)

For use with any "Chief" Master, Staff Stations may be connected "privately" or "non-privately." Connected "non-privately," persons can answer Master at a distance from the Staff without operation of any controls. Persons at "non-private" Staffs may reply to all Masters in the system (whether connected directly to them or not) and can originate calls to one, two, or up to six Masters, depending upon its capacity. Connected "privately" no one can "listen-in," but any Master can call Private Staff can originate calls and reply to 1, 2 or 6 Masters depending on its capacity. Staff Stations do not need electrical outlet. Handsomely styled in molded impact bakelite cabinets. Walnut finish. Size: 8 1/4" wide, 6 3/4" high, 7 1/2" deep.

- C-41 Staff Station for origination of call to one Master. Wt. 5 lbs. List Price each \$29.00... Net each **\$12.95**
- C-41M Same operation as C-41, but in brown metal case. Wt. 3 lbs. List Price each \$22.00... Net each **12.95**
- C-42 Staff Station for origination of call to two Masters. Wt. 5 lbs. List Price each \$29.00... Net each **17.00**
- C-42M Same operation as C-42, but in brown metal case. Wt. 3 lbs. List Price each \$22.00... Net each **17.00**
- C-46 Push Button Staff Station for origination of call to six Masters. Wt. 9 lbs. List Price each \$65.00... Net each **38.00**
- HP-3 Hi-Power Staff Station for wall mounting. Brown metal case. 5 watt capacity. Wt. 8 lbs. List Price each \$25.00... Net each **14.70**
- HP-2 Super Staff Station for wall mounting. Brown metal case. 15 watt capacity. Wt. 9 lbs. List Price each \$44.95... Net each **26.50**
- C-20 Nine-inch Weatherproof Re-Entrant Horn. For greater volume. (Fig. 4.) Capacity, 15 watts, with bracket for wall mounting. Wt. 5 lbs. List Price each \$44.95... Net each **26.50**

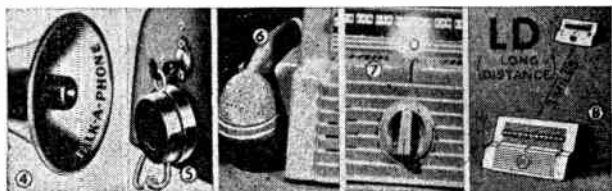

Optional Equipment

- Grade Phone (Fig. 6) Available on all Models, except metal staffs. Add "H" to Model No. when ordering. List Price each—add \$45.00... Net add **\$26.45**
- Earphone (Fig. 5) Available on all Models. Add "X" to Model No. when ordering. List Price each—add \$20.00... Net add **12.00**
- Busy Signal (Fig. 7) Available on all "Chief," "49" and "REDI-POWER" Masters. Add "B" to Model No. when ordering. List Price each—add \$12.00... Net add **7.00**
- LD—Long Distance Feature (Fig. 8) Available on "Chief," "49" and "REDI-POWER" Masters. Add "LD" to Model No. when ordering. List price each—add \$20.00... Net add **11.75**
- S-101 Wall Switch for origination of call through C-20, HP-2 or HP-3 in Chief systems. List Price each \$5.00... Net **2.95**
- S-102 Wall Switch for origination of call to two Masters through C-20, HP-2 or HP-3 in Chief systems. List Price each \$9.00... Net **5.25**
- Net RW-10 Right-of-Way Relay. For use with C-RP-5912-5920 Masters. To call any group of stations with single button. Capacity 10 stations. Add relays for greater number. Connects to one Master, others in system also utilize facility. List price each \$56.00... Net **32.95**

Cable

- 6924 Cable for connecting C-41, C-42, C-46, HP-3, C-20 and HP-2. List price per ft. 10c... Net per ft. **\$.06**
- 6912 Cable for inter-connecting C-4906 Masters. List Price per ft. 24c... Net per ft. **.14**
- 6924 Cable for inter-connecting C-4912, C-4920, C-4930, C-4940, C-4950, C-RP-5911, C-RP-5912 and C-RP-5920 Masters. List Price per ft. 47c... Net per ft. **.28**
- 6902 Cable for connecting HP-3, C-20 and HP-2 without origination of call. List Price per ft. .03 1/2c... Net per ft. **.02**



A System for Every Purpose

TALK-A-PHONE

THE ANSWER TO YOUR INTERCOM PROBLEMS

TALK-A-PHONE—designed, developed and precision-engineered by the leader in its field, with more than a quarter-century experience in electronics—proved in billions of hours of actual use. For the Home, Farm, Professional Man, Office and Business. A flick of a finger gives you instant and direct two-way conversation between any two points—anywhere. Designed to withstand continuous day and night use, TALK-A-PHONE operates at but a fraction of a cent a day . . . and it can be installed by anyone. All units are complete, ready to plug in. Walnut impact bakelite cabinets. Cabinets measure 8 1/4" x 6 1/4" x 7 1/2". Underwriters Laboratories Approved.



Master Selective Systems



A system consisting of one Master Station and one to ten Sub-Stations. Master Station can talk and listen to any one Sub-Station or with all simultaneously. Sub-Stations do not communicate with each other. Only the Master Station plugs into an electrical outlet. You may start with only one Master and one or two Sub-Stations and then add later when necessary. Installation of system has optional feature, whereby Sub-Stations can be connected "privately" or "non-privately" and still originate calls to the Master under either application. Once a conversation has been initiated with a "non-private" system, persons at Sub-Stations need operate no controls and can reply from a distance. When the system is connected "privately," Master unit cannot "listen in" on Sub-Stations. However, they can reply when called, and also originate calls to the Master. Operates universally on 110-120 volts, AC-DC, U.L. Approved. The AC-5406 and AC-5411 Master Stations operate as above with the added feature of 10 times volume output. A desirable feature for large areas or noisy locations. Operates on 110-120 volts, AC only. Only one master station can be used in these systems.

- Model LM-5 Master Selective Station for 5 Sub-stations, complete with tubes and easy-to-follow instructions. Wt. 7 lbs. List Price each \$45.00.
- Model LR-3 Sub-Station for use with LM-5 or LM-10 Masters. Wt. 5 lbs. List Price each \$15.95.
- Model LR-3M Sub-Station in brown metal case. Wt. 3 lbs. List Price each \$15.95.
- Model AC-5406 Master Station. 5 sub-station capacity. High Volume Output. Wt. 8 lbs. List Price each \$55.00.
- Model AC-5411 Master Station. 10 sub-station capacity. High Volume Output. Wt. 8 lbs. List Price each \$68.00.
- Model AR-3 Sub-Station for use with AC-5406 or AC-5411 Masters. Wt. 5 lbs. List Price each \$16.95.
- Model AR-3M Same as AR-3 above, but in brown metal case. Wt. 3 lbs. List Price each \$16.95.
- Model HP-3 Hi-Power Staff Station for wall mounting. Brown metal case. Wt. 8 lbs. List Price each \$25.00.
- Model C-20 Nine-Inch Weatherproof Re-entrant Horn. Wt. 5 lbs. List Price each \$44.95. Net each \$26.50.
- S-100 Wall Switch for origination of call through C-20 or HP-3. List Price each \$5.00. Net each \$3.00.
- No. 5303 (3-conductor) Cable for connecting Sub-Stations to Master. List Price per foot 5c. Net per foot .03.

TALK-A-PHONE DE LUXE SYSTEMS

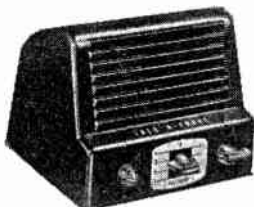

Super Selective Systems



A system of all Master Stations. Any Station can call any other Station. Several completely private 2-way conversations are possible at same time. A versatile, low cost intercom system offering extreme flexibility, meeting many requirements in industry, offices, homes, etc. Any Station can call and carry on a conversation with any other Station in the system with absolute "privacy." Have a visitor in your office and your mind is at ease that no one can eavesdrop on your conversation. Stations can be located even 1000 feet apart. Variable volume, adjustable for each unit, controls and incoming voice. You can start with two or three masters, and then add later as required. Operates universally on 110-120 volts, AC-DC, U.L. Approved.

- Model LS-5 Super Selective Station for five Masters, complete with tubes and easy-to-follow instructions. Wt. 7 lbs. List Price each \$45.00. Net each \$26.45.
- Model LS-10 Super Selective Station for ten Masters, complete with tubes and easy-to-follow instructions. Wt. 7 lbs. List Price each \$58.00. Net each \$34.00.
- No. 5506 (6-conductor) Cable for connecting LS-5 Masters. List Price per foot 13c. Net per foot .07 1/2.
- No. 9911 (11-conductor) Cable for connecting LS-10 Masters. List Price per foot 24c. Net per foot .14.

Combination Systems

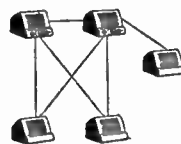

For the more flexible type of system requiring operation of more than one Master Station, along with Sub-Stations which need not originate calls. Personnel can answer incoming calls even though they are 25 to 40 feet from their unit. Master Stations may talk to each other and to all Sub-Stations in the system selectively, or you can have one or more Sub-Stations which are exclusive to only one Master Station (as illustrated in the diagram at left). Master Stations have the option of making themselves "private" or "non-private" at will. You can begin with two stations (at least one must be a Master) and add other units as required. Model CL-5 Master Station has a total inter-connecting capacity of five stations, including Masters and Sub-Stations; while Model CL-10 Master Station has a total capacity of ten stations. Sub-Stations are not plugged in to a source of electric current. Operates universally on 110-120 volts, AC-DC, U.L. Approved.

- Model CL-5 Combination Master for five station use, complete with tubes and easy-to-follow instructions. Wt. 7 lbs. List Price each \$55.00. Net each \$32.35.
- Model CL-10 Combination Master for ten station use, complete as above and with addition of junction box attached by 6' cable to unit. Wt. 8 1/2 lbs. List Price each \$74.00. Net each \$43.50.
- Model LR-2 Sub-Station for use with either of above Masters. List Price each \$15.95. Net each \$9.35.
- Model LR-2M Same as LR-2, but in brown metal case. Wt. 3 lbs. List Price each \$15.95. Net each \$9.35.
- Model HP-3 Hi-Power Sub-Station for wall mounting in brown metal case. Wt. 8 lbs. List Price each \$25.00. Net each \$14.70.
- Model C-20 Nine-inch weatherproof re-entrant horn. List Price each \$44.95. Net each \$26.50.
- No. 6212 (6-pair) Cable for interconnecting CL-5 Masters. List Price per foot 24c. Net per foot .14.
- No. 6224 (12-pair) Cable for interconnecting CL-10 Masters. List Price per foot 47c. Net per foot .28.
- No. 6902 (2-conductor) Cable for connecting Sub-Stations to CL-5 or CL-10. List Price per foot 3 1/2c. Net per foot .02.

2-Station Inter-Communication System

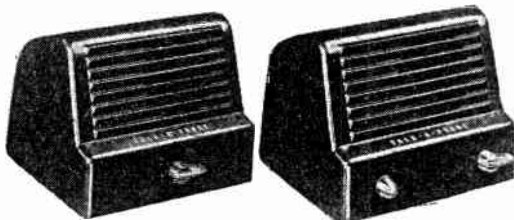

Provides voice communication between any two points. For homes, stores, offices, farms, etc. Ideal for nursery. No more getting up and down to see if baby is all right with "Elsie" on the job. "Elsie" is a packaged item, complete with a Master Station, a Sub-Station and 50 feet of interconnecting cable. Additional cable lengths are available for greater distances. "Elsie's" Sub-Station can optionally be operated "privately," so that the Master cannot listen in (but Sub-Station can answer calls and also originate calls), or "non-privately," allowing the Master to "listen in" and enabling persons at a distance from the Sub-Station to answer without operation of any controls. The volume can be adjusted from a bare whisper to the full output of the powerful high gain amplifier. Operates universally on 110-120 volts, AC-DC, U.L. approved.

- Model LC-2 2-Station System complete with tubes, easy-to-follow instructions, and 50 feet of cable. Wt. 11 lbs. List Price complete \$51.00. Net complete \$29.95.
- No. 5303 (3-conductor) Cable. For use where additional lengths are required between the Master and the Sub-Station. List price per foot 5c. Net per foot .03.

The New TALK-A-PHONE Wireless Intercom with the Exclusive "Sonic Gate" Circuit



A quality wireless intercom system for use in Homes, Apartments, Offices, Stores, Factories and Farms. No installation, no wiring, no cables. Just plug in any electrical outlet and talk. More stations can be added at any time; all stations will receive any messages transmitted by any other station. Mobile-users can be moved anywhere an electrical outlet is available. Uni-trans gives you dictation and supervisory control. When set for Uni-Trans, unit provides continuous transmission to other unit, to dictate or to "listen in" . . . for example, on baby's room. The "Sonic Gate," together with the Talk-A-Phone "Squelch," effectively suppresses line noises and hum while system is in actual operation as well as when in stand-by position. Beautifully styled in sturdy, impact bakelite cabinets, finished in rich walnut or executive gray. For 110-120 volt AC-DC, size 8 1/4" x 6 1/4" x 7 1/2". Complete with tubes and instructions.

- LC-33 consists of two master stations. Shipping weight 14 lbs. Walnut cabinets. List Price complete \$120.00. Net \$69.95.
- Executive Gray Cabinets. List Price complete \$125.00. Net \$72.95.
- LC-17 Additional single station. Shipping weight 7 lbs. Walnut Cabinet. List Price complete \$60.00. Net \$35.00.
- Executive Gray Cabinet. List Price complete \$62.50. Net \$36.50.

Earphones—Units above available with earphone attachment. List Price per station add \$20.00. Net add \$12.00.
Executive Gray Cabinets available at additional cost. List Price each unit, add \$2.50.
For LC-2 (2-Station System) List Price add \$5.00. Net add 3.00.

HOW TO DETERMINE CABLE REQUIREMENTS

For MASTER SELECTIVE SYSTEMS measure from each Sub-Station to the Master and order total. For SUPER SELECTIVE SYSTEMS—(LS-5, LS-10)—measure from first Master to second Master only, from second Master to third Master only, etc., and from second Master to third Master, net total. Cable between first and last Master not necessary. For COMBINATION SYSTEMS, (CL-5, CL-10)—Master cable, measure from first Master to second Master only, from second Master to third Master only, etc., and total, Sub-Station cable, measure from each Sub-Station to nearest Master only.



For more complete installations . . . send for information on the TALK-A-PHONE "CHIEF" Intercom Systems.

Thank You!

When writing for additional
information or when ordering
from sources of supply listed
in this book, please mention

RADIO'S MASTER



RCA ELECTRONIC COMPONENTS

SPEAKERS ANTENNA ACCESSORIES

RCA SPEAKERS—Quality Engineered for Superior Performance

- Alnico V magnets used for all PM types.
- Rugged mechanical construction with welded housing assembly.
- Moisture-resistant cone and voice-coil suspension assures high efficiency and dependability.
- Dust-sealed and rust resistant.
- RETMA mounting standards are followed.
- Speaker mounting bracket supplied with all 4", 4" x 6" and 5" PM types.
- Universal transformer mounting bracket supplied on all 4", 4" x 6", and 5" PM types.



A Complete Line for Your Replacement Needs

PERMANENT-MAGNET TYPES

Size	RCA Type	Magnet Weight oz.	Voice-Coil Impedance* ohms	Power Rating watts	Sugg'd List Price
2" x 3"	214S1	1.0	11.8	0.125	\$4.75
3"	216S1	1.0	3.2	2	3.70
4" (shallow pot type)	304S2	1.0	3.2	3	4.00
4"	404S2	1.47	3.2	3	4.35
4" x 6"	246S2	0.68	3.2	3	4.20
4" x 6"	446S2	1.47	3.2	3	4.75
5"	205S2	0.68	3.2	3	4.00
5"	405S2	1.47	3.2	3	4.60
5 3/4"	217S1	1.0	3.2	4	4.00
5" x 7"	257S1	1.47	3.2	6	5.75
6 1/2"	220S1	2.15	3.2	4	5.20
6" x 9"	218S1	2.9	3.2	8	8.25
8"	208S2	2.15	3.2	8	7.50
8"	208S4	2.15	6-8	8	7.50
10"	215S1	6.8	6-8	10	13.25
12"	112S1	2.15	3.2	12	10.50
12"	412S6	6.8	3.2	12	13.75
12"	412S7	6.8	6-8	12	15.00

*Measured at 400 cps. except Type 214S1 which is measured at 1000 cps.

FIELD-COIL TYPES

Size	RCA Type	FIELD COIL		Voice-Coil Impedance* ohms	Power Rating watts	Sugg'd List Price
		DC Resistance ohms	Current ma			
4" x 6"	746S1	450	65	3.2	3	\$6.00
5"	705S1	450	65	3.2	3	6.00
6" x 9"	869S1	6	1000	3.2	8	8.25
12"	712S2	1000	70	3.2	12	14.00

ANTENNA ACCESSORIES

UHF LIGHTNING ARRESTERS (UL Approved)

- Ultra Low Loss • For Popular Type Transmission Lines

Standing-wave ratio less than 2:1 at 800 Mc. Low-capacitance design. Low loss... approximately 1 db at 800 Mc. Will accommodate most of the tubular round and over UHF transmission lines without the need of splicing or baring conductors. Resistance elements are made of a conductive rubber that is non-corrosive and impervious to moisture.

Screw Type 234A1 Suggested List Price: \$1.53
Strap Type 235A1 Suggested List Price: \$1.40

VHF LIGHTNING ARRESTERS (UL Approved)

- For 300-Ohm Ribbon-type Line • Simple to Install

Screw Type for use with FM and TV antennas. Easy to install—no cutting or stripping of transmission line. Fits any 1/2"-2" pipe. Continually dissipates static surges. Does not unbalance line. Type 214X1 Suggested List Price: \$1.10

Strap Type Arrester — wood screw firmly secured in body — no special tools needed. No cutting or stripping of transmission line. Type 215X1 Suggested List Price: \$1.25

TV SET COUPLER (UL Approved)

- For 300-Ohm Ribbon-type Line • Easy to Install • Economical

The RCA-240A1 TV Set Coupler permits simultaneous operation of two TV receivers from a common antenna. Can also be used in combinations of two to four units for simultaneous operation of two to four TV receivers from a common antenna. The 240A1 reduces oscillator radiation between sets and has a flat bandpass response over the VHF bands. No cutting, splicing, or soldering necessary. Self-contained wood screw, no special tools needed.

Type 240A1 Suggested List Price: \$1.95 each



234A1

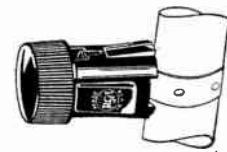

235A1

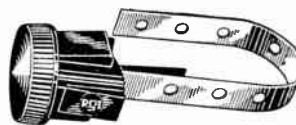

214X1

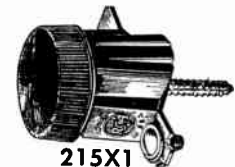

215X1



240A1



SPEAKERS

A Speaker For Every Application!

HIGH-FIDELITY ★ LONG LIFE

CATALOG NUMBER	Size (Inches)	Magnet Weight (Ozs.)	Rating Power (Watts)	V.C. Imp. (Ohms)	Response (Cycles)	List Price*
HIGH FIDELITY SPEAKERS						
1201A	12	14.5	25	8.0	50 to 13,000	\$20.37
1203A	12	9.0	25	8.0	50 to 13,000	14.22
PUBLIC ADDRESS SPEAKERS						
818D	8	6.8	12	8.0	80 to 10,000	14.40
1018D	10	6.8	12	8.0	60 to 7,000	18.10
1218D	12	6.8	12	8.0	60 to 8,000	19.55
DRIVE-IN THEATRE SPEAKERS						
400C22	4	1.3	4	3.2	160 to 7,000	4.00
525C18	5¼	1.3	4	3.2	120 to 7,000	4.30
GENERAL REPLACEMENT SPEAKERS						
400D	4	1.3	4	3.2	140 to 7,000	4.60
402D	4	1.0	4	3.2	140 to 7,000	4.25
403D	4	.68	4	3.2	140 to 7,000	4.00
500D	5	1.3	4	3.2	125 to 8,000	4.80
503D	5	.68	4	3.2	125 to 8,000	4.20
525D	5¼	1.3	4	3.2	120 to 7,000	5.00
526D	5¼	1.0	4	3.2	120 to 7,000	4.65
527D	5¼	.68	4	3.2	120 to 7,000	4.60
625D	6½	1.3	4	3.2	110 to 9,000	5.20
626D	6½	1.0	4	3.2	110 to 9,000	5.00
650D	6½	2.98	8	3.2	100 to 10,000	6.10
703D	6x9	1.47	8	3.2	70 to 13,000	8.65
800D	8	2.98	8	3.2	80 to 11,000	10.30
810D	8	6.8	12	3.2	80 to 10,000	13.80
1000D	10	6.8	12	3.2	60 to 7,000	17.55
1001D	10	14.5	25	8.0	60 to 8,000	28.45
1003D	10	9.0	25	8.0	60 to 8,000	21.30
1012D	10	3.16	12	3.2	60 to 7,000	11.80
1200D	12	6.8	12	3.2	60 to 8,000	19.00
1212D	12	3.16	12	3.2	60 to 8,000	12.95

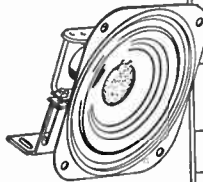

4" Speaker

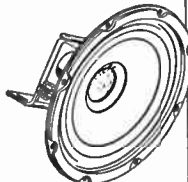

5" Round Speaker

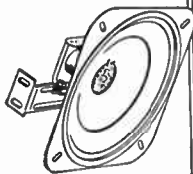

5¼" Speaker



6" x 9" Speaker

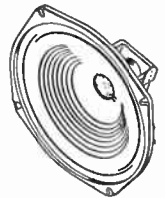

6½" Speaker

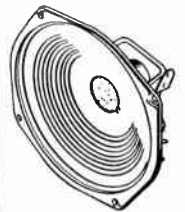

8" Speaker



10" Speaker

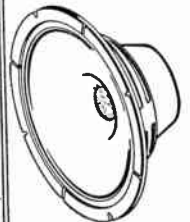

12" Speaker

*Prices subject to change without notice.

WRITE FOR COMPLETE INFORMATION: General Electric Company, Section R394, Electronics Park, Syracuse, New York.

GENERAL ELECTRIC

**speakers, cabinets
multicellular horns**

ALTEC
LANSING CORPORATION

9356 Santa Monica Blvd.
Beverly Hills, Calif.
161 Sixth Avenue
New York 13, N.Y.

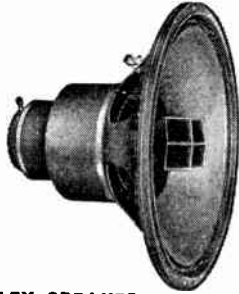

604C DUPLEX SPEAKER

The 604C Duplex is the finest single speaker on the market. Factory guaranteed frequency range from 30-22,000 cycles. Handles 50 watts peak power. The perfect speaker for music systems, highest quality paging, and public address. 90° horizontal distribution, 30° vertical. Network impedance, 16 ohms. Dimensions: 15 7/8" diam., 11 1/8" deep. Weight with network, 40 pounds.

Net Price including Network: \$156.00

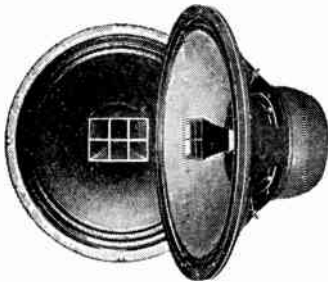

601A and 602A DUPLEX SPEAKERS

Highest quality for the home. Completely independent high and low frequency speakers in a single frame. Factory guaranteed range of 30-22,000 cycles.

601A—POWER: 20 watts cont.; 35 watts peak. IM-PEDANCE: 8 ohms. DIM.: 12 1/4" diam., 5 1/2" deep. WT. with network: 17 lbs.

Net Price with network: \$99.00

602A—POWER: 20 watts cont.; 35 watts peak. IM-PEDANCE: 8 ohms. DIM.: 15 7/8" diam., 7 1/4" deep. WT. with network: 25 lbs.

Net Price with network: \$114.00

CABINETS

Engineered for high quality sound reproduction. Cabinets are made of heavy plywood. All joints are screwed and glued. Interiors padded to eliminate spurious rattles and reflections. Code letters show speaker size: A-15"; B-12"; C-8".

605-A—Furniture Finish Walnut or Mahogany. Height 35 3/4", Width 31", Depth 17 1/8".
Net Price: \$165.00

606-A, B—Corner cabinet. Height 36 1/2", Width 36", Depth 23 1/2".
Walnut or Mahogany Net Price: \$122.00
Limed Oak Net Price: \$128.00

612-A, B—Hammertone Gray. Height 29 1/2", Width 25 1/2", Depth 17 3/4".
Net Price \$56.00

614-A, B, C—Portable, Hammertone Gray. Height 24 3/4", Width 18 3/4", Depth 14 1/4".
Net Price \$47.50

618-B, C—Portable, Slanting Front, Hammertone Gray. Height 22", Width 17", Depth 13 3/4".
Net Price: \$36.00

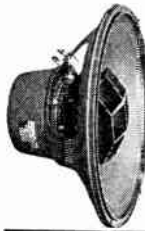

603B MULTICELL DIA-CONE SPEAKER

Offers high efficiency, broad distribution, wide frequency response, freedom from distortion. Dia-Cone principle provides extended frequency response. Multicellular horn loads high frequency diaphragm and distributes sound over 60° hor., 40° vert.: 15" cone insures full bass reproduction and 25 watt power-handling capacity. Voice coil: 8 ohms. Weight: 18 lbs. Diameter: 15 3/8". Depth 7".
Net Price: \$75.00



600B DIA-CONE SPEAKER

Efficiency, small space requirements, light weight and superior quality of reproduction, make the 600B an ideal unit in the lower priced speaker field. Utilizes Dia-Cone principle. Similar in construction to the 603B. V. C. 8 ohms. Power rating: 20 watts. Weight: 12 lbs. Diameter: 12 1/4". Depth: 5 1/4".
Net Price: \$46.50



400B DIA-CONE SPEAKER

Designed for use where the benefits of large-speaker performance cannot be utilized because of space and weight limitations. An extremely efficient, high quality unit, it is ideal for use in portable devices, airplanes, busses, etc. V. C. imp. 8 ohms. Power rating: 12 watts. Weight: 4 lbs. Diameter: 8 1/4". Depth: 3 5/8".
Net Price: \$22.50



755A SPEAKER*

Exceptional frequency response, small size and moderate power handling capacity provide an ideal combination for low level distribution systems where multiple speakers are used. Its small size makes wall installations practical and easy. 70-13,000 cps. Impedance, 4 ohms. 8 watts. Dimensions: 8 3/4" dia. x 3 3/8" deep. Weight: 4 1/2 lbs.

List Price: \$30.95

*Distributed by Graybar Electric Co.

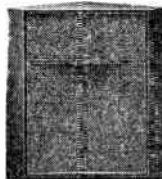

820A CORNER SPEAKER SYSTEM

The Concert Grand of the loudspeaker world—full two-way system built into an attractive mahogany corner cabinet—includes newly designed direct radiating horn in reflex cabinet, an 802B H.F. unit mounted on H-808 multicellular horn, two 803A L.F. units and an N-800D (800 cycle) network. Provides unsurpassed quality over the entire audio range for home music installations, small auditoriums, audition rooms, etc. Impedance 12 ohms—30 watts. Dimensions: height 47 3/4"; maximum width 42 1/2"; maximum depth 29". Wt. 230 lbs.

Net Price: \$525.00

821A frame only—Net Price: \$99.00

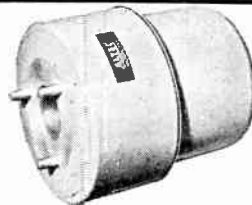

290C DRIVER UNIT

For use with Altec multicellular horns. When attached to H-808 8 cell horn will produce sound level of 127 db at 5 feet with an input of 150 Watts warble frequency of 700-1300 cycles. Diaphragm and voice coil unit field replaceable. 300-8000 cycles. Has provision for mounting 15945-70 volt matching transformer under weather proof hood. Continuous power above 300 cycles 125 Watts, peak 150 Watts. When used as all-range speaker must attenuate frequencies below 300 cps. Impedance 4 ohms. Dimensions: 5 1/2" diameter, 7 1/2" high, weight 19 lbs.

Net Price without transformer \$195.00

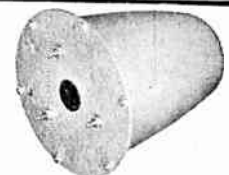

730A DRIVER UNIT

For use with Altec 30A and 40A horns. Has provision for mounting 15037X-70 Volt matching transformer under weather proof hood. 200-7,000 cycles. Diaphragm and voice coil assembly field replaceable. Power 40 Watts continuous, 80 Watts peak. When used as all-range speaker must attenuate frequencies below 200 cps. Impedance 8 ohms. Dimensions: 5 1/2" diameter, 7" high.

Net Price without transformer \$36.00



SPEAKERS

These speakers are engineered and manufactured solely for the replacement field for use in home receivers, auto sets, television sets and intercommunication systems. RETMA standard dimensions. Fully dust-proofed. Baked aluminum enamel finish. RETMA service guarantee. QUAM UNIVERSAL MOUNTING BRACKET comes with all 3 1/2" to 6 1/2" speakers and may be attached to any two of the FOUR mounting holes in the U shaped pot. Voice coil impedance of speakers listed below is 3.2 ohms ±10%.

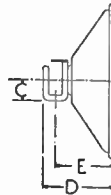

Fig. A

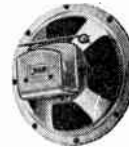

Fig. B



Fig. C

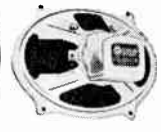

Fig. D

QUAM ADJUST-A-CONE® SUSPENSION

This patented QUAM feature is your added assurance of trouble-free operation. In other speakers the spider is cemented in place with no means of accurate adjustment. The Adjust-a-Cone suspension permits precision centering of the voice coil as a final production operation.

QUAM U-SHAPED COIL POT

Another QUAM exclusive, this patented U-shaped coil pot construction, used throughout the QUAM replacement line, provides an unbroken flux path of sufficient cross-section to carry the full energy of the magnetic field.

REPLACEMENT SPEAKERS

ED — Electro Dynamic Speakers

PM — Permanent Magnet Speakers

TYPE	CAT. No.	SIZE	FIGURE	FIELD	MAX. WATTS INPUT (approx.)	DIMENSIONS IN INCHES			SHIP. WT., LBS.	LIST PRICE
						C	D	E		
ED	3E45	3 1/2"	A	450 Ohms	2.5	1-1/4	1-7/8	1-1/4	3/4	\$ 4.40
PM	3A07*	3 1/2"	A	.68 oz. Alnico 5	2.5	3/4	1-19/32	1-3/16	1/2	4.00
ED	4E45	4"	A	450 Ohms	3	1-1/4	2	1-7/16	1	4.40
	4E10	4"	A	1000 Ohms	3	1-1/4	2	1-7/16	1	4.40
	4E27	4"	A	2700 Ohms	3	1-1/4	2	1-7/16	1	4.40
PM	4A07*	4"	A	.68 oz. Alnico 5	3	3/4	1-23/32	1-5/16	1/2	4.00
	4A1	4"	A	1.0 oz. Alnico 5	3	1	2-3/16	1-9/16	3/4	4.25
	4A15	4"	A	1.47 oz. Alnico 5	3	1	2-3/16	1-9/16	3/4	4.70
ED	5EY6	5"	C	6 Volt	3.5	1-1/4	2-1/8	1-19/32	1-1/4	4.60
	5E45	5"	C	450 Ohms	3.5	1-1/4	2-1/8	1-19/32	1	4.60
	5E10	5"	C	1000 Ohms	3.5	1-1/4	2-1/8	1-19/32	1	4.60
	5E18	5"	C	1800 Ohms	3.5	1-1/4	2-1/8	1-19/32	1-1/4	4.60
	5E27	5"	C	2700 Ohms	3.5	1-1/4	2-1/8	1-19/32	1	4.60
PM	5A07*	5"	C	.68 oz. Alnico 5	3.5	3/4	1-7/8	1-7/16	3/4	4.20
	5A1	5"	C	1.0 oz. Alnico 5	3.5	1	2-5/16	1-11/16	1	4.45
	5A15	5"	C	1.47 oz. Alnico 5	3.5	1	2-5/16	1-11/16	1	4.85
ED	5ZEV6	5 1/4"	A	6 Volt	4	1-1/4	2-1/2	1-13/16	1-1/2	5.00
	5ZE10	5 1/4"	A	1000 Ohms	4	1-1/4	2-1/2	1-13/16	1-1/4	5.00
PM	5ZA1	5 1/4"	A	1.0 oz. Alnico 5	4	1	2-23/64	1-3/4	1	4.65
	5ZA21	5 1/4"	A	2.15 oz. Alnico 5	4	1-1/8	2-5/8	1-7/8	1-1/4	5.70
ED	6EV6	6 1/2"	C	6 Volt	5	1-1/4	2-23/32	2-1/32	1-1/2	5.40
	6EHV6	6 1/2"	C	6 Volt	6	1-31/64	2-25/32	2-1/16	2	6.10
	6E10	6 1/2"	C	1000 Ohms	5	1-1/4	2-23/32	2-1/32	1-1/2	5.40
	6E18	6 1/2"	C	1800 Ohms	5	1-1/4	2-23/32	2-1/32	1-1/2	5.40
	6E25	6 1/2"	C	2500 Ohms	5	1-1/4	2-23/32	2-1/32	1-1/2	5.40
	6E45	6 1/2"	C	450 Ohms	5	1-1/4	2-23/32	2-1/32	1-1/2	5.40
PM	6A1	6 1/2"	C	1.0 oz. Alnico 5	5	1	2-5/8	2	1	4.80
	6A15	6 1/2"	C	1.47 oz. Alnico 5	5	1	2-5/8	2	1	5.20
	6A21	6 1/2"	C	2.15 oz. Alnico 5	5	1-1/8	2-7/8	2-1/8	1-1/4	5.85
	6A31	6 1/2"	C	3.16 oz. Alnico 5	6	1-3/8	3-11/64	2-9/32	1-3/4	6.75
ED	7EV6	7"	F	6 Volt	7	1-9/32	2-3/4	—	2	6.75
	7EV6A†	7"	F	6 Volt	7	1-9/32	2-3/4	—	2	6.75
PM	7A21*	7"	F	2.15 oz. Alnico 5	6	7/8	2-21/32	—	1	7.25
	7A31	7"	F	3.16 oz. Alnico 5	9	1-1/4	3-1/32	—	2	8.50
ED	8EV6	8"	C	6 Volt	7	1-1/4	3-9/32	—	1-3/4	6.75
	8E10	8"	C	1000 Ohms	7	1-1/4	3-9/32	—	1-1/2	6.75
	8EH10	8"	C	1000 Ohms	9	1-11/32	3-13/16	—	2-1/4	7.75
	8E18	8"	C	1800 Ohms	7	1-1/4	3-9/32	—	1-3/4	6.75
	8EH18	8"	C	1800 Ohms	9	1-11/32	3-13/16	—	2-1/4	7.75
	8E25	8"	C	2500 Ohms	7	1-1/4	3-9/32	—	1-1/2	6.75
	8EH25	8"	C	2500 Ohms	9	1-11/32	3-13/16	—	2-1/4	7.75
PM	8A21	8"	C	2.15 oz. Alnico 5	7	1-1/8	3-13/32	—	1-1/2	7.20
	8A31	8"	C	3.16 oz. Alnico 5	9	1-3/8	3-21/32	—	2-1/4	8.50
ED	10E60	10"	B	600 Ohms	10	1-3/4	5-1/16	—	4	10.50
	10E10	10"	B	1000 Ohms	10	1-3/4	5-1/16	—	4	10.50
	10E15	10"	B	1500 Ohms	10	1-3/4	5-1/16	—	4	10.50
	10E25	10"	B	2500 Ohms	10	1-3/4	5-1/16	—	4	10.50
PM	10A31	10"	B	3.16 oz. Alnico 5	9	1-3/8	4-1/2	—	2-3/4	10.50
	10A4A	10"	B	4.64 oz. Alnico 5	10	1-3/8	4-1/2	—	3-1/4	11.70
	10A6A	10"	B	6.8 oz. Alnico 5	12	1-7/16	4-5/8	—	3-3/4	13.60
ED	12E60	12"	B	600 Ohms	12	1-3/4	5-5/8	—	5	12.65
	12E10	12"	B	1000 Ohms	12	1-3/4	5-5/8	—	5	12.65
	12E15	12"	B	1500 Ohms	12	1-3/4	5-5/8	—	5	12.65
	12E25	12"	B	2500 Ohms	12	1-3/4	5-5/8	—	5	12.65
PM	12A31	12"	B	3.16 oz. Alnico 5	10	1-1/4	4-19/32	—	3-3/4	11.35
	12A4A	12"	B	4.64 oz. Alnico 5	12	1-3/8	5-1/8	—	4	12.65
	12A6A	12"	B	6.8 oz. Alnico 5	14	1-7/16	5-1/4	—	4-1/2	14.50

*Very shallow construction.

†Rotated Pot

3 1/2" Speakers — without Adjust-a-Cone suspension.



SPEAKERS

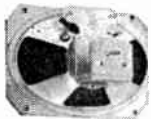

Fig. E



Fig. F



Fig. G



Fig. H

QUAM speakers have been produced under the same management since 1923 and are used by leading set and sound manufacturers throughout the world. Only QUAM speakers use the Adjust-a-Cone feature and the U shaped coil pot. Fully protected by patents—their use insures customer satisfaction.

Replacement Speakers (Cont'd)

TYPE	CAT. No.	SIZE	FIGURE	FIELD	MAX. WATTS INPUT (approx.)	DIMENSIONS IN INCHES			SHIP. WT., LBS.	LIST PRICE
						C	D	E		
ED	46E45	4"x6"	E	450 Ohms	3.5	1-5/64	2-15/64	1-5/8	1-1/4	\$ 5.30
	46E10	4"x6"	E	1000 Ohms	3.5	1-5/64	2-15/64	1-5/8	1-1/4	5.30
	46E15	4"x6"	E	1500 Ohms	3.5	1-5/64	2-15/64	1-5/8	1-1/4	5.30
PM	46A07*	4"x6"	E	.68 oz. Alnico 5	3.5	3/4	1-15/16	1-27/64	3/4	4.45
	46A1	4"x6"	E	1.0 oz. Alnico 5	3.5	1	2-1/4	1-9/16	1	4.75
	46A15	4"x6"	E	1.47 oz. Alnico 5	3.5	1	2-1/4	1-9/16	1	5.15
ED	57E45	5"x7"	D	450 Ohms	5	1-1/4	3-1/64	2-11/32	1-1/2	6.00
	57E10	5"x7"	D	1000 Ohms	5	1-1/4	3-1/64	2-11/32	1-1/2	6.00
PM	57A1	5"x7"	D	1.0 oz. Alnico 5	5	1	2-57/64	2-9/32	1	5.40
	57A15	5"x7"	D	1.47 oz. Alnico 5	5	1	2-57/64	2-9/32	1	5.80
	57A21	5"x7"	D	2.15 oz. Alnico 5	5	1-1/8	3-9/64	2-13/32	1-1/4	6.45
ED	69E6	6"x9"	D	6 Volt	8	1	3-13/16	—	2	7.50
	69E10	6"x9"	D	1000 Ohms	8	1	3-13/16	—	2	7.50
PM	69A2*	6"x9"	D	1.4 oz. Alnico 5	8	7/8	2-15/16	—	1-1/2	7.50
	69A3	6"x9"	D	3.2 oz. Alnico 5	10	1-1/4	3-5/16	—	1-3/4	8.95

*Very shallow construction.

Voice coil impedance of above speakers is 3.2 ohms ±10%

High-Fidelity Adjust-a-Cone® Speakers

PM	8A10X	8"	B	10 oz. Alnico 5	10	1	3-3/4	—	3-1/4	\$18.60
	10A10X	10"	H	10 oz. Alnico 5	12	1	5-1/4	—	3-3/4	24.00
	12A10X	12"	H	10 oz. Alnico 5	15	1	5-7/8	—	4-3/4	26.00

Co-axial Speakers

COAX	12A6CO	12"	G	6.8 oz. Alnico 5	14.0	2-1/4	6-11/16	—	6-1/2	\$30.00
	15A10CO	15"	G	10 oz. Alnico 5	20.0	2-5/16	8-3/8	—	8-1/2	47.50

Voice coil impedance of above speakers is 6-8 ohms.

Tweeters

	3A15T	3 1/2"	—	1.47 oz. Alnico 5	10	3-1/2	2-1/16	3-1/2	3/4	\$ 5.75
	5A15T	5"	—	1.47 oz. Alnico 5	10	2-5/8	5	—	1	6.50

Voice coil impedance of above speakers is 14 ohms.

Public Address Speakers

PM	8A4	8"	B	4.64 oz. Alnico 5	12	1-3/8	3-3/4	—	2-3/4	\$10.20
	8A6	8"	B	6.8 oz. Alnico 5	12	1-7/16	3-7/8	—	3-1/4	12.10
PM	10A4	10"	B	4.64 oz. Alnico 5	14	1-3/8	4-1/2	—	3-1/4	11.70
	10A6	10"	B	6.8 oz. Alnico 5	14	1-7/16	4-5/8	—	3-1/2	13.60
	10A10	10"	B	10 oz. Alnico 5	20	1-3/8	4-21/64	—	3-1/2	18.00
PM	12A4	12"	B	4.64 oz. Alnico 5	15	1-3/8	5-1/8	—	4	12.65
	12A6	12"	B	6.8 oz. Alnico 5	15	1-7/16	5-1/4	—	4-3/4	14.50
	12A10	12"	B	10 oz. Alnico 5	25	1-3/8	4-15/16	—	4-3/4	19.00

Voice coil impedance of above speakers is 6-8 ohms.

Intercom Speakers

PM	3A07Z45	3 1/2"	A	.68 oz. Alnico 5	2.5	3/4	1-19/32	1-3/16	1/2	\$ 4.25
	4A07Z45	4"	A	.68 oz. Alnico 5	3.0	3/4	1-23/32	1-5/16	1/2	4.25
	4A1Z45	4"	A	1.00 oz. Alnico 5	3.0	1	2-3/16	1-9/16	3/4	4.50
	5A07Z45	5"	C	.68 oz. Alnico 5	3.5	3/4	1-7/8	1-7/16	3/4	4.45
	5A1Z45	5"	C	1.00 oz. Alnico 5	3.5	1	2-5/16	1-11/16	1	4.70

Television Speakers

ED	5E62	5"	C	62 Ohms	3.5	1-1/4	2-7/16	1-19/32	1-1/4	\$ 4.60
	5E95	5"	C	95 Ohms	3.5	1-1/4	2-7/16	1-19/32	1-1/4	4.60
	46E62	4"x6"	E	62 Ohms	3.5	1-5/64	2-15/64	1-5/8	1-1/4	5.30
	46E95	4"x6"	E	95 Ohms	3.5	1-5/64	2-15/64	1-5/8	1-1/4	5.30
	6E62	6 1/2"	C	62 Ohms	5	1-1/4	2-23/32	2-1/32	1-1/2	5.40
	6E95	6 1/2"	C	95 Ohms	5	1-1/4	2-23/32	2-1/32	1-1/2	5.40

Voice coil impedance of above speakers is 3.2 ohms

Outdoor Theatre Speakers

QUAM weatherproofed speakers are designed for outdoor application. A time tested moisture resistant cone treatment and a special finish over air gap surfaces plus the rugged QUAM construction assure

long, trouble free life under the most adverse conditions. Quantity quotations on request. All types and sizes are available.

PM	4A1 OT	4"	A	1.0 oz. Alnico 5	3	1	2-3/16	1-9/16	3/4	\$ 4.25
	5A15 OT	5"	C	1.47 oz. Alnico 5	3.5	1	2-5/16	1-11/16	1	4.85
	6A15 OT	6 1/2"	C	1.47 oz. Alnico 5	5	1	2-5/8	2	1	5.20



TRU-MATCH

OUTPUT TRANSFORMERS

Designed by speaker engineers to give a true impedance match for a wide range undistorted sound. Specifications of each unit include a full stack of best electrical steel, the maximum amount of copper, highest quality insulation and adhesives. Underwriters approved lead wire and complete vacuum impregnation. Individually packed in attractive boxes using the widely known QUAM descriptive part numbering system.

Catalog Number	Primary Impedance (Ohms)	Secondary Load (Ohms)	Core Size (Inches)	Power Rating (Watts)	Primary M.A. (Max.)	Shipping Weight (Oz.)	List Price
TA20	2000	3.2	1/2 x 1/2	5	60	6	\$1.50
TA50	5000	3.2	1/2 x 1/2	5	40	6	1.75
TA75	7500	3.2	1/2 x 1/2	5	35	6	1.75
TA100	10000	3.2	1/2 x 1/2	5	30	6	1.75
TA100T	10000	CT ₁	1/2 x 1/2	5	30	6	2.00
TA160	16000	3.2	1/2 x 1/2	5	10	6	1.75
TA250	25000	3.2	1/2 x 1/2	5	10	6	1.75
TAL	LINE ₂	3.2	1/2 x 1/2	5	—	6	2.50
TC20	2000	3.2	5/8 x 5/8	8	60	10	\$2.25
TC50	5000	3.2	5/8 x 5/8	8	50	10	2.25
TC70	7000	3.2	5/8 x 5/8	8	40	10	2.25
TC85	8500	3.2	5/8 x 5/8	8	40	10	2.25
TC100T	10000	CT ₁	5/8 x 5/8	8	40	10	2.50
TC140T	14000	CT ₁	5/8 x 5/8	8	40	10	2.50
TC160	16000	3.2	5/8 x 5/8	8	15	10	2.25
TC250	25000	3.2	5/8 x 5/8	8	40	10	2.25
TCL	LINE ₂	6-8	5/8 x 5/8	8	—	10	3.00
TCU	UNIV ₃	3.2	5/8 x 5/8	8	50	10	3.50
TD25	2500	3.2	3/4 x 3/4	12	70	17	\$3.00
TD50T	5000	CT ₁	3/4 x 3/4	18	150	17	3.25
TD70	7000	3.2	3/4 x 3/4	12	50	17	3.00
TD100T	10000	CT ₁	3/4 x 3/4	12	50	17	3.25
TD140T	14000	CT ₁	3/4 x 3/4	12	50	17	3.25
TDL	LINE ₂	6-8	3/4 x 3/4	15	—	17	3.75
TDU	UNIV ₃	3.2	3/4 x 3/4	12	50	17	4.00

1. TA10T, TC10T, TC14T, TD5T, TD10T & TD14T have center tapped primaries for push-pull output use. Plate to plate impedance is given.

2. TAL, TCL & TDL are for speaker to line use and have primary taps at 500, 1000, 1500 & 2000 ohms.

3. TCU & TDU are universal type output transformers and provide matching impedances of 2500, 4000, 7500, 10000 & 16000 ohms, also 7500 ohm CT, 10000 ohm CT & 16000 ohm CT.

QUAM FOCALIZER UNIT KITS

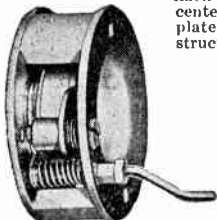

Each kit consists of a Focalizer unit, a centering handle, an aluminum mounting plate, mounting screws and nuts and instruction sheet.

- Provides sharper focus of the Television picture.
- Unaffected by temperature and voltage fluctuations.
- Easy to install.
- Ideal for replacement or rebuilding Television sets for larger tubes.
- Used as original equipment in many leading sets.

Dimensions: O.D. 3 3/4". Thickness: 1 1/4". Weight: 1 1/2 lbs.

QF1—for use with most picture tubes anode voltages up to 12KV. List Price \$4.75

QF2—for use with picture tubes operating at anode voltages of 12 KV and up. List Price \$5.95

QF3—for use with picture tubes operating at anode voltages of 15 KV to 18 KV. List Price \$5.95

QUAM ION TRAPS



Quam ion traps can be used on any picture tube where a trap was used as original equipment. IT1 and IT2 Traps are equipped with wing nut and binding screw. IT3 and IT4 are spring type. Individually packed with instruction sheet.

IT1—Double field for tubes up to 10" in diameter. Field strength of 38 Gauss. Generally used with straight gun tubes. List Price \$1.50

IT2—Double field for tubes from 10" in diameter up. Field strength of 46 Gauss. Generally used with straight gun tubes. List Price \$1.50

IT3—Single field for tubes requiring field strength of 35 to 45 gauss. Generally used with tubes having a bent gun. List Price \$1.00

IT4—Single field for tubes requiring field strength of 45 to 55 gauss. Generally used with tubes having a bent gun. List Price \$1.00

QUAM REAR SEAT AUTO SPEAKERS

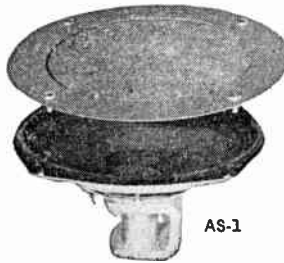

AS-1

Catalogue #AS-1 6 1/2" PM

Kit includes Quam 6 1/2" PM Adjust-A-Cone speaker with capacity to handle full output of any single-ended auto set; 1.47 oz. Alnico V Magnet; 3/4" voice coil; rugged 3-position switch for dash mounting, ample cable for any installation, flocked grill screen, baffle plate, all necessary hardware, and installation instructions. Shipping weight 2 lbs.

List Price \$9.95

Catalogue #AS-3 5"x7" PM

Kit includes 5" x 7" PM Adjust-A-Cone speaker with capacity to handle full output of any single-ended auto set; 1.47 oz. Alnico V Magnet; 3/4" voice coil; rugged 3-position switch for dash mounting, sufficient cable for any installation, flocked grill screen, baffle plate, all necessary hardware and installation instructions. Shipping weight 2 1/4 lbs.

List Price \$11.95

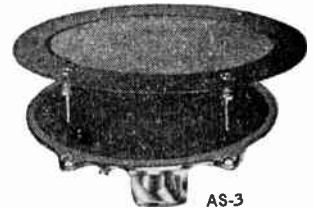

AS-3

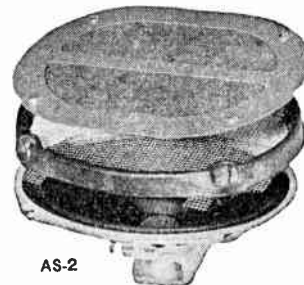

AS-2

Catalogue #AS-2 6"x9" PM

Deluxe model: Kit includes Quam heavy duty 6" x 9" PM Adjust-A-Cone speaker with ample capacity to handle full output of the most powerful auto set; 2.15 oz. Alnico V Magnet; rugged 3-position switch for dash mounting, sufficient cable for any installation, flocked grill screen, baffle plate, sponge rubber gasket for easy and trouble-free installation, all necessary hardware, and installation instructions. Shipping weight 3 1/2 lbs.

List Price \$13.95

Chrome plated grille for AS-2

List Price \$2.15



RACON ACOUSTICAL EXCELLENCE

RE-ENTRANT TRUMPETS
RADIAL HORNS and SPEAKERS
PM DRIVER UNITS

Re-Entrant Trumpets, Radial Horns and Speakers



RE-35 RE-50 RE-60

RACON re-entrant horns and speakers are designed to deliver highly concentrated sound with great efficiency over long distances. This is due to true exponential design throughout and the elimination of all vibratory members and sound dissipating devices. The base and inside tone arms are husky aluminum castings and bell is a heavy gauge aluminum spinning. The

RE-35, RE-50 and RE-60 incorporate reflectors made of patented RACON ACOUSTIC MATERIAL to prevent resonant effects. All models are supplied with "U"-bracket mounting (ratchet swivel type on request). Finish is in weatherproof hard baked gray hammertone. RE-60 & RE-50 recommended for maximum low frequency music reproduction. RE-35 and RE-25 best suited for incidental music and high speech intelligibility.

The SR-35R and SR-60R are weatherproof radial re-entrant horns designed to project sound over an area of 360 degrees. The centre reflectors are of patented RACON ACOUSTIC MATERIAL and the deflectors are aluminum spinnings covered with this same non-vibratory material. Standard "U" bracket supplied. Thread size is 1 1/8"-18, permitting the use of any driver unit listed below. 1 1/8"-16 thread on request. The SR-60R is ideal for church tower sound installations and the SR-35R for incidental music and speech.

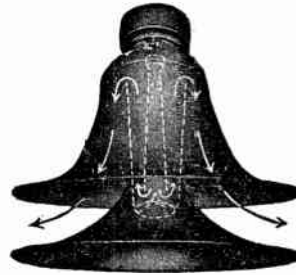

SR-35R SR-60R



SR-15R SR-12R

The SR-15R and SR-12R are rated at 20 and 10 watts respectively and are supplied complete with built-in 15 ohm* driver units. These models are intended primarily for speech in paging and "talk back" systems and are completely weatherproof. Supplied with cast swivel ratchet and wall bracket.

Model No.	Acoustic Length	Bell Diam.	Over-all Length	Cut-off (cycles)	Distrib. Angle	Ship. Wt. lb.	Code	List Price
**RE-60	6'	26"	28"	112	45°	21	REMOL	\$70.00
**RE-50	4 1/2'	25 1/4"	23 1/2"	140	50°	19	REMOY	52.50
**RE-35	3 1/2'	19"	16 1/4"	175	55°	12 1/2	REMOX	35.50
**RE-25	2 1/2'	13 1/2"	11"	225	60°	9	REMOD	29.50
**SR-60R	6 1/2'	36"	34 1/2"	115	360°	47	RADAL	100.00
**SR-35R	4'	17"	16"	175	360°	16	RADAK	47.50
SR-15R	20"	9"	12"	350	360°	7	RADAS	39.75
SR-12R	15"	7"	9"	450	360°	4	RADAB	31.00

* 8 ohms on request at same price. 4 or 45 ohm 1.00 list additional.
** horn only

Waterproof Permanent Magnet Driver Units

The driver unit is the most important single element in a successful public address system. In these four new driver units, primary emphasis is on: high continuous power handling capacity with ample reserve

for overload peaks up to 100%, maximum conversion efficiency, response ranges suitable for every type sound system, and waterproof construction.

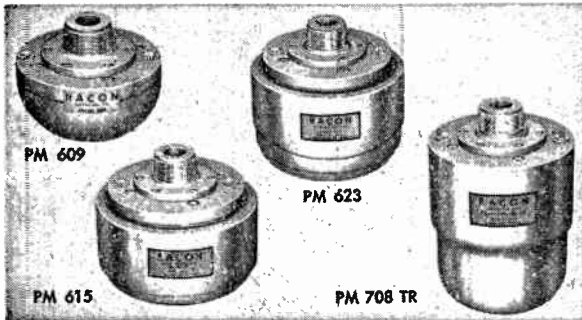

These four units employ Alnico V magnets and Armco magnetic iron throughout. All soft steel parts are doubly plated to prevent corrosion. An automatic electromagnetic cut-out switch is used in the magnetizing process, assuring maximum flux density in the gap and high uniformity. Units are individually measured for flux density. Each unit is tested with special equipment for power handling capacity as well as a 350-volt ground test.

Long life plastic diaphragms and formers are supplied. Voice coil leads are non-fatiguing beryllium copper, insuring lifetime performance. All units are completely waterproof, yet permit ready replacement of diaphragm where needed.

NEW SUPER X UNITS USING LATEST ALNICO V MAGNETS

Model No.	Weight		Flux Density per sq. cm.	Frequency Range	Imp.	Diam.	Ht.	Thread	Capacity (watts)		Code	List Price
	Net	Ship.							Peak	Oper.		
PM-623	6 lbs.	6.5 lbs.	15,500 gaussess	80-7000	15	5"	5"	1 3/8"-18	65	35	RETIX	\$52.50
PM-615	6.5 lbs.	7 lbs.	13,500 gaussess	90-7000	15	5"	4 1/2"	1 3/8"-18	60	30	RETIN	38.50
PM-609	4 lbs.	4.5 lbs.	12,000 gaussess	90-7000	15	4"	3 1/2"	1 6/8"-18	60	30	RETEG	29.00
PM-708TR*	6 lbs.	6.5 lbs.	11,000 gaussess	90-7000	15	4 1/2"	5 1/2"	1 5/8"-18	50	25	RETOY	42.75

*NOTE: Contains built-in 25-watt line matching transformer, primary tapped at 500, 1000, 1500, 2000; secondary; secondary 8 and 15 ohms.



RACON ACOUSTICAL EXCELLENCE

**DOUBLE RE-ENTRANT MARINE SPEAKERS
RE-ENTRANT PAGING SPEAKERS
CONE SPEAKER ENCLOSURES**

DOUBLE RE-ENTRANT MARINE SPEAKERS

The Models MR-30M, MG-21J, MG-21B and MN-15B marine speakers are designed primarily to meet the vigorous sound systems requirements aboard ship.

The driver unit and connecting leads are all enclosed, resulting in a completely waterproof speaker. Heavy aluminum spinnings are used throughout and back base is a husky, non-corrosive aluminum casting. A baked chromatic undercoat plus an outside lacquer finish is assurance of lasting service under severe conditions of humidity and temperature. Designed for three legged flush rear mounting. All models provided with cast aluminum transformer housing. Model MN-15B supplied with "U" bracket; "U" bracket for other models on request at slight additional cost.

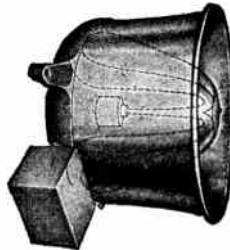

MR-30M

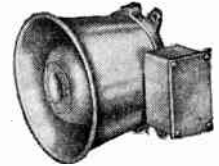

MG-21B
MG-21J
MN-15B

Model No.	Frequency Range	Distribution Angle	Bell Diam.	Capacity (watts) Oper. Peak Imp.	No. Driver Units	Over-all Length	Ship. Wt. lb.	Code	List Price
MR-30-M	250-6000	50°	14"	30 60 15	1	10"	29 3/4	REDIX	\$175.00
MR-32M	250-6000	50°	14"	60 120 8	2	18 1/2"	43	REDIT	235.00
MG-21J	350-5000	55°	9 1/2"	25 50 15	1	6 3/4"	13 3/4	RASOM	70.50
MG-21-B	350-6000	55°	9 1/2"	20 35 15*	1	6 3/4"	9 1/4	RASOB	66.00
MN-15B	450-6000	65°	6 1/4"	20 35 15*	1	4 3/4"	6 3/4	REDUP	48.00
MN-15C	(same as MN-15B, but less "U" bracket)							REDUT	45.75
MN-15D	(same as MN-15B, but less "U" bracket and less transformer box)							REDUZ	42.00

* 8 ohms on request at same price. Four or 45 ohm 1.00 list additional.

RE-ENTRANT PAGING SPEAKERS



RE-15 RE-12



DW-9R

These weatherproof re-entrant paging speakers are capable of high intelligibility in locations where high noise levels prevail. Construction is non-vibratory throughout and consists of heavy aluminum spinnings and castings. Voice coils are designed to provide a high degree of efficiency when these speakers are also used as microphones in "talk-back" systems. Ideal for replacing conventional cone speakers. RE-12 and RE-15 provided with heavy cast aluminum ratchet bracket. DW-9R is supplied with flange for flush mounting.

Model No.	Frequency Range	Distribution Angle	Operating Capacity	Imp.	Bell Diam.	Over-all Length	Ship. Wt. lb.	Code	List Price
RE-15	350-8500	60°	20 watts	*15 ohms	9"	9 3/4"	6	REMAC	\$36.00
RE-12	450-10,000	65°	10 watts	*15 ohms	7"	6 1/2"	3 3/4	REMAC	27.80
DW-9R	750-10,000	70°	8 watts	*15 ohms	5"	2 1/2"	2	REDOX	32.50

* 8 ohms on request at same price. Four or 45 ohm 1.00 list additional.

NEW PAGING AND TALK-BACK SPEAKERS

RE-20 — Model RE-20 has a nominal rating of 25 watts and incorporates a varnish vacuum impregnated transformer provided with a removable weatherproof aluminum spinning. Primary impedances are 625, 1250, 2500 and 5000 ohms and the secondary is tapped at 4, 8, and 16 ohms. By connecting directly to and between these terminals, the resulting impedances of 310, 625, 1250, 2500, 3650, 5000, 7300, 10000, 14,500 and 29,000 ohms are equivalent to 16, 8, 4, 2, 1.3, 1.0, 0.7, 0.5, 0.34 and 0.17 watts respectively when connected across a 70 volt line. Weatherproof construction throughout.

RE-11 — Similar to the RE-20, but has a higher cutoff and a nominal rating of 12 watts. The built-in 10 watt transformer has primary impedances of 500, 1000, 1500 and 2000 ohms and a secondary tapped at 8 and 15 ohms.

RE-18 — This is the economical answer to all paging and "talk-back" applications where low to medium power levels are necessary and where "specs" do not call for line transformers. Bell and back cover are integrally spun of aluminum to assure weatherproof performance of the 12 watt driver unit. Complete with adjustable "U" bracket.



MODEL RE-20, RE-11

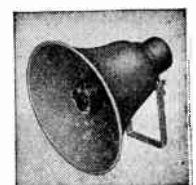

MODEL RE-18

SPECIFICATIONS

MODEL NO.	RE-20	RE-11	R-18
Power	25 W.	12 W.	12 W.
Range (cps.)	350-8,500	450-10,000	350-10,000
Dist. Angle	60°	65°	60°
V C Imp.	†8 ohms	†15 ohms	†15 ohms
*Sensitivity	107.5 db.	104 db.	104 db.
Bell Dia.	9"	7"	9"
Length	12.5"	9.75"	9.25"
Weight (net)	7 lbs.	4 lbs.	3 lbs.
Weight (ship.)	9 lbs.	5.5 lbs.	3.5 lbs.

* 4 ft., 1 watt input, warble signal 1,200-2,000 cps.

† 8 ohm available at same price. 4 and 45 ohm \$1.00 list additional.

‡ Built-in transformer. See text.



STRAIGHT EXPONENTIAL TRUMPETS



Output from any straight trumpet is approximately 2 DB higher than corresponding re-entrant type because it lacks the attenuation inherent in all re-entrant horns. "Stormproof" Trumpets are made of non-vibratory RACON ACOUSTIC CLOTH. Weather-treated for indoor or outdoor use. "All Aluminum" Trumpets are made of

heavy gauge aluminum spinnings with rolled beaded edge and cast aluminum throat sections. "Unbreakable" Trumpets are made of heavy gauge aluminum spinnings reinforced and damped with Patented RACON ACOUSTIC MATERIAL. Large sizes are useful for church chime systems, C-D systems, airports and stadiums, parks, playgrounds, music festivals, for both speech and music. Smaller sizes for railroad and bus terminals, waiting rooms, factories.

Model No.	Air Column (length)	Units Required	Cut-off (cycles)	Distribution Angle	Bell Diam.	Material	Ship. Weight	Code	List Price
*ST-415A	6'	1	115	45°	30"	Unbreakable	37 lb.	REGON	\$145.00
**ST-414A	6'	1	115	45°	30"	Stormproof	39 lb.	RIDER	120.00
*ST-417A	6'	1	115	45°	30"	All Aluminum	35 lb.	RHINO	120.00
**ST-412A	4½'	1	145	50°	25"	Stormproof	34 lb.	RACEY	76.00
*ST-413A	4½'	1	145	50°	25"	All Aluminum	27 lb.	RIANT	73.50
**ST-411A	3½'	1	195	50°	22"	Stormproof	28 lb.	RENEW	52.50
*ST-251A	2'	1	250	55°	12"	Stormproof	6 lb.	RISAT	18.35
**ST-251B	2'	1	250	55°	12"	All Aluminum	5 lb.	RIMAD	17.50

* Delivery, 4 weeks. ** Delivery, 1-2 weeks.
NOTE: Models with 2, 4 and 8 unit throats available. Prices on request.

CAST ALUMINUM HORN TWEETERS

Response is essentially flat to 12,000 cycles, with excellent usable output to 15,000 cycles. Horn design permits wide angle distribution. Designed for a 1000 and 1500 cycle crossover to assure optimum cone response. These

models must be used with a cross-over network. The networks listed below are recommended and when employed, the CHU-5 and CHU-2 may be used with amplifiers having an output rating to 25-30 watts.

NOTE: Instructions are packed with each tweeter, providing an easy method of home building a professional type 1000-cycle crossover network.

Model No.	Impedance	Freq. Range	Dispersion Horiz.	Angle Vert.	Material	Ship. Wt.	Code	List Price
CHU-2	15 Ohms	750-15000	100°	50°	Alum. Cast.	6 lbs.	RALUX	\$42.75
CHU-5	15 Ohms	1000-15000	80°	40°	Alum. Cast.	4½ lbs.	RALUM	34.50

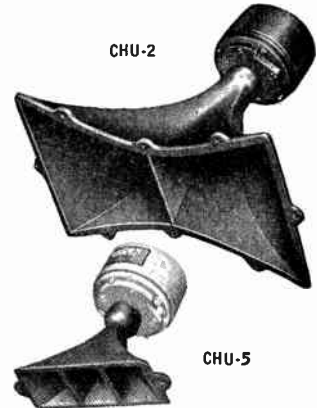

CON-30
CON-20



CON-15R
CON-17R

CROSSOVER NETWORKS

The models CON-20 and CON-15R have crossovers of 1000 cycles. The CON-30 and CON-17R cross over at 1500 cycles. The CON-20 and CON-30 are R-C-L Networks. The CON-15R and CON-17R are of the high-pass filter type. Cone speaker impedances may vary from 4-15 ohms. Both models include HF level controls.

Model No.	Description	Var. Audio	Ship. Wt.	Code	List Price
CON-15R	Var. Audio Taper R-C Network	2½ lbs.	2½ lbs.	RAFIR	\$11.80
CON-17R	Var. Audio Taper R-C Network	2½ lbs.	2½ lbs.	RAFIT	\$11.80
CON-20	Var. Audio Taper R-C-L Network	3½ lbs.	3½ lbs.	RADUX	\$24.00
CON-30	Var. Audio Taper R-C-L Network	3½ lbs.	3½ lbs.	RADUT	\$24.00

COBRA TYPE HORN

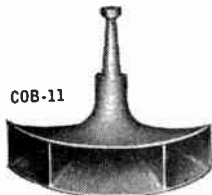

The RACON COB-11 "cobra" type horn is designed for public address systems requiring high clarity reproduction with maximum concentration of sound in a horizontal plane. It is of "straight" horn design and exponentially flared for maximum transfer of energy. The low cutoff of 250 cycles results in crisp, highly articulate quality without a trace of boominess. The horn consists of a heavy two-piece non-vibratory aluminum casting and is provided with a two-section serrated mounting bracket. Finish is baked gray hammertone over a zinc chromate primer.

Cut-off	250 cycles
Dispersion	120° H, 40° V
*Thread	1½" — 18
Dimensions	17¾" H, 22¼" W, 13¾" D
Net Wt.	12 lbs.
Shipping Wt.	17 lbs.
Code	ROBON
List Price	\$75.00

* 1-7/16"-16 on request at same price.

CONE SPEAKER ENCLOSURES

These housings are strongly constructed, practically abuse-proof. Back spinings are steel and incorporate a watertight overlap seal which eliminates rain leakage at the juncture of front bell and rear housing. Two offset mounting hooks are provided for easy installation. Aluminum Bell; Steel back acoustically damped — cone opening protected by wire screening and silk gauze.



CP-12AW
CP-8AW

Model No.	Cone Size	Bell Diameter	Length	Shipping Wt.	Code	List Price
CP-12AW	12"	17"	20"	8 lbs.	ROBOT	\$21.00
CP-8AW	8"	15"	15"	6 lbs.	RIFLE	\$17.00



THE WIDEST LINE OF REPLACEMENT
SPEAKERS AVAILABLE TO THE TRADE

RADIO PRODUCTS CO., INC.
HUNTINGTON, INDIANA

STANDARD PERMANENT MAGNET GROUP

Group Size	Model Number	Voice Coil Impedance Ohms	Voice Coil Diameter Inches	Optimum Audio Watts	Alnico V Weight Ounces	Shipping Weight Pounds	Standard Pack	List Price
3"	SP3A	3-4	9/16	2-4	.68	3/4	12	\$3.95
3"	SP3B	3-4	9/16	2-4	1.00	3/4	12	4.10
3"	SP3C	3-4	9/16	2-4	1.47	3/4	12	4.45
4"	SP4A	3-4	9/16	2-4	.68	3/4	12	3.95
4"	SP4B	3-4	9/16	2-4	1.00	3/4	12	4.35
4"	SP4C	3-4	9/16	2-4	1.47	1	12	4.60
5"	SP5A	3-4	9/16	2-4	.68	3/4	12	4.10
5"	SP5B	3-4	9/16	2-4	1.00	3/4	12	4.45
5"	SP5C	3-4	9/16	2-4	1.47	1	12	4.90
6"	SP6A	3-4	9/16	2-4	.68	1	8	4.75
6"	SP6B	3-4	9/16	2-4	1.00	1 1/2	8	4.90
6"	SP6C	3-4	9/16	2-4	1.47	1 1/2	8	5.30
6"	SP6D	3-4	3/4	4-9	1.47	1 1/2	8	5.40
6"	SP6E	3-4	3/4	4-9	2.15	1 1/2	8	5.90
6"	SP6F	3-4	3/4	4-9	3.16	1 1/2	8	6.65
7 1/2"	SP8D	3-4	3/4	4-9	1.47	1 3/4	6	6.95
7 1/2"	SP8E	3-4	3/4	4-9	2.15	1 3/4	6	7.25
7 1/2"	SP8F	3-4	3/4	4-9	3.16	1 3/4	6	8.55
7 1/2"	SP8G	3-4	1	6-12	3.16	2 1/2	6	8.90
7 1/2"	SP8H	3-4	1	6-12	4.64	2 1/2	6	9.25
7 1/2"	SP8J	3-4	1	6-12	6.80	2 3/4	6	9.55
10"	SP10D	3-4	3/4	4-9	1.47	3 3/4	1	9.45
10"	SP10F	3-4	3/4	4-9	3.16	3 3/4	1	10.35
10"	SP10G	3-4	1	6-12	3.16	4	1	10.95
10"	SP10H	3-4	1	6-12	4.64	4	1	11.60
10"	SP10J	3-4	1	6-12	6.80	4 1/4	1	13.35
12"	SP12D	3-4	3/4	4-9	1.47	4	1	10.50
12"	SP12C	3-4	1	6-12	3.16	4 3/4	1	11.25
12"	SP12H	3-4	1	6-12	4.64	4 3/4	1	12.75
12"	SP12J	3-4	1	6-12	6.80	4 3/4	1	14.55
12"	SP12K	8	1 1/4	12-20	6.80	5 1/2	1	16.50



SP5A

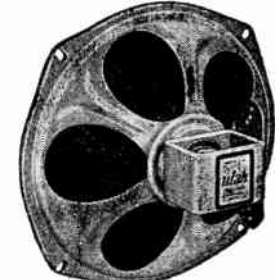

SP8D



PA8J



SP57A

PUBLIC ADDRESS SPEAKER GROUP
Standard Series

Group Size	Model Number	Voice Coil Impedance Ohms	Voice Coil Diameter Inches	Optimum Audio Watts	Alnico V Weight Ounces	Shipping Weight Pounds	Standard Pack	List Price
6"	PA6D	3-4	3/4	4-9	1.47	1 1/2	8	\$5.75
8"	PA8D	8	3/4	4-9	1.47	1 3/4	6	7.25
10"	PA10D	8	3/4	4-9	1.47	3 3/4	1	9.50
12"	PA12C	8	1	6-12	3.16	4 3/4	1	12.95

Finished in cadmium plating.

Deluxe Series

Group Size	Model Number	Voice Coil Impedance Ohms	Voice Coil Diameter Inches	Optimum Audio Watts	Alnico V Weight Ounces	Shipping Weight Pounds	Standard Pack	List Price
6"	PA6E	3-4	3/4	4-9	2.15	1 1/2	8	\$6.50
8"	PA8J	8	1	6-12	6.80	2 3/4	6	12.50
10"	PA10J	8	1	6-12	6.80	4 1/4	1	13.95
12"	PA12J	8	1	6-12	6.80	4 3/4	1	15.95

Finished in gold lacquer over cadmium plating.

Heavy Duty Series

Group Size	Model Number	Voice Coil Impedance Ohms	Voice Coil Diameter Inches	Optimum Audio Watts	Alnico V Weight Ounces	Shipping Weight Pounds	Standard Pack	List Price
12"	PA12L	8	1 1/4	12-20	10.00	6 1/4	1	\$18.95
12"	PA12M	8	1 1/4	15-25	14.70	7	1	27.95
12"	PA12P	8	1 1/2	20-30	21.50	7 1/2	1	34.95
15"	PA15P	8	1 1/2	20-30	21.50	10	1	37.95
15"	PA15R	8	2	30-40	31.80	11	1	59.95

Finished in gold lacquer over cadmium plating, and complete with pot cover.

Speakers available from factory mounted in Utone wall baffles at no additional cost.

Also available with transformer mounted.

EXPORT DEPT. — ROCKE INTERNATIONAL CORP. — N. Y. C.

Utah

THE WIDEST LINE OF REPLACEMENT SPEAKERS AVAILABLE TO THE TRADE

RADIO PRODUCTS CO., INC. HUNTINGTON, INDIANA

OVAL PERMANENT MAGNET GROUP

Group Size	Model Number	Voice Coil Impedance Ohms	Voice Coil Diameter Inches	Optimum Audio Watts	Alnico V Weight Ounces	Shipping Weight Pounds	Standard Pack	List Price
4x6"	SP46A	3-4	9/16	2-4	.68	1	8	\$4.50
4x6"	SP46B	3-4	9/16	2-4	1.00	1 1/4	8	4.70
4x6"	SP46C	3-4	9/16	2-4	1.47	1 1/4	8	5.20
5x7"	SP57A	3-4	9/16	2-4	.68	1 1/4	6	4.95
5x7"	SP57C	3-4	9/16	2-4	1.47	1 1/4	6	5.75
5x7"	SP57E	3-4	9/16	2-4	2.15	1 1/2	6	6.50
5x7"	SP57F	3-4	3/4	4-9	3.16	1 1/2	6	6.95
5x7"	SP57G	3-4	3/4	4-9	2.15	1 1/2	6	6.50
6x9"	SP69A	3-4	9/16	2-4	.68	1 1/4	6	7.40
6x9"	SP69D	3-4	9/16	2-4	1.47	1 3/4	6	8.15
6x9"	SP69E	3-4	3/4	4-9	2.15	1 3/4	6	9.00

AUTOMOTIVE SPEAKER GROUP

Group Size	Model Number	Voice Coil Impedance Ohms	Voice Coil Diameter Inches	Optimum Audio Watts	Alnico V Weight Ounces	Shipping Weight Pounds	Standard Pack	List Price
4"	C4A	3-4	9/16	2-4	.68	3/4	12	\$4.15
5"	C5A	3-4	9/16	2-4	.68	3/4	12	4.35
5 1/4"	C52A	3-4	9/16	2-4	.68	3/4	12	4.50
6"	C6A	3-4	9/16	2-4	.68	3/4	12	4.70
7"	C7A	3-4	9/16	2-4	.68	1 1/4	12	6.95
7 1/2"	C75D	3-4	9/16	2-4	.68	1 1/4	8	7.10
4x6"	C46A	3-4	3/4	4-9	1.47	1 3/4	6	4.50
5x7"	C57A	3-4	9/16	2-4	.68	1 1/4	8	5.25
6x9"	C69A	3-4	9/16	2-4	.68	1 1/2	6	6.95
5"	C5R4	3-4	9/16	2-4	.68	1 1/2	6	4.75
5 1/2"	C52R4	3-4	9/16	2-4	4 ohms	1 1/4	12	5.25
6"	C6R4	3-4	3/4	2-4	4 ohms	1 1/4	12	5.50
7"	C7R4	3-4	3/4	2-4	4 ohms	2	8	6.95
7 1/2"	C75R4	3-4	3/4	2-4	4 ohms	2	6	6.95
5x7 1/2"	C57R4	3-4	3/4	2-4	4 ohms	2	6	7.25
6x9"	C69R4	3-4	3/4	2-4	4 ohms	2	6	7.95

For rear deck kits see separate listing, or write for full particulars.

OUTDOOR SPEAKER GROUP

Group Size	Model Number	Voice Coil Impedance Ohms	Voice Coil Diameter Inches	Optimum Audio Watts	Alnico V Weight Ounces	Shipping Weight Pounds	Standard Pack	List Price
3"	SP3AO	3-4	9/16	2-4	.68	3/4	12	\$4.15
4"	*SP4AO2	3-4	9/16	2-4	.68	3/4	12	5.95
4"	SP4CO	3-4	9/16	2-4	1.47	1	12	4.95
4"	*SP4CO2	3-4	9/16	2-4	1.47	1	12	6.50
5"	SP5CO	3-4	9/16	2-4	1.47	1	12	4.95

*Employs two cones.

Finished in bright blue outdoor enamel over heavy cadmium plating for extra protection.

AIRCRAFT INTERCOMMUNICATION SPEAKER GROUP

Group Size	Model Number	Voice Coil Impedance Ohms	Voice Coil Diameter Inches	Optimum Audio Watts	Alnico V Weight Ounces	Shipping Weight Pounds	Standard Pack	List Price
5"	A5F1	3-4	3/4	4-9	3.16	1 1/4	12	\$7.75

INTERCOMMUNICATION SPEAKER GROUP

Group Size	Model Number	Voice Coil Impedance Ohms	Voice Coil Diameter Inches	Optimum Audio Watts	Alnico V Weight Ounces	Shipping Weight Pounds	Standard Pack	List Price
3"	SP3A1	45 ohms	9/16	2-4	.68	3/4	12	\$3.75
4"	SP4A1	45 ohms	9/16	2-4	.68	3/4	12	3.95
5"	SP5A1	45 ohms	9/16	2-4	.68	3/4	12	4.15

TELEVISION ELECTRO-MAGNETIC GROUP

Group Size	Model Number	Voice Coil Impedance Ohms	Voice Coil Diameter Inches	Optimum Audio Watts	Alnico V Weight Ounces	Shipping Weight Pounds	Standard Pack	List Price
5"	SE5T6	3-4	9/16	2-4	62 ohms	1 1/4	12	\$4.50
5"	SE5T10	3-4	9/16	2-4	100 ohms	1 1/4	12	4.60
6"	SE6T6	3-4	3/4	5-7	62 ohms	2	8	5.25
6"	SE6T10	3-4	3/4	5-7	100 ohms	2	8	5.30
10"	SE10T6	3-4	3/4	4-9	62 ohms	2 3/4	1	10.30
10"	SE10T10	3-4	3/4	4-9	100 ohms	2 3/4	1	10.35
4x6"	SE46T6	3-4	9/16	2-4	62 ohms	1 1/4	8	5.30
4x6"	SE46T10	3-4	9/16	2-4	100 ohms	1 1/4	8	5.40
6x9"	SE69T6	3-4	3/4	4-9	62 ohms	2 1/2	6	7.30
6x9"	SE69T10	3-4	3/4	4-9	100 ohms	2 1/2	6	7.35

See also listing of all permanent magnet speakers this advertisement.

HIGH-FIDELITY

Write for particulars—co-axial and high-fidelity speaker systems and enclosures.

Copyright by U. C. P., Inc.

TRADE DISCOUNT APPLIES TO LIST PRICES ONLY

World Radio History



C69A

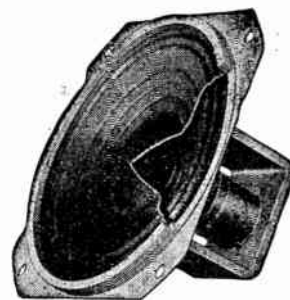

SP4AO2

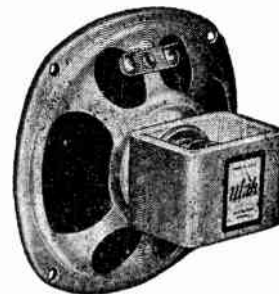

A5F1

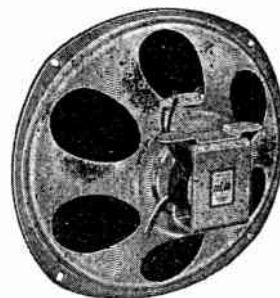

SE10T6



FINE HIGH-FIDELITY SPEAKER SYSTEMS AND SPEAKER ENCLOSURES

RADIO PRODUCTS CO., INC.

HUNTINGTON, INDIANA

CHORDETTE

The Chordette is a fine piece of functional furniture. Use as a chair side or end table, bookshelf, or without legs—mount vertically.

SPEAKER SYSTEM: Utah two-way, two speaker high-fidelity speaker and enclosure system. One Utah 8" high-fidelity speaker—one, 3 1/2" high frequency unit. Speaker system designed so full

compensation is made for deficiency in human ear, as shown by Fletcher-Munson curves. Enclosure volume 1.4 cubic feet. Air gap flux density averages 9,500 gauss. Rated at 8 watts of program material.

OVERALL DIMENSIONS: Height (with legs) 22" — Cabinet only 11" — Width 22" — Depth 13 1/4"



MODELS	DESCRIPTION	SHIPPING WEIGHT	AUDIOPHILE NET
HF 500 M	— Mahogany, complete with speaker system HF 501	25 lbs.	\$49.95
HF 500 B	— Korina, complete with speaker system HF 501	25 lbs.	52.50
HF 500 C	— Cherry, complete with speaker system HF 501	25 lbs.	52.50
HF 502	— Chordette Leg Assembly (Specify finish)		5.00

CONCERTO



The fine woods and construction features of the new Concerto are a master achievement in the art of sound engineering and woodworking. Acoustically correct, the Concerto is a modified labyrinth type, dampened with 1" of fibre glass with a volume of 4.5 cubic feet.

SPEAKER SYSTEM: A Utah high-fidelity speaker system — with the unique Trio high frequency unit — a two-way, four speaker system. One Utah 12" high-

fidelity speaker, plus three, 3 1/2" high frequency units, gives full coverage of the audio spectrum with a deep, rich bass. The two outer tweeters are angle mounted to assure in excess of 90 degrees dispersion of high frequencies. Frequency response of plus or minus 6 db from 30 to 15,000 cps. Usable range 20 to 20,000 cps. Air gap density — 11,000 gauss. Rated at 16 watts of program material.

OVERALL DIMENSIONS: Height 30" — Width 21" — Depth 17 1/2"

MODELS	DESCRIPTION	SHIPPING WEIGHT	AUDIOPHILE NET
HF 300 M	— Mahogany, complete with speaker system HF 301	63 lbs.	\$142.50
HF 300 B	— Korina, complete with speaker system HF 301	63 lbs.	147.50
HF 300 C	— Cherry, complete with speaker system HF 301	63 lbs.	147.50

TRIO

A finely designed and executed small cabinet with three high frequency units, the Trio can be connected with any radio, phonograph, television or audio amplifier — extending response beyond 15,000 cps. Reaches greatest effectiveness above 5,000 cycles — but the better the audio source — the better the Trio will sound. Begins functioning at 3,000 cps.

SPEAKER SYSTEM: Three Utah, 3 1/2" high frequency units, facing directly forward, the two outer units angle mounted to assure 90 degree dispersion of high frequencies. The Trio will match any voice coil impedance. It is complete with resistance, allowing user to match sensitivity to his present audio system. Rated at 16 watts of program material.

OVERALL DIMENSIONS: Height 5" — Width 12" — Depth 5 1/8"

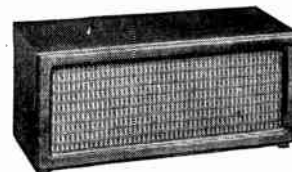

MODELS	DESCRIPTION	SHIPPING WEIGHT	AUDIOPHILE NET
HF 400 RM	— Red mahogany, complete with speaker system HF 401	6 lbs.	\$32.50
HF 400 BM	— Brown mahogany, complete with speaker system HF 401	6 lbs.	32.50
HF 400 B	— Korina, complete with speaker system HF 401	6 lbs.	34.95
HF 400 C	— Cherry, complete with speaker system HF 401	6 lbs.	34.95

BRILLANTE

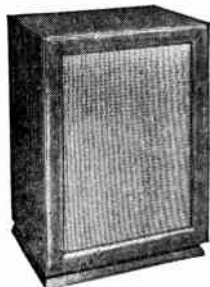

The Brillante is a finely styled cabinet made from the finest hard wood veneers with expert woodworking craftsmanship. The enclosure is a modified labyrinth type, acoustically correct, dampened with 1" of fibre glass with a volume of 4.8 cubic feet.

SPEAKER SYSTEM: Full coverage of the audio spectrum in achieved with one Utah 12" high-fidelity speaker of unique cone and special basket design,

which handles more than the usual amount of power. Frequency response of plus or minus 5 db from 30 to 10,000 cps. Usable range from 20 to 19,500 cps. Air gap flux density averages 9,500 gauss. Rated at 10 watts of program material.

OVERALL DIMENSIONS: Height 30" — Width 21" — Depth 17 1/2"

MODELS	DESCRIPTION	SHIPPING WEIGHT	AUDIOPHILE NET
HF 100 M	— Mahogany, complete with speaker system HF 101	58 lbs.	\$ 99.50
HF 100 B	— Korina, complete with speaker system HF 101	58 lbs.	104.50

Utah

FINE HIGH-FIDELITY SPEAKER SYSTEMS AND SPEAKER ENCLOSURES

RADIO PRODUCTS CO., INC.

HUNTINGTON, INDIANA



ESQUIRE

The Esquire has a beauty, style and grace of design, executed in fine woods that are hand rubbed to a patina of the finest furniture. It is a matched vented type of enclosure with a volume of 5.25 cubic feet.

SPEAKER SYSTEM: The Esquire has a Utah developed two-way, four speaker high-fidelity sound system, employing one Utah, 12" speaker and three, 3 1/2" high

frequency units. More than a 90 degree dispersion of high frequencies is assured by angle mounting. Usable range 20 to 20,000 cps. Reasonably flat response from 40 to 15,000 cps. Rated at 16 watts of program material.

OVERALL DIMENSIONS: Height 30 9/16" — Width 23 7/8" — Depth 18"

MODELS DESCRIPTION

HF 800 M — Mahogany, complete with speaker system HF 801	-----	45 lbs.	\$89.95
HF 800 K — Korina, complete with speaker system HF 801	-----	45 lbs.	99.95
HF 800 C — Cherry, complete with speaker system HF 801	-----	45 lbs.	99.95

SHIPPING WEIGHT

AUDIOPHILE NET

SQUIRE

The Squire is styled and designed as a perfect companion piece to all the Utah High-Fidelity line of speaker enclosures, but it especially complements the Esquire.

The Squire has been engineered and designed to house in one complete console unit, an AM-FM tuner, high-fidelity amplifier, standard record changer or professional three-speed turntable and pick-up arm. The compartments are arranged for the high-fidelity enthusiast's convenience. The pull-out record changer drawer is at the top, and the tilt-out tuner com-

partment is at the bottom with ample space for the high-fidelity amplifier at the rear.

DIMENSIONS:

OVERALL CABINET: Height 30 9/16" — Width 23 7/8" — Depth 18"

CHANGER DRAWER: Height 11" — Width 18 1/2" — Depth 16"

TUNER DRAWER: Height 10" — Width 17 3/8" — Depth 12"

AMPLIFIER: Height 10" — Width 1" — Depth 12"



MODELS DESCRIPTION

HF 700 M — Mahogany, Console equipment enclosure only	-----	69 lbs.	\$79.95
HF 700 B — Korina, Console equipment enclosure only	-----	69 lbs.	89.95
HF 700 C — Cherry, Console equipment enclosure only	-----	69 lbs.	89.95

SHIPPING WEIGHT

AUDIOPHILE NET

QUARTET

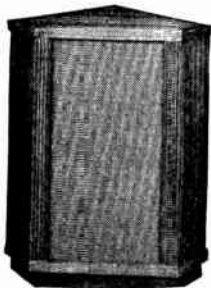

The Quartet is a perfect high-fidelity console for room corner applications. Its beautiful styling, fine woods and construction features will fit any decor. It is a matched vented type enclosure, acoustically dampened with 1" fibre glass on the two back surfaces and has a volume of 4.6 cubic feet.

SPEAKER SYSTEM: The Quartet has a Utah developed two-way, four speaker high-fidelity system, comprised of one Utah, 12" unit with a voice coil diameter of 1 1/4", and three Utah, 3 1/2" high frequency units,

angle mounted to obtain a more than 90 degree dispersion. Frequency response of plus or minus 5 db from 30 to 15,500 cps. An air gap flux density of approximately 11,500 gauss. Rated at 18 watts of program material.

OVERALL DIMENSIONS: Height 38 1/2" — Width 30 1/2" (at widest point) — 21" (at front) — 18 1/2" (at back) — 19 11/16" (from back to face) — 21 5/16" (along wall)

MODELS DESCRIPTION

HF 600 M — Mahogany, complete with speaker system HF 601	-----	83 lbs.	\$179.95
HF 600 B — Korina, complete with speaker system HF 601	-----	83 lbs.	189.95
HF 600 C — Cherry, complete with speaker system HF 601	-----	83 lbs.	189.95

SHIPPING WEIGHT

AUDIOPHILE NET

UTONE WALL BAFFLES

BUILT TO SELL — BUILT TO LAST

Utone wall baffles will complement any interior where speaker housing is needed. Quality built of five ply, 3/8" veneer, they are morticed and secured with waterproof glue and free from vibration and rattles. Their beautiful lacquer finish with matching

grill cloth, makes them attractive without being obtrusive—and they are priced right. Utone wall baffles are also available with a quality Utah Public Address Speaker mounted at the factory—at no additional charge for factory mounting. Can also be supplied with line matching transformers—factory mounted.

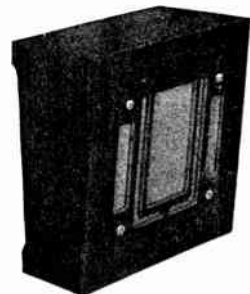

Speaker Size	Red Mahogany Finish		Brown Mahogany Finish		Futuristic Blonde		Natural Wood Unfinished	
	Model No.	Price	Model No.	Price	Model No.	Price	Model No.	Price
6 Inch	RM-6	\$ 5.95	BM-6	\$ 5.95	BB-6	\$ 5.95	NW-6	\$5.35
8 Inch	RM-8	6.95	BM-8	6.95	BB-8	6.95	NW-8	6.25
10 Inch	RM-10	8.95	BM-10	8.95	BB-10	8.95	NW-10	8.05
12 Inch	RM-12	10.95	BM-12	10.95	BB-12	10.95	NW-12	9.85

Copyright by U. C. P., Inc.

Net

Radio's Master — 19th Edition

Page C-13

500 D AMPLIFIER



List Price \$184.00

500-D DIRECT DRIVE AMPLIFIER

FINEST AMPLIFIER BUILT—NO OUTPUT TRANSFORMER

- Frequency response $\pm 1/4$ db 20-70,000 c.p.s. • Full 20 watts of audio
- Distortion is less than $1/2$ of one per cent • Phase shift—less than 15° at 20 c.p.s. (Above figures are a true picture at full output of 20 watts.)

Here's the first amplifier to successfully eliminate the output transformer. All distortion introduced by transformers is eliminated. Great clarity of tone is noticeable at once. Hum and noise are at a minimum. Frequency response is $\pm 1/4$ db 20-70,000 c.p.s., achieved with far less phase shift than can be obtained with a transformer . . . especially on the low end. Matching Stephens Tru Sonic speakers with 500 ohm v.c. impedance designed as companion units for the 500 D Amplifier are shown on adjoining page.

CHARACTERISTICS—ELECTRICAL
POWER SUPPLY: 117 V. AC 50-60 c.p.s. 1.2 amps. 140 va full output.
INPUT: 0.1 megohm. One side ground.
VOLTAGE GAIN: 47 db

CHARACTERISTICS—PHYSICAL
OUTPUT: Impedance: 500 ohms, 5 ohms at 1000 c.p.s. (apparent), 100 ohms at 20 c.p.s. (apparent).
 Level: 100 V. rms across 500 ohms, 20 watts.
POWER: Permanently attached 6-foot cord.

DIMENSIONS: $7\frac{3}{4}$ " wide by $15\frac{1}{4}$ " long by 7" high.
WEIGHT 27 lbs.

CABINETS AND RECOMMENDED SYSTEMS

- MODEL 610** WITH NO. III TWO-WAY SYSTEM. Has 105LX 15" low frequency speaker, 216 high frequency driver, 814H 1x4 Horn, 800X-2 high pass filter mounted in a lawboy blonde or mahogany cabinet 20" deep x 36" wide x 29 1/2" high.
 List Price 16 ohm \$397.00, 500 ohm \$410.00
- MODEL 615** WITH NO. II TWO-WAY SYSTEM. Has 103LX 15" low frequency speaker, 216 high frequency driver, 824H 2 x 4 horn, 800X crossover and high frequency attenuator. Mounted in a blonde or mahogany cabinet 19" deep x 28 1/4" wide x 36" high.
 List Price 16 ohm \$444.00, 500 ohm \$457.00
- MODEL 617** 800 CYCLE TWO-WAY SYSTEM. Has 103LX 15" low frequency speaker, 216 high frequency driver, 824H 2 x 4 horn, 800X crossover and high frequency attenuator. Silver hammetone or natural hardwood cabinet 20 1/4" deep x 26" wide x 36" high. List Price 16 ohm \$397.00, 500 ohm \$410.00
- MODEL 612** WITH NO. 102FR 15" FULL RANGE SPEAKER. 16 or 500 ohms, blonde or mahogany cabinet 17" deep x 24" wide x 34 1/2" high.
 List Price 16 ohm \$238.00, 500 ohm \$246.00
- MODEL 618** WITH NO. I TWO-WAY SYSTEM. Has two 103LX 15" low frequency speakers, 216 high frequency driver, 824H 2 x 4 horn, 800X crossover network and high frequency attenuator. Mounted in a blonde or mahogany cabinet 24 1/2" deep x 42 1/2" wide x 36" high. List Price 16 ohm \$574.00, 500 ohm \$595.00
- MODEL 620** WITH NO. 112FR 12" FULL RANGE SPEAKER. 8 to 16 ohms. Blonde or Mahogany cabinet 14" deep x 21" wide x 29 1/2" high.
 List Price 16 ohm \$146.00, 500 ohm \$154.00
- MODEL 622** WITH NO. 112FR 12" FULL RANGE SPEAKER. 8 to 16 ohms. Blonde or Mahogany cabinet 18" deep x 27 1/2" wide x 29 1/2" high.
 List Price 16 ohm \$146.00, 500 ohm \$154.00
- MODEL 626** WITH NO. 206AX 15" COAXIAL SPEAKER. 2 voice coils, 7 1/2 lb. Alnico V magnet. Blonde or Mahogany cabinet 21" deep x 32" wide x 32" high.
 List Price 16 ohm \$326.00, 500 ohm \$339.00

OTHER COMBINATIONS ARE AVAILABLE

CABINETS ONLY

- MODEL 610** cabinet only—List Price \$172.00
- MODEL 612** cabinet only—List Price \$144.00
- MODEL 615** cabinet only—List Price \$175.00
- MODEL 618** cabinet only—List Price \$215.00
- MODEL 620** cabinet only—List Price \$104.00
- MODEL 622** cabinet only—List Price \$104.00
- MODEL 626** cabinet only—List Price \$160.00
- MODEL 617** sold as complete unit only.

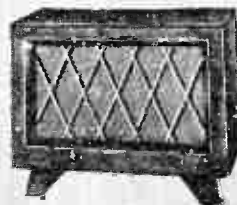

MODEL 610



MODEL 615



MODEL 617

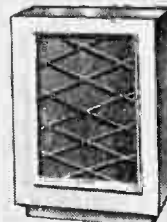

MODEL 612

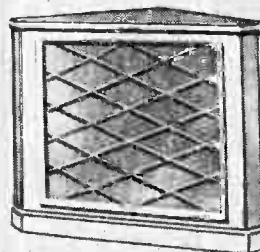

MODEL 618

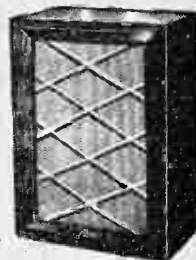

MODEL 620

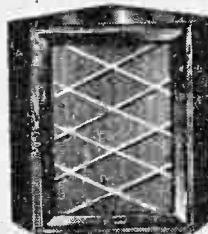

MODEL 622
MODEL 626

SPEAKERS

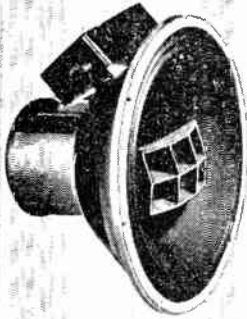

MODEL 206-AX
COAXIAL SPEAKER

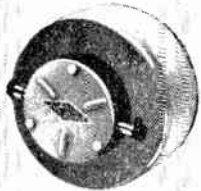

MODEL 216
MODEL P-35
MODEL 108A

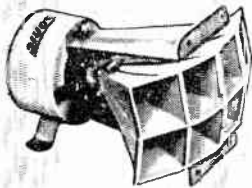

MODEL 214

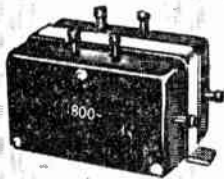

MODEL 800X

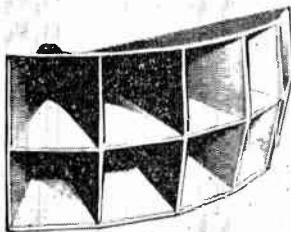

MODEL 825-H HORN

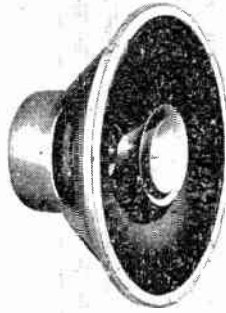

MODEL 101FR
MODEL 102FR

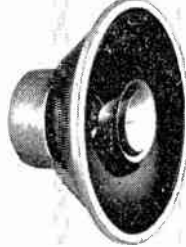

MODEL 112FR



MODEL 105LX
MODEL 103LX

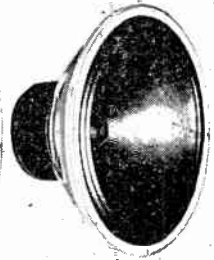

MODEL 120LX

16 OHM		500 OHM		VOICE COIL DIAMETER	TYPE SPEAKER	MAGNET WEIGHT	OVERALL DIMENSIONS		WEIGHT
TYPE	LIST PRICE	TYPE	LIST PRICE				DIA.	DEPTH	
206AX	\$166.00	5206AX	\$179.00	2" LF 1 1/2" HF	COAXIAL	7 1/2 lbs.	15 1/4"	10"	31 lbs.
102FR	94.00	5102FR	102.00	2"	FULL RANGE	4 1/4 lbs.	15 1/4"	8 1/2"	27 lbs.
101FR	78.00	5101FR	86.00	2"	FULL RANGE	2 1/2 lbs.	15 1/4"	7 1/2"	25 lbs.
112FR	42.00	5112FR	50.00	2"	FULL RANGE	1 1/2 lbs.	12 1/4"	5 1/2"	11 lbs.
103LX	90.00	5103LX	98.00	2"	LOW FREQUENCY	4 1/4 lbs.	15 1/4"	8 1/2"	27 lbs.
105LX	74.00	5105LX	82.00	2"	LOW FREQUENCY	2 1/2 lbs.	15 1/4"	7 1/2"	25 lbs.
120LX	39.00	5120LX	47.00	2"	LOW FREQUENCY	1 1/2 lbs.	12 1/4"	5 1/2"	11 lbs.
P-35	130.00	P-535	138.00	2 1/2"	HIGH FREQUENCY	4 1/4 lbs.	7"	4 5/8"	22 lbs.
216	84.00	5216	89.00	1 1/2"	HIGH FREQUENCY	1 1/2 lbs.	5"	3 3/4"	6 1/2 lbs.
P-30	118.00	P530	128.00	2 1/2"	HIGH FREQUENCY	2 1/2 lbs.	7"	3 3/4"	20 lbs.
214*	44.00	16 ohms only for use with 5000 c.p.s. high pass filter		1"	ULTRA HIGH FREQUENCY	14 oz.	6 1/4" x 3 1/4"	7 1/4"	7 lbs.
*500 ohm matching transformer for use with Model 214. List Price \$5.00									
409	234.00	800 CYCLE TWO WAY SYSTEM. Model 105LX Low Frequency Speaker, 216 High Frequency Driver, 814-H Horn, 800X-2 High Pass Filter mounted on a flat board baffle.							

CROSSOVER NETWORKS

MODEL 800X CROSSOVER 800 c.p.s. 16 ohm input and output.	List Price \$40.00
MODEL 5800X CROSSOVER 800 c.p.s. 500 ohm input and output.	40.00
MODEL 600X CROSSOVER 600 c.p.s. 16 ohm input and output.	60.00
MODEL 5600X CROSSOVER 600 c.p.s. 500 ohm input and output.	60.00
MODEL 400X CROSSOVER 400 c.p.s. 16 ohm input and output.	84.00
MODEL 5400X CROSSOVER 400 c.p.s. 500 ohm input and output.	84.00
MODEL 800X-2 HIGH PASS FILTER NETWORK, 800 c.p.s. 16 ohm input and output.	28.00
MODEL 5000X-2 HIGH PASS FILTER NETWORK, 5000 c.p.s. 16 ohm input and output.	16.00

STANDARD HORNS

MODEL 814H 1x4 HORN. 800 c.p.s. cutoff. Takes Model 216 high frequency driver.	List Price, \$28.00
MODEL 824H 2x4 HORN. 800 c.p.s. cutoff. Takes Model 216 high frequency driver.	List Price, \$49.00
MODEL 825H 2x5 HORN. 800 c.p.s. cutoff. Takes Model 216 high frequency driver.	List Price, \$62.00
MODEL 826H 2x6 HORN. 800 c.p.s. cutoff. Takes Model 216 high frequency driver.	List Price, \$68.00
MODEL 625H 2x5 HORN. 600 c.p.s. cutoff. Takes Model P-30 or P-35 high frequency driver.	List Price, \$101.00
MODEL 425H 2x5 HORN. 400 c.p.s. cutoff. Takes Model P-30 or P-35 high frequency driver.	List Price, \$182.00
MODEL 436H 3x6 HORN. 400 c.p.s. cutoff. Y throat to accommodate two Model P-30 or P-35 high frequency drivers.	List Price, \$308.00

STEPHENS MANUFACTURING CORPORATION
CULVER CITY, CALIFORNIA

University

LOUDSPEAKERS

RELIABLE...RUGGED DRIVER UNITS
with these Exclusive Built-in Features



MODEL PA-30—Recommended for reproduction of chimes, carillons, organ music. Ideal for rental work, high efficiency, maximum distance penetration. Built-in transformer with various impedances and for 70 V. systems.



MODEL SA-30 — Completely die-cast aluminum housing makes it a "must" in hazardous locations or rough service. Built-in transformer with various impedances and for 70 V. systems.

- W-shaped Alnico 5 magnet results in maximum efficiency by reducing reluctance losses and surface leakage.
- Built-in transformers provide installation flexibility to meet any impedance requirement.
- Bi-sectional mechanism with foolproof automatic "rim-centered" diaphragm voice coil assembly assures immunity to shock and vibration... facilitates field maintenance.
- Full selection to meet all power, frequency response, impedance and mechanical requirements.



MODEL SA-HF—Meets all PA and industrial requirements. For heavy noise areas, speech or quality music.



MODEL MA-25 — Fills low cost requirements without compromising quality. Rugged, weatherproof. Highly efficient to 6000 cycles.

BI-SECTIONAL MECHANISMS

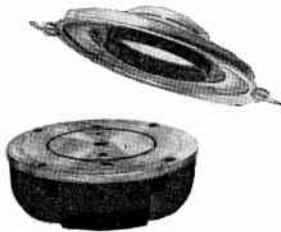

Specially tapered, one-piece linen-base phenolic diaphragms are set in an exclusive aluminum acoustical booster which applies phase correction at the upper register of the spectrum. This assures exceptionally uniform overall frequency response, and enables the diaphragm/voice coil assembly to automatically center in the voice coil gap on the magnet top plate. This exclusive University "rim-centering" technique results in shock-proof permanent voice coil concentricity; means smaller magnetic gap for greater flux density and conversion efficiency.

MODEL	PA-30	SA-30	SA-HF	MA-25	T-30
Continuous Power	30 watts	30 watts	25 watts	25 watts	20 watts
Frequency Response	80-10,000 cps.	90-10,000 cps.	90-10,000 cps.	90-6000 cps.	250-15,000 cps.
Voice Coil Impedance	16 ohms	16 ohms	16 ohms	16 ohms	8 ohms
Transformer Impedances	165/250/500/ 1000/2000 ohms	45/165/250/500/ 1000/2000 ohms			
Diameter, Overall	6 3/4"	5"	4 1/2"	4 1/8"	3 1/2"
Length, Overall	6 3/4"	6 3/4"	5"	5 3/4"	3 7/8"
Shipping Weight	6 lbs.	5 lbs.	4 lbs.	3 1/2 lbs.	3 1/2 lbs.
LIST PRICE	\$50.00	\$45.00	\$35.00	\$27.50	\$27.50

WEATHERPROOF LINE MATCHING TRANSFORMERS

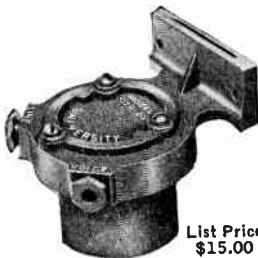

List Price \$15.00

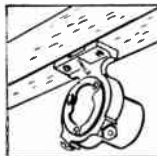

Mounted to wall or ceiling.

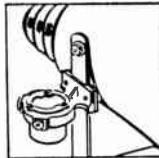

Clamp to "U" type mounting bracket used on trumpets and radial projectors.

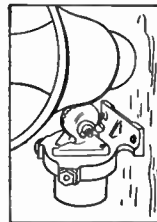

Easy to mount to University Paging speakers.



WEA Adapter

Adapts WE and RCA Horns for use with any University driver. List Price \$2.50



2YC Connector—Used with two driver units, provides to 60 watts for any trumpet or projector. List Price \$10.00

Designed to afford maximum utility in application and utmost convenience of installation. Since most University Loudspeakers and drivers are capable of response to 10,000 cycles and beyond, these transformers have been engineered to assure perfect performance throughout the entire audio spectrum.

- Versatile—multi-tap primary and secondary windings.
- Rugged, durable—water-tight construction.

PRIMARY IMP.	45, 500, 1000, 1500, 2000 ohms
SECONDARY IMP.	4-8-16 ohms
POWER HANDLING	capacity 25 watts
SHIPPING WEIGHT	3 lbs.

Model 5420—Same as above, but for indoor use; strap mounting. List Price \$6.00

For complete product information get your copy of University Loudspeakers TECHNLOG at your local distributor.

University

LOUDSPEAKERS

DIRECTIONAL SOUND PROJECTION — WITH MINIMUM SPACE Reflex Trumpets



Model
PH
with
Model
PA-30
Driver
Unit

Pioneered by University, the most efficient modern method of sound distribution

- Economy — Reduces amplifier power requirements.
- Ruggedly constructed — weatherproof.
- Four trumpet sizes to cover every requirement.

MODEL	GH	LH	PH	SMH
Low Frequency Cutoff	85 cps.	120 cps.	150 cps.	200 cps.
Sound Distribution	65°	75°	85°	95°
Air Column Length	6 1/2 ft.	4 1/2 ft.	3 1/2 ft.	2 1/2 ft.
Bell Diameter	30 3/4"	25 3/4"	20 1/4"	16 1/4"
Horn Length (less driver unit)	27 7/8"	19"	15 3/4"	12"
Shipping Weight (less driver unit)	25 lbs.	20 lbs.	11 lbs.	9 lbs.
LIST PRICE	\$65.00	\$44.50	\$31.00	\$26.00

For Your Added Protection . . .

There is more to University quality than meets the eye. All metals used in the manufacture of University equipment are given a number of special treatments prior to and during fabrication to insure life-long protection against destructive elements which may be present in the environment, as well as to maintain the physical and acoustical properties for which they were originally selected. These treatments—plus the baked paint finish—serve as further protection against corrosion, and as further proof of UNIVERSITY superiority.

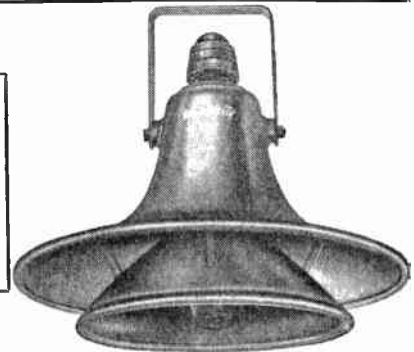

Radial Reflex Projectors

Uniform Sound in All Directions

- More economical — reduces the total number of loudspeakers required to cover a given area.
- More efficient — driver-driven radial speakers provide as much as 500% greater output than cone speaker radials.
- Versatile — ideal for spacious areas necessitating suspension installation, such as hangers, church towers, etc. Suitable for voice and music.

MODEL	RLH	RPH	RSH
Low Freq. Cutoff	120 cps.	140 cps.	180 cps.
Sound Distrib.	360°	360°	360°
Air Column Lgth.	5 ft.	4 ft.	3 ft.
Bell Diameter	28 1/4"	25 1/2"	18 7/8"
*Overall Height	18 1/2"	14"	11"
*Shipping Weight	27 lbs.	21 lbs.	18 lbs.
LIST PRICE	\$59.00	\$45.00	\$38.50
*Less Driver Unit.			



Explosion-Proof Speakers — Designed for Hazardous Duty

Approved by Underwriters' Laboratories for use in locations where flammable liquids, gases, dust and other combustibles are present. Permits use in industries previously denied the advantages of sound, paging and intercom.

Complete with built-in line matching transformer, the University Explosion-Proof speaker line is versatile, ruggedly constructed and compact.

Model 7101 is UL approved for Class I, Groups C and D.

Model 7102 is approved for Class I, Groups C and D, and Class II, Groups E, F and G.



MODEL PMA
ADAPTER — For
mounting University "U"
bracket speakers on standard
1/2" pipe. List Price \$1.50

Cont. Power	25 watts
Voice Coil	16 ohms
Impedance	
Transformer	45, 500, 1,000
Impedances	1500, 2,000 ohms
Frequency	200-10,000 cps.
Dispersion	95°
Dimensions	19" length
	15 3/4" height
Shipping Weight	25 lbs.
	7101 7102
LIST PRICE	\$125.00 \$150.00

For complete product information get your copy of University Loudspeakers TECHNOLOG at your local distributor.

University

LOUDSPEAKERS

A TRUMPET DESIGN OF AMAZING VERSATILITY WITH SUPERIOR NOISE PENETRATION

THE NEW COBREFLEX - 2

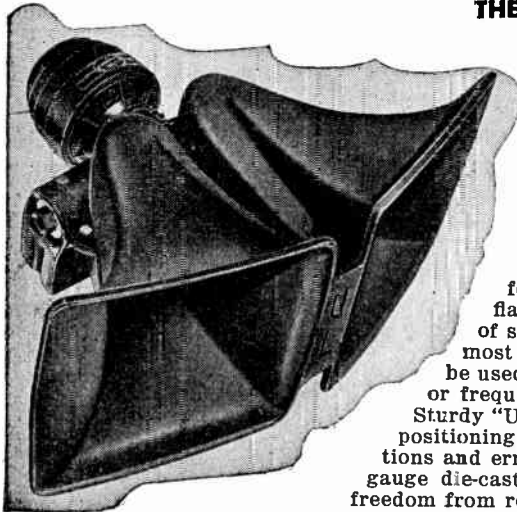

Meets Every Requirement for —

- Paging and Talk-Back Installations
- Fixed or Mobile Systems
- Heavy Industry Applications
- 2 or 3-way hi-fi Systems

Lifetime Guarantee

Cont. Power	} Dependent on University Driver Unit used.
Impedance	
Frequency Res.	
Dispersion	
Dimensions	120° x 60°
	10 1/4" lg. bell,
	18 1/2" x 9 1/4" mouth
Shipping Weight	11 lbs.
LIST PRICE	\$35.00

A unique combination of battle-ship construction and swiss watch precision. . . . Features a pair of exponential horns having twin air columns in a single assembly—made possible for the first time through the perfection of a "dual exponential flare" design. This advance design provides wide-angle dispersion of sound, concentrating energy in the horizontal plane where it is most needed in covering wide areas efficiently and economically. Can be used with any University driver unit to meet any impedance, power or frequency response. See page C-16 for driver unit listings. Sturdy "U" bracket with serrated swivel joint permits up to 180° vertical positioning and positive locking. Clever one-piece design prevents vibrations and erratic performance by elimination of any separate parts. Heavy gauge die-castings set a new standard in rugged construction and assure freedom from resonant type vibration.

FOR WIDE ANGLE HORIZONTAL DISPERSION . . .

Cobra-12

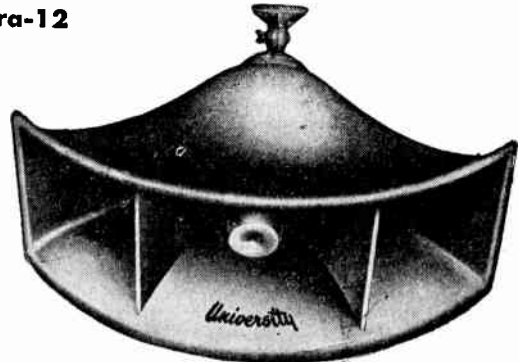

Maximum Sound Coverage at Minimum Cost

The Cobra-12, sister to the Cobreflex-2, provides moderate power with maximum intelligibility and a dispersion pattern expressly designed for greatest sound distribution in the horizontal plane. Built-in hermetically sealed driver features highest sensitivity for greatest amplifier economy and effective talk-back work. Adjustable swivel mounting bracket directs the sound where it is needed. The result is truly effective coverage over wide areas.

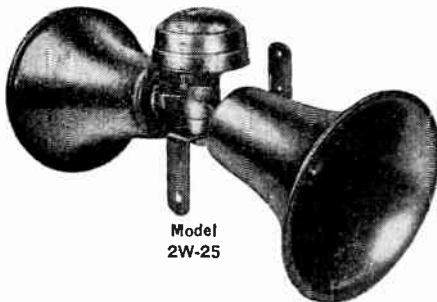

Model
2W-25

MODEL	Cobra-12	2W-25
Continuous Power	12 watts	25 watts
Impedance	8 ohms	16 ohms
Dispersion	120° x 60°	120° each horn
Frequency	250-10,000 cps.	350-6000 cps
Dimensions	14 1/2" lg. bell 20" x 9" mouth	20 1/2" lg. bell 8" dia. mouth
Shipping Weight	8 lbs.	9 lbs.
LIST PRICE	\$45.00 (including built-in driver)	\$48.00 (including driver)

Bi-Directional Speaker — Recommended for two-way

applications requiring perfect clarity . . .

A single heavy duty driver unit (supplied) serves both reflexed horns through a carefully designed acoustic coupler. Each horn has a wide 120° sound projection pattern, with the sound projected 10° downward (or 10° outward) so that no energy will be lost in unoccupied space.

- Covers two large areas with a single driver unit.
- Reduces installation and equipment costs.
- Versatile bracket arrangement provides 4 different mounting positions.
- Built for continuous heavy duty service.

For complete product information get your copy of University Loudspeakers TECHNOLOG at your local distributor.

University

LOUDSPEAKERS

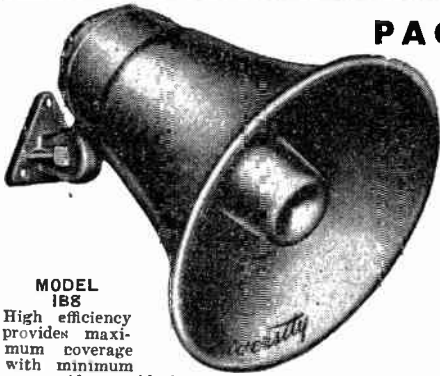

MODEL IB8

High efficiency provides maximum coverage with minimum power. Also an ideal talk-back speaker because of high sensitivity. Rising frequency characteristics result in exceptional noise penetration. Features high power capacity.

PAGING AND TALK-BACK SPEAKERS FOR GENERAL APPLICATION

Reproduction with crisp clarity for maximum penetration through areas with high noise density

Check These Features:

- ✓ Famous University Reflex Design
- ✓ Weatherproof, breakdown-proof construction
- ✓ Hermetically sealed driver units
- ✓ Small size — high efficiency

MODEL SPA ADAPTER

Replaces standard triangular base used on all University paging speakers in order to mount to threaded 1/2" pipe. Order separately. List Price \$1.50

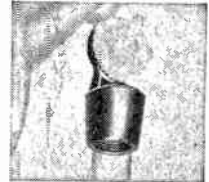

MODEL MIL

For installations requiring concentrated power to cover small areas. High conversion efficiency conserves amplifier power, ideal for low level systems.



MODEL MIS

Designed for flange or flush mounting in cabinets, walls, ceilings, bulkheads, etc. Ideal for replacement of cone speakers to increase output.



MODEL IBR

Small radial speakers, complete with built-in driver unit. Affords 360° horizontal dispersion resulting in wide coverage with a minimum of speakers.



MODEL CR

Reflex speaker conservatively rated at 20 watts continuous duty, and featuring built-in driver unit. Excellent tonal balance for music.

MODEL	IB8	MIL	MIS	IBR	CR
Continuous Power	12 watts	3 watts	3 watts	12 watts	20 watts
Impedances	8 ohms*	8 ohms (45 ohms on order)	8 ohms (45 ohms on order)	8 ohms	16 ohms
Dispersion	90°	120°	160° (45 ohms on order)	360°	90°
Frequency	300-10,000	400-9000	500-9000	300-10,000	250-6000
Dimensions	3 1/2" dia., 9" high	6 3/8" dia., 7" high	3 7/8" deep, 5 1/2" O.D., 4 7/8" mount. dia.	12 3/8" dia., 10 3/4" high	11 1/2" dia.
Shipping Weight	5 lbs.	4 lbs.	3 lbs.	5 lbs.	9 lbs.
LIST PRICE	\$32.50 *4Ω—Order 1B4 \$34.00	\$25.00 45Ω \$26.25	\$21.50 45Ω \$22.75	\$39.00	\$42.00

Wide Range Weatherproof



Coaxial System

Model WLC

Designed to simplify indoor and outdoor "high quality" sound installations . . .

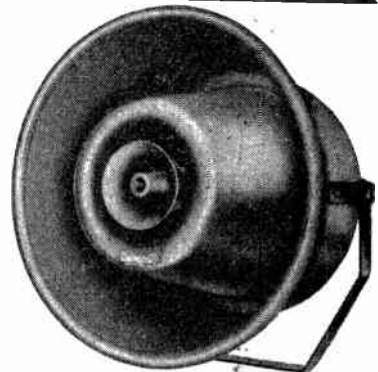
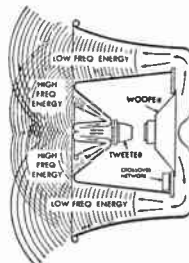

Power Capacity	30 watts
Impedance	8 ohms
Response	50-15000 cps.
Dispersion	90°
Diameter	33 1/2"
Depth	20"
Shipping Weight	80 lbs.
LIST PRICE	\$250.00

MODEL WLC is the new improved, all-weather coaxial speaker system designed to simplify indoor and outdoor "high quality" sound installations. A complete system comprising a low frequency cone speaker, driver type high frequency reproducer and a 1000 cycle LC crossover network. Completely wired and contained in a compact, heavy gauge all-metal dual horn assembly. Affords remarkably smooth overall response and is capable of 30 watts input and life-like reproduction from 50 to 15,000 cycles. Recommended for bandshells, outdoor movies, auditoriums, dance halls, rinks.

For complete product information get your copy of **University Loudspeakers TECHNOLOG** at your local distributor.

University

LOUDSPEAKERS

SUPER POWER SOUND PROJECTORS

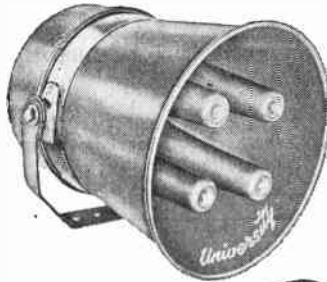

Powerful force capable of great distances and noise penetration
 Ideally suited for stadiums, airplane sound casting and for the transmission of chime and organ music from church towers. The perfect answer for civil defense alert and "panic-control" systems.

- Handle tremendous powers—up to 720 watts.
- Lightweight—rugged in construction—simple to install.
- Fool-proof in operation and immune to weather conditions.

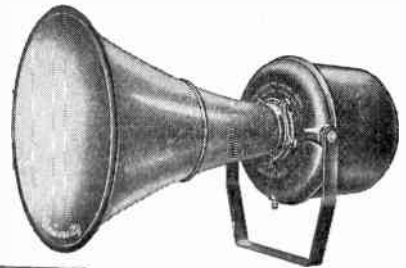

MODEL 4A4 projector uses four 25 watt driver units, each feeding into separate reflexed air columns which combine into a concentrated beam of high intensity sound. Supplied less driver units; use MA-25 or SA-HF.

MODEL B-6 is powered by six driver units feeding into a phase-corrected mixing chamber, and coupled to an exponential horn. Driver units supplied.

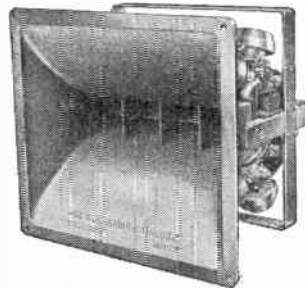

MODEL B-12 — Uses 12 special drivers. Ideal for high noise areas and transmitting great distances from a central point. Weatherproof and rugged. "U" mounting bracket and wired driver units included.

MODEL B-24—Newly designed, for super power sound-casting. Compact design and small dimensions permit its use either singly or in clusters to form any desired power or sound distribution pattern. Uses 24 special driver units, which are supplied completely wired.

*When used with SA-HF Driver Units. May be used with MA-25
 **10,000 cps. drivers available on request at extra cost.
 ***Available with SA-30 Driver Units on request at extra cost.

MODEL	4A4	B-6**	B-12	B-24
Power, Cont.	100 watts	150 watts	300 watts	720 watts
Frequency	200-10,000 cps.*	100-10,000 cps.	100-10,000 cps.	250-6000 cps.**
Impedance	Can be wired for 4, 16, 64 ohms	Supplied unwired; single and multiple inputs from 2 to 125 ohms possible.	Double input 90 ohms each; single input 45-50 ohms total	Supplied completely wired for 10 ohms
Dispersion	80°	80°	80°	90° x 45°
Dimensions (Overall)	18 1/4" high 20 1/2" depth 16 7/8" width	31 3/8" high 50 5/8" depth 31 3/8" (bell diam.)	31 3/8" high 47" depth 31 3/8" (bell diam.)	22" high 18 1/2" depth 24" width
Shipping Weight	30 lbs.	60 lbs.	90 lbs.	120 lbs.
LIST PRICE	\$93.00	\$542.50	\$972.50	On request

SUBMERGENCE-PROOF SPEAKERS



Immune to salt spray, gases, live steam, fungi and all harmful dirt and dusts.

Designed to U. S. Navy submergence specs . . . provide reliable, uninterrupted service with negligible maintenance under the most gruelling conditions. Numerous commercial and industrial applications: docks, bridges, boiler rooms, mines, railroads, etc.

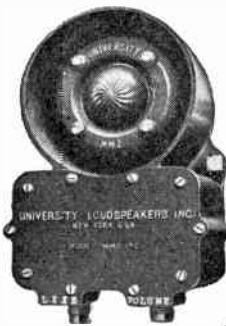

MODEL MM-2C
 Bulkhead-mounted, directional speaker providing a dispersion of 120°. Includes provision for a transformer and attenuator. Accessible from front, with cable entrance and control at bottom. (Also available complete with 5420 transformer and T-pad, Model MM2C-T.)

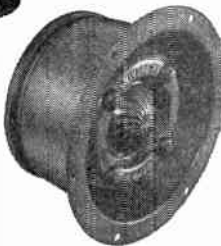

MODEL MM-2F
 Similar to Model MM-2 but designed for flange mounting. Permits flush mounting in wall, ceiling, bulkheads, dashboards or wherever appearance is important, or projecting objects might cause damage.

MODEL MM-2
 A compact speaker with reflex air column and hermetically sealed, built-in driver. Adjustable serrated swivel mounting bracket allows easy installation. Base fits Model CTR-20 weatherproof line matching transformers.

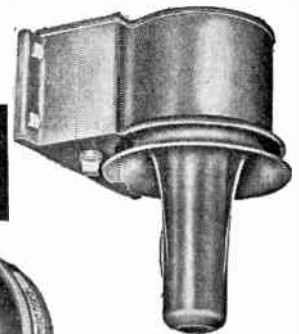

MODEL MSR

Reflexed air column horn for 360° horizontal dispersion. Features completely die-cast aluminum housing and horn, hermetically sealed driver unit. Provides for both line matching transformer and volume control within housing. For wall or bulkhead mounting. (Model MSR-T includes 5420 transformer and T-Pad.)

MODEL	MM-2C	MM-2F	MSR	MM-2
Continuous Power	15 watts	15 watts	15 watts	15 watts
Impedance	16 ohms	16 ohms	16 ohms	16 ohms
Dispersion	120°	150°	360°	150°
Frequency	300-6000 cycles	200-6000 cycles	250-6000 cycles	300-6000 cycles
Dimensions	10" high 4 1/2" depth 6 1/4" wide	7 1/4" O.D. 3 3/4" depth 6 3/4" mtg. hole dia.	10 3/4" high 8 1/4" depth 7 3/4" wide	4 3/4" depth
Shipping Weight	9 lbs.	5 lbs.	11 lbs.	5 lbs.
LIST PRICE	\$65.00	\$40.00	\$65.00	\$42.00

For complete product information get your copy of University Loudspeakers TECHNOLOG at your local distributor.

University

LOUDSPEAKERS

For Listening Pleasure That Is Performance Proven

The Dual Range Model 6201 Coaxial System

Now generally acknowledged as the industry's finest value in a high quality, 12" loudspeaker—and for good reason! The 6201 is one of the few true coaxial systems . . . complete with horn type "Tweeter" driven by a separate high efficiency, high frequency driver, plus built-in inductance/capacitance type crossover network complete with variable "balance" control, supplied with 36" of connecting cable and fully wired. A completely engineered package—just connect the two free wires to the amplifier output terminals and presto, the system is ready to give you lifelike, always pleasant reproduction of your favorite musical selection. You can pay more but won't find a better engineered 12" speaker than the popular model 6201.

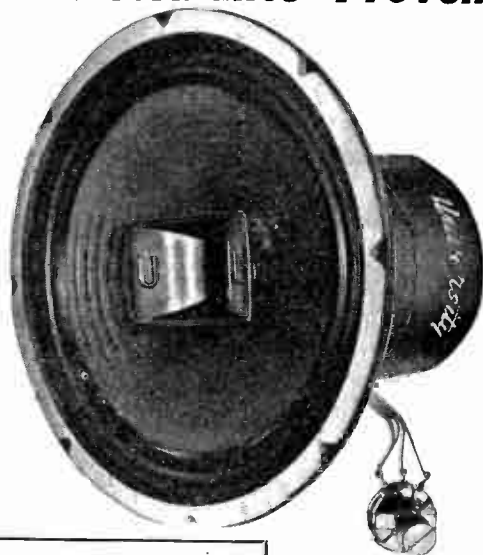

The Diffusicone 8 and 12 — Wide Range Speakers . . . at amazing low cost

University Diffusicone (pat. applied for) speakers bring within every music lovers grasp the endless pleasures of true concert hall quality reproduction without need for undue concern over speaker location. Exclusive "Diffusicone" design results in full fidelity anywhere in the room . . . full undistorted response, without loss of highs at listening points progressively off speaker axis.

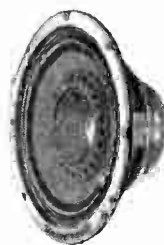

MODEL	6201	6200	DIFFUSICONE 8	DIFFUSICONE 12
Response	45-15,000 cps.	45-10,000 cps.	70-13,000 cps.	45-13,000 cps.
Power Capacity	25 watts continuous	30 watts	25 watts, cont. duty	30 watts, cont. duty
Source Impedance	8 ohms	6-12 ohms	8 ohms	8 ohms
Dimensions	12 1/2" dia., 8 1/4" depth RMA Stand. 12" mounting	12 1/4" dia., 4 1/2" depth RMA Stand. 12" mounting	8 3/4" dia., 3 3/8" depth 7 5/8" x 8 mtg. holes, 8 punched	12 1/4" dia., 4 1/4" depth 11 3/8" x 8 mtg. holes, 4 punched
Shipping Weight	10 1/2 lbs.	5 1/4 lbs.	3 1/2 lbs.	5 1/2 lbs.
LIST PRICE	\$75.00	\$35.00	\$35.00	\$45.00

EXTENDED RANGE SPEAKER

Designed for general applications requiring a highly efficient, extended range PM loudspeaker with full-bodied response to 10,000 cycles. Ideal for improvement of commercial type radio, phono and TV combinations, for high quality P.A. and for sound reinforcement in restaurants, churches, schools, hospitals, stores, etc.



Model 6200



C-15W SUPER 15" WOOFER

At last, a 15" loudspeaker designed not only to provide the acme of attainable perfection in the specific reproduction of low frequencies, but one which defies obsolescence due to impedance matching requirements as speaker systems are altered or expanded. The C-15W may be used in any 2, 3 or 4-way speaker system utilizing woofer crossover up to 2000 cycles. Amplifier rated to 50 watts may be employed. List \$125.00



- DUAL IMPEDANCE RANGE VOICE COIL—4-8 ohms and 10-16 ohms available at speaker terminals.
- LONGEST VOICE COIL AXIAL DEPTH—Coil remains in gap, results in superior conversion efficiency and transient response.

For complete product information get your copy of University Loudspeakers **TECHNILOG** at your local distributor.

University

LOUDSPEAKERS

FOR EXTENDED FREQUENCY RESPONSE HIGH EFFICIENCY TWEETERS

Exclusive "Reciprocating Flares" principle offers these important performance advantages

1. Uniformity of response—negligible variation of sound intensity at various positions off speaker axis.
2. True wide angle response with optimum angular distribution of sound—no radical shifts in energy level between vertical and horizontal planes.

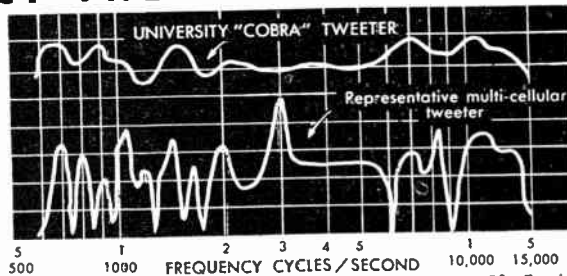

Tests made with same driver on both horns—curves at 45° off axis.
The Curve Tells the Difference

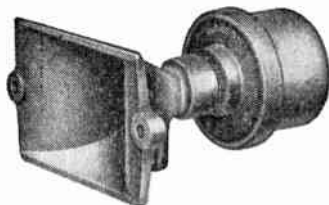

2000 Cycle Tweeter
Model 4401

Handles the output of amplifiers up to 25 watts when used with any suitable PM or field excited 8-15 inch cone speaker and proper high pass filter and cross-over network. Exceptional performance at a cost that cannot be ignored.

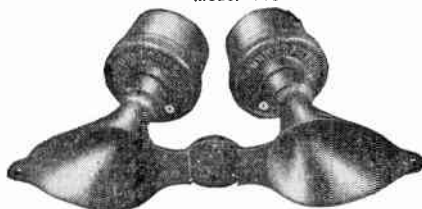

Wide Angle
Dual Tweeter
Model 4402

Electrical and acoustical characteristics make it the most versatile high frequency tweeter available.

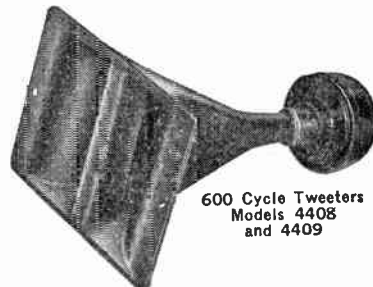

600 Cycle Tweeters
Models 4408
and 4409

Professional reproduction for two and three way speaker systems . . . economical wide-range response to the limits of audibility.

MODEL	4401	4402	4408	4409
Response	2000-15,000 cycles	2000-15,000 cycles	600-15,000 cycles	600-15,000 cycles
Impedance	For 6-16 ohm woofers	4-8 ohms and 10-16 ohms	Use with woofer from 6-16 ohms	For 6-16 ohm woofers
Power	Amplifiers up to 25 watts	Amplifiers up to 50 watts	Amplifiers up to 15-20 watts	Amplifiers up to 25-40 watts
Dispersion	90° Horizontal 45° Vertical	120° Horizontal 50° Vertical	120° Horizontal 60° Vertical	120° Horizontal 60° Vertical
Width (overall)	4 1/2"	9 1/2"	7 3/4"	7 3/4"
Depth (overall)	5 7/8"	5 1/8"	11 3/8"	10 1/2"
Height (overall)	2 5/8"	2 5/8"	5 1/8"	5 1/8"
Shipping Weight	2 lbs.	4 lbs.	5 lbs.	5 lbs.
LIST PRICE	\$25.00	\$40.00	\$30.00	\$40.00

University Crossover Networks — Effective . . . Economical . . . Assure Cleaner Reproduction

Frequency Dividing Networks
Model 4410, 4420



- Prevents low frequencies from entering the tweeter.
- Eliminates high frequencies from the woofer circuit.

All University Crossover Networks incorporate high-frequency balance control completely wired.

High Pass
Filter
Model 4405

Genuine inductance/capacitance networks which not only prevent low frequencies from entering the tweeter, but also eliminate high frequencies from the woofer circuit.

MODEL	4405	4410	4420
Crossover	2000 cycles	600 cycles	2000 cycles
Input Impedance	6-16 ohms	6-16 ohms	6-16 ohms
Height	2 3/8"	4 3/8"	2 3/8"
Length	3 3/8"	9 1/8"	7 1/8"
Depth	2 1/4"	3 1/8"	2 1/8"
Attenuator	Built-in, Variable	Built-in, Variable	Built-in, Variable
Shipping Weight	2 lbs.	4 lbs.	3 lbs.
LIST PRICE	\$10.00	\$35.00	\$20.00

For complete product information get your copy of University Loudspeakers TECHNOLOG at your local distributor.

Radio's Master — 19th Edition

Prices on West Coast Slightly Higher

Copyright by U. C. P., Inc.

LIST PRICES SUBJECT TO TRADE DISCOUNTS

University

LOUDSPEAKERS

UNIVERSITY MULTI-SPEAKER SYSTEMS . . . the ULTIMATE — for Limited or Spacious Settings

University, the leader in Sound Engineering, achieves the outstanding combination of the ultimate in craftsmanship and engineering with pleasing and compatible exterior design. Superior high fidelity "presence" is re-created by these University multi-speaker systems due to the selection of perfectly balanced and carefully controlled components . . . the lyrically brilliant highs, the soft-colored mid-range, and the rich, distortion-free low frequencies which emanate from a precision-built acoustical chamber in enclosures styled to complement every University hi-fi enthusiast's home.

The Classic . . .

- Houses Deluxe multi-speaker system comprised of a wide angle high frequency tweeter, mid-range Cobraflex-2 horn and driver, the NEW C15W low frequency woofer, and a specially designed three-way crossover network.
- Highly engineered front folded horn works in conjunction with a rear baffle chamber in perfected balance to faithfully reproduce deep dimension realism of bass tones.
- L/C type network crosses over at 350 and 6,000 cycles.
- Built-in "presence" and "brilliance" controls.
- Custom built Classic doubles as a Hi-Boy and Lo-Boy. Simple adjustable base accommodates Classic in a vertical or horizontal position for easy room arrangements.
- Available in hand rubbed Cherry and Blond Mahogany finishes.
- Hgt. 34 1/2", Wdth. 40 1/2", Dpth. 24 3/4".
- User Net Price \$395.00

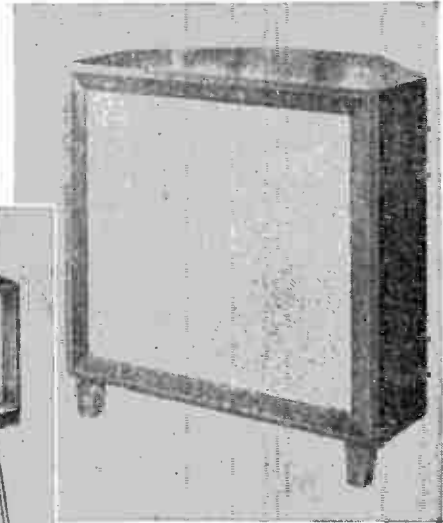
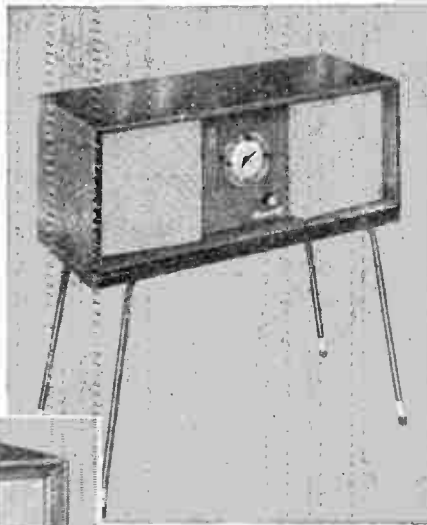

The Dean . . .

- Includes same Deluxe multi-speaker system and network used in Classic.
- "Cornerless-corner" design of full-folded horn path results in clean, superb efficiency in the reproduction of low frequency range.
- Optimum performance not dependent upon room position, due to new acoustic design of enclosure.
- Satin-like finishes in Cherry and Blond Mahogany. Both finishes same price.
- Height 36 3/4", Width 36", Depth 22".
- User Net Price: \$395.00

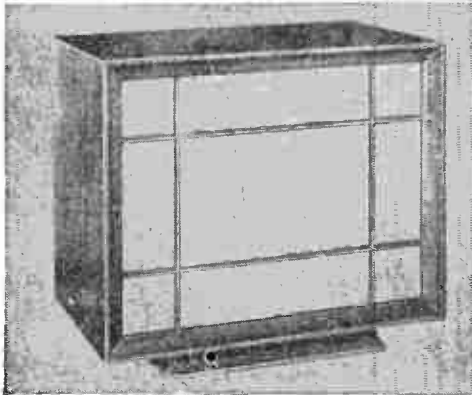

The Companion . . . Revolutionary musically balanced three-way high fidelity system employs combination woofer/mid-range and tweeter reproducers which are acoustically interconnected with a genuine inductance-capacitance dividing network.

- Special tonal balance control enhances personal listening tastes, program material and room acoustics.
- Automatic Sessions timepiece will plan your musical itinerary . . . record your favorite program in your absence . . . awaken and accompany you to sleep while your choice symphony plays . . . "shuts off" automatically, too.
- The Companion blends into many decorative patterns for the music room, library, living room, den, study, fits into your bookcase or functional headboard, and becomes an attractive floor unit when used with wrought iron legs.
- Modernly styled and available in Cherry and Blond Mahogany. Both finishes at same price.
- Height 29 5/8", Width 24", Depth 10".
- User Net Price: \$99.50

An Authoritative Manual on Speaker

Application and Installation

UNIVERSITY 28-PAGE TECHNILOG

Written by sound experts to simplify the work of installation and servicemen to make their sound job easier. In the TECHNILOG you may find the answers to such installation and service problems as —

- Selecting the proper loudspeaker system.
- Methods of connecting speakers to the amplifier.
- Impedance matching.
- Impedance matching transformers.
- Effects of mismatch upon power transfer.
- Controlling loudspeaker volume.
- Overload protection of loudspeakers.
- Phasing loudspeakers.
- Reverberation.
- Battling a cone speaker.

TECHNILOG is a valuable addition to any technical library and is available to you at no cost.



Request your copy from
your distributor today!





ATLAS SOUND CORP.

the complete line for every public address need!



ATLAS 'DR' WEATHERPROOF DOUBLE-REENTRANT PROJECTORS

Non-Resonant • Uniform Response • Sturdy • Stormproof
Compact • Demountable

The modified exponential taper developed in Atlas projectors has proved most efficient for overall performance. All acoustical paths are clean and uniform. Reflex turns are smooth and flowing. These important features eliminate turbulence, frequency cancellation and resultant signal distortion. Ruggedly constructed of heavy castings, precision stampings, accurate die castings and uniform metal spinnings. All metal-to-metal surfaces insulated with non-vibratory material. Bell rim dampened and mechanically protected with formed rubber rim. All metals specially processed by chemical and electro-chemical means to impart complete weather-protection. Heavy "U" bracket mountings, securely fastened to main body casting of each model, do not fail even under extreme stress, strain or vibration. 1 3/8" - 18 thread. For greatest efficiency and low frequency response, the larger size horns are recommended. The smaller horns are excellent where space and cost limitations pertain.

Model	Air Column	Low Frequency	Lgth.	Diam.	List Price
DR-32	2 1/2 ft.	175 c.p.s.	12 in.	14 in.	\$26.00
DR-42	3 1/2 ft.	135 c.p.s.	15 in.	21 in.	31.00
DR-54	4 1/2 ft.	105 s.p.s.	18 in.	23 in.	43.00
DR-72	6 ft.	85 c.p.s.	25 in.	31 in.	65.00

ATLAS SUPER-POWER ALNICO-V-PLUS DRIVER UNITS

All models include Atlas "Alnico-V-Plus" super-efficient magnetic circuit — magnetically shielded, hermetically sealed. One-piece unbreakable, high temperature and fatigue-proof phenolic diaphragm. Deluxe PD-5VT and PD-8VT include built-in "Uni-Match" transformer for universal matching to constant impedance and constant voltage systems. All transformer taps and direct voice coil connections are brought out to waterproof "terminal window" on rear of phenolic unit housing. 1 3/8" - 18 thread.



PD-5VH



PD-4V



PD-5VT
PD-8VT
PD-8VL

Model	Power	Impedance	Frequency	List
PD-4V	25 watts	16 ohms	90-6000	\$27.50
PD-5VH	25 watts	16 ohms	80-9000	35.50
PD-5VT	25 watts	16 ohms*	80-9000	45.00
PD-8VT	30 watts	16 ohms*	80-10,000	50.00
PD-8VL**	30 watts	16 ohms	80-10,000	42.50

*Actual voice coil impedance. "Uni-Match" transformer offers 165, 250, 500, 1000, 2000 ohms and variable 70-volt line connections.
**Identical to Model PD-8VT, but supplied less transformer.



RC-6
RC-8

RADIAL DRIVER UNIT PROJECTORS

- Non-Resonant • Dual Rubber Rims
- Uniform 360° Coverage
- 100% Stormproof

One of these models often is more efficient for large and high noise level areas than several ordinary projectors. For speech and music. All-aluminum construction—

smooth, uniform response. Thread 1 3/8" - 18. Use of H-2U 2-unit adapter doubles power output for single projector high power application.

	RC-8	RC-6
Air Column	5 feet	4 feet
Bell Diameter	29"	25"
Overall Ht. (incl. bracket)	26"	21 1/2"
Low Frequency Cutoff	120	150
List (horn only)	\$53.50	\$43.00

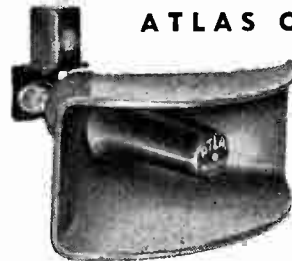

ATLAS COBRA-JECTOR

- Indestructible Fiber-Glass
- All-Weather
- Wide Angle Dispersion

New, versatile, all-purpose. Penetrating articulation assures wide angle intelligible coverage even under adverse sound conditions. Omni-directional mounting bracket. An amazing "power package"—excellent for the "tough" jobs.

Input Power (continuous)	15 watts
Input Impedance	8 ohms
Response	250-9000 cps
Dispersion	120° x 60°
Size	Opening, 14" x 6"; overall length, 14"
List	\$40.00

ATLAS SOUND CORP.



the complete line for every public address need!

ATLAS NEW ALNICO-V-PLUS PAGING AND TALK-BACK SPEAKERS

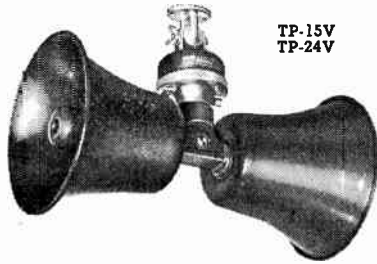

TP-15V
TP-24V



HU-24V



HU-12

HU-15V

Model	HU-12	HU-15V	HU-24V	TP-15V	TP-24V
Power*	5 watts	12 watts	12 watts	12 watts	12 watts
Impedance	8 ohms#	8 ohms †	8 ohms †	8 ohms †	8 ohms †
Frequency	375-9000 c.p.s.	300-7000 c.p.s.	200-7000 c.p.s.	250-7000 c.p.s.	190-7000 c.p.s.
Length	7½ in.	11 in.	14½ in.	15½ in.	22 in.
Diameter	6¼ in.	8½ in.	10 in.	8½ in.	10 in.
Air Column	13½ in.	16½ in.	24 in. ea. side	19½ in. ea. side	27 in. ea. side
List	\$25.00	\$32.50	\$35.75	\$47.50	\$52.00

These speakers include the newly developed, unbreakable, hermetically sealed driver units using the Alnico V-Plus magnetic circuit. As reproducers, and as microphones in talk-back circuits, they provide a maximum of efficiency. The new ball swivel mounting bracket permits quick and simple directional adjustment in every position, horizontal and vertical. All-aluminum construction, finished in high lustre gray enamel over electrochemically treated surfaces.

Model HU-12—Subminiature speaker with high intelligibility at minimum input power.

Model HU-15V—Medium-size speaker that withstands considerable input power. Large diaphragm and magnetic assembly similar to those used in the larger Atlas reproducers.

Model HU-24V—Oversize speaker with obvious advantage of longer air column, so that it also reproduces music with excellent results.

Model TP-15V—Dual speaker ideal for industrial and talk-back uses, often producing two-speaker results from a single unit.

Model TP-24V—Oversize dual speaker with longer air column for added efficiency, especially at the lower frequencies.

* Given power ratings are conservative and are for continuous input. Peak power ratings may safely exceed this amount by 25%.

Model HU-12 available in 45 ohms.

† Available in 16 ohms.

SPEAKER SUPPORT STANDS

SS-2 — Folding legs automatically level on uneven ground. Supports a cluster of speakers even under adverse wind conditions. Double clutch protection against accidental release. Tube assembly and legs are cadmium-plated steel; clutches and locks are machined iron castings. "Easy-off" top fitting permits attachment or removal of projector without tools. Ht. extension 5-10 ft. Wt. 20 lbs. List Price \$38.00



MODEL SS-2
With HM-2

MODEL SS-2

HM-2 Horn Mounting Accessory — Permits 3 speakers on SS-2 Stand, and their orientation in any direction. No tools needed for setting up or dismantling. List Price \$14.00

TWO-WAY ENCLOSURE for 8" Cone Speaker



TW-8

Speaker's front and back wave are used for good coverage in long corridors and central locations. Adjustable wall or ceiling mounting brackets and speaker mounting screws supplied. Outside diam. 10", depth 5".

Model TW-8

List Price \$9.00

NEW WEATHERPROOF LINE MATCHING TRANSFORMER

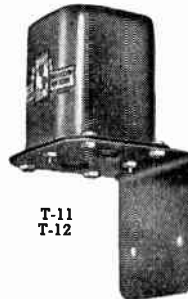

T-11
T-12

Specifically designed for high efficiency and ease of installation, these new transformers enable the matching of the popular Atlas "TP" and "HU" paging and talk-back speakers to either constant voltage (70-volt line) or constant impedance systems. The transformer taps eliminate the need for complex computations. Protective housings are heavy steel. Double rubber grommets and gaskets protect cable connections entering the housing. Convenient transformer bracket is easily integrated with speaker mounting bracket—no extra fastenings needed. Frequency response assures efficiency over entire range required, with a minimum insertion loss. Power-handling capacity of both models is 12 watts. Finish is in durable gray enamel.

Model T-11—Primary: 500, 1000, 1500, 2000 ohms. Secondary: 4 and 8 ohms. List Price \$8.50

Model T-12—Primary: 45 ohms. Secondary: 4 and 8 ohms, for matching 40-60 ohm intercom line to 8 ohm speaker. List Price \$8.00

TWO UNIT TO ONE PROJECTOR



H-2U

When it is necessary to obtain the greatest possible power output from a single projector, the H-2U is recommended. It permits the use of 2 driver units with any type of projector. Cast aluminum construction. Threads 1¾"-18.

List \$11.00

PIPE STANCHION FITTING



PS-1

"DR" reentrant or "RC" radial "U" brackets adapted to ¾" pipe fittings. This steel adapter has holes properly located to match holes in "U" bracket. All mounting bolts supplied. Female ¾" pipe thread. List \$1.50

Copyright by U. C. P., Inc.

LIST PRICES SUBJECT TO DISCOUNT

Radio's Master — 19th Edition

Page C-25

LOWELL XCP SERIES

Back Cover Protective Speaker Enclosure

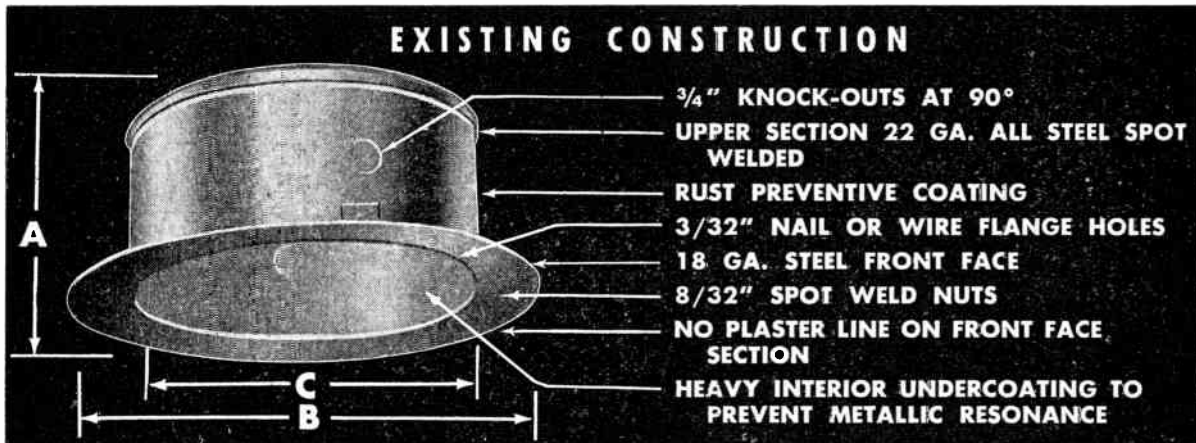

Model	A	B	C	Speaker Size Accommodated
XCP6	4"	10 1/8"	7"	6"
XCP8	4 1/4"	11 3/4"	8 1/2"	8"
XCP1012	7"	15 7/8"	12 1/2"	10" and 12"

USES: This back cover protective speaker enclosure is designed for quick and labor saving wall or ceiling installation of sound systems in EXISTING CONSTRUCTION, ready for plastering.

DESCRIPTION: An all steel spot welded construction of heavy 22 ga. metal complete with plaster ring attached. 3/4" knock-outs at 90° — rust preventive coating on exterior with very heavy undercoating material on interior to prevent metallic resonance. Sufficient back pressure relief for speaker is provided in order to operate at its highest peak of efficiency. Complete mounting hardware and mounting instructions are furnished to meet the problems of various types of installations.

Note: Special overall depths and additional "loading" may be ordered at slightly higher price. (If space allows in wall or ceiling).

IMPORTANT: When mounting back enclosure in wall or ceiling for slip fit, cut hole to the following size as per model ordered:

Model No. XCP6 — Cut hole 7 1/4" in diameter and nail to lath.
 Model No. XCP8 — Cut hole 8 5/8" in diameter and nail to lath.
 Model XCP1012 — Cut hole 12 3/8" in diameter and nail to lath.

FOR SUSPENDED CEILINGS:

Support XCP Series Back Cover Protective enclosures to Models SS 24 or 48 Steel Support Channels for positive strength.

FEATURES: Protects speaker cone from falling dust and mortar. Prevents rodents from attacking back of speaker cone. Easily serviced without damage to walls or ceiling. Reduces installation time.

Speaker Baffles That Will Mount to XCP Series Protective Speaker Enclosures:

Enclosure Model No.	Speaker Baffle Model Nos.
XCP6	AL6-A, RS5-A, RSA
XCP8	AL7-A, AL8-A, RS7-A, RS8-A, CE8-L, JG8, M-8, P58
XCP1012	AL10-A, AL12-A, RS10-A, RS12-A, JG-12

AL SERIES



RS SERIES



JG SERIES

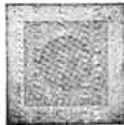

M SERIES

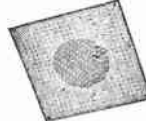

PS8 BLOCK PAN



LOWELL MANUFACTURING CO.

LOWELL CP SERIES

Back Cover Protective Speaker Enclosure

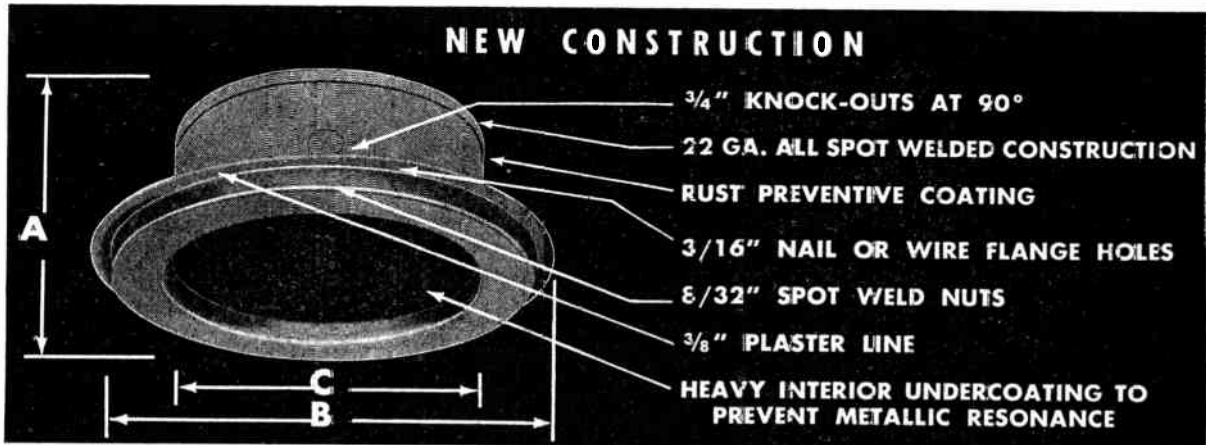

Model	A	B	C	Speaker Size Accommodated
CP6	4"	11 1/4"	7"	6"
CP8	4 1/4"	13"	8 1/2"	8"
CP1012	7"	17 1/8"	12 1/2"	10" and 12"

USES: This back cover protective speaker enclosure is designed for quick and labor saving wall or ceiling installation of sound systems in **NEW CONSTRUCTION**, ready for plastering.

DESCRIPTION: An all steel spot welded construction of heavy 22 ga. metal complete with plaster ring attached. 3/4" knock-outs at 90° — rust preventive coating on exterior with very heavy undercoating material on interior to prevent metallic resonance. Sufficient back pressure relief for speaker is provided in order to operate at its highest peak of efficiency. Complete mounting hardware and mounting instructions are furnished to meet the problems of various types of installations.

Note: Special overall depths and additional "loading" may be ordered at slightly higher price. (If space allows in wall or ceiling).

IMPORTANT: When mounting back enclosure in wall or ceiling for slip fit, cut hole to the following size as per model ordered:

Model No. CP6—Cut hole 7" in diameter and nail or tie to lath.
Model No. CP8—Cut hole 8 1/2" in diameter and nail or tie to lath.

Model CP1012—Cut hole 12 1/2" in diameter and nail or tie to lath.

FOR SUSPENDED CEILING:

Support CP Series Back Cover Protective enclosures to Models SS 24 or 48 Steel Support Channels for positive strength.

FEATURES: Protects speaker cone from falling dust and mortar. Prevents rodents from attacking back of speaker cone. Easily serviced without damage to walls or ceiling. Reduces installation time.

Speaker Baffles That Will Mount to CP Series Protective Speaker Enclosures:

Enclosure Model No.	Speaker Baffle Model Nos.
CP6	AL6-A, RS5-A, RS6-A
CP8	AL7-A, AL8-A, RS7-A, RS8-A, JG8, M-8, PS8
CP1012	AL10-A, AL12-A, RS10-A, RS12-A, JG12

AL SERIES



RS SERIES



JG SERIES



M SERIES

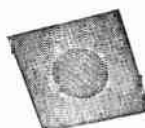

PS8 BLOCK PAN



LOWELL MANUFACTURING CO.

SURFACE MOUNTING CEILING BAFFLES

"WITH FLOATING CONICAL ACTION"

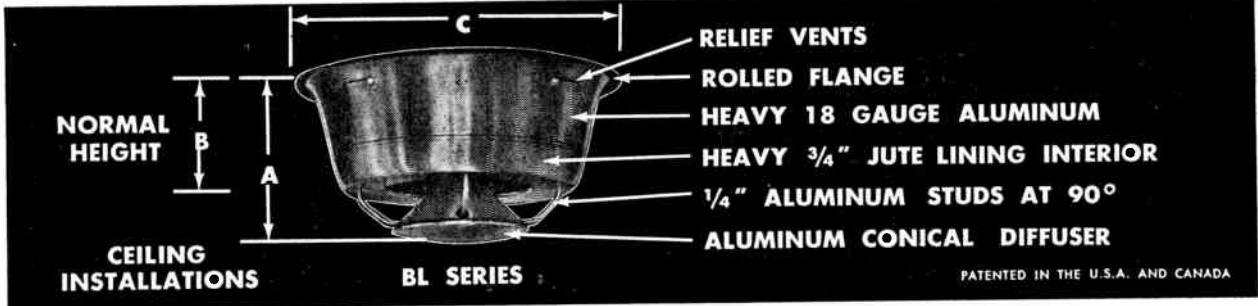

PATENTED IN THE U.S.A. AND CANADA

Model No.	Speaker Size	Dimensions			Will Mount to
		A	B	C	
BL6-A	5" or 6"	7 3/4	4 1/4	12 1/4	PL6
BL8-A	7" or 8"	8 1/8	5 1/4	14 3/4	PL8
BL10-A	10"	9 1/4	7 1/4	18 3/8	PL10
BL12-A	12"	9 1/4	7 1/4	18 3/8	PL12

IMPORTANT NOTE — Whenever additional cubical area is required, the CP or XCP Series may be installed in the ceiling. Choose the model on size of speaker planned in the installation.

PL Series Steel discs for mounting BL Series to concrete ceilings —

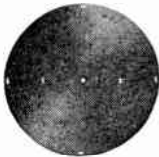

This type is a heavy 18 gauge steel disc with all hole locations punched for standard electrical outlet boxes.

GENERAL INFORMATION:

The BL Series Baffles are constructed of heavy gauge aluminum spinings accurately engineered for normal ceiling sound reinforcement. Due to its perfect speaker cone loading, feed-back is held to a minimum. CONTROLLED SOUND reproduction is obtained by proper conical dispersion of diffuser. The recommended placement of speaker baffles under normal ceiling heights are usually 25 feet off center of axis in straight line placement. High frequency diffuser is supported to housing by four 1/4" aluminum studs and threaded on one end mounted to housing. A press fit to diffuser thru soft rubber grommets to prevent metallic resonance. Sound coverage of 360° is obtained with this baffle. All models are finished in brushed satin and coated with a colorless lacquer. This finish will also furnish a wonderful base coat or primer for on-the-job painting. All models are available in colored lacquers at slightly higher prices. Further information furnished on request.

TYPE RS recessed wall type directional speaker baffles

AN EXCELLENT SPEAKER TRIM RING FOR MOST MODERN INSTALLATIONS. HIGHLY RECOMMENDED FOR DRESS SHOPS, DEPARTMENT STORES AND NIGHT CLUBS. PROVIDES CONCEALMENT OF SPEAKERS. EASILY INSTALLED.

description

Made of 18 gauge spun aluminum with 1/2" mounting flange. Mounts to wall with 4 toggle bolts or to Lowell models CP or XCP enclosures. Furnished with plastic grille cloth. Grille cloth and speaker mount to trim ring with 4 round head screws. Standard finish—satin aluminum.

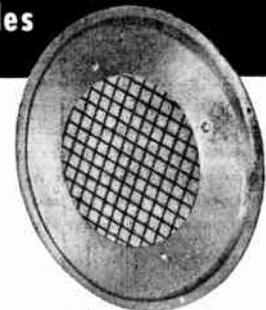

Model No.	Speaker Size	Dimensions	Wall Hole Size	Model No.	Speaker Size	Dimensions	Wall Hole Size
RS4-A	4"	7 1/2" dia. x 7/16" depth	5" dia.	RS8-A	8"	12 3/8" dia. x 1/2" depth	8 1/2" dia.
RS5-A	5"	10" dia. x 7/16" depth	7" dia.	RS10-A	10"	16 1/2" dia. x 1/2" depth	12 1/2" dia.
RS6-A	6"	10" dia. x 7/16" depth	7" dia.	RS12-A	12"	16 1/2" dia. x 1/2" depth	12 1/2" dia.
*RS7-A	7"	12 3/8" dia. x 7/16" depth	8 1/2" dia.	RS15-A	15"	23" dia. x 3" depth	17" dia.

*(For RCA 7" Accordion Speaker) Information on colored lacquers furnished on request for both models.

LOWELL MANUFACTURING CO.

LOWELL AL SERIES

Flush Mounting Low Ceiling Baffles

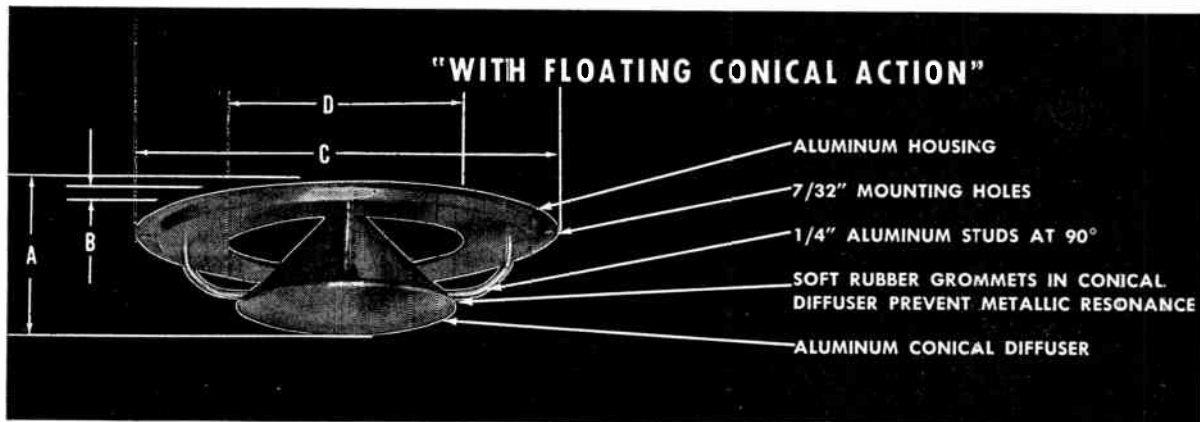

Speaker Baffle Model	Size Speaker Accommodated	Mount to Speaker Enclosure Models	Dimensions				Baffle Flange	No. of Flange Mounting Holes	Dia. of Required Hole in Ceiling	Weight (lbs.)		No. per Shpg. Carton
			A	B	C	D			Net	Shipping		
AL6-A	6"	CP6, XCP6, PR6 PS	2 1/2"	1/2"	10 1/2"	5 1/4"	1"	4	7"	1/2	3/4	12
AL7-A	7"	CP8, XCP8, PR8 PS	2 1/2"	1/2"	12 3/4"	5 1/4"	1"	4	8 1/2"	3/4	1	15
AL8-A	8"	CP8, XCP8, PR8 PS	2 1/2"	1/2"	12 3/4"	6 3/4"	1"	4	8 1/2"	3/4	1	15
AL10-A	10" or 12"	CP1012, XCP1012	3"	1/2"	17"	8 1/2"	1"	4	13"	1	1 1/2	6
AL12-A		PR1012										
AL15-A	15"	PR15	5"	2"	22"	13"	3/4"	8	15 1/2"	3	3 1/2	1

Lowell AL Series speaker baffles are top quality heavy gauge satin finished aluminum spinnings. Proper design assures 360° diffusion of undistorted, "ear-level" sound with minimum of echo and feedback. Conical diffuser "floats" on soft rubber grommets forming a press fit to aluminum support studs which thread to the speaker housing ring. Baffles are coated with clear lacquer which also serves as prime coat for on-the-job painting. Wide choice of colored lacquer finishes available on request. Shipped complete with hardware for mounting to Lowell Protective Speaker Enclosures illustrated.

360° Coverage Low "EAR LEVEL" Sound

Even, undistorted sound coverage is provided by Lowell speaker baffles. Recommended baffle placement is usually 25' from center of axis. Where straight line placement is impossible, triangulating the baffles in the ceiling is highly effective.

CP SERIES



XCP SERIES



PR SERIES



PS BLOCK PAN



LOWELL MANUFACTURING CO.

NO FINER CHOICE THAN

Electro-Voice

HIGH FIDELITY

SPEAKERS

DRIVERS • HORNS

TRX TRIAXIAL SPEAKERS

Exclusive features include concentric mounting of all elements for smooth room coverage; augmented bass response in conjunction with extended "silky" HF reproduction; tailored mid-range provides realism and "presence" at usual sound levels.

Adjustable AT37 brilliance control matches room acoustics. Includes X36 crossover network. Edgewise wound voice coil design affords 18% more efficiency and lower transient distortion; heavy magnet structures.



15TRX

Model 15TRX. Overall diameter 15 $\frac{3}{8}$ ". Resonance 38 cps, 30 watts. Magnet weight 5 $\frac{1}{4}$ lbs. Response ± 5 db 30-15,000 cps in recommended REGENCY enclosure. Mechanical crossover 2000 cps; electrical crossover 3500 cps. Depth behind mounting panel 9 $\frac{3}{8}$ ". Impedance 16 ohms. Sens. rtg. 51 db. Shpg. wt. 49 lbs.

List Price with X36 and AT37\$225.00

Model 12TRX. Same as 15TRX except for 12 $\frac{1}{2}$ " overall diameter. Resonance 41 cps, 25 watts. Magnet weight 3 $\frac{1}{2}$ lbs. Response ± 5 db 30-15,000 cps in recommended ARISTOCRAT enclosure. Mechanical crossover 2500 cps; electrical crossover 3500 cps. Depth behind mounting panel 8". Impedance 16 ohms. Sens. rtg. 49 db. Shpg. wt. 44 lbs.

List Price with X36 and AT37\$190.00

RADAX COAXIAL SPEAKERS

Discovery of the E-V RADAX Principle provides an economical and super-efficient method of utilizing two disparate coaxially mounted cones to divide the audio spectrum ... while both operate from only a single voice coil.

Built-in mechanical crossover from the low-frequency cone to the high-frequency propagator permits design of each cone for optimum response. This provides a true coaxial two-way speaker system that assures clean, sparkling wide-range reproduction. Frames are extra sturdy. Both speaker cones are moisture inhibited.



SP15

Model SP8B Radax Super-Eight. 8-inch coaxial speaker. Resonance 78 cps, 15-20 watts. Response 35-13,000 cps ± 6 db. 16 ohms impedance. Sens. rtg. 44 db. Crossover, 6000 cps. 1 lb. Alnico V magnet. 8 $\frac{1}{4}$ " diam., 7" baffle opening. 4 $\frac{3}{8}$ " depth behind mtg. panel. Shpg. wt. 8 $\frac{1}{2}$ lbs.

List Price\$47.50

Model SP12B Radax Twelve. 12-inch coaxial speaker. Resonance 55 cps, 15-20 watts. Response 30-13,000 cps ± 6 db. 16 ohms impedance. Sens. rtg. 45 db. Crossover. 4500 cps. 1 lb. Alnico V magnet. 12 $\frac{1}{2}$ " diam., 11" baffle opening. 5 $\frac{1}{4}$ " depth behind mtg. panel. Shpg. wt. 9 $\frac{3}{8}$ lbs.

List Price\$49.50

Model SP12 Radax Super-Twelve. 12-inch coaxial speaker. Resonance 49 cps, 25 watts. Response 30-13,000 cps ± 5 db. 16 ohms impedance. Sens. rtg. 48 db. Crossover, 4000 cps. 3 lb. Alnico V magnet. 12 $\frac{1}{2}$ " diam., 11" baffle opening, 7 $\frac{3}{8}$ " depth behind mtg. panel. Shpg. wt. 26 lbs.

List Price\$95.00

Model SP15 Radax Super-Fifteen. 15-inch coaxial speaker. Resonance 41 cps, 30 watts. Response 30-13,000 cps ± 5 db. 16 ohms impedance. Sens. rtg. 50 db. Crossover, 3000 cps. 5 $\frac{1}{4}$ lb. Alnico V magnet. 15 $\frac{1}{2}$ " diam., 13 $\frac{1}{2}$ " baffle opening, 9" depth behind mtg. panel. Shpg. wt. 44 lbs.

List Price\$130.00

SUPER SONAX VHF DRIVERS

Model T35. At least one more octave of silky highs is afforded through use of T35 for systems over 20 watts. Uniform response, 3500 cps to beyond audible range. Wide dispersion of 180°; Impedance 16 ohms. Diffraction horn cutoff 1500 cps. High sens. rtg., 56 db, requires use of AT37 level control for most systems; X36 crossover also required. Horn 4 $\frac{1}{2}$ " l, 1 $\frac{1}{2}$ " w; pot size 2 $\frac{1}{2}$ " diam., 3 $\frac{3}{8}$ " depth overall. Shpg. wt. 2 lbs.

List Price\$55.00

Model T35B. Same as T35 but for systems under 20 watts; sens. rtg. 52 db; Pot size 1 $\frac{3}{4}$ " diam.; 3" depth overall.

List Price\$35.00



T35

LOW FREQUENCY DRIVERS

Model 12W. 12-inch LF driver. Resonance 49 cps. 3 lb. Alnico V magnet. 20-30 watts. 16 ohms impedance. Sens. rtg. 48 db. 12 $\frac{1}{2}$ " diam., 11" max. baffle opening. 7 $\frac{1}{2}$ " depth behind mounting panel. Shpg. wt. 27 lbs.

List Price\$95.00

Model 12WK. Same as 12W but 3.2 ohms dc (for Klipsch "K" type baffles) 16 ohms nominal impedance.

Model 12BW. 12-inch LF driver. Resonance 55 cps. As used in EV 108 System. 1 lb. Alnico V magnet. 15-20 watts. 16 ohms impedance. Sens. rtg. 45 db. 12 $\frac{1}{2}$ " diam., 11" baffle opening, 6 $\frac{3}{8}$ " depth behind mtg. panel. Shpg. wt. 10 lbs.

List Price\$49.50

Model 15W. 15-inch LF driver. Resonance 37 cps. 5 $\frac{1}{4}$ lb. Alnico V magnet. 20-30 watts. 16 ohms impedance. Sens. rtg. 50 db. 15 $\frac{1}{8}$ " diam., 13 $\frac{1}{2}$ " maximum baffle opening. 9" depth behind mounting panel. Shpg. wt. 45 lbs.

List Price\$130.00

Model 15WK. Same as 15W but 3.2 ohms dc, 32 cps resonance (for Klipsch "K" type baffles). 16 ohms nominal impedance.

Model 18W. 18-inch LF driver. Resonance 27-30 cps. 5 $\frac{1}{4}$ lb. Alnico V magnet. 20-30 watts. 16 ohms impedance. Sens. rtg. 53 db. 18 $\frac{1}{2}$ " diam., 16 $\frac{1}{2}$ " max. baffle opening, 10" depth behind mtg. panel. Shpg. wt. 45 lbs.

List Price\$150.00

Model 18WK. Same as 18W but 3.2 ohms dc, 22-24 cps resonance (for Klipsch "K" type baffles). 16 ohms nominal impedance.

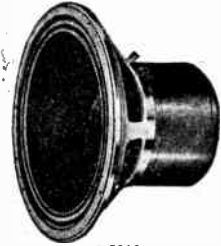

15W

COAXIAL MID-RANGE DRIVER

Model 848HF. Coaxial compression type mid-bass and treble assembly, 50 watts from 300-10,000 cps. Black outer horn fed from back of 2" phenolic driver diaphragm for fine acoustical properties; smaller metal horn works from front of same diaphragm through acoustical 1000 cps crossover. $\frac{1}{2}$ lb. magnet in close tolerance gap of high flux density; impedance 16 ohms. Sens. rtg. 51 db. Size 20 $\frac{1}{2}$ " w, 10 $\frac{1}{2}$ " h, 20" depth overall. Mounting hardware supplied. Shipping Weight 17 lbs.

List Price\$65.00

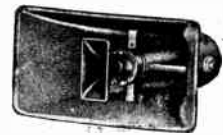

848HF

HIGH FREQUENCY DRIVERS

Model T10A. HF driver. 20 watts. Response ± 5 db 400-13,000 cps. Impedance 16 ohms. Sens. rtg. 50 db. $\frac{1}{2}$ lb. Alnico V magnet. 3 $\frac{3}{8}$ " diam., 3" deep. Throat diam. $\frac{1}{8}$ ". Shpg. wt. 4 $\frac{1}{2}$ lbs.

List Price\$67.50



T25A

Model T25A. HF driver. 20-30 watts. Response ± 5 db. 400-13,000 cps. Impedance 16 ohms. Sens. rtg. 53 db. 1 lb. Alnico V magnet. 3 $\frac{3}{4}$ " diam. 4 $\frac{1}{2}$ " deep. Throat diam. $\frac{1}{8}$ ". Shpg. wt. 7 lbs.

List Price\$95.00

DIFFRACTION HORNS

Model 8HD Diffraction Horn. New principle provides perfect dispersion of high frequencies through a 180° solid angle. Actual cutoff 600 cps, crossover 800 cps, eliminating cutoff disturbances. Made of fiberglass. For T10A or T25A driver. 3 $\frac{3}{8}$ " h, 14 $\frac{1}{4}$ " w, 7 $\frac{1}{2}$ " d. Mounting hardware included. Shpg. wt. 2 lbs.

List Price\$27.00



8HD

Model 6HD Diffraction Horn. For systems utilizing 600 cps crossover. Horn designed with actual 400 cps cutoff; prevents response disturbances associated with operation too near actual cutoff point. Diffraction principle effects 180° dispersion. 3 $\frac{3}{8}$ " h, 19 $\frac{1}{4}$ " w, 12" d. For T10A and T25A drivers. Shpg. wt. 3 lbs. Mounting hardware included.

List Price\$35.00

Notes: Sensitivity ratings are RETMA standard.

NO FINER CHOICE THAN

Electro-Voice

HIGH FIDELITY

SYSTEMS

COMPONENTS • ACCESSORIES



108



111

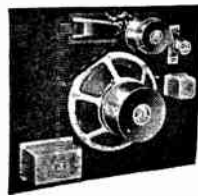

114B



105 in 106



106

SEPARATE MULTI-WAY SYSTEMS

Model 105 Package. GEORGIAN Driver Components Only. Use for converting existing Klipsch speakers to 4-way loudspeaker system. Includes complete instructions for constructing "K" bass section and outer furniture housing for GEORGIAN. Consists of 15WK LF driver, 848HF coaxial mid-range assembly, T35 VHF driver, X336 network, two AT37 level controls and 8574 cable harness. Shipping wt. 101 lbs.

List Price.....\$342.00

Model 106. Klipsch "K" basic LF driver horn only for 15WK driver unit, painted with flat matte black prime coat. Size 38 $\frac{1}{2}$ " high, 32 $\frac{1}{2}$ " wide, 22 $\frac{1}{4}$ " deep. Shipping wt. 75 lbs.

List Price.....\$150.00

Model 108. 800 cps. Crossover. Separate 2-way system. Consists of 12BW LF driver, T10A HF driver with 8HD horn, X825 crossover, mounting kit and baffle board. Can be used in custom installations. Size 27" high, 18" wide, 12 $\frac{1}{2}$ " deep overall. Shipping wt. 39 lbs.

Model 108 less cabinet. List Price.....\$184.00

Model 111 800 cps. Crossover. Deluxe separate 2-way system. Consists of 12W LF driver, T25A HF driver with 8HD horn, X8 crossover, AT37, mounting kit and baffle board. Can be used in custom installations. Overall size 27" high, 18" wide, 13 $\frac{1}{2}$ " deep. Shipping wt. 64 lbs.

Model 111 less cabinet. List Price.....\$277.00

Model 111A. Identical to 111 except with addition of T35, AT37 and X36. Shipping wt. 68 lbs.

Model 111A less cabinet. List Price.....\$352.00

Model 114A. 800 cps. Crossover. Separate 2-way system. Consists of 15W LF driver, T25A HF driver with 8HD horn and X8 crossover, AT37, mounting kit and baffle board. Size 26" high, 32 $\frac{1}{2}$ " wide, 13 $\frac{1}{2}$ " deep. Shipping wt. 86 lbs.

Model 114A less cabinet. List Price.....\$312.00

Model 114B. Identical to 114A except with addition of T35, AT37 and X36. Shipping wt. 90 lbs.

Model 114B less cabinet. List Price.....\$387.00

CROSSOVERS

All EV crossovers use high-Q air core coils. Insertion loss less than $\frac{1}{2}$ db, phase rotation 270° (135° in X825) attenuation 12 db per octave in $\frac{1}{2}$ section, 6 db per octave in $\frac{1}{4}$ section crossovers.

Model X825 Crossover as used in EV 108 system full M-derived $\frac{1}{4}$ section. 3 db loss point 800 cps. Impedances 16 ohms in and out. Size 5" x 7" x 2". Shipping weight 3 lbs.

List Price.....\$30.00

Model X8 Crossover. Full $\frac{1}{2}$ section M-derived. 3 db loss point, 800 cps. Impedances 16 ohms in and out. Size 4 $\frac{1}{8}$ " x 8 $\frac{1}{4}$ " x 5 $\frac{1}{2}$ ". Shipping weight 6 lbs.

List Price.....\$50.00

Model X6 Crossover. Full M-derived $\frac{1}{2}$ section. 3 db loss point, 600 cps. Impedances 16 ohms in and out. Non-metallic container measures 4 $\frac{1}{2}$ " x 9 $\frac{1}{4}$ " x 6". Shipping weight 7 lbs.

List Price.....\$60.00

X336 Crossover designed for GEORGIAN systems utilizes M-derived configuration. 3 db loss points at 300 and 3500 cps. Impedances 16 ohms in and out; non-metallic container. Size 4 $\frac{1}{2}$ " x 9 $\frac{1}{4}$ " x 6". Shipping weight 8 lbs.

List Price.....\$65.00

Model X36 Crossover. Recommended for use with T35 and T35B. Full M-derived $\frac{1}{2}$ section. 3 db loss point, 3500 cps. Impedances 16 ohms in and out. Metal case. Size 3 $\frac{1}{8}$ " x 3 $\frac{3}{8}$ " x 4 $\frac{1}{8}$ ". Shipping weight 1 $\frac{1}{2}$ lbs.

List Price.....\$14.00

Model X2635 4-Way Crossover. Full M-derived half sections. 3 db loss points, 200, 600, and 3500 cps. Impedances 16 ohms in and out. Non-metallic container size 4 $\frac{1}{2}$ " x 10" x 8". Shipping weight 11 lbs.

List Price.....\$120.00



X36



X2635

HIGH FIDELITY CERAMIC PHONO-CARTRIDGES

ULTRA-LINEAR • WIDE RANGE • HIGH COMPLIANCE



84D



4146



504

LEVEL CONTROL

AT37 Level Control. 16 ohm "L" pad. For use with Models T35, T35B and T25A. Adjusts output level to individual taste. **List Price**.....\$6.00



AT37

80 Series Ultra-Linear Ceramic Cartridges. Latest High Fidelity development employs stable, temperature-proof ceramic element. Response flat $\pm 2\frac{1}{2}$ db 20-15,000 cps with new standard RIAA curve. No preamp required; high level output works into 3-meg load at .5 volt. No inductive hum pickup; compliance 1.5 for clean extended highs. Distortion less than 2%. Standard mounting includes professional lifting lever.

Model 84-D WITH DIAMOND STYLUS (Microgroove) List Price.....\$38.50

Model 84-S WITH SAPPHIRE STYLUS (Microgroove) List Price.....\$16.00

Model 82-D WITH DIAMOND STYLUS (78 rpm) List Price.....\$38.50

Model 82-S WITH SAPPHIRE STYLUS (78 rpm) List Price.....\$16.00

MAGNETIC INPUT ADAPTER FOR MODEL 80 SERIES CARTRIDGES

Required for 80 series cartridges where only magnetic input is available. De-equalizes magnetic input and reduces output of ceramic to conform. **List Price**.....\$6.00

REPLACEMENT STYLII FOR MODEL 80 SERIES CARTRIDGES

1-MIL SAPPHIRE STYLUS (Red Dot) for MODEL 84-S Part No. 4127 List Price.....\$2.50

3-MIL SAPPHIRE STYLUS (Blue Dot) for MODEL 82-S Part No. 4130 List Price.....\$2.50

1-MIL DIAMOND STYLUS (Orange Dot) for MODEL 84-D Part No. 4146 List Price.....\$25.00

3-MIL DIAMOND STYLUS (Silver Dot) for MODEL 82-D Part No. 4145 List Price.....\$25.00

NO FINER CHOICE THAN

Electro-Voice

HIGH FIDELITY

ENCLOSURES

COMPATIBLE SYSTEMS

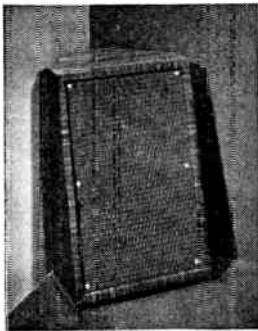

THE BARONET



THE ARISTOCRAT

THE PEERAGE

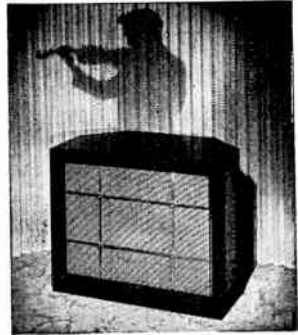

THE REGENCY

KLIPSCH-LICENSED FOLDED-HORN CORNER ENCLOSURES

New Concepts in Compact Corner Cabinets Provide Extended Bass Range

Utilizing the Klipsch principle, EV design extends the lows, enhances the highs. Employs the room walls as an extension of the exponential horn air load — assures one full octave of added bass range with unparalleled efficiency. Provides direct front radiation of higher frequencies; smoother, cleaner over-all musical balance. Increases power handling capacity of any speaker. Beautiful styling compliments any interior decor.

The Baronet. For EV or other 8" speaker. Response down to 35 cps. Conservative styling with graceful sloping front. Hand-rubbed hardwood veneers. Can be used anywhere. Size 22 $\frac{1}{2}$ " h, 14 $\frac{1}{2}$ " w, 13 $\frac{1}{2}$ " d. Shpg. wt. 24 lbs. Mahogany cabinet only — **List Price** **\$65.00**
Blonde Korina cabinet only — **List Price** **\$69.00**

The Aristocrat. For EV or any full range 12" speaker or EV separate 2 or 3-way systems, without modifications. Unusually smooth reproduction down to 35 cps. Selected mahogany veneers. Brushed brass grill. Size 29 $\frac{1}{2}$ " h, 19" w, 16 $\frac{1}{2}$ " d. Shpg. wt. 45 lbs. Mahogany cabinet only — **List Price** **\$110.00**
Blonde Korina cabinet only — **List Price** **\$120.00**

Aristocrat I. Includes EV Model 108 2-way system completely wired and installed in Aristocrat enclosure. Size 29 $\frac{1}{2}$ " h, 19" w, 16 $\frac{1}{2}$ " d. Shpg. wt. 59 lbs. Mahogany complete — **List Price** **\$299.00**
Blonde Korina complete — **List Price** **\$309.00**

Aristocrat II. Includes EV Model 111 deluxe 2-way system completely wired and installed in Aristocrat enclosure. Size 29 $\frac{1}{2}$ " h, 19" w, 16 $\frac{1}{2}$ " d. Shpg. wt. 79 lbs. Mahogany complete — **List Price** **\$392.00**
Blonde Korina complete — **List Price** **\$402.00**

Aristocrat III. Includes EV Model 111A 3-way system completely wired and installed in Aristocrat enclosure. Shpg. wt. 81 lbs. Mahogany complete — **List Price** **\$467.00**
Blonde Korina complete — **List Price** **\$477.00**

The Georgian. A complete 4-way system of exceptional cleanliness in handsomely styled cabinet of medium proportions. Uses Klipsch "K" indirect radiator folded corner horn with 15WK LF driver from 30-300 cps. X336 crossover feeds 848HF coaxial mid-bass and treble assembly with acoustic crossover at 1000 cps. 3500 cps section of X336 feeds T35 VHF driver to beyond aud.ble range. Two AT37 level controls adjust presence and brilliance to balance room acoustics. Sens. rtg. 54 db. Power handling: 35 watts program material, 70 watt peaks. Size 53" h, 34" w, 26" d. Shpg. wt. 290 lbs. Mahogany complete — **List Price** **\$825.00**
Blonde Korina complete — **List Price** **\$858.33**

Model 107. Georgian outer decorative furniture housing only. Mahogany without reproducer components — **List Price** **\$333.03**
Blonde Korina without reproducer components — **List Price** **\$366.30**

The Peerage Equipment Console. A beautiful and practical console designed to house any combination of the popularly known tuners, amplifiers and record changers. Simple, graceful styling harmonizes with EV speaker enclosures and lends itself to any contemporary setting. Supplied with list of tuner, amplifier and changer combinations which can be installed. Size 29 $\frac{1}{2}$ " h, 20 $\frac{1}{2}$ " w and 18 $\frac{1}{2}$ " d. Shpg. wt. 50 lbs. Mahogany cabinet only — **List Price** **\$160.00**
Blonde Korina cabinet only — **List Price** **\$170.00**

The Regency. For EV or other 15" speaker, or EV 2 or 3-way systems, without modifications. Has integral "built-in corner". Can be used in corner or against flat wall. Response flat ± 5 db down to 30 cps. Selected mahogany veneers. Grill in brushed brass finish. Size 28 $\frac{1}{2}$ " h, 33 $\frac{1}{2}$ " w and 19" d. Shpg. wt. 77 lbs. Mahogany cabinet only — **List Price** **\$200.00**
Blonde Korina cabinet only — **List Price** **\$215.00**

Regency II. Includes Model 114A separate 2-way system. Completely wired and installed in Regency enclosure. Shpg. wt. 126 lbs. Mahogany complete — **List Price** **\$517.00**
Blonde Korina complete — **List Price** **\$532.00**

Regency III. Includes EV 114B 3-way system completely wired and installed in Regency enclosure. Shpg. wt. 130 lbs. Mahogany complete — **List Price** **\$592.00**
Blonde Korina complete — **List Price** **\$607.00**

The Patrician. Complete 4-way speaker system in custom-crafted corner cabinet for very finest in reproduction. Divides audio spectrum between four drivers, each specifically designed for distortion-free fidelity. Includes EV 18WK 18" LF driver, EV 12W 12" LF driver, EV T25A HF driver with 6HD horn, EV T35 Super Tweeter, Two AT37 level controls and EV X2635 4-way crossover. Crossover frequencies 200, 600 and 3500 cps. Entire system wired and installed in elegant cabinet of selected woods and beautiful inlays. Heirloom finish in exquisite hand-rubbed mahogany or Korina. Size 60" h, 41" w, 30" d. Shpg. wt. 400 lbs. Mahogany or Blonde — **List Price** **\$1212.50**

THE GEORGIAN



The Skylark. 3-way speaker system in attractive functional design for bookcase or table use, vented with 2 tapered low frequency ports to properly load SP8C 8" coaxial driver for excellent bass and midrange. X36 crossover feeds T35B VHF driver from 3500 cps to beyond range of audibility. 1 $\frac{1}{2}$ lb. magnet. Impedance 16 ohms; sens. rtg. 45 db. Size 14" h, 33" w, 10 $\frac{1}{2}$ " d, 11 $\frac{1}{2}$ " high with legs removed. Shpg. wt. 30 lbs. Mahogany complete — **List Price** **\$149.50**
Blonde Korina complete — **List Price** **\$154.50**

The Piccolino. Compact housing for T35 or T35B driver, X36 crossover, and AT37 level control. An attractive addition to any Hi-Fi installation; provides silky, extended high frequencies for better listening. Lumite grille cloth. Size 6 $\frac{1}{2}$ " h, 8" w, 5 $\frac{1}{2}$ " d. Shpg. wt. 6 lbs. Mahogany or Blonde Korina cabinet only — **List Price** **\$15.00**

THE SKYLARK

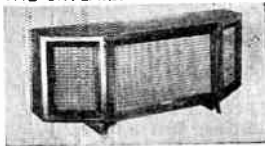

THE PICCOLINO



THE PATRICIAN



NO FINER CHOICE THAN

Electro-Voice

HIGH FIDELITY

P. A. PROJECTORS

MATCHED ACCESSORIES

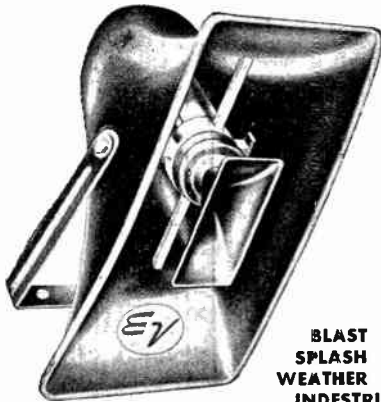

**BLAST PROOF
SPLASH PROOF
WEATHER PROOF
INDESTRUCTIBLE**

*Design Patent 169,904
Additional Patent Pending

**Public Address Loudspeaker System
for perfect**

VOICE PENETRATION AND FULL RANGE MUSICASTING

The COMPOUND DIFFRACTION PROJECTOR* provides a loudspeaker system so advanced in concept—so efficient in performance—that there is no basis for comparison with conventional P.A. reentrant horns. The "CDP" works in the same manner as an optical slit. When the slit width is of a shorter dimension than the wave length of the sound it passes, the sound energy is highly dispersed in the direction of this short dimension. Polar response of the "CDP" is phenomenal.

An increase in efficiency of three db over multi-cellular horns is achieved with better dispersion. There is no pinpointing effect since there are no cells to beam the sound path. Elimination of multiple throats at the driver mouth permits greater high-frequency efficiency as compared to multi-cellular horns. The direct path and optimum throat dimension of the "CDP" also has these advantages over the reentrant horn resulting in a greater transfer efficiency and smooth extended high-frequency response.

The Model 848 "CDP" provides peak-free response ± 5 db to 10,000 cps—delivers $2\frac{1}{2}$ octaves more musical range than usual P.A. units of even larger size. Speech articulation index is substantially increased. Polar distribution pattern exceeds 120° . The Model 848 utilizes two coaxially mounted horns working from opposite sides of a single diaphragm. Each horn is designed for optimum reproduction within its own range. Low end response is augmented by 100 cps horn taper, which insures at least one-half octave added bass over that possible from larger conventional P.A. horns.

The "CDP" bell and diaphragm are fabricated of molded fiberglass. Other parts are die-cast zinc and steel treated against corrosion. Edgewise-wound copper ribbon voice coil puts 30% more conductor in the gap, raising the efficiency 20%. In EV tests the "CDP" driver has been subjected to months of continuous operation under 30 watts of power at 60 cycles AC without failure for any reason whatsoever. Should it become necessary, the diaphragm is easily replaced in a moment. Silver contacts eliminate the need for soldering operations.

The "CDP" with its higher sensitivity and power handling on a basis of distributed signal, provides superior coverage of the listening area with fewer units and at far lower cost. The "CDP" unit is weather-proof, splash and blast proof, and virtually indestructible. It represents something so entirely new in public address efficiency and fidelity that it is indeed hard to believe such reproduction is possible.

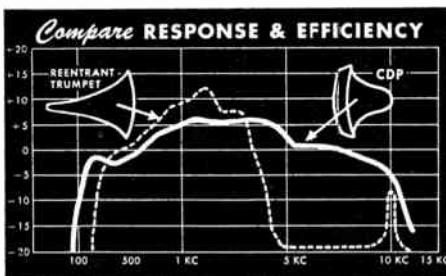
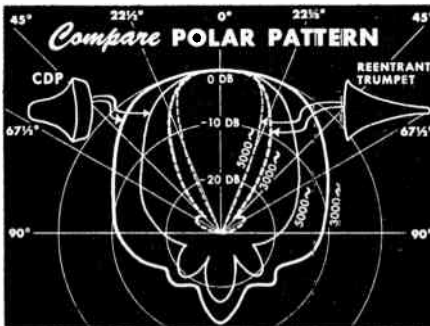

DIFFRACTION PRINCIPLE

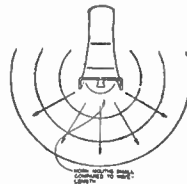

Uses the new acoustic application of optical slit diffraction for perfected smooth sound dispersion virtually independent of frequency.

COAXIAL HORNS

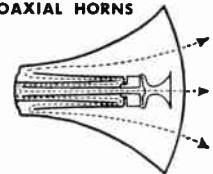

CDP utilizes two coaxially mounted diffraction horns working from both sides of a single diaphragm. Each horn is designed for optimum air loading and reproduction within its own range.

MODEL 848 COMPOUND DIFFRACTION PROJECTOR*

Conservatively rated at 25 watts. Nominal impedance is 16 ohms. The attractive neutral gray color is molded right into the bell material, which is impervious to acids, alkalis and most solvents. Hang up bracket has two mounting positions. Projector may be installed horizontally, or vertically for augmented dispersion. Dimensions at mouth: $10\frac{1}{2}$ " wide, $20\frac{1}{2}$ " high. Overall depth 20". Shipping weight 17 lbs. **List Price**.....\$65.00

ACCESSORIES

Model 876 25 Watt Line Matching Transformer. In protective case for mounting on rear of Model 848 System. Primary taps for 25, 10, 5 and 2.5 watts with 70-volt line. Impedance taps of 45, 200, 500, 1000 and 2000 ohms. Transformer bypasses frequencies below Model 848 Horn cutoff. Case extends $3\frac{1}{2}$ " behind Projector when mounted. $5\frac{1}{4}$ " maximum diameter. Shipping weight 4 lbs. **List Price**.....\$15.00

Model 877 Line Matching Transformer. Same as Model 876, but with added full-range thermal bimetallic relay for maximum protection against overload. Size: same as Model 876. Shipping weight 4 lbs. **List Price**.....\$17.50

Model 878 Bass and Thermal Overload Protector. Prevents distortion and excessive diaphragm excursion due to frequencies below Model 848 horn cutoff. Automatically reduces power to driver when 25 watt limit is exceeded without turning unit off and allows operation to continue. When overload clears the Model 878 restores full power to driver. Mounted in case similar to Model 876 Transformer. Shipping weight 4 lbs. **List Price**.....\$12.50

Model 879 Joining Kit. Required for fastening multiple projectors together in any array; use one joining kit Model 879, for each additional horn. Shipping weight 1 lb. **List Price**.....\$1.75

**SIMPLE
MULTIPLE
JOINING
USING 879
JOINING KIT**

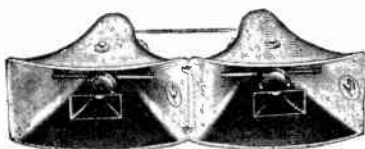

876



879

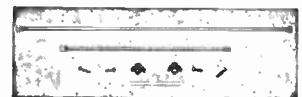

Jim Lansing

**JAMES B. LANSING
SOUND, INC.
LOS ANGELES
CALIFORNIA**

THE 175DLH HIGH FREQUENCY ASSEMBLY with the Koustical Lens



The Jim Lansing Koustical Lens is a true 14-element diffusion lens operating in accordance with the most advanced optical-acoustic theory. Sound is distributed smoothly over a solid 90° angle to all points in the listening area with equal intensity regardless of frequency. Phase interference, present in all types of horns including multi-cellular, is notably absent. The Koustical Lens is one unit in the 175DLH Assembly which includes a high-precision high frequency driver, machined pure iron phasing plug, and cast aluminum exponential horn. Nominal impedance, 16 ohms. Power input is 25 watts above 1200 cps. Field, permanent magnet. Horn throat diameter, 1". Mounting hole diameter, 5 3/8". Overall length, 11 1/2". Shipping weight, 12 lbs.

User Net \$118.50

COMPLETE TWO-WAY SYSTEM KITS

The D001 and D050 speaker systems can be purchased as a kit for installation in your own cabinet or for built-in installations.



D001—2 unit, 2-way system for use in #32, 33, 34, 35 Jim Lansing Enclosures.

1-130A 15" low frequency unit
1-175 DLH high frequency driver and horn-lens assembly

1-N1200 dividing network
Shipping weight 42 pounds

User Net \$226.50

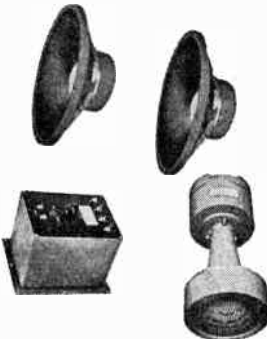

D050—3 unit, 2-way system for use in #31, 32, 33, 35 Jim Lansing Enclosures.

2-130B 15" low frequency units
1-175 DLH high frequency driver and horn-lens assembly

1-N1200 dividing network
Shipping weight 65 pounds

User Net \$299.25

GENERAL PURPOSE

Signature Speakers

Only Jim Lansing Speakers (15" and 12") are made with 4" diameter voice coils — of edge-wound aluminum ribbon in the General Purpose models. The 4" coil stiffens the cone for true piston action. Crisp, clean bass results — a distinguishing feature immediately apparent. The 4" dural center dome is attached directly to the voice coil — as it should be — for smooth reproduction of the high frequencies. Properly housed, Jim Lansing General Purpose Speakers will reproduce verbatim every frequency recorded on the finest modern transcriptions.



D130
User Net \$76.00

4"	VOICE COIL DIAMETER
25 watts	POWER INPUT
16 ohms	IMPEDANCE
37 c.p.s.	FREE CONE RESONANCE
15 1/8"	OUTSIDE DIAMETER
5 5/8"	DEPTH
	FIELD
23#	SHIPPING WEIGHT



D131
User Net \$72.00

4"	VOICE COIL DIAMETER
20 watts	POWER INPUT
16 ohms	IMPEDANCE
36 c.p.s.	FREE CONE RESONANCE
12 1/8"	OUTSIDE DIAMETER
5"	DEPTH
Permanent Magnet	FIELD
22#	SHIPPING WEIGHT



D208,
8 ohms
D216,
16 ohms
User Net \$25.92

2"	VOICE COIL DIAMETER
12 watts	POWER INPUT
8 ohms	IMPEDANCE
68 c.p.s.	FREE CONE RESONANCE
8 1/4"	OUTSIDE DIAMETER
2 7/8"	DEPTH
	FIELD
6#	SHIPPING WEIGHT

ENCLOSURES All Jim Lansing enclosures are furnished separately, or with systems factory installed. Enclosures to be used with Jim Lansing General Purpose Speakers must be ordered separately and will be shipped separately. All enclosures are available in Mahogany, Prima Vera Blond or Utility Gray finishes. Prices listed below are for mahogany only. Weights listed are for enclosures only.



31 Front Exponential Horn Enclosure

For use with the 050 system only.

Height 49"
Depth 28"
Front Width 37 1/2"
Shipping Wt. 157 lbs.

Mahogany, enclosure only
User Net \$240.00

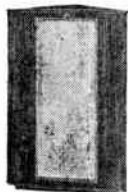

33 Corner Reflex Enclosure

For use with the 050 and 001 systems, or the D130 and D131 General Purpose Speakers.

Height 49"
Depth 17"
Front Width 35"
Shipping Wt. 96 lbs.

Mahogany, enclosure only
User Net \$117.00

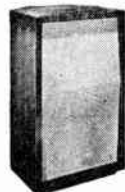

34 Folded Rear Exponential Horn Enclosure for flat wall or corner

For use with the 001 system or the D130 or D131 General Purpose Speakers.

Height 39 3/4"
Depth 22 1/2"
Front Width 23 3/4"
Shipping Wt. 111 lbs.

Mahogany, enclosure only
User Net \$135.00

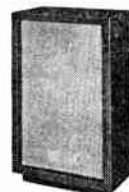

35 Console Reflex Enclosure

For use with the 050 or 001 systems, or the D130 or D131 General Purpose Speakers.

Height 38 1/2"
Depth 16"
Front Width 23 3/4"
Shipping Wt. 85 lbs.

Mahogany, enclosure only
User Net \$96.75



36 General Purpose Reflex Enclosure

For use with the D208, D130 or D131 General Purpose Speakers.

Height 29 1/2"
Height without legs 23 3/4"
Depth 15 7/8"
Front Width 19 3/4"
Shipping Wt. 48 lbs.

Mahogany, enclosure only
User Net \$51.30

EVERY NOTE A PERFECT QUOTE

DUOTONE SPEAKERS and MICROPHONES

MANUFACTURED FOR DUOTONE BY WORLD FAMOUS PHILIPS OF HOLLAND

HI-FI MASTER RANGE LOUSPEAKERS

MODEL 9762 — is a true Hi-Fi unit that replaces complex two-speaker systems using a "woofer" for the bass and a "tweeter" for the high frequencies. These old costly dual systems caused phase distortion and parasitic oscillations. Model 9762 is a 12" speaker with a record efficiency of 14% at 400 c/s due to the use of an extra powerful Ticonal magnet. Sound diffuser ensures uniform spatial distribution of high notes. With this loudspeaker the acoustical output and the reproduction range of Hi-Fi and other equipment can be raised to a level never before achieved! Frequency range is 40 to 20,000 c/s.

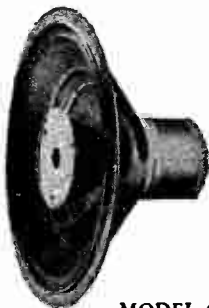

MODEL 9762

TECHNICAL SPECIFICATIONS

Frequency Response.....	40 to 20,000 c/s
Voice Coil impedance.....	.8 ohms
Power handling capacity.....	20 watts
Resonance frequency.....	45 c/s
Flux density.....	11,000 Gauss
Total magnetic flux.....	140,000 Maxwell
Cone diameter.....	12 inches

List Price \$94.95

MODEL 9760—12" in diameter, has a frequency range of 40 to 20,000 c/s. The reproduction curve is extremely smooth. Sound diffuser ensures uniform spatial distribution of high notes. This model is "just right" for the finest Hi-Fi equipment but is less efficient than 9762, namely efficiency of 7% at 400 c/s; Voice Coil impedance at 1000 c/s: 8 ohms.

List Price \$49.95

MODEL 9758—a 10" speaker with a 40 to 15,000 c/s frequency range. Far superior to any other speaker of this size. Copper ring fitted into deep air gap keeps Voice Coil impedance independent of the frequency. No frequency compensation needed in amplifier. Sound diffuser ensures uniform spatial distribution of high notes. Power: 10 Watts; Efficiency at 400 c/s: 6%; Voice Coil impedance at 1000 c/s: 8 ohms.

List Price \$49.95

MODEL 9750—is an 8½" speaker with frequency range of 40 to 13,500 c/s. Extremely low frequency and very regular characteristics. Sound diffuser ensures uniform spatial distribution of high notes. Twice the normal air gap depth due to "TICONAL" magnet. Power: 6 Watts; Efficiency at 400 c/s: 10%; Voice Coil impedance at 1000 c/s: 4 ohms.

List Price \$32.95

MODEL 7010 — A 5 Watt speaker, extremely low price, 8½" in diameter, 50 to 12,000 c/s frequency range that is specially constructed with magnetic system pressed into a high precision frame to avoid misalignment of the air gap, even in case of heavy shocks. Voice Coil impedance at 10,000 c/s: 4 ohms.

List Price \$16.50



MODEL 7010

MICROPHONES

DUOTONES SUPER "PENCIL" MIKE
OMNIDIRECTIONAL, MOVING COIL
EL 6040

Broadcast quality mike, especially designed for unobtrusiveness. This rugged, light microphone is truly omnidirectional, yet has a tremendous range of response—40 to 15,000 c/s. Excellent for tape recording, outdoor work—every sound installation that must meet the highest standard of sound quality. Slender... only 1" in diameter—model is ideal for television, reflecting no light and taking up minimum space. EL 6040 resists weather and rough handling. Impedance selector second plug for 50, 500 and 25,000 ohms. Sensitivity—55 db at 25,000 ohms. Shorting switch is convertible into an interrupting switch... Swivel will absolutely not loosen or jam.



MODEL EL 6040

List Price \$125.00

Stand (extra) \$10.00

Impedance	Voltage	Level
25,000 ohms	1.5 mV	— 56.5 dB
500 ohms	0.22 mV	— 73 dB
50 ohms	0.07 mV	— 83 dB

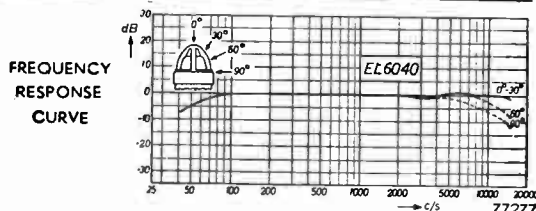

Output voltage for sounds of various frequencies and angles of incidence, expressed in decibels with respect to the output voltage at 1000 c/s.



MODEL 9564

HAND MICROPHONE
MOVING COIL TYPE 9564

Ideal for factories, ships, buses, planes, police cars, fairs, mobile transmitters. Perfect voice reproduction even with very high ambient noise level. Frequency response: 100 to 10,000 c/s. Minimum transmission of ambient noise; Impedance: 10,000 ohms; Diaphragm of "Diaphragm Plastic"; Equipped with switch, Withstands temperatures to 140° F, Supplied with 2 yards of twin flex with plug.

List Price \$59.00

CRYSTAL MICROPHONE
EL 6000

Clear, natural reproduction. Molded, ivory mike of high impact-strength plastic. Can be held in the hand, set on a table with or without the base, suspended or screwed on a floor stand. Response 50 — 8,000 c/s; sensitivity — 50 db. Annealed aluminum diaphragm. Maroon base available if desired.

List Price \$16.95

Base (extra) 3.00



MODEL EL 6000

Cinaudagraph Speakers

CINAUDAGRAPH CO. 7334 N. CLARK STREET CHICAGO 26, ILLINOIS



EXPORT DEPT.: 205 WEST WACKER DRIVE CHICAGO 6, ILL., U.S.A. Cable: ENOTS

WORLD'S FINEST

REPLACEMENT SPEAKERS

All Cinaudagraph permanent magnet speakers use Alnico 5 magnets for greatly improved performance without size or weight increase. Magnets are clamped or welded in place for long, trouble-free service. Speakers are dust-proof and of all-welded construction; voice coil forms are not affected by moisture or temperature variation. Cinaudagraph PM speakers are ideal for all installations requiring low cost, quality performance and long life. DUE TO EXACTING QUALITY CONTROL OF INSPECTION PROCEDURES AND PRECISION ASSEMBLY METHODS, WE ARE THE ONLY MANUFACTURER OF ACOUSTICAL DEVICES NOW KNOWN TO OFFER A 5 YEAR WARRANTY AGAINST WORKMANSHIP, MATERIALS AND PERFORMANCE.

Size	Model No.	†Approx. Gap Energy Level	Imped. Voice Coil	Watts	List Price
3 1/2"	P2A1	.25	3.2 ohms	1.5	\$ 4.75
3 1/2"	P3B1	.36	3.2	2.0	5.25
3 1/2"	P3C1	.51	3.2	2.5	6.25
4"	P4A1	.25	3.2	2.0	5.00
4"	P4B1	.36	3.2	2.5	5.50
4"	P4C1	.51	3.2	3.0	6.50
5"	P5A1	.25	3.2	2.5	5.50
5"	P5B1	.36	3.2	3.0	6.00
5"	P5C1	.51	3.2	3.5	7.00
5 1/2"	P53A1	.25	3.2	3.0	5.75
5 1/2"	P53B1	.36	3.2	3.5	6.25
5 1/2"	P53C1	.51	3.2	4.0	7.25
6"	P6A1	.25	3.2	3.0	6.00
6"	P6B1	.36	3.2	3.5	6.50
6"	P6C1	.51	3.2	4.0	7.50
6 1/2"	P6E1	.74	3.2	5.0	8.50
7"	P7E2	.74	3.2	5.5	9.00
7 1/2"	P7G2	1.1	3.2	6.5	10.50
7 1/2"	P75D1	.51	3.2	5.0	10.25
7 1/2"	P75E1	.74	3.2	6.0	11.75
8"	P8D1	.51	3.2	5.0	8.50
8"	P8E1	.74	3.2	6.0	10.00
8"	P8G2	1.1	3.2	7.0	11.50
10"	P10G1	1.1	6.8	8.0	12.50
10"	P10H1	1.5	6.8	9.0	16.50
12"	P12G1	1.1	6.8	9.0	15.00
12"	P12H1	1.5	6.8	10.0	19.00

OVAL SPEAKERS

4" x 6"	P46A1	.25	3.2	1 1/2"	4.0	6.00
4" x 6"	P46B1	.36	3.2	1 1/2"	5.0	6.50
4" x 6"	P46C1	.51	3.2	1 1/2"	6.0	7.50
5" x 7"	P57B1	.36	3.2	1 1/2"	6.5	7.00
5" x 7"	P57C1	.51	3.2	1 1/2"	7.5	8.00
6" x 9"	P69C1	.51	3.2	1 1/2"	6.0	9.00
6" x 9"	P69E1	.74	3.2	1 1/2"	7.0	10.50
6" x 9"	P69F1	1.1	3.2	1 1/2"	8.0	12.00

Send for Catalog on Field Coil Models. Address Department C.

EFFICIENCY MODELS

This low cost line is designed for replacement purposes or for installation in original equipment. These speakers are engineered to deliver the utmost in quality at a minimum of cost, and are **WARRANTED FOR ONE YEAR FROM DATE OF MANUFACTURE** against faulty materials and workmanship. Voice coil impedances of all speakers listed are 3-4 ohms. All mounting dimensions are standard R.T.E.M.A.

Size	Model	Maximum Watts	Dealers Net Price
3 1/2"	SP3	2	\$ 2.13
4"	SP4	2	2.11
5"	SP5	2.5	2.26
5 1/2"	SP525	3	2.34
6"	SP6	3.5	2.45
7"	SP7	4.5	3.47
8"	SP8	5	3.39
10"	SP10	7	5.63
12"	SP12	9	6.27
4" x 6"	SP46	3	2.62
5" x 7"	SP57	4	3.20
6" x 9"	SP69	5	3.68

* Model SPB mounting bracket set available at \$.25 each net
† Approx. Gap Energy Level in millions of ergs

REAR DECK AUTO SPEAKER INSTALLATION KITS

Kits include a rugged speaker designed for simplicity of installation; capable of handling the full output of the most powerful auto radio. Beside speaker, kits consist of rugged 3 position switch for dash mounting, ample cable for all auto installations, attractive grill with dust protector and instruction sheet.

Speaker Size	Model No.	List
6"	KA6	\$14.50
6"	KA6-CF*	17.50
4" x 6"	KA46	15.00
4" x 6"	KA46-CF*	18.00
6" x 9"	KA69	17.50
6" x 9"	KA69-CF*	21.50

* Kits contain a Fader control in lieu of 3 position switch with installation instructions. This control permits increasing volume of either speaker over the other (Fading).

GRILLS ONLY FOR REAR DECK INSTALLATIONS

6"	G6	4.00
4" x 6"	G46	4.00
6" x 9"	G69	5.00

AUTO REPLACEMENTS

See Replacement List. Cinaudagraph replacement speakers are constructed to withstand all rigors imposed by use in car.

MIGHTY MITES

Designed for space saving in intercoms, personal portables, experimentation, test equipment and for replacement. Alnico V permanent magnets. A large selection of voice coil values and magnet sizes. Conservatively rated at 1.5-2.5 watts power handling capacity.

Size Inches	†Approx. Gap Energy Level	3.4 Ohm Voice Coil		16 Ohm Voice Coil		45 Ohm Voice Coil		70 Ohm Voice Coil	
		Model	List	Model	List	Model	List	Model	List
2 1/2 x 2 1/2	.25	P2A1	\$4.75	P2A16	\$5.50	P2A21	\$6.00	P2A70	\$7.00
	.36	P2B1	5.25	P2B16	6.00	P2B21	6.50	P2B70	7.50
	.51	P2C1	6.25	P2C16	7.00	P2C21	7.50	P2C70	8.50
3 x 3	.25	P3A1-I	4.75	P3A16-I	5.50	P3A21-I	6.00	P3A70-I	7.00
	.36	P3B1-I	5.25	P3B16-I	6.00	P3B21-I	6.50	P3B70-I	7.50
	.51	P3A1	8.25	P3A16	6.00	P3A21	6.50	P3A70	7.50
1 1/2 x 2 1/2	.36	P23B1	5.75	P23B16	6.50	P23B21	7.00	P23B70	8.00

INTERCOMMUNICATION SPEAKERS

Cinaudagraph intercommunication speakers are designed for rugged service, clear voice reproduction and easy installation. They are built to exacting specifications and are suitable for original installation or replacement in all intercommunication systems. Wide selection of voice coil impedance values.

Size	†Approx. Gap Energy Level	16 Ohm Voice Coil		45 Ohm Voice Coil		70 Ohm Voice Coil	
		Model	List	Model	List	Model	List
3 1/2"	.25	P3A16	\$5.00	P3A21	\$5.50	P3A70	\$6.50
	.36	P3B16	5.50	P3B21	6.00	P3B70	7.00
4"	.25	P4A16	5.00	P4A21	5.50	P4A70	6.50
	.36	P4B16	5.50	P4B21	6.00	P4B70	7.00
5"	.25	P5A16	5.50	P5A21	6.00	P5A70	7.00
	.36	P5B16	6.00	P5B21	6.50	P5B70	7.50

ALL WEATHER SPEAKERS

Designed and developed to give dependable service in all outdoor installations. Ruggedly built for trouble-free operation in all variations of humidity and temperature. Water resistant cones and specially treated voice coils. A three-year warranty from date of manufacture guarantees trouble-free performance.

Size	Model No.	†Approx. Gap Energy Level	Voice Coil		List Price	
			Imped.	Diam.		
4"	P4AW	.25	3.2 ohms	1 1/2"	2.5	\$5.75
4"	P4BW	.36	3.2	1 1/2"	3.0	6.25
4"	P4CO	.51	3.2	1 1/2"	3.5	7.25
5"	P5AW	.25	3.2	1 1/2"	3.0	6.25
5"	P5BW	.36	3.2	1 1/2"	3.5	6.75
5"	P5CO	.51	3.2	1 1/2"	3.75	7.75
6"	P6BW	.36	3.2	1 1/2"	3.5	7.25
6"	P6CO	.51	3.2	1 1/2"	4.0	8.25

†Approx. Gap Energy Level in Millions of Ergs.



When Making a SOUND INVESTMENT — Remember CINAUDAGRAPH SPEAKERS

Cinaudagraph Speakers

CINAUDAGRAPH CO. 7334 N. CLARK STREET
CHICAGO 26, ILLINOIS



EXPORT DEPT.: 205 WEST WACKER DRIVE
CHICAGO 6, ILL., U.S.A. • Cable: ENOTS

WORLD'S FINEST

HIGH FIDELITY SPEAKERS

Hi-Lo Extended Range Single Unit — Direct Radiator Loud Speakers

The Cinaudagraph Hi Lo extended range direct radiator speakers are completely new. Designed to meet the demands where fine tone quality is appreciated. Not only is a uniform frequency response obtained but a very low value of harmonic distortion has been achieved and a high rate of decay which overcomes the detrimental effects of "tails" and "hangovers." The active impedance curve of this model is also seen to be surprisingly flat over the operating frequency range, resulting in good power delivery from the output tubes of the amplifier to the voice coil. **DESIGNED RIGHT . . . CONSTRUCTED RIGHT . . . WARRANTED 5 YEARS.**

Size	Model No.	Approx. Gap Energy Level	Voice Coil Imped.	Diam.	Watts	List Price
8"	P8FHL	1.12	6-8	3/4"	6.5	\$ 20.00
8"	P8FHL-1	1.12	3-4	3/4"	6.5	20.00
8"	P8HHL	1.53	6-8	1"	8.0	22.50
8"	P8JHL	2.22	6-8	1"	9.0	25.00
8"	P8LHL	3.22	6-8	1 1/2"	10.0	35.00
8"	P8MHL	5.00	6-8	1 1/2"	18.0	42.50
8"	P8PHL	6.61	6-8	1 1/2"	20.0	60.00
8"	P8RHL	12.00	6-8	1 1/2"	25.0	77.50
12"	P12HHL	1.53	6-8	1"	9.0	24.00
12"	P12JHL	2.22	6-8	1"	11.0	27.50
12"	P12LHL	3.22	6-8	1 1/4"	14.0	37.50
12"	P12NHL	5.00	6-8	2"	20.0	45.00
12"	P12PHL	6.61	6-8	2"	23.0	62.50
12"	P12RHL	12.00	6-8	2"	25.0	80.00
12"	P12SHL	15.40	6-8	2"	30.0	90.00
15"	P15LHL	3.22	6-8	1 1/4"	12.0	52.50
15"	P15NHL	5.00	6-8	2"	22.0	60.00
15"	P15PHL	6.61	6-8	2"	28.0	77.50
15"	P15RHL	12.00	6-8	2"	30.0	95.00
15"	P15SHL	15.40	6-8	2"	35.0	105.00

HI-LO EXTENDED RANGE SINGLE UNIT

Direct Radiator Loud Speakers — Equipped with High Frequency Accentuator (Tweeter)

Constructional design achieves greater angle of dispersion of high frequencies than the single unit direct radiators. Engineering and research have provided a design to give dual speaker performance from a single unit radiator. **DESIGNED RIGHT . . . CONSTRUCTED RIGHT . . . WARRANTED 5 YEARS.**

Size	Model No.	Approx. Gap Energy Level	Voice Coil Imped.	Diam.	Watts	List Price
8"	P8N	5.00	6-8	1 1/2"	18.0	\$ 47.50
8"	P8P	6.61	6-8	1 1/2"	20.0	65.00
8"	P8R	12.00	6-8	1 1/2"	25.0	82.50
12"	P12N	5.00	6-8	2"	20.0	50.00
12"	P12P	6.61	6-8	2"	23.0	67.50
12"	P12R	12.00	6-8	2"	25.0	85.00
12"	P12S	15.40	6-8	2"	30.0	95.00
15"	P15N	5.00	6-8	2"	22.0	65.00
15"	P15P	6.61	6-8	2"	28.0	82.50
15"	P15R	12.00	6-8	2"	30.0	100.00
15"	P15S	15.4	6-8	2"	35.0	110.00

HEAVY DUTY PUBLIC ADDRESS SPEAKERS

Ruggedly built to give years of heavy duty service. Cinaudagraph public address speakers reproduce both voice and music with excellent tone fidelity. Acoustically selected cones supply uniform frequency response and maximum conversion to acoustical power. These units are conservatively rated—all have double-cemented voice coil forms to prevent breakdown from momentary overload. All speakers listed are moisture resistant and dustproof; Alnico 5 permanent magnets are either welded or clamped in place. Made to operate efficiently even at low power and frequency, these Cinaudagraph speakers are ideal for all public address requirements. Carefully designed, produced and inspected, all Cinaudagraph speakers represent the finest in acoustical equipment, and can safely be specified for the most exacting installations. **DESIGNED RIGHT . . . CONSTRUCTED RIGHT . . . WARRANTED 5 YEARS.**

Size	Model No.	Approx. Gap Energy Level	Voice Coil Imped.	Diam.	Watts	List Price
8"	P8JHD	2.22	6-8	1"	8-10	16.00
8"	P8LHD	3.22	6-8	1 1/4"	10-12	27.50
10"	P10JHD	2.22	6-8	1"	12-14	19.00
10"	P10LHD	3.22	6-8	1 1/4"	14-16	30.00
12"	P12JHD	2.22	6-8	1"	10-12	22.50
12"	P12LHD	3.22	6-8	1 1/4"	14-16	32.50
12"	P12NHD	5.00	6-8	2"	18-20	40.00
12"	P12PHD	6.61	6-8	2"	20-22	57.50
15"	P15LHD	3.22	6-8	1 1/4"	18-20	45.00
15"	P15NHD	5.00	6-8	2"	20-22	55.00
15"	P15PHD	6.61	6-8	2"	20-25	72.50

† Approx. Gap Energy Level in Millions of Ergs.

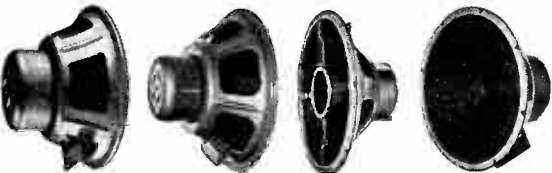

When Making a SOUND INVESTMENT — Remember CINAUDAGRAPH SPEAKERS

Copyright by U.C.P., Inc.

CINAXIAL SPEAKERS

Economical and space-saving Cinaudagraph Cinaxial speakers give finest reproduction. Good baffle conditions extend the response range from 40 to 15,000 c.p.s. Easily connected to all home receivers. Cinaxial speakers are designed for FM, television and all uses requiring finest reproduction over the widest frequency range. The 12-inch Cinaxial speakers have 3 1/2-inch high frequency units; the 15-inch have 5-inch high frequency units. Bridging network is built-in; no controls are required. For the very finest tonal reproduction over the widest frequency range, get a Cinaudagraph Cinaxial speaker. Top design and finest materials make Cinaxial speakers the world's best quality. **DESIGNED RIGHT . . . CONSTRUCTED RIGHT . . . WARRANTED 5 YEARS.**

Size	Model No.	V.C. Imped.	Power Rating	List Price
8"	CIN-8A	6-8	6.5-7	\$ 22.50
8"	CIN-8B	6-8	7.9	25.00
8"	CIN-8C	6-8	8-10	27.50
8"	CIN-8D	6-8	10-12	32.50
10"	CIN-10B	6-8	8.9	27.50
10"	CIN-10C	6-8	9-10	30.00
10"	CIN-10D	6-8	10-12	35.50
10"	CIN-10E	16	12-14	52.50
12"	CIN-12C	6-8	10-12	32.50
12"	CIN-12D	6-8	12-14	37.50
12"	CIN-12E	16	14-16	55.00
12"	CIN-12F	16	18-20	80.00
15"	CIN-15D	6-8	14-16	52.50
15"	CIN-15E	16	16-18	70.00
15"	CIN-15F	16	20-25	95.00
15"	CIN-15G	16	25-30	110.00

HIGH FREQUENCY TWEETERS AND CONVERSION HARDWARE

These tweeters are designed to provide extended range high-fidelity characteristics of two-way systems in existing single unit speakers. These are modernization units for radio receivers, phonographs and television sets equipped with 8", 10", 12" or 15" single unit direct radiator systems. Can be flange mounted directly on baffle board or with use of hardware will convert existing single unit radiator into co-axial speaker. **DESIGNED RIGHT . . . CONSTRUCTED RIGHT . . . WARRANTED 5 YEARS.**

Size	Model No.	For Use With	List Price
2 1/2 x 2 1/2"	TW2	8" or 10"	\$ 7.00
3 1/2"	TW3	10" or 12"	9.00
5"	TW5	15"	10.00
5"	TW5-S*	15"	16.00

* Super Tweeter

Hardware kits consist of brackets, screws, nuts, washers, gaskets and instruction sheet to convert single unit speakers into co-axials. **DESIGNED RIGHT . . . CONSTRUCTED RIGHT . . . WARRANTED 5 YEARS.**

For Use With	Kit No.	Speaker Size to Be Converted into Co-Axial	List Price
TW2	TK-1	8"	\$2.50
TW2	TK-2	10"	3.00
TW3	TK-3	10"	3.00
TW3	TK-4	12"	3.50
TW5	TK-5	15"	4.00

LOW FREQUENCY WOOFER

Heavy duty—fine quality. Rugged construction. **DESIGNED RIGHT . . . CONSTRUCTED RIGHT . . . WARRANTED 5 YEARS.**

Size	Model No.	Approx. Gap Energy Level	Voice Coil Imped.	Diam.	Watts	List Price
12"	P12RHLW	12	6-8	2"	30	\$80.00
15"	P15RHLW	12	6-8	2"	35	95.00

OUTPUT TRANSFORMERS

Designed for high efficiency operation. All transformers are vacuum impregnated, Underwriters' approved lead wire, tropicalized and fungicided.

Model No.	Primary Imped. Ohms	Secondary Leads	Core Size	Power Audio Watts	Pri. Current Max. M.A.	List Price
12A23	2000	3.2 ohms	1/2 x 1/2	5	65	\$1.80
12A43	4000	3.2	1/2 x 1/2	5	50	2.10
12A73	7500	3.2	1/2 x 1/2	5	45	2.10
12A100	10000 CT	3.2	1/2 x 1/2	5	25	2.40
12A160	16000	3.2	1/2 x 1/2	5	15	2.10
12A43UL	†Adjustable	3.2	1/2 x 1/2	5	50	3.00
58A23	2000	3.2	5/8 x 5/8	8	75	2.70
58A53	5000	3.2	5/8 x 5/8	8	60	2.70
58A83	8000	3.2	5/8 x 5/8	8	55	2.70
58A100	10000 CT	3.2	5/8 x 5/8	8	50	3.00
58A43UL	†Adjustable	8	5/8 x 5/8	8	80	3.60
58A8U	‡Adjustable	8	5/8 x 5/8	8	75	4.20
34A25	2500	3.2	3/4 x 3/4	15	80	3.60
34A53	5000 CT	3.2	3/4 x 3/4	18	165	3.90
34A100	10000 CT	3.2	3/4 x 3/4	15	70	3.90
34ABUL	†Adjustable	8	3/4 x 3/4	15	90	4.50
34ABU	‡Adjustable	8	3/4 x 3/4	15	80	4.80

† Universal type plate impedances of 500, 1000, 1500, 2000 ohms. No CT
‡ Universal type plate impedances of 3000, 5000, 6600, 7000, 10000 ohms. All CT

† Approx. Gap Energy Level in Millions of Ergs.

Radio's Master — 19th Edition

Smith-
BALDWIN
Weatheroid

SPEAKERS

HEARD ALL OVER THE WORLD

GENERAL PURPOSE AND REPLACEMENT SPEAKERS

Designed and engineered to meet all replacement needs. Well suited for experimenters, intercom systems, radio, phonograph and TV. Magnetic structures carefully engineered around Alnico V to produce maximum gap energy. Cones are carefully selected for uniformity and efficiency of response. TROUBLE-FREE OPERATION IS ASSURED BY A TWO YEAR WARRANTY FROM DATE OF MANUFACTURE.

Size	Model No.	*Gap Energy	Voice Coil		Audio Watts
			Imped.	Diam.	
8"	P3PSA	.24	3-4	1/2"	2-3
3 1/2"	P35PSA	.24	3-4	1/2"	2-4
3 1/2"	P35ARB	.34	3-4	1/2"	2-4
3 1/2"	P35ASC	.50	3-4	1/2"	2-4
4"	P4PSA	.24	3-4	1/2"	2-4
4"	P4ARB	.34	3-4	1/2"	2-4
4"	P4ASC	.50	3-4	1/2"	2-4
5"	P5PSA	.24	3-4	1/2"	2-4
5"	P5ARB	.34	3-4	1/2"	2-4
5"	P5ASC	.50	3-4	1/2"	2-4
5 1/4"	P5QASB	.34	3-4	1/2"	2-4
6"	P6PSA	.24	3-4	1/2"	2-4
6"	P6ARB	.84	3-4	1/2"	2-4
6"	P6ASC	.50	3-4	1/2"	4-9
6"	P6ASD	.72	3-4	1/2"	4-9
6"	P6CRE	1.0	3-4	1/2"	4-9
8"	P8ASD	.72	3-4	1/2"	4-9
8"	P8CRE	1.0	3-4	1/2"	4-9
8"	P8RF	1.4	3-4	1/2"	6-12
8"	P80XG	2.1	3-4	1/2"	12-20
10"	P10CRE	1.0	3-4	3/4"	5-7
10"	P10RF	1.4	3-4	3/4"	5-7
10"	P100XG	2.1	3-4	1/2"	6-12
12"	P12CRE	1.0	3-4	3/4"	6-12
12"	P12RF	1.4	3-4	3/4"	6-12
12"	P120XG	2.1	3-4	1/2"	12-20

O V A L S

4" x 6"	P46PSA	.24	3-4	1/2"	3-4
4" x 6"	P46ARB	.34	3-4	1/2"	4-5
4" x 6"	P46ASC	.50	3-4	1/2"	5-6
5" x 7"	P57ARB	.34	3-4	1/2"	5-6
5" x 7"	P57ASC	.50	3-4	1/2"	6-7
5" x 7"	P57ASD	.72	3-4	1/2"	7-8
6" x 9"	P69ASD	.72	3-4	1/2"	8-9
6" x 9"	P69CRE	1.0	3-4	1/2"	9-10

For Field Coil Models write for catalog. Address Department B.

AUTO REPLACEMENTS

See General Purpose and Replacement Speakers list.

P E E W E E ' S

Midgets in size — Giants in performance and durability. Designed for applications where size and space are at a premium. MATERIAL AND WORKMANSHIP WARRANTED FOR ONE YEAR.

2"	P2PSA	.24	3-4	1/2"	2-4
2"	P2PARB	.34	3-4	1/2"	2-4
3"	P3PSA	.24	3-4	1/2"	2-4
3"	P3PARB	.34	3-4	1/2"	2-4
2" x 3"	P23PSA	.24	3-4	1/2"	2-4
2" x 3"	P23ARB	.34	3-4	1/2"	2-4

WEATHEROID SPEAKERS

These speakers are especially designed for use in the open air and we highly recommend them for use in drive-in theatres, fairs, carnivals, circuses, amusement parks and race tracks. All models are dust-proofed and cones are treated to withstand moisture. Metal parts are treated to resist corrosion. MATERIAL AND WORKMANSHIP WARRANTED FOR ONE YEAR.

4"	P4PSA	.24	3-4	1/2"	3-4
4"	P4ARB	.34	3-4	1/2"	3-4
4"	P4ASC	.50	3-4	1/2"	4-5
5"	P5PSA	.24	3-4	1/2"	4-5
5"	P5ARB	.34	3-4	1/2"	4-5
5"	P5ASC	.50	3-4	1/2"	5-6

*Gap Energy—Ergs in Millions.

HIGH FIDELITY EXTENDED RANGE

Comparable to the best in both foreign and domestic hi-fidelity speakers at attractive prices. TROUBLE-FREE OPERATION IS ASSURED BY A TWO YEAR WARRANTY FROM DATE OF MANUFACTURE.

Size	Model No.	*Approx. Energy Level	Voice Coil		Audio Watts
			Imped.	Diam.	
8"	B82	1.0	6-8	3/4"	6-7
8"	B83	1.4	6-8	3/4"	8-9
8"	B84	2.1	6-8	1"	10-12
8"	B86	3.1	6-8	1"	12-14
10"	B102	1.0	6-8	3/4"	7-9
10"	B103	1.4	6-8	3/4"	9-10
10"	B104	2.1	6-8	1"	10-12
12"	B123	1.4	6-8	3/4"	9-10
12"	B124	2.1	6-8	1"	10-12
12"	B126	3.1	6-8	1"	12-14
12"	B1210	4.6	6-8	1 1/4"	15-20
12"	B1216	6.3	6-8	2"	20-25
15"	B154	2.1	6-8	1"	12-14
15"	B156	3.1	6-8	1"	14-16
15"	B1510	4.6	6-8	1 1/4"	16-18
15"	B1516	6.3	6-8	2"	22-25
15"	B1521	11.5	6-8	2"	25-30
15"	B1535	14.3	6-8	2"	30-35

Write for catalog and prices.

CO-AXIAL SERIES

Engineered and developed as an answer to an economical dual speaker system. The Co-Axial speaker should be used wherever quality is important. TROUBLE-FREE OPERATION IS ASSURED BY A TWO YEAR WARRANTY FROM DATE OF MANUFACTURE.

Size	Model No.	Impedance	Voice Coil		Audio Watts
			Impedance	Audio Watts	
8"	BC8-6	6-8			6-7
8"	BC8-7	6-8			8-10
8"	BC8-8	6-8			10-12
10"	BC10-6	6-8			7-8
10"	BC10-7	6-8			9-11
10"	BC10-8	6-8			10-12
10"	BC10-9	6-8			12-14
12"	BC12-6	6-8			8-9
12"	BC12-7	6-8			10-12
12"	BC12-8	6-8			12-13
12"	BC12-9	6-8			13-14
12"	BC12-10	6-8			14-16
15"	BC15-7	6-8			11-12
15"	BC15-8	6-8			12-14
15"	BC15-9	6-8			14-16
15"	BC15-10	6-8			16-18

TWEETERS FOR REPLACEMENT OR MODERNIZATION OF EXISTING EQUIPMENT

Size	Model
3 1/2"	T-1
5"	T-2
5"	T-3 (Extended Range)

WOOFERS

Highly efficient low frequency radiator designed to give best results when used with T-3 Extended Range Tweeter. TWO YEAR WARRANTY.

Size	Model No.	Impedance	Voice Coil	
			Impedance	Audio Watts
12"	12WF	6-8		16
15"	15WF	6-8		20

*Gap Energy—Ergs in Millions.

Write for catalog and prices. Address Department B.

CONSOLIDATED RADIO PRODUCTS CO.

CHICAGO 10, ILLINOIS

Export Department: 2020 Engineering Building, Chicago 6, Illinois, U. S. A. • Cable' 'ENOTS'

WRIGHT *Verified Speakers*



The second separate and rigid inspection which each speaker receives after it has been manufactured, makes it possible to replace any defective speaker with a new one. This enables the distributor to immediately give his customer a new speaker from stock when a defective unit is returned.

SPEAKERS, GRILLES, BAFFLES, CABINETS

Model Number	Speaker Size	Watts Output	Alnico 5 Magnet Wt.	V. C. Impd.	List Price
NP-468	4"	4	.68 oz.	3.5 ohms	\$3.75
NP-510	5"	5	1.00 "	3.5 "	4.20
NP-515	5"	6	1.47 "	3.5 "	4.60
NP-610	6"	6	1.00 "	3.5 "	4.80
NP-615	6"	6	1.47 "	3.5 "	5.15

All these speakers will accommodate our versatile mounting brackets, but the brackets are not included at the above prices. Please order them separately.

AMB — Adjustable Mounting Bracket..... .25c

NP-832	8"	8	3.16 oz.	3.5 ohms	\$ 8.50
NP-8680	8"	12	6.8 "	8 "	12.00

These 8" speakers are exceptional units, as tests will prove. Used with the 10-P Flush Mounting Grille or the B-1965 Harmonic Baffle they insure a splendid, satisfactory installation that will always be a good advertisement for additional business. The NP-832 also makes a fine replacement speaker for a full-console radio or TV set.

NP-1232	12"	8	3.16 oz.	3.5 ohms	\$11.00
---------	-----	---	----------	----------	---------

A perfect replacement speaker for a Full-console Radio or Television Receiver where a 12" unit is used. Also very good for light sound installations.

NP-1268	12"	14	6.8 oz.	8 ohms	\$14.50
---------	-----	----	---------	--------	---------

The many years that this 12" speaker has been used in all types of installations shows what the sound engineers think of it.

NOP-631	6x9"	9	3.16 oz.	3.5 ohms	\$9.00
NOP-521	5x7"	6	2.15 "	3.5 "	6.50

All the above prices include the Government Tax

Model B-1965 Wright Harmonic Baffle.....	\$12.00
Model B-1965-832 Baffle with NP-832 Speaker.....	19.50
Model B-1965-8680 Baffle with NP-8680 Speaker.....	21.75

Model M Cabinet.....	\$ 9.20
Model M-615 Cabinet with NP-615 6" Speaker.....	14.25

Model T-6 Cabinet.....	\$15.00
Model T-6-615 Cabinet with NP-615 Speaker.....	19.85
Model T-6-615-SW Cabinet with NP-615 and Switch.....	22.85

Model 10-PC Flush Mounting Grille.....	\$ 4.00
Model 10-PC-832 Grille with NP-832 Speaker.....	11.50
Model 10-PC-8680 Grille with NP-8680 Speaker.....	14.50
Model 10-PCW Grille and Wall Box.....	11.00
Model 10-PCW-832 Grille, Wall Box and NP-832.....	18.50
Model 10-PCW-8680 Grille, Wall Box and NP-8680.....	21.50

Model 108-WGB Grille and Wall Box.....	\$22.00
Model 108-WGB-832 Grille and Wall Box with NP-832.....	29.50
Model 108-WGB-8680 Grille and Wall Box with NP-8680.....	32.50

Model 12-A Grille for a 12" Speaker.....	\$12.50
Model 12-A-1232 Grille and NP-1232 Speaker.....	22.50
Model 12-A-1268 Grille and NP-1268 Speaker.....	24.50

Model M Cabinet — Outside diameter 6 $\frac{3}{4}$ " — Depth 3 $\frac{1}{4}$ ". Inside diameter at front 6 $\frac{1}{8}$ ". Four holes for mounting 6" speaker. Made of strong aluminum it can be used indoors or outside. Louvers front and back make it suitable for two way paging. Gives sufficient baffle for music. Can be used as is or painted..... List Price \$6.25

Model B-1965 Harmonic Baffle — These Dome like ceiling baffles with their silvery finish are pleasing to the eye. They are excellent for Paging, Singing, or Orchestral reproduction. For the best results use the NP-8680 8" speakers..... List Price \$10.95

Model 10-PC Flush Mounting Grille — Chrome Plated.

Model 10-PB Flush Mounting Grille — Bonderized and Prime Coated for Painting. These Grilles are an item that the Sound Engineers have wanted for a long time as they mount flush they used the entire wall or ceiling as a baffle. Used with either the NP-832 or NP-8680 speakers these grilles will make a satisfactory, well finished sound installation..... List Price \$4.00

WRIGHT HARMONIC BAFFLE

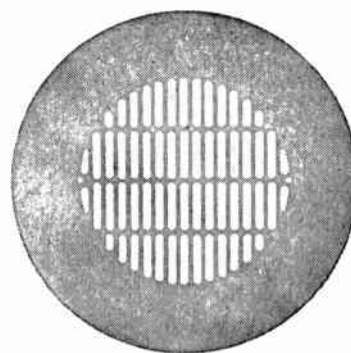

MODEL 10-P
Flush Mounting Grille

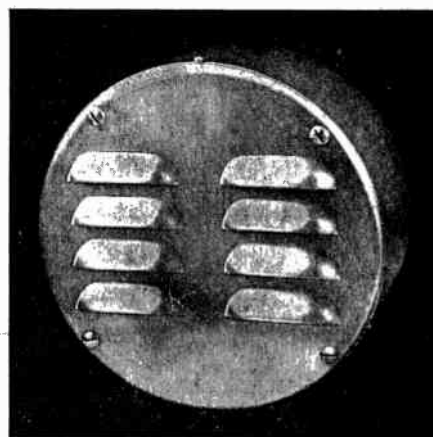

MODEL "M" CABINET

For Full Detailed Information Write for Catalog PC-No. 100



METAL SPEAKER ENCLOSURES



SILVER SONANCE LINE

The Silver Sonance Line is divided into three parts. The first is the Universal Speaker Enclosure. There are many advantages of the Universal type of speaker housing that makes it the most outstanding unit of its type. It can be used in hospitals, schools, factories, auditoriums, stores, airports, railroad stations, stadiums and any other place where a speaker is used.



A prominent feature of this housing is the adjustability that is achieved by mounting our speaker case with an accessory known as the Bud Adjustable Mounting Bracket. Full information on this bracket is given on page C-41. When the adjustable feature is not desired, the speaker housing may be attached directly to the wall. There are two holes in the sides of the speaker housing enabling installation in this manner. The holes in the cabinet are so spaced that the housing may be mounted either to an outlet box or screwed directly to the wall.

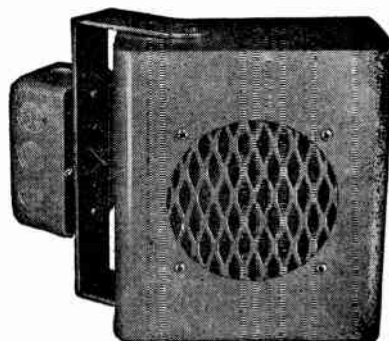

The new BUD UNIVERSAL speaker enclosures have a bi-lateral feature which permits sound to come from both the front and the back of the speaker housing. This is an ideal feature when speakers are used for paging purposes, or when speakers are used in corridors, hallways, or other places where the intention is to have the sound travel in two directions.

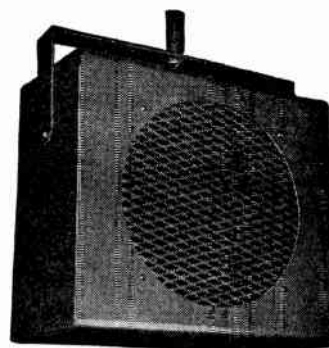

There is no danger of cracking, warping, splitting, or any of the other disadvantages found when a wood speaker baffle is used. Since our speaker enclosure is made of heavy gauge steel, none of these disadvantages are present. Changes in temperature and weather conditions have absolutely no effect on this speaker case. The finish is a beautiful silver grey hammertone. The hammertone finish assures ease of cleaning, as the housing may be cleaned by wiping with a damp cloth.

A special sound-deadening compound is used to eliminate the metallic resonant sound that is present in other metal speaker cases. All screws and nuts are furnished for mounting the speaker in the enclosure. There are no holes to drill and no time will be wasted in the installation.

Hammered Finish Catalog No.	Primer Coat Only Catalog No.	Speaker Size	Height	Width	Depth	Actual Weight Pounds	Dealer Cost
CS-2240	CS-2270	4" or 5"	7¼"	6¾"	3-15/32"	2½	\$3.60
CS-2241	CS-2271	5", 5½" or 6"	8¼"	7½"	4"	2¾	4.14
CS-2242	CS-2272	6" or 8"	10-37/64"	9½"	5-1/16"	4½	7.50
CS-2243	CS-2273	10" or 12"	15-1/32"	13½"	7-13/64"	9	9.60

Prices on above slightly higher west of the Mississippi River
Only a few of many BUD Products are shown. For complete catalog,
write BUD RADIO, INC., 2118 E. 55th St., Cleveland, Ohio



METAL SPEAKER ENCLOSURES

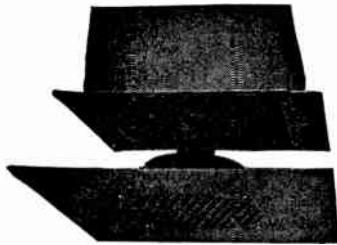

RECESSED CEILING and WALL ENCLOSURE

This speaker housing is suitable for an 8" speaker and reduces installation costs considerably. Adjustable brackets make the housing ideal for use in old or new construction. The depth of the box is 4", so that it can be mounted in walls where the studding is 2" x 4".

All of the features of acoustical perfection, durability and economy found in the universal type of speaker enclosure apply to the recessed enclosure as well.

This speaker housing is easily installed in a ceiling where acoustical tile has been used, since the grill plate is a 14" square. This, therefore, perfectly covers the space from which a 12" acoustical tile has been removed.

Hammered Finish Catalog No.	Primer Coat Only Catalog No.	Speaker Size	Type	Height	Width	Depth	Actual Weight Pounds	Dealer Cost
CS-2244	CS-2274	8"	Housing with grill	14"	14"	4-1/16"	8 3/4	\$9.00
				(Housing dimension 10" x 10" x 4")				
CS-2245	CS-2275	8"	Grill plate Only	14"	14"	1/16"	4	1.80

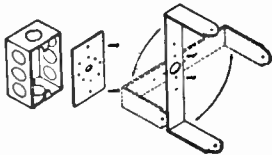

ADJUSTABLE MOUNTING BRACKET

The adjustable mounting bracket can be used with any of the universal type enclosures. This makes possible an adjustable feature by which the speaker housing can be adjusted in any angle in a horizontal plane. There is a hole in the bracket which will pass a half inch conduit, permitting the speaker housing to be suspended from the ceiling.

Catalog Number	Description	Actual Wt. lbs.	Dealer Cost
AB-2250	Adjustable bracket for CS-2240	3/4	\$1.14
AB-2251	Adjustable bracket for CS-2241	1	1.14
AB-2252	Adjustable bracket for CS-2242	1 1/4	1.41
AB-2253	Adjustable bracket for CS-2243	2 3/4	1.65
CP-2255	Outlet Box Cover Plate, 4 1/4" x 2 3/4"	1/2	.75

OUTLET BOX COVER PLATE

This unit is a cover plate for electrical outlet box enabling the adjustable bracket to be mounted directly to the outlet box. When used in conjunction with the adjustable bracket, movement in all horizontal and vertical directions is possible.

REAR SEAT SPEAKER ASSEMBLY

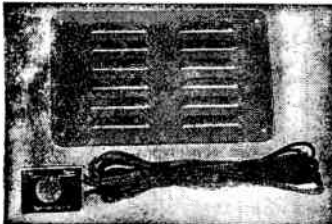

This unit is available in two types, as shown in the table below. The rear seat speaker grill assembly consists of the rear seat speaker grill, together with mounting screws, switch, bracket for

holding switch and sufficient wire for installation. The switch permits selection of either speaker or use of both speakers simultaneously.

The rear seat speaker grill is a finely louvered unit made from heavy gauge steel, which assures you of having a grill that will "take a beating." The finish is a beautiful silver grey hammertone, which is a fine enough finish to be attractive and yet dull enough to assure you that no glaring sun reflection will be picked up by a rear vision mirror and be a potential blinding flash to the driver.

Catalog Number	Plate Size	Actual Wt. lbs.	Dir. Cost
CS-2260	3/16" x 9" x 5 1/2"	3/4	\$1.80
CS-2261	(Consisting of CS-2260 plus switch, bracket and wire)	1 1/4	3.00

WALL TYPE SPEAKER CASES

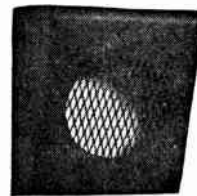

This is a distinctive line of speaker cabinets, for wall or table use. Since these units are made of steel, all troubles with wood warping and splitting are eliminated. Keyway holes are provided for wall mounting and four embossed feet on the bottom are provided to prevent damaging table surfaces. Finished in brown wrinkle enamel only.

Cat. No.	Hole Size	Speaker Size	Height	Width	Depth	Dealer Cost
CS-1948	3 1/2"	4"	7 1/2"	6 1/2"	4 1/2"	\$2.85
CS-1939	4"	5"	7 1/2"	6 1/2"	4 1/2"	3.00
CS-1940	4 3/4"	6"	9 1/2"	8"	5 1/2"	3.40
CS-1941	6 1/2"	8"	11 1/2"	9 1/2"	7"	3.90
CS-1942	8 1/2"	10"	13 1/2"	11 1/2"	8 1/2"	4.50
CS-1943	10 1/2"	12"	15 1/2"	13 1/2"	9 3/4"	5.00

MINIATURE SPEAKER CASE

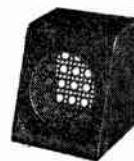

A safe, convenient housing for midget 2" and 3" speakers. These units are finished in black wrinkle only.

Catalog Number	Hole Dia.	Fits Speaker Size	Actual Wt. lbs.	Dir. Cost
CS-1685	2-3/16"	2"	3/4	\$1.50
CS-1686	2-13/16"	3"	3/4	1.50

Prices on above slightly higher west of the Mississippi River
Only a few of many BUD Products are shown. For complete catalog, write BUD RADIO, INC., 2118 E. 55th St., Cleveland, Ohio



Jensen Speakers



CONCERT SERIES

These well known loudspeakers offer the best for replacement service and for original equipment in sound reinforcing systems of all kinds. All models are dustproof. PM models use Alnico 5 magnets; field coil models include hum neutralizing coils. Cones are chosen for high sensitivity and optimized response characteristics.

CONCERT SERIES PM SPEAKERS

Nominal Size	Model No.	Stock No.	Gap Energy Level	Dimensions, Inches			Voice Coil		Power, Watts	*Transformer Size	List Price
				O.D.	Depth	Baffle Opening	Diam., Inches	Imped., Ohms			
15"	P15-N	ST-654	6.6	15 1/4	8	13 1/4	1 1/2	8	20.0	1 x 1"	\$70.50
15"	P15-P	ST-655	4.6	15 1/4	8	13 1/4	1 1/2	8	18.0	1 x 1"	\$4.75
12"	P12-N	ST-656	6.6	12 1/4	7	10 1/4	1 1/2	8	18.0	1 x 1"	\$2.50
12"	P12-P	ST-657	4.6	12 1/4	6 1/4	10 1/4	1 1/2	8	16.0	1/2 x 1/2"	\$3.60
12"	P12-R	ST-103	2.2	12 1/4	6 1/4	10 1/4	1	6-8	12.0	1/2 x 1/2"	\$6.50
12"	P12-S	ST-102	1.5	12 1/4	6 1/4	10 1/4	1	6-8	10.0	1/2 x 1/2"	\$4.75
12"	P12-S	ST-101	1.5	12 1/4	6 1/4	10 1/4	1	3-4	10.0	1/2 x 1/2"	\$4.75
12"	P12-T	ST-101	1.1	12 1/4	6 1/4	10 1/4	1	6-8	9.0	1/2 x 1/2"	\$3.60
12"	P12-T	ST-871	1.1	12 1/4	6 1/4	10 1/4	1	3-4	9.0	1/2 x 1/2"	\$3.60
10"	P10-S	ST-873	1.5	10 1/4	5 1/4	8 1/4	1	3-4	9.0	1/2 x 1/2"	\$3.40
10"	P10-T	ST-119	1.1	10 1/4	5 1/4	8 1/4	1	6-8	8.0	1/2 x 1/2"	\$3.40
10"	P10-T	ST-874	1.1	10 1/4	5 1/4	8 1/4	1	3-4	8.0	1/2 x 1/2"	\$3.40
8"	P8-R	ST-169	2.2	8 1/4	4	6 1/4	1	6-8	9.0	1/2 x 1/2"	\$2.50
8"	P8-S	ST-104	1.5	8 1/4	3 1/4	6 1/4	1	6-8	8.0	1/2 x 1/2"	\$1.80
8"	P8-S	ST-851	1.5	8 1/4	3 1/4	6 1/4	1	3-4	8.0	1/2 x 1/2"	\$1.80
8"	P8-T	ST-117	1.1	8 1/4	3 1/4	6 1/4	1	7.0	7.0	1/2 x 1/2"	\$2.20
8"	P8-U	ST-116	.74	8 1/4	3 1/4	6 1/4	1	3-4	6.0	1/2 x 1/2"	\$2.25
8"	P8-V	ST-115	.51	8 1/4	3 1/4	6 1/4	1	3-4	5.0	1/2 x 1/2"	\$2.25
6" x 6"	P6-V	ST-810	.51	6 1/4	3 1/4	5 1/4	1	3-4	5.0	1/2 x 1/2"	\$2.25
6" x 6"	P6-T	ST-112	1.1	6 1/4	3 1/4	5 1/4	1	3-4	6.0	1/2 x 1/2"	\$2.25
6" x 6"	P6-V	ST-110	.51	6 1/4	3 1/4	5 1/4	1	3-4	4.0	1/2 x 1/2"	\$2.25
6" x 6"	P6-X	ST-108	.25	6 1/4	2 1/4	5 1/4	1	3-4	3.0	1/2 x 1/2"	\$2.25
5" x 7"	P57-V	ST-859	.51	5 x 7 1/4	4 1/4 x 6 3/4	5 1/4	1	3-4	4.0	1/2 x 1/2"	\$2.25
5" x 7"	P525-V	ST-803	.51	6	2 1/4	4 1/4	1	3-4	4.0	1/2 x 1/2"	\$2.25
5" x 7"	P5-V	ST-107	.51	5	2 1/4	4	1	3-4	3.5	1/2 x 1/2"	\$2.25
5" x 7"	P5-X	ST-105	.25	5	2 1/4	4	1	3-4	2.5	1/2 x 1/2"	\$2.25
5" x 7"	P5-X	ST-740	.25	5	2 1/4	4	1	45-50	2.5	1/2 x 1/2"	\$2.25
4" x 6"	P46-W	ST-910	.36	4 1/2 x 6 1/2	3 1/2 x 5 1/2	2 1/4	1	3-4	3.0	1/2 x 1/2"	\$2.25
4" x 6"	P4-X	ST-113	.25	5	2	3 1/4	1	3-4	2.0	1/2 x 1/2"	\$2.25
4" x 6"	P4-X	ST-739	.25	5	2	3 1/4	1	45-60	2.0	1/2 x 1/2"	\$2.25
4" x 6"	P275-V	ST-911	.51	2 1/4	2 1/4	1 1/4	1	16	0.15	\$7.25

CONCERT SERIES FIELD COIL SPEAKERS

Nominal Size	Model No.	Stock No.	Gap Energy Level	Dimensions, Inches			Voice Coil		Field		*Transformer Size	List Price	
				O.D.	Depth	Baffle Opening	Diam., Inches	Imp., Ohms	Power, Watts	Resist., Ohms			Power, Watts
12"	F12-S	ST-173	1.5	12 1/4	6 1/4	10 1/4	1	3-4	10.0	1000	8.5	1/2 x 1/2"	\$15.20
10"	F10-S	ST-175	1.5	10 1/4	5 1/4	8 1/4	1	3-4	9.0	1500	8.5	1/2 x 1/2"	\$14.20
8"	F8-W	ST-736	.36	8 1/4	3 1/4	6 1/4	1/2	3-4	4.0	1000	5.0	1/2 x 1/2"	\$2.25
5" x 7"	F57-W	ST-884	.36	7 1/2 x 5"	2 1/4	6 1/4 x 4 1/4	1/2	3-4	3.5	85	5.0	1/2 x 1/2"	\$2.25
6" x 6"	F6-X	ST-189	.25	6 1/4	2 1/4	5 1/4	1/2	3-4	3.0	450	4.5	1/2 x 1/2"	\$2.25
6" x 6"	F6-X	ST-883	.25	6 1/4	2 1/4	5 1/4	1/2	3-4	3.0	85	4.5	1/2 x 1/2"	\$2.25
6" x 6"	F5-X	ST-882	.25	5	2 1/4	4	1/2	3-4	2.5	85	4.5	1/2 x 1/2"	\$2.25
6" x 6"	F5-X	ST-194	.25	5	2 1/4	4	1/2	3-4	2.5	450	4.5	1/2 x 1/2"	\$2.25
4"	F4-X	ST-196	.25	5	2 1/4	3 1/4	1/2	3-4	2.0	450	4.5	1/2 x 1/2"	\$2.25

*Size recommended. †Millions of ergs.

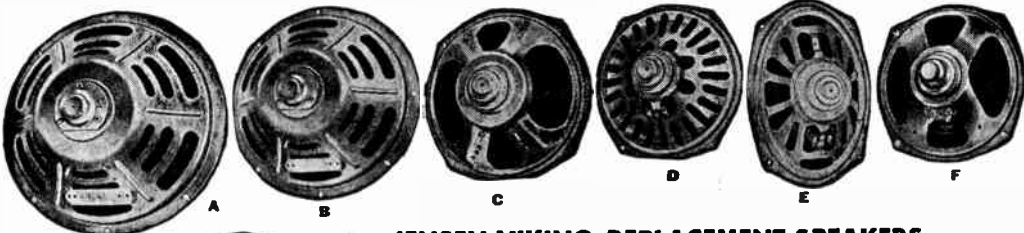

JENSEN VIKING REPLACEMENT SPEAKERS



CTM-1 Bracket Set. For mounting up to 1/2" x 1/2" transformer on speaker and speaker on chassis. Fits speakers up to 6" size

including 4" x 6". Furnished no charge on request by your distributor.

Nom. Size In.	Model No.	Fig.	Dimensions Overall		V. C. Imped. Ohms	Net Each
			Overall	Depth		
12	12J10	A	12 1/4	4 1/4	3-4	\$6.37
10	10J10	B	10 1/4	3 1/4	3-4	\$5.72
8	8J9	C	7 1/4	2 1/4	3-4	\$3.56
7	7J9	D	6 1/4	2 1/4	3-4	\$3.56
6x9	6J9	E	9 1/4 x 6 1/4	3	3-4	\$3.72
6	6J6	F	6 1/4	2 1/4	3-4	\$2.50
6x7	57J9	G	7 1/4 x 5	2 1/4	3-4	\$3.39

Nom. Size In.	Model No.	Fig.	Dimensions Overall		V. C. Imped. Ohms	Net Each
			Overall	Depth		
5 1/2	52J6	H	5 1/2	2 1/4	3-4	2.38
5	5J6	I	5	1 1/4	3-4	2.31
4x6	46J6	J	6 1/4 x 4 1/4	1 1/4	3-4	2.68
4	4J6	K	4 1/4	1 1/4	3-4	2.06
4	35J6	L	3 1/2	1 1/4	3-4	2.06
3	3J6	M	3	1 1/4	3-4	2.11

Jensen Hypex Projectors



VH-24

Because of the Hypex formula (Patent 2,338,282) giving wider sound distribution and greatly improved acoustical performance, JENSEN Hypex projectors are superior type horns. The Altoce 5 unit is entirely enclosed within the one-piece rigid horn yet easily removed and replaced. Stainless steel and other corrosion-resistant materials and specially treated steel parts insure against weather exposure. Models VH-24, VH-20 and VH-15 have mounting brackets with clutch-type heavy "U" trunnions which afford complete flexibility of adjustment with positive locking into desired position. Weatherproof terminal boxes provide easy, solderless connections with no exposed terminals. Model VH-91 has a universal mounting bracket which permits pointing in any direction and secure locking by a single wing nut.



VH-91

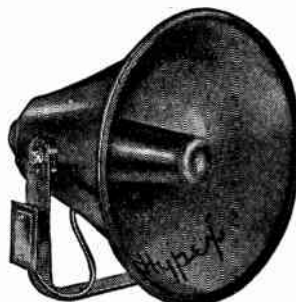

VH-15

SPECIFICATIONS

Model No.	Stock No.	Cut-Off CPS	Acoust. Path, In.	Coverage Angle Degrees	Power Rating Watts	Voice Coil Imped. Ohms	Diam. In.	Length In.	Trans.* Core Size	List Price
VH-24	ST-685	110	58	75	25	16	25	22½	1x1½	\$89.50
VH-20	ST-684	140	52	80	25	16	21	20½	1x1½	76.00
VH-15	ST-757	180	36	90	15	8	16	15	¾x¾	56.50
VH-91	ST-171	300	16	100	15	8	8½	7½	¾x¾	36.80

*Not included.

HYPEX "Three-sixty" PROJECTORS

Designed for the reproduction of speech and music signals at high efficiency where high noise levels exist. The Hypex formula is incorporated in their design. With the sound distributed over a circle, they are especially suitable for installations where coverage of relatively large areas and suspension from the ceiling are desired. Model VR-11 is recommended for speech reproduction while Model VR-241, of larger size, is intended for speech and music reinforcement. Driver unit has phenolic diaphragm; VR-241 uses same diaphragm as VH-24 and VH-20; VR-11 uses same diaphragm as VH-15 and VH-91. VR-241 is equipped with weatherproof terminal box with connecting cable passing through rubber grommet and leads attached to screw terminals provided. VR-11 has two-conductor rubber-covered cable for connections. Both equipped with heavy eyebolt at top for suspension.



VR-241



VR-11

SPECIFICATIONS

Model No.	Stock No.	Cut-Off CPS	Acoust. Path, In.	Coverage Angle Degrees	Power Rating Watts	Voice Coil Imped. Ohms	Diam. In.	Height In.	Trans.* Core Size	List Price
VR-241	ST-789	140	54	360	25	16	25	22	1x1	\$98.50
VR-11	ST-791	280	18	360	15	8	11	10½	¾x¾	46.50

*Not included.

MODEL V-21 DRIVER UNIT

This driver unit incorporates the driver element used in the new Hypex projectors and is electrically and mechanically interchangeable with the former U-20 ST-630 and U-201 ST-732 Driver units. It is designed for replacement service on former Models H-20 ST-726, H-201 ST-733 and H-24 ST-727 Hypex horns. Unit is PM type and equipped with internal screw terminals. Flange is designed for ¼" bolt attachment, with three ¼" holes spaced 120 degrees apart on a radius of 2¼". Voice coil input 16 ohms and power rating 25 watts.
Model V-21 Driver Unit, ST-787—List Price \$36.25

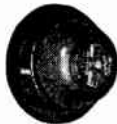

V-21

SPEECH MASTER PROJECTORS

Streamline design and exceptional acoustical performance recommend these projectors for paging and intercommunication. PM design. Good talk-back performance in PA systems. Hammered gray finish; chrome trim. RC 36° cord. Space within case for ¼" x ¼" transformer. Model AP-10 has base and tilt adjustment for desk mounting. Model AP-11 for panel mounting in 4 ¼" cut-out. Finished with eyelets, mounting screws and drilling template.

Model AR-10 projector is for paging, intercommunication and call systems at medium levels and under moderate noise conditions. Reflex horn increases mid-frequency range efficiency. Construction prevents direct access of rain, snow and dust to speaker diaphragm. Complete with mounting bracket.



AP-10

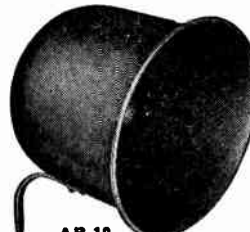

AR-10

Model	ST No.	V. C. Imp. Ohms	Power Watts	Diam. In.	Depth In.	List Price
AP-10	ST-630	3-4	5	5	5½	\$19.30
AP-10	ST-631	45-50	5	5	5½	20.30
AR-10	ST-643	3-4	6	10	8	23.50
AR-10	ST-644	45-50	6	10	8	24.50

THE "HYPEX" HORN FORMULA —AN EXCLUSIVE JENSEN FEATURE

"Hypex" comes from the mathematical term "Hyperbolic Exponential" which describes the important difference between Jensen Projectors and those based on the simple exponential theory. Jensen research discovered a better, more efficient horn formula which maintains effective acoustic loading right down to acoustic cut-off and all Jensen Hypex* Projectors have this exclusive feature for better performance. For the facts on this development and a complete description of horn behavior, write for Technical Monograph No. 5, "Horn-type Loudspeaker". Price, 25c.

*T.M. Reg.

Jensen High Fidelity Loudspeakers

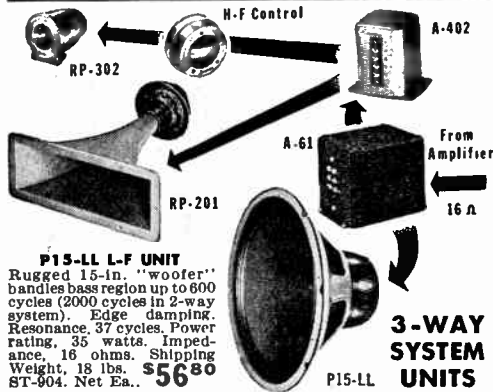

P15-LL L-F UNIT
Rugged 15-in. "woofer" handles bass region up to 600 cycles (2000 cycles in 2-way system). Edge damping. Resonance, 37 cycles. Power rating, 35 watts. Impedance, 16 ohms. Shipping Weight, 18 lbs. ST-904. Net Ea. **\$5680**

3-WAY SYSTEM UNITS

RP-201 H-F UNIT
Reproduces the range from 600 to 4000 cycles as the mid-channel in a 3-way system. Driver unit loaded by cast aluminum Hypex horn. Coverage angle, 115°. Impedance, 16 ohms. Power rating with A-61 network, 35 watts speech and music signal input to system. Shipping Weight, 8 lbs. ST-897. Net Each. **\$4260**

RP-302 ULTRA H-F UNIT
Covers the top of the range from 4000 cycles to the highest audible frequencies with unexcelled smoothness and freedom from distortion. Coverage angle, 120°. Impedance, 16 ohms. Power rating with A-402 network, 35 watts speech and music signal input to system. Mounts in 1 1/4" hole in baffle or on bracket. Satin finish. Shipping Weight, 3 lbs. ST-899. Net Each. **\$3360**

A-402 CROSSOVER NETWORK
Two-channel type; high pass transmits everything above 4000 cycles, low-pass everything below this frequency. 180° constant-resistance type. 4 3/4" high, 3 1/2" wide, 3 1/4" deep. Shipping Weight, 3 lbs. ST-898. Net Each. **\$820**

A-61 600 CYCLE NETWORK
Sends frequencies above 600 cycles to A-402 for further division; below 600 cycles to the P15-LL unit. Two-channel, 180° constant-resistance type, with 12 db/octave attenuation outside pass band. 5 1/4" high, 7" wide, 4 3/4" deep. Shipping Weight, 5 1/4 lbs. ST-896. Net Each. **\$1750**

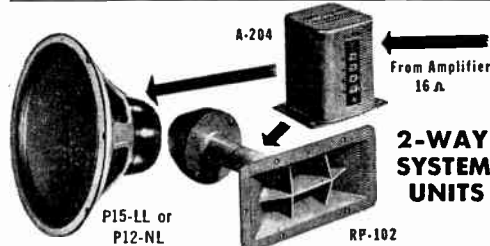

P12-NL LOW FREQUENCY UNIT
New, rugged 12" "woofer" especially designed for 2-way systems. Handles bass up to 2000 cycle crossover. Impedance, 16 ohms. Power rating, 25 watts. Shpg. weight, 10 lbs. ST-912. Net Each. **\$3650**

RP-102 HIGH FREQUENCY UNIT
A new advanced design "tweeter" for use in 2-way systems crossing over at 2000 cycles. Reproduces an unusually wide range from 2000 cycles to extremely high frequencies with smooth response, excellent balance and very low distortion. Impedance, 16 ohms. Power rating, 35 watts speech and music signal to input of 2-way system when used with A-204 network. Shipping Weight, 6 1/2 lbs. ST-895. Net Each. **\$2835**

A-204 CROSSOVER NETWORK
Two-channel type, High-pass section transmits everything above 2000 cycles, low-pass, everything below this frequency. 180° constant-resistance type. 4 3/4" high, 3 1/2" wide, 3 1/4" deep. Shipping Weight, 3 1/4 lbs. ST-894. Net Each. **\$1300**

H-F & LEVEL CONTROLS
Flush satin brass cup escutcheons, appropriately marked, mounting in 1 1/4" holes, and matching bar knobs. 25" leads attached.

H-F Balanced Control. For adjusting balance of H-F Units. 16 ohms. **\$415**
ST-901. Net Each. **\$430**

Level Control. Input control to speaker. 16 ohms. **\$430**
ST-880. Net Each. **\$430**

Z-3422 Autotransformer. For matching any two of 16/8/4 ohm impedances. Net Each. **\$5.15**

"L" PAD CONTROLS

L-pad type, complete with pointer knob and escutcheon. **Level Control ST-276** 6-8 ohms, 5-watts. Net. **\$1.80**

Level Control ST-760 3-4 ohms, 5-watts. Net. **\$2.01**

Level Control ST-761 500-600 ohms, 15 watts. Net Ea. **\$3.72**

Level Control ST-411 6-8 ohms, 15-watts. Net. **\$2.82**

Level Control ST-411 6-8 ohms, 15-watts. Net. **\$2.82**

G-610 TRIAXIAL

The G-610 consists of 3 independently driven elements each covering a portion of the range and a Crossover and Control Network. Crossovers are at 600 and 4000 cycles. Low frequencies reproduced by a heavy duty curvilinear diaphragm unit. Mid frequency section has compression driver unit, flared cone of h-f unit acting as final section of horn. Special small h-f tweeter at front covers high end to limits of audibility. Combination smoothly covers the widest range available today! Power rating 35 watts. Impedance 16 ohms. Mounts in any cabinet for 15" speaker; BL-151 cabinet recommended for outstanding results. Baffle opening 13 3/4"; OD 15 1/4"; depth 10 1/4". Shipping Wt., 50 lbs. ST-900. Net Each. **\$25275**

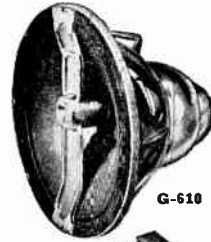

G-610

TRANSFORMERS FOR G-610

These transformers are high fidelity units, mounting directly on network chassis, with plug-in connections, to give alternate input impedances.

Model T-201—ST-846. 4 and 8 ohms. Net Each. **\$12.35**

Model T-202—ST-847. 500-600 ohms. Net Each. **\$12.35**

H-530 COAXIAL

In wide range extension, in the unusual degree of smoothness and the fine balance of response, this new coaxial has been acclaimed as a new milestone in speaker engineering. Low frequencies are reproduced by a highly efficient 15" L-F unit designed especially for a smooth transition in the crossover region. Upper channel is a new compression driver perfectly matched to a special H-F divided cellular Hypex horn to reproduce a wide frequency range above 2000 cycles. Impedance, 16 ohms. Power rating, 30 watts speech and music signal input. Complete with network and H-F control. Baffle opening, 13 1/4"; O.D., 15 1/4"; depth, 10 1/4". Shpg. Wt. **\$12950**
25 lbs. ST-893. Net Ea.



H-530

H-520 COAXIAL

A new coaxial loudspeaker with the smoothness, fine balance and wide range response you expect in a truly advanced-design 2-way system. A compression driver unit loaded by a 6-cell Hypex horn reproduces frequencies above 2000 cycles. An efficient 15" L-F unit handles the lower frequencies. Impedance, 16 ohms. Power rating, 25 watts speech and music signal input. Baffle opening, 13 1/4"; O.D., 15 1/4"; depth, 9 3/4". Shipping Weight, 16 lbs. ST-892. Net Each. **\$7950**



H-520

MODEL H-222 COAXIAL

Outstanding, efficient, new wide-range 12" coaxial with compression driver tweeter and 6-cell h-f horn brings a new meaning to high fidelity in a small speaker. Integral frequency division. Power rating 25 watts. Impedance 16 ohms. Baffle opening 10 1/4"; OD 12 1/4"; depth 8 1/4". Has h-f balance control on 36" cord. Shipping Weight, 12 lbs. ST-875. Net Each. **\$5450**



H-222

MODEL K-310A COAXIAL

A fine, low cost true two-way 15" high fidelity speaker that will outperform many at higher prices. Integral frequency division system. Power rating 16 watts. Impedance 16 ohms. Shipping Weight, 18 lbs. ST-891. Net Each. **\$3760**

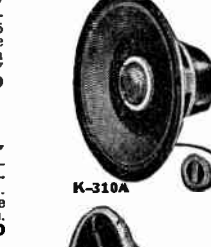

K-310A

MODEL K-210 COAXIAL

A 12" high fidelity speaker at extremely low cost. Integral frequency division system. Power rating 12 watts. Impedance 8 ohms. Shipping Weight, 7 lbs. ST-831. Net Each. **\$2485**



K-210

Jensen Hi-Fi Sound Reproducers

THE GREATER TRI-PLEX 3-WAY SPEAKER SYSTEM



Jensen's new greater TRI-PLEX is offered to you with the conviction that in quality of reproduction, it will outperform any comparable speaker system. Bass response has been enhanced with the new Bass-Ultraflex enclosure. The design objective has been the attainment of the full high-fidelity frequency range with extreme smoothness, precisely adjusted intra-range balance, and complete elimination of all false coloration effects. The result is a reproducer which in its outstanding listening qualities will delight the discriminating listener who seeks completely faithful music reproduction without harshness or exaggeration.

Technically, the TP-200 represents a high point in the development of the true 3-way system. Three completely independent reproducers divide the frequency range as indicated in the specifications, the combined total result being blended into a superb unity which cannot be approached with short-cut designs which simulate, but do not afford comfortable, livable listening quality. For example, both mid-frequency and high-frequency channels employ horn-loaded compression-driver units with plastic diaphragm moving systems in precision sound chambers for utmost smoothness—there are no metallic elements to introduce harsh or irritating effects. Individual controls are provided at the side of the cabinet for exact adjustment of response balance, presence and brightness to fit your surroundings and precise taste.

New cabinet styling is a natural blend of simplicity and elegance which will merge gracefully with traditional or modern decor. Woods are offered in a choice of fine selected Mahogany or satin Blonde Korina veneers with genuine solid matching hardwood trim, all finely crafted in the best furniture-making traditions.

Each TRI-PLEX is individually tested and is accompanied by a certificate and guarantee of performance meeting the high engineering standards established for the design.

SPECIFICATIONS

Frequency Range Rating: +8 LIM.

Input Impedance: 16 ohms.

Power Rating: 35 watts maximum speech and music signal input.

Components

High Channel: RP-302 Ultra High Frequency Unit (4,000 cycles to limits of audibility).

Mid Channel: RP-201 High Frequency Unit (600-4000 cycles).

Low Channel: P15-LL Low Frequency Unit (below 600 cycles). A-402 Crossover Network (4000 cycles). A-61 Crossover Network (600 cycles).

Controls: H-F Balance Control (in RP-302 circuit). M-F Balance control (in RP-201 circuit).

Dimensions: 38" high, 26" wide, 19 1/2" deep.

Shipping Wt.: 124 lbs.

Model TP-200, TRI-PLEX Reproducer

ST-909, Mahogany, Net Price

ST-908, Korina Blonde, Net Price

\$312.70

\$316.80

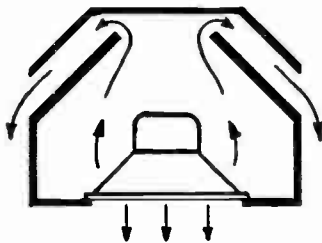

New Bass—Ultraflex. Enclosure principle used in the new TRI-PLEX TP-200, 2-way DP-100 and BL-220 and BL-250 cabinets, is the latest result of Jensen's advanced research on enclosure acoustics. Precisely matching "woofer" characteristics to enclosure volume, Bass—Ultraflex gives more true balanced bass response than previous methods employed in medium sized cabinets.

May be used either in a corner or against a sidewall with excellent results.

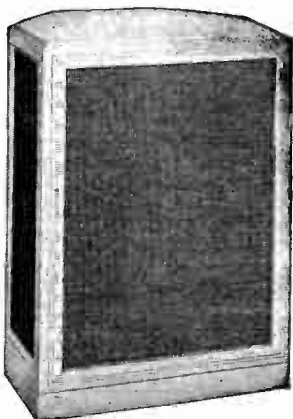

THE NEW *Concerto* 2-WAY SPEAKER SYSTEM

Here is high fidelity reproduction in a compact enclosure which fits even the crowded living space, yet embodying the smoothness balance and extreme frequency range coverage of the most expensive true coaxial speakers. There is economy too—with fine music reproduction not approached except at far greater cost.

The CT-100 is a true 2-way system with separate "woofer" and "tweeter". The low frequency unit is the new P12-NL 12-inch speaker which was especially designed for this reproducer. In combination with the Bass-Ultraflex cabinet, the system gives ample, full bass response. High frequencies above 2000 cycles are handled by the RP-102 High Frequency Unit which provides exceptional smoothness and range approaching the practical upper limits of audibility. A full 2-channel crossover network is employed. H-F Balance Control is located at the side of the cabinet.

The new cabinet design reflects fine proportions and clean sculptured appearance appropriate to fine traditional or modern interior decor. Available in your choice of selected Mahogany or Blonde Korina veneers. Reproducer is fully assembled and carefully tested at the factory. Shipping Weight 62 Lbs.

Model CT-100, Concerto 2-Way Reproducer

ST-915, Mahogany, Net Each

ST-914, Blonde Korina, Net Each

\$164.50

\$168.00

Jensen Cabinets and Enclosures

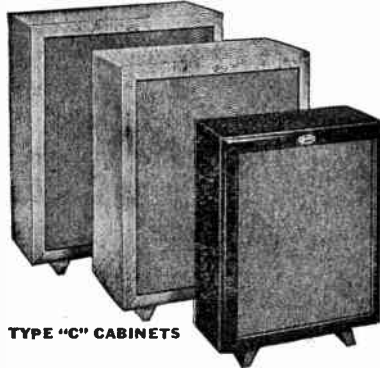

TYPE "C" CABINETS

Type "C" Cabinets were especially designed for low budget high fidelity systems. Sizes for 5", 12" and 15" speakers. Well constructed plywood, finished in choice of blonde or mahogany. Bass reflex type.
 Type "B" Cabinet for 12" speakers is an inexpensive utility unit durably constructed of composition board finished in brown hammer lacquer.
 Type "D" Cabinets are constructed of beautifully finished satin striped walnut veneers with interlaced bronze finished grille. For 12" and 15" speakers. Bass reflex type.
 Type "M" Sector Cabinet for 8" speakers is especially flexible in mounting. May be used in corner, on walls, at intersection of wall and ceiling or on post. Wood composition, finished in brown lacquer. Bass reflex type.

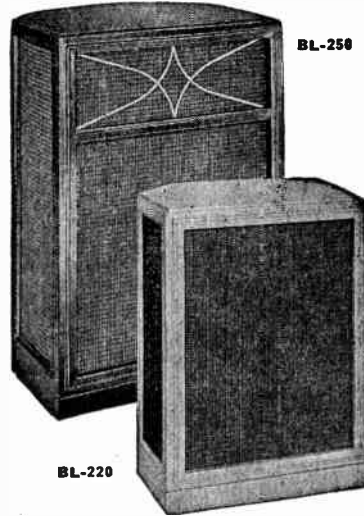

BL-250

BL-220

These new Type "BL" Cabinets are beautifully-styled loudspeaker enclosures offering improved efficiency in bass response and achieving a new high in flexible adaptability to mounting of coaxial or triaxial speakers, mid-channel and high-frequency units, woofers, super-tweeters, in any desired combination without sawing or cutting! All units are easily mounted from the rear of the cabinet and are concealed behind the Transacoustic plastic grille cloth. Unused pre-cut openings in front baffle are automatically blocked by adapter baffle. Easy to follow instructions make mounting a matter of moments.

The new cabinets are designed to fit in a corner or they may be placed against a sidewall. Low frequency radiation is augmented by carefully coordinated acoustic passages opening into the sides of the cabinet. Simple yet graceful styling with finely sculptured lines qualify these beautiful cabinets for a place in distinguished modern or traditional interiors. Choice of selected mahogany or korina blonde plywoods with genuine matching solid wood trim.

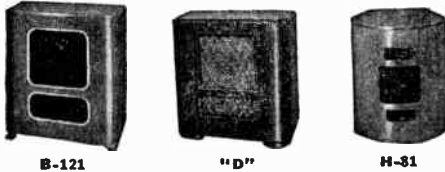

B-121

"D"

H-81

Jensen No.	Stock No.	Speaker Size	Finish	Dimensions Inches			Shipping Wt. Lbs.	Net Each
				Height	Width	Depth		
BL-250	ST-856	15"	Blonde Korina	38 3/4	26	19 1/4	86	\$130.90
BL-250	ST-857	15"	Cordovan Mahogany	38 3/4	26	19 1/4	86	128.00
D-151	ST-157	15"	Walnut	31	27 1/2	13 1/2	60	51.70
C-151	ST-868	15"	Blonde Mahogany	32	28	15	63	46.35
C-151	ST-869	15"	Cordovan Mahogany	32	28	15	63	46.35
BL-220	ST-852	12"	Blonde Korina	30 1/2	22 1/2	17 1/4	48	89.50
BL-220	ST-853	12"	Cordovan Mahogany	30 1/2	22 1/2	17 1/4	48	89.50
D-121	ST-156	12"	Walnut	31	27 1/2	13 1/2	60	51.70
B-121	ST-742	12"	Brown Lacquer	28 1/2	23 1/2	11 1/2	34	23.25
C-121	ST-866	12"	Blonde Mahogany	29	25	13 1/2	42	39.40
C-121	ST-867	12"	Cordovan Mahogany	29	25	13 1/2	42	39.40
H-81	ST-141	8"	Brown Lacquer	22 1/2	17 1/2	8 1/2	14	15.42
C-81	ST-864	8"	Blonde Mahogany	23 1/2	20	9	26	28.75
C-81	ST-865	8"	Cordovan Mahogany	23 1/2	20	9	26	28.75



EXTENDED RANGE SINGLE-UNIT SPEAKERS DIRECT-RADIATOR TYPE

These units, ranging from 5-inch to 15-inch size classes, attain a high level of performance by proper extension of the frequency range and control of all factors which lend "presence" to reproduction. The selection of a direct-radiator loudspeaker from this series, in size or cost appropriate to the application, insures the best quality obtainable in a "one-

way" speaker. Alternate models in the same size group differ mainly in efficiency and power rating.

JENSEN Extended Range loudspeakers are ideal as replacement-improvement units for less worthy speakers in radio, television and record playing equipment. The logical choice for better reproduction on a low budget.



Nominal Size	Model No.	Stock No.	*Gap Energy Level	Dimensions, Inches			Voice Coil			†Transformer Size	Net Each
				O.D.	Depth	Baffle Open	Diam., In.	Imped., Ohms	Power Watts		
15"	P15-NX	ST-817	6.6	15 1/2	8	13 1/2	1 1/2	6-8	18.0	1' x 1'	\$46.05
	P12-NX	ST-819	6.6	12 1/2	7	10 1/2	1 1/2	6-8	16.0	1' x 1'	36.25
	P12-RX	ST-885	2.2	12 1/2	6 1/2	10 1/2	1	6-8	11.0	1/2" x 1/2"	12.40
	P12-SX	ST-821	1.5	12 1/2	6 1/2	10 1/2	1	6-8	9.0	1/2" x 1/2"	11.35
10"	P10-SX	ST-823	1.5	10 1/2	5 1/2	8 1/2	1	6-8	8.0	3/4" x 3/4"	10.54
	P8-RX	ST-887	2.2	8 1/2	4	6 1/2	1	6-8	8.0	3/4" x 3/4"	8.50
8"	P8-SX	ST-825	1.5	8 1/2	3 1/2	6 1/2	1	6-8	7.0	3/4" x 3/4"	7.48
	P6-TX	ST-826	1.1	6 1/2	3 1/2	5 1/2	3/4	3-4	6.0	3/4" x 3/4"	6.05
5"	P5-TX	ST-827	1.1	5	2 1/2	4	3/4	3-4	4.0	1/2" x 1/2"	4.90

*Millions of Ergs.

†Size Recommended.

Jensen *Duette* Hi-Fi Reproducers

Duette DU-201



2-WAY HIGH FIDELITY REPRODUCER Measures only 23¼" x 11" x 10"

First to give you real high fidelity in a small package . . . with the advantages of the 2-way system principle, the new JENSEN "Duette" is the answer to the need for truly fine music reproduction when space for equipment is limited. Can be used on a table, in bookshelves or on the floor, either on its side or standing on end. Ideal for improving the performance of portable phonographs, radio and TV sets, as well as for a basic hi-fi system in a small space. Excellent as an additional living room speaker for spacial effects, as a pair for binaural sound and for hi-fi speaker extension. Comprises a special 8-inch "woofer" plus a multiceil horn-loaded compression driver "tweeter", with built-in frequency division system, in a small compact enclosure designed for adequate bass potential. (Some bass boost is desirable under most listening conditions but more than enough is available in modern amplifiers.) Capable of adequate, satisfying bass reproduction even at low listening levels. Clean, smooth reproduction with the remarkable power handling capacity and the unmistakable "presence" of the 2-way hi-fi reproducer. Corner position gives excellent performance with additional bass due to acoustic loading effect of corner. **Impedance:** 4 and 8 ohms. **Power Rating:** 20 watts maximum speech and music input. **Size:** 11" high, 23¼" wide, 10" deep. **Shipping Weight:** 24 lbs. Rich, attractive burgundy pigskin-grained Fabrikoid finished cabinet with contrasting front panel and cast metal trim burnished copper. **\$6250**

Jensen Model DU-201 "Duette" Reproducer—Net Ea. **\$6250**

NEW • *Duette* PORTABLE

Lets you take HI-FI with you!

Here's the first truly portable 2-way loudspeaker system with "big speaker" performance . . . the new Duette Portable! Ideal for use with tape recorders, portable record players, electronic musical instruments, for band sound reinforcement . . . by professional recording engineers, lecturers, musicians and hi-fi listeners. Two rugged receptacles on back of case allow you to plug in at either 4 or 8 ohms as needed. Lid holds 25-foot cable with plug, plus handy storage for two 7" or three 5" boxes of tape held by retaining strap. "Carry tested" rattle-proof handle on end of case. Sturdy construction, yet weighs only 21 lbs.

Jensen Model DU-202, ST-855. Same electrical and acoustic specifications as DU-201, with handy portable features described above. Black leatherette case with contrasting gray panel. Size 11" x 23¼" x 11¼". **\$7750**
Net Each

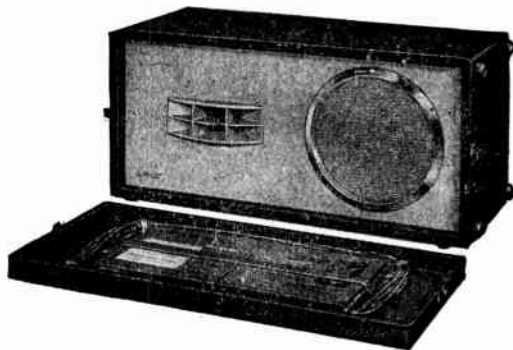

NEW • *Duette* Treasure Chest

Now the Duette becomes an elegant addition to traditional or modern home decor with these new "Treasure Chest" models. Handsomely styled chest design is available in both selected mahogany and blonde oak veneers with genuine matching hardwood trim. Fits on bookshelf or table in small space. For a free-standing piece, add the graceful modern wrought iron legs (not furnished—must be ordered separately).

Duette "Treasure Chest" gives the full performance of the true two-way system with its special 8-inch woofer and compression driver tweeter in an unusually compact scientifically designed acoustic enclosure. Ideal for small space hi-fi system, excellent as an improvement addition for true hi-fi from existing radio, TV, phonograph or tape recorder. Capable of adequate bass reproduction even at low listening levels. Clean, smooth response with the unmistakable presence of the true two-way reproducer. **Size:** 11" high, 23¼" wide, 10" deep. Same acoustic and electrical specifications as DU-201 above.

Model DU-300 Duette "Treasure Chest" Reproducer **\$7650**
Net Each
(Order ST-861 Mahogany, ST-860 Blonde Oak.)
ST-862—Set of wrought iron legs. Net Price. **\$425**

GALBRAITH MARINE SPEAKERS

Galbraith Reproducers and Amplifiers, while designed primarily for installation aboard ship, are especially suitable for use on docks, in shipyards, and other locations where exposed to extremes of varying temperatures and difficult moisture conditions.

10" MEDIUM POWER MARINE TYPE REPRODUCER E-27, Alt.-1



Approved by the U. S. Coast Guard (JJ/161,004) for installation on inspected merchant vessels when used with approved loudspeaker systems. This marine reproducer is a double re-entrant type of horn approximately 10" in diameter and 8" in depth. It is constructed of special salt water corrosion-resistant aluminum alloy castings and spinings. All surfaces are alodine treated followed by zinc chromate primer and finished with a durable baked gray enamel. The high powered "Alnico V Plus" driver unit is located within a one-piece casting consisting of base plate and junction box and is held in position by the dome-shaped casting forming the horn proper. A neoprene gasket clamped between these two castings provides the seal necessary to exclude all moisture. This permits the speaker to be used in any location even on the exposed weather decks. The junction box is drilled and tapped for 1/2" I.P.S. stuffing gland. Hermetic sealed feed-through leads prevent

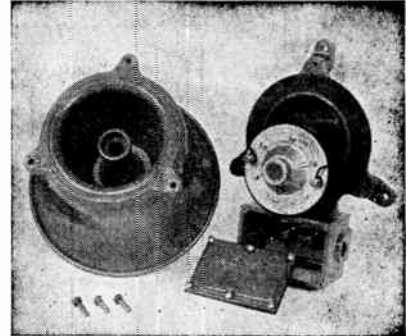

any entrance of moisture to the driver unit voice coil chamber. Spring type terminals on driver unit and in junction box permit easy connection. This speaker is suitable for direct bulkhead mounting as its simple design permits quick replacement of the driver unit without removing the speaker from the bulkhead or disconnecting the ship's wiring.

LIST PRICE \$75.00

15" HIGH POWERED MARINE REPRODUCER E-27, 544 Alt.-1

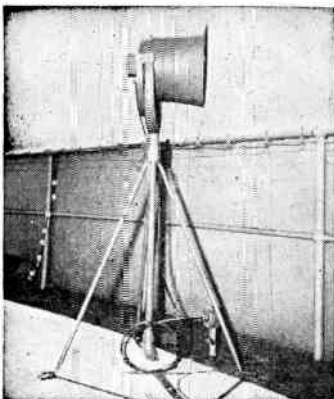

Searchlight Type Control Mechanism
No. E-27,545-B

Approved by the U. S. Coast Guard (161,004) for installation on inspected merchant vessels when used with approved loudspeaker system. It is a double re-entrant type of horn approximately 15" in diameter x 11" in depth, consisting of bronze castings and brass spinings. The high powered "Alnico V Plus" Driver unit is located within the base casting, held in position by the one piece, cast bronze, Junction Box with sealing flange. The Junction Box is drilled and tapped for 1/2" I.P.S. stuffing gland. Hermetic sealed feed-through terminals prevent any entrance of moisture to the driver compartment. Spring type terminals on driver unit and in Junction Box permit easy connection.

The Adjustable Mounting Bracket, No. E-27, 546, allows easy adjustment for directing speaker to cover the proper area, and permits quick replacement of the Driver Unit when necessary.



Adjustable Mounting Bracket
No. E-27,546

LIST PRICE \$210.00

The Searchlight Type Control Mechanism provides 350 degrees of horizontal movement and 30 degrees of vertical movement above and below the horizontal axis. The Control Rods extend down within the Pilot House for inside control.

Model E-27, 645-B is for deck mounting so that loudspeaker will clear the rail. This tripod stand raises the loudspeaker axis 54" above the deck. The overall height is 62" above the deck.

LIST PRICE \$415.00

Model E-27, 545-A (not shown) is for deck mounting where low clearances must be provided. Horizontal axis of loudspeaker is 18" above the deck. The overall height is 25" above the deck.

LIST PRICE \$375.00

OTHER GALBRAITH PRODUCTS INCLUDE: Docking and Navigating Systems, USCG approved; Emergency Announcing Systems, USCG approved; Music Broadcast and General Announcing Systems; Audio Power Amplifiers from 1 to 5000 Watts Output; Regulated Power Supplies; Standard Power Supplies

from 50 to 5000 Volts at 50 to 10,000 Watts Output; Transformers, Reactors, etc. to MIL-T-27 Specs. and to individual requirements, miniature to 25 KVA capacity; Drainage and Breather Valves, USCG approved; Electric Air Heaters for industrial and marine use, UL, USCG and US Navy approved.

OXFORD Speakers —

PERMANENT MAGNET SPEAKERS— STANDARD REPLACEMENT LINE

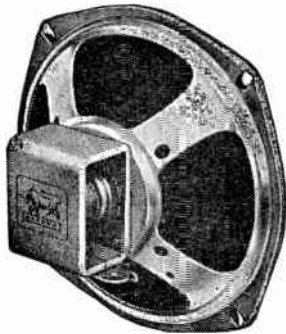

For Radio & Television

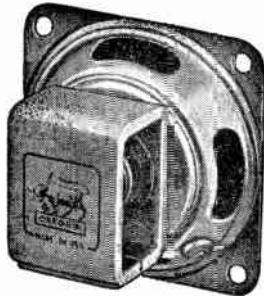

For Portables

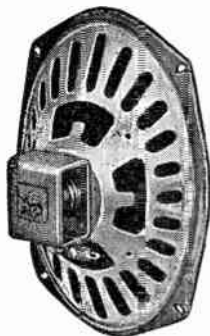

For Auto Radios

SIZE	MODEL NO.	MAG. WT.	LIST PRICE
2"	2AMS	.68 oz.	\$ 3.75
2"	2CMS	1.47	4.35
3"	3AMS	.68	3.75
3"	3CMS	1.47	4.35
4"	4AMS	.68	4.00
4"	4BMS	1.00	4.25
4"	4CMS	1.47	4.60
5"	5AMS	.68	4.25
5"	5BMS	1.00	4.50
5"	5CMS	1.47	4.85
5"	5PAMS	.68	4.35
5"	5PAMS	1.00	4.60
5"	5PCMS	1.47	5.00
5 1/4"	5ZAMS	.68	4.35
5 1/4"	5ZBMS	1.00	4.60
5 1/4"	5ZCMS	1.47	5.00
5 1/2"	5SCMS	1.47	5.25
6"	6AMS	.68	4.85
6"	6BMS	1.00	5.10
6"	6CMS	1.47	5.50
6"	6CVS	1.47	5.75
6"	6EVS	2.15	6.00
6"	6FOS	3.16	6.85
7"	7CVS	1.47	6.50
8"	8CMS	1.47	6.85
8"	8CVS	1.47	7.10
8"	8EVS	2.15	7.35
8"	8FOS	3.16	8.50
8"	8HBS	4.64	10.00
8"	8JBS	6.80	12.00
10"	10CVS	1.47	8.75
10"	10EVS	2.15	9.50
10"	10FOS	3.16	10.50
10"	10HBS	4.64	12.00
10"	10JBS	6.80	13.50
12"	12CVS	1.47	9.75
12"	12EVS	2.15	10.50
12"	12FOS	3.16	11.50
12"	12HBS	4.64	13.00
12"	12JBS	6.80	14.50
4"x6"	46AMS	.68	4.50
4"x6"	46BMS	1.00	4.75
4"x6"	46CMS	1.47	5.25
5"x7"	57CMS	1.47	5.75
5"x7"	57EVS	2.15	6.50
5"x7"	57FOS	3.16	7.85
6"x9"	69CVS	1.47	7.10
6"x9"	69EVS	2.15	7.85
6"x9"	69FOS	3.16	9.25

ELECTRO DYNAMIC SPEAKERS— STANDARD REPLACEMENT LINE

SIZE	MODEL NO.	FIELD	LIST PRICE
4"	4V455	450 Ohm	\$ 4.75
5"	5V455	450	5.00
6"	60A1005	1000	6.00
6"	60A1805	1800	6.00
6"	60A2505	2500	6.00
8"	80A1005	1000	7.50
8"	80A1805	1800	7.50
8"	80A2505	2500	7.50
10"	10E1005	1000	11.00
10"	10E2505	2500	11.00
12"	12E1005	1000	13.50
12"	12E2505	2500	13.50
4"x6"	46V455	450	5.50

HIGH-FIDELITY SPEAKERS

SIZE	MODEL NO.	MAG. WT.	LIST PRICE
8"	HF8JB	6.8 oz.	\$15.00
10"	HF10JB	6.8	17.50
12"	HF12JB	6.8	20.00
12"	HF12LN	14.0	35.00
12"	CO12JB	6.8	35.00

TV REPLACEMENT SPEAKERS

SIZE	MODEL NO.	FIELD	LIST PRICE
5"	5VBS	85	\$ 5.00
6"	60A85	85	6.00
8"	80A85	85	7.50
4"x6"	46VBS	85	5.50

AUTO REPLACEMENT SPEAKERS

SIZE	MODEL NO.	MAG. WT. or FIELD	LIST PRICE
5"	5CMS	1.47 oz.	\$ 4.85
5 1/4"	5ZCMS	1.47	5.00
6"	6EVS	2.15	6.00
7"	7EVS	2.15	7.10
7"	7FOS	3.16	8.00
8"	82EVS	2.15	7.50
6"x9"	69EVS	2.15	7.85
6"x9"	69FOS	3.16	9.25
5"	5V045	4 Ohm	5.00
5 1/4"	5ZV045	4	5.25
6"	60A045	4	6.00
7"	70A045	4	7.25
6"x9"	69A045	4	8.00

PUBLIC ADDRESS SPEAKERS

SIZE	MODEL NO.	MAG. WT.	LIST PRICE
8"	8JBS-7	6.80 oz.	\$12.50
10"	10JBS-7	6.80	14.00
12"	12JBS-7	6.80	15.00

INTERCOM SPEAKERS

SIZE	MODEL NO.	MAG. WT.	LIST PRICE
3"	3BMXS	1.00 oz.	\$ 4.75
4"	4BMXS	1.00	5.00
5"	5BMXS	1.00	5.25

WEATHERPROOF and DRIVE-IN THEATRE SPEAKERS

SIZE	MODEL NO.	MAG. WT.	LIST PRICE
3"	3CMWS	1.47	\$ 4.85
4"	4AM65	.68	3.92
4"	4CM13	1.47	5.81
5"	5BA3	.68	4.45
5"	5CM51	1.47	5.32
6"	6CMWS	1.47	6.15

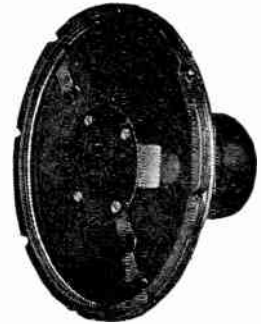

Coaxial for Hi-Fidelity

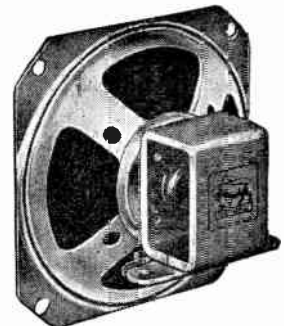

For Outdoor Applications

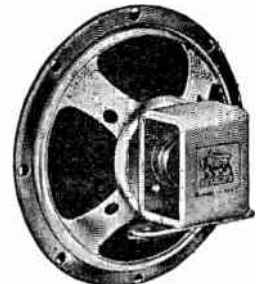

For Intercoms

There is an OXFORD Speaker to meet each requirement.

*Preferred for
Original Equipment
Proven for
Replacement!*

There is an OXFORD SPEAKER for every need . . . TV, FM, AM, Auto, Public Address, High Fidelity, and Outdoor Applications . . . from 2" to 15" units.



OXFORD ELECTRIC CORPORATION

Chicago 15, Illinois

EXPORT: ROBURN AGENCIES, NEW YORK CITY

IN CANADA: ATLAS RADIO CORP., LTD., TORONTO

PRICES

Prices of manufacturers and suppliers' products listed in **RADIO'S MASTER** are subject at all times to change without notice — they should not be considered final.

Get quick on-the-spot quotations from your distributor who subscribes to our perpetual up-to-the-minute **PRICING SERVICE**.

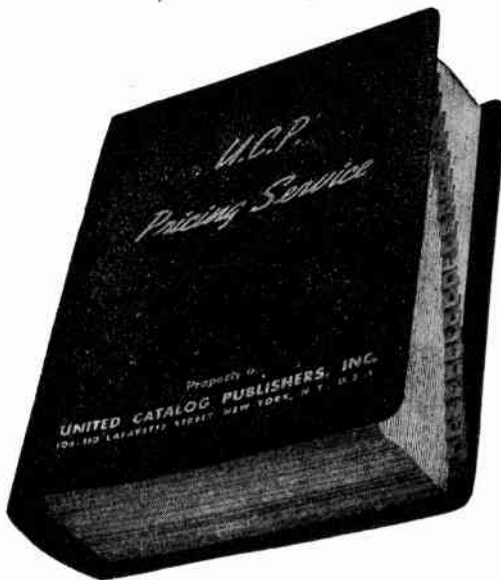

Official Pricing System of radio - electronic - television parts and equipment. Supported by the industry: distributors, manufacturers, and their sales representatives.

•
Loose-leaf, flexible binder.
Contains over 1100 pages.

•
Published by
UNITED CATALOG PUBLISHERS, INC.
106-110 Lafayette Street
New York 13, N. Y.

DELIVERY

Delivery is often dependent on the availability of raw materials. So check with your distributor for delivery information.

SHURE

Concert-Line

STUDIO MICROPHONES**UNI-DIRECTIONAL RIBBON MICROPHONE**

Model "333"
Concert-Line

Here is the Concert-Line "333", a new microphone created for discriminating users with the most exacting professional requirements. Here, indeed, is a major advance in microphone development and design! This small, ultra-cardioid "333" is highly recommended for movie studios, TV studios, radio stations, professional recording, and highest quality "home recording" applications. Here is performance never before achieved in such a small and slender microphone. Here is matchless beauty and striking design to appeal to those users who traditionally demand "the finest!" The "333" is uni-directional, will reduce the pickup of random noise energy by 73%—prevents the pickup of moving props, scuffling feet and moving "dollies," so common when conventional broadcast microphones are used. Following are the features that make the "333" Concert-Line so outstanding in performance, so dependable in operation: (1) patented world-famous "Uniphase" system—providing a true ultra-cardioid pickup pattern; (2) response plus or minus 2½ db, 30-15,000 c.p.s.; (3) multi-impedance switch; (4) voice music switch; (5) anti-"PFF," anti-blast filter screen; (6) high output; (7) vibration-isolation unit mounted in live rubber; (8) Cannon XL connector. All these important features, plus the striking design of the Concert-Line "333," make it ideal for critical studio applications that call for the highest possible broadcast quality, small size and matchless beauty. The "333" has two-tone "Grayje" non-reflecting finish. Dimensions: width, 1 1/8"; height, 3 9/16"; depth, 1 3/4."

IMPEDANCE TABLE	OUTPUT LEVEL
L-35-50 ohms	58 db below 1 Milliwatt per 10 microbar signal
M-150-250 ohms	58 db below 1 Milliwatt per 10 microbar signal
H-High	56 db below 1 volt per microbar



Model: 533
Broadcast Desk
Stand for
Models "300,"
"333," "525"

MODEL	LIST PRICE
"333"	\$250.00

OMNI-DIRECTIONAL DYNAMIC MICROPHONE

Model "525"
Concert-Line

The new Concert-Line "525" is an exceptionally fine probe microphone of broadcast quality. It features: (1) response, plus or minus 2½ db, 40-15,000 c.p.s.; (2) a moving-coil mounted in a highly efficient magnetic structure with an "Alnico V" magnet; (3) dual-impedance switch for high or low impedance; (4) high output; (5) long life "Duracoustic" diaphragm—specially designed to withstand moisture, heat, cold and physical shock. The "525" is furnished with a 20', two-conductor, rubber-covered, shielded cable with Cannon XL-3-11 connector attached; swivel adapter; adjustable leveler assembly (cord and clip), and a belt clip assembly. The "525" Concert-Line has a non-reflecting "Grayje" finish—which makes it blend into the background, giving the spotlight to the performer: Diameter, 1 1/8"; Length, 8 17/32".

IMPEDANCE TABLE	OUTPUT LEVEL
L-50-250 ohms	59 db below 1 Milliwatt per 10 microbar signal
H-High	58 db below 1 volt per microbar

MODEL	LIST PRICE
"525"	\$200.00

BI-DIRECTIONAL GRADIENT MICROPHONE

Model "300"
Concert-Line

This rugged, high fidelity, multi-impedance microphone is widely used for television, radio broadcasting, professional recording and high-fidelity uses. The "300" reduces reverberation and the pickup of random noise by 66%. The "300" combines the best features of conventional velocity microphones with advanced acoustic design—including an anti-"PFF," anti-blast filter screen. Its bi-directional polar pattern is effective over a broad frequency range. It provides sound pickup at the front and rear of the microphone, but greatly reduces pickup at the sides. One of the outstanding features of the "300" is the fact that the microphone can be placed at a 73% greater distance from the performer than is possible with omni-directional microphones! The "300" has a non-reflecting "Grayje" finish, so it blends into the background, gives the spotlight to the performer. The "300" has a readily accessible voice-switch, special vibration-isolation unit mounted in live rubber, and a multi-impedance switch, providing low, medium and high impedance. Response plus or minus 2 1/2 db, 40-15,000 c.p.s. Dims: Ht., 6"; Wth., 1 7/16"; Depth., 1 3/32."

IMPEDANCE TABLE	OUTPUT LEVEL
L-35-50 ohms	59 db below 1 Milliwatt per 10 microbar signal
M-150-250 ohms	60 db below 1 Milliwatt per 10 microbar signal
H-High	57 db below 1 volt per microbar

MODEL	LIST PRICE
"300"	\$135.00

OMNI-DIRECTIONAL DYNAMIC MICROPHONE



Model "530"
Slendyne

The new Slendyne "530" is a probe microphone highly recommended for fine quality sound systems. It features: (1) frequency response 60-15,000 c.p.s.; (2) a moving coil mounted in a highly efficient magnetic structure, with "Alnico V" magnet; (3) dual-impedance switch for high or low impedance; (4) high output; (5) long life "Duracoustic" diaphragm—specially designed to withstand moisture, heat, cold and physical shock. The "530" is furnished with a 20', two-conductor, rubber-covered, shielded cable with Cannon XL-3-11 connector attached; swivel adapter; adjustable lavalier assembly (cord and clip), and a belt clip assembly. The "530" Slendyne has a beautiful black and gold finish—which makes it especially ideal for those applications where a rich, distinctive microphone of striking design imparts added prestige and glamour to any sound system with which it is used. Dimensions: Diameter, 1 1/8"; length 7 11/32."

IMPEDANCE TABLE	OUTPUT LEVEL
L-50-250 ohms	59 db below 1 Milliwatt per 10 microbar signal
H-High	58 db below 1 volt per microbar

MODEL	LIST PRICE
"530"	\$110.00



Model "315"
Gradient

BI-DIRECTIONAL GRADIENT' MICROPHONES

This rugged, high-fidelity, multi-impedance microphone is recommended for highest-quality general purpose uses! The Gradient provides a bi-directional pickup pattern—permitting greater performer freedom (performers can stand at a 73% greater distance from the microphone!) The "315" picks up voice and music from front and back—is "dead" at the sides. Reduces reverberation and the pickup of distracting random noises by 66%! Has a "Voice-Music" switch and Multi-Impedance switch. Response is 50 to 12,000 c.p.s. Permits the sound system to operate at a level almost 6db higher than is possible with omni-directional microphones! Finished in rich, soft chrome. The "315" is "PFF"-proof—can be used in outdoor drafts and moderate breezes! Dims: Ht., 6"; Wth., 1 7/16"; Dpth., 1 3/32".

IMPEDANCE TABLE	OUTPUT LEVEL
L-35-50 ohms	59 db below 1 Milliwatt per 10 microbar signal
M-150-250 ohms	60 db below 1 Milliwatt per 10 microbar signal
H-High	57 db below 1 volt per microbar

MODEL	LIST PRICE
"315"	\$79.50



"Small Unidyne"
Model 555
"Small Broadcast"
Model 556S

UNIDIRECTIONAL DYNAMIC MICROPHONES

The "Small Unidynes" are the largest selling microphones throughout the world. A sturdy construction provides immunity of the moving coil system to abnormal atmospheric conditions and severe mechanical shock. Model "555" is highly recommended for fine-quality public address; theater-stage sound systems; recording and remote broadcasting. Is widely used for fixed station use in the police, fire, and transportation services. Model "556S" is recommended for studio broadcasting, television use, and professional recording. Has Cannon XL connector and vibration-isolation unit. Both models reduce the pickup of random noise by 67%; have smooth response from 40 to 15,000 c.p.s.; are supplied with a 20-ft., high quality cable and plug assembly. Both models have the world-famous, patented "Uniphase" system.

IMPEDANCE TABLE	OUTPUT LEVEL
L-35-50 ohms	59.4 db below 1 Milliwatt per 10 microbar signal
M-150-250 ohms	60.1 db below 1 Milliwatt per 10 microbar signal
H-High	60.5 db below 1 volt per microbar



Multi-Impedance
Switch on Models
"555", "556S", "51",
"300", "315", "333"

MODEL	LIST PRICE
556S	\$110.00
555	\$ 76.50

MULTI-IMPEDANCE HIGH OUTPUT DYNAMIC



Model "51"
Sonodyne

The "Sonodyne" is ideal for all general purposes, including public address, wire and tape recording, and similar applications. It is widely used by bands, instrumentalists, and professional recording artists because of its outstanding reproduction of both voice and music. Widespread usage by home users of tape recorders indicates that the "Sonodyne" is the ideal high-quality, moderately-priced replacement for the conventional microphone supplied with tape recorders. Has built-in receptacle and a 15-ft., two-conductor shielded cable with microphone plug attached. Satin chrome finish. Model "51" List Price: \$47.50

IMPEDANCE TABLE	OUTPUT LEVEL
L-35-50 ohms	53.0 db below 1 Milliwatt for 10 microbar signal
M-150-250 ohms	52.5 db below 1 Milliwatt for 10 microbar signal
H-High	52.0 db below 1 volt per microbar

CRYSTAL MICROPHONES

SHURE

THE NEW "SLIM-X" ALL-PURPOSE MICROPHONE

FOR:

- Low Cost P.A. Systems
- Home Recording
- Hams
- General Purpose



On S38 Desk Stand



On S38 Desk Stand (With A25 Swivel)



On Floor Stand



In the Hand

The new "777" Slim-X Microphones are rugged little microphones weighing only 6 ounces! They are designed for good-quality voice and music reproduction. Their versatility and "hand-ability" make them ideal for use by lecturers, announcers, instructors, and Hams; for audience participation shows; carnivals; panel and quiz shows; and use with home-recorders. When mounted on either cradle or swivel, the "777" can be removed in a flash (no tools

necessary)—simply by lifting it out of the holder. This makes it an ideal "walk-around" hand-held microphone.

TECHNICAL INFORMATION: Smooth frequency response—50 to 10,000 c.p.s.; special-sealed crystal element—for long operating life; high impedance; 7' single-conductor cable, disconnect type. Dimensions: (Microphone only) Length, 4½"; Diameter, 1". Finish: Rich satin chrome overall.

Note: All Models with Lavalier Cord, for suspension of microphone around neck.

"SLIM-X" ASSEMBLIES

MODEL 777A includes 777 Microphone; A-25 Swivel Adaptor; S-38 Desk Stand; Lavalier Cord. Model: 777A

List Price: \$29.00

MODEL 777SA includes 777S Microphone; A-25 Swivel Adaptor; S-38 Desk Stand; Lavalier Cord. Model: 777SA

List Price: \$31.00

ACCESSORIES FOR "777"

MODEL S38 STAND is a heavy die-cast base. Includes metal screw machine stud for connecting microphone adaptor to stand base.

Model: S38

List Price: \$3.30

MODEL A25 SWIVEL ADAPTOR features a long-life, high-quality swivel connector. Is lined with a long-life nylon sleeve—for noise-free and scratch-free insertion and removal of microphone. Model: A25

List Price: \$5.50

Model	Output	List Price
777		21.00*
777A	59db below	29.00
777S With Switch	1 volt per microbar	23.00*
777SA With Switch		31.00

*(Price includes cradle for mounting on stand.)



Fig. A



Fig. B



Fig. C



Fig. D



Fig. E

"MONOPLEX" (Fig. A)

The only Super-Cardioid Crystal Microphone made—far superior to conventional Crystal Microphones! Excellent for high-quality public address, communications, recording, and similar applications. The 737A operates under adverse conditions of background noise and reverberation—where a conventional microphone would be practically useless! Reduces pickup of random sound by 73%! Moisture-proofed "Metal Seal" crystal for long operating life. Case pivots at rear, can be pointed toward desired sound or upwards for horizontal plane pickup. Has 15 ft. shielded cable. Rich satin chrome finish. High impedance.

MODEL	OUTPUT	LIST PRICE
737A	54.0 db below 1 volt per microbar	\$42.50

THE "REX" (Fig. B)

Its low price makes this hand-held microphone a natural for "Hams" and low-cost public address systems. A rugged unit designed for high speech intelligibility. Saves extra costs, as it needs no desk stand! Has

a broad base, complete with stand adaptor for mounting on a floor stand. Sits firmly on a table top without tipping over. Die cast case. Frequency response 60 to 9,000 c.p.s. 5' shielded cable. Beautiful Burgundy-red metallic finish. Only 2¾" wide, 3¼" high, 1⅛" thick. High impedance.

MODEL	OUTPUT LEVEL	LIST PRICE
710A	50 db below 1 volt per microbar	\$10.95
710S (with switch)	50 db below 1 volt per microbar	\$12.95

MODEL 707A (Fig. C)

Ideal for low-cost P.A. systems, amateur 'phone transmitters and similar applications. Good-quality performance at low cost. Has typical semi-directional pickup. Has 7 ft. shielded cable. High impedance. Pearl Gray case with rich satin chrome finish on front grille. Diameter 2¾".

MODEL	OUTPUT	LIST PRICE
707A	51.0 db below 1 volt per microbar	\$16.95

LAPTEL MICROPHONE (Fig. D)

Specially designed unit widely used by lecturers, instructors, speakers, etc. High speech intelligibility. Response from 40 to 6,000 c.p.s. 1⅞" diameter. Has lapel clip. 20-foot shielded single-conductor cable. High impedance.

MODEL	OUTPUT LEVEL	LIST PRICE
76B	57db below 1 volt per microbar	\$27.00

STRATOLINER (Fig. E)

An expensive-looking crystal microphone of moderate cost. Wide-range response for good reproduction of either voice or music. Placed horizontally, the 708A is semi-directional; used vertically it becomes non-directional. Swivel permits 90° tilting of microphone. 7 ft. shielded cable and plug assembly. High impedance. Pearl Gray finish.

MODEL	OUTPUT LEVEL	LIST PRICE
708A	51.0 db below 1 volt per microbar	\$29.50

CONTROLLED RELUCTANCE MICROPHONES

SHURE

THE "HERCULES"

The "Hercules" is a hand-held magnetic unit. Provides the ruggedness, clear reproduction, and high output long needed for Public Address, Communications, and Recording—AT AN AMAZINGLY LOW PRICE! Recommended for Announcing and Mobile Public Address Systems; Communications; Home Recording; high quality Inter-Communication. Ideal for general-purpose use in tropical countries and all coastal areas where humidity is a problem.



510 SERIES

The output voltage is induced in a coil of wire by causing a sound wave to modulate the reluctance of the magnetic circuit. By the control of this reluctance the utmost in quality and stability is achieved. High impedance is obtained without the use of a transformer. The "Hercules" can be used either Indoors or Outdoors. Fits snugly in the hand, sits firmly on a desk. High impedance. Frequency response is 100 to 7,000 c.p.s. Furnished with 5' shielded cable. Green metallic finish. Die-cast case. Complete with stand adapter. 2 $\frac{2}{3}$ " wide, 3 $\frac{1}{4}$ " high, 1 $\frac{1}{2}$ " thick.

MODEL	OUTPUT LEVEL	IMPEDANCE	LIST PRICE
510C	52.5 db below 1 volt per microbar	HIGH	\$15.00
510S (with switch)	52.5 db below 1 volt per microbar	HIGH	\$17.00

THE "GREEN BULLET"



MODEL 520

The "Green Bullet" is a magnetic unit, especially designed to provide quality music and speech reproduction at moderate cost. It is practically immune to the effects of high temperatures and humidity. The "Green Bullet" has a stability assured by unique control of the reluctance of the magnetic system. It features: high output, good response, high impedance without the need of a transformer. The "Green Bullet" has a beautiful modern metallic green finish with a plated grille. Frequency response is 100 to 7,000 c.p.s. Furnished with 7' single-conductor shielded cable. High Impedance.

THE "DISPATCHER"



MODEL 520SL

This new Controlled Reluctance unit is designed to handle the most severe field requirements of paging and dispatching systems. The unit is supplied with 7 feet of 2-conductor shielded cable, and is wired to operate both microphone and relay circuits. The "Dispatcher" is ideal for police, taxi-cab, railroad, airport, bus, truck, and all emergency communications work where dependability is vital. Large grip-bar assures positive contact.

MODEL	OUTPUT LEVEL	IMPEDANCE	LIST PRICE
520	52.5 db below 1 volt per microbar	HIGH	\$19.50
520B	51 db below 1 milliwatt per 10 microbars	150-250 ohms	\$19.50

MODEL	OUTPUT	IMPEDANCE	LIST PRICE
520SL	52.5 db below 1 volt per microbar	High	\$38.50

THE "RANGER"

The new Shure "Ranger" is a new development of a similar magnetic unit originally housed in microphones used by the Armed Forces. The "Ranger" is especially recommended for those applications where long lines are used, and a rugged hand-held microphone is needed. It is ideal for outdoor public address (sports arenas, athletic fields), mobile communications, ham, audience participation shows, etc. The "Ranger" is designed for high speech intelligibility. Easy to use, fits snugly in the palm of the hand. Has heavy-duty single-throw, double-pole leaf-type switch for push-to-talk operation. Phosphor-bronze blades and silver contacts for maximum operating life. Furnished with 5' three-conductor shielded cable. Frequency response is 100 to 9,000 c.p.s.

MODEL	OUTPUT LEVEL	IMPEDANCE	SHPG. WT.	CODE	LIST PRICE
505B	47.0 db below 1 milliwatt per 10 microbar signal	150-250 ohms	1 $\frac{1}{8}$ lbs.	RUDAY	\$29.50
505C	50.5 db below 1 volt per microbar	High	1 $\frac{1}{8}$ lbs.	RUDAX	\$29.50



505 SERIES

COILED CORD SETS

Standard Copper Coiled Cord with trimmed and tinned leads. Used in "CB" and "100" Series Microphones. Model: C15C Code: RUCOR List Price: \$5.75
Tinsel Coiled Cord with Amphenol MC4M Connector for use with General Electric equipment. Model: C16C Code: RUCAG List Price: \$8.75
Tinsel Coiled Cord with spade lugs for use in Motorola equipment. Model: C17C Code: RUCAJ List Price: \$7.25
Standard Coiled Cord with Amphenol MC4M Connector for use with Motorola equipment. Model: C18C List Price: \$7.25
Tinsel Coiled Cord with Amphenol MC4M Connector for use with Motorola equipment. Model: C19C List Price: \$8.75

MODEL "100" SERIES CARBON MICROPHONES

Used around the world for police, taxi, bus, truck, and commercial applications — more than all other makes combined! Rugged unit with clear, crisp voice response and high output. Heavy duty switch for push-to-talk performance. Furnished with bracket for wall mounting, plus coiled-cord cable. Adapted as standard microphone by G.E., Link, Motorola, R.C.A. and others for 2-way radio communications equipment. Output level: 5db below 1 volt for 100 microbar speech signal.



REPLACEMENT CHART

MANUFACTURERS MODELS	REPLACEMENT MODEL
CB10, CB10B, CB10C, CB10D, CB15, CB15D,	101C
CB10E	101E
CB12, CB12A, CB12C, CB12D	102C
CB12E	102E
CB15F	103

CARBON MICROPHONE CARTRIDGE

Rugged microphone cartridge replacement for "CB", "100", and "120" Series Carbon Microphones. Furnished with necessary mounting hardware and complete installation instructions. Direct replacement for the cartridge used in the Models 101A, 101B, 101C, 102A, 102B, 102C, 120, CB10, CB10B, CB10C, SB10E, CB11, CB11B, CB12, CB12A, CB12B, CB12C, CB12D, CB12E, CB14, CB14A, CB15, CB15B, CB15C, CB15D, CB15F, CB20, CB162, 91A27 carbon microphones.
Model: R10 List Price: \$8.00



Model R10

Model	Cable	Switch Arrangement	List Price
101C	Standard Coiled Cord 11' retracted; 5' extended	Two Wire Relay Switch normally open. (No microphone switch)	\$27.50
101E	Tinsel Coiled Cord 11' retracted; 5' extended with Amphenol MC4M Connector	Two Wire Relay Switch normally open. (No microphone switch)	\$32.50
102C	Standard Coiled Cord 11' retracted; 5' extended	Relay normally open. Microphone switch normally open.	\$27.50
102E	Tinsel Coiled Cord 11' retracted; 5' extended with spade lugs	Relay normally open. Microphone switch normally open.	\$30.00
103	Standard Coiled Cord 11' retracted; 5' extended with Amphenol MC4M Connector	Two Wire Relay Switch normally open. (No microphone switch)	\$29.00

MICROPHONE ASSEMBLY

A Controlled Reluctance Microphone and Desk Stand Assembly—ideal for fixed-station used in all types of communications work. Has a built-in switch for controlling both the microphone circuit and an external relay or control circuit. Replacement for Mfrs. Model No. CR84.
Model 510MD List Price \$38.50



Model 510MD

CARBON "PACK" MICROPHONE

Designed for use with small portable and mobile transmitters. Only 2" in diameter and 1 1/2" thick. Has 3-conductor coiled cord, metal-spring strain relief, and Push-to-Talk switch. Has some operating characteristics as "100 Series" Carbon Microphones. Replacement for Mfrs. Model Nos. CB20, CB21.



Model 115

List Price: \$28.50 Model 115

SWITCHES AND ACCESSORIES

MICROPHONE REPLACEMENT CARTRIDGES



CONTROLLED RELUCTANCE
Model R5

Controlled Reluctance. Ideal for the replacement of Crystal Cartridges in Shure cases of the Model 707A and 708A Series, where heat and humidity are a problem. Also replaces cartridges in other mfrs. models of similar design, where space permits. Supplied with rubber mounting ring and installation instructions in English and Spanish.
Model: R5 List Price: \$10.00



CRYSTAL
Model R7

Model R7 Crystal Microphone. Available for service installation as a replacement for the cartridges in the Shure Crystal Microphones of the 707A and 708A Series, and other microphones of similar design. High output—48db below 1 volt per microbar. Cartridge supplied with rubber mounting rings and installation instructions.
Model: R7 List Price: \$7.75

CABLE-TYPE TRANSFORMER



Model A86A

Model A86A is a high quality, cable-type transformer, ideal for matching low-impedance microphone lines to high-impedance amplifier inputs (matches 35-50 and 150-250 ohm microphones of high impedance). 2-foot cable.
Model: A86A List Price: \$17.50

TAKE-APART STAND



Model S34B

Model S34B. Handy low-cost stand for desk or hand use. One twist of handle locks it securely in base for use as a table stand, or releases handle for use in hand. Metal base, wood handle.
Model: S34B List Price: \$3.30

"GRIP-TO-TALK SLIDE-TO-LOCK" SWITCH

Heavy-Duty Switch withstands the most severe field requirements of paging and dispatching systems. Ideal for Police, Taxi-Cab, Railroad, Airport, Bus, Truck, and all emergency communications work. Can be used with Shure connector-type crystal, dynamic and carbon microphones of any impedance. Fits handily on Shure S36A Desk Stand. Rich satin chrome finish.
Model: A88A List Price: 11.75 Model A88A



ON-OFF PRESS-TO-TALK SWITCHES



Model A83B. Rotary-type "On-Off" switch. Quickly attached to any cable-connector type Shure microphone.
Model: A83B List Price: \$8.50



Model A84B. Momentary Press-to-Talk "On-Off" switch.
Model: A84B List Price: \$8.50



Model A85C. Momentary Press-to-Talk Relay-Type Switch.
Model: A85C List Price: \$10.75

MODERN DESK STAND



Model S36A

Model S36A. Streamlined Desk Mount fits all Shure connector-type microphones. Adapter provided for mounting other type microphones. Ideal for use with A88A switch.
Model: S36A List Price: \$6.00



Fig. A
RECORD-PLAYBACK-ERASE



Fig. B
RECORD-PLAYBACK



Fig. C
RECORD-PLAYBACK



Fig. D
ERASE

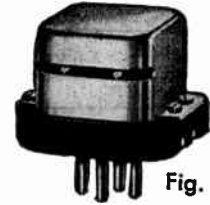

Fig. E
RECORD-PLAYBACK-ERASE

MAGNETIC TAPE RECORDING HEADS

TYPICAL OPERATING DATA

MODEL	815 (FIG. A)			815H (FIG. A)		816 (FIG. B)		817 (FIG. C)		TE2 (FIG. D)		
	3.75" per sec.		7.5"	3.75" per sec.		3.75" per sec.		3.75" per sec.		3.75" per sec.		
Bias & Erase Freq.	25KC	DC	50KC	25KC	DC	25KC	DC	25KC	DC	25KC	50KC	DC
Std.* Recording Level	.05 ma	.095 ma	.05 ma	.03 ma	.056 ma	.03 ma	.07 ma	.06 ma	.175 ma	—	—	—
Operating Bias Current	1.25 ma	.35 ma	1.5 ma	.72 ma	.24 ma	.80 ma	.26 ma	3.6 ma	.42 ma	—	—	—
Erase** Current	45 ma	35 ma	55 ma	45 ma	35 ma	—	—	—	—	45 ma	55 ma	35 ma
Impedance Erase Coil	750 ohm at 25KC	12 ohm	1300 ohm at 50KC	750 ohm at 25KC	12 ohm	—	—	—	—	800 ohm at 25KC	1250 ohm at 50KC	12 ohm
Impedance Recording Coil	1450 ohm at 1000 cps	180 ohm	1450 ohm at 1000 cps	5800 ohm at 1000 cps	556 ohm	5500 ohm at 1000 cps	556 ohm	1860 ohm at 1000 cps	180 ohm	—	—	—

*Determined in accordance with RTMA Standard REC.-134 August 1949.

Recording Medium—Minnesota Mining & Mfg. Co., Tape No. 111

**Erase current chosen for 50 db Erasure of Saturated 400 C.P.S. Recording.

5RBA1. Pressure Pad Force (Area—.025 sq. in.) Two Ounces.

NUMERICAL LISTING OF SHURE TAPE HEADS USED IN ORIGINAL EQUIPMENT

MODEL	ILLUSTR.	LIST PR.	DESCRIPTION	OPERATING DATA
812	Fig. E	15.00	Wire Recording Head.	Not shown
815	Fig. A	13.50	Upper track recording. Low impedance record-playback coil.	See 815
815H	Fig. A	13.50	Upper track recording. High impedance record-playback coil.	See 815H
816	Fig. B	10.50	Upper track recording. High impedance record-playback coil.	See 816
817	Fig. C	7.50	.093" record track width. Low impedance record-playback coil.	See 817
TR5	Fig. A	13.50	Upper track recording. (Replace with Model 815.)	See 815
TR5B	Fig. A	15.00	Upper track recording with 14-inch completely insulated leads. Cinch Plug attached.	See 815
TR5D	Fig. A	14.50	Upper track recording. Cinch Plug attached.	See 815
TR5G	Fig. A	15.00	Lower track recording. Cinch plugs attached. Reversed coils. High impedance record-playback coil.	See 815H
TR5H	Fig. A	14.00	Upper track recording with special long leads.	See 815
TR5K	Fig. A	14.50	Upper track recording. Cinch Plug attached.	See 815H
TR5L	Fig. A	13.50	Upper track recording. Special record-playback coil impedance.	Not shown
TR5N	Not Illustr.	14.00	Special Shield. Special Leads. Special Plug.	See 815
TR5P	Fig. A	14.00	Upper track recording. Special short leads.	See 815
TR5R	Fig. A	14.00	Lower track recording. High impedance record playback coil.	See 815H
TR6	Fig. B	10.50	Lower track recording. Low impedance record-playback coil.	Not shown
TR6C	Fig. B	10.50	Upper track recording. (Replace with Model 816.)	See 816
TR6G	Fig. B	10.50	Lower track recording.	See 816
TR6H	Fig. B	10.50	Upper track recording. Low impedance record-playback coil.	Not shown
TR6J	Fig. B	11.00	Upper track recording with special leads.	See 816
TR16	Fig. C	7.50	.093" record track width. High impedance record-playback coil.	Not shown
TR16A	Fig. C	7.50	.093" record track width. (Replace with Model 817.)	See 817
TE2	Fig. D	6.00	Erase head.	See TE2

CRYSTAL AND CERAMIC PICKUP CARTRIDGES

SHURE

FINE GROOVE CARTRIDGES FOR 33 1/3, 45 RPM RECORDS

MODEL NO.	ILLUSTRATION	TYPE	LIST PRICE	OUTPUT LEVEL	MIN. NEEDLE FORCE	RESPONSE TO	NET WT.	SHURE NEEDLE NO.
W21F*	Fig. B	Crystal	\$7.75	1.5V	6 grams	10,000 c.p.s.	4 1/2 grams	A63MG
W31AR	Fig. A	Crystal	6.50	2.1V	7 grams	7,500 c.p.s.	5 1/2 grams	A53MG
WC31AR	Fig. A	Ceramic	6.50	.87V	7 grams	7,500 c.p.s.	5 1/2 grams	A53MG
W53MG	Fig. G	Crystal	8.50	1.3V	6 grams	8,500 c.p.s.	12 grams	A64MG



Fig. A
"Direct Drive"



Fig. B
"Vertical Drive"



Fig. C
"Vertical Drive"



Fig. D
"Simple Mount"



Fig. E
"Vertical Drive"
With
Turnover Mechanism



Fig. F
"Simple Mount"
With
Turnover Mechanism



Fig. G
"Lever Type"



Fig. H
"Cutter Cartridge"



Fig. J
"Muted Stylus"



Fig. K
"Dual Voltage"



Fig. L
All-Purpose
High Output

TURNOVER CARTRIDGES FOR 33 1/3, 45, AND 78 RPM RECORDS

MODEL NO.	ILLUSTRATION	TYPE	LIST PRICE	OUTPUT LEVEL		MIN. NEEDLE FORCE	RESPONSE TO	NET WT.	SHURE NEEDLE NO.	
				MG	STD				MG	STD.
W22A	Fig. C	Crystal	\$10.50	1.2V	1.4V	8 grams	10,000 c.p.s.	4 1/2 grams	A65MG	A61A
W22AB	Fig. C	Crystal	9.50	1.2V	1.4V	8 grams	10,000 c.p.s.	4 1/2 grams	A65MG	A62A
W22AB-T	Fig. E	Crystal	10.00	1.2V	1.4V	8 grams	10,000 c.p.s.	12 1/2 grams	A65MG	A62A
WC24	Fig. D	Ceramic	8.75	0.6V	0.6V	8 grams	7,000 c.p.s.	4 1/2 grams	A53MG	A52A
WC24-T	Fig. F	Ceramic	9.25	0.6V	0.6V	8 grams	7,000 c.p.s.	12 1/2 grams	A53MG	A52A

ALL PURPOSE SINGLE NEEDLE CARTRIDGES FOR 33 1/3, 45, 78 RPM RECORDS

MODEL NO.	ILLUSTRATION	TYPE	LIST PRICE	OUTPUT LEVEL		MIN. NEEDLE FORCE	RESPONSE TO	NET WT.	SHURE NEEDLE NO.
				STD.	MG				
W26A	Fig. B	Crystal	\$8.50	1.0V	.87V	8 grams	8,000 c.p.s.	4 1/2 grams	A67U
W26B	Fig. B	Crystal	7.50	1.0V	.87V	8 grams	8,000 c.p.s.	4 1/2 grams	A66U
W36B	Fig. A	Crystal	6.50	2.5V	2.3V	9 grams	7,000 c.p.s.	5 1/2 grams	A56U
WC36B	Fig. A	Ceramic	6.50	.87V	.92V	9 grams	7,000 c.p.s.	5 1/2 grams	A56U
W66B	Fig. J	Crystal	7.00	2.3V	2.0V	8 grams	4,500 c.p.s.	12 grams	A66U
W70	Fig. L	Crystal	4.95	3.8V	3.0V	10-15 grams	5,000 c.p.s.	16 grams	None

STANDARD CARTRIDGES FOR 78 RPM RECORDS

MODEL NO.	ILLUSTRATION	TYPE	LIST PRICE	OUTPUT LEVEL	MIN. NEEDLE FORCE	RESPONSE TO	NET WT.	SHURE NEEDLE NO.
W23B	Fig. B	Crystal	\$7.75	1.1V	6 grams	8,000 c.p.s.	4 1/2 grams	A62A
WC33B	Fig. A	Ceramic	6.50	.92V	9 grams	7,000 c.p.s.	5 1/2 grams	A52A
W68†	Fig. J	Crystal	7.50	1.6V	1 oz.	4,500 c.p.s.	Dual Weight 25 grams or 12 grams	A62A
W78‡	Fig. K	Crystal	5.55	4.0V or 2.0V	1 oz.	6,000 c.p.s.	Dual Weight 25 grams or 12 grams	None
W56N**	Fig. H	Crystal	8.50	4.3V	1 oz.	10,000 c.p.s.	12 grams	A68D
W58HS***	Fig. G	Humi-Seal Crystal	6.55	1.6V	1 oz.	6,000 c.p.s.	25 grams	None
W60HS***	Fig. J	Humi-Seal Crystal	8.50	1.8V	1 oz.	4,500 c.p.s.	25 grams	A62A

*With .453 Mount for Oak Changer.

**Cutter-Cartridge for Wilcox-Gay "Recordette." Equipped with bifurcated needle.

***"Humi-Seal" Metal Wrapped Rochelle Salt Crystal ideal for Tropical Areas.

†Dual-Weight Cartridge. With weight-slug, net weight is 25 grams. Without weight-slug, net weight is 12 grams.

‡Dual-Weight Cartridge. Has same weight-slug as Model W68, with same net weight differential. In addition, Model W78 has capacitor, furnished as accessory. Without capacitor, output is 4.0 volts. With capacitor, output is 2.0 volts.

PHONOGRAPH PICKUPS

Like the popular Shure Cartridges, each Shure Phonograph Pickup has been designed to meet specific requirements. There is at least one model for each type of reproduction desired — standard (78 RPM), fine-groove (33 $\frac{1}{3}$ and 45 RPM), or single-needle "All Purpose" and dual-needle "Turnover" for playing all types of records. Each tone arm is scientifically curved and balanced for faithful tracking, and designed to emphasize the best qualities of the cartridge with which it is equipped.



Fig. A



Fig. B



Fig. C

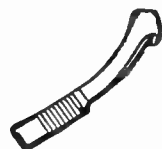

Fig. D



Fig. E

STANDARD FOR 78 RPM RECORDS

MODEL	ILLUSTRATION	LIST PRICE	OUTPUT LEVEL	NEEDLE FORCE	RESPONSE TO	SHURE CARTRIDGE USED	SHURE NEEDLE NUMBER
92H	Fig. D	\$5.50	3.5V	1 oz.	5000 c.p.s.	W42H	None
99DV	Fig. C	8.50	4.0V or 2.0V**	1 $\frac{1}{8}$ oz.	6000 c.p.s.	W78†	None
900H5*	Fig. B	11.50	1.8V	1 $\frac{1}{8}$ oz.	4500 c.p.s.	W60H5*	A62A

TURNOVER FOR 33 $\frac{1}{3}$, 45, 78 RPM RECORDS

MODEL	ILLUSTRATION	LIST PRICE	OUTPUT LEVEL		NEEDLE FORCE	RESPONSE TO	SHURE CARTRIDGE USED	SHURE NEEDLE NUMBER	
			MG	STD.				MG	STD.
901D	Fig. A	\$16.25	1.2V	1.4V	7 grams	10,000 c.p.s.	W22AB	A65MG	A62A

SINGLE-NEEDLE ALL-PURPOSE FOR 33 $\frac{1}{3}$, 45, 78 RPM RECORDS

MODEL	ILLUSTRATION	LIST PRICE	OUTPUT LEVEL		NEEDLE FORCE	RESPONSE TO	SHURE CARTRIDGE USED	SHURE NEEDLE NUMBER
			MG	STD.				
92U	Fig. D	\$9.75	2.0V	2.3V	8 grams	4500 c.p.s.	W66B	A66U

FINE-GROOVE FOR 33 $\frac{1}{3}$, 45 RPM RECORDS

MODEL	ILLUSTRATION	LIST PRICE	OUTPUT LEVEL	NEEDLE FORCE	RESPONSE TO	SHURE CARTRIDGE USED	SHURE NEEDLE NUMBER
902MG	Fig. B	\$10.50	2.0V	10 grams	7500 c.p.s.	W31AR	A53MG

SHURE PICKUP FOR "WEBSTER-CHICAGO" THREE SPEED CHANGERS

MODEL	ILLUSTRATION	LIST PRICE	OUTPUT LEVEL		NEEDLE FORCE	RESPONSE TO	SHURE CARTRIDGE USED	SHURE NEEDLE NUMBER	
			MG	STD.				MG	STD.
920W	Fig. E	\$11.50	1.2V	1.4V	6 grams	10,000 c.p.s.	W22AB	A65MG	A62A

**"Humi-Seal" Metal Wrapped Moisture Proofed Rochelle Salt Crystal for Use in Tropical Areas.

**Dual Voltage Cartridge: 4.0V without condenser; 2.0V with condenser. † Remove weight-slug.

PHONOGRAPH PICKUP NEEDLES



Fig. A



Fig. B



Fig. C

OSMIUM TIP



Fig. D

Crystal and Ceramic Cartridges manufactured under Shure Patents and Patents Pending. Licensed by the Brush Development Co.

†High-quality commercial-type synthesized sapphire specially designed for long operating life.

MODEL	ILLUSTRATION	DESCRIPTION	LIST PRICE
A52A	Fig. C	Std. Osmium	\$1.50
A53MG	Fig. C	MG Osmium	1.50
A56U	Fig. C	All Purpose Osmium Unipoint	1.50
A61A	Fig. A	Std. Sapphire†	2.50
A62A	Fig. B	Std. Osmium	1.50
A63MG	Fig. B	MG Osmium	1.50
A64MG*		MG Osmium	2.00
A65MG	Fig. A	MG Sapphire†	2.50
A66U	Fig. B	All Purpose Osmium Unipoint	1.50
A67U	Fig. A	All Purpose Sapphire Unipoint††	2.50
A68D	Fig. D	Osm. Playback Needle —Stelite Cutting Stylus	2.50

*Standard Bent Shaft Needle Not Illustrated.

microphones

ALTEC
LANSING CORPORATION

9356 Santa Monica Blvd.
Beverly Hills, Calif.

161 Sixth Avenue
New York 13, N.Y.

M-20 LIPSTIK MICROPHONE SYSTEM

The Altec Lipstik Microphone System was designed to meet the demands for a smaller housing for the world-famous 21 Type Condenser Microphone. In addition to this new, compact Lipstik housing, the 21C Microphone is used. This 21C Microphone is an improved version of the 21B and has an even wider and smoother frequency response. The compact Lipstik housing allows it to be used as a lapel microphone, a hand microphone, or a stand microphone as required. The size of the P-525A Power Supply makes a very small, compact, and handy package. Frequency response 20-15,000 cycles.

Components of the M-20 Lipstik Microphone System are:

- 21C Condenser Microphone
- 165A Lipstik Base
- 166A Stand Holder
- P-525A Power Supply

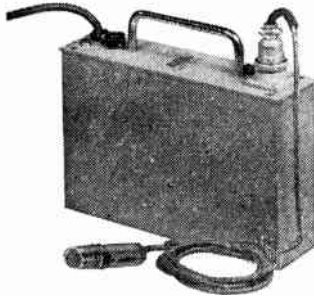

NET PRICE: \$198.00

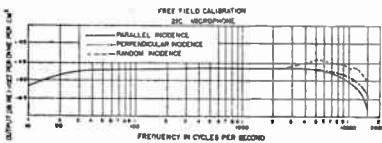

This microphone response curve is in agreement with measurements made by General Radio Company and other major acoustical laboratories.

M-11 MICROPHONE SYSTEM

The M-11 Microphone System will continue to be available to those customers who prefer the graceful shape of the 150A Base to the compactness of the Lipstik type base. The M-11 System will incorporate the new 21C Microphone as described above in the M-20 Lipstik Microphone System.

Components of the M-11 Microphone System are:
21C Condenser Microphone
150A Base
152A or 153A Cable Set
P-518A or P-519A Power Supply

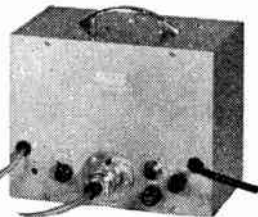

NET PRICE: \$230.00



CARDIOID MICROPHONE 670A

The 670A Cardioid Microphone consists of a ribbon type element coupled to an acoustical network enclosed in an attractive plastic housing. Similar in appearance and performance to the famous Model 639 Microphone and about half the size. It has three basic pickup patterns along with many variations of these three basic patterns. The 670A Microphone, because of its cardioid directional performance giving an 18 db attenuation between front and rear pickup, is an excellent all-purpose microphone for use in radio, TV, and recording studios as well as all types of difficult auditorium jobs. Frequency response uniform from 35 to 15,000 cycles in the cardioid position. Equipped with 5/8" x 2 1/2" swivel head. Output impedance 30/50 and 150/250 ohms. Output level — 58 dbm (10 dynes/cm².)

NET PRICE: \$130.00



CARDIOID MICROPHONE* 639A and 639B

Ideal for broadcast or public address, these cardioid microphones with ribbon and dynamic elements provide the best possible pick-up under varying, difficult conditions. High quality three-way (639A) and six-way (639B) directivity patterns are quickly selected by turning a screw. Each embodies a dynamic moving coil type pressure element. Impedance average 40 ohms. Power output level: —56 dbm (10 dynes/cm²). Frequency response: 40-10,000 cps.

LIST PRICE

639A\$234.60
639B\$235.60

*Distributed by Graybar Electric Co.



DYNAMIC MICROPHONE 660A and 660B

A dynamic microphone of broadcast quality and exceptional ruggedness and dependability. Equipped with 5/8" x 2 1/2" swivel head. Ideal for public address, paging and broadcast use.

Frequency response: 30-12,000 cps.

Power output level:

—59 dbm (10 dynes/cm²).

Impedance: 660A—30 ohms.

660B—30, 150, 20,000 ohms.

NET PRICE

660A\$45.00
660B\$52.00



DYNAMIC MICROPHONE* 633A and 633C

This rugged, dependable high-quality microphone for public address, sound distribution system, or broadcasting, affords both non-directional and semi-directional performance.

Frequency response: 40-15,000 cps.

(633A) Impedance: 30 ohms.

(633C) Impedance: 30, 150-250 ohms.

Power output level:

—59 dbm (10 dynes/cm²).

LIST PRICE

633A\$83.10
633C\$91.50

*Distributed by Graybar Electric Co.

Microphone Accessories*

Items	List Price
8R Attachment	\$10.65
9A Attachment	6.95
11A Attachment	18.15
22C Floor Stand	20.70
28A Desk Stand	9.50
24C Desk Stand	7.65
311A Plug	12.50
429A Jack	8.70
712A Adapter	3.30
713A Adapter	3.15
10994 Adapter	4.50

*Distributed by Graybar Electric Co.

THE ASTATIC CORPORATION

CONNEAUT OHIO

tv converters and boosters, microphones

MODEL CB-1A

● New, improved combination UHF converter and VHF booster. Provides continuous tuning throughout UHF channels. Absolute minimum oscillator drift. Greatly increased tuning ratio for easiest, accurate fine tuning. Consists of two tuned preselectors, a 6T4 or 6AF4 UHF oscillator and a 1N82 silicon diode mixer. Converter changes UHF TV channel to choice of 3, 4, 5 or 6 in VHF frequency. VHF amplification is obtained with the circuits of the Astatic CT-1 Booster which are incorporated. Switching and tuning is provided to permit using the VHF amplifier circuits as a VHF Booster only. The CB-1A easily connects to TV receiver with standard 300 ohm leads. Terminal board on rear of chassis has connections for both UHF and VHF antenna and lines to the receiver. Operates on 110-120 V., 60 cycle AC, 30 watts.

Attractive metal cabinet, finished in mahogany or blond simulated woodgrain with gold trim, 9"x6"x5 3/4". Shipping weight, 7 1/2 lbs.

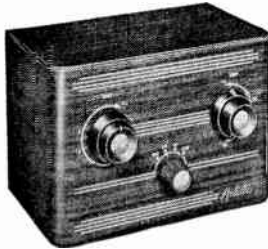

Model	Code	List Price
CB-1A	ASXES	\$59.50
CB-1AB	ASXFF	\$9.50

MODEL CT-1

● New, two-stage VHF Booster providing greatly improved picture quality. Band width over 7 megacycles on all VHF channels. The CT-1 features a neutralized 6J6 driving a push-pull dual triode grounded grid circuit. Balanced, cascaded circuit provides added signal strength with low noise level. Controls: Channel Selector and 3-position switch (Booster Off, Low Band, High Band). Has input and output connections for 72 or 300 ohm transmission lines. Housed in attractive metal cabinet finished in brown Hammerlin with gold trim,

6 1/2"x4 3/4"x4 7/8" deep. Also available in mahogany or blond simulated woodgrain. Complete with tubes and selenium rectifier. For operation from 110-120 volts, 60 cycle AC. Shipping Weight, 5 lbs.

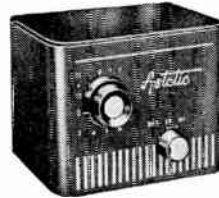

Model	Code	List Price
CT-1	ASAMC	\$35.00
CT-1B	ASAMB	35.00
CT-1M	ASAMA	35.00

CARBON MODEL 10M5



● For mobile applications, ship-to-shore communication, multitude of other uses. Unparalleled high sensitivity among carbon mikes, designed for greater ruggedness and convenience in use. Ideal response for speech clarity: 100 to 4500 c.p.s. range. Double-pole, single-throw switch, with relay and microphone circuits normally open (press-to-talk), adapts easily to wide variety of circuits. Four-conductor, self-coiling cable: retracted length, 12 inches; extended length, five feet. Coiled spring cable protector. Surface mounting wall, panel or dash hang-up bracket. Grey Hammerlin finish, die-cast housing.

Model	Code	List Price
10M5	ASUNM	\$29.50

CRYSTAL MODEL D-104

● For close talking applications, such as radio amateur communications and similar uses. With high output level approximately—45 db, it possesses definitely reduced R.F. feed-back tendencies. Yoke-driven, bridge-mounted Graphoil crystal element with METALSEAL protection against moisture or dryness, shock-proof mounting and barometric compensation. Speech range frequency response from 30 to 7,500, rising 500 to 4,000 c.p.s. Chrome finish. Standard equipment includes interchangeable plug and connector, spring cable protector, 5' shielded cable.

List Price

D-104—Code ASUPA	\$24.60
G-D-104—Code ASVAX, with G-Stand	37.65
D-104-S—Code ASUPB, with S-Switch	27.35

CERAMIC MODEL D-104-C

● Duplicate of Crystal Model except for employment of ceramic element, which is immune to extremes of temperature and humidity. Performance comparable except for slightly lower output of approximately —58 db.

List Price

D-104-C—Code ASUPC	\$24.60
G-D-104-C—Code ASVAW	37.65
D-104-C-S—Code ASUQZ, with S-Switch	27.35



CRYSTAL MODEL 54M3



● High output (—51 db) and smooth, distortion-free quality performance at modest cost. Miniature size and attractive new styling look the quality instrument part for recorder, PA, conference and other uses. Response (30 to 10,000 c.p.s.) is flat to 1,000 with gradual rise to 6,000 c.p.s. Non-directional when locked in base, as illustrated. Die cast housing with dark chocolate brown enamel finish; stamped metal grille with gold plate finish. Gold finish base adaptor has pin to lock handle to removable base with half-turn, is threaded to fit standard floor stands. Standard equipment: base with rubber feet, 5' shielded cable and protector.

Model	Code	List Price
54M3	ASUOZ	\$12.75

"DYNABAR"

UNIDIRECTIONAL DYNAMIC

● New Astatic development, unparalleled in over-all smoothness of response and high quality performance. Exclusive sintered metal method of acoustic phase shifting provides superior, uniform directional characteristics—front to back pickup differential of approximately 15 db, dead to sound from rear for practical purposes. Has multi-impedance transformer and impedance selector switch providing operating impedances of 50, 200, 500 and HZ. Dynamic element floated in rubber against shock. Output level, —54 db; range, 40 to 10,000 c.p.s. 18' shielded 2-conductor cable, detachable cable connector. With or without off-on switch (hinge ferrule strengthened with S-switch housing a built-in, fixed part of the ferrule).

Model	Code	List Price
DR-11	HSVFJ	\$68.00
DR-11S*	ASVFL	69.50

*With Off-on Switch.



"SYNABAR"

UNIDIRECTIONAL CRYSTAL

● Special sintered metal cancels out 15 db front to back, making this professional-class unit, for practical purposes, dead to sound from rear. Has excellent frequency range, 50 to 10,000 c.p.s., PLUS a Response Selector switch to provide choice of ideal pick-up characteristics for either crisp voice or general voice and music. Crystal element has special METALSEAL protection against moisture or dryness. Output level is —54 db, high impedance. Satin chrome finish. 18' single-conductor shielded cable, with or without off-on switch. Recommended for highest quality reproduction and elimination of extraneous noise, in a wide variety of modern applications.

Model	List Price
DR-10	\$37.25
DR-10-S*	39.95

*With Off-on Switch



NOTE: All microphone output ratings based on a reference level of one volt per microbar.

THE ASTATIC CORPORATION

KNOWN THE WORLD OVER
CONNEAUT OHIO

microphones

CRYSTAL MODEL DK-1

• New non-directional unit for studio and public address, featuring reduced size and design establishing primarily to allow unobstructed, least detracting view of performer. Brushed chrome finish contributes to this purpose by reducing distracting light reflections and glare. Excellent frequency range, with rising characteristic between 2,000 and 5,000 c.p.s. Output level is approximately —55 db. Crystal element has moisture-proof coating. Includes 10 ft. rubber covered, shielded single conductor cable. Available with off-on switch (SC-11) at \$2.70 extra.



List Price
DK-1—Code ASURV \$22.00

The JT-SERIES CRYSTAL & CERAMIC

• Because of their wide range of usefulness, excellent performance and low price, Astatic JT-Series Microphones are used extensively for amateur, public address and home recording. JT-Series Microphones are available in both wide and voice range models and, in addition to standard equipment, are furnished complete with concentric cable connector, convenient wood handle interlocking metal base. Crystal model has 10' cable; ceramic, 5'. Wood handle may be removed and microphone used on floor stand. Crystal models' output level, —52 db, provides ample reserve for use with high gain amplifiers. Ceramic models' output approximately —62 db. Opalescent gray with bright chrome grille.



List Price
JT-30 —Substantially flat—Code ASVLG \$16.95
JT-40 —Rising characteristics—Code ASVLD \$6.95
*JT-30-C—Substantially flat—Code ASVLF \$6.15
*JT-40-C—Rising characteristics—Code ASVLC \$6.15
*Ceramic Models.

"CARDINAL" CRYSTAL

• A sparkling gold finish, low-cost beauty with performance comparable to high-priced units. All-purpose microphone (see accessory list). Lifts from its streamlined, dark brown plastic desk stand for hand use. Wide range response, adaptable to standard AC or DC circuits, with 10' cable. Output level approximately —52 db.



List Price
CX —Substantially flat—(Microphone only) Code ASAOA \$9.75
CX-I—Rising characteristics—Code ASAPZ 9.75

"CARDINAL" DYNAMIC

• Duplicate of Model CX in appearance, but equipped with dynamic unit.



List Price
CDH—(High Impedance) Code ASAOF \$24.50

"CARDINAL" CERAMIC

• Duplicate of Model CX in appearance, but employing ceramic element, which is immune to extremes of temperature and humidity. Equipped with 5' cable. Output approximately —62 db. List Price

(Microphone only)
CC —Substantially flat—Code ASAPU \$8.95
CC-I—Rising characteristics—Code ASAPT 8.95

"CARDINAL" ACCESSORIES

• "Cardinal" plastic desk base, \$1.00; any model available with off-on switch, \$1.50 extra; hang-up hook, \$0.25; stand adapter, \$0.35.

"VELVET VOICE" CRYSTAL

• Here is a convertible type Crystal Microphone, providing ultra-smooth, velvety soft, wide range response, that may be used as desk, hand or floor stand microphone, to meet practically every microphone need. Beautiful gold finish housing and handle; bright chrome grille; brown baked enamel, detachable base; 10' shielded cable. Output level approximately —52 db. Two models: Model 200 with smooth, even frequency response characteristics from 30 to 10,000 c.p.s.; Model 241, with similar range but rising characteristics between 1500 and 5500 c.p.s. for added brilliance in speech range.

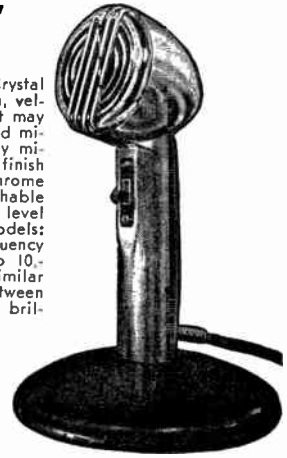

(Without Switch) List Price
200—Code ASUVA \$13.95
241—Code ASUVC 13.95
(With Off-On Switch)
200-S—Code ASUVB 15.00
241-S—Code ASUVD 15.00

"VELVET VOICE" DYNAMIC

• This microphone is identical with Model 200, in appearance, but is equipped with a dynamic unit. Semi-directional. Exceptionally high output level of High Impedance Model, approximately —50 db. Frequency response, 30 to 10,000 c.p.s.

(Without Switch) List Price
YDL —(50 ohms)—Code ASANA \$19.95
YDH*—(High Impedance)—Code ASAND 27.50
*High impedance model only available with ON-OFF switch, \$1.40 extra.

"VELVET VOICE" CERAMIC

• Also identical in appearance with Model 200, but employing the amazing, new piezoelectric ceramic element. Recommended where high temperatures and humidity are service factors. Equipped with 5' cable. Output level approximately —62 db. Frequency response 30 to 10,000 c.p.s.

List Price
VC —(5 Meg.)—Substantially flat—Code ASAOQ \$13.15
VC-I—(5 Meg.)—Rising characteristics—Code ASAOQ 13.15
Available with On-Off switch at \$1.05 extra

The DYNAMIC

• Three models—50 ohm impedance, high impedance or multi-impedance, the latter having a multi-impedance transformer and impedance selector switch to provide choice of 50, 200 and 500 ohms or high impedances. A semi-directional, all purpose dynamic microphone incorporating a unitary moving coil system, and carefully proportioned acoustic circuit to highly damp the natural resonance of the moving system and provide a response characteristic substantially flat from 50 to 7,000 cycles. Output level DN-HZ approximately —55 db. The "DN" design employs all features necessary for wide applicability, including Astatic's tilting-head, swivel mount permitting semi- or non-directional positions. Opalescent gray and bright chrome finish. High- or multi-impedance models only are available with Type SC-11 Off-On Switch (as illustrated) at \$2.75 extra. 10-ft. shielded cable.



List Price
DN-50—(50 ohms)—Code ASVNI \$21.90
DN-HZ—(High impedance)—Code ASVNG 29.50
DN-MZ—(Multi-impedance)—Code ASVNL 39.75
(All models available with G-Stand at \$13.00 extra.)

THE ASTATIC CORPORATION

KNOWN THE WORLD OVER
CONNEAUT OHIO

microphones, stands and microphone cartridges

CRYSTAL MODEL T-3

● Definitely established by long and continued popularity, Model T-3 Crystal Microphone is highly practical for many and varied applications. Its use is suggested for studio set-ups, with amateur rigs, intercommunicating systems, public address installations and for high-class recording purposes. Crystal element has special METALSEAL protection against moisture or dryness. Microphone head may be tilted with ease on unique swivel mounting and pickup pattern made semi or non-directional, as desired. Output level —52 db. Frequency response substantially uniform from 30 to 10,000 cycles. Equipped with interchangeable plug and socket connector and 15 ft. cable. All chrome finish.



List Price

T-3—Code ASVCX\$27.35
T-3-S—Code ASVCW, with S-Switch... 30.10
GT-3—Code ASUZD, with G-Stand... 40.40

CERAMIC MODEL T-3-C

● Duplicate of Model T-3 except for employment of heat and moisture-immune ceramic element. Output level —62 db with 5' cable.

T-3-C —Code ASVCU List Price \$25.55
T-3-C-S—Code ASVCT, with S-Switch 28.30

LAPEL TYPE MODEL L-1

● This very small dual-diaphragm crystal microphone was developed to meet especially difficult pickup conditions. Equipment includes lapel-type spring clip and over-shoulder cord to permit wide latitude of movement. Output level —62 db. Frequency response uniform from 30 to 10,000 c.p.s. Finish, black, oxidized. Furnished with 15' cable.



List Price

Model L-1—Code ASUSN\$27.35

MICROPHONE STANDS, SWITCH CONNECTORS AND ADAPTERS



Model	Finish	Height	List Price
A-10—Floor	Chrome & Gray	2' to 6'	\$10.00
G—(Grip-to-Talk)	Chrome & Gray	8 1/4"	18.50
F—Desk	Chrome & Gray	8 1/2"	10.00
E-1—Desk	Chrome & Gray	5 1/2"	5.40
E-5B—Desk	Chrome & Brown	8"	5.40
E-5G—Desk	Chrome & Gray	8"	5.40
F-11—Adapter	Chrome		4.75
SC-11—Switch Connector	Chrome		6.00
E-2—Desk Stand	Chrome & Gray	2 5/8"	7.00

MC-151 CRYSTAL MICROPHONE CARTRIDGE

● Replacement for Astatic Microphone Models CX, CX-1, 200, 241, JT-30, JT-40 and T-3. Output —52 db. Supplied with rubber mounting ring, complete instructions.

Model Code List Price
MC-151 ASAOP \$7.75

MC-127 Ceramic Microphone Cartridge

● Replacement for Astatic Microphone Models CC, CC-1, VC, VC-1, JT-30C, JT-40C and T-3-C. Output —62 db. Supplied with rubber mounting ring, complete instructions.

Model Code List Price
MC-127 ASAOO \$7.75

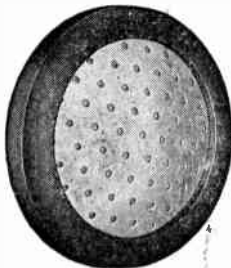

MC-451 CARBON MICROPHONE CARTRIDGE

● Replacement for Astatic Microphone Models 10M5 and 11M5. Unparalleled among carbon units for high sensitivity, ideal response for speech clarity. Complete, simple mounting instructions furnished.

Model Code List Price
MC-451 ASAPON \$11.00

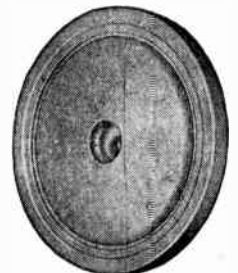

ASTATIC REPLACEMENT NEEDLES

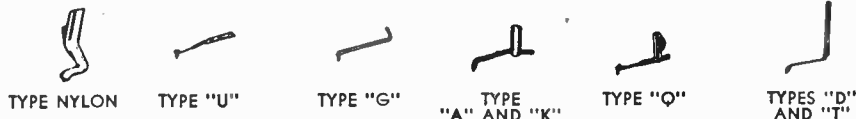

THE ASTATIC CORPORATION

KNOWN THE WORLD OVER
CONNEAUT OHIO

pickup cartridges, recording heads

CARTRIDGES FOR SLOW-SPEED AND STANDARD 78 RPM RECORDS

Model	Element	List Price	Minimum Needle Pressure	Output	Frequency Range c.p.s.	Needle Type	Record	Net Weight Gr.	Code	
6L3	Crystal	\$7.00	10 gr.	2.4†	50-4,000	K-M1	33-1/3, 45 RPM	9	ASXEP	
6L3-AG	Crystal	7.00	10 gr.	2.8†† 2.4†	50-4,000	K-M2	33-1/3, 45, 78 RPM	9	ASXEO	
6L3-78	Crystal	7.00	10 gr.	2.8†	50-4,000	K-M3	78 RPM	9	ASXEN	
6L3-D	Crystal	8.50	10 gr.	2.8† 2.4†	50-4,000	K-M1 K-M3	33-1/3, 45, 78 RPM	9	ASXEM	
6L3-D1	Same as 6L3-D except complete with spindle for turnover knob.									
8L3	Crystal	7.00	10 gr.	3.5†	50-4,000	K-M1	33-1/3, 45 RPM	9	ASXEL	
8L3-AC	Crystal	7.00	10 gr.	4.0†† 3.5†	50-4,000	K-M2	33-1/3, 45, 78 RPM	9	ASXEK	
8L3-78	Crystal	7.00	10 gr.	4.0††	50-4,000	K-M3	78 RPM	9	ASXEJ	
8L3-D	Crystal	8.50	10 gr.	4.0†† 2.4†	50-4,000	K-M1 K-M3	33-1/3, 45, 78 RPM	9	ASXEI	
8L3-D1	Same as 8L3-D except complete with spindle for turnover knob.									
16L3	Crystal	6.00	16 gr.	6.2†† 4.0†	50-5,000	Not Incl.	33-1/3, 45, 78 RPM	8	ASXET.	
18L3	Crystal	6.00	16 gr.	2.0†† 1.6†	50-5,000	Not Incl.	33-1/3, 45, 78 RPM	8	ASXEE	
401-A	Crystal	5.00	2 3/4 oz.	1.4††	50-4,500	Optional	Replacement for RCA	27	ASWTA	
402-M	Ceramic	6.90	12 gr.	0.7††	50-10,000	G-78(M)	Replacement for Admiral 78 RPM Snap-in Cartridge—Part No. A1372	8	ASWZN	
103-J	Crystal	7.50	Special replacement kit consisting of CAC-78-J Cartridge with necessary adapter plate and screws to replace RCA Part 70338, 70339 and 72551 silet sapphire cartridges.							ASWUZ
AC-AG-J	Crystal	6.50	6 gr.	1.0††	50-10,000	A-AG(J)**	33-1/3, 45 and 78 RPM	5	ASWYH	
AC-C-AG-J	Ceramic	6.50	6 gr.	0.4††	50-6,000	A-AG(J)**	33-1/3, 45 and 78 RPM	5	ASWTL	
AC-C-J	Ceramic	6.50	5 gr.	0.4†	50-6,000	A-1(J)	33-1/3 and 45 RPM	5	ASWTN	
AC-C-78-J	Ceramic	6.50	6 gr.	0.4††	50-6,000	A-3(J)	78 RPM	5	ASWTM	
ACD-C-J	Ceramic	9.50	6 gr.	0.4† 0.4††	50-5,000	A-1(J) A-3(J)	(Dual Needle) 33-1/3, 45 and 78 RPM	5	ASWTK	
ACD-C-1J	Ceramic	9.50	(Same as ACD-C-J except equipped with spindle for turnover knob. Replacement cartridge for ACD-C-2J assembly.)					7	ASWTJ	
ACD-C-2J	Ceramic	10.00	(Same as ACD-C-J except equipped with complete assembly turnover and knob.)					16	ASWTI	
ACD-J	Crystal	9.50	6 gr.	1.0† 1.0††	50-6,000	A-1(J) A-3(J)	(Dual Needle) 33-1/3, 45 and 78 RPM	5	ASWYL	
ACD-1J	Crystal	9.50	(Same as ACD-J except equipped with spindle for turnover knob. Replacement cartridge for ACD-2J assembly.)					7	ASWYF	
ACD-2J	Crystal	10.00	(Same as ACD-J except equipped with turnover bracket and knob.)					16	ASWYE	
AC-J	Crystal	6.50	5 gr.	1.0†	50-10,000	A-1(J)	33-1/3 and 45 RPM	5	ASWYJ	
AC-78-J	Crystal	6.50	6 gr.	1.0††	50-10,000	A-3(J)	78 RPM	5	ASWYN	
AC-R-J	Crystal	8.90	(Same as AC-J except equipped with special mounting bracket with .456" mounting hole centers.) Replacement for RCA Part 76257.					5	ASWYO	
B-2	Crystal	5.55	2 1/4 oz.	2.5††	50-4,000	Optional	78 RPM	26 26	ASWHJ ASWHH	

**J stands for Sapphire Tip, "M" for Precious Metal Tip.
 **ALL-GROOVE needle tip of special design and size to play 33-1/3, 45 and 78 RPM Records. †RCA 12-5-31-V Test Record or Equivalent.
 ***With Diamond Stylus at \$31.00. ††Audio-tone 78-1 Test Record.

NOTE: Cartridge type B also available with PN Crystal upon request.



AC-J
SMOOTH RESPONSE
SERIES



ACD-J, TURN-
OVER VERSION
OF AC SERIES



CAC-J,
FAMOUS INTERNALLY
EQUALIZED SERIES



GCD, REVOLUTIONARY
TURN-OVER-NEEDLE
DESIGN WITH CERAMIC
ELEMENT

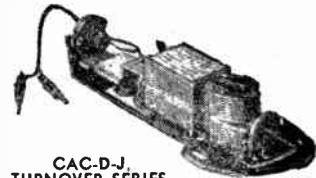

CAC-D-J,
TURN-OVER SERIES,
TWO COMPLETE CARTRIDGES
BACK TO BACK

RECORDING HEADS

Model	Type	Maximum Recording Voltage	Useful Upper Limit	Finish	Dimensions	Net Weight	Code	List Price
X-26	Crystal	150 V. RMS	6,000 c.p.s.		1 1/2" x 3/4" x 3/4"	5 1/2 oz.	ASXMI	\$12.80
M-41-B (8 Ohms)	Magnetic	3 V. RMS	7,000 c.p.s.	Dark Brown Enamel	1 1/2" x 1 1/4" x 3/4"	3 1/2 oz.	ASXMF	12.80
M-41-500 (500 Ohms)	Magnetic	30 V. RMS	7,000 c.p.s.		1 1/2" x 1 1/4" x 3/4"	3 1/2 oz.	ASXME	12.80



GC-J,
FAMOUS
CERAMIC
SERIES

THE ASTATIC CORPORATION

KNOW THE WORLD OVER
CONNEAUT OHIO

pick-up cartridges and needles

CARTRIDGES FOR SLOW-SPEED AND STANDARD 78 RPM RECORDS

Model	Element Type	List Price	Minimum Needle Pressure	Output Voltage 1000 c.p.s. 1.0 Meg. Load	Frequency Range c.p.s.	Needle Type*	For Record	Approx. Net Wt. in Grams	Code	
CAC-AG-J	Crystal	7.50	10 gr.	1.35††	30-1,500†	Q-AG(J)**	33-1/3, 45 and 78 RPM	5	ASWZX	
CAC-D-J	Crystal	\$10.50	10 gr.	0.7† 0.8††	30-1,500	Q-33(J) Q(J)	33-1/3, 45 and 78 RPM	28	ASXDJ	
CAC-J	Crystal	7.50***	6 gr.	1.0†	30-1,500	Q-33(J)	33-1/3 and 45 RPM	5	ASWZZ	
CAC-78-J	Crystal	7.50***	10 gr.	1.35††	30-1,500	Q(J)	78 RPM	5	ASWZY	
CAC-W-J	Crystal	7.50***	(Same as CAC-J except equipped with special terminals and fittings for easy installation in record changer tone arms with plug-in heads.)						5	ASWYB
CAC-78-W-J	Crystal	7.50***	(Same as CAC-78-J except equipped with special terminals and fittings for easy installation in record changer tone arms with plug-in heads.)						5	ASWYA
GC-AG-J	Ceramic	7.40	8 gr.	0.7††	50-10,000	G-AG(J)**	33-1/3, 45 and 78 RPM	5	ASWZM	
GC-J	Ceramic	7.40	6 gr.	0.55†	50-10,000	G(J)	33-1/3 and 45 RPM	5	ASWZK	
GC-78-J	Ceramic	7.40	12 gr.	0.7††	50-10,000	G-78(J)	78 RPM	5	ASWZI	
GCD-J	Ceramic	9.50	8 gr.	.7†	30-15,000	GDJ	33-1/3, 45 and 78 RPM	12	ASKEF	
L-12	Crystal	5.00	1 oz.	4.0††	50-5,000	Optional	78 RPM	19	ASWSG	
L-29	Crystal	6.00	10 gr.	3.0††	50-5,000	Not included	33-1/3, 45 and 78 RPM	8	ASWTS	
L-78	PN Crystal	11.15	(Special P.N. Crystal Cartridge for Seeburg Record Changers)					78 RPM	28	ASWVO
L-26A	Crystal	5.00	2 3/4 oz.	1.4††	50-4,500	Optional	78 RPM	30	ASWVZ	
L-40A	Crystal	5.00	1 1/4 oz.	0.6††	50-4,500	Optional	78 RPM	30	ASWUA	
L-70A	Crystal	5.55	1 1/4 oz.	1.0††	50-4,000	Optional	78 RPM	28	ASWVT	
L-72A	Crystal	6.65	1 1/4 oz.	3.5††	50-4,000	Optional	78 RPM	28	ASWVL	
L-74A	PN Crystal	10.00	1 1/2 oz.	1.4††	50-4,000	Optional	78 RPM	28	ASWVD	
L-82A	Crystal	5.55	1 1/2 oz.	3.5††	50-5,000	Optional	78 RPM	28	ASWSJ	
L-92A	Crystal	6.00	1 oz.	2.25††	50-7,000	Optional	78 RPM	19	ASWTR	
LQD-J	Crystal	9.50	8 gr.	1.0† 1.0††	50-7,000 Roll-off at 3,500	Q-33(J) Q(J)	(Dual Needle) 33-1/3, 45 and 78 RPM	8	ASXAL	
LQD-1J	Crystal	9.50	(Same as LQD-J except equipped with needle guards and spindle for turnover knob.)						9	ASXAM
LQD-1JB	Crystal	10.00	(Same as LQD-J except equipped with complete turnover assembly and knob.)						22	ASWYR
LT-4AG	Crystal	7.00	8 gr.	2.0††	50-5,000	D-AG(M)**	33-1/3, 45 and 78 RPM	8	ASXBX	
L-12-U	Crystal	5.50	1 oz.	1.25†† or 4.0	50-5,000	Optional	78 RPM	19	ASWSF	
M-22	Crystal	5.55	2 3/4 oz.	2.9††	50-6,500	Optional	78 RPM	21	ASWJM	
PT	Crystal	5.00	1 oz.	1.4††	50-10,000 Roll-off at 3,000	Not included	Replacement for Philco Parts—35-2671, 35-2671-1	27	ASWTB	
U-J	Crystal	8.90	5 gr.	0.5†	30-10,000	U(J)	33-1/3 and 45 RPM	4	ASXAT	
U-78-J	Crystal	8.90	5 gr.	0.5††	30-10,000	U-78(J)	78 RPM	4	ASWZC	

*"J" stands for Sapphire Tip, "M" for Precious Metal Tip.
 **ALL-GROOVE needle tip of special design and size to play 33-1/3, 45 and 78 RPM Records. †RCA 12-5-31-V Test Record or Equivalent.
 ***With Diamond Stylus at \$31.00. ††Audio-tone 78-1 Test Record.

NOTE: Cartridge type B also available with PN Crystal upon request.



6, 8, 16 and 18L-3 TYPES, EXTRA-HIGH OUTPUT SERIES



L-12U DUAL-OUTPUT, REMOVABLE CONDENSER HARNESS, UNIVERSAL TYPE

REPLACEMENT NEEDLES

Needle Type	LIST PRICE		Tip Size	For Cartridge Types
	Sapphire (J)	Osmium (M)		
A-1	\$2.50	\$1.50	1-mil	AC, ACD Series
A-3	2.50	1.50	3-mil	AC-78, ACD Series
A-AG	2.50	1.50	AG*	AC-AG
D	None	1.50	3-mil	LT-4D
D-33	None	1.50	1-mil	LT-4D
D-AG	None	1.50	AG*	LT-4-AG
G	2.50		1-mil	GC Series
G-78	2.50		3-mil	GC-78 Series, 402-M
GC-AG	2.50		AG*	GC-AG

Needle Type	LIST PRICE		Tip Size	For Cartridge Types
	Sapphire (J)	Osmium (M)		
K-M1	None	\$1.50	1-mil	6L3, 8L3, 6L3-D, 8L3-D
K-M2	None	1.50	AG*	6L3-AG, 8L3-AG
K-M3	None	1.50	3-mil	6L3-78, 8L3-78, 6L3-D, 8L3-D
Nylon	\$2.50		3-mil	Nylon Series
Q**	2.50	1.50	3-mil	CAC-78, CAC-D, LQD
Q-33**	2.50	1.50	1-mil	CAC, CAC-D, CQ, LQD
Q-AG	2.50	1.50	AG*	CAC-AG
R	None	1.50	1-mil	14L3, 15L3 Series
R-78	None	1.50	3-mil	14L3D, 15L3D Series
R-AG	None	1.50	AG*	14L3-AG, 15L3-AG Series
T	None	1.50	3-mil	LT1-M, LT2-M, LT3-M
T-33	None	1.50	1-mil	LT-33
U	2.50	1.50	1-mil	U Series
U-78	2.50	1.50	3-mil	U-78 Series

* All Groove Needle Tip of Special Design and Size to Play 33-1/3, 45, and 78 RPM Records.
 ** Also Available With Diamond Tip, List Price \$25.00.

THE ASTATIC CORPORATION

KNOWN THE WORLD OVER
CONNEAUT OHIO

phonograph pickups

MODEL 7 TURNOVER PICKUPS



● Hi-Fidelity Model 7-CAC-D employs revolutionary new Astatic "Twin CAC" turnover cartridge. See cartridge description, following page, for sensational performance qualities. Pickup Model 7-D employs Astatic's popular "smooth response cartridge," the tiny ACD turnover. Hi-Fidelity pickup 7-GCD employs the sensational new GCD Ceramic Cartridge in which only the double-tipped needle turns over. Cast aluminum arm design affords minimum tracking error and balanced groove sidewall pressure, resulting in reduced tracking distortion and longer record and needle life. Light brown Hammerlin finish.

400 SERIES PICKUPS



● Famous Astatic Studio Master "400," notable for tracking excellence, low needle talk. Gracefully curved, cast aluminum arm in light brown Hammerlin finish. Hi-Fidelity Model 400-CAC-D employs revolutionary new Astatic "Twin CAC" turnover cartridge. Model 400-D employs Astatic's popular "smooth response cartridge," the tiny ACD turnover. Hi-Fidelity pickup 400-GCD employs the sensational new GCD Ceramic Cartridge in which only the double-tipped needle turns over. Hi-Fidelity Model 400-CAC uses the CAC-J Crystal Cartridge with single sapphire stylus. Impartial experts have singled out the CAC-J as the ultimate for long-playing transcription performance.

MODEL P SERIES PICKUPS



● Handsomely curved new arm design assuring every performance advantage at amazingly low price. Model P-29 employs L-29 Crystal Cartridge, notable for high output, affording excellent results with standard phonograph amplifiers where other cartridges are unsatisfactory. Model P-12 Pickup uses L-12 Crystal Cartridge for full professional performances at bedrock price. Model P-GC is the ceramic version of this fine new pickup series. Model P-CAC em-

ploy the famous CAC-J Crystal Cartridge, internally equalized for ideal frequency response. Model P-LT-4AG has the LT-4AG Crystal Cartridge, a new high-output, low-cost unit employing the type "D-AG" needle.

PICKUPS FOR SPECIAL APPLICATIONS

MODEL 9-D—TURNOVER ASSEMBLY AND "TWIN CAC" CARTRIDGE, MOUNTED IN V-M STYLE TONE ARM



● Replaces the entire tone arm—easily, quickly, with only a screwdriver—for thrilling perfection in quality of reproduction on all record types. Simple instructions with each unit. Sapphire needle on slow-speed side, osmium on 78 RPM side. For V-M Models 920, 950, 955, 970, 971, 975, 980, 985.

MODEL 8-D TURNOVER ASSEMBLY AND DOUBLE-NEEDLE CARTRIDGE, MOUNTED IN WEBSTER-CHICAGO TONE-ARM



● Offers improved quality of reproduction for all record types. Installation is the easiest and speediest job of its type . . . you replace entire tone arm. No alterations to record changer . . . all you need is a screwdriver. Simple instructions with each unit. FOR WEBSTER-CHICAGO CHANGER MODELS: 246, 256, 255, 262, 264, 346, 356, 355, 362, 357, 364.

PICKUPS FOR SLOW-SPEED AND STANDARD 78 RPM RECORDS

Model	List Price	Finish	Cartridge Used*	Element Type	Stylus	For Record		Cable Length**	Shipping Weight	Code
						Size	Speed			
7-CAC-D	\$16.40	Light Brown Hammerlin	CAC-D-J	Crystal	Precious Metal† Sapphire†	7-10-12"	All	13"	2 lb.	ASXHT
7-D	15.90		ACD	Crystal	Precious Metal† Sapphire†	7-10-12"		13"	12 ozs.	ASXHV
7-GCD	15.90		GCD	Ceramic	Sapphire	7-10-12"		13"	12 ozs.	ASBCW
8-D	11.50	Brown Plastic	(Special for Webster-Chicago Record Changers)			7-10-12"		2"	12 ozs.	ASXHW
9-D	11.50	Brown Plastic	(Special for V-M Record Changers)			7-10-12"	2"	12 ozs.	ASXHX	
400-CAC-D	25.50	Light Brown Hammerlin	CAC-D-J	Crystal	Precious Metal† Sapphire†	10-12-16"	Slow	24"	1 lb. 8 ozs.	ASBCU
400-D	25.00		ACD-2	Crystal	Precious Metal† Sapphire†	10-12-16"		24"	1 lb. 8 ozs.	ASDCN
400-CAC	25.00		Opalescent Grey Hammerlin	CAC-J	Crystal	Sapphire		10-12-16"	24"	1 lb. 8 ozs.
400-GCD	25.00	Light Brown Hammerlin	GCD	Ceramic	Sapphire	10-12-16"		24"	1 lb. 8 ozs.	ASBCV
P-29	8.00	Opalescent Grey Hammerlin	L-29	Crystal	Not Included	7-10-12"	All	13"	1 lb.	ASXDC
P-12	6.00	Dark Brown Hammerlin	L-12	Crystal	Not Included	7-10-12"	78 RPM	13"	1 lb.	ASXDB
P-GC	10.75	Opalescent Grey Hammerlin	GC-J	Ceramic	Sapphire	7-10-12"	All	13"	1 lb.	ASXDA
P-CAC	10.75	Opalescent Grey Hammerlin	CAC-J	Crystal	Sapphire	7-10-12"	All	13"	1 lb.	ASXEZ
P-LT-4AG	9.50	Opalescent Grey Hammerlin	LT-4AG	Crystal	Precious Metal	7-10-12"	All	13"	1 lb.	ASXEY

†Precious metal stylus tip on 3-mil 78 RPM side. Sapphire stylus tip on 1-mil 45 and 33-1/3 RPM side.
*FOR PERFORMANCE DATA SEE CARTRIDGE CHART **Super-Flexible, Single Conductor, Shielded



MICROPHONES for SOUND PERFORMANCE

The TURNER Company Cedar Rapids, Iowa

BROADCAST DYNAMIC MICROPHONES

THE ARISTOCRAT MODELS 50D and 50D-TV

The Turner Aristocrat is an ultra wide range, high fidelity dynamic microphone. It offers high quality performance with the most realistic reproduction of voice and music yet attained with microphones of its type. Advanced circuit design with high output dynamic generator requires no closely associated auxiliary equipment.



The Aristocrat is now offered in satin black finish with matching desk stand (Model 50D-TV, illustrated) or in satin chrome finish with matching desk stand (Model 50D). Matching desk stands have built in shock mounts. The swivel coupler permits almost instantaneous change from stand to hand use and vice versa. The Aristocrat is essentially non-directional in operation — equally effective for individual or group pickups. Use the Aristocrat anywhere, indoors or out — on stand, in hand, suspended, or concealed in stage settings. Use the Aristocrat everywhere performance of the highest quality is demanded.

Model 50D. Finished in satin chrome. Complete with swivel coupler, cable set and matching desk stand with shock-mount.....List Price \$125.00

Model 50D-TV. Finished in satin black. Complete with swivel coupler, cable set and matching desk stand with shock-mount.....List Price \$125.00

If matching stand for either model is not desired subtract \$7.50 from List Price.

SPECIFICATIONS 50D and 50D-TV

FREQUENCY RESPONSE: 50 to 15,000 c.p.s. flat within $\pm 2\frac{1}{2}$ db.
OUTPUT LEVEL: 58 db. below 1 volt/dyne/sq. cm. at high impedance.
IMPEDANCE: Choice of 50, 200, 500 ohms or high impedance (25,000 ohms) connected for balanced line output.
POLAR PATTERN: Essentially non-directional in any position.
TRANSFORMER: Magnetically shielded for minimum hum pickup.
DIAPHRAGM: Specially designed aluminum alloy.
CASE: All metal. Specify satin chrome (50D) or satin black (50D-TV) finish.
MOUNTING: Swivel type. Standard $\frac{5}{8}$ " — 27 thread.
DIMENSIONS: 1 $\frac{1}{2}$ " maximum diameter; 6 $\frac{1}{2}$ " long (less cable connector).
WEIGHT: 16 ounces (less cable).
CABLE: 20 ft., high quality two conductor shielded cable with Cannon quick-disconnect plug.

MODEL 51D and 51D-TV

This dynamic microphone, handsomely finished in rich umber grey or satin black, offers exceptionally high quality performance at a low cost. No closely associated auxiliary equipment required.



Model 51D. Finished in umber grey. Complete with swivel coupler, cable set and matching stand with shock-mount.....List Price \$92.50

Model 51D-TV. Same as 51D but finished in satin black. List Price \$92.50
If matching stand for either model is not desired subtract \$7.50 from List Price.

SPECIFICATIONS 51D and 51D-TV

FREQUENCY RESPONSE: 80 to 13,000 c.p.s. substantially flat.
OUTPUT LEVEL: 58 db below 1 volt/dyne/sq. cm. at high impedance.
IMPEDANCE: Choice of 50, 200, 500 ohms or high impedance (25,000 ohms) connected for balanced line output.
POLAR PATTERN: Essentially non-directional in any position.
TRANSFORMER: Magnetically shielded for minimum hum pickup.
DIAPHRAGM: Special aluminum alloy.
CASE: All metal. Specify umber grey (51D) or satin black (51D-TV).
MOUNTING: Swivel type. Standard $\frac{5}{8}$ " — 27 thread.
DIMENSIONS: 1 $\frac{1}{2}$ " maximum diameter, 6 $\frac{1}{2}$ " long (less cable connector).
WEIGHT: 16 oz. (less cable).
CABLE: 12 foot high quality two conductor shielded cable with Cannon quick-disconnect plug.

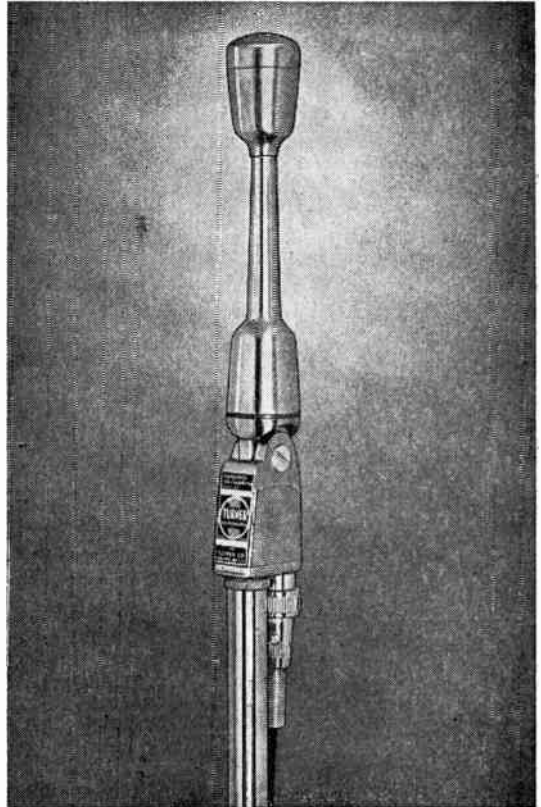

Compact, Slender Dynamic at a Popular Price

MODEL 95D

High quality, general purpose microphone with such features as Alnico V Magnets and moving coils. The 95D has excellent sound characteristics and a wide response range for premium performance with applications from tape recorders to commercial broadcasting. Excellent sensitivity to voice and music — modern, graceful lines — available in satin chrome or satin black finish.

Model 95D DynamicList Price \$35.00
Model 95D Dynamic (with slide switch)List Price \$38.50

SPECIFICATIONS 95D

FREQUENCY RESPONSE: 100 to 10,000 c.p.s.
OUTPUT LEVEL: 58 db below 1 volt/dyne/sq. cm.
CABLE: 20-foot removable cable set.
CASE: All metal. Specify satin chrome or satin black.
MOUNTING: Coupler swings microphone in 60° arc. Standard $\frac{5}{8}$ " — 27 thread.
IMPEDANCES: High impedance wired single ended (single conductor shielded cable). 50, 200, or 500 ohms wired for balanced line (two conductor shielded cable).



MICROPHONES for SOUND PERFORMANCE

The TURNER Company Cedar Rapids, Iowa

New, lightweight lapel microphone

THE TURNER L-100

with the swivel clip that grips from any angle

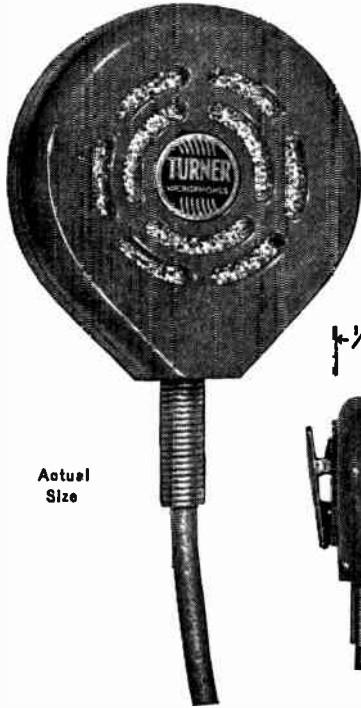

Actual Size



This brand new Turner beauty weighs only 1 ounce. It has an alligator clip with a tough spring that really holds, and it's rubber padded, can't tear clothing. Best of all, it's on an adjustable clip — you can clip on the Turner L-100 from any angle and the mike stays straight up . . . cord hangs straight down. Case is light-grey, design neat and inconspicuous. A high quality Bimorph, moisture-sealed crystal produces a top signal level. Speech reproduction is crisp, clear cut. Chest sound damped out. The L-100 is also available with a ceramic interior at the same price. Use for P. A., recording and demonstrations. Same mike is available as the Model 100 without clip for tape recording, dictographic and other uses requiring a lightweight hand held microphone.

Turner L-100 (with clip and 20-ft. cable) List Price \$12.50
 Turner Model 100 (without clip and with 7-ft. cable) List Price \$ 8.00

SPECIFICATIONS

Models L-100 and 100 Crystal
 RESPONSE: 50 to 10,000 c.p.s.
 LEVEL: -52 db.
 CABLE: 20-ft. attached single conductor shielded.
 DIMENSIONS: 2" x 1 1/16" without clip.

WEIGHT: 1 ounce, less cable.

Models L-100C and 100C Ceramic
 RESPONSE: 80 to 9,000 c.p.s.
 LEVEL: Approx. -61 db.
 CABLE: 7-ft. attached single conductor shielded.

Popular, Powerful, Miniature Crystal Microphone

THE TURNER MODEL 80

One of the most beautiful, serviceable and versatile crystal microphones of all time. The slender, graceful Model 80 is so tiny you can hide it in your palm, yet it is a big performer within its frequency range of 80 to 7,000 c.p.s. Level, about -58 db. The case of die-cast zinc alloy, satin chrome plated — total weight, 5 ozs. A 7-ft. attached single conductor shielded cable is included. High quality Bimorph moisture sealed crystal is blast and mechanical shock proofed.



Turner 80 on C-4 Stand

Model 80 (does not include stand) List Price \$15.95

THE C-4 STAND was especially designed to give maximum maneuverability to the Model 80 Microphone. It pivots the microphone in a 135° arc for any operational angle. It holds the microphone firmly by the unique, positive action hinge, yet moves smoothly and easily to any desired position without adjustment. The C-4 Stand is solidly built of die-cast zinc overlaid with matching satin chrome plate. It will not tip or slide with the weight of the cord. Standard 5/8" — 27 thread.

Model C4 Matching Stand List Price \$5.75



MODEL 81

Smaller than the Model 80, the Model 81 pictured here has a PC1M Amphenol connector attached. Same technical specifications as Model 80. Excellent for built-in applications, sound reinforcers, dictograph and detective work.

Model 81 List Price \$13.95
 (Available with 7 foot removable cable set at extra cost. Also available with Amphenol microphone switch Model 75-MC1S at extra cost.)

MODEL 82-3H



Nowhere is the diminutive size of this microphone more sharply evident than when adapted for use with the famous Turner "Third Hand." The "Third Hand" slips over your head in a jiffy and holds microphone close to your mouth for excellent volume without feedback. Ideal for window demonstrations, carnival and sideshow work and switchboard operators. Same technical specifications as Model 80. 20 foot attached single conductor shielded cable.

Model 82-3H. Complete with "Third Hand" List Price \$22.75



MICROPHONES for SOUND PERFORMANCE

The TURNER Company Cedar Rapids, Iowa

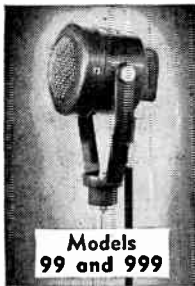

Models 99 and 999



Model U9S



Model 211



Model 22



Model 33



Model 87

RUGGED DYNAMIC MICROPHONES

ALL PURPOSE CRYSTAL AND DYNAMIC MICROPHONES

VELOCITY MICROPHONE

FAMOUS TURNER MODEL 99

Professional in appearance and performance. Smooth response not affected by heat, cold or humidity. Has adjustable saddle, $\frac{5}{8}$ " — 27 mounting. Semi- or non-directional operation. For announcing and mobile public address systems, paging systems, communications, recording machines, etc. Gunmetal metalustre finish. LEVEL: -52 db.

at high impedance. RESPONSE: 80-9,000 c.p.s. 20 ft. removable single conductor shielded cable set. 50, 200, 500 ohms or high impedance.

Model 99 List Price \$41.50

MODEL 999 BALANCED LINE DYNAMIC

Same as Model 99 but furnished with 3 pin polarized locking connector and 20 ft. balanced line low capacity cable.

Model 999 List Price \$45.00

MODEL U9S MULTI-IMPEDANCE DYNAMIC

50, 200, 500 ohms or high impedance — get it quickly with the turn of the switch on the Turner U9S Dynamic. Same precision engineering and rugged construction as the Model 999 with built-in tapped multi-impedance transformer and switch. Dependable at all

impedances and frequencies. Gunmetal metalustre finish. LEVEL: -52 db at high impedance. RESPONSE: 80-9,000 c.p.s. Complete with 20 ft. balanced line removable cable set.

Model U9S List Price \$49.50

MODEL 211

High Quality Dynamic, precision engineered for outstanding performance. Unique diaphragm structure of the 211 results in extremely low harmonic and phase distortion without sacrifice of high output level. A sensitive unit, yet ruggedly built for dependable use indoors or out under the most difficult acoustic and climatic conditions. Withstands rough handling. For quality recording, P. A., sound

systems and broadcast work, including FM. LEVEL: -54 db. at high impedance. RESPONSE: 50-10,000 c.p.s. Equipped with 90° tilting head, balanced line output connection, and 20 ft. 2-conductor, heavy duty removable cable set. Satin chrome finish. 50 ohms, 200 ohms, 500 ohms or high impedance.

Model 211 List Price \$42.50

MODEL 22X CRYSTAL 22D DYNAMIC

Accurate pickup and faithful reproduction have made these units the most popular general purpose microphones on the market. Used by amateurs, paging and call systems, home recording, and general sound work indoors and out. Modern styling and rich satin chrome finish. Full 90° tilting head for semi- or non-directional (microphone pointed straight up) operation. Standard $\frac{5}{8}$ " — 27 coupler mounting. MODEL 22X CRYSTAL has high quality humidity protected crystal in mechanical shock proofed mounting. LEVEL: -52 db. RESPONSE: 60-9,000 c.p.s. Complete with 7 ft. removable cable set.

MODEL 22D DYNAMIC features high quality Alnico magnets in high level dynamic circuit. LEVEL: -54 db. at high impedance. RESPONSE: 100-9,000 c.p.s. 7 ft. removable cable set. High impedance wired single ended (single conductor shielded cable). 50, 200 or 500 ohms wired for balanced line (two conductor shielded cable).

Model 22X List Price \$24.75
Model S-22X with slide on-off switch List Price \$27.25

Model 22D List Price \$29.95

Model S-22D with slide on-off switch List Price \$32.45

MODEL 33X — 33D

These high fidelity, all purpose units combine high output with smooth response over a wide frequency range. Excellent speech and music reproduction. Streamlined case design with rich satin chrome finish. 90° tilting head permits semi- or non-directional operation. Removable cable feature allows quick interchange of cables.

MODEL 33X CRYSTAL has high quality 2-element moisture sealed crystal and mechanical shock proofing. LEVEL: -52 db. RESPONSE: 60-9,000 c.p.s. Complete with 20 ft. removable cable set.

Model 33X List Price \$26.95
Model S-33X with slide on-off switch List Price \$29.45

MODEL 33D DYNAMIC — Smooth, high level dynamic circuit. Alnico magnets. LEVEL: -54 db. at high impedance. RESPONSE: 100-9,000 c.p.s. Complete with 20 ft. removable cable set. High impedance wired single ended (single conductor shielded cable). 50, 200 or 500 ohms wired for balanced line (two conductor shielded cable).

Model 33D List Price \$31.90

Model S-33D with slide on-off switch List Price \$34.40

MODEL 87 VELOCITY

A unit engineered with single element ribbon supported in the field of an Alnico V magnet for maximum sensitivity. Thorough shielding excludes hum pickup. The Model 87 has a bi-directional pickup pattern with exceptionally smooth response from 80-8,000 c.p.s. LEVEL: -62 db. at high impedance. Built-in impedance switch gives

selection of 50, 200, 500 ohms or high impedance output. Universal swivel mounting, $\frac{5}{8}$ " — 27 thread. Finished in dark amber grey with bright chromium screen. Complete with 20 ft. two conductor balanced line shielded cable.

Model 87 List Price \$60.00



MICROPHONES for SOUND PERFORMANCE

The TURNER Company Cedar Rapids, Iowa

CONVENIENT HAND-HELD MICROPHONES MULTI-PURPOSE MICROPHONE — THE "HAN-D"

Model 9D Dynamic • Model 9X Crystal Model 9R Carbon



One of the handiest and most useful microphones made. Hang it, hold it, or mount on any standard floor or desk stand. Standard $\frac{5}{8}$ "—27 thread mounting. Balanced to fit the hand. Especially engineered for maximum response to voice, "Han-D" also delivers smooth, natural response to music pickups. Ideal for stage, paging, public address, amateur, mobile and traveling mike broadcasting. Will not blast from close speaking. Die-cast zinc alloy case. Satin chrome finish.

MODEL 9D DYNAMIC — Recommended for more severe conditions and extremes of climate and temperature. LEVEL: -52 db. at high impedance. RESPONSE: 150-7,000 c.p.s. Complete with removable 7 ft. single conductor shielded cable set. 200, 200, 500 ohms or high impedance furnished standard with positive contact slide switch.

Model 9D List Price \$32.50
Model P9D List Price \$32.50

(Same as 9D with push-to-talk non-locking switch)

MODEL 9X CRYSTAL — Equipped with high quality, shock mounted, humidity protected crystal for indoor or outdoor use. LEVEL: -52 db. RESPONSE: 60-7,000 c.p.s. Complete with 7 ft. single conductor shielded cable set and positive contact slide switch.

Model 9X List Price \$25.85
Model P9X List Price \$25.85

(Same as 9X but with push-to-talk non-locking switch)



MODEL SR9R CARBON — Recommended for use with mobile equipment and for ham operations. Two circuit, side-button, push-to-talk switch for on-off microphone control and external relay circuit. Furnished with four-conductor, 7 foot unshielded attached cable. LEVEL: approximately -42 db. RESPONSE: 200-4,000 c.p.s. with rising characteristics for maximum intelligibility. 80 ohms nominal D.C. resistance.

Model SR9R List Price \$30.75
Model SR9D List Price \$37.40

(Same specifications as 9D but furnished with side-button, push-to-talk switch for external relay control. Attached 7 foot cable, three conductor, one shielded for high impedance; 4-conductor, 2 shielded balanced line for low impedances.)

New Carbon and Dynamic Mobile Microphones THE TURNER 90



MODEL SR-90R CARBON — Designed to fit your hand comfortably. Furnished with DPST push-to-talk switch, normally open, one pole in microphone circuit and one pole in external relay circuit — 4-conductor unshielded Koil-d Kord (11" retracted — 5' extended). Also available with push-to-talk on-off switch only and 2-conductor unshielded Koiled Kord as Model S-90R. FREQUENCY RESPONSE: 200 to 4,000* c.p.s. OUTPUT LEVEL: -42 db. 80 ohms nominal D.C. resistance. Satin chrome plated zinc die-cast case. Furnished with hook for hanging and bracket for wall or dash mounting.

Model SR-90R - Model S-90R List Price \$26.50

MODEL SR-90D DYNAMIC — Same general appearance as SR-90R. LEVEL: -48 db. at high impedance. RESPONSE: 200 to 9,000 c.p.s. SPST push-to-talk switch, normally open, for on-off control of external relay circuit; 200 ohm impedance furnished with 4-conductor, 2 shielded, 5 foot attached cable — high impedance furnished with 3-conductor, one shielded, attached 5 foot cable.

Model SR-90D List Price \$29.50

Watertight - Dust-Proof - Corrosion-Proof

MODEL 70D DYNAMIC



Clear, crisp voice response and high output unaffected by dust, corrosion, rainfall, mist, steam or total immersion. Heavy duty push-to-talk switch normally open. Hook for hanging or bracket for wall mounting (specify choice). Complete with 7 ft. attached cable, 2 conductor shielded for low impedances, single conductor shielded for high impedance. RESPONSE: 200 to 5,000 c.p.s. with slightly rising characteristic for maximum speech intelligibility. LEVEL: -52 db. IMPEDANCE: Choice of 50, 200 or 500 ohms connected for balanced line, or high impedance with single ended output. CASE: Zinc die-cast alloy. DIMENSIONS: $2\frac{1}{2}$ " x $1\frac{1}{8}$ " x $4\frac{1}{2}$ " overall.

Model 70D List Price \$42.50

MODEL 70R CARBON

Same as for 70D except with High quality carbon cartridge giving excellent articulation and intelligibility for speech. D.C. RESISTANCE: 80 ohms, nominal. OUTPUT LEVEL: -42 db.

Model 70R List Price \$38.50

Popular - Low Cost - Lightweight

MODEL 20X CRYSTAL • MODEL 20D DYNAMIC • MODEL 20R CARBON



Use for all fields of applications where low cost is a factor. Rugged die-cast metal case is finished in bronze metalustre. Equipped with hook ring for hanging. SIZE: $6\frac{1}{2}$ " x $2\frac{1}{8}$ " x $1\frac{1}{2}$ " overall.

MODEL 20X CRYSTAL — A high impedance microphone with -52 db. output. RESPONSE: 70-7,000 c.p.s. 7 ft. attached single conductor cable fully shielded. Weight less cable: 9 oz.
Model 20X* List Price \$17.00

MODEL 20D DYNAMIC — Recommended for more severe service conditions and extremes of climate and temperature. Either high impedance or 80 ohms available, please specify.

OUTPUT LEVEL: -52 db. at high impedance. RESPONSE: 100-7,000 c.p.s. 7 ft. attached single conductor cable fully shielded. Weight less cable: 12 oz.

Model 20D* List Price \$21.50

MODEL 20R CARBON — Has best response curve for highest articulation and intelligibility and low distortion. Excellent speech reproduction. OUTPUT LEVEL: -42 db. D.C. resistance of 80 ohms nominal. $\frac{1}{2}$ volt developed by normal speech. RESPONSE: 200-4,000 c.p.s. 48" two conductor unshielded cable included. Weight less cable: 10 oz.

Model 20R* single button carbon List Price \$17.00

*Models S20X, S20D and S20R with push-to-talk switch having slide-lock feature. Switch connected in microphone circuit, normally open. Add \$3.00 to list price of 20X, 20D or 20R.

Models SR-20X, SR-20D and SR-20R. Same as S20 models but normally open switch is wired for relay control. Add \$6.00 to list price of 20X, 20D or 20R.



MICROPHONES for SOUND PERFORMANCE

The TURNER Company Cedar Rapids, Iowa

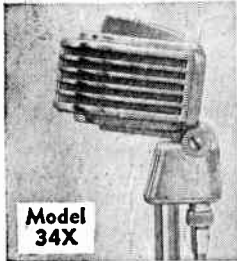

Model 34X



Model L40

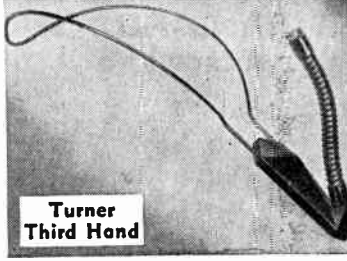

Turner Third Hand



Turner Challenger



Model 60X

MODEL 34X CRYSTAL MICROPHONE

Attractive, high fidelity, semi-directional crystal unit. Highly recommended for studio and public address installations as well as quality recording work. Advanced engineering design with full 90° tilting head permits tilting to most advantageous position. Quick removable cable feature. The Model 34X utilizes a high quality Bimorph moisture sealed crystal — is blast and mechanical shock proofed. Use indoors or out. Satin chrome finish. LEVEL: -52 db. RESPONSE: 60-10,000 c.p.s. Complete with 20 ft. removable cable set.

Model 34X List Price \$32.00
 Model S-34X with slide on-off switch List Price \$34.50

MODEL L40 LAPEL MICROPHONE

Small, lightweight and inconspicuous, the L40 can be worn on the lapel, used with the 3H or concealed. Highest quality Bimorph, moisture sealed crystal produces high signal level. Engineered for crisp, clear speech reproduction. Chest sounds damped out. Used for built-in applications, public address, recording and as sound reinforcers. Also used for dictographic and detective work. Alligator clip may be used to secure unit to clothing. Satin chrome finish. LEVEL: -52 db. RESPONSE: 50-8,000 c.p.s. With 20 ft. attached cable.

Model L40 List Price \$25.00
 With Third Hand — L40-3H slips over neck in a jiffy. Ideal for mobile sound work and call systems where operator needs both hands free. Indispensable for demonstrators.
 Model L40-3H List Price \$32.50

FAMOUS TURNER "THIRD HAND"

Slips over your head in a jiffy and holds microphone close to your mouth, where you get excellent volume without feedback. As natural to wear as a necktie. Lets you use both hands elsewhere. Stays out of your line of vision. Talk close without craning your neck. Cuts down background noises. Can be used with long line as traveling microphone. Ideal for window demonstrations, etc. Has 6 1/4" flexible gooseneck; 5/8" — 27 thread. Black enamel finish. Recommended for use with Turner microphones as they will not blast from close speaking.

Model 3H List Price \$5.00

TURNER DESK STANDS



Model C-3 Stand



Model C-4 Stand

MODEL C-3. Finished completely in beautiful satin chrome. 6 inches high with 4 3/8" upright, base 5 inches in diameter, weighs 14 ounces. 5/8" — 27 thread to fit any standard microphone.

Model C-3 List Price \$4.50

MODEL C-2. Same as C-3 but with 1" upright.

Model C-2 List Price \$4.50

MODEL C-5. Same as C-3 but with 2 3/8" upright.

Model C-5 List Price \$4.50

MODEL B-3. Same as C-3 but finished completely in rich brown metalustre.

Model B-3 List Price \$3.35

MODEL G-3. Same as C-3 but finished completely in handsome gunmetal lustre.

Model G-3 List Price \$3.35

MODEL C-4. Designed especially for Model 80 Microphone, but has 5/8" — 27 thread mounting so that other microphones may be mounted on it. Finished in satin chrome.

Model C-4 List Price \$5.75

THE TURNER CHALLENGERS

Priced within the range of almost every user, Turner Challengers offer performance, quality and appearance usually found in microphones listing at twice their low cost. Engineered with substantially flat response and high output level, they give clear cut reproduction of voice and music. Truly economical!

MODEL BX CRYSTAL — For recording, P. A. and amateur work. Brown Metalustre finish. LEVEL: -52 db. RESPONSE: 60-6,000 c.p.s. Complete with 7 ft. attached cable.

Model BX List Price \$11.75

MODEL BD DYNAMIC—Same appearance and finish as BX. Equipped with dynamic cartridge. Works equally well indoors or out. LEVEL: -52 db. at high impedance. RESPONSE: 100-6,000 c.p.s. Complete with 7 ft. attached cable. 50, 200, 500 ohms or high impedance.

Model BD List Price \$18.50

MODEL CX CRYSTAL — Satin chrome finish. 7 ft. removable cable set. Standard 5/8" — 27 thread mounting. LEVEL: -52 db. RESPONSE: 60-7,000 c.p.s.

Model CX List Price \$18.00

MODEL CD DYNAMIC — Same style and finish as CX. High quality magnets. 7 ft. removable cable set. LEVEL: -52 db. at high impedance. RESPONSE: 100-7,000 c.p.s. 50, 200, 500 ohms or high impedance.

Model CD List Price \$22.85

For Hand, Stand or Desk Use

MODEL 60X CRYSTAL

Good quality speech reproduction at low cost. For amateurs, P. A. and paging systems. Two-ply, torsional, moisture sealed crystal circuit has aluminum diaphragm, shock proof mounting, wind and blast proofed. Attractive die-cast alloy case is finished in baked-on peach enamel. Furnished with standard 5/8" — 27 thread for stand mounting. LEVEL: -52 db. RESPONSE: 70-7,000 c.p.s. 6 ft. attached single conductor shielded fabric covered cable. Anchored firmly to case with Heyco strain relief bushing. DIMENSIONS: 3 3/8" high x 2 3/8" wide x 1 1/4" thick. Weight, 10 oz.

Model 60X List Price \$10.85

Model S60X (with on-off slide switch) List Price \$12.85

MATCHING TRANSFORMERS



Turner transformers match low impedance microphones to high impedance amplifier input. Permit longer lines. Helps eliminate hum pickup.

MODEL TR2 — Matches any line to grid

Model TR2 matches 20-50, 200-250 and 500 ohms lines to grid. Incorporates finest transformer available. Wide range response: ±1 db. from 40-10,000 c.p.s. One hole mounting. Equipped with 3-contact locking connector and 7 ft. 2 conductor shielded, balanced line cable.

Model TR2 List Price \$16.00

Replacement cartridges for all Turner Microphones are available. Write for complete information.

PREFERRED BY LEADING P. A. MEN THE WORLD OVER



New AMPERITE STUDIO "Ribbon" MICROPHONE MODELS R80H-R80L A "Blastproof Velocity" Eliminates Feedback Troubles

The Finest in
Microphones
regardless of
Price

Reproduction is of the very highest type. Excellent for broadcasting, recording and public address. Eliminates feedback troubles. Will not become "boomy" on close talking. An entire orchestra can be faithfully reproduced.

Pick-up angle 120° front and back with practically no frequency discrimination. In spite of the wide pick-up angle, feedback is reduced to a minimum.

Not affected by temperature, altitude or humidity. Will operate under any climatic conditions—indoors or outdoors. Not affected by wind.

Frequency range 40-14,000 cps. Output—56 db. Complete with switch (optional), cable connector and 25' cable. Finish—Chrome. Stand. thread, Standard 5/8"-27.

Model R80L—200 ohms output.....	List \$80.00
Model R80H—High impedance.....	List 80.00
50 ohms available. Shipping Weight 10 lbs.	

AMPERITE KONTAK MIKE FOR MUSICAL INSTRUMENTS

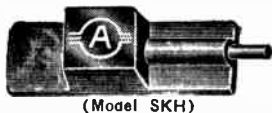

(Model SKH)

Gives natural reinforcement without peaks. Easily attached without tools. Will operate with either low or high-gain amplifiers. Frequency response 40 to 9000 cps. Output, —40 db.

Shipping Weight 2 lbs.



(Model KKH)

Model SKH—Hi-impedance	List \$12.00
Model KKH—With Hand Volume Control.....	List 18.00
Model KF —Foot Pedal Only	List 18.00
Low impedance available in model SKH at same price.	

New "RIBBON MICROPHONE," RBHG—RBLG Automatically Adjusted for Close or Distant Pick-Up A "Blastproof" Velocity

Studio reproduction—low feedback. A "ribbon" microphone that brings broadcast quality within everyone's reach. Perfectly natural reproduction on close talking—you can even shout into it. Will also faithfully reproduce an entire orchestra.

Pick up angle front and back—120° with practically no frequency discrimination. In spite of wide pick-up angle—feedback is reduced to an absolute minimum. Low feedback is due to flat response of the microphone.

Excellent for studio—P. A. or recording. Not affected by temperature, altitude or humidity. Can be used under all climatic conditions, and will withstand rough handling. Not affected by wind.

Frequency range 50-11,000 cps. Output—62 db. Complete with switch, cable connector, and 25' cable. Finish—Chrome. Stand thread—Standard 5/8"-27.

Model RBHG—High impedance	List \$42.00
Model RBLG—200 ohms output	List 42.00
50 ohms available. Shipping Weight 8 lbs.	

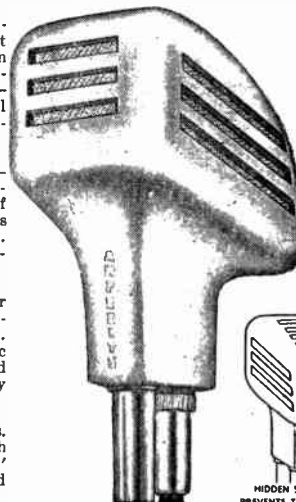

HIDDEN SWITCH PREVENTS TAMPERING

Amperite PG CARDIOID DYNAMIC MICROPHONE

Uni-Directional with superior ellipsoid pick up pattern; has lowest feedback point of all diaphragm type microphones and flat response with studio quality reproduction.

P.G. diaphragm follows air particle velocity where amplitude is a GRADIENT of the PRESSURE, and is a radical improvement in this type of microphone. Rugged, not affected by temperature, altitude or humidity.

Frequency range 40-10000 CPS. Output—55 db. Complete with switch, cable connector and 25' cable. Chrome finish, standard thread 5/8" - 27. Shipping weight 2 1/2 lbs. of both models.

Model PGH—hi-imp.	List \$32.00
Model PGL—50 ohms	List \$32.00



Amperite 7JH—7JL VELOCITY MICROPHONE "Lapel" Type

Reproduction is so perfect—you can hardly tell a microphone is working. Free from annoying peaks or mechanical reproduction. Output does not change with any position of the head. It can be concealed in clothing. Will operate under all climatic conditions. Unusually low feedback. Frequency range 60-7,000 cps. Output: —63 db. Cable length 25'. Vinyl case. Model 7JH—High impedance List \$32.00
Model 7JL—200 ohms output..... List 32.00
50 ohms available. Shipping Weight 3 lbs.



Model LGP—Input Transformer (Cable Type)

Enables the use of low impedance microphones and cable lengths up to 5,000' with amplifiers having high impedance input. Special shielding eliminates hum pick-up. Can be used with 25, 50, or 200 ohm microphones. Output connects directly into high impedance input of amplifier. Standard grade recommended for speech. Laboratory grade for music.

Model LGP—Lab—40 to 14,000 cps.	List 10.00
Shipping Weight 3 lbs.	





ATLAS SOUND CORP.

the complete line for every public address need!

ATLAS MICROPHONE STANDS

featuring **SPECIAL FULL-GRIP VELVET ACTION CLUTCHES**
 maximum **STABILITY, QUIET EASE AND WEAR**

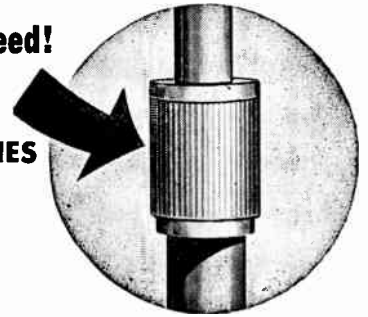

*MS-25 features
**SAFETY AIR-LOCK
 CUSHION**



The "Full-Grip" Clutch offers an extended length clutch body, permitting a secure, full-hand grip. The clutch mechanism is inner-lined with a wear-proof bakelite locking collet which grips without jamming, slipping, or sudden dropping. All bases are functionally designed to offer maximum stability for a given base weight. The maximum base mass is located at the outer periphery of the casting where the concentrated weight is most useful. All bases include self-leveling, shock-absorbent base pads, plus three additional "anti-tip" points located between the base pads. The complete tube assemblies of all models are "super-chrome" plated, assuring "life-time" wear. All models terminate in a 5/8"-27 carefully machined thread.

MODEL	Weight	Base Finish	Tube Finish	Height Adjust.	Base Diam.	LIST PRICE
MS-10C	9 lbs.	Gray Shrivel	Full Chrome	35" to 64"	10"	\$ 9.75
MS-12C	12 lbs.	Gray Shrivel	Full Chrome	35" to 65"	10"	10.50
MS-11C	12 lbs.	Full Chrome	Full Chrome	35" to 65"	10"	13.00
†MS-20	15 lbs.	Gray Shrivel	Full Chrome	42" to 72"	12"	15.50
†MS-25	24 lbs.	Chrome & Gray Hammerloid	Full Chrome	42" to 72"	17"	21.50
*CS-1	5 lbs.	Cadmium Plated	Full Chrome	23" to 62"	Collapsible	16.00
*CS-32	4 lbs.	Chrome & Gray	Full Chrome	35" to 64"	Demountable	10.25
*CS-33	3 lbs.	Hammerloid	Full Chrome	26" to 64"	Demountable	11.75

*Each stand is individually packed complete in a single carton.
 †The MS-20 and MS-24 use large diameter, oversize, telescoping brass tube assemblies (7/8" telescoping tube — 1 1/8" base tube) resulting in a handsome and fine-appearing stand that supplements the professional appearance of large-size high quality microphones.
 ‡Collapsible to a minimum overall length of 23 inches.

*SAFETY AIR-LOCK CUSHION

Sensational new Atlas feature that prevents accidental or sudden slippage of telescoping section. This section is always "cushioned on air," and the controlled escape-ment allows only a slow, smooth, quiet collapse of stand.

ADJUSTABLE BANQUET STAND

Features "Full-Grip Velvet-Action" adjustment. Tube and base handsome super-chrome finished. Adjustable 18"-32". Base diameter 8". Wt. 5 lbs.
 Model TS-6 List Price \$9.00

'VELVET ACTION' DESK STAND

DS-5 and DS-7 Desk Stands—Same fine finish and workmanship as floor models. Adjustable DS-7 has heavy duty 5/8" and 7/8" tubing. Felt base pads included. Base diameter 6", gray shrivel finish; tube chromium plated.

Model	Adj. Height	List Price
DS-5	Fixed 6"	\$3.00
DS-7	8" to 13"	5.00

MODEL DS-10—"The Streamliner"

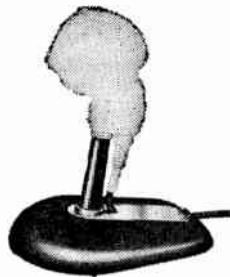

Modern — Attractive — Functional Stable!

Compliments appearance of any mike. Conceals mike cable in slot beneath center section of chromium trim and directs it out at rear of base. Adequate space under base for installation of "on-off" or "press-to-talk" switch.

Model DS-10 List Price \$5.00

ATLAS SOUND CORP.



the complete line for every public address need!

BS-36W Mobile

Model — Identical to BS-36 but features DeLux base having ball-bearing hard-rubber swivel castors that permit entire stand to be wheeled about.

List Price \$67.50



PROFESSIONAL BOOM STAND

New model! All advantages of "Floating Action" and "Safety Air-Lock Cushion" that prevents accidental slippage. All parts "Velvet Smooth" in operation. Boom easily removable to use upright as a conventional floor stand. Gyromatic swivel joint assures mike always hangs in proper position.

Specifications: Boom length 72" (more extension addable). Adjustable vertical extension 48"-72". Base diam. 17". Tubular sections super-chrome plated. Modernistic base finished in chrome and gun metal shrivel. "Snap On" hangers furnished to hold mike cable to boom section. Ship. wt. 33 lbs.

List Price \$60.00

'SNAP ON' MICROPHONE ATTACHMENT



Permits any mike to be attached to or removed from any floor stand — instantly, safely, without on-and-off threading. SO-1 is ball-bearing spring sleeve attachment: one section is attached to mike, other section is permanently fastened to stand.

Model SO-1

List Price \$2.75

FLEXIBLE GOOSE NECK



Attachable to any mike stand or fixture. Ends have 5/8"-27 male and female threads. GN-13 is 13" long; GN-19 is 19" long. Finished in polished chrome.

Model GN-13—List Price \$2.75

Model GN-19—List Price \$3.75

'BABY BOOM' ATTACHMENT



Easily attached to any mike stand and locked in any position. Also effectively used with bracket clamps BC-1 and SK-1. Boom length 32", chrome plated. Castings in gun metal shrivel. 5/8"-27 threads. Ship. wt. ?? lbs.

Model BB-1

List Price \$7.50

SKY HOOK



Answers many mike positioning problems. Fastens securely to ledges, round pipes, stanchions*. Has 5/8"-27 thread for any mike. Can also be used in combination with SW-1, GN-13, etc. Casting finish, gun metal shrivel; 3" long tube, chrome.

*Excellent for attaching an extra mike to a conventional floor stand.

Model SK-1

List Price \$3.50

TS-7 BANQUET STAND (Only)

For use with TB-1. Heavy base, 10" diam. All parts super-chrome plated. Adjustable tube assembly. Easily placed on and moved along speaker's table. Ship. wt. 11 lbs.

Model TS-7

List Price \$10.00



DUPLIX MIKE MOUNT



With Desk Attachment

Permits use of 2 mikes on any single stand. Reduces "off mike" possibility. Desk attachment and mike support arms detachable. Thus one mike alone may be used—to one side or rear of desk. Finished in chrome and cadmium. Moulded composition desk, 9" x 11". Ship wt. 2 1/2 lbs.

TB-1 List Price \$10.00

CABLE HANGER

Proven necessity on every mike stand. Fits all tubes, 7/8" to 1 1/4" diam.; attached and removed by 1 screw. All parts chrome finish. Model CH-1 List Price \$3.00



GYROMATIC SWIVEL

Permits any mike to be adjusted and locked into any angle on any floor or desk stand. Also useful with SK-1, BC-1, etc. Precision die castings, super-chrome finish. 4 1/2" long. 5/8"-27 male and female threads.

Model SW-1

List Price \$4.00

BOOM BRACKET KIT

Solves almost any mike placement problem. Set screw assembly enables tailoring bracket to any size. Mike cable feeds thru support arm and adjustable elbow. Bronze enamel finish. Main tubes 22" long; support tubes 5" long.

Model US-1

List Price \$11.50

BRACKET CLAMP

Very versatile. Usable with BB-1, GN-13, etc. Clamp can be removed and top flange screwed or bolted into position. Chrome tube 6" long. 5/8"-27 thread.

Model BC-1

List Price \$3.50

MICROPHONE ADAPTORS & FITTINGS

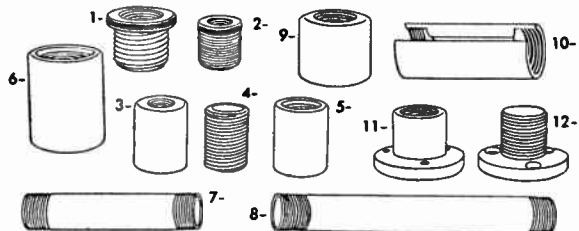

MODEL	Description	LIST PRICE
AD-1	5/8"-27 female to 1/2" pipe thread male (RCA Adaptor)	\$.85
AD-2	1/8" pipe female to 5/8"-27 male	.60
AD-3	1/8" pipe female to 5/8"-27 female	.60
AD-4	3/4" long, 5/8"-27 male running thread	.30
AD-5	5/8"-27 female to 5/8"-27 female coupling	.60
AD-6	5/8"-27 female to 1/2"-27 female coupling	.75
AD-7	3" long tube 5/8"-27 male each end	.60
AD-8	6" long tube 5/8"-27 male each end	.70
AD-9	5/8"-27 female to 5/8"-27 female	.70
AD-10	5/8"-24 female to 5/8"-27 female (W. E. Adaptor)	1.20
AD-11	Flange, 5/8"-27 female. Base Diameter 1 1/4"	.60
AD-12	Flange, 5/8"-27 male. Base holes on 7/8" mounting centers	.60

All adaptors chrome plated.

We are prepared to supply any special types of adaptors or fittings, and bent tube sections, to your specifications in reasonable quantities.

NO FINER CHOICE THAN

Electro-Voice MICROPHONES

RESEARCH-ENGINEERED

FOR TV • BC • RECORDING • P.A. • COMMUNICATIONS

DYNAMIC, CRYSTAL AND VELOCITY MICROPHONES

Model 636 "Silmal" Dynamic for P.A. Exceptionally fine for P.A. recording and general use. Response 60-13,000 cps. Output -55 db. Acoustalloy diaphragm. Pop-proof head. Alnico V. Omnidirectional. Wide pick-up range. On-off switch optional. Satin chrome finish. Tiltable head. Built-in MC-4 connector. $\frac{5}{8}$ "-27 thread. 18' cable. Size $10\frac{1}{2}$ " long including stud. $1\frac{1}{4}$ " diameter. Net wt. 1 lb. Choice of Hi-Z or Low-Z by changing one wire in connector.

List Price.....\$70.00

Model 636 G. With Gold finish.

List Price.....\$80.00

Model 630 High Fidelity, High-Output Dynamic. Brilliant, general purpose high-output dynamic, famous for quality at modest cost. Response 60-13,000 cps. Output level -55 db. Compact, light weight, unaffected by heat and humidity. Acoustalloy diaphragm. Tiltable head. Built-in MC-4 cable connector. Satin chrome finish. On-off switch. 18' cable. Available in 50, 150, 250 ohms or Hi-Z. Size 2" x $6\frac{1}{2}$ ". Net wt. 1 lb.

List Price.....\$47.00

Model 647 New P. A. Lavalier Dynamic. Small, rugged, versatile. For chest, desk or hand use, indoors and outdoors. Supplied with neck cord, support clips and 18' cord. Omnidirectional polar pattern. Response 60-13,000 cps at -57 db level. Available in 150 ohms or Hi-Z. Acoustalloy diaphragm. Built-in cable connector. Black anodized finish. Size 5" long. 1" diameter. Net wt. less cable 4 oz.

List Price.....\$80.00

Model 623 Slim Dynamic. E-V styled slim dynamic microphone in the medium price field. Ideal for P.A., recording and general use. Can be used on stand or in hand. Semi-directional. Response 65-8000 cps. Output -55 db. Choice of Hi or Low-Z by changing one wire in cable connector. Acoustalloy diaphragm. Pressure cast case finished in satin chrome. Tiltable head. On-off switch. Built-in MC-4 connector. $\frac{5}{8}$ "-27 thread. Size $7\frac{1}{2}$ " x $1\frac{1}{8}$ ". 18' cable. Net wt. 15 oz.

List Price.....\$49.50

Model 611 "Mercury" Dynamic. A traditionally styled fine performing dynamic microphone for general sound pick-up. Response 50-8000 cps. Output -55 db. Non-directional. Acoustalloy diaphragm. Tiltable head. On-off switch. Built-in MC-3 connector. $\frac{5}{8}$ "-27 thread. Satin chrome finish. Available in 50, 150 and 250 ohms or Hi-Z. Low impedance balanced to ground. Size $2\frac{3}{8}$ " x $3\frac{3}{8}$ " x $6\frac{1}{4}$ " incl. stud. Net wt. $1\frac{1}{4}$ lbs.

Model 611-8. With 6' cable List.....\$35.50

Model 611-20. With 18' cable List.....\$37.50

Model 911 "Mercury" Crystal. Same smart design and fine performance as Model 611. Response 50-8000 cps. Output -50 db. Metal Seal Crystal. Hi-Z. Net wt. $1\frac{1}{4}$ lbs.

Model 911-8. With 6' cable List.....\$25.50

Model 911-20. With 18' cable List.....\$27.50

Model 605 Durable Dynamic. For dependable, general-purpose use. Response 65-7500 cps. Output level -55 db. Non-directional, becoming directive at higher frequencies. Acoustalloy diaphragm. Head at 22° fixed tilt. Built-in MC-1 connector. Satin chrome. Choice of 50, 250 ohms or Hi-Z. Low impedance not balanced to ground. Net wt. 12 oz.

Model 605-8. With 6' cable List.....\$27.50

Model 605-20. With 18' cable List.....\$29.50



630



636



647



623



611



605

Model 920 "Spherex" Crystal. Fine quality all-direction pick-up for conferences, round table discussions, home recording and public address. Response 60-7000 cps. Output level -50 db. Omnidirectional polar pattern. Strong wire-mesh head acoustically treated for wind and moisture protection. High capacity, moisture sealed crystal. Hi-Z. Satin chrome. $\frac{5}{8}$ "-27 thread. Diameter $2\frac{1}{4}$ ". 18' cable. Net wt. 8 oz.

List Price.....\$22.50

Model 926 Slim Crystal. E-V styled slim crystal microphone. Level and response ideal for general purpose use such as home recording, P.A. and amateur. Response 70-8000 cps. Output -60 db. Hi-Z. Pressure cast case finished in satin chrome. Tiltable head. $\frac{5}{8}$ "-27 thread. Size $6\frac{3}{4}$ " x $1\frac{1}{8}$ ". 8' cable with integral strain relief. Net wt. 11 oz.

List Price.....\$24.50

Model 924 Lavalier Crystal. Unique crystal Lavalier for chest or hand use. Supplied with neck cord, support clips and 18' cable. For home recording, paging, P.A. and amateur. Pressure cast case in lustrous satin chrome finish. Wire-mesh head acoustically treated for wind and moisture protection. Output -60 db. Response 70-8000 cps. Hi-Z. Size $3\frac{3}{4}$ " x $1\frac{1}{2}$ ". 18' cable with integral strain relief. Net wt. 8 oz.

List Price.....\$18.00

Model 912 Crystal. Low cost crystal microphone. Fits needs of limited P.A., home recording, paging and general use. Handheld. Moisture sealed crystal. Response 60-7000 cps. High output -50 db. Hi-Z. Attractive gray Styron case. Size 3" x $2\frac{1}{4}$ " x $1\frac{3}{8}$ ". 5' cable. Net wt. 4 oz.

List Price.....\$8.25

Model V-2A Velocity. Superb bi-directional pick-up and reproduction of voice and music. Advanced design brings Dynamic advantages to Velocity performance. Response 40-10,000 cps. Output level -54 db. Zero pick-up at sides, top and bottom. Excellent for individual or group work in P.A., broadcasting, recording. Acoustalloy diaphragm. Choice of 50, 250 ohms or Hi-Z. Internal shock absorber. Locking cradle. On-off switch. Built-in MC-3 connector. $\frac{5}{8}$ "-27 thread. 18' cable. Size $3\frac{1}{2}$ " x $2\frac{3}{4}$ " x 8", including stud. Net wt. $2\frac{1}{2}$ lbs.

List Price.....\$65.00

Multi-Purpose Century. Incomparable for all low-cost applications. Hundreds of thousands in use for paging, recording, amateur. Can be used in any position—in hand, on table, on stand or overhead. Non-directional. Pressure cast case finished in durable satin chrome. Rugged, light weight. Size 3" x $2\frac{3}{8}$ " x 1". Furnished with $\frac{5}{8}$ "-27 thread stand adapter. AC—DC insulated.

Model 915 "Century" Crystal. Moisture sealed crystal. Response 60-7000 cps. Output -50 db. Hi-Z. 5' cable. Net wt. 10 oz.

List Price.....\$11.25

Model 915-S. Includes slide-to-talk sw. ..\$13.00

Model 615 "Century" Dynamic. Acoustalloy diaphragm. Withstands extreme temperature, humidity, corrosive effects of salt air, and severe mechanical shocks. Response 100-6000 cps. Output -55 db. Choice of 50 ohms or Hi-Z. Low impedance not balanced to ground. 5' cable. Net wt. 10 oz.

List Price.....\$19.50

Model 715 "Century" Ceramic. Moisture-proof ceramic element. Response 80-7000 cps. Output -65 db. Hi-Z. 5' cable. Net wt. 6 oz.

List Price.....\$11.25

Model 415 Reclining Desk Stand. Mounts Century at 15° tilt. Satin chrome. Size $2\frac{3}{8}$ " x $2\frac{3}{4}$ " x 1". Net wt. 4 oz.

List Price.....\$1.70



920



926



924



912



V-2A



615



715
on
415

NO FINER CHOICE THAN

Electro-Voice MICROPHONES

RESEARCH-ENGINEERED
FOR TV • BC • RECORDING • P.A. • COMMUNICATIONS

TELEVISION-BROADCAST DYNAMIC MICROPHONES

E-V engineering brings you new, versatile high-output designs in keeping with current requirements for better television-broadcast flexibility and quality. Unique Variable "D" cardioid principle delivers greater front-to-back discrimination, ultra wide range with rugged single dynamic element. Slim-Trim omnidirectional units set new style standards. Close tolerances and individual laboratory control guarantee uniformity. Ideal for recording, high quality public address and audience participation.



655



654

Model 655 Slim-Trim TV Dynamic. Frequency response 40-20,000 cps. Output level -55db. Achieves most extended efficient HF response in any microphone commercially available. Used in many laboratories as test standard. Excellent level affords high signal-to-thermal noise ratio. Pop-proof head stops blasts. Can be used on stand, in hand or on boom. Easily concealed in studio props. Acoustalloy diaphragm. Impedance 250 ohms; easily changed to 50 ohms. Cannon UA-3 connector. Has $\frac{1}{8}$ " pipe thread. $\frac{5}{8}$ "-27 adapter furnished. Black anodized finish. Size with swivel $1\frac{1}{8}$ " long, 1" diameter. 18' cable. Net wt. 11 oz.

List Price.....\$200.00

Model 654 Slim-Trim Broadcast Dynamic. Frequency response 50-14,000 cps. Output level -55 db. Quality matches closely, with less range, that of model 655; microphone is an excellent utility unit for all commercial uses. Recessed selector provides 50 or 250 ohms impedance. Pop-proof head. Acoustalloy diaphragm. Black enameled finish. Built-in Cannon XL-3 connector. $\frac{5}{8}$ "-27 thread. 18' cable. Size: 10" long with stud, 1" diameter. Net wt. $15\frac{1}{2}$ oz.

List Price.....\$95.00



635

Model 635 Broadcast Dynamic. Meets exacting requirements of TV and Broadcast service. Compact, rugged, versatile—used in studios and on remotes, on a stand or in the hand, indoors and out. Semi-directional, the Model 635 affords uniform high quality while meeting demand of most rigorous operating conditions. Uniform response from 60-13,000 cps. Output level -55 db. 50-250 ohms impedance selector. Acoustalloy diaphragm. Head tilts through 90° arc. $\frac{5}{8}$ "-27 thread. Built-in Cannon XL-3 connector. Satin chrome finish. 18' cable. Size 2" x $6\frac{1}{4}$ ". Net wt. $1\frac{1}{2}$ lbs.

List Price.....\$75.00



666

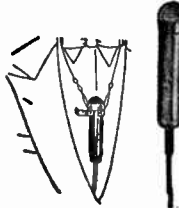

646

Model 666 Super Cardioid Microphone
Totally new concept in directional microphone design uses Variable D principle (variable acoustical distance between front and back openings). Automatically effects uniform discrimination against back sounds by an average of 24 db with no less than 14 db at any frequency. Highly resistant to mechanical shock. Model 666 affords another octave of uniform HF response over that found in conventional broadcast cardioids. Permits close talking with no bass accentuation. Increases working distance over pressure microphones by factor of 1.7:1 due to reverberation reduction. Designed for operation on boom, stand or in hand. Uses only one moving element with exclusive, rugged Acoustalloy diaphragm. Response range, typical 30-15,000 cps; output -57 db. Impedance changed on internal terminal board. Wired for 50 ohms, taps at 150 and 250 ohms. Aluminum cast case finished in TV gray. Built-in Cannon UA-3 connector. Clamp-on stand mount included with $\frac{1}{2}$ " pipe threads and $\frac{5}{8}$ "-27 adaptor. 20' cable. Size $7\frac{1}{2}$ " long, $1\frac{1}{4}$ " maximum diameter. Net wt. 11 oz.

List Price.....\$245.00

Model 650 Broadcast Dynamic. Uniform frequency response 40-15,000 cps. Output level -48 db. Dual-type external shock mount. Recessed impedance selector switch gives 50 or 250 ohms. Tiltable head. Pressure cast case, with durable satin chrome finish. Acoustalloy diaphragm. Built-in Cannon XL-3 connector. $\frac{5}{8}$ "-27 stand coupler. 18' cable. Size $2\frac{1}{4}$ " x $4\frac{1}{2}$ " x $5\frac{1}{2}$ " including stud. Shock mount is $1\frac{1}{2}$ " x $3\frac{1}{8}$ ". Net wt. including shock mount 3 lbs.

List Price.....\$150.00

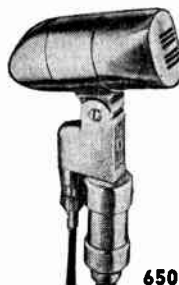

650

Model 646 New Lavaller Dynamic. Remarkably small, versatile. For chest, desk or hand use. Neck cord and support clips supplied. Frequency response, 40-15,000 cps. Output level -57 db. Choice of either 50, 150, 250 ohms impedance. Acoustalloy diaphragm. Omnidirectional pattern. Built-in cable connector. Gray anodized finish. 30' cable. Size $6\frac{3}{4}$ " long, 1" diameter. Net wt. less cable 7 oz.

List Price.....\$140.00

CARDIOID UNIDIRECTIONAL MICROPHONES

E-V Mechanophase® Principle provides wide-angle front pick-up—dead at rear. Solves difficult sound pick-up problems—assures finer, clearer reproduction of voice and music—simplifies microphone and speaker placement—increases pick-up range—permits higher volume levels. Tilttable head. Satin chrome; $\frac{5}{8}$ "-27 thread. 18' cable. Size, less shock mount, $2\frac{3}{4}$ " x 3" x 8".



731

Model 726 Dynamic (Cardyne I). Frequency response, 50-8000 cps. Output level -55 db. High-Low impedance selector. Built-in MC-3 type connector. On-off switch. Net wt. 2 lbs. 6 oz.

List Price.....\$75.00

Model 731 Dynamic (Cardyne II). Flat response 40-10,000 cps. Output level -52 db Dual-type external shock mount. High-Low impedance selector. Built-in Cannon XL-3 connector. On-off switch (optional). Net wt. $2\frac{1}{2}$ lbs.

List Price.....\$95.00



950

Model 950 Cardax Crystal. First high level cardioid crystal microphone with Dual Frequency Response—Flat response for wide range pick-up (output -57 db) or rising characteristic for extra crispness of speech (output -50 db). Hi-Z; fully enclosed Metal Seal crystal. Built-in MC-1 connector. On-off switch. Size $2\frac{1}{2}$ " x $2\frac{3}{8}$ " x $6\frac{1}{2}$ ", including stud. Net wt. 1 lb. 2 oz.

List Price.....\$42.50

*E-V Pat. No. 2,627,558.

NOTE: Reference Level: Low Impedance Dynamic Microphones 1mw/10 dynes/cm²; Crystal, Carbon Microphones: 1 volt/dyne/cm². "Low-Z" microphones operate satisfactorily with impedances of 50, 150 or 250 ohms. Weights include cables unless otherwise noted.

NO FINER CHOICE THAN

Electro-Voice

RESEARCH-ENGINEERED

MICROPHONES

STANDS AND ACCESSORIES

DIFFERENTIAL AND SPECIAL-PURPOSE MICROPHONES

Model 622SK Dynamic Handset. Meets rigid requirements of paging, intercom and communication services. Light weight, shock resistant, bakelite handset for rugged use. Standard 250-ohm magnetic receiver with response from 200-4000 cps. Switch closes microphone and relay circuit. Response 100-6000 cps. Output level -55 db. Microphone impedance 250 ohms. Acoustalloy diaphragm. 5' five-conductor unshielded coiled cord. Black phenolic. Size 9" x 3" x 2 3/8". Net wt. 1 3/4 lbs. **List Price.....\$78.00**



622

Model 805 Contact Microphone. For guitar, banjo, mandolin, violin or any vibrating musical instrument. Increases natural sound volume, enriches tonal effects. High impedance. Crystal sealed against moisture. Chrome finish. 15' cable. Net wt. 5 oz. **List Price.....\$19.75**



805

Model 606 Differential* Dynamic. Close-talking, noise-cancelling microphone. Used in airport control towers, police dispatching, close-talking P.A. and high noise industrial applications. Response substantially flat, 100-6000 cps. Output measured at 1/2" -55 db. Acoustalloy diaphragm. Head at 22° fixed tilt. 5/8"-27 thread. Built-in MC-1 connector. Satin chrome. Size 2" x 3 1/4" x 2 1/2" incl. stud. Net wt. 12 oz. Choice of 50, 250 ohms or Hi-Z. Low impedances not balanced to ground. 18' cable. **List Price.....\$45.00**



606

Only ELECTRO-VOICE can offer you noise-cancelling, DIFFERENTIAL microphones. By the DIFFERENTIAL principle, ambient or distant sound is fed into dual apertures in correct phase relationship to provide virtually complete cancellation.

*Pat. No. 2,350,010.

Model 600D Dynamic Mobile-Mike. Lightweight, hand held, extra-rugged. Output -55 db. Acoustalloy diaphragm. Press-to-talk switch. Size, 2 1/4" x 2" x 4". Black phenolic case with mounting bracket. 5' cable. Choice of 50, 250 ohms or Hi-Z. Net wt. less cable 8 oz. **List Price.....\$38.50**



600D

Model 210KK Carbon. Similar to Model 600 D, but single-button carbon. Gives high intelligibility speech transmission. Substantially flat response. Output -50 db. Press-to-talk switch. 5' coiled cord. Net wt. less cable 6 oz.

List Price.....\$32.50 (Also available in exact replacement models for Motorola, RCA, G.E. and similar mobile equipment)

Model 602 Differential* Dynamic. Similar to 600D but close-talking, noise cancelling differential. Output measured at 1/4" -55 db. Press-to-talk switch. 5' cable. Choice of 50, 250 ohms or Hi-Z. Net wt. less cable 8 oz. **List Price..\$49.50**



205KK

Model 205KK Differential* Carbon. Close-talking, noise cancelling single-button. Maximum intelligibility under high ambient noise. Blast-proof, waterproof, shock resistant. Output measured at 1/4" -50 db. Black phenolic case. Press-to-talk switch. With mounting bracket. 5' coiled cord. Size 2 1/4" x 2 1/4" x 4". Net wt. less cable 8 oz. **List Price.....\$42.50**

Model 205 STC. CAA Type Approved Certificate No. 1040 with coiled cord. **List Price.....\$54.00**

Model 205 STCP. Similar to above with WE-309 plug. **List Price.....\$58.75**

Model 208 Differential* Carbon. Single button, noise-cancelling carbon. Output -50 db. Articulation 88% under 115 db noise. Blastproof, shock resistant. Panel mounting bracket. Press-to-talk switch. 5' cable. Size 2 1/4" x 1 1/2" x 1 1/2". Net wt. less cable 3 oz. **List Price.....\$16.50**



208

MICROPHONE ACCESSORIES

Model 366 Suspension Shock Mount Extremely light boom suspension shock mount designed for use with 666 microphone. Combined weight of 366 and 666 is 17 oz., thus solving many problems of boom operation. No tools required for installing microphone. Pigtail cable connection with UA-3 connectors provides cable loop isolating boom shock noises. Made for any microphone with 1" diameter (EV 666, 655, 646). **List Price.....\$40.00**

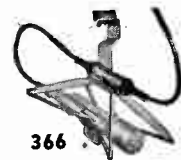

366

Model 300 Detachable Microphone Clamp Light weight adaptor fits any cylindrical microphone with 1" diameter. Provides positive means to mount on stand. Easily installed without tools with finger operated clamp. Rubber insert prevents slippage on microphone. 1" pipe thread or adaptor for 5/8"-27 thread. **List Price.....\$10.00**



300

Model 420 Desk Stand. Heavy cast iron stand attractively finished in TV gray. Specifically designed for use with E-V 666, 655, 646, or microphones with 1" diameter. Clamp attachment for mounting 1" cylindrical microphones without tools. Heavy cast iron base holds microphone in position when subjected to ordinary strain. Net wt. 3 lbs. **List Price.....\$20.00**



420

Model 416 Desk Stand. For use with 646, 647 microphones. Black rubber. Size 3 3/8" base diameter, 1" high. Net wt. 2 oz. **List Price.....\$5.00**



647 in 416

Model 423-A Desk Stand. Sturdy, smartly styled, round die-cast base, 5 1/8" diam. Rests firmly. Rich satin chrome. Rubber base buttons. 5/8"-27 thread. Choice of 3" or 5" matching stem riser. Net wt. 1 lb. **List Price.....\$4.50**



423-A

Model 427-A Desk Stand. Attractive, round die-cast base rests stably on desk or table. 5" stem riser. Satin chrome. Standard 5/8"-27 thread. Base diam. 4 3/8". Net wt. 10 oz. **List Price.....\$3.50**

Model 345 Shock Mount. Dual-type external shock mount prevents reproduction of external shocks and stand vibrations. Permits tilting microphone head. 5/8"-27 thread. Easily attached or removed. Satin chrome. Size 1 1/2" x 3 1/8". Net wt. 10 oz. **List Price.....\$13.00**



345

Model 428 Touch-to-Talk Stand. Fits standard 5/8"-27 thread. Lever-type switch for relay operation or microphone on-off—closes or opens instantly, or locks in "talk" position, with fingertip action. Gives easy "break-in" operation in communications, P.A., paging, dispatching. SPDT switch is self-contained unit, easily removable. Satin chrome. Gray plastic switch lever with locking button. Ht. 7". Base diam. 5 1/8". Net wt. 1 3/4 lb. **List Price.....\$16.00**



428

Model 335 Filter. Acoustically treated, scientifically curved grille stops wind and breath blasts in dynamic microphones. Does not affect frequency response. Easily fits over head of E-V Models 630, 635 and 605 microphones. Satin chrome. **List Price.....\$5.50**



335

Model 502 Matching Transformer. Transformer windings have low distributed capacity and are amply shielded against inductive hum by a shield inside a pressure cast case. Designed for mounting on amplifier chassis or in series with the microphone line. Designed for 50, 250 and 500 ohms—to Hi-Z. Broadcast fidelity. Response 40-20,000 cps ± 1 db, for speech or music. MC-4 input connector. **List Price.....\$15.00**

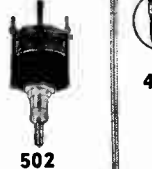

502

Model 425 Deluxe Floor Stand. Button at top of shaft gives one-hand height control from 37" to 66". Locks automatically on release. Shaft can be rotated without any adjustment device. Unique locking-type adjustable legs permit stand to be placed flush against wall or speaker's table. Easy to assemble or take apart. Folds into small, compact package. Modern die-cast base. 3-leg spread 17". Satin chrome. Net wt. 7 1/2 lbs. **List Price.....\$27.50**



425

Model 430 Utility Floor Stand. Similar to above, but with button control on lower section for height adjustment from 36" to 65". 3-leg spread 17". Gray finish. Extension shaft in satin chrome. Net wt. 7 1/2 lbs. **List Price.....\$17.00**

NO FINER CHOICE THAN

Electro-Voice

MODERN PHONOGRAPH

CARTRIDGES

FOR ALL RECORD SPEEDS

STOCK ONLY

6 BASIC PREFERRED TYPES ★

TO MAKE OVER **92%** OF ALL CARTRIDGE REPLACEMENTS

CARTRIDGES FOR 78 R.P.M.

Model 12 Crystal. The most versatile 78 r.p.m. cartridge. 2 volt output is ideal for most phono combinations. Weighs 1/5 ounce. Tracks perfectly with less needle force. Ideal for "in stock" cartridges for general replacement. Supplied with Snap-In Holder and mounting hardware. For standard 1/2" hole centers, RCA 13/16" mounting or Webster-Electric side mounting cartridges.



PREFERRED ★

Model 12, with O-3 Osmium needle. List...\$7.50

Model 32 Crystal. Provides the longest record life, lowest needle talk and greatest stylus life. Ideal for record enthusiasts with valuable libraries of 78 r.p.m. records. Frequency response to 10,000 cps. Output 1.8 volts, usable in most radio-phono combinations. Standard 1/2" mounting. Uses E-V whisker-type needle.



Model 32, with O-3 Osmium needle. List...\$6.50

Model 42 Ceramic*. The model 42 cartridge utilizes a ceramic generating element for complete moisture protection. Long-lasting in extremely hot, humid climates. Output is 1 volt. Mounting bracket of Model 42 for mounting in tone arms with 1/2" hole centers.



Model 42, with O-3 Osmium needle. List...\$6.50

CARTRIDGES FOR 45 and 33 1/3 R.P.M.

Model 14 Crystal. The Model 14 cartridge gets all the music from the extended range fine groove records. Response follows professional standards... free from peaks and distortion that mar wide range response. Response, 30 to 10 kc. A truly high fidelity phono-cartridge that requires no expensive preamplifier or equalizer. Output, 1 volt. Uses E-V 1-mil, whisker-type needle.



Model 14, with O-1 Osmium needle. List...\$7.50

Model 14-S, with S-1 Sapphire needle. List...\$8.50

Model 34 Crystal. The high compliance voltage product of this cartridge makes it a superb replacement for 45 and 33 1/3 r.p.m. players. Reproduction is fuller yet needle tracks with whisker touch. Records sound better and last longer. 1.25 volts output is slightly higher than average fine groove cartridge. Mounting bracket has 1/2" and 5/8" hole centers. Ideal replacement in RCA-type "45" changers and Columbia "LP" players. Uses E-V whisker-type 1-mil needle.



Model 34, with O-1 Osmium needle. List...\$6.50

Model 34-S, with S-1 Sapphire needle. List...\$7.50

Model 44 Ceramic*. Model 44 utilizes a ceramic generating element for complete moisture protection. Makes an ideal, long lasting replacement in hot, humid climates. Output is .8 volt. Model 44 mounts in tone arms with either 1/2" or 5/8" hole centers.



PREFERRED ★

Model 44, with O-1 Osmium needle. List...\$6.50

Model 44-S, with S-1 Sapphire needle. List...\$7.50

*Electro-Voice ceramic phono-cartridges are directly interchangeable with silent-needle-type crystal cartridges (those that do not use the thumb screw). E-V ceramic cartridges have equivalent output to the manufacturers' original crystal types they replace.

ELECTRO-VOICE REPLACEMENT NEEDLES

MODEL	TYPE AND APPLICATION	LIST PRICE
O-3	Single-Tip .003" Osmium for Models 12, 32, 42, 96, 96-T	\$1.50
S-3	Single-Tip .003" Sapphire for Models 12, 32, 42, 96, 96-T	2.50
O-2	Single-Tip .0023" Osmium for Models 33, 43	1.50
S-2	Single-Tip .0023" Sapphire for Models 33, 43	2.50
O-1	Single-Tip .001" Osmium for Models 14, 34, 44, 96, 96-T	1.50
S-1	Single-Tip .001" Sapphire for Models 14, 34, 44, 96, 96-T	2.50
SO-13	Twin-Tip .001" Sapphire-.003" Osmium for Models 16 & 16-TT	3.00
O-13	Twin-Tip .001" Osmium-.003" Osmium for Models 16 & 16-TT	2.50

†@Brash Development Co.

CARTRIDGES FOR 78, 45, 33 1/3 R.P.M.

Model 33 Crystal. Utilizes a special needle which plays all three speeds with a single tip. Simplifies operation of multi-speed changers. Tracks well in all grooves. 2.3 mil tip reduces record wear over other types of all-purpose needles. Output 1.25 volts on microgroove, 1.8 volts on 78 r.p.m. records. Mounting bracket has standard 3/8" hole centers. Uses E-V whisker-type 2.3 mil needle.



Model 33, with O-2 Osmium needle. List...\$6.50

Model 33-S, with S-2 Sapphire needle. List...\$7.50

Model 43 Ceramic*. Model 43 utilizes a specially designed all-purpose needle which plays all three speeds with a single tip. Ceramic generating element assures complete moisture protection. Ideal replacement for multi-speed changers in hot, humid climates. Output is .5 to 1 volt. Mounting bracket holes spaced at 1/2".



PREFERRED ★

Model 43, with O-2 Osmium needle. List...\$6.50

Model 43-S, with S-3 Sapphire needle. List...\$7.50

Model 16-TT Crystal TWIN TILT. Plays all 3 speeds with a one-piece, twin-tip needle without weight change. Complete with Tilt mechanism. Merely tilt the selector handle to select the 1-mil or 3-mil needle tip... for slow or fast speed records. Output, 1-volt on each tip. Exact replacement for Webcor tilt cartridges. With Osmium 3-mil tip and Sapphire 1-mil tip on single E-V silent, whisker-type stylus.



PREFERRED ★

Model 16-TT, List Price...\$10.00

Model 16. Cartridge only, without Tilt mechanism, but with Osmium 3-mil tip and Sapphire 1-mil tip, for exact replacement of units already installed.

List Price...\$9.00

Model 46-T Ceramic* TURNOVER. Popular turnover type cartridge with separate needles for fast and slow speed records. The two needles are isolated from one another allowing correct frequency response on each. "Free" needle does not cause distortion. Output, .8 volt on each needle. Positive-acting turnover mechanism prevents needle set-down error. Mounting plate supplied for LQD type cartridges. Complete with 3-mil Osmium needle and 1-mil Sapphire needle.



PREFERRED ★

Model 46-T, List Price...\$10.00

Model 46. Same but without turnover harness for installation in existing mechanism.

List Price...\$9.00

Model 96-T Crystal Turnover. Utilizes a crystal generating element. Output is 1 volt on each needle. Incorporates all construction features of 46-T.

Model 96-T, List Price...\$10.00

Model 96. Same but without turnover harness for installation in existing mechanism.

List Price...\$9.00

WITHOUT NEEDLE

Model 60 Crystal DUO-VOLT. This Bimorph crystal cartridge permits easy selection of high or medium output for the job. Connect leads to the two outer terminals for 4 volts output or to the center terminal and one outer terminal for 2 volts. On 78 r.p.m. records, output is 6 or 3 volts. No soldering. No accessories required. Uses any standard 3-mil, 1-mil, or all-purpose needle. 1/2" mounting hole centers. Aluminum case. Ideal for varied replacement needs.



PREFERRED ★

Model 60. Less needle. List Price...\$4.95

Model 50 Crystal. Bimorph high level cartridge, supplied without needle. Can be used with any standard 1-mil, 3-mil or all-purpose tip replacement needle. Output level with straight shank is 2.5 volts. Excellent replacement in record players with low gain amplifiers and in single play phonographs. Aluminum case.



Model 50. Less needle. List Price...\$4.50

PRICES

Prices of manufacturers and suppliers' products listed in **RADIO'S MASTER** are subject at all times to change without notice — they should not be considered final.

Get quick on-the-spot quotations from your distributor who subscribes to our perpetual up-to-the-minute **PRICING SERVICE**.



Official Pricing System of radio - electronic - television parts and equipment. Supported by the industry: distributors, manufacturers, and their sales representatives.

Loose-leaf, flexible binder.
Contains over 1100 pages.

Published by
UNITED CATALOG PUBLISHERS, INC.
106-110 Lafayette Street
New York 13, N. Y.

DELIVERY

Delivery is often dependent on the availability of raw materials. So check with your distributor for delivery information.

Capps

FRANK L. CAPPS & CO., inc.
valley stream, n.y.

CONDENSER MICROPHONES

"PROFESSIONAL"

Model CM 2001

The CAPPS "PROFESSIONAL" is designed especially for High Fidelity enthusiasts, professional musicians and recording artists. It combines the high performance standards of the CAPPS "STUDIO" microphone with economies achieved through volume production. It is supplied COMPLETE with self contained PREAMPLIFIER, POWER SUPPLY, and CABLE. Dimensions: $1\frac{1}{8}$ " dia. x 6" long; weight: 12 ozs.

High impedance.

SETS NEW RECORDING
INDUSTRY STANDARDS

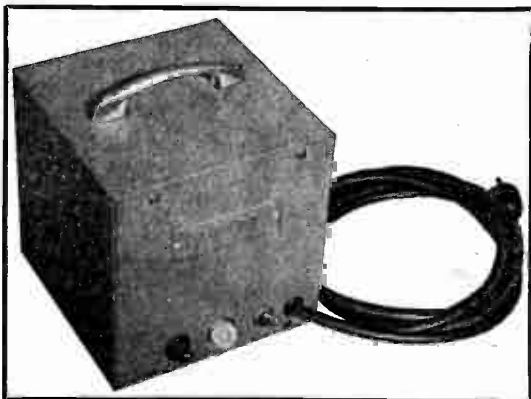

- 30-15,000 cps ± 3 db
- Omnidirectional
- Acoustically faithful
- Free from angular discrimination
- Blast proof
- Unaffected by moist atmospheres



"STUDIO"

Model CM 2030—30 Ohm
Model CM 2250—250 Ohm

Custom built and used by leading high fidelity recording and movie studios for the past several years, the CAPPS "STUDIO" condenser microphone is now available to all who want or must have the ultimate in acoustical transmission. Small and unobtrusive, this microphone has a quick-mount feature which allows its use either hand-held or on a microphone stand. It houses a miniature self-contained preamplifier.

Dimensions: $1\frac{1}{8}$ " dia. x 6" long. Microphone operates with Power Supply CM 3003 and Cable No. 51.

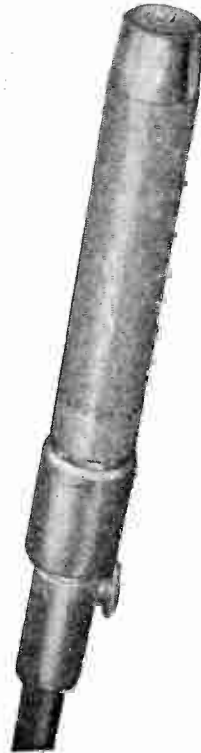

POWER SUPPLY, Model CM 3003

Designed for rugged and continuous operation, the CAPPS Model CM 3003 preamplifier power supply, used with the CAPPS Model CM 2030 or CM 2250 microphones assures the quality performance and dependability which is built into each CAPPS microphone.

CABLE No. 51 (not shown)

Cable connects microphone to power supply, 25 ft. long, equipped with Cannon connectors Nos. P-6-CG-11 and P-6-CG-12.

FINEST IN AUDIO SINCE 1929

American

FULL VISION

MICROPHONES

DR 330

RIBBON and DYNAMIC CARDIOID

FREQUENCY RESPONSE: 40-15,000 c.p.s., plus or minus 2.5 db.

OUTPUT LEVEL: -86 db. for 50 ohms impedance (0 db = 1 volt/dyne/cm²).

POLAR PATTERN: True cardioid. Easily and quickly changed to bi-directional ribbon only, or omni-directional dynamic only.

IMPEDANCE: Easily and quickly changed to 50, 150 or 250 ohms.

CONNECTOR: Cannon XL-3-11 "latch-lock" connector.

CABLE: 25 ft. two-conductor shielded rubber covered.

STAND COUPLING: 3/8"-27 thread on combination swivel and "slide-lock."

DIMENSIONS: Ht. 6 ins., dia. 2 ins., wt. 20 ozs.

LIST PRICE: Code; REBID **\$250.00**



D 33

DYNAMIC OMNI-DIRECTIONAL

FREQUENCY RESPONSE: 40-15,000 c.p.s., plus or minus 2.5 db.

OUTPUT LEVEL: -86 db for 30-50 ohms impedance (0 db = 1 volt/dyne/cm²).

IMPEDANCE: Easily and quickly changed to 30-50 or 250 ohms.

CONNECTOR: Cannon XL-3-11 "latch-lock" connector.

CABLE: 25 ft. two-conductor shielded rubber covered.

STAND COUPLING: 3/8"-27 thread on combination swivel and "slide-lock."

DIMENSIONS: Ht. 8 1/4 ins., dia. 1 in., wt. 7 ozs.

LIST PRICE: Code; DOING **\$125.00**

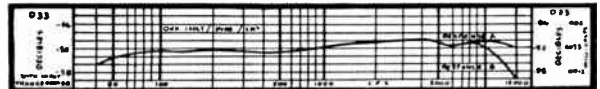

DR 331

RIBBON BI-DIRECTIONAL

FREQUENCY RESPONSE: 50-8000 c.p.s., plus or minus 3.0 db.

OUTPUT LEVEL: -55 db for high impedance (0 db = 1 volt/dyne/cm²).

POLAR PATTERN: True velocity bi-directional.

IMPEDANCE: Easily and quickly changed to low (30-50) med. (250) or high (40,000) ohms.

CONNECTOR: Cannon XL-3-11 "latch-lock" connector.

CABLE: 25 ft. single-conductor shielded rubber covered.

STAND COUPLING: 3/8"-27 thread on comb. swivel and "slide-lock."

DIMENSIONS: Ht. 6 ins., dia. 2 ins., wt. 20 ozs.

LIST PRICE: Code; DYRIB **\$75.00**

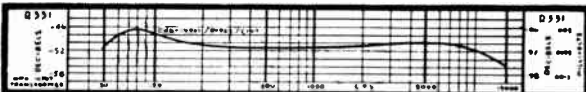

D 22

DYNAMIC OMNI-DIRECTIONAL

FREQUENCY RESPONSE: 100-8000 c.p.s., plus or minus 5.0 db.

OUTPUT LEVEL: -52 db for high impedance (0 db = 1 volt/dyne/cm²).

IMPEDANCE: Easily and quickly changed to low (30-50) or high (40,000) ohms.

CONNECTOR: Cannon XL-3-11 "latch-lock" connector.

CABLE: 25 ft. single conductor shielded rubber covered.

STAND COUPLING: 3/8"-27 thread on combination swivel and "slide-lock."

DIMENSIONS: Ht. 8 1/4 ins., dia. 1 in., wt. 7 ozs.

LIST PRICE: Code; doall **\$75.00**

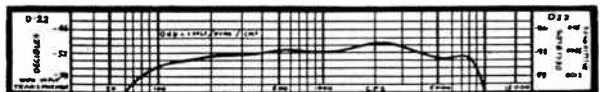

DR 332

RIBBON and DYNAMIC CARDIOID

FREQUENCY RESPONSE: 50-8,000 c.p.s., plus or minus 5.0 db.

OUTPUT LEVEL: -53 db for high impedance (0 db = 1 volt/dyne/cm²).

POLAR PATTERN: True cardioid.

IMPEDANCE: Easily and quickly changed to low (30-50), med. (250) or high (40,000) ohms.

CONNECTOR: Cannon XL-3-11 "latch-lock" connector.

CABLE: 25 ft. single-conductor shielded rubber covered.

STAND COUPLING: 3/8"-27 thread on combination swivel and "slide-lock."

DIMENSIONS: Ht. 6 ins., dia. 2 ins., wt. 20 ozs.

LIST PRICE: Code; BIRIB **\$85.00**

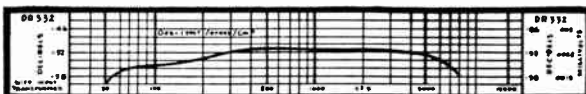

D 44

DYNAMIC OMNI-DIRECTIONAL

FREQUENCY RESPONSE: 50-15,000 c.p.s., plus or minus 2.5 db.

OUTPUT LEVEL: -88 db, 50 ohms impedance (0 db = 1 volt/dyne/cm²).

IMPEDANCE: 50 ohms.

CONNECTOR: American APF-1

COUPLING: Microphone terminated in male part of connector. Female part of connector has ring-lock ferrule for convenient disconnect. Coupling 3/8"-27 internal thread for installation on fish pole or boom.

DIMENSIONS: Ht. 6 3/4 ins., mic. unit 3 3/4 ins., wt. 7 ozs.

LIST PRICE: Code; dixie **\$225.00**

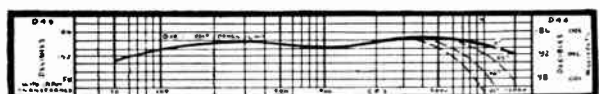

Licensed under Patents of the Brush Development Co.

Licensed under Patents of Western Electric Co., Inc.

American

MICROPHONE CO., 370 SOUTH FAIR OAKS AVE., PASADENA 1, CALIFORNIA

American

FULL VISION

MICROPHONES

D9AT

DYNAMIC UNI-DIRECTIONAL

FREQUENCY RESPONSE: 100-7,000 c.p.s.
 OUTPUT LEVEL: -54 db for high impedance
 (0 db=1 volt/dyne/cm²).
 IMPEDANCE: 38,000 ohms. (200 or 500 ohms available)
 CONNECTOR: Cannon XL-3-11 "latch-lock."
 CABLE: 25 ft. single-conductor shielded rubber covered.
 STAND COUPLING: 3/4"-27 thread.
 DIMENSIONS: Ht. 7 ins., breadth 2 1/2 ins., wt. 2 1/2 lbs.



LIST PRICE: Code; HIWEL..... **\$45.00**

D9A

LOW 50

LIST PRICE: Code; LOWEL..... **\$42.00**

D7T

DYNAMIC OMNI-DIRECTIONAL

FREQUENCY RESPONSE: Substantially flat.
 OUTPUT LEVEL: -57 db for high impedance
 (0 db=1 volt/dyne/cm²).
 IMPEDANCE: 38,000 ohms. (200 to 500 ohms available).
 CONNECTOR: MC-1M Amphenol.
 CABLE: 12 1/2 ft. single-conductor shielded rubber covered
 with Amphenol female fitting, loose end.
 STAND COUPLING: 3/4"-27 thread
 DIMENSIONS: Ht. 2 1/2 ins., dia. 1 1/2 in., wt. 8 1/2 ozs.



LIST PRICE: Code; DISET..... **\$27.00**

D7

LOW 50

LIST PRICE: Code; DISEV..... **\$24.00**

D7TP

DYNAMIC OMNI-DIRECTIONAL PRESS TO TALK SWITCH

FREQUENCY RESPONSE: Substantially flat.
 OUTPUT LEVEL: -57 db. for high impedance
 (0 db=1 volt/dyne/cm²).
 IMPEDANCE: 38,000 ohms. (200 or 500 ohms available).
 CABLE: 6 ft. single-conductor shielded rubber covered,
 loose end.
 DIMENSIONS: Ht. 8 ins., dia. 1 1/2 ins., wt. 10 1/2 ozs.



LIST PRICE: Code; DIMAT..... **\$31.00**

D7P

LOW 50

LIST PRICE: Code; DIMAR..... **\$28.00**

D5T

DYNAMIC SEMI-DIRECTIONAL

FREQUENCY RESPONSE: 50-6,000 c.p.s.
 OUTPUT LEVEL: -52 db for high impedance
 (0 db=1 volt/dyne/cm²).
 IMPEDANCE: 38,000 ohms. (200 or 500 ohms available).
 CONNECTOR: Cannon XL-3-11.
 CABLE: 25 ft. single-conductor shielded rubber covered.
 STAND COUPLING: 3/4"-27 thread on swivel.
 DIMENSIONS: Ht. 3 1/2 ins., dia 2 1/2 ins., wt. 1 1/2 lbs.



LIST PRICE: Code; DYHIM..... **\$37.00**

D5

LOW 50

LIST PRICE: Code; DYLOM..... **\$3.00**

D8T

DYNAMIC OMNI-DIRECTIONAL

FREQUENCY RESPONSE: Substantially flat 100-6,000
 c.p.s.
 OUTPUT LEVEL: -56 db (0 db=1 volt/dyne/cm²).
 IMPEDANCE: 38,000 ohms. (200 or 500 ohms available).
 CONNECTOR: Amphenol MC-1M.
 CABLE: 12 1/2 ft. single-conductor shielded rubber covered.
 STAND COUPLING: 3/4"-27 thread on swivel.
 DIMENSIONS: Ht. 3 1/4 ins., dia. 2 ins., wt. 13 ozs.



LIST PRICE: Code; DATAH..... **\$30.00**

D8

LOW 50

LIST PRICE: Code; DATAL..... **\$27.00**

D7TS

DYNAMIC OMNI-DIRECTIONAL SLIDE SWITCH

FREQUENCY RESPONSE: Substantially flat.
 OUTPUT LEVEL: -57 db. for high impedance
 (0 db=1 volt/dyne/cm²).
 IMPEDANCE: 38,000 ohms. (200 or 500 ohms available).
 CABLE: 6 ft. single-conductor shielded rubber covered,
 loose end.
 DIMENSIONS: Ht. 8 ins., dia. 1 1/2 ins., wt. 14 ozs.



LIST PRICE: Code; DIAHT..... **\$30.00**

D7S

LOW 50

LIST PRICE: Code; DIAHL..... **\$27.00**

D6T

DYNAMIC OMNI-DIRECTIONAL

FREQUENCY RESPONSE: 100-6,000 c.p.s.
 OUTPUT LEVEL: -54 db for high impedance
 (0 db=1 volt/dyne/cm²).
 IMPEDANCE: 38,000 ohms. (200 or 500 ohms available).
 CONNECTOR: Amphenol MC-1M.
 CABLE: 25 ft. single-conductor shielded rubber covered.
 STAND COUPLING: 3/4"-27 thread on swivel.
 DIMENSIONS: Ht. 3 3/4 ins., dia. 2 1/2 ins., wt. 1 3/4 lbs.



LIST PRICE: Code; DIXIT..... **\$33.00**

D6

LOW 50

LIST PRICE: Code; DIXIX..... **\$30.00**

D4T

DYNAMIC OMNI-DIRECTIONAL

FREQUENCY RESPONSE: 60-7,500 c.p.s.
 OUTPUT LEVEL: -56 db for high impedance
 (0 db=1 volt/dyne/cm²).
 IMPEDANCE: 38,000 ohms. (200 or 500 ohms available).
 CONNECTOR: Amphenol MC-1M.
 CABLE: 12 1/2 ft. single-conductor shielded rubber covered.
 STAND COUPLING: 3/4"-27 thread on swivel.
 DIMENSIONS: Ht. 4 ins., dia 2 ins., wt. 10 1/2 ozs.



LIST PRICE: Code; DFORT..... **\$24.00**

D4

LOW 50

LIST PRICE: Code; DEFOR..... **\$21.50**

Licensed under Patents of the Brush Development Co.

Licensed under Patents of Western Electric Co., Inc.

American

MICROPHONE CO., 370 SOUTH FAIR OAKS AVE., PASADENA 1, CALIFORNIA

American

FULL VISION

MICROPHONES

D4G



DYNAMIC LECTURERS MICROPHONE

FREQUENCY RESPONSE: 100-4,000 c.p.s.
 OUTPUT LEVEL: -86 db for low impedance
 (0 db = 1 volt/dyne/cm²).
 IMPEDANCE: 50 ohms.
 CONNECTOR: Cannon XL-3-11 "latch-lock."
 CABLE: 25 ft. two-conductor shielded rubber covered.
 DIMENSIONS: Wt. 12 ozs., complete.

LIST PRICE: Code; MICRO.....

D4GT

HL. LIST PRICE: Code; GETEE.....



C6



CRYSTAL SEMI and NON-DIRECTIONAL

FREQUENCY RESPONSE: 100-6,000 c.p.s.
 OUTPUT LEVEL: -55 db (0 db = 1 volt/dyne/cm²).
 IMPEDANCE: High.
 CONNECTOR: Amphenol. MC-1M.
 CABLE: 6 ft. single-conductor shielded rubber covered.
 STAND COUPLING: 3/4" 27 thread on swivel.
 DIMENSIONS: Ht. 3 ins., dia. 2 1/4 ins., wt. 8 ozs.

LIST PRICE: Code; CESIX.....

\$18.00

C7H



CRYSTAL MICROPHONE

FREQUENCY RESPONSE: 50-6,000 c.p.s.
 OUTPUT LEVEL: -55 db. (0 db = 1 volt/dyne/cm²).
 IMPEDANCE: High.
 CONNECTOR: Amphenol MC-1M.
 CABLE: 12 1/2 ft. single-conductor shielded rubber covered.
 STAND COUPLING: 3/4" 27 thread on swivel.
 DIMENSIONS: Length 3 1/2 ins., dia. 2 1/2 ins., wt. 15 ozs.

LIST PRICE: Code; CSEVN.....

\$24.50

C7L

LOW 50

LIST PRICE: Code; CSEVL.....

\$29.00

CL2



CRYSTAL LAPEL MICROPHONE

FREQUENCY RESPONSE: 50-5,000 c.p.s.
 OUTPUT LEVEL: -55 db. (0 db = 1 volt/dyne/cm²).
 IMPEDANCE: High.
 CABLE: 25 ft. single-conductor shielded plastic covered.
 DIMENSIONS: Dia. 2 1/4 ins., depth 3/4 in., wt. 6 1/4 ozs.

LIST PRICE: Code; LATAL.....

\$27.25

RC



CRYSTAL MICROPHONE

FREQUENCY RESPONSE: 50-6,000 c.p.s.
 OUTPUT LEVEL: -55 db. (0 db = 1 volt/dyne/cm²).
 IMPEDANCE: High.
 CABLE: 7 ft. single-conductor shielded rubber covered.
 STAND COUPLING: Base easily removed by half turn of bayonet lock for use as hand microphone. Handle has 3/4" 27 ext. thread, microphone unit 3/8" 27 int. thread for mounting on a floor stand.
 DIMENSIONS: Ht. 10 ins., wt. 1 lb.

LIST PRICE: Code; ARCEE.....

\$10.90

RCS

SWITCH

LIST PRICE: Code; ARCEX.....

\$13.50

"501" SERIES HAND-HELD MICROPHONE

CARBON

C501A 27.50
 C501B 31.50
 C501C 29.50
 C501D 33.00
 C501E 33.00
 C501F 33.00
 C501G 33.00

DYNAMIC

D501A 29.00
 D501B 31.50
 D501C 32.50
 D501D 33.00
 D501E 36.50



J1

PHONOGRAPH PICKUP



RECORD: 78 RPM.
 NEEDLE FORCE: 1 1/4 ounces.
 OUTPUT VOLTAGE: 3 volts.
 FREQUENCY RANGE: 50-8,000 c.p.s.
 AMERICAN CARTRIDGE USED: CR1A (no needle).
 LIST PRICE: Code; JADE.....

\$13.50

J3

LIGHTWEIGHT PHONOGRAPH PICKUP



RECORD: Long playing and 78 RPM.
 NEEDLE FORCE: 6 grams.
 OUTPUT VOLTAGE: 1 volt.
 FREQUENCY RANGE: 50-6,000 c.p.s.
 AMERICAN CARTRIDGE USED: CR5, CR6 or CR7 which includes Osmium or Sapphire tip needle. Specify corridge and needle required.

LIST PRICE: Code; JUBAL.....

\$8.00

Licensed under Patents of the Brush Development Co.

Licensed under Patents of Western Electric Co., Inc.

American

MICROPHONE CO., 370 SOUTH FAIR OAKS AVE., PASADENA 1, CALIFORNIA

American

CRYSTAL CARTRIDGES

CR1A 78 RPM



NEEDLE FORCE: 1½ ounces.
 OUTPUT VOLTAGE: 3 volts.
 FREQUENCY RANGE: 50-8,000 c.p.s.
 WEIGHT: 17 grams.
 NEEDLE TYPE: Optional (Not supplied).
 LIST PRICE: Code: CINCH.....

CR1A cartridges feature the exclusive American designed "Torque-Limit" needle chuck. Prevents chuck moving when tension or pressure is applied to the needle screw, insuring needle socket remaining centrally located in the cartridge, and guaranteeing excellent needle point compliance. Best operation is obtained with offset needles using Sapphire or precious metal tip.

CR2A 78 RPM



NEEDLE FORCE: 1½ ounces.
 OUTPUT VOLTAGE: 1½ volts.
 FREQUENCY RANGE: 50-7,000 c.p.s.
 WEIGHT: 17 grams.
 NEEDLE TYPE: Optional (Not supplied).
 LIST PRICE: Code: CIVIC.....

CR2A cartridges feature the exclusive American designed "Torque-Limit" needle chuck. Prevents chuck moving when tension or pressure is applied to the needle screw, insuring needle socket remaining centrally located in the cartridge, and guaranteeing excellent needle point compliance. Best operation is obtained with offset needles using Sapphire or precious metal tip.

CR4A 78 RPM



NEEDLE FORCE: 1½ ounces.
 OUTPUT VOLTAGE: 3½ volts.
 FREQUENCY RANGE: 50-8,000 c.p.s.
 WEIGHT: 17 grams.
 NEEDLE TYPE: Optional (Not supplied).
 LIST PRICE: Code: CLASP.....

The CR4A cartridge representing a desirable combination of high output together with wide frequency range, makes this a most desirable unit. Also features the exclusive American designed "Torque-Limit" needle chuck.

CR5 LONG PLAYING 33½ and 45 RPM



NEEDLE FORCE: 6 grams.
 OUTPUT VOLTAGE: 1 volt.
 FREQUENCY RANGE: 50-6,000 c.p.s.
 WEIGHT: 5 grams.
 NEEDLE TYPE: One mil radius Osmium tip needle supplied.
 LIST PRICE: Code: CABAL.....
 CR5 LONG PLAYING 33½ and 45 RPM.
 Same as above with Sapphire tip.
 LIST PRICE: Code: CADAN.....

The CR5 cartridge using one mil radius Osmium tipped stylus is highly recommended for replacement in most 33½ and 45 RPM record players.

CR6 78 RPM



NEEDLE FORCE: 8 grams.
 OUTPUT VOLTAGE: 1 1/2 volts.
 FREQUENCY RANGE: 50-6,000 c.p.s.
 WEIGHT: 5 grams.
 NEEDLE TYPE: Three mil radius Osmium tip needle supplied.
 LIST PRICE: Code: CUPAY.....
 CR6S 78 RPM.
 Same as above with Sapphire tip.
 LIST PRICE: Code: CUPAN.....

The CR6 cartridge using a three mil radius Osmium tipped or Sapphire tipped stylus is an exceptionally light weight unit for replacement in 78 RPM record players where required.

CR7 COMBINATION 33½, 45, and 78 RPM



NEEDLE FORCE: 8 grams.
 OUTPUT VOLTAGE: 1 volt.
 FREQUENCY RANGE: 50-6,000 c.p.s.
 WEIGHT: 5 grams.
 NEEDLE TYPE: .0017 mil radius Osmium tip supplied.
 LIST PRICE: Code: CADET.....
 CR7S COMBINATION 33½, 45 and 78 RPM.
 Same as above with Sapphire tip.
 LIST PRICE: Code: CADER.....

The CR7 cartridge is equipped with a combination Osmium tip stylus that will play both 78 RPM and microgroove records. Sapphire tip stylus available.

S2A 78 RPM



NEEDLE FORCE: 1 ounce.
 OUTPUT VOLTAGE: 1 volt.
 FREQUENCY RANGE: 50-6,000 c.p.s.
 WEIGHT: 17 grams.
 NEEDLE TYPE: 3 mil radius Osmium tip needle supplied.
 LIST PRICE: Code: DELTA.....

The S2A cartridge has rolled-off high frequency response for pleasant listening to all types of recordings and transcriptions. The reduction of surface noises restores old albums of favorite records to new usefulness.

PNMA 78 RPM



NEEDLE FORCE: 1½ ounces.
 OUTPUT VOLTAGE: 1 volt.
 FREQUENCY RANGE: 50-5,000 c.p.s.
 WEIGHT: 17 grams.
 NEEDLE TYPE: Optional (Not supplied).
 LIST PRICE: Code: CRESS.....

The PNMA cartridge is designed for use in extreme temperature and humidity conditions. Crystal element is moisture-resistant, sealed in a metal jacket, and will withstand temperatures to 200 degrees Fahrenheit. FOR BEST RESULTS: PNMA cartridges should be terminated into a load resistor of 5 megohms or higher. Low capacity cable from cartridge to amplifier input should be used, and should be as short as possible.

Licensed under Patents of the Brush Development Co.

Licensed under Patents of Western Electric Co., Inc.

American MICROPHONE CO., 370 SOUTH FAIR OAKS AVE., PASADENA 1, CALIFORNIA

Electro-Sonic Laboratories

"For Listening at its Best"

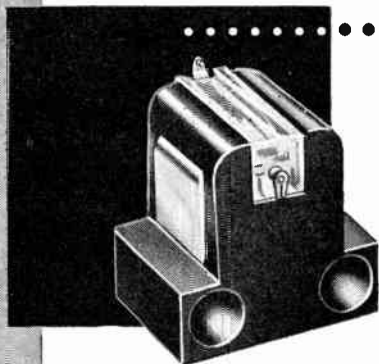

PHONOGRAPH CARTRIDGE

Electro-Sonic Laboratories phonograph cartridges are the finest available at any price. True electrodynamic design provide resonance — free performance over the entire audio range from 20 to 20,000 cycles at intermodulation levels well below 1%.

The Standard Series will mount in modern changers and tone arms. The Professional Series are magnificent products which may be considered the ultimate in transcription apparatus. They may be employed with the Type 309 or 310 tone arms.

CARTRIDGE PERFORMANCE DATA

Type	Standard Series	Professional Series
Weight (grams)	10	28
Impedance (ohms)	1.5	1.5
Equivalent mass at stylus (grams)	.003	.001
Compliance cm/dyne	4.43×10^{-6}	6.8×10^{-6}
Stylus force (grams)	5-15	3-10
*Min. output (mv)	1	2
frequency response (cycles per second)	20-20,000	20-20,000

*1000 cycles RCA test record 12-5-31V

STANDARD SERIES	NET
ESL 101 (.003" Sapphire)	\$14.95
ESL 111 (.001" Microgroove)	14.95
ESL 121 (.001" Diamond)	29.95
ESL 131 (.003" Diamond)	29.95

Professional Series Prices
Upon Request.



MATCHING TRANSFORMER

For application flexibility, Electro-Sonic Laboratories, Inc. provides a choice of high quality, heavily shielded matching transformers for use with Electro-Sonic Laboratories phonograph cartridges. The frequency response of these units is within 2 db between 20 and 20,000 cycles per second.

Type	Impedance ratio (ohms)	*Output Voltage (millivolts)	Price
ESL201	1.5:50	7.5	\$7.50
	1.5:200	15.0	
ESL211	1.5:90,000	200	6.25

*Standard Series operated from test record RCA 12-5-31V.

A 15 millivolt output level is sufficient to drive most amplifiers designed for magnetic cartridges to full output.

PROFESSIONAL TONE ARM

PHYSICAL CHARACTERISTICS

Type	Weight (grams)	Weight (lbs.)	*Effective Radius (Inches)	Overall Length (Inches)
309	575	1.33	12.5	15.375
310	600	1.38	12.5	15.750

*with professional series cartridge

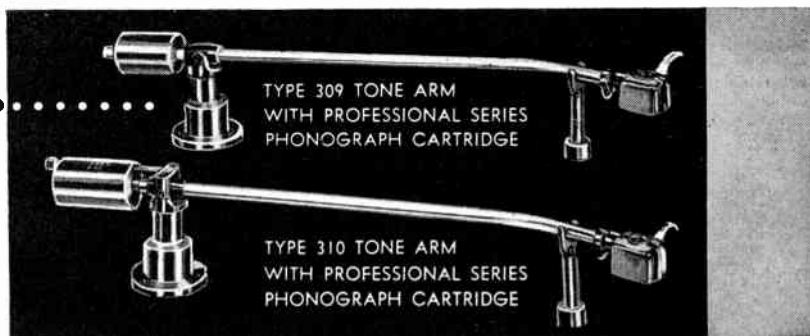

The Professional tone arms are superbly machined ball bearing devices for use with the Professional series cartridge. The stylus force is adjustable to a fine degree of tolerance by means of a movable counterweight in the case of the type 309, and by means of a spring balance in the type 310. The arm height is adjustable.

Professional Series Equipment Prices upon request.

ELECTRO-SONIC LABORATORIES, INC.

35-34 36th ST., LONG ISLAND CITY, N. Y.



MICROPHONES

BRUSH MODEL BA-106 MICROPHONE



The Brush Model BA-106 is a high quality microphone incorporating the hermetically sealed "Acoustical" with Sintered bronze damping. "Metalseal" crystal is used for protection against conditions of high humidity. This microphone offers unexcelled response in microphones of this type and price range.

Vibration, shock or low frequency wind noise do not affect the performance of this microphone.

Output level 50 db. below 1 volt/dyne cm².

Flat from 40 to 6,000 cps. Unexcelled for home recording, public address systems, ham shacks, monitoring and institutional and industrial applications.

Net Wt. 1 1/4 lbs.

Shipping Wt. 3 1/4 lbs.

List Price \$22.75

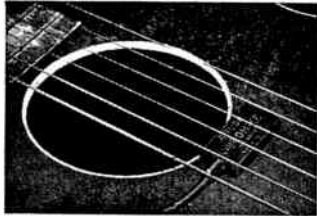

BRUSH MODEL BA-109 MICROPHONE

The Brush Model BA-109 microphone using the improved Acoustical* was created for public address, home recording and amateur applications. The "Metalseal" crystal insures long life and reliability. Styled in rich maroon plastic and brushed chrome in compliance with the recent trend in industrial design.

- Response from 40 to 10,000 cps.
- Output Level 54 db. below 1 volt/dyne cm².
- Non-directional.
- High Impedance equivalent to approximately .002 mfd. (1.8 meg. ohms at 1,000 cycles.)

The microphone is designed for use with standard 5/8" 27 thread microphone stand.

* Trade Mark Shipping Wt. 1 lb. List Price \$25.00

BRUSH MODEL "VM-1" VIBROMIKE *

The VM-1 or "Vibromike" is a miniature CONTACT-TYPE microphone with high sensitivity and unusually wide-range frequency response (30 to 6,000 cps.) Output voltage from .05 to .1 volt or higher. Size of microphone 7/8" x 3/4" x 3/8".

Designed for a broad field of reproduction applications through direct contact. Adaptable to musical instruments, industrial uses—detecting mechanical vibrations. Hermetically sealed in black rubber covered case.

Microphone complete with mounting clamp and 25' of cable.

Model VM-1 . . . (#325) \$19.50 list

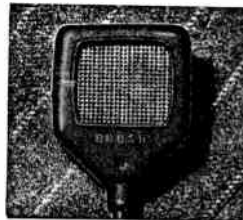

BRUSH MODEL "BL-2" LAPEL MICROPHONE

The improved Model BL-2 lapel microphone features virtually flat response from 30 to 10,000 cycles. Output level 57 db. below 1 volt/dyne/cm². Small and rugged (1 1/2" x 2 1/4") the BL-2 can be used in hand or as instrument pickup as well as in lapel.

Microphone complete with 25' of cable.

Model BL-2 . . . (BA-111) \$25.00 list
Net Wt. 8 oz. Shipping Wt. 2 lbs.

CRYSTAL CUTTER

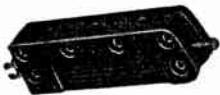

Brush Model "RC-20"

The Brush RC-20 Crystal Cutter has been designed to satisfy the demand for high quality, low cost recordings in the home, school and studio. Due to its inherent stiffness, the RC-20 will cut lateral type records in virtually all hard or soft disc materials. Being of simple and compact design, it is readily adaptable to all types of transcription equipment. A three watt amplifier is sufficient to satisfactorily drive the RC-20 cutter frequency response—flat within plus or minus 3 db. from 50 to 9,000 cps.

Cuts "Constant Amplitude" without equalization, and "Constant Velocity" or other desired frequency characteristics with suitable equalization. Complete technical data sent on request. Cutter (less stylus).

Net. Wt. 4 oz., Ship. Wt. 2 lbs. Mod. RC-20 (#385) \$25.00 list



HUSHATONE *

Model BA-303

A miniature, molded plastic extension speaker for under pillow use. Disc shaped (4 3/8" dia. by 1 1/8" thick). Makes no uncomfortable lump beneath the pillow. Tone quality comparable to cone type speaker because of specially engineered response. Speaker gives ample output with low power consumption (.001 watt). Hermetically sealed, can be dipped into disinfecting solution (temperature not above 120°F). Light weight BIMORPH* crystal drive element insures uniform response and high sensitivity. No parts to wear, loosen, or become detached. Furnished in maroon with satin chrome trim. HUSHATONE* with 10' cord.

Net. Wt. 8 oz., Ship. Wt. 2 lbs. BA-303 . . . \$13.00 list

Prices Subject to Change Without Notice

Complete technical data on request

* Trade Mark Reg. U. S. Pat. Off.

Radio's Master — 19th Edition

TRADE DISCOUNT APPLIES TO LIST PRICES ONLY

Copyright by U. C. P., Inc.

Page D-35

BRUSH

ACOUSTIC PRODUCTS



Brush crystal phones possess the following outstanding features:

1. **BIMORPH*** crystal drive element of such high impedance that line or circuit characteristics are not affected when monitored by Brush phones.

2. Wider range response with more uniform output.
3. Compensation for ear coupling.
4. Light-weight, rugged, shock-proof construction.

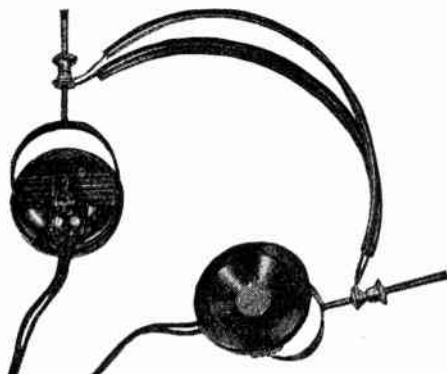

HEADPHONES

**Brush Model
BA-206**

Designed for use where High Fidelity and smooth frequency response are of paramount importance. They are especially applicable to broadcast monitoring, to laboratory use in the study of sound measurements, audiometry and similar exacting headphone applications. Features exceptionally flat frequency response. Impedance of 50,000 ohms at 1000 cps; no transformer required. Ideal for multiple installation. Sensitivity is approx. 6.3 dynes/cm²/volt at 1000 cps. Low

percentage of distortion. Designed to give your ear a smooth comfortable air-tight fit which provides an excellent bass response. The Metalseal Crystal* drive element is of such high impedance that line or circuit characteristics are not affected when monitored by these phones. Available in double, single and lorgnette models:

BA-206	Double	\$30.00 list
Net Wt. 8 oz.		Shipping Wt. 2 lbs.
BA-207	Single	\$16.50 list
Net Wt. 4 oz.		Shipping Wt. 1 lb.
BA-208	Lorgnette	\$22.95 list
Net Wt. 6 oz.		Shipping Wt. 1 lb.

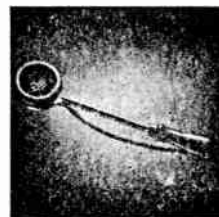

**BRUSH MODEL "A"
LORNETTE PHONE**

The "A" lorgnette phone is designed for use in group hearing aid sound systems installed in churches, concert halls, theatres and auditoriums. Telescope extension from 12" to 17". Attractively finished in satin black. Light weight, easy to handle, and comfortable at the ear.

Single phone complete with 5' cord and lorgnette handle.

Model A . . . (BA-202) . . . \$14.50 list
Net Wt. 5 oz. Shipping Wt. 1 lb.



**HIGH FIDELITY
MODEL "A-1"**

For use where HIGH FIDELITY and extended frequency response are of paramount importance. (60 to 10,000 cps. Corrected for rising response below 200 cps.) Especially suited to monitoring, sound measurement, audiometry, and similar exacting headphone applications. Sensitivity approx. 1.5 dyne/cm²/volt at 1,000 cps. Impedance over 80,000 ohms at any frequency within audio range. Headset complete with 5' cord and headband.

Model A-1 . . . (#205) . . . \$26.75 list
Net Wt. 6 oz. Shipping Wt. 2 lbs.



**BRUSH MODEL
"A"
Single Phone**

Particularly adapted to individual or group hearing aid and radio applications. Light weight, good ear seal, and comfortable to wear. Spring steel headband with soft rubber cushion to eliminate slipping.

Single phone complete with 5' cord and headband.

Model "A" . . . (#202) . . . \$11.25 list
Net Wt. 3 oz. Shipping Wt. 1 lb.



**BRUSH MODEL
"A"
General Purpose**

Designed for GENERAL PURPOSE applications including laboratory, studio and skilled amateur home use. The BIMORPH* crystal drive element insures wide ranges response 100 to 8,000 cps. and high sensitivity. High impedance; ideal for multiple installations.

Headset complete with 5' cord and adjustable headband.

Model "A" . . . (#200) . . . \$17.50 list
Net Wt. 6 oz. Shipping Wt. 2 lbs.

BRUSH ELECTRONICS

INDUSTRIAL AND RESEARCH INSTRUMENTS
PIEZO-ELECTRIC MATERIALS • ACOUSTIC DEVICES
MAGNETIC RECORDING EQUIPMENT
ULTRASONIC EQUIPMENT



COMPANY

formerly
*The Brush Development Co.
Brush Electronics Company
is an operating unit of
Clevite Corporation.*

Prices Subject to Change Without Notice Complete technical data on request

* Trade Mark Reg. U. S. Pat. Off.

Copyright by U. C. P., Inc.

Radio's Master — 19th Edition

Page D-36

TRADE DISCOUNT APPLIES TO LIST PRICES ONLY

MONOSET*

Direct Signal for Both Ears! Stethoscope design eliminates tiresome pressure . . . Blocks out background noise . . . Weighs only 1.2 oz. . . . Excellent for communications, dictation equipment, aircraft radio, etc.

	List
Monoset only	\$ 9.00
Monoset with Standard Cord	13.20
Monoset with Volume Control Cord	19.00
Standard Cord only	4.20
Volume Control Cord only	10.00

SPECIFICATIONS Sensitivity: 88 db. above .000204 dynes per sq. cm. for 10 microwatts input. Impedances: 128 ohms, 500 ohms, 2,000 ohms. Construction: Sealed magnetic receiver . . . Grey polished Tenite plastic . . . Removable plastic eartips . . . 5 ft. tinsel cord with standard plug . . . Built-in volume control optional.



TWINSET*

Nothing touches the ear! Adjusts to any head without pinching or pressure . . . Adjustable sound arm need not touch ear . . . Entire unit weighs only 1.6 oz. . . . Flexible, can be slipped into pocket . . . C. A. A. approved.

	List
Twinset only	\$13.05
Twinset with Cord	17.25
Monocord only	4.20

SPECIFICATIONS Sensitivity: 101 db above .000204 dynes per sq. cm. for 10 microwatts input. Impedances: 1,000 ohms—brown, 64 ohms yellow. Coding visible inside female socket. Construction: Tenite plastic and bright nickel. Headband, spring steel wire cased in Tenite. 5 ft. Monocord plugs into either receiver. Special cord with built-in volume control available.



PILLOW SPEAKERS



DYNAMIC

List
Model 54 Deluxe Dynamic Speaker complete with cord and plug \$10.20
Model 55 Deluxe Dynamic Speaker with Transformer—available upon request up to 10,000 ohms 12.10

MAGNETIC

List
Model R Complete with Cord and Plug \$11.40
Model R Unit only no Cord 7.20
Standard Cord and Plug 4.20

DYNASET*

New Dynamic Under-the-Chin Headset with dynamic driver in plug. Excellent for office transcribing, radio monitoring and telecasting. Higher fidelity brings more lows and highs to your ears. Extremely sensitive—lightweight, only 1.25 oz. Comfortable under-the-chin styling.

	List
Dynaset Complete	\$15.60

SPECIFICATIONS Sensitivity: Approximately 105 db. above .000204 dynes per square centimeter for one milliwatt power input. Recommended Maximum Power input: 25 MW. Impedance: 6 ohms. Construction: Anodized aluminum tone arm. Dynamic Driver housed in specially molded Tenite No. 2 plug. Frequency Range: 50 to 8,000 cps. or better.



NEW WAYS TO 6 TELEX LISTENING COMFORT

EARSET*

Slips onto the ear! Made with flat plastic frame or slim metal bow, Telex Earset holds sensitive receiver securely in place . . . Weighs only 1/2 oz. User's other ear is always free for phone calls or conversation . . . Fits either ear, may be worn by anyone.

PLASTIC EARSET

	List
Earset only	\$ 7.80
Earset with Cord & Plug	12.00
Standard Cord only	4.20

METAL EARSET

	List
Earset only	\$ 8.40
Earset with Cord & Plug	12.60
Standard Cord only	4.20

SPECIFICATIONS—Sensitivity: Comfortable listening level with 3 milliwatt input. Impedances: 120 ohms, 2,000 ohms. Construction: Clear plastic ear frame or metal bow. Sealed, rustproof receiver. 5 ft. Monocord with standard phone plug connection.



TELEX

HEARING AT ITS BEST!

STANDARD OF THE WORLD FOR QUALITY HEADSETS

ELECTRO-ACOUSTIC DIVISION • DEPT. AE54 TELEX PARK

ST. PAUL 1, MINN.; In Canada, Atlas Radio Corporation, Toronto

TRIMM

HEADSETS AND ACCESSORIES

FEATHERWEIGHT



The world-famous TRIMM FEATHERWEIGHT headset. Weight: 4½ oz. complete with two units, 6-ft. moisture-proof cord. Bakelite shell and cap. A custom-built phone throughout. Available in all standard ohmage.

24,000-OHM IMP. SPECIAL for amateurs

- No. 106—Double, adjustable nickel-plated headband.....\$11.00
- No. 107—Double, fabric-covered wire headband..... 11.00

STANDARD FEATHERWEIGHT HEADSETS are available in 3, 76, 220, 500, 2M, 4M and 5M ohms d.c. resistance (Impedance approximately 5 times greater).

- No. 100—Double, adjustable nickel-plated headband.....\$11.00
- No. 104—Double, fabric-covered wire headband..... 11.00



DEPENDABLE

When a high grade headset is desired, but price must be considered, choose the DEPENDABLE. Bakelite caps and shells. Extra heavy chrome steel forged magnets, 5-ft. cord, vinyl plastic covered wire headband.

- No. 65—Double, 2M ohms.....\$4.80
- No. 67—Single, 1M ohms..... 2.60
- No. 65-3—Double, similar to No. 65 except uses special 6 ft. plastic covered cord No. 890. Specially designed for institutional systems, as cord can be washed, etc. 5.75

PROFESSIONAL

The choice of countless users . . . The original TRIMM headset. Watch case bipolar design, cap and shell molded of black bakelite (unless specified otherwise). Chrome steel forged magnet, concealed terminals, 5-ft. tinsel-braided cord. Standard resistance for double headsets: 4, 78, 500, 2M, 3M and 4M ohms d.c.



- No. 70—Double (4M ohms furnished if not specified)..... \$5.80
- No. 72—Single (2M ohms maximum ohmage) 3.30

ACME

A superior lightweight, low-cost headset. Cap and shell of molded bakelite. Weight: 6 oz. Cord: 4½-ft.



- No. 24—Double, 2M ohms, vinyl-covered headband\$3.95
- No. 24—Double, 4M ohms, vinyl-covered headband 4.10
- No. 25—Double, 2M ohms, metal headband 3.35
- No. 25—Double, 4M ohms, metal headband 3.65
- No. 27—Single, 1M ohms, metal headband 2.00
- No. 27—Single, 2M ohms, metal headband 2.20

REX

Lowest cost TRIMM bi-polar type headset. Polished aluminum shell, molded bakelite cap. Double headsets, 4½ ft. braided cord. Single headsets, 4½ ft. all-rubber cord. Double headsets, adjustable, tubular plastic covered wire headband.



- No. 30—Double, 2M ohms.....\$4.10
- No. 32—Single, 1M ohms 2.40

COMMERCIAL



One of the most ruggedly built yet lightweight headsets. Practically non-breakable. Shell and cap molded of high strength plastic. Diameter 2½", depth ¾", cord 6-ft. tinsel, moisture-proof construction, type No. 501-10

plug attached. Leather-covered headband. This headset is recommended for monitoring service because of its high quality performance.

- No. 156—Double, 600 ohms Imp.....\$17.60
- No. 157—Double, 17M ohms Imp..... 17.60
- No. 158—Double, 600 ohms Imp., no plug 15.95
- No. 159—Double, 17M ohms Imp., no plug 15.95

Ohmage given are d.c. resistance unless specifically indicated as impedance which is about 4-7 times the d.c. resistance.

Prices subject to change without notice.

ARMY-NAVY

Very sensitive, 6-ft. waterproof cord, phone tip terminals. Plastic cap, metal shell. Leather headband. Weight: 1 lb. Available in two impedances.



- No. 29—Double, 2,200 ohms d.c. (20M ohms Imp.).....\$17.60
- No. 28—Double, 112 ohms d.c. (600 ohms Imp.)..... 17.60

TRIMM "B"

Suggested for hospital installations. Bakelite shell and cap. Forged bar magnet. Fabric-covered headband. 5-ft. tinsel cord.



- No. 42—Double, 2M ohms.....\$8.80
- No. 43—Double, 600 ohms Imp.....8.80
- No. 44—Single, 1M ohms..... 5.10
- No. 45—Single, 300 ohms Imp..... 5.10

"S" HEADSET

(Not illustrated). Designed particularly for broadcast station and other high fidelity applications. Response is substantially flat through all essential frequencies. Shell and cap molded plastic. Units provided with No. 656 ear cushions. Leather covered headband with restricted rotation of unit mounting to prevent cord snarl.

- No. 35—Double headset, 600 ohm impedance, two conductor off-the-shoulder flexible neoprene cord terminated with No. 501 plug\$24.50
- No. 35-4—Double headset for binaural use, 300 ohms impedance per unit. Split circuit three conductor off-the-shoulder braided cord terminated with No. 509 plug 28.75

EAR CUSHIONS



Sponge rubber ear cushions provide maximum ease in wearing headsets. Fit TRIMM Featherweight, Commercial, Acme, REX, and "E" types.

- No. 654\$1.50

For complete listing see TRIMM General Catalog

— TRIMM —

HEADSETS AND ACCESSORIES

GROUP HEARING AID COMPONENTS

FEATHERWEIGHT EARPHONES

The most widely used single earphones for group hearing aid systems in churches, theatres, mortuaries, etc., are of the FEATHERWEIGHT type. Available with either lorgnette handles, or single headbands. Standard ohmages: 76, 1,000 ohms d.c. Low (less than 100-ohm), medium (100-500-ohm), and high (500 ohms and over) lines respectively.



- No. 110—Headband type \$7.15
- No. 120—Lorgnette type 8.25

OUTLET BOXES AND CONTROLS

Boxes 460 and 461 are recommended for the majority of installations, combines volume control and jack. No. 460 has brown hammertone finish, No. 461 glossy ivory to improve visibility in theatres. Standard ohmages: 1000 for low impedance lines, 10,000 for high.



- No. 460—Outlet Box (Brown—specify ohmage)..... \$4.40
- No. 461—Outlet Box (Ivory—specify ohmage)..... 4.40
- No. 477—Outlet Box, dual jack, brown, same general shape as No. 460 3.85
- No. 478—Outlet Box, dual jack, ivory 3.85
- No. 484—Outlet Box, single jack, brown 3.30
- No. 485—Outlet Box, single jack, ivory 3.30

"512" PLUG

Compact, non-protruding design. Bakelite body, nickel-plated tip and sleeve. Cord pin tips held by set screws.



- No. 512 \$0.75

See Page L-42 of Radio's Master for TRIMM Plugs and Jacks.

"STOP-IT" Commercial Trimmer

Permits user to turn off audio signal of TV or radio set without getting up from chair, thus giving listener greater freedom in choking off unwanted commercials. Other uses that suggest themselves are to suppress loudspeaker when phone rings, etc.

- No. 639—"Stop-It" Commercial Trimmer. (Illustrated at right below) Consists of housing containing switch to which is attached 20 foot cord ready to install in accordance with instructions with each unit \$3.40

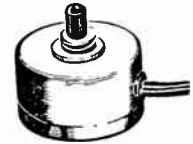
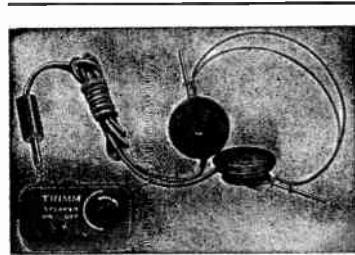

HEADSET KITS for TV and RADIO

Kits described provide simple means of attaching headset to TV or radio sets. Consists of one of several types of headsets and small outlet box with attached 15 foot cord. Box has remote on-off switch for loudspeaker and volume control for headset. Two jacks provided for multiple listening.

- No. 631—Outlet Box only \$ 7.15
- No. 632—Kit—Outlet Box plus one Acme headset and plug 11.90
- No. 633—Kit—Outlet Box plus one Dependable headset and plug 12.75
- No. 635—Kit—Outlet Box plus one single Commercial ear-phone and plug. Recommended for hard of hearing..... 15.10

See TRIMM Bulletin R-31 for additional listings and information on Commercial Trimmer and Headset Kits.

HEADSET REPLACEMENT PARTS

CORDS FOR TRIMM HEADSETS

- No. 811—Double, black, 4½ ft., braided. Fits Acme and Rex \$1.27
- No. 821—Double, black, 5 ft., braided. Fits Dependable 1.32
- No. 822—Double, black, 5 ft., braided. Fits Professional 1.54
- No. 831—Double, black, 6 ft., moisture resistant, braided. Fits Featherweight headsets produced previous to January 1954 2.09
- No. 870—Double, black, 6 ft., moisture resistant, braided. Fits Featherweight produced beginning January 1954. Also Commercial, B, E, K, S and W types requiring pin tips..... 1.76
- No. 870B—Double, same as No. 870 except terminal end designed for attachment to TRIMM No. 501, or PL-55, type plugs 2.09
- No. 890—Double, brown, 6 ft., all synthetic rubber cordage with molded plastic crotch. Blunt cylindrical terminals phone ends, standard pin tips opposite end unless ordered differently. Fits, as described, Dependable, Professional, Commercial, Feather-

- weight (after January 1954) B, E, K, S and W types. Other terminals to fit other phones available. Widely used in hospital radio installations. 2.00
- No. 807—Single, brown, 4½ ft., all rubber. Fits Acme and Rex62
- No. 826—Single, black, 5 ft., braided. Fits Dependable and Professional94
- No. 838—Single, black, 6 ft., braided. Fits Featherweight produced previous to January 1954..... 1.65
- No. 876—Single, black, 6 ft., braided. Fits Featherweight produced beginning January 1954, also Commercial, B, E, K, S, and W types 1.54

HEADSET CORDS FOR OTHER HEADSETS

- (All have standard pin tips at terminal end)
- No. 881—Double, black, 5 ft., braided. Standard pin tips at receiver end. 1.10
 - No. 882—Double, black, 5 ft., braided. Fits Brush type A and BA double headset 2.20
 - No. 883—Double, black, 5 ft., braided. Spade tip at receiver end 1.10

- No. 884—Double, black, 5 ft., braided. Eyelet at receiver end. Fits Brandes Superior etc. 1.21
- No. 887—Single, black, 6 ft. Fits Brush A and BA single earphones 1.65

DIAPHRAGMS

- No. 610—Featherweight (manufactured previous to January 1954)25
- No. 611—Featherweight (manufactured since January 1954), also Commercial, B, W, and K25
- No. 612—Professional and Dependable.. .20
- No. 613—Acme and Rex20

HEADBANDS

- No. 681—Double headset, braid covered wire headband. Used on Nos. 41, 104, 107 and 154 2.00
- No. 683—Double headset, single metal band nickel plated. Used on Nos. 100, 106, and 150 2.00
- No. 692—Double headset, flat tubular covered wire headband. Used on No. 70. Also fits No. 65 and Brush type A 1.35

HEADPHONES By C. F. CANNON



THE "CHIEF" Cannon-Ball Bakelite Headset

A high quality headset of durable molded black plastic. Attractive in appearance, it is a sensitive and practical phone for every headset use. Inside terminals. Diameter of diaphragm is 2 1/8". Double coils, two in each receiver. Chrome steel magnets 1/4" diameter. Supplied with braid-covered headband with permanent adjustment and no removable parts. Cotton covered cord, 4 1/2 ft. long.

CC-2—2000 ohms D.C. List \$4.25
CC-3—3000 ohms D.C. List 4.75
CC-5—5000 ohms D.C. List 6.00

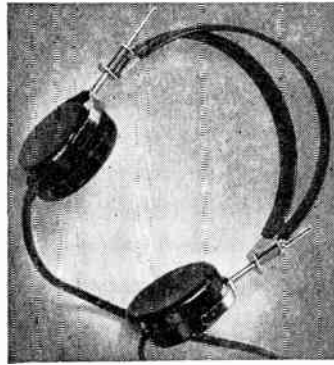

CANNON-BALL ALNICO MAGNETIC No. 25

A New Headset of Unusual Quality, Efficiency and Durability, powered by Alnico V magnets.

The headband is covered by attractive black extruded vinylite and provides utmost wearing comfort. Limits turn of phone to prevent twisting of cord. Cap and case of molded plastic. Large size diaphragm 2 1/8". Equipped with sanitary moisture-resistant plastic cord with riveted crotch piece.

AM-25-2 List \$6.50
AM-25-3 List 7.00
AM-25-5 List 8.50

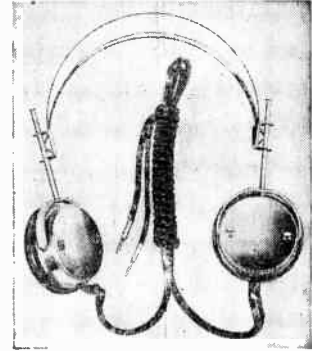

THE "MASTER" Cannon-Ball Headset

Used extensively in hospitals and other institutions as well as for general purposes, and is especially recommended for institutions. Inside terminals Aluminum cases with black bakelite caps. Spring steel adjustable headband with no removable parts. Diaphragm 2 1/8" diameter. Double coils. Chrome steel magnets. 4 1/2 ft. cotton-covered cord.
MC-2—2000 ohms D.C. List \$3.75
MC-3—3000 ohms D.C. List 4.25
MC-5—5000 ohms D.C. List 5.75

CANNON-BALL "EMPIRE" Lightweight Headset

A low-priced light-weight headset with large magnet and double coils. Reproduces with clarity and good volume. Diameter of diaphragm is 1 7/8". Polished aluminum cases with bakelite caps. Steel adjustable headband. 4 1/2 ft. cord. Inside terminal connections.

EC-2—2000 ohms D.C. List \$3.25
EC-3—3000 ohms D.C. List 3.50

THE "DIXIE" Cannon-Ball Headset

The "Dixie" is of the same general construction as the "Master" headset except that the terminals are on the outside.

CD-2—2000 ohms D.C. List \$3.50
CD-3—3000 ohms D.C. List 3.75



BRANDES "SUPERIOR" Matched Tone Headset

A rugged headset, millions of which are in use all over the world. Large size diaphragms of 2 1/8" diameter assure efficient performance. Outside terminals, with polished aluminum cases and bakelite caps. Double coils, two in each receiver. Chrome steel magnets. Steel headband with permanent adjustment. 4 1/2 ft. cotton covered cord.

BS-2—2000 ohms D.C. List \$3.75

BRANDES "ADMIRAL" Matched Tone Headset

The Brandes "Admiral" is of the same general construction as the Brandes Superior, but has terminals on the inside.

BA-2—2000 ohms D.C. List \$4.00
BA-3—3000 ohms D.C. List 4.50
BA-5—5000 ohms D.C. List 6.00

ALNICO MAGNETIC No. 15

A new, small size, extra sensitive headset, light in weight. Diameter of diaphragm 1 7/8". Molded cap and case. Steel adjustable headband. 4 1/2 ft. cord.

AM-15-2 List \$4.00
AM-15-3 List 4.50

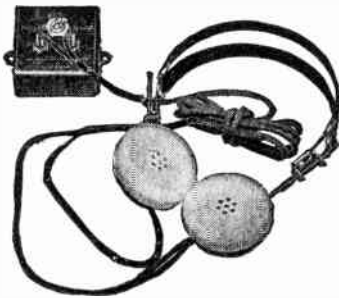

CANNON-BALL HEARING AID FOR RADIO OR TELEVISION

Provides private listening without disturbing others. Excellent for persons hard of hearing. Can be attached to any radio or television set and permits listening to phones alone, speaker alone, or both together.

FOR RADIO

With single phone List \$5.75
With double phones List 8.00

FOR TELEVISION

Kit complete with 15 foot cord, phone volume control and two sets of phones List \$16.50

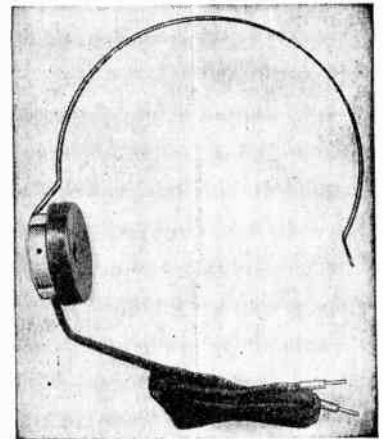

CANNON-BALL "GRAND" Single Headphone

Equal in clarity and volume to most double headsets, efficient and attractive. Permits listening while being addressed by others. Concealed terminals. Diaphragm 1 7/8". Aluminum case and bakelite caps. Chrome steel magnet, double coils. 4 1/2 ft. cord. Spring steel headband permanently attached.

SG-1—1000 ohms D.C. List \$2.00

Phones can be supplied with any resistance required or with variations to meet special requirements. Sanitary plastic covered cords available for institutional use. Write for special quotation.



Precision Professional Equipment

FOR TELEVISION and BROADCAST STATIONS
ACCEPTED and USED by ALL MAJOR NETWORKS
FOR RELIABILITY • VERSATILITY • PERFORMANCE

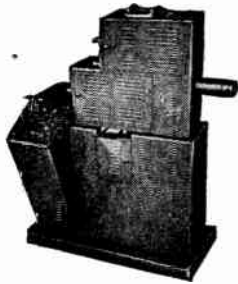

TELOP I... TELEVISION OPTICAL PROJECTOR

Telop I is one-man operated, economical and reliable. It projects low-cost, easily produced "commercials" for increased profits. The Telop completely eliminates keystone; any two photographs, glass lantern slides, or opaque cards can be projected, also small objects, with superposition, lap dissolves or fadeout. Metal slides holding either five or eight 4"x5" cards may be used for projection.

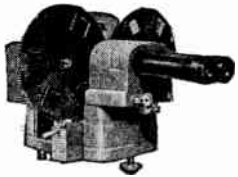

3A... TELEJECTOR

Compact, portable unit for automatic, remote control of standard 2" x 2" transparencies. Provides uninterrupted continuity with studio effects of fading, lapping and superposition. Slide turrets can be changed instantly.

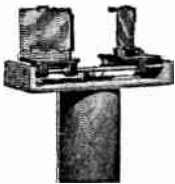

60A FOUR-WAY FILM MULTIPLEXER

A precision arrangement of mirrors for operation of pairs of projectors simultaneously in a single TV camera or individually into two separate cameras. Also available as a 62A two-way moving mirror multiplexer (illustrated) or a 61A two-way fixed mirror multiplexer.



35A MANUAL CONTROL BOX

Gray's Control Box is especially designed for use with the Telector. Control Box laps, fades, superpositions and permits remote changing of slides.

TELOP II... PROJECTOR

For smaller TV stations... one man operated... will project any combination of slides, transparencies, opaque cards or photographs. Eliminates costly film strips and live talent, yet achieves clear sharp pictures with superposition, lap dissolves and fade-out effects. Small initial investment assures greater profits because of low production and operating cost.



55A FILM CAMERA TURRET

One camera can serve up to 8 projectors with Gray camera turret. Mounted on heavy, welded steel frame, the turret revolves 360 degrees on heavy duty ball bearings with positive placement. Requires minimum space.



13A LIGHT BOX

This attachment will back-light 3 1/4" x 4" transparencies and make them part of a "commercial" along with opaque cards or other copy. The box mounts directly behind the slide holder groove in the optical channel opening of the Telop.

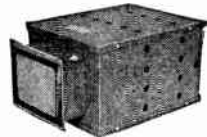

63A TELEJECTOR SHELF

The Gray Telector shelf is of steel construction. Strong, sturdy, it is easy to attach to Multiplexer stand. Telector mounts on shelf.



11B VERTICAL SCROLL DRIVE

The Vertical Scroll Drive will televise rollstock and broadcast running commentary or "commercials"—with or without sound accompaniment. Attaches to the optical openings of the Telop.

12A HORIZONTAL TAPE DRIVE

Horizontal Tape permits televising of 8 mm. news ticker tape. Tape can be projected on any part of screen—top, bottom or middle and superposed on copy televised from another Telop optical opening.

15R REVERSE CLOCK

Designed for time spots and announcements. Clock face is small enough to permit superposition of commercial or other copy. Also available in 15A direct reading model.

106SP TRANSCRIPTION ARM

106SP Transcription Arm meets the strict requirements of modern, highly compliant pick-up cartridges. 3 Cartridge slides furnished, enable GE 1-mil, 2 1/2 mil, or 3 mil cartridges or Pickering cartridges to be instantly installed. Fairchild cartridge slides also available.

108B VISCOUS-DAMPED TONE ARM

Radically new suspension development on the viscous damping principle for perfect tracking of records and elimination of tone arm resonances. For all records—33 1/3, 45, and 78 RPM. Solves all record reproducing problems.

602B EQUALIZER

The new 602B Equalizer provides balanced output, permitting operation of the Equalizer into either a balanced or unbalanced line. A convenient control allows instant switching from conventional records to micro-groove.

GRAY RESEARCH

and Development Co., Inc., Hilliard St., Manchester, Conn.

Division of the GRAY Mfg. Co. Originators of the Gray Telephone Pay Station, Gray Audograph and the Gray PhonAudograph.

Copyright by U. C. P., Inc.

Gray, as a special service to its many TV customers, now has available a custom-made test pattern with individual call letters for TV stations.



Radio's Master — 19th Edition

Page E-1

PRESTO RECORDING CORPORATION

WORLD'S LARGEST MANUFACTURER OF INSTANTANEOUS SOUND RECORDING EQUIPMENT AND DISCS

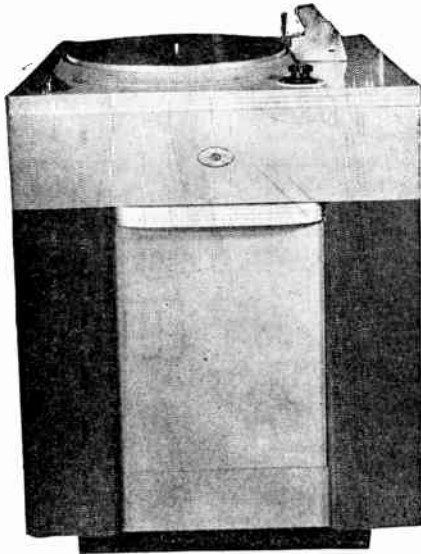

Presto Type 153 Reproducer extra

PRESTO 64-A TRANSCRIPTION TURNTABLE

The Presto 64-A transcription turntable offers the following features which are of major importance to the owner and operator: Unusual mechanical simplicity . . . low mechanical disturbance . . . maximum speed accuracy . . . extreme ruggedness for long continuous operation . . . instantaneous selection of desired speed . . . and no requirements for mechanical adjustments.

This transcription turntable is directly gear driven and employs two separate motors, one for 33-1/3, and the other for 78.26 rpm. There is no friction device of any kind in the mechanism and no mechanical shift is required to change speeds. To select 33-1/3 rpm, 78 rpm or "off," the operator merely throws a three position switch. These changes may be made as rapidly as desired while the turntable is in motion with no damage to the mechanism. Only one motor at a time is in operation. The transmission "over runs" the motor which is not turning and thus does not carry it along in rotation although the stationary motor is never disengaged from the mechanism.

SPECIFICATIONS

Standard Equipment: The 64-A transcription turntable includes the electro-mechanical gear drive, turntable and cabinet. A reproducer and network is not included.

Speed Accuracy: No deviation from 33-1/3 and 78.26 rpm.

Noise Level: Mechanical noise originating in the equipment over 50 db below program level.

Power Requirements: Approximately 75 watts from a 115 volt, 60 cycle line. Motors are of the 1800 rpm synchronous type and are available for other voltages and frequencies at additional cost.

Mounting: Turntable and gear drive mounted in heavy wood cabinet 24 x 24 x 33 inches (61 x 61 x 84 cm.)

List Price, \$585.00

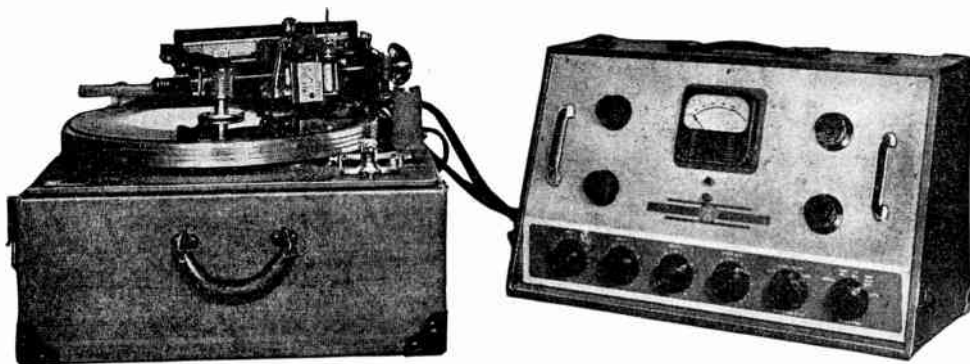

PRESTO 6-N RECORDER AND 90-B AMPLIFIER

The PRESTO 6-N Recorder and 90-B Amplifier is the ideal recording equipment for portable or stationery operation.

The 6-N Recorder is outstanding in its suitability for broadcast stations because it offers all the qualifications for good recordings, including master records, at the most economical price. It is ideal for the station requiring delayed broadcast of network programs, and for reference recordings.

The 6-N standard equipment includes the Presto 1-D cutting head, spiraling feed screw, vertical damper, time scale and pick-up. It is available for microgroove recording at additional cost.

The Presto 90-B recording amplifier contains all the facilities necessary for operation on remote assignments, but with an overall performance found only in high-fidelity studio equipment.

It consists of three preamplifiers with individual gain controls, a mixer circuit, a master gain control and power amplifier. Provision is made for connecting the Presto 161-A automatic equalizer (radius compensator).

A five-position selector switch provides the following characteristics: 1—flat response, 30 to 15,000 ±1 db; 2—NAB 33 1/3 rpm recording; 3—present day 78-rpm recording; 4—NAB playback, and

5—automatic equalization. The flat response can be modified by variable bass and treble controls, giving emphasis up to a maximum of 20 db at 100 and 7,500 cycles per second or 20 db de-emphasis at 7,200 cycles per second.

Noise is 55 db below recording level and distortion at maximum output is less than 1.5%.

The use of input and output selector switches makes the 90-B amplifier unusually flexible. It permits combining the signals of three microphones or of two microphones and either one of two pickups. By using the "Line" position, recordings can be made from an incoming program line. The output selector has three positions; playback (public address), continuous recording and simultaneous recording. While recording, the line jack provides a monitoring outlet or permits feeding a program line at the correct level.

The correct level is monitored by means of a Weston Type 30 VU indicator with illuminated scale and its closely controlled electrical and dynamic characteristics make it an ideal volume indicator for recording.

List Price of 6-N, in Case.....\$773.00
List Price of 90-B..... 623.50



RECORDING CORPORATION

WORLD'S LARGEST MANUFACTURER OF INSTANTANEOUS SOUND RECORDING EQUIPMENT AND DISCS

PRESTO K-10 RECORDER FOR MICROGROOVE AND REGULAR RECORDING



The PRESTO K-10 Recorder, formerly known as the K-8, the foremost machine of its kind to be used in schools for speech, voice, languages, dramatics, music, etc., is now offered for MICROGROOVE (long-playing) recording as well as the standard method

Note these features:

- Cutting pitches of 112 lines per inch Outside-in, 112 lines Inside-out, 224 lines per inch Outside-in and 224 lines per inch Inside-out.
- Standard unit is equipped for two speeds, 33 1/3 and 78 rpm. Available for three speeds, 33 1/3, 45 and 78 rpm at additional cost.
- The cutting head is equipped with an advance ball which regulates the depth of the groove more accurately than a counter spring.
- The K-10 is equipped with a turnover type cartridge having sapphire styli for both standard and microgroove records. The cartridge is a ceramic type which has high output and is not easily affected by high temperature and humidity.
- A single control permits instant choice of recording, playback, or public address. Amplifier also contains radio and monitor jacks.

The PRESTO K-10 will, when set for MICROGROOVE, record 6 3/4 minutes on every inch of disc used. This means that a 15-minute recording with good fidelity can be put on one side of a 12" disc! And a half-hour can be put on one side of a 13 1/4" disc. Seven minutes can be recorded on one side of a 6 1/4" disc.

Net Price of K-10, less microphone and stand.....\$366.50

*\$5.00 additional for 45 rpm pulley and record adapter.

TL-10 PRESTO TAPE DRIVE

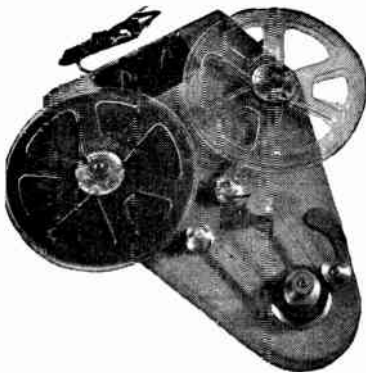

Presto offers an ingenious tape transport mechanism which can be quickly installed on any sixteen inch turntable. This mechanism derives its power from the turntable—it has no motors of its own. The present model is for tape reproduction only—no erasing or recording is included. No amplifier is provided. The equalized output of the playback head may be fed directly into standard speech input equipment.

The TL-10 Tape Drive consists of a triangular shaped cast chassis which mounts on two small posts fastened to the turntable panel. One point of the triangle carries the tape capstan and this rests directly on the center pin of the turntable to which the TL-10 is attached. A belt drive from the under side of the capstan rotates the take-up reel through a slip clutch. The reproducer head and guide pulleys are located on the upper side of the chassis and the equalizer network is placed below.

Two capstans are available for 15 or 7 1/2 inches per second tape speed based on the turntable speed of 78 rpm. Rewinding is achieved by transferring the empty reel to the take-up spindle and releasing the drag on the supply spindle. Specify type of turntable when ordering the TL-10.

The output of the head and equalizer is sufficiently high to be fed directly into a high quality preamplifier such as found in standard broadcast speech input equipment. An unusual type of capstan is employed, consisting of a wheel, relatively large in diameter, and having a rubber rim. The tape is wrapped around this capstan 180° and obtains very great traction against the rubber surface.

NET PRICES

TL-10 Tape Drive — 1-Speed	\$132.50
2-Speed	140.00

3-SPEED MICROGROOVE & STANDARD PLAYBACK TURNTABLE Type T-15

The Presto Type T-15 turntable is an unusually high quality unit for the reproduction of recordings at 33 1/3, 45 and 78 rpm. The design provides an instantaneous speed selection with a very convenient control arrangement.

FEATURES:

- Heavy cast aluminum 12" turntable accurately machined and balanced.
- Precision idler wheels and motor pulley.
- Good speed regulation—minimum "wow."
- Performance comparable to transcription equipment.
- May be connected to any radio or audio amplifier.

T-15 Chassis—Net Price.....\$53.50

Cabinet for above—Net Price..... 16.00

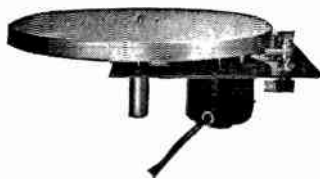



RECORDING CORPORATION

WORLD'S LARGEST MANUFACTURER OF INSTANTANEOUS SOUND RECORDING EQUIPMENT AND DISCS

PRESTO RECORDING DISCS

DESCRIPTION	TYPE NUMBER	DIAM. IN INCHES	LIST PRICE
GREEN LABEL			
Presto Green Label discs are, without question, the finest for instantaneous recording—discs to be played back without processing. The extremely clean lacquer and carefully selected flat aluminum base assure perfect cuts for standard or microgroove recording. The surface noise, even after many playings, is virtually inaudible and, what is most important, the consistently high quality is the recording engineer's guarantee of perfect results. Both sides of the Green Label are warranted flawless. Packed 25 per box—a spacer between each disc—with separate envelopes—no labels. Overall thickness of disc .050 inches.	610-A	10	\$1.40
	611-A	11 7/8	2.32
	616-A	16	4.20
BROWN LABEL			
Brown Label discs are identical to the perfect Green Label except that only one side is warranted to be flawless. They are offered to those who intend to cut on only one side of the disc. In other respects all of the superior qualities of the Green Label are present in the Brown Label disc. Packed 25 per box—a spacer between each disc—with separate envelopes—no labels. Overall thickness of disc .050 inches.	810-B	10	1.13
	811-B	11 7/8	1.65
	816-B	16	3.28
WHITE LABEL			
The White Label disc represents a quality disc at a saving. Both surfaces are warranted to be useable without danger of broaking a sapphire cutting stylus. The White Label is perfectly suited for reference recordings, playbacks, tests and rehearsals. Packed 25 per box—a spacer between each disc, with separate envelopes—no labels. Overall thickness of disc .050 inches.	510-A	10	1.13
	511-A	11 7/8	1.83
	516-A	16	3.28
ORANGE LABEL			
Orange Label Discs differ from other Presto types in that the aluminum base is of a lighter gauge. The fine lacquer, however, is the same as that used on all other Presto discs and is responsible for the very high quality of the Orange Label disc. It is designed specifically for educational institutions where good quality must be available at a reasonable cost. The fine surface of the Orange Label disc has made it popular also with recording studios as a "playback" where good quality at low cost is desired. Packed 50 per box in jackets of five discs each—in envelopes and with labels attached. Overall thickness of disc .040 inches.	306-A	6 1/2	.45
	308-A	8	.63
	310-A	10	.96
	311-A	11 7/8	1.35
DOUBLE SIDED MASTERS			
Double sided masters are truly the most perfect discs that can be produced for processing work. They are warranted to silver plate quickly and uniformly. Masters are packed with a spacer between each disc and individual envelopes are not included. However, envelopes when required may be had on request. Sizes 11 7/8 inches, 13 1/4 inches and 16 inches are packed 25 discs to the box. The 17 1/4 inch disc is, because of its additional thickness, packed 20 to a box. The overall thickness of the 17 1/4 inch disc is .064". Other master sizes are .050".	621-A	11 7/8	2.88
	623-A	13 1/4	3.67
	626-A	16	5.42
	627-A	17 1/4	6.33
SINGLE SIDED MASTERS			
Single sided masters are identical to double sided masters except that only one side is warranted perfect. The primary side is flawless. Single sided discs represent a definite saving since only one side of a master can be processed. In all other respects the single and double sided discs are similar.	821-B	11 7/8	2.26
	823-B	13 1/4	2.71
	826-B	16	4.29
	827-B	17 1/4	4.63

PRESTO RECORDING STYLII

DESCRIPTION	TYPE NUMBER	PACKING	LIST PRICE
SAPPHIRE CUTTING NEEDLES			
Sapphire cutting needles—dural shank—are for use where the very best is demanded. This needle cuts sharp, clean grooves which play back with the least possible surface noise. Long shank sapphires are for use with the Presto type 1-D cutting head. Short shank sapphires are for use with all other types of cutting heads. If needles for microgroove are required, simply add the word "micro" after the regular type number. Each Presto needle is individually tested and consistently uniform results are assured. Sapphire life varies considerably but 8 to 10 hours may generally be expected. Needles are packed individually or in boxes of six individual units.	603-A	Box of 6	\$8.00 each needle
	604-A	Box of 6	8.00 each needle
	Resharpening		3.15
BRASS SHANK CUTTING NEEDLES			
Brass shank cutting needles are generally similar to dural shank needles except that the high frequency response is not as good due to the increased weight of the shank. For this reason they are not supplied for microgroove. Both long and short brass shank needles are available. Needles are packed individually or in boxes of six individual units.	320-A	Box of 6	6.00 each needle
	321-A	Box of 6	6.00 each needle
	Resharpening		3.15
STELLITE NEEDLES			
Stellite needles produce a clean, quiet cut but their life is limited to 2 or 3 hours. They are useful in schools where inexperienced students might break the tips from the shanks of the more expensive sapphire needles. Also packed individually or in boxes of six.	330-A	Box of 6	1.75 each needle
	331-A	Box of 6	1.75 each needle
	Resharpening		.85

PRESTO

RECORDING CORPORATION

WORLD'S LARGEST MANUFACTURER OF INSTANTANEOUS SOUND RECORDING EQUIPMENT AND DISCS

PT-920 TAPE RECORDER

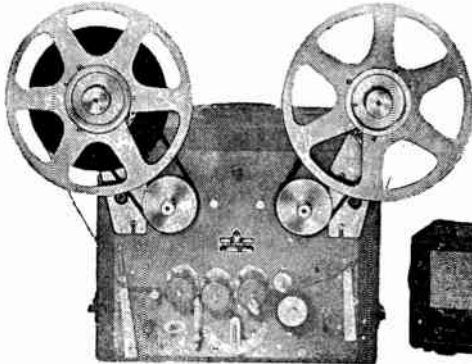

PT-920 with RA-1 Adapter In Position

Specifications

Speeds: 7½ and 15 ips. Frequency Response: 50-15,000 cps at 15"/sec. tape speed and 50-10,000 cps at 7½"/sec. Reels: 7 and 10½ in. Signal to noise ratio is 50 db with 2% distortion at 400 cps. Instantaneous speed variations at 15"/sec. is not more than 0.25%. Microphone input impedance normally 250 ohms. Output of amplifier 15 ohms, 10 watts. Bridging input 20,000 ohms, unbalanced. Weight: RC-7 — 40 lbs; A-920 — 35 lbs.

The Presto PT-920 tape recorder has been developed for fully professional recording work and hence no compromise has been made with quality of materials and workmanship. The PT-920 has been designed especially for broadcast stations and recording studios and has found wide acceptance among colleges and universities as well.

The PT-920 is composed of the R-7 mechanism and the A-920 amplifier.

The PT-920 may be operated with the RA-1 reel adapter which allows the use of 2400-ft. reels of tape. Every normal function and all of the wide range quality of the PT-920 are retained when using the RA-1 adapter.

The R-7 consists of a three-motor drive system, separate erase, record, and reproduce heads and two separate amplifiers — one for recording and the other for monitoring. This arrangement permits instantaneous monitoring of the tape. The equipment takes standard RMA 7" reels. Continuous recording with two mechanical sections (type R-7) and one amplifier section (A-920) may be done by interconnecting the units through the SA-12 changeover switch.

The A-920 amplifier has a single microphone input plus a high impedance bridging input. In the playback position it delivers 10 watts when used with an external speaker. Two small speakers are included in the amplifier and are mounted directly behind the front panel either side of the meter. A 2-stage amplifier provides instantaneous monitoring during recording. This is for use with high impedance phones or to be fed into an outside amplifier.

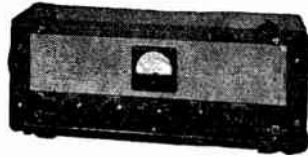

Prices

Complete PT-920	\$749.00
R-7 Tape Transport Mech.	425.00
SA-12 Transfer Switch	46.00
A-920 Amplifier	324.00
RA-1 Adapter	39.00

R-11 TAPE RECORDER

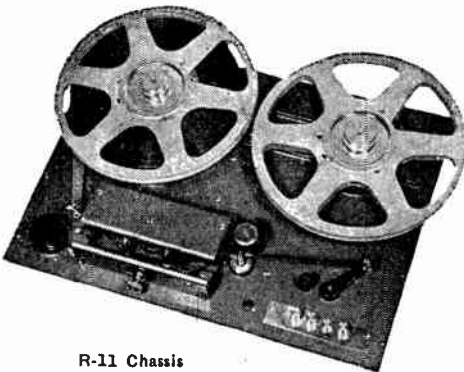

R-11 Chassis

The R-11 Recorder is an unusually fine mechanism which can be mounted in a relay rack, in the CS-10 carrying case or the CC-1 console. The main panel is a heavy aluminum casting to which all other components are attached, including the Presto CDR-200 self-contained capstan drive assembly.

The three heads of the R-11 are mounted as a group and are contained in a completely closed housing. Tape is threaded by simply dropping it into the opening made by pulling forward the front cover which also holds the tape off the heads for running the tape at fast speeds.

PERFORMANCE DATA

Frequency Response: 50-15,000 at 15 in/sec. and 50-10,000 at 7 in/sec.
Signal to Noise Ratio: 50 db at 3% distortion.
Flutter: 0.15% at 15 in/sec., 0.25% at 7½ in/sec.
Dimensions: 19" x 14" x 10". Weight: 48 lbs.

R-11 Chassis	Net Price \$520.00
CS-10 Carrying Case	Net Price 52.00
CC-2 Console	Net Price 125.00

PB-17A TAPE REPRODUCER

The Presto PB-17A has been especially designed for playing tape on wired music systems, in industrial plants, amusement parks, skating rings, etc. The capstan is centrally placed with a half-track head on either side. Dual track tape traveling at 3¼ in/sec provides a continuous playing cycle of 8 hours. Tape reels are 14 in. diameter and hold 4800 ft. of tape. The PB-17 mechanism reverses automatically at both ends of the tape. Frequency response is 50-8000 cps. Price \$650.00

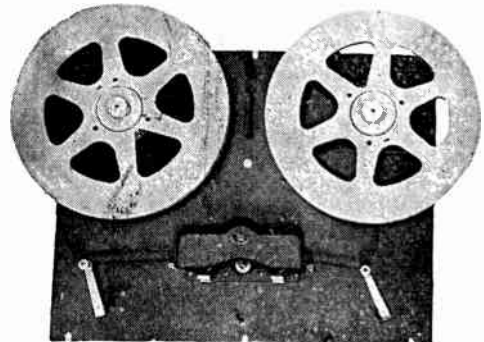

PB-17A Chassis

900-A3 AMPLIFIER

The 900-A3 amplifier (formerly 900-A2) actually consists of separate tape recording and reproducing (monitoring) amplifiers and a common power supply. Output of reproducing amplifier is plus 20 db, 500 ohms. Three-microphone mixer is normally wired for 250 ohms.

Type 901-A is similar to 900-A3 except three-microphone mixer is replaced by 500 ohm transformer for line level.

Net Price (Portable) \$403.00

A-920 AMPLIFIER

The A-920 amplifier is a combination tape recording and reproducing amplifier. Output is 15 ohms, 10 watts. Input is for single microphone, normally 250 ohms. Monitoring during recording is accom-

plished through the reproduce preamplifier using high impedance phones.

Net Price (Rack Mounting or Portable) \$324.00



REK-O-KUT COMPANY

MANUFACTURERS OF RECORDING AND TRANSCRIPTION EQUIPMENT FOR THE BROADCAST INDUSTRY

WORLD'S TWO GREATEST HI-FIDELITY PORTABLE SOUND SYSTEMS

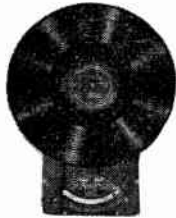

THE *Rhythmmaster*

The RHYTHMASTER is equipped with the CVS-12 Continuously-Variable Speed Turntable.



THE *Recitalist*

The RECITALIST is equipped with the LP-743, 3-Speed Turntable.



BOTH OFFER

3 INSTRUMENTS IN ONE

- ★ PHONOGRAPH
- ★ P.A. SYSTEM
- ★ BROADCAST RECEIVER (when used with FM Tuner)

Indispensable for Recreation Centers, Broadcast Stations, Advertising Agencies, Schools, Hospitals, Record Collectors, Musicians, Etc.

THE RHYTHMASTER AND THE RECITALIST are the only full-range portable phonographs that balance the response characteristics of amplifier, speaker and speaker enclosure. By carefully compensating the natural resonances of these three components, undesirable reverberations are eliminated, and truly lifelike sound reproduction is achieved.

THE POLYPHONIC SELECTOR, an exclusive Rek-O-Kut engineering triumph, found only in the Recitalist and the Rhythmmaster, maintains the proper relationship between the highs and lows when the record is played at any volume, either very softly or very loud! Thus, the high notes of the violins, chimes, triangles, cymbals, etc., are always reproduced clearly and distinctly in all their original beauty and cannot be drowned out by the loud passages of the brasses and percussion instruments.

THE RHYTHMASTER'S PATENTED CONTINUOUSLY-VARIABLE SPEED TURNTABLE plays records not only at 33 1/3, 45 and 78 R.P.M., but at ANY speed variation from 25 to 100 R.P.M. Not only will the CVS Turntable play your records back at the exact pitch and tempo they were recorded, but also at any increased or decreased tempo to fit a particular need: ★DANCING:—Set the rhythm of your folk-dance, tango, rumba to your own taste. ★PHYSICAL EDUCATION:—Set the rhythm most suitable for teaching swimming, exercises, etc.

★MUSICIANS:—(1) You can now set the pitch of your records to your own personal interpretation of any recording. (2) You can set the pitch of the record to match the pitch of your piano or other instrument for purposes of accompaniment. ★SCHOOLS:—Invaluable tool for teaching music, band instruments, languages, typing, dancing, gymnastics, etc. ★RECREATION CENTERS, CAMPS, COMMUNITY CENTERS:—Powerful amplifier and speaker afford undistorted volume to cover an assemblage of 500 people or more.

THE RHYTHMASTER AND RECITALIST ARE BOTH "FLEXIBLE" INSTRUMENTS. (1) A microphone input enables "mixing" of live music or voice simultaneously with a recording being played. (2) Can be used as a high fidelity public address system. (3) By connecting an AM or FM Tuner, these phonographs become superb broadcast receivers.

SPECIFICATIONS

TURNTABLE: 12" cast aluminum, with hardened and ground shaft.

MOTOR: Constant-speed, 4 pole induction.

SPEAKER: 10" PM type, built to our exacting specifications with heavy Alnico V magnet.

AMPLIFIER: Frequency response is controlled by Polyphonic Selector.

Position No. 1—Uniform within 1 db from 50 to 15,000 cycles.

Position No. 2—Bass up 4 db at 100 cycles, treble uniform above

5,000 cycles.

Position No. 3—Bass up 6 db at 100 cycles, treble uniform above

5,000 cycles.

Position No. 4—Uniform from 50 to 3,000 cycles, increasingly

sharp cut-off, 14 db down at 10,000 cycles.

PICKUP: 16" with dual stylus cartridge. Plays up to 16" broadcast

transcriptions, standard commercial pressings and micro-groove

records.

POWER OUTPUT: 10 watts at less than 3% total harmonic distortion.

INPUT CHANNELS—THREE: High impedance microphone, radio,

phono-pickup.

INPUT GAIN: Microphone, 120 db; phono-pickup, 80 db; radio,

80 db; magnetic pickup, 90 db.

OUTPUT IMPEDANCE: 6-8 ohms at speaker jack.

NOISE LEVEL: More than 50 db below rated output with all

controls set at maximum.

CONTROLS: Microphone, radio-phono, Polyphonic Selector.

TUBE COMPLEMENT: (2) 6SL7, (2) 6V6GT, (1) 5Y3GT plus

(1) 6SC7 for magnetic pickup.

POWER INPUT: 70 watts.

CASE: Sturdy Plywood, covered with rich grey leatherette.

DIMENSIONS: 17" wide, 9 1/2" high, 2 1/4" deep (Closed).

WEIGHT: 38 pounds.

Model	Description	Net Price
RP-43C RECITALIST	3 Speed, crystal pickup	\$229.95
RP-43M RECITALIST	3 Speed, pre-amp., mag. pickup	249.95
RT-43VC RHYTHMASTER	Variable Speed, crystal pickup	269.95
RP-43VM RHYTHMASTER	Variable Speed, pre-amp., magnetic pickup	289.95

289.95

289.95

309.95

329.95

Model SPK-43—Set of twin, high-powered, matched 10" portable

speakers only, for use with your own Recitalist or Rhythmmaster.

Complete with cable and jacks.....\$50.00 net, the Pair



REK-O-KUT COMPANY

MANUFACTURERS OF RECORDING AND TRANSCRIPTION EQUIPMENT FOR THE BROADCAST INDUSTRY

Challenger De Luxe

PROFESSIONAL 13 1/4" DISC RECORDER FOR STANDARD AND MICRO-GROOVE RECORDING

The "Challenger," America's finest professional 13 1/4" disc recorder, is built to meet the respective needs of the Professional Recordist, Musician, Educator and Recording Enthusiast who wants to make permanent, professional recordings. The "Challenger" embodies the most advanced design, engineering and production techniques in the disc recording industry. The many exclusive operating features incorporated in the "Challenger" simplify and improve the art of disc recording.



CHALLENGER DELUXE\$459.95

ACCESSORIES

LEAD SCREWS: see page E-8, Model M-12.

TR-103A.....Idler and Record Bushing for 45 RPM, interchangeable with 33 1/2 RPM idler 8.00

SPECIFICATIONS:

1. MOTOR: Hysteresis Synchronous motor (TR-12H, described in detail on page E-8), fitted with lamitex drive pulley. Suspended in sheer shock mounts to prevent transmission of motor vibration.
2. RECORDING AREA: Records from 6" up to 13 1/4" masters.
3. SPEEDS: Simple, finger-tip speed control for instantaneous selection of speed desired—78, 45, or 33 1/2 RPM.
4. OVERHEAD RECORDING MECHANISM:
 - (a) "LIFTOMATIC SAFETY CAM" prevents double cutting and damage to the stylus by automatically raising the cutter from the disc as it approaches the center of the record.
 - (b) FACILITATES INTERCHANGING LEADSCREWS for standard or micro-groove recording.
 - (c) SPIRAL GROOVES: Run-in, run-out and locked grooves are made with a simple, manual operation.
5. PICKUP ARM: 16" with dual stylus magnetic variable reluctance cartridge. Plays up to 16" broadcast transcriptions, standard commercial pressings and micro-groove records.
6. TURNTABLE: Precision machined aluminum fitted with hardened and ground shaft. Driven by two double-duty neoprene idlers running against the inside rim.
7. SPEAKER: 10" PM type. Custom-built to rigid REK-O-KUT specifications for extra power and wide range. Mounted into detachable cover of case.
8. CASE: Sturdy plywood covered with rich grey leatherette. Built to withstand rough usage.
9. DIMENSIONS: 25" x 22" x 12". Weight: 65 Lbs.

R-8A UNIVERSAL RECORDING AMPLIFIER (as used in DeLuxe "Challenger")

FREQUENCY RESPONSE: ± 1 db from 30 to 20,000 cycles at normal setting of equalizer controls.
 POWER OUTPUT: 19.5 watts at less than 3% total harmonic distortion into resistive load.
 TREBLE EQUALIZER: Boost of 14 db and attenuation of 15 db above 8,000 cycles, continuously variable.
 BASS EQUALIZER: Boost of 14 db and attenuation of 14 db below 50 cycles, continuously variable.
 INPUT CHANNELS—FOUR: 2 high impedance microphones, phono channel compensated for G.E. or Pickering pickup, radio. Switch on rear of chassis changes phono channel for crystal pickup operation.
 GAIN: Microphones—120 db; Phono—90 db; Radio—80 db.
 OUTPUT IMPEDANCE: 4, 8, 15, 125, 250, 500 ohms for cutter and speaker.
 OUTPUT SELECTOR: Three positions providing—recording, play-back and public address. Microphones are muted in play-back position.
 MONITORING: A switch is provided giving three positions of monitor level—off, medium, loud. Speaker or headphones may be used. Meter on front panel indicates correct recording level.
 HUM AND NOISE: 64 db below 13.5 watts with all controls turned for maximum hum and noise output.
 CONTROLS: Microphone "1", microphone "2", radio-phone fader, output selector, treble equalizer, bass equalizer, monitor.
 TUBE COMPLEMENT: (2) 6SJ7; (2) 6SL7; (1) 6SC7; (2) 6V6; (1) 5Y3.
 POWER SUPPLY: 105-125 volts, 50-60 cycles.



POWER CONSUMED: 100 watts.
 DIMENSIONS: Panel—19" x 6 1/4"; Chassis—17" x 8 3/4".

R-8A.....For rack mounting, including tubes.....\$149.95
 C-85.....Portable Case (illustrated), additional..... 22.95

RECORD PLAYERS 3 SPEED • VARIABLE SPEED

The quality instruments of the playback field. Play through any amplifier, sound projector, recorder, radio or TV set. Recommended for dubbing your favorite records into ANY type of recorder—wire, tape or disc.

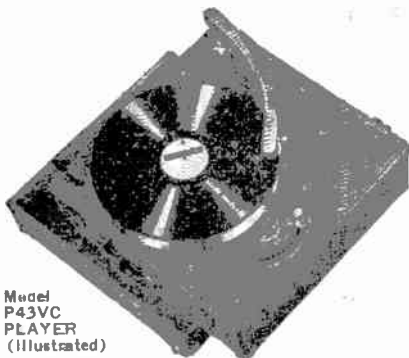

Model P43VC
PLAYER
(Illustrated)

Model	Turntable	Pick-up	Net Price
(See Page E-9 for Detailed Descriptions)			
P-43C	LP-743, 3 Speed	16" Crvstal. Dual Stylus	\$ 99.50
P-43M	LP-743, 3 Speed	16" Dual Stylus, Magnetic Variable Reluctance	104.50
P-43VC	CVS-12 Continuously Variable from 25 to 100 RPM	16" Crystal, Dual Stylus	124.95
P-43VM	CVS-12 Continuously Variable from 25 to 100 RPM	16" Dual Stylus, Magnetic Variable Reluctance	129.95



REK-O-KUT COMPANY

MANUFACTURERS OF RECORDING AND TRANSCRIPTION EQUIPMENT FOR THE BROADCAST INDUSTRY

MODEL V DELUXE DUAL SPEED 16" RECORDING TURNTABLES

The outstanding value in the recording field. Ruggedly constructed and precisely machined, the model "V" deluxe turntable will maintain the constant, wow-free speed and smoothness demanded in broadcast work.

The model M-5S Overhead Cutting Mechanism mounts to the "V" deluxe turntable in a matter of moments.

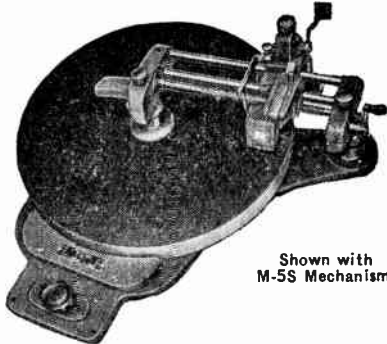

Shown with
M-5S Mechanism

- MOTOR:** Hysteresis Synchronous equipped with lamitex pulley for maximum drive. Suspended in sheer shock mounts to prevent transmission of motor vibration to turntable or chassis.
- TURNTABLE:** Normalized aluminum alloy casting, lathe turned and balanced.
- CHASSIS:** Cast-iron ribbed L beam type with socket for instantaneous installation of M-5S recording mechanism.
- IDLERS:** Double-duty type made of Neoprene compound provides maximum traction. Will not glaze under operating conditions.
- OILING:** Shafts and bearings are self-oiling. Require infrequent periodic lubrication.
- SPEED CHANGE:** Mastermatic self-locking instantaneous speed shift.

SPECIFICATIONS:

- DIMENSIONS:** Front to Back 20"; Width 20"; Height 2 1/2" above motor board; 5" below motor board; Weight 28 lbs.
- | | |
|--------------|------------------|
| Model | Net Price |
| "V-Deluxe" | \$215.00 |

ACCESSORIES

- P-11**—Portable case for "V" Deluxe recording table and M-5S cutting mechanism **64.00**
- C-7**—Console cabinet, metallic grey finish, with record drawer for storing 100 transcriptions. 4 adjustable screw jacks. Built-in electrical outlets. Motorboard cutout **129.95**
- V103A**—45 RPM Idler and record bushing interchangeable with 33 1/2 RPM Idler **8.00**

MODEL M-5S MASTER-PRO 16" OVERHEAD RECORDING MECHANISM

A precise tool for professional work. Working surfaces and moving parts are hardened, ground and polished to a micro finish. The Master-Pro is a universal machine that can be readily attached to all 16" recording turntables as well as the Rek-O-Kut model "V" recording table.

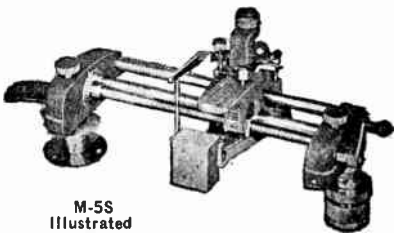

M-5S
Illustrated

- TILT AND LEVEL ADJUSTMENT:** Enables the operator to level and square his unit to disc in a matter of moments.
- DUAL CLUTCH SPIRALING CONTROL:** A fool-proof device which eliminates the danger of spoiling a record while the crank-handle is in motion.
- MICROMETER DEPTH ADJUSTMENT:** For positive depth control of the cutting head.
- LEADSCREW:** Stainless steel with matched bronze feednut.
- ANGLE OF CUT:** Is controlled by a simple micrometer adjustment.
- GEARS:** Drive gears completely enclosed to prevent fouling by loose chips.

SPECIFICATIONS:

- Unit equipped with 120-line O.I. Leadscrews.
- DIMENSIONS:** Length 16"; Width 6 1/2"; Height 9"; Weight 11 lbs.

Model	Net Price
M-5S.....Less cutter	200.00

EXTRA LEADSCREWS

Specify "Inside Out" or "Outside In" by letters I.O. or O.I. after part number.

Part No.	Lines Per Inch	Net Price
MS-105	105	\$ 37.50
MS-120	120	37.50
MS-135	135	37.50
MS-210 (Micro-Groove)	210	47.50
MS-240 (Micro-Groove)	240	47.50
MS-270 (Micro-Groove)	270	47.50

MODEL TR-12H DUAL SPEED 12" RECORDING TURNTABLE

The first 12" dual speed recording turntable to feature a SYNCHRONOUS MOTOR. Design and construction of the model TR-12H is similar to the Rek-O-Kut 16" professional recording tables. The model M-12 overhead recording mechanism is mounted to the chassis in a few moments.



Shown with
M-12 Mounted

- TURNTABLE:** Aluminum, lathe turned and balanced.
- CHASSIS:** Cast aluminum. Drilled and tapped for instantaneous mounting of the M-12 recording mechanism.
- MOTOR:** Hysteresis Synchronous, fitted with a lamitex drive pulley. Suspended in sheer shock mounts to prevent transmission of motor vibration.
- SHAFTS:** Hardened, ground and polished to a micro-finish.
- DRIVE:** Internal rim. Drives through double-duty Neoprene idlers which insure free, smooth and quiet operation.

SPECIFICATIONS:

- SPEED CHANGE:** Instantaneous speed shift engages either the 78 or 33 1/2 RPM idler.
- FINISH:** Beautiful grey wrinkle.
- DIMENSIONS:** Front to Back 16 1/2"; Width 16"; Height 1 1/2" above motor board. 5" below motor board. Weight 17 lbs.

Model	Description	Net Price
TR-12H	With Synchronous Motor	\$129.95

ACCESSORY

T-103A	45 RPM Idler and record bushing interchangeable with 33 1/2 RPM Idler	8.00
---------------	---	-------------

MODEL M-12 OVERHEAD RECORDING MECHANISM

The M-12 Overhead Cutting Mechanism is a truly professional machine for recording enthusiasts and professionals. It incorporates many of the features found only in 16" professional units. The M-12 records up to 18 1/2" master discs and can be mounted on any 12" recording turntable.

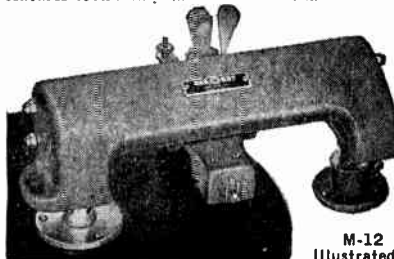

M-12
Illustrated

- SPIRAL GROOVE:** A run-in, run-out and locked groove made with a simple manual operation.
- LEADSCREW:** 108LPI stainless steel, lapped to a matched feednut which is in constant mesh.
- LIFT-O-MATIC:** Automatically lifts cutter from disc as it approaches end of leadcrew.
- MAGNETIC CUTTER:** 8 ohms, flat from 40 to 7,000 cycles.
- DIMENSIONS:** Length 11 1/4"; Width 4 1/4"; Height 6".

SPECIFICATIONS:

Model		Net Price
M-12	For 12" turntables	\$ 99.95

EXTRA LEADSCREWS

Specify "Inside Out" or "Outside In" by letters I.O. or O.I. after part number.

Part No.	Lines Per Inch	Net Price
M12-120	120	\$ 17.95
M12-144	144	17.95
M12-216 (Micro-Groove)	216	27.95
M12-240 (Micro-Groove)	240	27.95
M12-264 (Micro-Groove)	264	27.95



REK-O-KUT COMPANY

MANUFACTURERS OF RECORDING AND TRANSCRIPTION EQUIPMENT FOR THE BROADCAST INDUSTRY

MODEL "G-2" DELUXE 16" TRANSCRIPTION TURNTABLES

The model "G-2 Deluxe" Transcription Turntable is acknowledged without reservation by the broadcasting industry to be the finest rim-driven turntable on the market. The rigid requirements for network programs are easily met by the "G-2 Deluxe."

OPERATING DATA:

- STARTING:** From standing start to 78 RPM $\frac{3}{4}$ of a turn. From standing start at 33 $\frac{1}{2}$ RPM $\frac{1}{4}$ of a turn. Meets the NAB standard for speed variation and wow content.
- NOISE LEVEL:** 50 db below average recording level.
- CUEING:** 16 $\frac{3}{4}$ " turntable permits the record to overlap $\frac{1}{8}$ " which enables the operator to cue from the rim of the disc.
- CONSTRUCTION:** (A) Precision lathe-turned balanced turntable. (B) Hysteresis Synchronous motor with Lamitex pulley. (C) Double duty Neoprene idlers. (D) Cast-iron L beam no twist chassis. (E) Mastermatic self-locking instantaneous

speed shift. (F) All shafts hardened, ground, polished to micro finish.

- DIMENSIONS:** Front to Back 20"; Width 16"; Height 2 $\frac{1}{2}$ " above motor board; 5" below motor board. Weight 26 lbs.

Model	Description	Net Price
G-2 Deluxe.....	With Hysteresis Synchronous Motor, Mastermatic Shift	\$179.95
G-2 Standard..	With 4 pole Motor and Manual Shift.....	137.50

ACCESSORY

G 103 A.....	45 RPM Idler and record adapter interchangeable with 33 $\frac{1}{2}$ RPM Idler	8.00
--------------	---	------

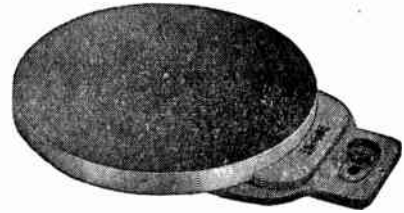

G-2 Standard Illustrated

MODELS T-12H and T-43H DUAL SPEED 12" TRANSCRIPTION TURNTABLES

The REK-O-KUT Models T-12H and T-43H are the only 12" dual speed turntables that meet the standards for speed regulation and wow content specified by the National Association of Broadcasters. The construction, design and performance standards equal the REK-O-KUT 16" broadcast models. The T-12H and T-43H are recommended for use with Hi-Fi amplifiers and speaker systems.

SPECIFICATIONS:

- NOISE LEVEL** (a) T-12H—T-43H: 50 db below average recording level.
(b) T-12—T-43: 40 db below average recording level.
- MOTORS:** (a) T-12H and T-43H — Hysteresis Synchronous.
(b) T-12 and T-43—4 pole, built to REK-O-KUT specifications.
All motors, shock mounted, are fitted with lamitex pulleys, which are pressed on, and ground concentric to the motor shaft—an exclusive REK-O-KUT feature which insures smooth, rumble-free operation.

- COMPONENTS:**
Turntable—Cast aluminum, machined and balanced.
Chassis—Aluminum casting, cross ribbed, flush mount. Requires a rectangular cutout for mounting. Easily installed.
Drive—Internal rim drive through double-duty Neoprene idlers insures free, smooth and quiet operation.

- Shafts—Hardened, ground and polished to a micro-finish.
- SPEED SELECTION:** Instantaneous speed shift engages either 78 or 33 $\frac{1}{2}$ RPM idler without stopping turntable or removing disc.
 - FINISH:** Grey Wrinkle.
 - DIMENSIONS:** Front to Back 15"; Width 13"; Height 1 $\frac{3}{8}$ " above motor panel and 5" below motor panel. Weight 13 lbs.

Model	Speeds	Net Price
T-12H	78 - 33 $\frac{1}{2}$	\$119.95
T-12	78 - 33 $\frac{1}{2}$	84.95
T-43H	45 - 33 $\frac{1}{2}$	119.95
T-43	45 - 33 $\frac{1}{2}$	84.95

ACCESSORIES

T-103A.....	45 RPM Idler, with record bushing, interchangeable with 33 $\frac{1}{2}$ RPM Idler.....	8.00
T-104-43.....	78 RPM Idler, interchangeable with 45 RPM Idler..	7.50
C-12H.....	Portable Case	26.95

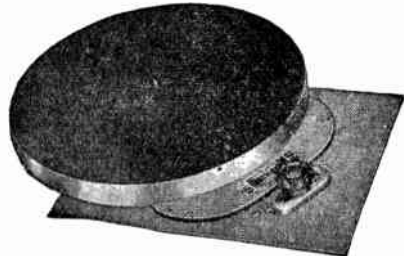

T-12H Illustrated

MODEL LP-743 — 3 SPEED 12" TRANSCRIPTION TURNTABLE

Here is the outstanding value for the discriminating buyer who seeks a quality three-speed turntable, at a moderate price. The LP-743 meets the growing demand for a good turntable which is priced between deluxe models and ordinary phono motors. Designed and dimensioned for easy replacement of obsolete motors in average consoles.

SPECIFICATIONS:

- NOISE LEVEL:** 30 db below average recording level.
- TURNTABLE:** Lathe-turned and balanced. Made of laboratory tested aluminum casting.
- MOTOR:** 4 pole, designed for smooth, quiet, vibration-free operation, fitted with a Lamitex motor pulley.
- SHAFT:** Turntable shaft hardened, ground and polished.
- SPEED CHANGES:** Instantaneous without stopping turntable or removing disc.
- FINISH:** Grey hammertone.
- DIMENSIONS:** Front to Back 14"; Width 12"; Height 1 $\frac{3}{8}$ " above motor panel; 5" below motor panel. Weight 10 lbs.

Model	Net Price
LP-743..... 3 Speeds: 78 - 45 - 33 $\frac{1}{2}$	\$59.50

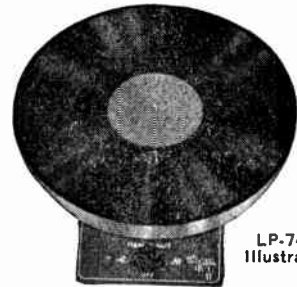

LP-743 Illustrated

MODEL CVS-12 — CONTINUOUSLY VARIABLE-SPEED TURNTABLE

Plays at any speed from 20 to 100 RPM without distortion or warble

Operates on 50 or 60 cycles. Just plug in . . . no more changing of motor pulley or idler to convert from 50 to 60 cycles, or vice versa. Speeds are regulated by a simple movement of the lever to compensate for any fluctuations in line voltage or frequencies. Plays all standard and microgroove records as well as 16" professional broadcast transcriptions. Excellent for broadcast stations, disc jockeys, schools, dance studios, musicians, singers, record collectors, gymnasiums, etc. The only turntable to use in areas of fluctuating line voltage, frequency, or with portable power plant.

SPECIFICATIONS:

- SPEED RANGES:** Continuously Variable.
(a) 110V-60 cycles, Range: 25 to 100 RPM.
(b) 110V-50 cycles, Range: 20 to 85 RPM.
- MOTOR:** Constant speed, 4 pole, with cone pulley.
- DRIVE:** Exclusive VARI-CON* self-seating rim drive.
- TURNTABLE:** 12" cast aluminum, with hardened and ground shaft.
- NOISE LEVEL:** 30 db minimum below average recording level.
- DIMENSIONS:** Front to Back 15 $\frac{1}{2}$ "; Width 12"; 1 $\frac{1}{2}$ " above chassis, 5" below chassis.

Model	Net Price
CVS-12..... Variable Speed, 25-100 RPM.....	\$84.95



CVS-12 Illustrated

REK-O-KUT COMPANY

MANUFACTURERS OF RECORDING AND TRANSCRIPTION EQUIPMENT FOR THE BROADCAST INDUSTRY



THE NEW 16-INCH 3-SPEED

TRANSCRIPTION TURNTABLE . . .

. . . for the BROADCASTER
and the RECORDING STUDIO

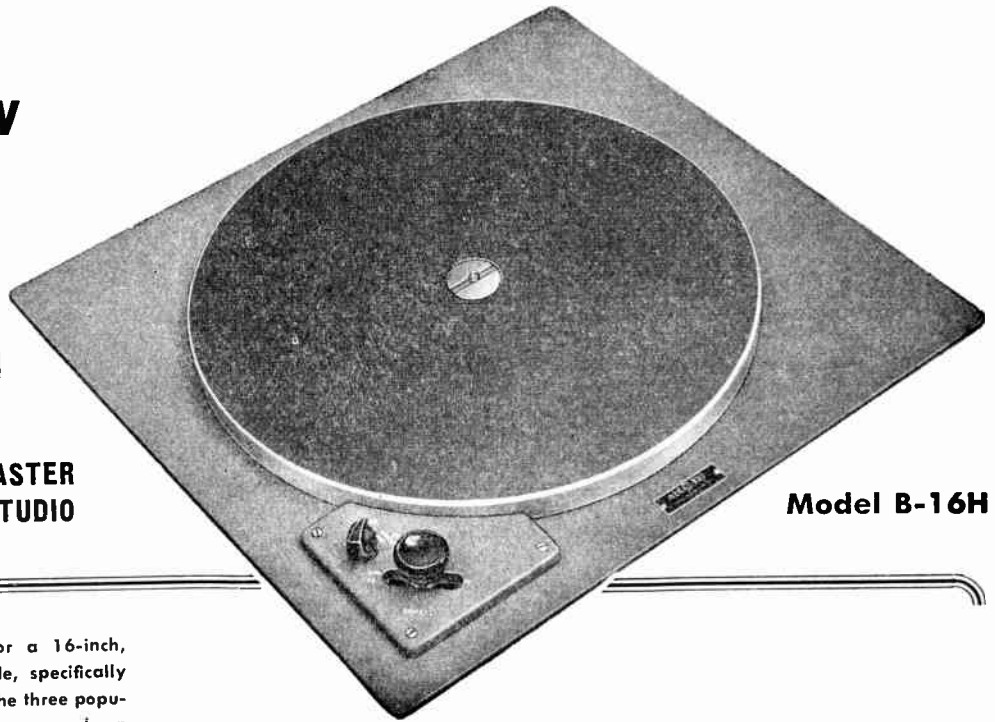

Model B-16H

THE UNIVERSAL DEMAND for a 16-inch, 3-speed transcription turntable, specifically designed and engineered for the three popular disc recording speeds, has now been filled by the REK-O-KUT Model B-16H.

Entirely new elements of design and engineering, based upon suggestions made by leading engineers in the field, were embodied to produce this "authentic" three-speed turntable. As a result, all three recording speeds—33 $\frac{1}{3}$, 45 and 78—can be selected with equal facility simply by turning an indicator.

The B-16H is dimensioned for ready replacement of your obsolete two-speed tables in your present consoles or cabinets. Some cabinets may require slight modifications for fitting.

New! MODEL C-7B CONSOLE CABINET for B-16H

Cabinet is designed to receive B-16H chassis without using screws or bolts. Floats on felt. Features two storage compartments with piano hinges and flush ring-latches. Includes built-in electrical outlet and adjustable levelling legs. Metallic-grey finish. Dimensions: 33" high, 22" wide, 20 $\frac{1}{2}$ " deep.

PRICE \$109.95 net



SPECIAL FEATURES

- THE TURNTABLE is cast aluminum, lathe turned and sub-mounted in base.
- 45 RPM ADAPTER . . . disappearing type . . . built into hub of turntable.
- BASE is drilled and tapped for mounting Audak, Gray 108B and Pickering arms.
- DIMENSIONED for ready replacement of your obsolete two-speed tables in your present consoles or cabinets. Some cabinets may require slight modifications for fitting.
- MAINTENANCE is simple . . . the turntable, motor pulley and idlers are easily accessible.

OPERATING DATA

STARTING:

From standing start to 78 rpm . . .
 $\frac{3}{4}$ of a turn.

From standing start at 45 and 33 rpm
. . . $\frac{1}{4}$ of a turn.

NOISE LEVEL: 50 db below average
recording level.

SPEED VARIATION: Meets the NAB
standard for speed variation and "wow"
content.

CUEING: 15 $\frac{3}{4}$ " Turntable permits the
record to overlap $\frac{1}{8}$ " which enables the
operator to cue from the rim of the disc.

DIMENSIONS: 1 $\frac{1}{2}$ " above base, 6"
below. 20" x 18 $\frac{3}{4}$ ".

SPECIFICATIONS

BASE: Cast aluminum, square shape,
machined. Radial ribbed for utmost
rigidity.

TURNTABLE: Cast aluminum—16-inch.
Lathe turned with extra heavy rim for
balanced flywheel action. Sub-mounted
in base.

SPEED CHANGE: Instantaneous for all
three speeds. Controlled by selector.

DRIVE: Rim driven through idlers.

SPEED SHIFT: Mastermatic, self-lock-
ing. A REK-O-KUT exclusive.

MOTOR: Hysteresis Synchronous. 60
cycles A.C. 115 volts. Motors available
in other frequencies and voltages at
additional cost.

FINISH: Blue-gray wrinkle.

SHIPPING WEIGHT: 30 lbs.

PRICE: \$250.00 net.

PENTRON

ONLY COMPLETE LINE OF TAPE RECORDERS AND ACCESSORIES

Professional quality at moderate price is the big appeal of Pentron Equipment. Compare . . . see how Pentron units match the performance of costlier equipment. For Hi-Fi custom installation, or portability, Pentron will satisfy your needs — at less than you expected to pay.

MODEL HT-225

with separate
"Roving Speaker"
\$225.00 list



2+1 SPEAKER TAPE RECORDER

First 3-Speaker Tape Recorder with separate "roving speaker" adds new dimension to sound. New mobile speaker can be placed anywhere and directioned to give balanced reproduction. This unique feature creates amazing realism and sparkling voice playback. Hear this new listening thrill!

- "Roving tweeter" in lid has own volume control.
- 2 internal matched speakers for bass and middle range.
- Complete LC crossover network at 1000 CPS.
- Only 33 lbs. total weight

HI-FI TAPE RECORDING EQUIPMENT FOR BUDGET-CONSCIOUS SOUND PERFECTIONISTS

Pentron components give you balanced recording throughout the entire audio range. Wired ready to plug into any audio system. Units can be ordered separate or pre-mounted in carrying case. You have a choice of a DeLuxe (HFP-1) Pre-Amplifier or the Standard (PRE-7) Pre-Amplifier. Model 9T-3M Tape Mechanism is matched with both.

These are the two pre-mounted combinations.

MODEL PMD-1 (HFP-1 + 9T3M + Carrying Case)

MODEL PMC (Pre-7 + 9T3M + Carrying Case)

Standard Pre-Amplifier MODEL PRE-7 \$ 39.75 net

Portable combination MODEL PMC \$114.50 net

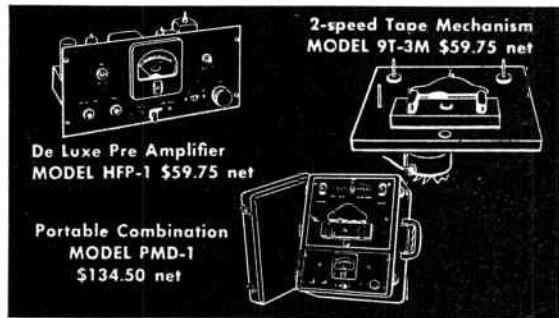

YOU'LL FIND MANY USES FOR THIS LOW-COST MULTI-SPEED TAPE RECORDER

It's the versatile Pentron Tape Recorder that will outplay and outperform any other recorder in its price class. Invaluable for uses in home, school, church and business. Compact and smartly styled, the ideal combination of top performance and appearance. It weighs only 27 lbs.

- 2 playing and recording speeds with push button control.
- Fast forward and rewind speeds.
- Editing key operates while playing.
- Magic Eye recording indicator.
- Positive interlock control switch.
- Accommodates 7" reels with lid closed.

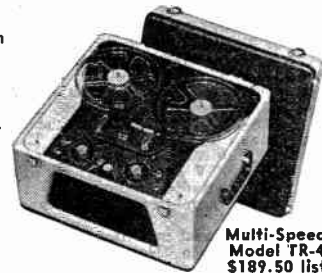

Multi-Speed
Model TR-4
\$189.50 list

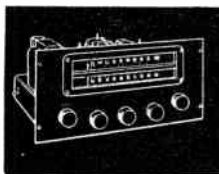

AM-FM TUNER—Model AFM. Intermatched with 9T-3M, HFP-1 and PRE-7. Exclusive "Tape-Mate" features. Foster-Seeley discriminator. Automatic frequency control with push-button AFC de-

feat switch, many other

\$89.95 net

"See . . . Hear Entire Line of
Pentron Tape Recorders
and Accessories"

OTHER PENTRON ACCESSORIES

- Foot Control
- Tape Carrying Case
- Reel Adapter
- Telephone Pick-up
- Magnetic Tape
- Extension Cords

TAPE PLAYER—Model PB-A2. 2 speeds. Plays back any pre-recorded tape. Fast rewind and forward. Self-contained amplifier and speaker. \$119.50 list



AUDIO-MIX—Model MM-4 electronic mixer for multiple mike recording on tape, wire, disc or P.A. system. Connects to any audio system.

\$59.50 list

The **PENTRON** Corp. Dept. RM54 • Chicago 24, Illinois

ONLY *WILCOX-GAY* tape Recordio

has the **PRESTOMATIC**
T.M. REG. U.S. PAT. OFF.
PUSH-BUTTON KEYBOARD
PATENT PENDING

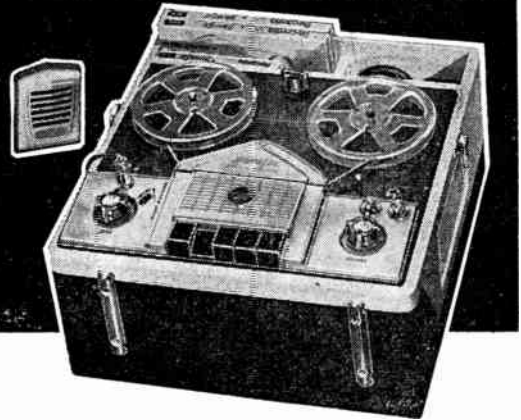

MODEL 4A10 • List Price \$149.95

At the press of a finger . . . "click," it's recording . . . "click," it's on playback . . . automatically. So easy a child can do it. Wilcox-Gay takes the mystery out of tape recording . . . with a remarkably simple easy-to-read keyboard. . . . The five PRESTOMATIC keys are marked: "RECORD," "PLAY," "STOP," "FORWARD" (high speed) and "REVERSE" (high speed) and for all its simplicity, RECORDIO maintains an unapproached standard of performance.

- Size: 9" x 13 $\frac{3}{8}$ " x 14 $\frac{1}{2}$ "
- Weight: Approximately 28 lbs.
- Speed Selector: 3 $\frac{3}{4}$ and 7 $\frac{1}{2}$ I.P.S.
- Speaker: 5" x 7" Elliptical.
- Reels: Uses 3", 5", 7" reels.
- Record Lock Button: Prevents accidental erasure.
- Radio-Phono-TV Input Jack: This low level input permits recording from Radio, Phono or TV.
- Microphone Supplied: Crystal type for maximum sensitivity and fidelity.
- Two Record Level Indicators: The "Easy View" neon indicators show at a glance "Normal" and "Overload."
- External Speaker Jack: For earphone monitoring or operation of external speaker.
- Tone Control: Full range variable control from maximum brilliance to a deep rich bass tone.
- Remote Control: (optional) Permits "ON and OFF" operation from a distance.

- Volume Control: Bass and treble compensated for best reproduction.
- Two Storage Compartments: To carry spare tape—microphone, built-in line cord and patch cords.
- Public Address System: Speeches or entertainment can be recorded at the same time the unit is being used as a public address system.
- Amplifier: 3 watts output.
- Fast Rewind and Fast Forward: Rewinds 7" tape in less than 2 $\frac{1}{2}$ minutes.
- Duplicating Tapes: Using two units—exact copies can be made.
- U. L. Approved.

Frequency Response 80 to 8000 Cycles	
WOW and Flutter	
.3% Max. at 7 $\frac{1}{2}$ IPS	
.5% Max. at 3 $\frac{3}{4}$ IPS	
Signal to Noise 35 db Minimum	

Recording Time Using Both Channels		
Reel Sizes	3 $\frac{3}{4}$	7 $\frac{1}{2}$
5-inch	1 Hr.	$\frac{1}{2}$ Hr.
7-inch	2 Hrs.	1 Hr.

stereophonic **3D** sound

WILCOX-GAY DUAL SPEAKER tape Recordio

featuring the **PRESTOMATIC** push-button keyboard
T.M. REG. U.S. PAT. OFF. PATENT PENDING

MODEL 4B10 • List Price \$179.95

- Size: 10" x 15 $\frac{5}{8}$ " x 14 $\frac{1}{4}$ "
- Weight: 32 pounds.
- Speed Selector: 3 $\frac{3}{4}$ and 7 $\frac{1}{2}$ I.P.S.
- Reels: Uses 3", 5", 7" reels.
- Dual Speakers: Two 5" x 7" speakers.
- Visual Tape Index: Any selection on the tape located quickly by number, Radio type pointer scale.
- Push-Button Type Record Lock: Easier to operate record lock prevents accidental erasure.
- Radio-Phono-TV Input Jack: This low level input permits recording from Radio, Phono or TV.
- Microphone Supplied: Crystal type for maximum sensitivity and fidelity.
- Two Record Level Indicators: The "Easy View" neon indicators show at a glance "Normal" and "Overload."
- External Speaker Jack: For earphone monitoring or operation of external speaker.
- Tone Control: Full range variable control from maximum brilliance to a deep rich bass tone.
- Volume Control: Bass and treble compensated for best reproduction.
- Remote Control: (optional) Permits "ON and OFF" operation from a distance.

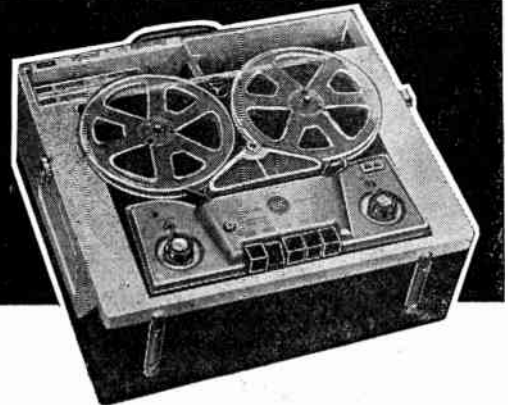

- Two Storage Compartments: To carry spare tape—microphone, built-in line cord and patch cords.
- Public Address System: Speeches or entertainment can be recorded at the same time the unit is being used as a public address system.
- Amplifier: 3 watts output.
- Fast Rewind and Fast Forward: Rewinds 7" tape in less than 2 $\frac{1}{2}$ minutes.
- Duplicating Tapes: Using two units—exact copies can be made.
- U. L. Approved.

Frequency Response 80 to 8000 Cycles	
WOW and Flutter	
.3% Max. at 7 $\frac{1}{2}$ IPS	
.5% Max. at 3 $\frac{3}{4}$ IPS	
Signal to Noise 35 db Minimum	

Recording Time Using Both Channels		
Reel Sizes	3 $\frac{3}{4}$	7 $\frac{1}{2}$
5-inch	1 Hr.	$\frac{1}{2}$ Hr.
7-inch	2 Hrs.	1 Hr.



WILCOX-GAY Recordio ACCESSORIES

RECORDIO ACCESSORIES

Model	List Price
EP-10—Ear Phone, lightweight, plastic, excellent fidelity.	\$12.00
9-2221-1—Microphone connecting cord complete with connectors 12 $\frac{1}{2}$ ft.	5.00
9-2221-2—Microphone connecting cord complete with connectors 25 ft.	5.50

Model	List Price
9-2233—Radio-Phono recording cable 6 ft. Complete with connectors and network. For Models 2A10, 2A11, 3C10	3.50
20-233—Radio-Phono recording cable for Models 3A10, 3A11, 3F10	1.35

RECORDIO TAPE

Model	List Price
115—5" Reel, 600 ft. roll, Plastic Base.	\$3.50
117—7" Reel, 1200 ft. roll, Plastic Base.	5.50
ER-95—5" Empty tape reel in box.50
(Minimum shipping quantity: 12 reels)	
ER197—7" Empty tape reel in box.60
(Minimum shipping quantity: 12 reels)	

THE WILCOX-GAY CORPORATION

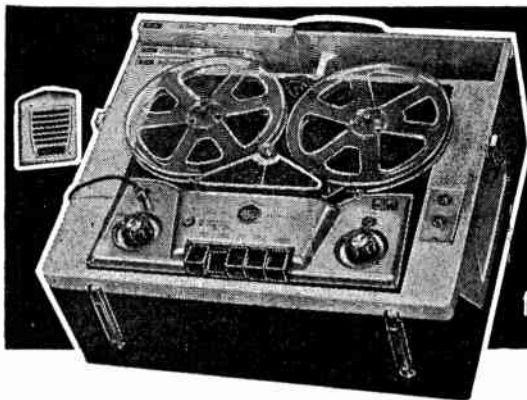

high fidelity **WILCOX-GAY**

tape Recordio®

stereophonic **3D** sound

featuring the **PRESOMATIC** push-button keyboard

T.M. REG. U.S. PAT. OFF.

PATENT PENDING

Never before has a unit so rich in fidelity, range and tone qualities been available for professional and home recording. Powerful enough to meet any volume requirement . . . sensitive enough to pick up the faintest whisper . . . with High Fidelity, Stereophonic 3D Sound.

- Size: 10" x 15 7/8" x 14 1/4"
- Weight: 35 pounds.
- Speed Selector: 3 3/4 and 7 1/2 I.P.S.
- Push-Pull Amplifier: Delivers 7 watts of undistorted output.
- Dual Speakers: Two 5" x 7" speakers.
- Reels: Uses 3", 5", 7" reels.
- Visual Tape Index: Any selection on the tape located quickly by number.
- Push-Button Type Record Lock: Prevents accidental erasure.
- Three Extension Speaker Jacks: To utilize any arrangement of external speakers.
- Radio-Phono-TV Input Jack: This low level input permits recording from Radio, Phono or TV.
- Microphone Supplied: Crystal type for maximum sensitivity and fidelity.

MODEL 4F10 • List Price \$199.95

- Remote Control: (optional) Permits "ON and OFF" operation from a distance.
- Two Record Level Indicators: "Normal" and "Overload."
- Full range variable tone control.
- Volume Control: Bass and treble compensated.
- Two Storage Compartments: For tape, mike and cords.
- Public Address System: Speeches or entertainment can be recorded at the same time the unit is being used as a public address system.
- Fast Rewind and Fast Forward: Rewinds 7" tape in less than 2 1/2 minutes.
- Duplicating Tapes: Using two units—exact copies can be made.
- U. L. Approved.

Frequency Response 70 to 10,500 Cycles
WOW and Flutter .3% Max. at 7 1/2 IPS .5% Max. at 3 3/4 IPS
Signal to Noise 35 db Minimum

Recording Time Using Both Channels		
Reel Sizes	3 3/4	7 1/2
5-Inch	1 Hr.	1/2 Hr.
7-Inch	2 Hrs.	1 Hr.

MODEL DS12-54 • Dual Extension Speakers

This is a unit type, dual speaker case for easy portability. Closed dimensions 20"x15"x9". Lock corner plywood construction with handsome two-tone fabricoid and tweed lumite covering. The case separates for use into two identical baffles each containing a 12" extended range PM speaker. Two 25 ft. connecting cords each with plug to fit standard contact jack are furnished. An additional jack on each half of the carrying case permits intercommunication, or the use of additional remote speakers for better audience coverage.

List Price \$64.50

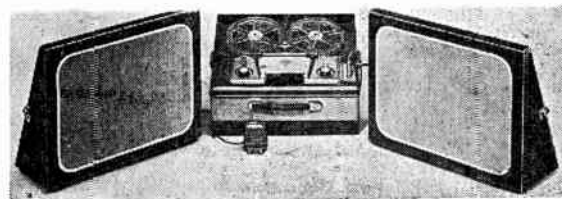

RECORD ON TAPE . . .

RECORD FROM ONE

RECORD ON DISC . . .

TO THE OTHER

WITH THE VERSATILE **WILCOX-GAY**
COMBINATION TAPE-DISC
Recordio®

MODEL 4C10 • LIST PRICE \$199.95

- Size: 19" x 16 1/2" x 11"
- Weight: 30 pounds.
- Two-Tone Streamlined Case.
- High Speed Wind: Forward and reverse.
- Microphone Supplied: Controlled reluctance microphone.
- Two Record Level Indicators: The "Easy View" neon indicators show at a glance "Normal" and "Overload."
- Can be used as a conventional phonograph and public address amplifier.

- Combination tape and disc recording.
- External Speaker Jack: For earphone attachment or to permit operation of an external speaker.
- Speaker: 6" x 9" elliptical PM speaker.
- Tone Control: This full range variable control may be rotated from maximum brilliance to deep rich bass tone.

PERFORMANCE DATA AT ±3 DB.	
3 3/4 IPS	80-6000 cps.

Tape Speed..... 3 3/4 I.P.S.
Record Speed..... 78 R.P.M.



Model	Recordio Discs	List Price	Model	List Price
A-26 1/2—6 1/2" Fiber Base, 6 to pks.		\$.60	G-28—8" Hvy. wt., Alum., single sleeves	\$.48
A-28—8" Fiber Base, 6 to pks.		1.00	G-210—10" Hvy. wt. Alum., single sleeves	.60
D-26 1/2—6 1/2" Lt. wt. Alum., 6 to Album		1.25	Recordio Point Needles	
D-28—8" Lt. wt. Alum., 6 to Album		1.75	D-9—Spring action playback needle	1.50
D-210—10" Alum. Base, 6 to pks.		2.50	D-10—Dual purpose cutting playback needle (3 speed)	2.50
			D-11—Dual purpose cutting playback needle (78 rpm)	2.50

THE WILCOX-GAY CORPORATION

Copyright by U. C. P., Inc.

TRADE DISCOUNT APPLIES TO LIST PRICES ONLY

Radio's Master—19th Edition

Page E-13

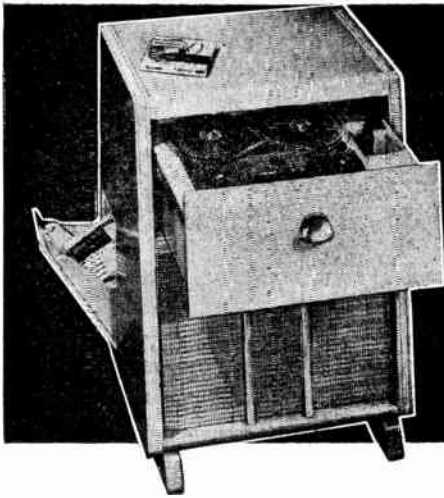

exclusive *WILCOX-GAY Hi-Fi*

Recordio Grand

The only tape recorder
made especially for the home

featuring the **PRESIOMATIC** push-button keyboard

List Price: MODEL 3F40 Mahogany \$289.50 • MODEL 3F41 Limed Oak \$299.50

Wilcox-Gay's master craftsmen have made this first console recorder a truly beautiful piece of furniture . . . available in the most exquisite mahogany veneers or modern limed oak. Storage compartments hold twelve 5" or 7" reels of tape.

- Sizes: 34" high, 22" wide, 21" deep at base, 14" deep at top.
- Weight: 64 pounds.
- Speed Selector: 3¾ and 7½ I.P.S.
- Dual Speakers: 12" wide range speaker and separate high frequency tweeter speaker.
- Hi-Fi Push-Pull Amplifier: Delivers 6 watts of undistorted output.
- Visual Index Counter: A completely accurate revolution counter locates the exact selection.
- Record Lock Button.
- Radio-Phono-TV Input Jack: Permits recording from Radio, Phono or TV.
- Microphone Supplied: Crystal type for maximum sensitivity and fidelity.
- Two Record Level Indicators: The "Easy View" neon indicators show at a glance "Normal" and "Overload."

- External Speaker Jack: For earphone monitoring or operation of external speaker.
- Tone Control: Full range variable control for maximum brilliance to a deep rich bass tone.
- Volume Control: Bass and treble compensated for best reproduction.
- Two Storage Compartments: To carry spare tape—microphone, built-in line cord and patch cords.
- Public Address System: Speeches or entertainment can be recorded at the same time the unit is being used as a public address system.

Performance Data
at ±3 db.

3¾ IPS	75-7,500 cps.
7½ IPS	55-10,500 cps.
Hum Level 50 db.	Noise Level 58 db.

Recording Time Using
Both Channels

Reel Sizes	3¾	7½
5-inch	1 Hr.	½ Hr.
7-inch	2 Hrs.	1 Hr.

Music that Lives!

WILCOX-GAY 400 high fidelity phonograph

Wilcox-Gay opens the door to a new world of high fidelity music with the "400." Here is your introduction to the joys of really fine music. A magnificent Hi-Fi instrument offering audio reproduction in its most advanced stage.

Now . . . high fidelity moves out of the upper income brackets and comes within the reach of all.

- Plays all records in all speeds . . . automatically.
- Stereophonic side mounted twin-speaker system.
- Acoustically designed cabinet forms a tone perfect chamber of unequalled qualities.
- Bentwood cabinet construction provides necessary bass-reflex.
- Dimensions: 18" wide, 11" high, 14" deep.

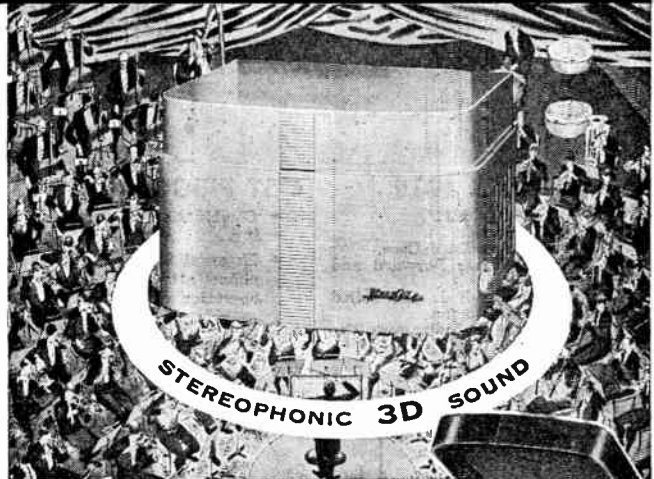

Model 400 List Prices:

Mahogany\$129.50
Limed Oak\$134.50
Ebony\$134.50



THE WILCOX-GAY CORPORATION

The *NEW* magnecord M-80

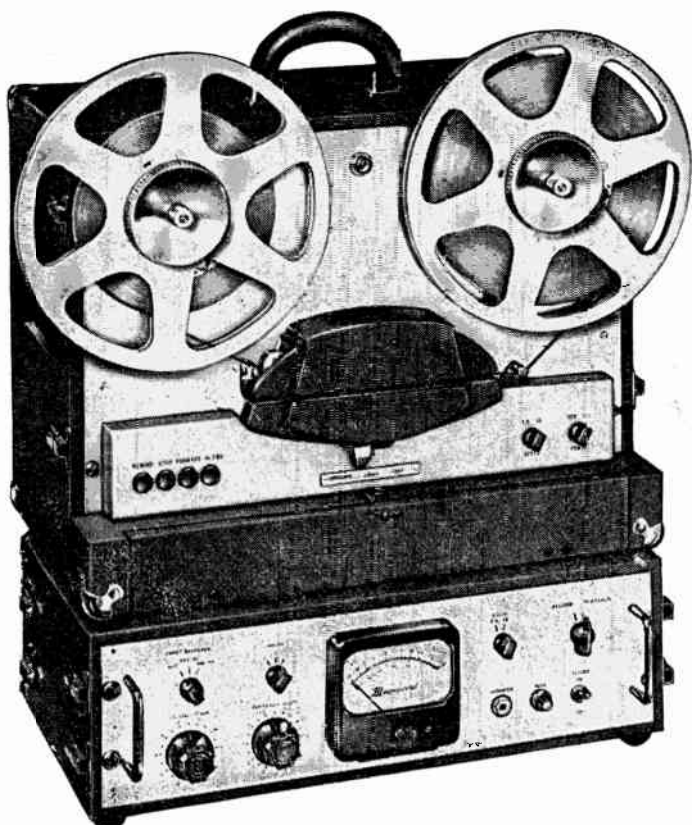

*World's Most
Versatile*

professional tape recorder

- ★ Slot-loading, easiest tape handling-editing.
- ★ Push button operation and full remote control.
- ★ 15,000 cps at 7½ inches

**Check these outstanding
new features!**

- ★ 30-15,000 cps, ±2 db at 15" per sec.
- ★ 50-10,000 cps, ±2 db at 7½" per sec.
- ★ 50-15,000 cps, ±4 db at 7½" per sec.
- ★ Timing accuracy ±3 sec. in 30 min.
- ★ Signal-to-noise exceeds 58 db
- ★ Flutter less than 0.1% RMS at 15 ips.
- ★ Standard NARTB playback curve
- ★ Instant dual speed selection
- ★ Microphone and bridging inputs
- ★ Full or half track operation
- ★ Case, rack, or console mounting

See and operate the brilliant new
Magnecord M-80 at your dealer's. Look in
the classified directory under "recorders".

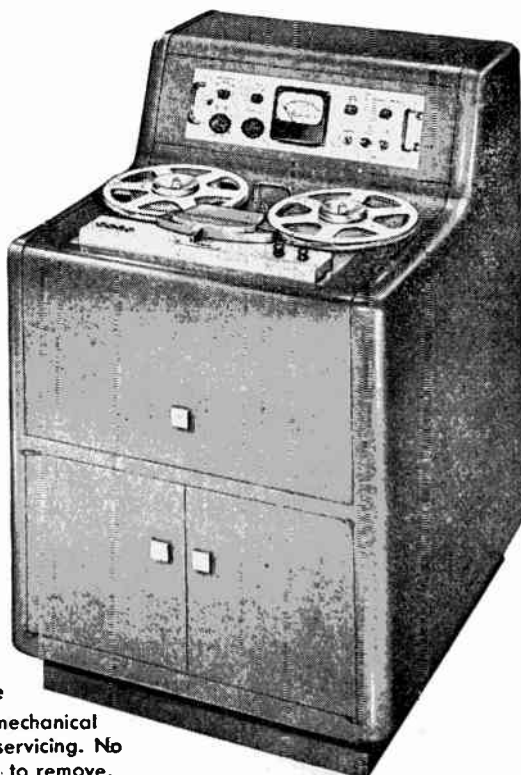

The new
M-80 Console

Amplifier and mechanical
unit inverts for servicing. No
mounting screws to remove.

Magnecord INC.

225 West Ohio Street, Dept. RM-54
Chicago 10, Illinois

LQ*

* *Listening Quality*

The prime function of your hi-fi **TONE ARM**

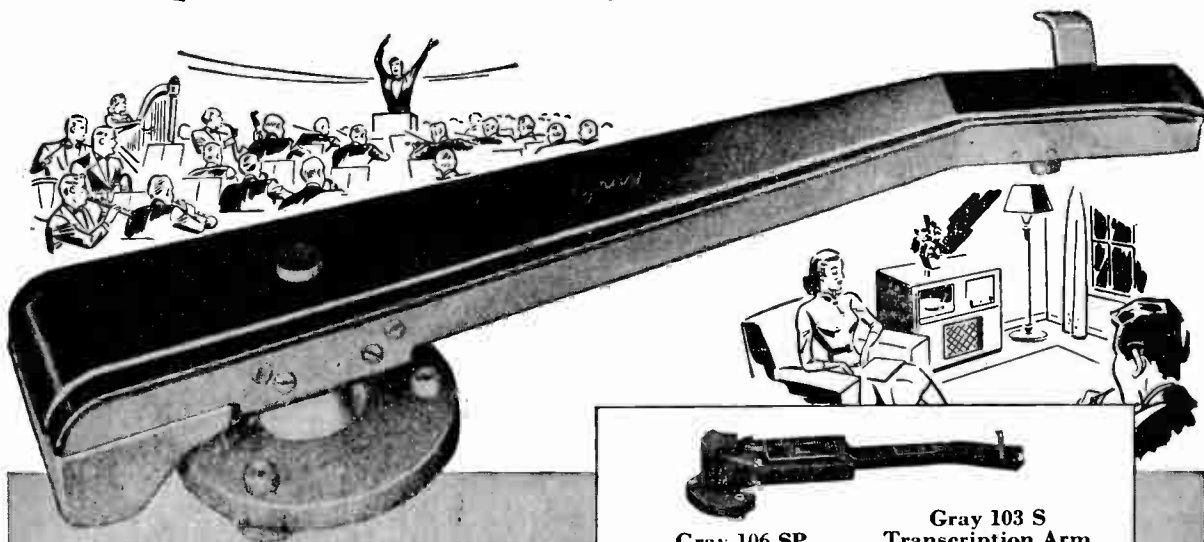

The **GRAY**
viscous-damped 108 B
TONE ARM

Gray offers a radical departure in tone arm design to assure the ultimate in performance from new and old recordings . . . 33 $\frac{1}{3}$, 45, and 78 RPM . . . up to 16" in diameter. The NEW suspension principle "damps" vertical and horizontal movement of the arm . . . stops groove jumping and skidding . . . prevents damage if arm is dropped. Instant cartridge change . . . Pickering, GE, Fairchild . . . with automatic adjustment to correct pressure.



Gray 106 SP
Transcription Arm
Chosen by professionals for superb tone reproduction . . . for every speed record.

Gray 103 S
Transcription Arm
Leading audio engineers recognize the true tone reproduction. Specifically designed for 78 RPM records.

Visit your nearest High Fidelity dealer today . . . examine the precision construction of Gray Tone Arms . . . hear them reproduce perfect Hi-Fi performance.



GRAY EQUALIZER 602B . . . for use with GE Cartridges. Provides in four steps various combinations of equalization required for all types of records.

GRAY EQUALIZER 603 . . . Ensures a selection of five response curves with selector switch to permit instant accommodation of either professional model GE or Pickering Cartridges.

GRAY RESEARCH

AND DEVELOPMENT CO., Inc., Hilliard St., Manchester, Conn.
Division of the GRAY MANUFACTURING COMPANY
Originators of the Gray Telephone Pay Station and the Gray Autograph and PhonAutograph.

CLARKSTAN

FINE ELECTRONIC & INDUSTRIAL EQUIP.

BEST FOR LP MICROGROOVE AND STANDARD DISCS

MODEL 213 — The new Clarkstan 12" record arm offers the best in standard disc and microgroove reproduction. Heavy aluminum casting eliminates audible resonance point. The slide-in cartridge holder allows instantaneous mounting of all types of standard cartridges. Silver-plated, spring loaded plungers maintain positive electrical contact without necessity of soldering. Quick acting weight adjustment is positive and accurate for change from microgroove to standard records. Arm has adjustable height, fits all standard turntables. Vertical roller bearing and thrust ball bearing minimize cramping — no mechanical bias on the pickup. Finish grey wrinkle and brushed chrome.

Net Price \$22.00

MODEL 213G — Same arm slotted to accommodate G.E. cartridge RPX-050.

Net Price \$22.00

WIDE RANGE RV PICKUP

MODEL 201 — Clarkstan RV wide range variable reluctance cartridge for best reproduction of LP microgroove and standard records. Instantaneously replaceable and interchangeable needles. Frequency velocity responsive to above 12,000 cps. Needle force 5-7 grams for LP microgroove, as low as 10 grams for conventional records. Output 60 millivolts. High impedance — 5, 50, 250 and 500 ohm models available. 1/2" mounting centers. Supplied with sapphire stylus. Specify .0012" for LP microgroove or .0030" tip radius for standard records. Tip radii of .0015", .0022", .0025" also available. (Can also be supplied with diamond stylus of any of above tip radii.) Net Price \$15.00

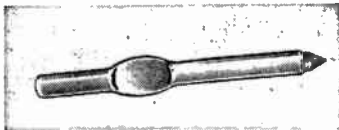

SAPPHIRE & DIAMOND STYLI

Extra styli (tubular shank) for Clarkstan Pickups:

Sapphire No.	Diamond	Ball Point Radius	Net Prices
251.10	254.10	.0012"	\$2.40
251.15	254.15	.0015"	\$2.40
251.2	254.2	.0022"	\$2.40
251.5	254.5	.0025"	\$2.40
251.3	254.3	.003"	\$2.40

CLARKSTAN MAGNETIC PICKUP

MODEL 204 "RV-Jr." variable reluctance pickup has a removable and replaceable stylus. It weighs only one-half ounce and plays all popular makes of record changers having standard mounting holes 1/2" between centers. It is 1 1/2" overall length. This magnetic pickup with balanced armature is velocity responsive (flat ± 2 db) from 50 cps to 10,000 cps. It delivers .030 volt from the average record.

204 "RV-Jr." Cartridge (only with 1 sapphire needle) Net Price \$5.40

204D "RV-Jr." Cartridge only (with 1 diamond needle) Net Price \$21.00

(Specify whether .0012" or .0030" radius needle desired.)

CLARKSTAN KNOBS

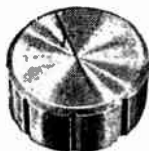

Attractive one-piece knobs accurately machined from DURAL add the professional appearance to control panels. All knobs have fluted sides and have screw-type mounting for round or flat shafts to fit standard 1/4" shafts. Back of all knobs recessed 3/4" dia. by 5/64" deep to accommodate panel bushing nut. Supplied with or without pointer.

Model Knob Dia. Height

275-0B	3/4"	5/8"
275-1B	1"	5/8"
275-12B	1 1/4"	21/32"
275-2B	1 1/2"	11/16"
275-3B	2"	3/4"
275-4B	2 1/2"	13/16"

PACIFIC TRANSDUCER CORP., Los Angeles 64, California
(formerly CLARKSTAN CORP.)

AUDIO SWEEP FREQUENCY TRANSCRIPTION

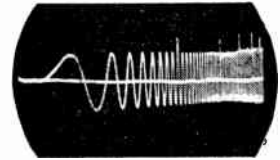

The Sweep Frequency Transcription is a new method of making instantaneous frequency response runs. It has been designed with all correction factors included in the original recording, therefore, no charts or graphs are needed. Before the development of the Sweep Frequency Transcription, the tone record was used for frequency response measurements on playback systems. This method was both time consuming and laborious. If adjustments were required, a new frequency run was required after each adjustment. Now all that is needed is a cathode ray oscilloscope and a Sweep Frequency Transcription for instantaneous response measurements. Only a few quick adjustments on the equalizer circuits and the job is done. For complete frequency checking of all broadcast transmission equipment and components for production testing of phonographic reproducers, filter networks, audio amplifiers, preamplifiers, tone control systems and components.

MODEL 1000A — 12" Vinylite transcription, 78 RPM, 70 to 10,000 cps. recorded flat ± 1 db. Net Price \$6.60

MODEL 1000D — 12" Vinylite transcription, 78 RPM, 5 KC to 15 KC. recorded flat ± 1 db. Net Price \$6.60

MODEL 100A — 16" Vinylite transcription, 33-1/3 RPM, 60 to 10,000 cps. recorded with NAB curve. Net Price \$10.00

MODEL 102M — 12" Vinylite, for microgroove testing, 33-1/3 RPM, 70 to 10,000 cps. modified NAB recording. Net Price \$6.60

MODEL 115 — audio sweep frequency film, 35mm, positive print, variable density, 10 ft. lengths Net Price \$10.00

MODEL 116 — audio sweep frequency film, 35mm, positive print, variable area, in 10 ft. lengths. Net Price \$10.00

MODEL 117 — audio sweep frequency film, 16mm, positive print, variable density, in 10 ft. lengths. Net Price \$10.00

STEADY STATE FREQUENCY RECORDS

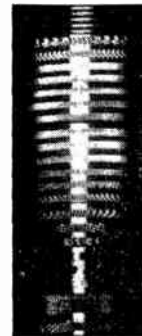

A series of new test records in which all the information for the engineer is annotated for both the cutting and reproduction. In recording these records harmonic distortion was kept to the lowest possible figure. Extreme care throughout the processing cycle was used. Careful reproduction, using the latest techniques insures exact duplication of the original recordings in each pressing.

MODEL 2000S — Steady State Frequency Record, 12" Vinylite, 78.26 RPM 50 cps. to 10,000 cps. flat recording (1 side only). Net Price \$3.90

MODELS 2001S & 2002S — Microgroove Steady State Frequency Record, 12" Vinylite, 33-1/3 RPM, 50 cps. to 10,000 cps. one side NAB, other side flat recording. Net Price \$3.90

MODEL 101 — Intermodulation Test Record, 12" Vinylite, 33-1/3 RPM, standard groove, 1/4 ratio, 7 KC and 100 cps. (1 side only). Net Price \$3.90

PICKERING

MODEL 260 • DIAMOND STYLUS

TURN-OVER PICKUP

to play all records

33 $\frac{1}{3}$ rpm

45 rpm

78 rpm

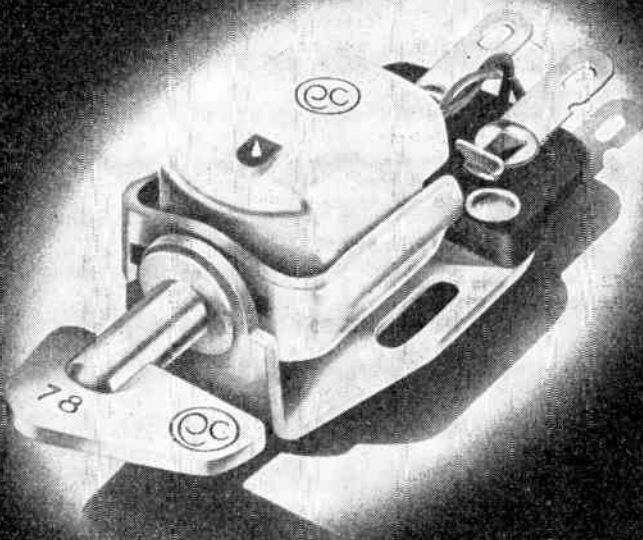

LOAD RESISTANCE: 25000 OHMS
TOLERANCE: WITHIN 2 db

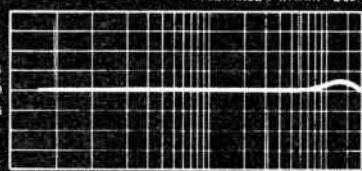

RELATIVE RESPONSE (db)

FREQUENCY IN CYCLES PER SECOND

20 50 100 1 KG 5 KG 10 KG 20 KG

26C TURNOVER CARTRIDGE
AVERAGE PRODUCTION FREQUENCY RESPONSE

The 260 Cartridge is a velocity-sensitive device and is inherently "flat" on a velocity basis. When measured with an equalized preamplifier having 6 db per octave bass boost and a standard test record, its performance characteristics are in accordance with the above curve.

PICKERING MODEL 260 DIAMOND STYLUS TURN-OVER PICKUP . . .

Inherent in the development, engineering and manufacture of the 260 Turn-Over Pickup, are the factors which have earned such a high reputation for Pickering Audio Components. . . . The 260 is now available with diamond styli — diamond styli wear longer, and prolong the life of recordings. The 260 has an output of 30 millivolts at 10 cm per second; it mounts easily in any type arm. The 260 Turn-Over Pickup may be used with the Pickering 410 Input System, 230H Preamplifier, 132E Record Compensator and 190 Arm or in any high quality playback system.

PICKERING PROFESSIONAL AUDIO COMPONENTS / MAXIMIZE PLAYBACK PERFORMANCE

"For those who can hear the difference"



PICKERING and company incorporated • Oceanside, L. I., New York



PICKERING PROFESSIONAL AUDIO COMPONENTS FOR RECORD PLAYBACK

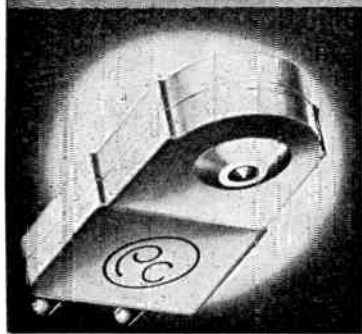

THE PICKERING CARTRIDGE

PICKERING CARTRIDGES . . .

are the choice of audio engineers throughout the world. They are universally acclaimed because of their high output, wide range performance and low distortion. They have an output of 50 millivolts at 10 cm per second and are used wherever a fine cartridge is required in radio stations, recording studios and for purposes of quality control by leading record manufacturers.

Models D-120M, S-120M, D-140S and S-140S, with diamond or sapphire stylus, are without equal; they produce the finest quality reproduction of lateral recordings.

MODELS D-120M AND S-120M are for playing standard records and transcriptions requiring 2.5 mil styli. MODELS D-140S AND S-140S are for long playing, microgroove records; 33 1/3 and 45 RPM.

Model S-120M with .0027" Sapphire stylus . . .

Model D-120M with .0025" Diamond stylus . . .

Model S-140S with .001" Sapphire stylus for long-playing MICRO-GROOVE recordings . . .

Model D-140S with .001" Diamond stylus for long-playing MICRO-GROOVE recordings . . .

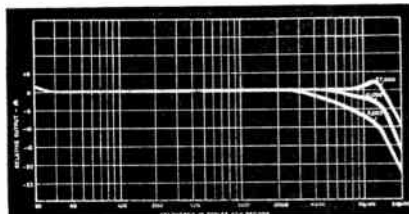

Series 140 and 120 frequency response characteristics with various load impedance values are shown in the accompanying curves.

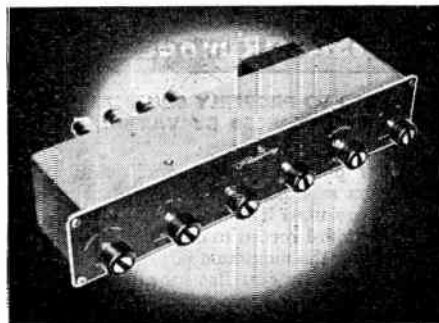

THE PICKERING 410 AUDIO INPUT SYSTEM

. . . is designed to provide a complete audio control center. Model 410 may be used in any high quality playback system. Three input channels are provided—one for magnetic cartridges and 2 "flat" channels for other audio circuits. A 3-position equalizer network is built into the magnetic cartridge channel and provides accurate equalization for LP, AES and 78 rpm recording characteristics. Separate bass and treble controls are also provided. These are of the step-type and permit bass and treble adjustments in 2 db increments. The tone control circuits are intended to compensate for record characteristics and for listener-environment acoustical conditions. They are not intended to compensate for amplifier and/or loudspeaker deficiencies. Model 410 is intended for use with the highest quality professional type playback equipment. The output of the Model 410 is fed from a cathode-coupled circuit and will work into any high quality audio or line amplifier having a high impedance input. It may also be used with a transformer for the purpose of feeding a 500 ohm line. Because of its flexibility, low noise and low distortion level, it is ideally suited for bridging and monitoring purposes and for critical listening applications.

follows circuit and will work into any high quality audio or line amplifier having a high impedance input. It may also be used with a transformer for the purpose of feeding a 500 ohm line. Because of its flexibility, low noise and low distortion level, it is ideally suited for bridging and monitoring purposes and for critical listening applications.

Playback and Tone Control Characteristics

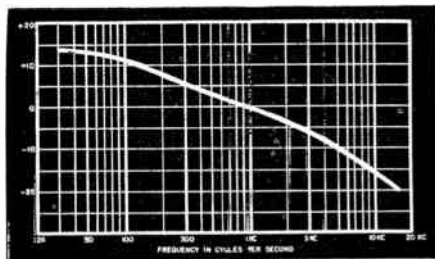

← "LP" Playback

Bass Control →

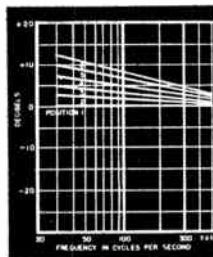

Treble Control →

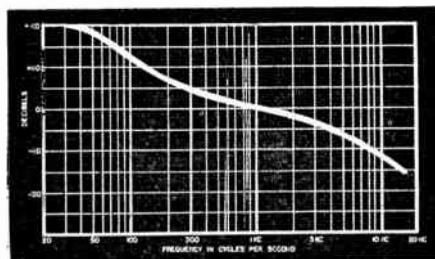
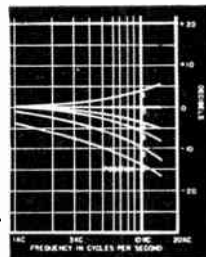

← "AES" Playback

→ "78" Playback

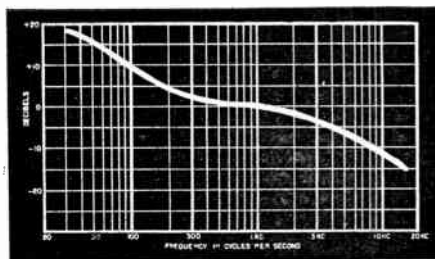



PICKERING PROFESSIONAL AUDIO COMPONENTS FOR RECORD PLAYBACK

PREAMPLIFIER model 230H

EQUALIZES THE BASS RESPONSE OF RECORDS AND TRANSCRIPTIONS AND PROVIDES THE NECESSARY GAIN FOR HIGH-QUALITY MAGNETIC PICKUPS.

The Pickering 230H Preamplifier is designed to operate with any high-quality amplifier having a high impedance input. It is self-powered, operates from the 115 volt AC line, and is installed by simply plugging in.

Model 230H is unique in its accuracy of equalization, being superior to most broadcast station equipment in this respect. Further, the intermodulation and harmonic distortion is lower than good engineering practice requires in professional equipment.

The 230H Preamplifier represents the most advanced design ever achieved in phonograph preamplifiers, and like all Pickering Audio Equipment, symbolizes maximum performance.

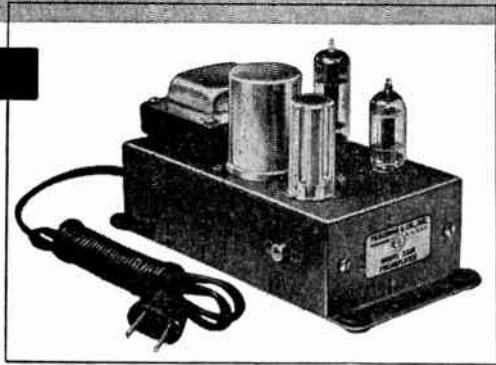

TECHNICAL SPECIFICATIONS

FREQUENCY RESPONSE: Within 2 db from 40 — 20,000 cps. Compensates for 6 db per octave loss below 500 cps. . . . **OUTPUT:** High impedance, 2 volts average from phonograph records. (For 500/600 ohm output at —10 dbm use Pickering 600G transformer, available as accessory equipment.) . . . **DISTORTION:** Not more than 0.2 percent intermodulation at normal output level. Not more than 0.4 percent intermodulation at +10 db over normal level. Not more than 1.7 percent intermodulation at +20 db over

normal level. . . . **HUM LEVEL:** —56 db below maximum signal. . . . **INSTALLATION:** Unit furnished with 6 ft. approved cord which can be connected to wall socket or amplifier. Input socket — standard type; matching plug furnished with unit. Output — terminal strip. Rubber shock mounts provided. . . . **DIMENSIONS, WEIGHTS AND TUBES:** Size of preamplifier: 7½ inches long, 3½ inches deep and 4¾ inches high. Weight: 2 lbs. 6 oz. Tubes: 6C4, 6x4, 6AU6 (any good, standard brand).

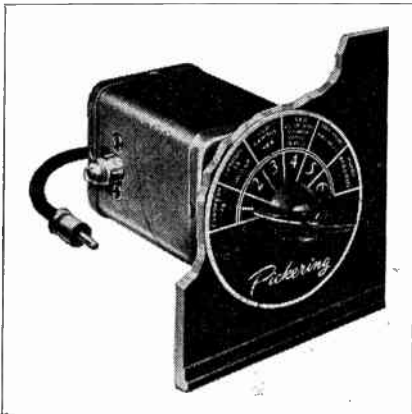

SWITCH POSITIONS

1 — European 78 — This group covers HMV, English Decca, FFRR 78's and American pressings of European recordings. 2 — London 33, Old LP — For London FFRR 33½, old Columbia LP's and most makes of 33½ microgroove recordings made before June 1953. 3 — Old Capitol, AES — For all Capitol recordings and most domestic 78's made before June 1953. Original AES playback characteristic. 4 — A.E.S., Victor Orthophonic, Columbia, Capitol 78, 45, 33 — The new AES characteristic for all of the latest RCA Victor, Columbia, Capitol and Decca recordings 78, 45, 33. 5 — Maximum Highs, Maximum Bass — No high frequency roll off — 500 cycle bass turnover. 6 — Noisy Records — This position permits playing of old noisy records with objectionable hiss removed.

RECORD COMPENSATOR model 132E

PROVIDES THE FLEXIBILITY REQUIRED TO PROPERLY EQUALIZE FOR THE DIFFERENT RECORDING CHARACTERISTICS USED BY VARIOUS RECORD MANUFACTURERS.

The Pickering Record Compensator permits proper equalization of the amplifier system to produce optimum reproduction of individual records; because all linear circuit elements are used it has no inherent distortion. This Compensator permits each individual record to offer all of its quality without compromise . . . permits getting the maximum use out of scratched and worn records. Its six positions correctly equalize for all of the established recording characteristics including microgroove and standard records, domestic and foreign.

The Pickering Record Compensator is a most important addition to any record player equipped with an amplifier system having a high gain preamplifier, such as the Pickering 230H. It is easily installed, and like all Pickering Audio Equipment, symbolizes maximum performance.

TECHNICAL SPECIFICATIONS

INPUT: High impedance magnetic cartridge . . . **OUTPUT:** To feed into high-gain amplifier which has 6 db per octave rise below 500 cycles per second, and which has an input resistance of 47,000 ohms . . . **INSTALLATION:** Unit can be mounted in any position (on panels up to ¾ inch thick) by means of threaded bushing. Since no power is required to operate the Record Compensator only a single connection has to be made to a suitable preamplifier. Input connection — standard socket. Matching plug furnished with unit. Maximum distance between record compensator and preamplifier input 20 inches, cable supplied . . . **DIMENSIONS AND WEIGHT:** Size of unit: 1 7/8" square by 3 1/8" overall, less switch shaft. Weight: 6 1/2 oz.

PICKERING PROFESSIONAL AUDIO COMPONENTS

MAXIMIZE PLAYBACK PERFORMANCE... *"For those who can hear the difference"*



PICKERING and company incorporated • Oceanside, L. I., New York



PICKERING PROFESSIONAL AUDIO COMPONENTS FOR RECORD PLAYBACK

PICKUP ARM model 190 D

**THE ONLY ARM CAPABLE OF OPTIMUM PERFORMANCE
ON BOTH MICROGROOVE AND STANDARD RECORDS.**

Much distortion in playing records can be caused by an inadequate pickup arm, regardless of how good the cartridge. The most common causes of distortion inherent in the operation of conventional arms are poor tracking and excessive record and stylus wear. These undesirable qualities are a result of improper lateral and vertical moments of inertia and an incorrect relationship between the two. Further, many arms cause tracking error which creates needless distortion.

The Pickering 190-D Pickup Arm is designed to overcome the disadvantage of all conventional arms, the shortcomings of which have been severely accentuated by the advent of LP microgroove records. Extensive investigation by Pickering engineers disclosed that reproducer arms which perform well on 78 RPM phonograph records and standard transcriptions will not necessarily produce good results on LP microgroove records. In fact no commercially available arm was found which would meet all of the requirements for this type of service.

The 190-D Pickup Arm embodies all the features determined as significant and important to enable a high quality cartridge to meet the stringent requirements for playing LP records without distortion and free of record and stylus wear: 1—The ratio of vertical-to-lateral moment of inertia is as low as possible . . . 2—The vertical mass has been minimized in order to track any record without imposing extra vertical load on grooves. It plays

badly warped records just as well as flat ones . . . 3—There is no spurious arm resonance at any frequency . . . 4—Pivot friction is lower than 3 gram centimeters and the bearings are rugged and trouble-free . . . 5—The arm is statically balanced about the vertical axis to eliminate tendency to jump grooves when subjected to bumping or jarring . . . 6—Offset head

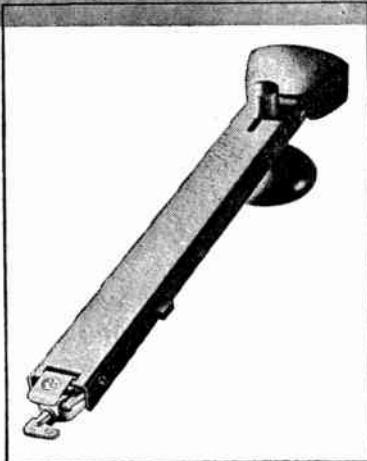

reduces tracking error to less than plus or minus 2 1/2° . . . 7—Stylus point is protected against contact with anything but the record grooves. It cannot strike the turntable mat or center-pin. It plays all size records up to 17 1/4" O.D. In addition to these important design considerations, the 190-D Pickup Arm features: Sensitive tracking force adjustment . . . height adjustments for turntables from 1/2" to 2" high . . . one-hole mounting and self-contained levelling screws . . . plug-in cartridge holder . . . magnetic arm rest . . . Model 190D, the new and smaller arm 14 1/4" long, when combined with a high quality manually operated turntable, requires a 17" x 17" motor board.

Pickering Cartridges used with the Model 190-D Arm require 50% less vertical tracking force than is required when using conventional arms.

EQUALIZER model 163A

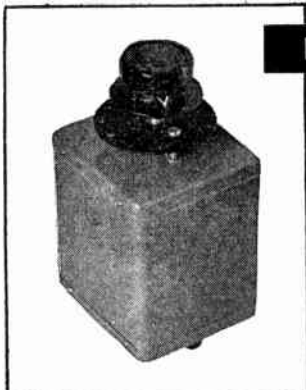

A loss-type equalizing network for use with the Model 161M Pickup. It is designed to compensate for most of the commonly encountered record characteristics. Position 1—flat high frequency response to over 15,000 cps. Low frequency rise to give full compensation from 500 to 40 cycles. Position 2—flat high frequency response. Low frequency response approximately 5 db. below position 1. Position 3—for NAB or Orthacoustic transcriptions. Position 4—Low frequencies same as position 2. High frequencies sharply attenuated to reduce surface noise. Attenuation starts at 4000 cycles. Position 5—low frequencies same as position 1. High frequencies same as position 4. 250/600 ohms output.—60 lb. Size 3 1/2 x 3 3/4 x 5 inches. Shipping weight 2 lbs.

EACH PICKERING PICKUP AND CARTRIDGE IS UNCONDITIONALLY GUARANTEED

With the exception of the stylus point, all models of the Pickering Cartridge Reproducer and Pickering reproducing equipment, are covered by an unconditional guarantee provided that the unit has not been tampered with nor subjected to extraordinary abuse. Replacement diamond and sapphire styli can be installed in cartridge reproducers for the following net charges:

**Pickering Reproducing Equipment is
Sold by All Principal Distributors**

For Models 160 or 161 Diamond stylus of any radius	\$22.50 Net
For Cartridge Reproducers	
.0027" Sapphire for 120 Series.....	2.50 Net
.001" Sapphire for 140 Series.....	5.00 Net
.0025" Diamond for 120 Series.....	15.00 Net
Special Radius Diamond for 120 and 140 Series	22.50 Net
.001" Diamond for 140 Series.....	22.50 Net

PICKERING PROFESSIONAL AUDIO COMPONENTS / MAXIMIZE PLAYBACK PERFORMANCE

"For those who can hear the difference"



PICKERING and company incorporated • Oceanside, L. I., New York

2 New Titone Pickup Cartridges

FEATURING THE FAMOUS SONOTONE CERAMIC PRINCIPLE

THE TITONE TURNOVER



SPECIFICATIONS

Tracking Force	9 grams
Compliance	0.9×10^{-6} cm/dyne
Unit Capacitance	400 uuf
Output Voltage	0.95 volts
Recommended Load	1-10 Megohms
Cartridge Weight	5.5 grams
Mounting Dimensions	Standard 1/2" mtg centers
Needle	Dual tip

*.001" sapphire or diamond for microgroove
.003" sapphire or diamond for standard records*

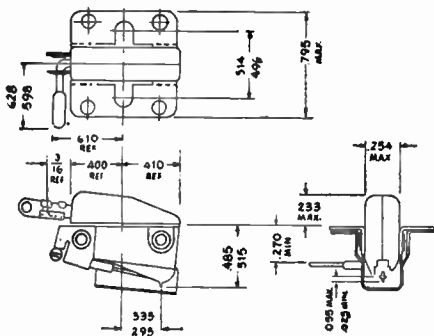

TITONE TURNOVER CARTRIDGES

	LIST PRICE
9980-S (2-sapphires)	\$9.50
9980-SD (1-mil diamond 3-mil sapphire)	34.00
9980-D (2-diamonds)	\$6.00

TITONE TURNOVER REPLACEMENT NEEDLES

	LIST PRICE
9987-S (2-sapphires)	\$3.50
9987-SD (1-mil diamond, 3-mil sapphire)	28.00
9987-D (2-diamonds)	50.00

A new and revolutionary cartridge designed to provide unequalled listening enjoyment of all records, regardless of speed or groove size.

Essentially two cartridges in one, the Titone Turnover represents the ultimate refinement of the needle change principle - only the tiny jewel tip itself is changed - thus permitting the design of a reproducer in which no unused but moving part can "eat up" the energy being transmitted by the needle.

Foremost among the many outstanding features of the new Turnover are:

Adaptability - Because of its small size and its standard half-inch mounting centers, the new Turnover will replace and modernize most three-speed cartridge installations.

Simplicity of replacement - Since only the needle rotates, the entire needle assembly may be readily removed or replaced.

Proper groove fit - Each jewel tip is accurately polished to insure an exact fit in the appropriate groove, thereby providing perfect coupling to the record.

Superior tracking ability - The high lateral compliance not only helps reduce record wear, but permits the stylus to track even the lowest frequencies at all speeds, and at a single low needle force.

High sensitivity - The new, improved ceramic element of the Turnover provides the unusually high output of 0.95 volts on the RCA 12-5-51 microgroove test record, eliminating the need for any pre-amplification.

Outstanding response - The wide frequency range of the new Turnover is unprecedented in piezoelectric pickups.

The curves below show the average response, without equalizers of any type, of the Turnover cartridge to the two most widely used recording characteristics. This outstanding response is pointed up in striking fashion by the dotted curve, showing the response of a typical competitive turnover type cartridge.

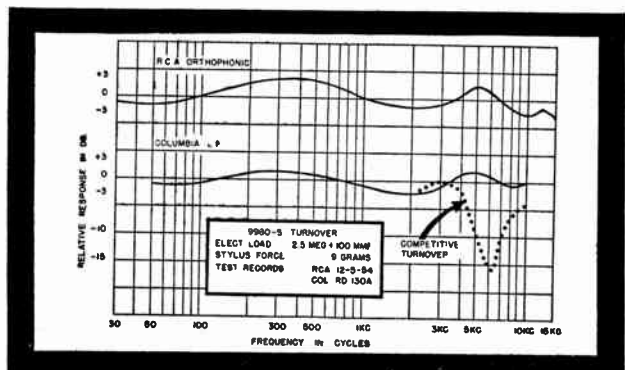

CERAMIC—the wonder element
that reproduces electrically the exact tones
recorded on the disc, yet is impervious to
moisture and unaffected by temperature.

**THE
TITONE PLAYAL**

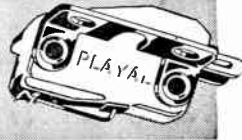

SPECIFICATIONS

The most versatile single cartridge ever developed, providing the means for playing all speed records without need for changing needle or adjusting tracking force

With the introduction of the Playal ceramic cartridge and the new "truncated-cone" needle, Sonotone has produced the first truly universal cartridge, able to track all groove sizes without the distortion common to the usual "compromise" 2-mil radius needle

This new cartridge, like the Turnover, is unequalled in performance, embodying the same advanced design features that have made the name Sonotone famous.

Principal among these features are.

Adaptability — Because of its standard half-inch mounting centers and small size, the Playal may be readily used to modernize most existing phono pickup installations.

Excellent Frequency Response — The curve below shows the smooth, wide range response of the Playal cartridge. The upper curve shows the response to the Columbia LP characteristic, the lower to that of the RCA Orthophonic characteristic.

Low Distortion — The extremely high lateral compliance combined with the unique "truncated-cone" needle enables the Playal to track any groove with negligible distortion, even at the very low frequencies

High Sensitivity — New advances in the development of the ceramic element have produced a cartridge with an output of approximately 1 volt on microgroove records.

Easy Replacement — The Playal needle may be replaced without even removing the cartridge from the pickup arm. If preferred, a conventional 1-mil or 3-mil sapphire-tip needle may be used instead of the "truncated-cone"

Tracking Force	9 grams
Compliance	0.7×10^{-6} cm/dyne
Unit Capacitance	400 uuf
Output Voltage	0.95 volts
Recommended Load	1-10 Megohms
Cartridge Weight	4.5 grams
Mounting Dimensions	Standard 1/2" mtg centers
Needle	Available in sizes listed below

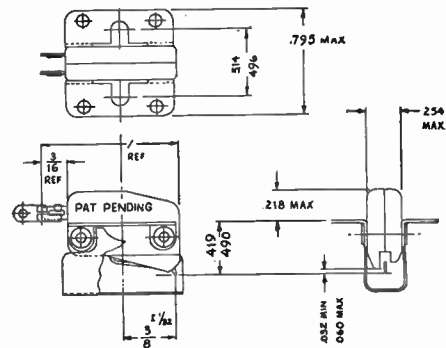

REGULAR TITONE PLAYAL CARTRIDGES

	LIST PRICE
7590-1S (1-mil sapphire)	\$7.50
7590-2M (2-mil truncated cone, osmium)	7.50
7590-3S (3-mil sapphire)	7.50

TITONE PLAYAL CARTRIDGES LESS BRACKETS

(Identical to above, except less mounting brackets)

	LIST PRICE
7590-LB-1S (1-mil sapphire)	\$7.50
7590-LB-2M (2-mil truncated cone, osmium)	7.50
7590-LB-3S (3-mil sapphire)	7.50

TITONE PLAYAL REPLACEMENT NEEDLES

	LIST PRICE
7529-1S (1-mil sapphire, spherical)	\$2.00
7529-3S (3-mil sapphire, spherical)	2.00
7552-2M (2-mil truncated cone, osmium)	1.50

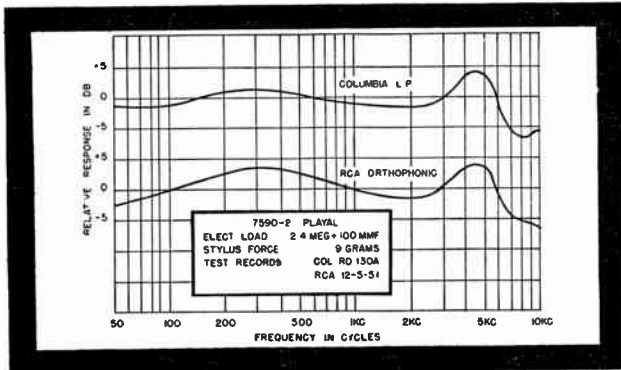

SONOTONE CORPORATION, ELMSFORD, N. Y.

Audax

Pickups for facsimile Reproduction

"The Standard by Which Others Are Judged and Valued"

POLYPHASE reproducers

In One Single Magnetic Unit 33-1/3—45—78 rpm

POLYPHASE LIST PRICES

D-L-6 CHROMATIC HEAD, for all lateral records, MICRO DIAMOND and a standard Sapphire. \$69.50

(The price of the new Chromatic is the cost of the L-6 plus the regular price of a Diamond)

L-6 Head — for all lateral records with two genuine SAPPHIRE jewels..... \$34.50

R-2 Head — for all lateral records with two genuine SAPPHIRE jewels..... \$24.50

VL-9 Vertical Lateral Head — (SAPPHIRE jewels) \$69.50

* Sapphires may be replaced with AUDAX DIAMONDS at any time.

RECORD CHANGER ADAPTERS

For Garrard Changer \$4.50

For Thorens Changer \$4.50

For Webster Changer \$4.50

POLYPHASE REPLACEMENT STYLI

Sapphire — Micro or Standard \$ 3.50

Diamond — standard — CHROMATIC \$25.00

Diamond — microgroove — CHROMATIC \$35.00

Diamond — Vertical \$35.00

Sapphire — Vertical \$ 6.00

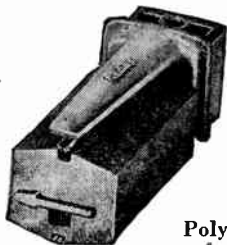

Polyphase Head for any arm

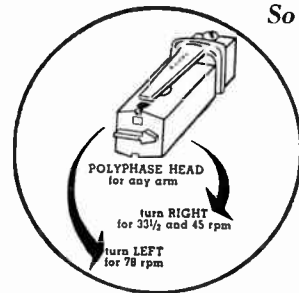

So simple

- One, single magnetic unit and one low point-pressure for all discs.
- Replaceable Sapphire (or diamond).
- Response 20 to over 15,000 cps.
- Needle-talk practically nil.*
- Near-infinite compliance.
- Tracking phenomenal.
- Flexible plug-in connectors.
- Listening Quality — Superb.

By merely inserting the desired styli, the POLYPHASE makes possible any of the following combinations:

1. Microgroove and 78 rpm
2. Both Microgroove
3. Both 78 rpm
4. Microgroove and lateral transcriptions
5. 78 rpm and lateral transcriptions
6. Both for lateral transcriptions

Write for "ELECTRONIC PHONO FACTS"

Audax

Cutters and Tone Arms

"The Standard by Which Others Are Judged and Valued"

COMPASS-PIVOTED tone-arms

unquestionably, the simplest and most efficient arms yet devised.

- Only THREE parts.
- Highest tracking efficiency.
- No restraint to stylus travel.
- Frontal oscillations nil.
- No springs.
- No fatigue.
- Maintains original point-pressure permanently—regardless of climatic changes.
- Greatest possible distance between stylus and vertical pivots.



turntable center
to end of arm LIST

#12 Arm to 12" disc.....	10"	\$23.00
#16 Arm to 16".....	13 $\frac{8}{16}$ "	\$33.00
STUDIO Arm to 16" disc.....	18 $\frac{1}{2}$ "	\$65.00

STYLUS-DISK

Trade Mark

1. Just as a fuse protects an electric circuit, the STYLUS-DISK protects your records against ruination by a worn stylus (needle). Periodic use of the STYLUS-DISK will relieve you of all worry.
2. The STYLUS-DISK gives VISUAL warning of ruinous stylus-wear . . . at its inception.
3. Will test any type of stylus, in any type of pickup—in a jiffy—33 $\frac{1}{3}$ -45-78.
4. Neither stylus nor the cartridge need be removed for the test.
5. The grooves may be used over and over again, until finally a defective stylus (needle) scrapes the groove-walls—(color change). Should last for years.



List
\$6.50

STYLUS-DISK

Pats. Pend.

Pointer #39 in Weil's "ELECTRONIC PHONO FACTS" reads: "No jewel-point is permanent, be it diamond or sapphire. Therefore, periodic checking is necessary if good reproduction and the records themselves are to be preserved." *The great variation in durability of jewel-points (any jewel point) gives extreme importance to the ever present question:*

WHEN TO CHANGE STYLUS?

HIGH FIDELITY CUTTERS

AUDAX CUTTER H-5 — Substantially FLAT to 10,000 cycles, Distortion about 1.2% at 1000 cycles. Fully modulates groove with input of about 18 db with 96 lines. Impedances up to 500 ohms.
List Price \$185.00

AUDAX CUTTER H-4 — Substantially FLAT to 8,000 cycles. Distortion about 1.7% at 1000 cycles. Fully modulates groove with input of about 18 db with 96 lines. Impedances up to 500 ohms.
List Price \$125.00

AUDAX CUTTER H-3 — Substantially FLAT to about 7500 cycles. Distortion about 2.1% at 1000 cycles. Fully modulates groove with input of about 18 db with 96 lines. Impedances up to 4000 ohms.
List Price \$83.00



AUDAX Cutters are readily interchangeable on most recording machines

WEBSTER**ELECTRIC**

RACINE

WISCONSIN



MODEL AX . . . for three-speed use. Delivers .8 volts at 33 1/3 - 45 rpm and 1.5 volts at 78 rpm with 7 grams tracking pressure. Furnished with two needles, removable twist mechanism and terminal lugs. **\$8.50**

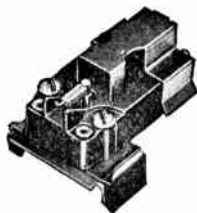

MODEL BX . . . for use with R.C.A. automatic changers and Columbia players. Tracks perfectly at 33 1/3 - 45 rpm. Equipped with needle, special mounting bracket, spacers, nuts and bolts. Develops .4 to .6 volts. **\$6.50**

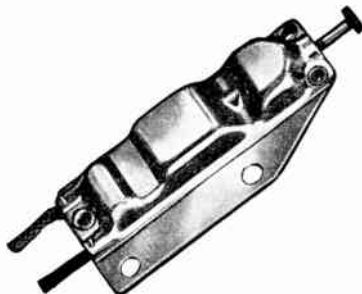

MODEL CX . . . single-needle cartridge for either 78 rpm or three-speed application. Use of three-mil needle makes CX a 78 rpm player. Two-mil needle adapts to three-speed use. May be flange, clip, stud or bracket mounted. Delivers 2.0 volts at 33 1/3 - 45 rpm and 4.5 volts at 78 rpm. **\$4.95**

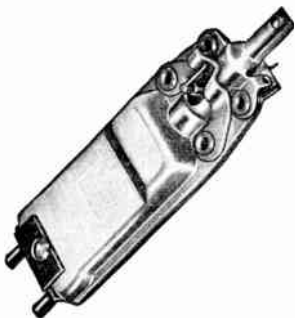

MODEL FX . . . two-needle twist cartridge for three-speed application. High output cartridge developing 2.5 volts at 33 1/3 - 45 rpm and 6.0 volts at 78 rpm. Shunting capacitor, furnished, adapts it to low output applications (0.6 volts at 33 1/3 - 45 rpm and 1.2 volts at 78 rpm). Besides capacitor, FX is furnished with needles and spacers. **\$8.50**



MODEL W5 . . . for 78 rpm replacements. Three-terminal construction. Develops either 1.5 or 4.0 volts at 3/4-ounce tracking pressure. Furnished with needle, rest button, extra needle screw, terminal lugs and jumper. **\$5.75**

For simpler stocking, the easier replacement and faster turnover, the Featheride Five fill the bill. Just these five crystal cartridges will replace 95% of all models in use today. They cover the full audible range and guarantee customer satisfaction.

Model AX replaces Webster No.

A1	A2-M	A7	A7SM-1
A1M	A3	A7-1	A8
A1M-1	A3M	A7-5	A8M
A1M-2	A4	A7-8	A8M-2
AISM	A5	A7M	A10
A1-8	A5M	A7M-1	A10M
A2	A6	A7M-5	A10M-2
A2-4	A6M	A7M-7	AB1M
A2-8			

Model CX replaces Webster No.

C2	C7-3	C9-3	C14
C2-1	C8	C9-4	C14-2
C3	C8-1	C9X	C14-3
C4	C8-2	C10	C14-8
C7	C8-5	C10-8	C15
C7-1	C9	C12	C15-4
C7-2	C9-1		

Model FX replaces Webster No.

F14-2	F18	F19-1	F21-4
F14-4	F18-1	F20	F22
F15	F18-3	F20-1	F22-1
F15-1	F18-4	F21	F23
F16	F18S	F21-3	F23-3
F16-1	F19		

Model W5 replaces Webster No.

E4	F7P	N6P-6	N10-2
E4-1	F7P-2	N7	N10-3
E9	F10-1	N7-1	N10-4
F1	F17P	N7-2	N10-5
F1P	N1	N7-3	N10-6
F1P-1	N2	N7-4	N10-7
F1P-2	N3	N7-P	N10P
F1P-3	N4	N7P-1	N10P-1
F1P-4	N5	N7P-2	N10P-2
F2	N6	N7P-3	N10P-3
F2P	N6-1	N8	N10P-4
F2P-1	N6P	N8-1	N10P-5
F2P-3	N6P-1	N8-2	N10P-6
F3P	N6P-2	N8P	N10P-7
F4P	N6P-3	N9	N11
F5P	N6P-4	N10	X-82
F6P	N6P-5	N10-1	X82C11-1

WEBSTER ELECTRIC
Featheride
 crystal cartridges

THORENS

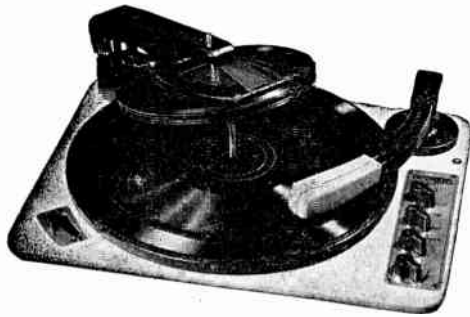

CD-43 RECORD CHANGER

FEATURES :

- Motor E-53
- 12 inch turntable
- High-fidelity designed tonearm for minimum tracking error
- Two plug-in heads easily adaptable for all popular American cartridges
- Styled to add beauty to any custom installation
- Automatically intermixes 10 inch and 12 inch records, special selector for 7 inch size with all metal spindle for large hole records sold separately
- Last record shut-off, reject, repeat, and pause controls
- Muting switch
- Tonearm tracking weight adjustment screw
- Built in condenser
- Specially designed rubber shielded shock mountings

NET PRICE \$93.75

THORENS

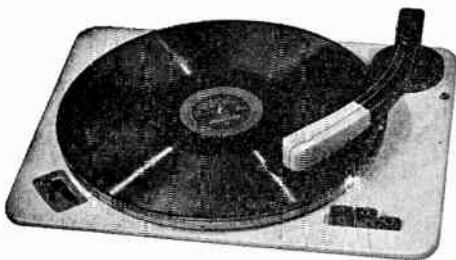

CBA-83 AUTOMATIC RECORD PLAYER

FEATURES :

- Motor E-53
- 12 inch turntable
- High-fidelity designed tonearm for minimum tracking error
- Two plug-in heads easily adaptable for all popular American cartridges
- Push button control for record size
- Reject control
- Automatic shut-off switch with tonearm returning to rest position
- Muting switch
- Tonearm tracking weight adjustment screw
- Built in condenser
- Specially designed rubber shielded shock mountings

NET PRICE \$67.50

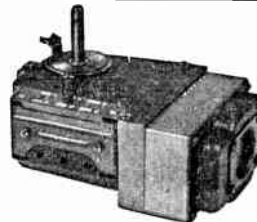

MOTOR E-53

Each THORENS unit is equipped with the direct drive, governor controlled variable speed motor E-53, world famous for its silent, rumble and wow-free operation.

THORENS

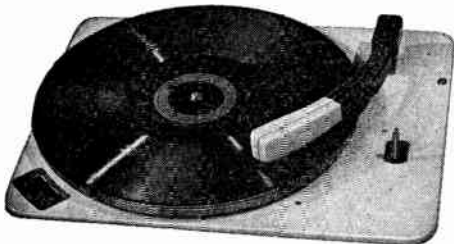

CB-33 MANUAL RECORD PLAYER

FEATURES :

- Motor E-53
- 12 inch turntable
- High-fidelity designed tonearm for minimum tracking error
- Two plug-in heads easily adaptable for all popular American cartridges
- Automatic shut-off
- Tonearm tracking weight adjusting screw
- Built in condenser
- Specially designed rubber shielded shock mountings

NET PRICE \$52.50

THORENS

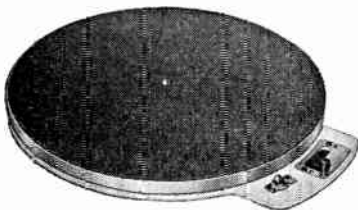

E-53 PA MOUNTING UNIT

FEATURES :

- Motor E-53
- 12 inch cast aluminum turntable with rubber mat
- On-Off switch
- Built in condenser
- Detailed mounting instructions and template to assure proper installation of your favorite tonearm and cartridge
- Shock springs for mounting board

NET PRICE \$60.00

THORENS COMPANY
NEW HYDE PARK, N. Y.

ACCESSORIES AVAILABLE

45-s—45 RPM spindle CD-43
WB-CD—Wood base CD-43
MB-CD—Mounting board CD-43
WB-CB—Wood base for record players

MB-CB—Mounting Board Record Players

MB-PA—Mounting Board Mounting Unit

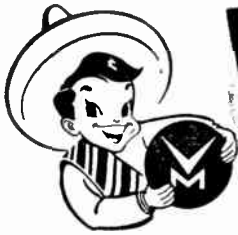

V-M RECORD CHANGERS

USED BY 9 OUT OF 10 RADIO-PHONO AND TV-PHONO MANUFACTURERS

Customers Prefer V-M FEATURES

- Automatic Set-Down for 7", 10" and 12" records. No controls necessary.
- Automatic Manual Operation, no extra control necessary for manual operation.
- Tri-o-matic Spindle affords positive record protection; records lowered—not dropped—on spindle shelf.
- Automatic Shutoff with all records. Tone arm returns to rest and motor shuts off.
- Completely Jamproof. All moving parts, including tone arm, may be held at any time without damaging mechanism.
- Underwriters Approved throughout, mechanically and electrically.
- Record Capacity, twelve 10" and ten 12", 33 1/3 or 78 rpm; fourteen 7", 45 rpm records. Positive intermix of any ten 12" or 10" records of same speed.



**V-M Model 920 tri-o-matic®
Record Changer Attachment**

Beautiful deluxe automatic, 3-speed record changer at a low price. Has handsome mahogany grained plastic base; all tri-o-matic features PLUS exclusive Siesta Switch that shuts off everything (including amplifier and lamp plug-in in base!) after last record plays. Model 920 plays through any standard TV or radio equipped with phono input. Has 6' AC cord and 4' phono cord. Size 12" x 9 3/4" x 7". Shipping wt. 9 1/4 lbs.

Men who know all changers well buy hundreds of thousands of V-M Record Changers for their installations. Quality, exclusive features and low price enable V-M Record Changers to out-sell any other line in the world. For good steady profits today, and tomorrow, buy V-M Record Changers!



**V-M tri-o-matic Model 936HF
high fidelity
Record Changer Attachment**

World's first changer attachment specifically designed for high fidelity. Features die cast arm, two plug-in heads included to fit most cartridges (pre-amp. stage required with magnetic pickup). Laminated turntable, balanced, has precision-formed concentricity. Extra powerful 4-pole, 4-COIL motor, muting switch, tri-o-matic spindle and V-M 45 spindle is included. Gold base, burgundy accessories. Complete with 6' AC cord, 4' phono cord with plugs. Is 13 1/2" x 13 1/4" x 9 1/4". Shipping wt. 18 lbs., 3 oz.

V-M Model 935HF

Same as 936HF less metal pan, for use with mounting board. Min. mounting space, 13 1/2" x 13 1/4" x 8 1/2". Shipping wt. 12 lbs., 6 oz.



**V-M tri-o-matic Model 951
Replacement Changer**

Has all tri-o-matic features. Is installed as original equipment in most phono combinations. Superior quality throughout. Deep maroon finish, gold 2-needle tone arm and record support arm. Complete with 42" AC and phono cords. Minimum mounting space, 13 3/8" x 11 1/2" x 7 1/4". Shpg. wt. 11 1/4 lbs.

**V-M tri-o-matic Model 951GE
Record Changer**

Has all the famous tri-o-matic features. Is same as Model 956GE less metal pan, 42" AC and phono cords. Rich maroon finish, gold accessories. Dimensions, 18 1/8" x 12" x 8 1/2". Shipping wt. 12 lbs., 15 oz.



V-M 45 Spindle Accessory

Permits automatic play of up to fourteen large center-hole records. Eliminates center-hole adapters. Slips quickly, easily over standard tri-o-matic spindle. Shipping wt. (per carton of six), 3 lbs., 2 oz.



**V-M tri-o-matic Model 956
Changer Attachment**

Is same as Model 951 but mounted on metal pan as wired changer to play through any standard radio or TV. Complete with 6' AC cord and 4' phono cord. Measures 13 1/4" x 12" x 8". Shipping wt. 14 lbs., 2 oz.

**V-M tri-o-matic Model 956GE
Record Changer Attachment**

Has all tri-o-matic features plus high fidelity GE twin sapphire variable reluctance cartridge (requires pre-amp. stage), constant-speed, 4-pole motor, muting switch. Maroon finish, gold accessories. Measures 18 1/2" x 12" x 8 1/2". Shipping wt. 15 lbs., 2 oz.



**V-M HIGH FIDELITY
PORTABLE P-A SYSTEM**

**V-M tri-o-matic Model 960
Record Changer**

Top quality unit is the famous V-M Model 950 automatic, 3-speed record changer in compact leatherette case. Measures 16 5/8" x 13 3/4" x 8 5/8". Shipping wt. 18 lbs., 5 oz.

V-M Model 160 Amplifier

Features Jensen 10" heavy-duty Alnico 5 PM speaker with 25' cord and plug for remote use. Slide out amplifier remains near changer or microphone. Two inputs: one for phono, other for high-impedance mike. Measures 13 1/4" x 9" x 14 7/8". Shipping wt. 22 lbs., 7 oz.

UL Approved

**Model 6305
and Model 6306HF
Plug-In Heads**



(One gold, one burgundy less cartridges) included with 935HF and 936 HF high fidelity changers. Gold colored head recommended for LP cartridges.

V-M CORPORATION
BENTON HARBOR, MICHIGAN
WORLD'S LARGEST MANUFACTURER OF PHONOGRAPHS AND RECORD CHANGERS

the Voice  of Music



GARRARD

World's Finest Record Player



RC90 — Deluxe 3 speed (variable) changer, less cartridge, 100/130, 200/250 Volts 60 cycles A.C. (50 cycle bushing available.)

RC80—3 speed changer, less cartridge, 100/130, 200/250 Volts, 60 cycles A.C. (50 cycle bushing available.)
RC80/DC — Same as RC80 but D.C. only. RC80/AC/DC — Same as RC80 but A.C. and D.C.



Model "T"—3 speed manual play unit, less cartridge. 100/130, 200/250 Volts, A.C. 60 cycles (50 cycle bushing available.)



Stylus Pressure Gauge—Accurately measures the weight exerted by a stylus upon a record. Use with any tone arm, any pickup.
WB-80/90—Wood base cut to fit RC80 or RC90. WB-T—Fits Model T. MB-80/90—Mounting Board, unfinished cut to fit RC80 or RC90 changers. MB-T—Fits Model T. CC—Carrying Case, board cut to fit RC80 and RC90, or solid board. GX/80—Garrard shell with turnover cartridge for RC80. GX/T90—For Model T and RC90.



LEAK AMPLIFIERS

TL/10—10 watt amplifier
Complete with "Point One" Remote Control pre-amplifier.
TL/12—12 watt amplifier only
TL/25—25 watt amplifier only
Vari Slope Pre Amplifier—Pre Amplifier for use with TL/12 or TL/25.



WHARFEDEALE SPEAKERS

Super 5—5" treble speaker.
8" Bronze—8" full range.
Super 8/CS/AL—3" full range (also for use as tweeter).
W10/CSB—10" full range (also for use as tweeter).
Super 12/CS/AL—12" full range.
W12/CS—12" low frequency driver.
W15/CS—15" low frequency driver.
1000 cycle crossover dividing network. 3000 cycle crossover dividing network. 3 way crossover dividing network.

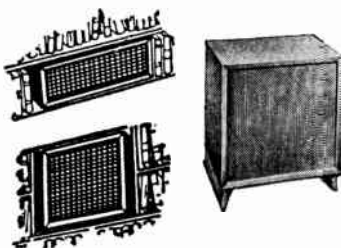

R-J ENCLOSURES

S-8-U—For 8" speaker. Single-Shelf model to fit in bookcase 11" high x 10" deep x 2 3/4" long. Finish sanded, unpainted.
S-12-U—For 12" speaker. Double-Shelf model to fit in bookcase 24" high x 21" long x 10" deep. Finish sanded, unpainted.
F-12-M—For 12" speaker. Floor Model. 20" high x 20" long x 16" deep. Hand rubbed, Mahogany finish.
F-15-M—Same as above. For 15" speaker.
F-12-B—For 12" speaker. Floor Model. 20" high x 20" long x 16" deep. Hand rubbed, Blonde, Kurlina Wood.
F-15-B—Same as above. For 15" speaker.
F-12-U—For 12" speaker. Floor Model. 20" high x 20" long x 16" deep. Finish sanded, unpainted.
F-15-U—Same as above. For 15" speaker.



S. G. BROWN HI-FI HEADPHONES

Type K—Hi-Fi Headphones of the very highest quality. Available with binaural wiring. Response—From 50 to over 10,000 cycles. Moving Coil type motor assemblies. Bakelized conical diaphragm. 8,000 lines flux density. 2 standard impedances—52 ohms and 600 ohms. 6 1/2 ft. cord. Rugged construction. Complete with foam rubber ear cushions. Highly polished headband and cases.

BRITISH INDUSTRIES CORPORATION

NEW YORK 13, N. Y.



Smooth Power

ELECTRIC PHONO MOTORS

RECORDING MOTORS

TAPE-DISC RECORDING ASSEMBLIES

HOME-RECORDING AND PHONOGRAPH ASSEMBLIES

TAPE-DISC RECORDING ASSEMBLY

MODEL 250

115 volts a. c., 60 cycles

List Price, \$77.50

When connected with the proper amplifier, the Model 250 performs the following functions:

- RECORDS TAPE FROM RECORDS
- RECORDS DISCS FROM TAPE
- RECORDS MICROPHONE ON TAPE
- RECORDS RADIO ON DISC
- RECORDS MICROPHONE ON DISCS
- RECORDS RADIO ON TAPE AND DISCS
- PLAYS ANY 78 R.P.M. RECORDS

TAPE RECORDING FEATURES:

One hour recording time.

Dual track.

Fast forward and reverse.

Permanent magnet erase head.

Turntable acts as flywheel,

giving constant tape speed.

Designed for use with 5" reels.

Tape speed $3\frac{3}{4}$ " per second.

Designed for use with either

plastic or paper base tape.

Automatically shuts off at end of tape playback.

No tape threading — Merely place tape around turntable — Automatically drops into correct position.

Due to ingenious clutch and drive mechanism, impossible to throw tape.

Mechanical interlock eliminates any possibility of accidentally erasing tape.

Equipped with a switch for recording head electrical interlock.

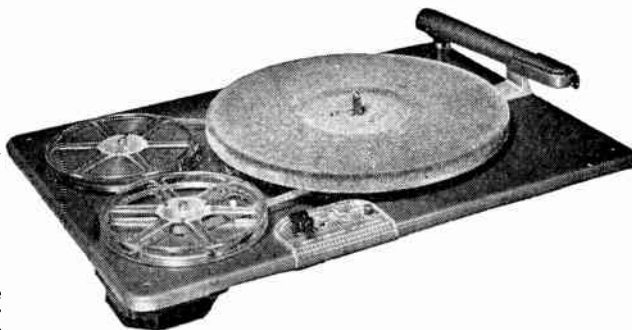

Plays 78 R.P.M. recorded discs and all 78 R.P.M. commercial records. When pivot of arm is lifted it snaps into recording position, engages lead screw, and insures proper angle for cutting stylus.

Merely push arm down for playback.

Simple to interchange cutting stylus and playback needle.

Dimensions: Width $12\frac{1}{2}$ ", Length $17\frac{1}{2}$ ", Depth below mounting plate 4". Equipped with G.I. smooth power, dynamically balanced four-pole motor. Net weight $10\frac{1}{2}$ lbs. Shipping weight 14 lbs.

DISC RECORDER AND PLAYBACK FEATURES:

Cuts records up to 10" in diameter at 78 R.P.M.

THE GENERAL INDUSTRIES COMPANY, ELYRIA, OHIO

G GENERAL INDUSTRIES G

Smooth Power PHONOGRAPH MOTORS, TAPE-DISC RECORDER AND DISC RECORDERS

Suitable for every phonograph instrument where low cost, dependable performance, compactness, light weight and quietness of operation are important considerations. GI phonomotors are even in speed and have ample power to play 10" and 12" records. Fan cooling permits use in partially closed cabinets. Designed to comply with Underwriters' Laboratories' requirements.

CONSTANT SPEED ELECTRIC PHONOMOTORS

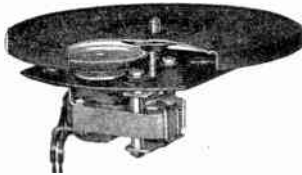

Model LX Model LX-3
Model LX-45

MODEL LX — 78 R. P. M. List Price, \$7.20
MODEL LX3 — 33-1/3 R. P. M. List Price, 8.40
MODEL LX45 — 45 R. P. M. List Price, 8.40
 115 volts a. c., 60 cycles

Rim drive, 2-pole motor. Rubber insulated from both mounting plate and turntable for quiet operation. Turntable shaft revolves with turntable, and is grooved for turntable clip. Furnished with 9" turntable and complete with mounting plate ready for installation.

Dimensions: Length—3 1/2"; Width—2"; Depth—2" below mounting plate.
 Packed in individual cartons. Shipping weight—4 lbs.

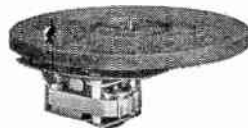

Model LC

MODEL LC — 78 R. P. M. List Price, \$6.50
 115 volts a. c., 60 cycles

A low-priced 78 R.P.M. 2-pole, rim drive motor suitable for installation where size and cost are prime factors. Furnished with 8" turntable and mounting plate ready for installation.

Dimensions: Length—3 1/2"; width—2"; depth—1 1/2" below mounting plate.
 Packed in individual cartons. Shipping weight—4 lbs.



Model RM4 Model RM4-3
Model RM4-45

MODEL RM4 — 78 R. P. M. List Price, \$19.50
MODEL RM4-3 — 33-1/3 R. P. M. List Price, 20.25
MODEL RM4-45 — 45 R. P. M. List Price, 20.25
 115 volts a. c., 60 cycles

Heavy duty, rim drive, 4-pole motor. Rubber insulated from both mounting plate and turntable for exceptionally quiet operation. Turntable shaft revolves with turntable and is grooved for holding clip. Retractable pin in turntable permits playing standard records without adjustment. Efficient performance is assured by positive alignment of driving pulleys, idler and turntable in one plane. Furnished with 10" weighted turntable and complete with mounting plate ready for installation.

Dimensions: Length—3 3/4"; Width—3 3/4"; Depth—2 1/8" below mounting plate.
 Packed in individual cartons. Shipping weight—9 lbs.

DUAL-SPEED PHONOGRAPH MOTORS

MODEL DS — 45, 33-1/3 R. P. M. 115 volts a. c., 60 cycles

A novel 45-33 1/3 R.P.M. rim drive, 2-pole motor. Very compact. Employs a Neoprene belt for the 33 1/3 R.P.M. speed. 45 R.P.M. speed is obtained direct from rotor shaft. Speed is changed by a simple external lever movement. Specially designed and manufactured to hold wow and rumble to a minimum for excellent reproduction of the new records. Turntable shaft revolves with turntable, and is grooved for turntable clip. Available with 8" or 9" turntable, using same mounting plate.

Dimensions: Length—3 1/2"; Width—2 1/4"; Depth—2 9/16" below mounting plate. Furnished complete with turntable and mounting plate ready for installation. Shipping weight—4 lbs.

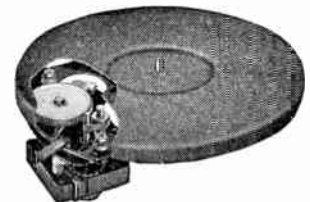

List Price, \$10.40

MODEL DM — 33-1/3, 78 R. P. M. • **MODEL DE** — 45, 78 R.P.M.
 115 volts a. c., 60 cycles

Novel and ingenious rim drive, 2-pole motors. Very compact. Employs a Neoprene belt for slow speeds. 78 R.P.M. speed is obtained direct from rotor shaft. Speed is changed by a simple external lever movement. Specially designed and manufactured to hold wow and rumble to a minimum for excellent reproduction of new records. Turntable shaft revolves with turntable, and is grooved for turntable clip. Available with 9" turntable.

List Price, \$10.40

Dimensions: Length—3 1/2"; Width—2 3/4"; Depth—2 3/8" below mounting plate. Furnished complete with 9" turntable and mounting plate ready for installation. Shipping weight—4 lbs.

[DUAL SPEED PHONOGRAPH MOTORS . . . CONTINUED ON PAGE E-33]

G GENERAL INDUSTRIES G

Smooth Power PHONOGRAPH MOTORS,
TAPE-DISC RECORDER AND DISC RECORDERS

THREE-SPEED PHONOGRAPH MOTORS

DELUXE THREE-SPEED RIM DRIVE FOUR POLE MOTOR

MODEL DSS — 78, 45, 33 $\frac{1}{3}$ R. P. M.

115 volts a.c., 60 cycles

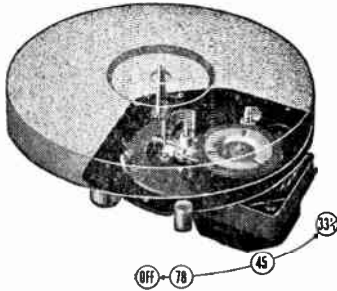

Model DSS

Simple speed change is accomplished by shifting the idler wheel vertically to the appropriate diameter on the motor shaft for desired turntable speed. When shifting speed selector to off position, a switch turns the motor off and the idler wheel is disengaged from the motor shaft. The driving motor is of the four-pole, shaded-pole type resulting in absolute minimum of stray field radiation—ideally suited for use with all types of pickups including magnetic. Motor uses oilless bearings and motor is dynamically balanced to a fine degree.

Precision construction throughout—low friction oilless turntable bearing—radially operated shift lever—10 inch turntable.

List Price, \$24.50

Dimensions: Length 6 $\frac{5}{8}$ "—Width 6 $\frac{1}{4}$ "—Depth 2 $\frac{3}{4}$ " below mounting plate. Furnished complete with 10 inch turntable, speed indicator dial, 45 RPM record adapter, off-on switch, and mounting plate ready for installation. Packed in individual cartons. Shipping Weight 6 $\frac{1}{2}$ lbs.

THREE SPEED TWO POLE PHONOGRAPH MOTORS

MODEL SS — 78, 45, 33 $\frac{1}{3}$ R. P. M.

115 volts a.c., 60 cycles

Very compact, three-speed, phonograph motor using the vertical idler shifting principle. Idler wheel drives the turntable directly from the appropriate step on the motor shaft. Idler wheel is disengaged from motor shaft during non-operating periods. Precision construction throughout. Uses a ribbed main mounting plate to assure stability and proper relationship of all components. Rumble and wow are held to a minimum. Motor uses oilless bearing and dynamically balanced rotor. Turntable shaft revolves with turntable and is grooved for turntable clip. Available with 8 inch turntable. A 45 RPM record adapter and a speed indicator dial are furnished with each motor.

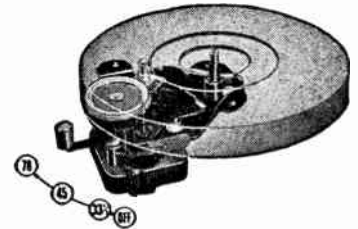

Model SS

List Price, \$10.95

Dimensions: Length 5"—Width 4 $\frac{3}{4}$ "—Depth 2 $\frac{3}{4}$ " below mounting plate. Furnished complete with turntable and mounting plate ready for installation. Packed in individual cartons. Shipping Weight 4 lbs.

MODEL TR — 45, 78, 33 $\frac{1}{3}$ R. P. M.

115 volts a.c., 60 cycles

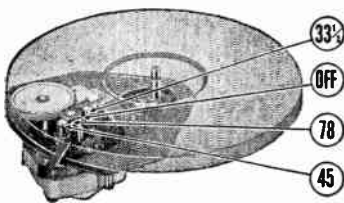

Model TR

Deluxe three-speed rim drive, 2-pole motor. Turntable speeds of 33 $\frac{1}{3}$, 45 and 78 R.P.M. are secured through three separate pulleys running on oil-impregnated bearings and mounted on a turret plate. By means of a simple lever, the desired pulley is brought into contact with the idler wheel. The two pulleys not in contact with the idler wheel remain stationary. Symmetrical electrical and mechanical design results in minimum stray field and maximum performance. Ingenious locking device holds turret plate firmly in driving position at any of the three speeds. Available with 8" or 9" turntable. A 45 R.P.M. record adapter and speed indicator dial are furnished with each motor.

List Price, \$12.10

Dimensions: Length—3 $\frac{1}{8}$ "; Width—2 $\frac{1}{4}$ "; Depth—2 $\frac{3}{8}$ " below mounting plate. Furnished complete with turntable and mounting plate ready for installation. Shipping weight—4 lbs.

G GENERAL INDUSTRIES G

Smooth Power PHONOGRAPH MOTORS, TAPE-DISC RECORDER AND DISC RECORDERS

DUAL-SPEED PHONOGRAPH MOTORS... (continued)

MODEL DR — 78, 33-1/3 R. P. M. • **MODEL DZ** — 78, 45 R. P. M.
MODEL DV — 45, 33-1/3 R. P. M. 115 volts a. c., 60 cycles

Deluxe rim drive, 4-pole motors with a simple and positive mechanism for shifting from one speed to the other. Speed change is accomplished by means of an external push-pull lever. An ingenious mechanism raises and lowers the entire idler assembly, disengages the idler wheel from the two-diameter motor shaft and moves the idler wheel from one diameter to the other. At the slow speed the idler wheel engages the small diameter of the motor shaft; at the fast speed it engages the large diameter.

Dimensions: Length—6"; Width—5 3/4"; Depth—2 3/4" below mounting plate. Furnished complete with 10" turntable and mounting plate ready for installation. Shipping weight—6 1/2 lbs.

List Price, \$21.75



TAPE, WIRE AND DISC RECORDING MOTORS

MODEL D-10

Heavy duty 4-pole, shaded pole induction motors. 1/70 H.P. Free speed: 1740 R.P.M. Maximum running torque: 11 ounce-inches.

Features include: A locating and locking arrangement for both top and bottom covers which assures high accuracy in alignment of rotor within the stator bore; new air intake; dual cooling fans and self-aligning, oil-impregnated sleeve bearings.

These high torque motors are used in practically all tape, wire and disc recorders now being manufactured.

Dimensions: Length—3 3/4"; Width—3 3/4"; Depth 3" below mounting plate; Shaft diameter—1/8"

115 volts a. c., 60 cycles



List Price, \$16.75

HOME RECORDING AND PHONOGRAPH ASSEMBLIES

MODEL GI-R85L — LP, 78 and 33-1/3 R. P. M.
with conversion spring for changing the 33-1/3 R. P. M. speed to 45 R. P. M.

MODEL GI-R90L — 78 & 33-1/3 R. P. M. — Standard

115 volts a. c.,
60 cycles

Model GI-R90L is the standard model which has been in the GI line for several years. It cuts 120 lines per inch, and plays back records with the standard needle pressure.

The Model GI-R85L incorporates a dual purpose pickup cartridge and an excellent and simple adjustment for playing the LP records and standard records. It cuts 160 lines per inch. In a separate envelope is furnished a conversion spring for changing the 33 1/3 R.P.M. speed to 45 R.P.M. with mounting instructions printed thereon.

Both models cut records up to 10" diameter... play records up to 12" diameter. To shift motor from one speed to the other, merely turn the speed change dial. Beautiful walnut wood grain on steel base plate. Streamline plastic trim on pickup and cutter arm attractively engraved with legends "Reproducer" and "Recorder". Turntable recessed into well in base plate. Merely lower cutting arm over record disc to start recording. Convenient, depth-of-cut adjustment. Dynamically-balanced, rim drive, 4-pole motor. Compensating switch operated by speed change dial.



MODEL GI-R85L — LP List Price, \$56.50
MODEL GI-R90L — STANDARD . List Price, 52.00

Assembly includes dual speed motor; 10" weighted turntable; crystal cutter; crystal pickup; compensation switch; pickup and cutter arm rests; drawn steel base plate with formed down edges.

Above prices include crystal cutter.
For (M41-10) magnetic cutter add \$2.00 each.

Dimensions: Base plate—15" wide; 11 1/2" front to back; height above lower edge of base plate—2 3/4"; depth below lower edge of base plate—3 3/4". Packed in individual cartons. Shipping weight—17 lbs.

ALLIANCE PHONOMOTORS

ALLIANCE MANUFACTURING COMPANY • ALLIANCE, OHIO

Phonomotors

New three-speed phonomotors for record players 33 $\frac{1}{3}$, 45 and 78 RPM records
New single speed 78 RPM phonomotors

General Purpose Motors

Alliance makes a variety of fractional horse-power, shaded pole induction motors to service many specific small load applications. One of the most popular is Model B. Others are used not only in the radio-phonograph and recording industry, but in a wide range of product classifications. The motors illustrated in this catalogue are standard models designed for practical utility and to meet the maximum number of mechanical and electrical requirements for motors in this class.

(Typical uses are electronic, mechanical, electric controls — radio tuning and turn-table drives — disc tape and wire recorders — fans — heating controls — coin operated mechanisms — miscellaneous uses.)

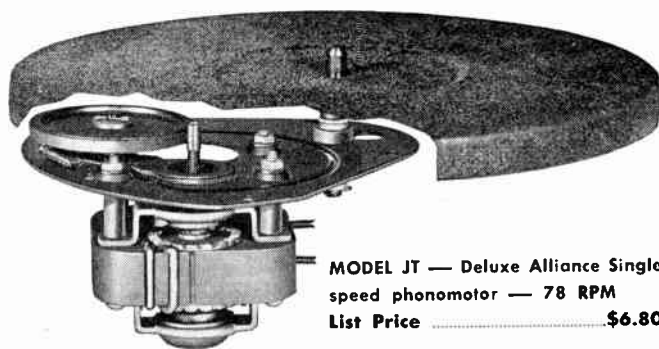

MODEL JT — Deluxe Alliance Single speed phonomotor — 78 RPM
List Price\$6.80

This deluxe 78 RPM phonomotor assembly is quiet and extremely smooth in operation. It embodies all of the superior features which made the original Model 80 famous, with a new, more powerful motor.

ALLIANCE 78 RPM PHONOMOTOR MODEL JT

Low Cost — Ideal for Hi-Fi

Model JT is available with 8 inch and 9 inch turn-table diameters and has the same basic motor as used on Model JPT with turn-tables available in color choice. Also available for motor winding for use in series with 25L6 vacuum tube filament. Rotating spindle revolves with turntable. Features shockproof vibration mounting — a truly fine performing unit made to highest precision standards.

ALLIANCE PHONOMOTORS

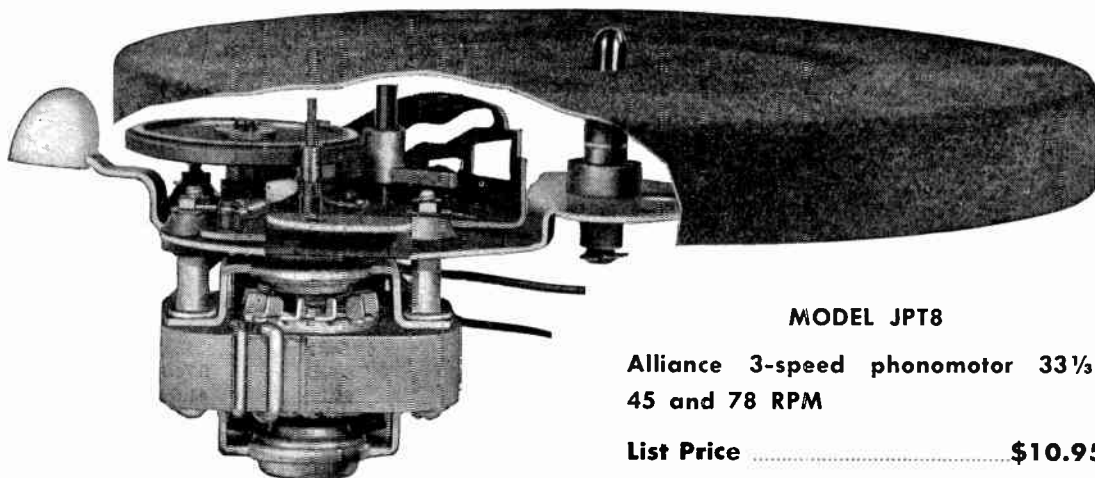

MODEL JPT8

Alliance 3-speed phonomotor 33 1/3, 45 and 78 RPM

List Price\$10.95

THREE SPEED PHONOMOTOR

THE LARGEST SELLING PHONOMOTOR IN THE WORLD

MODEL JPT — A completely new design. Retains all of the features of original model, which became the standard of the industry, with many added improvements. Adequate reserve power in motor. Elimination of stepped pulley reduces possibility of wow and rumble. Added neutral position on shifter lever removes drive shaft from contact with rubber tire when instrument is not in use. Attractive plastic knob on shifter lever available in color. **TURNTABLES AVAILABLE IN CHOICE OF COLORS.** Furnished with plastic 45 RPM center disc. Can be furnished with winding for operation in series with 25 L6 tube

filament if desired. Furnished with speed indicator escutcheon plate. Same mounting plate cut-out as single speed 78 RPM unit illustrated, thus providing greater versatility for manufacturers of phonograph equipment.

The model JPT provides unimpaired performance at all speeds. Single lever shifts and indexes speeds with freer movement. Electronic dynamically balanced rotor. Vibration-proof mountings. Minimum rumble and hum. Unexcelled speed regulation. Designed to meet U. L. requirements. Occupies minimum space. Millions have been sold.

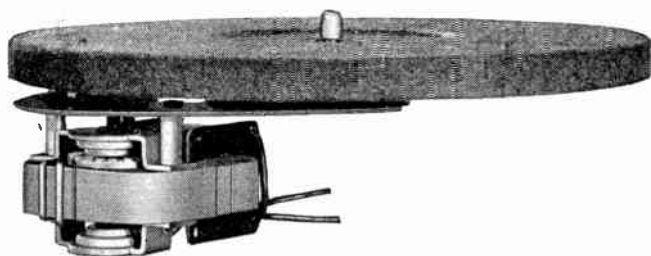

ALLIANCE SINGLE-SPEED PHONOMOTOR MODEL JP

List Price\$6.05

MODEL JP — The most economical player motor on the market. Available with 6 1/2", 8" and 9" turntable diameters. Same basic motor as used on JPT model. Same mounting cutout as three speed unit illustrated. Turntables available in color choice. Also available with motor winding for use in series with 25L6 vacuum tube filament. Scintered metal tip on turntable spindle revolves with record.

Deluxe unit also available. Uses rotating turntable spindle. Shock proof vibration mounting. Same mounting cut-out requirements as other units shown. A truly fine performing unit. Highest quality — lowest price.

ALLIANCE MOTORS

MODEL JS MOTOR—

This new model is an extremely versatile motor of high efficiency and compact design. In reality JS is a "big brother" power-wise to our famous, popular MS illustrated below.

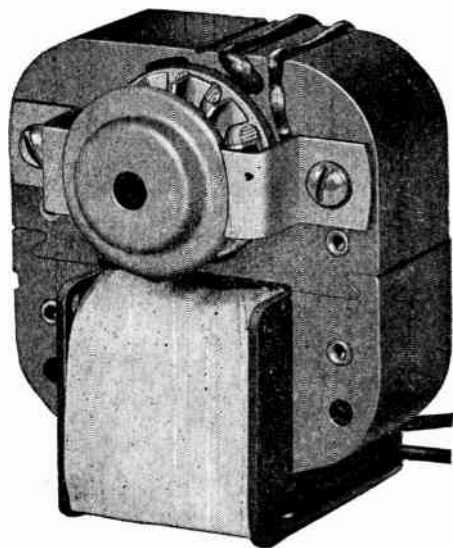

SPECIFICATIONS

	JS 0.600	JS 0.800	JS 1.100
Stack Thickness, Inches	0.600	0.850	1.100
Locked Amps. - Cold	0.710	0.920	0.930
Locked Watts - Cold	35	50	55
Starting Torque oz. in Cold	1.75	2.7	2.95
Idle Amps. - Hot	0.540	0.670	0.600
Idle Watts - Hot	22	30	30
Idle R.P.M. - Hot	3470	3475	3500
Full Load Amps.	0.575	0.760	0.725
Full Load Watts	29.0	41.5	44.0
Full Load Torque oz. in.	2.7	4.2	5.1
Full Load R.P.M.	2900	2900	2900
Full Load H. P.	0.008	0.012	0.13
Overall Dimensions (Less Shaft Extension)	2-53/64 x 2-13/32 x 2	2-53/64 x 2-13/32 x 2 1/4	2-53/64 x 2-13/32 x 3 1/2
Weight	1# 2 oz.	1# 8 oz.	1# 13 oz.
Rotor Shaft In.	0.181	0.181	0.181
Shaft Ext. W.	.750	.750	.750

117 volts 60 cycles, continues open rating with 65° centigrade temperature rise. Motor can be supplied with internal fans for mechanical duty. Mounting hole 1 7/8" center.

Prices vary with stack thickness

MODEL MS MOTOR

A LEADER FOR MANY YEARS

The Alliance Model MS motor is ideal for driving fans, timers, or other rotisseries, light loads. It is an adaptation of the quiet, smooth running motor which is used to power the Models MP8, MP9, and MP10 Phonomotors. It measures 3 1/8" x 2" x 1 3/4" not including the 7/16" long shaft extension which has an 11/16" diameter. Rotation is clockwise facing the shaft extension. Its self aligning bearings are of the porous bronze oilless type. Operating over a wide range of AC voltages from 24 to 250 and frequency of 40, 50, or 60 cycles, this compact lightweight motor can be incorporated as the vital power source in all kinds of electrical and mechanical devices. Large oil wicks provide lifetime lubrication.

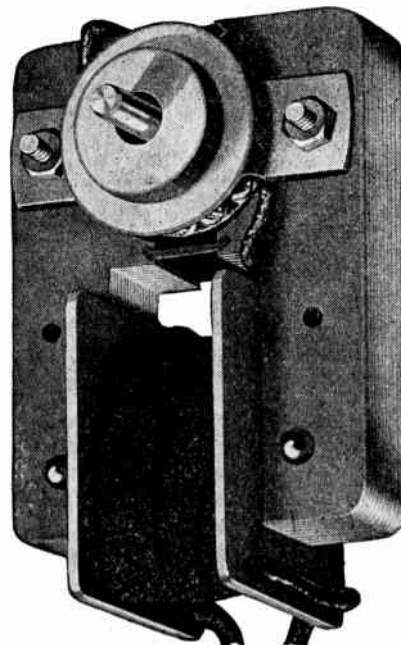

Model MS
List Price \$4.35

ALLIANCE MOTORS

GENERAL TYPES FOR SMALL LOADS

MODEL B

Shaded Pole Induction Motor

**FOR HI FIDELITY PLAYERS
FANS — RECORDERS — HEATERS
and OTHER DEVICES**

Model B is a 4-pole shaded pole induction motor, especially adapted for such devices as fans, unit heaters, blowers, air circulators, disc, tape and wire recorders. Comes in three standard lamination stack thicknesses. The range of power is from 1/100 h.p. up to 1/25 h.p. Where necessary the motor can be supplied completely enclosed with oil tubes.

Important advantages for Model B are economy of operation, low induced hum, low magnetic field, cool running, flexible power range and compactness. A real Hi-Fi power plant.

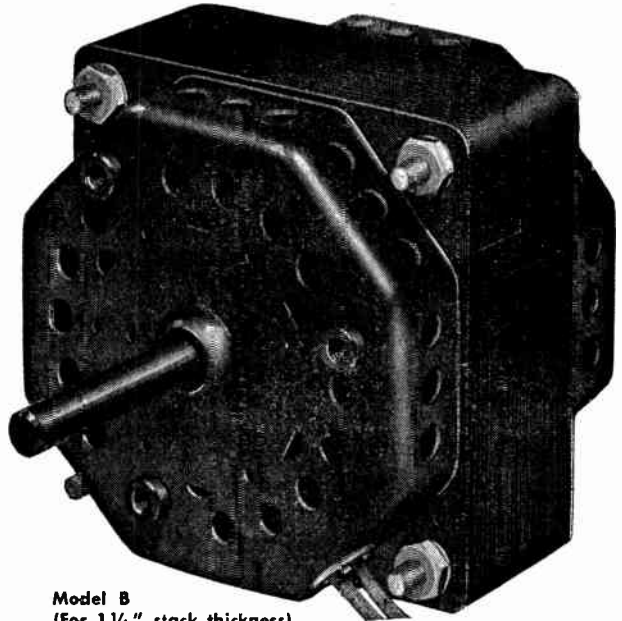

Model B
(For 1 1/4" stack thickness)
List Price\$15.10

SPECIFICATIONS

MECHANICAL

- 3 3/8" square, with length of 2 1/8" over the end bracket for the 1 1/4" stack. 5/16" diameter shaft.
- Porous bronze, oiliness type, self aligning bearings — amply proportioned, with large oil reserves.
- Semi-open or fully enclosed construction. Can be supplied with oil tubes if required.
- Four No. 10-32 bolts equally spaced for end mounting or motor can be supplied with mounting bushings on end covers.
- 3/4", 1 1/4" and 1 3/4" lamination stacks depending on rating required.

- Max. weight — approx. 5.6 lbs. for largest stack thickness.
- Single Phase, 4-pole, shaded pole induction motor with squirrel cage rotor.
- Approx. 1/25 h.p. for fans — approx. 1/40 h.p. for mechanical loads without external cooling. Entire power range runs from 1/100 h.p. to 1/25 h.p. for semi-enclosed construction.
- Starting torque approx. 40% of torque at full load rating. 1550 r.p.m. full load speed.
- A. C. only — 115 volts, 60 cycles. Clockwise or counter clockwise rotation — not reversible. Can be wound for 50 cycles and other voltages.
- Internal cooling fans on each end.

**FOR DETAILED INFORMATION . . . CATALOG SHEETS
OR ADVICE ON SPECIAL PROBLEMS WRITE THE FACTORY.**

ALLIANCE MANUFACTURING COMPANY
ALLIANCE, OHIO

Miller Replacement Phonograph Needles — **PACKAGED TO SELL** —



ALL STEEL

MASTER COUNTER DISPENSER

Designed to hold 300 or more needles for rapid reference — easy selection — faster sales — simplified inventory — uses limited counter space. Each of six compartments has illustrated identification card on outside to create impulse buying.

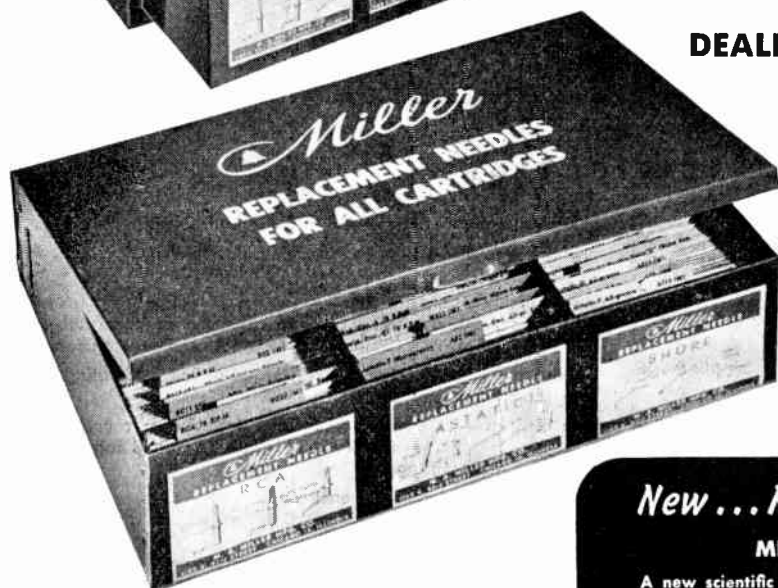

ALL STEEL

DEALER COUNTER DISPENSER

Holds 150 or more individually carded needles for easy reference.

Provides quick selection and identification.

Have you seen our "Carillon Dynamic" Line of conventional phonograph needles? Write today for literature!

New ... Revolutionary Sales Aid MILLER **PreTest**®

A new scientific technique for accurately measuring needle wear without removing needle from phonograph.

Dealers and servicemen give consumer PreTest card. Consumer makes own needle impression and sends card to M. A. MILLER Laboratories for inspection, report and new Miller replacement needle number. Consumer brings report back to dealer ... dealer makes sale and passes out new PreTest card.

Write today for sample PreTest card and complete details.

M. A.
Miller MANUFACTURING CO.

4th AND CHURCH STREETS
LIBERTYVILLE, ILLINOIS

Atlas Radio Corp., Ltd., 560 King St., West, Toronto 2, Canada
Export: Joseph Plasencia, Inc., 401 Broadway, New York 13, N. Y.

Miller REPLACEMENT NEEDLES

Cartridge Mfg's. Needle No.	ILLUSTRATION	POINT SIZE	MILLER CATALOG NEEDLE NUMBER	PRICE	Cartridge Mfg's. Needle No.	ILLUSTRATION	POINT SIZE	MILLER CATALOG NEEDLE NUMBER	PRICE
ASTATIC					MAGNAVOX				
T-33; D-33		MG	A-11(M)	\$ 1.50	560102		STD	M-13(M)	\$ 1.50
D or T		STD	A-13(M)	1.50	560138		* Dual	M-213(M)	2.50
D-AG-M		AG	A-113(M)	1.50	560153		* Dual	M-313(M)	2.50
D-AG-J		AG	A-113(S)	2.50	PHILCO				
Q-33-M		MG	A-21(M)	1.50	45-9674 Dyn. Reproducer		STD	PH-13(S)	2.25
Q(M)		STD	A-23(M)	1.50	45-9586		MG	PH-21(M)	1.50
Q-(AG)M		AG	A-213(M)	1.50	45-9587		* MG	PH-21(S)	1.50
Q-33(J)		* MG	A-21(S)	2.50	45-9588	* Dual	PH-313(M)	2.50	
Q-(J)		* STD	A-23(S)	2.50	45-9589	* Dual	PH-313(S)	3.50	
Q-(AG)J		* AG	A-213(S)	2.50	RCA				
G-33(M)		MG	A-31(M)	1.50	74068		* MG	RC-11(S)	1.60
G-78(M)		STD	A-33(M)	1.50	72345		* STD	RC-13(S)	3.95
G-AG(M)		AG	A-313(M)	1.50	74068		MG	RC-21(M)	1.50
G-33(J)		* MG	A-31(S)	2.50	72345	* STD	RC-23(M)	1.50	
G-78(J)		* STD	A-33(S)	2.50	75496	MG	RC-31(M)	1.50	
G-AG(J)		* AG	A-313(S)	2.50	75497	STD	RC-33(M)	1.50	
U-M		MG	A-41(M)	1.50	75496	* MG	RC-31(S)	1.60	
U-78(M)		STD	A-43(M)	1.50	75497	* STD	RC-33(S)	1.60	
		AG	A-413(M)	1.50	74818	* MG	RC-51(S)	1.60	
U-J		* MG	A-41(S)	2.50	SHURE				
U-78(J)		* STD	A-43(S)	2.50	A63MG		MG	P-31(M)	1.50
		* AG	A-413(S)	2.50	A62A		STD	P-33(M)	1.50
				A66U	AG		P-313(M)	1.50	
C-1(M)		MG	A-51(M)	1.50	A65MG	* MG	P-41(S)	2.50	
C-3(M)		STD	A-53(M)	1.50	A61A	* STD	P-43(S)	2.50	
C-AG(M)		AG	A-513(M)	1.50	A67U	* AG	P-413(S)	2.50	
C-1(J)		* MG	A51(S)	2.50	A53MG		MG	P-51(M)	1.50
C-3(J)		* STD	A-53(S)	2.50	A52A		STD	P-53(M)	1.50
C-AG(J)		* AG	A-513(S)	2.50	A56U		AG	P-513(M)	1.50
A-1(M)		MG	A-61(M)	1.50	SONOTONE				
A-3(M)		STD	A-63(M)	1.50	W-7590-1		* MG	SA-31(M)	1.50
A-AG-(M)		AG	A-613(M)	1.50	W-7590-3		* MG	SA-31(S)	2.50
A-1(J)	* MG	A-61(S)	2.50	W-7590-2	* STD		SA-33(M)	1.50	
A-3(J)	* STD	A-63(S)	2.50		* AG	SA-33(S)	2.50		
A-AG-(J)	* AG	A-613(S)	2.50		* AG	SA-313(M)	1.50		
Nylon 1J		STD	A-73(S)	2.50			* AG	SA-313(S)	2.50
American Microphone					WEBSTER CHICAGO				
CR-5; CO-1(M)		MG	AM-11(M)	1.50	NE-214 or NE-215		Dual	WC-213(M)	4.00
CR-6; CO-3(M)		STD	AM-13(M)	1.50	NE-316		* Dual	WC-313(M)	4.00
CR-7; CO-2(M)		AG	AM-113(M)	1.50	WEBSTER ELECTRIC				
AUDAK					Q-1		STD	WE-13(M)	1.50
Microgroove		* MG	AU-11(S)	3.50	F-13		MG	WE-21(M)	1.50
Standard		* STD	AU-13(S)	3.50	Q-2		STD	WE-23(M)	1.50
COLUMBIA					Q-3		AG	WE-213(M)	1.50
Model 101		* MG	COL-11(S)	1.50	A(M)1		AG	WE-31(M)	1.50
Models 102, 103, 104		* MG	COL-21(S)	2.50	A(M)3		STD	WE-33(M)	1.50
Model 105		See A-113(S) above			A(M)AG	AG	WE-313(M)	1.50	
ELECTRO-VOICE					A(J)1		* MG	WE-31(S)	2.50
O-1		MG	E-11(M)	1.50	A(J)3		* STD	WE-33(S)	2.50
O-3		STD	E-13(M)	1.50	A(J)AG		* AG	WE-313(S)	2.50
O-2		AG	E-113(M)	1.50	F-16(D)	MG	WE-41(M)	1.50	
S-1		* MG	E-21(S)	2.50	F-16(V)	STD	WE-43(M)	1.50	
S-3		* STD	E-23(S)	2.50	F-16(D)	STD	WE-403(M)	1.50	
S-2		* AG	E-213(S)	2.50	F-14	Dual	WE-513(M)	2.50	
O-13		Dual	E-313(M)	2.50	G-1		MG	WE-61(M)	1.50
S-13		* Dual	E-413(S)	3.50	G-3		STD	WE-63(M)	1.50
GENERAL ELECTRIC					G-2		AG	WE-613(M)	1.50
RPJ-005		* MG	GE-21(S)	3.50	M		STD	WE-73(M)	1.50
RPJ-001		* STD	GE-23(S)	3.50	AJ		MG	35-1	1.00
RPJ-006		* Trans	GE-213(S)	3.50	WS	STD	35-3	1.00	
RPJ-004		MG	GE-31(D)	27.50	C-9	AG	35-2	1.00	
RPJ-003		STD	GE-33(D)	27.50	F-20	MG	WE-81(M)	1.50	
RPJ-002		Trans	GE-313(D)	27.50	F-20	STD	WE-83(M)	1.50	
RPJ-010		* Dual	GE-113(S) STD-MG	5.95	* "1" before the suffix (M) or (S) designates a 1 mil needle for 33-45 RPM				
RPJ-007		* Dual	GE-513(S) Trans-MG	5.95	* "3" before the suffix (M) or (S) designates a 3 mil needle for 78 RPM				
RPJ-012		* Dual	GE-413(D) STD-MG	49.95	A three number designation ending in "13" indicates an All Groove or a dual needle for playing all record speeds				
RPJ-013		* Dual	GE-413(DS) STD-MG	31.00					
RPJ-011	* Dual	GE-513(D) Trans-MG	49.95						

* Available with Diamond Tip
 MILLER abbreviations and designations to assist in using this chart:
 MG Microgroove—Plays 33 1/3 and 45 RPM (M) After Miller Cat. No. designates Osmium Alloy Tip
 AG All Groove—Plays 33 1/3, 45 and 78 RPM (S) After Miller Cat. No. designates Sapphire Synthetic Tip
 STD Standard—Plays 78 RPM (D) After Miller Cat. No. designates Diamond

The above needles are representative Miller Replacement Needles . . . Miller has a needle for every cartridge. Needles not listed supplied on request.

Jensen NEEDLES for the replacement trade



The largest, most complete line of exact replacement needles for all popular phono cartridges. Figures in point column indicate point size 1 = .001" micro-groove for 33 1/3 and 45 rpm; 2 = .002" for all 3 speeds; 3 = .003" standard for 78 rpm; 1/2 = twin needle, 001" and 003"; 2.5 = .0025" transcription. Needles with sapphire points, indicated by asterisk (*), are also available with genuine diamond points; others have osmium points. Illustrations (except GE-11 and S-66) are exact size. Illustrations showing .003" needles apply also to corresponding 001" and .002" stock numbers. When ordering diamond point needles, simply add "D" to needle number.

For Astatic Cartridges				For Philco Cartridges					
Stock No.	Jensen Type	Point	For Cartridge Type No. Net ea.	Stock No.	Jensen Type	Point	For Cartridge Type No. Net ea.		
000000	A-70	3	14L3-78M; 15L3-78M; 14L3D; 15L3D .90	000000	PH-10	3*	76-1622 Dyn. Reproducer 1.35		
	A-70LP	1	14L3-M; 15L3-M; 14L3D; 15L3D .90		PH-11	1	45-1609; 45-1612 .90		
	A-702	2	14L3-AG-M; 15L3-AG-M .90		PH-12	1/2	76-4649 1.50		
	A-73	3*	LT-3D; LT-4D 1.50		PH-13	1/2	76-4649 2.10		
	A-73LP	1*	LT-3D; LT-4; LT-4D 1.50		M-60LP	1*	45-1609; 45-1612 .90		
	A-732	3*	LT-4-AG; LT-5-AG 1.50		PH-14	3	35-2671; 35-2674 .90		
	A-74	3*	GC-78-J 1.50		PH-15	3*	35-2671; 35-2674 1.20		
	A-74LP	1*	GC-J; GC-1J 1.50		For RCA Cartridges				
	A-742	2*	GC-AG-J 1.50	000000	M-70	3*	70338; 70339; 72551 2.37		
	A-75	3*	AC-78; ACD Series; 10L3; 11L3 1.50		M-70LP	1*	74067 .96		
	A-75LP	1*	AC; ACD Ser; 10L3; 11L3 1.50		M-71	3	70338; 70339; 72551 1.20		
	A-752	2*	AC-AG-J 1.50		M-71LP	1	74067 .90		
	A-78	3*	U-78-J 1.50		M-72	3*	9890; 39919; 39550; 38598; 70332; 39851 2.37		
	A-78LP	1*	U-J 1.50		M-73	3	9890; 39919; 39550; 38598; 70332; 39851 1.20		
	A-80	3	QT-M; QT2-M; LQD; LQD-1; CAC Series .90		M-74	3*	75475 .96		
	A-80LP	1	CG-M; LQD; LQD-1; CAC Series .90		M-74LP	1*	75475; 74625; 75575; 76318 .96		
	A-802	2	CQ-AG-M; CAC-AG-M .90		M-75	3	75475 .90		
	A-81	3*	QT-J; QT2-J; QT3-J; LQD; LDQ-1; CAC Series 1.50		M-75LP	1	75475 .90		
	A-81LP	1*	QT-33-J; CQJ; LQD; LQD-1; CAC Series 1.50		For Shure Cartridges				
	A-812	2*	CQ-AG-J; CAC-AG-J 1.50	000000	JP-30	3	P30; P57; P70; P72; P76; P77; P79; P85; P88; P89; P94; PN30; W22AB; WC22AB; W23B; W60B; W60HS; W60PN; W61B; W65B; Admiral 409A11. 90		
	A-82	3	Nylon 1M .90		JP-30LP	1	P73; P72V; P76V; W21F; Admiral 409A11 90		
	A-82-S	3*	Nylon 1J 1.50		IP-312	2	P71; P81; P37; W26B; W66B; Admiral 409A13. 90		
	A-83	3	MD 1.50		JPS-30	3*	P30; P57; P70; P72; P76; P77; P79; P85; P88; P89; P94; PN30; W22A; W23A; W26B; W60A; W66B; Admiral 409A13 1.50		
	A-83LP	1	LT-3D; LT-4; LT-4D; LT-4D1 .90		JPS-30LP	1*	P73; P72V; P76V; W21A; W21AR; W22A; W22AB; WC22AB; Admiral 409A11 1.50		
	A-832	2	LT-4-AG; LT-5-AG .90		JPS-312	2*	P71; P81; P37; P81AD; W26A; Admiral 409A13 1.50		
	A-84	3	GC-78-M; MG-78-M; 402-M .90		JP-32	3	WC33B; WC24; PC40; PC9 90		
	A-84LP	1	GC-M; GC-1M; MG-1M .90		JP-32LP	1	W31AR; WC31AR; WC24; PC40; PC11 90		
	A-842	2	GC-AG-M; MG-AG-M .90		JP-322	2	W36B; WC36B; PC10 90		
	A-85	3	AC-78; ACD Series; 10L3; 11L3 .90		JPS-32	3*	WC33B; WC24; PC40; PC9 1.50		
	A-85LP	1	AC; ACD Ser; 10L3; 11L3 .90		JPS-32LP	1*	W31AR; WC31AR; WC24; PC40; PC11 1.50		
	A-852	2	AC-AG-M .90		JPS-322	2*	W36B; WC36B; PC10 1.50		
	A-86	3	LT1-M; LT2-M; LT3-M .90		J-15LP	1	P93MG; P95MG; W53MG .75		
	A-86LP	1	LT-33 .90		J-752	2	P93MG; P95MG; W53MG 50		
	A-87	3	MD-3 Markel Playmaster. .90		For Webster-Chicago Cartridges				
	A-87LP	1	MD-1 Markel Playmaster. .90		000000	NE-215	1/2	21P247; 21P402; 21P403 2.40	
	A-88	3	U-78-M .90			NE-368	1/2	21P404 2.40	
	A-88LP	1	U-M .90		For Webster Electric Cartridges				
	A-89	3*	MD-3 Markel Playmaster. 1.50		000000	W-02	3	M-1 90	
	A-89LP	1*	MD-1 Markel Playmaster. 1.50			W-05	1/2	F14; F14-1; F14-2; F14-3; F14-4 1.50	
	J-15LP	1	L-92-33 .75			W-14	3*	A1; A7; A8 1.50	
	J-152	2	L-92-33 .75			W-15	1*	A1; A2; A3; A4; A5; A6; A7; A8 1.50	
	For Columbia Cartridges						W-15LP	1	F7; F7-1; F7-2; Q2; F13 90
000000	A-81LP	1*	CQ; CAC-J 1.50			W-16	3	A1M; A1M-1; A5M; A6M; A7M 90	
	M-60LP	1*	45-1609; 45-1612 .90			W-17	1	A1M; A1M-1; A2M; A5M; A6M; A7M 90	
	S-66	1/2	W9980-S; W9980-SD (both for 360) 2.10			W-30	3	Q1 90	
	For Electro-Voice Cartridges						W-38	2	A9M; A9-1; A11 90
	E-90	3*	10; 30; 40; Series 12, 32, 42, 36, 46, 96 1.50			W-412	2	Q3; A9; F-13 90	
	E-90LP	1*	Series 33, 43; Admiral 409A13-1 1.50			W-422	2	C9; C10 90	
	E-902	2*	Series 33, 43; Admiral 409A13-1 2.10			W-44	3	F20 90	
	E-91	1/2	16TT; 22TT 2.10			W-44LP	1	F20 90	
	E-93	1/2	16TT; 22TT 1.50			W-49	3	Q2 90	
	E-95	3	10; 30; 40; Series 12, 32, 42, 46, 96 .90			W-72	3	F16; F16-1; F16-2 90	
	E-95LP	1	Series 33, 43; Admiral 409A13-1 .90			W-73	1	F16; F16-1; F16-2 90	
	E-962	2	Series 33, 43; Admiral 409A13-1 .50			W-81	3	F15; F15-1; F18, F19 90	
	J-752	2	50; 60. .50			W-82	1	F15; F15-1; F18; F19 90	
	For G-E Cartridges						JP-30	3	F10; F11; F11-1 90
000000	G-10	3*	RPX-040; RPX-041; } 2.10			JP-30LP	1	F11; F11-1 90	
	G-10LP	1*	RPX-042; RPX-046; } 2.10						
	G-1025	2.5*	RPX-061; RPX-063 } 2.10						
	G-11	1/2	RPX-047; RPX-050; RPX-051; RPX-052; RPX-053 3.57						
	For Magnavox Cartridges								
000000	M-02	3	560101 .90						
	M-46	1/2	560133; 560151 1.50						

"50" Needle Display

Attractive counter display that holds 24 of the lowest priced quality phono needles on the market. Durosium tipped needles (individually packaged)—fine for both popular and classical recordings. 000000 Jensen No. 5D; per display, net \$6.00

Concert Needle Display

Colorful counter display that holds 13 individually packaged needles. The needles have Durosium tips, and are constructed with flexible shanks to protect records. Provide full-range recording reproduction. 000000 Jensen No. 10D; per display, net \$6.00

1470 Needle Display (illustrated)

Contains the most popular assortment of needles, as follows: 9 #J-5, 9 #J-10, 3 #J-15, 3 #NY-153, 3 #J-25.

Beautiful plastic display with compartment for storing needles (card type packaging). Inventory control feature solves your stocking problems. All needles in this assortment may be ordered individually in card type packaging. 000000 Jensen No. 1470, per display, net \$15.00



1470 Display

PERMO PRODUCT "Rep Agencies"

R. W. Ferris Co.

J. K. Rose & Co.

Carl E. Rosen Assoc.

Marsh Agencies

Cliff Landis Sales Co.

J. W. Marsh Co.

J. Alan Biggs & Co.

Ronald G. Bowen Co.

Crockett-Lund & Co.

The Maitland K. Smith Co.

Les A. Morrow Co.

Nation Wide Representation — Nation Wide Distribution.
 No matter where you are located — There are Authorized Permo Product
 Distributors to supply your needs.



PERMO, INC.

MANUFACTURERS OF "FIDELITONE", "PERMO POINT" AND "PERMO" PRODUCTS
 PHONOGRAPH NEEDLES, RECORD BRUSHES — RECORDING TAPE, WIRE AND ACCESSORIES

Copyright by U. C. P., Inc.

Radio's Master — 19th Edition

Page E-41

PERMO**Recording Tape****PERMO, INC.**
Chicago 26, Illinois**PLASTIC BASE — Red Oxide Coating — Plastic Reels**

Catalog Number		DESCRIPTION	Sug'd List Price
INSIDE WIND	OUTSIDE WIND		
T-60-I	T-60-O	3-inch plastic reel containing 150 ft. of tape*	\$1.00 ea.
T-61-I	T-61-O	4-inch plastic reel containing 300 ft. of tape*	\$1.75 ea.
T-66-I	T-66-O	5-inch plastic reel containing 600 ft. of tape*	\$3.50 ea.
T-68-I	T-68-O	7-inch plastic reel containing 1200 ft. of tape*	\$5.50 ea.
T-69-I		Standard Aluminum NAB hub with 2400 ft. of tape†	\$10.00 ea.
T-69-IF		Standard Aluminum NAB hub with flanges and 2400 ft. of tape†	\$12.85 ea.

PAPER BASE — Red Oxide Coating — Plastic Reels

Catalog Number		DESCRIPTION	Sug'd List Price
INSIDE WIND	OUTSIDE WIND		
T-80-I	T-80-O	3-inch plastic reel containing 150 ft. of tape*	\$.75 ea.
T-81-I	T-81-O	4-inch plastic reel containing 300 ft. of tape*	\$1.75 ea.
T-86-I	T-86-O	5-inch plastic reel containing 600 ft. of tape*	\$2.25 ea.
T-88-I	T-88-O	7-inch plastic reel containing 1200 ft. of tape*	\$3.50 ea.

ACCESSORIES — Plastic Reels — Splicing Tape

Catalog Number	DESCRIPTION	Sug'd List Price
T-3-PM	Empty 3-inch plastic reel for 150 ft. of Recording Tape*	\$.30 ea.
T-4-PM	Empty 4-inch plastic reel for 300 ft. of Recording Tape*	\$.50 ea.
T-5-PM	Empty 5-inch plastic reel for 600 ft. of Recording Tape*	\$.50 ea.
T-7-PM	Empty 7-inch plastic reel for 1200 ft. of Recording Tape*	\$.60 ea.
T-20-PM	Splicing Tape 100-inch roll, 1/2 inch wide, specifically designed for splicing recording tape	\$.35 ea.
T-10-PM	10 1/2 - inch NAB Aluminum Reel in Permo Box.	\$4.00 ea.

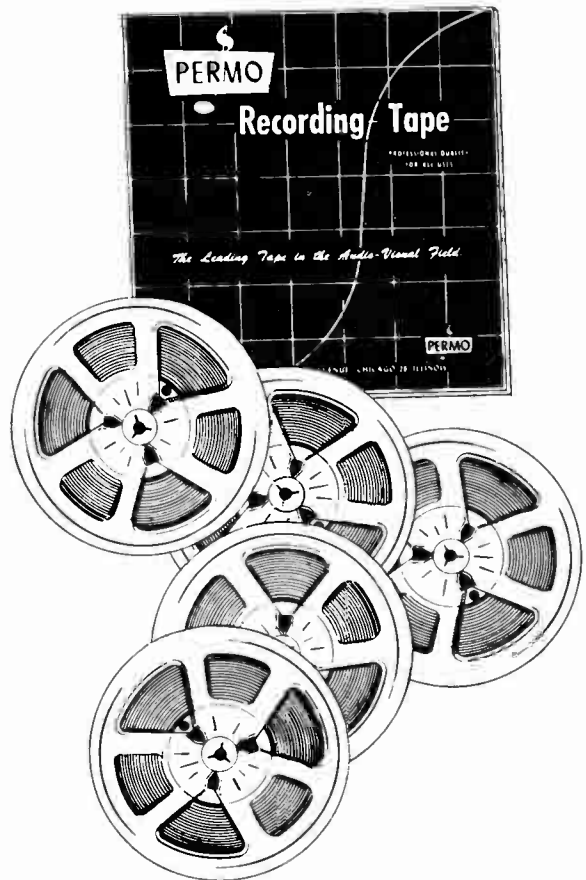
**THE LEADING TAPE IN THE AUDIO-VISUAL FIELD**

The same long years of design, engineering and production experience that have made PERMO the world's largest and oldest maker of long life phonograph needles are your assurance of highest professional standards in Permo Recording Tape and Accessories.

Permo Recording Tape is packed 12 individually boxed reels to the carton.

NOTES: *All reels packed in a sturdy album type box with indexing, logging, and filing features.

†All Nab hub and reel packages supplied in sturdy cloth hinge type box with tray and hub boss for secure handling.

PERMO

Recording Wire

PERMO, INC.

Chicago 26, Illinois

The Quietest Magnetic Recording Wire Ever Produced!

BECAUSE—Permo Recording Wire combines a new low D-C noise wire with *Lubri-Lo*. Permo's exclusive wire lubrication process achieves new professional standards of high fidelity in wire recording. An improvement of fully 10 db. over competitive wires.



PERMO RECORDING WIRE and ACCESSORIES

Catalog No.	Description	Sug'd List Price
RECORDING WIRE with PLASTIC LEADERS ATTACHED		
160-36N	1 Hour Spool, 7,200 Ft. of Wire on Metal Spool	\$6.00
260-36N	½ Hour Spool, 3,600 Ft. of Wire on Metal Spool	4.00
360-36N	¼ Hour Spool, 1,800 Ft. of Wire on Metal Spool (2 Nylon Leaders Included Loose in Each Box)	3.00
RECORDING WIRE with NYLON LEADERS ATTACHED		
160N-36	1 Hour Spool, 7,200 Ft. of Wire on Metal Spool	\$6.00
260N-36	½ Hour Spool, 3,600 Ft. of Wire on Metal Spool	4.00
360N-36	¼ Hour Spool, 1,800 Ft. of Wire on Metal Spool (2 Plastic Leaders Included Loose in Each Box)	3.00
ACCESSORIES		
PM-121N7	Empty Metal Spool for Up to 1 Hour of Wire with 2 Plastic and 2 Nylon Leaders in Box	\$.75
PM-125	Long Plastic Leader (17" Long)	Each .15
PM-122	Short Plastic Leader (6" Long)	Each .10
PM-123	3' Nylon Leaders per Pair	Pair .10

A convenient box designed for use as a wire album is supplied at no extra charge when wire is purchased 5 rolls at a time.

Copyright by U. C. P., Inc.

TRADE DISCOUNT APPLIES TO LIST PRICES ONLY

Radio's Master—19th Edition

Page E-43



**Conventional Type Phono Needles,
Cutting Stylus, Steel Needles
and Record Brushes**

PERMO, INC.
Chicago 26, Illinois

TYPE OF RECORDS PLAYED	ILLUSTRATION	PERMO NEEDLE NUMBER	DISPLAY CARD NUMBER	DESCRIPTION	SUG'D LIST PRICE
MICROGROOVE 33 1/3 & 45 RPM CONVENTIONAL TYPE NEEDLES					
Microgroove 33 1/3 & 45		A-311 A-311D		"Micro-Point" Shielded Jewel Needle Permopolished Diamond Tip Needle	\$ 1.50 25.00
			311-C8 311-C12	Card of 8, A-311 Needles Card of 12, A-311 Needles	12.00 18.00
STANDARD 78 RPM CONVENTIONAL TYPE NEEDLES					
Standard 78		C-370		"Permotone" Permometal Needle	.50
			370-C8 370-C12	Card of 8, C-370 Needles Card of 12, C-370 Needles	4.00 6.00
		C-427		"Standard Offset" Permometal Needle	1.00
			427-C8 427-C12	Card of 8, C-427 Needles Card of 12, C-427 Needles	8.00 12.00
		C-325		"Nylon" Permometal Needle	1.25
			325-C8 325-C12	Card of 8, C-325 Needles Card of 12, C-325 Needles	10.00 15.00
		C-312 C-312D		"Standard" Shielded Jewel Needle Permopolished Diamond Tip Needle	1.50 25.00
			312-C8 312-C12	Card of 8, C-312 Needles Card of 12, C-312 Needles	12.00 18.00
ALLGROOVE 33 1/3, 45 & 78 RPM CONVENTIONAL TYPE NEEDLES					
Allgroove 33 1/3, 45 & 78		B-310		"Compromise" Permometal Needle	1.00
			310-C8 310-C12	Card of 8, B-310 Needles Card of 12, B-310 Needles	8.00 12.00
		B-388 B-388D		"Compromise" Shielded Jewel Needle Permopolished Diamond Tip Needle	1.50 25.00
			388-C8 388-C12	Card of 8, B-388 Needles Card of 12, B-388 Needles	12.00 18.00

ILLUSTRATION	PERMO CATALOG NUMBER	DESCRIPTION	SUG'D LIST PRICE
CUTTING STYLUS			
	For Home Recorders D-366	"Cutting Stylus" With 87° Included Angle for All "Standard" Groove Recording.	1.50
STEEL NEEDLES			
	Standard For Standard 78 RPM Records 460-B50	"Standard" Type for Manual Players Display Box of 50 Envelopes 25 Needles per Envelope—Sug'd List 25c Each	12.50
	Changer 461-B50	"Changer" Type for Automatic Changers Display Box of 50 Envelopes 25 Needles per Envelope—Sug'd List 25c Each	12.50
RECORD BRUSHES			
	Fits All Tone Arms 700-B12	Display Box of 12 Record Brushes Ind. Pkgd. Instr. with Each Brush—Sug'd List 50c Ea.	6.00

Cross Reference

of Permo Metal, Jewel and Diamond Tipped Needles

*Know Your Needles - Know **WHY** Permo Needles add so much to listening pleasure.*

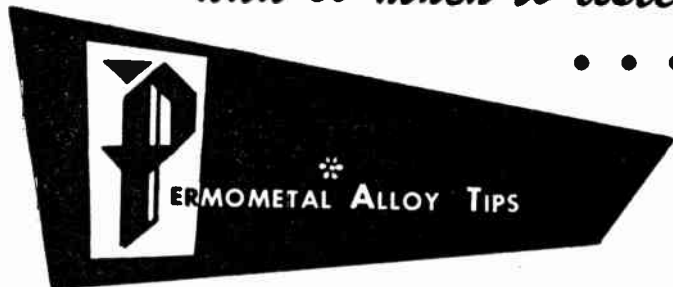

• • • Permometal alloys are produced from formulas which are the result of twenty-five years of continued basic metallurgical research in our Permo laboratories. Plus knowledge and experience gained from their extensive use in all phases of the phonograph industry such as coin operated phonographs, commercial recording studios, record demonstration booths, home phonographs, high fidelity equipment and many special applications.

Variations of the basic formula are used to produce the finest metal tipped needles obtainable for each type of service.



• • • • • Permolite shielded jewel tips are produced from the finest synthetic Sapphire. Synthetic Sapphire is more uniform and makes a better jewel tip for phonograph needles than natural Sapphire. In addition to the superb qualities of the jewel tip itself, each tip is uniquely mounted in metal shanks and shielded with shatter proof Permolite which is highly resistant to accidental damage.

Permo's mounting technique is unique in the needle industry and provides an overall reduction of mass and weight at the point in the moving system which is most critical.

This results in an improvement of frequency response which is extremely important—particularly to Hi-Fi fans.

This patented combination of tip material, method of mounting and process of shielding makes Permolite shielded jewel needles the outstanding leader in fine jewel needles.



• • • • • Diamond tipped needles will retain their shape and surface condition much longer than any other kind.

If the condition of the surface and the shape of the tip is correct to start with, Diamonds will also give maximum record life.

However, the slightest imperfection of surface condition or shape will also do more damage to records than any other kind of needle.

Permopolished Diamond tips are finished to the most rigid shape specifications and then given a special "Permopolish" treatment which conditions the surface to produce minimum surface friction and recard wear.

It is not enough to use Diamond tipped needles.

Insure the life of your records by using Permopolished Diamond Tipped Needles.

There is no substitute for Quality and Workmanship



Cross Reference of Permo Needles

PERMO, INC.
Chicago 26, Illinois

Permo Needle Number	Permometal	Permolite Shielded Jewel	Permopolished Diamond	Types of Records Played	Cartridge Originators Name and Needle Number	
A-300	A-322	A-300	A-300D	33 1/2 & 45	Shure	A65MG(J).
C-301		C-301	C-301D	78	Astatic	Nylon(M), Nylon(J).
A-302	A-302			33 1/2 & 45	Webster Electric	221-12882.
C-303	C-303			78	Webster Electric	221-14688.
A-304	A-304	A-332	A-332D	33 1/2 & 45	Astatic RCA	G(M). 74985(M).
A-305	A-357	A-305	A-305D	33 1/2 & 45	Astatic Columbia	Q-33(J), Q-33(X). 3135(J), 3521(J), 3709(J).
B-306	B-306	B-335	B-335D	33 1/2, 45 & 78	Shure	A66U(M).
B-307	B-307	B-346	B-346D	33 1/2, 45 & 78	Electro Voice	O-2(M).
C-308	C-308	C-327	C-327D	78	Astatic	Q(M).
C-309	C-309	C-348	C-348D	78	Astatic	A-3(M).
B-310	B-310	B-388	B-388D	33 1/2, 45 & 78	Permo	Conventional Type.
A-311		A-311	A-311D	33 1/2 & 45	Permo Shure	Conventional Type. A64MG(M).
C-312	C-370 C-427 C-325	C-312	C-312D	78	Permo	Conventional Type.
AC-313	AC-315(M&M)	AC-313(J&M)	AC-313D3(D&M)	33 1/2, 45 & 78	Philco	35-2693(M&M), 45-9588(M&M), 45-9589(J&J), 45-9677(M&M), 45-9678(J&J).
A-314	A-316	A-314	A-314D	33 1/2 & 45	Philco/Columbia	45-1650(J), 45-9587(J), 45-9676(J).
AC-315	AC-315(M&M)	AC-313(J&M)	AC-313D3(D&M)	33 1/2, 45 & 78	Philco	35-2693(M&M), 45-9588(M&M), 45-9677(M&M).
A-316	A-316	A-314	A-314D	33 1/2 & 45	Philco/Columbia	35-2678(M), 45-1613(M), 45-9586(M), 45-9675(M).
C-317		C-317	C-317D	78	Philco	35-2638(J), 35-2661(J), 45-1552(J), 45-1596(J), 45-9610(J), 45-9674(J).
C-318	C-320	C-318	C-318D	78	Shure	A61A(J).
A-319	A-319	A-347	A-347D	33 1/2 & 45	Astatic RCA	A-1(M). 76323(M).
C-320	C-320	C-318	C-318D	78	Shure RCA Webster Electric	A62A(M). 75046(M). 221-12211.
B-321	B-321	B-349	B-349D	33 1/2, 45 & 78	Astatic	A-AG(M).
A-322	A-322	A-300	A-300D	33 1/2 & 45	Shure RCA Webster Electric	A63MG(M). 75045(M), 76374(M) 221-12419.
C-323	Discontinued—Permo "Vinyl" Conventional Type Needle.					
C-324	Discontinued—Permo Coin Phonograph Needle.					
C-325	C-325 C-370 C-427	C-312	C-312D	78	Permo	Conventional Type.
B-326	B-326	B-334	B-334D	33 1/2, 45 & 78	Astatic Sonotone	G-AG(M). 7590-2(M).
C-327	C-308	C-327	C-327D	78	Astatic	Q(J), Q(X).
B-328	B-329	B-328	B-328D	33 1/2, 45 & 78	Astatic	Q-AG(J).
B-329	B-329	B-328	B-328D	33 1/2, 45 & 78	Astatic	Q-AG(M).
C-330	C-331	C-330	C-330D	78	Astatic Sonotone	G-78(J) 7890-3(J).
C-331	C-331	C-330	C-330D	78	Astatic	G-78(M).
A-332	A-304	A-332	A-332D	33 1/2 & 45	Astatic Sonotone	G(J). 7590-1(J).
AC-333	AC-367(M&M)	AC-333(J&M) AC-369(J&J)	AC-333D3(D&M) AC-369D1(D&J) AC-369D2(J&D) AC-369D(D&D)	33 1/2, 45 & 78	Electro Voice	SO-13(J&M)
B-334	B-326	B-334	B-334D	33 1/2, 45 & 78	Astatic	G-AG(J).
B-335	B-306	B-335	B-335D	33 1/2, 45 & 78	Shure	A67U(J).



Cross Reference of Permo Needles

PERMO, INC.
Chicago 26, Illinois

Permo Needle Number	Permometal	Permolite Shielded Jewel	Permopolished Diamond	Types of Records Played	Cartridge Originators Name and Needle Number
AC-336	AC-336(M&M)			33 1/2 & 78	Webster Chicago NE215(M&M).
A-337	A-337	A-339	A-339D	33 1/2 & 45	Electro Voice O-1(M).
AC-338	AC-338(M&M)			33 1/2, 45 & 78	Webster Chicago NE316(M&M).
A-339	A-337	A-339	A-339D	33 1/2 & 45	Electro Voice S-1(J).
C-340	C-340	C-345	C-345D	78	Electro Voice O-3(M).
C-341	C-341			78	Astatic/Markel D(M).
B-342	B-342			33 1/2, 45 & 78	Astatic D-AG(M).
A-343	A-343			33 1/2 & 45	Astatic D-33(M).
C-344	C-344			78	Astatic T(M).
C-345	C-340	C-345	C-345D	78	Electro Voice S-3(J).
B-346	B-307	B-346	B-346D	33 1/2, 45 & 78	Electro Voice S-2(J).
A-347	A-319	A-347	A-347D	33 1/2 & 45	Astatic A-1(J).
C-348	C-309	C-348	C-348D	78	Astatic A-3(J).
B-349	B-321	B-349	B-349D	33 1/2, 45 & 78	Astatic A-AG(J).
AC-350	AC-350(M&M)			33 1/2, 45 & 78	Magnavox 560138(M&M).
AC-351	AC-351(M&M)	AC-441(J&J)	AC-441D1(D&J) AC-441D2(J&D) AC-441D(D&D)	33 1/2, 45 & 78	Magnavox 560153(M&M).
C-352	C-352			78	Magnavox 560102(M).
C-353	Metal Tip Discontinued—Use C-355 Jewel Tip Needle				Astatic/Markel C-3(J).
A-354	Metal Tip Discontinued—Use A-356 Jewel Tip Needle				Astatic/Markel C-1(J).
C-355		C-355	C-355D	78	Astatic/Markel C-3(J).
A-356		A-356	A-356D	33 1/2 & 45	Astatic/Markel C-1(J).
A-357	A-357	A-305	A-305D	33 1/2 & 45	Astatic Columbia Q-33(M), 3135(J), 3521(J), 3709(J).
C-358	Metal Tip Discontinued—Use C-360 Jewel Tip Needle				Astatic U-78(J), U-78(X).
A-359	Metal Tip Discontinued—Use A-361 Jewel Tip Needle				Astatic U(J), U(X).
C-360		C-360	C-360D	78	Astatic U-78(J), U-78(X).
A-361		A-361	A-361D	33 1/2 & 45	Astatic U(J), U(X).
362	Unassigned				
363	Unassigned				
364	Unassigned				
365	Unassigned				
D-366	D-366			78	Permo Cutting Stylus.
AC-367	AC-367(M&M)	AC-333(J&M) AC-369(J&J)	AC-333D3(D&M) AC-369D1(D&J) AC-369D2(J&D) AC-369D(D&D)	33 1/2, 45 & 78	Electro Voice O-13(M&M).
D-368		D-368	D-368D	Trans.	Astatic U-TR(J), U-TR(X).
AC-369	AC-367(M&M)	AC-333(J&M) AC-369(J&J)	AC-333D3(D&M) AC-369D1(D&J) AC-369D2(J&D) AC-369D(D&D)	33 1/2, 45 & 78	Electro Voice S-13(J&J).
C-370	C-370 C-427 C-325	C-312	C-312D	78	Permo Conventional Type.
AC-371	AC-371(M&M)			33 1/2, 45 & 78	Webster Electric 221-12605.
C-372	C-372			78	Webster Electric 221-12881.
C-373	C-373			78	Webster Electric 221-12972.
A-374	A-374			33 1/2 & 45	Webster Electric 221-12973.
C-375	C-377	C-375	C-375D	78	Webster Electric 221-13014.
A-376	A-378	A-376	A-376D	33 1/2 & 45	Webster Electric 221-13015.
C-377	C-377	C-375	C-375D	78	Webster Electric 221-13016.
A-378	A-378	A-376	A-376D	33 1/2 & 45	Webster Electric 221-13017.
B-379	B-379			33 1/2, 45 & 78	Webster Electric 221-13320.
B-380	B-381	B-380	B-380D	33 1/2, 45 & 78	Webster Electric 221-13745.



Cross Reference of Permo Needles

PERMO, INC.
Chicago 26, Illinois

Permo Needle Number	Permometal	Permolite Shielded Jewel	Permopolished Diamond	Types of Records Played	Cartridge Originators Name and Needle Number	
B-381	B-381	B-380	B-380D	33 1/2, 45 & 78	Webster Electric	221-13912.
C-382	C-382			78	Webster Electric	221-14337
C-383	C-383			78	Webster Electric	221-14653.
A-384	A-384			33 1/2 & 45	Webster Electric	221-14653-1
B-385	B-385			33 1/2, 45 & 78	Webster Electric	221-14653-2
C-386	C-386			78	Webster Electric	221-30602.
A-387	A-387			33 1/2 & 45	American	CO-1(M), CS-1(J)
B-388	B-310	B-388	B-388D	33 1/2, 45 & 78	Permo	Conventional Type.
C-389	C-389			78	American	CO-3(M), CS-3(J)
B-390	B-390			33 1/2, 45 & 78	American	CO-17-RD(M), CS-17(J).
C-391	C-391			78	American	A-478(M)
C-392	C-392			78	Webster Electric	221-30130.
C-393	C-393			78	Webster Electric	221-30549
A-394	A-394			33 1/2 & 45	Webster Electric	221-12644
B-395	B-395			33 1/2, 45 & 78	Webster Electric	221-13314
A-396		A-396	A-396D	33 1/2 & 45	RCA	74068(J)
A-397	Superseded by A-435				RCA	77899(J)
A-398		A-398	A-398D	33 1/2 & 45	RCA	74818(J), 75770(J)
C-399		C-399	C-399D	78	RCA	38449(J), 70915(J)
C-400		C-400	C-400D	78	RCA	39863(J), 72345(J).
C-401	C-436	C-401	C-401D	78	RCA	75497(M) with Jewel Tip.
402	Unassigned					
AA-403	AA-404	AA-403	AA-403D	33 1/2 & 45	Astatic/Markel	M-5(J), Set of two needles.
AA-404	AA-404	AA-403	AA-403D	33 1/2 & 45	Astatic/Markel	M-5(M), Set of two needles.
CC-405	CC-406	CC-405	CC-405D	78	Astatic/Markel	M-6(J), Set of two needles.
CC-406	CC-406	CC-405	CC-405D	78	Astatic/Markel	M-6(M), Set of two needles.
A-407		A-407	A-407D	33 1/2 & 45	General Electric RCA	RPJ-005(J), RPJ-004(D) 74622(D).
D-408		D-408	D-408D	Trans.	General Electric	RPJ-006(J), RPJ-002(D).
C-409		C-409	C-409D	78	General Electric	RPJ-001(J), RPJ-003(D).
AC-410		AC-410(J&J)	AC-410D1(D&J) AC-410D(D&D)	33 1/2, 45 & 78	General Electric	RPJ-010(J&J), RPJ-012(D&D), RPJ-013(D&J).
D-411		D-411	D-411D	.002 Trans.	Pickering	S-20(J)
D-412		D-412	D-412D	.0025 Trans.	Pickering	S-25(J)
C-413		C-413	C-413D	78	Pickering Seeburg	S-30(J). 251621(J)
C-414	C-414	C-420	C-420D	78	Shure	A52A(M).
A-415	A-415	A-418	A-418D	33 1/2 & 45	Shure	A53MG(M).
B-416	B-416	B-419	B-419D	33 1/2, 45 & 78	Shure	A56U(M).
DA-417		DA-417(J&J)	DA-417D(D&D)	33 1/2 & 45 Trans.	General Electric	RPJ-007(J&J), RPJ-011(D&D).
A-418	A-415	A-418	A-418D	33 1/2 & 45	Shure	A53MG with jewel tip.
B-419	B-416	B-419	B-419D	33 1/2, 45 & 78	Shure	A56U with jewel tip.
C-420	C-414	C-420	C-420D	78	Shure	A52A with jewel tip.
A-421	A-421			33 1/2 & 45	Astatic	T-33(M).
AC-422	Superseded by AC-410D1				General Electric	RPJ-013(D&J).
A-423	A-423			33 1/2 & 45	Webster Electric	221-13906.
DB-424	DB-424(M&M)	Combination cutting and playing needle		33 1/2, 45 & 78	Wilcox Gay Shure	D-10(M&M). A68D(M&M).
DC-425	DC-425(M&M)	Combination cutting and playing needle		78	Wilcox Gay	D-11(M&M).
B-426		B-426	B-426D	33 1/2, 45 & 78	Columbia	105(J).
C-427	C-370 C-427 C-325	C-312	C-312D	78	Permo	Conventional Type.









































Cross Reference of Permo Needles

PERMO, INC.
Chicago 26, Illinois















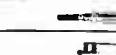

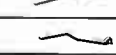











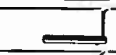



Permo Needle Number	Permometal	Permolite Shielded Jewel	Permpolished Diamond	Types of Records Played	Cartridge Originators Name and Needle Number	
A-428	A-428			33 1/2 & 45	Astatic	R(M).
B-429	B-429			33 1/2, 45 & 78	Astatic	R-AG(M).
C-430	C-430			78	Astatic	R-78(M).
AC-431	AC-431(M&M)			33 1/2, 45 & 78	Philco	45-9784(M&M).
A-432	A-432			33 1/2 & 45	Webster Electric	221-16910.
C-433	C-433			78	Webster Electric	221-16909.
AC-434		AC-434(J&J)	AC-434D1(D&J) AD-434D2(J&D) AC-434D(D&D)	33 1/2, 45 & 78	Sonotone Columbia	9987-S(J), (9987-SD(J&D), 9987-D(D&D). Model 360 Player.
A-435	A-437	A-435	A-435D	33 1/2 & 45	RCA	77899(J).
C-436	C-436	C-401	C-401D	78	RCA	75497(M).
A-437	A-437	A-435	A-435D	33 1/2 & 45	RCA	75496(M)
C-438		C-438		78	Crosley	145720(J).
B-439		B-439	B-439D	33 1/2, 45 & 78	Astatic/Markel	C-2(J)
440	Unassigned					
AC-441	AC-351(M&M)	AC-441(J&J)	AC-441D1(D&J) AC-441D2(J&D) AC-441D(D&D)	33 1/2, 45 & 78	Magnavox	560167(J&J)
A-442	A-442	A-443	A-443D	33 1/2 & 45	Webster Electric	222-15381
A-443	A-442	A-443	A-443D	33 1/2 & 45	Webster Electric	221-15390.
A-444	A-447	A-444	A-444D	33 1/2 & 45	Pickering/Seeburg	245795(M)
A-445		A-445	A-445D	33 1/2 & 45	Philco	45-9793(J).
AC-446		AC-446(J&J)	AC-446D1(D&J) AC-446D2(J&D) AC-446D(D&D)	33 1/2, 45 & 78	Astatic	GT(J).
A-447	A-447	A-444	A-444D	33 1/2 & 45	Pickering/Seeburg	245795(J).
A-448		A-448	A-448D	33 1/2 & 45	Collaro	5304L.
C-449		C-449	C-449D	78	Collaro	5304N.
B-450		B-450	B-450D	33 1/2, 45 & 78	Columbia	Model 202 Player.
A-451		A-451	A-451D	33 1/2 & 45	Clarkstan	251.10, 254.10.
C-452		C-452	C-452D	78	Clarkstan	251.3, 254.3.
D-453		D-453	D-453D	Trans.	Clarkstan	251.5, 254.5.

★ Walco REPLACEMENT NEEDLES ★

CARTRIDGE MANUFACTURER	CARTRIDGE NUMBER	ILLUSTRATION	Cartridge M'fctr's Needle Number	WALCO NEEDLE NUMBER	LIST PRICE	
AMERICAN MICROPHONE	S-1; S-1A; S-2; S-2A		S-1	W-55A	1.50	
	CR6; CR6A		CO-3	W-56A	1.50	
	CR5; CR5A		CO-1	W-56MGA	1.50	
	CR7; CR7A		CO-2	W-56AGA	1.50	
ASTATIC	LT-M, LT2-M, LT3-M LT-33		T-(M) T-33(M)	W-1A W-1MGA	1.50 1.50	
	QT-M; QT-2M; QT-3M; LQD; LQD-1 series QT-33-J; CQ-J; CQM; CAC; CQ-AG-M		Q-(M) Q-33(M) Q-AG(M)	W-2A W-2MGA W-2AGA	1.50 1.50 1.50	
	QT-J; QT-2J; QT-3J; LQD; LQD-1 series LQD, LQD-1 series; CQ-AG-J		Q-(J) Q-33(J) Q-AG(J)	W-2S W-2MGS W-2AGS	2.00 2.00 2.00	
	GC-78-M; 402-M GC-M; GC-1M GC-AG-M		G-78(M) G-(M) G-AG(M)	W-3A W-3MGA W-3AGA	1.50 1.50 1.50	
	GC-78-J GC-J; GC-1J GC-AG-J		G-78(J) G-(J) G-AG(J)	W-3S W-3MGS W-3AGS	2.00 2.00 2.00	
	U-78-M U-M		U-78(M) U-(M)	W-4A W-4MGA	1.50 1.50	
	U-78-J U-J		U-78(J) U-(J)	W-4S W-4MGS	2.00 2.00	
	AC-78; ACD series AC; ACD series AC-AG-M		A-3(M) A-1(M) A-AG(M)	W-5A W-5MGA W-5AGA	1.50 1.50 1.50	
	AC-78-J; AC-C-78J; ACD series AC-J; AC-C-J; ACD-J series AC-AG-J		A-3(J) A-1(J) A-AG(J)	W-5S W-5MGS W-5AGS	2.00 2.00 2.00	
	For Late Model Markel Changer #74 & #75	MD-5 MD-6	M-5(M) M-6(M)	W-5MGA-H(2) W-5A-H(2)	3.00 pr. 3.00 pr.	
	For Late Model Markel Changer #74 & #75	MD-5 MD-6	M-5(J) M-6(J)	W-5MGS-H(2) W-5S-H(2)	4.00 pr. 4.00 pr.	
	LT-3D; LT-4D; LT-4D1; MD LT-3D; LT-4; LT-4D1 LT-4-AG; LT-5-AG		D-(M) D-33(M) D-AG(M)	W-6A W-6MGA W-6AGA	1.50 1.50 1.50	
	LT-3D; LT-4D; LT-4D1; MD LT-3D; LT-4; LT-4D1; LT-5-AG LT-4-AG; Columbia 105 Player		D-(J) D-33(J) D-AG(J)	W-6S W-6MGS W-6AGS	2.00 2.00 2.00	
	Nylon 1M Nylon 1J		Nylon(J)	W-7S	2.00	
	GC-D		GT-J GT-M	W-8TPS W-8TPA	3.50 2.50	
	MD-3 MD-1		C-3(M) C-1(M)	W-19A W-19MGA	1.50 1.50	
	MD-3 MD-1		C-3(J) C-1(J)	W-19S W-19MGS	2.00 2.00	
	14L-3D; 15L-3D; 14L-3-78 14L-3D; 15L-3D; 14L-3; 15L-3 14L-3-AG; 15L-3-AG		R-78 R R-AG	W-25A W-25MGA W-25AGA	1.50 1.50 1.50	
	COLUMBIA	CQ; CAC-J		Q-33(J)	W-2MGS	2.00
		105 Player; LT-4-AG		D-AG(J)	W-6AGS	2.00
		45-1609; 45-1612		45-1650	W-45MGS	2.00
	ELECTRO-VOICE	12; 32; 42; 96; 96-T 14; 34; 44; 96; 96-T 33; 33-B; 43		O-3 O-1 O-2	W-20A W-20MGA W-20AGA	1.50 1.50 1.50
		12; 32; 42; 96; 96-T 14; 34; 44; 96; 96-T 33; 33-B; 43		S-3 S-1 S-2	W-21S W-21MGS W-21AGS	2.00 2.00 2.00
		16; 16TT 16; 16TT 16; 16TT		SO-13 O-13 S-13	W-22AS W-22TPA W-22TPS	2.00 2.50 3.50
RPX-040; RPX-041 RPX-042; RPX-046 NAB Transcriptions			RPJ-001 RPJ-005 RPJ-006	W-67S W-67MGS W-67Tr	3.50 3.50 3.50	
RPX-047; RPX-050; RPX-051; RPX-052 NAB Transcriptions			RPJ-010 RPJ-007	W-66TPS W-66Tr	5.95 5.95	
MAGNAVOX		560101		560102	W-50A	1.50
	560133		560138	W-51TPA	2.50	
	560153		560153-2	W-52TPA	2.50	
	560153			W-52TPS	3.50	
PHILCO	35-2671-1		45-1597	W-30A	1.50	
	35-2671-1		45-1651	W-30S	2.00	
	45-1609; 45-1612		45-1613	W-45MGA	1.50	
	45-1609; 45-1612		45-1613	W-45MGS	2.00	
	76-4649		35-2693	W-46TPA	2.50	
	76-4649		45-9589	W-46TPS	3.50	
	45-9792 Dynamic Reproducer		45-9793; 45-1993 45-1596	W-47 MGS W-48S	2.00 2.00	

IMPORTANT NOTICE! Walco model numbers also indicate specifications as follows: **A**—Alloy **S**—Sapphire (Syn.) **MG**—MicroGroove **AG**—All-Groove (3-speed) **TP**—Twin Point **C**—3 Mil Cutter and Playback **2C**—2 Mil Cutter and Playback **Tr**—Transcription (.0025" Tip radius)









★ Walco REPLACEMENT NEEDLES ★

RCA	74984; 76297		74985(M)	W-3MGA	1.50
	75044		74985(J)	W-3MGS	2.00
	75044		75045(M)	W-29A	1.50
	75044		75046(M)	W-29MGA	1.50
	75044		75045(J)	W-29S	2.00
	75044		75046(J)	W-29MGS	2.00
	70332; 70338; 70339; 72551; 74067 74625; 759/6; 9990; 38453; 38598		72345	W-42S	2.00
	39550; 39851; 39919		74068	W-42MGS	2.00
	75475			W-43A	1.50
	75475			W-44A	1.50
	75475			W-44MGA	1.50
	75475		75497	W-44S	2.00
	75475		75496	W-44MGS	2.00
	74466		74622	W-67MGS	3.50
	SEEBURG	(A-251620) 50 Record 78 RPM phono		S-140 (A251621)	W-53S
(A245789) 50 Record 45 RPM phono			S-120 (A245794)	W-53MGS	2.00
SHURE	W-22AB; W-22AB-T; W22A; WC-22AB; P76V; P76AFV;		Recommended for best results in Turn- over Cartridge models.	W-29A	1.50
	P77V; P77V; PC72V; P76AV; P77AV			W-29MGA	1.50
	W60A; W60B; W61B; W60HS; P30; P30B; P70; P74A0; P76; P76AF; P70A; P75A; W66B		A62A	W-29S	2.00
	W21F; P72; P73; W23B P75; P73A; P75A		A63MG	W-29MGS	2.00
	W66B; W26B; W26A; P37A; P34C; P71 P71B; P71C; P81; P81A; P81C		A66U	W-30A	1.50
	WC33B		A61A	W-30MGA	1.50
	W31AR; WC31AR		A65MG	W-30AGA	1.50
	WC36B; W36B		A67U	W-30S	2.00
	WC33B		A52A	W-30MGS	2.00
	W31AR; WC31AR		A53MG	W-30AGS	2.00
WC36B; W36B		A56U	W-31A	1.50	
W56N		A51A	W-31MGA	1.50	
SONOTONE	W-7590-3		7590-3(M)	W-31AGA	1.50
	W-7590-2		7590-2(M)	W-31MGS	1.50
	W-7590-1		7590-1(M)	W-31S	2.00
	W-7590-3		7590-3(J)	W-31AGS	2.00
W-7590-2		7590-2(J)	W-3MGS	2.00	
W-7590-1		7590-1(J)		2.00	
W-9980S		9987S	W-75TPS	3.50	
W-9980SD					
WEBSTER ELECTRIC	F14; F-14-2; F-14-4; F-14-1; F-14-3		F-14	W-9TPA	2.50
	A1; A1-8; A7; A7-1 A7-5; A7-8; A8; A10		A3S	W-10S	2.00
	A1M; A1M1; A2M; A5M; A6M; A7M; A8M; A10M; A81M; AX		A1S	W-10MGS	2.00
	Q1		A30	W-11A	1.50
	Q3; A9; F13		A10	W-11MGA	1.50
	C9		Q-1	W-12A	1.50
	Q2		A2	W-13AGA	1.50
	F16; F16-1; F16-2; F19; F19-1		C9	W-14AGA	1.50
	F15; F15-1; F18; F18-1		Q2	W-15A	1.50
	F7P F7; F7-1; F7-2; F13		F16-3	W-16A	1.50
	G3M		F16-1	W-16MGA	1.50
	G1M		F15-3	W-17A	1.50
	G2M		W15-1	W-17MGA	1.50
	WS; WS-1; WS-2		F7P(M)	W-18A	1.50
	F-20		F7	W-18MGA	1.50
	F-20		G3	W-23A	1.50
	B1M, BX		G1	W-23MGA	1.50
	AG1M, AG7M, AG1, AG7		G2	W-23AGA	1.50
	F11; F11-1; F10		WS	W-24A	1.50
	21P247; 21P404; 21P403		221-16910	W-26A	1.50
21P404		221-16909	W-26MGA	1.50	
21P404		221-16910	W-26S	2.00	
		221-16909	W-26MGS	2.00	
		221-15381	W-27MGA	1.50	
		221-16950	W-28A	1.50	
		221-16951	W-28MGA	1.50	
		F10	W-30S	2.00	
		F10-1	W-30MGS	2.00	
WEBSTER- CHICAGO	21P247; 21P404; 21P403		NE-215	W-60TPA	2.50
	21P404		NE-316	W-63TPA	2.50
	21P404		NE-317	W-63TPS	3.50
WILCOX GAY	23-2144; W56N .003" Cutter & Playback		D-11	W-80C	2.50
	23-2161; W56N .002" Cutter & Playback		D-10	W-80-2C	2.50

Walco DIAMOND NEEDLES available for the following cartridges

NEEDLE	ASTATIC CARTRIDGES	LIST PRICE	NEEDLE	SHURE CARTRIDGES	LIST PRICE
W-2D	QT-J; QT2-J; QT3-J; LQD; LQD-1 series; CAC-7B-J	25.00	W-29D	W-22AB-T; W-22A; W-22AB; WC22AB; P76V;	25.00
W-2MGD	QT-33-J; CQ-J; LQD; LQD-1 series; CAC-J; CAC-W-J	25.00	W-29MGD	P76AFV; P77V; P72V PC72V; P76AV; P77AV	25.00
W-2AGD	CQ-AG-J; CAC-AG-J	25.00	W-30D	W60A; W60B; W61B; W60HS; P30; P30B; P70;	25.00
W-3MGD	GC-J; GC-1J; MG-J	25.00	W-30MGD	P74AD; P76; P76AF; P70A; P75A	25.00
W-3D	GC-7B-J; MG-7B-J	25.00	W-30AGD	W-21AF; WC31AR; P72; P73; P75; P73A;	25.00
W-3AGD	GC-AG-J; MG-AG-J	25.00		W66B; W26B; W26A; P37A; P37C; P71; P71B;	25.00
W-4MGD	U-J	25.00		P71C; P81; P81A; P81C	
W-4D	U-7B-J	25.00			
W-5MGD	AC, ACD series; AC-J; AC-C-J; ACD-J	25.00			
W-5D	AC-7B-J; AC-C-7B-J	25.00			
W-5AGD	AC-AG-J	25.00			
W-19D	MD-3; MD-6J	25.00			
W-19MGD	MD-1; MD-5J	25.00			
W-6D	LT-3D series	25.00			
W-6MGD	LT-4D series	25.00			
W-6AGD	LT-4AG; LT-5AG	50.00			
W-5D-H	MD-5 (Markel)	30.00			
W-5MGD-H	MD-6 (Markel)	49.50			
W-8DS or W-8TPD	GC-D	30.00			
		49.50			
NEEDLE	WEBSTER ELECTRIC CARTRIDGES	LIST PRICE	NEEDLE	R.C.A. CARTRIDGES	LIST PRICE
W-10D	A1, AB	25.00	W-42D	7033B; 70339; 72551; 9890; 39919; 39550; 3859B;	25.00
W-10MGD	A1 thru A6, AB	25.00	W-42MGD	70332; 39851	25.00
			W-44D	74067; 74625	25.00
			W-44MGD	75475	25.00
				75475	
NEEDLE	ELECTROVOICE CARTRIDGES	LIST PRICE	NEEDLE	PHILCO CARTRIDGES	LIST PRICE
W-21D	12, 32; 42; 96; 96-T	25.00	W-30D	35-2671-1	25.00
W-21MGD	14, 34; 44; 96; 96-T	25.00	W-45MGD	45-1609; 45-1612	25.00
W-21AGD	33; 33-B; 43; 33-4	25.00	W-46TPD or W-46DS	76-4649	49.50
W-22TPD or W-22DS	16; 16TT; 22TT	30.00	W-48D	Dynamic Reproducer	30.00
					25.00
NEEDLE	MAGNAVOX CARTRIDGES	LIST PRICE	NEEDLE	GENERAL ELECTRIC CARTRIDGES	LIST PRICE
W-52TPD or W-52DS	560151-2	49.50	W-66TPD	RPX-050; RPX-047	49.50
		30.00	W-66DS		31.00
			W-66TRD		49.50
			W-67D		27.50
			W-87MGD		27.50
			W-67TRD		27.50

Walco CONVENTIONAL NEEDLES

<p>Walco "400" Floating Jewel Sapphire*</p> <p>List price</p> <p>WS-400 \$2.50</p> <p>WS-400-2, All-groove 2.50</p> <p>400MG5, Microgroove 2.50</p> 	<p>Walco "400" RUBY* JEWEL</p> <p>List price</p> <p>WR-400 \$2.00</p> <p>Cord of 6 only</p> 	<p>Walco "400" PRECIOUS METAL</p> <p>List price</p> <p>WA-400 \$1.50</p> <p>WA-400-2, All-groove 1.50</p> <p>400MGA, Microgroove 1.50</p> 
<p>Walco ENCORE</p> <p>List price</p> <p>WA-100 \$1.00</p> <p>WA-100-2 All-groove 1.00</p> <p><i>Exceptionally fine, precious metal tipped needle, priced for volume sales.</i></p> <p>Corded 12 to display cord</p> 	<p>Walco GROOVE MASTER</p> <p>List price</p> <p>WA-150 \$.50</p> <p>24 to display</p> <p>WA-150 2 All groove \$.50</p> <p><i>High-fidelity needle tipped with precious metal alloy. Hand-polished point with filter type shank.</i></p> 	<p>Walco TRU-TRAC SAPPHIRE*</p> <p>List price</p> <p>WN-50, Bent shank \$1.00</p> <p>WN-55, Straight shank 1.00</p> <p>WN-50-2 All groove 1.00</p> <p>WN-55-2 All groove 1.00</p> <p><i>For older type phones with heavier pick-ups. Hand polished sapphire* with notched dual shanks.</i></p> 
<p>Walco CUTTING Needles</p>		
<p>WC-2S SAPPHIRE*</p> <p>List price \$7.50</p> <p><i>Hand lapped, precision ground.</i></p> 	<p>WC-30 STELLITE**</p> <p>List price \$2.50</p> <p><i>Long life, hand-polished stylus.</i></p> 	<p>WC-20 STEEL***</p> <p>card of 5</p> <p>List price \$1.00</p> <p><i>For finer home recording.</i></p> 

*All Walco Sapphire and Ruby needles are tipped with synthetic sapphire. This same material is widely used by the watch industry for jewel bearings and movements where maximum resistance to wear is desired.

** Available 12 needles to a counter display cord
*** Available 12 packages to a counter display cord

All WALCO conventional shank needles, unless otherwise stated, are available in two types of packaging:
(1) Colorful counter displays of 12 needles each and
(2) Convenient-to-stock punchboard cards of 6.

Copyright 1954,
Electrovox Company, Inc.,
East Orange, New Jersey.

Walco Needles are used as **Original Equipment by Leading Manufacturers**

REG. U.S. PAT. OFF. SCOTCH BRAND Magnetic Tape

The acknowledged international standard of the recording industry

Rigid manufacturing standards, continuous research and testing have made "SCOTCH" Brand Magnetic Tape the international quality standard. More recording engineers use "SCOTCH" Brand Magnetic Tape than all other brands combined. Ask for it—look for it in the distinctive plaid decorated box. The brand name "SCOTCH" is your assurance of sound quality.

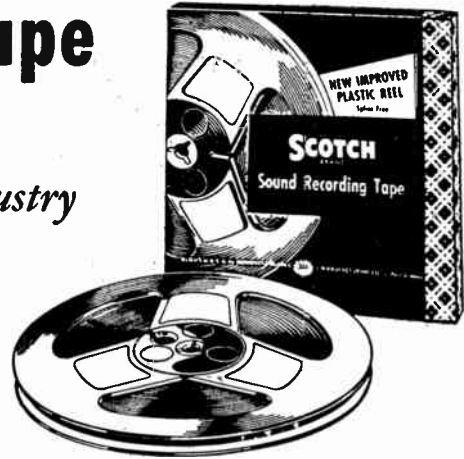

SCOTCH Magnetic Tape IS AVAILABLE IN THE FOLLOWING TYPES AND SIZES:

No. 101 (*A or **B) SCOTCH Magnetic Tape PAPER BASE—RED OXIDE COATING

For use in general recording work where economy is essential.

STOCK NO.	SIZE	LIST PRICE
101A-1.5	1/4" x 150 ft. plastic reel	\$0.75
101A-3	1/4" x 300 ft. plastic reel	1.50
101A-6	1/4" x 600 ft. plastic reel	2.25
101A-12	1/4" x 1200 ft. plastic reel	3.50

No. 111 (*A or **B) SCOTCH Magnetic Tape PLASTIC BASE—RED OXIDE COATING

High fidelity plastic tape for every recording need, the acknowledged international standard of the recording industry. Exclusive DRY LUBRICATION process insures flawless performance under all climatic conditions.

STOCK NO.	SIZE	LIST PRICE
111A-1.5	1/4" x 150 ft. plastic reel	\$1.00
111A-3	1/4" x 300 ft. plastic reel	1.75
111A-6	1/4" x 600 ft. plastic reel	3.50
111A-12	1/4" x 1200 ft. plastic reel	5.50
111AP-12	1/4" x 1200 ft. plastic professional reel—111AP	6.00
111A-24H	1/4" x 2400 ft. NARTB hub	10.00
111A-24R	1/4" x 2400 ft. NARTB 10 1/2" reel	12.85
111A-48H	1/4" x 4800 ft. NARTB hub	20.00
111A-48R	1/4" x 4800 ft. NARTB 14" reel	26.00

No. 120 (*A or **B) SCOTCH Magnetic Tape High Output PLASTIC BASE—GREEN COLOR FOR EASY RECOGNITION

Unequaled performance in difficult recording applications, giving at least 8 db more output with no increase in noise or harmonic distortion. DRY LUBRICATED.

STOCK NO.	SIZE	LIST PRICE
120A-3	1/4" x 300 ft. plastic reel	\$ 2.00
120A-6	1/4" x 600 ft. plastic reel	4.00
120A-12	1/4" x 1200 ft. plastic reel	6.50
120A-24H	1/4" x 2400 ft. NARTB hub	12.00
120A-24R	1/4" x 2400 ft. NARTB 10 1/2" reel	14.85
120A-48H	1/4" x 4800 ft. NARTB hub	24.00
120A-48R	1/4" x 4800 ft. NARTB 14" reel	30.00

*A Magnetic coating wound face in.
**B Magnetic coating wound face out.
Empty reels and boxes may also be purchased.

111AP is supplied on 7" plastic reel with special 2 3/4" hub. Other 1200 ft. lengths (7" reels) of tapes are supplied on new "V" slot 7" reels with 2 1/4" hubs.

SCOTCH Splicing Tape #41



This is a pressure sensitive tape specially designed for splicing magnetic tape. Its white thermosetting adhesive will not ooze and cause sticky splices when spliced to magnetic tape. 1/2" x 150" length on handy metal utility dispenser. Stock No. 41-1/2S.....List price 39¢

SCOTCH Leader & Timing Tape #43



This is a tough 1/4" high-impact strength paper tape that can be spliced to magnetic tape for a threading leader, identification of selections within reel, for cueing and exact timing. 1/4" x 150 ft. length. Stock No. 43-1.5.....List price 60¢

SCOTCH Write on Labels #48



"SCOTCH" Brand Write on Labels are specially designed for identifying reels. They are printed with "Reel No.—Date—Subject", and are available on handy metal utility dispensers. Stock No. 48-1/4S.....List price 25¢

Made in U. S. A. by MINNESOTA MINING & MANUFACTURING CO., St. Paul 6, Minn.



DUOTONE REGULAR NEEDLES, CUTTING NEEDLES, TAPE, DISCS, ELECTROWIPE CLOTH, 45 ADAPTERS

FILTER POINT No. 6

The Filter Point needle is a newly developed needle which actually filters surface noise, yet retains the brilliance of your recordings. The highly polished and rounded point assures smooth movement in the record groove, reducing record wear to a minimum. The needles are hand picked and will play from 12 to 15 records without frequency loss or distortion. The specially designed point is guaranteed not to break when used with any type of record changer.

- List Price**
- Package of 10 needles..... \$ 0.10
 - Cat. No. 610-B—Carton of 100 pkgs..... 10.00
 - Cat. No. 610-C—Display card of 50 pkgs..... 5.00
 - Packages of 25 needles..... \$ 0.25
 - Cat. No. 625-B—Carton of 50 pkgs..... 12.50
 - Cat. No. 625-C—Display card of 50 pkgs..... 12.50



UNITONE 3 SPEED NEEDLE

Sapphire Needle that plays all types of records with full brilliance and tone. Packaged in individual cases and counter displays of beautiful, clear Lucite as above.

- Cat. No. 36 Each needle in Lucite box..... List Price \$2.50
- Cat. No. 36-C 18 to giant Lucite case..... List Price \$45.00



MIRO-POINT No. 21

The Miro-Point Needle is the "low surface" specialist of the Duotone Line. Despite this fact it still brings out the highs in a manner never before attained by a needle of this type. Designed to play up to 1000 records the Miro-Point is the outstanding needle in the field today.

- List Price**
- Needle list price, each..... \$0.50
 - Cat. No. 21-B—Carton of 18 needles..... 9.00
 - Cat. No. 21-C—Display card of 18 needles..... 9.00



No. 19 "STAR"

- Cat. No. 19-B—Carton of 12 needles..... \$30.00
- 18 to Lucite Case..... \$45.00



SAPPHIRE CUTTING NEEDLES DURAL SHANK No. 11

This needle is similar to No. 12, and in addition is held to more exacting specifications, as established by leading engineers. Mounted in Dural shank. Packed in plastic container. Each \$7.50

- Available Stylus No. 12..... \$6.00 Each, List (Resharpening—Each \$1.75)



MICRO-GROOVE CUTTING NEEDLES

11-M—Special Sapphire Cutting Stylus, for use with Micro-Groove Equipment. \$7.50 Each, List

DURPOINT No. 15

Permanent needle for home use. Will play up to 4000 records without changing. Takes additional polish from the grove of the record thus minimizing record wear, and reducing surface noise. Because of this feature the Durpoint should not be removed from pick up until replacement is necessary. Packed on individual cards.

- List Price**
- Each Needle..... \$ 1.00
 - Cat. No. 15-C—Display card of 12 needles..... 12.00
 - Cat. No. 15-B—Carton of 12 needles..... 12.00
 - Cat. No. 15-C—(M) Micro-Groove..... 12.00
 - Cat. No. 15-AC—All Groove..... 12.00



DUOTONE No. 20 "LIFETIME" OSMIUM TIPPED

The Duotone Lifetime Needle was especially designed for use with record changers. Its brilliant performance coupled with low surface noise makes it ideal for this purpose. When properly used, it will give up to 5000 perfect playings, maintaining throughout its life the same bright reproductive qualities. Packed in beautiful plastic container.

- List Price**
- Each Needle..... \$ 1.50
 - Cat. No. 20-B—Carton of 12 needles..... 18.00
 - Cat. No. 20-C—Display card of 12 needles..... 18.00
 - Cat. No. 20-C—(M) Micro-Groove..... 18.00
 - Cat. No. 20-AC—All Groove..... 18.00



LAPPED STEEL CUTTING STYLUS No. 10

This new hand-made lap on the cutting edge of the needle makes a much smoother cut, thereby reducing surface noise and adding to the life of the needle. Especially recommended for making vocal recordings.

- List Price**
- 4 Needles on card..... \$ 1.50
 - Cat. No. 10-B—Carton of 10 cards..... 15.00
 - Cat. No. 10-C—Display card of 10 cards..... 15.00

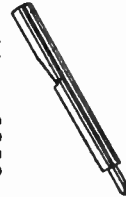

SHOCKPROOF NYLON NEEDLE No. 25

Unique in design, this needle has an osmium tip on spring steel set into a Nylon bumper. This eliminates damage to either needle or record should the pickup arm be accidentally dropped. This needle also eliminates surface noise. Individually packed in attractive Lucite container. This needle will play up to 5,000 recordings. Ideal for children.

- List Price**
- Each Needle..... \$ 1.75
 - Cat. No. 25-C—Display card of 12 needles..... 21.00
 - Cat. No. 25—(M) Micro-Groove..... 18.00
 - Cat. No. 25—(A) All Groove..... 18.00



DUOTONE RECORDING BLANKS

All Duotone recording discs have a "professional nitrate" coating

	Red Label (Aluminum Base)	Purple Label (Aluminum Base)	Orange Label (Compo Base)
	Carton Each	Carton Each	Carton Each
6 1/2 inch	100 \$.40	100 \$.30	100 \$.20
8 inch	50 \$.50	100 \$.40	100 \$.30
10 inch	50 \$.80	100 \$.60	—
12 inch	25 \$ 1.00	—	—



DUOTONE MAGNETIC RECORDING TAPE

High Constant Output with Minimum Background Noise
High Frequency Response—Long Life (No rub off oxide coating)—Interchangeable with other good quality tape.
*All Tape Comes on Six Spoke Polystyrene Reels.

- List Price**
- RPI (in) 1250 — RPI (in) 625..... \$5.50
 - Red Oxide Plastic Base, 1250 ft., 7" reel..... \$5.50
 - Red Oxide Plastic Base, 625 ft., 5" reel..... 3.50



- List Price**
- RPO (out) 1250 — RPO (out) 625..... \$5.50
 - Red Oxide Plastic Base, 1250 ft., 7" reel..... \$5.50
 - Red Oxide Plastic Base, 625 ft., 5" reel..... 3.50
 - Individually packed in boxes — 10 boxes to carton.
 - *2500 ft. on hub \$10.00 2500 ft. on reel \$12.85
 - RPI (in) 5000 ft. List Price..... \$20.00
 - NAB Aluminum Hub..... \$20.00

DUOTONE "ELECTRO WIPE" MAGIC RECORD CLOTH

Completely removes static charges from all records with one wipe. Ends annoying pops and clicks, cleans record grooves of harmful grit and increases record life. Cloth is chemically treated and harmless.

Packed in air tight plastic bag.

- List Price**
- 1 Electro Wipe Magic Record Cloth..... \$ 1.00
 - Packed 12 cloths to a display..... 12.00



45 RPM SLIP-PROOF ADAPTOR

Simplest, most efficient method for adapting 45 RPM records to standard spindle. Will not slow down turntable speed. 5 inserts to a package. 24 packages to an attractive display card.

List Price \$6.00



DUOTONE REPLACEMENT NEEDLES

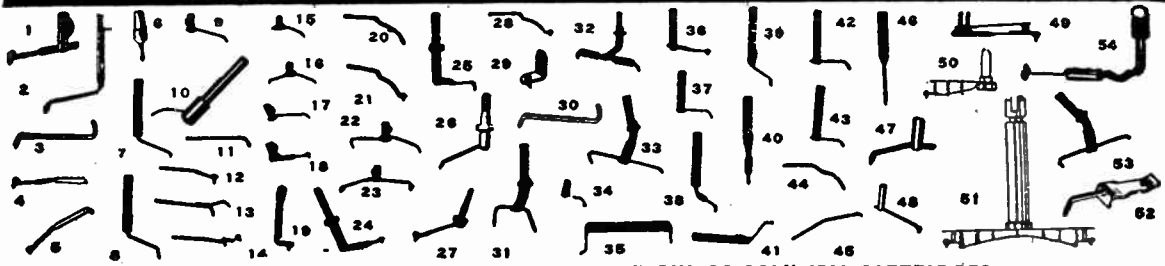

FOR AMERICAN MICROPHONE CARTRIDGES

Duotone Type	Fig.	For Cartridge Type Number	Type Point	LIST PRICE
AMO	8	S1; S1-A; S2; S2-A	Std.	1.50
AM01	9	C3	Std.	1.50
AM02-A	9	C1; C2	A-G	
AM01-LP	9	C1; C2	M-G	

FOR ASTATIC CARTRIDGES

ANS-10	6	1-J (Nylon)	Std.	2.50
AO1	1	QT-M; QT2-M; QT3-M; LQD; LQD-1	Std.	1.50
AO1-LP	1	QT33-M; CQ-M; LQD; LQD-1 Series	M-G	1.50
AO2	2	LT2; LDT's; MD; LT3-D; LT4-D, DL	Std.	1.50
AO2-LP	2	LTD3-D; LT4; LT4-D; LT4-D1	M-G	1.50
AO2-A	2	LT4-AG	A-G	1.50
AO5	3	GC78-J; GC78-M; MG78-J; MG78-M	Std.	1.50
AO5-LP	3	GC-J; GC-M; GC1-J; GC-1M; MG-J, M	M-G	1.50
AO5-A	3	GC-AG-M; MG-AG-M	A-G	1.50
AO7	4	U78-M	Std.	1.50
AO7-LP	4	U78-M	M-G	1.50
AO8-LP	5	MD-3	Std.	1.50
AO8-LP	5	MD-1	M-G	1.50
AO9	47	AG78; ACD Series	Std.	1.50
AO9-LP	47	AC; ACD Series	M-G	1.50
AO9-A	48	AC-AGM; AC-AG-J	A-G	1.50
AO11	7	LT1-M; LT2-M; LT3M	Std.	1.50
AO11-LP	7	LT33	M-G	1.50
AS3*	1	QT-J; QT2-J; QT3-J; LQD; LQD-1	Std.	2.50
AS4-LP*	1	CAC-J; QT33-J; CQ-J; LQD; LQD-1	M-G	2.50
AS4-A*	1	CQ; AG-M; CQ; AG-J	A-G	2.50
AS5*	3	GC-AG-J; MG-AG-J	Std.	2.50
AS7*	4	U78-J	M-G	2.50
AS7-LP*	4	U78-J	Std.	2.50
AS8*	5	MD-3	M-G	2.50
AS8-LP*	5	MD-1	M-G	2.50
AS9*	47	AG78; ACD Series	Std.	2.50
AS9-LP*	47	AC; ACD Series	M-G	2.50
AS9-A*	48	AC-AGM; AC-AG-J	A-G	2.50

†Available also with diamond tip. List Each 25.00

FOR AUDAK CARTRIDGES

AUS*	49	R-2; R-6	Std.	3.50
AUS-LP*	49	R-2; R-6	M-G	3.50

†Available also with diamond tip. List Each 25.00.

FOR CROSLY CARTRIDGES

CRO	10	145749	Std.	2.50
-----	----	--------	------	------

FOR ELECTRO-VOICE CARTRIDGES

EO19	11	M12; H12; L12	Std.	1.50
EO19-LP	11	14; 22; L14; 34	M-G	1.50
EO21	13	16TT; 22TT	Twin	2.50
ES0A25	11	130-33	A-G	1.50
ES22*	14	16TT; 22TT	Twin	3.50
ES22-DS	14	.001 diamond, .003 sapphire	Twin	27.50
ES23*	12	M12S; H12S; L12S	Std.	2.50
ES24-LP*	12	14S; 22S; 34S	M-G	2.50
ES25-A*	11	130-33S	A-G	2.50

†Available diamond tip, List 25.00 Twin diamond tip, List 50.00

FOR GENERAL ELECTRIC CARTRIDGES

GEA*	51	GE Needle RPJ-006	A-G	3.50
GED*	51	RPX-050; RFX-047	Twin	3.50
GEDS	51	.001 diamond, .003 sapphire	Twin	27.50
GE1-LP*	50	RFX-040; RFX-041; RFX-046	M-G	3.50
GE3*	50	RFX-040; RFX-041; RFX-046	Std.	3.50

†Available diamond tip List 25.00. Twin diamond tip, List 50.00

FOR MAGNAVOX CARTRIDGES

MAD16	15	560101	Std.	1.50
MAS17	16	560133	Dual	2.50
MAS17	16	Same, diamond tips	Dual	50.00
MASD17	16	.001 diamond, .003 sapphire	Dual	27.50
MAS18*	16	560138	Dual	3.50

FOR PHILCO CARTRIDGES

PHO15	22	76-4649	Twin	2.50
PHO16	20	35-2671	Std.	1.50
PHS14*	19	76-1622	Std.	2.25
PHS16*	21	35-2671	Std.	2.50

FOR PHILCO-COLUMBIA CARTRIDGES

Duotone Type	Fig.	For Cartridge Type Number	Type Point	LIST PRICE
CO5-LP	17	45-1609; 45-1612	M-G	1.50
CS6-LP*	18	45-1609; 45-1612	M-G	2.00
PHS15*	23	76-4649	Twin	3.50
PHS15-DS	23	.001 diamond, .003 sapphire	Twin	27.50

†Available diamond tip. List \$25.00 Twin diamond. List 50.00

FOR RCA CARTRIDGES

RO7	24	39550; 38598; 70332; 39851	Std.	2.00
RO9-LP	25	74067; 74625	M-G	1.50
RO10	26	75475	Std.	2.00
RO10-LP	26	75475	M-G	2.00
RS7*	24	70338; 70339; 72551; 39919; 212X1; 9890	Std.	3.50
RSS-LP*	24	74067; 74625	M-G	2.50
RS11*	27	75475	Std.	3.50
RS11-LP*	27	75475	M-G	2.50

†Available with diamond tip. List Each 25.00

FOR SHURE CARTRIDGES

MSO	20	P30; P70; P74-AD; P76; P76-AF; P57-S; P76-AFV; P77; W22; W22-AB; W23-A; W23-AB	Std.	1.50
MSS*	28	W60-A; W60-B; W60-HS; W60-PN; W61-B; W65-B; P70-A; P76-A; P76-AF; P76-B; P76-AV; P37-A; P75-A; P73; P72-V; P78-AV; P78-AFV; P77-AV; also turn-over Admiral 409-All	M-G	1.50
MSO-LP*	20	Admiral 409-A13; P71; P71-B; P71-C; P81; P81-AD; P81-C; P37; P37-C; P37-A; P81-A; W26-A; W66-A; W26-B; W66-B	M-G	2.50
MSS-LP*	28	P71-C; P81; P81-AD; P81-C; P37; P37-C; P37-A; P81-A; W26-A; W66-A; W26-B; W66-B	A-G	1.50
MSS-A*	28	P37; P37-C; P37-A; P81-A; W26-A; W66-A; W26-B; W66-B	A-G	2.50
SHO	52	WC33-B	Std.	1.50
SHO-LP	52	W31-AR; WC31-AR	M-G	1.50
SHO-A	52	W36-B; WC36-B	A-G	1.50
SHS*	52	WC-33B	Std.	2.50
SHS-LP*	52	W31-AR; WC31-AR	M-G	2.50
SHS-A*	52	W36-B; WC36-B	A-G	2.50

†Available with diamond tip. List Each 25.00

FOR SEEBURG CARTRIDGES

SES1*	29	MRN; A-25162	Std.	2.50
SES1-LP*	29	MRN; A-25162	M-G	2.50

FOR SONOTONE CARTRIDGES

SO-A	30	W-7590	A-G	1.50
SS-A	30	W-7590	A-G	2.50
COL360	54	S'0866	Twin	3.50

FOR WEBSTER-CHICAGO CARTRIDGES

WO11	33	21P404	Twin	4.00
WO11**	33	.001 diamond, .003 diamond	Twin	50.00
WO12	32	Nylon, 21P247; 21P402; 21P403	Twin	4.50
WO13	31	21P247; 21P402; 21P403	Twin	4.00
WO13**	31	.001 diamond, .003 diamond	Twin	50.00
WS11*	53	21P404	Twin	5.00

**Available .001 diamond, .003 sapphire. List Each 27.50.

FOR WEBSTER-ELECTRIC CARTRIDGES

WEO	44	F10; F11; F11-1	Std.	1.50
WEO17	34	M1	Std.	1.50
WEO18	35	F14; F14-1; F14-2; F14-3	Twin	2.50
WEO20	37	A1-M; A1-M1; A5-M; A6-M	Std.	1.50
WEO20LP	37	A1-M; A1-M1; A2-M; A6-M	M-G	1.50
WEO21-A	40	C9	A-G	1.50
WEO22	38	Q1	Std.	1.50
WEO26	39	Q2	Std.	1.50
WEO26LP	39	Q2; F7-1; F13; F7-2	M-G	1.50
WEOA30	41	Q3; A9; F13	A-G	1.50
WEO31A	37	A9-M	A-G	1.50
WEO32	42	F16; F16-1; F16-2	Std.	1.50
WEO32LP	42	F16; F16-1; F16-2	M-G	1.50
WEO33	43	F15; F15-1	Std.	1.50
WEO33LP	43	F15; F15-1	M-G	1.50
WEO34	45	C3-M	Std.	1.50
WEO34LP	45	C1-M	M-G	1.50
WEO34A	45	C2-M	A-G	1.50
WEO35	46	WS	Std.	1.50
WEO35LP	46	AJ4	M-G	1.50
WES-LP	44	F10; F11; F11-1	M-G	2.50
WES28*	36	A8; A1	Std.	2.50
WES29LP	*138	A1; A8; A6; A3; A5; A4	M-G	2.50

†Available with diamond tip. List Each 25.00

All needles listed have osmium tips except those marked (*) which are sapphire. Diamond tips so marked. M-G, micro-groove, .001" std., .003". A-G for all types, .002".

audiodiscs®

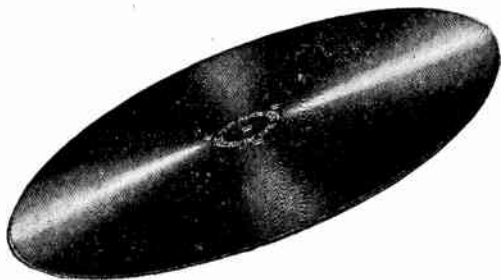

For truly fine recording and reproduction

For more than a decade, Audiodiscs have consistently maintained their position of eminent leadership in every field of instantaneous disc recording.

A superior lacquer coating, applied to the mirror-smooth aluminum base by a patented process, gives these outstanding advantages: maximum uniformity of coating, permanent resistance to humidity, longer stylus life, freedom from audible background scratch, long playback life, brilliant frequency response, and freedom from deterioration with age.

Type	Diameter	List Price per Disc	Box Contains	
RED LABEL Audiodiscs for professional use. Exceed the most exacting demands for highest quality professional recordings. The finest discs obtainable. Aluminum base. Double sided. Embossed labels.	7"*	\$1.28	25	
	8"	1.00		
	10"	1.40		
	12"	2.30		
	16"	4.22		
SINGLE FACE RED LABEL Audiodiscs. Same quality as double sided Red Label Audi-discs, listed above.	12"	1.86	25	
	16"	3.32		
YELLOW LABEL Audiodiscs for general use. High uniform quality. The popular choice for all general purpose recording. Aluminum base. Double sided. Yellow paper labels.	8"	.84	25	
	10"	1.12		
	12"	1.86		
	16"	3.32		
REFERENCE LABEL Audiodiscs. Provide maximum economy for test cuts, filing, reference recordings, auditions and equipment adjustments. Aluminum base. Double sided. White paper labels.	10"	.96	25	
	12"	1.42		
	16"	2.52		
	16"	2.52		
BLUE LABEL Audiodiscs for amateur use. Same high quality lacquer as professional discs, but on thinner aluminum base. Ideal for schools, homes, and general amateur use. Double sided. Blue paper labels.	6 1/2"	.45	50	
	8"	.62		
	10"	.90		
	10"	.90		
MASTER Audiodiscs. The outstanding choice of professional recordists for use where pressings are to be made. Give fine results with either silvering or gold sputterings. Aluminum base. Doublesided or single face.	Double Sided	12"	2.92	25
	Single Face	13 1/4"	3.75	
		16"	5.46	
		17 1/4"	6.30	
	Single Face	12"	2.30	25
		13 1/4"	2.64	
		16"	4.44	
17 1/4"		4.60		

*Standard 45 rpm disc with 1 1/2" center hole. Center-hole adapters included for recording on conventional turntable.

Prices slightly higher in Pacific Coast and Southwestern Areas.



AUDIODISC CHIP-CHASER

A simple but perfect solution to the thread removal problem in recording. The felt-lined wiper blade is set on the disc before starting the recording. The Chip-Chaser automatically and infallibly brushes the thread toward the center, winding it up on the overhead post or drive pins, as the case may be.

List Price { for 16" turntables, \$7.00
for 12" turntables, \$6.00



"HOW TO MAKE GOOD RECORDINGS"

A complete, authoritative and non-technical handbook on all phases of disc recording—materials, equipment and techniques. Contains 140 pages, profusely illustrated with photographs, charts and diagrams. Includes a glossary of recording terms. Now in its 9th printing. List price \$2.00

audiopoints®

microscopically matched
recording and playback
styli

The complete line of Audiopoints covers the full range of recording and playback needs—for professional as well as general use. Audiopoints are made by skilled craftsmen, and conveniently packaged in cards, boxes or envelopes.

RECORDING AUDIPOINTS



SAPPHIRE No. 14—long recognized as the finest recording stylus made. Short or long dural shank, and 87° or 70° included angle.

List Price—\$7.50
(Resharpening cost, 87°—\$3.75)
(Resharpening cost, 70°—3.75)

SAPPHIRE No. 202—a high-quality professional stylus. Short or long brass shank.

List Price—\$6.00
(Resharpening cost—\$3.25)

SAPPHIRE No. 20—especially designed for professional microgroove recording. Short or long dural shank.

List Price—\$7.50
(Resharpening cost—\$3.75)

STELLITE No. 34—a favorite with many professional and non-professional users. Short or long shank. 87° included angle.

List Price—\$2.00
(Resharpening cost—\$1.40)

DIAMOND LAPPED STEEL No. 50—most practical and economical stylus for non-professional use.

List Price—3 for \$1.75

PLAYBACK AUDIPOINTS



SAPPHIRE No. 113—meets the requirements of the most critical professional recordists. Straight dural shank.

List Price—\$4.50
(Resharpening cost—\$2.00)

SAPPHIRE No. 123—for professional use with microgroove recordings.

List Price—\$2.00

"RED CIRCLE" SAPPHIRE No. 103—for professional use with instantaneous recordings or vinyl transcriptions. Straight dural shank.

List Price—\$2.00

"RED CIRCLE" SAPPHIRE No. 303—same as No. 103, except with bent dural shank. Ideal for phonograph records.

List Price—\$2.00

STEEL TRANSCRIPTION NEEDLE No. 151—finest steel needles made. 100% shadowgraphed to assure perfection of every needle.

List Price—100 for \$1.25
20 for \$0.25

RESHARPENING SERVICE

Established years ago, our Resharpening Service materially reduces the over-all cost of using sapphire and stellite Audiopoints. Each resharpened point is disc-tested. Special cards and envelopes are available for returning Audiopoints for resharpening.



audiotape

it speaks for itself

AUDIOTAPE has been designed, formulated and perfected to meet the most exacting requirements of the professional sound recordist. Its mechanical and magnetic properties are proportioned to give truly balanced performance, assuring the most faithful reproduction of the original live sound.



AUDIO SELF-TIMING LEADER TAPE

Durable plastic material with spaced markings for accurate timing at all standard speeds. Individually boxed in 100 ft. rolls. **List Price, \$0.60**

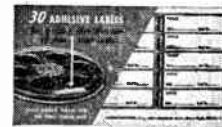

ADHESIVE REEL LABELS

Convenient press-on adhesive labels for positive identification of tape reels. Easy to apply or remove.

List Price per pack of 30, \$0.25

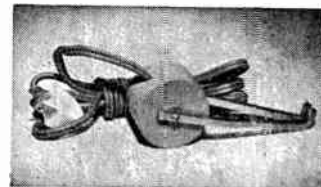

AUDIO HEAD DEMAGNETIZER

A 110-115 volt A-C electromagnet assembly for removing permanent magnetism from magnetic recording heads.

List Price, \$12.00

AUDIO HEAD ALIGNMENT TAPE

Recorded with perfect alignment at 2,000, 10,000 and 15,000 cps, 15" per sec. Three hundred ft. on 5" reel, individually boxed. **List Price, \$12.00**

audiodiscs and audiopoints

are listed on the following page

Length	Reel	TYPE NO.		List Price	
		Oxide Out	Oxide In		
PLASTIC BASE					
150 ft.	3" Plastic	150	151	\$0.85	
300 ft.	4" Plastic	350	351	1.60	
600 ft.	5" Plastic	650	651	3.50	
1200 ft.	{ 7" Plastic (2 1/4" hub)	1250	1251	5.50	
	{ 7" Plastic (2 3/4" hub)	1250L	1251L	5.50	
2500 ft.	{ Std. NAB Aluminum Hub	—	2551H	10.00	
	{ 10 1/2" Aluminum Reel	—	2551R	12.85	
	{ 10 1/2" Fiberglass Reel	—	2551F	12.85	
5000 ft.	{ Std. NAB Aluminum Hub	—	5051H	20.00	
	{ 14" Aluminum Reel	—	5051R	26.00	
PAPER BASE					
150 ft.	3" Plastic	120	121	0.70	
300 ft.	4" Plastic	320	321	1.25	
600 ft.	5" Plastic	620	621	2.15	
1200 ft.	{ 7" Plastic (2 1/4" hub)	1220	1221	3.50	
	{ 7" Plastic (2 3/4" hub)	1220L	1221L	3.50	
2500 ft.	{ Std. NAB Aluminum Hub	—	2521H	6.50	
	{ 10 1/2" Aluminum Reel	—	2521R	9.35	
	{ 10 1/2" Fiberglass Reel	—	2521F	9.35	
MYLAR*					
1 MIL	600 ft.	5" Plastic	660	661	4.25
	1200 ft.	7" Plastic (2 1/4" hub)	1260	1261	6.85
	2500 ft.	{ Std. NAB Aluminum Hub	—	2561H	12.50
		{ 10 1/2" Aluminum Reel	—	2561R	15.35
		{ 10 1/2" Fiberglass Reel	—	2561F	15.35
1 1/2 MIL	600 ft.	5" Plastic	670	671	5.00
	1200 ft.	7" Plastic (2 1/4" hub)	1270	1271	8.25
	2500 ft.	{ Std. NAB Aluminum Hub	—	2571H	15.00
		{ 10 1/2" Aluminum Reel	—	2571R	17.85
		{ 10 1/2" Fiberglass Reel	—	2571F	17.85
2 MIL	500 ft.	5" Plastic	580	581	5.00
	1000 ft.	7" Plastic (2 1/4" hub)	1080	1081	8.25
	2000 ft.	{ Std. NAB Aluminum Hub	—	2081H	15.00
		{ 10 1/2" Aluminum Reel	—	2081R	17.85
		{ 10 1/2" Fiberglass Reel	—	2081F	17.85

*DuPont trademark for its polyester film. AUDIOTAPE made of "Mylar" has exceptional mechanical strength and is virtually immune to the widest extremes of temperature and humidity.



AUDIOTAPE can also be supplied in any desired width and is available on green or blue plastic base for special identification at slightly higher prices.

Type EP AUDIOTAPE, extra precision magnetic recording tape for telemetering, electronic computers and other specialized applications, is also available. Ask for bulletin on EP AUDIOTAPE.

SOUNDCRAFT

Micro-Polished® Magnetic Recording Tapes

The only tapes specifically engineered by specialists in sound recording to get the best out of today's magnificent new tape recorders.

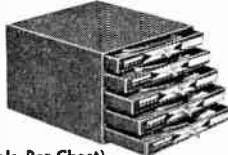
	TYPE	LENGTH	REEL	LIST EACH
<p>SOUNDCRAFT LIFETIME®. The latest addition to a distinguished line of fine recording tapes. The only tape guaranteed for life. Super high fidelity oxide coating. The base of DuPont "MYLAR" gives tremendous strength and dimensional stability . . . utmost durability, long-run economy. In the blue box with the yellow band.</p> <p>Red Oxide "Mylar" Base</p> 	L-1	150'	3" plastic	\$ 1.90
	L-6	600'	5" plastic	\$ 5.25
	L-12	1200'	7" plastic	\$ 9.75
	L-24	2400'	Hub Reel	\$16.95 \$19.80
<p>SOUNDCRAFT Plastic Base Magnetic Recording Tape, a superior tape in quality and performance. SOUNDCRAFT plastic base tape is attractively packaged in the familiar blue box with the red band and the famous Soundcraft design.</p> <p>Red Oxide Plastic Base</p> 	SPN 1	150'	3" plastic	\$ 1.00
	SPN 3	300'	4" plastic	\$ 1.75
	SPN 6	600'	5" plastic	\$ 3.50
	SPN 12	1200'	7" plastic	\$ 5.50
<p>SOUNDCRAFT Plastic Base Professional Tape. Packaged in the blue box with the light blue band, this tape has been specifically engineered for professional users. Micro-Polishing insures high fidelity—uniformity—sensitive high frequency response.</p> <p>All Plastic Base</p> 	SPN 12P	1200'	7" plastic prof. hub	\$ 6.00
	SPN 25P	2400'	Hub Reel	\$10.00 \$12.85
	SPN 33P	3300'	Hub	\$13.00
	SPN 48P	4800'	Hub Reel	\$20.00 \$28.00
<p>SOUNDCRAFT Tape Chests contain 5 reels of either SOUNDCRAFT plastic base, LIFETIME or Professional Tape the first two in 5" or 7" reels, the last in 7" reels only. This fine, handsome package with permanent pyroxylin covering stores tape horizontally in individual, easily indexed protective drawers.</p> <p>SOUNDCRAFT TAPE CHESTS</p>  <p>(5 Reels Per Chest)</p>	SPNC-5	600' plastic	5" plastic	\$17.50
	SPNC-7	1200' plastic	7" plastic	\$27.50
	SPNC-7P	1200' professional	7" plastic prof. hub	\$30.00
	LC-5	600' LIFETIME	5" plastic	\$26.25
	LC-7	1200' LIFETIME	7" plastic	\$48.75

TAPE RECORDING ACCESSORIES

EMPTY TAPE CHESTS

	PRICE
5" Tape Chest	\$1.35
7" Tape Chest	\$1.50

VINYL CARRYING CASES

Durable Vinyl cases designed to hold one SOUNDCRAFT Tape Chest, they're a wonderful convenience for your customers.

5" Carrying Case	\$1.50
7" Carrying Case	\$1.75



	Description	Type	Standard Package	Reels List Ea.	Boxes List Ea.	Reels in Boxes List Ea.
SOUNDCRAFT EMPTY REELS AND BOXES	3" Plastic Reel	3SR	10	\$.15	\$.15	\$.30
	4" Plastic Reel	4SR	10	\$.30	\$.15	\$.40
	5" Plastic Reel	5SR	10	\$.50	\$.15	\$.65
	7" Plastic Reel	7SR	10	\$.60	\$.20	\$.75
	7" Plastic Prof. Reel	7SPR	10	\$.80	\$.20	\$.95
	7" Aluminum Reel	7SAR	10	\$1.15	\$.20	\$1.30
	10½" Complete Aluminum Reel	10SAR	5	\$4.00	\$.90	\$4.90

SOUNDCRAFT

MicroLac® Recording Discs

For unmatched play-back perfection . . . far quieter, wider range signal straight through from cuttings to final stampers.

TYPE	SIZE	STANDARD PACKAGE	LIST PRICE EACH	TYPE	SIZE	STANDARD PACKAGE	LIST PRICE EACH	
MicroLac "MAESTRO" Oversize MASTER discs for originals in making phonograph records and transcriptions. Best available for either regular or Microgroove recording. Available either with standard one drive hole or with center hole only for 45 rpm masters. Processed regularly by all of the foremost phonograph record and transcription manufacturers.	(double face) 12"	25	\$2.85	MicroLac "PLAYBACK" (Single Face) The same quality as the double face "Playback" but intended for economy applications requiring the use of only one side. Both sides of the disc are coated, and the useable side is identified by the Soundcraft embossing.	10"	25	\$1.10	
	13 1/4"	25	\$3.70		12"	25	\$1.80	
	16"	20	\$5.40		16"	20	\$3.25	
	17 1/4"	20	\$6.30					
	(single face) 12"	25	\$2.25					
	13 1/4"	25	\$2.60					
	16"	20	\$4.25					
	17 1/4"	20	\$4.55					
MicroLac "BROADCASTER" A MASTER selection in instantaneous sizes for vitally important and critical recordings. A premium product guaranteeing absolute perfection. Available only in double face.	10"	25	\$1.55	MicroLac "AUDITION" A double face disc, selected from the regular runs, suitable for less important station and studio applications, for schools, amateur, and better home recording. Paper labelled for greater convenience.	6 1/2"	25	\$.70	
	12"	25	\$2.40		8"	25	\$.85	
	16"	20	\$4.40		10"	25	\$1.10	
					12"	25	\$1.80	
MicroLac "PLAYBACK" The standard broadcast-quality disc for all professional applications in radio stations, recording and motion picture studios. Physical and sound properties assure the finest quality of recorded sound.	6 1/2"	25	\$.80	MicroLac "45 R.P.M." A double-face recording blank that fits conventional spindle. When recording is made, center insert may be pushed out for immediate playback on 45 R.P.M. record player.	7"	25	\$1.25	
	8"	25	\$1.00					
	10"	25	\$1.40					
	12"	25	\$2.25					
	16"	20	\$4.15					
				MicroLac "BLUE DIAMOND" A double-face reference disc for utmost economy where perfection is not required. Excellent for program filing or for making test cuts.	10"	25	\$.95	
					12"	25	\$1.40	
					16"	20	\$2.50	

CUTTING and PLAYBACK STYLI (Sapphire Jewels)

- LONGER LIFE • EASIER THREAD CONTROL • CLEANER HIGH-FREQUENCY • WIDER LATITUDE • QUIETER CUTTING • TYPES FOR EVERY PURPOSE

PRICE LIST

Type	Description	List Price
Sapphire cutting stylus	Broadcast quality, dural shank, maximum length jewel. Standard 87° included angle, 1.5 mil radius. Available in Microgroove .5 mil radius. (Specify long or short shank.)	\$7.50
Stellite cutting stylus	For semi-professional recording, dural shank. (Specify if long or short shank.)	\$2.00
Sapphire transcription playback needle	Straight dural shank. Available in 2.5 mil standard radius or 1 mil radius for Microgroove.	\$4.50

RESHARPENING SERVICE

Mail Styli for resharpening in original package to your distributor.

Sapphire cutting stylus	\$3.75
Stellite cutting stylus	\$1.50
Sapphire transcription Playback	\$2.50

SOUNDCRAFT'S NEW RESHARP MAILERS ARE AVAILABLE THROUGH YOUR DISTRIBUTOR

For further information please write: **REEVES SOUNDCRAFT CORP.**
10 East 52nd Street, New York 22, N. Y.

RECOTON*

Always faithful

Phoneedles

SUPEROSMIUM No. 2412



Recoton's fine permanent-type needle made of the finest osmium alloys. Micro-tested and factory sealed for precision results. Exceptionally gentle to records.

List Price
No. 2412—1 needle to a container... \$ 1.00
12 to a display card... 12.00

NYLON PHONEEDLE* No. 2512



Recoton's precision-made nylon phoneedle provides long hours of enjoyable plays. Unconditionally guaranteed with shock absorbing action. Contains surface noise filter... eliminates needle scratches.

List Price
No. 2512—1 needle to a container... \$ 1.50
12 to a display card... 18.00
No. 2512—MG for 33 1/3 & 45 RPM Recordings

PRIMUS SAPPHIRE NEEDLE



Versatile... popular priced... ideal for every kind of electrical player including automatic changers. Features special wire-type grip to allow greater flexibility permitting needle to follow modulation track of record faithfully. Fine sapphire point eliminates surface noise, minimizes record wear. Reproduces entire tonal range.

List Price
No. 2612—Each needle... \$ 2.50
12 to carton... 30.00
No. 2612—MG for 33 1/3 & 45 RPM Recordings
No. 2912—Universal for all 3 Speeds

SUPERIOR RECOTON No. 15



Recoton's famous popular-priced steel needle, precision turned in Switzerland, made of Swedish steel. Fine reproduction and elimination of surface noise. Good for 12 to 15 plays.

List Price
No. 15—Package of 25 needles to an envelope... Each \$.25
50 envelopes to carton... 12.50

OSMIUM TIPPED FEATHER-LITE NEEDLE No. 2124



Recoton's new osmium tipped bent shank phoneedle. Permanent type construction. Fine value for needle of this quality!

List Price
No. 2124—1 needle to package... \$.50
24 pkgs. to a display card... 12.00

ALL GROOVE NEEDLES



No. 2712 SUPEROSMIUM UNIVERSAL 3-SPEED OSMIUM TIPPED

Recoton's fine permanent-type needle made of the finest osmium alloys. Micro-tested and factory sealed for precision results. Lowest surface noise and hiss. Exceptionally gentle to records.

List Price
No. 2712—1 needle to a card... \$ 1.00
12 to a display card... 12.00



No. 2812 ULTRA UNIVERSAL 3-SPEED SAPPHIRE

Popular-priced sapphire-tipped needle featuring high-level performance at low-level cost. Quality crafted... micro-tested, factory-sealed for fine results.

List Price
No. 2812—1 needle to a card... \$ 1.50
12 to a display card... 18.00

RECOTON LIGHTWEIGHT KIDDIE REPRODUCER



Is so constructed to take abnormal abuse without injury to diaphragm. Fine volume and appearance that will appeal to the kiddies. Ivory or blue. List Price \$ 1.50



RECOTON THROW-BACK ARM

Smooth simple action. Available in Ivory or blue. No. 61... List Price \$ 2.00



MAGNETIC RECORDING TAPE For All Tape Recorders

RECOTON Magnetic Recording Tape comes on sturdy six spoke plastic reels which turns true and resists warping.

RECOTON Magnetic Recording Tape is constant output controlled, 65 DB Dynamic Range with minimum background, eliminating rumble and even microscopic irregularities! Wide Bias latitude results in high uniform output and low distortion without critical bias adjustment.

RECOTON Magnetic Recording Tape is easy to erase and is guaranteed for thousands of recordings and playbacks.

Cat. No.	Oxide Base	Winding Faces	Lgth. in Ft.	Size of Plastic Reel	List Price
1112A	Red Plastic In	1250	7"	7"	\$ 5.50
1112B	Red Plastic Out	1250	7"	7"	5.50
116A	Red Plastic In	625	5"	5"	3.50
116B	Red Plastic Out	625	5"	5"	3.50



HOME RECORDING DISCS

Perfect for home, commercial and educational use, these popular recording discs are preferred for their excellent reproductive quality, long life, absence of surface noise. Each disc is smooth cutting, uniformly coated and free from warpage. Carefully inspected at every point of manufacture.

Label	Material	Thickness	Quantity	Price
RED LABEL	ALUMINUM BASE			
6 1/2"	packed 100 to a carton (40c each)			\$ 40.00
8"	packed 50 to a carton (50c each)			25.00
10"	packed 50 to a carton (80c each)			40.00
12"	packed 25 to a carton (1.00 each)			25.00
GREEN LABEL	THIN ALUMINUM BASE			
6 1/2"	(100 blanks to a carton) (30c ea.)			\$ 30.00
8"	(100 blanks to a carton) (40c ea.)			40.00
10"	(100 blanks to a carton) (60c ea.)			60.00



45 RPM RECORD INSERT

Its unique design guarantees that it will always fit! And it won't break under normal use—may be twisted and turned—adjusted and readjusted.

Cat No. 3224—Contains: 5 inserts in pkg. at 25c. ea. 24 pkgs. on display card. List Price \$ 6.00



ANTISTATIC RECORD BRUSHES

No. 3312—1 brush... \$ 1.00
12 brushes to display carton... \$ 12.00



RECORD SAVERS

Protects records from scratches, dust and fingerprints.

No. 3412	10 10" record savers in a bag... \$ 1.39
	12 pkgs. to a display carton... 16.68
No. 3512	10 12" record savers in a bag... 1.69
	12 pkgs. to a display carton... 20.28

CUTTING STYLI

SAPPHIRE CUTTING NEEDLES

Factory Tested and Sealed
Superbly crafted, equipped with finest sapphire point. For professional use.



List Price
No. 5—Brass shank, packed in wooden container... \$ 6.00
No. 7—Dural shank, packed in wooden container... \$ 7.50

* Available in "Long Shank"; specify with order LS after catalog number. No. 7 also available in Microgroove cutting. Specify No. 7MG when ordering.

STEEL CUTTING NEEDLES

Crafted of the highest-grade steel alloy to cut smooth grooves with low surface noise level. Shaped with careful precision, polished to mirror-like finish for accurate recordings. HAND-LAPPED for extra efficiency.

List Price
No. 1060
5 needles to a card... \$ 1.50
12 cards to a carton... 18.00

STELLITE CUTTING NEEDLES

Designed for professional use, these high-grade cutting needles have a special patented finish that cuts and polishes groove of disc at same time. Equipped with Dural shank, can be depended upon for noiseless, high-fidelity performances. Will improve any recorder; recommended for slow-speed recordings.

List Price
Cat. No. 11—Stellite Cutting Needle, packed in individual cards... \$ 2.00
1112—12 cards to a display card... 24.00

PRECISION-TURNED CUTTING STYLI

Made in Switzerland

These steel cutting styli are precision turned of finest Swedish steel alloy. They are diamond-dust hand-lapped for cutting smooth grooves with extremely low surface noise and minimum background.

List Price
No. 2330
Each stylus packed in individual container... \$.50
30 containers to a carton... 15.00

* Reg. U. S. Pat. Off.

RECOTON CORPORATION - NEW YORK 11, N. Y.

RECOTON Replacement Needles

NO DUPLICATION!

Of the same needle under another number! Keeps your inventory down.

SIMPLE CONSECUTIVE MODEL NUMBERS!

As 301, 302, 303 etc.

INVENTORY CONTROL!

A separate inventory control card for each number—more sales with less stock.

COMPLETE INFORMATION!

All the information is on the card the needle is mounted on.

Replacement Needles for Cartridges of
ASTATIC
AMERICAN MICROPHONE
COLUMBIA
CROSLEY
ELECTRO-VOICE
GENERAL ELECTRIC
MAGNAVOX
PHILCO
RCA
SEEBURG
SHURE
SONOTONE
WEBSTER-CHICAGO
WEBSTER ELECTRIC
AND MANY OTHERS

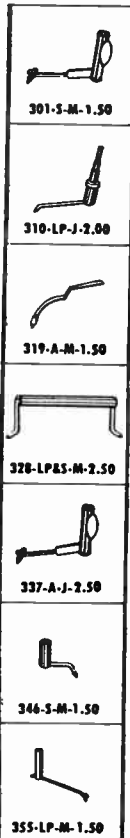

JEWEL and OSMIUM TIPPED

CAT. NO.	PRICE	CAT. NO.	PRICE	CAT. NO.	PRICE	CAT. NO.	PRICE
301	\$1.50	326	\$1.50	351	\$1.50	376	pr. \$2.50
302	2.50	327	2.50	352	2.50	377	pr. 2.50
303	2.50	328	2.50	353	3.50	378	1.50
304	1.50	329	1.50	354	1.50	379	2.50
305	1.50	330	1.50	355	1.50	380	1.50
306	2.50	331	2.50	356	1.50	381	1.50
307	1.50	332	3.50	357	1.50	382	1.50
308	2.50	333	2.50	358	1.50	383	3.50
309	3.50	334	2.50	359	2.50	384	3.50
310	2.00	335	1.50	360	2.50	385	3.50
311	1.50	336	1.50	361	1.50	386	2.50
312	2.50	337	2.50	362	1.50	387	2.50
313	4.00	338	1.50	363	1.50	388	2.50
314	5.50	339	1.50	364	1.50	389	1.50
315	1.50	340	2.50	365	1.50	390	1.50
316	1.50	341	1.50	366	3.50	391	1.50
317	2.50	342	1.50	367	3.50	392	1.50
318	1.50	343	2.50	368	5.95	2412R	1.00
319	1.50	344	2.50	369	3.50	2512R	1.50
320	1.50	345	1.50	370	2.50	2512MGR	1.50
321	1.50	346	1.50	371	2.50	2712R	1.00
322	1.50	347	1.50	372	2.50	2812R	1.50
323	4.00	348	1.50	373	2.50	2912R	2.50
324	2.25	349	2.50	374	2.50		
325	2.50	350	2.50	375	2.50		

DIAMOND TIPPED

CAT. NO.	PRICE	CAT. NO.	PRICE	CAT. NO.	PRICE	CAT. NO.	PRICE
302-D	\$25.00	327-SD	\$30.00	359-D	\$25.00	377-D	\$25.00
303-D	25.00	332-DD	49.00	360-D	25.00	379-D	25.00
304-D	25.00	332-SD	30.00	366-D	27.50	380-D	25.00
308-D	25.00	333-D	25.00	367-D	27.50	381-D	25.00
309-D	25.00	334-D	25.00	368-DD	49.00	382-D	25.00
310-D	25.00	337-D	25.00	368-SD	30.00	383-D	25.00
312-D	25.00	340-D	25.00	369-D	27.50	384-D	25.00
313-DD	49.00	343-D	25.00	370-D	25.00	385-DD	49.00
313-SD	30.00	344-D	25.00	371-D	25.00	385-SD	30.00
317-D	25.00	349-D	25.00	372-D	25.00	386-D	25.00
323-DD	49.00	350-D	25.00	373-D	25.00	387-D	25.00
323-SD	30.00	352-D	25.00	374-D	25.00	388-D	25.00
324-D	25.00	353-DD	49.00	375-D	25.00	2912-D	25.00
327-DD	49.00	353-SD	30.00	376-D	25.00		

For complete information regarding replacement needles, refer to Recoton Simplified Reference Guide. **WRITE US — IT'S FREE!**

No. 650 DISPLAY KIT

200 Power RECOTON Precision Microscope

Metal Replacement cabinet containing 2 needles each of Cat. No. 301-382 and including 2 each of 2412R, 2512R, 2512MGR, 2712R, 2812R, 2912R with FREE 200-power Recoton Microscope on illustrated display background.

No. 650 \$377.40

No. 751—Metal Replacement Cabinet contains 1 needle each of Cat. No. 301-392, 2412R, 2512R, 2512MGR, 2712R, 2812R, 2912R with FREE 200-power Recoton microscope.

List Price \$212.70

No. 850—Portable Service Kit containing 2 needles each of Cat. Nos. 302, 303, 310, 312, 317, 337, 352, 370, 371, 372, 2812R, 2912R, 2412, 2512, 2612 and 1 needle each of Cat. No. 309, 367, 368, free set of tools and professional jewelers' double eye loupe, guide, etc.

List Price \$79.95



RECOTON No. 171 KIT

Here is the basic space-saving starter kit you will want to own. Contains only the most popular replacement needles. The sturdy grey metal cabinet can be displayed to good advantage and the extra kit affords can be used "in the shop" and on "outside calls."

No. 171—Replacement Kit contains 1 needle each of 301, 304, 310, 311, 312, 316, 317, 318, 319, 320, 337, 339, 340, 354, 355, 372 and 388, included FREE is attractive metal cabinet, index cards for inventory control, high-powered jewelers' double eye loupe, forceps, screw driver, mirror, assorted nuts, all in convenient polyethylene bag. List Price \$32.00

No. 552—Replacement cabinet containing 2 needles each of Cat. No. 301 through 392 and including 2 each of 2412R, 2512R, 2512MGR, 2712R, 2812R, 2912R plus all the free merchandising aids similar to No. 171. List Price \$425.40



SOUND RECORDING



irish

BRAND

REG. U. S. PAT. OFF.

Tape

No. 211 IRISH Green-Band Professional Magnetic Tape
For professional application . . . red oxide, plastic base



SIZE	Individually Boxed Reels Per Carton	Hi-Fi Professional Net Price
150' x 1/4" plastic reel	12	\$.60
300' x 1/4" plastic reel	12	1.05
600' x 1/4" plastic reel	12	2.10
1200' x 1/4" plastic reel	12	3.30
2400' x 1/4" NARTB hub only	12	6.00
2400' x 1/4" NARTB new fiberglass reel	12	7.71
2400' x 1/4" NARTB 10 1/2" metal reel	12	7.71
4800' x 1/4" NARTB hub only	12	12.00
4800' x 1/4" NARTB 14" metal reel	12	15.60



No. 195 IRISH Brown-Band Magnetic Tape
Designed for all home recorders . . . red oxide, plastic base

150' x 1/4" plastic reel	12	\$.50
300' x 1/4" plastic reel	12	1.00
600' x 1/4" plastic reel	12	1.50
1200' x 1/4" plastic reel	12	2.50
2400' x 1/4" NARTB hub only	12	4.67
2400' x 1/4" NARTB new fiberglass reel	12	6.57
2400' x 1/4" NARTB 10 1/2" metal reel	12	6.57



No. 220 IRISH "Sound-Plate" Mylar Magnetic Tape
For all high speed applications . . . special high strength base

150' x 1/4" plastic reel	12	\$ 1.26
300' x 1/4" plastic reel	12	2.55
600' x 1/4" plastic reel	12	4.68
1200' x 1/4" plastic reel	12	9.30
2400' x 1/4" NARTB hub only	12	17.58
2400' x 1/4" NARTB new fiberglass reel	12	20.31
2400' x 1/4" NARTB 10 1/2" metal reel	12	20.31
4800' x 1/4" NARTB hub only	12	34.68
4800' x 1/4" NARTB 14" metal reel	12	39.63

Made in U. S. A. by ORRADIO INDUSTRIES, Inc., Opelika, Alabama

World's Largest Exclusive Magnetic Tape Manufacturer
Export Division: Morhan Exporting Corp., 458 Broadway, New York 13, N. Y.

Prices subject to change without notice.

MIP Molded-In-Plate Sockets



Molded of high dielectric black Bakelite, sturdy, steel mounting plate molded directly into the solid body, cannot come loose or vibrate. Contacts grip tube prongs firmly and retain their resiliency indefinitely. Mount in 1-5/32" round hole. Two 5/32" screw holes on 1-1/2" centers.

Number	Contacts	List	Number	Contacts	List
77-MIP-4	4 Contacts	\$.12	77-MIP-8	8, Octal	\$.14
77-MIP-5	5 Contacts	.12	77-MIP-9	9, Octal style	.18
77-MIP-6	6 Contacts	.12	77-MIP-11	11, Octal style	.24
77-MIP-7L*	7 Large	.14	77-MIP-12	12, Octal style	.30
77-MIP-7S	7 Small	.12	77-MIP-20	20 Contact	.80

* 77-MIP-7L mounts in 1-9/32" D. round hole.



Compact MIP Sockets

Same as MIP series above but smaller in diameter. Mount in 1-1/8" round hole. Two 5/32" diameter mounting holes on 1-5/16" centers. Black Bakelite dielectric.

Number	Contacts	List
88-8	8 Contacts	\$.14
88-8X	8, Loktal	.21



Saddle Type Octal Sockets

An economical socket for below chassis mounting. 74-8 mounts in a 1 1/8" hole with two 1/4" diameter mounting holes on 1 1/8" centers. 168-150 mounts in 1" hole with two .140" diameter mounting holes on 1 1/8" centers. Both with 4 grounding lugs, tuning fork contacts, black bakelite.
No. 74-8.....List \$.14
No. 168-015.....List .13

High Voltage Safety Sockets



For rectifier and other tubes with base diameter of 1.156". Socket is set at the bottom of a deep molded Bakelite shell. Heavy steel mounting plate molded into shell has 5/32" diam. mounting holes on 1-7/8" centers. Socket mounts from above or below in 1-1/2" round hole.

Number	Contacts	List
77A-4T	4 Contacts. Mica-filled	\$.151

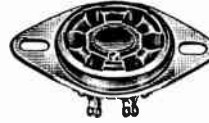

Replacement Sockets

Regular "S" sockets, assembled with No. 4 retainer ring to steel mounting plate with slotted holes to fit mounting centers from 1-1/2" to 1-7/8".

Black Bakelite	List	Contacts	Steatite	List
78-RS4	\$.14	4 Contacts	49-RSS4	\$.48
78-RS5	.14	5 Contacts	49-RSS5	.48
78-RS6	.14	6 Contacts	49-RSS6	.48
78-RS7C	.18	7 Comb.		
78-RS7L	.14	7 Large	49-RSS7L	.61
78-RS7S	.14	7 Small	49-RSS7S	.48
78-RS8	.18	8 Octal	49-RSS8	.48
78-RS8L	.22	8 Loktal		
78-RS9	.22	9 Octal style		
78-RS11	.30	11 Octal style		



Floating Octal Sockets

Live rubber grommets fit into mounting holes to cushion this socket for vibration-free operation. Black bakelite dielectric. Mounts in 1-3/16" round hole above or below chassis. Two 1/4" screw holes on 1-1/2" centers.

Number	Description	List
77-MIP-8FK	Octal. Complete with 4 rubber grommets, 2 mounting screws, nuts and washers	\$.39
11-3K	Kit for making floating connections using Amphenol MIP Sockets. 4 grommets, 2 mounting screws, nuts and washers only	.24

Tube Shield and Spring Assemblies

Number	Height	Description	List
5-401	1-3/8"	For 7 Pin Miniature Sockets	\$.14
5-402	1-3/4"	For 7 Pin Miniature Sockets	.14
Tube Shields No. 5-401 and 5-402 are used with Sockets No. 59-367, 147-905, 147-913, 147-925, 147-955 and 147-963.			
5-405	1-1/2"	For Noval Sockets	.20
5-408	1-15/16"	For Noval Sockets	.24
5-409	2-3/8"	For Noval Sockets	.24
Tube Shields No. 5-405, 5-408 and 5-409 are used with Sockets No. 59-369, 59-406 and 59-407.			

MINIATURE 7 AND 9 PIN SOCKETS

ZIP-IN, Ethylon-A



Molded of Ethylon-A with high "Q" factor. Mounting plate has .136" diameter holes on 1-5/16" centers. Round chassis holes are 27/32" for 7 pin and 15/16" for 9 pin.

Number	Description	List
59-357	7 Pin. Without tube shield base	\$.21
59-367	7 Pin. With tube shield base	.27
59-359	9 Pin. Without tube shield base	.51
59-369	9 Pin. With tube shield base	.61



Bakelite and Steatite Sockets

Used for television, FM, auto radios, portables, etc. 147 Series mount in 5/8" chassis hole; mounting centers 7/8"; screw holes 1/8". 59 Series mount in 3/4" chassis hole; mounting centers 1-1/8"; rivet holes .095".

Bottom Mounting—No Tube Shield Base			
Number	Contacts	Dielectric	List
147-500	7	Black Bakelite	\$.24
147-501	7	Steatite	.51
59-409	9	Black Bakelite	.39
59-410	9	Mica-Filled Bakelite	.40
Top Mounting—With Tube Shield Base			
147-905	7	Black Bakelite	.39
147-913	7	Mica-Filled Bakelite	.40
147-925	7	Steatite	.63
59-406	9	Black Bakelite	.56
59-407	9	Mica-Filled Bakelite	.57
Rubber Mounted—No Tube Shield Base			
147-502	7	Black Bakelite	.25
Rubber Mounted—With Tube Shield Base			
147-955	7	Black Bakelite	.50
147-963	7	Mica-Filled Bakelite	.51

TUBE SOCKETS and RADIO COMPONENTS • MICROPHONE CONNECTORS • INDUSTRIAL SOCKETS

RG COAXIAL CABLES • CABLE and WIRE ASSEMBLIES • EXTRUDED and INJECTION MOLDED PLASTICS

Retainer Ring "S" Type Sockets

Extremely compact sockets, furnished complete with retainer rings. Mount in 1-11/64" keyed hole. Use Amphenol No. 25-LD-1 Punch and Die.

	Black Bakelite	List	Contacts	Steatite	List
	78-S4	\$.13	4 Contacts	49-SS4	\$.47
	78-S5	.13	5 Contacts	49-SS5	.47
	78-S6	.13	6 Contacts	49-SS6	.47
	78-S7C*	.17	7 Comb. for 7L, 7S		
	78-S7L*	.13	7 Large	49-SS7L*	.59
Black Bakelite	78-S7S	.13	7 Small	49-SS7S	.47
	78-S8	.17	8 Octal	49-SS8	.47
	78-S8L	.21	8 Loktal		
	78-S9	.21	9 Octal Style		
	78-S11	.29	11 Octal Style		
	78-A7P†	.30	7 for Miniatures		
	78-A9P†	.45	9 for Miniatures		
	78-B	.07	Blank		

* Mounts in 1-21/64" keyed hole. Use 25-LD-2 Punch and Die.
† Mounts in standard socket hole. Has miniature socket in center.

Magnal Socket Has 1-1/16" pin circle for cathode ray and television tubes. Mounts in 1-5/8" hole. Steatite.
No. 49-SS11L 11 Contact, Magnal.....List \$1.21

Miniature Retainer Ring Type Sockets

Mount in 5/8" round or "D" shaped hole with No. 2-9 retainer rings.

	Black Bakelite	Number	Description	List
		78-S3S	For 3 prong min. photo cells.....	\$.17
		78-S4S	4 Contact.....	.17
		78-S5S	5 Contact.....	.21
		78-S6S	6 Contact.....	.21
		78-7P	7 Contact. Miniature.....	.21

Mica-Filled Bakelite
78-7PT 7 Contact. Miniature..... .28

Duodecal and Diheptal Tube Sockets



Designed for television viewing tubes, oscilloscopes and other cathode-ray tubes. Provides means of grouping leads within the socket housing and bringing them out radially. Grouping of the wires in the enclosed raceway eliminates flexing at solder terminals, minimizing breakage. Socket cap and body molded from high quality electrical bakelite. Designed for easy assembly and dis-assembly... requires no special tools.

Duodecal Socket for a maximum of 12 equally spaced pins on a circle diameter of 1.063".
No. 59-402.....List \$1.56

Diheptal Sockets for a maximum of 14 equally spaced pins on a circle diameter of 1.750".
No. 59-415 Small—for 2.050" D. Tube base.....List \$1.67
No. 59-417 Medium—for 2.250" D. Tube base..... 1.67

Barrier Type Industrial Octal Socket



Molded in one piece of Melamine. Contacts are removable. R.M.A. numbered reversible screw type terminals.

No. 146-103 Standard Socket without Tie Point Inserts—Top Mounted....List \$1.58
No. 146-104 Socket with Four Molded-in Threaded Inserts for Tie Points—Top Mounted.....List \$2.16

Laboratory Punch and Dies

For punching mounting holes for Amphenol connectors, plugs and receptacles. Made of tool steel, properly hardened.

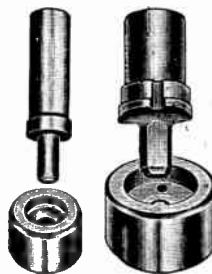

For Amphenol Retainer Ring Mounting Tube Sockets, Radio Plugs, etc.

Drill 1/2" hole for pilot punch.
No. Size of Hole List
25-LD-1 1-11/64" keyed..... \$12.00
25-LD-2 1-21/64" keyed..... 12.00

For Miniature Sockets and Microphone Connectors

Drill 3/8" pilot hole for 25-LD-3, 5 and 6 and 1/4" hole for 25-LD-4.
25-LD-3 13/16" round..... \$3.60
25-LD-4 5/8" round..... 3.60
25-LD-5 5/8" "D" hole..... 6.00
25-LD-6 1/2" "D" hole..... 6.00

Retainer Ring Hand Tools



Convenient for assembling miniature sockets, Plugs and tip jacks to panels or chassis. Designed for hand operation.

Number	Description	List
51-5	For No. 2-9 Rings.....	\$1.20
51-6	For No. 2-11 Rings.....	1.20
51-7	For No. 2-10 Rings.....	1.20
51-1	For "S" type sockets and "CP" type plugs except 7C and 7L sizes. Required where socket spacing is very close.	6.66
51-2	For "S" type sockets 7-large and 7-combination.....	6.66
51-3	For "SS" steatite sockets and "60" and "61" receptacles. Of two-piece construction... somewhat easier but slower to use than 51-1 (above) for "S" sockets and "CP" plugs	6.66

Magic Eye Assembly



For easily adapting or replacing a 6 prong magic eye tube in any radio having automatic volume control. Also for FM receivers, test instruments, signal tracers, and as volume level and modulation indicators. Includes 1 megohm target plate resistor wired into socket and 5 wire, color coded cable 22" long. Mounting bracket is slotted for tube adjustment. Complete as illustrated, with escutcheon and hardware for assembly. Tube not included.

No. 58-MEA6 Complete Magic Eye Assembly.....List \$1.51

Octal Magic Eye Assembly



Similar to No. 58-MEA6 shown above, but for octal type magic eye tubes. New universal short bracket for the smaller tube sizes permits use of any of the octal magic eye tubes including the dual pattern and the new multi-pattern types. Complete with 8 wire, color coded cable.

22" long, full vision escutcheon and hardware for assembly. Tube not included.
No. 58-MEA8 Complete Octal Magic Eye Assembly.....List \$1.51

Magic Eye Escutcheons

Hood type is of sturdy plastic with beautiful antique bronze finish. Full vision type for octal dual-pattern and new octal multi-pattern types is brass with antique bronze finish.

Number	Description	List
10-102	Hood Type. For 6 prong tubes.	\$.15
10-2	Full Vision Type. For octal tubes.....	.36



Shielded Cable Connectors, 110—250 Volt

End Cable Outlet—For cables up to 1/2" diameter



Fully shielded cable terminals with black Bakelite connector units encased in a tight cap that fits securely and is easily removed. Available with cable clamp that relieves soldered connections of strain, or with rubber grommets for protection against abrasion.

With Cable Clamp		With Grommet	
Part No.	List	Part No.	List
60-F11	\$.66	60-F4	\$.60
60-M11	.66	60-M4	.60
61-F11	.54	61-F4	.48
61-M11	.54	61-M4	.48
61-MP11	.54	61-MP4	.48

Flush Motor Plug, 110—250 Volt

Neat, compact plug or receptacle set in type 61-61 steel shell for below surface mounting. Room for insertion of Amphenol End Cable Outlet Plugs.

Number	Description	List
61-F10	2 Pole Universal Receptacle	\$.48
61-M10	2 Pole Standard Plug	.48
61-MP10	2 Pole Polarized Plug	.48

Molded-In-Plate Receptacle



Same as 61-F Receptacle with standard steel mounting plate molded into the Bakelite body. Mounts in 1-3/16" chassis hole; two 5/32" screw holes on 1-1/2" centers.

No. 61-MIP-61F 2 Pole Universal Receptacle.....List..... \$.30

Miniature Cable Connectors



Short Long Flared

For shielded or unshielded cables having up to 6 conductors. Black Bakelite elements are housed in cadmium plated brass shells and are held in place by side set screws. Polarized contact spacing makes incorrect insertions impossible. Accommodates cable up to 1/4" diameter.

Short Shell—13/16" Long		Long Shell—1-3/16" Long	
Male	List	Female	List
91-MPM3S	\$.36	91-MPF3S	\$.36
91-MPM4S	.40	91-MPF4S	.40

Also use with shielded chassis units shown below.

91-MPM3L	\$.36	3 Contact	91-MPF3L	\$.36
91-MPM4L	.40	4 Contact	91-MPF4L	.40
91-MPM5L	.45			
91-MPM6L	.45			

Note:
Use long shell type with shielded chassis units; use either long or short shells with unshielded types such as 78-S3S and 86-CP-3S.

Shielded Chassis Units



Economical chassis receptacles for connecting shielded or unshielded cables having from 2 to 6 conductors (for 2 wire cable use 3 contact unit and leave 1 contact unwired). Black Bakelite element; steel mounting plate. Can be mounted on surface or behind chassis or panel in 7/8" D. hole; 5/32" screw holes on 1-1/4" centers. Use with long shell cable connector above for a fully shielded connection.

Female	Description	List
78-PCC3	3 Contact	\$.36
78-PCC4	4 Contact	.36
78-PCC5	5 Contact	.41
78-PCC6	6 Contact	.41

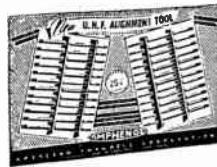

Alignment Tool



Made of Amphenol 912-A polystyrene. Has no capacity effect when aligning critical circuits. A necessary tool for anyone who must make adjustments on high frequency circuits.

No. 55 U.H.F. Alignment Tool (minimum order 24).....List \$.25
Illustrated above is the colorful sales card on which are mounted 24 Amphenol Alignment Tools.
No. 55-024 Sales Card with 24 Alignment Tools.....List \$6.00

Shielded Multi-Wire Cable Connectors



Multi-wire cable connectors consist of Amphenol "S" type tube sockets and "CP" plugs. Metal cap shields connections and provides an unbreakable cover for cable termination. Cap may be removed with an ordinary screw-

driver. Accommodates cable up to 7/16" diameter. Female chassis receptacles or sockets 78-S, 78-RS and 77-MIP; male receptacles are listed below.

With Rubber Grommets

With Rubber Grommet Type Plug Cap 3-13.

Female	List	Contacts	Male	List
78-PF4	\$.31	4 Contact	86-PM4	\$.31
78-PF5	.31	5 Contact	86-PM5	.31
78-PF6	.31	6 Contact	86-PM6	.31
78-PF7L	.31	7 Large	86-PM7L	.31
78-PF7S	.31	7 Small	86-PM7S	.31
78-PF8	.35	8 Octal	86-PM8	.35
78-PF9	.39	9 Octal Style	86-PM9	.39
78-PF11	.47	11 Octal Style	86-PM11	.47
		20 Contact	86-PM20	1.00

With Cable Clamps

With positive grip Cable Clamp Type Plug Cap 3-24.		List		
78-PF4-11	\$.37	4 Contact	86-PM4-11	\$.37
78-PF5-11	.37	5 Contact	86-PM5-11	.37
78-PF6-11	.37	6 Contact	86-PM6-11	.37
78-PF7L-11	.37	7 Large	86-PM7L-11	.37
78-PF7S-11	.37	7 Small	86-PM7S-11	.37
78-PF8-11	.41	8 Octal	86-PM8-11	.41
78-PF9-11	.45	9 Octal Style	86-PM9-11	.45
78-PF11-11	.53	11 Octal Style	86-PM11-11	.53

155 Series Miniature 7-Contact Connector



For use in the interconnection of miniature electronic equipment. Over-all diameter including the retaining flange is only 3/8". Bodies are threaded to mount without external shells. Contacts are for No. 20 wire.

No. 155-352 Male Connector.....List \$3.00
No. 155-353 Female Connector.....List 4.50

26 Series Rack and Panel Connectors



Eyelets for added strength in mounting, male contacts molded into the inserts. Female contacts of beryllium copper. High quality mica-filled phenolic inserts. Aluminum housing has cable clamp. Voltage rating 500 volts RMS, 60 CPS at sea level.

Insert Only		With Housing		
Part No.	List	Description	List	
26-804	\$1.90	Male, 11 Contacts	26-809	\$3.00
26-805	1.50	Female, 11 Contacts	26-808	2.60
26-151	2.30	Male, 15 Contacts	26-152	3.50
26-150	1.60	Female, 15 Contacts	26-153	2.80
26-806	3.30	Male, 20 Contacts	26-811	4.70
26-807	2.70	Female, 20 Contacts	26-810	4.10



ANTENNAS • RACK and PANEL TYPE CONNECTORS • AN TYPE CONNECTORS • FITTINGS and CONDUIT • RF TYPE CONNECTORS • AUDIO CONNECTORS • POWER PLUGS • MINIATURE SOCKETS

BLUE RIBBON CONNECTORS RACK and PANEL



These connectors feature a unique spring contact construction that provides positive contact, even under vibration, with low insertion and extraction force while maintaining high individual contact pressure. Spring members meet all service requirements with a safety factor of five or more.

Plug	No. of Con- tacts	List Each	Recep- tacle	No. of Con- tacts	List Each
26-182	8	\$ 1.90	26-183	8	\$ 2.60
26-159-16	16	3.10	26-190-16	16	4.50
26-159-24	24	3.80	26-190-24	24	5.60
26-159-32	32	4.40	26-190-32	32	6.80

Receptacle Shells



ACS Shell extends "CP" or "S" type sockets or plugs 13/16" above or below surface. 4 knockouts in sides. Mounts in 1-3/4" hole; has 3 notched holes for No. 6 screws.

Number	Description	List
23-1S	For small "S" Sockets.....	\$.12
23-1L	For large "S" Sockets.....	.12

61-61 Shell. Nickel plated steel shell, lowers bottom of "CP" and "S" type plugs and sockets and 60 and 61 connectors 1-3/16" below surface. Mounts in 1-7/16" hole; two 5/32" screw holes on 1-3/4" centers.

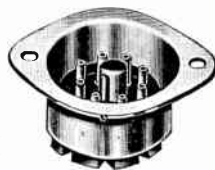

No. 61-61 Shell only.....List \$.18

Tip Jacks

Molded of Bakelite in black or red. Mount in 3/8" hole with retainer ring included. Use standard phone tips for 78-1P1, and 78-1 Contacts recessed 1/8". The body may be used as a feed-thru.



Number	Description	List
78-1S	For 3/32" Plug.....	\$.09
78-1L	For 5/32" Plug.....	.09
78-1M	For 1/8" Plug.....	.09
78-1P	For .080 Phone Tip.....	.09
78-1P1	High Voltage for .080 Phone Tip. Mounts in 1/2" hole.....	.12

Single Prong Plugs



Bakelite Plugs, black or red, for use with Tip Jacks above.

Number	Description	List
71-1S	For 3/32" Socket.....	\$.06
71-1M	For 1/8" Socket.....	.06
71-1L	For 5/32" Socket.....	.06

Inserts and Shells for Cable Plugs, Connectors and Receptacles. For Assembly into Type Required



For 110-250 Volt Plugs and Receptacles

Compact in design, molded from high dielectric black Bakelite. Rated at 15 amp., 110 v. or 10 amp., 250 v. Two-pole type accepts any standard electric plug. Retainer ring type mounts in 1-11/64" keyed hole as punched by Tools 25-LD-1. Mounting plate type requires 1-9/32" D. chassis hole; has slotted screw holes on 1-1/2 to 1-7/8" centers—Mounting plate type is similar to Type "RS" Replacement Sockets.

Retainer Ring Type Number	List
61-F	\$.30
60-F	.42

Receptacles

Description	With Mounting Plate Number	List
2 Pole, Universal	61-F1	\$.34
3 Pole, Polarized	60-F1	.46

Plugs

Description	With Mounting Plate Number	List
2 Pole, Standard	61-M1	\$.34
2 Pole, Polarized	61-MP1	.34
3 Pole, Polarized	60-M1	.46

For Multi-Wire Plugs and Receptacles

For quick, easy assembly to chassis or panels from 19 to 16 gage (.044 to .062") using Amphenol retainer ring. Black Bakelite or Mica-Filled Bakelite. Cadmium plated socket contacts for easy soldering; plug prongs are nickel plated brass; rotation feature for lining up contacts. Complete with retainer ring.

Can be assembled in any of the plug caps or receptacle shells below. For chassis mounting in 1-11/64" keyed hole as punched by Tools 25-LD-1.



"S" Socket (Listings on page 1).

"CP" Plug

"CP" Plugs

Black Bakelite	List	Contacts
86-CP4	\$.13	4 Prong
86-CP5	.13	5 Prong
86-CP6	.13	6 Prong
86-CP7L*	.13	7 Large
86-CP7S	.13	7 Small
86-CP8	.17	8 Prong, Octal
86-CP9	.21	9 Prong, Octal Style
86-CP11	.29	11 Prong, Octal Style

Mica-Filled Bakelite	List
86-CP4T	\$.21
86-CP5T	.21
86-CP6T	.21
86-CP7LT*	.21
86-CP7ST	.21
86-CP8T	.24
86-CP9T	.28
86-CP11T	.36

* Mounts in 1-21/64" keyed hole. Use 25-LD-2.

Plug Caps for Every Purpose



Cable terminals can be assembled with these plug caps, using retainer ring type plugs, sockets and 60 and 61 series shown above. Plug caps are designed to fit all but the 7-large and 7-combination sizes. For 7-large and 7-comb. use Plug Cap 3-13L shown below.

Number	Length	End Hole	Side Hole	Grommet	List
3-10	1"	None	None	None	\$.18
3-12	1"	5/16"	None	Metal	.18
3-13	1"	7/16"	None	Rubber	.18
3-17	1"	None	7/16"	Rubber	.18
3-24	Cap with Cable Clamp attached. Accommodates cables to 1/2" diameter.....				.24
79-CC4	Cable Clamp only. Same as used on Cap 3-24.....				.12
3-13L	Cap for large 7 Socket and Plugs, end rubber grommet 7/16" ID.....				.24

Crystal Holder Socket



Molded of mica-filled Bakelite... for crystal holders having 2 prongs on 3/4" centers. Easily mounted. May be used as dual tip jacks on test panels.

Number	Description	List
33-2T	For 1/8" Prongs... \$.17
33-3T	For 5/32" Prongs..	.17



Heavy Duty Power Plugs

Male unit has four heavy brass blades; female has heavy phosphor bronze contacts. For use with current loads up to 15 amperes at 125 volts or 10 amperes at 250 volts. Molded black Bakelite unit is enclosed in tight, heavy brass shell . . . bright cadmium plated. Polarized with shell keys and keyways. Strain is taken up by concealed cable clamp. Grounding screw in body for safe wiring. Threaded locking ring keeps shells tight. Chassis or panel receptacle mounts in 1 1/4" hole in any material up to 1/2" thick. Complete with lock washer, spacer washer and nut.



Plug



Jack



Receptacle

Mating parts are arranged in same horizontal line below.

Number	Contacts	List	Number	Contacts	List	Number	Contacts	List
92-M	Male	\$.301	92-F	Female	\$.301	92-C	Female	\$.301
92-F1	Female	3.01	92-M1	Male	3.01	92-C1	Male	3.01

Molded Speaker Plugs



Prongs are securely molded into one-piece black bakelite body. Each prong is deeply set into individually molded pocket, eliminating the possibility of shorts in case of pull-back of wire insulation.

With Finger Grip	Prongs	List	With Straight Sides	Prongs	List
71-4	4	\$.13	70-8	8	\$.17
71-5	5	.13	70-9	9	.21
71-6	6	.13	70-12	12	.30
71-7	7	.13	70-20	20	.61

Miniature Plugs



Cable Type used extensively for speaker connections in compact mid-gets. Ideal for all plug-in connections where space is limited. Brass prongs are deeply recessed in molded pockets preventing shorts due to insulation pulling back. With molded finger grip. Use with miniature sockets.



Chassis Type mounts in plain round 5/8" hole. No screws or rivets required. Held firmly by retainer ring included. Use with female miniature connectors (MPF type).

Cable Type	List Price	Description	Chassis Type	List
71-3S	\$.15	3 Prong	86-CP-3S	\$.15
71-4S	.15	4 Prong	86-CP-4S	.15
71-5S	.21	5 Prong		
71-6S	.21	6 Prong		

Cap and Chain



For sealing power plugs and radio connectors against dirt and moisture. Can be used with connectors listed above and below having male threads. Heavy brass cap, chrome plated. Nickel silver bead chain.

No. 79-CCC8 Cap and Chain List \$.61

Heavy Duty Radio Connectors

The plugs shown in bold face type mate with jacks and receptacles listed in bold type in the same horizontal line. For numbers in light faced type follow the same procedure . . . plugs mate with jacks and receptacles in the same horizontal line. Bold type also designates the most popular units.



Plug



Jack



Receptacle

Contacts	Plug		Jack		Receptacle		List
	Male	Female	Female	Male	Female	Male	
4	79-04M	79-04F1	79-04F	79-04M1	79-P04F	79-P04M	\$1.51
5	79-05M	79-05F1	79-05F	79-05M1	79-P05F	79-P05M	1.51
6	79-06M	79-06F1	79-06F	79-06M1	79-P06F	79-P06M	1.51
8	79-08M	79-08F1	79-08F	79-08M1	79-P08F	79-P08M	1.51
12	79-012M	79-012F1	79-012F	79-012M1	79-P012F	79-P012M	2.41

Rectangular Plugs and Sockets



For compact apparatus. Plugs are often used as a supported type self-sustaining coil form.



Style B

Style C

Number	Plugs		List
	Style	Prongs or Contacts	
70-25	B	3	.15
70-26	B	4	.18
Number	Sockets		List
	Style	Prongs or Contacts	
77-26	C	4	.30

Bulb Tester and Tube Socket



Standard 7 contact combination socket for large and small 7 prong tubes. For testing miniature bulbs, either screw or bayonet types.

Number	Description	List
78-7CD	With retainer ring	\$.53

Adapters

A simple way to make adapter units which may be used for modernizing tube checkers and analyzers, adapting new tubes to old circuits and for connections to output meter, phonograph pickup, etc.



Socket Tops Only			Bases Only		
Number	Contacts	List	With side stud accommodating a metal tube grid cap clip. Both tops (left) and bases are drilled for self-tapping screws which are supplied with bases.		
44-8	8 Octal	.24	Number	Prongs	List
For testing new 9 pin miniature tubes.			50-8SG	8 Octal	.36
44-9	9 Noval	.45			

Shell Only

Of metal tubing for snap-in connection on either end of Amphenol "S" type sockets or "CP" plugs. Combinations possible from 4 to 11 prongs or contacts.

No. 3-14D With side hole, rubber grommet List \$.24

Tap Change Switch



An 8-position single pole continuous switch with white markings clearly visible in window cap. Side set screw locks switch arm in position preventing accidental tap changes.

Number	Description	List
36-1	With numerals 1 to 8	\$.90
36-2	With impedance markings 0-2-4-8-16-250-50090

Universal Grid Cap



A grid cap of improved design for universal use with tube grid caps from 1/4 to 3/8" diameter including standard glass and metal tubes. Spring brass contacts in phenolic body.

63-1 Unwired Grid Cap List Price \$.18



ANTENNAS • RACK and PANEL TYPE CONNECTORS • AN TYPE CONNECTORS • FITTINGS and CONDUIT • RF TYPE CONNECTORS • AUDIO CONNECTORS • POWER PLUGS • MINIATURE SOCKETS



3 Contacts



4 Contacts

QWIK Microphone Connectors

AMPHENOL QWIK Microphone Connectors are the newest, the most efficient and certainly the most attractive connectors ever offered for microphone use. Available in 3 or 4 contacts with either male or female plugs or receptacles, the new QWIKs are distinguished not only by their appearance but by their many unique electrical and mechanical features.

Of course it is the remarkable design of the QWIKs which first catches the eye. The plugs are bullet shaped—streamlined perfectly into the deep black cord protector. The receptacles are smaller than any corresponding types yet carry out the clean appearance and sturdy construction typified by the plugs. Both the plug and the receptacle are finished in a rich satin nickle coating. The push buttons are a bright blue accent on the QWIKs. Invisible when the connectors are engaged are the brilliant gold plated contacts and the blue dielectric.

There are many utilitarian features which serve to back up the outward beauty of the QWIKs. All shell bodies are made of high grade zinc alloy—a material much stronger than microphone use demands. The satin nickle finish has excellent resistance to corrosion and has been well proved on other AMPHENOL products. The dielectric material is the famous 1-501 blue, an AMPHENOL developed compound that is also used in military AN

connectors under government specifications. Contacts are high conductivity bronze, gold plated over silver for appearance, easy soldering and indefinite shelf life. The push buttons are made of tough tenite, the same material used for such high impact applications as hammer and chisel handles. QWIKs incorporate a positive type cable clamp to supply internal cable strain relief.

All disconnection of the QWIKs is achieved by simple thumb pressure on the button. Female plugs are released from male receptacles by sliding the button on the plug forward. Male plugs are released from the female receptacle by depressing the button on the receptacle. This method of disconnection has been deliberately designed to prevent accidental disconnect. At the same time there is no hard tugging—QWIKs don't have to be worked loose. Another feature that will be enjoyed by the users of QWIKs is that all disconnection can be easily made by one hand.

3 Contacts

91-853 Male Plug

91-854 Female Plug

91-855 Male Receptacle

91-856 Female Receptacle

4 Contacts

91-857 Male Plug

91-858 Female Plug

91-859 Male Receptacle

91-860 Female Receptacle

(Refer to factory for prices)

Amphenol Radio Frequency Connectors, Continued

Military No.	Amphenol No.	Description	Series	List Each	Military No.	Amphenol No.	Description	Series	List Each
MX-564A/U	82-109	Armor Clamp	N	\$1.50	PL-258	83-1J	Adapter	UHF	\$1.70
MX-913/U	82-106	Cap and Chain	N	1.20	PL-259	83-1SP	Plug	UHF	1.30
MX-1142/U	82-512	Cap and Chain, Jacks	C	2.20	PL-259A	83-1SPN	Plug	UHF	1.50
MX-1143/U	82-513	Cap and Chain, Plugs	C	1.20	PL-259A	83-756	Plug	UHF	4.00
MX-1286/U	82-517	Armor Clamp	C	1.20	PL-274	83-1F	Bulkhead Adapter	UHF	3.00
49188	83-2SP	Plug, Large Twin	UHF	4.20	PL-275	83-22F	Bulkhead Adapter	UHF	3.70
49189	83-2J	Adapter, Large Twin	UHF	3.80	PL-284	83-22SP	Plug, Sm. Twin	UHF	1.70
49190	83-1SP	Plug	UHF	1.30	PL-285	83-22J	Adapter, Sm. Twin	UHF	2.50
49191	83-1J	Adapter	UHF	1.70	PL-293	83-22AP	Right Angle Adapter, Small Twin	UHF	3.20
49192	83-1AP	Right Angle Adapter	UHF	2.80	PL-295	83-2SP	Plug, Large Twin	UHF	4.20
49192A	83-58	Right Angle Adapter	UHF	3.00	PL-305	83-2J	Adapter, Large Twin	UHF	3.80
49193	83-1H	Receptacle Hood	UHF	.50	SO-239	83-1R	Receptacle	UHF	1.20
49194	83-1R	Receptacle	UHF	1.20	SO-239A	83-798	Receptacle	UHF	3.20
49195	83-1SPN	Plug	UHF	1.50	SO-264	83-22R	Receptacle, Small Twin	UHF	1.90
49196	83-2R	Receptacle, Large Twin	UHF	3.00	SO-265	83-2R	Receptacle, Large Twin	UHF	3.00
49199	83-1T	"T" Adapter	UHF	3.20	M-358	83-1T	"T" Adapter	UHF	3.20
49208	83-2H	Receptacle Hood, Large Twin	UHF	.90	M-359	83-1AP	Right Angle Adapter	UHF	2.80
49267	82-64	Right Angle Adapter	N	5.80	M-359A	83-58	Right Angle Adapter	UHF	3.00
49470	82-24	Receptacle	N	2.30	M-360	83-1H	Receptacle Hood	UHF	.50
49482	83-776	Plug	UHF	1.50	M-365	83-2H	Receptacle Hood, Large Twin	UHF	.90
491094	83-1F	Bulkhead Adapter	UHF	3.00					



83-1AP



83-1R



ANTENNAS • RACK and PANEL TYPE CONNECTORS • AN TYPE CONNECTORS • FITTINGS and CON.

DUIT • RF TYPE CONNECTORS • AUDIO CONNECTORS • POWER PLUGS • MINIATURE SOCKETS



Series 75 Microphone Connectors—Single Contact

Fit almost every microphone. Standard with leading manufacturers for many years. Compact, rugged, neat. Chassis receptacles are integral parts of microphones using single conductor cable. Widely used in amplifiers, transmitters, phonoelectric devices, home recorders and similar equipment. They are also suitable for connecting various units such as PM speakers, headphones, and for theft alarms or wall type coin operated devices, etc.

In the 75 Series, plugs mate with all cable jacks and receptacles. Circuit closing contacts are the same except that they close the circuit when plug is disengaged, eliminating open circuit grid howls.

Locknut Receptacles mount in .385" holes when grounding to chassis and 3/8" holes for ungrounded 2 circuit applications.



75-MC1FA
Angle Plug



75-MC1F
Straight Plug



75-MC1M
Cable Jack



75-CL-PC1M **75-PC1M**
Locknut Receptacles



Seals open chassis units against dirt and dust. Also used with 80 Series Connectors. **75-CCC1** . List \$.55
Cl. Cr. Closed Circuit

75-MC1FA Angle Plug		75-MC1F Straight Plug		75-MC1M Cable Jack		75-CL-PC1M / 75-PC1M Locknut Receptacles	
Contact	List	Contact	List	Contact	List	Contact	List
75-MC1F-A Flush	\$1.00	75-MC1F Flush	\$.45	75-MC1M Flush	\$.35	75-PC1M Flush	\$.30
						75-CL-PC1M Cl. Cr.	.45

Phone Plug Adapter



Screws into coupling ring of 75-MC1F and 75-MC1F-A plugs, permitting the cable to be plugged into any standard phone jack. No soldering or wiring.

75-MC1P List \$.50

Microphone Switch

Threaded on one end, coupling ring on the other end. For 75 Series Connectors. May be connected directly to any mike equipped with 75-PC1M or similar receptacle. Push-to-talk or slide button for permanent connection.



75-MC1S List \$1.40

Series 80 Microphone Connectors—Single and Double Contacts



80-MC2M



80-MC2F



80-PC2F

Plugs		Cable Jacks		Locknut Receptacles	
Contacts	List	Contacts	List	Contacts	List
SINGLE CONTACT					
80-M M	\$.71	80-F F	\$.71	80-C F	\$.44
80-F1 F	.71	80-M1 M	.71	80-C1 M	.44
TWO CONTACTS					
80-MC2M M	.88	80-MC2F F	.88	80-PC2F F	.49
80-MC2F1 F	.88	80-MC2M1 M	.88	80-PC2M M	.49

Series 80 Cable Connectors are designed for shielded cables; for single and two conductor coaxial cables, microphone cables; for twisted pairs, concentric lines, photo cell leads, patch cords and similar uses. Suitable for connecting model railroad equipment, pin ball games and other small electrical apparatus. Elements are high dielectric black Bakelite. Receptacles mount in 5/8" chassis holes. Maximum chassis thickness for locknut type receptacles is 11/32".

Mating families of connectors are listed in horizontal lines.

The most popular connectors are shown in bold face type.

Cap and Chain required is 75-CCC1.

M Male. F Female.



91-MC3M



91-MC3F



91-PC3F

Plugs		Cable Jacks		Chassis Receptacles	
Contacts	List	Contacts	List	Contacts	List
THREE CONTACTS					
91-MC3M M	\$1.10	91-MC3F F	\$1.10	91-PC3F F	\$.55
91-MC3F1 F	1.10	91-MC3M1 M	1.10	91-PC3M M	.55
FOUR CONTACTS					
91-MC4M1 M	1.20	91-MC4F F	1.20	91-PC4F F	.60
91-MC4F1 F	1.20	91-MC4M1 M	1.20	91-PC4M M	.60

M Male. F Female. The most popular connectors are shown in bold face type.

Series 91 Microphone Connectors 3 and 4 Contacts

Some of the advantages of Amphenol Series 91 Microphone Connectors . . .

- Accidental disconnections are eliminated by a positive screw-type connection.
- Incorrect insertions are impossible because connectors are polarized.
- Pulling and twisting strain on soldered contacts is eliminated because a squeeze-type clamp grips cable securely after assembly.

Chassis receptacles mount in 27/32" chassis holes. Maximum chassis thickness for chassis receptacle is 1/8".

Mating families of connectors are listed in horizontal lines.

Cap and Chain

For 91 Series Connectors. Same construction and material as No. 75-CCC1.

No. 91-CCC3 List \$.55

TUBE SOCKETS and RADIO COMPONENTS • MICROPHONE CONNECTORS • INDUSTRIAL SOCKETS

RG COAXIAL CABLES • CABLE and WIRE ASSEMBLIES • EXTRUDED and INJECTION MOLDED PLASTICS



14-271 Tubular Twin Lead AIR-CORE



U.S. Patent No.
2543696

AMPHENOL's AIR-CORE Twin-Lead is a superior low-loss lead-in for UHF. It is also ideal for VHF installations requiring long lengths of lead-in.

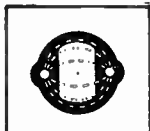

The concentrated field of energy between the two conductors is largely protected by the polyethylene. This field of energy is almost entirely unaffected by exterior conditions.

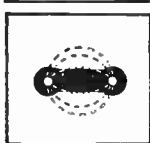

The field of energy in ordinary flat twin-lead is largely outside and exposed to all weather conditions. Under adverse conditions, the loss of flat lead-in will be three times the loss of Tubular Twin-Lead under identical conditions.

300 ohm Twin-lead
14-271 (500) Reels of 500 feet \$72.50
14-271 (1000) Reels of 1000 feet \$70.00

List Per
1000 ft.

End Seal



For use with 14-271 AIR-CORE Tubular Twin-Lead.
66-213.....List per 100 \$5.00

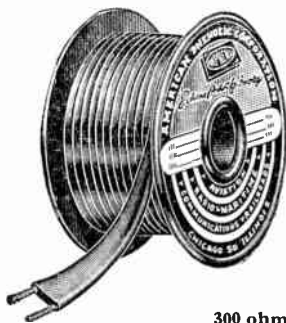

14-080 14-079
14-056 14-023



14-271 14-076



14-022

Twin-Lead Transmission Lines

The use of brown pigmented polyethylene dielectric assures minimum RF loss and a more constant impedance over the exceptionally long life of Amphenol Twin-Lead. This remarkable material remains flexible at -70°C., repels water and is unaffected by acids, alkalis and oils.

Receiving Twin-Lead

300 ohm Twin-Lead for FM and TV Antennas
14-056 (500) & (1000) Brown polyethylene..... \$35.00
150 ohm Twin-Lead for experimental work
14-079 Reels of 1000 feet..... \$26.50
75 ohm Twin-Lead for lower impedance applications
14-080 Reels of 1000 feet..... \$23.50

Amateur Transmitting and Copper Clad Types of Twin-Lead

75 ohm Twin-Lead for transmitting, rated 1 KW RF power
14-023 Reels of 1000 feet..... \$85.25
300 ohm Tubular Twin-Lead rated 1 KW RF power
14-076* Reels of 1000 feet.....
300 ohm Extra-Strength Twin-Lead with copper clad conductors
14-022 Reels of 1000 feet..... \$72.25

*Temporarily Withdrawn from Production

Universal Mast Clamp



Wrap-around mast clamp for Stand-off Insulator. Complete with 66-217 Screw-Eye Insulator.
No. 114-490.....List \$.20
No. 114-492 Same less insulator.....List .10

Universal Mounting Clamp

Will accommodate mast sizes of 1" to 1 1/2" O.D. Two U bolts and channeled plate establish and maintain perfect right angle alignment. Stress to horizontal member is spread over entire length of clamp.

No. 114-500.....List \$.55



Twin-Lead Connector



Solderless, low-loss twin-lead splice without impedance change. Use in pairs.
80-850.....List Each \$.25

Stand-Off Insulators



Universal	Per 100	Flat	Per 100	Coax	Per 100	Description
66-215	\$4.45	66-202	\$4.45	22-201	\$5.44	3 1/2" wood screw
66-217	6.11	66-204	6.11	66-203	6.42	3 1/2" machine screw
66-214	7.64	66-209	7.64	66-208	7.94	7 1/2" wood screw
66-216	8.35	66-210	8.35	66-219	10.00	7 1/2" machine screw
66-218	6.25	66-211	6.25	66-212	7.11	3 1/2" nail-in



Antenna Mast Extensions



Television Mast Extension for 114-302. Includes 5 foot length of 1-1/4" diameter alloy steel tubing, guy ring and two clamp-type stand-off insulators.

114-291.....List ea. \$3.00

FM and Television Mast Extension for FM and Television antennas. Includes 5 foot length 3/4" steel conduit and guy wire clamp.

114-300.....List ea. \$3.00



ISONET

Matching network for combined VHF/UHF installations. Lumped-circuit-constants-filter-network insures low-loss performance. Shielded from rain, snow and dirt by case.

114-061.....List ea. \$3.95



Stand-Off Insulator

For use with 14-056 Twin-Lead. Length 1 5/16". Sturdy, long-lasting.

66-909 ea. \$0.08



Lightning Arrestors



For VHF. Attaches to Flat Twin-Lead without cutting the conductors. UL approved. High resistance shunt permanently sealed against moisture.

115-338.....List ea. \$1.50

For VHF or UHF. New design, universal type for flat, tubular or open wire. UL approved, lowest measurable loss of any arrester on market.

114-328.....List ea. \$1.50



VHF Television Antennas

Engineered and perfected in the Amphenol Antenna Development Laboratories, the antennas illustrated and described on this page will provide unsurpassed reception of FM and VHF signals. Top-quality

materials, rugged construction and the latest in design are incorporated into each Amphenol antenna to provide perfect performance. Each antenna packaged complete with instructions for easy installation.



INLINE*
Single Bay
Model 114-005

*Reissue U.S.
Pat. No. 23,273



Piggy-Back
TV Antenna
Model 114-026

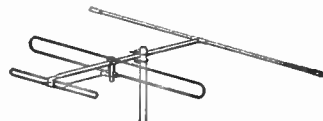

Installers INLINE*
Antenna Kit
Model
114-040

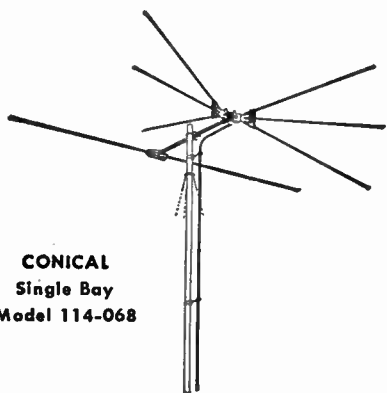

CONICAL
Single Bay
Model 114-068

INLINE*

114-005 TELEVISION ANTENNA ARRAY, complete with mast, swivel mounting plate, guy clamp, necessary hardware, stand-off insulators and 75 ft. Amphenol 300 ohm Twin-Lead.....List ea. \$19.50
114-009 Same less transmission line.....List ea. 17.00

114-301 STACKING KIT for building 114-005 into a Stacked Array includes single bay, connecting rods for symmetrical feed, two box brackets, two 5-foot lengths of 1-1/4" Mast, guy ring and stand-off insulators.....List ea. \$20.50

114-302 TWO BAY TV STACKED ARRAY consists of a top and bottom bay, connecting rods, two box brackets, two 5-foot lengths of 1-1/4" mast, guy ring and stand-off insulators. Twin-Lead transmission line is not included.....List ea. \$35.00

114-322 Same as 114-302 except has 100 ft. 300 ohm Twin-Lead.....List \$38.50

114-314 Same as 114-302 except has no mast.....List 29.00

114-324 Same as 114-302 except has 100 ft. 300 ohm Twin-Lead and has no mast.....List 32.50

114-026 PIGGY-BACK TV ANTENNA consists of one folded dipole and reflector for each band which may be oriented individually, phasing leads, guy clamp, stand-off insulators and 75 ft. Amphenol Twin-Lead.....List ea. \$19.50

114-029 Same less transmission line.....List ea. 17.00

114-040 INSTALLERS INLINE* ANTENNA KIT is furnished without mast, twin-lead or stand-off insulators. Shipped with mounting clamp for masts 3/8" to 1 1/2" O.D.....List ea. \$13.50

CONICAL

114-068 CONICAL single bay VHF antenna.....List ea. \$12.50

114-077 Two Bay CONICAL, complete with Stacking Harness.....List ea. 25.95

114-075 Four Bay CONICAL, complete with Stacking Harnesses.....List ea. 54.95

114-078 Two Bay CONICAL STACKING HARNESS.....List ea. 2.75

114-076 CONICAL KIT, complete with mast, stand-off insulators, flat twin-lead, lightning arrestor and twin-lead connectors.....List ea. 19.50

FM Antennas

114-010 DELUXE FM ALL-DIRECTION DOUBLE FOLDED DIPOLE ANTENNA, complete with quarter-wave phasing stub, mast, mounting plate, guy clamp, hardware, insulators, and 75 ft. Amphenol 300 ohm Twin-Lead.....List ea. \$16.25

114-008 DELUXE FM FOLDED DIPOLE WITH REFLECTOR, complete with mast, mounting plate, insulators, guy clamp, hardware and 75 ft. Amphenol 300 ohm Twin-Lead.....List ea. \$16.25

114-001 FM FOLDED DIPOLE ANTENNA, complete with mast, swivel mounting plate, insulators, guy clamp, necessary hardware and 75 ft. Amphenol 300 ohm Twin-Lead.....List ea. \$12.25

Folded Dipole Amateur Antenna Set

This Antenna Kit has been designed to meet the need for a simple effective folded dipole antenna system. The kit consists of: 2 lengths of #16 copper-clad steel conductor twin-lead—cut to band length, 1 75-foot length of standard 300 ohm twin-lead for lead-in, 1 high strength laminated "T" block and assembly and installation instructions.



Number	Frequency	Band	Length	List
139-010	28 mc	10 meters	20 feet	\$8.90
139-020	14 mc	20 meters	36 feet	10.00
139-040	7 mc	40 meters	68 feet	13.00
139-080	3.5 mc	80 meters	134 feet	18.75



ANTENNAS • RACK and PANEL TYPE CONNECTORS • AN TYPE CONNECTORS • FITTINGS and CON-

DUIT • RF TYPE CONNECTORS • AUDIO CONNECTORS • POWER PLUGS • MINIATURE SOCKETS

UHF TELEVISION ANTENNAS

AMPHENOL makes a complete line of **quality-tested** UHF antennas. Each different model is designed for better performance—each performs with distinction. There are certain features common to all AMPHENOL antennas which have become accepted by dealers and servicemen as the quality values with which to judge any antenna:

high gain and fine directivity, backed up by published charts which are scrupulously honest—sturdy construction and fine materials, backed up by years of dependable service. This combination of superior electrical and mechanical characteristics has made AMPHENOL antennas the **first** choice in fine antennas.

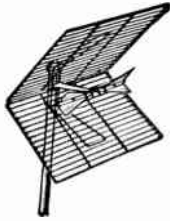

CORNER REFLECTOR is a high gain, exceptionally sturdy antenna that receives all UHF channels, 14 to 83. Single, the **CORNER REFLECTOR** gain reaches a high of 13db, while stacked the gain high is almost 18 db! Directivity patterns reveal one strong major lobe for all channels, single and stacked. Installation of the **CORNER REFLECTOR** is a matter of seconds and this added to its superior performance record has made the AMPHENOL model the number one **CORNER REFLECTOR** type on the market.

- 114-058 CORNER REFLECTOR** List ea. **\$12.50**
114-067 CORNER REFLECTOR STACKING HARNESS List ea. **1.95**

YAGI type UHF antennas are available in 8 custom models, each assigned to a broad channel coverage. Gain is peaked for each model to an average high of 11 db, single, and 13 db, stacked. Because each AMPHENOL **YAGI** will receive so many channels so well it may well be described as the only **broadbanded** UHF **YAGI** available today. State channel or channels wanted when ordering.

- 114-054 YAGI** List ea. **\$5.00**
114-066 YAGI STACKING HARNESS List ea. **\$1.00**

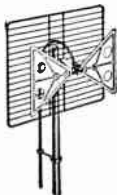

BO-TY AMPHENOL UHF antenna is available single or stacked. Recently re-designed for higher gain, the **BO-TY** is ideal for major signal areas or fringe locations. The single **BO-TY** gain is as high as 8.3 db single and over 12 db stacked. Larger aluminum dipoles, better dielectric material and improved construction are all features of the re-modeled AMPHENOL **BO-TY**.

- 114-062 BO-TY including stacking rod** List ea. **\$5.75**

RHOMBIC is an antenna type that offers needle-sharp directivity and extremely-high gain. The AMPHENOL **RHOMBIC** also features an exclusive **cross-braced** construction that assures long years of installation life. Gain for the **RHOMBIC** rises to almost 14 db!

- 114-060 RHOMBIC** List ea. **\$13.50**

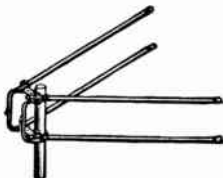
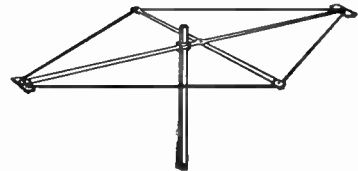

STACKED-V will receive VHF, UHF or both! The angle between the seamless aluminum elements need only be adjusted to provide for each frequency range. Gain and directivity of the AMPHENOL **STACKED-V** are unusually good for an all-channel antenna.

- 114-059 STACKED-V** List ea. **\$9.75**

CANNON PLUGS CANNON ELECTRIC CO.

3209 Humboldt Street, Los Angeles, Calif. • Telephone CApitol 5-1251

Note: All illustrations are not shown in same scale reduction.

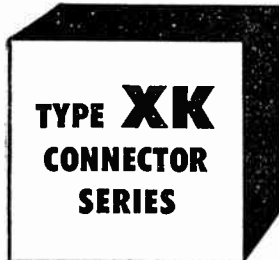

CANNON "TYPE XK" PLUGS AND RECEPTACLES—A quality line of Connectors, same inserts and similar in design to the "Type X" Series, but equipped with the fast-acting, sturdy Acme threaded coupling ring and therefore, ideal for use on equipment which is subjected to considerable vibration and tension on cables, such as on sound trucks and other portable units. XK-1 500v; XK-3 200v; XK-4, 133v service.

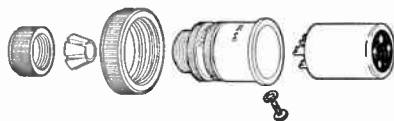

EXPLODED VIEW XK-4-14

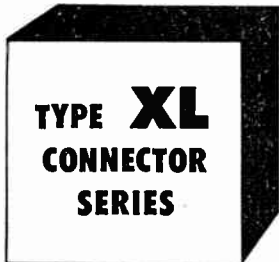

The Cannon Electric Type "XL" Connector combines various features found in other Cannon types into a small fitting comparable only in size to the Type "X" for low level sound transmission circuits. Among the leading features are the following: (1) convenient latchlock device to hold connector tight; (2) lightweight; (3) polarizing means; (4) compression gland with relief spring or integral clamp, if desired; (5) streamlined design; (6) tapped metal for insert retaining screw; (7) provision for special grounding contact and grounding to shell. Contacts are 15-amp. for No. 14 B&S stranded wire in 3 contact insert; 10-amp. in 4 contact insert. Various finishes are available, bright nickel being standard. Steel shell types are available with satin chrome finish. Flashover Voltage 1400-1600v.

(XL Series continued on next page)



TYPE "XK-11" STRAIGHT CORD PLUG (With Socket Insert)
Shell is of die-cast zinc, cad. plated finish. Equipped with quick-acting coupling ring. Solder pot connections are easily accessible. Takes $\frac{1}{8}$ " to $\frac{3}{32}$ " cable. Built for long, dependable service. Mates with -12, -14.

Contacts	Capacity	Wt. Lbs.	Cat. No.	List Pr.
1	15-amp.	0.081	XK-1-11	\$5.50
3	15-amp.	0.083	XK-3-11	5.50
4	{3-10-amp.} {1-15-amp.}	0.085	XK-4-11	7.80



TYPE "XK-12" STRAIGHT CORD PLUG (With Pin Insert)
For use in conjunction with Straight Cord Plug (Socket Insert) or Wall Receptacle (Socket Insert) with coupling nut. Shell is made of die-cast zinc, cad. plated finish. Takes $\frac{1}{8}$ " to $\frac{3}{32}$ " cable.

Contacts	Capacity	Wt. Lbs.	Cat. No.	List Pr.
1	15-amp.	0.081	XK-1-12	\$3.15
3	15-amp.	0.083	XK-3-12	3.15
4	{3-10-amp.} {1-15-amp.}	0.085	XK-4-12	4.75



TYPE "XK-14" WALL RECEPTACLE (With Pin Insert)
Body fits in a $\frac{3}{4}$ " hole and extends $\frac{1}{8}$ " behind a $\frac{1}{8}$ " flange. Flange is $1\frac{1}{2}$ " in diameter, drilled for four #4-40 oval-head mounting screws on a $\frac{5}{8}$ " radius, 90° apart. Shell is made of brass, nickel finish. Solder pots extend $\frac{3}{8}$ " beyond body. Has external Acme thread on shell and mates with straight cord plug XK-11.

Contacts	Capacity	Wt. Lbs.	Cat. No.	List Pr.
1	15-amp.	0.045	XK-1-14	\$3.15
3	15-amp.	0.047	XK-3-14	3.15
4	{3-10-amp.} {1-15-amp.}	0.049	XK-4-14	4.75

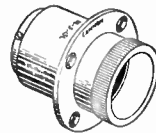

TYPE "XK-13L" WALL RECEPTACLE (With Socket Insert)
Body fits in $1\frac{1}{4}$ " hole and extends $1\frac{1}{8}$ " behind flange. Flange is $1\frac{1}{2}$ " in diameter and drilled for four #4-40 oval-head mounting screws on a $\frac{5}{8}$ " radius, 90° apart. Shell is made of brass, nickel finish. Solder pots on contacts extend $\frac{1}{8}$ " beyond body. Mates with a straight cord plug (Pin Insert) XK-12.

Contacts	Capacity	Wt. Lbs.	Cat. No.	List Pr.
1	15-amp.	0.144	XK-1-13L	\$5.90
3	15-amp.	0.146	XK-3-13L	6.05
4	{3-10-amp.} {1-15-amp.}	0.148	XK-4-13L	7.60

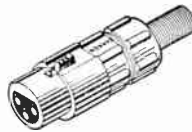

TYPE "XL-11" STRAIGHT CORD PLUG (Socket Insert)
Type XL-11 is equipped with latch lock device and has raised polarizing boss. No. 1 contact engages before Nos. 2 and 3, and may be used for grounding purposes, if desired. $\frac{1}{8}$ " cable accommodation. Overall dimensions: length, $2\frac{3}{4}$ ", with relief spring, $2\frac{3}{4}$ " approx.

Contacts	Capacity	Wt. Lbs.	Cat. No.	List Pr.
3	15-amp.	.099	XL-3-11	\$1.55
4	10-amp.	.099	XL-4-11	2.15



TYPE "XL-12" STRAIGHT CORD PLUG (Pin Insert)
Type XL-12 plug has alignment rib in addition to polarizing groove. Cable accommodation is $\frac{3}{8}$ ". Insert is removable for soldering or inspection. Overall dimensions: length, $1\frac{1}{8}$ ", with cable relief spring, $2\frac{5}{8}$ "; max. diameter $\frac{3}{4}$ ". Insert dia. $\frac{5}{8}$ ".

Contacts	Capacity	Wt. Lbs.	Cat. No.	List Pr.
3	15-amp.	.079	XL-3-12	\$1.50
4	10-amp.	.079	XL-4-12	2.00



TYPE "XL-13" RECEPTACLE (Socket Insert)
A wall mounting receptacle similar to XL-14 except that it has socket insert assembly and latch locking device. Overall dimensions: flange diameter, $1\frac{1}{8}$ "; flange thickness $\frac{3}{8}$ "; rear of flange to solder pot extension $1\frac{1}{8}$ "; dia. barrel, $\frac{1}{4}$ "; three mounting holes drilled .136.

Contacts	Capacity	Wt. Lbs.	Cat. No.	List Pr.
3	15-amp.	.132	XL-3-13	\$1.55
4	10-amp.	.132	XL-4-13	2.15



TYPE "XL-14" RECEPTACLE (Pin Insert)
This wall mounting receptacle has three mounting holes having .136 diameter. Overall dimensions: flange diameter, $1\frac{1}{8}$ "; flange thickness, $\frac{3}{8}$ "; length behind flange to solder pot extension, $1\frac{1}{8}$ "; barrel diameter, $\frac{3}{4}$ ". Material zinc, bright nickel finish.

Contacts	Capacity	Wt. Lbs.	Cat. No.	List Pr.
3	15-amp.	.059	XL-3-14	\$1.20
4	10-amp.	.059	XL-4-14	1.70

CANNON PLUGS CANNON ELECTRIC CO.

3209 Humboldt Street, Los Angeles, Calif. • Telephone CApitol 5-1251

(XL Series continued)

TYPE XL CONNECTOR SERIES

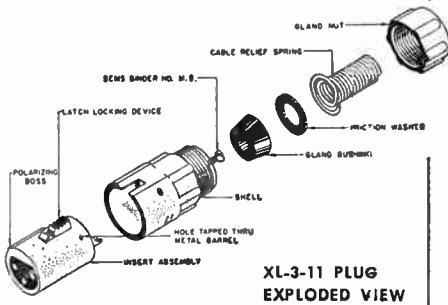

XL-3-11 PLUG EXPLODED VIEW

TWO GANG WALL RECEPTACLES List Pr.

XL-3-35-2G (2 socket inserts).....	\$9.35
XL-4-35-2G (2 socket inserts).....	10.55
XL-3-36-2G (2 pin inserts).....	9.30
XL-4-36-2G (2 pin inserts).....	10.25

TYPE P CONNECTOR SERIES

(P Series continued on next page)



TYPE "XL-13N" RECEPTACLE (Socket Insert)

Similar to XL-14N except has socket insert assembly, with latchlock device, and polarizing boss on insert barrel. No. 1 contact engages before Nos. 2 and 3 and may be used for grounding circuit, if desired. Overall dimensions: flange and barrel and nut are identical to XL-14N, length from face of flange including solder pot extension, 1 1/8".

Contacts	Capacity	Wt. Lbs.	Cat. No.	List Pr.
3	15-amp.	.2112	XL-3-13N	\$1.55
4	10-amp.	.2112	XL-4-13N	2.15

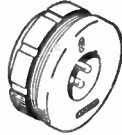

TYPE "XL-14N" RECEPTACLE (Pin Insert)

Designed to be mounted in a panel and has lock nut, accommodating up to 5/8" inch panel. Two fittings may be mounted on a single gang plate. Overall dimensions: flange diameter, 1 1/8"; barrel diameter, 1; width flange to barrel, 3/4", with 1/8" max. solder pot extension; flange thickness, 3/32".

Contacts	Capacity	Wt. Lbs.	Cat. No.	List Pr.
3	15-amp.	.2048	XL-3-14N	\$1.45
4	10-amp.	.2048	XL-4-14N	1.95



TYPE "XL" ADAPTER RECEPTACLES

	List Pr.		List Pr.		List Pr.
XL-3-50	\$1.75	XL-3-50T	\$1.90	XL-3-50N	\$2.15
XL-4-50N	2.40	XL-4-50T	2.60	XL-4-50	3.15

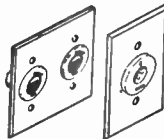

SINGLE GANG WALL RECEPTACLES Type XL-3-35 (Socket Insert)—Face plate similar to type used in P-35. Takes an XL-3-13N Receptacle. Wt. 0.3479.

Cat. No.	List Price	Cat. No.	List Price
XL-3-35	\$4.40	XL-3-36	\$4.45
XL-4-35	4.85	XL-4-36	4.95

TWO-GANG TYPES ALSO AVAILABLE Type XL-3-36 (Pin Insert)—Takes an XL-3-14N Receptacle. Bright nickel finish.



TYPE XL-42 RECEPTACLE (Pin Insert)

The XL-42 Receptacle is similar to the X-42 shown under "X" Fittings, except that it has the XL type insert. For special mounting purposes.

Contacts	Capacity	Wt. Lbs.	Cat. No.	List Pr.
3	15-amp.	0.063	XL-3-42	\$1.50
4	10-amp.	0.063	XL-4-42	1.65



STEEL SHELL PLUGS INTEGRAL CLAMP TYPES—TYPE XL-3-115C PLUG (Socket Insert)—The steel shell type is built for rugged service and has cable entry of 1/4" min., 5/8" max., 3/8" shorter overall shell than zinc type. Otherwise same construction, mating with regular XL receptacle. Bright nickel finish standard.

Contacts	Capacity	Wt. Lbs.	Cat. No.	List Pr.
3	15-amp.	.1333	XL-3-115C	\$3.40
4	10-amp.	.1333	XL-4-115C	4.00



TYPE XL-3-125C PLUG (Pin Insert)

Corresponds to XL-3-12 except that shell is steel with integral clamp. For 5/8" max. entry. Shell is 3/32" shorter in overall length than corresponding zinc shell.

Contacts	Capacity	Wt. Lbs.	Cat. No.	List Pr.
3	15-amp.	.1250	XL-3-125C	\$3.35
4	10-amp.	.1250	XL-4-125C	3.85



TYPE P-CG-115 CORD PLUG COMBINATION STEEL & ZINC (With Socket Insert)—This new type plug with steel shell and integral zinc clamp is 1/16" shorter than the old type and has an overall length of 3 1/8". The new rubber bushing allows a 3/32" D. cable entry, and on P4, P5, P6 and P8 1/2" D. max. cable entry. Satin chrome finish.

Poles	Capacity	Wt. Lbs.	Cat. No.	List Pr.
2	30-amp.	0.202	P2-CG-115	\$6.15
3	30-amp.	0.202	P3-CG-115	6.30
4	30-amp.	0.198	P4-CG-115	6.65
5	30-amp.	0.203	P5-CG-115	7.00
6	30-amp.	0.208	P6-CG-115	7.20
8	15-amp.	0.208	P8-CG-115	7.70

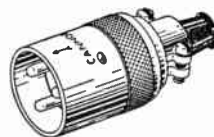

TYPE P-CG-125 CORD PLUG COMBINATION STEEL & ZINC (With Pin Insert)—Similar construction and materials to the -115, except for pin insert. New rubber bushing on P 4 to P 8 fittings is contained within the shell and lines the solder pot cavity. Same cable entry sizes as -115. Satin chrome finish.

Contacts	Capacity	Wt. Lbs.	Cat. No.	List Pr.
2	30-amp.	0.165	P2-CG-125	\$5.00
3	30-amp.	0.168	P3-CG-125	5.15
4	30-amp.	0.164	P4-CG-125	5.30
5	30-amp.	0.168	P5-CG-125	5.40
6	30-amp.	0.172	P6-CG-125	5.65
8	15-amp.	0.168	P8-CG-125	6.00



TYPE P CONNECTOR SERIES

CANNON "TYPE P" FITTINGS. Universally used in sound and allied applications. "Type P" Fittings include a size and type for every requirement, with a high standard of quality. All 90° Plugs have split-shell construction for quick, easy access for wiring or inspection. Splash-proof but not weather-proof. Plug and receptacle dust caps are available. Laboratory tests show an average voltage-drop of not more than 10 millivolts, with current flowing at the rated capacity. Insulating material is black phenolic which has a 0.7% absorption in 24 hours of immersion in water and a dielectric strength of 550 volts per mil at 60 cycles. Two to 6 contact inserts accommodate No. 10 B&S stranded wire; 8 contact insert No. 14 wire. Shell designs of the P-CG-11S and P-CG-12S, cord plugs have such improvements as shorter length, new rubber bushing, improved latch and spring, integral clamp. Shell of plug material is steel, integral clamp zinc.

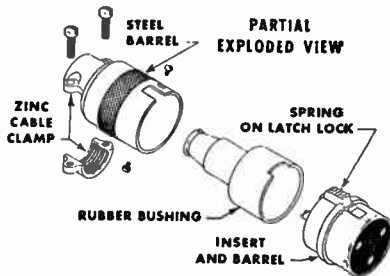

NEW TYPES WILL MATE WITH
SAME CORRESPONDING FITTINGS
AS OLD DESIGN

(P Series continued on next page)



TYPE "P-23" STRAIGHT CORD PLUG (with Socket Insert), HEAVY DUTY—Shell is die-cast zinc for severe service, but employing all features such as the latch type locking device which is standard on "Type P." It has integral clamp for $\frac{3}{4}$ " cable. Also made for $\frac{1}{8}$ " and $\frac{5}{8}$ " cable if specified. Satin chrome finish.

Contacts	Capacity	Wt. Lbs.	Cat. No.	List Pr.
2	30-amp.	0.166	P2-23	\$8.90
3	30-amp.	0.170	P3-23	9.20
4	30-amp.	0.174	P4-23	9.65
5	30-amp.	0.178	P5-23	10.10
6	30-amp.	0.182	P6-23	10.40
8	15-amp.	0.178	P8-23	11.05



TYPE "P-24" STRAIGHT CORD PLUG (with Pin Insert), HEAVY DUTY—Corresponds with "Type P-23" Plug (Socket insert). Built for hard service. The skirt is of steel, body die-cast zinc. Has Integral Clamp, for $\frac{3}{4}$ ", $\frac{5}{8}$ " or $\frac{1}{8}$ " cable, if specified. Satin chrome finish.

Contacts	Capacity	Wt. Lbs.	Cat. No.	List Pr.
2	30-amp.	0.170	P2-24	\$9.00
3	30-amp.	0.173	P3-24	9.20
4	30-amp.	0.176	P4-24	9.35
5	30-amp.	0.179	P5-24	9.55
6	30-amp.	0.182	P6-24	9.95
8	15-amp.	0.179	P8-24	10.40



TYPE "P-CG-15" 90° CORD PLUG (with Socket Insert) Has Split Shell and all other "Type P" features found in "Type P-15, 90° Plug" except cable connection, which is an Integral Clamp for $\frac{1}{2}$ " or smaller cable. Made of zinc shell, satin chrome finish. New, heavier clamp.

Contacts	Capacity	Wt. Lbs.	Cat. No.	List Pr.
2	30-amp.	0.220	P2-CG-15	\$6.90
3	30-amp.	0.224	P3-CG-15	7.15
4	30-amp.	0.228	P4-CG-15	7.50
5	30-amp.	0.232	P5-CG-15	7.80
6	30-amp.	0.236	P6-CG-15	8.00
8	15-amp.	0.232	P8-CG-15	8.50



TYPE "P-CG-16" 90° CORD PLUG (with Pin Insert) Corresponds with Type P-CG-15 90° Plug. (Socket insert), having Integral Clamp for $\frac{1}{2}$ " or smaller cable. Barrel is of steel and shell of cast aluminum alloy, tin plate finish. Removable cap for easy access to contacts for wiring or inspection. New heavier clamp.

Contacts	Capacity	Wt. Lbs.	Cat. No.	List Pr.
2	30-amp.	0.195	P2-CG-16	\$6.45
3	30-amp.	0.198	P3-CG-16	6.55
4	30-amp.	0.201	P4-CG-16	6.65
5	30-amp.	0.204	P5-CG-16	6.80
6	30-amp.	0.207	P6-CG-16	7.10
8	15-amp.	0.204	P8-CG-16	7.40



TYPE "P-17" PANEL RECEPTACLE (with Socket Insert) Surface Mounting—P-17 has Latch Locking Device and all other "Type P" features. Made of die-cast zinc. Satin chrome finish. Flange is 2" in diameter, drilled and countersunk at four points 90° apart on $\frac{1}{8}$ " radius for four #4-40 oval-head M.S. Body extends 1" in front of $\frac{1}{8}$ " mounting flange.

Contacts	Capacity	Wt. Lbs.	Cat. No.	List Pr.
2	30-amp.	0.125	P2-17	\$7.70
3	30-amp.	0.129	P3-17	8.00
4	30-amp.	0.133	P4-17	8.40
5	30-amp.	0.137	P5-17	8.90
6	30-amp.	0.141	P6-17	9.20
8	15-amp.	0.137	P8-17	9.85

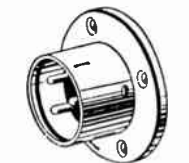

TYPE "P-18" PANEL RECEPTACLE (with Pin Insert) Surface Mounting—Corresponds to "Type P-17," Panel Receptacle. Shell is made of brass, satin chrome finish. Flange is 2" in diameter, drilled and countersunk at four points on $\frac{1}{8}$ " radius for four #4-40 oval-head machine screws.

Contacts	Capacity	Wt. Lbs.	Cat. No.	List Pr.
2	30-amp.	0.156	P2-18	\$4.15
3	30-amp.	0.159	P3-18	4.35
4	30-amp.	0.162	P4-18	4.50
5	30-amp.	0.165	P5-18	4.70
6	30-amp.	0.168	P6-18	5.05
8	15-amp.	0.165	P8-18	5.55



TYPE "P-13" PANEL RECEPTACLE (with Socket Insert) Flush Mounting—Has Latch Locking Device which operates from front of panel. Made of die-cast zinc, satin chrome finish. Flange is 2" in diameter and drilled and countersunk at four points on $\frac{1}{8}$ " radius for four #4-40 oval-head machine screws.

Contacts	Capacity	Wt. Lbs.	Cat. No.	List Pr.
2	30-amp.	0.202	P2-13	\$5.15
3	30-amp.	0.206	P3-13	5.35
4	30-amp.	0.210	P4-13	5.65
5	30-amp.	0.214	P5-13	6.00
6	30-amp.	0.218	P6-13	6.20
8	15-amp.	0.214	P8-13	6.65

CANNON PLUGS CANNON ELECTRIC CO.

3209 Humboldt Street, Los Angeles, Calif. • Telephone CAPITOL 5-1251

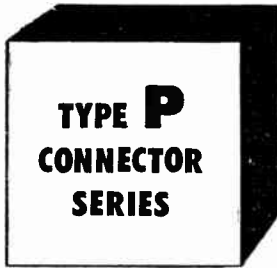

TYPE P CONNECTOR SERIES

ACCESSORY ITEMS DUST CAPS

Fits all "Type P" fittings with pin inserts. Made of brass, cadmium plated, with nickel silver bead chain.



Lbs.	Cat. No.	List
0.081	PPC	\$2.80
0.082	PCI*	3.30

*Type PCI is insulated inside for application where contacts are "hot".

TYPE PRC DUST CAP

Fits all "Type P" fittings with socket inserts. Made of brass, cadmium plated with nickel silver bead chain.



Lbs.	Cat. No.	List
0.095	PRC	\$2.37

MINIMUM FLASHOVER VOLTAGES ON P INSERTS

P2—1600v,	P3—1600v
P4—1900v,	P5—1600v
P6—1600v,	P8—1300v

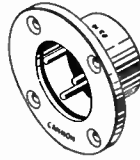

TYPE "P-14" RECEPTACLE (Pin Insert), FLUSH MOUNTING Flange is 2" in diameter, drilled with four .120" diameter holes to take four #4-40 oval-head mounting screws, arranged 90° apart on a radius of 1 1/8". Shell is die-cast zinc, satin chrome finish.

Contacts	Capacity	Wt. Lbs.	Cat. No.	List Pr.
2	30-amp.	0.104	P2-14	\$2.70
3	30-amp.	0.107	P3-14	2.80
4	30-amp.	0.110	P4-14	3.00
5	30-amp.	0.113	P5-14	3.10
6	30-amp.	0.116	P6-14	3.35
8	15-amp.	0.113	P8-14	3.70



TYPE "P-35" SINGLE GANG WALL RECEPTACLE (with Socket Insert)—Furnished with brackets for standard switch box. Shell is die-cast zinc, satin chrome finish. Plate is 4 1/2" high and 2 3/4" wide. Latch Locking Device operates from front of panel.

Contacts	Capacity	Wt. Lbs.	Cat. No.	List Pr.
2	30-amp.	0.341	P2-35	\$8.95
3	30-amp.	0.345	P3-35	9.15
4	30-amp.	0.349	P4-35	9.45
5	30-amp.	0.353	P5-35	9.80
6	30-amp.	0.357	P6-35	10.00
8	15-amp.	0.353	P8-35	10.45

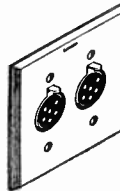

TYPE "P-35-2G" TWO-GANG WALL RECEPTACLE (With Socket Inserts)—Furnished with brackets for standard switch box. Plate is 4 1/2" high and 4 1/2" wide. Both receptacles have Latch Locking Device, operated from front of panel. Shell is die-cast zinc, satin chrome finish.

Contacts	Capacity	Wt. Lbs.	Cat. No.	List Pr.
2	30-amp.	0.448	P2-35-2G	\$18.00
3	30-amp.	0.456	P3-35-2G	18.55
4	30-amp.	0.464	P4-35-2G	19.50
5	30-amp.	0.472	P5-35-2G	20.40
6	30-amp.	0.480	P6-35-2G	20.95
8	15-amp.	0.472	P8-35-2G	22.25



TYPE "P-36" SINGLE GANG WALL RECEPTACLE (With Pin Insert)—Plate is 4 1/2" high and 2 3/4" wide. Furnished with brackets for standard switch box. Made of die-cast zinc, satin chrome finish.

Contacts	Capacity	Wt. Lbs.	Cat. No.	List Pr.
2	30-amp.	0.277	P2-36	\$6.95
3	30-amp.	0.280	P3-36	7.10
4	30-amp.	0.283	P4-36	7.20
5	30-amp.	0.286	P5-36	7.40
6	30-amp.	0.289	P6-36	7.60
8	15-amp.	0.286	P8-36	7.90

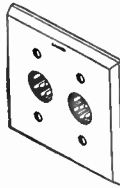

TYPE "P-36-2G" TWO-GANG WALL RECEPTACLE (With Pin Insert)—Plate is 4 1/2" high and 4 1/2" wide. Drilled to take four #6-32 oval-head mounting screws. Furnished with brackets for standard switch box. Made of die-cast zinc, satin chrome finish.

Contacts	Capacity	Wt. Lbs.	Cat. No.	List Pr.
2	30-amp.	0.554	P2-36-2G	\$14.25
3	30-amp.	0.563	P3-36-2G	14.65
4	30-amp.	0.572	P4-36-2G	14.95
5	30-amp.	0.579	P5-36-2G	15.35
6	30-amp.	0.588	P6-36-2G	16.10
8	15-amp.	0.579	P8-36-2G	17.05



TYPE "P-41" 90° MICROPHONE OR PANEL RECEPTACLE (With Socket Insert)—Can be mounted in equipment or instrument panel. Equipped with Latch Locking Device. Cap is removable for easy wiring. Shell is die-cast zinc, finished in black wrinkle enamel.

Contacts	Capacity	Wt. Lbs.	Cat. No.	List Pr.
2	30-amp.	0.249	P2-41	\$11.55
3	30-amp.	0.253	P3-41	11.80
4	30-amp.	0.257	P4-41	12.25
5	30-amp.	0.261	P5-41	12.75
6	30-amp.	0.265	P6-41	13.05
8	15-amp.	0.261	P8-41	13.70



TYPE "P-42" 90° MICROPHONE OR PANEL RECEPTACLE (With Pin Insert)—For mounting on equipment or instrument panel. Cap is removable for easy wiring. Shell is made of die-cast zinc with black wrinkle enamel finish.

Contacts	Capacity	Wt. Lbs.	Cat. No.	List Pr.
2	30-amp.	0.176	P2-42	\$8.40
3	30-amp.	0.179	P3-42	8.65
4	30-amp.	0.182	P4-42	8.80
5	30-amp.	0.185	P5-42	9.00
6	30-amp.	0.188	P6-42	9.35
8	15-amp.	0.185	P8-42	9.85

CANNON PLUGS CANNON ELECTRIC CO.

3209 Humboldt Street, Los Angeles, Calif. • Telephone Capitol 5-1251

TYPE O CONNECTOR SERIES

CANNON "TYPE O" PLUGS AND RECEPTACLES. This series consists of a line of 3-contact oval-shaped plugs and receptacles, equipped with Latch Locking Device, contacts are silver-plated, full-floating, non-twisting, carry 30-amp. capacity. Solder terminals are tinned for ease of wiring. 30-amp. contacts accommodate No. 30 amp. contacts accommodate No. 10 B&S stranded wire. 2400v flashover.



TYPE X CONNECTOR SERIES

CANNON "TYPE X" PLUGS AND RECEPTACLES. The "Type X" Series of small connectors offers inexpensive fittings of reliable quality for sound service, radio, public address systems and geophysical research. In addition to compactness, many exclusive Cannon features are embodied in this series, such as full floating contacts in all socket inserts. Solder pot cable connections are easily accessible. Cable glands are removable. Contacts are so positive that no latching device is needed for ordinary uses. Operating voltages X-1, 500v, X-3, 200v, X-4, 133v.

(X Series continued next page)



TYPE "03-42" MICROPHONE OR PANEL RECEPTACLE (with Pin Insert)—Has flat base, with two lugs for mounting with #4-40 oval-head screws. Made of die-cast zinc, and cadmium plated.

Contacts	Capacity	Wt. Lbs.	Cat. No.	List Pr.
3	30-amp.	0.271	03-42	\$8.65



TYPE "03-41" 90° MICROPHONE OR PANEL RECEPTACLE (Socket Insert)—Flat base is flanged and is attached to microphone or panel by means of two #4-40 oval-head mounting screws. Made of die-cast zinc, cadmium plated.

Contacts	Capacity	Wt. Lbs.	Cat. No.	List Pr.
3	30-amp.	0.274	03-41	\$8.65



TYPE "03-11" STRAIGHT CORD PLUG (with Socket Insert) Has Integral Clamp for $\frac{3}{8}$ " or smaller cable. Made of die-cast zinc, cadmium plated.

Contacts	Capacity	Wt. Lbs.	Cat. No.	List Pr.
3	30-amp.	0.113	03-11	\$6.10

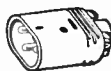

TYPE "03-12" STRAIGHT CORD PLUG (with Pin Insert) Corresponds with No. 03-11 "Type O" Straight Cord Plug (Socket Insert). Has integral cable clamp, for $\frac{3}{8}$ " or smaller cable. Made of die-cast zinc, cadmium plated.

Contacts	Capacity	Wt. Lbs.	Cat. No.	List Pr.
3	30-amp.	0.104	03-12	\$6.10



TYPE "03-13" FLUSH WALL RECEPTACLE (with Socket Insert) Flange is 2" in diameter, drilled with four holes to take #4-40 oval-head mounting screws, 90° apart on a radius of $\frac{1}{8}$ ". Made of die-cast zinc, cadmium plated. Latch Locking Device is operated from panel front.

Contacts	Capacity	Wt. Lbs.	Cat. No.	List Pr.
3	30-amp.	0.148	03-13	\$7.15

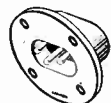

TYPE "03-14" FLUSH WALL RECEPTACLE (with Pin Insert) The flange is 2" in diameter, drilled with four holes to take #4-40 oval-head mounting screws, 90° apart, on a radius of $\frac{1}{8}$ ". Made of die-cast zinc, cadmium plated.

Contacts	Capacity	Wt. Lbs.	Cat. No.	List Pr.
3	30-amp.	0.107	03-14	\$7.15



TYPE "X-11" CORD PLUG (with Socket Insert) Sturdily built for dependable service. Light in weight. Shell is die-cast, zinc nickel finish. Will take $\frac{3}{8}$ " to $\frac{3}{2}$ " cable. Used in conjunction with the following: X-14 Wall Receptacle, X-12 Straight Cord Plug, and X-42 Microphone Receptacle X-44L Receptacle.

Contacts	Capacity	Wt. Lbs.	Cat. No.	List Pr.
1	15-amp.	0.081	X-1-11	\$2.30
3	15-amp.	0.083	X-3-11	2.30
4	{ 3-10-amp. } { 1-15-amp. }	0.085	X-4-11	4.25



TYPE "X-12" CORD PLUG (with Pin Insert) For use in conjunction with X-11 Straight Cord Plug (Socket Insert) or X-13 Wall Receptacle (Socket Insert). Shell is die-cast zinc, nickel finish. Will take $\frac{3}{8}$ " to $\frac{3}{2}$ " cable.

Contacts	Capacity	Wt. Lbs.	Cat. No.	List Pr.
1	15-amp.	0.061	X-1-12	\$2.05
3	15-amp.	0.063	X-3-12	1.65
4	{ 3-10-amp. } { 1-15-amp. }	0.065	X-4-12	3.00

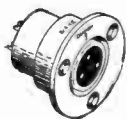

TYPE "X-13" WALL RECEPTACLE (with Socket Insert) Body fits in $\frac{7}{8}$ " hole and extends $1\frac{1}{8}$ " behind flange. Flange is $1\frac{3}{8}$ " in diameter and drilled for three #4-40 oval-head screws on $\frac{1}{8}$ " radius 120° apart. Shell is die-cast zinc, nickel finish. To be used in conjunction with the following X-12.

Contacts	Capacity	Wt. Lbs.	Cat. No.	List Pr.
1	15-amp.	0.081	X-1-13	\$2.30
3	15-amp.	0.083	X-3-13	2.30
4	{ 3-10-amp. } { 1-15-amp. }	0.085	X-4-13	4.25

CANNON PLUGS CANNON ELECTRIC CO.

3209 Humboldt Street, Los Angeles, Calif. • Telephone Capitol 5-1251

(Continued from previous page)

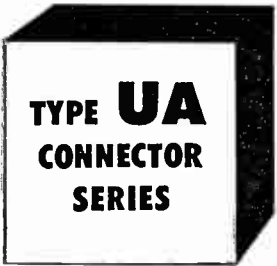
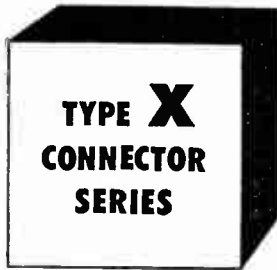

The UA Series of audio connectors designed in cooperation with the RETMA Committee has all the features of Type P, O and XL and, in addition, the following: (1) gold-plated contacts for long life and "no noise" (2) double protection rubber relief collar and rubber bushings (3) flat-top polarization for finger-touch action (4) stronger and better latch lock (5) steel plug shells and insert barrel (6) spring-action insert removal—no screws.

Insulators are high dielectric, molded general-purpose phenolic. 15-amp. contacts with 2400 v. minimum flashover; for No. 14 B&S stranded wire. Max. cable entry is 1/2". Write for special UA Bulletin for complete details.

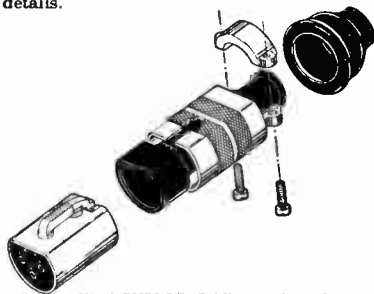

SEMI-EXPLODED VIEW UA-3-11

showing rubber cushion that fits over pin contacts to avoid shocks, provide protection from moisture, improve insulation factors.

(UA Series continued next page)

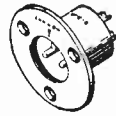

TYPE "X-14" WALL RECEPTACLE (With Pin Insert)

Body fits in 3/4" hole and extends 3/8" behind the flange, which is 1 1/2" in diameter and drilled for three #4-40 oval-head screws on 1/2" radius, 120° apart. Shell is zinc, nickel plated finish. Used in conjunction with straight cord plug (Socket Insert) X-11. Solder pots extend 1/4" beyond rear of body.

Contacts	Capacity	Wt. Lbs.	Cat. No.	List Pr.
1	15-amp.	0.040	X-1-14	\$1.65
3	15-amp.	0.042	X-3-14	1.65
4	{3-10-amp. 1-15-amp.}	0.044	X-4-14	3.00



TYPE "X-42" MICROPHONE RECEPTACLE (With Pin Insert)

Has all the features of "Type X" Straight Cord Plugs and Wall Receptacles but it is mounted on a flat base. Shell is die-cast zinc, nickel finish. Use with X-11 straight Cord Plug (Socket Insert). Mounting holes are .144" in diameter and 1" apart.

Contacts	Capacity	Wt. Lbs.	Cat. No.	List Pr.
3	15-amp.	0.063	X-3-42	\$1.65



TYPE UA-3-11 PLUG (Socket Insert)

The UA-11 plug is approximately 3 1/2" long, including rubber bushing; 1 1/8" maximum width and 1 1/2" thickness. Steel shell and barrel. Mates with UA-12, UA-32 and UA-42.

Contacts	Capacity	Wt. Lbs.	Cat. No.	List Pr.
3	15-amp.	0.15	UA-3-11	\$5.35



TYPE UA-3-12 PLUG (Pin Insert)

The UA-12 plug is approximately 3 1/4" long, including rubber relief collar. Steel shell. Mates with UA-3-11, UA-3-13, UA-3-31.

Contacts	Capacity	Wt. Lbs.	Cat. No.	List Pr.
3	15-amp.	0.11	UA-3-12	\$4.40



TYPE UA-3-13 RECEPTACLE (Socket Insert)

The UA-13 Receptacle has a round flange compared to the rectangular flange of the UA-31. Three mounting holes are provided, .120 diameter countersunk for #4 flat head machine screws. Mates with UA-3-12.

Contacts	Capacity	Wt. Lbs.	Cat. No.	List Pr.
3	15-amp.	0.14	UA-3-13	\$4.10

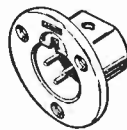

TYPE UA-3-14 RECEPTACLE (Pin Insert)

The UA-14 Receptacle has a flange construction similar to the UA-13. Barrel extends 3/8" behind flange with 3/8" solder pot extension. A 3/4" dia. (1") hole is required to mount. Mates with UA-3-11.

Contacts	Capacity	Wt. Lbs.	Cat. No.	List Pr.
3	15-amp.	0.08	UA-3-14	\$2.50



TYPE UA-3-31 RECEPTACLE (Socket Insert)

The UA-31 Receptacle has a rectangular flange construction, and extends 1 1/2" behind flange plus 3/8" max. solder pot extension and requires a 1" hole for 3/4" dia. barrel. Mates with UA-3-12.

Contacts	Capacity	Wt. Lbs.	Cat. No.	List Pr.
3	15-amp.	0.13	UA-3-31	\$4.10

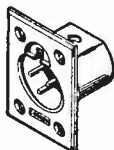

TYPE UA-3-32 RECEPTACLE (Pin Insert)

The UA-3-32 Receptacle is similar to UA-31. Barrel extends 3/8" plus 1/2" max. solder pot extension behind flange, and requires a 1" hole for 3/4" dia. barrel. Mates with XL-3-11.

Contacts	Capacity	Wt. Lbs.	Cat. No.	List Pr.
3	15-amp.	0.07	UA-3-32	\$2.50

CANNON PLUGS CANNON ELECTRIC CO.

3209 Humboldt Street, Los Angeles, Calif. • Telephone CApital 5-1251

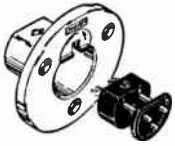

UA-3-14
EXPLODED VIEW

TYPE K(BP) CONNECTOR SERIES

For telephone recording connectors made by large suppliers of telephone equipment. The SK (BP) Plug and Receptacle are used widely for telephone equipment.

TYPE M1 CONNECTOR SERIES

UL APPROVED

"TYPE M1-4" PLUGS AND RECEPTACLES. For Power and Heavy Duty Circuits Four-Contact Plugs and Receptacles are U.L. approved for 250/dc, 600/ac 30-amp. service. Cable fittings have a clamp for $\frac{1}{8}$ " or smaller cable. Shells are of aluminum alloy. Cadmium plated. Pins and sockets cannot be forced out of alignment or broken by forcing together out of correct alignment. Pin contacts are brass of the split-compression type. The majority of drawings of M1-4 connectors shown are approximately $\frac{1}{2}$ actual size. See M2-1950 or M3-1952 Bulletins for complete dimensional data and engineering information.

(M1 Series continued next page)



TYPE UA-3-42 RECEPTACLE (Pin Insert)

The UA-42 is a special mounting receptacle adaptable to microphones and other applications where it is advisable to mount receptacle parallel to the equipment, etc. Similar to XL-42 and X-42 types.

Contacts	Capacity	Wt. Lbs.	Cat. No.	List Pr.
3	15-amp.	0.08	UA-3-42	\$4.95



TYPE SK (BP)-M7-21C- $\frac{1}{2}$ PLUG (With Socket Insert)

$\frac{1}{2}$ " clamp entry, mates with receptacle shown below.

Contacts	Capacity	Wt. Lbs.	Cat. No.	List Pr.
7	{ 3-10-amp. { 4-30-amp. }	0.66	BP-M7-21C- $\frac{1}{2}$	\$4.73

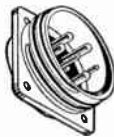

TYPE SK (BP)-M7-32S RECEPTACLE (With Pin Insert)

Mounting receptacle for BP-M7-21C- $\frac{1}{2}$ " plug shown above. Center line to center line mounting holes 1.038".

Contacts	Capacity	Wt. Lbs.	Cat. No.	List Pr.
7	{ 3-10-amp. { 4-30-amp. }	0.04	BP-M7-32S	\$1.98



TYPE "M1-4-21" STRAIGHT CORD PLUGS (With Socket Insert)

Shell has integral clamp accommodating $\frac{1}{8}$ " cable or smaller.

Contacts	Capacity	Wt. Lbs.	Cat. No.	List Pr.
4	30-amp.	0.750	M-4-21	\$12.25

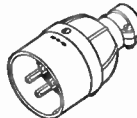

TYPE "M1-4-22" STRAIGHT CORD PLUGS (With Pin Insert)

Shell has integral clamp accommodating $\frac{1}{8}$ " cable or smaller.

Contacts	Capacity	Wt. Lbs.	Cat. No.	List Pr.
4	30-amp.	0.938	M1-4-22	\$12.25



TYPE "M1-4-23" 90° CORD PLUGS (With Socket Insert)

Integral clamp for $\frac{1}{8}$ " cable or smaller.

Contacts	Capacity	Wt. Lbs.	Cat. No.	List Pr.
4	30-amp.	0.781	M1-4-23	\$12.25



TYPE "M1-4-24" 90° CORD PLUGS (With Pin Insert)

Integral clamp for $\frac{1}{8}$ " cable or smaller.

Contacts	Capacity	Wt. Lbs.	Cat. No.	List Pr.
4	30-amp.	0.782	M1-4-24	\$12.25



TYPE "M1-4-25" 90° HANDLE TYPE CORD PLUGS (With Socket Insert)

Contacts	Capacity	Wt. Lbs.	Cat. No.	List Pr.
4	30-amp.	0.859	M1-4-25	\$14.70



TYPE "M1-4-26" 90° HANDLE TYPE CORD PLUGS (With Pin Insert)

Contacts	Capacity	Wt. Lbs.	Cat. No.	List Pr.
4	30-amp.	1.094	M1-4-26	\$14.70

CANNON PLUGS CANNON ELECTRIC CO.

3209 Humboldt Street, Los Angeles, Calif. • Telephone CAPITOL 5-1251

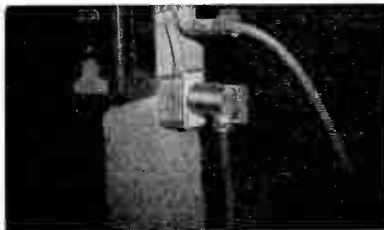
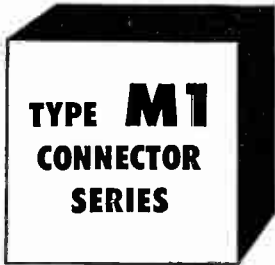

APPLICATION

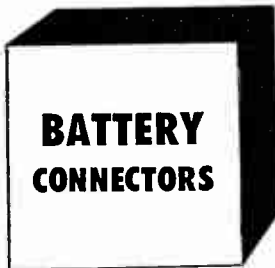

Cannon Battery Connectors shown here are limited to two plug and one receptacle types. Their major use is for connection and disconnection of battery circuits for oil field engine starting. Shells of plugs are rubber; receptacle aluminum alloy, cadmium plate finish.

For detailed drawings and data, see Battery Bulletin.



TYPE "M1-4-30" ROUND SURFACE WALL RECEPTACLES
Flange $3\frac{1}{2}$ " diameter. Four mounting holes, 90° apart on a $1\frac{1}{2}$ " radius for #6 oval-head screws.

Contacts	Capacity	Wt. Lbs.	Cat. No.	List Pr.
4	30-amp.	0.532	M1-4-30	\$12.25



TYPE "M1-4-33" ROUND FLUSH WALL MOUNTING RECEPTACLES—Flange $3\frac{1}{2}$ " diameter. Four mounting holes, 90° apart on a $1\frac{1}{2}$ " radius for #6 flat-head screws.

Contacts	Capacity	Wt. Lbs.	Cat. No.	List Pr.
4	30-amp.	0.578	M1-4-33	\$16.00

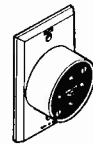

TYPE "M1-4-35" SURFACE RECEPTACLES (With Socket Insert)
Designed to fit Single-Gang Switch Box, Plate $4\frac{1}{2}$ " high and $2\frac{3}{4}$ " wide. Two #6 flat-head screws.

Contacts	Capacity	Wt. Lbs.	Cat. No.	List Pr.
4	30-amp.	0.468	M1-4-35	\$12.25

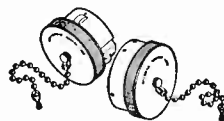

"TYPE M1" DUST CAPS—for Fittings with Socket Insert.
Lbs. Cat. No. List Pr.
0.500 M1-59A \$7.40

"TYPE M1" DUST CAPS—for Fittings with Pin Inserts.
Lbs. Cat. No. List Pr.
0.562 M1-60A \$7.40

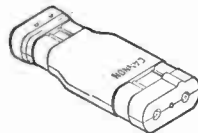

TYPE GB-3-21CF PLUG (With Socket Contacts)
Two 3/0 contacts, rated 600-amp., one No. 8 contact, 40-amp. mates with GB-3-34CDS Receptacle.

Contacts	Capacity	Wt. Lbs.	Cat. No.	List Pr.
3	600 & 40-amp.	1.16	GB-3-21CF	\$11.75

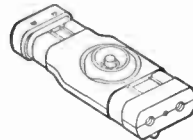

TYPE GB-3-21CFS PLUG (With Socket Contacts)
The main difference between this and above plug is the switch which eliminates arcing upon engagement of disengagement.

Contacts	Capacity	Wt. Lbs.	Cat. No.	List Pr.
3	600 & 40-amp.	1.16	GB-3-21CFS	\$14.95

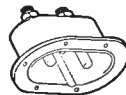

TYPE GB-3-34CDS RECEPTACLE (With Pin Contacts)
Mating receptacle to above two plugs.

Contacts	Capacity	Wt. Lbs.	Cat. No.	List Pr.
3	600 & 40-amp.	1.031	GB-3-34CDS	\$4.50

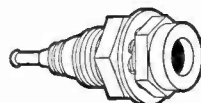

TEST POINT JACKS
High quality phone tip jack to accommodate standard ATMA 0.081 dia. phone tip for laboratory use. Rugged construction, nylon insulation for maximum life under hard usage. See Bulletin TJ-1 for details.

Contacts	Capacitance	Wt. Lbs.	Cat. No.	List Pr.
1	5-7ufd	0.006	45E	\$0.60

CANNON PLUGS CANNON ELECTRIC CO.

3209 Humboldt Street, Los Angeles, Calif. • Telephone Capitol 5-1251

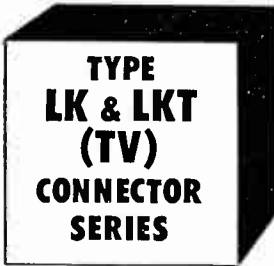

The TV (LK & LKT) connectors are used on television cameras and related equipment, and are a part of the Cannon "K" series. The assemblies with the "LK" prefix are standard "K", those prefixes with "LKT" have special shells and/or cable entry construction.

The R24C insert has the following arrangement of 24 contacts: 3 #16 coaxials, 21 ±14 contacts. Shells are aluminum alloy cadmium plated; insulators are melamine, contacts brass, silver plated.

LKT DUST CAPS



For pin insert assemblies. Chain 6 $\frac{3}{4}$ " long, Eyelet 1 $\frac{1}{2}$ " dia.

Cat. No.	Wt. Lbs.	List Price
LKT-60A-2	0.113	\$3.80

For socket insert assemblies.

Cat. No.	Wt. Lbs.	List Price
LKT-59A-2	0.147	\$3.03



HERMETICALLY SEALED

The sub-miniature "U" series is hermetically sealed on the receptacle side with vitreous insulation. The Plug side has resilient insulation. Steel shells, cadmium plate, bleached iridite finish. Contacts 1, 3, 6, and 12; 5-amp. contacts. 1700v flashover dc, 1000v (ac rms) solder pot terminals standard. eyelet optional. For the U-002 types, contact factory.

(U Series continued next page)

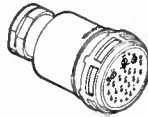

TYPE LKT-R24C-21-7/8 PLUG (With Socket Insert)

Special long end bell and coupling means include gland nut, friction washer, bushing, gland washer and packing ring to support cable.

Contacts	Cat. No.	Wt. Lbs.	List Pr.
24	LKT-R24C-21-7/8	1.01	\$19.75



TYPE LKT-R24C-22-7/8 PLUG (With Pin Insert)

Same basic construction as LKT-R24C-21-7/8, except pin insert exterior thread, rubber bumper ring.

Contacts	Cat. No.	Wt. Lbs.	List Pr.
24	LKT-R24C-22-7/8	0.860	\$19.90



TYPE LKT-R24C-23-7/8 ANGLE 90° PLUG (With Socket Insert)

Similar to above fittings except for shell style which is a special 90° type shell. 7/8" cable entry.

Contacts	Cat. No.	Wt. Lbs.	List Pr.
24	LKT-R24C-23-7/8	1.04	\$31.03



TYPE LKT-R24C-24-7/8 ANGLE 90° PLUG (With Pin Insert)

Similar to above except for pin insert, exterior thread and rubber bumper ring.

Contacts	Cat. No.	Wt. Lbs.	List Pr.
24	LKT-R24C-24-7/8	0.772	\$31.70

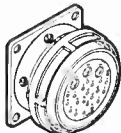

TYPE LK-R24C-315 RECEPTACLE (With Socket Insert)

Wall or box-mounting receptacle with four 0.169 dia. mounting holes 2.077", 2 $\frac{3}{8}$ " square flange.

Contacts	Cat. No.	Wt. Lbs.	List Pr.
24	LK-R24C-315	0.372	\$10.61



TYPE LK-R24C-325 RECEPTACLE (With Pin Insert)

Similar to above receptacle except for exterior thread.

Contacts	Cat. No.	Wt. Lbs.	List Pr.
24	LK-R24C-325	0.183	\$8.00

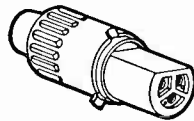

TYPE U-11 PLUGS (Socket Insert)

Silcan (silicone) resilient insulation mates with corresponding UC-50-002, UC-50N-302, UC-12-002.

Contacts	Cat. No.	Wt. Lbs.	List Pr.
3	UC-3-11	0.0011	\$2.67
6	UD-6-11	0.0187	3.27
12	UE-12-11	0.0265	4.23



TYPE U-50-002 RECEPTACLES (Pin Insert)

For solder applications; hermetically sealed. Mates with corresponding UC-11 Plug.

Contacts	Cat. No.	Wt. Lbs.	List Pr.
3	UC-3-50-002	0.0066	\$1.57
6	UD-6-50-002	0.0121	1.97
12	UE-12-50-002	0.0150	2.67



TYPE U-50N-302 RECEPTACLES (Pin Insert)

Locknut for Mechanical application including a lockwasher. Mates with corresponding U-11.

Contacts	Cat. No.	Wt. Lbs.	List Pr.
3	UC-3-50N-302	0.0077	\$2.55
6	UD-6-50N-302	0.0139	3.02
12	UE-12-50N-302	0.0298	3.89

CANNON PLUGS CANNON ELECTRIC CO.

3209 Humboldt Street, Los Angeles, Calif. • Telephone CApitol 5-1251

TYPE U subminiature CONNECTOR SERIES

TYPE D subminiature CONNECTOR SERIES

Type "D" sub-miniatures are small, compact, lightweight connectors in 4 sizes, having 15, 25, 37, or 50 gold-plated contacts of 5-amp. current, flashover 1700v. dc peak, 1200v ac rms. Wire size #20; steel shell, finish cadmium plate, bleached iridite. Rack type can be used to connect and make a movable plug with addition of junction shell. Insulation is high dielectric Nylon FM 10001, keystone polarization. Contact resistance 4.56 (8 max) milliohms per ampere. See "D" Bulletin for complete data.

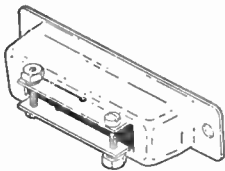

"D" JUNCTION SHELLS

Fit Pin or Socket Assemblies.

Cat. No.	Wt. Lbs.	List Pr.
DA-J/S	0.010	\$.35
DB-J/S	0.014	.40
DC-J/S	0.014	.45
DD-J/S	0.016	.50



TYPE UD-6-50N-302 RECEPTACLE (Pin Insert)

Vitreous insulation. Locknut for panel mounting application. Mates with UD-6-11, UD-12-50N-302.

Contacts	Cat. No.	Wt. Lbs.	List Pr.
6	UD-6-50N-302	0.014	\$3.02
12	UE-12-50N-302	0.030	3.88



TYPE UD-6-50-002 RECEPTACLE (Pin Insert)

Vitreous insulation; hermetically sealed with solder application.

Contacts	Cat. No.	Wt. Lbs.	List Pr.
6	UD-6-50-002	0.012	\$1.97
12	UE-12-50-002	0.015	2.67

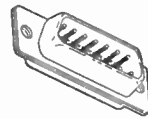

TYPE DA-15P CONNECTOR (Pin Insert)

(approx. actual size)

Contacts	Cat. No.	Wt. Lbs.	List Pr.
15	DA-15P	0.013	\$2.57

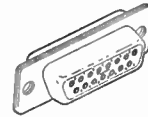

TYPE DA-15S CONNECTOR (Socket Insert)

Contacts	Cat. No.	Wt. Lbs.	List Pr.
15	DA-15S	0.014	\$3.10

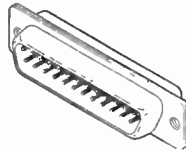

TYPE DB-25P CONNECTOR (Pin Insert)

Contacts	Cat. No.	Wt. Lbs.	List Pr.
25	DB-25P	0.023	\$3.67

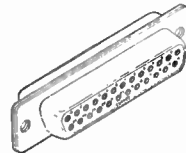

TYPE DP-25S CONNECTOR (Socket Insert)

Contacts	Cat. No.	Wt. Lbs.	List Pr.
25	DP-25S	0.031	\$4.57

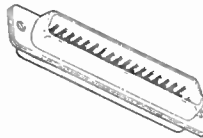

TYPE DC-37P CONNECTOR (Pin Insert)

Contacts	Cat. No.	Wt. Lbs.	List Pr.
37	DC-37P	0.035	\$5.20



TYPE DC-37S CONNECTOR (Socket Insert)

Contacts	Cat. No.	Wt. Lbs.	List Pr.
37	DC-37S	0.035	\$6.53

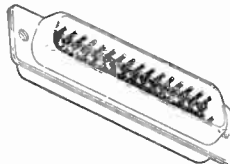

TYPE DD-50P CONNECTOR (Pin Insert)

Contacts	Cat. No.	Wt. Lbs.	List Pr.
50	DD-50P	0.035	\$6.77

TYPE DD-50S CONNECTOR (Socket Insert)

Contacts	Cat. No.	Wt. Lbs.	List Pr.
50	DD-50S	0.040	\$8.60

CANNON PLUGS CANNON ELECTRIC CO.

3209 Humboldt Street, Los Angeles, Calif. • Telephone CApitol 5-1251

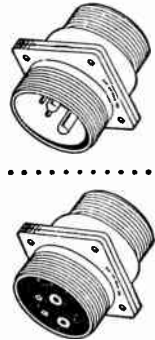
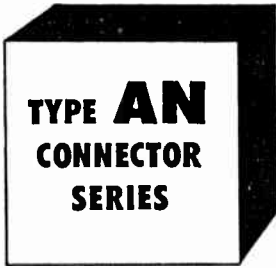

TYPE AN3100A WALL MOUNTING RECEPTACLE

The Type "AN" Series is designed and made according to specific military standards. While the outstanding feature of the "AN" series is interchangeability, the quality and design features have made it widely applicable to non-military and commercial uses. The military specification "AN" finish is cadmium plate with olive drab. The recommended commercial finish is cadmium plate only. Socket contacts are of the quality closed entry type. The "AN" connectors shown in this catalog have plastic inserts. Other assemblies are available in pressurized, environment resisting, and fireproof types. This catalog lists only "AN" connectors available from jobbers. For complete information on all "AN" and associated types, write for latest "AN" bulletin.

ASSEMBLY NUMBER	LIST PRICE	ASSEMBLY NUMBER	LIST PRICE	ASSEMBLY NUMBER	LIST PRICE
AN3100A-85-1P	\$1.07	AN3100A-165-3P	1.27	AN3100A-20-15P	2.57
AN3100A-85-1S	1.17	AN3100A-165-3S	1.37	AN3100A-20-15S	2.77
AN3100A-105-2P	1.10	AN3100A-165-4P	1.37	AN3100A-20-27P	2.90
AN3100A-105-2S	1.20	AN3100A-165-4S	1.50	AN3100A-20-27S	3.27
AN3100A-105L-3P	1.37	AN3100A-165-5P	1.47	AN3100A-20-29P	3.20
AN3100A-105L-4P	1.27	AN3100A-165-5S	1.60	AN3100A-20-29S	3.97
AN3100A-125-3P	1.27	AN3100A-165-6P	1.47	AN3100A-22-14P	3.53
AN3100A-125-3S	1.37	AN3100A-165-6S	1.60	AN3100A-22-14S	4.00
AN3100A-125-4P	1.17	AN3100A-165-8P	1.67	AN3100A-22-19P	3.03
AN3100A-125-4S	1.23	AN3100A-165-8S	1.87	AN3100A-22-19S	3.40
AN3100A-12-5P	1.20	AN3100A-16-2P	1.33	AN3100A-24-5P	3.40
AN3100A-12-5S	1.30	AN3100A-16-2S	1.43	AN3100A-24-5S	3.80
AN3100A-14S-1P	1.43	AN3100A-16-7P	1.70	AN3100A-24-7P	3.50
AN3100A-14S-1S	1.57	AN3100A-16-7S	2.00	AN3100A-24-7S	3.90
AN3100A-14S-2P	1.53	AN3100A-16-9P	1.67	AN3100A-24-28P	4.20
AN3100A-14S-2S	1.67	AN3100A-16-9S	1.83	AN3100A-24-28S	4.77
AN3100A-14S-4P	1.23	AN3100A-16-10P	1.63	AN3100A-28-11P	4.50
AN3100A-14S-4S	1.30	AN3100A-16-10S	1.77	AN3100A-28-11S	5.07
AN3100A-14S-5P	1.63	AN3100A-16-11P	1.47	AN3100A-28-12P	4.70
AN3100A-14S-5S	1.80	AN3100A-16-11S	1.60	AN3100A-28-12S	5.37
AN3100A-14S-6P	1.73	AN3100A-16-12P	1.80	AN3100A-28-15P	5.60
AN3100A-14S-6S	1.90	AN3100A-16-12S	2.07	AN3100A-28-15S	6.43
AN3100A-14S-7P	1.43	AN3100A-16-13P	2.37	AN3100A-28-21P	5.80
AN3100A-14S-7S	1.57	AN3100A-16-13S	2.60	AN3100A-28-21S	6.67
AN3100A-14S-9P	1.33	AN3100A-18-1P	2.40	AN3100A-32-7P	7.07
AN3100A-14S-9S	1.43	AN3100A-18-1S	2.70	AN3100A-32-7S	7.90
AN3100A-14-3P	1.47	AN3100A-18-10P	2.00	AN3100A-32-8P	6.50
AN3100A-14-3S	1.70	AN3100A-18-10S	2.17	AN3100A-32-8S	7.27
AN3100A-16S-1P	1.87	AN3100A-18-11P	2.17	AN3100A-36-7P	8.67
AN3100A-16S-1S	2.10	AN3100A-18-11S	2.33	AN3100A-36-7S	9.80
		AN3100A-20-7P	2.30	AN3100A-36-8P	8.37
		AN3100A-20-7S	2.57	AN3100A-36-8S	9.50

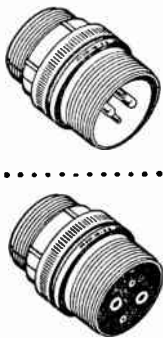

TYPE AN3101B CABLE EXTENSION RECEPTACLE

AN3101B-8S-1P	1.37	AN3101B-12-5S	1.77	AN3101B-16-7S	2.50
AN3101B-8S-1S	1.47	AN3101B-14S-1P	1.87	AN3101B-16-9P	2.20
AN3101B-10S-2P	1.43	AN3101B-14S-1S	2.00	AN3101B-16-9S	2.37
AN3101B-10S-2S	1.53	AN3101B-14S-2P	1.97	AN3101B-16-10P	2.13
AN3101A-105L-3P	1.77	AN3101B-14S-2S	2.13	AN3101B-16-10S	2.27
AN3101A-105L-4P	1.67	AN3101B-14S-4P	1.67	AN3101B-16-11P	2.00
AN3101B-12S-3P	1.63	AN3101B-14S-4S	1.77	AN3101B-16-11S	2.10
AN3101B-12S-3S	1.73	AN3101B-14S-5P	2.07	AN3101B-16-12P	2.30
AN3101B-12S-4P	1.53	AN3101B-14S-5S	2.27	AN3101B-16-12S	2.57
AN3101B-12S-4S	1.63	AN3101B-14S-6P	2.17	AN3101B-16-13P	2.87
AN3101B-12-5P	1.67	AN3101B-14S-6S	2.37	AN3101B-16-13S	3.10
		AN3101B-14S-7P	1.87	AN3101B-18-1P	2.93
		AN3101B-14S-7S	2.00	AN3101B-18-1S	3.23
		AN3101B-14S-9P	1.77	AN3101B-18-10P	2.53
		AN3101B-14S-9S	1.90	AN3101B-18-10S	2.70
		AN3101B-14-3P	2.00	AN3101B-18-11P	2.70
		AN3101B-14-3S	2.23	AN3101B-18-11S	2.87
		AN3101B-16S-1P	2.37	AN3101B-20-15P	3.13
		AN3101B-16S-1S	2.60	AN3101B-20-15S	3.37
		AN3101B-16S-3P	1.77	AN3101B-20-27P	3.47
		AN3101B-16S-3S	1.87	AN3101B-20-27S	3.87
		AN3101B-16S-4P	1.87	AN3101B-24-28P	4.97
		AN3101B-16S-4S	2.00	AN3101B-24-28S	5.57
		AN3101B-16S-5P	1.97	AN3101B-28-11P	5.43
		AN3101B-16S-5S	2.10	AN3101B-28-11S	6.00
		AN3101B-16S-6P	1.97	AN3101B-28-12P	5.63
		AN3101B-16S-6S	2.10	AN3101B-28-12S	6.27
		AN3101B-16S-8P	2.17	AN3101B-28-15P	6.53
		AN3101B-16S-8S	2.37	AN3101B-28-15S	7.36
		AN3101B-16-2P	1.83	AN3101B-28-21P	6.73
		AN3101B-16-2S	1.93	AN3101B-28-21S	7.60
		AN3101B-16-7P	2.23		

(AN Series cont. next page)

CANNON PLUGS CANNON ELECTRIC CO.

3209 Humboldt Street, Los Angeles, Calif. • Telephone CApitol 5-1251

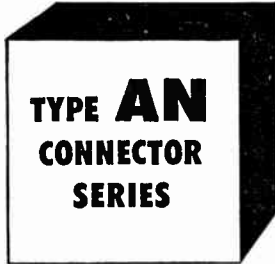

**TYPE
AN3102A
BOX
MOUNTING
RECEPTACLE**

ASSEMBLY NUMBER	LIST PRICE	ASSEMBLY NUMBER	LIST PRICE
AN3102A-85-1P	.70	AN3102A-16-10P	1.23
AN3102A-85-1S	.80	AN3102A-16-10S	1.37
AN3102A-10S-2P	.73	AN3102A-16-11P	1.10
AN3102A-10S-2S	.83	AN3102A-16-11S	1.20
AN3102A-10SL-3P	1.00	AN3102A-16-12P	1.40
AN3102A-10SL-4P	.90	AN3102A-16-12S	1.67
AN3102A-12S-3P	.90	AN3102A-16-13P	1.97
AN3102A-12S-3S	1.00	AN3102A-16-13S	2.20
AN3102A-12S-4P	.80	AN3102A-18-1P	2.00
AN3102A-12S-4S	.87	AN3102A-18-1S	2.30
AN3102A-12-5P	.87	AN3102A-18-10P	1.60
AN3102A-12-5S	.93	AN3102A-18-10S	1.77
AN3102A-14S-1P	1.07	AN3102A-18-11P	1.77
AN3102A-14S-1S	1.17	AN3102A-18-11S	1.97
AN3102A-14S-2P	1.17	AN3102A-20-7P	1.90
AN3102A-14S-2S	1.30	AN3102A-20-7S	2.17
AN3102A-14S-4P	.87	AN3102A-20-75	2.17
AN3102A-14S-4S	.93	AN3102A-20-15P	2.17
AN3102A-14S-5P	1.27	AN3102A-20-15S	2.37
AN3102A-14S-5S	1.43	AN3102A-20-27P	2.50
AN3102A-14S-6P	1.37	AN3102A-20-27S	2.87
AN3102A-14S-6S	1.53	AN3102A-20-29P	2.80
AN3102A-14S-7P	1.07	AN3102A-20-29S	3.57
AN3102A-14S-7S	1.17	AN3102A-22-14P	3.10
AN3102A-14S-9P	.97	AN3102A-22-14S	3.60
AN3102A-14S-9S	1.07	AN3102A-22-19P	2.60
AN3102A-14-3P	1.33	AN3102A-22-19S	3.00
AN3102A-14-3S	1.47	AN3102A-24-5P	2.97
AN3102A-16S-1P	1.70	AN3102A-24-5S	3.37
AN3102A-16S-1S	.87	AN3102A-24-7P	3.07
AN3102A-16S-3P	.97	AN3102A-24-7S	3.47
AN3102A-16S-3S	.97	AN3102A-24-75	3.77
AN3102A-16S-4P	1.10	AN3102A-24-8S	4.33
AN3102A-16S-4S	1.07	AN3102A-28-11P	4.07
AN3102A-16S-5P	1.23	AN3102A-28-11S	4.63
AN3102A-16S-5S	1.07	AN3102A-28-12P	4.27
AN3102A-16S-6P	1.23	AN3102A-28-12S	4.90
AN3102A-16S-6S	1.27	AN3102A-28-15P	5.17
AN3102A-16S-8P	1.47	AN3102A-28-15S	6.00
AN3102A-16S-8S	.93	AN3102A-28-21P	5.37
AN3102A-16-2P	1.03	AN3102A-28-21S	6.23
AN3102A-16-2S	1.33	AN3102A-32-7P	6.13
AN3102A-16-7P	1.60	AN3102A-32-7S	6.97
AN3102A-16-7S	1.30	AN3102A-32-8P	5.57
AN3102A-16-9P	1.47	AN3102A-32-8S	6.33
AN3102A-16-9S	1.47	AN3102A-36-7P	7.67
		AN3102A-36-7S	8.80
		AN3102A-36-8P	7.37
		AN3102A-36-8S	8.50



**TYPE
AN3106B
STRAIGHT
CORD
PLUG**

AN3106B-14S-2P	1.77	AN3106B-18-1P	2.73
AN3106B-14S-2S	1.93	AN3106B-18-1S	3.03
AN3106B-14S-4P	1.47	AN3106B-18-10P	2.33
AN3106B-14S-4S	1.57	AN3106B-18-10S	2.50
AN3106B-14S-5P	1.87	AN3106B-18-11P	2.47
AN3106B-14S-5S	2.03	AN3106B-18-11S	2.67
AN3106B-14S-6P	1.97	AN3106B-20-7P	2.70
AN3106B-14S-6S	2.17	AN3106B-20-7S	2.97
AN3106B-14S-7P	1.67	AN3106B-20-15P	2.97
AN3106B-14S-7S	1.80	AN3106B-20-15S	3.20
AN3106B-14S-9P	1.57	AN3106B-20-27P	3.30
AN3106B-14S-9S	1.67	AN3106B-20-27S	3.67
AN3106B-14-3P	1.83	AN3106B-20-29P	3.60
AN3106B-14-3S	2.07	AN3106B-20-29S	4.37
AN3106B-16S-1P	2.17	AN3106B-22-14P	3.97
AN3106B-16S-1S	2.40	AN3106B-22-14S	4.47
AN3106B-16S-3P	1.57	AN3106B-22-19P	3.47
AN3106B-16S-3S	1.67	AN3106B-22-19S	3.87
AN3106B-16S-4P	1.67	AN3106B-24-5P	3.83
AN3106B-16S-4S	1.80	AN3106B-24-5S	4.23
AN3106B-16S-5P	1.77	AN3106B-24-7P	3.93
AN3106B-16S-5S	1.90	AN3106B-24-7S	4.33
AN3106B-16S-6P	1.77	AN3106B-24-8P	4.63
AN3106B-16S-6S	1.90	AN3106B-24-8S	5.20
AN3106B-16S-8P	1.97	AN3106B-28-11P	4.97
AN3106B-16S-8S	2.17	AN3106B-28-11S	5.53
AN3106B-16-2P	1.67	AN3106B-28-12P	5.17
AN3106B-16-2S	1.77	AN3106B-28-12S	5.80
AN3106B-16-7P	2.07	AN3106B-28-15P	6.07
AN3106B-16-7S	2.37	AN3106B-28-15S	6.90
AN3106B-16-9P	2.03	AN3106B-28-21P	6.26
AN3106B-16-9S	2.20	AN3106B-28-21S	7.13
AN3106B-16-10P	1.97	AN3106B-32-7P	6.90
AN3106B-16-10S	2.13	AN3106B-32-7S	7.77
AN3106B-16-11P	1.83	AN3106B-32-8P	6.37
AN3106B-16-11S	1.97	AN3106B-32-8S	7.10
AN3106B-16-12P	2.17	AN3106B-36-7P	9.57
AN3106B-16-12S	2.43	AN3106B-36-7S	10.73
AN3106B-16-13P	2.70	AN3106B-36-8P	9.27
AN3106B-16-13S	2.93	AN3106B-36-8S	10.43

ASSEMBLY NUMBER	LIST PRICE
AN3106B-85-1P	1.20
AN3106B-85-1S	1.27
AN3106B-10S-2P	1.27
AN3106B-10S-2S	1.37
AN3106B-10SL-3S	1.67
AN3106B-10SL-4S	1.53
AN3106B-12S-3P	1.43
AN3106B-12S-3S	1.53
AN3106B-12S-4P	1.33
AN3106B-12S-4S	1.43
AN3106B-12-5P	1.47
AN3106B-12-5S	1.57
AN3106B-14S-1P	1.67
AN3106B-14S-1S	1.80

CANNON PLUGS CANNON ELECTRIC CO.

3209 Humboldt Street, Los Angeles, Calif. • Telephone CApitol 5-1251

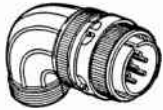

TYPE
AN3108B
ANGLE 90°
CORD
PLUG



ASSEMBLY NUMBER	LIST PRICE
AN3108B-85-1P	1.30
AN3108B-85-1S	1.37
AN3108B-105-2P	1.37
AN3108B-105-2S	1.47
AN3108B-105L-3S	1.77
AN3108B-105L-4S	1.67
AN3108B-125-3P	1.53
AN3108B-125-3S	1.67
AN3108B-125-4P	1.43
AN3108B-125-4S	1.53
AN3108B-12-5P	1.53
AN3108B-12-5S	1.63
AN3108B-145-1P	1.80
AN3108B-145-1S	1.93
AN3108B-145-2P	1.90
AN3108B-145-2S	2.03

AN3108B-145-4P	1.60	AN3108B-18-1S	3.17
AN3108B-145-4S	1.67	AN3108B-18-10P	2.47
AN3108B-145-5P	2.00	AN3108B-18-10S	2.63
AN3108B-145-5S	2.17	AN3108B-18-11P	2.60
AN3108B-145-6P	2.10	AN3108B-18-11S	2.80
AN3108B-145-6S	2.27	AN3108B-20-7P	2.83
AN3108B-145-7P	1.80	AN3108B-20-7S	3.10
AN3108B-145-7S	1.93	AN3108B-20-15P	3.10
AN3108B-145-9P	1.70	AN3108B-20-15S	3.33
AN3108B-145-9S	1.80	AN3108B-20-27P	3.43
AN3108B-14-3P	1.90	AN3108B-20-27S	3.80
AN3108B-14-3S	2.13	AN3108B-20-29P	3.73
AN3108B-165-1P	2.27	AN3108B-20-29S	4.50
AN3108B-165-1S	2.50	AN3108B-22-14P	4.10
AN3108B-165-3P	1.67	AN3108B-22-14S	4.60
AN3108B-165-3S	1.77	AN3108B-22-19P	3.60
AN3108B-165-4P	1.77	AN3108B-22-19S	4.00
AN3108B-165-4S	1.90	AN3108B-24-5P	4.00
AN3108B-165-5P	1.87	AN3108B-24-5S	4.40
AN3108B-165-5S	2.03	AN3108B-24-7P	4.10
AN3108B-165-6P	1.87	AN3108B-24-7S	4.50
AN3108B-165-6S	2.03	AN3108B-24-28P	4.80
AN3108B-165-8P	2.07	AN3108B-24-28S	5.37
AN3108B-165-8S	2.27	AN3108B-28-11P	5.10
AN3108B-16-2P	1.77	AN3108B-28-11S	5.67
AN3108B-16-2S	1.87	AN3108B-28-12P	5.30
AN3108B-16-7P	2.17	AN3108B-28-12S	5.97
AN3108B-16-7S	2.47	AN3108B-28-15P	6.20
AN3108B-16-9P	2.13	AN3108B-28-15S	7.03
AN3108B-16-9S	2.30	AN3108B-28-21P	6.40
AN3108B-16-10P	2.07	AN3108B-28-21S	7.27
AN3108B-16-10S	2.23	AN3108B-32-7P	7.07
AN3108B-16-11P	1.93	AN3108B-32-7S	7.93
AN3108B-16-11S	2.07	AN3108B-32-8P	6.53
AN3108B-16-12P	2.27	AN3108B-32-8S	7.27
AN3108B-16-12S	2.53	AN3108B-36-7P	9.93
AN3108B-16-13P	2.80	AN3108B-36-7S	11.07
AN3108B-16-13S	3.03	AN3108B-36-8P	9.63
AN3108B-18-1P	2.87	AN3108B-36-8S	10.77

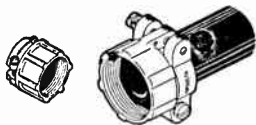

TYPE
AN3057
CABLE
CLAMPS

AN3057-3	.47	AN3057-3A	.60
AN3057-4	.47	AN3057-4A	.60
AN3057-6	.47	AN3057-6A	.63
AN3057-8	.53	AN3057-8A	.63
AN3057-10	.57	AN3057-10A	.67
AN3057-12	.63	AN3057-12A	.77
AN3057-16	.73	AN3057-16A	1.20



TYPE
AN3111
BONDING
RINGS

ASSEMBLY NUMBER	LIST PRICE
AN3111-4	.13
AN3111-7	.20
AN3111-8	.23



TYPE
AN3420
BUSHING

ASSEMBLY NUMBER	LIST PRICE
AN3420-3	.13
AN3420-4	.13
AN3420-6	.17
AN3420-8	.17
AN3420-10	.20
AN3420-12	.20
AN3420-16	.23

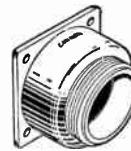

TYPE
2120
STRAIGHT
JUNCTION
SHELLS

ASSEMBLY NUMBER	LIST PRICE
CA2120-4	.62
CA2120-5	.67



TYPE
2209
DUST CAPS
WITH CHAIN

ASSEMBLY NUMBER	LIST PRICE
CA2209-1	1.17
CA2209-2	1.17
CA2209-3	1.17
CA2209-4	1.17
CA2209-5	1.17
CA2209-6	1.27
CA2209-7	1.27
CA2209-8	1.40
CA2209-9	1.40
CA2209-10	1.50



TYPE
2322
DUST CAPS
WITHOUT CHAIN

ASSEMBLY NUMBER	LIST PRICE
CA2322-1	1.03
CA2322-2	1.03
CA2322-3	1.03
CA2322-4	1.03
CA2322-5	1.03
CA2322-6	1.13
CA2322-7	1.13
CA2322-8	1.23
CA2322-9	1.23
CA2322-10	1.37



TYPE
17530
DUST CAPS
WITH CHAIN

ASSEMBLY NUMBER	LIST PRICE
CA17530-8	2.13
CA17530-10	2.17
CA17530-12	2.20
CA17530-13	2.23
CA17530-14	2.23
CA17530-15	2.63
CA17530-16	2.63
CA17530-17	2.80
CA17530-18	2.80
CA17530-20	2.87
CA17530-22	2.97
CA17530-24	3.47
CA17530-28	4.77

(K Series cont. next page)

CANNON PLUGS CANNON ELECTRIC CO.

3209 Humboldt Street, Los Angeles, Calif. • Telephone CApitol 5-1251



**TYPE
19741
DUST
CAPS
WITHOUT CHAIN**

ASSEMBLY NUMBER	LIST PRICE	CA19741-15	2.53
CA19741-8	2.03	CA19741-16	2.53
CA19741-10	2.07	CA19741-17	2.63
CA19741-12	2.10	CA19741-18	2.63
CA19741-13	2.13	CA19741-20	2.73
CA19741-14	2.13	CA19741-22	2.80
		CA19741-24	3.30
		CA19741-28	3.37



458 to 475



476 to 443



494 to 511

**TYPE
"025"
PLASTIC
PROTECTIVE
CAPS**

025-482-00	.07
025-483-00	.07
025-484-00	.07
025-485-00	.09
025-486-00	.09
025-487-00	.10
025-488-00	.12
025-489-00	.12
025-490-00	.14
025-491-00	.15
025-492-00	.17
025-493-00	.19
025-494-00	.05
025-495-00	.05
025-496-00	.05
025-497-00	.05
025-498-00	.07
025-499-00	.07
025-500-00	.07
025-501-00	.09
025-502-00	.10
025-503-00	.10
025-504-00	.12
025-505-00	.15
025-507-00	.07
025-508-00	.07
025-509-00	.07
025-510-00	.09
025-511-00	.14

ASSEMBLY NUMBER	LIST PRICE	025-470-00	.10
025-458-00	.05	025-471-00	.12
025-459-00	.05	025-472-00	.12
025-460-00	.05	025-473-00	.14
025-461-00	.07	025-474-00	.15
025-462-00	.07	025-475-00	.17
025-463-00	.07	025-476-00	.05
025-466-00	.07	025-477-00	.05
025-467-00	.09	025-478-00	.07
025-468-00	.09	025-479-00	.07
025-469-00	.09	025-480-00	.07
		025-481-00	.07

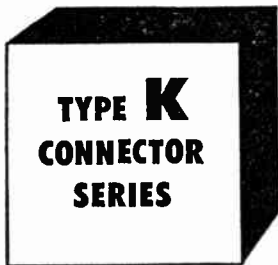

**TYPE K
CONNECTOR
SERIES**

The Type "K" Series were developed to meet the demands for a lighter and more compact electrical circuit quick disconnect fitting for aircraft. The "K" series preceded the "AN" series, and many features of the "K" connector were incorporated into the "AN" design. Since that time, the "K" series has undergone numerous changes, improvements, and additions in both shell sizes, types and insert arrangements. K's and RK's are used on aircraft interphone wing disconnects, D.F. loops, propeller cut-out switches, transmitters, instrument panels, Geiger-Muller counters, cathode ray recorders, ocellographs, fast-battery chargers, television cameras, phone recorder control circuits, power circuits, potentiometers, etc.



**TYPE
K-21
STRAIGHT
PLUG**

ASSEMBLY NUMBER	LIST PRICE
5K-19-21-1/2 AC & AN	4.33
1K-26-21-1"B & AN	7.60
LK-A50-21-1"B & AN	11.95



**TYPE
K-21C
STRAIGHT
PLUG
Integral Clamp**

ASSEMBLY NUMBER	LIST PRICE
WK-M2-21C 7/8	2.85
WK-C3-21C 7/8	3.45
WK-4-21C 1/2	3.05

WK-4-21C 3/8	3.05
WK-55-21C 1/2	3.40
WK-6-21C 1/2	3.25
GK-9-21C 1/2	3.65
GK-12-21C 3/8	3.95
SK-C7-21C 3/4	4.49
SK-19-21C 1/2	4.94
SK-M7-21C 1/2	4.74
NK-12-21C 3/8	4.84
NK-12-21C 1	4.84
NK-L15-21C 3/4	5.17
NK-27-21C 7/8	6.22
IK-26-21C 7/8	8.22
IK-30-21C 7/8	8.35
LK-37-21C-1"	10.66
LK-A50-21C-1"	12.59

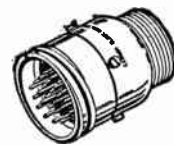

**TYPE
K-22
STRAIGHT
PLUG**

ASSEMBLY NUMBER	LIST PRICE
SK-19-22-1/2 AC & AN	4.52

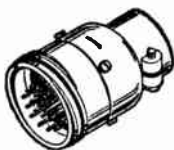

**TYPE
K-22C
STRAIGHT
PLUG
Integral Clamp**

ASSEMBLY NUMBER	LIST PRICE
WK-M2-22C 7/8	3.29
WK-55-22C 1/2	3.56
WK-6-22C 1/2	3.61
GK-9-22C 1/2	4.00
GK-12-22C 3/8	4.24
SK-C7-22C 3/4	4.26
NK-12-22C 3/8	5.28
NK-27-22C 3/8	6.36
IK-30-22C 7/8	9.15
RIK-26-22C 7/8	9.43
LK-37-22C-1"	11.59
RNK-L15-22C 3/4-1	5.74
RNK-L15-22C 3/4	5.74
RNK-27-22C 3/8	6.55

CANNON PLUGS CANNON ELECTRIC CO.

3209 Humboldt Street, Los Angeles, Calif. • Telephone CApitol 5-1251

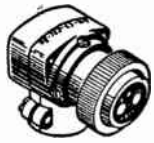

TYPE
K-23C
ANGLE 90°
PLUGS

ASSEMBLY NUMBER	LIST PRICE
WK-C3-23C $\frac{7}{8}$	3.86
WK-C3-23C $\frac{3}{8}$	3.86
GK-12-23C $\frac{5}{8}$	4.34
NK-27-23C $\frac{5}{8}$	6.68
IK-26-23C $\frac{7}{8}$	8.95

SAME AS
K-31SL
EXCEPT
SMALLER
FLANGE

ASSEMBLY NUMBER	LIST PRICE
WK-M2-31S	3.25
WK-55-31S	3.80
GK-12-31S	4.49

TYPE
K-31S
BOX
MOUNTING
RECEPTACLE

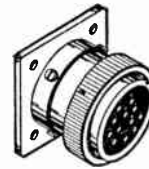

TYPE
K-31SL
BOX
MOUNTING
RECEPTACLE

ASSEMBLY NUMBER	LIST PRICE
WK-6-31SL	3.98
GK-9-31SL	4.52
SK-C7-31SL	5.55
NK-12-31SL	6.10
RNK-L15-31SL	4.43



TYPE
K-32S
BOX
MOUNTING
RECEPTACLE

ASSEMBLY NUMBER	LIST PRICE
WK-M2-32S	1.20
WK-C3-32S	1.34
WK-4-32S	1.36
WK-55-32S	1.47
WK-6-32S	1.52

GK-12-32S	2.07
SK-19-32S	2.82
SK-M7-32S	1.97
NK-27-32S	3.76
FK-19-32S	4.05
IK-26-32S	5.30
IK-30-32S	5.37

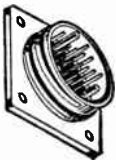

TYPE
K-32SL
LARGE
FLANGE
RECEPTACLE

ASSEMBLY NUMBER	LIST PRICE
GK-9-32SL	1.87
SK-C7-32SL	1.96
NK-12-32SL	2.72
NK-L15-32SL	2.99
NK-27-32SL	3.80



TYPE
K-59A-2
DUST
CAPS

ASSEMBLY NUMBER	LIST PRICE
GK-59 A-2	1.78
SK-59 A-2	1.96
NK-59 A-2	2.33
IK-59 A-2	3.63
LK-59 A-2	4.62

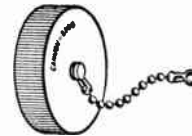

TYPE
K-60A-2
DUST
CAPS

ASSEMBLY NUMBER	LIST PRICE
GK-60 A-2	1.60
SK-60 A-2	1.73
NK-60 A-2	2.05
IK-60 A-2	3.22
LK-60 A-2	4.10
RNK-60 A-2	2.00

OTHER CANNON PLUG SERIES

AVAILABLE FROM

CANNON DISTRIBUTORS

BY SPECIAL ARRANGEMENT

DBP



DPD

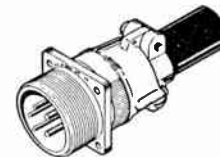
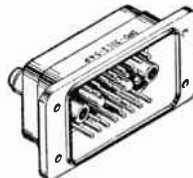

AN-''E''

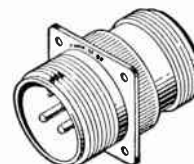

AN-''K''

HUBBELL



Interlock

TRADE-MARK

INTERLOCK TYPE "A" CONNECTORS and ACCESSORIES 10 AMPERE CAPACITY — CONTACT PRESSURE 24 OZS.

Interlock Straight Plugs are available with either crimp or solder terminals. In combination with a connector, which is also available with crimp or solder terminal, Interlock Plugs offer an automatic lock—"quick disconnect" separable wire connection. Splicing Links will receive a plug at both ends.



101A30 STRAIGHT PLUG
(Crimping Terminal)
Price.....\$17.75 per C



109A40 CONNECTOR
(Crimping Terminal)
Price.....\$11.50 per C



111A41 EYELET PANEL JACK
(Solder Terminal)
Price.....\$3.55 per C



124A31 STRAIGHT PLUG
(Solder Terminal)
Price.....\$20.00 per C



131A41 CONNECTOR
(Solder Terminal)
Price.....\$14.00 per C



116A43 JACK
(Screw Terminal)
Price.....\$10.00 per C



110A49 SPLICING LINK
Price.....\$14.00 per C



117A49 JACK
(Terminal Post Adaptor)
Price.....\$8.00 per C

**ANGLE PLUG
JUMPER CORDS**

		Per C
132A19	Black 6" wire	\$187.50
133A19	Red 6" wire	187.50
134A19	Black 12" wire	191.50
135A19	Red 12" wire	191.50
136A19	Black 24" wire	200.50
137A19	Red 24" wire	200.50
138A19	Black 36" wire	210.00
139A19	Red 36" wire	210.00

**PLASTIC and RUBBER
INSULATED ANGLE PLUG**
(With 4 ft. Rubber Covered Wire)

102A19—Black	103A19—Red
Price.....\$137.00 per C	



**PLASTIC ENTRY
JACK**
112A21—Black
113A21—Red
\$63.00 per C



**METAL ENTRY
JACK**
114A21—Black
115A21—Red
\$55.00 per C



**WATERPROOF
PLASTIC JACK**
126A21—Black
127A21—Red
\$60.50 per C

INTERLOCK TYPE "B" MINIATURE CONNECTORS and ACCESSORIES 5 AMPERE CAPACITY — CONTACT PRESSURE 10 OZS.



401B30 STRAIGHT PLUG
(Crimping Terminal)
Price.....\$19.00 per C



411B40 CONNECTOR
(Crimping Terminal)
Price.....\$13.00 per C



410B41 JACK
(Solder Terminal)
Price.....\$6.50 per C



409B43 JACK
(Screw Terminal)
Price.....\$11.50 per C



424B31 STRAIGHT PLUG
(Solder Terminal)
Price.....\$19.00 per C



**413B49
SPLICING LINK**
Price.....\$10.00 per C



414B41 EYELET PANEL JACK
Price.....\$3.35 per C



**122A91 TYPE "A"
EYELET SETTING
PUNCH**
Price \$1.25 ea. List

INTERLOCK TYPE "B" FLEXIBLE TERMINAL STRIPS

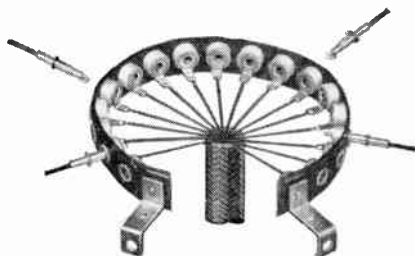

- | | |
|--|----------|
| | Per C |
| 450B94 TERMINAL STRIP, CLEAR—20"..... | \$668.00 |
| 451B94 TERMINAL STRIP, RED—20"..... | 668.00 |
| 452B94 TERMINAL STRIP, BLUE—20"..... | 668.00 |
| 453B94 TERMINAL STRIP, GREEN—20"..... | 668.00 |
| 454B94 TERMINAL STRIP, GOLD—20"..... | 668.00 |
| 455B99 MOUNTING STRAP | |
| 456B99 #2-56 ROUND HEAD SCREW | |
| 457B99 #5-36 ROUND HEAD SCREW | |
| 460B94 TERMINAL STRIP SET | |
| Includes 4 colored and one clear strip in 20 inch lengths; 5 mounting straps; 5 #2-56 screws and 5 #5-36 screws per strip, 49 eyelets in each strip. | |
| Price \$34.00 per Set List | |

May be used in a press or with a hammer to mount 111A41 Jacks in insulated boards or strips.

**422B91 TYPE "B"
EYELET SETTING
PUNCH**
Price \$1.25 ea. List

May be used in a press or with a hammer to mount 414B41 Jacks in insulated boards or strips.

**121Y91 INTERLOCK
PLIERS**
Price \$3.00 ea. List

For use on crimping terminals of "A" and "B" Plugs.



HARVEY HUBBELL, INC BRIDGEPORT, CONN., U.S.A.

HUBBELL



Interlock

TRADE-MARK

Automatic Locking . . . Quick Disconnect Electrical Connectors

LOCK AUTOMATICALLY **VIBRATION and PULL PROOF** **CONSTANT LOW RESISTANCE**

INTERLOCK TEST PROD COUPLERS and ATTACHMENTS INTERCHANGEABLE ATTACHMENTS LOCK AUTOMATICALLY

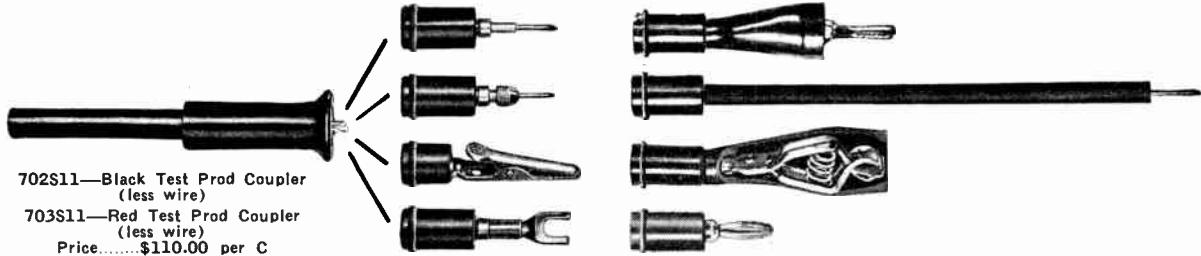

702S11—Black Test Prod Coupler (less wire)
703S11—Red Test Prod Coupler (less wire)
Price.....\$110.00 per C

A time saving universal testing unit, the Hubbell Interlock Coupler and attachments shown lock automatically to give a perfect low contact resistance connection—disconnect quickly and easily when desired. Attachments are instantly interchangeable, making it unnecessary to change the entire test lead when changing from one tip to another. Parts sold separately or as a unit.

INTERCHANGEABLE ATTACHMENTS

PHONE TIP	PHONO NEEDLE	ALLIGATOR CLIP	SPADE TERMINAL
704S29—Black	706S29—Black	708S29—Black	710S29—Black
705S29—Red	707S29—Red	709S29—Red	711S29—Red
Price \$37.00 per C	Price \$53.00 per C	Price \$52.00 per C	Price \$51.00 per C

EXTRA ATTACHMENTS FOR INTERLOCK TEST PROD

740S29—Extension Tip, Black 6 inch.....\$96.50 per C	744S29—Crocodile Clip, Black (with Black Vinylite Cover) \$117.50 per C
741S29—Extension Tip, Red 6 inch.....\$96.50 per C	745S29—Crocodile Clip, Red (with Red Vinylite Cover) \$117.50 per C
742S29—Universal Clip, Black (with Black Vinylite Cover) \$122.00 per C	746S29—Banana Plug, Black \$104 per C
743S29—Universal Clip, Red (with Red Vinylite Cover) \$122.00 per C	747S29—Banana Plug, Red \$104 per C

TEST PROD KIT — 5000 VOLTS

The complete Test Prod Kit includes one red and one black set of the following attachments:

Phone Tip — Phono Needle — Alligator Clip — Spade Terminal

Also included in the Kit is one Test Prod Coupler in red and one in black, each wired with four feet of test lead wire. Nylon insulated. Contact material: Brass with copper—nickel—silver plate. Each Kit individually packed.

700S90 (One Complete Kit)
Price.....\$8.75 per Kit List

INTERLOCK TYPE "S" PLUGS and JACKS 15 AMPERE CAPACITY

CONTACT PRESSURE 28 OZS.

PULL OUT 150 LBS.

CONTACT Material: Brass with copper-nickel-silver plate.

Wire size: No. 14 to No. 18.

Our Development Laboratory will cooperate with your engineers to adapt Interlock for your specific applications. Write to Harvey Hubbell, Inc., Interlock Dept., Bridgeport 2, Connecticut.



PLASTIC PLUG
(With Spring Terminal Wire Connection)

716S19—Black
717S19—Red
\$68.00 per C



PLASTIC ENTRY JACK

712S21—Black
713S21—Red
\$44.00 per C



METAL ENTRY JACK

714S21—Black
715S21—Red
\$57.00 per C



WATERPROOF PLASTIC JACK

718S21—Black
719S21—Red
\$55.00 per C

HARVEY HUBBELL, INC. BRIDGEPORT, CONN., U.S.A.



CINCH SOCKETS ARE STANDARD

MOLDED OCTAL 1.5/16" MOUNTING CENTERS



Molded from high dielectric black bakelite or mica-filled low loss bakelite. Solder coated brass contacts and sturdy steel press-on type saddle with 4 ground lugs. Mounts in 1" chassis hole.

No.	Description	List Price
8AB	Black	Each \$.17
8AM	Mica-Filled	Each .25

MOLDED OCTAL 1 1/2" MOUNTING CENTERS



Same as 8A series molded octal above except has clinch-on type saddle with 4 ground lugs and mounts in 1 1/2" chassis hole. Available in black, mica - filled bakelite, or ceramic.

No.	Description	List Price
8EB	Black	Each \$.17
8EM	Mica-Filled	Each .25
8EC	Ceramic	Each .59



RING MOUNT OCTAL

Molded from high dielectric black bakelite. Solder coated brass contacts. Used extensively on test equipment, public address amplifiers and on other apparatus where sockets are exposed. Molded keyway

in side engages key in chassis hole, preventing socket from turning. Mounts in 1 1/4" chassis hole. Crimped retainer ring is furnished with these sockets.

No.	Description	List Price
8R1	For 1/16" Chassis Black	Each \$.24
8R2	For 1/8" Chassis Black	.24
8R3	For 1/16" Chassis Mica-Filled	.35
8R4	For 3/32" Chassis Black	.24
8R5	For 3/32" Chassis Mica-Filled	.35
8R6	For 1/8" Chassis Mica-Filled	.35

RETAINER RING

A crimped retaining ring formed of spring steel that will securely anchor sockets designed for ring mounting, such as the one above. Standard finish is cadmium.



No.	Description	List Price
8R0	.020 Spring Steel	Each \$.06



MOLDED LOKTAL

Steel mounting saddle with solder coated brass contacts and center guide clip with locking spring. 1 1/8" mounting centers. Molded from high dielectric black bakelite or mica-filled low loss bakelite. Mounts in 1" chassis hole.

No.	Description	List Price
8LB	Black	Each \$.25
8LM	Mica-Filled	Each .33



MOLDED LOKTAL

Has same characteristics as molded loktal shown above, except saddle has 4 ground lugs.

No.	Description	List Price
8LB1	Black	Each \$.25
8LM1	Mica-Filled	Each .33



WAFER OCTAL

Laminated bakelite sockets with solder coated brass positive grip contacts. Designed to fit all standard eight prong tubes. Available to fit mounting centers. Both styles have .136 diameter mounting holes.

No.	Description	List Price
8W1	1 1/8" Mounting Centers	Each \$.17
8W2	1 1/2" Mounting Centers	Each .17

GLASS TUBE SOCKETS



Laminated bakelite sockets with solder coated positive grip brass contacts. 1 1/2" mounting centers. .140 diameter mounting holes. Designed to fit four, five and seven prong tubes.

No.	Description	List Price
4WX	4 Prong	Each \$.15
5WY	5 Prong	Each .15
6WZ	6 Prong	Each .16
7WU	7 Prong	Each .17
7WA	7 Prong (Large)	Each .17

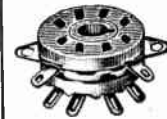

MOLDED OCTAL 1 1/2" MOUNTING CENTERS

Molded from mica-filled low loss bakelite. Silver plated Beryllium copper contacts with hot tinned tails. Heavy brass saddle nickel plated with 4 ground lugs hot tinned. Conforms to JAN-S-28A Specs.

No.	Description	Mtg. Hole	Jan Type No.	List Price
8JC	Ceramic	.156 Dia.	TS101C01	\$1.28
8JCN	Ceramic	6-32 Tap	TS101C02	1.80
8JM	Mica	.156 Dia.	TS101P01	.98
8JMN	Mica	6-32 Tap	TS101P02	1.65

CINCH CAPACITOR "PLUG-IN" SOCKETS

Motion picture, telephone, airborne radio, broadcasting equipment, electric organs, and other electrical equipment need instant replacement when failures in electronic circuits occur at the capacitor connections. Cinch "Know How" has solved this problem.



SMALL

Designed for use with Mallory and Magnavox 1" FP type condensers. Molded from high dielectric black bakelite. Sturdy steel mounting saddle has 4 ground lugs. 1 1/2" mounting centers. 3 recessed center contacts for extended prongs of condenser and two outer contacts flush with surface for short prongs of condenser. All contacts are solder coated for fast, easy soldering.

No.	List Price
2C5	Each \$.63



LARGE

Designed for use with Mallory and Magnavox 1 1/2" FP type condensers. Molded from high dielectric black bakelite. Sturdy steel saddle has 1 1/2" mounting centers. Four recessed center contacts for extended prongs of condenser and three outer contacts flush with surface for short prongs of condenser. All contacts are solder coated.

No.	List Price
2C7	Each \$.78

CRYSTAL SOCKETS



2 PRONG 31/64" CENTERS

Molded from high dielectric black bakelite or mica-filled low loss bakelite. Silver plated beryllium copper contacts on 3/16" centers. .120" diameter recessed mounting hole. Socket body is 1 1/8" long, 3/8" thick, and 3/16" high. For use with FT243 type crystal.

No.	Description	List Price
2KB	Black	Each \$.38
2KM	Mica-Filled	Each .43



4 PRONG

Molded from mica-filled low loss bakelite. Silver plated beryllium copper contacts on 1/4" centers. .140 diameter mounting hole recessed 3/16" from surface in 3/8" diameter hole. Socket body is 1 1/8" long, 3/8" wide, and 1/2" high. Designed for use with two No. FT243 type crystals.

No.	List Price
2K4	Each \$.51



2 PRONG 1/2" CENTERS

Molded from high dielectric black bakelite or mica-filled low loss bakelite. Silver plated phosphor bronze contacts on 1/2" centers. No. 4-40 tap mounting hole. 1 1/8" long, 3/8" wide and 7/16" high. For No. CR-1 and CR-7 type crystals.

No.	Description	List Price
2K1B	Black	Each \$.51
2K2C	Ceramic	Each .37

7 PIN MINIATURE SOCKETS AND SHIELDS



**MOLDED SADDLE TYPE
Top Mount**

Molded from high dielectric black bakelite, mica-filled low loss bakelite, or ceramic material. Cadmium plated steel saddle with 7/8" mounting centers and .093 diameter mounting holes. Solder coated brass contacts. Designed for mounting through top of chassis in 5/8" diameter hole. Will securely hold all standard seven pin miniature tubes.

No.	Description	List Price
7AB1	Black	Each \$.24
7AM1	M'ca-Filled	Each .31



**MOLDED SADDLE TYPE
Bottom Mount**

Molded from high dielectric black bakelite or mica-filled low loss bakelite. Cadmium plated steel saddle with 7/8" mounting centers. .093 diameter mounting holes. Solder coated positive grip brass contacts. Designed for mounting through bottom of chassis in 5/8" diameter hole. For use with all standard seven pin miniature tubes.

No.	Description	List Price
7EB	Black	Each \$.24
7EM	Mica-Filled	Each .31



WAFER TYPE SOCKET

Laminations consist of 1/32" top plate and 3/64" bottom plate made from high grade chocolate XP Bakelite. Solder coated brass contacts and center shield.

No.	Mtg. Centers	Mtg. Hole	List Price
7W2A	7/8"	.093	\$.15
7WL2	1"	.093	.18
7WL4	1-5/16"	.136	.19



SHIELD BASE TYPE

Shield base is attached to socket body for mounting through top of chassis. Molded from high dielectric black bakelite, mica-filled low loss bakelite or ceramic material. Solder coated brass contacts and center shield. Cadmium plated steel shield base with 7/8" mounting centers. Use No. 7S2, 7S3, or 7S4 shields illustrated below with these sockets.

Shield base with 7/8" mounting centers. Use No. 7S2, 7S3, or 7S4 shields illustrated below with these sockets.

No.	Description	List Price
7XB1	Black	Each \$.44
7XM1	Mica-Filled Bakelite	Each .50
7XC	Ceramic	Each .83

Molded from mica filled low loss bakelite or ceramic material. Shield base is attached to socket body for mounting through top of chassis. Same type as illustrated at the left. Materials and finishes are those required by JAN-S-28A Specifications. Shield base has 7/8" mounting centers.

Use No. 7S2, 7S3 or 7S4 shields as shown below.

No.	Description	JAN Type No.	List Price
7JC	Ceramic	TS102C01	\$1.10
7JM	Mica	TS102P01	.80

SHIELD BASES — Snap-On Type



Base is made of hardened carbon steel supplying adequate spring reactivity on shield. Base has 7/8" mounting centers with mounting holes that coincide with those for miniature 7 pin sockets as established by R. M. A. standards. For use with saddle type sockets with 7/8" mounting centers illustrated on this page.

No.	Description	List Price
7SB3	11/32" High	Each \$.07



For J Slot Type

Durable steel shield bases designed for use with "J" slot type shields illustrated at left. Available in two sizes: 7/16" high or 5/8" high. Both types have 7/8" mounting centers.

No.	Description	Material	List Price
7SB1	5/8" High	Steel	.22
7SB2	5/8" High	Brass	.44



TUBE SHIELDS — "J" Slot Type

Durable steel shields complete with tube securing spring. "J" slot feature designed to fit securely with Cinch shield base type sockets, such as 7X series shown above. Also fit 7SB type shield bases shown in end column at right. Available in three lengths:

shield bases shown in end column at right. Available in three lengths:

No.	Description	List Price
7S2	1 3/8" Long	Each \$.21
7S3	1 3/4" Long	Each .22
7S4	2 1/4" Long	Each .32

Durable brass nickel plated shields complete with tube securing spring. "J" slot feature designed to fit securely with the shield base type sockets listed above. Materials and finishes are those required by JAN-S-28A Specifications. Available in the sizes listed below.

No.	Description	JAN Type No.	List Price
7SJ2	1 3/8" Long	TS102U01	\$.33
7SJ3	1 3/4" Long	TS102U02	.36
7SJ4	2 1/4" Long	TS102U03	.54



**TUBE SHIELD
Snap-On Type**

Shield fits over and outside of shield base. Indentation on shield locks into ridge on base of 7SB3 as shown above.

No.	Description	List Price
7S1	1-53/64" High	\$.14

9 PIN MINIATURE SOCKETS AND SHIELDS

**MOLDED — SADDLE TYPE
Bottom Mount**



Molded from high dielectric black bakelite or mica-filled low loss bakelite. Designed for mounting through bottom of chassis in 3/4" diameter hole. 1 1/8" mounting centers with .093 diameter mounting holes. Solder coated brass contacts and center shield.

No.	Description	List Price
9EB	Black	Each \$.36
9EM	Mica-Filled Bakelite	Each .42

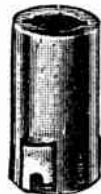

TUBE SHIELDS

Made from durable steel. Complete with tube securing spring. "J" slot feature designed to fit securely with Cinch 9X series shield base type sockets illustrated to the right. Will also fit No. 9SB shield base shown at left. Available in three lengths.

No.	Description	List Price
9S1	1 1/2" Long	Each \$.33
9S2	1 3/4" Long	Each .36
9S3	2 3/8" Long	Each .46

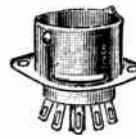

SHIELD BASE TYPE

Molded from high dielectric black bakelite, mica-filled low loss bakelite, or ceramic material. One-piece cadmium plated steel shield base and saddle with .093 diameter mounting holes on 1 1/8" centers. Solder coated brass contacts and center shield. Mounts through top of chassis in 3/4" diameter hole. Use Cinch 9S type shields with these sockets.

No.	Description	List Price
9XB	Black	Each \$.83
9XM	Mica	Each .68
9XC	Ceramic	Each .96



SHIELD BASE

Durable steel shield base designed for use with shields illustrated to right. 1 1/8" mounting centers. May be used with any 9 pin wafer or saddle type sockets shown at the right.

No.	List Price
9SB1	Each \$.28



**MOLDED—SADDLE TYPE
Top Mount**

Molded from high dielectric black bakelite or mica-filled low loss bakelite. Designed for mounting through top of chassis in 3/4" diameter hole. 1 1/8" mounting centers with .093 diameter mounting holes. Solder coated brass contacts and center shield.

No.	Description	List Price
9AB	Black	Each \$.36
9AM	Mica-Filled	Each .42



WAFER TYPE

Has two laminations consisting of 1/16" top plate and 3/64" bottom plate made from 1 1/8" mounting centers with .093 diameter holes. Solder coated brass contacts and center shield.

No.	Mtg. Centers	List Price
9W1	1-1/8"	Each \$.21
9W2	1-5/16"	Each .22



MOLDED CONNECTOR PLUGS AND SOCKETS

8 CONTACT PLUG



Molded from high dielectric black Bakelite. Pins are nickel-plated and have tapered ends for easy insertion. Mounts on $\frac{1}{8}$ " chassis using No. 1018 retaining ring, or can be used with No. 16F cap shown below. Will fit any standard octal socket.

No. **8PB** List Price Each \$.36

11 CONTACT PLUG



Molded from high dielectric black Bakelite. Pins are nickel-plated and have tapered ends for easy insertion. Mounts on $\frac{1}{8}$ " chassis using No. 1018 retaining ring. Can be used with No. 16F cap shown below. Will fit No. 11RB socket shown at right.

No. **11PB** List Price Each \$.41

11 CONTACT SOCKET



Molded from high dielectric black Bakelite. Solder coated brass contacts. Mounts on $\frac{1}{8}$ " chassis using No. 1018 retaining ring. Can be used with No. 16F Cap shown below. Used with No. 11PB plug shown at left.

No. **11RB** List Price Each \$.48

CONNECTOR PLUGS AND SOCKETS

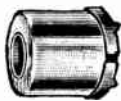

18G



6K2

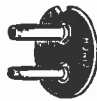

5K2



18E

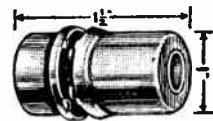

Assembled

These low cost plugs and sockets are ideal for a multitude of applications. A "Cinch" where space is at a premium. Complete assembly of plug, socket, male and female shell will close to a compact unit of $1\frac{1}{2}$ " long. Polarized—Nickel plated brass tube pins—Solder coated brass contacts. Plugs, sockets and shells have lock feature which prevents turning in shells.

PLUGS

Part No.	No. Prongs	Use Skt. No.	Use Shell No.	List Price
5K2	2	6K2	18E	.09 ea.
5K3	3	6K3	18E	.10 ea.
5K4	4	6K4	18E	.12 ea.
5K5	5	6K5	18E	.13 ea.
5K6	6	6K6	18F	.15 ea.

SOCKETS

Part No.	No. Prongs	Use Skt. No.	Use Shell No.	List Price
6K2	2	5K2	18G	.08 ea.
6K3	3	5K3	18G	.09 ea.
6K4	4	5K4	18G	.10 ea.
6K5	5	5K5	18G	.12 ea.
6K6	6	5K6	18H	.13 ea.

PLUG CAPS AND SHELLS

For above Battery Plugs and for Connector Plugs and Sockets on page F-34.



No. **18A**

Cadmium plated brass shell with rolled edge on $5/16$ " diameter neck opening. Outside diameter at base .625. Four $1/8$ " prongs coincide with notches on plugs. Designed for use with Cinch No. 5A1, 5B1, 5AB2, and 5AB3 type battery plugs.

List Price Each \$.05



No. **16F**

Made of steel, cadmium plated. Designed to snap on 8 and 11 prong sockets which are grooved for a $1/16$ " chassis. There is a screwdriver slot at the bottom to facilitate easy removal. Rubber grommet has a $25/64$ " dia. hole.

List Price Each \$.49



No. **18E**

Cadmium plated brass shells complete with fibre insulator. Available with $3/8$ " or $1/2$ " diameter hole with rolled edge. Inside diameter $31/32$ ". $1/2$ " high. For use with Cinch No. 5C1, 5C2, 5AB6, 5AB7, 5AB8, 5K2, 5K3, 5K4, 5K5, and 5K6 type plugs.

Description List Price
18E $3/8$ " Diameter Hole Each \$.09
18F $1/2$ " Diameter Hole Each \$.09



No. **18J**

Cadmium plated brass shell complete with fibre insulator. Same as Cinch No. 18B shell except has $1/2$ " neck with $3/8$ " hole riveted to base. For use with same plugs as No. 18E.

List Price Each \$.13



No. **5B1**

Cadmium plated brass shell with $23/64$ " diameter opening on top of shell. Outside diameter at base .625. Four $1/8$ " prongs coincide with notches on plugs. $1/2$ " high. Designed for use with Cinch No. 5A1, 5B1, 5AB2, and 5AB3 type battery plugs.

List Price Each \$.05



No. **18G**
18H

Cadmium plated steel shells complete with fibre insulator. Available with $3/8$ " or $1/2$ " diameter hole with rolled edge. Inside diameter $31/32$ ". $29/32$ " high. For use with Cinch No. 6K2, 6K3, 6K4, 6K5, and 6K6 type sockets.

Description List Price
18G $3/8$ " Diameter Hole Each \$.09
18H $1/2$ " Diameter Hole Each \$.09



CINCH-JONES SALES • DIVISION OF CINCH MANUFACTURING CORPORATION

MAGNAL—11 PRONG



Molded from mica-filled low loss bakelite. Socket is 1 3/8" wide and 1 3/4" high. Full floating silver plated beryllium copper contacts designed to insure easy insertion of tubes and yet provided excellent electrical connections. For use with 5BP1 and 2AP1 type cathode ray tubes.

No.	Description	List Price
3M11	Mica Socket	Each \$7.60
3R11	Steel Mounting Ring	Each .53

SECOND ANODE CONNECTORS



For television tubes—Silver plated snap button type plug well insulated by 1 1/2" diameter rubber protective cap. Snaps into opening on side of tube. Available in three lengths wire leads.

No.	Description	List Price
3A2	12" Wire Lead	Each \$1.14
3A3	15" Wire Lead	Each 1.33
3A4	18" Wire Lead	Each 1.59

CORONA SHIELDS



Specifically designed for Television and high voltage wiring. These cadmium plated brass shields will provide excellent protection at proper positions in electrical connections. Outside diameter .470. Hole diameter .136. Thickness .172.

No.	List Price
3C1	Each \$.04

110-250 VOLT SOCKET

(Underwriters Listed)



When space is at a premium use this 110-250 volt 2 prong socket. Rated at 15 Amp., 110 V. or 10 Amp., 250 V. Molded from high dielectric black bakelite. Solder coated brass contacts on 1/2" centers designed to accept any 2 prong standard electric plug. Mounts in 3/8" x 3/8" hole. .144 diameter mounting holes on 1 1/8" centers. Ideal for radio chassis and many other applications.

No.	List Price
2R2	Each \$.25

DIHEPTAL 14 PRONG



Molded from high dielectric black bakelite or mica-filled low loss bakelite. 2 5/8" wide and 1 1/4" high. Possesses same features as Cinch Magnal socket shown at left.

No.	Description	List Price
3B14	Black Socket	Each \$2.53
3M14	Mica Socket	Each 3.16
3R14	Steel Mounting Ring	Each .53

SECOND ANODE CONNECTOR



For diheptal based tubes. Cadmium plated brass contact surrounded by rubber insulator 3/4" wide and 1 1/8" long. Snaps over .096 diameter prong on side of diheptal tubes.

No.	List Price
3A1	Each \$.95

SUB-MINIATURE SOCKETS



No. 2H5



No. 5PC



No. 5WC



No. 8SM

Use extensively for hearing aids, radios and other electronic apparatus which require sub-miniature tubes. Molded from mica-filled low loss bakelite with silver plated beryllium copper contacts. Available with 5, 6, 7 or 8 contacts. Four prong tubes use No. 2H5 five prong socket. No. 2H5 can be used as a transistor socket. No. 5PC for printed circuits. No. 5WC for wired circuits.

No.	Description	List Price
2H5	5 Prong	Each \$.47
2H6	6 Prong	Each .49
2H7	7 Prong	Each .52
5PC	5 Prong	Each .62
5WC	5 Prong	Each .67
8SM	8 Prong	Each .89

PIN PLUGS — JACKS — CONNECTORS — STRIPS — TERMINALS



PHONO PLUGS

R.C.A. type. For a multitude of applications: record players, auto radios, receivers, recording and reproducing equipment, experimental units, etc. Nickel plated 1/8" diameter tube pin. Available in two lengths: 3/8" and 1/2". Use No. 13A with type 81A and 81B phono jacks. Use No. 13E with type 81E extension jack.

No.	Description	List Price
13A	3/8" Pin	Each \$.10
13E	1/2" Pin	Each .10

SINGLE PHONO JACK



Precision engineered for many uses, such as: R.C.A. type recording units, receivers, and auto sets. Single prong positive grip phono jack mounted on 1/8" chocolate bakelite disc with 1/8" mounting centers Use Cinch No. 13A phono plug with this jack.

No.	List Price
81A	Each \$.15

ANTENNA CONNECTOR

Flange Type

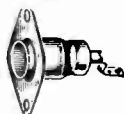

Motorola type shielded jack. Sturdy steel flange with 1/8" mtg. centers with .136 dia. mtg. holes. Solder coated shell, flange and contact. Can be mounted with screws or rivets. Used extensively on auto radios. Use Cinch No. 13B antenna plug with this jack.

No.	List Price
81F	Each \$.23



DOUBLE PHONO JACK

Two positive grip phono jacks mounted on 1/8" bakelite panel with 1/8" mounting centers. Jacks are spaced on 1/2" centers. Panel is 1 1/2" x 1 1/2". Used on recording units, receivers, etc. Use Cinch No. 13A phono plug with this jack.

No.	List Price
81B	Each \$.21



ANTENNA PLUG

Motorola type. Nickel plated 1/8" tube pin extends 1/2" from cadmium plated split brass shell whose 8 cutting edges provide positive grounded connection when inserted into a Cinch No. 81C or 81F connector.

No.	List Price
13B	Each \$.15

ANTENNA CONNECTOR

Shell Type



Same as No. 81F on right except without flange. This connector may be soldered in position. Use Cinch No. 13B antenna plug with this jack.

No.	List Price
81C	Each \$.15



INSULATED PIN PLUG

Nickel plated 1/8" brass tube pin 1/4" long, assembled to 1/8" long fibre insulator. May be used with Cinch No. 81A and 81B type phono jacks or with No. 49 series contact strips illustrated on page F-35.

No.	List Price
13C	Each \$.12

SHIELDED EXTENSION JACK



Cadmium plated brass shell 2 7/8" long with black bakelite insert providing insulation for solder coated brass positive grip contact. Use Cinch No. 13E Phono plug with this jack.

No.	List Price
81E	Each \$.32





CINCH-JONES SALES • DIVISION OF CINCH MANUFACTURING CORPORATION

CINCH BATTERY PLUGS



SAB1



6K4



SAB2 SAB3



SAB4



SAB5



SAB6



SAB7



SAB8



SA1



SA2



SA3



SA4



SA5



SB1A



SB2

5M

5F

5MFA

SC1

SC2

THIS REFERENCE CHART WILL ASSIST YOU IN SELECTING THE CORRECT PLUG FOR POPULAR BATTERIES

Part Number	Voltage	For Burgess No.	For Eveready No.	For R.C.A. No.	For Philco No.	For Ray-C-Vac No.	List Price
SA1	1½ "A"	4F, 4FL, 6F, 8F, 8FL, TE	741, 742, 743, 1052P	VS004, VS005, VS007, VS008	P94, P98, P8F1	P94A, P94L, PX, P98A, P98A, P98L	Ea. \$.07
SA2	3 "A"	20F2	X125	VS025	P8024	P9403	Ea. .08
SA3	4½ "A"	G-3	746	VS002	P100	P-83A	Ea. .07
SA4	6 "A"	2F4, 2F4L, F4PL, T5	A509, 71A, 744, 747	VS009, VS010, VS011	P4F4R	P694A, P696L, P698A, P698L	Ea. .07
SA5	7½ "A"	G-5	887	VS003		P95A	Ea. .10
SB1A	45 "B" Small	A30, B30, M30, Z30	482, 738, 762	VS012, VS013, VS014, VS015	P210, P305	430P, P7830, P5303	Ea. .08
SB2	45 "B" Large	A30, B30, M30, Z30	482, 738, 762	VS012, VS013, VS014, VS015	P210, P305	430P, P7830, P5303	Ea. .09
5M	87½ "B"	XX30, XX45	455, 487	VS018, VS058		P4367	Ea. .05
5F	87½ "B"	XX30, XX45	455, 487	VS018, VS058		P4367	Ea. .06
5MFA	67½ "B"	XX30, XX45	455, 487	VS018, VS058		P4367	Ea. .35
SC1	4½ "C"	2370PI	X771	VS030	P3D	P231W	Ea. .12
SC2	22½ "C"	S156PI	768	VS031	P15B5	P5151	Ea. .13
SAB1	1½ "A"-90 "B"	17GD60, 5DA80, 6TA60	758	VS022, VS043	P60D11L	AB82, 10793	Ea. .12
6K4	9 "A"-90 "B"	G8B60	752	VS047			Ea. .10
SAB2	1½ "A"-63-90 "B"	6FA60, 4GA41, 4GA42		VS037	P80A-4L, P41A4G	AB419	Ea. .09
SAB3	8 "A"-90 "B"	2FAA60		VS044	P60A6F4	AB594	Ea. .10
SAB4	6 "A"-90 "B"	F4B60		VS048			Ea. .15
SAB5	6 "A"-90 "B"	D4A60, 2F4B60, F4A41		VS048	P41AFL	10896, AB648	Ea. .12
SAB6	7½ "A"-90 "B"	G5A42, F5A60		VS036	P87, P941	AB794	Ea. .13
SAB7	9 "A"-90 "B"	F6A60, G6M60	753, 754	VS019, VS019	P841A	AB879, AB894	Ea. .15
SAB8	9 "A"-90 "B"	4FA60					Ea. .13

EQUIFLEX ALL METAL VIBRATION ISOLATORS

Equiflex Vibration Isolators consist of a double array of springs arranged to form two opposed cones, the springs serving to join the outer plate member resiliently to the inner tubular member. Within the two cones of multiple springs there is a damper consisting of two floating metal stampings held apart by an internal compression spring. The damper serves to keep the amplitude at resonance within safe limits. The mounting incorporates safety rebound washers attached to each end of the inner tubular member, thus taking care of overload and shock conditions and keeping the equipment within proper limits.

With this type of construction, vibration is controlled both vertically and horizontally at the rated load the mounting deflects 1/8" (within a tolerance of zero to 10%), whether the load is placed in the apical or the radial direction—vertically (either up or down), laterally (sideways, fore and aft, or diagonally), with the spring rate linear up to 1/8" deflection. The spring rate then stiffens slightly up to the maximum movement. The safety washers are designed to provide additional spring deflections when the mounted equipment is subjected to shock loads.

These units are made of steel finished in cadmium with a dichromate dip and will withstand a 100 hour salt spray test. Mountings will withstand 15G shocks without damage and will keep equipment captive up to 30G's. Two types of mounting are available. Square Plate Mounting and Circular Cap Mounting as illustrated.

SQUARE PLATE MOUNTING

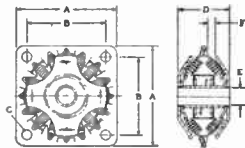

No.	Load in Pds	A	B	C	D	E	F	List Price Ea.
UES2C	6	1.74	1.37	.164	.776	.257		\$7.50
		to	to	to	to	to		
UES2E	10	1.76	1.38	.169	.786	.262		7.50
		F — Max. Movement		.1875				

CIRCULAR CAP MOUNTING

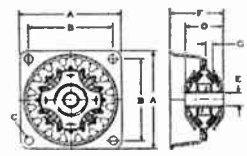

No.	Load in Pds	A	B	C	D	E	F	List Price Ea.
UEC2C	6	2.365	1.932	.194	.776	.257	1.12	\$8.30
		to	to	to	to	to	to	
UEC2E	10	2.385	1.942	.199	.786	.262	1.16	8.30
		G — Max. Movement		.1875				



CINCH-JONES SALES • DIVISION OF CINCH MANUFACTURING CORPORATION



STAND-OFF TERMINALS

These rugged Stand-Off Terminals consist of two heavily hot tinned metal caps insulated from each other by a solid Grade L-5 Ceramic Seatite spacer. One of the metal caps is shaped for riveting into a small chassis hole. The cap at the opposite end provides a junction point for solder connection of wire leads. The ceramic insulator effectively isolates the tie point from the chassis. The insulator is Dow Corning DC 200A treated to meet Military requirements.

With Stand-Offs, lead junctions can be spotted anywhere on the chassis permitting shorter, more direct wiring between component parts.

No.	Body Length	List Price Each
SOT-1	1/2"	\$.225
SOT-2	3/8"	.225
SOT-3	3/4"	.225

METAL SPACER SLEEVES

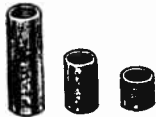

Zinc plated brass spacer sleeves. Six (6) popular sizes for spacing chassis, panels, etc. Illustrations are full size.

No.	Length	Out-side Dia.	In-side Dia.	Price
43A	1/8"	1/4"	3/16"	\$.02
43B	1/4"	1/2"	3/8"	.02
43C	3/8"	3/4"	5/8"	.02
43D	1/2"	5/8"	3/4"	.02
43E	3/4"	7/8"	5/8"	.03
43F	1"	1"	7/8"	.03

SCREEN TYPE PLUG BUTTON

For portable radios, transmitters, amplifiers, etc. Provides ventilation wherever required in radio, television and electronic equipment. Bright zinc plated steel button snaps in 1" diameter hole. Half size illustration.



No.	Description	List Price for 1" Hole
41V		\$.19



GRID CAP SHIELD

Fits firmly over the grid cap, completely shielding the tube. Cadmium plated shield is 1" high with 7/8" slot opening for grid leads.

No. 605

List Price Each \$.13

CABLE CLAMPS



Cadmium plated sturdy steel cable clamps designed for securing cables ranging from 1/16" diameter to 3/8" diameter. Illustrations are half size.

No.	Dia. of arc	Hole Dia.	Over-all Width	Hole cent. to arc Length	List Price Ea.
85A	1/8"	.149	1/8"	1/4"	\$.04
85B	3/16"	.140	3/16"	3/8"	.03
85C	1/4"	.144	1/4"	1/2"	.03
85D	5/16"	.136	5/16"	3/4"	.02
85E	3/8"	.147	3/8"	1"	.03
85F	1/2"	.171	1/2"	1 1/2"	.02

SCREW TYPE TERMINAL STRIPS



Ideal for chassis or breadboard layouts. Solder coated brass terminals. .136 diameter mounting holes. Strips with 1 to 6 lugs are of 3/8" bakelite; 7 to 10 terminals mounted on 3/4" bakelite. Ends of screws are captivated to prevent removal. Terminals are spaced on 7/8" centers.

No.	Lugs	Mounting Centers	List Price
17-1	1	7/8"	Each \$.07
17-2	2	1 1/8"	Each .10
17-3	3	1 3/4"	Each .15
17-4	4	2 1/8"	Each .20
17-5	5	2 3/8"	Each .23
17-6	6	3 1/8"	Each .28
17-7	7	3 1/2"	Each .35
17-8	8	3 3/8"	Each .39
17-9	9	4 3/8"	Each .45
17-10	10	4 1/8"	Each .49

LUG TYPE TERMINAL STRIPS

These bakelite strips are handy for neatly supporting resistors, condensers, etc., in circuit wiring. Solder coated brass lugs are spaced on 3/8" centers with .140 diameter mounting holes. Chocolate bakelite strips are 7/16" thick and 3/8" wide.

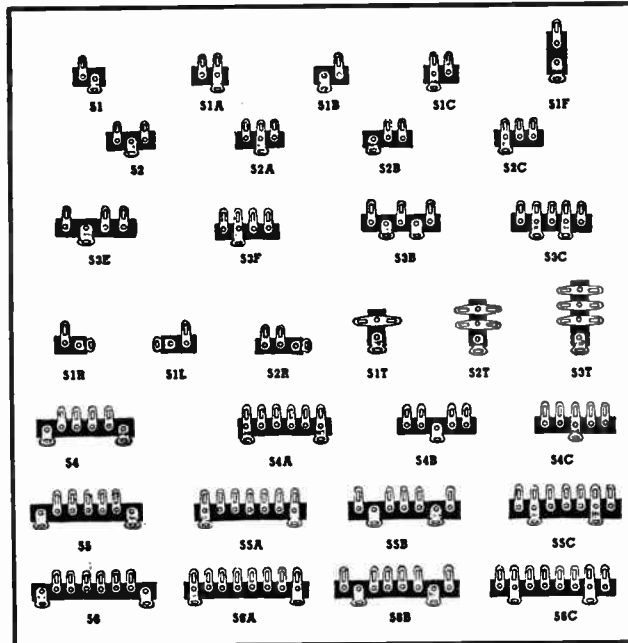

CONTACT STRIPS

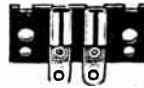

For connections which must be changed quickly and easily. Solder coated spring steel contacts spaced on 3/8" centers and mounted on 7/8" bakelite. Contacts are sized for 1/8" diameter tube pins such as Cinch No. 13C illustrated on page F-33.

No.	Contacts	Mounting Centers	List Price
49-1	1	3/4"	Ea. \$.07
49-2	2	1 1/8"	Ea. .10
49-3	3	1 1/2"	Ea. .13
49-4	4	1 7/8"	Ea. .16
49-5	5	2 1/4"	Ea. .20
49-6	6	2 3/8"	Ea. .23

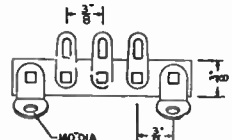

No.	Mtg. Centers	List Price Each
51		\$.03
51A		.03
51B		.03
51C		.03
51R		.04
51L		.04
51F		.04
51T		.04
52		.04
52A		.04
52B		.04
52C		.04
52R		.05
52T		.05
53B	3/4"	.07
53C	3/4"	.07
53E		.06
53F		.06
53T		.07
54	1 7/8"	.09
54A	1 7/8"	.09
54B		.07
54C		.07
55	2 1/4"	.10
55A	2 1/4"	.10
55B	1 1/2"	.10
55C	1 1/2"	.10
56	2 3/8"	.12
56A	2 3/8"	.12
56B	1 7/8"	.12
56C	1 7/8"	.12

PLUG BUTTONS



Used to cover punched or drilled holes in metal, wood, fibre, tubes, plastic, cardboard, etc. Nickel plated steel plug buttons for eight popular size holes. Other sizes available, let us know your requirements. Spring tension prongs hold plug bottom firmly in position. Illustrations are 1/3 actual size.

No.	For hole Diameter	Cap Diameter	List Price Ea.
41A	1/4"	3/8"	\$.04
41B	3/8"	1/2"	.04
41C	1/2"	3/4"	.04
41D	5/8"	1"	.04
41E	3/4"	1 1/8"	.04
41F	7/8"	1 1/4"	.05
41G	1"	1 3/8"	.07
41H	1 1/4"	1 7/8"	.08



TELEVISION WALL PLATES

FOR ANTENNA LEAD-IN



No. S-302-WPC

Cinch-Jones Wall Plates provide a convenient junction between antenna lead-in and television set. Made of steel with heavy chrome plate. Fits standard outlet box. Connection is made to a Jones S-302-AB socket. Wall Plate mounting screws furnished. We suggest using a Jones P-302-FHT Plug with this unit.

List Price Ea. \$1.90

FOR ANTENNA LEAD-IN and 4 CONTACT ROTOR

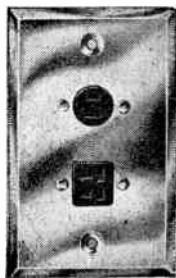

No. S-302-4WPC

This Wall Plate uses a Jones S-302-AB socket for the Antenna lead-in and a S-304-AB for the Rotor leads. Used with alliance, CTG Tool, Koenig, U. S. Devices and other rotors having 3 and 4 wires. We suggest using a P-302-FHT and P-304-FHT with this unit.

List Price Ea. \$2.30

FOR ANTENNA LEAD-IN and 8 CONTACT ROTOR

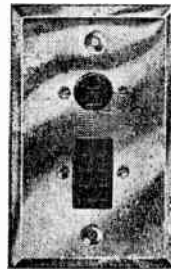

No. S-302-8WPC

This Wall Plate uses a Jones S-302-AB for the antenna lead-in and a S-308-AB for the rotor leads. Used with Cornell Dubilier, Crown, Radiant and other rotors having up to 8 wires. We suggest using a P-302-FHT and P-308-FHT for this unit.

List Price Ea. \$2.51

SERIES 101 PLUGS

The entire No. 101 Series of Plugs are identical with the exception of the cable ferrule which is furnished in four sizes as listed below. All metal parts are of brass. These Plugs fit all of the No. 101 Series Sockets. Assembly meets Navy Specifications. A low loss Plug and Socket ideal for high frequency connections.

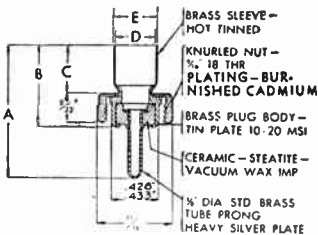

Code No.	A	B	C	D	E	List Price Ea.
P-101-1/4"	1-1/4"	3/4"	15/32"	1/4"	9/32"	\$.72
P-101-290	1-1/4"	3/4"	15/32"	.290	.319	.87
P-101-5/16"	1-11/32"	27/32"	9/16"	5/16"	11/32"	.87
P-101-3/8"	1-3/16"	11/16"	7/16"	3/8"	13/32"	.87
P-101-1/2"	1-7/8"	1-3/8"	1-1/16"	1/2"	9/16"	.97

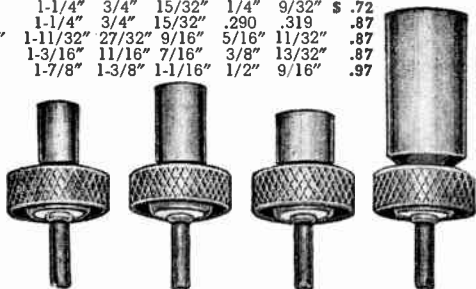

P-101-1/4" P-101-5/16" P-101-3/8" P-101-1/2"

SERIES 101 SOCKETS

The No. 101 Series Sockets are furnished in three types as shown below. Base is of Brass, Nickel Plated with Chrome Flash. Brass contact is Silver Plated. Insulation is of low loss natural color XXX Bakelite. Meets Navy Specifications. The S-101-D is similar to the S-101 except that the Bakelite is recessed in the base. S-101-D Mod. is the same as S-101-D except that two sides of the base are milled as shown. Mounting Holes No. 101—No. 41 drill on 1 1/8" centers. Mounting holes No. 101-D and 101-D Mod. No. 30 drill on 1 3/8" centers.



S-101 List Price Each \$0.64
S-101-D List Price Each \$0.97
S-101-D Mod List Price Each \$0.97
(Above Illustrations are Actual Size)

SERIES 201

PLUGS

The No. 201 Series Plugs are of the same design as the No. 101 but are of heavier stock and larger. Made in one size only with 3/8" ferrule. All metal parts are of Brass, same finish as No. 101 Series and Wax Impregnated Ceramic insulation. Overall length 1 9/16". Prong diameter 5/8". Fits only the 201 Socket.

SOCKETS

The 201 Socket is similar to the S-101-D except larger. Brass base is nickel plated with Chrome Flash. Brass contact is Silver Plated. Insulation is of low loss natural color XXX Bakelite. Both Plug and Socket meet Navy Specifications.

Mounting holes—No. 30 drill on 1" centers.

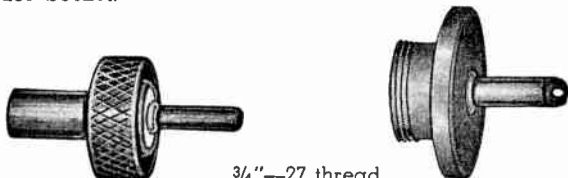

3/4"—27 thread.
Code List Price Ea. Code List Price Ea.
P-201-3/8 \$1.13 S-201 \$1.21

SERIES 202

PLUGS

SOCKETS

The 202 Series Plugs and Sockets are made in two contacts only. Metal parts are of Brass with burnished Cadmium Plate. Insulation is of Molded Bakelite. Phosphor Bronze "Knife Switch" type Socket Contacts engage both sides of flat Plug Contacts—double contact area. Formed Fibre linings in caps. Polarized. Knurled nut has 3/4"—27 thread. Socket Mounting Holes. No. 30 drill on 1" centers. The S-202-CCT-THR has been added to this series and when used with the P-202-CCT will make an ideal microphone connector.

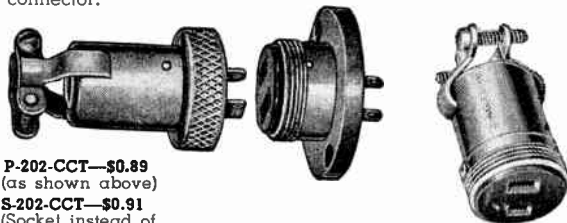

P-202-CCT—\$0.89 (as shown above)
S-202-CCT—\$0.91 (Socket instead of Plug)
S-202-B—\$1.05 (Socket for Base Mtg.)
P-202-FHT—\$0.72 (Same as above less Cable Clamps)
S-202-FHT—\$0.74 (Same except Socket)
S-202-CCT-THR—\$1.21 (as shown above)
Used with P-202-CCT as an extension connection



"300" SERIES PLUGS AND SOCKETS

General Specifications

Small in size with good separation between contacts. Made in sizes of 2 to 33 contacts. All Plugs and Sockets are polarized so that Plugs of one size cannot fit into Sockets of another size. Body of Molded Bakelite. Phosphor bronze "knife-switch" type Socket contacts engage both sides of flat Plug contacts—double contact area. Plug prongs are $\frac{5}{32}$ " wide by $\frac{3}{64}$ " thick. Formed metal caps are finished in Black Crystal. Fibre linings for caps

are also formed. Plugs and Sockets arranged for either cap or panel mounting. Two contact Plugs and Sockets are round as shown at the right, all others are rectangular. Illustrated are the P-302-CCT and S-302-AB. Standard 24 to 33 contact Plugs have a special long polarizing pin in approximate center position to assist in correct insertion and removal.



Plug with Angle Brackets



P-306-AB

No.	Contacts	List Price Each
P-302-AB	2	\$0.29
P-303-AB	3	.36
P-304-AB	4	.40
P-306-AB	6	.49
P-308-AB	8	.58
P-310-AB	10	.66
P-312-AB	12	.74

Socket with Angle Brackets

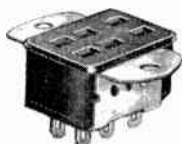

S-306-AB

No.	Contacts	List Price Each
S-302-AB	2	\$0.32
S-303-AB	3	.38
S-304-AB	4	.43
S-306-AB	6	.53
S-308-AB	8	.66
S-310-AB	10	.78
S-312-AB	12	.91

Plug, Flared Hole in Cap



P-306-FHT

No.	Contacts	List Price Each
P-302-FHT	2	\$0.49
P-303-FHT	3	.54
P-304-FHT	4	.60
P-306-FHT	6	.68
P-308-FHT	8	.77
P-310-FHT	10	.87
P-312-FHT	12	.99

Socket, Flared Hole in Cap



S-306-FHT

No.	Contacts	List Price Each
S-302-FHT	2	\$0.51
S-303-FHT	3	.55
S-304-FHT	4	.61
S-306-FHT	6	.72
S-308-FHT	8	.86
S-310-FHT	10	1.00
S-312-FHT	12	1.14

Plug with Flush Plate

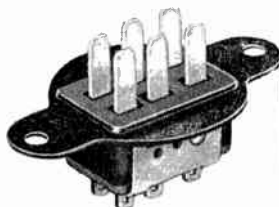

P-306-FP

No.	Contacts	List Price Each
P-302-FP	2	\$0.51
P-303-FP	3	.55
P-304-FP	4	.61
P-306-FP	6	.68
P-308-FP	8	.77
P-310-FP	10	.85
P-312-FP	12	.93

Socket with Flush Plate

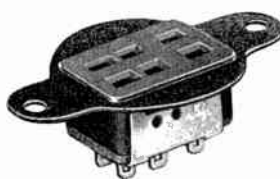

S-306-FP

No.	Contacts	List Price Each
S-302-FP	2	\$0.52
S-303-FP	3	.58
S-304-FP	4	.63
S-306-FP	6	.72
S-308-FP	8	.85
S-310-FP	10	.98
S-312-FP	12	1.10

Plug, Flared Hole in Cap and with Latches

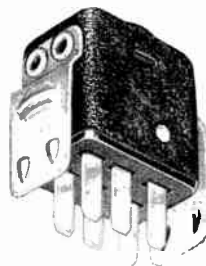

P-306-FHT-L

No.	Contacts	List Price Each
P-302-FHT-L	2	\$0.67
P-303-FHT-L	3	.72
P-304-FHT-L	4	.78
P-306-FHT-L	6	.86
P-308-FHT-L	8	.95
P-310-FHT-L	10	1.06
P-312-FHT-L	12	1.16

Socket, Flared Hole in Cap and with Keepers

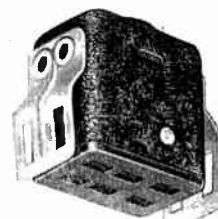

S-306-FHT-K

No.	Contacts	List Price Each
S-302-FHT-K	2	\$0.68
S-303-FHT-K	3	.74
S-304-FHT-K	4	.79
S-306-FHT-K	6	.91
S-308-FHT-K	8	1.05
S-310-FHT-K	10	1.18
S-312-FHT-K	12	1.33

Plug with Recessed Plate



P-306-RP

No.	Contacts	List Price Each
P-302-RP	2	\$0.59
P-303-RP	3	.64
P-304-RP	4	.70
P-306-RP	6	.79
P-308-RP	8	.92
P-310-RP	10	1.05
P-312-RP	12	1.16

Socket with Recessed Plate



S-306-RP

No.	Contacts	List Price Each
S-302-RP	2	\$0.61
S-303-RP	3	.67
S-304-RP	4	.72
S-306-RP	6	.86
S-308-RP	8	1.01
S-310-RP	10	1.16
S-312-RP	12	1.33



"300" SERIES PLUGS AND SOCKETS

Plug, Flared Hole in End

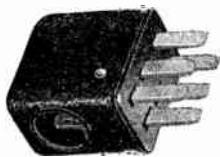

P-306-FHE

No.	Contacts	List Price Each
P-306-FHE	6	\$0.68
P-308-FHE	8	.77
P-310-FHE	10	.87
P-312-FHE	12	.98

Socket, Flared Hole in End



S-306-FHE

No.	Contacts	List Price Each
S-306-FHE	6	\$0.72
S-308-FHE	8	.86
S-310-FHE	10	1.00
S-312-FHE	12	1.14

Small size of caps of 302, 303 and 304 will not permit FHE type.

Plug, Cable Clamp in Cap

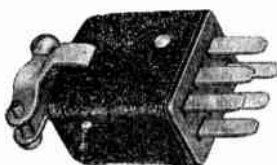

P-306-CCT

No.	Contacts	List Price Each
P-302-CCT	2	\$0.67
P-303-CCT	3	.72
P-304-CCT	4	.78
P-306-CCT	6	.86
P-308-CCT	8	.95
P-310-CCT	10	1.06
P-312-CCT	12	1.16

Socket, Cable Clamp in Cap

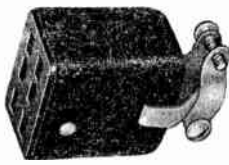

S-306-CCT

No.	Contacts	List Price Each
S-302-CCT	2	\$0.68
S-303-CCT	3	.74
S-304-CCT	4	.79
S-306-CCT	6	.91
S-308-CCT	8	1.05
S-310-CCT	10	1.18
S-312-CCT	12	1.33

Plug, Cable Clamp in Cap and with Latches



P-306-CCT-L

No.	Contacts	List Price Each
P-302-CCT-L	2	\$0.85
P-303-CCT-L	3	.90
P-304-CCT-L	4	.97
P-306-CCT-L	6	1.05
P-308-CCT-L	8	1.13
P-310-CCT-L	10	1.24
P-312-CCT-L	12	1.36

Socket, Cable Clamp in Cap and with Keepers

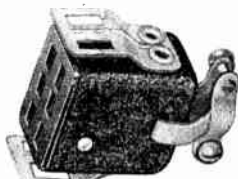

S-306-CCT-K

No.	Contacts	List Price Each
S-302-CCT-K	2	\$0.86
S-303-CCT-K	3	.92
S-304-CCT-K	4	.98
S-306-CCT-K	6	1.09
S-308-CCT-K	8	1.23
S-310-CCT-K	10	1.37
S-312-CCT-K	12	1.51

Plug, Cable Clamp in End

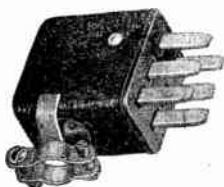

P-306-CCE

No.	Contacts	List Price Each
P-306-CCE	6	\$0.86
P-308-CCE	8	.95
P-310-CCE	10	1.06
P-312-CCE	12	1.16

Socket, Cable Clamp in End



S-306-CCE

No.	Contacts	List Price Each
S-306-CCE	6	\$0.91
S-308-CCE	8	1.05
S-310-CCE	10	1.18
S-312-CCE	12	1.33

Plug with Angle Brackets

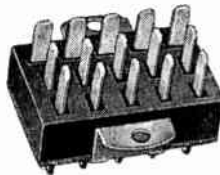

P-315-AB

No.	Contacts	List Price Each
P-315-AB	15	\$0.97
P-318-AB	18	1.21
P-321-AB	21	1.52
P-324-AB	24	1.84
P-327-AB	27	2.16
P-330-AB	30	2.48
P-333-AB	33	2.79

Socket with Angle Brackets

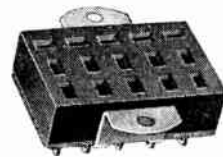

S-315-AB

No.	Contacts	List Price Each
S-315-AB	15	\$1.13
S-318-AB	18	1.36
S-321-AB	21	1.68
S-324-AB	24	2.00
S-327-AB	27	2.32
S-330-AB	30	2.65
S-333-AB	33	2.96

Plug with End Brackets

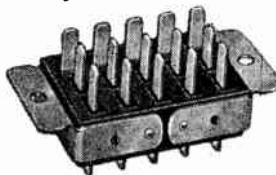

P-315-EB

No.	Contacts	List Price Each
P-315-EB	15	\$0.97
P-318-EB	18	1.21
P-321-EB	21	1.52
P-324-EB	24	1.84
P-327-EB	27	2.16
P-330-EB	30	2.48
P-333-EB	33	2.79

Sockets with End Brackets



S-315-EB

No.	Contacts	List Price Each
S-315-EB	15	\$1.13
S-318-EB	18	1.36
S-321-EB	21	1.68
S-324-EB	24	2.00
S-327-EB	27	2.32
S-330-EB	30	2.65
S-333-EB	33	2.96

Plug with Shallow Brackets

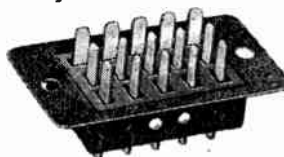

P-315-SB

No.	Contacts	List Price Each
P-315-SB	15	\$1.44
P-318-SB	18	1.77
P-321-SB	21	2.09
P-324-SB	24	2.48
P-327-SB	27	2.79
P-330-SB	30	3.19
P-333-SB	33	3.52

Sockets with Shallow Brackets



S-315-SB

No.	Contacts	List Price Each
S-315-SB	15	\$1.62
S-318-SB	18	1.93
S-321-SB	21	2.25
S-324-SB	24	2.65
S-327-SB	27	2.96
S-330-SB	30	3.37
S-333-SB	33	3.69

Plug with Deep Bracket

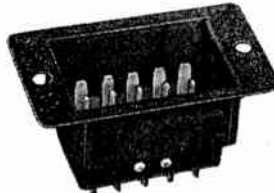

P-315-DB

No.	Contacts	List Price Each
P-315-DB	15	\$1.44
P-318-DB	18	1.77
P-321-DB	21	2.09
P-324-DB	24	2.48
P-327-DB	27	2.79
P-330-DB	30	3.20
P-333-DB	33	3.52

Socket with Deep Bracket



S-315-DB

No.	Contacts	List Price Each
S-315-DB	15	\$1.62
S-318-DB	18	1.93
S-321-DB	21	2.25
S-324-DB	24	2.65
S-327-DB	27	2.96
S-330-DB	30	3.37
S-333-DB	33	3.69



"300" SERIES PLUGS AND SOCKETS

Plug with Flared Hole in Top of Cap

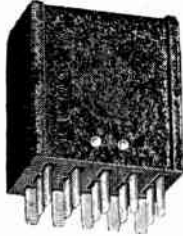

P-315-FHT

No.	Contacts	List Price Each
P-315-FHT	15	\$1.28
P-318-FHT	18	1.61
P-321-FHT	21	1.92
P-324-FHT	24	2.32
P-327-FHT	27	2.65
P-330-FHT	30	3.05
P-333-FHT	33	3.37

Socket, Flared Hole in Top of Cap

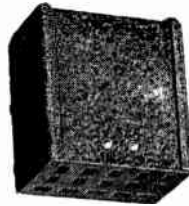

S-315-FHT

No.	Contacts	List Price Each
S-315-FHT	15	\$1.44
S-318-FHT	18	1.77
S-321-FHT	21	2.09
S-324-FHT	24	2.50
S-327-FHT	27	2.81
S-330-FHT	30	3.21
S-333-FHT	33	3.53

Plug, Cable C'amp in Top of Cap

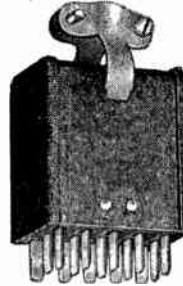

P-315-CCT

No.	Contacts	List Price Each
P-315-CCT	15	\$1.52
P-318-CCT	18	1.84
P-321-CCT	21	2.16
P-324-CCT	24	2.55
P-327-CCT	27	2.89
P-330-CCT	30	3.37
P-333-CCT	33	3.61

Socket, Cable Clamp in Top of Cap



S-315-CCT

No.	Contacts	List Price Each
S-315-CCT	15	\$1.68
S-318-CCT	18	2.00
S-321-CCT	21	2.32
S-324-CCT	24	2.74
S-327-CCT	27	3.05
S-330-CCT	30	3.53
S-333-CCT	33	3.77

Plug with Flared Hole in End of Cap

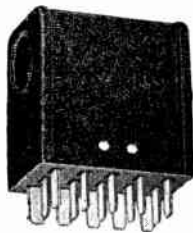

P-315-FHE

No.	Contacts	List Price Each
P-315-FHE	15	\$1.28
P-318-FHE	18	1.61
P-321-FHE	21	1.92
P-324-FHE	24	2.32
P-327-FHE	27	2.65
P-330-FHE	30	3.05
P-333-FHE	33	3.37

Socket, Flared Hole in End of Cap

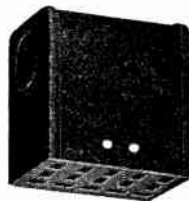

S-315-FHE

No.	Contacts	List Price Each
S-315-FHE	15	\$1.44
S-318-FHE	18	1.77
S-321-FHE	21	2.09
S-324-FHE	24	2.50
S-327-FHE	27	2.81
S-330-FHE	30	3.21
S-333-FHE	33	3.53

Plug, Cable Clamp in End of Cap

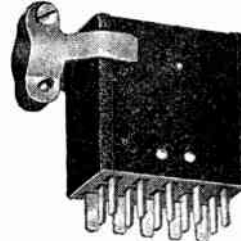

P-315-CCE

No.	Contacts	List Price Each
P-315-CCE	15	\$1.52
P-318-CCE	18	1.84
P-321-CCE	21	2.16
P-324-CCE	24	2.55
P-327-CCE	27	2.89
P-330-CCE	30	3.37
P-333-CCE	33	3.61

Socket, Cable Clamp in End of Cap



S-315-CCE

No.	Contacts	List Price Each
S-315-CCE	15	\$1.68
S-318-CCE	18	2.00
S-321-CCE	21	2.32
S-324-CCE	24	2.74
S-327-CCE	27	3.05
S-330-CCE	30	3.53
S-333-CCE	33	3.77

Plug, Flared Hole in Top of Cap with Latches



P-315-FHT-L

No.	Contacts	List Price Each
P-315-FHT-L	15	\$1.44
P-318-FHT-L	18	1.77
P-321-FHT-L	21	2.09
P-324-FHT-L	24	2.50
P-327-FHT-L	27	2.81
P-330-FHT-L	30	3.21
P-333-FHT-L	33	3.53

Socket, Flared Hole in Top of Cap and with Keepers



S-315-FHT-K

No.	Contacts	List Price Each
S-315-FHT-K	15	\$1.62
S-318-FHT-K	18	1.93
S-321-FHT-K	21	2.25
S-324-FHT-K	24	2.66
S-327-FHT-K	27	2.98
S-330-FHT-K	30	3.38
S-333-FHT-K	33	3.70

Plug, Cable Clamp in Top of Cap and with Latches

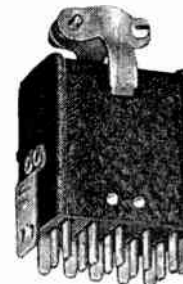

P-315-CCT-L

No.	Contacts	List Price Each
P-315-CCT-L	15	\$1.68
P-318-CCT-L	18	2.00
P-321-CCT-L	21	2.32
P-324-CCT-L	24	2.74
P-327-CCT-L	27	3.05
P-330-CCT-L	30	3.53
P-333-CCT-L	33	3.77

Socket, Cable Clamp in Top of Cap and with Keepers



S-315-CCT-K

No.	Contacts	List Price Each
S-315-CCT-K	15	\$1.85
S-318-CCT-K	18	2.17
S-321-CCT-K	21	2.50
S-324-CCT-K	24	2.90
S-327-CCT-K	27	3.21
S-330-CCT-K	30	3.70
S-333-CCT-K	33	3.93



"400" SERIES PLUGS AND SOCKETS

(Formerly "Heavy Duty")

General Specifications

Made in 2, 4, 6, 8, 10 and 12 contacts. All Plugs and Sockets are polarized. Body of molded Bakelite. Phosphor bronze "knife-switch" type Socket contacts engage both sides of flat Plug Contacts—double contact area. Plug prongs are 1/4" wide by 1/8" thick. Caps are finished in Black Crystal and equipped with fibre lining. Plugs and Sockets arranged for cap or panel mounting.

Note: Standard angle brackets cannot be attached to S-402-AB due to narrow block and insufficient material for screw threads. A special bracket is supplied (Type 46) See illustration. The Socket fits into this bracket which is attached to panel.

Check the No. 2400 Series Plugs and Sockets listed on pages F-42 and F-43 which are similar to the 400 Series except their design increases the creepage distances and therefore can take higher voltages.

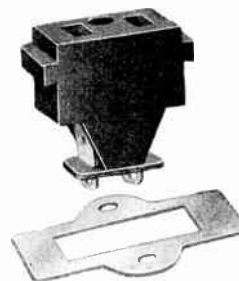

S-402-AB (No. 46 Bracket)

PLUG — Less Angle Brackets

Drilled and Tapped Unless Otherwise Specified

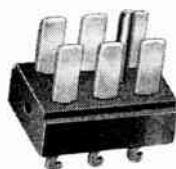

P-406-LAB

Code	Contacts	List Price Each
P-402-LAB	2	\$0.40
P-404-LAB	4	.55
P-406-LAB	6	.72
P-408-LAB	8	.87
P-410-LAB	10	1.05
P-412-LAB	12	1.21

SOCKET — Less Angle Brackets

Drilled and Tapped Unless Otherwise Specified

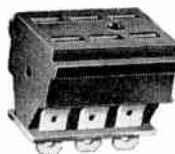

S-406-LAB

Code	Contacts	List Price Each
S-402-LAB	2	\$0.49
S-404-LAB	4	.72
S-406-LAB	6	.97
S-408-LAB	8	1.21
S-410-LAB	10	1.44
S-412-LAB	12	1.66

PLUG — With Angle Brackets

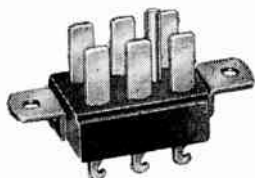

P-406-AB

Code	Contacts	List Price Each
P-402-AB	2	\$0.72
P-404-AB	4	.87
P-406-AB	6	1.05
P-408-AB	8	1.21
P-410-AB	10	1.37
P-412-AB	12	1.52

SOCKET — With Angle Brackets

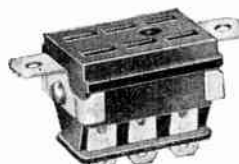

S-406-AB

Code	Contacts	List Price Each
S-402-AB	2	\$0.81
S-404-AB	4	1.05
S-406-AB	6	1.28
S-408-AB	8	1.52
S-410-AB	10	1.77
S-412-AB	12	2.00

PLUG — With Shallow Bracket for Flush Mounting



P-406-SB

Code	Contacts	List Price Each
P-402-SB	2	\$0.87
P-404-SB	4	1.13
P-406-SB	6	1.37
P-408-SB	8	1.61
P-410-SB	10	1.85
P-412-SB	12	2.09

SOCKET — With Shallow Bracket for Flush Mounting



S-406-SB

Code	Contacts	List Price Each
S-402-SB	2	\$0.97
S-404-SB	4	1.28
S-406-SB	6	1.61
S-408-SB	8	1.92
S-410-SB	10	2.24
S-412-SB	12	2.55

PLUG — With Deep Bracket for Recessed Mounting



P-406-DB

Code	Contacts	List Price Each
P-402-DB	2	\$0.87
P-404-DB	4	1.13
P-406-DB	6	1.37
P-408-DB	8	1.61
P-410-DB	10	1.85
P-412-DB	12	2.09

SOCKET — With Deep Bracket for Recessed Mounting

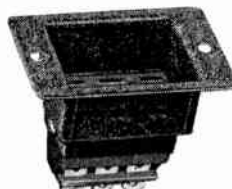

S-406-DB

Code	Contacts	List Price Each
S-402-DB	2	\$0.97
S-404-DB	4	1.28
S-406-DB	6	1.61
S-408-DB	8	1.92
S-410-DB	10	2.24
S-412-DB	12	2.55



"400" SERIES PLUGS AND SOCKETS (Formerly "Heavy Duty")

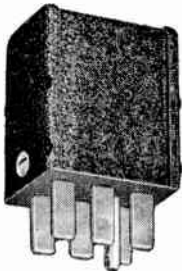

P-406-FHT

PLUG — With Flared Hole in Top

Code No.	Contacts	List Price Each
P-402-FHT	2	\$0.81
P-404-FHT	4	1.05
P-406-FHT	6	1.28
P-408-FHT	8	1.52
P-410-FHT	10	1.76
P-412-FHT	12	1.99



S-406-FHT

SOCKET — With Flared Hole in Top

Code No.	Contacts	List Price Each
S-402-FHT	2	\$0.89
S-404-FHT	4	1.22
S-406-FHT	6	1.53
S-408-FHT	8	1.85
S-410-FHT	10	2.17
S-412-FHT	12	2.50

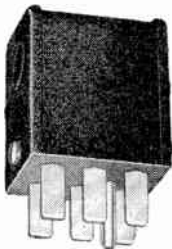

P-406-FHE

PLUG — With Flared Hole in End

Code No.	Contacts	List Price Each
P-402-FHE	2	\$0.81
P-404-FHE	4	1.05
P-406-FHE	6	1.28
P-408-FHE	8	1.52
P-410-FHE	10	1.76
P-412-FHE	12	1.99



S-406-FHE

SOCKET — With Flared Hole in End

Code No.	Contacts	List Price Each
S-402-FHE	2	\$0.89
S-404-FHE	4	1.22
S-406-FHE	6	1.53
S-408-FHE	8	1.85
S-410-FHE	10	2.17
S-412-FHE	12	2.50

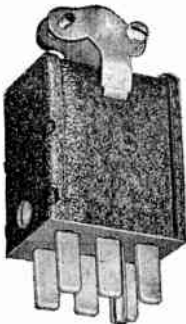

P-406-CCT

PLUG — With Cable Clamp in Top

Code No.	Contacts	List Price Each
P-402-CCT	2	\$1.13
P-404-CCT	4	1.37
P-406-CCT	6	1.61
P-408-CCT	8	1.84
P-410-CCT	10	2.07
P-412-CCT	12	2.31



S-406-CCT

SOCKET — With Cable Clamp in Top

Code No.	Contacts	List Price Each
S-402-CCT	2	\$1.22
S-404-CCT	4	1.53
S-406-CCT	6	1.85
S-408-CCT	8	2.17
S-410-CCT	10	2.50
S-412-CCT	12	2.81

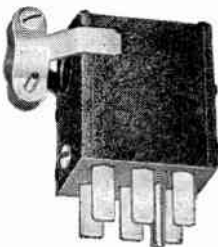

P-406-CCE

PLUG — With Cable Clamp in End

Code No.	Contacts	List Price Each
P-402-CCE	2	\$1.13
P-404-CCE	4	1.37
P-406-CCE	6	1.61
P-408-CCE	8	1.84
P-410-CCE	10	2.07
P-412-CCE	12	2.31

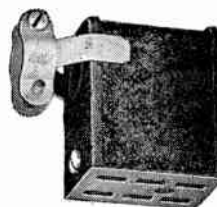

S-406-CCE

SOCKET — With Cable Clamp in End

Code No.	Contacts	List Price Each
S-402-CCE	2	\$1.22
S-404-CCE	4	1.53
S-406-CCE	6	1.85
S-408-CCE	8	2.17
S-410-CCE	10	2.50
S-412-CCE	12	2.81



"2400" SERIES PLUGS AND SOCKETS

The 2400 Series Plugs and Sockets are designed for highest electrical and mechanical efficiency, and although they carry the same rating as the 400 Series, they will actually handle considerably higher currents due to their improved construction.

An entirely new type of socket contact has been designed. Four individual flexing surfaces make positive contact over practically their entire length. Note in the illustration how they exert maximum pressure at every point. Also note unique method of anchoring terminals in the block—they cannot be moved up or down.

This design provides greater contact surface, increased pressure, with smoother action.

Socket contacts are of phosphor bronze, cadmium plated. Male contacts are of heavy brass 1/4" x 1/8", cadmium plated.



The contact to contact, and contact to ground distance has been considerably increased by mounting the contacts into recessed pockets with a Bakelite barrier surrounding and extending above. This method is used on both the top and bottom sides of both plugs and sockets, greatly increasing the leakage path.

The outside dimensions of corresponding plug and socket bodies are the same and can, therefore, be changed from brackets to caps, or vice versa.

Two styles of brackets are furnished "SB" (shallow bracket) for flush mounting and "DB" (deep bracket) for recessed mounting. Caps are furnished with flared hole in top or end, or with cable clamps in top or end. Unless otherwise specified the following size cable entrance holes will be supplied:

2402—3/8"	2406—7/8"	2410—9/8"
2404—1/8"	2408—1/8"	2412—5/8"

As noted above, the 2400 Series is furnished in 2, 4, 6, 8, 10, and 12 contacts. All plugs and sockets are polarized.

Plug and socket bodies are of molded Bakelite. The fibre linings in the caps are the same for both plugs and sockets.

A shoulder extends around the face side of plug and socket presenting a finished appearance when mounted in bracket or cap.

On account of this shoulder extending around the entire face of the body blocks, angle brackets cannot be used with the 2400 Series Plugs or Sockets.

The entire 2400 Series is interchangeable with the 400 Series as 2400 Plugs fit corresponding 400 Sockets, and 400 Plugs fit corresponding 2400 Sockets.



Solder connecting side of Plug Body showing Recessed Pockets with Barriers around contacts. Plug contacts are also in Recessed Pockets on opposite side.



Solder connecting side of Socket Body showing Recessed Pockets with Barriers around contacts. Socket contacts are also in Recessed Pockets on opposite side.

PLUG—Less Mounting Bracket

Drilled and Tapped Unless Otherwise Specified



Code	Contacts	List Price Each
P-2402	2	\$0.55
P-2404	4	.74
P-2406	6	.92
P-2408	8	1.10
P-2410	10	1.28
P-2412	12	1.48

SOCKET—Less Mounting Bracket

Drilled and Tapped Unless Otherwise Specified



Code	Contacts	List Price Each
S-2402	2	\$0.64
S-2404	4	.84
S-2406	6	1.02
S-2408	8	1.23
S-2410	10	1.41
S-2412	12	1.62

PLUG—With Shallow Bracket for Flush Mounting

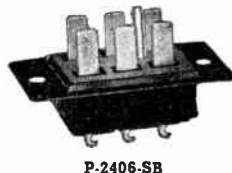

Code	Contacts	List Price Each
P-2402-SB	2	\$0.99
P-2404-SB	4	1.16
P-2406-SB	6	1.35
P-2408-SB	8	1.54
P-2410-SB	10	1.75
P-2412-SB	12	1.93

SOCKET—With Shallow Bracket for Flush Mounting



Code	Contacts	List Price Each
S-2402-SB	2	\$1.08
S-2404-SB	4	1.27
S-2406-SB	6	1.47
S-2408-SB	8	1.67
S-2410-SB	10	1.89
S-2412-SB	12	2.09

PLUG—With Deep Bracket for Recessed Mounting



Code	Contacts	List Price Each
P-2402-DB	2	\$1.08
P-2404-DB	4	1.25
P-2406-DB	6	1.43
P-2408-DB	8	1.63
P-2410-DB	10	1.82
P-2412-DB	12	2.02

SOCKET—With Deep Bracket for Recessed Mounting



Code	Contacts	List Price Each
S-2402-DB	2	\$1.15
S-2404-DB	4	1.38
S-2406-DB	6	1.54
S-2408-DB	8	1.76
S-2410-DB	10	1.97
S-2412-DB	12	2.17



"2400" SERIES PLUGS AND SOCKETS



P-2406-FHT

PLUG—With Flared Hole in Top

Code No.	Contacts	List Price Each
P-2402-FHT	2	\$1.08
P-2404-FHT	4	1.25
P-2406-FHT	6	1.43
P-2408-FHT	8	1.63
P-2410-FHT	10	1.82
P-2412-FHT	12	2.04



S-2406-FHT

SOCKET—With Flared Hole in Top

Code No.	Contacts	List Price Each
S-2402-FHT	2	\$1.15
S-2404-FHT	4	1.36
S-2406-FHT	6	1.54
S-2408-FHT	8	1.76
S-2410-FHT	10	1.97
S-2412-FHT	12	2.17

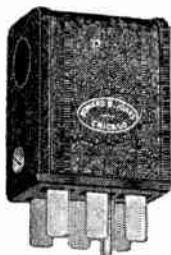

P-2406-FHE

PLUG—With Flared Hole in End

Code No.	Contacts	List Price Each
P-2402-FHE	2	\$1.08
P-2404-FHE	4	1.25
P-2406-FHE	6	1.43
P-2408-FHE	8	1.63
P-2410-FHE	10	1.82
P-2412-FHE	12	2.04

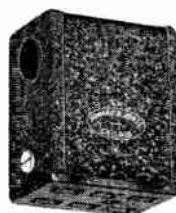

S-2406-FHE

SOCKET—With Flared Hole in End

Code No.	Contacts	List Price Each
S-2402-FHE	2	\$1.15
S-2404-FHE	4	1.36
S-2406-FHE	6	1.54
S-2408-FHE	8	1.76
S-2410-FHE	10	1.97
S-2412-FHE	12	2.17



P-2406-CCT

PLUG—With Cable Clamp in Top

Code No.	Contacts	List Price Each
P-2402-CCT	2	\$1.39
P-2404-CCT	4	1.56
P-2406-CCT	6	1.76
P-2408-CCT	8	1.94
P-2410-CCT	10	2.14
P-2412-CCT	12	2.35



S-2406-CCT

SOCKET—With Cable Clamp in Top

Code No.	Contacts	List Price Each
S-2402-CCT	2	\$1.50
S-2404-CCT	4	1.67
S-2406-CCT	6	1.86
S-2408-CCT	8	2.07
S-2410-CCT	10	2.28
S-2412-CCT	12	2.50

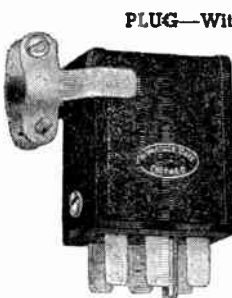

P-2406-CCE

PLUG—With Cable Clamp in End

Code No.	Contacts	List Price Each
P-2402-CCE	2	\$1.39
P-2404-CCE	4	1.56
P-2406-CCE	6	1.76
P-2408-CCE	8	1.94
P-2410-CCE	10	2.14
P-2412-CCE	12	2.35



S-2406-CCE

SOCKET—With Cable Clamp in End

Code No.	Contacts	List Price Each
S-2402-CCE	2	\$1.50
S-2404-CCE	4	1.67
S-2406-CCE	6	1.86
S-2408-CCE	8	2.07
S-2410-CCE	10	2.28
S-2412-CCE	12	2.50



“500” SERIES PLUGS AND SOCKETS

Designed for 3,000 volts and 25 amperes per contact. Circuit characteristics, however, may alter this rating one way or the other.

Long leakage path from terminal to terminal, and terminal to ground. Contacts are brass and phosphor bronze, silver plated. Metal parts of caps and brackets are steel, parkerized (rust-proofed). Plug and socket blocks are interchangeable in caps and brackets.

All sizes are polarized in a manner to prevent a smaller plug being inserted in a larger socket. Thus different sizes may be used on one installation without danger of making wrong connections.

Extreme care has been taken to make terminal connections under cap very accessible both for original wiring and subsequent inspection. The cap is insulated with canvas bakelite. Plug prong cross section $\frac{5}{16}$ " x $\frac{3}{32}$ ".

IMPORTANT: For safety with high voltages DEEP BRACKETS should always be used on one plug or socket, when the other plug or socket has a CAP. SHALLOW BRACKETS are for use only in connecting two units, each unit having plug or socket with SHALLOW BRACKET.

Cable entrance: Because of the great variation in type and size of cables, we have considered it best not to supply cable clamps of any kind. The cap end is made to accommodate standard EX clamps which may be obtained at any electrical jobbing house. The cap end will be furnished with round hole from $\frac{1}{2}$ " diameter and $1\frac{1}{4}$ " diameter in steps of $\frac{1}{8}$ ", if the size required is given on order. If no size is given, plain cap end with center punch locating center will be shipped.

P-506-CE
(Plug with Cap)
(BX Clamp shown
but not furnished)

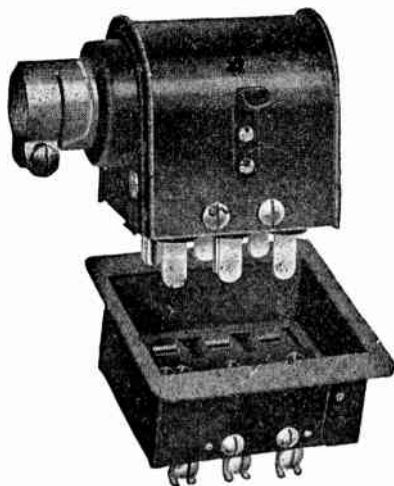

S-506-DB
(Socket with Deep Bracket)



S-506-CE
(Socket with Cap)

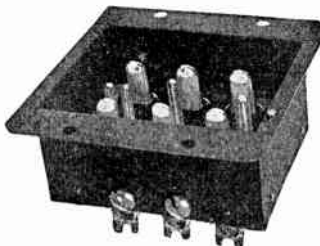

P-506-DB
(Plug with Deep Bracket)

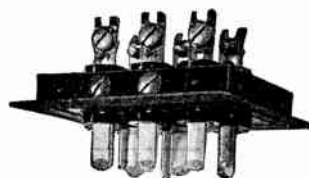

P-506-SB
(Plug with Shallow Bracket)



S-506-SB
(Socket with Shallow Bracket)

LOCKS FOR 500 SERIES PLUGS AND SOCKETS



No. 500-L Locks

Locks shown above are used in connection with any DEEP BRACKET and cap combination.

The locks securely hold the units together, but they can be released instantly.

The mounting plates are made to fit all DEEP BRACKETS, and are fastened by the same screws or rivets that hold the deep brackets to the panel. Can not be used on shallow brackets. Sold in pairs only.

PLUG With Cap

Code	Contacts	List Price Each
P-502-CE	2	\$3.48
P-504-CE	4	5.01
P-506-CE	6	6.54
P-508-CE	8	8.07
P-510-CE	10	9.60
P-512-CE	12	11.13

SOCKET With Cap

Code	Contacts	List Price Each
S-502-CE	2	\$3.48
S-504-CE	4	5.01
S-506-CE	6	6.54
S-508-CE	8	8.07
S-510-CE	10	9.60
S-512-CE	12	11.13

PLUG With Deep Bracket

Code	Contacts	List Price Each
P-502-DB	2	\$3.06
P-504-DB	4	4.39
P-506-DB	6	5.70
P-508-DB	8	7.04
P-510-DB	10	8.35
P-512-DB	12	9.68

SOCKET With Deep Bracket

Code	Contacts	List Price Each
S-502-DB	2	\$3.06
S-504-DB	4	4.39
S-506-DB	6	4.70
S-508-DB	8	7.04
S-510-DB	10	8.35
S-512-DB	12	9.68

PLUG With Shallow Bracket

Code	Contacts	List Price Each
P-502-SB	2	\$3.06
P-504-SB	4	4.39
P-506-SB	6	5.70
P-508-SB	8	7.04
P-510-SB	10	8.35
P-512-SB	12	9.68

SOCKET With Shallow Bracket

Code	Contacts	List Price Each
S-502-SB	2	\$3.06
S-504-SB	4	4.39
S-506-SB	6	5.70
S-508-SB	8	7.04
S-510-SB	10	8.35
S-512-SB	12	9.68



CINCH-JONES SALES • DIVISION OF CINCH MANUFACTURING CORPORATION

BARRIER TYPE TERMINAL STRIPS

No. 150 TERMINAL STRIPS

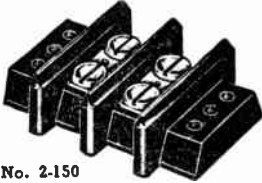

No. 2-150

1-13/16" wide by 25/32" high. Terminals are mounted on 11/16" centers. Screws: 10-32 x 5/16" brass, burnished nickel plate. Fits standard 50 Amp. solder lug for 6 Ga. stranded wire. Metal to metal spacing over bakelite 3/8".

Code	List Price Each	Code	List Price Each
1-150	\$0.55	6-150	\$2.48
2-150	.94	7-150	2.86
3-150	1.32	8-150	3.25
4-150	1.71	9-150	3.63
5-150	2.09	10-150	4.02

No. 151 TERMINAL STRIPS

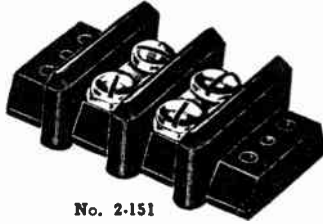

No. 2-151

2" wide by 15/16" high. Terminals are mounted on 7/8" centers. Screws: 12-32 x 3/8" brass, burnished nickel plate. Fits standard 70 Amp. solder lug for 4 Ga. stranded wire. Metal to metal spacing over bakelite 3/4".

Code	List Price Each	Code	List Price Each
1-151	\$0.94	5-151	\$4.02
2-151	1.71	6-151	4.79
3-151	2.48	7-151	5.56
4-151	3.25	8-151	6.33

No. 152 TERMINAL STRIPS

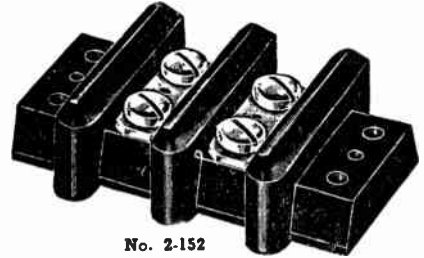

No. 2-152

2 1/2" wide by 1 1/8" high. Terminals are mounted on 1 1/8" centers. Screws: 1/4"-28 x 1/2" brass, burnished nickel plate. Fits standard 90 Amp. solder lug for 2 Ga. stranded wire. Metal to metal spacing over bakelite 1".

Code	List Price Each	Code	List Price Each
1-152	\$1.27	4-152	\$4.73
2-152	2.42	5-152	5.89
3-152	3.58	6-152	7.04

"W" Solder Terminal for Barrier Strips



Code	For use with Barrier Strip	List Price Each
No. W-140	No. 140	\$0.44
No. W-141	No. 141	.059
No. W-142	No. 142	.072

For use with Barrier Strip

Code	List Price Each
No. 140	\$0.44
No. 141	.059
No. 142	.072

For use with Barrier Strip

Code	List Price Each
No. 150	\$1.00
No. 151	.18
No. 152	.26



"Y" Solder Terminal

Code	For use with Barrier Strip	List Price Each
No. Y-140	No. 140	\$0.44
No. Y-141	No. 141	.059
No. Y-142	No. 142	.072

FANNING STRIPS FOR CONNECTING TO BARRIER TERMINAL STRIPS

Jones Fanning Strip Terminals are of .032" Brass, Cadmium Plated. The Bakelite strips are furnished with a hole in either the right or left end for fastening the cable with a cable clamp or lacing twine. Simplifies cable or harness wiring, assuring positive connections. Makes replacement of units an easy matter and assures correct connections after servicing.

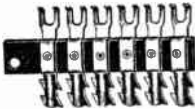

No. 6-160-L

THE 160 SERIES

The following Fanning Strips fit the 140 Series Barrier Strips. Terminals are mounted on 3/32" Bakelite, 1/2" wide and on 3/8" centers.

Code	List Price Each	Code	List Price Each
2-160-L	\$0.13	2-160-R	\$0.13
3-160-L	.20	3-160-R	.20
4-160-L	.25	4-160-R	.25
5-160-L	.32	5-160-R	.32
6-160-L	.39	6-160-R	.39
7-160-L	.45	7-160-R	.45
8-160-L	.51	8-160-R	.51
9-160-L	.57	9-160-R	.57
10-160-L	.64	10-160-R	.64
11-160-L	.70	11-160-R	.70
12-160-L	.76	12-160-R	.76
13-160-L	.83	13-160-R	.83
14-160-L	.89	14-160-R	.89
15-160-L	.96	15-160-R	.96
16-160-L	1.01	16-160-R	1.01
17-160-L	1.08	17-160-R	1.08
18-160-L	1.16	18-160-R	1.16
19-160-L	1.21	19-160-R	1.21
20-160-L	1.28	20-160-R	1.28
21-160-L	1.33	21-160-R	1.33



6-161-L (Cable Clamp on Left)
(No. 162 same type)

THE 161 SERIES

The following Fanning Strips fit the 141 Series Barrier Strips. Terminals are mounted on 3/32" Bakelite, 5/8" wide and on 7/16" centers.

Code	List Price Each	Code	List Price Each
2-161-L	\$0.14	2-161-R	\$0.14
3-161-L	.21	3-161-R	.21
4-161-L	.26	4-161-R	.26
5-161-L	.33	5-161-R	.33
6-161-L	.40	6-161-R	.40
7-161-L	.46	7-161-R	.46
8-161-L	.52	8-161-R	.52
9-161-L	.58	9-161-R	.58
10-161-L	.65	10-161-R	.65
11-161-L	.72	11-161-R	.72
12-161-L	.77	12-161-R	.77
13-161-L	.84	13-161-R	.84
14-161-L	.91	14-161-R	.91
15-161-L	.97	15-161-R	.97
16-161-L	1.03	16-161-R	1.03
17-161-L	1.09	17-161-R	1.09
18-161-L	1.17	18-161-R	1.17
19-161-L	1.22	19-161-R	1.22
20-161-L	1.29	20-161-R	1.29

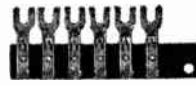

6-161-R (Cable Clamp on Right)
(No. 162 same type)

THE 162 SERIES

The following Fanning Strips fit the 142 Series Barrier Strips. Terminals are mounted on 3/32" Bakelite, 5/8" wide and on 9/16" centers.

Code	List Price Each	Code	List Price Each
2-162-L	\$0.17	2-162-R	\$0.17
3-162-L	.23	3-162-R	.23
4-162-L	.29	4-162-R	.29
5-162-L	.35	5-162-R	.35
6-162-L	.43	6-162-R	.43
7-162-L	.48	7-162-R	.48
8-162-L	.55	8-162-R	.55
9-162-L	.61	9-162-R	.61
10-162-L	.68	10-162-R	.68
11-162-L	.74	11-162-R	.74
12-162-L	.80	12-162-R	.80
13-162-L	.86	13-162-R	.86
14-162-L	.94	14-162-R	.94
15-162-L	.99	15-162-R	.99
16-162-L	1.06	16-162-R	1.06
17-162-L	1.11	17-162-R	1.11



CABLE CLAMPS

Cable Clamps are available for the Fanning Strips listed at the left and are furnished in 6 different sizes as listed below. Cable Clamp is of Brass Nickel Plated, with 6-32 round head Nickel Plated Brass Screws. For convenience the Cable Clamps are furnished unassembled.

CABLE CLAMP SIZES AVAILABLE

No.	I. D.
CC-161-4	1/4"
CC-161-6	3/8"
CC-161-8	1/2"
CC-161-10	5/8"
CC-161-12	3/4"
CC-161-14	7/8"

List Price Each \$0.14

Be sure to give code number when ordering.

On small sizes Lacing Twine can be used for anchoring cable to the Fanning Strip instead of Cable Clamp.

JAN SOCKETS AND SHIELDS

Part No.	DESCRIPTION	Designation Per JAN/S28A-1	List Price Each
235 BC	7 Pin Mica	TS 102P01	.59
238 BC	7 Pin Ceramic	TS 102C01	.97
169 BC	9 Pin Mica	TS 103P01	.77
176 BC	9 Pin Ceramic	TS 103C01	1.20
335 PHSPTD	Octal Mica	TS 101P01	.80
336 PHSPTD	Octal Mica—with Bushings	TS 101P02	1.12
338 PHSPTD	Octal Ceramic	TS 101C01	1.20
337 PHSPTD	Octal Ceramic—with Bushings	TS 101C02	1.54
342 PHSPTD	Octal Mica—GRC	TS 101P0	.78
121	7 Pin Shield 1-3/8"	TS 102U01	.25
120	7 Pin Shield 1-3/4"	TS 102U02	.25
149	7 Pin Shield 2-1/4"	TS 102U03	.31
193	9 Pin Shield 1-1/2"	TS 103U01	.31
191	9 Pin Shield 1-15/16"	TS 103U02	.34
195	9 Pin Shield 2-3/8"	TS 103U03	.39



**RTMA
SADDLE TYPE**
Bottom Mounting

Insulator Material	Model No.	List Price Ea.
7 PIN		
Gen. Purp. Mica Filled Ceramic	100	.14
	105	.17
	220	.45
9 PIN		
Gen. Purp. Mica Filled Ceramic	270	.20
	271	.24
	272	.63

Contact Material — Brass, Cad. Plated



**RMA
SADDLE TYPE**
with Ground Lugs
Bottom Mounting

Insulator Material	Model No.	List Price Ea.
7 PIN		
Gen. Purp. Mica Filled Ceramic	300	.15
	305	.19
	320	.46
9 PIN		
Gen. Purp. Mica Filled Ceramic	370	.20
	371	.25
	372	.65

Contact Material — Brass, Cad. Plated



**JAN
SADDLE TYPE**
Top Mounting

Insulator Material	Model No.	List Price Ea.
7 PIN		
Gen. Purp. Mico Filled Ceramic	240	.14
	241	.17
	113	.45
9 PIN		
Gen. Purp. Mica Filled Ceramic	196	.20
	197	.24
	170	.63

Contact Material — Brass, Cad. Plated



**JAN BASE
SHIELD TYPE**
Top Mounting

Insulator Material	Model No.	List Price Ea.
7 PIN		
Gen. Purp. Mica Filled Ceramic	ST 234	.30
	ST 235	.35
	ST 238	.56
9 PIN		
Gen. Purp. Mica Filled Ceramic	ST 167	.41
	ST 169	.47
	ST 176	.95

Contact Material — Brass, Cad. Plated



**SNAP-ON
JAN TYPE**
Top Mounting

Insulator Material	Model No.	List Price Ea.
7 PIN		
Gen. Purp. Mica Filled Ceramic	250	.16
	251	.20
	252	.47
9 PIN		
Gen. Purp. Mica Filled Ceramic	450	.24
	451	.29
	452	.69

Contact Material — Brass, Cad. Plated



JAN TYPE SHIELDS
Per Jan/S-28

Model No.	Height	Material	
		Steel, Cad. Plated	List Price Ea.
7 PIN			
127	1 3/8"		.18
126	1 3/4"		.19
148	2 1/4"		.28
9 PIN			
192	1 1/2"		.29
190	1-15/16"		.31
194	2 3/8"		.35

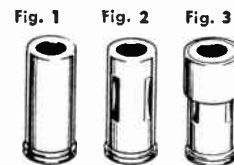

**SNAP-ON
TYPE
SHIELDS**

Fig.	Model No.	Desc.	Height	List Price Ea.
7 PIN				
1	200		1-53/64"	.08
2	224	Slit	1-53/64"	.12
3	225	Slit & Lead	1-53/64"	.49
9 PIN				
1	227		2-1/16"	.10
2	228	Slit	2-1/16"	.14
3	229	Slit & Lead	2-1/16"	.57



**PRINTED
CIRCUIT
SOCKETS**
with Ground Contact

Insulator Material	Model No.	List Price Ea.
7 PIN		
Gen. Purp. Mica Filled	545	.25
	546	.26
9 PIN		
Gen. Purp. Mica Filled	554	.30
	555	.31

Contact Material — Brass, Cad. Plated.
Also available in all subminiature sizes.



**7 PIN NON-
MICROPHONIC
TYPE**
Bottom Mounting

Insulator Material	Model No.	List Price Ea.
Gen. Purp. Mica Filled Ceramic	134	.30
	135	.35
	157	.56

Contact Material
Brass, Cad. Plated



**PRINTED
CIRCUIT
SOCKETS**
with Shield Contact

Insulator Material	Model No.	List Price Ea.
7 PIN		
Gen. Purp. Mica Filled	548	.27
	549	.28
9 PIN		
Gen. Purp. Mica Filled	557	.32
	558	.33

Contact Material — Brass, Cad. Plated.
Also available in all subminiature sizes.

AMERICA'S QUALITY LINE • RADIO, TELEVISION, ELECTRONIC COMPONENTS



FLAT TYPE SUB-MINIATURE

Insulator Material	Model No.	List Price Ea.
	5 PIN	
Mica Filled	765 BC	.52
	7 PIN	
Mica Filled	767 BC	.61
MOUNTING RINGS		
5 Pin	756	.03
7 Pin	768	.04



VENTILATED SHIELD

*Brass, Nickel Plated
**Steel, Cad. Plated

Model No.	Height	List Price Ea.
	7 PIN	
121V*	1 3/4"	.36
120V*	1 3/4"	.36
149V*	2 1/4"	.42
127V**	1 3/4"	.29
126V**	1 3/4"	.30
148V**	2 1/4"	.39
	9 PIN	
193V*	1 1/2"	.42
191V*	1-15/16"	.45
195V*	2 3/8"	.50
192V**	1 1/2"	.40
190V**	1-15/16"	.42
194V**	2 3/8"	.46



COMMERCIAL OCTAL SOCKETS

Insulator Material	Model No.	List Price Ea.
	BOT. MTD. — Less Ground Lugs	
Gen. Purp.	600	.15
Mica Filled	608	.20
	BOT. MTD. — With Ground Lugs	
Gen. Purp.	601	.15
Mica Filled	609	.20
	TOP MTD. — Less Ground Lugs	
Gen. Purp.	602	.15
Mica Filled	610	.20
Contact Material — Brass, Cad. Plated		

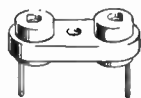

CRYSTAL SOCKET

Model No.	Contact Material	List Price Ea.
430	Brass, Cad. Plated	.23
430PH	Phos. Bronze, Cad. Pl.	.24
430BC	Ber'm. Cap., Silver Pl.	.32

Insulator Material
Ceramic, Grade 5, Glazed



ROUND OCTAL SUB-MINIATURE

Sub-Miniature Socket



Insulator Material	Model No.	List Price Ea.
Mica	701BC	1.03

Contact Material—Ber'm. Cop., Silver Pl.

SUB-MINIATURE SHIELD

Material	Model No.	List Price Ea.
Steel	752	.22



9 PIN RMA HIGH VOLTAGE TYPE

Contact Material
Brass, Cad. Plated

Insulator Material	Model No.	List Price Ea.
Mica Filled	403-1	.21
Gen. Purp.	410-1	.17



14 PIN FLAT SADDLE TYPE

Top Mounting

Insulator Material	Model No.	List Price Ea.
Mica	417PH5PTD	.79
Gen. Purp.	418PH5PTD	.70

Contact Material
Phos. Bronze, Silver Plated, Tin Dipped



RMA TYPE TURRET SOCKET

Base
Glass Melamine

Insulator Material	Model No.	List Price Ea.
	7 PIN	
Mica	T17-116PH5PTD	2.01
	9 PIN	
Mica	T17-277PH5PTD	2.09

Contact Material
Phos. Bronze, Silver Plated, Tin Dipped



20 PIN SADDLE TYPE

Bottom Mounting

Insulator Material	Model No.	List Price Ea.
Mica	571PH5PTD	3.78

Contact Material
Phos. Bronze, Silver Plated, Tin Dipped

TRANSISTOR TYPE SUBMINIATURE SOCKETS



Insulator Material	Model No.	List Price Ea.
	3 PIN	
	POINT & JUNCTION TYPE TRANSISTORS	
Mica Filled	799BC	.52
	4 PIN — LINOTETRA TYPE TRANSISTOR	
Mica Filled	803BC	.52



Contact Material — Beryllium Copper, Silver Plated and Gold Flashed

KEL-F SOCKETS

Per JAN/S28A-1

SPECIFICATION

Except for KEL-F Insulator

Model No.	7 PIN	List Price Ea.
214BC		1.89
Model No.	9 PIN	List Price Ea.
215BC		2.37

Elco Varicon Miniature-Connectors provide the simplest, quickest, most positive means for connecting electronic or electric circuits. Varicons introduce "Keying Control", making it impossible to connect unmatched parts. Contact combinations in any number demanded by your specific needs are possible with Varicons; and any connector may be assembled by you or us from stock parts.

Prices below are for Varicons in General Purpose phenolic. Varicons are also available in Low-Loss Mica Phenolic, Alkyd, and General Purpose Phenolic in assorted colors, prices for which will be furnished upon request. For general specifications of ALL Varicons, refer to description beneath Connector Kit at lower right hand corner of this page. For any other information regarding these "Miniature Connectors that work like Giants", your inquiry will meet with our immediate reply.

VARICONS

Plain with no hardware

2nd and 3rd digit numerals in Model Nos. designate number of Contacts in Connector

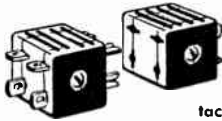

MALE		FEMALE	
Model No.	Price	Model No.	List Price Ea.
M1022	.25	F1022	.24
M1042	.34	F1042	.32
M1062	.43	F1062	.39
M1082	.52	F1082	.47
M1102	.61	F1102	.55
M1122	.70	F1122	.63
M1142	.80	F1142	.71
M1162	.90	F1162	.80
M1182	1.00	F1182	.89

VARICONS

With bracket

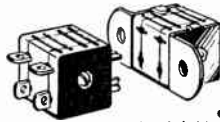

Substitute the numeral "2" instead of the numeral "1" in the first digit of the Model Number if a double tier is desired. List price can be computed by doubling the List Price of the appropriate Single Tier VARICON with Bracket and adding .03 ea.

MALE		FEMALE	
Model No.	Price	Model No.	List Price Ea.
M10220	.28	F10220	.27
M10420	.39	F10420	.37
M10620	.50	F10620	.46
M10820	.61	F10820	.56
M11020	.72	F11020	.66
M11220	.83	F11220	.76
M11420	.95	F11420	.86
M11620	1.07	F11620	.97
M11820	1.18	F11820	1.08

VARICONS

With cover top clamp

Hole can be located on End instead of Top by changing final digit from 4 to 5.

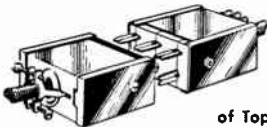

MALE		FEMALE	
Model No.	Price	Model No.	List Price Ea.
M10424	.82	F10424	.78
M10624	.82	F10624	.78
M10824	.94	F10824	.89
M11024	1.07	F11024	1.01
M11224	1.21	F11224	1.14
M11424	1.37	F11424	1.28
M11624	1.53	F11624	1.43
M11824	1.69	F11824	1.59
M22024	2.07	F22024	1.95
M22424	2.23	F22424	2.18
M22824	2.59	F22824	2.41
M23224	2.87	F23224	2.67
M23624	3.13	F23624	2.93

VARICONS

With handles

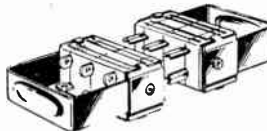

MALE		FEMALE	
Model No.	Price	Model No.	List Price Ea.
M10621	.65	F10621	.61
M10821	.76	F10821	.71
M11021	.87	F11021	.81
M11221	.98	F11221	.91
M11421	1.15	F11421	1.06
M11621	1.27	F11621	1.17
M11821	1.43	F11821	1.33
M22021	1.72	F22021	1.60
M22421	1.99	F22421	1.85
M22821	2.23	F22821	2.05
M23221	2.54	F23221	2.34
M23621	2.83	F23621	2.63

VARICONS

With covers — top hole

Hole can be situated on End instead of Top by changing final digit from 2 to 3.

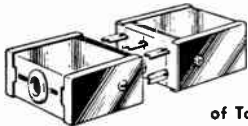

MALE		FEMALE	
Model No.	Price	Model No.	List Price Ea.
M10422	.66	F10422	.62
M10622	.66	F10622	.62
M10822	.78	F10822	.73
M11022	.91	F11022	.85
M11222	1.05	F11222	.98
M11422	1.21	F11422	1.12
M11622	1.37	F11622	1.27
M11822	1.53	F11822	1.43
M22022	1.86	F22022	1.74
M22422	2.11	F22422	1.97
M22822	.38	F22822	2.20
M23222	2.66	F23222	2.46
M23622	2.92	F23622	2.72

KITS

VARICON MINIATURE-CONNECTOR KITS now make it possible to assemble your own connectors when you want them! In General Purpose Phenolic, Low-Loss Mica Phenolic, Alkyd, Colors. Write for prices.



GENERAL SPECIFICATIONS

Current Rating 15 Amps, 115 Volts (in cover); 30 Amps (in free air) (withstanding voltage between closest terminals 4000 volts)
Contact Resistance .0001 ohm
Low Capacitance
All Male & Female components are identical
300 ohm line spacing
Contacts in use are always under pressure, cannot be overstressed or overstrained.

CHASSIS APPLICATIONS

CABLE APPLICATIONS

PLUG-IN APPLICATIONS

PANEL APPLICATIONS

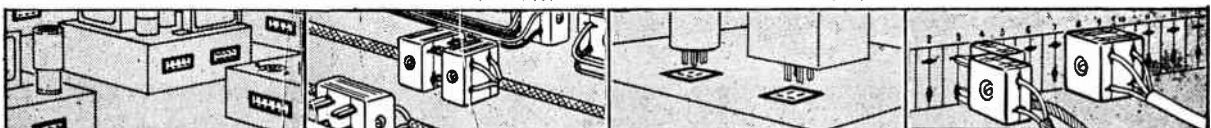

EBY

EBY SALES CO. of N. Y.



JAN SOCKETS & SHIELDS

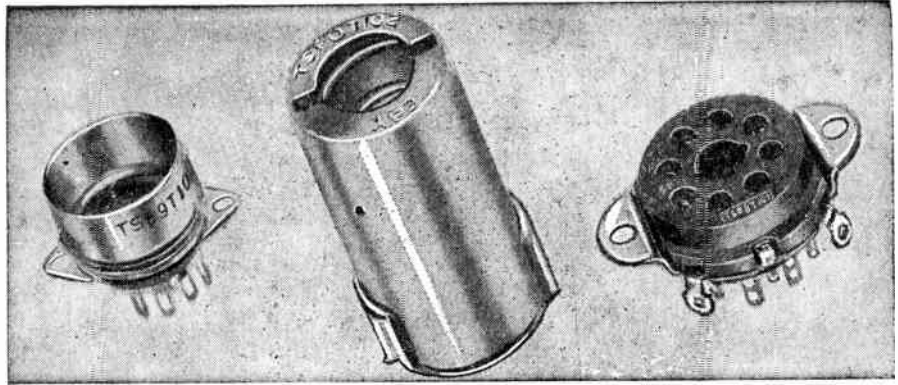

JAN NO.		EBY NO.	DESCRIPTION	LIST PRICE
S-28 A	S-28 A1			
TSE 7T 102	TS 102 C 01	9715	7 Pin Shield Base, Ceramic	\$1.05 Ea.
TSE 7T 101	TS 102 P 01	9736	7 Pin Shield Base, Mica-filled	.60 Ea.
TSE 9T 102	TS 103 C 01	9717	9 Pin Shield Base, Ceramic	1.30 Ea.
TSE 9T 101	TS 103 P 01	9719	9 Pin Shield Base, Mica-filled	.80 Ea.
TSF 0T 101	TS 102 U 01	9710	7 Pin Tube Shield—1 3/8"	.25 Ea.
TSF 0T 102	TS 102 U 02	9701	7 Pin Tube Shield—1 3/4"	.25 Ea.
TSF 0T 103	TS 102 U 03	9702	7 Pin Tube Shield—2 1/4"	.31 Ea.
TSF 0T 104	TS 103 U 01	9703	9 Pin Tube Shield—1 1/2"	.31 Ea.
TSF 0T 105	TS 103 U 02	9704	9 Pin Tube Shield—1 1/8"	.33 Ea.
TSF 0T 106	TS 103 U 03	9710	9 Pin Tube Shield—2 3/8"	.40 Ea.
TSB 8T 102	TS 101 C 01	9756	Octal. Saddle, Ceramic	1.25 Ea.
TSB 8T 101	TS 101 P 01	9753	Octal. Saddle, Mica-filled	.80 Ea.
	TS 101 P 02	9751-18	Octal. Saddle, Mica-filled W/PEM Nut	.97 Ea.
	TS 101 C 02	9751-21	Octal. Saddle, Cer. W/Thrd. Mtg. Hole	1.22 Ea.

STANDARD MINIATURE SOCKETS & SHIELDS

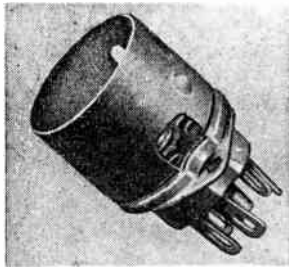

SHOCK SHIELD TYPE

Cat. No.	List each
8322 7 Pin, black bake., 7/8" M.C.	\$.30
8329 7 Pin, mica-filled, 7/8" M.C.	.35
8328 7 Pin, ceramic, 7/8" M.C.	.55
9723 9 Pin, black bake., 1 1/8" M.C.	.45
9714 9 Pin, mica-filled, 1 1/8" M.C.	.50
9716 9 Pin, ceramic, 1 1/8" M.C.	.95

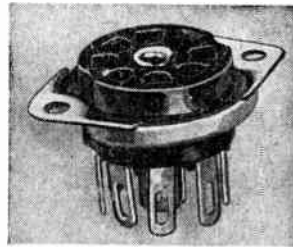

SADDLE TYPE, TOP MOUNT

Cat. No.	List each
8323 7 Pin, black bake., 7/8" M.C.	\$.15
8327 7 Pin, mica-filled, 7/8" M.C.	.20
8326 7 Pin, ceramic, 7/8" M.C.	.45
9001 9 Pin, black bake., 1 1/8" M.C.	.20
9430 9 Pin, mica-filled, 1 1/8" M.C.	.25
9735 9 Pin, ceramic, 1 1/8" M.C.	.75

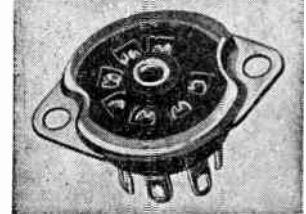

SADDLE TYPE, BOTTOM MOUNT

Cat. No.	List each
8578 7 Pin, black bake., 7/8" M.C.	\$.15
9064 7 Pin, mica-filled, 7/8" M.C.	.20
9012 9 Pin, black bake., 1 1/8" M.C.	.20
9401 9 Pin, mica-filled, 1 1/8" M.C.	.25
9713 9 Pin, ceramic, 1 1/8" M.C.	.75

SHIELDS FOR SADDLE TYPE SOCKET

8757 Shield for 7 pin, 1 3/4" high.	List Price, ea. \$0.10	8759 Shield for 9 pin, 2-1/16" high.	List Price, ea. \$0.15
8758 Adaptor for above.	.05	8760 Adaptor for above.	.05

See JAN table above for shields for shock shield type sockets.

OCTAL SADDLE SOCKETS

No. 9067—Black bake., cadmium plated steel saddle, 4 gnd. lugs. Cadmium plated brass contacts. 1 3/8" M.C. List, ea. \$0.14
 No. 8451—Loctal type, same specifications as above List, ea. .17

OCTAL ALL-MOLDED SOCKETS

No. 8490—Black bake., cadmium plated brass contacts. 1 3/8" mounting centers. List, ea. \$0.15
 No. 8191—Loctal type, same specifications as above List, ea. .15





EBY SALES CO. of N. Y.

ELECTRONIC PARTS

Latest additions to the ever growing line of EBY sockets. EBY again meets the increasing demands of the electronic industry.

TRANSISTOR SOCKET

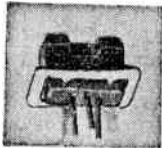

SM3. Low loss phenolic casting (Grade MTS-E-4 per Jan P14) three contacts of beryllium copper silver plated tin dipped to facilitate soldering. Supplied with push on mounting bracket. **List, ea. \$0.46**

SUBMINIATURE SOCKET & SHIELD

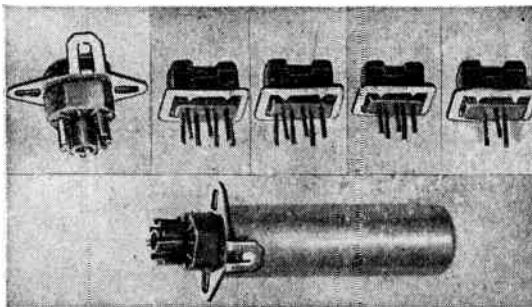

SM-3. Rectangular low loss phenolic casting (Grade MTS-E-4 per Jan P14). Three contacts of beryllium copper silver plated tin dipped to facilitate soldering. Supplied with mounting bracket. **List, ea. \$0.46**

SM-5. Same as above but with 5 contacts. **List, ea. \$0.47**

SM-6. Same as above but with 6 contacts. **List, ea. .54**

SM-7. Same as above but with 7 contacts. **List, ea. .56**

SM-8. Round subminiature socket made of the same low loss phenolic as the rectangular sockets. Nickel plated saddle for mounting. **List, ea. \$0.65**

SH-1. Brass nickel plated round metal shield for SM-8 socket. **List, ea. \$0.18**

PRINTED CIRCUIT SOCKET

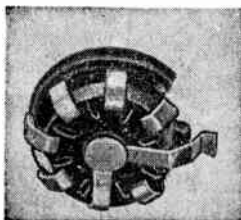

PC-7. 7 pin general purpose phenolic miniature socket for printed and etched circuit requirements. Rapid mounting with snap action contacts to secure socket. Available with long strap for grounding tube shield. **List, ea. \$0.22**

PC-9. Same as above but with 9 pin socket. **List, ea. \$0.34**

UHF SOCKET

Specifically designed socket for UHF applications requiring low inductance and low capacitance.

UHF-1. Recessed socket for under chassis mounting. **List, ea. \$0.36**

UHF-2. Top chassis mounting. **List, ea. \$0.30**

UHF3. Bottom chassis mounting. **List, ea. \$0.30**



SHOCK MOUNTED SOCKETS

1316. Special designed shock mounted socket for elimination of vibration and microphones. Mounting made of soft resilient rubber $\frac{7}{8}$ spacing. Available in 7 pin. **List, ea. \$0.50**

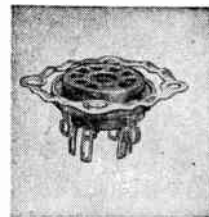
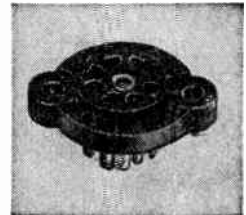

1315. Special designed shock mounted socket for elimination of vibration and microphonics. Mounting spring of grade C Phosphor Bronze. Available with 9 pin miniature socket. $1\frac{1}{8}$ mounting centers. **List, ea. \$0.27**

HIGH VOLTAGE SOCKETS

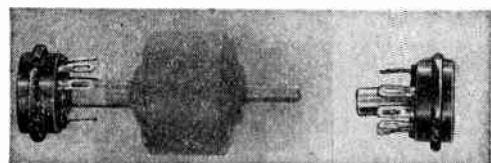

9 pin general purpose phenolic miniature socket for center mounting or for direct mounting on the high voltage filter condenser.

HU-1. Available with 6/32 outside thread. **List, ea. \$0.33**

HU-2. Available with 8/32 outside thread. **List, ea. .28**

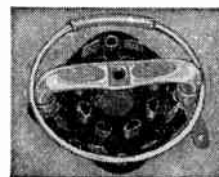

021-HV. Octal socket for use in high voltage circuit with 1B3 tube. Laminated bakelite with steel yoke that holds spring steel corona ring. **List, ea. \$0.47**

024-HV. High voltage socket assembly supplied with laminated octal socket, mounted in a round metal shield. Used in RCA type T.V. receivers. **List, ea. \$0.50**

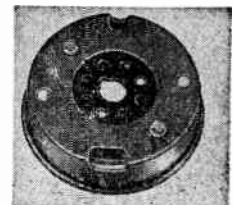



EBY SALES COMPANY of NEW YORK

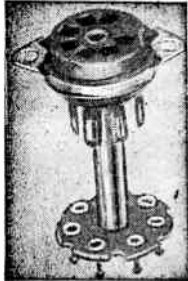

TURRET SOCKETS

Widely recognized for their usefulness in simplifying wiring and sub-assembly work. Space-saving and economical, lead lengths are reduced to a minimum thereby reducing capacitance. Available with 7 and 9 pin mica-filled miniature sockets. Spacer is brass cadmium plated; terminals are brass, silver plated; base is phenolic.

7 PIN				9 PIN			
Cat. No.			List Price each	Cat. No.			List Price each
9801	Saddle Mt., 1 1/8" shaft.....		\$1.25	9809	Saddle Mt., 1 1/8" shaft.....		\$1.50
9802	Saddle Mt., 1 1/2" shaft.....		1.25	9810	Saddle Mt., 1 1/2" shaft.....		1.50
*9805	Shield Mt., 1 1/8" shaft.....		1.40	9813	Shield Mt., 1 1/8" shaft.....		1.65
*9806	Shield Mt., 1 1/2" shaft.....		1.40	9814	Shield Mt., 1 1/2" shaft.....		1.65

*Supplied in two parts—A saddle mount socket and a separate shield base for assembly on the job.



LAMINATED MINIATURE SOCKETS

Cat. No.		List Price each
49-1	7 Pin, 7/8" M.C., 11/16" wide.....	\$0.10
49-2	W/center shield & ground strap.....	.11
49-21	9 Pin, 1 1/8" M.C., 1" wide.....	.13
49-22	W/center shield & ground strap.....	.14

Additional sizes available.

LAMINATED OCTAL SOCKET

Cat. No. 46-5-E 8 prong:		
Dimensions:		
Mounting Centers	1-5/16"	
Overall Width	1-13/32"	
Overall Length	1 3/8"	
List Price \$0.10 ea.		
Cat. No. 46-1-E 8 prong:		
Dimensions:		
Mounting Centers	1 1/2"	
Overall Width	1-13/32"	
Overall Length	1-27/32"	
List Price \$0.10 ea.		



CRYSTAL SOCKET

CR-7 For crystals having .050 diameter pins and .486 spacing between pins. Steatite, grade L-5 JAN-1-10.

Cat. No.		List Price Each
8879	Phosphor bronze cadmium plated contacts.....	\$0.25
9006	Beryllium copper silver plated contacts.....	.35



GLASS TUBE TYPE:

Cat. No.	Mounting Centers	Width	Length	List Price each
34-1AA	4 prong	1 1/2"	1 3/8"	\$0.12
34-1-B	5 prong	1 1/2"	1 1/2"	0.13
34-1-C	6 prong	1 1/2"	1 3/8"	0.14

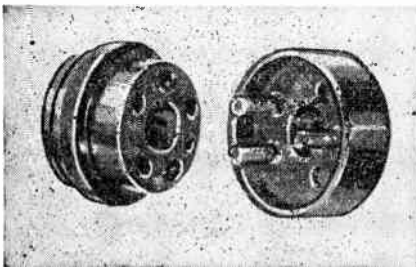

SPEAKER CONNECTORS

Made of general purpose bakelite, plug is one piece construction, with protective flange that prevents touching of live contacts. Female is supplied with separate contacts for rapid assembly.

60-3M	3 Prong Male	List Price \$.11 Ea.
60-4M	4 Prong Male	List Price .12 Ea.
60-5M	5 Prong Male	List Price .13 Ea.
60-5F	5 Contact Female for use with 3, 4, or 5 prong male	List Price .12 Ea.

Above with wire leads available on request.

PHONO CONNECTORS

Designed for use in combining radio and phonograph sections of instrument, made of general purpose bakelite. Female is supplied with separate contacts, for use with 2, 3 or 4 prong male.

75-2M	2 Prong Male	List Price \$.10 Ea.
75-3M	3 Prong Male	List Price .10 Ea.
75-4M	4 Prong Male	List Price .11 Ea.
57-4F	4 Contact Female	List Price .14 Ea.

Above with wire leads available on request.

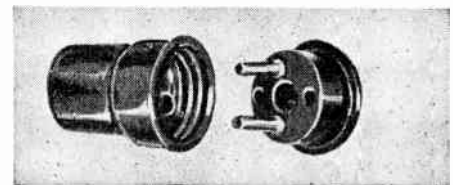

ALL-PURPOSE CONNECTOR

A new, compact connector made of general purpose bakelite for use where space is an important factor. Female, for use with 2, 3, 4 or 5 prong male, has saddle mount.

119-2M	2 Prong Male	List Price \$.10 Ea.
119-3M	3 Prong Male	List Price .10 Ea.
119-4M	4 Prong Male	List Price .10 Ea.
119-5M	5 Prong Male	List Price .10 Ea.
119-5F	5 Contact Female	List Price .15 Ea.

TERMINAL STRIPS & SCREW TERMINALS

A complete selection of terminal lug strips and screw terminals are available on request. Write for our complete catalog.



EBY SALES COMPANY of NEW YORK

INSULATED BINDING POSTS

Knob and base are molded bakelite, with brass inserts and have non-removable tops. Following have knurled base to prevent post twisting

Spec's.	No. 30 Junior	No. 37 Ensign	No. 40 Commander	No. 43 Admiral
Knob Diam.	1/2" x 7/16" H.	1/2" x 7/16" H.	9/16" x 1/2" H.	5/8" x 17/32" H.
Base Diam.	1/2" x 3/4" H.	1/2" x 3/4" H.	5/8" x 3/4" H.	23/32" x 3/4" H.
Stem	6-32, 5/8"	6-32, 5/8"	8-32, 7/8"	8-32, 3/4"
Neck Diam.	3/16"	3/16"	13/64"	13/64"
Neck Hole	3/32"	3/32"	3/32"	None
List Price	\$.35 Ea.	\$.40 Ea.	\$.55 Ea.	\$.70 Ea.



Following have boss on base to insulate stem from metal panel. Boss is flat on two sides. Stem length is from bottom of boss.

Spec's.	No. 38 Ensign	No. 41 Commander	No. 44 Admiral	No. 46 Admiral
Knob Diam.	1/2" x 7/16" H.	9/16" x 1/2" H.	5/8" x 17/32" H.	11/16" x 19/32" H.
Base Diam.	17/32" x 3/4" H.	5/8" x 3/4" H.	23/32" x 3/4" H.	23/32" x 3/4" H.
Stem	6-32, 1/2"	8-32, 3/8"	8-32, 9/16"	8-32, 9/16"
Neck Diam.	3/16"	13/64"	13/64"	13/64"
Neck Hole	3/32"	3/32"	None	None
List Price	\$.45 Ea.	\$.60 Ea.	\$.60 Ea.	\$.75 Ea.



Following have dowel pin on base.

Spec's.	No. 39 Ensign	No. 42 Commander	No. 45 Admiral	No. 47 Admiral
Knob Diam.	1/2" x 7/16" H.	9/16" x 1/2" H.	5/8" x 17/32" H.	11/16" x 19/32" H.
Base Diam.	1/2" x 3/4" H.	5/8" x 3/4" H.	23/32" x 3/4" H.	23/32" x 3/4" H.
Stem	6-32, 9/16"	8-32, 3/4"	8-32, 3/4"	8-32, 3/4"
Neck Diam.	3/16"	13/64"	13/64"	13/64"
Neck Hole	3/32"	3/32"	None	None
List Price	\$.45 Ea.	\$.60 Ea.	\$.60 Ea.	\$.75 Ea.



UNIVERSAL TYPE

Designed to give the added convenience of a banana plug connection. The brass bushing is fitted to take any of the standard banana plugs. Supplied with insulating base and two hex nuts as illustrated. Available in red and black.

\$.67 Ea.

TWIN BINDING POSTS



No. 21-R. All-molded Bakelite, non-removable tops. Both posts completely insulated. Center mounting screw 6/32" x 1/4" long. Base is 2" long, 11/16" wide and 3/16" thick. Center distance between posts is 7/8".

List Price \$0.85 Ea.

No. 21-S. Same as above with one post insulated. One mounting screw at end of base, ground post is second mounting screw.

List Price \$0.90 Ea.

Individual metal and spring type binding posts are also available in a variety of sizes and styles. Write for our complete catalog.

BATTERY STRAPS

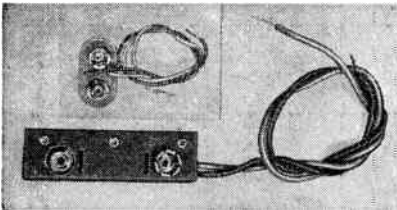

45-2 Newly designed for new miniature 45 volt batteries. Emerson portable, etc.

List Price \$0.53 Ea.

67-2 Battery snap fastener for 67 1/2 volt B Battery. + and - terminal connections securely staked on tough fibreboard insulator. List Price \$0.28 Ea.

69-2 Same as above for 90 volt battery. List Price \$0.30 Ea.

TIP JACKS

No. 49. Top diameter 1/2" x 5/32" thick. Threaded brass body 5/16" — 40 x 3/4" long. One hexagon nut and two insulating washers furnished. Hole for washers is 19/64". Red or black bakelite top.

List Price: Red and Black \$0.20 Ea.



No. 52. Top diameter 1/2" x 1/8" thick. Body is 5/16" x 3/4" long. Special steel assembly washers, cadmium plated, are furnished. Red or black bakelite.

List Price: Red \$0.13 Ea.
Black 0.11 Ea.



No. 76. Same style as No. 52. Top diam. 5/8" x 5/32" thick. Body is .500 x 27/32" long. List Price: Red \$0.20 Black \$0.17

SCREW TERMINAL STRIPS

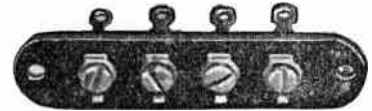

Brass contacts, steel screws cadmium plated. 1/16" laminated bakelite plates. Spacing between terminals 1/2".

No.	Terminals	List Price
*No. 56-2	2 terminals	\$.10 ea.
*No. 56-3	3 "	.13 ea.
*No. 56-4	4 "	.17 ea.
*No. 56-5	5 "	.20 ea.
No. 56-6	6 "	.45 ea.
No. 56-7	7 "	.50 ea.
No. 56-8	8 "	.60 ea.
No. 56-9	9 "	.65 ea.

*Available with 7/16" terminal spacing.

FUSE HOLDER

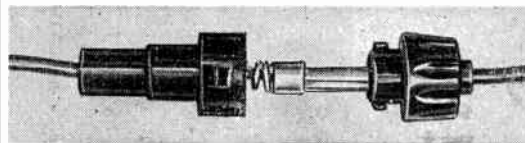

Molded fuse holder for use in automobile radios, television sets and other applications requiring "in the line" fuse holders. Wrap-around fuse clip assures a firm positive gripping contact. EBY "key" locking system affords greater mechanical strength and eliminates breakage. Furnished complete with wire leads and fuse. List Price, ea. \$0.45



RADIO FREQUENCY CONNECTORS

Standard Prices and Special Quotations Available Immediately on Request

TYPE BNC



UG-88B/U

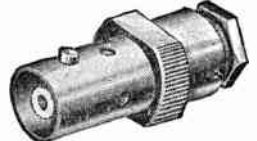

UG-89B/U



UG-262/U

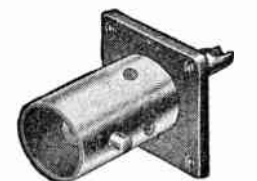

UG-290/U

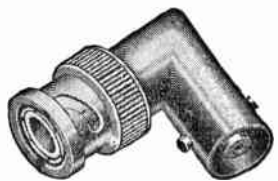

UG-306/U

ARMED SERVICES TYPE	DAGE No.	DESCRIPTION	IMPEDANCE	USED WITH CABLE
UG-88/U	056-1	Plug	52 ohms	RG-55, 58, 58A/U
UG-88B/U	359-1	Plug	52 ohms	RG-55, 58, 58A/U
UG-89/U	130-1	Jack	52 ohms	RG-55, 58, 58A/U
UG-89B/U	415-1	Plug	52 ohms	RG-55, 58, 58A/U
UG-90/U	239-1	Panel Jack	52 ohms	RG-55, 58, 58A/U
UG-185/U	145-1	Receptacle	52 ohms	
UG-201/U	379-1	Adapter (BNC female to N male)	52 ohms	
UG-260/U	073-1	Plug	Unmatched	RG-59, 62, 71/U
UG-260A/U	416-1	Plug	Unmatched	RG-59, 62, 71/U
UG-261/U	124-1	Jack	Unmatched	RG-59, 62, 71/U
UG-261A/U	417-1	Jack	Unmatched	RG-59, 62, 71/U
UG-262/U	121-1	Panel Jack	Unmatched	RG-59, 62, 71/U
UG-262A/U	371-1	Panel Jack	Unmatched	RG-59, 62, 71/U
UG-273/U	470-1	Adapter BNC-UHF	Unmatched	
UG-274/U	134-1	Adapter Tee	52 ohms	
UG-290/U	055-1	Receptacle	52 ohms	
UG-291/U	122-1	Panel Jack	52 ohms	RG-55, 58, 58A/U
UG-291A/U	413-1	Panel Jack	52 ohms	
UG-306/U	135-1	Adapter Right Angle	52 ohms	
UG-349/U	136-1	Adapter BNC to N	52 ohms	
UG-414/U	551-1	Receptacle, Double End	52 ohms	
UG-447/U	055-3	Similar to UG-290/U—Tapped holes replaced by .109 ^{+0.001} / _{-0.003} Dia. holes	52 ohms	
UG-492/U	547-1	Receptacle, Double End, Pressurized	52 ohms	
UG-535/U	240-1	Receptacle	52 ohms	
UG-589/U	549-1	Plug	Unmatched	Wire W-142
UG-625/U	081-1	Receptacle	52 ohms	
UG-657/U	237-1	Receptacle, Pressurized	52 ohms	
UG-924/U	501-1	Plug, Binding Post		
CW-123A/U	366-1	Cap and Chain		
CW-155A/U	399-1	Cap		
MX-554/U	534-1	Resistor Plug	Optional	

TYPE N

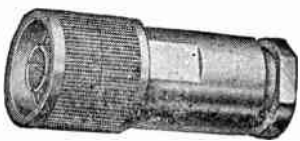

UG-188/U

ARMED SERVICES TYPE	DAGE No.	DESCRIPTION	IMPEDANCE	USED WITH CABLE
UG-188/U	131-1	Plug	50 ohms	RE-5, 5A, 6, 21/U
UG-198/U	132-1	Panel Jack	50 ohms	RE-5, 5A, 6, 21/U
UG-208/U	140-1	Jack	50 ohms	RE-5, 5A, 6, 21/U
UG-218/U	037-1	Plug	50 ohms	RG-8, 9, 9A, 10/U
G-21C/U	400-1	Plug	50 ohms	RG-8, 9, 9A, 10/U
UG-228/U	047-1	Panel Jack	50 ohms	RG-8, 9, 9A, 10/U

DAGE ELECTRIC CO., INC.

RADIO FREQUENCY CONNECTORS

DAGE

Dage RF Connectors Are Made in Strict Conformity with Military Specifications

TYPE N CONTINUED



UG-23B/U

ARMED SERVICES TYPE	DAGE No.	DESCRIPTION	IMPEDANCE	USED WITH CABLE
UG-23B/U	062-1	Jack	50 ohms	RG-8, 9, 9A, 10/U
UG-58A/U	019-1	Receptacle	50 ohms	
UG-83/U	565-1	Adapter N-UHF	Unmatched	
UG-201/U	379-1	Adapter (N male to BNC female)	50 ohms	
UG-349/U	136-1	Adapter, N to BNC	50 ohms	
UG-536/U	385-1	Plug	52 ohms	
UG-940A/U	582-1	Type N with MX-146 2/U	50 ohms	RG-55, 58, 58A/U
MX-913/U	583-1	Cap and Chain Assembly		RG-10, 12/U

TYPE C

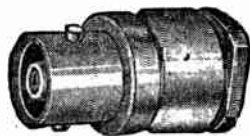

UG-572/U

ARMED SERVICES TYPE	DAGE No.	DESCRIPTION	IMPEDANCE	USED WITH CABLE
UG-568/U	306-1	Receptacle	50 ohms	RG-8, 9, 9A, 10/U
UG-569/U	307-1	Receptacle, Bulkhead	50 ohms	
UG-570/U	308-1	Jack, Bulkhead	50 ohms	
UG-571/U	309-1	Panel Jack	50 ohms	
UG-572/U	310-1	Jack	50 ohms	
UG-573/U	288-1	Plug	50 ohms	

TYPE MC

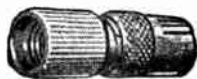

MC-10



MC-20

ARMED SERVICES TYPE	DAGE No.	DESCRIPTION	IMPEDANCE	USED WITH CABLE
MC-10	149-1	Plug	52 ohms	RG-58/U
MC-20	148-1	Receptacle	52 ohms	RG-59/U, 62/U, 71/U
MC-50	528-1	Plug	Unmatched	
MC-60	148-3	Receptacle	Unmatched	RG-58/U
MC-90	149-4	Plug (Has separate insulator & contact)	52 ohms	
MC-210	148-2	Receptacle	52 ohms	
MC-250	149-2	Plug (Has separate contact & Teflon insulator)	52 ohms	

TYPE BN

UG-206/U	407-1			
----------	-------	--	--	--

SPECIAL

TYPE BNC



302-1

TYPE N

ARMED SERVICES TYPE	DAGE No.	DESCRIPTION	IMPEDANCE	USED WITH CABLE
Special	365-1	Panel Jack BNC	Unmatched	RG-59, 62, 71/U
Special	302-1	BNC Coax. Termination Panel	Unmatched	
Special	406-1	BNC Coax. Termination Panel	52 ohms	
Special	345-1	Panel Jack N	50 ohms	RG-55, 58, 58A/U
Special	429-1	Plug N	50 ohms	RG-55, 58, 58A/U

Dage is vitally interested in your special RF connector needs.

Dage has the ability to quickly produce special RF connectors . . . from the smallest to the largest . . . with all the skill and precision you've come to expect in Dage standard type connectors. Dage tools for new RF connector designs as soon as drawings become available.

Your special requests are handled by Dage with *extra* care. Dage's experience and superb design facilities are always available to you during your planning phases. Dage and its representatives welcome your order, or your request for quotations or technical assistance.

For quality, quantity—*right now*—write Dage today.

DAGE ELECTRIC CO., INC.

Vector SOCKET-TURRETS

BACKGROUND FOR CIRCUITRY

Vector Socket-Turrets and Plug-In units provide a unique method for mounting electronic circuit components, saving space and increasing efficiency. Catalog numbers shown in bold face type are the most popular types.

OCTAL, MINIATURE and NOVAL SOCKET-TURRETS

Sockets are standard bottom mounting with steel saddles carrying 4 ground lugs. Body is mica-filled phenolic carrying wrap-around brass contacts, cadmium plated. Terminal posts are 1/2" O.D. with 1/16" wall, made of Grade XXXP laminated tan phenolic joined to socket. Six plated brass terminals at far end of turret plus three, six or none near socket. Mounting holes required are: for Octal 1" ctr. hole, side holes spaced 1-5/16" for 0.134" saddle holes (a larger type is also available—See 'A' below); for 7 pin miniature, 5/8" ctr. hole, side holes spaced 7/8" for 1/8" saddle holes; for 9 Pin Noval, 3/4" ctr. holes, side holes spaced 1 1/8" for 1/8" saddle holes.

Catalog Numbers			*Height	Description
10-O-12T	10-MB-12T	10-NB-12T	2 1/2"	12 term. in 2 rings spaced 1 3/8"
10-O-9T			2 1/2"	9 term. in 2 rings spaced 1 3/8"
8-O-12T	8-M-12T	8-N-12T	2"	12 term. in 2 rings spaced 1"
8-O-9T	8-M-9T	8-N-9T	2"	9 term. in 2 rings spaced 1"
6-O-6T	6-M-6T	6-N-6T	1 1/2"	6 term. in 1 ring only
	S7	S9		Shield Base for attaching shields

*Height measured from chassis to far end of turret.

For variations not always available from distributors but obtainable at the factory:

- Add 'A' to No. for large octal socket (1 1/2 Mtg. Ctrs., 1 1/8" hole).
- Add 'J' to No. for 'MFE' socket casting, beryllium contacts, silver plated, hot tin dipped.
- Add 'U' to No. for 4-40 U nuts which slip on saddle for easy mounting.
- Add 'C' to No. for impregnation of turret for moisture and fungus protection.
- Substitute 'L' for 'O' in No. if octal socket required. (1-1/16" hole, 1-5/16" mtg. ctrs.).

Note: Letters are printed on all above turrets to indicate terminal positions. A-F inclusive appear on remote end, C-L inclusive on row near socket (H, J, L for 3 terminal rows). "A" and "G" over "I" of socket. Socket-Turrets are covered by Patent Nos. 2,604,584 & 2,624,775.

SADDLE NUTS: A 'U' type nut which slips over standard socket saddles has been especially designed to promote easy mounting on the chassis. For #4-40 machine screws. Order as #440-U nut or simply add 'U' to number of socket ordered.

TEST ADAPTERS

Vector Test Adapters are ideal for making measurements from the tube side of electronic equipment, where it is inconvenient to reach into the wiring compartment. The adapter is simply inserted between tube and socket completing the circuit and providing test tabs connecting with tube elements.

The T-789 set combines the 7-pin and 9-pin miniatures and octal in a plastic case. Or adapters may be obtained separately as follows:

Catalog No.	Tube Type	Body Dia.	Skirt Dia.	Length less Prongs	Lead Shielding
T-7-M	7 Pin Min.	0.74"	1.03"	1.47"	None
T-8-O	8 Pin Octal	1.26"	1.56"	1.50"	None
T-9-N	9 Pin Noval	0.87"	1.16"	1.47"	None

T-789 Set of above three types in case (1.75" x 3.75" x 2.62")

TUBE BASE PLUGS

These plugs fit the 7 and 9 pin miniature sockets and are useful for many experimental or plug-in purposes.

Cat. No.	Type	Dimensions (Fig. 1)						Retainer Ring No.	
		A	B	C	D	E	F		
P7	7 Pin Min.	1 1/8"	17/32"	5/16"	.291	3/16"	.621	.568	None
P9	9 Pin Noval	1 1/8"	17/32"	5/16"	.291	3/16"	.748	.700	None

Vector Electronic Company

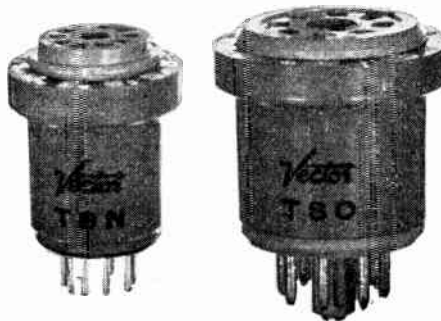
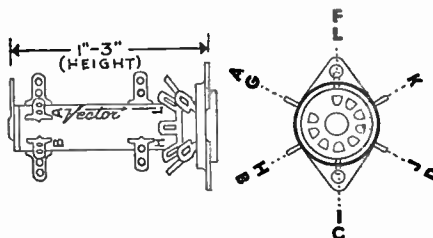
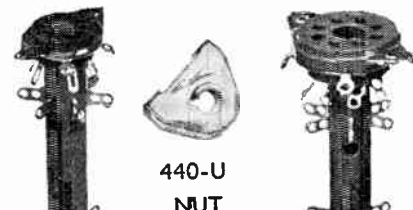
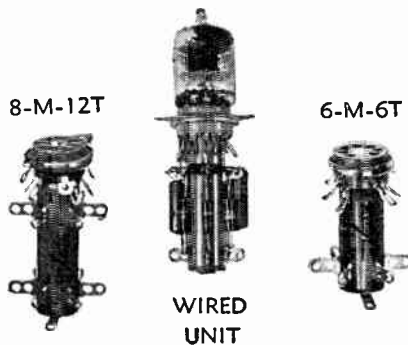

TEST ADAPTERS

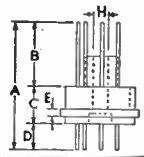
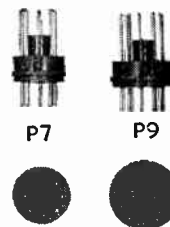

FIG 1



Vector **PLUG-IN UNITS**

FOR UNITIZED CIRCUITS

Amplifiers, counters, oscillators and the like can be readily assembled completely on Plug-Ins, permitting quick changes of circuits. Making a Plug-In unit involves little more than soldering in a few capacitors and resistors.

ECONOMICAL AND CONVENIENT

Plugs are standard mica-filled, ring mounted octal style with 8 prongs as standard. (9 or 11 prong plugs also available—see below). Sockets are standard mica-filled phenolic in octal, 7 Pin miniature or 9 Pin novel as ordered. Contacts are cadmium plated brass. Terminal turrets are Grade XXXP phenolic tubing 1/2" O.D. with 1/16" wall, carrying 12 plated brass terminals. Aluminum covers may be quickly detached by removing screws at base, making inside completely accessible. Miniature and novel types carry military type tube shield base. Main tube shield not furnished. Types in bold face are most widely used and generally preferred for distributor stock.

SINGLE TUBE TYPES

CATALOG NUMBERS			CAN SIZE		TERM. SPACE
Octal	7 Pin	9 Pin	A	B	C
B8 -M	B8 -M	B8 -N	1.37"	2.0"	0.87"
B10-0	B10-M	B10-N	1.37"	2.5"	1.37"
B12-0	B12-M	B12-N	1.37"	3.0"	1.87"
C8 -0	C8 -M	C8 -N	2.0"	2.0"	0.87"
C10-0	C10-M	C10-N	2.0"	2.5"	1.37"
C12-0	C12-M	C12-N	2.0"	3.0"	1.87"
A8 -0	A8 -M	A8 -N	No Can		0.87"
A10-0	A10-M	A10-N	No Can		1.37"
A12-0	A12-M	A12-N	No Can		1.87"

TWO TUBE TYPES

-----	C8 -MM	C8 -NN	2.0"	2.0"	0.62"
-----	C10-MM	C10-NN	2.0"	2.5"	0.87"
-----	C12-MM	C12-NN	2.0"	3.0"	1.37"

TYPES WITHOUT SOCKETS

Any of the types tabulated may be obtained less sockets but with terminal turrets and plugs. These are useful for a multitude of PLUG-IN applications where tubes are not involved.

CAT. NO.	CAN SIZE		CAT. NO.	CAN SIZE	
	A	B		A	B
B-8T	1-3/8"	2"	C-8T	2"	2"
B-10T	1-3/8"	2-1/2"	C-10T	2"	2-1/2"
B-12T	1-3/8"	3"	C-12T	2"	3"

TYPES WITH CAN AND PLUG ONLY

CAT. NO.	CAN SIZE		CAT. NO.	CAN SIZE	
	A	B		A	B
B-8	1-3/8"	2"	C-8	2"	2"
B-10	1-3/8"	2-1/2"	C-12	2"	2-1/2"
B-12	1-3/8"	3"	C-12	2"	3"

SPECIAL FEATURES. Variations obtainable at the factory:

- Add "H" to No. for 9 prong octal type plug.
- Add "K" to No. for 11 prong octal style plug.
- Add "J" to No. for "MFE" socket casting, beryllium contacts, silver plated, tin dipped.
- Add "G" to No. for impregnation of turret for moisture and fungus protection.
- Add "P" to No. for perforation of covers for ventilation.
- Anodized finishes, natural or in color to order.
- Studs to lock 2" sq. units firmly in sockets are available.

NOTE: Letters are printed on turrets to indicate terminal positions. A-F inclusive appear on 6 terminals at plug end, G-L inclusive on socket end, "A" & "G" in line with "I" of socket and "I" of plug. Key of 8 prong plug points toward corner of can but key of 9 & 11 prong plug points to side of can.

OTHER TYPES

Special round can Plug-Ins are available as follows: Type G2, 1 1/4" O.D. with Octal 8 or 11 pin plug; Type G2.1, 3/4" O.D. with 9 pin min. plug; Type G2.2, 5/8" O.D. with 7 pin min. plug. Larger rectangular units are also available with following cross-sectional dimensions: Type D, 2" x 3"; Type E, 1 1/2" x 3 3/4"; Type F, 2-5/16" x 4 3/8". Height of all units, 3" or less. Terminal strip mountings can be supplied instead of turrets if preferred.

Vector Electronic Company

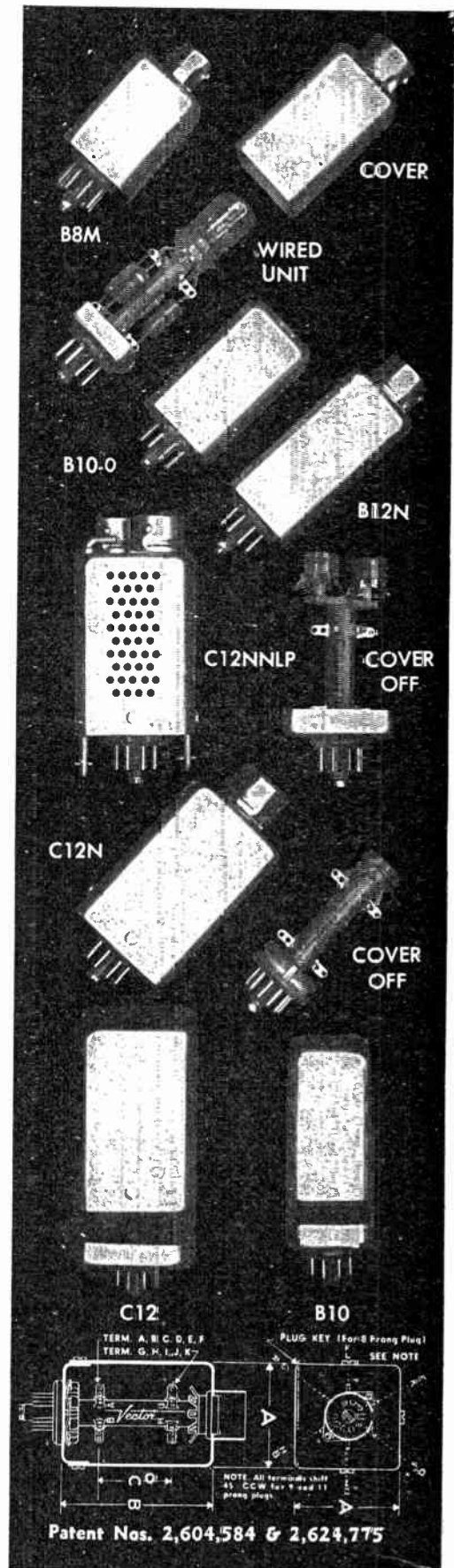



U. S. ENGINEERING CO.

STANDARDIZED ELECTRONIC HARDWARE

This is only a partial showing of our products. Hundreds of others available. We manufacture millions each week. Dependable service and unmatched quality and delivery is assured. Engineering manual and prices furnished when requested on business letterhead.

1200



1210



1220

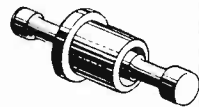

1230

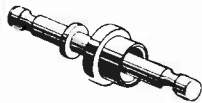

1250



1320



1330



1340



1340-T



1350

STANDARD TERMINAL LUGS

1260



1270-M



1280



1290



1300



1300-T



1310

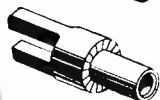

1360



1370



1380

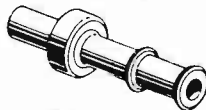

1390

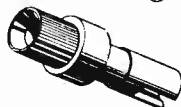

1391

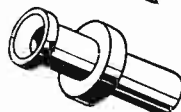

1392



2000



2010



2010-T



2020



2030

CHASSIS BEARING

1560



PLUGS

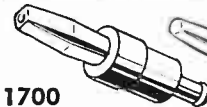

1700



1715

SOCKETS

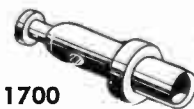

1700



1710

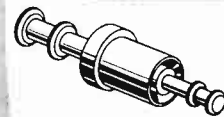

2040



2040-T



2050



2060

STAND OFFS

1530

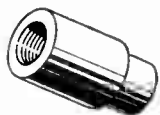

1531

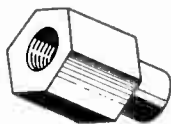

1540

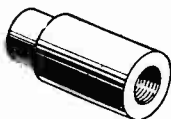

1541

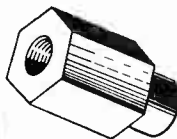

1550



1551-A-G



1590

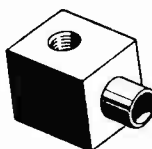

DIAL LOCK



1800

DIAL INDICATOR

1815



HANDLES

1020



1010



1520

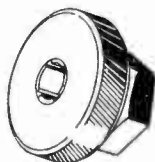

BRACKETS

11-2

11-3

11-5

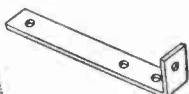

SHAFT LOCKS

1510



1512



1514



1515



KNOBS

625

1000

1038



INSULATED TERMINALS

1400-B



1410-B

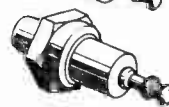

1417



1418



1419



1421



1422



1425



1426



1427



1428



1430



1433



1435



BINDING POSTS

3500

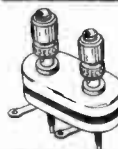

U. S. ENGINEERING CO. • GLENDALE 3, CALIF.



U. S. ENGINEERING CO.

Terminal Boards Made To Customer Print Specifications

USECO manufactures special terminal boards to customer print specifications. Made of certified materials to meet all approved MIL and JAN specifications. Now serving many of the most prominent names in the electronics industry. Gold plated lugs supplied on special order. Send for engineering manual and name of nearest representative.

1100

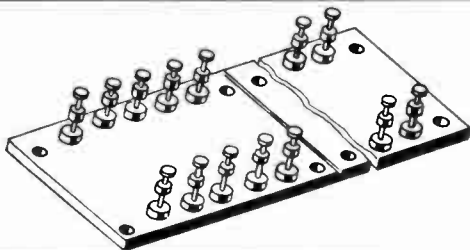

TERMINAL BOARDS

2200-A

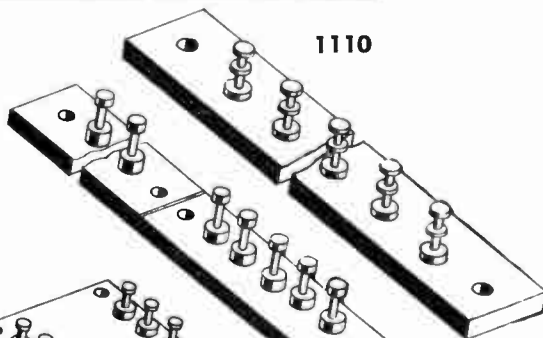

1110

2200-B-C

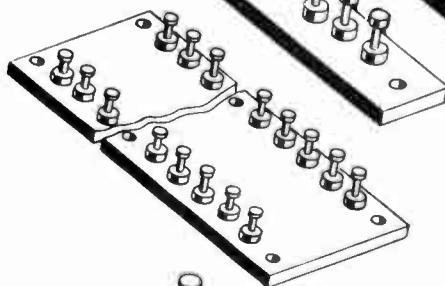

1181

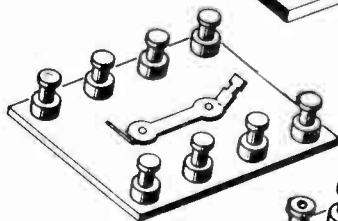

1180

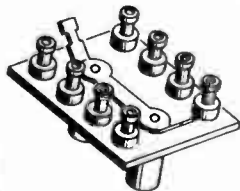

1182

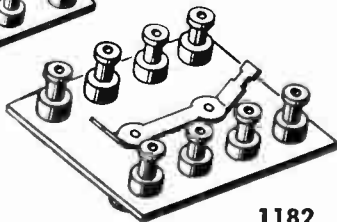

3200

CAPTIVE SCREW



3316

SHAFT COUPLING

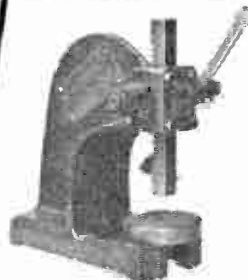

Machines \$35.00 ea.
Tools \$3.00 per set

PRESSURE SWAGING MACHINE



Engineering Manual furnished when requested on business letterhead.

U. S. ENGINEERING CO.

GLENDALE 3, CALIFORNIA





RCA TEST EQUIPMENT FOR SERVICE • INDUSTRY SCHOOLS • LABORATORIES

TEST EQUIPMENT FOR COLOR TV

COLOR-BAR GENERATOR WR-61A

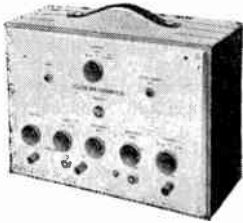

The RCA WR-61A Color-Bar Generator is a compact, lightweight, portable instrument that produces with crystal-controlled accuracy 10 bars of color corresponding to R-Y, B-Y, G-Y, I and Q axes. The 10 bars are accurately spaced at 30° phase intervals. Indispensable for checking the overall operation of color receivers and for adjusting color phasing, color synchronizing, and color matrixing. The phasing of the 10 bars is inherently accurate because an "offset" crystal-controlled oscillator is used to generate the color subcarrier in addition to the use of crystal-controlled oscillators for the picture carrier (channel No. 3), sound carrier, and the horizontal sync and bar frequency. The sound carrier (unmodulated) is provided to insure precise tuning of the receiver, to check sound rejection, and to check for presence of beat interference between the color subcarrier and the sound carrier.

Luminance signals are provided at the edges of the color bars to check the "fit" or registration of the luminance and chrominance signals. A brightness signal is also available to check for possible shift of hue in the bright areas or highlights. The amplitude of the color subcarrier is adjustable in order to check the color sync lock action in the receiver.

Color signals of positive or negative polarity are provided for both low impedance (75 ohms) and high-impedance (5000 ohms) video circuits.

The WR-61A has a shipping weight of 17¼ lbs. and is 9¼" h, 13½" w, 7½" d. It is supplied with a blue-gray hammered case, a satin-aluminum panel, and with separate cables for RF output and video signals.

\$247.50 (Suggested User Price)

DOT-BAR GENERATOR WR-36A

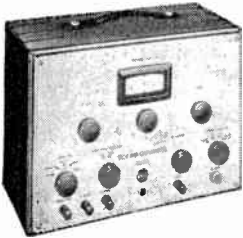

The RCA WR-36A Dot-Bar Generator is designed to provide a pattern of optimum-size rectangular dots for making all convergence adjustments in color receivers. It also provides choice of horizontal bars, vertical bars, or cross-hatch pattern for linearity adjustments in color and black-and-white receivers. The number of bars is adjustable: 8 to 15 horizontal bars; 11 to 13 vertical bars.

The WR-36A provides white dots on a black background. The dots are approximately 3/16" x 3/8", as viewed on a 15" tube. Experience has shown that, under normal room lighting conditions, the use of smaller dots creates a strong tendency to run the brightness too high, thereby causing blooming, which is definitely undesirable for correct convergence adjustments.

Both modulated-RF and video output are provided. The RF output is continuously tunable over Channels 2 to 6, with adjustable amplitude. Positive or negative video output of approximately 5 volts is provided for feeding into the video amplifier of color or black-and-white receivers. Choice of internal 60-cycle vertical sync or external sync is provided.

The WR-36A has a shipping weight of 17¼ lbs. and is 9¼" h, 13½" w, 7½" d. It is supplied with a blue-gray hammered case, a satin-aluminum panel, and with separate RF cable and leads.

\$147.50 (Suggested User Price)

WIDEBAND OSCILLOSCOPE WO-78A



Designed especially for servicing of color TV receivers, the RCA WO-78A features: (1) Dual bandwidth with dual sensitivity; (2) Voltmeter-like facilities for measuring any portion of waveforms up to 4.5 Mc; (3) Horizontal trace expansion of 3 times screen diameter; (4) Rise time 0.1 μ sec.; (5) Tilt or overshoot less than 5% for square wave with 0.05 μ sec. rise time; (6) Low-input capacitance, 9.5 μf; (7) High dc-input, 10 megohms; (8) 14-position attenuator with small steps for generous overlap of ranges; (9) Flat-face CRT type 5ABP-1 post-accelerator type operating at approximately 3000 volts. \$425.00 (Suggested User Price)

Frequency Response:

Vertical Amplifier:

Wide Band.....3 cps to 4.5 Mc within -1db

Narrow Band.....3 cps to 500 Kc within -3db

Horizontal Amplifier...3 cps to 1.0 Mc within -6db

Deflection Sensitivity:

Vertical Amplifier:

Wide Band.....100 mv p-p per inch

Narrow Band.....10 mv p-p per inch

Horizontal Amplifier.....200 mv p-p per inch

Sweep Frequencies:

Variable.....10 cps to 100 Kc

Preset.....Submultiple of 60 and 15,750 cycles

Synchronization.....Automatic

Attenuators (Frequency compensated on all positions):

Wide Band...7 positions from 0.10 to 100 p-p volts

Narrow Band...7 positions from .010 to 10 p-p volts

Calibration.....Built-in with push-button control

Power Supply.....105/125 volts, 50-60 cps

Dimensions.....13¼" h, 9" w, 19¼" d

Weight (shipping).....58 lbs.

Finish.....blue-gray hammered case
satin-aluminum panel

VIDEO MULTIMARKER WG-295A



The RCA WG-295A Video MultiMarker provides five simultaneous absorption-type markers accurately preset at the following frequencies required in marking the video response curves in color receivers:

0.5 Mc (for Q filter)

1.5 Mc (for I filter)

2.5 Mc (for band-pass filter)

3.58 Mc (color subcarrier frequency)

4.5 Mc (sound-trap frequency)

Each of the marker frequencies in the WG-295A is definitely and quickly identified simply by touching the corresponding contact on the MultiMarker; this has the effect of reducing the amplitude of the particular marker notch. The WG-295A is connected between the IF/VF output on the sweep generator and the regular video output cable.

\$24.95 (Suggested User Price)



RCA TEST EQUIPMENT for SERVICE • INDUSTRY SCHOOLS • LABORATORIES

5" OSCILLOSCOPE WO-88A

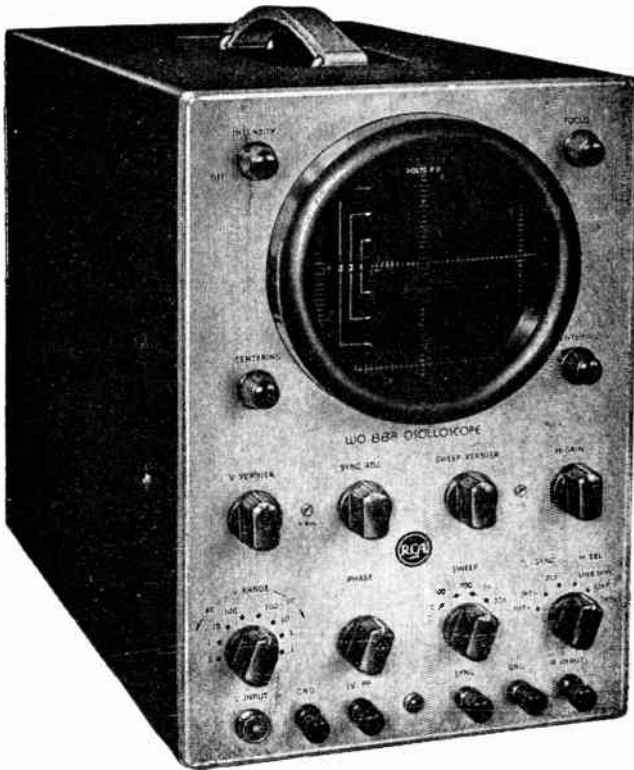

The popular WO-88A—the 'scope that will do a job for you—combines all the essential features required for TV servicing!

The WO-88A has built-in voltage calibrating facilities which permit simultaneous waveshape display and peak-to-peak voltage measurements. Frequently, the shape of the TV waveform under observation will be correct but its amplitude will be low and, consequently, cause improper operation. Therefore, a TV 'scope is complete only if it can measure the peak-to-peak voltage of the displayed waveform. Check this feature on the "88"!

On the WO-88A, sync polarity may be reversed instantly by simply clicking a front-panel switch. This feature is important because TV pulses may be either positive or negative, depending upon where the 'scope is connected. To avoid waveshape "jitter" or distortion, use a 'scope which will "lock in" readily on all types of TV waveforms. Check this feature on the "88"!

When you use the WG-216B Low-Capacitance Probe supplied with the WO-88A, the over-all input resistance is raised to 10 megohms! Because many TV circuits are extremely sensitive to resistive loading, normal circuit operation may be seriously disrupted by loading of the average 'scope. With the WG-216B Low-Capacitance Probe, however, loading problems are minimized. Check this feature on the "88"!

In addition, the WG-216B Low-Capacitance Probe decreases the over-all input capacitance to less than 10 μf ! Excessive capacitance loading can cause the horizontal oscillator to change frequency or stop oscillating. When the WO-88A is connected, the low over-all input capacitance leaves receiver operation essentially unaffected. Check this feature on the "88"!

Frequency Response (minimum values):

Vertical Amplifier:

From 0 to 10⁶ Kc. flat
At 500 Kc. within -3 db
At 1 Mc. within -10 db
Rise Time 0.5 microsecond or better

Horizontal Amplifier: (reference frequency 1000 cps)

At 10 cps. within -1 db
At 200 Kc. within -6 db

Deflection Sensitivity (minimum limits):

	Volts Per Inch	
	rms	p-p
Vertical Amplifier:		
With WG-218 Direct Probe and Cable	0.025	0.07
With WG-216B Low-Capacitance Probe	0.25	0.7
Horizontal Amplifier	0.6	1.7
Calibrating Voltage	0.35	1.0

Input Resistance and Capacitance:

Vertical Amplifier:

With WG-218 Direct Probe and Cable 1 megohm shunted by 75 μf

With WG-216B Low

Capacitance Probe 10 megohms shunted by 9.5 μf

Horizontal Amplifier:

At Input Terminals 2.2 megohms shunted by 55 μf

Sweep-Circuit Frequency (Four Ranges) 15 cps to 30 Kc

Tube Complement 1-6X4, 1-12AU7, 2-6AU6,
1-1V2, 2-12AT7, 1-5UP1

Power Supply 105/125 volts, 50/60 cps

Dimensions 13 $\frac{1}{2}$ " h, 9" w, 16 $\frac{1}{2}$ " d

Weight 25 lbs.

Finish ... Blue-gray hammeroid case, frosted-aluminum panel

\$149.50 (Suggester User Price) complete with matched probes and cables, including the WG-216B Low-Capacitance Probe, and instruction booklet.



RCA TEST EQUIPMENT for SERVICE • INDUSTRY SCHOOLS • LABORATORIES

7" OSCILLOSCOPE WO-56A

From the large 7" mu-metal-shielded CRT in a compact, space-saving cabinet to performance standards which include high sensitivity and wide frequency range—the WO-56A delivers peak performance for laboratory, factory and shop.

Identical vertical and horizontal direct-coupled, push-pull amplifiers have frequency-compensated and voltage-calibrated attenuator networks. A horizontal trace expansion of three times screen diameter with comparable vertical centering permits observation of minute trace detail. TV preset sweep facilities, retractable light shield, 60-cycle sweep and wide angle phasing control, "plus" and "minus" sync for locking-in "upright" or "inverted" wave shapes, high input impedance, peak-to-peak calibrating voltage, and many other time-saving features make this instrument one of the most desirable in the field.

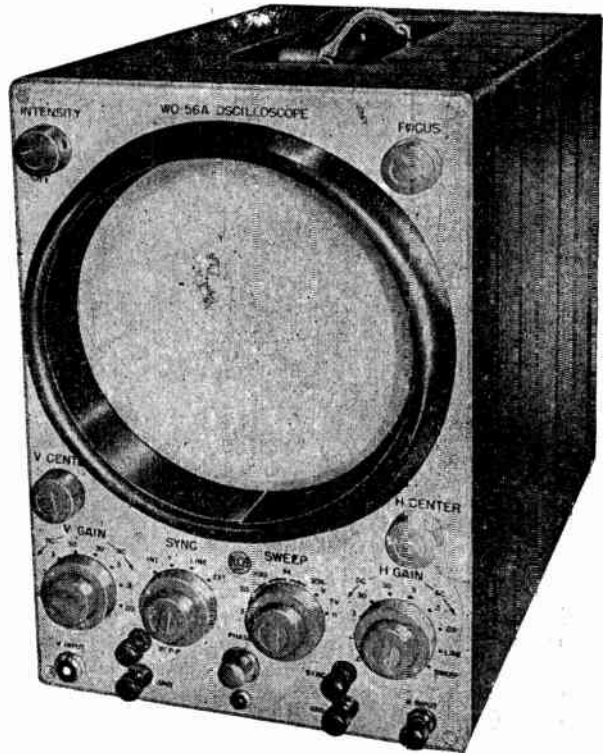

Frequency Response:

Vertical Amplifier { Flat from 0 to 500 Kc within — 2 db
 { Flat from 0 to 1 Mc within — 6 db

Input Resistance and Capacitance:

Vertical Amplifier
 With Direct Probe
 and Cable WG-218 1 megohm shunted by 75 $\mu\mu\text{f}$
 With Low-Capacitance
 Probe WG-216B 10 megohms shunted by 9.5 $\mu\mu\text{f}$
 Horizontal Amplifier . 1 megohm shunted by 35 $\mu\mu\text{f}$
 Sync Input 1 megohm shunted by 35 $\mu\mu\text{f}$

Deflection Sensitivity:

	Millivolts per inch	
	rms	p-p
Vertical Amplifier		
With Direct Probe and Cable WG-218	10.6	30.0
With Low-Capacitance Probe WG-216B	106.0	300.0
Horizontal Amplifier	21.2	60.0

Sweep Frequencies:

Variable 3 cps to 30,000 cps
 Preset { "TV/V" position approx. 30 cps
 { "TV/H" position approx. 7875 cps

Power Supply 105/125 volts, 50/60 cps

Tube Complement 4-BH6, 5-12AU7, 1-6X4,
 1-1V2, 1-7JP1

Dimensions 13 $\frac{3}{8}$ " h, 9" w, 16 $\frac{5}{8}$ " d

Weight 31 pounds

Finish Blue-gray hammeroid case
 satin-aluminum panel

\$274.50 (Suggested User Price) complete with matched probes and cables, including the WG-216B Low-Capacitance Probe.



RCA TEST EQUIPMENT for SERVICE • INDUSTRY SCHOOLS • LABORATORIES

TELEVISION SWEEP GENERATOR WR-59C

Service technicians find the WR-59C tops for visual alignment and trouble-shooting of TV tuners, sound and picture if amplifiers, trap circuits, and video amplifiers. Combining such outstanding features as preset switch positions for all VHF TV channels and continuous tuning from 300 Kc to 50 Mc, the WR-59C has a high-output voltage flat and free from spurious responses. Fundamental signals are generated on all channels by a push-pull oscillator.

Such bonus features as a special blanking circuit for producing a zero reference line on an oscilloscope for quantitative gain measurements and for balancing discriminator circuits, and a phase-controlled sweep voltage at power-line frequency for 'scopes lacking sweep and phase controls, a dual-piston attenuator with a range down to 5 microvolts . . . make this instrument a welcome addition to the most professional of service shops.



RF.....TV Channels 2 to 13-preset
Maximum Sweep Frequency is not less than 12 Mc
IF.....300 Kc to 50 Mc, continuous tuning
Sweep Width.....continuously variable for
both IF and RF ranges
Output Voltage (rms).....0.1 volt min.
Cable Termination:
RF Positions.....300 ohms balanced
IF Position.....100 ohms
Maximum Attenuator Ratio:
RF Positions.....20000 to 1
IF Position.....4000 to 1
Maximum Amplitude Variation of Sweep Envelope
(at maximum rate
sweep width).....All positions less than ± 1 db

Horizontal Sweep for Oscilloscope:
Phase Adjustment Range.....160°
Frequency.....Power Line
Tube Complement.....2-6J6, 2-6C4, 1-6AT6, 1-6X4
Power Supply.....105/125 volts, 50/60 cps
Dimensions.....9 3/4" h, 13 1/2" w, 7 1/2" d
Weight.....20 lbs.
Finish.....Blue-gray hammeroid case, satin-aluminum panel

\$274.50 (Suggested User Price) includes balanced 300-ohm rf output cable and resistance terminated if/vf-output cable, and instruction booklet.

CRYSTAL-CALIBRATED MARKER GENERATOR WR-89A

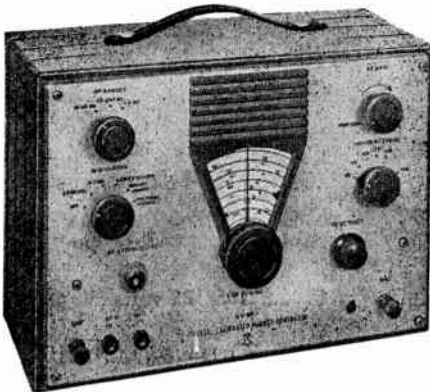

Featuring continuous tuning, the RCA WR-89A Crystal-Calibrated Marker Generator furnishes you with an rf carrier of crystal accuracy for use in aligning and trouble-shooting of TV and communications receivers, transmitters, and other equipment in such services as fm, aeronautical, and marine, operating in the frequency range of 19-260 Mc. Calibration of the generator may be checked at 2.5 Mc intervals throughout its tuning range by means of a built-in harmonic crystal oscillator of high accuracy.

In this one versatile instrument you not only get a multiple-marker generator, but also a very useful bar-pattern generator for checking both vertical and horizontal deflection linearity of a TV receiver. When video and sync information from an operating TV receiver is fed into the WR-89A, you can use the generator as a rebroadcast transmitter to produce a TV picture on any channel of another TV receiver.

And when an external rf signal is fed into the WR-89A, you may also use the generator as a heterodyne frequency meter for measuring the frequency of the external signal.

These and other important advantages reflect the expert engineering and functional design of the WR-89A—assuring you the dependability so essential for today's critical testing requirements.

Variable-Frequency Oscillators:
Frequency Ranges (on Fundamentals).....19-55 Mc
55-260 Mc
Output Voltage:
On VFO Ranges.....at least 0.1 rms volt
On 4.5 Mc.....at least 0.1 rms volt
Total Length of Dial Scale.....144 inches approx.
Fine Tuning Drive Ratio.....11.6 to 1
RF Attenuator:
Range of Attenuation.....at least 60 db
Type.....Single-piston capacitor
Output Cable Impedance.....90 ohms
2.5-Mc Crystal Calibrator:
Accuracy..... $\pm 0.01\%$
Total Number of Check Points.....96

4.5-Mc Crystal Oscillator:
Accuracy..... $\pm 0.02\%$
Internal Modulation.....4.5 Mc, 4.5 Mc & 600 cps, 600 cps, 100-150 Kc
External Modulation Frequency.....up to at least 10 Mc
Tube Complement.....1-OA2, 1-6AS6, 1-6CB6, 1-6J6, 1-6U8,
1-6X4, 1-6X8, 1-12AT7
Power Supply.....105/125 volts, 50/60 cps
Power Consumption.....55 watts
Dimensions.....10" h, 13 1/2" w, 7 1/2" d
Weight.....15 lbs.
Finish.....Blue-gray hammeroid case, satin-aluminum panel

\$242.50 (Suggested User Price) complete with rf-output cable, tubes, and instruction booklet.

Color has greatly increased the need for accuracy in rf-if alignment, and for complete sweep coverage of the video frequency range. The RCA WR-89A Crystal-Calibrated Marker Generator provides the accuracy that is essential for color alignment. The RCA WR-59C Sweep Generator provides complete coverage of the video-frequency range down to 50 Kc. Both of these instruments are ideally suited for color servicing.



RCA TEST EQUIPMENT for SERVICE • INDUSTRY SCHOOLS • LABORATORIES

UHF SWEEP GENERATOR WR-86A



• The RCA WR-86A UHF Sweep Generator is built around a frequency-modulated oscillator and is designed for production line and general service application on uhf receivers, converters, tuners, filters, antennas, transmission lines, and other equipment operating in the range of 300 to 950 Mc.

The Sweep oscillator employs the RCA-6AF4, a uhf oscillator triode, in a specially designed sweep circuit which results in excellent sweep linearity and a maximum amplitude variation of 0.1 db/MC combined with a large sweep width.

The oscillator compartment and its associated components are especially designed and sturdily constructed for best stability and reliable performance over extended operating periods. Critical parts are silver plated for maximum electrical efficiency. The entire oscillator section is enclosed in a special silver-plated case to minimize leakage.

A blanking circuit is included to provide a reference base line on an oscilloscope. The blanking circuit is normally in operation but may be incapacitated by a front-panel switch. The horizontal sweep frequency for the oscilloscope can be obtained from front-panel terminals.

The WR-86A has 50-ohm output and will work into a 50-ohm unbalanced or 300-ohm balanced load. For 50-ohm unbalanced circuits, the output cable is connected directly to the load. For 300-ohm balanced circuits, the cable is plugged into a specially designed shielded balun (WG-296) which provides 300-ohm balanced output. The balun is furnished with the WR-86A.

The instrument is engineered to give long trouble-free performance under severe operating conditions. Its simple tuning and directly read dial make the instrument easy to use on the production line and on the service bench.

Electrical:

Sweep Oscillators:

Frequency Range (Continuously variable)
Center frequencies from 300 to 950 Mc

Sweep Width (Continuously variable)
10% of indicated dial frequency up to 750 Mc;
75 Mc from 850 to 950 Mc.

Output System:

Attenuator { TypePiston
Range60 db

Output { Impedance50 ohms*
Voltage, across 50-ohm load or across
loaded 300-ohm balun at least 0.6 volts

Amplitude Variation of sweep envelope at maximum sweep width**.....0.1 db/Mc Max.

Power Supply:

Voltage105-125 volts

Frequency60 cps

Power60 watts

Mechanical:

Dimensions13½"L, 9¼"H, 7½"D

Weight.....14 lbs.

FinishBlue-grey hammeroid

*A 50-to-300-ohm balun (RCA WG-296) for matching the WR-86A to loads of 300 ohms is supplied with the instrument.

**When connected across properly terminated load of 50 ohms.

\$275.00 (Suggested User Price) complete with rf output cable (4 feet long), WG-296 50-to-300-ohm Padded balun, and instruction book.



RCA TEST EQUIPMENT for SERVICE • INDUSTRY SCHOOLS • LABORATORIES

AUDIO SIGNAL GENERATOR WA-44A

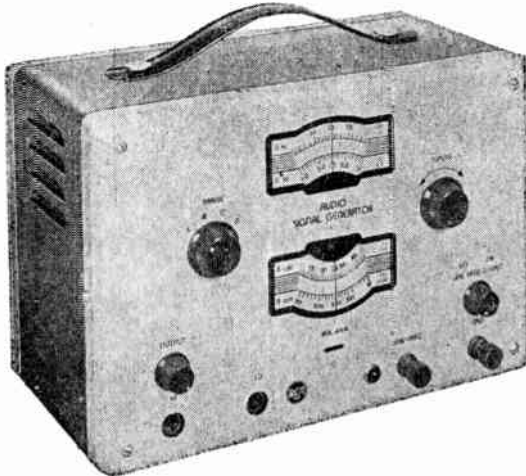

You'll find the WA-44A excellent for: amplifier frequency-response checks; use in measuring intermodulation distortion in amplifiers; frequency response checks of tone controls; running frequency response curves on phonograph equalizers; checking input and output impedances of amplifiers; use in measuring resonance frequency of loudspeakers and speed of recorder/reproducer mechanisms.

And this compact, lightweight instrument is equally useful in: tuning bass-reflex enclosures; determining unknown audio frequencies; determining inductance and capacitance; audio signal tracing; determining the resonance frequency of LC circuits; and locating cabinet resonance and rattles. The RCA WA-44A features a new RC-type oscillator having a wide frequency range, which facilitates checking response of high-fidelity amplifiers, and an age control circuit which insures stable performance. The output is flat within ± 1 db over the entire frequency range.

Frequency Ranges:

"A" band.....	11 to 110 cps
"B" band.....	110 to 1100 cps
"C" band.....	1.1 to 11 kc
"D" band.....	11 to 100 kc

Frequency Response..... ± 1 db from 11 cps to 100 kc with a reference frequency of 1100 cps

Frequency Stability... $\pm 3\%$ or better, under normal operating conditions

Output Voltage (continuously variable):

"HI".....	15 volts rms (max.)
"LO".....	2.5 volts rms (max.)

Total Harmonic Distortion.....	2% or less from 37 cps to 15 kc
Hum Level.....	0.1% or less of rated output
Power Characteristics:	
Supply Voltage.....	105-125 volts, 50/60 cps
Consumption.....	35 watts
Tube Complement.....	6BH6, 6AK6, 6A05, 6AV6, 6A2, 6X4
Dimensions.....	7" high x 10½" wide x 6" deep
Weight.....	10 lbs.
Finish.....	Blue-gray hammeroid case, satin aluminum panel

\$87.50 (Suggested User Price) complete with tubes, output cable, and instruction booklet.

RF SIGNAL GENERATOR WR-49A

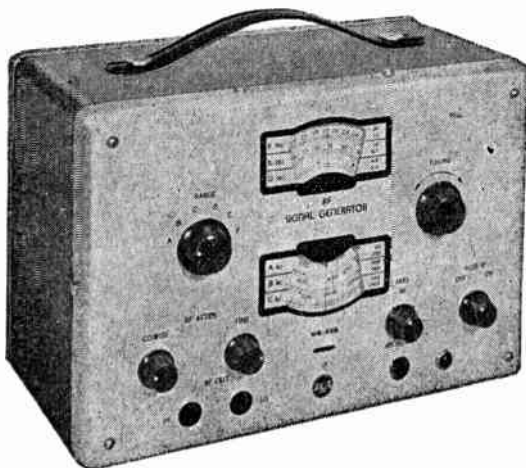

You don't have to bother with the nuisance job of connecting dc blocking capacitors to the probe tip of the RCA WR-49A RF Signal Generator, because it has built-in dc blocking capacitors. With it, you can inject rf signals into plate circuits and other points where dc is present without placing a dc load on the circuit under test—and with protection from burn-out in both the equipment and signal generator.

The functional-design dial facilitates accurate and easy readings. And full-length shielding of the output cable minimizes radiation and hum pickup in the receiver under test or adjacent test equipment. And that's not all! The extremely stable cathode-follower output stage isolates the oscillator from effects of load reactance and resistance, thereby maintaining good output waveform, voltage regulation, and frequency stability.

Compact and lightweight, the WR-49A can be depended upon in such applications as alignment and signal tracing of am and fm radio receivers, alignment of low-frequency if amplifiers in TV receivers, and signal tracing and troubleshooting in TV receivers.

(Performance figures taken at line voltage of 117 volts, 60 cps)

RF Characteristics:

Six Ranges:

"A" Range.....	.85 Kc to 200 Kc
"B" Range.....	2.0 Kc to 550 Kc
"C" Range.....	550 Kc to 1600 Kc
"D" Range.....	1.6 Mc to 4.8 Mc
"E" Range.....	4.7 Mc to 14 Mc
"F" Range.....	13 Mc to 30 Mc

Maximum RF Output Voltages* (all ranges):

At RF OUT HI Connector.....	at least 0.05 rms volt
At RF OUT LO Connector.....	at least 0.01 rms volt
Accuracy of Dial Calibration.....	$\pm 1\%$
Attenuator Range.....	.65 db
Internal Modulating Frequency.....	approx. 400 cps
Internal Percentage of Modulation†.....	adjustable up to 70%
Audio-Frequency Output.....	at least 8 rms volts across 15,000-ohm load

External Modulation:

Modulating Frequency.....	15 Kc max.
Voltage Required for 30% modulation using 400 cps.....	10 rms volts
Impedance at AF IN/OUT connector (400 cps).....	approx. 16,000 ohms
Tube Complement.....	1 RCA-12AU7, 1 RCA-6C4
Power Characteristics:	
Supply Voltage.....	105/125 volts, 50/60 cps
Consumption.....	15 watts
Dimensions.....	7½" h, 10½" w, 6" d
Weight.....	8 lbs.
Finish.....	Blue-gray hammeroid case, satin-aluminum panel
*Open-circuit value.	
†With WR-49A tuned to 1 Mc.	

\$59.50 (Suggested User Price) complete with tubes, output cable, and instruction booklet.



RCA TEST EQUIPMENT for SERVICE • INDUSTRY SCHOOLS • LABORATORIES

MASTER VOLTOHMYST* WV-87A

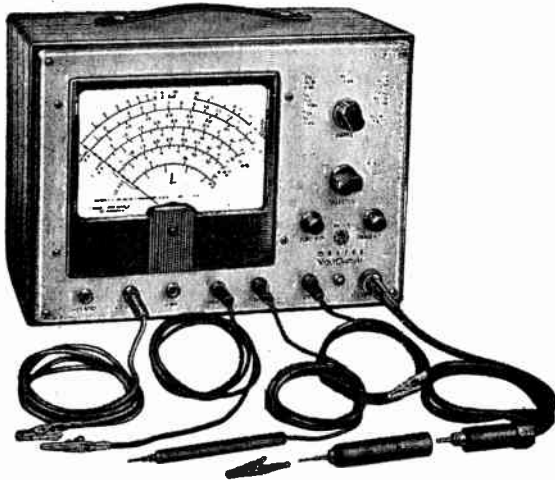

Featuring a 7½" meter, the new WV-87A Master Volt-Ohmyst is the deluxe member of the RCA VoltOhmyst family. It's peak-to-peak scales are particularly useful for television, radar, and other types of pulse work.

The WV-87A measures dc voltages accurately in high-impedance circuits, even with ac present. It also reads rms values of sine waves and the peak-to-peak values of complex waves or recurrent pulses, even in the presence of dc.

Like all RCA VoltOhmysts, the WV-87A features ±1% multiplier and shunt resistors, a ±2% meter movement, high-input resistance, zero-center scale adjustment for discriminator alignment, dc polarity-reversing switch, and a sturdy metal case for good rf shielding.

The RCA WV-87A Master VoltOhmyst has the accuracy and stability necessary for many laboratory applications. Its large, easy-to-read meter also makes it especially desirable as a permanently mounted instrument in the factory and repair shop.

DC Voltmeter:

Ranges.....0 to 1.5, 5, 15, 50, 150, 500, 1500 volts
Input Resistance All Ranges.....11 megohms
Sensitivity on 1.5-V Range.....7.3 megohms/volt
Overall Accuracy.....±3% of full scale

AC Voltmeter:

Ranges:
RMS Values of Sine Waves.....0 to 1.5, 5, 15, 50,
150, 500, 1500 volts
Peak-to-Peak Values of Sine
Waves and Complex Waves.....0 to 4, 14, 42, 140,
430, 1400, 4200 volts

Overall Accuracy.....±5% of full scale

Input Resistance and Capacitance (With Direct Probe and Cable
WG-218) 1.5, 5, 15, 50, 150, V Ranges.....0.83 meg,
shunted by 85 μmf

Frequency Response (up to and including the 500-volt range)
for Source impedances of approximately
100 ohms or lower.....30 cps to 3 Mc

For Source impedances of approximately

1000 ohms or lower.....30 cps to 500 Kc

Ohmmeter:

0 to 1000 Megohms in 7 Ranges....Rx1, Rx10, Rx100, Rx1000,
Rx10K, Rx100K, Rx1 Meg

Direct-Current Meter:

Ranges, Nine.....0 to 0.5, 1.5, 5, 15, 50, 150, 500 milliamperes;
0 to 1.5, 15 amperes

Overall accuracy.....±3% of full scale
Tube and Battery Complement.....2-6AL5, 1-12AU7, 1-VS036
Power Supply.....105/125 volts, 50/60 cps
Dimensions.....10" h, 13½" w, 7" d
Weight.....8 pounds
Finish.....Blue-gray hammeroid case, satin-aluminum panel

\$112.50 (Suggested User Price) Complete with probes and cables, including: Direct Probe and Cable, DC/ Direct Switch Probe, Ohms Probe and Cable, Positive Current Lead, Negative Current Lead, Ground Lead, and instruction booklet.

ULTRA-SENSITIVE DC MICROAMMETER WV-84A

DC Microammeter:

Ranges, Six...0 to 0.01, 0.1, 1, 10, 100, 1000 μa
Overall Accuracy:
On X.01 Range.....±5% of full scale
On all other ranges.....±4% of full scale
Voltage drop on all ranges.....0.5 volts

DC Voltmeter:

Ranges and Input Resistance:
0 to 1-Volt Range.....100 megohms
0 to 10-Volt Range.....1000 megohms
0 to 100-Volt Range.....1005 megohms

Megohmmeter:

Ranges, Two.....900 to 9000, 9000 to 90000 megohms

Tube and Battery Complement...2 RCA-3S4,
2 RCA-VS106 1½ volts,
2 RCA-VS102 2½ volts

Dimensions.....9½" h x 6¼" w x 5¼" d
Weight.....9½ lbs. (including batteries)

\$100.00 (Suggested User Price) includes instruction booklet, and two precision multiplier resistors, less batteries.



A battery operated microammeter, the RCA WV-84A is capable of reading from 0.002 to 1000 microamperes in six ranges. The WV-84A can be used with an external battery to measure resistance values as high as 90,000 megohms or may be used with an external resistor as a voltmeter with an input resistance of at least 100 megohms per volt.

Circuit features of the WV-84A include negligible loading of the circuit under test, meter movement electronically protected against burn-out, and a self-contained battery power supply which makes the instrument completely portable.

The WV-84A is finding increased use by research laboratories in many fields—chemistry, medicine, electro-mechanics, electronics, nucleonics—for conducting experiments involving feeble currents. Industrial users find it an excellent instrument for making current and voltage measurements in electrolysis and corrosion investigations. The WV-84A may also be used for checking currents in light meters, in ultra-violet and infra-red detectors, and in spectrophotometric devices.



RCA TEST EQUIPMENT for SERVICE • INDUSTRY SCHOOLS • LABORATORIES

SENIOR VOLTOHMYST WV-97A

DC Voltmeter:

Seven Continuous Ranges... 0 to 1.5, 5, 15, 50, 150, 500, 1500 volts

Input resistance (including 1 megohm in DC Probe):

All Ranges... 11 megohms

Sensitivity for the 1.5-volt Range... 7.3 megohms-per-volt

Overall Accuracy... $\pm 3\%$ of full scale

AC Voltmeter—Fourteen Continuous Ranges:

Peak-to-Peak Ranges... 0 to 4, 14, 42, 140, 420, 1400, 4200 volts

RMS Ranges (for sine waves)... 0 to 1.5, 5, 15, 50, 150, 500, 1500 volts

Input Resistance and Capacitance with WG-218 Direct Probe and Cable:

1.5, 5, 15, 50, 150-volt Ranges... 0.83 megohm shunted by 70 μf

500-volt Range... 1.3 megohms shunted by 60 μf

1500-volt Range... 1.5 megohms shunted by 60 μf

Frequency Response (with WG-218 Direct Probe and Cable)*:

1.5, 5, 15, 50, 150, 500-volt Ranges... flat from 30 cps to 3 Mc

Overall Accuracy. All Ranges... $\pm 5\%$ of full scale

Ohmmeter:

Seven Continuous Ranges... 0 to 1000 megohms

Center Scale Values... 10, 100, 1000, 10,000 ohms; 0.1, 1, 10 megohms

Tube and Battery Complement... 2-6AL5, 1-12AU7, 1-V5036

Power Supply... 105/125 volts, 50/60 cps

Dimensions... 7 $\frac{7}{8}$ " h, 5 $\frac{3}{4}$ " w, 4 $\frac{1}{2}$ " d

Weight... 5 $\frac{1}{2}$ pounds

Finish... Blue-gray hammeroid case, satin-aluminum panel

*For impedance of 100 ohms



Especially useful as a television signal tracer, the WV-97A features a high-impedance, high-frequency, full-wave rectifier for direct readings of peak-to-peak voltages up to 4,200 volts. With this instrument, you can readily obtain quantitative measurements of practically all of the important complex-waveform voltages found in video, sync, and deflection circuits.

The WV-97A is a deluxe instrument having such refinements as seven non-skipping ranges on all functions, uniform "3 to 1" ratio between scales, wide frequency range, and extended voltage range.

Like all RCA VoltOhmysts, it has high input resistance, electronic protection against burn-out, zero-center scale, molded plastic meter case, rugged 200 microampere meter movement, $\pm 1\%$ multiplier resistors, and other outstanding VoltOhmyst extras.

\$67.50 (Suggested User Price) including Direct Probe and Cable, DC/Direct Switch Probe, Ohms Lead, and Ground Lead, and instruction booklet.

JUNIOR VOLTOHMYST WV-77A

DC Voltmeter:

Ranges... 0 to 3, 12, 60, 300, 1200 volts

Input Resistance (with DC Probe), All Ranges... 11 megohms

Accuracy: With function selector set on "+VOLTS"... $\pm 3\%$ of full scale

With function selector set on "-VOLTS"... $\pm 5\%$ of full scale

AC Voltmeter:

Ranges (rms)... 0 to 3, 12, 60, 300, 1200 volts

Accuracy... $\pm 5\%$ of full scale

Input Characteristics: 3, 12, and 60-volt

Ranges... 0.2 megohms shunted by 75 μf

300-volt... 1.0 megohms shunted by 50 μf

1200-volt... 2.0 megohms shunted by 50 μf

Frequency Response... Flat within ± 1 db from 30 cps to 3 Mc

Ohmmeter:

Ranges, Five... 0 to 1,000 megohms

Center-Scale Values... 10, 1000, 10,000 ohms; 1.0, 10 megohms

Power Supply... 105/125 volts, 50/60 cps

Tube and Battery Complement... 1-12AL5, 1-12AU7, 1-V5036

Dimensions... 8" h, 5 $\frac{3}{8}$ " w, 4 $\frac{1}{2}$ " d

Weight... 4 pounds

Finish... Blue-gray hammeroid case

*On 3, 12 and 60-volt ranges with source impedance 100 ohms.



Unquestionably the greatest value in all-electronic, ac-operated vacuum-tube voltOhmmeters... the Junior VoltOhmyst provides versatility, accuracy, and dependability at low cost.

The WV-77A embodies all of the standard VoltOhmyst features such as high input resistance, low-input capacitance on dc functions, ability to measure dc in the presence of ac and vice versa, burn-out proof meter circuit, metal-case shielding against rf, $\pm 1\%$ multiplier resistors, dc polarity reversing switch, negative feedback bridge circuit, zero-center scale, plus wide frequency response and extended voltage ranges, positive-polarity ohms probe for quick testing of electrolytic capacitors, and many other features.

Factory-built, factory-tested, and calibrated against the finest laboratory standards, the Junior VoltOhmyst is deserving of its popularity.

\$47.50 (Suggested User Price) Complete with Probes and Cables, and instruction booklet.



RCA TEST EQUIPMENT for SERVICE • INDUSTRY SCHOOLS • LABORATORIES

TV ISOTAP WP-25A

Speed Up Your Servicing

... use the RCA TV Isotap to avoid wasted time and uncertainty in TV troubleshooting. Use the 500 volt-ampere autotransformer winding for testing power transformer types of TV receivers. Use the 275 VA isolated secondary winding for testing transformerless types of TV and ac-dc radio receivers.

Service sets at normal line voltage for quick check of circuit voltages—break down intermittent components by operating set at extra-high line voltage—make sure test functions satisfactorily at low-line voltage.

Prevent Damage to Your Test Equipment

... use the RCA TV Isotap to avoid expensive damage to your valuable test equipment. Eliminate possibility of crossed line plugs on transformerless receivers and test equipment and prevent costly short circuits.

Minimize Shock Hazard

... use the RCA TV Isotap to avoid the shock hazard in servicing transformerless types of radio and TV receivers. WP-25A provides complete isolation and greatly minimizes shock hazards.

Cut Down Costly Returns

... by using the RCA TV Isotap to avoid service recalls which are often caused by a difference of line voltage in the customer's home. With the WP-25A you can check the set in the shop at high, medium, and low-line voltages.



Supply Line:
 Voltage Range.....105-130 volts
 Switch Positions.....105, 110, 115,
 120, 125, 130, OFF
 Frequency50-60 cps
 Output Voltages:
 Direct Receptacles (with 500 max va
 load and selector set to value of supply-
 line voltage):
 LOW105 volts
 MED115 volts
 HIGH130 volts
 Isolated Receptacles (with resistive load
 of 275 max va and selector set to value
 of supply-line voltage):
 LOW105 volts
 MED115 volts
 HIGH130 volts
 Load Ratings (40° C Ambient):
 Continuous Operation:
 Direct Receptacles500 va max
 Isolated Receptacles ...275 va max
 Intermittent Operation:
 Direct Receptacles750 va max
 Isolated Receptacles ...450 va max
 Regulation (no load to full
 continuous load):
 Direct Receptacles ...approx. 1.5%
 Isolated Receptacles ...approx. 6%
 Dimensions.....5 $\frac{3}{4}$ " h, 5" w, 4 $\frac{3}{8}$ " d
 Weight12 lbs.
 Finish.....Dark cobalt, gray lacquer
\$17.95 (Suggested User Price)

RADIO BATTERY TESTER WV-37A

Now you can test portable-radio batteries under actual load or "turned-on" conditions without the necessity of placing batteries in the set. The RCA WV-37A's built-in load circuits eliminate the time-consuming method required to test batteries with the conventional voltmeter. And the RCA WV-37A also gives you a more accurate indication of true battery voltage than does the conventional voltmeter alone.

The selector switch on the front panel has nine prefixed positions to accommodate popular portable-radio batteries ranging from 1.5 volts to 90 volts. Eight blank test positions are provided to enable you to set up testing conditions of your own choosing for testing additional battery types.

Red and black plastic test prods joined to 36-inch test leads are permanently attached to the tester. Weighing less than 3 $\frac{1}{2}$ lbs. the WV-37A measures a full 9 $\frac{1}{2}$ " long, by 6" wide, by 1 $\frac{1}{2}$ " deep.

You'll find the new RCA WV-37A Radio Battery Tester a worthy addition to your service shop. Use it on the sales counter for checking used batteries or assuring the customer that replacement stock is fresh... on the service bench for accurate battery voltage indication under normal load conditions—on shelf stock to keep a "running-check" on the condition of your shelf battery stock.

\$24.95 (Suggested User Price)



Nine prefixed switch positions for testing popular portable-radio-type batteries

Rugged, easy-to-read, 4 $\frac{1}{2}$ " meter, all metal case, $\pm 2\%$ meter movement

Built-in load circuits provide "in-use" testing conditions

Double meter-scale simultaneously indicates percentage of rated battery voltage and relative "good" . . . "useable" . . . or "replace" condition

Extra positions for adaption of tester to new or different battery types . . . prevents obsolescence

DELUXE RACK WS-17A

The WS-17A is a deluxe three position test equipment rack. Add beauty and convenience to your test set-up with this streamlined rack. Sturdy all-steel construction with attractive satin-aluminum and blue-gray hammeroid finish.

\$59.50 (Suggested User Price)

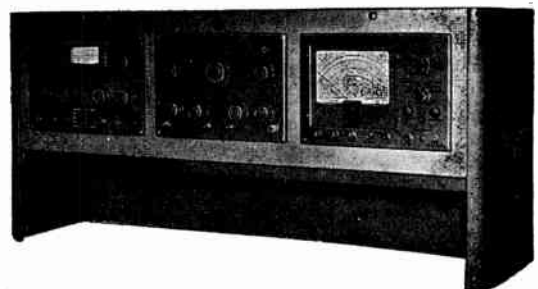



RCA TEST EQUIPMENT for SERVICE • INDUSTRY SCHOOLS • LABORATORIES

HIGH VOLTAGE PROBES WG-289, 290

RCA High Voltage Probes WG-289 and WG-290 are identical except for their connectors. The WG-289 is provided with microphone-type connector for use with the VoltOhmysts and other voltmeters having microphone-type connectors. The WG-290 is equipped with phone-tip connectors for use with voltmeters having phone-tip jacks.

These High Voltage Probes are capable of extending the dc voltage range of your meter to 50,000 volts. When used with a VoltOhmyst the input resistance is increased to 1000 megohms, an important feature when working in high-impedance circuits where loading seriously affects the stability of the circuit under test.

A choice of five multiplier resistors is available enabling these probes to be used with practically all popular electronic and non-electronic voltOhmmeters.

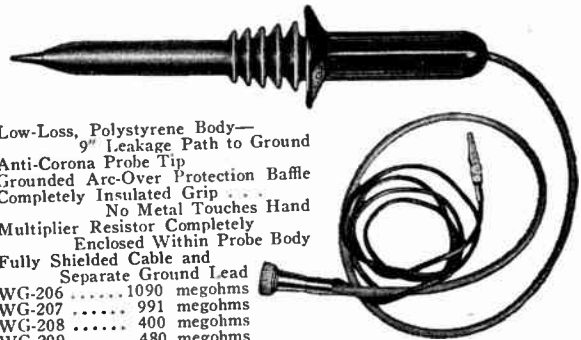

Low-Loss, Polystyrene Body—
9" Leakage Path to Ground
Anti-Corona Probe Tip
Grounded Arc-Over Protection Baffle
Completely Insulated Grip . . .
No Metal Touches Hand
Multiplier Resistor Completely
Enclosed Within Probe Body
Fully Shielded Cable and
Separate Ground Lead
WG-206 1090 megohms
WG-207 991 megohms
WG-208 400 megohms
WG-209 480 megohms
WG-210 900 megohms
\$7.15* Either Probe Only
\$2.80* Resistor Only
*(Suggested User Price)

SPECIAL PURPOSE PROBES

LOW-CAPACITANCE PROBE WG-216B



The WG-216B is a "slip-on" type probe, designed for use with either the WG-218 or WG-220 Direct Probe in conjunction with an oscilloscope. When the WG-216B is used with either the RCA WO-56A or WO-88A oscilloscopes, the total input resistance is 10 megohms shunted by a capacitance of less than 10 μf . **\$7.00***

DC PROBE WG-217



The WG-217 is a "slip-on" type probe, designed for use with either the WG-218 or WG-220 as a DC Probe for VoltOhmysts or other types of voltOhmmeters. The WG-217 contains a 1-megohm isolating resistor, and has a shunt capacitance of less than 2 μf . **\$2.75***

DEMODULATOR PROBE WG-291



The WG-291 Demodulator Probe has an input range of 500 Kc to 250 Mc with an input capacitance of only 2.25 μf . It separates the modulation from the RF carrier in an amplitude-modulated wave by means of a rectifier and a filter having a short time constant and an output frequency range of 30 to 5,000 cps. The WG-291 has a maximum input voltage of 20 rms volts and a maximum dc voltage rating of 250 volts. **\$7.95***

DC/DIRECT PROBE WG-222



The WG-222 is a "slip-on" type probe with a built-in 1-megohm isolating resistor and a unique switching facility. By virtue of the switch arrangement, it is possible to measure dc voltage or resistance, without changing probes. The WG-222 slips on the front of either the WG-218 or WG-220 and may be used with VoltOhmysts or other vacuum-tube voltmeters requiring a 1-megohm isolating resistor. **\$3.50***

DIRECT PROBE AND CABLE WG-218, WG-220



The WG-218 is a shielded input cable for use with volt-ohmmeters and oscilloscopes. It is fitted with a probe tip at one end and a microphone-type connector at the other end for connection to instruments having microphone-type cable connectors. The WG-220 is the same electrically as the WG-218 but is fitted with pin-plug tips for connection to instruments having tip jacks or binding posts. Either Probe **\$3.75***

CRYSTAL-DIODE PROBE WG-264



The WG-264 Crystal-Diode Probe consists of a germanium rectifier and RC network in a plastic housing . . . which conveniently slips on the Direct Probe of VoltOhmysts, such as the WV-97A. RF voltages at frequencies up to 250 Mc may be accurately measured with the WG-264. The ac voltage range extends from 20 millivolts to 20 volts rms; dc voltages up to 250 volts can be present. **\$7.75***

*(Suggested User Price)

RACK-ADAPTER PANEL WS-18A

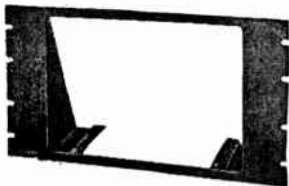

The WS-18A Rack Adapter Panel may be used for mounting any of the matched RCA Test Instruments in standard 19" relay racks. Add convenience, standardization and the professional touch to your test bench set-up. Umber-gray finish, all steel construction.

\$11.50 (Suggested User Price)

Chicago

INSTRUMENTS

**ADVANCED DESIGN
DECIDEDLY DIFFERENT
CHICAGO V T V M MULTITESTER**

**THE GREATEST VACUUM TUBE VOLTMETER
VALUE ON THE MARKET!**

- ✓ Capacitance and Milliampere ranges—found only on finest electronic multitesters.
- ✓ One zero adjustment holds for all ohm ranges.
- ✓ DC Probe furnished has ten megohm isolating resistor incorporated.
- ✓ Zero Center for TV and FM discriminator alignment.
- ✓ Additional jack provided for 5000 volt range.
- ✓ 30 complete ranges for maximum versatility.
- ✓ Line voltage changes have little effect on the stable, double triode, bridge-type circuit.
- ✓ Extremely high DC input resistance for making measurements without loading circuit under test.
- ✓ Audio frequency response virtually flat to 25 kc on 0 to 100 volt ranges.
- ✓ Slanted to give advantage of overhead lighting. Dual position, brown hammerloid aluminum panel shipped in 67½° angle position for ease of reading and convenient portability. May be readily changed to a 22½° angle for counter use by rotating in the rich brown steel case.
- ✓ Genuine leather snap-on, flexible carrying strap; may be removed when used in a permanent counter set-up.
- ✓ Unique, front of the panel type, big 5½" rectangular meter with three color scale; finest mechanical and electrical arrangement for an electronic device. Protected against possible burnouts in the circuit.
- ✓ Newly designed, original cylinder style battery holder houses two standard flash light cells. Contacts are made by designed torque spring pressure (no soldering).
- ✓ Precision calibrated 1% multipliers in all voltage and milliampere circuits.



**MODEL 504 VTVM
ELECTRONIC MULTITESTER**

Furnished complete with DC Probe and test leads.

COMPARE IT WITH THE BEST—BUY IT FOR LESS!! NET \$42.00

Overall Dimensions: 10"x7"x6"
Shipping Weight: 10 lbs.

RANGES

DC VOLTS: (7 ranges) 0-5/10/50/100/500/1000/5000
 AC VOLTS: (7 ranges) 0-5/10/50/100/500/1000/5000
 DECIBELS: — 20 to + 16
 OHMS: (6 ranges) 0-1000/10K/100K/1 Meg/100 Meg/1000 Meg
 OHMS readings at center scale 10/100/1000/10K/1 Meg/10 Meg
 DC MILLIAMPERES: (4 ranges) 0-1/10/100/500

CAPACITANCE: (6 ranges)
 50 mmf to 5000 mmf
 .0005 mf to .05 mf
 .05 mf to 5 mf
 .5 mf to 50 mf
 5 mf to 500 mf
 50 mf to 5000 mf

VTVM OUTSTANDING ELECTRICAL FEATURES

- Input Impedance: 20 Megohms including 10 megohms isolating resistor in the DC Probe on the 5 to 1000 VDC positions.
- 10 Megohms on the 5 to 1000 VAC positions.
- 100 Megohms on both 5000 VDC and 5000 VAC positions.
- DC Milliampere Ranges: (Not electronic) 50 Millivolt drop—will not change the characteristics of the circuit to be measured.
- Capacitance Ranges: Use of low voltage power source enables testing of electrolytic condensers without voltage error.
- Function Switch selects between plus or minus DC voltages.
- Unit operates on 105 to 125 VAC, 50-60 cycles.

ACCESSORIES

Model P505 R.F. Probe: Extends AC range to 200 megacycles. Not to be used over 50 volts. NET \$6.50
 Model P506 High Voltage Probe: Extends the range of the Model 504 VTVM to 30,000 VDC. Not to be used over 30,000 VDC. NET \$6.50



CHICAGO INDUSTRIAL INSTRUMENT CO.

CHICAGO 10, ILLINOIS

Copyright by U. C. P., Inc.

Net

Radio's Master — 19th Edition

Page G-11

Chicago INSTRUMENTS

**DEPENDABLE . . . ACCURATE
PORTABLE and MINIATURE
VOLT-OHM MILLIAMMETERS**



PORTAPLEX MODEL 431A Net \$19.50

AC-DC VOLTS OHMS—MILS—AMPERES

This small, convenient test unit offers all the important ranges with high accuracy and rugged dependability. Multipliers and shunts are bridge selected and guaranteed accurate within 1%. 860 Microampere meter. Aluminum case. Leather carrying strap included. 1000 Ohms per volt.

RANGES

AC-DC Volts: 0-15/30/150/300/1500/3000	Ohms Full Scale: 0-10,000/100,000/1 meg.
DC Amperes: 0-7.5	Ohms Center Scale: 60/600/6000
DC Milliampers: 0-1.5/150	Size: 6 1/8" x 3 1/4" x 2 3/4"



CHICAGO MODEL 421D Net \$24.50

Closed Case AC-DC VOLT OHM MILLIAMMETER

High Sensitivity (5000 Ohms per volt)

Designed for the hard usage of outside service work, the Model 421D has a slip-hinge cover to protect its sensitive 150 microampere meter. Bridge selected multipliers and shunts accurate within 1%. Handsome military type aluminum case with grey Hammerloid finish.

RANGES

AC-DC Volts: 0-4/10/40/100/400/1000 (5000 Ohms per Volt)	Ohms Full Scale: 0-10,000/100,000/1 meg.
DC Milliampers: 0-4/40/100/400	Ohms Center Scale: 60/600/6000
	Size: 6 1/8" x 3 1/4" x 3 1/4"



FEATHERWEIGHT MINIATURES

Palm Size Volt-Ohm-Milliammeters

Size: 3-15/16" x 2 7/8" x 2"

Accurate little Featherweights have been extremely popular with service men for many years. They slip into a jacket pocket with hardly a bulge. The same painstaking care with which multipliers and shunts are selected for higher priced instruments is used in the manufacture of Featherweight models. They are completely dependable and accurate. 1000 Ohms per volt. Molded Bakelite case.

RANGES

FEATHERWEIGHT MODEL 450
Price \$14.00 net
DC Volts: 0-5/10/50/500/1000
Milliampers: 0-1
Ohms Full Scale:
5000/50,000/500,000
Ohms Center Scale: 30/300/3000

FEATHERWEIGHT MODEL 453
Price \$19.50 net
AC-DC Volts:
0-15/30/150/300/1500/3000
DC Milliampers: 0-150
Ohms Full Scale: 5000/50,000/500,000

CHICAGO INDUSTRIAL INSTRUMENT CO.

CHICAGO 10, ILLINOIS

Chicago

INSTRUMENTS

Since 1933 we have been manufacturing a quality line of test equipment. For high accuracy and rugged dependability, Chicago Instruments are without compare in the service field. They represent the greatest test equipment values on the market!

PORTABLE BENCH TYPE VOLT-OHM-MILLIAMMETERS

Multiplex Model 458A. Volt-Ohm-Mils-Ammeter. Net \$29.50



MODEL 458A

More useful ranges and more exclusive features have been built into the new Multiplex than any instrument near its price. The slant-front panel, the big easy-to-read meter and convenient range selectors are all designed to make testing a simple, accurate operation.

In addition to broad coverage volt-ohm-milliammeter ranges, the Model 458A also has A.C. and D.C. ampere scales which are highly useful in checking various appliances, auto radios, portables, etc.

All multipliers and shunts are bridge selected, stable and guaranteed accurate within 1%. Attractive brown Hammerloid case. Genuine leather carrying strap and polarized test leads included. 1000 Ohms per volt sensitivity.

Volts AC-DC: 0-2.5/10/50/250/1000/5000

Milliamperes AC-DC: 0-1/10/100

Amperes: AC: 0-0.5/1/5/10

Amperes: DC: 0-1/10

Ohms Full Scale: 1000/200,000/2,000,000

Ohms Center Scale: 50/2250/22,500

Output: — 5 to + 55 Decibels

Size Overall: 10" x 7" x 6"

SELECTOHM

100,000 OHMS

25 WATTS

Used for Resistance Substitute In Radio • Television • Electronic

• Laboratory • Industrial Applications

Replaces Decade Box Precision Rheostat Precision Potentiometer
Precision Shunt Precision Multiplier

The Selectohm is a most useful, precision instrument for laboratory and service. It is directly calibrated to ohms from 0 to 100,000 and will hold its accuracy under powers up to 25 watts. The Selectohm is a real time saver in circuit design and for determining the value of blackened, burned out resistors when substituted in a circuit. The price represents a considerable value — approximately half the cost of comparable instruments.



MODEL 501—\$9.00

DRY BATTERY TESTER

A counter type merchandising tester that indicates the condition of dry cells at a glance. The customer can see for himself. Boosts battery sales.

Model 471. Dry Battery Tester. Complete with Test Leads. Net \$17.50.

Tests 1½ volt to 10 volt and 10 volt to 150 volt batteries under specified load. Big easy-to-read 5½" rectangular meter.



CHICAGO INDUSTRIAL INSTRUMENT CO.

CHICAGO 10, ILLINOIS

Chicago INSTRUMENTS

**NEW INSTRUMENTS
FOR LABORATORY,
PRODUCTION AND SERVICE**



MODEL 541

NEW, COMPACT VTVM WITH SINGLE SELECTOR SWITCH

The Model 541 VTVM, small as the average VOM, has a single, simplified range selector and uses only one probe. Here's a precision instrument so easy to use that you will carry it on every job. Readings are more stable than obtained from most VTVM's.

COMPARE THESE FEATURES:

- 4½" FAN STYLE METER OF HIGH ACCURACY. PEAK AND R.M.S. A.C. SCALES
- FLAT FREQUENCY RESPONSE FROM 25 CYCLES TO 250 K.C.
- ZERO CENTER FOR TV AND FM ALIGNMENT.
- ATTRACTIVE BLACK BAKELITE CASE WITH HANDLE. 6¾" x 5¼" x 3".
- 1% PRECISION RESISTORS USED IN ALL VOLT AND OHMS RANGES

— RANGES —

AC VOLTS: 3,30, 300 and 1200 DC VOLTS: 3,30, 300 and 1200
OHMS: 0-1000; 0-100,000; 0-10 Meg; 0-1000 Meg:

CHICAGO MODEL 541 VACUUM TUBE VOLTMETER . . . Net \$30.00
MODEL 541 - 1 High Voltage Probe 6.50
MODEL 541 - 2 High Frequency Probe (200 MC) . . . 6.50



MODEL 533

NEW RESISTANCE THERMOMETER HAS MANY INDUSTRIAL APPLICATIONS

An entirely new approach to measuring temperatures from -50° F to 1000° F in a small self-powered instrument now offers a much needed solution to a wide variety of temperature control problems. Ideal for checking deep freeze cabinets, refrigerators, air temperatures, ovens, lead or wax pots, heat treating furnaces, chimney stack controls, etc. 2 scales: -50° F to 300° F and 300° F to 1000° F. (Also calibrated in Centigrade.) Direct reading temperature scale. 1% Precision wire wound resistors used in Wheatstone bridge circuit.

Negative temperature coefficient resistor compensates for ambient temperatures.

Chicago Resistance Thermometer Model 533 Net \$58.00

NEW CHICAGO DYNAMIC PLATE CONDUCTANCE TUBE TESTER INCLUDES AC-DC VOM, CONDENSER LEAKAGE TESTER and DRY BATTERY TESTER

The Model 532 is a complete portable service unit which not only tests all receiving tubes but also includes a high grade volt-ohmmeter, a 300 volt condenser leakage tester with meter indication and a battery tester. For checking tubes, a patented switching arrangement provides quick set-ups to test diodes as diodes, triodes and pentodes and pentodes as pentodes. The Model 532 offers more useful features than other instruments of similar price.

PICTURE TUBE ADAPTOR INCLUDED.
UP-TO-THE-MINUTE ROLL CHART.

TESTS ALL RECEIVING TUBES.
TESTS HEARING AID AND OTHER BATTERIES.

LARGE CLEAR PLASTIC METER WITH 3-COLOR SCALE.
AC AND DC VOLT-OHMMETER INCLUDES FOLLOWING RANGES:

AC VOLTS: 0-10-100-500-1000
DC VOLTS: 0-10-100-500-1000
OHMS: 0-5000-50,000-500,000-50 Meg.

Extremely attractive 2-tone Fabricoid covered carrying case: 16" x 13" x 7½".

CHICAGO MODEL 532 TESTER, Complete Net \$90.00

CHICAGO DYNAMIC PLATE CONDUCTANCE TUBE and BATTERY TESTER

Similar to Model 532 above, for tube and battery testing only. A superior tube analyzer at extremely low cost. Attractive blue simulated leather covered wood carrying case: 16" x 13" x 7½". Picture tube adapter included.

CHICAGO MODEL 531 TUBE & BATTERY TESTER Net \$60.00

MODEL 531-4 CATHODE RAY TUBE ADAPTOR (Not Illustrated)

For use with Model 531 or 532 Tube Checker. Includes 6 ft. cord for testing picture tube in set. Net \$3.60

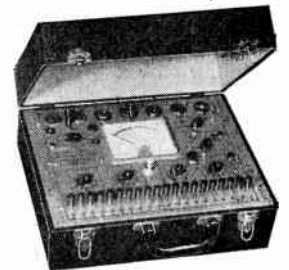

MODEL 532

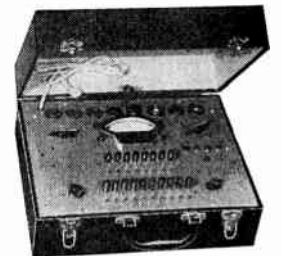

MODEL 531

CHICAGO INDUSTRIAL INSTRUMENT CO.

CHICAGO 10, ILLINOIS

Radio



Testers

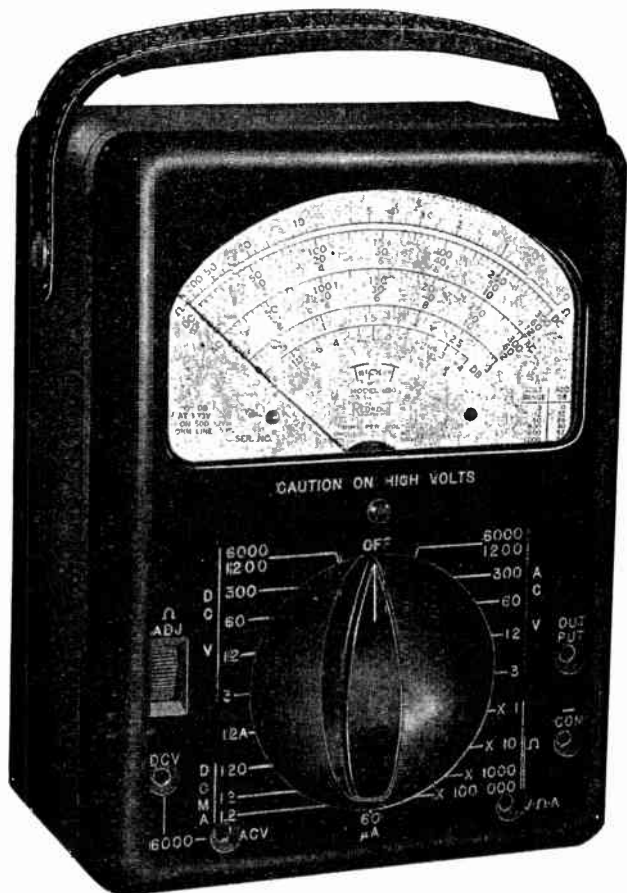

MODEL 630 VOLT-OHM-MIL-AMMETER

RANGES

- D.C. VOLTS: 0-3-12-60-300-1200-6000, at 20,000 Ohms/Volt. (For greater accuracy on TV and other High Resistance Circuits.)
- A.C. VOLTS: 0-3-12-60-300-1200-6000, at 5,000 Ohms/Volt. (For greater accuracy in Audio and other High Impedance AC Circuits.)
- DB.: -30, +4, +16, +30, +44, +56, +70 (For Direct Reading of Output Levels.)
- D.C. MICROAMPERES: 0-60, at 250 M. V.
- D.C. MILLIAMPERES: 0-1.2-12-120, at 250 M. V.
- D.C. AMPERES: 0-12, at 250 M. V.
- *OHMS: 0-1000-10,000 (4.4-44 at center scale)
- *MEGOHMS: 0-1-100 (4400-440,000 Ohms center scale)
- OUTPUT: Condenser in series with AC Volt ranges.

*Resistance ranges are compensated for greatest accuracy over wide battery voltage variations. Series Ohmmeter circuits for all ranges to eliminate possibility of battery drain when leaving switch in OHMS position.

Streamlined Tester with large 5 1/2" meter, flush with the panel. Unit construction — Resistors, shunts, rectifier, batteries — all housed in a molded base integral with the switch. Provides direct connections without cabling. Simple to operate — only one switch, flush with panel surface, selects both circuit and range. Special 1% resistors are sealed in molded compartment. Batteries easily replaced — Balanced double-spring tension grip makes this operation simple. Assures permanent contact. Pre-calibrated rectifier for easy replacement.

Enclosed selector switch of molded construction keeps dirt out. Retains contact alignment permanently. A Triplett design representing the culmination of a quarter-century of switch making experience.

This Volt-Ohm-Mil-Ammeter incorporating a 5 1/2" instrument with 4 3/4" scale, has RED • DOT Life-time Guarantee. Dial has black markings on white except AC and OHM are red. A completely insulated, molded, black case, 3 5/8" x 5 1/2" x 7 1/2", and panel with engraved white markings. Leather strap handle. Rubber feet provided without charge fit into rear holes of 630, 630-A and 650; prevent slipping of tester when it lays on flat surface.

Weight: 4 lbs.

MODEL 630.....U.S.A. DEALER NET.....\$39.50

See G-22 for Carrying Cases.

MODEL 630-T SPECIALLY DESIGNED FOR TELEPHONE AND INDUSTRIAL MAINTENANCE

RANGES

- D.C.: Accuracy 2%.
- VOLTS: 0-0.3-3-12-60-300-600 at 20,000 Ohms/Volt.
- M.A.: 0-.06-1.2-12-120 at 150 M.V.

- A.C.: Accuracy 5%.
- VOLTS: 0-3-12-60-300-600 at 3000 Ohms/Volt.
- OHMS: 0-1K-10K-100K-1 Meg and 10 Meg.

Designed for work inside on panel and checking circuits on pole.

Special straps supplied to hold instrument in easy reading position while supported from lineman's neck, leaving both hands free.

Large rectangular dial or 5 1/2" meter, flush with panel.

RED • DOT Lifetime Guaranteed meter. One recessed range switch will select any range on instrument.

Special banana jack connectors to eliminate all shock hazard.

Interior designed for easily accessible components.

Hand and neck strap, test leads with alligator clips and instruction manual supplied with unit.

Black molded case, completely insulated to protect instrument from ground, 7 1/2" x 5 1/2" x 3 3/8".

Weight: 4 lbs.

MODEL 630-T.....U.S.A. DEALER NET.....\$52.50



Radio **TRIPOLET** Testers

MODEL 630-A WITH MIRROR SCALE

A Laboratory-type Volt-Ohm-Mil-Ammeter with mirror-scales and more accurate components to compensate for the average individual characteristics of each instrument.

Especially designed for the engineer and technician who is in need of an instrument assuring the finest degree of accuracy possible in a commercially produced tester.

The long, mirrored scales eliminate parallax in making readings and special $\frac{1}{2}\%$ resistors provide for greater accuracy.

Tester has large $5\frac{1}{2}$ " meter, flush with panel. Unit construction—Resistors, shunts, rectifier, batteries—all housed in a molded base integral with the switch. Provides direct connections without cabling. Simple to operate—only one switch, flush with panel surface, selects both circuit and range and minimizes chance of incorrect settings and burnouts. $\frac{1}{2}\%$ resistors sealed in molded compartment. Batteries easily replaced—balanced double-spring tension grip makes this operation simple. Assures permanent contact. Precalibrated rectifier for easy replacement. Enclosed selector switch of molded construction keeps dirt out. Retains contact alignment permanently.

This Volt-Ohm-Mil-Ammeter incorporating a $5\frac{1}{2}$ " meter with $4\frac{3}{8}$ " scale, has RED • DOT Lifetime Guarantee. Dial has black markings on white except AC and OHM are red. A completely insulated, molded black case, $7\frac{1}{2}$ " x $5\frac{1}{2}$ " x $3\frac{1}{2}$ ", and panel with engraved white markings. Leather strap handle.

Rubber feet provided without charge fit into rear holes of 630, 630-A and 650; prevent slipping of tester when it lays on flat surface.

Weight: 4 lbs.

MODEL 630-A.....U.S.A. DEALER NET.....\$49.50

See G-22 for Carrying Cases



Model 630-A

RANGES

D.C. VOLTS: 0-3-12-60-300-1200-6000, 20,000 Ohms/Volt. (For greater accuracy on TV and other High Resistance Circuits.)

A.C. VOLTS: 0-3-12-60-300-1200-6000, at 5,000 Ohms/Volt. (For greater accuracy in Audio and other High Impedance AC Circuits.)

D.C. MICROAMPERES: 0-60, at 250 M.V.

D.C. MILLIAMPERES: 0-1.2-12-120, at 250 M.V.

D.C. AMPERES: 0-12, at 250 M.V.

D.B.: -30, +4, +16, +30, +44, +56, +70. (For Direct Reading of Output Levels.)

*OHMS: 0-1000-10,000 (4.4-44 center scale).

*MEGOHMS: 0-1-100 (4400-440,000 Ohms center scale).

OUTPUT: Condenser in series with A.C. Volt Ranges.

*Resistance ranges are compensated for greater accuracy over wide battery voltage variations. Series Ohmmeter circuits for all ranges to eliminate possibility of battery drain when leaving switch in OHMS position.



Model 625-NA

Weight: Approx. 3 lbs.

MIRROR SCALE VOLT-OHM-MIL-AMMETER

Widest range tester of its type with additional brand new features: Long 5" mirror scale for better reading accuracy; Resistance ranges to 40 Megohm; Low Ohm Range 0-2000 (12 ohms center scale); D. C. Volt ranges with dual sensitivity (10,000/20,000 Ohm/Volt) provide double the number of full scale readings of average testers. A. C. Volt ranges at 10,000 Ohm/Volt permit checking many audio and high impedance A. C. circuits where a vacuum tube voltmeter usually is required. Low voltage ranges permit direct measurement of many bias and output voltages. Special film type resistors provide greater stability on all ranges.

6" RED • DOT Lifetime guaranteed meter. Long mirror scale guarantees greater reading accuracy. Insulated, black molded case with removable strap handle, $2\frac{1}{2}$ " x $5\frac{1}{2}$ " x 6". Molded black panel with white markings. Leads and instructions furnished.

- 39 RANGES**
- D. C. VOLTS: 0-1.25-5-25-125-500-2500, 20,000 Ohm/Volt
 - 0-2.5-10-50-250-1000-5000, 10,000 Ohm/Volt
 - A. C. VOLTS: 0-2.5-10-50-250-1000-5000, 10,000 Ohm/Volt
 - D. C. MICROAMPS: 0-50, at 250 Millivolts
 - D. C. MILLIAMPS: 0-1-10-100-1000, at 250 Millivolts
 - D. C. AMPERES: 0-10, at 250 Millivolts
 - OHMS: 0-2,000-200,000 (12-1200 center scale)
 - MEGOHMS: 0-40 (240,000 ohms center scale)
 - DECIBELS: -30, +3, +15, +29, +43, +55, +69. (Reference level "0" DB at 1.73 V. on 500 Ohm line.)
 - OUTPUT: Condenser in series with A. C. Volt ranges
- Accessories available to special order for extending ranges: External pin jack shunts for D.C. Current ranges, resistors for A.C.-D.C. volt ranges.
- MODEL 625-NA. U.S.A. DEALER NET \$49.50
- CARRYING CASE**
- Attractive black leather carrying case with strap handle. Leather flap folds over the top and snaps in place.
- MODEL 629 CASE. U.S.A. DEALER NET \$6.50

ALL PRICES ARE SUBJECT TO CHANGE — ALL MODELS SUBJECT TO REVISION

Radio **TRIPOLET** Testers



POCKET-SIZE VOLT-OHM-MIL-AMMETER

RANGES

D.C. VOLTS: 0-10-50-250-1000-5000, at 1000 Ohms per volt.
 A.C. VOLTS: 0-10-50-250-1000-5000, at 1000 Ohms per volt.
 D.C. M.A.: 0-10-100, at 250 M.V.
 D.C. AMP.: 0-1, at 250 M.V.
 OHMS: 0-3000-300,000 (20-2000 center scale).
 MEGOHM: 0-3 (20,000 Ohm center scale). (Compensated Ohmmeter circuit.)

A New Pocket-Size Volt-Ohm-Mil-Ammeter with these latest specialized features meets your needs for A.C. and D.C. Voltage, Direct Current and Resistance analyses.

Enclosed selector switch of molded construction keeps dirt out. Retains contact alignment permanently. A Triplet design representing the culmination of a quarter-century of switch making experience. **UNIT CONSTRUCTION**—All resistors, shunts, rectifier and batteries housed in a molded base integral with the switch. Eliminates chance for shorts. Direct connections. No Cabling. All precision film or wire-wound resistors are mounted in their own compartment—assures greater accuracy.

3" 0-200 Microammeter, 250 M.V., RED DOT Lifetime guaranteed against defects in materials or workmanship. Red and black markings on a white background. Easy-to-read scale.

Precalibrated rectifier unit and batteries easily replaced. One 1.5 Volt Eveready #935 and two 1.5 Volt Eveready #915, or equivalent, self-contained.

Handy and pocket-size, black molded case is completely insulated. Size: 3 1/8" x 5 7/8" x 2 1/8". Leather strap handle. Black molded panel with engraved white markings.

Furnished complete with batteries, 50" test leads and instruction book at an amazingly low price.

Weight: 1 1/2 lbs.

MODEL 666-R.....U.S.A. DEALER NET.....\$26.50

CARRYING CASE—Black leather strap handle, snap cover.

MODEL 669.....U.S.A. DEALER NET.....\$5.50

POCKET-SIZE VOLT-OHM-MILLIAMMETER

A precision-manufactured marvel of compactness that provides a complete miniature laboratory for D.C. and A.C. voltage, Direct Current and Resistance analyses. Its many ranges, attractive appearance and other unique features provide an answer to the Volt-Ohm-Milliammeter requirements of radio servicemen and amateurs, industrial engineers, laboratory technicians, etc. Refinements in design feature:

Greater scale readability on the 3" RED DOT Lifetime guaranteed instrument with black and red scale markings.

Simplified switching provides greater ease in changing ranges.

Lower jack contact resistance and trouble-free plug-in connections by use of banana-type jacks. Banana jacks at top of panel reduce possibility of connecting leads falling over panel controls or meter scales.

Greater stability on voltage ranges by use of special resistors throughout and on current ranges by use of 250 M.V. instrument.

RANGES

D.C. VOLTS: 0-10-50-250-1000-5000, 1000 Ohm/Volt.

A.C. VOLTS: 0-10-50-250-1000-5000, 1000 Ohm/Volt.

D.C. MA: 0-10-100-500, at 250 Millivolts.

OHMS: 0-2000-400,000 (12-2400 center scale).

Attractive new streamlined black molded case, completely insulated, 3 1/8" x 5 7/8" x 2 1/8". Black molded panel with white markings. Battery self-contained, plug-in type, 1.5 V. Eveready No. 935 or equivalent. 50" test leads with clips and plugs furnished.

Weight: 1 1/2 lbs.

Accessories available to special order for extending ranges: External pin jack shunts for Direct Current ranges, resistors for A.C.-D.C. volt ranges, battery and resistors for Ohms ranges.

MODEL 666-HH.....U.S.A. DEALER NET.....\$24.50

CARRYING CASE

Attractive black leather carrying case with strap handle. Leather flap folds over the top and snaps in place.

MODEL 669 CASE.....U.S.A. DEALER NET.....\$5.50

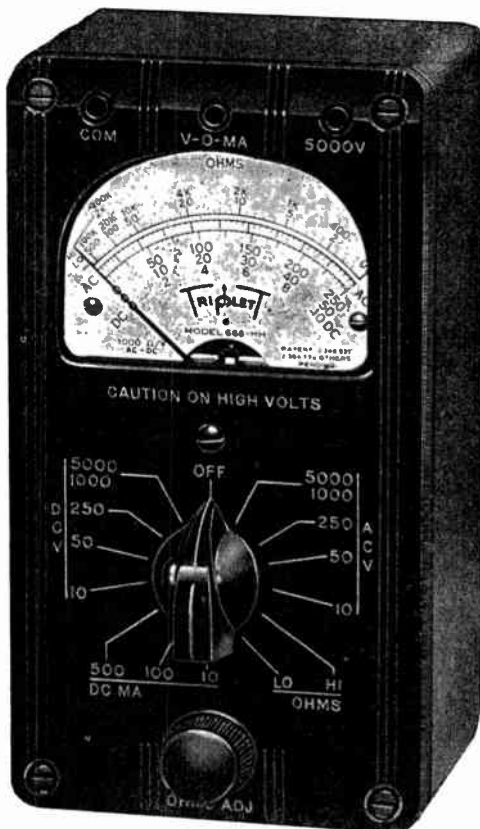

Radio TRIPLET Testers

COMBINATION VOLT-OHM-MIL-AMMETER AND VACUUM TUBE VOLTMETER

34 RANGES VOLT-OHM-MIL-AMMETER

D.C. VOLTS: 0-3-12-60-300-1200 at 20,000 ohms per volt.
 (For greater accuracy on TV and other high resistance circuits.)
 A.C. VOLTS: 0-3-12-60-300-1200 at 5,000 ohms per volt.
 (For greater accuracy in Audio and other high impedance A.C. Circuits. With the extra sensitivity of 5,000 ohms per volt, A.C. voltage readings can be taken without loading the circuit.)
 D.C. MICROAMPERES: 0-60 at 250 M.V.
 D.C. MILLIAMPERES: 0-1.2-12-120 at 250 M.V.
 D.C. AMPERES: 0-1.2-12 at 250 M.V.
 D.B.: -30, +4, +16, +30, +44, +56.
 OHMS: 0-1500-15,000 (6.8-68 center scale. First division is 0.1 ohm.)
 MEGOHMS: 0-1.5-150 (6,800-680,000 ohms center scale).
 OUTPUT: Condenser in series with A.C. Volts.

RANGES VACUUM TUBE VOLTMETER

D.C. VOLTS: 0-1.2-6-30-120. (First division is 0.02 volt.)
 Galvanometer center mark "—0—" for discriminator alignment.
 COMBINED wide-range testing facilities of two testers (Volt-Ohm-Mil-Ammeter plus a Vacuum Tube Voltmeter) in a single, easy-to-use unit. "TWO-FOR-ONE" combination saves you money. No need to invest in two separate testers when one will do your work at only half the price. ONE SWITCH selects all ranges and minimizes chance of incorrect settings and burnouts. Large, easy-to-grip knob, flush with panel. UNUSUALLY HANDSOME modern streamlined styling. The best-looking tester you've ever owned. Second to none in utility and convenience of operation. UNIT CONSTRUCTION—Insulated case. Resistors, rectifier, shunt and batteries all housed in molded compartments for easy accessibility. RECTIFIER—precallebrated rectifier unit for ease of replacement. BATTERIES EASILY REPLACED—batteries held in place with spring grip for reliable contact. MAXIMUM BATTERY LIFE for the Vacuum Tube Voltmeter circuit is an outstanding advantage. By using the Volt-Ohm-Mil-Ammeter for all general testing (90% of your testing) and the Vacuum Tube Voltmeter only when you need it, you have the advantage of a VTVM with extremely long battery life. Batteries are used only about one-tenth as much as in the ordinary battery-operated VTVM. INSTRUMENT—5 1/2" Meter separately housed, flush with panel. Exclusive Triplet RED • DOT Lifetime Guarantee. Adjusted to 50 Microamperes at 250 M.V. Has high flux magnet for increased ruggedness. Good temperature compensation. SCALE—4.588" long at top arc. D.C. and DB are black on white; A.C. and Ohms are red on white for easy reading. PUSH BUTTON—to check B- voltage for VTVM. Condition of batteries easily checked without opening tester case. MOLDED CASE—Heavy, black molded (1/4" thick) completely insulated. 3 3/8" x 5 1/2" x 7 1/2", with removable black leather strap handle. PANEL—black molded with colored markings engraved. LEADS—18" long, with test prods and removable alligator clips at one end. 48" lead with one meg built in for VTVM. Banana type for low contact resistance. Pencil-thin prods.

MODEL 631—Suggested U.S.A. Dealer Net.....\$59.50

Complete with leads, batteries, etc.

See G-22 for Carrying Cases.

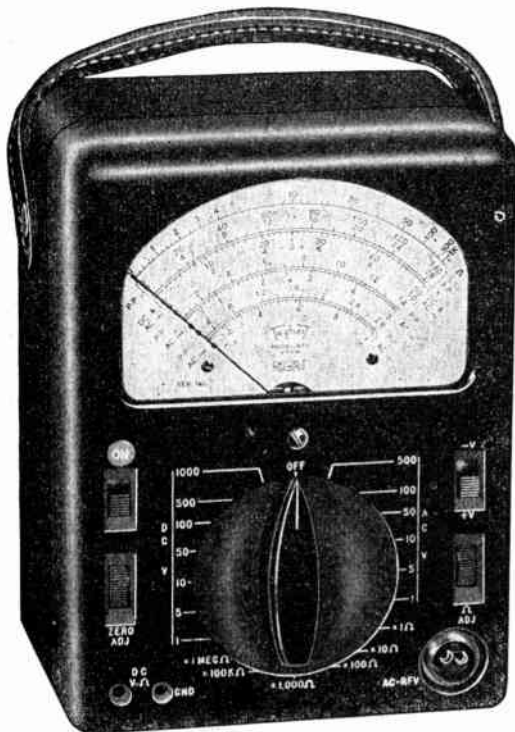
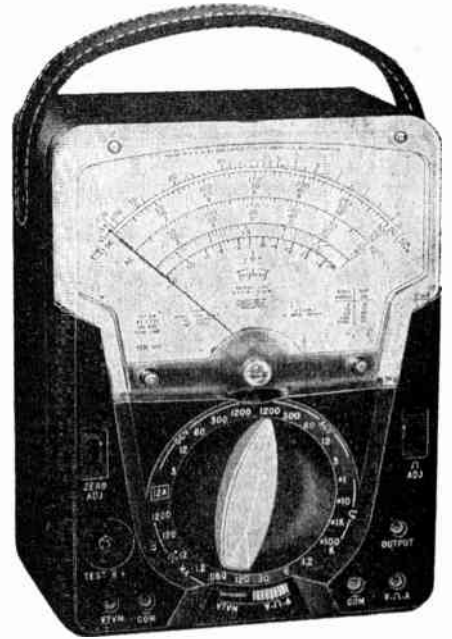

ENGINEERED FOR RADIO, TV, INDUSTRIAL, ELECTRONIC LABS & MAINTENANCE

READS PEAK TO PEAK VOLTAGE DIRECTLY FROM 15 CPS TO 110 MC.

32 RANGES

D.C. VOLTS: 0-1-5-10-50-100-500-1000.
 A.C.-R.F. VOLTS: 0-1-5-10-50-100-500.
 PEAK TO PEAK VOLTS: 0-2.8-14-28-140-280-700.
 (Read on 0-1400 scale.) (Peak-to-peak value of sine wave to 1400 volts.)
 OHMS: 0-1000-10,000-100,000.
 MEGOHMS: 0-1-100-1000.
 ACCURACY: D.C. Volts=3%. A.C.-R.F. Volts=5%, Ohms=3% of linear scale.
 DECIBELS: Tabled in instruction book for different impedances.
 Galvanometer Center "—0—" for discriminator alignment on all DCV ranges —.5 to +.5 volts on 0-1 DCV range.

1—Peak to Peak ACV and RF measurements made with one probe eliminates troublesome change of probe when changing from ACV to RF measurement. 3—ONE selector switch for all ranges. 4—One volt full scale reading on both AC and DC. 5—Especially designed and insulated, but still shielded RF probe with short leads for high frequency measurements. 6—Zero center mark for FM discriminator alignment plus other Galvanometer measurements. 7—High input impedance 11 Megohms on DC for accurate measurements. 8—Special means for making adjustment for ACV zero shift with line voltage variation. 9—High precision resistors throughout. 10—Special circuit arranged so that OFF position shorts meter for greater damping and meter safety during transportation. 11—RED • DOT Lifetime Guaranteed meter, 2-color scale 4 3/8" long. Insulated molded case and panel, dimensions, 3 3/8" x 5 1/2" x 7 1/2". Removable black leather strap handle. Weight: 5 lbs. (complete with battery and accessories).

Rubber feet provided without charge fit into rear holes of 650; prevent slipping of tester when it lays on flat surface.

Accessories supplied with 650: 1 each AC Power Cord, DC Volt-Ohm lead (Shielded); AC-RF Volt Shielded tube probe; 2 alligator clips for probe tips.

MODEL 650.....U.S.A. DEALER NET.....\$89.50

ACCESSORIES AVAILABLE: DC High Voltage Probe; 50 KV-500 DC Volt range, 10 KV-100 DC Volt range, 5 KV-50 DC Volt range, \$14.50; Stand for holding tester at about a 45° angle, \$5.00 net.

See G-22 for Carrying Cases.

Radio



Testers

NEW MUTUAL CONDUCTANCE TUBE TESTER

Here is Proportional Mutual Conductance tube testing by a new patented circuit—offering advantages hitherto unavailable to the service trade. The right Tube Tester for TV and Radio Tubes. The circuit provides the true proportional relationship to the G_m curve for measuring in Micromhos the tube characteristics. Diodes and low power thyratrons are tested on the GOOD-?-BAD scale.

This new tester handles the most perplexing tube testing problems in many fields—Radio Servicing, Industrial Production, Laboratory Testing, Theatre and P.A. Equipment, Communications, etc. Patented circuit for Proportional Mutual Conductance tube testing employs actual signal oscillator (4KC) for grid signal. Thus, hum and ripple, and tubes with open grids present no problem, and cannot give false readings. Signal component of output is picked off and measured by the specially designed instrument circuit. Tests all types of receiving tubes, low power transmitting tubes, rectifiers, thyratrons, voltage regulator tubes, eye tubes, subminiature, acorn, ballast tubes and pilot lamps. Continuity test circuit also may be used to check electrical appliances for shorts or open circuits. Flexible three-position lever switches for complete coverage of both present and future tube connections. Only three positions mean no guess work on settings. Speed and ease of operation marks use of the tester. 0-10 ACV (variable) available for testing low voltage tubes. Also five other voltages available, (10, 30, 70, 100 and 250). Full range filament voltage settings provides complete and accurate filament or heater voltage at tube base connections: .63, 1.4, 2.0, 2.5, 5, 6.3, 7.5, 12.6, 19.6, 25, 32, 50, 70, and 117 volts. Instrument is Model 420, 4"

long scale, knife edge pointer for easy readability; adjusted to 100 microamperes at 250 millivolts for good temperature compensation. Sockets: 4 prong, 5 prong, 6 prong, 7 prong large and small with combination for pilot lights and flashlight bulbs, 8 prong octal, 8 prong loctal, 7 prong miniature, 7 pin subminiature (for hearing aid tubes), 8 pin subminiature (round), 8 pin acorn, 9 pin subminiature. Wt. 21 lbs.

MODEL 3423 U.S.A. DEALER NET . . . \$199.50

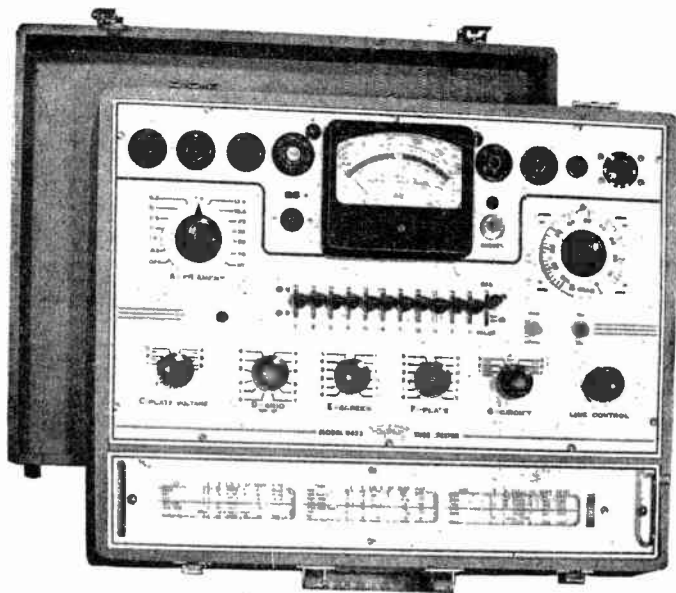

Model 3423

TUBE TESTER

A Triplett Tube Tester with new improved testing flexibility permitting checking any type radio receiving tube, miniature hearing aid tubes, and TV picture tubes. The tester gives both "short" and "open" circuit check of each element of every tube—an accurate analysis of the condition of all tube elements, connections, taps, etc. TV picture tubes are checked without removing them from the receiver, by use of an adapter that may be purchased separately. "Continuity" test is provided for checking electrical appliances, motors, etc.

Model 3413-A has flexible 3-position lever switches for complete coverage of present and future tube connections. RMA pin numbering of tube element levers makes for quick reference of tube base connections. Illuminated, easy-to-read roll type tube chart is built into the tester. Simplified test procedure makes it possible for user to add new tube data to chart when desired.

Line Voltage indication on center of meter dial permits observation and adjustment for line fluctuations. Filament voltage: 0.63 volts to 110 volts in 14 steps.

Large 6" meter, RED • DOT Lifetime guaranteed, has 3-color easy-to-read GOOD-?-BAD scale.

Portable metal case, 15 1/32" x 11 1/32" x 6 1/2", black satin wrinkle finish, with removable, hinged cover and leather handle. Panel attractively etched in black, silver and red. Complete instructions supplied. Power: 115 V., 50-60 cycle A.C. Wt. 20 lbs.

MODEL 3413-A . . U.S.A. DEALER NET . . \$79.50



Model 3413-A

PICTURE TUBE ADAPTER

BV Adapter T2247-BV for 3413-A permits testing picture tube right in the receiver or in a shipping carton.....DEALER NET.....\$4.50

ALL PRICES ARE SUBJECT TO CHANGE — ALL MODELS SUBJECT TO REVISION

Radio

TRIPLET

Testers

TV-FM SWEEP SIGNAL GENERATOR WITH BUILT-IN MARKERS

HARMONICS SUFFICIENT FOR SERVICING UHF RECEIVERS

FREQUENCY COVERAGE

Sweep Center Frequency: Range 1- 0- 60 MC
Range 2- 60-120 MC
Range 3-120-240 MC

Sweep Width: 0-12 MC
(Continuously Variable)

Marker Frequency: 3.5- 4.9 MC (Fundamental)
19.5-29.3 MC (Fundamental)
29 -48.6 MC (Fundamental)

48.6 MC to 243 MC on Harmonics
Crystal Frequency: To 20 MC (Fundamental)
Can be used to produce Harmonics up to 243 MC. (Plug-in Crystals not included.)
Modulation: 600 Cycle on Both Crystal and Marker frequencies.

Audio: 600 Cycles.
Model 3434-A provides a complete service laboratory for TV-FM servicing and other electronic requirements. No gaps in frequency. Continuous tuning over all TV-FM bands. Provisions for simultaneous presentation of two Markers. Audio output for quick check on video and sound amplifiers. Ladder type attenuator for coarse and fine output adjustment. Provision for simultaneous presentation of Crystal and Variable Markers. Illuminated, mirror-scaled Marker dials for precise adjustment. Smooth action dial drive with vernier scale. Balanced network for balanced input receivers. Sweep standby switch for temporary silencing of Generator during other work on equipment under test. Line filter. Regulated power supply. Completely shielded. Copper plated steel construction throughout.

Attractive steel case, black enamel finish, 15 1/2" x 11 1/2" x 8 1/4". Leather handle. Black, white and red etched markings on aluminum panel. Accessories — Two Co-Axial cables; heavy braid grounding strap; Polystyrene covered, shielded leads for audio. Phase 60 cycle output and additional ground.

Power: 105-115 volt, 50-60 cycle, 55 Watts.
MODEL 3434-A—U.S.A. DEALER NET . . . Wt. 23 lbs.

\$239.50



Model 3434A

A FEW REASONS YOU'LL WANT MODEL 3434-A

- ★ Output 1. to 1.5 Volts.
- ★ Continuously variable sweep width from 100 KC to 12 MC.
- ★ Illuminated Frequency dial marked with channels and frequencies.
- ★ Variable Marker provides continuous tuning over all present TV Video and Sound IFs. Illuminated Mirrored dial.
- ★ Designed to provide HIGH OUTPUT for stage-by-stage alignment.
- ★ Self-contained Horizontal Bar Generator covers all channels on Marker Harmonics.

MODEL 3441 TV-FM OSCILLOSCOPE

Push-Pull vertical and horizontal output amplifiers.

VERTICAL AMPLIFIER—Two frequency response ranges with four-range compensated attenuator.

4 MC Band width.

SENSITIVITY—10 M.V. per inch (rms) maximum.

HORIZONTAL AMPLIFIER—Frequency Range Flat within $\pm 20\%$ from 20 Cycle to 150 KC. Deflection Sensitivity—.15 RMS Volts/Inch.

INPUT IMPEDANCE—Vertical Amplifier 2 Megohms in parallel with 20 MMF. with low capacity probe. 2 Megohms in parallel with 45 MMF. at input terminals.

CALIBRATING METER (ILLUMINATED)—Reads peak to peak voltages from 0 to 1000 Volts in 8 ranges, the low range being 0-0.3 volt peak to peak. Reading peak to peak voltages with Triplet Model 3441 makes it possible to view the percentage of positive and negative; plus reading peak to peak voltage direct. Where reading peak to peak voltage on a VTVM only peak to peak voltage is known.

PHONE JACK is on front panel connected to the output of the vertical amplifier so you can hear as you see. This makes a convenient way to familiarize the visual pattern with the familiar audio sounds. Having a high gain amplifier system available also is ideal for tracing audio circuits and checking for noisy components.

LINEAR TIME BASE—10 CPS to 60 KC/Second linear, available at panel.

TUBE COMPLEMENT—5U1, 2-7A5, 5Y3, VR150, 6AC7, 12AT7, 3-6SN7, 2X2. Total 11. Wide frequency ranges provide for Television servicing requirements.

Phased 60 CPS horizontal sweep and return trace eliminator for use with Sweep Generators.

Synchronizing and horizontal Sweep Selector combined in same control for simplicity in operation.

CASE—Metal, with black suede enamel finish, 15 1/2" x 11 1/2" x 16". Leather handle.

PANEL—Black, red and white characters etched on aluminum.

ACCESSORIES—One Co-Axial lead for Vertical Input.

POWER—105-115 Volts, 50-60 Cycles, 80 Watts. Wt.: 38 lbs.



Model 3441

MODEL 3441 U.S.A. DEALER NET \$249.50
No. 9989 CRYSTAL (Demodulating or Signal Tracing PROBE, for use with MODELS 3441 or 3440. U.S.A. DEALER NET \$9.50

ALL PRICES ARE SUBJECT TO CHANGE — ALL MODELS SUBJECT TO REVISION

Radio **TRIPOLET** Testers

RADIO & TV SERVICING WITH LOAD-CHEK Model 660

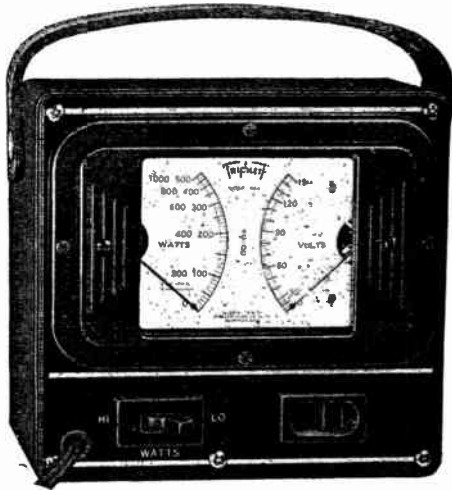

Model 660

RANGES

WATTS—A.C. or D.C.: 0-500 (50 division scale)
0-1000 (50 division scale)
VOLTS—A.C. or D.C.: 0-150 (65 division scale)

The LOAD-CHEK for the first time makes it possible for every technician to utilize what is perhaps the simplest and quickest of all service methods—servicing by Power Consumption Measurements, long proven by auto-radio servicemen as a rapid method of localizing troubles in auto radios. Triplet Model 660 is the first Wattmeter to be produced at moderate cost, and with the proper ranges, to bring this short-cut method within the reach of every radio and TV serviceman.

Following are only two of many time-saving uses of this new instrument:
LOCATING A SHORT—The chassis tag may show a normal consumption of 225 Watts. Simply plug a power cord of the chassis into LOAD-CHEK (no loose ends to connect or be in the way). Note the reading—which should be possibly 350 Watts. By removing the rectifier tube you can determine at once which side of the tube the short is on. With a soldering iron and long-nosed pliers you can check through the chassis, locate and correct the trouble without having to lay down tools or to check with lead wires!

REPLACING BURNED-OUT RESISTORS—With the chassis to be repaired plugged into a LOAD CHEK MODEL 660, note the wattage reading with the burned out resistor circuit open. Now replace the resistor. Should the increase in watts be greater than the resistor rating, it indicates an extra load has caused the trouble which has not been cleared. LOAD-CHEK is made-to-order for the busy serviceman because it's a Time Saver; and at its moderate cost can be standard equipment on every service bench.

RED • DOT Lifetime Guaranteed Meter.

Black, molded, insulated case, 2½" x 5½" x 6", with removable black leather strap handle. Black molded panel with white markings.

Weight: 2 lbs.

MODEL 660.....U.S.A. DEALER NET.....\$29.50
MODEL 629—LEATHER CARRYING CASE....U.S.A. DEALER NET....\$6.50

Model 661

RANGES

WATTS: D.C.-A.C. 0-150-300
VOLTS: D.C.-A.C. 0-150

This new LOAD-CHEK tester is designed for radio and low wattage appliances. Appearance and construction are the same as Model 660 with Watt range 150-300. Black molded case, 6" x 5½" x 2½", insulated to protect instrument from ground.

Weight: 2 lbs.

MODEL 661.....U.S.A. DEALER NET.....\$29.50

APPLIANCE TESTERS — Model 2002

RANGES: 0-1500-3000 Watts AC-DC at 10 Amp. normal, 20 Amp. Max., 40 Amp. momentary; 0-130-260 Volts AC-DC.

Model 2002 shows power consumption of industrial equipment, radios, electric ranges, refrigerators, washers, etc., under actual operating conditions, on either DC or AC between 25 and 133 cycles. Wattmeter on the left and Voltmeter on the right permit Watts and Volts to be read simultaneously or independently. Shows if voltage remains within limits under operating loads. Shows faulty power lines. Heavy inner construction. Heavy leather case, with snap cover and leather handle, 6½" x 4½" x 3¼". Storage space for cord and plug furnished.

Weight: 2 lbs.

MODEL 2002.....U.S.A. DEALER NET.....\$39.50

Model 2006

RANGES: 0-25 AC-DC Amperes: 0-130-260 AC-DC Volts.

Model 2206 is designed for those who prefer the Voltmeter-Ammeter method of testing electric ranges, refrigerators, washers and other household appliances, plus many industrial uses. Simultaneous readings of line voltage and current drain. Compact, portable, heavy leather case, with strap handle, 6½" x 4½" x 3¼". Adequate storage space for cord and plug furnished.

Weight: 2 lbs.

MODEL 2006.....U.S.A. DEALER NET.....\$34.50



Model 2002

ALL PRICES ARE SUBJECT TO CHANGE — ALL MODELS SUBJECT TO REVISION

Indicating



Instruments

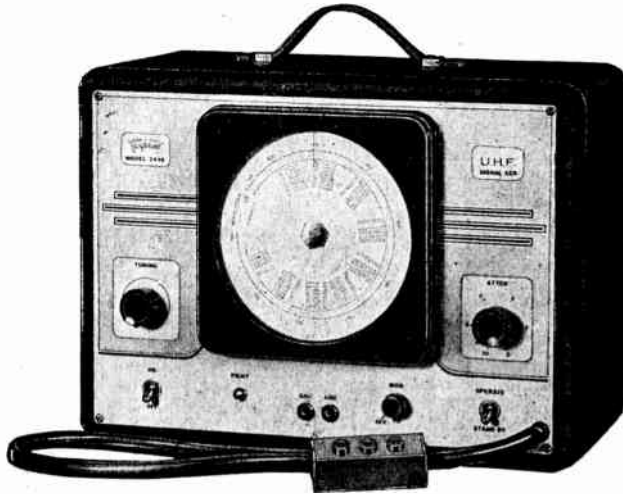

Model 3436

UHF MARKER GENERATOR AND ALL-PURPOSE SIGNAL GENERATOR

UHF Continuously Variable Through Channels 14-83 on Linear Scale 13" Long — All Fundamental Readings (470-900 MC) Accuracy — 1/2 % to 1 %

An easy-to-use invaluable test aid as a Signal Generator or Marker Generator for: (1) Adjusting UHF TV receiver front ends and UHF converters and receivers. (2) Setting the end limits of UHF converters and receivers. (3) Pre-setting fixed channel converters, a procedure especially needed in fringe areas where the station signal may be too weak for sufficient test indication. Pre-setting can be easily accomplished with the Triplet 3436. (4) A reliable signal source to compare the gain of UHF receivers and converters, also especially needed in fringe areas. Bad crystals in the UHF section can be detected by this method. (5) Used as an alignment generator for UHF converters and TV front ends. (6) Used as a UHF Horizontal Bar Generator, the tester generates approximately 12 lines by using the modulation and feeding into the front end of the receiver. This makes possible linearity adjustment of the TV picture.

Piston-type attenuator. Adjustable modulation of RF signal at approximately 1000 cycles. Can be used as horizontal bar generator. ON-OFF switch. Also ON-OFF plate switch for pre-heating oscillator tube filament before applying plate voltage.

Heavy steel case, handsomely finished and professional in appearance, 15 1/2" x 11 1/2" x 8 1/4". Black baked-on suede enamel finish. Sturdy leather strap handle for ease in carrying; makes the generator adaptable for portable as well as test bench use. Weight: 24 lbs. net.

Panel etched heavy aluminum with red and black characters. Tubes, 6AF4, 6J5, 6K6, VR105 and 6X5. Complete with instruction books and test leads.

MODEL 3436... U.S.A. DEALER NET... \$169.50

- Large dial with uniform frequency graduations—no crowding at end of dial. 13" of long easily readable scale. Marked in both frequency and channels. Hand drawn for extreme accuracy.
- RF output maximum .5 volt. Variations in output over the range of frequencies is minimized.
- Output impedance 150 to 300 ohms.
- Ranges: UHF all fundamentals on channels 14-83 (470-900 MC). No harmonics for confusion.
- Triple shielding and excellent stability through special construction.
- Audio output available at panel, 0-20 volts.
- Voltage regulated power supply—115 volt, 50-60 cycle AC. Control tube supplies RF oscillator with voltage independent of line fluctuations.

HIGH RANGE D.C. VOLTMETERS FOR AMATEURS

Designed particularly for radio amateurs. High range 3" D.C. Voltmeters—1000 ohms per volt. Provided with special external metalized multipliers mounted on bakelite strip. Specify this type when ordering, or standard voltmeters will be furnished. Available 3" case, Models 321-T, 327-T:

Range	Price	Range	Price
0-1000	\$13.10	0-4000	\$13.10
0-2000	13.10	0-5000	13.10
0-8000	13.10		

SENSITIVE RELAYS

Highly sensitive Triplet relays of the D'Arsonval moving coil type, are carefully designed to give dependable, satisfactory performance. Since relays cover such a wide field and most of them are made to special order, no standard models are listed. Contacts are normally rated at 25 Milliampères, 25 Volts; higher ratings if required. Instrument relays are provided in 2", 3" or Twin cases. Years of instrument experience are available to every relay user through Triplet's extensive service. Send us your applications with information specifying maximum and minimum currents and voltages which will pass through relay coil and contact points, etc.

RADIO AMATEUR EQUIPMENT FREQUENCY METER

A new band-switching, tuned Absorption type Frequency Meter covering five amateur bands. Incorporates the new germanium crystal and a D.C. Milliammeter indicator for greater sensitivity. Direct calibration on panel—no coils to change; switching permits instantaneous band change. Audio jack is provided for monitoring of phone signals—another new feature. Fully shielded. Calibration is in megacycles in the following bands: 3.5-4 MC; 7-7.3 MC; 14-14.4 MC; 20-21.5 MC; 28-30 MC. Coil is removable and other coils may be substituted for special bands, if desired.

USEFUL FOR CHECKING: (1) Fundamental frequency of oscillating circuits. (2) Presence, order and amplitude of harmonics. (3) For parasitic oscillations. (4) Neutralization of R. F. amplifiers. (5) Standing wave ratio on transmission lines. (6) Presence of undesirable or small quantities of R. F. (7) Monitoring of phone signals.

Red • Dot Lifetime Guaranteed Meter.

A fully shielded unit of compact pocket size. Overall height, including coil, 7 1/2"; width 2 1/2"; depth 2 1/4". Attractive gray "hammered" enamel finish with black trim.

MODEL 3256 U.S.A. DEALER NET \$17.50



ALL PRICES ARE SUBJECT TO CHANGE — ALL MODELS SUBJECT TO REVISION

Radio **TRIPLET** Testers

CARRYING CASES

MODEL 329—Black leather carrying case for molded base portables which accommodate Triplett 3" square model instruments.

U.S.A. DEALER NET.....\$2.70

MODEL 639-N—Black neolite carrying case for Models 630, 630-A, 630-T and 631. Neolite strap handle. Cover snaps back; compartment in rear. Complete with stand.

U.S.A. DEALER NET.....\$8.50

MODEL 639—Black leather carrying case for Models 630, 630-A, 631.

U.S.A. DEALER NET.....\$8.50

MODEL 639-P—Black leather carrying case, lined with $\frac{3}{8}$ " sponge rubber for Models 630, 630-A.

U.S.A. DEALER NET.....\$13.50

MODEL 659—Black leather carrying case for Model 650.

U.S.A. DEALER NET.....\$9.50

MODEL 659-P—Black leather carrying case, lined with $\frac{3}{8}$ " sponge rubber for Model 650.

U.S.A. DEALER NET.....\$14.50

MODEL 629—Black leather carrying case; flap folds over top; swivel fastener; for Models 625-NA, 660 and 661, also 625 series portable instruments.

U.S.A. DEALER NET.....\$6.50



329



639-N



639



669

MODEL 669—Black leather carrying case for Models 666-HH and 666-R.

U.S.A. DEALER NET.....\$5.50

MODEL 669-RL—Camera-type black leather case for Model 666-R. When case is opened, lower flap drops down and top folds back exposing entire tester panel and meter dial.

U.S.A. DEALER NET.....\$6.00

HIGH VOLTAGE PROBES

Completely insulated polystyrene test probe with guard-type handle contains the voltage dropping resistors, high stability hi-voltage insulating compound. Probe is 11 $\frac{3}{4}$ " long, with 48" hi-voltage wire

lead with banana plug at tester end. For measuring high voltage employed in television receivers and other applications, external probes are available.

MODELS 630 and 630-A

	Dealer Net
T-79-68.....0-12,000 D.C. Volts.....	\$14.50
T-79-69.....0-12,000 A.C. Volts.....	\$14.50
T-79-70.....0-30,000 D.C. Volts.....	\$14.50
T-79-71.....0-30,000 A.C. Volts.....	\$14.50

MODEL 625-NA

	Dealer Net
T-79-83.....0-10,000 D.C. Volts.....	\$14.50
T-79-74.....0-10,000 A.C. Volts.....	\$14.50
T-79-70.....0-30,000 D.C. Volts.....	\$14.50
T-79-75.....0-30,000 A.C. Volts.....	\$14.50

Indicating



Instruments

GENERAL CASE INFORMATION

Models	Scale Lengths		Flange	Body Dia.	Body Depth	Case Mounting		Style
	D.C.-R.F.	A.C.				Material	Type	
221-T D.C.; 241-T R.F.	1.76"		2 3/8" Dia.	2 1/2"	1 1/2"	Molded	Flush	Rim
231-S A.C.		1.58"	2 3/8" Dia.	2 1/2"	1 1/2"	Molded	Flush	Rim
222-T D.C.; 242-T R.F.	1.76"	1.58"	2 3/8" Dia.	2 1/2"	1 1/2"	Metal*	Flush	Rim
232-S A.C.			2 3/8" Dia.	2 1/2"	1 1/2"	Metal*	Flush	Rim
223-T D.C.; 243-T R.F.	1.76"		2 3/8" Dia.	2 1/2"	1 1/2"	Metal*	Flush	Rear Clamp
233-S A.C.		1.58"	2 3/8" Dia.	2 1/2"	1 1/2"	Metal*	Flush	Rear Clamp
227-T D.C.; 247-T R.F.	1.76"		2 3/8" Sq.	2 1/2"	1 1/2"	Molded	Flush	Rear Screws
237-S A.C.		1.58"	2 3/8" Sq.	2 1/2"	1 1/2"	Molded	Flush	Rear Screws
321-T D.C.; 341-T R.F.	2.49"		3 1/2" Dia.	2 3/8"	1 1/2"	Molded	Flush	Rim
331-S A.C.		2.22"	3 1/2" Dia.	2 3/8"	1 1/2"	Molded	Flush	Rim
322 D.C.; 342 R.F.	2.49"		3 1/2" Dia.	2 3/8"	1 1/2"	Metal*	Flush	Rim
332 A.C.		2.22"	3 1/2" Dia.	2 3/8"	1 1/2"	Metal*	Flush	Rim
324 D.C.; 334 A.C.	2.49"	2.22"	3 3/8" Dia.	2 3/8"	1 1/2"	Molded†	Projection	Rear Studs
327-T D.C.; 347-T R.F.	2.49"		3" Sq.	2 1/2"	1 1/2"	Molded	Flush	Rear Screws
337-S A.C.		2.22"	3" Sq.	2 1/2"	1 1/2"	Molded	Flush	Rear Screws
361 Dynamometer		2.22"	3 1/2" Dia.	2 3/8"	1 1/2"	Molded	Flush	Rear Screws
420 D.C.; 440 R.F.	4.06"		4 3/8" "x4 3/8"	2 3/8"	1 1/2"	Molded	Flush	Rear Screws
430 A.C.		3.6"	4 3/8" "x4 3/8"	2 3/8"	1 1/2"	Molded	Flush	Rear Screws
421 D.C.; 441 R.F.	3.11"		4 1/4" "x3 3/8"	2 3/8"	1 1/2"	Molded	Flush	Rim
431 A.C.		2.78"	4 1/4" "x3 3/8"	2 3/8"	1 1/2"	Molded	Flush	Rim
421-A D.C.; 441-A R.F.	3.11"		3 3/4" "x3 3/8"	2 3/8"	1 1/2"	Molded	Flush	Rear Clamp
431-A A.C.		2.78"	3 3/4" "x3 3/8"	2 3/8"	1 1/2"	Molded	Flush	Rear Clamp
422 D.C.; 442 R.F.	3.11"		4 3/8" Dia.	2 3/8"	1 1/2"	Molded	Flush	Rim
432 A.C.		2.78"	4 3/8" Dia.	2 3/8"	1 1/2"	Molded	Flush	Rim
426 D.C.; 446 R.F.	3.11"		4 1/4" "x4"	2 3/8"	1 1/2"	Molded	Flush	Rear Screws
436 A.C.		2.78"	4 1/4" "x4"	2 3/8"	1 1/2"	Molded	Flush	Rear Screws
521 D.C.; 541 R.F.	3.11"		5 1/4" Dia.	4 1/8"	1 1/2"	Molded	Flush	Rim
531 A.C.		2.78"	5 1/4" Dia.	4 1/8"	1 1/2"	Molded	Flush	Rim
524 D.C.; 534 A.C.	3.11"	2.78"	4 3/4" Dia.	2 3/8"	1 1/2"	Molded	Projection	Rear Studs
529-A D.C.; 539-A A.C.	3.11"	2.78"	4 1/2" "x4"	2 1/2"	1 1/2"	Molded	Flush	Rim
626 D.C.; 646 R.F.	5.6"	5.3"	6 1/2" "x5 3/8"	3 1/4"	1 1/2"	Molded	Flush	Rear Screws
636 A.C.		5.0"	6 1/2" "x5 3/8"	3 1/4"	1 1/2"	Molded	Flush	Rear Screws
726 D.C.; 746 R.F.	6"	5.75"	7 3/8" "x6 3/8"	3 1/2"	1 1/2"	Molded	Flush	Rear Screws
736 A.C.		5.25"	7 3/8" "x6 3/8"	3 1/2"	1 1/2"	Molded	Flush	Rear Screws
Twist	2.49"	2.22"	5 3/8" "x3 3/8"	2 3/8"	1 1/2"	Molded	Flush	Rim

*Molded base

NOTE: Special finish for cases available in quantity.

†Metal on Special Order.



D.C. VOLTMETERS — 1000 Ohms Per Volt (Film Type Resistors)

Range	Scale Div.	Models 221-T, 222-T, 223-T, 227-T		Models 321-T, 322, 324, 327-T		Models 420, 421-A, 421, 422, 426, 529-A		Models 521, 524	Model 626	Model 726
0-10	50	\$ 7.50	\$ 8.50	\$ 9.50	\$ 11.00	\$ 11.50	\$ 14.50	\$ 11.00	\$ 11.50	\$ 14.50
0-25	25	7.50	8.50	9.50	11.00	11.50	14.50	11.00	11.50	14.50
0-50	50	7.50	8.50	9.50	11.00	11.50	14.50	11.00	11.50	14.50
0-150	50	7.50	8.50	9.50	11.00	11.50	14.50	11.00	11.50	14.50
0-200	50	7.50	8.50	9.50	11.00	11.50	14.50	11.00	11.50	14.50
0-250	50	7.50	8.50	9.50	11.00	11.50	14.50	11.00	11.50	14.50
0-300	50	7.50	8.50	9.50	11.00	11.50	14.50	11.00	11.50	14.50
0-500	50	7.50*	8.50	9.50	11.00	11.50	14.50	11.00	11.50	14.50
0-750	50	12.10	13.10	14.10	15.60	16.10	19.10	15.60	16.10	19.10
0-1000	50	12.10	13.10	14.10	15.60	16.10	19.10	15.60	16.10	19.10
0-2000	50	12.10	13.10	14.10	15.60	16.10	19.10	15.60	16.10	19.10
0-3000	50	12.10	13.10	14.10	15.60	16.10	19.10	15.60	16.10	19.10
0-4000	50	12.10	13.10	14.10	15.60	16.10	19.10	15.60	16.10	19.10
0-5000	50	12.10	13.10	14.10	15.60	16.10	19.10	15.60	16.10	19.10

Models 221-T, 231-S, 241-T;
222-T, 232-S, 242-T; 321-T,
331-S, 341-T; 322, 332, 342

*Supplied with external resistors

D.C. VOLTMETERS — 1000 Ohms Per Volt

Range	Scale Div.	Models 221-T, 222-T, 223-T, 227-T		Models 321-T, 322, 324, 327-T		Models 420, 421-A, 421, 422, 426, 529-A		Models 521, 524	Model 626	Model 726
0-1	50	\$ 7.50	\$ 8.50	\$ 9.50	\$ 11.00	\$ 11.50	\$ 14.50	\$ 11.00	\$ 11.50	\$ 14.50
0-3	15	7.50	8.50	9.50	11.00	11.50	14.50	11.00	11.50	14.50
0-5	15	7.50	8.50	9.50	11.00	11.50	14.50	11.00	11.50	14.50
0-10	50	9.90	10.90	11.90	13.40	13.90	16.90	13.90	14.30	17.30
0-25	50	9.90	10.90	11.90	13.40	13.90	16.90	13.90	14.30	17.30
0-50	50	9.90	10.90	11.90	13.40	13.90	16.90	13.90	14.30	17.30
0-100	50	10.30	11.30	12.30	13.80	14.30	17.30	14.30	14.70	18.30
0-150	50	10.30	11.30	12.30	13.80	14.30	17.30	14.30	14.70	18.30
0-200	50	10.30	11.30	12.30	13.80	14.30	17.30	14.30	14.70	18.30
0-300	50	12.60	13.60	14.60	16.10	16.60	19.60	16.60	17.00	20.00
0-500	50	14.10†	15.10	16.10	17.60	18.10	21.10	18.10	18.50	21.50
0-750	50	16.20†	17.20	18.20	19.70	20.20	23.20	20.20	20.60	23.60
0-1000	50	28.40†	29.40†	30.40†	31.90†	32.40†	35.40†	32.40†	32.80†	35.80†
0-2000	50	46.60†	47.60†	48.60†	50.10†	50.60†	53.60†	50.60†	51.00†	54.00†

D.C. Voltmeters, 125 Ohms per volt, wirewound (vacuum impregnated) resistors, can be supplied to special order. Indicates instruments supplied with external wire-wound series resistors at prices shown. †Supplied with external resistor boxes at prices above. All other instruments are self-contained. Double-range panel voltmeters available on special order. D.C. VOLT-AMMETERS, VOLT-MILLIAMMETERS are available in combinations of listed Voltmeters and Ammeters. Prices on request.

D.C. MILLIVOLTMETERS

Range	Approx. Res.	Scale Div.	Models 221-T, 222-T, 223-T, 227-T		Models 321-T, 322, 324, 327-T		Models 420, 421-A, 421, 422, 426, 529-A		Models 521, 524	Model 626	Model 726
0-50	6.3	50	\$ 7.50	\$ 8.50	\$ 9.50	\$ 11.00	\$ 11.50	\$ 14.50	\$ 11.00	\$ 11.50	\$ 14.50
0-100	12.5	50	7.50	8.50	9.50	11.00	11.50	14.50	11.00	11.50	14.50
0-150	20	50	7.50	8.50	9.50	11.00	11.50	14.50	11.00	11.50	14.50

D.C. MICROAMMETERS

Range	Approx. Res.	Scale Div.	Models 221-T, 222-T, 223-T, 227-T		Models 321-T, 322, 324, 327-T		Models 420, 421-A, 421, 422, 426, 529-A		Models 521, 524	Model 626	Model 726
0-20	3000	40	\$12.50	\$14.50	\$15.50	\$ 14.00	\$ 14.50	\$ 17.50	\$ 14.00	\$ 14.50	\$ 17.00
0-50	1510	50	10.50	11.50	12.50	14.00	14.50	17.00	14.00	14.50	17.00
0-100	825	50	10.00	11.00	12.00	13.50	14.00	16.50	13.50	14.00	16.50
0-200	360	40	8.50	9.50	10.50	12.00	12.50	15.00	12.00	12.50	15.00
0-500	158	50	8.00	9.00	10.00	11.50	12.00	14.50	11.50	12.00	14.50
50-500	825	50	8.00	9.00	10.00	11.50	12.00	14.50	11.50	12.00	14.50
100-1000	360	50	8.50	9.50	10.50	12.00	12.50	15.00	12.00	12.50	15.00
500-5000	55	50	7.50	8.50	9.50	11.00	11.50	14.50	11.00	11.50	14.50

Lower torque microammeters are for use in horizontal positions only. For most photoelectric work, the 0-200 micro-ammeter, 360 ohms resistance is recommended. *Supplied only with knife-edge pointers. **Scale division for 2" models in parentheses.

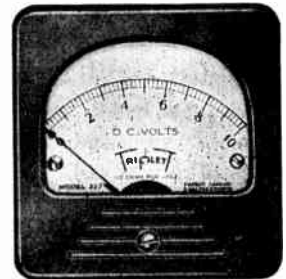

Models 227-T, 237-S, 247-T;
327-T, 337-S, 347-T

Radio TRIPLET Testers



TILTING CASE PORTABLES

Models 325 (D.C.); 335 (A.C.) are uniquely adapted for laboratory, experimental and special work. Advanced tilting feature permits moving the instrument case to any angle up to 90 degrees for accurate readings. Molded case and base. Overall dimensions 4 1/8" x 3 1/4" x 2 5/8". D.C. scale length 2.49"; A.C. 2.22". Accurate within 2%. Also available with mirror scales hand calibrated to 1% accuracy. Quotations on request.



4.6" SCALE PORTABLES

One of Triplet's most popular portables is the 6" molded case style: Model 625 (D.C.); and Model 635 (A.C.). A.C. styles are shielded. Hand calibrated mirror scales on white enameled metal dials, with knife-edge pointers. Accurate within 1%. Scale length: 4.61" D.C.; 4.4" A.C. Black molded case, 6" x 5 1/2" x 2 1/2". Detachable leather strap handle. Leather carrying case at extra charge.

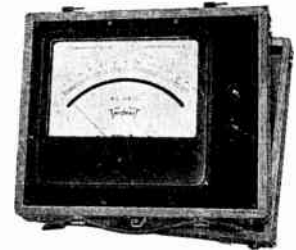

SCALE PORTABLES

Models 725 (D.C.) and 735 (A.C.) are precision portable instruments in handsome quarter-sawn golden oak cases. Hand-calibrated mirror scale and knife-edge pointer. Scale length: D.C. 6.4"; A.C. 5.7". Accurate within 1%. Reliable instruments appropriate for exacting work. Case, 11" x 9" x 4", with handle. Detachable cover.

VU METER

Volume Unit and Decibel Meters are used to measure sound or noise levels in amplifiers for Public Address, Theatres, Broadcasting Studios, Broadcasting Static Equipment, etc.

VU Meters are used for volume level measurements—including broadcast monitoring. Ballistic characteristics comply with standardization recommendations of NBC and CBS and Bell Telephone Laboratories. Internal impedance 3900 Ohms. Steady state reference 1 Milliwatt. For 600 Ohm line. Dynamic characteristics provide for 99% full scale deflection in .3 seconds. Specify scale type when ordering:

Type "A": 0-100 (black) -20 to +3 VU on top arc (red).
Type "B": 0-100 (black) -20 to +3 VU on bottom arc (red).

	Net Price
Model 420 VU	\$16.50
Model 420 VU (Illuminated)	18.00
Model 426 VU	16.50
Model 426 VU (Illuminated)	18.00
Model 327-T VU	15.50
Model 327-T VU (Illuminated)	17.00

WATTMETERS — ELECTRODYNAMOMETER

These instruments can be used on single phase A.C. or D.C. as Wattmeters. On special order they can be made up as voltmeters or ammeters. Instruments are self-contained to 300 Volts—10 Amperes. Over that external connection can be made. For use on frequencies up to 133 cycles per second. Available in three-inch model 361. Case dimensions same as 321-T, except for depth, 2" back of the flange (2 1/8" over studs). Also available in 3" rectangular Model 367-A. Case diameter same as 327-T, except for depth, 2 3/8", back of flange (2 3/8" over studs). Other characteristics of the 367-A, such as Range, Voltage, Amps., etc., same as 361. Wattmeters can be combined in the Triplet Twin case with a voltmeter or Ammeter. Accuracy within ±2%. Standard range as follows:



MODELS 361 AND 367-A — SINGLE PHASE					
Range Watts	Normal Voltage	Normal Amps.	Sc. Div.	Net Price	
0-75	150	1/2	75	\$19.50	
0-150	150	1	75	19.50	
0-300	150	2	60	19.50	
0-750	150	5	75	19.50	
0-1500	150	10	75	19.50	
0-150	300	1/2	75	21.50	
0-300	300	1	60	21.50	
0-600	300	2	60	21.50	
0-1500	300	5	75	21.50	
0-3000	300	10	60	21.50	
DOUBLE RANGE WATTMETERS (Double Voltage Limits Only)					
0-75-150	150-300	1/2	75	26.00	
0-150-300	150-300	1	75	26.00	
0-300-600	150-300	2	60	26.00	
0-750-1500	150-300	5	75	26.00	
0-1500-3000	150-300	10	75	28.50	

DECIBEL METER

DB Meters permit the operator of public address systems, etc., to make instant adjustments to prevent sound blasting or distortion. General purpose type reads up 6 and down 10 decibels. Zero decibel = 1.73 Volts. Calibrated for use on a 500 Ohm line. Reference level 6 Milliwatts. Resistance: 5000 Ohms. They consist of a sensitive D.C. instrument coupled to a copper-oxide rectifier. Standard damping is provided unless highly damped instruments are specified. Quotation on request.

	Net Price
Models 321-T or 327-T	\$12.40
Models 321-T or 327-T (Illuminated)	14.00
Models 420 or 426	13.40
Models 420 or 426 (Illuminated)	15.00

A.C. RECTIFIER TYPE INSTRUMENTS

Range	Scale Div.	1000 Ohms Per Volt		2000 Ohms Per Volt	
		Models 321-T, 327-T	Model 421	Models 321-T, 327-T	Model 421
0-1	50				
0-3	60				
0-5	50	\$15.70	\$16.70	17.80	\$18.80
0-10	50	15.70	16.70	17.80	18.80
0-15	75	15.70	16.70	17.80	18.80
0-50	50	15.70	16.70	17.80	18.80
0-100	50	15.70	16.70	17.80	18.80
0-150	75	16.90	17.90	19.00	20.00
0-300	60	17.80	18.80	20.00	21.00

MILLIAMMETERS

Range	Scale Div.	Approx. Resis.	Model 321-T		Model 421	
			Net Price	Net Price	Net Price	Net Price
0-5	50	1400	\$17.80	\$18.80	\$18.80	\$18.80
0-1	50	1300	15.60	16.60	16.60	16.60
0-2	40	1000	15.60	16.60	16.60	16.60
0-3	60	1000	15.60	16.60	16.60	16.60

Sine Wave 77° F. ±5% Accuracy. Moving Coil Permanent Magnet type.

D.C. AMMETER SWITCHBOARD SHUNTS

External shunts are available in the Ampere ratings listed and are to be used with instruments which operate at 50 M.V. full scale. The Ammeters will be supplied with dial reading in Amperes corresponding to rating of the shunt ordered. To determine price of the complete Ammeter, add shunt price to price of 0-50 Millivoltmeter in Model desired.

Shunts are furnished with 5 ft. wire leads. Quotation upon request for replacement, or special 24" or 30" leads.

Switchboard shunts have molded bases through 200 Amp. rating. Curve Type Shunts (mount on meter studs) —50 M.V. (Specify on order.) 50 DC Amp. \$3.40; 75 DC Amp., \$4.10; 100 DC Amp., \$4.70 net each.

Amps.	Price	Amps.	Price	Amps.	Price
50	\$ 7.00	200	\$ 7.00	600	\$14.90
75	7.00	300	8.40	800	19.40
100	7.00	400	10.50	1000	36.00
150	7.00	500	12.80	2000	60.00

★ Simpson IS READY FOR COLOR!

INSTRUMENTS THAT STAY ACCURATE

MODEL 260 Set Tester

World's Most Popular
High Sensitivity Set Tester
For RADIO and TELEVISION

There are more Simpson 260 high sensitivity volt-ohm-milliammeters in use today than all others combined. No other instrument of its kind has approached the world-wide popularity of the Simpson 260. In no other tester of its kind will you find the combination of useful ranges, accuracy, ruggedness, beauty and sensitivity developed to such a high degree of perfection.

Removal of the Model 260 from its heavy, handsome case of molded bakelite, will disclose how it differs from most set testers. You will see a sub-panel with a score of small recesses each holding a separate resistor or other component. You will notice complete absence of cable wiring. All connections are short and direct, thus offering a strength and firmness of assembly and the finest of insulation to reduce chances of shorts. All components are readily accessible. The front panel is a thing of beauty and long life. Pin jacks are recessed so no metal parts are exposed. All figures and symbols are molded into a heavy Bakelite panel and filled with durable white for long wear and legibility.

At 20,000 ohms per volt the 260 is highly dependable, rugged and accurate. Its practically negligible current consumption assures remarkably accurate voltage readings. It provides DC current readings as low as 2 microamperes and up to 10 amperes. Dependable resistance readings can be made up to 20 megohms and as low as 1/5 ohm. With the 260 you can measure automatic frequency control, diode balancing circuits, grid currents of oscillator tubes and power tubes, bias of power detectors, automatic volume control diode currents, high-mu triode plate voltage, as well as a wide range of other measurements which cannot be checked with ordinary servicing instruments.



NEW
ADJUST-A-VUE
HANDLE

RANGES

Model 260 Volt-Ohm-Milliammeter
20,000 Ohms per Volt DC, 1,000
Ohms per Volt AC
Volts, AC and DC: 2.5, 10, 50, 250,
1000, 5000
Output: 2.5, 10, 50, 250
Milliamperes, DC: 10, 100, 500
Microamperes, DC: 100
Amperes, DC: 10
Decibels (5 ranges): -12 to +55 DB.
Zero DB = .006 watt in 500 ohms.
Ohms: 0-2000 (12 ohms center),
0-200,000 (1200 ohms center),
0-20 megohms (120,000 ohms
center).

DEALER'S NET PRICES

Model 260, complete with test leads and Operator's Manual\$38.95
(Size: 5 1/4"x7"x3 1/8". Weight: 3 1/2 lbs. Shipping Wt.: 5 lbs.)	
1818 Leather Carrying Case 6.75
4236 Eveready Neolite Carrying Case 8.75
Model 260RT in Roll Top Safety Case, complete with test leads and Operator's Manual 46.90
(Size: 6 3/8"x9"x4 3/4". Weight: 6 1/2 lbs. Shipping Wt.: 9 lbs.)	
High Voltage Probe for 260 (25,000V) 9.95
High Voltage Probe for 260 (50,000V) 12.50
Model 260 available in standard all black or two tone tan and brown, at above prices. Specify color desired.	

25,000 VOLT DC PROBE FOR TELEVISION TESTING

Complete, nothing to add, for use with Model 260. Weight: 6 oz. Shipping weight: 8 oz.
DEALER'S NET PRICE
Complete with Instructions.....\$9.95

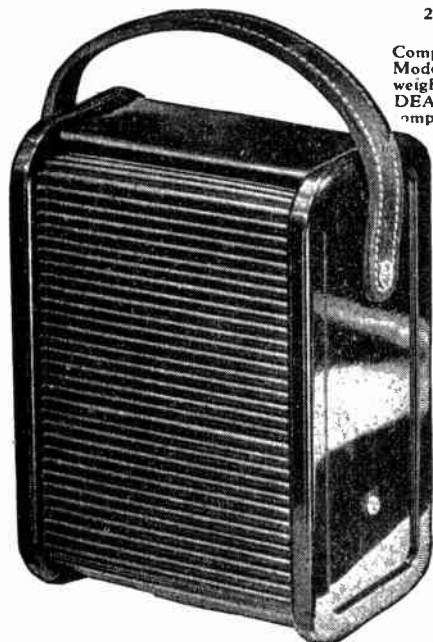

MODEL 260RT SET TESTER IN ROLL TOP SAFETY CASE

The Model 260, when placed inside our patented housing of heavy molded bakelite and permanently fastened in position, offers the highest degree of efficient, economical instrument protection. Now you can buy the famous 260 complete in this roll top safety carrying case with its built-in lead compartment at less than the price of a 260 and an Eveready leather carrying case. A flick of the finger rolls the top up and the instrument is ready to use. A downward flick rolls the top down and your instrument is fully protected.

★ Simpson IS READY FOR COLOR!

INSTRUMENTS THAT STAY ACCURATE

THE NEW MODEL 269

THE WORLD'S FIRST
COMMERCIALLY AVAILABLE
100,000 OHMS PER VOLT
VOLT-OHM MICROAMMETER

BIG 7 INCH METER 33 RANGES
COMPACT 7 INCH CASE

The Simpson Model 269 AC-DC ultra sensitive volt-ohm MICROammeter is ideal for voltage measurements in high resistance circuits . . . TV receivers — laboratory research work — other electronic equipment!

Use it in place of VTVM's for many voltage and resistance measurements in TV and other service work.

Eliminates line cord . . . drift . . . tube replacement.

The new Simpson Model 269 Volt-Ohm-MICROammeter is the most compact ultra high sensitivity instrument you can buy.

Every one of its 33 ranges has been customized to meet the needs of the electronic and electrical industries.

33 ranges through one control — saves time and assures accuracy.

Big seven-inch meter features an extra long scale for reading ease.

Rugged construction . . . designed for actual service use.

Measurement accuracy is 3% DC and 5% AC of full scale deflection.

Simpson Adjust-A-Vue handle may be used to instantly support the instrument at a convenient viewing angle on a bench top.

The 269 offers dependable accuracy in a lightweight completely portable and compact case.

RANGES

DC Voltage
0-1.6, 0-8, 0-40, 0-160, 0-400, 0-1600, 0-4000 volts . . . 100,000 ohms per volt sensitivity.

AC Voltage
0-3, 0-8, 0-40, 0-160, 0-800 volts . . . 5,000 ohms per volt sensitivity.

AF Output Voltage
0-3, 0-8, 0-40, 0-160 volts . . . 0.1 microfarad internal series capacitor.

Volume Level in Decibels
-12 to +11 decibels } Zero DB
-3.5 to +19.5 decibels } Power Level
+10.5 to +33.5 decibels } .001 watt
+22.5 to +45.5 decibels } in 600 ohms

DC Resistance
0-2,000 ohms (18 ohms center)
0-20,000 ohms (180 ohms center)
0-200,000 ohms (1800 ohms center)
0-2 megohms (18,000 ohms center)
0-20 megohms (180,000 ohms ctr.)
0-200 megohms (1.8 megohms ctr.)

DC Current
0-16 microamperes, 0-160 microamperes, 0-1.6 milliamperes, 0-16 milliamperes, 0-160 milliamperes . . . 267 millivolts maximum drop.

0-1.6 amperes, 0-16 amperes . . . 267 millivolts maximum drop.

NEW!



DEALER'S NET PRICE

Complete with test leads . . . removable alligator clips, 4000 volt DC multiplier, operator's manual. Size: 7-15/16" x 6" x 2-15/16". Weight 4 lbs. Shipping weight 6 lbs.

PRICE \$88.00

NEW!



MODEL 262

VOLT-OHM-MILLIAMMETER
20,000 OHMS PER VOLT
SENSITIVITY

33 RANGES . . . BIG 7 INCH METER
COMPACT 7 INCH CASE

The Simpson Model 262 Volt-Ohm-Milliammeter has a sensitivity of 20,000 ohms per volt DC and 5,000 ohms per volt AC . . . all in a 7 inch case!

Every one of its 33 ranges has been customized to meet the needs of the electronic and electrical industries.

Only one control is necessary — saves time and assures accuracy.

Big seven-inch meter features an extra long scale for reading ease.

Rugged construction . . . designed for actual service use.

Measurement accuracy is 3% DC and 5% AC of full scale deflection.

Simpson Adjust-A-Vue handle may be used to instantly support the instrument at a convenient viewing angle on a bench top.

The 262 offers dependable accuracy in a lightweight completely portable and compact case.

DEALER'S NET PRICE

Complete with test leads . . . removable alligator clips, 4000 volt DC multiplier, operator's manual. Size: 7-15/16" x 6" x 2-15/16". Weight 4 lbs. Shipping weight 6 lbs.

REDUCED PRICE NOW! \$59.50

RANGES

DC Voltage
0-1.6, 0-8, 0-40, 0-160, 0-400, 0-1600, 0-4000 volts . . . 20,000 ohms per volt sensitivity.

AC Voltage
0-3, 0-8, 0-40, 0-160, 0-800 volts . . . 5,000 ohms per volt sensitivity.

AF Output Voltage
0-3, 0-8, 0-40, 0-160 volts . . . 0.1 microfarad internal series capacitor.

Volume Level in Decibels
-12 to +11 decibels } Zero DB
-3.5 to +19.5 decibels } Power Level
+10.5 to +33.5 decibels } .001 watt
+22.5 to +45.5 decibels } in 600 ohms

DC Resistance
0-500 ohms (45 ohms center)
0-5000 ohms (45 ohms center)
0-50,000 ohms (450 ohms center)
0-500,000 ohms (4,500 ohms center)
0-5 megohms (45,000 ohms center)
0-50 megohms (450,000 ohms center)

DC Current
0-80 microamperes, 0-160 microamperes, 0-1.6 milliamperes, 16 milliamperes, 0-160 milliamperes . . . 267 millivolts maximum drop.
0-1.6 amperes, 0-16 amperes . . . 267 millivolts maximum drop.

5262 Eveready Leather Carrying Case for Models 262 and 269 . . . \$ 9.95
High Voltage Probe for 262 (16,000 V.) . . . \$11.50
High Voltage Probe for 269 (16,000 V.) . . . 11.50
High Voltage Probe for 262 (40,000 V.) . . . 12.50
High Voltage Probe for 269 (40,000 V.) . . . 12.50

BOTH MODELS 262 and 269

FEATURE BIG 7 INCH METERS

and COMPACT 7 INCH CASES

★ Simpson IS READY FOR COLOR!

INSTRUMENTS THAT STAY ACCURATE

MODEL 480 FM TV GENESCOPE

Ideal For Servicing Both VHF and UHF TV Receivers . . .

In addition to providing all the required signal sources for VHF television servicing, the Model 480 Genescope also includes a high sensitivity oscilloscope with unique advanced design in every detail and equipped with a high frequency crystal probe for signal tracing. Harmonics of the FM Generator can be used to observe overall response wave forms in UHF receivers and harmonics of the AM Generator make marking of this wave form possible through most of the band.

The variable oscillator sections are mounted one on each side of the oscilloscope section and are provided with large precision vernier dials having a 20:1 ratio and 1000 division logging scales. They are easy to read and can be quickly set to an exact frequency.

Modern FM and TV development and servicing requires the use of test equipment made to exacting standards. With this in mind we offer you the Genescope with the assurance that everything possible has been done to make it the most accurate, flexible and convenient instrument available.

Multiple shielding, generous bypassing of all power leads entering oscillator enclosures and adequate line input filtering eliminates excessive leakage and oscillator interaction.

Step and continuously variable attenuators on both AM and FM sections provide minutely controlled signal levels from a few microvolts for fringe area peaking operations to a magnitude suitable for single stage alignment.

A self contained impedance matching network is adjustable to any receiver input, balanced or unbalanced, in a matter of seconds. Values available include 300 ohm and 75 ohm termination with or without an intermediate attenuator pad and with or without an isolating condenser, open termination for maximum voltage output with or without isolating condenser and many other useful combinations.



The center section of the Genescope contains the oscilloscope and all associated controls. The cathode ray tube of the oscilloscope is mounted vertically in the case in order to conserve bench space. The pattern on the tube is brought into view by use of a highly polished adjustable mirror at the top of the cabinet. The mirror may be quickly adjusted for any position of the operator. The tube face is placed well below the top surface of the cabinet in order to shield it from incident light thus producing a clear, sharp image unhampered by narrow angle light shields. The mirror when closed provides adequate protection for the cathode ray tube when not in use.

Direct connection to vertical and horizontal deflection plates and other internal functions are available through removable cover on the front panel.

RANGES

AMPLITUDE MODULATED

MARKER OSCILLATOR

Band A—3.3-15.6 megacycles
 Band B—15-76 megacycles
 Band C—75-250 megacycles
 30% modulation at 400 cycles
 or unmodulated
 Continuously variable and step attenuators
 Visual method of beat frequency indication

Crystal calibrator—5 megacycles plus or minus .05%

Audio Oscillator 400 cycles

AM and FM oscillator sections provided with large, easy to read dials with 20-1 vernier control and 1000 division logging scale. Impedance matching RF output cable. Includes phasing and blanking controls.

FREQUENCY MODULATED

OSCILLATOR

Band A—2-120 megacycles
 Band B—140-260 megacycles
 Sweep width variable from zero to 15 megacycles
 Sweep rate 60 cycles per second
 Specially designed frequency sweep motor
 Continuously variable and step attenuators

OSCILLOSCOPE

Vertical sensitivity—35 mv per inch

Horizontal sensitivity—70 mv per inch

Linear sweep frequency—3 cycles thru 60 kilocycles

60 cycle sine sweep

Frequency response essentially flat to 200 KC

Size: 22"x14"x7 1/2". Weight 39 lbs. Shipping Weight 48 lbs.

LINE VOLTAGE: 105-125 volts, 60 cycles, 90 watts

DEALER'S NET PRICE complete with Test Leads and

Operator's Manual\$475.00

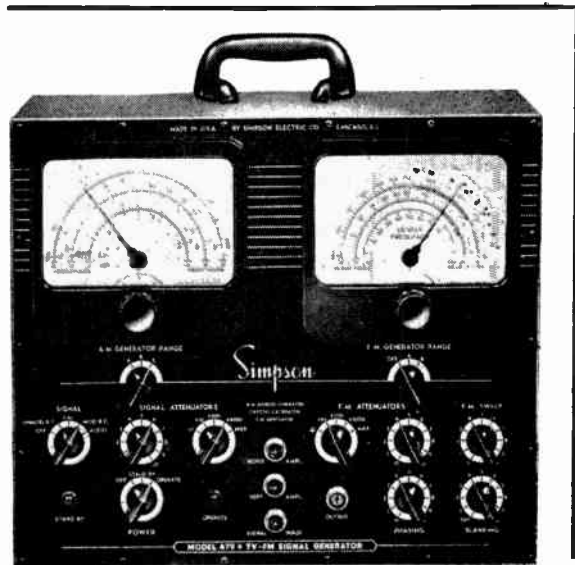

MODEL 479 TV-FM SIGNAL GENERATOR

A modern instrument for today's TV-FM problems. Exactly the same circuits, ranges and functions as the Model 480, described above, with the exception of the oscilloscope.

Size 17" x 14" x 7 1/2". Weight 29 lbs. Shipping Weight 35 lbs. Line Voltage: 105-125 volts, 60 cycles, 50 watts

DEALER'S NET PRICE with Test Leads and Operator's Manual\$325.00

With the new Simpson Model 406 Chromatic Amplifier and the Simpson Chromatic Probe, all Model 480 Genescopes and Model 479's are ready for color. Dealer's Net Price, Model 406 Chromatic Amplifier, with instruction booklet\$24.95
 Chromatic Probe 9.95

* Simpson IS READY FOR COLOR!

INSTRUMENTS THAT STAY ACCURATE

MODEL 303 VACUUM TUBE VOLT-OHMMETER

The Simpson 303 really is a versatile instrument. It can be used as an electronic DC voltmeter, an ohmmeter, an AC voltmeter, an AF voltmeter, an RF voltmeter (with accessory probe), an output-meter, and an FM indicator.

The 303 truly is a worthy companion of the world famous Simpson Model 260 Volt-Ohm-Milliammeter. Simpson engineers spent months of painstaking research in the laboratory, working in close co-operation with TV set manufacturers to produce the 303. This ruggedly built instrument has a volume of only 120 cubic inches, and is 60 to 70% more compact than any similar instrument. In achieving this compactness for greater portability Simpson did not sacrifice accuracy or functional value. Its large 4½-inch meter is easy to read.

Features such as low current consumption and wide voltage and resistance ranges make the 303 an extremely versatile instrument.

Like all other instruments bearing the Simpson name, the 303 is of the highest quality construction throughout, but sells at an amazingly low price.

SPECIFICATIONS

DC VOLTAGE: Ranges—1.2, 12, 60, 300, 1200 (30,000 with Accessory High Voltage Probe)

Input Resistance—10 megohms for all ranges
DC Probe—with one megohm isolating resistor

Polarity reversing switch
OHMS: Ranges—1000 (10 ohms center)

100,000 (1000 ohms center)
1 megohm (10,000 ohms center)

10 megohms (100,000 ohms center)
1000 megohms (10 megohms center)

AC VOLTAGE: Ranges—1.2, 12, 60, 300, 1200
Impedance (with cable) approx. 200 mmf shunted by 275,000 ohms

AF VOLTAGE: Ranges—1.2, 12, 60
Frequency Response—Flat 25 to 100,000 cycles

DECIBELS: Ranges—-20 to +3, -10 to +23, +4 to +37,
+18 to +51, +30 to +63

Zero DB .001 watt in 600 ohms
GALVANOMETER: Zero center for FM discriminator alignment
and other galvanometer applications

R. F. VOLTAGE: (Signal tracing with Accessory High Frequency
Crystal Probe)

Range—20 volts maximum
Frequency—Flat 20 KC to 100 M.C.

NEW . . .

JUST OUT . . .

ADJUST-A-VUE
HANDLE

On Every
303.
Same
Physical
Appearance
as Model
260.

See Page
G-27.



LINE VOLTAGE: 105-125 V. 50-60 cycles
SIZE: 5¼"x7"x3⅛" (bakelite case). Weight: 4 lbs. Shipping Wt.: 6½ lbs.

DEALER'S NET PRICE: Model 303, including DCV Probe, ACV
—Ohms probe and Ground Lead with Operator's Manual—\$68.00
4236 Eveready Neolite Carrying Case, \$8.75
Accessory High Frequency Probe, \$7.50
Accessory High Voltage Probe (30,000V), \$9.95
Also available with roll top case, Model 303RT—\$76.00

Three accessories—which are provided with every 303—are now also
available as separate items:

AC Probe for Model 303	\$3.00
DC Probe for Model 303	3.50
Ground Lead for Model 303	1.00



Twenty-five separate meters at the turn of a switch. That is what you get in the Simpson Model 221 Roto Ranger. The necessity of reading numerous scales, so common in ordinary volt-ohm-milliammeters, is forever eliminated when you own a Roto Ranger. The chances for errors in making readings are reduced to a minimum. The Model 221 provides a separate direct reading scale for each range and does it automatically. Calibrations are not cramped. Each scale is full size, the same as it would be for a separate instrument. As the selector switch on the panel is moved to the range desired, an ingenious mechanism rotates the proper range into position behind the meter window.

MODEL 221 ROTO RANGER (High Sensitivity AC-DC Volt-Ohm-Milliammeter)

RANGES

20,000 ohms per volt DC, 1000 ohms per volt AC.

Volts, DC: 2.5, 10, 50, 300, 1000, 5000.

Volts, AC: 2.5, 10, 50, 250, 1000, 5000.

Microamperes, DC: 100.

Milliamperes, DC: 10, 100, 500.

Amperes, DC: 10.

Output: 2.5, 10, 50, 250.

Ohms: 0-2000 (12 ohms center), 0-200,000 (1200 ohms center), 0-20 megohms (120,000 ohms center).

Size: 12¼"x10⅞"x5⅝".

Weight: 9 lbs. Shipping Weight: 13 lbs.

DEALER'S NET PRICE, complete with Test
Lead and Operator's Manual.....\$75.00

HIGH VOLTAGE PROBE AVAILABLE FOR TELEVISION SERVICING

30,000 V. DC—20,000 ohms per volt.

Weight: 6 oz. Shipping Weight: 8 oz.

DEALER'S NET PRICE, complete with
Instructions\$ 9.95

★ Simpson IS READY FOR COLOR!

INSTRUMENTS THAT STAY ACCURATE

MODEL 476 MIRROSCOPE

Simpson takes pleasure in presenting the revolutionary Model 476 Mirroscope. The objectives behind the design of the Model 476 were to eliminate certain inherent disadvantages found in the conventional type of oscilloscope.

By use of the Mirroscope principle the 5" cathode ray tube is mounted in a vertical position. This construction reduces bench space requirement to an area of only 9" x 8" thereby permitting better concentration of associated equipment for any type of test procedure.

The cathode ray image is reflected from a high grade mirror mounted in the adjustable cover at the top of the cabinet, thus the viewing surface is brought near eye level when the instrument is used on benches of normal height. The mirror angle is quickly and easily adjusted to any position of the operator.

The cover with integral side wings forms an effective shield against external light sources or may be closed down for protection of the tube and mirror when the instrument is not in use.

The upright construction permits location of controls and connections for maximum convenience and allows for internal cathode ray tube connections at the front of the panel instead of the rear.

These and many other advantages will be disclosed when the construction and specifications of the Model 476 Mirroscope are considered fully.

SENSITIVITY:

Vertical direct	— 12 volts rms per inch.
Vertical amplifier	— 20 millivolts rms per inch.
Horizontal direct	— 14 volts rms per inch.
Horizontal amplifier	— 38 millivolts rms per inch.

Horizontal trace expansion is over 4 times tube diameter. This makes it possible to examine minute portions of a response pattern for finer detail.

Linear Sweep frequency is continuously adjustable in five overlapping ranges from 15 cycles to 60,000 cycles. Internal, external or line frequency synchronization with variable amplitude is available.

Means for intensity or "Z axis" modulation is provided. Approximately 14 volts peak will blank a trace of normal intensity.

The vertical amplifier frequency response is within 3DB from 20 cycles to over 300,000 cycles and is usable to well over four megacycles. Square wave slant and overshoot is held to less than 5 per cent of amplitude. This response will be found adequate for all phases of television receiver service including observation and diagnosis of Sync. signals.

INPUT IMPEDANCE:

Vertical direct	- 10 megohms, 15 mmf.
Horizontal direct	- 10 megohms, 15 mmf.
Vertical amplifier	- 300,000 ohms, 30 mmf.
Horizontal amplifier	- 500,000 ohms, 15 mmf.

TUBE COMPLEMENT:

5UP4	Cathode Ray Tube.
4-6J6	Horizontal and Vertical Amplifiers.
1-12AU7	Vertical pre-amplifier.
1-6J6	Linear Sweep oscillator and Sync. injector.
2-6X4	High voltage rectifiers.



LINE VOLTAGE: 105-125 volts, 50-60 cycles. 40 watts

SIZE: Height 16 1/4" Width 9 1/8" Depth 8" over all

WEIGHT: 24 lbs.; Shipping weight 30 lbs. High Frequency Crystal Probe.....\$7.50

DEALER'S NET PRICE including operator's manual\$197.00

MODEL 276 OSCILLOSCOPE CALIBRATOR

The Simpson Model 276 Oscilloscope Calibrator adapts your oscilloscope for quick and accurate voltage measurements by comparative methods.

A twelve position switch provides six ranges each of RMS, Peak and Peak to Peak voltage with six alternate neutral positions for viewing the signal under observation.

Continuously variable calibrating voltage of power line frequency is supplied by the Model 276 and is indicated on a large 4 1/2 inch meter which indicates RMS values from 0.06 volt to 90 volts, peak values from 0.1 volt to 125 volts and peak to peak values from 0.2 volt to 250 volts.

When the Model 276 Oscilloscope Calibrator is connected in series between a signal source and the Oscilloscope input, a convenient switching arrangement makes it possible to make quick comparative checks between the relative amplitude of the signal and of the measured voltage source. This system is most convenient because leads do not have to be shifted around in order to calibrate the signal on the oscilloscope.

Housed in a rich black molded bakelite case identical to Models 260 and 303, this instrument will prove a worthy addition to the service dealer's equipment.

RANGES

RMS:	.36 - .9 - 3.6 - 9 - 36 - 90
PEAK:	.50 - 1.25 - 5 - 12.5 - 50 - 125
PEAK TO PEAK:	1.0 - 2.50 - 10 - 25 - 100 - 250

LINE VOLTAGE: 105-125 V. 50-60 cycles

SIZE: 5 1/4" x 7" x 3 1/8"

WEIGHT: 2 1/2 lbs.

SHIPPING WEIGHT: 4 lbs.

DEALER'S NET PRICE.....\$29.50

4236 Eveready Neolite Carrying Case for Model 276\$8.75



★ Simpson IS READY FOR COLOR!

INSTRUMENTS THAT STAY ACCURATE

MODEL 488 FIELD STRENGTH METER . . .

*Essential For Both VHF and UHF
TV Receiver Installations*

The Simpson Model 488 Television Field Strength Meter provides means for the measurement of Television signals in any locality. IT WILL WORK EQUALLY WELL FOR VHF AND UHF!

Although special consideration was given to fringe area applications in the design of this instrument it will be found of extreme value in all types of installations.

Location of maximum signal areas, antenna orientation and location, comparison of antenna systems, adjustment of boosters and checking antenna and lead-in installations are only a few of the many functions available.

Full scale sensitivity of the lowest range is approximately 50 microvolts and is an outstanding feature for those concerned with fringe area installations where maximum efficiency must be attained. Three additional ranges of approximately 500, 5000 and 50000 microvolts extends the usefulness of the Model 488 into areas of higher signal strength. Antenna installation for UHF reception requires exacting positioning and orientation and this requirement is completely satisfied with the Simpson 488.

The large 4½ inch modernistic meter is easily read from a considerable distance and all controls and connections arranged for greatest accessibility.

Model 488 is housed in a beautiful gray hammerloid finished case with sturdy leather handle for complete portability and ease of use.

Equipped for reception on all 12 VHF channels.



SIZE: 8" x 11" x 8½"

WEIGHT: 11½ lbs. Shipping wt. 15 lbs.

LINE VOLTAGE: 105-125 volts, 50-60 cycles, 45 watts.

DEALER'S NET PRICE, including operating instructions and shoulder strap.....\$115.00

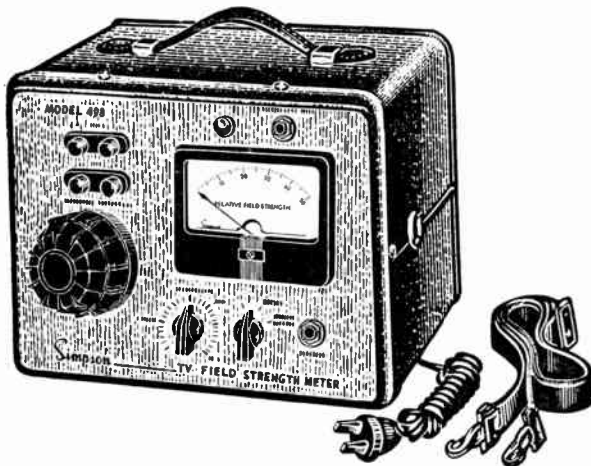

NEW SIMPSON MODEL 498 FIELD STRENGTH METER GOES ANYWHERE!

This practical Simpson field strength meter answers the long-felt need of service technicians for a combination power line or battery operated field strength meter.

Simpson Model 498 operates from any one of four sources:

1. Simpson 498 operates from 117 V AC line OR
2. Simpson 498 operates from self-contained storage battery OR
3. Simpson 498 operates from your automobile battery* OR
4. Simpson 498 operates from your external battery.

Models housed in beautiful grey hammerloid finished case with heavy leather handle for greater portability.

Dealer's Net Price including operating instructions and shoulder strap

Model 498-A for use on 117 volts AC only\$148.50

Model 498-D 117 volts AC and 6.3 volts DC 155.30

Storage battery 12 ampere hour capacity 9.50

Size: 8" x 11" x 8½" Weight: 11½ lbs. Shipping weight: 15 lbs.

*Internal storage battery can be recharged by self-contained charger or from your automobile battery while traveling between jobs.

* Simpson IS READY FOR COLOR!

INSTRUMENTS THAT STAY ACCURATE

SIMPSON MODEL 1000 PLATE CONDUCTANCE TUBE TESTER

Features Accurate Shorts and Leakage Tests with Indications in Ohms!

The Simpson Model 1000 will test *any* receiving tube including 9 pin miniatures and subminiatures with base arrangements in a line or circle. The Model 1000 tests an extremely important factor in the tube which is plate conductance. The dial indicates percentage of rated plate conductance which is closely related to mutual conductance since amplification factor remains constant throughout the life of the tube. Testing by the Simpson plate conductance method makes testing methods simpler . . . more positive . . . more accurate. These tests are made under conditions simulating actual use in radio, television, hearing aids and other electronic circuits.

Now, you can have reliable short tests because the Simpson 1000 quickly and conveniently shows you exact ohms values for interelement leakage and tube shorts.

Handy multi-position toggle switches help you make quick adjustments to proper voltages for bias, screen and plate supply. Each tube element is individually connected to the proper potential . . . insures against tube damage during testing.

Practical Simpson Snap-Out-Snap-In transparent plastic windows are provided over the fast action roll chart. They're instantly removed. You may add information on new tubes at any time. You'll like the easy-to-read type on the roll chart . . . eliminates squinting.

Simpson's roll chart service makes a new roll chart available each year and complimentary roll chart supplements are provided at regular intervals.

Every detail—no matter how small—has been engineered to meet your satisfaction. The fuse socket is on the front panel . . . dial cover is one piece unbreakable clear plastic.

The panel of the Model 1000 is finished in non-glare grey hammerloid and you'll like the rich burgundy carrying case, too. It looks like luggage. This is the tube tester you will be proud to own. See it at your parts jobber today.

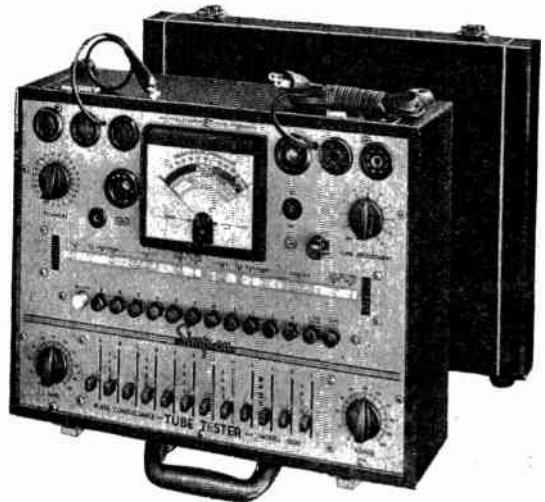

For 105-125 volts, 50-60 cycle

SIZE: 15 3/4" x 11 3/4" x 6"

WEIGHT: 15 lbs.

SHIPPING WEIGHT: 19 lbs.

DEALER'S NET PRICE, complete with

Operator's Manual \$135.00

MODEL 381 CAPACITY BRIDGE

The Model 381 embodies a new and revolutionary circuit which enables even the inexperienced to make capacity measurement with ease and assurance.

Simplicity and ease of operation are features of this instrument. You merely press a button for the desired range, adjust the bridge arm for maximum meter deflection and read the capacity on the scale.

The small size of this tester, together with its wide range of capacity measurement and low price makes the Model 381 the ideal instrument for Radio and Television service dealers, broadcast engineers, electric repair shops, X-ray servicing, industrial maintenance departments or any other service where condensers are tested.

Housed in a beautiful bakelite case with a durable etched aluminum panel and many specially designed parts, the Model 381 Capacity Bridge exemplifies the high quality construction found in all Simpson instruments.



RANGES

Range 1 20 mmfd. to 500 mmfd.

Range 20005 mfd. to .05 mfd.

Range 305 mfd. to 5 mfd.

Range 4 5 mfd. to 500 mfd.

SIZE: 3 3/8" x 5 1/2" x 2 3/8".

WEIGHT: 1 1/4 lbs. Shipping weight: 3 lbs.

LINE VOLTAGE: 105-125 volts, 50-60 cycle.

DEALER'S NET PRICE \$28.50

★ Simpson IS READY FOR COLOR!

INSTRUMENTS THAT STAY ACCURATE

MODELS 240 and 230 VOLT-OHM-MILLIAMETERS

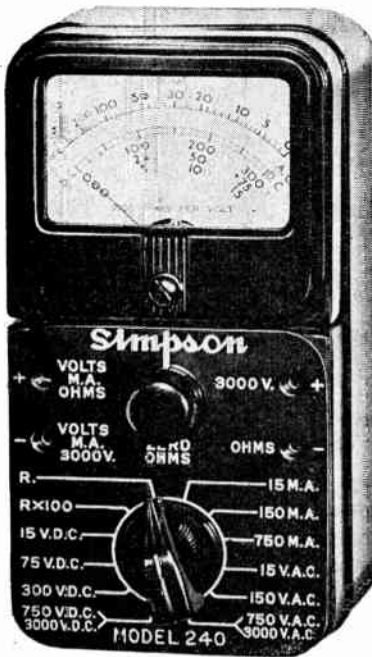

These two "Micro-Tester" portables are famous throughout the world for their ruggedness and built-in accuracy. They exemplify the construction features and utility that distinguish the entire Simpson line shown in this section.

Both are shock-proof and incorporate the special D'Arsonval Simpson movement which is known for its extreme accuracy. Resistors are in matched pairs to provide the greatest possible accuracy for all ranges.

Model 240 — the "Hammeter" — was designed for the additional voltage and sensitivity demanded in radio testing. With its maximum voltage range of 3000 AC or DC, it was the first self-contained pocket portable instrument built expressly to check high voltage and all the component parts of transmitters and receivers.

Model 230, with a maximum voltage of 1000 volts AC or DC, is ideal for most industrial testing. Its ranges are adequate for most line voltages, for telephone, teletype, and general purpose testing.

Both models are housed in heavily molded bakelite cases, with all numbers and symbols recessed in the panel and filled with white enamel for greatest legibility and ease of reading. Both have full size 3" meters.

RANGES

MODEL 240

AC Volts: 0-15, 150, 750, 3000
(1000 ohms per volt)
DC Volts: 0-15, 75, 300, 750, 3000
(1000 ohms per volt)

DC Milliamperes: 0-15, 150, 750
Ohms: 0-3000 (center scale 30)
0-300,000 (center scale 3000)

Accuracy: DC 3% — AC 5%
Size: 3"x5 7/8"x2 1/2". Weight: 1 1/4 lbs.
Shipping Weight: 3 lbs.

DEALER'S NET PRICE, complete with Leads and Printed Instructions....\$26.35



MODEL 230

(Same physical appearance as Model 240 pictured at left)

AC Volts: 0-10, 250, 1000
(400 ohms per volt)
DC Volts: 0-10, 50, 250, 1000
(1000 ohms per volt)

DC Milliamperes: 0-10, 50, 250
Ohms: 0-1000, 0-100,000

Accuracy: DC 3% — AC 5%
Size: 3"x5 7/8"x2 1/2". Weight: 1 1/4 lbs.
Shipping Weight: 3 lbs.

DEALER'S NET PRICE, complete with Leads and Printed Instructions....\$24.95

LEATHER AND LEATHERETTE CARRYING CASES TEST LEADS



1-113011

1-111818

1-114299

1-114236

Dealer's Net

1-111818	Leather Carrying Case for Model 260	\$6.75
1-114236	Eveready Neolite Carrying Case for Models 260-303-276 ...	8.75
1-115262	Eveready Neolite Carrying Case for Model 262-269	9.95
1-114299	Eveready Leather Carrying Case for Microtester	5.50
1-113011	Leatherette Covered Carrying Case for Microtester	5.50
1-113413	Leatherette Covered Carrying Case for 391-392	5.50

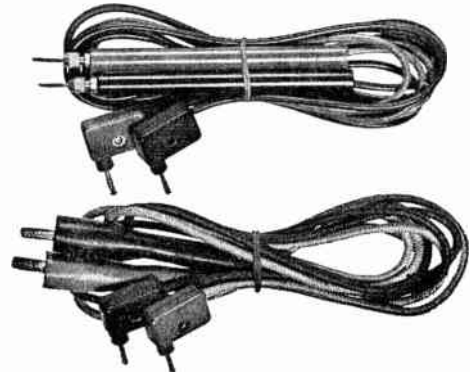

With Test Prods or Alligator Clips as shown. Colored red and black for easy identification. Length 48". Rubber insulated. Dealer's net prices.

0-008463	Removable Alligator Clips for use as Test Prods and Elbow Terminals (not illustrated)	\$1.85
0-008380	Test Prods and Elbow Terminals	1.25
0-008379	Test Prods and Spade Terminals	1.25
0-008377	Alligator Clips and Elbow Terminals	1.25
0-008376	Alligator Clips and Spade Terminals	1.25



HIGH VOLTAGE TV PROBE

DEALER'S NET PRICES

High Voltage Probe for 260 (25000 V)	Complete, nothing to add	\$ 9.95
High Voltage Probe for 260 (50000 V)		12.50
High Voltage Probe for 262 or 269 (40000 V)		12.50
High Voltage Probe for 221 (30000 V)	Complete, nothing to add	9.95
High Voltage Probe for 303 (30000 V)	Complete, nothing to add	9.95
High Voltage Probe for 262 or 269 (16000 V)		11.50

Here are Simpson's five High Voltage Test Probes for Television servicing, each designed for use with the models listed here. They are molded of high temperature polystyrene to provide high dielectric strength and maximum insulation. Their small diameter permits reaching in small spaces and narrow openings.

Size diameter 9/16", Length 11 1/2", Weight 6 oz. Shipping Weight 8 ozs.

* Simpson IS READY FOR COLOR!

INSTRUMENTS THAT STAY ACCURATE

MODEL 390 VOLT-AMP-WATTMETER

Ruggedly constructed for full load, continuous operation, the Simpson Model 390 is the first tester of its size ever made to give you volt, ampere and wattage readings in one compact instrument. It embraces two ranges each of voltage and current, providing four wattage ranges which cover practically all types and makes of appliances. The panel has volt-ampere combinations clearly indexed to the proper wattage range on the scale, which makes the instrument easy to use. All readings are shown on one meter. In normal position, the meter indicates volts. Ampere and watt readings are obtained by depressing button on the panel. The widely separated binding posts make it possible for the Model 390 to be used as an individual voltmeter or as an ammeter. The Model 390 has a molded bakelite case with all figures recessed in the panel, which are filled with white enamel for better legibility. Special sets of leads and plug furnished to simplify connections.

Size: 3"x5⁷/₈"x2¹/₂". Weight 1¹/₂ lbs. Shipping Weight: 2 lbs.

DEALER'S NET PRICE, complete with Break-in plug, leads and Operator's Manual.....\$39.50
Leatherette Covered Carrying Case, with compartment for Break-in plug and leads..... 5.50



RANGES
AC Current, 60 cycles
Volts: 0-150, 0-300
Amperes: 0-3, 0-15
Watts: 0-300, 0-600,
0-1500, 0-3000

MODELS 391 and 392 AC-DC VOLT-WATTMETERS

Designed for simultaneous reading of volts and watts, each of these handy little testers has two separate 3" square meters, one for volts and one for watts. Each has a built-in cord and plug for connection to the line outlet, and a receptacle for connecting the appliance under test. The ranges for each meter are selected by separate toggle switches recessed in the molded bakelite case. The low power consumption combined with the high efficiency of these instruments results in negligible loss and error in reading.

Model 391 (3000 watts max.)
Ranges: AC or DC
Volts: 0-130, 0-260
Watts: 0-1500, 0-3000
Size: 3"x5⁷/₈"x2¹/₂". Weight: 1¹/₂ lbs.
Shipping Weight: 2 lbs.
DEALER'S NET PRICE, with Operating Instructions\$30.00
3413 Leatherette carrying case 5.50

Model 392 (5000 watts max.)
Ranges: AC or DC
Volts: 0-130, 0-260
Watts: 0-1000, 0-5000
Size: 3"x5⁷/₈"x2¹/₂". Weight: 1¹/₂ lbs.
Shipping Weight: 2 lbs.
DEALER'S NET PRICE, with Operating Instructions\$35.00
3413 Leatherette carrying case 5.50



MODEL 385 TEMPERATURE INDICATOR

This is the newest addition to the Simpson Appliance Tester line. You will find this a compact instrument which is ideal for measuring temperatures from +70° F to as low as -50° F, where fast accurate temperature readings are important. The scale is designed so that the center portion is expanded, making the most widely used temperatures easy to read.

The Model 385 is ideal for use in the refrigeration service field and wherever temperature readings are important, such as deep freeze units, home refrigerators, walk-in coolers and air conditioning units.

The temperature readings can be taken at the end of the 15' lead which is supplied with the unit. The lead cord is small in diameter, making it possible to close the door of the equipment, thus obtaining temperature indications under actual conditions.

The probe can also be immersed in liquids where critical temperatures must be maintained.

Range: -50°F. to +70°F.
Battery, self-contained
Size: 3"x5⁷/₈"x2¹/₂".
Weight: 1¹/₂ lbs.
Shipping Weight: 4 lbs.
DEALER'S NET PRICE, complete with Test Lead and Operating Instructions\$30.00
3011 Leatherette Covered Carrying Case .. 5.50
4299 Eveready Leather Carrying Case .. 5.50



★ Simpson IS READY FOR COLOR!

INSTRUMENTS THAT STAY ACCURATE

MODEL 370 AC AMMETER

With self-contained current transformer
For use on 60 cycles

In the Model 370, a current transformer and indicating instrument have been combined in one small case to meet the consistent demand for a small multiple range AC ammeter, at a price that you can afford. Its many uses include the measurement of current drawn by all types of electric appliances and motors, heating elements, lamps, radio sets, etc. RANGES: 0-1, 0-2.5, 0-5, 0-10, 0-25 Amperes.

Size: 3"x5⁷/₈"x2¹/₂". Weight: 1¹/₂ lbs.
Shipping Weight: 2 lbs.

DEALER'S NET PRICE.....\$19.95



MODEL 371 AC VOLTMETER

This instrument is a "must" for the industrial service kit or the lineman. Designed primarily for testing line voltages applied to motors, heating equipment or other industrial installations, the ranges are such that many additional applications will suggest themselves. RANGES: 0-150, 0-300, 0-600 Volts.

Size: 3"x5⁷/₈"x2¹/₂". Weight: 1¹/₄ lbs. Shipping Weight: 2 lbs.

DEALER'S NET PRICE.....\$18.40

MODEL 372 OHMMETER

A complete instrument with self-contained batteries. Has a wide range from .2 ohms to 50 megohms. "Ohms" adjuster compensates for variations in battery voltages. Wire wound and matched metallized resistors are used throughout. The basic movement has a sensitivity of 85 microamperes. RANGES: 0-500 ohms (5 ohms center), 0-5000 ohms (50 ohms center), 0-50,000 (500 ohms center), 0-500,000 (5000 ohms center), 0-5 Meg. (50,000 ohms center), 0-50 Meg. (500,000 ohms center).

Size: 3"x5⁷/₈"x2¹/₂". Weight: 1¹/₂ lbs. Shipping Weight: 2 lbs.

DEALER'S NET PRICE, complete with Test Leads.....\$25.50

MODEL 373 DC MILLIAMMETER

The Model 373 provides for DC current measurements from .02 to 1000 MA. This tester is ideal for radio servicing and experimental work; checking burglar alarm circuits, railroad signal systems, telephone work, etc. RANGES: 0-1, 5, 10, 25, 50, 100, 250, 0-1000 MA.

Size: 3"x5⁷/₈"x2¹/₂". Weight: 1¹/₄ lbs. Shipping Weight: 2 lbs.

DEALER'S NET PRICE.....\$19.95

4299 Eveready Leather Carrying Case..... 5.50

3011 Leatherette-Covered Carrying Case..... 5.50

MODEL 374 DC MICROAMMETER

Incorporates a basic movement of 50 microamperes sensitivity with self-contained shunts for all other ranges. This tester can be used with external resistors or multipliers as a high sensitivity voltmeter at 20,000 ohms per volt. It is of particular value in photoelectric cell and other experimental work. The meter may be shorted out of the circuit by setting the selector knob to "short" position. RANGES: 0-50, 100, 250, 500, 1000 Microamperes.

Size: 3"x5⁷/₈"x2¹/₂". Weight: 1¹/₂ lbs. Shipping Weight: 2 lbs.

DEALER'S NET PRICE.....\$23.00

MODEL 375 DC AMMETER

Self-Contained

A new multi-range instrument which is extremely useful in testing the current in DC circuits. Provides a complete range from a fraction of an ampere to 25 amperes without the necessity of using auxiliary external shunts. Excellent for checking auto radios and experimental work in DC circuits. RANGES: 0-1, 2-5, 5, 10, 25 Amperes.

Size: 3"x5⁷/₈"x2¹/₂". Weight: 1¹/₂ lbs. Shipping Weight: 2 lbs.

DEALER'S NET PRICE.....\$19.95

MODEL 376 DC VOLTMETER

Rectifier Type 1000 ohms per volt

An AC Voltmeter, especially useful in circuits where a limited amount of current is present. Makes an excellent output meter when used with proper condenser. The wide variety of ranges covers both primary and secondary voltage ranges of transformers used in radio sets, toys and appliances. RANGES: 0-5, 10, 25, 50, 100, 250, 500, 1000 AC volts.

Size: 3"x5⁷/₈"x2¹/₂". Weight: 1¹/₄ lbs. Shipping Weight: 2 lbs.

DEALER'S NET PRICE.....\$19.95

MODEL 377 DC VOLTMETER

Resistance 1000 ohms per volt

Measures all dry battery voltage, both A and B, for radio sets, also grid and plate voltage and filament voltage in battery-operated sets. High ranges may be used for checking DC line voltage. RANGES: 0-1, 2.5, 5, 10, 25, 50, 100, 250, 500, 1000 DC Volts.

Size: 3"x5⁷/₈"x2¹/₂". Weight: 1¹/₂ lbs. Shipping Weight: 2 lbs.

DEALER'S NET PRICE.....\$19.95

MODEL 378 AC MILLIAMMETER

With self-contained current transformer

Here is the instrument that answers your need for a low cost, handy size milliammeter that combines a current transformer and an indicating instrument in one case. It offers five separate ranges, making it suitable for a wide variety of testing jobs. RANGES: 0-5, 25, 100, 250, 1000 MA.

Size: 3"x5⁷/₈"x2¹/₂". Weight: 1¹/₂ lbs. Shipping Weight: 2 lbs.

DEALER'S NET PRICE.....\$22.60

MODEL 379 BATTERY TESTER

Designed in accordance with the engineering specifications of leading battery manufacturers, this compact instrument is so ruggedly built that it will stand a lifetime of hard usage. The loading resistors have an accuracy of 1% and properly load all radio and hearing aid A and B batteries.

A single rotary switch selects the voltage of the battery under test and brings into line the correct loading resistor. The full 3" dial has three separate arcs, one for all radio A batteries, one for hearing aid A batteries, and one for all B batteries.

A percentage scale shows the exact condition of the battery in percentage of full voltage. The voltage reading can be quickly obtained by multiplying the percentage reading by the selector-switch voltage setting.

Size: 3"x5⁷/₈"x2¹/₂". Weight: 1¹/₄ lbs. Shipping Weight: 2 lbs.

DEALER NET PRICE WITH LEADS.....\$23.70

4299 Eveready Leather Carrying Case.....	\$5.50
3011 Leatherette-Covered Carrying Case.....	\$5.50
Test Leads with Prods.....	\$1.25 extra
Test Leads with Alligator Clips and Insulated Sleeves.....	\$1.25 extra

Simpson IS READY FOR COLOR!

INSTRUMENTS THAT STAY ACCURATE

NEW SIMPSON MODEL 430 COLOR BAR GENERATOR

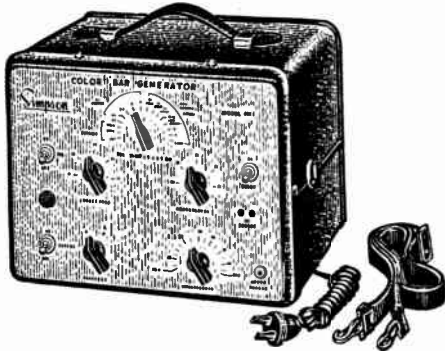

The Simpson Model 430 Color Bar Generator brings you 16 color signals: Red—Q, Green—R, Blue—G, White—B, R-Y—(R-Y), G-Y—(B-Y), B-Y—I, I—Q. Everything you need in a color bar generator including independent saturation and hue controls. RF output can be modulated with above NTSC signals. Video output: for signal injection directly into video system. Ample attenuation. Dealer's Net Price, complete with instruction manual \$395.00

NOW, NEW SIMPSON 454 CHROMOSCOPE BRINGS YOU EVERYTHING!



A true champion, the Model 454 Simpson Chromoscope has every necessary feature for your color-television service. Better than other scopes for black-and-white service, too, because this is what you get when you buy your Simpson 454 Chromoscope:

- Bandpass flat to 5 Mc, to show color burst accurately.
- DC response shows modulation percentage in chroma, Y, and sound circuits.

- Sensitivity of 0.02 volt per inch, to obtain full screen deflection when checking low-gain circuits.
 - Accurate peak-to-peak voltage measurements, for trouble-shooting video, sync, and sweep circuits.
 - Fast horizontal sweep, to 50 kc, for expansion of fine waveform detail and color burst.
 - Compensated decimal step attenuator for faster voltage measurements.
 - Flat vernier attenuator to eliminate waveform distortion.
 - Facilities for intensity modulation of CRT.
 - Complete set of accessory probes; Low-capacitance, demodulator, high-voltage capacitance-divider, direct, and isolating probes.
 - Unusual instruction book for color servicing, shows you what to do and how to do it; ONE HUNDRED pages, 150 WORKING PHOTOS, and numerous diagrams.
- Dealer's net price, including instruction book and set of probes \$395.00

NEW SIMPSON MODEL 388 "THERM-O-METER"

Features Fast Accurate Remote Temperature Readings from -50° to +1000° F.



Place convenient thermocouple lead in area (or solution) to be tested . . . obtain fast and accurate temperature readings.

Hundreds of practical and accurate temperature readings for laboratory technicians, engineers, industrial maintenance managers, installation and servicing men. Use "Therm-O-Meter" for: refrigerators, air conditioners, freezers, motor blocks, water jackets, exhaust gases, electric and gasoline motors (inside and outside measurements), electric irons, furnaces, driers, industrial stacks, many others. Ideal for medical, chemical, food processing research, too.

One scale 7" meter assures greater legibility and Simpson Adjust-A-View handle may be used to instantly support the instrument at a convenient viewing angle. Dealer's Net Price, complete with 15 foot thermocouple already at-

tached, internal batteries and operating instructions. 7-15/16" x 6" x 2-15/16". Weight: 4 lbs. Shipping Weight: 6 lbs. Price: \$59.50
5262 Carrying Case for Model 388 \$9.95

NEW SIMPSON MODEL 434 WHITE DOT GENERATOR

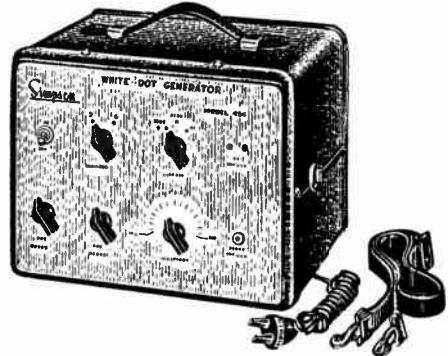

With the NEW Simpson Model 434 White Dot Generator . . . you make linearity adjustment of black and white TV and linearity and convergence adjustments on color TV receivers with confidence. Vertical and horizontal synchronization assures you of correct aspect ratio . . . ample attenuation . . . 300 ohm RF output. Positive or negative video output . . . excellent for accurate and fast checking transient response of video amplifiers. Housed in attractive Simpson grey hammerloid case. Weight: Approximately 11 1/2 lbs. Shipping weight: 15 lbs. Line Voltage: 117 volts, 50-60 cycles, 45 watts. Dealer's net price, including operating instructions and shoulder strap \$147.50.

NEW SIMPSON MODEL 307 VACUUM TUBE VOLTMETER

An incredibly accurate vacuum tube voltmeter with the same large, easy-to-read 7" meter as Model 262 volt-ohm-milliammeter.

Sturdy Adjust-A-View handle permits instant bench level viewing angle adjustment . . . eliminates those half-baked, bird-cage attachments.

New Simpson Model 307 gives you zero center adjustment for discriminator alignment or other galvanometer applications.

Ranges: DC Volts 0-1.6, 8, 40, 160, 400, 1600; 10 megohms input impedance; 1 megohm isolation in probe. AC Volts 0-3, 8, 40, 160, 800; 60 cycle input impedance 260,000 ohms; Input capacitance 200 mmf.

AC Peak-to-Peak Probe 20 volts maximum (voltage range can be extended by use of capacity divider). Frequency range flat 20 kc to 100 mc.; Input capacity 4 mmf.

Decibels: -12 to +45 in 4 ranges; zero DB = .001 watt in 600 ohms. Ohms: 0-1000 ohms (10 ohms center); 0-10,000 ohms (100 ohms center); 0-100,000 ohms (1,000 ohms center); 0-1 megohm (10,000 ohms center); 0-10 megohm (100,000 ohms center); 0-1000 megohm (10 megohms center).

Zero center adjustment for discriminator alignment or other galvanometer applications.

Dealer's Net Price: Model 307, including DCV Probe, ACV-Ohms probe and Ground Lead with Operator's Manual \$87.50
Size: 7-15/16" x 6" x 2-15/16".

Accessory Capacity Divider for Model 307 \$8.75
5262 Eveready Neolite Carrying Case for Model 307 \$9.95



NEW SIMPSON MODEL 355 "MIDGETESTER"

Smallest Practical Volt-Ohmmeter Commercially Available

Simpson Midgetester is as compact as a package of cigarettes. Size 1" thick, 4 1/2" long, and 2 3/4" wide . . . fits into your shirt pocket easily. Finished in attractive polished styrene case.

Ranges: AC and DC Volts 10,000 ohms per volt 0, 3, 12, 60, 300, 1200 volts. Resistance: 0-10,000 ohms, 0-100,000 ohms, 0-1 megohm, 0-10 megohms.

Dealer's Net Price, complete with test leads and instructions. . . \$29.95



Simpson

PANEL INSTRUMENTS



MODELS 25, 35, 45, 55
3 1/2" ROUND CASE — OPEN FACE
STYLE. Flange diameter, 3 1/2"; depth over-
all, 2 1/4"; body diameter, 2 3/4"; scale length,
2 9/16". Bakelite case.

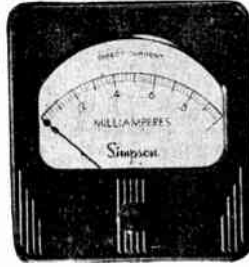

MODELS 27, 37, 47, 57
3 1/2" RECTANGULAR CASE. Width,
3"; height, 3 3/8". Mounts in round
hole. Body diameter, 2 3/4". Scale length
2 9/16". Bakelite case.



MODELS 29, 39, 49, 59
4 1/2" RECTANGULAR CASE. Width
4 21/32", height, 4 13/64". Mounts in
round hole. Body diameter 2 3/4". Scale
length 3 29/32". Bakelite case.

AMMETERS

MODEL →	125-127	25-27	29	155-157	55-57	59	RANGE	125-127	25-27	29
	D. C.			A. C.				D. C.		
RANGE										
0-1	\$7.65	\$8.70	\$9.75	\$7.50	\$8.10	\$ 9.90	0-100	\$7.65	\$8.70	\$9.75
0-1.5	7.65	8.70	9.75	7.50	8.10	9.90	0-150	7.65	8.70	9.75
0-2	7.65	8.70	9.75	7.50	8.10	9.90	0-200	7.65	8.70	9.75
0-3	7.65	8.70	9.75	7.50	8.10	9.90	0-250	7.65	8.70	9.75
0-5	7.65	8.70	9.75	7.50	8.10	9.90	0-300	7.65	8.70	9.75
0-10	7.65	8.70	9.75	7.50	8.10	9.90	0-500	7.65	8.70	9.75
0-15	7.65	8.70	9.75	7.50	8.10	9.90	0-750	7.65	8.70	9.75
0-25	7.65	8.70	9.75	7.80	8.40	10.50	0-1000	7.65	8.70	9.75
0-30	7.65	8.70	9.75	15-0-15	7.65	8.70	9.75
0-50	7.65	8.70	9.75	12.60	30-0-30	7.65	8.70	9.75
0-75	7.65	8.70	9.75	50-0-50	7.65	8.70	9.75

AC-DC ammeters are self-contained for ranges up to and including 50 amperes. Higher range DC ammeters can be supplied with external shunts and include 6 foot leads. Higher range AC ammeters can be supplied with external current transformers and include 2 foot leads.

WATTMETERS—DYNAMOMETER TYPE

RANGE	MAX.	MAX.	MODEL	MODEL	MODEL	RANGE	MAX.	MAX.	MODEL	MODEL	MODEL
WATTS	VOLTS	AMPS.	175-177	75-77	79	WATTS	VOLTS	AMPS.	175-177	75-77	79
0-75	150	.75	\$18.60	\$19.80	\$25.80	0-600	300	3.0	\$20.70	\$21.75	\$27.75
0-150	150	1.5	18.60	19.80	25.80	0-1500	300	7.5	20.70	21.75	27.75
0-300	150	3.0	18.60	19.80	25.80	0-3000	300	15.0	20.70	21.75	27.75
0-750	150	7.5	18.60	19.80	25.80						

A. C. VOLTMETERS — RECTIFIER TYPE

RANGE	MODEL → APPROX. RESISTANCE	45-47	49
0-1	1000 ohms per volt	\$12.75	\$13.65
0-3		12.75	13.65
0-5		12.75	13.65
0-10		12.75	13.65
0-15		12.75	13.65
0-50		12.75	13.65
0-100		12.75	13.65
0-150		12.75	13.65
0-300		12.75	13.65
0-1		2000 ohms per volt	13.05
0-3	13.05		14.25
0-5	13.05		14.25
0-10	13.05		14.25
0-15	13.05		14.25
0-50	13.05		14.25
0-100	13.05		14.25
0-150	13.05		14.25
0-300	13.05		14.25

A. C. MILLIAMMETERS — RECTIFIER TYPE

RANGE	OHMS	125-127	25-27	29
0-1	600 ohms	\$12.60	\$13.65	
0-2	400	12.60	13.65	
0-5	200	12.60	13.65	

A. C. MICROAMMETERS — RECTIFIER TYPE

RANGE	OHMS	125-127	25-27	29
0-100	3400 ohms	\$15.15	\$16.50	
0-200	2400	13.50	14.85	
0-300	1800	13.35	14.55	
0-500	1200	13.05	14.25	

D. C. GALVANOMETERS

SCALE	SENSITIVITY MICRO- AMPERES	MODEL → RESIST.	125-127	25-27
50-0-50	500-0-500	46 ohms	\$7.65	\$ 8.70
50-0-50	75-0-75	2000	9.45	10.50

R. F. AMMETERS INTERNAL THERMOCOUPLE TYPE

MODEL → RANGE	135-137	35-37	39
0-1	\$9.30*	\$10.50*	\$12.75
0-1.5	9.30	10.50	12.75
0-2	9.30*	10.50*	12.75
0-2.5	9.30	10.50	12.75
0-3	9.30*	10.50*	12.75
0-5	9.30*	10.50*	12.75
0-8	9.30	10.50	12.75
0-10	9.30	10.50	12.75

*See note at top of next page.

RF MILLIAMMETERS

RANGE	135-137	35-37	39
†0-115	\$21.45
0-150	12.60	\$14.55
0-250	12.60	14.55
0-500	12.60	14.55

†0-100 linear scale—50 divisions.

VOLUME LEVEL INDICATORS—DECIBEL METERS

ZERO POWER LEVEL—6 MW. 500 OHM LINE

MODEL → RANGE	145-147	45-47	49
GENERAL PURPOSE TYPE			
-10 to +6 db 5000 ohms	\$11.25	\$12.30	\$13.95
HIGH SPEED TYPE			
-10 to +6 db 5000 ohms	13.20	14.85
LOW SPEED TYPE			
-10 to +6 db 5000 ohms	13.20	14.85

VOLUME LEVEL INDICATORS—VU METERS

REFERENCE LEVEL—1 MW. 600 OHM LINE

Not illuminated A or B Scale—3900 ohms	\$15.90	\$16.80
Illuminated A or B Scale—3900 ohms	19.50
Model 142—4 Rectangular ↑			

Simpson

PANEL INSTRUMENTS



MODELS

125, 135, 145, 155

2 1/2" ROUND CASE — OPEN FACE STYLE. Flange diameter, 2 3/4"; depth overall, 2 5/16"; body diameter, 2 11/64"; scale length, 1 7/8". Bakelite case.



MODELS

127, 137, 147, 157

2 1/2" RECTANGULAR CASE. Width 2 3/8"; height, 2 3/8". Mounts in round hole. Body diameter, 2 3/16". Scale length 1 7/8". Bakelite case.



MODEL 27-37-57 ILLUMINATED

3 1/2" RECTANGULAR CASE. Width 3"; height 3 1/8". Mounts in round hole. Body diameter 2 3/4". Scale length 1 5/16". Bakelite case.

NOTE: The 2 1/2" and 3 1/2" rectangular instruments indicated () are also carried in stock with lucite illuminated dials. Supplied complete with socket and 6 volt bulb for an additional cost of \$1.50 dealer's net. R.F. ammeters lucite illuminated must be supplied with external thermocouple. Add \$4.95 for couple. All instruments are calibrated for use on non-magnetic panels.

VOLTMETERS

MODEL →	125-127	25-27	29	155-157	55-57	59
RANGE		D. C.			A. C.	
0-1.5				\$ 7.50	\$ 8.10	\$ 9.75
0-3	\$ 7.65	\$ 8.85	\$ 9.75	7.50	8.10	9.75
0-5	7.65	8.85	9.75	7.50	8.10	9.75
0-8	7.65	8.85	9.75			
0-10	7.65*	8.85*	9.75	7.50*	8.10*	9.75
0-15	7.65	8.85	9.75	7.50*	8.10*	9.75
0-25	7.65	8.85	9.75	7.50	8.10	9.75
0-30	7.95	8.85	9.75			
0-50	7.95*	8.85*	9.75			
0-100	7.95	8.85	9.75	7.50	8.10	9.75
0-150	7.95*	8.85*	9.75	7.50	8.10	9.75
0-200	7.95	8.85	9.75	8.85*	9.60*	10.50
0-250	7.95	8.85	9.75			
0-300	7.95*	8.85*	9.75	8.85	9.60	10.50
0-500	7.95	8.85*	9.75	8.85*	9.60*	10.50
0-750	7.95	8.85	9.75	12.75	13.50	14.40
0-1000	11.85	12.75*	13.65	12.75	13.50	14.40
0-1500	12.75	13.65
0-2000	12.75*	13.65
0-2500	12.75	13.65
0-3000	12.75*	13.65
0-4000	12.75*	13.65
0-5000	12.75*	13.65

External resistors are furnished on A.C. meters having a range of 500 volts or higher. D.C. 1000 volts or higher.

MILLIAMMETERS

MODEL →	125-127	25-27	29	155-157	55-57	59
RANGE		D. C.			A. C.	
0-1	\$7.65*	\$8.70*	\$9.75
0-1.5	7.65	8.70	9.75
0-3	7.65	8.70	9.75
0-5	7.65	8.70	9.75
0-10	7.65*	8.70*	9.75	\$7.50	\$8.10	\$9.90
0-15	7.65*	8.70*	9.75	7.50	8.10	9.90
0-20	7.65	8.70	9.75
0-25	7.65*	8.70*	9.75	7.50	8.10	9.90
0-50	7.65*	8.70*	9.75	7.50	8.10	9.90
0-75	7.65	8.70	9.75
0-100	7.65*	8.70*	9.75	7.50	8.10	9.90
0-150	7.65	8.70*	9.75
0-200	7.65*	8.70*	9.75
0-250	7.65	8.70	9.75
0-300	7.65*	8.70*	9.75	7.50	8.10	9.90
0-500	7.65*	8.70*	9.75	7.50	8.10	9.90
0-750	7.65	8.70	9.75
0-1000	7.65	8.70	9.75

MICROAMMETERS

MODEL →	125-127	25-27	29	125-127	25-27	29
RANGE	D. C.			D. C.		
0-25	\$13.65	\$14.85	\$17.10	25-0-25	12.00	13.20
0-50	10.80	11.85	13.05	50-0-50	11.40	12.75
0-100	10.20	11.25	12.60	100-0-100	9.75	11.10
0-200	8.55	9.60	10.95	500-0-500	8.85	9.90
0-500	7.95	9.15	10.35			

MILLIVOLTMETERS

MODEL →	125-127	25-27	29
RANGE	D. C.		
0-50	\$7.65	\$8.70	\$9.75
0-100	7.65	8.70	9.75

MARION ELECTRICAL INSTRUMENT CO., 401 CANAL ST., MANCHESTER, N. H.

marion meters

MANUFACTURERS OF MARION  *uggedized* PANEL METERS

In Canada: H. Roy Gray, 44 Danforth Road, Toronto, Ontario
Export Divisions 13 East 40th Street, New York 16, N. Y. Cable Address ARLAB

MARION RUGGEDIZED METERS HERMETICALLY SEALED



New Marion ruggedized meters are an especially accurate and sensitive means for electrical measurement, even under extreme conditions of shock, vibration, mechanical stress and strain, weather conditions, and climate.

Ruggedized meters offer new freedom of application. They give faster response time, more sustained accuracy, lower bearing friction and longer life.

Ruggedized instruments meet the dimensional requirements of JAN I-6 and are completely interchangeable with existing 2½" and 3½" types. They are manufactured in standard 1½", 2½", and 3½" sizes.

When you want the finest in electrical instruments you can depend upon these new Marion ruggedized meters.

RANGES DC INSTRUMENTS

DC MICROAMPERES

0-30
0-50
0-100
0-200
0-500
0-800

DC MILLIAMPERES

0-1 0-50
0-1.5 0-100
0-3 0-200
0-5 0-250
0-10 0-500
0-15 0-800
0-25

DC MILLIVOLTS

0-15
0-25
0-50
0-100

DC VOLTS

0-1.5 0-25
0-3 0-50
0-5 0-150
0-10 0-250
0-15 0-500

AC INSTRUMENTS

0-5 Volts AC
0-15 Volts AC
0-50 Volts AC

0-150 Volts AC
0-250 Volts AC
0-500 Volts AC

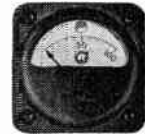

HS1 - 1½"

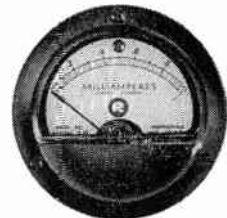

HS2 - 2½"

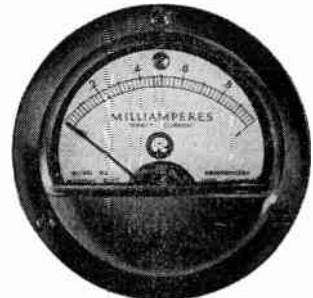

HS3 - 3½"

NULL INDICATORS

Marion Ruggedized Hermetically Sealed Null Indicators are now available in models HS2 and HS3. They are used primarily as bridge and potentiometer balance indicators and in any application where an

instrument with very high sensitivity about the zero or balance point is desired. The sensitivity at this point is 1 microampere per mm. or higher; the meter's shaded pole face and shielded core construction gives sharply logarithmic attenuation as it departs from null point, and provides ample overload protection. This Ruggedized meter opens up new applications for Null Indicators, for it permits use of the null system for precise measurement under field conditions that have been prohibitively severe up to now.

marion meters

MANUFACTURERS OF MARION  *uggedized* PANEL METERS

MARION ELECTRICAL INSTRUMENT CO., 401 CANAL ST., MANCHESTER, N. H.

marion meters

MANUFACTURERS OF MARION  *Ruggedized* PANEL METERS

In Canada: H. Roy Gray, 44 Danforth Road, Toronto, Ontario
Export Division: 13 East 40th Street, New York 16, N. Y. Cable Address ARLAB

MARION HERMETICALLY SEALED METERS

**SEALED LIKE A VACUUM TUBE
FOR GUARANTEED PERFORMANCE**

Magnetically shielded. 2½" x 3½". Dustproof and moistureproof.
Unaffected by heat, cold, humidity. Made to JAN specifications,
giving peak performance with critical accuracy. Interchangeable
round and square colored flanges for different panel needs.



HM3



HM2

RANGES DC INSTRUMENTS

DC MICROAMPERES	DC MILLIAMPERES	DC MILLIVOLTS	DC VOLTS
0-30	0-1	0-50	0-15
0-50	0-1.5	0-100	0-25
0-100	0-3	0-200	0-50
0-200	0-5	0-250	0-100
0-500	0-10	0-500	0-15
0-800	0-15	0-800	0-25

AC INSTRUMENTS

0-5 Volts AC	0-150 Volts AC
0-15 Volts AC	0-250 Volts AC
0-50 Volts AC	0-500 Volts AC

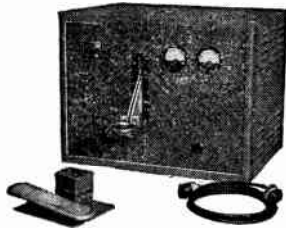

ADVANTAGES

- Speeds soldering operations by generating heat within the work in localized area.
- Improves quality by producing cleaner work. Avoids oxidation and scaling.
- Prevents damage to surface finish. This is important in glass-to-metal applications.
- Permits soldering of an entire seam or several jig-located parts at one time.
- Provides complete control, timing or duplication of soldering processes.
- Prevents mistakes and reduces rejects.
- Provides local heat for otherwise inaccessible parts.
- Gives expert results with inexperienced operators.
- Saves time, money, effort. Draws only 775 watts and then only at full load. Only 100 watts are used on standby.
- Practically free from maintenance. No moving parts to wear out. Uses only low-priced, easily replaceable tubes. Has high safety factor.
- Offers less hazard but does a neater, cleaner, faster job. No danger of sparking or RF burns from output terminal or work coils.

MODEL PM-1

MARION PORTABLE BENCH TYPE INDUCTION SOLDERING UNIT

COMPACT . . . ADAPTABLE . . . EFFICIENT
ECONOMICAL . . . SAFE . . . EASY TO USE

FOR QUANTITY PRODUCTION

Use this low-cost, low-powered portable Marion Induction Heating Unit wherever production soldering of small metal parts and assemblies is required. It cuts costs by minimizing time, reducing labor, improving quality and eliminating the need for a high degree of skill. The unit has made a place for itself in the field of Radio, Electronics, Jewelry, Watches, Electrical Fixture Components, Toys, Automotive Parts, Household Fixtures and other fabrication applications requiring Small Part Assemblies.

FOR GLASS-TO-METAL SOLDERING

With the Marion Portable Bench-Type Induction Unit you can do glass-to-metal soldering on Resistors, Relays, Photo Cells, Meters, Capacitors, etc. It makes true hermetic sealing possible right in your own plant. Also, it is ideal for terminal, magnet and bearing assembly. It gives machinelike uniformity to a normally inexact operation.

MARION "4 FOR 1" FEATURE

Interchangeable Round and Square Colored Flanges . . . one instrument can thus fill four different needs:

1. ROUND



2. ROUND FOR STEEL PANEL



3. RECTANGULAR



4. RECTANGULAR FOR STEEL PANEL



SPECIFICATIONS

Power Supply: 115 volts, 60 cycle.
Size: 15¾" x 21½" x 15".
Mounting: Standard relay rack cabinet.
Weight: 150 pounds.
Power: 775 watts at full power output, 100 watts standby.
The entire unit is rigidly assembled and mounted to prevent arc-over and failure of components.

marion meters

MANUFACTURERS OF MARION  *Ruggedized* PANEL METERS

MARION ELECTRICAL INSTRUMENT CO., 401 CANAL ST., MANCHESTER, N. H.

marion meters

MANUFACTURERS OF MARION  ruggedized PANEL METERS

In Canada: H. Roy Gray, 44 Danforth Road, Toronto, Ontario
Export Division: 13 East 40th Street, New York 16, N. Y. Cable Address ARLAB

MARION STANDARD INSTRUMENTS

SERIES 52

Space saver, yet has superior damping characteristics. 2 1/2" JAN Spec. round case (52N). Also available in standard 2 1/2" square (Model 52S) or with narrow flange brass case for R.F. Shielding (Model 52RM). Dependable, extra strong — has well-aged Alnico magnet and heavy flanged construction. Popular for pocket test, portable radio, medical equipment and general electrical service where size and dependability count.



52N



52S



52RM

SERIES 53

Standard commercial 3 1/2" rectangular type (53SN). Also available in 3 1/2" JAN Spec., round case (53RN). All Alnico construction. Excellent scale distribution characteristics. Ideal for portable test equipment and general electronic equipment application.



53SN



53RN

SERIES 55



Large, 4 3/4" x 4 1/8". Gives real microamp readability on 100° scale. Alnico V magnets for sensitive range; heavy Alnico for standard ranges. Extreme accuracy assured. Designed for permanent and portable test equipment.

SERIES 56



New 6 1/2" x 5 1/4" bakelite cased meter. Easy reading at a distance. Large open face has 100° scale in 5 1/2" arc. Room for multirange scale if needed. Milliamp ranges are Alnico II constructed, Alnico V for microamps. Strong, accurate, efficient, dependable.

SERIES 57S



Superb milliammeter — more than a mere overgrown 3 inch. 8 1/2" x 7" open face, extra long scale. Enlarged pole shoes — higher torque movement — higher damping factor. Accurate within 1%. Used in large vacuum tube voltmeters, multimeters and production testing.

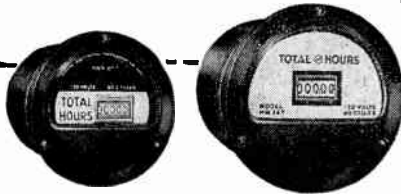

HM2ET 2 1/2"

HM3ET 3 1/2"

ELAPSED TIME INDICATORS

Two sizes, 2 1/2" and 3 1/2", standard JAN dimensions for panel mounting. Low temperature (—55°C) storing. Operating range —55°C to +85°C. True gloss-to-metal hermetic seal. Drown steel case provides magnetic shielding. Registers in 1/10 hour steps to 9999.9 or hour steps to 99999. Powered by a durable, self-storing synchronous motor. Available for 110-125, 220-250 volts, 50 or 60 cycle A.C.

RANGES—For The Models Illustrated

DC MICROAMPERES	DC MILLIAMPERES	DC AMPERES	DC MILLIVOLTS	DC VOLTS	AC VOLTS
0-20	0-1	0-250	0-15	0-1.5	0-5
0-30	0-1.5	0-250	0-25	0-3	0-15
0-50	0-3	0-800	0-50	0-5	0-50
0-100	0-5		0-100	0-10	0-150
0-200	0-10		0-10	0-15	0-250
0-500	0-15		0-15	0-25	0-500
0-800	0-25		0-25	0-50	
	0-50		Self-contained	0-150	
	0-100		Shunts	0-250	
	0-200			0-500	

AVAILABLE IN ZERO CENTER AND OTHER RANGES ON SPECIAL ORDER

marion meters

MANUFACTURERS OF MARION  ruggedized PANEL METERS

MARION ELECTRICAL INSTRUMENT CO., 401 CANAL ST., MANCHESTER, N. H.

marion meters

MANUFACTURERS OF MARION  *uggedized* PANEL METERS

In Canada: H. Roy Gray, 44 Danforth Road, Toronto, Ontario
Export Division: 13 East 40th Street, New York 16, N. Y. Cable Address ARLAB

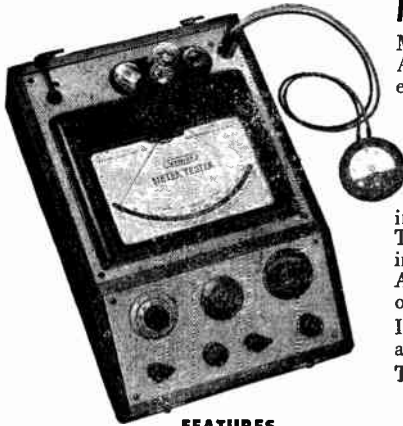

MARION MULTI-RANGE METER TESTER M-2

Marion Meter Tester (Model M-2) is the only instrument of its type available today. A laboratory and production tool for the measurement of the performance of DC electrical indicating instruments, it combines in one portable package an electronically regulated self-contained power supply, stepless vacuum tube voltage control, large 8½" mirror-scale individually hand-calibrated illuminated standard instrument, a decade of .1% accurate manganin wire wound resistors, a resistance bridge, null indicator and associated switches.

The Marion Meter Tester measures current sensitivity of electrical indicating instruments in 10 steps from 25 ua full scale to 10MA full scale and from 0-100v. The resistance measurement portion of the meter tester permits measuring of the internal resistance of the meter under test without exceeding its full scale rating. Accurate measurement of the internal resistance of sensitive microammeters and other instrument types is possible over the range of 0-5000 ohms.

It may also be used as a precise production limit-bridge in the same resistance range and will permit acceptance tolerances to be set for any value from ± ½ of 1% to ± 20%.

The Marion Meter Tester is a means of high speed production inspection and calibration of electrical indicating instruments as well as a versatile laboratory instrument to assist in the maintenance of high measuring standards.

The M-2 Model can also be used for additional purposes, such as a precise source of DC current and voltage and as a precision Wheatstone bridge in the 0-5000 ohm range.

FEATURES

- Regulated Power Supply
- Stepless Vacuum Tube Voltage Control
- Illuminated 8½" Mirror-Scale Standard Instrument, Hand Calibrated
- Marion Ruggedized Null Indicator movement for bridge balance indication
- Decade of .1% accurate Manganin Wire Wound Resistors
- Direct Reading Bridge Circuit using Helipot
- Complete. No accessories required

SPECIFICATIONS

ACCURACY: For current measurements Overall better than ¼ of 1%. For resistance measurements ± ½ ohm or ± ½ % whichever is greater.
RESISTANCE RANGE: 0-5000 ohms
POWER SOURCE: 115V AC 60 cycles
CASE SIZE: 15¼" x 10¼" x 5¼"
WEIGHT: 15 lbs.

Sensitivity Ranges

- 0-25UA
- 0-50UA
- 0-100UA
- 0-200UA
- 0-400UA
- 0-500UA
- 0-800UA
- 0-1MA
- 0-5MA
- 0-10MA
- 0-100 Volts

BUILD YOUR OWN TEST EQUIPMENT

with the **MARION MULTI-RANGER METER**
ACCURATE DURABLE DEPENDABLE
A GREAT VARIETY OF SIZES

When it comes to TEST EQUIPMENT build your own with Marion Multi-Ranger Meters. They will solve your problem of finding reasonably priced instruments with the critical accuracy you demand for test equipment or other auxiliary equipment with multiple functions.

These Multi-Ranger Meters permit you to assemble a highly accurate instrument for use as a voltmeter, milliammeter, high and low resistance ohmmeter, AC voltmeter and decibel meter. — Build As Many Ranges As You Desire.

All instruments use Alnico Magnets, have full 100° three-color scales, feature the new, tough Marion "Bulldozer" moving system that insures long life under severe operating conditions plus the highest degree of accuracy.

MARION RESISTOR KIT LOW-PRICED! VERSATILE!

Contains: 18 Resistors Ranging from .4 Ohms to 750,000 Ohms. A Schematic Diagram for Constructing Your Own Test Equipment. It's easy to construct accurate, useful, versatile test equipment with the Marion Resistor Kit, used in conjunction with Marion Multi-Ranger Instruments.
List \$13.75

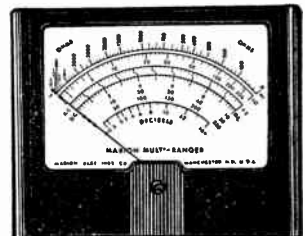

Model 56
List \$19.25

Model 57S
List \$22.00



Model 53SN
List \$13.20



Model 55
List \$16.50

SCALE RANGES POSSIBLE WITH STANDARD RESISTOR KIT

VOLTS AC-DC
0-10 Volts 0-50 Volts 0-250 Volts 0-1000 Volts
MILLIAMPERES
0-1 MA 0-10 MA 0-50 MA 0-500 MA
OHMS
0-500 Ohms 0-100 M 0-10 MEG 0-1 MEG
DECIBELS
-10 — +14 decibels +18 — +42 decibels
+4 — +28 decibels +30 — +54 decibels
ALSO AVAILABLE WITH VTVM SCALES

marion meters

MANUFACTURERS OF MARION  *uggedized* PANEL METERS

STERLING PANEL METERS



TYPE 80

Flush case, narrow flange, standard finish black enamel. Speed Nut Mounting. Diam. flange $2\frac{3}{8}$ ". Speed Diam. case 2". Depth case $\frac{3}{8}$ ". Requires hole $2\frac{1}{32}$ " in diam. Length terminals $\frac{1}{8}$ ".



TYPE 88

Flush case, narrow apron flange. Standard finish black enamel. Same dimensions as Type 80. Speed Nut Mounting.



TYPE 70

Flush case, wide flange, standard finish black enamel. Screw holes in flange for mounting. Diam. flange $2\frac{5}{8}$ ". Diam. case 2". Depth case $\frac{7}{8}$ ". Requires hole $2\frac{1}{32}$ " in diam.



STERLING'S NEW SPEED NUT CLAMP



REGULAR BACK CLAMP

ALTERNATING CURRENT METERS

A.C. VOLTMETERS

Number	Range	List Price
870	0-4 Volts	\$3.50
871	0-6 Volts	3.50
872	0-10 Volts	3.50
873	0-15 Volts	3.50
910	0-30 Volts	3.50
879	0-50 Volts	4.00
911	0-75 Volts	4.00
874	0-150 VHR†	5.25
912	0-250 Volts	5.75
875	0-300 Volts	6.00
913	0-500 Volts	7.00
876	0-600 Volts	7.00
877	0-750 Volts	8.50
878	0-10-140 Volts	5.25

†VHR—Volts High Resistance

A.C. MILLIAMMETERS

Number	Range	List Price
880	0-25 Milliampers	\$3.50
881	0-50 Milliampers	3.50
882	0-100 Milliampers	3.50
883	0-250 Milliampers	3.50
914	0-300 Milliampers	3.50
884	0-500 Milliampers	3.50

A.C. AMMETERS

Number	Range	List Price
886	0-1 Amperes	\$3.50
915	0-2 Amperes	3.50
887	0-3 Amperes	3.50
888	0-5 Amperes	3.50
916	0-7 1/2 Amperes	3.50
889	0-10 Amperes	3.50
917	0-15 Amperes	3.50
890	0-20 Amperes	3.75
918	0-25 Amperes	3.75
892	0-30 Amperes	3.75
891	0-60 Amperes	4.00
893	0-60 Amperes	4.25
894	0-75 Amperes	4.25
895	0-100 Amperes	4.25
919	0-125 Amperes	*

*Special Price on application.

DIRECT CURRENT METERS

D.C. VOLTMETERS

Number	Range	List Price
801	0-1 Volts	\$2.00
802	0-3 Volts	2.00
803	3-0-3 Volts	2.00
804	0-5 Volts	2.00
805	0-6 Volts	2.00
806	0-8 Volts	2.00
807	0-10 Volts	2.00
808	0-15 Volts	2.00
809	0-25 Volts	2.00
810	0-25 Volts High Res.	3.50
811	0-50 Volts	2.00
812	0-50 Volts High Res.	4.00
823	0-75 Volts	2.25
813	0-100 Volts	2.25
814	0-100 Volts High Res.	4.00
815	0-150 Volts	2.50
816	0-150 Volts High Res.	4.00
817	0-300 Volts	4.00
818	0-500 Volts	5.50
819	0-750 Volts	6.50
820	0-8-160 Volts	3.50

RESISTANCE METERS

Direct Reading

- 901.....4.5 Volts, 10,000 Ohms
3 Flashlight cells required
List Price \$3.50
- 902....2 M.A., 9 Volts, 100,000
Ohms, 6 Flashlight cells
required List Price \$5.00

D.C. MILLIAMMETERS

Number	Range	List Price
835	0-2 Milliamps.	\$4.50
836	0-5 Milliamps.	3.00
837	0-10 Milliamps.	2.50
838	0-15 Milliamps.	2.00
839	0-25 Milliamps.	2.00
840	0-50 Milliamps.	2.00
841	0-100 Milliamps.	2.00
842	0-150 Milliamps.	2.00
843	0-200 Milliamps.	2.00
844	0-300 Milliamps.	2.00
845	0-400 Milliamps.	2.00
846	0-20-100 Milliamps.	2.75
847	0-15-150 Milliamps.	2.75
848	0-500 Milliamps.	2.00

D.C. AMMETERS

Number	Range	List Price	Number	Range	List Price
855	0-1 Amperes	\$2.00	868	0-20 Amperes	\$2.25
859	1-0-1 Amperes	2.00	863	20-0-20 Amperes	2.00
856	0-3 Amperes	2.00	865	0-30 Amperes	2.50
860	3-0-3 Amperes	2.00	867	30-0-30 Amperes	2.50
857	0-5 Amperes	2.00	869	0-40 Amperes	3.25
861	6-0-6 Amperes	2.00	866	0-50 Amperes	3.25
858	0-10 Amperes	2.00	925	50-0-50 Amperes	3.50
862	10-0-10 Amperes	2.00	926	60-0-60 Amperes	3.50
864	0-15 Amperes	2.00	927	75-0-75 Amperes	3.75

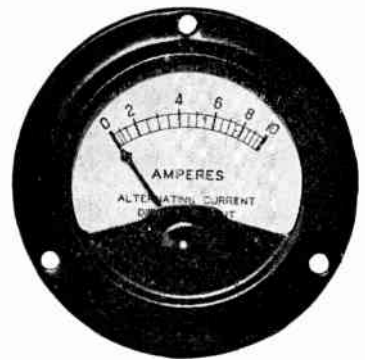

TYPE 78

Flush case, wide flange with apron. Standard finish black, screw holes in flange for mounting. Same dimensions as Type 70.



TYPE 68N

Flush case, square flange, standard finish black enamel. Screw holes in flange for mounting. Width flange $2\frac{5}{8}$ ". Diam. case $2\frac{1}{2}$ ". Depth case $\frac{3}{4}$ ".

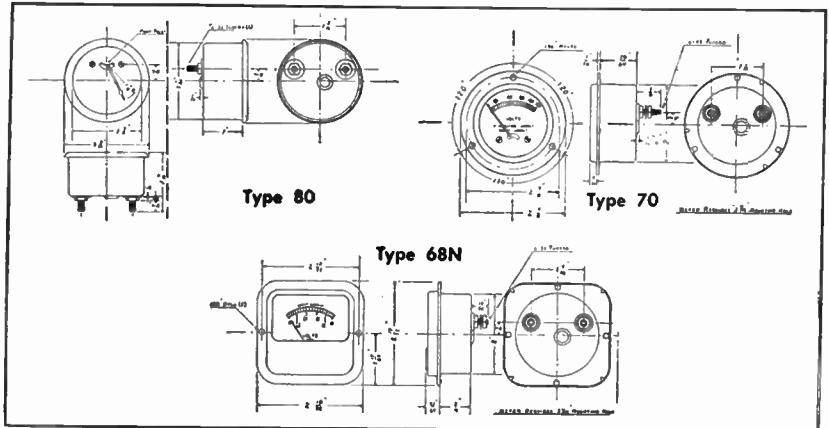

TYPE 70 PRICES LISTED

Note: Specify if for magnetic steel panel mounting.
Type 80, 88, 78, and 68N square flange case furnished for any range of meter at an additional list price of 25c each.

Sterling Hearing Aid Battery Testers



No. 31A

NO. 31A DOUBLE VOLTMETER—for special 30 or 45 v. "B" batteries and 1½ v. "A" batteries, scale 0-50 v. 1 v. div., scale 0-2 v. 1/10 v. divisions. Carefully engineered to impose the correct loads on the small delicate batteries used to operate vacuum tube hearing aids. Equipped with new STERLING flexible plugs. Price \$4.00

NO. 32A DOUBLE VOLTMETER—for special 30 v. "B" batteries and 1½ v. "A" batteries, scale 0-35 v. 1 v. div. scale 0-2 v. 1/10 v. divisions. Equipped with new STERLING flexible plugs. Price \$4.00

NO. 10 DUAL CONTACT PROD METER in pocket or desk model. Marked "A" at one contact and "B" at the other, the prod is simply inserted into the corresponding battery for quick and easy reading. No. 10 is for earlier type hearing aid batteries. Scale 50-0-50 v., 2 v. div. and 2-0-2 v., 1/10 v. div. No. 10 has one cord and one plug. Price \$4.75



No. 10

NO. 11 Formerly called the 10S this tester is used on 22½ v. and 30 v. "B" batteries. The load requirement is proportionately less than 1 mil. No. 11 has one cord and one plug. Price \$7.50

NO. 12 This new meter has no spur and a new voltage scale 30-0-30 v., 1 v. div. and 2-0-2 v., 1/10 v. div. Made extra sensitive for the latest type miniature batteries. Load: on 22½ v. batteries approx. 565 micro-amperes, on 15 v. batteries approx. 375 micro-amperes, on 1½ v. batteries approx. 40 mils. Price \$7.50

Sterling Pocket Meters

Standard Line Direct Current Pocket Ammeters, Voltmeters and Voltammeters.

Ammeters

LIST PRICE

- No. 23 for photo-flash dry batteries. 0-20 amp. scale, ½ amp. div. \$2.50
 No. 24 for testing No. 6 dry cells. 0-35 ampere scale, 1 ampere divisions \$2.25
 No. 24A for testing dry cells including the heavy-duty Ignition type of cell. 0-50 ampere scale, 1 ampere divisions \$2.30

Voltmeters

- No. 33 for ordinary single cells and "Flashlight" cells. 0-3 v. scale 1/10 v. div. \$2.30
 No. 34 for "Hot Shot" and Radio batteries. 0-10 volt scale, 1/5 volt. div. \$2.30
 No. 34A for 12 volt batteries. 0-16 volt scale, ½ volt divisions \$2.50
 No. 34B for ordinary 22½ v. radio "B" batteries. 0-30 v. scale, 1 v. divisions \$2.50
 No. 34C for testing ordinary 45 v. radio "B" batteries. 0-50 v. scale, 1 v. div. \$3.00

Voltammeters

- No. 44 for "Hot Shot" and Radio batteries and No. 6 dry cells, 0-35 ampere scale, 1 ampere divisions; 0-10 volt scale, 1/5 volt divisions \$2.75
 No. 44A for 12 volt batteries and No. 6 dry cells. 0-35 ampere scale, 1 ampere divisions; 0-16 volt scale, ½ volt divisions \$3.00
 No. 45 for testing No. 6 dry cells and ordinary 45 volt radio "B" batteries. 0-35 ampere scale, 1 ampere divisions; 0-50 volt scale; 1 volt divisions \$4.00
 No. 45A for testing dry cells including the heavy-duty Ignition type and ordinary 45 v. radio "B" batteries. 0-50 amp. scale, 1 amp. div.; 0-50 v. scale, 1 v. div. \$4.25

SPECIAL PURPOSE POCKET METERS

Voltmeters

- No. 37A for 45 v. "B" batteries and 1.5 "A" batteries. Scale 0-50 v., 1 v. div. Scale 0-2 v., 1/10 v. div. Tests 45 v. "B" and 1½ v. "A" batteries \$3.50
 No. 38A for 90 v. "B" batteries and 1.5 v. "A" batteries. Scale 0-100 v., 5 v. div. Scale 0-2 v., 1/10 v. div. Tests 45 v. and 90 v. "B" batteries and 1½ v. "A" batteries \$3.75
 No. 39A for 90 v. and 135 v. "B" batteries and 1.5 v. "A" batteries. Scale 0-150 v., 5-v. div. Scale 0-2 v., 1/10 v. div. Tests 90 v. and 135 v. "B" batteries and 1½ v. "A" batteries \$3.75
 No. 40A for 90 v. and 135 v. "B" batteries and 4.5 v., 6 v. and 7.5 v. "A" batteries. Scale 0-150 v., 5 v. div. Scale 0-10 v., 1/5 v. div. Tests 90 v. and 135 v. "B" batteries and 4½ v., 6 v. and 7½ v. "A" batteries \$4.00
 No. 42A Graphic General Tester. Red and Green color chart for all standard batteries including 45 v. and 90 v. "B" batteries and 1.5 v., 4.5 v., 6 v., and 7.5 v. "A" batteries. 0-100 v. scale for special sizes of "B" batteries, 5 v. div. Tests all Portable Radio batteries \$6.00

STANDARD LINE—Sterling's direct current pocket ammeters, voltmeters and voltammeters may be used in all kinds of battery testing, in railroad signal work, for photo flash purposes and in telephone and low-voltage electrical work generally. They are polarity indicators. Meters 2½" in diameter and ⅝" thick. Nickel finish. Standard package, ten instruments. Shipping Weight 4 lbs.



No. 42A GENERAL TESTER



No. 4 VOLTAMMETER



No. 23 AMMETER

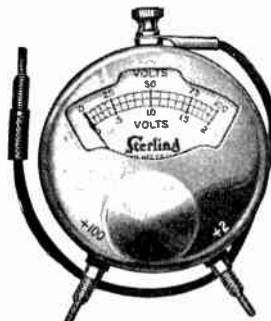

No. 38A VOLTMETER

Shurite PANEL METERS

Shurite panel meters are attractive, rugged, dependable instruments with accuracy well within 5%. All models have metal cases, telephone-black front; all require 2 $\frac{3}{8}$ " hole. DC meters are polarized-vane solenoid type, or moving-magnet construction when indicated, AC meters are double-vane repulsion type with jeweled bearing. Although the jewel construction costs more to build, it pays off by providing continuing accuracy during a longer useful life. All are guaranteed.

● **Guarantee:** All Shurite meters are guaranteed to users against defective workmanship and material, and will be repaired or replaced if sent to the factory postpaid with 40¢ handling charge within one year after date of purchase.

● **All-metal Dials**—age and moisture resistant, lithographed in black on white for high visibility.

● **Sturdy Design**—with husky new coil frames designed to prevent breakage, rigidly mounted in cases with anti-turning hex head studs. Interchangeable in other respects with a popular type of instrument formerly available.

● **Modern Appearance**—with concealed coils and new raised dial design, enhancing appearance and greatly increasing readability.

● **Wide Selection**—Shurite offers the broadest line of standard meters in the economy-priced field. Distributor stocks are backed by factory inventory, another reason why Shurite is first with distributors.

TYPICAL USES: Shurite products, with their rugged design, and ability to duplicate readings, enjoy wide acceptance in the electronic and electrical fields. Applications include transmitters, receivers, TV antenna rotator controls, battery indicators, appliances, power sources, battery eliminators, electric fence controllers, and the very popular basic meters in radio test kits.

Shurite products are also specified for battery voltage indicators on emergency lighting, burglar and fire alarm systems, output meters on rectifiers (copper oxide, tungar or selenium types), rate-of-charge indicators, testers for hearing aid batteries and their chargers, ammeters for plating sets, and polarity indicators for metals analysis.

Other uses range from automotive test equipment to pin-ball circuit testers, and well-depth indicators. Shurite has long been the favorite brand for those who take their hobbies and experiments seriously.

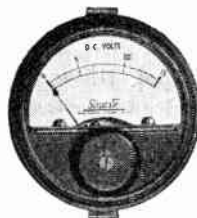

Model 550 DC
with Zero Adjuster

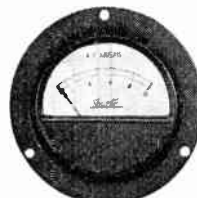

Model 650 AC (or DC)



Model 9300Z
Zero Adjuster Built In



Model 550 AC

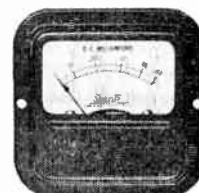

Model 950 DC (or AC)

DC MILLIAMMETERS

RANGE	RESIST.	MODEL 550*		MODEL 650*		MODEL 900	
		Approx. Ohms	Stock No. Net Each	Stock No. Net Each	Stock No. Net Each	Stock No. Net Each	
0-1**	1000	5300Z	\$3.20	6300Z	\$3.20	9300Z	\$3.25
0-3L**	500	5332Z	2.90	6332Z	2.90	9332Z	2.95
0-3	4800	5301	2.25	6301	2.25	9301	2.30
0-5	3475	5302	2.05	6302	2.05	9302	2.10
0-10	870	5303	1.95	6303	1.95	9303	2.00
0-15	485	5304	1.80	6304	1.80	9304	1.85
0-25	172	5305	1.55	6305	1.55	9305	1.60
0-50	46	5306	1.55	6306	1.55	9306	1.60
0-100	10.4	5307	1.55	6307	1.55	9307	1.60
0-150	4.7	5308	1.55	6308	1.55	9308	1.60
0-200	2.8	5309	1.55	6309	1.55	9309	1.60
0-300	1.5	5310	1.55	6310	1.55	9310	1.60
0-400	.46	5311	1.50	6311	1.50	9311	1.55
0-500	.30	5312	1.50	6312	1.50	9312	1.55

** Sensitive type, note internal resistance. Moving-magnet construction, patent pending. Price includes zero built-in adjuster.
* For zero adjusters add 35¢ to price and Z to stock number.
No zero adjuster on Model 950 stock models; except 9300Z and 9332Z.

AC MILLIAMMETERS

RANGE	RESIST.	MODEL 550		MODEL 650		MODEL 950	
		Approx. Ohms	Stock No. Net Each	Stock No. Net Each	Stock No. Net Each	Stock No. Net Each	
0-10	4800	5607	\$2.95	6607	\$2.95	9607	\$3.00
0-25	750	5601	2.65	6601	2.65	9601	2.70
0-50	150	5602	2.65	6602	2.65	9602	2.70
0-100	37	5603	2.65	6603	2.65	9603	2.70
0-250	5.4	5604	2.65	6604	2.65	9604	2.70
0-500	1.34	5605	2.65	6605	2.65	9605	2.70

DC AMMETERS

RANGE	RESIST.	MODEL 550*		MODEL 650*		MODEL 950	
		Approx. Ohms	Stock No. Net Each	Stock No. Net Each	Stock No. Net Each	Stock No. Net Each	
0-1	.105	5201	\$1.55	6201	\$1.55	9201	\$1.60
0-3	.02 Max	5202	1.55	6202	1.55	9202	1.60
0-5	.02 Max	5203	1.55	6203	1.55	9203	1.60
0-8	.02 Max	5204	1.55	6204	1.55	9204	1.60
0-10	.02 Max	5205	1.55	6205	1.55	9205	1.60
0-15	.02 Max	5206	1.65	6206	1.65	9206	1.70
0-25	.02 Max	5207	1.95	6207	1.95	9207	2.00
0-50	.02 Max	5208	2.25	6208	2.25	9208	2.30
3-0-3	.02 Max	5210	1.65	6210	1.65	9210	1.70
5-0-5	.022	5211	1.65	6211	1.65	9211	1.70
6-0-6	.02 Max	5212	1.65	6212	1.65	9212	1.70
10-0-10	.02 Max	5213	1.80	6213	1.80	9213	1.85
20-0-20	.02 Max	5214	1.85	6214	1.85	9214	1.90
30-0-30	.02 Max	5215	1.95	6215	1.95	9215	2.00
50-0-50	.02 Max	5216	2.10	6216	2.10	9216	2.15

* For zero adjuster, add 35¢ to price and Z to stock number.
No zero adjuster on Model 950 stock models.

Prices NET, F.O.B. New Haven, Conn., domestic packing, effective May 1, 1954. Subject to change without notice. Printed in U. S. A.

AC AMMETERS

RANGE	RESIST.	MODEL 550		MODEL 650		MODEL 950	
		Stock No.	Net Each	Stock No.	Net Each	Stock No.	Net Each
0-1	.42 Max	5501	\$2.65	6501	\$2.65	9501	\$2.70
0-3	.072 Max	5502	2.65	6502	2.65	9502	2.70
0-5	.041 Max	5503	2.65	6503	2.65	9503	2.70
0-10	.02 Max	5504	2.65	6504	2.65	9504	2.70
0-15	.02 Max	5508	2.65	6508	2.65	9508	2.70
0-20	.02 Max	5505	2.95	6505	2.95	9505	3.00
0-50	.02 Max	5506	3.15	6506	3.15	9506	3.20

DC VOLTMETERS

RANGE	RESIST.	MODEL 550*		MODEL 650*		MODEL 950	
		Stock No.	Net Each	Stock No.	Net Each	Stock No.	Net Each
0-1	10	5101	\$1.50	6101	\$1.50	9101	\$1.55
0-3	98	5102	1.55	6102	1.55	9102	1.60
3-9-3	250	5103	1.55	6103	1.55	9103	1.60
0-5	300	5104	1.55	6104	1.55	9104	1.60
0-6	390	5105	1.55	6105	1.55	9105	1.60
0-8	600	5106	1.55	6106	1.55	9106	1.60
0-10	880	5107	1.60	6107	1.60	9107	1.65
0-15	2370	5108	1.70	6108	1.70	9108	1.75
0-20	3500	5121	1.70	6121	1.70	9121	1.75
0-25	1240	5109	1.75	6109	1.75	9109	1.80
0-25H**	5800	5110	2.40	6110	2.40	9110	2.45
0-50	2540	5122	1.85	6122	1.85	9122	1.90
0-50H**	11800	5111	2.55	6111	2.55	9111	2.60
0-75	3740	5112	1.90	6112	1.90	9112	1.95
0-100	5140	5113	2.00	6113	2.00	9113	2.05
0-100H**	23800	5114	2.70	6114	2.70	9114	2.75
0-150	7540	5115	2.10	6115	2.10	9115	2.15
0-150H**	34800	5116	2.80	6116	2.80	9116	2.85
0-300H**†	74800	5117	3.05	6117	3.05	9117	3.10
0-500H**†	124800	5118	4.00	6118	4.00	9118	4.05
0-750H**†	184800	5119	4.75	6119	4.75	9119	4.80

* For zero adjuster, add 35c to price and Z to stock number.

** No zero adjuster on No. 950 stock models.

† H denotes high resistance.

‡ Supplied with external resistors.

AC VOLTMETERS

RANGE	RESIST.	MODEL 550		MODEL 650		MODEL 950	
		Stock No.	Net Each	Stock No.	Net Each	Stock No.	Net Each
0-4	11	5401	\$2.65	6401	\$2.65	9401	\$2.70
0-6	15.8	5402	2.65	6402	2.65	9402	2.70
0-10	27	5403	2.65	6403	2.65	9403	2.70
0-15	32.3	5404	2.65	6404	2.65	9404	2.70
0-50	96	5405	3.15	6405	3.15	9405	3.20
0-150	135	5406	3.40	6406	3.40	9406	3.45
0-300*	100	5407	3.80	6407	3.80	9407	3.85
0-600*	100	5408	4.80	6408	4.80	9408	4.85
0-750*	100	5409	5.40	6409	5.40	9409	5.45

* Supplied with external resistors.

RESISTANCE METERS

RANGE	Volts	MODEL 550*		MODEL 650*		MODEL 950	
		Stock No.	Net Each	Stock No.	Net Each	Stock No.	Net Each
10,000	4.5**	5701	\$2.10	6701	\$2.10	9701	\$2.15

* For zero adjuster add 35c to price and Z to stock number.

** No zero adjuster on No. 950 stock models.

† Requires 3 flashlight cells for resistance readings but does not require resistor for voltage readings.

POCKET TYPE METERS



Model 450

Various Shurite pocket meters using the bright-plated Model 450 case are in production. Stock numbers begin with 4 as the first digit. For example, the 0-3 DC Ammeter, as illustrated, is Stock No. 4202. The bulletin, "Shurite Pocket Types," available on request, is periodically revised to indicate pocket meters which are available.

(PRICES SHOWN ARE U.S.A. DEALER NET FOR INDIVIDUALLY BOXED METERS)

SHURITE METERS

NEW HAVEN 8, CONNECTICUT

Prices NET, F.O.B. New Haven, Conn., domestic packing, effective May 1, 1954. Subject to change without notice. Printed in U. S. A.

Copyright by U. C. P., Inc.

Net

Radio's Master — 19th Edition

Page G-47

FLANGE ADAPTER RING

A sturdy flange ring for use with any Model 550 (round) Shurite meter where flange appearance is preferred. Meter then looks like Model 650. Wide flange, 2 3/4" dia. to be attached from front of panel. Telephone black finish. Screws, lockwashers and nuts included.

Model 5-A, Net.....\$0.18

MOUNTING DETAILS

All Shurite Panel Meters have flush cases and require 2 3/2" hole. Most standard ranges have 6-32 studs, and are mounted as follows:

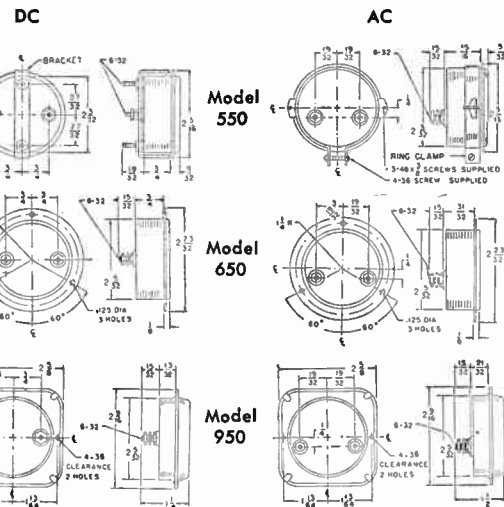

IMPORTANT—HOW TO ORDER:

For all standard models, give: (1) Model Number, (2) Range, (3) Stock Number. If Model number and stock number are not stated, Model 550 will be supplied.

ZERO ADJUSTERS (Z)

Zero adjusters are available only on Models 550-DC and 650-DC. No zero adjuster on models using 950 case, except as supplied on No. 9300Z and 9332Z. When ordering, add Z to stock number. Example: Stock number for Model 550-DC voltmeter, 0-1 volt range—without zero adjuster is 5101. With zero adjuster, it is 5101Z.

PANEL CALIBRATION (S)

Meters are calibrated for non-magnetic panels. If for magnetic (steel) panel mounting, specify thickness and overall size of panel, and add -S to stock number when ordering, as 5101-S. If thickness of steel panel is not specified, meter will be supplied for .040 panel.

VISCOSITY DAMPING (V)

Careful application of new silicone compound on bearing surfaces damps pointer overtravel. Add V to stock number, as 5406V, and 5 cents to price. Not regularly stocked; available only on quantity order.

SEE YOUR DISTRIBUTOR

Besides carrying most types, and being able to obtain your other needs promptly, your authorized Shurite distributor of electronic parts is qualified to suggest the right meter for your need.



AERO Instrument Company

NORTH HOLLYWOOD, CALIFORNIA

VIBRATING REED FREQUENCY & TIMING INSTRUMENTS

GENERAL DESCRIPTION

Vibrating Reed Instruments are direct reading frequency indicators for use where the efficient operation of A.C. equipment depends upon the maintenance of known or constant frequency. They are self contained, their accuracy is not affected by wide voltage variations or wave form distortions and require no auxiliary apparatus. They consist of a number of steel reeds, of high Q, each of which is tuned to a single frequency within the band covered by the instrument. Indication is by visual pattern formed by the vibration of the reed in resonance with the line frequency. Excitation is electromagnetic, and the reeds are the only moving elements. **Running Time Meters** are synchronous motor operated instruments to automatically measure service periods or service requirements.

APPLICATIONS

A large demand exists for **VIBRATING REED FREQUENCY METERS** for use with engine driven A.C. generator units as this is the most simple speed and frequency indicator yet devised for A.C. generator sets. These meters are also generally used in laboratory and portable test equipment, electronics, telephony, aircraft, industrial plants and numerous applications where electrical frequency indication is desired. Engineering services are available for those desiring assistance on their application problems. **Running Time Meters** are often used in conjunction with reed type frequency meters.



MODEL 7002

Range: 48-52 and 58-62 cycles for reading in either 50 or 60 cycles. **Voltage:** 125 volts ± 20 volts. **Accuracy:** $\pm 0.3\%$ of designated frequency. **Power Consumption:** 1 watt. **Resistance:** Approximately 100 ohms per volt. Flush panel mounting.

- 7002—48-52 and 58-62 cy. in 3 1/2" flange MIL-M-6A molded bakelite case \$25.00
- 7002-3M—48-52 and 58-62 cy. in 3 1/2" flange metal case 25.00
- 7002-M—48-52 and 58-62 cy in 3 1/4" flange metal case..... 25.00
- 7002-2M—48-52 and 58-62 cy. in 2 1/2" flange metal case 25.00

MODEL 1001

Direct reading indicators to automatically and cumulatively register total operating or idle time of any equipment, machine, circuit or system to which they are connected. **Range:** 0 to 10,000 hours in hours and tenths of hours—automatically resets. **Voltage:** 125 ± 20 volts. **Power consumption:** 2.5 watts. **Frequency:** 50, 60 and 400 cycles.



- 1001—50 or 60 cy. in 3 1/2" flange MIL-M-6A molded bakelite case. \$13.00
- 4001—400 cy.....Price upon request

3 1/2" SEALED METER

Meets all applicable requirements of MIL-M-6A Specification. All 3 1/2" meters can be supplied in hermetically sealed cases. **Electrical characteristics:** Same as unsealed instruments.



Prices on all models available upon request.

1 1/2" SEALED METER

Range: 380-420 cycles. For use in air borne or ground equipment where size and weight are important factors. **Voltage:** 125 ± 20 volts. **Resistance:** Approximately 70 ohms per volt. **Accuracy:** $\pm 0.2\%$ at 70° F. or 1.5% over range of -65° to +165° F. **Break-down voltage:** 1500 volts. **Power consumption:** Approximately 1.25 watts.



- 4005—380-420 cy. in 1 1/2" hermetically sealed case.....\$23.85

MODEL 7004

Range: 59-63 cycles. Used extensively on standby power supplies for measuring generator frequency and engine speeds. **Electrical characteristics:** Same as the Model 7002.

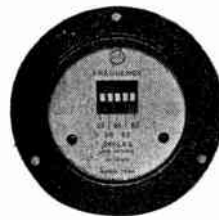

- 7004—59-63 cy. in 3 1/2" flange MIL-M-6A molded bakelite case...\$21.50
- 7004-3M—59-63 cy. in 3 1/2" flange metal case\$21.50
- 7004-M—59-63 cy. in 3 1/4" flange metal case\$21.50
- 7004-2M—59-63 cy. in 2 1/2" flange metal case\$21.50

MODEL 4009

Range: 380-420 cycles. For use on 400 cycle commercial power supplies and aircraft inverters. **Accuracy:** $\pm 0.2\%$ at 70° F. **Power consumption:** Approximately 1.25 watts. **Resistance:** Approximately 70 ohms per volt. Flush panel mounting.



- 4009—380-420 cy. in 3 1/2" flange MIL-M-6A molded bakelite case \$31.00
- 4009-3M—380-420 cy. in 3 1/2" flange metal case\$31.00
- 4009-M—380-420 cy. in 3 1/4" flange metal case\$31.00
- 4009-2M—380-420 cy. in 2 1/2" flange metal case\$31.00

VOLTAGES—All frequency meters can be supplied for voltages from 10 to 440 volts.

DISCOUNTS—Quantity prices quoted upon request.

SPECIAL INSTRUMENTS—Prices on special ranges will be furnished upon request.

RUNNING TIME METERS—Special ranges, frequencies and voltages available.

Write for catalog describing complete line of Aero stock instruments.

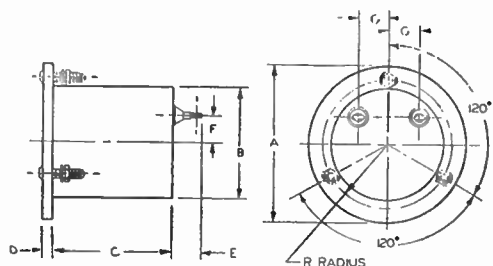

TABLE I

CASE SIZE CHART

CASE STYLE	A		B		C		D		E		F		G		MOUNTING SCREWS
	MAX	MIN	MAX	MIN	MAX	MIN	MAX	MIN	MAX	MIN	MAX	MIN	MAX	MIN	
A	2.10	1.51	1.56	0.14	2.40	.41	.33	.41	.33	.41	.33	.41	.33	.41	6-30PH-2A

Model 4005
Range 380 to 420 C.P.S. Hermetically Sealed.

WESTON INSTRUMENTS



Round Style

PANEL INSTRUMENTS

These panel instruments reflect half a century of instrument skill, and the Weston tradition of building instruments to the highest standards of dependability and service.

Models 301, 425 and 476 are available in round flush bakelite cases $3\frac{1}{2}$ " or $3\frac{3}{8}$ ", and $3\frac{1}{4}$ " metal cases with black finish; also in round surface metal and rectangular flush bakelite cases. Models 301 and 425 supplied in round surface bakelite cases. Models 506, 507, 517 regularly supplied in round flush $2\frac{1}{2}$ " bakelite and black finished metal cases; flush narrow flange metal and rectangular flush bakelite cases with a clamp for panel mounting. Model 506 available in surface metal case. All are calibrated normally for use on non-magnetic panels. For magnetic panel use, instruments will be adjusted for steel panel thickness of .09". Order instruments in bakelite cases for use on circuits above 300 volts when it is not possible to connect in grounded side of line. For other instrument prices, write to Weston Electrical Instrument Corporation, Newark 5, New Jersey.



Rectangular Style

$3\frac{1}{2}$ " PANEL INSTRUMENTS

MODEL 301 — D-C VOLTMETERS

Approximate resistance of Model 301 in ohms per volt — 1 to 30 volts, 62; 50 to 150 volts, 200; 200 volts, 250.

Range	Price	Range	Price	Range	Price
3	\$14.25	15	\$14.25	150	\$15.75
5	14.25	30	14.25	200	16.50
8	14.25	50	14.25		
10	14.25	100	15.00		

With Resistance of 1,000 ohms per volt

Range	Price	Range	Price	Range	Price
50	\$15.00	300	\$18.75	1.5KV	\$44.25*
100	15.75	500	23.25	2 KV	49.25*
200	17.25	1KV	30.75	3 KV	59.25*

* Supplied with external resistor.

MODEL 301 — D-C MILLIAMMETERS *

Range	Approx. Res. Ohms	Price	Range	Approx. Res. Ohms	Price
1	105	\$14.25	30	1.2	\$14.25
1.5	27	14.25	50	2.0	14.25
2	27	14.25	100	1.0	14.25
5	5.7	14.25	150	0.66	14.25
10	2.0	14.25	200	0.5	14.25
15	2.0	14.25	300	0.33	14.25
20	2.0	14.25	500	0.2	14.25

* Milliammeters with ranges above 40 MA. are shunted, and have a drop of approximately 100 MV.

MODEL 301 — D-C AMMETERS *

Single Ranges: 1/1.5/2/3/5/10/15/30/50 at \$14.25

* Ammeters are supplied in self-contained ranges up to 50 amperes inclusive, and have a drop of 50 MV $\pm 5\%$. Ranges above 50 amperes require external shunts.

MODEL 301 — D-C MICROAMMETERS

Range	Price	Range	Price
20	\$30.00	100	\$27.00
30	30.00	200	18.00
50	28.25	500	18.00

MODEL 301 — RECTIFIER TYPE A-C VOLTMETERS

1000 ohms 2000 ohms		1000 ohms 2000 ohms	
Range	Price	Range	Price
1	50	\$22.50
1.5	100	23.25
3	\$22.50	150	24.00
5	22.50	200	25.50
15	22.50	300	26.25

MODEL 301 — RECTIFIER TYPE A-C MILLIAMMETERS

Range	Price	Range	Price
0.5	\$25.50	2	\$21.75
1	21.75	5	21.75

MODEL 301 — RECTIFIER TYPE A-C MICROAMMETERS

Range	Price	Range	Price
100	\$34.50	250	\$25.50
200	25.50	500	25.50

MODEL 301 VU METER

A OR B SCALE Price \$35.00

MODEL 476 — A-C AMMETERS

Single Ranges: 1/1.5/2/3/5/10/15/30/50 at \$14.25

MODEL 476 — A-C VOLTMETERS

Single Ranges: 1.5/3/5/8/10/15/30/50 at \$14.25

Range	Price	Range	Price
100	\$15.00	250	\$17.25
130	15.75	300	18.00
150	15.75	500	21.00

MODEL 425 — THERMOCOUPLE TYPE AMMETERS

Single Ranges: 1/1.5/2/3/5/8/10/15/20 at \$21.00

MODEL 425 — THERMO MILLIAMMETERS

Ranges: 10/20/50	\$52.50
100/115/120/150/200/300/500	\$24.00

$2\frac{1}{2}$ " PANEL INSTRUMENTS

MODEL 506 — D-C VOLTMETERS

Approximate resistance of Model 506 in ohms per volt: 3 to 150 volts, 125; 300 volts, 1000.

Range	Price	Range	Price	Range	Price
3	\$11.25	10	\$11.25	100	\$12.00
5	11.25	15	11.25	150	12.75
8	11.25	50	11.25	300	15.75

MODEL 506 — D-C AMMETERS

Single Ranges: 1/1.5/3/5/10/15/30/50 at \$11.25

Ammeters, self-contained up to 50 amps., inclusive—drop 50 MV $\pm 5\%$

MODEL 506 — D-C MILLIAMMETERS

Range	Approx. Resis.	Price	Range	Approx. Resis.	Price
1	105	\$11.25	30	1.2	\$11.25
1.5	18	11.25	50	1	11.25
2	18	11.25	100	.5	11.25
3	18	11.25	150	.33	11.25
5	9.5	11.25	200	.25	11.25
10	3.2	11.25	300	.16	11.25
15	1.5	11.25	500	.1	11.25

Milliammeters above 40 MA are shunted — drop approximately 50 MV.

MODEL 507 — THERMO AMMETERS

For use on any frequency including radio frequency.
Single Ranges: 1/1.5/2/5/8/15/20 at \$18.00

MODEL 517 — A-C AMMETERS

Approx. Resis.			Approx. Resis.		
Range	In ohms	Price	Range	In ohms	Price
1	.22	\$13.50	20	.0012	\$13.50
3	.024	13.50	30	.0085	13.50
5	.010	13.50	50	.00072	13.50
10	.0037	13.50			

MODEL 517 — A-C VOLTMETERS

Approx. Ohms			Approx. Ohms		
Range	per volt	Price	Range	per volt	Price
5	10	\$13.50	50	52	\$13.50
10	14	13.50	130	110	15.00
15	14	13.50	150	110	15.00
25	26	13.50	250	167	16.50
			300	167	17.25

SUBJECT TO PRICE CHANGE OR WITHDRAWAL WITHOUT NOTICE

WESTON INSTRUMENTS

4 1/4" PANEL INSTRUMENTS

MODEL 961—D-C INSTRUMENTS

Rated accuracy 2% of full scale—Scale 3.17" (80.3 mm)—Permanent Magnet Moving Coil Type.

D-C VOLTMETERS

Range	Scale Div.	Price
1	50	\$21.75
2	40	21.75
3	60	21.75
5	50	21.75
7.5	75	21.75
10	50	21.75
15	75	21.75
25	50	21.75
50	50	21.75
80	40	21.75
100	50	22.50
130	65	23.25
150	75	23.25
200	40	24.00
250	50	25.50
300	60	26.25
500	50	29.25

Self-contained ranges listed have sensitivity of approximately 200 ohms per volt up to and including 200 volts; higher ranges are 1000 ohms per volt.

D-C MILLIAMMETERS

Range	Scale Div.	Approx. Res.	Price
1	50	80	\$21.75
.3	60	7.3	21.75
5	50	2.8	21.75
10	50	1.25	21.75
25	50	1.0	21.75
50	50	2	21.75
100	50	1	21.75
200	40	0.5	21.75
300	60	0.33	21.75
500	50	0.2	21.75

Ranges above 25 milliamperes are shunted and have a drop of approximately 100 millivolts.

MATCHED A-C AND D-C PORTABLE INSTRUMENTS

MODEL 433—A-C INSTRUMENTS

Scale Length 4.04"—Accuracy within 3/4 of 1% — Movable Iron Type — Shielded Case Size 5-1/16" x 5 1/4" x 3 1/4" — Weight 2 1/2 lbs. — Hand Calibrated Mirror Scales — Bakelite Case with Carrying Strap. Note: These instruments are calibrated for use in a horizontal position.

A-C VOLTMETERS

Made with single, double and triple ranges. For use on frequencies from 25 to 125 cycles.

Range	Net Price
10, 30, 50, 75	\$64.00
10/5, 20/10, 30/15	71.50
450/300/150	93.25
600/300/150	95.50
750/300/150	97.75

A-C MILLIAMMETERS

Made in single and double ranges only, for use on frequencies from 25 to 500 cycles.

Range	Net Price
15, 30, 75, 500	\$62.50
300/150	77.50

A-C AMMETERS

Made in single, double and triple ranges for use on frequencies from 25 to 500 cycles. All instruments have two binding posts; double and triple range instruments are provided with a range selector switch.

Range	Net Price
1, 1.5, 2, 3	\$ 62.50
15, 25, 30	68.50
77.50	77.50
2/1, 5/2.5, 10/5	77.50
3/1.5/0.75, 5/2.5/1, 10/5/1	122.50
20/5/2, 30/7.5/3, 50/20/5	128.50

D-C AMMETERS

Range	Scale Div.	Price	Range	Scale Div.	Price
1	50	\$21.75	5	50	\$21.75
1.5	75	21.75	10	50	21.75
2	40	21.75	25	50	21.75
3	60	21.75	50	50	21.75

Regularly supplied with self-contained shunts up to and including 50 amperes, but can be supplied with external 50 mv shunts and 5 foot (0.065 ohm) leads.

D-C MICROAMMETERS

Range	Scale Div.	Approx. Res. Ohms	Price
30	60	1800	\$37.50
50	50	720	35.75
75	75	450	35.75
100	50	250	34.50
200	40	400	25.50
300	60	175	25.50
500	50	80	25.50

MODEL 963—THERMO AMMETERS

Rated accuracy 2% of full scale . . . Scale 3.17" . . . Thermocouple type.

POWER CONSUMPTION: 1 to 4 amperes incl. varies from 0.2 to 0.4 watt per ampere. Approx. 5 amperes and above—0.2 watt per ampere.

Frequency errors less than 2% up to 65 megacycles.

Amps.	Scale Div.	Price	Amps.	Scale Div.	Price
1	50	\$28.50	5	50	\$28.50
1.5	75	28.50	6	60	28.50
2	40	28.50	8	40	28.50
2.5	50	28.50	10	50	28.50
3	60	28.50	15	75	28.50
4	40	28.50	20	40	28.50

The ranges are all self-contained.

Through the use of specially controlled characteristics, thermo ammeters can be supplied to meet the special requirements of the FCC for antenna ammeters.

MODEL 931—D-C INSTRUMENTS

Scale Length 4.04"—Accuracy within 1/2 of 1% Core Magnet Moving Coil Type. Case Size 5-1/16" x 5 1/4" x 3 1/4" — Weight 2 lbs. — Hand Calibrated Mirror Scales — Bakelite Case with Carrying Strap. Note: These instruments are calibrated for use in a horizontal position.

D-C VOLTMETERS

Range	Net Price	Net Price
	1,000 Ohms	5,000 Ohms
	Per Volt	Per Volt
3, 15, 50	\$73.00	\$ 88.00
300/150/3	91.00	106.00
750/300/150	97.75	112.75

D-C AMMETERS

Range	Net Price
1, 1.5, 3, 5	\$76.00
30/15/3	91.00
50/20/5	91.00

Self-contained up to 50 amperes inclusive, but can be supplied with external 50 mv shunts and 5 ft. leads.

D-C MILLIAMMETERS

Range	Net Price
15, 150	\$71.50
1500/150/15	91.00
15/1.5/15	95.50

Single range Milliammeters with ranges above 30 ma are shunted and have a drop of 50 mv ±5%.

D-C MICROAMMETERS

Range	High Resistance		Low Resistance	
	Approx. Res. Ohms	Net Price	Approx. Res. Ohms	Net Price
30	2300	\$95.50	490	\$103.00
100	2000	88.00	60	95.50
200	600	80.50	15	88.00

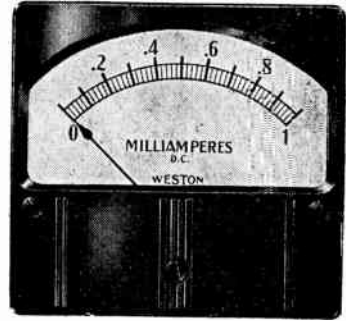

MODEL 961

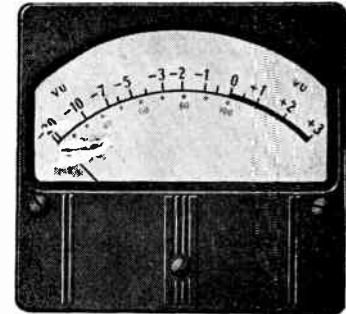

MODEL 962—TYPE 30 VU METERS

Model 962 VU Meters are available with a choice of two scales. Type A stresses the level in VU and is used largely in monitoring wire lines. Type B emphasizes per cent use of transmitter output and is the standard for broadcast service. Scale backgrounds are buff colored.

Scale A or B Model 962—\$42.50

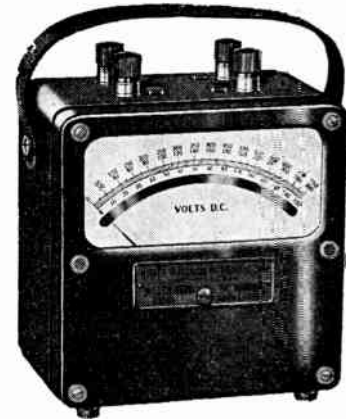

MODEL 432—D-C AND

SINGLE PHASE A-C WATTMETERS

Double voltage and single or double current ranges, self-contained up to 300 volts and 50 amperes, frequencies from 25 to 125 cycles.

Electrodynamometer Type		
Accuracy 1/2 of 1%	Scale Length 4.04"	
Case Size 5 1/4" x 5 1/4" x 3 1/4"	Wt. 3 1/4 lbs.	
Normal Volts	Normal Amps	Net Price
150/75	1	\$124.75
Double Current Ranges		
300/150	5/2.5	145.75

WESTON INSTRUMENTS

MODEL 785 INDUSTRIAL CIRCUIT TESTER

Established in industry as the most complete single unit for general maintenance and ultra-sensitive test purposes, particularly an electronic equipment. Provides 28 ranges for measuring D-C voltage and current; A-C voltage and current; and resistance.

Current and voltage ranges can be extended and insulation tested by the use of accessories. Current and potential leads can be connected at the same time for instantaneous current and voltage readings.

RANGES

D-C Volts: (Full scale) 1/10/50/200/500/1000 Volts (20,000 Ohms per volt), 100 Millivolts direct or with external shunts. Accurate within 2% to 500 V.; 3% at 1000 V.

A-C Volts: (Full scale) 5/15/30/150/300/750 Volts (1000 Ohms per volt). Accurate within 3%.

D-C Current: (Full scale) 50 Microamps; 1/10/100 Milliamps; 1/10 Amps. Accurate within 2%. Higher ranges with 100 mv. external shunts.

A-C Current: (Full scale) .5/1/5/10 Amperes. Accurate within 3% on 60 cycles. Higher ranges with external current transformers.

Resistance: (Full scale) 3,000/30,000/300,000 Ohms; 3/30 Megohms. (Center scale) 25/250/2,500/25,000/250,000 Ohms. Accurate within 2% of linear arc length on any ohmmeter range.

Size: 13" x 12 1/2" x 5 1/2".
Weight (complete) 13 1/2 lbs.

Model 785 (Oak carrying case) \$157.50 Net
Model 785 (Steel case) 127.50 Net

MODEL 785 ACCESSORIES

Model 792 Insulation Tester — for insulation and cable resistance measurements to 900 megohms at a test potential of 500 volts. Operates from any 100-130 volt, 50 to 60 cycle line. **\$37.50 Net**

Model 604 Current Transformer — inserted primary type used to increase A-C current. Type 1, accurate within 1% on frequencies from 25 to 125 cycles, capacity 2 volt-amperes. Type 2, accurate within 1% on frequencies from 50-125 cycles, capacity 5 volt-amperes. Ratios include 200:5, 300:5, 400:5, 500:5.

Type 1(200:5, 300:5) \$18.00 Net;
(400:5, 500:5) \$16.50 Net
Type 2(200:5) \$30.00 Net;
(400:5, 500:5) \$28.50 Net

100 MV External Shunt — used for extending D-C current ranges of Model 785 beyond 10 amperes.

Price50 or 100 amp., \$12.75;
250 amp., \$14.00;
500 amp., \$24.00 Net

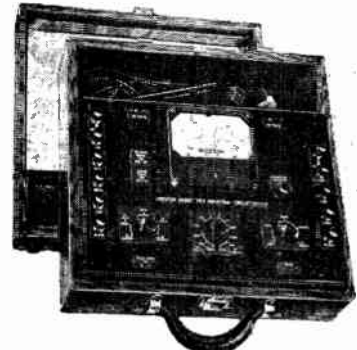

MODEL 785

WESTON POCKET-SIZE TESTERS Model 697 Volt-Ohm-Milliammeter



MODEL 697

SPECIFICATIONS —

Accurate within 2% D-C
5% A-C
Scale: 2.36"
Ranges: 0-7.5/15/150/750 a-c
and d-c (1000 ohms per volt)
Current: 0-7.5/75 milliamperes
d-c
Resistance: Full scale 5,000/
500,000 ohms. Center scale
35/3500 ohms
Size: 5-9/16" x 3 3/4" x 3-9/16"
Approx. Wt.: 1 3/4 lbs.

Model 697 (Incl. Test Leads) **\$49.50 Net**

Model 564 Volt-Ohmmeter

SPECIFICATIONS — Accurate within 2%
Scale: 2.36"
Ranges: 3/30/300/600 volts d-c (1000 ohms per volt)
Resistance: Full scale — 1,000/10,000/100,000/
1,000,000 ohms
Size: 5-33/64" x 3-45/64" x 2-9/16"
Approx. Wt.: 1 3/4 lbs.
Model 564, Type 3-C (Incl. Test Leads) **\$54.00 Net**

Model 689 Ohmmeters

SPECIFICATIONS — Accurate within 2%
Scale: 2.36"
Ranges: Type 1-E — double range 0-5,000 and
50,000 ohms-full scale.
Type 1-F — double range 0-10 and 0-1,000
ohms-full scale.
Size: 5" x 2 7/8" x 1 7/8". Approx. Wt.: 1 lb.
Model 689, Type 1-E (Incl. Test Leads) **\$27.00 Net**
Model 689, Type 1-F (Incl. Test Leads) **\$25.50 Net**

Model 633 Clamp Volt-Ammeter and Clamp-Ammeter



MODEL 633 Type VA-1

Net Price
Model 633 Type VA-1 (Incl. Potential Leads) — 1000/250/
100/25/10 amperes a-c 700/350/175 volts a-c **\$ 95.00**
Model 633 Type A-1 — 500/250/100/50/25/10 amperes a-c **\$ 87.00**
Model 633 Type A-2 — 1000/500/250/100/25/10 amperes a-c **\$ 87.00**
Model 633 Type A-3 — 2000/1000/500/250/100/50 amperes
a-c **\$ 95.00**
Model 9958, 50 Foot Extension Cable, Plug & Receptacle for
Model 633 Types A-1, A-2, A-3 **\$ 72.00**
Leather Carrying Case (Model 633 Types VA-1, A-1, A-2, A-3) **\$ 13.50**
Leather Carrying Case (Model 9958 — Cable, Plug and Re-
ceptacle) **\$ 22.50**

— NOTE —

Model 633 instruments may be used for continuous duty up to 500 amperes.

Approximate Dimensions and Weights

Model 633 Types VA-1, A-1, A-2, A-3 13 5/8" x 4 3/8" x 2 1/2" 3 1/4 lbs.
Leather Carrying Case (Types VA-1, A-1, A-2, A-3) 14 1/2" x 5 1/2" x 3 5/8"
2 1/4 lbs.
Model 9958, 50 Foot Extension Cable, Plug & Receptacle 4 1/4 lbs.
Leather Carrying Case (Model 9958 — Cable, Plug & Receptacle)
14" x 8 1/2" x 3 3/4" 4 1/4 lbs.

Prices Subject To Change Without Notice.

980 LINE WESTON TEST EQUIPMENT

MODEL 980 LINE — WESTON TEST EQUIPMENT

A New Simplified Approach to TV Alignment

The Weston Model 980 line provides servicemen with the most advanced, and by far the most simple and accurate method of TV receiver alignment. It comprises all of the instruments necessary for all-purpose observation of complex wave forms by the electronic industry.

With the Weston method, the output of the sweep generator is fed into the calibrator making it unnecessary to connect the calibrator to the TV set. Only two connections are necessary. This eliminates receiver oscillations ordinarily encountered with the conventional method of receiver test hook-up. Further, there is no disappearance of markers at trap resonant frequencies. Response curve is not disturbed. Annoying trimmer touch-up on trap circuits is minimized.

This simplified technique is only possible when the companion instruments — Weston Calibrator and Sweep Generator — are used with a scope having provisions for Z-axis intensity modulation. However, individual instruments in the Model 980 line can be used with available test equipment in the conventional method of alignment.

SEND FOR COMPLETE DATA ON THE NEW WESTON MODEL 983 OSCILLOSCOPE. (Wide band, Z-axis intensity modulated — ideal for color.) Accessories for all instruments described are available.

WESTON MODEL 985 CALIBRATOR

The Weston Model 985 Calibrator is a highly functional instrument for TV shop, engineering, laboratory, and industrial alignment applications. Markers are provided for waveform patterns, local tuner oscillator frequencies, and trap circuit alignment. The instrument is extremely useful for making linearity adjustments, calibrating signal generators, and determining signals of unknown frequencies.

FEATURES

SCALE CALIBRATION: The frequency calibration of each frequency setting can be checked and adjusted with crystal accuracy. Crystal calibrating points are available at 1.5 and 4.5 megacycles throughout the entire scale. A scale shift knob is provided to align properly the scale with the crystal calibrating dots. A neon type bulb is utilized to indicate visibly the crystal frequency points.

SCALE PRESENTATION: Slide rule type in which one scale is visible at a time. Ten scale range bands available . . . total scale length of 8¼ ft.

DUAL MARKERS: 4.5 mc side band markers permit simultaneous observation of video and sound carrier.

INTERNAL MARKERS: Special circuitry provides an internal marker of either a positive or negative pulse suitable for Z-axis intensity modulation of the scope pattern. This eliminates the necessity of feeding an RF calibrator signal directly into the TV receiver which can cause overload and oscillation in the TV set. The marker is visible even at the sound trap frequencies.

HETERODYNE DETECTION: With an input sensitivity of 500 microvolts, the local TV receiver-tuner channel oscillator frequency can be determined without tuner disassembly.

BAR PATTERN GENERATOR: Amplitude modulated signals of the band oscillator at 400 cycles for the horizontal linearity check and 300 KC for the vertical linearity check can be readily fed to TV antenna terminals to produce horizontal and vertical bars.



SPECIFICATIONS

FREQUENCY RANGE (with Variable Frequency Oscillator):

- 4-110 megacycles in 7 bands.
- 170-260 megacycles in 3 bands.
- Use of second harmonic is suitable for UHF 340-520 megacycles in 3 bands.

OUTPUT ATTENUATOR RANGE: 100% to 1%.

CRYSTAL MARKER ACCURACY: 1.5 mc position $\pm 0.01\%$
4.5 mc position $\pm 0.01\%$

INTERNAL MODULATION FREQUENCIES: 400 cps, 300 KC, 4.5 mc

HETERODYNE INPUT SENSITIVITY: 500 microvolts (VFO)

LINEARITY ADJUSTMENT: Horizontal — 400 cycles
Vertical — 300 KC

DUAL MARKERS: Video and sound . . . available for either Z-axis intensity modulation of scope or conventional marker pip display.

TUBE COMPLEMENT: 6BA7, 12AT7, 6CL6, 6AL5, 6X4, 6T4.

POWER SUPPLY: 105/125 volts, 50/60 cycles per second.

SCALE LENGTH: 8¼ ft.

CASE: Grey hammertone finished steel.

PANEL: Aluminum finish with etched black markings.

SIZE: 13.5" x 10" x 6.75"

APPROX. WEIGHT: 18¾ lbs.

Model 985 **Net Price \$199.50**

980 LINE WESTON TEST EQUIPMENT

WESTON MODEL 984 SWEEP GENERATOR

The Weston Model 984 is a top performance instrument, precision built for effective trouble shooting of sound and video IF circuits, associated trap circuits, TV tuners, video amplifiers and all-purpose visual alignment. It has a high flat output voltage.

FEATURES

- BLANKING:** Special circuitry produces a zero output reference base which is essential for relative gain measurements.
- RF OUTPUT:** Frequency modulated signal, TV Channels 2 to 13 inclusive, complete FM coverage available by means of two preset selector positions. **FREQUENCIES ARE FUNDAMENTALS OF THE OSCILLATOR FREQUENCY.**
- IF/VIDEO OUTPUT:** Frequency modulated signals ranging to 50 megacycles, continuous tuning, signals free from harmonics.
- SWEEP WIDTH:** Full 10 megacycles on all channels.
- Z-AXIS TERMINAL:** For use with the Model 985 Calibrator.

SPECIFICATIONS

- SWEEP WIDTH:** 0-10 Megacycles (continuously variable for both IF and RF ranges).
- OUTPUT VOLTAGE (RMS):** 0.1 Volt . . . sweep is linear.
- RF OUTPUT:** TV channels 2 to 13 preset. Complete FM coverage available by means of two additional preset selector positions.
- IF/VIDEO OUTPUT:** 50 Megacycles (continuous tuning).
- HORIZONTAL SWEEP FOR OSCILLOSCOPE:** Phase adjustment range — 165°. Frequency — Power Line 60 cycles per second.
- CABLE TERMINATION:** RF output — 300 ohms balanced. IF output — 100 ohms.
- POWER:** 105/125 volts, 60 cycles.

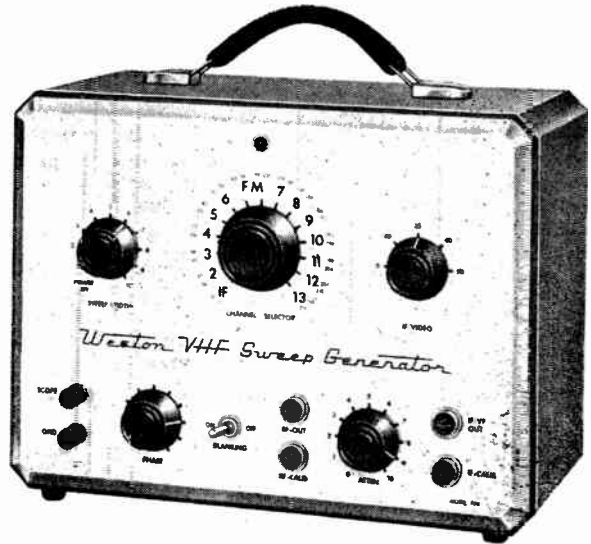

- TUBE COMPLEMENT:** 6J6, 6U8, 12AT7, 6X4.
- CASE:** Grey hammertone finished steel; leather carrying handle.
- PANEL:** Etched aluminum satin finish.
- SIZE:** 13.50" x 10" x 6.75".
- APPROX. WEIGHT:** 14 lbs. 4 oz.

Model 984 Net Price \$199.50

WESTON MODEL 981 PROPORTIONAL MUTUAL CONDUCTANCE TUBE CHECKER

FEATURES

- METER MEASUREMENT OF HIGH LEAKAGE RESISTANCE:** Provides an accurate meter measurement of leakage resistance as high as 5 megohms between tube elements, thus being particularly useful for TV servicing and TV line production assembly.
- MULTIPLE SWITCHING FACILITIES:** Protection against obsolescence is assured through the use of nine single circuit, twelve position, selector switches. These multiple switching facilities make possible many more combinations of tube connections.
- TWIN SECTION TUBES:** Three toggle switches make it possible to rapidly check and compare the respective sections of twin section tubes at only one setting of the selector switches.
- SINGLE SOCKET FOR EACH TUBE BASE REGARDLESS OF TUBE CONNECTION:** Eliminates the possibility of plugging a tube into the wrong socket. Sockets are provided for conventional type tube bases as well as acorn, and 7 and 8 pin subminiatures.
- HIGH TRANSCONDUCTANCE MEASUREMENT RANGE:** A multiplier switch provides the following ranges: 3000, 6000, 12,000, 24,000 micromhos. Signal voltages of 3.2, 1.6, .8, and .4 volts are provided at a frequency of 5 kilocycles.
- ROLL INDEX CHART:** Provides comprehensive, up-to-date test data on commonly encountered tubes, as well as those infrequently used.
- GRID BIAS, PLATE VOLTAGE, METER SENSITIVITY:** The grid bias and meter sensitivity are adjusted by variable panel controls. Plate and screen voltage selection allows checking of all receiving tubes including subminiature types.
- VOLTAGE REGULATOR TUBES:** A selenium rectifier supply furnishes 200 volts d-c for testing of voltage regulator tubes for maximum d-c current of 65 milliamperes.



SPECIFICATIONS

- FILAMENT VOLTAGES:** .65, 1.1, 1.5, 2, 2.5, 3.3, 5, 6.3, 7.5, 10, 13, 20, 27.5, 35, 47, 70, 85, 115.
- SIGNAL VOLTAGES:** 3.2, 1.6, .8, .4 volts, a-c.
- RANGES:** 3000, 6000, 12,000, 24,000 micromhos.
- POWER REQUIREMENTS:** 105 to 124 volts, 60 cycles single phase a-c, 30 watts.
- CASE:** Grey hammertone finished steel.
- SIZE:** 17.50" x 13.25" x 6.00".
- WEIGHT:** 29 lbs. (13.2 Kgs.).

Model 981 Net Price \$199.50

980 LINE WESTON TEST EQUIPMENT

WESTON MODEL 982 VACUUM TUBE VOLTMETER

The Weston Model 982 is a self-contained, battery operated Vacuum Tube Voltmeter. It is particularly adaptable to the Radio-TV Servicing industry where the requirements of peak to peak measurement of a-c voltages exclude the use of conventional meters. This instrument makes possible quantitative measurement of all complex wave form voltages utilized in video, sync and deflection circuits with no a-c line interference in critical measurements.

FEATURES

BATTERY OPERATED: Unit affords complete isolation from spurious response due to stray a-c fields and circulating ground currents. Extremely low drain for long battery life. Power Consumption: Less than 25 milliwatts.

DIRECT PEAK TO PEAK MEASUREMENTS.

NO SWITCHING OF LEADS IS REQUIRED: One shielded lead is used for all measurements, a-c, d-c, ohms, and peak to peak.

RANGE FUNCTION SWITCH: Makes negative and positive d-c potentials measurable DIRECTLY.

HIGH INPUT IMPEDANCE: 10 megohms on d-c for accurate measurements — 2.8 megs. a-c, RMS — 1 meg. a-c, peak to peak.

NO ZERO SCALE DRIFT: Instrument can be used immediately without waiting for warm up . . . resetting of zero corrector when switching from range to range is entirely eliminated.

DC ISOLATION ADAPTOR: Makes d-c measurements possible in the presence of a-c voltages.

FREQUENCY RESPONSE: Suitable for measurement of TV wave forms, such as sync pulses, saw tooth, drive voltages, and other complex wave form voltages.

DISCRIMINATOR ALIGNMENT: Zero corrector knob has sufficient latitude to center scale, so that discriminator measurements can be made.

1% PRECISION RESISTORS UTILIZED.

RF PROBE is available as an accessory.

SPECIFICATIONS

ACCURACY: $\pm 3\%$ d-c — $\pm 5\%$ a-c, RMS.

IMPEDANCE: 10 megs. d-c — 2.8 megs., a-c, RMS — 1 meg. a-c, peak to peak.



RANGES:

D-C Volts	1.6	8	40	160	400	800	1600
A-C Volts	1.6	8	40	160	400	800	1200
Peak to Peak Volts	1.6	8	40	160	400	800	1600
Ohms	XI Meg.	X100K	X10K	X1K	X100	X10	X1

(10 ohms center)

BATTERY LIFE: Battery A* — Approx. 90 days . . . is easily replaceable (Standard 1.5 volt, Size D Cell).
Battery B* — Shelf life approx. 1 year.

SCALE LENGTH: 4.63".

CASE: Grey hammertone finished steel with carrying strap.

PANEL: Aluminum finish with markings etched in black.

SIZE: 10" x 7.38" x 3.625".

APPROX. WEIGHT: 6 lbs. (complete with batteries and accessories).
4 lbs. (without batteries).

*Based on maximum use — 8 hours per day.

Model 982 **Net Price \$69.50**

WESTON MODEL 980 ANALYZER (VOLT-OHM-MILLIAMMETER)

The Weston Model 980 Volt-Ohm-Milliammeter is a highly sensitive, accurate and rugged instrument with a combination of functional ranges which provide a wide range of test measurement applications in the electronic field. The instrument has a d-c sensitivity of 20,000 ohms/volt, and an a-c sensitivity of 1000 ohms/volt. Accuracy is 2% d-c, 3% a-c.

Range and functional switching is greatly simplified by use of a single dial for all ranges and functions.

SPECIFICATIONS

ACCURACY: 2%, d-c; 3%, a-c.

SCALE LENGTH: 4.63".

RANGES:

D-C Volts: 1.6, 8, 40, 160, 400, 1600 . . . at 20,000 ohms/volt.

A-C Volts: 1.6, 8, 40, 160, 400, 1600 . . . at 1,000 ohms/volt.

DB Range: -15 db to +54 db (in six ranges).

D-C Milliampers: 8, 80, 800.

D-C Microampers: 80.

D-C Amperes: 8.

Ohms Range	Center Scale	Full Scale
R x 1	25	1,000
R x 10	250	10,000
R x 100	2,500	100,000
R x 1,000	25,000	1 megohm
R x 10,000	250,000	10 megohms

CASE: Black molded bakelite, with carrying strap.

PANEL: Black molded bakelite with engraved white markings.

SIZE: 6.25" x 7.50" x 3.25".

APPROX. WEIGHT: 2.69 lbs.



Model 980 **Net Price \$52.50**



Burlington PANEL INSTRUMENTS

TYPICAL INSTRUMENT CASE SHAPES AND SCALES

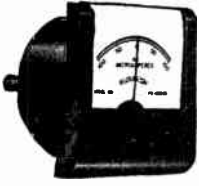

2 1/2" SQ. FLUSH
PLEXIGLAS FRONT



ROUND
FLUSH

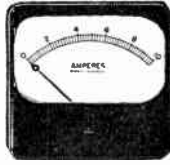

SQUARE
SEMI-FLUSH



SQUARE
FRONT BOARD



SQUARE
FLUSH
(Except Model 721)

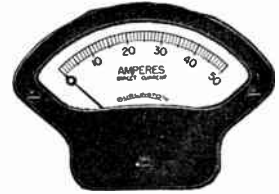

FAN
SHAPED

VOLTMETERS, AMMETERS, MILLIAMMETERS, MICROAMMETERS				VU & DB INDICATORS			R.F. AMMETERS			A.C. VOLTMETERS			RUNNING TIME					
Type of Case	Size in Inches	MODEL NUMBERS																
		DIRECT CURRENT				ALTERNATING CURRENT			RECTIFIER			THERMO-COUPLE		RECTIFIER			A.C.	
		*	B.	H.S.	R.	*	B.	H.S.	B.	H.S.	R.	*	B.	B.	H.S.	R.	B.	H.S.
Square Flush	1 1/2			311														
Round Flush	2 1/2	221	421	321	921	222	422	322	425	325	925	223	423	425	325	925		
Square Flush	2 1/2		521				522		525				523	525				
Square Semi-Flush	2 1/2		721				722		725				723	725				
Square Flush	3		531				532		535				533	535				538
Round Flush	3 1/2		431	331	931		432	332	435	335	935		433	435	335	935	438	338
Square Semi-Flush	3 1/2		731				732		735				733	735				
Square Semi-Flush	4 1/4		741				742		745				743	745				
Square Front Board	4 1/4		141				142		145					145				
Round Flush	4 1/2		441						445				443	445				
Fan Shape	4 1/2		841						845					845				

Legend: * — Non-Sealed Metal; B. — Bakelite; H.S. — Hermetically Sealed; R. — Ruggedized Sealed

LIST PRICES, F.O.B. BURLINGTON, IOWA

D.C. MICROAMMETERS

MODEL NUMBERS

Range	221	421	431	441	321	331	921	931	311	721	521	531	731	741	141	841
50	11.55	11.55	12.00	12.75	12.45	12.75	18.60	19.05	12.90	12.75	11.55	12.00	12.45	13.05	13.05	12.75
100	10.50	10.50	10.95	11.70	11.55	11.85	17.55	18.00	12.00	11.70	10.50	10.95	11.55	11.85	11.85	11.70
200	9.00	9.00	10.05	10.65	11.10	11.40	16.05	16.65	11.55	10.20	9.00	10.05	10.50	10.80	10.80	10.65
500	8.40	8.40	9.00	9.75	10.65	11.10	15.45	15.90	11.10	9.60	8.40	9.00	9.45	10.20	10.20	9.75

D.C. MILLIAMMETERS

*Supplied only as 1 ma, 100 ohm movement

(MODEL NUMBERS SAME AS ABOVE)

Std. Rngs.	8.10	8.10	8.55	9.00	10.20	10.80	15.15	15.60	*10.65	9.30	8.10	8.55	8.85	9.45	9.45	9.00
ALL STANDARD RANGES ARE SAME PRICE: 1, 1.5, 3, 5, 10, 15, 25, 50, 100, etc.																

D.C. AMMETERS

(MODEL NUMBERS SAME AS ABOVE)

Std. Rngs.	8.10	8.10	8.55	9.00	10.20	10.80	15.15	15.60	*10.65	9.30	8.10	8.55	8.85	9.45	9.45	9.00
ALL STANDARD RANGES ARE SAME PRICE: 1, 2, 5, 10, 15, 25, 50, 60, 75																

Prices do not include external shunts required with all ranges of Model 311; all ranges 5 and over Models 321, 331; All ranges 15 and over Models 921 and 931; and all Models with 75 Amp rating (or higher).

VU and DB POWER LEVEL INDICATORS

MODEL NO.	225	425	435	445	325	335	925	935	315	725	525	535	735	745	145	845
VU — Scale "A" or "B"	17.40	17.40	18.00	19.20	18.90	19.95	24.90	25.80	20.85	18.60	17.40	18.00	18.15	19.50	19.50	19.20
DB — Medium or High Speed	14.40	14.40	15.00	16.20	15.90	16.95	21.90	22.80	20.85	15.60	14.40	15.00	15.15	16.50	16.50	16.20

MANY OTHER RATINGS AND TYPES AVAILABLE IN D.C. AND A.C.

BURLINGTON INSTRUMENT CO. • Burlington, Iowa

phastron

METAL CASED

panel instruments

CUSTOM, RUGGEDIZED, SEALED, AND SPECIFICATION

Phaostron design and tooling permit the same basic movements in both Ruggedized and Non-Ruggedized instruments.

NOW AVAILABLE IN THE FOLLOWING COMBINATIONS

PHAOSTRON CUSTOM METER

PHAOSTRON RUGGEDIZED METER

PHAOSTRON SEALED METER

PHAOSTRON SPECIFICATION METER

(MIL-10304 Ruggedized and Sealed series)

With **INTERCHANGEABLE ROUND** or **SQUARE BEZELS**



Available in
2½", 3½", and 4½" sizes
JAN Spec. Round Case

NON-RUGGEDIZED METERS BUILT TO MEET JAN-I-6 and MIL-M-6A

The Non-Ruggedized Meter incorporates all the basic features and improvements of the famous Phaostron Ruggedized and Sealed Meter—with the exception of the shock mounts necessary to produce a Ruggedized instrument to MIL-10304 specifications.

For applications not requiring these extreme exposures to shock, here is a meter that still maintains its excellent constancy of calibration with the same ruggedized movement, miniaturized moving coil assembly, R. F. shielding and aged Alnico Magnets that are featured in the Ruggedized Phaostron models.

AVAILABLE IN THE FOLLOWING RANGES WITH RUGGEDIZED OR NON-RUGGEDIZED MOVEMENTS D. C. INSTRUMENTS

MICROAMMETERS		MILLIAMMETERS	
0-100		0-1	0-100
0-250		0-10	0-250
VOLTMETERS		VOLTMETERS	
1000 Ohms per Volt		20,000 Ohms per Volt	
0-2.5	0-150	0-2.5	0-150
0-10	0-300	0-10	0-300
0-25	0-500	0-25	0-500
0-50		0-50	
AC INSTRUMENTS			
VOLTMETER, RECTIFIER TYPE			
1000 Ohms per Volt			
0-10		0-150	
0-50		0-300	

Other ranges available on order



4½" Square Bezel, Mirror Scale

null indicators

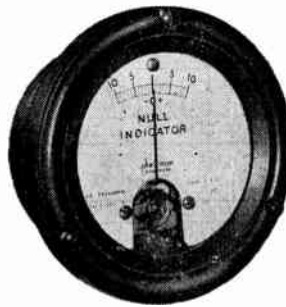

**AVAILABLE
RUGGEDIZED
and
NON-RUGGEDIZED**
in
2½", 3½",
and 4½" Sizes
JAN SPEC
Round Case
Round or Square Bezel

DISTRIBUTED BY

Terminal Radio	N. Y. C., N. Y.
Herbach & Raderman	Phila., Pa.
California Electronic Supply, Inc.	West L. A., Calif.
Hollywood Radio Supply, Inc.	Hollywood, Calif.
R. V. Weatherford	Glendale, Calif.



1½" METERS

Fast response time
Sustained accuracy
Low-bearing friction
Long life

Square Bezel Only, Round Case

ENVIRONMENT FREE
ELECTRICAL EQUIPMENT by



MANUFACTURED BY PHAOSTRON COMPANY, 151 PASADENA AVE., SOUTH PASADENA, CALIF.

PROVIDE ENVIRONMENT FREE OPERATION anywhere IN THE WORLD

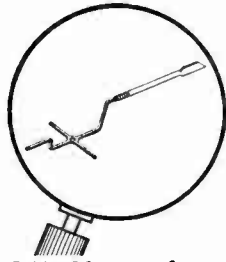

POINTERS... are formed of 52 SH aluminum alloy tubing locked to the balance cross of the moving coil system. This permits extreme overload, shock and vibration without damage.

WATERPROOF-O-RING SEAL... meets sealing requirements of MIL-10304, and the meter can be taken apart in the field for servicing. Re-assembly of the meter does not affect the integrity of the seal.

SELF CONTAINED RUBBER SHOCK MOUNTS... control deflection of the instrument movement under shock. The specially developed rubber has good low temperature characteristics and high dielectric strength. It exhibits no corrosive properties even when exposed to extreme temperatures.

INSTRUMENT HOUSING... Furnishes magnetic and electrostatic shielding which prevents external magnetic conditions from affecting the meter calibration.

RUGGEDIZED MOVEMENT... is a result of a miniaturized moving coil assembly, the mass is reduced to the point that it is not affected by high shock, tumbling or vibration.

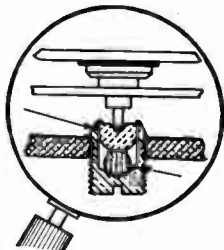

SHOCK MOUNTED JEWELS AND PIVOTS... Large radius pivots reduce the unit loading and are incorporated with shock mounted jewels, assuring continuous accuracy when exposed to extreme shock and vibrational environment.

HAIRSPRINGS... for Phastron RUGGEDIZED meters are formed of silver-coated beryllium copper springs of the shortest length consistent with the torque desired and are unaffected by high shock, vibration and impact.

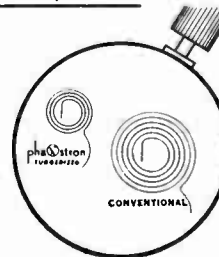

**BUILT TO MEET MIL-10304
JAN-1-6 and MIL-M-6A**

DISTRIBUTED BY

Terminal Radio	N.Y.C., N.Y.
Herbach & Raderman	Phila., Pa.
California Electronic Supply, Inc.	West L.A., Calif.
Hollywood Radio Supply, Inc.	Hollywood, Calif.
R. V. Weatherford	Glendale, Calif.

**ENVIRONMENT FREE
ELECTRICAL EQUIPMENT by**



MANUFACTURED BY PHAOSTRON COMPANY, 151 PASADENA AVE., SOUTH PASADENA, CALIF.

Hoyt

PANEL AND PORTABLE INSTRUMENTS

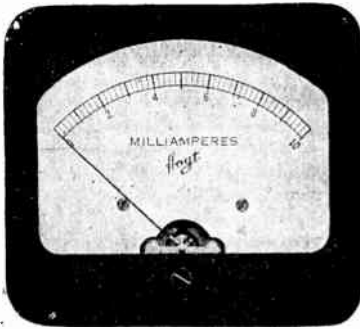

MODEL Nos. 600 and 607



MODEL Nos. 635 and 597

NOTE: Meters listed are standard in Flush cases. Surface cases can be supplied in No. 17/L, No. 570, No. 574, if desired—specify case on order. If "in-between" ranges are required, add 50c to price of next higher range listed. If "zero-center" ranges are required, add 50c to price of that range. For in-between ranges on moving-coil type voltmeters 300 volts and up, add \$2.00 to prices shown.

NOTE: Unless otherwise specified, all meters are calibrated on non-magnetic panels. If steel panels are used, kindly so state, giving thickness of steel and size of panel hole, and meters will be calibrated for steel panels at no extra charge. All prices are net—subject to change or withdrawal without notice.

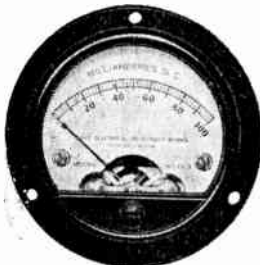

MODEL Nos. 582 and 17/3

HOYT moving-coil Meters, both panel-mounting and portable, are built on the D'Arsonval principle. All with carefully selected jewel bearings and insulated zero adjusters. Accuracy to 2% of full scale.

Alnico Magnets with soft-iron or sintered pole-pieces of uniform flux density used in all movements. Permanently correct balance assured by HOYT designed "cross arm" spiral wire

balance in two planes. High torque to weight ratio. Quick response and good damping under all conditions.

Either "knife-edge" or "lance" type pointers available on most models.



Small Meters (2½" x 4½") have external pivot construction—best for sensitive movements in small instruments. Larger Meters have internal pivots. A wide range of sizes in round and square cases.

MODEL	CASE TYPE	SCALE LENGTH	FLANGE	BODY DIA.	BODY DEPTH
DC AC	PANEL MTG.	AC-DC		AC-DC	AC-DC
17/3 552	Bakelite Rd.	1 7/8"	2.690"	2.200"	1 3/8"
17/3 552	Metal Rd.	1 1/8"	2 3/64"	2 1/16"	1 19/64"
635 636	Bakelite Sq.	1 7/8"	2 3/8" x 2 3/8"	2.200"	1.400"
17/L 560	Metal Rd.	2 1/4"	3 7/32"	2 1/2"	1 1/2"
17/L 560	Metal Surface	2 1/4"	3 1/16"	2 1/2"	—
582 584	Bakelite Rd.	2 1/2"	3 1/2"	2 3/4"	1 3/8"
597 598	Bakelite Sq.	2 1/2"	3" x 3"	2 3/4"	1 3/8"
570 580	Metal Rd.	2 5/8"	3 3/4"	3"	1 11/16"
570 580	Metal Surface	2 5/8"	3 5/8"	3"	—
607 610	Bakelite Sq.	2 3/4"	3 3/8" x 3 5/16"	2 1/4"	1 1/16"
574 617	Metal Rd.	3 3/4"	4 1/2"	3 3/4"	1 19/32"
574 617	Metal Surface	3 3/4"	4 1/2"	3 3/4"	—
600 601	Bakelite Sq.	3 3/4"	4 1/2" x 4"	2 3/4"	1 1/16"
602 —	Metal Rd.	5"	6 11/16"	3"	1 1/4"
583 —	Metal Rd.	6 1/4"	8 3/8"	3"	1 17/32"

Range	PANEL MOUNTING						PORTABLE		
	#17/3 #635	#17/L	#582 #597	#570 #607	#574 #600	#583	#602	#578	#515
D.C. MILLIAMMETERS									
	\$7.40	\$7.80	\$8.35	\$8.85	\$9.30	\$16.50	\$12.50	\$9.85	\$11.50
<small>Standard single Milliammeter ranges for all models at above prices are 0/1, 0/10, 0/30, 0/50, 0/100, 0/150, 0/200, 0/300, 0/500 MA.</small>									
D.C. MICROAMMETERS									
0/50	\$10.40	\$10.80	\$11.35	\$11.85	\$12.30	\$12.85	\$14.50
0/100	9.90	10.30	10.85	11.35	11.80	\$19.00	\$15.00	12.35	14.00
0/200	8.40	8.80	9.35	9.85	10.30	17.50	13.50	10.85	12.50
0/500	7.85	8.30	8.85	9.35	9.80	17.00	13.00	10.35	12.00
D.C. MILLIVOLTMETERS									
0/50	7.40	7.80	8.35	8.85	9.30	16.50	12.50	9.85	11.50
D.C. AMMETERS									
	7.40	7.80	8.35	8.85	9.30	16.50	12.50	9.85	11.50
<small>Standard single Ammeter ranges for all models at above prices are 0/1, 0/5, 0/10, 0/15, 0/25, 0/30, 0/50* Amps.</small>									
D.C. VOLTMETERS									
	7.40	7.80	8.35	8.85	9.30	16.50	12.50	9.85	11.50
<small>Standard single Voltmeter ranges for all models at above prices are 0/3, 0/5, 0/10, 0/15, 0/25, 0/30, 0/50*, 0/100, 0/150*, 0/300, 0/500, 0/600, 0/750 Volts.</small>									
<small>Voltmeter Sensitivity—Ranges 3-100 volts are 100 ohms per volt. Ranges 150-500 volts are 1000 ohms per volt. Ranges 500-750 volts are 2000 ohms per volt.</small>									

* These ranges carried in stock on Model 582 only. (Calibrated for non-magnetic panels.)

STANDARD SWITCHBOARD SHUNTS

For price of high current Ammeters, add price of 50 millivoltmeter to price of external shunt, shown below.

0/25	\$6.50	0/100	\$6.50	0/500	\$11.00	0/1500	\$35.35
0/30	6.50	0/150	7.00	0/600	13.00	0/2000	40.20
0/50	6.50	0/200	7.00	0/800	17.50	0/2500	51.00
0/75	6.50	0/300	7.50	0/1000	22.00	0/3000	61.20

All furnished with 3-ft. leads. 1500 amp. shunts and up are not supplied with bolts as holes are not tapped. No. 3A non-continuous shunts up to 400 amps. can be supplied on special order. Prices on request.

Hoyt

PANEL AND PORTABLE INSTRUMENTS

PRICES:	PANEL MOUNTING					PORTABLE	
	#552 #636	#560	#584 #598	#580 #610	#617 #601	#562	#517

A.C. MILLIAMMETERS

\$7.40	\$7.80	\$8.10	\$8.40	\$9.15	\$9.85	\$11.50
--------	--------	--------	--------	--------	--------	---------

Standard single Milliammeter ranges for all models at above prices are 0/10, 0/30, 0/50, 0/100, 0/150, 0/200, 0/300, 0/500 MA.

A.C. AMMETERS

\$7.40	\$7.80	\$8.10	\$8.40	\$9.15	\$9.85	\$11.50
--------	--------	--------	--------	--------	--------	---------

Standard single Ammeter ranges for all models at above prices are 0/1, 0/3, 0/5, 0/10, 0/15, 0/25, 0/30, 0/50* Amps. AC Ammeters are self-contained to 50 amps.

A.C. VOLTMETERS

\$7.40	\$7.80	\$8.10	\$8.40	\$9.15	\$9.85	\$11.50
--------	--------	--------	--------	--------	--------	---------

Standard single Voltmeter ranges for all models at above prices are 0/5, 0/10, 0/15, 0/25, 0/30, 0/50, 0/100 Volts. Higher ranges below.

For AC Rectifier-type Voltmeters—5 through 300 volts—add \$5.00 to price above of model wanted.

0/150	\$7.90	\$8.30	\$8.85*	\$9.15	\$9.90	\$10.60	\$12.25
0/300	8.75	9.15	9.60*	9.95	10.50	11.40	13.05
0/500	12.95	13.25	14.00	14.75	16.40
0/600	13.50	13.80	14.40	15.30	16.95

* These ranges carried in stock on Model 584 only (calibrated for non-magnetic panels).

NOTE: Meters listed above are standard in Flush cases. Type 560, 580 and 617 can be supplied in surface case, if desired—Specify case on order. If "in-between" ranges are required, add 50c to next higher price as shown above. Standard calibration is for non-magnetic panels. Steel panel calibration at no extra charge if order specifies thickness of steel and size of panel hole.

HIGH CURRENT DONUT TYPE TRANSFORMERS

For prices of higher current AC Ammeters, add price of ammeter model above to transformer price below.

100/5	\$7.75	200/5	\$7.75	600/5	\$11.45
150/5	7.75	300/5	9.40		



MODEL Nos. 636 and 598

HOYT A.C. Meters for indicating 60 cycle Voltage and Current are of the repulsion type with pneumatic damping. Furnished in the same case styles and sizes as HOYT D.C. Meters, they match the D.C. meter where both types are used on the same panel.

Accuracy is 2%. A choice of pointers is available, and special shields can be supplied if needed.



MODEL No. 593
2 1/2" Rect. Case

MAGNETIC VANE MOVEMENTS

HOYT magnetic Vane-type Indicators have been used for many years by the leading manufacturers of electrical devices.

Attractive appearance is combined with a

sturdy movement. Furnished in round or square cases at low cost. Standard finish on metal cases is black. Chrome Plate is available at slight additional cost.

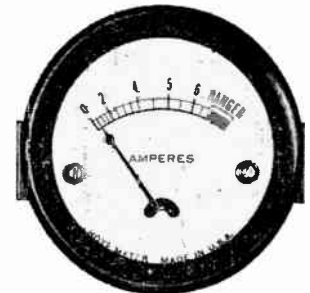

MODEL No. 566
2 1/4" Round Case

NOTE: A.C. Vane Meters are furnished in quantity only. Prices on request.

MODEL DC	AC	CASE TYPE PANEL MTG.	SCALE LENGTH AC - DC	FLANGE	BODY DIA. AC - DC	BODY DEPTH AC - DC
566	531AC	Nar. Metal Rd.	1 1/4"	2 9/32"	2"	1 5/64"
566	531AC	Metal Surface	1 1/4"	2 3/8"	2"	—
593	594	Metal Sq.	1 5/16"	2 5/8" x 2 5/8"	2 1/16"	1 1/16"

Range	#566	#593
D.C. MILLIAM.		
0/10	\$1.85	\$1.95
0/30	1.40	1.50
0/50	1.40	1.50
0/100	1.40	1.50
0/150	1.40	1.50
0/200	1.40	1.50
0/300	1.40	1.50
0/500	1.40	1.50

Range	#566	#593
D.C. AM.		
0/1	1.40	1.50
0/5	1.40	1.50
0/10	1.40	1.50
0/15	1.40	1.50
0/30	1.40	1.50
0/50	1.95	2.05
0/75	2.40	2.50
0/100	2.80	2.90

Range	#566	#593
D.C. VOLTM.		
0/3	1.40	1.50
0/5	1.40	1.50
0/10	1.40	1.50
0/15	1.40	1.50
0/30	1.40	1.50
0/50	1.40	1.50
0/100	1.90	2.00
0/150	2.20	2.30

HICKOK**TEST INSTRUMENTS****HICKOK**

DYNAMIC MUTUAL CONDUCTANCE TUBE TESTER

Most Accurate Engineers' Laboratory Model

Tests Tubes Per Tube Handbooks and JAN Specifications



Model 700: For precise laboratory measurements of the most important vacuum tube characteristics, Transconductance (Mutual Conductance). With this Tube Tester it is possible to duplicate the results found in tube manuals. This instrument places a separate voltage on each element of the tube. These voltages can be varied and measured by means of separate variable rheostats and meters in each circuit. A.C. ripple has been completely filtered out of the plate, screen and grid circuits.

In addition to providing accurate measurements of Mutual Conductance, it is possible to study the behavior of various tubes when used in non-conventional and special types of circuits. Amplification Factor and Plate Resistance may be obtained from the test results.

The HICKOK Model 700 may be operated in either of two ways. First, by making use of alternating current null methods of measurement in which capacitance and resistance errors have been eliminated; and second, by direct reading on a meter. The Null Method of making measurements on the tube is the most accurate and is the one which is recommended where sufficient time for the test is available.

Complete with all leads and accessories. Attractive and sturdy case.

Model 700

Price: \$792.50

TECHNICAL FEATURES...

1. Micromho ranges are available as follows: 600, 1500, 3000, 6000, 15,000, 30,000 and 60,000 micromhos.
2. Four separate signal voltages are available, 1.0 volts, 0.5 volts, 0.1 volt and 0.05 volts.
3. Plate voltage supply is continuously variable from zero to 300 volts. An individual D.C. voltmeter in the plate circuit reads plate voltage at all times.
4. Screen voltage is continuously variable from 0 to 300 volts. This is metered by means of a separate D.C. Voltmeter in the screen circuit.
5. The control grid voltage is continuously variable from 0 to 75 volts. This voltage is measured by means of a separate D.C. Voltmeter in the grid circuit. Provision is made to make bias either negative or positive. Suppressor can be used as control grid if desired.
6. An extra negative circuit is provided for holding unused tube elements negative while test is being made on other elements.
7. Provision is made for testing tubes under self-bias conditions when required by that particular tube or when such information is desired.
8. Filament voltage may be applied to the tube up to 117 volts A.C. The separate A.C. Voltmeter in this circuit measures the voltage applied to the filament at all times. This voltage is continuously adjustable.
9. A D.C. Milliammeter is provided for measuring plate current, screen current, or cathode current. This reads from 0 to 150 ma. and may be switched into the three circuits for this purpose.
10. A separate D.C. Microammeter is mounted in the control grid circuit to read grid current, if and when it exists.
11. Amplification factor can be easily calculated from values obtained from the meter readings. Other factors may be similarly calculated.
12. Provision is made for testing tapped filaments either in series or in parallel.
13. Provision is made for adjusting to the electrical center of filament type tubes.
14. Twin tube sections may be tested either singularly or in parallel.
15. Screen grid tubes can be connected as triodes or tetrodes, etc., as may be desired. Switching arrangement is provided for this purpose.
16. A built-in power supply is included with the instrument providing thoroughly filtered D.C. on plate, screen, and control grid.
17. A voltage adjustment with an accurate A.C. meter in the circuit is provided to insure exact signal voltage and correct phasing.
18. Designed and calibrated for 60 cycles, 110 to 120 volts operation. Calibration for other frequencies and voltages available.
19. Approximate size — 8" D. x 20" W. x 29" L. Approximate 70 lbs. net, 90 lbs. shipping.

Model 7001: Null Reading Apparatus is self-contained in a small case placed alongside the Model 700 tester. It consists of a voltage supply (source from the Model 700 to assure correct phasing), a sensitive A.C. Galvanometer, a calibrated resistor, and an accurate A.C. Voltmeter. It is connected directly into the plate circuit of the tube under test by binding posts on the panel of the Model 700. The grid-signal-produced-component of plate current is balanced by an equal and opposite current applied to the plate from the power supply through the calibrated resistor. The reading of the A.C. voltmeter at the bottom of the panel is proportional to the Transconductance of the tube, and is therefore calibrated in Micromhos. The effect of the Null Reading Method is to reduce resistance in series with the plate to zero, thereby assuring the highest accuracies obtainable. The A.C. Voltmeter calibrated in Micromhos is made as accurate as possible and has individually calibrated scales.

Model 7001: for obtaining bridge type null readings of 1½% accuracy. 8" D., 8" W., 13½" L.

Model 7001

Price: \$200.00



HICKOK . . . CHOICE OF THE EXPERTS

HICKOK

TEST INSTRUMENTS

HICKOK

DYNAMIC MUTUAL CONDUCTANCE TUBE TESTERS

ENGINEERS' LABORATORY MODEL RADIO, TELEVISION, LABORATORY, AVIATION and COMMUNICATION ENGINEERS' MODEL



Model 539A

Model 539A: Laboratory tube tester of highest accuracy. Dynamic Mutual Conductance with tube readings in micromhos for reliable test of tube gain under simulated operating conditions. Tests all tubes normally encountered in all phases of electronic work—including the ruggedized types used by airlines, hearing aid tubes, and miniature types used in TV receivers. Provides increased accuracy for testing high-gain type tubes.

Designed with professional accuracy for engineers and engineering technicians, in the radio, television, aviation, communication and industrial field.

Model 539-A, illustrated at the left. Strong portable carrying case with detachable cover. Most convenient to provide laboratory accuracy for the field engineer. Case is attractively covered with durable black leatherette. 16 $\frac{3}{4}$ " W., 18 $\frac{3}{8}$ " L., 7 $\frac{1}{2}$ " D. 28 lbs. net, 35 lbs. shipping wgt. 110-125 V.A.C. 40 watts. **Price: \$287.00**

SPECIFICATIONS:

Permits choice of 3 A.C. signals: 0.25 volts: 0-15,000, 30,000 micromhos. 0.5 volts: 0-6000 micromhos. 2.5 volts: 0-3000, 6000 micromhos. Vernier adjustment, with sensitive 2-range meter, permits accurate setting of grid voltage.

Provision for insertion of plate millimeter for measuring plate current.

Built-in, optional self-bias arrangement.

Separate voltmeter measures grid bias.

Separate A.C. meter measures line voltage at all times.

D.C. grid bias and D.C. plate and screen voltages.

Provides the HICKOK Tube Life, Tube Gas and Tube Noise tests.

Built with highest accuracy HICKOK meters.

An improved "Short Test" is incorporated into the design of this top-grade tester.

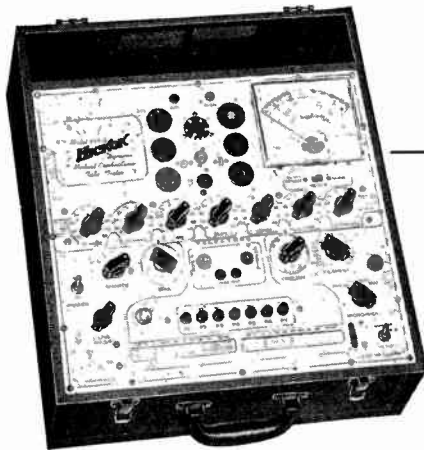

Model 533AP: Radio, television and communication technicians' portable model with true Dynamic Mutual Conductance circuits pioneered by HICKOK. Acclaimed by the experts as the only true test of a tube. **Model 533AP**, illustrated at the left. Strong, portable carrying case with detachable cover. Designed for on-location or shop-bench servicing. Case is attractively covered with durable black leatherette. 16 $\frac{3}{4}$ " W., 18 $\frac{3}{8}$ " L., 7 $\frac{1}{2}$ " D. 23 lbs. net, 30 lbs. shipping weight. 110-130 V.A.C. 40 watts.

Model 533AP

Price: \$185.80

SPECIFICATIONS:

New Bias Fuse prevents accidental damage to bias potentiometer. New lucite meter window has static-free coating.

Tube readings in micromhos — 0-3000, 6000, 15,000.

Tests tubes under simulated operating conditions.

Contains the HICKOK Tube Gas Test and Tube Noise test.

Incorporates the new test feature that forecasts future life of a tube.

Most valuable for accurate matching of tubes in television servicing.

Larger, 5" easy-to-read meter scale and calibrated GM circuit provide increased accuracy in testing today's newer tubes.

Tests all the latest tubes including miniature and subminiature types.

An improved "Short Test" is incorporated into the design of this tester.

Completely built of highest quality components for lasting accuracy and dependability.

HICKOK . . . CHOICE OF THE EXPERTS

HICKOK

TEST INSTRUMENTS

HICKOK

DYNAMIC MUTUAL CONDUCTANCE IN A SMALLER COUNTER MODEL

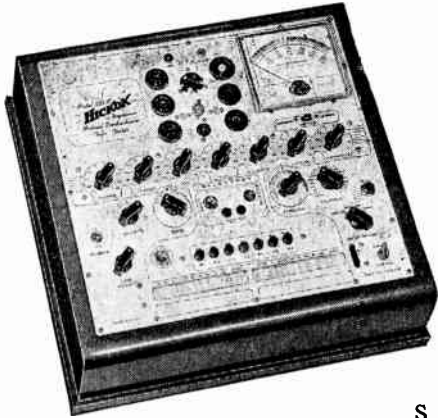

Model 533AC, a lower cost dealer's counter model. Attractively designed to set on the counter and increase your tube sales. Highly accurate Dynamic Mutual Conductance circuits. Encourages customers to bring their tubes in where they can see the actual test. If customers' tubes check "OK" you have an excellent opportunity to invite him to bring his receiver in for a thorough check of all its circuits. With the 533-AC you will build customer confidence, increase tube sales and promote your complete radio and TV service.

Model 533AC, illustrated at the left. Satin finish aluminum panel. Beautifully styled, blue enameled steel case. 17½" W., 18½" L., 6" H. 23 lbs. net, 30 lbs. shipping weight. 105-125 V.A.C. 40 watts.

Model 533AC

Price: \$185.80

SPECIFICATIONS :

Dual-scale meter provides readings in micromhos for the technician.
A.C. Signal 2.5 volts: 0-3000, 6000, 15,000 micromhos. Quick, impressive, accurate, and dependable.
Detects more weak, ordinarily passable tubes.
Contains the HICKOK Tube Gas Test and a circuit for accurate forecast of future tube life.
Simple to operate.

Contains all necessary tube information on a handy built-in roll chart.
Tests tubes under simulated operating conditions.
Tests all the latest tubes including television.
Large 5" easy-to-read meter scale and calibrated GM circuit provide increased accuracy in testing today's newer tubes.
Contains the new HICKOK improved "Short Test."

ATTRACTIVE DISPLAY MODEL



Model 533DM

Price: \$199.20

MOST EFFECTIVE TUBE SALESMAN

Model 533DM. Dealers who use this tube tester enthusiastically report that it is the best salesman they ever used.

Customer convincing, the 533-DM contains a huge, illuminated nine-inch meter that clearly and accurately shows condition of the tube under test. Dual-scale meter provides micro-mho readings for the technician, and a multi-color "Good", "Replace", scale for easy customer interpretation across the counter.

Contains the HICKOK Tube Gas Test, and a circuit for accurate forecast of future tube life.

Detects more weak tubes.
Tests all the latest tubes including television.

AC Signal 5 Volts: 0.3000, 6000, 15,000 micromhos.

Model 533DM, illustrated at the left. 9" chrome meter case, satin finish aluminum panel. Strong, attractive, enameled steel case. 26½" H., 17" W., 11" D. 33 lbs. net, 43 lbs. shipping weight. 110-130 V.A.C. 65 watts.

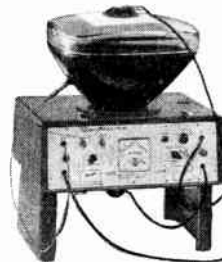

MODEL 590

Price: \$218.50

TV PICTURE TUBE TESTER

• Lights TV picture tube . . . Places actual raster on the face of the tube. **NO OTHER TESTER DOES THIS.** • Tests all sizes of electromagnetically deflected TV picture tubes . . . Both electromagnetic and magnetic focus . . . Both glass or metal shells. • Has definite and accurate rejection limits. Actually measures light output. • Dual fused for full protection. Shorting switch arrangement prevents shock hazard. • High voltage . . . 7000 volts DC is more than enough to illuminate aluminized screens. Horizontal sweep frequency is 15,750 cps nominal sawtooth; vertical is 60 cycle sinusoidal. • When used with any standard HICKOK Dynamic Mutual Conductance Tube Tester, 590 will also accurately check for emission, shorts, gas content and grid control. • Portable case 7½" H., 19½" W., 18" D. 25 lbs. net; 33 lbs. ship. 105-125 V., 50-60 cycles, 60 watts. Single and double ion traps, test leads and protective goggles are included.

TUBE TESTER ROLL CHARTS

HICKOK periodically issues revised tube reference charts to include the data on all tubes available at time of each printing. Announcement of the availability of each new chart is sent to all registered owners of

HICKOK tube testers. This is another HICKOK service designed to help you maintain the speed and accuracy necessary in your profession. \$1.00 delivers up-to-date chart to you.

HICKOK . . . CHOICE OF THE EXPERTS

HICKOK

TEST INSTRUMENTS

HICKOK

RADIO and TELEVISION TECHNICIANS' SMALL SIZE MODELS

DYNAMIC MUTUAL CONDUCTANCE IN A HANDIER, PORTABLE SIZE

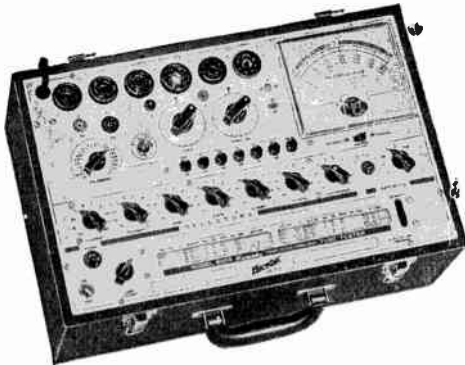

Model 600A Price: \$164.00

Model 600A: New lighter weight portable. Dynamic Mutual Conductance in a radio and TV technicians' popularly priced model. Smaller, handier, but built to the high HICKOK standard for accuracy and dependability. A very popular model for on-location or shop-bench servicing. The 600A may also be used for lab. and industrial applications.

Model 600A, illustrated at the left. Strong portable carrying case with detachable cover. Case is attractively covered in durable, dark red leatherette. 16 $\frac{3}{4}$ " W., 11 $\frac{3}{4}$ " L., 7 $\frac{1}{2}$ " D. 16 lbs. net, 21 lbs. shipping weight. 110-120 V.A.C. 40 watts.

HICKOK testers remain up to date. . . . Periodically revised roll-charts, covering new tubes, are available to all registered owners of HICKOK Tube Testers.

SPECIFICATIONS :

Scale readings in micromhos for most accurate tube evaluation. A.C. Signal 2.5 volts: 0-3000, 6000, 15,000 micromhos.

Contains the HICKOK Tube Gas Test. Acclaimed by the experts as a must for accurate television servicing.

New, large 5" meter scale is easier to read more accurately.

Detects more weak tubes with professional accuracy.

Tests tubes under simulated operating conditions.

Tests the latest tubes including miniature and sub-miniature types.

New bias fuse prevents accidental damage to bias potentiometer.

Contains the new HICKOK improved "Short Test."

ALL-PURPOSE TUBE and SET TESTER IN A HANDIER, PORTABLE SIZE

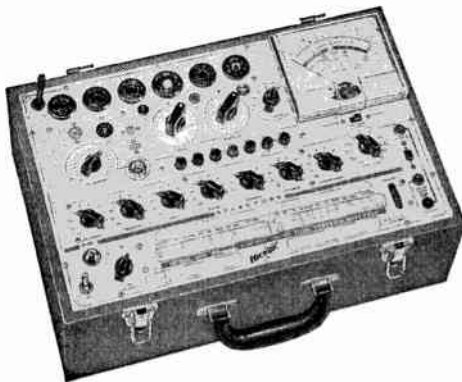

Model 605A Price: \$189.50 SPECIFICATIONS :

Model 605A: New, lighter weight portable. Radio and television technicians' popularly priced, all-purpose tube and set tester with built-in 20,000 ohm per volt D.C. multimeter panel. Designed for speedy, highly accurate radio and TV servicing.

Built to the high HICKOK quality standard throughout. Provides Dynamic Mutual Conductance circuits with tube readings in micromhos. A popular technicians model for on-location servicing. Smaller, lighter, but built entirely with highest quality components for accuracy and dependability.

Excellent for leakage tests of electrolytics, and checks for hum in any stage of receivers. Built with a minimum number of jacks. Ranges are selected with a rotary master switch. Test leads supplied.

Model 605A, illustrated at the left. Same case as Model 600A, above 17 lbs. net, 22 lbs shipping weight 110-120 V.A.C. 40 watts.

Contains all features of the Model 600A listed above, including the HICKOK standard built-in roll chart and new HICKOK improved "Short Test."

New, large 5" meter scale is easier to read more accurately. Attractive lucite window has static-proof coating.

Accurate, built-in multimeter panel measures:

Volts: 0-1000 A.C. — D.C. in four ranges each.

Ohms: 20,000 per volt D.C.
1,000 per volt A.C.

Resistance: 0.1 to 100 megohms. (Center scale 25, 2500, 500,000 ohms.)

Inductance: to 70 henries. (By use of conversion chart furnished).

Capacitance: 50 microfarads, 5 microfarads, as low as .001 microfarads.

Current: D.C.; 10, 100, 500 MA.

Decibels: —10 to +50.

New bias fuse prevents accidental damage to bias potentiometer.

HICKOK . . . CHOICE OF THE EXPERTS

HICKOK TEST INSTRUMENTS HICKOK

THE ACCEPTED TV ALIGNMENT GENERATOR



Model 610A

Price: \$219.00

Power Supply: 115-125 V., 50-60 cycles, A.C.

Tube Compliments: 6J6—Variable oscillator; 6J6—Fixed oscillator; 6J6—Mixer; 6SN7—Crystal oscillator & marker oscillator; 6J5—Audio oscillator; 6X5—Rectifier.

Net 28 lbs. Shipping Weight: 36 lbs.

Size: 16 $\frac{1}{4}$ "x13 $\frac{1}{4}$ "x7"; Satin aluminum finish panel; Blue Hammertex finished steel portable case.

Model 610A: Popularly priced TV sweep generator — Harmonic output useable for UHF. Contains 3 most practical markers including Absorption. Marker Range: 19.5 to 48 mc. — Covers all I.F. frequencies in TV receivers.

Contains linear sweep with unusual accuracy to 2%. Hickok ferrous modulator furnishes symmetrical pattern response curve for easier and more accurate readings.

THIS ONE INSTRUMENT DOES THIS

1. Provides accurate, complete visual alignment of any TV receiver.
2. Visually align IF stages of any television receiver—including the old and current bands, and new bands. Marker range—19 to 48 mc.
3. Align all traps with a calibrated signal—modulated or unmodulated—19 to 48 mc.
4. Insert a marker—accurate to .05 mc—at any point along the IF response curve. This marker frequency is directly calibrated on a dial 9 $\frac{1}{2}$ inches long.
5. Align IF or RF Sections by single stage method—with high output.
6. Attenuate the output down to a very low signal in microvolts.
7. Highly stable.
8. Output multiplier control is 5-stage with a vernier control calibrated from 1 to 10.
9. Panel Jack accommodates separate plug-in calibrating crystals for local TV channels, if desired.
10. Makes possible a crystal controlled frequency modulated or unmodulated for any frequency as low as 2 mc to the upper television channel No. 13 at 216 mc.
11. Temperature compensated.
12. Low amplitude modulation.
13. Completely shielded attenuator.
14. Sweep phasing control.
15. TV sweep frequency.
16. FM sweep frequency.

TELEVISION RF MARKER and Crystal Calibrator



Model 680

TECHNICAL CHARACTERISTICS

Power supply required: 20 Watts, 105-125V AC 50-70 cycles.

RF Output: 53-89 MC, 174-217 MC.
 VHF 106-178 MC 2nd harmonic
 UHF 424-712 MC 8th harmonic
 522-651 MC 3rd harmonic
 696-868 MC 4th harmonic

.15V. RMS RF output, 31 crystal check points at 2.5 MC.

Size 11 $\frac{1}{4}$ " W x 8 $\frac{1}{4}$ " H x 7" D, attractive portable steel case.

Weight: 13 $\frac{1}{4}$ lbs. net; 18 lbs. shipping.

Model 680: A perfect companion for the HICKOK 610-A TV Alignment Generator to provide the most complete, overall TV alignment including UHF.

The 680 is designed to rapidly solve the growing TV front-end maintenance problems. Thousands of TV front-ends are failing daily due to age. The usual procedure of returning these units to the manufacturer for replacement has become increasingly difficult. Now, with the 680 you can build a big business on repairing TV front-ends yourself—to crystal accuracy. The 680 has directly calibrated channel, sound and picture frequencies accurate to .05%. Covers the ranges of 53-89 MC and 174-217 MC on fundamentals and to 868 MC on harmonics.

The 680 also is a crystal standard with choice of 3 crystals provided by means of a front panel switch. (A 2.5 MC crystal is supplied.) The built-in magic eye provides a visible zero beat indicator; a phone jack is also provided for an audible indicator.

The 680 can be used as a heterodyne frequency meter for calibrating other generators up to 900 MC.

This fine instrument is the latest HICKOK development and can be used as a crystal standard in the shop, laboratory or factory, to check oscillators, generators and front-end or over all response curve of a TV receiver to an accuracy of .05%.

Price: \$129.50

HICKOK . . . CHOICE OF THE EXPERTS

HICKOK

TEST INSTRUMENTS

HICKOK



VHF-UHF MARKER GENERATOR

Model 690: Crystal controlled. High .25 volt RF output. Provides dual markers with any TV sweep generator. Features another HICKOK First — a Non-Parallax shadow type dial. Conventional dials unless viewed at exact, right-angle introduce error, since hairline indicator is always a slight distance from the scale. The HICKOK Non-Parallax dial can be viewed from any angle without introducing error. The 45 inches of dial can be self-calibrated to within .05% accuracy with self-contained crystal calibrator. Complete RF coverage channels 2 thru 83. Also, 3.57 mc crystal (color burst frequency) is available. Leading TV manufacturer's engineers have tested this unit and comment highly on its frequency, stability and time saving features. You need the 690 for VHF or UHF black and white alignment right now.

Model 690

Price: \$237.00

OUTSTANDING FEATURES

- Exceptionally rapid and time saving method is employed in calibrating the dial. No counting of beats —no interpolation—no remembering of frequencies.
- Calibrates other signal generators to crystal accuracy.
- Complete RF coverage thru channel 83. Picture and sound settings marked for all channels.
- Marker can be modulated by self-contained 400 cycle. Especially valuable in stage-by-stage alignment. Eliminates use of another instrument.
- Provision for two other crystals, in addition to 2.5 mc crystal supplied. (3.57 mc crystal, frequency of the color burst, available for color work.)
- View two markers at once on response curve . . . main marker and marker of crystal selected. Greatly speeds alignment.
- Both electronic-eye and headphone jack provide visual or audible zero-beat.
- Attenuation is controlled by both step attenuator and vernier for completely regulated output.
- Unit is completely double-shielded.
- All VHF frequencies on fundamentals. No spurious or confusing beats.
- Strong, attractive steel portable case. 16½" W., 13¼" H., 8" D. 26 lbs. Net; 34 lbs. Ship.

HETERODYNED MARKER ADDER



Model 691: This unit in conjunction with the Model 695 Sweep-Alignment and Model 690 Marker provides the utmost in TV alignment technique. Takes guesswork out of alignment jobs. Eliminates errors previously introduced by overload due to markers. The 691 provides a marker visible at all times (including trap points) and will not change in amplitude or distort the response curve WHAT-SO-EVER. This feature, in addition to the accuracy and minimum leakage of the other units (690-695), will greatly simplify any alignment. The outputs of the sweep and marker generators are heterodyned and applied to a scope in such a manner that the marker signal will never pass through the receiver itself — therefore cannot cause overloading. This unit will work well with any of your present equipment that has an output of 50,000 microvolts or more.

Model 691

Price: \$79.50

OUTSTANDING FEATURES

- Input RF voltage required; 50,000 microvolts.
- Output marker voltage; maximum 3 volts.
- Attenuation of marker; variable 0 to 60 db.
- Attenuation of response curve; variable 0 to 20 db.
- Input impedance: 90 ohms.
- Power supply required: 105-125 volts A.C., 50-60 cycles, 25 watts.
- Attractive steel portable case. 11¼" W., 8¾" H., 7" D. 10 lbs. Net; 15 lbs. Ship.

HICKOK . . . CHOICE OF THE EXPERTS

HICKOK**TEST INSTRUMENTS****HICKOK****VHF SWEEP-ALIGNMENT GENERATOR****All Electronic Sweep**

Model 695: Here is a completely new generator with ALL-ELECTRONIC sweep. It will exactly fill top requirements of the professional TV serviceman or lab. engineer. There are no moving parts to wear out. Though moderately priced, this unit features a sweep signal that is absolutely linear and without amplitude modulations. Features a high .3 volt output. Triple shielded — no leakage problem here. Signal can be attenuated from 3 to 300,000 microvolts. 0-12 volts variable bias voltage with continuous tuning allows set alignment to more sensitive for "fringe areas," or less sensitive for "prime areas" to prevent overloading. Continuous tuning and detailed, easy-to-read scales provide foolproof method of alignment. Three RF oscillators provide complete VHF coverage on fundamentals and heterodyned output IF 0 to 50 mc. This assures the strong signal necessary for aligning front ends.

Model 695**Price: \$265.00****OUTSTANDING FEATURES**

- All-Electronic sweep.
- Fundamental output on all VHF channels (.3 volt output).
- Continuously variable tuning.
- 0 to 50 mc. IF heterodyned output, .15 volts output.
- Blanking of oscillator, provides reference base line.
- 100 db. attenuation, .3 volt to 3 microvolts.
- Triple shielded, very low leakage. Provides attenuation down into "snow" region to check IF's for oscillation.
- Metered, variable DC bias voltage 0-12 volts. Eliminates use of batteries for fixed bias.
- 170° of phasing.
- Sweep width of 0-15 mc., ± 3 mc. depending on frequency.
- Linear sweep.
- Amplitude variation of less than 0.1 db. per mc.
- Output impedance is 90 ohms.
- Attractive steel portable case. 16 $\frac{1}{4}$ " W., 13 $\frac{1}{4}$ " H., 8" D. 30 lbs. net; 38 lbs. Shipping.

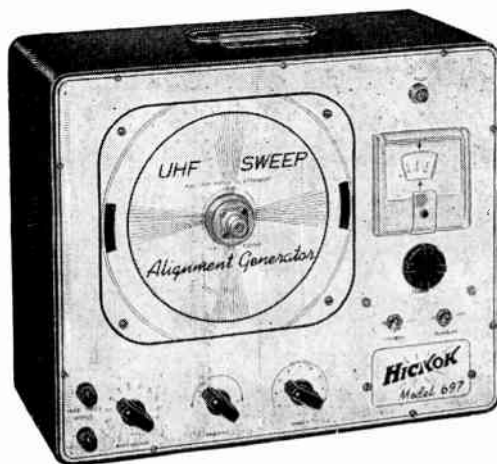
NEW UHF SWEEP-ALIGNMENT GENERATOR

- **Fundamental output on all UHF channels**
- **Linear, All-Electronic sweep**
- **Triple shielding — low leakage — better efficiency**

Model 697: An entirely new instrument developed to meet the critical requirements for UHF alignment. Previous methods of UHF alignment depended on the use of harmonics which in many cases were both confusing and erratic. Fundamental output on all channels from 14 to 83 is one reason why this instrument will speed up alignment tasks. Fundamental output and excellent linearity are provided along the entire sweep width, which is as high as 75 mc. Amplitude is constant over the entire sweep range. One of the major HICKOK achievements in the development of the 697 is ALL-ELECTRONIC sweep . . . no moving parts to wear out or lose efficiency. Triple shielding suppresses leakage to the practical level — far below other comparable equipment. This instrument is specifically designed to provide bare minimum loading effects on UHF circuits under alignment.

Model 697**Price available on request.****OUTSTANDING FEATURES**

- All-Electronic sweep.
- Fundamental output on channels 14 to 83 with .5 volt RF output.
- Continuous tuning.
- Blanking of oscillator gives reference base line.
- Piston type attenuator . . . better than 100 db. attenuation.
- Very low RF leakage . . . unit is triple shielded.
- Variable DC bias voltage of 0-12 volts with calibrated output.
- 170° of phasing.
- Sweep width of 0 to 25 mc. at low end of band, and 0 to 75 mc. at high end.
- Amplitude variation is less than 0.1 db. per mc.
- Very linear sweep.
- Output impedance is 50 ohms or 300 ohms.
- Strong steel portable case in attractive design to match the HICKOK set. 16 $\frac{1}{4}$ " L., 13 $\frac{1}{4}$ " H., 10" D. 24 lbs. Net; 31 lbs. Ship.

HICKOK . . . CHOICE OF THE EXPERTS

HICKOK

TEST INSTRUMENTS

HICKOK

NEW UNIVERSAL VIDEO GENERATOR COMPATIBLE FOR COLOR OR BLACK AND WHITE RECEIVERS



**Model
650C**

Price: \$318.90

This fine new instrument is the first of its kind. Now available to rapidly and accurately solve your service problems. Does in minutes many of the TV servicing jobs that would require hours by other methods.

The 650C has a new timer circuit which delivers video pulses of 60 cycles, 900 cycles, 15,750 cycles and 315 kc., singularly or in any combination, both positive and negative output. Pulses are all locked together and crystal controlled for greater accuracy.

Pulses can be used directly, metered in peak-to-peak volts or to modulate the self-contained RF oscillator.

RF oscillator covers all TV channels in two bands (2-6 and 7-13), all on fundamentals. RF output is metered at all times from 1 to 10,000 microvolts with calibrated attenuation and variable percentage modulation. RF can be externally modulated with video frequencies from 5 cycles to 4 MC with variable percentage modulation on all channels.

Self-contained, substitute external video amplifier, 5 cycles to 4 MC with a variable gain from 0 to 10, with high input impedance, low output impedance and metered peak-to-peak voltage output.

Includes horizontal and vertical sawtooth voltages which can be directly substituted for vertical and horizontal oscillator in a TV receiver. Both the vertical and horizontal sawtooth amplitude is sufficient to give full raster deflection and in the case of flyback type high voltage power supplies the horizontal sawtooth can be used to light up the picture tube.

The 650C also contains an AC line voltage scale for instantaneous check on line voltage fluctuation, a common source of TV trouble.

This tester is an absolute must for accurate registration adjustment of the three color guns of color TV receivers, as well as accurate adjustment of focus, convergence, centering of individual beams, purity yoke, dynamic convergence, linearity and aspect ratio. A real time saver, you need the 650C for black and white TV servicing now.

OUTSTANDING FEATURES

Quickly localizes and accurately identifies trouble in any section of a TV receiver.
Provides electronically accurate bar or dot pattern on the screen of any TV receiver — independent of station operation.
R.F. output, directly calibrated in microvolts for sensitivity measurements.
Attractive steel portable case. 16 1/4" x 13 1/4" x 7". 29 lbs. net; 37 lbs. shipping. Test leads included.

Substitute Video Amplifier with gain of 0 to 10.
Crystal controlled timer for greater accuracy.

Fast, accurate, the ideal instrument for fringe area TV servicing.
Increases TV maintenance profits — allows you to trouble shoot many more installations per day.
Built only by HICKOK. Contains highest quality components throughout for lasting accuracy and dependability.

MOST PRACTICAL UNIVERSAL NOISE GENERATOR

Industrial Engineer and
Radio-TV Technician's Model



Model 755

Price: \$262.00

(with 300 mc head)
Also available with
1000 mc head. Priced
accordingly higher.

Model 755: Extremely versatile unit for measurement of Noise factor in any receiver. This equipment is HICKOK engineered to provide the First Noise Generator in a completely self-contained unit. No additional equipment is required. Unit has two indicating Meters. Most valuable for improved TV service. Quickly indicates amount of Noise inherent in receiver. By reducing the Noise in a TV receiver, the snow is reduced resulting in a clearer picture.

The Model 755 is designed with a VTVM side and a Generator Noise Side.

VOLTMETER SECTION:

Meter readings: 0-0.1 V., 0.5 V., 1.0 V., and 5.0 V., Zero Center. Zero adjust provided for cancelling out contact potential (plus or minus 1 Volt maximum).

VTVM Meter scale permits reading double power to eliminate referring to instruction book for calculations.

VTVM is voltage regulated.

OUTPUT SECTION:

DF Meter output readings:

Receiver Input Impedance 300 Ohms: 0-19 db

Receiver Input Impedance 75 Ohms: 0-19 db

Receiver Input Impedance 50 Ohms: 0-17 db

NO BALUM NECESSARY TO MATCH IMPEDANCE.

Frequency Response: Flat from 10 MC to 250 MC.

SPECIAL FEATURES:

Permits extremely low sensitivity measurements. Has built-in standby position for Noise output. Spring loaded output control—increases life of noise diodes by returning it to zero output when not in use.

Noise diodes are built into probe whereby the output noise is connected directly to receiver input. This eliminates cancelling out capacities to the generator.

Three separate scales on the noise figure Meter permit more simplified reading.

UHF Head with 100-1000 MC is available . . . 50 Ohms output, 0-17 db. Dual-purpose portable case. 16 1/4" W., 13 1/4" H., 8" D. 25 lbs. Net; 33 lbs. Shipping. Power consumption: 50-60 cycles, 115 Volts, 50 Watts.

HICKOK . . . CHOICE OF THE EXPERTS

HICKOK

TEST INSTRUMENTS

HICKOK



Model 710 Price \$326.00

AMPLITUDE METERED OUTPUT IN 5 RANGES

Multiplier	Output Resistance	Sine Wave Volt. Range RMS VOLTS	Square Wave Volt. Range Peak-to-Peak Volts
X1	1000 Ohms	0-15	0-50
X.1	100 Ohms	0-1.5	0-5
X.01	10 Ohms	0-0.15	0-0.5
X.001	1 Ohms	0-0.015	0-0.05
X Zero*	0 Ohms	0	0

*Provided for zero reference.

NEW SINE-SQUARE WAVE GENERATOR

For Laboratory and Industrial Use

Model 710: This new instrument is a professional laboratory design to provide an accurately calibrated source of sine-wave and square-wave functions over a very wide frequency range.

TECHNICAL FEATURES

- Sine wave total harmonics distortion below 1%.
- Hum level better than 90 db down.
- Square wave rise time less than 0.1 Micro-second
- Direct coupled output for square wave.
- Synchronization output provided.
- Edge-lighted parallax correcting hairline on frequency dial facilitates highly accurate readings.
- May be used as a portable instrument or for rack Mounting.

FREQUENCY COVERAGE

20 cycles to 1 MC in 5 ranges.

(A) Scale: 20 to 200 cps; x1, x10, x100, x1K.
Calibrated to $\pm 2\%$, ± 1 cps.

(B) Scale: 200 KC to 1 MC.

POWER CONSUMPTION:

50-60 cps., 115 Volts, 110 Watts, 8 $\frac{1}{4}$ " H., 12" D., 16" W. (19" wide when rack mounted). 44 lbs. Net; 52 lbs. Shipping.

NEW UHF-VHF FIELD STRENGTH METER

Model 235 Price: \$159.00

Model 235: Attractively designed technician's equipment for measurement of Field Strength. Large 4" meter is accurately calibrated in microvolts. Handy portable size design has self-contained battery power supply.

RANGES: VHF range has a sensitivity of from 10 Microvolts to 100,000 Microvolts.

UHF range sensitivity is from 30 Microvolts to 50,000 Microvolts.

TECHNICAL FEATURES: Frequency calibration is marked in Channel numbers for easier measurement. An Impedance Matching Network is available. Phone Jack Audio Monitoring. 8 $\frac{1}{2}$ " W., 5" D., 11 $\frac{1}{2}$ " H., 10 lbs. Net; 15 lbs. Shipping.

UNIVERSAL CRYSTAL CONTROLLED SIGNAL GENERATOR

MODEL 288X

High Output AM-FM Generator



Model 288X Price: \$195.00

A variable frequency signal generator, crystal controlled, for accurate AM and FM alignment. Useable in TV alignment as a marker oscillator in connection with television front-end or IF alignment, or the 288X can also be used as an FM generator to align the sound IF amplifier of a TV receiver. RF unmodulated or internally amplitude modulated at 400 cycles, or internally frequency modulated. RF variable from 110 kc. to 110 mc. on AM and 110 kc. to 160 mc. on FM, in 7 bands, all fundamental. Fixed 50-mc. output is internally frequency modulated at 60 cycles or at 400 cycles for FM and television. Fixed, crystal-controlled 100-kc. and 1000-kc. outputs either unmodulated or internally amplitude modulated. Fixed 1000 kc. internally frequency modulated at 60 cycles for visual IF alignment. 50 mc. and 1000 kc. oscillators beat with variable RF oscillator to give variable FM signals. Variable AF output 0-15,000 cycles; fixed AF, 400 cycles. Outputs continuously variable with multiplier and linear controls. Db meter—10 to plus 38 in 3 ranges. 105-125-volt 60-cycle operation. Test leads included.

SPECIFICATIONS

Dimensions—13 $\frac{1}{4}$ " x 16 $\frac{1}{4}$ " x 7" D. Scale—over 100"
Net Weight—25 lbs.—Ship. 33 lbs. Satin-aluminum finish panel
Meter—Model 51X Blue baked Hammertex finished steel case

HICKOK . . . CHOICE OF THE EXPERTS

HICKOK TEST INSTRUMENTS HICKOK

NEW MICROVOLT SIGNAL GENERATOR for AM, FM, TV and Mobile Bands

MODEL 292X

125 KC to 120 MC and 150 MC to 220 MC on fundamentals.



Model 292X

Price \$296.00

Output cable, test leads, 1000 kc crystal, and 20 db pad are included.

Model 292X: Here's an outstandingly accurate microvolt signal generator that meets the servicing, alignment and calibration needs of such high-frequency users as police, fire departments, railroads, relay press, maritime mobile, etc. Covers from 125 kc to 120 mc and from 150 mc to 220 mc—all on fundamentals, with an accuracy of 1.0%. Has special provision for an optionally available crystal-controlled oscillator accurate to .005% in 30-50 and 152-162 mc mobile ranges. Has easy-to-read calibrated 8" dial with over 100° of scale. Output voltages: 400 cycles AF, variable 0-2 volts; RF unmodulated or modulated at 400 cycles—directly calibrated 0-100,000 microvolts by means of internal crystal detector for meter. Also has provision for external modulation. Internal 1000 kc crystal-controlled reference oscillator with an accuracy of 0.5%. Has excellent shielding; leakage is less than 0.2 microvolt. All controls are plainly marked. This new HICKOK Model 292X is the only popularly priced Microvolt Generator available that covers both Upper Channel TV and Mobile frequencies—on fundamentals.

FEATURES

- Covers all AM, FM, TV and Mobile Frequencies in 7 ranges. Also ideal for industrial applications.
- Crystal controlled. Temperature compensated.
- Amplitude Modulated and Unmodulated Output from .2 to 100,000 microvolts
- Cast Aluminum Attenuator for Minimum Signal Leakage
- May be externally modulated from 15 to 10,000 cycles per second
- Decibel Meter for faster servicing to indicate reference level
- Self-contained Crystal Oscillator Circuit—Crystals from 1 mc to 20 mc are available.
- Negligible Change in Frequency due to output
- Most accurate Microvolt Generator available for practical radio servicing and communication's manufacturers final inspections

TECHNICAL CHARACTERISTICS

Fundamental Frequency Coverage: Bands A through G—125 kc to 120 mc; Band H—150 to 220 mc. **Output Calibrated:** .2 to 100,000 microvolts. **Output Impedance:** X1, X10, and X100 microvolts—5 ohms; X1K—30 ohms, X10K—0 to 100 ohms. **Modulation Fixed:** 400 cycles. **AF Output:** 0-2 volts. The Model 292-X is wired for plug-in type crystals (152-162, 30-50 mc), with accuracy to .005%. Self-Contained crystal oscillator circuit has crystal jack on front panel permitting crystal outputs at any

frequency from 1000 kc to 20 mc on fundamentals; and to over 250 mc on harmonics. Type CCO-56 Crystal Oscillator unit available with frequency accuracy to .005% for Mobile Band coverage. **Self-Contained Decibel Meter:** -10 to +38 DB in 3 ranges. **Power Consumption:** 35 watts at 115 volts. **Meter Model:** 50; 105-125 V., 50-70 cycles, A.C. 1 3/4" H., 1 1/2" W., 7" D. 27 lbs. Net; 35 lbs. Ship. Satin Aluminum Panel. Blue hammett steel case. Test leads and 1000 kc crystal included.

AIRLINE MICROVOLT SIGNAL GENERATOR

Model 292XAL: The only Microvolt Generator to provide complete coverage from 125 KC to 165 MC on fundamentals.

Especially built to meet the exacting requirements of aircraft radio technicians. This one instrument provides complete coverage of the aircraft band including all the necessary IF frequencies, and covers all RF frequencies with calibrated output. Can be externally modulated from 15 to 10,000 cycles per second, and measures both input and output of units under test. This fine generator is, beyond a doubt, the best high quality oscillator available today at anywhere near its price range.

TECHNICAL FEATURES: Maintains dependable and accurate frequency calibration, is free of wave distortion, and has no spurious signals in the output system. Temperature compensation, self contained crystal oscillator reference level, and crystal controlled. Cast aluminum attenuator is especially designed to faithfully attenuate without frequency discrimination.

Doubly shielded for absolute minimum signal leakage. Model 292XAL Technical Characteristics are the same as the Model 292X listed above EXCEPTING that the 292XAL has continuous frequency coverage from 125 KC to 165 MC. However, all other features and accessories remain the same for both instruments.



Model 292XAL

Price \$326.00

HICKOK... CHOICE OF THE EXPERTS

HICKOK

TEST INSTRUMENTS

HICKOK

CAPACITANCE TESTER, TRUE VACUUM TUBE VOLT-OHM MILLIAMMETER



Model 209-A

POWER SUPPLY: 105-125 V, 50-70 cycles. Ranges: Volts, A-C and D-C 0-3, 12, 30, 120, 300, 1200. Mills (D-C): 0-3, 12, 30, 120, 300, 1200. Cap.: 0-10,000 mmf in 2 ranges, 0-1000 mf in 5 ranges. Ind.: 50 mh-100 henries. Ohms: 0.1 ohm to 10,000 megohms in 7 ranges. Frequency: A-C up to approximately 200 mc may be measured. Input Impedance: Volts D-C: 15 megohms, Volt A-C: 12 megohms. Tube Complement: 6X5GT A-C rectifiers, 6SJ7 cathode follower, 6SN7GT vacuum tube voltmeter.

LABORATORY SIZE . . . LARGE NINE-INCH METER WITH ZERO CENTER SCALE

Model 209-A: A universal test instrument for all radio and electronic service work. Accurately and easily measures wide ranges of inductances, capacitances, resistances, currents and voltages, both A.C. and D.C.

This new giant size instrument matches the size and attractiveness of the Hickok complete line of test equipment. Large 9-inch meter improves ease of operation. Has a 1200 Volt scale, and a new Peak-to-Peak Voltmeter to measure peak to peak or RMS values of A.C.

The new Zero-Center scale on D.C. permits much faster alignment of discriminator and other galvanometer applications.

SPECIFICATIONS:

Dimensions—13¼" H., 16¼" W., 7" D.
Weight—18 lbs. Net; 26 lbs. Ship.

Blue baked Hammertex finish steel case with etched aluminum panel.

High input impedance prevents loading when making voltage tests. Measurement of inductances are possible with the use of a conversion chart supplied in the instruction book. Possibility of damage due to overload is slight in all except current measurements. Power supply permits normal operation and accuracy with wide line voltage fluctuation.

Price \$132.50

Including high frequency probe and all leads.

NEW LOW PRICE ELECTRONIC VOLT OHMMETER



Model 225

- Huge HICKOK-Built 9" Meter
- Accurate Peak-to-Peak Scales
- Fast Continuity Tests
- AC-DC Single Unit Probe

Model 225: HICKOK practical engineering provides the low-cost answer to your needs for a multi-range Volt-Ohmmeter in a professional engineer's top quality instrument.

Designed around the HICKOK-built 9" internal pivot meter, the 225 offers many new features to improve the speed and accuracy of your radio-TV servicing.

Extra long scales minimize reading errors and permit permanent placement of the equipment at a more practical working distance.

Additional features: • Built-in audio tone speeds continuity tests • Accurate Peak-to-Peak scales for measurement of complex waveforms • D.C. Zero-Center scale for galvanometer applications • New, HICKOK single unit A.C.-D.C. probe.

SPECIFICATIONS:

Dimensions—13¼" H., 16¼" W., 7" D.
Weight—15 lbs. Net.—23 lbs. Shipping.

Blue baked Hammertex finish steel case with etched aluminum panel.

Price \$89.50

Test leads and dual-purpose AC-DC probe are included.

RANGES—D.C. VOLTMETER:

Plus D.C. Volts: 0 to 1.5, 3, 12, 30, 120, 300, 1200.

Minus D.C. Volts: 0 to 1.5, 3, 12, 30, 120, 300, 1200.

Input Resistance: 10 megohms with new HICKOK Dual-Probe.

Zero-Center Scale: For discriminator alignment and other galvanometer applications.

OHMMETER:

Design Center: 10 ohms.

Ranges: x1, x10, x100, x1000, x10,000, x100,000, x1 megohm.

Readability: 0.2 ohms to 1,000 megohms.

A.C. VOLTMETER:

7 Ranges A.C. RMS: 0 to 1.5, 3, 12, 30, 120, 300, 1200.

7 Ranges A.C. Peak-to-Peak: 0 to 4, 8, 32, 80, 320, 800, 3200.

Frequency Characteristics: Flat from 40 cps. to 3.5 mc.

HICKOK . . . CHOICE OF THE EXPERTS

HICKOK

TEST INSTRUMENTS

HICKOK

HANDY SIZE ELECTRONIC VOLTMETER

INCLUDES: NEW, DUAL-PURPOSE AC-DC PROBE



Model 215

Price: \$67.50

Dual Probe and Test leads included.

A single unit with built-in switching arrangement. (Patent applied for)

- ★ Combination RMS or Peak-to-Peak voltage measurements.
- ★ New, guaranteed insulated and shock-resistant case.
- ★ Modern lucite meter case with large 5" easy-to-read scale.
- ★ Handier size for greater portability.
- ★ Zero-Center for faster discriminator.

Model 215: Is a top grade instrument of highest quality, accuracy and dependability. Though ideal for the radio-television manufacturer or service shop, this fine instrument will meet a great number of applications in the electronic design or industrial laboratory. Exceptionally versatile, the 215 provides the sensitivity and ranges for quick and accurate measurements of sine or complex waves of TV or industrial devices.

RANGES

D. C. VOLTMETER

Volts: 0 to 1.5, 3, 12, 30, 120, 300, 1200.

Input Resistance: 10 megohms with new HICKOK Dual-Probe.

Zero-Center Scale: For discriminator alignment and other galvanometer applications.

OHMMETER

Design Center: 10 ohms.

Ranges: x1 x10, x100, x1,000, x10,000, x100,000, x1 megohm.

Readability: .2 ohms to 1000 megohms.

A. C. VOLTMETER

7 Ranges AC, RMS: 0 to 1.5, 3, 12, 30, 120, 300, 1200.

7 Ranges AC, Peak-to-Peak: 0 to 4, 8, 32, 80, 320, 800, 3200.

Frequency Characteristics: Flat from 40 cps. to 3.5 MC. Crystal Probe available to extend frequency range to 250 MC.

Input Impedance: With new HICKOK Dual-Probe, 30 megohms shunted by 150 uuf.

105-125 VAC. Insulated, shock-resistant case. 5¾" W., 8¾" H., 4½" D., 4½ lbs. net weight, 7 lbs. shipping.

Test leads included:

New combination AC-DC HICKOK Dual-Probe, ohms lead and ground lead.

HIGH SENSITIVITY VOLT-OHM-MILLIAMMETER

Compact Portable . . . Shock-Resistant Case

LARGE 5" METER

RANGES:

20,000 ohms per volt DC, 5,000 ohms per volt AC.

Volts AC and DC: 2.5, 10, 50, 250, 1,000, 5,000.

Output: 2.5, 10, 50, 250, 1,000.

Milliamperes, DC: 2.5, 10, 50, 250, 1,000.

Microamperes, DC: 0 to 50.

Amperes, DC: 0-10.

Decibels: -30 to +55, in 5 ranges.

OHMS:

0 to 1,000, 5 ohm center scale.

0 to 10,000, 50 ohm center scale.

0 to 1 meg., 5,000 ohm center scale.

0 to 100 meg., 500,000 ohm center scale.

Model 450: The last word in design for attractive, high sensitivity volt-ohm-milliammeters. It is thin, lightweight and fully portable.

The modern HICKOK lucite meter case provides increased readability. Large 5" meter scale can be read more accurately.

Compact HICKOK design provides the thinnest instrument of its kind. Handier for the Radio-TV or field engineer for on-location servicing. Provides work-bench accuracy for all field jobs. Durable neolite handle provides sturdy stand at just the correct angle for easy bench use.

The new HICKOK insulated and shock-resistant case protects the high sensitivity and accuracy of this fine instrument.

Rugged and dependable, the HICKOK 450 provides for long, hard, day-in, day-out service on the bench or in the field. (Battery operated).

8½" H., 5¾" W., x 2½" D. 2¾ lbs. net, 5 lbs. shipping.



Model 450

Price: \$46.50

Test leads included.

HICKOK . . . CHOICE OF THE EXPERTS

HICKOK

TEST INSTRUMENTS

HICKOK

DOUBLE RANGE DC KILOVOLT METER



Model 465

For measuring DC voltages as high as 30,000 volts. 20,000 ohm per volt sensitivity. Low current drain. Well insulated phenolic case for ample protection against the high voltages being measured. 7" x 6 1/8" x 4 1/8". 6 lbs. net; 8 1/2 lbs. shipping. Complete price including leads and carrying case \$61.25.

PORTABLE TRUE WATTMETER



Model 900-C

Tests all AC electrical units under actual use conditions. Continuity test for shorts. Accurately tests even smallest units. 4" meter shows wattage, amperes and line voltage. Portable case complete with leads, 9 3/8" x 6 1/4" x 3 1/4". 6 lbs. net; 10 lbs. shipping. \$105.00. C-105 external transformer for ranges to 10,000 watts and 130 amp. \$17.00. 9A and 9B leads for 220 volts, \$18.00. Strong, detachable-cover carrying case. \$10.20.

CRYSTALS

.005% accuracy for 292X\$18.80
4.5 MC for 610-A 4.65

Specified channels for 610-A..... 9.29
Special frequencies for 610-A..... Prices on request.



Model CRT TV Picture Tube Test Accessory — Built for use with any HICKOK tube tester. Tests all types TV receiver electromagnetic picture tubes including Philco. Tube gas test, grid control test, short test, cathode emission test.

\$9.90

PROBES and ACCESSORIES

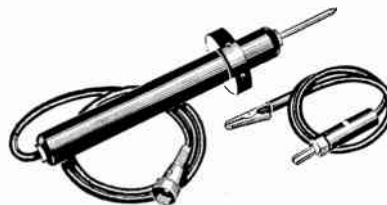

PR 30 KV — High Voltage DC Probe — Extends VTVM range to 30,000 volts DC. Doubles use of any voltmeter. Ideal for use with HICKOK 203 or 209. Heavy duty phenolic, 4 ft. cord and cable type connector. 12 oz. net; 2 lbs. ship. **\$11.90**

PR 30KVA — High Voltage DC Probe — For use with HICKOK Model 209A. 12 oz. net; 2 lbs. ship. **\$11.90**

PR 25 — Extends range of HICKOK Models 450 or 435-A to 25,000 volts DC. Can be used with any 20,000 ohm-per-volt multimeter with a 250 volt scale. 12 oz. net; 2 lbs. ship. **\$11.90**

PR 15 — RF Crystal Probe — For use with HICKOK Model 215 or Model 225. 12 oz., net; 21 lbs. ship. **\$7.59**



TYPE 34

"34" Crystal Demodulator Probe — Use with any 'scope to trace a modulated RF signal, at any frequency, through radio or TV receiver from the antenna post to the detector or discriminator. 4 ft. long. 2 oz. net; 2 lbs. shipping. A quick and accurate aid to trouble-shooting with your 'scope. **\$9.80**

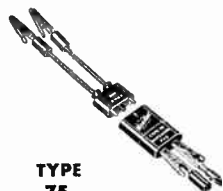

TYPE 75

"75" Termination Pad — This accessory is for use with the HICKOK 610A or any other TV-FM alignment generator. Eliminates most standing waves on the length of output cable to insure accurate impedance match of the generator and TV receiver. Can be used on both 90 and 300 ohm inputs. 6 oz. net; 2 lbs. shipping. **\$8.50**



Model 175

"175" Oscilloscope Voltage Calibrator—Handy size, easy to use to accurately measure peak-to-peak voltages on any 'scope. Ranges: Peak-to-Peak: 0.1 volts, 1.0 volts, 10.0 volts, 100.0 volts. Accurate to ±5% at 115 volts.

Calibrates scope in peak-to-peak in any desired voltage. Wave shapes may be measured in peak-to-peak volts without disconnecting calibrator from 'scope . . . Permitted through means of a self-contained switch.

Model 175: 6" H., 3 3/4" W., 2" D. 1 1/2 lbs. Net; 2 lbs. Ship. 50-60 cycles, 115 volts, 5 watts. **\$13.94**

HICKOK . . . CHOICE OF THE EXPERTS

HICKOK

TEST INSTRUMENTS

HICKOK

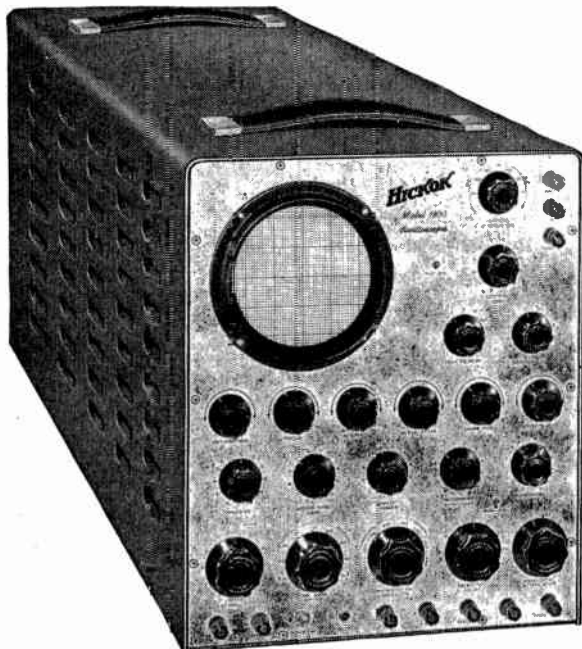

Professional Laboratory Cathode Ray OSCILLOSCOPE

Model 1800: This fine piece of equipment offers the ultimate in Oscilloscope function for the industrial electronic laboratory.

The exceptional range, sensitivity and stability of the Model 1800 makes it a most desirable instrument for the professional electronic engineer in his detailed visual study of any one electrical quantity as a function of another electrical quantity.

This practical HICKOK design provides unusual versatility and ease of application for dependable general purpose Oscilloscope use.

Model 1800

Price available on request.

FEATURES...

- Expansion: 12 times screen expansion.
- External capacity terminal for slower sweep is provided at the panel.
- Sweep stability control for driven sweep is also included.
- Astigmatism and focus controls provide excellent definition.
- Illuminated dial has adjustable light intensity.
- Balance control is provided at the front panel.
- Large knobs permit easy handling of controls.
- Standard 5" CRT visor for cameras is furnished.
- Z-axis and blanking amplifiers are included.

PERFORMANCE SPECIFICATIONS

VERTICAL AMPLIFIER

BALANCED INPUTS: Dual attenuation in steps of ten, from 1 to 1,000.
VERTICAL CALIBRATE POSITION: .01, .1, 1, 10, 100.

FREQUENCY RESPONSE: D.C. to 10 megacycles, 100 millivolts per inch rms, within 3 DB.

FREQUENCY RESPONSE: A.C., 3 cycles to 10 megacycles, 25 millivolts per inch rms, within 3 DB.

TRANSIENT RESPONSE: Over shoot; less than 2%.

Rise time; 10% to 90%, 0.07 microseconds.

VERTICAL DELAY: Maximum 0.25 microseconds.

UNDISTORTED DEFLECTION: 4" or better. (2000 v. acceleration).
Flat faced tube, post anode connection available.

MECHANICAL: Balanced push-pull shock mounted amplifiers.

INPUT IMPEDANCE: 1 megohm shunted by 30 uuf.

HORIZONTAL AMPLIFIER

FREQUENCY RESPONSE: 5 cycles to 1 megacycle within 3 DB.

SENSITIVITY: 100 millivolts per inch rms.

INPUT IMPEDANCE: 1 megohm shunted by 30 uuf.

TRANSIENT RESPONSE: Overshoot; less than 2%.

Rise time; 10% to 90%, 0.35 microseconds.

MECHANICAL: Balanced push-pull shock mounted amplifiers.

LINEAR TIME BASE

TUBES: All hard valve type.

FREQUENCY RANGE: 1000 milliseconds to 10 microseconds.

SYNCHRONIZATION: Driven (plus internal), (minus internal), (external).

Recurrent (plus internal), (minus internal), (external).

PHYSICAL CHARACTERISTICS

CASE SIZE: 14" high, 12" wide, 18" deep.

WEIGHT: 60 lbs. net.

POWER CONSUMPTION: 250 watts, 47-450 cycles.

HICKOK... CHOICE OF THE EXPERTS

HICKOK

TEST INSTRUMENTS

HICKOK

PROFESSIONAL MODEL LABORATORY OSCILLOGRAPH

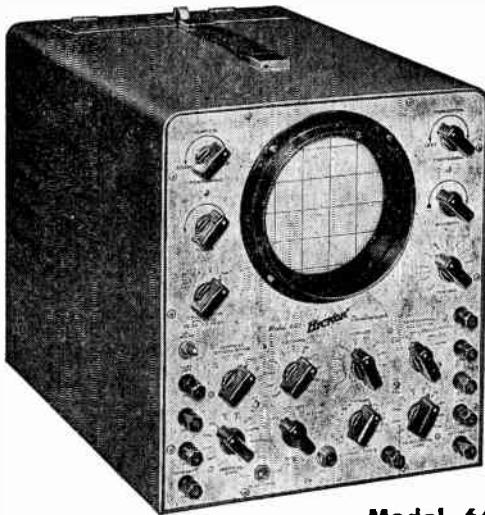

Model 640

The new Model 640 Oscilloscope is an outstanding, versatile instrument designed for General Purpose, Industrial Laboratory and Television applications for observation of transient or regular recurring phenomena.

Designed with outstanding range and sensitivity and completely built to the highest quality standards throughout. Rigidly field-tested and proved in the HICKOK laboratories.

Ideal for color TV applications.

SPECIFICATIONS:

WIDE BAND AMPLIFIER: Frequency response DC, 0 to 4.5 mc, (down 3 db).
VERTICAL DC AND AC AMPLIFIER: 17 M. V. per inch with sensitivity switch in high position. 35 M. V. per inch in low position.
FREQUENCY RESPONSE: 0 to 1,000,000 cycles (3 db point), in high position. 0 to 4,500,000 cycles (3 db point), in low position.
No jitter, even with high gain amplifiers.
Maximum Input Potential: 1000 volts peak.
Input Impedance: 2 megohms, 50 mmf.
Excellent stability and minimum microphonics and drift.

HORIZONTAL AMPLIFIER:

Deflection Factor —
Direct: 13 volts RMS per inch.
Full Gain Settings: 50 millivolts RMS per inch.
Frequency Response: 0 to 200,000 cycles, with 3 DB down at upper limit.
Maximum Input Potential: 1000 volts peak.
Input Impedance: 2 megohms, 50 mmf.

BUILT-IN CALIBRATING VOLTAGES:

Peak-to-Peak—100, 10, 1, .1 volts.
TEST SIGNALS: Line Frequency: 3 volts RMS per inch.
Sawtooth: Available from front panel.
Direct connection to both horizontal and vertical deflection plates.

SHOCK MOUNTED: Provides minimum microphonics due to external mechanical vibrations.

SHIELDED: Mu Metal magnetic shield gives maximum protection to the cathode ray tube against effects of external magnetic fields.

CALIBRATED SCALE: Provided for quantitative measurements and comparisons.

LINEAR TIME BASE: Recurrent and Driven Sweep: 2 cycles to 30,000 cycles.

Provision for external capacities for slower frequency sweeps of 10 seconds and slower.

Sweep Speeds: Faster than 0.75 inch per microsecond.

Television fixed frequencies; 30 and 7,875 for observing blanking and sync waveforms in the horizontal and vertical circuits of TV receivers.

Synchronization of line or 2-times line frequency.

EXPANDABLE SWEEP: 6 times expansion, or equivalent to 30 inches of screen diameter.

LINE FREQUENCY PHASING CONTROL: Zero, plus or minus 90° phase shift.

"Z" AXIS MODULATION: Capacitively coupled to the grid of the cathode ray tube.

15 volts will blank trace fully at normal intensity.

INTENSITY: Standard Model 640 includes 5UP1 cathode ray tube with medium persistence screen. High accelerating potentials give excellent intensity for viewing transient waves and high frequencies.

Some engineers may prefer a 5UP11 tube for short persistence, or a SUP7 tube for long persistence. Either is available in the Model 640 at slight additional cost.

STABILIZED: Designed so that sweep lengths and synchronizations are maintained as signal level varies.

DIMENSIONS: Portable steel case, 12"x13 1/2"x17 1/2", approximately 49 lbs. net; 59 lbs. shipping. Combination light shield and camera base provided.

Price: \$355.00

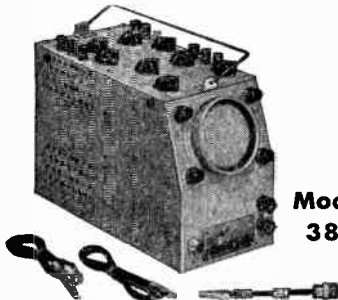

Model 385

Price: \$256.00

CATHODE RAY TUBE
3" Screen, Type 3RP-1

FREQUENCY RANGE:

- a) Vertical Amplifiers:
(D.C.) 0 to 4.5 MC, 3 db down.
(A.C.) 5 cycles to 2 MC, 3 db down.
- b) Horizontal Amplifiers:
(D.C.) 0-500 KC, 3 db down (Full gain setting).
(A.C.) 1 cycle to 500 KC, db down.
- c) Sweep Circuit Oscillator:
to 50,000 cycles.

INPUT IMPEDANCE:

- a) Vertical Amplifier:
(1) A.C. — 1.5 megohms shunted by 25 mmf capacity.

NEW, HANDY SIZE 3" PORTABLE OSCILLOSCOPE

Model 380A: Handy size oscilloscope is similar to equipment built for the armed forces and is of the highest quality throughout. It is slightly larger than a normal size telephone and provides a new high in dependable accuracy to both laboratory technicians and field engineers.

Features both vertical and horizontal DC Amplifiers with a sensitivity of better than .075 RMS volts per inch. Frequency coverage to beyond 5 MC.

Fully compensated horizontal and vertical attenuators, retractable light shield, direct connection to CR tube elements, and provision for Z-Axis modulation are other desirable characteristics.

Test leads, (3' coaxial test cable, 6" coaxial test cable, 3' ground lead), are included. Storage compartment for leads is in accessory case.

This fine instrument is also available in a shock mounted, waterproof, moisture-proof, strong aluminum case at \$276.00, or laboratory rack mount case at \$276.00.

TECHNICAL CHARACTERISTICS:

- (2) D.C. — 2 megohms.
- b) Horizontal Amplifier:
 - (1) A.C. — 1.5 megohms shunted by 25 mmf capacity.
 - (2) D.C. — 2 megohms.
- c) Vertical Direct connection:
9 megohms shunted by 11 mmf.
- d) Horizontal Direct connection:
9 megohms shunted by 11 mmf.

DEFLECTION SENSITIVITY:

- a) Horizontal and Vertical:
.075 RMS volts/inch.
- b) Vertical Direct connection:
17 RMS volt/inch.
- c) Horizontal Direct connection:
25 RMS volt/inch.

POWER SUPPLY

REQUIREMENTS:

- a) 105 to 125 volts A.C. at 50 to 1000 cycles.
- b) Power consumption 60 watts at 115 volts.

ACCESSORIES INCLUDED:

- 3 ft. Coaxial Test Cable, 6 inch Coaxial Test Cable, 3 ft. Ground Lead, and Ruled Celluloid Screen. Also available with strong, aluminum waterproof, moisture-proof, shock mounted carrying case.
- 5 1/2" wide x 8" high x 13 1/4" deep, less carrying case.
- 11 lbs. net.
- 6" wide x 9" high x 13 1/2" deep, including carrying case.
- 15 lbs. net.

HICKOK . . . CHOICE OF THE EXPERTS

HICKOK

TEST INSTRUMENTS

HICKOK



Model 670

NEW MODEL 670 OSCILLOSCOPE

Accurate, Stable, High Sensitivity with AC and DC AMPLIFIERS

Model 670: The more exacting requirements of today's television maintenance have made it necessary for the service technician to have a good 'Scope. The HICKOK Model 670 is designed with DC amplifiers to provide excellent square wave response — even down to DC.

Many TV receivers are so far out of alignment that extreme 'Scope sensitivity is necessary to properly show the response curve. The 670 provides this extra sensitivity — to 15 MV per inch.

To properly view all TV frequencies a wide band vertical amplifier is necessary. The 670 provides for this need by having a band width useable to beyond 2 MC. Push-pull amplifiers and polarity reversing switches are also new features you will find most useful in the 670.

TECHNICAL CHARACTERISTICS

Deflection Sensitivity:	
a. vertical amplifier	.015 volts (RMS) per inch
b. vertical direct	12 volts (RMS) per inch
c. horizontal amplifier	.07 volts (RMS) per inch
d. horizontal direct	13 volts (RMS) per inch

Input Impedance:	
a. vertical amplifier	2.2 megohms—30 mmf
b. vertical direct	3.3 megohms
c. horizontal amplifier	1 megohm—35 mmf
d. horizontal direct	3.3 megohms

Frequency Range:

- Vertical Amplifier: D.C. to 600 KC, within 3 db. Useful beyond 2 MC; pulse rise time 0.6 microseconds.
- Horizontal Amplifier: 0 to 250 KC; pulse rise time 1.2 microseconds.

Sweep Oscillator: 3 to 50 KC.

Power Supply: 105-125 VAC, 50-70 cycles, 65 watts at 115 VAC.

Size: 10" W x 13" H x 18" D. In attractive, steel portable case or matched set "D" case.

Weight: 27 lbs. net; 35 lbs. ship.

TECHNICAL FEATURES:

Highest practical sensitivity: 0.015 (15 millivolts) RMS per inch.

Demodulator circuit for viewing modulation on RF signal.

Recurrent linear sweep; 3 cycles to 50,000 cycles.

Reversing switches for both horizontal and vertical deflection.

Fixed sweep frequency for horizontal and vertical wave forms to TV receivers.

Both negative and positive synchronizing.

Line phasing control (approximately 180°).

Wide band vertical amplifier, useful beyond 5 MC.

Direct coupled, balanced (push-pull) amplifiers for both vertical and horizontal deflection.

Provision for Z-axis modulation.

Permits the study and analysis of wave forms, and other electric and magnetic phenomena.

Excellent square wave response.

Provides for the visual testing and alignment of amplitude and frequency modulated receivers, as well as television equipment when used with a frequency modulated RF oscillator or sweep generator.

Price: \$244.00

EXCEPTIONAL VALUE 5" OSCILLOSCOPE

Excellent Characteristics for Radio-TV Receiver Work

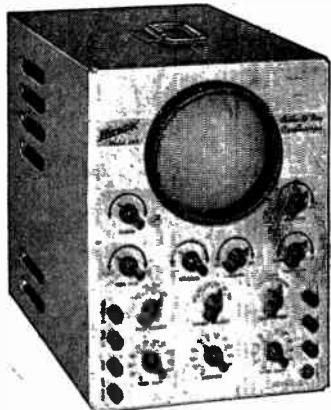

Model 665

Price: \$129.50

Model 665: Here is real value in a HICKOK 5" cathode ray oscilloscope. This new instrument is good quality at a price well within the reach of every radio-TV technician. Thoroughly HICKOK designed with very good square wave characteristics and a frequency range entirely adequate for all TV receiver work. Built to the same attractive — sturdy construction as all other HICKOK equipment and guaranteed to give excellent service within the range of its technical characteristics.

TECHNICAL SPECIFICATIONS

Frequency Range: 0.5 cycles to 700KC, down 3 db.

Accelerating Potential: 1775 Volts (high intensity).

Square Wave Response: 40 cps to 100KC, with less than 1% tilt, less than 2% overshoot.

Dual Fuse: B+ is fused and the line is fused.

Amplifier: Push—pull, vertical sensitivity .020 MV per inch.

Horizontal .030 MV per inch.

Vertical Input Impedance: 15 MMF, 2.2 Megohms.

Horizontal Impedance: 52 MMF, 0.1 Megohms.

Excellent locking.

Sweep Oscillator Range: 18 cps. to 50KC.

Withstands shock, vibration and humidity. CRT is shock-mounted.

Attractive blue hammertex steel case. 13" H., 16 1/4" D., 9 1/2" W. 25 lbs. net; 30 lbs. shipping. 105 — 125 VAC, 35 watts.

HICKOK . . . CHOICE OF THE EXPERTS

HICKOK

Meiers

For Accuracy and Dependability

MODEL 19 AC-DC ASTATIC MILLAMMETERS, AMMETERS, VOLTMETERS, WATTMETERS, WATTLSS COMPONENT INDICATORS

Astatic Electro-dynamometer movements. Accuracy within $\frac{1}{2}$ of 1% on AC or DC. Not affected by external magnetic fields. Scale length: $5\frac{1}{2}$ inches. Wattmeter scales are uniform, others uniformly squared. Mirror scales.

Model 19 portable instruments designed for precision AC and DC measurements. They are of astatic dynamometer type with a greater accuracy than most other portable AC and DC instruments. Owing to the astatic design the indications are the same on either AC or DC.

Dimensions: $4" \times 6\frac{1}{4}" \times 7\frac{1}{8}"$. Weight: $4\frac{1}{2}$ lbs. Case material: Molded phenolic.



MODEL 13 AC DYNAMOMETER INSTRUMENT

Accuracy $\frac{1}{2}$ of 1%. Shielded from effect of External Magnetic fields. Ammeters, Milliammeters, Voltmeters, Wattmeters — single phase. Mirror scales, Knife Edge Pointers. Scale length: $5\frac{1}{2}$ inches.

These instruments are correct on AC of any frequency up to 125 cycles. Built for use on higher frequencies. Deviations from the sinusoidal wave form met in ordinary testing have no noticeable effect on the calibration of these instruments. Voltmeters and wattmeters are self-contained up to 750 volts, designed to perform continuous service.

Dimensions: $3\frac{1}{4}" \times 6\frac{1}{4}" \times 7\frac{1}{8}"$. Weight: $3\frac{1}{2}$ lbs. Case material: Phenolic.



MODEL 14 DC AMMETERS, MILLIAMMETERS, MICROAMMETERS, VOLTMETERS, MILLIVOLTMETERS, VOLT-AMMETERS, THERMO-COUPLE METERS

D'Arsonval movements. Accuracy within $\frac{1}{2}$ of 1%. Shielded from effect of external magnetic fields. Uniform scales provided in DC meter with anti-parallax mirrors. Scale length: $5\frac{1}{2}$ inches.

Voltmeters in this model have a resistance of approximately 1000 ohms per volt, the exact resistance being marked on data card furnished with the instruments. Model 14 millivoltmeters are supplied with leads for connection to external shunts. Ammeters are self-contained up to 150 amperes, having negligible temperature coefficient built-in shunts. The drop across the ammeters is 50 millivolts. Model 14 microammeters are of the high torque, have excellent damping, and other rugged characteristics not usually found in high sensitivity instruments.

Dimensions: $7\frac{1}{8}" \times 6\frac{1}{4}" \times 4"$. Weight: $6\frac{1}{2}$ lbs. Case material: Polished phenolic. Excellent magnetic damping.

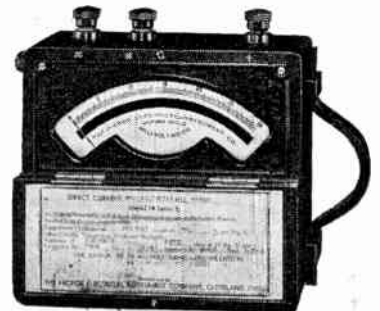

MODEL 18 DC INSTRUMENTS FOR ALL CLASSES OF DIRECT CURRENT TESTING

D'Arsonval movements. Accuracy within $\frac{1}{2}$ of 1%. Shielded from external magnetic fields. Voltmeters, millivoltmeters, ammeters, milliammeters, microammeters, and volt-ammeters. Uniform mirror scales engraved on moisture-proof stock. Scale Length: $5\frac{1}{2}$ inches.

Excellent damping characteristics. This model is so designed that there is only a small overshoot to the needle which results in quick and accurate readings. Voltmeters have a resistance of 1000 ohms per volt. Voltmeters are self-contained up to 1000 volts and are designed for continuous use at 1000 volts without temperature error. The Volt-ammeters in this model are especially adaptable for making tests where consecutive volt and ampere readings are desired, such as motor test and battery test. Model 18 instruments, except in the higher voltage ranges, will withstand an instantaneous overload of 10 times the full scale value without damage or change in calibration.

Dimensions: $7\frac{1}{8}" \times 6\frac{1}{4}" \times 3\frac{1}{4}"$. Weight: $5\frac{1}{4}$ lbs. Case material: Molded phenolic.

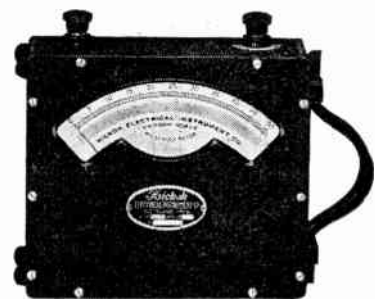

HICKOK... Electrical Indicating Instruments

HICKOK

Meters

For Accuracy and Dependability

3 1/2" ROUND-250 DEGREE METER

All DC meters can be supplied with accuracy either 1% or 2% of full scale deflection. The AC meters, which use copper-oxide rectifier-type movements, have accuracy within 5% of full scale deflection under all conditions. These instruments are as accurate as panel mounting instruments having equal size and have the advantage of two and one-half times longer scale. They are damped in accordance with American Standards Association Specifications, and their response time is also in accordance with these specifications. Allows readings to be taken quickly and more accurately.

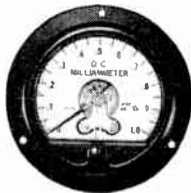

3 1/2" SQUARE 250 DEGREE METER SAME AS THE ROUND 250 DEGREE METER

All DC meters can be supplied with accuracy either 1% or 2% of full scale deflection. The AC meters, which use copper-oxide rectifier-type movements, have accuracy within 5% of full scale deflection under all conditions. These instruments are as accurate as panel mounting instruments having equal size and have the advantage of two and one-half times longer scale. They are damped in accordance with American Standards Association Specifications, and their response time is also in accordance with these specifications. Allows readings to be taken quickly and more accurately.



2 1/2" 250 DEGREE AIRCRAFT METER

This instrument is mounted in a regulation aircraft case per Army-Navy specification, including the shielding and dimensional requirements. Has scale approximately 4 3/8" long. Quick readability makes them desirable as flight instruments. Aircraft-type dial is available. Mechanism specially designed for aircraft service and will meet vibration-resistant requirements, etc.

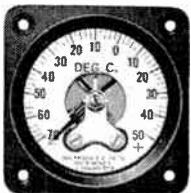

DIRECT READING FREQUENCY METER, AIRCRAFT TYPE

These Hickok improved self-contained frequency meters can be mounted in aircraft type cases of the large AN size. These are the smallest size frequency meters. This type of case is often convenient where space is a limiting factor. Suitable for aircraft use. Movement is shockproof. Case is dust and waterproof in accordance with Army-Navy aircraft instrument specifications. Radium or fluorescent dials and pointers available.



RUGGEDIZED PANEL METERS

2 1/2", 3 1/2" or 4 1/2"

The high Hickok standard of quality is now available in a ruggedized DC or rectifier type AC meter. This instrument provides the practical answer to requirements for shock proof meters with dependable accuracy. This highly efficient shock mount design permits pointer and scale divisions to be easily read when meter is under vibration. Rear panel is built with solder connections. Exceptionally thick flint hard glass withstands pressure and shock tests designated by military specifications. Designed for flush mounting. Luminous dials can be supplied. Zero adjuster is internal.

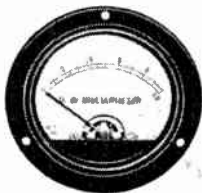

2 1/2" MINIATURE SQUARE PANEL MOUNTING

Flush mounting, phenolic case, wide flange only; and metal cases, wide and narrow flanges. Accurate within 1 1/2%. These miniature panel mounting instruments are of the standardized 2 1/2" size, but have extra long scale lengths by reason of the wide angle of deflection and longer scale radius. Five types of cases are available. Lance type pointers regularly supplied, however, small spade pointers can be furnished.



3 1/2" ROUND FLUSH MOUNTINGS

Accurate within 1 1/2%. Large opening symmetrically designed admits a maximum of light to the dial. Thick flange eliminates danger of breakage and improves appearance. Metal dials with white background are supplied in all standard ranges. Special dial designs are supplied on quantity orders, at no extra charge. Include internal illumination.



3 1/2" SQUARE FLUSH MOUNTINGS

Accurate within 1 1/2%. Large opening, symmetrically designed, admit maximum light to the dial. Thick flange eliminates danger of breakage and improves appearance. Require less panel space than round flush instruments. Metal dials with white background are supplied in all standard ranges. Special dial designs supplied on quantity orders at no extra charge. Internal illumination obtainable by means of bulb inserted in a socket through the instrument base.



HICKOK . . . Electrical Indicating Instruments

HICKOK

Meters

For Accuracy and Dependability

FOUR INCH RECTANGULAR PANEL

Accuracy within 1½%. Molded phenolic cases — for flush or surface mounting. Dull Black finish standard. Other phenolic colors available. DC Scale length 3¾" — longest which can be attained in an instrument of this size. AC Scale length 3.2", 85 degrees deflection. Can be furnished with or without illuminated dials. Available also in 2½", 3½", and 5", for flush mounting. Volt-ammeters, volt-milliammeters, etc., having built-in push-button switches available.



FIVE INCH RECTANGULAR

Large dial area. Accurate within 1½%. Molded bakelite cases — furnished shielded or unshielded. Dull black finish standard, other colors available. Flush mounting. DC scale length 5". AC scale length 4.25". Illuminated dials available. This instrument is a companion to other Hickok rectangular models but has proportionately larger dials, and is ideally suitable for use in electronic-testing equipment where multiple scale arcs are needed.



3½" RECTANGULAR SEMI-FLUSH

The new lucite-window model with a scale length of 3¾". Designed as attractive, modernistic replacements for conventional 3½" round or square flange instruments, and can be used in any space large enough to accommodate the standard 3½" meter. This instrument is furnished shielded or unshielded and available in most AC and DC ranges. Available in clear front or opaqued front as shown. Also available in 5".



4" RECTANGULAR FREQUENCY METER



Frequency meters are self-contained with dimensions of 3¾" x 4" x 2". No external reactor is used. The instruments can be supplied shielded from the effect of external magnetic fields.

CHARGICATOR PANEL MOUNT

The chargicator is an electrical hydrometer which places no load on the battery and may be left permanently connected. It has advantages over a hydrometer in that the batteries need not be disturbed when the reading is made, and the readings need not be made at the battery. The chargicator gives an accurate and instant measurement of battery conditions on a highly expanded scale, suppressed zero voltmeter. Available in 2½" and 3½" sizes as well as special designs, and for special purposes.



CHARGICATOR

The newest instrument designed to improve battery servicing. This instrument measures the state of charge in a lead-acid storage battery, instantly and accurately. It's handier, cleaner, and quicker than a hydrometer and avoids acid damage to clothing. The chargicator also provides a complete test of all other factors affecting the life or condition of a battery.

4" "P" SERIES PORTABLE INSTRUMENTS

Scale lengths — AC Models P49, P49M — 3.15". DC Model P48 — 3.7". Accurate within 1½%. Dimensions: 4" x 3¾" x 2-3/16". Not shielded. These meters are manufactured in many ranges of voltmeters, millivoltmeters, ammeters, milliammeters, microammeters, volt-ammeters, and wattmeters for use on both alternating and direct currents. A high quality solid leather carrying case can be supplied at extra charge.

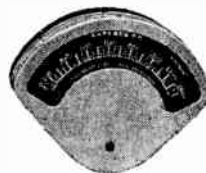
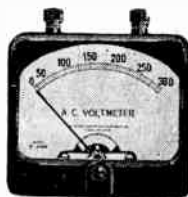

FAN TYPE METER

D'Arsonval movement. Accuracy 1%. Scale length: 7 inches. Dimensions: 8-19/32" x 6-11/16" x 2-1/16". This instrument is available in any combination of DC ranges. It has a window in the top of the case so that a light can be mounted above it for external illumination. This window is optional. It can be supplied with mirror scales and knife-edge pointers. The movements are especially designed for use in places where vibrations are encountered.

SHUNTS

Hickok Portable Precision Shunts are of sufficient size to keep the temperature rise within the limits of N. E. M. A. standards. Shunts are accurately adjusted for 50 millivolt drop at full current value. The shunt resistance material has negligible thermo-electric effect against copper and negligible temperature coefficient within the limits of operation of the shunt. Will operate at rated capacity continuously without impairment of accuracy. Leads supplied with all shunts when ordered with ammeters.

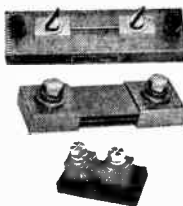

CURRENT TRANSFORMERS

Hickok midget current transformers "Donut" design — for use with inserted primaries. SERIES 1 is primarily intended for use with ammeters, and conforms to N. E. M. A. standards ½X as to ratio only. SERIES 2 conform to N. E. M. A. standards ½X as to ratio and phase angle, and are intended for use with wattmeters, also may be used with both wattmeters and ammeters. Secondary leads are five feet long with soldering lugs made to fit ¼" dia. stud.



HICKOK ... Electrical Indicating Instruments

HICKOK

Meters

For Accuracy and Dependability

POCKET PORTABLE

MODEL 480 and 481—Accuracy within 1%. Unshielded. DC Model 480: Scale length 3.7". Voltmeters, millivoltmeters, ammeters, milliammeters, microammeters, and volt-ammeters. AC Model 481. Scale length 3.15". Ammeters, milliammeters, voltmeters, wattmeters — single phase. Mirror scales, knife edge pointers.

Oak Case furnished with slip hinges permits the cover to be removed. The resistor compartment is separate from the meter movement and beneath the panel on which the binding posts are mounted. These instruments are specifically designed for smallness and accuracy. They will easily slip into the pocket and their high accuracy enables them to be used in many testing and inspecting applications. Found especially handy for field service work and are extensively used by the U. S. Signal Corps. Built with full open faces, enabling the use of multiple scales, which are easily readable and unusually long. The movements are especially designed for portable use in these models, and are of the very highest quality.

Dimensions: 6 $\frac{3}{4}$ " x 4 $\frac{3}{4}$ " x 2 $\frac{3}{4}$ ". Weight: 3 lbs.

MODEL 440—Accuracy either 1% or $\frac{1}{2}$ of 1%. Scale length 4 $\frac{1}{4}$ ". Panel and meter cover are phenolic. Has a built-in lead compartment with leads supplied.

The instrument comes in an oak case with strong, flexible carrying handle. Case is furnished with slip hinge cover, permitting the cover to be removed for easier use. This type of case is especially handy for field service work and is extensively used. All types have mirror scales, knife edge pointers and full open faces. The latter feature enables the use of multiple scales, which are easily readable and unusually long. The movements are especially designed for portable use in these models, and are of the very highest quality. This particular instrument has three DC voltage ranges; 30, 150, and 1500. Two millivolt ranges: 75 and 150. Three milliamper ranges; 30, 60, and 300. These instruments, however, are available in any combination of DC ranges.

Dimensions: 8 $\frac{1}{2}$ " x 7 $\frac{1}{4}$ " x 3 $\frac{1}{2}$ ". Weight: 4 lbs.

SWITCHBOARD TYPE

MODEL S12 DC, D'Arsonval Movements. Model S-11 AC, Electrodynamic meters. Model S-11M AC, Magnetic Vane Movements. Scale length of 5 $\frac{1}{8}$ ". Shielded from External Magnetic Fields Ideally suited for heavy industrial applications. Movements are of the large switchboard type. The AC Ammeter at left is furnished either self contained or with an external switchboard mounting current transformer. Cases can be supplied impervious to magnetic dust, dirt and moisture found in heavy industries. Can withstand severe vibration, shocks and extreme of temperature though still maintain the guaranteed accuracy of 1%. Available in surface type or flush type cases. Pressed steel cases, black enamel finish.

Dimensions: 5 $\frac{3}{8}$ "W., 5 $\frac{7}{8}$ "H., 4 $\frac{1}{4}$ "D. plus 1 $\frac{1}{4}$ " mounting studs.

Hickok is one of the foremost pioneers and manufacturers of electrical indicating instruments. Here shown are a few of the more popular types furnished. However, any practical range and type can be supplied. Your inquiry is invited. Kindly list details of your requirements. Prices are available on request.

THE HICKOK ELECTRICAL INSTRUMENT CO.

10500 Dupont Avenue, Cleveland 8, Ohio

HICKOK... Electrical Indicating Instruments

TELEVISION SIGNAL GENERATOR VHF — UHF* — COLOR

It's the ideal generator which fulfills all your TV requirements. Just read these brief specifications and make comparisons.

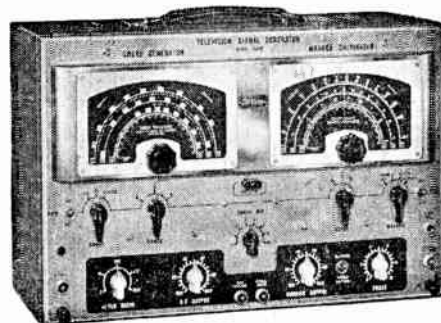

Model TVG-2

Sweep Oscillator: Three convenient ranges, 2 MC thru 38 MC; 38 MC thru 108 MC; 174 MC thru 216 MC are all on fundamentals. Large accurately calibrated dial with the TV channels clearly indicated. Reversible direction of sweep.

Sweep Width: Provided by rugged electro-mechanical sweep unit. Adjustable from 0 thru 18 MC in 7 steps for fast resetability. The full 18 MC sweep is essential to cover IF frequencies in color receivers and for sweeping badly detuned tuners.

Marker Oscillator: Accurately calibrated dial (1/4 of 1%) gives complete marker coverage from 4 MC thru 216 MC with all the television IF frequencies on highly stable fundamentals. Facilities for using 3 marker pips simultaneously.

Crystal Oscillator: Separate crystal oscillator for use either as a marker or as a calibrator. Stable circuit oscillates.

*Except tuners.

lates with any crystal fundamental from 3 MC to 20 MC. More than adequate for color receivers. Output is controlled by selector switch to provide variable marker, crystal marker or both for calibration purposes. A BEAT DETECTOR is also incorporated for audible or visual checking of beat between variable marker oscillator and crystal.

400 Cycle Modulation: Provided for use with either the variable or crystal marker so traps can be adjusted by either audible or meter method.

Oscilloscope Timing: A phased 60 cycle sine wave timing voltage is provided with PHASE CONTROL to provide adjustment of double pattern. BLANKING is also available for single pattern trace with reference base line for measurement.

Video Modulation: Provision made for insertion of video signal to modulate the external marker output making possible "rebroadcasting" of television signals on any channel. Also an audio signal may be used to produce horizontal or vertical lines for linearity checks.

RF Output: Completely controllable with output control and step attenuator. Output impedance 90 ohms with last tap variable from 0 to 500 ohms. Complete flexibility right at your finger tips.

Size: Same height as other Jackson TV instruments. Dimensions 13" high, 8 1/2" deep, 19 1/8" wide.

Finish and Weight: An all steel gray Ham-R-Tex cabinet. Shipping weight 35 pounds.

Dealer Net Price.....\$245.00

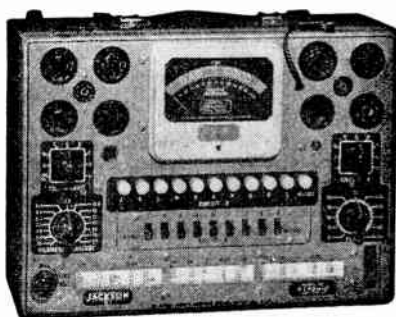

CHALLENGER DYNAMIC® TUBE TESTER

Model 715

SPECIFICATIONS

New in design and performance, including the latest Jackson patented switching circuits.

Modern in every feature of construction, appearance, and operation.

Complete with every valuable feature, including provision for CR tube testing.

Jackson Dynamic Test Principle: Applies separate element voltages to each tube element, making test under actual use conditions.

High Voltage Power Supply: By testing tubes at higher plate voltages (over 200 volts for some types), more accurate results are obtained. This is an important feature of the Dynamic Tube Tester.

Improved Switching System: Provides spare circuits together with switch and socket positions for future use.

Simplified Operation: Uses latest Jackson "Service Engineered" switching procedure.

Better Readability: Large 4-inch-square meter is easy to read.

Complete Shorts Test: Each tube element is fully tested for possible shorts and leaks.

Wide application: Tests all tubes — over 700 types — including television amplifiers and rectifiers.

Built-in Roll Chart: Indicates tube characteristics. One year free supplement service.

Finish and Weight: Finished in gray Ham-R-Tex with harmonizing ivory knobs, meter cover, and push-buttons. Net weight, 11 lbs.; shipping weight, 14 lbs.

Dealer Net Price\$79.50

JACKSON "SERVICE ENGINEERED" TEST INSTRUMENTS

THE JACKSON ELECTRICAL INSTRUMENT CO., DAYTON 2, OHIO

THE '54 MODEL CRO-2 5" OSCILLOSCOPE VHF — UHF — COLOR

High Sensitivity — Wide Band. .018 RMS volts per inch
— Within 1 db to 4.5 MC — CORRECT COLOR RESPONSE

Wide Band Amplifier: Flat within 1 db from 20 cycles thru 4.5 MC. This feature is absolutely essential for evaluating color burst signal and the Level of the Color Chrominance signal. You can depend on the CRO-2 because Jackson is the largest and oldest manufacturer in the world of high sensitivity-wide band scopes for the television industry.

Vertical Deflection Sensitivity: Two ranges with three positions for each range. Has fully compensated attenuators. Excellent transient response. Each unit completely tested for "tilt" and "overshoot."

Sensitivity Ranges: With a band width of 20 cycles thru 100 KC, the sensitivity ranges are .018, .18, 1.8 RMS volts per inch. The wide band position 20 cycles thru 4.5 MC has sensitivity ranges of .25, 2.5, 25 RMS volts per inch.

Internal Horizontal Sync: Positive or negative signal is available to provide excellent stability due to using the best available component of the waveform, such as the leading edge of the horizontal sync. pulse of the standard TV signal. Reversing the pattern vertically will not interfere with the sync.

Horizontal Sweep Expansion: Four times screen width — up to 20 inches of equivalent width. This feature is excellent for enlarging any small portion of the total waveform. For example, the color TV sync. pulse can be spread to easily observe the 3.58 MC color

burst signal so that the individual cycles can be clearly viewed.

Horizontal Deflection Sensitivity: Push-pull horizontal amplifiers have a sensitivity for all applications of 0.40 RMS volts per inch.

Vertical Input Impedance: 1.5 megohms, shunted by 20 micromicrofarads. Direct to plates balanced 6 megohms, shunted by 11 micromicrofarads.

Horizontal Input Impedance: 1.1 megohms.

Linear Sweep Oscillator: Saw tooth wave 20 cycles thru 50 KC per second in 5 steps. Sine wave sweep of 60 cycles also available. Provision for external sweep synchronization.

Input Calibration: A standard voltage is provided for use in determining unknown voltages. Permits peak-to-peak measurement of all waveforms.

Vertical Polarity Reversal: By merely flipping a switch you can reverse the polarity of the voltage being supplied to the vertical deflection plates.

Return Trace Blanking: A new amplifier-timer combination for blanking return traces, providing a clearer, sharper image at all times. Prevents confusion in waveform analysis.

Synchronizing Input Control: Four input control positions, Internal Positive — Internal Negative — External — 60 cycle.

Deflection Plate Connections: Direct

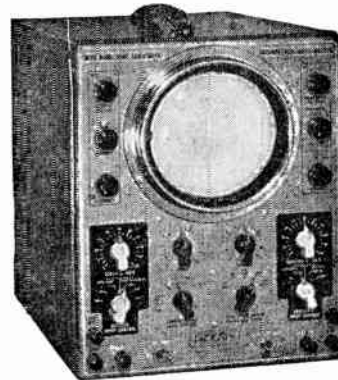

connections thru capacitors for AC only to deflection plates of CR tube by means of terminal block at back of instrument.

Intensity Modulation: Either 60 cycle internal intensity modulation or external intensity modulation through binding posts on front panel.

Accessories: Demodulation probe, Model CR-P, available for using scope as signal tracing instrument. Low capacity Cathode follower probe, Model 10LCP, with 2 to 1 ratio and not more than 10 mmf. effective input capacitance.

Size: Same height as other Jackson TV instruments, Dimensions 13" high, 10 1/4" wide, 15 3/4" deep.

Finish: An all steel gray Ham-R-Tex cabinet.

Model CRO-2 Shipping weight, 32 lbs. Dealer Net Price\$225.00

Model CR-P Probe Shipping wt., 6 oz. Dealer Net Price\$9.95

Model 10LCP Probe, Shipping wt., 10 oz. Dealer Net Price.....\$19.95

UHF TELEVISION SIGNAL GENERATOR Model 711



Ideal for all channel UHF alignment of tuners, converters, and tuning strips. Operation simplified by use of superheterodyne principles.

The Model 711 operates on fundamental frequencies for all channels 14 thru 83. Large enclosed dial accuracy $\pm 1\%$ of indicated frequency. Vernier logging scale average accuracy 0.1% of indicated center frequency. UHF channel frequency calibrated directly opposite channel number scale. This provides a quick check in the transmission frequency of any channel.

A swept signal having a center frequency of 43.5 MC from any VHF generator (such as Jackson TVG-2) must be applied to the input. This signal and the signal from a local oscillator are fed into a crystal mixer and the difference frequency is applied to the output jack on the front panel. The local oscillator calibration appears on

the center scale marked "Oscillator Frequency."

The VHF markers are also used for checking various channels. It is not necessary to change the VHF generator once it has been set up, exactly as if it were being used to mark a VHF response curve having a center frequency of 43.5 MC.

Input impedance, 93 ohms high side to ground. Output impedance, 300 ohms balanced to ground. Frequency coverage, 465 MC to 905 MC. Tube complement, 1—6X4, 1—6T4 and 2—6CB6. Dimensions, 10 1/4" high x 13" wide x 8 3/4" deep. Power rating, 110-120 volts 50/60 cycles.

Shipping Weight, 17 lbs.

Finish: Gray Ham-R-Tex.

Dealer Net Price\$129.50

JACKSON



"SERVICE ENGINEERED" TEST INSTRUMENTS

THE JACKSON ELECTRICAL INSTRUMENT CO., DAYTON 2, OHIO

DYNAMIC® TUBE TESTER

This tester incorporates the most important engineering advancements in 12 years of tube tester research, such as the Dynamic test method, sequence switching and automatic line voltage indication. The Jackson Dynamic test circuit applies separate element voltages to each tube element. Separate load circuits are used to test tubes under peak conditions. These voltages and loads have been carefully selected for each tube to meet most ideally the normal operating condition of the tube. The current flowing only in the plate circuit of the tube under test is indicated on the 4-inch meter in easy-to-read terms.

Sequence Switching makes possible **SIMPLIFIED OPERATION**, formerly unattainable in Dynamic test methods. There are actually only three control units to be set according to rotary chart listing for each tube. These are: Heater Voltage (upper left), Plate Control (upper right) and the Sequence Switch (center). The only other adjustments are line voltage control and shorts test. The line voltage control is calibrated to indicate actual line voltage from 100 to 125 volts. This elim-

Model 648

inates the need for carrying a volt meter to check line voltage in the home.

Fast, Accurate Shorts Test lamp indicates only when tube is shorted. The shorts test control moves only through 4 positions—yet completely tests each tube element for possible shorts or leakage. The tube is tested under a heated cathode condition.

Correct Test Voltage and Load Circuits protect tubes under test against damage by overload. Even low voltage battery types are provided with suitably low operating potentials. The full GOOD-BAD scale of the meter is used for each test. The meter scale is calibrated to read in percentage of relative micromhos. The meter is sufficiently sensitive that special "Low Scale" readings are not required (such as for diodes, etc.)

Life-line test shows you accurate fore-



cast of end of tube life. Reduced output caused by over-age gives reduced reading on meter. Lets you catch bad tubes before they actually go bad.

Steel cases and panels finished in gray Ham-R-Tex.

- Model CB48 Counter-Base Shipping Weight, 6 lbs. Dealer Net Price\$ 8.50
- Model 648B (Bench-type Steel case) Shipping Weight, 19 lbs. Dealer Net Price\$104.50
- Model 648P (Portable Tester in wood case) Shipping Weight 23 lbs. Dealer Net Price\$109.50

AUDIO OSCILLATOR Model 655

The model 655 provides an audio frequency voltage **DEVELOPED AT ITS FUNDAMENTAL FREQUENCY**. The basic design of this instrument is entirely different from the "beat frequency" type of Audio Oscillator.

FEATURES

Resistance Capacity Tuned Circuit Design, engineered for improved operating characteristics of audio measurements.

No Zero Adjustment — Tuned Fundamental Frequency method provides permanently locked calibration.

Output Characteristics — A choice of either transformer coupled or resistive

output is available. The Model 655 meets the most exacting requirements as to **Waveform-Uniform Frequency Characteristics and Output Load Impedance Selection**. A special feature of the output system is the 10 ohm tap for low impedance circuits such as speaker voice coils, etc.

Complete Stability — The stability of frequency calibration is constant throughout the entire range. The stabilized circuit permits large changes in line voltage to occur without affecting frequency or waveform and having negligible effect on output voltage.

Simplified Operation — It is only necessary to select desired **Frequency and Output**. There Are No Other

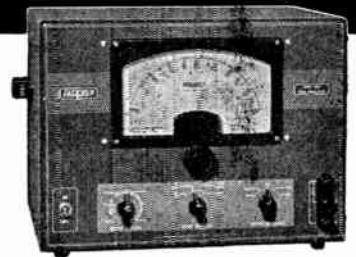

Controls — The possibility of errors in operation is therefore eliminated.

Construction — Frequency dial is glass enclosed so that calibrations cannot become disfigured. Rugged mechanical features assure trouble free operation under service conditions.

SPECIFICATIONS

Frequency Range — 20 cycles to 200,000 cycles in 4 ranges: 20-200 cycles/200-2000 cycles/2000 to 20,000 cycles/20,000 cycles to 200,000 cycles.

Calibration — Logarithmic variation of frequency over the scale provides constant percentage accuracy at all frequencies.

Scale Length — Over 33 inches.

Output Loading — Five values of output loading: 10 ohms/250 ohms/

500 ohms/5000 ohms/RESISTIVE. Controlled by selector switch.

Output Power — 500 Milliwatts (20 to 20,000 cycles transformer coupled).

Output Control — Continuously variable from zero to maximum.

Waveform — Less than 5% distortion at all frequencies between 30 and 15,000 cycles.

Frequency Characteristics — Plus or minus 1 DB 30-15,000 cycles using transformer coupled output.

Hum Level — Down more than 60 DB of maximum.

Accuracy — 3% or 1 cycle whichever is greater.

©Tubes — 1-6C6G, 1-6V6GT, 1-6SL7, 1-6C4, 1-6F6GT, 1-5Y3GT furnished installed.

Dimensions — 13" wide x 9½" high x 9½" deep.

Shipping Weight, 32 lbs.

Dealer Net Price\$135.00

JACKSON



"SERVICE ENGINEERED" TEST INSTRUMENTS

THE JACKSON ELECTRICAL INSTRUMENT CO., DAYTON 2, OHIO

DYNAMIC® CATHODE RAY TUBE ANALYZER

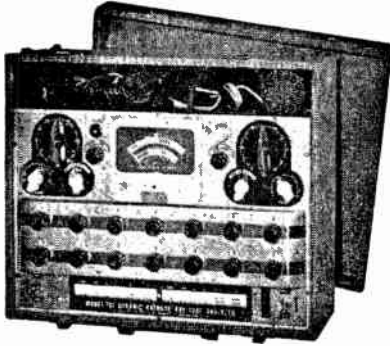

This is the *only* CRT analyzer that completely and accurately tests *all* TV picture tubes, including both magnetic and electrostatic deflected types. It also tests oscilloscope, radar, and other special purpose CR tubes. No need to remove any tube from chassis or carton.

Model 707

SPECIFICATIONS

Beam Current: Test is made to the *final* anode — the only anode that really counts. The meter gives you an accurate forecast of tube life.

Grid Test: The beam current may be up to par; but, if the grid does not have the ability to cut off and control it, the tube is useless. Test voltage is ample for every type tube.

Gas Test: Certain amounts of gas in a CRT will render the tube inoperative. By checking the "gas current" to the FINAL anode, the presence of harmful gases is detected. High gas content indicates that the tube should be replaced as the life of the screen and/or cathode will be very limited.

Shorts Test: All elements are isolated for individual inter-element leakage tests. A circuit of high sensitivity is

used to give indications of leakage on a neon lamp.

Roll Chart: Provided for rapid indication of proper selections.

Circuit Selector Switches: Placed on an escutcheon to make them easily accessible for every tube setup and to limit test setting confusion.

Test Voltages: Both high and low voltage power supplies are provided for the various test requirements of a cathode ray tube.

VTVM: The analyzer is designed around a highly sensitive, balanced bridge type VTVM. A continuously variable line voltage adjustment is provided to insure accurate readings.

Meter: An easy-to-read, full vision meter, designed especially for the CRT Analyzer, includes a line voltage adjust point, a "beam current" range, a "gas current" range, and a reference scale.

Case: The durable wooden airplane luggage covered carrying case is provided with ample space for storing the cable and adaptors.

Finish and Weight: Gray Ham-R Tex panel; ivory meter case. Net weight, 22 lbs.; shipping weight, 25½ lbs.

Dealer Net Price \$149.50

NEW TELE-VOLTER Model 709



"Super Vacuum Tube
Volt-Ohm-Meter"

Here is a *portable* instrument you might have designed yourself. For it has everything you'd want in an ideal VTVM, and more. Look at the features. See for yourself why the Jackson TELE-VOLTER, a truly "Service-Engineered" instrument, is the easiest reading, easiest using instrument you've ever seen.

SPECIFICATIONS

D.C. VOLTMETER

Input Resistance: 11 megohms.

Volts: 0 to 1, 5, 10, 50, 100, 500, 1000.

Calibrated Zero Center, positive or negative: 0 to .5, 2.5, 5, 25, 50, 250, 500.

A.C. VOLTMETER

Input Impedance: .2 megohms shunted by 150 mmf.

Volts: 0 to 1, 5, 10, 50, 100, 500, 1000.

Frequency Response: Essentially flat to 4.5 MC thru 0-100 scales.

Peak-to-Peak Ranges: 0 to 2.8, 14, 28, 140, 280, 1400, 2800.

Peak values may also be read directly by using the next lower scale than the one for which the instrument is set.

OHM METER

Expanded logarithmic scale gives highly accurate readings in the following ranges: 0 to 1000, 10,000, 100,000; 1 meg., 10 meg., 100 meg., 1000 meg.

ELECTRICAL CHARACTERISTICS

Meter Protection: The 7" square meter, with hair-line pointer, is electronically protected against overload.

Controls: Range switch, circuit switch (including on-off switch), zero adjust, ohms adjust, probe function switch (built into probe).

Probes: One ground lead and one combination probe for D.C. and A.C./ohms readings. Probe has built-in switch for changing from D.C. to A.C. or ohms.

Scale Colors: Scales are printed in color for maximum ease in use.

Styling: Sloping front style, fully portable. Finished in Gray Ham-R Tex. Red and black harmonizing colors in knobs, meter and nameplate.

Dimensions and Weight: 8¾" deep, 8¾" high, 7¾" wide. Net weight, 10 lbs. Shipping weight, 13 lbs.

Dealer Net Price \$95.00

Accessories: Model 79P High Voltage Probe for reading DC voltages to 30,000 volts \$14.95

Model 70 RFP High Frequency (200 MC) Probe \$9.85



KITS and INSTRUMENTS

You build EICO KITS in one evening . . .
but they last a lifetime!

EICO NEW Peak-to-Peak VTVM complete with New Dual-Purpose AC/DC Uni-Probe

(Pat. Pend.)

EICO's revolutionary new engineering design! The professional peak-to-peak VTVM that beats 'em all—in laboratory precision features AND low prices! Measures DIRECTLY p-p voltage of complex and sine waves: 0-4, 14, 42, 140, 420, 1400, 4200 volts p-p. DC/RMS sine voltage ranges: 0-1.5, 5, 15, 50, 150, 500, 1500 volts (up to 30,000 V. with HVP probe). Resistance ranges: 0.2 ohms to 1000 meg. 7 non-skip ranges on every function. 4 functions: +DC Volts, -DC Volts, AC Volts, Ohms. Uniform 3 to 1 scale ratio for extreme wide-range accuracy. Large 4 1/2" meter in can't-burn-out circuit. Calibration without removing from cabinet. Zero-center for TV-FM discriminator alignment. One zero-adjustment for all functions and ranges. Frequency Response: 30 cps-3 mc. 1% precision ceramic multiplier resistors. Exceptional circuit stability and accuracy. New satin finish etched panel, and grey wrinkle steel case. Leather handle. New compact size for extra-easy portability: 8 1/2" x 5" x 5". Ship wt. 7 lbs.

Model 232-K, **\$29.95** Factory wired **\$49.95**
KIT

EICO NEW Dual-Purpose AC/DC Uni-Probe

(Pat. Pend.)

Terrific time saver! Only 1 probe performs all functions—a half-turn of probe-tip selects DC or AC-OHMS!

EICO NEW! Deluxe Peak-to-Peak VTVM with 7 1/2" Meter and Exclusive Uni-Probe

(Pat. Pend.)

ALL the outstanding and exclusive features of Model 232—PLUS the extra convenience and readability of its big 7 1/2" meter. An ideal bench instrument.

Model 249K, **\$39.95** Factory wired **\$59.95**
KIT

EICO Vacuum Tube Voltmeter

The reliable, performance proved EICO VTVM—ever-popular universal instrument for all TV/radio/electronics servicing. Over 50,000 in use! Large 4 1/2" meter in can't-burn-out circuit. Zero center for TV/FM discriminator alignment. 4 functions: +DC Volts, -DC Volts, AC Volts, Ohms. Electronic AC/DC ranges: 0-5, 10, 100, 500, 1000 volts. Reads up to 30,000 volts with HVP accessory probe. Reads peak-to-peak with PTP accessory probe. 5 Resistance ranges: 0.2 ohms to 1000 meg. 5 DB ranges: -20 to +55. DC input resistance: 25 meg. 1% precision ceramic multiplier resistors. Double-triode bridge circuit for extra stability and accuracy. Rugged grey wrinkle steel case; 3-color etched rubproof panel. Leather handle. Complete with AC, DC and common leads. Size: 9 7/8" x 6" x 5".

Model 221-K, **\$25.95** Factory wired **\$39.95**
KIT

EICO Deluxe VTVM with 7 1/2" Meter

Model 214-K, **\$34.95** Factory wired **\$54.95**
KIT

ALL the versatility and performance-proven features of Model 221—PLUS the extra convenience and legibility of its big 7 1/2" meter. An excellent bench instrument. Size: 9" x 13 1/4" x 6". Ship wt. 11 lbs.

EICO NEW Vacuum Tube Voltmeter Probes

***VTVM PEAK-TO-PEAK PROBES:** For use with EICO or any VTVM. For direct reading of peak-to-peak voltages directly on VTVM DC scales. Model PTP-11: For any 11 megohm DC input res. VTVM. Model PTP-25: For any 25 megohm VTVM. Size: O.D. 3/8", L. 6". Ship wt. 4 oz.

Either Model, **\$4.95** Factory wired **\$6.95**
KIT, only

***VTVM RF PROBES:** For RF measurements up to 250 mc. Accuracy ±10%. Model PRF-11: For any 11 megohm VTVM. Model PRF-25: For any 25 megohm VTVM. Size: O.D. 3/8", L. 6". Ship. wt. 4 oz.

Either Model, **\$3.75** Factory wired **\$4.95**
KIT, only

*All the above new probes have ALL these EXCLUSIVE features: Fully shielded. Rugged terminal board mounting of all parts. Shock-mounted floating construction. Easy accessibility of all parts.

HIGH VOLTAGE PROBE: For use with EICO or any VTVM or 20,000 ohms/volt multimeter. Measures up to 30,000 volts DC in TV circuits. New streamlined design and 6-way safety protection: anti-dirt, anti-moisture design; 2 large flash-guards; completely enclosed resistor; insulated grip (no metal touches your hand); anti-corona probe tip; insulated high voltage cable. Supplied with high quality resistor to match your instrument. Size: Max. dia. 2 1/4", L. 11". Ship wt. 3/4 lb.

Model HVP-2 **\$4.95** Model HVP-1 **\$6.95**

Prices 5% higher on West Coast.

ELECTRONIC INSTRUMENT CO., Inc. • Brooklyn 11, N. Y.

AND YOU SAVE 50%!

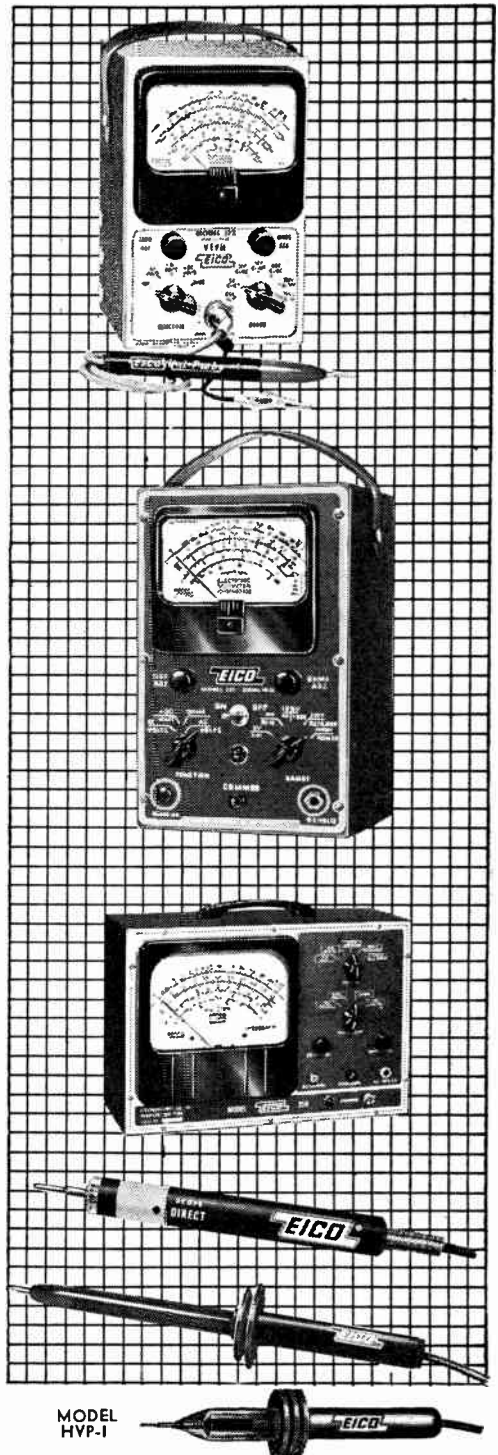

MODEL HVP-1



KITS and INSTRUMENTS

You build EICO KITS in one evening . . .
but they last a lifetime! AND YOU SAVE 50%!

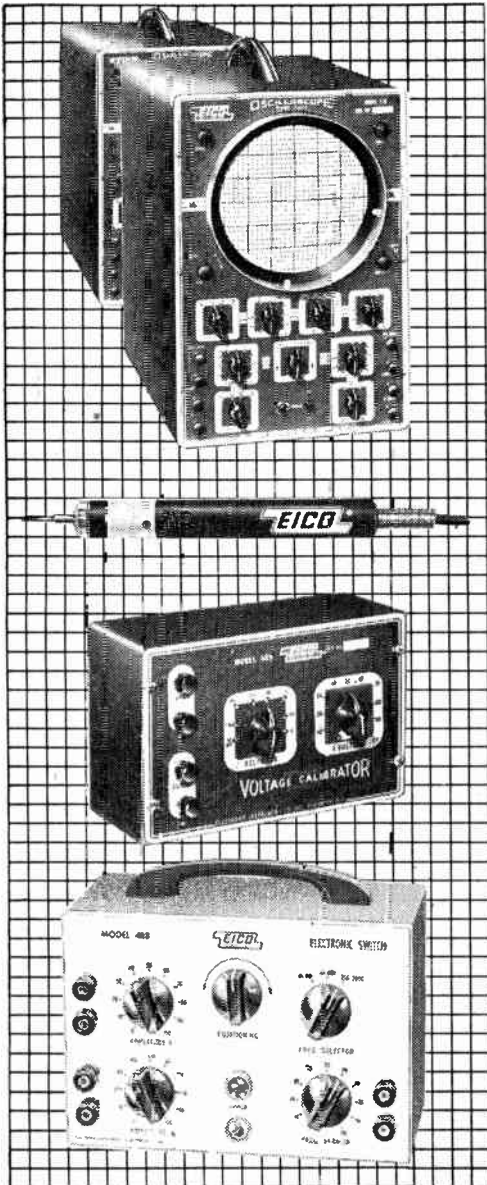

EICO NEW 7" Push-Pull Oscilloscope

America's greatest scoop in big-scope value — way up in versatility, way down in price. • Boosted vertical sensitivity, 10 mv rms/inch. • Extended flat frequency response, 10 cps to 1 MC (± 2 db). • 3-step frequency-compensated attenuator. • Cathode follower input. • Internal voltage calibrator. • Directly calibrated screen. • Extended sweep range, 15 cps to 100 kc. • Internal positive or negative, external, and line sync. • On front panel: sawtooth, 60 cps outputs; intensity modulation and external sync inputs. • Variable phasing of internal 60 cps sweep. • Direct connection to CRT plates available. • Size: 10" x 15" x 15". Ship wt. 33 lbs.
Model 470-K, **\$79.95** Factory wired **\$129.50**
KIT, only

EICO 5" Push-Pull Oscilloscope

All-new laboratory-precision scope with all the extra sensitivity and response for precise servicing of TV, FM and AM sets. • Push-pull undistorted vertical and horizontal amplifiers. • Boosted sensitivity, .05 to .1 rms volts/inch. • Useful to 2.5 MC. TV-type multivibrator sweep circuits, 15 cps — 75 KC. • Z-axis intensity modulation feature. • Dual positioning controls move trace anywhere on screen. • Complete with 2-6J5, 3-65N7, 2-5Y3, and 5" C.R. tube. • 3-color etched rubber-proof panel; rugged steel case. 115 v., 60 cycle AC. 8 1/2" x 17" x 13". Ship wt. 29 lbs.
Model 425-K, **\$44.95** Factory wired **\$79.95**
KIT, only

EICO NEW Oscilloscope Probes

*OSCILLOSCOPE DIRECT PROBE: Fully-shielded for TV waveform tracing in low impedance or low frequency circuits where effect of cable capacity is unimportant and full scope sensitivity is desired. Eliminates stray pick-up and signal re-radiation. Size: O.D. 3/8", L. 6". Ship wt. 4 oz.
Model PD-K, **\$2.75** Factory wired **\$3.95**
KIT, only

*OSCILLOSCOPE LOW CAPACITY PROBE: For TV waveform tracing in high impedance, high frequency or wide-band circuits. Eliminates distortion from overloading or frequency discrimination. Size: O.D. 3/8", L. 6". Ship wt. 4 oz.
Model PLC-K, **\$3.75** Factory wired **\$5.75**
KIT, only

*OSCILLOSCOPE DEMODULATOR PROBE: For signal tracing and checking of TV and radio RF and IF stages; for stage-by-stage alignment; and for locating hum modulation, ratio detector marking and marker generator calibration. Demodulates amplitude-modulated carriers between 150 kc and 250 mc. AF response flat from 20 cps to 6 kc. Size: O.D. 3/8", L. 6". Ship wt. 4 oz.
Model PSD-K, **\$3.75** Factory wired **\$5.75**
KIT, only

*All the above new probes have ALL these EXCLUSIVE features: Fully shielded. Rugged terminal board mounting of all parts. Shock-mounted floating construction. Easy accessibility of all parts.

EICO Oscilloscope Voltage Calibrator

Makes your oscilloscope a wide-range, accurate, peak-to-peak AC electronic voltmeter. Enables measurement of peak-to-peak voltages of complex and TV sweep circuit waveforms seen on a scope; calibration of Vertical and Horizontal scope amplifiers; determination of voltage amplitude required for intensity modulation or synchronization. Square wave output at power-line frequency with full-scale readings of 0.1, 1, 10 or 100 volts. Output variable from zero, and accuracy $\pm 5\%$ of full-scale on each range. Size: 5" x 7 1/8" x 4". Ship wt. 4 lbs.
Model 495-K, **\$12.95** Factory wired **\$17.95**
KIT, only

EICO NEW Electronic Switch

Makes your ONE scope more useful than TWO in many cases. Simultaneously observe 2 patterns on 1 scope's screen; for direct comparison of voltage and current amplitudes, waveforms, frequencies and phase relationships; setting up voltage reference level or zero base line; checking amplifier distortion or crossover networks. Continuously variable switching rates in 3 ranges from less than 10 cps to over 2000 cps. Very useful as a square wave generator over same range. 5 tubes: 2-6AU6, 2-12AU7, 1-6X5, transformer-operated. 105-125 VAC, 50/60 cps. Size: 6" x 8" x 6". Ship wt. 7 lbs.
Model 488-K, **\$24.95** Factory wired **\$39.95**
KIT, only

ELECTRONIC INSTRUMENT CO., Inc. • Brooklyn 11, N. Y.

Prices 5% higher on West Coast.

the exclusive EICO Make-Good GUARANTEE (included with every EICO product)

Each EICO Kit and Instrument is doubly guaranteed, by EICO and your jobber, to contain only selected quality components. EICO guarantees to replace any component which might become defective in normal use if returned to the factory transportation charges pre-paid within 90 days of purchase. EICO guarantees all kits assembled according to EICO's simplified instructions will operate as specified therein. EICO guarantees service and calibration of every EICO Kit and Instrument at the nominal charge as stated in the instructions.

The EICO Guarantee Only EICO gives you the Make-Good Guarantee — the strongest, most substantial guarantee in the industry! When you buy EICO, you enjoy the greatest protection available for your test equipment investment!

2 Instruction Manuals

Each EICO Kit contains both a Construction Book and an Operating Book — step-by-step assembly instructions with easy-to-follow schematic and pictorial diagrams; and easy application data. All small parts are packed in individually marked envelopes clearly identified in the drawings. Anyone can build the EICO Kits!



Dollar for dollar, feature for feature, EICO Instruments and Kits lead the industry!

EICO

Laboratory Precision at Lowest Cost—

KITS and INSTRUMENTS

You build EICO KITS in one evening . . .
but they last a lifetime! AND YOU SAVE 50%!

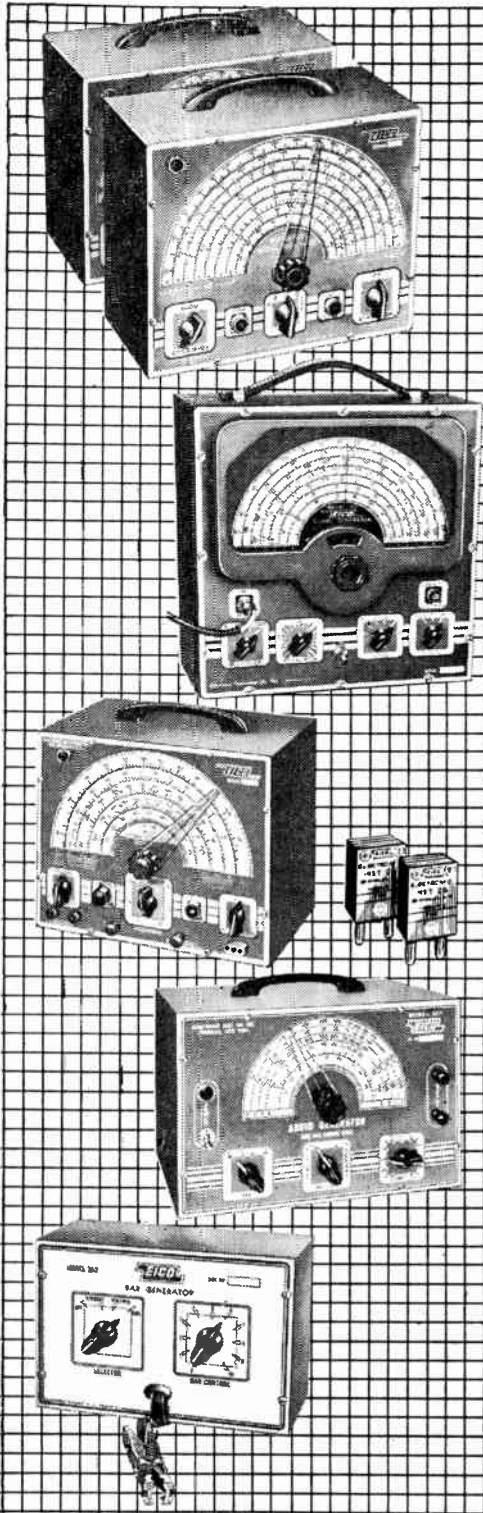

6 NEW GENERATORS TO CHOOSE FROM! 2 EICO RF-AF Signal Generators

Model 320: For AM-FM precision alignment and TV marker frequencies. Vernier Tuning Condenser. Highly stable RF oscillator, range: 150 KC - 102 MC with fundamentals to 34 MC. Separate audio oscillator supplies 400-cycle pure sine wave voltage. Pure RF, modulated RF or pure AF for external testing. 3-color etched panel; rugged steel case. Ship wt. 10 lbs.

Model 320-K, \$19.95 Factory wired \$29.95
KIT, only.

Model 322: In addition to all the outstanding laboratory-precision qualities of the famous EICO Model 320, the brand new Model 322 features the individual calibration of each of its 5 bands.

Model 322-K, \$23.95 Factory wired \$34.95
KIT, only.

EICO Deluxe RF-AF Signal Generator

Laboratory-precision generator EICO Service-Engineered with 1% accuracy. Frequency range: 75 kc-150 mc in 7 calibrated ranges. Extremely stable. Illuminated hairline VERNIER TUNING. VR stabilized line supply. 400-cycle pure sine wave with less than 5% distortion. Tube complement: 6X5, 7F7, 6C4, VR-150. 3-color etched panel; rugged steel case. 115 v., 60 cycles AC. Size: 12" x 13" x 7". Ship wt. 21 lbs.

Model 315-K, \$39.95 Factory wired \$59.95
KIT, only.

EICO TV-FM Sweep Generator

Covers all TV-FM alignment frequencies, 500 KC - 228 MC. Vernier-driven dial. Center of each of 13 TV channels marked on front panel. Sweepwidth variable 0-30 MC with mechanical inductive sweep — permits gain comparison of adjacent TV channels. Crystal marker oscillator, variable amplitude. Provides for injection of external marker. Phasing control. Complete with HF tubes. Less Crystal. Size: 10" x 8" x 6 3/4". 5 MC Crystal, each, \$3.95. Ship wt. 12 lbs.

Model 360-K, \$34.95 Factory wired \$49.95
KIT, only.

EICO 5 MC and 4.5 MC Crystals

EICO-designed for all generators and oscillators, these highest quality crystals accommodate all standard sockets and circuits. Give excellent performance with EICO Model 360 Sweep Generator.

Model C-5: \$3.95 Model C-4.5: \$3.95
5MC only. 4.5 MC only.

EICO New Sine & Square Wave Audio Generator

- Complete sine wave coverage: 20-200,000 cps.
- Complete square wave coverage: 60-50,000 cps.
- 4-gang tuning condenser.
- All frequency range resistors have 1% or better accuracy.
- Large easy-reading dial calibration; 0-100 linear reference scale.
- Response ± 1.5 db from 60 cps to 150 kc.
- Wien bridge RC oscillator.
- Improved cathode follower output circuit.
- Output Voltage: 10 v. at 1000 ohms load, 14 v. at 10,000 ohms and higher, 8 v. at 500 ohms on sine wave; square wave output higher.
- High power output: 100 mw into rated load.
- Rated load impedance: 1000 ohms resistive.
- Continuously variable output attenuator.
- Distortion 1% of rated output.
- Hum less than 0.4% of rated output.
- Tubes: 6X5, 6SJ7, 2-6K6, 6SN7, 6S6 (G-E 6-watt lamp).
- 3-color etched rub-proof panel; rugged steel case. 115 V., 50/60 cycles, 50 W. Size: 11 1/8" x 7 1/8" x 7 1/8". Shipping weight 14 lbs.

Model 377-K, \$31.95 Factory wired \$49.95
KIT, only.

EICO NEW Bar Generator

Enables rapid adjustment of TV picture Vertical and Horizontal linearity without hard-to-find station-transmitted test pattern. Produces 16 to 23 V bars and 13 to 22 H bars, adjustable in number to accommodate all screen sizes. Incorporates VHF osc., RF osc., and LF multivibrator. Adjustable from channel 2 to 6. Deluxe 3-way antenna terminal clip fits any type antenna terminal including plug-in type. Output voltage: 400,000 microvolts. Tubes: 1-12AU7, 1-6C4; selenium rectifier. Size: 5" x 7 1/2" x 4 1/2". Ship wt. 6 lbs.

Model 495-K, \$14.95 Factory wired \$19.95
KIT, only.

Prices 5% higher on West Coast.

ELECTRONIC INSTRUMENT CO., Inc. • Brooklyn 11, N. Y.

Dollar for dollar, feature for feature, **EICO** Instruments and Kits lead the industry!



KITS and INSTRUMENTS

You build EICO KITS in one evening . . .
but they last a lifetime! AND YOU SAVE 50%!

EICO NEW Flyback Transformer and Yoke Tester

Positive check of all types flybacks and yokes, in or out of set—in just seconds! Operates on the extremely sensitive grid-dip principle — shows up even 1 shorted turn. Exclusive separate calibration for air core and iron core flybacks for accurate testing of all types. Checks any inductance whose impedance is not too low. Large easy-to-read 4½" meter. 3 separate colored scales. Test continuity on yokes, coils, speakers, switches, etc. Smart professional styling—New satin finish etched panel and grey wrinkle steel case. New compact size for extra-easy portability: 8½" x 5" x 5". Ship. wt. 5 lbs.

Model 944-K, **\$23.95** Factory wired **\$34.95**
KIT, only

EICO Resistance-Capacitance Bridge and R-C-L Comparator

This brand new professional resistance-capacitance bridge-type instrument is specially EICO Service-Engineered for extremely wide usefulness. It directly reads 0.5 ohms to 500 megohms resistance (4 ranges), 10 mmfd to 5000 mfd capacitance (4 ranges), and power factor. (Kit includes precision calibrating resistor.) Unique PRECISION COMPARATOR RANGE for resistance, capacitance and inductance comparison measurement against external standard. Leakage testing of all capacitors at rated DC working voltage with internal 0-500 VDC source. Electron-ray tube as both bridge balance and capacitor leakage indicator. 110 v. 60 cps transformer and rectifier. All ranges calibrated on front panel. 3-color etched rubproof panel; rugged steel case. Size: 10" x 8" x 4¾". Ship. wt. 10 lbs.

Model 9508-K, **\$19.95** Factory wired **\$29.95**
KIT, only

EICO NEW Deluxe Multi-Signal Tracer

Entirely new 5-tube instrument provides high gain RF and low gain audio channels with both visual and aural monitors (electron-ray tube and 5" speaker). Permits RF, IF and audio signal tracing in TV, FM and AM sets. Highly useful noise localizer circuit that applies DC test voltage thru probe to suspected component and simultaneously picks up and amplifies effect. May be connected as test speaker, amplifier, or output transformer, and has output for VTVM or scope. Excellent for gain-per-stage estimation, null detector, scope preamplifier, utility amplifier, small P.A. system. New satin finish etched panel; grey wrinkle steel case. 105-125 VAC, 50/60 cps. Size: 8" x 10" x 4¾". Ship. wt. 10 lbs.

Model 147-K, **\$24.95** Factory wired **\$39.95**
KIT, only

EICO Multi-Signal Tracer

Audibly traces all IF, RF, video and audio from ANT to SPKR or CRT without switching. Response well over 200 mc. 5" test speaker. Provision for visual tracing with VTVM. Complete with 6SJ7, 6K6, 6X5. Germanium crystal diode probe. 3-color etched panel; rugged steel case. 105-125 VAC, 50/60 cps. Size: 10" x 8" x 4¾". Ship wt. 9 lbs.

Model 145-K, **\$19.95** Factory wired **\$28.95**
KIT, only

EICO NEW Dual 6V & 12V Battery Eliminator and Charger

Gives you all the electrical power you need for 6-volt and 12-volt battery charging and auto radio servicing. 2 DC ranges: 0-8 volts (10 amps continuous, 20 amps intermittent), 0-16 volts (6 amps continuous, 12 amps intermittent). Continuous voltage adjustment with variac-type transformer. Separate voltmeter and ammeter. Heavy duty selenium rectifiers. Fused primary; automatic reset circuit-breaker opens secondary circuit upon overload. Rugged, well-ventilated steel cabinet. Size: 8¾" x 10½" x 7¾". Ship wt. 15 lbs.

Model 1050-K, **\$29.95** Factory wired **\$38.95**
KIT, only

EICO 6V Battery Eliminator and Charger

Similar to Model 1050, but designed primarily for 6-volt operation (10 amps continuous, 20 amps intermittent). May be used for light 12-volt operation (trickle charging, etc.).

Model 1040-K, **\$25.95** Factory wired **\$34.95**
KIT, only

EICO NEW RTMA Resistance Substitution Box

Enables rapid substitution of resistances from 15 ohms to 10 megohms in decade multiples of 15, 22, 33, 47, 68, 100 ohms. Uses 36 standard 1 watt, ±10% RTMA resistors. 5-way jack-top binding post for connection of practically any type of test lead. Rugged, molded black bakelite cabinet; 2-color deep-etched satin aluminum panel. Size: 3¾" x 6½" x 3½". Ship. wt. 2 lbs.

Model 1100-K, **\$5.50** Factory wired **\$9.95**
KIT, only

Prices 5% higher on West Coast.

ELECTRONIC INSTRUMENT CO., Inc. • Brooklyn 11, N. Y.

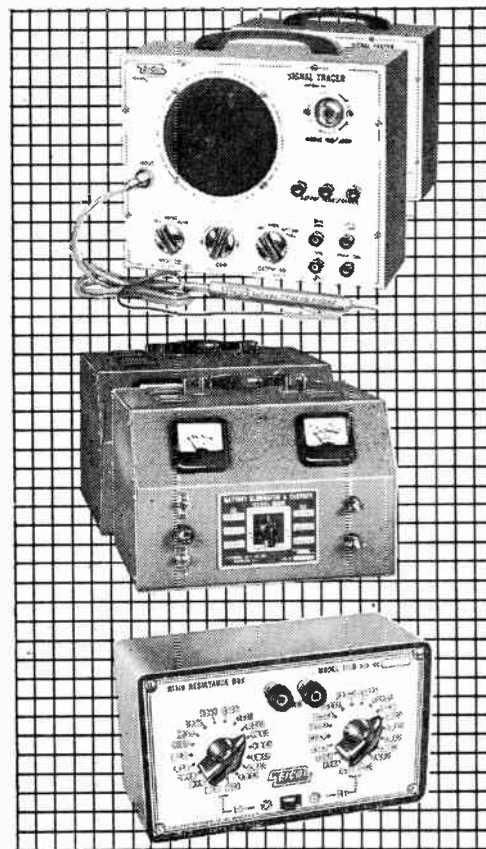
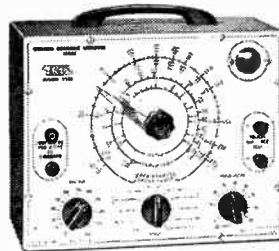
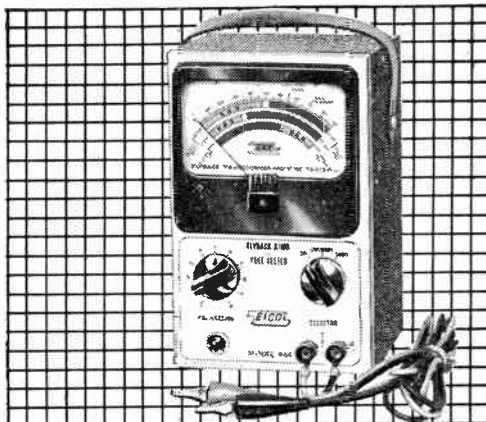



KITS and INSTRUMENTS

You build EICO KITS in one evening . . .
but they last a lifetime! AND YOU SAVE 50%!

EICO New Tube Tester

Brand new professional tube tester and merchandiser. EICO Service-Engineered for unbeatable value! Large 4 1/2" full-vision meter. Tests CONVENTIONAL and TV TUBES including 9-pin miniatures. New lever-action switches—tests EVERY tube element. Illuminated "Speed Roll-Chart." 2 grid caps. Short and open-element tests. Spare socket for new tubes. Protective overload bulb. Electronic rectifier. 3-color etched panel; rugged steel case. 115 v., 60 cycle AC. Size 12 1/2" x 9 1/2" x 4 1/4". Ship wt. 12 lbs.
Model 625-K, **\$34.95** Factory wired **\$49.95**
KIT, only

EICO New Picture Tube Test Adapter

(for EICO Models 625 and 625-K Tube Testers)
With the new Model CRA and your EICO Tube Tester, you check all sizes TV Picture Tubes as fast and easily as any ordinary tube. Model CRA gives a quantitative measurement of cathode emission, and tests for filament continuity and shorts between elements. Comes complete with standard 12-pin TV tube socket, octal plug-in connector, and extra long 4-foot cable that enables Pix Tube to remain in set WHILE TESTING.
Model CRA, only **\$4.50**

EICO NEW Cathode Ray Tube Checker

Easy, fast, dependable testing of all sizes TV picture and oscilloscope type C-R tubes—right in the set or carton. Bridge measurement of peak beam current (proportional to screen brightness) using neon lamp as sensitive balance indicator. Balancing control calibrated directly in terms of tube condition. Detects open and shorted elements. Size: 9 1/2" x 6 1/2" x 3". Ship wt. 5 lbs.
Model 630-K, **\$17.95** Factory wired **\$24.95**
KIT, only

6 NEW EICO VOLT-OHM-MILLIAMMETERS

EICO New Model 565 20,000 Ohms/Volt Multimeter KIT \$24.95. Wired \$29.95.

• 31 FULL SCALE RANGES! • DC/AC/OUTPUT VOLTS: 0-2.5, 10, 50, 250, 1000, 5000. • DC CURRENT: 0-100 ua; 10, 100, 500 ma; 10 Amp. • OHMS: 0-2000, 200K, 20 meg. • 5 DB RANGES: -12 to +55. • LARGE 4 1/2" 50 UA METER MOVEMENT. • HIGH-IMPACT Bakelite case. 6 3/4" x 5 1/4" x 3". Ship. wt. 2 3/4 lbs.

EICO New Model 555 20,000 Ohms/Volt Multimeter KIT \$29.95. Wired \$34.95.

As above, with 1% precision resistors.

EICO New Model 566 1000 Ohms/Volt Multimeter KIT \$14.90. Wired \$18.95.

RANGES: Same as Model 536 (see below), plus 7 output voltage ranges. Large 4 1/2" 400 ua meter movement. 6 3/4" x 5 1/4" x 3". Ship. wt. 3 lbs.

EICO New Model 556 1000 Ohms/Volt Multimeter KIT \$16.90. Wired \$23.50.

Same as Model 566, with 1% precision resistors.

EICO New Model 536 1000 Ohms/Volt Multimeter KIT \$12.90. Wired \$14.90.

• 31 1000 OHMS/VOLT FULL-SCALE RANGES! • DC/AC VOLTS: Zero to 1, 5, 10, 50, 100, 500, 5000. • DC/AC CURRENT: 0-1, 10 ma.; 0.1, 1 Amp. • OHMS: 0-500, 100K, 1 meg. • 6 DB RANGES: -20 to +69. • LARGE 3" 400 UA METER MOVEMENT. • HIGH-IMPACT Bakelite case. 6 1/4" x 3 3/4" x 2". Ship. wt. 2 lbs.

EICO New Model 526 1000 Ohms/Volt Multimeter KIT \$13.90. Wired \$16.90.

As above, with 1% precision resistors.

EICO Decade Resistance Box

Exceptional accuracy, wide range and easy operation. Extremely wide range of 0-99,999 ohms in 1-ohm steps with 5 decades and 1/2% precision at any setting. Comparator Position permits instant substitution of actual equivalent component of the resistance value indicated on the box. Uses 1/2% accuracy 1-watt resistors. Rugged, trouble-free construction. Heavy-gauge quality steel cabinet. Size: 12" x 3 1/2" x 3". Ship wt. 3 lbs.
Model 1171-K, **\$19.95** Factory wired **\$24.95**
KIT, only

EICO NEW Decade Condenser Box

Uses only highest quality precision silver-mica capacitors: ±1% accuracy, 500 VDC rated, .001 power factor, minimum of 50,000 megs insulation resistance. Capacitors arranged in 3 decades to provide extremely wide range of 100 mmf to 0.111 mf in steps of 100 mmf. Smooth-action, positive detent ceramic wafer switches with silver-plated contacts. 5-way jack-top binding posts. Excellent for lab and circuit development work. Size: 9" x 3 1/2" x 3 1/2". Ship wt. 3 lbs.
Model 1180-K, **\$14.95** Factory wired **\$19.95**
KIT, only

Prices 5% higher on West Coast.

ELECTRONIC INSTRUMENT CO., Inc. • Brooklyn 11, N. Y.

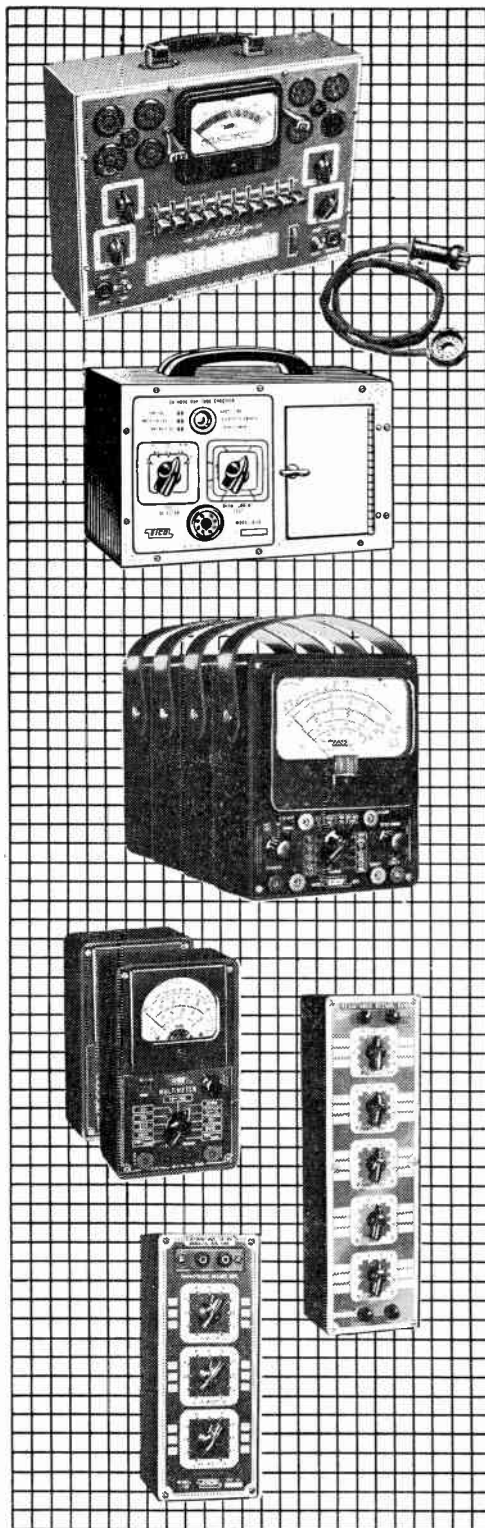



PRECISION INSTRUMENTS

FOR PANELS AND TEST SETS



TYPE NF-2C

EMICO panel and test meters are rugged and reliable instruments. Cases are of steel and finished in durable black. DC meters have the new HI-TORK magnetic movements and are accurate to well within 5%. AC meters are of the moving iron type and are also accurate to within 5%.

MOUNTING—All model NF-2C and RF-2C meters will fit into a $2\frac{1}{8}$ " diameter hole and are mounted by means of a U clamp.

DESIGN—EMICO meters are designed to give satisfactory service under the most severe conditions. They are styled to add to the prestige and appearance of electrical equipment.

CALIBRATION—Since the instruments are calibrated in steel cases, their accuracy is not affected by panels made of magnetic materials of nominal thickness.

GUARANTEED—All EMICO instruments are guaranteed against defective material and workmanship for a period of one year after date of purchase, and will be repaired or replaced if sent to the factory postpaid with a 50c handling charge.

EMICO instruments are available in quantities to jobbers or manufacturers in the following sizes: NF-2", RF-2½", and RF-4½" at 3% accuracy. We invite your inquiries on instruments for special application.



TYPE RF-2C

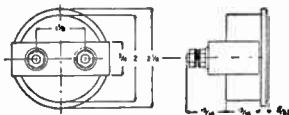

TYPE NF-2C

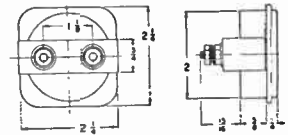

TYPE RF-2C

EMICO VOLTAGE TESTER

DESIGNED TO ACCURATELY TEST VOLTAGE AT THE RECEPTACLE

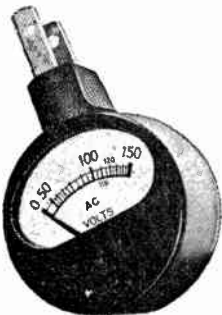

This new convenient voltage tester is strong, rugged and reliable. Case of steel finished in durable black. Damped meter movement, precision mechanism. Accuracy $\pm 5\%$. 90° swivel at the prongs make reading from angle easy. Dealers Net \$3.00.

DEALERS' PRICE LIST

DC AMMETERS

Range	Approximate Resist. Ohms	MODEL NF-2C		MODEL RF-2C	
		Catalog Number	Dealers' Net Price	Catalog Number	Dealers' Net Price
0-1	.16	2101	\$1.50	2201	\$1.60
0-5	.016	2102	1.50	2202	1.60
0-10	.00115	2103	1.50	2203	1.60
0-15	.00115	2103-A	1.50	2203-A	1.60
0-20	.00115	2104	1.50	2204	1.60
0-30	.00115	2105	1.50	2205	1.60
0-60	.00115	2106-A	2.00	2206-A	2.10
1-0-1	.08	2109	1.50	2209	1.60
3-0-3	.00115	2110	1.50	2210	1.60
6-0-6	.00115	2111	1.50	2211	1.60
10-0-10	.00115	2112	1.50	2212	1.60
15-0-15	.00115	2113	1.50	2213	1.60
20-0-20	.00115	2114	1.50	2214	1.60
30-0-30	.00115	2115	1.50	2215	1.60

DC MILLIAMMETERS

Range	Approximate Resist. Ohms	MODEL NF-2C	MODEL RF-2C
		Catalog Number	Dealers' Net Price
0-1	1000	2120	\$3.60
0-3	500	2121	2.15
0-5	1250	2125	1.95
0-10	430	2126	1.85
0-20	70	2127	1.50
0-30	60	2128	1.50
0-50	15	2129	1.50
0-100	8	2130	1.50
0-150	2.75	2130-A	1.50
0-200	2.75	2130-B	1.50
0-300	.50	2131	1.50
0-500	.35	2132	1.50

DC VOLTMETERS (HIGH RESISTANCE)

(100 ohms/volt except 150 and 300 volt ranges are 200 ohms per volt)

Range	Approximate Resist. Ohms	MODEL NF-2C	MODEL RF-2C
		Catalog Number	Dealers' Net Price
0-10	1050	2140	\$2.10
0-30	2800	2141	2.35
0-50	4000	2142	2.70
0-150	28000	2143	2.80
0-300	55000	2144	2.80

DC VOLTMETERS (LOW RESISTANCE)

Range	Approximate Resist. Ohms	MODEL NF-2C		MODEL RF-2C	
		Catalog Number	Dealers' Net Price	Catalog Number	Dealers' Net Price
0-1	33	2134	\$1.50	2234	\$1.60
0-3	100	2135	1.50	2235	1.60
3-0-3	30	2136	1.50	2236	1.60
0-5	140	2136-A	1.50	2236-A	1.60
0-8	225	2136-B	1.50	2236-B	1.60
0-10	280	2137	1.50	2237	1.60
0-15	450	2137-A	1.50	2237-A	1.60
0-30	1000	2137-C	1.50	2237-C	1.60
0-50	1400	2138	1.50	2238	1.60

AC AMMETERS

Range	Approximate Resist. Ohms	MODEL NF-2C	MODEL RF-2C
		Catalog Number	Dealers' Net Price
0-1	.365	6101	\$2.55
0-3	.078	6102	2.55
0-5	.023	6103	2.55
0-10	.013	6104	2.55

AC MILLIAMMETERS

Range	Approximate Resist. Ohms	MODEL NF-2C	MODEL RF-2C
		Catalog Number	Dealers' Net Price
0-25	750	6125	\$2.55
0-50	175	6126	2.55
0-100	58	6127	2.55
0-250	12	6128	2.55
0-500	1.75	6129	2.55

AC VOLTMETERS

Range	Approximate Resist. Ohms	MODEL NF-2C	MODEL RF-2C
		Catalog Number	Dealers' Net Price
0-5	50	6135	\$2.55
0-10	175	6136	2.55
0-15	300	6137	2.55
0-25	920	6137-A	2.55
0-50	1800	6138	2.55
0-150	9530	6139	3.50
0-300	32000	6140	4.10

PRICES—Prices listed are net and include all hardware and individual boxing. Resistance approximate. If important request factory engineering confirmation.



PRECISION TEST EQUIPMENT

STANDARD OF ACCURACY

All prices are subject to change without notice

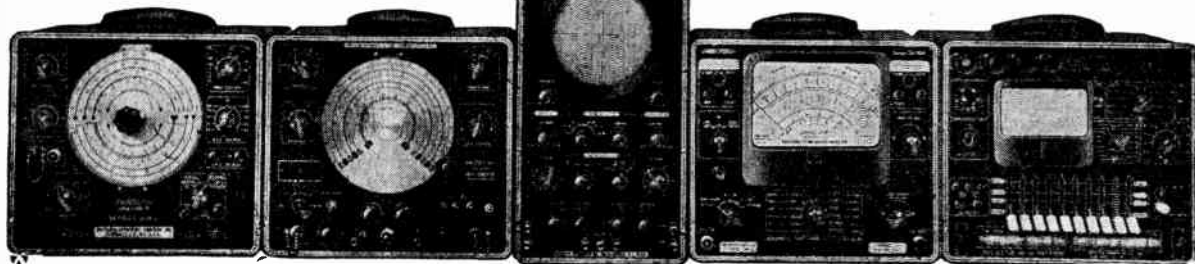

SERIES E-200-C
Modern Multi-band
**SIGNAL and MARKER
GENERATOR**
(see page G-92)

SERIES E-400
Wide Range H.F.
**SWEEP SIGNAL
GENERATOR**
(see page G-91)

SERIES ES-500A
5 in. Hi-Sensitivity
Wide Range
OSCILLOSCOPE
(see page G-91)

SERIES EV-10A
True Zero-Center
VTVM-MEGOHMMETER
with 7 in. Meter
(see page G-92)

SERIES 612
Modern Free-patent
**TUBE and BATTERY
TESTER**
(see page G-96)

**THESE FIVE MATCHED "PRECISION" INSTRUMENTS
PROVIDE A COMPLETE MODERN BASIC LABORATORY
FOR TV-FM-AM AT ONLY MODERATE COST**

OTHER MATCHED COMBINATIONS

The instruments shown above, and other "Precision" equipments, are available in various enclosure styles...Panel Mounts, Portable, Counter Types, etc. . . . designed to suit individual applications, field or shop. The illustration shows only one of the many possible "matched combinations" of diversified "Precision" Test Equipment. Each combination provides a selected and Basic, modern, efficient Laboratory at moderate cost.



SERIES TV
**THE SUPER HIGH VOLTAGE
SAFETY TEST PROBE**
for High D.C. Potential
Measurements up to
60,000 volts.
(see page G-95)



*** SERIES EV-20 VTVM
and MULTI-RANGE TEST SET**

Complete with coaxial Circuit Isolating Test Probe, Shielded Ohmmeter Test Cable, Standard #227 Super-Flex Test Leads, Ohmmeter battery and full operating instructions.

In modern, black ripple finished cabinet. Size—10½" x 6¼" x 5".
CODE: Party Net Price — \$69.75

SERIES EV-20 VTVM and Multi-Range Test Set

TRUE ZERO — CENTER ON ALL VTVM RANGES

WITH DIRECT PEAK READING HIGH FREQUENCY SCALES

Plus Complete Standard 1000 Ohms/Volt Functions

48 Ranges to 1200 Volts*, 2000 Megohms, 12 Amperes, +63 DB

Series EV-20 is a compact, high sensitivity, laboratory-type, circuit-testing instrument, incorporating the most modern electrical and physical design. It provides unparalleled performance, accuracy and versatility required for AM-FM-TV and general electronic circuit analysis.

Functionally similar to the deluxe Series EV-10A VTVM, with extra large 7" meter. (described on Page G-92) the Series EV-20 (with 4½-inch meter) affords a highly efficient instrument at moderate cost.

RANGE SPECIFICATIONS

- ★ **SIX ALL-ZERO CENTER VTVM RANGES:**
13⅓ Megs. Constant Input Resistance.
±3, ±12, ±30, ±120, ±300, ±1200 volts.
*Direct Reading to ±60 kV when used with Series TV-4 High Voltage Test Probe described on page G-95.
- ★ **SIX SELF-CONTAINED RESISTANCE RANGES:** 0-2000 - 200,000 ohms.
0-2-20-200-2000 Megohms.
- ★ **FOUR DIRECT PEAK READING HIGH FREQ. VTVM RANGES:** 0-3-12-30-120 volts. (Requires RF-10A High Freq. Vacuum Tube Probe, Net Price \$14.40. No crystal rectifiers employed.)
- ★ **SIX AC-DC AND OUTPUT VOLTAGE RANGES** at 1000 ohms per volt.
0-3-12-30-120-300-1200 volts.
- ★ **EIGHT D.C. CURRENT RANGES:**
0-300 microamps. 0-1-2-3-12-30-120-1200 MA.
0-12 Amperes.
- ★ **SIX DECIBEL RANGES** from -20 to +63DB.
Calibrated for 600 ohm, 1 mw., zero DB.
- ★ **ROTARY RANGE — FUNCTION SELECTORS** eliminate frequent and inefficient shifting of test leads.

IMPORTANT FEATURES

- ★ **VOLTAGE REGULATED — BRIDGE CIRCUIT**
- ★ **DIRECT READING, ALL ZERO-CENTER VTVM**
Indicates both Polarity and Magnitude without switching or test lead reversal.
- ★ **SHIELDED CONNECTORS** for D.C.—VTVM and RF—VTVM. Permits simultaneous and non-interfering connection of both the Circuit Isolating Test Probe and optional H.F. Vacuum Tube Probe Series RF-10A.
- ★ **DUAL - BALANCED ELECTRONIC BRIDGE OHMMETER—MEGOHMMETER** uses two 1.5 volt cells easily replaced at rear of cabinet.
- ★ **ADDITIONAL 1000 OHMS/VOLT FUNCTIONS** permit routine AC-DC voltage, DB and current measurements free of power line.
- ★ **4½" RECTANGULAR METER** — 200 microamperes, ±2%. D'Arsonval construction.
- ★ **1% Film type, Metallized and Wire-Wound resistors** for all shunts and multipliers.
- ★ **Heavy gauge; round-cornered, louvered steel case** with plastic handle. Etched, anodized, aluminum panel.



PRECISION TEST EQUIPMENT

STANDARD OF ACCURACY

All prices are subject to change without notice

Series E-400

Wide Range Sweep Signal Generator

Narrow and Wide Band Sweep
Direct Reading from 2 to 480 Megacycles

DIRECTLY COVERS UHF AND VHF I.F. ALIGNMENT REQUIREMENTS



Incorporating selected and true high frequency components and circuits, Series E-400 has been Application Engineered specifically for modern F.M. and TV oscillographic alignment methods.

Stressing utmost simplicity of operation, flexibility and stability, Series E-400 affords an unparalleled standard of performance and value for the efficient TV-FM Service Lab.

FEATURES

- ★ **Direct Frequency Reading**—2 to 480 MC in 7 bands without skip. Harmonically calibrated from 240 to 480 MC. Directly covers frequency requirements for I.F. alignment of UHF, VHF and color TV receivers.
- ★ **6 Position Rotary Band Switch** covers complete spectrum. No coil switching. Multiple oscillator B supply switch assures maximum frequency accuracy and stability.
- ★ **6½" Etched Aluminum Tuning Dial**—Engine turned finish.
- ★ **1500 Point Vernier Scale** for close calibration and resetting.
- ★ **Engraved Transparent Lucite Frequency Indicator.**
- ★ **Internal Retrace Blanking Circuit** eliminates dual trace of response patterns on oscillograph.
- ★ **Voltage Regulated Oscillators** free of power supply variations.
- ★ **The Basic Circuit and Tube Complement**—Uses 2 separate 6C4 high frequency beat oscillators plus a 6J6 reactance-modulated high frequency oscillator. This positively minimizes generation of unwanted extraneous signals. Also employs a 6J6 mixer-buffer, a 6C4 multiple crystal oscillator and a 6J6 final marker-mixer amplifier. 6X5 full wave rectifier. VR-105 voltage regulator. 4Y1 blanking voltage rectifier.
- ★ **Selected, True High Frequency Circuit Components.** Uses ceramic and air dielectric trimmers, coupling, by-pass and loading capacitors; rugged ceramic suspended, National Straight Line Frequency tuning condenser; modern miniature HF tubes; mica-filled low-loss sockets; shock mounted, compensated reactance modulator; copper plate shielding, etc.
- ★ **Narrow and Wide Band Sweep**—0 to 1 MC and 0 to 15 MC.
- ★ **Dual Continuous R.F. Attenuators** triple shielded. Smooth, stepless, effective control from extra high output for single stage alignment to minimum levels for multi-stage adjustments.
- ★ **Wide Range Phasing Control** for Hor. sweep of oscilloscope.
- ★ **Multiple Crystal Marker-Calibrator** built-in. Accommodates 4 rotary selected crystals. .31% accuracy 4.5 MC and 2 MC crystals furnished as standard equipment. Crystal signal separately attenuated for internal or external use.
- ★ **Crystal Calibrated and Control**—Each instrument calibrated against crystal standards. The 2 MC crystal permits crystal monitoring and calibration of external signal generators.
- ★ **Terminated RG/U Type Coaxial Output Cable** for efficient signal transmission with minimum standing wave effects.
- ★ **8 Element Double Section Balanced Line Filter** plus Thorough Multi-Section Copper Plate Shielding of instrument assures minimum leakage and radiation.
- ★ **Simultaneous A.M. and F.M. test facilities** for anti-A.M. check of F.M. second detector circuits. A.M. input jacks also permit use as a modulated H.F. A.M. Generator.
- ★ **External Deviation input facility** for sweep repetition frequencies other than internal 60 cycle source.
- ★ **Fuse Protected** at panel exterior fuse post.
- ★ **Heavy Gauge, Etched-Anodized Aluminum Panel.**
- ★ **Fully Licensed** under W. E. A. T. & T. and Pierce patents.
 - ★ **Series E-400** (illustrated)—In louvered portable copper-plated case. Size 10½" x 12" x 6". Complete with test cables, 2 crystals and elaborate Technical Manual.
Code: Nancy. Net Price—\$139.75
 - ★ **E-400-PM**—Consists of E-400 on 12¼" x 19" steel panel for standard rack mount. Complete as above.
Code: Niece. Net Price—\$145.25

Series ES-500A

High Sensitivity, Wide Range, 5" Oscilloscope

Push-Pull Vertical and Horizontal Amplifiers
20 MV. per inch "V" Sensitivity

SELF-CONTAINED 1 VOLT PEAK TO PEAK CALIBRATOR

Series ES-500A affords the ultimate in performance, flexibility and operational flexibility at moderate cost.

"Precision" engineers have incorporated every necessary feature which they found to be required to meet the needs of the rapidly advancing art of electronics.

Series ES-500A provides an unparalleled combination of high sensitivity, extended frequency range and other essential features specifically desired for experimental and commercial visual circuit analysis.

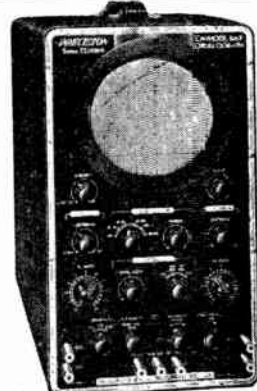

FEATURES

- ★ **High Sensitivity, Wide Range, Voltage Regulated, Push-Pull Vertical Amplifier**—.02V. per inch deflection sensitivity. 10 cycles to 1 MC response. 2 megohms input resistance. Approx. 22 mmf. input capacity.
- ★ **Compensated Vertical Input Step Attenuator**—X1, X10, X100.
- ★ **Built-in Peak to Peak Voltage Calibrator**, push-button controlled at front of panel.
- ★ **Vertical Phase-Reversing Switch** permits inversion of all patterns at will. Non-frequency discriminating.
- ★ **Extended Range, Push-Pull Horizontal Amplifier**—150 MV (.15 V) per inch high deflection sensitivity adequate for most all "H" drive purposes. 10 cycles to 1 MC response at full gain. ½ megohm, approx. 20 mmfd. input.
- ★ **Linear Multi-Vibrator Sweep Circuit**—10 cycles to 30 KC plus internal line or external sweep.
- ★ **Amplitude Controlled, Four Way Synch. Selection**—Internal Positive, Internal Negative, External and Line.
- ★ **"Z" Axis Modulation** input facility for blanking, timing, etc.
- ★ **Internal, Phasable 60 cycle Beam Blanking** for elimination of alignment retrace; clean display of synch. pulses, etc.
- ★ **Sweep Phasing Control** for sinusoidal line sweep usage. Wide angle bridge circuit.
- ★ **Direct H and V Deflection Plate Connections** and Audio Monitoring phone jacks at rear. All four plates accessible.
- ★ **High Intensity CR Patterns** through use of adequate high voltage power supply with separate 2X2 rectifier.
- ★ **The Circuit and Tube Complement**—6C4 Vertical input cathode follower. 6CB6 first "V" amplifier. 6C4 "V" phase inverter. Push-Pull 6J6's vertical CR driver. 6SN7 first "H" amplifier and phase inverter. Push-Pull 12AV7 horizontal CR driver. 6SN7 Multi-vibrator linear sweep oscillator. 6C4 retrace blanking amplifier. 5Y3 low voltage rectifier. 2X2 high potential rectifier. VR-150 voltage regulator. 5CP1A CR tube.
- ★ **7 Four-Way Lab-Type Input Terminals**—Take banana plugs, phone tips, bare wire or spade lugs.
- ★ **Light Shield and Mask** removable and rotatable.
- ★ **Extra Heavy-Duty Construction** and components to assure "Precision"-engineered performance.
- ★ **Fully Licensed** under Western Electric Co. patents.
 - ★ **Series ES-500A**—In louvered, black-ripple, heavy gauge steel case. Size 8¼" x 14½" x 18". Complete with light shield, calibrating mask and comprehensive instruction manual. Code: Quick. Net Price—\$173.70

Series SP-5—Oscilloscope Test Probe Set

FOR TV SIGNAL TRACING, ALIGNMENT,
TROUBLE SHOOTING AND WAVEFORM ANALYSIS

- ★ Specifically engineered for use with PRECISION Cathode Ray Oscillographs, Series ES-500 and ES-500A.
 - ★ Set consists of shielded Master Cable and four different, detachable probe heads in custom-made vinyl carrying case.
 1. HIGH IMPEDANCE—LOW CAPACITY PROBE
 2. CRYSTAL—DEMODULATOR PROBE
 3. RESISTIVE—ISOLATING PROBE
 4. SHIELDED—DIRECT PROBE
- Net Price—\$23.50

This equipment is Approved (and/or Tested) by the CSA Approval Laboratories.

Radio's Master—19th Edition

Page G-91



-PRECISION- TEST EQUIPMENT

STANDARD OF ACCURACY



- ★ EV-10A (MCP) (illustrated) In black ripple finished, heavy gauge steel case. Size 10 1/2" x 12" x 6". Complete with tubes, battery, and test probes. Code: Place. Net Price—\$99.75
- ★ EV-10A (P) In hardwood portable case with tool compartment. Size 12" x 13" x 6". Code: Phone. Net Price—\$102.50
- ★ EV-10A (PM) Consists of Series EV-10A on steel panel. Size 12 1/4" x 19". For standard rack mount. Code: Panel. Net Price—\$105.25

★ SERIES RF-10A VACUUM TUBE R.F. PROBE

Accessory for Series EV-10A & EV-20; affords direct high frequency peak voltage measurements. Connects directly to VTVM panel. Employs 9002 miniature tube. Code: Probe.



Net Price \$14.40

PRECISION SERIES EV-10A VTVM—Megohmmeter

TRUE ZERO-CENTER VTVM WITH 7" FULL-VIEW METER
FOUR DIRECT PEAK READING HIGH FREQUENCY SCALES

Plus standard 1000 Ohms per Volt Functions.
Ranges to 6000 Volts, 2000 Megohms, 12 Amperes, +77 DB.

All prices are subject to change without notice

A WIDE-RANGE, TRUE ZERO-CENTER ELECTRONIC INSTRUMENT, stressing the utmost in performance, accuracy, and ease of manipulation. The Series EV-10A permits rapid check of voltage, current, and resistance conditions encountered in modern A.M., F.M., and TV Networks, without materially disturbing the performance of circuits under analysis.

RANGE SPECIFICATIONS

- ★ Eight All Zero-Center VTVM Ranges. ± 3 , ± 12 , ± 60 , ± 120 , ± 300 , ± 600 , ± 1200 , ± 6000 volts D.C. self-contained.
- ★ High Input Resistance — 13 1/3 megs. constant to 600 volts. 26 2/3 megohms at 1200 volts. 133 1/3 megohms at 6000 volts.
- ★ 4 Direct Reading High Freq. Ranges: 0-3-12-60-120 peak volts. (Requires Series RF-10A High Frequency Vacuum Tube Test Probe described and illustrated at left.)
- ★ Extra-High Voltage Ranges to ± 60 KV. when employed with Series TV-4 High Voltage Probe described on page G-95.
- ★ Six Ohmmeter-Megohmmeter Ranges: 0-2000-200,000 ohms. 0-2-20-200-2000 megohms.
- ★ Eight Extra A.C.-D.C.-Output Voltage ranges at 1000 ohms per volt. 0-3-12-60-120-300-600-1200-6000 V.
- ★ Eight D.C. Current Ranges: 0-300 microamperes. 0-1.2-6-30-120-600-1200 MA. 0-12 amps.
- ★ Eight DB Ranges from -20 to +77DB. Calibrated for 1MW, 600 ohms zero DB.

IMPORTANT FEATURES

- ★ Voltage Regulated-Bridge Type Circuit: affords practical freedom from tube and line voltage variations.
- ★ True Zero-Center VTVM—Indicates both magnitude and polarity without reversal of test prods on all ranges.
- ★ Rotary Range and Function Selectors minimize shifting of test leads.
- ★ Recessed 6000 volt Safety Jacks.
- ★ Shielded Coax Test-Cable Connectors permit both D.C. and R.F. probes to be connected simultaneously.
- ★ Duo-Balanced Electronic-Bridge Ohmmeter—Megohmmeter. Uses 2 self-contained, standard 1.5 volt batteries.
- ★ Special 1000 Ohms/Volt Functions permit routine AC-DC circuit tests free of need for power line connection.
- ★ Extra-large 7" Rectangular Meter. 200 microamperes, $\pm 2\%$ sensitivity.
- ★ Highest Quality Components employed throughout • 1% wire, film and matched resistors • Silverplated switch contacts • Leakage-resistant, plastic insulated hook-up wire • Etched-anodized aluminum panel • Heavy duty line cord.

Precision Series E-200-C Signal Generator

A Modern Multi-Band Signal and Marker Generator for A.M., F.M., and Television Alignment.

Featuring "Servicing by Signal Substitution." The Dynamic Speed Approach to Receiver Alignment and Adjustment Problems.

SPECIFICATIONS

- ★ FREQUENCY COVERAGE: 68 KC. to 240 MC., 60 MC. on fundamental. 6 1/2" Dial direct reading in 9 bands to 240 MC. No charts required.
- ★ ACCURACY—CONSTANCY OF CALIBRATION: 1% accuracy on all bands. Uses "PRECISION" developed "UNIT-OSCILLATOR" turret construction.
- ★ 0-1000 POINT VERNIER SCALE, direct reading to one part in 1000.
- ★ THE CIRCUIT—employs a 6AU6 in stable E.C.O. circuit—modulated by a 6U8 sine-wave audio oscillator 5Y3 Full wave rectifier.
- ★ 400 CYCLE SIN-WAVE AUDIO OSCILLATOR—over 50 volts output.
- ★ DUAL R.F. ATTENUATORS — smooth stepless control of R.F. signal.
- ★ SHIELDING — Compartment shielding of vital components — Power transformer electrostatically shielded—A.C. line is R.F. filtered.
- ★ SHIELDED COAXIAL OUTPUT CABLE and (LO-HI) cable connectors.
- ★ FOUR TYPES OF SIGNALS — "Unmod. R.F.", "400 cycle Mod. R.F.", "EXTERNALLY Mod. R.F.", "400 cycle audio Output."
- ★ DIRECT READING VARIABLE MODULATION—0-100%—triples signal utility as against obsolete fixed or stepped modulation of only 30 or 40%.
- ★ BUILT-IN A.V.C.-A.G.C. SUBSTITUTION — Overcomes alignment troubles arising from varying receiver A.V.C. and A.G.C. voltage.
- ★ HAND CALIBRATED — Each instrument is INDIVIDUALLY calibrated.
- ★ FULLY LICENSED under patents of A. T. & T. and W. E. Co's.
- ★ Not only an efficient Signal Generator for purposes of alignment but also specifically designed for "Servicing by Signal Substitution."
- ★ IDEAL MARKING GENERATOR — Exceptional stability and high accuracy renders Series E-200-C an excellent variable frequency Marker Generator for use with the Series E-400 or similar high quality Sweep Signal Generator.



★ Series E-200-C—(illustrated) In black ripple finished, portable steel case. Size 10 1/2" x 12" x 6". Complete with tubes, output cable and FREE copy of "Servicing by Signal Substitution."

Code: Trade.

Net Price—\$78.50

★ Series E-200-C-PM—Consists of E-200-C on steel panel size 12 1/4" x 19", for standard rack mount.

Code: Trace. Net Price—\$84.00



"SERVICING BY SIGNAL SUBSTITUTION"

Nothing complex to learn, no extraneous equipment to purchase. A systematic method of dynamic signal analysis based entirely on fundamentals. Fully described in a bound illustrated text "Servicing by Signal Substitution." This highly valuable book is supplied with Series E-200-C at no charge. Additional copies available at your Precision distributor or directly from factory at 40¢ per copy.



PRECISION TEST EQUIPMENT

STANDARD OF ACCURACY

All prices are subject to change without notice

ELECTRONAMIC (Reg. U. S. Patent Office)



Series 10-15 *Electronamic Tube Master* De Luxe Tube and Battery Merchandiser with extra-large 9" Meter

The All-Inclusive, Positive Vacuum Tube Performance Test
that is not limited to Mutual Conductance Alone.

(See technical details in main catalog)

- ★ Incorporates the Electronamic tube performance and battery testing circuit, described for Series 10-54 on page G-94.
- ★ Designed particularly for equipment-conscious, progressive radio service-sales organizations, and tube-selling sections of department stores.
- ★ PROMOTE CUSTOMER CONFIDENCE and tube sales via this impressive "Precision" Tube Merchandiser.

- ★ DIRECT READING non-confusing tube performance indications in large, easy reading terms of Replace-Weak-Good.
- ★ ILLUMINATED by custom-built, highly polished, plated reflector.
- 10-15 Tube and Battery Merchandiser (illustrated). Heavy gauge steel cabinet in fine, dull black ripple, with chrome trim and reflector. Size 24" high, 17½" wide, base depth 10" tapering to 4" at top.
Code: Gable. Net Price—\$149.50

Series CR-30 CATHODE RAY TUBE TESTER TESTS ALL TV PICTURE TUBES (Tri-color, Magnetic and Electrostatic) OSCILLOSCOPE AND INDUSTRIAL CATHODE RAY TYPES

SERIES CR-30 IS A COMPLETE, SELF-CONTAINED INSTRUMENT particularly engineered for the very special needs of reliable, rapid and economical cathode ray tube testing, in the field, shop or laboratory.

Series CR-30 is indispensable to efficient TV Service-Installation. It provides reliable answer to the very important question. "IS IT THE CATHODE RAY TUBE OR IS IT THE TV CHASSIS?"

Series CR-30 incorporates a BEAM CURRENT TEST CIRCUIT which checks overall electron-gun performance for Proportionate Picture Brightness. Additional direct testing facilities are provided for positive check of accelerating anodes and deflection plate elements.

Tri-color Picture Tube Testing Data will be made available, as soon as practical, to all owners of the Model CR-30.

The Precision CR-30 should not be confused with cable adapters connecting to ordinary receiving tube testers which were never designed to meet the very specialized needs of CR tube checking. Similarly, it is not to be confused with neon lamp units or similar devices of limited technical merit and which do not check all CR tubes or all tube elements.

GENERAL AND TECHNICAL SPECIFICATIONS

- ★ Tests All Modern Cathode Ray Tubes—Magnetic and Electrostatic without removal from carton or TV chassis.
- ★ Tests All CR Tube Elements—Not just a limited few.
- ★ Absolute Free-Point 14 Lever Element Selection System for Short-Check, Leakage Testing and Quality Tests. Independent of multiple base pin and floating element terminations.
- ★ Beam Current Test Circuit checks all CR Tubes with Electron-gun in operation. It is the Electron Beam (and NOT total cathode emission) which traces the pictures or patterns on the face of the CR tube.

Total cathode emission can be very high and yet Beam Current (and picture brightness) unacceptably low. The CR-30 will reject such tubes because it is a Beam Current tester. Conversely, total cathode emission can be low and yet Beam Current (and picture brightness) perfectly acceptable. The CR-30 will properly pass such tubes because it is a Beam Current tester. The significance of the above rests in the fact that Beam Current (and picture brightness) is primarily associated with the condition of the center of the cathode surface and not the overall cathode area. (See illustration below.)

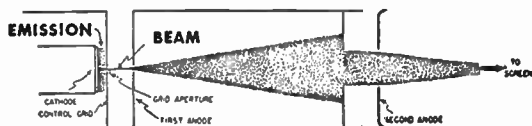

- ★ Voltage Regulated, Bridge Type VTVM provides the heart of the super-sensitive, tube quality test circuit. Such high sensitivity is also required for positive check of very low current anodes and deflection plates.
- ★ Multiple Test Sensitivities plus selectable element test potentials permit proper accommodation of all CR tube types.
- ★ Meter-Monitored, Micro-Line Voltage Adjustment provides close control of operating voltages.
- ★ Accuracy of test circuits closely maintained by use of factory adjusted internal calibrating controls; plastic insulated, telephone type cabled wiring; highest quality, conservatively rated components.
- ★ Built-in, High Speed, Roller Tube Chart.
- ★ Test Circuits Transformer isolated from power line.
- ★ 4½" Full Vision PACE Meter with special 4-color scale plate expressly designed and compensated for CR tube testing requirements.
- ★ Heavy Gauge Aluminum Panel, etched and anodized.
- ★ PLUS many other special "PRECISION" details and features.

SERIES CR-30—In hardwood, tapered portable case, with hinged removable cover. Extra-Wide Tool and Test Cable Compartment. Overall Dimensions 17¼" x 13¾" x 6¾". Complete with standard picture tube cable, universal CR Tube Test Cable and detailed Instruction Manual.

Code: Daisy.

Net Price—\$104.75

This equipment is Approved (and/or Tested) by the CSA Approval Laboratories.

Radio's Master—19th Edition

Page G-93



PRECISION TEST EQUIPMENT

STANDARD OF ACCURACY

All prices are subject to change without notice

ELECTRONAMIC (Reg. U. S. Patent Office)

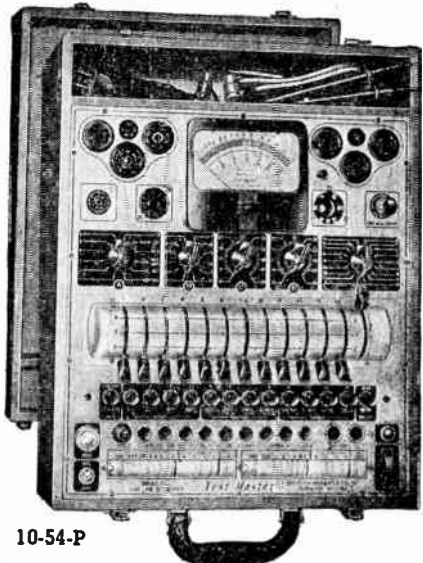

10-54-P

CIRCUIT TESTING FEATURES

A complete, wide-range, high speed, push-button operated, super-sensitive test set

Completely Self-contained

- ★ Six D.C. Voltage Ranges: 20,000 ohms per volt.
- ★ Six A.C. Voltage Ranges: 1000 ohms per volt.
- ★ Six Output Ranges at 100Ω ohms per volt. 0-6-12-60-300-1200-6000 volts.
- ★ Ranges to 30,000 Volts D.C. when used with Series TV-2 super high voltage test probe. Not included with 10-54. See page G-95.
- ★ Seven D.C. Current Ranges: 0-60-120 microamperes. 0-1-2-12-120-1200 MA. and 0-12 amperes.
- ★ Four Self-Contained Resistance Ranges: 0-6000-600,000 ohms; 0-6-60 megohms.
- ★ Six Decibel Ranges from -20 to +70 DB.
- ★ Automatic Push-Button range selection.
- ★ 1% Wire, Film and Metallized Resistors.

Series 10-54 Electronamic Test Master

Combination Tube Performance Tester, Battery Tester, and 35 Range, Push-Button Operated, Supersensitive, A.C.-D.C. Set Tester. Ranges to 6000 Volts, 60 Microamps, 12 amps, +70 DB, 60 Meg. 20,000 Ohms per Volt D.C.—1000 Ohms per Volt A.C.

The All-Inclusive, Positive Vacuum Tube Performance Test that is not limited to Mutual Conductance Alone. (See technical details in main catalog)

Series 10-54 affords to the discriminating instrument purchaser, THE COMPLETE PORTABLE SERVICE LABORATORY; engineered to meet the expanding needs of modern radio electronics. Provides every necessary facility for high speed, reliable tube and circuit testing associated with Industrial Electronics, Communications, Radio (A.M.-F.M.), Television, Laboratory, etc. . . .

TUBE AND BATTERY TESTING FEATURES

- ★ A TUBE "PERFORMANCE" TESTER: "Precision" ELECTRONAMIC circuit, effectively tests all tubes over a complete "Path of Operation" not just at one arbitrary operating point or for just one inconclusive characteristic.
- ★ TESTS ALL MODERN TUBE TYPES: Noval 9 pin, 7 pin Acorn, dual capped H.F. tubes, Single-Ended TV. and F.M. amplifiers, low power transmitting tubes, sub-miniature types, etc. . . . including direct facilities up to twelve element prongs!
- ★ ABSOLUTE FREE-POINT LEVER ELEMENT SELECTION: Highest possible, practical order of obsolescence insurance. Locates every tube element regardless of base position.
- ★ ABSOLUTE FREE-POINT, INTER-ELEMENT SHORT-CHECK and Visible Filament Continuity System.
- ★ DUAL SHORT-CHECK SENSITIVITY: Permits selection of tubes for special applications.
- ★ INDIVIDUAL TUBE SECTION TESTS of multi-section tubes.
- ★ A.M. and F.M. CATHODE RAY TUNING INDICATORS directly tested.
- ★ FILAMENT VOLTAGES ¼ to 117 V.
- ★ BALLAST UNIT TESTS.
- ★ NOISE and CONDENSER TESTS.
- ★ MICRO-LINE ADJUSTMENT via continuously variable line voltage control.
- ★ PILOT AND SIGNAL LIGHT TESTS.
- ★ ACCURACY of test circuits closely maintained by use of individual, internal calibrating controls.
- ★ HIGH SPEED ROLLER TUBE-CHART.
- ★ EXTRACTOR FUSE POST.
- ★ Test circuits completely transformer-isolated from power line.
- ★ TELEPHONE-TYPE, CABLED, plastic-insulated, moisture-resistant wire.
- ★ 4½" FULL VISION METER: 50 microampere, 2% accuracy.
- ★ TESTS RADIO A, B and C DRY BATTERIES via a "PRECISION" engineered circuit which performance checks each battery under actual load conditions. Battery quality read directly on a 3-color scale.

10-54-P (illustrated above) Hardwood, tapered, portable case, 13¾" x 17¼" x 6¾". With ohmmeter batteries and high voltage test leads. Net Price Code: Habit. 139.50

10-54-C (see 10-12-C illustration and description below) In modern, attractively finished, steel counter cabinet. Net Price Code: Handy. 144.25

10-54-PM (see 10-12-PM illustration and description below) In standard Panel Mount, with dust cover. Net Price Code: Harem. 144.25

Series 10-12 Electronamic Tube Master

Truly Free-Point Tube and Battery Performance Tester.

The All-Inclusive, Positive Vacuum Tube Performance Test that is not limited to Mutual Conductance Alone. (See technical details in main catalog)

The 10-00 Series of TUBE and TEST MASTERS represent the culmination of many years' development of tube testing equipment to meet the exacting needs of the rapidly advancing field of electronics.

Incorporating the "PRECISION" ELECTRONAMIC Tube Performance Testing Circuit, plus an advanced, "PRECISION" developed, multiple element, master lever selector system. It truly can be said that the MASTER 10-00 Series offers, to the discriminating equipment purchaser, the highest possible practical order of test results and anti-obsolescence insurance.

TUBE AND BATTERY TESTING FEATURES

The Series 10-12 Electronamic Tube Master incorporates the same time-proven circuit and exacting performance details described for the Series 10-54, above, under the heading: "Tube and Battery Testing Features."

★ 10-12-P (see 10-54-P illustration and description above) In hardwood, tapered, portable case with tool compartment. Code: Facil. Net Price — \$107.50

★ 10-12-C (illustrated at right) In modern, chrome-trimmed, round edged counter cabinet. Fine dull black ripple finish on heavy gauge steel. Size 17" x 17½" x 7½" sloping to 3" at front. Code: Faith. Net Price — \$112.25

★ 10-12-PM (illustrated at right) Consists of 10-12 chassis, mounted onto standard size steel panel, 17½" x 19" with dust cover. Fine, dull black ripple finish. Code: Favor. Net Price — \$112.25

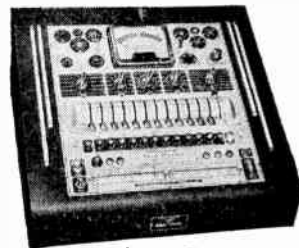

10-12-C

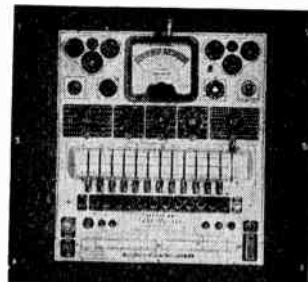

10-12-PM

Radio's Master — 19th Edition

Page G-94

This equipment is Approved (and/or Tested) by the CSA Approval Laboratories.



PRECISION TEST EQUIPMENT

STANDARD OF ACCURACY

All prices are subject to change without notice

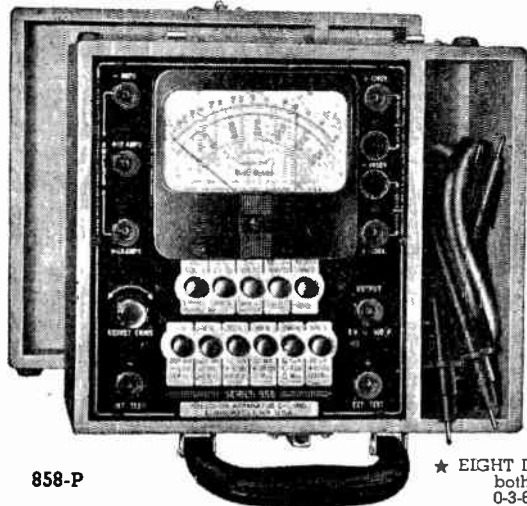

858-P

- ★ **858-P** (illustrated) In hardwood, portable case. Size 9"x10"x4 1/2". Complete with batteries and H.V. test leads. Code: Judge. Net Price — \$61.50
- ★ **858-L** In modern bakelite case. Size 7 1/2"x8 1/2"x3". Complete with batteries and H.V. test leads. Code: Jetty. Net Price — \$58.75

Series 858 High Sensitivity *Multi-Master*

HIGH SPEED, A.C.-D.C. MULTI-RANGE TEST SET

54 Ranges to

6,000 Volts, 60 Microamperes, 12 Amps., 600 Megs. +70DB.
20,000 and 1,000 Ohms per Volt D.C., 1,000 Ohms per Volt A.C.

Series 858 MULTI-MASTER features a "PRECISION" designed, positive action Push-Button Range and Function selection system, affording the ultimate in operational efficiency.

Designed for reliable measurements in modern TV, F.M., A.M. and other critical electronic circuits where only minute current drain of the measuring instrument can be tolerated.

When employed in conjunction with the Series TV-2 super-high voltage safety test probe (described below), direct reading facilities to 30,000 volts are provided. 60,000 volt multiplier is also available.

SPECIFICATIONS

- ★ EIGHT D.C. VOLTAGE RANGES both 20,000 and 1000 ohms per volt. 0-3-6-12-60-300-600-1200-6000 volts.
- ★ EIGHT A.C. and OUTPUT VOLTAGE RANGES at 1000 ohms per volt. 0-3-6-12-60-300-600-1200-6000 volts.
- ★ EIGHT D.C. CURRENT RANGES: 0-60-120 microamperes. 0-1.2-12-120-600 MA. 0-1.2-12 amps.
- ★ SIX RESISTANCE RANGES self-contained to 60 megohms. 0-6000-60,000-600,000 ohms. 0-6-60-600 megohms.
- ★ EIGHT DB RANGES: -26 to +70DB. 600 ohm, 1 mw., zero DB reference level.
- ★ Two Pin Jacks for all standard ranges.
- ★ 4 5/8" 50 microampere meter, ±2% accuracy. Rugged, double-jewelled D'Arsonval construction.
- ★ Safety Jacks for 6000 volt ranges.
- ★ HIGHEST GRADE MATERIALS and plastic insulated wiring employed.
- ★ ETCHED GRADE MATERIALS and gauge aluminum panels: resistant to moisture and wear.



Series TV Super High Voltage SAFETY TEST PROBES*

Voltage Ranges to 60,000 Volts D.C.
With standard V.T.V.M. or high sensitivity V-O-M

* U. S. Patent Nos. 2,641,630, Des. 162,813

"PRECISION" engineering solves the high voltage test problem with utmost safety to the operator. Series TV has been custom designed and patent protected for YOUR safety FIRST. Cartridge style high voltage tubular multiplier permits use of a single "TV" probe with many high sensitivity test sets and V.T.V.M.'s. Full details on reverse side of "PRECISION" catalog price sheet.

IMPORTANT FEATURES

- ★ Custom Molded Polystyrene Head, heavy duty bakelite handle and triple-ring barrier, specially machined internal lucite components, all spell out "HIGH VOLTAGE ENGINEERED."
- ★ High Dielectric Anti-Leakage Paths and wide, multi-channelled guard-barrier reiterate "HIGH VOLTAGE ENGINEERED."
- ★ Internal and External Protective Grounding — Full handle length grounded internal flash-over-shield. External, grounded arc-back barrier. HIGH VOLTAGE ENGINEERED!
- ★ Heavy Duty, Grounded-Shielded Connecting Cable.
- ★ Ceramic, Helical Film-Type, Cartridge Multiplier manufactured specifically for VERY HIGH VOLTAGE APPLICATION. Removed and changed quickly, conveniently and without tools!
- ★ Positive Grounds and High Voltage Connections through high compression contact springs.

- SERIES TVP—Test Probe less multiplier cartridge, with .080" pin plug terminations. Code: Ebony. Net Price — \$12.35
- SERIES TVP-A—Similar to TVP above, except terminates in standard screw-on connector for use with most VTVM's. (Less multiplier cartridge.) Code: Early. Net Price — \$12.35
- SERIES TV2—With 30 KV cartridge for "Precision" (or any) 20,000 ohms per volt test set with 6000 V. range. Net Price — \$14.75
- SERIES TV-2B—Same as TV-2 above, except terminates in high compression banana plugs for use with PRECISION 120 or any other 20,000 ohms per volt test set with 6000 volt range and banana jacks. Net Price — \$14.75
- SERIES TV-4—With cartridge for ranges to 60 KV for use with "Precision" EV-10A and EV-20. Code: Excel. Net Price — \$14.75
- SERIES TV-4A—Same as TV4 above, except with special adapter for Model EV-10, not EV-10A. Code: Exact. Net Price — \$14.75
- VTVM—Cartridge Multipliers only for Series TV. See reverse side of "Precision" catalog price sheet for complete listings.

Series 866 De Luxe *Multi-Master*

Panel-Mounted A.C.-D.C. Test Set,
with 9" Meter and Remote-Control Selector Unit
5000 and 1000 Ohms per V., D.C., 1000 Ohms per V., A.C.

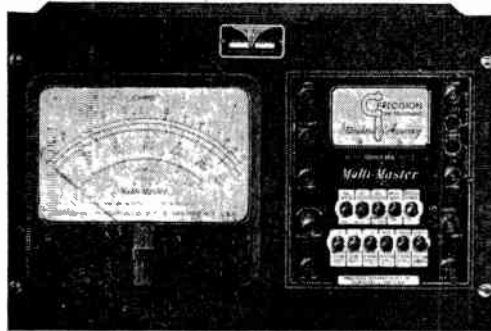

A LABORATORY TYPE HIGH VISIBILITY TEST SET INDISPENSABLE TO THE WELL EQUIPPED, MODERN TEST LABORATORY AND ELECTRONICS CLASSROOM.

The 9" meter and remote-control selector unit afford unparalleled operational efficiency with maximum physical meter protection via panel mounting above the work level.

RANGES and SPECIFICATIONS

Except for sensitivity, the ranges, features and functions of the Series 866 are similar to those listed for the Series 858, portable test set, described above.

5000 and 1000 ohms per volt D.C. 1000 ohms per volt A.C.
54 Push-button Selected Ranges to:
6000V., 300 Microamps, 12 Amps., 200 Megs., +70 DB.

- ★ 866 (illustrated) In standard panel mount, size 19"x12 1/4" with dust cover. Complete with high voltage test leads and ohmmeter batteries. Code: Novel. Net Price — \$85.00



PRECISION TEST EQUIPMENT

STANDARD OF ACCURACY

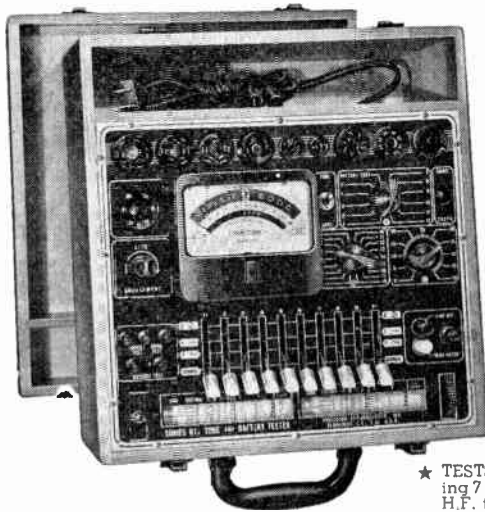

Series 612 CATHODE CONDUCTANCE TUBE TESTER

A Modern, Free Point, Lever-Operated
TUBE and BATTERY TESTER

The very popular "600" Series brings to modern electronic tube checking the **highest practical order of obsolescence insurance with utmost simplicity of operation, AT MODERATE COST.** This has been achieved with full conformity to the well-known "Precision" standards of quality, workmanship, and performance.

The "600" tube testing parameters are based upon the well-established, time-proven emission testing principles as have been recommended by both tube manufacturers and R.T.M.A. The "600" line affords advanced design features and performance which render it incomparable amongst instruments in its category and price range.

- ★ 612-P (illustrated) In hardwood, portable case. Size 12" x 13" x 6". Code: Begin. Net Price — \$79.50
- ★ 612-MCP Open style Metal Case Portable. Size 10½" x 12" x 6". Code: Brine. Net Price — \$76.75
- ★ 612-C In modern, chrome-trimmed, counter cabinet. Back ripple finish. Size 16" x 13½" x 7", sloping to 3" at front. Code: Bison. Net Price — \$82.25
- ★ 612-PM In standard size panel mount 12¼" x 19" with dust cover. Code: Blaze. Net Price — \$82.25

TUBE AND BATTERY TESTING FEATURES

- ★ TESTS ALL MODERN TUBE TYPES including 7 pin Acorns, Noval 9 pin, dual capped H.F. tubes, sub-miniature types, F.M. and TV amplifiers.
- ★ FILAMENT VOLTAGES ¾ to 117 volts.
- ★ ABSOLUTE FREE-POINT 10 element lever selection for merit and short tests.
- ★ DUAL SHORT-CHECK SENSITIVITY.
- ★ INDIVIDUAL TESTS OF MULTI-SECTION TUBES including tuning indicators.
- ★ BALLAST UNIT TESTS.
- ★ MICRO-LINE ADJUSTMENT
- ★ 4½" METER, 2% ACCURACY.
- ★ NOISE and CONDENSER TEST pin jacks.
- ★ Pilot Light Test Socket.
- ★ DYNAMIC "UNDER-LOAD" TEST for all popular radio A, B, and C dry batteries.
- ★ Built-in, brass geared hi-speed roll chart.
- ★ Anodized, deep-etched, heavy gauge aluminum panel, resistant to wear.
- ★ Panel-mounted Fuse Extractor Post.
- ★ Test circuits completely transformer-isolated from power line.
- ★ Telephone type cabled, plastic-insulated, moisture resistant hook-up wire.
- ★ Each instrument individually calibrated and sealed.

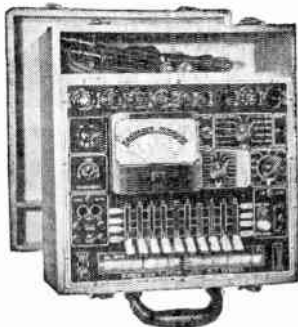

Series 654 COMBINATION TUBE, BATTERY & SET TESTER

20,000 OHMS PER VOLT D.C. 1,000 OHMS PER VOLT A.C.
Ranges to 6,000 V., 120 Microamperes, 12 Amps., 60 Megs., + 70 DB.

The Series 654 is available in the same four model types as described for the Series 612 above.

Model	Code	Net Price
654-P (Illus.)	Hardy	\$109.75
654-MCP	Hurry	107.00
654-C	House	112.50
654-PM	Heart	112.50

- ★ SERIES 654 is an economical, compact, **High Sensitivity Service Laboratory** designed to meet the specific needs of modern electronics service, installation and maintenance, A.M., F.M., and T.V.

Series 654 incorporates the identical tube and battery testing features as described for the Series 612 above, **PLUS** a complete wide range, high sensitivity, A.C. - D.C. circuit tester.

CIRCUIT TESTING FEATURES

- ★ 5 D.C. Voltage Ranges: 20,000 ohms per volt.
- ★ 5 A.C. and Output Voltage Ranges: 1000 ohms per volt. 0-12-60-300-1200-6000 volts.
- ★ Ranges to 30,000 Volts D.C. when used with Series TV-2 Super high voltage test probe. Not included with 654. See page G-95.
- ★ 6 D.C. Current Ranges: 0-120 microamperes. 0-1.2-12-120 MA. 0-1.2-12 Amperes.
- ★ 3 Wide Resistance Ranges: 0-600-600,000 ohms. 0-60 Megs. Self-contained batteries.
- ★ 5 Decibel Ranges from -12 to +70 DB.
- ★ Fully Rotary Selective Ranges and Functions.
- ★ Only 2 Pin Jacks for all standard ranges.
- ★ Recessed 6,000 V. safety pin jacks.
- ★ 50 microampere, 45° Wide-Angle meter.
- ★ 1% Wirewound and film-type resistors.
- ★ All circuits isolated from power line.

MODEL PTA — PICTURE TUBE ADAPTER CABLE

For Use With PRECISION Tube Testers



The Model PTA affords picture tube checking facilities within the limitations inherent in all devices of this type. It is ruggedly constructed from selected components and will provide long-lasting service.

The Model PTA is furnished complete with detailed instructions covering its use with all present PRECISION tube checkers in the 600 and 10-00 series. The Model PTA can also be used with previous PRECISION tube checkers, Models 910, 912, 914, 915, 920, 922 and 954.

Code: Cable.

Net Price — \$6.75



-PRECISION- TEST EQUIPMENT

STANDARD OF ACCURACY



Model 120: complete with batteries, test leads and manual. Cover-all case dimensions: 5 3/8" x 7 x 3 1/8".
Code: Wheel Net Price — \$39.95

Accessories Available for Model 120—
Model TV-2B: Super-High Voltage Safety Test Probe. Direct reading to 30KV.
Net Price — \$14.75

Model LC-3: Leather Instrument Case. Custom-crafted of top-grain cowhide.
Net Price — \$9.50

Part No. ST-1: Retractable, snap-on stand, permits convenient 45 degree table mount.
Net Price — \$1.00

Series 120 High Sensitivity, Multi-Range Test Set

20,000 OHMS PER VOLT DC — 5,000 OHMS PER VOLT AC

44 Self-Contained Ranges
from 1.2 volts to 6,000 volts, 60 microamperes to 12 amperes,
—20 to +77 db, 200 ohms to 20 megohms

The Model 120 provides a combination of features, ranges and functions that have been most wanted in a portable, high sensitivity, multi-range test set.

MORE RANGES . . . the '120' has 44 . . . which start lower and go higher than is usually associated with instruments of its size and type.

AN EXTRA-LOW RESISTANCE RANGE . . . a 2-ohm center scale range, powered by long-lived, internal 1.5 battery source.

AN EXTRA-LOW VOLTAGE RANGE . . . 1.2 volts full scale, AC and DC.

AN EXTENDED LOW CURRENT RANGE . . . a 60 microampere first DC current range.

A LARGER and EASIER READING SCALE FACE . . . on a new, extra-large 5 1/4" meter.

SIMPLE, POSITIVE RANGE SELECTION . . . an 18-position, positive-detenting, master range selector with low resistance, dependable silver-plated contacts.

RUGGED, POSITIVE CONTACT JACKS and PLUGS . . . the '120' incorporates specially designed, low resistance, solid brass, banana type plugs and jacks.

RANGES and SPECIFICATIONS

- ★ 8 DC Voltage Ranges: 20,000 ohms/volt. 0-1.2 3-12-60-300-600-1200-6000 volts.
- ★ 8 AC Voltage Ranges: 5,000 ohms/volt. 0-1.2 3-12-60-300-600-1200-6000 volts.
- ★ 8 AC Output Ranges: same as AC volt ranges. Built-in 600 V. blocking capacitor.
- ★ 7 DC Current Ranges: 0-60-300 Microamp-res. 0-1.2-12-120-600 Ma. 0-12 Amps.
- ★ 5 Resistance Ranges: self-contained. 0-200-2000-200,000 ohms. 0-2-20 megohms.
- ★ 8 Decibel Ranges: from —20 to +77 DB. 0 DB = 1 Milliwatt, 600 ohms
- ★ Extra Large 5 1/4" Rugged 'Face' Meter: 40 microamp sensitivity, 2% accuracy.
- ★ 1% Multipliers and Shunts: wire-wound and high stability deposited-film types.
- ★ Only 2 Plug-Jacks Serve All Standard Ranges: separately identified and isolated jacks provide for extra-high ranges.
- ★ "Transit" Safety Position on master range selector, protects meter during transportation and storage.
- ★ Custom-Molded Phenolic Case and Panel set a new standard for compact, efficient, laboratory instrument styling. Deeply engraved panel characters afford maximum legibility throughout the life of the instrument.

Series 40 Compact AC-DC Test Set

with full size 3" rectangular meter
31 Self-Contained Ranges
to 6000 Volts, 600 MA, +70 DB, 5 Megohms



In molded bakelite carrying case, Series 40 meets the need for a compact, yet rugged test set to withstand hard usage as is imposed by the service technician, maintenance engineer, production inspector, troubleshooter, etc.

The Series 40 offers every advanced design feature and full-bodied components as are regularly incorporated in "Precision's" larger multi-range test sets, including Rotary Range Selection—1% shunts and multipliers—heavy duty insulated pin jacks—large unparallel, easy reading meter.

All ranges, including 6000 volts and 5 megohms, are self-contained—no external batteries or multipliers are required.

RANGE SPECIFICATIONS

- ★ 6 A.C.-D.C. and Output Voltage Ranges at 1000 ohms per volt. 0-3-12-60-300-1200-6000 volts.
 - ★ 4 D.C. Current Ranges: 0-.6-6-60-600 MA.
 - ★ 3 Resistance Ranges: 3-5000-500,000 ohms. 0-5 megs.
 - ★ 6 Decibel Ranges: —22 to +70 DB.
 - ★ Full Size 3" Rectangular 'Face' Meter: 400 microampere sensitivity, ±2% accuracy.
 - ★ 1% Wire-Wound and Deposited-Film Type Resistors.
 - ★ Only 2 Pin Jacks serve all standard ranges and functions.
 - ★ Recessed 6000 volt safety jack for operational safety.
- Series 40: In molded bakelite case, 3 3/4" x 6 1/4" x 2 1/2". Complete with ohmmeter batteries, test leads, and manual.
Code: Visit Net Price — \$26.95
- LC-2: Genuine top-grain cowhide carrying case, custom-designed for the Series 40. Code: Young Net Price — \$5.75

Series 80 Wide Range Test Set

1000 Ohms per Volt A.C. and D.C.
34 Self-Contained Ranges to 6000 Volts,
12 Amperes, +70DB, 10 Megohms.

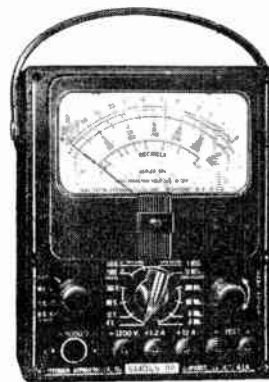

The Series 80 is a laboratory type, rotary selective, multi-range, circuit tester.

Combining rugged 1000 ohms per volt sensitivity with small overall size, the Series 80 is specifically intended for use where the ability to withstand greater electrical and physical overload is of more importance than extremely high sensitivity.

Series 80 is "Application-Engineered" for general purpose industrial, telephone and radio service testing.

SPECIFICATIONS

- ★ 6 A.C.-D.C.-Output Voltage Ranges: 1000 ohms per volt. 0-6-12-60-300-1200-6000 V.
 - ★ 6 D.C. Current Ranges: 0-.6-6-60-300 MA and 0-1.2-12 amps.
 - ★ 4 Resistance Ranges: Self-Contained batteries. 0-1000-100,000 ohms. 0-1-10 megohms.
 - ★ 6 Decibel Ranges: from —20 to +70DB.
 - ★ 4 3/8" Rectangular 'Face' Meter: 400 microampere, 2% accuracy.
 - ★ 1% Wire-Wound and Deposited-Film Type Resistors.
 - ★ Rotary Range Selection: All standard functions available at only 2 polarized tip jacks.
 - ★ Recessed 6000 volt safety jack for operational safety.
- Series 80: In molded bakelite case, 5 1/2" x 7 7/8" x 3". Complete with ohmmeter batteries and test leads.
Code: Weave Net Price — \$34.95
- LC-1: Genuine top-grain cowhide carrying case, custom-designed for the Series 80.
Code: Yeann Net Price — \$9.50

APPLIANCE TEMPERATURE TESTERS

A NEW IDEA IN TESTERS — The need for scientific but sturdy portable test equipment in the appliance service field is met by this exclusive line. Here the user profits from J-B-T's wide experience in building field test sets for many well-known manufacturers of ranges, irons, refrigerators, deep freeze units, and similar equipment. All J-B-T testers include the principle of remote reading of temperature, —and temperature measures the real usefulness of the appliance. Although called appliance testers, these handy portable testers have found a multitude of uses for trouble-shooting, experimenting and research in industry and in laboratories.

OVEN TESTERS

MODEL 23-JP-1. Latest addition to the widely-known family of J-B-T oven temperature testers is this modern and compact unit. Like the Models 32-JP-3 and 32-JP-4 described below, this indicating portable pyrometer is designed to save time and furnish reliable information in testing and setting thermostats on electric or gas ranges and other appliances by showing oven temperatures as they change. The same size of dial, 0-650°F., with 2½" scale arc reading, is used but covered by an all-plastic instrument front. The indicator is mounted on a black metal panel affixed inside a pocket-sized, black top-grain leather case 4½" x 2½" x 4¼" over hard-ware. Characteristic of more expensive pyrometers, the 23-JP-1 is automatically compensated for ambient temperature. Thus the tester eliminates calculations, avoids likelihood of serious error as temperatures change inside the instrument itself, and gives fool-proof direct readings. Supplied with attached SA-116 5½" calibrated thermocouple, clip, and convection shield. **\$23.50**



MODEL 32-JP-3. This sturdy, fast reading portable is by far the most widely used oven tester in the country. The rigid outer carrying case 6" x 3⅞" x 3¾" is covered in black leatherette; the glass-covered indicator fits in a 3¼" flanged metal case. The dial shows 0-650°F. in 10° divisions readable to 2½°. Exceptionally fast, continuous response. Automatic compensation for ambient temperature is valuable feature whether the tester is used for service work, sales demonstrations, or inspection. More details on the 32-JP-3 are available in Bulletin JP-103. Price includes attached SA-116 5½" calibrated thermocouple, clip for attaching to grill, and convection shield for steady readings. **\$25.05**



MODEL 32-JP-4. Companion tester to the 32-JP-3 with all the features of that tester, plus a leather carrying strap, and binding posts for quick attachment and interchanging of various thermocouples listed on this page, to check irons, washers, waffle-bakers, toasters, roasters, clothes dryers, etc. Range, 0-650°F.; black leatherette case 6" x 3⅞" x 3¾". More details on the 32-JP-4 are available in Bulletin JP-104. Price includes SA-116 5½" calibrated thermocouple, clip and convection shield. **\$26.15**



IRON TESTER

MODEL 32-JIT. Self-contained bench type tester; checks all makes of irons; measures thermostat temperatures; and shows open or short circuits. Automatically compensated for room temperature. Also indicates operating temperature of the sole plate (working surface) on non-electric or cordless irons. Black metal base; overall size 10" x 12" x 5½"; scale 0-650°F., 15 amp. fuse, 6' cord, 110-volt, 50-60 cycles. **\$31.85**

Note: Orders for 32-JIT Iron Testers are occasionally filled with 23-JIT Iron Testers. Identical with 32-JIT illustrated, but using indicators with all-plastic front.



ALL-PURPOSE TESTER

MODEL 61-JRT. This 9-in-1 tester speeds accurate temperature adjustment and current analysis of ranges, refrigerators, etc. Rapidly reads four cold zones, -100° F. to +80° F. up to 14' distant; two heat zones 0-600° F. up to 5½' distant; one voltage range 0-300 AC; and with transformer, two current ranges, 0-30 and 0-60 amps, AC. Sturdy, polished walnut case 15½" x 10⅝" x 4¾" with handle and slip hinges. Two-color etched metal panel. Separate switches protect bulb and ammeter circuits. Requires one standard flash-light cell, replaceable in the field. Temperature scale accuracy ±2% of full scale. Rectified AC readings ±5%. Accessories listed below may be added for testing irons, grills, roasters, washers, etc. Includes two SA-162 resistance bulbs, two SA-116 thermocouples, necessary electrical leads, and AS-TR-2 built-in transformer. **\$107.25**



For more details, see Bulletin JRT-349.

MODEL 61-JRT (LESS TRANSFORMER). Same unit, same scales, except does not read in amperes; AS-TR-2 transformer assembly omitted. **\$93.50**

THERMOCOUPLES

(See next page for Resistance Bulbs and Transformers)

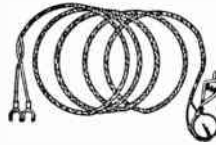

SA-116 with SHIELD and CLIP. Standard flexible No. 22 gauge iron constantan, asbestos insulated, 5½", with attachment clip and convection shield as normally supplied with 23-JP-1, 32-JP-1, 32-JP-2, 32-JP-3, 32-JP-4, 60-JRT and 61-JRT Testers. (See SA-199 for extra quality, glass insulated type). SA-116. **\$1.80**

SA-170 (REPLACEMENT THERMOCOUPLE for IRON TESTERS 32-JIT and IT-1). Thermocouple and lead, including aluminum plate and special tip, quickly installed in the field. **\$2.10**

SA-175 (PLAIN TIP). For roasters, waffle irons, etc., 5½" iron constantan flexible No. 22 gauge, asbestos insulated, with small ball tip; used where clip and shield of SA-116 not suitable; for Models 32-JP-2, 32-JP-4, 60-JRT, and 61-JRT. **\$1.45**

SA-176 (for TOASTERS, etc.) 5½" iron constantan No. 22 gauge asbestos insulated, with special disc to collect heat; easily attached to 32-JP-2 and 32-JP-4 oven testers, also 60-JRT and 61-JRT. **\$2.55**

SA-188 (for AUTOMATIC WASHER TEMPERATURES, etc.) ¼" diameter copper tube, 4" long, encloses thermocouple for insertion in pipe or sample of water. Has 6' leads for attachment to 32-JP-2 and 32-JP-4 oven testers, also 60-JRT and 61-JRT. **\$3.95**

SA-199 with SHIELD and CLIP. Same as SA-116 above, except duplex, non-fraying glass braid construction; diameter .115"; recommended for frequent use with these testers at temperatures above 400°F. **\$2.25**

SA-300 (for SURFACE READINGS). Spring-type iron constantan in Transite tip with handle and 5' No. 22 gauge lead for extremely rapid heat readings; for attachment to 32-JP-2, 32-JP-4, 60-JRT and 61-JRT appliance testers. **\$5.50**

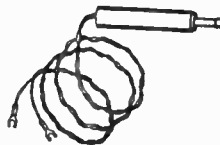

SA-301 (REPLACEMENT TIP FOR SA-300). Transite tip and thermal element only. **\$2.75**

ACCESSORY IRON TESTER, MODEL IT-1. This attachment is identical with the 32-JIT, except there is no meter. It is easily connected to Models 32-JP-2, 32-JP-4, 60-JRT and 61-JRT. Shows open circuits and shorts, checks sole plate temperatures and thermostats on all types of irons. **\$16.25**



TEMPERATURE INDICATORS

WHERE TO USE: To determine heat rise of motors, transformers and coils; for laboratory furnaces, inspection set-ups, for remote indication of infra-red and other oven temperatures; and to check temperatures in industrial processes such as heat treating and annealing.

When used with selector switch, permits centralized reading of one to ten thermocouples, as in Diesel exhaust manifold applications.

MODEL 32-J

MODEL 32-J PYROMETER IN SN-7 STAND. Mounted in sloping front black metal stand, 4 1/4" high x 4 3/4" deep x 4 1/4" wide. Compensated for ambient temperature. Medium resistance system, damped for quick reading on 2 3/4" scale, assures ruggedness and pointer stability. To retain the $\pm 2\%$ accuracy of the installation; use only the type and resistance of thermocouple and lead which are provided; do not cut extra lead—coil it—change in length changes calibration. A protection tube is not generally required. Many users find it convenient to keep an extra couple and lead on hand.



MODEL 32-J IN SN-7 STAND (Supersedes SN-3 Stand)

0°—650° F—350° C, includes SA-91 thermocouple, SA-84 lead, and CB-1 connector block.....\$30.25
 0°—1200° F—650° C, includes SA-87, SA-82, and CB-1.....30.25
 0°—2000° F—1100° C, includes SA-87, SA-82, and CB-1.....30.25

MODEL 32-J IN SN-8 STAND (not illustrated). With 3 binding posts to accommodate flexible extra lead and thermocouple for hard-to-reach locations. (Stand Supersedes SN-5)

0°—650° F with SA-91 thermocouple, SA-84 lead, CB-1 connector block, and SA-86 flexible lead and thermocouple.....\$34.10

MODEL 60-JPS

MODEL 60-JPS. This portable makes it easy to know temperatures at one to ten locations. Excellent for study of heat in various parts of the same equipment, or in a battery of units. Knife-edge pointer, 5.6" scale. Heavy-duty thermocouple switch has average contact resistance of .002 ohms or less. Automatically compensated for ambient temperature, indoors or outdoors. To retain accuracy of 1% full scale, use leads and thermocouples equal to resistance and $\pm m. f. vs. temperature$ characteristics for which instrument is calibrated. Medium resistance system assures portability. Housed in natural-finish wood case 1 3/8" x 8 3/8" x 4 3/8" over rubber feet. A "must" for inspection, maintenance, and engineering.



60-JPS—0°—600° F with SA-86, 7' thermocouple and lead for small apertures.....\$101.85
 60-JPS—0°—1200° F with SA-88, SA-82, and CB-1.....104.50
 60-JPS—0°—2000° F with SA-88, SA-82, and CB-1.....104.50
 60-JP—For one thermocouple only; furnished with thermocouple and lead same as 60-JPS, but without selector switch.
 0°—600° F, with SA-86.....\$74.35
 60-JP—0°—1200° F, with SA-88, SA-82, and CB-1.....77.00
 60-JP—0°—2000° F, with SA-88, SA-82, and CB-1.....77.00

Note: When ordering additional thermocouples, specify couples and leads as above. Centigrade equivalent scales available on order.

MODEL 70-J

MODEL 70-J PYROMETER. for accurate reading at a distance, has full 6" scale and spade pointer, with accuracy of 1% of total scale deflection. Automatically compensated for ambient temperature. Molded case mounted in metal protecting shell 7 3/8" x 8 1/8" x 1 1/2". Connections through bottom of case for wall or front-of-board mounting. When ordering, specify which standard scale range: 0°—600° F for 1938 std. I-C; 0°—1200° F for C-A; 0°—2000° F for C-A thermocouples.



PRICE, including 24" thermocouple and 26' lead.....\$66.00
 Note: Centigrade equivalent scales available on order.

RESISTANCE BULBS (FOR COLD TESTING)

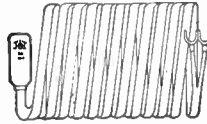

SA-142. Bulb with 14' polyethylene lead, for use only with Model 60-JRT; calibration is not interchangeable with SA-162; has no embossed number.....\$5.50

SA-162. Bulb with 14' polyethylene lead, for use only with Models 50-50 and 61-JRT; identified by embossed part number.....\$5.50

CL-90 CLAMP. Metal clamp for holding SA-142 and SA-162 resistance bulbs in contact with surfaces up to 1/4".....\$0.28

TRANSFORMERS

AS-TR-2. Attachment for compartment of 61-JRT all-purpose tester, completely housed, with jumper lead and panel; reads 30 and 60 AC amp. scales on tester.....\$16.50

AS-TR-3. Attachment for increasing usefulness of 60-JRT all-purpose tester. Includes side rails for attaching inside compartment; fully housed. Reads 30 and 60 AC amp. by dividing volt scale by 10 or 5.....\$18.15

TEMPERATURE ACCESSORIES

LEAD WIRES. To bring the reference junction within the pyrometer, compensating or extension lead wires should always be used. See the instrument dial for (1) the kind of lead and (2) combined resistance of lead and thermocouple. Standard leads include:

SA-82 6' compensating lead for chromel-alumel couples; duplex, stranded; asbestos-insulated, cotton-braid impregnated with moisture-proof and flame-proof compound; terminals at instrument end; other end tinned for connector block.....\$1.55

SA-83 26' compensating lead for chromel-alumel as above.....\$4.85

SA-84 6' extension lead for iron-constantan, 1938 calibration; duplex; moisture-proof and flame-proof; prepared as above.....\$1.55

SA-85 26' extension lead for iron-constantan, 1938 calibration; similar to above.....\$4.85

SA-86 7' iron-constantan thermocouple and lead combined; twisted pair No. 20 Ga., asbestos-insulated—for intermittent use on 650° F scales; terminals at meter end; other end welded. (Resistance not interchangeable with SA-84 or SA-85).....\$1.85



THERMOCOUPLES. For pyrometers and leads above, J-B-T thermocouples are carefully selected, standardized, and tested

SA-87 12" No. 14 Ga. chromel-alumel, 2-hole ceramic beads, fits 5/16" hole; welded tip.....\$3.10

SA-88 same except 24" No. 14 Ga.....\$3.85

SA-89 12" No. 8 Ga. chromel-alumel, 2-hole ceramic beads, fits 7/16" hole; welded tip.....\$3.10

SA-90 same except 24" No. 8 Ga.....\$3.85

SA-91 12" No. 14 Ga. iron-constantan, 1938 calibration; 2-hole ceramic beads, fits 5/16" hole; welded tip.....\$2.60

Flexible Thermocouple, 7' length, see SA-86 lead wire.

CONNECTOR BLOCK Model CB-1.

Lava connector block, withstands high temperatures, accommodates all thermocouples up to No. 6 Ga. Heavy brass connectors keep contact; resistance low. Can be used independent of connector head.....\$1.65

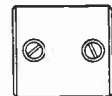

PROTECTION TUBES. To support, enclose, and protect thermocouples like the above, especially at higher temperature or in damaging atmospheres, various wrought iron or alloy protection tubes are recommended. Please request separate catalog sheet on them, also covering CH-6 connector head.

VIBRATING REED FREQUENCY METERS (PATENTED)

J-B-T Vibrating Reed Frequency Meters are used extensively in radio, telephone, and television service, on engine generator sets, in laboratories, in many types of electronic equipment, on panel and control boards in central stations and industrial plants—wherever constant or known frequency is important to efficient operation of equipment. More than ten years of continuous experience covering many thousands of these instruments are your assurance of quality for both commercial and defense applications.

The response patterns differ with the increments of frequency between reeds. For example, at 60 cycles, half-cycle steps give the broad response shown below at left, whereas full cycle steps bring the sharp response at right.

The patented, simplified design used in the J-B-T meter operates on AC or interrupted DC. The instrument consists of a case, base, dial and central mounting frame, with a series of spring steel reeds screwed to a reed mounting bar, individual driving coil surrounding each bank of reeds, permanent magnet, series resistor and terminal studs.

Each reed is adjusted to respond by resonance to but one frequency. As the alternating current (or interrupted direct current) excites the driving coil, the one reed "in tune" with the frequency in the coils will respond by vibrating rapidly because of permanent magnet polarization and induced magnetism from the coil. The instrument is adapted to specified operating voltage by a series resistor. Frequency of the current is read on the graduated face of the instrument.

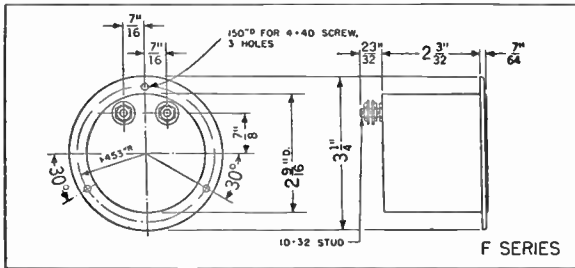
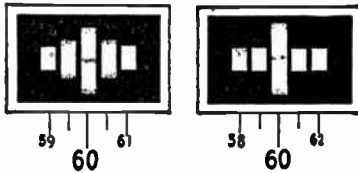

Above: Models 30-F, 31-F, 33-F, 34-F; 3/4" Metal Case

Below: Models 30-FX, 31-FX, 33-FX, and 34-FX; Molded Case Meets Mounting Dimensions of JAN-I-6; ASAC39.1-1951; and MIL-M-6A (Type MR 34 or 35)

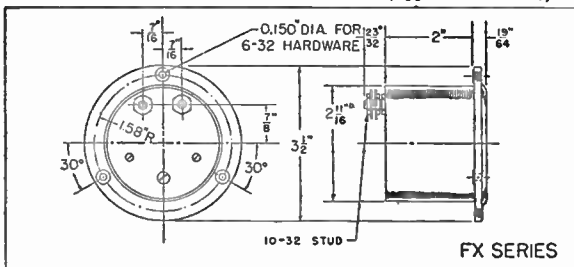

ADVANTAGES: Guaranteed accuracy at reference temperature of 77°F is $\pm 0.3\%$ or better of the AC frequency being measured, unless otherwise stated. Accuracy on interrupted DC may be somewhat less. High fatigue safety factor for continuous operation. Temperature compensations are not required as temperature coefficient of reeds is only approximately 75 parts per million per degree F., negative.

All meters are permanently calibrated at the factory and do not require subsequent adjustment. J-B-T reeds have relatively high Q characteristics, an especially desirable factor in electronic circuits. Wave form or external magnetic fields do not ordinarily have an adverse effect. Built with no pivoted parts and with lock washers at every critical point, these rugged meters can take rougher treatment than many instruments.

CAUTION: If a meter plugged in on a 60 cycle AC power line does not indicate a frequency of exactly 60 cycles, trust the meter! Power supply may momentarily be off-frequency due to changing load conditions beyond the control of the Utility. All J-B-T Vibrating Reed Frequency Meters are accurately calibrated at the factory, entirely independent of frequency of power supply. Production and inspection equipment are checked regularly against National Bureau of Standard frequency signals.

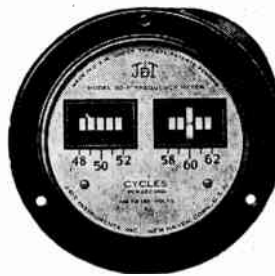

MODEL 30-F
(Operating at 60 cy.)

MODEL 30-F

Range: 48-52 and 58-62 cycles. Double window for ease of reading frequency in either range. Often specified for export. 100-130 volts; 130 ohms per volt; 1 watt power consumption. Accuracy $\pm 0.3\%$ at reference temperature. Flush panel mounting.
30-F, 48-52 and 58-62 cy., 3/4" Metal Case \$27.50
30-FX, 48-52 and 58-62 cy., 3/2" Molded Case, JAN-I-6 mtg. \$27.50

MODEL 31-F

Used in standby power equipment. Handy for accurately measuring frequency of power source. Five reeds, 58-62 cycles, 100-130 volts. Other characteristics same as Model 30-F.

31-F, 58-62 cy., 3/4" Metal Case \$23.65
31-FX, 58-62 cy., 3/2" Molded Case, JAN-I-6 mtg. \$23.65

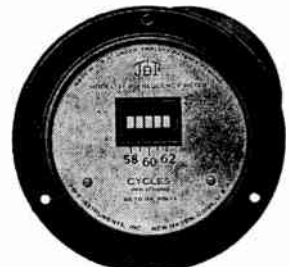

MODEL 31-F

MODEL 34-FX

Covers a broader frequency band. Nine reeds, 56-64 cycles, or in half-cycle steps (accuracy $\pm 0.2\%$) 58-62 cycles. 100-130 volts; 130 ohms per volt; 1 watt power consumption. Flush panel mounting.

34-F, 56-64 cy., 3/4" Metal Case, 1 cycle steps \$27.25
34-FX, 56-64 cy., 3/2" Molded Case, JAN-I-6 mtg. \$27.25
34-F-Z, 58-62 cy., 3/4" Metal Case, 1/2 cycle steps \$28.90
34-FX-Z, 58-62 cy., 3/2" Molded Case, JAN-I-6 mtg. \$28.90



MODEL 34-FX

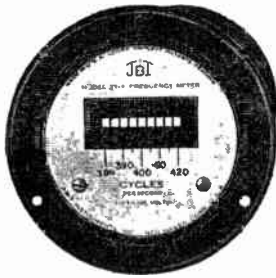

MODEL 33-F

400-cycle. Used for measuring frequency of high-cycle power sources, particularly aircraft. Accuracy $\pm 0.3\%$ at reference temperature. Nine reeds, 380 to 420-cycle range. 100-130 volts; 70 ohms per volt; 1.75 watts power consumption. Flush panel mounting.

33-F, 380-420 cy., 3/4" Metal Case, 5 cycle steps\$34.10
 33-FX, 380-420 cy., 3/2" Molded Case, JAN-1-6 mtg.\$34.10

MODEL 21-FX

Matches other 2 1/2" panel instruments. Meets ASA C39.1-1951 and MIL-M-6A (Type MR 24 or 25) in depth of case and mounting dimensions. Weighs only 4 1/2 ozs.; 5 reeds; 58-62 cycles; 100-130 volts; 190 ohms per volt; 0.6 watt power consumption. Also 116 to 124 cy.; 160 ohms per volt; 0.7 watt power consumption. 390 to 410 cy.; 85 ohms per volt; 1.3 watts power consumption. Flush panel mounting, see Print MD-20. Also available 380-420 cy.

21-FX, 58-62 cy., 2-11/16" Molded Case, 1 cy. steps.....\$22.55
 21-FX, 116-124 cy., 2-11/16" Molded Case, 2 cy. steps.....\$25.30
 21-FX, 390-410 cy., 2-11/16" Molded Case, 5 cy. steps.....\$27.50

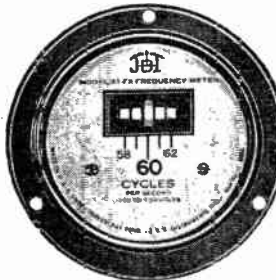

PORTABLE FREQUENCY TESTERS

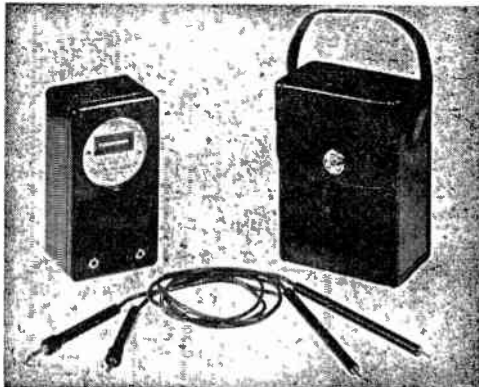

MODEL 33-FP-9L. Handy, compact, portable instrument of exceptional accuracy characteristic of J-B-T panel type reed meters. Meets exacting test requirements of aviation, signal and communication equipment. Housed in sturdy molded case 5 7/8" x 3 1/2" x 2 3/8" with black polished top-grain leather carrying case 6 3/4" x 4 1/4" x 2 3/4". 4' leads are supplied complete with sharp 5" insulated test picks and banana plugs. Electrical characteristics of 33-FP-9L and 34-FP-9L are identical with 400 cycle 33-F and 60 cycle 34-FX, respectively. For portables: in metal cases, request quotations on 33-FP-9M and 34-FP-9M.

33-FP-9L, 380-420 cy., 100-130 volts, 9 reeds.....\$47.60
 34-FP-9L, 58-64 cy., 100-130 volts, 9 reeds.....\$40.70

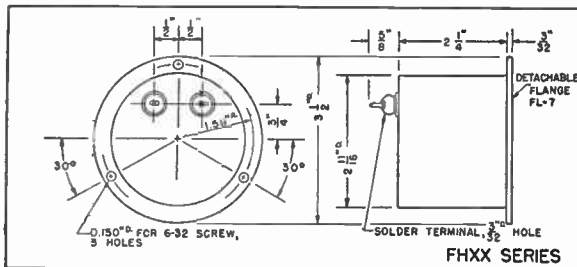

All FHXX Type 3 1/2" Frequency Meters; Sealed Metal Case (Type MR36 of MIL-M-6A)

NOTE ON METER VOLTAGE

J-B-T Vibrating Reed Frequency Meters of all sizes normally are made with two studs and are designed to be connected across one phase of a multi-phase line. The single phase voltage where the meter will be used thus becomes the voltage to be specified for the meter. Special meters with extra studs are made only for the purpose of reading two or more voltages, not additional phases.

3 1/2" SEALED METERS

FHXX TYPE sealed meters, glass-to-metal construction, with solder terminals and detachable flange, supersede the former FHX sealed meters (Print SK-24). While JAN-1-6 and MIL-M-6A (Type MR36) do not refer to frequency indicators, the FHXX series uses the front mounting dimensions, and meets or exceeds the sealing and electrical requirements including the 3000 volt breakdown. Mounting dimensions are shown below. Standard voltage is 100-130. Electrical characteristics and accuracy are the same as for corresponding models without the HXX designation. Every meter tested in water where the absolute pressure of the air above the water is reduced to 2.5 inches of mercury (approx. 57,000 ft. altitude) and is maintained for one minute. While not regularly stocked, these meters are in production.

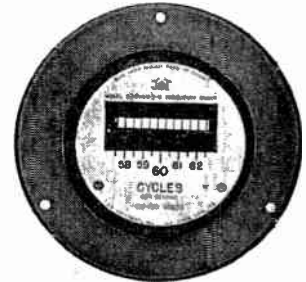

30-FHXX, 10 reeds, 48-52 cy. and 58-62 cy.....\$34.30
 31-FHXX, 5 reeds, 58-62 cy.....30.45
 33-FHXX, 9 reeds, 380-420 cy.....40.80
 34-FHXX, 9 reeds, 56-64 cy.....34.05
 34-FHXX-11, 11 reeds, 55-65 cy.....36.25
 34-FHXX-Z-11, illustrated, 11 reeds, 57.5-62.5 cy.....37.90

2 1/2" SEALED METERS

As instruments available on special order, J-B-T can supply 2 1/2" sealed frequency meters with mounting as in Type MR 36 of MIL-M-6A.

1 1/2" SEALED METERS

MODEL 15-FHAC. Widely used on audio-oscillators as the frequency standard, the model illustrated operates 2 reeds, 60 and 400 cycles, at approximately 8-10 volts for cathode follower circuit. Accuracy $\pm 0.5\%$ at 77°F. Steel case has black telephone finish; solder terminals. Barrel is 1 1/2" diameter; 2.094" detachable flange covers glass-to-metal seal. See complete dimensions below.

15-FHAC \$20.30

15-FH-5 METERS (lower photo), use the same 1 1/2" black metal case, glass-to-metal seal, and 2.094" detachable flange as the Model 15-FHAC. The 15-FH-5 series provides 5 reeds in a row for 100-130 volt operation. Used where size and weight are design considerations. 100% inspected for approx. 57,000 ft. altitude by same test as FHXX Type, above. Standard meter, but not regularly stocked. See complete dimensions below.

15-FH-54, 5 reeds, 390-410 cy.....\$25.85

15-FH-56, 5 reeds, 58-62 cy..... 21.45

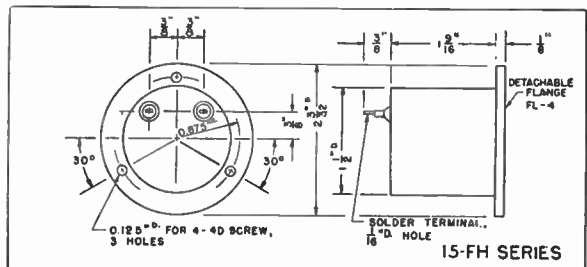
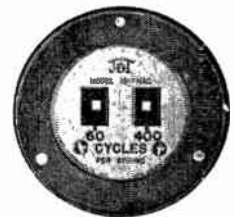

Sealed 1 1/2" Models 15-FHAC, 15-FH-54 and 15-FH-56. (Military specifications covering this size of instrument pending)

ELAPSED (OR RUNNING) TIME METERS AND 4" FREQUENCY METERS

ELAPSED TIME METERS—60 Cycles



MODEL 31-EX. To record operating time of AC electrical and electronic equipment, this self-starting synchronous instrument registers in 1/10th hour steps to 9,999.9 hours, then automatically re-sets. Shows tenths in red numerals, all others in black. Black molded case per diagram below matches FX, 3 1/2" frequency meters, and fully encloses all parts. J-B-T engineers recommend AC elapsed time meters for superior accuracy, especially where voltage or ambient temperatures vary

widely. Popular for tube life, TV equipment, punch presses, conveyors, oil burners, maintenance schedules, etc. 99,999 hour type is available on special order.

- 31-EX, 60 cy., 110-125 volts \$15.95
- 31-EX, 60 cy., 230 volt (not regularly stocked) \$17.05
- MODEL 31-ES, (Square Case), Same as 31-EX except black molded case 3" x 3", per print SK-34; 60 cy., 110-125 volts (not regularly stocked) \$17.05

ELAPSED TIME METERS—Tenths of Minutes

MODEL 31-EXM, 60 cycles, 110-125 volts, reading 0-9,999.9 minutes; for short-run applications or readings at closer intervals than 31-EX. Tenths of minutes in red, minutes in black numerals, otherwise identical with 31-EX \$16.25

3 1/2" SEALED ELAPSED TIME METER—60 Cycles



MODEL 31-EHXX. Where rugged requirements make a completely sealed elapsed time meter desirable, this glass-to-metal construction, with flat glass front and 3 1/2" diameter separable flange, often is specified. Heavy-duty solder terminals are supplied. Every instrument is checked in a vacuum chamber. Overall dimensions and appearance match the FHXX series sealed frequency meters per drawing on preceding page. See print SK-53 for complete mounting data. The meter registers in 1/10 hour steps to 9,999.9 hours, then automatically re-sets. Tenths indicator is in red, all others in black.

31-EHXX, 60 cy., 110-125 volts \$19.75

2 1/2" SEALED ELAPSED TIME METERS—60 Cycles

MODEL 21-EHXX. This new 2 1/2" sealed meter, with front mounting dimensions the same as Type MR-26 electrical indicating instruments in MIL-M-6A, nevertheless offers a full-size counter reading 0-9,999.9 hours in 1/10th hour steps and a rugged self-starting synchronous motor. Glass-to-metal seal makes the instrument completely tamper-proof. Please ask for mounting diagram. 21-EHXX, 60 cycles, 110-125 volts \$24.75

SEALED ELAPSED TIME METER—400 Cycles

MODEL 33-EHXX. Meeting a long-felt need for a stable 400-cycle elapsed time meter compact enough to fit in a 3 1/2" flanged case, with all parts enclosed, is this new 400-cycle elapsed time meter. The instrument now is being produced only in sealed construction, glass-to-metal, with separable flange, heavy-duty solder terminals, and flat glass front. External appearance matches FHXX series and Model 31-EHXX sealed, 60-cycle, elapsed time meter. A slightly larger case is used per drawing in the next column.

33-EHXX, 400 cy., 0-9,999.9 hours, 1/10 hour steps, 110-125 volts \$58.00

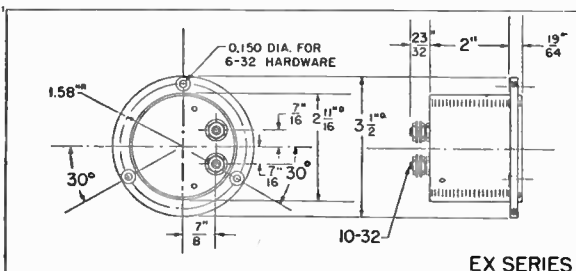

Model 31-EX Molded Case, meets type MR-34 or MR-35 flange dimensions of MIL-M-6A, also JAN-1-6 and ASA C39.1-1951

400 CYCLE BROAD AND VERNIER INDICATOR

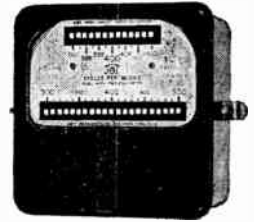

MODEL 41-FX. This 2-window frequency meter is widely used for electronic and aircraft testing in commercial and military applications. The lower window shows a broad range of 300-500 cycles, with 21 reads in 10-cycle steps. The upper window gives a vernier effect with 13 reads indicating 380-420 cycles in 4-cycle steps, with 2-cycle increments in the critical range of 396-404 cycles. Housed in black molded case with flush front 4 1/8" wide x 4 1/8" high and 2 1/4" deep behind panel over studs, the instrument blends well with other panel meters. Made for 100-130 volt operation. Also available with 4 studs for 200-240, 115, and 30 volts as used in aircraft analyzers. Full dimensions on drawing MD-38.

- 41-FX, 100-130 V \$120.00
- 41-FX, triple voltage, without switch 135.00

ELAPSED TIME AND FREQUENCY METERS

31-FE SERIES. To conserve panel space and centralize information, this panel instrument combines the elapsed time or running time meter with frequency reads. It is used on motor generator sets and on electrical equipment where maintenance routine calls for periodic servicing. The J-B-T design, proved by years of field experience, uses a separate exciting coil for the reads to achieve close control of read amplitude and frequency. Reads 0-9,999.9 hours, and 58-62 cycles with 5 reads, for 100-130 volt operation; self starting. Tenths shown in red, all other numerals in black. Black metal case with front mounting same as model 31-F. Other dimensions per drawing below. For variations having 7, 9, or 11 reads, not regularly stocked, such as Model 34-FE, see revised print SK-45.



- 31-FE, 3/4" metal case \$33.00
- 31-FEX-1, (per print SK-44— not regularly stocked) like Model 31-FE, except with 3 1/2" metal flange permanently attached for MIL-M-6A (MR-34 or MR-35) front mounting \$34.10

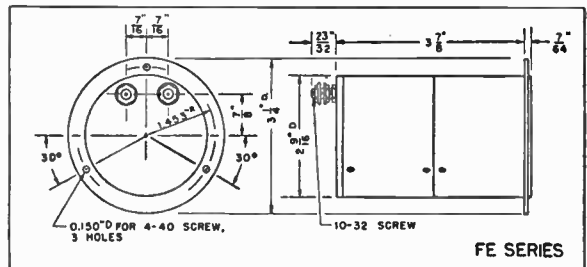

Model 31-FE and variations in 3/4" metal case; 2 5/8" diameter recommended drill hole for barrel.

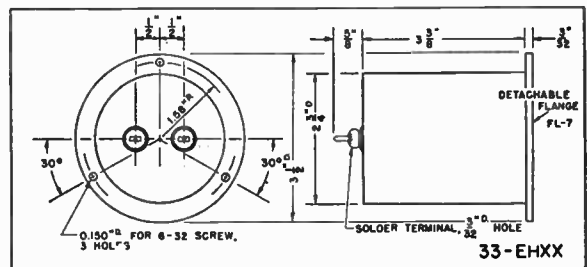

Model 33-EHXX elapsed time meter, 400 cycles only, 3 1/2" metal case; meets type MR-36 flange dimensions of MIL-M-6A, also JAN-1-6 and ASA C39.1-1951

SYLVANIA TEST EQUIPMENT . . .

the last word in accuracy & dependability



TV LABORATORY OSCILLOSCOPE—TYPE 404

An exceptionally high-gain, wide band oscilloscope created especially for designing and servicing TV receivers. Accurately displays any TV pulse waveform or signal on a large 7-inch screen. Sensitivity: 10 millivolts rms per inch peak to peak deflection. Vertical response useful to 4.0 mc. Recommended for servicemen, laboratories, schools and industry.



TV SERVICE OSCILLOSCOPE—TYPE 403

Designed for excellent low frequency response, is an exceptionally high-gain DC coupled instrument and incorporates many of the advanced features of higher priced models. It is particularly suitable for observing the many complex waveforms in television and will competently fulfill many service, production laboratory and industrial requirements.



DELUXE POLYMER—TYPE 302

Dependable for accurate measurement of ohms, DC, AC and RF voltages, DC current and Decibels. Accurate measurement of complex waveforms accommodated by new Peak to Peak scale. Special subminiature diode tube in RF probe provides for a flat response from 10 kc to 300 mc on scales to 300 volts. The 7 inch meter movement and illuminated scale allows maximum readability.

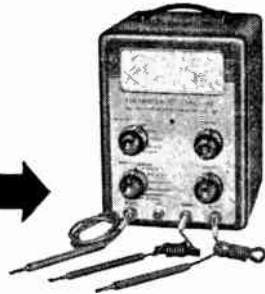

SERVICE POLYMER—TYPE 301

A compact polymeter unit designed for dependable accurate measurement of ohms, DC volts, AC volts, DC current and Decibels. Features new Peak to Peak scale for accurate measurement of complex waveforms. The 7 inch meter movement and illuminated scale allows maximum readability.

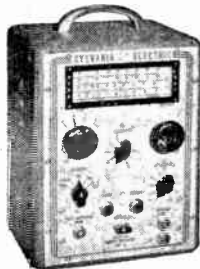

MARKER GENERATOR—TYPE 501

Provides 2 separate signals for marking an oscilloscope trace of response curves. Accurate adjustment of traps, frequency spotting, measuring bandwidth, and correct adjustment of the popular 4.5 mc, intercarrier sound circuits. VFO covers 15 to 240 mc. range.



SWEEP GENERATOR—TYPE 500

No mechanical sweep. Uses reactance tube sweep in two ranges; 0-15 mc for TV, 0-600 kc. for FM. Fundamentals from 2 to 230 mc. Special circuits to assure extreme linearity. Output 300 to 100,000 microvolts. Companion to 501 Marker.



TUBE TESTERS—TYPES 219 & 220

Two models available the 219 counter type, 220 portable type. Composite mutual conductance and emission checker rejects tubes failing either requirement. Relative amount of heater-cathode and inter-element shorts or leakage shown on METER. *Designed by a tube manufacturer to check tubes for modern applications.*

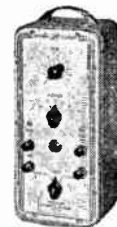

VOLTAGE CALIBRATOR—TYPE 300

Accurately measures Peak to Peak voltage of any waveform displayed on scope. Uses voltage regulated clipper circuit to give extreme accuracy in spite of line voltage fluctuation. Switch feeds either calibrating voltage or signal voltage to scope.

For Further
Information,
Write To:

TELEVISION
RADIO
ELECTRONICS
LIGHTING



SYLVANIA

SYLVANIA ELECTRIC PRODUCTS INC.
Radio and Television Div., WILLIAMSPORT, PA.

SUPERIOR TEST EQUIPMENT

The New Model TV-11

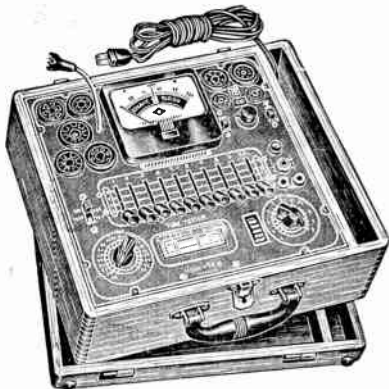

The model TV-11 operates on 105-130 Volt 60 Cycles A.C. Comes housed in a beautiful hand-rubbed oak cabinet complete with portable cover.

TUBE TESTER

SPECIFICATIONS

- ★ Tests all tubes including 4, 5, 6, 7, Octal, Lock-in, Peanut, Bantam, Hearing Aid, Thyatron, Miniatures, Sub-miniatures, Novals, Sub-Minars, Proximity fuse types, etc.
- ★ Uses the new self-cleaning Lever Action Switches for individual element testing. Because all elements are numbered according to pin-number in the RMA base numbering system, the user can instantly identify which element is under test. Tubes having tapped filaments and tubes with filaments terminating in more than one pin are truly tested with the Model TV-11 as any of the pins may be placed in the neutral position when necessary.
- ★ The Model TV-11 does not use any combination type sockets. Instead individual sockets are used for each type of tube. Thus it is impossible to damage a tube by inserting it in the wrong socket.
- ★ Free-moving built-in roll chart provides complete data for all tubes.
- ★ Newly designed Line Voltage Control compensates for variation of any line voltage between 105 Volts and 130 Volts.
- ★ NOISE TEST: Phono-jack on front panel for plugging in either phones or external amplifier will detect microphonic tubes or noise due to faulty elements and loose internal connections.

EXTRA SERVICE

The Model TV-11 may be used as an extremely sensitive Condenser Leakage Checker. A relaxation type oscillator incorporated in this model will detect leakage even when the frequency is one per minute.

\$47⁵⁰
NET

The New Model TV-40

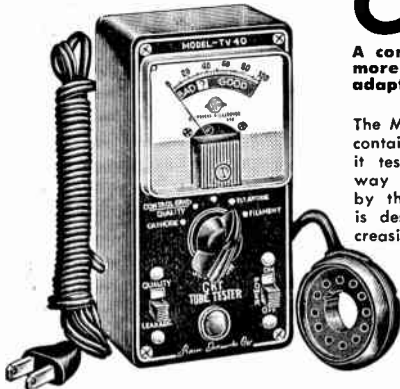

C. R. T. TUBE TESTER

A complete picture tube tester for little more than the price of a "make-shift" adapter!!

The Model TV-40 is absolutely complete! Self-contained, including built-in power supply, it tests picture tubes in the only practical way to efficiently test such tubes; that is by the use of a separate instrument which is designed exclusively to test the ever increasing number of picture tubes!

EASY TO USE:

Simply insert line cord into any 110 volt A.C. outlet, then attach tester socket to tube base (Ion trap need not be on tube). Throw switch up for quality test . . . read direct on Good-Bad scale. Throw switch down for all leakage tests.

Tests all magnetically deflected tubes . . . in the set . . . out of the set . . . in the carton!!

SPECIFICATIONS

- Tests all magnetically deflected picture tubes from 7 inch to 30 inch types.
- Tests for quality by the well established emission method. All readings on "Good-Bad" scale.
- Tests for inter-element shorts and leakages up to 5 megohms.
- Test for open elements.

Model TV-40 C.R.T. Tube Tester comes absolutely complete — nothing else to buy. Housed in round cornered, molded bakelite case. Only....

\$15⁸⁵
NET

FOR ELECTRICAL CONTRACTORS AND MAINTENANCE MEN
The New Model 640

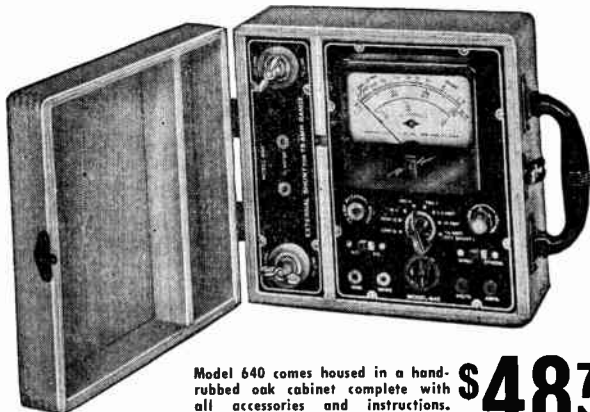

Model 640 comes housed in a hand-rubbed oak cabinet complete with all accessories and instructions. Size 5" x 9" x 9".

\$48⁷⁵
NET

INDUSTRIAL ANALYZER

The new Model 640 provides all the measuring services required for electrical maintenance, development, testing and repair work. Model 640 operates on a self-contained standard battery and is therefore always ready for use. No external source of current is required.

Features

Precision Calibrated External Shunt for High Currents. An accurately calibrated external shunt enables exact HIGH CURRENT measurements up to 75 amperes.

Automatic Current Measurements. The Model 640 will measure the actual current consumption of any electrical device while the unit is in operation and without breaking any connections.

Specifications

A.C. VOLTAGES: 0-15 Volts, 0-150 Volts, 0-750 Volts.

D.C. VOLTAGES: 0-15 Volts, 0-150 Volts, 0-750 Volts.

RESISTANCE: 0-1,000 Ohms, 0-10,000 Ohms.

CURRENT: 0-7.5 Amperes, 0-15 Amperes, 0-75 Amperes.

Manufactured by

SUPERIOR INSTRUMENTS CO.
NEW YORK 67, N. Y.



SUPERIOR TEST EQUIPMENT



The New Model 770-A The FIRST Pocket-Sized VOLT-OHM MILLIAMMETER USING THE NEW "FULL-VIEW" METER

71% MORE SCALE AREA!!

Yes, although our new FULL-VIEW D'Arsonval type meter occupies exactly the same space used by the older standard 2 1/2" Meters, it provides 71% more scale area. As a result, all calibrations are printed in large easy-to-read type and for the first time it is now possible to obtain measurements instead of approximations on a popular priced pocket-sized V.O.M.

FEATURES

- * Compact — measures 3 1/8" x 5 7/8" x 2 1/4"
- * Uses "Full View" 2% accurate, 850 Microampere D'Arsonval type meter
- * Housed in round-cornered, molded case
- * Beautiful black etched panel. Depressed letters filled with permanent white, insures long-life even with constant use.

The Model 770-A comes complete with self-contained batteries, test leads and all operating instructions

- Specifications**
- 6 A.C. VOLTAGE RANGES: 0-15/30/-150/300/1500/3000 volts.
 - 6 D.C. VOLTAGE RANGES: 0-7.5/15/-75/150/750/1500 volts.
 - 2 RESISTANCE RANGES: 0-10,000 Ohms, 0-1 Megohm.
 - 3 D.C. CURRENT RANGES: 0-15/150 Ma., 0-1.5 Amps.
 - 3 DECIBEL RANGES: -6 db to + 18 db, + 14 db to + 38 db, + 34 db to + 58 db.

\$15⁸⁵ NET

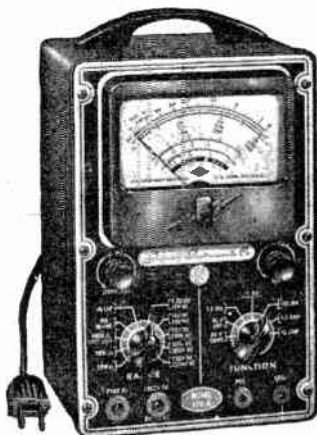

The new model 670-A SUPER-METER

A COMBINATION VOLT-OHM MILLIAMMETER PLUS CAPACITY REACTANCE INDUCTANCE AND DECIBEL MEASUREMENTS

- SPECIFICATIONS:**
- D.C. VOLTS: 0 to 7.5/15/75/150/750/1,500/7,500 Volts
 - A.C. VOLTS: 0 to 15/30/150/300/1,500/3,000 Volts
 - OUTPUT VOLTS: 0 to 15/30/150/300/1,500/3,000 Volts
 - D.C. CURRENT: 0 to 1.5/15/150 Ma. 0 to 1.5/15 Amperes
 - RESISTANCE: 0 to 1,000/100,000 Ohms 0 to 10 Megohms
 - CAPACITY: .001 to 1 Mfd. 1 to 50 Mfd. (Quality test for electrolytics)
 - REACTANCE: 50 to 2,500 Ohms 2,500 Ohms to 2.5 Megohms
 - INDUCTANCE: .15 to 7 Henries 7 to 7,000 Henries

DECIBELS: -6 to +18 + 14 to + 38 + 34 to + 58

ADDED FEATURE:

The Model 670-A includes a special GOOD-BAD scale for checking the quality of electrolytic condensers at a test potential of 150 Volts.

The Model 670-A comes housed in a rugged, crackle-finished steel cabinet complete with test leads and operating instructions. Measures 6 1/4" x 9 1/2" x 4 1/2".

\$28⁴⁰ NET

The new model 660-A — A NEW AC OPERATED

SIGNAL GENERATOR

Provides Complete Coverage for A.M.-F.M. and TV Alignment

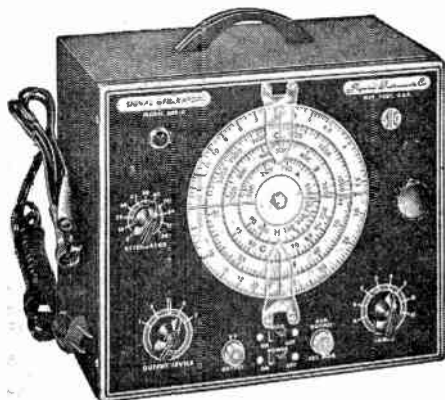

- Generates Radio Frequencies from 100 Kilocycles to 60 Megacycles on fundamentals and from 60 Megacycles to 220 Megacycles on powerful harmonics.
- Accuracy and stability are assured by the use of permeability trimmed Hi-Q coils.
- R. F. available separately or modulated by the internal audio oscillator. Built in 400 cycle sine wave audio oscillator used to modulate the R. F. signal also available separately for audio testing of receivers, amplifiers, hard of hearing aids, etc.
- R. F. Oscillator Circuit: A high transconductance heptode is used as an R. F. Oscillator, mixer and amplifier. Modulation is effected by electron coupling in the mixer section thus isolating the oscillator from load changes and affording high stability.
- A. F. Oscillator Circuit: A high transconductance heptode connected as a high-mu triode is used as an audio oscillator in a high-C Colpitts Circuit. The output (over 1 Volt) is nearly pure sine wave.
- Attenuator: A 5 step ladder type of attenuator is used.

Tubes used: 1-6BE6 as R. F. Oscillator, mixer and amplifier, 1-6BE6 as Audio Oscillator, 1-6H6 as Power Rectifier.

The Model 660-A comes complete with coaxial cable, test lead and instructions

\$42⁹⁵ NET



Manufactured by
SUPERIOR INSTRUMENTS CO.
NEW YORK 67, N. Y.

MULTI-METERS



The Supreme Model 543 (left) and Model 542 (right) volt-ohm-milliammeters have become real companions to maintenance men everywhere. Both instruments are the same size (approx. 6 x 3 x 2 inches) and are available in either the moulded "B" style case (illustrated) or the metallic type case with leather handle and meter protector shield (Style "M"). Model 543 has 4 functions and 12 ranges and the Model 542 has 6 functions and 24 ranges.



Model 543B	\$24.60	Model 542B	\$27.70
Model 543M	\$28.30	Model 542M	\$32.10
Test Leads	\$ 1.40	Test Leads	\$ 1.40

MINIMETERS



About the size of a cigarette pack, these fine little multi-range, single function instruments have found their way into a lot of shirt and vest pockets of electrical troubleshooters. Convenient size and durable construction for portability. Built with highest quality materials and workmanship for dependability. Quantity production for a budget price. Model 440 Ohmmeter only \$12.90 complete with test leads. Other functions available from \$10.65 to \$14.50.



PANEL METERS

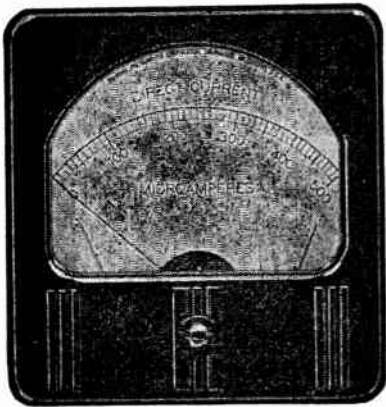

Leading manufacturers of electrical and electronic devices select Supreme meters for use in their products because they are quality built and dependable. Supreme meters are supplied for end equipment uses in a variety of sizes and designs "customed" to meet the need for special scales, dials and case appearance. A sketch or drawing of your meter needs will bring you a prompt quotation and delivery schedule from Supreme.



WRITE FOR ADDITIONAL INFORMATION: For prompt action, address your request for additional information to SUPREME, INC., BOX 5524, GREENWOOD, MISSISSIPPI. In addition to the items illustrated above, Supreme also makes Oscilloscopes, Tube Testers, Signal Generators, and special purpose instruments for both government and industry.



EMC PRECISION INSTRUMENTS

tops in value! tops in service!

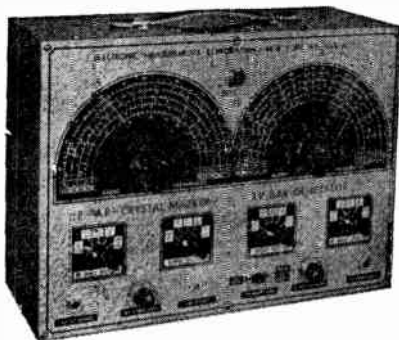

EMC MODEL 700

RF-AF-Crystal Marker — TV Bar — Generator

Only the EMC Model 700 gives you all of these outstanding features:

1. Complete coverage from 18 cycles to 108 megacycles on fundamentals.
2. Bar generator for TV adjustment with a variable number of bars available for horizontal or vertical alignment.
3. Square Wave Generator to 20 kilocycles.
4. Wien Bridge AF oscillator with sine wave output from 18 cycles to 300 kilocycles.
5. Crystal marker and amplitude control.
6. Individually tuned coils.
7. Constant RF output impedance.
8. Stepped RF attenuator.
9. Electrostatically shielded transformer.
10. Thorough shielding.
11. Colpitts RF oscillator from 300 KC to 108 megacycles on fundamentals — up to 216 megacycles on 2nd harmonic.
12. Variable percentage of modulation.

MODEL 700 \$55.90



EMC MODEL 103

VOLOMETER*

EMC's economy line offers another accurate and efficient instrument housed in a molded-bakelite case. This model features a 4 1/2 inch, accurate to within 2%—800 microamperes D'Arsonval-type meter with three AC current ranges; and the same zero adjustment for both resistance ranges.

SPECIFICATIONS:

- AC VOLTAGE—5 RANGES: 0 to 12-120-600-1200-3000 volts.
- DC VOLTAGE—5 RANGES: 0 to 6-60-300-600-3000 volts.
- FIVE DB RANGES: -4 to +64 DB.
- AC CURRENT—3 RANGES: 0 to 30-150-600 ma.
- DC CURRENT—4 RANGES: 0 to 6-30-120 ma.; 0 to 1.2 amps.
- TWO RESISTANCE RANGES: 0 to 1000 ohms, 0 to 1 megohms.

MODEL 103—Weight 2 lb. 3 oz. Size: 5 1/4" x 6 3/4" x 2 7/8" \$18.75
 MODEL 103-S: with plastic carrying strap 19.25

*Reg. trade mark for volt-ohm milliammeter.

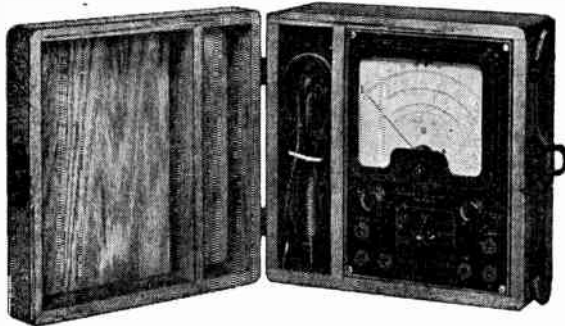

EMC MODEL 120

- Only 20,000 ohms-per-volt instrument giving widest resistance range (.2 ohm to 300 megs.)
- Highest AC voltage sensitivity (10,000 ohms per volt). Modern, clearly defined panels—large, easy-to-read meters function with unflinching accuracy.

SPECIFICATIONS:

- DC VOLTS at 20,000 ohms per volt: 0-3v, 0-15v, 0-60v, 0-300v, 0-1500v, 0-6000v.
- AC VOLTS at 10,000 ohms per volt: 0-6v, 0-30v, 0-120v, 0-600v, 0-3000v, 0-6000v.
- DECIBELS: -4 to +11, +10 to +25, +22 to +37, +36 to +51, +50 to +65, +62 to +77.
- DC CURRENT: 0.60 microamps, 0-6ma, 0-60ma, 0-600ma, 0-6 amps.
- RESISTANCE: 0-3000, 0-300,000, 0.3 megs, 0-300 megs.

MODEL 120P—Illustrated \$36.95
 MODEL 120—Open Face 31.95

EMC MODEL 500

R.F. Signal Generator

This precision-engineered instrument, recognized as the leader in its class, offers the following high quality features . . .

- Electrostatically-shielded transformer for 115v 60 cycle operation.
- All coils not in use automatically shorted out.
- Provision for external modulation.
- Covers range from 150KC to 36 megacycles on fundamentals—over 100 megacycles on harmonics.
- Two-tone gray hammertone panel and case.
- 400 Cycle internal modulation available.

MODEL 500 Illustrated \$29.75
 MODEL 500 In Kit Form 19.75



ELECTRONIC MEASUREMENTS CORP.
 280 Lafayette Street • New York 12, N. Y.
 EXPORT DEPT.—136 LIBERTY ST. N. Y. 6, N. Y.
 Cable Address: INTEX-COM

EMC PRECISION INSTRUMENTS

tops in value! tops in service!

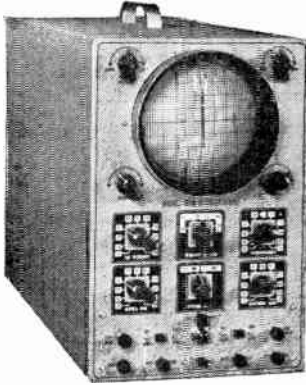

NEW EMC MODEL 600 OSCILLOSCOPE

- Uses new 5UP1—5" scope tube for sharp focusing and good intensity.
- Retrace blanking amplifier to eliminate confusion and give clearer pictures.
- Has built-in 60 cycle phasing control and sweep for TV servicing.
- Uses astigmatism control for better focusing.
- Provision for Z axis input or intensity modulation.
- Synchronization available on positive or negative phase of input voltage or from external source.
- Uses a 2 step compensated attenuator input.
- Has a 2 stage push-pull vertical amplifier with sensitivity of 0.2 volts per inch.
- Multivibrator swap from 15 cycles to over 75 kilocycles.
- Direct connections to scope plates available.

SPECIFICATIONS

Tube Complement: 1-5UP1 cathode ray; 3-12AU7 (vert. & horiz. amplifier and multivibrator); 2-5Y3 rectifier tubes; 2-6C4 (phase splitter and blanking amplifier); 1-12AT7 (horizontal amplifier).

Power Requirement: 105-130 volts 50/60 cycles AC-50 watts.

Dimensions: 8 3/4" wide x 14" high x 15 1/2" deep—weight 29 lbs.

NEW MODEL 600 (completely wired and tested) \$99.50



VOLOMETER* EMC MODEL 102

A sturdy, durable pocket instrument from EMC's economy line housed in a molded-bakelite case. This instrument features a three-inch, accurate to within 2%—800 microamperes D'arsonval-type meter with three AC current ranges; and the same zero adjustment for both resistance ranges.

SPECIFICATIONS:

AC VOLTAGE—5 RANGES: 0 to 12-120-600-3000 volts. DC VOLTAGE—5 RANGES: 0 to 6-60-300-600-3000 volts. AC CURRENT—3 RANGES: 0 to 30-150-600 ma. DC CURRENT—4 RANGES: 0 to 6-30-130 ma; 0 to 1.3 amps. TWO RESISTANCE RANGES: 0 to 1000 ohms, 0 to 1 megohms.

MODEL 102—Weight 1 lb. 5 oz.; Size 3 3/4" x 6 1/4" x 2" \$14.90
* Reg. trade mark for volt-ohm milliammeter.



VOLOMETER* EMC MODEL 104

A valuable addition to EMC's economy line is this accurate, precision-engineered instrument. This model features a 4 1/2 inch, 50 microampere meter, with alnico magnet . . . housed in a molded-bakelite case; with three AC current ranges to 3 amps and three resistance ranges to 20 megohms.

SPECIFICATIONS:

AC VOLTAGE—5 RANGES (1,000 ohms per volt): 0 to 6-60-300-600-3000 volts. DC VOLTAGE—5 RANGES (20,000 ohms per volt): 0 to 6-60-300-600-3000 volts. AC CURRENT—5 RANGES: 0 to 30-300 ma. 0 to 3 amps. DC CURRENT—3 RANGES: 0 to 6-60-600 ma. THREE RESISTANCE RANGES: 0 to 20K, 0 to 200K, 0 to 20 megs. FIVE DB RANGES: -4 to +67 dB.

MODEL 104—With carrying strap. Wt. 2 lb. 5 oz. Size: 5 1/4" x 6 3/4" x 2 7/8" \$26.95
MODEL HVT—30,000 Volt Probe for MODEL 104 7.95
* it-g. trade mark for volt-ohm milliammeter.



VACUUM TUBE VOLTMETER EMC MODEL 106

CHECK THESE FEATURES . . .

- Specially designed for field alignment of television and radio sets.
- Uses dual triode balanced bridge circuit
- All functions and ranges completely electronic—meter cannot burn out
- Zero center position for FM discriminator alignment
- Uses 1% precision resistors for voltage multipliers
- 5 DB ranges
- Full scale deflection of 1 1/2 volts for both AC-DC volts
- Measures resistance in 5 ranges from .2 to 1000 megs.
- 1 meg. isolating resistor in probe
- Housed in compact, portable bakelite case
- Size: 4 1/4" x 5 1/4" x 2 7/8", net wt. 3 lbs.

SPECIFICATIONS:

AC VOLTAGE—5 RANGES: 0 to 1.5, 10, 100, 300, 1000 volts. Input resistance 2 megohms. Frequency response flat from: 25 to 100,000 cycles. DC VOLTAGE—5 RANGES: 0 to 1.5, 10, 100, 300, 1000 volts (up to 30,000 volts with accessory probe). Input Resistance: 16.5 megs. or 1 1/2 megohms per volt. OHMS: 1000-10,000-100,000-10 megohms, 1000 meg-ohms, 10 megohms center on 1000 megohms range. DECIBELS RANGES: -24 to -1.5, -8 to +15, +12 to +35, +21.5 to +44.5, +32 to +55.

MODEL 106—Illustrated \$35.90
MODEL 106—In Kit Form 23.90
MODEL RFP—High Frequency Probe (useful to 200 megacycles) 6.95
MODEL HVP—30,000 Volt Probe for MODEL 106 8.75
MODEL IS—Rubber covered. Instrument stand for volt-ohm, milliameters and VT volt-meters 0.98

EMC

ELECTRONIC MEASUREMENTS CORP.
280 Lafayette Street • New York 12, N. Y.
EXPORT DEPT.—136 LIBERTY ST. N. Y. 6, N. Y.
Cable Address: INTEX-COM

EMC PRECISION INSTRUMENTS

tops in value! tops in service!

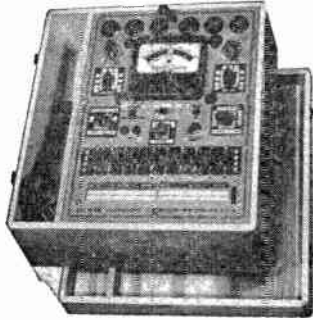

MUTUAL CONDUCTANCE TUBE TESTER EMC MODEL 206

This completely flexible model using lever-type switches offers extremely accurate results with ease of operation. It represents the finest in tube testing equipment at a price comparing favorably with emission-type testers.

CHECK THESE FEATURES . . .

- Checks mutual conductance on a calibrated micromho and "reject-good" scale
- Checks 5 element tubes as pentodes
- Checks tubes for gas content
- Sufficient plate current to check both emission and mutual conductance
- Detects both shorted and open elements
- Complete switching flexibility allows all present and future tubes to be tested, regardless of location of elements on tube base
- Tests tubes for radio frequency and other noise
- Tests all tubes from .75 volts to 117 filament volts
- Tests all loctal, octal, and miniature tubes
- Tests cold cathode, magic eye, voltage regulator, ballast resistors
- Instrument fuse is easily replaced from panel front
- Individual sockets for each tube base type eliminates possible errors
- Checks individual sections of multi-purpose tubes
- Checks 9-prong miniature tubes
- Checks subminiature tubes
- Attractive four-color panel with durable hardwrinkle finish
- Built-in roll chart.

MODEL 206P—With hand-rubbed oak carrying case.....	\$83.50
MODEL 206C—Sloping counter case.....	79.50
MODEL CTA—Cathode ray tube adaptor for MODEL 206.....	9.95

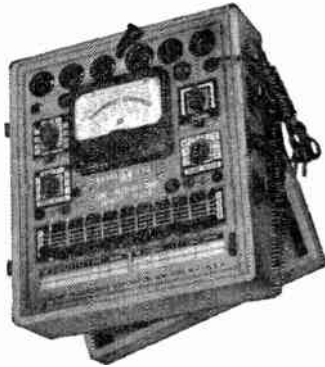

TUBE-BATTERY-OHM CAPACITY TESTER EMC MODEL 204

In this model EMC offers a durable, accurate instrument that gives easy, direct readings for all tubes through the standard emission method of testing. It uses four-position lever-type switches and is housed in a hand-rubbed, portable oak carrying case with removable hinged cover.

CHECK THESE FEATURES . . .

- Tests all tubes including Noval and subminiatures
- Completely flexible switching arrangement
- Checks batteries under rated load on "reject-good" scale
- Individual sockets for each type of tube base
- Tests all tubes from .75 volts to 117 filament volts
- Tests cold cathode, magic eye, voltage regulator and ballast tubes
- Has pilot light indicator
- Checks for shorts and leakages
- Line voltage control compensates for line variations between 105 and 135 volts
- Built in roll chart protected by non-breakable transparent plastic
- Checks condenser leakage to 1 megohm
- Checks resistance up to 4 megohms
- Checks capacity from .01 to 1 mfd.
- Three color hammertone panel

MODEL 204C—Sloping counter case.....	\$54.90
MODEL 204P—Illustrated.....	55.90
MODEL CRA—Cathode ray tube adaptor.....	4.50



TUBE TESTER EMC MODEL 205

In this durable, accurate instrument EMC offers a model that gives easy, direct readings for all tubes through the standard emission method of testing. It uses four-position lever-type switches and is housed in either a hand-rubbed, portable oak carrying case with removable hinged cover; or in a sloping counter case.

CHECK THESE FEATURES . . .

- Tests all tubes including Noval and sub-miniatures
- Completely flexible switching arrangement
- Individual sockets for each type of tube base
- Tests all tubes from .75 volts to 117 filament volts
- Tests all cold cathode, magic eye, voltage regulator and ballast tubes
- Has pilot light indicator
- Line voltage control compensates for line variations between 105 and 135 volts
- Checks for shorts and leakages
- Three color hammertone panel

MODEL 205C—Sloping counter case.....	\$46.50
MODEL 205P—With hand-rubbed oak carrying case (illustrated).....	47.50
MODEL CRA—Cathode ray tube adaptor.....	4.50

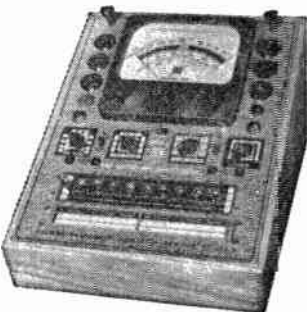

EMC MODEL 207

Tube-Battery-OHM-Capacity-Tester

Features large, easy to read, 7 1/2" meter for counter use. In this model EMC offers a durable, accurate instrument that gives easy, direct readings for all tubes through the standard emission method of testing. It uses four-position lever-type switches and is housed in a hand-rubbed, portable oak carrying case with removable hinged cover.

CHECK THESE FEATURES . . .

- Tests all tubes including Noval and subminiatures
- Completely flexible switching arrangement
- Checks batteries under rated load on "reject-good" scale
- Individual sockets for each type of tube base
- Tests all tubes from .75 volts to 117 filament volts
- Tests all cold cathode, magic eye, voltage regulator and ballast tubes
- Has pilot light indicator
- Checks for shorts and leakages
- Line voltage control compensates for line variations between 105 and 135 volts
- Built in roll chart protected by non-breakable transparent plastic
- Checks condenser leakage to 1 megohm
- Checks resistance up to 4 megohms
- Checks capacity from .01 to 1 mfd.
- Three color hammertone panel

MODEL 207C—Illustrated.....	\$65.90
MODEL 207P—Portable case, removable cover.....	69.50
MODEL CRA—Cathode ray tube adaptor.....	4.50

EMC

ELECTRONIC MEASUREMENTS CORP.

280 Lafayette Street • New York 12, N. Y.

EXPORT DEPT.—136 LIBERTY ST. N. Y. 6, N. Y.

Cable Address: INTEX-COM

Instruments IN KIT & WIRED FORM . . . **precise**
above all else

12,080 HOURS OF ENGINEERING TO BRING YOU THE
**NEW AMAZING
PRECISE MODEL #300 OSCILLOSCOPE!**

The Oscilloscope you've been seeking. . . . No other oscilloscope at any price — high or low — with these desirable features — in both Kit and Wired Form:
SPECIFICATIONS: PRECISE MODEL 300 OSCILLOSCOPE. —
VERTICAL: Vertical-flat (3db) DC through 5 mc. cycles with sensitivity of greater than 10 millivolts push-pull (3.94 Millivolts/cm); Constant Resistance; Push-pull input immediately converted to single-ended normal or reverse phase by shorting bar at inputs 1 and 2; Frequency compensated vertical stepping attenuator selects AC or DC inputs; Push-pull DC amplifiers from input through output; Internal electronic mixing through inputs 1 and 2; five-way binding posts.
POSITIONING: Bridge type positioning on vertical and horizontal does not vary tube characteristics.
HORIZONTAL: Frequency compensated stepping attenuator in horizontal amplifier; Push-pull Horizontal out.
BLANKING: Internal (return trace blanked), external (return trace not blanked), 60 cycle or 120 cycle Blanking through Blanking amplifier circuit.
SYNCHRONIZATION: External, Internal Positive, Internal Negative, Internal 60 cycle or Internal 120 cycle synchronization.
SWEEP RATE: Driven or non-driven linear sweeps from 1 cycle to 80KC in five ranges (1-10 cycles uses external C circuit); Trigger potentiometer.
MAGNIFIER: Electronic magnifier and magnifier positioner allow any part of a signal to be magnified up to ten times (equivalent to 70 inches of horizontal deflection).
CALIBRATION: Internal square wave calibrator and potentiometer for using oscilloscope as a VTVM on Peak to Peak measurements.
CALIBRATION SCREEN: Edge-illuminated scale and graticule may be turned on or off; filtered screen.
OUTPUTS ON FRONT PANEL: Plus Gate output; Sawtooth output; 60 cycle phasing output; 60 cycle unphased output; Calibration output.
FOCUSING: Astigmatism, focus and intensity control.
CRT: NEW 7" Tube, normally supplied is medium persistence type 7VP1, or 7JP1 may also be used (oscilloscope green trace) — high persistence types available at additional cost.
DIRECT: Deflection plates available from rear of cabinet.
INTENSITY MODULATION: Z modulation through modulation amplifier.
GENERAL: Low loss components; Over-designed fused power supply for additional circuitry; Deeply etched aluminum panel. New parts from original manufacturers — (NO SURPLUS); Steel cabinet; 11" x 14" x 17"; complete with instruction book and all components; Accessories: Model 912T (MM) Demodulator Probe and Model 960 Capacity Attenuator Probe available at extra cost — please see specifications on following pages.
 There are many additional features and circuits in kit form, which may be added to the Model 300. Please write us for descriptive literature.

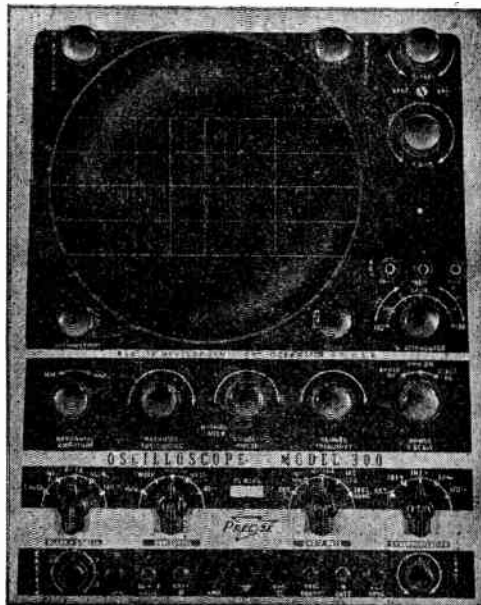

300K kit form **\$94⁹⁵**
 300W factory wired **\$199.50**

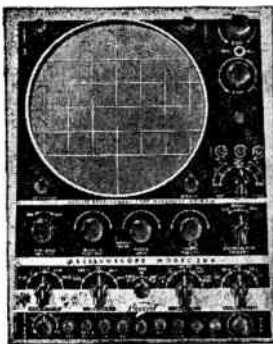

• **NEW PRECISE 8 1/2" OSCILLOSCOPE MODEL 308**

Big Screen Scope

An oscilloscope unique in the industry . . . THE ONLY 8 1/2" scope on the commercial market . . . All the general specifications of the time proven PRECISE Model #300; over 72 sq. inches of viewing space provided by its NEW 8 1/2" tube; ANODE INTENSIFIER; FREQUENCY SYNCHRONIZATION CONTROL TO ELIMINATE HORIZONTAL JITTERS (this and other features not found in other scopes at even greater cost) PLUS FULL VOLTAGE REGULATION.

Weight.....35 lbs. Size.....11" x 14" x 19"

308K kit form **\$129⁵⁰**
 308W factory wired **\$229.50**

• **NEW PRECISE MODEL 303 PORTABLE THREE INCH OSCILLOSCOPE**

A THREE INCH PICTURE TUBE SCOPE . . . NEW IN DESIGN . . . SMALL IN SIZE . . . BIG IN ACCURACY . . . COMPLETE PORTABILITY. Offers vertical and horizontal bridge type positioning; complete blanking amplifier circuit; vertically flat DC through 5 megacycles with sensitivity greater than 10 millivolts push-pull (3.94 millivolts/cm), plus general specs of model #300. FREQUENCY SYNCHRONIZATION CONTROL TO ELIMINATE HORIZONTAL JITTERS (this and other features not found in other scopes at even greater cost) PLUS FULL VOLTAGE REGULATION, in Kit or Wired form.

WEIGHS ONLY 14 lbs. Size: 8" x 11" x 15"

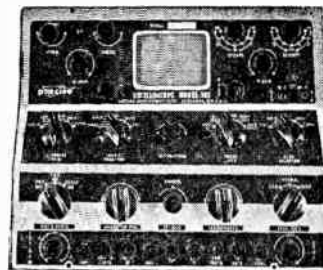

PRECISE DEVELOPMENT CORP. • OCEANSIDE, N. Y.



• **PRECISE MODEL 630 RF-AF-TV and Marker Generator**

The very first kit to reach 110 MC on fundamentals, 330 MC on harmonics. The first kit to offer a complete factory preassembled and calibrated RF head. *Pre-tuned RF Head; Audio: 20-20,000 cycles; variable percent modulation; cathode-follower output; stepping attenuator; external modulation; speech amplifier; crystal marker; crystal amplitude control; RF & AF stand-by; Wien Bridge AF Oscillator; Colpitts RF Oscillator; Drum Dials; Coaxial fittings; individually tuned coils; constant output impedance; filtered line; Vernier tuning on RF & AF; Separate RF Section; Complete shielding.

RF FREQUENCIES: BAND 1—300KC to 1MC FUNDAMENTALS • BAND 2—1MC to 3MC FUNDAMENTALS • BAND 3—3MC to 10MC FUNDAMENTALS • BAND 4—10MC to 30MC FUNDAMENTALS • BAND 5—30MC to 110MC FUNDAMENTALS • BAND 5A—60MC to 220MC 2nd HARMONIC • BAND 5B—90MC to 330MC 3rd HARMONIC

AF FREQUENCIES: Band 1—20 to 40 Cycles • Band 2—40 to 200 Cycles • Band 3—200 to 2K Cycles • Band 4—2K to 20K

8" x 11" x 5"; leather handle; wrinkle steel cabinet; deeply etched aluminum panel; amphenol type connectors; wt.: 10 lbs.

630K..... **\$33⁹⁵** *630KA \$38.95
 Factory Wired.....\$53.95

• **PRECISE MODEL 610**
Newest RF Signal Generator for AM, FM and TV

The first low-priced RF Signal Generator to reach 110 MC on fundamentals, 330 MC on harmonics, with the accuracy and stability of high-priced equipment. PRECISE achieves this by slug and capacity tuning of the coils, along with complete isolation of the Colpitts Oscillator by a Cathode Follower Buffer Output.

*The first kit to offer a complete factory pre-assembled and pre-tuned RF Head; Cathode-Follower Output; External Modulation; Speech Amplifier; Bridge Type AF Oscillator; Colpitts RF Oscillator; Drum Dial; Coaxial Fittings; Individually Tuned Coils; Vernier Tuning; Separate RF Section; Complete Shielding, 400 Cycle and 60 Cycle Internal Modulation.

RF FREQUENCIES:

BAND 1—300KC to 1MC FUNDAMENTALS
 BAND 2— 1MC to 3MC FUNDAMENTALS
 BAND 3— 3MC to 10MC FUNDAMENTALS
 BAND 4— 10MC to 30MC FUNDAMENTALS
 BAND 5— 30MC to 110MC FUNDAMENTALS
 BAND 5A—60MC to 220MC 2nd HARMONIC
 BAND 5B—90MC to 330MC 3rd HARMONIC

8" x 11" x 5"; leather handle; wrinkle steel cabinet; deeply etched aluminum panel; amphenol type connectors; wt.: 10 lbs. TUBE COMPLEMENT: 6C4, 12AX7, 6X5.

610K..... **\$23⁹⁵**
 *610KA\$28.95
 610W (factory wired).....\$39.95



• **PRECISE MODEL 909 Vacuum Tube Voltmeter**

WHAT BETTER WAY TO BUY THAN BY MAKING A COMPARISON!

Ceramic precision resistors—1% OR BETTER; deeply etched panel; steel cabinet; Amphenol type DC connector; special, separate 5 V. AC scale for accuracy on low voltages; 250 V. scale enables you to read line voltages accurately.

FREQUENCY RANGE: Up to 250 megacycles with PRECISE 912 Probe (available at additional cost).

VOLTAGE RANGE: Up to 30,000 V. with PRECISE 999 High Voltage Probe (available at additional cost).

FM & TV: Special true zero alignment scale for FM & TV discriminators; Burn-out proof circuit; 25 Megohm input impedance on DC; complete with test leads and internal battery; oversize 4 1/2" meter; 105-120V., 50-60 cycles, AC; wt.: 10 lbs.; 9 1/2" x 6" x 5".

RANGES: +DC: 0-5-25-250-500-1000 Volts; —DC: 0-5-25-250-500-1000 Volts; AC: 0-5-25-250-500-1000 Volts
 Ohms: Rx1-Rx10-Rx1000-Rx1,000,000 ohms; from .2 Ohms to 1 Billion Ohms; DB: From —20 to +55 DB.

909K.....\$25.98 • Factory Wired..... **\$37⁵⁰**



• **NEW PRECISE MODEL 9071**
Voltage Regulated VTVM

Special 7 1/2" meter • 1% CERAMIC PRECISION RESISTORS • FM zero alignment scale • Coax DC connector • Burn-out proof circuit • DC input 25 Meg • Power transformer operated (no selenium rectifier used) • 4 tube circuit • Compact design • Size: 8" x 11" x 5".

9071K.....kit form \$35.95 • 9071W.....factory wired **\$49⁹⁵**

Prices slightly higher in the West
 Prices and specifications subject to change without notice
ALL EQUIPMENT HAS THE PRECISE GUARANTEE
SOLD THROUGH LEADING JOBBERS
WRITE FOR CATALOG #54-AR

PRECISE DEVELOPMENT CORP. • OCEANSIDE, N. Y.

Instruments IN KIT & WIRED FORM . . . **precise**
above all else

• **NEW PRECISE MODEL 111 Mutual Conductance and Emission Tube Tester**

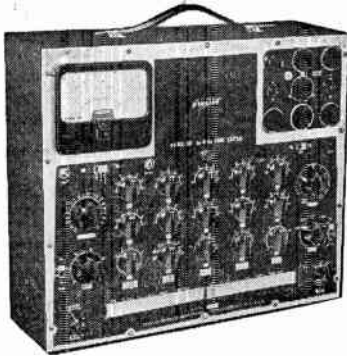

111K..... kit form **\$69⁹⁵**
111W... factory wired **\$139.95**
Weight..... 30 lbs.
Size..... 14" x 16" x 6"

ENGINEERING DESIGN CONSIDERATION: To understand the Model 111 Mutual Conductance and Emission Tube Tester, it is perhaps best to spend a moment with the original design considerations. Basically we recognize the fact that:

1. A GM or Emission type tube tester actually reads a goodly percentage of tube troubles—BUT each alone missed a great many. We could not say with any degree of assurance which type of tube test was the best. Certain applications required GM, while others required Emission. **PRECISE Solution:** The Model 111 checks Gm and Emission separately. It indicates on the roll chart the most important single test for normal applications. It is, of course, desirable to make both tests.
2. In AC-DC equipment, or series filaments arrangements, which are daily enjoying greater popularity, the "Voltage Sapper" (a tube which developed too much filament voltage as compared to the other tubes) was a constant trouble. **PRECISE Solution:** The Model 111 allows the filament current to be measured directly on the meter.
3. A whole series of different test voltages (sweeping from zero voltage up) was required. **PRECISE Solution:** The Model 111 sweeps from 0 through the normal testing range when making measurements. This gives an average evaluation for the tube over an extended range of operation.
4. Short tests usually require elaborate switch manipulation. **PRECISE Solution:** The Model 111 uses a single rotary switch which checks each element against every other element. No conversion chart is required to ascertain which pins are shorted. This test may be made at any time hot or cold without changing any other switches.
5. The instrument would have to be rugged to stand the "trunk of a car" type of abuse. **PRECISE Solution:** In the Model 111 a heavy steel cabinet houses the entire unit. The panel is deeply etched aluminum.
6. Tube Bias, being an important consideration, should actually be measured on the meter. **PRECISE Solution:** The Model 111 measures tube bias directly on the indicating meter.
7. The instrument should be simple to operate. **PRECISE Solution:** The Model 111 uses different type knobs, a no-backlash roll chart, and a sectionalized design setting off each section.
8. There should be a provision for new tubes. **PRECISE Solution:** The Model 111 is one of the simplest type tube testers to set up for new tubes. The pin connections and function positions may be taken directly from the tube manual. The instrument already includes provisions for testing many color tubes.
9. It should check all modern tubes. **PRECISE Solution:** The Model 111 is provided with sockets for testing the following type bases. Large 4 prong, large 5 prong, large 6 prong, large 7 prong, medium 7 prong, miniature 7 prong, in-line 7 prong (sub-miniature), Octal, Noval, sub-miniature 8 prong, Acorn CRT and Localtals.
10. The instrument should check Cathode Ray Tubes. **PRECISE Solution:** The Model 111 also checks cathode ray tubes by an included adaptor.

• **PRECISE MODEL 760 Voltage Regulated Power Supply**

The Model 760 is an extremely versatile electronically regulated power supply capable of delivering an assortment of different voltages. It is invaluable in general repair and laboratory use.

REGULATED VOLTAGE

Range—160 volts to over 450 volts.
% Regulation—Within 1% at specified current duration.
% Ripple—.01% at specified currents.
Max. Current—100 ma depending on voltages.
Metering—Voltage and current are both metered by switches.
High Voltage—Unregulated variable to 1000 volts DC positive or negative. Voltage is metered. Maximum current of 1 ma.
Low AC Voltage—Unregulated 6.3 volts AC, 4 amperes capacity.
High AC Voltage—375 volts AC, 50 ma, DC Capacity. Unregulated.
V.R. Tube Reference DC Voltage—DC reference voltage, low current, available for reference or screen operation.

All voltages are capable of being used simultaneously except for the plus or minus 1000 volts. Either plus or minus may be used but not simultaneously.

GENERAL

The instrument is housed in a sturdy steel cabinet with a deeply etched aluminum panel. A rugged 4½" meter movement is used for all metering. Shunt and multiplier resistors are within 1% accuracy. A leather carrying handle is provided. 5 Way binding posts are used for the regulated outputs. All other voltages are available by pin jacks. The high and low voltage supplies each have a standby position and the voltage metered is indicated by a jeweled pilot light for the HV and LV. Basically the PRECISE 760 is a general purpose source of regulated voltages for substitution and experimental work. No returns are made to the cabinet allowing the instrument to be used for AC-DC applications.

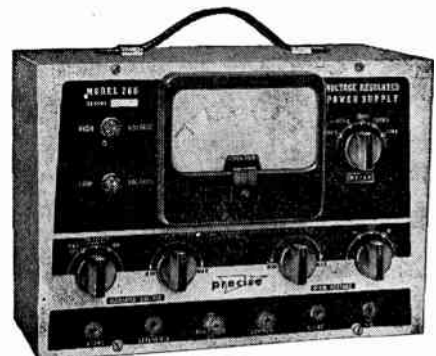

Weight 11 lbs.
Size..... 11" x 8" x 5"
\$39⁹⁵
760K..... kit form
760W..... factory wired **\$59.95**

T1 — TRANSISTOR KIT
ANOTHER NEW EXCLUSIVE KIT BY PRECISE

Now PRECISE makes it possible for you to build your own countless experiments with the most remarkable construction kit you've ever seen . . . the brand new PRECISE T1 TRANSISTOR KIT. Components include transformer, chassis, TRANSISTORS, germanium diode, wire, etc. — everything you need for experimental construction plus the finest step-by-step instruction book ever prepared.

NEW HIGH FIDELITY INSTRUMENTS IN KIT & WIRED FORM

WRITE FOR 1954 CATALOG



PRECISE DEVELOPMENT CORP. • OCEANSIDE, N. Y.

Instruments IN KIT & WIRED FORM . . . **precise**
above all else



• **PRECISE MODEL 635**

Universal AF Sine, Square and Pulse Generator

Efficiently and effectively ascertains all Audio and Video troubles

Sine waves; square waves; Wien Bridge Oscillator; Pulses; variable impedance output; voltage regulation insures a veritably constant output; cathode follower output; Minimum overshoot & round-off through 50,000 cycles on square waves and pulses; sine waves through 200,000 cycles.

8 x 11 x 5"; leather handle; wrinkle steel cabinet; deeply etched aluminum panel; amphenol type connectors; wt.: 10 lbs.

TUBE COMPLEMENT:

1—6AU6; 3—6SN7; 1—6X5; 1—6S6

RANGES: 20-40 cycles • 40-200 cycles • 200-2000 cycles • 2000-20,000 cycles • 20,000-200,000 cycles.

635-W.....Factory wired \$52.50 • 635K.....Kit form **\$33⁵⁰**

• **PRECISE NEW MODEL 468**

Resistance Decade Box



3 3/4" x 6 1/4" x 2"

PRECISE AGAIN LEADS THE FIELD with its New Low-Priced Resistance Decade Box. Compact in size for Bench Drawers and Tool Boxes.

5 Separate Switches, 11 Positions on Each; plus or minus 1%. Readings from 10 OHM to 1,111,110 OHM in 5 Decades. 1% Dep. Carbon Non Ind. above 10 OHM. Binding Posts permit quick substitution of equivalent Resistors indicated on Selector Panel. Deeply etched Aluminum Panel; Rugged Construction; Complete with Simplified Construction Manual.

468K.....kit form **\$18.95**

468W.....factory wired \$24.95

• **PRECISE MODEL 478**

Newest Capacity Decade Box

PUTS 10,000 CAPACITORS IN YOUR POCKET

... first in the low price field to reach over 1

MFD at 1% accuracy . . . Four decades from

100 MMFD to 1.1111 MFD (100 MMFD steps)

... 10 TIMES THE CAPACITY RANGE . . .

Capacitors well within 1%; SILVER MICA, except

for highest values which are special low-drift,

molded, nil impregnated; rated at 600 volts, except

for highest ranges rated 400 volts. . . All capacitors

fully tested, including: leakage resistance

(thousands of megohms); accuracy measured on

standard bridges; voltage breakdown tested; power

factor, temperature cycling and aging. — STURDY

HIGH IMPACT BAKELITE CASE REDUCES

GROUND CAPACITY AND INSURES LONG LIFE.

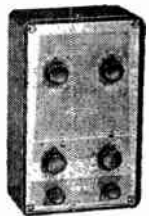

3 3/4" x 6 1/4" x 2"

478K.....kit form **\$18.95**

478W.....factory wired \$24.95

• **PRECISE MODEL 960**

The lowest priced CAPACITY ATTENUATOR PROBE, and what's more IT ALLOWS SCOPE MEASUREMENTS TO BE MADE WITH 1/10th the CAPACITY LOADING EFFECT.

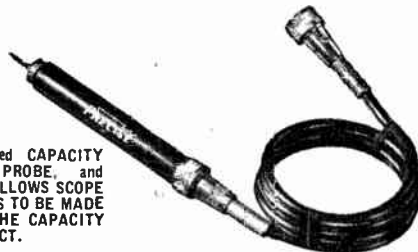

- **FREQUENCY RANGE:** Through 100 MC, flat through normal commercial oscilloscope frequencies.
- **READINGS:** Attenuated by a factor of ten to one.
- **MAXIMUM A.C.:** 1000 Volts.
- **INPUT CAPACITY:** Less than 7 mmfd.
- Each probe may be individually calibrated.
- Non hydro-sopic insulation.

960
factory wired
\$5.95

• **PRECISE MODEL 999**

High Voltage Probe

The PRECISE MODEL 999 High Voltage Probe was designed for high voltage measurements with special emphasis on SAFETY, OPERATIONAL SIMPLICITY AND RUGGED CONSTRUCTION. First in the industry to include any one or more of the following features:

- **MULTIPLE INSULATION:** The only probe with at least three individual media must be penetrated before voltage breakdown can occur.
- **MECHANICALLY SHOCKPROOF CONSTRUCTION:** The only probe to utilize a double spring suspension system in order to protect the Ceramic high wattage multiplier resistor.
- **INTERCHANGEABLE TIPS:** The only probe where two tips are supplied—one, the conventional type for probing; the other, an alligator clip for connecting permanently to the circuit.
- **SWIVEL LEAD CONSTRUCTION:** A special-fixed slip-ring arrangement is provided which prevents the test lead cable from snagging or developing high strains at the junction of the cable and probe handle.
- **INTERCHANGEABLE RESISTORS:** To match your instrument.

999.....factory wired **\$6.98**

• **PRECISE MODEL 912 R.F. Probe**

Individually calibrated at 75 megacycles for accuracy, impedance and shunt capacity. The lowest priced, wired, calibrated R.F. Probe.

- **FREQUENCY RANGE:** RMS readings from AF through 250 megacycles. Veritably flat through 100 megacycles.
- **BUILT IN 600 VOLT BLOCKING CAPACITATOR.**
- **INPUT CAPACITY:** The approximate input capacity is less than 3 mmfd usually about 1.2 mmfd.
- **INPUT RESISTANCE:** Approx. 200,000 ohms at 1 MC. • Approx. 150,000 ohms at 10 MC. • Approx. 25,000 ohms at 100 MC.

912.....factory wired **\$4.25**

PRECISE DEVELOPMENT CORP. • OCEANSIDE, N. Y.

FREED Test Instruments

TYPE 1030-A LOW FREQUENCY "Q" INDICATOR

USES

The Type 1030-A Low Frequency "Q" Indicator measures directly the "Q" factor of coils. The instrument can also be used to measure the inductance of coils, distributed capacity, impedances, and dielectric losses. The "Q" Indicator can be used to study the magnetic properties of iron, such as stability of iron cores in function of applied voltages, and iron losses as a function of the frequency.

FEATURES

The main and essential feature of the instrument is that the "Q" factor is read directly without any complicated computations. The possibility of measuring "Q" through the whole audio and supersonic frequency range is provided. The setting up and the measuring of the "Q" of coils is practically instantaneous. The instrument is unaffected by line voltage variations, is entirely self-contained and A.C. operated. Both meters ("multiply-by" and "Q") are protected against overloads and cannot be burned out. The frequency range for "Q" measurements is 20 to 200,000 cycles. The terminals of the variable decade condensers are available directly on the front panel of the instrument. The condensers, therefore, can be used as high quality precision variable condensers. To reduce the residual capacitance a link is provided on the front panel of the instrument which disconnects all but the 100 mmfd variable air condenser. When the link is closed five decade capacitors and the air variable are connected across the condenser

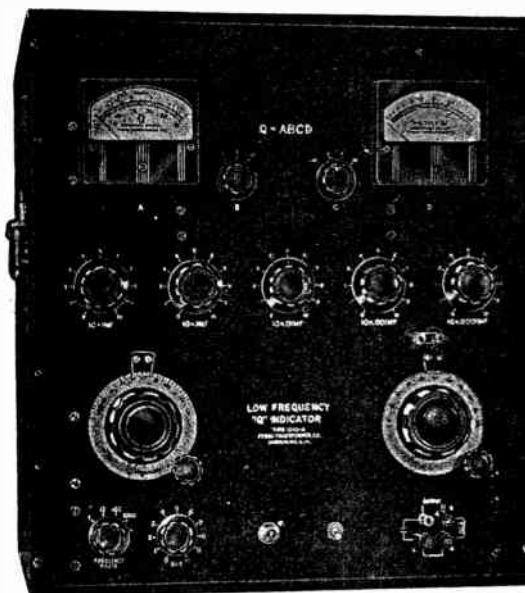

terminals. The R. C. Oscillator and variable impedance amplifier can be used as a separate low frequency generator with an output power of five watts into a 50 ohm load. The "Q" scale is calibrated from 0 to 100. A high accuracy of measurement is obtained, since "Q" variations from 0 to 100 are read on a 4 inch meter. "Q" factors of coils can be measured with up to 100 volts across the coil, and therefore makes it possible to determine the stability and the variations of the "Q" factor of coils in function of the applied voltage. The voltage fed into the series circuit is variable from 10 volts to .01 volt.

SPECIFICATIONS

Range of "Q" Measurements: The range of "Q" factors is from 0.1 to 1000 over the frequency range from 20 to 200,000 cycles with an accuracy of 5%.

Oscillator Frequency Range: Continuously variable from 20 to 200,000 cycles in four ranges.

Frequency Accuracy: 1% under normal temperature conditions. The frequency stability is better than 2% over a long period of time.

Output Impedance and Voltage: Four output impedances are available.

- (a) 10 ohms impedance — 25 V Output Voltage
- (b) 1 ohm impedance — 2.5 V Output Voltage

- (c) .2 ohm impedance — .25 V Output Voltage
 - (d) .1 ohm impedance — .02 V Output Voltage
- These Impedances are measured at 50,000 cy.

Variable Condenser: The variable condenser is composed of a 10 x 1 mfd., 10 x 0.1 mfd., 10 x 0.01 mfd., 10 x 0.001 mfd. and 10 x 0.0001 mfd. decade condenser and a 100 mmfd. variable air condenser.

Power Supply: The instrument is entirely self-contained and A.C. operated. Total consumption 200 watts.

Dimension: Width 19 1/2" x Depth 14 1/2" x Height 23"

Weight: 120 lbs.

FREED Test Instruments

TYPE 1020-B MEGOHMMETER



USES

The Freed Type 1020-B Megohmmeter is a self contained and A.C. operated instrument equally useful in the laboratory or for production testing of the leakage resistance of insulation materials, condensers, cables, motors and transformer windings.

FEATURES

Resistance values indicated directly on a four inch meter protected against over-load. Rapid and safe to use, test voltage removed from terminals and capacitive component discharged to ground in all positions of multiplier switch. Low resistance in series with component under test provides very short charging time for even the very largest capacitors. Calibration position provided to check accuracy of 500 volts D.C. potential.

500 volt test supply electronically regulated.

SPECIFICATIONS

Range: 1 megohm to 2,000,000 megohms in six overlapping ranges selected by a multiplier switch.

Accuracy: Plus or minus 3% on resistance values up to 100,000 megohms; plus or minus 5% from 100,000 to 2,000,000 megohms.

Voltages on Unknown: The voltage applied to the unknown terminals is 500 volts D.C. and is independent (less than 1%) of the value of the unknown.

Stability: Line voltage variations from 105-125 volts will cause less than 2% variation in the meter reading.

Power Supply: 105-125 volts A.C. 50-60 cycles 30 watts.

Dimensions: 9 1/2 x 10 1/2 x 8 inches.

Net Weight: 18 pounds.

TYPE 1620 MEGOHMMETER



CONTROLS

1. Range selector and calibrating switch.
2. Zero adjust control for setting meter scale to infinity.
3. Push button switch for activating the relay which applies test voltage to terminals — when released, discharges capacitive component across the unknown terminals.
4. Variable D.C. adjust — for setting the D.C. test voltage at desired level.
5. A.C. on-off switch.

DESCRIPTION

The instrument is a direct-reading, precision-balanced electronic ohmmeter with a variable D.C. test potential included as part of the unit. The D.C. test potential is variable from 50 to 1000 volts and is indicated by a four inch meter.

The insulation resistance is measured in six overlapping ranges and is indicated by a four inch meter, protected against overload. A relay, operated from the front panel, disconnects the high voltage from the test terminals and eliminates all danger of shock due to exposed high potential. In the standby position (when push button is released) a resistance is connected between the chassis and the high voltage terminal, so that when measuring capacitors the danger of shock is eliminated when disconnecting the component under test.

SPECIFICATIONS

Range: .5 megohms to 4,000,000 megohms in six overlapping ranges selected by a multiplier switch.

Accuracy: Plus or minus 5%.

Voltages on Unknown: The voltage applied to the unknown terminals is continuously variable from 50 volts to 1000 volts. A 4" meter indicates the voltage applied to the unknown.

Terminals: Four terminals are provided, two for connecting the unknown, one guard and one ground.

Power Supply: 105-125 volts A.C. — 50-60 cycles.

Cabinet: 15" x 9" x 7 1/2".

FREED Test Instruments

TYPE 1010-A COMPARISON AND LIMIT BRIDGE

USES

This instrument is a comparison and limit bridge for use in both laboratory and production testing of resistors, condensers and inductors. The manufacturer of these components can use it for production tests, the user for incoming inspection and acceptance tests. The instrument is particularly useful for laboratory work (bridge or filters) where very accurate components are required.

FEATURES

For precision and production testing, the bridge has many advantages. Power line operation and the visual indicator make the instrument completely self-contained. It can be used in noisy locations. Its small size and light weight permit the instrument to be moved easily and to be set up wherever necessary.

DESCRIPTION

The instrument is composed of an oscillator, a bridge and a selective amplifier. The oscillator output is coupled into the bridge through a shielded isolation transformer. A switch is provided which connects either a high or low impedance winding across the bridge, consisting of two fixed resistors, the unknown impedance and the standard. A variable resistor between the two fixed resistors makes it possible to read the percentage difference between the unknown and the standard on a specially calibrated dial. A high gain selective amplifier indicates the balance of the bridge. The general method of testing is the comparison of an unknown component with a standard component of the same type. Accurate percentage measurements are obtained by the use of precision components in the arms of the bridge. The use of a high gain amplifier and adequate internal shielding assures a very sharp and distinct balance.

A visual null indicator, consisting of a meter used in connection with the high gain amplifier makes it possible to use the No. 1010-A Bridge as a precision limit bridge in production testing.



SPECIFICATIONS

Frequency: Three test frequencies are available: 50 or 60 cycles, 1000 cycles and 10,000 cycles.

The 50 or 60 cycles are taken from the line. The 1000 and 10,000 cycles are generated by an oscillator and are accurate to within $\pm 2\%$.

Range: Two comparison ranges are provided, 5% and 20%. The percentage difference is read directly on a calibrated dial.

Resistor Measurements: Resistors from 1 ohm to 20 megohms may be compared at 60 cycles to an accuracy of $\pm 0.1\%$.

Condenser Measurements: Condensers from 50 mmfd to 10 mfd are measured at 1000 cycles. Condensers above 10 mfd are measured at 60 cycles. Condensers below 50 mmfd may be measured if the ground-unground switch is in the unground position.

Inductor Measurements: Inductors may be measured at 60, 1000 or 10,000 cycles depending on their value. Range: 10 microhenries to 1000 henries.

Accuracy: On the 5% position the components can be adjusted to within an accuracy of $\pm 0.1\%$.

Voltage Applied to the Unknown: Two controls are provided to vary the voltage across the unknown. A special low impedance winding is used when measuring small impedances and the voltage across these may be varied from .1 to 1 volts. For higher values of impedance the voltage may be varied from .5 to 15 volts.

Power Supply: 105-125 volts; 50-60 cycles.

Portable: Carrying cabinet of all metal construction.

Dimensions: $10\frac{1}{2}$ " x 12" x 12".

Net Weight: 17 lbs.

TYPE 1870 INCREMENTAL INDUCTANCE COMPARISON BRIDGE

USES

The Freed Type 1870 is designed for rapid production testing of transformers and chokes under actual operating conditions.

The unit consists of a variable D.C. Supply (0 to 500 ma) a 60 cps. variable supply (0 to 135 volts) a comparison circuit and a vacuum tube voltmeter.

SPECIFICATIONS

Inductance Range: 25 mh to 25 h.

Deviation Range: $\pm 20\%$ with an accuracy of 1%. $\pm 50\%$ with an accuracy of 5%.

Frequency: The line frequency is used for most measurements. If another frequency is desired a jack is provided for connecting an external oscillator.

Voltage Applied to Unknown: Variable from 0 to 135 volts.

D.C. Current Range: 0 to 500 ma in four overlapping ranges, 0-5 ma, 0-25 ma, 0-100 ma, 0-500 ma.

Vacuum Tube Voltmeter: .01, .1, 1, 10, and 100 volts full scale.

Power Supply: The instrument is entirely self contained and operates on 100-125 volts, 50-60 cycles.

Dimensions: $19\frac{1}{2}$ " high x 22" wide x 15" deep.



FREED Test Instruments

TYPE 1110-A INCREMENTAL INDUCTANCE BRIDGE

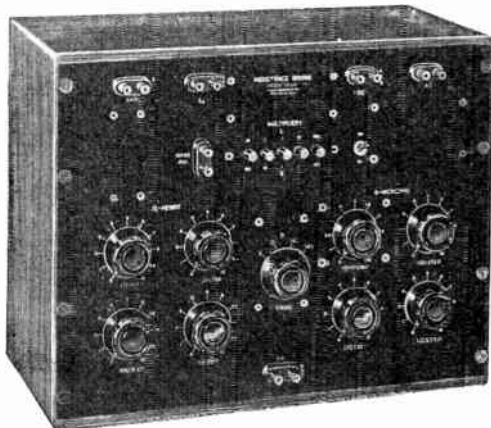

Frequency Range: The bridge is calibrated and adjusted at both 60 and 1000 cycles, but can be used at any frequency up to 10,000 cycles. Errors resulting from stray capacity increase with frequency. A compensated bridge with lower stray capacities is available for making more accurate inductance measurements of large inductors at higher frequencies. Order Freed Model 1110A-B.

Range of Superimposed D.C.: On multiplier switch position L X 100 the D.C. is limited to 10 ma.

USES

The Incremental Inductance Bridge is designed for measuring the inductance of Iron Core components at any frequency up to 10,000 cycles. Inductors can be measured with a superimposed direct current, therefore, the bridge will measure the incremental inductance of coils. The bridge can be used for determination of storage factor, "Q", either at a given frequency in function of the applied voltage or at a given voltage in function of the applied frequency. The bridge can be used by the manufacturers of iron core components, such as filter chokes, high Q coils, and iron core audio and supersonic frequency components. Due to its very wide inductance range the instrument can be used as a general purpose laboratory inductance bridge.

SPECIFICATIONS

Inductance Ranges: One millihenry to one thousand henries in five ranges. Inductance values are read directly from a four dial decade and a multiplier switch. The last range may be extended to 10,000 henries through the use of an external resistance.

Conductance Ranges: One micromho to one mho in five ranges, read directly from a four dial decade and a multiplier switch. This conductance represents the reciprocal of the A.C. resistance of the coil.

"Q" Range: "Q" is measured as the product of Inductance (L), Frequency (W) and Conductance (G). The range of "Q" measured on the bridge is 0.5 to 100. Measurement of inductance is independent of the values of "Q".

Accuracy: 1% through the frequency range from 60-1000 cycles 2% for frequencies from 1000 to 10,000 cycles. This accuracy is decreased for extreme positions of the multiplier. Conductance measurements 5% from 60-1000 cycles.

On the position L X 10, the D.C. is limited to 250 ma.

Inductors up to 11 Henries may be measured with 1. Amp DC through them.

Mounting: The bridge is supplied in a walnut cabinet or on special order for standard rack mounting.

Dimensions: Rack: 19" Wide x 8" Deep x 14" High.
Cabinet: 21" Wide x 8" Deep x 16 1/2" High.

Net Weight: Rack: 37 lbs. Cabinet: 48 lbs.

TYPE 1150 UNIVERSAL BRIDGE

FEATURES

The Universal Bridge offers a variety of five possible bridge circuits. A wide range of capacitance, inductance, impedance, and phase angle measurement can be made throughout the frequency spectrum from 20 cycles to 20,000 cycles.

Decade resistors in the variable arms allow the unknown to be measured to four significant figures.

Operation is simple and both terminals and controls are arranged for convenience and ease of measurements.

SPECIFICATIONS

Frequency Range: The bridge can be used at frequencies from 20 cycles to 20,000 cycles.

Accuracy: All resistors of the bridge arms are adjusted to 0.1%. The absolute accuracy of measurement will depend upon the accuracy of standards used.

Inductance Range: The bridge will measure inductance of coils from 0.1 mh to 1000 henries with an accuracy of 0.5% at 1000 cycles.

Capacitance Range: Condensers from .001 mf to 1 mf can be measured to within 0.5% at 1000 cycles. Condensers below .001 mf should be measured by the substitution method.

Mounting: The bridge is supplied in a walnut cabinet or on special order for standard rack mounting.

Dimensions: Rack: 19" Wide x 8" Deep x 14" High.
Cabinet: 21" Wide x 8" Deep x 16 1/2" High.

Weight: Rack: 32 lbs. Cabinet: 43 lbs.

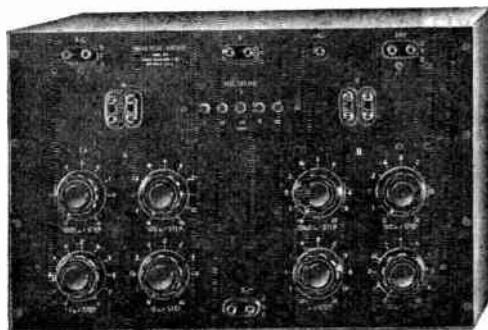

TYPE 1180 A.C. SUPPLY

A valuable laboratory instrument with continuously variable output from 1/10 volt to 100 volts at 60 cycles.

Dimensions: 19" Wide x 5" Deep x 7" High.

Weight: 13 1/2 lbs.



FREED Test Instruments

TYPE NO. 1170 D.C. SUPPLY

USES

The Type 1170 Power Supply is intended to be used as a dependable source of direct current for the Incremental Inductance Bridge Type No. 1110-A. The supply can also be used as a general laboratory substitute for a high voltage storage battery.

DESCRIPTION

The Type 1170 D.C. supply consists of an electronically regulated high voltage supply. Four independent control circuits provide four current ranges, namely 5 milliamperes, 25 milliamperes, 100 milliamperes and 500 milliamperes. The output current is indicated by a multirange 4" meter.

SPECIFICATIONS

Current Ranges: Four current ranges — 5, 25, 100 and 500 milliamperes.
Voltage Ranges: The maximum no load voltages corresponding to the four current ranges are the following: 500 MA — 270 volts, 100 MA — 270 volts, 25 MA — 55 volts, 5 MA — 25 volts. On both 500 MA and 100 MA range with the control set to zero, the output voltage is independent of the load.
Voltage Regulation: The unit operates from a 115 volts, 50-60 cycle line. For a line variation of plus or minus 10%, the output voltage shall not vary more than $\pm 1\frac{1}{2}\%$.
Power Consumption: Under 500 MA full load the power consumption is 360 watts. Under no load conditions the consumption is 150 watts.
Hum Level: On the 270 volt, 500 milliampere range the hum level under full load condition is 6 millivolts which corresponds to -93 Db.



Mounting: The instrument is supplied for mounting on a 19-inch relay rack or for cabinet mounting.
Dimensions: Rack: 19" Wide x 12 $\frac{1}{2}$ " Deep x 12 $\frac{1}{4}$ " High. Cabinet: 21 $\frac{1}{2}$ " Wide x 15" Deep x 14" High.
Net Weight: Rack Mounted 68 lbs. In Cabinet 89 lbs.

TYPE 1210-A NULL DETECTOR AND VACUUM TUBE VOLTMETER

USES

The Type 1210-A Null Detector and Vacuum Tube Voltmeter is primarily designed for bridge measurements. The Null Detector indicates the balance of the bridge, and the Vacuum Tube Voltmeter indicates the voltage across the unknown two terminal or four terminal network. The three selective circuits provide means for sharply tuning the instrument to audio frequencies commonly used for measurements. The Vacuum Tube Voltmeter can be used as a general purpose audio Vacuum Tube Voltmeter.

DESCRIPTION

The Type 1210-A Null Detector and Vacuum Tube Voltmeter is a combination of the Model 1140 Null Detector Amplifier, and a modified Model 1060 high input impedance Vacuum Tube Voltmeter. Both instruments are independent and feed two separate 4" meters.

SPECIFICATIONS

NULL DETECTOR
Input Impedance: 1 megohm in parallel with 25 mmf.
Frequency Response: 2 db from 20 to 20,000 cycles — 5 db at 50,000 cycles with filter switch in "out" position.
Null Detector Sensitivity: At 1000 cycles, 100 microvolts will give a 15% meter deflection.
Selective Amplifier: 26 db second harmonic attenuation at 60, 400 and 1000 cycles. Selectivity at any other frequency between 20 cycles and 20 kc. may be obtained by connecting Freed Model 1940 to the external filter jack.
VACUUM TUBE VOLTMETER
Voltage Range: .01 volts to 100 volts in four ranges — (0.1, 1, 10, 100 volts at full scale).

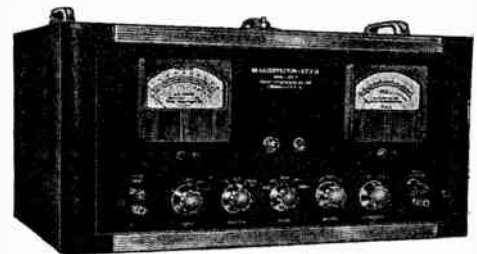

Waveform Error: The instrument is a full wave average meter and is free of turnover effects. For small amounts of distortion the accuracy of the instrument is independent of the waveform.
Frequency Range: 20 cycles to 200,000 cycles (1 db).
Input Impedance: Equivalent to 50 megohms resistance in parallel with a 25 mmf condenser.
Meter Scale: Logarithmic Voltage Scale calibrated from 1 to 10 plus a linear db scale calibrated from 0 to 20 db.
Dimensions: Rack Mounting 19" x 9" x 11 $\frac{1}{2}$ " — 25 lbs. In cabinet 21" x 15" x 13" — 37 lbs.

TYPE 1140-A NULL DETECTOR-AMPLIFIER

USES

The Freed Model 1140-A Null Detector Amplifier is a sensitive null indicator for bridge measurements, providing visual null indications or aural when used in conjunction with headphones. The unit may also be used as a high gain amplifier for general laboratory work.

DESCRIPTION

Functionally the instrument consists of a high gain linear amplifier with a 30 db. input attenuator in addition to the variable gain control. A four-inch panel meter provides visual null indications, the response of the meter circuit is approximately logarithmic over a 40 db. voltage range. Resonant circuits tuned to 60, 400 and 1000 cycles limit the amplifier transmission characteristics to the three audio frequencies commonly used for bridge measurements or it may be used as a non-selective amplifier with filter "off."

SPECIFICATIONS

Input Impedance: 1 megohm in parallel with 25 mmf. **GAIN:** 98 db. with 1 megohm load (6 mmf. shunt capacity), down 1.5 db. at 25,000 cycles, down 5 db. at 50,000 cycles, down 2 db. at 20 cycles.

Null Detector Sensitivity: At 1 kc. 100 microvolts will give a 15% meter deflection.

Selective Amplifier: 26 db. second harmonic attenuation at 60, 400 and 1000 cycles. Selectivity at any other frequency between 20 cycles and 20 kc. may be obtained by connecting Freed Model 1940 to the external filter jack.

Output Impedance: Approximately 50,000 ohms.



Output Voltage: 40 volts undistorted into 1 megohm load, 10 volts into 20,000 ohms.
Power Supply: 105-125 volts, 50-60 cycles, 35 watts consumption.
Mounting: This instrument can be supplied in cabinet model (Type No. 1140-A) or in a standard relay rack mount with dust cover (Type No. 1140-AR).
Dimensions: (Type No. 1140-A) 13 $\frac{1}{2}$ " x 8 $\frac{1}{2}$ " x 10" overall (Type No. 1140-AR) 19" L. x 8 $\frac{1}{4}$ " W. x 9" D.
Weight: 24 lbs.

FREED Test Instruments

TYPE 1040 A.C.-V.T. VOLTMETER



USES

The type 1040 Vacuum Tube Voltmeter is a high impedance wide frequency range voltmeter which can be used at audio and supersonic frequencies. It is particularly recommended for (1) vibration studies involving very low frequencies, (2) frequency characteristics and gain measurements on amplifiers, (3) transmission losses on telephone circuits: filter and carrier systems up to 250,000 cycles, and (4) acoustic measurements, such as, determination of frequency response of microphones and loudspeakers. Because of the high sensitivity of the instrument, the voltmeter can be advantageously used as a null detector in A.C. bridge measurements. In addition to its use as a voltmeter, the instrument can be used as an ammeter to measure a wide range of currents by connecting it across suitable resistors. An output jack is provided so that the instrument may be used as an amplifier.

FEATURES

Because of the low input capacity, a high value of input impedance is maintained over the five ranges of the voltmeter. A balanced rectifier, a balanced D.C. amplifier circuit, and a high amount of degeneration throughout the amplifier makes it independent of line voltage variations and changes in tube characteristics. A very important feature of the instrument is the logarithmic voltage scale of the meter. With this type of scale, the percentage accuracy of reading is uniform over the entire scale. Another advantage of the logarithmic scale is that it provides a uniform decibel scale which is a very valuable feature in sound and communication measurements. A zero adjustment and full scale adjustment are provided. These two controls serve for all ranges and no re-setting is necessary when switching from one range to another. The time constant of the instrument is adjusted in order to read very low frequencies of 7 to 10 cycles without any vibration of the needle. The circuit of the meter is arranged so that it cannot be burned out by any overload of the instrument. The vacuum tube voltmeter is small, compact, entirely self-contained, A.C. operated.

frequencies of 7 to 10 cycles without any vibration of the needle. The circuit of the meter is arranged so that it cannot be burned out by any overload of the instrument. The vacuum tube voltmeter is small, compact, entirely self-contained, A.C. operated.

SPECIFICATIONS

Voltage Ranges: .001 volts to 100 volts in five ranges (0.01, 0.1, 1.0, 10 and 100 volts full scale).

Accuracy: 2% of full scale on all five ranges, on sinusoidal voltages.

Waveform Error: The instrument is a peak voltmeter calibrated to read RMS values. On distorted wave-forms, the percentage deviation of the reading from RMS values may be as large as the percentage of the harmonics present.

Frequency Ranges: 10 to 250,000 cycles, .1 db. variation from 20 cycles to 150,000 cycles; .50 db. variation from 10 cycles to 250,000 cycles.

Input Impedance: Equivalent to 500,000 ohm resistance in parallel with a 15 mmf. condenser.

Stability: Effect of variation in line voltage from 100 volts to 125 volts is 1%. Effect in changes of tubes is less than .5%.

Scale: Logarithmic voltage scale calibrated from 1 to 10 plus a linear decibel scale calibrated from 0 db. to 20 db.

Meter: 4" suppressed zero 1 MA meter protected against overloads.

Power Supply: The instrument is entirely self-contained and operates on 100-125 volts, 50-60 cycles. Total consumption, 40 Watts.

Dimensions: 4 1/2" x 5 1/2" x 9 1/2".

Weight: 12 pounds.

TYPE 1060 VACUUM TUBE VOLTMETER

USES

The Type 1060 Vacuum Tube Voltmeter is a high impedance, wide frequency range voltmeter which can be used at audio and supersonic frequencies. It is particularly recommended for

1. Determining transmission losses on — telephone circuits, filter and carrier systems up to 300,000.
2. Making high impedance tuned circuit measurements where the high input resistance and low capacity are invaluable.
3. Determining frequency characteristics and making gain measurements on amplifiers.
4. Making acoustic measurements, such as, determination of frequency response of microphones and loudspeakers.
5. Observing vibration studies involving very low frequencies.

Because of the high sensitivity of the instrument, the voltmeter can be advantageously used as a Null Detector in A.C. bridge measurements. In addition to its use as a voltmeter, the instrument can be used as an ammeter to measure a wide range of currents, by connecting it across suitable resistors.

FEATURES

Because of the low input capacity, a high value of the input impedance is maintained over the five ranges of the voltmeter. A high amount of degeneration throughout the amplifier makes it independent of line voltage variations and changes in tube characteristics. A very important feature of the instrument is the logarithmic voltage scale of the meter. With this type of scale, the percentage accuracy of reading is uniform over the entire scale. Another advantage of the logarithmic scale is that it provides a uniform decibel scale, which is a very valuable feature in sound and communication measurements. A full scale adjustment is provided. This control serves for all ranges and no re-setting is necessary when switching from one range to another. The time constant of the instrument is adjusted in order to read very low frequencies of 7 to 10 cycles without any vibration of the needle.



SPECIFICATIONS

Voltage Ranges: .001 volts to 100 volts in five ranges (.01, .1, 1, 10 and 100 volts full scale).

Waveform Error: The instrument is a full wave average meter, and is free of turnover effects. For small amounts of distortion the accuracy of the instrument is independent of the waveform.

Frequency Range: 20 cycles to 300,000 cycles.

.1 db variation from 20 to 200,000 cycles.

.5 db variation from 10 to 300,000 cycles.

Input Impedance: Equivalent to 50 megohms resistance in parallel with a 15 mmfd condenser.

Stability: Effect of variation in line voltage from 100 volts to 125 volts is less than 2%. Effect in changes of tubes is less than 1/2%.

Dimensions: 11" x 8" x 8".

REED Test Instruments

TYPE 1560 DIFFERENTIAL VOLTMETER

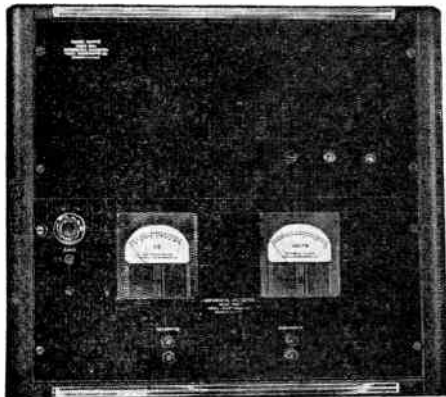

USES

The Freed Type 1560 difference voltmeter has been designed to measure difference in voltage levels as low as 0.1 db. It is extremely useful when checking response and attenuation of filters, transformers and amplifiers. Because of its excellent stability and high sensitivity the type 1560 difference voltmeter may also be used to observe drift in amplifiers meters and filters.

SPECIFICATIONS

Difference Voltage: 0.01 db. to 1 db., 0.1 db., 1 db. full scale.

Accuracy: .01 db.

Frequency Range: 30 cps to 200,000 cps.

Input Impedance: 1 megohm.

Reference Voltage: 2 volts monitored by vacuum tube volt meter on 4" meter scale.

Scale: Calibrated in db. 4" meter protected against overload.

Power Supply: The instrument operates from a 100 to 125 volt 50 to 60 cycle line.

TYPE 1580 DB DECADE AMPLIFIER

USES

The Freed Type 1580 DB Decade Voltmeter is intended to be used as a dependable means of measuring transformer turns ratio, and transformer, filter or amplifier attenuation. These measurements may be made to an accuracy of .1 db.

DESCRIPTION

Functionally, the instrument consists of a high impedance input cathode follower, a precision 6-step attenuator, a preamplifier, three db decade attenuators (10 db/step, 1 db/step and 0.1 db/step). A high amount of degeneration throughout the amplifier makes it independent of line voltage variations and changes in tube characteristics. The 4" meter is protected against overload.

SPECIFICATIONS

Voltage Ranges: 0.001 to 100 volts in five ranges (0.01, 0.1, 1, 10 and 100 volts full scale).

Accuracy: 2% of full scale on all ranges

Waveform Error: The instrument is a full wave average meter and is free of turnover effects.

Frequency Range: 20 cycles to 200,000 cycles.

Input Impedance: Equivalent to 50 megohms resistance in parallel with 25 mmfd condenser.

Meter: 4" meter protected against overload.

DB Attenuators: Three ten position db attenuators (10 db/step, 1 db/step and 0.1 db/step).

Dimensions: 11" x 12" x 10 1/2".



TYPE 1570 DIRECT READING COMPARISON BRIDGE

USES

The Type 1570 is a direct reading comparison bridge which may be used to compare a wide range of inductors. The per cent difference between the standard and unknown component is indicated quickly and accurately on a 5" meter. The instrument may be calibrated to indicate inductance directly.

Two deviation ranges are provided; $\pm 5\%$ and $\pm 20\%$. On the 5% range, units can be compared to an accuracy of $\pm 0.1\%$.

DESCRIPTION

For precision and production testing the direct reading comparison bridge has many advantages. The unit is entirely self contained and A.C. operated. By providing a minimum of operating controls the unit has been designed to be used by even the most inexperienced operators. The per cent deviation is indicated quickly and accurately on a 5" meter.

SPECIFICATIONS

Deviation Range: $\pm 5\%$ and $\pm 20\%$ indicated on a 5" meter.

Accuracy: $\pm 0.1\%$.

Test Frequency: 1000 cycles.

Inductance Range: 1 mh to 10 h.



FREED Test Instruments

TYPE 1940 INTERSTAGE FILTER

USES

This filter may be used with the Freed Type 1140-A Null Detector and Type 1210-A Null Detector VTVM or similar amplifiers. It can be set to any one of 7 fixed frequencies to reduce noise and harmonics when making bridge measurements.

DESCRIPTION

The filters are parallel resonant circuits, and are designed to be used in the plate circuit of the amplifier. D.C. current through the inductor is limited to 3 ma. Terminals are provided for connecting an external capacitor to tune to any frequency between 50 cps and 20 kc.

FEATURES

1. Each of 7 tuned frequencies is quickly available.
2. Any resonant frequency between 50 cps and 20 kc can be obtained with external capacitors.
3. Sharp anti resonant tuning.
4. Can be used directly in plate circuit.

SPECIFICATIONS

Frequencies: 100 cps, 200 cps, 500 cps, 800 cps, 1200 cps, 2000 cps and 10 kc adjusted to an accuracy of $\pm 2\%$.
Discrimination vs. 2nd harmonic approximately 23 db.
Terminals: Shielded cord and plug for connection to null detector.
Binding posts for connecting external capacitors.
Dimensions: 6" x 6" x 6".



SERIES 1950 NULL "T" FILTERS

The Freed Series 1950 Null T networks consist of two resistance capacitance networks, whose outputs completely cancel each other at the balance frequency. They may be used as rejection networks particularly at low frequencies where LC filters become excessively large.

Standard models are available for 30, 60 and 120 cycles in a wide range of impedances. Each network will give a minimum of 50 db attenuation of the null frequency.

The null frequency is adjusted to a tolerance of $\pm 2\%$.



TYPE 1410 DISTORTION METER

USES

The Type 1410 Distortion Meter may be used in the laboratory or in production testing of receivers, amplifiers and oscillators.

DESCRIPTION

The instrument consists of a capacitive input attenuator, a low impedance output preamplifier, a null T network and a high gain vacuum tube voltmeter.

The signal to be measured is applied to the capacitive input attenuator, which reduces it sufficiently so that it may be fed into a three stage distortionless amplifier. The output impedance of this amplifier is 1 ohm due to the high amount of inverse feedback applied. In order to prevent the amplifier from being driven into non-linearity, a monitoring circuit is included in the instrument.

The attenuated signal is fed into a null T network which completely eliminates the fundamental. The residual signal consists wholly of harmonics and noise, and this is measured by the vacuum tube voltmeter.

The null T network is now switched out of the circuit and the signal level is attenuated by a calibrated resistive divider. When the voltmeter indicates the same level as the level of harmonics, the divider reads the percentage distortion directly.

FEATURES

The high sensitivity of the instrument permits measurements to be made on signals as low as 0.2 volts to an accuracy of 0.1%. Signals as high as 1000 volts may be applied to the input terminals directly.

The frequency range of the instrument is 20 kc to 1 mc. in 10 overlapping ranges. Frequencies up to 3 mc. are passed without attenuation by the amplifier circuits, so that distortion measurements can be made on fundamental frequencies up to 1 mc.

An isolation transformer and line filter provided with the instrument prevent any feedback through the power line.

SPECIFICATIONS

Frequency Range: 20 kc to 1 mc.

Input Impedance: 500,000 ohms shunted by 70 mmfd. (plus capacity of input cable) on all ranges but the 0.1 volt range. The shunt capacity on this range is 800 mmfd.

Accuracy: Harmonic Distortion can be measured accurately to 0.1%.

Sensitivity: Distortion levels of 0.1% can be read accurately for a signal input as low as 0.2 volts. Maximum input signal is 1000 volts rms.

Elimination Characteristics: Eliminates fundamental completely while attenuating second harmonic approximately 3%.

Power Supply: 105-125 volts, 50-60 cycles.

Dimensions: 19 3/4" x 16 3/4" x 15 3/4".

Net Weight: 60 pounds.

FREED Test Instruments

FREED DECADE CAPACITORS

Freed decade capacitors are high quality capacitors designed for use in wave filters, tuned circuits and equalizers for audio and supersonic frequencies where a rather large variable capacitance is desired. Their stability, accuracy and low dissipation factor make them especially useful during the preliminary design period when capacitance values are determined experimentally.

Each decade is variable from 0 to 10 by use of 11 position selector switch. The losses in the switches and mountings are kept low by the use of special low loss, impregnated switch wafers. A positive detent mechanism allows the switch to be set accurately. The accuracy is $\pm 1\%$ at frequency of 1 kc.

No. 1415 is a 1 mfd/step mylar capacitor. Total capacitance 10 mfd.

No. 1416 is a 0.1 mfd/step polystyrene capacitor. Total capacitance is 1 mfd.

No. 1417 is a .01 mfd/step polystyrene capacitor. Total capacitance is 0.1 mfd.

No. 1418 is a .001 mfd/step polystyrene capacitor. Total capacitance is .01 mfd.

No. 1419 is a 100 mmfd/step mica capacitor. Total capacitance is .001 mfd.

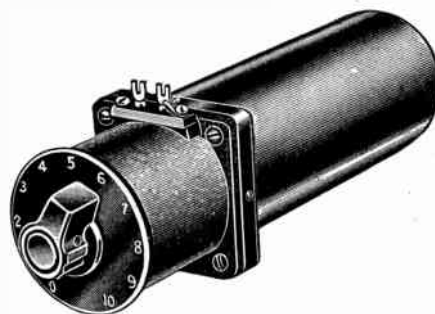

No. 1415 No. 1416 No. 1417
 No. 1418 No. 1419

No. 1250 is a three section decade capacitor. The type 1416, 1417 and 1418 are assembled together in a single wooden cabinet to give a total capacity of 1.110 mfd in .001 mfd steps.



No. 1250

No. 1350 is a five section decade capacitor. The type 1415, 1416, 1417 and 1418 are mounted on one panel with a 1000 mmfd precision air variable condenser.

No. 1351 is a six section decade capacitor. The type 1415, 1416, 1417, 1418 and 1419 are mounted on one panel with a 100 mmfd precision variable condenser. The 100 mmfd may be used singly in which case the stray capacity is less than 10 mmfd or it may be used in conjunction with the other decades by simply closing a shorting link.

The capacity is continuously variable from 10 mmfd to 11.11 mfd in 100 mmfd steps with $\pm 1\%$ accuracy.

The maximum voltage that may be applied to these decades is 500 D.C. working volts.

The dissipation factor of the polystyrene units when measured at 1 kc. is less than .0002. The dissipation factor of the 1 mfd/step decade (mylar) is less than .005.



No. 1350

No. 1351

FREED Test Instruments

FREED DECADE INDUCTORS

Primarily designed for use in wave filters, tuned circuits and equalizers for audio and supersonic frequencies. The stability, accuracy and high value of "Q" makes these Decade Inductors invaluable laboratory instruments.

FREQUENCY RANGE 30 TO 2000 CYCLES
Q=50 @ 200 CYCLES

‡*Type 1164 Decade Inductor — 111 Henry total in steps of .1 Henry.

FREQUENCY RANGE 100 TO 2000 CYCLES
Q=80 @ 500 CYCLES

†Type 1341 Decade Inductor — 100 Henry total in steps of 10 Henry.

FREQUENCY RANGE 500 TO 20,000 CYCLES
Q=60 @ 1000 CYCLES

‡Type 1160 Decade Inductor — 11.1 Henry total in steps of 0.01 Henry.
 ‡Type 1163 Decade Inductor — 1.11 Henry total in steps of 0.001 Henry.
 ‡Type 1260 Decade Inductor — 11.11 Henry total in steps of 0.001 Henry.

FREQUENCY RANGE 500 TO 20,000 CYCLES
Q=160 @ 1000 CYCLES

†Type 1220 Decade Inductor — 0.01 Henry total in steps of 0.001 Henry.
 †Type 1230 Decade Inductor — 0.1 Henry total in steps of 0.01 Henry.
 †Type 1240 Decade Inductor — 1 Henry total in steps of 0.1 Henry.
 †Type 1270 Decade Inductor — 10 Henry total in steps of 1 Henry.
 †Type 1280 Decade Inductor — 1.11 Henry total in steps of 0.001 Henry.
 †Type 1290 Decade Inductor — 11.11 Henry total in steps of 0.001 Henry.
 †Type 1310 Decade Inductor — 11.1 Henry total in steps of 0.01 Henry.

FREQUENCY RANGE 500 TO 50,000 CYCLES
Q=200 @ 10,000 CYCLES

†Type 1161 Decade Inductor — 1.11 Henry total in steps of .001 Henry.

FREQUENCY RANGE 10,000 TO 300,000 CYCLES
Q=200 @ 100,000 CYCLES

†Type 1162 Decade Inductor — 0.111 Henry total in steps of .1 Millihenry.

ACCURACY OF INDUCTANCE

Inductance per Step	1 mh	10 mh	100 mh	1 h
Accuracy	±2%	±1%	±0.5%	±0.25%

*Type 1164 Decade Inductor is wound on a special nickel alloy core.
 †Single Decade Unit. ‡Three Decade Unit. ‡‡Four Decade Unit.

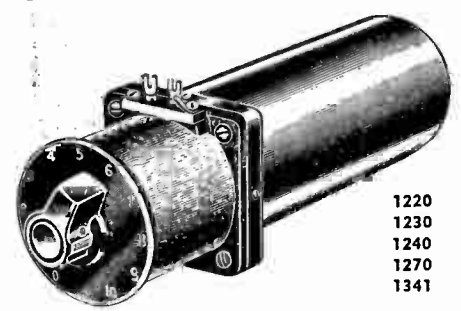

1220
1230
1240
1270
1341

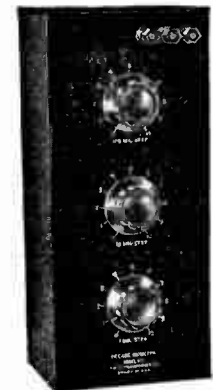

1160
1161
1162
1163
1164
1280
1310

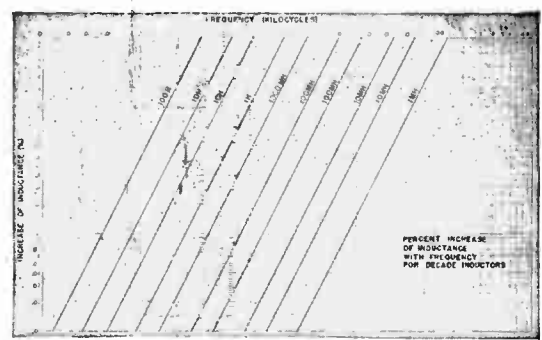
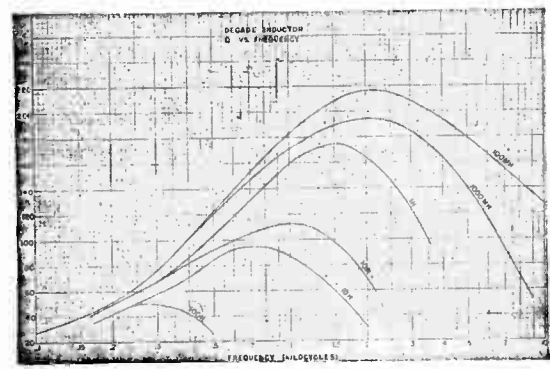

TYPE 1905 WIDE-BAND AMPLIFIER



This amplifier is particularly valuable for filter work where the output of the test oscillator is inadequate for the required signal levels. It is extremely stable and will deliver 15 volts to a 600 ohm load at very low distortion over a wide range of frequencies.

SPECIFICATIONS

Frequency Response: 10 cycles to 3.5 Mc. ± 1 db.
 20 cycles to 2.5 Mc. ± 5 db.
Output Voltage: 10 volts across 600 ohm load.
 30 volts across 10,000 ohm load.
Distortion: Less than .2% total harmonic at rated output.
Voltage Gain: 15 db.
Source Impedance: 600 ohm.
Load Impedance: 600 ohm minimum.
Power Supply: Self-contained, 105-125 volts, 50-60 cycle input.
Dimensions: 5 1/2" x 9 3/4" x 4 3/4".

FREED Test Instruments

FREED MAGNETIC A.C. VOLTAGE REGULATORS AND D.C. VOLTAGE REGULATED SUPPLIES

The Freed 2000 Series Magnetic Voltage Regulators and Supplies are designed for laboratory and production applications where exacting voltage control with high reliability and instantaneous correction is required.

Closely regulated voltages over a wide range of line and load variations are provided. The exceptional performance of the regulators and supplies is achieved without the use of vacuum tubes or moving parts.

Additional features include high accuracy panel-mounted output voltmeters, double fuse protection, and dual output sockets. For ease of operation, voltage controls, output sockets and fuses are mounted on the front panel.



Units are furnished in attractive black wrinkle finish steel cabinets or for rack mounting.

AC MAGNETIC VOLTAGE REGULATORS SPECIFICATIONS

Nominal Output Voltage and Frequency	Input* Voltage Range	Adjustable Output Voltage Range	Load Range in Amperes	Rated Output KVA	Type No.	
115V., 60 cps.	95-135AC	110-120AC	0- 2.2AC	0.25	2102-6	Regulation Accuracy= $\pm 0.1\%$ Distortion=3% max. P.F. Range=down to 0.7 lagging Time Constant=0.1 sec. max.
115V., 60 cps.	95-135	110-120	0- 4.5	0.50	2105-6	
115V., 60 cps.	95-135	110-120	0- 8.5	1.00	2110-6	
115V., 60 cps.	95-135	110-120	0-48.5	5.00	2150-6	
115V., 400 cps.	95-135AC	110-120AC	0- 2.2AC	0.25	2102-4	Regulation Accuracy= $\pm 0.1\%$ Distortion=3% max. P.F. Range= down to 0.7 lagging Time Constant=0.05 sec. max.
115V., 400 cps.	95-135	110-120	0- 8.5	1.00	2110-4	
115V., 400 cps.	95-135	110-120	0-48.5	5.00	2150-4	

*Units for operation from 230V. supply can be furnished.

MAGNETICALLY REGULATED DC SUPPLY SPECIFICATIONS

Power Input	Output Voltage Ranges	Output Current Ranges	Type No.	
105-125V 60 cps.	B+ 0-500V. DC Bias-0-150V. DC 6.3V. AC Unregulated	0-300 m.a. DC 0-5 m.a. DC 5 amps AC	2101-D	Regulation Accuracy: $\pm 0.5\%$ Ripple: 10 m.v. max. Time Constant: 0.1 sec.

HOW TO ORDER

Determine the line voltage and frequency and the characteristics of the load you wish to supply. Then refer to the appropriate section of the rating charts for a unit to meet your requirements.

If you cannot find a Freed Regulator which will meet your requirements, supply the following information when requesting quotations or recommendations:

1. Frequency, number of phases, input voltage range, nominal input voltage, voltage unbalance between phases.
2. Nominal output voltage, output voltage range, load current, load KVA, load unbalance, load fluctuation.
3. Frequency and severity of line and load transients.
4. Special features such as finish, mounting, ambient temperature range, corrosive atmospheres, speed of correction required.



Plant No. 1

Laboratory  Standards

MEASUREMENTS CORPORATION

Boonton, New Jersey



Copyright by U. C. P., Inc.

Radio's Master — 19th Edition

Page G-125



MEASUREMENTS CORPORATION

Laboratory Standards



The Model 82 provides extremely wide frequency coverage, designed for audio-frequency and radio-frequency measurements of AM, FM and TV receivers, and for many other applications.

STANDARD SIGNAL GENERATOR Model 82 20 Cycles - 50 Mc.

FREQUENCY RANGE: 20 cycles to 200 kilocycles in four ranges. 80 kilocycles to 50 megacycles in seven ranges, plus one blank range.

FREQUENCY ACCURACY: Each range is individually calibrated. 20 cycles to 200 kilocycles, accurate to $\pm 5\%$. 80 kilocycles to 50 megacycles, accurate to $\pm 1\%$.

OUTPUT VOLTAGE AND IMPEDANCE: 0-50 volts across 7500 ohms from 20 cycles to 200 kilocycles. (The output voltage and impedance in this range can be reduced by an external attenuator). 0.1 microvolt to 1 volt across 50 ohms over most of the range from 80 kilocycles to 50 megacycles.

MODULATION: Continuously variable 0-50% from 20 cycles to 20 kilocycles from internal variable oscillator or external source.

HARMONIC OUTPUT: Less than 1% from 20 cycles to 20 kilocycles; 3% or less from 20 kilocycles to 50 megacycles.

LEAKAGE AND STRAY FIELD: Less than 1 microvolt from 80 kilocycles to 50 megacycles.

POWER SUPPLY: 117 volts, 60 cycles. 75 watts.

DIMENSIONS: 15" high x 19" wide x 12" deep overall.

WEIGHT: 50 pounds.



The Model 80 is an extremely stable and accurate instrument for laboratory work and production testing. It is completely self-contained with built-in power supply and modulator.

STANDARD SIGNAL GENERATOR Model 80 2 Mc. - 400 Mc.

FREQUENCY RANGE: 2 to 400 megacycles in 6 bands, individually calibrated direct reading dial.

FREQUENCY ACCURACY: $\pm 0.5\%$.

OUTPUT VOLTAGE: Continuously variable from 0.1 to 100,000 microvolts.

OUTPUT IMPEDANCE: 50 ohms.

MODULATION: Amplitude modulation is continuously variable from 0 to 30%. Modulation depth is indicated by a meter on the panel. Internal modulation of 400 or 1000 cycles is available. Modulation may also be applied from an external source. Pulse modulation may be applied to the oscillator from an external source through a special connector.

LEAKAGE AND STRAY FIELD: Attenuator leakage less than 0.1 microvolt. Power line leakage less than 0.5 microvolt. Stray fields less than two microvolts.

POWER SUPPLY: 117 volts, 50 to 60 cycles. 70 watts.

DIMENSIONS: 11½" high x 19½" wide x 11½" deep, overall.

WEIGHT: 45 pounds.



PULSE GENERATOR • Model 79-B

The Model 79-B generates voltage pulses of variable width and frequency for use with associated equipment such as the Model 80 Standard Signal Generator.

FREQUENCY RANGE: 60 to 100,000 pulses per second.

PULSE WIDTH: Continuously variable from 0.5 to 40 microseconds.

OUTPUT VOLTAGE: Approximately 150 to 200 volts peak positive with respect to ground.

"SYNC" OUTPUT: 35 volts positive with respect to ground. Displaced by ½ period from pulse output.

"SYNC" INPUT: May be synchronized with as little as 2 volts peak from an external source.

POWER SUPPLY: 117 volts, 60 cycles. 115 watts.

DIMENSIONS: 10-13/16" high x 14½" wide x 11-9/16" deep, overall.

WEIGHT: Approximately 31 pounds.

MEASUREMENTS CORPORATION BOONTON • NEW JERSEY



MEASUREMENTS CORPORATION

Laboratory Standards

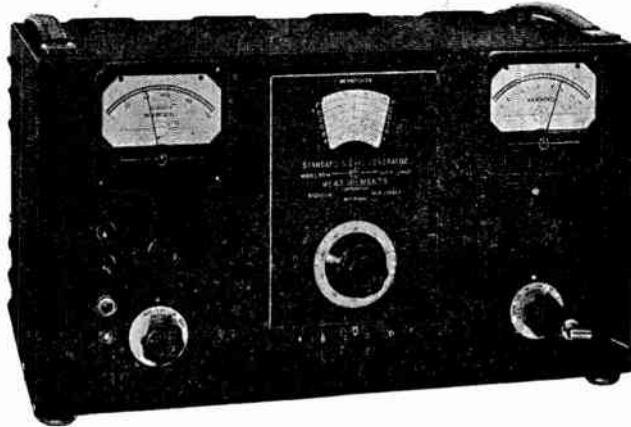

The Model 65-B provides accurate test signals for the measurement of the sensitivity, selectivity, overload, distortion, noise and stage gain characteristics. In design and operation, it meets the exacting requirements for laboratory use and production testing.

STANDARD SIGNAL GENERATOR Model 65-B 75 Kc. - 30 Mc.

FREQUENCY RANGE: 75 kilocycles to 30 megacycles in 6 push button ranges.

FREQUENCY CALIBRATION: Individually calibrated direct reading dial, for each range. Accurate to $\pm 0.5\%$.

OUTPUT VOLTAGE: Continuously variable from 0.1 microvolt to 2.2 volts.

OUTPUT IMPEDANCE: 5 ohms to 0.2 volt, rising to 15 ohms at 2.2 volts.

MODULATION: Continuously variable from 0 to 100%; indicated directly by a meter on the panel. Modulation may be obtained either from an internal source of 400 or 1000 cycles or from an external source.

ENVELOPE DISTORTION: 4% at 100% modulation at 1 megacycle; 8% at 100% modulation at 15 Mc; 1% at 30% modulation.

LEAKAGE: Less than 0.1 microvolt leakage with attenuator set for 0 output.

POWER SUPPLY: 117 volts, 60 cycles, 115 watts.

DIMENSIONS: 11 $\frac{7}{8}$ " high x 20-5/16" long x 10 $\frac{1}{2}$ " deep, overall.

WEIGHT: Approximately 55 pounds.



FM STANDARD SIGNAL GENERATOR Model 78-FM 86 Mc. - 108 Mc.

FREQUENCY RANGE: 86 to 108 megacycles, individually calibrated dial. Accurate to $\pm 0.5\%$.

OUTPUT VOLTAGE: Continuously variable from 1 to 100,000 microvolts.

LEAKAGE: Less than 1 microvolt.

MODULATION: 400 and 8200 cycle internal audio oscillator. Can be modulated from an external source providing 7 volts across 5000 ohms.

FIDELITY: Flat within two db from DC to 15,000 cycles. Distortion is less than 1% at 75 kilocycles deviation. Transient response is excellent.

POWER SUPPLY: 117 volts, 50 to 60 cycles, 36 watts.

DIMENSIONS: 10 $\frac{3}{4}$ " high x 14 $\frac{1}{4}$ " wide x 7 $\frac{1}{2}$ " deep, overall.

WEIGHT: Approximately 25 pounds.



I.F. CONVERTER • Model M-275

For use with the Model 78-FM Standard Signal Generator to provide carrier output at the IF frequencies used in FM and Television receivers.

FREQUENCIES: 4.5, 10.7, 21.7 Mc. Provision for one extra frequency.

OUTPUT VOLTAGE: 10 microvolts to 1.0 v. when used with Model 78-FM.

BAND WIDTH: ± 250 Kc. from center frequency.

AMPLITUDE MODULATION: Up to approximately 80%, combined with or exclusive of, FM. There is negligible spurious FM due to AM. The envelope distortion is less than 10% at 80% modulation.

POWER SUPPLY: 117 volts, 50 to 60 cycles, 45 watts.

DIMENSIONS: 10" high x 13" wide x 7" deep, overall.

WEIGHT: 15 pounds.

MEASUREMENTS CORPORATION

BOONTON • NEW JERSEY



MEASUREMENTS CORPORATION

Laboratory Standards

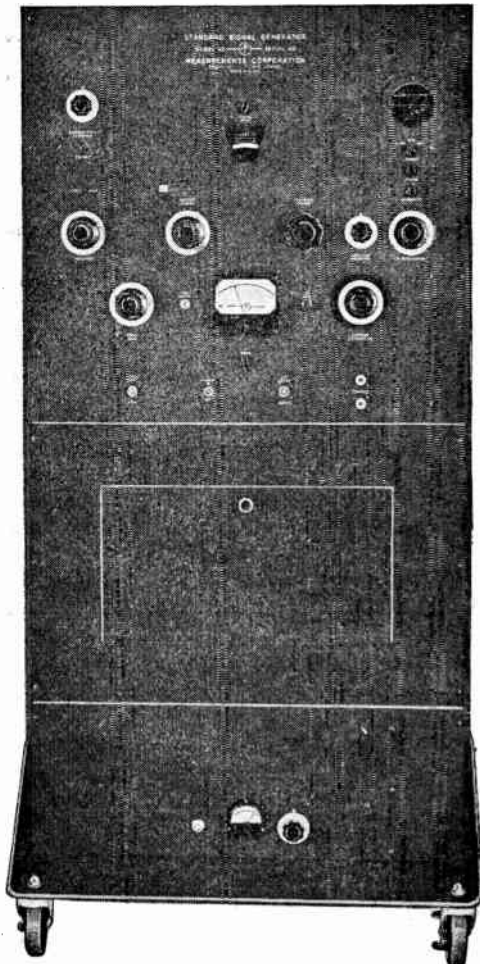

TELEVISION SIGNAL GENERATOR Model 90

The first commercial wide-band, wide-range Signal Generator to be developed to meet the exacting standards of high definition television use.

CARRIER FREQUENCY:

RANGE: 20 to 250 megacycles, in eight ranges.

ACCURACY: Built-in Crystal Frequency Standard permits setting to .01%. Dial scale may be set to 0.1%.

STABILITY: Warm-up drift less than .05%. Less than .01% after warm-up.

LEAKAGE: Less than 10 microvolts.

MODULATION:

Continuously variable from zero to 100%.

ENVELOPE: Sinusoidal, or composite television. Bandwidth to 3 db is 4 Mc. Rise time from 10% to 90% modulation 0.15 microsecond. Overshoot less than 5%. Slope less than 5% on 60-cycle square wave.

INPUT IMPEDANCE: 75 ohms $\pm 10\%$ (RMA Standard).

INPUT LEVEL: 1.5 volts peak to peak minimum level for 100% modulation. Black negative polarity.

MODULATION PERCENTAGE: 15% to 110%; within $\pm 2\%$.

OUTPUT:

LEVEL: Continuously variable from 0.3 microvolt to 0.1 volt balanced to ground (measured at 100% modulation level).

IMPEDANCE: (a) 107 ohms line-to-line (balanced).

(b) 53.5 ohms line to ground (unbalanced).

(c) Suitable pads may be employed to alter these impedances.

DIMENSIONS:

OVERALL: Height—60"; Width—27 $\frac{3}{4}$ "; Depth—25".

WEIGHT: Model 90—302 pounds.

External Voltage Regulator: 92 pounds.

POWER SUPPLY: With regulator, 117 volts, 60 cycles. 825 V.A.; without regulator, 117 volts, 60 cycles. 600 V.A.



VACUUM TUBE VOLTMETER • Model 62

RANGE: Push button selection of 5 ranges—1, 3, 10, 30 and 100 volts full scale AC or DC.

ACCURACY: $\pm 2\%$ of full scale on each range, both DC and sine-wave AC at line voltage of 117 v.

INDICATION: Linear for DC and calibrated to indicate RMS values of a sine-wave or 70.7% of the peak value of a complex wave on AC.

FREQUENCY ERROR: Less than 10% from 30 cycles to over 150 megacycles. Resonant frequency of the probe with input terminals shorted is 300 megacycles.

INPUT IMPEDANCE: The input capacitance is approximately 7 mmf. The input resistance is a function of frequency.

POWER SUPPLY: 117 volts, 60 cycles. 24 watts.

DIMENSIONS: 7-3/16" high x 4 $\frac{3}{4}$ " wide x 9-3/16" deep, overall.

WEIGHT: Approximately 8 pounds.

MEASUREMENTS CORPORATION BOONTON • NEW JERSEY



MEASUREMENTS CORPORATION

Laboratory Standards

STANDARD SIGNAL GENERATOR • Model 84



300 Mc. - 1000 Mc.

FREQUENCY RANGE: 300 to 1000 megacycles in one band; individually calibrated direct reading dial.

FREQUENCY ACCURACY: $\pm 0.5\%$.

OUTPUT VOLTAGE: Continuously variable from 0.1 to 100,000 microvolts.

OUTPUT IMPEDANCE: 50 ohms.

MODULATION: 0 to 30% within $\pm 20\%$ as determined by DC meter. Internal sine-wave oscillator; choice of 400, 1000, or 2500 cycles is provided. External modulation up to 30 kilocycles may be applied.

PULSE FREQUENCY: 60 to 100 Kc in three ranges, 60-1000, 600-10,000 and 6000-100,000 pulses per second.

POWER SUPPLY: 117 volts, 50 to 60 cycles.

DIMENSIONS: 13" high x 26" wide x 12 1/8" deep, overall.

WEIGHT: Approximately 135 pounds, including external line voltage regulator.

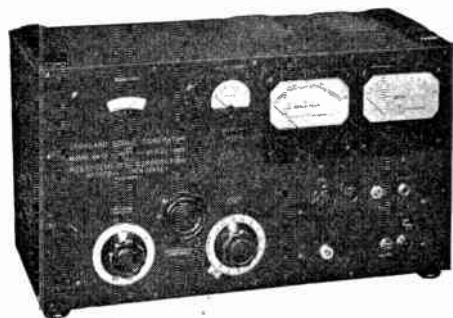

U.H.F.-TV STANDARD SIGNAL GENERATOR

Model 84-TV

300 Mc. - 1000 Mc.

Model 84-TV Standard Signal Generator has been developed to meet the need for a reliable signal source for the UHF Television band. Research requirements as well as production testing needs are met with accuracy, stability and ease of operation.

The Model 84-TV incorporates a built-in power supply for DC operation of the oscillator tube filament. This feature insures a low percentage of residual hum modulation.

FREQUENCY DATA: 300 to 1000 megacycles, in one band. The individually calibrated dial reads directly in megacycles, and is accurate to $\pm 0.5\%$.

OUTPUT VOLTAGE AND IMPEDANCE: The carrier output voltage is continuously variable from 0.1 microvolt to 1.0 volt across 50 ohms. The full 1 volt output, however, may not be possible above 900 megacycles. Output impedance, is seen at the panel connector, is approximately 53 ohms resistive.

MODULATION: Continuously variable from zero to 30% from an internal 1000-cycle oscillator. Provision is made for applying external modulation from 50 to 20,000 cycles. Approximately 5 volts r.m.s. across 100,000 ohms are required for 30% modulation.

POWER SUPPLY: Optimum performance is obtained from a 117 volts, 60 cycle power supply. The power consumption is 120 watts. An external step-down transformer for 220 volt, 50 cycle operation is available on special order.

LEAKAGE: Negligible.

DIMENSIONS: 11 5/8" high x 19 1/8" wide x 10 3/4" deep, overall.

WEIGHT: Approximately 40 pounds.

MEASUREMENTS CORPORATION

BOONTON · NEW JERSEY



MEASUREMENTS CORPORATION

Laboratory Standards



INTERMODULATION METER Model 31

FEATURES:

- Compact, completely self-contained unit with—
Test Signal Generator, Analyzer, Voltmeter, Power Supply.
- Direct-reading meter indicates percentage of intermodulation.
- Accurate metering of input voltage to analyzer.
- Easy to operate.
- Quick, accurate measurements.
- May be mounted in standard 19" relay rack. (7" relay rack panel space.)
- Connection for oscilloscope.

SPECIFICATIONS:

GENERATOR:

LOW FREQUENCY: 60 cycles.

HIGH FREQUENCY: 3000 cycles.

LF/HF VOLTAGE RATIO: Fixed 4/1.

OUTPUT VOLTAGE: 10 v. max. into high impedance or +5 DBM matched to 600 ohms.

OUTPUT IMPEDANCE: 2000 ohms.

RESIDUAL INTERMODULATION: 0.2%.

ANALYZER:

INPUT VOLTAGE: Full scale ranges of 3, 10 and 30 volts RMS. Less than one volt of mixed signal is sufficient for operation.

INPUT IMPEDANCE: Greater than 400 K ohms.

INTERMODULATION: Full scale ranges of 3, 10 and 30%.

ACCURACY: $\pm 10\%$ of full scale.

POWER SUPPLY: 117 volts, 60 cycles, 30 watts.

DIMENSIONS: 7 $\frac{1}{4}$ " high x 19" wide x 8 $\frac{1}{2}$ " deep.

WEIGHT: 16 pounds.

USES:

- Insuring peak performance from all audio systems.
- Correct adjustment and maintenance of AM and FM receivers and transmitters.
- Checking linearity of film and disc recordings and reproductions.
- Checking phonograph pick-ups and recording styli.
- Checking record matrices.
- Adjusting bias in tape recordings.
- For quality control of all audio components and equipment.

CRYSTAL CALIBRATORS

Model 111

and

Model 111-B



Designed for the Calibration and Frequency Checking of —

- Signal Generators • Transmitters • Receivers • Grid-Dip Meters
- And other equipment where a high degree of frequency accuracy is required.

FREQUENCY RANGES

Model 111
.25 to 1000 Mc.

Model 111-B
.1 to 1000 Mc.

These instruments have been designed as dual-purpose calibrators. They not only provide a test signal of crystal-controlled frequency, but also have a self-contained receiver of 2 microwatts sensitivity. A new circuit arrangement with quartz crystal control utilizes the cross-modulation products of three separate oscillators. The fundamental frequencies of Model 111 are .25, 1.0 and 10 megacycles, while those of the Model 111-B are .1, 1 and 10 megacycles.

FREQUENCY ACCURACY: 0.002%.

DIMENSIONS: 6" wide, 9 $\frac{5}{8}$ " high, 5 $\frac{3}{8}$ " deep, overall.

POWER SUPPLY: 117 volts, 60 cycles; 18 watts.

WEIGHT: 4 lbs.

MEASUREMENTS CORPORATION BOONTON · NEW JERSEY



MEASUREMENTS CORPORATION

Laboratory Standards

V.H.F. RADIO NOISE and FIELD STRENGTH METER

Model 58



POWER SUPPLY: Built-in regulated dual power supply for operation from either 117 volts AC (55 watts) or 6 volts DC.

This versatile, portable instrument is useful in measuring signal-to-noise ratios, noise levels and for field strength surveys on TV, FM and AM transmitters.

FREQUENCY RANGE: 15 to 150 megacycles in five bands —dials directly calibrated in megacycles to an accuracy of $\pm 2\%$.

INPUT VOLTAGE RANGE: 1 to 100,000 microvolts induced in antenna. 1 to 100 microvolts on semi-logarithmic output meter, balanced resistance attenuator with ratios of 10, 100 and 1000 ahead of all tubes.

GAIN STANDARDIZATION: Internal "shot noise" diode provides calibration standard. Special dial eliminates need for charts.

CIRCUIT: Superheterodyne circuit with tuned RF amplifier reduces image response.

BAND WIDTH: 150 kilocycles @ 2X down.

DIMENSIONS: 9" high x 16" wide x 11" deep, overall
WEIGHT: 35 pounds.

SQUARE WAVE GENERATOR • Model 71

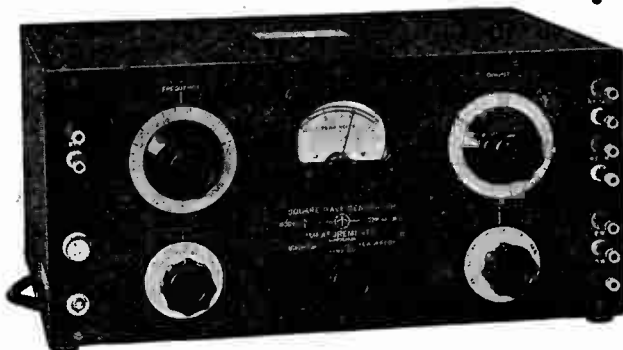

POWER SUPPLY: 117 volts, 50-60 cycles. 100 watts.
DIMENSIONS: 7 $\frac{3}{8}$ " high x 15" wide x 8 $\frac{7}{8}$ " deep, overall.
WEIGHT: Approximately 20 pounds.

Recommended for television testing and many different applications in developing AM, FM and TV equipment where square-wave analysis is of great importance.

FREQUENCY RANGE: Continuously variable from 6 to 100,000 cycles per second.

WAVE SHAPE: Rise time less than 0.2 microseconds with approximately 5% overshoot at 75 peak volts output. At 5 volts or less rise time is less than 0.1 microsecond.

OUTPUT VOLTAGE: Step attenuator giving 75, 50, 25, 15, 10, 5 peak volts fixed and 0 to 2.5 volts continuously variable.

SYNCHRONIZING OUTPUT: 25 volts peak.

R. F. MODULATOR: 5 volts maximum carrier input. Translation gain is approximately 0.1. Output impedance is 600 ohms.

PEAK-TO-PEAK VOLTMETER • Model 67



Designed for audio and video level measurements and the measurement of audio electrical interference. The Model 67 is ideally suited for uses where the indication of true peak values is required.

VOLTAGE RANGE: 5 ranges; .0005 to 300 volts peak-to-peak. (Approximately .0002 to 100 r.m.s. volts.)

SEMI-LOGARITHMIC SCALES: Hand calibrated; 0 to 30 peak-to-peak and 0 to 10 r.m.s. volts.

FREQUENCY RANGE: 5 to 100,000 sine-wave cycles per second.

INPUT IMPEDANCE: 1 megohm shunted by 30 mmfd.

STABILITY: Less than 2% error with line variations from 110 volts to 120 volts.

RECORDER TERMINALS: Self-shorting type for external one milliamperere graphic recorder or millimeter.

POWER SUPPLY: 117 volts; 50-60 cycles, 35 watts.

DIMENSIONS: 7 $\frac{1}{2}$ " high x 7" wide x 9 $\frac{3}{8}$ " deep, overall.

WEIGHT: 10 lbs.

MEASUREMENTS CORPORATION BOONTON, NEW JERSEY



MEASUREMENTS CORPORATION

Laboratory Standards

MEGACYCLE METER Model 59

The Only Grip-Dip Meter Covering
the Wide Frequency Range of
2.2 Mc. to 400 Mc.

- For determining the resonant frequency of tuned circuits, antennas, transmission lines, or any resonant circuit.
- For measuring capacitance, inductance, Q, mutual inductance.
- For quartz crystal measurements.
- For preliminary tracking and alignment of receivers.
- As an auxiliary signal generator; modulated or unmodulated.
- For antenna tuning and transmitter neutralizing, power off.
- For locating parasitic circuits and spurious resonances.
- As a low sensitivity receiver for signal tracing.
- As a beat-frequency oscillator in conjunction with a fixed frequency oscillator for measuring video or wide-band amplifier bandwidths.
- As an oscillating or absorption marker for use with a sweep-frequency oscillator.
- For transmitter or oscillator frequency checking by beat note method and absorption wave meter method.

And Many Other Applications.

TELEVISION

The Model 59 is most useful in the construction and servicing of television receivers. It can be used for aligning video amplifiers, for peaking coils, sound traps, filters, stagger-tuned i.f.s, stagger-tuned amplifiers, sound i.f.s, local oscillators, carrier circuits, grid mixing circuits, etc. It is very effective for locating interference and for making traps and filters.



Available in the following frequencies:
Model 59LF—0.1 to 4.5 Mc.
Model 59UHF—430 to 940 Mc.

FREQUENCY RANGE: 2.2 megacycles to 400 megacycles with seven plug-in coils.

FREQUENCY ACCURACY: Individually calibrated dial, direct reading to an accuracy of $\pm 2\%$.

OUTPUT: CW or MCW. Modulation fixed at approximately 30%, 120 cycles.

POWER SUPPLY: 117 volts, 60 cycles, 20 watts.

DIMENSIONS: Power unit: $5\frac{1}{8}$ " wide, $7\text{-}13/16$ " high, $8\frac{3}{8}$ " deep, overall.

Weight: approximately $6\frac{1}{2}$ lbs.

Oscillator unit: $3\frac{3}{4}$ " diameter, 2" deep.

Weight: approximately 1 lb.

MEASUREMENTS CORPORATION BOONTON · NEW JERSEY



WHEATSTONE BRIDGE

● A carefully engineered bridge made for all around use in lab., plant, or field. All models contain own 4½-volt battery power supply and galvanometer. Provision for external batteries and galvanometer if desired. All models have ratio dial settings of .001, .01, .1, 10, 100, and 1000 as well as built-in resistance standards of 1, 10, 100, and 1000-ohm decades. Ratios are guaranteed to .05% tolerance. Resistance dial resistors to .1%. Self-cleaning, four-leaf phosphor bronze wiper switches with detent mechanism mounted below panel. Galvanometer of well-known moving-coil type. Separate binding posts for use of external galvanometer if desired, and for use of bridge as resistance decade. Hardwood case with removable cover. 9¼" x 7½" x 6¼" h. Wt. 9¼ lbs. net; 12¼ lbs. shipping.

- MODEL RN-1.** Standard Portable Wheatstone Bridge, complete with batteries Net Price \$138.00
MODEL RN-2. Standard Portable Wheatstone Bridge with Murray & Varley Loops Net Price \$154.00
MODEL RN-3. Same as RN-2 but with additional ratio settings of 1/9, 1/4 and 1/1 and varying galvanometer sensitivity control. Net Price \$198.00

RESISTANCE DECADES

● Available in standard models with resistance ranges of .9 to 999,990 ohms total. Accuracy to ±0.1%. Self-cleaning, four-leaf phosphor bronze wiper switches with detent mechanism mounted below the panel. Hardwood case. Models DR-1A to DR-4, 5¼" x 8" x 4" h.; wt. 4 lbs. net; 6 lbs. shipping. Models DR-10 to DR-14, 4¼" x 6" x 4" h.; wt. 3 lbs. net; 5 lbs. shipping. Models DR-50 to DR-52, 6¼" x 9" x 4¼" h.; wt. 5 lbs. net; 7 lbs. shipping.

Model No.	Total Resistance Ohms	Decade Steps	Accuracy	Net Price
DR-1A	999,000	9x(1,000 + 10,000 + 100,000)	±.1%	\$ 70.00
DR-2A	99,900	9x(100 + 1,000 + 10,000)	±.1%	56.00
DR-3	9,990	9x(10 + 100 + 1,000)	±.1%	54.00
DR-4	999	9x(1 + 10 + 100)	±.1%	50.00
DR-10	.9	9x.1	±.1%	22.00
DR-11	9	9x1	±.1%	22.00
DR-12	90	9x10	±.1%	22.00
DR-13	900	9x100	±.1%	22.00
DR-14	9,000	9x1,000	±.1%	25.00
DR-50	9,999.9	9x(.1 + 1 + 10 + 100 + 1,000)	±.1%	83.00
DR-51	99,999	9x(1 + 10 + 100 + 1,000 + 10,000)	±.1%	88.00
DR-52	999,990	9x(10 + 100 + 1,000 + 10,000 + 100,000)	±.1%	110.00



CAPACITANCE DECADES

● Instrument calibrated directly in capacitance so that reading from left to right, the dial settings will give the exact value in microfarads. Progressive adjustment in .01, .001, or .0001 mfd. steps depending on model. .001 to 11.1 mfd. can be obtained by group assembly. All units employ paper or mica capacitors of highest quality and stability. Enclosed in hardwood case. DK-4, DK-10 and DK-2A, 8" x 5½" x 7¼" H.; wt. 8 lbs.; 12 lbs. shipping. DK-5, DK-11, 11" x 8¼" x 7" H.; wt. 10 lbs. net; 12 lbs. shipping.

Model	Capacitance Mfd. Steps	Accuracy	Dielectric Section	P.F.	Peak Volts	Price
DK-5	11.1 in .01	1%	.01 Mica	.2%	700 DC	\$ 85.00
			.1 paper	1%	400 DC	
			1.0 paper	1%	400 DC	
DK-4	1.11 in .001	1%	.001 mica	.2%	700 DC	70.00
			.01 mica	.2%	700 DC	
			.1 paper	1%	400 DC	
DK-2A	1.11 in .001	1%	Mica	.2%	700 DC	150.00
			throughout		500 AC	
DK-10	.111 in .0001	.5%	Mica	.2%	700 DC	100.00
			or 10 mmfd. throughout		500 AC	
					60 cycle	
DK-11	11.1 in .01	.5%	.01 Mica	.2%	700 DC	165.00
			.1 mica	.2%	500 DC	
			1.0 paper	1%	400 DC	

INDUSTRIAL INSTRUMENTS, INC. • CEDAR GROVE, N. J.

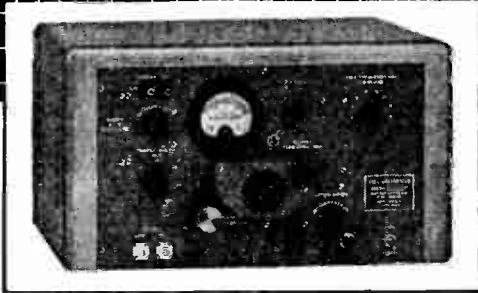
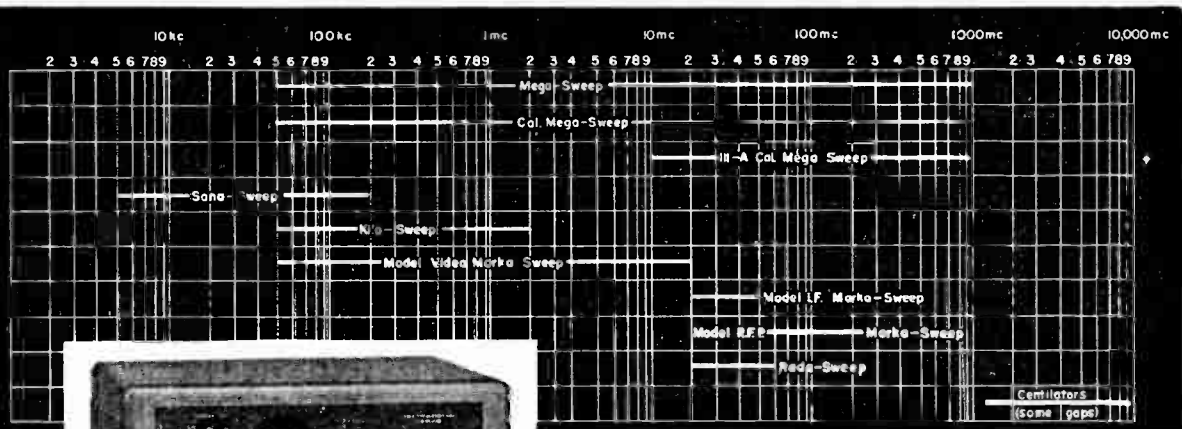

NEED SWEEPING OSCILLATORS

FOR RAPID and ACCURATE VISUAL MEASUREMENTS ?

	Frequency Range	Tuning	Maximum Sweep Width	Markers	Output (Open Circuit)	Price* f.o.b. factory
Mega-Sweep	50 kc - 1000 mc	Continuous	30 mc	None	0.1 volt	\$395.00
Calibrated Mega-Sweep	50 kc - 950 mc	Continuous	30 mc	None	0.1 volt	425.00
111-A Calibrated Mega-Sweep	10 mc - 950 mc 450 mc - 900 mc	Continuous	40 mc	None	0.3 volt, 70 ohms 0.6 volt, 300 ohms	575.00
Sana-Sweep	5 kc - 200 kc	Continuous	20 kc	Up to six crystal positions	1.0 volt	525.00
Kilo-Sweep	50 kc - 2 mc	Continuous	100 kc	Up to six crystal positions	1.0 volt	525.00
Model Video Marka-Sweep	50 kc - 20 mc	Three Ranges 50 kc - 5 mc 50 kc - 10 mc 50 kc - 20 mc	Complete Range	Up to six crystal positions	0.6 volt	495.00
Model LF Marka-Sweep	20 mc - 50 mc	Four Ranges	500 kc (Narrow) 15 mc (Wide)	Up to nine crystal positions	0.5 volt	295.00
Model RF-P Marka-Sweep	All 12 channels, VHF TV Range	Switchable	15 mc	Pix and Sound crystal positions	0.5 volt, 70 ohms 1.0 volt, 300 ohms	795.00
Rada-Sweep	30 & 60mc centers; Others, special	Switchable	3 mc (Narrow) 20 mc (Wide)	Up to nine crystal positions	0.5 volt	395.00
No. 1214 Centilator	1245 mc - 1460 mc	Continuous	5 mc	None	134 mw	595.00
No. 3439 Centilator	3400 mc - 3960 mc	Continuous	40 mc	None	106 mw	495.00
No. 4249 Centilator	4240 mc - 4910 mc	Continuous	35 mc	None	115 mw	450.00
No. 6274 Centilator	6250 mc - 7425 mc	Continuous	50 mc	None	110 mw	450.00
No. 8596 Centilator	8500 mc - 9660 mc	Continuous	60 mc	None	30 mw	395.00

*In some cases small extra charge for crystal substitutions or additions

- Marker Generators
- Pulse Generators
- Random Noise Generators
- Spectrum Analyzers
- Reflected Energy Measuring Equipment
- Attenuators
- Noise, Vibration and Speech Analyzers
- Gain Measuring Equipment
- Tachometers
- Other LF, HF, UHF, Microwave Test Equipment.



REQUEST NEW
1954 CATALOG
FOR FULL DETAILS



KAY ELECTRIC COMPANY

14. Maple Avenue

Phone CALdwell 6-4000

Pine Brook, New Jersey

BERKSHIRE LABORATORIES

300 BEAVER POND ROAD
LINCOLN, MASSACHUSETTS

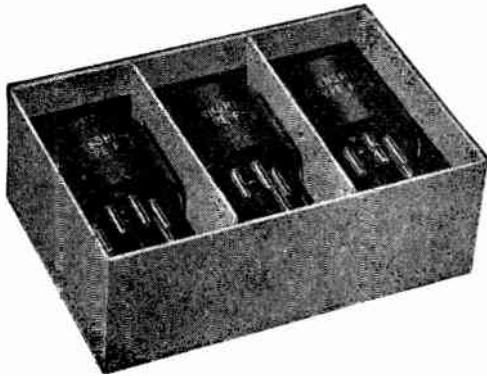

BERKSHIRE LABTRANS PULSE TRANSFORMERS

These miniature pulse transformers combine compactness, convenience, and versatility. Designed for use in the microsecond and fractional-microsecond range, in equipment where space must be saved at no sacrifice in quality, they are provided with standard octal bases, for quick interchangeability in electronic assemblies. Height is only 1.1 inch above chassis, diameter 1.37 inch.

These transformers are available at considerable savings in a sample package containing one of each type, at only \$21.50 f.o.b. Lincoln, Mass. Postage prepaid if remittance accompanies order. Additional details and specifications on request.

Type	Ohms Imp.	Rise Time	Percent droop at:				Price
			1 μ s	2 μ s	5 μ s	10 μ s	
PT-1	100	.04 μ s	20	50	60	80	\$8.95
PT-2	100	.04 μ s	20	30	50	70	8.95
PT-3	120	.03 μ s	20	40	55	75	9.50



BERKSHIRE LABCASES

Your own three- or four-terminal networks can be made into convenient plug-in units by using Berkshire LABCASES. Useful for housing wave filters, wave-shaping circuits, and other standard or special circuits, the resulting plug-in units can easily be added to or removed from experimental set-ups for comparison purposes. The input terminals of one unit may be plugged into the output terminals of another, for cascade or tandem circuit arrangements. The cylindrical aluminum housing is 5½ inches long including terminals, and 1½ inches in diameter. Input terminals are banana-type, with standard ¾ inch spacing. Output binding posts accept banana plugs, spade lugs, or plain wire leads.

Model 19-S four-terminal networks \$4.00

Model 19-G three-terminal networks \$3.50

The Model 19-P LABCASE is designed to house complete circuits using up to 2 miniature tubes. A molded Tenite housing holds an octal plug, two 9-pin Noval sockets, and ample space for circuit components. Price \$2.00. Quantity prices on application.



BERKSHIRE LABMARKER

This compact, self-contained unit converts the sinusoidal output of an oscillator into sharp pulses which may be used as vertical markers on a crt display, or as blanking or intensifying pulses. Pulse frequency is the same as that of the primary oscillator, with a lower limit of 25 cycles per second and an upper limit of one megacycle per second. Input terminals are banana plugs, for quick insertion into standard oscillator jacks. Output binding posts accept banana plugs, spade lugs, or plain wire leads. Overall length is 5½ inches, diameter 1½ inches (1¾ for Models 1-U and 1-U1).

Labmarker Mod. No.	1-U	1-N	1-P	1-U1	1-N1	1-P1
Mox. rms input volts..	34	34	34	36	36	36
Pulse polarity	Both	Neg.	Pos.	Both	Neg.	Pos.
Pulse length/osc. cycle	0.3	0.3	0.3	0.1	0.1	0.1
Pulse omp./input omp.	0.5	0.5	0.5	0.05	0.05	0.05
Price f.o.b. Lincoln	18.50	15.00	15.00	24.00	17.50	17.50

Special LABMARKERS having other characteristics can be supplied to order. If you have special requirements, please write for a quotation.

BERKSHIRE LABSTROBE

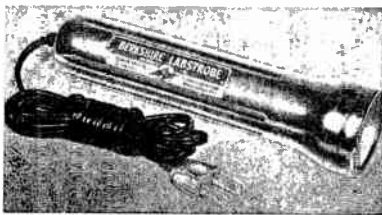

The Model 18 LABSTROBE gives you a convenient means for stroboscopic observation of moving objects, such as motors, cyclic machinery, or phonograph turntables. The instrument plugs into any 60-cycle 115-volt outlet, and delivers 100-microsecond flashes at a repetition rate of 60 per second. The aluminum reflector produces maximum light output from a standard long-life neon bulb. Six-foot cord and chromed metal case the size of an ordinary flashlight. Price. \$9.95 f.o.b. Lincoln. Phonostrobe disks, for use with the LABSTROBE in checking speed of turntables at 78, 45, and 33-1/3 RPM, are also available at 75c each.

Order all Berkshire products from your distributor, who has them in stock, or can get them.

Waterman POCKETSCOPE

The Pocket-Size Oscilloscope

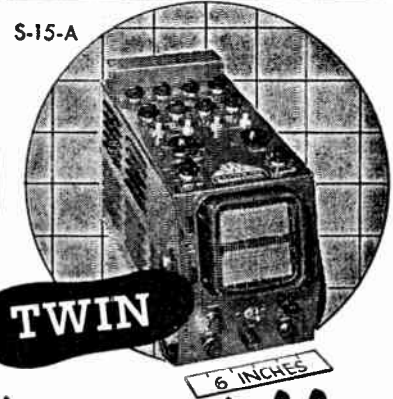

...light... compact... accurate... portable

Featuring small size, light weight and outstanding performance the HIGH, WIDE and TWIN POCKETSCOPES have become the "triple threat" of the oscilloscope field. Their incomparable versatility, reliability and accuracy have skyrocketed this team of truly portable instruments into unparalleled demand. Each oscilloscope features DC coupled amplifiers in both vertical and horizontal channels.

HIGH The S-14-A HI-GAIN POCKET-SCOPE provides the optimum in oscilloscope flexibility for analysis of low-level electrical impulses. Extremely light weight (12¼ lbs.), compact in size (12 x 5¼ x 7 in.), dependable and accurate in performance. Vertical and horizontal channels: 10mv rms/inch with response within 2DB from DC to 200 KC and pulse rise of 1.8 µs . . . non-frequency discriminating attenuators and gain controls with internal calibration of trace amplitude . . . repetitive or trigger time base with linearization from ½ cycle to 50 KC with ± sync or trigger.

WIDE The S-14-B WIDE BAND POCKETSCOPE is ideal for investigations of transient signals, DC signals, aperiodic pulses or recurrent waveforms. Vertical channel: 50 mv rms/in. within -2DB from DC to 700 KC . . . pulse rise time of 0.35 µs. Horizontal channel: 0.15v rms/in. within -2DB from DC to 200 KC . . . pulse rise of 1.8 µs. Attenuators and gain controls are non-frequency discriminating . . . trace amplitude calibration . . . repetitive or triggered time base from ½ cycle to 50 KC . . . ± sync or trigger . . . trace expansion, filter graph screen and many other features . . . 14 lbs. . . 12 x 6 x 7 inches.

TWIN The S-15-A POCKETSCOPE is a portable, twin tube, high sensitivity oscilloscope with two independent vertical as well as horizontal channels. It is indispensable for investigation of electronic circuits in industry, school and laboratory. Vertical channels 10 mv rms/in. with response within -2DB from DC to 200 KC and pulse rise time of 1.8 µs . . . horizontal channels 1v rms/in. within -2DB from DC to 150 KC . . . non-frequency discriminating controls . . . internal signal amplitude calibration . . . linear time base from ½ cycle to 50 KC, triggered or repetitive, for both horizontal channels.

S-11-A The S-11-A INDUSTRIAL POCKETSCOPE is a small, compact (5x7x11 inches), and lightweight (8¼ lbs.) instrument for observing electrical circuit phenomena. The flexibility of the POCKETSCOPE permits its use for AC measurements as well as for DC. The vertical and horizontal amplifiers are capable of reproducing within -2DB from DC to 200 KC with a sensitivity of 0.1v rms/in. . . . repetitive time base from 3 cycles to 50 KC continuously variable throughout its range . . . variations of input impedance, line voltage or controls do not "bounce" the signal—the scope stabilizes immediately.

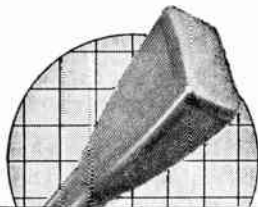

RAYONIC CATHODE RAY TUBES BY WATERMAN

TUBE	PHYSICAL DATA		STATIC VOLTAGE		DEFLECTION*		LIGHT OUTPUT**
	FACE	LENGTH	A3	A2	VERT	HOR	
3JP1	3"	10"	3000	1500	111	150	352
3MP1	3"	8"		750	99	104	33
3RP1	3"	9.12"		1000	61	86	44
3SP1	1.5x3"	9.12"		1000	61	86	44
3XP1	1.5x3"	8.875"		2000	33	80	218

The basic properties of the cathode ray tube that concern the designer or the user are: deflection sensitivity, unit line brightness, line width, static voltage requirements and physical size. A comparison between cathode ray tubes manufactured by Waterman Products Company is shown in the table adjoining. These tubes are available in P1, P2, P7 and P11 phosphors. 3JP1, 3JP7, 3SP1 and 3XP1 are available as JAN tubes.

*Deflection in volts per inch.

**Light output of an element of a raster line (one mm long and not exceeding .65 mm in width) in microlumens.

Write for your complimentary copy of "POCKETSCOOP" - Official Waterman publication.

PULSESCOPE

by **Waterman**

The Oscilloscope that Portrays the Pulse

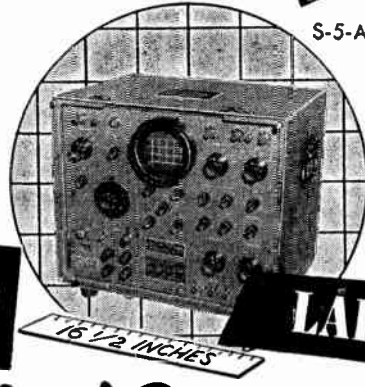
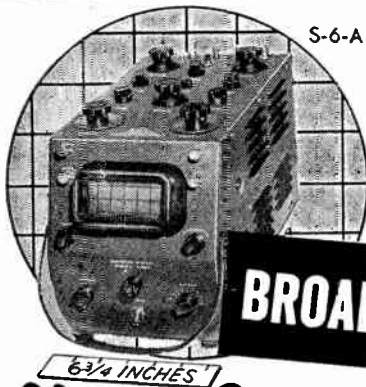

Classic Examples of Precision Engineering...

The PULSESCOPES are cathode ray tube oscilloscopes that portray the attributes of the pulse: shape, amplitude, duration and time displacement. All PULSESCOPES have internally generated markers with the basic difference that in the SAR PULSESCOPE the markers initiate the sweep while in the others the sweep starts the markers.

BROAD The S-6-A BROAD BAND PULSESCOPE is a POKETSCOPE in size. The instrument measures DC as well as AC signals. Unique DC calibration methods permit rapid measurements of either positive or negative, AC or DC signals. Vertical amplifier sensitivity of 0.2v rms/inch, and response to 5 mc within 3DB... pulse rise time of 0.1 μ s... internal markers from 1 to 1000 μ s... repetitive or trigger sweep from 5 cycles to 500 KC with 5X sweep expansion... sweep, marker and DC calibrating voltage available externally. Size 8 1/2 x 6 3/4 x 13 1/4 in. Weight 22 lbs. Operates from 50 to 400 cycles at 115 volts AC.

LAB The S-5-A LAB PULSESCOPE is a JANized (Gov't Model No. OS-26) portable, AC, wide band-pass, laboratory oscilloscope ideal for pulse as well as general purpose measurements. Internal delay of 0.55 μ s permits observation of pulse leading edge. Includes precision amplitude calibration, 10X sweep expansion, internal trace intensity time markers, internal trigger generators and many other features. Video amplifier 0.1v p to p/inch... pulse rise time of .035 μ s or response to 11 mc. 1.25 to 125,000 μ s triggered or repetitive sweep... internally generated markers from 0.2 to 500 μ s... trigger generator from 50 to 5000 pps. for internal and external triggering. Operates from 50 to 400 cycles at 115 volts AC.

SAR The S-4-C SAR PULSESCOPE is a JANized (Gov't Model No. OS-4) portable instrument (31.5 lbs.) for precision pulse measurements for radar, TV and all electronic measurements. Portrays all attributes of the pulse... internal crystal controlled markers of 10 and 50 μ s available for self-calibration... in R operation a small segment of the A sweep is expandable for detailed observation with a direct-reading calibrated dial accurate to 0.1%. Video amplifier band-pass up to 11 mc... optional video delay 0.55 μ s... pulse rise and fall time better than 0.07 μ s... R pedestal (sweep) 2.4 to 24 μ s... video sensitivity of 0.5v. p to p/inch. Easily convertible from μ s to yards. Operates from 50 to 400 cycles at 115 volts AC.

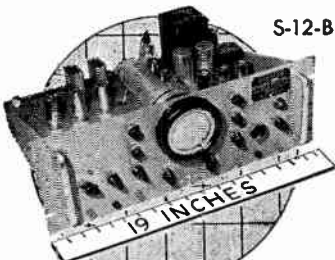

RAKSCOPE Because the panel is only 7" high and fits any standard rack, the S-12-B RAKSCOPE admirably fills the need for a small oscilloscope of wide versatility. With all the features of the S-11-A POKETSCOPE, the RAKSCOPE is JANized (Gov't Model No. OS-11), and has many additional advantages; the sweep, from 5 cycles to 50 KC, is either repetitive or triggered... vertical and horizontal amplifiers are 50 mv rms/inch with band-pass from 0 to 200 KC... special phasing circuitry for frequency comparison.

WATERMAN PRODUCTS CO., INC.



PHILADELPHIA 25, PENNA., U.S.A.

CABLE ADDRESS, POKETSCOPE, PHILA.

Manufacturers of POKETSOPES® • RAKSCOPES® • PULSESCOPES® and RAYONIC® TUBES



TEST EQUIPMENT

PASADENA, CALIFORNIA



OSCILLOSCOPE MODEL 613

SPECIFICATIONS

Sensitivity 0.1 volt peak-to-peak per inch; Freq Resp (vertical amplifier) 20 cps to 4 mc; Calibrated Attenuator in steps of 0.1, 0.3, 1, 3, 10, 30, 100, 300 volts per inch; Sweep Range Continuously variable 10 to 50,000 micro-seconds; Sweep 1) Internal or external synchronizing 2) Positive or negative synchronizing 3) Recurrent; Power Supply 115 volts, 60 cycles; Approximate Weight 20 lbs.; Case Size 8½ x 11 x 10 inches.

Model 613 230.50

VACUUM TUBE VOLTMETER AND TUBE CHECKER MODEL 612

SPECIFICATIONS

VTVM: Specifications same as those of Vacuum Tube Voltmeter Model 614.

Tube Checker: Emission type, illuminated chart. Checks all standard tubes including kinescopes; 4¼ inch meter; Power Supply 115 volts, 60 cycles; Approx. Weight 7 lbs. Case Size 8½ x 11 x 7½ inches.



Model 612 135.00

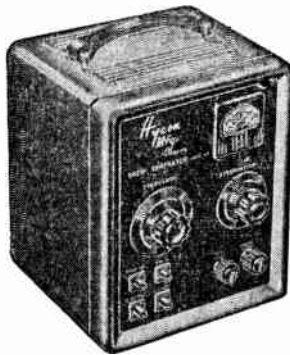

SWEEP GENERATOR MODEL 610

SPECIFICATIONS

Osc Freq 19 mc to 900 mc; Tuning Ranges 19-50 mc, 160-220 mc, 450-900 mc; Output 0.1 volt; Hi-Output 2 volts; Output Impedance 75 ohms unbalanced (accessory baluns available); Att'n 0-80 db; Sweep Range (Max): a) ±20% of center frequency to 250 mc. b) ±10% of center frequency above 250 mc; Sweep Output Jack; marker dial calibration 0.1% accuracy; Power Supply 115 volts, 60 cycles; Approx. Weight 20 lbs; Case Size 8½ x 11 x 7½ inches.

Model 610 330.40

VACUUM TUBE VOLTMETER MODEL 614

SPECIFICATIONS

AC and DC Ranges 0 - 3, 10, 100, 300, 1000 volts, with auxiliary probe 0 - 30,000 volts (dc); Resistance Ranges 0-100, 1000, 10K, 100K, 10 megohms; AC Freq Resp 30 cps to 50 mc (with auxiliary probes); Input Impedance 10 megohms.

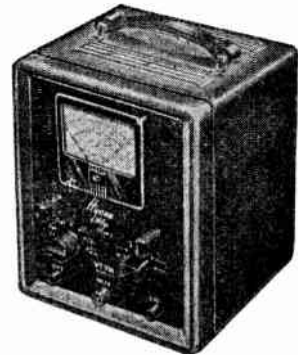

Model 614 85.25

These units have been developed to meet the needs of technicians engaged in the servicing of TV equipment, both black and white and COLOR.

These instruments are compact, ruggedized, lightweight and sturdily cased to withstand rough usage and will give complete satisfaction under all conditions.

They were designed for industry, field and laboratory uses. Stacking features have been provided as shown, thereby reducing bench space requirements.

All Prices Subject to Change

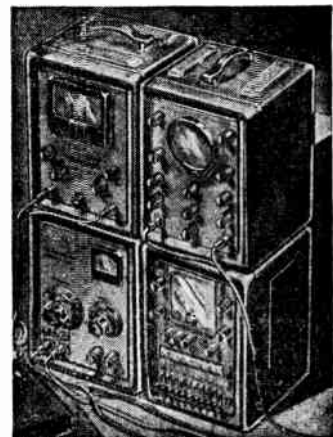

Scala SUPER MARKER INJECTOR

BEST FOR B & W TV AND LABORATORIES! ABSOLUTELY A MUST FOR COLOR!

... with the Scala Super Marker Injector

SAVE UP TO 75% IN TIME

ON ALIGNMENT

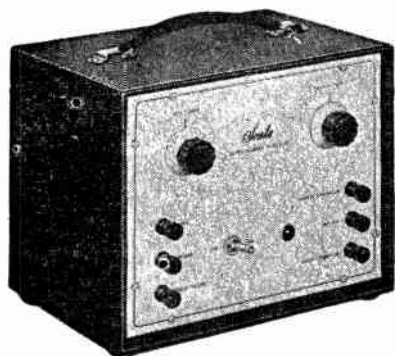

SCALA SUPER-MARKER INJECTOR mixer-amplifier unit mixes small sample of sweep voltage with small sample of marker voltage (from external sweep-marker generator). Injects a large, stable pip into scope being used for alignment of TV receiver. Marker pip is always same size—from base line to top of curve. Pip does not affect pattern on scope, even at resonance peaks. *Greatly speeds up and simplifies alignment jobs.* Separate video and marker gain controls. May be used with any standard marker generator, sweep generator, and scope. Five tubes and Germanium diode. Size, 10" x 8" x 7". Cables and instructions supplied. For operation from 110-120 volts, 60 cycle A.C. Model SMI-53. At leading jobbers, **\$67.50**

DUAL MARKER INJECTOR (SMI-53X), same physical appearance as SMI-53, above—but also has built-in crystal oscillator. Simply set marker generator on picture frequency and get both picture marker and sound marker out. Complete with 4.5 Mc. crystal. For color, 3.579 Mc. crystal can be plugged into jack in front panel. At leading jobbers, **\$79.50**

Scala

OSCILLOGRAPH PROBES

— NEW TOOLS TO MAKE TV SERVICING EASIER,
FASTER, MORE ACCURATE, MORE PROFITABLE



SCALA TEST PROBES

May be accurately used with all oscilloscopes. Complete with cable and instructions.

BZ-1 Signal Tracing Probe for individual check of IF stages, calibrating marker generator, checking output of sweep generator, etc. Low C, Hi-Z demodulator range, non-resonant to 225 mc; useful to 1000 mc. Net, at leading jobbers, **\$9.75**

BZ-2 Low Capacity Probe permits tracing waveforms through Hi-Z circuits without excessive distortion from circuit loading. Cuts effective input capacity of scope, attenuation 10 to 1. Net, at leading jobbers, **\$9.75**

BZ-3 Voltage Divider Probe for checking horizontal sweep waveforms and voltages at plates of horizontal output or damper tubes. Does not distort waveform up to 15,000 volts peak to peak. 100-1 capacitance divider. Net, at leading jobbers, **\$9.75**

BZ-4 Voltage Doubler Probe provides virtually double deflection on scope screen compared to half-wave probes. Dual low C Hi-Z demodulators useful to 150 mc. Net, at leading jobbers, **\$10.75**

BZ-123—Consists of one each SCALA BZ-1, BZ-2 and BZ-3 probes complete with one coaxial cable, instructions and removable Klipzon tip which can be fastened to any Scala probe to make a firm connection to test point. Net, at leading jobbers, **\$27.45**

BZC—Spare calibrated cable. Net, at leading jobbers, **\$1.00**

PRECISE MEASUREMENTS COMPANY

BROOKLYN 23, N. Y.

TRANSPARENT CIRCUIT STAMPS

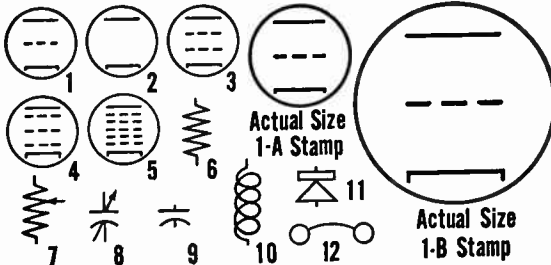

Provide clear sharp impressions of all the most used radio and electrical circuit symbols. Saves considerable drawing and drafting time. Provides neat looking standardized symbols on all your drawings. Used by leading manufacturers and laboratories. Stamps are made of Vinylite and are acid proof and resistant to many common substances like petroleum solvents, greases, gasoline, benzene, etc. They are crystal clear and easily lined up by looking right through them. Built-in "CROSS HAIRS" allow pin point positioning. Not to be confused with shallow die stamps, these are made on expensive master dies which are very deeply sunk in and result in stamps with razor sharp impressions and anti-clogging qualities. Outlasts rubber stamps many times because Vinylite resists abrasion and is more resilient. Available in two popular sizes. May be purchased separately or in complete set. When ordering specify stamp number and size.

SIZE A	CIRCUIT STAMP SET	(12 stamps)	\$ 8.50
SIZE A	Individual Circuit Stamps	each	.85
SIZE B	CIRCUIT STAMP SET	(12 stamps)	10.00
SIZE B	Individual Circuit Stamps	each	.95

Larger size sets with more complete selections of symbols are available. Send for our complete listings.

METER SCALE PRINTING MACHINE



Prints lettering, numbers and divisions on meter scales. Use any kind of scale material such as metal, paper, plastics, etc. Perfect lettering is assured because machine uses standard printers type available everywhere. Will print a single scale and make it look like expensive die printing. In daily use by many instrument manufacturers and testing laboratories.

- Model
1500 Standard Scale Printer.....\$150.00
 Ruling Pen Attachment—Lever operated, for quickly ruling in the division lines..**\$35.00**
 Duplicating Attachment—Turns your scale printer into a duplicating machine for making up to 5,000 copies. Prints in black and white or brilliant colors.....**\$35.00**

Basic Supply Kit—Contains an assortment of metal type, spacers, ink roller, printing ink and just about every item needed to turn out neatly printed scales and dials.....**\$25.00**

ELECTRO-GRAPHIC RECORDER

Designed to make the recording of voltages and currents a simple and straight forward matter. Unit features small size and low cost. Response is approximately 2 seconds full scale. Standard sensitivity is 1 Ma. Unit is direct writing and graph paper perfectly linear (no difficult curved scales to interpret). Field tests are continuing to be made on this unit and upon their completion, the unit will be released to the general market.

INSTRUMENTS BUILT TO SPECIFICATIONS

We supply custom built magnetic amplifiers, transformers, high voltage equipment, printing machines. Our equipment is used by leading industrial concerns, research laboratories and the U. S. Government. We will gladly send quotations on your specific requirements.

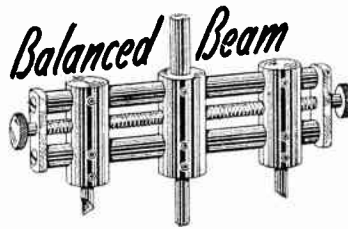

MICRO CIRCLE CUTTER

Cuts Metals
Woods
Plastics

For quickly cutting those extra large hole sizes. Perfect for making washers.

Model	Shank	Size	Price
9	Round	10"	\$12.50
10	Round	15"	15.00
Extra cutting bits 50c			

MICRO CIRCLE CUTTER

Cuts holes in all types of metals from stainless steel to magnesium. Perfect for plastics and wood. Especially recommended for cutting meter holes in panels.

Built-in micrometer type size control for precise settings. Extra heavy construction of the main beam and body make it useful for production jobs as well as experimental work. All are equipped with a 1/4" high speed steel cutting bit.

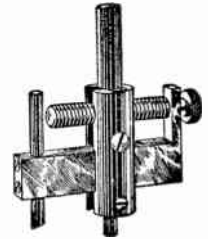

Model	Type	Size	Price
1	Round Shank (for drill press or hand drill)	4"	\$5.00
1-A	Square Tapered (for hand brace)	4"	5.00
5	Round Shank	6"	7.50
6	Morse #2 Taper	6"	8.50
Extra cutting bits 60c			

INFRA RED MATERIALS

We have about the largest selection of Infra Red Materials ever assembled under one roof. Stocks include filters, infra red sensitive phosphors, cesium vapor lamps, etc. Let us know your requirements. We may be able to ship from stock.

HIGH VOLTAGE TRANSFORMER

Small physical size is the result of engineering studies into this problem. Used for Oscilloscopes, Photoflash Units, and Miniature High Voltage Power Supplies. Primary has tap for rectifier tube. Several diagrams furnished. Provides 4500 Volts D.C.



Part No.	Primary	Secondary	Size
3 KVT	115 Volts 60 Cycle with 1 1/2 Volt Tap.	3200 Volts AC at 1 Ma	2" high x 2 1/4" wide. Base 2 3/8" Mtg. Centers 2 7/8"
Price \$15.00			

MINIATURE HIGH VOLTAGE CONVERTER

Connect primary to batteries or 60 cycle AC and obtain high voltage output. Single compact unit contains both an efficient vibrator and a special step-up transformer. Works well on regular flashlight cells. Use for photoflash outfits, isolated power supplies and wherever high potentials and small size are required. Circuit diagrams supplied with each converter show suggested hookups to obtain any voltage between 50 volts and 7,000 volts at currents up to 1 Ma. Diagrams show how output can be easily stabilized (to better than 2%) using only a minimum of parts thus making it useful for gieger counters, megohm meters, photomultiplier tubes, miniature oscilloscopes, etc.

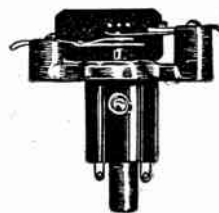

Part No.	Primary	Secondary	Price
5 MVT	1 1/2 to 6 Volts DC or 60 Cycle AC	7,000 Volts Maximum	\$8.50

YOUR LOCAL DISTRIBUTOR WILL BE GLAD TO SHOW YOU OUR PRODUCTS

FROM MILLIWATTS TO KILOWATTS HIGH VOLTAGE POWER SUPPLIES AND EQUIPMENT

Precise has sold thousands of these power supplies to laboratories, industrial concerns, the government and universities. Only the best available selected material goes into these units so that you will have many years of dependable service. Only a few of our standard models are shown below. Quotations on special power supplies cheerfully given.

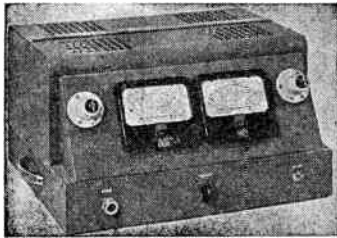

HIGH VOLTAGE POWER SUPPLIES

A precision, well constructed high voltage supply for television, meter testing and calibration, electrostatic painting, breakdown tests, nuclear physics and wherever high potentials at low currents are needed. Output is well filtered direct current. Adjustable by means of a control on the front panel. Available with or without meter. Input voltage is 115 v., 60 cycles.

Model	Maximum Voltage	Price
6000	2,500	\$60.00
6000-A With Meter	2,500	80.00
6005	5,000	75.00
6005-A With Meter	5,000	95.00
6010	10,000	85.00
6010-A With Meter	10,000	105.00
6015	15,000	95.00
6015-A With Meter	15,000	115.00
6025	25,000	115.00
6025-A With Meter	25,000	155.00

Also available with two meters (as ill.) thus current and voltage can be read simultaneously. Perfect for breakdown and leakage measurements. Current limiter circuits protect meter on shorts. Price \$35 additional. Specify 50 uamps, 100 uamps or 1 mill meter. Same delivery time.

Megohm Reading Scales are available for the current reading models. This makes a fine megohmmeter where moderate degree of accuracy is required and when it is desired to have a known test voltage applied to the unit under test. The actual resistance in megohms as well as the leakage current and applied voltage are all read simultaneously on direct reading meters.

Price \$40.00 additional on any kilovoltmeter equipped power supply. Regulated Power Supplies. Any model can be had with built-in regulation circuits. Output remains within 5% over most of the range. Same delivery time. Closer regulation on special order.

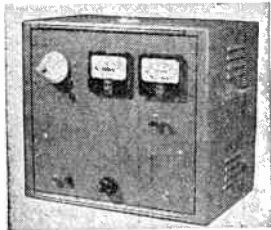

REGULATED AND HIGHER VOLTAGE SUPPLIES

Industrial Series Power Supplies. Available in ranges up to 100,000 volts DC. Widely used throughout the nation. These units offer the finest in materials obtainable and are all backed by our famous service guarantee. Regulation circuits used depends on your accuracy requirements. Amplifier type regulators are used for moderate degrees of regulation. Chopper type stabilizer circuits that compare the high voltage output to known reference voltages are used if stability in the order of .02% is required. Direct voltage reading switches and dials can be supplied so that the exact output voltage is shown at all times and at accuracies that exceed that of the best meter movements. Tubeless power supplies using magnetic amplifiers and metallic rectifiers can be provided when your requirements call for equipment of this nature. The Model 6050-A1H supply is illustrated. This unit provides up to 50,000 volts output. It has both a built-in direct reading kilovoltmeter and current meter. Regulation is in the order of 1% over most of the control range.

COMBINATION POWER SUPPLIES

Equipment can be supplied that provides many voltages from a single convenient source. For example many customers want the High Voltage Power Supply to also feed B+ voltages to certain apparatus as well as filament power for tubes. We can usually give you good service on this type of equipment.

HIGH CURRENT POWER SUPPLIES

These industrial type power supplies are built for service and efficiency. All are of the transformer type and employ husky components that have been selected for their power handling capacity. Controls are arranged so that operation is greatly simplified and a number of safety features are built in for maximum protection of personnel and equipment. Output is continuously variable from zero to full rated value. Polarity reversing models (as illustrated) can be had at additional cost.

Model	Voltage	Current
F 6005-AI-H	5000	100 Ma.
F 6005-AI-5H	5000	500 Ma.
F 6005-AI-K	5000	1000 Ma.



ONE HUNDRED THOUSAND VOLTS!

At Fifty Thousand Ohms/Volt
KILOVOLTER Model 4000

- Shielded Polyesterene Probe
- Choice of Ranges
- Simple Foolproof Circuits

Measures television and X-ray voltages with extra high input impedances. All voltage is dissipated in the shielded polyesterene probe. "Normal-Reverse" key is provided so that probe may be used regardless of polarity of voltage under test. Indicator has large clear scale for easy reading. Additional low leakage path, Special insulated probe is supplied on all 100 KV models.

Model	Range	Kilovolts	Price
4000	0-25/50		\$67.50
4000-A	0-100		80.00
4000-B	0-50/100		85.00
4000-C	0-10/50/100		95.00

High gain magnetic amplifier kilovoltmeters (AC or DC types) can be provided where extra high input impedances are needed. Has advantage over electrostatic meters due to robust construction and fast response.

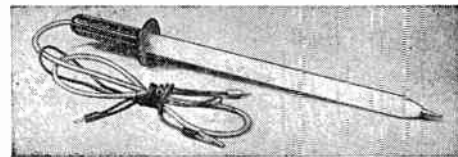

PHOTO SHOWS THE SPECIAL 100 K.V. PROBE SUPPLIED WITH THE HIGHER RANGE INSTRUMENTS.

MAGNETIC AMPLIFIERS

We can supply magnetic amplifiers for the conversion of low voltages or currents into readily useable power levels. Units are silent in operation and outlast vacuum tube circuits many times. A high order of stability is maintained and noise level is quite low. Power gains of up to a half million is readily obtainable. Complete magnetic amplifier systems are available for regulation and control of power supplies, motors, machinery, etc. Let us know your needs. We may be able to ship from stock.

100,000 VOLT TESTING TRANSFORMER

Widely used for testing of instruments, meters, resistors, insulation and wherever an AC type of voltage check is applicable. Primary is designed for the standard 115 volt 60 cycle power line and may be controlled if desired with any of the standard variable transformers. Output 0 to 100,000 volts AC. A special voltmeter winding is incorporated and by placing a 100 volt meter across this winding the high voltage output can be accurately determined. This winding is balanced for exactly 1/1000th of the output (accuracy 2%).

Model 100 KVT.....Price

100 KVT CONTROL SYSTEM

Consists of variable transformer, voltmeter (indicates output test voltage), current meter (indicates current in output circuit) as well as special current overload interrupter circuits.

Model CONTROLLER KVT.....Price

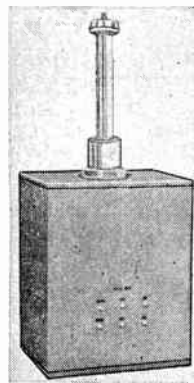

MEG OHM BRIDGE

This direct reading instrument will be found useful for the measurement of those extra high resistances and leakages. Uses a patented circuit that eliminates effects due to amplifier drift and results in greatly increased reading accuracy. Three dials are incorporated: Range Switch, .1 Switch and Ten Turn Potentiometer. Readings may be made to the fifth place and accuracy depends only upon the built-in standards. Range .1 megohms to 1 million megohms.

Model 7000.....Price

PRECISE MEASUREMENTS COMPANY

942 KINGS HIGHWAY • BROOKLYN 23, NEW YORK • TEL. ES. 5-9435

Waveforms

Precision in miniature

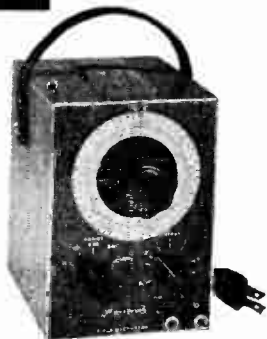

the **FIRST**
the **SMALLEST**
and still the **BEST**

• Waveforms 510-B

MINIATURE AUDIO OSCILLATOR

FREQUENCY RANGE from 18 Cycles to 1.1 Megacycles, with CONSTANT OUTPUT $\pm \frac{1}{2}$ db, and $\pm 2\%$ Calibration accuracy. STABILITY $\pm \frac{1}{2}\%$ with temperature and line voltage. DISTORTION less than 2/10% over most of the useful range. Maximum Output 10 Volts or 4 ma. (± 15 dbm into 2000 ohms). Source Impedance 400 ohms. Logarithmic output control calibrated approximately in volts. BRIEFCASE PORTABLE, less than 6 pounds. 95-130 Volts, 50-400 Cycles. T-10 MATCHING TRANSFORMER . . . attaches securely below 510-B; 150/600 ohms balanced.

520-A EXTENDED RANGE VOLTMETER

FREQUENCY RANGE from 10 Cycles to 2 Megacycles. 1 Millivolt full scale sensitivity; 12 ranges up to 300 Volts. $\frac{3}{4}$ " Illuminated Weston meter calibrated in volts and dbm. Full wave average rectifier. Input Impedance 10 Megohms, 24 uufd. Meter protected against overload. Amplifier output provided. BRIEFCASE PORTABLE. Weight 6 lbs. Buff or mirror scale on special order. 105-130 Volts, 50-400 Cycles.

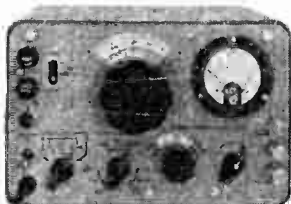

512 EXTENDED RANGE OSCILLATOR

LOW FREQUENCY 9/10 Cycle to 500 Kc. 2 WATTS OUTPUT (34.5 Volts, ± 33 dbm) into 600 Ohms; 50 Volts Max. into 1200 or more ohms. 1/10% DISTORTION over most of range. OUTPUT CALIBRATED and continuously variable with four step DECADE ATTENUATOR. FLAT $\pm \frac{1}{2}$ db. SOURCE IMPEDANCE less than 50 ohms. VERNIER TUNING: Calibration accuracy $\pm 2\%$. SIZE: $7\frac{3}{4}$ " High, 6" Wide, 8" Deep.

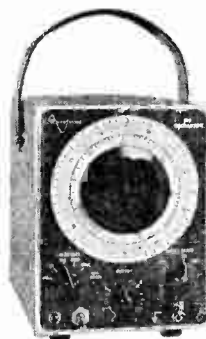

MODEL 1100 AUDIO FREQUENCY GENERATOR

Frequency range from 18 cycles to 500 kc, with output constant ± 0.5 db, and calibration accuracy of 1%. Output 150 or 600 ohms balanced ± 26 dbm max.; low imp. 50 volts or 1 watt. Distortion less than 0.1% over most of useful range. Output continuously variable from ± 26 to -70 dbm; 50 volts to 0.1 millivolt. Step attenuator. Output meter calibrated in volts and dbm. Equivalent to SG/83. Miniature size 6" x 9" x 10" deep.



601-A WAVETRACER — AN AUDIO CURVE TRACER

Instantaneous visual display of frequency response of any audio system. Logarithmic vertical scale; linear in db. Completely self-contained including audio sweep generator, attenuator, mike preamplifier, and logarithmic voltmeter using 7" long-persistence CR tube.

540-A HETERODYNE CRYSTAL CALIBRATOR

Crystal controlled output at 100 kc, 1 mc, and 10 mc, or from external crystal. Sensitive heterodyne detector provides wideband output; self contained speaker monitors audible beat. Miniature unit 6" x $4\frac{1}{4}$ " x 6". 95-130 volts, 50-400 cycles.

Waveforms, inc.

SPECIFICATIONS SUBJECT TO CHANGE WITHOUT NOTICE

NEW YORK 14, N. Y.



Model 655 "DO-ALL" P-P VTVM

Provides for the accurate measurement of complex waveshapes, with peak-to-peak voltages able to be read directly from the scales of the instrument. Serves a variety of industrial applications in the maintenance of vibrator power supplies, AC generators and industrial equipment utilizing complex waves. Supplied with the New "RCP SOLDERLESS" Test Leads. For operation on 50-60 cycle 105-125 V AC.

Features:

- Peak-to-peak AC measurements of from .2 V to 4200 V on 7 ranges.
- AC RMS measurements of .1 V to 1500 V on 7 ranges.
- DC measurements of from .02 V to 1500 V on 7 ranges.
- RESISTANCE measurements of from 2 ohms to 1000 Megohms on 7 ranges.
- Size 10" x 6" x 5".
- Wt.: 7 lbs. 12 oz.

Price **\$59⁵⁰** Net



HVMP-2—High-voltage multiplier probe. Extends range to 30,000 V.....\$8.95

Model 740A TV "DO-ALL" GENERATOR

HERE—AT LAST! One compact, efficient instrument—which gives the performance of several combined instruments—Each of which is higher priced and all of which are needed for properly servicing TV and FM Receivers.

Signal Generator . . .
Generates a modulated or unmodulated carrier signal covering every channel (VHF) and every IF band on any TV or FM Receiver — ALL ON FUNDAMENTALS. It will supply a 360 cycle audio signal at the audio output.

Marker Generator . . .
Accurate to within 1/10 of 1% on 9-11 megacycle band, and better than 1/2 of 1% overall. Perfect for alignment.

Pattern Generator . . .
Produces either horizontal or vertical bars or cross hatch.

DATA: RANGE: 9 megacycles to 220 megacycles ALL ON FUNDAMENTALS — bands 9-11 meg; 21-47 meg; 54-220 meg.
MODULATION: Internal modulation has been provided. Both 360 cycles and 141.75 kilocycles are available.

TUNING: Dial continuously calibrated thru 340°, giving extremely long calibration scale; enables easy reading and tuning. Each TV channel is precisely spotted on the dial. Accuracy for alignment, achieved by use of fine anti-backlash reducing mechanism. The only single easily portable instrument that provides for testing and checking alignment of: Front Ends, IF's, Horizontal and vertical linearity, syncs, sweeps, size, position, focus coil, deflection coil, ion trap. Unusually fine circuit design, extreme stability, rugged mechanical construction. Smart looking unit with new brushed aluminum etched panel and dial. Size 10" x 6" x 6". Weight 8 lbs.

MODEL 740A—COMPLETE WITH OUTPUT CABLE, READY TO OPERATE, ON 50 60 CYCLE 105-125 V AC

\$69⁵⁰ Net



Model 750 UHF and VHF "DO-ALL" TV SIGNAL GENERATOR

Completely covered in one instrument:

Signal	} Generator for UHF and VHF
Marker	
Pattern	

Versatile in concept, the RCP Model 750 can check and test alignment of front ends, IF's, sound and pix traps, linearity, syncs, sweeps, positioning, focus and deflection. Designed for portable or bench use, the 750 reflects the finest in construction and appearance. It is handsomely finished in an attractive brushed aluminum panel with a steel carrying case. For operation on 50-60 cycle 105-125 V AC.

- Inductuner insures accuracy of within 1/2 of 1% over the entire range of 9 Mc to 900 Mc.
- All VHF frequencies are on fundamentals.
- RF's and IF's are clearly calibrated on a large etched aluminum dial.
- Steady horizontal bars, vertical bars and cross-hatch pattern individually produced on all channels.
- Supplies a 360 cycle Audio Signal.

SPECIFICATIONS

BANDS: 9-11 MC, 21-47 MC, 54-220 MC, 465-690 MC, 650-900 MC.

TUNING: Special anti-backlash drive combined with the inductuner guarantees the extreme accuracy. Dial is continuously calibrated through 340°.

MODULATION: 360 cycles and 141.75 Kilocycles internal modulation has been provided —unmodulated carrier signal is also available.

SIZE: 10 1/4" x 6 1/2" x 5 1/8".

WEIGHT: 9 lbs.

PRICE: **\$79⁵⁰** Net



Remember You Can Do More With A "DO-ALL"



Model 324 — "DO-ALL" Tube and Battery Tester

... Packs Into One Instrument the Performance of Four

Sufficient Facilities to Test:

1. All TV and Radio Tubes—Sockets for all standard 4, 5, 6, 7, octal, loctal, miniature and subminiature are provided. Tests transmitting, hearing aid, ballast, pilot light, gaseous rectifiers and tuning indicator types. All readings are indicated on a large easily read meter.
2. Cathode Ray Tubes—Checks all magnetic deflection types right in the set or carton. Will locate and isolate all shorts or leaks.
3. Batteries—Tests popular portable battery types under load. Indicates true condition of battery under check.
4. All This and a Reactivator Too—Gives extra life to otherwise dim or bad picture tubes.

Adds a professional note to any service bench or store counter. Available in both counter and portable models, complete with CR Tube Adapter Cable. For 105-125 V, 50 to 60 cycle operation.

Two Styles to Meet Your Service Needs—**MODEL 324C**—Counter model with open style metal case. Size 13 3/4" x 12 1/4" x 4". Weight: 10 lbs. **\$69.95**
NET PRICE

MODEL 324P—Combination portable-counter model. Smart looking, hand-rubbed carrying case with slip-hinge cover—includes battery test leads. Size 16 1/4" x 14 1/4" x 5". Weight: 12 lbs. **\$79.50**
NET PRICE

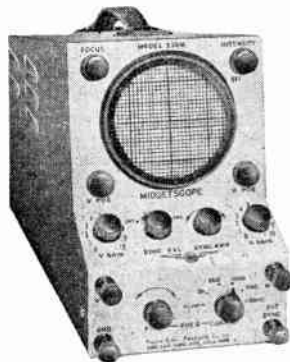

Model 533M MIDGETSCOPE

- Masterfully Engineered for Top Performance
- All Controls on Front Panel
- Quality—Dependability—Accuracy—Economy
- Operates in Either Horizontal or Vertical Position

- Cathode Ray Tube is Tilted at Best Angle for Viewing
- Shielded C R T With Protective Bezel and Graph Screen
- Perfect for TV Servicing in the Shop or House

CHECK THIS PERFORMANCE

- **SENSITIVITY** . . . Vertical—20 millivolts (.020 volts for 1" rms deflection on CRT face). Horizontal—.6 volts.
- **FREQUENCY RESPONSE** . . . 2 db from 20 cycles to 180 kilocycles. Excellent Transient Response.
- **TUBE COMPLEMENT** 3MP1 CRT, 12AT7, 12AU7, 12AX7, 6J6, 117Z6.

- **PUSH-PULL DEFLECTION** . . . For undistorted Response — Eliminates Parallax. Full Vertical and Horizontal Expansion of Trace.
- **INPUT IMPEDANCE** . . . Vertical—5 megohms shunted by 50 MMF. Horizontal—5 megohms shunted by 70 MMF. In metal case with leather

handle — Etched panel — Smart brushed aluminum face — Fuse protected—for 105-125 volts, 50 to 60 cycle AC operation. SIZE: 11 3/4" x 7 3/4" x 5 1/4". **MODEL 533 M** complete, ready to operate. **\$99.50 Net**

Model 808A—"DO-ALL" TUBE AND SET TESTER

ALL IN ONE UNIT!

- **AN OHMMETER:** Reads all Resistance 0.2 ohms to 1000 megohms on 5 ranges. Use this instrument also to check condensers for leakage and shorts.
- **A REACTIVATOR** Revives and Reactivates many otherwise Dim or Bad Television Picture tubes. Can also be used on other tubes.
- **A CATHODE RAY TUBE TESTER** Will check all magnetic de-

REVOLUTIONARY DESIGN includes all the features of the famous RCP Dynotimum Tube Tester plus a cathode ray tube tester and reactivator plus a vacuum tube voltmeter with ohmmeter.

- **A VT VOLTMETER (AC-DC)** This really outstanding 17 Range instrument is a VT Voltmeter for AC as well as DC. Balanced bridge type push-pull circuit. Draws negligible current due to high impedance of 25 megohms. Accuracy ± 3% DC, ± 5% AC. Discriminator alignment

- **A TUBE TESTER:** All the features of the famous Dynotimum free point tube tester — protected against obsolescence—tests all modern standard, miniature, noval base and subminiature tubes. Easily read on 4 1/2" meter.

Equipped with a double rollindex and enlarged, easy to read letters and numbers, the new RCP 808A is so designed as to simplify each operation. Truly a professional instrument for the professional technician.

The RCP 808A is housed in a handsome hand-rubbed oak carrying case and features an attractive, highly visual panel. Compartment available to hold test leads, isolation probe, batteries, etc. Size 12 1/2" x 12 3/4" x 4 3/4". Weight 12 lbs.

MODEL 808A—complete, ready to operate on 105-125 v, 50-60 cycle AC. Net **\$99.95**

High Voltage Multiplier Probe for Model 808. Extends Range of VTVM to 30,000 volts. Model No. HVMP-1. **\$8.95 Net**



Model 123 "FLYBACKER"

The answer to fast, reliable testing of flyback transformers and yokes. Quickly, accurately, checks the horizontal output circuit of all TV receivers.

Extremely sensitive, the Model 123 Flybacker immediately shows up a single shorted turn in a flyback transformer or yoke. Its light, portable design serves to advantage in the shop and in the home.

All tests can be carried out with the components in place in the TV receiver, and call-backs can be prevented by checking all flyback transformers and yokes in stock for opens, shorts, etc. Flybacker tests are also applicable to inductive windings on any transformer, choke, solenoid, relays, etc. where the impedance is not relatively low. In fact the instrument may be used as a proportional AC Ohmmeter.

- Three "GOOD BAD" scales.
- One scale for yokes.
- Tests low and high impedance yokes.
- Direct reading numbered scale.
- Tests while components are in TV receiver.
- Tests high impedance sections of all transformers.

Complete with test leads with alligator clips and tube and instructions ready to use. Operates on 105-125 volts 60 cycle AC—size 6" x 9 3/4" x 4 3/4"—weight 6 1/2 lbs.—shipping weight 8 lbs. **\$39.75 Net**

Remember You Can Do More With A "DO-ALL"



SERIES 8020 • "DO-ALL" TV SERVISHP

"You are in business . . .
with a DO-ALL SERVISHP"

for TV & FM . . . UHF & VHF

PORTABLE • COMPACT • VERSATILE

Handles 95% of your service in the home and in the shop. Check, test and align the set from antenna to picture tube or speaker. All the instruments for necessary measurements right at your fingertips. The Series 8020 includes:

1. Model 750 The DO-ALL TV Signal Generator—UHF-VHF
2. Model 533M The Midgetscope
3. Model 808A The DO-ALL Tube & Set Tester
4. Model HVMP-1 . . . HI-Voltage Multiplier Probe

(See detailed performance and specifications for these units elsewhere in this folder)

IN ONE PRACTICAL PORTABLE CASE

of finely finished natural oak with a compartment for tools, tubes, leads, etc. SIZE: 17" x 14½" x 12½". WEIGHT: 4½ LBS. Series 8020 complete—incl. all necessary leads, ready to operate... **\$310.00 Net**

• SERIES 8023

Same as the Series 8020—Includes Models 750, 533M, 808A and HVMP-1. PLUS Model 730 SIGNALIGNER AF-AM(RF)-FM Signal Generator. For quickly and easily aligning and checking all circuits in AM and FM receivers. Fits snugly into portable case. (See detailed performance and specifications for this unit elsewhere **\$341.00 Net** in this folder.) Series 8023.

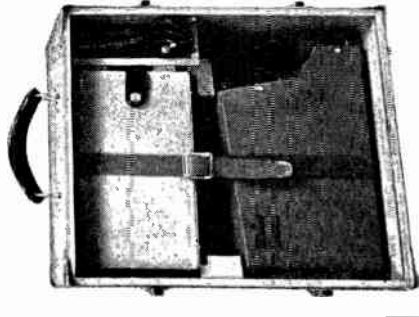
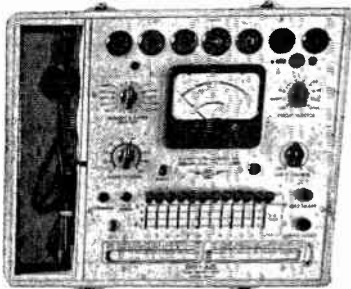

MODEL 8873A • SERVISHP

- Cathode Ray Tube Tester
- Cathode Ray Tube Reactivator
- Tube Tester
- AF Signal Generator
- Vacuum Tube Voltmeter
- AM Signal Generator
- FM Signal Generator

**A Service Package to Meet
Your AM-FM, and TV Test
Needs!**

This unit includes: An up-to-date tube tester for testing and rejuvenating Cathode Ray Tubes as well testing all modern, miniature, noval base and sub-miniature tubes. Uses the speedy Rollindex Tube Chart. A complete 17 range VTVM with exceptionally high input impedance (25 megohms). Check AC and DC volts with negligible loading of circuit. Accuracy ±3% DC, ±5% AC. Measures ohms from .2 to 1000 megohms. Includes High-Voltage Probe. The Signal Generator is a fixed frequency AM, FM generator and Audio Oscillator.

Advanced engineering results in the fine performance of the Model 808A Tube Tester-Reactivator and VTVM in combination with the Model 730 AF-AM-FM Signalignr.

Complete with tubes, batteries, leads, etc. in beautifully finished oak portable case, ready to operate on 50-60 cycle, 105 to 125 V. **\$139.95 Net**
AC. Size 16½" x 12¾" x 5¼". Wt. 18 lbs.



Model 730 • Universal Signaliner

AF-AM (RF) — FM SIGNAL GENERATOR

Simplicity, speed and accuracy are accomplished by fixed frequency points at which circuits are calibrated. BROADCAST BAND ALIGNMENT is provided by fixed frequencies of 1500 KC and 550 KC. Intermediate Frequencies of 456 KC and 465 KC are also supplied. Calibration provides for alignment of 460 KC IF systems.

FM BAND ALIGNMENT is provided by fixed frequencies at 88 MC and 108 MC which are at the ends of the band. Fixed frequencies of 10.7 MC and 9.1 MC provide for IF alignment. The FM section is frequency modulated for use with ratio detectors. RF frequency deviation is plus and minus 500 KC.

AUDIO FREQUENCY MODULATION is provided for AM at 400 cycles. A Separate audio output of 400 cycles is also provided.

Calibrated to be accurate within 1%. Suitable trimmers permit recalibration. Perfect operation from either AC and DC lines with equally high accuracy and stability. Entirely safe as the chassis and case are completely isolated from the line. Attenuator provides smooth control from high signal level to a high degree of attenuation.

Complete with tubes, shielded output cable, line cord and plug, ready to use on 105-125 V, 50-60 cycle AC. Attractively finished panel and case.

Size 7" x 2¼" x 2¾". **\$32.95 Net**
Wt. 2 lbs.

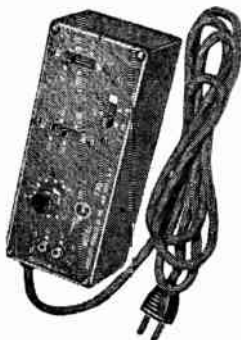

Remember You Can Do More With A "DO-ALL"

TEST EQUIPMENT



"RCP SOLDERLESS" TEST PROD NO. 950

A completely new patented solderless design. All internal. Assures a better contact electrically and mechanically. Will not cut the wire. Neat smart 5/16" pencil type prod permits entering into tight places. Handles are scived to minimize slippage. No more loose caps, lost caps or broken leads. (When ordering be sure to specify color.)

No. 950..... Red or Black..... \$.27 each

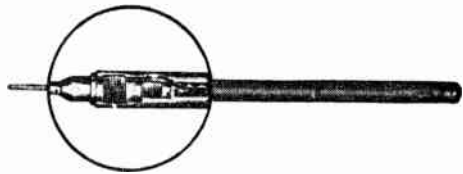

"RCP SOLDERLESS" TEST LEADS NO. 921

The finest solderless test leads obtainable. Made with the new "RCP Solderless" test prod (No. 950 described above) which assures a neat, solid, dependable internal connection. Test leads are 48" long, pliable kinkless strand #18AWG wire insulated for 6000 volts.

No. 921 Standard Phone Tip \$1.08 pr.	No. 923 Insulated Phone Tip \$1.41 pr.
No. 921S Standard Spade Lug 1.08 pr.	No. 923S Insulated Spade Lug 1.41 pr.
No. 921A Standard Alligator Clip 1.20 pr.	No. 923A Insulated Alligator Clip 1.53 pr.

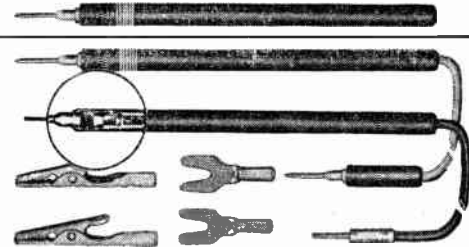

RETRACTO-LEAD NO. 930

A self coiling retractable test lead that will not lose tension. Made with a fine quality heavily insulated stranded wire that has a built-in permanent curl. The prod is the new "RCP Solderless." The Retracto-Lead is needed on every test bench and lab. Extend it for use and then let it pull back and coil itself out of the way. Neat—clean—ready for instant use again. Eliminates tangled lines—shorts—messy benches. Extended leads are 7 1/2 feet long. Phone tips are insulated.

No. 930..... \$2.95 Pair

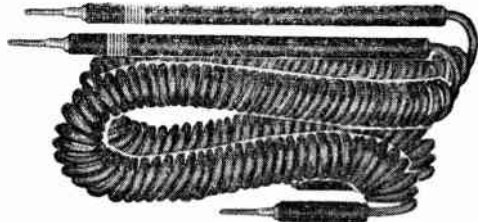

TEST LEAD NO. 901

High quality test leads for professional use under all working conditions. Materials and workmanship are tops assuring dependability and long life. Slim, good looking 5/16" pencil type prod handles are firmly soldered to well insulated, kinkless, stranded wire. Leads are 48" long.

No. 901 Standard Phone Tip \$.96 pr.	No. 903 Insulated Phone Tip \$1.29 pr.
No. 901S Standard Spade Lug .96 pr.	No. 903S Insulated Spade Lug 1.29 pr.
No. 901A Standard Alligator Clip 1.08 pr.	No. 903A Insulated Alligator Clip 1.41 pr.

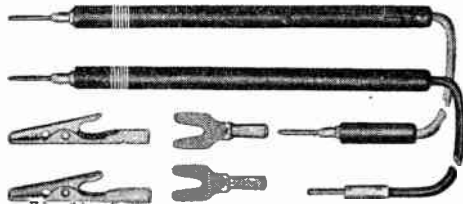

HEAVY DUTY HIGH VOLTAGE TEST LEADS NO. 910

"Scientific" High Voltage Test Leads are designed for use up to 30,000 volts with a good safety factor. Attractive in appearance, they incorporate the highest quality materials and construction. Features include—7" heavy duty prod—heavy duty hardened steel prod points—triple barrier leakage guard—heavy duty kinkless leads 54" long with negligible leakage.

No. 910..... \$3.60 Pair

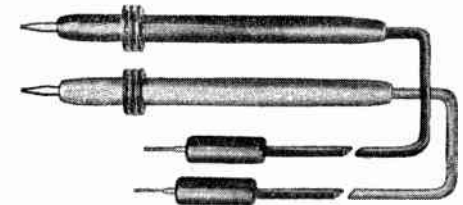

HIGH VOLTAGE MULTIPLIER PROBE

A fine, well made hi-voltage multiplier probe to extend the range of our units to 30,000 volts. Absolutely safe for handling high voltage. Streamlined tip is convenient for getting into "tight" places.

HVMP-1—For use with Models 808, 654, 345.....	\$8.95
HVMP-2—For use with Model 655.....	8.95
HVMP-3—For use with Model 657.....	
HVMP-20—For use with Models 453 and 488A.....	8.95
HVMP-C—Universal probe without termination, or resistor. For any VTVM and 20,000 ohm per volt multimeter.....	4.95

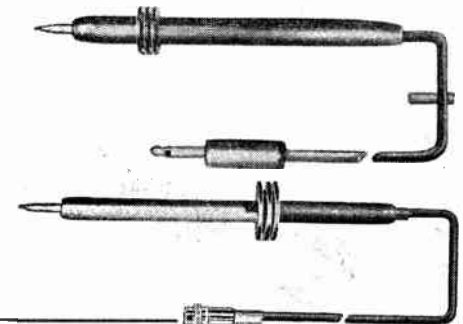

BAR KNOB

A scientifically designed smart looking bar knob. Will not crack or split. Easier to grip because of flat parallel surfaces. Large recessed cup allows this knob to sit flush over even the largest lock nut. Size: 1/4". Available in red or black.

No. 990 Bk.....	Black.....	\$ 10
No. 990 Rd.....	Red.....	5.10



Remember You Can Do More With A "DO-ALL"



Model 657...RCP Electronic "DO-ALL"

62 INDIVIDUAL ELECTRONIC RANGE MEASUREMENTS

Never before has there been engineered one instrument to sell for under \$100 that can possibly match the versatility, efficiency and speed of measurement built into this latest RCP design. Here are combined in one instrument five independent instruments essential in service—production—development. Outstanding in performance, measuring low frequency sinusoidal and both low and high repetition rate non-sinusoidal waveform.

D.C. Voltage: 16 ranges 0 ± 1.5 ± 3 ± 6 ± 30 ± 150 ± 600 ± 1500 ± 6000 .
 D.C. Voltage: Zero Center 14 ranges ± 1.5 ± 1.5 ± 3 ± 15 ± 75 ± 300 ± 750 .
 A.C. Voltage: Peak-to-Peak 7 ranges 0 —4.2 —8.5 —17 —85 —420 —1700 —4200.
 A.C. Voltage: RMS—7 ranges 0 —1.5 —3 —6 —30 —150 —600 —1500.
 A.C. High Voltage: RMS—Range 0-6000 Volts.
 Ohmmeter: 8 ranges—0 —1000 —10,000 —100,000 ohms. 0-1-10-100-1000-10,000 meg-ohms. Center Scale 10.
 Capacity meter: 6 ranges 1 micro-microfarad to 1,000 microfarads: 1-10 μmf ; .00001-.001 mfd.; .0001-.01 mfd.; .001-.01 mfd.; 1-10 mfd.; 10-1000 mfd.

Years Ahead in Design —

- 8 1/2" Easy-to-View Meter provides instant measurement recognition of the several scales.
- Simplified Controls save time. Illuminated individual settings of function and range.
- Carrying Handle serves as inclinable rest—tilts the instrument for maximum readability.
- HVMP-3—high-voltage multiplier probe. Extends range to 30,000 volts.....\$8.95



\$99⁸⁵
Net

Model 706A... "Wide Range" Signal Generator

This new signal generator is the finest performer in its class. For equivalent performance the model 706A should be compared only with other signal generators selling from \$90 to \$125. It provides continuous coverage from 150 KC to 220 MC in 8 ranges. Six FUNDAMENTAL ranges cover up through 55 Megacycles.

ACCURACY: within 1% of calibration adjustment.

STABILITY: and constancy of calibration is assured by special electron-coupled circuit design, permeability adjusted coils and air trimmer capacitors.

MODULATION: 400 cycle sine wave audio oscillator with modulation continuously variable from 0% to 80%. Above 80% has no practical application. At this point tremendous distortion occurs in all signal generators. Unmodulated signal is available if desired.

SHIELDING: Thorough shielding of all critical circuits and components either individually or in compartment or both.

This includes oscillator tube, coil assembly, attenuator, switching circuit. Transformer is electrostatically shielded.

ATTENUATION: Ladder type step attenuator consisting of a multiplier and fine attenuator control.

AUDIO OSCILLATOR: 400 cycles at 50 ohms output impedance is available for external use — terminals on panel. Eight scales are clearly calibrated — continuous reading from 150 kilocycles to 220 megacycles. Planetary drive gives vernier tuning with no backlash. Tube complement—68A6, 6SJ7, 6X4.

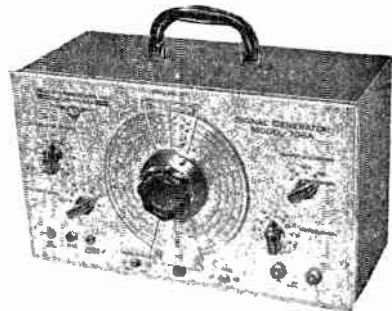

\$67⁵⁰
Net

A high quality instrument in performance, construction and appearance. Size 15" x 9" x 7". Wt. 14 lbs. Complete with leads ready for operation on 105-125 volts, 50 to 60 cycles.

Model 453C...New Master Multitester

• The One Great 20,000 Ohms Per Volt Multitester

A brilliant new completely self contained unit. The Model 453C was designed for direct metering—eliminates warm-up time, grounding, etc. Assures accurate dependable measurements for TV, FM, AM and industry.

RANGES:

DC VOLTS: 0-2.5-10-50-250 500-1000-5000 at 20,000 ohms per volt.
 AC VOLTS: 0-2.5-10-50-250-500-1000 volts.
 DC MICROAMPS: 0-100 — DC MILLIAMPS: 0-10-100-500.
 OHMS: 0-2000 200,000 — MEGOHMS: 0-2-20 Meg.
 DECIBELS: -12 to -3 to 15, 14 to 29, 28 to 43, 34 to 49, 40 to 55.

HVMP—20

High Voltage Probe — \$8.95

Extends range to 25,000 volts

HFP — 20

High Frequency Probe — \$7.95

Increases Range to 400 Mc.

Multiplier and shunts selected within 1% accuracy. Handsome with deeply etched brushed aluminum panel mounted in hand-rubbed shock resistant oak case.

Size 10 1/4" x 6 1/2" x 3 1/4". Wt. 4 1/4 lbs. Complete ready to operate at

\$36⁵⁰
Net



Remember You Can Do More With A "DO-ALL"



Model 780 — INCRA — COLOR — SWEEP GENERATOR

- RCP "Compatible" All Electronic Sweep Generator
For Black and White and Color Television — Plus FM and AM Radio

Years ahead in design — Unexcelled in performance and versatility, the RCP Model 780 is engineered as a completely electronic sweep circuit without any motors or moving parts. Unique electronic unidirectional coupling provides for sweep in one direction only, at a uniform output level (AGC).

Features:

- 180° 60 cycle phasing voltage for use on all oscilloscopes.
- Minimum 150,000 microvolts output, terminated with multiple shielded push-button attenuator with minimum leakage.
- Anti-parallax, illuminated dial scales on all ranges, with anti-backlash dial mechanism.
- Detector/Comparator output to permit comparison of the sweep output on any oscillograph.

Size: 9/4" wide x 9/4" high x 12/2" deep. Complete with output, scope, detector/comparator cables.....**\$159.50**

Model 463 — NEW 20,000 PER VOLT MULTITESTER

- Low Enough in Cost so that No One Should Be Without a 463!

Small in size and with the utmost sensitivity, this compact, efficient unit assures dependable measurement for TV, FM, AM and industry. Designed for direct metering, the Model 463 eliminates warm-up time.

DC voltage multipliers are kept within one percent tolerance and are of the deposit type. Meter tolerance is well within two percent.

Light in weight.....only 19 ounces
Shipping weight.....32 ounces
Small in size.....7" x 4 3/8" x 2 7/8"

RANGES

DC Voltmeter.....	0-5-50-250-1000 volts at 20,000 ohms per volt
AC Voltmeter.....	0-10-100-500-1000 volts.
Output Voltmeter.....	0-10-100-500-1000 volts.
DC Milliammeter.....	0-1-10-1000 mils.
Ohmmeter.....	0-10,000 100,000 ohms 10-1 meg 0-10 meg
Decibel Meter.....	-8 to +55 Decibels

COMPLETE WITH BATTERIES, READY TO OPERATE.....\$26.95

Model 327P — PORTABLE TUBE TESTER

- Meets All of Today's Tube Testing Needs, Plus Tomorrow's Color Television Types

Here is a completely new approach in the development of a tube tester. Streamlined to meet all possible physical limitations, and yet with more testing performance built-in than any related type. Tests all tubes in current radio and television receivers, as well as test tubes in color TV receivers; will check transmitting, hearing aid, ballast, gaseous rectifiers, and tuning indicator types.

A new approach to the tube testing data permits easy and rapid insertion of new information when available. Data is also given on current color TV tubes.

It will check CR Picture Tubes both black and white and color by use of CR adapter cable (available at slight additional cost). Black and white picture tubes can readily be reactivated with this tester.

A fine instrument designed for ease of operation and portability. In solid oak carrying case with slip-hinge cover.

Size: 9 1/2" x 11" x 5 1/2"
Shipping Size: 12" x 13 1/2" x 8"
Weight: 9 1/2 lbs.
Shipping Weight: 11 lbs.

PRICE \$51.95

PICTURE TUBE ADAPTER CABLE—Will permit checking and reactivation of all magnetic deflection types while in the set or carton.

PTA-1—For Blk/Wht Picture Tubes.....\$3.95
PTA-2—For 3 Gun Color Picture Tubes.....\$9.95

Model 480 — AC-DC MULTITESTER

- Exceptional Performance Achieved with Latest RCP Design

Based upon the world-famous RCP 447 Multitester, the Model 480 sets an all-time high in value for an economical, rugged, universal tester that is a must for every laboratory, shop and serviceman's kit. 3" square meter with 800 microampere D'Arsonval movement, gives 1000 ohms per volt sensitivity on DC and AC. Battery for ohmmeter circuit is readily removable and replaceable without soldering or unsoldering. Special spring contact clips make replacement immediately and easily.

Excellent rectifier characteristics and quality control of components in a very large production result in an unusually low price. Here is a better, yet more inexpensive instrument than the Model 447.

Housed in a compact, smart looking custom-molded case and panel, the Model 480 equals in appearance its quality and performance.

RANGES

DC Voltmeter.....	0-5-50-250-500-1000 volts.
AC Voltmeter.....	0-10-100-500-1000 volts.
Output Voltmeter.....	0-10-100-500-1000 volts.
DC Milliammeter.....	1-10-100 1000 milliamperes.
Ohmmeter.....	0-10,000 ohms-100,000 ohms- 1 meg and 10 meg external.
Decibel Meter.....	-8 to +55 Decibels.
MODEL 480: Size 7" x 4 3/8" x 2 7/8"; Weight 20 ozs. Shipping Weight 34 ozs.	

**COMPLETE WITH BATTERY
READY TO OPERATE.....\$14.85**

Ask Your Local Parts Distributor For The New 1954 RCP Catalog

DIALIGHT CORPORATION

Foremost Manufacturer of Pilot Lights

PILOT LIGHT ASSEMBLIES

for

T-3 $\frac{1}{4}$ NEON LAMP • NE-51

11/16" MOUNTING HOLE

BUILT-IN RESISTOR

(Patent No. 2,421,321)

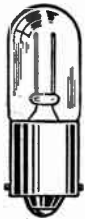

NE-51

For 110 and 220 volts

The new NE-51 lamp is especially useful for pilot lights to be operated on commercial voltages. It has a distinctive orange-red glow and consumes very little current.

MULTI-VUE CAP

In addition to the advantages given by the provision of the built-in resistor, these assemblies offer another feature that is especially important in obtaining effective indication with the NE-51 lamp. The "Multi-vue" cap shown at the right gives a high degree of visibility by directing an increased amount of light toward the eye when the indicator is viewed from any angle. When it is desirable to view the electrodes directly, the clear caps shown below are very effective. For concentrating the light into a beam the metal lens holders are equipped with convex lenses as shown.

CATALOGUE NUMBERS

- 521308-991 Multivue cap, Screw terminals (Fig. 1)
- 531308-991 Multivue cap, Screw terminals (Fig. 2)
- 91408-931 Long clear cap, Soldering terminals (Fig. 4)
- 95408-931 Clear cap, Soldering terminals (Fig. 3)
- 81408-111 Screw-in cap, Convex lens, Soldering terminals (Fig. 20)
- 80408-831 Screw cap, Dome plastic lens, Soldering terminals (Fig. 21)
- 801308-831 Screw cap, Dome plastic lens, Screw terminals
- 51408-111 Screw cap, Convex lens, Soldering terminals (Fig. 22)
- 511308-111 Screw cap, Convex lens, Screw terminals

COLOR—The final figure 1 in the listed numbers indicates RED LENS COLOR. If other color is desired, change final figure to one from table below:

- Green-2*, Amber-3, Blue-4*, White-5, Yellow-6, Clear-7
- *not recommended with neon lamps.*

BUILT-IN RESISTOR

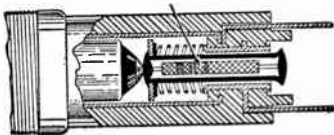

PATENTED
No. 2,421,321

External resistors will be furnished which will permit use of these pilot lights on voltages higher than 220 volts.



All of these assemblies are listed by Underwriters' Laboratories, Inc.

Equipped with BINDING SCREWS

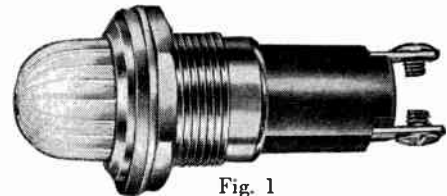

Fig. 1
Multivue caps

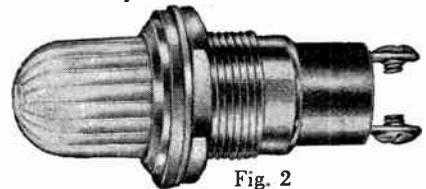

Fig. 2

Equipped with SOLDERING TERMINALS

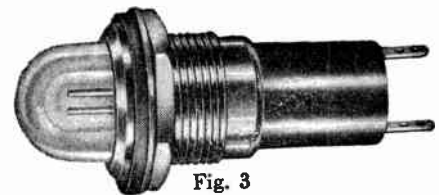

Fig. 3

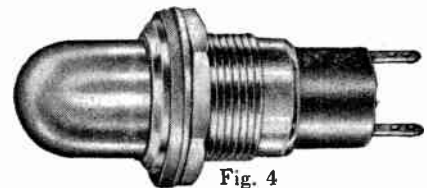

Fig. 4

This series of pilot light assemblies is unique and has several exclusive features. The resistors are permanently built into the high quality DIALCO designed socket.

This socket is constructed with heavy molded bakelite insulation in which the terminals are securely anchored. The insulated socket is mounted in a threaded bushing equipped with nut and shakeproof washer for mounting on a panel of any usual thickness.

DIALIGHT CORPORATION

Foremost Manufacturer of Pilot Lights

BROOKLYN 37, N. Y.

DIALIGHT CORPORATION

Foremost Manufacturer of Pilot Lights

BROOKLYN 37, N. Y.

CAPS

All illustrations are approximately actual size

FRICTION
Convex lens



Fig. 5

BAYONET
Convex lens



Fig. 6

SCREW
Torpedo lens



Fig. 7

Large convex lens

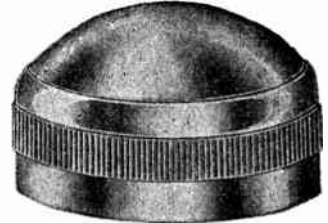

Fig. 8

SCREW

Dome plastic lens



Fig. 9

Faceted lens



Fig. 10

Convex lens



Fig. 11

Large torpedo lens



Fig. 12

ASSEMBLIES FOR 1 INCH MOUNTING HOLE

DOUBLE CONTACT BAYONET



Screw terminals Fig. 15

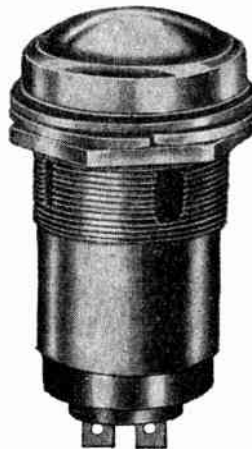

Soldering terminals Fig. 17

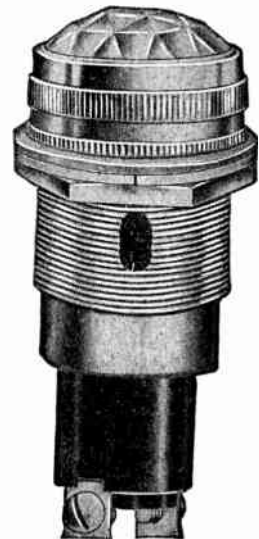

Screw terminals Fig. 16

CANDELABRA SCREW

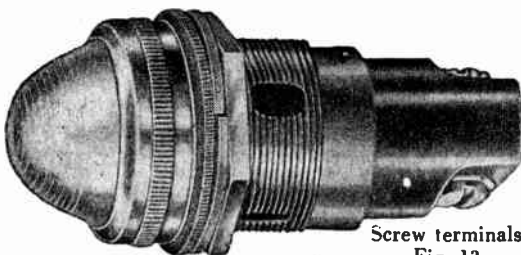

Screw terminals
Fig. 13

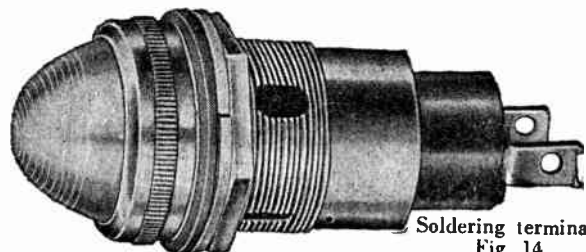

Soldering terminals
Fig. 14

DIALIGHT CORPORATION

Foremost Manufacturer of Pilot Lights

BROOKLYN 37, N. Y.

CATALOG NUMBERS FOR ENCLOSED ASSEMBLIES

Mount in one inch clearance hole
UNDERWRITERS' LISTED

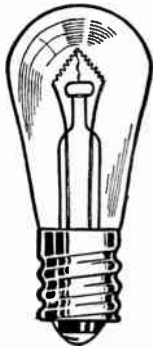

For S-6 Lamp with Candelabra Screw Base

- 51901-111 Screw cap, Convex lens, frosted back (Fig. 11) Screw terminals (Fig. 13)
- 61901-111 Screw cap, Large convex lens, frosted back (Fig. 8) Screw terminals (Fig. 13)
- 51901-431 Screw cap, Faceted lens (Fig. 10) Screw terminals (Fig. 13)
- 19901-531 Screw cap, Large torpedo lens (Fig. 12) Screw terminals (Fig. 13)
- 51101-111 Screw cap, Convex lens, frosted back (Fig. 11) Soldering lugs (Fig. 14)
- 41901-111 Bayonet cap Convex lens (Fig. 6) Screw terminals (Fig. 13)
- 31901-111 Friction cap Convex lens (Fig. 5) Screw terminals (Fig. 13)
- 47901 Light Shield cap (Fig. 19) Binding Screw terminals (Fig. 13)
- 71101-111 Mechanical dimmer (Fig. 18) Soldering terminals (Fig. 14)
- 78101-111 Polaroid dimmer (Fig. 18) Soldering terminals (Fig. 14)

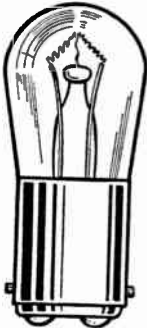

For S-6 Lamp with Double Contact Bayonet Base

- 513202-111 Screw cap, Convex lens, frosted back (Fig. 11) Screw terminals (Fig. 16)
- 613202-111 Screw cap, Large convex lens, frosted back (Fig. 8) Screw terminals (Fig. 16)
- 513202-111 Screw cap, Faceted lens (Fig. 10) Screw terminals (Fig. 16)
- 803202-531 Screw cap, Torpedo lens (Fig. 7) Screw terminals (Fig. 16)
- 413202-111 Bayonet cap Convex lens, frosted back (Fig. 6) Screw terminals (Fig. 16)
- 313202-111 Friction cap Convex lens, frosted back (Fig. 5) Screw terminals (Fig. 16)

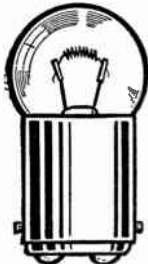

For G-6 Lamp with Double Contact Bayonet Base

- 51701-111 Screw cap, Convex lens, frosted back (Fig. 11) Screw terminals (Fig. 15)
- 51701-431 Screw cap, Faceted lens (Fig. 10) Screw terminals (Fig. 15)
- 80704-531 Screw cap, Torpedo lens (Fig. 7) Screw terminals (Fig. 15)
- 80704-841 Screw cap, Dome plastic lens, matted back (Fig. 9) Screw terminals (Fig. 15)
- 51204-111 Screw cap, Convex lens, frosted back (Fig. 11) Soldering terminals (Fig. 17)
- 41204-111 Bayonet cap Convex lens (Fig. 6) Soldering terminals (Fig. 17)
- 31204-111 Friction cap Convex lens (Fig. 5) Soldering terminals (Fig. 17)



For NE-45 Neon Glow Lamp, Candelabra Screw Base

- 51914-131 Screw cap, Convex lens (Fig. 11) Binding screw terminals (Fig. 13)
- 80914-841 Screw cap, Dome lens (Fig. 9) Binding screw terminals (Fig. 13)
- 41914-131 Bayonet cap Convex lens (Fig. 6) Binding screw terminals (Fig. 13)
- 31914-131 Friction cap Convex lens (Fig. 5) Binding screw terminals (Fig. 13)
- 51114-131 Screw cap, Convex lens (Fig. 11) Soldering terminals (Fig. 14)
- 80114-531 Screw cap, Torpedo lens (Fig. 7) Soldering terminals (Fig. 14)

COLOR—The final figure 1 in the above number indicates RED LENS COLOR. If other color is desired, change final figure to one from table below.

Green-2. Amber-3. Blue-4. White-5. Yellow-6. Clear-7

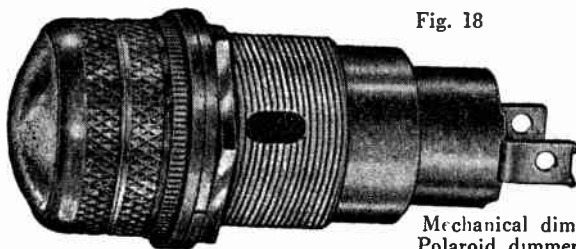

Fig. 18

Mechanical dimmer
Polaroid dimmer

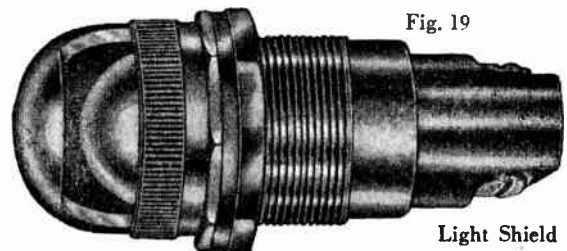

Fig. 19

Light Shield

DIALIGHT CORPORATION

Foremost Manufacturer of Pilot Lights

BROOKLYN 37, N. Y.

PILOT LIGHT ASSEMBLIES



ASSEMBLIES FOR T-3 $\frac{1}{4}$ LAMPS

MINIATURE BAYONET BASE

(for low voltages)

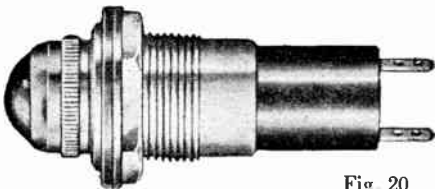

Fig. 20

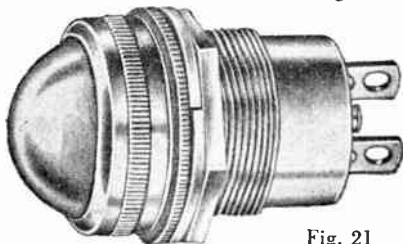

Fig. 21

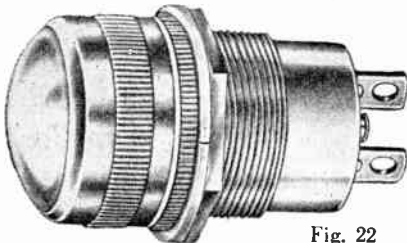

Fig. 22

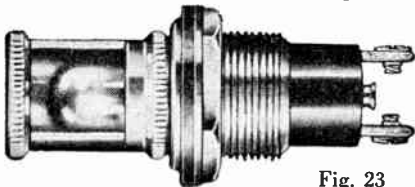
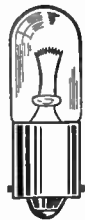

Fig. 23

CATALOGUE NUMBERS

- 521310-991 Multivue cap, Screw terminals (Fig. 1)
- 531310-991 Multivue cap, Screw terminals (Fig. 2)
- 91410-931 Long clear cap, Soldering terminals (Fig. 4)
- 95410-931 Clear cap, Soldering terminals (Fig. 3)
- 81410-111 Screw-in cap, Convex lens, Soldering terminals (Fig. 20)
- 80410-831 Screw cap, Dome plastic lens, Soldering terminals (Fig. 21)
- 801310-831 Screw cap, Dome plastic lens, Screw terminals
- 51410-111 Screw cap, Convex lens, Soldering terminals (Fig. 22)
- 511310-111 Screw cap, Convex lens, Screw terminals
- 211310 Light shield cap Screw terminals (Fig. 23)
- 93410-111 Polaroid dimmer cap, Convex lens, Soldering terminals (Fig. 25)
- 98410-111 Dimmer cap, Convex lens, Soldering terminals (Fig. 24)



COLOR—The final figure 1 in the listed numbers indicates RED LENS COLOR. If other color is desired, change final figure to one from table below:

Green-2, Amber-3, Blue-4, White-5, Yellow-6, Clear-7

Smaller assemblies as illustrated in Figs. 20, 23, 24 and 25 mount in 11/16" clearance hole. Figs. 21 and 22 require 1" clearance hole.

MECHANICAL and POLAROID DIMMERS

mechanical

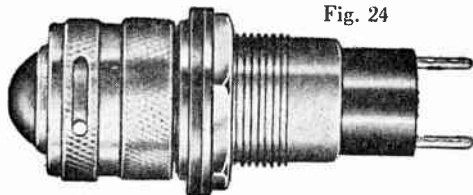

Fig. 24

polaroid

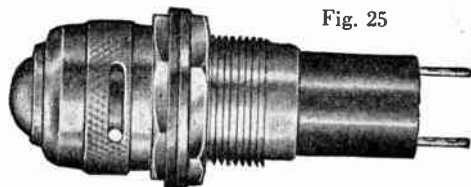

Fig. 25

Any of the mechanical dimmers can be supplied in either the "Complete Blackout" or the regulation type.

DIALIGHT CORPORATION

Foremost Manufacturer of Pilot Lights

BROOKLYN 37, N. Y.

PILOT LIGHT ASSEMBLIES

A SELECTION OF OPEN TYPES
For T-3 $\frac{1}{4}$ Low voltage Incandescent Lamps



Miniature Screw Base

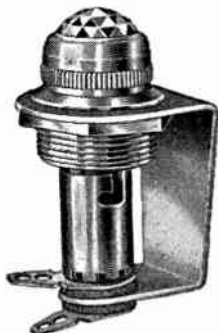
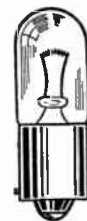

FIG. 26

Typical assemblies for bayonet base lamp.
Available also for screw type, see listing below.



Miniature Bayonet Base

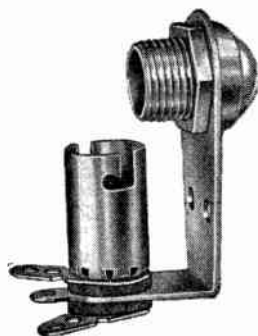

FIG. 27



FIG. 28



CATALOGUE NUMBERS

Assemblies for T-3 $\frac{1}{4}$ miniature bayonet base lamps

No. 810B-431	Faceted $\frac{1}{2}$ " lens.	For $\frac{1}{16}$ " mounting hole.	Fig. 26
No. 710-121	Convex $\frac{1}{2}$ " lens.	For $\frac{1}{16}$ " mounting hole.	Fig. 27
No. 755-621	Convex $\frac{1}{32}$ " lens.	For $\frac{9}{32}$ " mounting hole.	Fig. 28
No. 857B-431	Faceted $\frac{1}{2}$ " lens.	For $\frac{1}{16}$ " mounting hole.	Fig. 29
No. 67B-111	Convex $\frac{3}{4}$ " lens.	For $\frac{1}{16}$ " mounting hole.	Fig. 30

Assemblies for T-3 $\frac{1}{4}$ miniature screw base lamps

No. 810M-431	Faceted $\frac{1}{2}$ " lens.	For $\frac{1}{16}$ " mounting hole.	Similar to Fig. 26
No. 510-121	Convex $\frac{1}{2}$ " lens.	For $\frac{1}{16}$ " mounting hole.	Similar to Fig. 27
No. 555-621	Convex $\frac{1}{32}$ " lens.	For $\frac{9}{32}$ " mounting hole.	Similar to Fig. 28
No. 855-431	Faceted $\frac{1}{2}$ " lens.	For $\frac{1}{16}$ " mounting hole.	Similar to Fig. 29
No. 66M-111	Convex $\frac{3}{4}$ " lens.	For $\frac{1}{16}$ " mounting hole.	Similar to Fig. 30

COLOR—The final figure 1 in the listed numbers indicates RED LENS COLOR. If other color is desired, change final figure to one from table below:

Green-2, Amber-3, Blue-4, White-5, Yellow-6, Clear-7



FIG. 29

Octagon lock nut and bracket on these two units welded into one-piece construction.

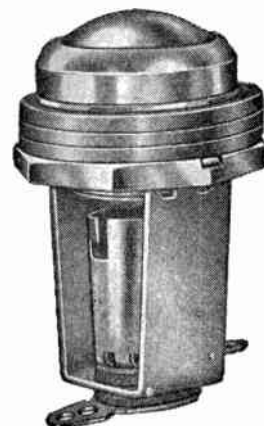

FIG. 30

DIALIGHT CORPORATION

Foremost Manufacturer of Pilot Lights

BROOKLYN 37, N. Y.

PILOT LIGHT ASSEMBLIES

A SELECTION OF OPEN TYPES

For Candelabra Screw Base Lamps

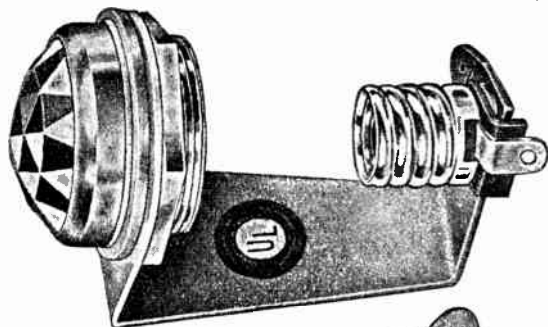

FIG. 31

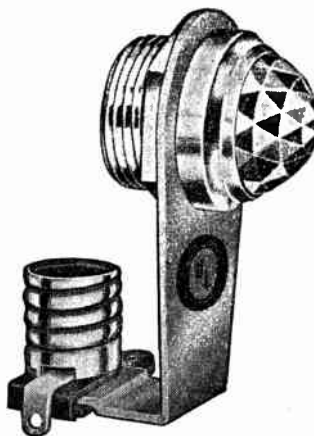

FIG. 33

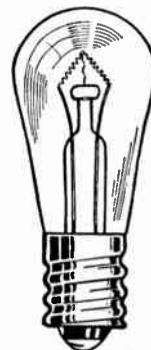

FIG. 32

For S-6 Incandescent Lamps, candelabra screw base

No. 10-18-14-431 Faceted $\frac{1}{2}$ " Lens (for $\frac{7}{16}$ " mounting hole) (Fig. 32)

No. 25-18-15-431 Faceted $\frac{3}{8}$ " Lens (for $\frac{11}{16}$ " mounting hole) (Fig. 33)

No. 31-18-16-431 Faceted 1" Lens (for 1" mounting hole) (Fig. 31)

All of the above assemblies are listed by Underwriters' Laboratories, Inc.

COLOR—The final figure 1 in the listed numbers indicates RED LENS COLOR. If other color is desired, change final figure to one from table below:

Green-2, Amber-3, Blue-4, White-5, Yellow-6, Clear-7

Octagon lock nut and bracket on these two units welded into one-piece construction.

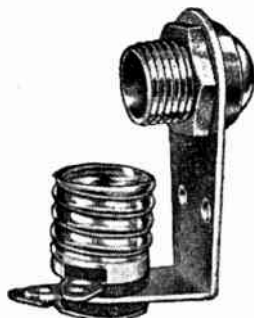

FIG. 34

For G-6 Low voltage lamps, candelabra screw base

No. 610-121 Convex $\frac{1}{2}$ " lens

Fig. 34 (for $\frac{7}{16}$ " mounting hole)

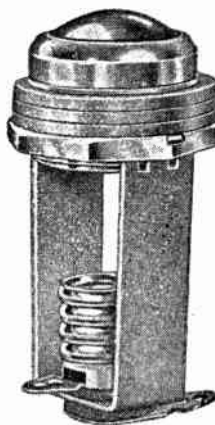

FIG. 36

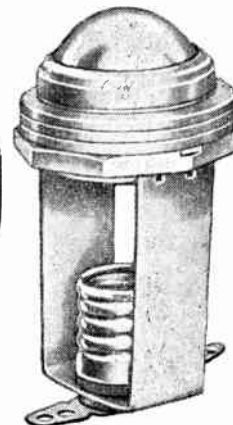

FIG. 35

For NE-45 Neon Glow Lamps, candelabra screw base

No. 67BN-831 Dome Plastic Lens ($\frac{3}{4}$ " diam.) Fig. 35

No. 66N-131 Convex Glass Lens ($\frac{3}{4}$ " diam.) Fig. 36

(Both mount in $\frac{13}{16}$ " hole. Cap removable)

DIALIGHT CORPORATION

Foremost Manufacturer of Pilot Lights

BROOKLYN 37, N. Y.

Lens Holders with Lenses for Panel Mounting

Screw Types Are Complete With Nut for Shank

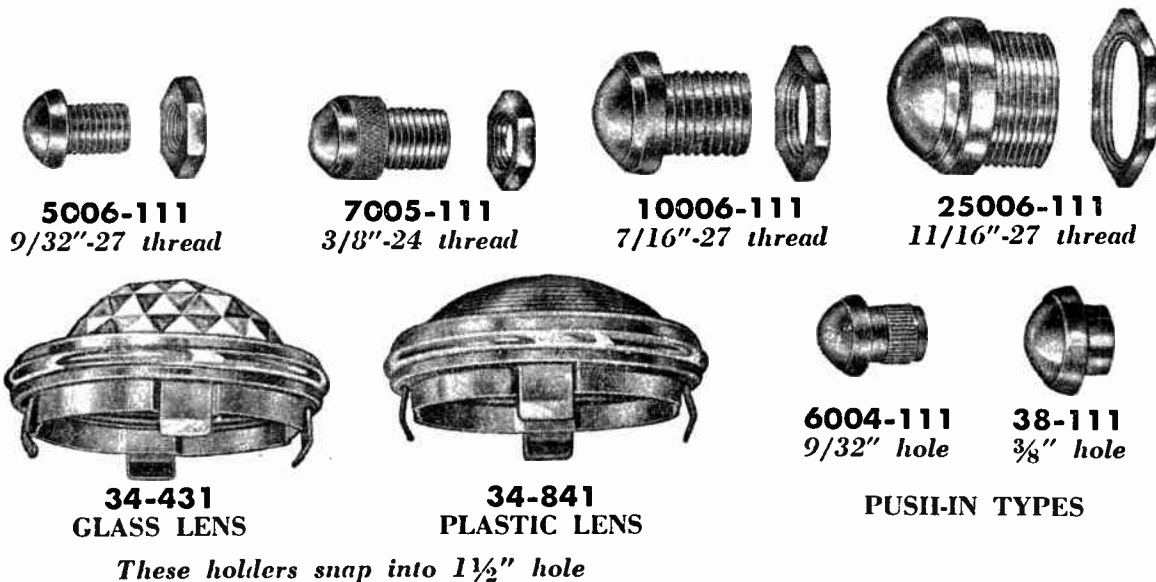

34-431
GLASS LENS

34-841
PLASTIC LENS

PUSH-IN TYPES

These holders snap into 1 1/2" hole

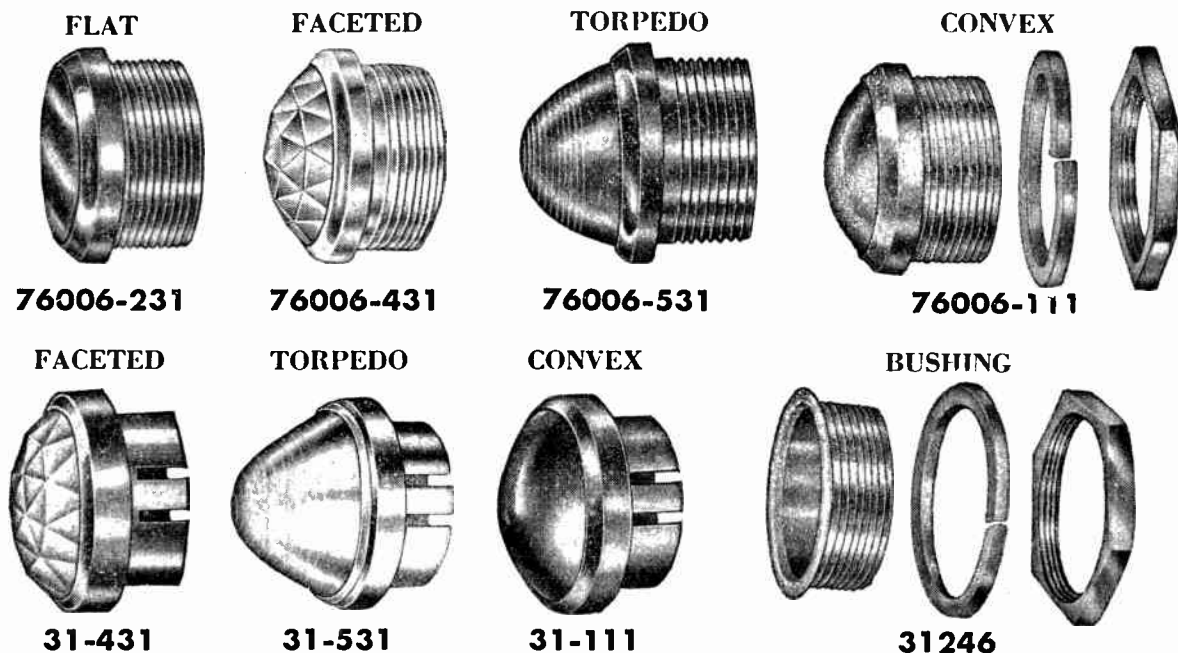

76006-231

76006-431

76006-531

76006-111

31-431

31-531

31-111

31246

The above two groups mount in 1" clearance hole. The upper series lock to the panel and are tamper proof. The lower series permit lamp replacement from the front of the panel.

LENS COLOR—The final figure 1 in the listed numbers indicates RED LENS COLOR. If other color is desired, change final figure to one from table below:

Green-2, Amber-3, Blue-4, White-5, Yellow-6, Clear-7

SOCKETS BRACKET MOUNTED



MINIATURE BAYONET

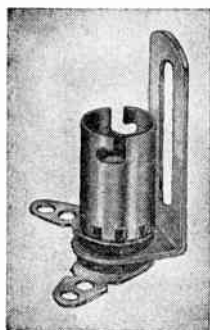

No. 7 Series

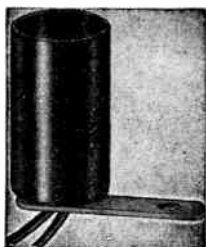

No. 2 Series
FIBRE TUBE

Wire
Leads



No. 3 Series
MOLDED BAKELITE

MINIATURE SCREW

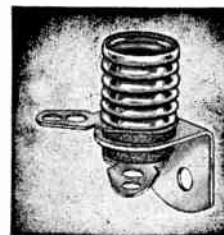

No. 5 Series

Socket
suffix

Bracket Description

- 01—Plain clip, upturned
- 02—Plain clip, downturned
- 03—Clip with ears, upturned
- 04—Clip with ears, downturned
- 05—Right angle, upturned, slotted. Slot— $\frac{7}{8}$ " x $\frac{3}{16}$ "
- 06—Right angle, downturned, slotted. Slot— $\frac{7}{8}$ " x $\frac{3}{16}$ "
- 07—Plain socket, no bracket
- 08—Right angle, downturned, short. Hole Size— $\frac{5}{32}$ "
- 09—Right angle, upturned, short. Hole Size— $\frac{5}{32}$ "

Socket
suffix

Bracket Description

- 11—Square U-shaped. Hole Size— $\frac{5}{32}$ "
- 12—Horizontal (no bend), short. Hole Size— $\frac{5}{32}$ "
- 13—Horizontal (no bend), slotted. Slot— $\frac{7}{8}$ " x $\frac{3}{16}$ "
- 14—Vee with locking tongue, short—1"
- 15—Vee with locking tongue, short— $1\frac{1}{4}$ "
- 16—Vee with locking tongue, intermediate— $1\frac{5}{16}$ "
- 17—Vee with locking tongue, long— $1\frac{3}{8}$ "
- 18—Vee with locking tongue, long— $1\frac{1}{2}$ "
- 19—Right angle, upturned, long. Hole Size— $\frac{9}{64}$ "
- 20—Right angle, downturned, long. Hole Size— $\frac{9}{64}$ "

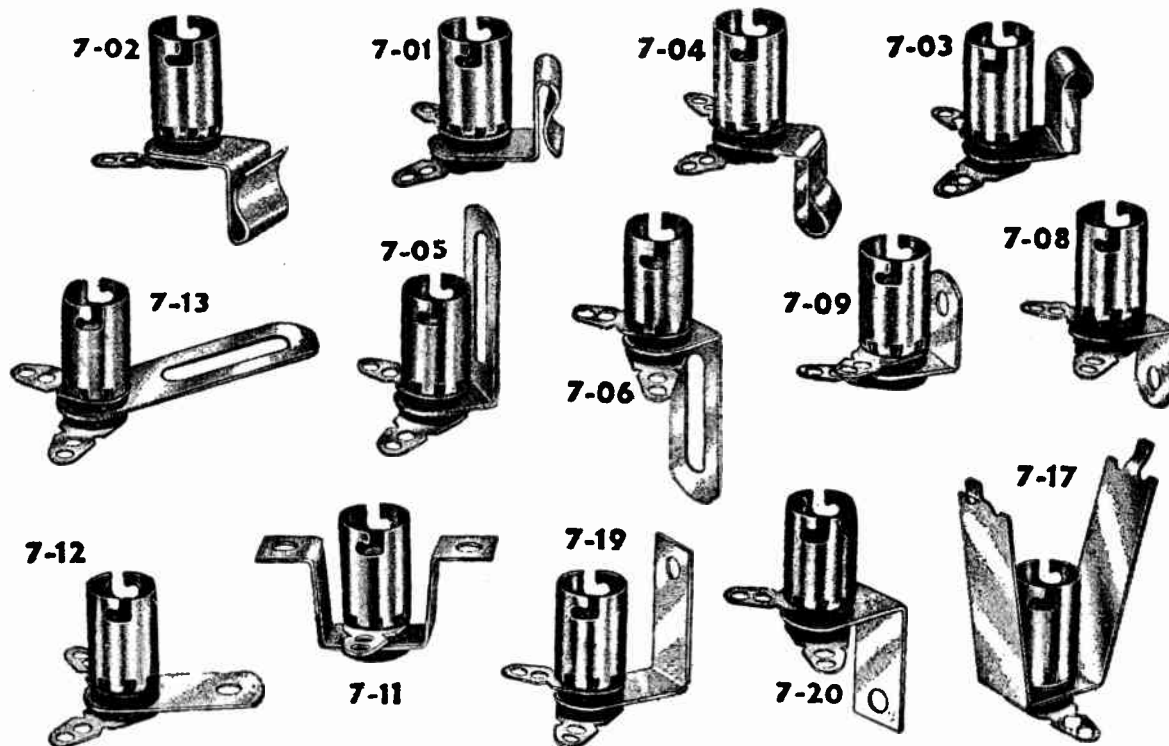



SOCKETS

BRACKET MOUNTED

75 Watts, 125 Volts

UNDERWRITERS'



LISTED

No. 4 Series Wire Leads

Insulated with heavy molded Bakelite. Square shoulder locks into square hole in bracket—all securely held by large tubular rivet.



IDEAL FOR S-6
and C-7 LAMPS

No. 18 Series

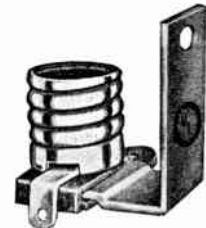

Soldering Terminals
(locked in position)

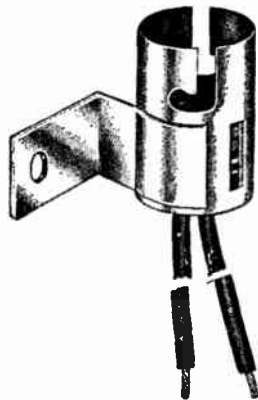

No. 12 Series
CERAMIC DISK

No. 12 Series — Double Contact Bayonet Ceramic Insulating Disk

The new "12" series socket is constructed with a high quality ceramic disk supporting the socket contacts. Recesses in the disk receive the lead wires so that no live metal is exposed.

Wire Leads

The standard flexible leads are of plastic insulated approved wire, 18 gauge. Usual length is 8 inches; longer leads will be supplied when specified.

Many Bracket Types

NAVY SPECIFICATION SOCKETS

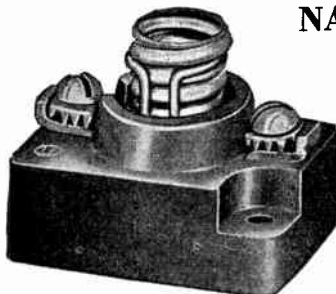

Candelabra screw 9S2036
Candelabra screw 9S5038
(not illustrated)

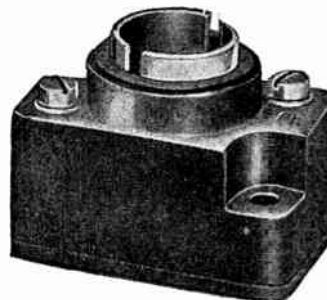

Double Contact bayonet 9S4634

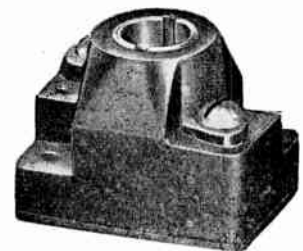

Miniature bayonet
9S4931

LAMP INSTALLER

The DIALCO lamp installer shown below is a useful tool in installing lamps and in servicing pilot lights.



No. L-73

No. L-45
For NE-45 Neon

DIALIGHT CORPORATION

Foremost Manufacturer of Pilot Lights

BROOKLYN 37, N. Y.

CONNECTORS FOR SINGLE CONDUCTOR CABLE FOR MICROPHONES - SPEAKERS - PICK-UPS - JACKS

(using cable shield for second conductor)

The fittings shown here are designed for use with standard metal shielded single conductor cable up to $\frac{1}{4}$ " diameter. These connectors are heavily constructed from solid brass and all exposed parts are chrome plated and highly polished.

The cable end connectors are provided with rugged wire spring protectors which prevent sharp bends at the connection. The protector is soldered to the cable sheath and secured in the connector by a set screw so that all strain is relieved from the conductor.



No. 101

MALE CONNECTOR FOR CABLE

With spring protector to prevent sharp bending of cable. Solders to cable sheath — secured by set screw.



No. 100

FEMALE CONNECTOR FOR CABLE

With spring protector to prevent sharp bending of cable. Solders to cable sheath — secured by set screw.

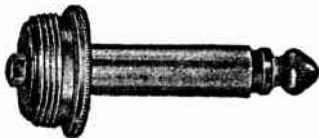

No. 102

PLUG WITH MALE CONNECTOR

Fits standard jacks



No. 51

MALE CONNECTOR FOR CHASSIS

Has sprung center contact which grounds before cable connection is broken preventing open circuit howls.

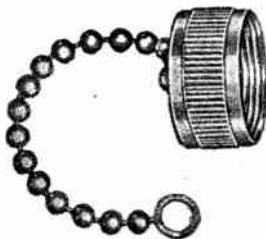

No. 103

CAP AND CHAIN

To protect unused male connectors. Chain secured by screw prevents loss when removed to make connection.



No. 50

MALE CONNECTOR FOR CHASSIS

Shell grounds to panel — or may be insulated by washers. Fit $\frac{3}{8}$ " — 24 threaded hole or may be secured by nut.

No. 50 P

MALE CONNECTOR FOR CHASSIS

(Similar to No. 50 above)

Designed for force fit in hole in panel. Requires no nut to secure in place.



Dial and Jewel PILOT LIGHT ASSEMBLIES

JEWEL LIGHT ASSEMBLIES

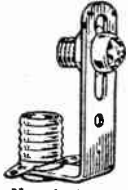

No. 5 Type

11/32" JEWEL . . . VERTICAL MOUNTING

Adjustable to the focal length of any miniature screw or bayonet lamp. Mounts in 9/32" diameter hole on panels up to 1/4" thick. Tested at 125 volts. Faceted glass. Panel Hardware, bright nickel — other parts cadmium. Standard colors.

No. 5 _____ Min. Screw _____ List \$0.55
No. 5B _____ Min. Bayonet _____ List .57



No. 10 Type

1/2" JEWEL . . . VERTICAL MOUNTING

Mounts in 7/16" hole on panels up to 1/4" thick. Tested at 125 volts. Standard colors. Faceted glass. Panel Hardware, bright nickel — other parts cadmium. No. 10B has bracket with oblong hole permitting adjustment to obtain best position for lamp filament back of Jewel.

No. 10 _____ Min. Screw _____ List \$0.49
No. 10G _____ Min. Bayonet _____ List .50
No. 10B _____ Min. Bayonet _____ List .51



No. 10C Type

1/2" JEWEL . . . VERTICAL MOUNTING UNDERWRITERS APPROVED

Candelabra screw base Jewel light which is Underwriters Approved for 75 watt — 125 volt service. Takes minimum depth behind panel. Oblong hole permits adjustment for placing lamp filament behind Jewel for maximum illumination. Mounts in 7/16" hole on panels up to 1/4" thick. Standard colors. FAC-SP-SFB glass finishes. Standard plating.

No. 10C _____ Candelabra Screw _____ List \$0.60



No. 20S Type

1/2" JEWEL HORIZONTAL MOUNTING

Lamp removable from front of panel. Mounts in 11/16" hole. Tested at 125 volts. Standard colors. Faceted glass. Regular plating.

TYPE NUMBER	STYLE SOCKET	DEPTH BACK OF PANEL	PANEL THICKNESS	LIST PRICE
20	Min. Bay.	1-13/32"	0" to 7/64"	\$0.76
30	Min. Bay.	1-7/32"	1/4"	.76
40	Min. Bay.	1-11/32"	1/8" to 15/64"	.76
20S	Min. Screw	1-1/16"	0" to 15/64"	.74
30S	Min. Screw	15/16"	1/4"	.74

1/2" POLARIZED VARIABLE INTENSITY



No. 80 Type

Incorporates use of polarized discs to regulate light intensity. A partial turn of the Jewel dims the light. Supplied with three fibre washers to compensate for different panel thicknesses. Mounts in 11/16" hole. Finish bright nickel. Standard Colors. Regularly supplied with smooth glass frosted on back only. Other glass types optional.

TYPE NUMBER	STYLE SOCKET	LIST PRICE
80	Miniature Bayonet	\$1.91
80S	Miniature Screw	1.89



No. 75AP \$2.20

1" JEWEL . . . Underwriters App.

A heavy-duty Candelabra screw base assembly designed to be used on rugged equipment. UL for 125 volt 75 watt service. The socket assembly and mounting tube are one piece. Solder terminals. Mounts in 1" hole on panels up to 1/2" thick. Panel Hardware, highly polished chrome. All other parts cadmium plated. Standard colors in FAC, SP or SFB glass. Depth back of panel 2 1/4".

1/2" JEWEL . . . HORIZ. MOUNTING

Specially designed for use on more than one thickness of panel. Two fibre washers compensate for panel thicknesses. Mounts in 11/16" hole. Lamp removable from front of panel. Tested at 125 volts. Regular plating. Faceted jewel in standard colors.

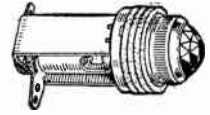

No. 50 Type

TYPE NUMBER	STYLE SOCKET	DEPTH BACK OF PANEL	PANEL THICKNESS
50	Min. Bayonet	1-9/16"	0" to 1/4"
50.5	Min. Bayonet	1 1/2"	17/64" to 3/8"
50S	Min. Screw	1 1/8"	0" to 1/4"
50.5S	M.n. Screw	1 1/8" to 1 1/4"	17/64" to 3/8"

LIST PRICES

No. 50 \$1.07 No. 50.5 \$1.10 No. 50S \$1.05 No. 50.5S \$1.07

5/8" PLASTIC CAP HORIZONTAL MOUNTING

Gives wide angle vision . . . easily seen from sides. Lamp removable from front of panel. Supplied with three 1/16" thick fibre washers for adjustment of thickness of panel. Mounts in 11/16" hole. Tested at 125 volts. Regular plating. Colors: amber, colorless, green and red.

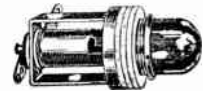

No. 51 Type

Type No.	Length			Style Socket	Number of Spacing Washers Required			
	A to B	C to D			1/8"	1/4"	3/8"	1/2"
51	1 1/8"	1 1/8"	Min. Bay.	Panel thickness	3	2	1	0
51.5	1"	1 1/8"	Min. Bay.	Washers	2	1	0	0
				Panel thickness	1/4"	3/8"	1/2"	0
51S	7/8"	1 1/8"	Min. Screw	Panel thickness	1/8"	1/8"	3/8"	1/4"
				Washers	2	1	0	0

A to B: length of socket assembly without lamp. C to D: overall length of socket assembly with lamp installed.

LIST PRICES

No. 51 \$0.95 No. 51.5 \$0.97 No. 51S \$0.94

3/4" JEWEL . . . HORIZ. MOUNTING

Polished chrome "slip-fit" bezel. Mounts in 13/16" hole. Supplied with fibre washers to compensate for panel thickness. Miniature types tested at 125 volts. Candelabra type stands 1000 volts breakdown. Standard colors. No. 60 Types are regularly supplied with colorless smooth glass frosted on back, behind which is placed a colored disc so glass appears white until lamp is lighted.

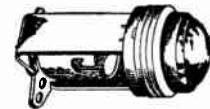

No. 60 Type

TYPE NUMBER	STYLE SOCKET	LIST PRICES
60	Miniature Bayonet	\$ 1.55
60N	Cand. Screw for NE45 Lamp	1.64
60S	Miniature Screw	1.53
60T	Cand. Screw for 115V, 6W, T4 1/2 Lamp	1.65

1" JEWEL . . . HORIZ. MOUNTING

Easy to install. Has "slip-fit" bezel. Mounts in 1" diameter hole on panels up to 1/2" thick. Will withstand a voltage breakdown of 1000 volts. No. 75 will take any candelabra screw base lamp up to 1 7/8" long and 7/8" diameter. Nos. 175 and 275 take any miniature lamp up to 1-3/16" long and 7/8" diameter. All parts are burnished cadmium plated except the bezel, which has a highly polished chrome finish. Standard colors. No. 75 Types are regularly supplied with colorless smooth glass frosted on back, behind which is placed a colored disc so that glass appears white until the lamp is lighted. Comes in FAC, SP or SFB. We recommend smooth plain glass for use with Neon Glow Lamps.

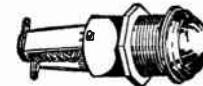

No. 75 Type

TYPE NUMBER	STYLE SOCKET	LIST PRICES
75	Candelabra	\$1.82
175	Miniature Screw	1.72
275	Miniature Bayonet	1.74
375	S.C. Cand. Bayonet or Bay.	1.77



Dial and Jewel PILOT LIGHT ASSEMBLIES

TOTALLY ENCLOSED MINIATURE BAYONET ASSEMBLIES



UNDERWRITERS LISTED



No. 100 Type — 1/2" JEWEL
(ALSO Types 100N, 101N for Use with NES1 NEON GLOW LAMPS)

No. 101 Type — PLASTIC DOME

The 100 and 100N have glass Jewels. The 101 and 101N have transparent plastic domes. The fluted-on-inside type plastic dome has three times the visibility of the plain cap. All types mount in 11/16" diameter hole on panels up to 3/8" thick. Breakdown 2000 volts. 101 and 101N come in amber, colorless, red and milky white in the transparent; and blue, green, red, milky white and yellow in the translucent.

With proper current limiting resistors 100N and 101N can be operated on any voltage over 65 volts AC and 90 volts DC. Resistor is built into the housing. Units carried in stock have 100,000 ohm resistors for 115 volt operation.

LIST PRICES

No. 100.....\$1.34 No. 100N.....\$1.56 No. 101.....\$1.20 No. 101N.....\$1.42

NEON INDICATOR LIGHTS



No. 105
POSTLITE

for maximum
visibility



No. 110 FLUSHLITE

No. 110 FLUSHLITE is Underwriters Listed. Comes equipped with NE-2 neon lamp with built-in 100,000 ohm resistor. Can be mounted by two screws or on studs on either front or back of panel. Body is milky white polystyrene. Rated at 125 volts, 1/10 watt.

No. 105 POSTLITE comes equipped with NE-2 neon lamp with built-in 100,000 ohm resistor. Body and head molded in one piece from clear, colorless polystyrene. Mounts in 1/2" diameter hole. Rated at 125 volts, 1/10 watt.

LIST PRICES

No. 105 POSTLITE.....\$1.35 No. 110 FLUSHLITE.....\$1.05

DIAMOND-CUT JEWELS IN STANDARD COLORS THREADED TYPE — WITH NUTS

TYPE No.	SHANK	O.D.	LIST PRICES
14-15	3/8" long	9/32"	\$.38
16-17	3/8" long	7/16"	.32
16L-17	1/2" long	7/16"	.43
16S-17	9/32" long	7/16"	.34
60A3-27	3/8" long	11/16"	.76



TYPES
16-17
1/4" Jewels



No. 60A3
3/4" Jewels

No. 75A3-C — 1" threaded jewel, mounts in 1" hole on panels up to 1/4" thick. Complete assembly supplied with fibre washer, hex nut and lock-washer. LIST PRICE.....\$1.13

No. 60A3-27 and 75A3-C POLISHED CHROME FINISH. OTHER NOS., NICKEL FINISH.

SLOTTED TYPES

TYPE No.	SHANK	O.D.	LIST PRICES
22	1/8" long	3/8"	\$.28
23	3/16" long	3/8"	.28
24	1/4" long	9/32"	.22



No. 75A3-C
1" Jewels



No. 24 OTHER JEWEL FINISHES
11/32" SP.....Smooth Plain
JEWEL SFB.....Smooth Frosted Back
SFA.....Smooth Frosted All Over

Nos. 22, 23
1/2" JEWEL



LOOK FOR THIS

DRAKE DISPLAY BOARD

AT YOUR DEALER'S

It shows a representative assortment of DRAKE units . . . will help you in selecting exactly the right Jewel or Pilot Lights for your requirements.

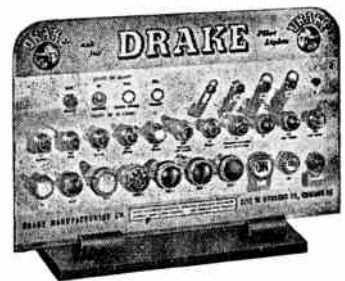

BASIC TYPES



117H
MINIATURE SCREW



217H
MINIATURE BAYONET



417H
CANELABRA SCREW

DIAL LIGHT ASSEMBLIES

Code numbers for Types:
MIN. SCREW — 100 SERIES MIN. BAYONET — 200 SERIES
CAND. SCREW -- 400 SERIES

CLIP BRACKET TYPES

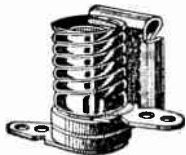

103AH - 203AH
403AH WITH FLANGE BRACKETS

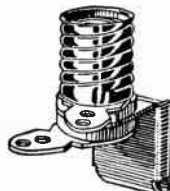

103CE
203CE - 403CE WITH FLANGE BRACKETS



104AH - 204AH
404AH WITH FLAT BRACKETS

LIST PRICES

103	\$.15	117H	\$.12	206	\$.16	403	\$.18	409	\$.17
104	.15	119	.18	207	.16	404	.18	417H	.12
106	.15	156B	.15	208	.16	406	.17	419	.20
107	.15	203	.17	209	.16	407	.17	456B	.18
108	.15	204	.17	217H	.13	408	.17	617H	.15
109	.15	256B	.17	219	.20				

MISCELLANEOUS TYPES

106AE
206AE
406AE

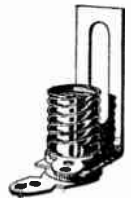

108AH
208AH
408AH

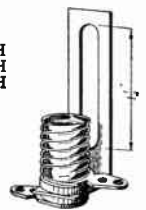

109CH
209CH
409CH



PROTECT against Fire hazards!



REPLACE INSTANTLY!
Can be fused with **LITTLE-FUSE.**
3 AG up to 8 amps,
3 AB up to 20 amps; underwriters approval up to 15 amps.

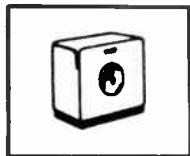

LIST PRICE

39¢

Less Fuses

ELMENCO

FUSED PLUGS

NOW AVAILABLE WITH TOUGH SHOCK-RESISTING HYCAR* SHELL for equipment subject to frequent handling and movement

* B. F. Goodrich Trademark

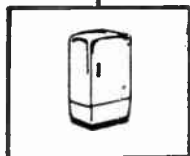

**SALES GETTING DISPLAY
MAKES ELMENCO
EASY TO SELL
EASY TO SEE**

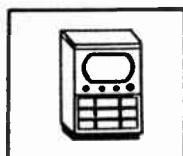

COMPLETE PROTECTION!

The Elmenco Fused Plug is like any standard plug, is light in weight, but easier to handle because of finger grips. However, it contains 2 small fuses which provides complete protection against damage to the appliance and to the main line. The blown fuse is easy to remove and simple to replace. Fits any standard wall outlet.

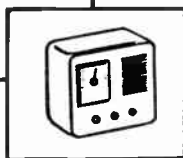
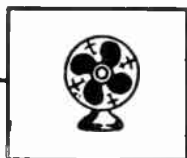
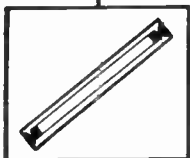

NEW MARKETS! GREATER VALUE!

Approved by Underwriters Laboratories and used by many of the largest manufacturers of radio and electronic equipment, battery chargers, washing machines, curling irons, lighting equipment, automatic relay equipment, motors of every description, and practically every other type of product that consumes electricity. Every wired home, office and store is a prospect.

MANUFACTURED BY

ELMENCO PRODUCTS CO.

We list a few of the larger consumers of the
ELMENCO FUSED PLUG

- Auto-Lite
- Bell Telephone Labs.
- Bulldog Electric
- Cambridge Instrument
- Canaday Cooler
- Dictaphone
- Dile-Therm
- Eagle Electric
- Eastman Kodak
- Electro-Physical Labs.
- General Electric
- Gerlat Lighting
- I. B. M.
- Buick Motors
- Philco
- R. C. A.
- Sylvania
- Thomas Edison
- Webster-Chicago
- Western Electric
- Westinghouse

BUSS Fuses

FUSETRON DUAL-ELEMENT Fuses and Fuse Holders

for Protection of Radios, Instruments and Electronic Equipment

BUSS FUSE CLIPS for 1/4 inch Fuses

(SFE 4, 6, 9, 14, 20, AGX, AGC, ABC, MDL, MDX, MJB, MJW, MTH fuses)



Spring bronze clips are made of Herculoy — a bronze of distinctly superior quality for spring clips. This metal gives clips great gripping strength and ability to retain spring under adverse conditions.

Beryllium copper clips combine low electrical resistance with great gripping strength. This means maximum electrical conductivity and results in cooler operation of clips and fuse.

Size of mounting hole; .130 to .135 inch.
Center of hole to back-stop; .125 to .135 inch.
Min. length of contact surface; 3/32 inch
Maximum height; 1 1/2 inch
Maximum width; 1 1/2 inch

4548 Spring bronze clip, Nickel plated.
4592 Beryllium copper clip, Silver plated.

List Price
\$0.02
.05

BUSS CLIP ASSEMBLIES for 1/4 inch Fuses

(SFE 4, 6, 9, 14, 20, AGX, AGC, ABC, MDL, MDX, MJB, MJW, MTH fuses)



Clips as described above. Brass terminal. 3/16 inch 6-32 washer head terminal screw. 1/4 inch 4-40 flat head iron mounting screw.

4431 includes No. 4548 spring bronze clip, terminal screw, terminal and mounting screw. List Price \$0.10
4432 includes No. 4592 beryllium copper clip, terminal screw, terminal and mounting screw. List Price \$0.13

BUSS FUSE BLOCKS

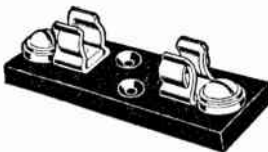

Bakelite base blocks 3/16 inch thick. Countersunk mounting holes for No. 6 flat head screws. Brass No. 6 terminal screws. No. 4548 spring bronze clips.

Full base, Screw terminal Blocks

For Fuses	One Pole	List Price	Two Pole	List Price	Three Pole	List Price
SFE4	4511	\$0.35	4521	\$0.70	4531	\$1.00
SFE6	4516	.35	4526	.70	4536	1.00
SFE9	4517	.35	4527	.70	4537	1.00
SFE14, AGX, MJB, MJW }	4514	.35	4524	.70	4534	1.00
SFE20, ABC, AGC, MDL, MDX, MTH }	4512	.35	4522	.70	4532	1.00



Small base, Solder Terminal Blocks

For Fuses	One Pole	List Price	Two Pole	List Price	Three Pole	List Price
SFE14, AGX, MJB, MJW }	4520	\$0.15	4485	\$0.30	4403	\$0.45
SFE20, ABC, AGC, MDL, MDX, MTH }	4405	.15	4408	.30	4411	.45

Other standard and special fuses, fuse blocks and fuse holders

If the fuses, blocks and holders shown do not fit your requirements ask for information on other types.

Fuses and fuse mountings to meet JAN and Military specifications also are available.

If you have a special problem in protection send description or sketch giving number of circuits, type of fuse, terminals, etc., desired. We welcome such inquiries.

BUSS FUSE HOLDERS

Make it convenient to mount fuse on any equipment. Changing or inspection of fuse is easy and quick.

Holder has removable knob. Fuse projects beyond body of holder and is not held tight on other end when knob is removed.

Fuse and contacts are protected from dirt and fumes.

Good contact on fuse is made certain by strong coil spring pressure. Poor contact heating that often causes fuse to blow needlessly is eliminated.

Holder bodies are made of black bakelite. All current carrying parts are of brass or copper. Terminals and all contact parts are bright alloy plated.

PANEL MOUNTED HOLDERS for 1/4 inch Fuses



Holders are inserted through hole in panel and are locked in place by nut on holder. They can be used on panels up to 3/16 inch thick.



Bayonet type knob requires only quarter turn to remove fuse. No screw driver is needed.

Side terminal is held mechanically as well as by solder. Heat of soldering wire to it will not cause it to loosen or come off.

Vibration will not cause failure of terminals as they are designed to stand severe service.

Neoprene washer and steel locking nut (zinc plated, chromate dipped) furnished with each holder.

Wire hole in terminals; .115 inch.

Normal current carrying capacity; 15 amperes.

Listed as approved by Underwriters' Laboratories.

HJM for 1/4 x 1 inch fuses (AGX, MJB, MJW, SFE 14) \$0.40
HKP for 1/4 x 1 1/4 inch fuses (ABC, AGC, SFE20, MDL, MDX, MTH) .40

IN-THE-LINE HOLDERS for 1/4 inch fuses



These holders are for mounting fuse in wire. Holders consist of body and bayonet type knob — two contacts ready to be staked on ends of wire — a pressure spring that is used under contact in base of holder.

Holders can also be mounted in panel up to 3/16 inch thick by means of a No. 9969 Spring nut (Nut not furnished). Flat spot on holder permits it to be locked against rotation.

Normal current carrying capacity: 15 amperes.

HDI for 1/4 x 1 inch fuses (AGX, MJB, MJW, SFE 14) \$0.20
Takes No. 18 or smaller wires.
HDJ-A for 1/4 x 1 1/4 inch fuses (ABC, AGC, MDL, MDX, MTH, SFE 20) .20
Takes No. 18 or smaller wires.
HDJ-B for 1/4 x 1 1/4 inch fuses (as above) .20
Takes No. 14 or 16 wires.
No. 9969 Spring nut for panel mounting above holders. .04

Holder-and-Fuse Assemblies

Assembly consists of holder, fuse and 19 inch loop of No. 14 wire already staked and soldered to terminals.



Offer simplest way to install protection. Wire can be cut to give leads of desired length. A spring nut, furnished with holder, can be used to mount holder on panel up to 3/32 inch thick.

HRJ Complete with SFE 20 fuse \$0.40
HRI Complete with SFE 14 fuse .40
HRH Complete with SFE 9 fuse .40

BUSS Fuses

FUSETRON DUAL-ELEMENT Fuses and Fuse Holders

for Protection of Radios, Instruments and Electronic Equipment

FAST ACTING FUSES for PROTECTION OF INSTRUMENTS, Etc.



Formerly called 8AG.
Dimension $\frac{1}{4}$ x 1 inch, Glass tube.

Provide high speed action necessary to protect sensitive instruments.

Test specification—carry 100%, open at 200% in 5 seconds.

Voltage	Symbol	Amperes	List Price
250 or less	MJB	$\frac{1}{500}$	\$0.70
"	MJB	$\frac{1}{200}$.30
"	MJB	$\frac{1}{100}$ or $\frac{1}{32}$.20

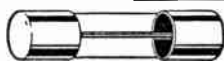

Formerly called 8AG
Dimension $\frac{1}{4}$ x 1 inch, Glass tube.

Provide high speed action necessary to protect instruments.

Test specification—carry 100%, open at 200% in 5 seconds.

AGX are listed as approved by Underwriters' Laboratories.

Voltage	Symbol	Amperes	List Price
250 or less	MJW	$\frac{1}{16}$ or $\frac{1}{8}$	\$0.15
"	AGX	$\frac{1}{8}$.15
"	AGX	$\frac{1}{4}$, $\frac{3}{8}$ or $\frac{1}{2}$.12
125 or less	AGX	$\frac{3}{4}$.12
"	AGX	1, $1\frac{1}{2}$ or 2	.10

The MJW fuses are special low resistance fuses.

BUSS FUSES — SFE STANDARD

All cuts actual size. Fuses of different amperages are of different lengths — to make it impossible to insert too large a size — thereby preventing over-fusing.

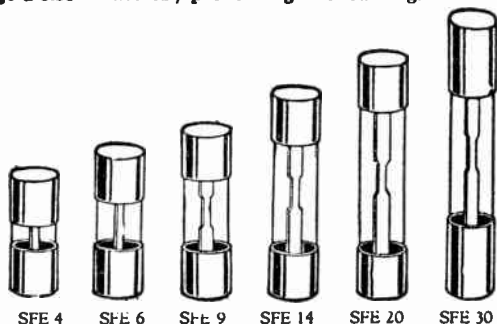

Glass tube — diameter $\frac{1}{4}$ inch. Length as per table below.

Test specification—carry 100%, open at 125% in $\frac{1}{2}$ hour.

Listed as approved by Underwriters' Laboratories.

Made according to specifications of Society of Automotive Engineers.

Voltage	Symbol & Amperes	Length Inches	Pounds per 100	List Price
32 or less	SFE 4	$\frac{5}{8}$.70	\$0.05
"	SFE 6	$\frac{3}{4}$.71	.05
"	SFE 9	$\frac{7}{8}$.72	.04
"	SFE 14	$1\frac{1}{16}$.77	.04
"	SFE 20	$1\frac{1}{4}$.83	.035
"	SFE 30	$1\frac{7}{16}$	1.05	.06

BUSS PIG-TAIL FUSES

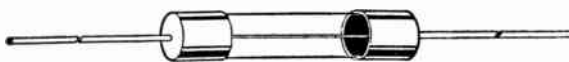

$\frac{3}{4}$ x $1\frac{1}{4}$ inch Glass tube fuse with $1\frac{3}{4}$ inch leads of No. 20 tinned copper wire. Symbol GJV.

$\frac{1}{4}$ x $1\frac{1}{8}$ inch Paper tube fuse with $1\frac{3}{4}$ inch leads of No. 20 tinned copper wire. Symbol GJC.

Test specifications — carry 110%, open at 135% in 1 hour.

Listed as approved by Underwriters' Laboratories.

Voltage	Symbol	Amperes	List Price
250 or less	GJV	$\frac{1}{8}$, $\frac{1}{4}$, $\frac{3}{8}$, $\frac{1}{2}$ or $\frac{3}{4}$	\$0.20
"	GJV	1, $1\frac{1}{2}$, 2 or 3	.15
"	GJC	$\frac{1}{8}$, $\frac{1}{4}$, $\frac{3}{8}$, $\frac{1}{2}$ or $\frac{3}{4}$.20
"	GJC	1, $1\frac{1}{2}$, 2 or 3	.15

BUSS GLASS TUBE FUSES, $\frac{1}{4}$ x $1\frac{1}{4}$ inch

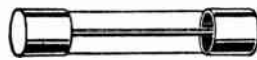

AGC and MTH 4, 5 and 6



MTH 8

Formerly called 3AG

Test specification—carry 110%, open at 135% in 1 hour.

Listed as approved by Underwriters' Laboratories.

Voltage	Symbol	Amperes	List Price
250 or less	AGC	$\frac{1}{8}$, $\frac{1}{4}$, $\frac{3}{8}$, $\frac{1}{2}$ or $\frac{3}{4}$	\$0.15
"	AGC	1, $1\frac{1}{2}$, 2 or 3	.07
"	MTH	4, 5 or 6	.10
"	MTH	8	.15



Formerly called 3AG

Test specification—carry 110%, open at 135% in 1 hour.

Voltage	Symbol	Amperes	List Price
32 or less	AGC	5, 6 or $7\frac{1}{2}$	\$0.05
"	AGC	10 or 15	.04
"	AGC	25 or 30	.05

20 ampere size is an SFE 20 fuse.

Sizes larger than 30 ampere are not recommended as clips or fuse holders would not permit fuse to carry such high currents. If surges or starting currents make heavier fuse necessary, use MDL Fuse-tron dual-element fuses.

BUSS CERAMIC TUBE FUSES

$\frac{1}{4}$ x $1\frac{1}{4}$ inch



Formerly called 3AB

Test specification—carry 110%, open at 135% in 1 hour.

Listed as approved by Underwriters' Laboratories, 15 amps and less.

Voltage	Symbol	Amperes	List Price
250 or less	ABC	10, 12, 15 or 20	\$0.15

FUSETRON FUSES, $\frac{1}{4}$ x $1\frac{1}{4}$ inch



Glass tube — Dual-Element type

LONG TIME-LAG OR SLOW BLOWING TYPE

These fuses avoid needless blows from starting currents or surges. They have a fuse link which operates only on very high overloads or short-circuits — they have a thermal cutout which functions on low overloads — the thermal cutout cannot operate quickly at any load, hence long time-lag is obtained. Yet protection is afforded against short-circuits or continued overloads.

Test specification—carry 110%, open at 135% in 1 hour.

Approximate blowing time: at 200% load MDL 25 sec. MDX 12 sec.
at 300% " " 8 " " 3 "
at 500% " " 3 " " $\frac{1}{2}$ "

125 and 250 volt sizes listed as approved by Underwriters' Laboratories.

Voltage	Symbol	Amperes	List Price
250 or less	MDL	$\frac{1}{100}$, $\frac{1}{32}$, $\frac{1}{16}$, $\frac{1}{10}$, $\frac{1}{100}$, $\frac{3}{10}$, $\frac{3}{10}$, $\frac{1}{2}$, $\frac{3}{4}$, $\frac{1}{10}$, $\frac{3}{10}$ or 1	\$0.25
125 or less	MDL	$1\frac{1}{4}$, $1\frac{1}{2}$, 2, $2\frac{1}{2}$, $2\frac{3}{4}$ or $3\frac{3}{4}$.20
"	MDX	$3\frac{1}{10}$, 4, 5, $6\frac{1}{4}$ or 7	.20
32 or less	MDL	4, 5, $6\frac{1}{4}$, 8, 10, 15, 20, 25 or 30	.20

FUSETRON PIG-TAIL FUSES

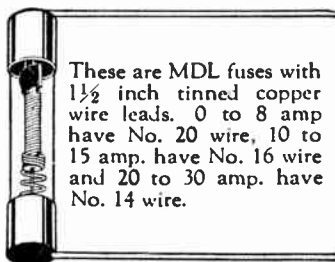

Symbol MDV

For sizes and all other information see MDL fuses above.

These are MDL fuses with $1\frac{1}{2}$ inch tinned copper wire leads. 0 to 8 amp have No. 20 wire, 10 to 15 amp. have No. 16 wire and 20 to 30 amp. have No. 14 wire.

Amperes	List Price
$\frac{1}{100}$ to 1	\$0.30
$1\frac{1}{4}$ to 2	.25
$2\frac{1}{2}$ to 30	.23

LITTELFUSE

"Quicker than a Short Circuit"

3 AG "LITTELFUSES"

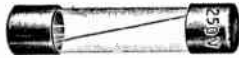

¼" x 1¼"

Standard Package—100

Blow Time	Percentage of rating	Blow Time
	110%	Life
	135%	0-1 hour
	200%	0-2 minutes

311000 Series Littelfuses—Quick to medium-blowing fuses—for use in radios, auto-radios, amplifiers, etc. Straight-type fuse element—positioned to center of fuse—makes open link always in the visible portion of fuse.

Catalog No.	Amp. rating	Max. volt.	List Price, each
311005.	5	32	\$0.05
31107.5	7½	32	.05
311010.	10	32	.04
311015.	15	32	.04
311020.	20	32	.035
311025.	25	32	.05
311030.	30	32	.05

312000 Series Littelfuses—Quick-acting fuses—for low time-lag applications similar to the 311000 fuse series above. Protective-coated elements, on fuses to 3 amperes, prevent oxidation and promote clean break on fusion. Diagonal element alignment of this fuse assures accurate alignment and calibration, even when the fuse element is expanded by heat.

Catalog No.	Amp. rating	Max. volt.	List Price each
312.062	1/16	250	\$0.15
312.125	3/16	250	.15
312.150	15/100	250	.15
312.175	.175	250	.15
312.187	3/16	250	.15
312.250	3/4	250	.15
312.300	3/10	250	.15
312.375	3/8	250	.15
312.500	3/4	250	.15
312001.	1	250	.07
31201.5	1½	250	.07
312002.	2	250	.07
312003.	3	250	.07
312004.	4	250	.10
312005.	5	250	.10
312006.	6	250	.10
312008.	8	125	.15

Approved by Underwriters' Laboratories.

3 AG "SLO-BLO" "LITTELFUSES"



¼" x 1¼"

Standard package—100

Blow time	Percentage of rating	Blow Time
	110%	Life
	135%	0-1 hour
	200	60 seconds max. 5 seconds min.

313000 Series Littelfuses—Slo-Blo fuses with high time-lag to withstand heavy surges—quick on shorts. Designed for circuits with equipment having high inductive or capacitive surges, such as magnets, solenoids, etc., and for circuits with heavy starting currents, such as motors and lamp circuits. Anti-fatigue construction (compound element, with spring and resistor) makes these fuses ideal for intermittent-duty circuits on vibrators, control circuits, hi-tension electric fences, small magnets, coils, etc. "Pioneered by Littelfuse."

Catalog No.	Former No.	Amp. rating	Max. volt.	List Price, each
313.010	1259	1/100	125	\$0.25
313.032	1261	1/32	125	.25
313.062	1262	1/16	125	.25
313.100	1/10	125	.25
313.125	1263	1/8	125	.25
313.150	15/100	125	.25
313.175175	125	.25
313.187	1263-A	3/16	125	.25
313.200	2/10	125	.25
313.250	1264	1/4	125	.25
313.300	2/10	125	.25
313.375	1265	3/8	125	.25
313.400	4/10	125	.25
313.500	1266	1/2	125	.25
313.600	6/10	125	.25
313.700	7/10	125	.25
313.750	1267	3/4	125	.25
313.800	8/10	125	.25
313001.	1268	1	125	.25
3131.25	1½	125	.20
31301.5	1041-C	1½	125	.20
31301.6	1-6/10	125	.20
313002.	1042-C	2	125	.20
31302.5	2½	125	.20
313003.	1043-C	3	125	.20
31303.2	3-2/10	125	.20
313004.	4	125	.20
313005.	1080-C	5	125	.20
3136.25	6¼	32	.20
313008.	8	32	.20
313010.	1081-C	10	32	.20
313015.	1082-C	15	32	.20
313020.	1083-C	20	32	.20
313025	25	32	.20
313030	30	32	.20

Approved by Underwriters' Laboratories through 5 amps.

3 AB "TINY MIGHTY" "LITTELFUSES"



¼" x 1¼"

Standard package—100.

Blow Time	Percentage of rating	Blow Time
	110%	Life
	135%	0-1 hour
	200%	0-2 minutes

314000 Series Littelfuses—The smallest Underwriters' Laboratory approved fuses in ratings this high. Steatite enclosed, arc-quenching, powder filled fuses. Shatter-proofed against quick shorts. Medium time lag. Recommended for use with amplifiers, rectifiers, battery charging equipment, small generators, control panels, amusement devices, communication and electronic equipment, radios, signal apparatus, small motor circuits, etc. Take less space than N.E.C. fuses—"Pioneered by Littelfuse."

Catalog No.	Amp. rating	Max. volt.	List Price, each
314001.	1	250	\$0.15
314002.	2	250	.15
314003.	3	250	.15
314005.	5	250	.15
314008.	8	250	.15
314010.	10	250	.15
314012.	12	250	.15
314015.	15	250	.15
314020.	20	250	.15
314030.	30	125	.15

Approved by Underwriters' Laboratories 8 amps through 15 amps.

LITTELFUSE

"Quicker than a Short Circuit"

LITTELFUSE BERYLLIUM COPPER AND PHOSPHOR BRONZE FUSE CLIPS

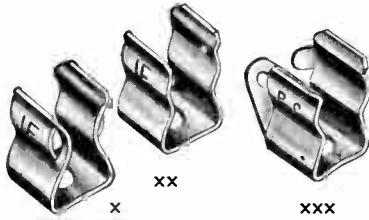

Littelfuse fuse clips are available in three standard styles: "X," with "ears" or fuse stops; "XX," earless; and "XXX," "Lug-Clips," a new Littelfuse clip having a lug or solder terminal made as an integral part of the clip. All styles are furnished in either Phosphor-Bronze or Beryllium Copper.

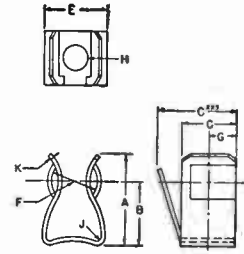

Catalog Number	Former Number	Fuse Adaptation	Type	DIMENSIONS								Unit Wt. grams	Std. Pkg. 100 Wt.—lbs.	List Price Each
				A	B	C	E	F	G	H				

BERYLLIUM COPPER CLIPS

SILVER PLATED—WITH FUSE STOP "EARS"

121001	1216B	SFE, 3AG & 8AG Fuses	X	29/64	3/8	5/16	11/32	1/4	5/16	1/2	.131	1	1	\$0.05
123001	1217B	4AG & 4AB Fuses	X	9/16	3/8	13/32	.385	1/2	5/16	3/4	.171	1.6	1	.08
125001	1218B	5AG, Hi-Voltage-Midget	X	8/4	1/2	7/16	1/2	13/32	3/16	3/4	.196	3	2	.15
127001	1219	N.E.C.-30 Fuses	X	15/16	9/16	19/32	5/8	1/2	5/16	3/4	.203	5.5	2	.18
129001	1221	Standard Hi-Voltage	X	17/32	15/16	.750	7/8	13/16	5/16	3/4	.265	14.5	4	.40

SILVER PLATED—EARLESS TYPE

121002	1417	SFE, 3AG & AB, & 8AG	XX	29/64	3/8	5/16	11/32	1/4	5/16	1/2	.131	1	1	.05
123002	1437	4AG & 4AB	XX	9/16	3/8	13/32	.385	1/2	5/16	3/4	.171	1.6	1	.08
125002		5AG, Hi-Voltage-Midget	XX	8/4	1/2	7/16	1/2	13/32	3/16	3/4	.196	3	2	.15
127002	1475	N.E.C.-30 Fuses	XX	15/16	9/16	19/32	5/8	1/2	5/16	3/4	.203	5.5	2	.18
129002	1476	Standard Hi-Voltage	XX	17/32	15/16	.750	7/8	13/16	5/16	3/4	.265	14.5	4	.40

SILVER PLATED—"LUG-CLIP"—SOLDER TERMINAL ATTACHED

121004	New	SFE, 3AG, AB, & 8AG	XXX	29/64	3/8	37/64	11/32	1/4	5/16	1/2	.131	1.2	1	.08
123004	New	4AG & 4AB Fuses	XXX	9/16	3/8	3/4	.385	1/2	5/16	3/4	.171	1.7	1	.12
125004	New	5AG & Midget Fuse	XXX	8/4	1/2	.820	15/32	13/32	3/16	3/4	.196	3.5	2	.20

PHOSPHOR BRONZE CLIPS

BURNISHED NICKEL PLATE—WITH FUSE STOP "EARS"

101001	1011B	SFE, 3AG & AB, & 8AG	X	29/64	3/8	5/16	11/32	1/4	5/16	1/2	.131	1	1	.02
103001	1319	4AG & 4AB	X	9/16	3/8	13/32	.385	1/2	5/16	3/4	.173	1.7	1	.04
105001	2049	5AG, Hi-Voltage-Midget	X	8/4	1/2	7/16	1/2	13/32	3/16	3/4	.196	3.2	2	.05
107001	5048	N.E.C.-30 Fuses	X	15/16	9/16	19/32	5/8	1/2	5/16	3/4	.203	5.8	2	.06
109001	1463	Standard Hi-Voltage	X	17/32	15/16	.750	7/8	13/16	5/16	3/4	.265	15.6	4	.16

BURNISHED NICKEL PLATE—EARLESS TYPE

101002	125-2	SFE, 3AG & AB, 7AG & 8AG	XX	29/64	3/8	5/16	11/32	1/4	5/16	1/2	.131	1	1	.02
104002		4AG & 4AB	XX	9/16	3/8	13/32	.385	1/2	5/16	3/4	.173	1.7	1	.04
105002	2049B	5AG, Hi-Voltage-Midget	XX	8/4	1/2	7/16	1/2	13/32	3/16	3/4	.196	3.2	2	.05
107002	SP-178	N.E.C.-30 Fuses	XX	15/16	9/16	19/32	5/8	1/2	5/16	3/4	.203	5.8	2	.06
109002		Standard Hi-Voltage	XX	17/32	15/16	.750	7/8	13/16	5/16	3/4	.265	14.5	4	.16

BRIGHT-DIP PHOSPHOR BRONZE—"LUG CLIP"—SOLDER TERMINAL ATTACHED

101003		SFE, 3AG & AB & 8AG	XXX	29/64	3/8	37/64	11/32	1/4	5/16	1/2	.131	1.2	1	.03
103003		4AG & 4AB	XXX	9/16	3/8	3/4	.385	1/2	5/16	3/4	.171	1.7	1	.05
105003		SFE, 3AG & AB & 8AG	XXX	8/4	1/2	.820	15/32	13/32	3/16	3/4	.196	3.5	2	.08

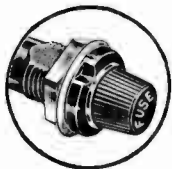

Finger Operated Knob



341001



342003

"LITTELFUSE"

FUSE EXTRACTOR POSTS

Quicker, safer method for mounting and changing fuses. Held in end of removable knob, fuse is easily replaced by unscrewing knob. Available with finger-operated knob or with screw driver slot knob.

Catalog No.	Former No.	Descr.—Knob, How Operated	Mtg. Hole	Length Under Panel	List Price Each
341001	1075S	3AG—Screw Driver	.500-.505"	2 1/2"	\$0.45
342001	1075F	3AG—Finger	.500-.505"	2 1/2"	.45
342003		3AG—Miniature	.500-.505"	1.035	.45
342006		3AG—Miniature—Watertight	.620-.625"	1.312	2.35
342007		3AG—(elongated hole)	.535-.685" .540 x .690"	1.171	2.20
342008		3AG—Miniature—Dustproof	.500-.505"	1.035	.75
442001		4AG	.625-.630"	2.156	1.25
442006		4AG—Finger—Watertight	.620-.625"	1.312	2.35
442007		4AG	.620-.625"	1.312	2.20
570001		5AG	.850-.855"	1.472	1.35
571004		5AG—Finger	.850-.855"	1.472	1.50
371001	1087S	8AG—Screw Driver	.500-.505"	2 1/2"	.45
372001	1087F	8AG—Finger	.500-.505"	2 1/2"	.45

In-line fuse retainer now assembled with 19" loop of wire lead.

LITTELFUSE

"Quicker than a Short Circuit"

8AG INSTRUMENT high speed LITTELFUSES

Locked Cap Assembly and other exclusive Littelfuse features for protection of delicate test equipment, galvanometers, microammeters, milliammeters, voltmeters, etc. Glass-enclosed: 1 x 1/4" dia., accurately rated, high speed action, short time lag. Voltage ratings up to 250 V., AC or DC. For higher voltages use fuses in series.



Catalog No.	Former No.	Amp. Rating	Max. Volt.	APPLICATIONS			List Price Ea.
				Volt-meters Ohms P.V.	All Magnetic Movement Milliammeters	Thermo-couples	
361.002		1/500	250	Over 1000	Galvanometers	0-0.1 to 0-0.5	\$0.70
361.005	1000	1/200	250	Over 1000	Galvanometers	Up to 0.1	.30
361.010	1001	1/100	250	1000	Up to 0-1	0-5 to 0-10	.20
361.031	1002	1/50	250	500-1000	0-1 to 0-10	0-10 to 0-25	.20
361.062	1003	1/25	250	100-500	0-10 to 0-25	0-25 to 0-60	.15
361.125	1004	1/10	250	20-100	0-25 to 0-75	0-75 to 0-150	.15
361.250	1005	1/5	250	10-20	0-75 to 0-150	0-115 to 0-300	.15
361.375	1006	3/8	250	5-10	0-150 to 0-250	0-200 to 0-300	.15
361.500	1007	1/2	250	3-5	0-250 to 0-350	0-300 to 0-400	.15
361.750	1007-A	3/4	250		0-350 to 0-500	0-400 to 0-1000	.10
361001.	1008	1	250		0-500 to 0-750	0-600 to 0-1500	.10
36101.5	1008-A	1 1/2	250		0-750 to 0-1000	0-1000 to 0-1500	.10
361002	1009	2	250		0-1000 to 0-1500	0-1500 to 0-2000	.10
361003.		3	250		0-1500 to 0-2000	0-2000 to 0-3000	.10
361005.		5	32		0-2000 to 0-4000	0-3000 to 0-5000	.10

METER BACK MOUNTING



Cat. No. 383002 (1059)—Mounts directly on meter binding post. Will not touch other posts on smallest standard meter. Linen bakelite base, 1" x 1 1/8". Length over screw terminal, 1 1/2". Standard Package 20. Weight 1/2 lb.

List Price Each \$0.20

BAKELITE IN-LINE FUSE RETAINER



Designed to hang in the cable or mount in the chassis, the in-line fuse retainer molded of high impact bakelite is primarily for low-voltage applications; car radios, heaters, spot lights, clocks, etc.

The disassembled unit consists of the bakelite body receptacle, bakelite knob with metal insert, one spring, two knife-edge rivet contacts.

155000 Series—Assembled with a 19" loop of wire lead:
 155001A For 4-amp SFE and 1AG fuses
 155004A For 6-amp SFE fuses
 155009A For 9-amp SFE and 7AG fuses
 155011A For 14-amp SFE and 8AG fuses
 155020A For 20-amp SFE and 3AG fuses

List Prices
.40 ea.

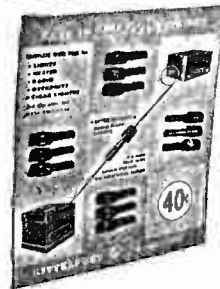

NEW TV SNAP-ON MOUNTINGS



Time saver for pig-tail replacement. Snap on blown pig-tail, then use regular fuse in other side. No soldering.



This Snap-On Mounting has a cut out on both sides which makes the fuse accessible for replacement from both sides. These are available in bulk, on cards and in plastic boxes of ten.

List Price

No. 094024
 Card of 24. \$7.20

No. 094025
 Box of 10.. 3.00



Catalog Number	Description	List Price Each	Catalog Number	Description	List Price Each
3AG SLO-BLO PIGTAIL FUSES			3AG PIGTAIL FUSES		
315.010	1/100 amp. (125 volt).....	.30	31S.062	1/16 amp. (250 volt).....	\$.20
315.032	1/32 amp. (125 volt).....	.30	31S.125	1/8 amp. (250 volt).....	.20
315.062	1/16 amp. (125 volt).....	.30	31S.250*	1/4 amp. (250 volt).....	.20
315.100	1/10 amp. (125 volt).....	.30	31S.375*	3/8 amp. (250 volt).....	.20
315.150	15-100 amp. (125 volt).....	.30	31S.500*	1/2 amp. (250 volt).....	.20
315.187	3/16 amp. (125 volt).....	.30	31S.750	3/4 amp. (250 volt).....	.20
315.200	2/10 amp. (125 volt).....	.30	31S001.	1 amp. (250 volt).....	.12
315.250*	1/4 amp. (125 volt).....	.30	31S01.5	1 1/2 amp. (250 volt).....	.12
315.300	3/10 amp. (125 volt).....	.30	31S002.	2 amp. (250 volt).....	.12
315.400	4/10 amp. (125 volt).....	.30	31S003.	3 amp. (250 volt).....	.12
315.500*	1/2 amp. (125 volt).....	.30	31S004.	4 amp. (250 volt).....	.15
315.600	6/10 amp. (125 volt).....	.30	31S005.	5 amp. (250 volt).....	.15
315.750	3/4 amp. (125 volt).....	.30	31S006.	6 amp. (250 volt).....	.15
315.800	8/10 amp. (125 volt).....	.30	8AG T.V. FUSES (No Pigtail)		
315001.	1 amp. (125 volt).....	.30	362.125	1/4 amp. (250 volt).....	.15
3151.25	1 1/4 amp. (125 volt).....	.25	362.250*	1/2 amp. (250 volt).....	.15
31501.5	1 1/2 amp. (125 volt).....	.30	362.375*	3/8 amp. (250 volt).....	.15
31501.6	1-6/10 amp. (125 volt).....	.25	362.500	1/2 amp. (250 volt).....	.15
315002.	2 amp. (125 volt).....	.25	362.750	3/4 amp. (250 volt).....	.15
31502.5	2 1/2 amp. (125 volt).....	.25	362001.	1 amp. (250 volt).....	.10
315003.	3 amp. (125 volt).....	.25	36201.5	1 1/2 amp. (125 volt).....	.10
31503.2	3-2/10 amp. (125 volt).....	.25	362002.	2 amp. (125 volt).....	.10
315004.	4 amp. (125 volt).....	.25	362003.	3 amp. (125 volt).....	.10
315005.	5 amp. (125 volt).....	.25	362005.	5 amp. (125 volt).....	.05

*Most commonly used by large volume set manufacturers.

All above fuses approved by Underwriters' Laboratories except 315004 and 315005.



SELENIUM RECTIFIERS

General Electric manufactures selenium rectifiers for every type of electronic and industrial application. The G-E selenium cells are produced by a unique "evaporation" process which produces exceptionally high electrical characteristics.

Long Life—Because of their low forward voltage drop and low backward leakage, G-E selenium stacks age more slowly. They offer the design engineer a quality, nonexpendable component which will last in service. The characteristics do not vary from stack to stack, affording better performance of the end equipment.

Stability and Reliability are two other important features of G-E selenium rectifiers. They have excellent initial characteristics and deteriorate very little with time and use.

Sizes and Ratings are available to meet practically any requirement. They have been used successfully from a few microamperes at 500,000 volts to over 100,000 amperes at 9 volts. Whenever direct current is required, their application should be considered. The three basic types of construction used in G-E selenium rectifiers are shown in the illustrations.

Applications—There are many electronic applications for selenium rectifiers. General Electric selenium rectifiers are ideal for voltage doubler circuits, voltage tripler circuits, clipping or slicing operations in electronic applications, or wherever rectification or d-c blocking is required. G-E miniature selenium rectifiers

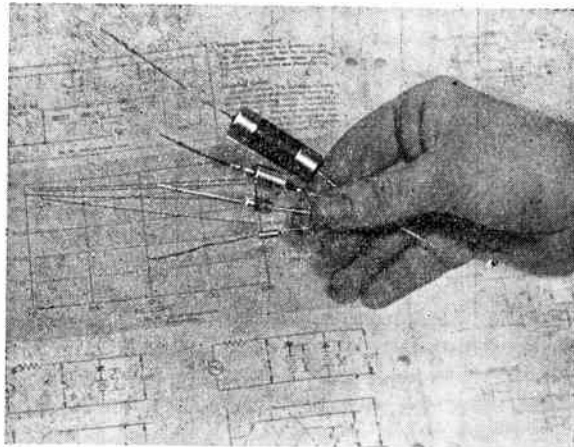

MINIATURE SELENIUM RECTIFIERS are available in standard ratings of 50 ma and below at 26 volts to 5200 volts RMS. Stacks are available either in Textolite* tubes or metal-clad casings to meet government specifications for environmental protection. Either lead or bracket mountings can be furnished.

are used for blocking, electronic computer, magnetic amplifier, communication and signal circuits. Other applications include supplying power to operate d-c relays in control circuits, and as components in electronic equipment.

For Complete Information on G-E metallic rectifiers, consult your nearest General Electric Apparatus Sales Office, or write to Section 640-381, General Electric Company, Schenectady 5, New York.

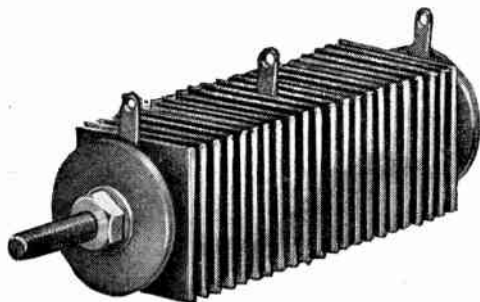

STANDARD CONSTRUCTION of a typical G-E selenium stack consists of cells mounted on a metal stud, separated by spacers and spring contacts. Any rectifier circuit or combination of circuits can be assembled in a single stack. Various mounting and screw-terminals connections are available.

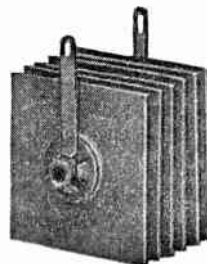

PHENOLIC TUBE construction is used when a less expensive and lighter-weight rectifier stack is desired. Good strength can be attained up to 10 cells on a single assembly.

Progress Is Our Most Important Product

GENERAL  ELECTRIC

*Registered trade-mark of General Electric Co.

SCHAUER INSTRUMENT RECTIFIERS

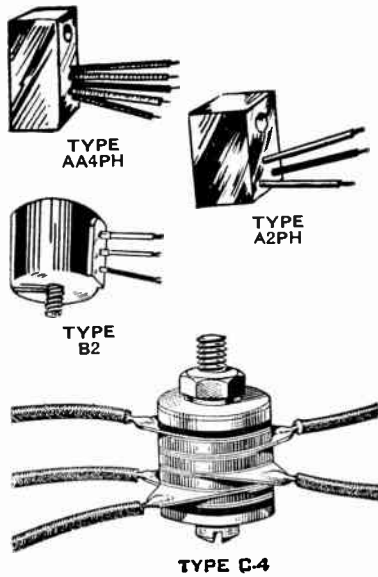

Schauer copper oxide rectifiers for instrument and other uses are processed and individually tested to meet the requirements of the user. Versatile processing techniques make possible variations in characteristics for special or unusual applications. Each rectifier is rated conservatively for long life and dependable operation.

Size "AA," "A" and "B" Rectifiers are encapsulated—fully sealed in special formula polyester plastic in attractive red color. Cells are specially processed with vacuum evaporated gold contact areas to give maximum efficiency, stable operation and low aging characteristics. All rectifiers are supplied with 3" leads, color-coded. (Red, positive; black, negative; yellow, A.C.) Plastic encapsulated rectifiers have lead insulation imbedded in the plastic for better sealing, eliminating short circuits at the rectifier. Lead lengths of other than 3" can be supplied on special order.

"AA" SIZE CELLS are $\frac{1}{8}$ " dia. cells for low capacitance and high frequency response. Maximum rating is 2 volts D.C. at 1 MA in a full wave bridge.

"A" SIZE CELLS have good frequency response above the audio range and can be used at higher frequencies. Recommended for meter applications needing 1 MA or less for operation. Can be used for other applications requiring up to 5 MA.

"B" SIZE CELLS are for meter, relay and other applications requiring 1 MA up to their maximum rating. Recommended for commercial and low audio frequency operation.

"C" SIZE CELLS are for general applications requiring larger output currents and operation of meters, relays and other apparatus. Special process cells for varistor applications. Write, wire or telephone for complete information. We welcome your inquiries concerning any special rectification problem.

Max. Cont. Rating			Circuit Diagram Fig.	Cell Dia. Inches	No. of Cells	Leads	Mounting Screw Size	DIMENSIONS*					Type
D.C. M.A.	D.C. Volts	Max. RMS Volts						(Dia.) A	B	C	D	E	
.5	1	1.5	2	$\frac{1}{8}$	2	3	Hole for 2-56	$\frac{1}{16}$	$\frac{1}{8}$	$\frac{1}{8}$	$\frac{1}{2}$		AA2PH
1	2	3.0	3	$\frac{1}{8}$	4	5	Hole for 2-56	$\frac{1}{16}$	$\frac{1}{8}$	$\frac{1}{8}$	$\frac{1}{16}$		AA4PH
5	1.5	2.5	2	$\frac{3}{16}$ sq.	2	3	Hole for 2-56	$\frac{3}{16}$	$\frac{1}{4}$	$\frac{1}{16}$			A2M
5	3.0	5.0	3	$\frac{3}{16}$ sq.	4	4	Hole for 2-56	$\frac{3}{16}$	$\frac{1}{4}$	$\frac{1}{16}$			A4M
5	1.5	2.5	2	$\frac{3}{16}$ sq.	2	3	Hole for 2-56	$\frac{1}{16}$	$\frac{1}{16}$	$\frac{1}{2}$			A2PH
5	3.0	5.0	3	$\frac{3}{16}$ sq.	4	5	Hole for 2-56	$\frac{1}{16}$	$\frac{1}{16}$	$\frac{5}{8}$			A4PH
5	1.5	2.5	1	$\frac{3}{16}$ sq.	1	2	None	$\frac{1}{4}$	$\frac{3}{8}$	$\frac{3}{8}$			A1P
5	1.5	2.5	2	$\frac{3}{16}$ sq.	2	3	None	$\frac{1}{4}$	$\frac{3}{8}$	$\frac{3}{8}$			A2P
5	1.5	2.5	4	$\frac{3}{16}$ sq.	2	3	None	$\frac{1}{4}$	$\frac{3}{8}$	$\frac{3}{8}$			A2P
5	3.0	5.0	3	$\frac{3}{16}$ sq.	4	5	None	$\frac{1}{16}$	$\frac{1}{16}$	$\frac{3}{8}$			A4P
13	1.5	2.5	1	$\frac{1}{16}$	1	2	6-32	$\frac{1}{16}$			$\frac{1}{16}$	$\frac{1}{32}$	B1
13	1.5	2.5	2	$\frac{1}{16}$	2	3	6-32	$\frac{1}{16}$			$\frac{1}{8}$	$\frac{1}{16}$	B2
26	1.5	2.5	4	$\frac{1}{16}$	2	3	6-32	$\frac{1}{16}$			$\frac{1}{8}$	$\frac{1}{16}$	B2
26	3.0	5.0	3	$\frac{1}{16}$	4	5	6-32	$\frac{1}{16}$			$\frac{11}{32}$	$\frac{1}{16}$	B4
32	1.5	2.5	1	$\frac{3}{4}$	1	2	10-32	$\frac{3}{4}$			$\frac{11}{16}$	$\frac{1}{16}$	C1
32	1.5	2.5	2	$\frac{3}{4}$	2	3	10-32	$\frac{3}{4}$			$\frac{3}{4}$	$\frac{1}{16}$	C2
64	1.5	2.5	4	$\frac{3}{4}$	2	3	10-32	$\frac{3}{4}$			$\frac{3}{4}$	$\frac{1}{16}$	C3
64	3.0	5.0	3	$\frac{3}{4}$	4	5	10-32	$\frac{3}{4}$			$\frac{11}{16}$	$\frac{1}{16}$	C4

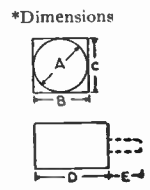
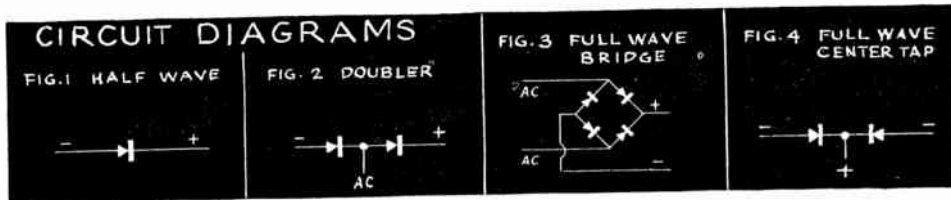

SCHAUER MANUFACTURING CORP. • Cincinnati 36, Ohio
Manufacturers of high-quality, dry-disc rectifiers since 1930.

SE11 Series

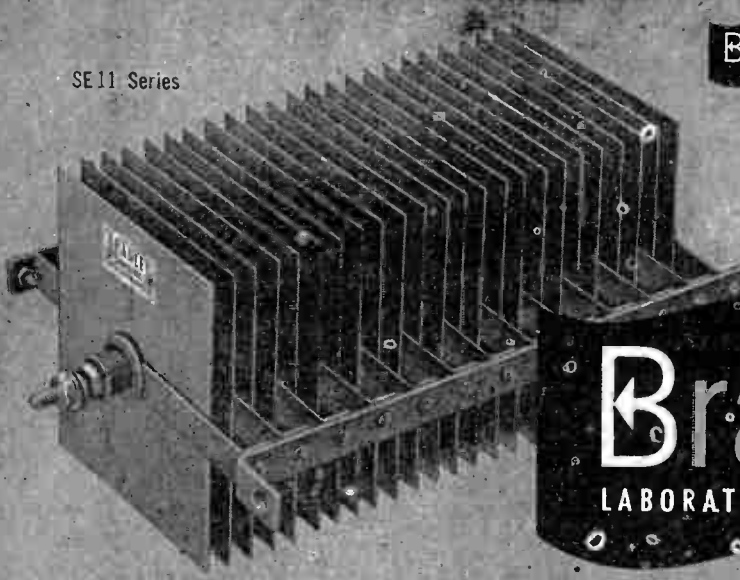

Bradley POWER STACKS

Ratings from 50 milliamperes to thousands of amperes. Used as power supplies, in electro-plating equipment, in battery chargers, and for numerous other applications.

Bradley

LABORATORIES, INC.

VACUUM-PROCESSED

RECTIFIERS

MODULATORS

VARIATORS AND BALANCED BRIDGES. Copper oxide (CX3 Series) and selenium (SM3 Series). Current and temperature characteristics precisely balanced. Hermetically sealed.



DIODES

Selenium (SE8L Series) and copper oxide (CX8 Series) types for low current use, providing excellent stability over a wide temperature range. Rugged and conservatively rated. Dependable operation maintained under moderate overload.



SELENIUM — HIGH VOLTAGE

SE8 Series

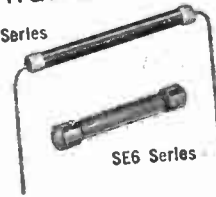

Ratings up to 6,000 volts peak inverse (higher in series) and 12.5 ma D.C. per unit. Diameter from 1/4" to 3/8". SE8 Series completely sealed in phenolic housings. SE6 Series hermetically sealed in glass tubes.

INSTRUMENT RECTIFIERS



CX2E Series. Rated up to 6 volts A.C., 4.5 volts D.C., 5 ma D.C. with 3-inch gold leads. Used for multimeters, computers and other low current applications requiring maintenance of calibration and electrical characteristics.

PHOTOELECTRIC CELLS



Model 1-1A

Self-generating. Convert light directly into electric energy. No external power source required. No current drain when inoperative. Rugged, lightweight, true to rating.

MAGNETIC AMPLIFIERS:

SM11 Series. Low leakage, uniform operating characteristics over a wide range of temperature variation, and a low rate of forward aging.

Bradley

LABORATORIES, INC.

Our engineering aims at top performance. Our exclusive vacuum process enables us to provide top performance at the lowest possible cost. Our engineers will be glad to work with you on your rectifier applications. We welcome special problems.

BRADLEY LABORATORIES, INC. 168R Columbus Ave., New Haven 11, Conn.

CONANT

Miniature Metallic Rectifiers

STANDARD SINCE 1933

SERIES 500

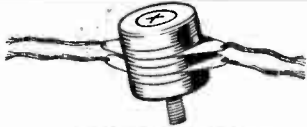

SERIES 500 ERM

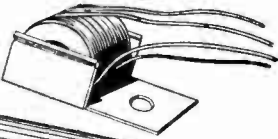

SERIES 500 TUA

SERIES 500 TUR

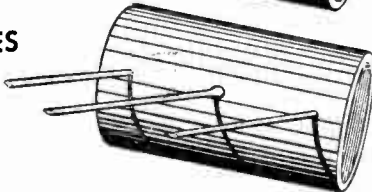

SERIES 280 ERM



SERIES 280 TUA

SERIES 280 TUR



SERIES 160

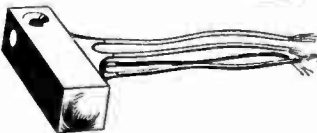

SERIES 160C



SERIES 160 ERM



ALL RECTIFIERS SHOWN ACTUAL SIZE

INTERNAL CIRCUITS

Standard rectifiers are connected internally according to one of the five circuit diagrams shown.

SERIES 500 Copper oxide only. Color coded. Welded lead wires 3" long. Synthetic lacquer-enamel finish. Single 6-32 stud mounting. Available in special types. Cell diameter .500". Cell rating 5 r.m.s. volts, 30 average mils.

SERIES 500-ERM Copper oxide or selenium. Color coded. Solid lead wires 3" long. Lacquer finish. Single hole mounting. Available in special types. Cell diameter .500". Cell ratings, copper oxide 5 r.m.s. volts, 30 average mils; selenium, 25 r.m.s. volts, 30 average mils.

SERIES 500-TUA Selenium only. Color coded. Solid axial leads 3" long. Lacquer finish. Mounts by lead wires only. Fully enclosed and sealed in phenolic tube. Half wave types only for high voltage. Cell diameter .500". Cell rating 25 r.m.s. volts, 30 average mils. Per cell ratings subject to derating according to rectifier design.

SERIES 500-TUR Selenium only. Color coded. Solid radial leads 3" long. Lacquer finish. Mounts by lead wires only. Fully enclosed and sealed in phenolic tube. Cell diameter, .500". Cell rating 25 r.m.s. volts, 30 average mils. Per cell ratings subject to derating according to rectifier design.

SERIES 280-ERM Copper oxide or selenium. Color coded. Solid lead wires 3" long. Lacquer finish. Mounts by "Bracketterminal" combining cathode (plus) terminal and mounting bracket. Available in standard types only. Cell diameter .280". Cell rating, copper oxide, 5 r.m.s. volts, 10 average mils; selenium, 25 r.m.s. volts, 10 average mils.

SERIES 280-TUA Selenium only. Color coded. Solid axial leads 3" long. Lacquer finish. Mounts by lead wires only. Fully enclosed and sealed in phenolic tube. Half wave types only, for high voltage. Cell diameter .280". Cell rating 25 r.m.s. volts, 10 average mils. Per cell rating subject to derating according to rectifier design.

SERIES 280-TUR Selenium only. Color coded. Solid radial leads 3" long. Lacquer finish. Mounts by lead wires only. Fully enclosed and sealed in phenolic tube. Cell diameter .280". Cell rating 25 r.m.s. volts, 10 average mils. Per cell rating subject to derating according to rectifier design.

SERIES 160 Copper oxide or selenium. Color coded. Welded lead wires 3" long. Fully enclosed and sealed in molded phenolic case. Mounts by #2 screw. Cell diameter .160". Cell rating, copper oxide, 5 r.m.s. volts, 5 average mils; selenium, 25 r.m.s. volts, 5 average mils.

SERIES 160-C Copper oxide or selenium. Color coded. Welded lead wires 3" long. Fully enclosed and sealed in welded brass case. Mounts in midjet fuse clip. Cell diameter .160". Cell rating, copper oxide, 5 r.m.s. volts, 5 average mils; selenium, 25 r.m.s. volts, 5 average mils.

SERIES 160-ERM Copper oxide or selenium. Color coded. Solid leads 1" long. Lacquer finish. Mounts by lead wires only. Cell diameter .160". Cell rating, copper oxide, 5 r.m.s. volts, 5 average mils; selenium, 25 r.m.s. volts, 5 average mils.

Standard rectifiers are connected internally according to one of the five circuit diagrams shown.

Series 500, 160 and 160-C are the well known standard line of instrument rectifiers and are constructed to the highest standards of quality. Construction is conventional.

TUA (tubular, axial leads) and TUR (tubular, radial leads) construction is desirable especially in rectifiers designed for high voltage operation. Total enclosure of the stack however limits heat radiation necessitating derating of cells.

ERM (external resilient member) construction insures maintenance of optimum stack pressures regardless of ambient or operating temperatures. Rectifiers in ERM construction are smaller, lighter and cheaper.



STANDARD SINCE 1933

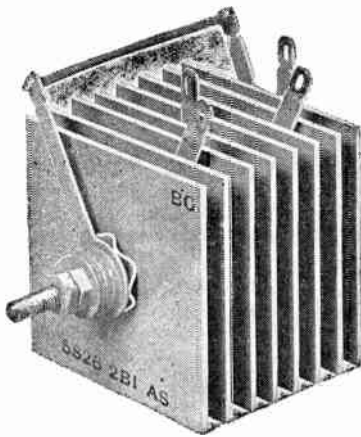

**Sarkes
Tarzian**

"Centre-Kooled"

POWER RECTIFIERS

SINGLE PHASE — FULL WAVE RECTIFIER STACKS

DC OUTPUT At 35°C. Amb.		CIRCUIT Refer to Diagram	Max. AC Input	APPROXIMATE DIMENSIONS—Refer to			Figure	Catalog No.	CIRCUITS AND DIMENSIONAL DIAGRAMS
Volts	Max. Amps.			Volts	A	B			
6-10	2	C.T.	13	3"	2 1/2"	3"	2	D-10	
6-10	4	C.T.	13	4"	2 1/2"	4"	2	D-11	
6-10	6	C.T.	13	4"	2 7/8"	4"	2	D-12	
6-10	8	C.T.	13	5"	2 1/2"	6"	2	D-13	
6-10	12	C.T.	13	5"	2 7/8"	6"	2	D-14	
6-10	15	C.T.	13	4 1/4"	2 1/2"	12"	3	D-15	
6-10	22.5	C.T.	13	4 1/4"	2 7/8"	12"	3	D-16	
6-20	2	BR.	26	3"	3 3/8"	3"	2	D-17	
6-20	4	BR.	26	4"	3 1/8"	4"	2	D-18	
6-20	6	BR.	26	4"	4"	4"	2	D-19	
6-20	8	BR.	26	5"	3 1/8"	6"	2	D-20	
6-20	12	BR.	26	5"	4 1/8"	6"	2	D-21	
6-20	15	BR.	26	4 1/4"	3 1/8"	12"	3	D-22	
6-20	22.5	BR.	26	4 1/4"	4"	12"	3	D-23	
20-40	2	BR.	52	3"	4 5/8"	3"	2	D-24	
20-40	4	BR.	52	4"	4 5/8"	4"	2	D-25	
20-40	6	BR.	52	4"	6 5/8"	4"	2	D-26	
20-40	8	BR.	52	5"	4 5/8"	6"	2	D-27	
20-40	12	BR.	52	5"	6 5/8"	6"	2	D-28	
20-40	15	BR.	52	4 1/4"	4 5/8"	12"	3	D-29	
20-40	22.5	BR.	52	4 1/4"	6 5/8"	12"	3	D-30	
40-60	2	BR.	78	3"	6"	3"	2	D-31	
40-60	4	BR.	78	4"	6"	4"	2	D-32	
40-60	6	BR.	78	4"	8 5/8"	4"	2	D-33	
40-60	8	BR.	78	5"	6"	6"	2	D-34	
40-60	12	BR.	78	5"	8 5/8"	6"	2	D-35	
40-60	15	BR.	78	4 1/4"	6"	12"	3	D-36	
40-60	22.5	BR.	78	4 1/4"	8 5/8"	12"	3	D-37	
60-100	.5	BR.	130	1.6"	5 1/8"	1.6"	1	D-38	
60-100	1	BR.	130	2"	5 1/8"	2"	1	D-39	
60-100	2	BR.	130	3"	8 1/8"	3"	2	D-40	
60-100	4	BR.	130	4"	8 1/8"	4"	2	D-41	
60-100	6	BR.	130	4"	13 1/4"	4"	2	D-42	
60-100	8	BR.	130	5"	8 1/8"	6"	2	D-43	
60-100	12	BR.	130	5"	13 1/4"	6"	2	D-44	
100-120	.5	BR.	156	1.6"	6"	1.6"	1	D-45	
100-120	1	BR.	156	2"	6"	2"	1	D-46	
100-120	2	BR.	156	3"	10 1/4"	3"	2	D-47	
100-120	4	BR.	156	4"	10 1/4"	4"	2	D-48	
100-120	6	BR.	156	4"	15 7/8"	4"	2	D-49	
100-120	8	BR.	156	5"	10 1/4"	6"	2	D-50	
100-120	12	BR.	156	5"	15 7/8"	6"	2	D-51	

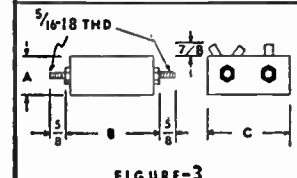
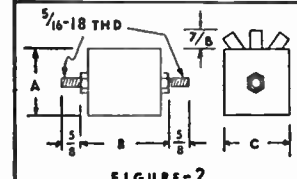
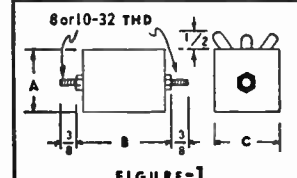
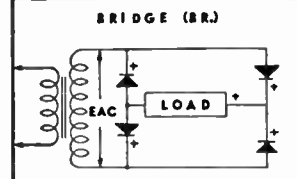
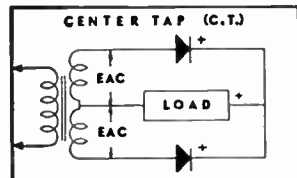

ALL DIMENSIONS
ARE APPROXIMATE

SARKES TARZIAN, INC., RECTIFIER DIVISION

Dept. RM

Sarkes
Tarzian

"Centre-Kooled"

SELENIUM RECTIFIERS

For All DC Power Requirements

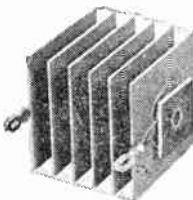
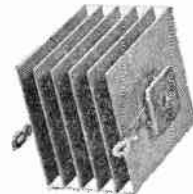
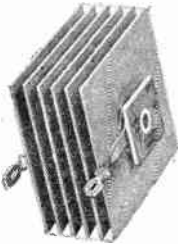
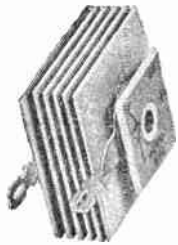
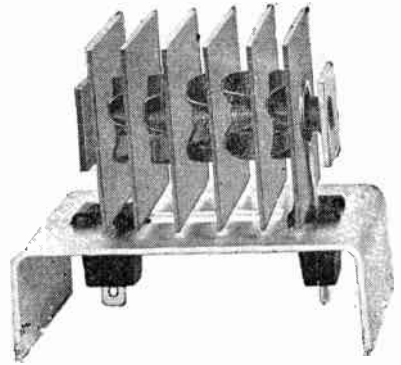

Model No.	Max. DC Current	Max. RMS Input Voltage	Max. RMS Current (MA)	Max. Inverse Peak Voltage	Max. Peak Current (MA)	Dimensions	Application
50	50	130	125	380	500	3/8"x5/8"x5/8"x5/8"	Boosters
65	65	130	102	380	650	13/32"x1"x1"x11/16"	B+ Supply—Portable & AC-DC Radio
75	75	130	187	380	750	13/32"x1"x1"x13/16"	B+ Supply—Portable Radio
100	100	130	250	380	1000	13/32"x1"x1"x1"	B+ Supply—AM-FM Radio
100A	100	130	250	380	1000	1 1/4"x1 1/4"x13/16"	B+ Radio
150	150	130	375	380	1500	13/32"x1"x1"x1"	B+ Supply—Radio-Television
200	200	130	500	380	2000	1 1/4"x1 1/4"x1-3/16"	B+ Supply—Television
250	250	130	625	380	2500	7/16"x1.6"x1.6"x1"	B+ Supply—Television
300	300	130	750	380	3000	7/16"x1.6"x1.6"x1 1/8"	B+ Supply—Television
400	400	130	875	380	3500	13/32"x2"x2"x1-5/16"	B+ Supply—Television
500	500	130	1125	380	4500	13/32"x2"x2"x1 7/8"	B+ Supply—Radio-Television
600	600	130	1500	380	6000	1-3/32"x2"x2-3/16"	B+ Supply—Television
108	100	160	250	440	1000	13/32"x2-3/16" Max.	B+ Supply—1/2 Wave, Mobile Radio-TV
78D	75	160	187	440	750	1 1/4"x1 1/4"x31/32"	B+ Supply—Doubler
108D	100	160	250	440	1000	13/32"x1"x1"x1 1/2"	—Radio-Television
208D	200	160	500	440	2000	13/32"x1 1/4"x1 1/4"x1 5/8"	B+ Doubler
154B	150	25	270	35	1800	7/16"x1.6"x1.6"x1 1/8"	—Radio-Television
304B	300	25	540	35	2400	13/32"x1"x1"x11/16"	B+ Doubler
604B	600	25	1080	35	4000	13/32"x1 1/4"x1 1/4"x11/16"	—Radio-Television
						7/16"x1.6"x1.6"x1 1/8"	Filament—Relay Supply
						x1.6"x1.6"x15/16"	Filament—Relay Supply

HIGH VOLTAGE SELENIUM RECTIFIERS

Sarkes Tarzian high voltage selenium rectifiers are designed for use in photo-flash supplies, cathode ray oscilloscopes, television receivers, high potential test equipment, and electronic equipments used by military forces.

Designated as Type 0 for current ranges to 5 milliamperes and as Type 1 for current ranges to 25 milliamperes, the units are available in half wave, full wave bridge, and center tap stacks. Both types are available with voltage ratings to 4000 in a single unit and hundreds of thousands of volts by using multiple units in series. In center tap and bridge circuits the maximum allowable D.C. current is 10 MA for Type 0 and 50 MA for Type 1 assemblies.

The Type 0, in a glass enclosure is hermetically sealed for high humidity operation (Half Wave units only) and mounting is by means of silver plated ferrules. The bakelite enclosed Type 0 rectifiers are designed for normal commercial use and electrical connection is made by means of axial pigtail leads. For inverse voltage ratings to 208 volts A.C. the unit is self supporting; longer assemblies require a mounting clip.

The Type 1 rectifier is available only in square bakelite enclosures. The unit, normally supplied, is not hermetically sealed; however, it is possible to "capsulize" the Type 1 rectifier for high humidity applications.

For complete information or engineering assistance—write, phone or wire. No obligations on your part.

New Handbook Available

72 pages of valuable information about Radio and Television circuit diagrams — includes Color T.V. and new Sarkes Tarzian Plug-In Rectifiers, Power Rectifiers, and High Voltage Rectifiers — advance information on applications. Handy reference size — 8 1/2 x 11". Price \$1.00.

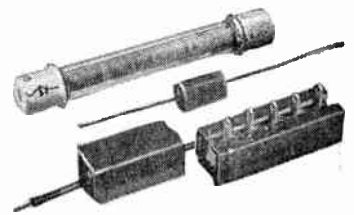

SARKES TARZIAN, INC., RECTIFIER DIV.

Dept. RM



Germanium Diodes

FEATURING POLARITY AT A GLANCE!

Radio Receptor's new Germanium Diodes feature polarity at a glance combined with simplicity of construction and sound design principles. The distinctive tapered shape of the glass-filled phenolic cartridge body speeds assembly because operators can see at a glance the correct direction of assembly.

Users are enthusiastic over the quality of the product which gives a maximum of trouble-free operation even under the most adverse conditions. Radio Receptor Germanium Diodes are currently being used in walkie-talkies, computers, TV sets, tuners and other electronic applications.

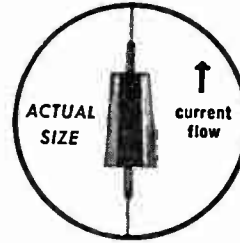

All values measured at 25° C.

CODE NO.	MINIMUM FORWARD CURRENT AT 1 VOLT (MA)	MAXIMUM REVERSE CURRENT (MICRO-AMPERES)	AVERAGE RECTIFIED CURRENT (MA MAX.)	MINIMUM REVERSE VOLTS	MAXIMUM CONTINUOUS REVERSE OPERATING VOLTS	DIODE LIST PRICE
1N34	5.0	50 @-10V, 800 @-50V	50	75	60	1.50
*1N34A	5.0	30 @-10V, 500 @-50V	50	75	60	1.65
‡1N35	7.5	10 @-10V	22.5	75	50	3.65
1N38	3.0	6 @-3V, 625 @-100V	50	120	100	2.90
1N38A	4.0	5 @-3V, 500 @-100V	50	120	100	3.65
1N48	4.0	833 @-50V	50	85	70	1.10
1N51	2.5	1,667 @-50V	25	50	40	.85
1N52	4.0	150 @-50V	50	85	70	2.15
1N54	5.0	10 @-10V	50	75	35	1.75
1N54A	5.0	7 @-10V, 100 @-50V	50	75	50	2.40
1N55	3.0	300 @-100V, 800 @-150V	50	170	150	4.85
1N55A	4.0	500 @-150V	50	170	150	7.15
1N58	4.0	800 @-100V	50	120	100	2.40
1N58A	4.0	600 @-100V	50	120	100	3.00
1N60		Minimum of 1.8V peak to peak in 40MC test circuit		30		1.25
1N63	4.0	50 @-50V	50	125	100	4.85
1N64		Minimum of 0.100 MA in 44 MC test circuit		20		1.10
1N65	2.5	200 @-50V	50	85	70	1.15
*1N69	5.0	50 @-10V, 850 @-50V	40	75	60	1.50
		Rectification efficiency: 35% minimum in 100 MC test circuit				
*1N70	3.0	25 @-10V, 300 @-50V	30	125	100	4.00
‡1N72		Noise figure as a mixer better than 15DB @ 750 MC with 43.5 MC-IF circuit having a noise bandwidth of 3 MC and a noise figure of 4 DB.				1.60
1N75	2.5	50 @-50V	50	125	100	4.15
*1N81	3.0	10 @-10V	30	50	40	3.25
‡1N110		Noise figure as a mixer better than 12DB @ 750 MC with 43.5 MC-IF circuit having a noise bandwidth of 3 MC and a noise figure of 4 DB.				1.75

*JAN type.

†Supplied without leads unless specified.

‡Average half wave rectified current at 60 CPS and 25°C. Consult us for ratings at other conditions.

§For zero dynamic resistance.

¶Two diodes mounted in a bracket and matched so that forward current at +1V through the lower resistance unit is within 10% of that in the higher resistance unit. Ratings are for each diode.

JUST ADDED! THE FOLLOWING DIODES ALSO AVAILABLE: 1N91, 1N92, 1N93, 1N111, 1N112, 1N113, 1N114, 1N115.

Seletron & Germanium
Division

RADIO RECEPTOR COMPANY, INC.
In Radio and Electronics Since 1922



**DIFFUSED
PNP
JUNCTION**

HERMETICALLY SEALED TRANSISTORS

TYPE RR14, RR20, RR34, 2N34, 2N36, 2N37, 2N38 Intended for applications in low level audio circuits. Particularly applicable where small size and economy of operation are desirable.

TYPE RR21 Intended for applications in low level audio circuits requiring power outputs in the 10 milliwatt range.

TYPE RR38 Intended for applications requiring economy of operation at low power levels. Particularly applicable as the output stage for hearing aids and personal receivers.

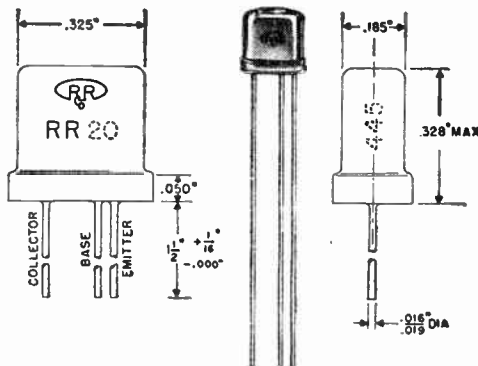

TENTATIVE DATA

ABSOLUTE MAXIMUM RATINGS		RR14	RR20	RR21	RR34	RR38	2N34	2N36	2N37	2N38	
Collector Voltage	Volts	-25	-25	-25	-25	-25	-25	-25	-25	-25	
Collector Current, Emitter Current:	Limited only in terms of dissipation.										
Dissipation @ 50°C	mw.	70	70	70	70	70	70	70	70	70	
Junction Temperature	°C	85	85	85	85	85	85	85	85	85	
Junction temperature increases approx. 0.5°C above ambient per mw. of dissipation.											
Collector Cut-off Current (I _{co})	V _c										
@ -15V	ua.	15	15	40	15	—	15	15	15	15	
@ -25V	ua.	50	50	100	50	—	50	50	50	50	
I _{co} doubles for approx. every 10°C rise in temperature.											
CHARACTERISTICS @ 25°C (collector voltage: -4.5V, emitter current: 1ma, Frequency: 1000 cps)											
Collector Resistance (r _c)	ohms	Min. 500K Avg. 1.0meg	500K 1.0meg	500K 1.0meg	500K 1.0meg	Minimum of 1 mw power output @ 10% distortion in amplifier test circuit	—	—	—	—	
Base Resistance (r _b)	ohms	Min. 550 Avg. 1000	600 1000	350 1000	400 1000		—	—	—	—	
Emitter Resistance (r _e)	ohms	Min. 30 Avg. 28	30 45	30 19	30 15		—	—	—	—	
Current Amplification Factor (α _{cb}) (Grounded Emitter; R _L =0)		Min. 20 Avg. 34	35 —	15 —	10 19		—	—	—	—	
Noise Figure	db	Min. 19 Avg. 19 Max. 24	19 — 24	19 — 24	19 — 24		—	—	—	—	
Compared with noise of 1500 ohm input resistor @ 1000cps with 100cps bandwidth.											
TYPICAL GROUND Emitter OPERATING CHARACTERISTICS @ 25°C (Frequency: 1000 cps)											
Collector Voltage	Volts	-1.5	-1.5	-1.5	-1.5		-1.3 to -1.5	-6	-6	-6	-6
Emitter Current	ma.	0.5	0.5	0.5	0.5		3	1	1	1	1
Base Connection Current	ua.	10	5	10	25		—	25	10	20	50
Power Gain	db.	36	40	36	32	28	40	40	36	32	
Current Amplification Factor (α _{cb})		—	—	—	—	—	40	45	30	15	
Source Impedance	ohms	1K	1K	1K	1K	50	500	1K	1K	1K	
Load Impedance	ohms	30K	30K	5K	30K	350	30K	30K	30K	30K	
List Price		\$18.00	\$21.50	\$13.00	\$11.50	\$13.00	\$22.50	\$20.50	\$16.25	\$12.00	

- Max. noise figure of 16db may be specified for RR14, RR20 & RR34 types by ordering units marked with yellow dot.
- The tinned flexible leads may be soldered directly into the circuit or plugged into a standard socket by cutting the leads to 0.20 inches in length. Use socket type: Cinch No. 54A14956 or equivalent. Use heat sink when soldering to protect transistor from excessive heating.
- RRco Junction Transistors are hermetically sealed for light-proof, moisture proof and contamination-free operation.



GERMANIUM DIODES

1N34	1N54	1N64	1N92
*1N34A	1N54A	1N65	1N93
1N35	1N55	*1N69	1N110
1N38	1N55A	1N70	1N111
1N38A	1N58	1N72	1N112
1N48	1N58A	1N75	1N113
1N51	1N60	*1N81	1N114
1N52	1N63	1N91	1N115

*JAN TYPE

For full specifications and prices see our Germanium Diode listings on page H-26.



Seletron and Germanium Division
RADIO RECEPTOR COMPANY, INC.
In Radio and Electronics Since 1922

**For Industrial Applications
More and More Engineers Specify...**



SELETRON RECTIFIERS

INDUSTRIAL TYPE SELETRON RECTIFIERS DISTRIBUTED BY JOBBERS											
SINGLE PHASE - FULL WAVE BRIDGE - RESISTIVE-INDUCTIVE LOAD - FIGURE NO. 1											
D.C. OUTPUT @ 35°C.			INPUT R.M.S. VOLTS	SELETRON RECTIFIER CODE NO.	RECTIFIER DIMENSIONS IN INCHES See Figure No. 2					RECTI- FIER PRICE	BRACK- ETS EACH
MAX. AMPS	APPROX. NEW	AGED			A	B	C	D	E		
0.9	18.6	17.6	24	Q1B1S1F	2	1-9/16	1-1/2	1-1/2	3/8	\$ 2.40	.17
	15.2	14.1	20								
	10.8	9.7	15								
1.4	19.0	18.0	24	S1B1S1F	2-1/16	1-11/16	2	2	1/2	4.16	.22
	15.3	14.2	20								
	10.9	9.9	15								
3.2	18.0	17.0	24	U1B1S1F	3-7/8	2-5/8	3	3	5/8	6.34	.22
	15.1	13.8	20								
	10.7	9.5	15								
6.0	18.0	17.0	24	W1B1S1F	3-7/8	2-5/8	4	4	3/8	8.82	.28
	15.0	13.5	20								
	10.6	9.2	15								
10.0	18.0	17.0	24	H1B1S1F	4-3/16	2-15/16	6	5	1-3/8	12.38	.44
	14.9	13.7	20								
	10.5	9.4	15								
20.0	18.0	17.0	24	H1B2S1F	6-1/16	4-13/16	6	5	1-3/8	23.43	.44
	14.9	13.7	20								
	10.5	9.4	15								
30.0	18.0	17.0	24	WH1B3S1F	9-1/4	8	6	5	1-3/8	35.26	.44
	14.9	13.7	20								
	10.5	9.4	15								
0.45	37.0	35.0	48	P2B1S1F	3-1/16	2-5/16	1-3/16	1-3/16	3/8	5.00	.17
	30.0	28.0	40								
	21.6	19.4	30								
0.9	37.0	35.0	48	Q2B1S1F	3-1/16	2-5/16	1-1/2	1-1/2	3/8	5.64	.17
	30.0	28.0	40								
	21.6	19.4	30								
1.4	38.0	36.0	48	S2B1S1F	3-3/8	2-5/8	2	2	1/2	7.60	.22
	31.0	29.0	40								
	22.0	20.0	30								
3.2	37.0	35.0	48	U2B1S1F	5	3-3/4	3	3	5/8	11.25	.22
	30.0	28.0	40								
	21.6	19.4	30								
6.0	37.0	35.0	48	W2B1S1F	5	3-3/4	4	4	3/8	16.08	.28
	30.0	28.0	40								
	21.6	19.4	30								
10.0	37.0	34.0	48	H2B1S1F	5-13/16	4-9/16	6	5	1-3/8	22.71	.44
	30.0	27.0	40								
	21.0	18.8	30								
16.0	37.0	35.0	48	H2B2S1F	9-1/2	8-1/4	6	5	1-3/8	42.73	.44
	30.0	28.0	40								
	22.0	19.3	30								
24.0	37.0	35.0	48	H2B3S1F	13-1/16	11-13/16	6	5	1-3/8	61.95	.44
	30.0	28.0	40								
	22.0	19.3	30								
0.9	111	105	144	WQ6B1S1F	7-5/8	6-7/8	1-1/2	1-1/2	3/8	14.65	.17
	92	84	120								
	56	49	80								
1.4	114	108	144	WS6B1S1F	8-9/16	7-13/16	2	2	1/2	21.32	.22
	95	89	120								
	60	54	80								
2.4	112	106	144	U6B1S1F	9-7/8	8-5/8	3	3	5/8	27.53	.22
	93	87	120								
	58	52	80								
6.0	110	103	144	WW6B1S1F	12-13/16	11-9/16	4	4	3/8	44.46	.28
	91	84	120								
	56	48	80								
0.9	130	122	168	WQ7B1S1F	8-5/8	7-7/8	1-1/2	1-1/2	3/8	16.57	.17
	106	98	140								
	71	63	100								
1.4	133	126	168	WS7B1S1F	9-11/16	8-15/16	2	2	1/2	24.56	.22
	108	102	140								
	74	67	100								
2.4	131	123	168	U7B1S1F	11-1/16	9-13/16	3	3	5/8	31.29	.22
	106	99	140								
	72	64	100								
6.0	129	120	168	WW7B1S1F	14-1/2	13-1/4	4	4	3/8	50.97	.28
	104	96	140								
	70	61	100								

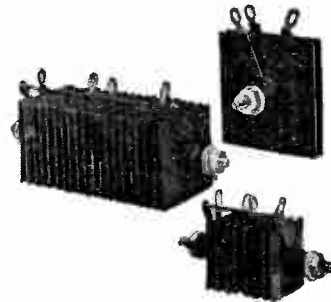

Rugged, high powered, center protected SELETRON Selenium Rectifiers are ideal for diversified industrial applications because of their flexibility and high efficiency over a wide range of load. Typical of such uses are installations operating elevators in more than 150 office buildings in New York and Chicago and the spectacular Eveready searchlight on New York's Great White Way.

RECTIFIER CIRCUITS, CONNECTIONS AND DIMENSIONS

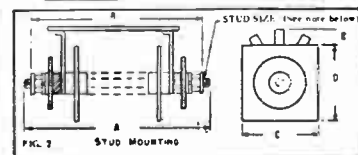
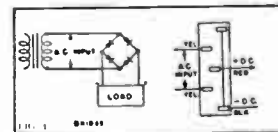

NOTE: #10-32 for all stacks with code numbers starting P, Q, S, WQ, WS, #5/16-18 for all stacks with code numbers starting U, W, H, WW, WH.

Our engineering department will be glad to aid you in the solution of your rectifier problems without obligation. Write for booklet on SELETRON Selenium Rectifiers.

**Seleton and Germanium Division
RADIO RECEPTOR COMPANY, INC.**



Since 1922 in Radio and Electronics



**MILLIONS OF MINIATURES IN SERVICE
IN RADIO AND TELEVISION!**

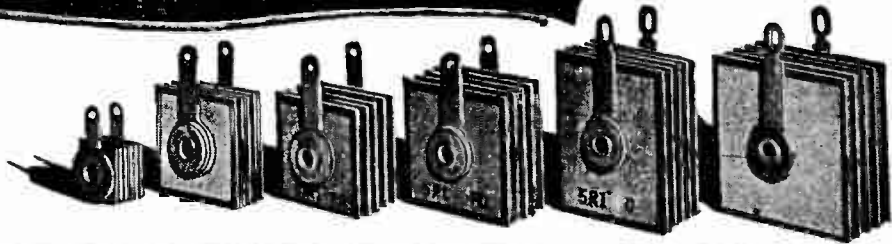

MINIATURE SELETRON SELENIUM RECTIFIERS

MODEL NO.	PLATE SIZE	STACK THICKNESS	MAX. INPUT VOLTAGE R.M.S.	MAX. PEAK INVERSE VOLTAGE	MAX. D.C. OUTPUT CURRENT	LIST PRICE
1M1	1" sq.	3/8"	25	75	100 MA	\$0.80
8Y1	1/2" sq.	9/16"	130	380	25 MA*	1.25
16Y1	1/2" sq.	15/16"	260	760	20 MA†	2.50
8J1	1 1/16" sq.	9/16"	130	380	65 MA	1.40
5M4	1" sq.	1 1/16"	130	380	75 MA	1.85
5M1	1" sq.	7/8"	130	380	100 MA	2.05
5P1	1-3/16" sq.	7/8"	130	380	150 MA	2.15
6P2	1-3/16" sq.	1 3/16"	156	456	150 MA	2.25
5R1	1 1/2" x 1 1/4"	7/8"	130	380	200 MA	2.75
5Q1	1 1/2" sq.	1 1/8"	130	380	250 MA	2.95
6Q1	1 1/2" sq.	1 1/8"	156	456	250 MA	3.15
6Q2	1 1/2" sq.	1 3/8"	156	456	250 MA	3.15
6Q4 (1)	1 1/2" sq.	130	380	300 MA	3.30	
5QS1	1 1/2" x 2"	1 1/8"	130	380	350 MA	3.90
6QS2	1 1/2" x 2"	1 1/4"	156	456	350 MA	4.10
6QS4 (1)	1 1/2" x 2"	156	456	350 MA	4.10	
5S2	2" sq.	1 1/8"	130	380	400 MA	4.25
6S2	2" sq.	1 3/8"	156	456	500 MA	4.40

Current ratings above are for a maximum plate temperature of 75° C. when the rectifiers are new, in a maximum ambient temperature of 45° C. Recommended plate temperature for new rectifiers is 70° C. Output current ratings are based on R.M.S. rectifier current not in excess of 2.5 times rated output current.

*This rectifier is rated at 30 MA when used with a 47 ohm series resistor.

†This rectifier is rated at 25 MA when used with a 47 ohm series resistor.

(1) Stud mounted—overall: 2".



**SELENIUM
RECTIFIERS**

Miniature SELETRON Selenium Rectifiers are specified by an ever increasing number of engineers in the U. S. and throughout the world for radio, television and other electronic applications. The small size and thorough dependability under all types of punishing conditions make them ideal wherever long life and high efficiency are needed. The wide range of available sizes is listed to the left.

*See your local distributor
for your requirements.*

**Seletron and Germanium Division
RADIO RECEPTOR COMPANY, INC.**

RR Since 1922 in Radio and Electronics **RR**

Federal Radio-TV Selenium Rectifiers

For unlimited use in radio • television • electronics

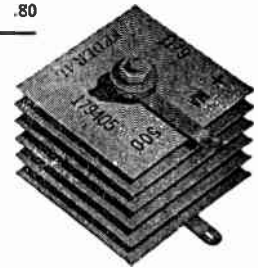
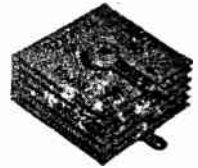
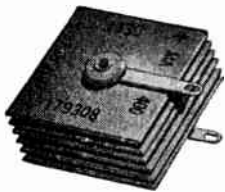

Federal Cat. No.	Output MA-DC	Max. Input (RMS) Volts	Min. Res. Ohms	Ser. "R" Volts	Peak Inverse Peak (Max.)	Peak Current (Max.)	Plate Size	Mtg. ("H") Dim. (Max.)	Application	List Price Each
1159	20	130	54	50	380	200	3/8" Dia.	—	B+ Booster; Bias	\$1.55
1002A	65	130	175	22	380	650	1" Sq.	1/8"	B+ AC-DC (5 tube)	1.50
1003A	75	130	200	22	380	750	1" Sq.	3/8"	B+ 3-way Radios	1.85
1101A	100	130	270	22	380	1000	1" Sq.	1 1/8"	B+ Radios, Telev.	1.90
1004A	100	130	270	22	380	1000	1 1/2" x 1 1/2"	3/8"	B+ Radios, Telev.	2.05
1005A	150	130	410	15	380	1500	1 1/2" x 1 1/2"	1"	B+ Radios, Telev.	2.25
1006A	200	130	540	5	380	2000	1 1/2" Sq.	1"	B+ Television	3.15
*1028A (1010)	250	130	675	5	380	2500	1 1/2" Sq.	1 1/4"	B+ Booster; Bias	3.15
1090A	300	130	810	5	380	3000	1 1/2" Sq.	2 3/8"	B+ Television	3.30
1023 (120G)	350	130	945	5	380	3500	1 3/4" Sq.	2 3/8"	B+ Television	4.10
1130 (105G)	400	130	1080	5	380	4000	2" Sq.	1 1/4"	B+ Television	4.25
1179 (1021)	500	130	1350	5	380	5000	2" Sq.	2 3/8"	B+ Television	4.40
1022	450	160	1200	5	460	4500	2" Sq.	2 1/8"	B+ Television	4.95
1016	300	25	350	35	1500	1 1/2" x 1 1/2"	3/8"	Bridge Rectifier	2.40
1017	600	25	700	35	3000	1 1/2" Sq.	3/8"	Bridge Rectifier	3.15
1013	360	9†	1 1/2" Sq.	1/4"	Battery Charger	1.40
1018	1600	26‡	4 1/4" (Mtg. Pit.)	5/8"	Battery Charger	3.85
1001	75	20	200	35	750	1" Sq.	3/8"	Bias Rectifier	.80

Federal Selenium Rectifier Handbook\$0.50

Federal Selenium Rectifier Replacement Guide50

*Eyelet construction — Replaces catalog No. 1010.

†The input voltage shown is the maximum which may be applied in a half-wave rectifier circuit for battery charging.

‡The input voltage shown is the maximum which may be applied to the outside terminals in a center-tap rectifier circuit.

Letter "A" after catalog number indicates locking lug.

Federal's Universal Replacement Line

Cat. No.	Output MA-DC	Max. Input (RMS) Volts	MA.	Mtg. (H) Dim. Max.	Min. Res. Ohms	Ser. "R" Volts	Peak Inverse Peak (Max.)	Peak Current (Max.)	Plate Size	Application	List Price Each
1263A	65	130	175	1 1/2" ± 1/32"	22	380	650	1 1/8" sq.	1 1/8" sq.	B+ AC-DC (5 tube)	\$1.35
1236A	300	130	810	1 3/8" ± 1/32"	5	380	3000	1 5/8" sq.	1 5/8" sq.	B+ Television	3.30
1238A	350	130	945	1 3/8" ± 1/32"	5	380	3500	1 3/4" sq.	1 3/4" sq.	B+ Television	4.10
1241A	400	130	1080	1 1/4" ± 1/32"	5	380	4000	2" sq.	2" sq.	B+ Television	4.25
1237A	500	130	1350	1 3/8" ± 1/32"	5	380	5000	2" sq.	2" sq.	B+ Television	4.40

6/32" x 4 1/2" mounting bolts available for mounting rectifiers in tandem. Bolt Part No. IDR-6131; Nut Part No. IDR-6015.

Eyelet construction. 6/32" mounting screw enclosed.

Letter "A" placed after catalog number indicates locking lug.

Cross-Reference Guide

Universal No.	FTR.	Radio Receptor Co., Inc.	Sarkes Tarzian, Inc.
1263A	1002A	8J1	65
1236A	1090	6Q4	300
1238A	1023 (120G)	6QS2, 6QS4	350
1241A	1130 (105G)	—	400
1237A	1179 (1021)	6S2	500



Consult your local Federal Distributor

PACKAGED POWER SELENIUM RECTIFIER STACKS

by *Federal* 

Federal has America's largest stock of stacks for all popular applications . . . available for prompt shipment. Special design data and prices for the asking.

Price List and Data Sheet — Effective May 17, 1954

NOTE: Ratings for 35° C. Ambient; Resistive or Inductive loads; all designs shown are for single phase full wave rectification.

Maximum D.C. Output (Approximate) ‡		Rectifier Stack Code Number	Maximum A.C. Input Volts	*Rectifier Stack Dimensions		Catalog Number	Net User's Price
Volts	Amps.			A	B ± 1/8"		
10	3.0	106C1AX1	13	3 3/8"	1 9/16"	2100	\$ 4.62
	6.0	133C1AX1	13	4 3/8"	1 3/4"	2101	6.18
	12.0	136C1AX1	13	5" x 6"	1 3/4"	2102	7.70
20	3.0	106B1AX1	26	3 3/8"	2 1/8"	2103	8.40
	6.0	133B1AX1	26	4 3/8"	2 1/8"	2104	11.00
	12.0	136B1AX1	26	5" x 6"	2 3/4"	2105	14.10
40	3.0	106B2AX1	52	3 3/8"	3 3/16"	2026	15.28
	6.0	133B2AX1	52	4 3/8"	5"	2107	20.15
	12.0	136B2AX1	52	5" x 6"	5 1/4"	2108	26.20
60	3.0	106B3AX1	78	3 3/8"	4 1/2"	2118	20.43
	6.0	133B3AX1	78	4 3/8"	6 3/8"	2033	28.53
	12.0	136B3AX1	78	5" x 6"	7 5/8"	2085	37.82
80	3.0	106B4AX1	104	3 3/8"	5 1/2"	2109	25.63
	6.0	133B4AX1	104	4 3/8"	8 5/8"	2110	35.75
	12.0	136B4AX1	104	5" x 6"	9 7/8"	2111	49.23
100	1.0	139B5AX1	130	2" sq.	5 3/8"	2112	19.38
	2.4	106B5AX1	130	3 3/8"	6 5/8"	2113	31.02
	6.0	133B5AX1	130	4 3/8"	10 9/16"	2114	41.80
120	0.3	103B6AX1	156	1 8/16" x 1 1/16"	4 3/4"	2115	13.83
	0.6	104B6AX1	156	1 1/2" sq.	4 7/8"	2036	15.68
	1.0	139B6AX1	156	2" sq.	6 7/8"	2116	22.68
	2.4	106B6AX1	156	3 3/8"	7 5/8"	2038	36.23
	6.0	133B6AX1	156	4 3/8"	12 5/8"	2117	49.38

*A dimension is cell size.
B dimension is mounting size.

‡Resistive or Inductive Loads.

Federal "S-C-S" (Single-Crystal-Stabilized) Germanium Diodes

Type	Description	List		
GENERAL PURPOSE				
*IN34	Low Back Voltage	\$1.35	<ul style="list-style-type: none"> • SINGLE-CRYSTAL GERMANIUM • SMALL SIZE—1/4" diameter, 1/2" long • MOISTURE-PROOF—sealed in non-porous ceramic • FLEXIBLE LEADS—for easy mounting • COMPLETELY INSULATED CASE • NO FILAMENT—no heater power drain or hum • LOW SHUNT CAPACITY—average 1μmf • SELF-HEALING—for temporary overloads • HEAT SINKS—protect during soldering • WITHSTANDS adverse temperature-humidity cycling • NO CONTACT POTENTIAL • POLARITY clearly identified 	
*IN38	100 Volt Back Voltage	3.00		
IN39	200 Volt Back Voltage	—		
IN48A	Medium Back Resistance	1.10		
IN51A	Low Back Resistance85		
IN52A	High Back Resistance	2.85		
*IN54	High Back Resistance	—		
*IN55	150 Volt Back Voltage	—		
*IN56	High Conduction Diode	—		
*IN58	100 Volt Back Voltage	—		
IN63A	High Back Resistance at High Voltage	5.25		
IN75A	High Back Resistance at High Voltage	4.45		
TELEVISION TYPES				
IN64A (IN60)	Video Detector65		
IN65A	DC Restorer	1.10		

*Hermetically Sealed; Universal Mounting.



LARGEST SUPPLIERS

Executive Offices: 1521 E. Grand Ave., El Segundo, Calif. • Phone: OREGON 8-6281
Chicago Branch Office: 205 West Wacker Drive • Phone: Franklin 2-3889
New York Branch Office: 501 Madison Avenue • Phone: Plaza 5-8665

Selenium Rectifiers

COLOR TV, RADIO and TV MINIATURE RECTIFIERS

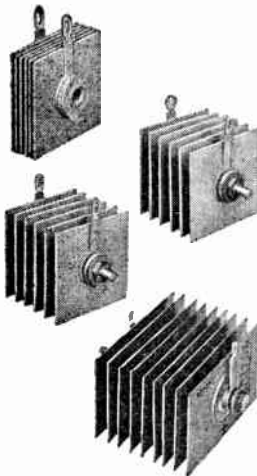

Type No.	Max. DC MA	Max. Input RMS Volts	Min. Series Resistor Ohms	Max. Dimensions		
				A	B	MD
RS65Q	50	130	22	.67	.67	3/4"
RS65	65	130	22	1"	1"	3/4"
RS75	75	130	22	1"	1"	3/4"
RS100	100	130	22	1.2"	1.2"	3/4"
RS150	150	130	15	1.2"	1.2"	1"
RS200	200	130	5	1.5"	1.5"	1"
RS250	250	130	5	1.5"	1.5"	1 1/4"
RS300	300	130	5	1.5"	1.5"	1 1/8"
RS350	350	130	5	2"	2"	1 1/8"
RS400	400	130	5	2"	2"	1 3/8"
RS450	450	130	5	2"	2"	1 1/8"
RS500	500	130	5	2"	2"	1 1/8"
RS1000	1000	130	2	3"	3"	3"

Widest Range in the Industry for electronic application up to 1000 MA

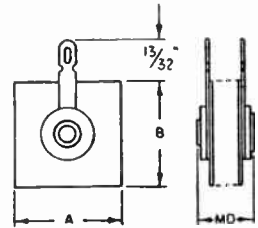

INDUSTRIAL and POWER RECTIFIERS

*Ratings to 250 KW • Efficiency 87% • Power Factor 95%

Type No.	Output		Max. Input AC Volts	Circuit & Connecting Diag. Fig.	Dimensions (Inches)						
	DC Volts	DC Amp			Fig.	A	B	MD ± 1/4"	X	Y	Stud
JD-500G	0-10	0.4	13/26	1	A	1 1/4	1 1/4	1 1/8	3/8	3/8	8-32
JD-3011		1.5	13/26	1	A	2	2	1 3/8	1/2	3/8	1/4-20
JD-503G		3.0	13/26	1	A	3	3	2 1/8	3/8	3/8	3/8-16
JD-504G		6.5	13/26	1	A	4 3/4	4 3/4	2 1/8	3/8	3/8	3/8-16
JD-506G		15.0	13/26	1	A	7 1/4	6 1/4	2 1/8	3/4	1 1/8	3/8-16
JD-507G	0-20	0.4	26	2	A	1 1/4	1 1/4	1 1/2	3/8	3/8	8-32
JD-3022		1.5	26	2	A	2	2	1 1/8	1/2	3/8	1/4-20
JD-510G		3.0	26	2	A	3	3	2 3/8	1/2	3/8	3/8-16
JD-512G		9.5	26	2	A	6	5	3 3/8	1/2	1 1/8	3/8-16
JD-513G		15.0	26	2	A	7 1/4	6 1/4	3 3/8	1/2	1 1/8	3/8-16
JD-514G	0-40	0.4	52	2	B	1 1/4	1 1/4	2 3/8	3/8	3/8	8-32
JD-3023		1.5	52	2	B	2	2	3	1/2	3/8	1/4-20
JD-517G		3.0	52	2	B	3	3	4 1/8	1/2	3/8	3/8-16
JD-518G		6.5	52	2	B	4 3/4	4 3/4	4 1/8	1/2	3/8	3/8-16
JD-520G		15.0	52	2	B	7 1/4	6 1/4	5 3/8	3/4	1 1/8	3/8-16
JD-3012	0-100	0.3	130	2	B	1 1/4	1 1/4	4 1/8	3/8	3/8	8-32
JD-3008		1.2	130	2	B	2	2	6 1/4	1/2	3/8	1/4-20
JD-3009		2.4	130	2	B	3	3	8 3/8	1/2	3/8	3/8-16
JD-3010		5.25	130	2	B	4 3/4	4 3/4	8 3/8	1/2	3/8	3/8-16
JD-3014		13.0	130	2	B	7 1/4	6 1/4	12 3/8	3/4	1 1/8	3/8-16
JD-3015	0-120	0.3	156	2	B	1 1/4	1 1/4	5 3/8	3/8	3/8	8-32
JD-3017		1.2	156	2	B	2	2	7 3/4	1/2	3/8	1/4-20
JD-3018		2.4	156	2	B	3	3	10	1/2	3/8	3/8-16
JD-3020		8.5	156	2	B	6	5	15	3/4	1 1/8	3/8-16
JD-3021		13.0	156	2	B	7 1/4	6 1/4	15	3/4	1 1/8	3/8-16

*35° C ambient temperature

BATTERY CHARGING RECTIFIERS

JD-116G	0-10	2	26	3	C	3	3	1/2	Eyelet type
JD-117G		4	26	3	C	4 3/8	4 3/8	1/2	Eyelet type
JD-241G		6	26	3	C	6	5	1/2	Eyelet type
JD-240G		9	26	3	C	7 1/4	6 1/4	1/2	Eyelet type

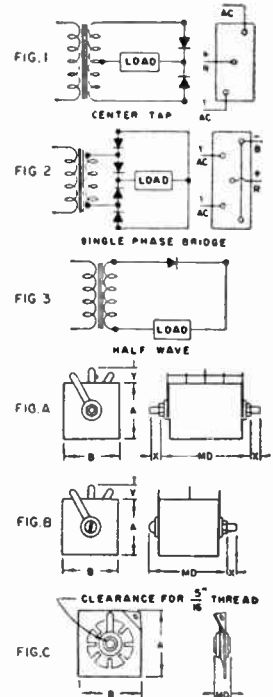

▼ Descriptive Literature Available on Request—Write Dept. E—on your letterhead, please

INTERNATIONAL RECTIFIER CORPORATION



INDUSTRIAL RECTIFIERS

Executive Offices: 1521 E. Grand Ave., El Segundo, Calif. • Phone: OREGON 8-6281
 Chicago Branch Office: 205 West Wacker Drive • Phone: Franklin 2-3889
 New York Branch Office: 501 Madison Avenue • Phone: Plaza 5-8665

Diodes

GERMANIUM DIODES

The Germanium Diodes produced by International Rectifier embody a completely new and superior design. Excellent shock and vibration resistant characteristics are obtained by the use of non-skid germanium crystal surface, double housing, precision formed whisker, and thermosetting plastic end seals. Retention of whisker adjustment is maintained by welded anchor pins. Kits of 10 diodes are also available.

Type No.	Description	Peak Inverse Voltage—25° C	Fdw. MA at 1V
1N48	General Purpose	80 V	4.0
1N51	General Purpose	50 V	2.5
1N52	High Resistance Diode	85 V	4.0
1N63	General Purpose	125 V	4.0
1N64	Video Detector	50 V	2.5
1N65	General Purpose	85 V	2.5
1N69	JAN type—Gen. Purpose	75 V	5.0
1N70	JAN type—Gen. Purpose	125 V	3.0
1N75	General Purpose	125 V	2.5
1N81	JAN type—Gen. Purpose	50 V	3.0
G02	UHF Mixer	5 V	—
G02A	UHF Mixer	5 V	—
G14	"Red Dot" Series High Temp. Diode	80 V	5.0
G21	"Red Dot" Series High Resistance Diode	80 V	5.0
G44	"Red Dot" Series High Temp. Diode	60 V	4.0
G60	JAN type—Gen. Purpose	75 V	5.0



Actual Size



High Temperature "Red Dot" Series

SELENIUM DIODES

These subminiature selenium diodes have been developed for use in electronic equipment where space is at a premium and ambient temperature is high. They are designed for stable operation in ambient temperatures from minus 50° C to plus 100° C. Small and compact in size each unit is provided with pigtail leads to facilitate wiring into a crowded chassis. Potting within a thermosetting compound affords protection against corrosive atmosphere, moisture, fungus, and salt spray. Kits of 18 diodes are available.

Type	DC Output*		Max Input Volts (RMS)	Max. Freq.	Dimensions Inches Tolerance ± .015	
	Volts	MA			L	W
1S1	20	0.1	26	200 kc	0.120"	0.210"
2S1	40	0.1	52	200 kc	0.150"	0.210"
1T1	20	0.2	26	200 kc	0.120"	0.210"
2T1	40	0.2	52	200 kc	0.150"	0.210"
1U1	20	1.5	26	100 kc	0.160"	0.250"
2U1	40	1.5	52	100 kc	0.175"	0.250"
3U1	60	1.5	78	100 kc	0.175"	0.250"
4U1	80	1.5	104	100 kc	0.250"	0.250"
5U1	100	1.5	130	100 kc	0.250"	0.250"
6U1	120	1.5	156	100 kc	0.330"	0.250"
7U1	140	1.5	182	100 kc	0.330"	0.250"
8U1	160	1.5	208	100 kc	0.330"	0.250"
1V1	20	5.0	26	25 kc	0.300"	0.320"
2V1	40	5.0	52	25 kc	0.305"	0.325"
3V1	60	5.0	78	25 kc	0.305"	0.325"
1Y1	20	11.0	26	10 kc	0.415"	0.460"

* Into capacitive load



Actual Size

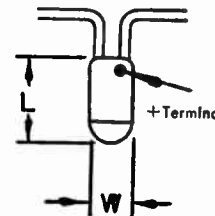

PHOTOELECTRIC CELLS

Type	Size	Average* Output (µa)
A-15	—Unmounted 2" diam.	750
A-10	—Unmounted 1 3/4" diam.	500
A-5	—Unmounted 1 1/8" diam.	250
B-15	—Unmounted 1 3/8" x 1 3/8"	750
B-10	—Unmounted 1 1/4" x 7/8"	350
B-5	—Unmounted 1 3/8" x 3/4"	220
B-2	—Unmounted 3/4" x 3/4"	75
B-10-M	—Mounted 2 1/4" x 1 1/8" x 1/4"	350

* At 100 ft. candles illumination and 100 ohm external resistance.

150 microamperes—120 MA—20 volts—6000 volts and up. Over 500 types to meet special requirements. Cell sizes from 1/8" to 1" outside dia. From 1/2" to 10" max. length.

HIGH VOLTAGE CARTRIDGE RECTIFIERS

Circuits	Assembly	Terminals
Half Wave • Voltage Doublers	Triple "X" Phenolic Tubing	Pigtail Ferrule Stud
Full Wave • Triplers	Hermetically Sealed	

BOOSTER AND CONVERTER TYPES

Miniature selenium rectifiers for original equipment or replacement in TV boosters and UHF converters



CR series

DC output to 50 MA
 Dimensions from .50" x .60" to .75" x .60"

▼ Descriptive Literature Available on Request—Write Dept. E—on your letterhead, please

INTERNATIONAL RECTIFIER CORPORATION

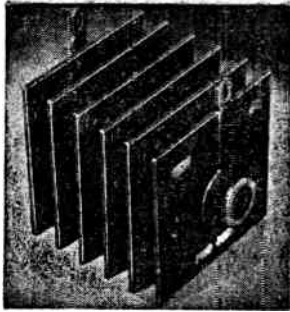

RECTISEL Conventional Open Type Assembly

Types: PRS 65, 75, 100, 150, 250, 300, 350, 400, 500
from 65-500 Ma.

Greatly improved due to the use of high quality plates of matched characteristics. This insures long life, dependability and maintenance free operation.

NEW RECTISEL

Miniature Selenium Rectifiers

The NEW RECTISEL Line of miniature electronic selenium rectifiers was expressly designed for urgently needed applications in the following fields: RADIO and TELEVISION as voltage suppliers; VOLTAGE REGULATORS; MULTIPLIERS; BIAS SUPPLY and FILAMENT SUPPLY; TELEGRAPHY, TELEPHONE and TELETYPE MACHINES. For Power: DC VALVES; ARC SUPPRESSORS; FREQUENCY MULTIPLIERS; VENDING MACHINES; RELAYS; BUSINESS MACHINES; SIGNAL CIRCUITS; CHOKES (especially for phonographs), etc., etc.

No center mounting therefore no center pressure and no center hot spots, due to the unique construction plates cannot loosen and turn. Light in weight. Better voltage regulation because the initial forward resistance is much lower and RATINGS FROM 25 25-100 MA. LONG LIFE are fully guaranteed.

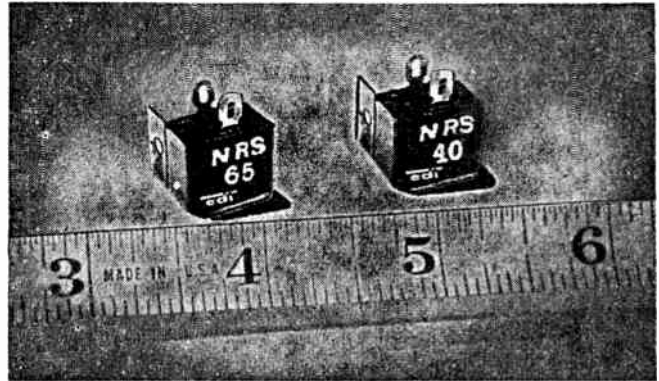

NEW PLASTISEL

Miniature Selenium Rectifiers

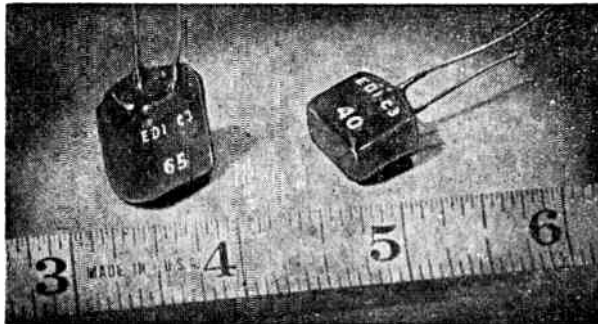

In all ratings through 200 Ma. NEW-PLASTISEL rectifiers are molded into plastic, which gives them the appearance of small molded condensers. These sealed in units have the following advantages.

They fit ideally into miniaturization programs and printed circuit applications because they can be mounted against chassis or in contact with other complements.

Shock hazard in small contact chassis is completely eliminated when NEW-PLASTISEL units are used.

No wiring need be run to rigid terminals as every NEW-PLASTISEL unit has pig tail leads.

Aids in heat dissipation.

COMPLETELY INSULATED AVOIDING ACCIDENTAL SHORTS. NOTHING TO MELT OR SOFTEN. NON-INFLAMMABLE.



MINISEL
Phenolic
Cartridge Type

MINISEL
Sealed-in-Glass
Fuse Type

Hermetically Sealed
Metal Type

High Voltage — Low Current Rectifiers

The entire facilities of the E.D.I. Engineering Department are available to assist you with your problem. There is no obligation for this service. A letter, telegram, or phone call will result in a prompt reply.

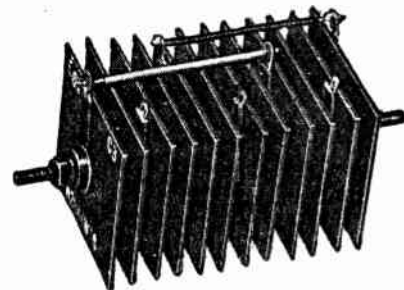

POWERSEL HIGH POWER TYPE RECTIFIERS

ELECTRONIC DEVICES INC.

Precision Rectifier Division
BROOKLYN 15, N. Y.



DIRECTRON

Industrial Selenium Rectifiers, Transformers, Chokes and Power Supplies

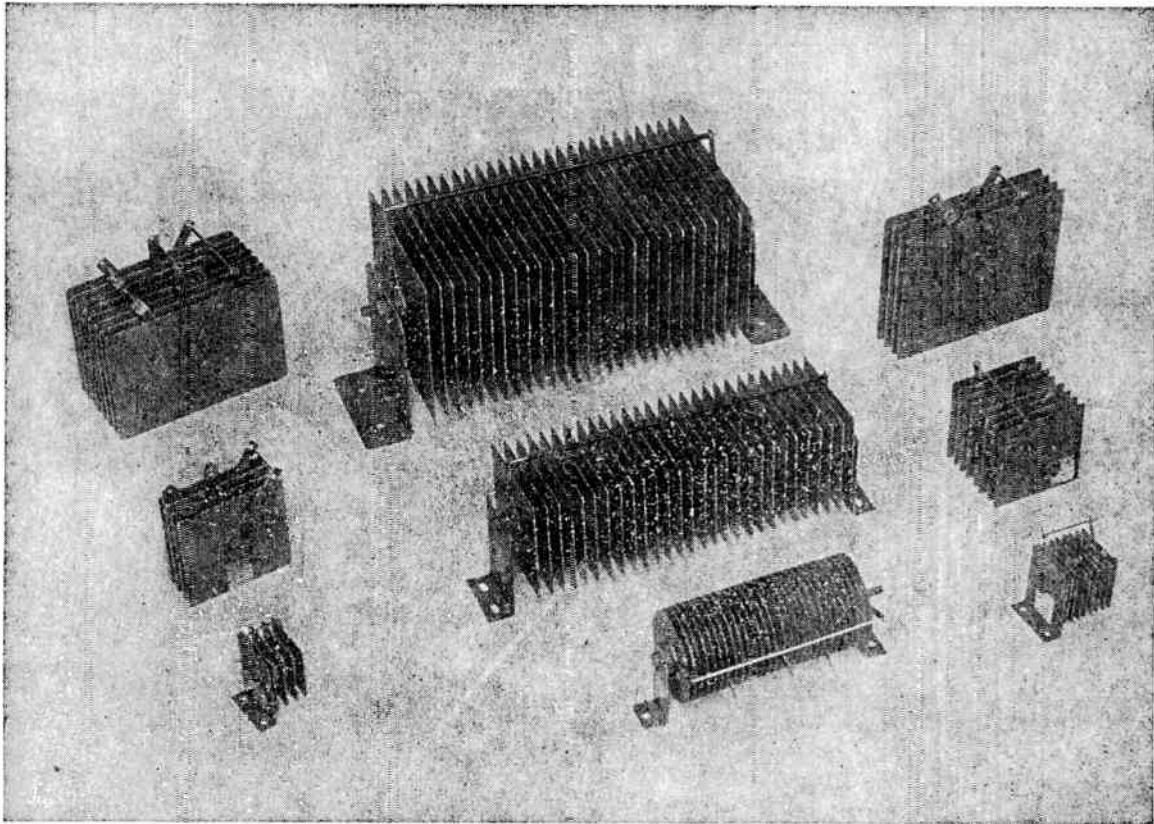

Full Wave Bridge Rectifiers, Single Phase, Resistive-Inductive Loads ALL PRICES SHOWN ARE USER'S NET

Max. Amps	15v. in-14v. out	36v. in-28v. out	54v. in-42v. out	130v. in-100v. out
1	\$ 1.40	\$ 2.40	\$ 3.80	\$ 8.50
2	2.10	3.00	5.40	10.50
2½	3.00	4.20	6.00	13.00
4	3.75	7.50	11.50	25.25
6	4.50	9.00	13.00	33.00
10	6.60	12.75	20.00	42.50
12	8.20	16.25	22.50	46.00
20	13.25	25.50	38.00	79.50
24	16.25	32.50	45.00	86.50
30	20.00	38.00
36	25.00	48.50

For Half-Wave, Center-Tap, Doubler, Tripler or 3-Phase, Quotations on Request
Custom Built Stacks — 24 Hour Service

SELENIUM RECTIFIER TRANSFORMERS

4 Amps	115 ac in 9, 12, 18, 24 and 36v out	
4 Amps	\$ 8.75
12 "	16.75
24 "	35.75
30 "	45.00
50 "	59.75

HIGH CURRENT CHOKES

4 Amps	.07 hy.	.6 ohm	\$ 7.95
12 "	.01 "	1 "	14.95
24 "	.004 "	.025 "	29.95

Mfd. by **SANFORD MILLER COMPANY**
BROOKLYN 6, N. Y.



Thank You!

When writing for additional
information or when ordering
from sources of supply listed
in this book, please mention

RADIO'S MASTER

IN A CLASS *by itself...* THE NEW **NC-98**

No need to write a book about the new NC-98. One quick comparison proves it's in a class by itself—in performance and price! For only \$149.95, what other receiver offers you all the "high-priced" features listed below?

- CRYSTAL FILTER
- S-METER
- 550 KCS. TO 40 MCS. RANGE
- CALIBRATED AMATEUR BANDSPREAD OR CALIBRATED SWL BANDSPREAD*
- NEW MINIATURE TUBES
- AN RF STAGE
- ACCESSORY SOCKET
- TWO IF STAGES
- EDGE-LIGHTED LUCITE DIALS
- NOISE LIMITER
- SEPARATE HF OSCILLATOR
- 3-POSITION SELECTIVITY
- ANTENNA TRIMMER
- PHASING CONTROL
- SENSITIVITY CONTROL

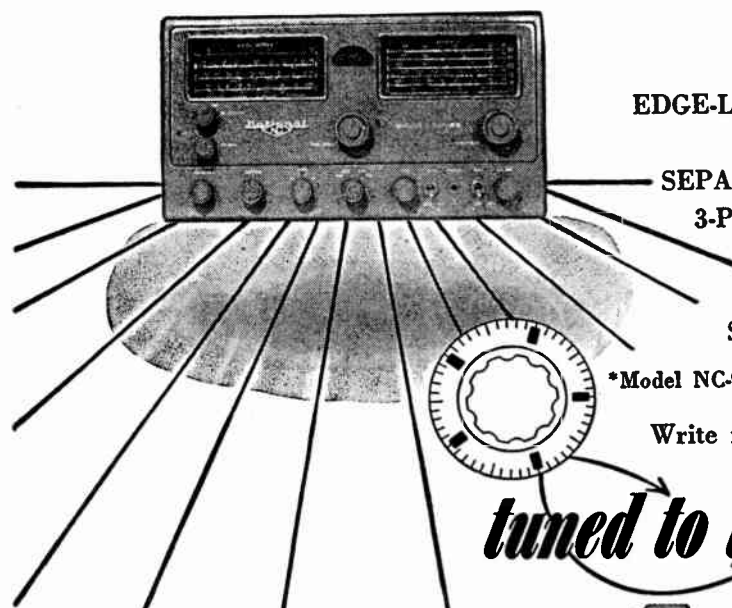

*Model NC-98SW (for shortwave listeners)

Write for complete specifications today to Dept. Q454

tuned to tomorrow

National \$ **149⁹⁵**



NATIONAL COMPANY, INC., MALDEN & MELROSE, MASS.

NC-88**\$119.95***

THE ALL NEW

World Master

8 Big Features

No Comparable

Receiver Can Offer!

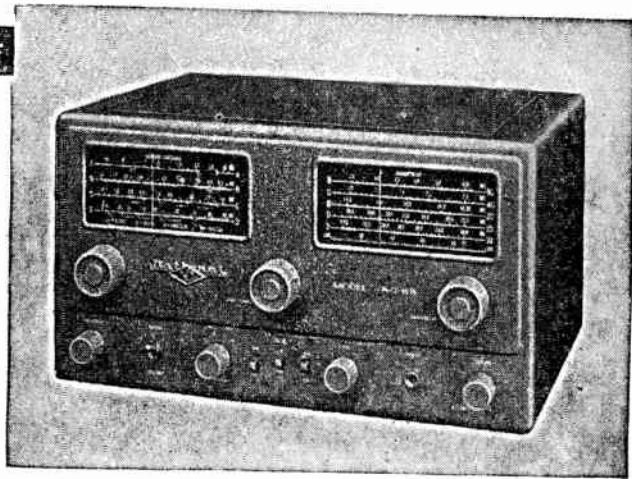

No other receiver at anywhere near the low price offers you these eight "high-priced" features: (1) Calibrated bandspread for 80, 40, 20, 15 and 11 meter bands (large 6" indirectly-lighted lucite scales). (2) Delayed A.V.C. (3) Higher sensitivity. (4) New miniature tubes used exclusively. (5) Antenna trimmer. (6) Better selectivity. (7) An extra tube (total of eight plus rect.). (8) More compact.

Other wanted features include: Range of 540 kcs. to 40 mcs. in 4 bands. Tuned R.F. stage. Two I.F.

stages, 2 audio stages with phono input and 2-position tone control. Built-in-speaker. Separate high frequency oscillator. Sensitivity control. Series valve noise limiter. Headphone jack. Standby-receive switch.

CONTROLS: Ant. trimmer, main tuning, bandspread, sensitivity, receive-standby, band selector, ANL-OFF, tone, AM-CW, pitch, vol.-A.C. OFF.

TUBE COMPLEMENT: 6BA6, r.f.; 6BE6, mixer; 6C4, h.f. osc.; 6BD6, 1st i.f.; 6BD6, 2nd i.f.; 6AL5, 2nd det., AGC, ANL: 12AX7, 1st aud. and c.w. osc.; 6AQ5, aud. output; 5Y3/GT rect.

**SW-54****\$49.95***THE *Mighty Midget**Top Novice and Standby Receiver*

COVERAGE: Entire frequency range from 540 kc. to 30 mc. in 4 bands. Voice, music or code.

FEATURES: Sensitive and selective superhet circuit, using new miniature tubes. Slide rule general coverage dial with police, foreign, amateur and ship bands clearly marked. Unique plastic bandspread dial is adjustable to assure jogging accuracy over entire range. Built-in speaker and power supply.

CONTROLS: Main tuning and Bandspread, On-Off and Volume, Receive-Standby, Bandswitch, AM-CW, Speaker, Phones.

TUBE COMPLEMENT: 12BE6, converter; 12BA6, CW osc. IF amp; 12AV6, 2nd det., 1st ud., AVC; 50C5, audio output; 35Z5, rectifier.

SIZE: 11" wide, 7" high, 7" deep.

NATIONAL COMPANY, INC.

HRO-*Sixty* \$533.50* (less speaker)

*Greatest Tuning Range
and Best Sensitivity of
Any Commercial Receiver!*

COVERAGE: 50-130 kc. 480 kc-35 mc. And 50-54 mc. Voice, CW, NFM (width adaptor).

FEATURES: Edge-lighted, direct frequency-reading scale with one range in view at a time. 3 I.F. stages at 456 kc. employing 12 permeability-tuned circuits on all bands plus one I.F. stage at 2010 kc. on all frequencies above 7 mcs. Switching is done automatically when coil set is plugged in. Built-in, isolated heavy-duty power supply. Sensitivity of 1 mv. or better at 6 db. sig. noise. Selectivity variable from 8 kc. overall to app. 1200 cps. at 40 db. Current-regulated high frequency oscillator and second converter heaters. Voltage-regulated high frequency oscillator and S-meter amplifier. Negligible drift after warm-up. Micrometer dial for logging. Provision for crystal calibrator unit. Variable ant. trimmer. Lively S-meter. Min. tubes in front end and high freq. osc. Osc. circuits not disabled when receiver in send position. High-fidelity push-pull audio (± 2 db 50-15,000 cps.) with phono jack. BFO switch separated from BFO freq. control. Illumination dimmer control. Accessory socket for



Select-O-Ject. Smooth gray finish (table and rack).

CONTROLS: Bandswitch, Oscillator, Tone, Ant. Trimmer, Dimmer, AVC, Limiter, AF Gain, Calibration, CWO, Phasing, Selectivity, On-Off, RF gain, AM-NFM-PHONO.

TUBE COMPLEMENT: 6BA6, 1st r.f.; 6BA6, 2nd r.f.; 6BE6; mixer; 6C4 h.f. oscillator; 6 BE6, 2nd high-frequency conv.; 6SG7, 1st i.f.; 6SG7, 2nd i.f.; 6SG7, 3rd i.f.; 6H6 det. & AVC. 6H6, ANL; 6SJ7, 1st audio, 6SN7, phase splitter and S-meter amp.; 6V6GT (2) p.p. audio; 5V4G, rect.; 6SJ7, BFO; OB2, volt. reg. 4H4 Osc. Fil. Cur. Reg.

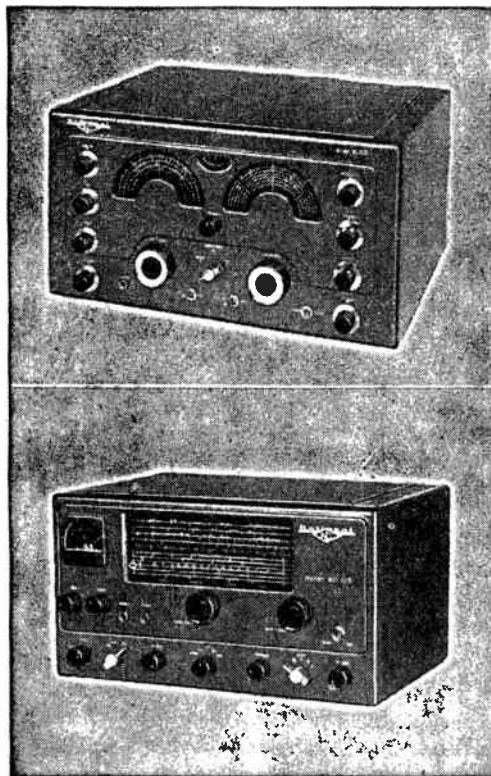

NC-183D \$399.50* (less speaker)

'Highest Price' Features Yet Almost \$120 Less!

COVERAGE: Continuous from 540 kc. to 31 mcs. plus 48 to 56 mcs. for 6-meter reception.

FEATURES: Two tuned R.F. stages. 3 stages of I.F. Voltage regulated osc. and BFO. Main tuning dial covers range in five bands. Bandspread dial calibrated for amateur 80, 40, 20, 15, 11-16 and 6-meter bands. Bandspread usable over entire range. Six-position crystal filter. New-type noise limiter. High fidelity push-pull audio. Accessory socket for NFM adaptor or other unit, such as crystal calibrator.

CONTROLS: CWO, Switch, CWO pitch, Tone, AF Gain, Main Tuning, Bandspread, Ant. Trimmer, Bandswitch, Send-Receive Phono-Radio, Selectivity, Phasing, Limiter, RF Gain.

TUBE COMPLEMENT: 6BA6, 1st r.f.; 6BA6, 2nd r.f.; 2-6BE6 first and second converter; 3-6BA6 I.F.; 1-6AL5 second det.-AVC; 1-6AH6, AVC amplifier; 1-6SJ7, c.w. osc.; 1-6AL5, limiter; 1-6SJ7 first audio; 1-6J5, phase inverter; 2-6V6GT, audio output; 1-OB2, voltage reg.; 1-5U4G, rect.

NC-125 \$199.95* (less speaker)

The Only Receiver With the Famous Select-O-Ject Circuit — Yet Moderately Priced!

COVERAGE: 660 kc. to 35 mc. in 4 bands. Voice or CW.

FEATURES: Edge-lighted direct-reading scale with amateur, police, foreign, ship frequencies clearly marked. Sensational National Select-O-Ject built-in. Exceptional sensitivity on all bands. S-meter reads S9 to 50 mv. signal; AVC, ANL, jack for phono or NFM adaptor, volt. reg., stabilised osc., audio essentially flat to 10,000 c.p.s.

CONTROLS: Main Tuning, Bandspread, Freq. (SOJ) Boost (SOJ), Send-Receive, Pitch, CWO-MVC-AVC-ANL, AF Gain, Tone, Trimmer, Bandswitch, RF Gain.

TUBE COMPLEMENT: 6SG7 RF amp., 6SB7-Y osc.-mixer, 6SG7 1st IF, 6SG7 2nd IF, 6H6 2nd det.-AVC-ANL, 6SL7GT phase shifter, 6SL7GT boost-reject aud. amp., 6SL7GT 1st aud.-CWO, 6V6GT aud. output, OD3 VR-150 volt. reg., 5Y3GT rect.

**Slightly higher west of the Rockies*

61 SHERMAN STREET, MALDEN, MASS.



NATIONAL

COIL FORMS



XR-50. These mica-filled bakelite coil forms may be wound as desired to provide a permeability tuned coil. The form winding length is 11/16" and the form winding diameter is 1/2 inch. The iron slug is 3/8" dia. by 1/2" long.

XR-51. same but with brass slug. High-grade ceramic coil forms conforming to JAN specifications. May be wound as desired to provide a permeability-tuned coil. Extra lugs provided.



XR-60 Grooved for #26 wire with iron slug.

XR-61 Grooved for #26 wire with brass slug.

XR-62 Not grooved, winding length 1 1/4" with iron slug.

XR-63 Not grooved, winding length 1 1/4" with brass slug.



XR-70 Grooved for #19 wire with iron slug.

XR-71 Grooved for #19 wire with brass slug.

XR-72 Not grooved, winding length 1" with iron slug.

XR-73 Not grooved, winding length 1" with brass slug.

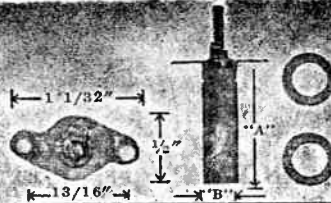

TYPE	CORE	"A" DIM.	"B" DIM.
XR 80	BRASS	1 1/4"	17/64"
XR 81	IRON	1 1/4"	17/64"
XR 82	BRASS	1 3/4"	17/64"
XR 83	IRON	1 3/4"	17/64"
XR 90	BRASS	1 1/4"	3/8"
XR 91	IRON	1 1/4"	3/8"
XR 92	BRASS	1 3/4"	3/8"
XR 93	IRON	1 3/4"	3/8"

Small ceramic coil forms designed primarily for high frequency applications and conforming to government specifications. Call form is Grade L4 ceramic (JAN 1-10); base is silver-plated brass; core is brass or iron. Supplied with two nylon rings to separate coils if more than one is wound on same form. Small holes in rings can be used to secure leads.

COUPLINGS

TX-1. Leakage path 1".

TX-9. This small insulated flexible coupling provides high electrical efficiency when used to isolate circuits. Insulation is steatite. 1 5/8" diam. Fits 1/4" shaft.

TX-10. A very compact insulated coupling free from backlash. Insulation is canvas bakelite. 1-1/16" diam. Fits 1/4" shaft.

TX-19. A steatite insulated flexible coupling for 1/4" shafts. Conservatively rated at 5000 volts peak. Diameter 1 3/4", length 1". Length and flashover voltage can be increased by turning collars outboard.

TX-23. A deluxe insulated flexible coupling designed for coupling 1/4" shafts. Will handle a maximum radial misalignment of 1/16" also 2 degrees maximum angular misalignment.



TX-1



TX-9



TX-10



TX-19



TX-23

SAFETY GRID AND PLATE CAPS

SPP-9. Ceramic insulation. Fits 9/16" diameter.

SPP-3. Ceramic insulation. Fits 3/8" diameter. National Safety Grid and Plate Caps have a ceramic body which offers protection against accidental contact with high voltage caps on tubes.



SPP-9



SPP-3

GRID AND PLATE GRIPS

Type 12, for 9/16" Caps.

Type 24, for 3/8" Caps.

Type 8, for 1/4" Caps.

National Grid and Plate Grips provide a secure and positive contact with the tube cap and yet are released easily by a slight pressure on the ear.



12



24



8

Write Dept. 830 for complete catalog or detail drawings of parts advertised

COMPONENTS

PRECISION-WOUND R.F. CHOKES

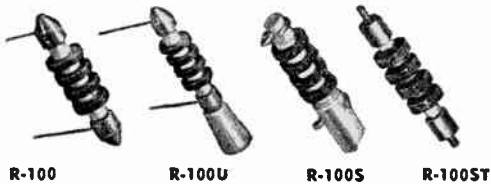

R-100 R-100U R-100S R-100ST

These RF chokes are identical electrically, but differ in mounting provisions. The R-100 employs pigtail leads; the R-100U has pigtail leads and a removable stand-off insulator; the R-100S has cotter-pin lug terminals and a non-removable stand-off insulator; the R-100ST has a 6-32 threaded stud at each end. These chokes are available in 2.5, 5 and 10 millihenry sizes and are rated at 125 milliamperes.

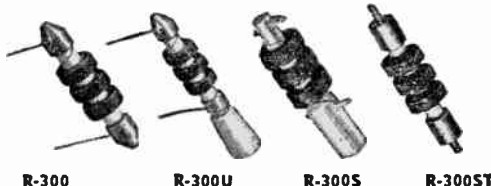

R-300 R-300U R-300S R-300ST

These RF chokes are similar in size to R-100 series but have higher current capacity. The R-300U is provided with a removable stand-off insulator at one end. The R-300S has a non-removable stand-off insulator and cotter-pin lug terminals. The R-300ST has a 6-32 threaded stud at each end. Inductance values of 0.5, 1.0, 2.5 and 5.0 millihenries are available with a current rating of 300 milliamperes. R-300, R-300U, R-300S and R-300ST are identical electrically.

CAPTIVE NUTS

National Captive Nuts of stainless steel may be pressed into aluminum and certain types of brass sheet metal to provide integral flush-mounted tapped holes in a wide variety of sizes. Four basic types have been designed for metal thicknesses of 1/16", 3/32", 1/8", 3/16" and 1/4".

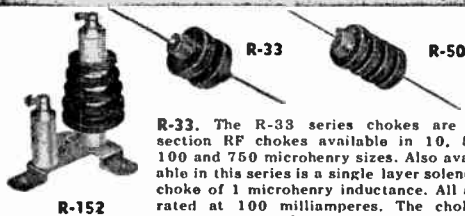
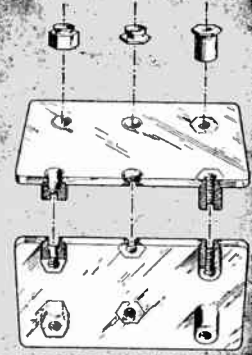

R-152

R-33. The R-33 series chokes are 2-section RF chokes available in 10, 50, 100 and 750 microhenry sizes. Also available in this series is a single layer solenoid choke of 1 microhenry inductance. All are rated at 100 milliamperes. The chokes are wound on a 3/8" long form and range in diameter up to 5/16" maximum.

R-50, R-50-1. The R-50 series chokes are 3 and 4-section RF chokes and available in 0.5, 1, 2.5, and 10 millihenry sizes. They are rated at 100 milliamperes. The chokes are wound on a 1" long form and have a maximum diameter of 15/32". The 10 millihenry R-50-1 choke is wound on an iron core.

R-152. For use in the range between 2 and 4 Mc. Ideal for high power transmitter stages operated in the 80 meter amateur band. Inductance 4 m.h., DC resistance 10 ohms, DC current 600 ma. Coils honeycomb wound on steatite core.

DIALS, MECHANISMS AND KNOBS

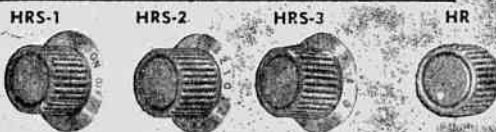

HRS (gray or black) The HRS series knobs are a popular easy to grip knob. They are molded of high quality plastic and have 1 3/8" dia. chrome plated bevel skirts fit 1/4" shafts available in the following scales:

HRS-1	ON-OFF	through 30°
HRS-2	5-0-5	through 180°
HRS-3	0-10	through 300°
HRS-4	Single etched line	
HRS-5	0-10	through 180°

HR (gray or black) An HRS type knob without the chrome plated skirt but with a white dot for spotting relative control settings.

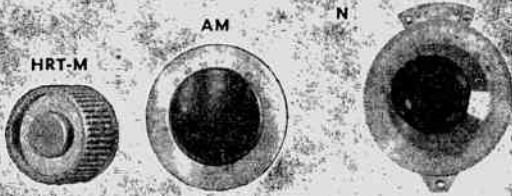

HRT-M. This smaller version of the HRT — now available in choice of gray or black — is 1-7/16" in diameter.

AM Dial. The original "Velvet Vernier" mechanism in a metal skirted dial 3" in dia. ratio 5 to 1. It is available with 2, 3, 4, 5 or 6 scale and fits 1/4" shaft. Mechanisms also available separately.

N Dial. The four-inch N and AD Dials have engine divided and die stamped scales respectively. The N Dial has a decimal vernier; the AD Dial employs a pointer. The planetary drive has a ratio of 5 to 1, and is contained within the body of the dial. 2, 3, 4, 5 or black scale. Fits 1/4" shaft. Specify scale.



HRM KNOB. This straight knurl brass satin chrome finished knob with arrowhead fits 1/4" shaft. See catalog for description.



NATIONAL COMPANY, INC., 61 SHERMAN STREET, MALDEN, MASS.



COMMUNICATIONS EQUIPMENT

GONSET CO.

801 South Main St. - - Burbank, Calif.

SUPER-CEIVER

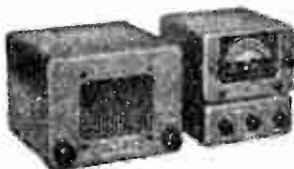

May be used in conjunction with any good quality amateur converter, such as the Gonset Super-Six to provide a complete mobile receiver of outstanding performance on both phone and CW.

Unit is xtal controlled for maximum stability and utilizes 8 tuned circuits at 262 kcs for high selectivity. Self-contained vibrator power supply furnishes voltage regulated power to converter and to BFO. Latter is highly stable with adjustable pitch control. Separate RF and AF Gain controls, adjustable squelch, effective noise clipper. Built-in speaker with connections for external speaker, if desired. Pertinent controls are on a small control head which mounts near the converter for "fingertip" operation. Connecting cables and plugs are supplied. Power pack is designed for quick conversion to 12V DC. Xtal furnished is for 1430 kc (Super-Six) input, but may be factory exchanged for other common inputs at no charge. Compact, 6⁷/₈" wide, 6³/₄" deep, 5¹/₄" high. Price does not include converter.

Model #3041-Net-119.50

TWO METER CONVERTER

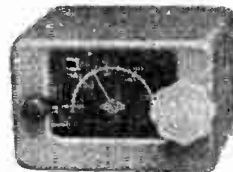

Covers 144-148.3 for amateur or CAP fixed or mobile service. Superimposition tuning and 1 mc output I.F. doubles band-spread and speeds tuning, avoids image. High stability, excellent sensitivity. Utilizes power supply of receiver to which connected. Standard Gonset drawn aluminum case. Tubes 6CB6, 12AT7 and OB2.

Model #3008.....
Net 44.50

VHF AIRCRAFT ADAPTER

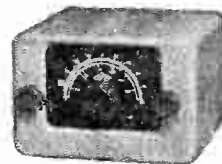

Used in conjunction with auto radio or LF aircraft receiver etc., to provide inexpensive, sensitive receiver covering 108-128 mcs. For 6 or 12 volt operation with 24 volt special. Includes series gate noise clipper. Installation does not effect operation of existent equipment. Rugged, stable and compact. Specify 6 or 12 volts. (Add \$5.00 for 24 volts)

Model #3014..... Net 69.50

Model #3015
(squelch)
Net 79.50

AUDIO AMPLIFIER-POWER SUPPLY



An audio amplifier-power supply specifically designed to supply output audio and power for tuners with low-level audio outputs. Has built-in PM panel speaker, audio gain and tone controls. Ideal for use with Gonset FM-AM tuners, two meter tunable and crystal controlled tuners, to provide a complete, independent communications receiver. Size 6¹/₈" deep, 7" wide, 6¹/₄" high.

Model #3034 (6V input) Model #3036 (115V-AC) Net-44.50

TWO METER TUNER WITH CASCODE

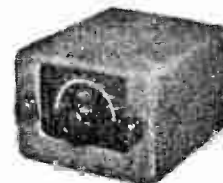

The receiver portion of the extremely popular "Communicator" is now available as a separate unit. Has 6BQ7A Cascode RF, 12AT7 Mixer-oscillator, three stages of I.F., second detector and low-level audio. Includes the famous Gonset Noise Clipper with Gonset Squelch an optional feature. Requires power supply and output audio which may be ideally supplied by Gonset Audio-Amplifier Power Supply unit. Size: 5¹/₄" x 3¹/₂" x 5¹/₄" deep.

Model #3037-Net-89.50

De Luxe Model #3038-with squelch-Net-99.50

"SUPER-SIX" SIX BAND CONVERTER

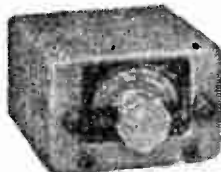

The new six band de luxe converter covering 10-11, 15, 20, 40 and 75 meters. Improved sensitivity and added band spread. Also covers 19 and 49 meter SW broadcast bands. Built-in BC trap. Separate isolated antenna inputs for converter and BC set. Oscillator correction control on rear of chassis. Sturdy, drawn aluminum outer case.

Model #3030.....
Net 52.50

VHF CRYSTAL CONTROLLED TUNERS

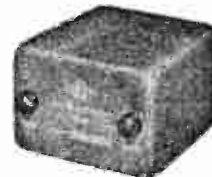

This unit is similar in circuitry to the receiver used in the "Communicator" with the exception that it is specifically designed for fixed, nontunable AM or FM operation on any single frequency in the range of 30 to 170 mcs. The unit includes a Cascode RF, crystal controlled HF oscillator, I.F. and low level audio. Also, Gonset Noise Clipper and adjustable squelch. The unit becomes a highly sensitive communications receiver when used with Gonset Audio-Amplifier Power Supply or with equivalent sections of a LF receiver. Size: 5¹/₄" x 3⁵/₈" x 5¹/₄" deep. Specify frequency and whether FM or AM. (Price includes quartz crystal.)

Model #3029-Net-125.00

"3-30" SW CONVERTER

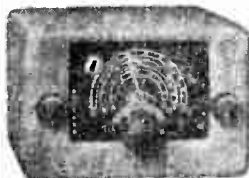

An excellent general coverage converter where extreme band-spread is not required. Covers 3 to 30 mcs in three ranges. Uses four tubes: 6BH6 RF, 6AV6 mixer, 6C4 oscillator and 6BH6 I.F. stage. Extremely compact and easy to install with any car radio.

Model #3002..... Net 44.75

COMMERCIAL-TYPE FM-AM TUNERS



Gonset tuners provide an inexpensive yet sensitive and stable receiver when used in conjunction with ordinary auto, home or communication receivers or with the Gonset Audio-Amplifier Power Supply unit. Tuners include squelch and noise clipper, I.F., and low-level audio. Very compact . . . mounts on steering post or under dash for mobile applications. 50 ohm input, simple to connect to Audio-Power supply unit or equivalent sections of LF receiver.

30-40 mc. FM-Model #3009
30-40 mc. AM-Model #3009
40-50 mc. FM-Model #3010
40-50 mc. AM-Model #3010
88-108 mc. FM-Model #3011*
(less squelch)
152-162 mc. FM Model #3012
162-174 mc. FM-Model #3013
(all models)-Net-69.50



POLICE-MARINE CONVERTER

Overall performance and construction comparable to 3-30 model except covers 1.6 to 6 mcs in two bands and employs 1 mc output. Ideal for police, marine, CAP, Civil Defense, disaster communications as well as amateur 75 and 160 meter mobile work. Compact, efficient, ruggedly constructed.

Model #3003.....
Net 46.00



COMMUNICATIONS EQUIPMENT

GONSET CO.

801 South Main St. - Burbank, Calif.

GONSET "COMMUNICATORS"

The well known Gonset Communicator is now available in four different models to fully meet the varied requirements of Amateur, CAP, Commercial, Industrial and Airport services. Each model is a complete station superhet receiver with "Cascode" RF, xtl controlled transmitter. (VFO is also available separately.) Self-contained power supply for 115V AC and 6V DC. Modulator may also be used as a PA system, mobile or fixed. All models highly compact. 8-3/16" x 10-7/16" x 10-3/8". Light in weight, conveniently portable.



COMMUNICATOR -II

Tunable receiver, xtal controlled transmitter, (AM). Covers 144-148.3 mcs. 2E26 final delivers 5.7 watts carrier. Has adjustable squelch (silent standby), famous Gonset noise clipper, phone jack with speaker muting, dial light switch etc.

Model #3025-Net-229.50

COMMUNICATOR I- Model #3026 (less squelch, etc.)-Net-209.50

LOW POWERED INDUSTRIAL "COMMUNICATOR"



Includes all basic features of other Communicators except has xtal controlled transmitter and receiver for single, fixed frequency operation between 152-172 mcs. Includes squelch and noise clipper. Power limited to F.C.C. regulations for low powered industrial services. Price includes built-in power supply for 6V DC and 115V AC and xtals for both transmitter and receiver.

Model #3042-Net-299.50 plus 13.48 Federal Excise Tax.

"UNICOM" "COMMUNICATOR"

Same as Industrial Communicator except receiver tunes frequency range 108 to 128 mcs. Power output 6-7 watts, or lower if application similar to low power industrial. Ideal for use at airports, air test centers, ambulances, etc. for communication with aircraft or control tower.

Model #3043-Net-299.50 plus 13.48 Federal Excise Tax.

"COMMUNICATOR" ZIPPER CARRYING BAG

Convenient carrying bag for all Communicator models. Holds Communicator plus mike, antenna, coax and other accessories. Constructed of heavy canvas, padded. Attractive green color.

CARRYING BAG-Model #3023-Net-14.95

"COMMANDER" 35-50W Multi-band Transmitter



Complete with tubes, less power supply, xtl and microphone.

Model #3016
Net 124.50

FREQ. RANGE: 1.7-54 mcs continuous.

TUBES: RF-6AG7, 6146. AF-12AT7, two 7C5's.

POWER REQUIREMENTS: 300V-500V @ 200-225 ma (phone) and 6.3V, AC or DC @ 3.15A. Up to 50W input, phone or CW.

MODULATOR: Class AB2 tetrodes and integral hi-level speech clipping.

ANTENNA FEED: All conventional feed lines, Coax, ribbon or open line or direct to Marconi antenna.

MICROPHONE INPUT: Any standard carbon or PA type hi-impedance dynamic or crystal.

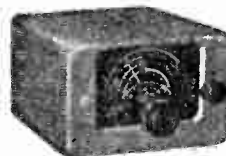

Model #3020
Net 29.95

VFO FOR COMMANDER

A companion unit for use with the Commander. Unique circuit employs no tubes therefore affords good stability because of no heat generated in heavy aluminum box. Same size as Super-Six. Covers 10, 15, 20 and 75 phone bands. Merely plug into receptacle on Commander panel. Stable, with construction extremely sturdy for rugged mobile use.

"CASCODE" PRE-AMPLIFIER

Gain is over 10 DB, with noise figure of 5 DB over entire 2 meter band. Uses low-noise 6BQ7. Heater and plate voltages are obtained from associated receiver. Standard coax input socket and 30" lead of coax cable is supplied for connection to antenna terminals of 2 meter receiver. Also available for spot frequencies, between 50 and 174 mcs. Size: 3" wide, 3 1/2" high, 3 3/4" deep.

Model #3027-net 19.95



DE LUXE NOISE CLIPPER-SQUELCHER

The combination is applicable to any amateur mobile or communications receiver. Small size permits easy mounting directly beneath any of the Gonset standard converters. The unit is very simply connected to existing auto receivers. Size: 4 1/8" deep x 5 1/8" wide x 2 1/8" high.

Model #3000-Net-24.50



TWO METER VFO



Designed for use with Communicator or most any other 2 meter rig. Has output at 24 mcs., and plugs directly into existing xtal socket. Multiple tuned circuits minimize spurious radiations. Also has built-in audio preamplifier to increase mike pickup where desired. Has self-contained 115V AC power supply, panel switch to permit "Zeroing in" on received signals. Attractive cabinet matches Communicator-same height, half as wide. Highly stable, rugged, dependable.

Model #3024-Net-84.50

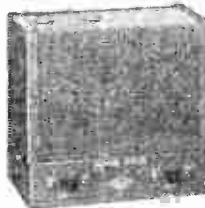

"SIGNAL SLICER"

A highly selective I.F. amplifier for use with any car or home radio using standard I.F. Will increase selectivity to 3.5 kc for better reception on crowded bands. Has built-in noise clipper to greatly reduce ignition and similar noise. Broad-sharp switch. Is powered from car radio. Draws only 1.5 ma plus heaters. Size 6 1/8" x 5 7/8" x 3".

Model #3048 (262 kc) Model #3028 (455 kc)
Net 29.95 Net 29.95

NOISE CLIPPER

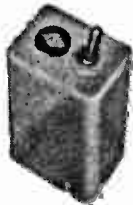

A "must" for every mobile installation operating above 2 or 3 mc to reduce ignition interference. Works with

Model #3001-net 9.25

all AM receivers using conventional diode detectors. easy to install. Complete instructions furnished.

STEERING POST MOUNTING BRACKET

Can be mounted on either right or left hand side of steering post. May be rotated to mount the converter above or below the steering post in the most convenient position in relation to the driver of the automobile. Complete with mounting straps and hardware.

Model #3006-Net-3.90

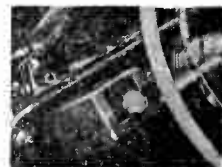



THE ROBERT DOLLAR CO.

COMMUNICATIONS EQUIPMENT DIVISION

50 DRUMM ST.

SAN FRANCISCO, CALIF.

**A COMPLETE LINE
TRANSMITTERS • RECEIVERS • ACCESSORIES**
to meet the requirements of any communications service

RADIO PAGING

GROUND-TO-AIR



**MODEL 330
250W OUTPUT**

The Model 330 is a complete, crystal controlled, amplitude modulated transmitter specifically designed for continuous-service operation in Radio Paging or similar applications. The self-contained modulator unit has ample capacity to permit 100% voice modulation at the rated carrier power output of 250 watts. This Transmitter is available for operation on 35.58 or 43.58 megacycles or on any other spot frequency within the range of 30 to 50 megacycles. Special filters and equipment shielding combine to reduce spurious and harmonic emissions to a very low value.

**MODEL 310
50W OUTPUT**

The Model 310 provides a complete two-way fixed station for operation on any single frequency from 118 to 132 mcs. within the aviation bands. The elements contained within the single compact housing include an amplitude modulated transmitter rated at 50 watts output, a crystal controlled receiver, speech with audio limiting control equipment and necessary power supplies.

The equipment is not limited in scope to this specific application however since its dependability and excellent performance characteristics are equally applicable to point-to-point, base station-to-vehicular mobile or similar VHF services.



GENERAL PURPOSE - H F

CIVIL DEFENSE

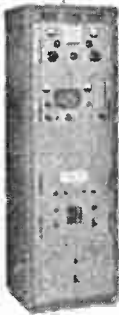

**MODEL A4912
300W OUTPUT**

The Model A-4912 transmitter is designed for either CW or voice operation within the frequency range from 2 to 27 mcs. It has provision for ten crystals. Power input is from 500 to 800 watts depending upon the type of operation. This is a general purpose unit built to exacting commercial standards and is well suited for point-to-point, marine and ground aviation services. Arranged for high speed keying, also FSK when used with Robert Dollar FSK exciter. Modulation is normally low level but high level Class B modulator and external speech console available.

**MODEL 237
250W OUTPUT**

The Model 237 is a complete, crystal controlled, amplitude modulated transmitter specifically designed for continuous-service operation in Civil Defense or fixed, point-to-point applications. The self contained modulator unit has ample capacity to permit 100% voice modulation at the rated carrier output of 250 watts. This transmitter is available for operation on two frequencies within the 1750-1800 kc. band or on other adjacent-channel frequencies up to 15 mc. Special filters and equipment shielding combine to reduce spurious and harmonic emission to a very low value.



6 METER, 50 WATT

CIVIL DEFENSE

2 METER, 50 WATT

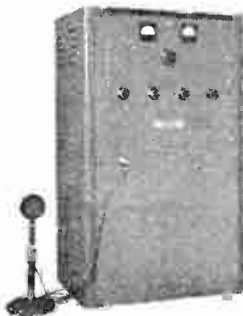

**MODEL 234
50W OUTPUT**

The Model 234 is a complete xtal controlled transmitter with a power output of 50 watts, intended for C-D or amateur operation within the frequency range from 50 to 54 mcs. This unit is designed to fully meet FCDA specs. Has output filter for harmonic reduction, modulation clipper/limiter followed by BP filter. Audio range is limited to 3 kcs. Emission is 6A3, amplitude modulated with band-width attenuated beyond 6 kcs. Excellent construction, conservatively rated components. Unit is similar to Model 309.

**MODEL 309
50W OUTPUT**

Model 309 is a complete xtal controlled transmitter with a power output of 50 watts, intended for C-D or amateur operation within the frequency range from 144 to 148 mcs. This unit is designed to fully comply with FCDA specs. Has LP output filter for harmonic reduction, modulation clipper/limiter followed by BP filter. Audio range limited to 3 kcs. Emission is 6A3, amplitude, modulated with band-width attenuated beyond 6 kcs. A carefully designed, conservatively rated transmitter. Unit is similar to Model 234.

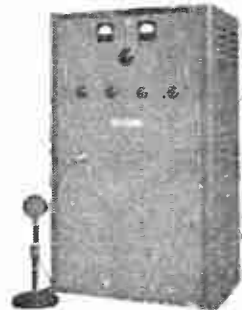

THE ROBERT DOLLAR CO.

COMMUNICATIONS EQUIPMENT DIVISION

50 DRUMM ST.

SAN FRANCISCO, CALIF.



**A COMPLETE LINE
TRANSMITTERS • RECEIVERS • ACCESSORIES**
to meet the requirements of any communications service

V H F MOBILE

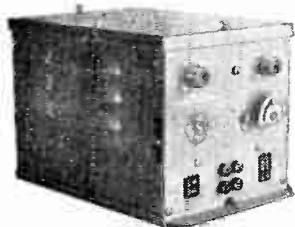

**TRANSMITTER
MODEL 222**
144-148 mcs.

Model 222 is a crystal controlled transmitter covering the amateur 144-148 mc range and adjacent CAP frequencies. It is intended primarily for mobile operation where a transmitter with greater power output is required. Power output into 50 ohms is 6 watts. Modulation is high-level. Has antenna relay and tuned link output circuit. Highest quality components throughout.



**RECEIVER
MODEL 226**
144-148 mcs.

Model 226 is a tunable superheterodyne receiver designed for mobile service and covers the amateur 144-148 mc band and adjacent CAP frequencies. Multiple tuned circuits and proper tube selection in RF and I.F. stages provide excellent sensitivity, selectivity and image rejection. High quality components for dependable mobile operation. Crystal controlled models are available on special order.

EXCITERS

FREQUENCY SHIFT (F S K)

CONVERTERS

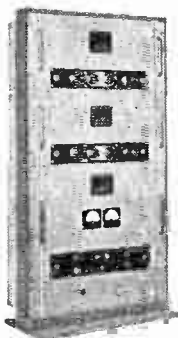

**MODEL
A4920**

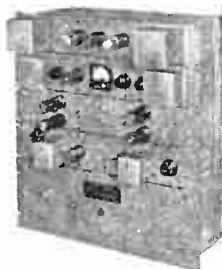

**MODEL
5123**

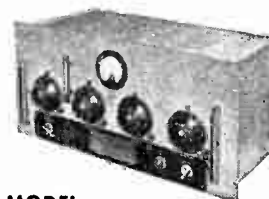

**MODEL
A4722**

Model A4920 is a complete frequency shift terminal offering extremely high selectivity. Uses two separate crystal controlled receivers to permit dual diversity reception. Commercial type construction throughout. Highly conservative component ratings . . . trouble-free and proven performance.

Model 5123 is a low-cost FSK converter offering excellent selectivity and S-N-R. Provides DC output to operate teletype as well as tone output. Three, optional frequency, audio tones are available for operation directly into carrier telephone systems.

Model A4722 exciter is a standard FSK transmitting keyer with exceptional stability at moderate cost. Range 2 to 6 or 2.5 to 7 mcs. Separate power supply included.

OTHER FREQUENCY-SHIFT EQUIPMENT

Fixed frequency receiver for use with Model 5123 converter . . . Crystal controlled oscillator for use with general purpose communications receivers . . . tone keyers . . . line amplifiers . . .

TONE REMOTE CONTROL EQUIPMENT

MISCELLANEOUS

Robert Dollar Co. can supply Remote Tone Control equipment which can be used to perform various control functions at a remote location. The basic control equipment consists of two units: (1)—a tone generator which supplies two sequential audio tones of predetermined frequency. (2)—a receiver with frequency selective circuits tuned to respond only to the frequency of the transmitted tones and suitable circuitry to enable these tone pulses to actuate control relays. Typically, one transmitted tone may latch in a "Start" relay, a second tone may release the same relay. Various stop-go or start-stop functions are thus possible. Radio or land wire circuits may be utilized in the transmission of these control tones from one location to another. This type of equipment is being used successfully for the remote control of pumps, transmitters or receivers and many other devices which may be controlled by relays.

Complete radio equipment for installation of control and remote locations is also available. This equipment is designed for operation on 27.255 mcs. in conformity with existing regulations covering Citizens Band radio for remote control purposes. Transmitters and receivers are quartz crystal controlled and can be supplied for operation from 115V AC or from storage battery power.

Full information on individual units, or on a complete remote control package, will be supplied upon request.

Other Robert Dollar Equipment includes:

Crystal controlled or tunable receivers for all frequency ranges

Audio amplifiers for portable marine and vehicular use

Receivers and accessory equipment for Radio Paging services

Transmitters and receivers for Low Powered Industrial services

Accessory equipment for Frequency Shift Keying circuits including crystal controlled oscillators for receivers . . . tone keyers . . . line amplifiers, etc.

Complete information on any of the above items upon request.

Harvey-WELLS ELECTRONICS, INC.

SOUTHBRIDGE, MASS.

BANDMASTER TRANSMITTER

The World's Most Versatile Transmitter

40 to 50 Watts — 8 Bands — Phone or CW
NO PLUG-IN COILS

80, 40, 20, 15, 11, 10, 6 and 2 Meters
(completely wired and tested — not a kit)

100% BREAK-IN OPERATION

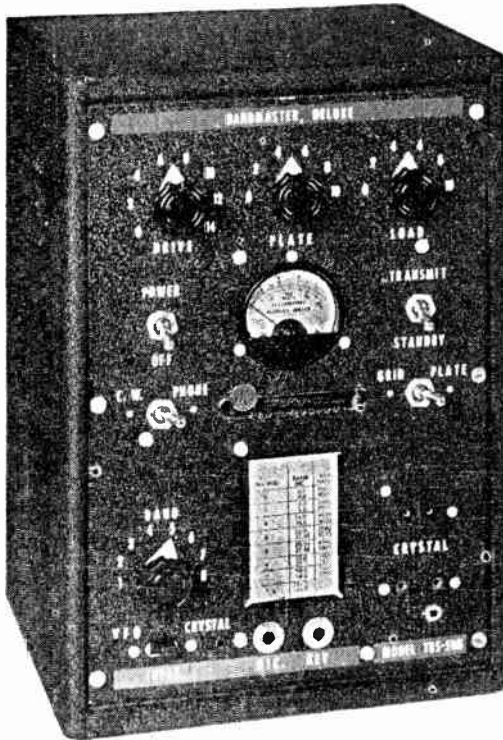

BUY THE XMTR —
YOU WILL USE FOR YEARS
for MOBILE or
FIXED OPERATION

FOR NOVICE OR EXPERT

BANDMASTER SR. \$111⁵⁰

A complete ready to go transmitter including the new crystal-oscillator-vfo switching circuit. Phone or CW — Eight bands — 80, 40, 20, 15, 11, 10, 6 and 2 Meters. Ideal for either mobile or fixed station use. Will operate from A.C. power packs up to 450 volts at 275 ma., vibrator supply or dynamotor supply for portable mobile operation. Employs Pi antenna matching net work. Power input to final is 50 watts with 450 volt power supply on Bands 1 through 7, 30 watts on Band 8. No tuning adjustments are necessary except those required to resonate the final output to the antenna. May be mounted on rack panel with power supply. For use with carbon microphone. No plug in coils.

CONTROLS: Band Switch, Excitation Control, Antenna Loading, Amplifier Tuning, Power-on Switch, Carrier-on Switch, Meter Switch. Antenna network will match non-reactive feeder of approximately 50-500 ohms. Frequency calibration chart on front panel as well as two scale grid and plate D.C. milliammeter.

TUBES: 6AQ5 Crystal Oscillator, 6AQ5 Buffer-Multiplier, 807 Final Amplifier, 2—6L6G Class B Modulators. In sturdy steel cabinet, 8" wide by 12" high by 8" deep.

NO BANDMASTER EVER BECOMES
OBSOLETE OR OUTMODDED —
IT IS PROTECTED BY AN INSURANCE POLICY

YOUR BANDMASTER
REMAINS MODERN BECAUSE —
It is PROTECTED by a continuous Technical Bulletin Service
mailed regularly to all registered owners:
AN INSURANCE POLICY
Which provides methods of adding new features to your
present BANDMASTER as they are developed. In this way
no BANDMASTER becomes obsolete or outmoded.

BANDMASTER DELUXE \$137⁵⁰

The last word in a versatile small transmitter for ham or commercial use. Used extensively in foreign countries for important commercial applications. Has built-in three tube preamplifier for use with crystal mike, and ALL the features of the Bandmaster Sr.

POWER SUPPLIES

APS-50 BANDMASTER POWER SUPPLY
FOR 110v A.C.

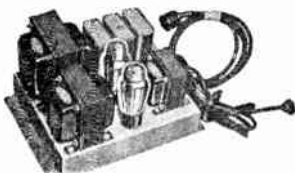

Delivers 425 v. at 275. ma.
and 6.3 v. at 4 amps. May
be mounted on rack panel.
For 110 Volt A.C. 50-60
cycles. \$39.⁵⁰

FOR PORTABLE OPERATION DPS-50

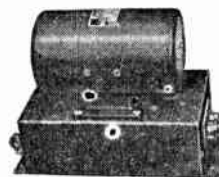

A dynamotor supply for portable operation. Delivers 300 Volts 250 ma.

For 6 Volt operation \$87.⁵⁰

For 12 Volt operation (400 Volts
250 ma) \$54.⁵⁰

Harvey-WELLS ELECTRONICS, INC.

SOUTHBRIDGE, MASS.

The NEW BANDMASTER VFO

DESIGNED SPECIFICALLY FOR THE HARVEY-WELLS BANDMASTER, BUT MAY BE USED WITH ALL TYPES OF TRANSMITTERS.

EXTREMELY STABLE — BOTH ELECTRICALLY AND MECHANICALLY — RUGGED TESTS PRODUCE NO LOSS OF POWER OR FREQUENCY SHIFT EVEN ON 28 MC.

Slanted, illuminated dial face provides ease of operation and full visibility

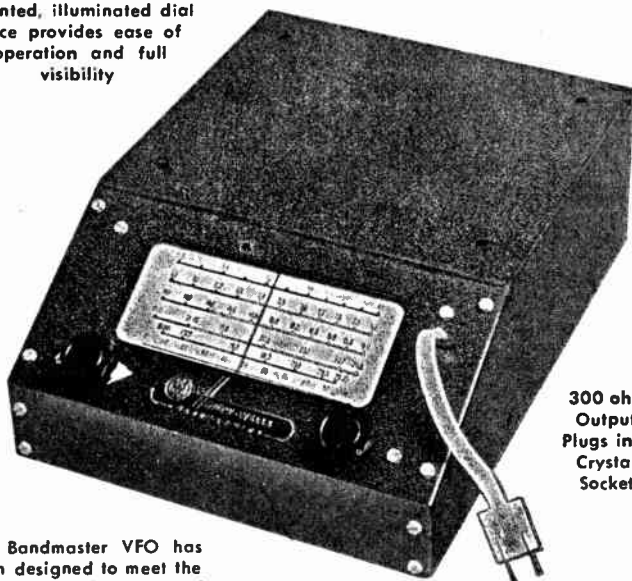

300 ohm Output Plugs into Crystal Socket

Only
\$ 47⁵⁰



Cabinet styled specifically to save valuable space in the Shack. Your Bandmaster and VFO become an integral unit

The Bandmaster VFO has been designed to meet the flexible requirements of today's versatile amateur. Six bands — each directly calibrated on the oversize slide rule dial — provides 20-25 volts R.F. output over entire frequency range, measured across the 6AQ5 in the transmitter oscillator — Plate and heater voltages are obtained from the terminal strip on the transmitter. Power requirements are 6.3 v @ 0.65 amps. and 300 v @ 30 ma. Highly stable clapp type oscillator circuit uses 6AG7 and OB2 voltage regulator. Cabinet size 9" x 11½" x 4" Weight 6 lbs.

ACCESSORIES

REMOTE CONTROL PANEL FOR MOBILE OPERATION



For dashboard mounting, complete with interconnecting and microphone cables.

Provides for a complete remotely controlled installation.\$22.50

CRYSTAL MIKE PRE-AMPLIFIER

CMA-50

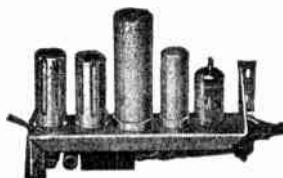

Crystal microphone pre-amplifier. The unit built into the Bandmaster Deluxe which you may add to other Bandmaster models. Simple to install.

\$22.00

CONVERTERS
RECEIVERS

TRANSMITTING
EQUIPMENT

MORROW
RADIO MANUFACTURING CO.
SALEM, ORE

5 BRF SERIES CONVERTERS



FTR FIXED-TUNED RECEIVER

The latest of the famous MORROW converters. Tunes 75-40-20-15 & 10 meter bands. Full dial bandspread on 5 easy to read scales. Sensitivity is less than 1/2 micro-volt on all bands. Recommended for 5SB reception because of extreme stability. Uses 15 "Hi Q" coils and 10 Zero temp ceramic trimmers in Mixer and Osc assembly. Oscillator temperature compensated. I.F. amplifier uses 2 transformers, 4 tuned circuits. Antenna trimmer on front panel. Solid aluminum machined knobs. Tube compliment 6CB6 RF amplifier, 12AT7 Mixer-Oscillator, 6BA6 I.F. amplifier, and 6AL5 noise limiter (5 BR) only. Housed in steel case, gray hammarstone finish, size H-4" W-5 1/2" D-6 3/4" 5BRF for use with FTR only, 5BRLN basic converter, 5BR same as above plus noise limiter. 6 or 12 volt. Amateur net price: 5BRF \$67.95. 5BRLN \$69.95. 5BR \$74.95.

The FTR is a revolutionary new crystal controlled receiver tuned to 1525 KC and when combined with a MORROW converter serves as an I.F. and Audio amplifier to form an outstanding communications receiver. The following features are all included and many of them are exclusive in MORROW receivers. Features include: A crystal controlled local oscillator; an I.F. amplifier (200KC) with a pass band of 3.5 KC at 6DB down; An automatic noise limiter; A three stage audio amplifier; A noise balanced squelch; A 5SB relay B.F.O.; A hermetically sealed "S" meter; A field strength meter; A stable controlled vibrator power supply; complete switching and a full compliment of controls on the front panel. Built for amateur service with the design requirements of commercial equipment. Supplied complete with power supply, less speaker. Amateur net price including tax . . . \$128.40. 6 or 12 volt.

GC-10 and GC20.

The GC 10 and 20 are generator hash filters to be installed on the car generator. After installation just tune to minimum hash in receiver. GC-10 for 10 meters and GC-20 for 20 meters. Price: amateur net 3.25.



TH-1.

The TH-1 is a capacity hat used to increase the capacity of the mobile whip antenna tip to ground. The two rods may be adjusted to tune the antenna across the band. Increases signal radiation. Price: amateur net 2.50.

SH-5.

The SH-5 speaker is a companion unit for the FTR receiver, however it may be used on any receiver. Voice coil winding has 3.4 Ohm impedance. Supplied in cast aluminum case with steel front grill. Price: amateur net 7.50.

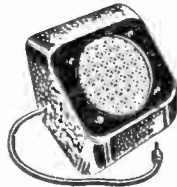

MVL-50.

The MVL-50 is a motor driven variable inductance coil that is remote controlled from the dash of the car. Used to tune the antenna to the transmitter frequency for maximum output. Can be used on all bands, 10 through 75. The 40' and 75 meter bands require external loading coils. Supplied with coax fitting and remote control switch. Price: amateur net 24.95.

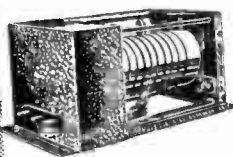

The FC-20-1 is a 25 watt AM modulated, Crystal controlled, Base station. Modulation is limited to 100%. Available in single or dual channel models with a carrier frequency in the 30-45 MC band. Meets FCC and FCDA requirements. The receiver is equipped with a noise balanced squelch and opens on 1/4 micro-volt signal. Power source is 115 V 60 Cycles.

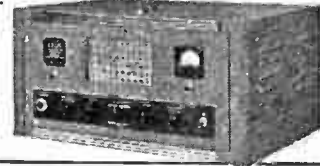

FC-20-1

FP-1086.

The FP-1086 is a 250 milliwatt, crystal controlled, AM modulated pack set. It is available for single channel operation in the 30-60 MC band. A four tube super-regenerative receiver is used. The case is of welded aluminum. A telescoping whip antenna and a canvas carrying bag is supplied. Dry battery power, is self contained.

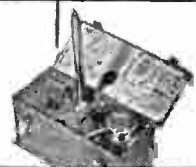

FL FLP

The FL or FLP is a 2.5 watt, crystal controlled, AM modulated base or pack station. Available in single or dual channel models with a carrier frequency in the 30-45 MC band. Meets FCC and FCDA requirements. The receiver has a sensitivity of 1 micro-volt and is equipped with an "S" meter and battery volt meters. Housed in an aluminum case with handle. The two sets are identical except the FLP has a telescoping whip antenna and a battery compartment.

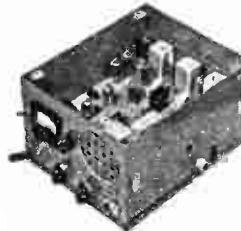

The MB5 and MB25 are mobile, receiver transmitters, crystal controlled, AM modulated with modulation limiters. The power output of the MB5 is 5 watts and the MB25 is 25 watts. Available in single or dual channel models with a carrier frequency in the 30-45 MC band. Meets FCC and FCDA requirements. The receiver is equipped with a noise balanced squelch that opens on 1/4 micro-volt. Available in 6 or 12 volts.

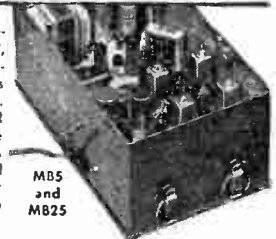

MB5
and
MB25

FOR ADDITIONAL INFORMATION
AND PRICE WRITE: MORROW RADIO MFG. CO.
SALEM, OREGON

MOBILE CONVERTERS

HIGH SENSITIVITY • BUILT-IN NOISE LIMITER • HIGH-GAIN CIRCUIT

MC-55 FIVE BAND MOBILE CONVERTER

For 10, 15, 20, 40 and 80 meters. 1.25 micro-volt sensitivity on all bands. Large, attractive edge-lighted dial, 25-to-1 worm gear tuning. Efficient automatic noise limiter built-in. Integral transmit-receive switch. Three gang tuning capacitor. Individual coils for each band and each circuit controlled by single band switch. Aperiodic i.f. stage aids in providing high-gain characteristic. Input impedance 50-72 ohms. Output frequency 1550 kc. Separate input for car antenna is automatically switched to car radio when converter is switched out.

Requires 150-180 v. at 18 ma. Provisions for either 6 or 12-volt operation. Tube lineup: 6BJ6 r.f. amp; 12AT7 osc-det; 6BJ6 i.f. amp; 6AL5 noise limiter. Attractive cabinet finished in dark gray enamel. Complete with tubes, cables and instruction sheets. Size: 4 7/8" high, 5 3/4" wide, 5 1/4" deep. Shipping weight, 7 lbs. **Amateur Net. \$69.50**



MC-55

MC-53 THREE BAND MOBILE CONVERTER

Specially designed for 2, 6 and 10-11 meters. 1.25 micro-volt sensitivity on all bands. 25-to-1 worm gear tuning insures mechanical tuning stability. Individual coils for each band and each circuit. Three gang tuning. Aperiodic i.f. stage aids in providing high gain characteristic. Separate input connectors for each band and for car antenna. Handy send-receive switch. Built-in automatic noise limiter. Voltage regulator provides excellent stability. Designed for 6-volt operation. Requires 150-180 v. at 25 ma. Switching converter out automatically connects regular car antenna to car radio.

Output frequency 1550 kc. Tube lineup: 6AK5 r.f. amplifier; 12AT7 osc-det; 6BJ6 i.f.; 6AL5 limiter and OB2 voltage regulator. Attractive cabinet finished in gray enamel, measures only 5 3/4" wide, 4 7/8" high and 5 1/4" deep. Complete with all tubes, cables and instruction sheets. Size: 4 7/8" high, 5 3/4" wide, 5 1/4" deep. Shipping weight, 7 lbs. **Amateur Net. \$66.60**



MC-53

DB-23 PRESELECTOR

20-DB MINIMUM GAIN • 3 PUSH-PULL STAGES • SELF-TUNING

Substantially improves the performance of any receiver. Employs three 6J6 twin triodes as neutralized push-pull stages in a unique combination of selective and wide band r.f. amplifiers. Provides minimum gain of 20 db throughout all ham bands from 3.5 to 30 mc with substantial image rejection. Signal-to-noise ratio improvement is better than 7.5 db over that of the receiver alone. Permits optimum use of mechanical, crystal or audio filters. Input circuits accurately match any standard type antenna. Operation is simple; merely set band selector and adjust peaking control for maximum signal.

Entirely self-contained with built-in power supply. Handsome cabinet is small, compact and finished in blue-gray. Complete with all tubes and instruction sheet. Size: 5" high, 7 7/8" wide, 6" deep. Shipping weight, 8 lbs. **Amateur Net. \$49.50**

DB-23

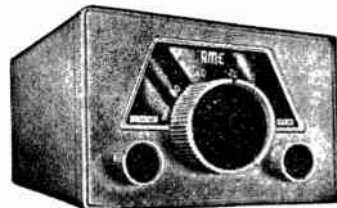

RME 100 SPEECH CLIPPER

3-20 DB CLIPPING • PI LOW-PASS FILTER • UNITY GAIN

Specially designed peak limiting pre-amplifier that provides higher articulation and intelligibility to combat QRM and QRN in phone bands. Ideal for use with Johnson Viking, Collins 32V and all ham-built phone equipment. Clipping level adjustable from 3-20 db. Pi low-pass filter provides high suppression of generated harmonics above 3000 cps, concentrating voice power to most effective band of frequencies. Frequency response 200-3000 cps.

If set to provide 100% modulation, louder speech will not over-modulate. Front panel input for high-impedance microphone takes PC1M connector. Tube lineup: 6SC7, 6H6 and 6X5GT rectifier. Entirely self-contained in handsome blue-gray steel cabinet. Complete with tubes, shielded output cable and instruction sheet. Size: 5" high, 7 7/8" wide, 6" deep. Shipping weight, 9 lbs. **Amateur Net. \$39.50**

RME 100



SECOND OP DX INFORMATION COMPUTER

No ham can afford to be without this ingenious computer, whether he is a DX enthusiast or not. Here on one clever instrument you can instantly read complete data on every country and amateur sub-division in the world.

Right at your fingertips is the following information: great circle beam headings; time and date at DX location; continent; DX zone; prefix-to-country translations; QSL bureau addresses; postal rates for airmail, first class and QSL cards; international reply coupon exchange rates, etc. The "Second Op" includes log space to indicate date of contact and receipt of QSL from each country. Well made, of heavy stock with long lasting varnish finish. **Amateur Net. \$1.00**



SECOND OP

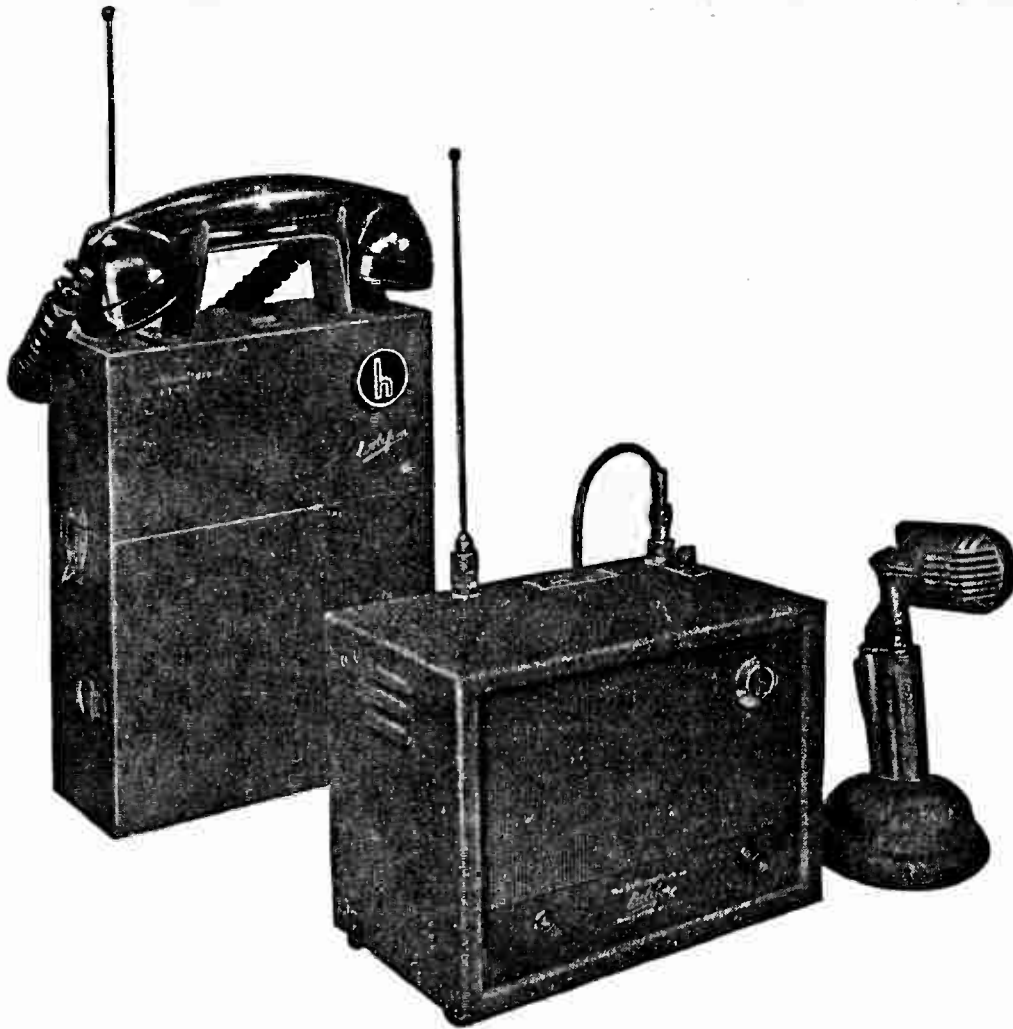

hallicrafters littlefone - portable radio-telephone

The Littlefone series of equipment are *FMA* two-way radio telephone units operating at 25-50 Mc or 144-174 Mc. Both the receiver and transmitter are crystal controlled and a total of 22 sub-miniature tubes are used. The complete portable model with antenna and telephone hand-set weighs only fourteen pounds and will operate for more than eight hours on the self-contained rechargeable storage batteries. Models for AC power line and 6/12 volts

DC operation employ the same r-f chassis as the portable units but an audio power output stage is added to drive the loud speaker. Adjustable squelch controls are available on all models. Power outputs 2 watts on 25-50 Mc and 1 watt on 144-174 Mc. Lower powered wet and dry battery models also available.

Hand Carry from **\$32495** to **\$39995**
plus \$17.12 F. E. T. plus \$21.93 F. E. T.

Central Station . . . Same performance and specifications as Hand Carry unit. Audio-amplifier, providing one watt of audio for loud speaker. AC operated with power consumption of 35 watts.

Plugs in any AC outlet of 117 V. Hallicrafters S-81 receivers may be used as extra stationary stations.

Central Station **\$48500**
plus \$23.00 F. E. T.

*Write for information on additional Hallicrafters products.
 World's Leading Exclusive Manufacturer of Communications and
 High Fidelity Equipment, Radio and Television*

THE ALLEN D. CARDWELL

ELECTRONICS PRODUCTIONS CORP.

PRECISION CAPACITOR TYPE PL-24,050

Designed for frequency meters requiring maximum mechanical and electrical precision, Type No. 4.080 gear and worm driven capacitor incorporates special design features representing years of research and usage. Capable of operating in a temperature range of minus 30 degrees C (-86F) to plus 55 degrees C (+131F).

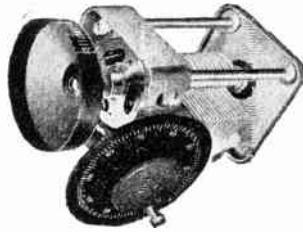

CAPACITY RANGE: Maximum capacity 220 mmfd., minimum capacity 21 mmfd.

CAPACITY CHARACTERISTIC: Straight Line Frequency.

INSULATION: Moisture-proofed ceramic or glass-bonded mica.

BACKLASH: Negligible.

RESETTABILITY: To 10 parts in one million.

GEAR DRIVE: Precision split worm gear, equipped with precision ball bearings. Ratio 100: 1 throughout 360°.

DIMENSIONS: 5 3/4" long (over drum dial) x 3 1/2" deep x 3 1/2" high.

WEIGHT: 1 3/4 lbs. (with cast aluminum frame).

ROTOR CONTACT: Silver plated phosphor bronze spring with 2 rotor contacts bearing on silver plated disc.

MOUNTING: 3 point, to bottom of main casting.

PL-24,050 includes capacitor (PL 4.080), drum dial (PL 4.089-1-A), fast running dial (PL 3.200) and vernier ring (PL 3.004). Dials are aluminum, black anodized and precision engraved.

NOTE: This unit can be supplied with intermediate capacitance ranges straight line capacitance or special gear reduction on request.

MIDGETS FOR V.H.F.

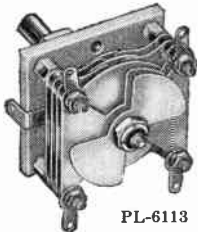

PL-6113

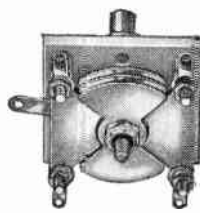

PL-6076

Ninety degree capacitor with butterfly rotor plates, low distributed inductance and no moving contacts. Plates are easily removable so that capacity range can be changed. Minimum and maximum capacity values as shown are measured from stator-to-stator and are effective values as used when a coil is connected stator-to-stator with the rotor floating. Double bearing construction available on request.

SPECIFICATIONS

INSULATION: Moisture-proofed, low loss isolantite.

SHAFT: 1/4 inch diameter, brass, nickel plated.

PLATES: Aluminum, 0.020 inch thick, rounded edges.

MOUNTING: 3/8 inch diameter panel mounting, or by trim-air mounting.

NOTE: All trim-air hardware fits these units.

V. H. F. 90 DEGREE TRIM-AIR MIDGETS

Part Number	Max. Cap.	Min. Cap.	No. Plates Rotor	No. Plates Stator	Air Gap	Length Overall	List Price
PL-6076	5	1.5	3	2	.030"	1 13/32"	
PL-6077	7	2.0	4	3	.030"	1 31/32"	
PL-6078	13	3.0	7	6	.030"	2 3/8"	
PL-6079	20.4	3.4	8	7	.020"	2 5/32"	
PL-6080	27	4.0	10	9	.020"	2 3/8"	
*PL-6081	38	6.0	14	13	.020"	2 31/32"	

TRIM-AIR MIDGET CAPACITORS

Combine essential sturdiness with the flexibility obtained only in a spacer-built rotor and stator type assembly. Intermediate capacitance values and special air gaps on all models are available on request. Single section units with double bearing construction also available.



PL-6300

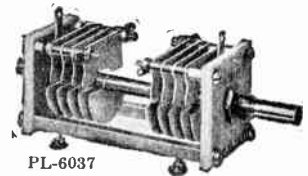

PL-6037

SPECIFICATIONS

CAPACITY CHARACTERISTICS: Straight line capacity.

INSULATION: Moisture-proofed, low-loss isolantite.

PLATES: Aluminum, .020 inch thick, rounded edges.

(Note: Brass supplied on special order.)

SHAFT: 1/4 inch diameter brass, nickel plated.

MOUNTING: Single section units either by 3/8 diameter panel mounting or mounted bracket. Dual section capacitors also supplied with 4 No. 4-36 screws and spacers for post mounting.

NOTE: Dual section units have rear shaft extension for coupling and dual capacitors having air gaps of .020 and .030 inches have a shield between sections which is removable.

TRIM-AIR (SINGLE) (LONG SHAFT*)

Part Number	Max. Cap.	Min. Cap.	No. Plates	Air Gap	Length	List Price
PL-6016	75	2.7	15	.020	1 3/8"	
PL-6017	100	3	19	.020	1 1/2"	
PL-6018	140	5	27	.020	1 23/32"	
PL-6000	10	1.2	3	.030	7/8"	
PL-6001	15	1.5	5	.030	31/32"	
PL-6002	25	2	7	.030	1 1/16"	
PL-6003	35	2.5	11	.030	1 9/32"	
PL-6004	50	2.8	13	.030	1 3/8"	
PL-6055	108	6.6	29	.030	2 9/64"	
PL-6024**	5	1.5	3	.060	7/8"	
PL-6044	5	2	3	.070	31/32"	
PL-6010	11	3.6	6	.070	1 1/16"	
PL-6011	15	3	9	.070	1 1/2"	
PL-6012	30	4	17	.070	2 17/64"	
PL-6022	4	1.5	5	.140	1 1/2"	
PL-6023	7	4	7	.140	1 27/32"	

*Iso. rear end plate—ball and strap rear bearing.

**Supplied with 2 segment stator for UHF circuits. Extra plate also supplied, making 3 plates as listed.

TRIM-AIR (DUAL)

Part Number	Max. Cap.	Min. Cap.	No. Plates	Air Gap	Length	List Price
PL-6041	75	2.7	15	.020	3 1/32"	
PL-6042	100	3	19	.020	3 1/32"	
PL-6043	140	5	27	.020	3 11/16"	
PL-6028	10	1.2	3	.030	2 3/16"	
PL-6029	15	1.5	5	.030	2 3/16"	
PL-6030	25	2	7	.030	2 3/16"	
PL-6031	35	2.5	11	.030	3 1/32"	
PL-6032	50	2.8	13	.030	3 1/32"	
PL-6065	100	6.9	25	.030	3 11/16"	
PL-6037	15	3	9	.070	3 1/32"	
PL-6039	30	4	17	.070	4 15/32"	
PL-6033	4	1.5	5	.140	3 1/32"	
PL-6035	7	4	7	.140	3 11/16"	

CARDWELL

MAIN OFFICE:
PLAINVILLE, CONN.



CAPACITORS

PLANTS: PLAINVILLE, CONN.
STAMFORD, CONN.

THE ALLEN D. CARDWELL

ELECTRONICS PRODUCTIONS CORP.

MIDWAY TRANSMITTING CAPACITORS

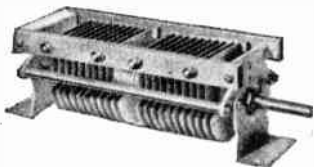

PL-7030 with PL-5051 Mtg. Brackets

The Midway is ideal for low and medium power transmitters for portable mobile and aircraft equipment, due to its light weight, compact size and extremely sturdy construction. Incorporates original patented features of the larger "X" type standard transmitting capacitor.

GENERAL SPECIFICATIONS:

CAPACITY CHARACTERISTICS: S.L.C.

FRAME: All aluminum end plates and tie rods.

SHAFT: 1/4" C.I. steel, cadmium plated.

PLATES: .025" aluminum. On sizes having airgap of .070" or over, plates have rounded edges, buffed to minimize corona loss.

BEARINGS: Brass, nickel plated shoulder type front bearing with ball thrust rear bearing.

INSULATION: Mycalex.

MOUNTING: 3 point front panel mounting by means of 3 screws and hex. posts. Two aluminum mounting feet with screws. Cardwell Part List No. 5052 for regular chassis mounting, provided instead, if so ordered. Type "M" special brackets (Part List No. 5051) permit inverted mounting.

MIDWAY SINGLE CONDENSERS

Parts List No.	Max. Cap.	Min. Cap.	No. Plates	Air Gap	Length Over End Plates	List Price
PL-7000	25	6	3	.030	1 3/4	
PL-7001	50	6	5	.030	1 3/4	
PL-7002	70	7	7	.030	1 3/4	
PL-7003	112	9	11	.030	1 3/4	
PL-7004	150	10	15	.030	1 3/4	
PL-7005	260	13	25	.030	2 3/4	
PL-7006	365	16	35	.030	2 3/4	
PL-7015	25	8	5	.070	1 3/4	
PL-7016	35	6	7	.070	1 3/4	
PL-7017	50	10	11	.070	1 3/4	
PL-7018	70	10	15	.070	2 3/4	
PL-7019	100	14	21	.070	2 3/4	
PL-7020	150	18	31	.070	3 1 1/16	
PL-7021	35	14	15	.171	3 1 1/16	
PL-7024	165	15	25	.050	2 3/4	

MIDWAY DUAL CONDENSERS

Parts List No.	Per Section			Air Gap	Length Over End Plates	List Price
	Max. Cap.	Min. Cap.	No. Plates			
PL-7007	25	5	3	.030	1 3/4	
PL-7008	47	7	5	.030	2 3/4	
PL-7009	70	8	7	.030	2 3/4	
PL-7010	112	9	11	.030	2 3/4	
PL-7011	150	10	15	.030	2 3/4	
PL-7013	260	13	25	.030	3 1 1/16	
PL-7026	20	6	5	.070	2 3/4	
PL-7027	35	8	7	.070	2 3/4	
PL-7028	50	9	11	.070	2 1 5/16	
PL-7029	70	11	15	.070	3 1 1/16	
PL-7030	100	13	21	.070	5 1 1/32	
PL-7031	190	15	29	.050	5 1 1/32	

"N" TYPE TRANSMITTING CAPACITORS

Designed for medium power high frequency transmitters and short wave therapy apparatus, the Cardwell "N" series maintains the customary high standard of Cardwell construction, yet eliminates closed circuit loops completely.

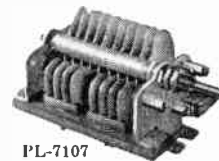

PL-7107

GENERAL SPECIFICATIONS:

CAPACITY CHARACTERISTIC: S.L.C.

FRAME: Improved aluminum end plates support heavy lateral ceramic insulating bars which carry the stators.

SHAFT: 1/4" diameter cadmium plated steel.

PLATES: Aluminum, .040" thick, with rounded edges. PL-7105 has .025" thick plates, buffed and polished edges.

BEARINGS: Cardwell shoulder type front bearing, with ball thrust rear bearings.

MOUNTING: Can be single hole mounted, or by three mounting posts and screws, to front panel. Chassis mounting on feet which form part of end plates, or use Cardwell "M" brackets, Cardwell part No. 301, for inverted mounting, for lowest stator-to-ground capacity.

ULTRA-HIGH FREQUENCY SINGLE CONDENSERS

Parts List No.	Max. Cap.	Min. Cap.	No. Plates	Air Gap	Length Back of Panel	List Price
PL-7100	50	9	13	.084	3 3/8	
PL-7101	75	11	19	.084	4 5/32	
PL-7102	100	13	25	.084	5 7/32	
PL-7103	150	19	39	.084	6 1 1/16	
PL-7104	35	11	15	.171	5 7/32	

ULTRA-HIGH FREQUENCY DUAL CONDENSERS

Parts List No.	Per Section			Air Gap	Length Back of Panel	List Price
	Max. Cap.	Min. Cap.	No. Plates			
PL-7105	50	7	11	.070	4 5/32	
PL-7116	17	4	5	.084	4 5/32	
PL-7106	35	5	9	.084	4 3/32	
PL-7110	17	4	5	.084	4 5/32	
PL-7108	50	9	13	.084	5 7/32	
PL-7109	75	11	19	.084	6 1 1/16	
PL-7115	13	6	7	.218	5 1 5/16	

"NA" NEUTRALIZING CAPACITORS

The "NA" group offers 180° neutralizing capacitors of restricted range, for dial or screw driver adjustment. Shaft lock for permanent setting. Single rotor bearing with beryllium tension washer and special bushing for rigidity. Plates are .040" thick aluminum, rounded and buffed edges. Three point panel mounting or foot mounting.

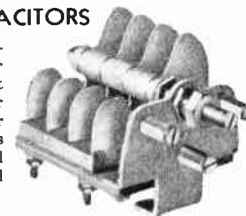

Parts List No.	Max. Cap.	Min. Cap.	No. Plates	Air Gap	Length Back of Panel	List Price
PL-7111	4	3.25	2	.218	1 1 9/32	
PL-7112	6	4	3	.218	1 1 9/32	
PL-7113	12	6	6	.218	2 1 9/32	
PL-7114	16	7	8	.218	3 3/32	

CARDWELL

MAIN OFFICE:
PLAINVILLE, CONN.



CAPACITORS

PLANTS: PLAINVILLE, CONN.
STAMFORD, CONN.

THE ALLEN D. CARDWELL

ELECTRONICS PRODUCTIONS CORP.

INSULATED COUPLINGS

For isolating R.F. controls. Ceramic insulation (Alsimag No. 196). All flexible types have N.P. phosphor bronze springs, and heavy N.P. brass hubs, permanently swaged or spun riveted into the springs. Two fillister head, cup point, case hardened, steel set screws in each hub insure positive lock to shaft.

All rigid types have improved three-point-spider construction, carefully machined solid brass castings, and are absolutely rigid.

Flexible types C, D, E and F fit both 1/4" diameter shaft or a 3/8" shaft by removing bushing supplied.



"ENF" Rigid Coupling
PL-5201



"FNF" Rigid Coupling
PL-5013

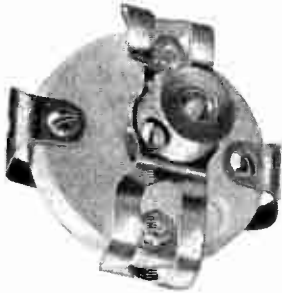

"A" Rigid Coupling
PL-5004



"C" Flexible Coupling
PL-5000

INSULATED COUPLINGS—Flexible

Parts List No.	Type	DIMENSIONS		Peak Flashover	To Fit Shaft Diameter	List Price
		(Width)	(Length)			
5000	A	1 9/32"	3/4"	3,700 V.	1/4"	
5002	B	1 9/32"	1 3/32"	7,000 V.	1/4"	
5202	AB	1 9/32"	2 9/32"	5,000 V.	1/4"	
5004	C	2 5/8"	2 3/32"	13,500 V.	1/4 & 3/8"	
5006	D	2 5/8"	1 3/8"	9,000 V.	1/4 & 3/8"	
5008	E	2 1/16"	1 3/4"	10,000 V.	1/4 & 3/8"	
5010	F	2 1/16"	1 1/16"	5,000 V.	1/4 & 3/8"	

INSULATED COUPLINGS—Rigid

5014	CNF	2 1/4"	2 1/16"	12,000 V.	3/8"	
5201	ENF	1 3/8"	1 13/16"	10,000 V.	1/4"	
5013	FNF	1 3/8"	1 5/16"	7,500 V.	1/4"	

"X" TYPE STANDARD TRANSMITTING CAPACITOR

The Original grounded rotor, metal frame variable air capacitor.

Frames, tie rods, bearing bushings, spacers and stator blocks, nickel plated brass. Cadmium plated 1/4" steel shaft supports securely locked rotor assembly. Mycalex insulation. Panel spaces 1 1/8" x 3 3/8". Panel mounting. N.P. brass mounting feet provided on special order, for chassis mounting. See Accessories.

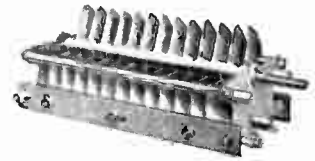

"X" TYPE STANDARD SINGLES

Parts List No.	Max. Cap.	Min. Cap.	No. Plates	Air Gap	Length Over End Plates	List Price
PL-8000	50	11	3	.030	1 1/2	
PL-8001	100	12	5	.030	1 1/2	
PL-8002	150	12.5	7	.030	1 1/2	
PL-8003	250	13	11	.030	1 1/2	
PL-8004	375	16	17	.030	2 1/16	
PL-8005	475	18	21	.030	2 1/16	
PL-8007	950	30	41	.030	3 3/16	
PL-8013	1500	50	65	.030	5	
PL-8048	220	20	21	.070	3 3/16	
PL-8050	440	40	43	.070	5	
PL-8040	90	16	11	.084	2 1/16	
PL-8041	165	22	19	.084	3 3/16	
PL-8043	290	35	33	.084	5	
PL-8044	330	37	37	.084	5 5/8	
PL-8029	120	19	17	.100	3 3/16	
PL-8031	240	30	33	.100	5 5/8	
PL-8025	160	28	27	.125	5 5/8	
PL-8032	25	8	5	.171	2 1/16	
PL-8033	50	15	11	.171	3 3/16	
PL-8034	110	26	23	.171	5 5/8	
PL-8020	19	8	5	.200	2 1/16	
PL-8021	40	15	11	.200	3 3/16	
PL-8022	65	20	17	.200	5	
PL-8023	100	28	25	.200	6 5/8	
PL-8037	55	20	15	.230	5	

"X" TYPE STANDARD DOUBLES

Parts List No.	Per Section			Air Gap	Length Over End Plates	List Price
	Max. Cap.	Min. Cap.	No. Plates			
PL-8018	500	18	21	.030	3 3/16	
PL-8068	80	11	9	.070	3 3/16	
PL-8070	210	22	21	.070	5	
PL-8065	95	15	11	.084	3 23/32	
PL-8066	165	23	19	.084	5 5/8	
PL-8067	325	38	37	.084	10 3/16	
PL-8061	120	19	17	.100	5 5/8	
PL-8062	240	32	33	.100	10 3/16	
PL-8060	160	28	27	.125	10 3/16	
PL-8063	50	14	11	.171	5 5/8	
PL-8064	110	27	21	.171	10 3/16	
PL-8056	40	14	11	.200	6 5/8	
PL-8057	75	21	19	.200	10 3/16	
PL-8081	Multi-Band			.100	10 3/16	

CARDWELL

MAIN OFFICE:
PLAINVILLE, CONN.



CAPACITORS

PLANTS: PLAINVILLE, CONN.
STAMFORD, CONN.

Copyright by U. C. P., Inc.

Radio's Master—19th Edition

Page J-17

THE ALLEN D. CARDWELL

ELECTRONICS PRODUCTIONS CORP.

40MC I. F. STRIP

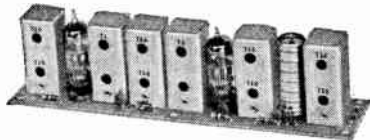

BANDWIDTH: 3.75 mc (between 6 db points) 3 I. F. stages plus crystal detector.

SENSITIVITY: 70 micro-volts input to mixer grid for one volt output at second detector with zero bias.

TRAP REJECTIONS: 39.75 mc adjacent video at least 40 db.

41.25 mc accompanying sound at least 30 db.

47.25 mc adjacent sound at least 55 db.

PLATE SUPPLY: 150 volts.

FILAMENT SUPPLY: 6.3 (parallel).

CURRENT DRAIN: 28 ma at -3 volt bias.

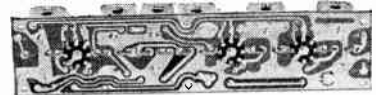

Designed for use in monochrome T.V. receivers using inter-carrier sound systems, this I. F. strip is a compact "in-line" design featuring high gain and full band pass response. The complete unit can be pre-aligned and tested to customer specifications.

The laminate used for the chassis board and transformers has been especially designed for this application and has mechanical rigidity without be-

ing brittle. Transformer windings are etched on both sides of the laminate material. All laminate parts are protected with a special wax dip.

All tuning adjustments are above chassis through openings provided in the cans. Aluminum discs are threaded into center-tapped nylon inserts to provide accurate and reliable tuning.

DESIGN IDEAS IN

PHOTO WIRING

Quality at lowest price. Save labor, space, weight, cost.

Absolute uniformity throughout an entire production run. Selective soldering—our method prepares each circuit to accept solder only at selected points. One dip solder operation.

PHOTO BLANKING

No dies or jigs, fast delivery, low costs. Ideal for short or long production runs. Frequent changes at very low costs. Intricate designs do not affect cost or delivery.

FOR AN EFFICIENT AND ECONOMICAL SOLUTION
BRING US YOUR PROBLEM

Comparative Standards



since Radio's Conception

MAIN OFFICE:
PLAINVILLE, CONN.

PLANTS: PLAINVILLE, CONN.
STAMFORD, CONN.

JAMES MILLEN

MALDEN · MASSACHUSETTS



90901

ONE INCH INSTRUMENTATION OSCILLOSCOPE

Miniaturized, packaged panel mounting cathode ray oscilloscope designed for use in instrumentation in place of the conventional "pointer type" moving coil meters uses the 1" 1CP1 tube. Panel bezel matches in size and type the standard 2" square meters. Magnitude, phase displacement, wave shape, etc. are constantly visible on scope screen. No. 90901, less tube..... \$

INSTRUMENT DIAL

The No. 10030 is an extremely sturdy instrument type indicator. Control shaft has 1 to 1 ratio. Veeder type counter is direct reading in 99 revolutions and vernier scale permits readings to 1 part in 100 of a single revolution. Has built-in diol lock and 1/4" drive shaft coupling. May be used with multi-revolution transmitter controls, etc., or through gear reduction mechanism for control of fractional revolution capacitors, etc., in receivers or laboratory instruments.

No. 10030..... \$

GRID DIP METER

The No. 90651 MILLEN GRID DIP METER is compact and completely self contained. The AC power supply is of the "transformer" type. The drum dial has seven calibrated uniform length scales from 1.7 MC to 300 MC with generous over laps plus an arbitrary scale for use with special application inductors. Internal terminal strip permits battery operation for antenna measurement.

No. 90651, with tube..... \$

Additional Inductors for Lower Frequencies

- No. 46702—925 to 2000 KC..... \$
- No. 46703—500 to 1050 KC..... \$
- No. 46704—325 to 600 KC..... \$
- No. 46705—220 to 350 KC..... \$

LABORATORY SYNCHROSCOPES

The 5" laboratory synchroscopes are available with and without detector-video strips.

- Model P-4-2, with tubes..... \$
- Model P-4E-2, with tubes..... \$

MINIATURE SYNCHROSCOPE

The compact design of the No. 90952, measuring only 7 1/2" x 5 1/4" x 1 3/4", and weighing only 17 lbs., makes available for the first time a truly DESIGNED FOR APPLICATION "field service" Synchroscope.

No. 90952, with tubes..... \$

CATHODE RAY OSCILLOSCOPES

The No. 90902, No. 90903 and No. 90905 Rack Panel Oscilloscopes, for two, three and five inch tubes, respectively, are inexpensive basic units comprising power supply, brilliancy and centering controls, safety features, magnetic shielding, switches, etc. As a transmitter monitor, no additional equipment or accessories are required. The well-known trapezoidal monitoring patterns are secured by feeding modulated carrier voltage from a pickup loop directly to vertical plates of the cathode ray tube and audio modulating voltage to horizontal plates. By the addition of such units as sweeps, pulse generators, amplifiers, servo sweeps, etc., all of which can be conveniently and neatly constructed on companion rack panels, the original basic 'scope unit may be expanded to serve any conceivable industrial or laboratory application.

- No. 90902, less tubes..... \$
- No. 90903, less tubes..... \$
- No. 90905, less tubes..... \$

'SCOPE AMPLIFIER—SWEEP UNIT

Vertical and horizontal amplifiers along with hard-tube, saw tooth sweep generator. Complete with power supply mounted on a standard 5 1/4" rack panel.

No. 90921, with tubes..... \$

REGULATED POWER SUPPLIES

A compact, uncased, regulated power supply, either for table use in the laboratory or for incorporation as an integral part of larger equipments. Regulated, unregulated, bias and filament voltages provided.

Model 90201, less tubes..... \$



10030

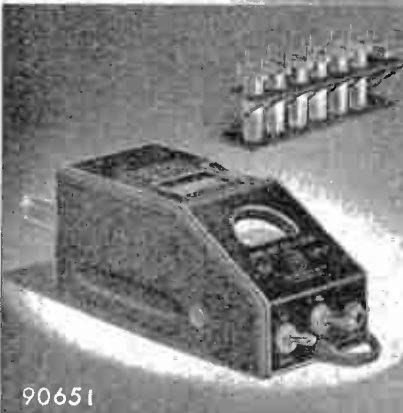

90651

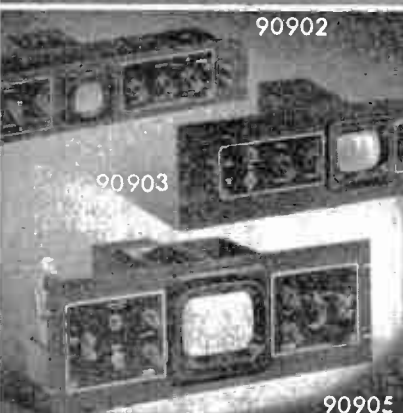

90902

90903

90905



90952



90921



90201

JAMES MILLEN

MALDEN · MASSACHUSETTS



90671

STANDING WAVE RATIO BRIDGE
The Millen S.W.R. bridge provides easy and inexpensive measurement of standing wave ratio on antennas using co-ax cable. As assembled the bridge is set up for 52 ohm line. A calibrated 75 ohm resistor is mounted inside the case for substitution in the circuit when 75 ohm line is used.
No. 90671 \$

PHASE-SHIFT NETWORK
A complete and laboratory aligned pair of phase-shift networks in a single compact 2" x 1 1/8" x 4" case with characteristics so as to provide a phase shift between the two networks of 90° ± 1.3° over a frequency range of 225 cycles to 2750 cycles. This unit is equally well adapted for use in either single sideband transmitting or receiving equipment. When used in a suitably designed transmitter it is possible to obtain a 40 db suppression of the unwanted sideband. The No. 75012 precision adjusted phase-shift network makes possible the building of single sideband equipment without the necessity of complicated laboratory equipment for network adjustment.
No. 75012 \$

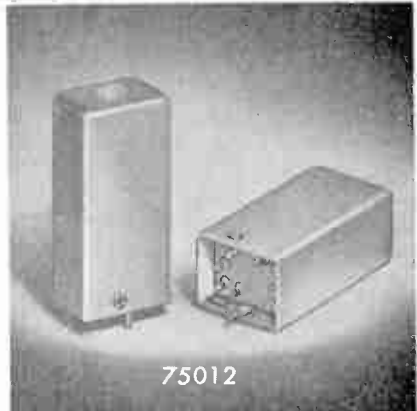

75012



92101

99'er MATCHING PREAMPLIFIER
The Millen 92101 is an electronic impedance matching device and a broad-band preamplifier combined into a single unit, designed primarily for operation on 6 and 10 meters. Coils for 20 meter band also available.
No. 92101, less tubes \$

50 WATT EXCITER-TRANSMITTER
Modern design includes features and shielding for TVI reduction, bandswitching for 4-7-14-21-28 megacycle bands, circuit metering. Conservatively rated for use either as a transmitter or exciter for high power PA stages. 5763 oscillator-buffer-multiplier and 6146 power amplifier. Rack mounted.
No. 90801, less tubes \$



90801



90711

VARIABLE FREQUENCY OSCILLATOR
The No. 90711 is a complete transmitter control unit with 6SK7 temperature-compensated, electron coupled oscillator of exceptional stability and low drift, a 6SK7 broad-band buffer or frequency doubler, a 6A67 tuned amplifier which tracks with the oscillator tuning, and a regulated power supply. Output sufficient to drive an 807 is available on 160, 80 and 40 meters and reduced output is available on 20 meters. Since the output is isolated from the oscillator by two stages, zero frequency shift occurs when the output load is varied from open circuit to short circuit. The entire unit is unusually solidly built so that no frequency shift occurs due to vibration. The keying is clean and free from all annoying chirp, quick drift, jump, and similar difficulties often encountered in keying variable frequency oscillators.
No. 90711, with tubes \$

HIGH VOLTAGE POWER SUPPLY
The No. 90281 high voltage power supply has a d.c. output of 700 volts, with maximum current of 235 ma. In addition, a.c. filament power of 6.3 volts at 4 amperes is also available so that this power supply is an ideal unit for use with transmitters, such as the Millen No. 90801, as well as general laboratory purposes. The power supply uses two No. 816 rectifiers. The panel is standard 8 3/4" x 19" rack mounting.
No. 90281, less tubes \$



90281

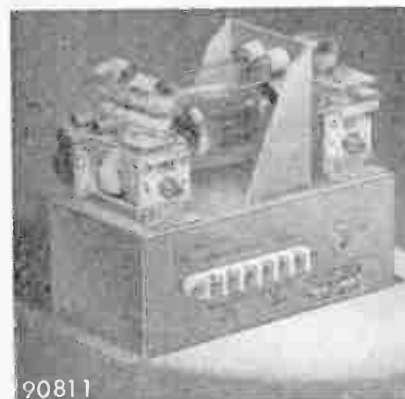

90811

HIGH FREQUENCY RF AMPLIFIER
A physically small unit capable of a power output of 70 to 85 watts on 160 phone or 87 to 110 watts on C-W on 20, 15, 11, 10, 6 or 2 meter amateur bands. Provision is made for quick band shift by means of the new No. 48000 series VHF plug-in coils. The No. 90811 unit uses either an 829-B or 3E29.
No. 90811 with 10 meter band coils, less tube \$

RF POWER AMPLIFIER
This 500 watt amplifier may be used as the basis of a high power amateur transmitter. The No. 90881 RF power amplifier is wired for use with the popular "812A" type tubes. Other popular tubes may be used. The amplifier is of unusually sturdy mechanical construction, on a 10 1/2" relay rack panel. Plug-in inductors are furnished for operation on 10, 20, 40 or 80 meter amateur bands. The standard Millen No. 90801 exciter unit is an ideal driver for the new No. 90881 RF power amplifier.
No. 90881, with one set of coils, but less tubes \$



90881

JAMES MILLEN

MALDEN · MASSACHUSETTS

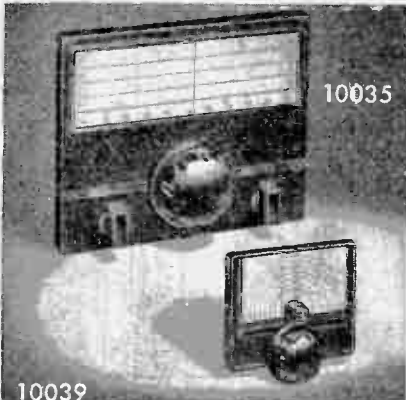

10035

10039

PANEL DIALS

The No. 10035 illuminated panel dial has 12 to 1 ratio; size, 8½" x 6½". Small No. 10039 has 8 to 1 ratio; size, 4" x 3¼". Both are of compact mechanical design, easy to mount and have totally self-contained mechanism, thus eliminating back of panel interference. Provision for mounting and marking auxiliary controls, such as switches, potentiometers, etc., provided on the No. 10035. Standard finish, either size, flat black art metal.

No. 10039 \$
 No. 10035 \$

WORM DRIVE UNIT

Cast aluminum frame may be panel or base mounted. Spring loaded split gears to minimize back lash. Standard ratio 16/1. Also in 48/1 on request.

No. 10000—(state ratio) \$

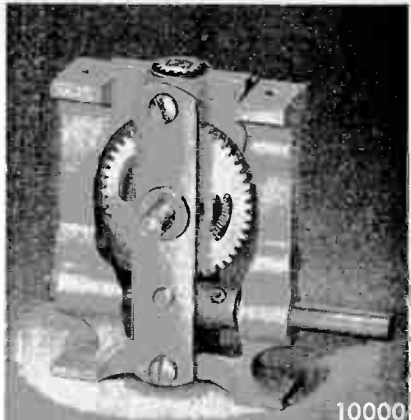

10000

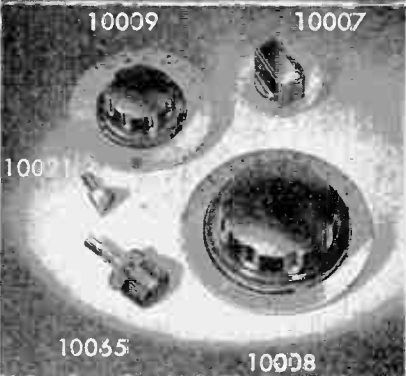

10009

10007

10021

10035

10008

DIALS AND KNOBS

Just a few of the many stock types of small dials and knobs are illustrated herewith. 10007 is 1¼" diameter, 10009 is 2½" and 10008 is 3½".

No. 10007 \$
 No. 10008 \$
 No. 10009 \$
 No. 10015 \$
 No. 10018 \$
 No. 10021 \$
 No. 10065 \$

RIGHT ANGLE DRIVE

Extremely compact, with provisions for many methods of mounting. Ideal for operating potentiometers, switches, etc., that must be located, for short leads, in remote parts of chassis.

No. 10012 \$

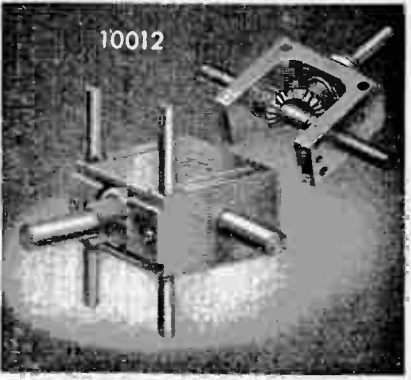

10012

HIGH VOLTAGE INSULATED SHAFT EXTENSION

No. 10061 shaft locks and the No. 39023 insulated high voltage potentiometer extension mountings are available as a single integrated unit—the No. 39024. The proper shaft length is independent of the panel thickness. The standard shaft has provision for screw driver adjustment. Special shaft arrangements are available for industrial applications. Extension shaft and insulated coupling are mated as a single unit to provide accuracy of alignment and ease of installation.

No. 39023, non locking type \$
 No. 39024, locking type \$

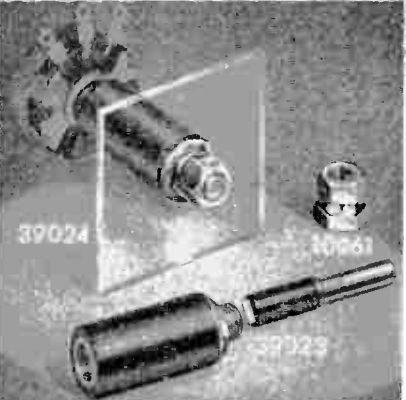

39024

10061

39023

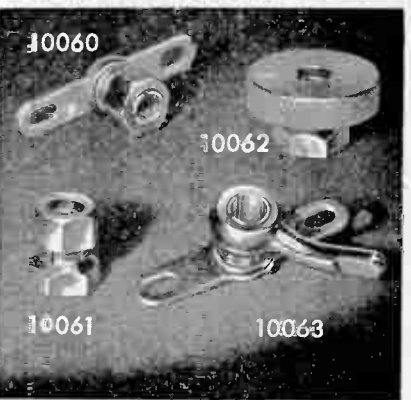

10060

10062

10061

10063

SHAFT LOCKS

In addition to the original No. 10060 and No. 10061 "DESIGNED FOR APPLICATION" shaft locks, we can also furnish such variations as the No. 10062 and No. 10063 for easy thumb operation as illustrated above. The No. 10061 instantly converts any plain ¼" shaft volume control, condenser, etc. from "plain" to "shaft locked" type. Easy to mount in place of regular mounting nut.

No. 10060 \$
 No. 10061 \$
 No. 10062 \$
 No. 10063 \$

TRANSMISSION LINE PLUG

An inexpensive, compact, and efficient polystyrene unit for use with the 300 ohm ribbon type polyethylene transmission lines. Fits into standard Millen No. 33102 (crystal) socket. Pin spacing ½", diameter .095".

No. 37412 \$

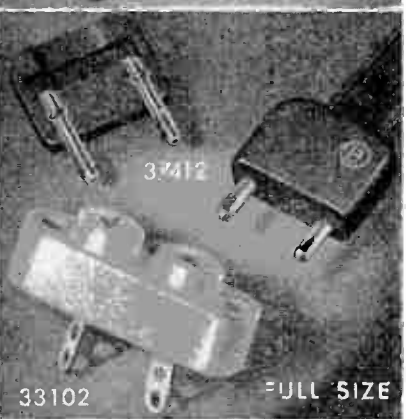

37412

33102

FULL SIZE

DIAL LOCK

Compact, easy to mount, positive in action, does not alter dial setting in operation! Rotation of knob "A" depresses finger "B" and "C" without imparting any rotary motion to Dial. Single hole mounted.

No. 10050 \$



FULL SIZE

JAMES MILLEN

MALDEN · MASSACHUSETTS



TUBE SOCKETS DESIGNED FOR APPLICATION

MODERN SOCKETS for MODERN TUBES! Long Flashover path to chassis permits use with transmitting tubes, 866 rectifiers, etc. Long leakage path between contacts. Contacts are type proven by hundreds of millions already in government, commercial and broadcast service, to be extremely dependable. Sockets may be mounted either with or without metal flange. Mounts in standard size chassis hole. All types have barrier between contacts and chassis. All but octal and crystal sockets also have barriers between individual contacts in addition.

The No. 33888 shield is for use with the 33008 octal socket. By its use, the electrostatic isolation of the grid and plate circuits of single-ended metal tubes can be increased to secure greater stability and gain.

The 33087 tube clamp is easy to use, easy to install, effective in function. Available in special sizes for all types of tubes. Single hole mounting. Spring steel, cadmium plated.

Cavity Socket Contact Discs, 33446 are for use with the "Lighthouse" ultra high frequency tube. This set consists of three different size unhardened beryllium copper multifinger contact discs. Heat treating instructions forwarded with each kit for hardening after spinning or forming to frequency requirements.

Voltage regulator dual contact bayonet socket, 33991 black phenolic insulation and 33992 with low loss high leakage mica filled phenolic insulation.

No. 33004	\$
No. 33005	
No. 33006	
No. 33007	
No. 33008	
No. 33888	
No. 33087	
No. 33002	
No. 33102	
No. 33202	
No. 33302	
No. 33446*	
No. 33991	
No. 33992	

*For set of 3. Single discs \$0.00 each.

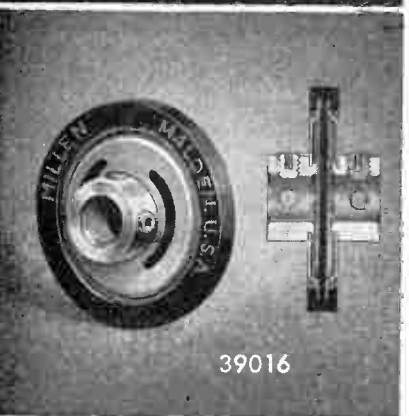
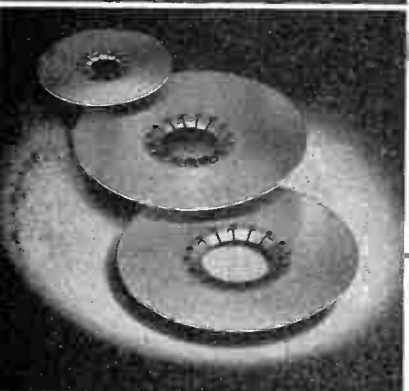
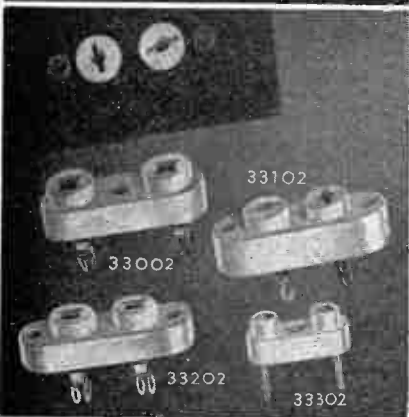

FLEXIBLE COUPLINGS

The No. 39000 series of Millen "Designed for Application" flexible coupling units include, in addition to improved versions of the conventional types, also such exclusive original designs as the No. 39001 insulated universal joint and the No. 39006 "slide-action" coupling (in both steatite and bakelite insulation).

The No. 39006 "slide-action" coupling permits longitudinal shaft motion, eccentric shaft motion and out-of-line operation, as well as angular drive without backlash.

The No. 39005 is similar to the No. 39001, but is not insulated and is designed for applications where relatively high torque is required. The steatite insulated No. 39001 has a special anti-backlash pivot and socket grip feature. All of the above illustrated units are for 1/4" shaft and are standard production type units. The No. 39016 incorporates features which have long been desired in a flexible coupling. No Back Lash—Higher Flexibility—Higher Breakdown Voltage—Smaller Diameter—Shorter Length—Higher Alignment Accuracy—Higher Resistance to Mechanical Shock—Solid Insulating Barrier Diaphragm—Molded as a Single Unit.

No. 39001	\$
No. 39002	
No. 39003	
No. 39005	
No. 39006	
No. 39016	

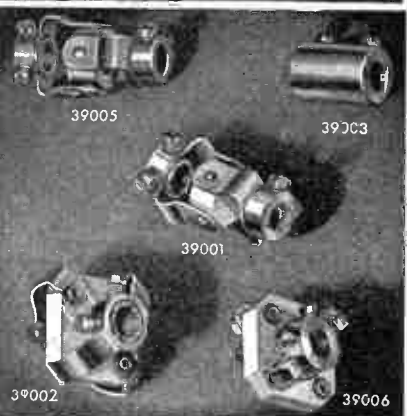

JAMES MILLEN

MALDEN · MASSACHUSETTS

04000 and 11000 SERIES TRANSMITTING CONDENSERS

A new member of the "Designed for Application" series of transmitting variable air capacitors is the 04000 series with peak voltage ratings of 3000, 6000, and 9000 volts. Right angle drive, 1-1 ratio. Adjustable drive shaft angle for either vertical or sloping panels. Sturdy construction, thick, rounded, polished aluminum plates with 1 3/4" radius. Constant impedance, heavy current, multiple finger rotor contactor of new design. Available in all normal capacities.

The 11000 series has 16/1 ratio center drive and fixed angle drive shaft.

Code	Volts	Capacity	Price
11035	3000	35	\$
11050	3000	50	
11070	3000	70	
04050	6000	50	
04060	9000	60	
04100	6000	90	
04200	3000	205	

12000 and 16000 SERIES TRANSMITTING CONDENSERS

Rigid heavy channeled aluminum end plates. Isolantite insulation, polished or plain edges. One piece rotor contact spring and connection lug. Compact, easy to mount with connector lugs in convenient locations. Same plate sizes as 11000 series above.

The 16000 series has same plate sizes as 04000 series. Also has constant impedance, heavy current, multiple finger rotor contactor of new design. Both 12000 and 16000 series available in single and double sections and many capacities and plate spacing.

THE 28000-29000 SERIES VARIABLE AIR CAPACITORS

"Designed for Application," double bearings, steatite end plates, cadmium or silver plated brass plates. Single or double section .022" or .066" air gap. End plate size: 19/16" x 11/16". Rotor plate radius: 3/4". Shaft lock, rear shaft extension, special mounting brackets, etc., to meet your requirements. The 28000 series has semi-circular rotor plate shape. The 29000 series has approximately straight frequency line rotor plate shape. Prices quoted on request. Many stock sizes.

NEUTRALIZING CAPACITOR

Designed originally for use in our own No. 90881 Power Amplifier, the No. 15011 disc neutralizing capacitor has such unique features as rigid channel frame, horizontal or vertical mounting, fine thread over-size lead screw with stop to prevent shorting and rotor lock. Heavy rounded-edged polished aluminum plates are 2" diameter. Glazed Steatite insulation.

No. 15011..... \$

THRU-BUSHING

Efficient, compact, easy to use and neat appearing. Fits 1/4" hole in chassis. Held in place with a drop of solder or a "nick" from a crimping tool.

No. 32150..... \$

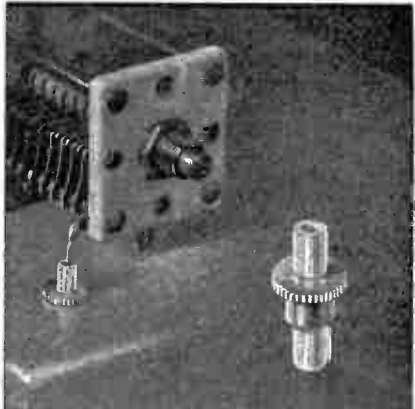
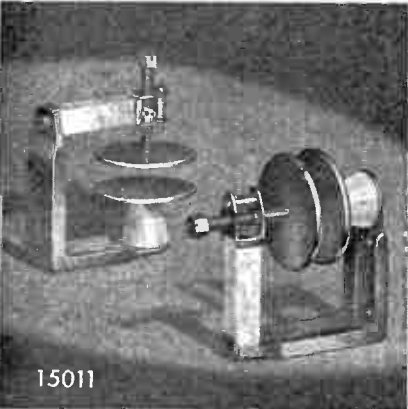
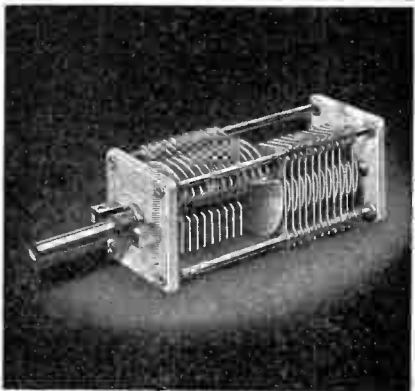
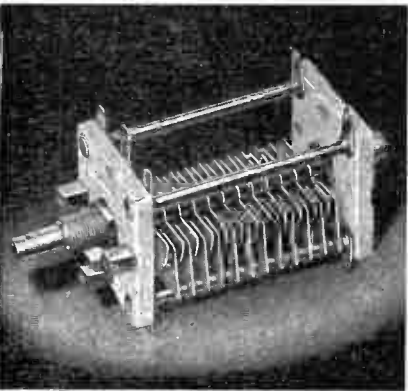
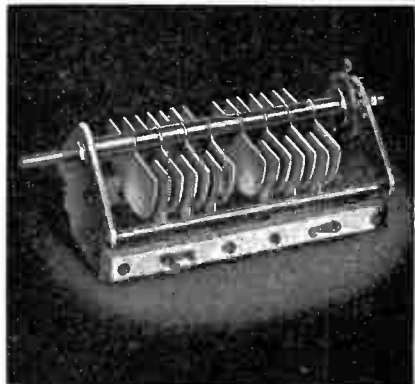
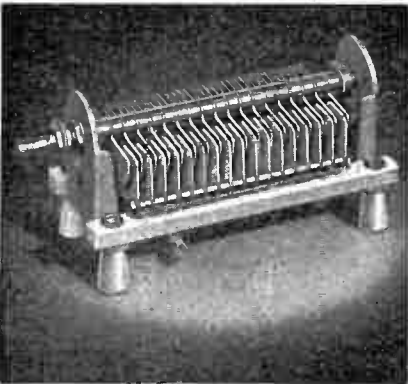
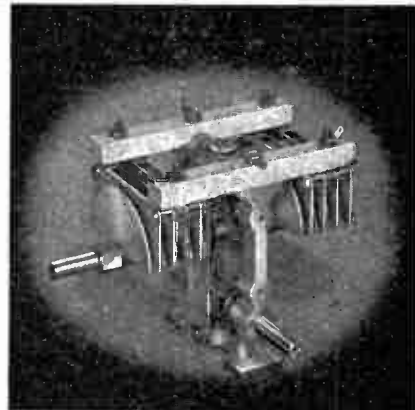
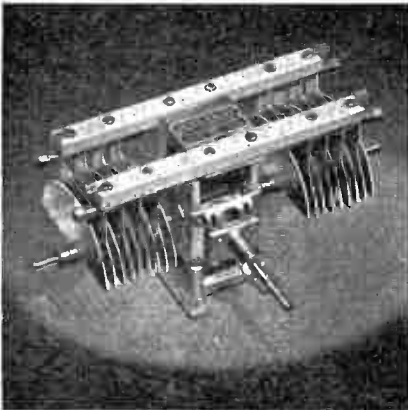

15011

JAMES MILLEN

MALDEN · MASSACHUSETTS



43000

TRANSMITTING TANK COILS
A full line—all popular wattages for all bands. Send for special catalog sheet.

TUNABLE COIL FORM
Standard octal base of low loss mica-filled bakelite, polystyrene 1/2" diameter coil form, heavy aluminum shield, iron tuning slug of high frequency type, suitable for use up to 35 mc. Adjusting screw protrudes through center hole of standard octal socket.
No. 74001, with iron core..... \$
No. 74002, less iron core.....

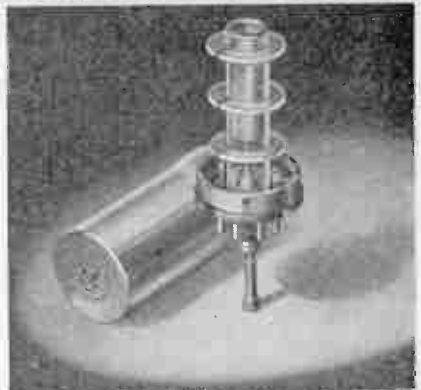

34108

RF CHOKES
Many have copied, few have equalled, and none have surpassed the genuine original design Millen Designed for Application series of midget RF Chokes. The more popular styles now in constant production are illustrated herewith. Special styles and variations to meet unusual requirements quickly furnished.

Figures 1 and 4 illustrate special types of RF chokes available on order. The popular 34300 and 34200 series are shown in figures 2 and 3 respectively.

General Specifications: 2.5 mH, 250 mA for types 34100, 34101, 34102, 34103, 34104, and 1 mH, 300 mA for types 34105, 34106, 34107, 34108, 34109.

- No. 34100..... \$
- No. 34101.....
- No. 34102.....
- No. 34103.....
- No. 34104.....

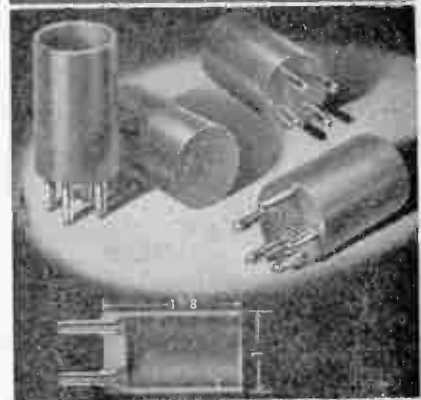

2

MIDGET COIL FORMS
Made of low loss mica filled brown bakelite. Guide funnel makes for easy threading of leads through pins.
No. 45000..... \$
No. 45004.....
No. 45005.....

OCTAL BASE AND SHIELD
Low loss phenolic base with octal socket plug and aluminum shield can 1 1/8 x 1 1/8 x 3 1/8.
No. 74400..... \$



74400

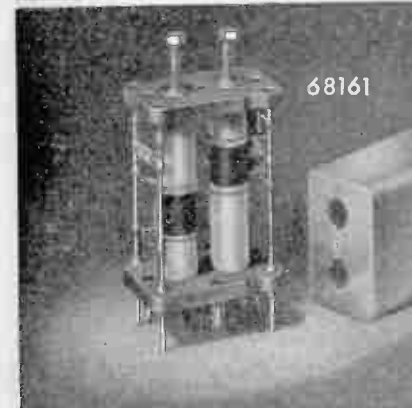

68161

I.F. TRANSFORMERS
The Millen "Designed for Application" line of I.F. transformers includes air condenser tuned, and permeability tuned types for all applications. Standard stock units are for 456, 1600 and 5000 kc.B.F.O. also available.

PERMEABILITY TUNED CERAMIC FORMS
In addition to the popular shielded plug-in permeability tuned forms, 74000 series, the 69040 series of ceramic permeability tuned unshielded forms are available as standard stock items. Winding diameters and lengths of winding space are 1 1/2 x 7/8 for 69041-2; 1/4 x 3/8 for 69043-7-8; 1/2 x 1 1/8 for 69045-6; 3/8 x 3/8 for 69044.
No. 69041—(Copper Slug)..... \$
No. 69042—(Iron Core).....
No. 69043—(Iron Core).....
No. 69044—(Copper Slug).....
No. 69045—(Copper Slug).....
No. 69046—(Iron Core).....
No. 69047—(Copper Slug).....
No. 69048—(Iron Core).....

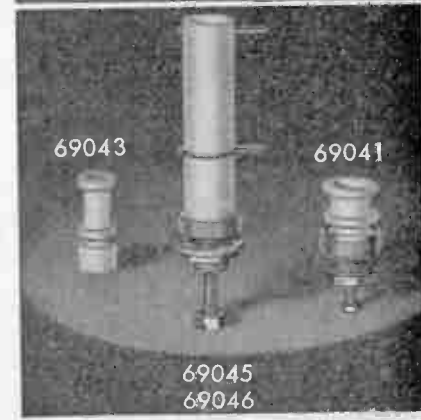

69043

69041

69045

69046

JAMES MILLEN

MALDEN · MASSACHUSETTS

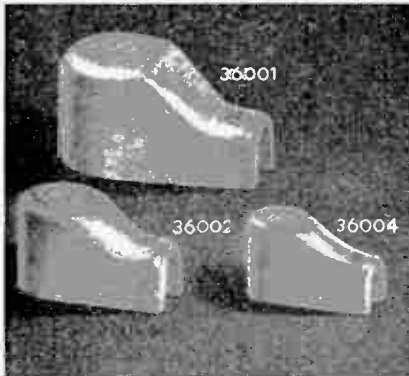

CERAMIC PLATE OR GRID CAPS

Soldering lug and contact one-piece. Lug ears annealed and solder dipped to facilitate easy combination "mechanical plus soldered" connection of cable.

- No. 36001—9/16"..... \$
- No. 36002—3/8".....
- No. 36004—1/4".....

SNAP LOCK PLATE CAP

For Mobile, Industrial and other applications where tighter than normal grip with multiple finger 360° low resistance contact is required. Contact self-locking when cap is pressed into position. Insulated snap button at top releases contact grip for easy removal without damage to tube.

- No. 36011—9/16"..... \$
- No. 36012—3/8".....

SAFETY TERMINAL

Combination high voltage terminal and thru-bushing. Tapered contact pin fits firmly into conical socket providing large area, low resistance connection. Pin is swivel mounted in cap to prevent twisting of lead wire.

- No. 37001, Black or Red..... \$
- No. 37501, Low loss.....

TERMINAL STRIP

A sturdy four-terminal strip of molded black Textolite. Barriers between contacts. "Non turning" studs, threaded 8/32 each end.

- No. 37104..... \$

POSTS, PLATES and PLUGS

Designed for Application! Compact, easy to use. Made in black and red regular bakelite as well as low loss brown mica filled bakelite or steatite for R.F. uses. Posts have captive head.

- No. 37202 Plates (pr.)..... \$
- No. 37212 Plugs.....
- No. 37222 Posts (pr.).....

STEATITE TERMINAL STRIPS

Terminal and lug are one piece. Lugs are Navy turret type and are free floating so as not to strain steatite during wide temperature variations. Easy to mount with series of round holes for integral chassis bushings.

- No. 37302..... \$
- No. 37303.....
- No. 37304.....
- No. 37305.....
- No. 37306.....

CATHODE RAY TUBE SHIELDS

For many years we have specialized in the design and manufacture of magnetic metal shields of nicolai and mumetal for cathode ray tubes in our own complete equipment, as well as for applications of all other principal complete equipment manufacturers. Stock types as well as special designs to customers' specifications promptly available.

- No. 80045—Nicolai for 5BP1..... \$
- No. 80055—Nicolai for 5CP1.....
- No. 80043—Nicolai for 3" tube.....
- No. 80042—Nicolai for 2" tube.....

BEZELS FOR CATHODE RAY TUBES

Standard types are of satin finish black plastic. 5" size has neoprene support cushion and green lucite filter. 3" and 2" sizes have integral cushioning.

- No. 80075—5"..... \$
- No. 80073—3".....
- No. 80072—2".....
- No. 80071—1".....

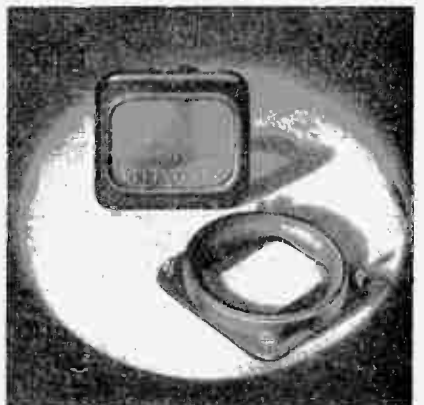
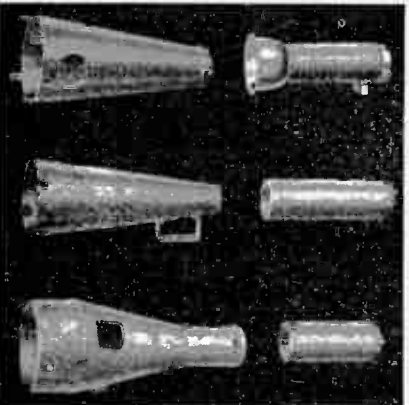
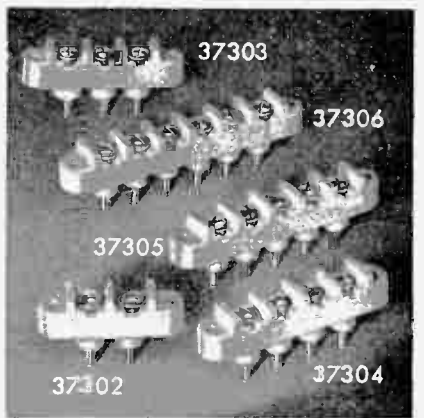
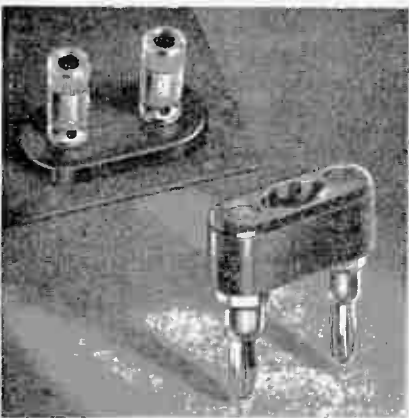
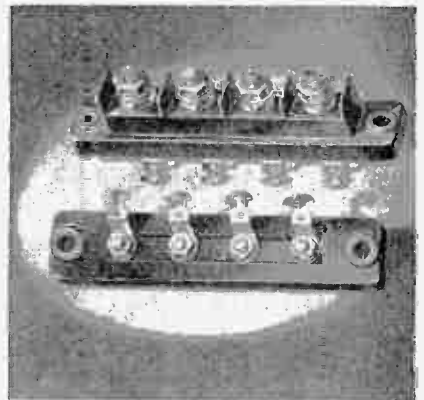
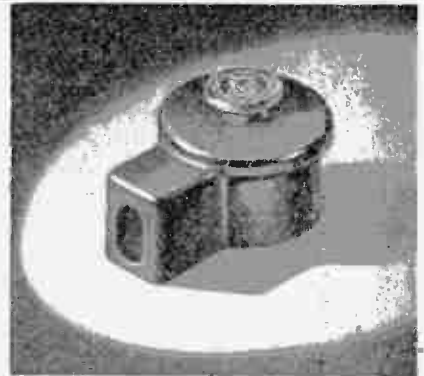

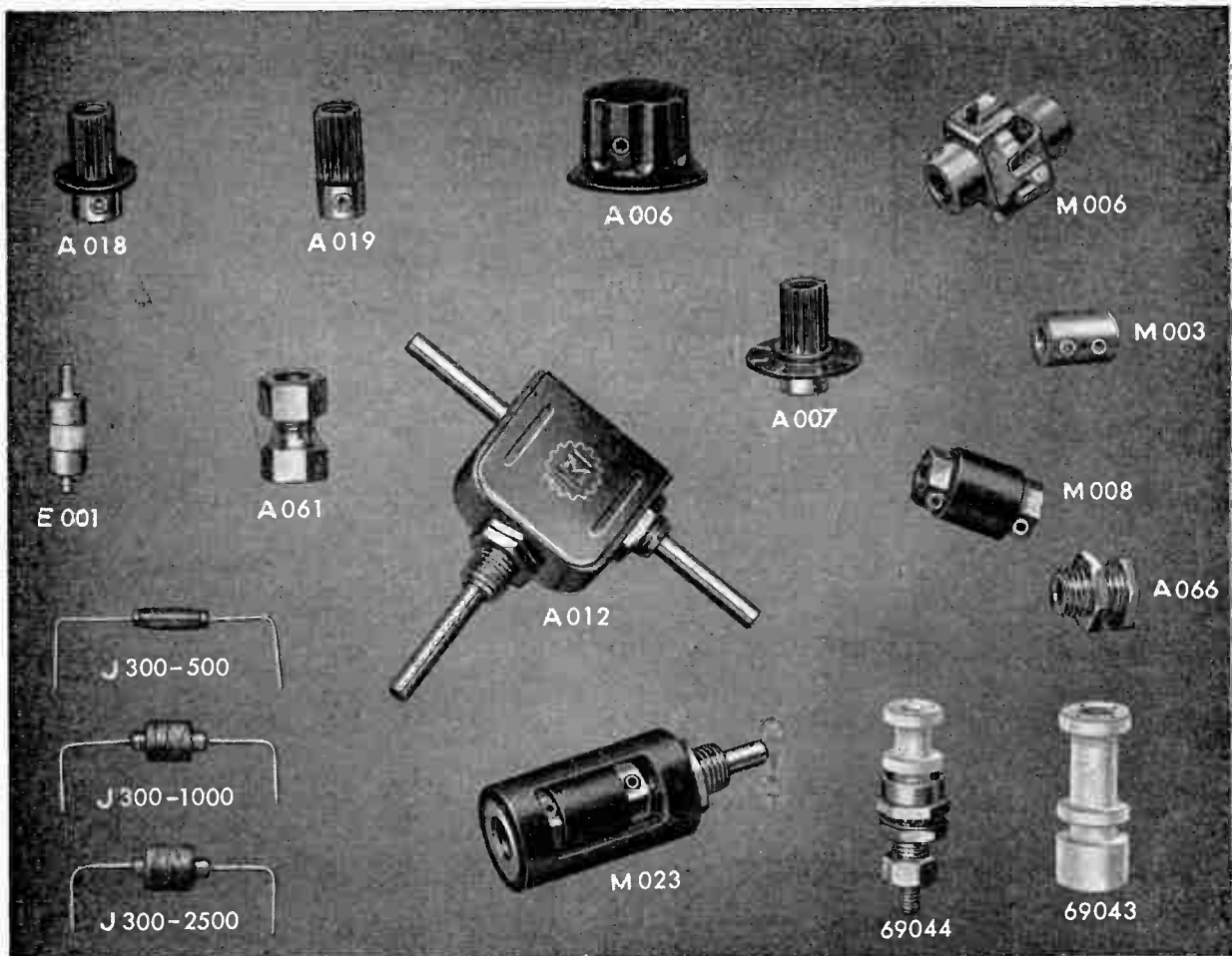

MINIATURIZED COMPONENTS

DESIGNED for APPLICATION miniaturized components developed for use in our own equipment such as the 90901 Oscilloscope, are now available for separate sale. Many of these parts are similar in most details except size with their equivalents in our standard component parts group and in certain devices where complete miniaturization is not paramount, a combination of standard and miniature components may possibly be used to advantage. For convenience, we have also listed on this page the extremely small sized coil forms from our standard catalogue. Additional miniature and subminiature components are in process of design and will be announced shortly.

CODE	DESCRIPTION	NET PRICE
A006	Matches standard knobs in style. Black plastic with brass insert. For $\frac{1}{8}$ " shaft. Overall height $\frac{1}{2}$ ". Diameter $\frac{3}{4}$ ".	\$
A007	Same as A018 except for $\frac{3}{8}$ " diameter plastic dial with 5 index lines.	
A012	Right angle drive. $\frac{1}{8}$ " diameter shafts. Single hole mounting bushing $\frac{1}{4}$ "-32 diameter.	
A018	$\frac{1}{4}$ " diameter black plastic knob with brass insert for $\frac{1}{8}$ " shaft. Skirt diameter $\frac{3}{8}$ ". Overall height $\frac{3}{8}$ ". Unique design has screwdriver slot in top.	

CODE	DESCRIPTION	NET PRICE
A019	Similar to A018, but without flange.	\$
A061	Shaft lock for $\frac{1}{8}$ " diameter shaft. $\frac{1}{4}$ "-32 bushing. Nickel plated brass.	
A066	Shaft bearing for $\frac{1}{8}$ " diameter shafts. Nickel plated brass. Fits $\frac{1}{4}$ " diameter hole.	
E001	Stegite standoff or tie-point integral mounting eyelet .205 overall diameter. Box of five.	
J300-500	Iron core RF choke 500 uh.	
J300-1000	Iron core RF choke 1000 uh.	
J300-2500	Iron core RF choke 2500 uh.	
M003	Solid coupling for $\frac{1}{8}$ " diameter shaft. Nickel plated brass.	
M006	Universal joint style flexible coupling. Spring finger. Steagite insulation. Nickel plated brass for $\frac{1}{8}$ " diameter shafts.	
M008	Insulated coupling, with nickel plated brass inserts or $\frac{1}{8}$ " diameter shafts.	
M023	Insulated shaft extension for mounting sub miniature potentiometer with $\frac{1}{8}$ " diameter shafts and $\frac{1}{4}$ "-32 bushing.	
69043	Stegite coil form. Adjustable core. Top tuned. Topped 4-40 hole in case for mounting. Winding space $\frac{1}{4}$ " diameter x $\frac{1}{32}$ " length.	
69044	Stegite coil form. Adjustable brass core. Bottom tuned. Mounting by No. 1D-32 brass base. Winding space .187 diameter by $\frac{1}{16}$ " length.	

JAMES MILLEN
MALDEN · MASSACHUSETTS

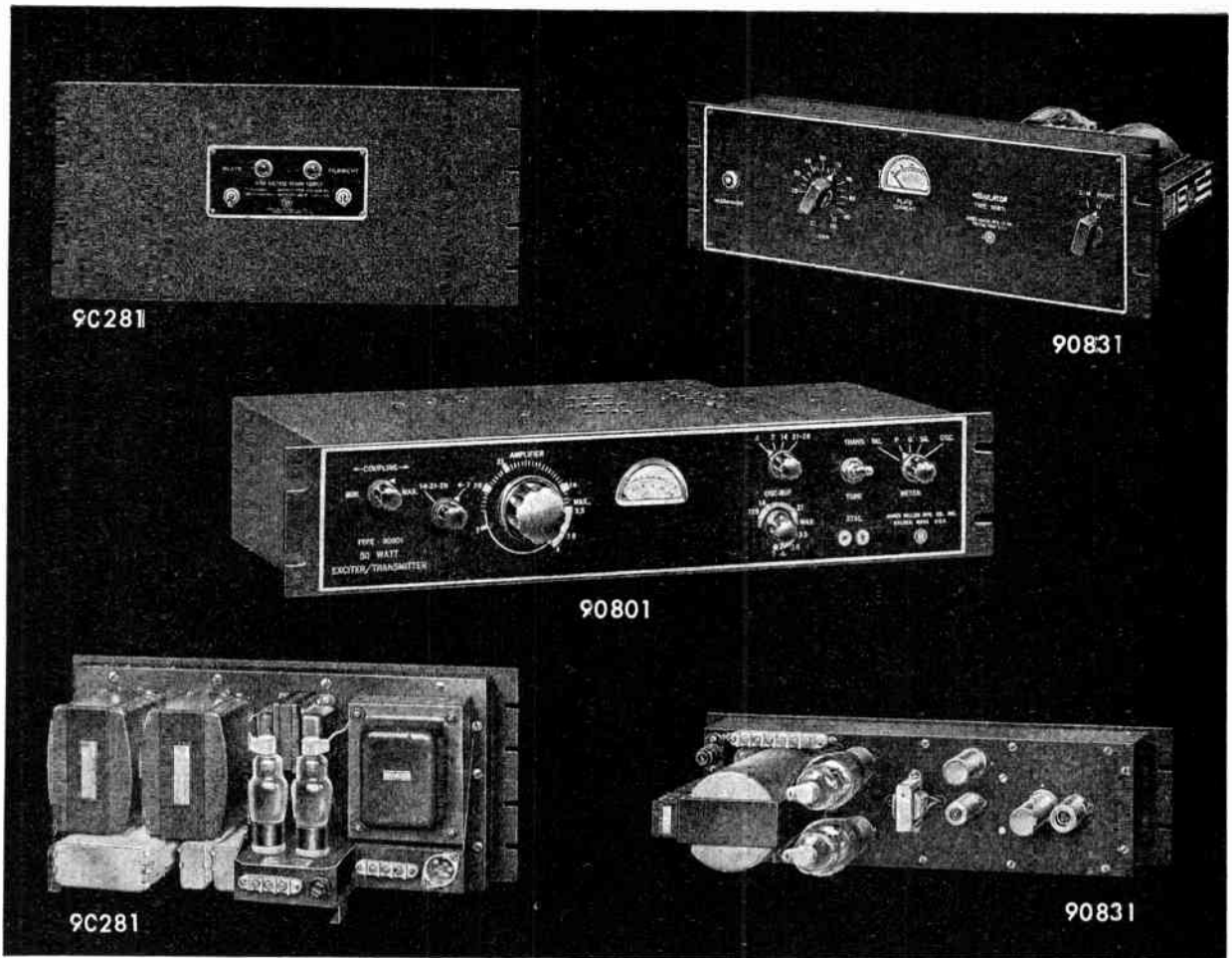

Exciters, Modulators and Power Supplies

EXCITER-TRANSMITTER

The 90801 Exciter-Transmitter is of the most modern design including features and shielding for TVI reduction, band-switching for the 4-7-14-21 and 28 megacycle bands, circuit metering. Conservatively rated for use either as a transmitter or exciter. 5763 oscillator-buffer-multiplier and 6146 power amplifier. 90 watts input for CW. Can be keyed in the oscillator and/or amplifier or by means of keyed external V.F.O. such as the 90711. 67 watts input phone. Rack mounted. 3½" panel height.

No. 90801, less tubes.....\$60.00

HIGH VOLTAGE POWER SUPPLY

The 90281 high voltage power supply has a d.c. output of 550 to 700 volts, with maximum current of 235 ma. In addition, a.c. filament power of 6.3 volts at 4 amperes is also available. This power supply is an ideal unit for use with transmitters as well as general laboratory purposes. A single power supply will provide high voltage for both the 90801 Transmitter and the 90831 Modulator. Uses 2 — 816 mercury vapor rectifiers and incorporates a two section filter which results in excellent regulation and very low ripple. Rack mounted. 8¾" panel height.

No. 90281, less tubes.....\$60.00

MODULATOR

The 90831 40 watt modulator designed especially for use with 90801 transmitter. 12AX7 speech amplifier-6C4 voltage amplifier-class AB1 6146's. Suitable for modulating transmitters with power input up to 80 watts. Gain is ample for the use of low level, high impedance crystal or dynamic microphones. Frequency response is adjusted for good communication intelligibility with limited side bands. Modulator incorporates a switch for complete change-over of modulator and transmitter from CW to 'phone. Rack mounted. 5¼" panel height.

No. 90831, less tubes.....\$60.00

LOW VOLTAGE POWER SUPPLY

(not illustrated)

The 90201 is a compact uncased regulated and general purpose power supply either for table use, in the laboratory or for incorporation as an integral part of larger equipments. It will provide modulator and exciter low voltage as well as bias and heater voltages when used with the 90801 and 90831. Its multiple outputs include 250 volt 125 ma. unregulated — 105 volt 35 ma. regulated-bias voltage to minus 100 volts — 6.3 volt filament power at 4.2 amperes.

Model 90201, with tubes.....\$60.00

JAMES MILLEN
MALDEN · MASSACHUSETTS

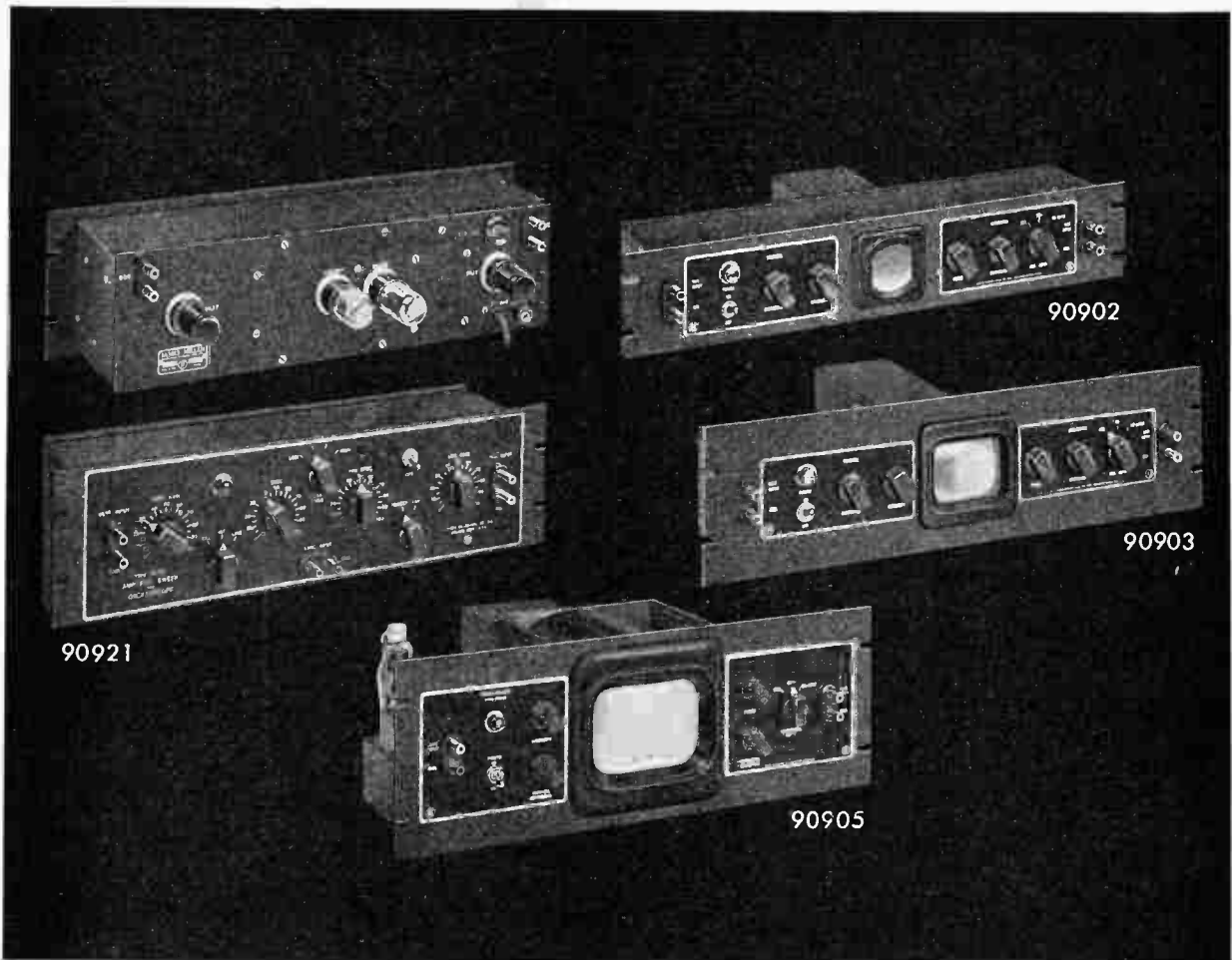

The Oscilloscopes and the Amplifier Sweep

The oscilloscopes in their packaged form are entirely adequate for many laboratory as well as industrial and communication uses. As a transmitter modulation monitor, no additional equipment or accessories are required. By the addition of such units as sweeps, pulse generators, amplifiers, servo sweeps, etc., all of which can be conveniently and neatly constructed on companion rack panels, the original basic scope unit can be expanded to serve any conceivable application.

Here again the research engineer is freed of the drudgery of time consuming mechanical construction and other such details of the basic scope before being able to proceed with his specialized work.

The oscilloscopes are designed for standard rack mounting and incorporate mumetal shielding and power supply as well as functional controls.

NO. 90902 TWO INCH OSCILLOSCOPE

Power Supply: 105-125 volts — 60 cycles. Power consumption — 19 watts

Physical Dimensions: Height — 3½ Inches, Width — 19 Inches, Depth — 9½ Inches. Weight — 12 Pounds

Tube Complement: 1 — 2B1P1 — Cathode Ray Tube, 1 — 2X2-A High Voltage Rectifier

Deflection Sensitivity: Vertical — 100 volts d.c. per inch. Horizontal — 120 volts d.c. per inch

No. 90902: Two Inch Oscilloscope less tubes..... \$00.00

NO. 90903 THREE INCH OSCILLOSCOPE

Power Supply: 105-125 volts — 60 cycles. Power consumption — 19 watts

Physical Dimensions: Height — 5¼ Inches, Width — 19 Inches, Depth — 13½ Inches. Weight — 14 Pounds

Tube Complement: 1 — 3KP1 Cathode Ray Tube, 1 — 2X2-A High Voltage Rectifier

Deflection Sensitivity: Vertical — 40 volts d.c. per inch. Horizontal — 16 volts d.c. per inch

No. 90903: Three Inch Oscilloscope less tubes..... \$00.00

NO. 90905 FIVE INCH OSCILLOSCOPE

Power Supply: 105-125 volts — 60 cycles. Power consumption — 32 watts

Physical Dimensions: Height — 6½ Inches, Width — 19 Inches, Depth (Overall) — 16½ Inches. Weight — 21 Pounds

Tube Complement: 1 — 5U1P — Cathode Ray Tube, 1 — 2X2-A — Negative High Voltage Rectifier, 1 — 5Y3-GT-Positive High Voltage Rectifier

Deflection Sensitivity: Vertical — 50 volts d.c. per inch. Horizontal — 60 volts d.c. per inch

No. 90905: Five Inch Oscilloscope less tubes..... \$00.00

The Millex 90921 Amplifier-Sweep may be used with any basic oscilloscope even though designed especially for use with the Millex 90902, 90903 and 90905 basic oscilloscopes. It contains both horizontal and vertical amplifiers together with a sawtooth sweep generator using a "hard" tube oscillator. The sweep amplifier is designed for standard rack mounting and matches the MILLEX basic oscilloscopes in appearance.

NO. 90921 AMPLIFIER SWEEP

Power Supply: 105-125 volts — 60 cycles. Power consumption — 32 watts

Physical Dimensions: Height — 5¼ Inches, Width — 19 Inches, Depth (Overall) — 8¾ Inches. Weight — 13 Pounds

Tube Complement: 2 — 6SJ7s Vertical and Horizontal Amplifiers, 1 — 6SN7-GT-Sweep Generator, 1 — 5Y3-GT-Rectifier

Gain of each amplifier — Approximately 25 db.

Frequency Response — 15 cycles to 125 kilocycles. Flat within 2 db.

Sweep Frequencies — 15 cycles to 10 kilocycles, 1 overlapping ranges

Maximum D.C. to amplifier input — 400 volts

Maximum undistorted amplifier output — Approximately 70 volts peak

to peak both vertical and horizontal amplifiers

No. 90921 Amplifier-Sweep with tubes..... \$00.00

JAMES MILLEN
MALDEN · MASSACHUSETTS

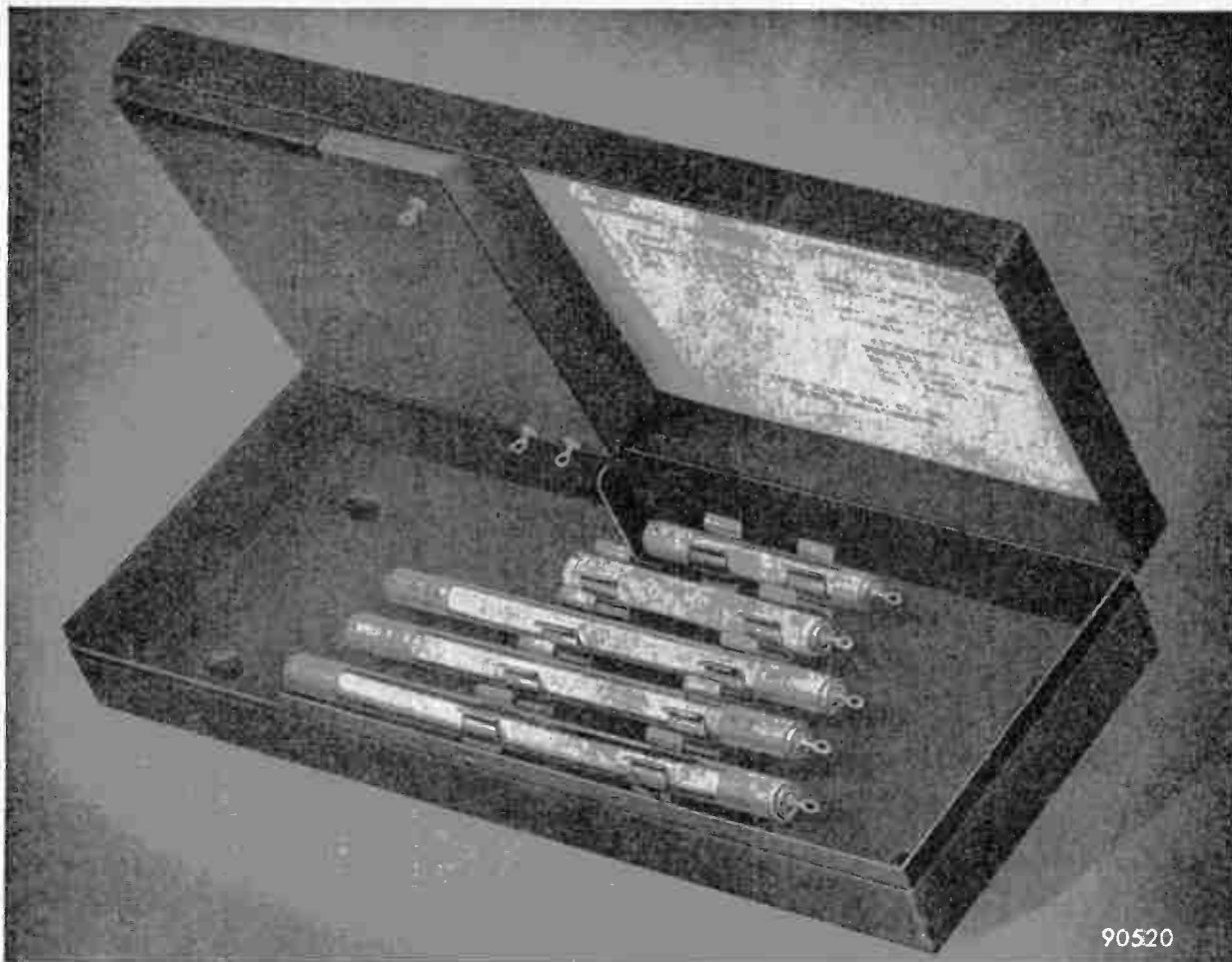

90520

LABORATORY DELAY LINE STANDARDS

The Millen delay line kit effectively provides a means for the development and design engineer to check the affect of various delays in their actual developmental setups without the time loss and expense of producing separate lines for each trial. Increased requirement for time delay circuits in radar, color television and other modern electronic applications has presented a problem to the design and development engineer as it has been both time consuming and expensive to obtain delay lines for developmental work as each line was necessarily cut to the estimated delay and any change in requirements necessitated the fabrication of a new delay line. The Millen delay line kit is designed to provide a ready means of obtaining various delays from .10 microseconds through 2 microseconds in increments of .05 microseconds except at the extreme end of this range. The lines may be used repeatedly without deterioration as they are hermetically sealed, the smaller lines in glass tubes, the 1 microsecond line in a metal container.

Each set consists of:

NOMINAL DELAY	TOL.	CALIBRATION TOLERANCE
2—.10 μ s.	\pm 0.01 μ s.	\pm 0.002 μ s.
2—.25 μ s.	\pm 0.025 μ s.	\pm 0.002 μ s.
1—.30 μ s.	\pm 0.03 μ s.	\pm 0.002 μ s.
1—1.00 μ s.	\pm 0.05 μ s.	\pm 0.01 μ s.

Actual delay as measured by phase shift method are marked on each delay line. The laboratory calibration of each delay line is accurate to \pm 0.002 microseconds on all of the .10 microsecond, .25 microsecond and .03 microsecond lines and \pm 0.01 microsecond on the 1 microsecond line. Combination of delay lines supplied makes possible the following delays:

0.10 μ s.	0.55 μ s.	1.10 μ s.	1.55 μ s.
0.20	0.60	1.20	1.60
0.25	0.65	1.25	1.65
0.30	0.70	1.30	1.70
0.35	0.75	1.35	1.75
0.40	0.80	1.40	1.80
0.45	0.90	1.45	1.90
0.50	1.00	1.50	2.00

Characteristic impedance — 1350 ohms \pm 20%.

PHYSICAL DIMENSIONS:

0.1 μ s.	$1\frac{1}{2}$ " dia. x $4\frac{1}{8}$ " long
0.25 μ s.	$1\frac{1}{2}$ " dia. x $7\frac{3}{8}$ " long
0.30 μ s.	$1\frac{1}{2}$ " dia. x $7\frac{3}{8}$ " long
1.00 μ s.	$4\frac{3}{4}$ " x $4\frac{3}{4}$ " x 1"

All seven lines are mounted in a metal case $9\frac{1}{2}$ " x 5" x $1\frac{3}{4}$ " for convenience in storing and safety in handling.

JAMES MILLEN
M A L D E N · M A S S A C H U S E T T S

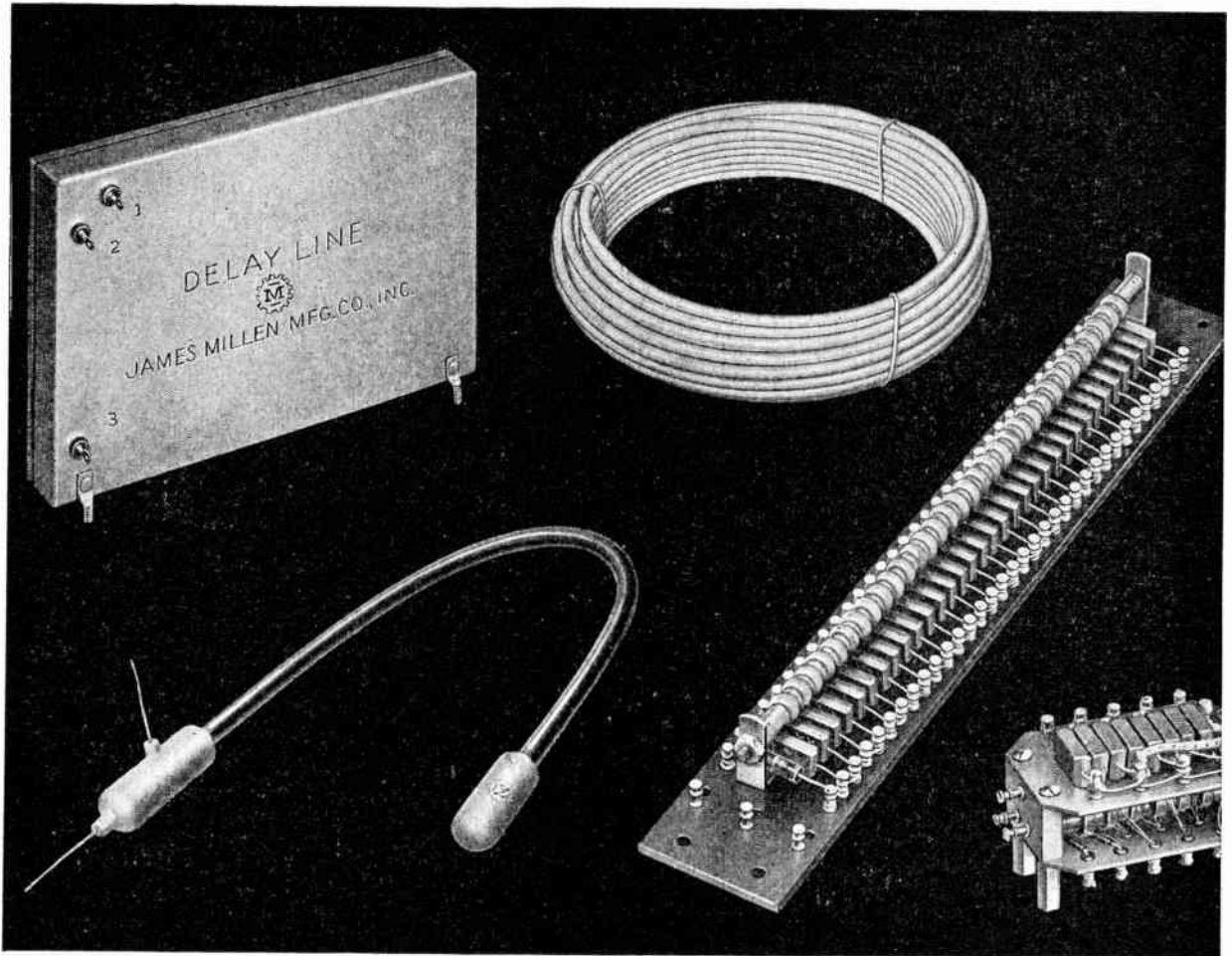

"Designed for Application"

Delay Lines and Networks

The James Millen Mfg. Co., Inc. has been producing continuous delay lines and lump constant delay networks since the origination of the demand for these components in pulse formation and other circuits requiring time delay. The most modern of these is the distributed constant delay line designed to comply with the most stringent electrical and mechanical requirements for military, commercial and laboratory equipment.

Millen distributed constant line is available as bulk line for laboratory use and in either flexible or metallic hermetically sealed units adjusted to exact time delay for use in production equipment. Lump constant delay networks may be preferred for some specialized applications and can be furnished in open or hermetically sealed construction. The above illustrates several typical lines of both types. Our engineers are available to assist you in your delay line problems.

JAMES MILLEN
MALDEN · MASSACHUSETTS

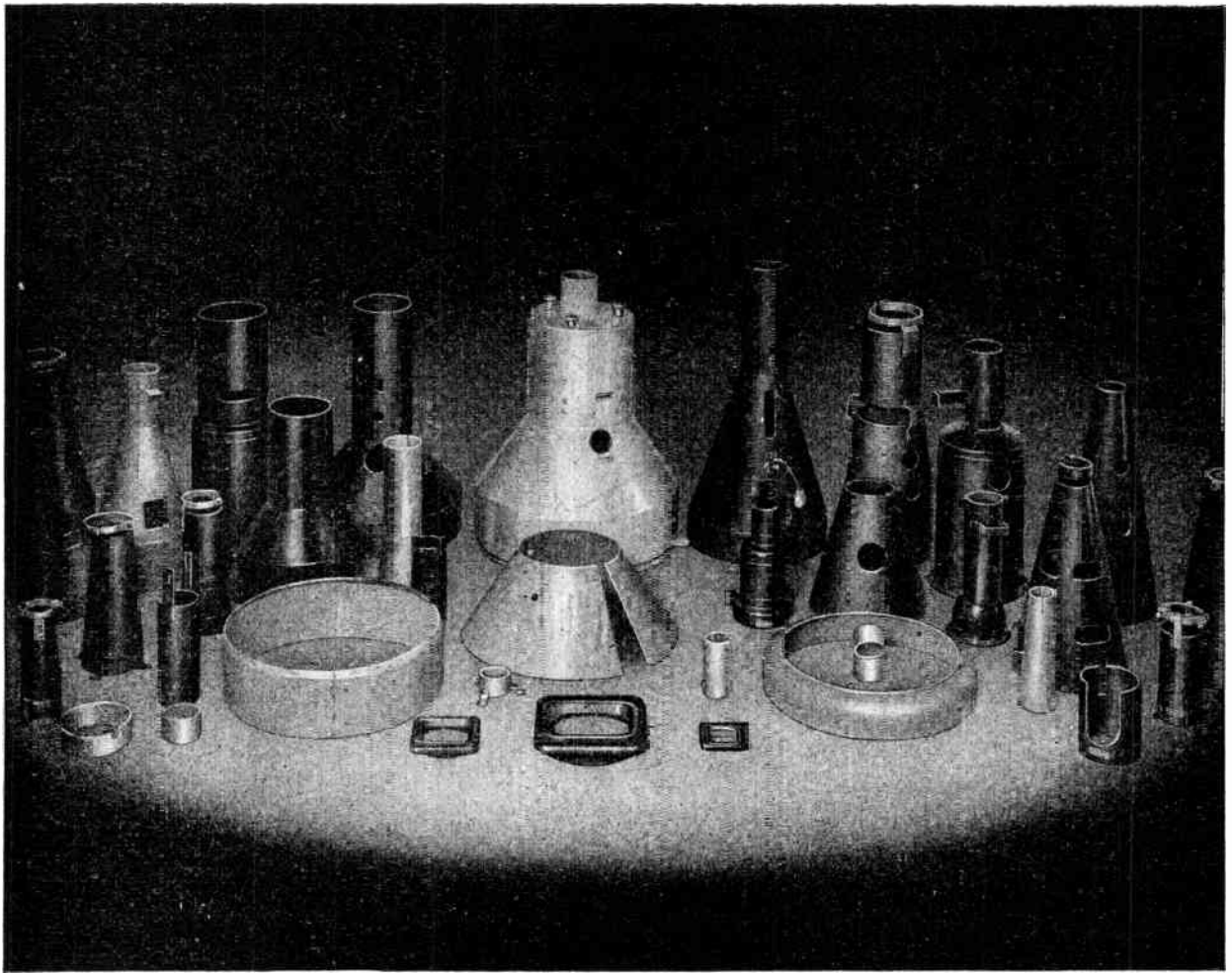

Designed for Application

Mu Metal Shields

The James Millen Mfg. Co. Inc. has for many years specialized in the production of magnetic metal cathode ray tube shields for the entire electronics industry, supplying magnetic metal shields to manufacturing companies, laboratories and research organizations. Stock shields are immediately available for all of the more popular sizes and types of cathode ray tubes as well as bezels for 2", 3" and 5" size tubes.

Many production problems, however, make desirable special shields designed in conjunction with the specialized requirement of the basic apparatus. Herewith, are illustrated a number of such custom built shields. Our custom design and fabrication department is at the service of our customers for the development and manufacture of magnetic metal shields of either nicoloi or mumetal for such specialized applications.

JAMES MILLLEN
MALDEN · MASSACHUSETTS

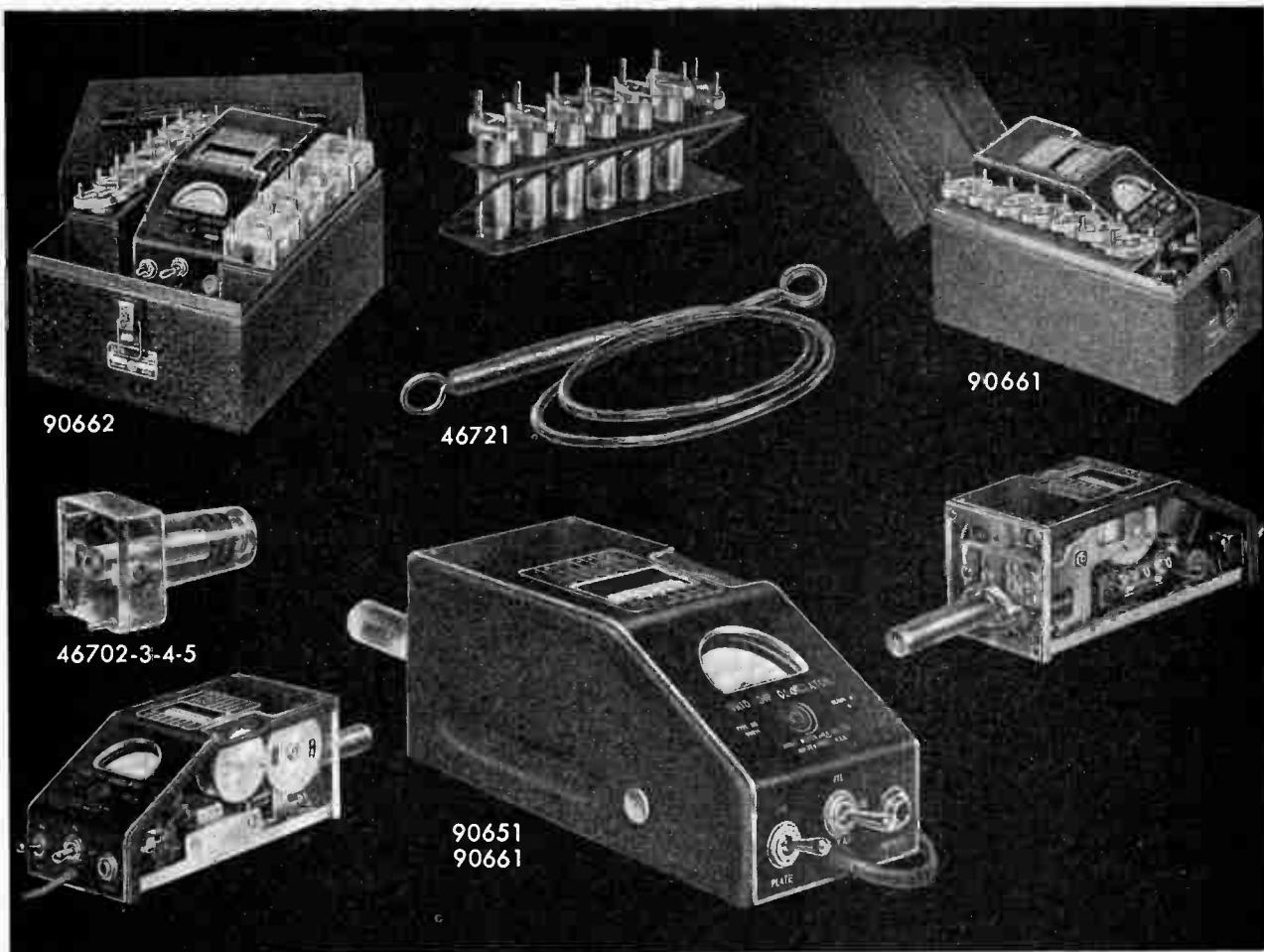

Grid Dip Meters

Millen Grid Dip Meters are available to meet all various laboratory and servicing requirements.

The 90662 Industrial Grid Dip Meter completely calibrated for laboratory use with a range from 225 kc. to 300 mc. incorporates features desired for both industrial and laboratory application, including three wire grounding type power cord and suitable carrying case.

The 90661 Industrial Grid Dip Meter is similar to the 90662 except for a reduced range of 1.7 to 300 mc. It likewise incorporates the three wire grounding type cord and metal carrying case.

The 90651 Standard Grid Dip Meter is a somewhat less expensive version of the grid dip meter. The calibration while adequate for general usage is not as complete as in the case of the industrial model. It is supplied without grounding lead and without carrying case. The range is 1.7 to 300 mc. Extra inductors available extends range to 220 kc.

The Millen Grid Dip Meter is a calibrated stable RF oscillator unit with a meter to read grid current. The frequency determining coil is plugged into the unit so that it may be used as a probe.

These instruments are complete with a built-in transformer type A.C. power supply and interterminal terminal board to provide connections for battery operation where it is desirable to use the unit on antenna measurements and other usages where A.C. power is

not available. Compactness has been achieved without loss of performance or convenience of usage. The incorporation of the power supply, oscillator and probe into a single unit provides a convenient device for checking all types of circuits. The indicating instrument is a standard 2 inch General Electric instrument with an easy to read scale. The calibrated dial is a large 205° drum dial which provides seven direct reading scales, plus an additional universal scale, all with the same length and readability. Each range has its individual plug-in probe completely enclosed in a contour fitting polystyrene case for assurance of permanence of calibration as well as to prevent any possibility of mechanical damage or of unintentional contact with the components of the circuit being tested.

The Grid Dip Meters may be used as:

1. A Grid Dip Oscillator
2. An Oscillating Detector
3. A Signal Generator
4. An Indicating Absorption Wavemeter

The most common usage of the Grid Dip Meter is as an oscillating frequency meter to determine the resonant frequencies of de-energized tuned circuits.

Size of Grid Dip Meter only (less probe): 7 in. x 3 $\frac{3}{16}$ in. x 3 $\frac{3}{8}$ in.

JAMES  **MILLEN**
 MALDEN · MASSACHUSETTS

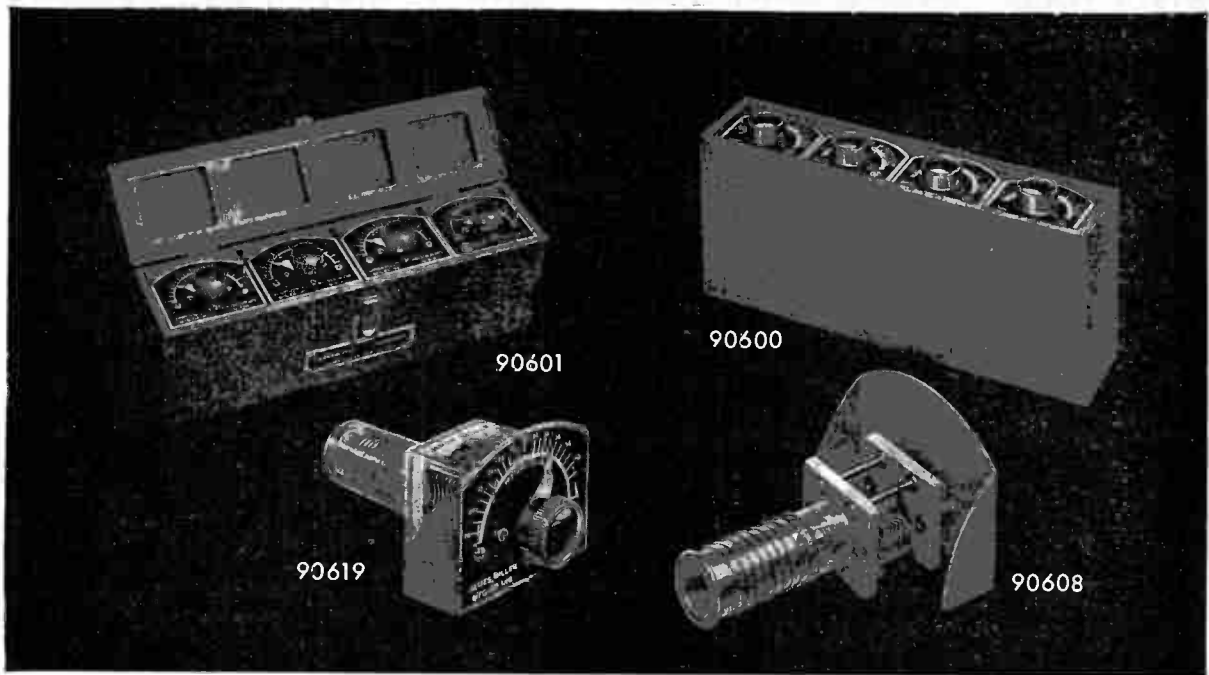

Midget Absorption Frequency Meters

Many amateurs and experimenters do not realize that one of the most useful "tools" of the commercial transmitter designer is a series of very small absorption type frequency meters. These handy instruments can be poked into small shield compartments, coil cans, corners of chassis, etc., to check harmonics; parasitics; oscillator-doubler, etc., tank tuning; and a host of other such applications. Quickly enables the design engineer to find out what is really "going on" in a circuit.

Types 90605 thru 90609 are extremely small and designed primarily for engineering laboratory use where they

will be handled with reasonable care. The most useful combination being the group of four under code No. 90600 and covering the total range of from 3.0 to 140 megacycles. When purchased in sets of four under code No. 90600 a convenient carrying and storage case is included. Series 90601 are slightly larger and very much more rugged. They are further protected by a contour fitting transparent polystyrene case to protect against damage and dirt. This latter series is designed primarily for field use and are not quite as convenient for laboratory use as the 90605 thru 90608 types. All types have dials directly calibrated in frequency.

Code	Description	Net Price
90604	Range 160 to 210 mc.	\$
90605	Range 3.0 to 10 mc.	
90606	Range 9.0 to 23 mc.	
90607	Range 23 to 60 mc.	
90608	Range 50 to 140 mc.	
90609	Range 130 to 170 mc.	
90610	Range 105 to 150 mc.	
90619	Range 350 to 1000 kc.—Neon Indicator	
90620	Range 150 to 350 kc.—Neon Indicator	
90625	Range 2 to 6 mc.—Neon Indicator	
90626	Range 5.5 to 15 mc.—Neon Indicator	
90605H	Complete set of 90605 thru 90608, in case	
90601	Complete set Field type Frequency Meters in metal carrying case 1.5 to 40 mc.	

DISTRICT SALES OFFICES

NEW YORK
Cooper-DiBlosi
259 W. 14th Street

SEATTLE
V. Jensen
2616 Second Avenue

SAN FRANCISCO
Mouthrop & Hunter
160 Tenth Street

DALLAS
Jack Yount
1431 Pleasant Drive

GREENSBORO, N. C.
Atcheson & Adams
P.O. Box 2158

CANADA
H. R. Gray
46 Danforth Rd.
Toronto

PHILADELPHIA
L. D. Lowery
50 E. Wynnewood Rd.
Wynnewood

INDIANAPOLIS
V. MacNobb
915 Westfield Blvd.

CHICAGO
G. G. Ryon
549 W. Washington Blvd.

LOS ANGELES
W. Bert Knight
10373 W. Pico Blvd.

MINNEAPOLIS
Merrill Franklin Co.
338 E. Franklin Ave.

EXPORT
Technical Equipment Co.
Main & Milton Sts.
Rohway, N. J.

BOSTON
Harry Gerber
739 Boylston Street

KANSAS CITY
J. O. Schmitz
34th & Broadway Aves.

JAMES MILLEN
MAIN OFFICE



MFG. CO., INC.
AND FACTORY

150 EXCHANGE ST., MALDEN, MASSACHUSETTS, U. S. A.

Copyrighted 1954 by J. M. Mfg. Co., Inc. Printed in U. S. A.

HAMMARLUND

DATA TRANSMISSION • SELECTIVE CALLING AND SUPERVISORY CONTROL EQUIPMENT

POINT TO POINT SIGNALING

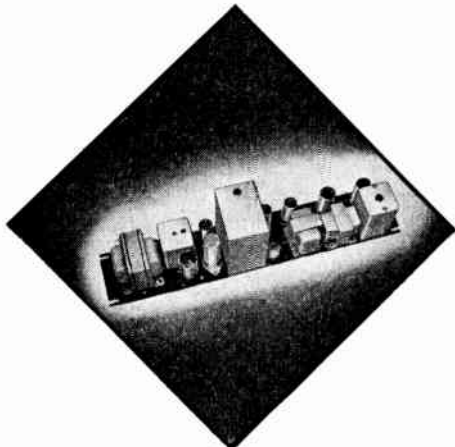

The Hammarlund Standard Duplex Signaling Unit consists of a tone generator and receiver designed to operate over wire lines, telephone or power line carrier, and radio or microwave communications circuits for signaling, dialing, slow speed telemetering, supervisory controls or other information. Transmitters and receivers are available for 36 frequency channels between 2000 and 6475 cps. This equipment is being used by military and governmental agencies, pipeline and power companies, railroads and other groups requiring remote on-off switching, continuous indication of operating conditions, and automatic detection of wire line or power source failures along their systems.

PROTECTION THROUGH SUPERVISORY CONTROL

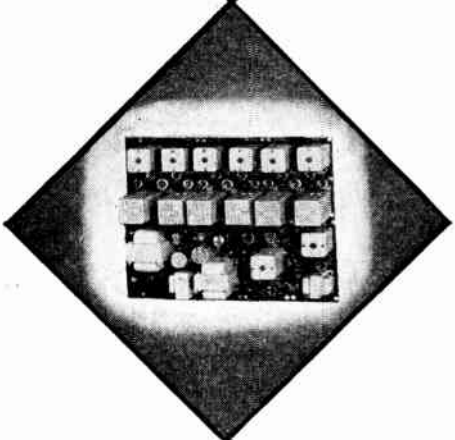

The Hammarlund "Multi-Gate" Remote Supervisory and Control System is engineered to provide highly efficient, fully reliable operational controls of important remote equipment such as used by refineries, pipelines, utilities, railroads, civil defense and other commercial, as well as military, groups. Because of a unique design by which a single tone activates a receiver, which in turn will then accept a second tone to operate a relay, this equipment can be used where disturbances on connecting wire or radio circuits make ordinary tone-operated remote controls impractical. Up to 21 individual on-off functions can be handled over a single circuit employing only 7 audio signaling tones.

SELECTIVE CALLING OR SIGNALING

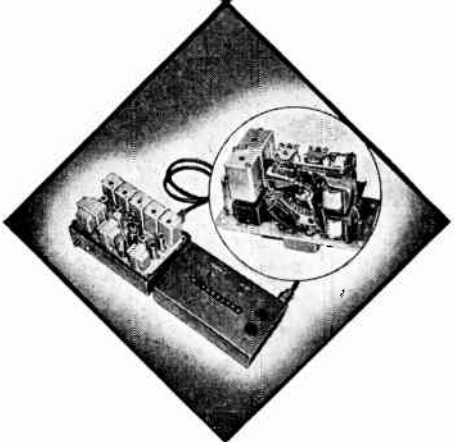

Hammarlund Selective Calling equipment, added to 2-way radio systems used to control large fleets of vehicles, or distant fixed stations, adds privacy, speed, safety, quietness and convenience to day-in-day-out operations. By the push of a button the dispatcher within 0.8 of a second selects the station which he wants to contact. Only the selected operator or group of operators can receive the call. If the operator of the car or station being called doesn't answer, an indicator lamp remains lighted to show he was called. This simple equipment can be added to any present installation, or incorporated in any type of installation now projected.

THE HAMMARLUND MANUFACTURING COMPANY, INC.

HAMMARLUND

COMMUNICATIONS RECEIVERS

The New "HQ-140-X"

The "HQ-140-X" is a new superheterodyne type receiver that provides amateurs and other short wave listeners with all the advantages of modern professional design and circuitry. In addition, it incorporates those outstanding features that have made Hammarlund "HQ's" famous for quality and performance. This receiver retains the high degree of sensitivity and selectivity of the "HQ-129-X," and in addition features notably improved frequency stability and image ratio. It covers a continuous range of frequencies from 540 kc to 31 mc, or from 555 meters to 9.7 meters, in six bands.

Band spread tuning is supplied on the four higher frequency bands, with actual calibration in the 80, 40, 20, 15, and 10 meter amateur bands. Many types of noise and other interference have been substantially reduced by the outstanding noise limiter and the special Hammarlund patented crystal filter.



FEATURES

TUNING RANGES: .54—1.32 mc, 1.32—3.2 mc, 3.2—5.7 mc, 5.7—10 mc, 10—18 mc, and 18—31 mc.

CALIBRATED BAND SPREAD: 3.5—4 mc, 7—7.3 mc, 14—14.4 mc, 20.9—21.6 mc, and 28—30 mc.

TUBE LINE-UP: 6C4 Oscillator, 6BA6 RF Amplifier, 6BE6 Mixer, 6BA6 1st IF Amplifier, 6BA6 2nd IF Amplifier, 6BA6 3rd IF Amplifier, 6AL5 combination detector, AVC and noise limiter, 12AU7 1st AF Amplifier and BFO, 6V6GT/G Audio Power Output, OC3/VR105 Voltage Regulator and 5U4G Full Wave Rectifier.

The "SP-600-JX"

The "SP-600-JX" communications receiver, now also available to hams, is a masterpiece of receiver design and already is world-known for its outstanding construction and performance. This professional receiver, with its six bands covering the frequency spectrum from 540 kc to 54 mc, is being used in large quantities by the military and governmental agencies, as well as by commercial services, for both single and diversity reception.

This magnificent receiver is a 20 tube dual conversion superheterodyne. The power supply is an integral part of the receiver chassis. Operation on any of six crystal controlled fixed frequency channels within the range of the receiver is immediately available. This designates it as the perfect receiver for point-to-point and network operations. Pre-arranged day and night fixed frequencies. With crystal control you can select your desired channels immediately.



Stability is .001 to .01 percent depending on frequency to which receiver is tuned, image rejection is 80 db to 120 db down, and spurious responses are at least 100 db down. Sensitivity is 1 microvolt CW and 2 microvolts AM, while selectivity for the three calibrated crystal and three non-crystal ranges is from 200 cycles to 13 kc. Radiation is negligible with no cross-talk in multi-receiver installations.

Write HAMMARLUND for detailed information

HAMMARLUND

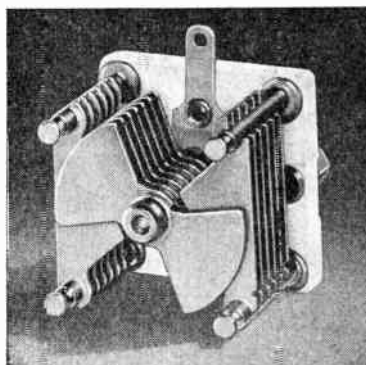

"BFC" CAPACITORS

FEATURES—The "BFC" "butterfly" type capacitor has very low minimum capacity, low inductance and isolated rotor for use in VHF applications as a series capacitor with no rotor contact. Mechanical and electrical symmetry and stator terminal locations minimize circuit inductance.

CONSTRUCTION—Brass rotors and stators are soldered and nickel-plated. The contact wiper is heavily silver-plated beryllium-copper. Tapped studs on the silicone treated steatite front panel permit mounting the capacitor without grounding the rotor. The sleeve type bearing is nickel-plated brass.

SPECIFICATIONS—Straight line capacity. 90° rotation from minimum to maximum capacity position. Air gap is 0.030" nominal. Tested at 1200 V. R.M.S., 60 cycles between rotor and each stator.

High Speed Ball-Bearing Models Also Are Available

CODE	CAPACITY/SECTION		SERIES CAPACITY		PLATES	
	Max.	Min.	Max.	Min.	Rotor	Ea. Stator
BFC-12	14.5	3.4	7.6	2.2	4	3
BFC-25	27.3	4.8	14.1	2.9	7	6
BFC-38	40.1	6.2	20.6	3.6	10	9

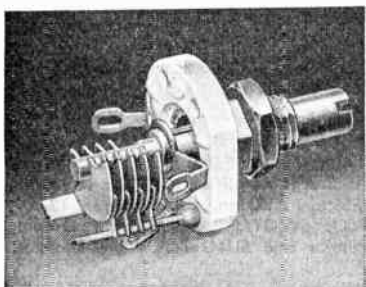

"MAC" CAPACITORS

FEATURES—The "MAC" provides the low minimum capacity essential for use as a trimmer in the VHF range. It was engineered to achieve the smallest dimensions practical to meet the requirements of a miniaturized component.

CONSTRUCTION—Its silicone treated steatite base is only 3/4" x 5/8". Rotor and stator are soldered assemblies and are of brass, silver-plated. Rotor and stator terminals are positioned to permit single hole mounting.

SPECIFICATIONS—Straight line capacity. Screwdriver adjustment. Air gap is 0.017" nominal. Tested at 750 V. R.M.S., 60 cycles.

CODE	CAPACITY		PLATES	CODE	CAPACITY		PLATES
	Max.	Min.			Max.	Min.	
MAC-5	5.0	1.4	5	MAC-15	14.2	2.2	15
MAC-10	8.7	1.7	9	MAC-20	19.6	2.7	21

"FC" and "FNC" COUPLINGS

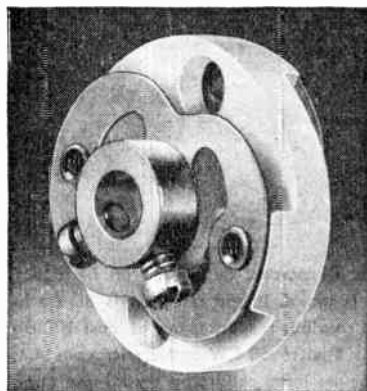

FEATURES—The "FC-46-S" is an insulated flexible coupling designed to provide for mechanical ganging of shafts even though angularly misaligned. The smallest dimensions have been incorporated consistent with the rugged construction necessary for general service. A high degree of electrical isolation is achieved through the use of silicone treated steatite insulation. Flash-over voltage is approximately 5000 V. R.M.S. Brass hubs and spring temper phosphor bronze flexible arms are nickel plated. An exclusive and important feature of this coupling is its characteristic of uniform side-thrust through 360° of rotation. This eliminates tendency to vibrate at high speeds, minimizes bearing wear and assures accurate tracking.

The "FNC-46-S" is a non-insulated coupling for use where electrical continuity between shafts is required. The flexible arms are held securely to a nickel plated brass ring instead of an insulator.

STANDARD STOCK TYPES

CODE FC-46-S	Insulated flexible coupling
CODE FNC-46-S	Non-insulated flexible coupling

THE HAMMARLUND MANUFACTURING COMPANY, INC.

HAMMARLUND

"APC" CAPACITORS

FEATURES—The "APC" trimmer capacitor originated by Hammarlund over twenty years ago is still widely recognized as the standard capacitor of its type. Its use is indicated in all classes of equipment where a compact, high quality air dielectric trimmer is required. It was designed to resist effects of temperature, moisture and vibration. Silicone treated steatite insulation is used to insure high leakage resistance.

CONSTRUCTION—Brass rotor and stator plates are soldered to brass supports. Nickel-plated phosphor bronze wiper assures positive rotor contact. All metal parts are nickel-plated. Terminals are hot-tin dipped. Tapped brass mounting studs fastened to silicone treated steatite base permit mounting capacitor without grounding the rotor.

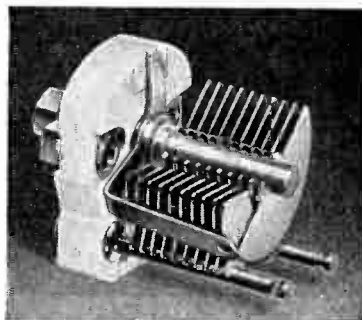

CODE	CAPACITY		PLATES
	Max.	Min.	
APC-25	25.	3.0	7
APC-50	50.	3.9	14
APC-75	75.	4.6	20
APC-100	100.	5.5	27
APC-140	140.	6.7	37

SPECIFICATIONS—Straight line capacity characteristic. Hexagonal collar on slotted shaft permits rotor adjustments to be made with wrench or screwdriver. Air Gap is 0.015" nominal. Tested at 600 V. R.M.S., 60 cycles.

"MAPC" CAPACITORS

FEATURES—The "MAPC" capacitor is representative of Hammarlund's efforts to meet the demand for smaller dependable components. It is a scaled-down version of the popular "APC" with everything reduced except the quality and performance characteristics. For example, an "MAPC" is about half the size and weight of an "APC." Lower minimum capacities and low inductance make the "MAPC" suitable for VHF use.

CONSTRUCTION—The standard "APC" construction is used in this capacitor. Rotors and stators are fabricated by soldering brass plates to supporting members and nickel-plating the assemblies. Nickel-plated phosphor bronze wiper assures positive rotor contact. Tapped brass mounting studs fastened to silicone treated steatite base permit mounting capacitor without grounding rotor.

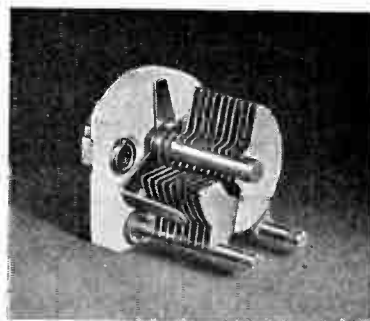

CODE	CAPACITY		PLATES
	Max.	Min.	
MAPC-15	15.	2.3	6
MAPC-25	25.	2.6	10
MAPC-35	35.	2.9	14
MAPC-50	50.	3.2	19
MAPC-75	75.	3.9	29
MAPC-100	100.	4.5	38

SPECIFICATIONS—Straight line capacity. Screwdriver or socket wrench adjustment. Air gap is 0.0135" nominal. Tested at 600 V. R.M.S., 60 cycles.

"NZ-10" CAPACITORS

FEATURES—The "NZ-10" is a compact transmitter neutralizing capacitor designed for easy and accurate adjustment. The rotor is attached to a fine-thread lead screw which may be adjusted with smooth and precise action by a screwdriver and locked securely by a readily accessible clamping screw. A stop prevents shorting of plates at maximum capacity. Long leakage paths to ground from both rotor and stator are provided. Glazed steatite insulators and smoothly rounded aluminum plates minimize flashover.

SPECIFICATIONS—Capacity is adjustable from 2.3 to 10 mmf. Peak voltage rating is 3000 V. at maximum capacity (minimum gap) position.



Write for the new HAMMARLUND Capacitor Catalog

HAMMARLUND

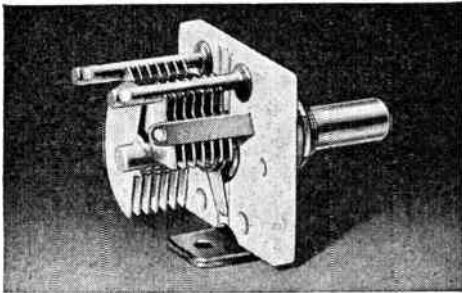

SPECIFICATIONS—Straight line capacity. Single spaced types (HF and HFD) have 0.015" air gap and are tested at 600 V. R.M.S., 60 cycles. Wide spaced types (HF-X and HFD-X) have 0.045" air gap and are tested at 1400 V. R.M.S., 60 cycles.

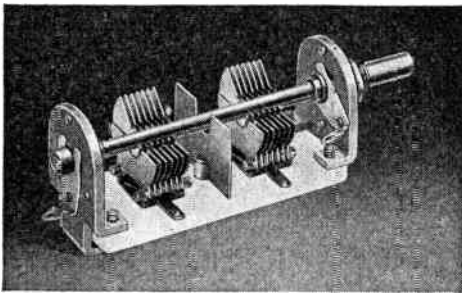

"HF" and "HFD" CAPACITORS

SINGLE SECTION CAPACITOR—The "HF" is a single section tuning capacitor employing "APC" rotor and stator design. Extra long sleeve bearing and positive contact nickel-plated phosphor-bronze wiper make this unit ideally suited to high frequency applications. Silicone treated steatite insulation. Single hole or base mounting.

DOUBLE SECTION CAPACITOR—The "HFD" dual capacitor, like the "HF" singles, incorporate advanced features providing for maximum efficiency at high frequency. Aluminum front and rear end panels are mounted on a heavy silicone treated steatite base. Wide front and rear bearings with individual silver-plated beryllium-copper wipers for each section assure long life and maximum contact efficiency. Single hole panel mount or base mounting.

CODE	CAPACITY		PLATES/ SECTION
	Max.	Min.	
HF-15	17.5	2.8	5
HF-35	36.	3.2	10
HF-50	52.	3.7	14
HF-100	102.	5.3	27
HF-140	142.	6.3	37
HF-15-X	15.	3.6	10
HF-30-X	30.	5.2	20
HFD-50	52.	3.6	14
HFD-100	102.	5.0	27
HFD-140	142.	6.0	37
HFD-15-X	16.	3.8	11
HFD-30-X	28.5	5.0	19

D—Split stator

X—Wide-Spaced

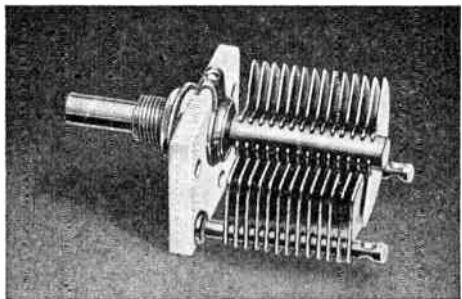

SPECIFICATIONS—Straight line capacity. Air gaps and test voltages are as indicated in table. However, "HFBD" breakdown voltages are doubled and capacitance values approximately halved when stator sections are connected in series.

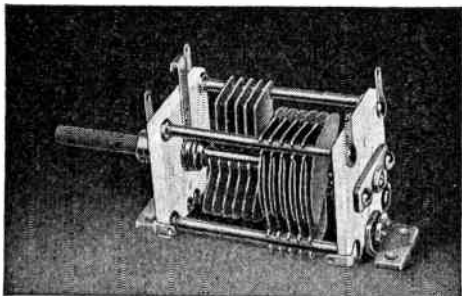

"HFA" and "HFBD" CAPACITORS

SINGLE SECTION CAPACITOR—The "HFA" is a single section tuning capacitor similar to "HF" except that larger plates permit wider air-gaps for the same capacitance values. Resultant higher break-down ratings extend the use of the capacitor into the high frequency low-power transmitter field. A threaded sleeve bearing permits single hole mounting and the bracket supplied may be used for base mounting. A lug type terminal soldered to the bearing provides an efficient rotor connection.

DOUBLE SECTION CAPACITOR—The "HFBD" is a dual, balanced rotor transmitting capacitor employing front and rear panels plus a ball-thrust rear bearing, but otherwise incorporating constructional features identical to the smaller "HFA." An insulated shaft extension safeguards operating personnel from the high voltages which may be applied to the rotor. The small size, rugged construction, balanced rotor and range of capacitance values and breakdown voltages make this capacitor ideally suited to many applications.

CODE	CAPACITY		SPACING	PLATES/ SECTION
	Max.	Min.		
HFA-100-A	102.	4.5	0.020	19
HFA-140-A	145.	6.0	0.020	27
HFA-10-B	9.	2.3	0.030	3
HFA-15-B	16.	2.8	0.030	5
HFA-25-B	25.	3.0	0.030	7
HFA-50-B	50.	4.3	0.030	14
HFA-100-B†	100.	7.5	0.030	27
HFA-15-E	16.	4.0	0.070	9
HFBD-50-C	50.	9.0	0.050	11
HFBD-100-C	105.	14.0	0.050	23
HFBD-35-E*	37.	9.5	0.070	11
HFBD-65-E*	63.	12.5	0.070	19

60 Cycle Test Voltage:

"HFA" — "A" 800 V. R.M.S. "B" 1200 V. R.M.S. "E" 1750 V. R.M.S.

"HFBD" — "C" 1500 V. R.M.S. "E*" 3000 V. R.M.S.; plates have

rounded edges.

†Has front and rear supporting panels.

THE HAMMARLUND MANUFACTURING COMPANY, INC.

Radio's Master — 19th Edition

Page J-38

Copyright by U. C. P., Inc.

HAMMARLUND

"MC" and "MCD" CAPACITORS

FEATURES—The "MC" is a versatile single section tuning capacitor designed to give a choice of mountings, connections and capacity characteristics. "MC-S" capacitors have a straight line capacity characteristic. "MC-M" units have offset plates resulting in a "Midline" characteristic which more equally spaces frequencies. "MC-X" units are wide-spaced for high voltages. The "MCD" is a split-stator panel-mounted capacitor.

SPECIFICATIONS—Straight line or "Midline" capacity characteristic. Single-spaced types have 0.0245" nominal air gap and are tested at 1000 V. R.M.S., 60 cycles. Wide-spaced ("X") types have 0.0715" nominal air gap and are tested at 1750 V. R.M.S., 60 cycles.

CODE	CAPACITY		PLATES/SECTION	CODE	CAPACITY		PLATES/SECTION
	Max.	Min.			Max.	Min.	
MC-20-S	20.	5.5	3	MC-20-SX	20.	6.8	7
MC-35-S	35.	6.0	5	MC-35-MX	32.	7.8	11
MC-50-M	50.	6.3	7	MC-35-SX	32.	8.5	11
MC-50-S	50.	6.5	7	MC-50-MX	53.	10.5	19
MC-75-M	80.	7.3	11	MC-50-SX	53.	11.5	19
MC-75-S	80.	8.0	11	MC-100-SX	100.	16.5	35
MC-100-M	100.	7.7	14	MCD-50-M	50.	5.5	7
MC-100-S	100.	8.3	14	MCD-100-M	100.	6.3	14
MC-140-M	140.	9.0	19	MCD-100-S	100.	7.0	14
MC-140-S	140.	10.0	19	MCD-140-M	140.	7.8	19
MC-200-M	200.	10.3	27	MCD-35-MX	31.	6.0	11
MC-250-M	250.	12.0	34	MCD-35-SX	31.	6.8	11
MC-325-M	320.	13.5	43				

M—Midline plates S—Straightline plates
X—Wide-Spaced

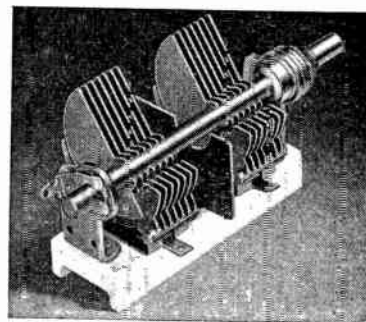
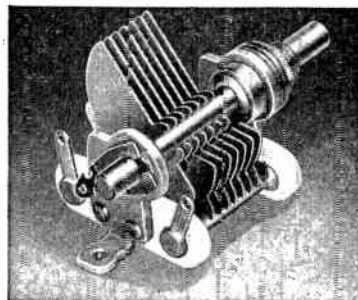

"RMC" CAPACITORS

FEATURES—The "RMC" was designed specifically for applications requiring an "MC" type tuning capacitor with very rigid construction. Its sturdy frame consists of heavy gauge aluminum end panels held together by three aluminum tie rods. It has a brass sleeve front bearing and a single ball thrust rear bearing for smooth tuning and a high degree of resetability. The rotor contact is a forked silver-plated beryllium-copper spring wiping against a wide disc on the rotor.

SPECIFICATIONS—Straight line capacity. Air gap is 0.0245" nominal.

CODE	CAPACITY		PLATES
	Max.	Min.	
RMC-50-S	50.	7.3	7
RMC-100-S	105.	9.5	14
RMC-140-S	143.5	11.0	19
RMC-325-S	327.	17.5	43

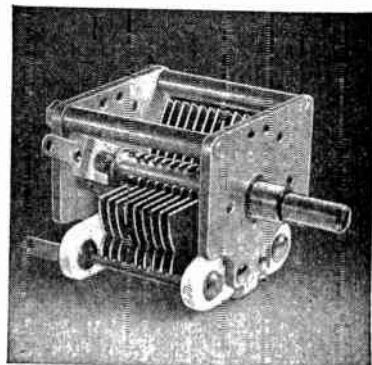

"VU" CAPACITORS

FEATURES—The "VU" is a uniquely designed UHF tuning capacitor using completely original concepts. With it, conventional "lumped constant" circuits, rather than tuned cavity techniques, can be efficiently used up to 500 megacycles. In addition to employing the capacitor sections in series to eliminate the rotor wiper, the design also utilizes Pyrex balls to form precision bearings and to completely isolate the rotor. Thus, noise generated by rubbing metal-to-metal contacts and variable resistance paths in the bearings have been totally eliminated. Circuit connections are made to threaded studs on each stator. This permits vacuum tube and inductor to be mounted adjacent to and on opposite sides of the capacitor to minimize circuit inductance.

CODE	SERIES CAPACITY		PLATES/SECTION
	Eff.	Min.	
VU-20	22.5	3.35	11
VU-30	31.5	3.5	15
VU-45	45.0	3.8	21

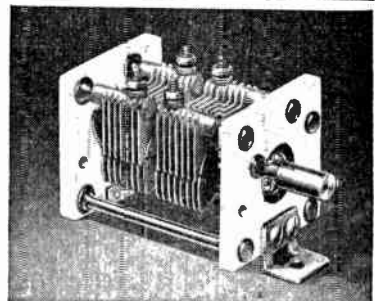

SPECIFICATIONS—The capacity characteristic approaches a straight line frequency curve as indicated by nominal values in table at left. Air gap is .0168" nominal. Tested at 700 V. R.M.S., 60 cycles, between rotor and each stator.

Special Capacitors Built to Your Specifications

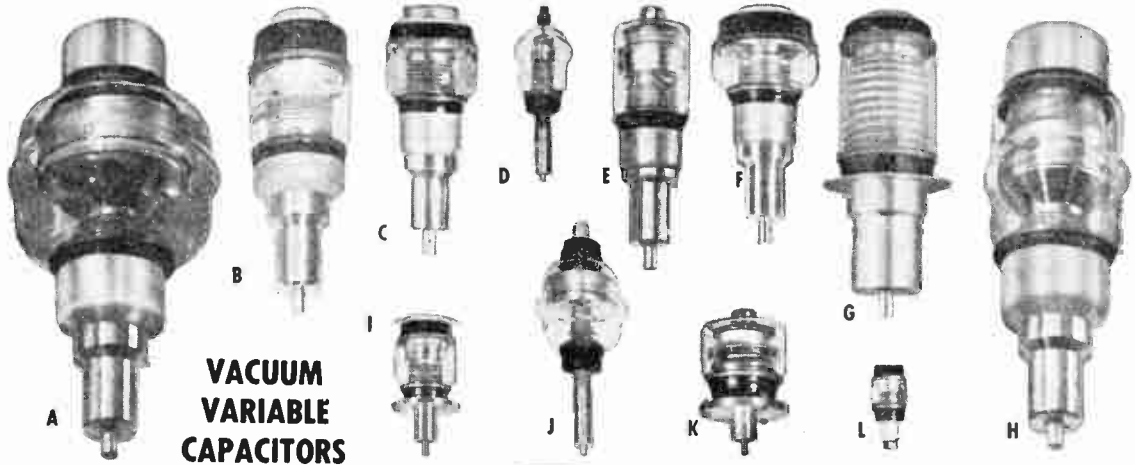

**VACUUM
VARIABLE
CAPACITORS**



VACUUM FIXED CAPACITORS

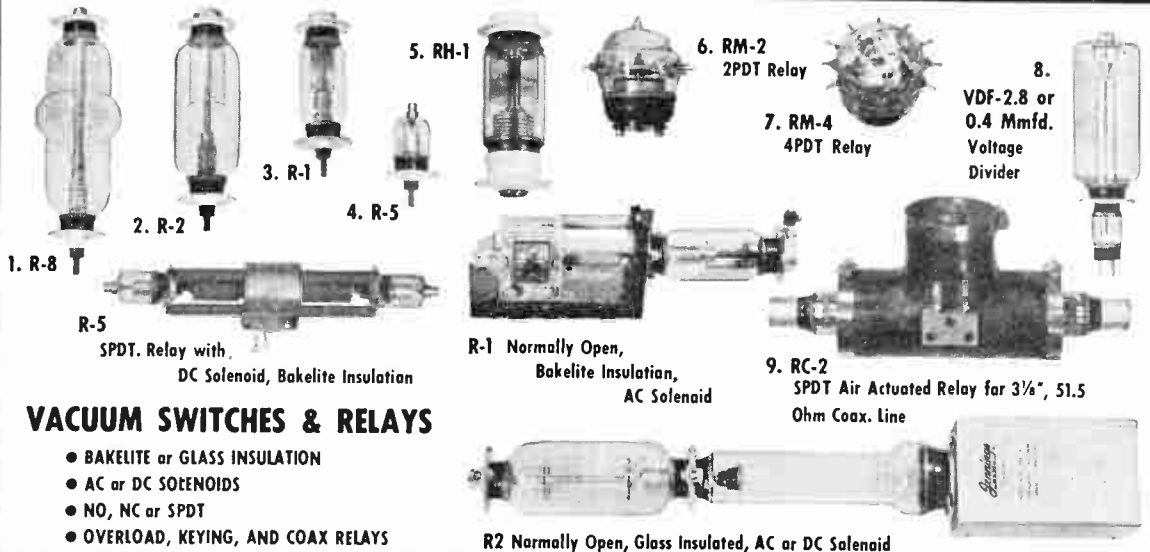

VACUUM SWITCHES & RELAYS

- BAKELITE or GLASS INSULATION
- AC or DC SOLENOIDS
- NO, NC or SPDT
- OVERLOAD, KEYING, AND COAX RELAYS

JENNINGS RADIO MANUFACTURING CORPORATION - 970 McLAUGHLIN AVE. P. O. BOX 1278 - SAN JOSE 8, CALIFORNIA

FIGURES	NICKEL TYPES	COPPER TYPES	CAPACITY MMFD.	PEAK VOLTAGE KILOVOLTS	RMS AMPERES NICKL. CPPR.	OVERALL LENGTH	MAX. O. D.	CONTACT DIA.	MOUNTING CENTERS
VARIABLE CAPACITORS									
NOMINAL DIMENSIONS									
D	T		5-25	20	10.5	6 $\frac{3}{8}$	2 $\frac{1}{4}$	1 $\frac{1}{2}$ x $\frac{5}{8}$	4 $\frac{1}{8}$
J		TC	5-25	20	20	6 $\frac{5}{8}$	2 $\frac{1}{8}$	$\frac{5}{8}$	4 $\frac{3}{8}$
L		ECS	2-8, 3-30	10, 15	20	2 $\frac{7}{8}$	1 $\frac{3}{8}$	1	2 $\frac{1}{8}$
D	AT		10-50, 15-75	20, 25, 30	10.5	6 $\frac{3}{4}$	3	1 $\frac{1}{2}$ x $\frac{5}{8}$	4 $\frac{3}{8}$
J		ATC	10-50	20, 30	20	7	3 $\frac{1}{8}$	3 $\frac{3}{8}$ x $\frac{5}{8}$	4 $\frac{3}{8}$
J		ATCS	10-150, 15-190	7.5, 10, 15	20	7	3 $\frac{1}{8}$	3 $\frac{3}{8}$ x $\frac{5}{8}$	4 $\frac{1}{2}$
K		VAC	4-40	10	42	4 $\frac{5}{8}$	2 $\frac{3}{4}$	1 $\frac{1}{2}$ x $\frac{7}{8}$
I		GCS	5-100	7.5, 10, 15	30	4 $\frac{5}{8}$	2 $\frac{1}{8}$	2 $\frac{1}{8}$	3 $\frac{3}{8}$
E		UCS	5-200, 10-300	7.5, 10, 15	42	8 $\frac{3}{4}$	2 $\frac{5}{8}$	7 $\frac{1}{8}$ x2	4 $\frac{5}{8}$
E		UCS	10-375, 10-400, 25-500	7.5, 10, 15	42	9	3 $\frac{1}{8}$	7 $\frac{1}{8}$ x2	4 $\frac{7}{8}$
F		UCS F	5-250, 12-500	7.5, 10, 15	60	7 $\frac{3}{4}$	3 $\frac{5}{8}$	2
I		UCS L	4-250	3, 5	30	4	2 $\frac{1}{4}$	2 $\frac{1}{8}$	2 $\frac{1}{2}$
C		UCS L	4-500, 5-750, 7-1000	3, 5	42	7 $\frac{5}{8}$	3 $\frac{1}{8}$	2	3 $\frac{1}{2}$
C		UCS L	20-2000	2, 3	42	8 $\frac{3}{8}$	3 $\frac{1}{8}$	2	4 $\frac{1}{4}$
K		UCS V	8-110	7.5, 10, 15	60	4 $\frac{3}{4}$	3	7 $\frac{1}{8}$
K		UCS V	100-250	7.5, 10, 15	60	5 $\frac{1}{4}$	3	7 $\frac{1}{8}$
K		UCS V H	8-35	25, 35	60	4 $\frac{3}{4}$	3	7 $\frac{1}{8}$
G		UCS M	4-500	7.5, 10, 15	80	10 $\frac{5}{8}$	3 $\frac{5}{8}$	2x3 $\frac{3}{8}$	6
B		UCS X	25-700, 25-1000	7.5, 10, 12	60	9 $\frac{3}{4}$	3 $\frac{3}{4}$	2x3 $\frac{1}{8}$	5
F		UCS X F	10-1000, 20-1500	7.5, 10, 12	60	9 $\frac{3}{4}$	5 $\frac{1}{8}$	3 $\frac{1}{8}$	4 $\frac{7}{8}$
F		UCS X F	50-2000, 50-2300	5, 7.5, 10	60	10	5 $\frac{1}{8}$	3 $\frac{1}{8}$	5 $\frac{1}{8}$
B		UCS X H	10-200	35, 45	60	10 $\frac{3}{4}$	4 $\frac{1}{2}$	2	5 $\frac{1}{2}$
F		UCS X H	20-450	35, 40	60	10	5 $\frac{1}{8}$	3 $\frac{1}{8}$	5 $\frac{1}{8}$
A	U	UC	50-250	10, 15, 20	21	60	11 $\frac{1}{2}$	5	2
A	UH	UHC	10-75, 75-150	35, 45, 55, 60	21	60	12	5	2
H	UX	UXC	25-500	10, 15, 20	21	60	14	5	3 $\frac{1}{8}$
H	UXH	UXHC	25-150	35, 45, 55	21	60	14 $\frac{5}{8}$	5	3 $\frac{1}{8}$
A	VMM	VMMC	50-1000, 100-2000	10, 15	35	125	15 $\frac{7}{8}$	6 $\frac{1}{8}$	4 $\frac{1}{8}$
A		VMMC	100-5000	5, 7.5, 10	125	125	19 $\frac{1}{2}$	9 $\frac{1}{4}$	4 $\frac{1}{8}$
A	VMMH	VMMHC	10-250, 25-450	35, 45, 55	21	125	16	8 $\frac{1}{8}$	4 $\frac{1}{8}$
A		VMMHC	60-1000	35, 40, 45	125	125	19 $\frac{1}{2}$	9 $\frac{1}{4}$	4 $\frac{1}{8}$

NOTE: Adjustable Capacitors are available to cover range of 8 mmfd to 1000 mmfd at 10 kV.

FIXED CAPACITORS

O	VC	VCC	6, 12, 25, 50, 75, 100, 150	20, 30	14	60	6 $\frac{1}{2}$	2 $\frac{5}{8}$	7 $\frac{1}{8}$	5 $\frac{7}{8}$
O	VC	VCC	200, 250	20, 30	14	60	6 $\frac{1}{2}$	2 $\frac{3}{4}$	7 $\frac{1}{8}$	5 $\frac{7}{8}$
R	W		6, 12, 25, 50, 100	20	10.5		4 $\frac{1}{4}$	2 $\frac{1}{4}$	3 $\frac{1}{8}$	3 $\frac{7}{8}$
W	X		5, 10, 15, 20, 25	17	7		3 $\frac{1}{4}$	1 $\frac{1}{8}$	3 $\frac{3}{8}$	2 $\frac{7}{8}$
W	Y		1, 2, 3, 4, 5	17	7		3 $\frac{1}{4}$	3 $\frac{1}{4}$	3 $\frac{3}{8}$	2 $\frac{7}{8}$
X		JCS-1	25, 50, 75, 100, 150	7.5, 10, 15	42		3 $\frac{3}{4}$	2 $\frac{1}{8}$	7 $\frac{1}{8}$	3 $\frac{1}{4}$
S		JCS-2	10, 20, 25, 50	7.5, 10, 15	20		2 $\frac{3}{4}$	1 $\frac{1}{2}$	3 $\frac{1}{8}$	2 $\frac{1}{4}$
X		JCS	250	7.5, 10, 15	42		3 $\frac{3}{4}$	2 $\frac{5}{8}$	7 $\frac{1}{8}$	3 $\frac{1}{8}$
X		JCS	500	7.5, 10, 15	42		4	3 $\frac{1}{8}$	7 $\frac{1}{8}$	3 $\frac{1}{2}$
Q		JCS	1000	7.5, 10, 12	42		4 $\frac{5}{8}$	3 $\frac{5}{8}$	2	3 $\frac{7}{8}$
X		JCS H	75	35, 45, 55, 60	42		4	2 $\frac{7}{8}$	7 $\frac{1}{8}$	3 $\frac{3}{8}$
S		JCS L	100	3, 5	20		2 $\frac{5}{8}$	1 $\frac{1}{2}$	3 $\frac{1}{8}$	2 $\frac{1}{4}$
S		JCS L	250	3, 5	20		2 $\frac{5}{8}$	1 $\frac{7}{8}$	3 $\frac{1}{8}$	2 $\frac{1}{8}$
X		JCS L	500, 750	3, 5	42		3 $\frac{7}{8}$	2 $\frac{1}{8}$	7 $\frac{1}{8}$	3 $\frac{3}{8}$
X		JCS L	1000, 1500	3	42		3 $\frac{3}{4}$	2 $\frac{7}{8}$	7 $\frac{1}{8}$	3 $\frac{1}{4}$
X		JCS L	2000	2	42		4	2 $\frac{7}{8}$	7 $\frac{1}{8}$	3 $\frac{1}{2}$
N		JC-2	25, 50, 75, 100	20, 30	42		4	3 $\frac{1}{4}$	7 $\frac{1}{8}$	3 $\frac{1}{4}$
P		JC-3	20, 40, 50, 60	35, 45, 55, 60	140		8 $\frac{1}{4}$	3 $\frac{1}{2}$	2	6 $\frac{1}{4}$
U		JC-4	75, 100, 125	35, 45, 55, 60	175		9 $\frac{1}{4}$	5	3 $\frac{1}{8}$	7
U		JC-5	200	35, 45, 55, 60	225		11 $\frac{1}{4}$	7	4 $\frac{1}{8}$	8 $\frac{3}{4}$
T	M	MC	500, 750, 1000	10, 15, 20	21	120	8 $\frac{3}{8}$	5	2	6 $\frac{1}{4}$
T	ML	MLC	500, 750, 1000	25, 30	21	120	9 $\frac{1}{4}$	5	2	7 $\frac{1}{4}$
M	MM	MMC	1500, 2000	10, 15	35	125	9 $\frac{1}{4}$	6 $\frac{1}{8}$	4 $\frac{1}{8}$	6 $\frac{3}{4}$
M		MMC	5000	5, 7.5, 10	125	125	15 $\frac{1}{2}$	9 $\frac{1}{4}$	4 $\frac{1}{8}$	11 $\frac{1}{8}$
M	MMH	MMHC	450	35, 45, 55	21	125	9 $\frac{1}{4}$	6 $\frac{1}{8}$	4 $\frac{1}{8}$	6 $\frac{3}{4}$
M		MMHC	1000	35, 40, 45	125	125	15 $\frac{1}{2}$	9 $\frac{1}{4}$	4 $\frac{1}{8}$	11 $\frac{1}{8}$
V		MC-1	500, 750, 1000	10, 15	75		4 $\frac{1}{8}$	4 $\frac{1}{8}$	2	3
V		MMC-1	2000	10, 15	125		5	6 $\frac{1}{8}$	3 $\frac{1}{8}$	4

NOTE: Feed-thru Capacitors and glass standoff insulators are available on special order.

VACUUM SWITCHES & VOLTAGE DIVIDER

FIGURE	TYPE	DESCRIPTION	PEAK KILOVOLTS	RMS AMPS					
3	R-1	Vacuum Switch	50, 60	55	6 $\frac{5}{8}$	1 $\frac{7}{8}$	2 $\frac{1}{8}$	5	
2	R-2	Vacuum Switch	50, 60, 70	50	8 $\frac{1}{2}$	2 $\frac{5}{8}$	2 $\frac{1}{8}$	6 $\frac{5}{8}$	
4	R-5	Vacuum Switch	20	50	4	1 $\frac{1}{2}$	3 $\frac{1}{2}$ x2 $\frac{1}{8}$	2 $\frac{5}{8}$	
1	R-8	Vacuum Switch	40, 70, 85	100 (RF)	10 $\frac{1}{4}$	3 $\frac{3}{8}$	2 $\frac{1}{8}$	8 $\frac{3}{8}$	
5	RH-1	Vacuum Switch	40, 50	200	7 $\frac{1}{8}$	3	3	6	
6	RM-2	2PDT Vacuum Relay	12	10 (RF)	3 $\frac{1}{2}$	3 $\frac{1}{2}$		
7	RM-4	4PDT Vacuum Relay	12	10 (RF)	3 $\frac{1}{2}$	3 $\frac{1}{2}$		
9	RC-2	SPDT for 51.5 ohm, 3 $\frac{1}{8}$ " Coax. Line	20	50 (RF)				
8	VDF	Vac. Capacitor Voltage Divider	40, 50, 60	9 $\frac{1}{2}$	2 $\frac{1}{2}$	3 $\frac{1}{8}$	6 $\frac{1}{2}$ x2 $\frac{5}{8}$	

NOTE: Switch current ratings approximately 50% at 10 megacycles.
ALL CURRENT RATINGS BASED ON 75° F. TEMPERATURE RISE.

JENNINGS RADIO MANUFACTURING CORPORATION - 970 McLAUGHLIN AVE. P.O. BOX 1278 - SAN JOSE 8, CALIFORNIA



RELAY RACKS



DELUXE RELAY RACKS

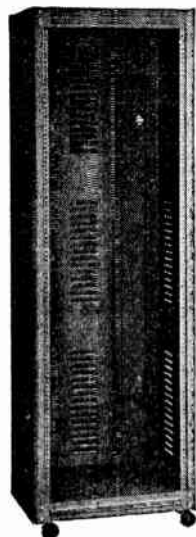

These relay racks are made of 16 gauge steel with 1/4" panel mounting supports. The panel mounting supports are recessed so that no edges of the panel will be exposed.

The front and back of the top, the two sides and the door are well louvered to provide adequate ventilation. The door is hung on sturdy, loose joint hinges; it is held closed by two attractive aluminum die cast plunger type snap action catches. A streamlined appearance is achieved by the use of rounded corners and red lined chrome trim. This relay rack is shipped knocked down and complete with all necessary hardware for assembly. All standard 19" panels will fit these racks.

A SPECIAL FEATURE IS THE USE OF FOUR STURDY SUPPORTS IN THE BOTTOM, SO THAT CASTERS CAN BE FASTENED DIRECTLY TO THE BASE, THEREBY ACHIEVING READY MOBILITY.

Bud RC-7756 casters will fit this unit. The casters are not included in the price of the cabinet. These relay racks are supplied in either black or grey wrinkle finish, or light grey hammered finish. Use suffix letter "B" for black wrinkle finish. Use suffix letter "G" for grey wrinkle finish. Use suffix letters "HG" for light grey hammered finish.

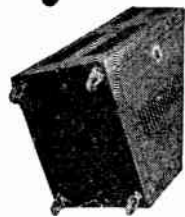

Catalog No.	Overall Height	Panel Space	Shipping Weight	Dealer Cost
CR-1774	42-1/16"	36 3/4"	90 lbs.	\$32.70
CR-1771	47-5/16"	42"	95 lbs.	37.45
CR-1772	66-9/16"	61 1/4"	122 lbs.	48.60
CR-1773	82-5/16"	77"	150 lbs.	58.50

SUPER DELUXE RACKS 2 DOOR

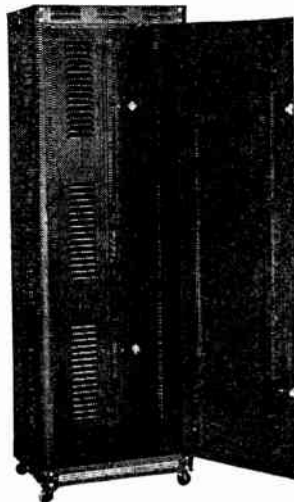

This relay rack is an entirely new model that consists of a relay rack made of 16 gauge steel with 1/4" panel mounting supports. The panel mounting supports are recessed so that no edges of the panel will be exposed. IN ADDITION, THEY ARE ADJUSTABLE FROM FRONT TO BACK IN VARIOUS STOPPING POINTS. THIS ENABLES YOU TO USE THE SPACE IN FRONT AND BEHIND THE PANEL TO ANY DEGREE THAT YOU MAY FIND NECESSARY. Adjustable points are at 1" intervals up to a point 6" behind the front paneling. These racks are fitted with both front and rear doors. The rear door is to cover any of the equipment behind the panel and at the same time provide easy accessibility to it. The front door is to provide a means of concealing dials, knobs, etc., that may be in front of the panel.

The exclusive Bud feature of supports on the bottom so the casters may be fixed directly to the base, eliminating the need and expense of dollies, is also present in this series of racks. Bud RC-7756 casters will fit these units. The casters are not included in the price of the cabinet.

If black wrinkle finish is desired, specify same by suffix letter "B." If grey wrinkle finish is desired, specify by use of suffix letter "G." If light grey hammered finish is desired, specify by use of suffix "HG."

Catalog No.	Overall Height	Panel Space	Shipping Weight	Dealer Cost
CR-2174	42-1/16"	36 3/4" x 19"	108 lbs.	\$44.50
CR-2171	47-5/16"	42" x 19"	117 lbs.	51.00
CR-2172	66-9/16"	61 1/4" x 19"	146 lbs.	65.10
CR-2173	82-5/16"	77" x 19"	191 lbs.	78.95

ADD-A-RACK SERIES

It always has been necessary to buy special racks without louvers on one side to obtain maximum interior space with a minimum of floor space. Now, you no longer need to buy an entire new cabinet when you want additional space. When multiple rack units are required, we not only offer additional racks at a lower cost, but provide a sturdier, better looking assembly. Only Add-A-Rack series can accomplish this savings.

Illustration A shows the two Add-A-Rack cabinets assembled together. Illustration B shows the unique and ingenious method of adding a unit to your present equipment. Instead of buying an entirely new outfit, you purchase, as a unit, four parts: 1. The door, 2. the top, 3. the bottom, 4. an Add-A-Rack Coupling Unit. The right or left side of your present relay rack is removed and replaced by the Add-A-Rack Coupling Unit. Next, the top and bottom are fastened into place. The side taken from the first rack is then fastened onto the second rack. Place the additional door into position and you now have two racks, properly and efficiently coupled together. In the same simple way, more racks can be added at any time. Every one will be in a continuous one piece assembly.

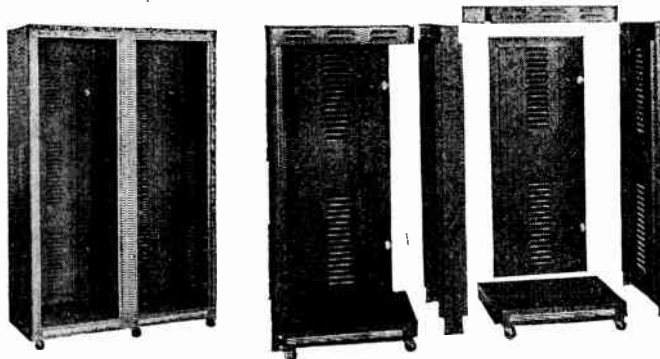

This series is available in two ways. The first is a double unit consisting of a rack and a rack coupling unit. The second is an Add-A-Rack unit consisting of a door, a top, a bottom and an Add-A-Rack coupling unit. These units are furnished with all necessary assembly and panel mounting hardware. The same fine feature of the sturdy supports on the bottom for direct affixing of casters is present on the model.

Catalog No.	Used to Add-A-Rack to	Shipping Weight	Dealer Cost	Catalog No.	Makes Two Racks Same Size as	Shipping Weight	Dealer Cost
AR-1778	CR-1774	75 lbs.	\$31.00	CR-1779	CR-1774	165 lbs.	\$ 63.70
AR-1775	CR-1771	77 lbs.	36.00	CR-1780	CR-1771	185 lbs.	73.45
AR-1776	CR-1772	100 lbs.	45.00	CR-1786	CR-1772	222 lbs.	93.60
AR-1777	CR-1773	127 lbs.	55.00	CR-1799	CR-1773	277 lbs.	113.50

If black wrinkle finish is desired, specify same by suffix letter "B." If grey wrinkle finish is desired, specify by use of suffix "G." If light grey hammered finish is desired, specify by use of suffix "HG."

Prices on above slightly higher west of the Mississippi River
Only a few of many BUD Products are shown. For complete catalog, write BUD RADIO, INC., 2118 E. 35th St., Cleveland, Ohio



CABINET RACKS—RELAY RACKS

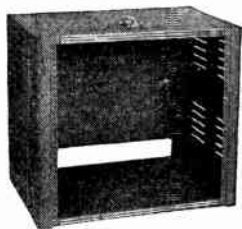

DELUXE CABINET RACKS

These cabinet racks are so made that a professional appearance is given. They are ideal for commercial broadcast stations, for amateur transmitters, for sound equipment or test equipment.

The five larger sizes have a hinged rear door, while the smaller sizes have the welded panel in the rear.

No other manufacturer has the wide variety of sizes that are included in the Bud line of deluxe cabinet racks.

Adequate ventilation is assured by means of louvered sides and a 2" opening in the bottom of the back, which extends the entire width of the cabinet. "No scratch" extended metal feet are embossed on the bottom to minimize marring of the table top or any other equipment that this is placed on.

Specify a suffix "B" when black wrinkle is desired, the suffix "G" when grey wrinkle is desired, or the suffix "HG" when light grey hammered is desired.

Catalog No.	Overall Height	Panel Space	Shipping Weight	Dealer Cost
CR-1741	10-9/16"	8 3/4"	28 lbs.	\$12.00
CR-1740	12-5/16"	10 1/2"	30 lbs.	13.70
CR-1742	14-1/16"	12 1/4"	32 lbs.	14.55
CR-1739	15-13/16"	14"	34 lbs.	16.20
CR-1743	19-5/16"	17 3/4"	38 lbs.	19.20
CR-1727	22-13/16"	21"	39 1/2 lbs.	20.83
CR-1744	28-1/16"	26 1/4"	47 1/2 lbs.	22.50
CR-1728	33-5/16"	31 1/2"	52 lbs.	24.00
CR-1745	36-13/16"	35"	60 lbs.	24.90

Telephone Type Relay Racks



1263

1265

Catalog Nos. RR-1263 and RR-1264 are made of 1/4" steel channels, three inches deep, with cross bars of the same thickness. The design of the base has been improved to incorporate a chassis type bottom, together with the usual side angles, making this rack exceptionally strong and stable.

Holes are provided in the base to accommodate Bud RC-7756 casters. Depth 22". Finish black wrinkle only.

The RR-1265 is a heavy duty rack, suitable for broadcast stations and other commercial installations, where it is desired that exceptionally sturdy construction be utilized. The usual manner of installation is to bolt this unit to the floor.

To emphasize the heavy duty construction, it is necessary to realize that the base is made of two angles 4" x 6" x 5/16", 20% long. The channels are 7 1/2" long and made of 3" x 1 3/8" iron channel. The two supporting cross bars are made of 5/16" x 2" steel. Depth 15". Finish black wrinkle only.

Any of the panel chassis shown on page J-45 or the standard relay rack panels shown on page J-44 can be used with these racks.

Catalog No.	Height	Panel Space	Shipping Weight lbs.	Dealer Cost
RR-1263	35 1/2"	31 1/2"	38	\$17.60
RR-1264	70 1/2"	66 1/2"	53	20.06
RR-1265	72 1/2"	66 1/2"	100	44.40



JUNIOR CABINET RACKS

This cabinet rack is a multi-purpose unit that is attractive, and useful, and inexpensive. The cabinet is constructed to accommodate two panels: one panel is 10 1/2" x 18-5/16" and the other is 8 3/4" x 18-5/16". These panels are supplied with the cabinet. The Bud Junior Cabinet Rack is spacious enough to accommodate a chassis up to 10" x 17".

The rear of the cabinet is covered by a hinged door with a locking device. The cabinet is finished in black wrinkle finish only.

Catalog No.	Shipping Weight Pounds	Dr. Cost
RC-1749A	34	\$15.95

DESK TYPE RELAY RACKS

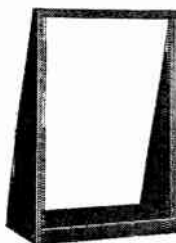

These racks are perfect for table mounting of low and medium powered transmitters, public address systems and other electronic instruments. The rack has strong chassis for mounting heavy components. These units are shipped knocked down with necessary hardware and are easy to assemble. Standard 19" wide panels can be used and the panels are set in recess so that no edges are exposed. Black wrinkle finish only.

Catalog No.	Panel Space	Height	Actual Wt. Lbs.	Dealer Cost
RR-1248	21" x 19"	24"	15	\$6.71
RR-1249	28" x 19"	31"	17	8.38

CHASSIS SUPPORTING ANGLES



Where heavy weights are encountered in chassis construction, the Bud Chassis Supporting Angles will distribute the weight on the sides of the racks to relieve the panel. The angles are made in two sizes from steel 1/4" thick and are finished in black enamel only. The drawing shown around the chassis supporting angles in the picture which accompanies

this is intended to show the manner in which the chassis will be supported by these angles. Sold in pairs only.

Catalog No.	Length	Actual Weight lbs.	Dealer Cost
SA-1349	14 1/2"	4	\$1.75 pr.
SA-1350	12"	3	1.65 pr.

HANDLE-CATCH SET (Plunger Type)

CL-7777 is an attractive handle and catch set now featured on all Bud Cabinet Racks and Relay Racks. Handle is cast aluminum with chrome plated finish. Snap catch is spring type. IMPORTANT FEATURE IS THE PLUNGER WHICH ASSURES EFFICIENCY AND EASY OPERATION. Supplied complete with mounting hardware. Actual weight 1/4 lb.



CL-7777

Dealer Cost \$0.86

Prices on above slightly higher west of the Mississippi River
Only a few of many BUD Products are shown. For complete catalog, write BUD RADIO, INC., 2118 E. 55th St., Cleveland, Ohio



PANELS-BRACKETS



CHASSIS MOUNTING BRACKETS

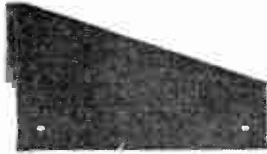

and MB-451 are designed for a chassis height of 4". These units are sold in pairs only.

Mounting brackets are essential to insure proper support of chassis. These brackets are formed of heavy gauge steel cut away at the bottom to provide chassis clearance so that the chassis can be mounted flush against the panel. Finished in black enamel only. Chassis mounting bracket Nos. MB-450

Catalog No.	Height	Depth	Actual Weight	Dealer Cost
MB-458	6 1/2"	8"	1 1/4 lbs.	\$.85 pr.
MB-448	6 1/2"	10"	1 3/4 lbs.	1.10 pr.
MB-459	6 1/2"	11"	2 lbs.	1.20 pr.
MB-449	6 1/2"	12"	2 lbs.	1.45 pr.
MB-460	6 1/2"	13"	2 1/2 lbs.	1.35 pr.
MB-450	8 1/2"	10"	2 1/4 lbs.	1.60 pr.
MB-451	8 1/2"	13"	3 lbs.	1.70 pr.

STANDARD RELAY RACK PANELS

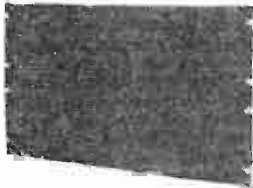

panels at no extra charge. Be sure to specify by use of suffix "B" for black wrinkle finish, suffix "G" for grey wrinkle finish or suffix "HG" for light grey hammered finish.

These panels are available in either steel or aluminum. The steel panels are made of high grade steel 1/8" thick. Aluminum panels are standard at 1/8" thick aluminum. All panels are 19" wide. Aluminum panels 3/16" thick are available at a 60% increase in cost over the standard 1/8" panel.

For the first time, we are offering light grey hammered finish

STEEL

Catalog No.	Height	Actual Weight lbs.	Dealer Cost	Catalog No.	Height	Actual Weight lbs.	Dealer Cost
PS-1250	1 3/4"	1 1/4	\$.66	PS-1256	12 1/2"	8 1/4	\$ 1.85
PS-1251	3 1/2"	2 1/4	.75	PS-1257	14"	9 1/2	2.15
PS-1252	5 1/4"	3 1/4	.93	PS-1258	15 3/8"	10 3/4	2.45
PS-1253	7"	4 1/2	1.08	PS-1259	17 1/2"	11 3/4	2.70
PS-1254	8 3/4"	6	1.30	PS-1260	19 1/4"	13	3.00
PS-1255	10 1/2"	7	1.55	PS-1261	21"	14 1/4	3.30

ALUMINUM

Catalog No.	Height	Actual Weight lbs.	Dealer Cost	Catalog No.	Height	Actual Weight lbs.	Dealer Cost
PA-1101	1 3/4"	1/4	\$.75	PA-1107	12 1/2"	2 3/4	\$ 2.85
PA-1102	3 1/2"	3/4	1.08	PA-1108	14"	3	3.18
PA-1103	5 1/4"	1	1.38	PA-1109	15 3/8"	3 1/2	3.60
PA-1104	7"	1 1/4	1.80	PA-1110	17 1/2"	4	3.99
PA-1105	8 3/4"	2	2.10	PA-1111	19 1/4"	4 1/4	4.35
PA-1106	10 1/2"	2 1/4	2.49	PA-1112	21"	5	4.65

VENTILATING GRILL PANELS



These panels are made of 1/8" thick steel. The grill is stamped into the panel itself and is recommended for use where additional ventilation is desirable. All panels are 19" long and are furnished in black or grey wrinkle finish or light grey hammered finish. Please specify by proper suffix the color desired.

Catalog No.	Height	Grille Size	Actual Weight	Dealer Cost
PS-808	5 1/4"	3 3/8" x 14 3/8"	2 1/2 lbs.	\$ 2.64
PS-809	7"	4 3/8" x 14 3/8"	3 1/2 lbs.	2.85
PS-810	8 3/4"	3 3/8" x 14 3/8"	5 lbs.	3.45
PS-811	10 1/2"	5 3/8" x 14 3/8"	5 3/4 lbs.	3.65
PS-812	12 1/2"	7 3/8" x 14 3/8"	6 1/4 lbs.	3.90

*Allows 3 1/2" space for chassis mounting.

Prices on above slightly higher west of the Mississippi River. Only a few of many BUD Products are shown. For complete catalog, write BUD RADIO, INC., 2118 E. 55th St., Cleveland, Ohio

ENCLOSED METER PANEL



This meter panel is designed to give maximum protection to any meter. The steel panel has a large cut-out behind which is mounted a blank masonite sub-panel. This sub-panel has a meter mounting area of 4 1/2" x 15 1/2". This is sufficient space to mount four 3" meters. The meters are protected by a glass insert that mounts in slides. Due to the danger of breakage in shipment, the glass is not supplied with the panel. The glass insert should be cut 16" long x 4 1/2" wide. Finished in either black wrinkle, grey wrinkle or light grey hammered enamel finish. Please be sure to specify the proper suffix when ordering.

Catalog No.	Actual Weight	Dealer Cost
PS-439	3 lbs.	\$ 5.85

METER PANELS



All meter panels are made of 1/8" thick steel. The small holes will fit either a 2" square or round meter. The large holes will fit either a 3" square or round meter. If black wrinkle finish is desired, specify by use of suffix "B", grey wrinkle finish by use of suffix "G" and light grey hammered finish by use of suffix "HG".

Catalog No.	Number of Holes	Diameter of Holes	Actual Weight	Dealer Cost
PS-440	2	2.334"	2 3/4 lbs.	\$ 1.30
PS-441	3	2.334"	2 3/4 lbs.	1.85
PS-442	3	2.835"	2 1/2 lbs.	1.30
PS-443	5	2.835"	2 1/2 lbs.	1.85

METAL DOOR RACK PANELS



When accessibility to component parts on the chassis is a vital point, this panel is extremely useful. The panels are available in either grey or black wrinkle finish or light grey hammered finish. Please be certain that you specify, by use of the proper suffix, for color when ordering. Panels are made of 1/8" sheet steel.

Catalog No.	Height	Door Opening	Actual Weight	Dealer Cost
PS-615	10 1/2"	15 3/8" x 6"	7 1/4 lbs.	\$ 4.50
PS-616	12 1/2"	15 3/8" x 7 1/2"	8 1/4 lbs.	4.95

VENTILATED DOOR RACK PANELS

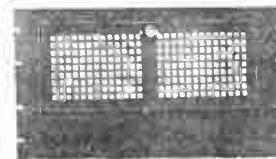

The Bud Ventilated Door Rack Panel has a generous perforated area in the door providing adequate ventilation for adjacent units. The panels are 19" long and are available in either black or grey wrinkle finish or light grey hammered finish.

OF SPECIAL INTEREST TO THE USER IS THE NEWLY DESIGNED IMPROVED LOCK ON THIS PANEL. THE LOCK IS A PLUNGER TYPE THAT MAKES CERTAIN IT IS EASY TO OPEN THE DOOR.

Catalog No.	Height	Door Opening	Actual Weight	Dealer Cost
PS-814	10 1/2"	15 3/8" x 6"	6 lbs.	\$ 5.85
PS-815	12 1/2"	15 3/8" x 7 1/2"	7 lbs.	6.45

RACK SHELVES



Heavy power supplies, modulator units, etc., can be mounted on these rack shelves, which are supported in the cabinet by the chassis supporting angles which are shown on page J-43. The shelves are made of heavy gauge steel and are finished in black enamel only.

Catalog No.	Depth	Actual Weight	Dealer Cost
CB-1976	17"	6 1/2 lbs.	\$ 3.10
CB-1977	12"	5 1/2 lbs.	2.35



CHASSIS

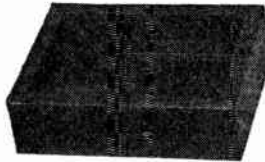

STEEL CHASSIS

These Chassis are made from one piece of steel. All corners are reinforced and spot welded. The four sides are folded at the bottom for additional strength. This also permits a bottom plate to be attached if desired.

As shown in table below, chassis are available in either black wrinkle finish or electro-zinc plated.

Black Wrinkle Cat. No.	Zinc Plated Cat. No.	Depth	Width	Height	Gauge	Actual Weight lbs.	Dealer Cost
CB-628	CB-629	5"	7"	2"	22	1	\$.85
CB-644	CB-643	5"	9 1/2"	2 1/2"	22	1 1/4	.90
CB-788	CB-776	5"	9 1/2"	1 1/2"	22	1	1.00
CB-604	CB-605	5"	10 1/2"	3"	22	1 1/4	1.05
CB-755	CB-756	6"	14"	3"	20	1 3/4	1.27
CB-789	CB-1191	7"	7"	3"	22	1 1/2	.90
CB-790	CB-1192	7"	9"	3"	22	1 1/2	1.05
CB-791	CB-1193	7"	11"	2"	20	1 1/2	1.10
CB-792	CB-793	7"	12"	3"	20	1 3/4	1.25
CB-646	CB-1194	7"	13"	2"	20	2	1.20
CB-647	CB-1198	5"	13 1/2"	2 1/2"	20	1 3/4	1.30
CB-649	CB-1189	7"	15"	3"	20	2	1.45
CB-663	CB-666	8 1/2"	15"	3"	20	2 1/2	1.65
CB-1068	CB-1066	4"	17"	3"	20	2 1/4	1.30
CB-648	CB-1199	7"	17"	3 1/2"	20	2	1.55
CB-757	CB-758	7"	17"	3 1/2"	20	1 3/4	1.57
CB-701	CB-702	8"	10"	2 1/2"	20	2	1.42
CB-703	CB-704	8"	12"	2 1/2"	20	2 1/2	1.50
CB-759	CB-750	8"	12"	3"	20	1 3/4	1.43
CB-650	CB-774	8"	17"	3"	20	2	1.45
CB-651*	CB-775	8"	17"	3"	20	2 1/8	1.55
CB-652	CB-1195	10"	12"	3"	20	3	1.50
CB-653	CB-779	10"	14"	3"	20	4	1.60
CB-654*	CB-769	10"	17"	3"	20	3 1/4	1.60
CB-636*	CB-637	10"	17"	3"	20	4	1.60
CB-655*	CB-1196	10"	18"	3"	18	2 1/4	1.85
CB-656	CB-1197	10"	23"	3"	18	2 1/2	2.44
CB-657*	CB-770	11"	17"	2"	18	4 1/2	2.00
CB-658*	CB-771	11"	17"	3"	18	4 1/2	2.20
CB-663*	CB-661	12"	17"	2"	18	4 1/2	1.70
CB-664*	CB-662	12"	17"	3"	18	5 1/4	2.00
CB-659*	CB-772	13"	17"	3"	18	5 1/2	2.35
CB-660*	CB-773	13"	17"	3"	18	6 1/2	2.04
CB-640*	CB-641	10"	17"	4"	18	6 1/2	3.00
CB-642*	CB-643	13"	17"	4"	18	7 1/2	3.00
CB-623	CB-624	19"	17"	5"	18	7 1/2	3.65
CB-625	CB-626	13"	17"	5"	18	8	4.00

*Indicates chassis punched to accommodate Chassis Mounting Brackets.



NEW PANEL CHASSIS

This new series of panel mounting chassis is for professional type installations primarily. These units are constructed from .062" aluminum with an etched finish. The front flange is notched with standard notching suitable for mounting to a rack.

Catalog No.	Width	Depth	Height	Dealer Cost
CB-1370	19"	5-9/32"	1 3/4"	\$1.90
CB-1371	19"	5-9/32"	3 1/2"	2.15
CB-1372	19"	5-9/32"	5 1/4"	2.25
CB-1373	19"	5-9/32"	7"	2.60
CB-1374	19"	5-9/32"	8 3/4"	3.05
CB-1375	19"	5-9/32"	10 1/2"	3.30
CB-1376	19"	5-9/32"	12 1/4"	3.70
CB-1377	19"	5-9/32"	14"	4.00

REMOVABLE TOP CHASSIS

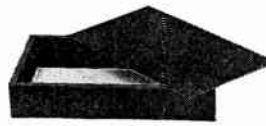

Amateurs and experimental technicians, who make periodic changes, can do so with a minimum of waste by discarding the top that has been drilled and replacing it with a new one. These chassis are supplied in black wrinkle finish or electro-zinc plated.

Black Wrinkle Cat. No.	Zinc Plated Cat. No.	Depth	Width	Height	Dealer Cost
CB-196	CB-193	10"	17"	3"	\$3.30
CB-197	CB-194	10"	17"	4"	3.65
CB-251	CB-210	13"	17"	3"	3.45
CB-252	CB-211	13"	17"	4"	4.25



ALUMINUM CHASSIS

The construction and design of these chassis are exactly the same as that of our steel chassis bases. The aluminum chassis are welded on Government approved spot welders that are the same as

those used in the welding of aluminum aircraft parts. As a result, you can depend on Bud Aluminum Chassis to do a perfect job and to stand up under all conditions.

Please note that the gauges shown in the table are aluminum gauges. These chassis are supplied in an etched aluminum finish.

Catalog Number	Depth	Width	Height	Gauge	Dealer Cost
AC-430	4"	6"	3"	18	\$1.02
AC-431	4"	6"	2"	18	1.02
AC-432	4"	17"	3"	16	1.83
AC-402	5"	7"	2"	18	.84
AC-439	5"	9 1/2"	3"	16	1.05
AC-403	5"	9 1/2"	2"	18	.99
AC-421	5"	13"	3"	18	1.17
AC-404	5"	13"	3"	18	1.20
AC-422	5"	13"	3"	18	1.26
AC-433	6"	17"	3"	16	1.89
AC-405	7"	7"	2"	18	1.08
AC-406	7"	9"	2"	18	1.20
AC-407	7"	11"	2"	18	1.41
AC-408	7"	12"	3"	18	1.26
AC-409	7"	13"	2"	16	2.04
AC-411	7"	15"	3"	16	1.83
AC-423	8"	17"	3"	16	1.71
AC-424	8"	12"	2"	16	1.89
AC-435	8"	17"	2"	16	2.22
AC-412	8"	17"	3"	16	1.89
AC-413	10"	12"	3"	16	2.40
AC-414	10"	14"	3"	16	2.26
AC-415	10"	17"	2"	16	2.58
AC-416	10"	17"	3"	16	2.37
AC-426	11"	17"	2"	14	3.00
AC-417	11"	17"	3"	14	3.18
AC-418	12"	17"	3"	14	2.82
AC-419	13"	17"	2"	14	3.36
AC-420	13"	17"	3"	14	2.97
AC-427	18"	17"	4"	14	3.84
AC-428	13"	17"	4"	14	

HEAVY DUTY CHASSIS

(Furnished with Bottom Plate)



These chassis, made of 16 gauge steel, are designed for applications requiring unusual sturdiness and where large weights are involved. The bottom plates for these chassis are furnished at no extra charge. Available in either black wrinkle finish or electro-zinc plated.

Black Wrinkle Cat. No.	Zinc Plated Cat. No.	Depth	Width	Height	Dealer Cost
CB-1757	CB-1764	8"	17"	2"	\$2.90
CB-1758	CB-1765	8"	17"	3"	3.15
CB-1759	CB-1766	11"	17"	2"	3.30
CB-1760	CB-1767	11"	17"	3"	3.65
CB-1761	CB-1768	13"	17"	2"	4.00
CB-1762	CB-1769	13"	17"	3"	4.40
CB-1763	CB-1770	13"	17"	4"	4.84



CHASSIS DECKS

These chassis decks are suitable for use in carrying cases, utility cabinets, etc. Each unit is folded over 1 1/2" on the front, 1/2" on the side and is made from steel which is electro-zinc plated. They are also useful for interstate shielding and supports in regular panel and chassis layouts.

Cat. No.	Width	Depth	Fits Cab. No.	Dealer Cost
CB-522	4 3/4"	5 1/2"	CU-1098	\$.52
CB-523	4 3/4"	4 1/2"	CU-1099	.50
CB-524	6 3/4"	6 1/2"	CU-879	.65
CB-525	5 3/4"	5 1/2"	CU-1124, CC-1096	.60
CB-526	8 3/4"	7 1/2"	CU-880	.92
CB-527	9 3/4"	7 1/2"	CU-881	.95
CB-528	7 3/4"	6 1/2"	CU-882	.75
CB-36	6 1/2"	6 1/2"	CC-1097	.66
CB-37	8 3/4"	6 1/2"	CC-1100	.82

Prices on above slightly higher west of the Mississippi River. Only a few of many BUD Products are shown. For complete catalog, write BUD RADIO, INC., 2118 E. 55th St., Cleveland, Ohio



CHASSIS—AMPLIFIER FOUNDATIONS



OPEN END CHASSIS

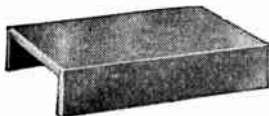

These are primarily intended to be used with the various styles and sizes of Bud Metal Cabinets. These chassis are ideal for any type of small built-up units such as record amplifier, code oscillator, etc. From this you can see that there is a wide variety of applications. The U-shaped construction is used with ends folded over $\frac{3}{8}$ " for additional strength. The finish is electro-zinc plated.

Cat. No.	Depth	Width	Height	Fits Cab. No.	Dealer Cost
CB-38	7"	6"	2"	C-1584	.66
CB-30	5"	7"	1 1/2"		.60
CB-41	7"	8"	1 1/2"	C-973	.75
CB-39	7"	8"	2"	C-1585	.84
CB-996	5 1/2"	9"	1 1/2"	C-993	.70
CB-976	7 1/2"	9"	1 1/2"	C-999, C-1746	.95
CB-40	7"	10"	2"	C-1586	.90
CB-997	7"	11"	1 1/2"	C-994, C-1747	1.00
CB-998	7"	13"	1 1/2"	C-995, C-1748	1.16
CB-34	10 3/4"	14"	2"	C-975	1.41
CB-35	7 3/4"	15"	2"	C-1190A	1.38

MINIATURE ALUMINUM CHASSIS



These small, open end aluminum chassis are the answer for miniature tube applications or sub-assemblies. They are made of hard aluminum with $\frac{1}{4}$ " flanges on the bottom allowing the chassis to be fastened down, or allowing a bottom plate to be attached. They are extremely useful for a wide variety of applications such as small receivers, narrow band FM adapters or any place where the space is limited. The finish is etched aluminum.

Cat. No.	Depth	Width	Height	Fits Cabinet No.	Dealer Cost
CB-1623	2 3/4"	3 1/4"	1 1/4"	C-1784	.30
CB-1624	1 3/4"	3 1/4"	1"	CU-883	.33
CB-1625	3 1/4"	4 1/4"	2"	C-1788	.36
CB-1626	2 3/4"	4 1/4"	1"	CU-728	.36
CB-1627	3 3/4"	4 1/4"	1 1/2"	CU-729	.36
CB-1628	3"	6 1/4"	1 1/2"	C-1785	.42
CB-1629	5 3/4"	4 3/4"	1 1/2"	CU-1098	.45
CB-1617	4"	3 1/4"	1"	C-1602	.36
CB-1618	4"	4 1/4"	1"	C-1603	.39
CB-1619	4"	5 1/4"	1"	C-1604	.42
CB-1620	4"	6 1/4"	1"	C-1605	.45

STREAMLINED AMPLIFIER FOUNDATIONS

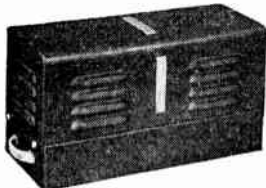

This unit is most often used to obtain beauty in an amplifier and similar apparatus. Each foundation consists of a standard chassis on which is mounted a removable top cover. Chrome trim is used to give additional attractiveness to the equipment. Sturdy, easy grip handles are attached to the chassis. Specify with the suffix "B" for black wrinkle finish or the suffix "G" for grey wrinkle.

Cat. No.	Width	Depth	Dealer Cost
CA-1750	10-1/16"	5"	\$3.90
CA-1751	12-1/16"	7"	5.06
CA-1752	17-1/16"	7"	5.50
CA-1753	17-1/16"	10"	6.33

SLOPING PANEL AMPLIFIER FOUNDATIONS

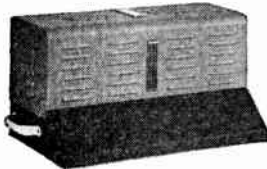

Each foundation consists of a 4" sloping front chassis on which is mounted a removable top cover. The top cover contains grill cutouts and louvers for adequate ventilation. All have handles mounted on the chassis. The cover is finished in grey wrinkle with chrome trim, and the chassis is finished in black wrinkle to give a unique and attractive appearance.

Cat. No.	Top Depth	Chassis Length	Chassis Depth	Dealer Cost
CA-1980	5"	10"	8"	\$5.60
CA-1981	7"	12"	10"	6.53
CA-1982	7"	17"	10"	7.56
CA-1983	10"	17"	13"	8.25

CHASSIS BOTTOM PLATES

Steel and Aluminum

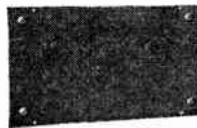

These bottom plates make excellent dust covers and protect all wiring and component parts of the chassis. Each plate has four formed bosses to prevent sharp edges from scratching a table top or other surface. Those numbers prefaced by "BP" are steel bottom plates, supplied in black wrinkle finish or electro-zinc plated finish. Those bottom plates prefaced by "BPA" are made of aluminum and have an etched finish.

STEEL

Black Wrinkle	Zinc Plated	Cat. No.	Width	Length	Dealer Cost
BP-705	BP-706		5"	7"	\$.46
BP-680	BP-667		5"	9 1/2"	.47
BP-536	BP-538		5"	10"	.46
BP-681	BP-668		7"	7"	.67
BP-682	BP-669		7"	9"	.67
BP-683	BP-670		7"	11"	.71
BP-537	BP-539		7"	12"	.68
BP-684	BP-671		7"	13"	.75
BP-685	BP-672		5"	13 1/2"	.60
BP-516	BP-513		7"	15"	.75
BP-541	BP-540		8 1/2"	15"	.76
BP-1069	BP-1067		4"	17"	.60
BP-686	BP-673		6"	17"	.86
BP-707	BP-708		8"	10"	.75
BP-709	BP-710		8"	12"	.86
BP-687	BP-674		8"	17"	.90
BP-688	BP-675		10"	12"	.90
BP-517	BP-514		10"	14"	.92
BP-689	BP-676		10"	17"	1.10
BP-690	BP-677		11"	17"	1.10
BP-691	BP-678		12"	17"	1.20
BP-692	BP-679		13"	17"	1.40
BP-518	BP-515		10"	23"	1.50

ALUMINUM

BPA-1589	5"	7"	\$.70
BPA-1590	5"	9 1/2"	.71
BPA-1591	5"	10"	.71
BPA-1592	7"	7"	.73
BPA-1593	7"	9"	.77
BPA-1594	7"	11"	.86
BPA-1595	7"	12"	.92
BPA-1596	7"	13"	1.09
BPA-1597	10"	17"	1.46
BPA-1598	13"	17"	1.97

AMPLIFIER FOUNDATIONS

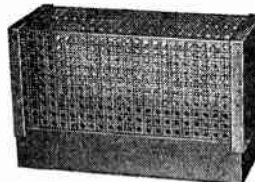

This standard Bud Amplifier Foundation consists of a regular chassis on which is attached a perforated metal cover providing all that you require in ventilation. Easy grip handles attached to the chassis. These units are furnished in black wrinkle finish only.

Cat. No.	Height	Width	Depth	Chassis Height	Dealer Cost
CA-699	8-5/16"	9 3/4"	5 1/2"	2 1/2"	\$3.85
CA-1125	8-5/16"	13 3/8"	5 1/2"	2 1/2"	4.25
CA-1126	8-5/16"	17 1/8"	7 1/2"	2 1/2"	5.50
CA-1127	8-13/16"	17 1/8"	10 1/2"	3"	7.15
CA-1128	8-13/16"	12 1/2"	10 1/2"	3"	6.05

BOX SHIELDS

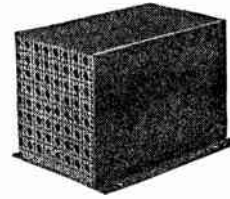
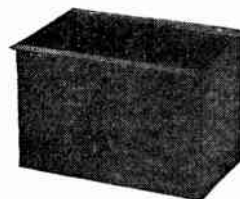

These shields have many uses; shielding power transformers and chokes; covering and protecting various other components in power supplies, transmitters, receivers and other electronic units. The top and the sides are one piece steel. BS-1244 has perforated steel ends for ventilation. BS-1891 has solid ends. Flanges at the bottom provide for mounting. These units are finished in black wrinkle enamel only.

Catalog No.	Ends	Actual Weight lbs.	Dealer Cost
BS-1244	Ventilated	1	\$2.33
BS-1891	Solid	1 1/2	1.65

Prices on above slightly higher west of the Mississippi River
Only a few of many BUD Products are shown. For complete catalog, write BUD RADIO, INC., 2118 E. 55th St., Cleveland, Ohio



CABINETS - CASES



INSTRUMENT and RECEIVER CABINETS

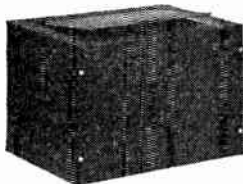

Each cabinet has an evenly recessed hinge cover with convenient finger lift. The panel in the front of the cabinet is readily attached with self tapping screws. Louvers provide satisfactory ventilation. For chassis to fit these cabinets, see the open end chassis listed on page J-46. Finished in black wrinkle enamel only.

Cat. No.	Height	Width	Depth	Dealer Cost
C-973	7"	8"	8"	\$3.20
C-993	7"	10"	8"	3.48
C-994	7"	12"	8"	4.00
C-995	7"	14"	8"	4.20
C-1190	8"	16"	8"	6.00
C-975	9"	15"	11"	6.00
C-999	12"	18"	12"	8.25

STREAMLINED CABINETS

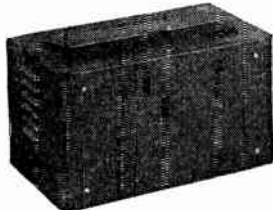

Distinctive features of these cabinets are the rounded front corners and recessed hinge tops. All parts built into these cabinets are, therefore, easily accessible. Suitable chassis may be found under the listing of open end chassis on page J-46. These units are furnished in black wrinkle finish only.

Catalog Number	Panel Size	Cabinet Width	Cabinet Height	Dealer Cost
C-1789	8" x 8"	10 1/2"	8"	\$3.25
C-1746	8" x 10"	12 1/2"	8"	4.00
C-1747	8" x 12"	14 1/2"	8"	4.50
C-1748	8" x 14"	16 1/2"	8"	5.15
C-1790	8" x 16"	18 1/2"	8"	5.75
C-1730	12" x 18"	20 1/2"	12"	9.30

DELUXE STREAMLINED CABINETS

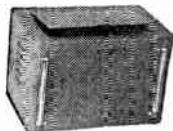

These cabinets are identical with those listed above, except that they have a 1/2" vertical chrome strip at each side of the panel and are supplied in grey wrinkle enamel finish only.

Catalog Number	Panel Size	Cabinet Width	Cabinet Height	Dealer Cost
C-1791	8" x 8"	10 1/2"	8"	\$4.15
C-1781	8" x 10"	12 1/2"	8"	4.62
C-1782	8" x 12"	14 1/2"	8"	4.95
C-1783	8" x 14"	16 1/2"	8"	6.18
C-1792	8" x 16"	18 1/2"	8"	6.50
C-1731	12" x 18"	20 1/2"	12"	10.25

STREAMLINED SCOPE and UTILITY CABINETS

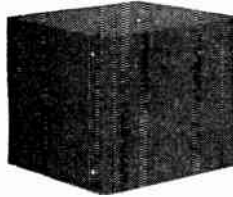

These are attractive cabinets that are adaptable to a variety of uses. All cabinets are supplied with chassis. Chassis height on all except CU-1991 and CU-1992 is 1 1/2". CU-1991 is designed for 3" cathode ray tube and has a hinged cover to provide easy access to tube and other components. The chassis height is 2". CU-1992 is designed for a 5" cathode ray tube and also has a hinged cover. Chassis height 3".

Catalog Number	Width	Depth	Height	Dealer Cost
CU-1990	5 1/2"	8 1/4"	8"	\$3.50
CU-1984	7 1/2"	8 1/4"	8"	3.52
CU-1985	9 1/2"	8 1/4"	8"	3.92
CU-1986	11 1/2"	8 1/4"	8"	4.30
CU-1987	13 1/2"	8 1/4"	8"	5.00
CU-1988	15 1/2"	8 1/4"	8"	5.50
CU-1989	17 1/2"	8 1/4"	8"	6.25
CU-1991	7 1/2"	13"	8"	6.00
CU-1992	9 1/2"	19"	12"	8.00

CARRYING CASES



These carrying cases have many uses. An easy grip handle is fastened to the top. Front and back panels are removable. Welded construction assures maximum strength where needed, and this unit is also available in aluminum to provide minimum weight where required for portable work. For chassis to fit these cabinets, see the chassis decks on page J-45. Prefix "CC" represents steel construction. Prefix "ACC" represents aluminum construction with etched finish.

Cat. No.	Depth	STEEL		Height	Dealer Cost
		Width	Height		
CC-1095	5"	6"	9"	\$2.48	
CC-1091	5"	9"	6"	2.48	
CC-1096	6"	7"	12"	2.90	
CC-1092	6"	12"	7"	2.90	
CC-1097	7"	7 3/4"	15"	3.60	
CC-1100	8"	10"	10"	3.42	
CC-1093	7"	15"	9"	5.00	

Cat. No.	Depth	ALUMINUM (Etched Finish)		Height	Dealer Cost
		Width	Height		
ACC-2095	5"	6"	9"	\$2.40	
ACC-2091	5"	9"	6"	2.40	
ACC-2096	6"	7"	12"	3.00	
ACC-2092	6"	12"	7"	3.00	

MINIATURE AMPLIFIER FOUNDATIONS



With the increased use of miniature tubes, smaller cabinets can be used when designing a compact amplifier. This amplifier foundation was designed expressly for this purpose. The chassis is 5" x 7" x 2". The cover is made of perforated metal. A streamlined handle makes this cabinet portable. Black wrinkle finish only.

Cat. No.	Actual Weight lbs.	Dealer Cost
CA-1754	1 1/2	\$3.50

MINIATURE UTILITY CABINETS

(With Attached Chassis)

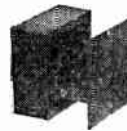

A long sought for item has been a small cabinet with a chassis attached to the front panel. This is indispensable for building electronic devices using miniature tubes or transistors. Front and rear panels are removable and fastened with self tapping screws that permit easy accessibility. Finished in black wrinkle enamel only.

Cat. No.	Height	Width	Depth	CHASSIS SIZE			Dealer Cost
C-1793	4"	4"	2"	1"	3 1/2"	1 1/2"	\$1.05
C-1794	4"	5"	3"	1"	4 1/2"	2 1/2"	1.15
C-1795	5"	4"	3"	1 1/2"	3 1/2"	2 1/2"	1.15
C-1796	6"	5"	4"	5 1/4"	4 1/2"	3 1/2"	1.43
C-1797	5"	6"	4"	6 1/4"	5 1/2"	3 1/2"	1.43
C-1798	6"	6"	6"	1 3/4"	4 7/8"	5 7/8"	1.48

UTILITY CABINETS



A large number of sizes available makes this line useful for all types of electronic equipment. These cabinets have two removable panels for easy accessibility. Units prefixed by CU are made from cold rolled steel and are finished in black wrinkle enamel. Those prefixed by AU are made from high grade sheet aluminum and have etched finish.

Cat. No.	Depth	STEEL		Height	Dealer Cost
		Width	Height		
CU-883	2"	4"	4"	4"	\$.95
CU-728	3"	5"	4"	4"	.95
CU-729	4"	5"	6"	6"	1.20
CU-1098	6"	6"	6"	6"	1.30
CU-1099	5"	6"	6"	9"	1.86
CU-879	5"	8"	8"	10"	2.30
CU-1124	6"	7"	7"	12"	2.46
CU-880	8"	10"	10"	10"	2.90
CU-881	8"	11"	12"	12"	3.60
CU-882	7"	9"	15"	15"	4.10

Cat. No.	Depth	ALUMINUM		Height	Dealer Cost
		Width	Height		
AU-1083	2"	4"	4"	4"	\$.90
AU-1028	3"	5"	4"	4"	1.02
AU-1029	4"	5"	6"	6"	1.32
AU-1039	6"	6"	6"	6"	1.39
AU-1040	5"	6"	9"	9"	1.98

Prices on above slightly higher west of the Mississippi River
Only a few of many BUD Products are shown. For complete catalog, write BUD RADIO, INC., 2118 E. 55th St., Cleveland, Ohio



CABINETS - BOXES



SLOPING PANEL CABINETS



This entire front panel of this cabinet is removable if so desired. THIS CABINET IS ALSO PROVIDED WITH A HINGED TOP FOR EASY ACCESSIBILITY TO TUBES AND OTHER PARTS THAT ARE MOUNTED ON THE CHASSIS. WITHOUT NECESSITATING REMOVAL OF THE FRONT PANEL. These cabinets are finished in black wrinkle enamel only.

Catalog Number	Height	Width	Depth	Fits Chassis	Dealer Cost
C-1584	6 1/2"	7-1/16"	7 1/8"	7" x 6" x 2"	\$3.15
C-1585	6 1/2"	9-1/16"	7 1/8"	7" x 8" x 2"	3.58
C-1586	6 1/2"	11-1/16"	7 1/8"	7" x 10" x 2"	3.96
C-1892	8"	13-1/16"	8 1/2"	8" x 12" x 2 1/2"	4.75
C-1893	10"	18-1/16"	10 1/2"	10" x 17" x 3"	6.66

SLOPING PANEL UTILITY BOXES



The sloping panel utility box offers a streamlined appearance and enough space to house conveniently a two or three miniature tube amplifier or gadget. A 3/8" flange around the rear opening of the cabinet provides convenient back cover mounting. Extremely compact, it will accommodate a Bud Miniature Aluminum Chassis. Finished in black wrinkle enamel only.

Catalog No.	Width	Use Chassis No.	Actual Weight lbs.	Dealer Cost
C-1602	4"	CB-1617	1 1/2	\$1.20
C-1603	5"	CB-1618	1 1/2	1.30
C-1604	6"	CB-1619	1	1.40
C-1605	7"	CB-1620	1	1.50

SLOPING PANEL UTILITY CABINETS



This cabinet is similar to the Sloping Panel Utility Box, with the exception of the fact that the opening is on the bottom of the cabinet rather than in the back. It is finished in black wrinkle enamel only. Height on all units 4", depth 4 1/2".

Catalog No.	Width	Actual Weight lbs.	Dealer Cost
C-1578	4"	3/4	\$1.00
C-1579	5"	3/4	1.15
C-1580	6"	1	1.32
C-1581	7"	1	1.59

STREAMLINED MULTIPURPOSE CABINET



A handsome streamlined metal cabinet, finished in grey wrinkle enamel only. The back of the cabinet is completely open for ventilation purposes.

Cat No.	Height	Width	Depth	Use Chassis No.	Dealer Cost
C-1784	4 1/2"	3 3/8"	3 1/4"	CB-1623	\$1.65
C-1785	4 1/2"	7 1/8"	3 1/4"	CB-1628	1.93
C-1787	4 1/2"	5 1/2"	3 1/2"	CB-1625	1.70
C-1788	6 1/2"	5 1/2"	3 1/2"	CB-1625	1.75

TRUCK CASTERS



No. RC-7756 Heavy Duty type casters are recommended for our Deluxe Relay Racks and where weights of 400 lbs. or less are to be distributed on four casters. No. RC-7757 casters are light duty and are recommended for lighter weight. The wheels are high grade, hard rubber composition and ball bearing type.

Catalog No.	Height	Actual Weight per Set (4)	Dealer Cost
RC-7756	2 3/8"	1 3/4 lbs.	\$.90
RC-7757	2"	1 lb.	.40

These handles are designed to provide sufficient strength and comfortable hand grip. They are made from aluminum tubing and are given an etched aluminum finish. The handles are furnished complete with screws, washers and nuts.



UTILITY HANDLES



HANDY BOXES

The design of the Handy Box permits a large number of small components to be easily wired or serviced. The cover is held by four self tapping screws. Made from 22 gauge steel and is furnished in black wrinkle finish only.

Catalog No.	Height	Width	Depth	Actual Weight lbs.	Dealer Cost
HB-1621	2 1/4"	4 1/4"	1 1/2"	1 1/2	\$.90
HB-1622	2"	4"	2 3/4"	1 1/2	1.00

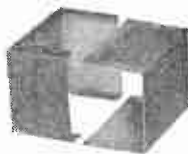

MINIBOXES

There are thousands of uses in the field of radio and electronics for these boxes. They are made of high quality aluminum. The design of the box permits installation of more components than would be possible in the more conventionally designed box of the same size. Construction is of the two piece type, each half forming three sides. The flange type construction assures adequate shielding. These units are available in either etched aluminum finish or grey hammertone finish.

Gray Cat. No.	Etched Cat. No.	Length	Width	Height	Dealer Cost
CU-2100	CU-3000	2 3/4"	2 1/8"	1 3/8"	\$.63
CU-2101	CU-3001	3 1/4"	2 1/8"	1 3/8"	.63
CU-2102	CU-3002	4"	2 1/8"	1 3/8"	.66
CU-2103	CU-3003	4"	2 1/8"	2 1/4"	.87
CU-2104	CU-3004	5"	2 1/4"	2 1/4"	.90
CU-2105	CU-3005	5"	3"	3"	.99
CU-2106	CU-3006	5 1/4"	3"	2 1/8"	.96
CU-2107	CU-3007	6"	5"	4"	1.23
CU-2108	CU-3008	7"	5"	3"	1.38
CU-2109	CU-3009	8"	6"	3 1/2"	2.01
CU-2110	CU-3010	10"	6"	3 1/2"	2.49
CU-2111	CU-3011	12"	7"	4"	2.94
CU-2112	CU-3012	17"	5"	4 1/2"	3.45
CU-2113	CU-3013	10"	2"	1 5/8"	1.20
CU-2114	CU-3014	12"	2 1/2"	2 1/2"	1.35
CU-2115	CU-3015	4"	2 1/2"	2 3/4"	.84
CU-2116	CU-3016	4 1/2"	3 1/4"	1 1/2"	.87
CU-2117	CU-3017	3 1/4"	2 1/8"	1 1/8"	.63

METER CASES



Designed for all applications requiring a modern meter case. All cases have a sloping front with the top corner rounded. Meter cases No. CM-1241 and CM-1242 have insulators on the top for leads to the meter. CM-1965 and CM-1966 are furnished without insulators. These steel units are finished in black wrinkle enamel only.

Also available are our new-aluminum meter cases, prefixed by the letters CMA, as shown in the table below. These units are the same size and design as the steel meter cases, but are especially suitable for use when a case that will have no magnetic effect on a meter is required. No insulators furnished. These cases are etched aluminum finish.

Catalog Number	Hole Diameter	Fits Meter Size	Dealer Cost
CM-1241	2.334"	2"	\$1.25
CM-1242	2.835"	3"	1.25
CM-1965	2.334"	2"	.95
CM-1966	2.835"	3"	.95
CMA-2065	2.334"	2"	1.02
CMA-2066	2.835"	3"	1.02

TRIANGULAR MOUNTING BRACKETS



For panel and chassis assemblies where large weights are involved, these triangular mounting brackets make extremely convenient supports. They are constructed of heavy gauge steel and are furnished in black enamel finish only. These are sold only in pairs.

Catalog No.	Height	Depth	Actual Weight lbs.	Dealer Cost
MB-1266	5"	5"	1	\$.80
MB-1267	7"	7"	1	.91
MB-1268	9"	9"	1 1/2	1.10

Prices on above slightly higher west of the Mississippi River
Only a few of many BUD Products are shown. For complete catalog, write BUD RADIO, INC., 2118 E. 55th St., Cleveland, Ohio



SPECIAL SHEET METAL FABRICATION



Now, Bud Radio, through its Metal Products Division, offers greatly increased facilities for the production of special sheet metal items. New machinery has been added, departments have been modernized and streamlined, and new methods have been developed.

We make over four hundred different sheet metal products as stock items, which are illustrated elsewhere in this catalog. Often a slight change in one of our standard items will eliminate the necessity of special tools and dies, thereby reducing costs greatly. Since we produce thousands of sheet metal products, every month, for ourselves and for leading firms throughout the country, we are able to

effect economies in production which mean lower prices and faster delivery.

Our expanded facilities, expert workmanship, years of experience and manufacturing "know how" assure high quality products. In addition, our Engineering Staff is always available for consultation and advice. We suggest that you send us your blueprints for estimate.

Whether the quantity be one, ten, one hundred, one thousand or many thousands, we are interested in the opportunity to be of service to you.

Illustrated on this page are a few examples of specially fabricated sheet metal products.

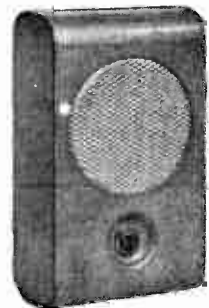
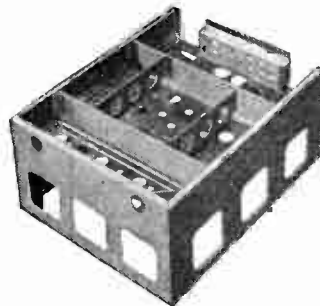
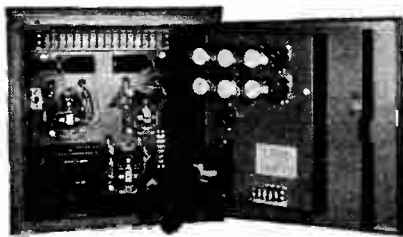
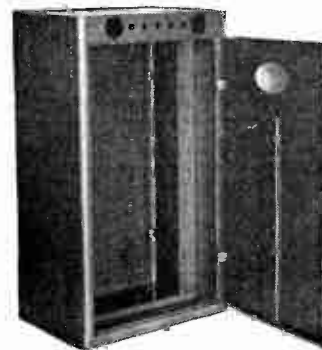
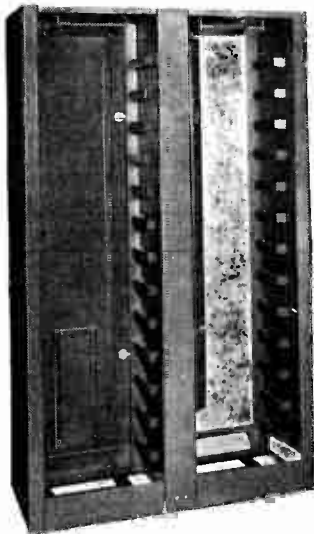

Only a few of many BUD Products are shown. For complete catalog, write BUD RADIO, INC., 2118 E. 55th St., Cleveland, Ohio



AMATEUR EQUIPMENT



BUD CODE PRACTICE OSCILLATOR AND MONITOR CPO-128A



The BUD CODEMASTER is a real money-saver. No longer do you have to consider your code practice oscillator useless after you have learned the code. A flip of the switch and you have a good CW monitor. This is a really versatile instrument. It has a 4" built-in permanent magnetic dynamic speaker and will operate up to twenty earphones. 2 tubes—50C5 and 35W4.

A volume control, and pitch control permit adjustments to suit individual requirements.

Any number of keys can be connected in parallel to the oscillator for group practice.

This unit will operate on 110 volts A.C. or D.C. An external speaker may be plugged in without the use of an output transformer. All controls are placed on the front of the unit and all jacks are in the rear. The units is 6 1/2" high, 5 1/2" wide and 3 1/2" deep. It is finished in Grey Hammertone enamel with red lettering.

Catalog No.
CPO-128A

Dealer Cost
\$15.75

BUD GIANT TRANSMITTER CONDENSER—Single Section

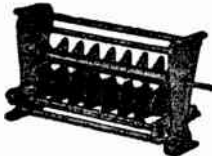

BUD GIANT TRANSMITTER CONDENSERS are built with a sturdy frame consisting of 3/16" thick aluminum end plates, connected by 1/8" diameter duraluminum rods. Formed brackets at top and bottom of end plates provide for mounting these units, and permit placing of associated inductances directly on the condenser.

Rotor and stator plates are accurately stamped from 0.064" thick highly polished aluminum with all edges rounded to minimize corona loss and danger of peak-voltage flash-over. The plates are separated by accurately machined duraluminum spacers that insure a constant air-gap throughout the entire length of the condenser.

The large two-finger rotor-contact spring, made from plated spring brass, assures positive contact with noise-free operation. Steatite bars insulate the stator, and are placed well outside the electrostatic field to keep dielectric losses at a minimum.

Catalog Number	Max. Cap. MMFD.	Min. Cap. MMFD.	No. of Plates	Air Gap	Mtg. Hole Spcg.	Over-All Length	Dealer Cost
GC-1800	195	24	15	.250"	8 1/2"	12 3/4"	\$26.13
GC-1801	345	32	27	.250"	12 1/4"	16 1/2"	37.02
GC-1802	530	48	41	.250"	16 3/8"	20 1/2"	49.68
GC-1803	55	19	7	.500"	7 1/2"	11 3/8"	20.85
GC-1804	95	25	15	.500"	12"	15 3/8"	29.19
GC-1805	150	33	21	.500"	15 3/8"	19 1/4"	34.98
GC-1806	255	52	35	.500"	23 1/2"	27 1/4"	49.02
GC-1807	50	22	9	.750"	10 1/2"	14 1/2"	24.21
GC-1808	75	27	13	.750"	13 3/8"	17 3/8"	29.34
GC-1809	110	40	19	.750"	18 3/8"	22 3/8"	32.67
GC-1810	160	50	29	.750"	26 3/8"	30 3/8"	46.86
GC-1811	55	30	11	1.000"	14 3/8"	18 3/8"	28.11
GC-1812	85	40	17	1.000"	21 3/8"	25 3/8"	36.03
GC-1813	105	45	23	1.000"	27 1/2"	31 3/8"	44.43

BUD MASTER TRANSMITTING CONDENSERS—Dual Section



All tie-rods in this series are insulated by glazed Steatite pillars, thus completely eliminating all closed metallic loops in the condenser frame. A special outstanding feature, developed by BUD engineers, is that of placing the positive double wiping rotor contact between the two sections at the center of the rotor. These features contribute to perfect circuit balance and eliminate the majority of difficulties encountered in high frequency equipment due to parasitics, circulating currents and poor neutralization. Use BUD condensers throughout and be trouble free.

Catalog Number	Cap. Per Sec. Max. Min.	No. Plates Per Sec.	Air Gap	Mtg. Hole Spcg.	Over-All Length	Dealer Cost
BC-1635A	25 9 5	200"	6-13/32"	8-1/32"	\$13.91	
BC-1636A	35 12 7	200"	7-13/32"	9-1/32"	14.70	
BC-1637A	50 13 11	200"	9-13/32"	11-1/32"	15.96	
BC-1638A	75 16 15	200"	11-13/32"	13-1/32"	17.28	
BC-1633A	100 20 21	200"	14-13/32"	16-1/32"	19.55	
BC-1634A	50 15 13	300"	12-13/16"	14-7/16"	17.43	

Panel space to mount Master Condensers 3 3/4" wide by 4 7/8" high

BUD CODE PRACTICE OSCILLATOR AND MONITOR EARPHONE MODEL CPO-130A

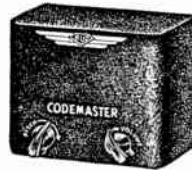

This unit is similar to the CPO-128A. The difference is that the 4" speaker is not included. The monitor feature, however, is included. A phone jack is provided for the output and as many as 20 pairs of phones and keys can be operated at one time for classroom operation. This model will also operate a permanent magnetic dynamic speaker.

Plug the voice coil leads into the phone jack—no output transformer is needed. Size of case is 5 1/2" wide, 4 1/2" high and 3 1/2" deep.

Catalog No.
CPO-130A

Dealer Cost
\$14.10

BUD FREQUENCY CALIBRATOR FCC-90A

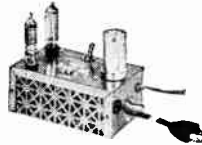

To comply with federal regulations, some means of accurately checking transmitter frequency must be available at every "ham" station. The BUD FCC-90A consists of a 100 kc. crystal oscillator that is Completely Self-Powered and has 2 tubes. It will give 100 kc. check points on all bands up to 30 megacycles. This enables the operator to determine exact band edges.

No extra wiring is required to install this unit. Plug the FCC-90A into a 110 volt receptacle, connect the pick-up lead to the antenna binding post of the receiver and the unit is ready for operation. An ON-OFF switch and a STANDBY switch are provided.

Catalog No.
FCC-90A

Dealer Cost
\$17.25

BUD MIDGET CONDENSERS



Small size, sturdy construction and high mechanical and electrical efficiency are the outstanding features. Insulation used is Steatite. Rotor and Stator plates are brass and are electro-soldered to their respective rods. All metal parts are cadmium plated. These condensers have both front and rear bearings and are furnished in either mid-line type plates

(straight line wave length), or semi-circular plates (straight line capacity).

SEMI-CIRCULAR TYPE — DOUBLE BEARING

Catalog Number	Cap. in MMFD. Max. Min.	Air Gap	Number Plates	Dealer Cost
MC-1850	15 3	.024"	3	\$1.65
MC-1852	33 4	.024"	5	1.65
MC-1853	50 5	.024"	7	1.92
MC-1855	100 7	.024"	14	2.10
MC-1856	140 7	.024"	19	2.43
MC-1858	190 9	.024"	27	2.58
MC-1859	235 10	.024"	33	2.97
MC-1860	300 12	.024"	43	3.18
MC-1861	15 4	.060"	5	1.86
MC-1862	35 5	.060"	11	2.10
MC-1863	50 7	.060"	15	2.31
MC-1864	75 9	.060"	23	2.70
MC-1865	100 12	.060"	31	2.94
MC-1866	35 8	.095"	15	2.43
MC-1867	50 10	.095"	23	2.76
MC-1868	75 13	.095"	33	3.18

MID-LINE TYPE — DOUBLE BEARING

Catalog Number	Cap. in MMFD. Max. Min.	Air Gap	Number Plates	Dealer Cost
MC-900	25 4	.024"	4	\$1.87
MC-902	35 5	.024"	6	1.92
MC-903	50 6	.024"	8	2.01
MC-904	75 7	.024"	11	2.10
MC-905	100 7	.024"	15	2.28
MC-906	140 7	.024"	20	2.61
MC-908	190 9	.024"	27	2.73
MC-909	250 11	.024"	36	2.97
MC-910	300 13	.024"	43	3.33
MC-865	15 4	.060"	5	2.10
MC-867	35 6	.060"	11	2.40
MC-868	50 7	.060"	16	2.76
MC-869	75 8	.060"	23	3.15
MC-941	100 11	.060"	31	3.00
MC-965	35 8	.095"	15	2.49
MC-966	50 12	.095"	23	2.70
MC-967	75 14	.095"	33	3.18

Only a few of many BUD Products are shown. For complete catalog, write BUD RADIO, INC., 2118 E. 55th St., Cleveland, Ohio



VARIABLE CONDENSERS



BUD "CE" MIDGET CONDENSERS SINGLE SECTION DOUBLE BEARING

These Midget Condensers were designed to meet the rigid requirements in design of efficient high frequency electronic devices and precision laboratory equipment. Brass rotor and stator plate stacks are assembled into permanent units by means of electro-soldering, which assures long life and accurate plate spacing. End-plates of Steatite

insulate the mounting bushings and angles from the rotor and stator assemblies. A large front sleeve bearing provides for smooth rotation. Special wiper contact provides noise-free tuning. All metal parts are cadmium plated. Rotor plates are semi-circular shaped. Provision for either panel or base mounting.

Catalog Number	Max. Cap. MMFD.	Min. Cap. MMFD.	Air Gap	No. of Plates	Over-all Length	Dealer Cost
CE-2000	15	4	.030"	3	2 1/2"	\$2.19
CE-2001	35	6	.030"	7	2-23/32"	2.43
CE-2002	50	7	.030"	9	2-27/32"	2.76
CE-2003	75	8	.030"	14	3-5/32"	3.03
CE-2004	100	9	.030"	18	3-11/32"	3.30
CE-2005	150	10	.030"	27	3-13/16"	3.53
CE-2006	200	11	.030"	35	4 1/4"	4.20
CE-2007	250	12	.030"	44	4 3/4"	4.44
CE-2008	300	15	.030"	52	5-3/16"	4.65
CE-2011	15	5	.060"	5	2 3/4"	2.25
CE-2012	35	7	.060"	11	3 1/4"	2.55
CE-2013	50	8	.060"	15	3-9/16"	2.97
CE-2014	75	10	.060"	23	3 3/4"	3.45
CE-2015	100	13	.060"	31	4-9/16"	3.95
CE-2016	35	9	.095"	15	4-1/16"	3.09
CE-2017	50	10	.095"	23	5-1/32"	3.42
CE-2018	75	14	.095"	33	6-7/32"	4.02

BUD NEUTRALIZING AND HIGH FREQUENCY TUNING CONDENSERS



This line of condensers will fill every neutralizing and high frequency tuning requirement that modern circuits pose. The two-pillar construction makes this unit unusually sturdy and eliminates any possibility of capacity variation due to vibration. The movable plate is adjusted by means of the threaded shaft to which it is attached, and it is permanently locked in any position by the lock-nut provided. Any loose thread is taken up by a special nut and locked

to give smooth operation. Plates have rounded edges. Steatite insulation is used.

Catalog Number	Plate Diameter	MMFD. Capacity Max.	Min.	Dealer Cost
NC-1000	1-27/32"	11	1	\$2.58
NC-1001	2-13/16"	24	2	3.75
NC-1002	4 3/4"	27	6	5.25

BUD FEED-THROUGH AND BASE MOUNTED NEUTRALIZING CONDENSERS



In circuits utilizing tubes with the grid lead terminated in the base a feed-through type of neutralizing condenser is particularly suited. One hole is required for mounting of feed-through condensers. Neutralizing condenser illustrated is feed-through type. Plates are made of aluminum rounded at edges to cut down losses. After proper tuning is attained, movable plate can be locked with the knurled nut.

No. 890 and No. 852 are ideal neutralizers for popular low power beam tubes. No. 890 condenser is based mounted only.

Catalog Number	Plate Diameter	Size Hole for Mtg.	MMFD. Capacity Max.	Min.	Dealer Cost
NC-852	1"	5/16"	6	.5	\$1.50
NC-853	1-27/32"	13/32"	11	1	2.73
NC-890	1"		6	.5	1.50

NEW BUD THREE-GANG TINY MITE CONDENSERS



Hams, Radio Constructors and Experimenters can find many uses for these compact, three-gang condensers. Designed particularly for high frequency use, they are adaptable for use in converters, preselectors and receivers covering the Amateur, Television and F.M. bands. Well constructed with soldered brass plates and ceramic brackets. Rotor shaft extended 1/4" at rear. Height 1-5/16". Width 1-3/16". Length behind panel 3 3/4". Mounting holes 2-3/16" apart.

Catalog Number	Cap. Per Section Max.	Min.	No. of Plates Per Section	Dealer Cost
LC-1845	11	5	3	\$4.38
LC-1846	17	5	4	4.98
LC-1847	25	6	5	5.40

BUD "CE" TYPE DUAL MIDGET CONDENSERS

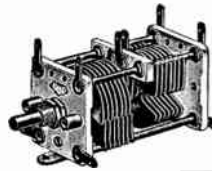

These well constructed dual condensers are similar in design to the double-bearing "CE" types. They feature a rotor wiping contact placed at center of the rotor assembly to assure maximum efficiency at high frequency. Opposed rotor construction assures perfect counterbalance and provides even torque at any position of rotation. Steatite insulation eliminates closed induction loop in frame.

Catalog Number	PER SECTION Max. Cap.	Min. Cap.	No. of Plates	Air Gap	Distance Behind Panel	Dealer Cost
CE-2032	35	6	7	.030"	3-1/32"	\$3.27
CE-2033	50	7	9	.030"	3 1/4"	3.60
CE-2034	75	8	14	.030"	3-21/32"	3.99
CE-2035	100	9	18	.030"	4-3/32"	4.59
CE-2036	150	10	27	.030"	5-3/16"	5.28
CE-2039	15	5	5	.060"	3-1/32"	3.78
CE-2040	35	7	11	.060"	4-1/32"	4.35
CE-2041	50	8	15	.060"	4-23/32"	4.77

BUD TINY MITE PADDERS



For applications requiring a constant padder capacity under all temperature and humidity conditions, these units are ideal. They lend themselves readily to I. F. transformer applications, fixed tuned circuits for exciters, ganged condenser air trimmers, and plug-in-coil padding as they fit inside of standard 1 1/2" diameter coil forms. Rotor and stator assemblies are made up of brass plates (.015" thick) and rods electrically soldered into a solid unit and then are bright cadmium plated. Insulation is Steatite. Each unit may be adjusted in capacity by either a screw-driver or a 1/4" hex. wrench.

Catalog Number	Max. Cap. MMFD.	Min. Cap. MMFD.	Air Gap	No. of Plates	Dealer Cost
LC-2076	15	2	.017"	5	\$1.32
LC-2077	25	2.5	.017"	7	1.56
LC-2078	35	3	.017"	10	1.74
LC-2079	50	3.9	.017"	14	1.92
LC-2080	75	4.5	.017"	20	2.25
LC-2081	100	5.5	.017"	27	2.64
LC-2082	140	6.5	.017"	37	3.21

BUD TINY MITE TUNING CONDENSER SINGLE SECTION



This series of condensers has been designed for applications where space or weight are limiting factors and for tuning of high frequency circuits. Rigid construction, close fitting bearing, positive rotor contact and Steatite insulation are the outstanding features. Cadmium plated, soldered, brass plates and rods insure high frequency efficiency.

Catalog Number	Max. Cap. MMFD.	Min. Cap. MMFD.	Air Gap	No. of Plates	Dealer Cost
LC-1640	8	2.5	.017"	3	\$1.41
LC-1641	15	3	.017"	5	1.47
LC-1642	25	4	.017"	9	1.77
LC-1643	35	5	.017"	13	1.77
LC-1644	50	6	.017"	19	1.86
LC-1645	75	7	.017"	29	2.07
LC-1646	100	9	.017"	37	2.19
LC-1648	10	4	.037"	7	1.62
LC-1649	15	5	.037"	11	1.62
LC-1650	25	5.5	.037"	17	1.92
LC-1651	35	6	.037"	21	2.10
LC-1652*	50	8	.037"	35	3.00
LC-1653	6	3.5	.073"	5	1.68
LC-1654	15	5.5	.073"	15	2.10
LC-1655*	25	9	.073"	27	3.00

*Denotes double bearing.

BUD TINY MITE DUAL CONDENSERS



The construction of these units is similar to the regular Tiny Mite Tuning Condensers. The two end pieces are held together firmly with two tie-rods.

A separate round plate is soldered on rotor rod to shield the two stator sections. Large surface front and rear sleeve bearings, provide smooth rotation.

Catalog Number	CAP. PER SECTION Max. MMFD.	Min. MMFD.	Air Gap	No. Plates Per Section	Over all Length	Dealer Cost
LC-1659	8	2.5	.017"	3	1 19/16"	\$2.64
LC-1660	15	3	.017"	5	2 1/16"	2.94
LC-1661	25	4	.017"	9	2 1/8"	3.24
LC-1662	50	6	.017"	19	2 1/2"	3.63
LC-1663	100	9	.017"	37	4 1/4"	4.02
LC-1664	10	4	.037"	7	2 1/8"	2.94
LC-1665	15	5	.037"	11	2 1/8"	3.57
LC-1666	25	5.5	.037"	17	3 3/4"	3.93
LC-1667	35	6	.037"	21	4"	3.93

Only a few of many BUD Products are shown. For complete catalog, write BUD RADIO, INC., 2118 E. 55th St., Cleveland, Ohio



R. F. CHOKES



LATTICE WOUND R. F. CHOKES



For all general purpose applications requiring a high quality choke at a reasonable price, this line finds wide acceptance. Each choke is wound from silk-covered enameled copper wire on a white ceramic bobbin. Leads are terminated with two convenient soldering lugs.

Chokes can be mounted with a 6-32 screw through the center of the form, and each winding is thoroughly impregnated against moisture. The wide range of sizes fills practically every choke requirement in standard radio circuits. Choke base diam. 1-1/16", distance between ends of leads 1 1/2"

Catalog Number	Inductance mh.	D.C. Res. Ohms	Current M.A.	Height	Dealer Cost
CH-1212	2.5	28	125	11/16"	\$.44
CH-1213	3.4	36	125	11/16"	.55
CH-1214	5.5	46	125	11/16"	.55
CH-1215	8.	60	125	11/16"	.68
CH-1216	10.	65	125	11/16"	.72
CH-1217	16.	84	125	11/16"	.75
CH-1218	30.	190	100	15/16"	.85
CH-1219	60.	279	90	15/16"	.96
CH-1220	80.	332	80	15/16"	1.00

TRANSMITTING CHOKES



Here are two heavy duty R. F. Chokes that can really take it in high powered transmitter plate circuits. Each choke is wound on 9/16" dia. Steatite rod, has connection lugs and a mounting foot.

All chokes have a heavy ceramic coating which prevents moisture absorption and enables them to withstand momentary overloads without collapsing the individual pies. Consists of five graduated pies wound in continuous winding. Care has been taken to prevent any of the pies from being resonant on an anateur band and to keep the distributed capacity at a minimum. Overall height 3 3/4".

Catalog Number	Inductance	Current Capacity	D. C. Resistance	Dealer Cost
CH-568	2.2 mh.	1 amp.	5 ohms	\$1.98
CH-569	4.3 mh.	6 amp.	12 ohms	1.80

IRON CORE R. F. CHOKES

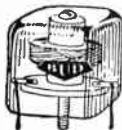

The efficiency of any circuit requiring an R. F. choke will be definitely improved by utilizing one of these chokes with a finely divided molded metallic core. The improved "Q" possible with this construction results from the D. C. resistance of these chokes being from 40 to 50% less for a given inductance than for regular air-core types. Thus, the D. C. voltage drop through the choke is

considerably less, yet the choking action is equally as good. Windings are made with silk-covered enameled wire terminated on convenient soldering lugs, and the chokes are mounted in small square shield cans measuring 1 1/2" x 1 1/2" x 1-7/16".

Catalog Number	Inductance mh.	D. C. Resis. Ohms	Current ma.	Dealer Cost
CH-1277	1.5	11.5	125	\$.93
CH-1278	2.5	16.	125	.96
CH-1279	3.4	19.5	125	1.05
CH-1280	5.5	27.5	125	1.05
CH-1281	8.	35.	125	1.11
CH-1282	10.	42.5	125	1.11
CH-1283	16.	53.	125	1.23
CH-1284	30.	82.	100	1.29
CH-1285	60.	131.	100	1.44
CH-1286	80.	163.	90	1.53
CH-1287	125.	221.	90	1.80
CH-294	Shield Can Only	21

HEAT RADIATING PLATE AND GRID TUBE CONNECTORS

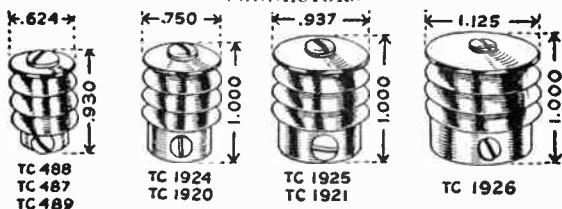

Bud heat radiating connectors fit all sizes of industrial and transmitting vacuum tubes. These connectors serve a dual purpose, not only are they useful to make connections to plate or grid terminals, but they provide a large heat radiating surface that will dissipate heat from the glass seal and tube element. Eight sizes fit all grid and plate leads and also provide sufficient heat radiation for any tube operating in the range of 50 to 2000 watts. All radiators are machined from special aluminum rod. Edges are rounded to minimize corona loss.

Only a few of many BUD Products are shown. For complete catalog, write BUD RADIO, INC., 2118 E. 55th St., Cleveland, Ohio

BUD INSULATED FLEXIBLE COUPLINGS



Tandem operation of two or more units is readily accomplished through the use of these couplers. Direct shaft alignment is not essential, and all couplers are made to fit 1/4" shafts.

Cat. No.	Diameter	Height	Insulation	Dir. Cost
FC-795	1-1/16"	11/16"	Ceramic	\$.48
FC-845	1-1/16"	5/8"	Bakelite	.33
FC-855	1 1/2"	11/16"	Bakelite	.39

BUD HIGH VOLTAGE FLEXIBLE COUPLINGS



A new type spring construction in these couplings permits a wide gap between shaft connections, freedom from back-lash, and unusual flexibility. The springs are attached to glazed Steatite discs 1 1/2" in diameter and 3/16" thick, and the overall diameter of the finished coupling is 1-15/16". Coupling accommodates standard 1/4" shaft. Springs are also attached to Bakelite discs 1 1/4" in diam.

Catalog No.	Insulation	Dealer Cost
FC-614	Steatite	\$.75
FC-619	Bakelite	.68

ULTRA HIGH FREQUENCY R. F. CHOKES



These chokes were designed to meet the requirements of builders of high frequency receivers and transmitters. Consists of ceramic rod with a single layer winding terminated with strap leads at each end. Particularly suitable for use on 2 or 6 meters. CH-570 is supplied with a mounting foot and is sometimes used as a filament choke in certain types of high frequency oscillator and amplifier circuits.

Catalog Number	Inductance mh.	Max. Current	D. C. Resistance	Lengths	Dealer Cost
CH-925	5.7 uh.	750 ma	1.4 ohms	1 1/2"	\$.30
CH-570	1.5 uh.	1.7 a	0.2 ohms	2 3/4"	1.20

PIE WOUND R. F. CHOKES



Each choke has a continuous winding of silk covered enameled copper wire and the pies constituting this winding are wound on a 1/4" diameter ceramic core. Chokes are made with both strap and wire leads. The CH-876 is a heavy duty choke intended for circuits, such as transmitter plate circuits, where high currents are present. All chokes in this series have an overall length of 1 1/2".

WITH STRAP LEADS

Catalog Number	Inductance mh.	D. C. Resistance	Current Rating	Dealer Cost
CH-920N	2.5	45 ohms	125 ma	\$.48
CH-922N	5.5	60 ohms	125 ma	.57
CH-923N	8.0	72 ohms	100 ma	.69
CH-924N	10.0	78 ohms	100 ma	.81
CH-876S	2.5	16 ohms	250 ma	.30

WITH WIRE LEADS

CH-920W	2.5	45 ohms	125 ma	.48
CH-922W	5.5	60 ohms	125 ma	.57
CH-923W	8.0	72 ohms	100 ma	.69
CH-924W	10.0	78 ohms	100 ma	.81
CH-876W	2.5	16 ohms	250 ma	.30

Table below lists Connectors to fit various Tubes

Cat. No.	Hole Size for Lead	Head Radiating Connectors to Fit the Following Tubes	Dealer Cost
TC-488	.052	3C24, 24, 24G, 25T, 27	\$.48
TC-487	.062	UH50, HK24, 304B, 329B, 832A, 834	.42
TC-489	.072	35T, 35TC, 75TH, HK254, HK257H, 484, 8001	.42
TC-1924	.125	HK57, 152TH	.48
TC-1920	.375	4-125A, 150TH, 2-150D, 250R, 250TH, 250TL, 420A, 802, 803, 804, 807, 808 Grid, 814, 815, 828	.48
TC-1925	.125	304TH, 304TL	.60
TC-1921	.570	ZB60, HF60, HF100, 111H, 211H, 203H, HF175, HF300 Grid, 100R, HK357C, 450TH, 454, 750TH, 805, 806, 808, 809, 810, 811, 812, 813, 823, 832, 856, 854, 1500T, 2000T, 1054, 5331, 5332, 8000, 8003, 8005	.78
TC-1926	.810	WL463, WL463, WL460, HF200, HF201, HF300	.54

NOTE: TC-1923 Heat Radiating Connector with hole size of .110" is still in our line and can be furnished. Dir. Cost \$.48

STANWYCK COILS

Mfrd. by STANWYCK WINDING CO.

TELEVISION - I.F. - ANT. - R.F. - F.M. - OSCILLATOR COILS



S-949

TELEVISION REPLACEMENT COMPONENTS FOR MOTOROLA, TELEKING, MAGNAVOX, EMERSON, HALLICRAFTER, AND OTHER TELEVISION RECEIVERS

NEW ABOVE CHASSIS TYPE TUNED 455 K.C. I.F. COILS

The latest in IF coils featuring the complete above chassis type tuned IF coils that are permeability tuned resulting in high Q, no drift for stable long life operation, supplied with snap spring clip for mounting through suitable holes in chassis.

- S-1601 Miniature size IF high Q high gain for battery filament type tubes Size $\frac{3}{4}$ x 2" Shielded List Price, \$1.90
- S-1617 Miniature size IF high Q high gain for AC DC Filament type tubes. Size $\frac{3}{4}$ x 2" Shielded List Price, \$1.90
- S-1607 Miniature size IF with exceptionally high Q and gain in many cases this IF will outperform standard IF transformers, Size $\frac{3}{4}$ x 2" Shielded List Price, \$1.90

4.5 mc IF COMPONENTS

Featuring the latest all above chassis type tuning using internal type hex wrenching eliminating core breakage. They are of the permeability tuned type using fixed silver mica condensers insuring high Q no drift long life operation supplied with snap spring clip for mounting through suitable holes in chassis.

- S-985 4.5 mc Sound ratio detector Size $\frac{3}{4}$ x 2" Shielded List Price, \$3.30
- S-986 4.5 mc Sound discriminator transformer $\frac{3}{4}$ x 2" Shielded List Price, 3.30
- S-989 4.5 mc Sound take off coil Size $\frac{3}{4}$ x 2" Shielded List Price, 2.50
- S-974 4.5 mc Sound trap $\frac{3}{4}$ chassis hole mount. Unshielded List Price, 1.10

TELEVISION REPLACEMENT COMPONENTS FOR RCA REPLACEMENT

RCA Stanwyck	List Price	RCA Stanwyck	List Price
203-L1 S-943 Video peaking 180 uh-39K	\$0.50	203-K1 S-954 Sound discriminator	\$2.55
203-L2 S-944 Video peaking 250uh-10meg.	.50	202-K1 S-955 Converter Trans.	2.65
203-L3 S-945 Video peaking 120 uh-22K	.50	204-L1 S-956 Fil. Choke	.70
203-L4 S-946 Video peaking 93 uh-10 meg.	.50	201-R1 S-957 Hor. width control	.95
202-K2 S-949 1st Pix IF	3.00	201-R3 S-958 Linearity control	.95
202-K3 S-950 2nd Pix IF	2.10	208-T8 S-959 Syncrolock	2.75
202-L1 S-951 3rd & 4th Pix IF	.75	203-R1 S-966 Syncroguide	2.00
202-K4 S-952 Cathode trap	2.55	205-R1 S-977 Hor. Freq. & Phase coil	2.75
201-K1 S-953 Sound IF	2.10		

HIGH VOLTAGE COILS

- S-999 High voltage flyback. This transformer is similar to the GE No. 77J1 and delivers approximately 14KV for ample width and picture brilliancy up to 21" picture tubes. List Price, \$11.00
- S-980 GE type linearity coil 5 to 36 mh List Price, \$1.75
- S-981 GE type width coil with AGC winding List Price, \$1.75
- S-930 10 KV R. F. power transformer designed for corona-less performance at full rated output. List Price, \$11.55
- S-918 R.F. Filament transformer will deliver 30 KV when used with one S-930 and two S-918 in a voltage tripler circuit. List Price, \$2.20

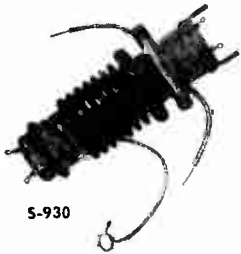

S-930

NEW ABOVE CHASSIS 10.7 PERMEABILITY TYPE TUNED MIDGET FM COILS

- S-626 Midget ratio detector to meet the critical demands for a sensitive and unusually stable FM detector. A peak to peak band width of 325 Kc with linearity exceeding plus or minus 125 Kc results in a high quality audio reproduction. Permeability tuned plus silver mica condensers offers long life low drift for the ultimate in fine FM reproduction. List Price, \$3.30
- S-628 Midget FM IF High performance in gain and band width with symmetrical wave shape is a result of correct L/C ratio, High Q threaded iron cores and low drift silver mica capacitors make this a much desired IF for new set or replacement. List Price, \$2.50
- S-627 Midget FM Discriminator. The electrically centered secondary results in perfect symmetry between negative and positive peaks. High output and excellent discrimination are obtained. List Price, \$3.30
- S-609 FM Choke. An excellent parasitic suppressor in the oscillator plate and filament circuits. 200 ma. List Price, \$0.45

CUSTOM HIGH PERFORMANCE FERRITE LOOPSTICKS

- S-537 Adjustable design for small midget sets will outperform standard loop. List Price, \$0.90
- S-539 Adjustable design for average table size set has exceptionally high gain and low drift, has outside ant. connection. List Price, \$1.25
- S-540 This antenna coil has twice the gain of the S-539 with a Q of over 300 over the entire broadcast and eliminating an outside antenna. List Price, \$1.50



Miller



Television Components

24 MC Unshielded Picture I.F. Transformers



For use as replacement units in television receivers where unshielded coils are called for and standard circuitry is employed. Mounting clip to fit 5/8" hole in chassis. Shielded I.F. trans. are 3/4" sq. x 2" high. Maximum Dimensions: 2 1/2" long.

Cat. No.	Description	Trap	List Price
6245	25.5 MC First I.F.		\$2.50
6246	22 MC Second I.F.	27.25 MC	2.50
6247	21.25 MC Cathode Trap	21.2 MC	2.50
6248	24.5 MC Video Det. I.F.		1.50
6249	21-25 MC Bifilar Wound I.F.		1.50
6250	25-29 MC Bifilar Wound I.F.		1.50
6251	21-25 MC Bifilar I.F. Shielded		2.25
6252	25-29 MC Bifilar I.F. Shielded		2.25
6253	21-25 MC Bifilar I.F.	20-23 MC	2.75
6254	25-29 MC Bifilar I.F.	24-29 MC	2.75



Converter and Picture I.F. Transformers

Dimensions: 7/8" x 7/8" x 2 1/4" high.

Cat. No.	Description	Trap	List Pr.
6185	21.8 MC Conv. I.F. Trans.	21.25 MC	\$2.75
6186	25.3 MC 1st Pix I.F. Trans.	27.25 MC	2.75
6187	22.3 MC 2nd Pix I.F. Trans.	19.75 MC	2.10



Picture I.F. Inductors Unshielded

Dimensions: 1/2" max. o.d. x 1 1/2" long.

Cat. No.	Description	Freq.	List Pr.
6188	3rd Pix I.F. Trans.	25.2 MC	\$1.25
6189	Video Detector I.F. Trans.	23.4 MC	1.25
6193	Cathode Sound Trap	30 MC	2.00
6171	Tunable Choke	21-25 MC	1.25
6171A	Tunable Choke	25-29 MC	1.25



21.25 MC Television Sound I.F. Transformers

Dimensions:
6190 and 6191 7/8" x 7/8" x 2 1/4" high.
6184 and 6192 1 1/8" x 1 1/8" x 2 1/2" high.

Cat. No.	Item	Freq.	List Pr.
6190	1st Sound I.F. Trans.	21.25 MC	\$2.40
6191	2nd Sound I.F. Trans.	21.25 MC	2.40
6192	Sound Disc. Trans.	21.25 MC	2.75
6184	Sound Ratio Det. Trans.	21-25 MC	3.30



4.5 MC Miniature I.F. Transformers

Clip Mounting
Dimensions: 3/4" square by 2" high.
Shell Core Permeability tuned
Manufactured under patents of Automatic Manufacturing Corp.

Cat. No.	Item	List Price
6203	4.5 MC Input or Interstage	\$2.75
6204	4.5 MC Discriminator	3.30
6205	4.5 MC Ratio Detector	3.30



Sync. Stabilizer Coil (Ringing Coil)

Cat. No.	Item	List Price
6210	Sync. Stabilizer Coil	\$2.25



Universal Adjustable Ion Trap

Due to its adjustable feature, which allows the magnetic field to be varied between 32-55 gauss, this trap will, in most instances, replace the older style ion traps having a specific magnetic field.

Cat. No.	Description	List Price
6295	Adjustable Ion Trap	\$1.25



4.5 MC Intercarrier Sound I.F. Components

Dimensions: 1 1/8" x 1 1/8" x 2 1/8" high.
#1470-A 3/4" x 3/4" x 2" high
#1498 1 3/8" x 1 3/8" x 2 1/2" high

Cat. No.	Item	Freq.	List Pr.
1466	Input or Inter. I.F. Trans.	4.5 MC	\$2.40
1467	Sound Discrim. Trans.	4.5 MC	3.00
1468	Sound Ratio Det. Trans.	4.5 MC	3.30
1469	Sound Pick Off Coil	4.5 MC	1.25
1470	Sound Trap Unshielded	4.5 MC	1.25
1470-A	Sound Trap Shielded	4.5 MC	1.65
1498	Sound Ratio Det. Trans.	4.5 MC	3.30



TV Antenna Coupling Transformers

Matches antenna impedance to line or line to T.V. receiver. Signal input may be improved as much as four times. Housed in impregnated, weather-tight aluminum shield.

Cat. No.	Impedance Ratio	List Price
6161	52/300 or 300/52 ohms	\$2.75
6162	72/300 or 300/72 ohms	2.75
6201	450/300 or 300/450 ohms	2.75



TV High-Pass Filter

Improves picture clarity by reflecting interference from short wave stations, amateur transmitters, X-ray and diathermy equipment, electric appliances, etc. Attenuates all signals from zero to 40 MC. Passes all television channels with minimum loss. Installed easily in antenna lead-in at receiver. No tuning required.

Cat. No.	Use	List Pr.
6167	TV High-Pass Filter—72-ohm line	\$5.50
6168	TV High-Pass Filter—300-ohm line	5.50



Adjustable Linearity & Width Controls

Cat. No.	Inductance Range	List Price
6313	.50-5.0 Mh	\$1.50
6314	2.0-18. Mh	1.75
6315	4.0-30 Mh	1.80
6316	4.0-30 Mh with A.G.C.	2.25
6317	3.2-9.0 Mh with A.G.C.	2.25
6318	.20-3.0 Mh	1.50
6319	15-60 Mh	2.25
6320	.20-3.0 Mh tapped	1.50
6321	1.0-5.0 Mh tapped	1.50
6322	1.5-10 Mh	1.75
6323	.50-5.0 Mh tapped	1.50

Cat. No.	Inductance Range	List Price
6195	.185-1 Mh	\$1.25
6196	.054-.245 Mh	1.10
6196-A	.054-.50 Mh tapped	1.25
6197	.55-.20 Mh tapped	1.25
6198	.170-.61 Mh	1.10
6199-A	1.3-.41 Mh tapped	1.30
6199-B	.50-1.7 Mh	1.25



Horizontal Oscillator & Sync. Control Coils

Cat. No.	Item	List Price
#6194	Sync. Lock	
#6182	Sync. Guide	
#6183	Sync. Freq. & Phase	
Dimensions: 1 7/8" x 1 7/8" x 2 1/2" high.		
6194	Osc. & A.F.C. Discrim. Trans.	\$2.75
6182	Osc. and Sync. Control Coil	2.25
6183	Osc. and Sync. Stabilizer Coil	2.75

Miniature 44 MC Pix Trans.



Permeability Tuned

Converter and 1st pix I.F. Grid transformer have 75 ohm link winding. Dimensions: 3/4" Square x 2" high. Manufactured under patents of Automatic Manufacturing Corp.

Cat. No.	Description	Trap	List Pr.
6230	Converter I.F.		\$2.40
6231	44 MC First I.F.		2.40
6232	42.5 MC Second I.F.	41.25 MC	2.00
6233	45.5 MC Third I.F.	47.25 MC	2.40
6234	44 MC Fourth I.F.		1.75



Video Peaking Coils, Filament Choke

No. 6175 Filament Choke—5/8" dia. x 7/8" long; Video Peaking Coils—5/8" dia. x 1/2" long.

Cat. No.	Use	Inductance	Shunt Resistor	List Price
6175	Filament	0.8	None	\$.50
6152	Peaking	20	None	.50
6176	Peaking	36	None	.50
6172	Peaking	73	None	.60
6177	Peaking	93	None	.60
6178	Peaking	120	22K	.60
6153	Peaking	120	None	.60
6179	Peaking	180	39K	.60
6180	Peaking	180	None	.60
6154	Peaking	200	None	.60
6173	Peaking	250	22K	.60
6181	Peaking	250	None	.60
6155	Peaking	300	None	.60
6174	Peaking	500	None	.60

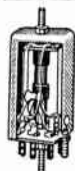

"40 MC" TV Picture I.F. Transformers

Converter transformer and 1st pix I.F. grid transformer have 75-ohm link winding.

Cat. No.	Description	Trap	List Pr.
6215	Converter I.F. Trans.		\$2.50
6216	1st Pix I.F. Grid Trans.	39.25 MC	3.00
6217	1st Pix I.F. Plate Trans.	41.25 MC	3.00
6218	2nd Pix I.F. Grid Trans.	47.25 MC	2.75
6219	3rd-4th & 5th I.F.	41.75-45.75 MC	1.25
Unshielded 1/2" O.D. x 1 1/4" long.			



R.F. Transformer for HV Power Supply

These R.F. power supply transformers for use with television receivers and cathode ray oscilloscope make possible construction of an inexpensive source of high voltage. Two types are available, the 4525 for voltages to 5000 DC and the 4526 for voltages to 10,000 DC (or 30,000 DC in a voltage rectifier tripler circuit). Typical circuit diagrams are supplied with each coil.

Cat. No.	Item	List Price
4525	H.V. R.F. Trans. (to 5 KV) Dimensions: 1 1/4" dia. x 3 3/4" high.	\$8.25 (illus.)
4526	H.V. R.F. Trans. (to 30 KV) Dimensions: 2 1/4" dia. x 6" high.	\$13.75

For a Complete Listing of MILLER PRODUCTS ask for a copy of our Latest General Catalog.

Radio's Master—19th Edition



Miller

Intermediate Frequency Transformers



Permeability Tuned Transformers

Miller permeability tuned intermediate frequency transformers are recommended for all applications where a high degree of frequency stability and operation under humid conditions will be encountered.

Dimensions: 1 3/8" square x 3 1/4" high. #6/32 spade bolt mounting.

Cat. No.	Freq.	KC Range	Use	List Price
912-H1	262	250-275	Input	\$4.00
912-H2	262	250-275	Interstage	4.00
912-H3	262	250-275	Full-Wave	4.00
912-H4	262	250-275	Half-Wave	4.00
912-C1	455	450-475	Input	4.00
912-C2	455	450-475	Interstage	4.00
912-C3	455	450-475	Full-Wave	4.00
912-C4	455	450-475	Half-Wave	4.00
912-W1	1500	1400-1600	Input	4.00
912-W2	1500	1400-1600	Interstage	4.00
912-W3	1500	1400-1600	Full-Wave	4.00
912-W4	1500	1400-1600	Half-Wave	4.00



Midjet I.F. Transformers

Dimensions: 1 1/8" square x 2" high. #6/32 spade bolt mounting.

Air Core Transformers

Cat. No.	Freq.	KC Range	Use	List Price
112-H1	262	250-275	Input	\$2.40
112-H2	262	250-275	Interstage	2.40
112-H3	262	250-275	Full-Wave	2.40
112-H4	262	250-275	Half-Wave	2.40
112-H6	262	250-275	Output Stage & Filter	2.65
112-C1	455	450-475	Input	2.40
112-C2	455	450-475	Interstage	2.40
112-C3	455	450-475	Full-Wave	2.40
112-C4	455	450-475	Half-Wave	2.40
112-W1	1500	1400-1600	Input	2.40
112-W2	1500	1400-1600	Interstage	2.40
112-W3	1500	1400-1600	Full-Wave	2.40
112-W4	1500	1400-1600	Half-Wave	2.40

Iron Core Transformers

Cat. No.	Freq.	KC Range	Use	List Price
012-K1	175	165-185	Input	\$2.75
012-K2	175	165-185	Interstage	2.75
012-K3	175	165-185	Full-Wave	2.75
012-K4	175	165-185	Half-Wave	2.75
012-H1	262	250-275	Input	2.65
012-H2	262	250-275	Interstage	2.65
012-H3	262	250-275	Full-Wave	2.65
012-H4	262	250-275	Half-Wave	2.65
012-C1	455	450-475	Input	2.65
012-C2	455	450-475	Interstage	2.65
012-C3	455	450-475	Full-Wave	2.65
012-C4	455	450-475	Half-Wave	2.65



TV and FM Wave Traps

These new high-Q series-resonant traps may completely eliminate interference and undesirable images in television and FM receivers. Assembled in aluminum shields designed for connection direct to antenna twin-lead. Convenient screwdriver tuning adjustment at top. Four traps will cover frequency ranges from 20 to 250 megacycles.

Dimensions: 1 7/8" x 1 7/8" x 3 1/2" high.

Cat. No.	Freq. Range	List Price
6163	150-250 mc	\$4.40
6164	75-150 mc	4.40
6165	40-80 mc	4.40
6166	20-40 mc	4.40



Miniature I.F. Transformers

Supplied with a snap spring mounting clip which may be installed through suitable holes in the chassis. Also furnished is an adapter plate for use over a standard tube socket hole. Dimensions: only 3/4" square x 2" high. Manufactured under patents of Automatic Manufacturing Corp.

Cat. No.	Item	List Price
12-H1	262 KC Input I.F. Trans.	\$2.50
12-H2	262 KC Output I.F. Trans.	2.50
12-H6	262 KC Output I.F. Trans. with diode filter capacitors	2.65
12-C1	455 KC Input I.F. Trans.	2.20
12-C2	455 KC Output I.F. Trans.	2.20
12-C6	455 KC Output I.F. Trans. with diode filter capacitors	2.35
12-C7	455 KC Input I.F. Trans. For Battery Radios	2.20
12-C8	455 KC Output I.F. Trans. For Battery Radios	2.20
12-C9	455 KC Input I.F. Trans. For AC-DC Radios	2.20
12-C10	455 KC Output I.F. Trans. For AC-DC Radios	2.20
1463	10.7 MC Input or Interstage	\$2.75
1464	10.7 MC Discriminator	3.30
1465	10.7 MC Ratio Detector	3.30



Universal I.F. Transformers

For general replacement purposes in auto receivers and many types of household and portable receivers.

Type No. 312 Air Core Transformers

Dimensions: 1 1/4" square x 2 1/2" high.

Cat. No.	Freq.	KC Range	Use	List Price
312-H1	262	250-275	Input	\$1.75
312-H2	262	250-275	Interstage	1.75
312-H4	262	250-275	Output	1.75
312-H6	262	250-275	Output & Filter	2.65
312-C1	455	440-470	Input	1.75
312-C2	455	440-470	Interstage	1.75
312-C4	455	440-475	Output	1.75
312-C6	455	440-470	Output & Filter	2.65

Type No. 412 Iron Core Transformers

Dimensions: 1 1/4" square x 2 1/2" high.

Cat. No.	Freq.	KC Range	Use	List Price
412-H1	262	250-275	Input	\$2.40
412-H2	262	250-275	Interstage	2.40
412-H4	262	250-275	Output	2.40
412-C1	455	440-470	Input	2.40
412-C2	455	440-470	Interstage	2.40
412-C4	455	440-470	Output	2.40

Ferrite Rod Loop Antenna

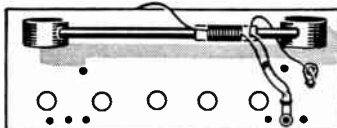

The electrical characteristics of this newly developed type Ferrite Rod Loop Antenna make possible a general replacement loop that offers outstanding performance. Reception of distant stations will be improved to the extent that no antenna or ground will be required, and on local stations much better reception will be insured. The Loop Rod Antenna has an adjustable inductance which makes it possible to peak the antenna stage by merely sliding the coil along the ferrite rod; this also enables it to be used with a variety of tuning condensers.

Cat. No.	Dimensions	List Price
705-A	3 1/4" x 9 1/2"	\$2.75



Sub-Miniature I.F. Transformers

Through the use of a Ferrite shell core material these Sub-Miniature I.F. Transformers offer the gain and bandwidth characteristics previously obtained in only larger I.F. assemblies. (For Battery or AC-DC Radios.)

Dimensions:	1/2" sq. x 1 1/2" high.	
Cat. No.	Item	List Price
10-C1	455 KC Input I.F. Trans.	\$2.50
10-C2	455 KC Output I.F. Trans.	2.50



Miniature 1500 KC I.F. Transformers

These transformers are permeability tuned and comparable in performance to standard size components. Expressly designed for use with the new miniature tubes. Supplied with spring clip for mounting to the chassis.

Dimensions:	3/4" x 3/4" x 2" high.		
Cat. No.	Description	Range	List Pr.
12-W1	Input or Interstage	1400-1600 KC	\$2.50
12-W2	Half-wave output	1400-1600 KC	2.50



Replacement I.F. Transformers

These transformers are an essential part of the stock of every serviceman and dealer. In many cases they will give better performance than the original transformer. These transformers may be used as replacements in most makes of radio receivers of the same physical size.

Dimensions:	1 3/8" square x 2 5/8" high.			
Cat. No.	Freq.	KC Range	Use	List Price
512-H1	262	250-275	Input	\$2.40
512-H2	262	250-275	Interstage	2.40
512-H3	262	250-275	Full-Wave	2.40
512-H4	262	250-275	Half-Wave	2.40
512-C1	455	450-475	Input	2.40
512-C2	455	450-475	Interstage	2.40
512-C3	455	450-475	Full-Wave	2.40
512-C4	455	450-475	Half-Wave	2.40
512-W1	1500	1400-1600	Input	2.40
512-W2	1500	1400-1600	Interstage	2.40
512-W3	1500	1400-1600	Full-Wave	2.40
512-W4	1500	1400-1600	Half-Wave	2.40

Iron Core Transformers

Dimensions: 1 3/8" square x 3 3/4" high. #6/32 spade bolt mounting.

Cat. No.	Freq.	KC Range	Use	List Price
612-K1	175	165-185	Input	3.50
612-K2	175	165-185	Interstage	3.50
612-K3	175	165-185	Full-Wave	3.50
612-K4	175	165-185	Half-Wave	3.50
612-H1	262	250-275	Input	2.90
612-H2	262	250-275	Interstage	2.90
612-H3	262	250-275	Full-Wave	2.90
612-H4	262	250-275	Half-Wave	2.90
612-C1	455	450-475	Input	2.90
612-C2	455	450-475	Interstage	2.90
612-C3	455	450-475	Full-Wave	2.90
612-C4	455	450-475	Half-Wave	2.90

FM I.F. Trans. (10.7 MC)

These permeability tuned 10.7 MC intermediate frequency transformers are assembled in aluminum shields 1 1/2" square x 2 1/8" high. Mounting is by two #6-32 spade bolts on 1-1/16" centers. Three interstage transformers Cat. No. 1451 are usually required when followed by a discriminator transformer Cat. No. 1452, while two may be sufficient in conjunction with a ratio detector transformer Cat. No. 1453.

Cat. No.	Item	List Price
1451	10.7 MC Interstage Trans.	\$2.40
1452	10.7 MC Discriminator Trans.	3.30
1453	10.7 MC Ratio Detector Trans.	3.30

For a Complete Listing of MILLER PRODUCTS ask for a copy of our Latest General Catalog.



Miller Radio Frequency Coils



Miniature Adjustable R.F. Coils

These high Q adjustable iron core coils are for general replacement use.

Dimensions:
 $\frac{1}{2}$ " dia. x $\frac{1}{2}$ " long (Nos. 70-A and 70-RF).
 $\frac{1}{2}$ " dia. x $\frac{1}{8}$ " long (Nos. 69-OSC and 70-OSC).

Cat. No.	Use	Freq. Range	List Price
70-A	Antenna Stage	540-1600 KC	\$1.50
70-RF	R.F. Stage	540-1600 KC	1.50
70-OSC	Oscillator Stage	540-1600 KC	1.50

Has pri. and tapped sec. (I.F. 100-550 KC)
69-OSC Oscillator Stage 540-1600 KC 1.50
Capacity coupled type (100-550 KC)



Universal Adjustable Oscillator Coil

These adjustable iron core oscillator coils are for general replacement use.

Dimensions: $\frac{5}{8}$ " x $1\frac{1}{2}$ " high.

Cat. No.	Use	Freq. Range	List Pr.
71-OSC	Oscillator Stage R.F.	500-1800 KC	\$2.00

(I.F. 100-550 KC)



High-Q Ferrite Antenna Coil

Supplied with mounting bracket

Dimensions: $\frac{3}{8}$ " diameter x $2\frac{1}{4}$ " long.

Cat. No.	Use	Freq. Range	List Pr.
6300	Antenna Stage	540-1700 KC	\$1.25



Adjustable FM R.F. Coils

Dimensions: $\frac{1}{2}$ " O.D. x $1\frac{1}{8}$ " long.

Cat. No.	Item	List Price
1474	88-108 MC Antenna Coil	\$1.50
1475	88-108 MC R.F. Coil	1.50
1476	88-108 MC Osc. Coil (10.7 MC I.F.)	1.50



Standard Bank Wound Coils

High gain general purpose coils featuring high impedance coupled antenna and R.F. units with progressive wound litz wire secondary (except oscillator coils). Far use with standard 365 mmdf tuning condenser. All windings are thoroughly impregnated with tropicalized R.F. lacquer.

Shielded

Dimensions: $1\frac{1}{8}$ " square x $2\frac{1}{2}$ " high.

Cat. No.	Use	Freq. Range	List Price
44-A	Antenna Stage	540-1700 KC	\$1.35
44-RF	R.F. Stage	540-1700 KC	1.35
44-BP	Band-Pass Stage	540-1700 KC	1.35

Cat. No. I.F. Freq. Series Pad List Price

44-K	175 KC	.001 mfd.	\$1.35
44-H	262 KC	.0006 "	1.35
44-C	455 KC	.0004 "	1.35

Tapped asc. coils (for 65A7 and similar tubes)

Cat. No.	I.F. Freq.	Series Pad	List Price
41-K	175 KC	.001 mfd.	\$1.35
41-H	262 KC	.0006 "	1.35
41-C	455 KC	.0004 "	1.35

Unshielded

Dimensions: $\frac{3}{8}$ " diameter (form) x $2\frac{1}{8}$ " high.

Cat. No.	Use	Freq. Range	List Pr.
43-A	Antenna Stage	540-1700 KC	\$1.10
43-RF	R.F. Stage	540-1700 KC	1.10
43-BP	Band-Pass Stage	540-1700 KC	1.10

Cat. No. I.F. Freq. Series Pad List Price

43-K	175 KC	.001 mfd.	\$1.10
43-H	262 KC	.0006 "	1.10
43-C	455 KC	.0004 "	1.10

Tapped asc. coils (for 65A7 and similar tubes)

Cat. No.	I.F. Freq.	Series Pad	List Price
45-K	175 KC	.001 mfd.	\$1.10
45-H	262 KC	.0006 "	1.10
45-C	455 KC	.0004 "	1.10

Germanium Crystal Diode Band-Pass TRF Tuner Kit

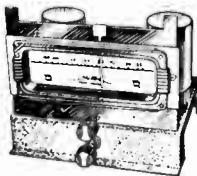

High fidelity! Uses germanium diode detector! No tubes! No power supply! No hum! A simple 2-tuned circuit negative mutual-coupled band-pass tuner. Easy to assemble and wire. Full 22 kc. pass-band assures all brilliance of treble

tones. Yet selective enough to separate local stations. With good antenna, AM stations in 20-25 mile range give output .05V to .5V. Use with your amplifier and speaker system for extra high quality reception. The Miller #585 TRF Tuner Kit contains coupling and TRF coils, 2-gang condenser, slide rule dial, chassis and hardware. (Resistors, condensers, germanium crystal and volume control not included.)
#585 TRF Tuner Kit List \$19.50

Midget R.F. Coils (Adjustable Inductance)

Particularly recommended for aircraft, marine and mobile equipment and general custom receiver construction. Coils are designed for use with standard 365 mmdf. tuning condenser.

Dimensions: $1\frac{1}{8}$ " square x 2" high.

Broadcast Band 540-1700 KC

Cat. No.	Use	I.F. Freq.	List Pr.
A-320-A	Antenna		\$1.95
A-320-RF	Interstage		1.95
A-320-M	2-coil Osc.	132 KC	1.95
A-320-C	2-coil Osc.	455 KC	1.95
A-321-M	Tapped Osc.	132 KC	1.95
A-321-C	Tapped Osc.	455 KC	1.95

Marine & Aircraft Band 2100-6300 KC

B-320-A	Antenna	\$1.95
B-320-RF	Interstage	1.95
B-320-M	2-coil Osc.	132 KC
B-320-C	2-coil Osc.	455 KC
B-321-M	Tapped Osc.	132 KC
B-321-C	Tapped Osc.	455 KC

Short Wave Band 6.0-18 MC

C-320-A	Antenna	\$1.95
C-320-RF	Interstage	1.95
C-320-C	2-coil Osc.	455 KC
C-321-C	Tapped Osc.	455 KC

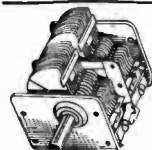

Midget Variable Condensers

Split outer plates on the rotors permit accurate alignment. High frequency trimmers are provided on the short side of the condenser.

Mounting is provided by tapped holes in the frame of the condenser. Counter-clock rotation for capacity increase. Shaft dia. is $\frac{1}{4}$ " x $1\frac{1}{2}$ " long. Capacity range—10 to 365 mmdf.

Cat. No.	Sections	Dimensions	List Price
2111	1	$1\frac{1}{8}$ " x $1\frac{1}{2}$ " x $1\frac{1}{8}$ "	\$2.50
2112	2	$2\frac{1}{8}$ " x $1\frac{1}{2}$ " x $1\frac{1}{8}$ "	3.50
2113	3	$3\frac{1}{8}$ " x $1\frac{1}{2}$ " x $1\frac{1}{8}$ "	5.00

General Purpose Filter



This filter is recommended for use with marine and D.C. appliances and radios. It is also for use with extremely noisy A.C. appliances. A good, permanent connection to ground should be used with this filter.

Dimensions: $2\frac{1}{4}$ " square x 5" lang.

Cat. No.	Volts	Watts	List Price
7813	115	200	\$8.25



Universal Replacement Coils (Permeability Tuned)

This series of variable inductance iron core coils are well suited for general replacement. Adjusted to cover the standard broadcast band with a tuning condenser having a maximum capacity of between 250 and 450 mmdf. The oscillator coils may be used with any I.F. amplifier operating in the 100 to 550 KC range.

Unshielded

Dimensions: $\frac{7}{8}$ " diameter x 2" high. "L" mtg. bracket.

Cat. No.	Use	Freq. Range	List Pr.
72-A	Antenna Stage	500-1800 KC	\$2.20
72-RF	R.F. Stage	500-1800 KC	2.20
72-OSC	Oscillator Stage (see text above)		2.20

Shielded

Dimensions: $1\frac{1}{8}$ " square x $2\frac{1}{2}$ " high.

Cat. No.	Use	Freq. Range	List Pr.
73-A	Antenna Stage	500-1800 KC	\$2.75
73-RF	R.F. Stage	500-1800 KC	2.75
73-OSC	Oscillator Stage (see text above)		2.75

Unshielded

High-Q R.F. Coils



A complete line of Unshielded Permeability tuned coils for replacement use as at the front end components in new receiver design.

These #5495 series coils can be shielded in our π -32 shields ($1\frac{1}{8}$ " sq.) with very little loss in Q. Mounting is by means of a single $\frac{1}{4}$ " hole. Dimensions (form): $3\frac{3}{8}$ " x 2". Ranges shown are for use with a 365 mmdf. variable tuning condenser.

Long Wave Coils (140-420 KC)

Cat. No.	Use	List Price
X-5495-A	Antenna Stage	\$2.00
X-5495-RF	RF Stage	2.00
X-5495-C	Standard Osc. 455 KC	2.00
X-5496-C	Tapped Osc. 455 KC	2.00

Broadcast Band Coils (540-1700 KC)

A-5495-A	Antenna Stage	\$2.00
A-5495-RF	RF Stage	2.00
A-5495-C	Standard Osc. 455 KC	2.00
A-5496-C	Tapped Osc. 455 KC	2.00

Medium Wave Coils (1.7-5.5 MC)

B-5495-A	Antenna Stage	\$2.00
B-5495-RF	RF Stage	2.00
B-5495-C	Standard Osc. 455 KC	2.00
B-5496-C	Tapped Osc. 455 KC	2.00

Short Wave Broadcast Coils (5-18 MC)

C-5495-A	Antenna Stage	\$2.00
C-5495-RF	RF Stage	2.00
C-5495-C	Standard Osc. 455 KC	2.00
C-5496-C	Tapped Osc. 455 KC	2.00

High Frequency Coils (12-36 MC)

D-5495-A	Antenna Stage	\$2.00
D-5495-RF	RF Stage	2.00
D-5495-C	Standard Osc. 455 KC	2.00
D-5496-C	Tapped Osc. 455 KC	2.00

TV Appliance Filter



These filters are designed to eliminate radio interference caused by horizontal oscillators in T.V. receivers and small electrical appliances such as sewing machines, vacuum cleaners, food mixers, and other similar devices requiring less than 550 watts. Inductive capacitive circuit assures maximum attenuation of interference. Dimensions: $2\frac{1}{4}$ " square x 4" lang.

Cat. No.	Volts	Watts	List Price
7815	115	550	\$7.70

For a Complete Listing of MILLER PRODUCTS ask for a copy of our Latest General Catalog.

Copyright by U. C. P., Inc.

TRADE DISCOUNT APPLIES TO LIST PRICES ONLY

Radio's Master — 19th Edition

Page J-57



**World's largest precision
Coil Manufacturers**

**TELEVISION AND F. M.
I. F. Transformers**

Type No.	List Price	Fig.	Use	Freq. MC	Mtg.	H.	Dimensions W. x D.
17-1001	\$2.75	ST	1st video amplifier	Tune 25.3 Trap 27.25	15/16	2 3/4	15/16 x 15/16
17-1002	2.10	ST	2nd video amplifier	Tune 22.3 Trap 19.75	15/16	2 3/4	15/16 x 15/16
17-1003	.75	IF	3rd video amplifier	Tune 25.2	5/16 hole	1 3/8	5/16 Diam.
17-1004	.75	IF	4th video amplifier	Tune 23.4	5/16 hole	1 3/8	5/16 Diam.
17-1062	1.50	IF	2nd video amplifier	Tune 25.7	5/16 hole	1 1/2	5/8 Diam.
17-1063	1.50	IF	3rd video amplifier	Tune 23.4	5/16 hole	1 1/2	5/8 Diam.
17-1064	1.50	IF	4th video amplifier	Tune 25.7	5/16 hole	1 3/8	5/8 Diam.
17-1066	1.50	IF	Video amplifier—Pri Shunt 22K ohms	Tune 21.5	5/16 hole	1 3/8	5/8 Diam.
17-1011	2.10	ST	Input sound amplifier	Tune 21.25	15/16	2 1/4	15/16 x 15/16
17-1012	2.10	ST	Output sound amplifier	Tune 21.25	15/16	2 1/4	15/16 x 15/16
17-1013	2.75	ST	Sound discriminator	Tune 21.25	1 1/8	1 3/4	1 3/8 x 1 1/8
17-1020	2.75	ST	Converter	21.8	15/16	2 3/4	15/16 x 15/16
17-1025	2.75	ST	Sound takeoff	4.5	1 1/2	1 1/2	7/8 x 7/8
17-1031	1.25	ST	Sound takeoff	4.5	1 1/2	1 1/2	7/8 x 7/8
17-3402	1.25	IF	Sound takeoff	4.5	5/16 hole	1 1/2	7/8 Diam.
17-3400	1.25	IF	Sound takeoff	4.5	5/16	1 3/8	1/2 Diam.
17-3401	1.25	IF	Sound takeoff	4.5	7/16 hole	1 3/8	1/2 Diam.
16-3445	1.25	ST	Interstage sound	4.5	7/8	1 3/8	7/8 x 7/8
17-3412	1.25	IF	Interstage sound	4.5	5/16 hole	1 1/4	1/2 Diam.
17-1021	2.75	ST	Input or interstage sound	4.5	1 1/8	2 1/4	1 1/8 x 1 1/8
17-1071	2.75	ST	Interstage sound	4.5	15/16	1 1/2	7/8 x 7/8
17-1023	3.00	ST	Discriminator	4.5	1 1/8	3	1 1/8 x 1 1/8
17-1033	3.30	ST	Ratio detector	4.5	1 1/8	2 1/2	1 1/8 x 1 1/8
17-1043	3.30	ST	Ratio detector	21.25	1 1/8	1 3/4	1 1/8 x 1 1/8
17-3493	3.30	ST	Ratio detector	4.5	1 1/8	2 1/2	1 1/8 x 1 1/8
17-3497	3.30	UM	Ratio detector	4.5	3/4 x 1 1/2	2 1/2	3/4 x 3/4
17-4522	1.25	IF	2nd video amplifier	Tune 43	5/16 hole	1 3/8	1/2 Diam.
17-4523	1.25	IF	3rd video amplifier—Shunt 56K ohms	Tune 45.5	5/16 hole	1 1/2	1/2 Diam.
17-4524	1.25	IF	4th video amplifier—Shunt 56K ohms	Tune 44.5	5/16 hole	1 1/4	1/2 Diam.
17-4500	2.50	IG	Converter	Tune 43.1 Trap 41.6	5/16 hole	2 1/2	5/8 Diam.
17-4501	2.50	IG	1st video amplifier	Tune 42.5 Trap 40	5/16 hole	2 1/8	5/8 Diam.
17-4502	2.50	IG	2nd video amplifier	Tune 45.75 Trap 47.25	5/16 hole	2 1/8	5/8 Diam.
17-4503	3.00	ST	3rd video amplifier	Tune 43.3 Trap 40	15/16	2 1/4	15/16 x 15/16
17-4531	3.00	ST	1st video amplifier	Tune 44.0 Trap 39.25	15/16	2 1/4	7/8 x 7/8
17-4504	3.00	ST	4th video amplifier	Tune 44.2 Trap 47.5	15/16	2 1/4	15/16 x 15/16
17-4521	1.25	ST	1st video amplifier—Shunt 27K ohms	Tune 45.75	15/16	2 1/4	7/8 x 7/8

BROADCAST

Type No.	List Price	Fig.	Use	Freq. Range	Peak Factory Setting	Selectivity 2X	10X	Mtg.	H.	Dimensions W. x D.
16-6649	\$2.00	MT	Input	140-200 KC	175 KC	6.0	17.5	1 1/4	2 1/2	1 1/4 x 1 1/4
16-6650	2.00	MT	Interstage	140-200 KC	175 KC	5.7	15.0	1 1/4	2 1/2	1 1/4 x 1 1/4
16-6651	2.00	MT	Output	140-200 KC	175 KC	11.5	29.5	1 1/4	2 1/2	1 1/4 x 1 1/4
16-6652	1.75	MT	Input	200-310 KC	262 KC	9.5	24.7	1 1/4	2 1/2	1 1/4 x 1 1/4
16-6653	1.75	MT	Interstage	200-310 KC	262 KC	10.4	27.6	1 1/4	2 1/2	1 1/4 x 1 1/4
16-6654	1.75	MT	Output	200-310 KC	262 KC	20.5	57.1	1 1/4	2 1/2	1 1/4 x 1 1/4
16-6655	1.50	MT	Input	305-480 KC	370 KC	8.4	24.4	1 1/4	2 1/2	1 1/4 x 1 1/4
16-6656	1.50	MT	Interstage	305-480 KC	370 KC	11.3	30.0	1 1/4	2 1/2	1 1/4 x 1 1/4
16-6657	1.50	MT	Output	305-480 KC	370 KC	18.8	46.6	1 1/4	2 1/2	1 1/4 x 1 1/4
16-6658	1.75	MT	Input	400-550 KC	456 KC	18.8	46.6	1 1/4	2 1/2	1 1/4 x 1 1/4
16-6659	1.75	MT	Interstage	400-550 KC	456 KC	12.5	33.0	1 1/4	2 1/2	1 1/4 x 1 1/4
16-6660	1.75	MT	Output	400-550 KC	456 KC	17.5	50.5	1 1/4	2 1/2	1 1/4 x 1 1/4
16-6666	2.20	MT	Input	400-600 KC	456 KC	14.1	37.5	1 1/8	2 1/2	1 1/8 x 1 1/8
16-6667	2.20	MT	Output	400-600 KC	456 KC	18.0	49.5	1 1/8	2 1/2	1 1/8 x 1 1/8

3/4" I. F.'S PERMEABILITY TUNED

Type No.	List Price	Fig.	Use	Freq. Range	Peak Factory Setting	Selectivity 2X	10X	Mtg.	H.	Dimensions W. x D.
16-6752	\$2.40	UM	Input	245-275 KC	262 KC	12	35	3/4 x 1 1/2	2	3/4 x 3/4
16-6754	2.50	UM	Output	245-275	262 KC	18	45	3/4 x 1 1/2	2	3/4 x 3/4
16-6758	2.20	UM	Input or output	400-500	456 KC	28	60	3/4 x 1 1/2	2	3/4 x 3/4
16-6770	2.30	UM	Output	400-500	456 KC	30	65	3/4 x 1 1/2	2	3/4 x 3/4

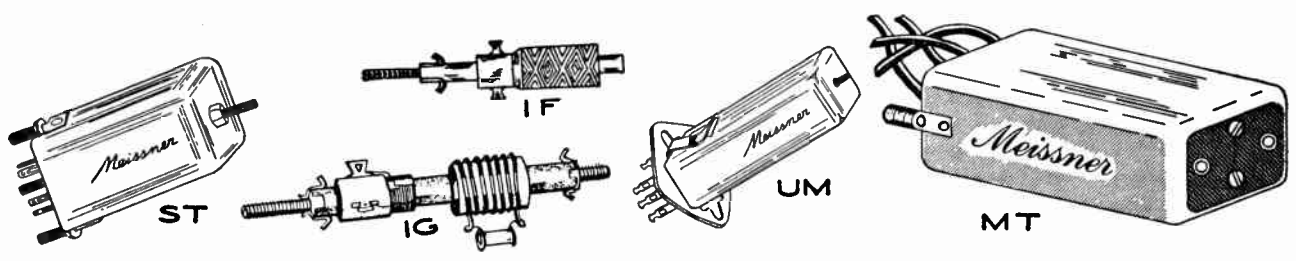



Mt. Carmel, Illinois . . .

World's largest precision
Coil Manufacturers

HI Q IRON CORE "PLASTIC"

Type No.	List Price	Fig.	Use	Freq. Range	Peak Factory Setting	Selectivity 2X	10X	Mtg.	H.	Dimensions W. x D.
16-6662	\$2.50	MT	Input.....	380-600 KC	456 KC	11.2	30.0	1 1/4	2 1/2	1 1/4 x 1 1/4
16-6663	2.50	MT	Output.....	380-600 KC	456 KC	11.2	30.0	1 1/4	2 1/2	1 1/4 x 1 1/4

HI Q IRON CORE "STANDARD" GENERAL REPLACEMENT

Type No.	List Price	Fig.	Use	Freq. Range	Peak Factory Setting	Selectivity 2X	10X	Mtg.	H.	Dimensions W. x D.
16-5728	\$3.30	MT	Input.....	127-208 KC	175 KC	12.5	30.0	1 3/8	3 1/2	1 3/8 x 1 3/8
16-5730	3.30	MT	Output.....	127-208 KC	175 KC	16.5	44.0	1 3/8	3 1/2	1 3/8 x 1 3/8
16-6668	2.40	MT	(Battery input)	350-550 KC	456 KC	22.5	54.3	3/4	2	3/4 x 3/4
16-6669	2.40	MT	(Battery output)	350-550 KC	456 KC	22.5	58.0	3/4	2	3/4 x 3/4
16-6678	2.40	MT	ACDC input or output	375-550 KC	456 KC	16.6	41.1	3/4	2	3/4 x 3/4
16-5740	3.00	MT	Input.....	360-600 KC	456 KC	8.4	20.0	1 3/8	3 1/2	1 3/8 x 1 3/8
16-5742	3.00	MT	Output.....	360-600 KC	456 KC	13.8	38.0	1 3/8	3 1/2	1 3/8 x 1 3/8
16-5782	3.00	MT	Input.....	340-550 KC	456 KC			1 3/8	3 1/2	1 3/8 x 1 3/8
16-5784	3.00	MT	Output.....	340-550 KC	456 KC			1 3/8	3 1/2	1 3/8 x 1 3/8
16-8091	3.00	MT	Input or interstage	1250-200 KC	1500 KC	8.5	35	1 3/8	3 1/2	1 3/8 x 1 3/8
16-8099	3.00	MT	Output.....	1250-200 KC	1500 KC	10	50	1 3/8	3 1/2	1 3/8 x 1 3/8

ANTENNA, R. F. AND OSCILLATOR COILS
"Adjustable" Inductance Coils

Type No.	List Price	Fig.	Use	Mtg.	H.	Dimensions W. x D.
14-1026	\$2.20	PC	Antenna coil.....	3/8 hole	1 3/4	1 1/4 x 1 1/4
14-1027	2.20	PC	R. F. coil.....	3/8 hole	1 3/4	1 1/4 x 1 1/4
14-1028	2.20	PC	Oscillator coil.....	3/8 hole	1 3/4	1 1/4 x 1 1/4
14-1076	2.20	IF	R. F. coil.....	3/8 hole	1 3/4	5/8 Diam.
14-1077	3.00	IF	Oscillator coil.....	5/8 hole	1 1/4	5/8 Diam.
14-1056	2.20	PT	Antenna coil.....	3/4 hole	1 3/8	3/4 Diam.
14-1057	2.20	PT	R. F. coil.....	3/4 hole	1 3/8	3/4 Diam.
14-1058	2.20	PT	Oscillator coil.....	3/4 hole	1 3/8	3/4 Diam.
14-7413	3.00	AE	Antenna coil.....	1 3/4	2 1/2	1 3/4 x 1 3/4
14-7558	3.00	AE	R. F. coil.....	1 3/4	2 1/2	1 3/4 x 1 3/4
14-7000	1.00	IF	Loop antenna replacement	5/8 hole	2 1/2	1/2 Diam.
14-7560	3.00	AE	Oscillator coil.....	1 3/4	2 1/2	1 3/4 x 1 3/4

"STANDARD" GENERAL REPLACEMENT COILS

Type No.	List Price	Fig.	Use	I. F. Freq.	Padder Required	Mtg.	H.	Dimensions W. x D.
14-1010	\$1.25	NT	Antenna coil.....			Single Bracket	2 1/2	1 1/4 Diam.
14-1011	1.25	NT	R. F. coil.....			Single Bracket	2 1/2	1 1/4 Diam.
14-1022	1.10	NT	Antenna coil.....			Single Bracket	2 1/2	1 1/4 Diam.
14-1023	1.25	NT	R. F. coil.....			Single Bracket	2 1/2	1 1/4 Diam.
14-1004	1.75	AE	Antenna coil.....			1 3/4	2 1/2	1 3/4 x 1 3/4
14-1005	1.75	AE	R. F. coil.....			1 3/4	2 1/2	1 3/4 x 1 3/4
14-2436	1.50	AE	Antenna coil.....			1 3/8	2	1 3/8 x 1 3/8
14-2437	1.50	AE	R. F. coil.....			1 3/8	2	1 3/8 x 1 3/8
14-3732	1.25	PC	Oscillator coil.....	175 KC	900 UUFD	3/8 hole	1 1/8	1 x 1
14-6590	1.25	PC	Oscillator coil.....	262	700 UUFD	3/8 hole	1 1/8	1 x 1
14-6592	1.25	PC	Oscillator coil.....	370	500 UUFD	3/8 hole	1 1/8	1 x 1
14-4034	1.25	PC	Oscillator coil.....	456	350 UUFD	3/8 hole	1 1/8	1 x 1
14-4242	1.50	AE	Oscillator coil.....	175	900 UUFD	1 1/2	1 3/4	1 1/2 x 1 1/2
14-4243	1.50	AE	Oscillator coil.....	456	350 UUFD	1 1/2	1 3/4	1 1/2 x 1 1/2

"PENTAGRID" OSCILLATOR COILS
Tapped Type for 6SA7, 12SA7 and other Pentagrid Converter Tubes. 456 KC.

Type No.	List Price	Fig.	Use	Mtg.	H.	Dimensions W. x D.
14-1033	\$1.10	PT	Standard padder required 420 UUFD.....	1/4 hole	1	3/4 Diam.
14-1053	1.10	PT	Cut section padder 162 UUFD.....	1/4 hole	1	3/4 Diam.

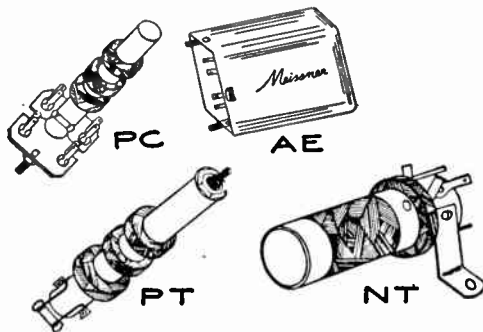

Coils and components shown in MEISSNER catalog, and transformers, chokes, etc. shown in the new companion THOR-DARSON catalog, are also listed in SAM's "Photofacts" and "Counterfacts."

Brand new THORDARSON-MEISSNER COMBINED T. V. REPLACEMENT GUIDE available free on request, shows correct replacement on about 6000 different T. V. sets. Covers: Horizontal syncs . . . deflection yokes . . . vertical outputs . . . ratio detector & discriminator coils . . . chokes . . . I. F.'s . . . peaking coils . . . flybacks . . . powers . . . width controls . . . horizontal blocking oscillators . . . focus coils . . . vertical blocking oscillators . . . traps . . . audio outputs.

Burnell TOROIDAL DECADE INDUCTORS

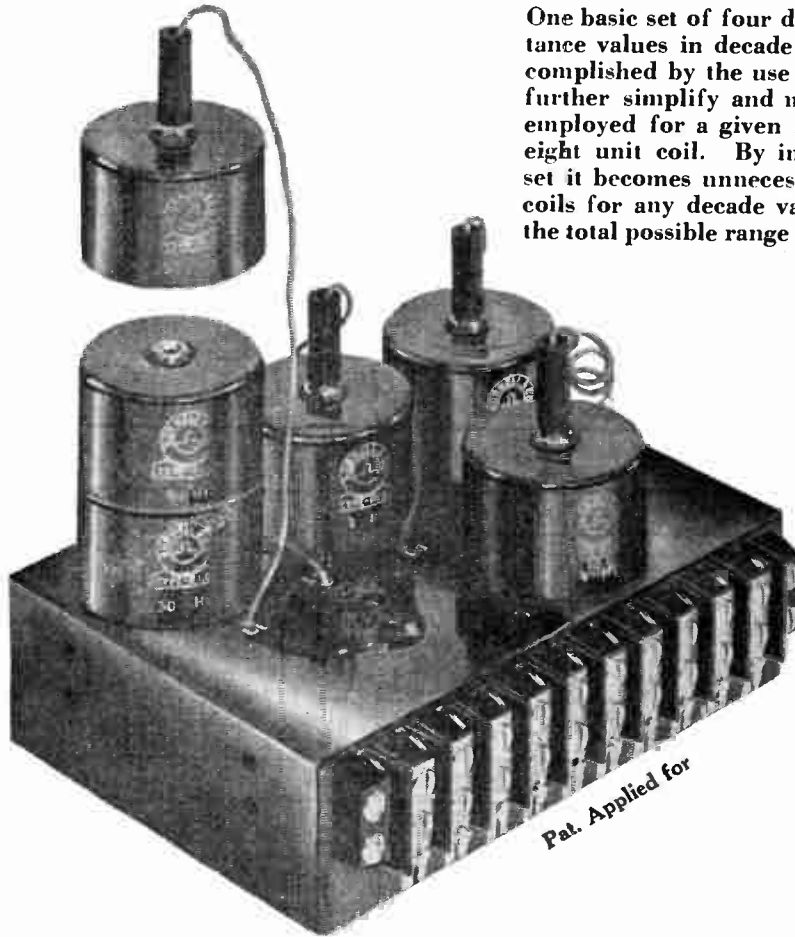

One basic set of four decade units will provide inductance values in decade steps of 1 to 10. This is accomplished by the use of the 1, 2, 3, 4, system. To further simplify and minimize the number of units employed for a given inductance, we have added an eight unit coil. By including this coil in the basic set it becomes unnecessary to employ more than two coils for any decade value up to twelve and extends the total possible range for all five coils up to eighteen.

	NET PRICE
P.I.D. 1 (MHYS)*.....	\$10.40
P.I.D. 2 "	10.40
P.I.D. 3 "	10.40
P.I.D. 4 "	10.40
P.I.D. 8 "	10.40
P.I.D. 10 (MHYS)*.....	11.70
P.I.D. 20 "	11.70
P.I.D. 30 "	11.70
P.I.D. 40 "	11.70
P.I.D. 80 "	11.70
P.I.D. 100 MHYS.....	13.00
P.I.D. 200 "	13.00
P.I.D. 300 "	13.00
P.I.D. 400 "	13.00
P.I.D. 800 "	14.30
P.I.D. 1000 MHYS.....	15.60
P.I.D. 2000 "	15.60
P.I.D. 3000 "	15.60
P.I.D. 4000 "	15.60
P.I.D. 8000 "	18.20
P.I.D. 10000 MHYS.....	19.50
P.I.D. 20000 "	20.80
P.I.D. 30000 "	22.10
P.I.D. 40000 "	23.40
P.I.D. 80000 "	27.30
Wired Chassis	\$8.50

B.I.F. (BAND INTERSTAGE FILTERS)

B.I.F. (BAND INTERSTAGE FILTERS)

This new series of interstage band pass filters will be of interest to project and design engineers to whom the time required for specially designed filters is prohibitive. A stock supply will be maintained for most commonly used center frequencies between 60 cycles and 50,000 cycles. The filter is designed to operate between the triode plate and the grid of a tube and provides a voltage gain of approximately 6DB. Filters are hermetically sealed. Small size permits use in compact or even miniaturized equipment. Dimensions are 1-3/16 x 1-11/16 x 2-1/4" high. When ordering specify BIF___ Cycles.

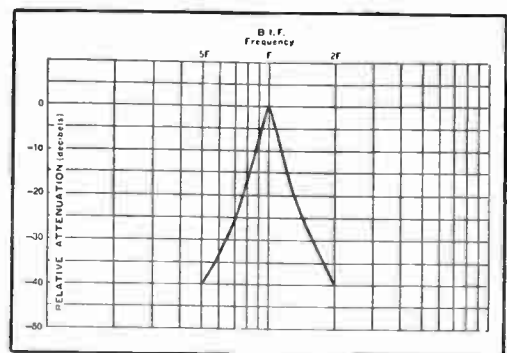

BIF net price \$24.00 each

EXCLUSIVE MANUFACTURERS OF COMMUNICATIONS NETWORK COMPONENTS



Burnell

TOROIDAL INDUCTORS

TC-0		TC-4		TC-15	
IND. MHY	NET PRICE	IND. MHY	NET PRICE	IND. MHY	NET PRICE
1	\$ 6.00	1	\$ 7.10	1	\$10.45
10	6.00	10	7.10	10	10.45
20	6.10	20	7.30	20	10.45
30	6.40	30	7.60	30	10.45
50	6.75	50	7.85	50	10.45
100	7.10	100	8.65	100	10.45
250	7.60	250	9.10	250	10.95
500	7.85	500	9.55	500	11.40
750	8.00	750	9.80	750	11.85
1000	8.25	1000	10.00	1000	12.40
1500	9.35	1500	10.45	1500	12.75
2000	10.45	2000	11.25	2000	13.45
		3000	11.95	3000	14.25
		4000	13.45	4000	14.95
		5000	14.95	5000	15.75
		6000	17.25	6000	16.45
		7000	19.45	7000	17.25
		10 HYS	21.70	10 HYS	17.95
		15 HYS		12.5 HYS	18.75
				15 HYS	19.45
				20 HYS	20.20
				30 HYS	22.45
				50 HYS	25.40
				75 HYS	29.90
				100 HYS	34.80
				125 HYS	37.70

TC-1		TC-5	
IND. MHY	NET PRICE	IND. MHY	NET PRICE
1	\$ 7.10	1	\$ 9.10
10	7.10	10	9.10
20	7.30	20	9.45
30	7.60	30	9.75
50	7.85	50	10.10
100	8.65	100	11.25
250	9.10	250	11.95
500	9.55	500	12.75
750	9.80	750	13.45
1000	10.00	1000	14.25
1500	10.45	1500	14.95
2000	11.25	2000	16.45
3000	11.95	3000	18.55
4000	12.75		
5000	13.45		
6000	14.25		
7000	14.95		
10 HYS	16.45		
12.5 HYS	17.55		
15 HYS	18.55		

For hermetic sealing add \$1.50 to net price

TC-0 Frequency Inductance Range 1 KC to 20 KC Inductance Range .001 to 2 HYS Nominal coil size 1 x 13/32 Case Size 1.162 x 3/4"

TC-1 Frequency Inductance Range 100 CPS to 10 KC Inductance Range .001 to 15 HYS Nominal Coil Size 1 5/8 x 5/8 Nominal Case Size 1 11/16 x 1 13/16 x 2 1/4"

TC-4 Frequency Inductance Range same as TC-1 Inductance Range .001 to 10 HYS Nominal Coil Size 1 7/32 x 19/32 Nominal Case Size 1.287 x 1"

TC-5 Frequency Inductance Range 1 KC to 100 KC Inductance Range .001 to 750 MHY Nominal Coil Size 1 7/32 x 19/32 Nominal Case Size 1.287 x 1"

TC-15 Frequency Inductance Range 100 to 5000 C. P. S. Inductance Range .001 to 125 HYS Nominal Coil Size 1 7/8 x 7/8 Nominal Case Size 1 1/4 x 2 5/8 x 3"

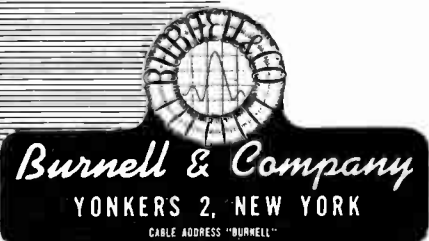

VIKING "RANGER" TRANSMITTER/EXCITER KIT

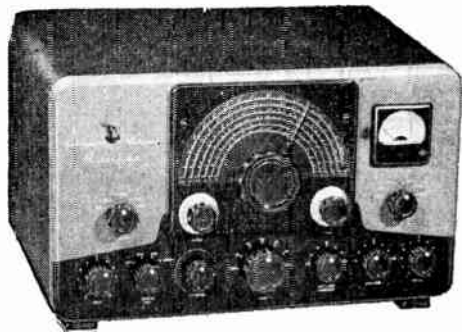

Extremely compact (only 15" x 11 1/8" x 9"), the unit is designed throughout for easy assembly by the novice or experienced amateur. Wiring harness, punched chassis, all parts hardware and connectors are furnished along with complete step-by-step assembly instructions, pictorial diagrams and operating directions.

Cat. No. 240-161 Viking Ranger Kit, less tubes, crystal, key and mike.....\$179.50 Amateur Net
Cat. No. 240-161-2 wired and tested. See your distributor for details.

BUILT-IN VFO—TVI SUPPRESSED

Designed as a completely self-contained, compact transmitter which can also be used as a flexible exciter unit without modification, the new Viking Ranger offers more features than any transmitter-exciter ever built for amateurs.

As a transmitter, the Ranger is a compact, self-contained 75 watt CW or 65 watt Phone unit with 100% AM modulation and antenna load matching from 50 to 500 ohms. Operating on 160-80-40-20-15-11 and 10 meters crystal or VFO, it features high gain audio with communications speech range and complete TVI shielding and filtering.

As an Exciter, the Ranger will drive any of the popular kilowatt level tubes and provides a high quality speech driver system for high powered modulators. Its design also enables basic control functions for the high powered stage to be handled right at the exciter. No internal changes are necessary to change from transmitter to exciter operation.

The built-in VFO has exceptional stability—accurate within 1 KC—dial calibrated in 10 KC increments. A smooth running planetary drive and a large edge-light excited plexiglass dial with ruled plexiglass pointer assures tuning accuracy without parallax. Easy to tune, the Ranger's basic tuning controls are located on the VFO Dial escutcheon. QSY within the phone or CW portion of a band is usually possible by merely changing the VFO frequency setting. For larger frequency excursions, simply touch up the grid (buffer) tuning, adjust loading and dip the final. Simple as A B C. Other controls, used for initial tuning up, changing bands or changing mode of transmission, are as follows: Off-Tune-Phone-Standby-CW switch, Bandswitch, Crystal 1-Crystal 2-VFO-VFO Zero switch, Meter Off-Osc.-Buffer-Grid-Plate-Mod. switch, Audio Gain, RF Drive, Coupling and Auxiliary Coupling. The VFO frequency control, Final Plate tuning and Buffer tuning dials are on the VFO dial escutcheon.

A nine pin receptacle on the rear of the transmitter brings out TVI filtered control and audio leads for exciter operation. This plug also permits the Ranger to be used as a filament and plate power source and a modulator for operating auxiliary equipment such as a VHF transmitter. Available at the output plug are 6.3 VAC at 5.5 Amp., 500 VDC at up to 210 MA and 300 VDC at up to 50 MA along with the full 33 watts output of the modulator.

The Viking Ranger tube lineup is as follows: 6AU6 VFO—OA2 voltage reg., 6CL6 crystal osc., 6CL6 buffer, 6146 final amplifier, 6AQ5 clamper, 12AX7 dual triode speech amp., 12AU7 dual triode audio driver, 2-1614 push pull modulators, 6AX5 low voltage rectifier and 5R4 high voltage rectifier.

JOHNSON AMATEUR EQUIPMENT AND ACCESSORIES



LOW PASS FILTER

The Johnson Low Pass Filter consists of four individually shielded sections. Handles more than 1000 watts RF, provides 75 DB or more attenuation above 54 mc. Insertion loss, less than .25db. Teflon insulated fixed capacitors are replaceable. SO-239 coaxial connectors at each end. Furnished completely wired and pre-tuned.

Cat. No. 250-20 Low Pass Filter.....\$13.50 Amateur Net



STANDING WAVE RATIO BRIDGE

Provides accurate measurement of standing wave ratios to insure most effective use of a low pass filter and antenna coupler for ultimate in TVI suppression. 52 ohms impedance can be changed to 70 ohms or other desired value. Equipped with SO-239 connectors and polarized meter jacks.

Cat. No. 250-24 SWR Bridge.....\$ 9.75 Amateur Net

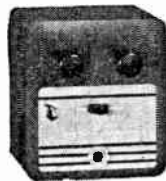

JOHNSON SIGNAL SENTRY CW OR PHONE MONITOR—ALL BANDS, NO TUNING

A non-frequency sensitive RF actuated monitor, the Johnson Signal Sentry monitors CW or phone on all amateur bands to 50 mc. Triggered directly by transmitter RF, unit acts as "On the Air" indicator because transmitter failure is immediately apparent by lack of monitor output. Circuit designed to mute receiver audio when energized by transmitter enabling break-in operation. Powered from receiver or other available supply, the Signal Sentry is easily installed by plugging into receiver headphone jack—plugging headphones into monitor and coupling RF probe to transmitter. Controls: CW TONE and audio VOLUME.

Maroon cabinet only 3 1/8" x 3 3/8" x 3 3/4". Unit is supplied wired and tested including instructions and all cables and connectors for installation. Tubes required but not furnished: one 12AX7, one 12AU7. Shipping weight 3 lbs
Cat. No. 250-25 Johnson Signal Sentry, less tubes and power supply.....\$14.70 Amateur Net

E. F. JOHNSON COMPANY

VIKING II TRANSMITTER KIT



**INSTANT BANDSWITCHING
TVI SUPPRESSED
SELF-CONTAINED, NO PLUG-IN
COILS**

Output Range

Band	Frequency Range	Band	Frequency Range
160	1.8 mc.—2.4 mc.	20	9.8 mc.—15.0 mc.
80	2.9 mc.—4.4 mc.	15	15.0 mc.—21.8 mc.
40	5.2 mc.—8.0 mc.	10-11	21 mc.—30 mc.

RF section consists of a 6AU6 oscillator, a 6AQ5 buffer/doubler and parallel 6146 output amplifier. Modulator pp 807's operating class AB1 with 6AU6 speech amplifier and 6AU6 driver. Parallel 5R4GY HV rectifiers. 5V4G low voltage rectifier with 6AL5 bias rectifier and 6AQ5 clamper screen voltage regulator. Fixed bias applied to buffer and output amplifier for break-in CW operation. Audio response limited to center of speech range.

Bandswitching and completely self-contained, the Viking II transmitter delivers 130 watts CW output and 100 watts phone, 160 through 10 meter amateur bands.

Effectively TVI suppressed, features include a heavily copper plated cabinet serving as a simple RF shield. Lid is bonded to cabinet with silver plated phosphor bronze contact fingers yet is easily opened by removing just three thumb screws. Cabinet lid and bottom plate are perforated for effective air cooling.

Special shields provided for meter, dial window and shaft openings. Choke-capacitor type filters for power line leads, VFO receptacle, antenna relay terminals as well as key and mike jacks, plus internal filters at RF tubes effectively eliminate spurious radiation. Wide range pi-network output tuning system provides up to 30 db second harmonic attenuation before any external filtering. Shielded coaxial connectors are used for RF output and VFO input terminals.

All parts furnished including a complete set of tubes, cabinet, punched chassis, wiring harness, wire, terminals, grommets and all other hardware. Carefully detailed and illustrated instructions for assembly, test, and operation are also included. Supplied for 115 volt 50/60 cycle operation only. Cabinet dimensions 20" wide, 10 $\frac{1}{8}$ " high, 13" deep. Net weight assembled, 65 pounds.

Cat. No.

240-102 Viking II Transmitter Kit with tubes, less crystals, key, and mike... **\$279.50**

240-102-2 Viking II Transmitter, wired and tested... **\$337.00**

Amateur Net

JOHNSON AMATEUR EQUIPMENT AND ACCESSORIES

JOHNSON "MATCHBOX"

Bandswitching and completely self-contained, the "Matchbox" performs all transmission line matching and switching functions required in medium power amateur stations.

Almost an infinite variety of antennas can be loaded throughout the amateur bands from 3.5 to 30.0 mcs. Balanced antennas from 25 to 1200 ohms resistance can be matched while unbalanced or single wire antennas within the range of 25 to 3000 ohms resistance can be successfully loaded. Furthermore, the "Matchbox" is capable of tuning out large amounts of reactance. Nominal input impedance is 52 ohms; can be used with any transmitter having 250 watts maximum power input and a PA plate voltage not exceeding 1000 volts. Self-contained antenna changeover relay. Bandswitching—front panel controls—no internal adjustment required to change bands. Extra terminal is provided for attachment of an RF probe, or the connection of a phone-CW monitor such as the JOHNSON "Signal Sentry".

Supplied only as a completely assembled and tested unit in a fully shielded maroon and gray cabinet, 9 $\frac{3}{8}$ " wide, 10 $\frac{1}{2}$ " deep, 7" high. Weight, approximately 6 pounds. Ceramic insulated output terminals, SO-239 coaxial RF input connector and terminal strip for connection to receiver and relay all located on rear of cabinet. SWR Bridge required for proper installation.

Cat. No. **250-23** "Matchbox"..... **\$49.85** Amateur Net



VIKING VFO KIT

Variable frequency oscillator with 160 and 40 meter output for frequency multiplying transmitters. Accurately calibrated for all amateur bands from 160 thru 10 meters. 6AU6 electron coupled oscillator, OA2 voltage regulator. Excellent stability is assured by temperature compensated padders and rigid construction. 6-1 vernier tuning with high reset accuracy. Power requirements 6.3 volts, 3 amperes, 250-300 volts 15 ma, DC unregulated. (Power and input connections provided on every Viking I and II.) Kit furnished complete, less tubes. All parts, assembly and calibration instructions included. When used with a Viking II or other shielded transmitter having filtered power leads, no TVI suppression measures are required.

Cat. No. **240-122** Viking VFO Kit, less tubes..... **\$42.75** Amateur Net

Cat. No. **240-122-2** Viking VFO kit, wired and tested..... **\$63.75** Amateur Net

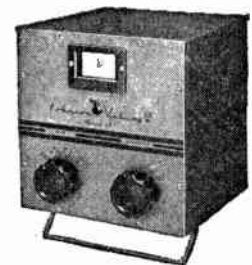

WASECA, MINNESOTA

JOHNSON MOBILE EQUIPMENT

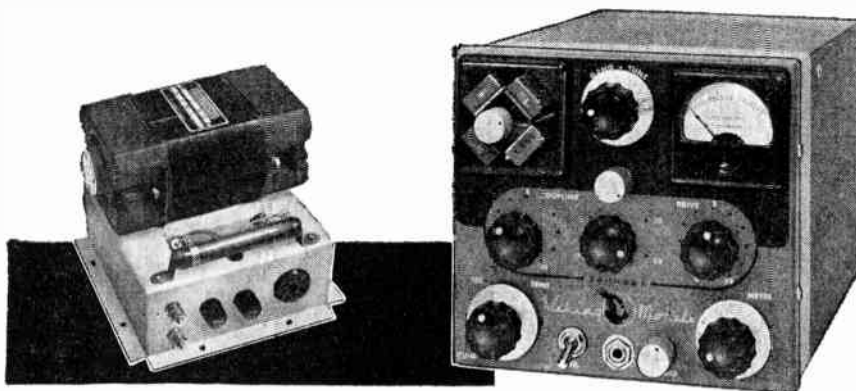

Power-packed mobile kit for advanced amateurs. 60 watts PA input, **instant bandswitching** (75, 40, 20, 15, 11, and 10 meters)—**gang-tuned**. 100% AM modulation engineered for communications audio pass band. Single control coupling system simplifies loading. Ganged coupling circuits pre-tuned for efficient antenna matching. Separate PA trimmer permits large frequency excursions without antenna loading coil adjustments. RF section, 6BH6 oscillator, 6AQ5 buffer doubler and 807 power amplifier. Powerful PP 807 modulator is designed for extra audio punch. 6BH6 speech amplifier and 6BH6 driver has sufficient gain for either high impedance or carbon microphone.

Unique RF bias system protects RF tubes and modulators. "Tune Receive, Transmit" switch enables "non-swish" VFO tuning and receiver muting. Other controls: Audio Gain, PA Excitation, Meter Switch, Crystal selector and filament On-Off. Unit may be wired for either 6 or 12 volts. Designed to use power supplies delivering 300 volts (30 watts PA input) to 600 volts (60 watts PA input) at 200 MA. Furnished in kit form with all parts, punched chassis, hardware and connectors. Instructions completely illustrated for simplified assembly by the experienced amateur. Control wiring specifications and antenna suggestions included. Dimensions $6\frac{1}{8} \times 7\frac{1}{8} \times 10\frac{3}{8}$ ". Weight 16 lbs. Less tubes, crystals, microphone and power supply.
Cat. No. 240-141 Viking Mobile Transmitter Kit..... **\$99.50** Amateur Net
Cat. No. 240-141-2 Viking Mobile wired and tested available on special order.

DYNAMOTOR POWER SUPPLIES AND BASE KITS

Supplies plate voltages for all stages of JOHNSON VIKING MOBILE and MOBILE VFO. Base contains contactor, fuses, filter and 50 watt adjustable dropping resistor. Supplied with connectors for Viking Mobile. Completely wired and assembled. Dimensions $6\frac{1}{8} \times 7\frac{1}{8} \times 7\frac{1}{8}$ ". Rated 500 volts, 200 ma. intermittent. Weight 13 $\frac{3}{4}$ lbs.
Cat. No. 239-102 Dynamotor Power Supply 6 volt primary..... **\$89.50** Amateur Net
Cat. No. 239-104 Dynamotor Power Supply 12 volt primary..... **92.50** Amateur Net
 Complete base kit with all parts, less dynamotor. Supplied with receptacles and plugs for Viking Mobile power and control cables.
Cat. No. 239-101 6 volt Base Kit..... **\$16.50** Amateur Net
Cat. No. 239-103 12 volt Base Kit..... **17.40** Amateur Net

VIKING MOBILE VFO

A diminutive variable frequency oscillator designed specifically for mobile use, the Viking Mobile VFO measures only $4 \times 4\frac{1}{4} \times 5$ ". Double bearing ceramic insulated tuning capacitor... ceramic air dielectric trimmers... ceramic switches... ceramic coil form and heavy aluminum cabinet minimize frequency shift due to road shock and vibration. Split Colpitts oscillator, compensated for an extremely wide range of ambient temperatures, is voltage regulated. Separate amplifier-multiplier stage, operating essentially class A, provides isolation for constant oscillator loading. Edge lighted lucite dial with vernier tuning designed for maximum visibility and accurate reset. VFO is calibrated for 75, 40, 20, 15, 11 and 10 meter bands. Output 3.5 to 4 mc. for 75 meter band and 7.05 to 7.45 for 40, 20, 15 and 10. 10.5 mc. output also available for straight doubling to 15 meters. Tube lineup, 6BH6 oscillator, 6BH6 buffer-multiplier and OA2 regulator. Adequate output will drive any straight pentode crystal stage. Cables and connectors for use with Viking Mobile supplied; easily adapted for use with virtually any mobile transmitter. Complete kit includes all parts, hardware and assembly and operating instructions. Weight approximately 3 lbs.
Cat. No. 240-152 Viking Mobile VFO Kit, less tubes..... **\$29.45** Amateur Net
Cat. No. 240-152-2 Viking Mobile VFO wired and tested, less tubes..... **44.95** Amateur Net

JOHNSON "BI-NET" ANTENNA RESONATOR

Dual-band mobile antenna loading network for 10 and 20 meters. Mounts in center of standard mobile whip antenna for completely automatic band change while in motion. No relays or mechanical control required. Consists of two adjustable silver plated inductors and ceramic insulated fixed capacitor enclosed in a streamlined plastic housing. $\frac{3}{8}$ " .24 female threads for antenna mounting. Size, $4\frac{1}{16}$ " high, $5\frac{1}{16}$ " long, $2\frac{3}{8}$ " wide. Weight, 14 oz.
Cat. No. 250-22..... **\$10.95** Amateur Net

"WHIPLoad 6" NEW BANDSWITCHING MOBILE LOADING SYSTEM

The new JOHNSON "Whipload 6" provides high efficiency base loading for mobile whips with instant bandswitch selection of six amateur bands: 75, 40, 20, 15, 11 and 10 meters.
 On 75 meters, a special variable capacitor, with a dial scale for accurate calibration, is shunted across the coil to permit tuning the entire band with accurate reset possible on any frequency. Complete coverage is available on the other bands without tuning.
 The large diameter airwound coil with low loss polystyrene support strips provides extremely high "Q" factor and much greater efficiency than usual small diameter loading coils. Taps for each band are easily adjusted initially using a grid dipper or field strength measurements and require no further attention. A fibre-glass housing protects assembly against mechanical shock and exposure without sacrificing high Q and efficiency. Unit mounts on standard mobile whip with hardware provided. May be used in conjunction with the Johnson Bi-Net to provide automatic 10-20 meter operation without switching.
Cat. No. 250-26 Whipload-6, Bandswitching Mobile Antenna Loading Coil..... **\$19.50** Amateur Net

E. F. JOHNSON COMPANY

ROTOMATIC ROTATOR AND ANTENNA ARRAYS

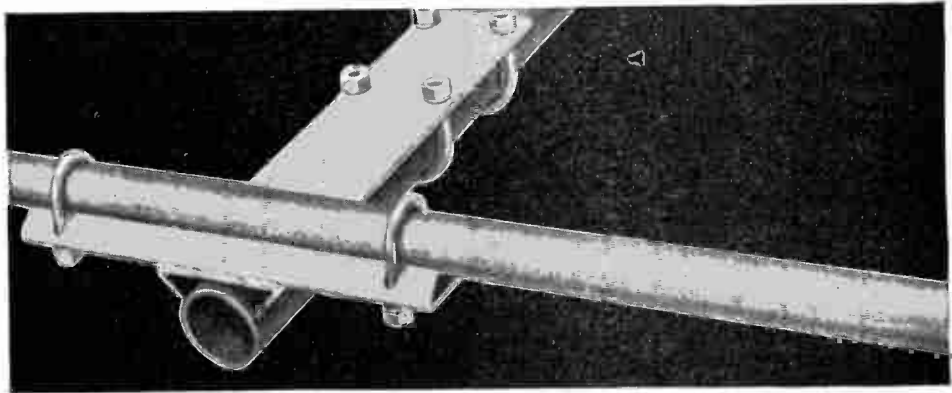

JOHNSON ANTENNA ARRAYS

Rugged, parasitic beam antennas for the 20, 15 and 10 meter amateur bands, designed for years of service in all weather conditions. Booms are 2" galvanized steel tubing, elements are of strong aluminum alloy. Heavy duty galvanized steel clamps will not work loose yet provide adjustable element spacing. Angle feet welded to boom for sturdy mounting. Adjustable "T" or "Gamma" matching assembly included with element kits.

Elements are of adjustable length with specially designed bushings for maximum rigidity. Booms and element kits are available separately for maximum design convenience. A complete array for one band consists of one element kit and appropriate boom assembly. Dual beams require element kit for each band, 138-153 boom and 138-108 antenna switching relay. Relay is DPDT, enclosed in weatherized can with clamps and procelain feed-through connectors.

Boom assemblies have fixed length and are available as follows:

Cat. No.	Length	For beams:	Amateur Net
138-151	9'0"	3 elements 10 meters.....	\$13.00
138-152	12'0"	3 elements 15 meters.....	17.00
138-153	18'9"	3 elements 20 meters, 4 elements 15 meters or dual interlaced beams.....	24.00

Element kits complete with "T" match, hardware and element clamps but less boom.

Cat. No.	Description	Amateur Net
138-210-3	3 element 10 meter kit....	\$43.50
138-210-4	4 element 10 meter kit....	56.50
138-215-3	3 element 15 meter kit....	49.00
138-215-4	4 element 15 meter kit....	62.00
138-220-3	3 element 20 meter kit....	77.50
138-108	beam switching relay.....	19.60

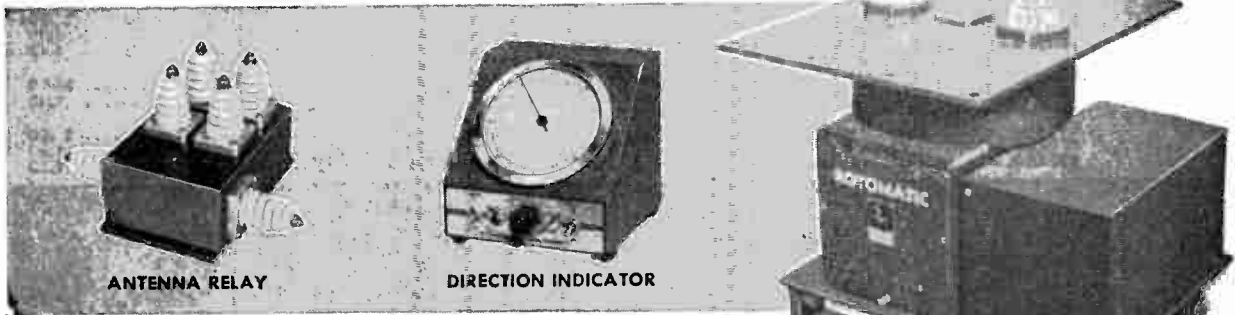

ANTENNA RELAY

DIRECTION INDICATOR

IMPROVED ROTOMATIC ANTENNA ROTATOR

Designed for rigorous service, the Johnson Rotomatic Rotator supports beam antennas weighing up to 175 pounds even under heavy icing conditions or high wind loading. Rotates 1 1/4 RPM—full 360° either direction—over-all gear reduction, 1200 to 1.

Heavily chrome plated RF slip rings provide smooth, noise free operation and low contact resistance. Auxiliary slip rings provided for antenna switching relay control. Rotator housing is cast aluminum; with 5/16 steel rotating table. Unit hinged to tilt 90° for antenna adjustments; can be rotated in tilted position. Complete assembly includes attractive desk top control box with selsyn indicator. Azimuth bearings continuously presented on illuminated dial. Controls include reversible rotation switch, power switch, and antenna relay switch. Weight 76 pounds.

Cat. No. 138-112 Rotomatic Rotator.....	\$324.00	Amateur Net
Cat. No. 144-16 8 Conductor Control Cable.....	\$26.00	fr. Amateur Net

WASECA, MINNESOTA

JOHNSON AIR WOUND INDUCTORS

HIGH POWER VARIABLE INDUCTORS

Heavy duty glass bonded mica insulated inductors for amateur and commercial use. Easily handles over a KW of modulated RF energy to 30 mc. Winding $1/4" \times 1/8"$ edgewise copper. Positive spring loaded beryllium copper contact moves on slide bar as coil rotates. Silver plated winding contact and slide bar. Variable pitch winding provides wide freq. band coverage and increases efficiency at high freq. range. Height $6 1/2"$, width $4"$.

Cat. No.	Inductance	Mounting Centers	No. Turns	Net Price
226-1	22.5 uh	13 1/2"	27 1/2	\$57.00
226-3	13.5 uh	11 1/2"	19 1/2	53.50

SWINGING LINK INDUCTORS

Swinging link inductors for amateur bands 160 thru 6 meters; 150, 500 and 1000 watt sizes. Two inductance values for each band permit choice of appropriate L/C ratio dictated by amplifier plate voltage and plate current. Polystyrene insulation, steatite bases and heavy wire sizes insure highest efficiency. HCS-Inductors match high voltage, low current tubes. LCS-Inductors match low voltage, high current tubes. Complete assembly includes Inductors for bands desired, one Jack Bar, one Link Arm Assembly and one or more Plug-in Links required for matching to line or antenna coupler.

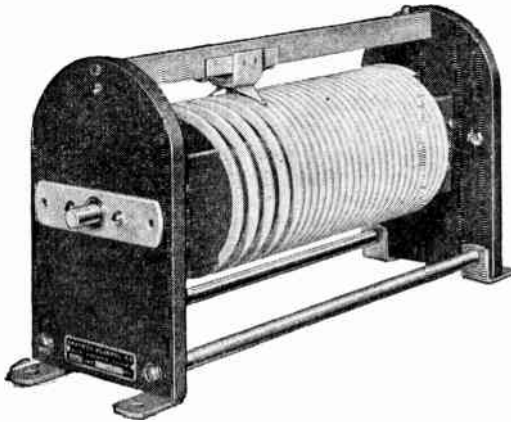

226-1

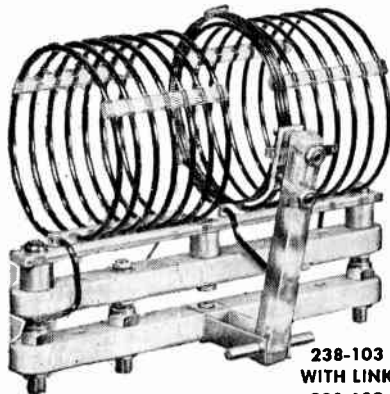

238-103 WITH LINK
238-192

INDUCTOR CLIPS

Clip No. 235-804 is plated phosphor bronze and is designed for making connection to edgewise wound inductors. 235-860 will admit wire from No. 20 to No. 10 without moving and shunting adjacent turns.

Cat. No.	Net Price
235-804	\$.22
235-860	.11

Cat. No.	Type No.	1,000 watts		Height	Width	Net Price
		Wire Size	Cap. *mmf.			
238-106	1000HCS160	10	99	5 11/16"	4 13/16"	\$7.50
238-107	1000LCS160	10	140	5 11/16"	4 13/16"	7.50
238-101	1000HCS80	10	46	5"	3 23/32"	6.70
238-102	1000LCS80	10	73	5"	3 23/32"	6.70
238-103	1000HCS40	10	24	5"	3 23/32"	6.05
238-104	1000LCS40	8	55	5"	3 3/8"	6.05
238-105	1000HCS20	8	19	4 7/8"	3 3/8"	5.55
238-111	1000LCS20	.250"	26	5 1/8"	4"	5.55
238-112	1000H/LCS14	.250"	19	4 3/8"	3 1/2"	5.20
238-113	1000H/LCS10	.250"	18	4 7/8"	3 1/2"	4.90
500 watts						
238-125	500HCS160	14	100	4 7/8"	3 1/8"	3.75
238-126	500LCS160	14	148	4 7/8"	3 1/8"	3.75
238-121	500HCS80	14	45	3 3/8"	2 5/8"	3.45
238-122	500LCS80	12	76	3 3/8"	2 21/32"	3.45
238-123	500HCS40	12	27	3 3/8"	2 21/32"	3.15
238-124	500LCS40	10	50	3 23/32"	2 23/32"	3.15
238-131	500HCS20	6	25	3 15/16"	2 15/16"	2.70
238-132	500LCS20	6	37	3 15/16"	2 15/16"	2.70
238-133	500H/LCS14	6	19	3 11/16"	2 9/16"	2.25
238-134	500H/LCS10	6	19	3 11/16"	2 9/16"	2.10
238-135	500H/LCS6	6	18	3 5/16"	2 5/16"	2.10
150 watts						
238-147	150HCS160	18	102	4 3/16"	3 1/8"	3.30
238-148	150LCS160	16	151	4 3/16"	3 5/8"	3.30
238-141	150HCS80	16	51	4 7/16"	2 19/32"	3.00
238-142	150LCS80	16	68	4 7/16"	2 19/32"	3.00
238-143	150HCS40	14	28	3 3/8"	2 5/8"	2.70
238-144	150LCS40	12	57	3 3/8"	2 21/32"	2.70
238-145	150HCS20	12	21	3 1/2"	2 15/32"	2.40
238-146	150LCS20	12	32	3 1/2"	2 15/32"	2.40
238-151	150H/LCS14	8	19	3 1/2"	2 1/2"	2.10
238-152	150H/LCS10	8	19	3 1/2"	2 1/2"	2.10
238-153	150H/LCS6	8	16	3 1/2"	2 1/2"	1.95

*Total circuit capacity required to effect resonance at low frequency end of band. To determine split-stator capacitor required, subtract tube output and wiring capacity (usually 5 to 20 mmf.) from total capacity in chart, then double the resulting value for capacity per section needed.

PLUG-IN SWINGING LINKS

Select the link to match your line, coupler or output filter for optimum power transfer.

Cat. No.	Type No.	No. Turns	Net Price	Cat. No.	Type No.	No. Turns	Net Price
238-181	150/500SL12	12	\$1.80	238-191	1000SL10	10	\$1.90
238-182	150/500SL5	5	1.15	238-192	1000SL5	5	1.45
238-183	150/500SL2	2	1.00	238-193	1000SL2	2	1.10

SWINGING LINK ARM ASSEMBLIES

238-179	150/500SLA	—Arm assembly for 150/500 watt inductors.....	\$1.15
238-180	1000SLA	—Arm assembly for 1000 watt inductors.....	1.40

JACK BAR ASSEMBLIES

238-171	150JBS	—150 watt, 3 3/4" x 1/16" x 3/8".....	\$.90
238-172	500JBS	—500 watt, 5 3/4" x 3/8" x 3/8".....	1.20
238-173	1000JBS	—1000 watt, 7 1/2" x 1/2" x 1/2".....	1.80

229-201

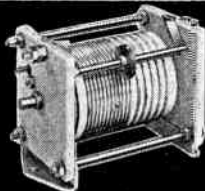

ROTARY INDUCTOR

Same efficient inductor used in final tank of the VIKING II. May be used in any low and medium power transmitter with band-switching exciter to provide continuous tuning throughout the range 3.5 to 30.0 mcs. without changing coils. Variable pitch winding of No. 14 tinned copper wire. Maximum inductance 10 microhenries. Form and end plates steatite. Positive rolling contact assured by beryllium copper tension springs. Overall size: 2 1/2" wide x 4 1/2" long x 3" high. Supplied with Typical tuning curves.

Cat. No. 229-201	Net Price \$8.85
------------------	------------------

232-610

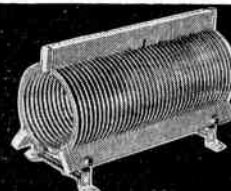

EDGEWISE WOUND "HI-Q" INDUCTORS

Edgewise wound, 1/4" copper strip, cadmium plated, glass bonded mica supporting bars. Widely used commercially, they will safely handle more than 1000 watts in continuous service. Write for information on other types for industrial and broadcast applications.

Cat. No.	Winding L x ID	Inductance micro H	Net Price
232-610	7 1/2" x 2 1/2"	31	\$ 8.90
232-620	8 1/2" x 4"	84	11.40
232-622	6 1/8" x 3 1/4"	41	8.90
232-624	6" x 3 1/4"	20	6.30
232-626	4 3/4" x 2 1/2"	10	5.80

E. F. JOHNSON COMPANY

JOHNSON KEYS AND PRACTICE SETS

DELUXE SEMI-AUTOMATIC KEYS

An improved deluxe model mounted on heavy steel base $6\frac{1}{4}'' \times 3\frac{1}{2}'' \times \frac{1}{2}''$. Five adjustments with lock nuts assure dependable operation at all speeds. Smooth, easy action, adjustable from lowest to highest speeds. Vibrator arm, posts, circuit closing switch, and all machine parts heavily chrome plated. Heavy brass connector strips under base insure low resistance circuit. Two block fiber paddles can be adjusted separately to best height. Vibrator bearings are perfectly aligned and free-acting. Complete with circuit-closing switch, adjustable weight, and rubber feet.

Cat. No.		Net Price
114-500	— $\frac{1}{8}''$ contacts, black wrinkle base.....	\$13.50
114-501	— $\frac{1}{8}''$ contacts, polished chrome base.....	17.95
114-501-2	—Same as 114-501 except left handed.....	19.75

114-500,
-501,
-501-2

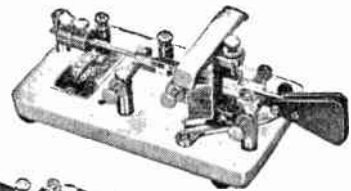

NEW SPECIAL SEMI-AUTOMATIC KEY

Combines the best features of former amateur and professional models. Heavy cast metal base $6\frac{1}{4}'' \times 3\frac{1}{2}'' \times \frac{1}{2}''$, attractively finished in black wrinkle enamel. Some vibrator as on deluxe key. Easy action, speed adjustable from lowest to highest speeds. All hardware and vibrator heavily chrome plated. Contacts are of $\frac{1}{8}''$ coin silver. Adjustments have lock nuts for stable operation. Rubber mounting feet prevent slipping or scratching. Circuit closing switch added.

Cat. No.		Net Price
114-520	Special Model, Semi-Automatic.....	\$11.50

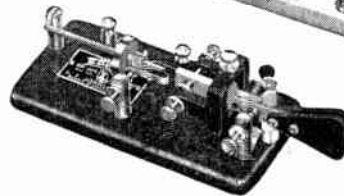

114-520

HEAVY DUTY KEYS

Heavy die cast base, chrome plated key arm, brass connector strips under base. Well insulated for heavy duty service. Large $\frac{1}{4}''$ coin silver contacts. Improved Navy type knob. Adjustable steel bearings and spring design give light keying touch.

Cat. No.		Net Price
114-320	—Black wrinkle enamel base.....	\$4.10
114-321	—Polished chrome plated base.....	5.10

114-320, -321

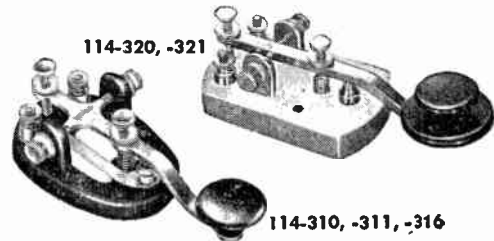

114-310, -311, -316

STANDARD KEYS

Heavy die cast base. Smooth adjustable bearings. Provision for plugging in semi-automatic keys. Contacts are $\frac{1}{8}''$ coin silver. A high quality key at low cost.

Cat. No.		Net Price
114-310	—Black wrinkle, no switch.....	\$2.60
114-310-3	—Black wrinkle with switch.....	3.00
114-311	—Chrome plated, no switch.....	4.00
114-311-3	—Chrome plated with switch.....	4.75
114-316	—Brass wrinkle, no switch.....	2.65

114-100-3



HIGH SPEED STANDARD KEYS

A superior high speed hand key formerly available from Signal Electric Company. Spring tension, contact spacing and bearings fully adjustable. Base and binding posts are brass with instrument lacquer finish. Plain contacts .072" diameter.

Cat. No.		Net Price
114-100	R48 Key, polished brass, no switch.....	\$4.90
114-100-3	M100 Key, polished brass with switch.....	5.55



114-100

PHENOLIC BASE KEYS

High quality, black, phenolic base key. Adjustable, smooth-acting bearings, improved spring, pigtail connection. $\frac{1}{8}''$ coin silver contacts—nickel plated metal parts.

Cat. No.		Net Price
114-301	Molded phenolic base, no switch.....	\$1.95

114-301



TELEGRAPH SAUNDER

Improved telegraph saunder formerly manufactured by Signal Electric Company. Designed for instant response, the brass saunder provides a clear resonant tone. Bar frame is steel with black enamel finish. Bridge and adjustment screws brass with instrument lacquer finish. Saunder plate is black lacquered steel. Mounted on mahogany finished wood base with brass binding posts and rubber mounting feet.

Cat. No.		Resistance	Net Price
114-112	112S Saunder	4 ohms	\$6.70
114-113	113S Saunder	20 ohms	6.95

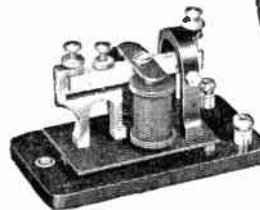

114-112, -113



LEARNER SET

Telegraph practice set for two way operation. Bar frame steel, black enameled bridge. Brass instrument lacquer finish. Brass sounding bar—black lacquered steel saunder plate. Adjustable, nickel plated key arm. Mahogany finished wood base, brass binding posts, rubber feet.

Cat. No.		Net Price
114-110	M110 4 ohms resis....	\$9.50
114-111	M111 20 ohms resis....	9.75

PRACTICE SET

Constant frequency buzzer and key on a $4'' \times 6''$ molded Bakelite base. Use singly or in pairs for code practice.

Cat. No.		Net Price
114-450	Practice Set.....	\$4.25

CONSTANT FREQ. BUZZER

Fully adjustable. Coin silver contacts. Uses 2 dry cells or "C" battery.

Cat. No.		Net Price
114-400	Buzzer.....	\$1.60

CORD AND WEDGE FOR SEMI-AUTOMATIC KEYS

Cord and wedge for quick, easy attachment of semi-automatic key across the circuit-closing switch of a standard hand key. Used almost universally by railroad telegraphers, it is also ideal for amateur service where both hand key and semi-automatic are used.

Cat. No.		Net Price
114-380	Cord and wedge....	\$1.00

PRACTICE KEYS

An inexpensive practice key—perfect in design for the average beginner. All the metal parts except the base are nickel plated. Furnished with an adjustable key arm spring and smooth action bearings. Contacts are of $\frac{1}{8}''$ coin silver.

Cat. No.		Net Price
114-300	Mld. phenolic base	\$1.75

WASECA, MINNESOTA

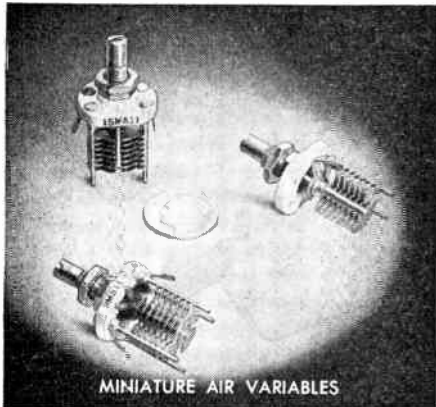

MINIATURE AIR VARIABLES

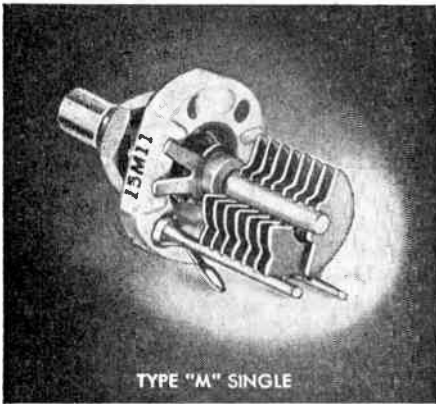

TYPE "M" SINGLE

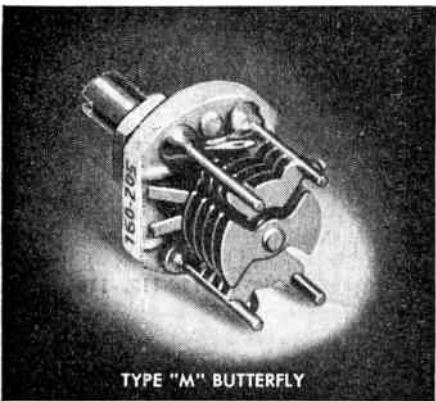

TYPE "M" BUTTERFLY

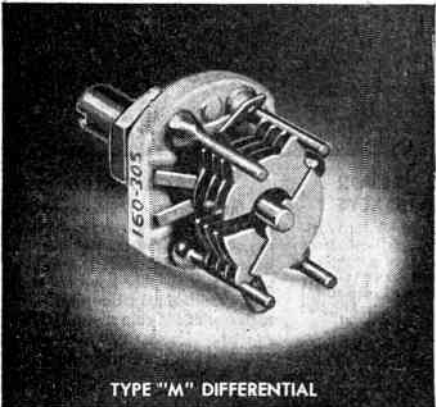

TYPE "M" DIFFERENTIAL

TYPE "M" CAPACITORS

Requiring a panel area just $\frac{3}{8}$ " wide by $\frac{3}{4}$ " high, these diminutive capacitors provide the perfect answer to problems encountered in the design of compact radio frequency equipment. Designed and constructed to provide peak performance throughout the VHF range, JOHNSON Miniature Capacitors are ideal for compact aircraft and mobile equipment. Small in size, their low inertia mass and sturdy soldered construction assure reliability and long service life under the most rigorous conditions.

FEATURES

Bridge type stator terminal provides extremely low inductance path to both stator supports. Soldered plate construction, oversize bearings, and heavily anchored stator supports insure extreme rigidity. Relatively large beryllium copper compression spring rotor contact provides steady torque—rotor stays "put" where set. Rotor contact silver plated for low noise level at high frequencies—all other metal parts nickel plated. Steatite end frames DC-200 treated to maintain high insulation resistance.

GENERAL SPECIFICATIONS

Mounting bushing threaded $\frac{1}{4}$ "-32 with flats to prevent turning—mounting nut furnished. Peak voltage 1250 volts on .017" spaced units—850 volts on 160-130 which is spaced .013" diameter shaft* slotted for screwdriver adjustment.

*Instrument type tuning knob to fit $\frac{3}{16}$ " shaft available. (See knob and dial section of this catalog.)

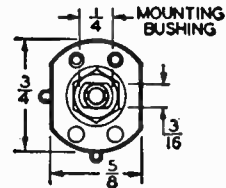
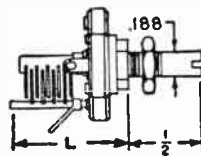

SINGLE SECTION

An ideal replacement for adjustable padders used in trimming RF and IF circuits, where stability and reliable capacity change are required. Plate spacing .017" on all but 160-130 which has .013" spacing.

Cat. No.	Type No.	Cap. per Sec.		Plates per Sec.	L	Net Price
		Max.	Min.			
160-102	5M11	5	1.5	5	$\frac{1}{2}$ "	\$0.95
160-104	9M11	8.7	1.8	9	$\frac{13}{16}$ "	1.00
160-107	15M11	14.2	2.3	15	1"	1.15
160-110	20M11	19.6	2.7	21	$1\frac{1}{16}$ "	1.30
160-130	30M8	32	3	28	$1\frac{1}{8}$ "	1.35

BUTTERFLY

Applicable wherever a small split stator capacitor is required. Electrically symmetrical, Butterflies provide perfect circuit balance. Plate spacing .017". Capacity is per section.

Cat. No.	Type No.	Cap. per Sec.		Plates per Sec.	L	Net Price
		Max.	Min.			
160-203	3MB11	3.1	1.5	5	$\frac{1}{2}$ "	1.35
160-205	5MB11	5.1	1.8	9	$\frac{13}{16}$ "	1.50
160-208	9MB11	8	2.2	15	1"	1.70
160-211	11MB11	10.8	2.7	21	$1\frac{1}{16}$ "	1.90

DIFFERENTIAL

Designed to vary the capacity from 70 to 27 to either of two stators providing equal capacity increase and decrease on each side of circuit. Plate spacing .017".

Cat. No.	Type No.	Cap. per Sec.		Plates per Sec.	L	Net Price
		Max.	Min.			
160-303	6MA11	5.0	1.5	5	$\frac{3}{8}$ "	1.40
160-305	9MA11	8.7	1.8	9	$\frac{13}{16}$ "	1.55
160-308	15MA11	14.2	2.3	15	1"	1.75
160-311	19MA11	19.6	2.7	21	$1\frac{1}{16}$ "	2.00

SPECIALS

JOHNSON Miniature Air Variables are available in production quantities with the following features: 1. Locking bearing. 2. 180° stop. 3. Various shaft extensions. 4. High torque. On your special requirements—we will be happy to furnish quotations.

EXPLANATION OF TYPE NUMBERS

The first portion of the type number indicates the capacity per section in mmd. The following letter indicates the frame size or type. A second letter D indicates a two-section type. The final number multiplied by 100 is the approximate peak breakdown voltage.

Stated maximum and minimum values of capacitors are nominal, subject to plus or minus tolerances. Guaranteed values, or "lowest maximum, highest minimum" if necessary should be requested from the factory.



TYPE "L" CAPACITORS

A superior quality general purpose capacitor by JOHNSON embodying important advances in design and construction. The rotor bearing, stator support rods and mounting posts are actually soldered directly to the ceramic (steatite) end frames making the capacitor virtually vibration proof. This exclusive ceramic solder feature makes the "L" a perfect choice for portable, mobile and aircraft applications where vibration might cause failure of standard types.

FEATURES

Rugged in electrical and mechanical design throughout, a special split sleeve tension bearing and silver plated beryllium copper contact provide constant torque and smooth, silent capacity variation. Heavy brass soldered plates and large diameter tie rods provide great rigidity to withstand extreme acceleration and deceleration forces. Plating is new "bright alloy", which is much more corrosion resistant and has higher conductivity than standard platings.

GENERAL SPECIFICATIONS

Shaft diameter $\frac{1}{4}$ " with $\frac{3}{8}$ "-32 threaded bearing and 6-32 tapped mounting studs on $1\frac{3}{16}$ " centers. Removable chassis mounting brackets provided, can be used to mount auxiliary equipment. Plate spacing .030".

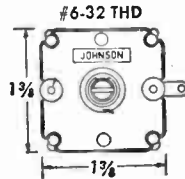
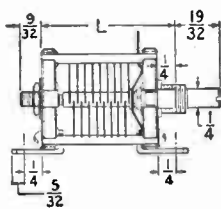
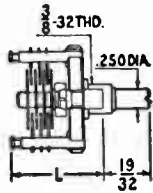

SINGLE SECTION

Cat. No.	Type No.	Cap. per Sec.		Plates Per Sec.	L	Net Price
		Max.	Min. Spacing			
Single End Plate						
167-101	10L15	11	2.8 .030"	3	$1\frac{13}{16}$ "	\$1.85
167-102	25L15	27	3.5 .030"	7	$1\frac{3}{4}$ "	1.95
167-103	50L15	51	4.6 .030"	13	$1\frac{7}{16}$ "	2.15
167-104	75L15	75	5.7 .030"	19	$1\frac{3}{4}$ "	2.35
Double End Plate						
167-151	100L15	99	6.8 .030"	25	$2\frac{1}{16}$ "	3.60
167-152	200L15	202	11.6 .030"	51	$3\frac{3}{16}$ "	4.50
BUTTERFLY						
167-201	10LB15	10.5	2.8 .030"	5	$1\frac{3}{4}$ "	2.20
167-202	25LB15	26	4.3 .030"	12	$1\frac{7}{16}$ "	2.50
167-203	50LB15	51	6.8 .030"	23	$1\frac{13}{16}$ "	2.90
DIFFERENTIAL						
167-301	10LA15	11	2.8 .030"	3	$1\frac{5}{16}$ "	2.10
167-302	25LA15	27	3.5 .030"	7	$1\frac{3}{4}$ "	2.35
167-303	50LA15	51	4.6 .030"	13	$1\frac{7}{16}$ "	2.65
DUAL SECTION						
167-501	25LD15	27	3.5 .030"	7	$1\frac{13}{16}$ "	3.90
167-502	50LD15	51	4.6 .030"	13	$2\frac{1}{16}$ "	4.30
167-503	100LD15	99	6.8 .030"	25	$3\frac{3}{8}$ "	5.05

SPECIALS

Available with .020", .060" and .080" spacing as well as special platings, shaft lengths and stator terminal locations in production quantities. Models without mounting posts with locking bearing or standard bearing can also be supplied.

CAPACITORS FOR HIGHER VOLTAGES

The JOHNSON line includes heavy duty pressurized or air dielectric fixed and variable capacitors for high voltage commercial applications. Data sheets furnished on request.

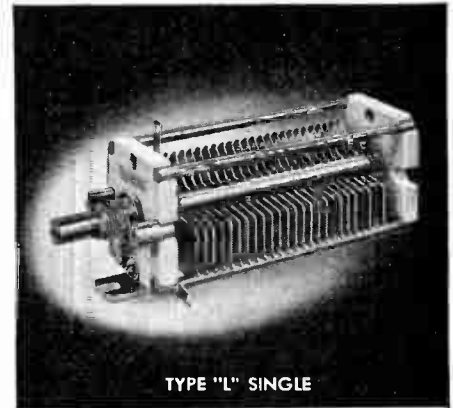

TYPE "L" SINGLE

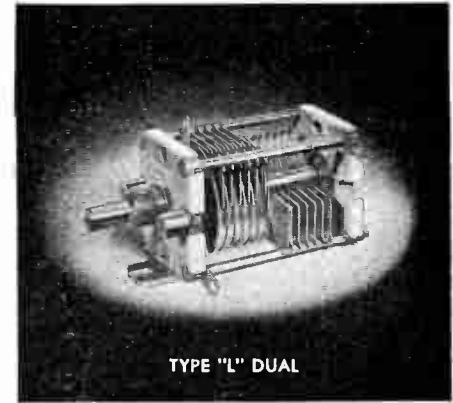

TYPE "L" DUAL

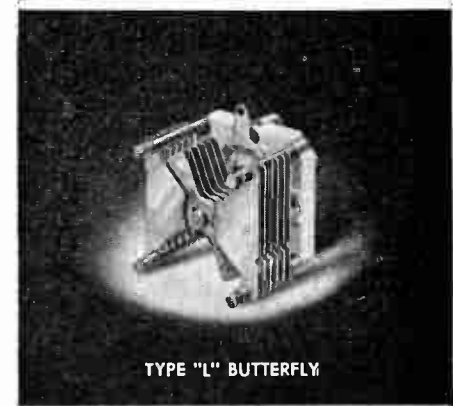

TYPE "L" BUTTERFLY

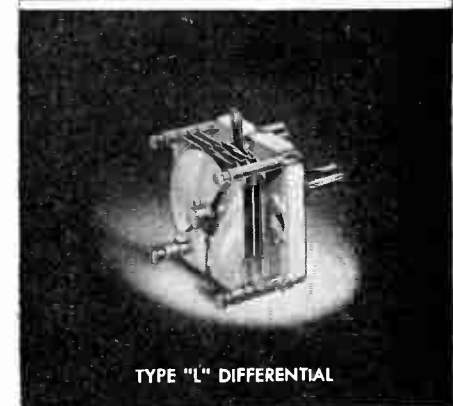

TYPE "L" DIFFERENTIAL

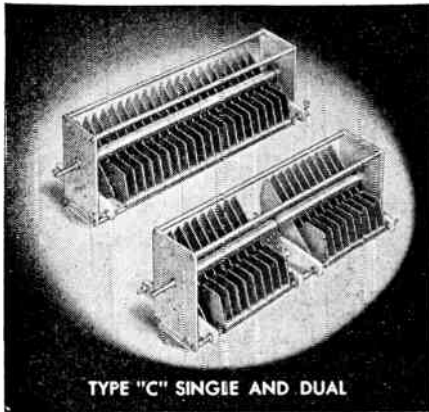

TYPE "C" SINGLE AND DUAL

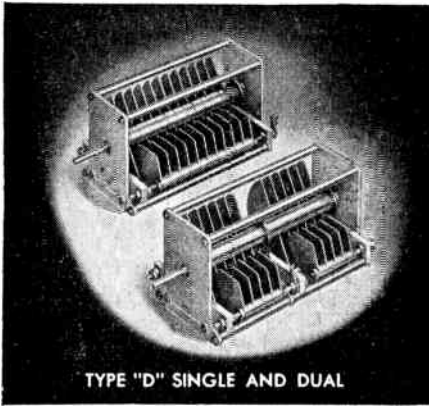

TYPE "D" SINGLE AND DUAL

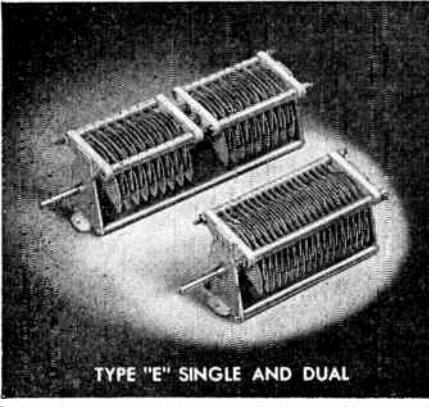

TYPE "E" SINGLE AND DUAL

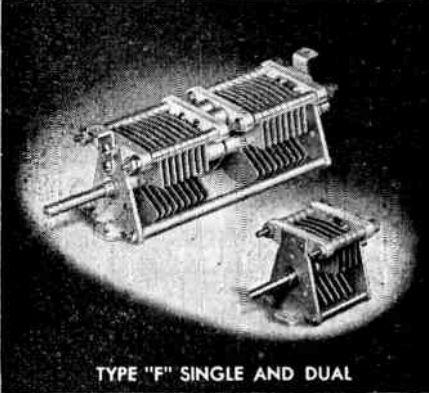

TYPE "F" SINGLE AND DUAL

TYPE "C" AND "D" CAPACITORS

Functional favorites built to exacting standards for medium power RF equipment. Heavy .051" aluminum plates and 3/16" tie rods. Shafts are 1/4". Laminated phosphor bronze contacts. Dual types have center rotor connection for balance. End frames tapped for panel mounting Brackets furnished for chassis mounting. Shaft length, 1 1/2". Panel area required on "C's": 5 1/2" high x 5 1/2" wide. "D's": 4" high x 4 1/2" wide. L dimension is length between end frames. Mounting length, L dimension plus 3/8". Rear shaft extension 3/4".

TYPE C SINGLE SECTION							L	Net Price
Cat. No.	Type No.	Max. Cap. per Sec.	Min. Spacing	Plates per Sec.	per Sec.	per Sec.		
152-1	250C70	252	34	.175"	24	6 13/32"	\$14.25	
152-2	500C70	496	56	.175"	47	12 3/16"	17.40	
152-6	100C110	103	30	.350"	17	8 19/32"	10.60	
152-8	50C130	51	24	.500"	10	7 11/16"	9.75	
152-9	100C130	102	42	.500"	21	13 11/32"	12.20	
TYPE C DUAL SECTION							L	Net Price
Cat. No.	Type No.	Max. Cap. per Sec.	Min. Spacing	Plates per Sec.	per Sec.	per Sec.		
152-501	200CD45	204	21	.125"	15	8 19/32"	14.90	
152-502	300CD45	290	26	.125"	21	10 3/16"	17.70	
152-503	200CD70	198	27	.175"	19	12 3/16"	17.20	
152-504	300CD70	305	37	.175"	29	16 25/32"	22.80	
152-505	150CD90	147	30	.250"	19	14 27/32"	18.00	
152-507	50CD110	50	18	.350"	8	10 3/16"	12.35	
152-509	100CD110	103	32	.350"	17	16 25/32"	18.40	
TYPE D SINGLE SECTION							L	Net Price
Cat. No.	Type No.	Max. Cap. per Sec.	Min. Spacing	Plates per Sec.	per Sec.	per Sec.		
153-6	500D35	496	36	.080"	39	6 25/32"	13.50	
153-8	150D45	146	23	.125"	17	4 25/32"	8.35	
153-11	100D70	98	23	.175"	15	4 25/32"	8.10	
153-12	150D70	151	31	.175"	23	6 13/16"	9.65	
153-13	250D70	244	45	.175"	37	10 3/16"	12.00	
153-15	50D90	53	20	.250"	10	4 25/32"	7.40	
153-16	70D90	73	25	.250"	14	5 18/16"	8.20	
153-17	100D90	99	30	.250"	19	7 11/16"	9.15	
153-18	150D90	149	43	.250"	29	10 3/16"	11.00	
TYPE D DUAL SECTION							L	Net Price
Cat. No.	Type No.	Max. Cap. per Sec.	Min. Spacing	Plates per Sec.	per Sec.	per Sec.		
153-501	100DD35	95	13	.080"	8	4 25/32"	9.30	
153-502	150DD35	147	15	.080"	12	5 18/16"	10.70	
153-503	200DD35	202	19	.080"	16	7 11/16"	13.00	
153-504	300DD35	291	24	.080"	23	9 15/16"	14.90	
153-505	500DD35	496	38	.080"	39	13 11/16"	20.70	
153-506	150DD45	155	24	.125"	17	9 15/16"	13.30	
153-507	200DD45	198	27	.125"	23	12 3/16"	15.00	
153-508	50DD70	52	15	.175"	8	5 18/16"	9.50	
153-509	70DD70	72	17	.175"	11	7 11/16"	11.00	
153-510	100DD70	97	22	.175"	15	9 15/16"	12.40	
153-511	150DD70	151	31	.175"	23	13 11/16"	16.00	
153-513	50DD90	52	19	.250"	10	9 15/16"	11.00	
153-514	100DD90	97	30	.250"	19	14 27/32"	14.55	

TYPE "E" AND "F" CAPACITORS

Rugged units providing a large amount of capacity per cubic inch and extremely low capacity to chassis. Panel or chassis mounting. Aluminum plates .032" thick with rounded edges—stainless steel shafts—heavy, phosphor bronze contact springs—center contact on duals—large 1/2" tie rods. Extra mounting brackets furnished. Shaft length 1 1/2". Panel area required on "E's": 2 19/32" high by 2 3/8" wide. "F's": 2" high by 2 1/8" wide. L dimension is length between end frames. Mounting length, L dimension plus 1/16". Rear shaft extension 3/8".

TYPE E SINGLE SECTION							L	Net Price
Cat. No.	Type No.	Max. Cap. per Sec.	Min. Spacing	Plates per Sec.	per Sec.	per Sec.		
154-1	250E20	244	12	.045"	23	2 25/32"	\$5.35	
154-2	350E20	353	15	.045"	33	3 17/32"	6.10	
154-3	500E20	488	19	.045"	45	4 15/16"	7.05	
154-7	100E30	100	11	.075"	15	2 9/16"	4.95	
154-8	150E30	154	14	.075"	23	3 7/16"	5.55	
154-9	250E30	251	20	.075"	37	4 15/16"	6.55	
154-10	350E30	347	25	.075"	51	5 7/16"	7.70	
154-11	35E45	38	9	.125"	9	2 5/16"	4.40	
154-12	50E45	53	11	.125"	12	2 21/32"	4.75	
154-13	70E45	74	13	.125"	17	3 3/8"	5.05	
154-14	100E45	101	16	.125"	23	4 17/32"	5.45	
154-15	150E45	145	20	.125"	33	5 3/8"	6.30	
154-16	250E45	241	32	.125"	55	9 9/16"	8.05	
TYPE E DUAL SECTION							L	Net Price
Cat. No.	Type No.	Max. Cap. per Sec.	Min. Spacing	Plates per Sec.	per Sec.	per Sec.		
154-502	300ED20	312	13	.045"	29	6 21/32"	9.90	
154-503	50ED30	52	8	.075"	8	4 3/8"	6.80	
154-504	70ED30	72	8	.075"	11	4 17/32"	7.15	
154-505	100ED30	99	10	.075"	15	5 3/8"	7.85	
154-506	150ED30	153	13	.075"	23	7 1/8"	9.20	
154-507	200ED30	196	15	.075"	29	8 3/8"	10.80	
154-508	50ED45	52	10	.125"	12	6 5/8"	7.20	
154-509	70ED45	74	12	.125"	17	7 1/8"	8.05	
154-510	100ED45	100	15	.125"	23	9 9/32"	9.45	
TYPE F SINGLE SECTION							L	Net Price
Cat. No.	Type No.	Max. Cap. per Sec.	Min. Spacing	Plates per Sec.	per Sec.	per Sec.		
155-1	35F20	35	7	.045"	6	1 15/16"	4.50	
155-2	50F20	54	8	.045"	9	1 5/8"	4.70	
155-3	70F20	66	8	.045"	11	1 25/16"	4.85	
155-4	100F20	106	10	.045"	17	2 1/8"	5.30	
155-5	150F20	154	12	.045"	25	2 7/8"	5.90	
155-6	250F20	252	17	.045"	41	4 3/8"	6.95	
155-8	50F30	52	9	.075"	13	2 5/8"	5.00	
155-9	70F30	67	11	.075"	17	3 23/32"	5.35	
155-10	100F30	99	14	.075"	25	3 19/32"	5.90	
155-11	150F30	148	18	.075"	37	4 7/8"	6.75	
TYPE F DUAL SECTION							L	Net Price
Cat. No.	Type No.	Max. Cap. per Sec.	Min. Spacing	Plates per Sec.	per Sec.	per Sec.		
155-501	50FD20	53	7	.045"	9	3 3/8"	6.40	
155-502	70FD20	66	7	.045"	11	3 27/32"	6.80	
155-503	100FD20	104	9	.045"	17	4 11/16"	7.60	
155-504	150FD20	153	11	.045"	25	6"	8.80	
155-505	200FD20	202	14	.045"	33	7 1/8"	9.85	
155-506	50FD30	51	8	.075"	13	4 27/32"	6.90	
155-507	70FD30	66	10	.075"	17	5 25/32"	7.70	
155-508	100FD30	99	13	.075"	25	7 1/16"	8.90	



WASECA, MINNESOTA

TYPE "R" CAPACITORS

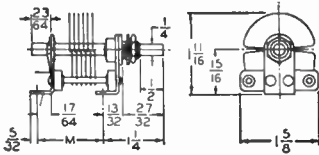

The rugged JOHNSON version of a popular standardized capacitor. Featuring extra heavy steatite stator support insulators and soldered .023" thick brass plates, all metal parts are heavily nickel plated for corrosion resistance. Brass end frames are thicker and heavier than other types. Double bearing construction and silver plated beryllium copper wiping contacts provide smooth, reliable performance in a wide variety of electronics applications. Plate spacing .024", bearing threaded $\frac{3}{8}$ "-32.

Cat. No.	Type No.	Cap. per Sec.		Plates per Sec.	M	Net Price
		Max.	Min.			
149-1	20R12	20	5	3	$1\frac{1}{2}$ "	\$2.05
149-2	35R12	35	6.5	5	$1\frac{1}{2}$ "	2.10
149-3	50R12	50	8	7	$1\frac{1}{2}$ "	2.15
149-4	75R12	80	8	11	$1\frac{1}{2}$ "	2.30
149-5	100R12	102	8.5	14	$1\frac{1}{2}$ "	2.45
149-6	140R12	320	13.5	19	$1\frac{1}{2}$ "	2.65

Johnson Type R capacitors are available with .036", .050", .071" or .095" plate spacings as well as special platings and shaft lengths in production quantities. Also available without mounting feet for panel mounting applications.

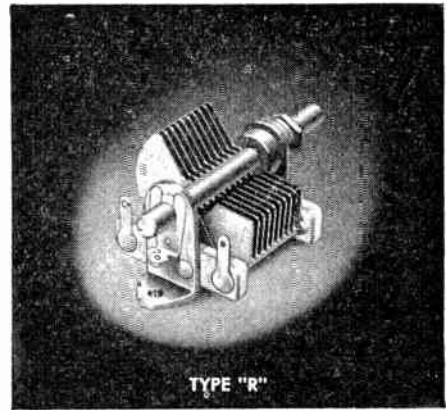

TYPE "R"

TYPE "K" CAPACITORS

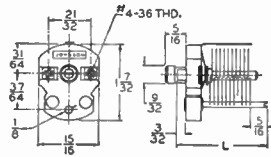

Widely used for military and many commercial applications, the JOHNSON type K features DC 200 impregnated steatite end frames, slotted stator contacts and extra rigid soldered plate construction. Square mounting studs tapped 4-36 on $2\frac{1}{2}$ " centers. Plates are brass, bright alloy plated.

Cat. No.	Type No.	Cap. per Sec.		Plates per Sec.	L	Net Price
		Max.	Min.			
158-1	10K10	10	2.9	3	$\frac{3}{8}$ "	\$1.10
158-2	25K10	25	3.7	7	$\frac{3}{8}$ "	1.20
158-3	50K10	50	4.6	14	$1\frac{3}{8}$ "	1.40
158-4	75K10	75	5.5	20	$1\frac{3}{8}$ "	1.55
158-5	100K10	100	6.4	27	$1\frac{3}{8}$ "	1.75

Other capacities and variations for special military and commercial specifications available in production quantities.

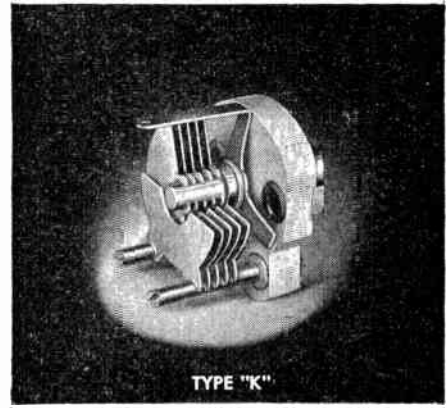

TYPE "K"

TYPE "J" CAPACITORS

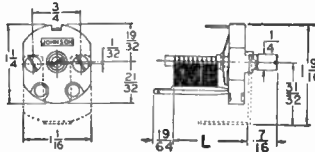

A heavy duty miniature type has wider spacing (.025") than most small air variables, yet occupies little more space. Useful for small space plate tank circuits in low power stages where standard miniatures have insufficient plate spacing. Soldered plate construction. 6-32 tapped mounting studs on $\frac{3}{4}$ " centers. Mounting brackets and 6-32 screws provided.

Cat. No.	Type No.	Cap. per Sec.		Plates per Sec.	L	Net Price
		Max.	Min.			
157-1	7J12	8	2.6	3	$\frac{19}{32}$ "	\$1.65
157-2	15J12	17	3.3	6	$\frac{25}{32}$ "	1.75
157-3	25J12	29	3.6	10	$\frac{1}{2}$ "	1.90
157-4	50J12	52	4.9	19	$1\frac{1}{2}$ "	2.15
157-5	75J12	73	6	26	$1\frac{17}{32}$ "	2.40
157-6	100J12	102	7	36	$1\frac{31}{32}$ "	2.70

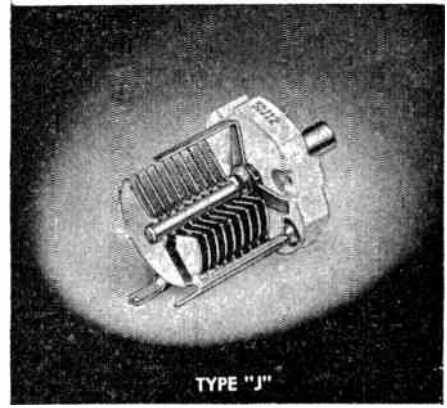

TYPE "J"

TYPE "G" CAPACITORS

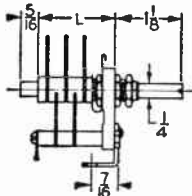

Neutralizing capacitor for medium and low power stages. .032" rounded aluminum plates, steatite insulation. Furnished with universal mounting bracket and locking nut. Mounting space required: $2\frac{1}{16}$ " wide, $2\frac{1}{8}$ " high.

Cat. No.	Type No.	Cap. per Sec.		Plates per Sec.	L	Net Price
		Max.	Min.			
165-2	50G20	52	5	9	$1\frac{3}{32}$ "	\$3.00
165-4	13G45	13	4.7	5	$1\frac{5}{32}$ "	2.75
165-5	23G45	23	6.4	9	$1\frac{13}{16}$ "	3.00
165-6	6G70	5.7	3.5	3	$1\frac{1}{16}$ "	3.00
165-7	12G70	12	6	7	$2\frac{5}{8}$ "	3.50

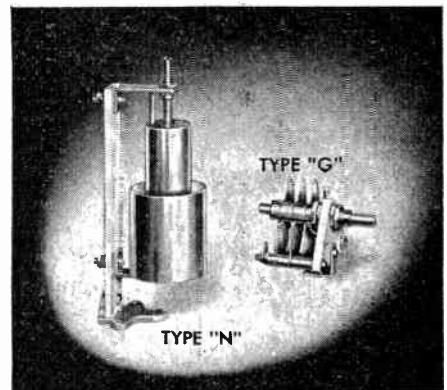

TYPE "G"

TYPE "N" CAPACITORS

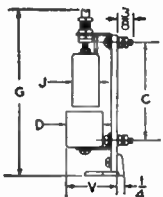

Extremely high voltage rating in proportion to size requiring a small mounting area. Constant voltage rating throughout full capacity range. Plates are aluminum cups supported by steatite frame with cast aluminum mounting bracket. Peak RF breakdown ratings at 2 MC.: N125-8,500, N250-11,500, N375-14,500.

Cat. No.	Type No.	Cap. per Sec.		D	C	G	V Spacing	Net Price
		Max.	Min.					
159-125	N125	11.0	1.1	$1\frac{3}{8}$ "	$3\frac{1}{8}$ "	$6\frac{13}{32}$ "	$1\frac{15}{16}$ " .125"	\$5.70
159-250	N250	10.6	1.4	$1\frac{17}{64}$ "	$3\frac{3}{4}$ "	$7\frac{17}{32}$ "	$2\frac{9}{16}$ " .250"	6.75
159-375	N375	10.7	1.7	$2\frac{3}{8}$ "	$5\frac{19}{32}$ "	$8\frac{23}{32}$ "	$2\frac{15}{16}$ " .375"	8.60

TYPE "N"

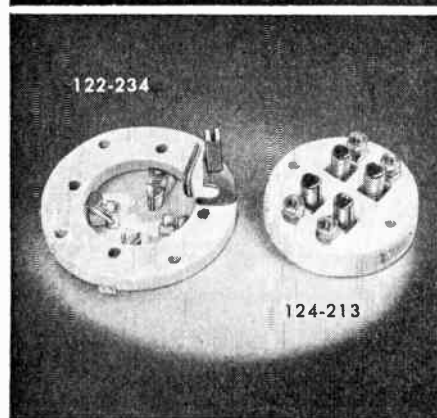
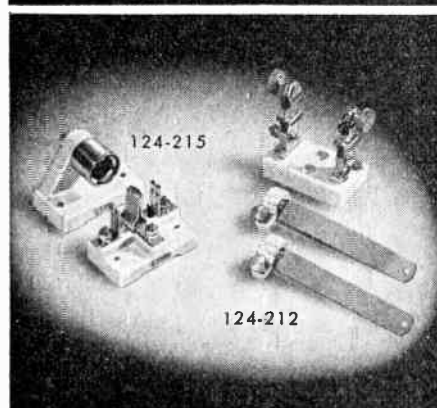
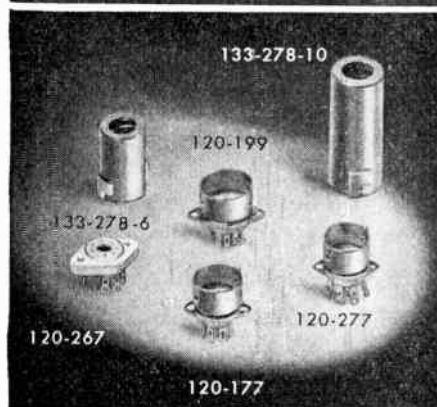
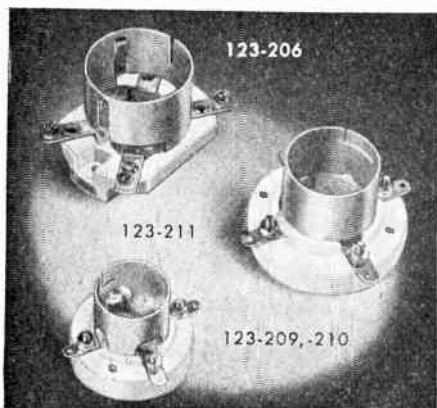

BAYONET

123-211 Standard "50 watt" socket for jumbo 4 pin bayonet based tubes, RETMA No. A4-29. Etched aluminum shell, glazed porcelain base with two mounting holes. Double filament contacts, phosphor bronze cadmium plated, designed for heavy current.
 123-211-100 similar to 123-211 except base is DC200 impregnated steatite and contacts are beryllium copper .005 silver plated. Iridite #14 treated aluminum shell, fungus resistant washers.
 123-209 Heavy duty socket for medium 4 pin bayonet base tubes, RETMA No. A4-10. White porcelain base equipped with four mounting holes. High current side wiping contacts are phosphor bronze, cadmium plated.
 123-209-100 similar to 123-209 except DC200 impregnated steatite base and beryllium copper contacts .005 silver plated. Iridite #14 treated aluminum shell, fungus resistant washers.
 123-210 Medium duty type bayonet, accepts 4 pin medium base tubes, RETMA No. A4-10. Compact $2\frac{1}{2}$ " diameter, glazed porcelain base with two mounting holes. Cadmium plated phosphor bronze contacts. Popular for rectifier tube applications.
 123-206 Industrial bayonet socket for extremely high voltage applications. Rugged aluminum shell. Socket will accommodate 8008, 5C22, FG104, GL146 and other tubes with super jumbo 4 pin bayonet bases, RETMA No. A4-18. Has steatite insulation, silver plated beryllium copper contacts, screw terminals and three heavy retaining springs in the shell to hold tubes securely.

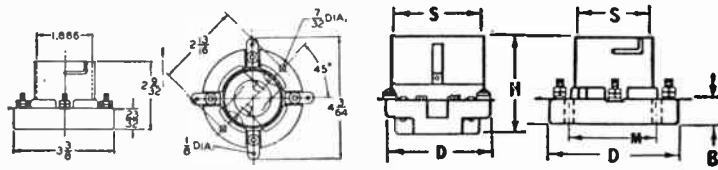

Cat. No.	D	H	M	S	Pins	Tube Base	Net Price
123-211	$3\frac{3}{8}$	$2\frac{1}{32}$	$2\frac{1}{16}$	1.886	4	Jumbo	\$1.40
123-211-100	$3\frac{3}{8}$	$2\frac{1}{32}$	$2\frac{1}{16}$	1.886	4	Jumbo	2.90
123-209	$2\frac{15}{16}$	$1\frac{27}{32}$	$2\frac{5}{16}$	1.386	4	Med. Bay.	1.10
123-209-100	$2\frac{15}{16}$	$1\frac{27}{32}$	$2\frac{5}{16}$	1.386	4	Med. Bay.	2.30
123-210	$2\frac{1}{2}$	$1\frac{1}{8}$	$2\frac{1}{16}$	1.386	4	Med. Bay.	1.10
123-206	$2\frac{3}{8} \times 3\frac{1}{2}$	$2\frac{1}{2}$	$2\frac{3}{4}$	2.250	4	Super Jumbo	2.25

MINIATURE SOCKETS

Sockets for tubes with miniature button 7 pin bases, RETMA No. E7-1. Bases are steatite, DC-200 impregnated. Silver plated phosphor bronze contacts. Contacts for -277 are hot tin dipped. -277 shield base is brass, nickel plated. Mounting centers $\frac{1}{8}$ ".

Cat. No.	Miniature socket, all ceramic	Net Price
120-267	Miniature socket, all ceramic	\$.33
120-277	Miniature socket with shield base	.49

MILITARY TYPE MINIATURE SOCKETS

Tap mounting, saddle type sockets per JAN spec. S-28A. One piece ceramic insulator, grade L-4B or better, top glazed, DC200 impregnated. Brass shell and center shield nickel plated to withstand salt spray test. Contacts beryllium copper, silver plated. Terminals hot tin dipped. Mounting centers $\frac{1}{8}$ " on 7 prong type, $1\frac{1}{8}$ " on 9 prong type. -177 is for tubes with 7 prong bases RETMA No. E7-1, -199 for tubes with 9 prong bases RETMA No. E9-1.

Cat. No.	Military Designation	Type	Net Price
120-177	TS102C01	7 prong	\$.59
120-199	TS103C01	9 prong	.79

MINIATURE TUBE SHIELDS

Brass, nickel plated to meet JAN specifications. Twist to lock type construction with internal tube retaining spring. Both spring and shield are non-ferrous, non-magnetic material.

Cat. No.	Military Designation	Fits Socket	Length	Net Price
133-278-6	TS102U01	177, 277	$1\frac{1}{8}$ "	\$.15
133-278-7	TS102U02	177, 277	$1\frac{1}{8}$ "	.19
133-278-8	TS102U01	177, 277	$2\frac{1}{4}$ "	.22
133-278-9	TS103U01	199	$1\frac{1}{8}$ "	.22
133-278-10	TS103U02	199	$1\frac{1}{8}$ "	.24
133-278-11	TS103U03	199	$2\frac{1}{8}$ "	.29
133-277	Miniature shield base only for use with 120-267 socket			.12

SPECIAL PURPOSE 250 WATT

124-215 A two unit socket for "250 watt" tubes such as the 204A and 849. Anode cap RETMA Nos. C1-8, C1-9 and C1-10, cathode mounting RETMA Nos. A3-20, A3-21, A3-22 and A3-23. Bases are glazed porcelain, contacts phosphor bronze nickel plated.

SPECIAL FOR 833 AND 833A

124-212 is a special socket assembly for the 833 and 833A consisting of a steatite base which supports the tube and a pair of 119-843 tube cap connectors. Knurled thumb nuts permit easy installation of tube and base is designed to minimize strains on the tube envelope and prevent breakage. Heat radiating aluminum plate terminals have $4\frac{3}{8}$ " flexible laminated leads.

SPECIAL FOR EIMAC 152TL AND 304TL

124-213 A special socket for Eimac 152TL and 304TL. Contacts may be connected for either series or parallel filaments.

SPECIAL FOR 5D21, 705A AND 715A & B

122-234 For Western Electric tubes 5D21, 705A and 715A & B. Includes heavy top glazed steatite base and special locking device for retaining tube in socket.

Cat. No.	Base	Net Price
124-215	"250 Watt"	\$4.10
124-212	"833"	6.55
124-213	"Eimac"	1.45
122-234	"Western Electric"	2.00

Heat Radiating plate connector only as used on 124-212 above.

Cat. No.	Net Price
119-843	\$1.05



STEATITE WAFER SOCKETS

All JOHNSON wafer sockets are insulated with grade L4 or better steatite—top and sides glazed—undersides impregnated in conformance with latest military specifications to prevent moisture absorption. Contacts, designed for maximum area against tube prongs, are mounted against fungus resistant glass melamine cushion washers in molded recesses so they cannot turn. Tubes seat into contacts with constant spring tension against prongs. Rivets on all types are countersunk and socket mounting holes are bossed to permit sub-panel mounting. Pin circles have locating grooves to facilitate tube insertion.

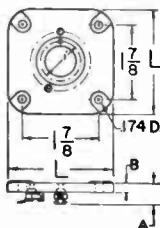
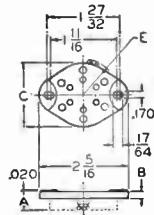

STANDARD WAFERS

For standard receiving and low power transmitting tubes. Contacts are brass with steel springs, cadmium plated.

Cat. No.	Dim. A	Dim. B	C	E	Net Price
122-224	9/16"	3/4"	1 11/16"	5/8"	\$.39
122-225	9/16"	1/2"	1 11/16"	5/8"	.42
122-226	9/16"	1/4"	1 11/16"	5/8"	.46
122-227	9/16"	1/4"	1 13/16"	3/4"	.49
122-228	15/32"	3/4"	1 11/16"	5/8"	.52

SUPER JUMBO 4 PIN

Heavy duty 4-pin wafer, steatite insulated. Takes super jumbo base tubes such as the 8008 and many rectifier and thyratron types. Contacts especially designed for long parallel contact against tube pins to withstand high current. Steel springs and brass contacts are cadmium plated.

Cat. No.	Dim. A	Dim. B	L	Net Price
122-244	1 1/16"	9/16"	2 5/8"	\$1.35

GIANT 7 PIN

A rugged wafer socket for tubes having the giant 7 pin base, RETMA No. A-7-17, such as the 4E27, HK257 and 813. Contacts designed for maximum surface area against tube prongs, are cadmium plated brass with steel springs. Ventilating hole in base 3/4" diameter provides tube seal cooling.

Cat. No.	Dim. A	Dim. B	L	Net Price
122-237	9/16"	1/4"	2 5/8"	\$.72

GIANT 5 PIN

Large steatite wafer socket for tubes having the giant 5 pin base, RETMA specification A5-19, such as the 4-125A, 4-250A and RK48. Ventilation for tube seals is provided by a central hole and five holes between contacts. Base is 2 7/8" square with four .194" mounting holes on 2 1/4" centers. Pin circle, 1 1/4" diameter. Contacts, designed for heavy current, are brass with steel springs, cadmium plated.

Cat. No.	Net Price
122-275	\$1.31

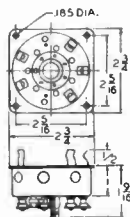

SEPTAR SOCKETS

Sockets 122-247 and 122-248 are designed for 7 pin tubes, RETMA No. E7-2. Bases are steatite equipped with brass contacts, steel springs, cadmium plated. Each socket furnished with 2 3/32" diameter aluminum shield ring 1 1/16" high.

Cat. No.	Dim. A	Dim. B	L	Net Price
122-247	1 1/2"	1 1/4"	2 3/8"	\$.85
122-248	1 1/2"	1 1/4"	2 3/8"	1.10

SPECIAL SEPTAR SOCKET

The 122-101 is a 7 pin Steatite wafer socket for tubes with medium molded flange Septor base, RETMA No. E7-2. Socket is equipped with a ventilated base shield, five tube retainer springs and provision for mounting button mica capacitors directly to the socket. Socket is specially designed for VHF use with tubes such as the 826, 829, 832, 4D32 and 4D22. Contacts phosphor bronze, beryllium copper springs heavily silver plated. Special terminals permit direct mounting of grid coils. Two holes provided for mounting of buss bar neutralizing leads.

Cat. No.	Net Price
122-101	\$2.00

TUBE SOCKET STANDARDIZATION

A new standardization program calculated to simplify the selection of sockets and to provide complete specifications for standard, industrial and military requirements has been instituted recently. By reducing the number of variations in special socket types, it will permit the maintenance of stocks of military and industrial types as well as standard sockets and provide shorter delivery cycles on quantity orders. Specifications for the three variations of each socket type are as follows:

Standard: Commercial grade for general requirements. Bases, glazed porcelain or L4 steatite. Cushion washers, fungus resistant glass base melamine.

Industrial: Higher quality with glazed steatite bases, DC200 treated, phosphor bronze or beryllium copper contacts. .0005 silver plated. Aluminum retaining shells or shields are Iridite #14 treated. Glass base melamine cushion washers, fungus resistant.

Military: Top quality to meet all military requirements. Bases L4 or better glazed steatite, DC200 treated. Phosphor bronze or beryllium copper contacts, heavy silver plated. Fungus resistant glass base melamine cushion washers. Solder terminal ends hot tin dipped. Retaining shell brass. .0003 nickel plated. Aluminum shields or shield bases Iridite #14 treated. Threaded hardware .0002 nickel plated, unthreaded hardware .0003 nickel plated. Entire socket protected for 200 hour salt spray.



122-224 -226, -227, -228

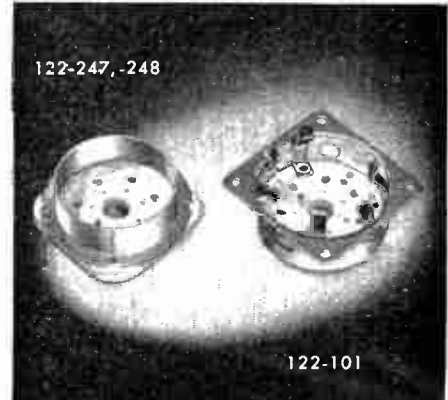
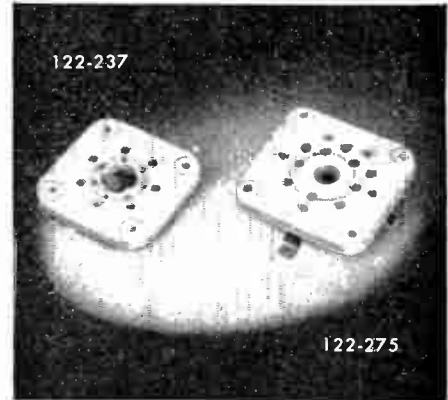
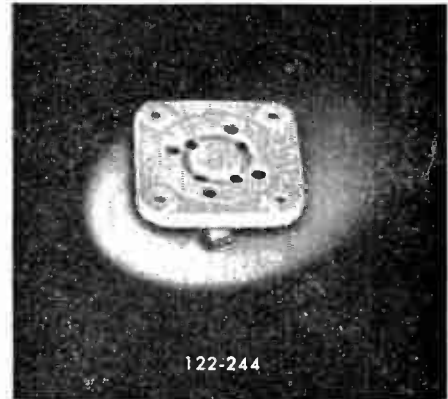



JOHNSON KNOBS AND DIALS

A distinctive line of matching knobs and dials suitable for the finest electronic equipment. All types are derived from a new basic knob design, the first in years. Knobs have twelve well defined flutes and present an essentially round appearance.

Tough, scratch resistant black phenolic is used for all molded parts. Metal dial scales have an etched satin chrome finish. This contrasts greatly with deeply etched and filled engravings, provides maximum legibility under poor lighting conditions. All types have accurately centered brass inserts for $\frac{1}{4}$ " shafts.

In addition to the items listed, JOHNSON is prepared to supply variations (in production quantities) such as, special shaft sizes, scales, set screws or indicators.

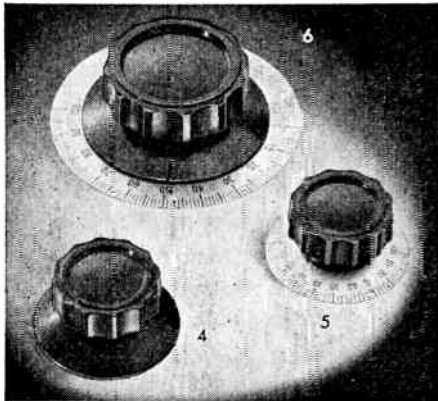
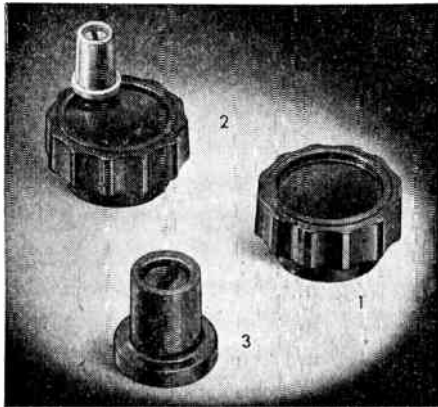

Cat. No.	Illus.	Description	Net Price
KNOBS			
116-220	1	Knob, $1\frac{1}{8}$ " dia., black phenolic.....	\$.29
116-260	1	Knob, $1\frac{5}{8}$ " dia., black phenolic.....	.39
116-280	1	Knob, $2\frac{3}{8}$ " dia., black phenolic.....	.59

SPINNER KNOBS			
For multi-turn devices such as variable inductors, potentiometers, etc.			
116-226	2	Spinner knob $1\frac{1}{8}$ " black phenolic.....	\$.56
116-266	2	Spinner knob $1\frac{5}{8}$ " black phenolic.....	.67
116-286	2	Spinner knob $2\frac{3}{8}$ " black phenolic.....	.82

INSTRUMENT KNOBS			
Unique black phenolic knob may be finger operated or mounted so as to project thru panel and screwdriver actuated. Length $1\frac{3}{16}$ ", skirt diameter $\frac{3}{4}$ " main body diameter $\frac{1}{2}$ ". Equipped with set screw.			
116-214-1	3	Knob for $\frac{1}{4}$ " shaft.....	\$.33
116-214-2	3	Knob for $\frac{3}{16}$ " shaft.....	.33

SKIRTED KNOBS			
116-221	4	Knob, $1\frac{1}{8}$ " dia. with $1\frac{1}{2}$ " black phenolic skirt.....	\$.54
116-261	4	Knob, $1\frac{5}{8}$ " dia. with $2\frac{1}{16}$ " black phenolic skirt.....	.67
116-281	4	Knob, $2\frac{3}{8}$ " dia. with 3" black phenolic skirt.....	.82

DIALS			
116-222	5	Dial, $1\frac{1}{2}$ " bevelled satin chrome scale with $1\frac{1}{8}$ " knob. Scales as follows:	
116-222-1		100-0 over 180 degrees.....	\$.56
116-222-2		10-0 over 270 degrees.....	.56
116-222-3		7-1 over 180 degrees.....	.56
116-222-4		ON-OFF over 60 degrees.....	.56
116-222-5		Line indication.....	.56
116-262	6	Dial, $2\frac{3}{4}$ " satin chrome scale 0-100 over 180 degrees.....	\$.140
116-282	6	Dial, 4" satin chrome scale 0-100 over 180 degrees.....	2.00
116-290	6	Dial, 4" satin chrome scale 100-0 over 360 degrees.....	1.64

VERNIER DIALS			
116-265		Dial, $2\frac{3}{4}$ " satin chrome scale 0-100 over 180 degrees with 3 to 1 friction vernier drive.....	\$.300
116-285		Dial, 4" satin chrome scale 0-100 over 180 degrees with 5 to 1 friction vernier drive.....	3.60
116-288		Dial, 4" satin chrome scale 100-0 over 360 degrees with 5 to 1 friction vernier drive.....	3.60

COUNTER DIAL			
A positively calibrated drive for rotary variable inductors and other multi-turn devices. Counter records up to 99 turns. Vernier dial calibrated 100-0 over 360 degrees, making possible accurate return to any pre-determined setting. Built-in dial lock, "spinner knob" and attractive black phenolic escutcheon. Furnished with mounting template for easy installation.			
116-208-1		Counter dial with dial lock, escutcheon and $2\frac{3}{8}$ " spinner knob.....	\$.11.10
116-208-4		Same as above without dial lock.....	9.80

ESCUTCHEON PLATE
Available separately, attractive black phenolic escutcheon as shown on 116-208-1 counter dial. Provides neat "window" for any indicator dial application. Can be mounted "upside down" for attaching a standard $\frac{3}{8}$ " wide etched name plate. Opening $1\frac{1}{4}$ " wide x $\frac{3}{8}$ " high. Overall size $2\frac{1}{4}$ " x $1\frac{11}{16}$ ". Furnished with No. 2 screws and nuts.



Steatite and porcelain RF insulators with a long history of user satisfaction. Dense molding and glazing impart fracture resistance together with low moisture absorption. Extended creepage paths provide maximum voltage breakdown compatible with compact design. Relatively large mounting faces permit substantial lateral loads. Heavily nickel plated brass hardware suitable for exposed applications. Insulator catalog numbers designated -2 have jack to accommodate standard banana plug. See photo showing 135-20-2.

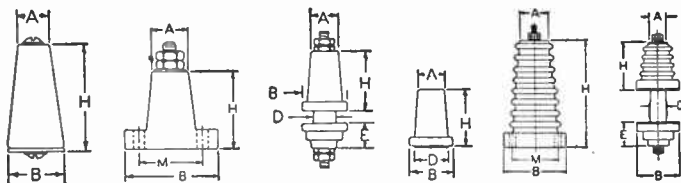

STAND-OFF INSULATORS

Steatite insulators combining excellent strength with economy for surface mounting applications. Heavy integral mounting bases; ample clearance for screw heads.

Cat. No.	H	B	M	A	Hdwe.	Net Price
135-20	1 1/8	1 3/4	1 1/16	3/4	10-32	\$0.15
135-20-2	1 1/8	1 3/4	1 1/16	3/4	74 Jack	.20
135-22	1	1 1/2	1 1/16	13/16	8-32	.13
135-22-2	1	1 1/2	1 1/16	13/16	74 Jack	.16
135-24	5/8	1	1 1/16	3/8	6-32	.10

Ribbed porcelain insulators with square mounting bases and four mounting holes; top glazed.

135-60	4 1/2	2 1/2	1 7/8	1 1/16	1/4-20	.68
135-62	2 3/4	1 7/8	1 3/8	7/8	1/4-20	.36

Surface mounting porcelain insulators with drawn and etched aluminum bases. Nos. 135-65, 135-65-2, 135-68, 135-68-2 are ribbed.

135-65	1 3/8	1 1/2	1 1/2	5/8	10-32	.21
135-65-2	1 3/8	1 1/2	1 1/2	5/8	74 Jack	.29
135-66	2 3/4	1 3/4	1 3/8	1 1/16	1/4-20	.50
135-66-2	2 3/4	1 3/4	1 3/8	1 1/16	76 Jack	.72
135-67	4 1/2	2 1/4	1 3/4	1 1/16	1/4-20	.72
135-67-2	4 1/2	2 1/4	1 3/4	1 1/16	76 Jack	.94
135-68	2 1/16	1 3/4	1 3/8	1 1/16	10-32	.34
135-68-2	2 1/16	1 3/4	1 3/8	1 1/16	74 Jack	.42

*Height dimension includes cushion mounting washer.

THRU-PANEL INSULATORS

High voltage insulators compression mounted by means of a stud throughout length. Extrusion of insulator base extends thru mounting hole increasing breakdown rating. Flat mounting surfaces with cushion washers eliminate breakage. Types equipped with jacks have terminal permitting connection above as well as below the panel.

STEATITE

Cat. No.	H	B	D	E	A	Hdwe.	Net Price
135-40	1 1/4	1 1/2	3/16	1/2	1 1/16	10-32	\$0.25
135-40-2	1 1/4	1 1/2	3/16	1/2	1 1/16	74 Jack	.33
135-42	7/8	3/4	1 1/16	3/8	1/2	10-32	.24
135-42-2	7/8	3/4	1 1/16	3/8	1/2	74 Jack	.32
135-44	5/8	5/8	3/16	5/16	3/8	6-32	.18

PORCELAIN

135-45	1 3/8	1 1/4	1/2	1 1/16	5/8	10-32	\$0.33
135-45-2	1 3/8	1 1/4	1/2	1 1/16	5/8	74 Jack	.41
135-46	2 3/4	1 3/4	1	1 1/16	1 1/16	1/4-20	.84
135-46-2	2 3/4	1 3/4	1	1 1/16	1 1/16	76 Jack	1.06
135-47	4 1/2	2 1/4	1 3/4	1 1/2	1 1/16	1/4-20	1.24
135-47-2	4 1/2	2 1/4	1 3/4	1 1/2	1 1/16	76 Jack	1.46
135-48	2	1 3/8	1 1/16	1/2	3/4	10-32	.48
135-48-2	2	1 3/8	1 1/16	1/2	3/4	74 Jack	.60

INSULATED THRU-PANEL BUSHINGS

Assemblies consist of a pair of identical steatite insulators, hardware and cushion washers. The 135-55 assembly has interlocking insulators which are self-centering in mounting hole and may be used on a very thin panel.

Cat. No.	H	B	D	A	Hdwe.	Net Price
135-50	1/2	3/4	1 1/16	3/8	6-32	\$0.24
135-51	1 1/16	1 1/4	2 1/16	5/8	10-32	.40
135-52	1 1/8	1 3/4	1 1/2	1 1/16	1/4-20	.59
135-55	1/4	3/4	1 1/16	1/2	6-32	.23

STEATITE CONE INSULATORS

Material, grade L-4 or better, steatite. Deep clean threads are tapped directly into the ceramic. Furnished complete with machine screws, brass and cork cushion washers.

Cat. No.	H	B	A	Hdwe.	Net Price
135-500	2 1/2	5/8	7/16	6-32	\$0.20
135-501	1 1/2	3/4	1/2	8-32	.24
135-502	1 1/2	1	1/2	8-32	.43
135-503	2 1/2	1 1/2	3/4	10-32	.49
135-504	3 1/2	1 1/2	3/4	10-32	.85

*Height dimension includes cushion mounting washer.

FEED-THRU BOWL ASSEMBLIES

Bowls, electrical glass, 6 1/16" maximum diameter. 4 3/8" high. Steel mounting flange 7 3/4" dia. Stud threaded 1/2"-13. Cork gaskets and spun aluminum carana shields included in fittings. 135-15-1 consists of single bowl with fittings, 10 1/4" stud. 135-15-3 two bowls and fittings with 16" stud for walls up to 4". 135-15-7 with 24" stud for walls up to 12". Can also be furnished with special hollow studs.

Cat. No.	Net Price
135-15-1 One bowl and fittings	\$12.30
135-15-3 Two bowls and fittings	\$1.50
135-15-7 Two bowls and fittings	\$2.00
135-15-11 Glass bowl only, less fittings	6.65

LEAD-IN BUSHINGS

Single porcelain insulators less all hardware except cushion washer. Mounting flanges listed separately.

Cat. No.	H	B	D	A	Net Price
135-53	1 3/4	2 1/2	1 1/16	1 1/16	\$0.26
135-54	4	3 1/2	2 1/16	1	.62

MOUNTING FLANGES

Stamped aluminum mounting flanges for lead-in bushings 135-53 and 135-54. Three mounting holes spaced 120 degrees apart.

Cat. No.	For Bushing No.	Net Price
135-90	135-53	\$0.25
135-91	135-54	.55

THREADED BRASS ROD

Intended primarily for use with lead-in bushings 135-53 and 135-54. Rod threaded overall 1/4"-20. Complete assembly includes rod, 4 brass washers and 4 nuts, all parts heavily nickel plated.

Cat. No.	Length	Net Price
115-240	8"	\$0.40
115-241	10"	.50
115-242	15"	.70

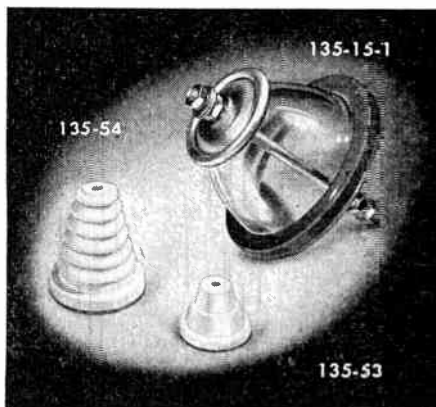
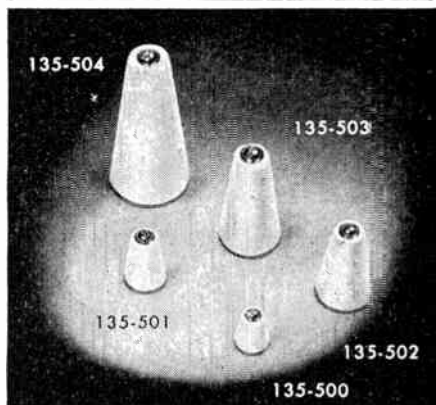
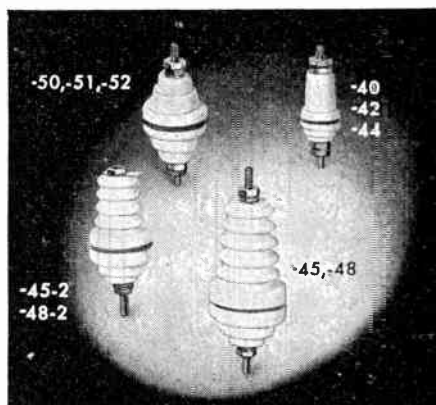
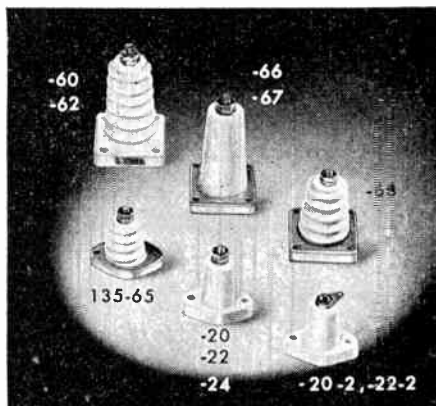

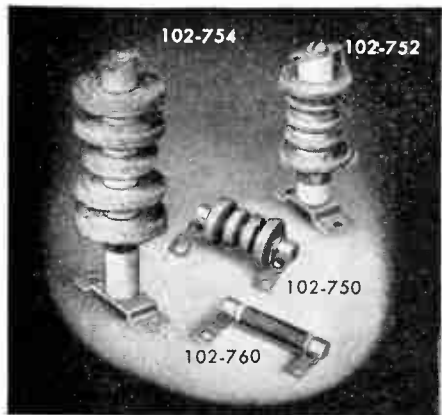

RADIO FREQUENCY CHOKES

Have high reactance over the range for which they are designed. Coils are of enamelled silk-covered wire impregnated with high grade RF lacquer and wound on steatite cores. Current ratings may be increased for intermittent use.

Cat. No.	Frequency	Current	Induct. (1 mc.)	Ohms DC	Lgth.	Net Price
102-750	1.7 to 30 mc.	150 ma	.83 mh	15	1 1/2"	\$1.15
102-752	1.7 to 30 mc.	500 ma	1.0 mh	5.2	2 3/8"	1.80
102-754	1.7 to 30 mc.	750 ma	1.9 mh	4	4 5/16"	2.50
101-760	Ultra-high	250 ma	6.8 uh	.33	1 1/2"	.49

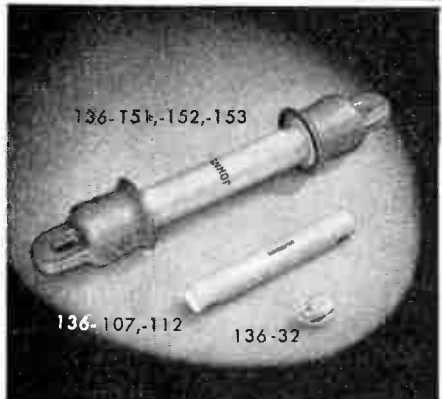

ANTENNA STRAIN INSULATORS

5000 LB. COMMERCIAL STRAIN INSULATORS

The 136-151, 136-152, and 136-153 are heavy duty 1 1/2" diameter wet process porcelain with specially sealed end bells of non-corrosive aluminum alloy. Porcelain glazed to prevent moisture absorption.

Catalog No.	Breaking Strength	Length		Net Price
		Net	Overall	
136-151	5000 lbs.	8"	15 1/2"	\$7.70
136-152	5000 lbs.	12"	19 1/2"	8.25
136-153	5000 lbs.	20"	25 1/2"	13.25

ANTENNA INSULATORS

Numbers 136-107 and 136-112 are wet process, glazed porcelain 1" diameter round. Number 136-104 is dry process, glazed 3/4" square.

Catalog No.	Breaking Strength	Length	Net Price
136-104	400 lbs.	4"	\$.15
136-107	800 lbs.	7"	.75
136-112	800 lbs.	12"	.85

EGG INSULATOR

The 136-132 is a compression type strain insulator for aircraft or guy wire applications. Dry process, glazed porcelain.

Catalog No.	Length	Net Price
136-32	1 1/2"	\$.10

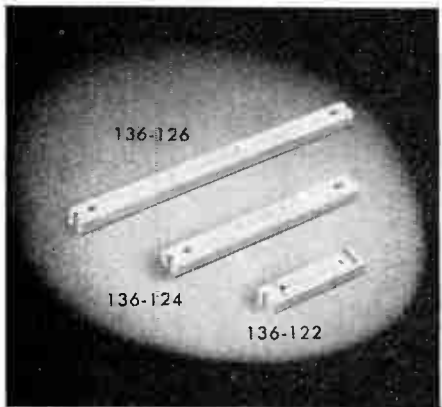

FEEDER INSULATORS

Numbers 136-122, 136-124, and 136-126 are conventional feeder spreaders for constructing open-wire antenna feeders and transmission lines.

Made of high grade, low absorption porcelain, they are silicone impregnated for moisture resistance.

Number 136-122 has extra notches for 1 1/2" line spacing. All have 3/8" x 1/2" cross section.

Catalog No.	Length	Net Price
136-122	2"	\$.12
136-124	4"	.17
136-126	6"	.22

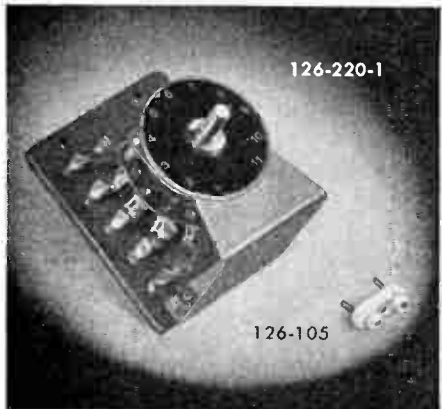

CRYSTAL SOCKETS

Designed for HC-6/U crystal holders. Conforms to JAN-1-10. Glazed steatite L4 or better, Dow Corning 200 impregnated. Contacts spaced .486" accept pins .050" diameter, .248" long, and are silver plated with hot tin dipped solder terminals. Single 1/8" mounting hole.

Cat. No.	Net Price
126-105 Crystal socket, phosphor bronze contacts	\$.12
126-105-2 Crystal socket, beryllium copper contacts	.15

Multiple crystal holder accommodates up to ten FT-243 crystals (.093" diameter pins spaced .486") Base is mica filled phenolic, contacts are brass, cadmium plated.

Cat. No.	Net Price
126-120-1 Crystal Board Only	\$2.30

Complete crystal selector assembly consisting of crystal board, bracket, 11 position phenolic insulated switch and index plate.

Cat. No.	Net Price
126-220-1 Crystal Selector Assembly	\$4.20



SHAFT COUPLINGS

All JOHNSON shaft couplings are manufactured with high quality, low loss insulation, accurately machined and suitably finished metal parts. Each is capable of many thousands of operating cycles without failure due to fatigue. DC "breakdown" ratings derated in accordance with good engineering practice. The phosphor bronze springs of the -250 and -251 series shaft couplings provide flexibility without backlash and adjust to minor shaft misalignments. Rigid types -252 and -262 meet the requirements of accurate shaft alignment and high torque. The -259 is a bar type shaft coupling recommended for high voltages or very high frequencies. The -264 is a small bakelite insulated flexible shaft coupling for DC or low voltage RF applications.

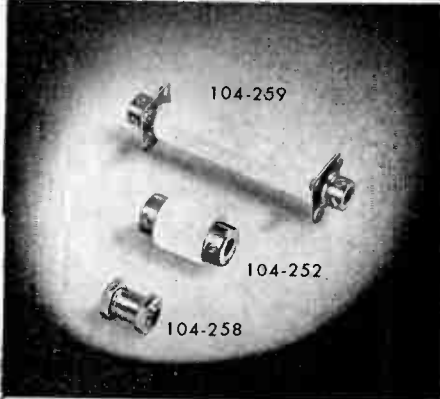
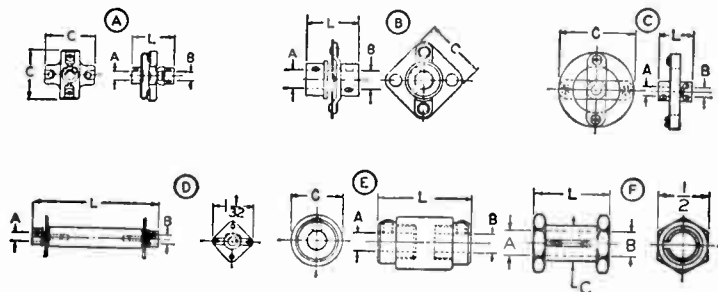

Cat. No.	DC "Breakdown"	Dwg.	Dimension				Net Price
			C	L	A	B	
104-250	4000	A	1 1/16	1 1/8	1/4	1/4	\$.70
104-250-3	4000	A	1 1/16	1 1/8	1/4	3/8	.90
104-251	8000	A	2 1/8	1 13/32	3/8	3/8	1.00
104-251-2	8000	A	2 1/8	1 13/32	1/4	3/8	1.00
104-251-3	8000	A	2 1/8	1 13/32	1/4	3/8	1.00
104-252	7000	E	1 1/16	1 1/4	1/4	1/4	.65
104-258			1/2	3/4	1/4	1/4	.29
104-259	8000	D		3 3/8	1/4	1/4	1.30
104-262	5000	C	2	2 9/32	1/4	1/4	.67
104-264	750	B	1 5/16	2 5/32	1/4	1/4	.52

FLEXIBLE SHAFTS

Phosphor bronze, non-rusting flexible shafts with 1/4" nickel plated brass hubs. Permit out of line or up to 90 degree angular control. Total length including hubs 3" for 115-253 and 6" for 115-254.

Cat. No.		Net Price
115-253	3" Flexible Shaft.....	\$.36
115-254	6" Flexible Shaft.....	.50

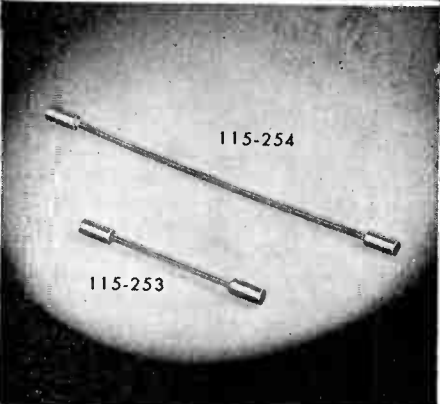

PANEL BEARINGS

Number 115-255 is nickel plated brass for 1/4" shaft and up to 3/4" panels. The 115-256 and 115-256-2 have 3" and 6" nickel plated brass shafts. Standard 3/8"-24 nut furnished. Models with locking nut and special shaft lengths available on production quantity orders. Bearing threads 3/8"-24.

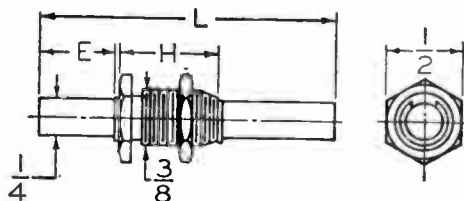

Cat. No.		E	H	L	Net Price
115-255	Panel Bearing Only		2 1/16		\$.17
115-256	Bearing and 3" Shaft	1/2"	2 1/32"	3"	.30
115-256-2	Bearing and 6" Shaft	1/2"	2 1/32"	6"	.40

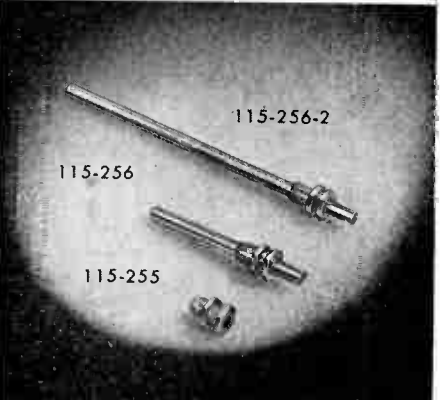

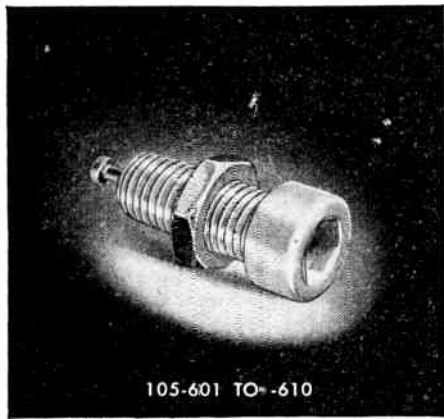

105-601 TO -610

NYLON TIP JACKS
PATENT PENDING

Highest quality, completely insulated jack, body molded from tough, low loss nylon. Suitable for test points in high frequency circuits operating under the most rigorous conditions. Retains low loss characteristics through extremely wide temperature range and high relative humidity conditions. Voltage breakdown 11000 volts, capacity to $\frac{1}{8}$ " metal panel only 2.0 mmf. Threads on body will not strip using production assembly methods. Conventional soldering methods will not damage dielectric. Machined beryllium copper contact, heat treated and silver plated, is recessed in head for safety. Integral solder terminal hot tin dipped. Single nut furnished for mounting; no auxiliary mounting hardware needed. Mounts in $\frac{1}{4}$ " hole.

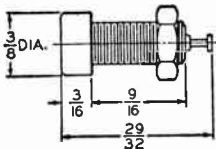

Cat. No.	Color	Net Price
105-601-1	White	\$0.25
105-602-1	Red	.25
105-603-1	Black	.25
105-604-1	Dark Green	.25
105-605-1	Light Blue	.25
105-606-1	Orange	.25
105-607-1	Yellow	.25
105-608-1	Brown	.25
105-609-1	Light Green	.25
105-610-1	Dark Blue	.25
105-611-1	Ivory	.25

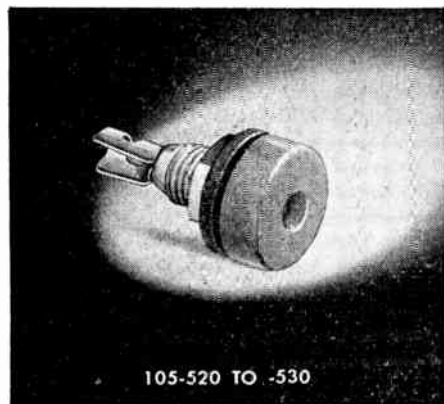

105-520 TO -530

REMOVABLE PLASTIC HEAD TIP JACKS

Popular general purpose jack for a wide variety of applications. Specially formed beryllium copper contact, cadmium plated, grips tip plug along almost entire length—has large, easy wiring terminal with solder barrier and plenty of room for several wires. Body nickel plated, threaded $\frac{1}{4}$ "-32. Supplied with extruded shoulder bushing and nickel plated hex nut. Mounts in $\frac{3}{8}$ " hole. Maximum panel thickness, $\frac{1}{4}$ " where insulating washers are used, $\frac{1}{4}$ " where omitted.

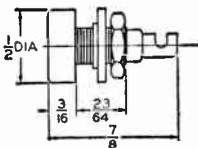

Cat. No.	Color	Net Price
105-520	Red	\$0.14
105-521	Black	.14
105-522	Dark Green	.14
105-524	Brown	.14
105-525	Light Blue	.14
105-526	Orange	.14
105-527	Yellow	.14
105-528	Light Green	.14
105-529	Dark Blue	.14
105-530	Ivory	.14

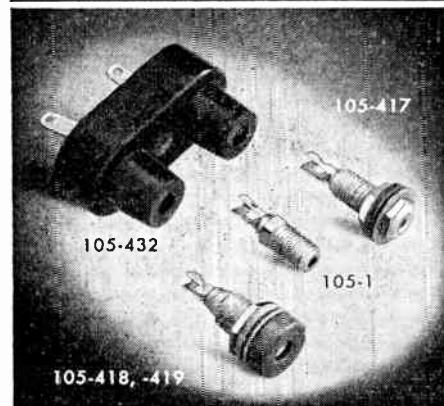

105-418, -419

HEAVY DUTY TIP JACKS

Plastic head molded integral with rugged nickel plated brass body. Popular for military and heavy duty industrial applications. Contacts, beryllium copper, cadmium plated. Furnished with extruded shoulder washer, extra phenolic washer and nickel plated hex nut. $\frac{3}{16}$ "-40 thread. Red and Black only.

Cat. No.	Color	Net Price
105-418	Red	\$.22
105-419	Black	.22

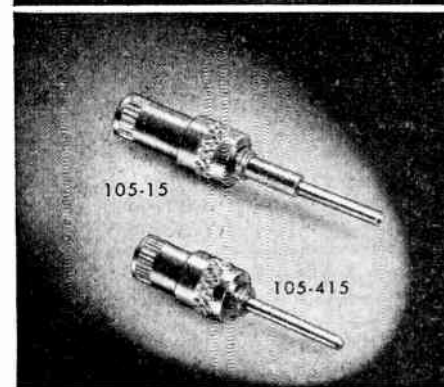

105-15

105-415

HEADLESS TIP JACK

Economical headless jack for molded plastic instrument cases or insulated jack strip panels where jack body can be screwed into tapped panel. Body has hex shoulder for tightening—threaded $\frac{1}{4}$ "-32. Contact, beryllium copper, cadmium plated.

Cat. No.	Net Price
105-1	\$.10

HEX HEAD TIP JACK

All metal construction, brass nickel plated body with beryllium copper contact, cadmium plated. Threaded $\frac{1}{4}$ "-32, supplied with one extruded washer, one flat washer and nickel plated nut. Mounts in $\frac{3}{8}$ " hole.

Cat. No.	Net Price
105-417	\$.14

SHORTING TYPE TWIN TIP JACK

Circuit closes automatically when tips are removed. Jacks spaced $\frac{3}{8}$ ". Single hole mounting. Molded black body.

Cat. No.	Net Price
105-432	\$.39

SOLDERLESS PHONE TIP PLUGS

Pin length $\frac{13}{16}$ " with $\frac{1}{2}$ " of tip .081" diameter. Knurled body and nut permit leads to be firmly secured without soldering. Body and nut brass, nickel plated. May be used with all tip jacks listed.

Cat. No.	Net Price
105-15	\$.16

Short solderless tip plug same as above except tip is $\frac{3}{16}$ " long and .081 diameter throughout its length. May be used with all tip jacks listed except 105-432.

Cat. No.	Net Price
105-415	\$.15



BANANA PLUGS AND JACKS

Nickel-silver (not spring brass) springs with high nickel content for resistance to corrosion. High grade nickel plated brass with accurate threads and milled nuts. Studs extend full length for added strength. JOHNSON banana plugs can be furnished on special order with beryllium copper springs and are available plated nickel, cadmium or silver when required. A selection of miniature solder type plugs is available with beryllium copper springs and a variety of platings. Orders for special plugs should be of sufficient quantity to insure economical production runs.

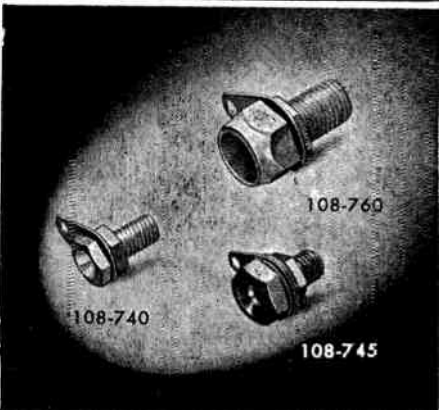
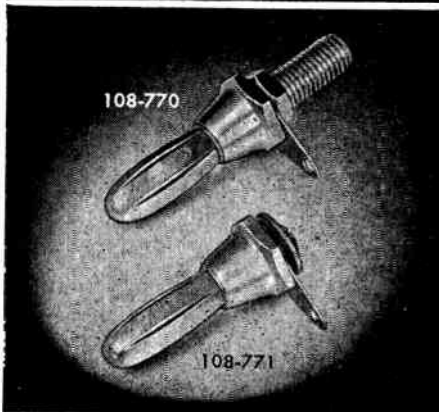
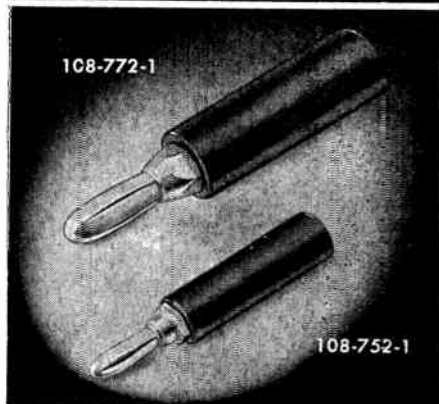
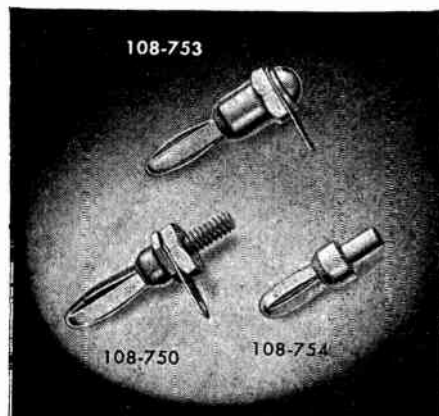
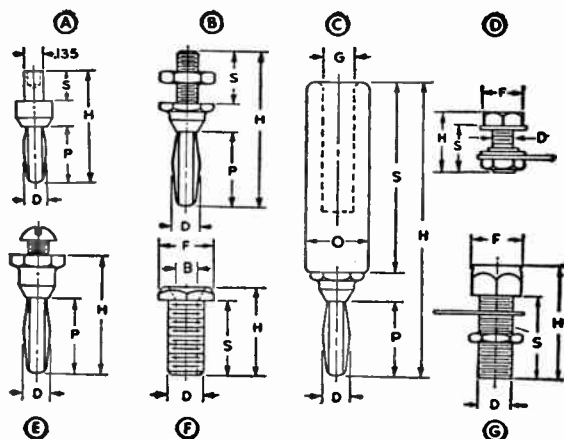

PLUGS

108-750 (75) and 108-750-2 (75A) and 108-753 (75C) have nickel silver springs, securely swaged to machined full length studs. Hardware including solder terminal furnished. 108-754 (75D) is designed for riveting. Spring is beryllium copper. 108-752-1 (75BB) has 1 3/8" black plastic handle. 108-752-2 (75BR) has 1 3/8" red plastic handle. 108-770 (77) and 108-771 (77A) are jumbo size plugs with nickel silver springs and machined studs. Furnished with hardware and solder terminal. 108-772-1 (77BB) Jumbo plug with 1 3/8" black plastic handle. 108-772-2 (77BR) Jumbo plug with 1 3/8" red plastic handle.

Cat. No.	Old No.	Dwg.	S	P	D	H	G	O	Thread	Net Price
108-750	108-75	B	3/8	17/32	.175	1 1/8	6-32	\$0.11
108-750-2	108-75A	B	3/8	17/32	.175	1 1/8	6-32	.12
108-752-1	108-75BB	C	1 3/8	17/32	.175	2 3/8	.215	3/1628
108-752-2	108-75BR	C	1 3/8	17/32	.175	2 3/8	.215	3/1628
108-753	108-75C	E	17/32	.175	1 5/16	6-32	.11
108-754	108-75D	A	1/2	13/32	.155	1 3/808
108-770	108-77	B	5/8	3/4	.300	1 3/8	3/4-28	.24
108-771	108-77A	E	3/4	.300	1 3/8	10-32	.27
108-772-1	108-77BB	C	1 3/8	3/4	.300	2 3/8	3/8	3/839
108-772-2	108-77BR	C	1 3/8	3/4	.300	2 3/8	3/8	3/839

JACKS

108-740 (74) is a quality nickel plated jack of machined brass. Solder terminal and nut furnished. 108-745-1 (7451) similar to the 108-740 with a red plastic head molded integral with body. Supplied with fibre insulating washer. 108-745-2 (7452) same as 108-745-1 but black. 108-760 (76) for jumbo plugs. Supplied with solder terminal and nickel plated hex nut.

Cat. No.	Old No.	Dwg.	F	D	S	H	Hole Dia.	Thread	Net Price
108-740	108-74	F	3/8	3/4	17/32	3/8	.166	3/4-28	.10
108-745-1	108-7451	D	3/8	3/4	3/2	2 1/2	.166	3/4-28	.20
108-745-2	108-7452	D	3/8	3/4	3/2	2 1/2	.166	3/4-28	.20
108-760	108-76	F	3/8	3/4	2 1/2	1	.277	3/4-24	.26

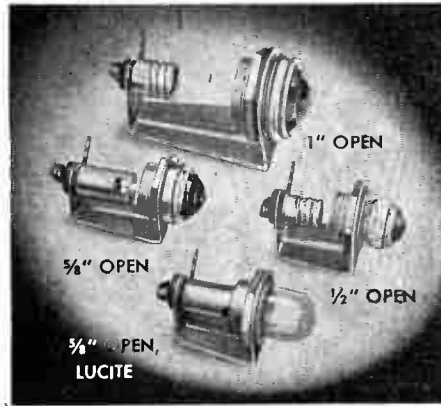
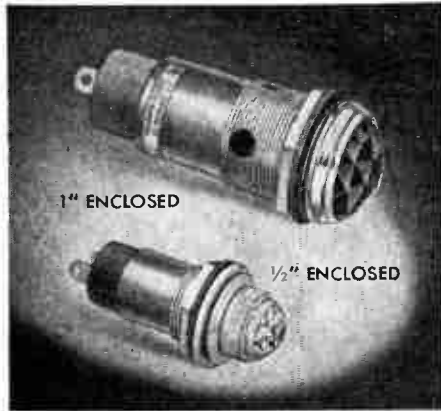

ENCLOSED 1" FRICTION

UL approved, 1" friction type jewel holder. Bezel chrome plated brass. Lamp replaceable from front of panel. Mounting hole required 1". Porcelain insulated candelabra screw socket, solder terminals.

Cat. No.	Length Behind Panel	Bulb Shape	Jwl.	Net Price
147-1000	2 1/2"	S-6	F	\$1.02
147-1001	2 1/2"	S-6	S	1.07
147-1002	2 1/2"	S-6	CD	1.07
147-1003	2 3/4"	T 4 1/2, NE45	F	.99
147-1004	2 3/4"	T 4 1/2, NE45	S	.99
147-1005	2 3/4"	T 4 1/2, NE45	CD	1.04

Following assemblies are identical except socket bases are phenolic, with screw terminals.

147-1032	2 3/4"	S-6	F	\$1.25
147-1033	2 3/4"	S-6	S	1.25
147-1034	2 3/4"	S-6	CD	1.30
147-1035	2 3/4"	T 4 1/2, NE45	F	1.23
147-1036	2 3/4"	T 4 1/2, NE45	S	1.23
147-1037	2 3/4"	T 4 1/2, NE45	CD	1.28

ENCLOSED 1" BAYONET

1" friction type jewel holder, lamp replaceable from front of panel. Hard rubber insulation, screw terminals. All UL approved except 147-1050, -1051 and -1052 which have single contact bayonet sockets. Mounting hole 1".

Cat. No.	Length Behind Panel	Bulb Shape	Lamp Base	Jwl.	Net Price
147-1050	2 1/2"	G-6	SC B	F	\$1.07
147-1051	2 1/2"	G-6	SC B	S	1.07
147-1052	2 1/2"	G-6	SC B	CD	1.10
147-1053	2 1/2"	G-6	DC B	F	1.20
147-1054	2 1/2"	G-6	DC B	S	1.20
147-1055	2 1/2"	G-6	DC B	CD	1.30
147-1056	2 3/4"	G-6, NE48	DC B	F	1.21
147-1057	2 3/4"	G-6, NE48	DC B	S	1.21
147-1058	2 3/4"	G-6, NE48	DC B	CD	1.26
147-1076	2 3/4"	G-6, NE48	DC B*	F	1.45
147-1077	2 3/4"	G-6, NE48	DC B*	S	1.45
147-1078	2 3/4"	G-6, NE48	DC B*	CD	1.50

*30,000 ohm series resistor built in for NE48.

1" THREADED JEWEL

Enclosed 1" light assemblies with candelabra screw bases; porcelain insulated sockets. UL approved. Knurled brass, threaded jewel holder polished chrome plated. Mounting hole size 1".

Cat. No.	Length Behind Panel	Bulb Shape	Jwl.	Trm.	Net Price
147-1200	2 1/2"	S-6	F	Sold.	\$1.26
147-1201	2 1/2"	S-6	S	Sold.	1.26
147-1202	2 1/2"	S-6	CD	Sold.	1.27
147-1209	2 3/4"	S-6	F	Screw	1.37
147-1210	2 3/4"	S-6	S	Screw	1.37
147-1211	2 3/4"	S-6	CD	Screw	1.38
147-1212	2 3/4"	T 4 1/2, NE45	F	Screw	1.49
147-1213	2 3/4"	T 4 1/2, NE45	S	Screw	1.49
147-1214	2 3/4"	T 4 1/2, NE45	CD	Screw	1.50

ENCLOSED 1/2" JEWEL

Threaded jewel holder and bulb removable from front of panel. All brass construction heavily plated. Phenolic insulated miniature bayonet socket equipped with solder terminals. Furnished in two lengths for either T 3 1/4 or G 3 1/2 bulb. Mounting hole 1 1/8" diameter.

Cat. No.	Length Behind Panel	Bulb Shape	Jwl.	Net Price
147-1110	1 3/8"	T 3 1/4	F	\$.76
147-1111	1 3/8"	T 3 1/4	S	.76
147-1112	1 3/8"	G 3 1/2	F	.76
147-1113	1 3/8"	G 3 1/2	S	.76

Enclosed lights with 1/2" friction type jewel holders. Otherwise identical of those above.

147-1122	1 3/8"	T 3 1/4	F	.86
147-1124	1 3/8"	T 3 1/4	S	.86

OPEN PILOT LIGHTS

1" FRICTION JEWEL

1" friction type jewels removable from front of panel. All parts heavily plated, jewel holder polished chrome. 1" mounting hole. Use on panels up to 3/8" thick.

Cat. No.	Length Behind Panel	Bulb Shape	Base	Jwl.	Net Price
147-100	1 1/2"	G 3 1/2, T 3 1/4	MS	F	\$.60
147-101	1 1/2"	G 3 1/2, T 3 1/4	MS	S	.60
147-103	2 1/8"	S-6	CS	F	.61
147-104	2 1/8"	S-6	CS	S	.61
147-106	1 1/2"	G 3 1/2, T 3 1/4	MB	F	.63
147-107	1 1/2"	G 3 1/2, T 3 1/4	MB	S	.63

3/4" OPEN

Horizontal lamp bracket and jewel secured by single mounting nut. Mounting hole required 1 1/8" for panels up to 1/2" thick. Polished chrome jewel holder.

Cat. No.	Lgth. Bhd.	Bulb Shape	Base	Jwl.	Net Price
147-700	1 1/4"	G 3 1/2	MS	F	\$.39
147-701	1 1/4"	G 3 1/2	MS	S	.39
147-703	1 1/4"	G 3 1/2	MB	F	.43
147-704	1 1/4"	G 3 1/2	MB	S	.43

1/2" THREADED JEWEL

Jewel removable from front of panel, up to 1/2" thick. Nickel plated jewel holder and bracket. Mounting hole clearance for 1 1/8" thread.

Cat. No.	Lgth. Bhd.	Bulb Shape	Base	Jwl.	Net Price
147-400	1 1/4"	G 3 1/2, T 3 1/4	MS	F	\$.47
147-401	1 1/4"	G 3 1/2, T 3 1/4	MS	S	.47
147-403	1 1/4"	G 3 1/2, T 3 1/4	MB	F	.50
147-404	1 1/4"	G 3 1/2, T 3 1/4	MB	S	.50

3/4" LUCITE LENS

Efficient utilization of low powered light sources. Wide angle visibility; low cost. Use with neon or incandescent lamps with 3 watts or less dissipation. Mounting hole 1 1/8", length behind panel 1 1/4".

Cat. No.	Bulb	Base	Net Price
147-406	T 3 1/4	MB	\$.42
147-407	NE51	MB*	.66
147-408	NE51	MB†	.66

*200,000 resistor built in
†100,000 resistor built in

WIDE ANGLE LUCITE LENS

For use with low powered light sources. Good visibility—designed for neon or low powered incandescent lamps. Jewels furnished in standard colors; red, amber or clear recommended for neon lamps. UL approved.

1" THREADED JEWELS

Chrome plated, threaded bezels. Hard rubber or phenolic insulation, screw terminals. Mounting hole required, 1".

Cat. No.	Lgth. Bhd.	Bulb Shape	Lamp Base	Ins.	Net Price
147-1217	1 1/2"	T 4 1/2	CS	Ph.	\$1.16
147-1218	1 1/2"	T 3 1/4	MB	Ph.	1.10
147-1219	2 1/8"	T 4 1/2, G6 DC-CB	HR		1.46
147-1220	2 1/8"	T 4 1/2, G6 DC-CB	HR		1.80
147-1220	has 30,000 ohm resistor for NE48.				

3/4" THREADED JEWELS

Mounting hole required 1 1/8", length behind panel 1 1/4". Single contact miniature bayonet socket, phenolic socket body, solder terminals.

Cat. No.	Lgth. Bhd.	Bulb Shape	Lamp Base	Net Price
147-1142	T 3 1/4	47, 49, 1490	CS	\$.68
147-1143	T 3 1/4	NE-51*	MB	.89
147-1144	T 3 1/4	NE-51†	MB	.89

*Built in 200,000 ohm resistor
†Built in 100,000 ohm resistor

WIDE ANGLE LENS

Good visibility from extremely wide angles. Lamp extends into internally ribbed, 1 1/8" glass bullseye jewel providing diffused light of good intensity. Chrome plated brass bezel, phenolic or hard rubber insulated socket, screw terminals. Mounting hole 1". 147-1600 and 147-1605 UL approved.

Cat. No.	Lgth. Bhd.	Bulb Shape	Lamp Base	Net Price
147-1600	2 1/4"	S-6	CS	\$1.54
147-1604	1 1/8"	G-6	SC-CB	1.46
147-1605	1 1/8"	G-6	DC-CB	1.59

1" DETACHABLE SOCKET

Economy 1" pilot light. Chrome plated friction jewel holder. Lamp replaceable from front or rear of panel. Socket detachable from panel bushing. Mounting hole 1". Two solder terminals, both insulated.

Cat. No.	Lgth. Bhd.	Bulb Shape	Lamp Base	Jwl.	Net Price
147-800	1 1/4"	G 3 1/2, T 3 1/4	MS	F	\$.69
147-801	1 1/4"	G 3 1/2, T 3 1/4	MS	S	.69
147-802	2 1/8"	T 4 1/2	CS	F	.71
147-803	2 1/8"	T 4 1/2	CS	S	.71
147-804	1 1/4"	G 3 1/2, T 3 1/4	MB	F	.70
147-805	1 1/4"	G 3 1/2, T 3 1/4	MB	S	.70
147-808	1 1/4"	G 3 1/2, T 3 1/4	MB	CD	.75

PANEL LIGHT

For front panel illumination. Polished nickel plated hood, easily removable for lamp replacement; rotates to any position. 1/2" mounting hole. Miniature bayonet or screw base, T 3 1/4 or G 3 1/2 bulbs.

Cat. No.	Net Price
147-330 Miniature Screw Base	... \$.75
147-329 Miniature Bayonet Base90



E. F. JOHNSON COMPANY

WASECA, MINNESOTA

VERTICAL MOUNTING OPEN

Jewel holder and bracket heavily nickel plated. Brackets and nuts are steel, other metal parts brass.

¾" JEWEL					
Mounting Hole ¼"		Clearance			
Cat. No.	Panel Behind	Bulb	Base	Jewel	Net Price
147-500	1 ¼"	G 3 ½	MS	F	\$2.25
147-501	1 ¼"	G 3 ½	MS	S	.28
147-503	1 ¼"	G 3 ½	MB	S	.28
147-504	1 ¼"	G 3 ½	MB	S	.28

½" JEWEL					
Mounting Hole ¼"		Clearance			
Cat. No.	Panel Behind	Bulb	Base	Jewel	Net Price
147-300	1 ¼"	G 3 ½	MS	F	.30
147-301	1 ¼"	G 3 ½	MS	S	.30
147-303	1 ¼"	S-6	CS	S	.31
147-304	1 ¼"	S-6	CS	S	.31
147-306	1 ¼"	G 3 ½	MB	S	.33
147-307	1 ¼"	G 3 ½	MB	S	.33

¾" JEWEL					
Mounting Hole 1 ¼"		Jewel Holder		Polished Chrome Plated.	
Cat. No.	Panel Behind	Bulb	Base	Jewel	Net Price
147-200	1 ¼"	G 3 ½	MS	F	.49
147-201	1 ¼"	G 3 ½	MS	S	.49
147-203	1 ¼"	S-6	CS	S	.50
147-204	1 ¼"	S-6	CS	S	.50
147-206	1 ¼"	G 3 ½	MB	S	.53
147-207	1 ¼"	G 3 ½	MB	S	.53

VARIABLE INTENSITY LIGHTS

CAMERA SHUTTER TYPE. Rotation of jewel head thru a small angle opens shutter disc uniformly illuminating lens or closed, shuts off all light. A pin hole can be placed in one shutter making jewel faintly visible in off position. Except for jewel head, these pilot lights are identical to types listed under heading "Similar Cat. No."

Cat. No.	Similar Cat. No.	Net Price
147-430	147-403	\$1.14
147-431	147-404	1.14
147-1114	147-1110	1.40
147-1115	147-1111	1.40
147-1116	147-1112	1.40
147-1117	147-1113	1.40
147-1504	147-1209	2.14
147-1505	147-1210	2.14
147-1506	147-1211	2.14
147-1508	147-800*	1.58
147-1509	147-801*	1.58
147-1510		1.58
147-1511	147-804*	1.59
147-1512	147-805*	1.59
147-1513		1.59
147-1514	147-802*	1.59
147-1515	147-803*	1.59
147-1516		1.59
147-1518	147-1053*	2.16
147-1519	147-1054*	2.16
147-1520	147-1055*	2.16

*Threaded jewels instead of friction holders.

POLARIZED TYPE Light passes thru two polarized discs. Rotation of jewel holder thru 90 degrees varies light from full intensity to near cut-off. Graduation of light intensity may be obtained by varying angle of rotation. ½" jewels. See similar catalog numbers.

Cat. No.	Similar Cat. No.	Net Price
147-420	147-403	\$1.14
147-421	147-404	1.14
147-1118	147-1110	1.40
147-1119	147-1111	1.40
147-1120	147-1112	1.40
147-1121	147-1113	1.40

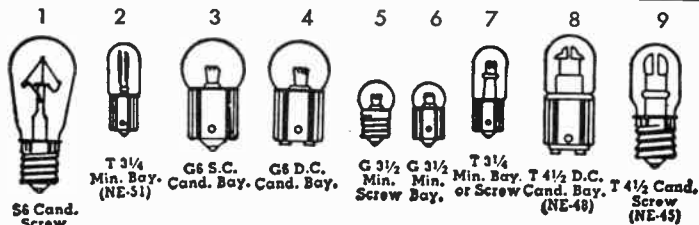

Bulbs used on all pilot lights may be identified from these illustrations. (Not included in prices.)

DIAL LIGHT BRACKETS

Both terminals insulated on all types. Many other styles and combinations including wire leads, can be furnished from available tools.

Cat. No.	Socket	Net Price
147-600, Min. Screw (Bracket down)		\$.10
147-601, Min. Screw (Bracket up)		.10
147-610, Min. Bay. (Bracket down)		.12
147-611, Min. Bay. (Bracket up)		.12
147-620, Cand. Screw (Bracket down)		.11
147-621, Cand. Screw (Bracket up)		.11
147-630, Min. Bay. (Bracket down)		.14
147-631, Min. Bay. (Bracket up)		.14
147-640, Min. Screw (Bracket down)		.12
147-641, Min. Screw (Bracket up)		.12

JEWEL ASSEMBLIES

Colors, all types: Red, Green, Amber, Blue, Opal, Clear.

1" JEWEL
Polished chrome bezel with panel bushing to fit 1" hole, fiber washer and nut.

Cat. No.	Net Price
147-110	Faceted Jewel \$4.3
147-111	Smooth Jewel .43
147-112	Colored Disc .48

¾" JEWEL
Polished chrome holder fits ¼" mounting hole. Furnished with nut.

Cat. No.	Net Price
147-210	Faceted Jewel .34
147-211	Smooth Jewel .34

½" JEWEL
Nickel plated holder and nut, fits ¼" mounting hole.

Cat. No.	Net Price
147-310	Faceted Jewel .18
147-311	Smooth Jewel .18

½" JEWEL
Nickel plated internally threaded panel bushing fits ½" hole. Furnished with nut.

Cat. No.	Net Price
147-410	Faceted Jewel .34
147-411	Smooth Jewel .34

¾" JEWEL
Nickel plated holder and nut, fits ¾" mounting hole.

Cat. No.	Net Price
147-510	Faceted Jewel .13
147-511	Smooth Jewel .13

LEGEND

MS—Miniature Screw F—Faceted
MB—Miniature Bayonet S—Smooth
CS—Candelabra Screw CD—Colored Disc
CB—Candelabra Bayonet
SC—Single Contact DC—Double Contact

GENERAL SPECIFICATIONS

The listings on these pages include only those standard units in greatest demand. Specials, including those meeting military specifications are available in production quantities. Standard finish for jewel holder bezels is polished chrome except for ½" and ¾" sizes which are finished in nickel.

In addition to smooth and faceted types, 1" clear inside frosted jewels with plastic discs to impart color are available. Lettering or numerals can be printed on backing disc and arranged to be visible continuously or only after lamp is lit. Standard jewel colors are clear, red, green, amber, blue and opal. Be certain to specify jewel color on all orders.

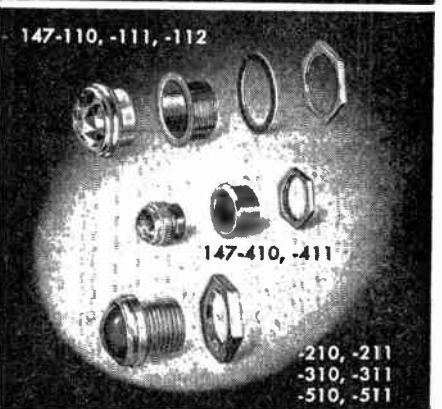
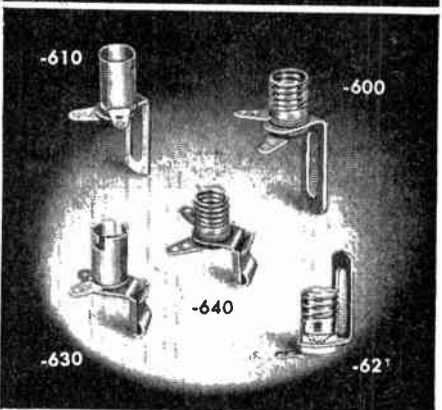
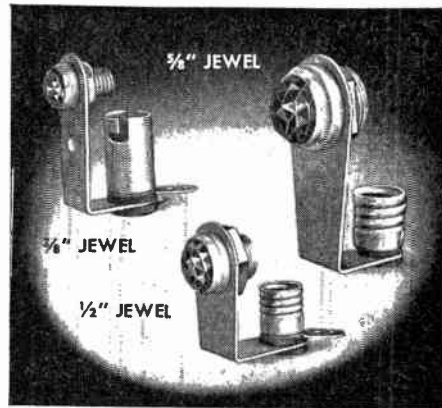

The

Vibroplex



Telegraph & Wireless Transmitting Machines

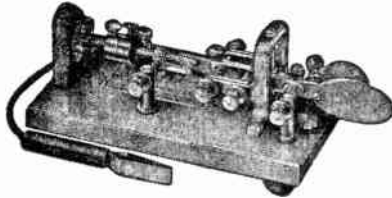

Your name engraved on base, \$1.50
Additional engraving, 15c per letter

New SUPER DE LUXE "PRESENTATION" VIBROPLEX

The Finest Bug Ever Built! 24K Gold-Plated Base Top,
Patented Jewel Movement and Super-Speed Control!

New patented adjustable main spring affords wider range of speed than ever obtained before in semi-automatic transmitting key. Beautifully-designed with polished chromium precision-machined parts mounted on a 24K gold-plated base top with colorful red switch knob, finger and thumb piece. This new Super-DeLuxe "Presentation" Vibroplex key at \$29.95 affords a life-time of sending enjoyment. Harder than metal, the jewels in this key reduce friction, maintain smoother, easier operation and prolong life.

Amateur Net Price..... **\$29.95**

THE Improved "ORIGINAL" VIBROPLEX

Suitable for All Classes of Transmitting work Where Speed and Perfect Morse Are Prime Essentials

This great new Vibroplex is a smooth and easy working BUG. It has won fame on land and sea for its clarity, precision and ease of manipulation. Can be slowed down to 10 words per minute or less or geared to as high rate of speed as desired. Maintains the same high quality signal at whatever speed, insuring easy reception under all conditions. Weight, 3 lbs. 8 oz. Complete with cord and wedge.

Standard—Chromium top parts, grey base. Amateur Net Price..... **\$17.95**
DeLuxe—Chromium base and top parts, with jeweled movement. Amateur Net Price **22.50**

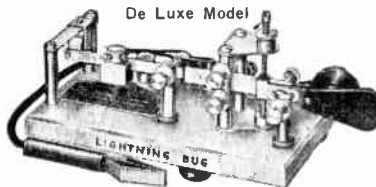
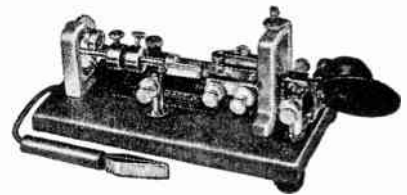

De Luxe Model

THE "LIGHTNING BUG" VIBROPLEX

High Quality Signals at All Speeds

Flat pendulum model. Complete with cord and wedge. Weight 3 lbs. 8 oz.
Standard—Polished Chromium top parts, grey base.

Amateur Net Price..... **\$15.95**

DeLuxe—Polished Chromium base and top parts, with jeweled movement.
Amateur Net Price..... **21.50**

THE "ZEPHYR" VIBROPLEX

1/8" size contact points. Slightly smaller base. Weight 3 lbs. 2 oz. Cord and wedge.
Standard finish only. Chromium: finished top parts, with grey crystal base.

Amateur Net Price..... **\$13.95**

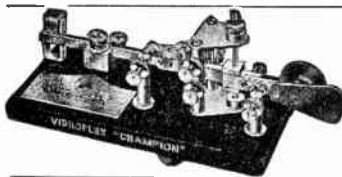
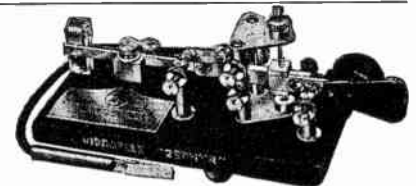

THE "CHAMPION" VIBROPLEX

Weight 3 lbs. 8 oz. Without circuit closer, cord and wedge. Standard finish only. Chromium finished top parts, with grey crystal base.

Amateur Net Price..... **\$12.95**

THE "BLUE RACER" VIBROPLEX

Weight, 2 lbs. 8 ozs. Complete with cord and wedge.

Standard—Finish Chromium top parts, grey base . . . Amateur Net Price..... **\$17.95**

DeLuxe—Polished Chromium base and top parts, with jeweled movement.

Amateur Net Price..... **22.50**

NOTE: All Machines Above Available in Left Hand Models \$1.00 Extra.

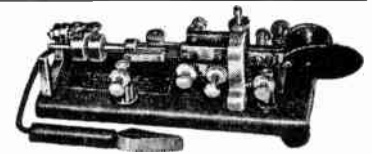

Small and Compact

VIBROPLEX CARRYING CASE

Keeps the Machine Free From



Dust, Dirt &
Moisture —
Insures Safe-
keeping when
Not in Use.

A cloth-lined case, finished in handsome simulated black morocco. Has lock and key.

PRICE..... **\$5.75**

Announcing the new edition of the PHILLIPS CODE SPECIAL EDITION Including:

- Radio Code Signals
- International Morse
- American Morse
- Russian, Greek, Arabic, Turkish
- and Japanese Morse Codes
- World Time Chart
- United States Time Chart
- Commercial "Z" Code
- Aeronautical "Q" Code



\$2 Post Paid

Speed-Chassis

CHASSIS

Chassis only, 5" wide, 5¼" deep, 16⅞" long; 20 ga. steel heavily cad. plated; 4 insulated tie-point strips, 1 grounded. Ea. **C-100 \$6.00**

Chassis Kit plus assortment of plates. Ea. Kit. **CK-200 9.95**

Chassis Super-Kit: One chassis kit CK-200 plus rack panel and dust cover. Ea. Kit. **CK-300 18.95**

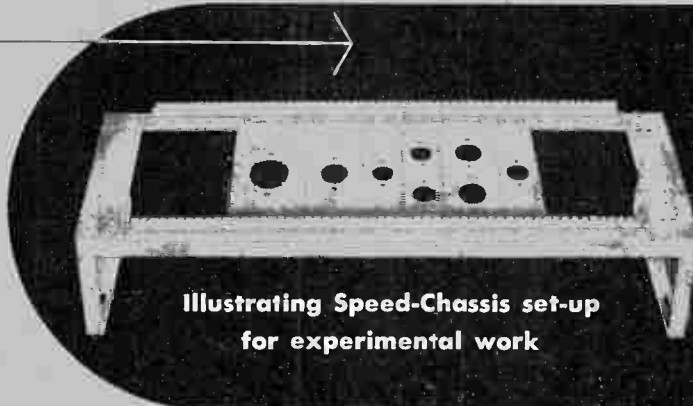

Illustrating Speed-Chassis set-up for experimental work

Individual PLATES for:

Single, 7-pin miniature, 1⅞" wide, ea.	P-175 \$.20	Single, octal, 1⅝" centers, 2⅞" wide, ea.	P-28B5 \$.26
Double, 7-pin miniature, 1⅞" wide, ea.	P-17D .25	Dual of preceding item, ea.	P-28BD .31
Single, 7-pin Vector turret lug, 1⅞" wide, ea.	P-17ST .30	Volume control. ea.	P-11V .35
Double, 7-pin Vector turret lug, 1⅞" wide, ea.	P-17DT .35	Universal transformer (2 req'd) 1⅞" wide, p.	P-11T .35
Single, 9-pin miniature, 1⅞" wide, ea.	P-19S .23	Blank, 1⅞" wide, ea.	P-11B .15
Double, 9-pin miniature, 1⅞" wide, ea.	P-19D .28	Blank, 1⅞" wide, ea.	P-21B .18
Single, 9-pin Vector turret lug, 1⅞" wide, ea.	P-19ST .33	Blank, 2⅞" wide, ea.	P-31B .21
Double, 9-pin Vector turret lug, 1⅞" wide, ea.	P-19DT .38	(All plates heavily cad. plated 20 ga. steel)	
Single, octal, 1⅞" centers, 2⅞" wide, ea.	P-28AS .26	Turret lug, bakelite, 2⅞" wide, ea.	BP-31L .95
Dual of preceding item, ea.	P-28AD .31		

PANELS 5¼" x 19", .024 steel with formed edges, drilled to match tapped holes in rack brackets, gray prime coat finish, ea. **PA-150 1.50**

RACK BRACKETS For mounting chassis in standard rack (2 req'd) pr. Same as above except for mounting two chassis together. Pr. **RB-200 1.00**
RB-400 1.50

DUST COVERS Dust cover, gray hammer-tone finish, with suitable bracket for mounting over chassis. Ea. **DC-10 5.00**

POWER SUPPLIES Power supply, D.C., adjustable from 75 v. to 275 v. @ 50 ma., adequately filtered. Mounting plate to fit C-100 chassis, 4" wide. Power supply, each **AP5-275A 29.95**

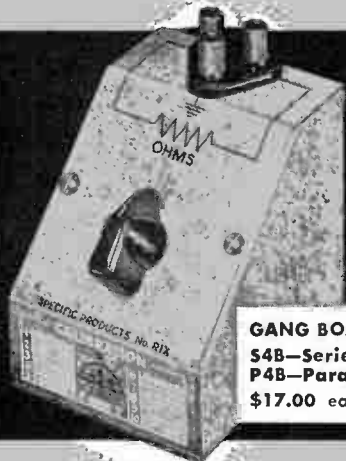

INDIVIDUAL 10-STEP
DECADE BOXES
for RESISTANCE,
INDUCTANCE
or CAPACITANCE

GANG BOX
S4B—Series
P4B—Parallel
\$17.00 ea.

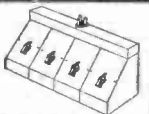

RESISTANCE

R1X—1 ohm steps	± ½%	\$13.95 ea.
R10X—10 ohm steps	± ½%	13.95 ea.
R100X—100 ohm steps	± ½%	13.95 ea.
R1KX—1 K steps	± ½%	13.95 ea.
R10KX—10 K steps	± ½%	13.95 ea.
R100KX—100 K steps	± ½%	13.95 ea.
R1mX—1 meg. steps	± ½%	13.95 ea.

INDUCTANCE

LX001—.001 henry	± 3%	\$32.00
LX01—.01 henry	± 1%	32.50
LX1—.1 henry	± 1%	33.25
L1X—1 henry	± 1%	39.75

CAPACITANCE

CX001—.001 mfd.	± 5%	\$15.00
CX01—.01 mfd.	± 5%	17.00
CX1—.1 mfd.	± 5%	20.20
C1X—1 mfd.	± 5%	29.20

10-step Decade Boxes, each having "OFF" and 10 positions.

All prices and specifications subject to change.

All prices net, F. O. B. Los Angeles

SPECIFIC PRODUCTS
14515 DICKENS STREET
SHERMAN DAKS, CALIF.

SINCE
1921



insuline Corporation of America

OVER 3 DECADES OF QUALITY RADIO-TELEVISION PRODUCTS

ICA DE LUXE TRANSMITTER RACKS

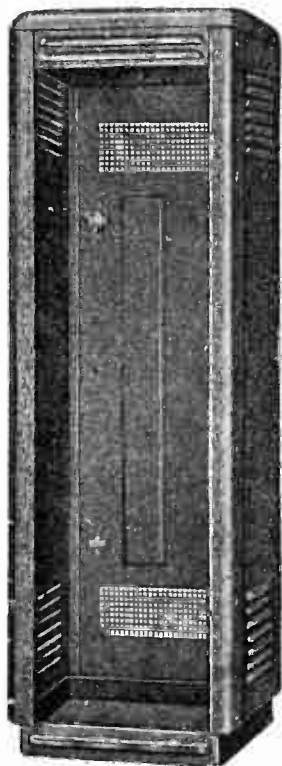

New modern design, streamlined transmitter and public address racks. Removable vertical corner mouldings are rounded and completely cover panel edges and mounting screws. Chrome trim. Rack is made of $\frac{1}{8}$ " cold rolled steel. Panel mounting angles drilled for RMA, Amateur or Western Electric type panels. Screen ventilators on rear door and louvers afford ample ventilation. Easily assembled. Supplied in Marine gray ripple finish. Black ripple finish furnished only on specification.

No. 3865

Overall Size...43 $\frac{1}{4}$ "x22"x18"
Panel Space.....36 $\frac{3}{4}$ "x19"
Interior Width.....17 $\frac{3}{4}$ "
Interior Depth.....16 $\frac{3}{4}$ "
Shipping Weight.....81 lbs.

Dealer Cost \$43.38

No. 3866

Overall Size...67 $\frac{3}{4}$ "x22"x18"
Panel Space.....61 $\frac{1}{4}$ "x19"
Interior Width.....17 $\frac{3}{4}$ "
Interior Depth.....16 $\frac{3}{4}$ "
Shipping Weight.....116 lbs.

Dealer Cost \$53.95

No. 3867

Overall Size...83 $\frac{1}{2}$ "x22"x18"
Panel Space.....77"x19"
Interior Width.....17 $\frac{3}{4}$ "
Interior Depth.....16 $\frac{3}{4}$ "
Shipping Weight.....133 lbs.

Dealer Cost \$64.35

ICA TABLE MOUNT RELAY RACKS



Sturdily constructed heavy duty table rack with one piece base. Accurately drilled mounting holes universally spaced for RMA, Western Electric or Amateur panels. Finished in black ripple. Supplied "KNOCKED DOWN" with all necessary hardware.

No.	W.	H.	D.	Panel Space	Dir. Cost
3910	21"	25"	12"	21" x 19"	\$6.60
3911	21"	32"	12"	25" x 19"	8.25

OPEN FACE RELAY RACK

For standard 19" Rack Panels. Black Ripple Finish. Rigidity assured with top cross-brace and vertical sections strongly welded. Designed for P.A. units, various types of transmitters, etc. Sturdily made of $\frac{1}{8}$ " thick steel. Base depth: 22". Accurately drilled mounting holes.

No.	Size Overall	Panel Space	Dir. Cost
3912	73 $\frac{1}{2}$ " x 20" x 20 $\frac{7}{8}$ "	71 $\frac{3}{4}$ "	\$22.36
3913	38 $\frac{1}{4}$ " x 20" x 18 $\frac{3}{4}$ "	36 $\frac{3}{4}$ "	19.14

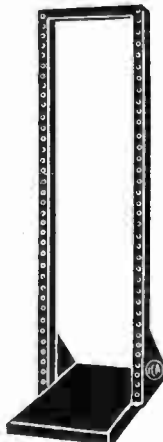

ICA RACK DOLLY

Especially designed to simplify the moving of heavy or large racks or cabinets of any type. Constructed of heavy gauge steel, all-welded with reinforcing corner gussets.

The Insuline rack dolly measures 21" x 22". Accommodates a wide range of cabinet sizes. Has sturdy heavy duty casters. Supplied in black wrinkle finish

No. 4086

Dealer Cost \$9.60

ICA MULTI-USE METAL CABINETS

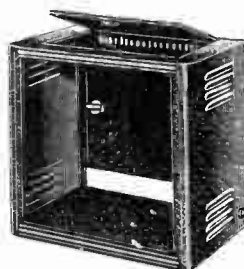

An ideal unit for public address systems, transmitters, receivers, test equipment, etc. Has rounded corners on front of Cabinet. Trimmed with handsome chrome trim moulding. Equipped with hinge doors, and nickel-plated snap locks. Completely assembled, ready for use. Finished in Black or Marine Gray Ripple Enamel. Black will be supplied unless Gray is specified. Accommodates RMA, W.E., or Amateur panels.

No.	Size	Panel Space	Dealer Cost
* 3880	10 $\frac{1}{2}$ " x 21" x 15"	8 $\frac{3}{4}$ " x 19"	\$12.00
* 3885	12 $\frac{1}{4}$ " x 21" x 15"	10 $\frac{1}{2}$ " x 19"	13.50
* 3881	14" x 21" x 15"	12 $\frac{1}{4}$ " x 19"	14.58
* 3886	15 $\frac{3}{4}$ " x 21" x 15"	14" x 19"	16.20
† 3882	19 $\frac{1}{4}$ " x 21" x 15"	17 $\frac{1}{2}$ " x 19"	19.16
† 3883	28" x 21" x 15"	26 $\frac{1}{4}$ " x 19"	22.49
† 3884	36 $\frac{3}{4}$ " x 21" x 15"	35" x 19"	25.00

*Door on top. †Doors on top and rear. ††Door on rear panel.

ICA DE LUXE HINGED STEEL CABINETS

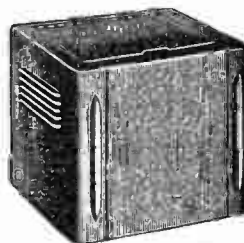

The cabinets have rounded corners with specially designed Chrome plated "Air-Gate" ventilators on sides; and vertical Chrome Plated Trim moulding on front. Modern grille type ventilators are provided on the back panels which also have an opening on the bottom to allow for leads, cable connections, etc.

Bottoms have 4 embossed feet.

Finished in a beautiful Marine Gray Ripple Enamel.

No.	H.	W.	D.	Panel Size	Dealer Cost
3550	8"	10" x 8"	8"	8" x 8"	\$ 4.15
3561	8"	12" x 8"	8"	8" x 10"	4.67
3562	8"	14" x 8"	8"	8" x 12"	4.95
3563	12"	20" x 12"	12"	12" x 18"	10.66

ICA STANDARD HINGED STEEL CABINETS

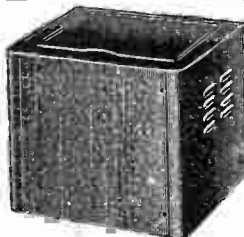

Designed in the same style and appearance as the De Luxe cabinets shown above except that the Chrome Trim is eliminated. Sides and backs have ventilating louvers. Backs have opening for cable connections, etc. Top panel hangs on full sized piano type hinge. Bottoms have 4 embossed feet. Finished in Marine Gray Ripple Enamel.

No.	H.	W.	D.	Panel Size	Dealer Cost
3925	8"	10" x 8"	8"	8" x 8"	\$3.60
3926	8"	12" x 8"	8"	8" x 10"	3.90
3927	8"	14" x 8"	8"	8" x 12"	4.58
3928	12"	20" x 12"	12"	12" x 18"	9.96

CHASSIS FOR ICA CABINETS

No.	Size	For Cabinet Numbers	Dir. Cost
4024	7" x 7" x 2"	3860 and 3925	\$.90
4004	7" x 9" x 2"	3861 and 3926	1.08
4005	7" x 11" x 2"	3862 and 3927	1.12
4033	10" x 17" x 3"	3863 and 3928	1.63

SEE FOLLOWING PAGES FOR COMPLETE LINE OF RACK PANELS, METER PANELS, RACK SHELVES, MOUNTING BRACKETS, ETC.

INSULINE CASTERS



Heavy gauge steel frames; durable composition rollers (2" diam. x 1" w.) on ball bearing swivel that adds mobility to any cabinet, rack, etc. The mounting plate measuring 1 $\frac{1}{8}$ " x 2 $\frac{3}{8}$ " has 4 holes of $\frac{3}{8}$ " diam.; mounting hole centers 1" x 2 $\frac{1}{4}$ ". Overall height: 2 $\frac{1}{2}$ ". Rated load: 500 lbs. Shipping weight: 7 oz.

No. 3209

Dealer Cost \$0.90

SINCE
1921



insuline Corporation of America

OVER 3 DECADES OF QUALITY RADIO-TELEVISION PRODUCTS

ICA STANDARD AMPLIFIER FOUNDATION UNITS

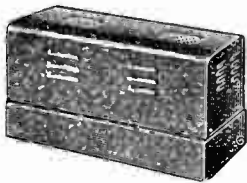

Top covers have rounded corners. The front, sides and back are equipped with louvre ventilators. The tops have raised screen openings for additional ventilation.

Finished in beautiful Marine Gray Ripple Enamel. Height of Chassis 3".

No.	Over-all Size	Dealer Cost	Bottom Plate No.	Dealer Cost
3980	5 1/2" x 10" x 9"	\$2.70	1677	\$.50
3981	8" x 12" x 9"	4.00	1679	.85
3982	7" x 17" x 9"	4.33	1681	.85
3983	10" x 14" x 9"	4.66	1683	.92
3984	10" x 17" x 9"	5.00	1685	1.07

ICA DE LUXE AMPLIFIER FOUNDATION CHASSIS

Top covers have rounded corners and fronts are embellished with the newly created Chrome plated "Air-Gate" Ventilators. Additional ventilation is obtained through the raised screen openings on the top as well as louvres on both sides and back.

Have beautiful Chrome mouldings and Chrome handles. Finished in Marine Gray Ripple Enamel. Height of Chassis 3".

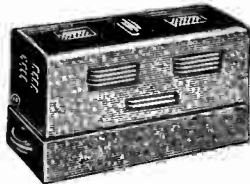

No.	Over-all Size	Dealer Cost	Bottom Plate No.	Dealer Cost
3971	5 1/2" x 10" x 9"	\$3.90	1677	\$.50
3972	8" x 12" x 9"	5.00	1679	.85
3973	7" x 17" x 9"	5.50	1681	.85
3974	10" x 14" x 9"	5.67	1683	.92
3975	10" x 17" x 9"	6.33	1685	1.07

ICA DE LUXE SLOPING PANEL CABINETS

The top corners are rounded and trimmed with an attractive striped chrome trim. The sides of the cabinets have the beautiful "Air-Gate" Chrome ventilators.

The front panel is removable so that the chassis can be attached to it and used as one unit. Beautifully finished in Marine Gray Ripple Enamel.



No.	H.	W.	D.	Dealer Cost
3990	8"	8"	8"	\$4.88
3991	8"	10"	8"	5.75
3992	8"	14"	8"	7.00
3993	12"	18"	12"	9.41

ICA SLOPING PANEL CABINETS

Small—Compact



New streamlined cabinets, rugged, small and compact, have various uses such as speaker cabinets, oscillator cases, input stages, small receivers, teletalk systems, monitors, etc.

3905



3906

Beautifully designed, with rounded corners and finished in marine gray ripple.

No.	W.	H.	D.	Dir. Cost
3905	4 3/8"	4 1/2"	4 1/4"	\$1.00
3906	7 1/2"	4 1/2"	4 1/4"	1.67

ICA MIDGET SPEAKER CASES

Especially designed for the smaller type speakers. Beautifully finished in gray ripple with attractively embossed grille. Speaker mounts on special removable internal chassis, punched for proper speaker opening. This unit fastens to side of cabinet with no visible screws to mar cabinet front. Facilitates ease of assembly. Measures 4 1/4" d. x 4 3/8" w. x 4 1/2" h.

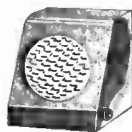

No.	Description	Hole Dia.	Dir. Cost
3986	For 2" speakers	2 3/8"	\$1.50
3987	For 3" speakers	2 3/8"	1.50

ICA DE LUXE METER CASES

Finished in Marine Gray Ripple Enamel with rounded tops and trimmed with beautiful Chrome band. Available for 2" or 3" meters. No. 3999 is equipped with stand-off insulators.



No.	D.	W.	H.	Meter Hole	Dealer Cost
3995	4 1/4"	4 3/8"	4 1/2"	2 3/8"	\$.95
3996	4 3/4"	4 1/8"	4 1/2"	2 3/8"	.95
3999	4 1/4"	4 1/8"	4 1/2"	2 3/8"	1.45

ICA PERFORATED AMPLIFIER FOUNDATION CHASSIS

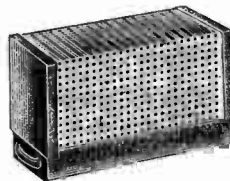

Features a perforated metal cover that provides the maximum ventilation. Includes streamlined chrome handles. Finished in marine gray ripple enamel. Height of chassis: 3".

No.	Overall Size	Dealer Cost
3965	5 1/2" x 10" x 9"	\$3.90
3966	8" x 12" x 9"	5.00
3967	7" x 17" x 9"	5.50
3968	10" x 14" x 9"	5.67
3969	10" x 17" x 9"	6.33

ICA DE LUXE SLOPING CHASSIS AMPLIFIER UNITS

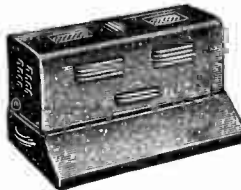

Chassis are sloped and are equipped with beautiful chrome trimmed handles. Slope provides ample space for mounting instruments.

The top covers have beautiful Chrome Plated "Air-Gate" Ventilators with striped chrome trim. Supplied with ventilating louvres on sides and back. Have raised rectangular screen opening on the tops, embellished with chrome moulding. Marine Gray Ripple finish. Chassis Ht. 3 1/2"; Slope 4".

No.	Over-all Size	Chassis Bottom	Dealer Cost	Bottom Plate No.	Dealer Cost
3962	7" x 17" x 9 1/2"	10" x 17"	\$7.55	1681	\$.85
3963	10" x 14" x 9 1/2"	13" x 14"	8.00	1683	.92
3964	10" x 17" x 9 1/2"	13" x 17"	8.30	1685	1.07

ICA "SUPER" STREAMLINED SLOPING-FRONT AMPLIFIER CHASSIS

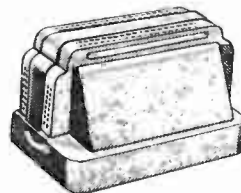

New, modern design amplifier chassis. Front panel sloped with streamlined top cover. Removable front panel Marine Gray Ripple finish with Chrome trim. Bottom plates supplied. Top cover 6 1/2" high.

No.	Chassis Size	Dir. Cost
3930	10" x 12" x 3"	\$7.25
3931	10" x 17" x 3"	8.33
3932	13" x 17" x 3"	9.58

ICA STREAMLINED METER CASES

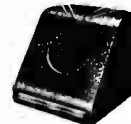

Modern streamlined cases, with raised "futura" design on top of cabinet. Finished in Marine Gray Ripple Enamel and trimmed with chrome band.

No.	D.	W.	H.	Meter Hole	Dealer Cost
3997	4 1/4"	4 1/8"	4 1/2"	2 3/8"	\$1.98
3998	4 1/4"	4 1/8"	4 1/2"	2 3/8"	1.98

ICA CABINET REAR COVERS

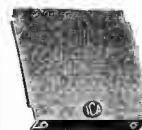

Rear cabinet covers designed specifically for the ICA cases indicated. Made of heavy duty steel in grey wrinkle finish.

No. 4155—For ICA cabinets Nos. 3905, 3995, 3996, 3986, 3987. Size: 4 1/2" x 4 1/8". Dealer Cost \$.30

No. 4156 For ICA cabinet No. 3906. Size: 4 1/2" x 7 1/2". Dealer Cost \$.42

SINCE
1921



insuline Corporation of America

OVER 3 DECADES OF QUALITY RADIO-TELEVISION PRODUCTS

ICA SLOPING FRONT CHASSIS

Has a sloping front for mounting instruments. Has the effect of a beautiful open cabinet receiver, or amplifier unit, when used without top covers. Heavy Duty Steel, finished in Black Ripple Enamel.



No.	Top of Base	Bottom of Base	Hgt.	Size of Slope	Dir. Cost
3320	7x17"	10x17"	3 1/2"	4"	\$2.53
3321	10x14"	13x14"	3 1/2"	4"	2.83
3322	10x17"	13x17"	3 1/2"	4"	3.27



ICA DE LUXE SPEAKER CABINETS

Features rounded corners; neatly chrome trimmed front; equipped with chrome handle. Steel grille. Marine Gray Ripple finish.

No.	Size	Hole Size	Speaker Size	Dir. Cost
3935	10" x 10" x 6"	4 3/4"	6"	\$3.92
3936	12" x 12" x 7"	6 1/2"	8"	5.00
3937	14" x 14" x 8"	9"	10"	6.13
3938	16" x 16" x 8"	11"	12"	7.50

ICA STANDARD SPEAKER CABINETS

Finished in Black Ripple Enamel with plain black steel handles to match.

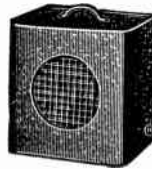

No.	Size	Hole Size	Speaker Size	Dir. Cost
3942	10" x 10" x 6"	4 3/4"	6"	\$3.42
3943	12" x 12" x 7"	6 1/2"	8"	4.33
3944	14" x 14" x 8"	9"	10"	5.58
3945	16" x 16" x 8"	11"	12"	7.33

COMPOSITE SPEAKER CABINET

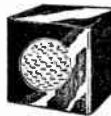

A neatly designed composite unit to house either a 4" or 5" speaker. Measures 7" w. x 4" d. x 7" h. Gray ripple finished steel with embossed grille. Removable back plate has key ways for easy hanging.

No. 3988..... Dealer Cost \$3.33

ALUMINUM MESH GRILLE

Expanded aluminum grille for use on custom built radios, phonographs, P.A. speakers, speaker cases, etc., results in unimpaired reproduction of sound. Permanent non-fading, non-tarnishing, gold finish. Non-dust catching. May be easily cut to desired size.

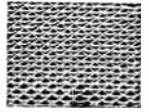

No.	Size	Dealer Cost
3947	12" x 18"	\$2.12
3948	18" x 24"	4.19
3949	24" x 36"	8.42

Sold in lots of 6 each size.

ICA PORTABLE STEEL CABINETS



Ideal for housing oscillators, transceivers, test equipment, etc. Both front and back panels are removable and are held with self-tapping screws which are supplied. Equipped with leather handle. Finished in black ripple.

No.	Size	Dir. Cost
No. 3850	Size 12" x 7 3/4" x 7"	\$2.90
No. 3851	Size 15" x 7 3/4" x 7"	3.63

CHANNEL-LOCK ALUMINUM BOXES

Latest two-piece box with special "channel-lock" feature for snug and firm fit. Makes all mounting space easily accessible. Ideal for oscillators, amplifiers, etc. Easily assembled: merely tighten the two set screws provided. These sturdy boxes made of heavy aluminum in black wrinkle, gray hammertone and natural aluminum finish.

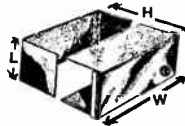

Natural Aluminum No.	Dealer Cost	Black Wrinkle No.	Gray Ham. No.	Dealer Cost	Size, inches
29200	\$.72	29300	29400	\$.83	4 x 2 1/4 x 1 3/8
29205	1.00	29305	29405	1.12	5 x 2 1/4 x 2 1/8
29210	1.10	29310	29410	1.23	5 1/4 x 3 x 2 1/8
29215	.93	29315	29415	1.05	3 x 4 x 5
29220	1.03	29320	29420	1.20	6 x 4 x 5
29225	2.00	29325	29425	2.17	10 x 4 x 2 1/2

ICA HINGED COVER CABINETS



Supplied in knocked-down form for easy handling. Easily assembled.

Finished in Black Ripple Enamel. See listing of chassis bases to fit above cabinet.

No.	W.	D.	H.	Dealer Cost
3825	9"	5"	6"	\$3.30
3826	10"	8"	7"	3.92
3828	12"	8"	7"	4.46
3829	12"	11"	8"	5.30
3830	14"	8"	7"	5.30
3831	18"	12"	9"	6.63

UTILITY CABINETS with built-in chassis

A multi-use small cabinet. Ideal for minor radio-television assemblies. The chassis is welded to front panel, making it a time-saving, convenient unit. Front and rear panels easily removable. Of sturdy steel in black ripple finish.

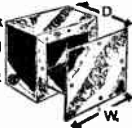

No.	Cabinet Size W. D. H.	Chassis Size			Dealer Cost
		W.	D.	H.	
3816	4" x 2" x 4"	2 7/8"	1 7/8"	1"	\$1.05
3817	4" x 3" x 5"	2 7/8"	2 7/8"	1 1/8"	1.15
3818	5" x 3" x 4"	3 7/8"	2 7/8"	1 1/4"	1.15
3819	4" x 5" x 6"	2 7/8"	4 7/8"	1 3/8"	1.43
3821	6" x 5" x 4"	4 7/8"	4 7/8"	1 1/4"	1.43
3823	6" x 6" x 6"	4 7/8"	5 7/8"	1 1/4"	1.50

ALUMINUM . . . STEEL CABINETS

Popular utility cabinets now available in aluminum in gray hammertone and natural finish. Excellent for amplifiers, monitors, input stages, meters, transceivers, etc. Removable front and back covers may be fastened to cabinet with self-tapping screws provided. Also supplied in steel with black ripple finish.



Aluminum Natural	Dealer Cost	Aluminum Gray Hammertone	Dealer Cost	Size W. L. H.	STEEL Black Ripple	Dealer Cost
29840	\$0.90	29810	\$1.02	4" x 4" x 2"	3810	\$.85
29841	1.02	29811	1.17	4" x 5" x 3"	3811	.95
29842	1.32	29812	1.47	4" x 6" x 5"	3812	1.20
29843	1.39	29800	1.56	6" x 6" x 6"	3800	1.30
29844	1.98	29801	2.25	9" x 6" x 5"	3801	1.87
				10" x 7" x 8"	3802	2.30
				10" x 10" x 8"	3803	2.90
				12" x 8" x 11"	3804	3.60

"FLEXI-MOUNT" ALUMINUM CASES

A two-piece case designed for maximum accessibility. Solves many problems demanding installation of numerous elements in limited space while assuring necessary shielding. Has wide application. Made of heavy aluminum—finished in gray hammertone or natural aluminum.

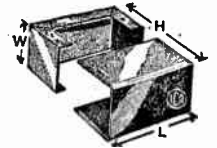

Cat. No.	Dealer Cost	Cat. No. Natural	Dealer Cost	Dimensions		
				W.	L.	H.
29435	\$.63	29335	\$.57	2 1/2"	2 1/4"	1 1/8"
29436	.63	29336	.57	2 1/2"	3 1/4"	1 1/8"
29437	.66	29337	.60	2 1/2"	4"	1 1/8"
29438	.87	29338	.78	2 1/2"	4"	2 1/4"
29439	.90	29339	.84	2 1/2"	5"	2 1/4"
29441	.96	29341	.90	3"	5 1/4"	2 1/8"
29440	.99	29340	.93	4"	5"	3"
29442	1.23	29342	1.14	5"	6"	4"
29443	1.38	29343	1.26	5"	7"	3"
29447	3.45	29347	3.00	5"	17"	4"
29444	2.01	29344	1.89	6"	8"	3 1/2"
29445	2.49	29345	2.07	6"	10"	3 1/2"
29446	2.94	29346	2.64	7"	12"	4"

SLIP COVER ALUMINUM BOXES

Suitable for a variety of electronic device housing needs. Slide cover permits easy accessibility to mounted parts; offers shielding and dust-proof protection. May be used for television strips; terminal barriers, special equipment, amplifier units, etc. Heavy aluminum in natural finish or gray hammertone.



Gray Hammertone No.	Dealer Cost	Natural Finish No.	Dealer Cost	Size W. L. H.
29130	\$3.62	29100	\$3.45	3 1/2" x 13" x 2 5/8"
29135	3.92	29105	3.75	5 1/2" x 13" x 2 5/8"
29140	3.75	29110	3.58	3" x 17" x 2 5/8"

SINCE
1921



insuline Corporation of America

OVER 3 DECADES OF QUALITY RADIO-TELEVISION PRODUCTS

NEW ICA BAKELITE INSTRUMENT CASES

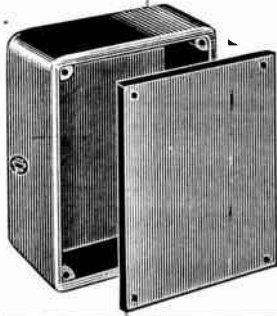

Solid molded bakelite one-piece case for a variety of electronic housings. Light in weight but durable. Has tapped corner holes and brass inserts with 4-36 threading for flush panel mounting. Offers shielding and dust proof protection for small amplifiers, oscillators, etc. Complete with 1/8" bakelite panel, drilled for mounting.

- No. 8201—6 1/4" x 3 3/4" x 2" h.
Dealer Cost \$1.65
- No. 8202—6 3/4" x 5 1/4" x 2 3/8" h.
Dealer Cost \$2.19

CONTROL... SWITCH CASE

Strongly welded steel case; removable cover. Suitable for control or switch box; enclosing small assemblies, etc. Includes cover screws. Gray hammertone finish. Outside dimensions: 3 1/4" x 5 1/4" x 2 1/8".

No. 3797 Dealer Cost \$1.00



RECORD CHANGER BASES



Sturdy steel base in beautiful brown hammertone finish with protective, non-marring cork rubber cushion. Especially designed for the better known record changers. Grommets holes provided for AC lead on rear apron; also punched for easy addition of insuline No. 2385 phono plug-socket.

No.	Description	Dealer Cost
3308	For WEBSTER No. 100 Series changer models and similar sizes	\$3.13
3308-BP	Steel bottom plate in matching finish; rubber bumpers and mounting screws complete, for above base	.94
3309	For WEBSTER No. 106 Series changer models and similar sizes	3.13
3309-BP	Steel Bottom Plate in matching finish; rubber bumpers and mounting screws complete, for above base	.94

GARRARD CHANGER BASE

Made for the new Garrard Model RC-80 3-way record changer. This steel base is finished in brown hammertone with protective cushions. Includes grommets holes for AC lead. Complete with bottom plate.

No. 3315 Dealer Cost \$5.70

ICA CHASSIS MOUNTING BRACKETS

Designed for rack panels and chassis where additional strength is required for heavier units such as power supplies, etc. Heavy gauge steel, black ripple finish.

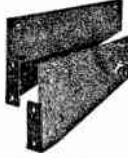

No.	Front	Back	Dealer Cost
4092	6 1/2" Ht. x 8" D. x 4" Ht.		.85
4077	6 1/2" Ht. x 10" D. x 3" Ht.		1.13
4093	6 1/2" Ht. x 11" D. x 4" Ht.		1.20
4079	8 1/2" Ht. x 10" D. x 4" Ht.		1.80
4081	6 1/2" Ht. x 12" D. x 3" Ht.		1.50
4094	6 1/2" Ht. x 13" D. x 4" Ht.		1.35
4083	8 1/2" Ht. x 13" D. x 4" Ht.		1.92

ICA CHASSIS MOUNTING BRACKETS

Made to fit on 17" relay rack chassis. Panels must be at least 7" high. Black ripple finish



No.	Dir. Cost
3955—For 8" base.....Per Pair	\$.85
3958—For 10" base.....Per Pair	1.02
3956—For 11" base.....Per Pair	1.20
3957—For 13" base.....Per Pair	1.70

ICA RELAY RACK BRACKETS

Black Ripple Finish. Used to reinforce racks and for mounting of panels, shelves, chassis, etc.



No.	Dir. Cost
3950—5" Base Brackets.....Per Pair	\$.80
3951—8" Base Brackets.....Per Pair	.92
3952—11" Base Brackets.....Per Pair	1.10

CHASSIS BRACING ANGLES

For supporting chassis bearing heavy loads. Angles provide necessary bracing, thus freeing panel from weight load. 1/8" steel in black wrinkle finish.



No. 3856—14" L. x 3" W.....	Dealer Cost \$1.75 pair
No. 3857—12" L. x 3" W.....	Dealer Cost 1.65 pair

STEEL RACK SHELVES

Made of heavy gauge steel in black wrinkle finish. Easily slid into rack for supporting heavier units such as power supplies, etc.



No. 3854—19" W. x 1" H. x 15" D.....	Dealer Cost \$3.10
No. 3855—19" W. x 1" H. x 12" D.....	Dealer Cost 2.35

ICA MASONITE RELAY RACK PANELS

Made of Tempered Masonite—a non-magnetic material, sturdy and tough yet easily drilled and worked with ordinary wood-working tools and punches. Finish—

ed in Black or Gray. Supplied in Black Ripple finish unless Gray is specified. RMA notching. If Western Electric notching is desired, add "WE" to catalog No.

no.	Size	Dir. Cost	No.	Size	Dir. Cost
*3662RS	1 3/4" x 19"	\$.67	3668RS	12 1/4" x 19"	\$1.67
*3663RS	3 1/2" x 19"	.83	3669RS	14" x 19"	1.83
*3664RS	5 1/4" x 19"	.97	3670RS	15 3/4" x 19"	2.03
*3665RS	7" x 19"	1.10	3671RS	17 1/2" x 19"	2.37
*3666RS	8 3/4" x 19"	1.33	*3672RS	19 1/4" x 19"	2.57
*3667RS	10 1/2" x 19"	1.50	3673RS	21" x 19"	2.87

*RMA and "WE" notching specifications are identical.

SPECIAL SIZES OF RACK PANELS AVAILABLE ON ORDER

Insuline Corporation of America is geared to supply rack panels in various sizes, thicknesses and finishes. Materials include Steel, Aluminum, or Masonite in any thickness from 1/8" to 1/4". Any finish according to specifications.

STANDARD RELAY RACK PANELS

ICA standard relay rack panels are slotted to fit any standard 19" relay rack. ICA relay rack panels are supplied in 1/8" thickness. Notched according to RMA specifications. If Western

Electric notching is desired, add "WE" to catalog numbers. Made of steel (in black ripple or gray finish) or aluminum (in black ripple or gray wrinkle; also in gray hammertone on request).

STEEL			ALUMINUM		
	Dir. Cost		Dir. Cost	Dir. Cost	
Black	Gray	Size	Black	Gray	Wrinkle
*3600RS	*3612RS	\$.67	1 3/4"	*8600RS	*8620RS
*3601RS	*3613RS	.75	3 1/2"	*8601RS	*8621RS
*3602RS	*3614RS	.93	5 1/4"	*8602RS	*8622RS
*3603RS	*3615RS	1.08	7"	*8603RS	*8623RS
3604RS	3616RS	1.32	8 3/4"	8604RS	8624RS
*3605RS	*3617RS	1.58	10 1/2"	*8605RS	*8625RS
3606RS	3618RS	1.88	12 1/4"	8606RS	8626RS
3607RS	3619RS	2.17	14"	8607RS	8627RS
3608RS	3620RS	2.40	15 3/4"	8608RS	8628RS
3609RS	3621RS	2.70	17 1/2"	8609RS	8629RS
*3610RS	*3622RS	3.00	19 1/4"	*8610RS	*8630RS
3611RS	3623RS	3.30	21"	8611RS	8631RS

*RMA and "WE" notching specifications are identical.

SINCE
1921



insuline Corporation of America

OVER 3 DECADES OF QUALITY RADIO-TELEVISION PRODUCTS



STEEL OR ALUMINUM CHASSIS BASES
For receivers, transmitters, etc. Bases are folded over on bottom or additional strength and drilled to permit attaching of bottom plates. Solidly constructed. **STEEL BASES**—one piece; heavy duty; zinc plated or black ripple finish. **ALUMINUM BASES**—First grade aluminum, electronically welded. Thickness: 16 gauge (.050).

ICA CHASSIS BOTTOM PLATES



Designed to fit all ICA Chassis Bases and amplifier units listed to the left. Four raised bosses prevent marring or scratching. Supplied in steel or aluminum.

Steel—Zinc Plated Finish		Steel—Black Ripple Finish		Aluminum					
No.	Dir. Cost	No.	Dir. Cost	Gauge	W.	Size L	H.	No.	Dealer Cost
1560*	\$.77	4000*	\$.77	20	4	x 6	x 2	29043	\$1.02
1586	.88	4037	.88	20	4	x 6	x 3	29044	1.02
					4	x 17	x 3	29027	1.85
1530	.78	4001	.78	20	5	x 7	x 2	29030	.93
1587	.93	4038	.93	20	5	x 7	x 3	29047	1.05
1565	1.08	4002	1.08	20	5	x 9 1/2	x 1 1/2	29033	.99
1564	1.08	4042	1.08	20	5	x 9 1/2	x 3	29002	1.17
1566	1.33	4003	1.33	20	5	x 10	x 3	29048	1.20
1582	1.17	4032	1.17	20	5	x 13	x 3	29003	1.26
					5 1/2	x 10	x 3	29004	1.43
1518	1.26	4043	1.26	16	6	x 17	x 3	29050	1.89
1526	.90	4024	.90	20	6	x 14	x 3	29034	1.80
1569	1.08	4004	1.08	20	7	x 7	x 2	29005	.99
1570	1.12	4005	1.12	20	7	x 9	x 2	29006	1.08
1527	1.27	4006	1.27	20	7	x 11	x 2	29007	1.20
1571	1.20	4007	1.20	20	7	x 12	x 3	29008	1.41
1572	1.43	4008	1.43	20	7	x 13	x 2	29009	1.26
1528	1.57	4009	1.57	20	7	x 15	x 3	29010	2.27
1567	1.62	4013	1.62	20	7	x 17	x 3	29011	1.83
1573	1.45	4014	1.45	20	8	x 12	x 3	29012	1.71
1575	1.58	4035	1.58	20	8	x 17	x 2	29013	1.89
1588	1.65	4039	1.65	20	8	x 17	x 3	29014	2.22
1520	1.50	4016	1.50	20	8 1/2	x 15	x 3	29037	2.30
1568	1.58	4017	1.58	20	10	x 12	x 3	29015	1.89
1589	1.60	4040	1.60	20	10	x 14	x 3	29016	2.40
1583	1.63	4033	1.63	20	10	x 17	x 2	29039	2.28
1521	1.87	4018	1.87	18	10	x 17	x 3	29017	2.58
1580	2.03	4030	2.03	18	10	x 17	x 3		
1522	2.43	4019	2.43	18	10	x 17	x 4	29025	2.97
1577	2.17	4027	2.17	18	10	x 23	x 3	29018	3.32
1519	2.20	4023	2.20	18	11	x 17	x 2	29019	2.37
1574	1.77	4020	1.77	18	11	x 17	x 3	29020	3.00
1578	2.03	4028	2.03	18	12	x 17	x 2	29021	2.70
1579	2.35	4029	2.35	18	12	x 17	x 3	29022	3.18
1524	2.55	4021	2.55	18	13	x 17	x 2	29023	2.82
1581	3.00	4031	3.00	18	13	x 17	x 3	29024	3.36
					18	x 17	x 4	29026	3.84

*Open ends.

MINIATURE OPEN END ALUMINUM CHASSIS



Of first grade aluminum for less weight but long service. Base flange permits attaching of bottom plate or fastening down of chassis. Ideal where limited space is factor. Suitable for all small unit assemblies.

No.	W.	L.	H.	Dealer Cost	No.	W.	L.	H.	Dealer Cost
29076	1 1/4	x 3 1/2	x 1 1/4	\$.33	29083	4	x 4 1/2	x 1	\$.39
29075	2 1/2	x 2 3/4	x 1 1/4	.30	29084	4	x 5 1/2	x 1	.42
29078	2 1/2	x 4 1/2	x 1 1/2	.36	29085	4	x 6 1/2	x 1	.45
29080	3	x 6 1/2	x 1 1/4	.42	29000	4 1/2	x 8	x 1 1/2	.90
29077	3 1/4	x 4 1/2	x 2	.36	29001	5	x 9 1/2	x 1 1/2	.99
29079	3 3/4	x 4 1/2	x 1 1/2	.36	29081	5 3/4	x 4 1/2	x 1 1/2	.45
29082	4	x 3 1/2	x 1	.36					

ICA METER PANELS

Notched to RMA specifications ("WE" notching identical). Will fit all standard racks. Finished in Baked Black or Gray Ripple. Size 5 1/4" x 1 9/16".

Black will be shipped unless Gray is specified.



STEEL PANELS				
No.	No. Holes	Meter Size	Hole	Dealer Cost
3651	5	2"	2 1/8"	\$1.85
3652	3	2"	2 1/8"	1.30
3653	5	3"	2 1/8"	1.85
3654	3	3"	2 1/8"	1.30

MASONITE PANELS				
No.	No. Holes	Meter Size	Hole	Dealer Cost
3641	3	2 1/4"	2 1/4"	\$1.32
3642	4	2 1/4"	2 1/4"	1.45
3643	3	2 3/8"	2 3/8"	1.32
3644	4	2 3/8"	2 3/8"	1.45

OPEN END STEEL CHASSIS



Permits easier wiring of the smaller assemblies. Has wide variety of applications. Made of sturdy steel with zinc plated finish.

No.	W.	L.	H.	Dealer Cost	No.	W.	L.	H.	Dealer Cost
1547	5	x 7	x 1 1/2	\$.60	1596	7	x 10	x 2	\$.90
1559	5 1/2	x 9	x 1 1/2	.70	1597	7	x 11	x 1 1/2	1.00
1546	7	x 6	x 2	.68	1595	7 1/2	x 9	x 1 1/2	.95
1548	7	x 7	x 1 1/2	.78	1599	7 3/4	x 15	x 2	1.38
1556	7	x 8	x 2	.85	1598	10 1/4	x 14	x 2	1.43

ICA STEEL . . . MASONITE . . . ALUMINUM PANELS



Steel panels are made in 1/8" thickness, black ripple finish. Masonite panels are 3/8" thick, black ripple finish. Aluminum panels have bright silver finish, 1/8" thick.

Steel No.	Dealer Cost	Size	Masonite No.	Dealer Cost	Alum. No.	Dealer Cost
3175	\$.72	7" x 10"	810	\$.77	1194	\$1.00
3176	.80	7" x 12"	811	.85	1195	1.17
3177	.93	7" x 14"	812	.97	1196	1.27
3178	1.20	7" x 18"	813	1.17	1198	1.53
		7" x 21"	814	1.27	1199	2.17
		7" x 24"			1200	2.70
3183	1.03	8" x 12"	815	1.00		
3184	1.10	8" x 14"	816	1.10		
		8" x 16"	817	1.28		
3186	1.23	8" x 18"	818	1.37		
		10" x 12"			3157	2.00
3191	1.60	10" x 14"				
3192	1.87	10" x 18"			3198	2.27
3194	2.17	10" x 24"			3159	4.00

SINCE
1921



insuline Corporation of America

OVER 3 DECADES OF QUALITY RADIO-TELEVISION PRODUCTS

ICA BAKELITE RADIO PANELS



Smooth Finish. Laminated Indestructible Material. For Panels and general use where low moisture absorption, good electrical properties and fine surface finish are required. Tensile strength 8,000 lbs. per square inch.

1/8" Thickness			3/16" Thickness		
No.	Size	Dealer Cost	No.	Size	Dealer Cost
832	7" x 10"	\$1.17	842	7" x 10"	\$1.73
833	7" x 12"	1.42	843	7" x 12"	2.10
834	7" x 14"	1.53	844	7" x 14"	2.50
835	7" x 18"	2.30	845	7" x 18"	2.97
836	7" x 21"	2.40	846	7" x 21"	3.33
837	7" x 24"	2.70	847	7" x 24"	4.17
840	7" x 30"	3.67	850	7" x 30"	5.16
860	10" x 12"	2.10	863	10" x 12"	3.17
861	10" x 18"	2.90	864	10" x 18"	4.35

ICA FULL SIZE BAKELITE SHEETS

Black Glossy Finish

No.	Size	Thickness	Apprx. Wt.	Dealer Cost
852	38" x 49"	3/8"	6 lbs.	\$16.35
853	38" x 49"	3/4"	9 lbs.	20.56
854	38" x 49"	1/2"	12 lbs.	33.49
857	38" x 49"	7/8"	18 lbs.	41.73
858	38" x 49"	1/4"	24 lbs.	50.11

Prices on other sizes or thicknesses quoted on request.

CHROME VENTILATING LOUVRES

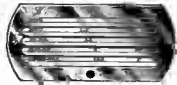

Adds the attractive touch to any receiver, amplifier, transmitter, etc. A polished chrome finished steel "Air-Gate," consisting of 5 ventilating louvres. Over-all size: 5 1/4" long—3" wide. Distance between mounting hole centers:

4 3/4". Diameter of holes: 3/8". Length of louvres: 4 1/4". Air space between louvre plates: 1/8".

No. 3525.....Dealer Cost \$.67



Beautiful chrome trim mouldings to dress up any cabinet, chassis, receiver, speaker cabinet, transmitter, etc. All moulding furnished with mounting tracks or clips.

ICA CHROME TRIM MOULDING

No.	Dealer Cost
3510—Chrome Moulding, with single Stripe. Size: 1/2" wide by 4" long	\$.67
3513—Chrome Moulding, with double Stripe. Size: 3/4" wide by 8" long	1.07
3514—Chrome Moulding, with double Stripe. Size: 3/4" wide by 12" long	1.23
3515—Chrome Moulding, with double Stripe. Size: 3/4" wide by 17" long	1.50
3505—Bullet Shape all Chrome Moulding. Size 1/4" wide by 6" long67

CHROME HANDLES . . . PLASTIC HANDLES



A neatly styled adornment for any cabinet, amplifier chassis transmitter, etc. Furnished with mounting screws. Supplied in gleaming chrome or attractive plastic.

No.	Dealer Cost
3500—Chrome. 4" l.; 1 1/8" w. Mounting centers: 2 3/4" apart.....	\$.58
3502—Plastic. 4" l.; 5/8" w. Mounting centers: 2 3/4" apart.....	.48
3501—Chrome. 6 1/4" l.; 5/8" w. Mounting centers: 4 1/8" apart.....	.77

HANDLE . . . LOCK SET



A complete, attractive handle and lock set that will dress up a variety of cabinets. Streamlined handle of zinc with nickel-plated finish; spring snap lock of durable steel for long service. Includes screws and nuts.

No. 3532.....Dealer Cost \$.60

METAL GOODS TO YOUR SPECIFICATIONS

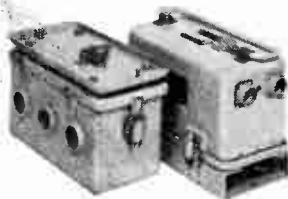

In addition to its wide range of stock metal items herein listed, Insuline's vast facilities are available for the manufacture of an extensive variety of products to particular specifications. Production capabilities includes Screw Machine Work, Stamping, Drilling, Assembling, Engraving, Screening, Machining, Finishing. Supplying some of the country's leading industrial organizations, Insuline is also available for sub-contract orders (industrial or military) including assemblies, sub-assemblies, completely wired junction boxes, shock mounts, wiring or any similar type of production.

Detailed brochure describing Insuline's special manufacturing facilities, supplied on request.

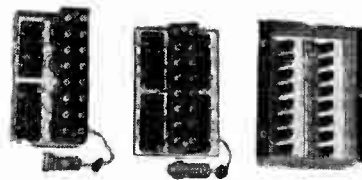
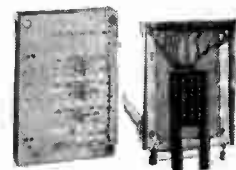



PAR-METAL PRODUCTS *Made by Electronic Specialists!*

TYPE "C" DELUXE CABINET RACKS

FOR 19" WIDE PANELS — 18" and 24" DEEP

Since 1927, PAR-METAL has been a pioneer in the design and creation of superior metal equipment for the radio and communications industries. This experience in combination with skilled craftsmen and high quality material, have made PAR-METAL PRODUCTS the standard of the industry.

The beauty of these new enclosed type racks should prove a welcome addition to our line. It will appeal to those who wish to combine the rugged construction of our standard Type "C" racks with modern styling and improved design.

The vertical trims which conceal the panel mounting screws are fastened by means of two "Cowl type" fasteners on each side, which permits the trims to be removed quickly and easily by a half-turn on the screw heads.

The design of the vertical posts permits these racks to be installed in rows or "gangs," without the use of front joining strips between the racks. This provides a greater flexibility in their installation, particularly in broadcast stations.

SPECIFICATIONS FOR THESE DELUXE TYPE RACKS

CABINET: Entire cabinet is welded together into one integral unit. Body of cabinet is made from $\frac{1}{8}$ " thick cold rolled sheet steel; top of cabinet is made from $\frac{5}{64}$ " thick steel; bottom is made from $\frac{7}{64}$ " thick steel.

PANEL MOUNTING: Angle irons are $\frac{3}{8}$ " thick structural steel, holes are accurately drilled and tapped 12/24 thread on standard $1\frac{1}{4}$ "- $\frac{1}{2}$ " spacings.

DOOR: Doors are of a new type with vastly improved construction features. They are stamped from one piece of steel into a rigid unit. Door edges are folded to provide a smooth double thick edge. There are no "patch" type braces, etc., used for reinforcement.

HARDWARE: Doors are equipped with die-cast "automobile" type sturdy handles. Hinges are of the "slip-joint" type so that doors may be easily removed. Screws for mounting panels are supplied. Front of rack is trimmed with chrome plated trims at top and bottom.

OUTLETS: A duplex receptacle and outlet box are provided in the back under the door. A rectangular opening is provided in the bottom for conduits, leads, etc.

CORNER TRIMS: All racks have quick detachable corner trims, which are fastened to the rack by means of two "Cowl Type" fasteners on each trim.

PANELS: Panels 19" wide to fit these racks are described on Page J-96.

FINISH: Black ripple with corner trims finished in dull black; or slate grey ripple with corner trims finished in slate grey are standard. Prime coat only is optional in place of ripple enamel finish at no extra charge, if so specified in your order.

Aluminum grey lacquer is available at an additional charge. The letter "P" before Catalog No. indicates black ripple enamel; the letter "PG" before Catalog No. indicates slate grey ripple enamel.

RACK SHELVES: Shelf R-2218 fits the 18 $\frac{1}{2}$ " deep racks; and Shelf R-2224 fits the 24" deep racks. See Page J-95.

ROLLER TRUCKS: Truck RT-418 fits the 18 $\frac{1}{2}$ " deep racks; and Truck RT-424 fits the 24" deep racks. See Page J-95.

MODIFIED RACKS: The deluxe type racks listed on this page can be supplied for 24" wide panels on special order. Grille openings in top for additional ventilation are also available. Special openings in doors can also be provided.

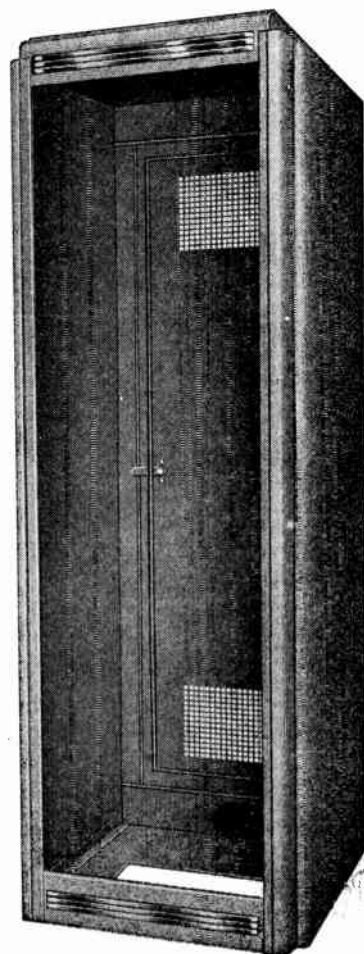

No. P-6918

18 $\frac{1}{2}$ " Deep Racks

Cat. No.	Overall Size	Panel Space	Shp. Wt. Lbs.	Net Price
P, PG, 6918	69 $\frac{3}{8}$ x 23 $\frac{5}{8}$ x 18 $\frac{1}{2}$ "	61 $\frac{1}{4}$ x 19"	155	\$ 94.50
P, PG, 7818	78 $\frac{3}{8}$ x 23 $\frac{5}{8}$ x 18 $\frac{1}{2}$ "	70 x 19"	165	103.50
P, PG, 8518	85 $\frac{3}{8}$ x 23 $\frac{5}{8}$ x 18 $\frac{1}{2}$ "	77 x 19"	180	117.00

24" Deep Racks

P, PG, 6924	69 $\frac{3}{8}$ x 23 $\frac{5}{8}$ x 24"	61 $\frac{1}{4}$ x 19"	175	111.00
P, PG, 7824	78 $\frac{3}{8}$ x 23 $\frac{5}{8}$ x 24"	70 x 19"	190	120.00
P, PG, 8524	85 $\frac{3}{8}$ x 23 $\frac{5}{8}$ x 24"	77 x 19"	200	135.00



TYPE "C" STANDARD RACKS FOR 19" and 30" WIDE PANELS

These racks have been a standard unit in the electronic industry for many years, and have been adapted to a broad field of requirements. The construction is essentially the same as our DeLuxe Racks on Page J-90, and similar specifications would apply as to **CABINET, PANEL MOUNTING, DOOR, HARDWARE and OUTLET.** Corner trims are described below.

Models **G-2218, G-2219** and **G-3024** have additional reinforcement at the rear corners, and are suitable for transmitter equipment. The louvres on the rear door are covered with mesh screening on the inside, and additional knockouts are provided for conduit and 4" square duct.

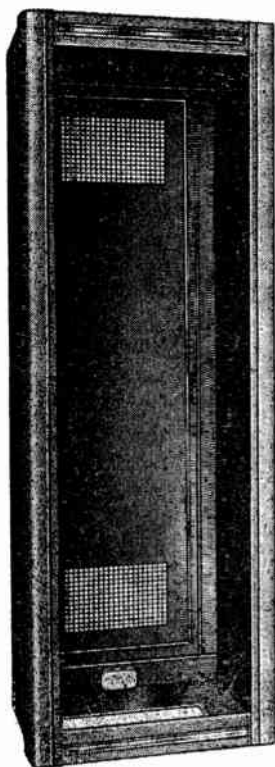

No. P-6625

CORNER TRIMS: All racks have quick, detachable, new corner trims, which are fastened to front of rack with two finger type "captive screws." This permits quick, simple removal without the use of screw-drivers, etc.

TO SET UP IN GANGS OR ROWS: The racks may be joined together by means of a flat trim fastened to the front of the adjacent support angles, overlapping both racks. Knockout holes 1 1/8" in diameter are provided at the sides of the racks to permit connections between them.

Racks are regularly shipped with corner trim as illustrated; where specified, the front joining trim is furnished without additional charge in place of the corner trim.

SIDE LOUVRES: Racks are available with louvres at sides if so ordered at no extra charge. (This is not suitable for "gang" installations.)

MODIFIED RACKS: Depth may be increased up to 28" to your specifications. Grille openings in top for additional ventilation are also available. Special openings in doors can also be provided.

FINISH: Black ripple with corner trims finished in dull black; or slate grey ripple with corner trims finished in slate grey are standard. Prime coat only is optional in place of ripple enamel finish at no extra charge, if so specified in your order. Aluminum grey lacquer is available at an additional charge. The letter, "P" before Catalog No. indicates black ripple enamel; the letter "PG" before Catalog No. indicates slate grey ripple enamel.

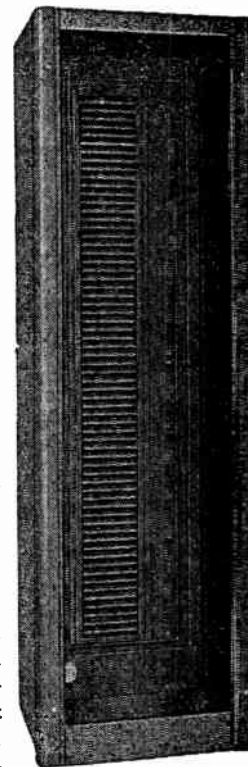

No. G-2218

15 1/4" Deep Racks

Cat. Nos.	Overall Size	Panel Space	Clear Depth	Shp. Wt. Lbs.	Net Price
P, PG, 3675	42 3/8 x 22 x 15 1/4"	36 3/4 x 19"	13 3/4"	100	\$54.00
P, PG, 6625	67 3/8 x 22 x 15 1/4"	61 1/4 x 19"	13 3/4"	140	72.00
P, PG, 8325	83 1/8 x 22 x 15 1/4"	77 x 19"	13 3/4"	165	93.00

18" Deep Racks

Cat. Nos.	Overall Size	Panel Space	Clear Depth	Shp. Wt. Lbs.	Net Price
P, PG, 3618	42 3/8 x 22 x 18"	36 3/4 x 19"	16 7/8"	110	60.00
P, PG, 6618	67 3/8 x 22 x 18"	61 1/4 x 19"	16 7/8"	150	78.00
P, PG, 8318	83 1/8 x 22 x 18"	77 x 19"	16 7/8"	180	99.00

Cat. No.	Overall Size	Panel Space	Clear Depth	Shp. Wt. Lbs.	Net Price
G-2218	76 1/8 x 22 x 18"	70 x 19"	16 7/8"	185	\$105.00
G-2219	83 1/8 x 22 x 18"	77 x 19"	16 7/8"	300	117.00
G-3024	76 1/8 x 33 x 24"	70 x 30"	22 7/8"	360	174.00

RACK SHELVES: Shelf R-2015 fits the 15 1/4" deep racks; Shelf R-2018 fits the 18" deep racks. Shelves are listed on Page J-95.

PANELS: Panels 19" wide are listed on Page J-96. Blank panels 30" wide for No. G-3024 racks are available also on Page J-96. Other types can be made 30" wide on special order.

ROLLER TRUCKS: Truck RT-415 fits the 15 1/4" deep racks; and Truck RT-412 fits the 18" deep racks. Roller trucks are listed on Page J-95.

ALL PRICES F.O.B. LONG ISLAND CITY, N. Y. • FOR WEST COAST PRICES, ADD 10%
Export Dept.: Rocke International Corp., 13 E. 40th St., New York 16, N. Y.



PAR-METAL PRODUCTS *Made by Electronic Specialists!*

TYPE "C" UNIVERSAL CABINET RACKS

FOR 19" and 24" WIDE PANELS

WITH REAR DOOR ONLY

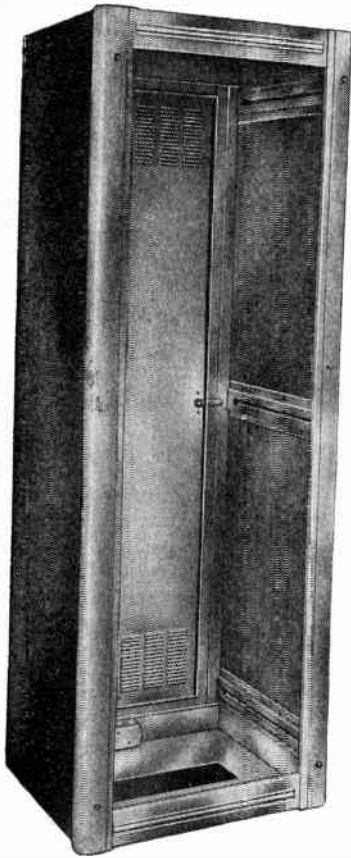

No. PX-6718

CORNER TRIMS: "PX Series racks: Regular corner trims to cover panel screws are standard. "Narrow Type" trims will be supplied if so specified on your order. "Narrow Type" trims are standard on "FX" Series racks. Front joining trims may be substituted without extra charge.

FINISH: Black wrinkle enamel is standard. Grey wrinkle enamel or prime coat only is optional at same price.

These universal racks are similar in construction to our Type "C" standard racks listed on Page J-91, except that the design has been modified to facilitate the location and mounting of chassis supports, shelves, standard sliding devices, and sliding shelves.

Specifications are the same as those applying to CABINET, PANEL MOUNTING, DOOR, HARDWARE and OUTLETS on Page J-90.

The front vertical corners of the rack are regular cabinet design, so that panels may be recessed without exposed edges. New "narrow type" vertical corner trims maintain the attractive conventional design of similar racks, even though panel mounting screws are visible. Sliding shelves or drawers may be freely operated, or rack panel assemblies removed, without disturbing the trims.

The "narrow type" corner trims are standard equipment on all series "FX" racks. On series "PX" racks, regular trims to cover the panel mounting screws are standard, but "narrow type" trims are optional where so specified.

Advantages of universal type racks may be summarized as follows:

1. The panel mounting angles are fully adjustable, and may be positioned from front to back.
2. Racks will accommodate all standard panels up to 7/16" thick.
3. Either regular or "narrow type" trims are available on Series "PX" racks, and are interchangeable.
4. Vertical side supports (listed on Page J-93) may be installed without drilling or fitting.
5. Side brackets, with or without shelves, may be attached to vertical side supports without drilling or fitting.
6. Various types of standard sliding devices in general use may be installed on the vertical side supports.
7. Racks with or without front doors, for either 19" or 24" wide panels, intermixed, may be "ganged" in continuous rows.

WITH FRONT & REAR DOOR

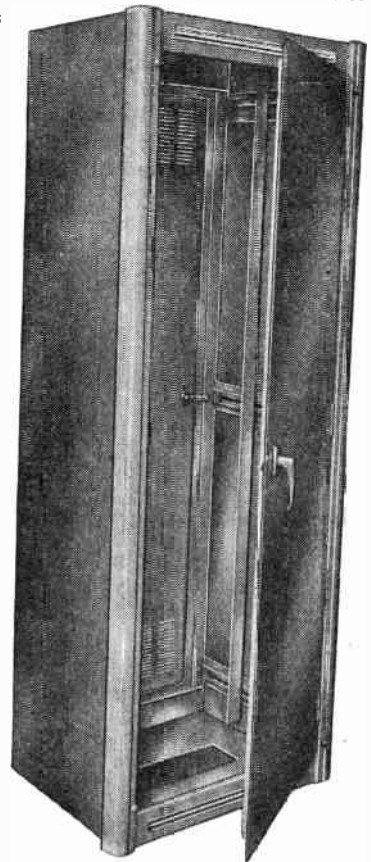

No. FX-6718

ROLLER TRUCKS: (listed on Page J-95) Specify No. RT-418 for all racks with 19" panels. Specify No. RT-427 for all racks with 24" wide panels.

PANELS: Panels 19" or 24" wide to fit these racks are listed on Page J-96.

WHEN ORDERING, PLEASE GIVE FOLLOWING INFORMATION: Catalog number, FINISH (if other than black). Specify if "narrow type" trims are required on Series "PX" racks, otherwise regular type trims will be supplied.

Type "PX" Series Racks

FOR 19" WIDE PANELS — WITH REAR DOORS ONLY

Cat. No.	Overall Size	Panel Space	Ship. Wt.	Net Price
PX-6718	67 3/8 x 22 x 18"	61 1/4 x 19"	170 lbs.	\$ 80.00
PX-7718	76 1/8 x 22 x 18"	70 x 19"	190 lbs.	90.00
PX-8418	83 1/8 x 22 x 18"	77 x 19"	200 lbs.	100.00

FOR 24" WIDE PANELS — WITH REAR DOORS ONLY

Cat. No.	Overall Size	Panel Space	Ship. Wt.	Net Price
PX-6727	67 3/8 x 27 x 24"	61 1/4 x 24"	220 lbs.	\$125.00
PX-7727	76 1/8 x 27 x 24"	70 x 24"	240 lbs.	135.00
PX-8427	83 1/8 x 27 x 24"	77 x 24"	255 lbs.	150.00

Type "FX" Series Racks

FOR 19" WIDE PANELS — WITH FRONT AND REAR DOORS

Cat. No.	Overall Size	Panel Space	Ship. Wt.	Net Price
FX-6718	67 3/8 x 22 x 18"	61 1/4 x 19"	190 lbs.	\$100.00
FX-7718	76 1/8 x 22 x 18"	70 x 19"	210 lbs.	115.00
FX-8418	83 1/8 x 22 x 18"	77 x 19"	220 lbs.	125.00

FOR 24" WIDE PANELS — WITH FRONT AND REAR DOORS

Cat. No.	Overall Size	Panel Space	Ship. Wt.	Net Price
FX-6727	67 3/8 x 27 x 24"	61 1/4 x 24"	240 lbs.	\$150.00
FX-7727	76 1/8 x 27 x 24"	70 x 24"	260 lbs.	160.00
FX-8427	83 1/8 x 27 x 24"	77 x 24"	280 lbs.	180.00

*Racks for 19" Wide Panels are also made as standard units in 24" depth. All Universal Racks are obtainable with open sides for use as single units, or multiple ganging in rows; removable side panels are available as standard units.

Open side racks may be intermixed and ganged with Series PX-6718 and Series FX-6718 Racks listed on this page.



TYPE "C" UNIVERSAL CABINET RACKS

VERTICAL SIDE SUPPORTS



These vertical side supports are supplied in sets of four uprights to fit Type "PX" and "FX" racks listed on J-92. (Cut shows side mounting brackets in place, which are sold separately—see listing below.) Uprights are fastened to grooved bolt retainers which hold panel mounting angles in place, and are adjustable from front to back. Holes are drilled and tapped vertically on "universal" centers to provide adequate vertical adjustment for side mounting brackets, shelves, and various sliding devices made for electronic equipment.

When installed in racks for 19" wide panels, the clearance between uprights (from right to left) is 17 3/4". In racks for 24" wide panels, the clearance is 22 3/4". Uprights are 2 5/8" wide and 1 1/2" deep.

Uprights are made from 1/8" steel, finished in aluminum lacquer. Supplied with necessary bolts for mounting in rack.

Cat. No.	Height	To Fit Racks	Ship. Wt.	Net Price
VS-61	65 3/4"	PX, FX, 6718-6727	40 lbs.	\$18.00
VS-70	74 1/2"	PX, FX, 7718-7727	45 lbs.	21.00
VS-77	81 1/2"	PX, FX, 8418-8427	50 lbs.	23.40



Brackets BR-118 and Shelf SS-1918

SIDE MOUNTING BRACKETS

Sold in pairs. Slotted to provide additional vertical adjustment when fastened to Vertical Side Supports. Brackets are 2" wide and 1-13/16" high. Length fits 18" and 24" deep racks. Made from 1/8" steel, zinc plated. Necessary bolts supplied.

Cat. No.	Length	To Fit Racks	Net Price
BR-118	14"	All 18" deep racks	\$2.70 pr.
BR-124	20"	All 24" deep racks	3.60 pr.

EQUIPMENT SHELVES

To be used with Side Mounting Brackets listed above. Makes a complete shelf between Vertical Side Supports. Material is 1/16" sheet steel; necessary holes and bolts for assembly included.

Cat. No.	Width	Depth	Height	To Fit Racks	Net Price
SS-1918	15 3/8"	14 1/4"	7/8"	18" deep	\$2.85
SS-2724	20 3/8"	20 1/4"	7/8"	24" deep	4.05

SLIDING SHELF UNITS

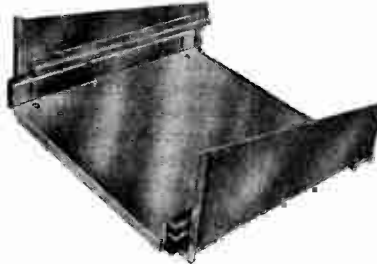

Basic Slide Assembly SD-1916

These sliding shelves may be mounted in either Type "PX" or "FX" racks. When mounted on Type "PX" racks, narrow trims must be used (see Page J-92). They are fastened directly to the front panel mounting angles, similar to regular panels.

The basic assembly illustrated is sold as a complete unit. Panel and chassis assemblies may be bolted to the shelves. Standard chassis brackets listed on Page J-97 may also be bolted to the shelves, using either flat or formed panels with a minimum height of 7". Forward movement of shelf is 13 1/4" on 18" deep racks, and 17 1/4" on 24" deep racks. The shelf may be quickly inserted or removed from the slide, when in an extended position.

Cat. No.	Usable Space		Panel Width	Rack Depth	Net Price
	Width	Depth			
SD-1916	15 3/8"	14 1/4"	19"	18"	\$13.95
SD-2416	20 3/8"	20 1/4"	24"	24"	25.50

PHONO DRAWER ASSEMBLIES

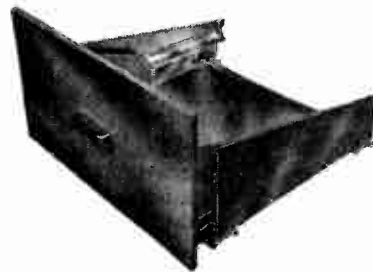

Phono Drawer Assembly PH-1916

Consists of a basic sliding shelf assembly with a drawer front and handle as illustrated. Drawer front is similar to regular formed panel 10 1/2" high. Base or platform for changer not supplied by us, as they are generally available

from changer manufacturers.

Cat. No.	Usable Space		Panel Size	Rack Depth	Net Price
	Width	Depth			
*PH-1916	15 3/8"	14 1/4"	10 1/2 x 14"	18"	\$19.50
*PH-2416	20 3/8"	20 1/4"	10 1/2 x 24"	24"	31.20

*Available in black or grey wrinkle, blue grey enamel, or prime coat only. SPECIFY FINISH REQUIRED.

METAL BASE for RC-80 GARRARD CHANGER

Metal base for Garrard RC80 changer to fit shelf space available is listed below as a separate item.

Cat. No.	Size	Finish	Net Price
MB-50	15x12 1/2 x 4"	Brown	\$4.50

ALL PRICES F.O.B. LONG ISLAND CITY, N. Y. • FOR WEST COAST PRICES, ADD 10%
Export Dept.: Rocke International Corp., 13 E. 40th St., New York 16, N. Y.



PAR-METAL PRODUCTS *Made by Electronic Specialists!*

TYPE "A" ENCLOSED RELAY RACKS FOR 19" WIDE PANELS

DELUXE TYPE

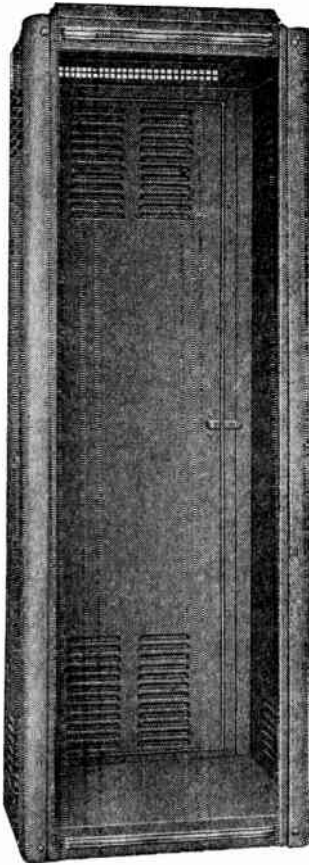

No. ER-225

Our Type "A" Racks are produced in the modern, streamlined style in order that they blend in harmoniously with other equipment you have. In our DeLuxe type units (Series ER-225), the removable vertical corner mouldings are rounded and cover the panel mounting screws.

CABINET: Entire cabinet is constructed of $\frac{1}{8}$ " thick cold-rolled steel. These racks are shipped "knocked-down" with necessary bolts for easy assembly.

PANEL MOUNTING: Angle irons are $\frac{7}{64}$ " thick steel, holes are accurately drilled and tapped 10/32 thread on universal centers for all types of panels.

CORNER TRIMS: All racks have quick, detachable, new corner trims which are fastened to front with two studs. This provides for rapid, fingertip removal without the use of screwdrivers, etc.

HARDWARE: Doors are of new design same as our Type "C" commercial racks. No. ER-223 is equipped with a "push-button" type concealed snap catch. The two larger models have "automobile" type handles. Hinges are the "slip-joint" type so that doors may be easily removed. Front of rack is trimmed with chrome finished mouldings. Screws for mounting panels are supplied.

GANGING: These units may be ganged in double or "multi-rack" units. When so ordered, racks are supplied with common intermediate sides which are joined to adjacent tops and bottoms. Solid intermediate sides are supplied unless otherwise specified. In multiple units, center joining trims are supplied.

FINISH: Slate grey ripple enamel with corner trims finished in slate grey is standard. Black ripple enamel with corner trims finished in dull black will be supplied without extra charge if so specified in your order.

Cat. No.	Overall Size	Panel Space	Shp. Wt. Lbs.	Net Price	RACK SHELVES: Shelf ER-2212 listed on Page J-95 fits these 3 racks.
ER-223	43 $\frac{1}{4}$ x22x18"	36 $\frac{3}{4}$ "	90	\$46.50	ROLLER TRUCK: Truck RT-412 listed on Page J-95 fits these 3 racks.
ER-225	67 $\frac{3}{4}$ x22x18"	61 $\frac{1}{4}$ "	120	57.00	
ER-227	83 $\frac{1}{2}$ x22x18"	77"	140	69.00	

DE LUXE TYPE WITH FRONT DOORS — FOR 19" RACK PANELS

These racks are similar in design to our No. ER-225 and ER-227 racks listed above, except that they are equipped with both front and rear doors. The front door is provided with a lock which is an integral part of the handle.

An important feature of these racks is provided by the full adjustment of panel mounting angles, so that they may be positioned at any distance from the front or rear doors. All other specifications are the same as DeLuxe racks listed above.

ALL PRICES F.O.B. LONG ISLAND CITY, N. Y. • FOR WEST COAST PRICES, ADD 10% Export Dept.: Rocke International Corp., 13 E. 40th St., New York 16, N. Y.

ROUNDED CORNER TYPE

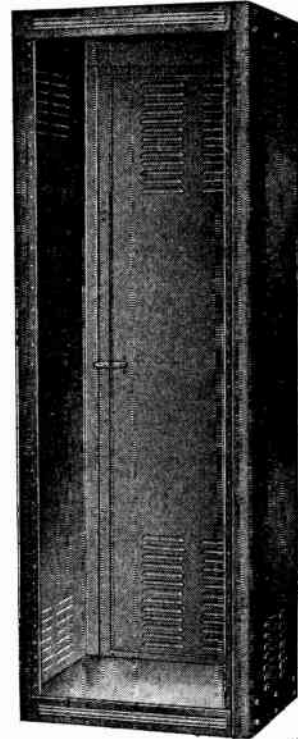

NO. ER-215

These racks are similar in construction to the ER-225 type listed on this page. The panels fit into a recess so that the edges are not exposed; corner trims are omitted. Combines standard functional design and superior construction at an economical price.

FINISH: Slate grey ripple enamel is standard. Black ripple enamel is optional without extra charge, if so specified on your order.

RACK SHELVES: Shelf ER-2112 listed on Page J-95, fits these three racks.

ROLLER TRUCKS: Truck RT-411, listed on Page J-95, fits these three racks.

Cat. No.	Overall Size	Panel Space	Shp. Wt. Lbs.	Net Price
ER-213	42 x22x16 $\frac{1}{2}$ "	36 $\frac{3}{4}$ "	85	\$32.70
ER-215	66 $\frac{1}{2}$ x32x16 $\frac{1}{2}$ "	61 $\frac{1}{4}$ "	110	48.60
ER-217	82 $\frac{1}{4}$ x22x16 $\frac{1}{2}$ "	77"	130	58.50

ROLLER TRUCKS: No. RT-418 fits racks listed below.

Cat. No.	Overall Size	Shp. Wt.	Net Price
FD-225	67 $\frac{3}{4}$ x22x18"	145 lbs.	\$72.00
FD-227	83 $\frac{1}{2}$ x22x18"	165 lbs.	90.00



TYPE "A" CHANNEL RELAY RACKS

For Standard 19" Rack Panels



Black Ripple Finish

Ideal for use on all types of transmitters and public address systems. Substantially constructed of $\frac{3}{4}$ " pressed steel. Vertical members and top crossbrace securely welded together. Base is 22" deep and extends both front and rear on the RR-195 rack; it is 19" deep on the RR-193 rack. Panel mounting holes accurately drilled on universal centers for either "Amateur" or type "C" panels, tapped for 10/32 machine screws. Ample supply of panel mounting screws supplied.

Cat. No.	Overall Size	Panel Space	Shp. Wt. Lbs.	Net Price
RR-195	73 1/4 x 20 x 20 7/8"	7 1/4"	55	\$21.00
RR-193	38 1/4 x 20 x 18 3/8"	3 6/8"	45	18.00

TABLE TYPE RELAY RACKS

Useful where floor type heavy duty rack is not required. Mounting holes accurately drilled on universal centers. Tapped for 10/32 screws. Finished in black ripple enamel and shipped "knocked-down" with all necessary screws.



Cat. No.	Overall Size	Panel Space	Shp. Wt. Lbs.	Net Price
TR-2520	25x21x12"	21x19"	17	\$ 9.00
TR-3220	32x21x12"	28x19"	20	8.55

SHELVES for CABINET RACKS



These shelves are designed to fit into the various enclosed racks listed in this catalog. They are

constructed to be mounted inside the rack, with side bolt mounting. All shelves are 1" high, and finished in black ripple enamel. Shipping weight of all shelves, 10 lbs.

Cat. No.	Will Fit Rack No.	Shelf Size	Net Price
R-2015	P, PG or A-3675 P, PG or A-6625 P, PG or A-8325 F-6618, F-8318	13x21 7/8"	\$4.50
R-2018	P, PG or A-3618 P, PG or A-6618 P, PG or A-8318	16x21 7/8"	4.65
ER-2112	ER-213, ER-215, ER-217	13x21 1/8"	3.15
R-2128	DL-128, DL-1225, DL-1413, DL-1713, DL-2613, DL-3513	12x21 1/8"	2.55
ER-2212	ER-223, ER-225, ER-227	15x21 1/8"	3.15
R-2215	FD-215, FD-217	10 5/8 x 21 1/8"	3.15
R-2218	P, PG or A-6918 P, PG or A-7818 P, PG or A-8518	16x23 1/2"	4.20
R-2219	G-2218, G-2219	16x21 5/8"	4.50
R-2224	P, PG or A-6924 P, PG or A-7824 P, PG or A-8524	22x23 1/2"	5.10

DESK PANEL CABINET RACKS

For Standard 19" Rack Panels
21 1/2" Long x 15" Deep

Streamlined styling. The vertical front corners are rounded and trimmed with mouldings. Panels fit into a recess, so that the edges are not exposed. Panel mounting holes drilled on universal centers, for "Amateur" or type "C" panels; holes are tapped 10/82. May be used with any chassis up to 13" x 17" in size. Louvers provide ample ventilation. Panel mounting screws and washers furnished. Black ripple enamel is standard. Slate grey is optional at same price.

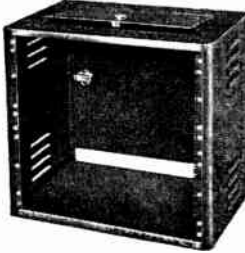

Cat. No.	Overall Height	Panel Space	Shp. Wt. Lbs.	Net Price
DL-128	10 1/2"	8 3/4"	28	\$12.48
DL-1210	12 1/4"	10 1/2"	29	14.10
DL-1225	14"	12 1/4"	30	15.15
DL-1413	15 3/4"	14"	32	16.80
With Door in Top and Door on Rear Panel				
DL-1713	19 1/4"	17 1/2"	38	19.20
DL-2613	28"	26 1/4"	48	22.50
DL-3513	36 3/4"	35"	58	24.90

ROLLER TRUCKS FOR RACKS



Designed for use on our racks. Overall size is wider than racks for better distribution of weight. Has rubber composition wheels. Finished in slate grey ripple, with chrome trim. Shipping Weight on all size Roller Trucks is 20 lbs.

Cat. No.	Will Fit Rack No.	Net Price
RT-410	DL-2613, DL-3513	\$ 9.00
RT-411	ER-213 ER-215, ER-217	9.60
RT-412	All 18" deep racks	10.50
RT-415	All 15 1/4" deep racks	11.40
RT-418	All 18 1/2" deep racks	12.30
RT-424	All 21" deep racks on P. J-90	13.50
RT-427	All 24" deep racks on P. J-82	16.00

*RT-412 Roller Trucks are used for 18" Deep Racks except those listed on Page J-92 and FD-225, FD-227 which use RT-418 Trucks.

STEEL UTILITY CASES

These cases have flat tops and bottoms, which are removable. Made from 20 gauge sheet steel, with flanged edges and spot-welded corners. Finished in black ripple enamel.

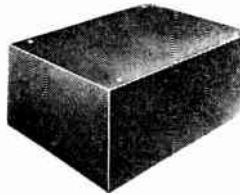

Cat. No.	Overall Size	Shp. Wt. Lbs.	Net Price
MC-442	4x 4 x 2"	1	\$0.81
MC-453	4x 5 x 3"	2	.93
MC-596	5x 9 x 6"	4	1.77
MC-654	6x 5 x 4"	3	1.20
MC-666	6x 6 x 6"	3	1.53
MC-8101	8x10 x 10"	7	3.24
MC-8107	8x10 x 7"	6	2.76
MC-1128	11x12 x 8"	9	3.60
MC-1576	15x 7 3/4 x 6 1/2"	9	3.15
MC-1597	15x 9 x 7"	8	3.90

HINGED STEEL CABINETS

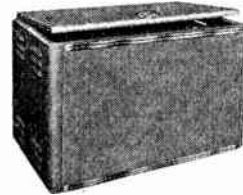

DeLuxe Type

Has rounded front corners. New type formed top door hinged at back with large opening for full access to interior. Chrome finished mouldings, modern handle at top and bottom opening at rear for leads. Grey ripple enamel finish. Prices do not include chassis.

Cat. No.	H. L. D.	For Chassis	Shp. Wt. Lbs.	Net Price
CA-300	9x12 1/2 x 8"	7x 9x2"	6	\$ 5.55
CA-301	9x16 1/2 x 8"	7x13x2"	7	6.30
CA-302	10x17 1/2 x 11"	10x14x3"	8	9.90
CA-303	10x20 1/2 x 9"	8x17x3"	11	9.90
CA-304	13x20 1/2 x 12"	10x17x3"	15	11.10

HINGED STEEL CABINETS

Rounded Corner Type

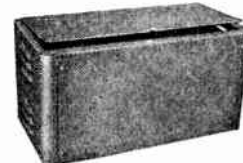

These cabinets are similar in design to DeLuxe type with hinges at back for full access to interior. Rear opening allows for necessary leads.

etc. Slate grey ripple finish. Prices do not include chassis.

Cat. No.	H. L. D.	For Chassis	Shp. Wt. Lbs.	Net Price
CA-200	8 1/2 x 10 1/2 x 8"	7x 7x2"	6	\$4.05
CA-201	8 1/2 x 12 1/2 x 8"	7x 9x2"	7	4.35
CA-202	8 1/2 x 16 1/2 x 8"	7x13x2"	8	5.25
CA-203	9 1/2 x 17 1/2 x 11"	10x14x3"	11	8.25
CA-204	12 1/2 x 20 1/2 x 12"	10x17x3"	15	9.75

SLOPING FRONT CABINETS

Adaptable as instrument cases for studios, laboratories, etc. Top corner rounded and trimmed with chrome moulding. Slate grey ripple finish. A chassis may be mounted to front



panel and removed as a unit. Rear of case ventilated, with opening for connections. Prices do not include chassis.

Cat. No.	H. W. D.	For Chassis	Shp. Wt. Lbs.	Net Price
SF-500	8x 8x 8"	7x 7x2"	6	\$3.96
SF-501	8x10x 8"	7x 9x2"	7	4.41
SF-502	8x14x 8"	7x13x2"	8	4.74
SF-503	9x18x 8"	7x17x3"	10	7.20
SF-504	12x18x12"	10x17x3"	14	9.00

STEEL METER CASES

These meter cases may be obtained for 2" and 3" meters, in both single and triple units. They are substantially made of steel, with welded joints, and black ripple enamel finish. Top front corner is rounded.



Cat. No.	Meters	Meter Hole	Shp. Wt. Lbs.	Net Price
SM-12	Single 2"	2 1/4"	1	\$ 9.99
SM-32	Three 2"	2 1/4"	2	2.76
SM-13	Single 3"	2 1/8"	1	9.99
SM-33	Three 3"	2 1/8"	2	2.76

ALL PRICES F.O.B. LONG ISLAND CITY, N. Y. • FOR WEST COAST PRICES, ADD 10%
Export Dept.: Rocke International Corp., 13 E. 40th St., New York 16, N. Y.



PAR-METAL PRODUCTS *Made by Electronic Specialists!*

TYPE "C" RACK PANELS—19"-24"-30" WIDE

Panels are available in 1/8" thick steel or aluminum; also from 1/16" steel formed to 7/16" thickness. They will fit both Type "A" and "C" relay racks listed, or any other racks having multiple 1 1/4"-1/2" spacings.

Standard finishes are black or grey ripple enamel. Light grey enamel to match Utility Desk Assemblies listed on Pages J-98 and J-99 are also available on all panels listed on this page.

STANDARD BLANK PANELS

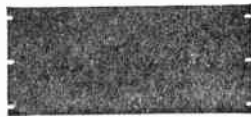

Regular flat panels made from 1/8" thick steel, either 19", 24", or 30" wide. Black as listed. For

or Slate Grey ripple enamel add 20%. Light Grey enamel, add 20%.

19" WIDE PANELS — 1/8" STEEL

Cat. No.	Cat. No.	Height	Ship. Wt. Lbs.	Net Price
Black	Grey			
6600	G-6600	1 3/4"	2	\$.66
6601	G-6601	3 1/4"	3	.75
6602	G-6602	5 1/4"	4	.96
6603	G-6603	7"	5	1.14
6604	G-6604	8 3/4"	7	1.38
6605	G-6605	10 1/2"	8	1.59
6606	G-6606	12 1/4"	9	1.89
6607	G-6607	14"	10	2.16
6608	G-6608	15 3/4"	12	2.46
6609	G-6609	17 1/2"	13	2.70
6610	G-6610	19 1/4"	14	3.00
6611	G-6611	21"	15	3.30

24" WIDE PANELS — 1/8" STEEL

Cat. No.	Cat. No.	Height	Ship. Wt. Lbs.	Net Price
Black	Grey			
6201	G-6201	3 1/2"	4	\$1.14
6202	G-6202	5 1/4"	6	1.41
6203	G-6203	7"	7	1.65
6204	G-6204	8 3/4"	9	2.01
6205	G-6205	10 1/2"	10	2.40
6206	G-6206	12 1/4"	12	2.68
6207	G-6207	14"	14	3.30
6208	G-6208	15 3/4"	15	3.75
6209	G-6209	17 1/2"	17	4.11
6210	G-6210	19 1/4"	18	4.59
6211	G-6211	21"	20	5.04

30" WIDE PANELS — 1/8" STEEL

Cat. No.	Cat. No.	Height	Ship. Wt. Lbs.	Net Price
Black	Grey			
6301	G-6301	3 1/2"	4	\$1.56
6302	G-6302	5 1/4"	6	1.92
6303	G-6303	7"	8	2.25
6304	G-6304	8 3/4"	10	2.70
6305	G-6305	10 1/2"	12	3.30
6306	G-6306	12 1/4"	14	3.90
6307	G-6307	14"	16	4.44
6308	G-6308	15 3/4"	18	4.95
6309	G-6309	17 1/2"	20	5.55
6310	G-6310	19 1/4"	22	6.15
6311	G-6311	21"	24	6.75

BLANK PANELS — 19" WIDE 1/8" ALUMINUM

Cat. No.	Cat. No.	Height	Ship. Wt. Lbs.	Net Price
Black	Grey			
6675	G-6675	1 3/4"	1	\$0.75
6676	G-6676	3 1/4"	1	1.08
6677	G-6677	5 1/4"	2	1.50
6678	G-6678	7"	2	1.80
6679	G-6679	8 3/4"	3	2.19
6680	G-6680	10 1/2"	3	2.76
6681	G-6681	12 1/4"	4	3.21
6682	G-6682	14"	4	3.69
6683	G-6683	15 3/4"	5	4.11
6684	G-6684	17 1/2"	5	4.53
6685	G-6685	19 1/4"	6	4.95
6686	G-6686	21"	7	5.40

Aluminum Panels 24" or 30" wide are also available, either 1/8" or 3/8" thick. For Light Grey enamel, add 10%.

STANDARD GRILLE PANELS 19" WIDE PANELS — 1/8" STEEL

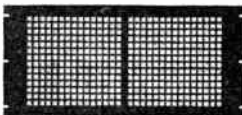

This modern type ventilating grille is stamped into the panel itself; it is not a piece assembly.

P—Black Wrinkle G—Grey Wrinkle

Cat. No.	Panel Size	Grille Size	Shp. Wt. Lbs.	Net Price
P. G-661	5 1/4"	3 3/4" x 1 3/4"	4	\$2.64
P. G-662	7"	4 7/8" x 1 3/4"	5	2.85
P. G-663	8 3/4"	6 7/8" x 1 3/4"	6	3.45
P. G-664	10 1/2"	8 3/4" x 1 3/4"	6	3.15
P. G-665	12 1/4"	8 3/4" x 1 3/4"	7	3.75
P. G-666	14"	8 3/4" x 1 3/4"	7	3.45
P. G-667	15 3/4"	7 3/4" x 1 3/4"	8	3.90

*Allows 3 1/2" space at bottom for chassis mounting.

STANDARD DOOR PANELS 19" WIDE PANELS — 1/8" STEEL

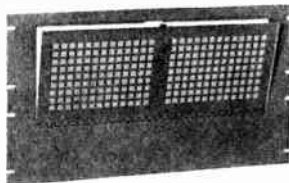

These panels have flush hinged doors with modern type ventilating grille. Doors are equipped with piano hinges, knob and concealed catch. All doors start 1" from top to allow space for chassis at bottom. Regular chassis brackets may be used.

P—Black Wrinkle G—Grey Wrinkle

WITH GRILLE DOORS

Cat. No.	Panel Size	Door Size	Shp. Wt. Lbs.	Net Price
P. G-680	8 3/4"	4 1/2" x 1 5/8"	7	\$5.70
P. G-681	10 1/2"	6" x 1 5/8"	8	6.15
P. G-682	12 1/4"	7 1/2" x 1 5/8"	9	6.75

WITH SOLID DOORS

Cat. No.	Panel Size	Door Size	Shp. Wt. Lbs.	Net Price
P. G-670	8 3/4"	4 1/2" x 1 5/8"	7	\$4.41
P. G-671	10 1/2"	6" x 1 5/8"	8	4.71
P. G-672	12 1/4"	7 1/2" x 1 5/8"	9	5.19

STANDARD DESK PANELS



Tables are rigidly made of 1/16" thick steel. Securely mounted to regular 1/8" steel panels, size 10 1/2" x 19". Tables 22" wide give full working space across front of racks when mounted in place.

Cat. No.	Finish	Width	Depth	Net Price
BT-2216	Black enamel	22"	16"	\$13.50
BT-2220	Black enamel	22"	20"	14.75
GT-2216	Grey enamel	22"	16"	14.40
GT-2220	Grey enamel	22"	20"	15.90

FORMED BLANK PANELS

Made from 1/16" steel with formed edges to make overall thickness 1/8". Finished in black or grey ripple enamel as listed.

For light grey enamel, add 20%.



19" WIDE PANELS — 1/16" STEEL

Cat. No.	Cat. No.	Height	Ship. Wt. Lbs.	Net Price
Black	Grey			
P-601	G-601	3 1/2"	2	\$.90
P-602	G-602	5 1/4"	2	1.05
P-603	G-603	7"	3	1.20
P-604	G-604	8 3/4"	4	1.45
P-605	G-605	10 1/2"	5	1.80
P-606	G-606	12 1/4"	6	2.10
P-607	G-607	14"	6	2.35
P-608	G-608	15 3/4"	7	2.70
P-609	G-609	17 1/2"	7	3.00
P-610	G-610	19 1/4"	8	3.30
P-611	G-611	21"	9	3.60

24" WIDE PANELS — 1/16" STEEL

Cat. No.	Cat. No.	Height	Ship. Wt. Lbs.	Net Price
Black	Grey			
P-641	G-641	3 1/2"	2	\$1.45
P-642	G-642	5 1/4"	3	1.70
P-643	G-643	7"	4	1.90
P-644	G-644	8 3/4"	5	2.30
P-645	G-645	10 1/2"	6	2.90
P-646	G-646	12 1/4"	7	3.40
P-647	G-647	14"	8	3.80
P-648	G-648	15 3/4"	9	4.30
P-649	G-649	17 1/2"	9	4.80
P-650	G-650	19 1/4"	10	5.30
P-651	G-651	21"	10	5.80

FORMED BLANK PANELS 19" WIDE PANELS — 1/16" STEEL

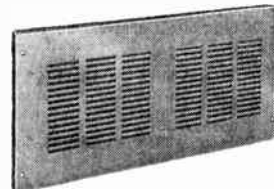

Formed panels same as above with louvers to match those used in Utility Desk Assemblies. Finished in black or grey ripple enamel. For light grey enamel, add 10%. 24" wide panels are also available.

Cat. No.	Cat. No.	Size	Ship. Wt. Lbs.	Net Price
Black	Grey			
PV-603	GV-603	7"	3	\$2.85
PV-604	GV-604	8 3/4"	4	3.15
PV-605	GV-605	10 1/2"	5	3.45
PV-606	GV-606	12 1/4"	6	3.90
PV-611	GV-611	21"	9	6.00

ALL PRICES F.O.B. LONG ISLAND CITY, N. Y. • FOR WEST COAST PRICES, ADD 10%

Export Dept.: Rocke International Corp., 13 E. 40th St., New York 16, N. Y.



STEEL CHASSIS BASES

STANDARD TYPE CHASSIS



Construction is the same as our heavy-duty chassis. Stamped from one piece of cold rolled steel, and have four solid sides with welded corners. Bottom edges are flanged in on four sides to provide additional reinforcement, and they are drilled for bottom plates. The chassis are made from #20 gauge steel, except those marked (*) which are stamped from $\frac{1}{8}$ " steel exactly like our heavy-duty type.

Cat. No. Black Ripple	Cat. No. Zinc Plated	Size	Shp. Wt. Lbs.	Net Price
B-4500	C-4500	5 1/2 x 9 1/2 x 1 1/2"	2	\$0.81
B-4507	C-4507	5x 7x2"	2	.90
B-4508	C-4508	5x10x3"	3	1.08
B-4509	C-4509	6x14x3"	4	1.35
B-4510	C-4510	7x 7x2"	2	.96
B-4511	C-4511	7x 9x2"	2	1.08
B-4512	C-4512	7x11x2"	3	1.17
B-4513	C-4513	7x13x2"	3	1.26
B-4514	C-4514	7x15x3"	4	1.53
B-4518	C-4518	4x17x3"	4	1.32
B-4515	C-4515	7x17x3"	4	1.62
B-4502	C-4502	8x12x3"	5	1.50
B-4531	C-4531	8x17x2"	4	1.62
B-4532	C-4532	8x17x3"	5	1.74
B-4525	C-4525	10x12x3"	4	1.59
B-4524	C-4524	10x14x3"	5	1.65
B-4528	C-4528	10x17x2"	5	1.71
B-4529	C-4529	10x17x4"	7	2.04
B-4526	C-4526	10x17x3"	7	1.77
B-4527	C-4527	10x23x3"	7	2.34
B-4533*	C-4533*	11x17x2"	7	2.40
B-4534*	C-4534*	11x17x3"	9	2.70
B-4516	C-4516	12x17x2"	5	1.92
B-4517	C-4517	12x17x3"	6	2.13
B-4530	C-4530	12x17x4"	6	2.55
B-4535*	C-4535*	13x17x2"	8	2.70
B-4536*	C-4536*	13x17x3"	9	3.15
B-4537*	C-4537*	12x17x4"	10	3.54
B-4540	C-4540	17x17x4"	13	4.05

BOTTOM PLATES

Bottom plates have holes to match the chassis, and have pressed "bumpers" at the corners.

Cat. No. Black Ripple	Cat. No. Zinc Plated	Size	Shp. Wt. Lbs.	Net Price
BP-4507	CP-4507	5x 7"	1	\$0.39
BP-4502	CP-4502	8x12"	1	.75
BP-4500	CP-4500	5 1/2 x 9 1/2"	1	.42
BP-4508	CP-4508	5x10"	1	.42
BP-4509	CP-4509	6x14"	1	.60
BP-4510	CP-4510	7x 7"	1	.51
BP-4511	CP-4511	7x 9"	1	.54
BP-4512	CP-4512	7x11"	1	.63
BP-4513	CP-4513	7x13"	2	.66
BP-4514	CP-4514	7x15"	2	.70
BP-4518	CP-4518	4x17"	2	.57
BP-4515	CP-4515	7x17"	2	.72
BP-4531	CP-4531	8x17"	2	.75
BP-4525	CP-4525	10x12"	2	.75
BP-4524	CP-4524	10x14"	2	.75
BP-4528	CP-4528	10x17"	2	.96
BP-4527	CP-4527	10x23"	3	1.26
BP-4533	CP-4533	11x17"	2	.90
BP-4516	CP-4516	12x17"	3	1.08
BP-4535	CP-4535	13x17"	3	1.20
BP-4540	CP-4540	17x17"	4	1.65

HEAVY DUTY TYPE CHASSIS

These heavy duty bases resemble the standard types illustrated in the column at the left.

However, they are substantially constructed for "heavy duty" uses since they are formed from one piece of 1/16" sheet steel. Bottom plates and mounting screws are supplied with each of these chassis.

Ends are drilled to fit standard chassis mounting brackets listed at the bottom of this column.

Cat. No. Black Ripple	Cat. No. Zinc Plated	Dimensions	Shp. Wt. Lbs.	Net Price
15280	15208	8x17x2"	8	\$2.92
15281	15209	8x17x3"	9	3.18
15282	15218	11x17x2"	9	3.39
15210	15219	11x17x3"	11	3.60
15212	15214	13x17x2"	11	3.90
15213	15215	13x17x3"	12	4.35
15216	15217	13x17x4"	13	4.74
15283	15284	17x17x4"	18	5.70

RACK TYPE CHASSIS

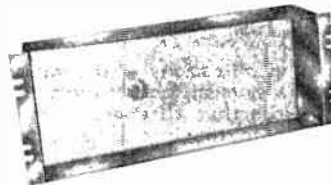

These chassis are suitable for vertical mounting on pedestals or standard relay racks. They may be mounted under the formed panels listed on Page J-95 as they are made with additional slotted holes to clear panel mounting screws. They may be obtained from $\frac{1}{8}$ " thick aluminum with etched finish, or $\frac{1}{8}$ " thick steel, zinc plated. Overall length, including mounting flanges, is 18 3/4".

STEEL			ALUMINUM		
Cat. No.	Dimensions	Net Price	Cat. No.	Dimensions	Net Price
SC-402	4 1/2" x 17" x 3"	\$2.40	AC-402	4 1/2" x 17" x 3"	\$3.30
SC-403	6 1/2" x 17" x 3"	2.70	AC-403	6 1/2" x 17" x 3"	3.75
SC-404	8 1/2" x 17" x 3"	3.00	AC-404	8 1/2" x 17" x 3"	4.20
SC-405	10 1/2" x 17" x 3"	3.30	AC-405	10 1/2" x 17" x 3"	4.65
SC-406	11 1/2" x 17" x 3"	3.60	AC-406	11 1/2" x 17" x 3"	5.20

SLOPING FRONT TYPE Amplifier Foundation Chassis



Latest trend in amplifier design. Combination of sloping front panel and streamlined cover enables you to build up a job similar to that used on commercial deluxe type amplifiers. All parts finished in slate grey ripple enamel trimmed with chrome moulding and handles. Front panel removable and protrudes 3" from face of screen cover. Chassis supplied complete WITH bottom plates.

Cat. No.	Chassis Size	Screen Cover	Shp. Wt. Lbs.	Net Price
F-10120	10x12x3"	6 1/2" high	11	\$6.90
F-10170	10x17x3"	6 1/2" high	13	7.80
F-13170	13x17x3"	6 1/2" high	15	8.85

ROUNDED CORNER TYPE Amplifier Foundation Chassis

Modern professional type. Rounded corners on screen cover. Chrome mouldings and handles. Cover finished in slate grey, with black ripple chassis.



Cat. No.	Chassis Size	Depth of Cover	Shp. Wt. Lbs.	Net Price
DF-510	5x10x3"	6"	7	\$4.23
DF-615	6x14x3"	6"	8	4.65
DF-717	7x17x3"	6"	9	5.40
DF-1012	10x12x3"	6"	9	5.40
DF-1017	10x17x3"	6"	10	6.15
DF-1317	13x17x3"	6"	12	7.35

CHASSIS MOUNTING BRACKETS



These brackets will fit any of the chassis listed above, as the mounting holes are drilled to match. Panels must be at least 7" high. Finished in black enamel.

Cat. No.	Dimensions	Shp. Wt. Lbs.	Net Price
SB-78	For 8" Base	2	\$0.84
SB-710	For 10" Base	2	1.08
SB-711	For 11" Base	2	1.20
SB-713	For 13" Base	3	1.41
SB-717	For 17" Base & Larger	4	2.04

STANDARD TYPE Amplifier Foundation Chassis



Rounded corners effectively streamline the covers on these units. Grille type ventilation gives them a modern appearance. Chassis stamped from one piece of cold rolled steel, with corners securely spot welded. Covers finished in slate grey, chassis in black ripple enamel. Chassis are drilled for bottom plates.

Cat. No.	Size	Depth of Cover	Shp. Wt. Lbs.	Net Price
F-510	5x10x3"	6"	7	\$3.24
F-615	6x14x3"	6"	8	3.54
F-717	7x17x3"	6"	9	4.26
F-1012	10x12x3"	6"	9	4.26
F-1017	10x17x3"	6"	10	5.04
F-1317	13x17x3"	6"	12	6.00

ALL PRICES F.O.B. LONG ISLAND CITY, N. Y. • FOR WEST COAST PRICES, ADD 10%
Export Dept.: Rocke International Corp., 13 E. 40th St., New York 16, N. Y.



PAR-METAL PRODUCTS *Made by Electronic Specialists!*

UTILITY DESK ASSEMBLIES

Standardized Units Adaptable to Individual Requirements

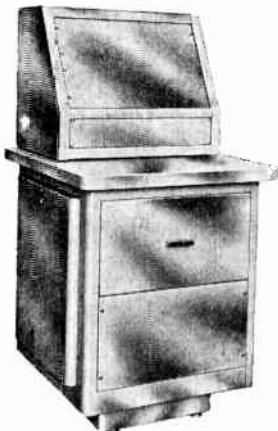

**SINGLE UNIT
ASSEMBLY**

The combination of a control cabinet mounted on a table, desk or similar support has been in general use in the electronics industry for some time. Due to the various functions for which it may be employed, such equipment has assumed various forms, arrangements and sizes, requiring costly, custom-built construction to achieve their purpose.

While it is obvious that no particular fixed design can serve every demand, we have devised a group of **standardized units**, the combination of which is readily adaptable for control stations, testing apparatus, sound distribution systems, and similar applications.

The sizes and specifications of the various units are catalogued on the following page. There are several features which warrant your consideration, particularly the pedestal. Note that all doors of the pedestal are easily removable, allowing complete access to the interior **from all sides**. (See illustration at left.) Each side of the four supporting posts has also been drilled and tapped on "universal" centers, making it possible to mount standard rack panels or doors on any or all sides, at your preference. Each door is equipped with a "push-button" spring catch, plus a lock with interchangeable keys. The use of the lock is optional.

Another time-saving aid is the method of supporting apparatus in the interior of the pedestal. Universal brackets are easily attached to any of the four sides by utilizing the tapped panel mounting holes. The brackets are slotted, so that almost continual vertical adjustment may be made. They may be used to support regular 17" wide chassis, or standard shelves. The shelves are suitable for mounting amplifiers, power supplies, record changers, etc.

All table-tops have screw type studs, which are inserted in matching holes already drilled in the pedestals. The desk cabinets have necessary mounting holes, but they have been omitted from the table top to permit a flexible assembly of similar cabinets, or other equipment.

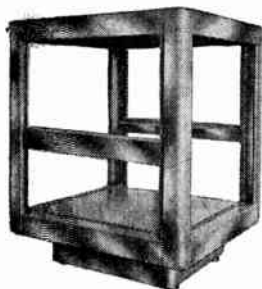

The above will illustrate how brackets are mounted. They are used for mounting chassis, standard shelves, or drawers. With all sides open, easy access saves considerable time in assembly.

SPECIFICATIONS: The Desk Panel Cabinets, Table Tops and Pedestals are constructed of 1/16" thick furniture steel. They are rigidly braced and reinforced wherever necessary, and substantially welded into integral units. No holes have been drilled in the table tops for desk cabinets, to permit cabinets to be located wherever desired.

FINISH: Unless otherwise specified, the standard finish for all items on Pages J-98 and J-99 is light grey enamel. Black wrinkle, slate grey wrinkle, grey hammertone, or prime coat only is available at same price. Samples of above finishes will be mailed upon request.



DOUBLE UNIT ASSEMBLY

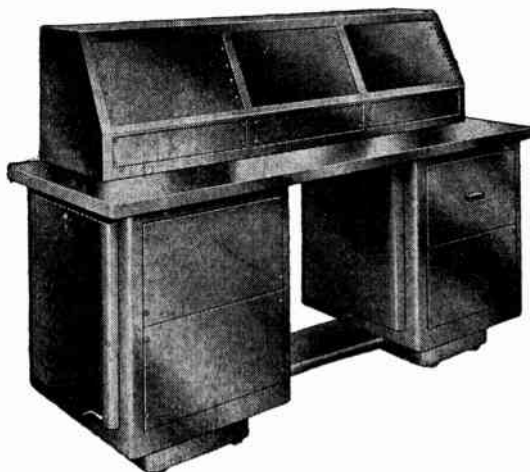

TRIPLE UNIT ASSEMBLY

ALL PRICES F.O.B. LONG ISLAND CITY, N. Y. • FOR WEST COAST PRICES, ADD 10%
Export Dept.: Rocke International Corp., 13 E. 40th St., New York 16, N. Y.



UTILITY DESK ASSEMBLIES

DESK PANEL CABINETS

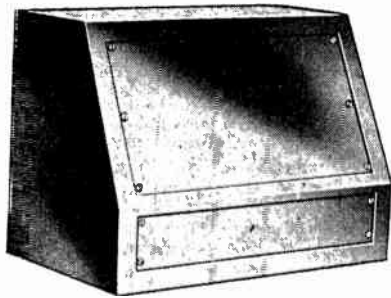

These cabinets are available in single, double and triple units, as listed below. Double and triple units are shown on opposite page.

DOORS: Hinged door at back is removable; adequately louvered for ventilation.

Equipped with combined "push-button" catch and lock. Individual doors on each section of multiple unit cabinets.

PARTITION: Solid partition between each section in multiple units, with wiring access holes.

PANELS: Any panel up to 7/16" thick may be used. Upper panel is 12 1/4" x 19", lower panel is 3 1/2" x 19". Upper panel is mounted at 30° angle. (See Page J-96 for panels.)

MOUNTING HOLES: Drilled in bottom. Also two "knockout" holes 1 1/8" diameter near back.

Cat. No.	Description	Length	Depth	Height
CC-101	Single Unit	21 5/8"	18 1/4"	16"
CC-102	Double Unit	42"	18 1/4"	16"
CC-103	Triple Unit	62 1/4"	18 1/4"	16"

TABLE TOPS

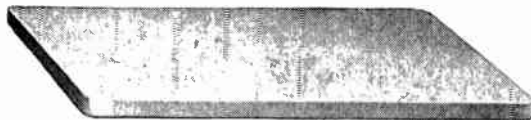

TABLE TOPS are made in three lengths, for use with single, double or triple unit assemblies. They are constructed from 1/16" furniture steel, braced on underside; all edges flanged underneath to provide smooth surface. Screw studs are inserted to match holes in pedestals. No holes are drilled in top for desk cabinets, so that cabinets may be located wherever desired.

Cat. No.	Description	Width	Length	Depth
T-301	Single Unit	28"	25"	1 1/2"
T-302	Double Unit	28"	55"	1 1/2"
T-303	Triple Unit	28"	71"	1 1/2"

MOUNTING BRACKETS AND SHELF



BRACKETS are essential for mounting interior apparatus. Slotted for vertical adjustment on sides of rack pedestals. They may be used with or without shelf which fits between brackets. Drilled for easy assembly.

BRACKET	Cat. No.	Size
	CB-20	18 3/4" x 2 x 2 3/4"
SHELF	CD-12	17 1/2" W 22" D 3/4" H

RACK PEDESTALS

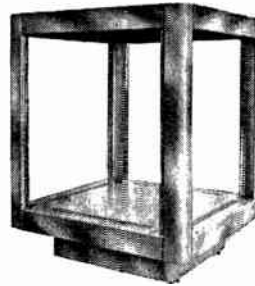

RACK PEDESTALS are rigidly welded together into one integral unit.

PANEL MOUNTING space is 21" x 19" on all four sides, with holes tapped 10/32 on "universal centers." Either panels or doors may be mounted on any side (not both).

DOORS are slip-in type held closed by combined "push-button catches" and locks. Doors are interchangeable and are available both plain and ventilated.

BASE is 4" high, set in for toe space; equipped with adjustable "glider type" casters.

PEDESTAL (less doors and panels). No. PD-200.

Overall Size: 22" long, 24" deep, 26" high.

Panel Space: 21"x19" on all four sides.

Clearance between corner posts: 17 3/4".

Clearance inside (front to back): 23".

Clearance inside (left and right side): 21".

Base height: 4".

PLAIN DOOR (without louvres). Catalog No. PD-201. **Overall Size:** 21" high, 19" wide, 1 1/2" deep.

VENTILATED DOOR (with louvres). No. PD-202.

NOTE: PANELS and CHASSIS for these units are listed on Pages J-96 and J-97.

END PEDESTAL AND FLOOR BRACE

For use with 42" table top to make up **DOUBLE UNIT ASSEMBLY**. End pedestal is 6" wide and 24" deep, with step in base to match rack pedestal. Floor brace is 25 1/2" long. Shipped complete with necessary holes and hardware.

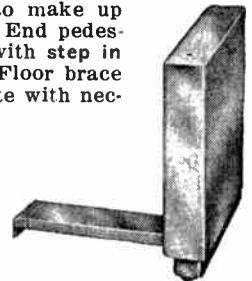

Cat. No.	Unit
PD-210	Pedestal & Floor Brace (for double unit assembly)
PB-211	Floor Brace Only (for triple unit assembly)

SLIDE DRAWER



Suitable for mounting turntables, record changers, etc. Drawer front is similar to 10 1/2" x 19" formed panel. If door is mounted at top of pedestal, a pair of brackets No. CB-20 is required. Since no base is supplied by us, we suggest it be purchased with changer or turntable.

Panel size (drawer front): 10 1/2" x 19".

Mounting platform: 17 1/2" long, 21" deep.

Clear height above platform: 8 3/4".

Forward movement of drawer: 14".

Catalog No. CD-10

SEE PAGE J-98 FOR FINISHES AVAILABLE.

ALL PRICES F.O.B. LONG ISLAND CITY, N. Y. • FOR WEST COAST PRICES, ADD 10%

Export Dept.: Rocke International Corp., 13 E. 40th St., New York 16, N. Y.

PREMIER PRECISION BUILT METAL HOUSINGS

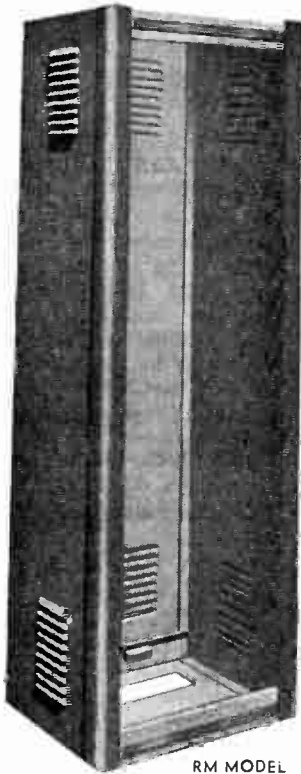

RM MODEL

TRANSMITTER RACKS

- Rigidly constructed of #16 gauge steel with a #12 gauge steel bottom and welded throughout.
- Panel mounting angles are 3/16 thick and are tapped 12-24 on Universal spacing.
- Rear doors are hung on sturdy loose-jointed hinges and closed by a chrome handle.
- A rectangular cut-out is made in the bottom for leads, etc.
- Racks are supplied with or without louvers.
- Vertical rounded corner moldings are supplied on RM racks.
- Tops and bottoms are trimmed with red striped chrome moulding.
- Panel mounting angles are adjustable to any distance from the front door by means of channel slides.
- FD racks have handles and locks.
- Racks finished in either black or gray wrinkle.
- For Gray Hammertone add 10% to net cost.

A Duplex Receptacle and Outlet Box are furnished in the Back Under the Door.

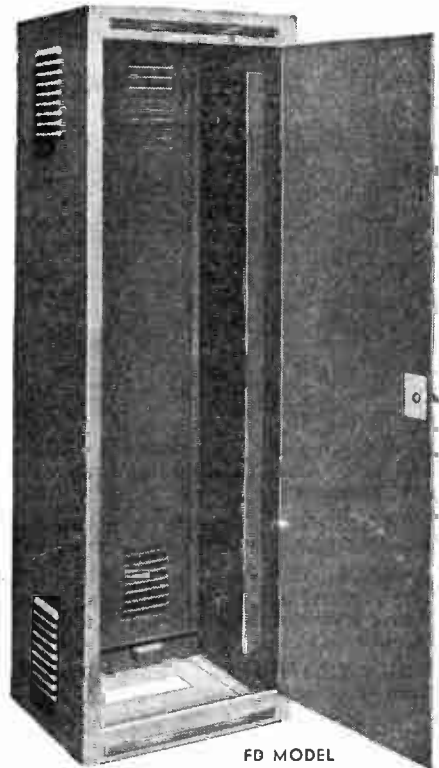

FB MODEL

18" DEEP RACKS

Cat. No.	Size	Panel Space	Shp. Wt. Lbs.	List Price
RM-3619	42 ⁷ / ₈ x22"	36 ³ / ₄ x19"	160	\$100.00
RM-6119	67 ³ / ₈ x22"	61 ¹ / ₄ x19"	230	130.00
RM-7618	76 ¹ / ₈ x22"	70 x19"	250	160.00
RM-7719	83 ¹ / ₈ x22"	77 x19"	270	165.00

24" DEEP RACKS

Cat. No.	Size	Panel Space	Shp. Wt. Lbs.	List Price
RM-6124	67 ³ / ₈ x23 ⁵ / ₈ "	61 ¹ / ₄ x19"	250	\$185.00
RM-7019	76 ¹ / ₈ x23 ⁵ / ₈ "	70 x19"	275	200.00
RM-7724	83 ¹ / ₈ x23 ⁵ / ₈ "	77 x19"	300	225.00
RM-7030	76 ¹ / ₈ x33"	70 x30"	400	290.00

18" DEEP RACKS WITH DOORS

Cat. No.	Size	Panel Space	Shp. Wt. Lbs.	List Price
FD-3619	42 ⁷ / ₈ x22"	36 ³ / ₄ x19"	175	\$155.00
FD-6119	67 ³ / ₈ x22"	61 ¹ / ₄ x19"	270	175.00
FD-7019	76 ¹ / ₈ x22"	70 x19"	280	200.00
FD-7719	83 ¹ / ₈ x22"	77 x19"	320	215.00

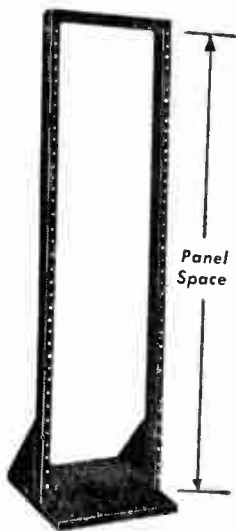

CHANNEL RELAY RACKS

- Rigidly constructed of #12 gauge cold rolled sheet steel and finished in Black Wrinkle.
- Vertical members and top cross-brace are welded together.
- Panel mounting holes are tapped for 10/32 machine screws on Universal Spacings.
- Racks are shipped knocked down with all necessary bolts for easy assembly.

Cat. No.	Overall Dimensions	Panel Space	Shp. Wt. Lbs.	List Price
RR-800	39 ¹ / ₄ " x 20" x 18 ³ / ₈ "	36 ³ / ₄ "	45	\$29.00
RR-801	74 ¹ / ₄ " x 20" x 20 ⁷ / ₈ "	71 ³ / ₄ "	55	34.50
RR-802	79 ¹ / ₂ " x 20" x 20 ⁷ / ₈ "	77"	60	40.00

All prices F.O.B., Bronx, N. Y.

TABLE TYPE RELAY RACKS

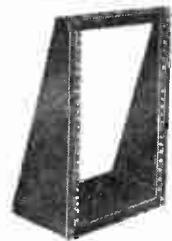

- Rigidly constructed of #16 gauge cold rolled sheet steel and finished in Black Wrinkle.
- Base constructed of one piece, similar to a chassis.
- Panel mounting holes are tapped for 10/32 machine screws on Universal Spacings.
- Racks are shipped knocked down with all necessary bolts for easy assembly.

Cat. No.	H.	W.	D.	Panel Space	Shp. Wt. Lbs.	List Price
TR-2119	25"	21"	12"	21 x 19"	20	\$11.00
TR-2819	32"	21"	12"	28 x 19"	20	13.75

PREMIER METAL PRODUCTS COMPANY

PREMIER PRECISION BUILT METAL HOUSINGS

ENCLOSED RELAY RACKS



STANDARD TYPE

Catalog No. RS-3619
Overall Dimensions: $41\frac{7}{8} \times 22 \times 18$ "
Panel Space: $36\frac{3}{4} \times 19$ "
Shipping Weight: 85 Lbs.
List Price: \$54.50

Catalog No. RS-6119
Overall Dimensions: $66\frac{3}{8} \times 22 \times 18$ "
Panel Space: $61\frac{3}{4} \times 19$ "
Shipping Weight: 120 Lbs.
List Price: \$81.00

Catalog No. RS-7719
Overall Dimensions: $82\frac{1}{8} \times 22 \times 18$ "
Panel Space: 77×19 "
Shipping Weight: 150 Lbs.
List Price: \$97.50

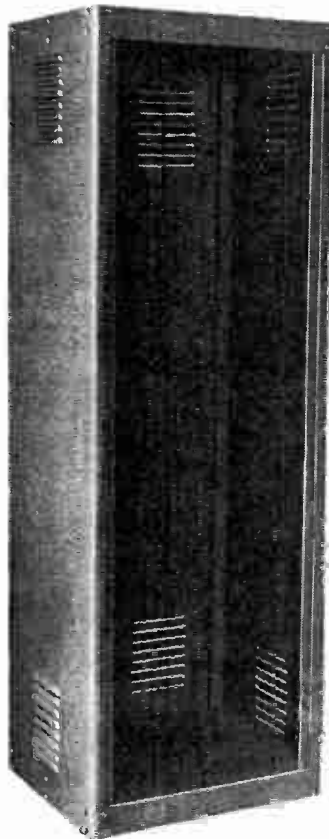

ROUNDED TYPE

Catalog No. R-3619
Overall Dimensions: $41\frac{7}{8} \times 22 \times 18$ "
Panel Space: $36\frac{3}{4} \times 19$ " Shp. Wt.: 85 Lbs.
List Price: \$54.50

Catalog No. R-4219
Overall Dimensions: $47\frac{1}{8} \times 22 \times 18$ "
Panel Space: 42×19 " Shp. Wt.: 100 Lbs.
List Price: \$62.40

Catalog No. R-6119
Overall Dimensions: $66\frac{3}{8} \times 22 \times 18$ "
Panel Space: $61\frac{1}{4} \times 19$ " Shp. Wt.: 120 Lbs.
List Price: \$81.00

Catalog No. R-7719
Overall Dimensions: $82\frac{1}{8} \times 22 \times 18$ "
Panel Space: 77×19 " Shp. Wt.: 150 Lbs.
List Price: \$97.50

All prices F.O.B., Bronx, N. Y.

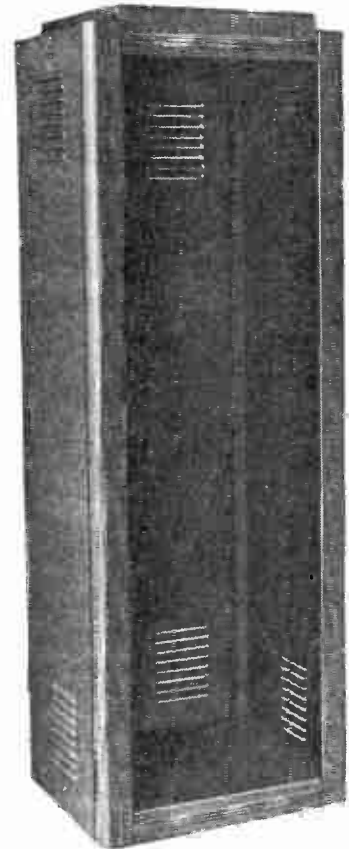

DELUXE TYPE

Catalog No. DR-3619
Overall Dimensions: $43\frac{1}{8} \times 22 \times 18$ "
Panel Space: $36\frac{3}{4} \times 19$ "
Shipping Weight: 90 Lbs.
List Price: \$77.50

Catalog No. DR-6119
Overall Dimensions: $67\frac{5}{8} \times 22 \times 18$ "
Panel Space: $61\frac{1}{4} \times 19$ "
Shipping Weight: 135 Lbs.
List Price: \$95.00

Catalog No. DR-7719
Overall Dimensions: $83\frac{3}{8} \times 22 \times 18$ "
Panel Space: 77×19 "
Shipping Weight: 165 Lbs.
List Price: \$115.00

- Rigidly constructed of #16 gauge cold rolled sheet steel.
- The panel mounting angles are of #12 gauge steel and are tapped for 10/32 machine screws on Universal spacings.
- Panels fit into a recess so that the edges are not exposed.
- Racks are shipped knocked down with all necessary bolts for easy assembly.
- Rear doors are hung on sturdy loose-jointed hinges, and closed by a chrome handle.

- Cabinets finished in either Black or Gray wrinkle.
- For Gray Hammer-tone finish add 10% to net cost.
- ROUNDED TYPE have front vertical rounded corners.
- DELUXE TYPE — The removable vertical corner mouldings are rounded and cover the mounting screws.
- DELUXE TYPE — Top and bottom are trimmed with red striped chrome finished moulding.

MULTIPLE RACK UNITS

The above racks can be joined together to make multiple units by means of a solid center partition which is bolted to the top and bottom. Vertical trim mouldings are supplied on the DR models. When ordering multiple units specify number of units, such as double, triple, etc. Each multiple section comprises a top, bottom, rear door and a center partition. Use the prefix MR for Models R and RS, such as MR-3619; and DMR for DR Models, such as DMR-3619.

PREMIER METAL PRODUCTS COMPANY

PREMIER PRECISION BUILT METAL HOUSINGS

DELUXE DESK PANEL CABINET RACKS FOR STANDARD 19" RACK PANELS

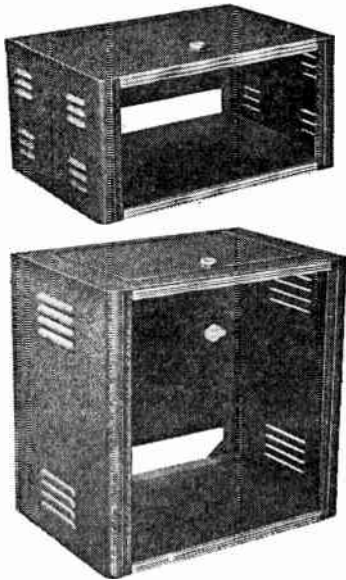

- Front vertical corners are rounded and the top and bottom are trimmed with red striped chrome finished moulding.
- Rigidly constructed of #16 gauge cold rolled sheet steel.
- Panels fit into a recess so that the edges are not exposed.
- Panel mounting holes are tapped for 10/32 machine screws on Universal Spacings.
- Piano type hinges are used on the top doors, which are provided with flush snap catches.
- Cabinets finished in either Black or Grey Wrinkle.
- For Gray Hammertone add 10% to net cost.

SINGLE UNIT (with door in top only)

Cat. No.	Cabinet Size	Available Panel Space	Shp. Wt. Lbs.	List Price
DCR-70	8 3/4 x 21 3/4 x 15 1/4" deep	7 x 19"	22	\$19.00
DCR-80	10 1/2 x 21 3/4 x 15 1/4" deep	8 3/4 x 19"	24	20.00
DCR-100	12 1/4 x 21 3/4 x 15 1/4" deep	10 1/2 x 19"	26	22.50
DCR-120	14 x 21 3/4 x 15 1/4" deep	12 1/4 x 19"	28	24.25
DCR-140	15 3/4 x 21 3/4 x 15 1/4" deep	14 x 19"	32	27.00

DOUBLE UNIT (with door in top and door on rear panel)

DCR-170	19 1/4 x 21 3/4 x 15 1/4" deep	17 1/2 x 19"	40	32.00
DCR-190	21 x 21 3/4 x 15 1/4" deep	19 1/4 x 19"	42	33.50
DCR-210	22 3/4 x 21 3/4 x 15 1/4" deep	21 x 19"	44	34.75

TRIPLE UNIT (with door in top and door on rear panel)

DCR-260	28 x 21 3/4 x 15 1/4" deep	26 1/4 x 19"	45	37.50
DCR-310	33 1/4 x 21 3/4 x 15 1/4" deep	31 1/2 x 19"	40	39.50

QUAD UNIT (with door in top and door on rear panel)

DCR-350	36 3/4 x 21 3/4 x 15 1/4" deep	35 x 19"	55	41.50
---------	--------------------------------	----------	----	-------

CABINETS



SLOPING FRONT

Cabinet has rounded top corners and a removable front panel. Back of cabinet is perforated and has opening for leads. Constructed of #20 gauge steel. Finished in Grey Wrinkle.

Cat. No.	H. W. D.	For Chassis	Shp. Wt. Lbs.	List Price
SFC-500	8 x 8 x 8"	7 x 7 x 2"	6	\$ 6.40
SFC-501	8 x 10 x 8"	7 x 9 x 2"	7	7.10
SFC-502	8 x 14 x 8"	7 x 13 x 2"	8	7.65
SFC-503	9 x 18 x 8"	7 x 17 x 3"	10	11.00
SFC-504	12 x 18 x 12"	10 x 17 x 3"	14	14.00

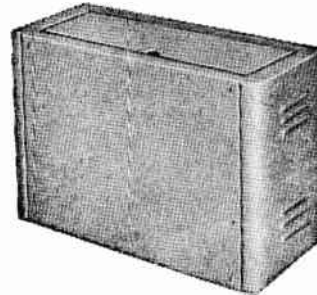

HINGED TOP ROUNDED CORNER TYPE

Cabinet has front vertical rounded corners and a removable front panel. Back of cabinet is perforated and has opening for leads. Constructed of #20 gauge steel. Finished in Grey Wrinkle.

Cat. No.	H. W. D.	Panel Size	For Chassis	Shp. Wt. Lbs.	List Price
HTC-200	8 x 10 x 8"	8 x 8"	7 x 7 x 2"	6	\$ 6.00
HTC-201	8 x 12 x 8"	8 x 10"	7 x 9 x 2"	7	6.50
HTC-202	8 x 16 x 8"	8 x 14"	7 x 13 x 2"	8	8.45
HTC-203	9 x 17 x 11"	9 x 15"	10 x 14 x 3"	10	13.15
HTC-204	12 x 20 x 12"	12 x 18"	10 x 17 x 3"	15	15.50
HTC-205	8 x 14 x 8"	8 x 12"	7 x 11 x 2"	7 1/2	7.50

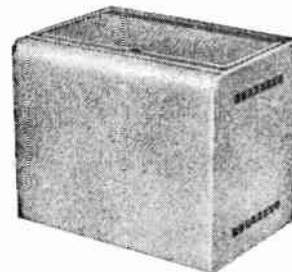

HINGED TOP STANDARD TYPE

Front Panel has a rounded corner on top and is removable. Top door has a piano hinge. Constructed of #20 gauge steel. Finished in Black Wrinkle.

Cat. No.	H. W. D.	For Chassis	Shp. Wt. Lbs.	List Price
HTC-100	7 1/4 x 10 1/2 x 6"	5 1/2 x 9 1/2 x 1 1/2"	5	\$ 4.80
HTC-101	7 1/4 x 8 x 8"	7 x 7 x 2"	6	4.80
HTC-102	7 1/4 x 10 x 8"	7 x 9 x 2"	7	5.50
HTC-103	7 1/4 x 14 x 8"	7 x 13 x 2"	8	6.25
HTC-104	9 x 15 x 10 3/4"	10 x 14 x 3"	11	10.25
HTC-105	12 x 18 x 12"	10 x 17 x 3"	15	12.00
HTC-106	7 1/4 x 12 x 8"	7 x 11 x 2"	7 1/2	6.00

All prices F.O.B., Bronx, N. Y.

PREMIER METAL PRODUCTS COMPANY

PREMIER PRECISION BUILT METAL HOUSINGS

DESK CABINET RACKS IN SUPER DELUXE AND KNOCKED DOWN MODELS

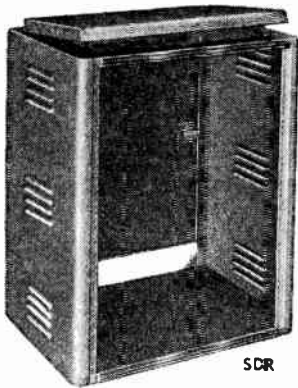

SDR

SAME FEATURES AS DCR MODEL CABINET RACKS PLUS:

- Top door on Models SDR and SDRK open to 90° and have a rounded front corner.
- Models SDRK and DRK are supplied knocked down with all necessary bolts for assembly. On these models the bolts are not visible from the outside and have the same appearance as the welded models.
- Cabinets finished in either Black or Gray Wrinkle.
- For Gray Hammertone add 10% to net cost.

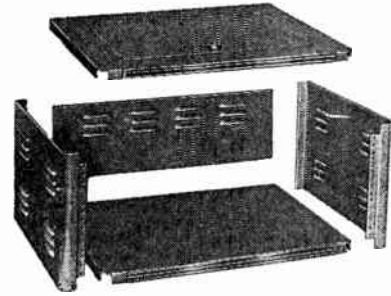

DRK

SINGLE UNIT (with door in top only)

Catalog No.	List Price	Catalog No.	List Price	Catalog No.	List Price	Cabinet Size	Ship. Wt. Lbs.	Available Panel Space
SDR-70	\$24.00	SDRK-70	\$25.00	DRK-70	\$18.00	8 3/4" x 21 3/4" x 15 1/4" deep	22	
SDR-80	27.00	SDRK-80	26.00	DRK-80	19.00	10 1/2" x 21 3/4" x 15 1/4" deep	24	8 3/4" x 19"
SDR-100	29.50	SDRK-100	28.50	DRK-100	21.50	12 1/4" x 21 3/4" x 15 1/4" deep	26	10 1/2" x 19"
SDR-120	31.25	SDRK-120	30.25	DRK-120	23.25	14" x 21 3/4" x 15 1/4" deep	28	12 1/4" x 19"
SDR-140	34.00	SDRK-140	33.00	DRK-140	26.00	15 3/4" x 21 3/4" x 15 1/4" deep	32	14" x 19"

DOUBLE UNIT (with door in top and door on rear)

SDR-170	39.00	SDRK-170	38.00	DRK-170	31.00	19 1/4" x 21 3/4" x 15 1/4" deep	40	17 1/2" x 19"
SDR-190	40.50	SDRK-190	39.50	DRK-190	32.50	21" x 21 3/4" x 15 1/4" deep	42	19 1/4" x 19"
SDR-210	41.75	SDRK-210	40.75	DRK-210	33.75	22 3/4" x 21 3/4" x 15 1/4" deep	44	21" x 19"

TRIPLE UNIT (with door in top and door on rear)

SDR-260	44.50	SDRK-260	43.50	DRK-260	36.50	28" x 21 3/4" x 15 1/4" deep	45	26 1/4" x 19"
SDR-310	46.50	SDRK-310	45.50	DRK-310	38.50	33 1/4" x 21 3/4" x 15 1/4" deep	50	31 1/2" x 19"

QUAD UNIT (with door in top and door on rear)

SDR-350	48.50	SDRK-350	47.50	DRK-350	40.50	36 3/4" x 21 3/4" x 15 1/4" deep	50	35" x 19"
---------	-------	----------	-------	---------	-------	----------------------------------	----	-----------

SLIDING DRAWER TO FIT STANDARD 19" ENCLOSED RELAY RACK CABINETS (22" wide x 18" deep)

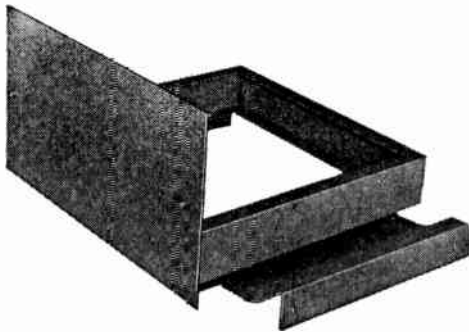

Panel made of #12 gauge steel; chassis of #16 steel and has a 1" flange on top and bottom to accommodate plywood for the record changer. The chassis is mounted on ball-bearing suspension slides which can sustain 40 lbs. Drawer extends 11" from front of cabinet. Entire unit mounts on angle brackets which can be bolted on to the cabinet. Supplied knocked down with all necessary bolts for easy assembly. Locks in place by means of 2 adjustable pawl fasteners. Finished in black or gray wrinkle.

For gray Hammertone add 10% to net cost.

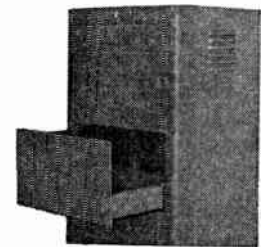

PHOTOGRAPH SHOWING SLIDING DRAWER MOUNTED IN RACK CABINET

(R MODEL)

Catalog No.	Will Fit Rack No.	Panel Size	Chassis Size	Ship. Wt. Lbs.	List Price
RD-10	R and RS Models	10 3/8" x 18 7/8"	17" wide x 16 1/2" deep x 3" high	15	\$22.50
RD-12	R and RS Models	12 1/8" x 18 7/8"	17" wide x 16 1/2" deep x 4" high	18	25.00

FRONT DOORS TO FIT STANDARD 19" DESK RACK CABINETS

Constructed from one piece of #16 gauge steel. Two concealed piano hinges are provided with holes, punched to accommodate universal spacings and are made to fit on top of the panels. Supplied with cylinder lock and angle bracket to hold door in position. All necessary bolts furnished for easy assembly. Finished in Black or Gray Wrinkle. For Gray Hammertone add 10% to net cost.

Cat. No.	Will Fit Rack No.	Size	Ship. Wt. Lbs.	List Price
FD-300	DCR, DRK, SDR, SDRK-260	26 1/4" x 19" x 1 1/4"	10	\$18.75
FD-301	DCR, DRK, SDR, SDRK-310	31 1/2" x 19" x 1 1/2"	11	21.25
FD-302	DCR, DRK, SDR, SDRK-350	35 1/2" x 19" x 1 1/2"	12	23.75
FD-303	DCR, DRK, SDR, SDRK-120	12 1/4" x 19" x 1 1/4"	6	13.75
FD-304	DCR, DRK, SDR, SDRK-140	14" x 19" x 1 1/4"	7	15.00
FD-305	DCR, DRK, SDR, SDRK-170	17 1/2" x 19" x 1 1/4"	8	16.25
FD-306	DCR, DRK, SDR, SDRK-210	21 1/2" x 19" x 1 1/4"	9	17.50

PHOTOGRAPH SHOWING FRONT DOOR MOUNTED IN RACK CABINET

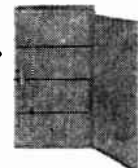

PREMIER METAL PRODUCTS COMPANY

PREMIER Aluminum CHASSIS • PANELS • CABINETS

VERTICAL PANEL CHASSIS TO FIT 19" STANDARD RACKS

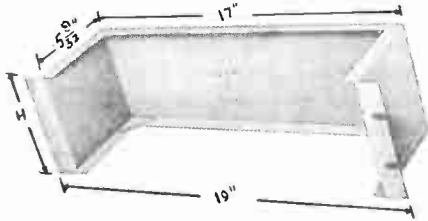

Made of 14 gauge (.064) Aluminum. Flanges are notched for standard rack mounting. All chassis depths are 5-9/32". Gussets are spot welded in each corner for greater strength. Etched finish.

Catalog No.	Height	Ship. Wt. Lbs.	List Price
ACH-1200	1 3/4"	3/4	\$3.50
ACH-1201	3 1/2"	1 3/4	3.80
ACH-1202	5 1/4"	1 1/2	4.15
ACH-1203	7"	2	4.80
ACH-1204	8 3/4"	2 1/4	5.65
ACH-1205	10 1/2"	2 3/4	6.05
ACH-1206	12 1/4"	3	6.80
ACH-1207	14"	3 1/4	7.35

ALUMINUM OPEN END CHASSIS



Made of .040 Aluminum Etched Finish.

Catalog No.	Depth	Width	Height	Ship. Wt. Lbs.	List Price
ACH-1350	2 5/8"	2 3/4"	1 1/4"	1/4	\$.50
ACH-1351	1 3/4"	3 1/8"	1"	1/4	.55
ACH-1352	3 1/4"	4 1/2"	2"	1/4	.60
ACH-1353	2 3/4"	4 1/8"	1"	1/4	.60
ACH-1354	3 3/4"	4 1/8"	1 1/2"	1/4	.60
ACH-1355	3"	6 1/8"	1 1/4"	1/4	.70
ACH-1356	5 3/4"	4 7/8"	1 1/2"	1/4	.75
ACH-1357	4"	3 1/8"	1"	1/2	.60
ACH-1358	4"	4 1/8"	1"	1/2	.65
ACH-1359	4"	5 1/8"	1"	1/2	.70
ACH-1360	4"	6 1/8"	1"	1/2	.75

ALUMINUM BOTTOM PLATES

The bottom plates have holes to match the chassis and have 4 pressed dimples. Aluminum plates made of #18 gauge (.040). Natural aluminum finish.

Catalog No.	Size	Ship. Wt. Lbs.	List Price
ABP-400	5 1/2 x 9 1/2"	1	\$1.19
ABP-401	5 x 10"	1	1.19
ABP-402	6 x 14"	1	1.80
ABP-403	7 x 7"	1	1.22
ABP-404	7 x 9"	1	1.29
ABP-405	7 x 11"	1	1.45
ABP-406	7 x 13"	2	1.80
ABP-407	7 x 15"	2	1.80
ABP-408	4 x 17"	2	1.80
ABP-409	7 x 17"	2	1.85
ABP-410	8 x 17"	2	2.09
ABP-412	10 x 12"	2	2.04
ABP-413	10 x 14"	2	1.87
ABP-414	10 x 17"	2	2.35
ABP-418	11 x 17"	3	2.92
ABP-419	12 x 17"	3	3.12
ABP-422	13 x 17"	3	3.29
ABP-423	5 x 7"	1	1.15

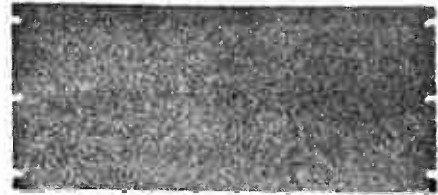

ALUMINUM BLANK RACK PANELS 19" WIDE

For racks with multiple 1 1/4 - 1/2 spacings. Made of 1/8" thick aluminum. Finished in either black or gray wrinkle.

Cat. No.	Width	Ship. Wt. Lbs.	List Price	Cat. No.	Width	Ship. Wt. Lbs.	List Price
ARP-119	1 3/4"	1	\$1.25	ARP-1219	12 1/4"	4	\$5.65
ARP-319	3 1/2"	2	1.80	ARP-1419	14"	4 1/2	6.50
ARP-519	5 1/4"	2 1/2	2.65	ARP-1519	15 3/4"	5	7.25
ARP-719	7"	3	3.20	ARP-1719	17 1/2"	5	8.00
ARP-819	8 3/4"	3	3.85	ARP-1019	19 1/4"	5 1/2	8.75
ARP-1019	10 1/2"	3 1/2	4.85	ARP-2119	21"	6	9.50

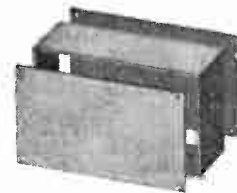

ALUMINUM UTILITY CASES

Constructed of #18 Ga. (.051) aluminum with flanged edges, spotwelded corners and two removable flat covers. Natural Aluminum finish or Gray Hammertone.

Natural Aluminum Cat. No.	List Price	Size W H D	Ship. Wt. Lbs.	Gray Hammertone Cat. No.	List Price
AC-442	\$1.70	4x4x2	1	PAC-442	\$1.90
AC-453	1.90	4x5x3	1	PAC-453	2.20
AC-596	3.70	5x9x6	2	PAC-596	4.20
AC-666	2.55	6x6x6	1	PAC-666	2.90
AC-1276	5.10	12x7x6	2	PAC-1276	5.65
AC-1597	7.00	15x9x7	3	PAC-1597	7.75

ALUMINUM MINIATURE CASES

A two piece case made of #18 Ga. (.051) aluminum. Natural Aluminum Finish or Gray Hammertone.



Natural Aluminum Cat. No.	List Price	L W H	Ship. Wt. Lbs.	Gray Hammertone Cat. No.	List Price
AMC-1000	\$.95	2 3/4 x 2 1/8 x 1 5/8	1/4	PMC-1000	\$1.05
AMC-1001	.95	3 1/4 x 2 1/8 x 1 5/8	1/4	PMC-1001	1.05
AMC-1002	1.00	4 x 2 1/8 x 1 5/8	1/4	PMC-1002	1.10
AMC-1003	1.30	4 x 2 1/4 x 2 1/4	1/4	PMC-1003	1.45
AMC-1004	1.35	5 x 2 1/4 x 2 1/4	1/2	PMC-1004	1.50
AMC-1005	1.55	5 x 4 x 3	1/2	PMC-1005	1.65
AMC-1006	1.50	5 1/4 x 3 x 2 1/8	1/2	PMC-1006	1.60
AMC-1007	1.90	6 x 5 x 4	1/2	PMC-1007	2.05
AMC-1008	2.10	7 x 5 x 3	1/2	PMC-1008	2.30
AMC-1009	3.15	8 x 6 x 3 1/2	1/2	PMC-1009	3.35
AMC-1010	3.95	10 x 6 x 3 1/2	3/4	PMC-1010	4.15
AMC-1011	4.45	12 x 7 x 4	3/4	PMC-1011	4.90
AMC-1012	5.25	17 x 5 x 4	3/4	PMC-1012	5.75
AMC-1013	1.55	10 x 2 1/2 x 1 5/8	3/4	PMC-1013	1.65
AMC-1014	2.05	12 x 2 1/2 x 2 1/4	3/4	PMC-1014	2.25
AMC-1015	1.25	4 x 2 x 2 1/4	3/4	PMC-1015	1.60
AMC-1016	1.30	4 1/4 x 2 1/4 x 1 1/2	3/4	PMC-1016	1.45

PREMIER METAL PRODUCTS COMPANY

PREMIER PRECISION BUILT METAL HOUSINGS

ALUMINUM BLANK CHASSIS

Constructed from one piece of #18 Ga. (.040) aluminum except those marked * which are of #16 Ga. (.051). Corners are spot-welded. Bottom edges are flanged in on four sides and punched for bottom plates. Natural aluminum finish.

Cat. No.	Size	Ship. Wt. Lbs.	List Price
ACH-400	5 1/2 x 9 1/2 x 1 1/2"	1	\$1.70
ACH-401	5 x 10 x 3"	1	2.00
ACH-402	6 x 14 x 3"	1 1/2	3.35
ACH-403	7 x 7 x 2"	1	1.70
ACH-404	7 x 9 x 2"	1	1.80
ACH-405	7 x 11 x 2"	1	2.00
ACH-406	7 x 13 x 2"	1	2.10
ACH-407	7 x 15 x 3"	1 1/2	3.75
ACH-408	4 x 17 x 3"	1	3.05
ACH-409	7 x 17 x 3"	1 1/2	3.70
ACH-410	8 x 17 x 2"	1 1/2	3.75
ACH-411	8 x 17 x 3"	1 1/2	3.95
ACH-412	10 x 12 x 3"	1 1/2	3.50
ACH-413	10 x 14 x 3"	2	4.45
ACH-414	10 x 17 x 2"	2	4.25
ACH-415*	10 x 17 x 3"	2	4.75
ACH-416*	10 x 17 x 4"	2	5.50
ACH-417*	11 x 17 x 2"	2 1/2	4.55
ACH-418*	11 x 17 x 3"	3	5.55
ACH-419*	12 x 17 x 2"	2	5.00
ACH-420*	12 x 17 x 3"	2	5.90
ACH-421*	12 x 17 x 4"	2	6.50
ACH-422*	13 x 17 x 2"	3	5.25
ACH-423*	13 x 17 x 3"	3	6.25
ACH-424*	13 x 17 x 4"	3 1/2	7.15
ACH-425	7 x 11 x 3"	1	2.10
ACH-426	5 x 7 x 2"	1	1.40
ACH-427	8 1/2 x 15 x 3"	1 1/2	3.80

*Made from #16 gauge aluminum.

METER PANELS



Cat. No.	No. of Holes	Meter Size	Hole Size	Ship. Wt. Lbs.	List Price
MRP-900	3	2"	2 1/4"	7	\$2.15
MRP-901	5	2"	2 1/4"	7	3.00
MRP-902	3	3"	2 1/2"	7	2.15
MRP-903	5	3"	2 1/2"	7	3.00

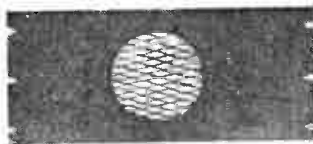

SPEAKER PANELS 19" WIDE

Made of #12 gauge steel. Finished in Black or Gray Wrinkle. A piece of expanded metal is spot welded behind the opening.

Cat. No.	Panel Size	Spkr. Size	Hole Size	Ship. Wt. Lbs.	List Price
SRP-819	8 3/4"	6"	4 5/8"	6	\$4.10
SRP-1019	10 1/2"	8"	6 1/2"	8	5.25
SRP-1219	12 1/4"	10"	8 1/2"	9	6.25
SRP-1419	14"	12"	10"	10	7.25

STEEL BLANK CHASSIS



Constructed from one piece of #20 gauge cold rolled steel, except those marked * which are of #16 gauge. Corners are spot-welded. Bottom edges are flanged in on four sides and punched for bottom plates. Finished in either Black Wrinkle or Zinc Plated.

Cat. No.	Size	Ship. Wt. Lbs.	List Price
CH-400	5 1/2 x 9 1/2 x 1 1/2"	2	\$1.30
CH-401	5 x 10 x 3"	3	1.80
CH-402	6 x 14 x 3"	4	2.10
CH-403	7 x 7 x 2"	2	1.50
CH-404	7 x 9 x 2"	2	1.80
CH-405	7 x 11 x 2"	3	1.85
CH-406	7 x 13 x 2"	3	2.00
CH-407	7 x 15 x 3"	4	2.40
CH-408	4 x 17 x 3"	3	2.15
CH-409	7 x 17 x 3"	4	2.60
CH-410	8 x 17 x 2"	4	2.40
CH-411	8 x 17 x 3"	5	2.60
CH-412	10 x 12 x 3"	4	2.50
CH-413	10 x 14 x 3"	5	2.65
CH-414	10 x 17 x 2"	5	2.65
CH-415*	10 x 17 x 3"	5	2.75
CH-416*	10 x 17 x 4"	5	3.40
CH-417*	11 x 17 x 2"	7	3.75
CH-418*	11 x 17 x 3"	9	4.10
CH-419*	12 x 17 x 2"	5	2.85
CH-420*	12 x 17 x 3"	5	3.40
CH-421*	12 x 17 x 4"	6	3.75
CH-422*	13 x 17 x 2"	8	4.10
CH-423*	13 x 17 x 3"	9	4.75
CH-424*	13 x 17 x 4"	10	5.40
CH-425	7 x 11 x 3"	3	2.00
CH-426	5 x 7 x 2"	1 1/2	1.47
CH-427	8 1/2 x 15 x 3"	4	2.75

*Made from #16 gauge steel.

HEAVY DUTY BLANK CHASSIS

Constructed from one piece of #16 Gauge cold rolled steel. Corners are spot welded. Bottom edges are flanged in on four sides and punched for bottom plates. Bottom plates are supplied with each chassis. Finished in either black wrinkle or zinc plated.

Cat. No.	Dimensions	Ship. Wt. Lbs.	List Price
HC-910	8 x 17 x 2"	8	\$4.60
HC-911	8 x 17 x 3"	9	5.00
HC-912	11 x 17 x 2"	10	5.25
HC-913	11 x 17 x 3"	11	5.60
HC-914	13 x 17 x 2"	11	5.80
HC-915	13 x 17 x 3"	13	6.45
HC-916	13 x 17 x 4"	14	7.10
HC-917	17 x 17 x 4"	17	9.50

For 30" wide Rack Panels double the list price. For Gray Hammertone panels add 10% to net cost. All prices F.O.B., Bronx, N. Y.



BLANK RACK PANELS—19" WIDE

For Racks with Multiple 1 1/4"—1 1/2" Spacings

Made of #12 Gauge Steel

Finished in either Black or Grey Wrinkle

Cat. No.	Width	Ship. Wt. Lbs.	List Price
RP-119	1 3/4"	2	\$1.10
RP-319	3 1/2"	5	1.25
RP-519	5 1/4"	7	1.55
RP-719	7"	8	1.80
RP-819	8 3/4"	9	2.20
RP-1019	10 1/2"	10	2.65
RP-1219	12 1/4"	12	3.15
RP-1419	14"	13	3.60
RP-1519	15 3/4"	14	4.10
RP-1719	17 1/2"	15	4.50
RP-1919	19 1/4"	16	5.00
RP-2119	21"	16	5.50

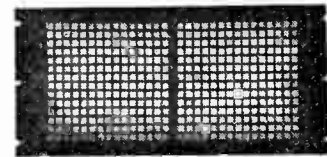

GRILLE PANELS—19" WIDE

Made of #12 Gauge Steel

Finished in either Black or Grey Wrinkle

Cat. No.	Panel Size	Grille Size	Ship. Wt. Lbs.	List Price
GRP-601	5 1/4"	3 7/8 x 13 3/8"	2	\$4.40
GRP-602	7"	3 7/8 x 13 3/8"	2	4.75
GRP-603	8 3/4"	5 7/8 x 13 3/8"	2 1/2	5.75
GRP-604	8 3/4"	*3 7/8 x 13 3/8"	2 1/2	5.25
GRP-605	10 1/2"	7 7/8 x 13 3/8"	2 1/2	6.25
GRP-606	10 1/2"	*5 7/8 x 13 3/8"	2 1/2	5.75
GRP-607	12 1/4"	*7 7/8 x 13 3/8"	3	6.50

* Allows 3 1/2" space at bottom for chassis mounting.

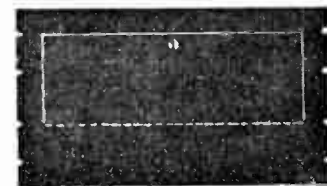

DOOR PANELS—19" WIDE

Made of #12 Gauge Steel

Finished in either Black or Grey Wrinkle Panels have flush hinged doors with piano hinges, and are equipped with a chrome knob and concealed snap catch. All doors are located 1" from top to allow space for chassis at bottom.

Cat. No.	Panel Size	Door Size	Ship. Wt. Lbs.	List Price
DRP-700	8 3/4"	4 1/2 x 15 3/8"	9	\$7.00
DRP-701	10 1/2"	6 x 15 3/8"	10	7.50
DRP-702	12 1/4"	7 1/2 x 15 3/8"	12	8.25

PREMIER METAL PRODUCTS COMPANY

PREMIER PRECISION BUILT METAL HOUSINGS

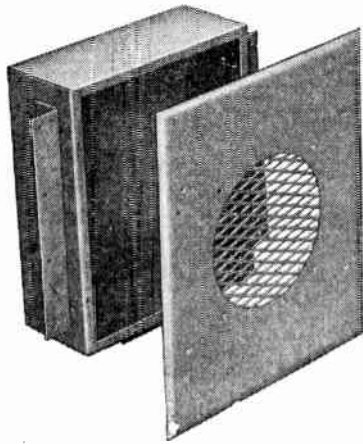

RECESSED SPEAKER BOXES FOR CEILING AND WALL

Designed for easy installation in ceiling with acoustical tile. Mounting brackets are adjustable for attaching to studs in walls or ceilings. The speaker plate has beveled edges to give the same appearance as an acoustical tile. Box made of #20 gauge steel; speaker plate of #16 gauge steel with piece of expanded metal spot-welded behind the opening. Box interior is sprayed with special undercoating to eliminate metallic sound. Finished in Gray primer or Gray Hammetone.

Catalog No.	BOX SIZE			Ship. Wt. Lbs.	List Price
	W	H	D		
SP-1010	10	10	4"	4	\$ 7.10
SP-1012	10	12	4"	5	7.50
SP-1417	14	17	7 1/2"	10	11.25

Catalog No.	Speaker Plate Size	Speaker Size	Ship. Wt. Lbs.	List Price
SP-1214	12 x 14"	8"	3	3.75
SP-1619	16 x 19"	12"	5 1/2	6.25

SPECIAL FEATURE

Easy fastening of the speaker plate to the box is accomplished with a Tinnerman nut, which is adjustable in the flange of the enclosure.

STEEL UTILITY CASES WITH CHASSIS ATTACHED

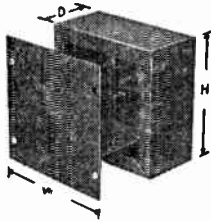

Made of #20 gauge steel with a chassis spot welded to front panel. Front and rear panels are removable. Finished in black wrinkle.

Catalog No.	Height	Width	Depth	Chassis Size	Ship. Wt. Lbs.	List Price
CA-1400	4"	4"	2"	1 x 2 7/8 x 1 7/8"	3/4	\$1.75
CA-1401	4"	5"	3"	1 x 3 7/8 x 2 7/8"	1	1.95
CA-1402	5"	4"	3"	1 1/4 x 2 7/8 x 2 7/8"	1	1.95
CA-1403	6"	5"	4"	1 3/4 x 3 7/8 x 3 7/8"	1 3/4	2.40
CA-1404	5"	6"	4"	1 1/4 x 4 7/8 x 3 7/8"	1 3/4	2.40
CA-1405	6"	6"	6"	1 3/4 x 4 7/8 x 5 7/8"	2 3/4	2.50

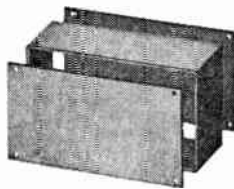

STEEL UTILITY CASES

Constructed of #20 gauge sheet steel with flanged edges, spot-welded corners, and two removable flat covers. Finished in Black Wrinkle.

Cat. No.	Size	Ship. Wt. Lbs.	List Price
C-442	4 x 4 x 2"	2	\$1.25
C-453	4 x 5 x 3"	3	1.45
C-564	5 x 6 x 4"	4	1.75
C-596	5 x 9 x 6"	5	2.75
C-666	6 x 6 x 6"	3	2.00
C-695	6 x 9 x 5"	5	2.75
C-754	7 x 5 x 4"	4	1.88
C-8101	8 x 10 x 10"	7	4.50
C-8107	8 x 10 x 7"	6	3.70
C-1128	11 x 12 x 8"	9	5.00
C-1576	15 x 7 3/4 x 6 1/2"	11	4.50
C-1597	15 x 9 x 7"	9	5.15
C-1276	12 x 7 x 6"	6	3.75

AMPLIFIER FOUNDATION CHASSIS

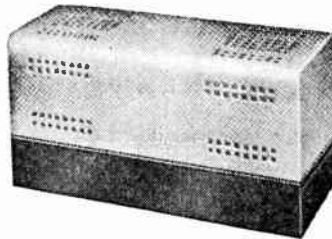

Top cover has grille perforations and rounded corners. Finished in Grey Wrinkle. Chassis are constructed of one piece with corners spot-welded. Constructed of #20 gauge steel. Finished in Black Wrinkle. Cover 6" deep.

Cat. No.	Size	Ship. Wt. Lbs.	List Price
AF-510	5 x 01 x 3"	9	\$6.25
AF-615	6 x 14 x 3"	10	7.25
AF-717	7 x 17 x 3"	11	8.25
AF-1012	10 x 12 x 3"	11	8.25
AF-1017	10 x 17 x 3"	13	9.75
AF-1317	13 x 17 x 3"	15	11.75



CHASSIS MOUNTING BRACKETS

These brackets will fit any of the above chassis because the mounting holes are drilled to match. Panels must be at least 7" high. Notched for 3" chassis. Nos. CB-810 and CB-813 are notched for 4" chassis. Finished in black enamel.

Cat. No.	Dimensions	Ship. Wt. Lbs.	List Price
CB-78	For 8" Base	2	\$1.30
CB-710	For 10" Base	2	1.75
CB-711	For 11" Base	3	1.90
CB-712	For 12" Base	3	2.05
CB-713	For 13" Base	3	2.20
CB-717	For 17" Base and larger	5	3.40
CB-810	For 10" Base	2 1/2	2.60
CB-813	For 13" Base	3 1/2	2.75

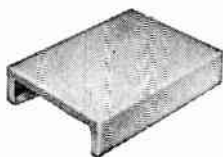

OPEN END CHASSIS

Made of #20 gauge steel and zinc plated.

Catalog No.	Depth	Width	Height	Ship. Wt. Lbs.	List Price
CH-1300	7"	6"	2"	1	\$1.10
CH-1301	5"	7"	1 1/2"	3/4	1.00
CH-1302	7"	7"	1 1/2"	3/4	1.60
CH-1303	7"	8"	2"	1	1.40
CH-1304	5 1/2"	9"	1 1/2"	3/4	1.20
CH-1305	7 1/2"	9"	1 1/2"	1	1.60
CH-1306	7"	10"	2"	1 1/4	1.50
CH-1307	7"	11"	1 1/2"	1 1/4	1.70
CH-1308	7"	13"	1 1/2"	1 1/2	2.00
CH-1309	10 3/4"	14"	2"	2 1/2	2.40
CH-1310	7 3/4"	15"	2"	2	2.30

PREMIER METAL PRODUCTS COMPANY

PREMIER PRECISION BUILT METAL HOUSINGS

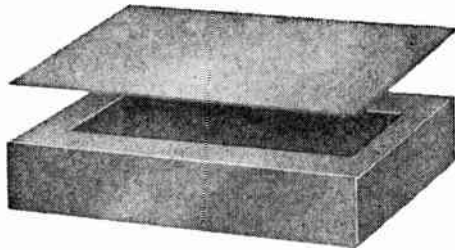

REMOVABLE TOP CHASSIS

Made of #16 Ga. Cold Rolled Steel. Top and Bottom edges flanked in on four sides. Top plate is removable. Finished in either Black Wrinkle or Zinc Plated.

Cat. No.	Size	Ship. Wt. Lbs.	List Price
RCH-415	10 x 17 x 3	5	\$5.50
RCH-416	10 x 17 x 4	5	6.10
RCH-423	13 x 17 x 3	9	5.75
RCH-424	13 x 17 x 4	10	7.10

REPLACEMENT TOPS

Cat. No.	Size	Ship. Wt. Lbs.	List Price
RTC-415	10 x 17	2	\$2.10
RTC-423	13 x 17	3	2.60



CHASSIS SUPPORTS

Made of #12 gauge steel. Finished in black enamel. Sold in pairs only.

Cat. No.	Size	Ship. Wt. Lbs.	List Price
CS-12	12 x 3 x 3	3	\$2.75
CS-14	14 1/2 x 3 x 3	4	3.00



SLOPING PANEL CABINETS

Made of #20 Ga. Steel with Rounded Top Corners and sloping front. Finished in Black Wrinkle.

Cat. No.	W	H	D	Ship. Wt. Lbs.	List Price
SPC-1200	4 7/8	4 1/2	4 1/4	3	\$1.70
SPC-1201	5 7/8	4 1/2	4 1/4	3	1.95
SPC-1202	6 7/8	4 1/2	4 1/4	4	2.20
SPC-1203	7 7/8	4 1/4	4 1/2	4	2.65

STEEL BOTTOM PLATES

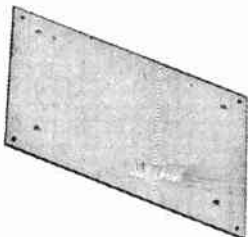

The bottom plates have holes to match the chassis and have 4 pressed dimples. Made of #20 gauge steel, finished in either Black Wrinkle or Zinc Plated.

Cat. No.	Size	Ship. Wt. Lbs.	List Price	Cat. No.	Size	Ship. Wt. Lbs.	List Price
8P-400	5 1/2 x 9 1/2"	1	.60	8P-409	7 x 17"	2	\$1.10
8P-401	5 x 10 1/2"	1	.65	8P-410	8 x 17"	2	1.10
8P-402	6 x 14"	1	.90	8P-412	10 x 12"	2	1.10
8P-403	7 x 7"	1	.65	8P-413	10 x 14"	2	1.15
8P-404	7 x 9"	1	.70	8P-414	10 x 17"	2	1.45
8P-405	7 x 11"	1	.85	8P-418	11 x 17"	3	1.50
8P-406	7 x 13"	2	.95	8P-419	12 x 17"	3	1.60
8P-407	7 x 15"	2	1.05	8P-422	13 x 17"	3	1.70
8P-408	4 x 17"	2	.85	8P-423	5 x 7"	1	1.15

All prices F.O.B., Bronx, N. Y.



RACK SHELF

Made of one piece of #16 Ga. Cold Rolled Steel, 1" high. Holes are punched on sides for mounting to rack. Finished in Black or Gray Wrinkle. For Gray Hammertone add 10% to net cost.

Cat. No.	Will Fit Rack No.	Shelf Size	Ship. Wt. Lbs.	List Price
RS-1106	All DCR Racks	15x21 7/8	7	\$4.25
RS-1107	R, RS, DR and RM Racks	15x21 1 3/8	7	5.25
RS-1108	FD Racks	13x21 1 3/8	7	4.75
RS-1109	24" deep RM Racks	22x23 7/8	7	8.50

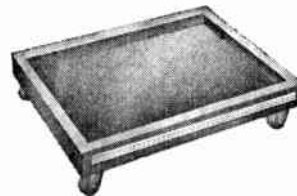

ROLLER TRUCKS FOR RACKS

Made from 1 piece of #16 Ga. Cold Rolled Steel. Supplied with 2" Dia. Composition Wheels and bolts for easy assembly. Finished in either Black or Gray Wrinkle and has a red striped Chrome moulding. For Gray Hammertone add 10% to net cost.

Cat. No.	Will Fit Rack No.	Inside Dimensions	Ship. Wt. Lbs.	List Price
RT-1100	All DCR Racks	15 3/4 x 22 1/4	22	\$15.00
RT-1101	R, RS, DR, RM and FD Racks	18 3/4 x 22 3/4	22	19.00
RT-1102	RR-801	20 1/2 x 21 1/2	22	21.00
RT-1105	24" deep RM Racks	24 1/2 x 24 1/2	23	23.00

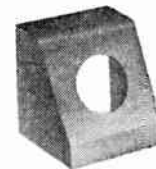

METER CASES

Made of #20 Ga. Steel with Rounded Top Corner and sloping fronts. Accommodates 2" or 3" Meters. Finished in Black Wrinkle.

Cat. No.	W	H	D	Meter Size	Hole Size	Ship. Wt. Lbs.	List Price
SPC-1208	4 7/8	4 1/2	4 1/4	2"	2 7/8"	1	\$1.60
SPC-1209	4 7/8	4 1/2	4 1/4	3"	2 1 1/8"	1	1.60

PREMIER METAL PRODUCTS COMPANY



CABINETS CHASSIS

CASES PANELS

MIDDLETOWN IN CONNECTICUT

D.C. DELUXE CABINET RACKS—USE 19" RACK PANELS

Middletown D. C. Cabinets conform to the conventional design of streamlined cabinets used by builders of amateur and commercial equipment.

FEATURES

- ★ Constructed of heavy gauge 1/16" steel, electrically welded.
- ★ Adequate ventilation is provided by sufficient louvres in sides, and ventilation in back.
- ★ Front Vertical posts rounded.
- ★ Flush panel mounting (recessed).
- ★ Drilled and tapped for 10/32" screws on universal centers.
- ★ Flush door in top fitted with flush snap-lock and piano hinges.
- ★ Black Wrinkle finish. *Grey Wrinkle if desired.*

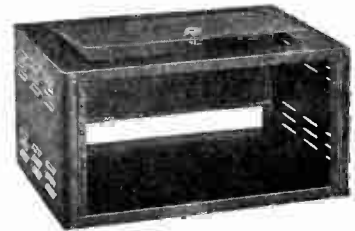
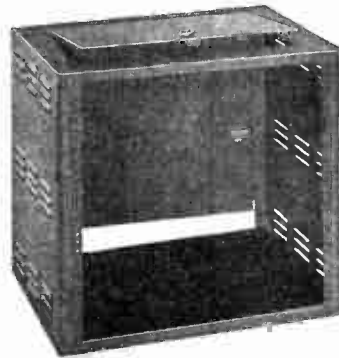

Cat. No.	Panel Size	Size of Cabinet	Dealer Cost	Cat. No.	Panel Size	Size of Cabinet	Dealer Cost
D.C. 108	8 3/4" x 19"	10 1/2" x 21 1/2" x 15"		D.C. 1917	17 1/2" x 19"	19 1/4" x 21 1/2" x 15"	
	Single Unit		\$11.64		Double Unit—Door Top and Back		\$18.84
D.C. 1412	12 1/4" x 19"	14" x 21 1/2" x 15"	14.19	D.C. 2826	26 1/4" x 19"	28" x 21 1/2" x 15"	22.14
	Single Unit				Triple Unit—Door Top and Back		
D.C. 1514	14" x 19"	15 3/4" x 21 1/2" x 15"	15.84	D.C. 3635	35" x 19"	36 3/4" x 21 1/2" x 15"	24.54
	Single Unit				Quad. Unit—Door Top and Back		

BLANK STEEL CHASSIS Heavy Duty

Middletown heavy duty Chassis are made from one piece of 1/16" sheet steel—Spot Welded at all four corners. Bottom edges are folded over on all four sides for additional rigidity and rilled to match bottom plates. Ends are drilled to fit standard Middletown brackets Bottom plates are supplied with these Chassis.

Cat. No.	Stock Sizes Black Wrinkle	Dealer Cost
H.D. 8172	8 x 17 x 2"	\$2.90
H.D. 8173	8 x 17 x 3"	3.15
H.D. 11172	11 x 17 x 2"	3.30
H.D. 11173	11 x 17 x 3"	3.65
H.D. 13172	13 x 17 x 2"	4.00
H.D. 13173	13 x 17 x 3"	4.40
H.D. 13174	13 x 17 x 4"	4.84

CHASSIS BRACKETS Mounting

These brackets are for chassis listed above. Front end of the bracket is seven inches high. Finished in black wrinkle.

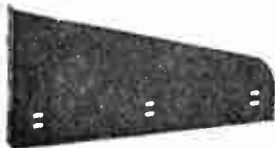

Cat. No.	Size	Shipping Weight	Dealer Cost
C.B. 8	For 8" Base	2 lbs.	\$0.87
C.B. 11	For 11" Base	3 lbs.	1.26
C.B. 13	For 13" Base	3 lbs.	1.47

BLANK CHASSIS Standard Type

Middletown Chassis are made from one piece of No. 20 gauge steel spot-welded at all 4 corners—bottom edges are folded over on four sides for additional rigidity and drilled to match bottom plates.

Bottom plates are drilled to match holes on flange of chassis and have pressed bumpers at corners. Material No. 20 gauge steel.

Standard Chassis Steel Black Wrinkle			Aluminum Chassis	
Cat. No.	Size	Dealer Cost	Cat. No.	Dealer Cost
*B.S. 442	4 x 4 x 2"	\$0.72	†ABC 591	\$1.05
*B.S. 591	5 1/2 x 9 1/2 x 1 1/2"	.78	†ABC 5103	1.26
*B.S. 5103	5 x 10 x 3"	1.08	†ABC 4173	1.83
B.S. 4173	4 x 17 x 3"	1.29	†ABC 6143	1.98
B.S. 6143	6 x 14 x 3"	1.26	†ABC 772	.99
*B.S. 772	7 x 7 x 2"	.90	†ABC 792	1.08
*B.S. 792	7 x 9 x 2"	1.08	†ABC 7112	1.20
B.S. 7112	7 x 11 x 2"	1.11	†ABC 7132	1.32
B.S. 7132	7 x 13 x 2"	1.20	†ABC 7153	2.16
B.S. 7153	7 x 15 x 3"	1.44	†ABC 7173	2.25
B.S. 7173	7 x 17 x 3"	1.56	†ABC 8172	1.98
B.S. 8172	8 x 17 x 2"	1.44	†ABC 8173	2.34
B.S. 8173	8 x 17 x 3"	1.56	†ABC 10123	1.98
B.S. 10123	10 x 12 x 3"	1.50	†ABC 10143	2.52
B.S. 10143	10 x 14 x 3"	1.59	†ABC 10172	2.40
B.S. 10172	10 x 17 x 2"	1.59	†ABC 10173	2.73
B.S. 10173	10 x 17 x 3"	1.65	†ABC 11172	2.49
*B.S. 11172	11 x 17 x 2"	2.01	†ABC 11173	3.15
*B.S. 11173	11 x 17 x 3"	2.22	†ABC 12172	3.00
B.S. 12172	12 x 17 x 2"	1.71	†ABC 12173	3.36
B.S. 12173	12 x 17 x 3"	2.04	†ABC 12174	3.90
B.S. 12174	12 x 17 x 4"	2.25	†ABC 13172	3.00
*B.S. 13172	13 x 17 x 2"	2.30	†ABC 13173	3.54
*B.S. 13173	13 x 17 x 3"	2.60	†ABC 13174	4.05
*B.S. 13174	13 x 17 x 4"	3.00		
	*18 ga.			
	**22 ga.			



Bottom Plates Black Wrinkle

Cat. No.	Size	Dealer Cost
B.P. 59	5 1/2 x 9 1/2"	\$0.39
B.P. 510	5 x 10"	.45
B.P. 417	4 x 17"	.57
B.P. 614	6 x 14"	.42
B.P. 77	7 x 7"	.45
B.P. 79	7 x 9"	.45
B.P. 711	7 x 11"	.57
B.P. 713	7 x 13"	.63
B.P. 715	7 x 15"	.69
B.P. 717	7 x 17"	.72
B.P. 817	8 x 17"	.72
B.P. 1012	10 x 12"	.78
B.P. 1014	10 x 14"	.96
B.P. 1017	10 x 17"	.99
B.P. 1117	11 x 17"	1.05
B.P. 1217	12 x 17"	1.05
B.P. 1317	13 x 17"	1.14

CABINETS CHASSIS



CASES PANELS

MIDDLETOWN IN CONNECTICUT

AMPLIFIER FOUNDATIONS—DeLuxe Models

This unit is designed to meet the most critical requirements. It has rounded corners, special Middletown designed louvers on all 4 sides and elongated holes on top to give maximum ventilation. Chassis are finished in Black wrinkle. Covers are finished in Grey wrinkle. Chassis are drilled for bottom plates which are listed separately. Covers all have a depth of 6".

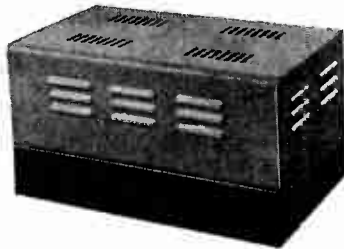

Cat. No.	Size	Dealer Cost
A.F.-5109	5 x 10 x 9"	\$2.80
A.F.-6149	6 x 14 x 9"	3.00
A.F.-7179	7 x 17 x 9"	3.75
A.F.-10129	10 x 12 x 9"	3.75
A.F.-10179	10 x 17 x 9"	4.50
A.F.-13179	13 x 17 x 9"	5.40

SLOPING FRONT PANEL CABINETS



Sloping front panel cabinets have a wide application in the electronic field since they are adaptable for various uses. They are constructed of heavy gauge steel electrically spot-welded. Top corner is rounded, front panel is removable, and louvers on sides provide ventilation.

Back panel is ventilated on top and an opening is provided on the bottom so that connections can be made directly to the rear of the chassis. Finished in Grey wrinkle.

Cat. No.	H.W.D.	Chassis Size	Dealer Cost
S.F.-888	8 x 8 x 8"	7 x 7 x 2"	\$3.84
S.F.-8108	8 x 10 x 8"	7 x 9 x 2"	4.26
S.F.-8128	8 x 12 x 8"	7 x 11 x 2"	4.44
S.F.-8148	8 x 14 x 8"	7 x 13 x 2"	4.59
S.F.-121812	12 x 18 x 12"	10 x 17 x 3"	8.40

STEEL UTILITY CANS

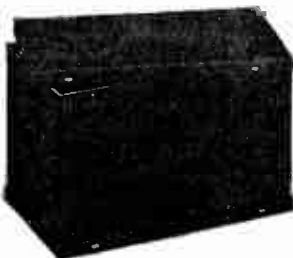

These Utility Cans are substantially made from sheet steel with spot welded reinforced corners. Tops and bottoms are removable and are flanged on all four sides. Held in place with self-tapping screws.

Cat. No.	Size	Weight	Dealer Cost
U.C. 565	5 1/2 x 6 x 5 1/2"	3 lbs.	\$1.38
U.C. 596	5 x 9 x 6"	5 lbs.	1.86
U.C. 8107	8 x 10 x 7"	6 lbs.	2.70
U.C. 81010	8 x 10 x 10"	7 lbs.	3.45
U.C. 11128	11 x 12 x 8"	9 lbs.	4.35

RACK PANELS — 19" LONG (Steel and Aluminum)

Middletown Rack Panels are offered in either 1/8" steel or 1/8" aluminum. They are 19" wide and are slotted for conventional W. E. mounting. Fourteen standard sizes. Furnished in black or grey wrinkle finish.

Note: When ordering grey wrinkle, add prefix "G" to catalog number. * Available on special order.



Cat. No.	Dealer Cost	Height	Cat. No.	Dealer Cost
Steel (Bk. Wrinkle)			Aluminum (Black Wrinkle)	
R.P. 1	\$0.77	1 3/4"	A.R.P. 1	\$0.87
R.P. 3	.84	3 1/2"	A.R.P. 3	1.20
R.P. 5	1.05	5 1/4"	A.R.P. 5	1.80
R.P. 7	1.20	7"	A.R.P. 7	2.16
R.P. 8	1.50	8 3/4"	A.R.P. 8	2.58
R.P. 10	1.68	10 1/2"	A.R.P. 10	3.24
R.P. 12	2.10	12 1/4"	A.R.P. 12	3.78
R.P. 14	2.40	14"	A.R.P. 14	4.35
R.P. 15	2.70	15 3/4"	A.R.P. 15	4.80
R.P. 17	2.97	17 1/2"	A.R.P. 17	5.34
R.P. 19	3.30	19 1/4"	A.R.P. 19	5.85
R.P. 21	3.66	21"	A.R.P. 21	6.30
R.P. 26*		26 1/4"	A.R.P. 26*	
R.P. 35*		35"	A.R.P. 35*	

METER PANELS

Middletown Meter Panels are made 5 1/4" high and are made to the same specifications as our Rack Panels — are available to fit 3" meters.

Cat. No.	Holes	Hole Size	Dealer Cost
R.P.M. 33	3	2 3/8"	\$1.30
R.P.M. 35	5	2 3/8"	1.85

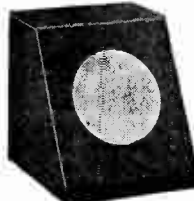

METER CASES

These cases have sloping front panel with rounded top corner which blends with streamline equipment. They are sturdily constructed from sheet steel with welded joints.

Cat. No.	Meter	Hole Size	H.W.D.	Dealer Cost
M.C. 13	Single 3"	2 1/8"	4 1/2 x 4 x 4	\$1.14
M.C. 33	3-3" Meters	2 1/8"	4 1/2 x 11 1/4 x 4	3.06

STEEL CASES — STANDARD

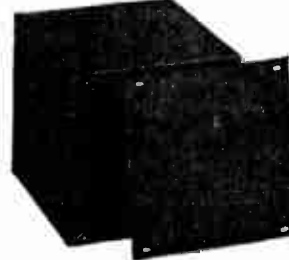

These cases are similar to our standard steel utility cans except they have flat tops and bottoms which are held in place with self tapping screws and are removable. These cases are of sturdy construction and have spot welded corners. Case has flanges on all edges. Furnished in black wrinkle.

Cat. No.	Size	Weight	Dealer Cost
S.C. 442	4 x 4 x 2 "	2 lbs.	\$0.84
S.C. 453	4 x 5 x 3 "	3 lbs.	.96
S.C. 666	6 x 6 x 6 "	3 lbs.	1.32
S.C. 1276	12 x 7 x 6 "	5 lbs.	2.49
S.C. 1597	15 x 9 x 7 "	9 lbs.	3.39
S.C. 1287	12 x 7 3/4 x 6 1/2 "	9 lbs.	2.88
S.C. 1576	15 x 7 3/4 x 6 1/2 "	11 lbs.	2.97

CABINETS CHASSIS



CASES PANELS

DE LUXE RELAY RACKS

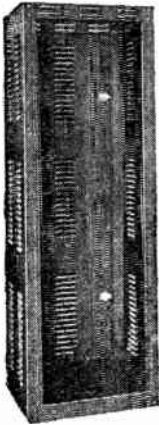

Middletown De Luxe Relay Racks are made of 16-gauge steel with $\frac{1}{2}$ " panel supports which are recessed so that edges of panels set flush. Standard 19" panels fit these racks. (See page J-113 for panel sizes.) Adequate ventilation is provided by louvers in the two sides, the door and in the top at front and back. Door is hung on sturdy hinges and has snap catches. Racks come with rigid, built-in caster supports. (Casters not included in price of rack.) Furnished in either black or grey wrinkle finish. Shipped knocked down with all necessary hardware. Rack shelves and supporting angles to fit these Relay Racks are available. Information and prices on request.

Cat. No. (Black Wrinkle)	Overall Size			Panel Size			Dealer Cost
	H	W	D	H	W	D	
DRR 4236	42 $\frac{1}{2}$ "	22	17 $\frac{1}{4}$ "	36 $\frac{3}{4}$ "	19	19	\$52.70
DRR 4742	47 $\frac{1}{2}$ "	22	17 $\frac{1}{4}$ "	42	19	19	37.45
DRR 6661	66 $\frac{1}{2}$ "	22	17 $\frac{1}{4}$ "	61 $\frac{1}{4}$ "	19	19	48.60
DRR 8277	82 $\frac{1}{2}$ "	22	17 $\frac{1}{4}$ "	77	19	19	58.50

Note: When ordering grey wrinkle, add prefix "G" to catalog number. Dimensions in Inches.

OPEN-TYPE TABLE RELAY RACKS

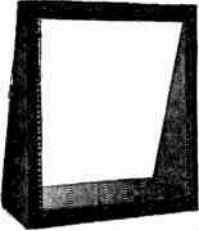

For table mounting of power transmitters, P. A. systems and other radio and electronic apparatus. Rack is ruggedly constructed with strong base to accommodate heavy components. Drilled and tapped for conventional 19" wide panels which set in recess so that no edges are exposed. (See page J-113 for panel sizes.) Shipped knocked down with necessary hardware. Black wrinkle finish.

Catalog Number	H	Overall Size			Panel Space		Dealer Cost
		W	D	H	W		
TRR 24	24	21	12	21	19	\$6.50	
TRR 31	31	21	12	28	19	8.25	

OPEN-TYPE CHANNEL RELAY RACKS

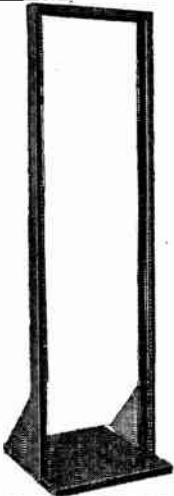

Sturdy construction with rigid supporting members and side angle braces make these racks perfectly suited to all heavy-duty assignments. Made of $\frac{1}{8}$ " steel channels, 3" deep, welded together with angle cross pieces of the same material. Chassis type base. Drilled and tapped to accommodate conventional 19" panels. (See page J-113 for panel sizes.) Black wrinkle finish. Shipped knocked down with necessary hardware.

Cat. No.	Overall Size			Panel Size			Dealer Cost
	H	W	D	H	W	D	
OCR 35	35 $\frac{1}{2}$ "	21	22	31 $\frac{1}{2}$ "	19	19	\$17.40
OCR 70	70 $\frac{1}{2}$ "	21	22	66 $\frac{1}{2}$ "	19	19	20.70

Dimensions in Inches.

SPEAKER PANELS



Made from $\frac{1}{8}$ " steel, panels fit either 6", 8", 10" or 12" speakers. They are 19" wide, slotted for standard W.E. mounting. Furnished in black or grey wrinkle finish. Opening covered with an attractive clover-leaf design steel grille.

Catalog Number (Black Wrinkle)	Panel Space		Hole Diameter	Speaker Size	Dealer Cost
	H	W			
SP 8	8 $\frac{3}{4}$ "	19	4 $\frac{3}{4}$ "	6	\$2.46
SP 10	10 $\frac{1}{2}$ "	19	6 $\frac{1}{2}$ "	8	3.15
SP 12	12 $\frac{1}{4}$ "	19	9"	10	3.75
SP 14	14	19	11	12	4.35

Note: When ordering grey wrinkle, add prefix "G" to catalog number. Dimensions in Inches.

ROUNDED CORNER CABINETS

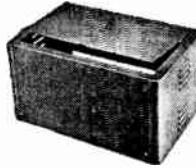

These are de luxe streamlined cabinets with front vertical corners rounded. Flush panel door, hung on full-length piano hinge, provided in top for convenient access. Ventilating louvers on sides. Opening at bottom of rear panel permits easy accessibility for leads, cables, etc. Front panel held in position with self-tapping screws. Grey wrinkle finish. Sturdily built of sheet steel.

Catalog No.	H	Size		Panel Space			Chassis Size			Dealer Cost
		W	D	H	W	H	D	W	H	
RC 8108	8	10	8	8	8	7	7	2	\$3.60	
RC 8128	8	12	8	8	10	7	9	2	3.90	
RC 8168	8	16	8	8	14	7	13	2	5.07	
RC 91711	9	17	11	9	15	10	14	3	7.89	
RC 122012	12	20	12	12	18	10	17	3	9.30	

Chassis are not included unless ordered. See J-112 for chassis listings. Dimensions in Inches.

STANDARD SPEAKER CABINETS



These cabinets are designed especially for permanent or portable public address systems. Made from heavy sheet steel with front vertical corners rounded for neat, streamlined appearance. Attractive clover-leaf grille. Removable back cover. Black or grey wrinkle finish.

Catalog Number (Black Wrinkle)	Cabinet Size			Hole Diam.	Speaker Size	Dealer Cost
	H	W	D			
SS 10106	10	10	6	4 $\frac{3}{4}$ "	6"	\$3.45
SS 12127	12	12	7	6 $\frac{1}{2}$ "	8"	4.65
SS 14148	14	14	8	9"	10"	5.55
SS 16168	16	16	8	11"	12"	7.35

Note: When ordering grey wrinkle, add prefix "G" to catalog number.

ALUMINUM MIDGET CHASSIS

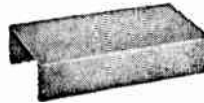

These small, open-end aluminum chassis are ideal for miniature tube assemblies and all applications where space is limited. Made of prime sheet aluminum with $\frac{1}{4}$ " flange on bottom for fastening down, or attaching bottom plate. Finish is etched aluminum.

Cat. No. AMC	D	Size		Dealer Cost	Cat. No. AMC	D	Size		Dealer Cost
		W	H				W	H	
221	2 $\frac{5}{8}$ "	2 $\frac{3}{4}$ "	1 $\frac{1}{4}$ "	\$0.30	541	5 $\frac{3}{8}$ "	4 $\frac{7}{8}$ "	1 $\frac{1}{2}$ "	\$0.45
131	1 $\frac{3}{4}$ "	3 $\frac{1}{2}$ "	1"	.33	431	4"	3 $\frac{1}{4}$ "	1"	.36
342	3 $\frac{3}{4}$ "	4 $\frac{1}{2}$ "	2"	.36	441	4"	4 $\frac{1}{4}$ "	1"	.39
241	2 $\frac{3}{4}$ "	4 $\frac{1}{8}$ "	1"	.36	451	4"	5 $\frac{1}{4}$ "	1"	.42
341	3 $\frac{3}{4}$ "	4 $\frac{1}{8}$ "	1 $\frac{1}{2}$ "	.36	461	4"	6 $\frac{1}{8}$ "	1"	.45
361	3"	6 $\frac{1}{8}$ "	1 $\frac{1}{4}$ "	.42					

MULTI-MOUNTS

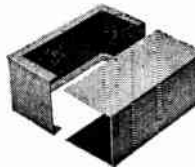

These are all-purpose boxes with an unlimited field of application in radio and electronics. Made from prime sheet aluminum. Two-piece telescoping construction, each half forming three sides. Finish is etched aluminum or grey hammer-tone.

Cat. No. MM	D	Size		Dealer Cost	Cat. No. MM	H	Size		Dealer Cost
		W	H				W	D	
122	1 $\frac{1}{2}$ "	2 $\frac{3}{4}$ "	2 $\frac{1}{2}$ "	\$0.63	386	3 $\frac{1}{2}$ "	8"	6"	\$2.01
132	1 $\frac{1}{2}$ "	3 $\frac{1}{4}$ "	2 $\frac{1}{2}$ "	.63	3106	3 $\frac{1}{2}$ "	10"	6"	2.49
142	1 $\frac{1}{2}$ "	4"	2 $\frac{1}{2}$ "	.66	4127	4"	12"	7"	2.94
242	2 $\frac{1}{4}$ "	4"	2 $\frac{1}{4}$ "	.87	4175	4"	17"	5"	3.45
252	2 $\frac{1}{4}$ "	5"	2 $\frac{1}{4}$ "	.90	1102	1 $\frac{1}{2}$ "	10"	2 $\frac{1}{2}$ "	.99
354	3"	5"	4"	.99	2122	2 $\frac{1}{4}$ "	12"	2 $\frac{1}{2}$ "	1.35
253	2 $\frac{1}{4}$ "	5 $\frac{1}{4}$ "	3"	.96	2420	2 $\frac{3}{4}$ "	4"	2"	.84
465	4"	6"	5"	1.23	1420	1 $\frac{1}{2}$ "	4 $\frac{1}{4}$ "	2 $\frac{1}{4}$ "	.87
375	3"	7"	5"	1.38					

Note: When ordering grey hammer-tone, add prefix "GH" to catalog number. Dimensions in Inches.

Proven Performance

when
you
use

SONAR



TVI SUPPRESSED
• SRT-120 •

MOBILE OR FIXED • KIT OR WIRED/TESTED

The finest all band medium powered amateur transmitter available. "One-knob" tuning for 80-75, 40, 20, 15, 10-11 meter plus space for 160 meters if desired, 100 watts Phone (high level Class B) or 120 watts cw. 5894A final amp, 40 and 80 meter crystals for all band operation. Available in 2 models.

SRT-120 MOBILE CAB. less pwr. sup.....Kit \$159.50; W/T \$198.50
SRT-120P FIXED STATION—XMTR & pwr. sup.....Kit \$198.50; W/T \$279.50

CLASS "B" HIGH LEVEL MODULATION

**AMAZING NEW PORTABLE
MARINE TELEPHONE**

Sonafone®

SONAFONE — MODEL M4W FCC REGISTERED

Portable Marine Radio telephone can be licensed to the owner to be used on his boat, making it the only completely mobile unit—and/or to his vessel for permanent use. A four channel, four watt, light weight (19 lbs.), compact unit for use on boats of any size with or without power. M4W contains its own power, a rechargeable battery, contains built-in public address system. No installation required. Complete with mike, battery, carrying strap, tubes, antenna, less crystals.

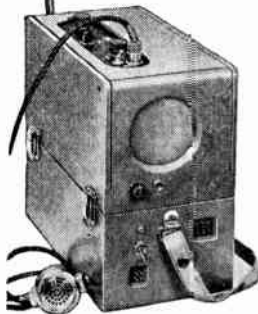

Model M4W.....\$198.50 plus F.E.T.

SONACHARGE

Complete with cable ready to use with M4W. Any 110-120 volts AC. Model 43.....\$19.95
Also available for 6 or 12 VDC source.

Model 0CB\$19.95
Other voltages available on special order.

TELEPHONE HANDSET

Complete with push-to-talk button and cable to M4W. Provides sound in earphone.....\$18.00

TOP HAT

Antenna tuning section for extending range of M4W antenna\$5.00
Zippered Water Repellent Case.....\$3.95



AIRCRAFT TRANSMITTER AT-10

8 channel, 6 tube, 6, 12, or 24 VDC operation. 108-132 mc spectrum. Registered with FCC. Designed to comply with CAA specification. PUSH to talk operation. Designed to be combined with AC-109 receiver. 5686 power amp. 5 watt output. 15 watt peak, due to 18 db speech compression. 250 to 300 VDC at 100 ma. 12V at 3a. Pi network tuning. Complete with 2 crystals, hard ware and connectors. 2 3/4 lbs.

AT-10\$150.00



AIRCRAFT RECEIVER AC-109

Complete, compact 9 tube receiver. High signal to noise ratio. 6, 12, 24 volt operation. 108-132 mc spectrum. Companion to AT-10 transmitter. Built-in ANL. Designed to comply with all CAA specs. Frequency stability equal to crystal. 3 watts audio, 250 VPC at 80 ma. 12V fil. 1.4 amp. 2 3/4 lbs.

AC-109\$99.75

V-120 VFO TUNING HEAD

Designed specifically for the SRT-120 & SRT-120P. Extremely stable using 4 high Q circuits. Tuning ratio of 8:1, no power required. Covers all bands.

V-120 \$19.95

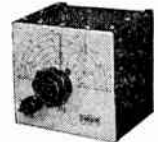

V-32 VIBRATOR POWER SUPPLY

"SONAPACK" 300 VDC at 200 ma. 6 VDC input. NON-SYNCHRONOUS—uses full wave bridge selenium rectifier. Low Hash Compact 3"x4"x2". Provision for standby and B-voltage for bias.

V-32\$27.00



SR-9 COMPLETE MOBILE RECEIVER

9 Tubes, 3 watt output to any PM speaker. 220 to 275 VDC 70 to 90 ma. 6.3 at 2.5 amp. 35 to 75 ohm impedance input. 1 microvolt or less sensitivity (RMA test) A.N.L. built in. 3 lbs. 5 1/4"x5 3/4"x1 1/2". Available on these frequencies: 27 to 30 mc; 30 to 40 mc; 40 to 50 mc; 50 to 54 mc; 72 to 75 mc; 143.8 to 149 mc; 152 to 163 mc.
\$72.45



MB-26 TRANSMITTER

Compact, stable, 6 tube 12 watts input. 12AT7's PP parallel final. 225 to 300 VDC at 100 to 150 ma. 6.3 fil. 8 or 24 mc (overtone) crystal. Shock mount proved. Companion to SR-9 available on same frequencies. Inter cable hook-up makes full operation with on-off switch on receiver and push to talk switch on mic. MB-26.....\$72.45

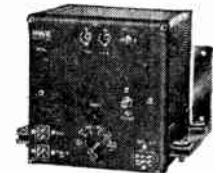

LP-7 LOW PASS FILTER

75 db attenuation of Harmonics. Compact, adjustable input and output for better matching. Cut off freq. 44 mc-52 ohms. Teflon insulation 1 KW fully modulated.
LP-7 \$12.95



PHONE PATCH

Ideal for hams who DX and want to patch a contact via phone. Compact, lightweight, easy to install. Totally shielded—NO HUM. Designed for break-in operation. Model PP-24.....\$19.50



JIFFY-SPICE MAGNETIC RECORDING TAPE SPLICER

Simple device for professional splicing. \$1.50



JIFFY-RASE

A magnetic device to erase recording tape in the complete reel. Save time. Neutralize recording heads. Improves signal to noise ratio of recording tape. A must in studios, shops, and the perfectionist in recording.
Model P-30.....\$21.60



PRICES

Prices of manufacturers and suppliers' products listed in RADIO'S MASTER are subject at all times to change without notice — they should not be considered final.

Get quick on-the-spot quotations from your distributor who subscribes to our perpetual up-to-the-minute PRICING SERVICE.



Official Pricing System of radio - electronic - television parts and equipment. Supported by the industry: distributors, manufacturers, and their sales representatives.

Loose-leaf, flexible binder. Contains over 1100 pages.

Published by
UNITED CATALOG PUBLISHERS, INC.
106-110 Lafayette Street
New York 13, N. Y.

DELIVERY

Delivery is often dependent on the availability of raw materials. So check with your distributor for delivery information.

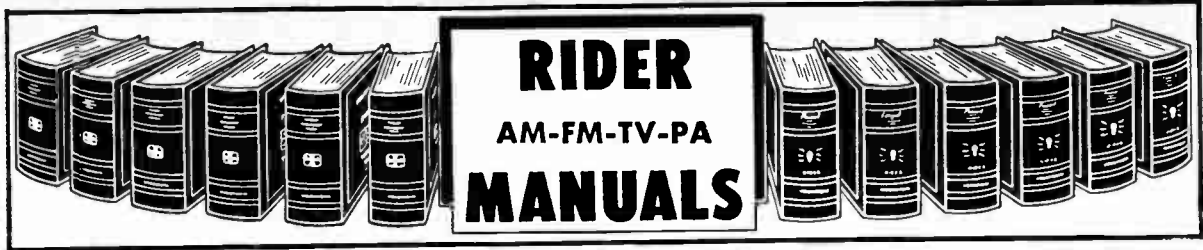

RIDER AM-FM-TV-PA MANUALS

RIDER TV MANUALS

For complete factory-authorized, factory-approved, unabridged TV servicing information — direct from the receiver manufacturers — there's only one authentic source — RIDER TELEVISION MANUALS. Schematics, chassis views, tube layouts, voltages and resistance

readings, alignment procedures, parts lists and values, pilot model schematics as well as all production runs, in fact, you will find all information necessary to speedier, easier, more profitable servicing. Dependable replacement parts listings starting with Volume 10.

TV MANUAL VOL. 13
with dependable replacement parts listings
Makes TV Servicing Easy



- Includes color TV servicing information — RCA, CBS
- Circuit action descriptions!
- Unpacking and installation data!
- Signal waveforms for trouble shooting!
- Large, easy to read diagrams!

(Cat. No. 2013)

Complete coverage for the period July 1953 through April 1954. All pages filed in proper place. Single index for all 13 TV Volumes. Over 2,000 (equivalent of 8½x11" size) pages.

Vol.	Cat. No.	Pages	Cover	Price
13	2013	2300	In Preparation	\$24.00
12	2012	2,000	Mar. 53 - July 53	24.00
11	2011	2,200	Oct. 52 - Feb. 53	24.00
10	2010	2,350	Mar. 52 - Sept. 52	24.00
9	2009	2,136	Oct. 51 - Feb. 52	24.00
8	2008	2,688	June 51 - Sept. 51	24.00
7	2007	2,352	Sept. 50 - June 51	24.00
6	2006	2,320	Aug. 50 - Jan. 51	24.00
5	2005	2,320	Mar. 50 - July 50	24.00
4	2004	2,296	Oct. 49 - Feb. 50	24.00
3	2003	2,032	Jan. 49 - Oct. 49	24.00
2	2002	1,896	Jan. 48 - Jan. 49	24.00
1	2001	2,000	Up to Jan. 48	19.80

RIDER AM-FM RADIO MANUALS

Proved best by 24 years of continuous test, Rider AM-FM Radio Manuals are used by an overwhelming majority of competent, progressive servicemen. They find the profit-making, time-saving value of the Manuals to be without equal. All information comes directly from the receiver manufacturers—alignment, i.f. peaks, operating voltages, parts lists and values, voltage ratings of condensers, wattage ratings of resistors, coil resistance data, gain data, dial drives, etc. You'll find the greatest coverage at the lowest cost. Every service technician, set manufacturer, design and research lab, component parts manufacturer — should own a complete set of Rider Manuals.

Vol.	Cat No.	Pages	Year	Price
23	1023	1,152	51-53	\$15.00
22	1022	1,520	50-51	18.00
21	1021	1,648	49-50	21.00
20	1020	1,776	1949	21.00
19	1019	2,122	48-49	22.50
18	1018	2,036	1948	22.50
17	1017	1,648	47-48	19.80
16	1016	768	46-47	9.90
15	1015	2,000	42-46	22.50
14	1014	1,376	1942	19.80
13	1013	1,672	41-42	19.80
12	1012	1,648	40-41	19.80
11	1011	1,652	39-40	19.80
10	1010	1,664	38-39	19.80
9	1009	1,672	37-38	19.80
8	1008	1,650	36-37	19.80
7	1007	1,600	35-36	19.80
6	1006	1,240	34-35	15.00

Rider Public Address Equipment Manual VOLUME I



(Cat. No. 3001)

Public Address Systems — Outdoor Announcing — Musical Instruments — Phonographs — Theater, Church Hearing Aids — Intercom Systems — Home and Theater Motion Pictures—Mobile and Portable Sound Systems.

Coverage from 1938 to 1948. 147 manufacturers. Schematics, voltage and resistance tables, tube and chassis layouts, installation notes, operational instructions, impedance matching.

2024 pages "HOW IT WORKS" book
Index Only \$18.00

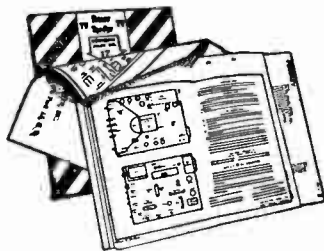

RIDER TEK-FILE

Tailor-made for specific model TV servicing

The same official, factory-authorized, factory-approved servicing data as in Rider TV Manuals, except that it is in packaged form. Grouped by manufacturers and models. Suitable for house call servicing and easy bench use in the shop. TEK-FILE makes servicing easy! Each Pack contains all the data you need . . . and it's guaranteed to match the set! Dependable replacement parts listings starting with Pack No. 57. New Packs available monthly. Send for FREE complete index. *Only \$1.50 per Pack.*

"HOW TO" BOOKS

TV MANUFACTURERS' RECEIVER TROUBLE CURES SERIES

POSITIVE CURES for TV troubles! Gives you exact directions for correcting TV receiver performance "bugs." Each cure is official, factory-authorized, direct from the receiver's manufacturer. Listings by manufacturer and model or chassis number. Helps correct the most difficult faults — picture jitter, hum, buzz, tearing, etc. *One service job will more than pay the cost of this series of time-saving books!*

VOLUME 1 covers: Admiral, Airing, Andrea, Arvin, Belmont-Raytheon, Bendix, Calbest, Capehart-Farnsworth, CBS-Columbia, Certified, Crosley, Dumont.

(Cat. No. 143)

VOLUME 2 covers: Emerson, Fada, Firestone, Freed, Gamble-Skogmo, General Electric, Hallicrafters, Hoffman, Industrial TV, International TV, Jackson.

(Cat. No. 143-2)

VOLUME 3 covers: Kaye-Halbert, Kent, Magnavox, Majestic, Meck, Mercury, Midwest, Montgomery Ward, Motorola, Muntz, National, North American Philips, Olympic, Pacific-Mercury, Packard-Bell, Philco.

(Cat. No. 143-3)

VOLUME 4 covers: Philharmonic, Pilot, Radio & Television (Brunswick), RCA Victor, Remington (Rembrandt), Scott, Sears-Roebuck, Sentinel, Setchell-Carlson, Shaw TV.

(Cat. No. 143-4)

VOLUME 5 covers: Sparton, Stewart-Warner, Stromberg-Carlson, Sylvania, Tele King, Trad TV, Transvision, Travler, Wells-Gardner, Western Auto (Truetone), Westinghouse, Zenith.

(Cat. No. 143-5)

Each volume over 115 pages 5 1/4" x 8 1/4"
Illustrated Each vol. Net Price \$1.80

HOW TO USE METERS

by John F. Rider

PANEL TYPE, volt-ohm-milliammeter, vacuum-tube voltmeters for servicing TV and radio receivers, audio amplifiers, power supplies; for use and repair of amateur transmitters. Written for the service technician, the TV and radio student, and ham. Completely practical!

CHAPTERS: 1. Principle and Construction of AC Meter Movements; 2. Principle and Construction of Meters Other than the Moving Coil Type; 3. Current and Voltage Readings; 4. Power Measurement and Wattmeters; 5. Adapting Meter Movement for DC Measurements; 6. Adapting Simple Meters for Audio and Power Frequencies; 7. Adapting Simple Meters for RF Measurements; 8. Volt-ohm-milliammeters; 9. Vacuum Tube Voltmeters and Volt-ohm Meters; 10. Applications of Meters; 11. Do's and Don'ts of Meter Use; Index.

Over 140 pages 5 1/2" x 8 1/2" Illustrated
(Cat. No. 144) Paper bound Net Price \$2.40

HOW TO TROUBLESHOOT A TV RECEIVER

by J. Richard Johnson

HERE IS A BOOK written expressly for the newcomer — or for the TV service technician with limited experience. Written by an expert who knows and has taught the subject. A clear, easily understandable approach to TV servicing. There is no other book like it! Aids the service technician to systematically troubleshoot all TV receivers with a step-by-step guide. Explains picture tube patterns and trouble symptoms. Interprets schematics; which tools to buy for field and for shop servicing; what test equipment, what tube stock is needed; discusses common tube faults, etc. It will more than pay for itself in a few days of use.

128 Pages 5 1/2" x 8 3/8" Illustrated Paper bound
(Cat. No. 152) Price \$1.80

RADIO TROUBLESHOOTING GUIDEBOOK

by John F. Rider & J. R. Johnson

MORE THAN 100 MILLION radio receivers are now in use. Many millions are sold every year. Here is a troubleshooting guide-book that covers them all! Every type of AM and FM receiver is discussed—with explicit information about troubles and possible causes. Completely practical for the radio service technician and the radio student.

CONTENTS: Part 1. Superheterodyne Receivers. Chapter 1.

"HOW TO" BOOKS

SERVICING TV VERTICAL AND HORIZONTAL OUTPUT SYSTEMS

by Harry Thomas

A **COMPLETE** explanation of how vertical and horizontal output systems function. Discusses types of circuits used in TV receivers—waveforms encountered, construction of components, component constants, requirements and troubleshooting. For the TV service technician and the student of TV servicing. No other book in print offers equivalent coverage of the subject or explains details as clearly.

CHAPTERS: 1. The Basic TV Picture System in Receivers; 2. Organization of the Basic Vertical and Horizontal Output System; 3. How the Vertical Output System Works; 4. How the Horizontal Output System Works; 5. The Deflection Yoke; 6. Variations in Horizontal Output Systems; 7. Construction and Replacement of Components in TV Output Systems; 8. Troubleshooting Vertical Output Systems; 9. Troubleshooting Horizontal Output Systems; Index.

Over 140 pages 5 1/2" x 8 1/2" Illustrated Net Price \$2.40
(Cat. No. 150)

TV SWEEP ALIGNMENT TECHNIQUES

by Art Liebscher, Former RCA Test Equipment Specialist

NEVER BEFORE has there been a book such as this on TV sweep alignment! An expert gives you accurate, time-saving methods—and tells you how they work. The new **SUPER-MARK** method of TV sweep alignment is introduced. Get maximum value from your test equipment and learn new uses. Chock-full of sweep curve pictures. Valuable for servicing in UHF signal areas.

CHAPTERS: 1. Introduction to Modern Sweep Alignment; 2. Modern Sweep Alignment Techniques; 3. Markers; 4. The Supermark; 5. Sweep Curves; 6. Tuner Curve Formation; 7. Intermediate Frequency Alignment; 8. Intermediate Frequency Curve Alignment; 9. Sound I-F and Sound Detector Alignment; 10. Video Amplifier Response Testing; 11. UHF Sweep Alignment, Index.

(Cat. No. 145)

123 pages 5 1/2" x 8 1/2" Illustrated Net Price \$2.10

OBTAINING AND INTERPRETING TEST SCOPE TRACES

by John F. Rider

OVER 500 actual photographs of test scope traces. Shows how to use scopes and what the traces mean. Valuable for servicing TV receivers, FM and AM radio receivers, audio systems and test equipment. Specific test equipment set-ups shown with each application. No other book like it!

Typical Chapters: What's in a Scope; Getting Familiar With the Scope; Auxiliary Test Equipment for the Scope; Using the Scope for Checking Test Equipment; Applying the Scope to Testing Transmitters; How to Use the Scope with FM Receivers; How to Use the Scope With AM Receivers; Checking Audio Systems With the Scope; Checking Power Supplies with the Scope; the Scope's Use in Checking Components; How to Use the Scope With TV Receivers.

Over 140 pages 5 1/2" x 8 1/2" Illustrated Net Price \$2.40
(Cat. No. 146) Paper bound

ALL PRICES SUBJECT TO CHANGE WITHOUT NOTICE

Our 25th Anniversary Year

"HOW TO" BOOKS

HOW TO USE SIGNAL & SWEEP GENERATORS

by J. Richard Johnson

THE FIRST BOOK devoted entirely to Signal Generators. Gives various test uses for AM Signal Generators, FM Signal Generators, Test Oscillators, Marker Generators, Calibrators, and Sweep Generators. Problems involved in using this equipment and how to overcome them. Illustrations of typical test set-ups. Shows means of adapting signal generators to various applications to increase their usefulness. Completely discusses all applications of all generators used in AM, FM Radio and TV servicing. Explains exactly what signal generators are and what they do.

CHAPTERS: 1. Purposes and Types of Signal Generators; 2. AM Signal Generators; 3. Marker Generators and Calibrators; 4. Sweep Generators; 5. Frequency Characteristics; 6. Output-Voltage Characteristics; 7. Terminating, Matching, and Grounding; 8. Principles of Sweep-response Analysis; 9. How to Set-up for TV Sweep Alignment; 10. Other Signal Generator Applications; (1) AM Receiver Alignment; (2) AM Receiver Performance Tests; (3) General AM Signal Generator Applications; (4) General Applications of Sweep Generators; 11. Signal-generator Maintenance Tests; Index.

(Cat. No. 147)

Approx. 120 pages 5 1/2"x8 1/2" Illustrated Net Price \$2.10

TV INSTALLATION TECHNIQUES

by Samuel L. Marshall, TV Instructor,
George Westinghouse Vocational High School

WHEREVER and whenever an installation is a problem, this authoritative book will help you. It puts at your fingertips accurate data on receiver adjustments in the home, municipal regulations governing the installation of TV antennas and masts in all the major TV areas in the United States. You get the facts about such matters as ice loading and wind surface. Mounting requirements, whether for a short chimney-attached mast or an 80-foot tower, are explained thoroughly.

(Cat. No. 131)

336 pages 5 1/2"x8 1/2" 270 Illustrations Net Price \$4.50

HOW TO INSTALL AND SERVICE AUTO RADIOS

by Jack Darr

DISCUSSES installation problems and special servicing requirements of the automobile radio. Gives information on car antenna installations, vibrator testing, noise suppression, plus a complete list of tools, spare parts, and other equipment needed to do auto radio repairing and servicing. In addition, you learn, how to set up and operate the auto radio service department or shop.

CHAPTERS: Section I. Installing Auto Radios - Auto Antennas, Remote Control Heads, Noise Elimination, Separate Speaker Installation, Installation for pickups and heavy trucks. Section II. Servicing Auto Radios - Servicing in the car, Vibrator Power Supplies, Intermittence, Parts Replacement, Servicing Automatic Tuners, Remote Control Shafts, Realignment, Preventative Maintenance. Section III. The Auto Radio Service Shop - Special Tools and Equipment, Test Instruments, Hand and Power Tools, Parts Stock, Showmanship, and Service Records.

120 Pages (Cat. No. 159) Only \$1.80

HOW TO LOCATE AND ELIMINATE RADIO AND TV INTERFERENCE

by Fred D. Rowe, Northern Calif. Electricity Bureau

BOTH RADIO AND TELEVISION interference are discussed. Generally, the basic methods of locating and eliminating many troubles are equally applicable to both radio and TV—the major differences being in frequencies and types of source involved. When fundamentals are understood the solution to overcoming interference as explained thoroughly in this book is not too difficult.

CHAPTERS: 1. The Interference Problem 2. Antennas and Interference Sources and Sounds. 4. Interference Locating Equipment 5. Electrical Equipment and Appliance Sources 6. Locating the Source 7. Power Line Interference 8. Noise Filters 9. Appliance and Equipment Interference Elimination 10. Florescent Lamp Interference 11. Television Interference Filters 12. Eliminating Interferences at the TV Receiver Appendix I. Questions and Answers. Appendix II. Ordinances.

128 Pages (Cat. No. 158) \$1.80

SOUND

HIGH FIDELITY SIMPLIFIED

by Harold D. Weiler

LEARN what components you need to start you on the path to the ultimate in listening enjoyment. "Those planning high fidelity music systems for their homes will save themselves time, money and trouble by reading this first, then making purchases." *Radio-Television News*.

Typical chapters: Sound!; Acoustics, Electronics and Music; The Simple Loudspeaker; The High-Fidelity Loudspeaker; Loudspeaker Enclosures; The Basic Amplifier; The Amplifier—Part 2; the Record Player; The Tuner; Use of the Home Music System, Tape Recorders.

208 pages 5 1/2"x8 1/2" (Cat. No. 142) Net Price \$2.50

GUIDE TO AUDIO REPRODUCTION

by David Fidelman

HERE'S AN A TO Z explanation of the reproduction of sound. Discusses all phases of audio reproduction systems and their requirements. Design, construction, assembly, and testing of these systems and their components are fully covered. Full explanation of the circuitry of preamplifiers, amplifiers; complete discussion of phono cartridges, tuners, microphones, loudspeakers, and enclosures. Valuable for the radio and TV service technician, engineer and experimenter. A companion volume to the best-selling HIGH FIDELITY SIMPLIFIED.

(Cat. No. 148)

Over 250 pages 5 1/2"x8 1/2" Illustrated Net Price \$3.50

RADIO OPERATOR'S LICENSE Q&A MANUAL

By Milton Kaufman

Fourth Edition, January 1953

(Elements 1 through 8)

SYSTEMATICALLY LISTED are the questions and answers to past FCC exams plus a FOLLOW-THROUGH discussion of the answer, so necessary for a complete understanding of the technical question. Abundant illustrations make difficult technical questions picture-clear.

Not simply an optional text, but an indispensable reference volume for student and operator, it is up-to-date in all respects as of the publication date. Based on the Government Study Guide and supplementary FCC releases, the volume offers valuable appendices (Small Vessel Direction Finders and Automatic Alarm) never before available in a book of this type.

(Cat. No. 130)

730 pages 5 1/2"x8 1/2" 243 Illustrations Net Price \$6.60

ELEMENT VIII—SHIP RADAR TECHNIQUES

Identical text as in book, separately bound for those specially interested in Ship Radar. Uses the same question-answer-discussion pattern.

32 pages 5 1/2"x8 1/2" (Cat. No. 130A) Net Price \$.78

BROADCAST OPERATOR'S HANDBOOK

Second Edition (October, 1951) by Harold E. Ennes

COMPLETELY REVISED and brought up to date, the text deals with the practical considerations of radio broadcasting and its equipment. It explains all the why's and wherefore's of daily studio routine. The first four parts of the book cover actual operating procedure in control rooms, the master control, remote controls, and the transmitter; the fifth and sixth parts discuss technical data for operators and technicians, including vital preventive maintenance.

(Cat. No. 138)

440 pages 5 1/2"x8 1/2" 226 Illustrations Net Price \$5.40

RIDER BOOKS—THE STANDARD OF THE INDUSTRY

COLOR TV

INTRODUCTION TO COLOR TELEVISION

by M. Kaufman, Engineer, Color Engineering Labs
CBS-Columbia (A division of Columbia Broadcasting System)
and H. Thomas, Senior Project Engineer
Federal Communications Labs, Inc. (A division of I. T. & T.)

ANSWERS technical questions on color TV which the layman might ask the service technician. Discusses color wavelengths and frequencies; primary colors and what they mean. Production of color by reflection and projection. Brightness, hue and saturation are defined. Gives basic features of the N. T. S. C. system. Differences between Tri-color, Colortron, and the Chromatron tubes are explained. Discusses circuits used in color TV receivers and gives complete explanations as to their operation—Setting up and adjustment procedure.

CHAPTERS: 1. Introduction. 2. Fundamentals of Color for Television. 3. N. T. S. C. Color Television System. 4. Tri-Color Picture Tubes. 5. The Color Television Receiver. 6. Adjustment of Color Television Receivers.

(Cat. No. 156)

144 pages Illustrated Paper bound Only \$2.10

HIGHLIGHTS OF COLOR TELEVISION

by John R. Locke, Jr., Radio and Television Dept.
General Electric Company, Syracuse, New York

THIS BOOK introduces color television at a level which will be understandable to persons who are familiar with the black and white television system. All material is based on the recommendations of the N. T. S. C. Since a color television receiver must provide the necessary circuitry to reproduce the color information, the new problem is to understand the nature of these added circuits. Highlights of Color Television supplies this information.

CHAPTERS: 1. Introduction. 2. Colorimetry. 3. The N. T. S. C. Color Signal. 4. The Transmitter. 5. Color Receiver. 6. The Shadow Mask Tri-Color Picture Tube. 7. Some Receiver Details. 8. General Comments.

(Cat. No. 157)

48 Pages Paper bound Illustrated Only \$9.99

UHF

UHF TELEVISION ANTENNAS AND CONVERTERS

by Allan Lytel

ALMOST all of the receiver manufacturers have brought out a UHF system for use with their existing VHF receivers on the new band. These systems range from the simple single-channel device to complete tuners that can cover the entire band. This book explains in simple terms, the function and operation of the UHF conversion systems that are appearing on the market in ever increasing numbers. This book is meant to prepare the service dealer and serviceman to know the answers to the UHF question, as well as to prepare for the installation and maintenance.

(Cat. No. 153)

128 pages 5 1/2"x8 1/2" Illustrated Net Price \$1.80

UHF PRACTICES AND PRINCIPLES

by Allan Lytel

LEARN NOW about the uhf practices and principles that will affect you in your everyday work in the near future. Operate successfully and profitably with the knowledge of special uhf techniques, concepts, and circuits explained here. UHF transmitting and receiving equipment is discussed as it applies to the various services using it. Much of the emphasis is on the practical applications to uhf television. UHF will mean added income for you. Learn about it now!

(Cat. No. 141)

390 pages 5 1/2"x8 1/2" 285 Illustrations Net Price \$6.60

TV SERVICING

TV FIELD SERVICE MANUAL VOLUME 1

by Harold Alsberg

BY AND LARGE, the public is very reluctant to part with its receivers for any prolonged period of time. In the event of any trouble in the equipment. It is with the realization that more and more servicing must be done in the home that the field service data was conceived. Every set model of each manufacturer contains: Top view diagrams of tube locations; diagrams of rear controls—and front controls; tube listings and circuit functions; key voltages; diagrams of picture tube adjustments, AM tuner drive cord assemblies, and TV-FM tuner drive cord assemblies. On the opposite page is a listing of trouble symptoms (audio-video) and specific directions for trouble cures.

VOLUME 1 COVERS: Admiral, Affiliated Retailers (Artone), Aimee, (AMC), Air King, Air Marshal, Allied Purchasing, Andrea, Arvin and Automatic.

120 pages (Cat. No. 155) Only \$2.10

TV TROUBLESHOOTING & REPAIR GUIDEBOOK

by Robert G. Middleton

Volume 1

A NEW, PRACTICAL, easy-to-use book for the TV service technician. It tells you how to spot receiver troubles and correct them. Contains factual information you must know to be a TV troubleshooting and repair expert. The Contents include: split-sound and intercarrier receivers, circuit variations and how they affect operating waveforms, simplified TV receiver troubleshooting by scope and picture tube screen display analysis, remedies for circuit troubles, visual methods of alignment and recognition of alignment problems. Also hundreds of handy hints and time-saving short cuts for troubleshooting sync circuits, video-amplifier circuits, locating buzz, etc. TV troubleshooting charts included. Not a theory book—but a practical, down-to-earth troubleshooting and repair guide that will help you earn more money.

204 pages 8 1/2"x11" (Cat. No. 140) Net Price \$3.90

Volume 2

A GOLD MINE of valuable TV service information: Trouble-shooting front ends; Servicing the Video I-F strips; Faults in video amplifiers; Trouble analysis in sound I-F and detector systems; Practical pointers in audio amplifier servicing, Troubles in horizontal circuits. Not theoretical—everything is practical from beginning to end.

(Cat. No. 140-2)

160 pages 8 1/2"x11" Paper covered Net Price \$3.30

RECEIVING TUBE SUBSTITUTION GUIDEBOOK

by H. A. Middleton

ANSWERS ALL TUBE PROBLEMS by listing 2,500 radio-television tube substitutions in numerical sequence with accompanying wiring instructions, original and substitute tube socket illustrations. You will find information to help you turn out jobs that would otherwise remain on the shelf because of lack of proper tubes.

224 pages 8 1/2"x11" (Cat. No. 135) Net Price \$3.00

FIRST SUPPLEMENT

750 completely new and different radio-TV tube substitutions not listed in the first edition. Special section on substituting tubes in television receivers.

48 pages 8 1/2"x11" (Cat. No. 139) Net Price \$.99

SECOND SUPPLEMENT

The Second Supplement features 134 TV PICTURE TUBE SUBSTITUTIONS as well as over 190 AM-FM-TV receiver tube substitutions. Used with original and first supplement volumes it is the most complete coverage available on tube substitutions.

48 Pages 8 1/2"x11" (Cat. No. 139-2) Net Price \$.99

Indispensable Rider Books for Electronic maintenance—research—education

GENERAL

ENCYCLOPEDIA ON CATHODE-RAY OSCILLOSCOPES AND THEIR USES

by John F. Rider and Seymour D. Uslan

THE ONLY BOOK of its kind that tells you all you should know about an oscilloscope, this text fully and clearly describes the device, its construction and its capabilities. It explains what a scope is, what it can do, and how it is used. The authors thoroughly cover the applications of the oscilloscope in servicing, engineering, and research, and offer thousands of time-saving, labor-saving references, charts, waveforms, etc.

All oscilloscopes produced during 1940-1950, a total of more than 70 different models, are accurately described, with specifications and wiring diagrams.

If you are planning to buy a scope, this book will help you select the type best suited to your needs. If you already own one, it will show you how to increase your instrument's usefulness and value to you. We guarantee this book will save and earn many, many times its cost to you!

(Cat. No. 133) • Half a million words • Easy to read
992 pages 3,000 Illustrations 8 1/2"x11" Net Price \$9.00

INSIDE THE VACUUM TUBE

by John F. Rider

Clear, simple discussion of the theory of the vacuum tube and its operation.

CONTENTS: Introducing the Electron; Electron Emission; Movement of Charges; Space Charge and Plate Current; Fundamentals of Tube Characteristics; The Diode; The Triode; Static Characteristics of Triodes; Triode Dynamic Characteristics and Load Lines; Dynamic Transfer Characteristics; Voltage Amplification; The Tetrode and Pentode Vacuum Tubes; The Cathode Circuit; Power Amplifiers; Miscellaneous Vacuum Tubes. Appendix. Index. (Cat. No. 115)

424 pages 5 1/2"x8 1/2" Illustrated Net Price \$4.50

HIGH FREQUENCY MEASURING TECHNIQUES USING TRANSMISSION LINES

by E. N. Phillips, W. G. Sterns, and N. J. Gamara

Shows how to measure wavelength, impedance, etc., in four-terminal networks. (Cat. No. 125)

58 pages 8 1/2"x11" Illustrated Net Price \$1.50

FM TRANSMISSION AND RECEPTION

Second Edition (November, 1950) by Rider & Uslan

ALL YOUR QUESTIONS about new developments in f.m. are answered in this text. The latest functions and applications of f.m. are thoroughly and clearly discussed. Transmitting and receiving antennas are covered as well as various types of receivers, including television, their functioning and servicing. Radio servicemen, radio amateurs, engineers, students will find this an indispensable reference volume combining theory and practice.

EXTRA: Review Questions at the end of each chapter.

(Cat. No. 102)

460 pages 5 1/2"x8 1/2" Illustrated Net Price \$4.95

UNDERSTANDING MICROWAVES

by V. J. Young

This book provides foundation for understanding microwave radio, television and radar. Mathematics are confined to footnotes wherever possible. Covers theory and operation. Typical chapters: The Ultra-High Frequency Concept; Transmission Lines; Waveguides; Resonant Cavities; Radar and Communication.

385 pages 5 1/2"x8 1/2" Illustrated
(Cat. No. 107) Cloth bound Net Price \$6.00

UNDERSTANDING VECTORS AND PHASE IN RADIO

by John F. Rider and Seymour D. Uslan

A shorthand method to easier understanding of radio theory, the text is written for every man in radio and electronics who has not had the advantage of technical training. Vectors are the engineer's shorthand—a picturegraph adopted to eliminate mathematical and complex waveform presentations; an understanding of which is necessary in following developments in FM and television.

160 pages Paper Cover (Cat. No. 103) Net Price \$9.99

TECHNICIAN'S GUIDE TO TV PICTURE TUBES

by Ita Remer

A PICTURE TUBE servicing guide for the television installation and repair man. Covers the care, methods of handling, replacement maintenance and repair of the picture tube. It is written for the technician who desires basic and specific information on the picture tube and its accessories (including conversion) without wading through reams of technical data, complicated circuit explanations.

140 pages 5 1/2"x8 1/2" Illustrated (Cat. No. 163) Only \$2.40

FUNDAMENTALS OF TRANSISTORS

by Leonard Krugman

THE TRANSISTOR is now evolved to a point where it is suitable for many applications, both as a direct replacement and as a supplement to electron tubes. An expert has consolidated in practical form for the repair man, the engineer, the hobbyist and the engineering student the explanation and application of the transistor. Basic transistor operation, characteristics, performance and applications are explained.

160 pages 5 1/2"x8 1/2" Illustrated (Cat. No. 160) Only \$2.70

ADVANCED TELEVISION SERVICING TECHNIQUES

WRITTEN BY THE RETMA Pilot Training School Teaching Staff. A completely NEW approach to books for TV service technicians. Written by experts who are teaching every day. The contents have been tried and proven to be the finest ever written. Completely practical. A step-by-step approach to how to service every section of a TV receiver with every kind of test equipment — by resistance measurement, by voltage measurement, by means of the scope. It explains the uses of test equipment of all kinds in connection with TV receiver servicing, such as sweep generators — signal generators — vacuum tube voltmeters — scopes, ohmmeters!

This is not a theory book! It is a book which every technician can use on the bench — and every student in a TV school can use, because it tells what-to-do and how-to-do-it.

Approx. 175 pages 8 1/2"x11" (Cat. No. 161) Only \$3.60

COLOR TV DICTIONARY

by J. R. Johnson

FIRST COMPLETE explanation of new color TV terms with their definitions that everyone — service technicians, students, engineers, amateurs — interested in color television must be familiar with. This is more than a dictionary! Over 50 illustrations.

72 pages 5 1/2"x8 1/2" (Cat. No. 164) Only \$1.25

R-C AND R-L TIME CONSTANT

Edited by Alexander Schure, Ph.D., Ed.D.

FIRST IN A SERIES of review books written expressly for the student who is studying electronics or the technician who has studied electronics and wishes to understand Time Constant (R-C and R-L) more clearly. It supplements the contents of courses in text books which are on a technical institute level. Covers practical applications of Time Constant and how it effects circuit operation.

About 48 pages 5 1/2"x9 1/2" (Cat. No. 166) Only \$9.90

ANTENNAS

TV AND OTHER RECEIVING ANTENNAS

(Theory & Practice) by Arnold B. Bailey, Antenna Consultant

COMPLETE INFORMATION on all antenna types. Exclusive data available through no other source. Vitally useful in selection of antennas for various reception areas. Tables, charts and graphs replace mathematics. Valuable for technicians, engineers and students.

(Cat. No. 134)

606 pages 5 1/2"x1 1/2" 310 Illustrations Net Price \$6.90

TV AND ELECTRONICS AS A CAREER

by Ira Kamen and Richard H. Dorf and others

Here's your guide book to a profitable career in the electronics industry. Experts tell you what opportunities are offered, how to prepare yourself for them, how to go about getting the job you want.

(Cat. No. 137)

326 pages 5 1/2"x8 1/2" 136 illustrations Net Price \$2.50

TV PICTURE PROJECTION AND ENLARGEMENT

by Allan Lytel

THE STORY behind TV picture enlargement by viewing lenses and by projection systems is important to every serviceman. Read this text, which explains "how" and "why," and you will find adjustments of these receivers can be simple and rapid. It is a combination of theory and practice . . . dollar-making, time-saving practice!

192 pages 140 illus. (Cat. No. 128) Net Price \$3.30

A NEW Kind of Rider Manual NOW AVAILABLE!

A TERRIFIC BUY!!

2½ years production in each of the 11 volumes . . . June 1951 thru December 1953. Dollar for dollar it has no equal! Comparable data from other services costs you 5 to 20 times as much!



Each Volume Contains the Following Data:

- ★ Schematics
- ★ Tube Layout
- ★ Voltages
- ★ Alignment
- ★ Cabinet Picture
- ★ Dial Stringing
- ★ Trimmer Location
- ★ Parts List
- ★ Chassis Views
- ★ Individually Indexed

Cat. No. 4001—Vol. 1	Admiral, Allied, Arvin, Automatic Bendix.....	\$1.65
Cat. No. 4002—Vol. 2	Bogen, CBS-Columbia, Capehart, Farnsworth, Crosley.....	1.65
Cat. No. 4003—Vol. 3	DeWald, Emerson, Fada, Firestone.....	1.65
Cat. No. 4004—Vol. 4	Gamble Skogmo, G.E., Goodrich, Hallionafters, Jackson.....	1.65
Cat. No. 4005—Vol. 5	Jewel, Meck, Mitchell, Montgomery Ward.....	1.65
Cat. No. 4006—Vol. 6	Motorola, Olympic, Packard Bell.....	1.65
Cat. No. 4007—Vol. 7	Philco.....	2.40
Cat. No. 4008—Vol. 8	RCA.....	1.65
Cat. No. 4009—Vol. 9	Radio Craftsman, Raytheon, Sears Roebuck, Sentinel, Setchell Carlson, Sonora, Sparton.....	1.65
Cat. No. 4010—Vol. 10	Spiegel, Stewart Carlson, Sylvania, Tele-King, Trav-ler.....	1.65
Cat. No. 4011—Vol. 11	Wells Gardner, Western Auto, Westinghouse, Zenith.....	1.65

Each Volume 8½"x11", soft cover

Volume 7 contains 192 pages . . . All other volumes 96 pages

It is the MOST accurate service information that you can buy. . . . It is factory authorized . . . factory prepared . . . factory applied methods! This information protects and builds your technical reputation. With these data in your hands you know as much about the receivers as the manufacturers who made them! You service easily and profitably!

The Easy — Inexpensive Way of Getting The Best in Radio Service Information!

No Other Auto Radio Servicing Manual Like It!!

5 years production in each of the volumes . . . 1950 through 1954. Contains more data . . . at a lower cost . . . than is available from any source either in package or in book form. Complete factory data giving ALL service information including installation on factory installed radios.

NOW AVAILABLE

Volume 1-A, (Cat. No. 5001-A): FORD, LINCOLN, MERCURY	208 pages	8½" x 11", illustrated	Only \$3.00
Volume 2-A, (Cat. No. 5002-A): BUICK, CADILLAC, OLDSMOBILE	200 pages	8½" x 11", illustrated	Only \$3.00
Volume 3-A, (Cat. No. 5003-A): CHEVROLET, PONTIAC, GMC TRUCKS and CHEVROLET TRUCKS	128 pages	8½" x 11", illustrated	Only \$1.80
Volume 4-A, (Cat. No. 5004-A): CHRYSLER, PLYMOUTH, DE SOTO, DODGE, DODGE TRUCKS	176 pages	8½" x 11", illustrated	Only \$3.00

This is the finest service information available on auto radio receivers. It's factory complete — factory accurate!

COMING SOON

Other car manufacturers' auto radio volumes to come.

Each Volume Contains the Following Data:

- ★ Full Model Description
- ★ Tube Compliment
- ★ Power Supply
- ★ Alignment (Recommended Test Equipment)
- ★ Complete Cross Index
- ★ Installation Instructions
- ★ Noise Suppression
- ★ Schematics
- ★ Chassis Views
- ★ Chassis Picture
- ★ Many More Outstanding Features



Another Series of RIDER Manuals That Will Become The Standard of The Industry

A.R.R.L. PUBLICATIONS

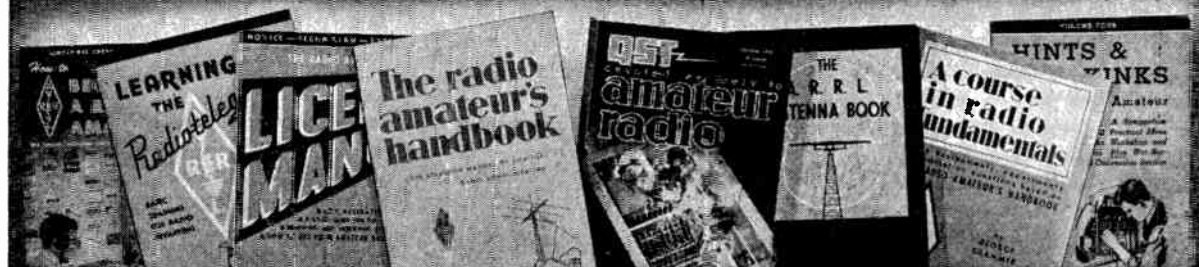

QST. Ranking high among the leading technical publications of the world, QST presents cover to cover reading each month. The oldest continuously published radio magazine (it was founded in 1915), its technical articles are aimed at all classes of radio enthusiasts. Articles on radio theory literally paint word pictures for easy and thorough understanding of the subject . . . construction articles are clearly illustrated with pictures and diagrams. Typography and clarity are tops. Through the years its pages have presented many famous "firsts" in the radio field. General interest articles and special columns abound. Complete advertising coverage. Truly, the "complete magazine on amateur radio.".....QST and ARRL membership, \$4 in USA, \$4.25 in Canada, \$5 Elsewhere

The RADIO AMATEUR'S HANDBOOK. Internationally recognized as one of the most valuable and widely used books in electronics, the Radio Amateur's Handbook is universally consulted by both amateur and professional alike. Its more than 700 pages are annually revised and modified in the light of current application and technique. Known as the standard manual of amateur radio communication, the Handbook is found on the desks of executives, engineers, technicians and purchasing agents of the radio industry as often as in the shacks of radio amateurs throughout the world. In its capacity as a text alone it is widely used in radio schools, colleges and the Armed Forces. Twenty-seven chapters plus a catalog section including invaluable complete data on all types of vacuum tubes.....\$3.00

HOW TO BECOME A RADIO AMATEUR. Pointing the way for the beginner, How to Become a Radio Amateur tells what amateur radio is and how to get started in this fascinating hobby. Through its pages in clear, concise language you learn about amateur radio. Special emphasis given to the needs of the Novice licensee with three complete simple stations featured.50c

The RADIO AMATEUR'S LICENSE MANUAL. Study guide and reference book, the License Manual points the way toward the coveted amateur license. Complete with typical questions and answers to all of the FCC amateur examinations — Novice, Technician, General and Extra-Class — it provides an ideal means of self-study and examination. Continually kept up to date. Complete FCC regulations included.....50c

The ARRL ANTENNA BOOK. A complete book on antennas and antenna systems representing an accumulation of years of practical experience and know-how. Its fourteen chapters are divided into two principal divisions: (1) a basis text on antennas and transmission lines, wave propagation and its relationship to antenna design, and the performance characteristics of directive antenna systems, and (2) specific designs for a multitude of antennas for various amateur bands. 268 pages, 408 illustrations.\$1.50

A COURSE IN RADIO FUNDAMENTALS. A complete course of study for use with the Radio Amateur's Handbook, it enables the student to learn thoroughly the principles of radio by following the time tested principle of "learning by doing." Study assignments, experiments and examination questions make this book equally applicable to individual home study or classroom use. Eight parts lead the student from basic Electricity and Magnetism to Wave Propagation and Antennas.50c

HINTS AND KINKS. If you build equipment and operate an amateur radio station you will find Hints and Kinks a mighty valuable book in your shack and workshop. More than 300 practical ideas give you a helping hand at all times.....\$1.00

LEARNING THE RADIOTELEGRAPH CODE. Supplying the key toward mastery of the International Morse Code, this publication trains you to handle the code skillfully and easily. Based on the accepted method of "sound conception," it is a boon to the beginner without access to the help of an experienced operator or code machine. Practical material for both home study and classroom use, as well as general operating information, is included.....25c postpaid

ARRL WORLD MAP. Printed in eight colors on heavy map paper with 267 countries clearly outlined. Call letter prefixes printed on the countries and in the margin. Continental boundaries and time zones plainly marked. Thirteen countries have call districts indicated. An equi-distant azimuthal projection centered on Wichita, Kansas. Prepared by ARRL and Rand-McNally. \$2.00

QST BINDERS. No need to let your copies of QST rest in a disordered pile. . . . A QST Binder will keep them neat and orderly. Sturdy binders hold a one year file, protecting and preserving your copies. QSTs in the Binder open and lie flat at any page permitting quick and easy reference.....\$2.50

ARRL LIGHTNING CALCULATORS. Quick as a flash the answer is yours when you use an ARRL Lightning Calculator to solve your radio problems. TYPE A provides rapid, accurate and simple solutions of problems involving frequency, inductance and capacity. TYPE B provides direct reading answers to Ohm's Law problems involving resistance, voltage, current and power. An invaluable aid for the amateur, technician or engineer.\$1.25 each

LOG BOOK. Record keeping made easy. Fully ruled 8½ by 11 inch pages with legible headings permitting all necessary entries. Spiral bound to lie flat when open.50c

MINILOG. Mobile and portable operational needs are met by this pocket size log. Spiral bound, 4 by 6 inch pages. Headings for all necessary information.30c

RADIOGRAMS. First impressions are important. Official ARRL Radiogram Forms printed on high grade paper add prestige; inform the addressee about amateur radio.Per pad of 70 blanks, 35c

The AMERICAN RADIO RELAY LEAGUE, Inc.



RCA TECHNICAL LITERATURE

THE MOST AUTHORITATIVE IN THE INDUSTRY

• **RCA KINESCOPES, KB-1022**

Complete information on Characteristics, Interchangeability, Conversion



Here is the most complete booklet on kinescopes available in the industry. It was prepared by the RCA Commercial Engineering organization, which has produced the most authoritative and widely used technical literature in the trade. This 20-page booklet furnishes you with all the information you need on virtually every kinescope now

on the market, well over 100 types. It tells you what to do when converting from glass to metal, from round to rectangular, from small to large size. You'll find that "RCA Kinescopes" is one of the most valuable pieces of literature in your technical library. It's available now, at 25c per copy.

• **SERVICE PARTS DIRECTORY FOR RCA VICTOR TV RECEIVERS (1952)**

SP-1021 (10 $\frac{7}{8}$ " x 16 $\frac{3}{4}$ ")—36 pages. Schematic diagrams, wiring diagrams, replacement parts, and top and bottom views for the 27 models of 1952 RCA Victor television receivers. The comprehensive index references RCA TV model names to model numbers, and model numbers to the publication in which information may be found. The format is similar to the popular directory for 1950-1951, the SP1014. Price, 50 cents per copy.



• **SERVICE PARTS DIRECTORY FOR RCA VICTOR TV RECEIVERS (1950-1951)**

SP-1014 (10 $\frac{7}{8}$ " x 16 $\frac{3}{4}$ ")—142 pages. Schematic diagrams, replacement parts, and top and bottom views for the 71 models of 1950 and 1951 RCA Victor television receivers. The comprehensive index, easy to read model and chassis numbers, and the grouping of information on each set provide a ready source of reference for the service technician.

Price, \$1.50 per copy.



• **SERVICE PARTS DIRECTORY FOR RCA VICTOR TV RECEIVERS (1946-1950)**

SP-1007 (10 $\frac{7}{8}$ " x 16 $\frac{3}{4}$ ") — 80 pages. Schematic Diagrams and replacement parts lists for all RCA Victor television receivers manufactured from 1946 thru June 1950 (56 models). Large-size book opens so that each schematic diagram faces its corresponding parts list for quick reference. Price, 75 cents per copy.

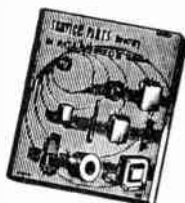

• **RCA TV COMPONENTS**



CTV-1015 (10 $\frac{7}{8}$ " x 8 $\frac{3}{8}$ ")—20 pages. Tabulated, easy-to-read specifications on over 80 RCA TV Components. Gives electrical ratings and characteristics, outline drawings, associated components, and typical circuits. Price, 35 cents per copy.

• **RCA VICTOR SERVICE DATA**

- Schematics
- Alignment Procedures
- Trouble-Shooting Suggestions
- Waveforms
- Wiring Diagrams



Complete, authoritative servicing information on all RCA Victor Radio, Phono, and TV sets . . . which cannot be found elsewhere. You'll find the servicing information you need, quickly and easily in RCA Victor Service Data.

BOUND VOLUMES—RADIO, PHONOGRAPH, TELEVISION

Volume No.	Years	Pages	Price
I	1923 through 1937	880	\$3.50
II	1938 through 1942	816	\$4.00
III	1943 through 1946	290	\$4.00
IV	1947 through 1948	566	\$6.00
V	1949	330	\$5.00
VI	1950	472	\$5.50
VII	1951	288	\$5.00
VIII	1952	314	\$5.00

Copies of the publications listed on this page may be obtained from your RCA Distributor, or direct from Commercial Engineering, Tube Division, Radio Corporation of America, Harrison, New Jersey.

All prices are net and apply in the U.S.A.

They are subject to change and cancellation without notice.

RCA TECHNICAL LITERATURE

THE MOST AUTHORITATIVE IN THE INDUSTRY



• RECEIVING TUBE MANUAL

RC-17 (8 $\frac{3}{8}$ " x 5 $\frac{1}{2}$ ")—320 pages. Supersedes RC-16. Revised, expanded, and brought up-to-date. Contains the latest receiving tubes, including types for black and white and color television applications. Features tube theory written for the layman, application data, resistance-coupled amplifier section, and several new circuits for high fidelity audio amplifiers. Features lie flat binding. Price 60 cents.

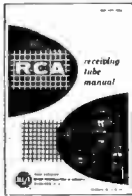

• RCA BATTERY CATALOG (BAT-134B)

Up-to-the-minute information on RCA's complete line of dry cell batteries. Includes these important features:



- Complete RCA Battery Type descriptions
- Accurate socket data
- Battery Interchangeability Directory (cross reference on 13 Battery Brands shows the correct RCA replacement for 498 different battery types)
- Battery Replacement Guide (lists correct RCA Battery complement for portables from 57 different manufacturers)

Price, 10 cents each

• RADIOTRON DESIGNER'S HANDBOOK

The long-awaited 4th edition of the Radiotron Designer's Handbook covers comprehensively and thoroughly the design of radio and audio circuits and equipment.



- More than 4 times larger than the third edition.
- 1500 8 $\frac{3}{4}$ " x 5 $\frac{1}{2}$ " pages, 1000 illustrations.
- More than 2500 references, many keyed in text.
- Extensive, cross-reference index — 7000 entries.
- Price \$7.00.

• TUBE HANDBOOK

ALL TYPES HB-3 (7 $\frac{3}{8}$ " x 5"). The bible of the industry—contains over 2700 pages of looseleaf data and curves on all RCA receiving tubes including kinescopes, power tubes, cathode-ray tubes, phototubes, and special tubes. Four deluxe 4 prong binders imprinted in gold. Available on subscription basis. Price \$13.50 including service for first year. Write to Commercial Engineering for descriptive folder and order form.



• PHOTOTUBES, CATHODE-RAY AND SPECIAL TUBES

Bulletin CRPS-102-A (11" x 8 $\frac{1}{2}$ ")—20 pages. Completely revised and brought up to date. Technical information on 150 single-unit, twin-unit, and multiplier phototubes, cathode-ray tubes, camera tubes, monoscopes, and types for special applications. Includes terminal connections. Price 15 cents.*



• POWER AND GAS TUBES FOR RADIO AND INDUSTRY



Bulletin PG-101-A (11" x 8 $\frac{1}{2}$ ")—20 pages. Technical information on more than 160 RCA vacuum power tubes, rectifier tubes, thyatrons, ignitrons, and voltage regulators. Includes terminal connections. Price 15 cents.*

• RECEIVING TUBES FOR AM, FM, & TELEVISION BROADCAST



Bulletin 1275-F (10 $\frac{7}{8}$ " x 8 $\frac{3}{8}$ ")—24 pages. Completely revised and up to date. Contains characteristics of more than 495 RCA receiving tubes and kinescopes. Socket connection diagrams arranged for quick and easy reference. Price 15 cents.*

• INSTRUCTION BOOKLETS

Complete authorized information on RCA transmitting tubes and other tubes for communications and industry. Be sure to mention tube-type booklet desired. Single copy on any type free on request.



• RCA INTERCHANGEABILITY DIRECTORY



Form 1D-1020 (10 $\frac{7}{8}$ " x 8 $\frac{3}{8}$ ")—20 pages. Contains detailed industrial tube replacement information. 1600 type designations of 29 different manufacturers are listed in numerical-alphabetical sequence in this directory. Free.

Copies of the publications listed above may be obtained from your RCA Tube Distributor, or direct from Commercial Engineering, Tube Division, Radio Corporation of America, Harrison, New Jersey.

*Prices shown apply in U.S.A. and are subject to change without notice.

Coyne and Boyce Books

DISTRIBUTED BY:
HOWARD W. SAMS & CO., INC.
 INDIANAPOLIS 5, INDIANA

FAMOUS COYNE SHOP-TESTED TECHNICAL BOOKS

Here are the latest volumes in the practical COYNE book series. The data contained in these publications is up-to-the-minute. All facts have been carefully pre-tested in the COYNE Shops, so that the information you get is authoritative and applicable to actual work in the field. COYNE Books pay for themselves in the useful, practical and complete information they provide.

TV SERVICING CYCLOPEDIA



The fact-packed Television reference book by H. P. Manly. Covers every phase of TV, including latest data on color TV and UHF. Provides a complete understanding of how TV receivers work, how to repair them and keep them operating properly. Special complete section on picture pattern servicing (dozens of actual photos). Includes methods of testing and measuring performance in each section of any TV set, alignment, amplifiers, antennas, controls, ion traps, sync circuits, power supplies, video IF amplifiers, sweep oscillators, adaptors, converters—everything covered fully, practically, understandably. An essential book for TV service technicians, experimenters, students—packed with practical, helpful instructional data. Over 450 illustrations, 750 pages, 5 1/2" x 8 1/2".

No. CTB-1.....\$5.95

LATEST TESTING INSTRUMENTS FOR SERVICING RADIO-TV



The latest edition tells all about modern television, radio and electrical testing equipment and how to use it most effectively. Packed with money-making shortcuts on trouble-shooting, servicing, construction and other subjects involving the use of test instruments. Includes 220 photos and diagrams. Covers Multipliers, Resistors, Ohmmeters, Oscilloscopes and many other subjects. All data has been pre-tested for practical use in the Coyne radio shops. 350 pages, 5 3/4" x 8 3/8".

No. CTB-3.....\$3.25

TELEVISION AND RADIO HANDBOOK



Here is the remarkable latest edition television and radio "answer" book. With its 3000 facts packed into a single handy volume, the radioman, amateur and professional will find complete practical radio service instructions to speed his trouble-shooting. Covers most frequently encountered troubles in radio servicing; offers short-cut, time-saving and work-saving solutions. Illustrated with hundreds of charts, diagrams, tables, circuits and short-cuts. Latest data on UHF conversion methods, TV boosters, etc. Fully indexed for quick, convenient reference. 375 pages, 4 1/2" x 7 1/2".

No. CTB-5.....\$2.75

PRACTICAL TV SERVICING AND TROUBLE- SHOOTING

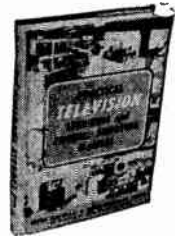

Authoritative, complete, invaluable. Shows how to align sets, how to service by patterns, how to install antennas, how to use deflection methods, how to install, adjust and tune every part of the Audio and Video sections, how to handle problems in the high and low voltage power supply sections. Full data on sweep oscillators, frequency control, FM, amplifiers, tuners, etc. Features data on color TV and new UHF channels. Includes 300 illustrations (many in 4 colors); gives 1500 TV facts. Absolutely essential for a complete grasp of proper servicing techniques. 400 pages, 5 1/2" x 8 1/2".

No. CTB-4.....\$4.25

TRANSISTORS AND THEIR APPLICATIONS



Explains in simple language the theory and practical applications of Transistors in TV, Radio and Electronics. Explains Transistor theory, circuitry, characteristics, components, testing, installation and servicing. Clears up common misconceptions; clearly explains the nature and use of Transistors. 100 pages 5 1/2" x 8 1/2".

No. CTB-7.....\$1.50

INDUSTRIAL ELECTRONICS



Written especially for busy electricians who want practical "on-the-job" simplified electronic information. TV-Radio technicians and electricians will find this book a "gold-mine" of easy-to-follow electronic data. Starts right at the beginning—explains in simple language all the basic principles of electronics. Fully illustrated with helpful photographs, diagrams and tables. 468 pages, 5 3/4" x 8 3/8".

No. CTB-2.....\$3.75

ELECTRICAL TROUBLE- SHOOTING MANUAL



Written for maintenance men—for "beginners" as well as "old timers"—to help increase earning capacity. Contains a new step-by-step trouble-shooting course and over 600 commercial diagrams. In addition to full coverage of Electricity, the book also covers Refrigeration, and contains a large section devoted to servicing every type of Industrial Electronic Equipment. 626 pages, 8 1/2" x 11".

No. CTB-101.....\$6.95

ELECTRICIAN'S H ANDBOOK



Here is the book every electrician needs. Includes the latest code requirements, building codes, rules, tables, charts, testing guides, sizes of wire to use on certain jobs; full data on motors, currents and hundreds of other subjects every electrician needs to refer to. Makes available for immediate reference over 600 different electrical subjects. Electronics, too, is included. 348 pages, 4 1/2" x 7 1/2", illustrated.

No. CTB-102.....\$2.75

APPLIED PRACTICAL RADIO-TV



New set (1952 Edition) of 5 practical, invaluable books. Up-to-the-minute 1780 page library, 5 3/4" x 8 3/8". 500 subjects on latest Radio and TV "know-how." Includes color TV and UHF. Tells how to install, align, balance all TV and Radio sets. For clarity, over 1200 illustrations and photographs show the "breakdown" of equipment and circuits. VOLUME 1: Application of Radio and TV Principles. VOLUME 2: Radio, TV and FM Receivers. VOLUME 3: Radio and TV Circuits. VOLUME 4: Latest Testing Instruments for Servicing Radio-Television. VOLUME 5: Practical TV Servicing and Trouble-Shooting Manual.

No. CTB-11—Vol. 1, 299 pages.....\$3.25
 No. CTB-12—Vol. 2, 403 pages..... 3.25
 No. CTB-13—Vol. 3, 336 pages..... 3.25
 No. CTB-14—Vol. 4, 350 pages..... 3.25
 No. CTB-15—Vol. 5, 400 pages..... 4.25
 No. CTB-50—Complete 5 Vol. Set.....\$15.00

POPULAR BOYCE BOOKS

Here are the two widely used volumes that completely and thoroughly digest the subjects of Television and Radio. Easy-to-understand, thorough in their coverage, these best-selling books are a "MUST" for the library of anyone interested in Electronics.



VIDEO HANDBOOK

Affords valuable instruction on the entire subject of Television; gives expert data on methods of design, construction, production, installation, operation and servicing. Fourteen complete sections, profusely illustrated and clearly written, cover the field of TV exhaustively. This remarkable and practical handbook is widely used by schools, engineers, students, experimenters and industrial technicians. 892 pages, 5" x 7".

Sec. 1—TV Past, Present and Future
 Sec. 2—Fundamentals of Electronic TV
 Sec. 3—The TV Receiver
 Sec. 4—The TV Station
 Sec. 5—TV Antenna Systems
 Sec. 6—Creating a TV Show
 Sec. 7—Description of Modern TV Receivers
 Sec. 8—Installing TV Receivers
 Sec. 9—Servicing TV Receivers
 Sec. 10—TV Test Equipment
 Sec. 11—Building a TV Receiver
 Sec. 12—Data Section
 Sec. 13—TV Terms
 Sec. 14—Bibliography

No. BB-2.....\$5.95

RADIO & ELECTRONICS HANDBOOK

Here is the basic knowledge and data of Radio and Electronics digested into 18 sections, in complete easy-to-find form. This is the most widely used handbook of its kind, packed with practical data presented in understandable language and supported by a wealth of illustrations. Clearly explains radio and electronic theory, and covers in detail all phases of the subject. Absolutely invaluable to anyone concerned with radio or electronics. 890 pages, 5" x 7".

Sec. 1—Fundamentals of Radio
 Sec. 2—Vacuum Tubes
 Sec. 3—Resistors
 Sec. 4—Capacitors
 Sec. 5—Chokes and Transformers
 Sec. 6—Switches and Dry Rectifiers
 Sec. 7—Basic Circuits
 Sec. 8—A-M Receivers and Transmitters
 Sec. 9—Frequency Modulation
 Sec. 10—Television
 Sec. 11—Sound Systems
 Sec. 12—Recording
 Sec. 13—Power Supplies
 Sec. 14—Antennas and Transmission Lines
 Sec. 15—Meters and Test Equipment
 Sec. 16—Testing, Measuring and Aligning
 Sec. 17—Radio and Electronic Data
 Sec. 18—Vacuum Tube Chart and Pin Index

No. BB-1.....\$4.95

Howard W. Sams Publications



PHOTOFACT SERVICE MANUALS

Here's the radio-TV service data that saves time and helps you earn more! Preferred and used daily by thousands of Radio and TV Service Technicians. Complete, accurate—based on analysis of the actual equipment. Uniform treatment for each model. Includes Standard Notation Schematics; full chassis photo coverage; complete circuit analysis and replacement parts data; wave forms, alignment data; record changer analysis—everything needed for quick, profitable servicing. Each volume in deluxe binding.

- VOL. 1—Post-war models to Jan. 1, 1947
 - VOL. 2—Jan. 1, 1947—July 1, 1947
 - VOL. 3—July 1, 1947—Jan. 1, 1948
 - VOL. 4—Jan. 1, 1948—July 1, 1948
 - VOL. 5—July 1, 1948—Dec. 1, 1948
 - VOL. 6—Dec. 1, 1948—May 1, 1949
 - VOL. 7—May 1, 1949—Oct. 1, 1949
 - VOL. 8—Oct. 1, 1949—Dec. 1, 1949
 - VOL. 9—Dec. 1, 1949—Mar. 31, 1950
 - VOL. 10—Mar. 31, 1950—July 31, 1950
 - VOL. 11—July 31, 1950—Oct. 31, 1950
 - VOL. 12—Oct. 31, 1950—Jan. 1, 1951
 - VOL. 13—Jan. 1, 1951—Apr. 30, 1951
 - VOL. 14—Apr. 30, 1951—Aug. 1, 1951
 - VOL. 15—Aug. 1, 1951—Oct. 31, 1951
 - VOL. 16—Oct. 31, 1951—Jan. 31, 1952
 - VOL. 17—Jan. 31, 1952—Apr. 30, 1952
 - VOL. 18—Apr. 30, 1952—July 31, 1952
 - VOL. 19—July 31, 1952—Nov. 30, 1952
 - VOL. 20—Nov. 30, 1952—Feb. 28, 1953
 - VOL. 21—Feb. 28, 1953—May 31, 1953
 - VOL. 22—May 31, 1953—Sept. 15, 1953
 - VOL. 23—Sept. 15, 1953—Dec. 15, 1953
 - VOL. 24—Dec. 15, 1953—Apr. 1, 1954
 - VOL. 25—Apr. 1, 1954—June 30, 1954
 - VOL. 26—June 30, 1954—Oct. 15, 1954
- Each Volume in DeLuxe Binder.....\$21.00

PHOTOFACT FOLDER SETS

The easiest way to own the world's finest TV-Radio Service Data. Issued 3 sets per month.

Per Set.....\$1.75
Binders only for Photofacts Sets.....\$3.50

Photofact Cumulative Index

Featured in every other issue of PF INDEX—the fine magazine available from your jobber. The Index lists sets by make and model—helps you find instantly the Folder Sets you need.

NOW—ONLY \$25 DOWN puts the complete PHOTOFACT Manual Library in your shop! Ask your jobber for complete details.

HANDY SERVICE GUIDES

AM-FM SERVICING SHORT-CUTS

Describes actual AM and FM service case histories; shows practical ways to solve similar troubles in any AM or FM set. 152 pages, 5 1/2" x 8 1/2".

No. RK-1.....\$1.50

DIAL CORD STRINGING GUIDES

Volume 4—Shows the one right way to string dial cords in receivers made from mid-1951 through 1953. With index. 96 pages, 5 1/2" x 8 1/2".

No. DC-4.....\$1.00

Volume 3—Covers sets produced from 1950 through mid-1951, and TV-radio sets from 1946 through mid-1951. 96 pages, 5 1/2" x 8 1/2".

No. DC-3.....\$1.00

Volume 2—Covers receivers produced from 1947 through 1948. 96 pages, 5 1/2" x 8 1/2".

No. DC-2.....\$1.00

Volume 1—Covers receivers produced from 1938 through 1946. 112 pages, 5 1/2" x 8 1/2".

No. DC-1.....\$1.00

RADIO SET TUBE REPLACEMENT GUIDE

Shows where to replace each tube in 5500 receivers made from 1938 to 1948. 196 pages, 5 1/2" x 8 1/2".

No. TP-1.....\$1.25

INVALUABLE TELEVISION BOOKS

TELECASTING OPERATIONS

The only complete coverage of every phase of Telecasting, from theory through equipment, operation, maintenance, production—indispensable to anyone interested in Telecasting. 600 pages, 6" x 9".

No. OH-1.....\$7.95

PHOTOFACT TELEVISION COURSE

A "must" for everyone interested in Television. Gives a clear, complete understanding of TV principles, operation and practice. With glossary of terms. 308 pages; 8 1/2" x 11"; illustrated.

No. TV-1.....\$3.00

TV SERVICING SHORT-CUTS

Describes actual TV service case histories; shows how to solve similar problems in any TV receiver quickly and profitably. 100 pages, 5 1/2" x 8 1/2".

No. TK-1.....\$1.50

TV TEST INSTRUMENTS

Tells how each test instrument operates. Covers: Vacuum Tube Voltmeters, AM Signal Generators, Sweep Signal Generators, Oscilloscopes, Video Signal Generators, Field Intensity Meters, Voltage Calibrators. 148 pages, 8 1/2" x 11"; illustrated.

No. TN-1.....\$3.00

UHF CONVERTERS

Describes UHF converter design and shows how they work. Covers 21 different converters in all popular makes. An essential book for the TV technician. 44 pages, 8 1/2" x 11".

No. UC-1.....\$1.00

UHF ANTENNAS, CONVERTERS & TUNERS

Covers all UHF antenna types, transmission lines and matching networks, UHF installation practices, UHF converters and UHF tuners. 136 pages, 5 1/2" x 8 1/2".

No. UHF-1.....\$1.50

TELEVISION ANTENNAS, 2nd Edition

Describes all TV antenna types. Tells how to select and install antennas, find troubles, use short-cuts. Full coverage of antenna principles and construction. 224 pages; 5 1/2" x 8 1/2".

No. TAG-1.....\$2.00

SERVICING TV IN CUSTOMER'S HOME

Shows how to diagnose trouble using capacitor probe and VTVM. Describes "tube-pulling" method of trouble diagnosis and other short cuts for field servicing. 96 pages, 5 1/2" x 8 1/2"; illustrated.

No. TC-1.....\$1.50

MAKING MONEY IN TV SERVICING

Shows how to start and operate a profitable servicing business. Covers all phases of operation. 136 pages, 5 1/2" x 8 1/2"; illustrated.

No. MM-1.....\$1.25

TV TUBE LOCATION GUIDES

VOL. 4—Shows tube positions and functions in hundreds of important TV receivers. Quickly helps locate the faulty tube. All new diagrams continue data coverage from Volume 3 (below). 192 pages, 5 1/2" x 8 1/2"; illustrated.

No. TGL-4.....\$2.00

VOL. 3—Covers receivers not included in Vols. 1, 2 and 4. 192 pages, 5 1/2" x 8 1/2".

No. TGL-3.....\$2.00

VOL. 2—Gives tube positions and functions in hundreds of TV receivers. Covers receivers not included in Vols. 1 and 3. 208 pages, 5 1/2" x 8 1/2".

No. TGL-2.....\$2.00

VOL. 1—Covers hundreds of TV receivers made by 56 manufacturers. 208 pages, 5 1/2" x 8 1/2"; illus.

No. TGL-1.....\$1.50

AUDIO PUBLICATIONS

THE RECORDING AND REPRODUCTION OF SOUND

Enlarged 2nd Edition. New, completely revised and vastly enlarged. Biggest selling volume on the entire subject of Audio. Covers all aspects of recording, with full analysis of recorders and techniques. Complete data on amplifiers, speakers, microphones, phonograph equipment, P.A., etc. Authoritative work by Oliver Read. 810 pages, 6" x 9". Profusely illus.

No. RR-2.....\$7.95

AUDIO AMPLIFIERS

VOL. 4—Provides detailed, clear, uniform analysis of 75 important audio amplifiers and tuners produced during 1951 and 1952. Analyses are based on study of the actual equipment in the laboratory. Includes circuit diagrams; parts information, full technical coverage. 352 pages, 8 1/2" x 11".

No. AA-4.....\$3.95

VOL. 3—Covers 50 amplifiers and 22 tuners made during 1950. 352 pages, 8 1/2" x 11".

No. AA-3.....\$3.95

VOL. 2—Covers 104 well-known audio amplifiers and 12 important tuners produced during 1949. 368 pages, 8 1/2" x 11". Profusely illustrated.

No. AA-2.....\$3.95

RECORD CHANGER MANUALS

VOL. 5—Provides clear, easy-to-use electrical and mechanical data on 22 record changers and tape recorders made during 1952 and 1953. Features exclusive "exploded" view diagrams, profuse photographic illustrations; full change cycle data; information on adjustments; service hints and kinks; complete replacement parts lists. 288 pages, 8 1/2" x 11"; illustrated.

No. CM-5.....\$3.00

VOL. 4—Covers 38 changers and recorders produced during 1951. 288 pages, 8 1/2" x 11".

No. CM-4.....\$3.00

VOL. 3—Covers 44 models made in 1949 and 1950, including wire and tape recorders. 288 pages, 8 1/2" x 11".

No. CM-3.....\$3.00

VOL. 2—Covers 45 changer models made in 1948 and early 1949, plus leading wire and tape recorders. 432 pages, 8 1/2" x 11"; illustrated.

No. CM-2.....\$4.95

COMMUNICATIONS RECEIVERS

VOL. 2—Complete design and construction analysis of 26 popular communications receivers produced in recent years. Each unit is thoroughly analyzed from actual laboratory study. Over 190 pages, 8 1/2" x 11".

No. CR-2.....\$3.00

VOL. 1—Covers more than 50 of the most popular communications receivers manufactured between the end of the war and 1948. 264 pages, 8 1/2" x 11".

No. CR-1.....\$3.00

AUTO RADIO SERVICE MANUALS

VOL. 3—Full service data on 47 chassis used in 1950, 1951 and 1952 auto radio receivers. 288 pages, 8 1/2" x 11".

No. AR-3.....\$3.00

VOL. 2—Covers 60 chassis (90 models) used in 1948, 1949 and 1950 auto radios. 288 pages, 8 1/2" x 11".

No. AR-2.....\$3.00

VOL. 1—Covers 100 auto radio models made from 1946 to 1949 by 24 mfgs. 396 p., 8 1/2" x 11".

No. AR-1.....\$4.95



RADIO HANDBOOK (13TH EDITION) \$600 IN U.S.A.

The most valuable reference work for practical radiomen, radio technicians and advanced amateurs. How to design, construct and operate standard types of radio transmitting and receiving equipment, at both low and high frequencies. Reference data galore; profusely indexed for easy finding, clearly illustrated, easy to read. New information on simplified TVI-proofing, bandswitching fixed-station and mobile transmitters, a remotely-tuned v-f-o for mobile or fixed-station use and many new ideas for improved operation. THE LARGEST "RADIO HANDBOOK" EVER PUBLISHED. 734 pages. Clothbound, goldstamped.

The still larger **RADIO HANDBOOK, 14th ed.**, to be published winter 1954-55 tentative price **\$750 IN U.S.A.**

BETTER TV RECEPTION in fringe and low signal areas . . . **\$250 IN U.S.A.**

Every TV man needs it; every TV fan needs it. This amazing book has taken the failure out of many unsuccessful installations in low-signal areas, has improved the picture for many discouraged TV owners. Practical, easy to understand. How to select the best transmission lines, boosters and receivers . . . eliminate "ghosts" . . . minimize fading. How to reduce interference and improve receiver performance. The standard guide for every installation engineer as well as a popular text for all TV enthusiasts. Paperbound. **NEW SECOND EDITION.**



ANTENNA MANUAL \$350 IN U.S.A.

A necessity for everyone interested in transmission or reception. Gives the "why" and "how" of radio-wave propagation in the HF, VHF and UHF ranges, with a comprehensive coverage of antennas and transmission lines for all frequency ranges. Practical data on all the more popular types of antennas, and constructional information on many new FM, TV and communication antennas. Has the same happy combination of simply explained reference and background material combined with practical how-to-build-it data which has made the RADIO HANDBOOK one of the largest selling radio texts. Clothbound, goldstamped.

RADIOTELEPHONE LICENSE MANUAL \$375 IN U.S.A.

Now combined in one convenient, easy to use volume . . . all the information necessary to obtain any commercial radiotelephone license. The complete list of questions and the clear, easily understood answers make this study guide an absolute necessity for everyone interested in any grade of radiotelephone license. Contains four elements: Element I: **Questions On Basic Law**; Element II: **Basic Operating Practice**; Element III: **Basic Radiotelephone**; Element IV: **Advanced Radiotelephone**. Paperbound.

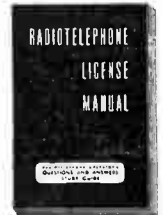

SURPLUS RADIO CONVERSION MANUALS \$250 Per Volume IN U.S.A.

Conversions and data for: **VOLUME I**—BC-221 Frequency Meter; BC-342 Receiver; BC-348 Receiver; BC-312 Receiver; BC-412 Oscilloscope as a test scope or as a television receiver; BC-645 420-Mc. Transmitter/Receiver; BC-453A Series Receivers; BC-457A Series Transmitters; SCR-522 144-Mc. Transmitter/Receiver; TBY Transceiver with Xtal Control; PE-103A Dynamotor; BC-1068A V-h-f Receiver; Electronics Surplus Index; Cross Index of VT-Number tubes. **VOLUME II**—ARC-5 and BC-454 Receivers for 28 Mc; ARC-5 and BC-457 Tx for 28-Mc. Mobile; ART-13 and ATC Xmmitter; Surplus Beam Rotating Mechanisms; Selenium-Rect. Power Units; Hi-Fi Tuner from BC-946B Receiver; ARC-5 V-h-f Transmitters; GO-9 and TBW Xmmitters; 9-W Amplifier from AM-26; TA-12B & TA-12C Xmmitters; AVT-112A Aircraft Xmmitter; BC-375 & BC-191 Xmmitters; Model LM Freq. Meter; Primary Power Requirements Chart; ARB Recr. Diagram Only. Paperbound.

WORLD'S RADIO TUBES (BRAN'S RADIO TUBE VADE MECUM) . . . \$500 IN U.S.A.

The most complete list of transmitting and receiving tubes ever compiled. Characteristic data for over 15,000 tubes from 253 manufacturers. The only book of its kind, published in 16 languages. Paperbound.

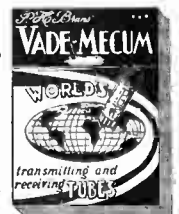

WORLD'S EQUIVALENT TUBES

(BRAN'S EQUIVALENT TUBE VADE MECUM) **\$500 IN U.S.A.**

A Companion volume to World's Radio Tubes. Lists in tabular, easy to follow form, completely equivalent tubes; tubes having a few differences and what these differences are. An invaluable aid to technicians and service-men in all parts of the world. Paperbound.

WORLD'S TELEVISION TUBES (BRAN'S TELEVISION TUBE VADE MECUM) . . . \$500 IN U.S.A.

Due about June, 1954. Contains data on television tube only, similar to above.

GERNSBACK LIBRARY

NEW BOOKS

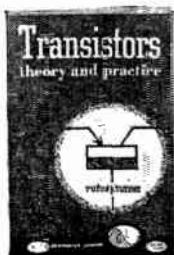

TRANSISTORS — THEORY AND PRACTICE

No. 51—By Rufus P. Turner. 144 Pages Illustrated. \$2.00. A practical book on transistors written in straightforward style for those who work with TV, radio and audio. Features a complete manual on the characteristics of commercial transistors and for the first time in any book, a discussion of the surface-barrier transistor.

SOME OF THE CONTENTS

Semiconductor Theory
 Transistor Characteristics
 Equivalent Circuits
 Transistor Amplifiers
 Transistor Oscillators
 Duality in Transistor Circuit Design
 Triggers and Switches
 Practical Transistor Circuits
 Tests and Measurements
 Characteristics of Commercial Transistors

THE OSCILLOSCOPE*

No. 52—192 Pages. Fully illustrated. Practical book on how to use the scope in servicing, including full instructions for alignment of AM, FM, and TV receivers.

RADIO-CONTROL HANDBOOK*

No. 53—A how-to-do-it book with practically no theory! How to build and maintain simple or complex model control equipment. Bands to work on—licenses required.

*Prices of these books were not available at press time. Refer to your jobber for further information.



TV REPAIR TECHNIQUES

No. 50—The experience of top technician-writers in quickly finding and solving tough TV servicing problems. Can save you hours of valuable servicing time. 128 Pages. \$1.50



RADIO & TV TEST INSTRUMENTS

No. 49—How to build just about every instrument needed in modern servicing. Chapters on a servicing bench and carrying case. 128 Pages. \$1.50



HIGH-FIDELITY—Design, Construction, Measurements

No. 48—An audio man's audio book. New 3-way approach. 21 top audio men tell you how to get top performance from your equipment. 128 Pages. \$1.50



RADIO & TV HINTS

No. 47—Offers over 300 sure-fire hints, gimmicks and short cuts on radio, TV and audio-high fidelity, as tested and tried by experts. Grouped in seven meaty sections. 112 Pages. \$1.00



TELEVISION TECHNOTES

No. 46—Symptoms, causes and cures of over 600 tough troubles which crop up in scores of sets made by leading manufacturers. Cuts troubleshooting time to the bone. 128 Pages. \$1.50



BASIC RADIO COURSE

No. 44—John T. Frye's popular classic on fundamentals. Covers everything from Ohm's Law to advanced techniques in an easy-going style. 176 Pages. Cloth bound. \$2.25

PRACTICAL LOW-COST BOOKS

RADIO TUBE FUNDAMENTALS

No. 45—How and why tubes behave as they do in modern radio circuits. Explains the theory and function of tubes for the technician. 112 Pages. \$1.00

MODEL CONTROL BY RADIO

No. 43—Control model planes, boats and trains by radio. Theory and construction details for components as well as for complete units. 112 Pages. \$1.00

HIGH-FIDELITY TECHNIQUES

No. 42—James R. Langham's light-hearted book on hi-fi is hailed as one of the best yet—at any price! Covers design, construction, operation. 112 Pages. \$1.00

RADIO-ELECTRONICS

is today's most important magazine on servicing television, radio and audio-high fidelity equipment and the practical as well as the unusual application of electronics.

35¢ per copy

Gernsback Publications, Inc.

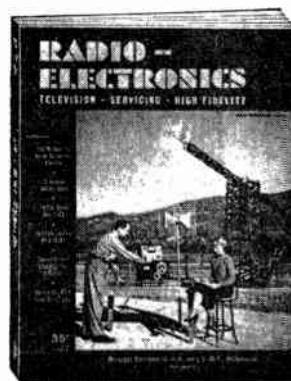

New up-to-the-minute data now in the new printing of

Mandl's Television Servicing

EASY TO USE

A complete Master Trouble Index, listing 100 trouble symptoms in picture and sound with their possible causes and references to the pages on which directions for servicing are given, makes it easy for you to locate the source of trouble and correct it in minimum time. Detailed trouble-shooting procedures tell you just what to do. Simple, clear explanations show how each unit in the TV receiver functions, with lists of the flaws that may occur in it, what points in the circuitry cause these flaws, how they affect other components, and how they show up on the TV screen. Whether you want specific servicing instructions or further information about any part of the set, you can easily and quickly find it here.

THE PRACTICAL DETAILS YOU WANT

All the faults likely to occur, including those hard-to-find troubles, are dealt with. And you won't be confused by unnecessary theory. Only the essentials actually needed for practical servicing are given. You'll learn many practical time-saving methods:—simple signal-tracing procedures; how to improve reception in fringe areas; how to trouble-shoot keyed A.G.C. and synchroguide circuits; align I.F. stages; how to use the oscilloscope and other test equipment, and many trade tricks for diagnosing trouble quickly.

HUNDREDS OF HELPFUL ILLUSTRATIONS

Original photographs, especially made for this book, show you what appears on the screen test patterns when there is a defective picture tube, diathermy interference, and scores of other causes of imperfect pictures. 50 scope patterns give you handy checks for signal tracing and analysis of cir-

cuit performance. Hundreds of large, clear schematics, many from the major manufacturers, show you each circuit in each part of the TV receiver, and helpful block diagrams show you the arrangement of the various parts in the set as a whole.

- NEW CHAPTER ON THE NTSC COLOR SYSTEM WITH SERVICING FACTORS
- UP-TO-DATE DATA ON

cascode tuners
 automatically focused tubes
 new types of high-frequency I.F. Systems
 transistors
 servicing UHF-VHF receivers
 and other recent developments



Mandl's TELEVISION SERVICE COURSE LABORATORY MANUAL

Working instructions and report sheets for 46 problems typical of those the serviceman meets. Covers each part of the receiver and tells exactly what to do and what to observe. Trouble index shows how flaws appear in test patterns. Tables of useful data appended.

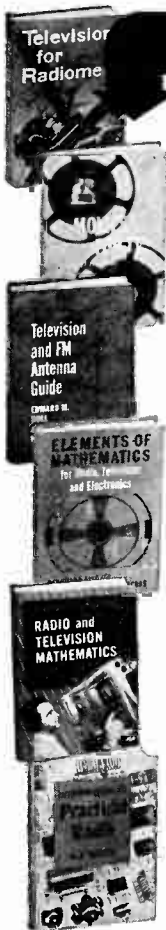

Men on the job recommend these top-ranking aids

Television for Radiomen 2nd Ed.

by E. M. Noll

"By the time you are through with this book you'll have a GOOD foundation in TV," writes a radio and TV engineer. Written by a man nationally known for his many helpful articles and lectures on TV operation and servicing, this book explains very fully and clearly the construction, operating principles, and function of every circuit and element in TV reception, the principles of transmission, and the techniques of installation, alignment, and adjustment. The new edition includes color and all latest developments.

Television & FM Antenna Guide

by E. M. Noll and Matthew Mandl

A basic course on antenna theory combined with a complete handbook on all types of antennas. Shows you exactly how to determine, quickly and accurately, the best type of antenna for a particular site, the best position for it, and how to minimize the various kinds of interference. Includes full data on characteristics, dimensions, and comparative performance of the different types of antennas.

Movies for TV

by John Battison

The basic information needed to insure success with movies for televising. Clear, simple explanations of TV principles that govern the telecasting of movies. Full details on construction, operation, and comparative costs of cameras, projectors, kinescope recordings, sound and lighting equipment, equipment for animation, editing, making titles and special effects. Practical do's and don'ts of making newsreels, commercials, and features on film for telecasting.

Introduction to Practical Radio

by D. J. Tucker

One of the best "fundamentals" books ever published—all the basic how's and why's of radio in terms you can EASILY understand. The necessary math is explained at the points where it is used. Each principle is illustrated by many examples of its use in the construction and operation of radio apparatus. Hundreds of practical problems for training.

Elementary Mathematics for Radio, TV, and Electronics

by Bernhard Fischer and Herbert Jacobs

If you've ever hesitated to use a time-saving equation because you were not quite sure how to set it up, or had moments of doubt about decimals and percentages, or wanted a quick check on your figures—this is the book for you! It makes crystal clear each step in the reasoning and each procedure in the arithmetic, geometry, and algebra needed by radio and TV technicians. You'll see how the simple, basic calculations are used in more complex problems. You'll find it easy to work out frequency resolutions, voltage drops, inductive reactances, decibels, and the many other problems in radio, television, and electronics in which accurate mathematics is essential. Hundreds of sample problems, both in the math itself and in its radio and TV applications, give you ample practice.

Radio and Television Mathematics

by Bernhard Fischer

A handbook of step-by-step solutions for every question requiring math in the FCC Study Guide and for hundreds of other circuit problems in radio, television, and electronics. Conveniently arranged under radio topics such as antenna power, plate-to-plate voltage, and 400 others, you'll find the formulas to use, the numerical values to substitute, and the step-by-step solutions to typical problems. "By far the best book for preparing for FCC exams," says one radio man; and Radio-Electronics recommends it "for the place of honor beside its natural partner, the slide rule."

See them at your local distributor's or write for on-approval copies

The Macmillan Co.





SMALL SWITCHES, LIMIT SWITCHES, AND MAGNETIC RELAYS

SMALL SNAP-ACTION SWITCH, G-E SWITCHETTE CR1070

This new, lightweight switch mechanism lends itself especially to applications where space is limited and long life is required.

The Switchette is operated by movement of the spring-return button located in the housing. This button can be actuated by a lever, bellows, or other means. Snap-action, double-break-contact construction gives the G-E Switchette a high current rating and makes it suitable for applications where the vibration is severe.

FEATURES AND ADVANTAGES

1. Small (approximately 1¼ in. by ½ in. by ½ in.) and weighs only 9 grams (0.02 lb.).
2. Resists vibration and corrosion.
3. Phenolic-resin operating button provides better protection from live parts during operation.
4. Contact tips are 99.95 per cent pure silver.
5. Particularly suited to electronic applications because of negligible amount of contact bounce.
6. Five terminal arrangements are available, including the two shown above.
7. Wide variety of forms available; for example, three basic contact arrangements: single-circuit, normally open; single-circuit, normally closed; and two-circuit, normally open and normally closed. Also many special forms.

Switchettes are available in ratings up to 10 amperes at 115 or 230 volts a-c. Write for Bulletin GEC-796.

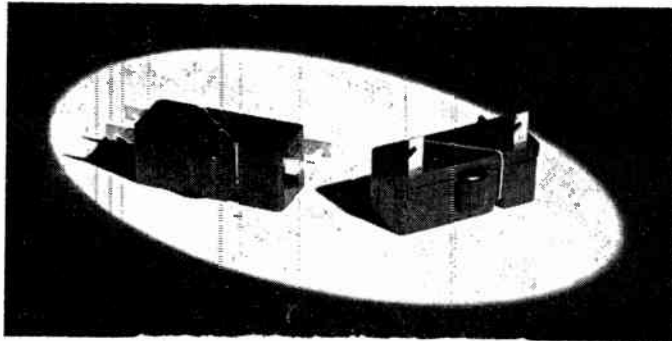

Switchettes showing two terminal arrangements

LIMIT SWITCH, CR1070-D112

This sturdy, open-type limit switch is operated by a plunger which provides 3/4-inch overtravel. The contact mechanism of this device is the G-E Switchette, which can be wired to control one normally open circuit and one normally closed circuit. Rated 10 amperes at 230 volts a-c. Write your nearest G-E Apparatus Sales Office for Bulletin GEC-197.

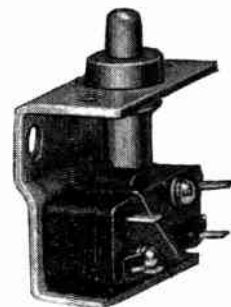

Open-type limit switch with push-rod operation

GENERAL-PURPOSE RELAY, CR2790-E

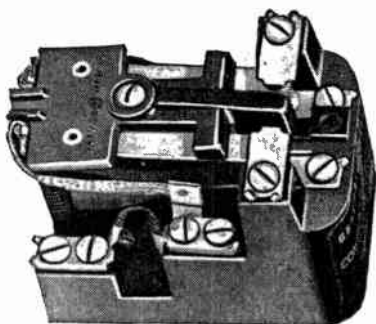

The CR2790 relay is a compact, attractively finished device for use either as a motor starter or a relaying unit. Available in either an open form or enclosed in a general-purpose or explosion-proof housing. Three contact arrangements available: single-pole, single-throw; double-pole, single-throw; and double-pole, double-throw. In the open form, all three contact arrangements use the same base, which facilitates mounting. In the enclosed form, the U-shaped cover makes wiring and servicing convenient. Rated 10 amp continuous, 110/120 volts a-c.

Applications

Control of pilot circuits in response to remote control switch or thermostat, or for direct control of small motors which have built-in thermal overload protection.

As a fractional-horsepower motor starter, or in conjunction with a magnetic switch controlling larger motors, heating or lighting circuits, and signal systems. Bulletin GEC-257.

INSTRUMENT AND TESTER SWITCHES (LAMINATED)

Rotary Selector — Single and Multi-Gang — Non-Shorting and Shorting

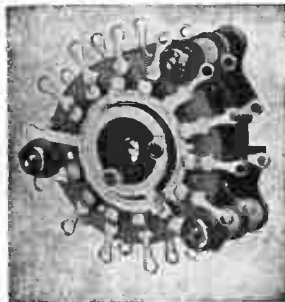

SS-14-2

Low Contact Loss—Double-grip collector arms, and large-area contacts, silver to silver, result in an average contact resistance of .007 ohms or less during the useful life of the switch.

Ample Dielectric—AC or DC; normal carrying capacity (not make-and-break), 1 amp.; maximum momentary capacity (not make-and-break), 5 amp.; maximum voltage between contacts 1,500 volts R.M.S.; between decks and ground, 2000 volts R.M.S.

JBT Instrument-type Rotary Selector Switches are used widely in quality test equipment, portable instruments, inspection setups and avionics where trouble-free, dependable performance is of major importance. Available in two basic types—14 and 20 position—the design gives extra contacts in minimum space. One to six decks.

FEATURES:

Reliability—Rigid, 3-post deck suspension, instead of the usual 2; all current carrying parts are brass or phosphor bronze, silver flashed and then heavily plated with pure silver to meet 100 hour salt spray test; ball bearing action, beryllium-copper balanced spring (SS-14); leaf-type (SS-20), and sharp detent assure positive indexing. Springs of both switches are generally replaceable without disturbing soldered connections. Laminated plastic decks and rotors selected for maximum mechanical and dielectric strength.

Exceptional Compactness—14-position switch takes 13 circuits and "off" in 2" circle; 20-position switch handles 19 circuits and "off" in 2-23/32" circle. Each deck above first adds only 5/16".



SS-20-2

Military Variations—The following can be supplied on special order at extra cost: (a) laminated plastic, Type PBE-P per Spec. MIL-P-3115B; (b) vacuum impregnation of rotors, decks, spacers, and ceramic spacers with approved fungicides; (c) hot tin dip on contact surfaces to be soldered; (d) 14 to 20 live positions, no off, (add suffix F, as SS-14-2F); (e) common position in non-standard location.

BASIC 14-POSITION: 1 1/4" Bar knob supplied only on individually packed units—not on bulk orders unless specified. Collector arm placed directly opposite to flat of shaft, unless otherwise specified. Contact lugs and common lugs positioned as shown below, 13 contacts per deck. **One to six decks;** for each additional deck (for gang) add 5/16" to depth. **Continuous rotation type** supplied unless otherwise specified. **Adjustable Stop** normally is supplied on standard cataloged switches. **Fixed Stops** can be supplied on quantity orders at moderate cost. **Panel locator** positioned as shown unless otherwise specified on bulk orders.

BASIC 20-POSITION: 2" Bar knob supplied only on individually packed units—not on bulk orders unless specified. Collector arm placed directly opposite to flat on shaft, unless otherwise specified. Contact lugs and common lugs positioned as shown, 19 contacts per deck, continuous rotation types. **One to six decks;** for each additional deck, add 5/16" to depth. **Continuous rotation type** supplied unless otherwise specified. **Panel locator** positioned as shown unless otherwise specified on bulk orders.

SWITCH KIT (Laminated Phenolic)

Most of the 14 and 20 position laminated switches, plus special variations as needed, can be assembled quickly from the kit shown on an adjoining page. Designers, service engineers, laboratories, and industrial maintenance departments will especially appreciate the convenience, flexibility, and time saved.

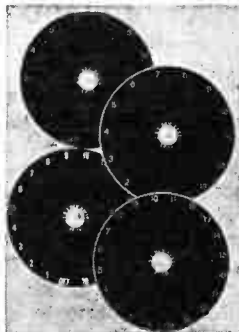

ETCHED DIAL PLATES

For SS-14 or MS-14 Series; and for SS-20 or MS-20 Series. Dull black finish — with raised bright metal numerals. 2 3/4" diameter.

- EP-13 off thru 13.....\$0.21
- EP-14 1 thru 14......21
- EP-19 off thru 19......21
- EP-20 1 thru 20......21

Non-Shorting—Break before make. **Shorting**—Make before break.

LAMINATED SWITCHES, SS-14 TYPE

(14 positions; angular indexing 25° 43')

Model	Positions Per Circuit	Circuits Per Deck	Decks or Gangs	Shorting, Non-Shorting	Boxed, Including Knob
SS-14-1	14	1	1	N-S	\$1.50
SS-14-1A*	5†	2	1	N-S	1.55
SS-14-1S*	14	1	1	S	1.50
SS-14-1CS*‡	14	1	1	CS	1.85
SS-14-2	14	1	2	N-S	1.80
SS-14-2A*	5†	2	2	N-S	1.95
SS-14-2S*	14	1	2	S	1.80
SS-14-2CS*‡	14	1	2	CS	2.55
SS-14-3	14	1	3	N-S	2.25
SS-14-3S*	14	1	3	S	2.25
SS-14-4	14	1	4	N-S	2.90
SS-14-6	14	1	6	N-S	4.25

*Standard items, but not regularly stocked; check with your electronic parts distributor.

†Denotes correction in former catalogs; 5 positions include 4 "live" and 1 "off".

‡Complete shorting — all contacts shorted except one in use.

LAMINATED SWITCHES, SS-20 TYPE

(20-positions; angular indexing, 18°)

SS-20-1	20	1	1	N-S	\$1.95
SS-20-1A*	6‡	2	1	N-S	2.00
SS-20-1S*	20	1	1	S	1.95
SS-20-2	20	1	2	N-S	2.40
SS-20-2S*	20	1	2	S	2.40
SS-20-3	20	1	3	N-S	3.25
SS-20-4	20	1	4	N-S	3.95
SS-20-6	20	1	6	N-S	5.60

*Standard items, but not regularly stocked; check with your electronic parts distributor.

‡Denotes correction in former catalogs; 6 positions include 5 "live" and 1 "off".

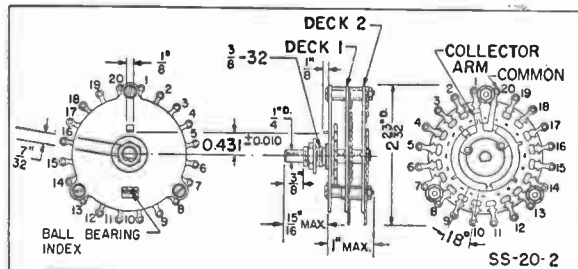
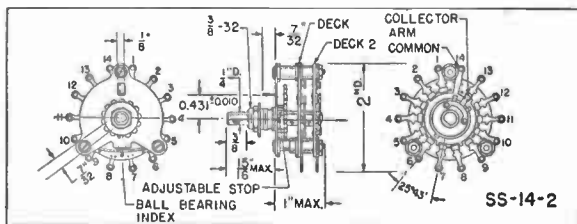

UNIQUE — MOLDED ROTARY SELECTOR SWITCHES

Fully Enclosed — Single and Multi-Gang — Shorting and Non-Shorting

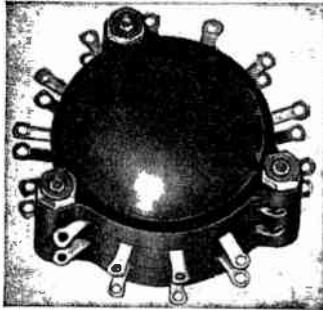

MS-14-2

- All moving contacts enclosed — minimizes dirt and corrosion.
- Contact lugs permanently integrated into switch assembly.
- Sturdy construction with 3-post deck suspension, double grip collector arms, and rectangular drive shaft through decks for precision indexing.
- Interchangeable, electrically and mechanically, with J-B-T 14- and 20-position laminated switches, widely used by industry and Armed Services.

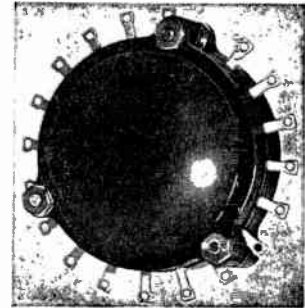

MS-20-1

FEATURES:

For description of rigid 3-post construction; heavy pure silver plating to meet 100-hour salt-spray test; excep-

tional compactness; .007 ohm average contact resistance; current-carrying capacity and voltage breakdown; see adjoining page on SS-14 and SS-20 laminated switches. Besides fully enclosing all the moving contact parts, the molded switches differ from the laminated construction in the design of the detent mechanism, but both types provide the positive indexing which quickly identifies the superior quality of J-B-T switches.

BASIC 14-POSITION MOLDED (MS-14): 13 circuits and "off" per deck in 2 3/8" circle for compactness. Molded end cover regularly supplied. 1 1/4" Bar knob included with individually boxed units—not on bulk orders unless specified. Collector arm placed directly opposite to flat of shaft, so that knob pointer points to live contact. Common or "off" contact lug is bent down for ready identification. Internal construction: double-grip collector arms hold contact lug on upper and lower surfaces; collector ring is self-wiping. One to ten decks add 1/8" per deck (or gang) to depth; for eleven decks and over, add 1/2" to depth for double indexing mechanism; add 3/8" to depth for adjustable stop mechanism. Continuous rotation type supplied unless adjustable stop (type MAS) is ordered or, on quantity orders, pre-set fixed stops are specified. Panel locator is available on quantity orders when specified; on MS-14-4 and MS-14-6, extra hex nut and longer screw are supplied for inverting supporting screw nearest common, thus converting into panel locator.

BASIC 20-POSITION MOLDED (MS-20): 19 circuits and "off" per deck in 2 3/8" circle for compactness. Molded end cover regularly supplied. 2" Bar knob included with individually boxed units—not on bulk orders unless specified. Collector arm placed directly opposite to flat of shaft, so that knob pointer points to live contact. Common or "off" contact lug is bent down for ready identification. Internal construction: double-grip collector arms and self-wiping collector ring are standard construction. One to seven decks; add 1/8" per deck (or gang) to depth. Continuous rotation type supplied; on quantity orders, pre-set fixed stops are available. Panel locator available on quantity orders when specified; on MS-20-4 and MS-20-6, extra hex nut and longer screw are supplied for inverting supporting screw nearest common, thus converting into panel locator.

MOLDED SWITCHES, MS-14 TYPE

(14 positions; angular indexing 25° 43')

Continuous rotation, no stops

Non-Shorting—Break before make. Shorting—Make before break.

Model	Positions Per Circuit	Circuits or Per Deck	Decks or Gangs	Shorting or Non-Shorting	Depth Behind Panel	Boxed Including Knob
MS-14-1	14	1	1	N-S	1 1/8"	\$1.50
MS-14-1S*	14	1	1	S	1 1/8"	1.50
MS-14-2	14	1	2	N-S	1 3/8"	1.80
MS-14-2S*	14	1	2	S	1 3/8"	1.80
MS-14-3	14	1	3	N-S	1 7/8"	2.25
MS-14-4	14	1	4	N-S	1 3/4"	2.90
MS-14-6	14	1	6	N-S	2 3/8"	4.25

* Standard items, but not regularly stocked; check with your electronic parts distributor.

MOLDED SWITCHES, MS-20 TYPE

(20 positions; angular indexing 18°)

Continuous rotation, no stops

Non-Shorting—Break before make. Shorting—Make before break.

Model	Positions Per Circuit	Circuits or Per Deck	Decks or Gangs	Shorting or Non-Shorting	Depth Behind Panel	Boxed Including Knob
MS-20-1	20	1	1	N-S	1 1/8"	\$1.95
MS-20-1-6DT	2	6	1	N-S	1 1/8"	2.70
MS-20-1S*	20	1	1	S	1 1/8"	1.95
MS-20-2	20	1	2	N-S	1 1/8"	2.40
MS-20-2-6DT	2	6	2	N-S	1 1/8"	3.90
MS-20-2S*	20	1	2	S	1 1/8"	2.40
MS-20-3	20	1	3	N-S	1 3/4"	3.25
MS-20-4	20	1	4	N-S	1 3/4"	3.95
MS-20-6	20	1	6	N-S	2 3/8"	5.60

ADJUSTABLE STOP MOLDED SWITCHES, MAS-14 TYPE

(14 positions; angular indexing 25° 43')

IMPORTANT: Enclosed adjustable stop mechanism increases switch length 1/8" behind panel; decreases effective bushing length by 1/8"; and shortens shaft extending from bushing by 1/8". Rings RI-23 and RI-24 are supplied.

Non-Shorting—Break before make. Shorting—Make before break.

Model	Positions Per Circuit	Circuits or Per Deck	Decks or Gangs	Shorting or Non-Shorting	Depth Behind Panel	Boxed Including Knob
MAS-14-1	14	1	1	N-S	1 1/8"	\$1.95
MAS-14-1S*	14	1	1	S	1 1/8"	1.95
MAS-14-2	14	1	2	N-S	1 3/8"	2.25
MAS-14-2S*	14	1	2	S	1 3/8"	2.25
MAS-14-3	14	1	3	N-S	1 7/8"	2.70
MAS-14-4	14	1	4	N-S	1 3/4"	3.35
MAS-14-6	14	1	6	N-S	2 1/2"	4.70

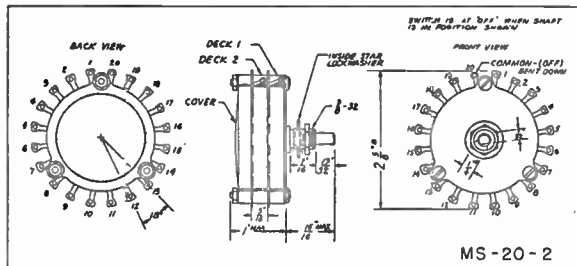
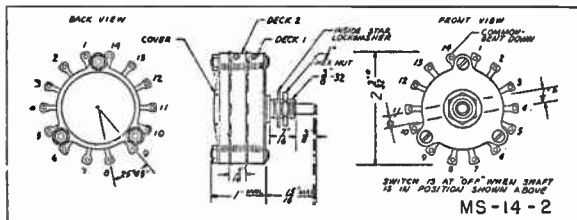

LEVER ACTION SWITCHES, KITS AND SPECIAL SWITCHES

3- and 4-Position Lever Switches — New 5-Position — Unique 6-Pole Double-throw per Deck

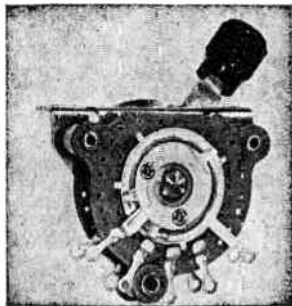

SS-14-1L4F-2
Two-Deck Lever-Action Switch

drawing below. Variations in mounting hole sizes, lever length, and tapped mounting holes can be supplied on long runs involving set-up charges. Switches are normally individually boxed with mounting hardware and KN-17 black pointed knob instead of the knob illustrated. Spacing between single decks: recommended $\frac{3}{4}$ " minimum $\frac{1}{2}$ ". Also see list of available mounting plates.

Spring Return Type. Single deck 3-position switches also may be ordered with spring return. Lever returns to position 11, giving momentary action at positions 9 and 10 (Model Suffix -R).

Two-Deck Lever Action Switches. These use the same strong parts, 3-pole suspension and double-grip collector arms as the one-deck type, but are specified where quality is the prime requirement. Spacing is $\frac{3}{8}$ " between decks, the same distance as TV twinlead wires. Non-shortening (break before make) positive action, individually boxed including KN-17 knob and hardware. Recommended spacing between decks $\frac{1}{2}$ "; minimum spacing $\frac{1}{8}$ ".

POSITIVE TYPE, 3- and 4-Positions. (Single-deck.)

Specified where quality is a consideration, these lever switches offer many of the design features of the J-B-T SS-14 instrument-type rotary switches. The single-deck models (not illustrated) come in the conventional three-positions and in a newer four-position. Present uses include tube checkers, inspection apparatus, communication systems, hobby equipment, consoles, and sound devices. The four-position types, interchangeable except in slot length with the standard three-position, provide the extra circuit which is often needed. Dimensions are shown on the

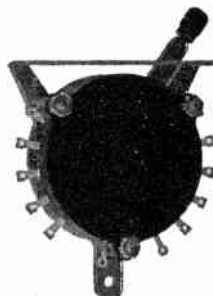

MS-20-1L5A-1
5-Position Lever Switch

MS-20-1L5A-1, 5-position, 2 circuit (1-deck) \$2.25

MODEL MS-20-1L5A-1. For the first time designers and servicemen have available 5 live positions, two circuits per deck in a fully enclosed, lustrous black molded construction. Adapted from the MS-20 series of instrument-quality switches shown on a preceding page and having similar electrical characteristics, this positive action lever switch made an instant hit for sound systems. Now that it is released for general use, control, inspection, test and experimental circuits can be simplified by its use. Shipped individually boxed with hardware and threaded black molded knob. Sketch for mounting will be supplied upon request.

KNOBBS FOR LEVERS



Spare knobs, push-on type, are:
KN-17, black, modern pointed design, metal insert, shown at left, now regularly supplied \$0.06
KN-18, walnut, same as KN-1905
KN-19, black, round, flat-type, shown at right; no insert needed05

6-POLE DOUBLE-THROW PER DECK—1 or 2 DECKS

6-Pole Switches. Double-throw switching, 6 circuits per deck, becomes easy with this unique rotary-type molded switch. It is fully enclosed and similar in appearance to the molded MS-20 switches described on another page. The illustration at the right shows internal construction with back protective cover cut away. Circuit arrangement is designated on the metal front of the switch. Quality features include .007 ohm average contact resistance; heavy, pure-silver plating for 100-hour salt spray test; double-grip collector arms, and 3-post deck suspension. Available only in non-shortening (make before break), popular for both military and civilian circuitry. $2\frac{3}{8}$ " maximum diameter, one deck, $\frac{1}{8}$ " behind panel; two deck, $1\frac{1}{8}$ " behind panel; up to four decks on special order.

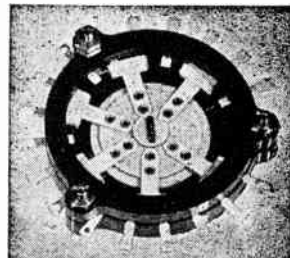

MS-20-1-6DT, 6-pole, double throw (1-deck) \$2.70
 MS-20-2-6DT, 6-pole, double throw on each of two decks 3.90

SWITCH KIT — 14- and 20-Positions

MODEL K-1. The instrument-quality, laminated phenolic switches described previously as SS-14 and SS-20 rotary types now are available in kit form for quick assembly. This arrangement is especially helpful to engineers, experimenters, hams, and electronic maintenance departments, for special assemblies or emergency requirements. The sturdy, 4-drawer, steel cabinet with 48 compartments contains 15 SS-14 index assemblies; 11 SS-20 index assemblies; 50 14-position decks, including non-shortening (break before make), shorting (make before break); A-type (2 circuits); CS-type (complete shorting); F-type (14 live positions); and 33 20-position decks including non-shortening, shorting; A-type (2 circuits); and F-type (20 live positions). One simple tool for pushing rotors on switch shafts, also replacement parts list for ordering refills through distributors are included.

K-1 Kit \$76.00

Model	Pos. per Circuit	Ckts. per Deck	Short. or Contact Pos.	Stand.* Pos.	Boxed Incl. Knob
SS-14-1L3	3, no "off"	1	NS	A	\$0.75
SS-14-1L3A	3, no "off"	2	NS	B	.90
SS-14-1L3S	3, no "off"	1	S	A	.75
SS-14-1L3-R Sp. Rct.	3, no "off"	1	NS	A	.85
SS-14-1L3S-R Sp. Rct.	3, no "off"	1	S	A	.85
SS-14-1L3-2	3, no "off"	1	NS	A	1.35
SS-14-1L4	3 & "off"	1	NS	C	.85
SS-14-1L4F	4, no "off"	1	NS	D	.85
SS-14-1L4F2	4, no "off"	1	NS	D	1.45
SS-14-1L4S	3 & "off"	1	S	C	.85

*A—common at 12, contacts at 9, 10, 11; B—common at 9, 10, contacts at 6, 7, 8, 12, 13, 14; C—common and off at 12, contacts at 9, 10, 11; D—common at 12, contacts at 8, 9, 10, 11.

MOUNTING PLATES



These .035" stamped steel plates in black crackle finish simplify alignment of standard 3-position 1-deck switch models having symbol 1L3. Separation is $\frac{3}{4}$ " between switches; all plates are $2\frac{5}{8}$ " high.

PL-36, $\frac{3}{4}$ " long, for one switch \$0.25
 PL-37, $1\frac{1}{2}$ " long, for two switches35
 PL-38, 3" long, for four switches (illustrated)40

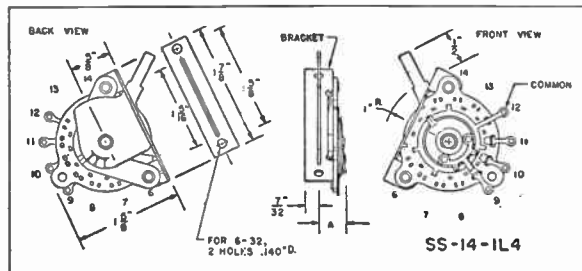

Dimension A = $\frac{1}{2}$ " on 1-deck Switches; $\frac{3}{8}$ " on 2-deck. Non-shortening type with standard lever length is shown.

SINGLE HOLE · FLUSH MOUNTING TOGGLE SWITCHES DESIGNED FOR GOVERNMENT SPECIFICATIONS JAN-S-23 AND MIL-S-6745 (AN-S-20a)

NEW

MEET ADVERSE OPERATING CONDITIONS

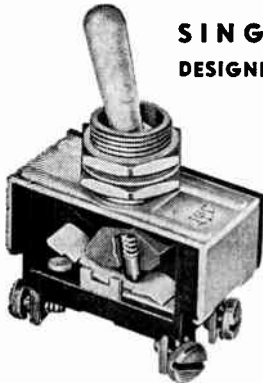

Single Pole • Double Pole
Single Throw • Double Throw
Screw Terminal • Solder Lug
Series ST-40, ST-42
Series ST-50, ST-52

Smaller, lower capacity toggle switches such as ST-12, -13, ST-22, -23, -26 and -27, also designed for JAN-S-23, are being tooled for production. Inquiries invited.

Heat and Cold . . . Specialized aircraft lubricant facilities operation at both low and high temperatures (−67°F to 185°F.)











High Humidity . . . Materials, plating, construction and lubricant enable switches to withstand tropical climates.

Salt . . . Meet 100 hour Salt-Spray Test QQ-M-151a which is twice the required minimum.

Vibration and Shock . . . No momentary make or break or mechanical damage during stringent shake tests and 75 Gs drop test.

Overload . . . Tested to make and break at 50% overload for brief periods because of ample size **solid** coin silver contacts and rocker arms instead of clad or brazed construction. Contact resistance is under 0.005 ohms. High dielectric exceeds 900 volts r.m.s. at 60 cycles.

Rugged Service . . . Generously proportioned and substantially built for extra life. For instance, both screw-type terminals and solder lugs easily withstand a 30 pound pull test. Operating cycles far in excess of minimum specified as acceptable. Springs are stainless steel. Quality standards are maintained by in-plant testing of production samples.

SINGLE POLE		CIRCUIT ARRANGEMENT					DOUBLE POLE				
SCREW TERMINAL ST-40	SOLDER LUG ST-42	LETTER	TYPE				KEY WAY	SCREW TERMINAL ST-50	SOLDER LUG ST-52	LETTER	TYPE
		A B C	SPST SPST SPST	on on off	none none none	off off* on*				K L M	DPST DPST DPST
		D E F G H	SPDT SPDT SPDT SPDT SPDT	on on on on* on	none off none off off	on on* on* on* on*				N P R S T	DPDT DPDT DPDT DPDT DPDT

*Momentary Position

For Electrical Characteristics, Current Values and Full Information, Ask for Bulletin TS-4.

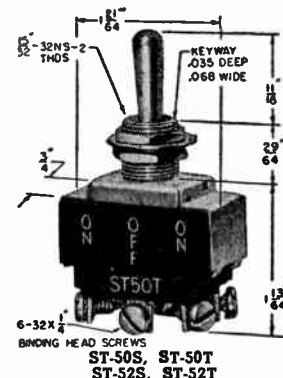
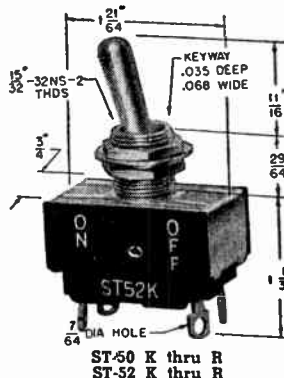
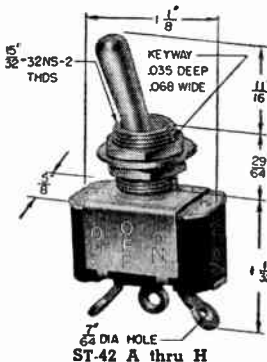
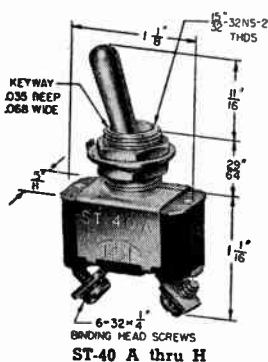

Multi-Section Rotary Switches



High grade, phenolic-insulated, rotary switches for radio and electronic equipment in circuits not exceeding 500 volts DC. These switches have self-wiping, silver-plated, copper alloy contacts which assure long, useful life. All models feature an adjustable stop. A 2 1/2" mounting area is required. Mounting depth is dependent on number of sections. Switches have 1/4" round shafts, 2" long, and 3/8"-32 bushings. Each switch supplied with pointer knob and mounting hardware. All switches have 1/2" spacing between sections, except the 3 and 4 section which have 1" spacing.

Shorting Type Catalog Number	Non-Shorting Type Cat. No.	No. of Circuits per Section or Gang	Total No. of Circuits per Switch	No. of Positions	List Price
1211L	1311L	1	1	2 to 11	\$1.55
1215L*	1315L*	2	2	2 to 5	1.65
1213L*	1313L*	3	3	2 to 3	1.80
1212L*	1312L*	4	4	2 to 2	1.90
1221L	1321L	1	2	2 to 11	2.30
1225L*	1325L*	2	4	2 to 5	2.60
1223L*	1323L*	3	6	2 to 3	2.80
1222L*	1322L*	4	8	2 to 2	2.95
1231L	1331L	1	3	2 to 11	3.10
1235L*	1335L*	2	6	2 to 5	3.30
1241L	1341L	1	4	2 to 11	3.95
1245L*	1345L*	2	8	2 to 5	4.60
1251L	1351L	1	5	2 to 11	4.90
1256L	1356L	2	10	2 to 6	6.05
1261L	1361L	1	6	2 to 11	5.80
1266L	1366L	2	12	2 to 6	7.40

* These switches are provided with an "Off" position which is in addition to the greatest number of positions listed. The "Off" position precedes the other positions.

Typical Dimensions of 1200L, 1300L Rotary Switch

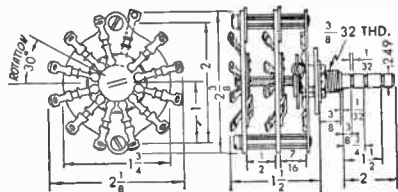

Single-Section Rotary Switches



Small, compact, phenolic-insulated switches equipped with 3/8"-32 bushings, and easy-to-cut grooved shafts, 1/4" diameter x 2" long. The 1 1/4" base styles have 30° indexing. The 1 1/16" base styles have 20° indexing and are equipped with adjustable stops.

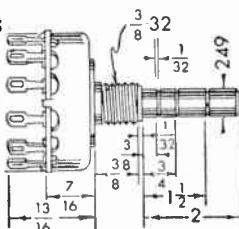

Shorting Type Catalog Number	Non-Shorting Type Cat. No.	Number of Circuits	Number of Positions	Diameter of Base	List Price
3115J	3215J	1	5	1 1/4	\$1.15
31112J	32112J	1	12	1 1/4	1.15
3122J	3222J	2	2	1 1/4	1.15
3123J	3223J	2	3	1 1/4	1.15
3126J	3226J	2	6	1 1/4	1.15
3134J	3234J	3	4	1 1/4	1.20
3142J	3242J	4	2	1 1/4	1.20
3143J	3243J	4	3	1 1/4	1.20
31117J	32117J	1	2 to 17	1 1/16	1.80
3129J	3229J	2	2 to 9	1 1/16	1.80
3136J	3236J	3	2 to 6	1 1/16	1.95
3163J	3263J	6	2 to 3	1 1/16	1.95

Ceramic Section Selector Switches



High grade, ceramic-insulated, rotary switches for use in transmitters, test and high frequency radio equipment. Supplied with silicone treated, ceramic sections and double, self-wiping, silver-plated, copper alloy contacts. All models have adjustable stops. A 2" mounting area is required. Two-section models have 1/2" spacing; 3-section models have 1" spacing. Equipped with 1/4" round shafts, 2" long, and 3/8"-32 bushings. Pointer knob and mounting hardware included.

Catalog Number	Number of Gangs or Sections	Number of Circuits per Gang or Section	Number of Positions	List Price
172C	1	1	2 to 11	\$2.25
173C*	1	2	2 to 5	2.25
174C*	1	3	2 to 3	2.25
176C	2	1	2 to 11	3.50
177C*	2	2	2 to 5	3.50
178C*	2	3	2 to 3	3.50
180C	3	1	2 to 11	5.00
181C*	3	2	2 to 5	5.00

* These switches are provided with an "Off" position which is in addition to the greatest number of positions listed. The "Off" position precedes the other positions.

Lever Action Switches



Bat-handle design. For circuit selection in intercommunication, PA and similar equipment. 2" mounting depth behind panel required for all models. Switches of the 5000 Series have No. 8 by 1/4" elongated mounting holes with 2 1/4" mounting centers. Switches of the 6000 and 7000 Series have No. 6 mounting holes with 1 3/8" mounting centers. Provided with knob and hardware.

Shorting Type Catalog No.	Non-Shorting Type Catalog No.	Number of Poles or Circuits	Number of Positions or Contacts	List Price
Positive Indexing				
5124	5224	2	4	\$1.50
6142	6242	4	2	1.25
6143	6243	4	3	1.25
Spring Return				
7122L	7222L	2	2	1.25
7123C	7223C	2	3	1.25
7142L	7242L	4	2	1.25
7143C	7243C	4	3	1.25
7162L	7262L	6	2	1.25

24-Position Tap Switch



For test equipment. Switches have 1 circuit and 24 positions. Phenolic insulation. Furnished with 3/8"-32 brass bushing and 1/4" x 2" notched shaft. Dial plate 394, knob and mounting hardware supplied.

Catalog No. 13124L List Price \$3.50

Circuit-Opening Switch



For meter and circuit switching in test equipment and small transmitters. Switches have 4 sections and 2 to 12 positions with adjustable stop. Phenolic-insulated for 500 volt DC operation. Mounting depth behind panel is 2 1/4". Supplied with 1/4" x 2" notched shaft and 3/8"-32 brass bushing. Pointer knob, dial plate 382, and mounting hardware included.

Catalog No. 1400L List Price \$5.90

"HAM," PUSH-BUTTON AND JACK SWITCHES

P. R. MALLORY & CO., INC. · INDIANAPOLIS



Two-Section, Five-Position "Hamswitch®"

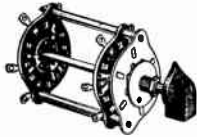

For meter or circuit switching in transmitters. Rated at 1000 volts AC up to 1500 volts DC. Two section, 5 position. 2 1/4" spacing between sections. 60° indexing between positions. Adjustable stop. Non-shorting type. Supplied with 3/8"-32 bushing, 1/4" x 2" notched round shaft. Pointer knob and mounting hardware furnished. Requires 3/4" mounting depth.

Catalog No. 151L

List Price \$2.75

Two-Section, Two-Circuit, Six-Position "Hamswitch"



Coil and circuit rotary switch with 6 positions, 2 circuits and 2 sections (1/2" spacing) designed to short out automatically all unused positions. Ideal for test oscillator switching, band-switching or meter-switching uses. Phenolic insulated and

equipped with 3/8"-32 bushing, 1/4" x 2" notched round shaft and adjustable stop. Supplied with pointer knob and mounting hardware.

Catalog No. 152L

List Price \$3.25

Decade Switches

Especially designed for use in the construction of capacitor and resistor decade instruments.

The unusual circuit arrangement of these switches permits real economies in the construction of precision resistor and capacitor decade assemblies since they require only 4 standard resistors or capacitors to complete a full decade of test values. Each switch is equipped with high grade phenolic insulation and heavily silvered contact members to assure excellent electrical stability. Adjustable stops are provided to permit interconnecting with other switches for multiple decade operation. One Mallory No. 366 bar knob and mounting nut furnished. Dial plates with 30 degree numeral spacing must be employed.

Catalog No. 153L Capacitor Decade Switch

List Price \$3.30

Catalog No. 154L Resistor Decade Switch

List Price \$3.70

Jack Switches



Leaf-type switches actuated by rotary motion. Both types adaptable for use in such applications as laboratories, test panels and meter circuits. Standard models extend perpendicularly to panel; junior style parallel to panel. The 3/8"-32 bushing may be used in panels up to 1/4" in thickness. Both types suitable for mounting in a single hole 7/16" diameter. Shaft is 1/4" round with suitable flat. Supplied with mounting hardware, but no knob.

	Junior Cat. No.	List Price	Circuit Arrangement
Two Position Jack Switches	720	\$1.10	Single-Pole, Single-Throw
	730	1.35	Single-Pole, Double-Throw
	740	1.50	Double-Pole, Single-Throw
	745	1.75	Five Springs, two break and one make
	760	1.95	Double-Pole, Double-Throw
Three Position Jack Switches	733	1.95	Three-Pole, Single-Throw
	744	2.55	Four-Pole, Single-Throw
	732	1.35	Double-Pole, Single-Throw Center "Off" Position
	762	1.90	Double-Pole, Double-Throw Center "Off" Position
Three Position Jack Switches	763	2.50	Three-Pole, Double-Throw Center "Off" Position
	764	3.10	Four-Pole, Double-Throw Center "Off" Position

Single Push-Button Switches



Plunger-type switches for panel mounting in radio and electronic circuits. Available in a choice of 8 different circuit combinations for use in laboratories, on test panels, in meter circuits and in a wide variety of other applications. "L" indicates locking-type.

Other types have spring return to normal position. Switches require 7/16" mounting hole, and will fit panels up to 1/4" in thickness. Mounting radius is 1 3/8"; mounting depth is approximately 1 1/4". Switch body extends 1 1/16" behind panel. Supplied with polished phenolic button and mounting hardware.

Catalog No.	Circuit Arrangement	List Price
2001	SPST—Make	\$1.30
2001L	SPST—Make	1.30
2002	SPST—Break	1.30
2002L	SPST—Break	1.30
2003	SPDT	1.40
2003L	SPDT	1.40
2004	DPST—Make 2	1.60
2004L	DPST—Make 2	1.60
2005	DPST—Break 2	1.60
2005L	DPST—Break 2	1.60
2006	DPDT	1.95
2006L	DPDT	1.95
2007	DP—Make 2, Break 1	1.75
2007L	DP—Make 2, Break 1	1.75
2008	DPDT—Make before Break	2.20
2008L	DPDT—Make before Break	2.20

Multiple Push-Button Switches



For making, breaking or transferring multiple circuits. Spacing of 3/8" between plungers. Equipped with brown knobs, escutcheon plate and window inserts.

Catalog Number	Number of Buttons	Operation Per Button	List Price
2164	4	DP Circuit Closing	\$5.25
2166	6	DP Circuit Closing	6.55
2168	8	DP Circuit Closing	7.90
2184	4	DPDT, Make Before Break	5.25
2186	6	DPDT, Make Before Break	6.55
2188	8	DPDT, Make Before Break	7.90
2194*	4	DPDT, Break Before Make	5.25
2196*	6	DPDT, Break Before Make	6.55
2198*	8	DPDT, Break Before Make	7.90

* Non-Shorting Types

Ceramic Section "Ham Band" Switches



For use in transmitter plate circuits not exceeding 1000 volts DC with power up to 100 watts. Switches have 4 positions in 360° rotation with each section a single circuit. 90° indexing. All models are non-shorting. Ceramic insulation provides low losses at high frequencies. Equipped with double-contact tie points. A 2" mounting area is required. Two-section models have 1 3/8" spacing, all others have 1". Switches are supplied with 1/4" round shafts, 2" long, and 3/8"-32 bushings. Each switch is furnished with pointer knob and mounting hardware.

Catalog Number	Number of Gangs or Sections	Spacing Between Sections	Circuits Per Switch	List Price
161C	1		1	\$2.25
162C	2	1 3/8"	2	3.50
163C	3	1"	3	5.00
164C	4	1"	4	6.00
165C	5	1"	5	7.50

Mallory Page 2

Jacks



Metal parts on all jacks have protective plating. Fine contact surfaces provide excellent electrical conductivity. Suitable mounting hardware supplied with all jacks. LA Jacks are economy jacks similar to the SC Series (see listing this page).

Long Frame Cat. No.	List Price	Junior Jacks Cat. No.	List Price	Infant and Midget Jacks Cat. No.	List Price
	1	701	\$0.65	A-1	\$0.30
	2	702	.80	A-2	.50
	2A	702A	.80	A-2A	.55
	2B	702B	.80		
	3	703	.95		
	3A	703A	.95	A-3A	.80
	3B	703B	.95		
	3C	703C	.95		
	4	704	1.10	LA Series	
	4A	704A	1.10	LA-1	\$0.40
	4B	704B	1.10	LA-2	.45
	5	705	1.20	LA-2A	.50
	6	706	1.30	These Jacks equivalent electrically to A-1, A-2 and A-2A listed above	

GJ-1 Airplane Grounding Jack—Similar to A-1 Jack except for insulation. List Price \$0.50

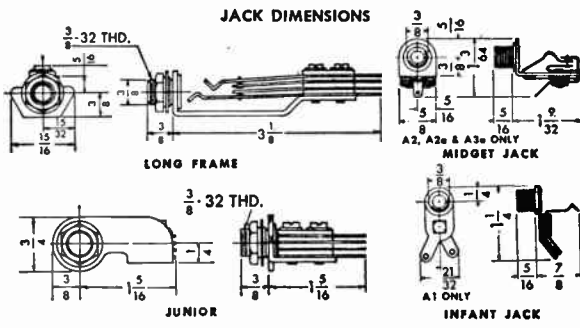

Cat. No.	Type
XP1	(Open Circuit)
XP2B	(Three-Circuit Microphone)
XP3B	(Single Circuit, Make before Break)

SC Jacks and LA Jacks



Both SC Type Jacks have standard brass 3/8"-32 bushings. Mounting depth behind panel 1 1/16". LA Jacks are similar in basic design and size, but have commercial construction. Use with No. 75, 75N, 75A or 85 phone plugs.

Cat. No.	Description	List Price
SC-1A Phone Jack	Commercial equivalent of military jack No. JJ-034. Same spring arrangement as No. 1 long-frame jack. Designed to receive the following plugs: Mallory No. 75, Western Electric Nos. 47A and 47B, Signal Corps Nos. PL-47, PL-48, PL-55, PL-148, PL-155, PL-125 and JAN plugs PJ-055, PJ-155, PJ-634, PJ-636, PJ-047.	\$0.55
SCA-2B	Commercial equivalent of military jack No. JJ-033. Same spring arrangement as No. 2B Long frame jack. Designed to receive the following plugs: Western Electric No. 109 and Signal Corps Nos. PL-68, PL-168, and JAN plugs PJ-068, PJ-168, and PJ-309.	.65
LA-1	Open Circuit	.40
LA-2	Circuit closing	.45
LA-2A	Two circuits	.50

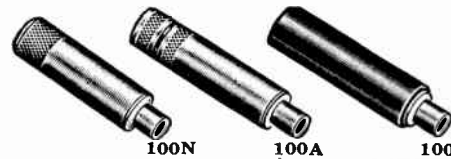

Extension Jacks

Cat. No.	Description	List Price
100	Two-Way Extension Jack (Fiber Shell) for No. 75 Phone Plug. Overall length 3/4".	\$1.30
100N	Two-Way Extension Jack (Shielded One-Piece Nickel Shell) for No. 75N Phone Plug. Overall length 3/4".	1.65
100A	Two-Way Extension Jack (Shielded Two-Piece Nickel Shell) for No. 75A Phone Plug (with Built-in Cable Clamp). Overall length 3/4".	2.30

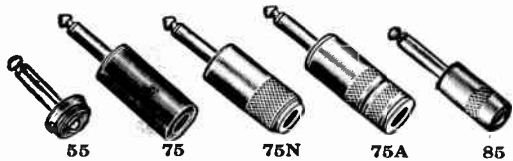

Plugs

Cat. No.	Description	List Price
55	Adapts standard microphone connector for use with conventional Jack.	\$0.45
75	Two-Way Phone Plug with Tie-Cord Anchor (Phenolic Shell)	.65
75N	Two-Way Phone Plug with Tie-Cord Anchor (Shielded One-Piece Nickel Shell)	1.00
75A	Two-Way Phone Plug with Tie-Cord Anchor (Shielded Two-Piece Nickel Shell) (with Built-in Cable Clamp)	1.65
78	Three-Way Microphone Plug (Phenolic Shell)	1.00
78A	Three-Way Microphone Plug (Shielded Two-Piece Nickel Shell) (with Built-in Cable Clamp)	1.95
85	Two way miniature phone plug, shielded.	.50

"X" Type Jacks Plain bushing type for telephone switchboard service. Furnished with 1 mounting nut and washer.

Cat. No.	Type	List Price
XP1	Open Circuit	\$0.90
XP2B	3-Circuit Microphone	1.00
XP3B	Single Circuit—Make before Break	1.30

SPECIAL COMPONENTS AND MISCELLANEOUS ITEMS

R. R. MALLORY & CO., INC. - INDIANAPOLIS

R. R. MALLORY & CO. INC.
MALLORY

Knobs



Catalog No.	Description	List Price
364	1 1/16" Dia. Similar to 368, but with pointer at base. Black.....	\$0.15
365-1	2 1/4" Bar Type Knob, Black.....	.25
366-1	1 1/4" Bar Type Knob, Black.....	.20
366-R-1	1 1/4" Bar Type Knob, Red.....	.20
367-1	1 1/2" Dia. Round Knob, Black.....	.25
368-1	1 1/8" Dia. Round Knob, Black.....	.20

Dial Plates

For Mallory Circuit Selector, Tap and All-Wave Switches.
List Price \$0.20 each (all types)



Neat-appearing Dial plates with easy-to-read aluminum figures clearly etched on solid black background. Dimensions are 1 1/8" in diameter with 7/16" hole, with figures 7/64" high. .020" aluminum stock.

For all types 3100J, 3200J Switches, with 1 1/16" base. 20 degree spacing between numerals.	For all Switch types 1200L, 1300L and 1/4" base 3100J, 3200J. 30 degree spacing between numerals.	Marking
Catalog Number	Catalog Number	
453	372	1 to 2
454	373	1 to 3
455	374	1 to 4
456	375	1 to 5
457	376	1 to 6
458	377	1 to 7
459	378	1 to 8
460	379	1 to 9
461	380	1 to 10
462	381	1 to 11
463	382	1 to 12
464		1 to 13
465		1 to 14
466		1 to 15
467		1 to 16
468		1 to 17
472		1 to 18
473		Off 1 to 2
474	383	Off 1 to 3
475	384	Off 1 to 4
476	385	Off 1 to 5
477	386	Off 1 to 6
478	387	Off 1 to 7
479	388	Off 1 to 8
480	389	Off 1 to 9
481	390	Off 1 to 10
482		Off 1 to 11
483		Off 1 to 12
484		Off 1 to 13
485		Off 1 to 14
486		Off 1 to 15
		Off 1 to 16
		1 to 24
		1 to 5
		1 to 4
	*394 Special	
	†487 Special	
	‡488 Special	

Mounting Nuts For Switches and Controls



Catalog Number	Description	Thread	Dimension	List Price
232	Flat Hex Mounting Nut.....	3/8-32	1/2 x 3/32	\$0.35 *
255	Hex Mounting Nut.....	3/8-32	1/2 x 7/64 x 7/64 shoulder nut	.20
A-11260-2	Hex Mounting Nut.....	3/8-32	1/2 x 7/64 x 1 1/2 shoulder nut	.30
A-11260-12	Hex Mounting Nut.....	3/8-32	1/2 x 7/64 x 7/32 shoulder nut	.25

* Per 10 pieces.

Washers—For Switches and Controls



Catalog Number	Description and Dimensions	List Price
203	Extruded Washer—Fiber—3/8" O.D. x 3/8" I.D. x 1/16"; Extruded 1/2" x 1/32". For Set See No. 212 Flat Washer.....	\$0.30 *
212	Flat Washer—3/8" O.D. x 3/8" I.D. x 1/32"; Phenolic.....	.20 *
225	Metal Washer—Nickel Finish—3/8" O.D. x 3/8" I.D. .040 Brass.....	.20 *
226	Metal Washer—Nickel Finish—3/8" O.D. x 7/16" I.D. .040 Brass.....	.20 *
227	Lock Washer—Cadmium Plated Steel—1 1/16" O.D. x 2 5/64" I.D.....	.20 *

* Per 10 pieces.

Soldering Iron Tips



No. 311—Replacement tip for soldering irons that are turned on for short periods only. Heats quicker than No. 312, but is not as long wearing. Made of a special Mallory copper alloy long in use as a welding tip material. Nickel plated to resist corrosion. Size—3/8" diameter, 4" length. Plunger style with "screw driver" point.

List Price \$0.85

* 15° Spacing Between Numerals † 90° Spacing Between Numerals
‡ 60° Spacing Between Numerals

No. 312—Replacement tip for soldering irons that are used continuously for long periods of time. Made of a special Mallory copper alloy of great hardness and high electrical conductivity. Nickel plated to resist corrosion. Size—3/8" diameter, 4" length. Plunger style, with "screw driver" point.
List Price \$0.95

Mallory Midgetrol

Single Section

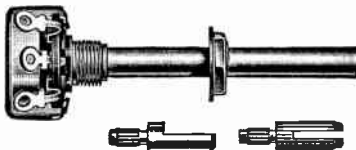

Dual Section

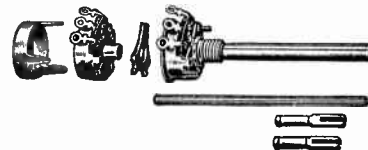

For complete listing and description see Page 1, Mallory Resistors and Controls Section.

Mallory Page 4

SWITCHES • ATTENUATORS • POTENTIOMETERS

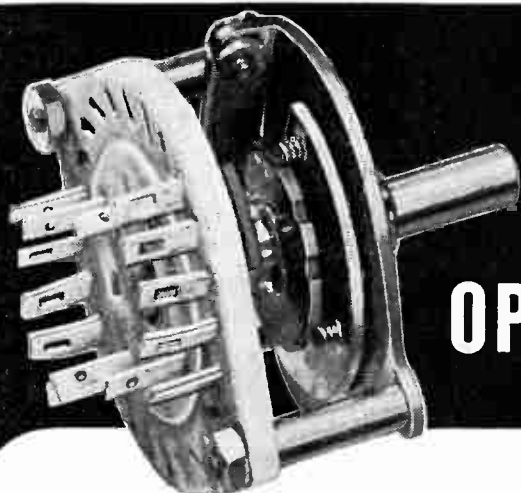

Still "On Tap"
after 1,000,000
OPERATING CYCLES!

**That's why the SYSTEM ANALYZER CORP.
 Chose Tech Laboratories Tap Switches
 for \$200,000 Electronic "Brain"**

TYPE 2C TAP SWITCH SPECIFICATIONS

Contact resistance: 3-4 milliohms
Contact material: Silver plated brass
Contact design: Laminated wiper arm, self-cleaning, shorting or non-shorting
No. of contacts: 2 to 24 single pole, 2 to 11 double pole, 2 to 7 triple pole, 2 to 5 four pole; shorting or non-shorting
Spacing: 15° or 20° shorting or non-shorting
No. of poles per deck: 1 to 4
No. of decks: According to requirements
Current carrying cap.: 3 amp.
Max. operating voltage: 120 V., a.c.
Mounting: Single hole, 3/8"-32 bushing
Size: 1 3/4" dia.
Detent: Ball and spring
Weight: Approx. 1 oz. per deck

PRICE LIST FOR TYPES 2A & 2C*

No. of Decks	No. of Poles/Deck	No. of Pos. Shorting	Type No. for 2C	2A	2C
1	1	24	C1S24	\$4.50	\$6.75
1	2	12	C2S12	4.75	7.12
1	3	6	C3S6	5.00	7.50
1	4	5	C4S5	5.25	7.87
2	1	24	C1S24-2	7.00	10.50
2	2	12	C2S12-2	7.50	11.25
2	3	6	C3S6-2	8.00	12.00
2	4	5	C4S5-2	8.50	12.75
3	1	24	C1S24-3	9.50	14.25
3	2	12	C2S12-3	10.25	15.37
3	3	6	C3S6-3	11.00	16.50
3	4	5	C4S5-3	11.75	17.62
4	1	24	C1S24-4	12.00	18.00
4	2	12	C2S12-4	13.00	19.50
5	1	24	C1S24-5	14.50	21.75
5	2	12	C2S12-5	15.75	23.62
6	1	24	C1S24-6	17.00	25.50
6	2	12	C2S12-6	18.50	27.75

*Ceramic insulation

**WE MAKE A GREAT MANY KINDS OF
 ATTENUATORS & ROTARY SWITCHES**

2 to 3 weeks delivery on orders up to 6 units.

TECH LABORATORIES INC.

PALISADES PARK, N. J.,

WRITE FOR NEW BULLETINS

on Switches • Decade Resistors

Potentiometers

and Power Supplies for Mobile Equipment

SPLICING BLOCKS. PRECISION AND VERTICAL ATTENUATORS

VERTICAL ATTENUATORS

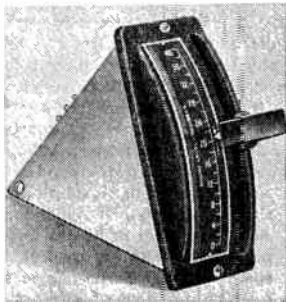

Precision designed and manufactured to perform satisfactorily in every conceivable type of sound equipment, from the most elaborate broadcasting station to the simplest P.A. installation. Easily operated, completely shielded and dustproof. Narrow construction permits as many as seven mixers in one row on a standard 19" rack.

SPECIFICATIONS:

- Noise Level:** 130-140 db. below zero level.
- Range:** Standard units are furnished with 20 steps at 2 db. and inf. loss (off) on last contact..... 22 contacts.
- Circuit:** Ladder "T" or potentiometer is standard, other circuits can be furnished to order.
- Impedance:** Standard values 30, 50, 150, 200, 250, 500 and 600 ohms for ladders, and 250,000 ohms for potentiometers.
- Pilot Light Switch:** Normally closed, open in off position, S.P.S.T.
- Size:** 2 1/8" x 5 1/8", depth 4 3/4".
* (T-Pads are 2 5/8" wide.)
- Insertion Loss:** 2 to 5 db. depending on circuit.
- Mounting:** Two 6-32 screws in center line 4 1/8" c. to c. Cut hole in panel 2 3/8" x 4 1/2".
- Dial:** Linear, etched, easily read.
- Contact Arms:** Multiple laminated—wiping action.
- Shielding:** Electrostatic shield, dust proof.
- Frequency Response:** Flat to 50 kilocycles.

EDITALL TAPE SPLICING BLOCK

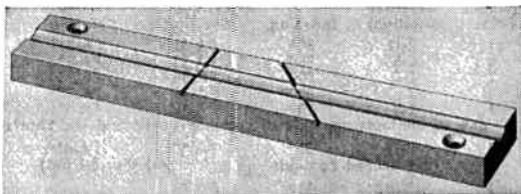

A new exclusively designed tape splicing block that can be used in conjunction with any tape recorder using standard tape. Splices can be easily and quickly made with a minimum of time and effort. Made of lifetime Duraluminum with no clips or mechanical parts to go out of order. Can be used as a separate unit or mounted as part of the tape recorder itself. Approximate overall dimensions—6 1/2" long x 1" wide x 3/8" high. Furnished with drilled and countersunk holes for easy mounting.

TYPE 850 PRECISION ATTENUATOR

With the increased demand for precision in laboratory measurement of volume levels, transmission losses, gains of amplifiers, etc., the older methods and standards have become obsolete. The present units are a complete redesign of our older precision attenuators and will serve as laboratory standards. These precision units are now furnished with jack terminals and are completely shielded. They are flat for all frequencies in the audio range and reasonably flat to 200 kc. up to 70 db. They are furnished with either rack or box mounting in gray finish.

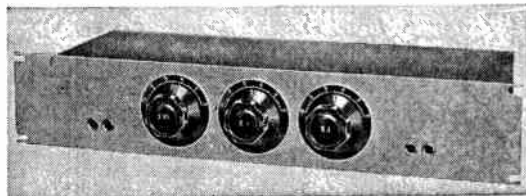

SPECIFICATIONS:

- Mounting:** Type 850-AT and 850-AH, standard rack panels, 3 1/2" x 19" x 1/8". Type 850-B furnished with dust cover.
- Switches:** Multiple leaf, silver alloy blades with silver contacts. Ball type detent.
- Terminals:** Telephone type jacks are used for input and output connections. Solder terminals are provided on rear panels for permanent connections. Insertion of plugs into twin-jacks lifts rear terminal connections.
- Type of Resistors:** All resistors are non-inductively wound. Negligible phase angle.
- Accuracy of Resistors:** All windings are adjusted to within 0.1% of the calculated value except on very low resistance values which are adjusted to within 0.25%.
- Frequency Characteristics:** For "T" configuration, the frequency error is negligible up to 80 db. loss, below 50 kilocycles. Balanced "H" configuration should be used where measurements above 50 kilocycles are necessary.

NEW TYPE 850 PRECISION ATTENUATORS

Type	Mounting	Circuit	Range	Db/Step	Size Rack Panel
850-AT	Rack	"T"	111 db.	0.1	3 1/2" x 19" Std.
850-AH	Rack	Bal. "H"	111 db.	0.1	3 1/2" x 19" Std.
850-BT	Box	"T"	93 db.	0.1	9 1/2" x 4" x 4 3/4"
850-BH	Box	Bal. "H"	93 db.	0.1	9 1/2" x 4" x 4 3/4"
850-CT	Box	"T"	111 db.	0.1	12 3/4" x 4" x 4 3/4"
850-CH	Box	Bal. "H"	111 db.	0.1	12 3/4" x 4" x 4 3/4"

TECH LABORATORIES INC.

PALISADES PARK • NEW JERSEY



SWITCHES

MINIATURE ROTARY SWITCHES

PA-2000 SWITCHES

STEATITE INSULATION

New Small Size 1-7/16" d. gives saving of 7/16" over standard switches. One piece shaft construction for accurate indexing; adjustable stop allows selection of positions or continuous rotation; meet 50 hour salt spray tests. Available as complete switches or separate assemblies. Same ratings as the larger 2500 series switches plus excellent r.f. characteristics. Shaft 1/8" from bushing.

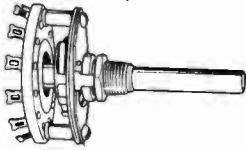

MINIATURE SWITCHES WITH 30° INDEXING

Total Number Poles	Total Positions	Number Sections	Poles Per Section	Cat. No. Shorting	Cat. No. Non-Shorting	List Price
1	2-12	1	1	—PA-2000	—PA-2001	\$2.50
2	2-6	1	2	—PA-2002	—PA-2003	2.60
2	2-12	2	1	—PA-2004	—PA-2005	3.75
3	2-5	1	3	—PA-2006	—PA-2007	2.75
3	2-12	3	1	—PA-2008	—PA-2009	5.00
4	2-6	2	2	—PA-2010	—PA-2011	3.90
4	2-12	4	1	—PA-2012	—PA-2013	6.25
5	2-3	1	5	—PA-2014	—PA-2015	2.85
5	2-12	5	1	—PA-2016	—PA-2017	7.50
6	2	1	6	—PA-2018	—PA-2019	2.85
6	2-5	2	3	—PA-2020	—PA-2021	4.00
6	2-6	3	2	—PA-2022	—PA-2023	5.25
6	2-12	6	1	—PA-2024	—PA-2025	8.75
8	2-6	4	2	—PA-2026	—PA-2027	6.50
9	2-3	3	3	—PA-2028	—PA-2029	5.25
10	2-6	5	2	—PA-2030	—PA-2031	4.25
10	2-6	5	2	—PA-2032	—PA-2033	7.75
12	2	2	6	—PA-2034	—PA-2035	4.25
12	2-6	6	2	—PA-2036	—PA-2037	9.00
15	2-3	3	5	—PA-2038	—PA-2039	5.75
18	2	3	6	—PA-2040	—PA-2041	5.75

SPECIAL

1	2-10	1	1	—PA-2042	-----	2.50
2	4	2	1	(1 off, 9 progressively shorting positions) —PA-2050	-----	2.50
2	2-12	2	1	(For switching dual lines) —PA-2049	-----	5.75
				(Solid-silver clips and contacts)		

MINIATURE SWITCHES WITH 60° INDEXING

1	2-6	1	1	-----	—PA-2043	2.50
2	2-6	2	1	-----	—PA-2045	3.75
				(1/2" spacing between sections)		

SEPARATE STEATITE SECTIONS FOR MINIATURE SWITCH 30° INDEXING

Number Poles	Number Positions	Cat. No. Shorting	Cat. No. Non-Shorting	List Price	
1	2-12	—PA-0	—PA-1	\$1.35	
2	2-6	—PA-2	—PA-3	1.35	
3	2-5	—PA-4	—PA-5	1.50	
5	2-3	—PA-6	—PA-7	1.50	
6	2	—PA-8	—PA-9	1.50	
1	2-5	—PA-10	-----	1.35	
1	2-11	—PA-11	—PA-18	1.35	
1	2-10	—PA-12	-----	1.35	
				(Unused contacts one side of common connected and shorted out)	
				(All unused contacts connected and shorted out)	
				(1 off, 9 progressively shorting positions)	

60° INDEXING

1	2-6	-----	—PA-17	1.35
---	-----	-------	--------	------

SOLID SILVER CLIPS AND CONTACTS 30° INDEXING

1	2-11	—PA-16	-----	2.50
2	2-5	—PA-14	-----	2.50
4	2	—PA-15	-----	2.50

SEPARATE INDEX ASSEMBLIES FOR MINIATURE SWITCH

Suggested No. Sections	Indexing	Rear Shaft Length	Cat. No.	List Price
1 to 3	30°	2"	—PA-300	\$1.50
4 to 6	30°	4"	—PA-301	2.00
7 to 9	30°	6"	—PA-302	2.50
1 to 3	60°	2"	—PA-304	1.50
4 to 6	60°	4"	—PA-305	2.00

ADJUSTABLE STOP PLATE	—P-319	.25
INTERSECTION SHIELD	—P-320	.25

MINIATURE PHENOLIC ROTARY SWITCHES PA-1000 SWITCHES

PHENOLIC INSULATION

A complete, new line that matches our 1400 Series in switching, and our PA-2000 Series in physical size. Index assemblies and hardware are identical to PA-2000 Series accessories. High-strength, high-resin, laminated phenolic insulation exceeds Phenolic Standards Grade XXXP. One-piece shaft construction permits accurate indexing. Adjustable stop permits selection of positions or continuous rotation (11 active positions, 1 off-position). Grade L-5 steatite spacers are used with nickel-plated brass shafts, bushings, tie bolts, and nuts. All other metal parts are treated to pass 50-hour salt-spray test. Rating same as 1400 Series. General use, 6 watts. Excellent r.f. characteristics. Shaft 1/8" from bushing.



MINIATURE SWITCHES WITH 30° INDEXING

Total Number Poles	Total Positions	Number Sections	Poles Per Section	Cat. No. Shorting	Cat. No. Non-Shorting	List Price
1	2-11	1	1	PA-1000	PA-1001	\$2.25
2	2-5	1	2	PA-1002	PA-1003	2.25
2	2-11	2	1	PA-1004	PA-1005	3.00
3	2-3	1	3	PA-1006	PA-1007	2.25
3	2-11	3	1	PA-1008	PA-1009	3.75
4	2	1	4	PA-1010	PA-1011	2.25
4	2-5	2	2	PA-1012	PA-1013	3.00
4	2-11	4	1	PA-1014	PA-1015	4.50
5	2-11	5	1	PA-1016	PA-1017	5.25
6	2-3	2	3	PA-1018	PA-1019	3.00
6	2-5	3	2	PA-1020	PA-1021	3.75
6	2-11	6	1	PA-1022	PA-1023	6.00
8	2	2	4	PA-1024	PA-1025	3.00
8	2-5	4	2	PA-1026	PA-1027	4.50
10	2-5	5	2	PA-1030	PA-1031	5.25
12	2	3	4	PA-1028	PA-1029	3.75
12	2-5	6	2	PA-1032	PA-1033	6.00
1	2-10	1	1	PA-1034	-----	2.25

(One off—nine progressively shorting positions pick up and hold each progressive position)

MINIATURE SWITCHES WITH 60° INDEXING

1	2-6	1	1	-----	PA-1035	2.25
2	2-6	2	1	-----	PA-1037	3.00

SEPARATE MINIATURE PHENOLIC SECTIONS

Use with Index Assemblies No. PA-301, PA-302 for assembly of special units of your own spacing and design.

Number Poles	Number Positions	Indexing	Cat. No. Shorting	Cat. No. Non-Shorting	List Price
1	2-11	30°	PA-30	PA-31	\$1.00
2	2-5	30°	PA-32	PA-33	1.00
3	2-3	30°	PA-34	PA-35	1.00
4	2	30°	PA-36	PA-37	1.00
1	2-5	30°	PA-38	PA-39	1.00
					(All unused contacts one side of common connected and shorted out)
1	2-11	30°	PA-40	PA-41	1.00
					(All unused contacts connected and shorted out)
1	2-10	30°	PA-43	-----	1.00
					(One off—nine progressively shorting positions pick up and hold each progressive position)
1	2-6	60°	PA-45	-----	1.00

SEPARATE INDEX ASSEMBLIES

Same as for PA-2000 Series shown at left.

KIT No. 2000—MINIATURE STEATITE SWITCHES

Kit No. 2000 of miniature switch parts is made available to meet the demand of commercial users and the armed forces for smaller units. The kit has 39 sections, 12 complete index assemblies and extensive hardware. All metal parts will withstand a salt spray test of fifty hours.

Kit No. 2000.....List Price \$80.00

MINIATURE SWITCH HARDWARE AND ACCESSORIES

See listing on Page L-15 of this catalog.



SWITCHES (Cont'd)

KIT NO. 1000 — MINIATURE PHENOLIC SWITCHES

Kit No. 1000 is to phenolic miniature switches what Kit No. 2000 is to miniature steatite switches. It's a lab and experimental stock of switch sections, hardware, and indexes which puts any standard and practically any special switch in the hands of the user without delay. Specifications are the same as for regular PA-1000 Series switches. The kit has 36 sections, 15 complete index assemblies, and hardware.

Kit No. 1000.....List Price \$100.00

LEVER ACTION SWITCHES

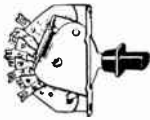

Coil spring and cam index design provides guaranteed minimum life of 150,000 switching cycles. Smooth, "clean" action. Coil type index spring easily replaceable. Mounting plates available. Furnished with black paddle-type knob (same style knob also available in red and white). Shorting—make before break. Non-shorting—break before make.

Number Poles	Number Positions	Type Indexing	Cat. No. Shorting	Cat. No. Non-Shorting
2	3	Positive	1452	1454
2	3	Spring Return	1453	1455
2	3	Positive Spring Return	1466	1467
4	2	Spring Return	1456	1457
4	2	Positive	1459	1458

List Price of above items.....\$1.25

MOUNTING PLATES FOR LEVER SWITCHES



TYPE A—Made of .035" die cut steel, black crackle finish. Eliminate alignment problems, provide 3/4" spacing between switches. Available for 1 to 5 switch mounting. Height of all plates is 2 5/8".



TYPE B—Specially furnished for mounting lever switches in electrical outlet boxes. Chrome plated wall plates will fit all standard boxes with mounting holes 3-5/16" between centers. Ideal for P.A. or Intercom installations.

MOUNTING PLATE—Type A

No. Switches	Length	Cat. No.	List Price
1	3/4"	P-1755	\$0.35
2	1 1/2"	P-1756	.40
3	2 1/4"	P-1757	.50
4	3"	P-1758	.60
5	3 3/4"	P-1759	.75

WALL PLATE—Type B

No. Switches	Cat. No.	List Price
2	P-221	\$0.75
1	P-222	.60

Size: 2 3/4" x 4 1/2" overall.
3/4" spacing between switches.

DUAL SPEAKER SWITCH MOUNTING KIT

Kit No. PK-300—Contains complete assembly for switching between dual speakers such as auto rear seat and front seat speakers including etched dial-mounting plate and complete installation instructions.

Contents:



- 1 Cat. No. 1484 Dual speaker switch
- 1 Cat. No. P-216 Mounting bracket and dial
- 1 Cat. No. P-197 White split knurl pointer knob
- 2 Self tapping sheet metal mounting screws

Kit No. PK-300.....List Price \$1.50

DIAL-MOUNTING BRACKET



Use with switch PA-2050 marked 1-2-3-4, for switching twin-lead antenna lines.

Cat. No. P-218.....List Price \$0.55

23 POSITION SELECTOR SWITCH

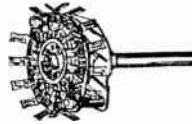

1443 "23 CLIPPER"®—Single pole, 23 positions, shorting type contacts. High quality "W" type construction requires only 1" behind the panel. Double wiping silver plated contacts mean low loss. Include dial plate.

List Price\$3.25

SMALL GENERAL PURPOSE SWITCHES

TYPE 1460—Single pole, 2 position, shorting contacts, positive index. Can be used as SPST or SPDT. For phono-radio, tone or sensitivity control.



List Price \$0.75

TYPE 1461—Single pole, 3 position, shorting contacts, positive index. Useful in miniature and band change, step type tone or sensitivity control, P.A. channel selector switch.



List Price \$1.00

TYPE 1462—Double pole, 2 position, shorting contacts, positive index. Can be used as SPST, SPDT, DPST, DPDT—for meter reversing, P.A. channel, or switching both lines on phono-radio.



List Price \$1.00

TYPE 1463—Single pole, 2 position, non-shorting contacts, spring return index. Same size as Type 1460. Useful for meter reversing or momentary intercom talk switch. Non-shorting.



List Price \$1.00

TYPE 1464—Double pole, 2 position, non-shorting contacts, spring return index. Same physical size as Type 1462. Can also be used as SPST, SPDT or DPST. Used as meter switch and momentary line or remote speaker return on intercoms.



List Price \$1.00

TYPE 1465—Single pole, 4 position, shorting, positive index, with SPST AC line switch attached. The selector switch has 3 active positions and "off." The line switch operates between "off" and first active selector position. Line switch is Underwriters' approved for 3 amperes at 125 volts, 1 ampere at 250 volts A.C. Type 1465 is a replacement for "on-off" step tone control switches used in many AM and FM receivers. Shaft is 2 1/2" long from end of 1/4" bushing.



List Price \$1.75

TYPE 1472—2 pole, 3 position, non-shorting contacts, positive index. An economical change switch for AM, FM, phono selector to amplifier in custom installations.



List Price \$1.25

TYPE 1473—Same as 1472 except shorting contacts.

List Price \$1.25

TYPE 1483—Single pole, 3 position, shorting contacts, positive index. For use with dual or auxiliary rear seat auto radio speakers. Permits operation of either speaker separately or both simultaneously.



List Price \$0.90

TYPE 1484—Single pole, 3 position remote speaker switch. Same as Cat. No. 1483 except with 1/4" bushing and 7/16" split knurl shaft. 15/16" White split knurl pointer knob, Cat. No. P-197, is furnished.

List Price \$0.90

Shorting Contacts
... make before break.
Non-shorting Contacts
... break before make.

SWITCHES (Cont'd)

ROTARY SELECTOR SWITCHES 2500 SERIES — STEATITE INSULATION



2500 Series Switches have highest quality (grade L-5) Steatite insulation, meet critical requirements of r.f. circuit applications. Bushing $\frac{3}{8}$ " x 32 thd. x $\frac{3}{8}$ " long. Shaft $1\frac{1}{8}$ ". Positive 30° Index with adjustable stop. Separate parts also available. Packaged with Mtg. nut, lockwasher and $1\frac{1}{4}$ " black bar knob. Shorting—make before break. Non-Shorting—break before make.

Total Poles	No. of Positions	Total Sections	Poles per Section	Cat. No. Shorting	Cat. No. Non-Shorting	List Price
1	2 to 6	1	1	2500	2501	\$2.25
1	2 to 11	1	1	2502	2503	2.25
2	2 to 5	1	2	2504	2505	2.25
3	2 to 3	1	3	2506	2507	2.25
2	2 to 6	2	1	2510	2511	3.50
2	2 to 11	2	1	2512	2513	3.50
4	2 to 5	2	2	2514	2515	3.50
6	2 to 3	2	3	2516	2517	3.50
3	2 to 6	3	1	2520	2521	5.00
3	2 to 11	3	1	2522	2523	5.00
6	2 to 5	3	2	2524	2525	5.00

STEATITE SECTIONS ONLY FOR 2500 SERIES

Standard: .064" Rotor Slot. Use with above switches or P-121, 122, 123 Index.

Number Poles	Number Positions	Standard Shorting	Standard Non-Shorting
1	2 to 6	T	X
1	2 to 11	U	Y
2	2 to 5	R	RR
3	2 to 3	S	SS
4	2	V	Z
1	2 to 10	GG	—
1	2 to 10	—PIS	—

(All unused contacts connected and shorted out)
(1 off—9 progressively shorting positions)

STANDARD INDEX ASSEMBLIES

2-piece shaft, .064" thick rotor shaft for use with standard phenolic or steatite sections. Individually cartoned, all hardware included.

Sugg'd No. Sections	Indexing	Cat. No.	List Price
1 to 3	30°	P-121	\$1.50
4 to 6	30°	P-122	2.00
7 to 9	30°	P-123	2.50
Basic Index only, no hardware		1435W	1.10

STEATITE HAM-TYPE SWITCHES

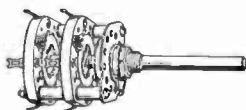

90° Indexing Ham Switches will handle 15 watts and can be operated with tubes up to 1000 volts and inputs up to 150 watts. Extra heavy steatite sections and spacers assure high breakdown point.

Heavily silver plated contacts. Non-shorting type switching.

Poles	Per Total Sec.	Positions	Cat. No.	List Price
1	1	2 to 4	2542	\$2.25
1	2	2 to 4	2543	3.50
1	3	2 to 4	2544	4.75
1	4	2 to 4	2545	6.00
1	5	2 to 4	2546	7.25

Separate Sections		
Cat. No.	Section	List Price
XX	1 pole, 2 to 4 positions, non-shorting type with 4 fibre washers.	\$1.25

Separate Index Assemblies		
For No. Section	Cat. No.	List Price
1 or 2	P-170	\$1.50
3 or 4	P-171	2.00
5 or 6	P-172	2.50

ROTARY SELECTOR SWITCHES 1400 SERIES PHENOLIC INSULATION

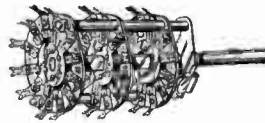

Series 1400 offers compact design and quality construction. Laminated phenolic insulation. Mounting Bushings $\frac{3}{8}$ " x 32 thd. x $\frac{3}{8}$ " long. Shafts $1\frac{1}{8}$ " from end of bushing. Positive 30°

index with adjustable stop. Revisions or additions can easily be made due to availability of all parts separately (see listings under hardware switch sections). Packaged with mtg. nut, lockwasher, $1\frac{1}{4}$ " black bar knob. Shorting—make before break. Non-shorting—break before make.

Total Poles	No. of Positions	Total Sections	Poles per Section	Cat. No. Shorting	Cat. No. Non-Shorting	List Price
1	2 to 6	1	1	1400	1401	\$1.50
1	2 to 11	1	1	1402	1403	1.75
2	2 to 5	1	2	1404	1405	1.75
3	2 to 3	1	3	1406	1407	2.00
4	2 only	1	4	1408	1409	2.00
2	2 to 6	2	1	1410	1411	2.50
2	2 to 11	2	1	1412	1413	2.50
4	2 to 5	2	2	1414	1415	2.50
6	2 to 3	2	3	1416	1417	2.75
8	2 only	2	4	1418	1419	2.75
3	2 to 6	3	1	1420	1421	3.00
3	2 to 11	3	1	1422	1423	3.25
6	2 to 5	3	2	1424	1425	3.50
4	2 to 6	4	1	1426	1427	3.75
4	2 to 11	4	1	1428	1429	4.25
8	2 to 5	4	2	1430	1431	4.50

PHENOLIC SECTIONS ONLY — 1400 SERIES

.064" Rotor Slot.

Use with above switches or P-121, 122, 123 Index.

Poles	Positions	Cat. No. Shorting	Cat. No. Non-Shorting	List Price
1	2 to 6	A	H	\$1.00
1	2 to 11	B	J	1.00
2	2 to 5	C	K	1.00
3	2 to 3	D	L	1.00
4	2 only	E	M	1.00
4	2 to 3	EE	—	1.50
1	2 to 5	F	—	1.00

(On F section unused contacts on one side of common connected and shorted out.)

1	2 to 10	G	—	1.00
---	---------	---	---	------

(On G section all unused contacts connected and shorted out.)

N and P Special—Combine for resistance decade switch.....\$1.00
Q—Special for capacitance decade switch..... 1.00
P-1 Special—10 pos. progressively shorting out 9 positions 1.00
(See listing of "Deluxe" sections—DD rotor slot—Page R-30)

UNIVERSAL FLAT AND P.A. TYPE SWITCHES



1450 "ECONO-SWITCH"®—A 4 pole, 2 position economically designed switch which requires only $\frac{5}{8}$ " depth behind panel. Can be used as SPST and up to 4 pole, 2 position. Positive, non-shorting, leaf type index.
List Price\$1.00

1451 "PERMA-SWITCH"®—The famous Centralab long life coil spring switch with a minimum of 150,000 cycles. Similar in style to the 1450 switch, 4 pole 2 position. Designed for hard life and long use in test equipment and intercom use. Coil spring can be replaced without removing switch. Non-shorting, spring return index. List Price.....\$1.75

1448-1449 "ALL PURPOSE"®—Intercom switches. Six pole three position, will fit practically every intercom application in use. Both units have replaceable coil spring indexing assuring 150,000 cycles minimum.

Cat. No.	List Price
1448 Spring ret. both sides	\$2.25
1449 Spring ret. one side	2.25



SWITCHES (Cont'd)

MEDIUM DUTY ROTARY POWER SWITCHES

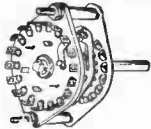

STEATITE—750 Watts at 115 Volts A.C.

An accurate, long-life unit for transmitter, power supply, and specialized application. Has positive, non-stall 20° indexing, double wiping solid silver contacts. Mounting bushing $\frac{3}{8}$ "-32 thd. x $\frac{3}{8}$ " long. 2 7/8" between locating rods. With adjustable stop and dial plate.

Total Poles	Number Positions	Total Sections	Cat. No. Shorting	Cat. No. Non-Shorting	List Price
1	2-17	1	JV-9000	JV-9001	\$14.00
3	2-5	1	JV-9002	JV-9003	14.00
2	2-17	2	JV-9004	JV-9005	22.50
6	2-5	2	JV-9006	JV-9007	22.50
3	2-17	3	JV-9008	JV-9009	32.00
9	2-5	3	JV-9010	JV-9011	32.00
4	2-17	4	JV-9012	JV-9013	42.00
12	2-5	4	JV-9014	JV-9015	42.00
5	2-17	5	JV-9016	JV-9017	55.00
15	2-5	5	JV-9018	JV-9019	55.00
6	2-17	6	JV-9020	JV-9021	65.00

SECTIONS ONLY FOR JV-9000 SERIES

SHORTING				NON-SHORTING			
No. Poles	Positions	Cat. No.	List Price	No. Poles	Positions	Cat. No.	List Price
1	2-17	KV-8	\$10.00	1	2-17	KVN-8	\$10.00
3	2-5	KV-9	10.00	3	2-5	KVN-9	10.00

INDEX ASSEMBLY ONLY FOR JV-9000 SERIES

Includes shaft, tie rods, spacers, nuts and lockwashers, adjustable stop pin, 2" black bar knob and dial plate.
Cat. No. KV-7 _____ List Price \$7.00

Dial Plates—2 3/4" Diameter—20° Markings	List Price
P-230 Marked 1 to 5	\$0.30
P-231 Marked 1 to 17	\$0.30

**ROTARY SWITCH KITS
1500 SWITCH KIT**

A four drawer cabinet containing an adequate supply of sections and indexes listed on this page to custom build two 4 section switches, two 3 section, six 1 section, one 2 section condenser decade, and one 1 section resistor decade switch. For labs, engineers, hams, and experimenters needing specialized switching arrangements. Cabinets can be replenished with stock parts. List Price \$60.00



414 DELUXE SWITCH KIT — PHENOLIC

An extra large assortment of switch hardware and sections to make the widest possible assortment of phenolic switches to your needs. Contains 111 sections including 34 of the special "DD" deluxe sections listed below, 31 Index assemblies, 25 doz. spacers, 5 doz. shafts, 8 doz. tie rods, 40 dial plates, and complete hardware. Especially suited to large users of specialized switches. All kit parts may be purchased for refill from stock listings. List Price \$200.00

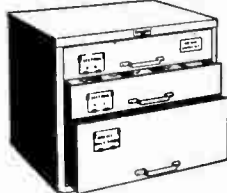

419 DELUXE SWITCH KIT — STEATITE

Similar to the 414 Kit, but all sections are made of Centralab's high quality grade L-5 steatite ceramic, long regarded as "the best." Contains standard and special deluxe sections below. Has 81 sections, 31 Index Assemblies, 26 doz. spacers, 35 knobs, 30 dial plates and assorted hardware. This is Centralab's finest switch kit. List Price \$190.00

"DD" DELUXE SWITCH PARTS

"Double-D" describes CRL's extra heavy ($\frac{3}{8}$ " thick) rotor shaft switch and the corresponding hole in the section rotor. Also, deluxe switches have one-piece, positive indexing shaft and index assembly.

DELUXE INDEX ASSEMBLIES

Includes all hardware to use with separate sections listed above.

Rotor Shaft Length	Sections	Cat. No.	List Price
2"	1 - 3	P-270	\$1.50
4"	1 - 6	P-271	2.00
8"	7 - 9	P-272	2.50

FOR OTHER SWITCH HARDWARE AND ACCESSORIES, see the latest complete Centralab catalog available at your distributor.

DELUXE SECTIONS

PHENOLIC					STEATITE				
No. Poles	Positions	Cat. No. Shorting	Cat. No. Non-Shorting	List Price	No. Poles	Positions	Cat. No. Shorting	Cat. No. Non-Shorting	List Price
1	6	AD	HD	\$1.00	1	6	TD	XD	\$1.35
1	11	BD	JD	1.00	1	11	UD	VD	1.35
2	5	CD	KD	1.00	2	5	RD	RRD	1.35
3	3	DD	LD	1.00	3	3	SD	SSD	1.35
4	2	ED	MD	1.00	4	2	VD	ZD	1.35
4	3	EED	—	1.50	1	10	GGD	—	1.35
1	5	FD	—	1.00					

Unused contacts shorted out
1 side of common

1 10 GD — 1.00
All unused contacts shorted out

Combine for resistance ND
Decade PD — 1.00

For capacitance QD — 1.00
1 10 PID — 1.00

#1 off, 9 progressively shorting.

MINIATURE SWITCH HARDWARE AND ACCESSORIES

STEATITE SPACERS—120" I.D., 187" O.D.—1 dozen minimum.

Length	Cat. No.	Doz.	List Price
1/8"	P-325	\$0.50	
3/16"	P-326	.50	
1/4"	P-328	.36	
9/32"	P-329	.36	
5/16"	P-330	.36	
3/8"	P-332	.38	
7/16"	P-334	.38	
1/2"	P-336	.40	
9/16"	P-338	.36	

Length	Cat. No.	Doz.	List Price
5/8"	P-340	\$0.42	
11/16"	P-342	.42	
3/4"	P-344	.45	
13/16"	P-346	.45	
7/8"	P-348	.55	
15/16"	P-350	.55	
1"	P-352	.48	
1-1/2"	P-354	.60	

TIE BOLTS—Nickel-plated brass, 4-40 thread, #4 head, 1 doz. minimum.

Length	Cat. No.	Doz.	List Price
3/4"	P-360	\$0.30	
1"	P-362	.30	
1-1/4"	P-364	.30	
1-1/2"	P-366	.50	
1-3/4"	P-368	.50	
2"	P-370	.75	
2-1/4"	P-372	.75	
2-1/2"	P-374	.75	

Length	Cat. No.	Doz.	List Price
2-3/4"	P-376	\$1.50	
3"	P-378	2.00	
3-1/2"	P-380	2.00	
4"	P-382	2.25	
5"	P-384	2.25	
6"	P-386	2.50	
7"	P-388	2.50	

TIE-BOLT NUTS—4-40 thread nickel-plated brass. Minimum order, 1 dozen. CAT. No. P-390. List Price \$0.25

TIE-BOLT LOCKWASHERS—Split ring, stainless steel. Minimum order, 1 dozen. CAT. No. P-392. List Price \$0.25

FIBRE SPACER WASHERS—For use between steatite sections and steatite spacers. Minimum, 1 dozen. CAT. No. P-394. List Price \$0.25

STANDARD SWITCH HARDWARE AND ACCESSORIES

SPACERS—Cadmium-plated seamless brass tubing, .133" I.D., .187" O.D., chamfered edges. Packaged 12 per envelope (minimum order). List Price

Length	Cat. No.	Doz.	List Price
1/8"	P-150	\$0.15	
1/4"	P-124	.15	
3/8"	P-125	.30	
1/2"	P-126	.30	
5/8"	P-151	.30	
3/4"	P-127	.50	

Length	Cat. No.	Doz.	List Price
7/8"	P-152	\$0.50	
1"	P-128	.50	
1-1/4"	P-153	.50	
1-1/2"	P-154	.60	
2"	P-155	1.00	

ATTACHABLE FLAT SHAFTS—For use with 1435W Basic Index or in place of shafts furnished in P-121, -2, and -3. .064" thick, 1/4" wide. Packaged in dozen lots minimum. List Price

Length	Cat. No.	Doz.	List Price
1"	P-166	\$0.36	
2"	P-129	.30	
3"	P-130	.30	
4"	P-131	.50	

Length	Cat. No.	Doz.	List Price
5"	P-132	\$0.75	
6"	P-133	.75	
7"	P-134	.75	
8"	P-135	.85	

HAM-TYPE SWITCH HARDWARE AND ACCESSORIES

STEATITE SPACERS—Can be used with 1400 Series and 2500 Series switches, as well as ham-type switches. Minimum order, 1 dozen.

Length	Cat. No.	Doz.	List Price
1/8"	P-181	\$0.50	
1/4"	P-187	.36	
3/8"	P-188	.38	
1/2"	P-189	.40	
5/8"	P-190	.42	
3/4"	P-191	.45	

Length	Cat. No.	Doz.	List Price
7/8"	P-182	\$0.55	
1"	P-192	.48	
1-1/4"	P-183	.60	
1-1/2"	P-184	.60	
2"	P-185	.70	
3"	P-186	.75	

FIBRE WASHERS—For use between steatite section and steatite spacer. Minimum, 1 dozen. CAT. No. P-180. List Price \$0.25

CE

Carling Electric, Inc.

WEST HARTFORD, CONN.

(Switches shown are Underwriters Lab. approved)

Switches ONE HOLE MOUNTING AC OR DC

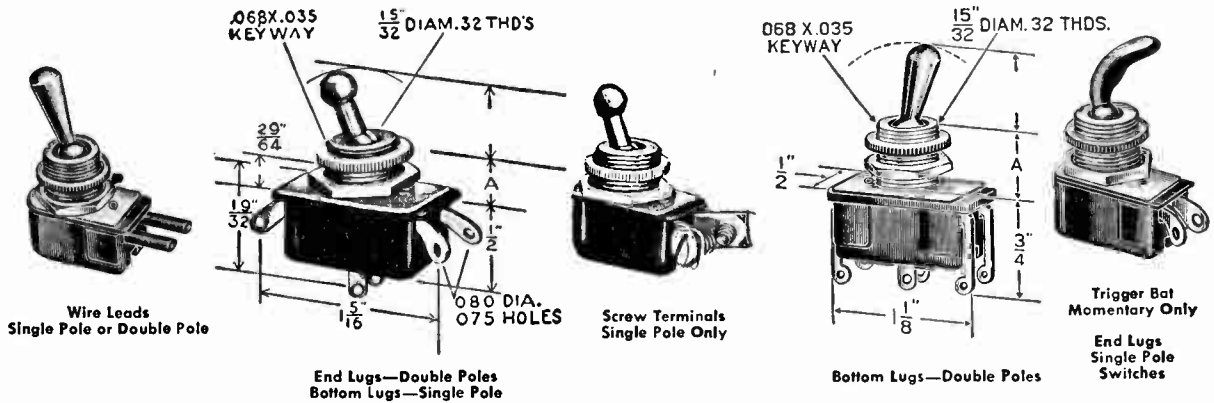

Illustrations above show types of TOGGLES and TERMINALS available on these SWITCHES

MAINTAINED CONTACTS				MOMENTARY TYPES — Stem Length 15/32" ONLY					
NOMINAL RATING AC or DC	POLES-CIRCUIT	TYPES OF TERMINALS	CATALOG NUMBER	NOMINAL RATING AC or DC	POLES-CIRCUIT	TYPES OF TERMINALS	CATALOG NUMBER		
3 Amp—250 V. 6 Amp—125 V.T. (T Rated)	S.P.—S.T.	Lugs—End	T-110	6 Amp—125 V. 3 Amp—250 V.	S.P.—S.T. Normally Open (Off) (Momentarily On)	Lugs—End	110-M-NO		
		Lugs—Bottom	T-110-B			Lugs—Bottom	110-BM-NO		
3 Amp—250 V. 6 Amp—125 V.	S.P.—S.T.	Lugs—2 Ends	T-110-S		S.P.—S.T. Normally Closed (On) (Momentarily Off)	Lugs—2 Ends Screw Wire—2 Ends	Lugs—2 Ends	110-M-DNO	
		Wire	111-16				Wire	111-16M-NO	
		Wire—2 Ends	111-D				Wire—2 Ends	111-16M-DNO	
		Lugs—End	112				Lugs—End	110-M-NC	
		Wire	112-A				Wire	110-BM-NC	
1 Amp—250 V. 3 Amp—125 V.	S.P.—D.T.	Lugs—End	216		3 Amp—125 V. 1 Amp—250 V.	S.P.—D.T.	Lugs—End	112-M	
		Wire	216-A				Wire	112-M-A	
	D.P.—S.T.	Lugs—Bottom	216-B			D.P.—S.T. Normally Open (Off) (Momentarily On)	Lugs—End	Wire	216-M-NO
		Lugs—Bottom	316	216-M-ANO					
3 Amp—250 V. 6 Amp—125 V.	D.P.—D.T.	Lugs—Bottom	316-A	D.P.—S.T. Normally Closed (On) (Momentarily Off)	Lugs—End	Wire	216-M-NC		
		Lugs—Bottom	316-B				216-M-ANC		
10 Amp—125 V. 5 Amp—250 V.	S.P.—S.T.	Lugs—End	516	Two Circuit (1 On—1 Off)	Lugs—End	Wire	316-M		
		Lugs—Bottom	516-A				316-BM		
3 Amp—250 V. 6 Amp—125 V.	D.P.—S.T.	Lugs—End	28B62	Lugs—Bottom	Screw	Lugs—Bottom	516-M		
		Lugs—End	28K62				516-AM		
10 Amp—125 V. 5 Amp—250 V.	D.P.—D.T.	Lugs—Bottom	28L62	Screw	Lugs—Bottom	Screw	516-BM		
		Lugs—Bottom	28L63				516-SM		
				TOGGLE TYPE & LENGTH					
				BALL 3/8"		BAT 1/2"		BAT 11/16"	
				SUFFIX NO. —23		—63		—73	
				—93				TRIGGER BAT	
				BALL—3/8" LONG		BAT—1/2"		BAT—11/16"	
				STEM LENGTH (A)		SLOTTED (See Poae 5)			
				1/4"		11/32"		1/2"	
				11/32"		1/2"		11/32"	
				SUFFIX NO. —21		—22		—23	
				—25		—62		—63	
						—73		—42	

IMPORTANT—ADD correct SUFFIX NUMBER to CATALOG NUMBER to receive type TOGGLE and STEM wanted

Note: Solderless quick disconnect terminals are available on #110 switch above

**MARINE APPLICATIONS
USE PREFIX M-**

CE

Carling Electric, Inc.

WEST HARTFORD, CONN.

Switches — TOGGLE — AC or DC

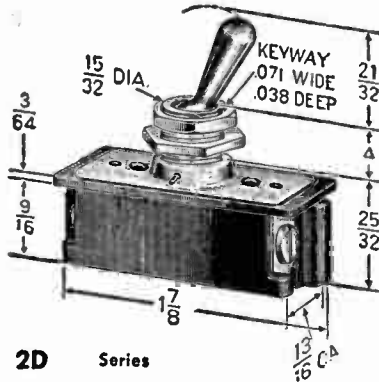

2D Series

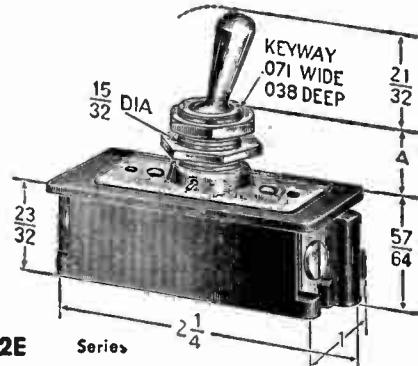

2E Series

NOMINAL RATING A.C. OR D.C.	POLES OR CIRCUIT	TYPE OF TERMINALS	CATALOG NUMBER
12 Amps—125 V. 6 Amps—250 V. 1 H.P. 125—250 V.	S.P.—S.T.	Screw Wire Leads	2DA25 2DA21
	D.P.—S.T.	Screw Wire Leads	2DK25 2DK21
15 Amps—125 V. 10 Amps—250 V. 1 1/2 H.P. 125—250 V.	S.P.—S.T.	Screw Wire Leads	2EA55 2EA51
	D.P.—S.T.	Screw Wire Leads	2EK55 2EK51

CATALOG NUMBER SUFFIX FOR TOGGLE & STEM LENGTHS (Bat Toggle Only)		
TOGGLE LENGTH	STEM LENGTH	SUFFIX NO.
2 1/2"	1 1/2"	-72
2 1/2"	1 3/4"	-73

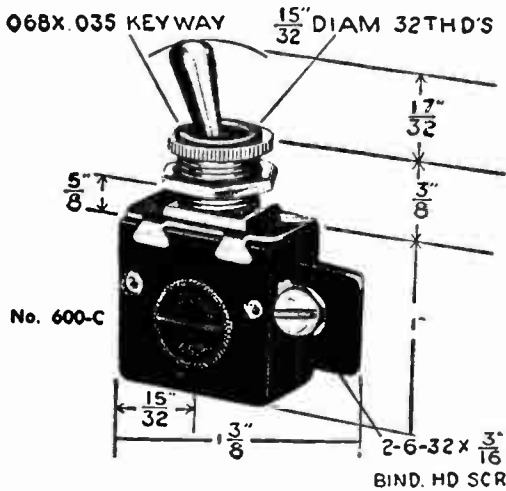

No. 600-C



No. 600-20

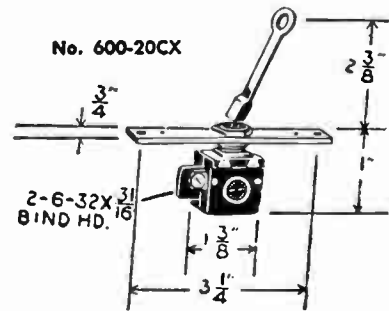

No. 600-20CX

NOMINAL RATING A.C. OR D.C.	POLES OR CIRCUIT	TYPE OF TERMINALS	CATALOG NUMBER
20 Amps—125 V. 10 Amps—250 V. A.C.—D.C.	S.P.—S.T.	Screw	600-C 600-20 600-20CX (See Illustrations)

Finishes — ALL ONE HOLE MOUNTING TYPE SWITCHES

Standard Finish — Nickel Natural Brass available at No Extra Charge
Other Finishes — Chrome, Cadmium, Bronze, Black Oxide at a Slight Extra Charge.



Carling Electric, Inc.

WEST HARTFORD, CONN.

Switches — ONE HOLE MOUNTING — AC

SINGLE POLE SWITCHES

035" DEEP X 068" WIDE KEYWAY

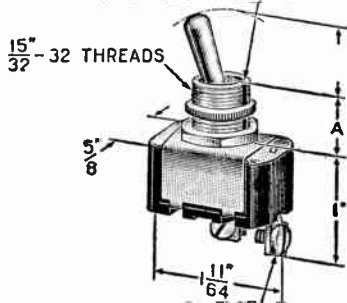

#6 - 32 X 3 16 LONG BINDING HEAD SCREWS

.035" DEEP X .068" WIDE KEYWAY

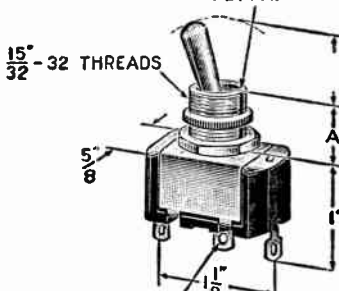

1 8 DIA. HOLES

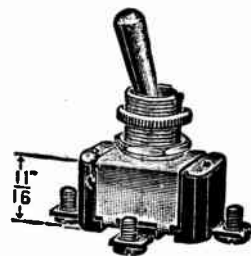

End and Side Terminals (Lug or Screw) Available on Special Order

CATALOG NUMBERS				ELECTRICAL CIRCUIT CHARACTERISTICS			CATALOG NUMBER SUFFIX		
NOMINAL RATINGS				(NOTE—Keyway Indicates "Down" Position)			FOR TOGGLE and STEM LENGTHS		
15 Amp—125 V. A.C.		6 Amp—125 V. A.C.		UP POSITION	CENTER POSITION	DOWN POSITION	(Bot Toggle Only)		
10 Amp—250 V. A.C.		3 Amp—250 V. A.C.					TOGGLE LENGTH	STEM LENGTH (A)	SUFFIX NO.
3/4 H.P.—115-230 V. A.C.		1/4 H.P.—115-230 V. A.C.							
SOLDER LUGS	SCREW TERMINALS	SOLDER LUGS	SCREW TERMINALS						
2FA53	2FA54	2FA63	2FA64	SINGLE POLE—SINGLE THROW			1 3/32"	1 1/2"	-52
6FA57	6FA58	6FA67	6FA68	On	None	Off	9/16"	1 1/2"	-62
6FA53	6FA54	6FA63	6FA64	On	None	Momentarily Off	9/16"	1 3/4"	-63
				Off	None	Momentarily On	1 1/8"	1 1/2"	-72
				SINGLE POLE—DOUBLE THROW			1 1/8"	1 3/4"	-73
2FB53	2FB54	2FB63	2FB64	On	None	On			
2FC53	2FC54	2FC63	2FC64	On	Off	On			
6FB53	6FB54	6FB63	6FB64	On	None	Momentarily On			
6FC53	6FC54	6FC63	6FC64	Momentarily On	Off	Momentarily On			
6FC57	6FC58	6FC67	6FC68	On	Off	Momentarily On	3"	1 3/4"	-03

.035" DEEP X .068" WIDE KEYWAY

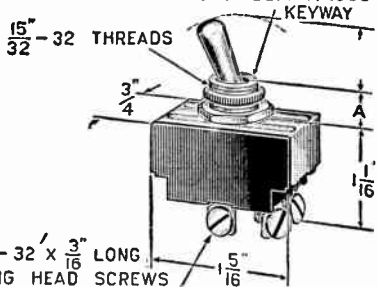

#6 - 32 X 3 16 LONG BINDING HEAD SCREWS

.035" DEEP X .068" WIDE KEYWAY

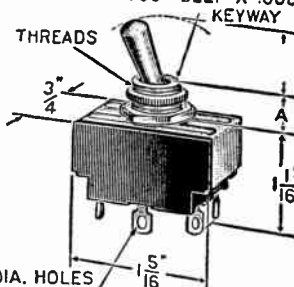

1 5 16 DIA. HOLES

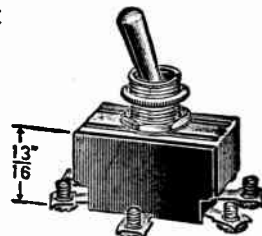

End and Side Terminals (Lug or Screw) Available on Special Order

CATALOG NUMBERS				ELECTRICAL CIRCUIT CHARACTERISTICS			CATALOG NUMBER SUFFIX		
NOMINAL RATINGS				(NOTE—Keyway Indicates "Down" Position)			FOR TOGGLE and STEM LENGTHS		
15 Amp—125 V. A.C.		6 Amp—125 V. A.C.		UP POSITION	CENTER POSITION	DOWN POSITION	(Bot Toggle Only)		
10 Amp—250 V. A.C.		3 Amp—250 V. A.C.					TOGGLE LENGTH	STEM LENGTH	SUFFIX NO.
3/4 H.P.—115-230 V. A.C.		1/4 H.P.—115-230 V. A.C.							
SOLDER LUGS	SCREW TERMINALS	SOLDER LUGS	SCREW TERMINALS						
2GK53	2GK54	2GK63	2GK64	DOUBLE POLE—SINGLE THROW			1 3/32"	1 1/2"	-52
6GK57	6GK58	6GK67	6GK68	On	None	Off	9/16"	1 1/2"	-62
6GK53	6GK54	6GK63	6GK64	On	None	Momentarily Off	9/16"	1 3/4"	-63
				Off	None	Momentarily On	1 1/8"	1 1/2"	-72
				DOUBLE POLE—DOUBLE THROW			1 1/8"	1 3/4"	-73
2GL53	2GL54	2GL63	2GL64	On	None	On			
2GM53	2GM54	2GM63	2GM64	On	Off	On			
6GL53	6GL54	6GL63	6GL64	On	None	Momentarily On			
6GM53	6GM54	6GM63	6GM64	Momentarily On	Off	Momentarily On			
6GM57	6GM58	6GM67	6GM68	On	Off	Momentarily On			
NOMINAL RATING				PROGRESSIVE TWO CIRCUIT					
Circuit 1—1/2 H.P.		2GG53		2 Circuits On		Circuit 1 On	Off		
6 Amp—125-250 V. A.C.		6GG57		Momentarily		Circuit 1 On	Off		
Circuit 2—1/2 H.P.				2 Circuits On					
15 Amp—125 V. A.C.									
10 Amp—250 V. A.C.									

DOUBLE POLE and TWO CIRCUIT SWITCHES

Momentary Types — Suffix 73 only.

All switches on this page are available with solderless type quick disconnect terminals



Carling Electric, Inc.

WEST HARTFORD, CONN.

Switches — TOGGLE — A C

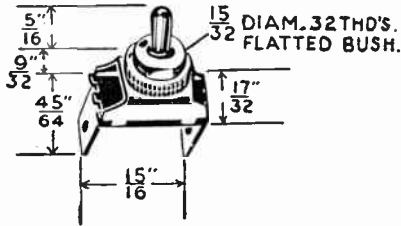

No. 125

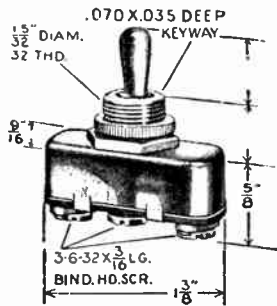

No. 126 No. 127 No. 128

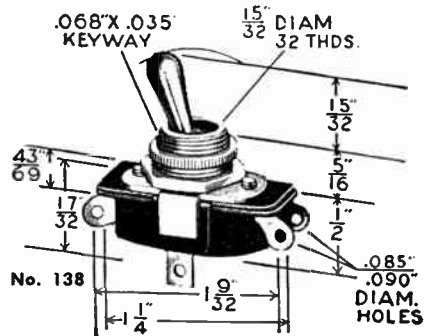

NOMINAL RATING	POLES OR CIRCUIT	CATALOG NUMBERS			STEM TYPE	CONTACTS EXTENDING FROM
		SCREW TERMINALS	SOLDER LUGS	WIRE LEADS		
3 Amp—125 V. A.C.	S.P.—S.T.	125—R 125—RS	125—RB 125—RBS	125—RA 125—RAS	(Round with Keyway)	Bottom End
		125 125—S	125—B 125—BS	125—A 125—AS	(Flatted)	Bottom End
3 Amp—125 V. A.C.	S.P.—D.T. S.P.—D.T.—Center Off	126 127	127—B	127—A	Round with Keyway	Nos. 126, 127, and 128 available with either 3/16" or 1/8" stem length.
15 Amp—125 V. A.C. 10 Amp—250 V. A.C. 1/2 H.P.	S.P.—S.T. S.P.—D.T. S.P.—D.T.—Center Off	128—15 126—15 127—15	128—15B 126—15B 127—15B	128—15A 126—15A 127—15A		
1 Amp—125 V. A.C.	D.P.—D.T.—Center Off	138				

Grounding or Shorting Switches

— TOGGLE TYPE —

for GASOLINE MOTORS, MAGNETO USE, or other APPLIANCES

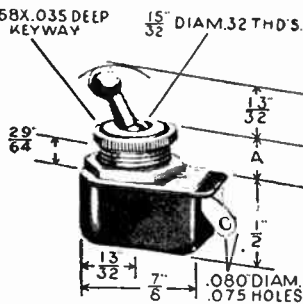
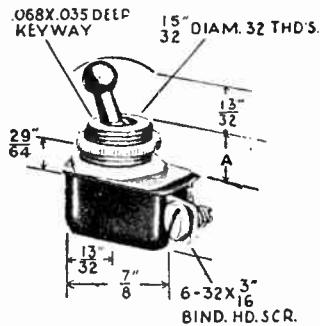

NOMINAL RATING	POLES OR CIRCUIT	TYPE OF TERMINAL	CATALOG NUMBER
15 Amp—30 V. D.C. 6 Amp—125 V. 3 Amp—250 V. A.C.—D.C.	S.P.—S.T. D.P.—S.T.	Screw Lug Wire Lead Lug Wire Lead	110-SH 110-H 111-H 216-H 216-AH
Grounded Through Stem			

STEM LENGTH	CATALOG SUFFIX NOS.		
	TYPE OF TOGGLE		
	BALL	1/2" BAT	1 1/16" BAT
1/4"	-21		
1 1/32"	-22	-62	
1 1/16"	-23	-63	-73
3/8"	-25		

When used with Indicator plates, switch will show "OFF" when grounded.

For Double Terminal types, other switches shown on Pages 1, 2, 3, and 4 can be used. Use Prefix "SH" to such Catalog Numbers to be used for grounding purposes.

Indicator Plates

(for SWITCHES Page 1, 2, 3 and 4)

Types Available: ON—OFF, HI—LO, HOT—COLD, DRY—WET, BLANK, ON—OFF (horiz.), (others made to order if ordered in sufficient quantities)

Appliance Switches — ROTARY

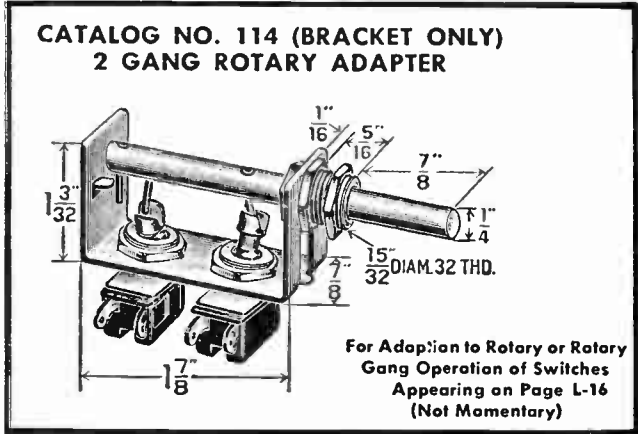
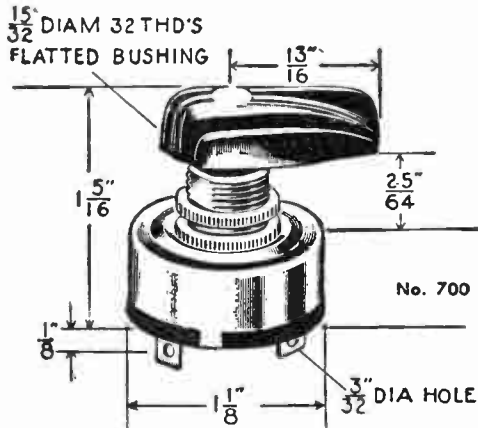

NOMINAL RATING	POLES OR CIRCUIT	OPERATION	TERMINALS	CATALOG NUMBER
4 Amp—125 V. A.C. 1 Amp—125 V. D.C.	S.P.—S.T.—2 Position	OFF—ON	LUG	700-1
	S.P.—S.T.—3 Position	OFF—ON—OFF	LUG	700-3
	S.P.—D.T.—3 Position	ON—OFF—ON	LUG	700-6
	S.P.—S.T.—2 Position	OFF—ON—ON	LUG	700-4
	S.P.—S.T.—3 Speed	OFF—ON—ON	LUG	700
	S.P.—S.T.—3 Position	ON—ON—ON	LUG	700-7
	S.P.—D.T.—2 Position	ON—ON	LUG	700-8
	S.P.—T.T.—3 Position	ON—ON—ON	LUG	700-8

“Snap’n” Line — MATCHING — INTERCHANGEABLE

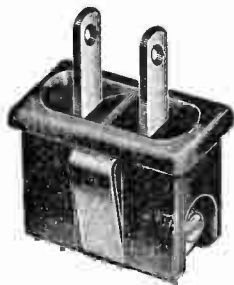
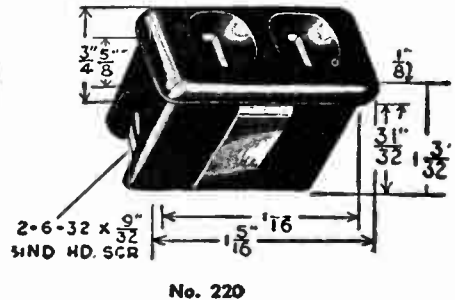
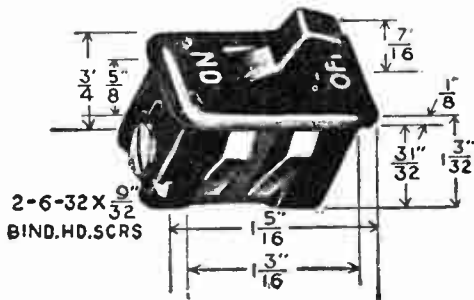

NOMINAL RATING	ITEM	CATALOG NUMBER		COLOR OF CASE	CATALOG SUFFIX NO.
		SCREW TERMINALS	WIRE LEADS		
15 Amp—125 V. A.C. 10 Amp—250 V. A.C.	S.P.—S.T. Switch	215	215A	Black White Brown Gray	—BL —WH —BR —GY
	Outlet	220	220A		
15 Amp—125 V. 10 Amp—250 V. A.C.—D.C.	Cap	221	221A		
110 V. A.C.—D.C.	Pilot Light	222	222A	COLOR OF PILOT LIGHT LENS	ADDITIONAL CATALOG SUFFIX NO.
230 V. A.C.—D.C.	Pilot Light	222-6	222-6A		

MOUNTING: The only provision necessary for mounting these units is a rectangular opening (1-7/32" x 21/32") in a .045" thick panel or base into which the unit can be snapped.

CE

Carling Electric, Inc.

WEST HARTFORD, CONN.

Appliance Switches **MOMENTARY PUSH**

WITH INSULATING PLASTIC CAP (5/16" Stem Length ONLY)

NOMINAL RATING	POLES OR CIRCUIT	TYPE TERMINALS	CATALOG NUMBER				
3 Amp 125 V. A.C.	S.P.—S.T.—Normally Open (OFF) (Momentarily ON)	Lug Wire	16-3POFF-C 16-3APOFF-C				
	S.P.—S.T.—Normally Closed (ON) (Momentarily OFF)	Lug* Wire*	16-3PON-C 16-3APON-C				
1 Amp 125 V. A.C.	S.P.—D.T.	Lug Wire	116-P-C 116-AP-C				
	D.P.—S.T.—Normally Open (OFF) (Momentarily ON)	Lug Wire	216-P-OFF-C 216-AP-OFF-C				
	D.P.—S.T.—Normally Closed (ON) (Momentarily OFF)	Lug* Wire*	216-P-ON-C 216-AP-ON-C				
	D.P.—D.T.	Lug	316-P-C				
	S.P.—2 Circuit (1 On—1 Off)	Lug Wire	516-P-C 516-AP-C				
COLOR OF CAP		BLACK	WHITE	RED	GREEN	YELLOW	BLUE
USE CATALOG SUFFIX NO.		BL	WH	RD	GN	YL	LU

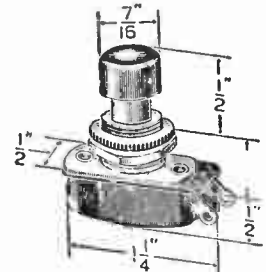

With Solder Lugs

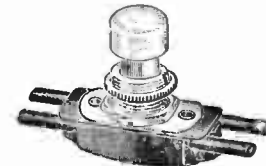

With Wire Leads

WITH ALL METAL PLUNGER

NOMINAL RATING	POLES OR CIRCUIT	TYPE TERMINALS	CATALOG NUMBER	
			STANDARD PLUNGER	WITH OVERTRAVEL
3 Amp 125 V. A.C.	S.P.—S.T.—Normally Open (OFF) (Momentarily ON)	Lug Wire	16-3POFF 16-3APOFF	16-3POFF-OV 16-3APOFF-OV
	S.P.—S.T.—Normally Closed (ON) (Momentarily OFF)	Lug Wire	16-3PON 16-3APON	* *
1 Amp 125 V. A.C.	S.P.—D.T.	Lug Wire	116-P 116-AP	116-P-OV 116-AP-OV
	D.P.—S.T.—Normally Open (OFF) (Momentarily ON)	Lug Wire	216-P-OFF 216-AP-OFF	216-P-OFF-OV 216-AP-OFF-OV
	D.P.—S.T.—Normally Closed (ON) (Momentarily OFF)	Lug Wire	216-P-ON 216-AP-ON	* *
	D.P.—D.T.	Lug	316-P	316-P-OV
	S.P.—2 Circuit (1 ON—1 OFF)	Lug Wire	516-P 516-AP	516-P-OV 516-AP-OV
USE CATALOG SUFFIX			STEM LENGTH	
FOR STEM LENGTH		NO.	5/16" ONLY WITH OVERTRAVEL	
3/16"		-2		
1/8"		-4		



Standard Plunger
5/16" or 1/8" Stem Length



With OVERTRAVEL
5/16" Stem Length Only

NOMINAL RATING	POLES or CIRCUIT	CATALOG NUMBERS			STEM LENGTH
		SCREW TERMINALS	SOLDER LUGS	WIRE LEADS	
10 Amp. 125-250 V. A.C.	S.P.—S.T. Normally Open (Off) S.P.—S.T. Normally Closed (On)	172 *170	172-B *170-B	172-A *170-A	5/16" ONLY
CATALOG NO. 172 SWITCHES HAVE ON OVERTRAVEL OF APPROX. 1/32"					

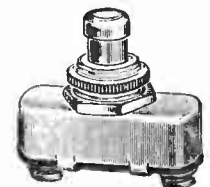

17 Series

*Note: All Normally Closed (ON) switches on this page have an OVERTRAVEL in the Open Circuit or "OFF" position.



Carling Electric, Inc.

WEST HARTFORD, CONN.

Appliance Switches **PUSH** —

MAINTAINED CONTACTS
OR
MOMENTARY CONTACTS
AC-DC

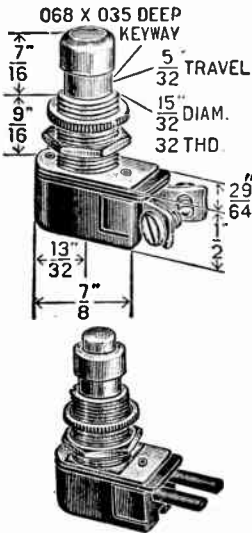

NOMINAL RATING	POLES OR CIRCUIT	TYPE TERMINALS	CATALOG NUMBERS		
			MAINTAINED CONTACTS	MOMENTARY CONTACTS	
				NORMALLY OPEN	NORMALLY CLOSED
6 Amp—125 V. 3 Amp—250 V. A.C.—D.C.	S.P.—S.T.	Lug (Bottom) Screw Wire	110—P	110—PM—OFF	110—PM—ON
			110—BP	110—PBM—OFF	110—PBM—ON
			110—SP	110—SPM—OFF	110—SPM—ON
			111—16P	111—PM—OFF	111—PM—ON
10 Amp—125 V. 5 Amp—250 V. A.C.—D.C.	S.P.—S.T.	Lug (Bottom) Screw Wire	160—P	None	None
			160—BP		
			160—SP		
			160—AP		
3 Amp—125 V. 1 Amp—250 V. A.C.—D.C.	D.P.—S.T.	Lug Wire	216—PP	216—PM—OFF	216—PM—ON
			216—PPA	216—PAM—OFF	216—PAM—ON
	S.P.—D.T.	Lug Wire			112—PM 112—PAM
			D.P.—D.T.	Lug Wire	
2 circuit	Lug Wire				

Overtravel available for Momentary Switches only—Add CATALOG SUFFIX NO. —OV

Appliance Switches **SLIDE**

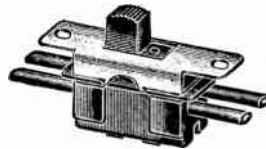
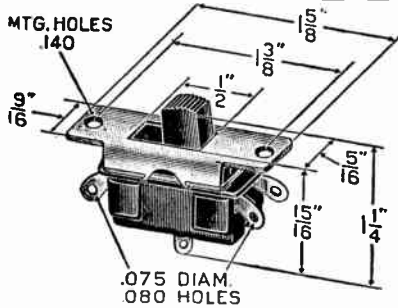

With Wire Leads

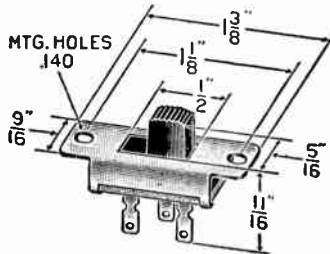
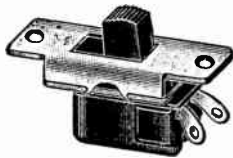
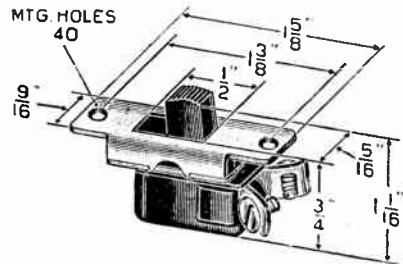

S6 Series

NOMINAL RATING	POLES OR CIRCUIT	TERMINALS	CATALOG NUMBER			
6 Amp—125 V. 3 Amp—250 V. A.C. or D.C.	S.P.—S.T.	Lugs—End	S—110			
		Lugs—Bottom	S—110—B			
		Screw	S—110—S			
		Wire Leads	S—111			
		Wire—2 Ends	S—111—D			
3 Amp—125 V. 1 Amp—250 V. A.C. or D.C.	S.P.—D.T.	Lugs	S—112			
		Wire	S—112—A			
	D.P.—S.T.	Lugs	S—216			
		Wire	S—216—A			
	D.P.—D.T.	Lugs	S—316			
Wire		S—316—A				
S.P.—2 Circuit	Lugs	S—516				
	Wire	S—516—A				
4 Amp—125 V. A.C.	S.P.—S.T.	Lugs	S60A			
	S.P.—D.T.	Lugs	S60B			
3 Amp—125 V. A.C.	D.P.—S.T.	Lugs				
		Lugs				
COLOR OF SLIDE			BLACK	RED	GRAY	DARK RED
USE CATALOG SUFFIX NO.			—BL	—RD	—GY	—MR

Note: Due to the special nature of the switches shown in this CATALOG, they are made to order ONLY. As no stock of any type is carried on hand, therefore NO RETURNS are permitted without valid reason. Always be certain switches ordered suit the application. Samples will be furnished upon request to manufacturer. All shipments made are F.O.B. West Hartford, Conn. with no freight allowed. Terms 2% 10 days—Net 30.



Carling Electric, Inc.

WEST HARTFORD, CONN.

Single Pole Switches Toggle Type

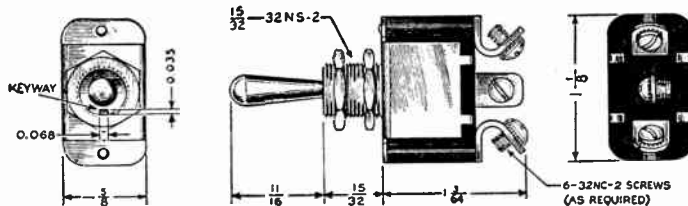

CARLING CATALOG NUMBERS

Government Type Conforming to Specs.			Commercial Type—UL				Electrical Circuit Characteristics		
JAN		Mil	15 Amp.-125 V. AC. 10 Amp.-250 V. AC. ¼ HP-115-230 V. AC.		6 Amp.-125 V. AC. 3 Amp.-250 V. AC. ¼ HP-115-230 V. AC.		Up Position	Center Position	Down Position
Screw Terminals	Solder Lugs	Screw Terminals	Solder Lugs	Screw Terminals	Solder Lugs	Screw Terminals			
ST40A	ST42A	AN3021-2	2FA53	2FA54	2FA63	2FA64	SINGLE POLE	—	SINGLE THROW
ST40B	ST42B	AN3021-9	6FA57	6FA58	6FA67	6FA68	On	—	Off
ST40C	ST42C	AN3021-8	6FA57	6FA54	6FA63	6FA64	On	—	Momentarily Off
							Off	—	Momentarily On
							SINGLE POLE	—	DOUBLE THROW
ST40D	ST42D	AN3021-3	2FB53	2FB54	2FB63	2FB64	On	—	On
ST40E	ST42E	AN3021-1	2FC53	2FC54	2FC63	2FC64	On	Off	On
ST40F	ST42F		6FB53	6FB54	6FB63	6FB64	On	—	Momentarily On
ST40G	ST42G	AN3021-7	6FC53	6FC54	6FC63	6FC64	Momentarily On	Off	Momentarily On
ST40H	ST42H	AN3021-5	6FC57	6FC58	6FC67	6FC68	On	Off	Momentarily On

Double Pole Switches Toggle Type

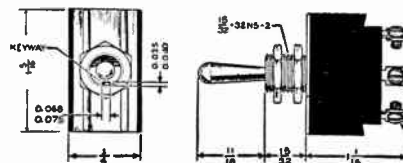

CARLING CATALOG NUMBERS

Government Type Conforming to Specs.			Commercial Type—UL				Electrical Circuit Characteristics		
JAN		Mil	15 Amp.-125 V. AC. 10 Amp.-250 V. AC. ¼ HP-115-230 V. AC.		6 Amp.-125 V. AC. 3 Amp.-250 V. AC. ¼ HP-115-230 V. AC.		Up Position	Center Position	Down Position
Screw Terminals	Solder Lugs	Screw Terminals	Solder Lugs	Screw Terminals	Solder Lugs	Screw Terminals			
ST50K	ST52K	AN3027-2	2GK53	2GK54	2GK63	2GK64	DOUBLE POLE	—	SINGLE THROW
ST50L	ST52L	AN3027-4	6GK57	6GK58	6GK67	6GK68	On	—	Off
ST50M	ST52M	AN3027-5	6GK53	6GK54	6GK63	6GK64	On	—	Momentarily Off
							Off	—	Momentarily On
							DOUBLE POLE	—	DOUBLE THROW
ST50N	ST52N	AN3027-3	2GL53	2GL54	2GL63	2GL64	On	—	On
ST50P	ST52P	AN3027-1	2GM53	2GM54	2GM63	2GM64	On	Off	On
ST50R	ST52R	AN3027-6	6GL53	6GL54	6GL63	6GL64	On	—	Momentarily On
ST50S	ST52S	AN3027-7	6GM53	6GM54	6GM63	6GM64	Momentarily On	Off	Momentarily On
ST50T	ST52T	AN3027-8	6GM57	6GM58	6GM67	6GM68	On	Off	Momentarily On

These switches are government type approved for use in Airborne Electronics.

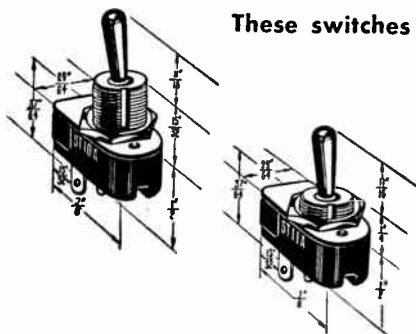

Single Pole Switches

Type designation and Carling Cat. No	Continuous current-carrying capacity	Endurance-test-current values (nominal ratings)			
		Resistive load		Inductive load	
		125 volts	250 volts	125 volts	250 volts
ST10A	3	6	3	1.5	1.5
ST11A	3	6	3	1.5	1.5

CUTLER-HAMMER SWITCHES ...

These Cutler-Hammer switches are of the one-hole mounted type, designed for convenient installation on panels, housings and other flat surfaces of machines and appliances. Experienced Cutler-Hammer engineers working closely with the electronics and appliance manufacturers — have developed these devices to meet the requirements of every type of apparatus and every class of service.

One Hole Mounting — Commercial Applications

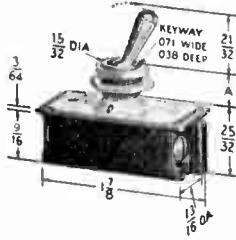

Cat. No. 7320 (D.P., S.T.)
Standord Duty

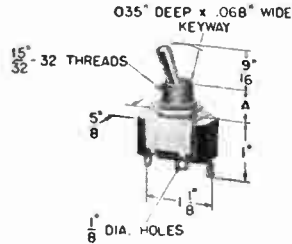

Cat. No. 7503 (S.P. D.T.)
Standord Duty

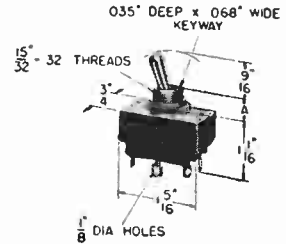

Cat. No. 7563 (D.P. D.T.)
Standord Duty

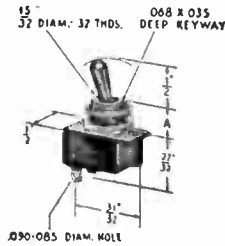

Cat. No. 8280 (S.P. S.T.)
Light Duty

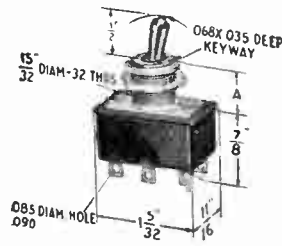

Cat. No. 8363 (D.P. D.T.)
Light Duty

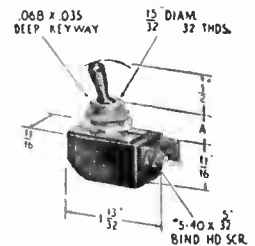

Cat. No. 8396 (S.P. S.T.)
Light Duty

Rotings A-c Only	Single Pole		Double Pole		Three Pole		Four Pole	Ter- mi- nal
	S.T.	D.T.	S.T.	D.T.	S.T.	D.T.	S.T.	
3 A. 125 V.	8098 8098	7141 7140 †						L S S
10 A. 230 V. and 15 A. 125 V.	7500 7501	7504 7505 7503 † 7502 †	7560 7561	7564 7565 7563 † 7562 †	7610 7611	7614 7615 7613 † 7612 †		S L L S
10 A. 230 V.	7506		7566		7616		7697	L 1
	7506		7566			7696	S 1	
	7507		7567			L 2		
	7507		7567			S 2		
		7508 †		7568 †			L 3	
		7508 †		7568 †		7617 †	S 3	
		7509 †		7569 †			L 4	
		7509 †		7569 †			S 4	
	7510		7570				L 5	
	7510		7570				S 5	

Rotings A-c and D-c	Single Pole		Double Pole		Ter- mi- nal
	S.T.	D.T.	S.T.	D.T.	
1 A. 250 V.			8282 8297 8292		Lugs Screw Wire
3 A. 250 V.	8280 8290 8295		8360 8361 8362	8363 8364 8365	Lugs Wire Screw
3 A. 250 V. and 6 A. 125 V.	8381 8391 8396		8370 8371 8372	8373 8374 8375	Lugs Wire Screw
6 A. 250 V. and 12 A. 125 V.	7321	7328	7320	8680	Screw
10 A. 250 V. and 15 A. 125 V.	7361		7360	8690	Screw

Standord bushing lengths — 11/32" and 15/32"

S — Screw Terminal L — Solder Lug

† Center Off, 1 — Normally open, 2 — Normally closed, 3 — Momentary one side, 4 — Momentary both sides, 5 — One side normally open, other, nor-
mally closed.

Standord bushing lengths 1/4", 11/32" and 15/32"



CUTLER-HAMMER, Inc.

1465 W. St. Paul Ave., Milwaukee 1, Wis.



... for Electronics, Radio, Small Motors

These switches are designed to meet the exacting requirements of communication and power apparatus for all branches of the government. The single pole and double pole switches meet the specifications of JAN-S-23 and the four pole switches are designed to meet the same rigid requirements. Standard bushing length — 15/32".

One Hole Mounting Aircraft Type Applications

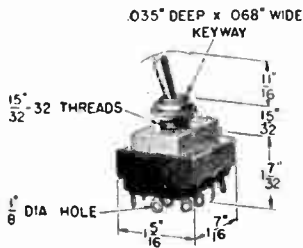

Cot. No. 7663
(4 Pole D.T. — with Solder Lug)

Cot. No. 8800
(S.P., D.T. — with Screw Terminals)

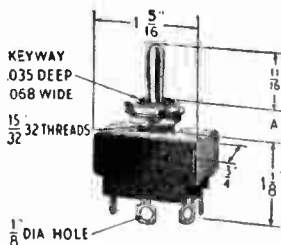
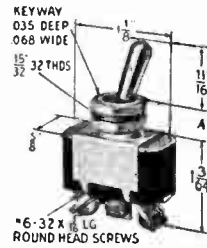

Cot. No. 8821
(D.P., D.T. — Solder Terminal)

SINGLE POLE						FOUR POLE			
Single Pole		Terminol	Single Pole		Terminol	Lever Position	Four Pole	Terminol	Lever Position
ST No.	Cot. No.		ST No.	Cot. No.			Cot. No.		
40A	8801K13	S	42A	8803K6	L	On None Off	7660K8	S	On None Off
40B	8813K12	S	42B	8819K5	L	On None Off★	7661K6	L	On None Off
40C	8811K12	S	42C	8817K5	L	Off None On★	7662K5	S	On Off On
40D	8810K12	S	42D	8816K5	L	On None On	7663K5	L	On Off On
40E	8800K13	S	42E	8802K6	L	On Off On	7664K3	S	On None On
40F	8804K12	S	42F	8805K5	L	On None On★	7665K4	L	On None On
40G	8812K13	S	42G	8818K5	L	On★Off On★	7666K6	S	Off None On★
40H	8809K13	S	42H	8815K6	L	On Off On★	7667K6	L	Off None On★
							7668K4	S	On None Off★
							7669K4	L	On None Off★
							7670K4	S	On Off On★
							7671K4	L	On Off On★
							7672K4	S	On★Off On★
							7673K4	L	On★Off On★
							7674K4	S	On None On★
							7675K4	L	On None On★

DOUBLE POLE						
Double Pole		Terminol	Double Pole		Terminol	Lever Position
ST No.	Cot. No.		ST No.	Cot. No.		
50K	8822K8	S	52K	8823K5	L	On None Off
50L	8828K5	S	52L	8829K5	L	On None Off★
50M	8826K5	S	52M	8827K5	L	Off None On★
50N	8824K8	S	52N	8825K5	L	On None On
50P	8820K10	S	52P	8821K5	L	On Off On
50R	8830K5	S	52R	8831K5	L	On None On★
50S	8834K4	S	52S	8835K3	L	On★Off On★
50T	8832K4	S	52T	8833K3	L	On Off On★

★Momentary contact

S — Screw terminal

L — Solder lug

The switches shown on these pages constitute only a partial listing of standard type Cutler-Hammer switches available. Additional data on other standard and special types may be obtained from your Cutler-Hammer electrical distributor or your nearest Cutler-Hammer sales office.

SALES OFFICES

ALBANY 7, N. Y.	91 State St.	MINNEAPOLIS 15, MINN.	523 S. 7th St.
ATLANTA, GA.	714 Spring St., N.W.	NEWARK 2, N. J.	155 Washington St.
BALTIMORE 18, MD.	1115 E. 30th St.	NEW ORLEANS 12, LA.	833 Howard Ave.
BOSTON 15, MASS.	784 Commonwealth Ave.	NEW YORK 18, N. Y.	8 W. 40th St.
BUFFALO 3, N. Y.	295 Moin St.	OMAHA, NEBR.	320 N. O. W. Bldg.
CHARLOTTE 2, N. C.	237 Tryon St.	PHILADELPHIA 7, PENNA.	112 N. 12th St.
CHICAGO 6, ILL.	400 W. Madison St.	PITTSBURGH 22, PA.	355 5th Ave.
CINCINNATI 2, OHIO	804 Plum St.	PORTLAND 4, ORE.	208 S. W. Stork St.
CLEVELAND 3, OHIO	2010 E. 46th St.	ROCKFORD, ILL.	1404 N. Moin St.
COLUMBUS 9, OHIO	2700 E. Moin St.	SACRAMENTO 17, CALIF.	4840 Cabrillo Way
DALLAS 2, TEXAS	1331 Drogan St.	SAGINAW, MICH.	107 N. Franklin St.
DAVENPORT, IOWA	220 Moin St.	SPOKANE 14, WASH.	W. 3013 Princeton Ave.
DAYTON 2, OHIO	410 W. First St.	SALT LAKE CITY 1, UTAH	165 S. First West
DENVER 2, COLO.	1031 15th St.	ST. LOUIS 3, MO.	1914 Washington Ave.
DETROIT 38, MICH.	15427 Woodrow Wilson Ave.	SAN FRANCISCO 7, CALIF.	2130 3rd St.
FRESNO, CALIF.	2946 Michigan Ave.	SEATTLE 4, WASH.	619 8th Ave., So.
GRAND RAPIDS 2, MICH.	407 Bldg. & Loon Bldg.	SOUTH BEND 5, IND.	108 N. Moin St.
HOUSTON 3, TEXAS	1605 Jefferson St.	SYRACUSE 2, N. Y.	109 S. Warren St.
INDIANAPOLIS 5, IND.	644 E. Mople Road	TAMPA, FLA.	P. O. Box 2714
LOS ANGELES 31, CALIF.	1795 Posodeno Ave.	TULSA 3, OKLA.	315 So. Boulder St.
MIDLAND, TEXAS	508 N. Moin St.	WASHINGTON D. C.	8055 13th St., Silver Spring, Md.
MILWAUKEE 3, WIS.	536 W. Wisconsin Ave.	YOUNGSTOWN 3, OHIO	25 E. Boardman St.



CUTLER-HAMMER, Inc.
1465 W. St. Paul Ave., Milwaukee 1, Wis.



LINEMASTER

AMERICA'S FOOT SWITCH LEADER

A LINEMASTER Safety Extra!

FOOT SWITCH GUARD

... a necessary precaution wherever accidentally tripping machine might be dangerous or costly. Strong and durable, with a black crackle finish on cast iron, it fits over and encloses switch.



Available for all Senior Models.

Price \$3.00

Tip-Toe Control for Tip-Top Production!

LINEMASTER, Jr. FOOT SWITCH

Lightweight, sensitive... Ideal for women workers! Needs only a touch of the toe, while heel remains comfortably on the floor.



#121-S
& #122-S

Aluminum housing, black crackle finish. Weight 1 lb. 5/2" long, 3/4" wide, 1/4" high. Rated at 15 amps., 115 volts A.C.; 15 amps., 250 volts A.C. Can be wired to operate as single pole, normally open; single pole, normally closed; or single pole double throw. Momentary Contact only. Price \$7.50 #122-S—Rated at 20 amps., 115-250 volts A.C. Price \$7.75

The LINEMASTER

TWIN-COMPACT



Forward-Reverse Switch
#4915 Twin

Twice as efficient because it works both ways!

The TWIN-COMPACT gives you all the advantage of the famous COMPACT—doubled—because it actually is two complete LINEMASTER COMPACTS, mounted on a single base. Foolproof bridge between mountings prevents accidental operations of both at once.

Strong steel housing, black crackle finish. 6" long, 3" wide, 1 1/2" high. Weight 1 lb. Specifications (for each switch) same as for LINEMASTER COMPACT No. 491-S. Price \$8.50

The LINEMASTER

CLIPPER SWITCH

Rugged industrial features — trim modern lines!



The CLIPPER is especially designed to fit the requirements of Product Engineers and Machine Operators, and can be operated equally well from sitting or standing positions. It is nearly 100% dustproof, yet easy to wire—the removal of two screws makes interior accessible.

#632-S—A.C. Rating: 20 amps. at 115 and 250 volts, single pole, double throw. Price \$7.50

#634-S—A.C. Rating: 10 amp. at 115 and 250 volts, simulated double pole, double throw. Price \$9.75

Cast iron housing, with sponge rubber skid pad; black crackle finish. 4 1/2" long, 3 1/2" wide, 1 1/2" high. Weight, 2 1/2 lbs.

Safety guard available for all above models—\$1.65 extra.

The LINEMASTER

EXECUTIVE

Two Switches in One "On-Center" Mechanical Interlock!

This handsome switch is fool-proof and easy-to-operate! Selective circuits and guaranteed interlock eliminates possibility of accidentally tripping both circuits simultaneously while low, wide casing saves excessive leg movement—foot pivots easily from one side to the other.

Easy to wire—remove only one screw and switch is ready. Either interior (or both) may be wired as normally open or normally closed—single pole—double throw. Cord sets available to your specifications.

Heavy steel housing, baked hammertone grey finish. Weight, 14 oz., 4 3/8" long, 4" wide, 1 1/4" high. Each interior rated at 15 amps at 125-250 volts A.C. Price \$6.50

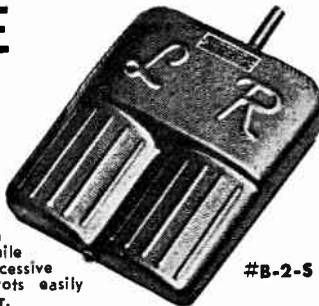

#B-2-S

The LINEMASTER

DUPLEX FOOT TREADLE SWITCH

Actually 2 switches in one compact housing!

LINEMASTER'S new DUPLEX FOOT TREADLE SWITCH is especially well adapted for sound and transmission equipment; relays, solenoids and magnetic switches. The DUPLEX provides either forward-and-reverse or start-and-stop action with slight heel or toe pressure, and allows two circuits to be selectively operated from one neutral position. Available in two spring weights, to allow for operation from either sitting or standing positions.* Cast aluminum housing, black crackle finish. Weight, 1 3/4 lbs.; length, 8 1/2"; width, 3 1/2"; height, 2". Rated at 15 amps, 110 volts A.C.; 15 amps., 220 volts A.C. Either switch, or both, may be wired as single pole, normally open; single pole, normally closed; single pole, double throw.

*Specify #475-S—heavy spring—for standing operation. #476-S—Light spring—for seated position. Price \$15.00



#475-S
& #476-S

"When awkward jobs hold you up—a LINEMASTER FOOT SWITCH is your third hand!"

LINEMASTER

PRECISION-BUILT • DEPENDABLE • RUGGED • ECONOMICAL • OVER 1000 APPLICATIONS

LINEMASTER

"SENIOR" 4000 SERIES

10 Maintained and Momentary Contact Models



A sturdy industrial-type switch that operates with light pressure from foot or knee, leaving both hands free for work. Economical and built to give years of trouble-free service—fully enclosed and hooded for protection against dirt and chips,

with additional heavy spring and cast stop under cover casting, to relieve pressure and strain on spring inside switch proper.

Heavy-duty cast iron housing; black crackle enamel finish. 7" long, 4" wide, 3/4" high. Weight, 5/4 lbs.

MAINTAINED CONTACT MODELS: Press to start—press to stop.
MOMENTARY CONTACT MODELS: Press to start—release to stop.

ELECTRICAL CHARACTERISTICS					MAINTAINED CONTACT		MOMENTARY CONTACT		
De- scription	Amps. AC	Volts D.C.	Horse- power	Ph.	Cat. No.	Price	Cat. No.	Price	
D-P	20	20	125	1	1				
S-T	20	20	250	1	1	4141-D	\$ 8.50	4141-S	\$ 8.95
D-P	10	10	125	1/2	1				
D-T	5	5	250	1/2	1	4142-D	10.05	4142-S	10.55
S-P	15	15	125	1/2	1				
D-T	10	10	250	1/2	1	4143-D	8.50	4143-S	9.95
(3-way)	10	10	250	1/2	1				
D-P	15		115	1	1				
S-T	15		230	2	1	4151-D	11.30	4151-S	10.70
	5		575	2	1				
Three Pole	15		115-230	2	3				
	5		575	2	3	4351-D	11.20	4351-S	10.85

Safety guard available for all above models—\$3.00 extra.

The LINEMASTER

COMPACT

Amazingly versatile—
amazingly low-priced!

Small, lightweight—and instantly responsive to the slightest pressure of foot, finger, knee or elbow! Substantially built to insure long life, with an actuating mechanism superior to any other on the market today.

Available in a wide variety of wiring plans. Strong steel housing, black crackle finish. 2 3/4" long, 2 1/2" wide, 7/8" high. Weight, 6 1/2 ozs. Momentary contact only.



Prices on other combinations on application.

Cat. No.	DESCRIPTION	RATING	PRICE
491-S	Single Pole, Double Throw A.C. only	10A at 115V 10A at 230V	\$3.75
492-S	Single Pole, Double Throw A.C. only	20A at 115V 20A at 230V	\$4.00
493-S	Single Pole, Single Throw A.C. only, double break	10A at 115V 5A at 230V	\$4.50
494-S	2 interiors so arranged as to simulate D-P-D-T	10A at 115V 5A at 230V	\$6.00
495-S	Single Pole, Double Throw A.C.	15A at 125V 15A at 250V 15A at 460V	\$3.90
496-S	Foto with cord & light, Single Pole, Double Throw A.C.	20A to 115V 20A at 230V	\$6.25

#491-S furnished from stock, wired with 6 ft. cord set and series plug—\$1.50 extra. Prices on other switches with cord sets on application.

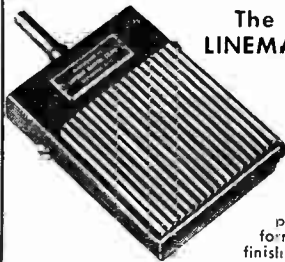

The LINEMASTER TREADLITE

Trim, small,
lightweight, instantaneous!

MODEL T-51-S

Accurate control in a modern, minute, treadle switch! Single pole, double throw, momentary contact interior, that can be wired open or closed. Rubber base pad and rubber-ribbed treadle, formed steel casing with black crackle finish. Interior rated at 5 amps., 110 volts and 250 volts A.C. Weight 7 ozs.; 3 1/2" long, 2 3/4" wide, 1" high. Price, without cord \$2.95

(Supplied on order, wired with 6' cord and series plugs, \$1.50 extra)

MODEL T-52-S

ONE treadle activates TWO switching operations! A partial downward stroke opens or closes one circuit; added pressure actuates the second circuit. Both interiors, as well as exterior, meet specifications for single-switching Model T-51-S.

Price, without cord, \$4.20

(Prices with cord-set on application)

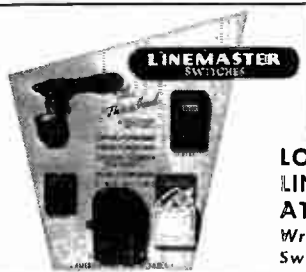

LOOK FOR THIS
LINEMASTER DISPLAY
AT YOUR DEALER!

Write Us for Your Special
Switch Requirements

The LINEMASTER LEKTRO-LOK SWITCH

Small, sensitive,
automatically safe!

Particularly ideal for
transmission equipment!

Mechanical Interlock allows only one circuit to function at a time—and you can depend on it! LEKTRO-LOK operates on the teeter-totter system, with selective circuits. Pressure on one side actuates one circuit, release of pressure automatically returns switch to normal "off" position. Pressure on the other side is required before second switch is actuated, independent of first. Yet LEKTRO-LOK requires only a single cord—eliminates costly harness assemblies! Rugged stamped metal housing, black crackle finish. Weight, 10 ozs. 5" long, 2 3/4" wide, 1 1/4" high. Single pole, double throw. Rating (A.C. only) 15 amps. at 125 volts, 15 amps. at 250 volts.*

#L-2-S



*LEKTRO-LOK is available, and can be supplied to your specifications, in many electrical combinations, such as:

Single pole, single throw, A.C. only	10 A at 115V
Double break	5 A at 230V
Interiors so arranged as to simulate	10 A at 115V
Double pole, double throw	5 A at 230V

Special cord sets available to your specifications.

LINEMASTER SWITCH CORPORATION

WOODSTOCK, CONNECTICUT

SWITCHCRAFT INC.

CHICAGO 22, ILLINOIS

PHONE JACKS • PHONE PLUGS
SWITCHES: Push-Button . . .
Rotary and Lever Action . . .

SWITCHCRAFT PHONE JACKS

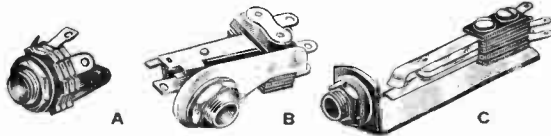

The "Littel-Jax" (A), features notched insulating washers mechanically interlocking springs and lugs; "V-bend" in tip spring firmly "holds" mating Plug; minimum space requirements, economical. Mounts in single $\frac{3}{8}$ " dia. hole, panels up to $\frac{1}{2}$ " thick.

No. C-11 (JJ-034) and C-12A (JJ-089) mate with No. 440 (PJ-055B) Plug; C-12B (JJ-033), S-12B and S-13B mate with No. 480 (JAN PJ-068 or W.E. No. 309) Plug. No. C-11 and C-12B have locating pins (non-turn devices). No. S-11 similar to No. 11 except .210" I.D. sleeve to mate with S-250 and S-280 Plugs. C-11 (JJ-034), C-12B (JJ-033) and C-12A (JJ-089) per JAN-J-641.

The short frame type Jack "SF-JAX" (B), requires minimum panel depth, mounts in single $\frac{3}{8}$ " dia. hole, panels up to $\frac{3}{16}$ " thick.

The long frame type Jack "LF-JAX" (C), requires minimum panel space. 3" deep, mounts in single $\frac{3}{8}$ " dia. hole, panels up to $\frac{1}{4}$ " thick.

"LITTEL-JAX"		"SF-JAX"		"LF-JAX"		Schematic No. (See below)
Part No.	U. S. A. List Price	Part No.	U. S. A. List Price	Part No.	U. S. A. List Price	
11	\$0.40					
C-11	\$0.60					I
S-11	\$0.45	21	\$0.55	31	\$0.65	
		22	\$0.70	32	\$0.85	II
12A	\$0.45					
C-12A	\$0.75	22A	\$0.70	32A	\$0.85	III
12B	\$0.55					
C-12B	\$0.70					IV
S-12B	\$0.65	22B	\$0.70	32B	\$0.85	
		23	\$0.85	33	\$0.95	V
		23A	\$0.85	33A	\$0.95	VI
13B	\$0.75					
S-13B	\$0.95	23B	\$0.85	33B	\$0.95	VII
		23C	\$0.85	33C	\$0.95	VIII
		23E	\$0.85	33E	\$0.95	IX
		24	\$0.95	34	\$1.10	X
		24A	\$0.95	34A	\$1.10	XI
		24B	\$0.95	34B	\$1.10	XII
		25	\$1.15	35	\$1.25	XIII
		26	\$1.25	36	\$1.40	XIV

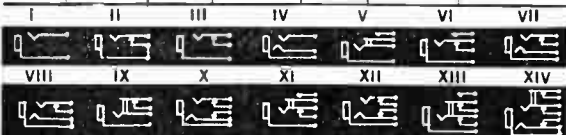

SWITCHCRAFT "FLAT PLUG"



A radically new design, in both 2 and 3-conductor types. Removable Plastic Cap; terminals and body mechanically interlocked; Cover of Black or Red Tenite; one-piece tip rod; high grade insulation; terminal identification.

Ideal for theatre or church hearing-aid installations. Office dictation equipment, disc, wire or tape recorders, test equipment, etc.

Part No.	U. S. A. List Price	Color or Type of Handle	Description
220	\$0.75	Black	2-conductor Screw Term.
225	\$0.75	Red	" " " " "
227	\$0.70	Black	" " Lug. Term.
229	\$0.70	Red	" " " " "
230	\$1.10	Black	3-conductor Screw Term.
235	\$1.10	Red	" " " " "
237	\$1.05	Black	" " Lug. Term.
239	\$1.05	Red	" " " " "

SWITCHCRAFT PHONE PLUGS

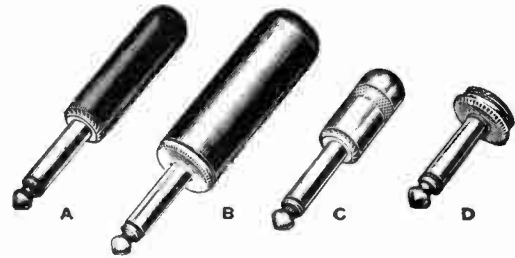

The "Littel-Plug" (A), radically new, fitting standard Jacks; solder lug type features clamp terminal serving as a cable clamp and terminal—perfect for metal braid cable. Screw type terminals—no clamp. Tenite or Metal handles are $1\frac{1}{2}$ " L., $\frac{1}{2}$ " dia. Exterior metal parts bright nickel Pl.

No. S-250 and S-280 have a .206 dia. sleeve; mates with S-11 and S-128 Jacks. No. S-180 and 288 have wide insulator between sleeve and tip—makes it possible to use a 2-conductor Plug in a 3-conductor Jack.

The Standard Plugs (B), conventional design, available both black Bakelite or metal handles $2\frac{1}{4}$ " L. x $1\frac{1}{8}$ " O.D., except No. 90 and No. 160 have metal handles 1" long. Exterior metal parts bright nickel Pl.

The "Lug Plug" (C), low-cost two conductor, solder lug term. Exterior metal parts bright Nickel Pl. Red or Black Tenite Handles are $1\frac{1}{2}$ " L., $\frac{1}{2}$ " O.D. No. 380 has metal handle 1" L., bright Nickel Pl.

Plug Adapter (D) used with 2501F Connector for use with standard Jacks. For special adapters see separate listing.

Part No.	U. S. A. List Price	Plug Type	Color or Type of Handle	Description
240	\$0.75	"Littel-Plug"	Black	2-conductor. Screw Term.
245	\$0.75	" " "	Red	" " " " "
270	\$1.05	" " "	Metal	" " " " "
250	\$0.70	"Littel-Plug"	Black	2-conduct. Clamp-lug Term.
255	\$0.70	" " "	Red	" " " " "
280	\$1.00	" " "	Metal	" " " " "
260	\$1.20	"Littel-Plug"	Black	3-conductor. Screw Term.
290	\$1.40	" " "	Metal	" " " " "
267	\$1.05	"Littel-Plug"	Black	3-conduct. Clamp-lug Term.
269	\$1.05	" " "	Red	" " " " "
297	\$1.30	" " "	Metal	" " " " "
40	\$0.70	Standard	Black	2-conductor. Screw Term.
70	\$1.20	" " "	Metal	" " " " "
160	\$0.90	" " "	Metal	" " " " "
44	\$0.50	Adapter	—	" " " " "
60	\$1.05	Standard	Black	3-conductor. Lug Terminals
90	\$1.30	" " "	Metal	" " " " "
350	\$0.55	"Lug-Plug"	Black	2-conductor. Lug Terminals
355	\$0.55	" " "	Red	" " " " "
380	\$0.70	" " "	Metal	" " " " "
180	\$1.05	Standard	Metal	2-conductor. Screw Term.
288	\$1.05	"Littel-Plug"	Metal	2-concl. Clamp-lug Term.
S-250	\$0.75	" " "	Black	" " Clamp-lug Term.
S-280	\$1.00	" " "	Metal	" " Clamp-lug Term.

SWITCHCRAFT "EXTENSION JAX"



Features a clamp type terminal providing a cable anchor. Spring tempered nickel silver springs, designed to properly "hold" mating plug. Exterior metal parts N.P.: Terminals mechanically interlock. High grade insulation. Available in 2 and 3-conductor types, solder lug or screw type terminals. Bakelite or Brightly Nickel Plated Brass handles. Mates with any standard plug.

Part No.	U. S. A. List Price	Color or Type of Handle	Description
80	\$1.15	Black	2-conductor. Screw Term.
88	\$1.00	" " "	" " Lug. Term.
120	\$1.55	Shielded	" " Screw Term.
128	\$1.40	" " "	" " Lug. Term.
830	\$1.55	Black	3-conductor. Screw Term.
838	\$1.40	" " "	" " Lug. Term.
1230	\$1.95	Shielded	" " Screw Term.
1238	\$1.80	" " "	" " Lug. Term.
S-128	\$1.50	" " "	2-cond Spec. Lug. Term.

SWITCHCRAFT INC.

CHICAGO 22, ILLINOIS

SWITCHCRAFT "T" & "M" JAX

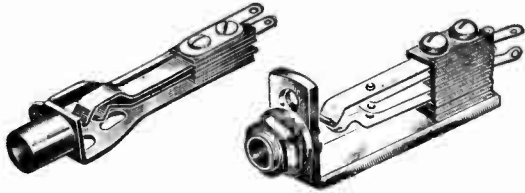

"T" JAX — Long frame, Switchboard type, designed for quality communication and military equipment.
 "M" JAX — Heavy, long frame Jack, often referred to as Navy Jack, designed for industrial and military equipment requirements. Circuits listed are standard; more complex circuits available.

"T-JAX"		Similar Jan Type No.	Schematic		
Part No.	U.S.A. List Price				
T-331	\$1.05	*** FOR JAN EQUIVALENTS REQUEST SPECIAL BULLETIN DESCRIBING MILITARY TYPES	[Schematic symbols for T-JAX types]		
T-332A	\$1.20				
T-332B	\$1.20				
T-332C	\$1.45				
T-333	\$1.35				
T-334A	\$1.50				
T-334B	\$1.60				
T-334C	\$1.50				
T-334F	\$1.50				
T-335	\$1.60				
T-336	\$1.75				
"M-JAX"					
M-444B	\$2.20				
*M-444	\$2.30				
M-446	\$3.50				
M-446A	\$3.90				

*Bushing .2085" to mate PJ-068, PJ-168 & PJ-309.

PHONE JACKS • PHONE PLUGS

SWITCHES: Push-Button . . .

Rotary and Lever Action . . .

SWITCHCRAFT "LEV-R-SWITCHES"

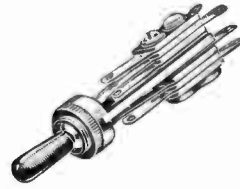

Unusually small, lever action switch, available in numerable circuits, to provide the simplest in switching design. Ideal for inter-comm. equip., test equip., model r.r. switch panels, recording equip., etc.

Mounts in single $\frac{1}{8}$ " dia. hole, panels up to $\frac{1}{4}$ " thick; Long life springs; soft, easy action — real detent action on locking types; Springs assembled into a conventional stack assembly; fine silver contacts rated at 3 amperes, 120 volts A.C., non-inductive load; other contacts available.

TWO-POSITION TYPE			Schematic	
Part No. Non-locking	Part No. Locking	U.S.A. List Price		
3001	3001L	\$1.95	[Schematic symbols for two-position types]	
3002	3002L	\$1.95		
3003	3003L	\$2.25		
3004	3004L	\$2.50		
3005	3005L	\$2.50		
3006	3006L	\$2.75		
THREE-POSITION TYPE				
3033	3033L	\$2.50	[Schematic symbols for three-position types]	
3034	3034L	\$2.60		
3035	3035L	\$2.60		
3036	3036L	\$2.90		
3037	3037L	\$2.95		
INTER-COMM. SWITCHES				
3033T		\$2.50		[Schematic symbols for inter-comm. switches]
3037T		\$2.95		

SWITCHCRAFT PUSH-BUTTON & ROTARY SWITCHES



The "Littel-Switch" (A), available in 3 circuits, either in Red or Black one-piece Plastic Push-Button, non-locking only. Mounts in single $\frac{3}{8}$ " dia. hole, panels up to $\frac{1}{4}$ " thick. Integral contacts are standard, recommended for low current only.

The "FF-Switch" (B), all common circuits, one-piece Black Plastic Push-Button, non-locking only. Mounts in single $\frac{3}{8}$ " dia. hole, panels up to $\frac{1}{4}$ " thick. Fine silver contacts rated 3 amperes, 120 volts A.C., non-inductive.

The "RS-Switch" (C), locking and non-locking, 2- or 3- position, all common circuits. Mounts in single $\frac{3}{8}$ " dia. hole, panels up to $\frac{1}{4}$ " thick. Fine silver contacts rated 3 amperes, 120 volts A.C. (non-inductive).

"LITTEL-SWITCH"			"FF-SWITCH"		"RS-SWITCH"			Schematic Circuit
Part No. Red-Button	Part No. Black-Button	U.S.A. List Price	Part No.	U.S.A. List Price	Part No. Non-Locking	Part No. Locking	U.S.A. List Price	
101	201	\$0.85	1001	\$0.95	2001	2001L	\$1.00	I
102	202	\$0.85	1002	\$0.95	2002	2002L	\$1.00	II
103	203	\$0.90	1003	\$1.10	2003	2003L	\$1.20	III
			1004	\$1.20	2004	2004L	\$1.25	IV
			1005	\$1.20	2005	2005L	\$1.25	V
			1006	\$1.45	2006	2006L	\$1.65	VI
			1009	\$2.00				VII
THREE-POSITION TYPES								
					2034	2034L	\$1.25	VIII
					2035	2035L	\$1.25	IX
					2036	2036L	\$1.65	X

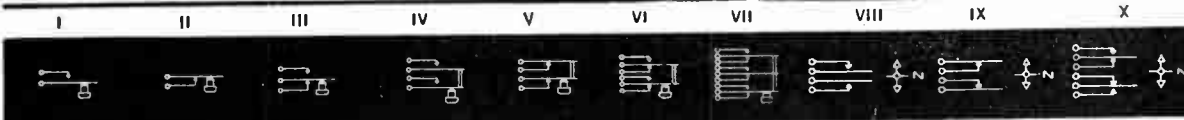

Copyright by U. C. P., Inc.

Radio's Master — 19th Edition

TRADE DISCOUNT APPLIES TO LIST PRICES ONLY

Page L-29

SWITCHCRAFT INC.

CHICAGO 22, ILLINOIS

SWITCHCRAFT "ADAPTERS" & "SHIELDED JAX"

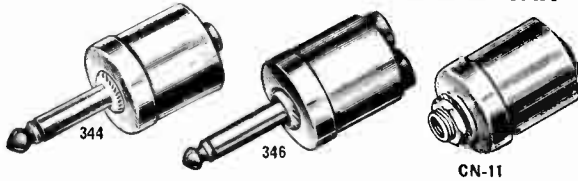

"ADAPTERS"—Various "Adapters" provide convenient interchange of equipment between various connector devices. Sturd construction; brass nickel plated housing supports respective connecting devices.
"SHIELDED JAX"—Ideal in high impedance circuits; regular "Littel-Jax" (described separately) assembled into shield.

"ADAPTERS"

Part No.	U.S.A. List Price	DESCRIPTION
332	\$1.75	Phone Jack Input to Female Microphone Connector Output.
334	\$1.45	Phono Jack Connector Input to Female Microphone Connector Output.
336	\$1.45	Phone Jack Input to Phono Plug Connector Output.
338	\$1.45	Male Microphone Connector Input to Phono Plug Connector Output.
342	\$2.60	Dual-Purpose Binding Post/Banana Jack Input to Phone Plug Output.
344	\$1.45	Phono Jack Connector Input to Phone Plug Output.
346	\$2.15	Tip Jack Input to Phone Plug Output.

"SHIELDED JAX"

Part No.	U.S.A. List Price	DESCRIPTION
CN-11	\$0.80	Open circuit. (See No. 11 "Littel-Jax").
CN-12A	\$0.85	Closed circuit. (See No. 12A "Littel-Jax").
CN-12B	\$0.95	Open circuit, 3 conductor (See No. 12B "Littel-Jax").
CN-13B	\$1.15	Closed circuit, 3-conductor (See "Littel-Jax" No. 13B).

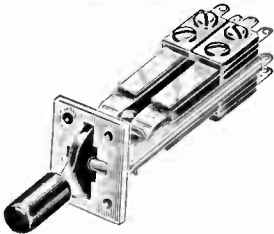

SWITCHCRAFT "TELEVER SWITCH"

Rugged Telephone Type Lever Switch; 3" depth behind panel; Nickel Silver springs; Cross bar Palladium contacts rated 3 amps., 120 volts A.C. (non-inductive). Nylon rollers; solder lug terminal. Insulated black knob. Chrome plated brass actuator. Standard mounting centers $\frac{1}{2}$ " x $\frac{1}{16}$ "; usually mounted by four No. 3-18 screws (not furnished); can be assembled to escutcheon plate.

TWO POSITION TYPE

PART NUMBER		U.S.A. LIST PRICE	CONTACT ASSEMBLY
Non-Locking	Locking		
6006	6006L	\$ 5.00	2-C
6008	6008L	\$ 5.60	4-A
6009	6009L	\$ 6.00	3-C
60012	60012L	\$ 6.80	4-C
60024	60024L	\$10.00	8-C

THREE POSITION TYPE

PART NUMBER		U.S.A. LIST PRICE	POS. 1	POS. 2
Non-Locking	Locking			
6036	6036L	\$ 5.00	1-C	1-C
6038	6038L	\$ 5.60	2-A	2-A
60312	60312L	\$ 6.80	2-C	2-C
60324	60324L	\$10.00	4-C	4-C
530 Escutcheon Plate with 4 Mtg. Screws		\$ 0.60		

BASIC CONTACT FORMS

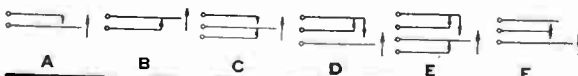

Wiring Master — 19th Edition

PHONE JACKS • PHONE PLUGS

SWITCHES: Push-Button . . .

Rotary and Lever Action . . .

SWITCHCRAFT "LITTEL-PLUG" AND "EXTENSION JAX" (NME TYPES)



Designed to meet exacting requirements of Industry and the Armed Services. Molded construction provides complete continuity of insulation in plugs. Jack per JAN-J-611; Plugs per JAN-P-642.

Part No.	U.S.A. List Price	DESCRIPTION
440	\$1.40	2-cond.—Screw Term. Black Plastic Handle—Type PJ-055B (Old Signal Corps No. PL-55).
445	\$1.40	2-cond.—Screw Term. Red Plastic Handle—Type PJ-055R.
470	\$2.00	2-cond.—Screw Term. Shielded Handle—Type PJ-055M (Old Signal Corps No. PL-125).
480	\$3.60	3-cond.—Screw Term. Black Plastic Handle—Type PJ-068 (Old PL-68).
820	\$2.00	2-cond.—Screw Term. Black Plastic Handle—Type JJ-026 (Old Signal Corps No. JK-26).

\$0.85 for PKG. of 25 Strain Relief Clamp, Nickel Plate Brass.

SWITCHCRAFT "PHONO" AND "MICROPHONE" CONNECTORS

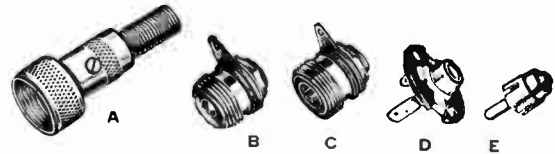

Designed for use with single conductor microphone conductor cable. Panel receptacle mounts in .385" hole.

Fig.	Part No.	U.S.A. List Price	DESCRIPTION
A	2501F	\$0.60	Straight Connector, single contact, female type, coupling ring.
	2501M	\$0.45	Straight Connector, single contact, male type.
B	2501MP	\$0.35	Panel Connector, single contact, male type.
C	2501MPC	\$0.45	Panel Connector, closed circuit, male type.
D	2501R	\$0.15	Coupling Ring, used with 2501M to convert to 2501F.
	3501F	\$0.15	Phono Jack—2 conductor.
E	3501M	\$0.10	Phono Plug—2 conductor.



SWITCHCRAFT "CABLE ASSEMBLIES"

Twenty five foot lengths of 2- and 3-conductor plastic covered cable (Polyvinyl), shielded and multi-conductor types, terminated with popular Switchcraft "Littel-Plugs", "Extension Jax" and "Connectors".

Part No.	U.S.A. List Price	DESCRIPTION
8252	\$ 6.40	2-cond. cable; No. 250 "Littel-Plug" to No. 88 "Ext. Jax".
8282	\$ 6.95	2-cond. cable; No. 280 "Littel-Plug" to No. 128 "Ext. Jax".
8256	\$ 7.25	2-cond. shielded cable; No. 250 "Littel-Plug" to No. 88 "Ext. Jax".
8286	\$ 7.80	2-cond. shielded cable; No. 280 "Littel-Plug" to No. 128 "Ext. Jax".
8259	\$ 7.80	2-cond. shielded cable; No. 2501M connector to No. 2501F connector.
8263	\$10.00	3-cond. shielded cable; No. 267 "Littel-Plug" to No. 838 "Ext. Jax".
8293	\$11.50	3-cond. cable; No. 297 "Littel-Plug" to No. 1238 "Extension Jax".



SINGLE SECTION ROTARY SWITCHES

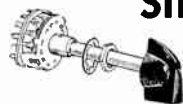

3612-01 to 3612-10

These single section rotary switches were designed to keep pace with the demand for smaller components. They are the smallest switches available to handle multi-circuit switching and are ruggedly built with heavy silver plated contacts, high grade phenolic insulators, best spring brass and steel. These switches are ideal for radio-phonos, wave band, tone control, meter and antenna switching applications, as well as many other uses in electronic equipments. All switches are supplied with one knob, mounting nut and lock washer.

Order by Part Number from Table Below

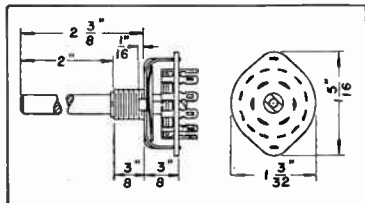

Erie No. Shorting Type	Erie No. Non-Shorting Type	No. of Circuits Per Switch	No. of Positions	Erie No. Shorting Type	Erie No. Non-Shorting Type	No. of Circuits Per Switch	No. of Positions
3612-01	3612-02	1	12	3612-07	3612-08	3	4
3612-03	3612-04	2	6	3612-09	3612-10	2	3
3612-05	3612-06	1	5				

MULTI-SECTION ROTARY SWITCHES

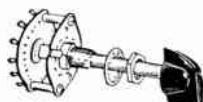

3612-11, 12, 15, 19

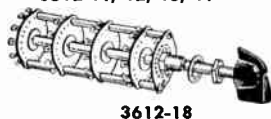

3612-18

The flat rivet "Wedglock" which fastens the contact to the stator is a unique feature of these switches. The small cross sectional area permits the use of sturdily designed contacts without sacrificing over-all stator size. The outstanding feature of this flat rivet is a contact assembly that will not loosen or rotate due to soldering heat. A free floating rotor assembly results in this rugged construction as the rotor blades do not support the assembly and only required rotor blades are used. One, two and four section switches in both shorting and non-shorting types are stocked to meet applications such as meter switching, test equipment and various electronic instruments. All switches are supplied with one knob, mounting nut and lock washer.

Order by Part Number from Table Below

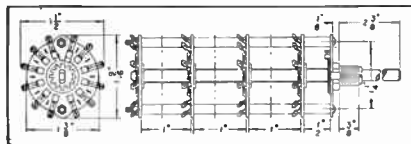

Erie No. Shorting Type	Erie No. Non-Shorting Type	No. of Circuits Per Section	No. of Sections Per Switch	Total No. of Circuits Per Switch	Number of Positions
3612-11	3612-12	1	1	1	11
3612-13	3612-14	1	2	2	11
.....	3612-15	2	1	2	5
.....	3612-16	3	2	6	3
.....	3612-17	2	2	4	4
.....	3612-18	1	4	4	11
.....	3612-19	3	1	3	3

LEVER ACTION SWITCHES

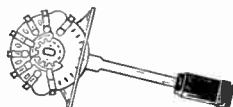

3612-20, 21, 22

Erie Lever Action Switches employ the same type stator and construction as the Multi-Section Switches assuring a high quality assembly for inter-communication and test equipment applications. Smooth, positive action and indexing, high quality phenolic insulation, heavy silver-plated contacts and best spring brass are features which make the switch ideal for replacement or new uses. Each switch is supplied with mounting screws and knob. Packaged individually in a durable sealed plastic bag in the familiar Erie display box for maximum protection against corrosion.

Order by Part Number from Table Below

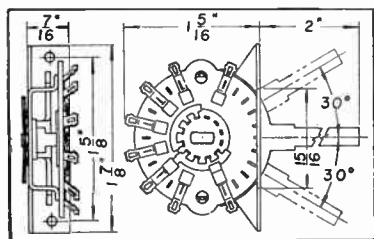

Erie No. Shorting Type	Erie No. Non-Shorting Type	Type Indexing	Number of Circuits	Number of Positions
3612-20	3612-21	Positive	2	3
....	3612-22	Positive	4	2

GENERAL PURPOSE SWITCHES

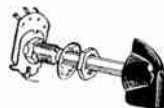

3612-23, 24, 25

Extreme care was taken in the design of these very small compact switches to insure a very rugged and accurate construction. Again, the flat rivet is used to firmly secure the contacts against rotation in a very strong phenolic insulator. The stator assembly is attached directly to the detent plate insuring positive indexing. Heavy silver-plated contacts provide dependable and efficient operation. They may be used for simple circuit switching and wherever space is at a premium. Each switch is supplied with one knob, mounting nut and lock washer. Packaged in individual durable sealed plastic bags and the familiar Erie display box.

Order by Part Number from Table Below

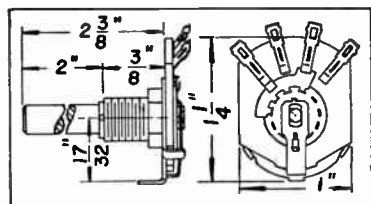

Erie No. Shorting Type	Type Indexing	Number of Circuits	Number of Positions
3612-23	Positive	1	3
3612-24	Positive	1	3
3612-25	Positive	2	3

THE SPEMCO LINE

H & H SWITCHES

SPEMCO SWITCHES BALL LEVER TOGGLE SWITCHES



Underwriters' approved, 3 amp. 125 volts, laminated bakelite base. Nickel plated finished.

No.	Description	Sleeve	List Price
1120	SPST	1/2"	\$0.80 ea.
1121	SPST	1"	1.00 ea.
1122	SPDT	1/2"	1.00 ea.
1123	SPDT	1"	1.15 ea.
1124	DPST	1/2"	1.40 ea.
1125	DPST	1"	1.65 ea.
1126	DPDT	1/2"	1.65 ea.
1127	DPDT	1"	1.80 ea.

BAT LEVER TOGGLE SWITCHES



Underwriters' approved. 3 amp. 125 volts, laminated bakelite base. Nickel plated finished.

No.	Description	Sleeve	List Price
1135	SPST	1/2"	\$0.80 ea.
1121-B	SPST	1"	1.00 ea.
1136	SPDT	1/2"	1.00 ea.
1123-B	SPDT	1"	1.15 ea.
1137	DPST	1/2"	1.40 ea.
1125-B	DPST	1"	1.65 ea.
1138	DPDT	1/2"	1.65 ea.
1127-B	DPDT	1"	1.80 ea.

MOLDED BAKELITE SWITCH, BAT LEVER



Underwriters' approved, 6 amp. 125 volts, 3 amp. 250 volts. Back connected, slotted sleeve.

No.	Description	Sleeve	List Price
1142	SPST	1/2"	\$1.15 ea.
1143	SPDT	1/2"	1.25 ea.
1144	DPST	1/2"	1.70 ea.
1145	DPDT	1/2"	2.00 ea.



ON AND OFF PLATE

No.	List Price
1132	\$0.06 ea.



UTILITY SWITCHES TOGGLE TYPE

Underwriters' approved, 10 amp. 250 volts AC, 15 amp. 125 volts AC, 3/4 H.P. 115V-230V AC.

No.	Description	Sleeve	List Price
1185	SPST	1/2"	\$1.25 ea.
1186	SPDT	1/2"	1.50 ea.
1188	DPST	1/2"	2.15 ea.

PUSH BUTTON DOUBLE ACTION SWITCH



Underwriters' approved, 3 amp. 250 volts. Press lever to make contact, press lever to break contact. Nickel plated finish.

No.	Description	Sleeve	List Price
1156	SP	1/2"	\$1.35 ea.

MOMENTARY BAT LEVER TOGGLE SWITCHES



Underwriters' approved, 3 amp. 125 volts, laminated bakelite base. Nickel plated finished.

No.	Description	Sleeve	List Price
1166	SPST	1/2"	\$1.45 ea.
1167	SPDT	1/2"	1.55 ea.
1155	DPST	1/2"	1.90 ea.
1150	DPDT	1/2"	2.15 ea.

MOMENTARY PUSH BUTTON SWITCH



Underwriters' approved, 1 amp. 125 volts AC. Nickel plated finish. Laminated bakelite base. Single Pole, slow make and slow break, normally off, with bakelite snap-on button in red or black.

No.	Button	Sleeve	List Price
1157-A	Red	1/2"	\$1.40 ea.
1157-B	Black	1/2"	1.40 ea.

Two circuit slow make and slow break, momentary switch. One circuit normally on, the other off, with snap-on plastic button, in red or black. (Pushing the button reverses the contact.)

No.	Button	Sleeve	List Price
1158-A	Red	1/2"	\$1.50 ea.
1158-B	Black	1/2"	1.50 ea.



Underwriters' approved, 1 amp. 125 volts AC. Momentary contact. Nickel plated finish.

No.	Description	Sleeve	List Price
1141	SP Normally ON	1/2"	\$1.00 ea.
1141-A	SP Normally OFF	1/2"	1.00 ea.

MOLDED BAKELITE MOMENTARY PUSH BUTTON SWITCH, NORMALLY OFF



Underwriters' approved, 6 amp. 125 volts, 3 amp. 250 volts. Back connected, slotted sleeve.

No.	Description	Sleeve	List Price
1146	SPST	1/2"	\$2.00 ea.
1147	SPDT	1/2"	2.20 ea.
1148	DPST	1/2"	2.45 ea.
1149	DPDT	1/2"	2.70 ea.

ROTARY SWITCHES



Underwriters' approved, 3 amp. 125 volts. Nickel plated finish. Laminated bakelite base.

No.	Description	Shaft	Sleeve	List Price
1128	SPST	1/4"	1/4"	\$1.20 ea.
1129	SPDT	1/4"	1/4"	1.30 ea.
1130	DPST	1/4"	1/4"	1.75 ea.
1131	DPDT	1/4"	1/4"	1.95 ea.



ROTO-LOCK SWITCH

Underwriters' approved, 3 amp. 250 volts.

No.	Description	Sleeve	List Price
1128-K	SPST	1/2"	\$1.60 ea.
1128-KA	Key only for above		0.30 ea.

BAT LEVER TOGGLE SWITCH NEUTRAL CENTER



Underwriters' approved, 6 amp. 125 volts, either AC or DC. A 3 position switch, on-off-on. Black bakelite case.

No.	Description	Sleeve	List Price
1175	SPDT	1/2"	\$2.10 ea.
1176	DPDT	1/2"	2.35 ea.



Underwriters' approved, 10 amp. 250 volts AC, 15 amp. 125 volts AC, 3/4 H.P. 115V-230V AC.

No.	Description	Sleeve	List Price
1187	SPDT	1/2"	\$1.55 ea.

SPECIALTIES MANUFACTURING CO. • DETROIT 38, MICH.

POWER SWITCHES



Underwriters' approved, 10 amp. 125 volts. Size of case 1 7/8" long, 1 1/2" wide, 1 1/2" high.

No.	Description	Sleeve	List Price
1133	SPST	1 1/2"	\$1.60 ea.



Underwriters' approved, 12 amp. 125 volts. Size of case, 1 3/4" long, 3/4" wide, 3/8" high.

No.	Description	Sleeve	List Price
1159	DPST	1 3/4"	\$1.90 ea.



Underwriters' approved, 12 amp. 125 volts, size of case 1 3/4" long, 3/4" wide, 3/8" high.

No.	Description	Sleeve	List Price
1159-B	DPST	1 3/4"	\$1.90 ea.



Underwriters' approved, 15 amp. 125 volts. Size of case, 2" long, 1" wide, 3/8" high.

No.	Description	Sleeve	List Price
1134	DPST	1 3/4"	\$2.85 ea.
1134-Bat	DPST	1 3/4"	2.85 ea.



Fully enclosed tumbler switch, 20 amp. 250 volts, 1 1/2 horsepower, 250 volts. Size of case, 2 1/4" long, 1 1/2" wide, 1 1/2" high.

No.	Description	Sleeve	List Price
1170	DPST	1 3/4"	\$4.75 ea.

ROTARY CANOPY SWITCH With Fixed Plastic Handle



No.	Stem	Wire Lead	List Price
1179	3/8"	8"	\$0.60 ea.

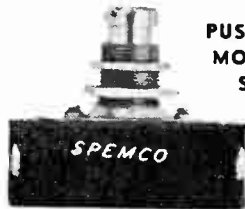

PUSH BUTTON MOMENTARY SWITCH

This switch is primarily intended as a safety switch to be used as an interlock connection on doors of dangerous high voltage devices when they are opened. Rated at 12 amp. 125 volts, 1 horsepower, 250 volt AC. Normally OFF. Size of case, 1 3/4" long, 3/4" wide, 3/8" high.

No.	Description	Sleeve	List Price
1160	DPST	1 3/4"	\$2.70 ea.

EXTRA HEAVY DUTY SWITCHES NEUTRAL CENTER



Used in heavy current circuits, such as transformers, power amplifiers, motors, etc. Contacts arranged to be wired from the back for simplicity in wiring. Approved by Underwriters' at 10 amp. 250 volts, 15 amp. 125 volts, 1/2 H.P. 110V-220V A.C., 2 1/4" long, 3/4" wide, 1 1/2" high.

No.	Description	Sleeve	List Price
1161	DPDT	1 3/4"	\$6.25 ea.

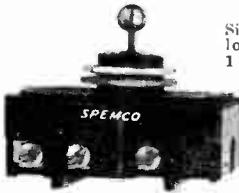

Size of case, 2 1/4" long, 2" wide, 1 1/2" high. Rated 10 amp. 125 volts, 1/2 horsepower, 115-230 volt AC.

No.	Description	Sleeve	List Price
1177	3 P DT	1 3/4"	\$ 8.25 ea.
1178	4 P DT	1 3/4"	12.00 ea.

CORD CONNECTORS



Brown Bakelite Cord Connector Complete, 3/8" O.D. x 2 1/2" long, 10 amps. 250 volts. End opening for wire size up to 5/8" O.D.

No.	List Price
1162	\$1.95 ea.

FEED THROUGH CORD SWITCH



Underwriters' approved, black bakelite case sliding lever, 10 amp. 125 volts, 5 amp. 250 volts, 3/8" cord hole.

No.	Description	List Price
1163	SP	\$1.85 ea.

All aforementioned switches are manufactured by H. & H. for S.M.C.

PORTABLE TOOL HANDLE SWITCHES

Tool handle switch, fully enclosed, normally OFF with locking latches. Rated and approved by the Underwriters' for 6 amp. 250 volts, 12 amp. 125 volts, 1 HP., 250 volts, 1 3/4" long, 3/4" wide, 3/8" high.

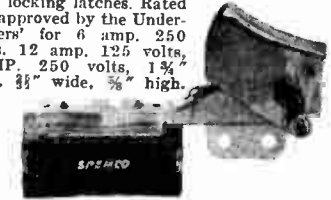

No.	Description	List Price
1168	DPST	\$3.35 ea.



Small tool switch, mechanism fully enclosed in bakelite case. Rugged construction, current carrying parts made of phosphor bronze and contacts of hard drawn copper. Contacts arranged to be wired from the back for simplicity in wiring. Approved by Underwriters' at 10 amp. 250 volts, 15 amp. 125 volts, 1/2 H.P. 110V-220V A.C., 2 1/4" long, 3/4" wide, 1 1/2" high.

No.	Description	List Price
1172	DP	\$4.10 ea.



This switch is arranged with momentary contacts, normally OFF. Approved by the Underwriters' at 10 amp. 250 volts, 15 amp. 125 volts, 2 3/8" long, 3/8" wide, 1 1/4" high.

No.	Description	List Price
1173	DP Trigger Lever	\$4.25 ea.

All aforementioned switches are manufactured by H. & H. for S.M.C.

SLIDE SWITCHES

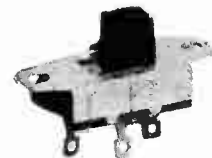

Housings are made of steel and are cadmium plated 1 1/2" long, 3/8" wide and 1 1/4" mounting centers.

No.	Description	List Price
1180	SPST .75A-125V AC-DC	\$0.31 ea.
1181	SPDT .75A-125V AC-DC	0.37 ea.
1182	DPST .5GA-125V AC-DC	0.44 ea.
1183	DPDT .50A-125V AC-DC	0.55 ea.

SPECIALTIES MANUFACTURING CO. • DETROIT 38, MICH.

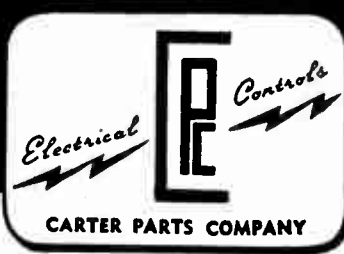

Carter

PARTS COMPANY

213 INSTITUTE PLACE, CHICAGO 10, ILLINOIS
FORMERLY CARTER RADIO DIVISION OF UTAH RADIO PRODUCTS

CARTER "imp" PHONE PLUGS



Fits standard 2-conductor jacks $\frac{1}{4}$ " diameter. New types now stocked for wide range of uses. For headphones, microphones, speakers, musical instruments, medical and test equipment, many others.

Molded handles. Metal Shield handles. Bright nickel plated with internal 2-layer, high quality tubular insulators, preventing short circuits in handle.

(A) "imp" Phone Plug—Trend to miniaturization is reflected in the new "imp" phone plug. All features same as standard plug but $\frac{1}{2}$ " diameter handle.

(B and C) Carter Two Conductor Phone Plugs—Old standby original Carter "imp" two conductor phone plug. General purpose type. Screw type terminals designed to take phone tips singularly or in pairs, slide lugs. Screws are binding head terminal type. Handles $\frac{1}{8}$ " diameter, $2\frac{1}{16}$ " long. Type B uses molded black phenolic handle. Type C has nickel plated handle.

Part Number	Type	Handle	Circuit	Terminal
P1	A	Black	2 Conductor	Clamp Type
P2	A	Red	2 Conductor	Clamp Type
P3	A	Metal	2 Conductor	Clamp Type
P4	A	Black	2 Conductor	Screw Type
P5	A	Red	2 Conductor	Screw or Clamp Type
P6	A	Metal	2 Conductor	Screw Type
P7	A	Black	2 Conductor	Lug Type
P8	A	Red	2 Conductor	Lug Type
P9	similar to A	Short Metal	2 Conductor	Lug Type
P10	similar to A	Black	3 Conductor	Clamp Type
P11	except 3	Red	3 Conductor	Clamp Type
P12	conductor	Metal	3 Conductor	Clamp Type
P24	B	Black $\frac{1}{8}$ dia.	2 Conductor	Screw Type
P26	C	Metal $\frac{1}{8}$ dia.	2 Conductor	Screw Type



(D and E) Two-Conductor Portable Jacks—Used on end of extension cord. Fits 2-conductor plugs. Screw terminals take one pair phone tips, terminals or wires. Shield handles have tubular insulator to prevent short circuits. Ideal for use in connecting audio and recording equipment. (J-80 and J-82).

"imp" PUSHBUTTON SWITCHES



These switches are similar in general construction to the widely popular Carter "Imp" Short Jacks. Finest nickel-silver springs with integral contacts. High grade phenolic insulation. Body, nuts and washers bright nickel-plated. Red or black Catalin 1-piece shaft and button. Springs fully insulated from the mounting bushing and shaft.

Made in three circuit arrangements:

- IS-10 Series: "Make" contact, single circuit, normally open
- IS-20 Series: "Break" contact, single circuit, normally closed
- IS-30 Series: "Break-Make" contacts, single circuit, double throw

Description	Circuit	Contact Arrangement	Red Pushbutton Stock No.	Black Pushbutton Stock No.
One-piece combined shaft and pushbutton. Mount in $\frac{3}{8}$ " hole in panels up to $\frac{1}{8}$ " thick. Supplied with one nickel-plated hex. nut and washer.		"Single Make"	IS-11	IS-13
		"Single Break"	IS-21	IS-23
		"One Break-Make"	IS-31	IS-33

CARTER TELEPHONE JACKS



Circuit	Function	Part Numbers	
		AJ-Frame	CJ-Frame
	Break Contact on Tip Spring	J-120	J-132
	Open Circuit	J-108	J-175
	Separate Make	J-181	J-151
	Break Contact on Tip Spring, and Separate Break Contacts	J-125	J-169

SPECIFICATIONS

CONTACTS: Silver-zinc alloy is standard. Coin silver, fine silver and others can also be supplied in production quantities.

BUSHING: Plain brass is standard. Available with nickel-plate when specified.

SPRINGS: Finest grade nickel silver with soldering terminals hot tinned for easy soldering.

INSULATION: Spacers made of high grade laminated phenolic.

FRAME: Frame and face plate cadmium plated steel. Frame and face plate are electrically brazed to form one integral unit. This provides outstanding strength and superior ability to "stand the gaff." Where paramount quality and ruggedness is desired this telephone jack is recommended.

Carter "imp" Telephone Jacks can be supplied in many circuit combinations to suit your requirements. They are ideal for use in telephone, broadcast studio and audio equipment.

CARTER'S "imp" PLUNGER SWITCH

- Wiping-Rotating Action
- Minimum Arcing
- No Impact Load on Plunger
- No Corroding Carbides or Oxides
- Silver Plated Contactor and Terminals

Electrical Specifications and Types Available: Carter's "imp" Plunger switch is available in a variety of mountings to meet most demands for this type of a switch.

Electrical Specs: "Imp" plunger switch is designed to handle $\frac{3}{4}$ Amperes at 100-125 Volts, $\frac{1}{4}$ Amperes at 250 Volts.

CIRCUITS: Normally closed.



LONG AND SHORT FRAME JACKS



LONG JACKS . . . The original long jacks were adapted from the telephone switchboard jacks. Long rugged, phosphor-bronze springs parallel to the plug axis give precise action. These jacks take minimum panel mounting space, less than the short jacks. Supplied with nickel-plated Palnut.



SHORT JACKS . . . Carter short jacks are small and compact, but do a full-sized job. Depth behind the panel is cut down by placing the tempered nickel-silver springs parallel to the panel. High quality sheet phenolic and tubular ebonite insulators are used throughout—no paper or fibre used in Carter Jacks. Supplied with nickel-plated Palnut.

Short and long jacks mount in single $\frac{3}{8}$ " hole in panels up to $\frac{1}{8}$ " thick. Fit of the plug in the jack is not affected by the thickness of the panel. Fit all standard plugs in two and three conductor types. Cadmium plated steel frame. All contacts between springs are fine silver, giving minimum contact resistance.

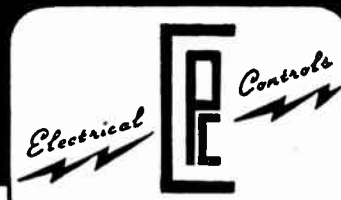

Carter

PARTS COMPANY

CARTER PARTS COMPANY

213 INSTITUTE PLACE, CHICAGO 10, ILLINOIS
FORMERLY CARTER RADIO DIVISION OF UTAH RADIO PRODUCTS

CARTER "Imp" JACKS

Schematic	Part No.	Description
	J1	2 conductor—open circuit
	J2	2 conductor—closed circuit
	J3	3 conductor—open circuit
	J4	3 conductor—closed circuit on tip spring
	J5	3 conductor—closed circuit on sleeve spring
(Same as J1)	*J6	2 conductor—open circuit
(Same as J3)	*J7	3 conductor—open circuit
	J8	2 conductor—break-make circuit
	J9	2 conductor—separate break circuit
	J10	2 conductor—separate make circuit
(Same as J1)	J11	2 conductor—open circuit
(Same as J2)	J12	2 conductor—closed circuit
	J13	3 conductor—closed circuit grounded
	J14	same as J4 except .2085" dia. bushing
	J15	same as J5 except .2085" dia. bushing
	J16	2 conductor—closed circuit grounded
	J17	same as J7 except .2085" dia. bushing
(Same as J2)	*J20	2 conductor—closed circuit XXXX Laminate insulation

* Built to meet JAN Specs.

"Imp" SHORT JACKS

- J-1 Open Circuit "Imp" Short Jack—Has tip and sleeve circuits only.
- J-2 Closed Circuit "Imp" Short Jack—Similar to J-1 with an additional spring making contact with tip spring until plug is inserted.
- J-3 Microphone "Imp" Short Jack—A new 3-conductor jack having tip, ring and sleeve circuits. Fits standard 3-circuit 1/4" dia. microphone plugs.

Inquire regarding JAN Specs. Jacks and Plugs

SHORT PUSHBUTTON SWITCHES Non-Locking and Locking Types

Silver contacts for minimum resistance. High-quality, nickel-silver spring. Bright cadmium-plated steel frame. Highest quality insulation used throughout. Mount in single 3/8" hole in panels up to 3/8" thick. Supplied with 1/2" polished black bakelite button and set-screw, nickel-plated hex, mounting nut and washer.

Circuit	Contact Arrangements	Non-Locking Type	Locking Type
	Single Make Contact	422-M	422-AM
	Single Break Contact	422-B	422-AB
	Single Break-Make Contact	433	433-A
	Two Make Contacts	444-M	444-AM
	Two Break Contacts	444-B	444-AB
	Two Break-Make Contacts	666	666-A

VARIABLE RESISTORS — Wire Wound Type



Standard Specifications

The shaft and housing are constructed of steel, cadmium plated. Bushing and hex. nuts are brass, but can be supplied nickel-plated. Terminals are made of steel, silver-plated over copper plate. Insulating material as described for individual types. Low temperature coefficient wire used on all units except where physical size of wire will not permit.

Stock Number		Resist. Ohms	Stock Number		Resist. Ohms
Pots.	Rheos.		Pots.	Rheos.	
MP-1/2	MR-1/2	1/2	MP-40	MR-40	40
MP-1	MR-1	1	MP-50	MR-50	50
MP-2	MR-2	2	MP-75	MR-75	75
MP-3	MR-3	3	MP-100	MR-100	100
MP-6	MR-6	6	MP-200	MR-200	200
MP-10	MR-10	10	MP-400	MR-400	400
MP-15	MR-15	15	MP-500	MR-500	500
MP-20	MR-20	20	MP-1000	MR-1000	1000
MP-25	MR-25	25	MP-1500	MR-1500	1500
MP-30	MR-30	30			

Type MP — 3 WATT RATING

Stock No.	Value in Ohms	Stock No.	Value in Ohms	Stock No.	Resist. Ohms	Stock No.	Resist. Ohms
RCP-10	10	RCP-800	800	PW-100	100	PW-1M	1000
RCP-20	20	RCP-1M	1000	PW-150	150	PW-2M	2000
RCP-30	30	RCP-2M	2000	PW-200	200	PW-3M	3000
RCP-50	50	RCP-3M	3000	PW-250	250	PW-5M	5000
RCP-100	100	RCP-4M	4000	PW-300	300	PW-7500	7500
RCP-200	200	RCP-5M	5000	PW-400	400	PW-10M	10000
RCP-300	300	RCP-6M	6000	PW-500	500	PW-20M	20000
RCP-400	400	RCP-10M	10000	PW-800	800	PW-50M	50000
RCP-500	500	RCP-15M	15000				
RCP-600	600						

Type RCP—4 WATT RATING

Type PW—15 WATT RATING

WATCH FOR NEW CARTER HI-WATT CONTROL

CARTER "T" & "L" PAD WIREWOUND ATTENUATORS



(LW) 4-WATT "L" PADS ENCLOSED SINGLE TYPE. BODY: 1 7/8" diameter, 1 1/2" deep. BUSHING: 3/8" diameter, 3/8" long. SHAFT: 1/4" diameter, 1 1/2" long, from bushing. Mount in single 3/8" hole.

(TA) 10-WATT "T" PADS OPEN FRAME TYPE. BODY: 2 1/4" diameter, 3/4" deep. BUSHING: 7/8" diameter, 3/8" long. SHAFT: 1/4" diameter, 7/8" long, from bushing.

(LE) 8-WATT "L" PADS ENCLOSED DUAL TYPE. BODY: 1 7/8" diameter, 1 1/2" deep. BUSHING: 3/8" diameter, 3/8" long. SHAFT: 1/4" diameter, 1 1/2" long, from bushing.

(LA) 15-WATT "L" PADS OPEN FRAME TYPE.

STOCK NO.	IMPEDANCE
LW/TA/LE/LA—8	8 Ohms
LW/TA/LE/LA—16	16 Ohms
LW/TA/LE/LA—50	50 Ohms
LW/TA/LE/LA—200	200 Ohms
LW/TA/LE/LA—500	500 Ohms
LW/TA/LE/LA—1000	1000 Ohms

WATCH FOR NEW CARTER HI-WATT CONTROL

TYPE AD ADJUSTABLE WIREWOUND RESISTOR

The Carter Type AD Resistor is an inexpensive and compact adjustable resistor capable of dissipating one watt. The arm is slotted for ease of adjustment. Its sturdy construction permits mounting either by its terminals or through the large eyelets.

Stock No.	Resist. in Ohms	Stock No.	Resist. in Ohms
AD-10	10	AD-200	200
AD-20	20	AD-250	250
AD-25	25	AD-400	400
AD-40	40	AD-500	500
AD-50	50	AD-750	750
AD-75	75	AD-1000	1000
AD-100	100	AD-2000	2000



MINIATURE TAP SWITCHES

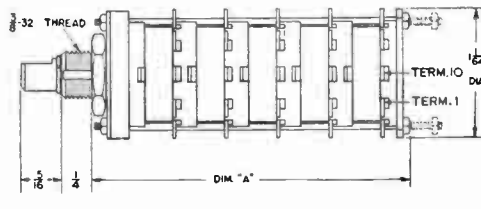
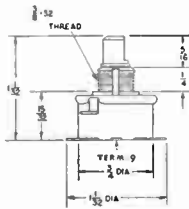

Designed to meet current miniaturization trend — all models are tested to 10,000 complete cycles (one cycle equals one complete rotation both clockwise and counter-clockwise). All metal parts on these switches are plated to withstand 100 hours salt spray exposure in accordance with QQ-M-151a.



SERIES 5000

Available up to 6 Decks—2 to 10 contact positions per deck
Shorting (make before break) or Non-shorting (break before make)
Note: Add "S" following switch number to designate shorting contacts

Rated to break—1 amp., 115 v., A.C., non-inductive
To carry—5 amps., 115 v., A.C.
Bushing keyway .066" wide, .036" deep.
Bushing 1/4" Long—3/8-32 thread.

Number of Decks or Poles	DIM. "A"	NUMBER OF POSITIONS PER DECK OR POLE									
		2	3	4	5	6	7	8	9	10	
1	See Single Deck Drawing	5002 \$0.75	5003 \$0.80	5004 \$0.85	5005 \$0.90	5006 \$0.95	5007 \$1.00	5008 \$1.05	5009 \$1.10	5010 \$1.15	
2	1-1/4	5202 \$2.65	5203 \$2.70	5204 \$2.74	5205 \$2.78	5206 \$2.82	5207 \$2.86	5208 \$2.90	5209 \$2.94	5210 \$2.98	
3	1-21/32	5302 \$2.88	5303 \$3.00	5304 \$3.12	5305 \$3.24	5306 \$3.36	5307 \$3.48	5308 \$3.60	5309 \$3.72	5310 \$3.84	
4	2-1/16	5402 \$3.42	5403 \$3.58	5404 \$3.74	5405 \$3.90	5406 \$4.06	5407 \$4.22	5408 \$4.38	5409 \$4.54	5410 \$4.70	
5	2-15/32	5502 \$3.96	5503 \$4.16	5504 \$4.36	5505 \$4.56	5506 \$4.76	5507 \$4.96	5508 \$5.16	5509 \$5.36	5510 \$5.56	
6	2-7/8	5602 \$4.50	5603 \$4.74	5604 \$4.98	5605 \$5.22	5606 \$5.46	5607 \$5.70	5608 \$5.94	5609 \$6.18	5610 \$6.42	

SERIES 24

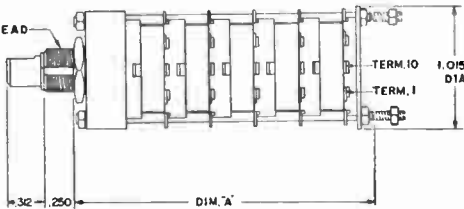

Provides more positive detent action and better feel for precision requirements.
Available up to 6 decks—2 to 10 contact positions per deck.
Shorting (make before break) or non-shorting (break before make).
Note: Add "S" following switch number to designate shorting contacts.
Rated to break—1 amp., 115 v., A.C., non-inductive.
To carry—5 amps., 115 v., A.C.
Bushing keyway .066" wide, .036" deep.
Bushing 1/4" Long—3/8-32 thread.

Number of Decks or Poles	DIM. "A"	NUMBER OF POSITIONS PER DECK OR POLE									
		2	3	4	5	6	7	8	9	10	
1	.969	24YY2031-2 \$3.58	24YY2031-3 \$3.69	24YY2031-4 \$3.80	24YY2031-5 \$3.91	24YY2031-6 \$4.02	24YY2031-7 \$4.13	24YY2031-8 \$4.24	24YY2031-9 \$4.35	24YY2031-10 \$4.46	
2	1.391	24YY2032-2 \$4.27	24YY2032-3 \$4.38	24YY2032-4 \$4.49	24YY2032-5 \$4.60	24YY2032-6 \$4.71	24YY2032-7 \$4.82	24YY2032-8 \$4.93	24YY2032-9 \$5.04	24YY2032-10 \$5.15	
3	1.766	24YY2033-2 \$4.96	24YY2033-3 \$5.12	24YY2033-4 \$5.29	24YY2033-5 \$5.45	24YY2033-6 \$5.62	24YY2033-7 \$5.78	24YY2033-8 \$5.95	24YY2033-9 \$6.12	24YY2033-10 \$6.28	
4	2.141	24YY2034-2 \$5.65	24YY2034-3 \$5.87	24YY2034-4 \$6.09	24YY2034-5 \$6.31	24YY2034-6 \$6.53	24YY2034-7 \$6.75	24YY2034-8 \$6.97	24YY2034-9 \$7.19	24YY2034-10 \$7.41	
5	2.516	24YY2035-2 \$6.33	24YY2035-3 \$6.60	24YY2035-4 \$6.88	24YY2035-5 \$7.15	24YY2035-6 \$7.43	24YY2035-7 \$7.70	24YY2035-8 \$7.98	24YY2035-9 \$8.25	24YY2035-10 \$8.53	
6	2.891	24YY2036-2 \$7.04	24YY2036-3 \$7.37	24YY2036-4 \$7.70	24YY2036-5 \$8.03	24YY2036-6 \$8.36	24YY2036-7 \$8.69	24YY2036-8 \$9.02	24YY2036-9 \$9.35	24YY2036-10 \$9.68	

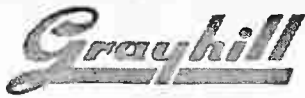

PUSH BUTTON SWITCHES for Manual Operation

SERIES 2000 Snap-action



Momentary contact, single pole, single throw.
Rated Life—approx. 50,000 operations
Terminals—solder type only
Housing and Button—molded phenolic
O. D.— $\frac{7}{16}$ " dia. x 1-59/64" overall length
Rated 10 amps., 115 v., A.C., non-inductive
Bushing $\frac{1}{8}$ " long— $\frac{1}{8}$ -32 NS-2 thread

Model No. 2201—Normally open (Red Button) \$1.65 ea.
Model No. 2202—Normally closed (Black Button) \$1.65 ea.

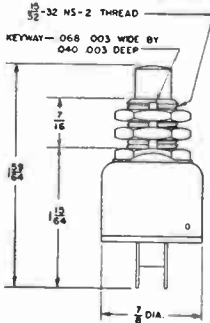

SERIES 4000

Momentary Contact for Manual Operation

Single pole, single throw
Rated Life— $\frac{1}{2}$ amp., approx. 800,000 operations
1 amp., approx. 100,000 operations
Terminals—solder type only
Housing and Button—molded phenolic
O. D.— $\frac{51}{64}$ " dia. x $1\frac{1}{2}$ " overall length
Rated $\frac{1}{2}$ amp., 115 v., A.C., non-inductive
Bushing $\frac{3}{8}$ " long— $\frac{1}{8}$ -32 NS-2 thread

Model No. 4001—Normally open (Red Button) \$0.60 ea.
Model No. 4002—Normally closed (Black Button) \$0.60 ea.

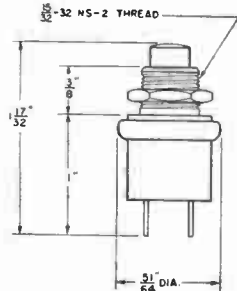

SERIES 23

Momentary Contact Miniature Switch

Single pole, single throw
Rated Life—approx. 500,000 operations
Terminals—solder type only
Housing and Button—molded phenolic
O. D.— $\frac{1}{2}$ " dia. x 1-3/64" overall length
Rated $\frac{1}{4}$ amp., 115 v., A.C., non-inductive
Bushing $\frac{1}{4}$ " long— $\frac{1}{8}$ -32 NS-2 thread

Model No. 23-1—Normally open (Red Button) \$0.75 ea.

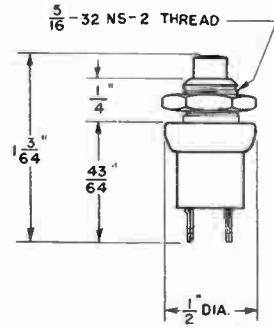

TEST CLIPS

(Shown actual size)

Dependable, positive contact is always insured — speed and convenience in testing of assembly line products and experimental apparatus in the laboratory is greatly facilitated by these spring action clips.

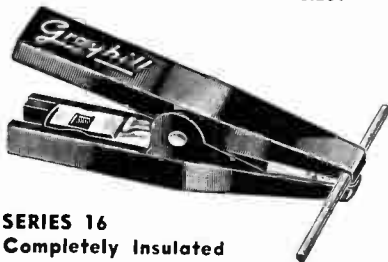

SERIES 16 Completely Insulated

Finger grip—molded phenolic. Hinge pin—totally enclosed in nylon tubing. Low contact resistance (approx. .0015 ohm) is insured by an .008" silver overlay on the contacting surface. Terminals—silverplated for easy soldering.

No. 16-B (Black) \$0.75 ea.

No. 16-R (Red) \$0.75 ea.



SERIES 2 TEST CLIPS

No. 2-0 Threaded Stud

Spring clip for positive contact
Price—\$0.15 ea.

No. 2-1 →
Banana Plug
Ideal for "Q" Meters and similar precision testing
Price—\$0.30 ea.

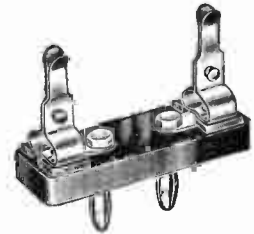

No. 2-2—Plug-in Adapter
Designed to greatly simplify the testing of resistors, capacitors, germanium diodes, and similar pigtail type components. Banana plugs are spaced on $\frac{3}{4}$ " centers for use with the type of jacks predominantly used on laboratory test equipment.
Price \$1.25 ea.



TWIN-LINE CONNECTORS

No. 14-0

General purpose polarized connector
Price — \$0.84 net

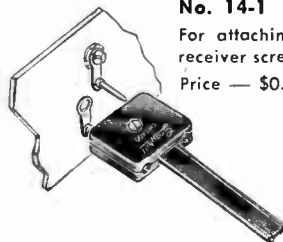

No. 14-1

For attaching direct to receiver screw terminals
Price — \$0.45 net

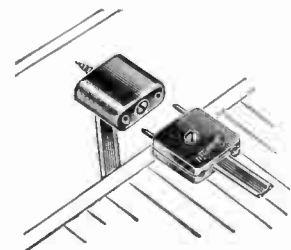

No. 14-2 —Baseboard type
Price — \$0.84 net



Note: Also request complete information on Grayhill Molded Plastic Parts including: Stand-off Insulators, Germanium Crystal Holders, Insulating Shoulder Washers, Coil Forms, etc.

La Grange, Illinois

HETHERINGTON

AIRCRAFT-TYPE SWITCHES AND INDICATOR LIGHTS

"JR" SWITCHES

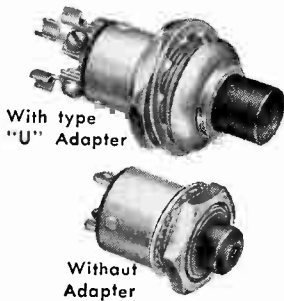

"JR" Series PUSH BUTTON SWITCHES

Momentary Contact

Exceptionally rugged and durable. Hetherington "JR" Series switches are available with any of 20 anodized aluminum adapters for practically any mounting requirement. "JR" Series switches have the patented Hetherington snap-action mechanism which positively cannot be "teased" on or off contact and provides exceptionally fast make-and-break for reduced arcing and contact wear. Contact surfaces and terminals are of heavy silver overlay on a copper base. Terminals are molded in phenolic and cannot be torn loose by heavy wires.

RATINGS: 10 amps resistive load, 5 amps inductive load, 3 amps lamp load at 115 volts ac or 30 volts dc. U.L. Approved for ac. 50,000 cycles minimum life under rated loads.

CONTACT ARRANGEMENTS: Normally open, Normally closed, 2-circuit,

3-terminal N.O., 3-terminal N.C., or SP-DT.

DIMENSIONS: (Basic switch, without adapter): $1\frac{3}{8}$ " l. x $\frac{3}{8}$ " diam. Mounts in $\frac{1}{2}$ " panel hole. Weight $\frac{1}{4}$ oz.

MOUNTING ADAPTERS: See Hetherington Catalog for dimensions and listings of over 20 types.

Subminiature INDICATOR LIGHTS and SWITCH-LIGHT COMBINATIONS

These tiny, light-weight Hetherington indicator lights are sturdily constructed for military and industrial uses where long, trouble-free service under adverse conditions is a requisite. All types use standard AN-3140 lamps with ratings of 6, 12, or 28 vdc. Removable plastic lens caps available in amber, blue, green, red, or white. Write for details on any type.

SERIES L1000: (A) For regular panel mounting in $\frac{1}{2}$ " hole. Supplied with removable insulating bushings, spacers, and ground terminal. Sealed against moisture. $1\frac{1}{8}$ " l. by $\frac{1}{8}$ " diam. Also available for edge-lit panel mounting as Series L2000.

SERIES L6000: (B) Subminiature indicator or warning light with exceptionally wide visibility. Unique bevelling of long plastic lens "pipes" light throughout entire periphery. Lens and lamp removable as a unit from the front. For standard or edge-lit panels. Mounts in $\frac{1}{8}$ " panel hole. Lens extends $\frac{3}{4}$ " beyond panel. $1\frac{1}{2}$ " overall length x $\frac{1}{2}$ " diam.

SERIES L3000: (C) "Push-to-Test" indicator lights. Lamp circuit is

"tested" by pressing spring-mounted plastic lens to make contact. Available with or without silicone boot for moisture protection. For flange-type mounting in $\frac{1}{2}$ " hole. Overall length, $1\frac{3}{8}$ ". Lens extends $\frac{3}{4}$ " from panel.

SWITCH-LIGHT COMBINATIONS: (D) Designed originally as hostess call lights, these space-saving Hetherington switches with built-in lights now serve many industrial uses as well. Types include: Push-pull snap switches with auxiliary momentary contact and lamp circuit. Push button momentary contact switch with auxiliary lamp circuit, and Push-on pull-off or Push-off pull-on switch with integral lamp circuit. Switch ratings up to 15 amps, ac-dc. Details on request.

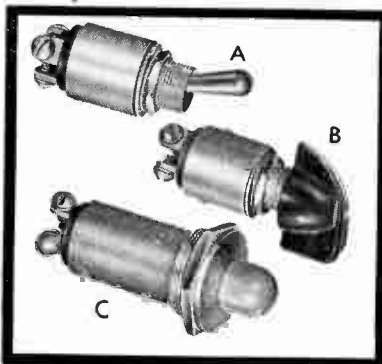
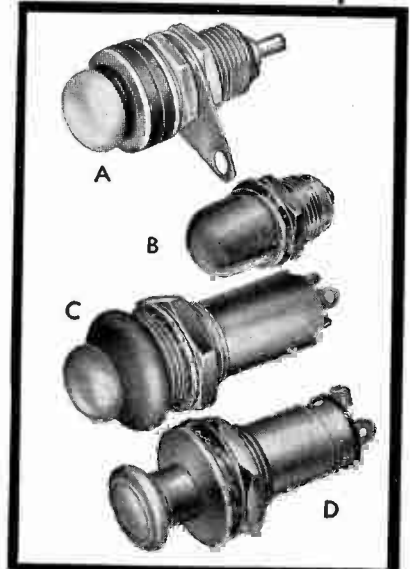

TOGGLE, ROTARY and "PUSH-PUSH" SWITCHES

Cam-roller action Hetherington switches positively cannot be "teased off" contact. Cylindrical anodized aluminum case reduces size by 25% over conventional rectangular switches. Continuous current ratings of 40 amps at 28 vdc or 115 vac. Write for details on any type.

SERIES T1000: (A) Bat-handle toggle switch. Available in: SP-ST on-off, SP-DT on-on, SP-ST momentary on—normally off, SP-ST momentary off—normally on, SP-DT on—momentary on. Mounts in $\frac{1}{2}$ " hole. Overall length inc. toggle: $2\frac{3}{8}$ ".

SERIES R1000: (B) Snap-action, rotary switch available in SP-ST or

SP-DT. Mounts in $\frac{1}{2}$ " hole. Overall length inc. $\frac{3}{8}$ " long shaft: $1\frac{3}{4}$ ".

SERIES J100: (C) "Push-Push" switch providing maintained contact with push button operation. SP-ST push-on push-off, or SP-DT available. Mounts in $\frac{3}{4}$ " hole. Overall length $2\frac{1}{8}$ ".

HETHERINGTON • INC.

SHARON HILL, PENNA., U.S.A.

West Coast Division: 8568 W. Washington Blvd., Culver City, California

INTER-MATIC TIME SWITCHES

A Complete Line of Quality Time Switches
For All Automatic Control Requirements

SERIES TS60

- Standard On-Off Time Switches



TS60SP

Recommended for automatic control of most electrical apparatus . . . neon signs, store window lighting, motors, fans, etc. Heavy duty—35 ampere rating . . . large, silver, snap-action contacts. Available in single pole, double pole and single pole-double throw models—125 or 250 volts.



TS60LV

MODEL TS60LV

FOR INDEPENDENT SWITCHING

Designed for switching low voltage thermostats to control heating and air conditioning systems. Separate terminals provided for connecting timing motor which operates on line voltage. Available in 125 or 250 volts (motor rating).



TS65SP

PORTABLE PLUG-IN TIME SWITCH

Similar to TS60SP except that case is equipped with receptacle and 6 ft. cord set. Recommended for all-around use on farms, in the home, and stores.

Model Number	Switch	Amps per Pole	Voltage 60 Cycles	List Price
TS60SP	SPST	35	125	\$10.95
TS60SP-2	SPST	17.5	250	11.95
TS60DP	DPST	35	125	12.95
TS60DP-2	DPST	17.5	250	13.95
TS60SPDT	SPDT	35	125	12.95
TS60SPDT-2	SPDT	17.5	250	13.95
TS60LV	SPST	35	125	10.95
TS60LV-2	SPST	17.5	250	11.95
*TS65SP	SPST	15	125	12.95

For 125 volts-50 cycles, 125 volts-25 cycles, or 250 volts-50 cycles add \$1.00. All models U.L. approved except TS65SP.

*Portable plug-in—available only in 125 volts-60 cycle.

INTER-MATIC TIME-ALL

- Portable Plug-in Appliance Timer

For all-around use in the home, office or store. Ideal for converting any radio to a clock-radio; for controlling lights when no one is at home; for defrosting refrigerators (user selects defrost starting time to meet his needs); for controlling de-humidifiers, coffee-makers, broilers, fans, etc. Has manual control with automatic reset. Unique feature permits manual control without automatic reset, for continuous "off" or "on." Minimum on time — one hour; maximum, 23 hours, 24-hour, large, easy-to-read, time dial. Plug-in receptacle for equipment to be controlled. Attractive light gray plastic case, in modern design. Has 2 wall-mounting holes in rear. Size, 5 x 4 x 2 1/2". Complete with 6 ft. cord, plug and full instructions. Shipping weight, 2 lbs. U.L. approved.

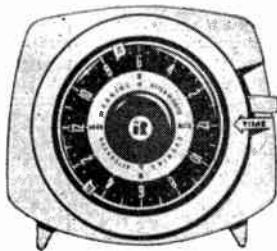

Model Number	Switch	Capacity	Volts (60 Cycles)	List Price
A211	SPST	15 amp. - 1650 watt	125	\$11.95

SERIES TS66 "SKIPPER"

- To Omit Operation On Selected Days



For control applications where it is desired to skip operation of the time switch on Saturdays, Sundays, or other selected days.

Recommended for fully automatic time control of air conditioning units, preheating of oil, lead, glue and melting pots, water softening equipment, signs, animated displays, heating, pumps, motors and other applications for industrial and commercial use where offices, factories, and stores are closed on weekends or holidays.

SIMPLE TO SET — EASY TO OPERATE

The Skipper has two dials, a time dial and a day dial. Day Dial is equipped with seven holes marked Mon., Tues., Wed., etc. Merely insert a screw in the hole beside each day or days on which operation is to be skipped. "On-Off" trippers operate in the regular manner. A special cutout tripper rotates the day dial every 24 hours.

The SKIPPER is also available in models for independent switching* and portable plug-in models.**

Model Number	Switch	Amps per Pole	Voltage 60 Cycles	List Price
TS66SP	SPST	35	125	\$16.95
TS66SP-2	SPST	17.5	250	17.95
TS66DP	DPST	35	125	18.95
TS66DP-2	DPST	17.5	250	19.95
TS66SPDT	SPDT	35	125	18.95
TS66SPDT-2	SPDT	17.5	250	19.95
TS66LV*	SPST	35	125	16.95
TS66LV-2*	SPST	17.5	250	17.95
TS66SP-S**	SPST	15	125	21.95

For 125 volts - 50 cycles, 125 volts - 25 cycles, or 250 volts - 50 cycles add \$1.00. All models U.L. approved except TS66SP-S.

**Portable plug-in—available only in 125 volts-60 cycles.

SERIES T670

- For Timings from 5 to 60 Minutes

EXCLUSIVE T670 FEATURE

Up to 12 trippers can be placed on the same dial, at one time, with each tripper set for different "on-off" cycles ranging from 5 to 60 minutes.

Recommended for commercial refrigeration defrosting, automatic poultry feeders, ventilating systems, process timing, intermittent pumping of oil and water wells, or any application where timings of less than one hour are desired.

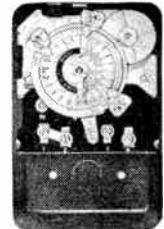

IT'S ALL IN THE TRIPPER

Specially designed trippers provide variable settings ranging from 5 to 60 minutes. A minute selector is provided for setting the number of minutes the "on-off" cycle will operate. To set the tripper, loosen set screw, move the minute-selector to the desired number of minutes shown on scale. Tighten the screw and return the tripper to the dial.

Model Number	Switch	Amps per Pole	Voltage 60 Cycles	List Price
T675	Can be used 3 ways — single pole, single throw normally open or normally closed, or single pole, double throw.	35	125	\$16.95
T676		17.5	250	17.95

For 125 volts-50 cycles, 125 volts-25 cycles, or 250 volts-50 cycles add \$1.00.

Prices include three trippers furnished with time switch.

Manufactured by INTERNATIONAL REGISTER CO.

BE RIGHT WITH OHMITE

RHEOSTATS
RESISTORS
SWITCHES
CHOKES

POWER TAP SWITCHES NON-SHORTING TYPE



Each switch is a non-shorting, single pole, rotary, multi-position unit, but switches can be ordered assembled 2 or 3 in tandem (2 maximum, 5 taps, for Model 111) to form multipole assemblies. All ceramic insulation, large, solid silver-to-silver contacts, and "slow-break" action especially designed for alternating current use establish new standards of dependability and performance. Switch shafts are electrically "dead"—insulated by strong ceramic hubs. Contacts and mechanism are entirely enclosed and protected (except for the Model 111).

MODEL 111 TAP SWITCH

Alternating Current Rating 10 Amps. 150 Volts—Diameter 1 3/4" — Shaft Diameter 1/4" — Standard Mounting: For 1/4" panel maximum, by means of 3/8"-32 threaded bushing and hex. nut.

Depth Behind Panel		Single Unit		2 in Tandem	
		1 1/8"		2 3/4"	
No. of Taps	Total Rotation	Stock Number	List *Price	Stock Number	List *Price
11	300°	111-11	\$4.67
10	270°	111-10	4.53
9	240°	111-9	4.53
8	210°	111-8	4.36
7	180°	111-7	4.36
6	150°	111-6	4.19
5	120°	111-5	4.19	111-5-T2	\$16.22
4	90°	111-4	4.06	111-4-T2	15.89
3	60°	111-3	4.06	111-3-T2	15.89
2	30°	111-2	4.06	111-2-T2	15.89
Recommended Knobs		Stock No. 5150 or 4516		Stock No. 4509 or 4510	

*Without Knob.

MODEL 212 TAP SWITCH

Alternating Current Rating 15 Amps. 150 Volts—Diameter 2 1/4" — Shaft Diameter 1/4" — Standard Mounting: For 1/4" panel maximum, by means of 3/8"-32 threaded bushing and hex. nut. Tandem Mounting: For 1/4" panel maximum, three No. 10-32 flat-head machine screws 3/8" long.

Depth Behind Panel		Single Unit		2 in Tandem		3 in Tandem	
		1 3/4"		4 1/8"		6 3/16"	
No. of Taps	Total Rotation	Stock No.	List *Price	Stock No.	List *Price	Stock No.	List *Price
12	330°	212-12	\$11.70	212-12-T2	\$31.50	212-12-T3	\$46.80
11	300°	212-11	11.70	212-11-T2	31.50	212-11-T3	46.80
10	270°	212-10	11.31	212-10-T2	30.78	212-10-T3	45.64
9	240°	212-9	11.31	212-9-T2	30.78	212-9-T3	45.64
8	210°	212-8	10.95	212-8-T2	29.97	212-8-T3	44.47
7	180°	212-7	10.95	212-7-T2	29.97	212-7-T3	44.47
6	150°	212-6	10.53	212-6-T2	29.17	212-6-T3	43.30
5	120°	212-5	10.53	212-5-T2	29.17	212-5-T3	43.30
4	90°	212-4	10.14	212-4-T2	28.39	212-4-T3	42.14
3	60°	212-3	10.14	212-3-T2	28.39	212-3-T3	42.14
2	30°	212-2	10.14	212-2-T2	28.39	212-2-T3	42.14
Recommended Knobs		Stock No. 5150 or 4516		Stock No. 4509 or 4510		Stock No. 4509 or 4510	

*Without Knob.

MODEL 312 TAP SWITCH

Alternating Current Rating 25 Amps. 300 Volts, 150 V. A.C. between taps—Diameter 3 1/8"—Shaft Diameter 1/4"—Standard Mounting: For 1/4" panel maximum, three No. 10-32 flat-head machine screws 3/8" long.

Depth Behind Panel		Single Unit		2 in Tandem		3 in Tandem	
		2 1/4"		4 3/8"		7"	
No. of Taps	Total Rotation	Stock No.	List *Price	Stock No.	List *Price	Stock No.	List *Price
12	330°	312-12	\$16.36	312-12-T2	\$42.61	312-12-T3	\$64.44
11	300°	312-11	16.36	312-11-T2	42.61	312-11-T3	64.44
10	270°	312-10	16.00	312-10-T2	41.81	312-10-T3	63.17
9	240°	312-9	16.00	312-9-T2	41.81	312-9-T3	63.17
8	210°	312-8	15.61	312-8-T2	41.03	312-8-T3	62.11
7	180°	312-7	15.61	312-7-T2	41.03	312-7-T3	62.11
6	150°	312-6	15.20	312-6-T2	40.23	312-6-T3	60.83
5	120°	312-5	15.20	312-5-T2	40.23	312-5-T3	60.83
4	90°	312-4	14.83	312-4-T2	39.48	312-4-T3	59.72
3	60°	312-3	14.83	312-3-T2	39.48	312-3-T3	59.72
2	30°	312-2	14.83	312-2-T2	39.48	312-2-T3	59.72
Recommended Knobs		Stock No. 4509 or 4510		Stock No. 4511 or 4512		Stock No. 4511 or 4512	

*Without Knob.

MODEL 412 TAP SWITCH

Alternating Current Rating 50 Amps. 300 Volts, 150 V. A.C. between taps—Diameter 4 1/8"—Shaft Diameter 1/4"—Standard Mounting: For 1/4" panel maximum three No. 10-32 flat-head machine screws 3/8" long.

Depth Behind Panel		Single Unit		2 in Tandem		3 in Tandem	
		2 1/8"		5 1/8"		7 3/8"	
No. of Taps	Total Rotation	Stock No.	List *Price	Stock No.	List *Price	Stock No.	List *Price
12	330°	412-12	\$21.84	412-12-T2	\$53.50	412-12-T3	\$80.81
11	300°	412-11	21.84	412-11-T2	53.50	412-11-T3	80.81
10	270°	412-10	20.89	412-10-T2	51.64	412-10-T3	78.00
9	240°	412-9	20.89	412-9-T2	51.64	412-9-T3	78.00
8	210°	412-8	20.50	412-8-T2	50.87	412-8-T3	76.83
7	180°	412-7	20.50	412-7-T2	50.87	412-7-T3	76.83
6	150°	412-6	19.56	412-6-T2	49.00	412-6-T3	73.94
5	120°	412-5	19.56	412-5-T2	49.00	412-5-T3	73.94
4	90°	412-4	19.11	412-4-T2	48.03	412-4-T3	72.53
3	60°	412-3	19.11	412-3-T2	48.03	412-3-T3	72.53
2	30°	412-2	19.11	412-2-T2	48.03	412-2-T3	72.53
Recommended Knobs		Stock No. 4511 or 4512		Stock No. 4511 or 4512		Stock No. 4511 or 4512	

*Without Knob.

MODEL 608 TAP SWITCH

Alternating Current Rating 100 Amps. 300 Volts—Diameter 6"—Shaft Diameter 3/8"—Standard Mounting: For 1" panel maximum, three flat-head machine screws 1/4"-20 x 1 1/4".

Depth Behind Panel		Single Unit		2 in Tandem		3 in Tandem	
		3 3/8"		6 1/8"		10 3/8"	
No. of Taps	Total Rotation	Stock No.	List *Price	Stock No.	List *Price	Stock No.	List *Price
8	280°	608-8	\$46.81	608-8-T2	\$108.90	608-8-T3	\$160.14
7	240°	608-7	46.81	608-7-T2	108.90	608-7-T3	160.14
6	200°	608-6	45.23	608-6-T2	105.79	608-6-T3	155.47
5	160°	608-5	45.23	608-5-T2	105.79	608-5-T3	155.47
4	120°	608-4	43.67	608-4-T2	102.65	608-4-T3	150.78
3	80°	608-3	43.67	608-3-T2	102.65	608-3-T3	150.78
2	40°	608-2	43.67	608-2-T2	102.65	608-2-T3	150.78
Recommended Knobs		Stock No. 4508 or 4515 or 4517		Stock No. 4508 or 4515 or 4517		Stock No. 4515	

*Without Knob.

ADC

TRUE! — more ADC Plugs and Jacks in broadcast use today than those of any other manufacturer.

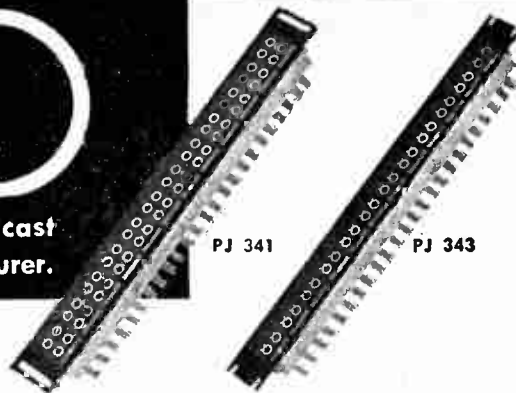

JACKS

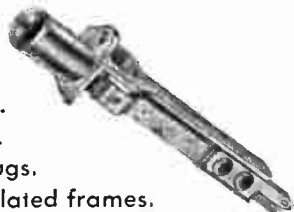

Nickel silver springs.
Silver alloy contacts.
Tinned connecting lugs.
Die formed, nickel plated frames.
Standard dimensions, interchangeable with any telephone type jack using a 1/4-inch plug.
Spring arrangements available as follows:

Figures

FIG.	FIG.	TYPE	FIG.	LIST
FIG. 1	FIG. 2	PJ 116	1	\$1.70
FIG. 3	FIG. 4	PJ 318	2	1.27
		PJ 125	3	1.70
		PJ 123	4	1.16
FIG. 6	FIG. 7	PJ 117	6	1.60
		PJ 203	7	1.38
		PJ 115	8	1.48
FIG. 8	FIG. 9	PJ 638	9	1.70
		PJ 339	9	1.92

For use with plugs PJ-5 PL-55 WE-47 except PJ 339, use with WE-291.

JACK PANELS

Constructed of solid bakelite, reinforced with steel.
Slotted mounting brackets for use in 19" relay racks.
Spacing prevents cross connection of adjacent circuits with double plug.
Designation strip included on all panels.
Single panel holds 24 jacks, requires 1 3/4" panel space.
Double panel holds 48 jacks, requires 2 1/8" panel space.

TYPE	DESCRIPTION	LIST
PJ 31	Double, less Jacks	\$15.75
PJ 33	Single, less Jacks	14.20
PJ 341	Double, with 48 PJ 318 Jacks	75.00
PJ 343	Single, with 24 PJ 318 Jacks	44.10

PLUGS

Interchangeable with standard plugs as shown.
Designed for easy assembly and cord replacement.
Insulated for 500 V. RMS. breakdown.



TYPE	EQUIVALENT	NO. COND. (Ea. Plug)	LIST
PJ-1	WE 241	3	\$4.60
PJ-5	PL55, WE47	2	1.30

In addition to the plugs, jacks, and jack panels illustrated above — ADC manufactures a custom line of iron core components, such as transformers, filters, reactors and chokes, designed and built in production quantities to your specifications. For complete information address your inquiry to:

PATCH CORDS

Best quality tinned copper 2 conductor stranded wire.
Heavy braided cover, with 6" reinforcement at each end.
Shield normally grounded both ends.

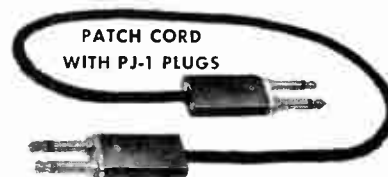

LENGTH	CORD WITH PJ-1 PLUGS		CORDS WITH PJ-5		REPLACE-MENT CORDS ONLY	
	LIST	LIST	LIST	LIST	LIST	LIST
1-Foot	PJ 11	\$12.10	PJ 51	\$6.05	PJ 21	\$2.50
2-Foot	PJ 12	12.35	PJ 52	6.38	PJ 22	2.75
3-Foot	PJ 13	12.65	PJ 53	6.82	PJ 23	2.90
4-Foot	PJ 14	13.10	PJ 54	7.37	PJ 24	3.00
5-Foot	PJ 15	13.45	PJ 55	7.92	PJ 25	3.15

A LEADER IN THE CUSTOM TRANSFORMER FIELD SINCE 1934

AUDIO DEVELOPMENT COMPANY

— TRIMM —

PLUGS • JACKS • PATCH CORDS • JACK PANELS

STANDARD PHONE PLUGS



The standard radio phone plug, widely used on P. A., etc., equipment. Designed to fit all standard jacks and available in both two and three conductor types. The "511" series, the two conductor plugs, are provided with binding head screws in terminal, handles of molded bakelite or metal when shielded plugs are required. The "513" series are three conductor types. The "515" adapter couples Amphenol type mike plug to standard phone jack.

No. 511—Black plastic shell	\$.65
No. 511-1—Red plastic shell65
No. 511-2—Shielded, single piece shell	1.05
No. 511-3—Shielded, two piece shell	1.65
No. 511-4—Shielded, stubby shell90
No. 513—Three circuit, black plastic shell	1.40
No. 513-3—Shielded, two piece shell	2.00
No. 515—Adapter50

"514" MIN-A-PLUG



Developed especially for shielded microphone cable. Wing type terminal clamps directly onto cord shield. Center conductor solders to lug. Also widely used for ordinary cords.

No. 514—Black plastic shell	\$.65
No. 514-1—Red plastic shell65
No. 514-2—Shielded, single piece shell	1.00
No. 514-3—Shielded, stubby shell85

"512" PLUG

Compact, non-protruding design. Bakelite body, nickel plated tip and sleeve. Cord pin tips held by set screw.



No. 512—Black	\$.75
No. 512-1—Red75

"518" PLUG — "562" JACK



Two circuit miniature disconnect plug and jack series. Ideal for small size cordage. Plugs have two grooved, parallel pins which engage with multi-leafed contact springs in jack. No. 518 and 562 have acetate half shells cemented together. No. 518-7 has molded bakelite shells held together with screws.

No. 518—Plug	\$.72
No. 518-7—Plug80
No. 562—Jack80

"501" and "509" PLUGS



Well known PL-55 and PL-68 types respectively. Brass body, precision profiled and polished. Shell of acetate. The "501" series are two conductor types having sleeve diameter of 0.250". The "509" series are three conductor types having sleeve diameter of 0.206".

No. 501—Black plastic shell	\$1.60
No. 501-1—Red plastic shell	1.60
No. 509—Black plastic shell	4.15

PATCH CORDS and PLUGS



Widely used by majority of radio stations. "840" series cord assembly uses TRIMM No. 506 twin plug and high quality shielded cord. Plug self-aligning.

Number following "840" represents length.

No. 506—Plug	\$ 4.65
No. 840-1-PP—Cord Assembly	12.00
No. 840-2-PP—Cord Assembly	12.50
No. 840-3-PP—Cord Assembly	13.00
No. 840-4-PP—Cord Assembly	13.45
No. 840-5-PP—Cord Assembly	13.95
No. 840-6-PP—Cord Assembly	14.40
No. 840-10-PP—Cord Assembly	16.30

No. "841" series patch cords use a single triple-circuit plug No. 517. Two program circuits connect to tip and ring, ground going to sleeve of plug.

No. 517—Single, three-circuit plug	\$ 4.15
No. 841-1-PP—Cord Assembly	11.28
No. 841-2-PP—Cord Assembly	11.55
No. 841-3-PP—Cord Assembly	11.99

Other lengths cords available—4, 6, and 10 ft. Replacement cords also available for all standard patch cord assemblies. See TRIMM Bulletin R-15 for complete listing.

JACK PANELS

TRIMM "96" series. Most widely used, and intended for use with standard twin type patch cords. Mounts on standard 19 inch rack; single row 1 3/4" wide, double row 2 3/8" wide. Constructed of bakelite, reinforced with steel. Designation strip included on panel.



No. 96-01—Single row, 12 pair jacks	\$45.00
No. 96-02—Double row, 24 pair jacks	82.00

See TRIMM Bulletin R-23 for complete listing.

JACKS



"90" SERIES

Uses the commonly known telephone type construction. Bushing at end of frame of brass, unthreaded, jack mounted by means of screw in back side of panel. Frame, steel, zinc plated dichromate treated for maximum corrosion resistances. Springs are nickel silver, contacts are of palladium-silver alloy. Standard dimensions, interchangeable with any similar type jack. More common circuits listed at right, all other circuits not shown available.

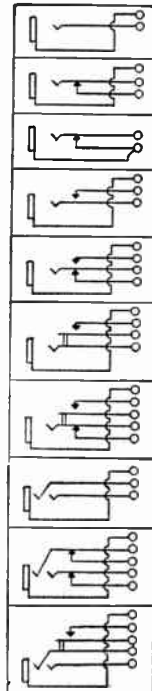

CODE No.	LIST
90-01	\$1.15
90-02	1.25
90-03	1.25
90-04	1.25
90-05	1.40
90-06	1.40
90-07	1.80
90-25	1.30
90-26	1.80
90-27	1.90

"95" SERIES

Provide low cost jack suitable for P.A., etc., applications. Panel mounting by means of threaded bushings, fits in 3/8" dia. hole, panels up to 3/8" thick. Projects behind panel 3/4". Spring contacts of nickel silver, held in place by interlocking insulating washers. Circuits designated similar to "90" series.



No. 95-01—Open circuit	\$.40
No. 95-02—Closed circuit48

NOTE: For more detailed information on TRIMM phone plugs and jack including a large variety not listed here, see Bulletins R-15, R-18, R-21 and R23.



RELAYS FOR AMATEUR AND INDUSTRIAL USES



MINIATURE RELAYS

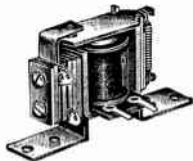

These units are very compact and are especially designed for plate circuit and general purpose control application. Overall dimensions: MR 1 1/2" x 1 3/8" x 7/8".—MRD 1 7/8" x 1 3/8" x 1 1/4". Contacts are fine silver rated 5 amps at 115 V. All AC relays are free from hum and AC chatter. The MR-2 and MRD-2 have 2500 ohm

coil, will pick up at 6 ma. and 12 ma. respectively. The MR-5 and MRD-5 have 5000 ohm coils, will pick up at 3 ma. and 7.5 ma. respectively. The drop out value of these relays is approximately 50% of the pick up value.

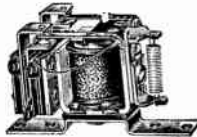

MRD

Type	A.C.	D.C.	Contacts	Net Prices
MR-2		Plate Circuit	SPDT	\$2.10
MR-5		Plate Circuit	SPDT	2.40
MR-6		6 V.	SPDT	2.10
MR-7	6 V.		SPDT	2.19
MR-11	110 V.		SPDT	2.19
MRD-2		Plate Circuit	DPDT	3.60
MRD-5		Plate Circuit	DPDT	3.90
MRD-6		6 V.	DPDT	3.60
MRD-7	6 V.		DPDT	3.69
MRD-11	110 V.		DPDT	3.69

OVERLOAD RELAYS

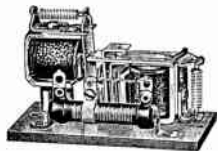

Adjustable overload relays provide accurate and positive protection against current surges and continuous overloads. Contact arrangements SPDT using 1/16" fine silver contacts. This allows the use of either audible or visual signal to advise of overload. All models are of the electrical reset type which allows remote control resetting of the relay. Size—3 3/4" x 2" x 1 1/2".

Type	Current Range	Reset Coil	Net Prices
OA-2	250-500 ma.	110 V. A.C.	\$5.40
OA-5	500-1000 ma.	110 V. A.C.	5.40
OC-2	250-500 ma.	6 V. A.C.	5.40
OC-5	500-1000 ma.	6 V. A.C.	5.40
OD-2	250-500 ma.	6 V. D.C.	5.40
OD-5	500-1000 ma.	6 V. D.C.	5.40

LATCHING RELAYS

These relays are employed where it is not desirable to have current continuously on the coil. The latching arrangement is such that when the relay coil is energized the armature closes and locks in a closed position by mechanical latching. An electrical impulse on the reset coil releases the armature from the latch and allows the relay to assume its initial position. 3/16" fine silver contacts. Bakelite Base. Size—3 3/4" x 2" x 3/4".



Type	Reset Coil	Pull-in Coil	Net Prices
LEA	110 Volts A.C.	110 Volts A.C.	\$4.50
LEA-6	6 Volts A.C.	6 Volts A.C.	4.50
LED	6 Volts D.C.	6 Volts D.C.	4.50

COMMUNICATION RELAYS

Ideally suited for use in telephone, remote control, signaling, communications circuits etc. High speed operation plus high sensitivity with high contact pressure. Contacts will handle 4 amps at 115 V. non-inductive load. Each relay has one make and one break contact sets. Size—3 3/4" x 1 9/16" x 1 1/8".



Type	Res. of Coil Ohms	Volts Pick-up	M.A. Pick-up	Net Prices
T10G	10,000	31	3.2	\$4.20
T63F	6,300	24	4.0	4.20
T40F	4,000	19	5.0	4.05
T10F	1,000	10	10.0	3.75
T25E	250	5	20.0	3.45
T10E	100	3	31.6	3.45

ANTENNA CHANGE-OVER

Mycalex Insulation is satisfactory for operation up to 60 MC. Triple-X insulation for operation up to 15 MC. All models use 3/16" fine silver wiping action contacts rated at 4 amps. These relays are designed with ball-bearing armature pivot and have large contact spacing to assure minimum capacity between contact arms. The armature is designed so as to eliminate AC chatter. Size—3 3/8" x 3 1/8" x 2 3/16".

Type	Insulation	Coil Voltage	Net Prices
ABA	TRIPLE-X	110 V. A.C.	\$4.50
ABD	TRIPLE-X	6 V. D.C.	4.50
AMA	MYCALEX	110 V. A.C.	5.70
AMD	MYCALEX	6 V. D.C.	5.70



BREAK-IN RELAYS

Same type of relay as above only two additional poles are added, one normally open, one normally closed. This arrangement is perfect for PUSH-TO-TALK control. Contacts etc. identical with Antenna-Change-Over Relay. Size—4 1/2" x 3 3/8" x 2 3/16".



Type	Insulation	Coil Voltage	Net Prices
BBA	TRIPLE-X	110 V. A.C.	\$5.70
BBD	TRIPLE-X	6 V. D.C.	5.70
BMA	MYCALEX	110 V. A.C.	7.50
BMD	MYCALEX	6 V. D.C.	7.50

R.F. AND GENERAL PURPOSE RELAY

An excellent relay for R.F. or high voltage remote control. Contacts are 3/16" fine silver rated 4 amps. Designed with extremely short R.F. path, Ball-bearing armature pivot. All metal parts cadmium plated. RB Series are TRIPLE-X insulated for frequencies up to 15 MC., RM series are MYCALEX insulated for frequencies up to 60 MC. Size—2 1/4" x 3 1/4" x 2 3/16".

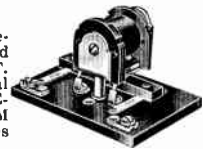

Type	Insulation	Contact Combination	Coil Voltage	Net Prices
RBA-1	TRIPLE-X	SPST (dble-break)	110 V. A.C.	\$3.30
RBD-1	TRIPLE-X	SPST (dble-break)	6 V. D.C.	3.30
RMA-1	MYCALEX	SPST (dble-break)	110 V. A.C.	4.05
RMD-1	MYCALEX	SPST (dble-break)	6 V. D.C.	4.05
RBA-2	TRIPLE-X	DPST (sgle-break)	110 V. A.C.	3.45
RBD-2	TRIPLE-X	DPST (sgle-break)	6 V. D.C.	3.45
RMA-2	MYCALEX	DPST (sgle-break)	110 V. A.C.	4.65
RMD-2	MYCALEX	DPST (sgle-break)	6 V. D.C.	4.65

KEYING RELAY

Same specifications as RB Series except that the coil and return spring are faster acting. Follows a "Bug" with ease.

Type	Coil Voltage	Contacts	Net Prices
KBA	110 V. A.C.	SPST (double-break)	\$3.30
KBD	6 V. D.C.	SPST (double-break)	3.30
KBA-6	6 V. A.C.	SPST (double-break)	3.30

MERCURY-SWITCH RELAY

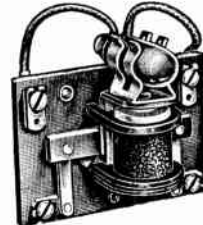

This type relay is used for controlling inductive loads and may be safely used in the presence of explosive dust, gas and vapor. This unit will safely handle a 1/4 H.P. motor or its equivalent. This single pole single throw mercury relay can easily be changed from normally open to normally closed by reversing the mercury tube in the clip. In addition this relay is equipped with SPST double break 3/16" fine silver contact sets which can be used to electrically lock this relay, or other applications. Mounts vertically with adjusting screws. Size—3 3/8" x 2 3/8" x 3 1/2".

Type	Coil Voltage	Net Prices
MSA	110 V. A.C.	\$4.50
MSA-6	6 V. A.C.	4.50
MSD-6	6 V. D.C.	4.50

TIME-DELAY RELAY

Low cost Thermostatic Time delay relays designed for transmitting and industrial use. Prevents damage to tube filaments due to application of plate current before filaments are thoroughly heated. TD-11 is equipped so that it automatically compensates for ambient temperature changes. Time delay can be adjusted by means of screwdriver. Stock models are 110 V. A.C. Size—3 3/8" x 3 1/8" x 2 3/16". TD-11 (10-60 Sec.)—With compensator. Net \$6.00

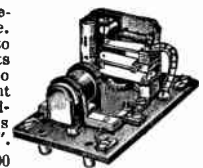



Potter & Brumfield

PRINCETON, INDIANA

STANDARD RELAYS

FOR EVERY ELECTRICAL AND ELECTRONIC APPLICATION

PR Series—HEAVY DUTY POWER RELAYS



PR 11

For across-the-line or starting circuits (up to 1 HP), heater loads up to 20 amp., remote break-in transmitter control, elevator control, electro-plating equipment or any similar circuit. Pure silver contacts rated 20 amp. (double break), 15 amp. (single break), 115 volts, 50-60 cy. AC non-inductive load. Re-inforced, one-piece molded plastic base; molded contact support integral with base.

Dimensions: PR1, 3, 5: $2\frac{1}{2}$ " x $2\frac{1}{2}$ " x $2\frac{5}{16}$ " high. PR 7: $2\frac{9}{16}$ " x $2\frac{1}{2}$ " x $2\frac{7}{16}$ " high. PR 11: $3\frac{3}{8}$ " x $2\frac{1}{2}$ " x $2\frac{3}{8}$ " high. Mounted with two $\frac{3}{16}$ " dia. holes on $1\frac{7}{8}$ " mounting centers. When ordering, specify coil voltages.

Contacts	A.C. RELAYS 6-12-24-115-230 Volts 50-60 Cy.		D.C. RELAYS 6-12-24-110 Volts	
	Type	Net	Type	Net
SPST-NO	PR1A	\$3.50	PR1D	\$3.50
SPST-NO-DB	PR3A	3.60	PR3D	3.60
SPDT	PR5A	3.80	PR5D	3.80
DPST-NO	PR7A	4.25	PR7D	4.25
DPDT	PR11A	5.70	PR11D	5.70
		Add 65c for 230V. coil.	Add 65c for 110 V. coil.	

MS Series—MOTOR STARTING RELAYS

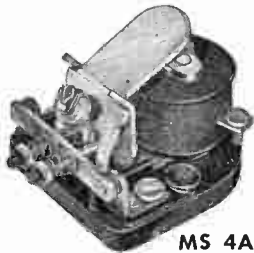

MS 4A

For hermetically sealed, explosion-proof or other capacitor start, induction-run motors. Operates on back EMF of running winding. Armature gap can be altered to change pull-in; 115-volt relay pulls in at 140 volts, releases at 40 volts; 230-volt relay pulls in at 255 volts, releases at 80 volts.

Dimensions: $2\frac{3}{4}$ " x $2\frac{1}{16}$ " x 2" high. Mounted with two $\frac{5}{32}$ " dia. holes on $1\frac{1}{16}$ " centers.

When ordering, specify motor voltage and horsepower.

Type	Net
Type MS2A: SPST-NC (1 form B), pure silver contacts for motors up to 1 HP	
For 115-volt 50-60 cy. motor	Net \$2.55
For 230-volt 50-60 cy. motor	Net \$2.65
Type MS4A: SPST-NC-DB (1 form V), silver cadmium oxide contacts for motors up to 3 HP	
For 115-volt, 50-60 cy. motor	Net \$3.75
For 230-volt, 50-60 cy. motor	Net \$3.85

MR Series—MEDIUM DUTY POWER RELAYS

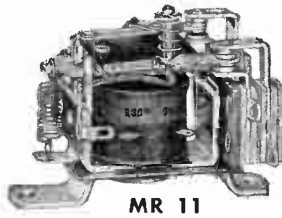

MR 11

For safety, signalling, protective, transmitter keying, photographic or electric sign circuits. Pure silver contacts rated 10 amp. double break, 8 amp. single break, 115 V 50-60 cy. AC non-inductive load.

Dimensions: Single pole units, $2\frac{31}{32}$ " x $1\frac{5}{16}$ " x $1\frac{5}{8}$ " high; double pole units, $2\frac{19}{32}$ " x $2\frac{3}{16}$ " x $1\frac{15}{16}$ " high. Mounted with two $\frac{3}{32}$ " dia. holes on $2\frac{5}{8}$ " centers.

When ordering, specify coil voltage.

Contacts	A.C. RELAYS 6-12-24-115-230 Volts 50-60 Cy.		D.C. RELAYS 6-12-24-110 Volts	
	Type	Net	Type	Net
SPST-NO	MR1A	\$2.25	MR1D	\$2.25
SPST-NO-DB	MR3A	2.90	MR3D	2.90
SPDT	MR5A	2.40	MR5D	2.40
DPST-NO	MR7A	3.20	MR7D	3.20
DPDT	MR11A	3.65	MR11D	3.65
3PDT	MR14A	4.40	MR14D	4.40
		Add 45c for 230 V. coil.	Add 45c for 110 V. coil.	

SP Series—HEAVY DUTY, SHOCK-PROOF RELAYS

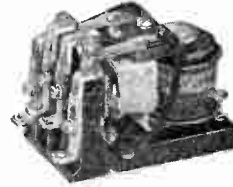

SP 11

For industrial equipment control circuits, transmitter keying circuits or any application requiring fast and positive repetitive action. Balanced armature withstands shock and vibration. Fine silver contacts rated 8 amps., double break, 5 amps., single break.

Dimensions: $2\frac{7}{16}$ " x $1\frac{5}{8}$ " x $1\frac{31}{32}$ " high. Mounted with two 6-32 tapped holes on $1\frac{3}{16}$ " centers.

When ordering, specify coil voltage.

Contacts	A.C. RELAYS 6-12-24-115 Volts 50-60 Cy.		D.C. RELAYS 6-12-24 Volts	
	Type	Net	Type	Net
DPDT	SP11A	\$4.75	SP11D	\$4.30

CONTACT LEGEND: S—Single; D—Double; P—Pole; T—Throw; N—Normally; O—Open; C—Closed; B—Break; M—Make.

Highest quality parts and workmanship throughout.

NOTE: All relays described are standard types and can be purchased direct from P&B distributors' stocks. When ordering specify type and coil voltage or resistance. Ex: "PR1A, 115 volts AC 60 cycles or LM5, 2500 ohms." To operate 110V DC relays on 220V DC put a 5 watt wire-wound resistor of a value approximating the relay coil resistance in series with the relay coil.



Potter & Brumfield

PRINCETON, INDIANA

KL Series—MULTIPLE CONTACT RELAYS



KL 17

Varied contact combinations and high dielectric phenolic insulation afford extreme versatility and utility. Especially suited for multiple switching in industrial applications where space is limited. Ex: machine tools, conveyors, automation circuits, etc. Pure silver contacts, rated 5 amps., 115 V 50-60 cy. AC non-inductive load.

Dimensions: KL5: $1\frac{15}{16}$ " x $1\frac{1}{32}$ " x $1\frac{15}{16}$ " high; KL11: $1\frac{15}{16}$ " x $1\frac{3}{8}$ " x $1\frac{7}{8}$ " high; KL14: $1\frac{15}{16}$ " x $1\frac{1}{16}$ " x $1\frac{15}{16}$ " high; KL17: $1\frac{15}{16}$ " x $1\frac{1}{16}$ " x $1\frac{15}{16}$ " high. Mounted with two 6-32 tapped holes on $1\frac{1}{16}$ " centers.

When ordering, specify coil voltage.

Contacts	A.C. RELAYS 6-12-24-115 Volts 50-60 Cy.		D.C. RELAYS 6-12-24-110 Volts	
	Type	Net	Type	Net
SPDT	KL5A	\$2.95	KL5D	\$2.75
DPDT	KL11A	3.40	KL11D	3.20
3PDT	KL14A	4.30	KL14D	4.00
4PDT	KL17A	5.80	KL17D	5.50

Add 65c for 110 V. coil.

KR Series—SMALL, LIGHT DUTY RELAYS

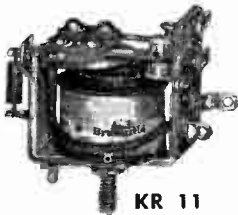

KR 11

Small, light-weight, sturdy. For medium or low power antenna switching or any circuit requiring transfer of low or medium voltages. Pure silver contacts rated 5 amps., 115V 50-60 cy. AC non-inductive load.

Dimensions: $1\frac{1}{8}$ " x $1\frac{3}{16}$ " x $1\frac{1}{16}$ " high. Mounted with single 6-32 screw.

When ordering, specify coil voltage.

Contacts	A.C. RELAYS 6-12-24-115 Volts 50-60 Cy.		D.C. RELAYS 6-12-24-110 Volts	
	Type	Net	Type	Net
SPDT	KR5A	\$2.20	KR5D	\$2.10
DPDT	KR11A	2.75	KR11D	2.65
3PDT	KR14A	3.50	KR14D	3.40

Add 75c to above prices for 110 V. coil.

LK Series—LATCHING RELAYS

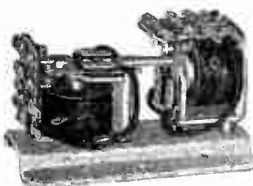

LK 17

Electrical latch, electrical release for automatic control of industrial machinery, safety or protective circuits. Readily adaptable to multi-circuit switching. Fine silver contacts rated 5 amps., 115 V 50-60 cy. AC non-inductive load. Coils withstand 500 V RMS breakdown.

Dimensions: $2\frac{29}{32}$ " x $1\frac{13}{16}$ " x $1\frac{25}{32}$ " high. Mounted with two $\frac{5}{32}$ " dia. holes on $1\frac{3}{8}$ " centers.

When ordering, specify coil voltage. (Available only with coils of the same voltage. Example: LK 17A, two 6 V 50-60 cy. coils; LK 17D, two 6 V DC coils.)

Contacts	Type	Coil Voltage	Net	Type	Coil Volt.	Net
4PDT	LK17A	6 V. 50-60 Cy.	\$6.90	LK17D	6 V. DC	\$6.75
4PDT	LK17A	12 V. 50-60 Cy.	6.90	LK17D	12 V. DC	6.75
4PDT	LK17A	24 V. 50-60 Cy.	6.90	LK17D	24 V. DC	6.75
4PDT	LK17A	115 V. 50-60 Cy.	6.90	LK17D	110 V. DC	8.25

KRP—ENCLOSED KR SERIES RELAYS

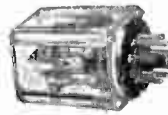

KRP 11

The KRP is the KR relay enclosed in a clear polystyrene, dust and weather-proof cover through which the actual working of the relay may be seen. Supplied with standard octal plug only.

Dimensions: $1\frac{13}{32}$ " x $1\frac{13}{32}$ " x 2" high (above socket).

When ordering, specify coil voltage.

Contacts	A.C. RELAYS 6-12-24-115 Volts 50-60 Cy.		D.C. RELAYS 6-12-24-110 Volts	
	Type	Net	Type	Net
SPDT	KRP5A	\$5.50	KRP5D	\$5.40
DPDT	KRP11A	6.05	KRP11D	5.95

Add 75c to above prices for 110 V. coil.

MH Series—MINIATURE TELEPHONE RELAYS



MH 17

Open Dimensions: $1\frac{1}{8}$ " x $2\frac{5}{32}$ " x $1\frac{3}{8}$ " high.

Extremely versatile. Fit hundreds of electrical or electronic circuits. 4 Form C pure silver contacts rated 5 amps., 115 V 50-60 cy. AC non-inductive load. Open relays mount with four 3-48 tapped holes on $\frac{3}{8}$ " x $\frac{3}{8}$ " centers.

Sealed units resist all climatic conditions. All-glass compression type header affords minimum leakage resistance of 10,000 megohms at 50% relative humidity; withstands high thermal shock. Metal housing. Mounts with three 6-32 studs on $\frac{1}{2}$ " x $1\frac{1}{4}$ " centers. Size: $1\frac{1}{16}$ " x $1\frac{1}{32}$ " x $2\frac{1}{32}$ " high.

Open and sealed DC units withstand better than 10G vibration and shock.

OPEN CONSTRUCTION		
Type	Coil Voltage	Net
MH17A	6 V. 50-60 Cy.	\$5.15
MH17A	24 V. 50-60 Cy.	5.30
MH17A	115 V. 50-60 Cy.	5.40
MH17D	6 V. DC	4.85
MH17D	24 V. DC	4.95

HERMETICALLY SEALED CONSTRUCTION		
Type	Coil Voltage	Net
MH17AM	6 V. 50-60 Cy.	\$12.45
MH17AM	24 V. 50-60 Cy.	12.55
MH17AM	115 V. 50-60 Cy.	12.65
MH17DM	6 V. DC	12.10
MH17DM	24 V. DC	12.20

RELAY DUST COVER No. 35D013

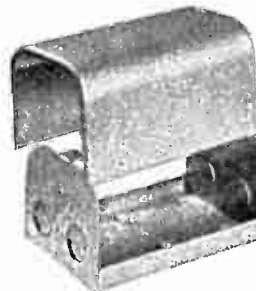

Protects relays in dust-laden atmosphere. Fits all PR relays; change in mounting holes for other P&B relays and tube sockets. Sheet steel base with 4 knock-outs; sheet aluminum cover with flanged ends fits down over base. Durable, hammerloid grey baked enamel finish.

Dimensions: $5\frac{3}{8}$ " x $3\frac{3}{8}$ " x $3\frac{1}{8}$ " high.

Net \$4.00



Potter & Brumfield

PRINCETON, INDIANA

AP Series—RATCHET, IMPULSE RELAYS

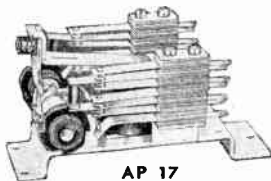

AP 17

For equipment requiring accurate repetitive switching. Stop mechanism assures positive positioning regardless of speed. Phenolic cams, wear-resistant nylon pawl and ratchet with pin-hinged armature. Fine silver contacts

rated 5 amps., 115 V 60 cy. AC non-inductive load. Dimensions: $3\frac{1}{16}$ " x $2\frac{5}{16}$ " x $2\frac{1}{4}$ " high. Mounted with three $\frac{5}{32}$ " diameter holes on $3\frac{3}{8}$ " x $\frac{7}{8}$ " centers. When ordering, specify coil voltage.

Contacts	A.C. RELAYS 6-12-24-115-230 Volts 50-60 Cy.		D.C. RELAYS 6-12-24-110 Volts	
	Type	Net	Type	Net
DPDT	AP11A	\$7.50	AP11D	\$7.50
4PDT	AP17A	9.00	AP17D	9.00
	Add 45c for 230 V. coil.		Add 65c for 110 V. coil.	

SU Series—MULTIPLE LEAF RELAYS

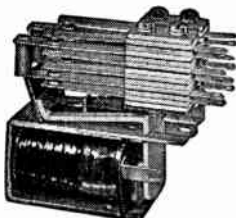

SU 17

For multiple switching in signal, temperature control, overload or underload protective circuits. Pure silver contacts rated 5 amps., 115 V 50-60 cy. AC non-inductive load.

Dimensions: $2\frac{9}{16}$ " x $1\frac{7}{16}$ " x $2\frac{7}{16}$ " high. Mounted with two 6-32 tapped holes on $\frac{7}{16}$ " centers. When ordering, specify coil voltage.

Contacts	A.C. RELAYS 6-12-24-115 Volts 50-60 Cy.		D.C. RELAYS 6-12-24-110 Volts	
	Type	Net	Type	Net
SPDT	SU5A	\$2.35	SU5D	\$2.35
DPDT	SU11A	2.95	SU11D	2.95
3PDT	SU14A	3.45	SU14D	3.45
4PDT	SU17A	4.00	SU17D	4.00
	Add 65c for 110 V. coil.			

LM Series—PLATE CIRCUIT RELAYS

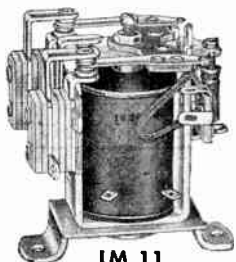

LM 11

For photo-electric control, counting, sorting, conveyor, safety interlock and similar automatic circuits. Fine silver contacts, rated 5 amps., 115 V 50-60 cy. AC non-inductive load. Tail spring adjustment screw provided to re-set pull-in.

Dimensions: LM5 $2\frac{5}{16}$ " x $1\frac{1}{4}$ " x $2\frac{7}{16}$ " high. Mounted with two 6-32 tapped holes on $1\frac{13}{16}$ " centers. LM11 $2\frac{3}{16}$ " x $2\frac{5}{32}$ " x $2\frac{1}{2}$ " high. Mounted

with two 6-32 tapped holes on $1\frac{13}{16}$ " centers. When ordering, specify coil resistance.

Contacts	Type	Coil Resistance	Factory Adjustment Pull in MA	Net
SPDT	LM5	2500 ohms	6.3	\$2.80
SPDT	LM5	5000 ohms	4.5	2.95
SPDT	LM5	10000 ohms	3.2	3.30
DPDT	LM11	2500 ohms	9.0	4.20
DPDT	LM11	5000 ohms	6.3	4.35
DPDT	LM11	10000 ohms	4.5	4.70

MB Series—MINIATURE DC CONTACTOR

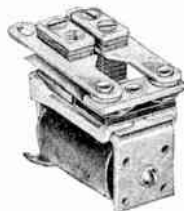

MB

Designed for very high current applications. Pure silver contacts and contact-shorting bar rated at 60 amperes non-inductive load, 28 V DC. Contact arrangement is 1 Form X (SPST—NO—DM). Contact arms are heavy brass with large, tinned solder terminals. These contactors pull in at 75% of nominal voltage.

Dimensions: $1\frac{5}{8}$ " x $2\frac{7}{32}$ " x $1\frac{3}{8}$ " high. Mounted with four 3-48 tapped holes on $\frac{3}{8}$ " centers.

When ordering, specify coil voltage.

Type	Coil Voltage	Coil Resistance	Net
MB3D	6 V. DC	13.3 ohms	\$4.00
MB3D	12 V. DC	62.3 ohms	4.00
MB3D	24 V. DC	245 ohms	4.00
MB3D	110 V. DC	3670 ohms	4.40

KCP Series—ENCLOSED PLATE CIRCUIT RELAYS



KCP

Constructed similar to KRP. Enclosed in polystyrene case with standard octal plug. For plate circuit use in photo-cell control or similar circuits. Fine silver contacts rated 2 amps., 115 V, 50-60 cy. AC non-inductive load.

Dimensions: $1\frac{13}{32}$ " x $1\frac{13}{32}$ " x 2" high. When ordering, specify coil resistance.

Contacts	Type	Coil Resistance	Factory Adjustment Pull in MA	Net
SPDT	KCP5	2500 ohms	7.2	\$5.85
SPDT	KCP5	5000 ohms	5.0	5.95
SPDT	KCP5	10000 ohms	3.6	6.35
DPDT	KCP11	2500 ohms	10.0	6.30
DPDT	KCP11	5000 ohms	7.2	6.40
DPDT	KCP11	10000 ohms	5.0	6.80

LS Series—PLATE CIRCUIT RELAYS



LS 5

A low-priced relay designed for use in photo-cell control units and similar plate circuit applications. Pull-in readjustable by bending tail spring hook. Pure silver, SPDT contacts, rated at 5 amperes, 115V AC; 28V DC non-inductive load.

Dimensions: $2\frac{11}{16}$ " x $1\frac{1}{4}$ " x $1\frac{3}{8}$ " high. Mounted with two $\frac{3}{16}$ " diameter holes on $2\frac{1}{32}$ " centers.

When ordering, specify coil resistance.

Contacts	Type	Coil Resistance	Factory Adjustment Pull in MA	Net
SPDT	LS5	2500 ohms	9.0	\$2.25
SPDT	LS5	5000 ohms	6.3	2.35
SPDT	LS5	10000 ohms	4.5	2.55

75A047—COIL BOBBIN KIT



Twenty-four assorted molded phenolic (85°C rise—1000 V RMS) bobbins—three each of 8 different sizes; core diameters from $\frac{1}{32}$ " to $\frac{3}{16}$ ". For industrials, experimenters and amateurs. Net \$1.50.



Potter & Brumfield

PRINCETON, INDIANA

SS Series—DC SUPER SENSITIVE RELAYS

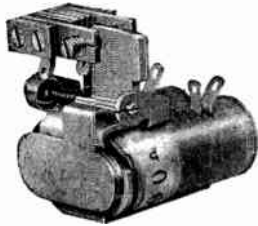

SS

For circuits requiring low energy operation such as photo-electric control, counting, sorting, batch monitor or safety interlock. Pure silver contacts rated 2 amps., 115 V 50-60 cy. AC or 28 V DC non-inductive load. Operates with 10G vibration resistance on 10 MW. Armature precision balanced on needle-point bearings; virtually friction-free movement. Dual

series coils give greater sensitivity.

Dimensions: $1\frac{1}{16}$ " x $1\frac{5}{16}$ " x $1\frac{1}{16}$ " high. Mounted with two 6-32 tapped holes on $\frac{23}{32}$ " centers.

Type	Contacts	Coil Resistance	Max. Pull In	Net
SS5D	SPDT	10,000 ohms	1.0 MA	\$9.90



SM

SM Series—MINIATURE RELAYS

Silver-rhodium contacts rated $\frac{1}{4}$ amp., 115 V 50-60 cy. AC non-inductive load or 28 V DC non-inductive load. Withstands 10G vibration up to 55 cps. Hermetically sealed in deep drawn steel can. Fits standard 7-pin miniature tube socket.

Dimensions: Height, $1\frac{1}{16}$ " (above socket); diameter, $\frac{3}{4}$ ". Contacts: SPDT.

SM5DS			SM5LS		
Nom. Voltage	Pull In V	Net	Coil Resistance Ohms	Pull In MA	Net
8.0	4.5	\$4.35	5000	3.8	\$4.85
24.0	18.0	4.35	10000	2.7	5.55



PW

PW Series—MINIATURE RELAYS

Pure silver contacts rated 2 amps., 115 V AC or 28 V DC non-inductive load. Withstands 10G vibration to 500 cps; 10G minimum shock. The PW is small, light weight. Hermetically sealed in deep drawn brass can. Fits standard 7-pin miniature tube socket.

Dimensions: $1\frac{21}{32}$ " high (above socket); $\frac{3}{4}$ " diameter. Contacts: SPDT.

PW5DS			PW5LS		
Nom. Voltage	Pull in V	Net	Coil Resistance Ohms	Pull in MA	Net
8.0	4.5	\$9.25	5000	2.8	\$9.55
24.0	18.0	9.70	10000	2.0	9.95

FR Series—PHOTO FLASH RELAYS



FR-5

For photo-flash units employing high voltage discharge through a gas-filled tube. Contacts designed to carry a high surge current without sticking, burning or pitting. Repetitive accuracy comparable to a precision built camera shutter. For intermittent duty.

Dimensions: $2\frac{31}{32}$ " x $1\frac{3}{16}$ " x $1\frac{5}{8}$ " high. Mounted with two $\frac{5}{32}$ " diameter holes on $2\frac{5}{8}$ " centers.

When ordering, specify voltage.

Type	Contacts	Coil Voltage	Net
FR5A	SPDT	6 Volts, 50-60 cy. AC	\$3.60 Net
FR5D	SPDT	2 Volts, DC	3.60 Net

MC Series—CERAMIC INSULATED RELAYS

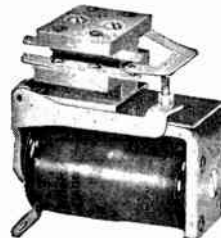

MC

Inter-contact capacitance, 1.5 mmfd. maximum. Ceramic contact spacers minimize losses at high frequencies. Pure palladium contacts, rated 1 amp., 28 V DC resistive load; 115 V 60 cy. AC non-inductive load. DC types withstand 10G vibration up to 300 cps and 25G shock.

Dimensions: $2\frac{5}{32}$ " wide x $1\frac{1}{32}$ " high x $1\frac{5}{16}$ " long.

Contacts	Type	Coil Voltage	Net
SPDT	MC5A	6 V. 50-60 cy. AC	\$3.80
SPDT	MC5A	115 V. 50-60 cy. AC	3.90
SPDT	MC5D	6 V. DC	3.50
SPDT	MC5D	24 V. DC	3.60

AF Series RELAY—400 CYCLE AC OPERATED

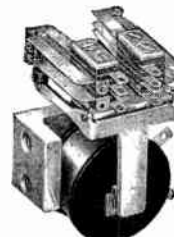

AF

For replacement in aircraft—also industrial or government experimental laboratories using 400 cycle AC power source. Fine silver contacts rated 5 amps., 115 V 60 cy. AC non-inductive load.

Contact arrangement 2 Form C. Coil voltage: 115 V, 400 cy. AC.

Dimensions: $1\frac{3}{8}$ " x $1\frac{1}{16}$ " x $1\frac{1}{8}$ " high. Price Net \$7.60

POTTER & BRUMFIELD RELAYS LEAD IN "USERSHIP"
—WITH OVER 20 YEARS SATISFACTION

ADVANCE RELAYS



POWER CONTROL TYPE

PG SERIES
(Formerly Series 9000/9100)

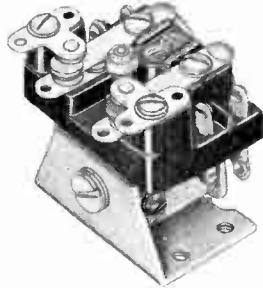

Size: H—1 $\frac{7}{8}$ " ; W—1 $\frac{1}{2}$ " ; L—1 $\frac{5}{8}$ "

Compact, uniquely-designed general-purpose double-pole relays. High magnetic strength, excellent wiping action and short blade structure. The many uses are extended by the small size — allowing practical hermetic sealing in a small enclosure. Vibration and shock are withstood easily by these relays due to the special armature and frame design. PG types can be built to meet Army-Navy specifications.

List Prices:

for 24 V.D.C. DPDT — order:	PG/2C/24VD	\$8.47
for 6 V.A.C. DPDT — order:	PG/2C/6VA	8.47
for 115 V.A.C. DPDT — order:	PG/2C/115VA	8.47
Max. coil voltage obtainable: 440 V.A.C. and 230 V.D.C.		
Contact ratings: 15 amperes @ 115 V.A.C. or 26.5 V.D.C. (Resistive)		
Max. operating power: 4.0 watts A.C., 2.0 watts D.C.		

SMALL COAXIAL TYPE

CS SERIES
(Formerly Series 7400/8400)

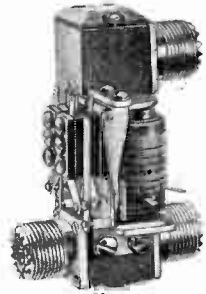

Size:
H—2 $\frac{1}{8}$ " ; W—2 $\frac{1}{2}$ " ; L—2 $\frac{1}{2}$ "

Designed for coaxial line switching in small space. Very low standing wave ratio. Excellent for use in mobile, aircraft, marine, experimental and fixed-station communications equipment. The CS type is engineered for peak performance on 52-ohm coaxial lines, and has $\frac{1}{8}$ " fine silver internal SPDT contacts. Will easily handle $\frac{1}{4}$ KW at frequencies to 300 megacycles. On special order, BNC or other type connectors, sometimes preferred by manufacturers, will be supplied.

List Prices:

for 115 V.A.C. SPDT — order:	CS/1C/115VA	\$15.73
for 115 V.A.C. (with DPDT aux.) — order:	CS/1C2C/115VA	17.55
for 6 V.D.C. (with DPDT aux.) — order:	CS/1C2C/6VD	17.55
Max. coil voltage obtainable: 220 V.A.C. and 150 V.D.C.		
Auxiliary contacts: 2 amperes @ 115 V.A.C. or 26.5 V.D.C. (Resistive)		

VERY SENSITIVE TYPE

SV SERIES
(Formerly Series 1200)

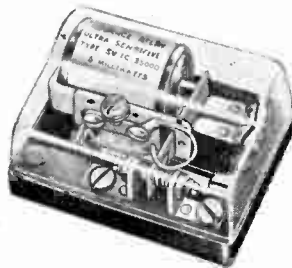

Size: H—1 $\frac{1}{2}$ " ; W—2" ; L—2 $\frac{3}{16}$ "

SV Series D.C. relays are incomparable for use in any circuit restricted to a few thousandths of a watt power consumption. Excellent operation in any position, even under extreme vibration and shock. Transparent, molded plastic covers. Sturdy molded bakelite bases have both screw and solder terminal connectors, and are easy to mount. Adjustments are easily made with the vernier screws which vary relay sensitivity from the 5-milliwatt factory setting.

List Prices:

for 2200 ohms SPDT — order:	SV/1C/2200D	\$10.97
for 8700 ohms SPDT — order:	SV/1C/8700D	11.98
for 14000 ohms SPDT — order:	SV/1C/14000D	12.64
for 20000 ohms SPDT — order:	SV/1C/20000D	14.56
for 40000 ohms SPDT — order:	SV/1C/40000D	21.63
Contact rating: 2 amperes @ 115 V.A.C. or 26.5 V.D.C. (Resistive)		
Contact combination: SPDT only. Max. coil resistance: 40,000 ohms.		

F.O.B. Burbank, or Chicago warehouse for stock items. Prices for relays with over standard range coils will be supplied upon request.

ANTENNA TYPE

AT SERIES
(Formerly Series 400)



Size: H—1 $\frac{1}{2}$ " ; W—2 $\frac{3}{4}$ " ; L—3 $\frac{1}{2}$ "

Heavy-duty RF transmitter antenna changeover relay. Conservative 1 kilowatt rating. Heavy $\frac{1}{4}$ " fine silver contacts. Insulated with ceramic Steatite. Positive wiping action of the contacts assures the flow of most minute currents for receiving positions. These ruggedly built relays have binding post terminals for easy connection to antenna lines. Available with auxiliary single-pole single-throw — normally open contacts.

List Prices:

for 115 V.A.C. DPDT — order:	AT/2C/115VA	\$13.17
Max. coil voltage obtainable: 440 V.A.C. and 230 V.D.C.		
Auxiliary contacts: 10 amperes @ 115 V.A.C. or 26.5 V.D.C. (Resistive)		
Max. operating power: 4.5 watts A.C., 2.3 watts D.C.		



ADVANCE RELAYS

MIDGET ANTENNA TYPE

AM SERIES
(Formerly Series
K1504RF/K1604RF)

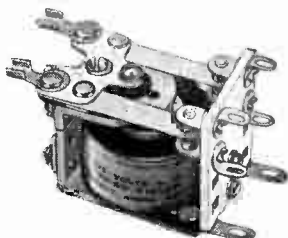

Size: H—1¼"; W—1½"; L—1⅞"

Space-saving "transmit-receive" antenna relays, ideally suited for hundreds of low-power RF applications. Efficient, yet inexpensive, these midget antenna units fill the need for 300-ohm circuit switching in mobile, marine, aircraft, television, communication and fixed-station service. Silicone glass insulation for low RF loss. Conically-shaped silver contacts assure low resistance paths for either "receive" or "transmit" positions. Beryllium-copper hinge holds armature firmly in place for smooth operation.

List Prices:

for 115 V.A.C. DPDT — order: AM/2C/115VA\$5.45
for 6 V.A.C. DPDT — order: AM/2C/6VA 5.45
for 6 V.D.C. DPDT — order: AM/2C/6VD 5.45
Max. coil voltage obtainable: 220 V.A.C. and 120 V.D.C.
Contact rating: 2 amperes @ 115 V.A.C. or 26.5 V.D.C. (Resistive)
Contact combinations: DPDT only. Max. operating power: 3.0 watts A.C., 1.5 watts D.C.

TIME DELAY TYPE

DM SERIES
(Formerly Series 3008F)

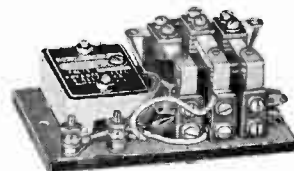

Size: H—1⅝"; W—2⅝"; L—3¼"

These relays are excellent for use in pre-heating tube filaments, for specialized lighting circuits, photographic controls, etc. These relays provide an adjustable delay before make for the controlled circuit. When the controlled circuit is completed, it remains closed until the initial circuit is broken. Utilizes bi-metal thermal delay unit which can be adjusted for delays from 10 to 60 seconds. For proper recycling, the units require cooling of 8 to 10 times the delay period. DB Series units provide delay before break.

List Prices:

for 115 V.A.C. SPDT — order: DM/1C/115VA\$15.25
for 115 V.A.C. DPDT — order: DM/2C/115VA 15.65
for 6 V.A.C. DPDT — order: DM/2C/6VA 15.65
for 115 V.A.C. DPDT — order: DB/2C/115VA 15.65
Max. coil voltage obtainable: 440 V.A.C. and 230 V.D.C.
Contact rating: 15 amperes @ 115 V.A.C. or 26.5 V.D.C. (Resistive)
Max. contact combination: DPDT. Operating power: 4.5 watts A.C.

POWER CONTROL TYPE

PC SERIES
(Formerly Series
950B, 960B, 970B & 9800B)

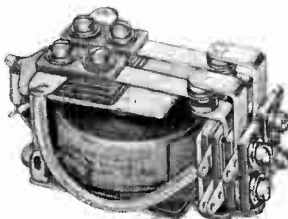

Size: H—1⅞"; W—1⅞"; L—2⅝"

These small-size, low-wattage power-control relays are available up to 4PDT. They are fully dependable units for operation on either AC or DC — as you specify. Thousands of applications for these relays. Adequate armature overtravel provides good wiping action, thus keeping the large contact surfaces clean. Standard-voltage units are obtainable quickly and at low cost.

List Prices:

for 6 V.D.C. SPDT — order: PC/1C/6VD\$ 5.12
for 115 V.A.C. SPDT — order: PC/1C/115VA 5.12
for 6 V.A.C. DPDT — order: PC/2C/6VA 7.32
for 115 V.A.C. DPDT — order: PC/2C/115VA 7.32
for 115 V.A.C. 3PDT — order: PC/3C/115VA 8.78
for 115 V.A.C. 4PDT — order: PC/4C/115VA 13.17
Max. coil voltages obtainable: 440 V.A.C. and 230 V.D.C.
Contact rating: 15 amperes @ 115 V.A.C. or 26.5 V.D.C. (Resistive)

MIDGET TELEPHONE TYPE

TA SERIES
(Formerly Series 5000/6000)

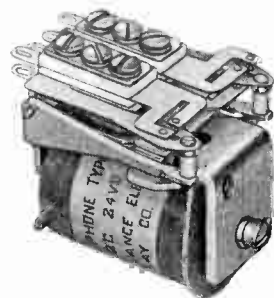

Size: H—1⅝"; W—1⅞"; L—1⅞"

Used by industries in every category for a host of applications. Minimum power consumption and resistance to extreme vibration are provided through the use of short blades, short armature travel and long leverage actuation of contacts — plus highly efficient electro-magnets. Blades are bifurcated for double-make platinum-silver alloy contacts. Many military specifications are easily met by these types.

List Prices:

for 6 V.D.C. DPDT — order: TA/2C/6VD\$6.66
for 115 V.A.C. DPDT — order: TA/2C/115VA 6.66
for 24 V.D.C. 3PDT — order: TA/3C/24VD 8.31
for 6 V.A.C. 4PST-NO-order: TA/4A/6VA 8.31
for 10000 ohms DPDT — order: TA/2C/10000D 9.06
Max. coil voltage obtainable: 220 V.A.C. Resistance: 26000 ohms D.C.
Contact rating: 2 amperes @ 115 V.A.C. or 26.5 V.D.C. (Resistive)

F.O.B. Burbank, or Chicago warehouse for stock items. Prices for relays with over standard range coils will be supplied upon request.



ADVANCE RELAYS

SMALL ANTENNA TYPE

AH SERIES
(Formerly Series 1000/2000)

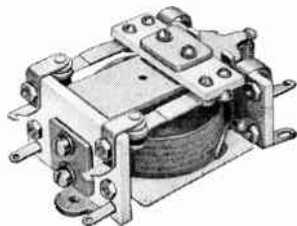

Size: H—1 $\frac{1}{4}$ " ; W—1 $\frac{1}{8}$ " ; L—2 $\frac{3}{4}$ "

A changeover relay designed specifically for RF use in fixed-station operation — aircraft, marine, mobile and portable radio communications equipment. The small size of this relay makes it ideal for use in compact sets where the load does not exceed $\frac{1}{2}$ KW. For reliable transfer of antenna power, contacts are one-quarter inch fine silver. Units are fast and positive in action, and will operate in any position.

List Prices:

for 115 V.A.C. DPDT — order: AH/2C/115VA\$10.97
 for 6 V.A.C. DPDT — order: AH/2C/6VA 10.97
 for 6 V.D.C. DPDT — order: AH/2C/6VD 10.97
 Max. coil voltage obtainable: 440 V.A.C. and 230 V.D.C.
 Contact rating: 10 amperes @ 115 V.A.C. or 26.5 V.D.C. (Resistive)
 Max. operating power: 4.0 watts A.C.; 2.0 watts D.C.

HIGH-VOLTAGE TYPE

HV SERIES
(Formerly Series 2800)

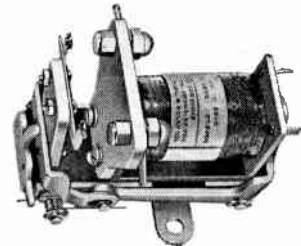

Size: H—1 $\frac{7}{8}$ " ; W—2 $\frac{1}{8}$ " ; L—2 $\frac{7}{8}$ "

A small-size D.C. unit engineered and developed for making and breaking high-voltage, low-current circuits. Leverage armature principle is employed allowing the wide contact gap necessary for high-voltage switching, but keeping the size of the relay to a minimum. You can use this relay where bulky, "standard" design high-voltage units occupy too much space. Contact assembly is mounted on ceramic Stealite. This ADVANCE original will meet many of your specialized high-voltage needs.

List Prices:

for 24 V.D.C. SPST-NO-order: HV/1A/24VD\$16.75
 for 6 V.D.C. SPST-NO-order: HV/1B/6VD 16.75
 for 24 V.D.C. SPDT — order: HV/1C/24VD 25.13
 for 6 V.D.C. SPDT — order: HV/1C/6VD 25.13
 Max. coil voltage obtainable: 230 V.D.C. Contact rating: 5000 V.D.C. @ 200 milliamperes.
 Max. contact combination: SPDT. Max. operating power: 4.0 watts D.C.

MIDGET TYPE

MF SERIES
(Formerly Series
K1500A/K1600A)

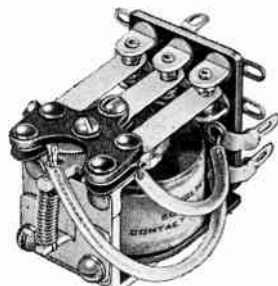

Size: H—1 $\frac{1}{2}$ " ; W—1 $\frac{1}{4}$ " ; L—1 $\frac{1}{2}$ "

These ADVANCE design originals are general-purpose relays engineered for high efficiency and low price. The small size of these midgets invites their installation in many cramped locations. For 2-ampere contact ratings, specify the MG Series. For 5-ampere contacts order the MF Series. These relays offer beryllium copper armature hinges for perfect alignment — wiping action for positive contact — operation in any position — a combination assuring long, trouble-free life.

List Prices:

for 115 V.A.C. SPDT — order: MG/1C/115VA\$4.31
 for 115 V.A.C. DPDT — order: MG/2C/115VA 4.65
 for 115 V.A.C. DPDT — order: MF/2C/115 VA 5.72
 for 6 V.D.C. DPDT — order: MF/2C/6VD 5.72
 for 115 V.A.C. 3PDT — order: MF/3C/115VA 6.92
 Max. coil voltages obtainable: 220 V.A.C. and 120 V.D.C.
 Max. contact combination: 3PDT. Operating power: 1.5 watts D.C.

OVERLOAD TYPE

OE & OF SERIES
(Formerly Series 750A & 750B)

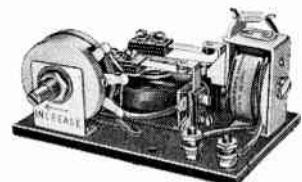

Size: H—2 $\frac{3}{8}$ " ; W—2 $\frac{3}{4}$ " ; L—4 $\frac{1}{4}$ "

Safeguards equipment against current surges or continuous overloads. Designed for D.C. circuits, and especially applicable to radio transmitters. Set the potentiometer to provide the desired current limit — any overload will open the circuit. The circuit remains open until electrically reset. The OE Series is adjustable for any desired overload current between 250 and 500 milliamperes, and the OF Series ranges from 500 to 1000 milliamperes.

List Prices:

for 115 V.A.C. (reset) DPST — order: OE/2B/115VA\$17.57
 for 115 V.A.C. (reset) DPST — order: OF/2B/115VA 17.57
 Max. reset voltages: 440 V.A.C. and 230 V.D.C.
 Contact rating: 15 amperes @ 115 V.A.C. or 26.5 V.D.C. (Resistive)
 Contact combination: DPST-NC only. OH and OJ Series: manual reset.

F.O.B. Burbank, or Chicago warehouse for stock items. Prices for relays with over standard range coils will be supplied upon request.

ADVANCE RELAYS



COAXIAL TYPE

CB SERIES
(Formerly Series 7200/8200)

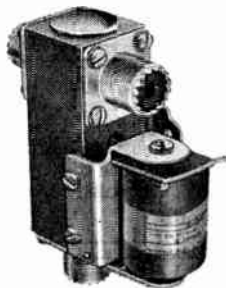

Size: H—3 $\frac{1}{2}$ " ; W—1 $\frac{7}{8}$ " ; L—3 $\frac{1}{8}$ "

Unsurpassed for coaxial switching. Designed for 52-ohm lines, the units operate equally well in any position. Low standing wave ratios permit usage on frequencies up to 300 megacycles. The internal single-pole double-throw contacts are heavy quarter-inch fine silver. An inspection port at the contact end of the anodized housing permits easy access to the internal contacts. External auxiliary stacking is available up to DPDT.

List Prices:

for 115 V.A.C. SPDT — order:	CB/1C/115VA	\$16.63
for 115 V.A.C. SPDT (DPDT aux.) order:	CB/1C/115VA	20.63
for 6 V.D.C. SPDT — order:	CB/1C/6VD	16.63
for 6 V.D.C. SPDT (DPDT aux.) order:	CB/1C/6VD	20.63
for 24 V.D.C. SPDT (DPDT aux.) order:	CB/1C/24VD	20.63
Max. coil voltage obtainable: 440 V.A.C. and 230 V.D.C.			
Auxiliary contact rating: 2 amperes @ 115 V.A.C. or 26.5 V.D.C. (Resistive)			

"TINY MITE" MINIATURE TYPE

MM SERIES
(Formerly Series 000)

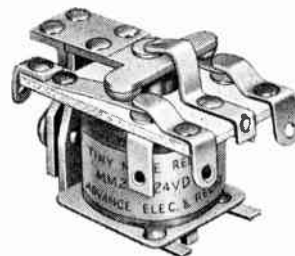

Size: H—1 $\frac{1}{8}$ " ; W—1" ; L—1 $\frac{1}{8}$ "

Ultra-small and feather-light ADVANCE "Tiny Mite" D.C. relays require less than $\frac{1}{2}$ cubic inch mounting space! Peanut-sized, hermetically-sealed enclosures are available to further expand the uses of these soundly-engineered units. All switching is entirely above ground. Insulation is silicone glass. Single 2-56 screw mounting. Beryllium copper armature hinge assures stable performance under vibration and shock. Platinum-silver alloy contacts.

List Prices:

for 6 V.D.C. SPDT — order:	MM/1C/6VD	\$3.52
for 24 V.D.C. DPDT — order:	MM/2C/24VD	4.24
for 2000 ohms DPDT — order:	MM/2C/2000D	5.20
for 3800 ohms DPDT — order:	MM/2C/3800D	5.81
for 5000 ohms DPDT — order:	MM/2C/5000D	6.66
Max. coil resistance obtainable: 10,000 ohms. Weight: 10 grams.			
Contact rating: $\frac{1}{2}$ ampere. Operating power: 0.7 watt.			

SENSITIVE TYPE

SD SERIES
(Formerly Series 4000)

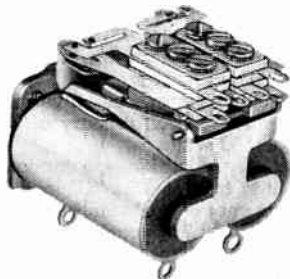

Size: H—1 $\frac{1}{8}$ " ; W—1 $\frac{1}{8}$ " ; L—1 $\frac{1}{8}$ "

Small sensitive D.C. relays available up to six-pole, double-throw. Applicable for hundreds of sensitive electronic circuit uses. Platinum-silver alloy contacts. A variety of hermetically-sealed enclosure styles is available. High sensitivity, dual magnets, bifurcated blades with double-make contacts — all this in a compact unit occupying minimum space.

List Prices:

for 1000 ohms DPDT — order:	SD/2C/1000D	\$11.93
for 1600 ohms DPDT — order:	SD/2C/1600D	11.93
for 2500 ohms DPDT — order:	SD/2C/2500D	13.43
for 2500 ohms 4PDT — order:	SD/4C/2500D	16.73
for 20000 ohms DPDT — order:	SD/2C/20000D	16.73
Max. coil resistance obtainable: 60000 ohms. Nominal operating power: 25 milliwatts.			
Contact rating: 2 amperes @ 115 V.A.C. or 26.5 V.D.C. (Resistive)			

LATCHING TELEPHONE TYPE

LS SERIES
(Formerly Series 5900A/6900A)

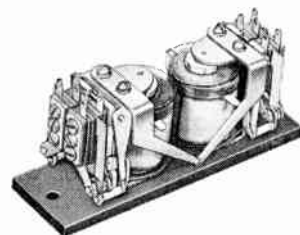

Size: H—1 $\frac{1}{8}$ " ; W—1 $\frac{1}{4}$ " ; L—3 $\frac{1}{4}$ "

This telephone-type latching relay is used where it is impractical to keep holding coils in constant service. Operates on low momentary power. Compact and space saving. Three-sixteenth inch contacts are fine silver. Available in a wide variety of coil resistances and contact combinations. 10-ampere contacts available on LT Series for D. C. operation.

List Prices:

for 6 V.D.C. DPDT — order:	LS/2C/6VD	\$15.05
for 115 V.A.C. DPDT — order:	LS/2C/115VA	15.05
for 24 V.D.C. 4PDT — order:	LS/4C/24VD	19.10
for 115 V.A.C. 4PDT — order:	LS/4C/115VA	19.10
Max. coil volt. obtainable: 220 V.A.C. Max. resistance: 26000 ohms D.C.			
Contact rating: 5 amperes @ 115 V.A.C. or 26.5 V.D.C. (Resistive)			

F.O.B. Burbank, or Chicago warehouse for stock items. Prices for relays with over standard range coils will be supplied upon request.

RELAYS BY GUARDIAN

A COMPLETE LINE OF AMATEUR AND INDUSTRIAL RELAYS

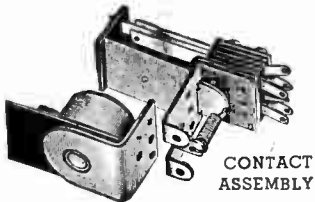

COIL ASSEMBLY

SERIES 200—INTERCHANGEABLE

Two basic parts—a coil assembly and a contact assembly—comprise this simple, yet versatile, relay. Coil assembly consists of coil and field piece. Contact assembly consists of switch blades, armature, return spring and mounting bracket. The new midget contact assembly, which is interchangeable with the standard assembly, is also available in either single pole double throw, or double pole, double throw. The standard contact assembly is 2 $\frac{7}{8}$ " long, 1 $\frac{1}{4}$ " high, 1" wide. The midget assembly is 1 $\frac{5}{8}$ " long, 1 $\frac{1}{2}$ " high, 1" wide. The four contact assemblies can be used with any one of 13 coils to make a required relay. Contact points are rated at 8 amps., 115 volts, 60 cycles AC, non-inductive load.

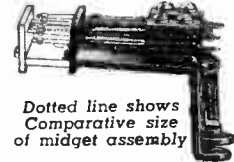

Dotted line shows comparative size of midget assembly

MIDGET CONTACT ASSEMBLY

CONTACT SWITCH ASSEMBLIES

Type	Description	List Price ea.
Type 200-1	Stand., with SPDT Contact Ass'ly, 8 Amps.	\$2.25
Type 200-2	Stand., with DPDT Contact Ass'ly, 8 Amps.	3.05
Type 200-4	Standard, DPDT, 12.5 Amps	3.55
Type 200-5	Four Pole, Double Throw, 8 Amps.	5.50
Type 200-M1	Midget, with SPDT Contact Ass'ly, 8 Amps.	2.20
Type 200-M2	Midget, with DPDT Contact Ass'ly, 8 Amps.	2.70
Type 200-M3	Midget, Contact Switch Parts	2.25
Type 200-M5	Midget, 4PDT, 8 Amps	4.70

AC COILS

Voltage	List Price ea.
6 Volt	\$2.70
12 Volt	2.70
24 Volt	2.70
115 Volt	3.40
230 Volt	4.70

DC COILS

Voltage	List Price ea.	
6 Volt	\$2.70	
12 Volt	2.70	
24 Volt	2.70	
32 Volt	2.70	
110 Volt	3.40	
5000-D	For Current Type Operation	3.55

CONTACT PARTS KIT 200-3. Assortment of contact parts to make other switch combinations. May be used with SPDT or DPDT contact assemblies to make 3PST, 4PST, 4PDT combinations, etc. Either contact assembly takes any combination up to four pole double throw. Includes complete assembly and wiring information for all possible combinations. Complete with all necessary hardware. Shipping weight 4 oz.

List Price **\$2.25 ea.**

RC-100 REMOTE LOCKING CONTROL RELAY



A Guardian development of the momentary impulse locking control relay. The circuit to the coil needs to be energized only long enough to close armature; contacts lock automatically. Each impulse reverses position of contacts.

Standard coils operate on 115 volts, 50-60 cycles AC. Coils for other voltage and currents on specification.

Contacts, $\frac{1}{4}$ " fine silver metal rated at 1500 watts at 115 volts, 60 cycle, non-inductive. Can also be used in AC primary circuits of any power supply delivering up to 1 KW. 3" long, 2 $\frac{1}{2}$ " wide, 1 $\frac{1}{2}$ " high.

Applications—break-in control and phone to CW switching. Any circuit control where locking circuits are used.

Type	Shp. Wt.	List Price
RC-100-AR—(4PST)	.8 oz.	\$8.70 ea.
RC-100-BR—(3PDT) (SPDT) (DPST)	.8 oz.	9.05 ea.
RC-100-GR—(DPDT)	.8 oz.	8.55 ea.

U-100 AND U-200 ADJUSTABLE UNDERLOAD RELAYS

Sensitive, precise, designed and constructed for long, trouble-free service. Relays are encased in attractive black finished metal containers, protecting them from dirt, dust and maladjustment. Normal current through the coil on the U-100 is 300 milliamperes with an adjustable range of 100 to 200 milliamperes DC. Normal current through the coil on the U-200 is 600 milliamperes with an adjustable range of 200 to 400 milliamperes. Oversize contacts of fine silver, rated for the AC primary of any power supply delivering up to 500 watts.

Radio Application—protection of class "B" audio equipment in case of class "C" load failure, also class "C" amplifier in case of excitation failure.

Industrial Application—Any DC circuit where it is desirable to maintain currents above a set value.

U-100 and U-200 are 3 $\frac{5}{8}$ " in diameter, 2 $\frac{1}{4}$ " high. Shipping weight 14 oz. **List Price \$13.00 ea.**

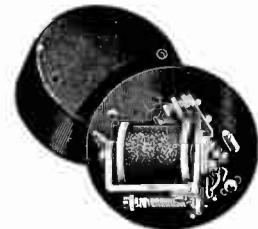

T-100 AND T-110 TIME DELAY RELAYS

Standard coils operate on 115 volts, 50-60 cycles non-inductive AC. Coils available on other voltages on specification. Oversize contacts rated at 1500 watts on 115 volts, 50-60 cycles non-inductive. Can also be used in the AC primary of any power supply delivering up to 1 KW. Adjustable time delay for any period between 10 and 60 seconds.

Applications—Radio. In transmitter circuits to prevent damage of rectifiers and tube filaments by application of plate current before filaments are sufficiently heated. Industrial. Any control problem requiring the changing of circuits after a predetermined interval.



GUARDIAN SERIES T-110 TIME DELAY RELAY

T-100—5 $\frac{1}{4}$ " long, 3" wide, 2 $\frac{1}{4}$ " high. Shipping weight 1 $\frac{1}{4}$ lbs. Laminated construction **List Price \$20.75 ea.**

The T-110 is a compact, sturdy, economical time delay relay for use in applications not requiring the capacities of the T-100. Contact capacity — 1250 watts on 115 volt, 60 cycle non-inductive AC. Can also be used in the AC primary circuit of any power supply delivering up to, and including, 1 KW. Adjustable time delay between 10 and 60 seconds.

T-110—5 $\frac{3}{8}$ " long, 3 $\frac{1}{8}$ " wide, 2 $\frac{7}{8}$ " high. Shipping Weight 8 oz. **List Price \$15.65 ea.**

RELAYS BY GUARDIAN

A COMPLETE LINE OF AMATEUR AND INDUSTRIAL RELAYS

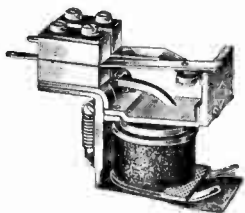

SERIES R-100
H.F. RELAY

HIGH FREQUENCY RELAYS

The Series R-100, R-100B, and A-300 Guardian Relays are primarily designed for high frequency applications. They are low-loss insulated, compact, economical and sturdily constructed. The R-100 and R-100B are AlSiMag insulated, while the A-300 is mounted on a mycalex base with mycalex contact mounting bar.

Radio Applications—Antenna changeover, break-in, high voltage keying, grid controlled rectifier keying, remote control of receiver and transmitter, and other high frequency applications.

Industrial Applications—Oven control, remote motor control, short wave therapy and diathermy, heating equipment.

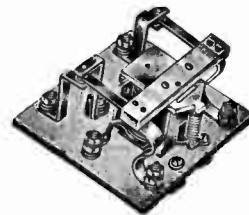

SERIES A-300
H.F. RELAY

	Length	Width	Height	Shpg. Wght. (oz.)	List Price ea.
R-100 —SPST (normally open).....	2¾"	1"	2"	6	\$4.80
R-100-B—SPST (normally closed).....	2¾"	1"	2¾"	6	4.80
R-100-C—SPDT	2¾"	1½"	2¾"	6	5.75
R-100-G—DPDT	2¾"	1¾"	2¾"	6	10.40
A-300 —DPDT	3"	3"	2-1/16"	7	11.00

X-300-ER ADJUSTABLE OVERLOAD RELAY

with Electrical Reset

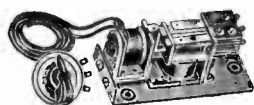

This relay offers positive, precise protection against current surges and continuous overloads — remote panel installation of the control potentiometer simplifying adjustment of relay to operate on any current value from 250 to 750 milliamperes — auxiliary contacts for pilot light indication of "overload" or "clear" position — reset relay can be operated from any convenient point. Voltage drop across overload coil is less than 10 volts at any current value. Insulation between coil and ground rated at 3000 volts.

X-300-ER—4¾" long, 1-15/16" wide, 2" high. Shipping weight 12 oz.

List Price.....\$11.20 ea.

B-100 BREAK-IN RELAY

Specially designed for break-in operation on amateur transmitters. Low current drain and compact construction, plus the use of a laminated field piece and armature insuring efficient



operation, make the B-100 an ideal relay for this application. Standard coil operates on 115 V., 50-60 cycle AC. Silver contacts rated at 1500 watts, 60 cycles AC non-inductive, and in AC primary circuits of any power supply delivering up to 1 KW.

B-100—2¾" long, 2½" high, 2¼" wide. Shipping weight 11 oz.

List Price.....\$13.00 ea.

K-320 KEYING RELAY

A standard coil operates on 6 volts AC. Coils for other voltages on specification at a minimum of 10% additional to list price. Contacts—special over-size silver. Can handle 5,000 watts on 60 cycle non-inductive 115 volts AC and in AC primary circuit of any power supply delivering up to and including 1 KW. Control capacity—up to 2,000 volts with clean make and break.



Applications—Control of filament center tap keying of any stage having up to 2,000 volts on plate; primary keying or control of power supplies up to and including 1,000 watts; and grid-controlled rectifier keying of 3,000 volt power supplies.

K-320—3" long, 1½" wide, 1-15/16" high. Shipping weight 4 oz.

List Price.....\$5.45 ea.

THERMOSTATIC

AMPERITE

DELAY RELAYS

GLASS ENCLOSED • HERMETICALLY SEALED • A.C., D.C., OR PULSATING CURRENT



STANDARD

AMPERITE THERMOSTATIC DELAY RELAYS



MINIATURE

EXCLUSIVE FEATURES:

- Actuated by a heater.
- Operates on A.C., D.C., or Pulsating Current.
- Hermetically sealed, Amperite Relays are not affected by altitude, moisture or other atmospheric conditions.
- Compact, lightweight and inexpensive.

TECHNICAL CHARACTERISTICS

CIRCUITS: SPST only—Normally open or normally closed.
 HEATER WATTAGE: 2 W prox.—Heaters can be operated continuously.
 STANDARD CONTACT RATING: 115V.—3A A.C. (or 220V.—0.5A A.C.);
 Maximum voltage between contacts and heater—1500V. D.C.
 MINIATURE CONTACT RATING: 115V.—2A A.C., other specifications same as standard.
 AMBIENT TEMPERATURES: Relays are compensated for temperatures of -55° to +70° C. Tolerances given are for 20° C.
 LIFE: With 115 V—1A A.C., non-inductive, at least 500,000 operations.

BASE WIRING:

Standard Radio Octal: Prongs 2-3-heater; Prongs 5-7-contacts.
9-Pin Miniature: Prongs 1-6-heater; Prongs 3-4-1 contact; Prongs 8-9-2nd contact

LIST PRICE: Standard and miniature types listed.....\$4.00
 RESALE: Standard and miniature types listed.....\$2.40
 DELIVERY: The types shown in bold type are most popular, and usually available from stock. Other types delivered in approximately 6 weeks.

Delay-Seconds	Tolerance Seconds	NORMALLY OPEN CONTACTS						NORMALLY CLOSED CONTACTS					
		HEATER VOLTAGES						HEATER VOLTAGES					
		2.5 V.	5.0 V.	6.3 V.	12 V.	26 V. (22-30)	115 V.	2.5 V.	5.0 V.	6.3 V.	12 V.	26 V. (22-30)	115 V.
2	± 1	2N02	5N02	6N02	12N02	26N02	115N02	2C2	5C2	6C2	12C2	26C2	115C2
3	± 1	2N03	5N03	6N03	12N03	26N03	115N03	2C3	5C3	6C3	12C3	26C3	115C3
5	± 2	2N05	5N05	6N05	12N05	26N05	115N05	2C5	5C5	6C5	12C5	26C5	115C5
10	± 3	2N010	5N010	6N010	12N010	26N010	115N010	2C10	5C10	6C10	12C10	26C10	115C10
15	± 3	2N015	5N015	6N015	12N015	26N015	115N015	2C15	5C15	6C15	12C15	26C15	115C15
20	± 4	2N020	5N020	6N020	12N020	26N020	115N020	2C20	5C20	6C20	12C20	26C20	115C20
30	± 8	2N030	5N030	6N030	12N030	26N030	115N030	2C30	5C30	6C30	12C30	26C30	115C30
45	± 10	2N045	5N045	6N045	12N045	26N045	115N045	2C45	5C45	6C45	12C45	26C45	115C45
60	± 12	2N060	5N060	6N060	12N060	26N060	115N060	2C60	5C60	6C60	12C60	26C60	115C60
75	± 15	2N075	5N075	6N075	12N075	26N075	115N075	2C75	5C75	6C75	12C75	26C75	115C75
90	± 15	2N090	5N090	6N090	12N090	26N090	115N090	2C90	5C90	6C90	12C90	26C90	115C90
120	± 30	2N0120	5N0120	6N0120	12N0120	26N0120	115N0120	2C120	5C120	6C120	12C120	26C120	115C120

MINIATURE TYPES: Designated by letter T. (e.g. 6N05T) is available in all delays shown above bold dotted line. Delays of 2 to 90 seconds are available in both standard radio octal and 9-Pin miniature. Prices of both standard and miniature type.....List—\$4.00

Flashers available only in low voltage heaters 6.3 — 26 V. List — \$4.00 each
 Flash Rate available — pre-set at factory — 5 to 100 fpm. Dealers Cost — \$2.40 each

L-R BLOWERS — "Mighty-Mites"

The L-R Blowers are designed for applications requiring the movement of large air volumes where space and weight are prime factors. These small blowers can be adapted to many applications such as the dispersion of heat generated by electronic equipment, induction heaters, tube cooling in movie projectors, instrument cabinets, drying operations, photographic darkrooms and in other confined enclosures. Available in CW and CCW Rotation, Rotation determined by viewing from motor side.

No. 1½

Weight, less motor, 2 ½ ounces. Wheel is 1 ½" in diam. Standard shaft bores, ¼" or ⅜". Overall height 3". Overall width 2 ⅞". Depth 1". Blower opening 1" wide by 1 ⅜" high. **List Price \$4.13 each**



No. 2

Weight, less motor, 5 ounces. Wheel is 2" in diam. Standard shaft bores, ¼" or ⅜". Overall height 3 ¾". Overall width 3 ½". Depth 1 ⅜". Blower opening 1 ¼" diameter. **List Price \$4.21 each**



L-R MOTOR & BLOWER ASSEMBLIES

Model	Blower Size	Input Voltage	R.P.M.	Output (free air) C.F.M.	List Price
8437	1 ½	115V. 60 Cy. AC	3,150	4	\$13.29
8446-E	1 ½	115V. 60 Cy. AC-DC	8,000	12	17.96
8446-D	1 ½	115V. 60 Cy. AC-DC	11,000	17	17.96
8446-C	1 ½	115V. 60 Cy. AC-DC	15,000	23	17.96
8438	2	115V. 60 Cy. AC	3,100	10	13.48
8444-E	2	115V. 60 Cy. AC-DC	6,500	20	18.14
8444-D	2	115V. 60 Cy. AC-DC	10,000	30	18.14
8444-C	2	115V. 60 Cy. AC-DC	13,000	40	18.14
8433	2 ½	115V. 60 Cy. AC	2,800	17	13.60
8445-E	2 ½	115V. 60 Cy. AC-DC	6,000	35	18.26
8445-D	2 ½	115V. 60 Cy. AC-DC	9,000	53	18.26
8445-C	2 ½	115V. 60 Cy. AC-DC	12,000	70	18.26
8472	3	115V. 60 Cy. AC	3,100	77	16.05
8473	3	115V. 60 Cy. AC	1,550	40	16.78
8452	3	115V. 60 Cy. AC-DC	7,200	328	22.40

No. 2½

Weight, less motor, 5 ½ ounces. Wheel is 2" in diam. Standard shaft bores, ¼" or ⅜". Overall height 4 ¾". Overall width 3 ¾". Depth 1 ½". Blower opening 1 ⅞" wide by 1 ½" high. **List Price \$4.43 each**

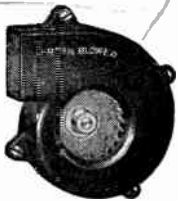

No. 3

Weight, less motor, 12 ½ ounces. Wheel is 3" in diam. Standard shaft bores, ¼" or ⅜". Overall height 6 ¾". Overall width 5 ½". Depth 2 ¾". Blower opening 2 ¾" wide by 2 ¼" high. **List Price \$5.08 each**

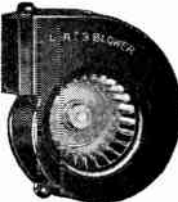

SUNSWITCH LIGHT CONTROL

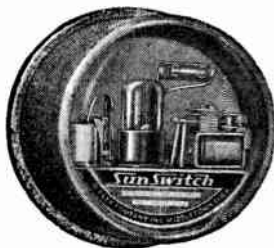

The SUNSWITCH uses an amplifier and phototube that responds to the foot candle value of daylight. When illumination falls below a predetermined value, the lights are turned on. When the illumination has increased to the correct value, the lights are automatically turned off. Applications for the SUNSWITCH are numerous—Radio & TV Towers, Signs, Factories, Construction Work, Airports, Railroads, Street Lights, etc. Mounted in standard weather-proof watt-hour meter case. Available in various models, carrying loads up to 60 Amps.

ELECTRONIC RELAYS AND SWITCHES

Engineered for exceptional reliability, long life with minimum maintenance. These Relays are highly sensitive and utilize no coaxial cable. Designed for applications needing a very short or medium impulse . . . as short as .0005 seconds, and will furnish pulse to operate a reset, lock or predetermined counter. The Ripley Phototube Relays have countless uses such as starting and stopping lighted displays, drinking fountains and machinery. Controls automatic paint sprays, announces the entrance and passing of customers.



ELECTRONIC TIMERS



The Ripley Timers are of the short interval period, stop cycle, type. Built to control industrial processes, they meet the most exacting requirements of this service by delivering dependable, accurate, and long-lived performance. Basic Models cover the ranges of from .05 to .5, .1 to 10., and 1. to 100. seconds and are available with any one of three different circuits. Principle of operation is electronic, assuring freedom from trouble caused by mechanical lag or wear.

ELECTRONIC Phototube COUNTERS

These sturdy, well built Electronic Counters are furnished with 5-digit counters. Available with outside light source as well as a built-in light source. The model with built-in light source incorporates a reflector mirror which directs the beam back into the phototube, thus eliminating the need for an extra pair of wires. Operates on 110 or 220 volts, 25 or 60 cycles. Dimensions: 5 ¼" x 6" x 6 ¼" high.



L-55

ELECTRONICALLY OPERATED RELAYS
MODEL 63

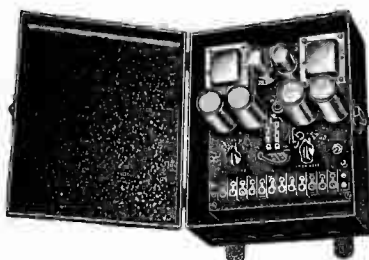

Especially designed for use with a correct combination of the standardized Worner Photo-Cell and Exciter Lamp units shown at right. However, this Electronically Operated Relay will operate also from light sources

such as daylight, artificial lights, radiant energy from metallic processing, etc.

Model 63 Electronically Operated Relay is a specially engineered, highest quality unit. It enjoys wide preference as it efficiently meets exacting requirements and replaces the need of costly individually engineered equipment. Technical details on request.

ELECTRONICALLY OPERATED RELAYS

Model 63, Described Above.....	Price, Each
Model 63-A, combines Model 63 and Time Delay Circuit giving delay from zero to 45 seconds.....	\$100.00
Model 63-B, same as Model 63 with additional amplification to operate on less active change of light.....	\$150.00

ELECTRONICALLY OPERATED RELAY
MODEL 64

An economical unit for practically any industrial application where cost is a factor. Designed for use with a combination of standardized Worner Photo-Cell and Exciter Lamp units shown at right.



Model 64 Electronically Operated Relay.....each \$67.50

EXCITER LAMP & PHOTO-CELL RECEIVER UNITS

For Use With Models 63, 63-A, 63-B and 64 Electronically Operated Relays



Model 33 Model 23 Model 31 Model 21

The Exciter Lamp unit is designed to project the light beam and the Photo-Cell Receiver is designed to pick up the beam and convert its light into electrical energy through the Electronically Operated Relay unit.

Model 33 Exciter Lamp is "standard" for general applications and is most generally recommended. Its light beam covers a distance from a few inches to 10 feet from Exciter Lamp to Photo-Cell. Heavy duty cast iron unit with 1/2-inch conduit fittings. Gray finish.

Model 23 Photo-Cell Receiver is engineered for use with Model 33 Exciter Lamp. Same case specifications.

For use in damp surroundings, Models 33 and 23 can be made moisture-proof at slight additional cost.

Model 31 Exciter Lamp is "standard" where a lighter weight case is practical. Its light beam covers a distance from a few inches to 15 feet from Exciter Lamp to Photo-Cell. Case is 18 gauge steel, gray wrinkle finish. Has 1/2-inch knockout.

Model 21 Photo-Cell Receiver is engineered for use with Model 31 Exciter Lamp. Same case specifications.

Model No.	Description	Size, Inches	Price, Each
33	Exciter Lamp.....	4 1/4 x 2 3/4 x 2 3/4	\$13.50
23	Photo-Cell Receiver.....	4 1/4 x 2 3/4 x 2 3/4	19.50
31	Exciter Lamp.....	6 5/8 x 2 x 1 3/4	11.00
21	Photo-Cell Receiver.....	6 5/8 x 2 x 1 3/4	17.00

FOTOELECTRIC ANNOUNCER SET

Automatically Announces the Entrance or Passing of Any Person

COMPLETE WITH MIRROR AND CHIME



The unit has efficient grid controlled rectifier circuit which insures maximum stability. The Unit combines Exciter Lamp and sensitive Photo-Cell in metal case, size 8 1/4" x 6 1/2" x 2 3/4", beautifully finished in gray hammerloid. Bulb has long lamp-life rating of 2000 hours. Operates on 110-120V; 50-60 cycle, A.C.

The unit has efficient grid controlled rectifier circuit which insures maximum stability. The Unit combines Exciter Lamp and sensitive Photo-Cell in metal case, size 8 1/4" x 6 1/2" x 2 3/4", beautifully finished in gray hammerloid. Bulb has long lamp-life rating of 2000 hours. Operates on 110-120V; 50-60 cycle, A.C.

Model 61 Fotoelectric Announcer, three-piece set including Unit, Mirror and Chime.....Set, each \$32.00

MODEL 62 R & L
ELECTRONICALLY OPERATED RELAY
AND EXCITER LAMP SET



Model 62-R Electronically Operated Relay



Model 62-L Exciter Lamp

This "two-unit" set has specially designed Exciter Lamp Unit and an Electronically Operated Relay unit that includes the Photo-Cell Receiver, Relay and other electrical components. This combination has proved efficient for countless simple applications for distances from a few inches to 75 feet or where Relay is not required to operate in excess of 300 times a minute. Supervises efficiently on simple applications such as: Counting or sorting large objects; limit switches; start and stop operations; opening doors, etc.

Model 62 R & L "Two-Unit Set".....per set	\$85.00
Model 62-R Electronically Operated Relay.....each	69.75
Model 62-L Exciter Lamp.....each	21.75

FOTOLECTRIC BURGLAR ALARM SYSTEMS

An invisible light beam is projected by the Exciter Lamp to the Photo-cell contained in the Electronically Operated Relay. These two units constitute the "Fotoelectric Set." The units are illustrated below.

MODEL 9000 SERIES The Worner Master Control System consists of a Master Control Panel used in combination with 1, 2, 3, or 4 Fotoelectric Sets. Operates alarms the user installs. May be used with foil systems, etc. Sets off alarm if wiring of Fotoelectric Set is tampered with. Relays controlled by a key-switch. For 110-120V. Panels are supplied with plate relays for the number of Fotoelectric Sets ordered. Should Fotoelectric Sets be added later, plate relays are supplied with Fotoelectric Sets ordered.



Model 9000-R Master Control Panel prevents false alarm if power fluctuates 5 volts or more. If power fails completely, the unit automatically resets supervision when power is restored. each \$74.00

Model 9000 Master Control Panel is equipped to prevent false alarms when power fails completelyeach \$54.00

Sets for 150', 250', and 500' have unwanted light rejector which increases day-light range. Ranges listed are for infra-red light.

Model No.	Fotoelectric Set	Range	Per Set
9100	Master Trespass Trap	100 ft.	\$ 84.00
9150	Master Trespass Trap	150 ft.	108.00
9250	Master Trespass Trap	250 ft.	145.00
9500	Master Trespass Trap	500 ft.	225.00

MODEL 7000 SERIES operates with burglar alarm company's central office control, police signal or local alarm. The Relay may be connected either in series or parallel to meet circuit requirements. One or more Fotoelectric Sets can be used and can be operated by an existing control panel. Can be used with foil systems, etc. For 110-120V or 24V.

Model No.	Fotoelectric Set	Range	Per Set
7100	Remote Cont. Trespass Trap	100 ft.	\$ 84.00
7150	Remote Cont. Trespass Trap	150 ft.	108.00
7250	Remote Cont. Trespass Trap	250 ft.	145.00
7500	Remote Cont. Trespass Trap	500 ft.	225.00

MODEL 5000 SERIES for 100' range and 150' range for interior use where a single beam is ample protection. Not intended for use with foil systems, etc. The Electronically Operated Relays of this series are equipped with lock and key. For 110V.

Model No.	Fotoelectric Set	Range	Per Set
5100	Single Beam Trespass Trap	100 ft.	\$ 90.00
5150	Single Beam Trespass Trap	150 ft.	114.00



Exciter Lamp

Electronically Operated Relays
For 100' Range For 150' Range

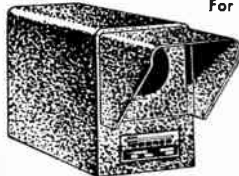

Exciter Lamps and Electronically Operated Relays for 250' and 500' ranges are externally the same and are weatherproof.

FOTOLECTRIC COMBUSTION SUPERVISOR

A three-piece set consisting of Exciter Lamp, Photo-cell Receiver and a choice of three Electronically Operated Relay units. Operates on the smoke detection principle. Dependably sets into operation the controls that maintain combustion efficiency. Fotoelectric units are mounted opposite each other on the boiler breeching, so that the beam of light traverses the flow of smoke. A predetermined increase in density of smoke operates whatever alarm or automatic control equipment is used.

Electronically Operated Relay and Control Cabinets available in three models:

MODEL No. 71A — For use where no time delay is necessary. Usually used as an alarm device, and to actuate automatic combustion control equipment.

MODEL No. 71B — Equipped with input time delay circuit to prevent needless operation of control equipment from voltage drop or short puffs of smoke.

MODEL No. 71C — Same as Model 71B plus additional time delay holding circuit to continue operation of combustion control equipment for a predetermined period of time. Prevents cycling of equipment.



FOTOLECTRIC FIRE PROTECTION

The Worner Fan Motor Stop installed on ventilating ducts detects smoke, gives alarm, stops fan to prevent fan-driven fire to a succession of outbreaks. Approved by Underwriters Laboratories. For full details, write for Bulletin 650.

WORNER COMMUNICATING SYSTEMS

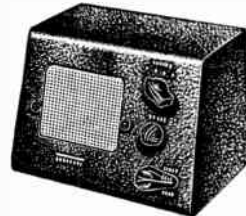

Models P-359, P-353

Model P-360

All WORNER units operate efficiently as far as 2000 feet apart. Persons at or near Sub-stations when called may answer without leaving their work, from as far away as 25 feet. "Silent feature" shuts out noise in vicinity at Station. 110 volt to 120 volt, A.C. or D.C.

MODEL P-359 Selective Master Station. Handles 1 to 5 Sub-stations. Has 3-tube amplifier. 1 watt output. Contains 5-inch speaker for maximum input without talking directly into unit. All-metal cabinet; size 9 x 6 1/4 x 6 inches. Finished in hammered walnut lacquer finish.each \$34.75

MODEL P-353 Combination Master Station. 2 to 5 units may be used, in any combination of Masters to Masters, or Masters to Sub-stations. Contains 3-tube amplifier.each \$47.50

MODEL P-360 Sub-station. Has 5-inch speaker. Talk-listen switch used by Sub to originate call; not used after Master answers. All-metal cabinet; size: 7 1/4 x 4 x 6 inches; finished in attractive hammered walnut lacquer finish.each \$11.50



PHOTOELECTRIC RELAYS AND ACCESSORIES

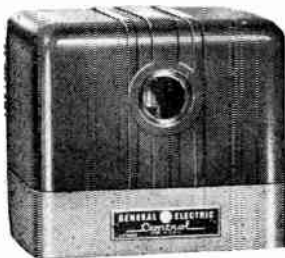

CR7505-K100G3 Relay

The CR7505-K100G3 photoelectric relay and accessories provide a complete line of inexpensive, but thoroughly reliable, apparatus for general-purpose indoor applications which include counting, diverting, controlling, signaling, limiting, and protecting. Underwriters Laboratories approved.

The CR7505-K100G3 includes phototube and thyatron, has a contact rating of 10 amp a-c, may be used to start 1-hp motors directly, and can operate all motor starters up to and including NEMA Size 4.

Accessories for Use with -K100G3

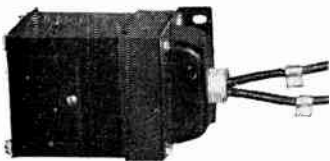

Cat. No. 71G620 light-source transformer, rated 115 volts, 50/60 cycles, primary: 4.8 volts secondary; lens-barrel assembly CR7505-B207G1, 3 in. in diameter, for mounting directly on relay; two light sources, -C201G1 with

1 1/2-in. lens and -C203G1 with 3-in. lens; two phototube holders with six feet of special phototube cable and a plug for connecting to tube socket in the relay, -P211G1 with 1 1/2-in. lens, and the -P212G1 with 3-in. lens. With 1 1/2-in. lens, maximum operating distance is 12 ft.; with 3-in. lens, maximum operating distance is 30 ft. Sensitivity of -K100G3 may be increased five times by use of B207G1 lens-barrel assembly.



CR7505-K201G1, -K202G1 Relays

These photoelectric relays will perform the same type of functions as the -K100 with greater speed and sensitivity. These relays operate on either light increase or decrease, depending on connections. The relays will operate from light flashes on interruption of 1/15 second between impulses, with not less than 1/15 second between flashes. The d-c phototube circuit permits remote location of phototube with no loss in sensitivity.



CR7505-K108G15 Relay

This device has a dust-tight, weather-resistant enclosing case for outdoor use, operates from either a 115-volt d-c or a 25-cycle supply with a power requirement of 20 volt-amperes. The cover of the enclosing case has a 3-in. lens and aperture for admission of light to the phototube. A metal visor minimizes the effects of slanting sun rays and general daylight illumination. Maximum light-source distance from phototube is approximately 35 ft. A minimum illumination of 3 foot-candles is necessary for satisfactory operation.

CR7505-N210, -N211, -N212 Relays

These three relays are similar in circuit design and are especially adapted for photoelectric applications where a device must respond to rapid light changes or high operating rates.

A time-delay feature, adjustable up to 1/2 second by means of a potentiometer dial, is provided to delay the dropout of the magnetic relay in cases where the relay would be energized for such a short time that the period would not be sufficient to perform the external control operation desired.

The relays will respond to light changes as small as 1/2 foot-candle, providing there is sufficient light on the phototube.

Separate phototube holders are required for these units.

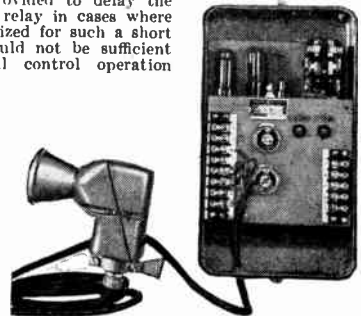

Maximum Distance Between Light Source and Phototube, Feet	Maximum Operating Rate per Min	Type of Relay Contacts	Minimum Light Level to Operate Relay Foot-Candles*	Nominal Voltage	Line Frequency	Self-contained Phototube	Enclosure, NEMA Type	Minimum Required Duration Light Change (Seconds)	Volt-amperes Required (excluding Light Source)	Nomenclature CR 7505-
30	150	DPDT	40 fc	115	50/60	Yes†	I	0.2	10	K100
1000	300	SPDT	—	115/230	60	Yes	III	0.1	40	B100
35	450	SPDT	3 fc	115	DC/25	Yes†	III/V	0.07	20	K108
70	450	DPDT	2 fc	115/230	50/60	Yes†	III/V	0.07	10	K201
70	450	DPDT	2 fc	115/230	50/60	Yes†	IV or VII	0.07	10	K202
210	600	DPDT	1 fc	115/230	50/60	No	III/V	0.001‡	60	N210
210	600	DPDT	1 fc	115/230	25/50/60	No	IV or VII	0.001‡	60	N211
210	600	DPDT	1 fc	115/230	25	No	III/V	0.001‡	60	N212

*Light level measured in foot-candles at the phototube lens with a standard light meter, with entire lens illuminated. †May use separate phototube holder. ‡Relay will respond .015 sec. after light change. Internal timing circuit insures operation on pulses as short as 0.001 sec. and may be adjusted to keep relay energized up to 0.5 sec.

NEMA ENCLOSURE TYPES: I—Protection only, III—Weather-resistant, IV—Watertight, V—Dust-tight, VII—Explosion-proof.



PHOTOELECTRIC RELAYS AND DEVICES

Photoelectric Accessories for Use with -K201 and -N210 Series



1. The CR7505-C200G1 light source is for general indoor application.
2. The following light sources are of die-cast aluminum construction. The -C201G1 light source has a 1 1/2-in. lens, focusable from 2 feet to infinity. The -C202G1 has a double lens for short focus, for a concentrated spot approximately 1/4 in. in diameter at a distance of 2 1/2 - 4 in. in front of the lens. The -C203G1 light source has a 3-in. lens, with high-intensity beam for long-distance operation. The -C201G2, -C202G2, and -C203G2 are identical

in operation with the G1 group, but have rubber gaskets between the front and back covers which makes them weather-resistant and dust-tight in accordance with NEMA Standards.

4.8 volts is required for all the above light sources and the following transformers are recommended:

Light-source transformers. The 9TY51A1 is enclosed in a conduit box with knockouts for conduit connections. It is rated 115/230 volts, 50/60 cycles. The 9TM321A1 is of open-type construction, but has same rating as 9TY51A1. The 92G34 for 25/50/60 cycles is of weather-resistant construction; except for size and type of construction, rating is identical with 9TY51A1.



3. The -C208 light source is explosion-proof and can be made watertight by applying a rubber gasket which is furnished. It has a 3-in. lens and a self-contained step-down transformer for 115/230-volt operation.
4. The phototube holders are similar in construction to the light sources. The -P202G2 has a 1 1/2-in. lens and the -P203G2 has a 3-in. lens. Both come with a 9-ft. phototube cable with spade terminals.

CR7504-A142 Electronic Timer



CR7504-A142 Electronic Timer

The -A142 timer is for timing applications of short time duration (-A142G1, 0.06 to 1.2 sec.; -A142G2, 0.6 to 12 sec.; and -A142G3, 6 to 120 sec.) where long life, low maintenance, and high repetitive accuracy is required.

The -A142 has double-pole, double-throw contacts; can be used to start f-hp motors directly. Time-range dials read directly in seconds.

Two different types of operation available; immediate-start for timing operations or delayed-start for providing a time delay. Power supply, 115/230 volts, 50/60 cycles; power consumption, 15 watts.

For complete information, consult your nearest G-E Apparatus Sales Office or Distributor, or write direct to Section 640-381, General Electric Company, Schenectady 5, New York.

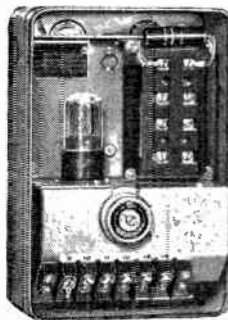

CR7511-A126 Resistance-sensitive Relay

This relay is used to obtain a reliable contact from the touch of two conductors through which only small currents flow. It will operate motors, lights, contactors, and solenoids whenever there is sufficient change in the resistance of a circuit, including liquid-level-control applications. In this way, large amounts of power can be controlled from a low-current high-resistance input.

It has 10 amp a-c contact rating, two single-pole, double-throw contacts for controlling two independent circuits. Enclosure is weather-resistant and dust-tight.

CR7505-R201G1 Smoke-density Indicator

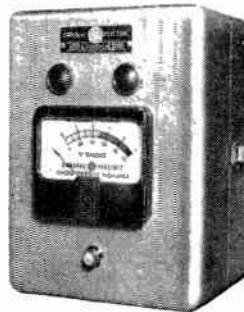

This control and associated equipment can be used to indicate smoke density, gas density, or the density of any fluid where density is directly related to the light transmission through the fluid. It can be used to warn furnace operators of excessive smoke conditions, to turn on blowers or relevant equipment at any smoke-density level, and when used with a suitable recorder, a continuous permanent record of smoke density is always available.

The indicator has a semi-dust-tight enclosure (NEMA Type 1A) and an industrial-type relay, 45 amp make-break and 10 amp carry, at 115 or 230 volts, a-c. Simple calibration adjustments are made with four locking-type knobs on the panel, while indicating lights and a smoke-density instrument are on the front cover of a panel.

CR7505-B100 Photoelectric Relay and -C105 Light Source

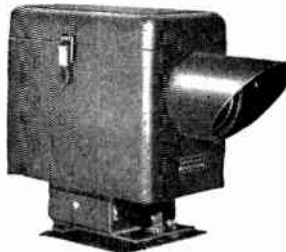

The CR7505-B100 incorporates a tuned circuit which allows the relay to be responsive only to a light beam modulated at approximately 900 cycles per second. Hence, it is insensitive to changes of natural or artificial light.

The CR7505-C105 contains a light-source lamp, a transformer, and a motor-driven slotted disk which "chops," or modulates, the light beam at approximately 900 cycles per second.

When operating at distances of 1000 ft. or less, this equipment in general has sufficient sensitivity so that the light from the source must be reduced twenty times before the relay will drop out. This helps reduce false operation caused by adverse weather conditions. Both units are mounted in outdoor enclosures.

The units operate on 115/230 volts, 60 cycles, a-c. Contacts are rated 10 volts, 115/230 volts, a-c. The relay is provided with a sensitivity control for adjustment for particular light-path distance.

PRICES

Prices of manufacturers and suppliers' products listed in **RADIO'S MASTER** are subject at all times to change without notice — they should not be considered final.

Get quick on-the-spot quotations from your distributor who subscribes to our perpetual up-to-the-minute **PRICING SERVICE**.



Official Pricing System of radio - electronic - television parts and equipment. Supported by the industry: distributors, manufacturers, and their sales representatives.

Loose-leaf, flexible binder. Contains over 1100 pages.

Published by
UNITED CATALOG PUBLISHERS, INC.
106-110 Lafayette Street
New York 13, N. Y.

DELIVERY

Delivery is often dependent on the availability of raw materials. So check with your distributor for delivery information.

EVEREADY

TRADE-MARK

BATTERIES FOR RADIO ELECTRONIC AND OTHER APPLICATIONS

PORTABLE "A" TYPES



PORTABLE "B" TYPES

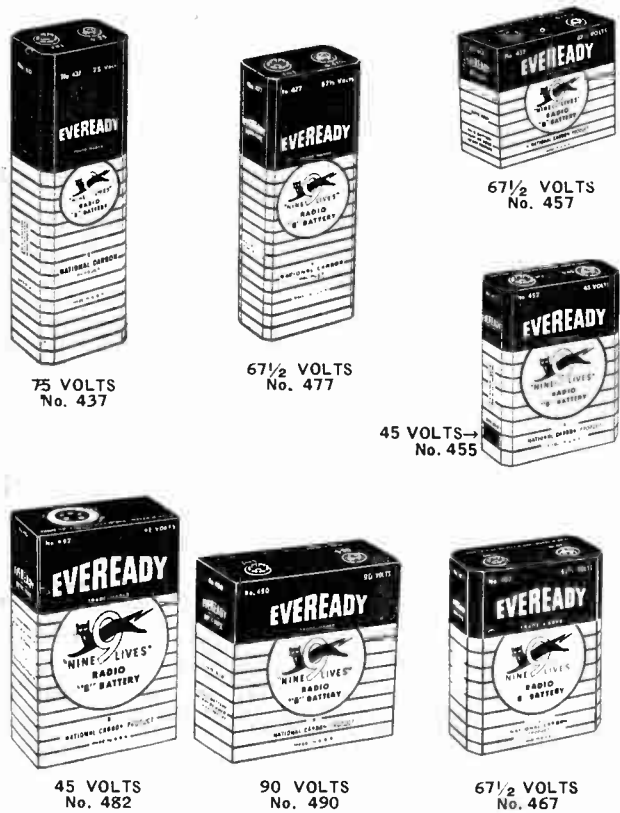



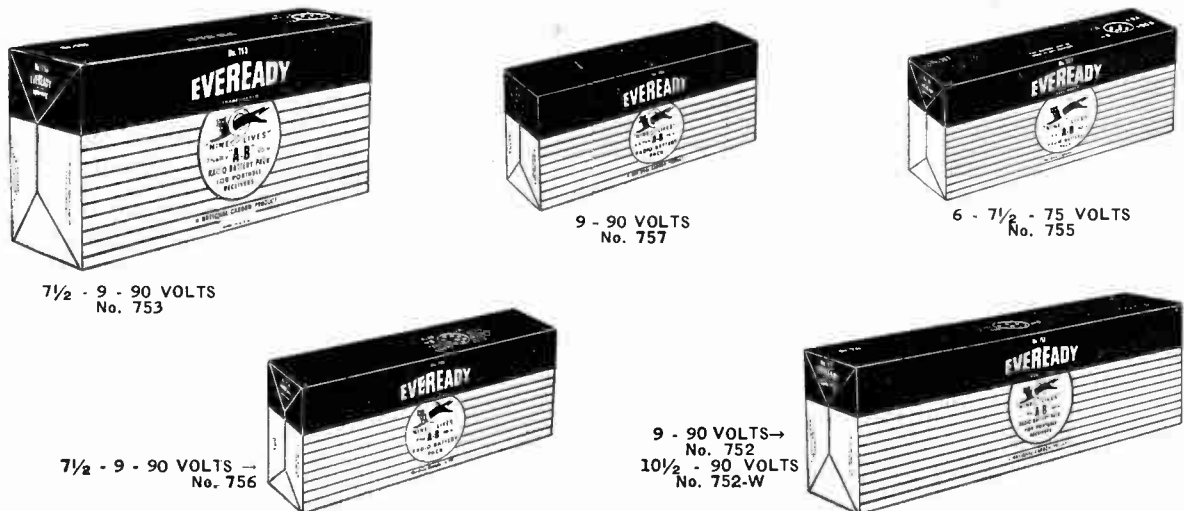

















PORTABLE "A-B" BATTERY PACKS

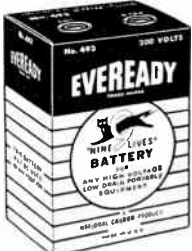

DEALER OR DISTRIBUTOR PRICES AVAILABLE UPON REQUEST

"EVEREADY" RADIO BATTERIES (Continued)

NEW COMPLEMENT	RADIO PAGING	HOME TYPE	EXTERNALLY CONNECTED A-B PACK	FARM PACK
 1 1/2 VOLT No. 635 "A" BATTERY	 45 VOLTS No. 415 "B" BATTERY	 30 VOLTS No. 507	 45 VOLTS No. 487	 7 1/2 - 9 - 90 VOLTS No. 776
EVEREADY BATTERIES FOR OTHER APPLICATIONS				
FLASHLIGHT TYPES	LANTERN TYPES	DRY CELL	HOT SHOT	
 1 1/2 VOLT No. D-99	 950	 935	 915	
 912	 409	 509	 1 1/2 VOLT No. 6 IGNITOR	
 6 VOLT No. 1461				
GENERAL PURPOSE	EMERGENCY LIGHTING	HIGH VOLTAGE	LIGHTING TYPES	"AIR CELL"
 1 1/2 VOLT No. 735	 7 1/2 VOLTS No. 715	 300 VOLTS No. 493	 6 VOLTS No. 510S	 1/4 VOLT No. T-1600
 2 1/2 VOLTS No. T-2600				

COMPLETE LINE SPECIFICATIONS

"Eveready" Battery Number	NEDA Number	VOLTAGE	Overall Dimensions			Unit Package Quantity	Weight of Unit Package in Lbs.	Battery Weight	Terminals	List Price Each	
			L	W	H						
"B" BATTERIES FOR PORTABLE RADIO, INSTRUMENT & ELECTRONIC APPLICATIONS											
411	208	15	1 1/2"	x	3 1/2"	x	2 1/2"	5	3/8 oz.	Flat Contact—, +15	\$ 0.95
412	215	22 1/2	1 1/2"	x	5 1/2"	x	2 1/2"	5	5/8 oz.	Flat Contact—, +22 1/2	1.15
413	210	30	1 1/2"	x	6 1/2"	x	2 1/2"	5	1 1/2 oz.	Flat Contact—, +30	1.40
415	213	45	1 1/2"	x	8 1/2"	x	2 1/2"	6	2 1/2 oz.	Snap Type—, +45	2.00
417	—	15	1 1/2"	x	3 1/2"	x	2 1/2"	6	4 1/2 oz.	Flat Contact—, +15	1.00
420	—	22 1/2	1 1/2"	x	5 1/2"	x	2 1/2"	6	2 1/2 oz.	Flat Contact—, +22 1/2	1.50
430	—	30	1 1/2"	x	6 1/2"	x	2 1/2"	24	5 1/2 oz.	Flat Contact—, +30	1.75
437	212	75	1 1/2"	x	1 1/2"	x	6 1/2"	3	2 1/2 oz.	Snap Type—, +75	3.25
455	201	45	2 1/2"	x	1 1/2"	x	3 1/2"	6	3 oz.	Snap Type—, +45	1.95
457	203	67 1/2	2 1/2"	x	1 1/2"	x	2 1/2"	6	3 1/2 oz.	Snap Type—, +67 1/2	2.50
467	200	67 1/2	2 1/2"	x	1 1/2"	x	3 1/2"	6	4 1/2 oz.	Snap Type—, +67 1/2	2.75
477	211	67 1/2	1 1/2"	x	8 1/2"	x	5 1/2"	6	3 oz.	Snap Type—, +67 1/2	2.35
482	202	45	3 1/2"	x	1 1/2"	x	5 1/2"	6	1 1/2, 15 oz.	Socket—, +45	2.50
484	207	45	3 1/2"	x	2 1/2"	x	5 1/2"	1	3 1/2, 2 oz.	Socket—, +45	3.25
490	201	90	3 1/2"	x	1 1/2"	x	3 1/2"	6	6 1/2 oz.	Snap Type—, +90	3.60
507	—	30	3 1/2"	x	1 1/2"	x	2 1/2"	1	9/10 oz.	Flat Contact—, +30	1.25
738	205	45	3 1/2"	x	2 1/2"	x	4 1/2"	2	2 1/2 oz.	Socket—, +22 1/2; +45	3.50
"A" BATTERIES FOR PORTABLE RADIO, INSTRUMENT & OTHER APPLICATIONS											
D99	—	1 1/2	1 1/2"	Diam.	x	2 1/2"	18	10 3/4 oz.	Flashlight	0.20	
635	—	1 1/2	1 1/2"	Diam.	x	1 3/4"	12	1 1/2 oz.	Flashlight	0.15	
713	8	7 1/2	3 1/2"	x	3 1/2"	x	2 1/2"	1	6 1/2 oz.	Socket—, +7 1/2	1.10
717	9	7 1/2	3 1/2"	x	1 1/2"	x	3 1/2"	6	8 oz.	Socket—, +7 1/2	1.00
†718	1	6	3 1/2"	x	2 3/4"	x	5 1/2"	1	2 3/4 oz.	Socket—, +6	2.45
720	18	1 1/2	3 1/2"	x	1 1/2"	x	3 1/2"	6	6 1/2 oz.	Socket—, +1 1/2	0.65
723	19	6	1 1/2"	x	1 1/2"	x	2 1/2"	1	2 1/2 oz.	Flashlight	0.75
726	2	4 1/2	1 1/2"	x	1 1/2"	x	1 1/2"	6	4 1/2 oz.	Socket—, +4 1/2	0.75
736	3	4 1/2	1 1/2"	x	1 1/2"	x	1 1/2"	6	1 lb.	Socket—, +4 1/2	0.90
†741	17	1 1/2	3 1/2"	x	2 1/2"	x	5 1/2"	1	2 1/2 oz.	Socket—, +1.5	2.10
742	4	1 1/2	3 1/2"	x	2 1/2"	x	3 1/2"	6	1 lb. 5 oz.	Socket—, +1.5	1.15
†743	5	1 1/2	3 1/2"	x	2 1/2"	x	4 1/2"	3	1 lb. 15 oz.	Socket—, +1.5	1.65
744	—	6	3 1/2"	x	2 1/2"	x	3 1/2"	6	1 lb. 5 oz.	Socket—, +6	1.15
†745	21	1 1/2	3 1/2"	x	1 1/2"	x	1 1/2"	2	2 lb. 10 1/2 oz.	Socket—, +1.5	2.25
746	7	4 1/2	3 1/2"	x	1 1/2"	x	4 1/2"	6	7 1/2 oz.	Socket—, +4.5	0.95
†747	16	6	3 1/2"	x	1 1/2"	x	10 1/2"	2	5 1/2 oz.	Socket—, +6	2.15
†912	24	1 1/2	0.4"	Diam.	x	1 1/2"	12	1 1/2 oz.	Flashlight	0.10	
†915	15	1 1/2	3 1/2"	Diam.	x	1 1/2"	12	1 1/2 oz.	Flashlight	0.10	
†935	14	1 1/2	1 1/2"	Diam.	x	2"	12	1 1/2 oz.	Flashlight	0.125	
†950	13	1 1/2	1 1/2"	Diam.	x	2 1/2"	48	9 1/2 oz.	Flashlight	0.15	
980-P	—	1 1/2	1 1/2"	Diam.	x	4 1/2"	1	5 oz.	Socket—, +1.5	0.45	
984	20	1 1/2	1 1/2"	Diam.	x	4 1/2"	12	4 1/2 oz.	Flashlight	0.30	
†1016	—	1 1/2	1 1/2"	x	3 1/2"	x	2 1/2"	24	1 1/10 oz.	2 brass cans—2 zinc caps	0.30

*NEDA number same as an "Eveready" number on a different battery. Omitted to prevent errors in shipping. †Flashlight Types. ††Shipped from factory only.

DEALER OR DISTRIBUTOR PRICES AVAILABLE UPON REQUEST

"Eveready" Battery Number	NEDA Number	VOLTAGE	Overall Dimensions			Unit Package Quantity	Weight of Unit Package In Lbs.	Battery Weight	Terminals	List Price Each
			L	W	H					
"A-B" PACKS FOR PORTABLE RADIO										
†729	*	1 1/2 "A" 90 "B"	7 3/8" x 2 3/8" x 3 3/8"	1	2 1/2	2 lb. 7 oz.	Socket— "A", +1 1/2 "A"			
752	100	9 "A" 90 "B"	14 1/8" x 2 3/8" x 4 1/8"	1	6 1/4	6 lb. 2 oz.	Recessed Plug— "A"			\$ 5.25
752-W	116	10 1/2 "A" 90 "B"	14 1/8" x 2 3/8" x 4 1/8"	1	7	6 lb. 8 oz.	+9 "A", — "B", +90 "B"			6.65
753	101	7 1/2 & 9 "A" 90 "B"	9 3/8" x 2 3/8" x 4 1/8"	1	5	4 lb. 12 oz.	Recessed Plug— "A"			7.10
754	402	7 1/2 & 9 "A" 90 "B"	10 3/8" x 3 1/4" x 4"	1	6 1/4	6 lb. 1 oz.	+10 1/2 "A", — "B", +90 "B"			6.25
755	403	6 & 7 1/2 "A" 75 "B"	8 3/8" x 2 3/8" x 3 3/8"	1	3 3/4	3 lb. 9 oz.	Socket— "A", +7 1/2 "A"			6.75
756	*	7 1/2 & 9 "A" 90 "B"	8 3/8" x 2 3/8" x 3 3/8"	1	3	2 lb. 14 oz.	+9 "A", — "B", +90 "B"			5.50
757	*	9 "A" 90 "B"	9 3/8" x 2 3/8" x 4 1/8"	1	5	4 lb. 12 oz.	Recessed Plug— "A", +9 "A"			5.95
776	*	7 1/2 & 9 "A" 90 "B"	7 3/8" x 4 1/8" x 9 3/8"	1	15 1/4	14 lb. 12 oz.	Socket & Recept Plug— "A", +7 1/2 "A", +9 "A", — "B", +90 "B"			6.25
										10.95
"B" BATTERY FOR RADIO & MISC. APPLICATIONS										
487	*	45	5 3/8" x 2 3/8" x 7 1/4"	6	26 1/4	4 lb. 2 oz.	Socket—, +22 1/2, +45			3.45
"A-B" PACKS FOR FARM RADIO										
758	414	1 1/2 "A" 90 "B"	10 1/8" x 1 1/8" x 6 1/8"	1	14 3/4	11 lb. 4 oz.	Socket— "A", +1.5 "A"			7.95
759	*	1 1/2 "A" 90 "B"	15 1/8" x 4 1/8" x 6 1/8"	1	17	16 lb. 4 oz.	Socket— "A", +1.5 "A"			7.95
"A" BATTERY FOR HOME RADIO										
†740	719	1 1/2	1 3/8" x 3 3/8" x 7 3/4"	1	6 1/4	6 lb.	Socket—, +1.5			5.15
LANTERN BATTERIES										
409	—	6	2 5/8" x 2 5/8" x 3 3/8"	1	1 3/4	1 lb. 6 oz.	Spring & Coil			0.90
509	—	6	2 5/8" x 2 5/8" x 3 3/8"	12	16 1/2	1 lb. 5 oz.	Spring & Coil			0.90
NO. 6 DRY CELLS										
"Ignitor" 6 Gen. Purpose "Gray" Label 6 Telephone & Railroad & Industrial	—	1 1/2	2 5/8" Diam. x 6 5/8"	12	27	2 lb. 2 oz.	**Screw			0.90
	—	1 1/2	2 5/8" Diam. x 6 5/8"	12	26 1/4	2 lb. 2 oz.	***Spring			0.85
	—	1 1/2	2 5/8" Diam. x 6 5/8"	12	27 1/2	2 lb. 2 oz.	**Screw			0.95
"HOT SHOT" BATTERIES										
1461	—	6	10 3/8" x 2 3/8" x 7 1/4"	6	58 1/4	9 lb. 9 oz.	Ins. Sc.—, +6			3.75
1462	—	6	3 3/8" x 5 3/8" x 7 1/4"	4	39 1/4	9 lb. 7 oz.	Ins. Sc.—, +6			3.75
1562	—	7 1/2	7 7/8" x 5 3/8" x 7 1/4"	4	50 1/2	11 lb. 10 oz.	Ins. Sc.—, +7 1/2			4.75
1662	—	9	7 1/8" x 5 1/4" x 7 1/4"	4	60 3/4	14 lb. 1 oz.	Ins. Sc.—, +9			5.50
HIGH VOLTAGE BATTERY										
493	722	300	2 3/8" x 2 3/8" x 3 3/8"	1	1	14 1/2 oz.	Pin Jacks—, +300			11.00
SHOT FIRING BATTERIES										
702	—	1 1/2	2 3/8" x 7/8" x 3 1/8"	1	6/8	5 oz.	Recessed Plug—, +4 1/2			0.90
704	—	3	2 1/8" x 1 1/8" x 4 1/8"	1	1	11 1/2 oz.	Plug—, +3			1.05
708	—	22 1/2	2 5/8" x 2 5/8" x 4 1/8"	1	2	1 lb. 11 oz.	Plug—, +22 1/2			2.85
MISCELLANEOUS TYPES FOR EMERGENCY LIGHTING, EXIT LIGHTS, IGNITION										
510 F	—	6	2 5/8" x 2 5/8" x 1 1/8"	1	1 1/4	1 lb. 6 oz.	Spring—, +6			0.90
510 S	*	6	2 5/8" x 2 5/8" x 1 1/8"	1	1 1/4	1 lb. 6 oz.	Screw—, +6			0.90
706	—	6	8 3/8" x 2 3/8" x 6 1/8"	1	6 3/8	5 lb. 14 oz.	Ins. Sc.—, +6			3.60
715	—	7 1/2	7 1/8" x 1 1/8" x 6 1/8"	1	8	7 lb. 10 oz.	Ins. Sc.—, +7 1/2			4.50
716	—	9	8 3/8" x 4 1/8" x 6 1/8"	1	9	8 lb. 8 oz.	Ins. Sc.—, +9			5.25
735	900	1 1/2	2 5/8" x 2 5/8" x 4 1/8"	12	15 1/2	1 lb. 4 oz.	Screw—, +1 1/2			0.90
"C" BATTERIES & TYPES USED IN INSTRUMENTS, TELEPHONE & OTHER APPLICATIONS										
703	*	4 1/2	2 5/8" x 2 5/8" x 3 1/8"	1	1 3/8	5 oz.	Spring—, +4 1/2			0.60
714	—	4 1/2	3 3/8" x 1 1/8" x 3 3/8"	1	1	14 1/2 oz.	Screw—, +4 1/2			0.60
750	*	3	1 1/8" x 1 1/8" x 2 1/8"	10	1 1/2	2 oz.	Spring—, +3			0.50
751	—	1 1/2	2 5/8" x 2 5/8" x 2 1/8"	10	2	3 oz.	Spring—, +4 1/2			0.60
760	—	1 1/2	2 5/8" x 2 5/8" x 2 1/8"	6	1	4 1/2 oz.	Wire—, +4 1/2			0.60
761T	*	4 1/2	1 1/8" x 1 1/8" x 3 1/2"	5	5	14 oz.	Screw +, —1 1/2, —3, —4 1/2			.95
762S	709	15	4 1/8" x 2 1/8" x 6 1/8"	1	3	2 lb. 12 oz.	Screw—, +22 1/2, +45			3.35
763	*	22 1/2	3 1/2" x 2 3/8" x 2 3/8"	1	1	14 oz.	Screw—, +22 1/2			1.95
766T	*	22 1/2	6 3/8" x 4 1/8" x 3 1/8"	6	32	4 lb. 10 oz.	Spring—, +16 1/2, +18, +19 1/2, +21, +22 1/2			3.65
768	721	22 1/2	4 1/8" x 2 3/8" x 2 3/8"	1	1 1/2	1 lb. 8 1/2 oz.	Socket +, —3, —4 1/2, —16 1/2, —22 1/2			2.15
771	*	4 1/2	3 3/8" x 1 1/8" x 3 1/8"	5	4 1/2	13 oz.	Socket +, —3, —4 1/2			.95
773	*	7 1/2	3 3/8" x 1 1/8" x 3 1/8"	5	3	9 oz.	5 Screw; 1 wire +, —4 1/2, —3, —1 1/2, —6, —7 1/2			1.10
774	—	7 1/2	1 1/8" x 1 1/8" x 3"	5	3	8 1/2 oz.	Socket +, —7 1/2			1.75
778	—	22 1/2	2 1/8" x 2 3/8" x 3 3/8"	10	17	1 lb. 8 oz.	Falnstock +, —3, —4 1/2, —6, —9, —10 1/2, —16 1/2, —22 1/2			2.30
781	*	4 1/2	4 1/8" x 1 1/8" x 3 1/4"	5	1 3/4	5 oz.	Screw +, —4 1/2			0.65
780	—	3	5 1/8" x 1 1/8" x 3 1/4"	1	1 1/2	1 lb. 1 1/2 oz.	Flat—, +3			1.10
799	—	49 1/2	8 3/8" x 4 1/8" x 8 3/8"	6	9 1/2	13 lb. 5 oz.	Spring—, +22 1/2, +45, +49 1/2			7.55
"EVEREADY" "AIR CELL" BATTERIES										
T-1600	—	1.25	5 3/8" x 6 3/8" x 11 3/8"	1	13	11 1/2 lb. Dry	Spring—, +1.25			7.60
T-2600	—	2.5	9 3/8" x 6 3/8" x 11 3/8"	1	24	21 lb. Dry	Spring—, +2.5			13.70
T-1300	—	1.25	5 3/8" x 4 3/8" x 8 3/8"	1	7	6 lb. Dry	Spring—, +1.25			5.70
T-2300	—	2.5	8 3/4" x 5 3/8" x 8 3/8"	1	12 1/2	11 lb. Dry	Spring—, +2.5			10.25

*NEDA number same as an "Eveready" number on a different battery. Omitted to prevent errors in shipping. †Flashlight Types. ††Shipped from factory only.
 **Equipped with screw terminals unless Falnstock spring terminals are specified.
 ***Equipped with Falnstock spring terminals unless screw terminals are specified.

DEALER OR DISTRIBUTOR PRICES AVAILABLE UPON REQUEST



FLASHLIGHTS

No. 212 Small Penlite Black and Chrome
List Price Each (without batteries) \$0.89



No. 7231P Two-cell Small Square Spotlight Easy Grip, Chrome Finish, Unbreakable "Safety Glow" lens guard.
List Price Each (without batteries) \$1.85



No. 2351 Three-Cell Automatic Spotlight.
List Price Each (Without Batteries) \$2.20



No. 8251 Two-Cell End Loader — Automatic Spotlights with removable bottom cap ring hanger.
List Price Each (without batteries) \$1.59

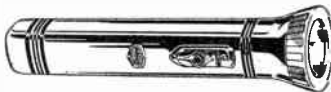

No. 7351P Three-cell square spotlight easy grip cell chrome unbreakable "Safety Glow" lens guard.
List Price Each (without batteries) \$2.35



No. 7551P "Slim Jim" Unbreakable Lens Guard and Matching Rear Cap Guard Unbreakable "Safety Glow" lens guard.
List Price Each (without batteries) \$3.50



No. 1251 — Two-Cell Pre-focused Industrial Flashlight — General purpose type. List Price Each (Without Batteries) \$2.95



No. 1259 — Two-Cell Pre-focused Permissible Safety Flashlight.
List Price Each (Without Batteries) \$5.00



No. 25H With each flashlight, customer gets a FREE "HANDY HANGER" for placing flashlight in convenient home location ready for any emergency.
List Price Each (without batteries) \$1.85



Display Package Christmas gift assortment No. 127 Contains 12 popular "Eveready" spotlights—including individual gift cartons.
List Prices Each (without batteries) from \$1.19 to \$2.35

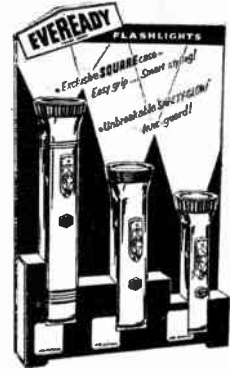

Display Package "Eveready" Masterlite No. 128 Flashlights — Exclusive square case—Unbreakable "Safety Glo" lens guard.
List Prices Each (without batteries) from \$1.85 to \$2.35



DISPLAY PACKAGE No. 73

Contains six two-cell Spot-Flood flashlights — A close range Floodlight or a long range Spotlight. (Without Batteries.)
List Price Each \$2.70



DISPLAY PACKAGE No. 126

Contains 2 - 8251; 2 - 8251P; and 2 - 7251P Automatic Spotlights. (Without Batteries)
8251 List Price \$1.19
8251P List Price \$1.59
7251P List Price 1.95



DISPLAY PACKAGE No. 53

Contains 6 No. 5251 Automatic Spotlights, brass with all chrome finish.
List Price Each (Without Batteries) \$1.19

SCHEDULE OF PRICES

Cat. No.	No. of Cells	Cell Size	List Price Each	Unit Pkg. Qty.	Weight of Unit Packages	
					Lbs.	Ozs.
912	1	K	\$.10	12	—	4
915	1	AA	.10	12	—	7
935	1	C	.125	12	1	2
950	1	D	.15	48	9	7½
099	1	D	.20	48	10	—

Lantern Battery

509	4	F	.80	12	16½	8
-----	---	---	-----	----	-----	---

"Eveready" Miniature Lamps for Radio Panel Service

"Eveready" No.	Bulb	Volts	Amp.	List Price
40	T-3¼	6-8	0.15	\$.12
41	T-3¼	2.5	0.50	.12
44	T-3¼	6-8	0.25	.12
46	T-3¼	6-8	0.25	.12
47	T-3¼	6-8	0.15	.12
48	T-3¼	2	0.06	.16
49	T-3¼	2	0.06	.16
50	C-3½	6-8	C.P. 1	.12
1490	T-3¼	3.2	0.16	.12
1458	G-5	2.0	0.25	.15

FLASHLIGHT LENS ASSORTMENT

Cat. No.	Type	Unit Package Quantity
102	30 No. 53419 Spotlight Lenses for Nos. 2251, 2671, 2351, 7251, 8251, 4351 Spotlights	1 Assortment
	6 No. 53123 Spotlight Lenses for No. 2231 Baby Spotlight	
	4 No. 53390 Searchlight Lenses for No. 2552 Searchlight	

"EVEREADY" LAMPS TWO CELL

"Eveready" No.	Bulb	Volts	Amp.	List Price	Use with Following "Eveready" Batteries"
14	G-3½	2.5	0.30	\$.12	2 Nos. 935 or 950
PR-2	B-3½	2.4	0.27	.17	2 No. 950
PR-4	B-3½	2.3	0.27	.17	2 No. 935
PR-6	B-3½	2.5	0.30	.17	2 Nos. 935 or 950
222	TL-3	2.2	0.25	.13	2 No. 915
224	TL-2¼	2.15	0.22	.14	2 No. 912

THREE CELL

13	G-3½	3.8	0.30	\$.12	3 No. 950
PR-3	B-3½	3.6	0.50	.17	3 No. 950
PR-7	B-3½	3.8	0.30	.17	3 No. 950

FIVE CELL

605	G-4½	6.0	0.50	\$.15	5 No. 950
PR-12	B-3½	6.0	0.50	.17	5 No. 950

DEALER OR DISTRIBUTOR PRICES AVAILABLE UPON REQUEST

BURGESS BATTERIES

AMERICA'S MOST COMPLETE LINE OF DRY BATTERIES



4FH



4F2H



F4H



No. 2



No. 1



Z



No. 7

BURGESS FLASHLIGHT & LANTERN BATTERIES



4F6H

No. 1.	1½ volts. Size, 6 ³ / ₁₆ " x 1 ¹ / ₁₆ ". Standard package 12.....	List price, \$1.25
No. 2.	1½ volts. Size, 1 ¹ / ₁₆ " x 2 ³ / ₈ ". Standard package 48.....	List price, .15
No. Z.	1½ volts. Size, 3 ⁵ / ₁₆ " x 1 ³ / ₃₂ ". Standard package 24.....	List price, .10
No. 7.	1½ volts. Size, 1 ³ / ₁₆ " x 1 ³ / ₄ ". Standard package 24.....	List price, .10
F4H.	6 volts. Size, 2 ⁵ / ₈ " x 2 ⁵ / ₈ " x 3 ¹ / ₁₆ ". Standard package 12.....	List price, .90
4F2H.	3 volts. Size, 3 ³ / ₃₂ " x 2 ¹ / ₁₆ " x 5 ¹ / ₂ ". Standard package 8.....	List price, 1.55
No. 210	1½ volts. Size, 1 ¹ / ₁₆ " x 2 ³ / ₈ ". Standard package 50.....	List price, .175
N (Bare)	1½ volts. Size, 7 ¹ / ₁₆ " x 1 ¹ / ₁₆ ". Standard package 24.....	List price, .075
530	45 volts. Size, 4 ¹ / ₁₆ " x 2 ¹ / ₃₂ " x 5 ¹ / ₁₆ ". Standard package 2.....	List price, 3.40

BURGESS IGNITION BATTERIES



6 Ign.

6 Tel.

4FH.	1½ volts. Size, 2 ⁵ / ₈ " x 2 ⁵ / ₈ " x 4". Standard package 12.....	List price, .90
4F2H.	3 volts. Size, 3 ³ / ₃₂ " x 2 ¹ / ₁₆ " x 5 ¹ / ₃₂ ". Standard package 8.....	List price, 1.5
4F4H.	6 volts. Size, 8 ⁵ / ₁₆ " x 2 ¹ / ₁₆ " x 5 ¹ / ₁₆ ". Standard package 6.....	List price, 3.60
4F5H.	7½ volts. Size, 7 ⁷ / ₁₆ " x 3 ³ / ₃₂ " x 5 ¹ / ₁₆ ". Standard package 4.....	List price, 4.50
4F6H.	9 volts. Size, 8 ¹ / ₂ " x 3 ³ / ₃₂ " x 5 ¹ / ₁₆ ". Standard package 4.....	List price, 5.20
2Z2PI	3 volts. Size, 1 ³ / ₃₂ " x 1 ³ / ₃₂ " x 2 ¹ / ₃₂ ". Standard package 12.....	List price, .75

BURGESS NO. 6 LINE

No. 6 R. R. and Ind.	1½ volts. Size, 2 ¹ / ₂ " Diam. 6 ⁵ / ₈ ". Standard package 12.....	List price, .95
No. 6 IGN.	1½ volts. Size, 2 ¹ / ₂ " Diam. 6 ⁵ / ₈ ". Standard package 12.....	List price, .90
No. 6 TEL.	1½ volts. Size, 2 ¹ / ₂ " Diam. 6 ⁵ / ₈ ". Standard package 12.....	List price, .85
S 461.	6 volts. Size 10 ¹ / ₂ " x 2 ³ / ₄ " x 7 ¹ / ₃₂ ". Standard package 6.....	List price, 3.75

FOR INDUSTRIAL APPLICATIONS

BURGESS "A" BATTERIES



2F2H

No. 2F2H.	3 volts. Size, 2 ⁵ / ₈ " x 2 ⁵ / ₈ " x 4 ¹ / ₁₆ ". Standard package 5.....	List price, 1.00
No. 2FBP.	1½ volts. Size, 2 ¹ / ₃₂ " x 1 ³ / ₈ " x 4 ¹ / ₃₂ ". Standard package 5.....	List price, .95
No. B2BP.	3 volts. Size, 1 ⁵ / ₈ " x 1 ¹ / ₁₆ " x 2 ¹ / ₁₆ ". Standard package 6.....	List price, 1.40
No. F2BP.	3 volts. Size, 2 ¹ / ₃₂ " x 1 ³ / ₈ " x 4 ¹ / ₃₂ ". Standard package 5.....	List price, .95
No. F4BP.	6 volts. Size, 2 ⁵ / ₈ " x 2 ⁵ / ₈ " x 4". Standard package 10.....	List price, .90
5R	1½ volts. Size, 4 ⁹ / ₁₆ " (Diam.) 2 ¹ / ₁₆ ". Standard package 12.....	List price, .125
8R	1½ volts. Size, 1 ³ / ₁₆ " (Diam.) 3 ¹ / ₁₆ ". Standard package 24.....	List price, .35
9R	1½ volts. Size, 3 ⁵ / ₁₆ " (Diam.) 1 ¹ / ₁₆ ". Standard package 12.....	List price, .15
2Z	1½ volts. Size, 1 ¹ / ₈ " x 1 ³ / ₃₂ " x 1 ¹ / ₁₆ ". Standard package 10.....	List price, .39
422	3 volts. Size, 1 ¹ / ₃₂ " x 3 ³ / ₃₂ " x 2 ⁵ / ₁₆ ". Standard package 10.....	List price, .50
432	4½ volts. Size, 1 ³ / ₁₆ " x 2 ¹ / ₁₆ " x 2 ¹ / ₄ ". Standard package 10.....	List price, .60
532	4½ volts. Size, 2 ¹ / ₃₂ " x 1 ³ / ₁₆ " x 2 ³ / ₃₂ ". Standard package 10.....	List price, .60
2F4FL	6 volts. Size, 4 ¹ / ₈ " x 2 ¹ / ₁₆ " x 5 ¹ / ₂ ". Standard package 12.....	List price, 2.13

(C Batteries Continued on Next Page)

A QUALITY DRY BATTERY FOR EVERY PURPOSE

BURGESS BATTERIES

AMERICA'S MOST COMPLETE LINE OF DRY BATTERIES



5208



5640



2370



10308



2308

FOR INDUSTRIAL APPLICATIONS (Cont'd.)

BURGESS "B" BATTERIES

No. W30.	45	volts.	Size, 3" x 1 1/4" x 3 3/32"	Standard package 6.....	List price,	3.15
W30PBX.	45	volts.	Size, 3" x 1 1/4" x 3 25/32"	Standard package 6.....	List price,	2.73
No. Z30NX.	45	volts.	Size, 3 1/2" x 1 7/8" x 4 1/32"	Standard package 5.....	List price,	3.10
K10	15	volts.	Size, 1 1/2" x 7/8" x 1 1/4"	Standard package 20.....	List price,	1.00
K15	22 1/2	volts.	Size, 2 3/32" x 7/8" x 1 1/4"	Standard package 20.....	List price,	1.50
K20	30	volts.	Size, 1 1/4" x 1 1/4" x 2 23/32"	Standard package 20.....	List price,	1.75
U10	15	volts.	Size, 3 1/32" x 7/16" x 1 1/16"	Standard package 20.....	List price,	.95
U15	22 1/2	volts.	Size, 3 1/32" x 7/16" x 1 31/32"	Standard package 20.....	List price,	1.15
U20	30	volts.	Size, 3 1/32" x 7/16" x 2 1/2"	Standard package 20.....	List price,	1.40
XX15	22 1/2	volts.	Size, 1 1/2" x 1 1/16" x 3 7/8"	Standard package 24.....	List price,	1.65
XX22	33	volts.	Size, 2 1/32" x 3 1/32" x 3 1/8"	Standard package 10.....	List price,	2.00
XX30PI	45	volts.	Size, 2 1/32" x 3 1/32" x 4 1/2"	Standard package 24.....	List price,	2.05
Y10	15	volts.	Size, 1 1/32" x 1 1/32" x 1 3/4"	Standard package 12.....	List price,	.95
Y15	22 1/2	volts.	Size, 1 1/32" x 1 1/32" x 1 3/4"	Standard package 12.....	List price,	1.15
Y20	30	volts.	Size, 1 1/32" x 1 1/32" x 1 3/4"	Standard package 12.....	List price,	1.40
Y20S	30	volts.	Size, 1 1/32" x 1 1/32" x 2 1/2"	Standard package 12.....	List price,	1.25



F2BP

BURGESS "C" BATTERIES

No. A8BP.	12	volts.	Size, 2 5/8" x 1 3/4" x 2 1/2"	Standard package 3.....	List price,	\$3.29
No. W5BP.	7	volts.	Size, 2 3/32" x 2 3/32" x 1 1/4"	Standard package 6.....	List price,	1.93

BURGESS FARM RADIO & INDUSTRIAL "B" BATTERIES

No. 10308SC or Pl.	45	volts.	Size, 8 3/32" x 4 1/2" x 7 3/4"	Standard package 6..	List price,	4.80
No. 21308SC or Pl.	45	volts.	Size, 8 1/8" x 4 1/2" x 7 3/4"	Standard package 6..	List price,	5.22
No. 2308 SC or Pl.	45	volts.	Size, 8 3/32" x 2 3/4" x 7 1/4"	Standard package 6..	List price,	3.27
No. 5156SC.	22 1/2	volts.	Size, 4 1/8" x 2 1/2" x 2 3/4"	Standard package 5..	List price,	2.30
No. 5156PI.	22 1/2	volts.	Size, 4 1/4" x 2 3/8" x 2 5/8"	Standard package 5..	List price,	2.30
No. 5308.	45	volts.	Size, 4 1/8" x 2 1/4" x 5 1/8"	Standard package 5..	List price,	3.35

BURGESS RADIO "B" & "C" BATTERIES

No. 2156.	22 1/2	volts.	Size, 6 3/32" x 4 1/8" x 2 31/32"	Standard package 6.....	List price,	3.85
No. 2370.	4 1/2	volts.	Size, 3 1/16" x 1 3/8" x 2 7/8"	Standard package 5.....	List price,	.96
No. 2370PI.	4 1/2	volts.	Size, 4 1/4" x 1 7/16" x 2 3/4"	Standard package 5.....	List price,	.96
No. 4156.	22 1/2	volts.	Size, 3 1/32" x 2 1/8" x 2 3/4"	Standard package 5.....	List price,	1.97
No. 5360.	4 1/2	volts.	Size, 2 13/32" x 1 1/2" x 2 3/4"	Standard package 5.....	List price,	.65
No. 5540.	7 1/2	volts.	Size, 4" x 7/8" x 2 3/4"	Standard package 5.....	List price,	1.12

BURGESS FARM RADIO "A" BATTERIES

No. 20F.	1 1/2	volts.	Size, 7 3/8" x 2 1/4" x 6 1/4"	Standard package 3.....	List price,	5.45
No. 20F2.	3	volts.	Size, 11 1/2" x 4" x 6 1/8"	Standard package 1.....	List price,	9.30

BURGESS QUALITY FLASHLIGHT CASES

146.	2 cell	prefocused	Maroon & Chrome.	Standard package 6.....	List price,	\$1.89	
152.	New slim	Penlight	Chrome.	Standard package 12.....	List price,	.88	
248.	5 cell	Prefocused	Chrome.	Standard package 1.....	List price,	4.25	
250.	Rangefinder	2 cell	focusing	Chrome.	Standard package 4.....	List price,	2.25
251.	Zebra Light	with cells.		Standard package 12.....	List price,	.69	
252.	3 cell	prefocused	Maroon & Chrome.	Standard package 1.....	List price,	2.95	
346.	2 cell	Baby Prefocused	Maroon & Chrome.	Standard package 6.....	List price,	1.70	
350.	2 cell	Tough Industrial	Light.	Standard package 6.....	List price,	1.90	
P92.	Penlight	Maroon	Chrome.	Standard package 6.....	List price,	.88	
TW2.	Focusing	Lantern.		Standard package 4.....	List price,	3.70	
953.	Key Chain	Zebra Light	with Cells.	Standard package 12.....	List price,	.79	



146



152



251

A QUALITY DRY BATTERY FOR EVERY PURPOSE

BURGESS BATTERIES

AMERICA'S MOST COMPLETE LINE OF DRY BATTERIES

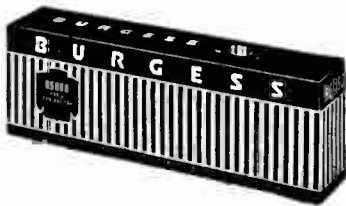

G6B60



T5Z50

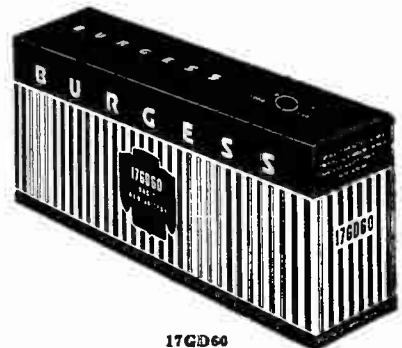

17GD60



6TA60

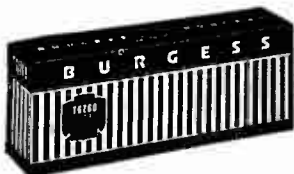

T6Z60



F6A60



F4B60

FLASHLIGHT CASES & LANTERNS

- 450 3 Cell Tough Industrial. Standard package 6....List price, \$2.15
- 452 2 Cell Prefocused—Chrome. Standard package 6..List price, 1.45
- 453 2 Cell Industrial—Safety Light. Std. package 1..List price, 5.00
- 553 2 Cell—Chrome. Standard package 6.....List price, 1.75
- 653 2 Cell Chrome Bullet End. Standard package 1..List price, 1.55
- 753 2 Cell Baby, Chrome Bullet End. Std. package 1..List price, 1.40
- 853 3 Cell Chrome—Bullet End. Std. package 1.....List price, 1.75
- LD34 Lens Display Kit (32 Popular Lenses).
Standard package 1..List price, 3.20

BURGESS FARM "A & B" BATTERIES

- No. 17GD60. 1½ volt "A", 90 volt "B". Size 15¹¹/₁₆" x 4³/₄" x 7⁷/₁₆". Standard package 1. List price, \$7.95
- No. 4SD60. 1½ volt "A", 90 volt "B". Size 10¹¹/₁₆" x 4⁵/₁₆" x 6¹/₁₆". Standard package 1. List price, \$7.95
- No. S6D60. 7½ volt "A", 9 "A" 90 volt "B". Size 9⁷/₈" x 4¹/₈" x 7⁷/₁₆". Standard package 1. List Price, \$10.95

BURGESS PORTABLE "A" & "B" BATTERIES

No.	Voltage	Size	List Price
2TXX40.	1½ A, 60B	2 ¹ / ₂ " x 1 ¹¹ / ₃₂ " x 7 ¹ / ₃₂ "	3.75
4GA42.	1½ A, 63B	9 ¹ / ₁₆ " x 2 ¹ / ₈ " x 4 ¹ / ₄ "	5.10
6TA60.	1½ A, 90B	9 ³ / ₃₂ " x 2 ¹ / ₄ " x 4 ¹ / ₁₆ "	6.25
F4A50.	6A, 75B	9 ¹ / ₃₂ " x 2 ² / ₃₂ " x 3 ² / ₃₂ "	6.25
F6A60.	7½, 9A, 90B	9 ⁵ / ₁₆ " x 2 ¹ / ₃₂ " x 4 ¹ / ₁₆ "	6.25
F6A60P.	9A, 90B	9 ⁷ / ₁₆ " x 2 ³ / ₄ " x 4 ¹ / ₃₂ "	6.25
T5Z50.	6, 7½ A, 75B	8 ¹ / ₂ " x 3 ¹ / ₃₂ " x 2 ³ / ₈ "	5.50
G6B60.	9A, 90B	13 ² / ₃₂ " x 2 ¹ / ₁₆ " x 4 ¹ / ₃₂ "	6.65
G6M60.	7½, 9A, 90B	10 ¹ / ₁₆ " x 3 ¹ / ₈ " x 4 ¹ / ₃₂ "	6.75
T6Z60 or P.	7½, 9A, 90B	2 ³ / ₁₆ " x 8 ¹ / ₁₆ " x 3 ¹ / ₁₆ "	5.95
4TZ60.	1½ A, 90B	7 ⁷ / ₈ " x 2 ¹ / ₈ " x 3 ³ / ₄ "	5.25

PHOTO-FLASH BATTERIES

- 120 1½ volts. Size, 1" (diam.) 1¹/₁₆". Standard package 12
List price, .15
- 220 1½ volts. Size, 1¹/₃₂" (diam.) 2³/₄". Standard package 12
List price, .15
- 920 1½ volts. Size, 3³/₄" (diam.) 1³/₃₂". Standard package 24
List price, .125
- U15PF 22½ volts. Size, 3¹/₃₂" x 1¹/₁₆" x 1³/₃₂". Standard package 20
List price 1.15

A QUALITY DRY BATTERY FOR EVERY PURPOSE

Radio's Master — 19th Edition

Copyright by U. C. P., Inc.

BURGESS BATTERIES

AMERICA'S MOST COMPLETE LINE OF DRY BATTERIES



4F



2R



G3



F4PI



T5



F3



A30

BURGESS PORTABLE "A" BATTERIES

No. 2F.	1½ volts. Size, 2 ¹ / ₃₂ " x 1 ³ / ₈ " x 4 ¹ / ₄ ". Standard package 1.	List price, \$.75
No. 2F4.	6 volts. Size, 4" x 2 ¹ / ₁₆ " x 5 ³ / ₁₆ ". Standard package 1.	List price, 2.60
No. 2R.	1½ volts. Size, 1 ² / ₆₄ " x 2 ²⁵ / ₆₄ " diameter. Standard package 48.	List price, .15
No. 4F.	1½ volts. Size, 2 ³ / ₈ " x 2 ⁵ / ₈ " x 4 ³ / ₃₂ ". Standard package 6.	List price, 1.15
No. 4FL.	1½ volts. Size, 4 ⁷ / ₈ " x 1 ³ / ₈ " x 5 ¹ / ₈ ". Standard package 1.	List price, 1.93
No. 6F.	1½ volts. Size, 4 ³ / ₃₂ " x 2 ³ / ₄ " x 4 ¹ / ₈ ". Standard package 3.	List price, 1.75
No. 8F.	1½ volts. Size, 3 ² / ₃₂ " x 2 ² / ₃₂ " x 5 ¹ / ₂ ". Standard package 1.	List price, 2.22
No. F4PI.	6 volts. Size, 2 ² / ₃₂ " x 2 ² / ₃₂ " x 4 ¹ / ₈ ". Standard package 6.	List price, 1.15
No. G3.	4½ volts. Size, 4 ¹ / ₈ " x 1 ⁷ / ₈ " x 4 ¹ / ₈ ". Standard package 6.	List price, .95
No. T5.	7½ volts. Size, 2 ¹ / ₃₂ " x 2 ¹ / ₃₂ " x 3 ² / ₃₂ ". Standard package 3.	List price, 1.38
No. D3.	4½ volts. Size, 3 ⁷ / ₈ " x 1 ¹ / ₈ " x 2 ¹ / ₈ ". Standard package 6.	List price, .75
No. 2D.	1½ volts. Size, 2 ¹ / ₈ " x 1 ¹ / ₃₂ " x 2 ¹ / ₃₂ ". Standard package 12.	List price, .65
No. Z4.	6 volts. Size, 1 ¹ / ₈ " x 1 ¹ / ₈ " x 2 ¹ / ₃₂ ". Standard package 1.	List price, .75
No. B5.	7½ volts. Size, 3 ² / ₃₂ " x 7 ¹ / ₈ " x 2 ¹ / ₃₂ ". Standard package 6.	List price, 1.10
No. C5.	7½ volts. Size, 2 ¹ / ₃₂ " x 1 ¹ / ₈ " x 3 ¹ / ₃₂ ". Standard package 6.	List price, 1.00
No. F3.	4½ volts. Size, 4" x 1 ¹ / ₈ " x 4 ¹ / ₈ ". Standard package 6.	List price, .87
No. 21R.	1½ volts. Size, 1 ² / ₆₄ " (diam.) 4 ¹ / ₈ ". Standard package 24.	List price, .30
No. 37.	1½ volts. Size, 1 ¹ / ₈ " (diam.) 6 ¹ / ₈ ". Standard package 1.	List price, .85



N60



M30



XX45

BURGESS PORTABLE "B" BATTERIES

No. A30.	45 volts. Size, 3 ¹ / ₈ " x 2 ¹ / ₄ " x 4 ¹ / ₈ ". Standard package 2.	List price, 2.85
No. B30.	45 volts. Size, 4 ¹ / ₈ " x 2 ¹ / ₃₂ " x 5 ³ / ₈ ". Standard package 2.	List price, 3.25
No. M30.	45 volts. Size, 3 ¹ / ₈ " x 1 ³ / ₄ " x 5 ¹ / ₂ ". Standard package 6.	List price, 2.50
No. XX30.	45 volts. Size, 2 ¹ / ₃₂ " x 3 ¹ / ₃₂ " x 3 ² / ₃₂ ". Standard package 6.	List price, 1.95
No. XX45.	67½ volts. Size, 2 ³ / ₄ " x 1 ¹ / ₃₂ " x 3 ³ / ₄ ". Standard package 6.	List price, 2.75
No. XX50.	75 volts. Size, 1 ² / ₃₂ " x 1 ¹ / ₈ " x 6 ¹ / ₈ ". Standard package 6.	List price, 3.25
No. Z30.	45 volts. Size, 3" x 2 ⁵ / ₈ " x 4 ¹ / ₈ ". Standard package 2.	List price, 3.50
No. U200.	300 volts. Size, 2 ³ / ₄ " x 2 ³ / ₃₂ " x 3 ⁷ / ₈ ". Standard package 1.	List price, 11.40
No. N60.	90 volts. Size, 3 ¹ / ₁₆ " x 1 ¹ / ₃₂ " x 3 ¹ / ₃₂ ". Standard package 6.	List price, 3.60
No. K45.	67½ volts. Size, 2 ¹ / ₁₆ " x 1 ⁵ / ₈ " x 2 ¹ / ₄ ". Standard package 6.	List price, 2.50
No. XX69.	103½ volts. Size, 1 ¹ / ₃₂ " x 1 ¹ / ₃₂ " x 11 ² / ₃₂ ". Standard package 6.	List price, 5.38
No. P45.	67½ volts. Size, 1 ⁷ / ₈ " x 3 ¹ / ₃₂ " x 5 ³ / ₃₂ ". Standard package 6.	List price, 2.35
No. U30.	45 volts. 1 ¹ / ₃₂ " x 1 ¹ / ₃₂ " x 3 ¹ / ₃₂ ". Standard package 6.	List price, 2.00
P45M	67½ volts. Size, 1 ⁷ / ₈ " x 3 ¹ / ₃₂ " x 5 ³ / ₃₂ ". Standard package 6.	List price, 2.95



XX30



P45



21R

A QUALITY DRY BATTERY FOR EVERY PURPOSE

be sure with



GENERAL

DRY BATTERIES

GENERAL dry batteries contain many outstanding advancements such as extra heavy seamless extruded zinc cups, the famous paper thin separator permitting more mix and more active zinc area by utilization of the cell bottom, the curled rim lock seal which seals each cell individually. These features, found only in Generals, assure long shelf life as well as the maximum in dry battery performance.

GENERAL A & B RADIO FARM PACKS

General A-B packs are made with L size cells in the A section. These cells are 40% longer than the largest conventional 1 1/4" diameter cell. This construction assures the perfect balance between these "A" and "B" sections for current drains established by the Radio Industry.

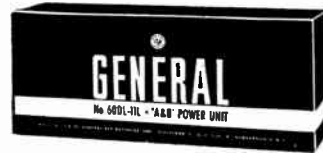

Type	Voltage	Standard Package	Pkg. Lbs. Weight	Eveready	Interchangeable With Burgess	Ray-O-Vac	Price
60DL11L	1 1/2-90	1	24.5	759	17GD60	AB82	\$ 7.95
60D12L6	9-90	1	24	—	3GD60	AB982	10.95
6086L	1 1/2-90	4	39	758	—	AB85	7.95
318	1 1/2-90	1	22.5	—	18GD60	—	7.95

GENERAL ABC HOME RADIO BATTERIES

All cells used in General batteries are filled with active mix by loading equipment developed by General which automatically puts the right amount of mix into each cell and packs it uniformly. General home radio batteries are accepted for their uniformity, dependability and long service.



Type	Voltage	Standard Package	Pkg. Lbs. Weight	Eveready	Interchangeable With Burgess	Ray-O-Vac	Price
I2L1L	1 1/2	4	34	740	20F	P9203	\$5.15
P24L2	3	1	17	X125	20F2	P9403	6.95
Y30D	45	6	45	—	2308	P5233	3.45
Y30F	45	6	68	—	10308	P5933	4.70
Y30FL	45	3	39	—	21308	P9303	5.30
H38S	4 1/2	10	3	781	5360	531R	.65
V58	7 1/2	10	6.3	773	5540	551	1.20
H15B8	22 1/2	10	15.4	768	5156PI	P5151	2.45
H15A	22 1/2	10	10	763	4156	4151	1.95

GENERAL PORTABLE A & B PACKS

The small size cells used in portable batteries greatly reflect the benefits derived from General's patented construction. General Batteries deliver more service hours per dollar, therefore you will find them used as original equipment in more battery radios than any other brand.



Type	Voltage	Standard Package	Pkg. Lbs. Weight	Eveready	Interchangeable With Burgess	Ray-O-Vac	Price
40N2CF	1 1/2-60	6	8.7	—	—	—	\$3.60
41A4FL	1 1/2-6 1 1/2	6	25.5	—	4GMA41	AB419	5.20
60A6F6-5	7 1/2-9-90	1	6	753	F6A60	AB994	5.95
362	7 1/2-9-90	6	24	756	TSZ60	—	5.95
Z60B6H6	9-90	6	24	—	G4850	AB670	6.65
50AASCE45	6-7 1/2-75	6	21.5	755	TS250	AB775	5.50
60A6F6	9-90	6	36.75	—	F6A60P	AB909	10.25

GENERAL PORTABLE A BATTERIES

Type	Voltage	Pkg. Std.	Pkg. Weight Lbs.	Interchangeable With			Price
				Eveready	Burgess	Ray-O-Vac	
D	1 1/2	50	12	—	—	—	\$.15
4F1	1 1/2	6	9	742	4F	P94A	1.15
3H3	4 1/2	6	8	746	G3	P83A	.95
4F4	6	6	9	744	F4PI	P694A	1.15
G	1 1/2	25	11	964	Z1R	8R	.30
5C5	7 1/2	14	7	717	C5	P751	1.00
3F3	4 1/2	6	7	736	F3	P93A	.75



GENERAL PORTABLE B BATTERIES

Type	Voltage	Std. Pkg.	Pkg. Weight Lbs.	Interchangeable With			Price
				Eveready	Burgess	Ray-O-Vac	
V30A	45	6	11.4	—	A30	P430	\$2.50
V30B	45	6	17	—	B30	P5303	2.50
V30AA	45	6	9	738	Z30	P7R30	3.50
V30AA2	45	6	9	—	Z30N	—	3.50
W30B	45	6	12	482	M30	P7830	2.50



GENERAL "DuroMite" BATTERIES

New General DuraMite batteries are the finest in battery design and assembly. Thin, well-balanced flat cells are stacked like a roll of wafers. Each stack of cells sealed in its own plastic case, keeping the cells fresh until put in use. Maximum service life can be obtained from minimum of space used.

Type	Voltage	Std. Pkg.	Pkg. Weight Lbs.	Interchangeable With			Price
				Eveready	Burgess	Ray-O-Vac	
W45A	67 1/2	12	10	467	XX45	4367	\$2.75
W30A	45	12	7	455	XX30	P3A30	1.95
W60A	90	12	13.5	490	—	946	3.60
W-46A	67 1/2	12	6.25	477	P45	4375	2.35
W-50A	75	6	6.25	437	XX50	—	3.25
±150	45	24	4	415	—	—	2.00
±172	67 1/2	12	6	457	K45	—	2.50



GENERAL "FlashLite" & LANTERN BATTERIES

The New General "Flashlite" cell comes to the market to fulfill the demand of practically every user. This demand is for extra long service, years of shelf life and protection against corrosion damage. The Industrial cell is recommended when light is needed frequently and for long periods.

Type	Voltage	Std. Pkg.	Pkg. Weight Lbs.	Interchangeable With			Price
				Eveready	Burgess	Ray-O-Vac	
C	1 1/2	72	8	935	1	1LP	\$0.125
D	1 1/2	240	57	950	2	—	.15
D Industrial	1 1/2	250	59.5	1050	# 2 Ind	2111	.15
AA	1 1/2	180	8	915	Z	7-R	.10
V4F Lantern	6	10	15.8	409	F4H	941	.90
4FB Bicycle	6	10	15.5	—	—	—	.90



GENERAL IGNITION & ELECTRIC FENCE BATTERIES

All General batteries are designed to use the most efficient cells available. The 641 is made with 12 L cells and this construction has proven to produce exceptional performance when used on Electric Fence controls and other ignition applications.

Type	Voltage	Std. Pkg.	Pkg. Weight Lbs.	Interchangeable With			Price
				Eveready	Burgess	Ray-O-Vac	
# 6	1 1/2	24	60	# 6 lg	—	# 6 lg	\$0.90
# 6 Tele	1 1/2	24	60	# 6 Co.	—	# 6 Tele	.85
641 Multiple	6	6	54	1461	—	641	3.75



GENERAL DRY BATTERIES, INC.

MAIN OFFICES AND FACTORY • 13000 ATHENS AVE., CLEVELAND, OHIO

FACTORIES • DUBUQUE, IA. • MEMPHIS, TENN. • TORONTO, ONT.

BRANCH OFFICES & WAREHOUSES • NEW YORK, CHICAGO, DALLAS, SAN FRANCISCO,

LOS ANGELES, PORTLAND, MEMPHIS, MINNEAPOLIS



OLIN PORTABLE

SPECIFICATIONS

Type	Catalog Number	Voltage	Overall Dimensions In Inches			Unit Package Quantity	Weight Of Unit Package In Pounds	Terminal	Suggested Price Each	
			L	W	H				List	Dealer
"B" BATTERIES	922	300	2½ x 2½ x 3½	1	1	Pin Jacks	\$11.00	\$7.70		
	1709	67½	1¾ x 1 x 5¾	6	3½	Snap Type	2.35	1.65		
	1710	67½	2¼ x 1¾ x 3½	6	5¼	Snap Type	2.75	1.93		
	1712	67½	2½ x 1¾ x 2¾	6	3	Snap Type	2.50	1.75		
	1713	90	3½ x 1¾ x 3¾	6	6	Snap Type	3.60	2.52		
	1914	15	1½ x ¾ x 1½	24	1½	Flat Contact	.95	.65		
	1915	22½	1½ x ¾ x 2	24	2	Flat Contact	1.15	.80		
	1916	30	1½ x ¾ x 2½	24	2½	Flat Contact	1.40	.96		
	5115	22½	3½ x 1¾ x 2¾	6	6	Screw	1.95	1.37		
	6118	45	3½ x 2¾ x 4¾	1	1¾	Socket	2.45	1.71		
	6210	45	3½ x 1¾ x 5½	6	11	Socket	2.50	1.75		
	6211	45	2¾ x 1¾ x 3¾	6	3¼	Snap Type	1.95	1.32		
	6218	45	4½ x 2¾ x 5¾	1	2¾	Socket	3.25	2.28		
	6219	45	4½ x 2¾ x 5¾	1	3	Screw	4.50	3.15		
	6518 *	45	7½ x 2½ x 7¾	6	48	Socket	3.45	2.42		
	6718	45	2¾ x 2¾ x 4½	1	1½	Socket	3.50	2.42		
	"A" BATTERIES	1311	1½	1 Diam. x 1¾	12	1½	Flashlight	.125	.08	
		1550	1½	1½ Diam. x 2¾	48	10	Flashlight	.15	.0975	
2416		1½	1½ Diam. x 4¾	12	4¾	Flashlight	.30	.21		
2516		1½	2¾ x 1¾ x 3	6	3	Socket	.65	.45		
3816		4½	3½ x 1¾ x 4½	10	11	Socket	.90	.63		
4516		4½	3½ x 1¾ x 2¾	6	4	Socket	.75	.53		
4813		1½	3½ x 1¾ x 10¾	6	20	Socket	2.25	1.58		
4814		1½	3½ x 2¾ x 4	6	13	Socket	1.65	1.16		
4815		6	3½ x 1¾ x 10¾	6	20	Socket	2.75	1.93		
4816		1½	2¾ x 2¾ x 4	10	15	Socket	1.15	.81		
4817		6	3½ x 2½ x 5½	10	30	Socket	2.45	1.72		
4819		1½	3½ x 2¾ x 5¾	6	18	Socket	2.10	1.47		
4914		6	2¾ x 2¾ x 4	10	15	Socket	1.15	.81		
4918		4½	3¾ x 1¾ x 4½	10	13	Socket	.95	.67		
4919		6	1¾ x 1¾ x 2½	12	2¼	Flat Contact	.75	.53		
5219	7½	3½ x 1¾ x 2¾	6	3	Socket	1.10	.77			
5316	7½	2¾ x 1¾ x 3	12	.6	Socket	1.00	.70			



#1710



#6210



#6211



#1709



#1550 Leakproof

Please forward your order to your Olin wholesaler

RADIO BATTERIES

S P E C I F I C A T I O N S

Type	Catalog Number	Voltage	Overall Dimensions In Inches		Unit Package Quantity	Weight Of Unit Package In Pounds	Terminal	Suggested Price Each		
			L	W				H	List	Dealer
"A-B" PACKS	513 **	1½ "A" 90 "B"	10¾	2¾	6¾	1	9	Socket	\$7.95	\$5.96
	518 ***	1½ "A" 90 "B"	15¾	4¼	6¾	1	22	Socket	7.95	5.96
	611	1½ "A" 90 "B"	11¼	1¾	6¾	1	5	Socket	5.95	4.17
	614	7½ & 9 "A" 90 "B"	9	2¼	4¼	1	6	Socket	6.25	4.38
	615	7½ & 9 "A" 90 "B"	10¾	3¾	4¾	1	7½	Socket	6.75	4.73
	616	9 "A" 90 "B"	14¾	2¾	4	1	8½	Recessed Plug	6.65	4.65
	616W	9 "A" 90 "B" Plus 1½ "A"	14¾	2¾	4	1	9	Recessed Plug and Socket	7.10	4.97
	618	6 & 7½ "A" 75 "B"	8¾	2¾	3¼	1	3¾	Socket	5.50	3.85
	619	7½ & 9 "A" 90 "B"	8¼	2½	3¾	1	4	Socket	5.95	4.17
	620	9 "A" 90 "B"	9	2¼	4¼	1	5	Recessed Plug	6.25	4.38
	622	1½ "A" 90 "B"	9¾	2½	4¼	1	5	Socket	5.79	4.05
	623	7½ "A" 67½ "B"	9¾	2¼	4¼	1	4¾	Socket	4.50	3.15
	624	1½ "A" 67½ "B"	9¾	2	4¼	1	4½	Socket	4.50	3.15
	"C" BATTERIES	3217	4½	2¾	1¾	3	10	4	Screw	.65
3516		4½	3¼	1¾	3¼	10	8	Socket	1.15	.79
5216		22½	4¼	2¾	2¾	10	18	Socket	2.15	1.51
5216-8		22½	4¼	2¾	2¾	10	18	Fahnstock Clip	2.45	1.72
5218		7½	3¼	1¾	3	10	7	Screw	1.20	.84

- * "B" Battery for Farm Receivers
 ** "A-B" Battery Pack for Farm and Portable Receivers
 *** "A-B" Battery Pack for Farm Receivers



#614



#622



#3816

OLIN INDUSTRIES, INC. • ELECTRICAL DIVISION • NEW HAVEN 4, CONN.

Makers of Olin Flashlights • Lanterns • and Olin Batteries for Flashlights • Lanterns • Hearing Aids • Farm and Industrial Uses.

Mueller Electric Co.

CLEVELAND, OHIO

MUELLER BATTERY AND TEST CLIPS

U.S. PATENTS: 1,521,903; 1,686,842; 1,779,442; 1,794,976; 1,965,151; 1,994,251; 1,999,613; 2,074,324; 2,136,814; 2,416,113; 2,549,589; 2,593,130

For use in making quick, temporary electrical connections. Screw connections.

WEE-PEE-WEE No. 88



Entirely Non-ferrous. Smaller Than Ever! An extremely small clip for fine testing in radio and electrical work. Light-Weight; thin-nosed; spring-temper phosphor bronze. Ideal for close-wound coils. $1\frac{1}{8}$ " long; jaw spread $\frac{3}{8}$ ".

EACH NET.....\$0.19 LOTS OF 10.....\$0.13
Use No. 93 R.F. Insulator.



No. 45 PEE WEE

A very small test clip for radio, ignition, meter and similar work. $1\frac{1}{2}$ " long. Jaw spread $\frac{1}{8}$ ". Steel, cadmium plated.

EACH NET.....\$0.07 LOTS OF 10.....\$0.05

No. 45-C

Solid Copper R.F. Test Clip

Solid copper radio frequency test clip. Phosphor bronze spring, brass screw. Will not heat up in high frequency test work, entirely non-ferrous. $1\frac{1}{2}$ " long.



No. 45-C Clip
No. 47 Insulator

EACH NET.....\$0.11 LOTS OF 10.....\$0.08
Use No. 47 Insulator for clips 45 and 45-C.



No. 48-B

A small test and battery clip for radio use and general testing purposes. 2" long. Jaw spread $\frac{3}{8}$ ". Steel, cadmium plated.

EACH NET.....\$0.08 LOTS OF 10.....\$0.055
No. 48C—Solid Copper. Same size as 48-B.

EACH NET.....\$0.13 LOTS OF 10.....\$0.09

No. 50-C Needle Clip

Solid bronze. Needle pierces insulation of wire for quick test contact. $2\frac{1}{4}$ " long. EACH NET \$0.25 LOTS OF 10 \$0.18
No. 51-C—Large crocodile clip. Same as 50-C but without needle.



EACH NET \$0.19 LOTS OF 10 \$0.13

Use No. 49 insulator for Clips 48-B, 48-C, 50-C and 51-C.

No. 27

A high grade test clip with meshing teeth on three sides of jaws. For laboratory and shop test work $2\frac{1}{4}$ " long. Jaw spread $\frac{3}{8}$ ". Steel, cadmium plated.

EACH NET.....\$0.11 LOTS OF 10.....\$0.08

No. 27 C—Solid copper. Same size as No. 27.

EACH NET.....\$0.19 LOTS OF 10.....\$0.13

Use No. 29 Insulator for clips 27 and 27-C.

CROCODILE CLIPS

U.S. Patent No. 1,999,613



No. 85 or 85-C Clip with
No. 87 Insulator

No. 85—A very small clip with slender, elongated jaws for getting into tight places in radio or electrical test work. Screw connection. $2\frac{1}{8}$ " long.

EACH NET.....\$0.08 LOTS OF 10.....\$0.55

No. 85-C—Same as No. 85, except solid copper. A radio frequency, entirely non-ferrous test clip.

EACH NET.....\$0.14 LOTS OF 10.....\$0.10

No. 85-T—New Crocodile "Tip-Clip"—equipped with standard phone tip on one jaw, otherwise same as No. 85. Ideal for use as a prod, for ordinary clip connections and for connections to insulated binding posts having non-removable heads. $2\frac{1}{8}$ " long.

EACH NET.....\$0.18 LOTS OF 10.....\$0.13

Use No. 87 Insulators for clips 85, 85-C and 85-T. Red and Black. Cover entire clip except nose. Protect against short and shock. Help to distinguish leads.



No. 85-T Clip

NEW INSULATED ALLIGATOR CLIPS

Patent Pending



No. 63 or 63-C Clip

Sold only as a unit, with factory-applied insulators.

A radically new development that doubles the usefulness of Alligator Clips! Completely insulated right down to the nose. Flexible 2-piece skin-type vinyl insulator of high dielectric strength, with "lip action" slotted nose that permits opening of clip without exposing metal. Insulator nose is only $15/64$ " O.D. The tight fitting sheath preserves all the slimness of the Alligator Clip, still giving complete protection against shorts in even the tightest spots. These clips could be bunched together—touching all around—without danger of shorting. Screw connection easily made by slipping insulator forward.

No. 63 INSULATED ALLIGATOR CLIP (STEEL)

Composed of Mueller No. 60-S Alligator Clip steel, cadmium plated, screw connection, complete with 2-piece vinyl insulator. Shipped half with red insulators, half black.

EACH NET.....\$0.30 LOTS OF 10.....\$0.21

No. 63-C INSULATED ALLIGATOR CLIP (COPPER)

Composed of Mueller No. 60-CS Alligator clip, solid copper, brass screw connection. Shipped half with red insulators, half black.

EACH NET.....\$0.33 LOTS OF 10.....\$0.23

ALLIGATOR CLIPS

No. 60—CONVENTIONAL TYPE

Accurately made, slim jaws, fine meshing teeth. Convenient, round thumb grip, barrel connection for banana plug. Equipped with small soldering lip. Strong spring with a hard bite. Cadmium plated. 2" long.



EACH NET.....\$0.07 LOTS OF 10.....\$0.046

No. 60-S—SCREW CONNECTION

Eliminates necessity for soldering. Otherwise same as No. 60.



EACH NET \$0.08 LOTS OF 10 \$0.53

No. 60-CS—COPPER R.F. ALLIGATOR CLIP

Same as No. 60-S except made of solid copper. Has brass screw connection. Ideal for R.F. work. Will not heat up in H.F. circuits. Bright, natural copper finish. 2" long.



EACH NET.....\$0.11 LOTS OF 10.....\$0.077

No. 62 FLEXIBLE VINYL INSULATOR

New! Red and black insulators for Alligator Clips 60S, 60CS and 60.



EACH NET.....\$0.07 LOTS OF 10.....\$0.05

No. 60-HS—STEEL ALLIGATOR CLIP WITH INSULATED HANDLE

Same as No. 60-S except equipped with red and black insulating sleeves on end. Very convenient for distinguishing leads. Has screw connection also. Cadmium plated. $2\frac{1}{4}$ " long. Shipped half red, half black.



EACH NET.....\$0.12 LOTS OF 10.....\$0.084

No. 60-CHS—COPPER ALLIGATOR CLIP WITH INSULATED HANDLE

Same as No. 60-CS except equipped with red and black insulating sleeves on end. Brass screw connection, for R.F. work. $2\frac{1}{4}$ " long. Shipped half red, half black.



EACH NET.....\$0.16 LOTS OF 10.....\$0.11

Mueller Electric Co.

FLEXIBLE INSULATORS FOR CLIPS



A convenient protection against short circuit and electric shock. Packed half red and half black to indicate polarity. Long tail prevents breakage of wire. Constructed so that clip is held in firmly.

Insulator No.	For Use with Clip No.	Each Net	Lots of 10
13	11-A, 11-C	\$0.72	\$0.50
23	21-A, 21-C	.39	.27
26*	24-A, 24-C	.25	.18
29*	27, 27-C	.17	.12
35	33-C	1.72	1.20
47*	45, 45-C	.07	.05
49*	48-B, 48-C, 50-C, 51-C	.10	.07
62*	60S, 60CS, 60	.07	.05
87*	85, 85-C, 85-T	.07	.05
93	88	.05	.035

* Also available in yellow and blue colors.

LARGER SIZES OF CLIPS



No. 24-A

A medium sized battery clip. Stands erect on battery post. Lead coated, copper shunt protects spring. 2 3/4" long. Jaw spread 3/4". Steel, lead plated.

EACH NET\$0.16
LOTS OF 10\$0.11

No. 24-C—Solid copper. Same size as No. 24-A.
EACH NET\$0.28 LOTS OF 10\$0.20
Use No. 26 Insulator for Clips 24-A and 24-C.



No. 21-A—Steel, Lead Plated—4" Long
Each Net

No. 21-A—Heavy Duty Steel, lead plated, 4" long\$0.30 LOTS OF 10\$0.21



No. 21-C—100 Amp. Solid Copper, 4 1/2" long.....\$0.73 \$0.51
No. 11-A—100 Amp. Steel, lead plated, 6" long84 .59
No. 11-C—200 Amp. Solid Copper, 6" long..... 1.40 .98
No. 33-C—300 Amp. Solid Copper, 7 3/4" long..... 2.70 1.90

(Furnished with detachable lug connection for easy securing to large cables.)

THE SNAPPER

A Long Insulated Test Clip and A "Triple Threat" Radio Tool

U. S. Patent
No. 2,074,324

No. 99 7" Long Insulated



The long tube is of insulating material and is fitted with spring contact jaws on the far end. The jaws are operated by a push of the thumb on the near end. Wire is quickly and easily connected in a hole in the insulator knob binding post on the near end. May be used as (1) A "Deep Sea" Electric Test Clip—test contacts with ease, deep in the recesses of radio chassis with no danger of short circuits; (2) An Electric Contact Prod—clip jaws may be used to make quick prod contacts, or clip one Snapper on ground circuit and prod with another; (3) A Retriever—start small screws and nuts or pick up odds and ends that may accidentally be dropped into inaccessible places.

PRICE.....\$1.20 EACH Dealers' Wholesale Price, each....\$0.72 Net
Snappers are generally used in pairs—1 red and 1 black.

CLAMPIPE GROUND CLAMP

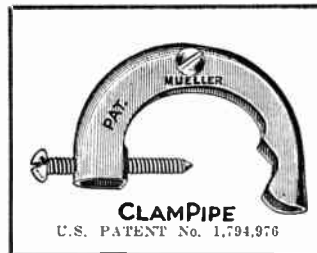

No. 58

The best ground clamp value on the market. Applicable to pipe 3/8" to 1 1/2" outside diameter.

Packed 10 in a box
EACH NET.....\$0.16 LOTS OF 10.....\$0.11

The exclusive patented feature of a U-shaped cross section in combination with a U-shaped clamp gives a rigidity and effectiveness to the ClamPipe that cannot be found in any other make.

The ClamPipe will not bend or lop over when applied to a pipe. The point of the large case hardened screw, cuts through rust, paint or corrosion into clean, fresh metal, insuring a good contact. The Clamp may be installed on a pipe lying flush against a wall. Will not spread open.

THE "TENNA-CLAMP"

A New 3-in-1 Stand-off Insulator Clamp!

Supports TV and FM Lead-ins on MASTS, PIPES, GUTTERS and GUY-WIRES

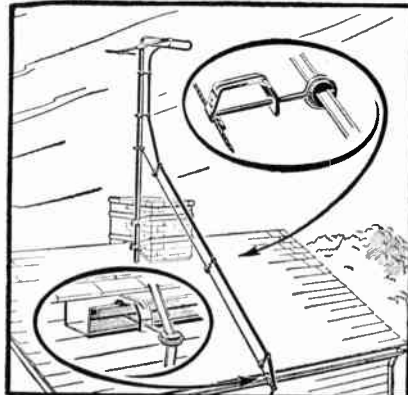

HAS THESE USEFUL FEATURES —

- One standard size solves many lead-in problems — far more useful than straps or wire bands.
- Brings lead-in to edge of roof — right where you want it — no more "draping" of wire across the roof.
- On those high jobs, come right down a guy-wire — and get around the gutter in the clear.

LOW PRICES!

All packed 100 in a carton
No. 135—For all types of Cables.
EACH NET, \$0.14 LOTS OF 10, \$0.10
LOTS OF 100, \$0.084

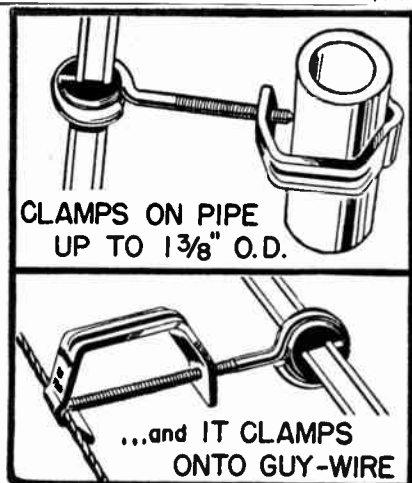

CLAMPS ON PIPE
UP TO 1 3/8" O.D.

...and IT CLAMPS
ONTO GUY-WIRE



INSIST on ATR VIBRATORS—Get the Best!!



ATR Replacement Vibrator Specifications

Base Diagrams

External Views

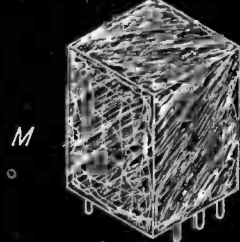
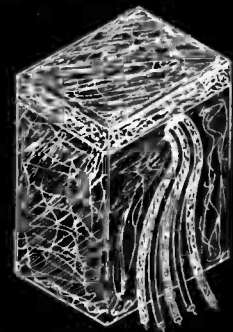
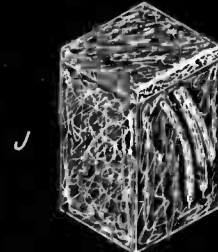
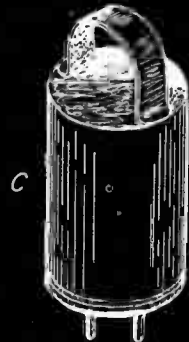
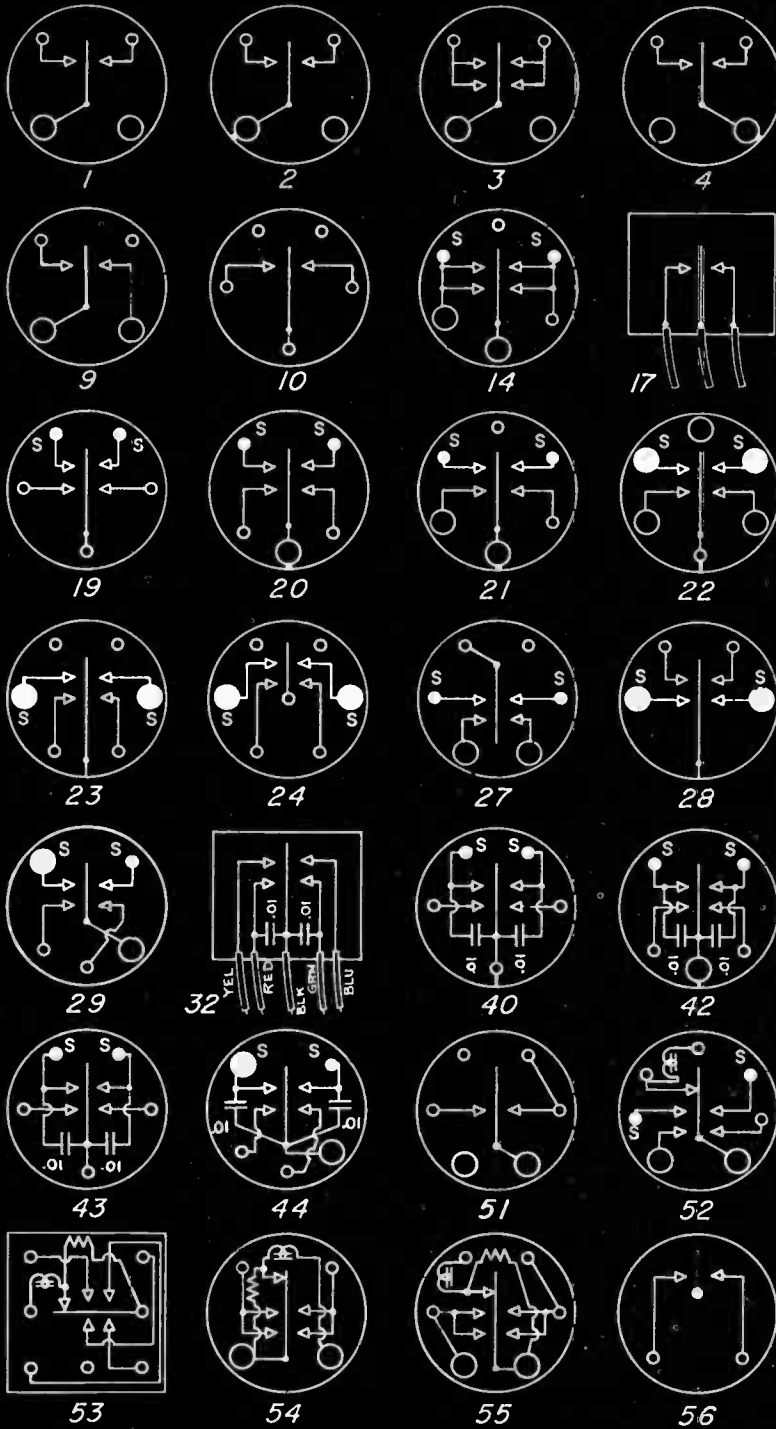



ATR VIBRATORS *have Ceramic Stack Spacers*



ATR Replacement Vibrator Specifications

Frequency: 115 Cycles except as noted.

N.S.—Non Synchronous S.—Synchronous

Type No.	Voltage	Type	Base Dia.	Can Style	Dimensions	List Price	Type No.	Voltage	Type	Base Dia.	Can Style	Dimensions	List Price
303	6	N.S.	17	J	1½" x 1⅜" x 2½"	\$6.35	523	6	S.	22	A	1½" x 3⅜"	\$7.70
320	6	N.S.	10	A	1¼" x 3⅜"	6.35	524	6	S.	23	A	1½" x 3⅜"	7.70
324	6	N.S.	1	A	1½" x 3⅜"	4.90	525	6	S.	24	A	1½" x 3⅜"	7.70
324A	6	N.S.	2	A	1⅝" x 3⅝"	4.90	529	4	S.	21	A	1½" x 3⅜"	7.70
324B	6	N.S.	1	A	1⅝" x 3½"	4.90	540	6	S.	27	A	1½" x 3⅜"	7.70
324C	6	N.S.	2	A	1⅝" x 4¾"	4.90	541	4	S.	19	A	1½" x 3⅜"	8.25
325	6	N.S.	51	A	1½" x 2⅞"	6.35	541A	4	S.	19	A	1⅝" x 3⅜"	8.25
328	6	N.S.	4	A	1½" x 3⅜"	4.90	544†	6	S.	28	A	1⅝" x 2⅞"	7.70
335	6	N.S.	9	A	1⅝" x 3⅝"	4.90	545†	6	S.	28	A	1½" x 3⅜"	7.70
337	6	N.S.	14	A	1⅝" x 3½"	6.35	547	6	S.	29	C	1⅝" x 3½"	7.70
338	6	N.S.	9	C	1½" x 3⅜"	4.90	*548	6	S.	24	A	1½" x 3⅜"	8.55
340	6	N.S.	1	A	1½" x 2⅞"	4.45	*549	6	S.	21	A	1½" x 3⅜"	8.95
*344	6	N.S.	3	A	1½" x 3⅜"	8.55	550	6	S.	32	K	4⅞" x 1¾" x 1¾"	9.15
345	6	N.S.	9	A	1½" x 2⅞"	4.90	561	6	S.	24	A	1½" x 2⅞"	7.70
3471	6	N.S.	1	A	1½" x 3⅜"	6.35	562	6	S.	21	A	1¼" x 3⅜"	7.70
*348	6	N.S.	54	A	1½" x 2⅞"	8.95	564#	6	S.	23	A	1½" x 2⅞"	7.70
*349	6	N.S.	55	A	1½" x 2⅞"	8.95	*574	6	S.	23	A	1½" x 3⅜"	8.95
350	6	N.S.	1	A	1¼" x 2⅞"	4.90	*575	6	S.	24	A	1½" x 3⅜"	8.95
380	4	N.S.	1	A	1½" x 2⅞"	4.90	900	2	S.	52	A	1⅝" x 2⅞"	9.80
503	6	S.	43	A	1⅝" x 4½"	9.15	902	2	S.	53	M	1½" x 2⅞" x 1½"	10.70
ADAPTER						1.50	1340	12	N.S.	1	A	1½" x 2⅞"	5.50
506	6	S.	40	A	1⅝" x 4½"	9.15	1343	12	N.S.	56	A	1½" x 3⅜"	4.90
507	6	S.	44	A	1⅝" x 4½"	9.15	*1344	12	N.S.	3	A	1½" x 3⅜"	9.95
508	6	S.	42	A	1⅝" x 4½"	9.15	*1348	12	N.S.	54	A	1½" x 2⅞"	9.95
520	6	S.	19	A	1½" x 3⅜"	7.70	1520	12	S.	19	A	1½" x 3⅜"	9.95
520A	6	S.	19	A	1⅝" x 3½"	7.70	1524	12	S.	23	A	1½" x 3⅜"	8.55
521	6	S.	20	A	1½" x 3⅜"	7.70	*1548	12	S.	24	A	1½" x 3⅜"	9.95
522	6	S.	21	A	1½" x 3⅜"	7.70	2324	32	N.S.	1	A	1½" x 3⅜"	7.15
522A	6	S.	21	A	1⅝" x 3½"	7.70	2401	32	S.	22	A	1½" x 3⅜"	8.55

‡140 Cycles †180 Cycles †With 5 Ohm Resistors *Communications Type Vibrator for Super Service.

Recommended Substitutions for Discontinued Vibrators

Discontinued Type	Recommended Replacement	Discontinued Type	Recommended Replacement	Discontinued Type	Recommended Replacement
305	303	330	324C	543	522A (Refer Note 3)
307	303 (Refer Note 1)	332	522 (Refer Note 8)	543A	522A (Refer Note 3)
314	324	342	325	546	522 (Refer Note 6)
316	324	504	503	551	550 (Refer Note 14)
317	324	505	503 (Plus Adapter)	553	550 (Refer Note 11)
323	340	531	550 (Refer Note 13)	591	524 (Refer Note 9)
326	325	536	524 (Refer Note 10)	2327	2324 (Refer Note 12)
327	325	537	525	2403	2324

The Installation Notes listed above are shown in Section I.



ATR VIBRATORS have Ceramic Stack Spacers



ATR Vibrator Equivalent Charts by Vibrator Manufacturers' Replacement Part Number

Part No.	ATR Part No.	Part No.	ATR Part No.	Part No.	ATR Part No.	Part No.	ATR Part No.
CORNELL-DUBILIER		CORNELL-DUBILIER (Cont.)		DELCO - GM (Cont.)		DELCO - GM (Cont.)	
C00.	340	5342	340	8520	324B	1208174	No Rep.
C00-32.	2324	5313	324	8521	324B	1208239	550
C01.	340	5363	303	8522	324C	1208920	2401
C03.	345	5366	325	8523	340	1209280	508
C04.	324	5367-32.	2324 (Refer Note 12)	8524	340	1209282	508
C07.	No Rep.	5370	380	8525	344	1209810	340
C08.	347	5400	524	8526	340	1209811	340
C09.	328	5404	540	8527	340	1209812	340
C14.	350	5406	525	8528	345	1209813	340
C20P.	324B	5407	545	8529	340	1211375	520A
C21.	340	5408	564	8530	328	1211573	520A
C23P.	340	5409	520	8531	338	1211594	345
C26P.	340	5409-4	541	8532	340	1211595	345
C28P-32.	No Rep.	5410	521	8533	340	1212660	345
C31.	328	5411	522	8534	340	1212968	340
C33.	338	5413-4	541A	8538	522	1213446	525
C35.	345	5425	508	8539	347	1213655	340
C42M.	340	5426	547	8540	340	1213671	345
C43M.	324	5429	507	8541	340	1213732	345
C63.	303	5431-4	No Rep.	8542	340	1213881	340
C66.	325	5434	522 (Refer Note 3)	8543	350	1214832	561
C67-32	2324	5435	522	8544	325	1215198	340
C803-12	1344	5435-4	No Rep.	8550	1343	1215909	340
C803-32	1344	5438	No Rep.	8601	No Rep.	1220155	1343
C804P	337	5437	545	8602	550	5035120	550
C806	No Rep.	5438	524	8603	550 (Refer Note 11)	5037400	508
C810	No Rep.	5440	524 (Refer Note 10)	8604	550 (Refer Note 13)	5037916	550
C811-12	No Rep.	5443	523	8605	No Rep.	5038055	508
C815	344	5443-32	No Rep.	8606	550 (Refer Note 14)	5039861	508
D00	524	5454	561	8607	No Rep.	5039757	508
D04	540	5463	550	8608	No Rep.	5040000	324
D06	525	5464	503 (Refer Note 2)	8609	No Rep.	5040700	508
D07	545	5468-2	902	8610	520	5041125	520A
D08	544	5469-2	900	8611	520A	5041245	508
D09.	520	5503-12	1344	8612	521	5041376	507
D09-4	No Rep.	5504	337	8613	522	5042240	340
D10	521	5506	No Rep.	8614	562	5042703	324B
D11	522	5510	No Rep.	8615	523	5043025	324
D13	520A	5511-12	No Rep.	8616	524	5050050	547
D13-4	No Rep.	5513-12	No Rep.	8617	525	5050498	547
D16	503	5514-4	No Rep.	8618	503	5050651	520
D21	522	5515	344/348	8619	503	5050673	335
D22	No Rep.	5516	324	8620	506	5051301	335
D25	508	5517-12	No Rep.	8621	508	5052370	503 (Refer Note 2)
D26	547	5518	349	8622	507	5052374	325
D29	507	5519	348	8623	No Rep.	5052378	324
D31	No Rep.	5560	No Rep.	8624	524 (Refer Note 9)	5052525	522
D34	522	5604	506	8625	No Rep.	5052538	324
D35	522	5605	1548	8626	522 (Refer Note 6)	5052869	524
D35-4	No Rep.	5605-12	1548	8627	524 (Refer Note 10)	5053141	503
D36	No Rep.	5605-32	No Rep.	8628	525	5053179	523
D37	545	5607	No Rep.	8629	547	5053181	521
D38	524	5607-12	No Rep.	8630	547	5053183	525
D40	524	5607-32	No Rep.	8631	522 (Refer Note 3)	5053185	520
D43	523	5609-12	1520	8632	548	5053501	524
D13-32	2401	5610	562	8633	522A (Refer Note 3)	5053699	303
D54	561	5610-12	No Rep.	8634	522	5054500	547
D63	550	5611-12	1548	8635	545	5057220	340
D64	503	5615	545	8636	545	5059777	345
DS04	306	5615-12	No Rep.	8637	540	5060845	345
DS05	548	5615-24	No Rep.	8638	345	5061036	340
DS05-12.	1548	5616	No Rep.	8639	345	7232741	547
DS05-32.	No Rep.	5616-12	No Rep.	8642	561	7233419	547
DS07	No Rep.	5620	574	8643	524	7233427	335
DS07-12.	No Rep.	5621	549	8701	No Rep.	7235651	547
DS07-32.	No Rep.	5622	No Rep.	8702	No Rep.	7236066	547
DS09-12.	1520	5623	575	8703	No Rep.	7237244	345
DS10	562	6330	1343	8704	2324	7237245	345
DS10-12.	No Rep.	6370	340	8705	No Rep.	7237246	345
DS14-12.	No Rep.			8706	2324	7237247	345
DS15-12.	No Rep.	DELCO - GM		8707	2324 (Refer Note 12)	7237499	338
DS15-24.	No Rep.	8500	No Rep.	8708	No Rep.	7237500	338
DS16	No Rep.	8501	No Rep.	8709	No Rep.	7237501	338
DS16-12.	No Rep.	8502	No Rep.	8710	2324	7237600	338
DS20	524	8503	303	8731	No Rep.	7237663	338
6VL10-2.	No Rep.	8504	324	8732	No Rep.	7237664	338
5300	2524	8505	324	8733	2401	7237665	338
5300-32	310	8506	324	8751	No Rep.	7237666	338
5301	340	8507	303	8752	541	7238525	547
5303	345	8508	324	8753	No Rep.	7238685	345
5307	No Rep.	8509	345	8754	No Rep.	7238829	345
5308	340	8510	328	8757	1548	7239123	340
5309	328	8511	325	605664	335	7239124	340
5314	350	8512	325	605665	550	7239439	347
5320	324B	8513	325	605666	508		
5321	340	8514	No Rep.	1206048	303		
5323	340	8515	No Rep.	1207758	303		
5326	340	8516	324C	1207849	303		
5331	328	8517	324A	1208000	550		
5333	338	8518	303	1208115	No Rep.		
5335	345	8519	522 (Refer Note 7)	1208152	550		

Note:—For recommended replacement refer to listings by receiver name and model number in Section A.



ATR VIBRATORS have Ceramic Stack Spacers



ATR Vibrator Equivalent Charts

by Vibrator Manufacturers' Replacement Part Number

Part No.	ATR Part No.	Part No.	ATR Part No.	Part No.	ATR Part No.	Part No.	ATR Part No.
OAK—(Cont.)		RADIART—(Cont.)		RADIART—(Cont.)		RADIART—(Cont.)	
V5370.....	340	3850.....	524 (Refer Note 9)	5341M.....	340	5615-24.....	No Rep.
V5608.....	No Rep.	3865.....	340	5342.....	341)	5616.....	No Rep.
V5624.....	No Rep.	3880.....	303	5342M.....	340	5616-12.....	No Rep.
V5641.....	340	3883.....	524 (Refer Note 10)	5343M.....	324	5620.....	574
V5645.....	522	3888.....	340	5355.....	No Rep.	5621.....	549
V5670.....	522	4251H.....	324	5355-14.....	No Rep.	5622.....	No Rep.
V5704.....	No Rep.	4253.....	344	5356-14.....	No Rep.	5623.....	575
V5709.....	No Rep.	4253-32.....	2324	5356-28.....	No Rep.	6330.....	1343
V5745.....	340	4254.....	No Rep.	5363.....	303	6370.....	340
V5770.....	328	4254-12.....	No Rep.	5365.....	325		
V5868.....	522	4254-32.....	No Rep.	5366.....	325		
V8027.....	No Rep.	4255.....	548	5367-32.....	2324 (Refer Note 12)		
V8087.....	1344	4255-12.....	1548	5370.....	380	TURNER	
V8248.....	1344	4255-32.....	No Rep.	5400.....	524	T1.....	340
V8270.....	522	4255H.....	548	5404.....	540	T1A.....	303
V8347.....	No Rep.	4256.....	No Rep.	5405.....	521	T3.....	324
V6605.....	No Rep.	4256-12.....	1344	5406.....	525	T38.....	324
V6633-32.....	No Rep.	4256-32.....	2324	5406-12.....	1548	T3SP.....	340
V6763.....	No Rep.	4257.....	No Rep.	5407.....	545	T48.....	325
ZW-37216.....	328	4257-12.....	No Rep.	5408.....	564	T5.....	No Rep.
		4257-32.....	No Rep.	5409.....	520	T68.....	325
		4258.....	No Rep.	5409-4.....	541	T68.....	328
		4258-12.....	1548	5409-12.....	1520	T9.....	345
		4258-32.....	No Rep.	3409-32.....	No Rep.	T9S.....	345
		4260.....	340	5410.....	521	T108.....	522 (Refer Note 7)
		4301.....	324	5411.....	522	T11.....	324
RADIART		4306.....	No Rep.	5413.....	520A	T12.....	324
2742.....	303	4306-12.....	No Rep.	5413-4.....	541A	T14S.....	325
2743.....	303	4306-24.....	No Rep.	5415.....	541	T158.....	340
2747.....	303	4313.....	324	5416.....	508	T198.....	325
2819.....	303	4314.....	2324 (Refer Note 12)	5418.....	520	T50.....	550 (Refer Note 11)
2844.....	303	4318.....	522 (Refer Note 7)	5418-12.....	520	T54.....	508
3200.....	303	4319.....	No Rep.	5420P.....	522	T55.....	503
3223.....	325	4320.....	325	5421.....	522	T56.....	524 (Refer Note 9)
3225.....	No Rep.	4332.....	No Rep.	5422.....	No Rep.	T58.....	522
3226.....	No Rep.	4402.....	508	5425.....	508	T59.....	523
3227.....	303	4403.....	520A	5426.....	547	T60.....	521
3260.....	340	4404.....	2401	5427.....	529	T61.....	520
3261.....	325	4414.....	525	5428.....	522 (Refer Note 6)	T62.....	527
3262.....	340	4415.....	550 (Refer Note 13)	5428.....	507	T62.....	525
3263.....	325	4415-12.....	No Rep.	5430.....	522 (Refer Note 3)	T64.....	522 (Refer Note 6)
3264.....	324	4416.....	522	5431.....	No Rep.	T65.....	524
3283.....	503	4417.....	541	5431-4.....	No Rep.	T66.....	547
3290.....	No Rep.	4500.....	550	5435.....	522 (Refer Note 3)	T67.....	524 (Refer Note 10)
3299.....	325	4501.....	524	5435-4.....	No Rep.	T69.....	540
3300.....	303	4502.....	503	5437.....	545	TU3S.....	324
3302.....	325	4604.....	507	5438.....	524	12T21.....	1344
3308.....	550 (Refer Note 14)	4605.....	506	5439.....	522	12T33.....	1548
3310.....	No Rep.	4607.....	No Rep.	5439-12.....	No Rep.	32T1A.....	No Rep.
3311.....	No Rep.	4608.....	No Rep.	5440.....	524 (Refer Note 10)	32T3S.....	2324
3312.....	No Rep.	4610.....	No Rep.	5443.....	523	32T88.....	2324
3313.....	303	4611.....	507	5443-32.....	No Rep.	32T198.....	2324 (Refer Note 12)
3314.....	No Rep.	4612.....	522	5454.....	561	32T50.....	No Rep.
3315.....	550	4613.....	508	5463.....	560	32T59.....	No Rep.
3316.....	No Rep.	4614.....	508	5464.....	503 (Refer Note 2)	32T61.....	No Rep.
3317.....	550 (Refer Note 11)	4631.....	340	5467.....	900		
3318.....	No Rep.	5300.....	324	5469-2.....	902		
3319.....	503 (Refer Note 2)	5300-12.....	1344	5469-2.....	900		
3320.....	340	5300-32.....	2324	5500.....	324	UTAH	
3356.....	325	5303.....	315	5501.....	324	NL3.....	303
3375.....	303	5304-32.....	No Rep.	5503.....	244	NL3M.....	No Rep.
3395.....	2324	5305.....	340	5503-12.....	1344	NP4.....	324
3397.....	2324 (Refer Note 12)	5306.....	325	5503-32.....	2324	NP6.....	325
3398.....	303	5307.....	No Rep.	5504.....	337	NP40.....	324
3399.....	324	5308.....	340	5504P.....	337	NP41.....	340
3407.....	2324 (Refer Note 12)	5309.....	328	5510.....	No Rep.	NP42.....	324
3417.....	324	5310.....	340	5511-12.....	No Rep.	NP43.....	338
3442.....	No Rep.	5312.....	325	5513-12.....	No Rep.	NP44.....	340
3443.....	No Rep.	5313.....	324	5514-4.....	No Rep.	NP45.....	345
3444.....	No Rep.	5314.....	350	5515.....	344/348	NP46.....	340
3445.....	No Rep.	5320.....	324B	5516.....	344	NP47.....	324
3460.....	No Rep.	5320P.....	324B	5517-12.....	No Rep.	NP48.....	324
3461.....	508	5321.....	340	5518.....	349	NP49.....	324B
3462.....	No Rep.	5322.....	340	5519.....	348	NP51.....	No Rep.
3463.....	No Rep.	5322P.....	340	5560.....	No Rep.	NP61.....	325
3481.....	2324 (Refer Note 12)	5323.....	340	5604.....	506	NP62.....	522 (Refer Note 7)
3503.....	2324 (Refer Note 12)	5323P.....	340	5605.....	548	NP63.....	325
3589.....	No Rep.	5324.....	337	5605-12.....	1548	NP64.....	324B
3607.....	No Rep.	5324P.....	337	5605-32.....	No Rep.	NP65.....	325
3608.....	No Rep.	5325.....	340	5607.....	No Rep.	NP476.....	340
3651.....	No Rep.	5325P.....	340	5607-12.....	No Rep.	NP480.....	345
3679.....	521	5326.....	340	5607-32.....	No Rep.	NP481.....	324
3741.....	340	5327.....	340	5609-12.....	1520	NP482.....	324
3774.....	1344	5327P.....	340	5610.....	562	NP483.....	340
3782.....	340	5328P-32.....	No Rep.	5610-12.....	No Rep.	NP484.....	340
3786.....	No Rep.	5330.....	340	5614-12.....	1548	NP485.....	340
3789.....	340	5331.....	328	5615.....	545	NP487.....	345
3806.....	340	5333.....	338	5615-12.....	No Rep.	NP489.....	324
3815.....	324	5334.....	345			NP490.....	350
3818.....	340	5335.....	345			SLH.....	No Rep.
3842.....	324	5339.....	345				
3848.....	550 (Refer Note 14)	5340M.....	340				

Note:—For recommended replacement refer to listings by receiver name and model number in Section A.



INSIST on ATR VIBRATORS—Get the Best!!



ATR Vibrator Equivalent Charts

by Vibrator Manufacturers' Replacement Part Number

Part No.	ATR Part No.	Part No.	ATR Part No.	Part No.	ATR Part No.	Part No.	ATR Part No.
UTAH —(Cont.)		UTAH —(Cont.)		UTAH —(Cont.)		UTAH —(Cont.)	
SL4H.....	No Rep.	SP63.....	524 (Refer Note 9)	12NP42.....	No Rep.	32SP5.....	No Rep.
SL5.....	550 (Refer Note 11)	SP64.....	522 (Refer Note 3)	12NP48.....	No Rep.	32SP5H.....	No Rep.
SL51.....	503 (Refer Note 2)	SP65.....	No Rep.	12NP482.....	1344	32SP6.....	No Rep.
SL52.....	No Rep.	SP66.....	522	12NP489.....	1344	32SP56.....	No Rep.
SP5.....	520	SP67.....	No Rep.	12SL52.....	No Rep.	32SP71.....	No Rep.
SP5H.....	No Rep.	SP68.....	No Rep.	12SP5.....	1520	32SP72.....	No Rep.
SP6.....	523	SP69.....	524 (Refer Note 10)	12SP61.....	No Rep.		
SP7.....	No Rep.	SP71.....	348	12SP66.....	No Rep.		
SP50.....	503	SP72.....	525	12SP71.....	1548		
SP51.....	508	SP633.....	540	12S172.....	No Rep.		
SP52.....	507	SP640.....	545	32NL3.....	No Rep.		
SP53.....	503	SP641.....	545	32NL3M.....	No Rep.		
SP54.....	547	SP644.....	562	32NP6.....	2324 (Refer Note 12)		
SP55.....	521	SP645.....	543	32NP42.....	2324		
SP56.....	520A	SP646.....	522	32NP48.....	2324		
SP57.....	520	4SP5.....	No Rep.	32NP61.....	2324 (Refer Note 12)		
SP60.....	522 (Refer Note 6)	4SP5A.....	541	32NP489.....	2324		
SP61.....	530 (Refer Note 13)	4SP5.....	No Rep.	32S15.....	No Rep.		
SP62.....	524	4SP68.....	No Rep.	32S152.....	No Rep.		
						VOKAR	
						NP6V.....	325
						NP42V.....	340
						NP43V.....	328
						NP44V.....	340
						NP487V.....	345
						SP51V.....	508
						SP54V.....	547
						SP60V.....	522
						SP71V.....	525

Section F

THESE 12 POPULAR ATR VIBRATORS MEET 90% of Your Service Needs



N.S.—Non Synchronous

S.—Synchronous

Type No.	Voltage	Type	Base Diameter	Can Style	Dimensions
324	6	N.S.	1	A	1½" x 3⅛"
328	6	N.S.	4	A	1½" x 3⅛"
340	6	N.S.	1	A	1½" x 2⅞"
345	6	N.S.	9	A	1½" x 2⅞"
350	6	N.S.	1	A	1¼" x 2⅞"
508	6	S.	42	A	1½" x 4½"
520	6	S.	19	A	1½" x 3⅛"
522	6	S.	21	A	1½" x 3⅛"
524	6	S.	23	A	1½" x 3⅛"
525	6	S.	24	A	1½" x 3⅛"
547	6	S.	29	C	1⅞" x 3½"
1343	12	N.S.	56	A	1½" x 3⅛"

THE BIG 12 ATR VIBRATOR TEAM, as listed above, meets 90% of your replacement needs. Give your customers quick service and real satisfaction by keeping on hand at least one each of these 12 popular ATR vibrators.

ATR Vibrator are precision built, featuring Ceramic Stack Spacers, and are backed by more than 23 years of vibrator design and research, development and manufacturing—ATR Pioneered in the Vibrator Field.

**Let THE BIG 12 ATR VIBRATOR TEAM
Help You Win Satisfied Customers.**



TAPE RECORDER INVERTERS

Specially Designed for Operating Standard A.C. Tape Recorders, Wire Recorders, Dictating Machines, Radios, Public Address Systems, Amplifiers, Electric Razors, Record Players, Mixers, and Electronic Test Equipment from D.C. Voltages in Automobiles, Buses, Trucks, Boats, Trains, and Planes. Ideal for Emergency Lighting.

This group of ATR Inverters is especially recommended for use with standard A.C. operated tape or wire recorders, dictating machines, radios, amplifiers, and similar electronic equipment, being exceptionally well filtered to insure interference free radio reception. With ATR Inverters, the need for special equipment is eliminated. They are designed for quiet, long-life operation. All models indicated are equipped with ATR plug-in Inverter Vibrators. These Inverters also come equipped with four-point voltage regulators which make possible the correct output voltage for minimum to maximum loads and also help compensate for input voltages which are lower or higher than normal. The operating efficiency is in excess of 75%. To figure approximate current consumption from storage battery, divide the rated input wattage of the recorder (or load) being operated by the storage battery voltage and further divide this answer by .75 which will give the actual current consumption based on the actual load and efficiency. The battery current consumption required for a tape recorder is normally less than that drawn by ordinary automobile headlight(s). These Tape Recorder Inverters are recommended only for use with loads having power factors in excess of 70%. ATR Inverters should be used only for the applications as outlined above.

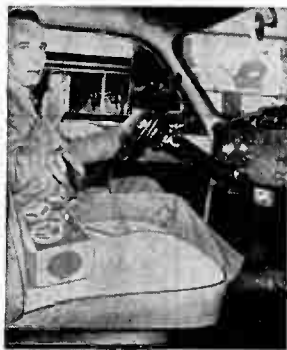

Above illustrates operation of tape recorder in car utilizing Inverter Remote Control Unit as shown below.

Let your car be a ROLLING OFFICE — dictate your reports promptly and accurately in the field — on the spot.

TYPE	INPUT D.C. VOLTS	A.C. OUTPUT 60 CYCLES	OUTPUT WATTAGE		SHIPPING WEIGHT	LIST PRICE
			INTERMITTENT	CONTINUOUS		
6-RSE	6	110 volts	80	65	19 lbs.	\$ 59.95
6-RMF	6	110	125	100	25	69.95
6-HSH	6	110	150	125	34	109.50
12-RSE	12	110	125	100	19	59.95
12-RMF	12	110	150	125	25	69.95
*28-RSE	28	110	125	100	19	75.00
*28-RMF	28	110	150	125	25	95.00
32-RSE	32	110	150	100	19	69.50

Radio frequency interference completely suppressed. *Recommended for 24 Volt Battery Systems. Any of the above type Inverters are available with 220 volt A.C. output at prices slightly higher. In ordering, specify "S" after the type number and substitute for the last letter in the code word "T"; that is, if a 110 volt D.C. Inverter having a 220 volt A.C. output is desired, this would be ordered as Type 110S covered by code word, "GRSET."

All models designated above are housed in attractively finished grey-hammerloid metal cabinets. Dimensions of Standard (RSE) Model Inverters, 8 3/8" x 9" x 5 1/4"; shipping weight, 19 lbs. Dimensions of Heavy Duty (RHF) Model Inverters, 6 1/2" x 11 1/4" x 8 1/2"; shipping weight, 25 lbs. Dimensions of Super Heavy Duty (HSH) Model Inverters, 6 1/2" x 12 7/8" x 8 1/2"; shipping weight, 34 lbs.

For correct replacement vibrator, consult Inverter Vibrator Guide.

ACCESSORIES



REMOTE CONTROL UNIT — for under-dash mounting permitting installation of Inverter in auto-trunk compartment. List Price \$6.95



MOUNTING BRACKETS — to securely mount Inverter in trunk compartment of car or under-dash, as illustrated. List Price \$4.95 pr.

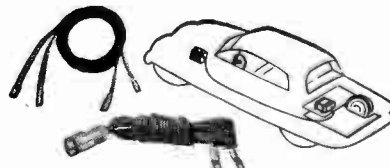

CIGARETTE LIGHTER CORD SET — to plug into cigarette lighter receptacle on dash. List Price \$3.95

EXTENSION CABLES — to provide additional cable lengths for installation of Inverter in trunk compartment. List Price \$11.95 Pr.

JOBBER ATTENTION: See Pages M-30 and M-31 in this ATR Section for your Catalog Needs!



DICTATING MACHINE INVERTERS

Specially Designed for Operating Standard A.C. Dictating Machines, Small Radios, Record Players, Mix-masters, Food Blenders, Electric Razors, Electronic Test Equipment, and Most Small Electrical and Electronic Devices from D.C. Voltages in Automobiles, Buses, Trucks, Boats, Planes, and Trains.

This group of ATR Inverters is especially recommended for use with standard A.C. dictating machines, small radios, record players, mix-masters, food blenders, electric razors, and other similar small electronic or electrical equipment. The Inverters are filtered to suppress radio frequency interference. With ATR Inverters, the need for special equipment is eliminated. They are designed for quiet, long-life operation. All ATR models indicated are equipped with ATR plug-in Inverter Vibrators. Models RME and RSE come equipped with a four-point voltage regulator which makes possible the correct output voltage for minimum to maximum loads. These two ATR Inverter models connect to the storage battery by means of the heavy cables provided; whereas, ATR Mighty Midget (DME) Model Inverter, being a smaller output capacity unit, plugs directly into the cigarette lighter of car. The battery current consumption required is normally less than that drawn by one ordinary automobile headlight. The operating efficiency is approximately 75%. These Inverters are recommended only for use with loads having power factors in excess of 70%, and should be used only for the applications as outlined above.



Illustrates ATR Mighty Midget (DME) Model Inverter Having Cigarette Lighter Plug Attachment.



Illustrates ATR Medium (RME) Model Inverter Having Four-Point Voltage Regulator.

EASY TO INSTALL
EASY TO OPERATE



Illustrates Under-Dash Mounting for ATR Models RME and RSE. See Page M-22 for available accessories.

TYPE	INPUT D.C. VOLTS	A.C. OUTPUT 60 CYCLES	OUTPUT WATTAGE		SHIPPING WEIGHT	LIST PRICE
			INTERMITTENT	CONTINUOUS		
6-DME	6	110 volts	40	30	5 lbs.	\$22.50
6-RME	6	110	60	50	12	39.50
6-RSE	6	110	80	65	19	59.95
12-DME	12	110	50	40	5	22.50
12-RME	12	110	100	80	12	39.50
12-RSE	12	110	125	100	19	59.95
*28-RME	28	110	100	80	12	65.00
*28-RSE	28	110	125	100	19	75.00
32-RSE	32	110	150	100	19	69.50

For Inverters having larger or smaller capacities, or for operation on other D.C. input voltages, please consult available ATR Inverter catalog sheets. *Recommend for 24-Volt Battery Systems.

All models designated above are housed in attractively finished grey-hammerloid metal cabinets. Dimensions of Standard (RSE) Model Inverter, 8 $\frac{3}{8}$ " x 9" x 5 $\frac{1}{4}$ "; shipping weight, 19 lbs. Dimensions of Medium (RME) Model Inverters, 8 $\frac{3}{8}$ " x 8" x 3 $\frac{3}{4}$ "; shipping weight, 12 lbs. Dimensions of Mighty Midget (DME) Model Inverters, 5 $\frac{1}{4}$ " x 4 $\frac{3}{4}$ " x 2 $\frac{3}{4}$ "; shipping weight, 5 lbs. For correct replacement vibrator, consult Inverter Vibrator Guide.

JOBBER ATTENTION: See Pages M-30 and M-31 in this ATR Section for your Catalog Needs!



RADIO INVERTERS

Specially Designed for Operating Standard A.C. Radios, Radio-Phonographs, Tape Recorders; Wire Recorders, Record Players, Dictating Machines, Public Address Systems, Amplifiers, Radio Transmitters, Mix-masters, Food Blenders, Electric Razors, and Electronic Test Equipment from D.C. Voltages in Trains, Rural Areas, and in D.C. Districts.



This group of ATR Inverters is especially recommended for use with standard AC radios, record players, tape or wire recorders, dictating machines, amplifiers, and similar electronic equipment being exceptionally well filtered to insure interference free radio operation. With ATR Inverters the need for special equipment is eliminated. They are designed for quiet, long-life, radio operation. All models indicated are equipped with ATR plug-in Inverter Vibrators. These Inverters also come equipped with four-point voltage regulators which make possible the correct output voltages which are lower or higher than normal. The operating efficiency is in excess of 85%. To figure approximate current consumption from D.C. voltage source, divide the rated input wattage of the radio set (or load) being operated by the D.C. voltage and further divide this answer by .85 which will give the actual current consumption based on the actual load and efficiency. These Radio Inverters are recommended only for use with loads having power factors in excess of 70%. ATR Radio Inverters should be used only for the applications as outlined above.

ATR Inverters are not recommended for operating refrigerators, washing machines, or similar motor-driven appliances; also, ATR Inverters are not recommended for operating toasters, electric irons, sun lamps, or similar appliances of high wattage or low power factor. Any attempt to use the Inverter for applications not recommended will ruin the inverter immediately and void the guarantee.

Type	Input D.C. Volts	A.C. Output 60 Cycles	Output Wattage		SHIPPING WEIGHT	LIST PRICE
			Intermittent	Continuous		
32-RME	32	110	100	80	12 lbs.	\$57.50
32-RSE	32	110	150	100	19	69.50
32B-RHF	32	110	200	180	30	89.50
50-RSE	50	110	150	100	19	79.50
110-RME	110	110	150	100	12	47.50
110-RSE	110	110	250	150	19	59.95
220-RSE	220	110	250	150	19	69.50

Radio Frequency Interference Completely Suppressed

For Inverters having larger or smaller output capacities or operating on other D.C. input voltages, please consult available ATR Inverter Catalog Sheets.

Any of the above type Inverters are available with 220 volt A.C. output at prices slightly higher. In ordering, specify "S" after the type number and substitute for the last letter in the code word "T"; that is, if a 110 volt D.C. Inverter having a 220 volt A.C. output is desired, this would be ordered as Type 110S covered by code word, "NRSET."

ATR Medium, Standard, and Heavy Duty Radio Inverters having designations RME, RSE, and RHF respectively, are housed in attractively finished grey-hammerloid metal cabinets.

Dimensions of Medium (RME) Model Radio Inverters, 8 $\frac{3}{8}$ " x 9" x 3 $\frac{3}{4}$ "; shipping weight, 12 lbs.

Dimensions of Standard (RSE) Model Radio Inverters, 8 $\frac{3}{8}$ " x 9" x 5 $\frac{1}{4}$ "; shipping weight, 19 lbs.

Dimensions of Heavy Duty (RHF) Model Radio Inverters, 6 $\frac{1}{2}$ " x 11 $\frac{1}{8}$ " x 8 $\frac{1}{2}$ "; shipping weight, 30 lbs.

For correct ATR replacement vibrator, consult ATR Inverter Vibrator Guide.

JOBBER'S ATTENTION: See Pages M-30 and M-31 in this ATR Section for your Catalog Needs!



TELEVISION INVERTERS

Specially Designed and Carefully Adjusted for Operating Television Receivers from D.C. Voltages in Automobiles, Buses, Trucks, Boats, Trains, Planes, and D.C. Districts. Suitable for Use with All Types of Electronic Equipment where Precise Output Frequency is Required.

This group of ATR Inverters has been selected from the ATR line of Standard and Heavy Duty Radio Inverters and Super Heavy Duty Inverters and have specially adjusted ATR Vibrators installed in them to provide the precisely adjusted output power frequency required for the operation of Television Sets. They are exceptionally well filtered to insure interference-free reception. They are equipped with four-point voltage regulators. The operating efficiency is in excess of 85 percent. They are recommended for use with loads having power factors in excess of 70 percent.

ATR Inverters should be used only for the applications as outlined above.

ATR Inverters are not recommended for operating refrigerators, washing machines or similar motor-driven appliances; also, ATR Inverters are not recommended for operating toasters, electric irons, sun lamps, or similar appliances of high wattage or low power factor. Any attempt to use the Inverter for applications not recommended will ruin the Inverter immediately and void the guarantee.

Featured cut above illustrates Model 110AT-RHF.

ATR Standard (RSE), Heavy Duty (RHF), and Super Heavy Duty (HSH) Television Inverters are housed in attractively finished grey-hammer-loid metal cabinets.



Dimensions of Standard (RSE) Model Television Inverters, 8 $\frac{3}{4}$ " x 9" x 5 $\frac{1}{4}$ "; Shipping weight, 19 lbs.

Dimensions of Heavy Duty (RHF) Model Television Inverters, 6 $\frac{1}{2}$ " x 11 $\frac{1}{8}$ " x 8 $\frac{1}{2}$ "; Shipping weight, 30 lbs.

Dimensions of Super Heavy Duty (HSH) Model Television Inverters, 6 $\frac{1}{2}$ " x 12 $\frac{1}{8}$ " x 8 $\frac{1}{2}$ "; Shipping weight, 34 lbs.

For correct replacement vibrator, consult Inverter Vibrator Guide.

TYPE	INPUT D.C. VOLTS	A.C. OUTPUT 60 CYCLES	OUTPUT WATTAGE		SHIPPING WEIGHT	LIST PRICE
			INTERMITTENT	CONTINUOUS		
6T-HSH	6	110 Volts	150	125	34 lbs.	\$119.50
12T-HSH	12	110	250	200	34	119.50
*28T-HSH	28	110	250	200	34	145.00
32BT-RHF	32	110	200	180	30	94.50
32T-HSH	32	110	325	225	34	135.00
110T-RSE	110	110	250	150	19	65.00
110AT-RHF	110	110	325	250	25	79.75
110BT-RHF	110	110	500	350	30	105.75
110T-HSH	110	110	600	400	34	135.00
220T-RSE	220	110	250	150	19	75.00
220T-HSH	220	110	500	300	34	155.00

*Recommended for 24 volt battery systems.

ACCESSORIES for 6, 12, and 28 Volt D.C. Input Inverters.

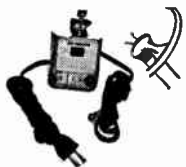

REMOTE CONTROL UNIT — for under-dash mounting permitting installation of inverter in auto-trunk compartment. List Price \$6.95



MOUNTING BRACKETS — to securely mount inverter in trunk compartment of car or under-dash, as illustrated. List Price \$4.95 pr.

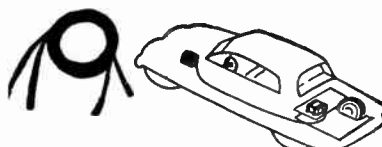

EXTENSION CABLES — to provide additional cable lengths for installation of inverter in trunk compartment. List Price \$11.95 pr.

JOBBER'S ATTENTION: See Pages M-30 and M-31 in this ATR Section for your Catalog Needs!



"A" BATTERY ELIMINATORS

... FOR DEMONSTRATING AND TESTING AUTO RADIOS

6 VOLT OR 12 VOLT!

Specially Designed for Testing and Operating Auto Radios and D.C. Electrical Apparatus on Regular A.C. Lines, 105-125 Volts, 50-60 Cycles.

SUGGESTED USES:

As a power supply for radio sets, aircraft instruments, relays, motors and other electrical and electronic equipments. In the laboratory, for supplying various low D.C. voltages.

Battery Eliminators may be treated as batteries in the sense that they can be connected in series for higher voltages at the same current output per unit or in parallel for the same output voltage per unit at higher currents.

- ✓ Eliminates Storage Batteries and Battery Chargers.
- ✓ Operates the Equipment at Maximum Efficiency at All Times.
- ✓ Delivers Filtered Direct Current at the Correct Voltage for Proper Operation.
- ✓ Fully Automatic and Fool-Proof.



Featured cut illustrates Heavy Duty "A" Battery Eliminator, Model 620C-ELIR; equipped with Voltmeter, Ammeter and Voltage Control.



Illustrates Standard "A" Battery Eliminator, Model 610C-ELID; equipped with Voltmeter, Ammeter and Voltage Control.

Equipped with Full-Wave Dry Disc Selenium Rectifier, Assuring Noiseless, Interference-Free Operation and Extreme Long Life and Reliability.

TYPE 610-ELID—Rated output 6 volts at 10 amperes continuous. Size 6½" x 9⅞" x 8½". Shipping weight 22 lbs. Code word "SELIE." Similar to illustration on left but with Voltmeter only. LIST PRICE \$59.40

TYPE 610C-ELID—Rated output 6 volts at 10 amperes continuous or 12 volts at 6 amperes continuous. Size 6½" x 9⅞" x 8½". Shipping weight, 22 lbs. Appearance similar to 20C-ELIR, above. Code word "SELIF." LIST PRICE \$66.58

TYPE 620C-ELIR—Rated output 6 volts at 20 amperes continuous or 12 volts at 10 amperes continuous. Uses dual rectifiers. Size 6½" x 12⅞" x 8½". Shipping weight, 33 lbs. Code word "HELIR." LIST PRICE \$93.90

Either 6 or 12 volt output obtainable by means of simple output toggle switching arrangement having locking device to prevent accidental switching.

All ATR Eliminators have as standard equipment: On-Off Switch, 8-Position Voltage Control, Meter(s), Fuse Protection, Rubber Mounting Feet, 6-ft. All-Rubber Cord Set and Cabinet of heavy gauge metal having attractive grey-hammerloid finish.

JOBBER ATTENTION: See Pages M-30 and M-31 in this ATR Section for your Catalog Needs!



† INDUSTRIAL INVERTERS

For Operating Small A.C. Motors, Electronic Apparatus, Electrical Testing Equipment, and A.C. Electrical Appliances from D.C. Lines.

These units are specially designed for applications as indicated, permitting the use of standard A.C. equipment on D.C. lines. These Inverters operate at an efficiency in excess of 75% and are carefully built and equipped to give the longest possible life and operating satisfaction. All models indicated are equipped with an ATR plug-in Inverter Vibrator of new design and construction, insuring increased long life and reliable service. All Inverters (except LIG) come equipped with four-point voltage regulators, which make possible the correct output voltage for minimum to maximum loads and also help compensate for input voltages which are lower or higher than normal. These Industrial Inverters are recommended for use with loads having power factors as low as 60%, and as low as 50% for the "P" Inverters indicated. These Inverters should not be used with Neon signs.



ATR Inverters should be used only for the applications as outlined above.

ATR Inverters are not recommended for operating refrigerators, washing machines or similar motor-driven appliances; also, ATR Inverters are not recommended for operating toasters, electric irons, sun lamps, or similar appliances of high wattage or low power factor. Any attempt to use the Inverter for applications not recommended will ruin the Inverter immediately and void the guarantee.

Type	INPUT D.C. VOLTS	A.C. OUTPUT 60 CYCLES	OUTPUT WATTAGE		SHIPPING WEIGHT	LIST PRICE
			INTERMITTENT	CONTINUOUS		
6-LIG	6	110 volts	50	40	8 lbs.	\$ 35.75
6-ISR-F	6	110	80	65	19	69.95
12-LIG	12	110	65	50	8	35.75
12-ISR-F	12	110	125	100	19	69.95
†28-LIG	28	110	65	50	8	47.50
32-LIG	32	110	65	50	8	47.50
32-ISR-F	32	110	150	100	19	79.50
32P*-ISR-F	32	110	150	125	19	89.50
328-IHS-F	32	110	200	180	30	105.50
110-LIG	110	110	80	65	8	39.50
220-LIG	220	110	80	65	8	47.50
110-ISR-F	110	110	250	150	19	69.50
110P*-ISR-F	110	110	250	150	19	86.50
110A-IHS-F	110	110	325	250	25	94.75
110B-IHS-F	110	110	500	350	30	115.75
220-ISR-F	220	110	250	150	19	79.50
220P*-ISR-F	220	110	300	150	19	89.50

†Radio frequency interference suppressed. †Recommended for 24 volt battery systems.

All models designated above are housed in attractively finished grey hammerloid metal cabinets. The feature cut above illustrates Heavy Duty (IHS) Model Inverters. Dimensions of Standard Model (ISR) Inverters 8 $\frac{3}{8}$ " x 9" x 5 $\frac{1}{4}$ "; shipping weight, 19 lbs.

Dimensions of Heavy Duty Model (IHS) Inverters, 6 $\frac{1}{2}$ " x 11 $\frac{1}{8}$ " x 8 $\frac{1}{2}$ "; shipping weight, 30 lbs. Dimensions of Low Power Model (LIG) Inverters, 5 $\frac{5}{8}$ " x 4" x 6 $\frac{3}{4}$ "; shipping weight, 8 lbs.

*"P" Inverters are corrected for loads having power factors as low as 50%. For correct replacement vibrator, consult Inverter Vibrator Guide.

JOBBERS ATTENTION: See Pages M-30 and M-31 in this ATR Section for your Catalog Needs!



GERMICIDAL LAMP INVERTERS

Specially Designed for Operating Standard A.C. Germicidal Lamps from Storage Battery Voltages in Trucks, Buses, Boats, Trains, and Planes.

This group of ATR Inverters is especially recommended for use with standard A.C. operated germicidal lamps providing protection against bacteria and mold spores in perishable food areas or hospital-like areas in trucks, boats, planes, and trains. Bacteria and mold spores cause losses of millions of dollars each year through spoilage, contamination, and added maintenance costs. Effective control of air-borne germs, bacteria and mold spores by use of germicidal lamps is widely used in processing and packaging of fresh food products. This same protection against contamination during delivery is now possible using germicidal lamps operating from an ATR Inverter connected to D.C. Storage Battery Power. With ATR Inverters, the need for special equipment is eliminated. They are designed for quiet long-life operation. These rugged, efficient, little power houses are self-maintaining — require no warm-up. They change your D.C. battery power to 110 volt A.C. (household type) power instantly and quietly. ATR Inverters are fully protected and are big enough to do a proper job and small enough to fit most anywhere. All models indicated are equipped with ATR plug-in Inverter Vibrators. These Inverters (except Model LIG) also come equipped with four-point voltage regulators which make possible the correct output voltage for minimum to maximum loads, and also help compensate for input voltages which are lower or higher than normal. The operating efficiency is in excess of 75%. The battery current consumption required is normally less than that drawn by ordinary automobile headlight(s). These ATR Inverters should be used only for the application as outlined above.



Illustrates ATR Standard (ISR) Model.

EASY TO INSTALL
EASY TO OPERATE

TYPE	INPUT D.C. VOLTAGE	A.C. OUTPUT 60 CYCLES	OUTPUT WATTAGE		RECOMMENDED GERMICIDAL LAMP LOAD	SHIPPING WEIGHT	LIST PRICE
			INTERMITTENT	CONTINUOUS			
6-LIG-L	6	115 volts	50	40	1 †WL-782H-30 Sterilamp or equivalent	8 lbs.	\$45.00
6-ISR-FL	6	115	80	65	1 or 2 †WL-782H-30 Sterilamp or equivalent	19	79.50
12-ISR-FL	12	115	125	100	1 or 2 †WL-782H-30 Sterilamp or equivalent	19	79.50
12-LIG-L	12	115	50	40	1 WL-782H-30 Sterilamp or equivalent	8	45.00
*28-ISR-FL	28	115	125	100	1 or 2 †WL-782H-30 Sterilamp or equivalent	19	89.50
*28-LIG-L	28	115	50	40	1 WL-782H-30 Sterilamp or equivalent	8	55.00
32-ISR-FL	32	115	150	100	1 or 2 †WL-782H-30 Sterilamp or equivalent	19	89.50

Radio frequency interference completely suppressed. *Recommended for 24-volt battery systems.
 †The WL-782H-30 Westinghouse Sterilamp should be used with Westinghouse type SB-30 fixture S #1371936 having ballast S #1371900.
 All models designated above are housed in attractively finished grey hammerloid metal cabinets. Dimensions of Standard (ISR) Model Inverters, 8 3/4" x 9" x 5 1/4"; shipping weight, 19 lbs. Dimensions of Low Power (LIG) Model Inverters, 5 1/2" x 4" x 6 3/4"; shipping weight, 8 lbs.
 For correct replacement vibrators, consult Inverter Vibrator Guide.
 Installation accessories are indicated below. In truck installations, Inverter will be installed usually in the cab and germicidal lamp operation will be controlled OFF and ON by means of the Inverter switch.
 Illustration on right hand side below shows Germicidal Lamps mounted in truck van with Inverter installed in cab compartment.

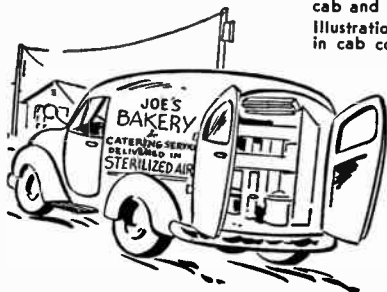

Illustrating Small Panel Perishable Food Truck Having Germicidal Lamp Installation Operating from ATR Inverter. Protects Perishable Foods During Delivery.

ACCESSORIES

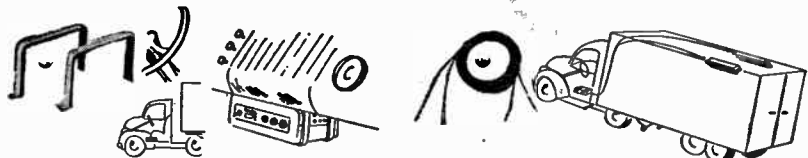

MOUNTING BRACKETS — To securely mount Inverter under seat or under dash in cab compartment, as illustrated. List Price \$4.95 pr.

EXTENSION CABLES — To provide additional cable lengths for installation of Inverter in cab compartment to connect with storage battery. List Price \$11.95 pr.

JOBBER ATTENTION: See Pages M-30 and M-31 in this ATR Section for your Catalog Needs!



SHAV-PAKS

Specially Designed for Operating Standard A.C. Electric Shavers in Automobiles, Buses, Trucks, Boats, and Planes.

ATR SHAV-PAKS are miniature DC-AC Inverters designed especially for the operation of standard A.C. electric shavers from 6 or 12-volt storage batteries in automobiles, buses, trucks, boats, and planes. They are ideally suitable for traveling salesmen, executives, sportsmen, and all owners of electric shavers. The ATR SHAV-PAK very simply plugs into the cigarette lighter receptacle on the dash and changes the D.C. battery power to standard 110-volt A.C. electricity for the operation of electric shavers anywhere! The ATR SHAV-PAK may also be used for operating other small A.C. devices having a wattage requirement of not more than 15 watts such as flea power timing motors. ATR SHAV-PAKS are equipped with ATR plug-in type vibrators which will give many years of satisfactory and dependable service.

EASY TO OPERATE



**PLUGS INTO
CIGARETTE LIGHTER
RECEPTACLE ON DASH**

KEEP IN GLOVE COMPARTMENT



SALESMEN AND EXECUTIVES — "Be Neat," have your electric razor handy! Shave in the comfort of your own car, boat, or plane.

Features—

- Small Size
- Plug-in ATR Vibrator
- Fuse Protection
- Rubber Mounting Feet
- Steel Case
- Rugged Construction

TYPE	INPUT D.C. VOLTS	A.C. OUTPUT 60 CYCLES	OUTPUT WATTAGE	SHIPPING WEIGHT	LIST PRICE
6-SPB	6	115 volts	15	2½ lbs.	\$12.95
12-SPB	12	115	15	2½	12.95

Radio frequency interference not suppressed:
 For inverters having larger or smaller output capacities, or for operation on other D.C. input voltages, please consult available ATR Inverter Catalog Sheets.
 All ATR SHAV-PAKS are housed in attractively finished grey hammerloid steel cabinets. Dimensions 4" x 2½" x 2¾"; shipping weight, 2½ lbs.
 For correct replacement vibrator, consult Inverter Vibrator Guide.

JOBBER'S ATTENTION: See Pages M-30 and M-31 in this ATR Section for your Catalog Needs!



PRODUCTS

AMERICAN TELEVISION & RADIO Co. *Quality Products Since 1931*

ALL ATR INVERTER PRODUCTS CHANGE D.C. STORAGE BATTERY CURRENT TO STANDARD 110 VOLT A.C. *Household* ELECTRICITY *Anywhere!*



**EASY TO INSTALL
EASY TO OPERATE**

TAPE RECORDER INVERTERS

IDEAL FOR EMERGENCY LIGHTING

Specially Designed for Operating Standard A.C. Tape Recorders, Wire Recorders, Dictating Machines, Radios, Public Address Systems, Amplifiers, Electric Razors, Record Players, Mix-masters, and Electronic Test Equipment from D.C. Voltages in Automobiles, Buses, Trucks, Boats, Trains, and Planes.

TYPE	INPUT D.C. VOLTS	OUTPUT WATTAGE		SHIPPING WEIGHT	LIST PRICE
		INTERMITTENT	CONTINUOUS		
6-RSE	6	80	65	19 lbs.	\$ 59.95
6-RHF	6	125	100	25	69.95
6-HSH	6	150	125	34	109.50
12-RSE	12	125	100	19	59.95
12-RHF	12	150	125	25	69.95
*28-RSE	28	125	100	19	75.00
*28-RHF	28	150	125	25	95.00
32-RSE	32	150	100	19	69.50

All ATR Inverters deliver 110 Volts A.C. 60 Cycles Current.
Radio frequency interference completely suppressed.
*Recommended for 24 Volt Battery System.



Illustrates ATR Mighty Midget (DME) Model Inverter Having Cigarette Lighter Plug Attachment.



Illustrates ATR Medium (RME) Model Inverter Having Four-Point Voltage Regulator.



**Dictating
Machine**

INVERTERS

Specially Designed for Operating Standard A.C. Dictating Machines, Small Radios, Record Players, Mix-masters, Food Blenders, Electric Razors, Electronic Test Equipment, and Most Small Electrical and Electronic Devices from D.C. Voltages in Automobiles, Buses, Trucks, Boats, Planes, and Trains.

TYPE	INPUT D.C. VOLTS	OUTPUT WATTAGE		SHIPPING WEIGHT	LIST PRICE
		INTERMITTENT	CONTINUOUS		
6-DME	6	40	30	5 lbs.	\$22.50
6-RME	6	60	50	12	39.50
6-RSE	6	80	65	19	59.95
12-DME	12	50	40	5	22.50
12-RME	12	100	80	12	39.50
12-RSE	12	125	100	19	59.95
*28-RME	28	100	80	12	65.00
*28-RSE	28	125	100	19	75.00
32-RSE	32	150	100	19	69.50

All ATR Inverters deliver 110 Volts A.C. 60 Cycles Current.
*Recommended for 24 Volt Battery Systems.



SHAV-PAKS

EASY TO OPERATE

PLUGS INTO
CIGARETTE LIGHTER
RECEPTACLE ON DASH

Keep in Glove Compartment

Specially Designed for Operating Standard A.C. Electric Shavers in Automobiles, Buses, Trucks, Boats, and Planes.

TYPE	INPUT D.C. VOLTS	OUTPUT WATTAGE	SHIPPING WEIGHT	LIST PRICE
6-SPB	6	15	2 1/2 lbs.	\$12.95
12-SPB	12	15	2 1/2	12.95

ATR SHAV-PAKS deliver 115 Volts A.C. 60 Cycles Current.

Features —

- Small Size
- Plug-in ATR Vibrator
- Fuse Protection
- Rubber Mounting Feet
- Steel Case
- Rugged Construction

ACCESSORIES

For all Mobile INVERTERS

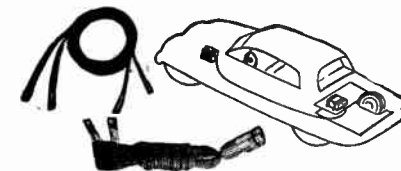

REMOTE CONTROL UNIT — for under-dash mounting permitting installation of inverter in auto trunk compartment.
List Price \$6.95

MOUNTING BRACKETS — to securely mount inverter in trunk compartment of car or under-dash, as illustrated.
List Price \$4.95 pr.

EXTENSION CABLES — to provide additional cable lengths for installation of inverter in trunk compartment.
List Price \$11.95 pr.

CIGARETTE LIGHTER CORD SET — to plug into cigarette lighter receptacle on dash.
List Price \$3.95



PRODUCTS

AMERICAN TELEVISION & RADIO Co. *Quality Products Since 1931*

ALL ATR INVERTER PRODUCTS CHANGE D.C. STORAGE BATTERY CURRENT TO STANDARD 110 VOLT A.C. *Household* ELECTRICITY *Anywhere!*



TELEVISION INVERTERS

Specially Designed and Carefully Adjusted for Operating Television Receivers from D.C. Voltages in Automobiles, Buses, Trucks, Boats, Trains, Planes, and D.C. Districts. Suitable for Use with All Types of Electronic Equipment where Precise Output Frequency is Required.

TYPE	INPUT D.C. VOLTS	OUTPUT WATTAGE		SHIPPING WEIGHT	LIST PRICE
		INTER-MITTENT	CONTINUOUS		
6T-HSH	6	150	125	34 lbs.	\$119.50
12T-HSH	12	250	200	34	119.50
*28T-HSH	28	250	200	34	145.00
32BT-RHF	32	200	180	30	94.50
32T-HSH	32	325	225	34	135.00
110T-RSE	110	250	150	19	65.00
110AT-RHF	110	325	250	25	79.75
110BT-RHF	110	500	350	30	105.75
110T-HSH	110	600	400	34	135.00
220T-RSE	220	250	150	19	75.00
220T-HSH	220	500	300	34	155.00

All ATR Inverters deliver 110 Volts A.C. 60 Cycle Current.

*Recommended for 24 volt battery systems.



INDUSTRIAL INVERTERS

For Operating Small A.C. Motors, Electronic Apparatus, Electrical Testing Equipment, and A.C. Electrical Appliances from D.C. Lines.

TYPE	INPUT D.C. VOLTS	OUTPUT WATTAGE		SHIPPING WEIGHT	LIST PRICE
		INTER-MITTENT	CONTINUOUS		
6-LIG	6	50	40	8 lbs.	\$ 35.75
6-ISR-F	6	80	65	19	69.95
12-LIG	12	65	50	8	35.75
12-ISR-F	12	125	100	19	69.95
*28-LIG	28	65	50	8	47.50
32-LIG	32	65	50	8	47.50
32-ISR-F	32	150	100	19	79.50
†32P-ISR-F	32	150	125	19	89.50
32B-IHS-F	32	200	180	30	105.50
110-LIG	110	80	65	8	39.50
220-LIG	220	80	65	8	47.50
110-ISR-F	110	250	150	19	69.50
†110P-ISR-F	110	250	150	19	86.50
110A-IHS-F	110	325	250	25	94.75
110B-IHS-F	110	500	350	30	115.75
220-ISR-F	220	250	150	19	79.50
†220P-ISR-F	220	300	150	19	89.50

All ATR Industrial Inverters deliver 110 Volts A.C. 60 Cycle Current.

*Recommended for 24 volt battery systems.

†"P" Inverters are recommended for loads having power factors as low as 50%.



'A' BATTERY ELIMINATORS

for...
DEMONSTRATING AND TESTING
AUTO RADIOS
6 VOLT OR 12 VOLT

Featured cut illustrates Heavy Duty "A" Battery Eliminator, Model 620C-ELIR; equipped with Voltmeter, Ammeter and Voltage Control.

Specially Designed for Testing and Operating Auto Radios and D.C. Electrical Apparatus on Regular A.C. Lines, 105-125 Volts, 50-60 Cycles.

TYPE 610-ELID—Rated output 6 volts at 10 amperes continuous. Size 6 1/2" x 9 1/8" x 8 1/2". Shipping weight 22 lbs. Similar to illustration on left but with Voltmeter only. LIST PRICE \$59.40

TYPE 610C-ELID—Rated output 6 volts at 10 amperes continuous or 12 volts at 6 amperes continuous. Size 6 1/2" x 9 1/8" x 8 1/2". Shipping weight 22 lbs. Appearance similar to 620C-ELIR, left. LIST PRICE \$66.58

TYPE 620C-ELIR—Rated output 6 volts at 20 amperes continuous or 12 volts at 10 amperes continuous. Uses dual rectifiers. Size 6 1/2" x 12 7/8" x 8 1/2". Shipping weight 33 lbs. LIST PRICE \$93.90



RADIO INVERTERS

EASY TO INSTALL...
EASY TO OPERATE

Specially Designed for Operating Standard A.C. Radios, Radio-Phonographs, Tape Recorders, Wire Recorders, Record Players, Dictating Machines, Public Address Systems, Amplifiers, Radio Transmitters, Mix-masters, Food Blenders, Electric Razors, and Electronic Test Equipment from D.C. Voltages in Towns, Rural Areas, and in D.C. Districts.

TYPE	INPUT D.C. VOLTAGE	OUTPUT WATTAGE		SHIPPING WEIGHT	LIST PRICE
		INTER-MITTENT	CONTINUOUS		
32-RME	32	100	80	12 lbs.	\$57.50
32-RSE	32	150	100	19	69.50
32B-RHF	32	200	180	30	89.50
50-RSE	50	150	100	19	79.50
110-RME	110	150	100	12	47.50
110-RSE	110	250	150	19	95.95
220-RSE	220	250	150	19	69.50

All ATR Radio Inverters deliver 110 Volts A.C. 60 Cycles Current.

ADDITIONAL PRODUCTS

- ATR Germicidal Lamp Inverters
- ATR Chargo-Verters
- ATR Phono Inverters
- ATR Battery Chargers
- ATR Sine-Wave Inverters
- ATR Rectifier Packs
- ATR Vibrator Packs
- ATR Inverter Vibrators

Write for literature covering all additional ATR products.

VIBRATORS AND VIBRAPACK® POWER SUPPLIES

P. R. MALLORY & CO. INC.
MALLORY

P. R. MALLORY & CO., INC. - INDIANAPOLIS



Vibrators

Mallory Vibrators are engineered to exacting specifications. Their superior action is a result of more than 20 years' research. Pure, natural rubber liners deaden sound and assure quiet operation. Special, tough-spring steel eliminates reed breakage. Heavy framing insures correct and exact alignment. Extra size and quality of contact points assure longer life. Each Mallory Vibrator is tested individually for correct output, starting voltage and wave form.

Cat. No.	Volt	Type	Base Dia.	Size	List Price
*245	6	Syn.	21	1½ x 3¼	\$7.70
247	6	Syn.	46	1½ x 3¼	7.70
G248	12	Syn.	44	1½ x 3¼	8.55
271HD	6	Syn.	24	2 x 4½	9.15
273C	6	Syn.	29	2 x 4½	9.15
273D	6	Syn.	31	2 x 4½	9.15
294	6	Int.	8	1½ x 3¼	4.90
*F294	32	Int.	8	1½ x 3¼	7.15
298	6	Int.	51	1½ x 2½	6.35
505P	6	Int.	8	1 1/8 x 3 1/2	4.90
506P	6	Int.	36	1 1/8 x 3 1/2	6.35
509P	6	Int.	8	1½ x 2½	4.15
716	6	Syn.	30	1 1/8 x 3 1/2	7.70
725C	6	Syn.	32	1½ x 3¼	8.55
G725C	12	Syn.	32	1½ x 3¼	9.95
742	6	Syn.	32	1½ x 2½	7.70
743	6	Syn.	38	1½ x 3¼	7.70
748	6	Syn.	44	1½ x 2½	7.70
G749C	12	Syn.	21	1½ x 3¼	9.95
W759	4	Syn.	21	1½ x 2½	8.25
825C	6	Int.	8	1½ x 3¼	6.90
826C	6	Int.	8	1½ x 3¼	6.35
F826C	32	Int.	8	1½ x 3¼	7.70
G826C	12	Int.	8	1½ x 3¼	7.70
854	6	Int.	11	1½ x 3¼	4.90
*859	6	Int.	8	1½ x 2½	4.70
G859	12	Int.	8	1½ x 2½	5.50
W859	4	Int.	8	1½ x 2½	4.90
870	6	Int.	14	1½ x 2½	4.90
G874	12	Int.	55	1½ x 3¼	4.90
903M	6	Int.	8	1½ x 2½	4.15
953W	6	Syn.	16	1½ x 3 3/8	7.70
954	6	Syn.	39	1½ x 3	7.70
1100	6	Int.	8	1 1/8 x 2 1/2	4.90
T4002	2	Syn.	52	1½ x 2 1/8 x 1 1/2	10.70
T4003	2	Syn.	50	1 1/8 x 2 1/2	9.80
4501	6	Int.	53	1½ x 2½	6.35
G4501	12	Int.	53	1½ x 2½	6.90
4502	6	Int.	54	1½ x 2½	6.90
4546	6	Syn.	38	1½ x 3¼	7.70
4548	6	Syn.	44	1½ x 3¼	7.70
4549	6	Syn.	32	1½ x 3¼	7.70
G4549	12	Syn.	32	1½ x 3¼	8.55
GC7†		Ground Cup			.45
AR-1		Adapter			1.50
*SK-1		Socket Kit			1.25
VP-1		Vibrator Puller			2.50

Int.—Interrupter

Syn.—Synchronous

* Use only these types in design of new equipment. Other types are for replacement purposes only.

* Hermetically Sealed Construction.

† A grounding cup for 1½" diameter vibrators which makes a low r.f. ground connection between vibrator can and power supply chassis.

* Five special sockets for Practical Vibrator Tester. Supplied as complete kit only.

NEW! THE '54 MALLORY VIBRATOR GUIDE

Contains Vibrator Replacement Information.
See Your Mallory Distributor.

Vibrapacks



VP-540



VP-555H
VP-557

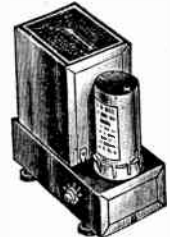

VP-552
VP-G556

Mallory Vibrapacks are the ideal vibrator power supplies designed to provide at low cost, dependable, high-voltage, direct current from low-voltage, storage batteries. Mallory Vibrapacks offer high efficiency, dependability, low maintenance cost and long life because of years of field testing. Added features are; light weight, compactness and simplicity of installation.

Catalog Number	Nominal Operating Voltage	Nominal Output Voltage	Maximum Output Current	Type	List Price
VP-540*†	6.3	250	60 ma.	Self-Rectifying	\$46.20
VP-551	6.3	125-150 175-200	100 ma.	Self-Rectifying	31.00
VP-552†	6.3	225-250 275-300	100 ma.	Self-Rectifying	34.50
VP-553	6.3	125-150 175-200	100 ma.	Tube Rectifier	38.00
VP-554H†	6.3	225-250 275-300	100 ma.	Tube Rectifier	40.00
VP-555H†	6.3	300	200 ma.	Tube Rectifier	79.95
VP-557†	6.3	400	150 ma.	Tube Rectifier	79.95
VP-G556	12.6	225-250 275-300	100 ma.	Self-Rectifying	36.00
VP-F558‡	32.	225-250 275-300	100 ma.	Tube Rectifier	48.00

* Includes complete audio filter.

† Maximum ratings are for mobile transmitter service. For continuous duty with radio receivers where longer vibrator life is essential. Reduces maximum output watts ratings to 75% of listed values.

‡ Will be deleted when present stock is exhausted.

● Use the Mallory 12VT1D Vibrator Checker for direct readings on "good-bad" conditions of doubtful vibrators. For complete description and illustration of the 12VT1D see page 3, Mallory Rectifier and Power Supply section, this catalog.

Vibrator Base Diagrams

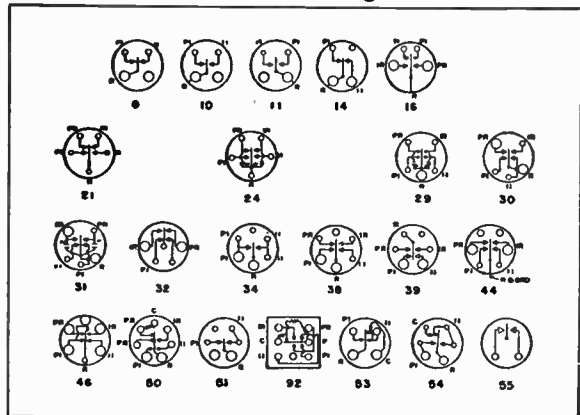

R=Reed PR=Pull Rectifier IR=Inertia Rectifier FR=Frame
PI=Pull Interrupter II=Inertia Interrupter C=Coil

Mallory Page 1

RECTIFIER STACKS

P. R. MALLORY & CO., INC. · INDIANAPOLIS

P. R. MALLORY & CO. INC.
MALLORY

Selenium Rectifier Stacks

Mallory Selenium stacks are conservatively rated to provide long dependable service and good voltage regulation at high efficiency. Rectification is immediate—no warm-up period is required. 5-volt average drop across stack results in cooler operation.



Recommended Minimum Capacity in Mfd.

Rectifier Stack Cat. No.	AC Input: Volts R.M.S.				DC MA. Cont.	Approx. DC Volts	Min. Series Resistor In Ohms R1	Full-Wave Doubler and Half-Wave		Series Capacitor Half-Wave Doubler		Approx. Dimensions In Inches			List Price
	Capacitive Load		Resistive and Inductive Load					Mfd. C1	Volts WV DC	Mfd. C2	Volts WV DC	A*	B*	C*	
	Design	Max.	Design	Max.											
8S20	117	130	200	220	20	120	47	20	150	30	150	½	½	1 1/8	\$1.25
8S35	117	130	200	220	35	120	47	30	150	40	150	¾	2 1/2	¾	1.40
8S65	117	130	200	220	65	125	22	30	150	40	150	¾	1	¾	1.50
6S75	117	130	200	220	75	125	22	40	150	50	150	¾	1	1 3/8	1.85
6S100	117	130	200	220	100	125	22	50	150	80	150	¾	1 ¼	1 3/8	2.05
6S100A	117	130	200	220	100	125	22	50	150	80	150	¾	1	1 ½	1.90
6S150	117	130	200	220	150	125	15	80	150	150	150	¾	1 ¼	1	2.25
6S200	117	130	200	220	200	125	5	100	150	150	150	¾	1.6	1	3.15
6S250	117	130	200	220	250	125	5	150	150	200	150	¾	1.6	1 ¼	3.15
6S300	117	130	200	220	300	125	5	150	150	250	150	¾	1.6	1 ¾	3.30
6S350	117	130	200	220	350	125	5	250	150	300	150	¾	2	1 15/16	4.10
6S400	117	130	200	220	400	125	5	250	150	300	150	¾	2	1 ¼	4.25
6S450	117	130	200	220	450	125	5	300	150	400	150	¾	2	1 15/16	4.30
6S500	117	130	200	220	500	125	5	300	150	400	150	¾	2	1 ¾	4.40
8S75	150	160	245	270	75	160	22	40	250	50	250	¾	1	1	2.75
8S100	150	160	245	270	100	160	22	50	250	80	250	¾	1.2	1	3.75
8S200	150	160	245	270	200	160	5	100	250	150	250	¾	1.6	1 ¼	3.35
8S450	150	160	245	270	450	160	5	300	250	400	250	¾	2	2 ½	4.75

A*—Terminal Extension Beyond Plate. B*—Dimension of Plate. C*—Overall Length.

Chart of Replacement Magnesium-Copper Sulfide Rectifier Stacks

New Catalog Number	List Price	Maximum AC Volts (Normal Line)		Approx. DC Volts			Max. DC † Amperes		Approximate Overall Dimensions in Inches		
		No Load	Full Load	Inductive Load	Resistive Load	Capacitive-Battery Load	Continuous Duty ‡	Intermittent Duty	Length	Width	Height
IB4R	\$2.40	3.6	3.2	1.5	1.7	2.5	1.5	5.0	1	¾	¾
IB8R	2.85	7.2	6.4	3.1	3.4	5.1	1.5	5.0	1 ¾	¾	¾
IB12R	3.25	10.8	9.7	4.8	5.2	7.8	1.3	5.0	1 ¾	¾	¾
IB12L5	5.85	10.8	9.7	4.5	5.0	7.6	4.5	15.0	2 ½	2 ½	2 ¾
IB12C1J	6.55	10.8	9.8	4.6	5.1	7.7	3.2	24	2 ¾	1 ¾	1 ¾
IB12C3	6.80	10.8	9.7	4.5	5.0	7.6	4.5	24	2 ¾	1 ¾	2 ¾
IB12C5	7.40	10.8	9.7	4.5	5.0	7.6	5.3	24.0	3	2 ¾	2 ¾
F16C3	8.85	14.4	13.0	6.1	6.8	10.2	3.9	24	3	1 ¾	2 ¾
IF16CB7M	10.20	14.4	12.8	5.9	6.6	9.9	6.0	24	3	2 ¾	3 1/8
IS16CB7	10.20	14.4	12.8	5.9	6.6	9.9	6.0	24	3 ¾	2 ¾	3
IS16B7	11.25	14.4	12.8	5.8	6.5	9.8	8.3	24	5 ½	2 ¾	3
IS16B9	12.80	14.4	12.7	5.7	6.4	9.7	11.6	24	5 ½	3 ¾	4 ¾
F20C7	12.75	18.0	16.2	7.6	8.4	12.6	4.8	24	4 ¾	2 ¾	3 1/8
IS24C7J	12.60	21.6	19.4	9.0	10.1	15.1	4.0	24	4 ¾	2 ¾	3 1/8
IS24B9	17.95	21.6	19.1	8.5	9.6	14.4	11.0	24	7 ½	3 ¾	4 ¾
IS28C7J	15.30	25.2	22.7	10.7	11.7	17.8	4.3	24	6	2 ¾	3
F16HIP	7.05	14.4	13.1	6.3	7.0	10.4	2.2	24	2 ½	1 ¾	2
F20HIP	8.65	18.0	16.4	7.9	8.7	13.0	2.0	24	2 ¾	1 ¾	2
F24HIP	10.30	21.6	19.7	9.6	10.4	15.7	1.9	24	3	1 ¾	2
F28HIP	11.90	25.2	23.0	11.2	12.2	18.4	1.7	24	3 ½	1 ¾	2
F32HIP	13.55	28.8	26.2	12.8	14.0	21.0	1.6	24	3 ¾	1 ¾	2

NOTE: All rectifiers are single phase, full wave, bridge type. Mounting Prefix: IB=Insulated Bolt; F=Grounded Foot; IF=Insulated Foot; IS=Insulated Stud.

P suffix designates reverse polarity stacking. Center terminal is DC positive.

J suffix designates universal construction with loose mounting feet for foot, bolt or stud mounting replacement.

† To determine AC Amps: Multiply the DC amps by the following factors: Inductive load by 1.1; resistive load by 1.2; capacitive load by 1.4.

‡ Ratings given are for resistive and inductive loads. To determine the Max. continuous DC amp. rating for capacitive and battery loads multiply these ratings by 0.82.

Mallory Page 2

**Rectifier Battery Chargers—
Power Supplies • UL Approved**

Mallory Automotive, Marine and Aviation Battery Chargers provide convenient, efficient and economical charging of any storage battery used in automobiles, buses, trucks, tractors, taxicabs, small boats, airplanes and on the farm. Taper charging (an automatically decreasing charging rate) is designed into all Mallory chargers to prevent damage to battery plates and to insure maximum battery life. These chargers also are ideal for charging any 6 or 12-volt storage battery used in industrial, engineering and research laboratories.



6SAC10



6SAC6



6SAC4



R670

R675

Mallory Charger Model Number	Nominal Battery DC Volts	Maximum Charging Rate DC Amps.	Tapered Rate DC Amps.	Maximum Continuous DC Amps. as Power Supply	DC Output Termination	Type of Charging Indicator	Approx. Overall Dimensions in Inches			Approx. Shipping Wt. in Pounds	List Price
							Height	Width	Depth		
6SAC4*	6	4	2	3	Universal	None	4%	4%	4%	5½	\$16.95
6SAC6*	6	6	4	5	Universal	Light	6%	4%	4%	6	19.95
6SAC10*	6	10	7	8	Universal	Light	7%	6½	5%	9	29.95
6AC75	6	75 (fast)	60	60	8' Clamps	Meter	15	7½	6½	34	109.50
		10 (slow)	9	10							
12SAC5*	12	5	3	4	Universal	Light	7%	6½	5%	9	29.95
12SAC10D	6	20	15	16	6' Clamps	Meter	9%	6½	5%	15½	54.95
	12	10	8	8							
12AC60D	6	80 (fast)	60	80							
	and	15 (slow)	8	8-25	8' Clamps	Meter	15	7½	6½	38	149.50
	12	40 (fast)	30	40							
		7 (slow)	3	3-12							

* These chargers are equipped with a Universal DC Output Socket. No DC Cable Assemblies are packaged with Charger. Purchase either R670 or R675 Cable Assembly.

Mallory 6RS25 Heavy Duty Six Volt DC Power Supply

The Mallory 6RS25 6 volt, 25 ampere rectifier type power supply is designed to replace storage battery-charger combinations for bench testing medium power 2-way mobile-phone equipment. It may also be utilized for non-radio uses requiring well-filtered low voltage DC in the 25 ampere range. Heavy sheet-steel housing makes it adaptable for use in garages as mobile radio bench equipment.



The 6RS25 operates from a standard 115 volt 60 cycle source to supply DC voltage from 0 to 8 volts at continuous or variable loads of 0 to 25 amperes. Intermittently, it will supply a maximum of 40 amperes at 6 volts.

An adjustable variable control allows quick selection of any voltage from 0 to 8 at 0 to 25 amperes. Three capacitors totaling 30,000 mfd. filter the output to less than 1 volt ripple and suppress RF and power line interference. A 0-10 volt DC voltmeter and a 0-40 ampere DC ammeter are included.

Conduction cooling of the full-wave Selenium Rectifier Cells, automatic overloading protection, and a self resetting circuit breaker insure long life.

Overall dimensions—11" high, 10½" wide, 8¾" deep. Shipping weight—26 lbs. Catalog No. 6RS25 \$74.50 Net

Mallory Service Bench Rectopower Supplies

Models 12RS14D and 28RS15D are designed to operate from 110-120 volts, 60-cycles, and are equipped with accurate reading DC voltmeters and ammeters, self-enclosing overload circuit breakers in the DC circuit, fuse protection in the AC circuit and an "on-off" switch. Both models are equipped with a continuously adjustable transformer-rotor system to provide precise adjustment of the output voltage to any value from 0 to rated output voltage. Both models are filtered by high-capacity electrolytic capacitors.



These models are also equipped with a new, simplified automatic voltage regulating system (no relays) which keeps the output voltage relatively constant as the load changes from no-load to full load. Model 12RS14D will supply 0-8VDC @ 25A or 0-16VDC @ 14A. Model 28RS15D will supply 0-16VDC @ 30A or 0-32VDC @ 15A. Model 12RS14D \$99.50 Net. Model 28RS15D \$199.50 Net.

Mallory Vibrator Testers

The Mallory Vibrator Testers have been designed as companion units to the famous Mallory Service Bench Rectopower® Supplies 6RS10, 6RS25-1, 12RS5, 12RS6D or 12RS14D (acting as variable power supplies) to test directly, without adapters, most of the popular vibrators and all of the 6 volt passenger car radio vibrators used since 1940. Either 6X5 or 0Z4 rectifier tubes may be plugged into the front panel, thus permitting interrupter vibrators to be tested in conjunction with the rectifier tube with which they normally work in the equipment. Defective vibrators or rectifiers can readily be determined by the substitution method. Self rectifying vibrators are tested by removing the rectifier tube. Either shunt or separate drive vibrators can be tested of any frequency from 100 to 250 cycles. The condition of the vibrator being tested may be read directly from the "good-bad" meter scale. Shipping weight approximately 8 lbs.



Model 6VT1—for 6-volt vibrators only \$29.50 Net
Model 12VT1D—for either 6-volt or 12-volt vibrators \$34.95 Net

Mallory 12RS6D Bench Power Supply

The Mallory 12RS6D is a dual purpose bench power supply designed for use on the radio service bench for operating conventional 6 and 12 volt automobile and truck radio sets. Fully AC-operated from the 115V/60 cycle line, the 12RS6D supplies rectified and filtered DC in either of 2 ranges. Range "A" supplies 0 to 16 volts at 6 amperes continuously, or 12 amperes intermittently. Range "B" supplies 0 to 8 volts at 10 amperes; or 20 amperes intermittently. Both ranges are infinitely variable from zero to maximum output to permit precise adjustment of bench test voltages. The 12RS6D is equipped with a DC voltmeter, a DC ammeter, infinitely variable voltage control, a range switch, an on-off toggle switch, automatic overload protection, primary fuse and rubber-covered line cord and plug. The rectifying system employs a full-wave metallic rectifier. The cabinet is sheet steel finished in blue enamel and measures 6¾" high, 10¾" wide and 5½" deep. Shipping weight approximately 8 lbs. Catalog No. 12RS6D \$39.95 Net

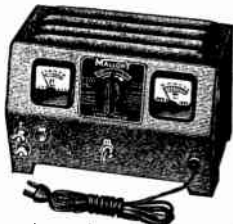

Catalog Number	Accessories	List Price
R670	Polarized Battery Clip D.C. Cord Assembly for 6SAC4, 6SAC6, 6SAC10 and 12SAC5.	\$1.95
R675	Universal Cigarette Lighter Plug D.C. Cord Assembly for 6SAC4, 6SAC6, 6SAC10 and 12SAC5.	2.25
R653	Extra Battery Clip.	.25

**Mallory VA Series Rectopower®
Rectifier DC Power Supplies**

Seven models are contained in the line of general utility filtered rectifier DC power supplies for designing, building, testing and repairing electrical and electronic equipment for the automotive, aviation and military equipment industries. The models may also be used for battery charging and electrolytic processes such as plating, anodizing, electrocleaning and electropolishing. These units incorporate voltmeter, ammeter, isolating-type transformer and many other features which make them desirable for production or laboratory use.

The four independent filtered output circuits may be paralleled, series-paralleled, seriesed, used independently or connected in several different combinations to provide simultaneous outputs as required. Delivery information and more detailed specifications on special Rectostarters® for aircraft engine starting and industrial electric truck battery charging, may be had by writing to P. R. Mallory & Co., Inc., Box 1558, Indianapolis, Ind.



VA400
VA800

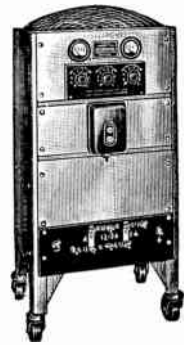

VA1500
VA3000
VA4500
VA6000

MODEL	VA400	VA800	VA1500	VA3000	VA4500	VA6000
AC Input						
Volts ± 10%	115	208-230 or 115	208-230 or 460	208-230 or 460	208-230 or 460	208-230 or 460
Phase*	1	1	3	3	3	3
Cycles	60	60	60	60	60	60
KVA	1.2	2.4	3.0	6.0	9.0	12.0
DC Output Rating						
Max. Amperes at Nominal Volts of different Circuit Combinations.	Amps.	Amps.	Amps.	Amps.	Amps.	Amps.
6 volts (all paralleled)	50	100	200	400	600	800
12 (series-paralleled)	25	50	100	200	300	400
24 (all seriesed)	12½	25	50	100	150	200
DC Output Adjustment						
Voltage Adjustment Range at Max. Rated Ampere Output.	Volts	Volts	Volts	Volts	Volts	Volts
6 volt nominal	0-8	0-8	4-8	4-8	4-8	4-8
12 volt nominal	0-16	0-16	8-16	8-16	8-16	8-16
24 volt nominal	0-32	0-32	16-32	16-32	16-32	16-32
Number of Voltage Controls	1	1	1	1	1	1
Number of Voltage Control Positions	Infinite	Infinite	28	28	28	28
DC Output Ripple—At Rated Output Less Than	2%	2%	2%	2%	2%	2%
DC Output Regulation						
From 0 to Rated Amps. at Max. DC Volts and Constant AC Volts	15%	15%	25%	25%	25%	25%
Overall Dimensions—Width	22	25½	25½	25½	25½	25½
Depth	9	12½	19	19	19	19
Height	14	15½	55	55	55	55
Weight in Pounds—Net	90	175	300	370	415	480
Shipping	95	175	415	485	530	600
List Price	\$360.00	\$575.00	\$740.00	\$900.00	\$995.00	\$1100.00

* 25 and 50 cycle Rectopower supplies are available at additional cost.



Line Voltage Adjuster and Isolation Transformer

The Mallory Line Voltage Adjuster and Isolation Transformer is designed for electric and electronic applications requiring line voltage adjustment, line isolation or low voltage, heavy current output. It is a versatile and worthwhile accessory for use in radio-TV shops, laboratories and industrial service shops.

Completely enclosed in an enamelled metal case, the LVA-2 provides: infinitely variable AC-line adjustment from 90-130 volts @ 1200 watts; an electrostatically-shielded, isolated, infinitely variable low voltage AC from 0 to 40 volts @ 4 amperes in the isolation position, and 0 to 40 volts @ 8 amperes in the common line position; and an electrostatically-shielded, isolated, infinitely variable, 90-volt to 130-volt AC output @ 350 watts. The unit is designed to operate from 105 to 125 volts, 60 cycles, single-phase. The infinitely variable common line and isolation outputs are selected in "common line-isolation" switch, and are fed to two standard AC outlets. Accurate output-voltage adjustment is afforded by the two-inch, 130 volt, AC meter. Overall case dimensions are: height-7½"; depth-5¾"; width-6½".

Catalog No. LVA-2

\$41.95 Net



Capacitor-Resistor Tester

The CRT-1 Capacitor-Resistor Tester is a practical analyser for laboratories and production lines. It provides checking of extended resistor and capacitor ranges in addition to power factor and leakage measurements of capacitors. Inductances may be checked by the substitution method.

The CRT-1 measures resistances from 1/10 ohm to 50 megohms; capacitances from 10 mmfds. to 5000 mfd.; electrolytic capacitor power factors from 0 to 50%; paper, mica or ceramic capacitor leakages from .2 to 18 micro-amperes; electrolytic capacitor leakages from 1/10 to 10 milliamperes; and insulation resistances to more than 2000 megohms. Provision is also made for direct comparison of inductances such as unknown values of speaker coils, transformers, or choke coils against like units of known values. Capacitors up to 450 WVDC may be checked at their rated voltages.

Fully AC operated from 110-120 volts, 60 cycles, the CRT-1 has a built-in power supply. It comes complete with tubes. Dimensions are: 6¾" high; 5½" deep; and 10¾" wide.

Catalog No. CRT-1

\$67.50 Net

Mallory Page 4

CORNELL



DUBILIER

CAPACITORS — ROTATORS — VIBRATORS — AUTO ANTENNAS — TV ANTENNAS — POWER SUPPLIES

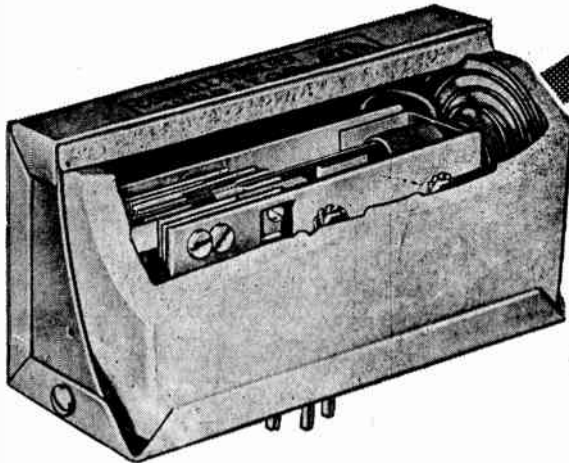

C - D Heavy Duty REPLACEMENT VIBRATORS

Catalog No.	Voltage	Frequency in Cycles	Dimensions			List Price	C-D "POWERCON" - REPLACEMENT VIBRATORS	
			L.	W.	H.		For Mod. No.	Use Vibrator No.
6VB6	6	60	5 1/8 x 2 3/8 x 2 3/8	\$12.25				
110VB6	110	60	5 1/8 x 2 3/8 x 2 3/8	12.25				
110VLGH	110	60	4 1/2 x 1-15/16 Diam.	14.10	6R5	3103		
330**	12	60	5 1/8 x 2 3/8 x 2 3/8	12.25				
390**	12	60	5 1/8 x 2 3/8 x 3 3/8	17.70	6R10	4123		
425**	6	60	4 1/8 x 2 3/8 Diam.	12.25				
426**	6	60	5 1/8 x 2 3/8 x 2 3/8	12.25	12R8	3087		
427	6	60	4 1/8 x 2 3/8 Diam.	12.25				
490	6	60	5 1/8 x 2 3/8 x 3 3/8	14.10	12RU15	3047		
491	6	60	5 1/8 x 2 3/8 x 2 3/8	12.25				
1057**	6	120	5 1/8 x 2 3/8 x 2 3/8	17.10	32R8	2989		
1083**	110	60	5 1/8 x 2 3/8 x 3 3/8	12.25				
1315	110	60	5 1/8 x 2 3/8 x 2 3/8	17.10	32RU15	2989		
1315H	110	60	5 1/8 x 2 3/8 x 3 3/8	17.10				
1506	32	60	5 1/8 x 2 3/8 x 2 3/8	14.55	110PA5	2522		
1640***	110	60	5 1/8 x 2 3/8 x 2 3/8	21.35				
1684**	6	120	5 1/8 x 2 3/8 x 2 3/8	9.70	110PB5	2522		
1823**†	6	180	3 1/8 x 1 1/2 Diam.	8.65	110R10	1315		
2117	12	100	5 1/8 x 2 3/8 x 3 3/8	21.35				
2507	45*	60	2 7/8 x 1 1/2 Diam.	8.65	110R15	1315		
2522	45*	60	2 7/8 x 1 1/2 Diam.	8.65				
2639	6	60	5 1/8 x 2 3/8 x 3 3/8	17.10	110RT15	1315H		
2641	24	60	5 1/8 x 2 3/8 x 2 3/8	15.35				
2989	32	60	5 1/8 x 2 3/8 x 2 3/8	12.25	110WR15A	1315		
3047	12	60	5 1/8 x 2 3/8 x 3 3/8	17.10				
3077*	110	60	5 1/8 x 2 3/8 x 2 3/8	14.55	110WR15B	1315		
3077V	Use 1315H							
3079	110	60	5 1/8 x 2 3/8 x 3 3/8	19.40				
3087	12	60	5 1/8 x 2 3/8 x 2 3/8	12.25	110T22	110VL6H		
3103	6	60	5 1/8 x 2 3/8 x 2 3/8	12.25				
3217**	32	90	2 3/8 x 5 1/8 x 2 3/8	15.35	110RT35	3079		
4123	6	60	5 1/8 x 2 3/8 x 3 3/8	17.10				
11028	110	60	5 1/8 x 2 3/8 x 2 3/8	12.25				
11030**	110	60	5 1/8 x 2 3/8 x 2 3/8	15.35				
11032**	115	60	2 3/8 x 5 1/8 x 3 3/8	21.35				
32171	32	60	5 1/8 x 2 3/8 x 2 3/8	12.25				

*For operation on 115 volts DC, connect a 2200 ohm resistor in series with the coil.

**Available only on Special Order.

***Denotes adjustable frequency vibrator. Use 1000 ohm variable resistor in coil circuit.

• Refer to C-D Catalogs No. 410 & VC for detailed applications and specifications.

†Now known as Type 5513.

RAILROAD Converter VIBRATORS

Catalog No.	Voltage	Frequency in Cycles	Dimensions			Net Price	Use in C-D Railroad Converter Model No.
			L.	W.	H.		
12VG6H	12	60	5 1/8 x 2 3/8 x 3 3/8	\$9.90		3212A	
32VF6H	32	60	5 1/8 x 2 3/8 x 3 3/8	9.90		3232 and 3248	
64VF6H	64	60	5 1/8 x 2 3/8 x 3 3/8	9.90		3264	
64VG6H	64	60	5 1/8 x 2 3/8 x 3 3/8	9.90		3128	
110VF6H	110	60	5 1/8 x 2 3/8 x 3 3/8	9.90		3210	

WARNING: Always check the Buffer Capacitors before installing a new vibrator: Failure to do so will void the guarantee. Always use C-D Buffer Capacitors for replacement. Prices Subject to Change Without Notice.



* CORNELL-DUBILIER AUTO RADIO VIBRATORS

FEATURES

- C-D designed electronic micrometric equipment removes guesswork in contact point setting and assures consistent high quality.
- Exclusive C-D pole piece design and armature weight results in a perfectly-balanced unit with greater efficiency.
- Exclusive C-D base mounting results in a full floating unit. That's why C-D vibrators last longer.
- Unit completely enclosed in new floating sock— an exclusive with C-D vibrators. Eliminates usual difficulties found in other vibrators.
- New stack design will take peak voltages of even 4,200 volts with no damage to vibrator.

Mr. Serviceman: Always have these types on hand. They constitute 88% of all your demand in the ratio shown.

530022%	5342 8%	5605 5%
530114%	5400 3%	5620 4%
532610%	5426 4%	6326 3%
5335 8%	5515 6%	6330 4%

NEW 12 VOLT SERIES

Type No.	List Price	Used In
6326	\$5.50	Philco - Chrysler
6330	4.90	Oldsmobile - Buick
6370	4.70	Cadillac - GMC Truck Autronic Eye

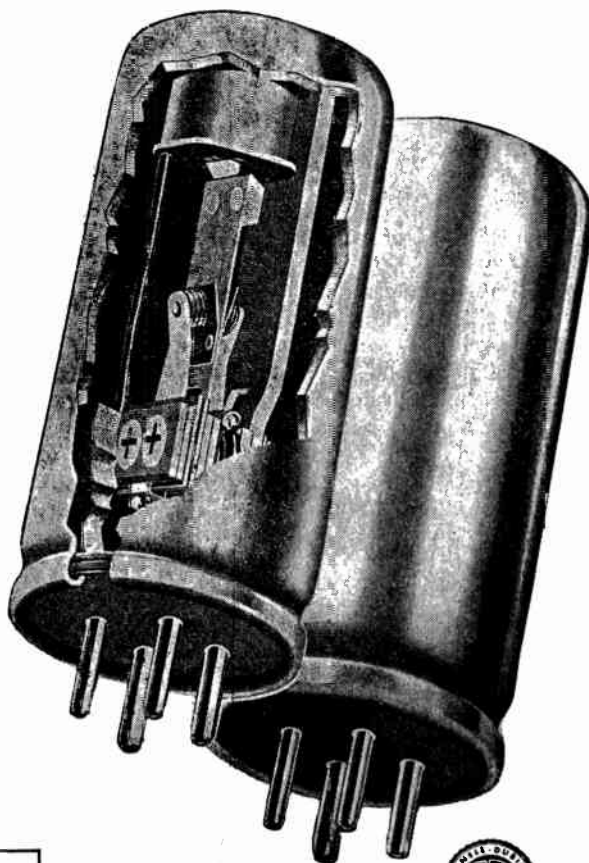

* Refer to C-D Cat.-VC for detailed applications and specifications.

5300 SERIES Standard Automotive and Household Non-Synchronous units.						5400 SERIES Standard Automotive and Household Synchronous units.					
Type No.	List Price	Type No.	List Price	Type No.	List Price	Type No.	List Price	Type No.	List Price	Type No.	List Price
5300	\$4.70	5314	\$4.90	5333	\$4.90	5400	\$7.70	5411	\$7.70	5429	\$9.15
5300-32	7.15	5320	4.90	5335	4.90	5404	7.70	5413	7.70	5431-4	8.55
5301	4.70	5321	4.90	5342	4.15	5406	7.70	5413-4	7.70	5434	7.70
5303	4.90	5323	4.15	5343	6.35	5407	7.70	5416	9.15	5435	7.70
5304	6.35	5326	4.15	5363	6.35	5408	7.70	5421	7.70	5435-4	7.70
5307	4.90	5328-32	9.15	5366	6.35	5409	7.70	5422	8.55	5436	7.70
5308	6.35	5331	4.90	5367-32	7.70	5409-4	7.70	5425	9.15	5437	7.70
5309	4.90			5370	4.90	5410	7.70	5426	7.70	5438	7.70
										5440	\$8.55
										5443	7.70
										5443-32	8.55
										5454	7.70
										5463	9.15
										5464	9.15
										5468-2	10.70
										5469-2	9.80
5500 SERIES Special Application Non-Synchronous units.						5600 SERIES Special Application Synchronous units.					
Type No.	List Price	Type No.	List Price	Type No.	List Price	Type No.	List Price	Type No.	List Price	Type No.	List Price
5503-12	\$7.70	5511-12	\$7.70	5516	\$6.90	5604	\$9.15	5607-12	\$9.95	5610-12	\$8.55
5504	6.35	5513-12	7.70	5517-12	7.70	5605	8.55	5607-32	9.95	5614-12	8.55
5506	7.15	5514-4	7.70	5518	6.90	5605-12	9.95	5609-12	9.95	5615-12	8.55
5510	7.15	5515	6.90	5519	4.90	5605-32	9.95	5610	7.70	5615-24	8.55
				5560	8.55	5607	8.55			5616	8.55
										5620	7.70
										5621	6.90
										5622	8.55
										5623	7.70

WARNING: Always check the Buffer Capacitors before installing a new vibrator: Failure to do so will void the guarantee. Always use C-D Buffer Capacitors for replacement. Prices Subject to Change Without Notice.

For CD "POWERCON" Battery Charger see page M-38



**Low Cost
Easy Installation
Long Life**

C-D POWERCONS

for DC to AC or AC to DC Power Conversion

Here is an assortment of converters that are outstanding for their dependable operation, their low initial cost and their simple, economical installation. A complete line for every purpose.



110 VOLT 60 CYCLE OUTPUT FROM DC INPUT

Model No.	Applications	DC Input Volts	Output - Watts		Size	Weight Lbs.	List Price
			Cont.	Int.			
6R5	Automobile, Bus, Truck, Airplane, Marine & other	6	50	55	6 3/4 x 7 3/4 x 5 7/8	12	\$ 48.25
6R10		6	100	125	7 x 12 5/8 x 7 1/2	19	68.45
12R8	General Uses: Mobile, Portable, Stationary	12	80	120	6 3/4 x 7 3/4 x 5 7/8	12	48.25
12RU15		12	150	200	7 x 12 5/8 x 7 1/2	22	90.80
32R6	Farm, Marine, Railroad	32	80	100	6 3/4 x 7 3/4 x 5 7/8	13 3/4	55.80
110PA5	Record Players—Automatic & Manual	110	50	Volt-Amperes	3 3/4 x 6 1/4 x 2 3/4	2	17.20
110PB5		110	50	Volt-Amperes	3 3/4 x 6 1/4 x 2 3/4	2	19.50
110RA10	Radio and Business Machines	110	100	150	6 3/8 x 7 3/4 x 5 1/4	10 1/2	45.95
110RA15		110	150	250	6 3/8 x 7 3/4 x 5 7/8	13 1/2	56.10
110RT15	Especially Designed for Television—Adjustable Frequency Control	110	150	350	6 3/8 x 12 1/4 x 7 1/2	16 3/4	74.75
110T22		110	225	250	6 x 8 3/4 x 7 1/4	17 1/2	78.85
110RT35		110	350	500	7 1/2 x 14 x 8 3/8	40 1/2	143.50
110RT25DL	TV-Radio, Sound & Comm. Systems	110	250	300	6 3/4 x 12 3/4 x 8 3/4	23	127.38
110WR15A	Dual Vibrator (Phantom switch)	110	150	200	6 3/8 x 12 3/4 x 7 1/2	22 1/2	76.50
110WR15B	Wire or Tape Recorders (Phantom switch)	110	150	200	6 3/8 x 12 3/4 x 7 1/2	21	90.75

HIGH-VOLTAGE DC OUTPUT — from 6-Volt DC Input

Model No.	Applications	Input Volts	Output Power (Continuous, Max.)	Type	List Price
6DS2	Operation of Mobile Transmitters, Receivers, and similar equipment from 6-volt Battery. (12-volt units are available on special order.)	6vDC	250vDC at 60ma., or 180vDC at 40ma.—15 watts	Synch.	\$35.65
6DS3		6vDC	300, 275, 250 or 225vDC at 100ma.—30 watts	Synch.	39.10
6DR3		6vDC	300, 275, 250 or 225vDC at 100ma.—30 watts	Rect. Tube	41.40
6DRA6		6vDC	300vDC at 200ma.—60 watts	Rect. Tube	59.80
6DRB6		6vDC	400vDC at 150ma.—60 watts	Rect. Tube	59.80

BATTERY ELIMINATOR "POWERCON" BATTERY CHARGER

Here is the ideal, compact, efficient unit for testing and demonstrating auto radios. SMOOTH DC POWER, 6 or 12 volts from the 110 volt 60 cycle AC line.

Model No.	Output	Watts	Size	Wt. Lbs.
6BE10	6V DC @ 10A	60	7 x 8 3/4 x 7 3/4	14 1/2
110BA12	6V DC @ 20A } or 12V DC @ 10A }	120	7 3/8 x 13 x 8 3/2	24 1/2

Model 6BE10 — Net Price \$36.75 Model 110BA12 — Net Price \$59.01



PRICES SUBJECT TO CHANGE WITHOUT NOTICE.

TODAY'S OUTSTANDING D. C. POWER SUPPLIES...

**in performance! in reliability!
in dollar-for-dollar value!**

SCHAUER BATTERY ELIMINATORS FOR SERVICING BOTH 6 and 12 VOLT AUTO RADIOS

Again Schauer leads the field! Here are streamlined, new Battery Eliminators specifically engineered to meet the growing needs of auto radio service men. In one compact unit, quality-built D.C. Power Supplies which more than meet manufacturers' specifications for the operation and servicing of any 6- or 12-volt auto radio equipped with signal-seeking, push-button or manual tuners.

SCHAUER MODEL AR 5612 — Output adjustable by means of a rugged, silver contact tap switch. Toggle switch changes unit from 6-volt to 12-volt operation. Low range output: 7½ volts at 12 amps., continuous; 20 amps., intermittent. High range: 15 volts at 6 amps., continuous; 11 amps., intermittent. Components include Selenium rectifiers, transformer, condenser-type filters, accurate 0-20 V. and 0-20 A. meters, heavy wing-nut binding posts and carrying handle. Housed in sturdy steel case 7½" wide x 9½" deep x 9" high.

SCHAUER MODEL AR 4612 — Non-adjustable 6-volt and 12-volt Battery Eliminator. Built to same high-quality standards as Model AR 5612, above. Equipped with high-low switch to change from nominal 6-volt to nominal 12-volt operation.

Own SCHAUER Battery Eliminators — they're the choice of leading service men. Specifications and illustrations of these units are found in Bulletin No. 1469. Write for your free copy.



SCHAUER MODEL AR 5612

ALSO AVAILABLE:

SCHAUER MODEL AR-5 — Adjustable 6-volt Battery Eliminator. Delivers 6 volts D.C. with output adjustable for any load current between 3 and 15 amps., indicated by 0-15 A. and 0-8 V. meters.

SCHAUER MODEL AR-4 — A practical, low-cost, non-adjustable 6-volt Battery Eliminator. Delivers 6-volts at approx. 15 amps.

SCHAUER BATTERY CHARGERS

A complete line of battery chargers designed for safe recharging of storage batteries. Available in models for charging 6-volt batteries and other models for charging 12-volt batteries. Four to 20 ampere capacities. Equipped with exclusive Schauer "Charger-Guard" — an automatic corrector which acts instantly in case of an overload or short circuit. No manual resetting of the circuit breaker, and fuses are eliminated. Approved by Underwriters' Laboratories, Inc. Write for Bulletin 2469.

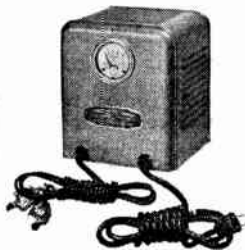

Model BX-2

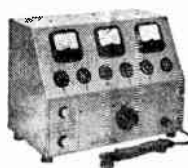

Model AR-6

SCHAUER VIBRATOR ANALYZER AND POWER SUPPLY MODEL AR-6

Don't gamble on auto radio vibrator performance! Protect your profits and avoid comebacks by owning the original and most reliable vibrator analyzer available today. Schauer AR-6 combines an adjustable 0-8 volt D.C. Power Supply with a Vibrator Analyzer that will thoroughly test practically all interrupter and synchronous, shunt or series-driven 6-volt vibrators. Test results are determined by *accurate meter readings* — not by the unreliable substitution method! See your Schauer jobber. Write for Bulletin 1469.

RECTIFIER



DIVISION

SCHAUER MANUFACTURING CORP.

4513 ALPINE AVENUE
CINCINNATI 35, OHIO



DC POWER SUPPLIES and BATTERY ELIMINATORS

New Model "D-612"



TEST SERVICE 12 & 6 VOLT AUTO RADIOS
Switch selects 12 or 6 V. output. 2 ranges: 0-8 and 0-16 V. continuously variable. 0-10 amps. continuous duty up to 12 V. 20 amps. intermittent current rating. Unequaled quality and performance at lowest cost.

Model "NF"

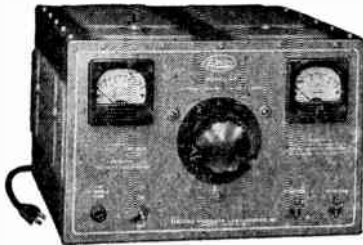

TEST, SERVICE DC EQUIPMENT FROM AC LINES

Choke input and Pi type filters with 1 choke, 2000 mfd. condenser plus 1 choke, 4000 mfd. condenser. D'Arsenal-type voltmeter 0-50 volts; ammeter 0-25 amperes, 2% accuracy. Bridge type selenium rectifiers. Superior Powerstat for incremental voltage adjustment.

Model "B"

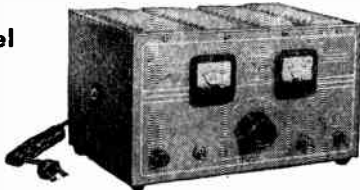

TEST, SERVICE DC EQUIPMENT FROM AC LINES

Less than 3% AC ripple or hum. Damped volt and ammeters (no wiggling). 8 Heavy-duty power tap adjustments. Voltmeter 0-10 volts 3% accuracy. Heavy duty selenium rectifiers, switch, transformer, choke and 6000 mfd. filter condenser.

Model "S"



"A" Supply Output: 5-6 tubes (average) 1.4 volts at 320 ma; 4 tubes 1.4 volts at 250 ma; 4 tubes 1.4 volts at 200 ma. "B" Supply Output: 90 volts DC at 12 ma. Primary: 115 volts AC at 60 cycles. Also for 220 volt operation.

Priced to Compete with Kits
Less than 5% Ripple Over Rated Ranges
MODEL "D-612" — 0-8 and 0-16 v. Cont. Variable
10 amperes continuous duty up to 12 volts
20 amperes intermittent current rating

An unmatched combination of unequalled performance, low price and quality makes this a must for service technicians. Operates all auto radios. For relays, phone circuits, low voltage devices, electroplating and battery charging. Patented EPL conduction cooling. Withstands high overloads for lifelong service. Changes from 6 to 12 volts at the flick of a switch. Same top quality as other EPL models.

MODEL C-12 Our popular DC POWER SUPPLY MODEL "C-12" — 12 and 6 volt auto radio. 0-16 volts from 0-8 amperes continuous output. Up to 12 amperes intermittently. Only 3% ripple at full load. Extremely fine voltage control with Superior Powerstat Voltage Control (Model 10).

Less than 1% Ripple at Top Load
MODEL "NF" — 0-28 VOLTS, 0-15 amperes
continuous rating, 25 amperes intermittent rating

Serves broadest uses in industry, research and servicing. Only moderately priced Power Supply with less than 1% ripple at this output. Exclusive "EPL" selenium rectifier application increases power rating, lowers cost per ampere output. Finest components, trouble-free operation. Peak instantaneous current rating of 25 amperes (from 50/60 cycle 115 volt source). 0-36 volts up to 6 amperes. Size 14 1/4 x 14 1/4 x 9 3/4". Net Weight: 71 lbs.

MODEL "N". Same rating and specifications except for: 5% ripple at 10 amperes, 8% at 15 amperes, less 1 choke and 2 condensers, lower cost, net weight 65 lbs.

MODEL "B" — 6 Volts, 1-20 amperes
continuous rating, 35 amperes intermittent rating

Tests, operates auto radios, relays, phone circuits, other low voltage devices. Conduction cooling increases rectifier power rating 1 1/2 times, lowest cost per ampere output. Ample power to operate two auto radios at once. Peak instantaneous current rating of 35 amperes (from 50/60 cycle 115 volt source). Supplies 3 to 9 volts at other ratings. Size: 12x7x8 1/2". Net weight: 29 lbs.

MODEL "BJ". 6 VOLTS, 1-12.5 amperes
Continuous rating, 25 amperes intermittent rating
Same as "B" except for: lower output and cost; operates 1 auto radio; AC ripple less than 5% at 6 volts, 8 amperes; voltmeter 0-10 volts; ammeter 0-20 amperes 5% accuracy.

MODEL "S" BATTERY ELIMINATOR
Converts battery radios to AC all-electric operation

Model "S" operates 1.4 volt 4 to 6 tube battery radio from 115 volt 50/60 cycle source. Complete filtering insures hum-free silent operation. Easily fits into battery compartment of most radios. Eliminates batteries, saves money. Low operating cost, uses only 11 watts. Has on-off switch, standard plug and sockets. Cabinet: Blue Hammerloid finished steel. Size: 2 3/8 x 3 3/4 x 6 3/4". Net weight: 2 1/2 lbs.

ELECTRO PRODUCTS LABORATORIES, INC. • Pioneer Manufacturers of DC Power Supplies

JAMES

Angle Drive VIBRATORS



JAMES vibrators, the engineers standard, are designed for the more difficult applications. Featuring "Angle Drive", ceramic spacers, dynamic contact wiping and other JAMES exclusive patented designs. These components are demanded by critical service engineers.

AUTO REPLACEMENT

JAMES	TYPE	CAN	DIA.	DESCRIPTION	MALLORY	RADIART
J2S	Intr.	1½ x 3⅛	3	4 prong std. — Medium height	294	5300
J2SP	"	1½ x 2⅞	3	4 prong std. — Short height	859	5301
J2SF	"	1½ x 2⅞	3	4 prong std. — Philco	509P	5326
J2SM	"	1½ x 2⅞	3	4 prong std. — Motorola	903M	5342
12J7	"	1½ x 2⅞	38	3 prong-12 volt — GM	G-874	6330
J8S	"	1½ x 3⅛	8	4 prong std. — special wiring	854	5331
J9	"	1½ x 3⅛	9	Delco base, large can	852	5303
J9SA	"	1½ x 2⅞	9	Delco base, small can	870	5335
J21	"	1½ x 2⅞	3	4 prong std. small can, Ford	1100	5314
J54	Syn.	1¾ x 4½	17	Large can, Pontiac	273C	5425
J66	"	1½ x 3½	28	Large can, with handle, Buick	716	5426

COMMUNICATIONS

JAMES	TYPE	CAN	DIA.	DESCRIPTION
J22	Intr.	1½ x 3⅛	3	8 contact, heavy duty, Motorola, Link receiver service.
J23	"	1½ x 2⅞	33	Heavy duty for transmitter service, Motorola, Link.
J24	"	1½ x 2⅞	34	6 prong, 8 contact, Motorola Unichannel, Bendix.
J58	Syn.	1½ x 3⅛	20	6 prong, Karr.
J63	"	1½ x 3⅛	24	Reversible, Link, RCA.
J65M	"	1½ x 3⅛	27	Reversible, Motorola.
J73	"	1½ x 3⅛	24	General Electric.

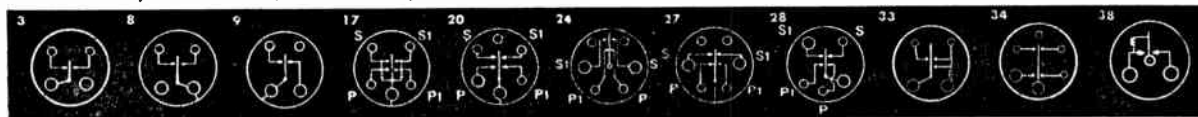

QUIET — DEPENDABLE — LONG LIFE

THE **RADIART** CORPORATION
CLEVELAND 2, OHIO



- ROTATORS
- VIBRATORS
- AUTO AERIALS
- TV ANTENNAS
- POWER SUPPLIES



NOW — with the RADIART SEAL VENT, the vibrator is sealed BEFORE it is used — and VENTED after it is put into use. The RED SEAL rubber-faced bakelite plug prevents formation of an insulating film on the contacts. Heat generated when the vibrator is put into service melts the wax out of the sealed vent-hole and permits air circulation . . . FOR LONGER LIFE AND EVEN GREATER PERFORMANCE!

The Radiart Vibrator Guide is the Standard of the Industry — Ask your jobber for your copy today!

There are many reasons for the nation-wide preference for Radiart Vibrators! One is the absolutely complete selection of types manufactured . . . there is a CORRECT Radiart replacement vibrator for most every need, to original specifications. In addition, the precision engineering behind the design of each type is backed up by highest standards of manufacture that assure peak performance . . . always!

6300 series vibrator types are the NEW standard vibrators for the NEW 12 VOLT AUTO CIRCUITS on many of the new cars. They are stocked by all RADIART distributors who carry a complete line.

- 6326 \$5.50
- 6330 4.90
- 6370 4.70

5300 SERIES vibrator types are Standard Automotive and Household Non-Synchronous units. They are stocked by all RADIART Distributors who carry a complete line.

5400 SERIES vibrator types are Standard Automotive and Household Synchronous units. They are stocked by all RADIART Distributors who carry a complete line.

Type No.	Price	Type No.	Price	Type No.	Price
5300	\$.4.70	5320	\$.4.90	5363	\$.6.35
5300-32	7.15	5321	4.90	5366	6.35
5301	4.70	5323	4.15	5370	4.90
5303	4.90	5326	4.15		
5304	6.35	5331	4.90		
5307	4.90	5333	4.90		
5314-4	4.90	5335	4.90		
5314	4.90	5342	4.15		

Type No.	Price	Type No.	Price	Type No.	Price
5400	\$.7.70	5422	\$.8.55	5438	\$.7.70
5404	7.70	5425	9.15	5454	7.70
5406	7.70	5426	7.70	5468-2	10.70
5407	7.70	5429	9.15	5469-2	9.80
5408	7.70	5431-4	8.55		
5409	7.70	5435	7.70		
5410	7.70	5436	7.70		
5411	7.70	5437	7.70		

5500 SERIES vibrator types are Special Application Non-Synchronous units. These are stocked by RADIART Distributors in accordance with local requirements. They are available for immediate shipment from the Factory. Order through your local distributor.

5600 SERIES vibrator types are Special Application Synchronous units. These are stocked by RADIART Distributors in accordance with local requirements. They are available for immediate shipment from the Factory. Order through your local distributor.

5503-12	\$.7.70	5513	\$.9.70	5517-12	\$.7.70
5504	6.35	5514-4	7.70	5518	6.90
5506	7.15	5514-12	9.95	5519	4.90
5510	7.15	5515	6.90	5560	8.55
5511-12	7.70	5516	6.90		

5604	\$.9.15	5609-12	\$.9.95	5615-24	\$.8.55	5622	\$.8.55
5605	8.55	5610	7.70	5616	8.55	5623	7.70
5605-12	9.95	5610-12	8.55	5616-12	9.95		
5607	8.55	5614-12	8.55	5620	7.70		
5607-12	9.95	5615-12	8.55	5621	6.90		



- ROTATORS
- VIBRATORS
- AUTO AERIALS
- TV ANTENNAS
- POWER SUPPLIES

VIBRATOR BASE DIAGRAM CROSS INDEX

A—A hot line into vibrator.
 B—By-pass for driving point.
 C—External coil lead in shunt vibrator.
 P₁—Primary contact, usually, but not necessarily connected to the magnet coil in shunt vibrators.
 PP₁—Dual primary contact, closed when P₁ is closed.

Symbols Used in Vibrator Base Diagrams

P₂—Primary contact, may be the magnet coil connection instead of P₁.
 PP₂—Dual primary contact, closed when P₂ is closed.
 R—Vibrating reed in single-reed vibrators.
 RP—Primary vibrating reed in split-reed vibrators.
 RS—Secondary vibrating reed in split-reed vibrators.
 S₁—Secondary contact, closed when P₁ is closed.
 S₂—Secondary contact, closed when P₂ is closed.
 * All dimensions given are in inches.
 † For further information see Vibrator type in Radiart Replacement Guide.

Radiart Type No.	Base Diagram	Voltage	Frequency	Max. Lead	Dia.*	Height
5300	A	6	115	6	1 1/2	3 1/4
5300-32	A	32	115	1.4	1 1/2	3 1/4
5301	A	6	115	6	1 1/2	2 3/4
5303	F	6	115	6	1 1/2	3 1/2
5304	I	6	115	6	1 1/2	3 1/2
5307	A	6	150	6	1 1/2	3 1/2
5314	A	6	115	6	1 1/2	2 3/4
5314-4	A	4	180	5	1 1/2	2 3/4
5320	A	6	115	6	1 1/2	3 1/2
5321	A	6	115	6	1 1/2	3 1/2
5323	A	6	115	6	1 1/2	4 1/4
5326	A	6	115	6	1 1/2	2 3/4
5331	C	6	115	6	1 1/2	3 1/2
5333	F	6	115	6	1 1/2	3 1/2
5335	F	6	115	6	1 1/2	3
5342	A	6	115	6	1 1/2	2 3/4
5363	LEADS	6	115	4	—	—
5366	R	6	115	6	1 1/2	2 3/4
5370	A	6	115	6	1 1/2	3 1/2
5400	AB	6	115	6	1 1/2	3 1/2
5404	AH	6	130	6	1 1/2	3 1/2
5406	AD	6	115	6	1 1/2	3 1/2
5407	AB	6	180	5	1 1/2	3 1/2
5408	AB	6	140	6	1 1/2	2 3/4
5409	K-1	6	115	6	1 1/2	3 1/2
5410	O-1	6	115	6	1 1/2	3 1/2
5411	V-1	6	115	6	1 1/2	3 1/2
5422	AE-1	6	115	5	1 1/2	3 1/2
5425	O-2	6	115	6	1 1/2	4 1/2
5426	P-1	6	115	6	1 1/2	3 1/2
5429	P-3	6	115	6	1 1/2	4 1/2
5431-4	AG	4	115	5	1 1/2	3 1/2
5435	V	6	115	6	1 1/2	3 1/2
5436	V	6	180	—	1 1/2	2 3/4
5437	AB	6	180	5	1 1/2	2 3/4
5438	AB	6	140	6	1 1/2	3 1/2
5454	AD	6	115	6	1 1/2	2 3/4
5468-2	AM	2	115	2	1 1/2	2 1/2
5469-2	AN	2	115	2	1 1/2	2 1/2
5503-12	A	12	115	6	1 1/2	3 1/2
5504	V	6	115	6	1 1/2	3 1/2
5506	D	6	115	10	1 1/2	3 1/2
5510	OA	6	115	10	1 1/2	3 1/2
5511-12	OB	12	115	6	1 1/2	3 1/2
5513	AK	6	180	5	1 1/2	3 1/2
5514-4	A	4	180	5	1 1/2	2 3/4
5514-12	A	12	180	3	1 1/2	2 3/4
5515	A	6	115	9	1 1/2	3 1/2
5516	A	6	115	9	1 1/2	3 1/2
5517-12	V	12	180	3	1 1/2	3 1/2
5518	V	6	115	10	1 1/2	2 3/4
5519	A	6	115	6	1 1/2	2 3/4
5560	A	6	60	5	1 1/2	3 1/2
5604	K-2	6	115	6	1 1/2	4 1/2
5605	AD	6	115	10	1 1/2	3 1/2
5605-12	AD	12	115	6	1 1/2	3 1/2
5607	AJ	6	180	5	1 1/2	2 3/4
5607-12	AJ	12	180	3	1 1/2	2 3/4
5609-12	K-1	12	115	3	1 1/2	3 1/2
5610	V	6	115	6	1 1/2	3 1/2
5610-12	V	12	115	3	1 1/2	3 1/2
5614-12	AD	12	115	4	1 1/2	2 3/4
5615-12	V	12	180	3	1 1/2	2 3/4
5615-24	V	24	180	1.4	1 1/2	2 3/4
5616	AJ	6	180	5	1 1/2	2 3/4
5616-12	AJ	12	180	3	1 1/2	2 3/4
5620	AB	6	115	6	1 1/2	2 3/4
5621	V	6	115	10	1 1/2	2 3/4
5622	AE	6	115	5	1 1/2	2 3/4
5622S	AE-2	6	100	5	1 1/2	2 3/4
5623	AD	6	115	6	1 1/2	2 3/4
6326	A	12	115	4	1 1/2	2 3/4
6330	DA	12	115	4	1 1/2	3 1/2
6370	A	12	115	4	1 1/2	3 1/2

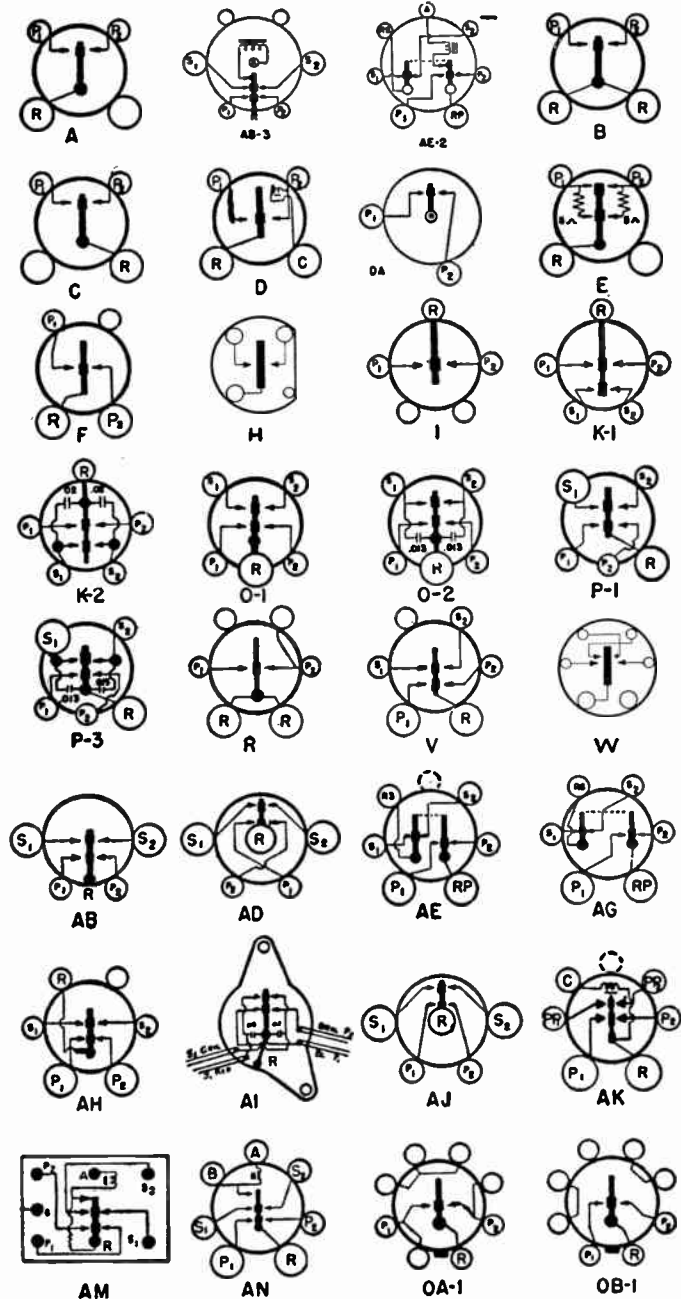

Dotted pin on AE-1 and AK units furnished at our option

THE **RADIART** CORPORATION
CLEVELAND 2, OHIO



- ROTATORS
- VIBRATORS
- AUTO AERIALS
- TV ANTENNAS
- POWER SUPPLIES

RADIART *Heavy Duty* REPLACEMENT VIBRATORS

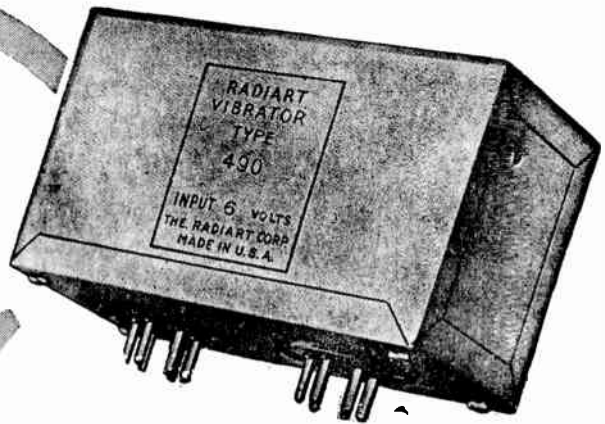

As in the standard "RED SEAL" line of replacement vibrators, the RADIART HEAVY DUTY Replacement Vibrators offer a complete selection for every standard need. Quality construction

and superb performance featuring long life make this heavy duty line the "Standard of Comparison".

MODEL NO.	VOLTAGE	FREQ. CYCLES	TYPE	CONTAINER	USED IN
6VB6	6	60	H-D Single	$5\frac{1}{8} \times 2\frac{1}{2} \times 2\frac{1}{8}$	{ 110WR15A 110WR15B 110R10 110R15 110RT25
110VB6	110	60	H-D Single	$5\frac{1}{8} \times 2\frac{1}{2} \times 2\frac{1}{8}$	
427	6	60	H-D Single	$2\frac{1}{8} \times 4\frac{1}{4}$	
490	6	60	H-D Tandem	$5\frac{1}{8} \times 2\frac{1}{2} \times 3\frac{3}{8}$	
491	6	60	H-D Tandem	$5\frac{3}{8} \times 2\frac{1}{2} \times 2\frac{1}{8}$	
1083	110	60	H-D Tandem	$5\frac{1}{8} \times 2\frac{1}{2} \times 3\frac{3}{8}$	
1315	110	60	H-D Single	$5\frac{1}{8} \times 2\frac{1}{2} \times 2\frac{1}{8}$	
1315H	110	60	H-D Single	$5\frac{1}{8} \times 2\frac{1}{2} \times 2\frac{1}{8}$	
1506	32	60	H-D Tandem	$5\frac{1}{8} \times 2\frac{1}{2} \times 3\frac{3}{8}$	
1684	6	120	H-D Single	$5\frac{1}{8} \times 2\frac{1}{2} \times 2\frac{1}{8}$	
2507	45*	60	Polarity Changer	$1\frac{1}{2} \times 2\frac{3}{8}$	110PA5 110PB5
2522	45*	60	Polarity Changer	$1\frac{1}{2} \times 2\frac{3}{8}$	
2639	6	60	H-D Tandem	$5\frac{1}{8} \times 2\frac{1}{2} \times 3\frac{3}{8}$	32R8 32RU15 12RU15 110RT15 110RT35 12R8 6R5 6R10
2989	32	60	H-D Single	$5\frac{1}{8} \times 2\frac{1}{2} \times 2\frac{1}{8}$	
3047	12	60	H-D Tandem	$5\frac{1}{8} \times 2\frac{1}{2} \times 3\frac{3}{8}$	
3077***	110	60	H-D Single	$5\frac{1}{8} \times 2\frac{1}{2} \times 2\frac{1}{8}$	
3079	110	60	H-D Tandem	$5\frac{1}{8} \times 2\frac{1}{2} \times 3\frac{3}{8}$	
3087	12	60	H-D Single	$5\frac{1}{8} \times 2\frac{1}{2} \times 2\frac{1}{8}$	
3103	6	60	H-D Single	$5\frac{1}{8} \times 2\frac{1}{2} \times 2\frac{1}{8}$	
4123	6	60	H-D Tandem	$5\frac{1}{8} \times 2\frac{1}{2} \times 3\frac{3}{8}$	
11028	110	60	H-D Single	$5\frac{1}{8} \times 2\frac{1}{2} \times 2\frac{1}{8}$	
32171	32	60	H-D Single	$5\frac{1}{8} \times 2\frac{1}{2} \times 2\frac{1}{8}$	

* For operation on 115 volts DC, connect a 2200 ohm resistor in series with the coil.
*** Denotes adjustable frequency vibrator.

- ROTATORS
- VIBRATORS
- AUTO AERIALS
- TV ANTENNAS
- POWER SUPPLIES



THE **RADIART** CORPORATION
CLEVELAND 2, OHIO

DC TO AC CONVERTERS

The RADIART line of converters is complete and furnishes 110 volt 60 cycle AC current from 6, 12, 32, or 110 volt direct current sources. Vibrator powered, they are completely dependable . . . easily installed and fit most any requirement. The RADIART name plate on each converter is your assurance of long life and outstanding performance.

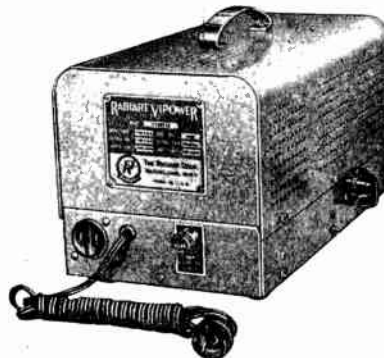

110 VOLT 60 CYCLE OUTPUT:

Model No.	Application	DC Input Volts	Output Watts	Size	Weight Lbs.
6R5	Automotive	6	50	6¾ x 7¾ x 5½	12
6R10		6	100	7 x 12½ x 7½	19
6WR12	Wire Recorder	6	125	8¾ x 15 x 8½	35
12R8	Marine-Craft, Busses and Trailers	12	80	6¾ x 7¾ x 5½	12
12RU15		12	150	7 x 12½ x 12½	22
32R8	Farm and Marine	32	80	6¾ x 7¾ x 5½	13¼
32RU15		32	150	6¾ x 12¾ x 7½	22¼
110PA5	Phonograph Motors	110	50VA	3¾ x 6¾ x 2¾	2
110PB5		110	50VA	3¾ x 6¾ x 2¾	2
110R10	Radio and Business Machines	110	100	6¾ x 7¾ x 5½	10½
110RA15		110	150	6¾ x 7¾ x 5½	14
110RT15		110	150	6¾ x 12¾ x 7½	16¾
110RT22		110	225	8¾ x 6 x 7¾	17½
110RT35		110	350	7½ x 14 x 8½	40½
110WR15A	Wire Recorders	110	150	6¾ x 12¾ x 7½	16¾
110WR15B		110	150	6¾ x 12¾ x 7½	16¾

Super RADIART VIPOWERS

Vipower Model	DC Input Volts (Nominal)	DC Output Volts (Nominal)	Output Mills.	Type
451	6	250	60	Self-rectifying
452	6	300*	100	Self-rectifying
453	6	300*	100	OZ4A Rectifier
454	6	300	200	Two OZ4A Rectifiers
455	6	400	150	Two 6X5GT Rectifiers

RADIART vibrator power supplies top the field. Complete RF and AF filtering is built into each unit. No extra filter accessories are required. Easily installed with the exclusive Snap-on base plate that allows instant removal of the entire chassis by opening one snap-latch.

Easily Removable Cover

Complete RF and AF Filters

Exclusive Detachable Snap on Base



* NOTE: — Tapped at 275V, 250V, 225V. 12 volt models available on special order at slightly higher prices.

Dynamotors

Carter

Genemotors

Trade **CHANGE A VOLT** Mark
DYNAMOTOR

THE NEW

DUO⁶V¹²
Trade mark
GENEMOTORS



**Operates 6 v. Radios
 from 12 v. Batteries**

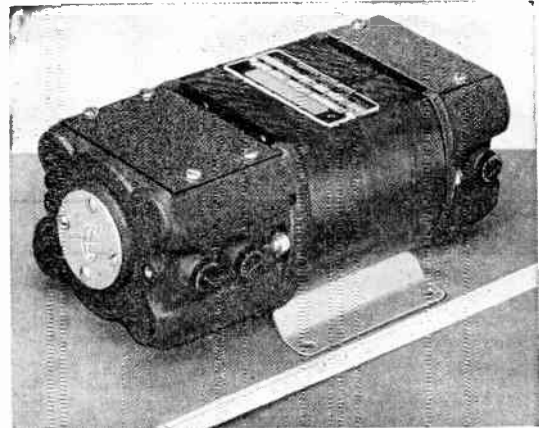

**Operates from either
 6 or 12 v. Battery Power**

It is now possible to operate 6 v. Two-Way radio equipment from 12 v. systems without rewiring or modifications with the New Carter Change-A-Volt Dynamotor.

Designed for long life, this dynamotor comes complete with all necessary fuses, hookup wire and relay to directly convert a 12 v. battery to a 6 v. radio supply. Model B615V for 30 watt transmitters delivers 15 amperes continuously for receive and 45 amperes for transmit. Also available in 24, 28, 32, 48 and 64 volt inputs to change directly to 6 or 12 volt and can be furnished less the fuse block, relay, switch and wiring.

Change-A-Volt can also be used as a battery equalizer when used with a double pole switch or relay for operating low volt equipment on several cells of higher voltage battery systems.

Change-A-Volt Model	Input		Output		Duty	Temp. Rise °C.	List Price
	Volts	Amps	Volts	Amps			
B615V	12	11.5	6	15	Con.	50	\$88.95
E615V	24	5.7	6	15	Con.	50	88.95
J615V	28	5.0	6	15	Con.	50	88.95
C615V	32	4.3	6	15	Con.	50	88.95
W615V	48	2.9	6	15	Con.	50	89.95
H615V	64	2.2	6	15	Con.	50	89.95
E128V	24	6.0	12	8	Con.	50	88.95
J128V	28	5.3	12	8	Con.	50	88.95
C128V	32	4.6	12	8	Con.	50	88.95
W128V	48	3.1	12	8	Con.	50	89.95
H128V	64	2.3	12	8	Con.	50	89.95

Other models available on order.

Above models will deliver about three times continuous output current rating on intermittent transmitter service.

All models 10 1/4" long, 4 1/2" wide, 5" high, less relay. Weight with accessories, approximately 25 lbs.

The six volt storage battery, has been replaced by a 12 volt battery in many of the new automobiles. This has created a need for a dual-voltage power supply for operating mobile radio equipment . . . a genemotor unit that will operate efficiently either on 6 or 12 volts.

DUOVOLT powered mobile radio equipment may be transferred from one car to another, regardless of battery voltage, without the slightest impairment of transmitting or receiving quality, without replacement of the genemotor, and without modification of the wiring hook-up.

The 6/12 v. Carter DUOVOLT Genemotor incorporates two separate 6 volt input windings, each having its own field. Six or twelve volt operation is obtained simply by connecting the four input leads in parallel or in series. You get full efficiency at either 6 or 12 volt operation.

The DUOVOLT is the same size as standard Carter Genemotors, except for 1/8" longer length. It will fit in almost any space accommodating the standard unit, a great advantage to set manufacturers.

For NEW radio installations, specify the Carter DUOVOLT when the equipment is purchased.

Code	Input		Input		Output		Temp. Rise °C.	List Price
	V.	A.	V.	A.	V.	A.		
420VBNS	5.5	26	11	13	400	.200	Con.	50 \$86.00
450ABNS	6	29	12	14.5	400	.250	Int.	50 87.00
4037ABNS	6	41	12	20.5	400	.375	Int.	50 91.40
4228VBNS	5.8	33	11.6	16.5	420	.280	Int.	50 87.73
520ABNS	6	28	12	14	500	.200	Int.	50 87.00
520VBNS	5.5	31	11	13.5	500	.200	Int.	50 88.00
617VBNS	5.5	30	11	13	600	.170	Int.	50 88.00
624VBNS	5.7	46	11.4	23	600	.240	Int.	50 91.19

(Other ratings within frame capacity, available on order)

Magmotor

Carter

Genemotor

**THE CARTER MAGMOTOR FOR
POLICE - TAXICAB - MARINE AND
AIRCRAFT RADIO RECEIVERS
GEOPHYSICAL AND RESEARCH
ELECTRONIC EQUIPMENT**

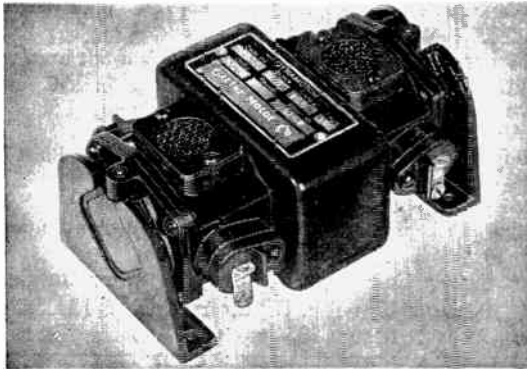

5 5/8" x 3-11/16" x 2 1/2" HIGH, WEIGHT 4 3/4 LBS.

Furnished with Rigid Mounting.
Shock Mounting Illustrated, \$1.00 List Extra.

Code No.	DC Input Volts	DC Input Amps	DC Output Volts	DC Output MA	Duty	List Price
MV1865	5.5	5	180	65	Con.	\$53.00
MC2190	32	1	210	90	Con.	\$55.00
MD2190	115	.4	210	90	Con.	\$56.00
MA2550	6	4.3	250	50	Con.	\$55.00
MV280	5.5	5.8	200	80	Con.	\$54.00
MA2565	6	5.4	250	65	Con.	\$56.00
MA251	6	8	250	100	Con.	\$56.50
MB251	12	3.8	250	100	Con.	\$57.50
MJ251	28	1.5	250	100	Con.	\$57.50
MBS2525S	12	8	250	250	Int.	\$67.00
MA301	6	9.5	300	100	Con.	\$57.00
MB301	12	4.6	300	100	Con.	\$58.00
MA351	6	10.3	350	100	Con.	\$58.00
MVS3215	5.5	18.5	325	150	Int.	\$58.00
MAS320	6	19	300	200	Int.	\$60.00
MVS415	5.5	19	400	150	Int.	\$61.50
MBS415	12	8.5	400	150	Int.	\$61.50

AC AND DC GENERATORS—

The Magmotor is available on special order for AC output up to 220 volts at 120 cycles. DC output up to 400 volts 30 watts continuous, 50 intermittent, depending upon armature speed.

EXTENDED SHAFTS—

Available on all Magmotor models add "S" to end of code number and \$5.00 to list.

MANY OTHER STANDARD INPUT AND OUTPUT RATINGS AVAILABLE.

FILTERS — STARTING RELAYS

FILTERS—

Any of the above Carter Genemotors or Magmotors can be furnished with complete filter mounted in metal box mounted below unit. Add "X" to end of code number and following prices. 1 1/2" and 2" Frame Genemotor models and Magmotors, \$26.00 list, 3" Frame Genemotor Models, \$28.00 list.

STARTING RELAYS—

Heavy Duty solenoid contactor starting relays are available for 5.5, 6, 12, 24, 28, 32 and 115 volt DC input. Add "R" to end of code number and \$3.00 to list price (Relay draws 1.3 amps at 6 volts). Seldom required on low power Magmotors.

See replacement parts reference chart page for other special models, parts and prices.

**THE ORIGINAL CARTER GENEMOTOR
FOR POLICE - TAXICAB -
MARINE AND
SMALL AIRCRAFT
MOBILE COMMUNICATIONS**

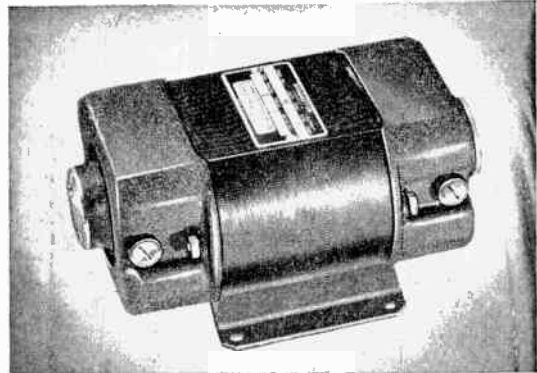

3" FRAME—7 1/8" x 4 1/8" x 3 1/2" HIGH, WEIGHT 10 LBS.

Code No.	DC Input Volts	DC Input Amps	DC Output Volts	DC Output MA	Duty	List Price
325A	6	21	300	250	Con.	\$65.00
420A	6.0	23.4	400	200	Con.	\$65.00
420V	5.5	25	400	200	Con.	\$66.00
425BS	12.0	12.8	400	225	Int.	\$67.00
450AS	6.0	28	400	250	Int.	\$67.00
4037AS	6.0	41	400	375	Int.	\$71.40
4228VS	5.5	35	420	280	Int.	\$67.73
4228VSC	5.8	33	420	280	Int.	\$69.30
4228BSC	11.8	17	420	280	Int.	\$69.30
520AS	6.0	28	500	200	Int.	\$67.00
520VS	5.5	31	500	200	Int.	\$68.00
5925AS	6.0	42	590	250	Int.	\$73.50
617V	5.5	30	600	170	Int.	\$68.00
620AS	6.0	29.5	600	200	Int.	\$69.50
624VS	5.5	46	600	240	Int.	\$71.19
624BS	12	18	600	240	Int.	\$71.19
650AS	6.0	39.0	600	250	Int.	\$71.19
6030BSM	12	23	600	300	Int.	\$72.45
6040BSM	12	28	600	400	Int.	\$74.55
6040CSM	32	10.5	600	400	Int.	\$74.55
6050DSM	115	4	600	500	Int.	\$77.70
2" Frame—6 1/8" x 4 1/8" x 3 1/2" high, weight 8 lbs.						
3515VB	5.5	18.0	350	150	Con.	\$60.00
415VB	5.5	20.0	400	150	Con.	\$61.00
415AB	6.0	18.2	400	150	Con.	\$60.00
1 1/2" Frame—5 9/16" x 4 1/8" x 3 1/2" high, weight 7 lbs.						
210AB	6	6	200	100	Con.	\$54.00
251AB	6	7.9	250	100	Con.	\$55.50
351AB	6	10.9	350	100	Con.	\$57.00

DUTY RATINGS

Intermittent duty shall be considered 10 seconds on 20 seconds off. Continuous duty is considered 24 hours per day.

INPUT VOLTAGES—

Any Carter Genemotor or Magmotor can be supplied for special input voltages other than 6 volts. For 5.5, 12, 24, 28, 32 or 64 volt input add \$2.50 to list. For 115 volt DC input add \$3.50 to list.

LINE-O-LIFE* BRUSHES—

All Carter products equipped with exclusive "LINE-O-LIFE" Brushes. Takes guess work out of brush replacements.

*TRADE MARK REG.

Carter

Super Converter

The oldest name in Rotary Power Supplies for Mobile Radio

**CARTER SUPER CONVERTER—Changes DC to AC for
Amplifiers - Radios - High Power Factor equipment**

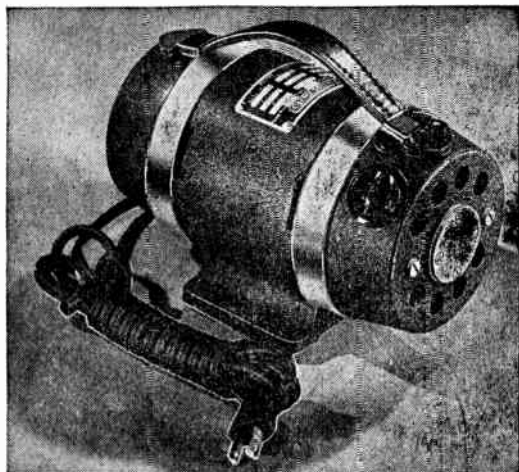

**CARTER SUPER CONVERTER, LESS FILTER, 8 1/4" LONG,
4 1/2" WIDE, 5" HIGH, WEIGHT 13 LBS.**

Wherever DC to AC Conversion is necessary, the Carter Super Converter provides an efficient and reliable source of AC power. Standard models are designed for high power factor, non-inductive AC loads such as amplifiers, radio receivers, (requires filtered converter), etc. Ball bearing equipped, 3600 RPM. CAUTION: Standard Super Converters will not satisfactorily operate inductive loads such as AC motors, low power factor transformers, etc.

Manually operated frequency controlled Converters available on special order. Maintain 60 cycle output with a + or - 10% input voltage fluctuation.

Special custom-matched Converters are also available for Wire and Tape Recorders, Sound Projectors, Television Receivers, etc. See Carter Selector Chart

HEAVY DUTY SUPER CONVERTER

10 1/4" long, 4 1/2" wide, 5" high, weight 19 lbs.

Overall efficiency 60% AC voltage regulation 25%.

Code No.	DC Input Volts	DC Input Amps	AC Output Volts	60 cy. (Watts)	Type Duty	List Price
K1020C	230	1.3	115	200	Con.	\$97.50
K1025C	230	1.6	115	250	Con.	\$102.50
D1020C	115	2.6	115	200	Con.	\$87.50
D1025C	115	3.2	115	250	Con.	\$92.50
H1020C	64	4.8	115	200	Con.	\$90.00
H1025C	64	5.3	115	250	Con.	\$95.00
C1020C	32	10	115	200	Con.	\$90.00
C1025C	32	12	115	250	Con.	\$95.00
J1020C	28	12	115	200	Con.	\$90.00
J1025C	28	14	115	250	Con.	\$95.00
E1020C	24	15	115	200	Con.	\$90.00
E1025C	24	19	115	250	Con.	\$95.00
B1020C	12	30	115	200	Con.	\$90.00
B1025C	12	34	115	250	Con.	\$95.00

OUTSTANDING FEATURES

SMALL SIZE—Smallest Rotary Converter. Lightweight. **CARRYING HANDLE**

Easier to carry, no more "juggling" with a hot unit.

OUTPUT RECEPTACLE—Convenient plug-in AC outlet.

ARMATURE

Double wound, insulated ungrounded winding. Built-in cooling fan.

BALL BEARINGS

Sealed ball bearings require no lubrication or attention.

SPECIFICATIONS

Carter Super Converter, 40 to 150 watts models
8 1/4" long, 4 1/2" wide, 5" high, weight 13 lbs.
High power factor, 85 to 100%. Less filter.

Code No.	DC Input Volts	DC Input Amps	AC Output Volts	60 cy. (Watts)	Type Duty	List Price
K1040C	230	.36	115	40	Con.	\$80.00
K1060C	230	.5	115	60	Con.	\$81.00
K1080C	230	.6	115	80	Con.	\$81.50
K1010C	230	.8	115	100	Con.	\$82.00
K1015C	230	1.	115	150	Con.	\$85.00
D1040C	115	.7	115	40	Con.	\$70.00
D1060C	115	1	115	60	Con.	\$71.00
D1080C	115	1.1	115	80	Con.	\$71.50
D1010C	115	1.7	115	100	Con.	\$72.00
D1015C	115	2.0	115	150	Con.	\$75.00
H1040C	64	1.5	115	40	Con.	\$71.00
H1060C	64	2	115	60	Con.	\$72.00
H1080C	64	2.2	115	80	Con.	\$72.50
H1010C	64	2.5	115	100	Con.	\$73.00
H1015C	64	3.4	115	150	Con.	\$76.00
C1040C	32	3	115	40	Con.	\$71.00
C1060C	32	4	115	60	Con.	\$72.00
C1080C	32	5	115	80	Con.	\$72.50
C1010C	32	5.5	115	100	Con.	\$73.00
C1015C	32	7.4	115	150	Con.	\$76.00
J1040C	28	3	115	40	Con.	\$71.00
J1060C	28	4	115	60	Con.	\$72.00
J1080C	28	5.2	115	80	Con.	\$72.50
J1010C	28	7	115	100	Con.	\$73.00
J1015C	28	9	115	150	Con.	\$76.00
E1040C	24	3.5	115	40	Con.	\$71.00
E1060C	24	4.3	115	60	Con.	\$72.00
E1080C	24	6	115	80	Con.	\$72.50
E1010C	24	8.3	115	100	Con.	\$73.00
E1015C	24	10	115	150	Con.	\$76.00
B1040C	12	8	115	40	Con.	\$71.00
B1060C	12	10	115	60	Con.	\$72.00
B1080C	12	14	115	80	Con.	\$72.50
B1010C	12	15	115	100	Con.	\$73.00
B1015C	12	23	115	150	Con.	\$76.00
A1040C	6	15	115	40	Con.	\$71.00
A1060C	6	19	115	60	Con.	\$72.00
A1080C	6	25	115	80	Con.	\$72.50
A1010C	6	27	115	100	Con.	\$73.00
A1015C	6	40	115	150	Con.	\$76.00

FILTERS—Available on all Super Converters. Eliminates Converter noise on most frequencies from 560 KC to 54 MC. Filter mounted in cast aluminum housing below Converter. Add "X" to Code Number and \$25.00 to list.

FREQUENCY CONTROL—Manually operated frequency control available on all models. Complete with vibrating reed meter, and rheostat control in aluminum housing. Add \$60.00 to list.

FOR LOW COST—"Change-a-Cycle" Frequency Control, add "A" to end of Code No. and \$10.00 to list.

VOLTAGE-FREQUENCY—Add \$5.00 to list for 50 cycle output. Add \$10.00 to list for 230 volt D.C. input.

See Carter Selector Chart for Wire and Tape recorder, Television receivers, etc., recommended Converters.

New Carter



Converters

CUSTOM CONVERTER 300-400-500 WATT, 115 V. 60 CYCLE AC OUTPUT

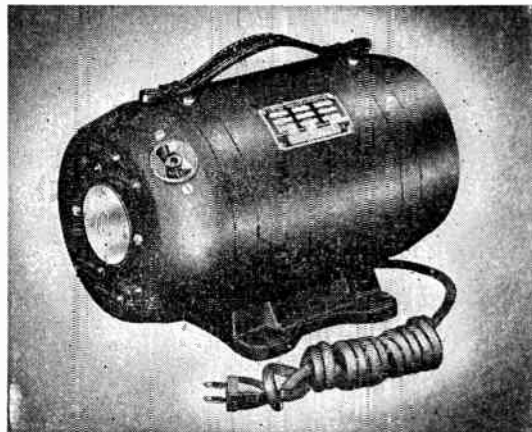

The Custom is the latest addition to the Carter line of small DC to AC rotary converters. Created to meet the demands for a compact and highly efficient two pole rotary converter, the Custom has been designed especially for amplifiers, office business machine, marine and mobile communications and high quality tape recorder requirements.

The Custom is the only small rotary converter manufactured in recent years that has been expressly created to incorporate in its design all of the new materials and technical improvements developed in the past few years.

HIGH POWER FACTOR—85 TO 100% LESS FILTER

Cast aluminum base with rubber feet supplied, as illustrated. Average efficiency, 60% all models listed less filter single phase output only. Regulation approximately 20% from no load to full load.

300 watt, 11 $\frac{1}{8}$ " long, 6 $\frac{1}{2}$ " wide, 7 $\frac{1}{4}$ " high — Weight 38 lbs.
400 and 500 watt, 12 $\frac{5}{8}$ " long, 6 $\frac{1}{2}$ " wide, 7 $\frac{1}{4}$ " high — Weight 44 lbs.

Code No.	DC Input Volts	DC Input Amps	AC Output 60 Cy. Volts	AC Output 60 Cy. Watts	Type	Temp. Rise °C	List Price
230 Volt	K1030CP	2.3	115	300	Con.	50°	\$190.00
	K1040CP	2.8	115	400	Con.	50°	\$220.00
	K1050CP	3.5	115	500	Con.	50°	\$225.00
115 Volt	D1030CP	4.6	115	300	Con.	50°	\$180.00
	D1040CP	5.6	115	400	Con.	50°	\$210.00
	D1050CP	7	115	500	Con.	50°	\$215.00
64 Volt	H1030CP	8.2	115	300	Con.	50°	\$183.50
	H1040CP	10	115	400	Con.	50°	\$213.50
	H1050CP	12.5	115	500	Con.	50°	\$218.50
32 Volt	C1030CP	19	115	300	Con.	50°	\$183.50
	C1040CP	21	115	400	Con.	50°	\$213.50
	C1050CP	25	115	500	Con.	50°	\$218.50
28 Volt	J1030CP	20	115	300	Con.	50°	\$183.50
	J1040CP	24	115	400	Con.	50°	\$213.50
	J1050CP	28	115	500	Con.	50°	\$218.50
24 Volt	E1030CP	22	115	300	Con.	50°	\$183.50
	E1040CP	28	115	400	Con.	50°	\$213.50
	E1050CP	33	115	500	Con.	50°	\$218.50

12 Volt B1030CP 12 45 115 300 Con. 50° \$185.00
300 Watt Largest Continuous Duty Output Available for 12 Volt Input.

FREQUENCY CONTROLLED CUSTOM FOR PROFESSIONAL AND BROADCAST TAPE RECORDING



The new Custom Converter with manual frequency control has been developed to provide a portable DC to AC power source for professional and broadcast tape recorders, heavy duty electronic measuring devices, and Tape recorder-AC motor driven camera combinations. Now for the first time, sufficient frequency constant AC power is available to operate this type of equipment from DC lines or battery source.

The rheostat control and the frequency meter are mounted in the attractive aluminum housing. A noise filter is also available in the same housing, although it is not usually necessary for operating recorders, amplifiers or other audio devices. Filtering is required when radios or other RF circuits are operated from the converter.

Convenient recessed DC male plug is furnished for 32, 64, 115 and 230 volt DC input models. 12, 24 and 28 models are equipped with heavy stranded input leads for battery connections, as shown. A flush AC mounted receptacle is supplied on all models for quick AC connections. The sturdy carrying handle allows the converter to be moved immediately after its operation, a life-saver for taping remote broadcasts.

Each model must be designed to properly match the power factor, voltage, frequency, and load requirements. Any of the Custom models can be furnished with frequency control. Model listed below has been laboratory tested and is matched to provide perfect operation. Kindly send your special requirement to the factory for prompt and careful consideration.

Frequency Controlled Custom Converters			
Recorder Model	CUSTOM CONVERTER MODEL		
Ampex 400A-401A	12V	28V	115V
Magnecord	BR1021CP	JR1021CP	DR1021CP
Binaural	\$255.00	\$255.00	\$255.00

300 watt with Frequency Control, 11 $\frac{1}{8}$ " long, 6 $\frac{1}{2}$ " wide, 10 $\frac{1}{4}$ " high, Weight 44 lbs.
400 and 500 watt, 12 $\frac{5}{8}$ " long, 6 $\frac{1}{2}$ " wide, 10 $\frac{1}{4}$ " high — Weight 54 lbs.

Carter

Selector Chart

Carter Custom-Matched Converters for Popular Wire and Tape Recorders - Sound Projectors - Phono Motors - Television

Whenever DC to AC Rotary Converters are used to power wire and tape recorders or other similar recording equipment, the Converter AC output frequency and Converter Power Factor must be perfectly matched to the recorder load to assure proper recording and play back performance. Most wire and tape recorders are of medium Power Factor design, approximately 70%. Standard high power factor (85 to 100%) Rotary Converters therefore *will not operate* the recorders properly as this type Converter will produce higher AC voltage and frequency because of the inductive recorder load. It is imperative therefore, only factory-tested and recommended Converters be selected for wire and tape recorder operation. The equipment listed below has been laboratory-tested and the correct Carter Converter recommended for each model. Use this chart for your recorder Converter requirements. If the equipment is not listed on the chart, please write to the factory and information will be supplied, if available.

WIRE AND TAPE RECORDER CONVERTERS 70% P.F.

EQUIPMENT MAKE & MODEL	CARTER CONVERTER MODEL AND DC INPUT				Size and Weight
	6 Volt	12 Volt	115 Volt		
60 WATT	Air King 750, Ampro 730-731 Crescent H22A1, 903; Knight Wire Web-Cor 80-180-228-18 Wilcox-Gay 8-U-12, Wireway Edison Voicewriter and VP (for 115 V. DC only) Dictorel - Soundscriber	A1060CW (29 amps drain) \$72.00	B1060CW (14 amp drain) \$72.00	D1060CW (1 amp drain) \$71.00	8 1/4" L, 4 1/2" W, 5" H Wt. 13 lbs.
	WITH FILTER	A1060CW (29 amps) \$97.00	B1060CW (14 amps) \$97.00	D1060CW (1 amp) \$96.00	8 1/4" L, 4 1/2" W, 7 1/2" H Wt. 15 lbs.
80 WATT	Bell Record-O-Fone RT50-RT65B Crestwood CP201, Dukane Ecor 1000-15-115, Gray Audograph General Industries Foundation Unit* Knight Tape, Peirce 55B Masco D37, LD37, DC37 Pentron T-3, 9T3, 9T3C—RCA Revere T-100, T-500 Sales-O-Matic LR-1 Tape Master Foundation Unit** Wilcox-Gay 1-C-10, 2-C-10, 3F10 Web-Cor 210-1	A1080CW (31 amps drain) \$72.50	B1080CW (15 amps drain) \$72.50	D1080CW (1.5 amps drain) \$71.50	8 1/4" L, 4 1/2" W, 5" H Wt. 13 lbs.
	WITH FILTER	Revere TR-200, TR-600 Masco LD37R Ultratone PT-9	A1080CW \$97.50	B1080CW \$97.50	D1080CW \$96.50
130 WATT	Brush BK411-414 BK-422-BK443P Web-Cor 2010 RCA SRT-301 Ampro 755 (not rec. for 6 V.) Berlant Concertone Model 1401, 1501 Brush BK401-403 Crescent H19A1, Revere T-700 Magnecord PT6-PT6-JA-PT63-Voyager Peirce 260-265-270—Reeltest Webster Racine, Ekotape 101-109-111-114-205	A1090CW4 (35 amps drain) \$82.00	B1090CW4 (17 amps drain) \$82.00	D1010CW (2 amps drain) \$72.00	6 & 12 Volt 10 1/4" L, 4 1/2" W, 5" H Wt. 18 lbs. 115 Volt 8 1/4" L, 4 1/2" W, 5" H Wt. 13 lbs.
	210 WATT	Ampex 400A-401A, Magnecord Binaural *Including average recorder amplifier **Including Preamplifier only	6 Volt not recommended	B1021CP \$180.00	D1021CP \$180.00

SOUND PROJECTORS AND PHONO MOTOR CONVERTERS

Ampro Premier 20 & 30, Bell & Howell No. 179, DeVry Super No. 16, Victor Life Weight*, Victor Triumph No. 60*, Victor Sonomaster*, General Industries RM4, Green Filer Dual Speed D1015C **\$75.00**
 *Victor Animatograph Co. CONVERTER OPERATES SOUND AMPLIFIER ONLY, NOT PROJECTOR LAMP OR MOTOR.
 WILL NOT OPERATE PROJECTORS FROM BATTERY INPUT. 115 OR 230 VOLT D.C. INPUT ONLY

CARTER TELEVISION CONVERTERS

	6 V.	12 V.	28 V.	115 V.	
100 to 130 WATTS	A1013CT	B1013CT	J1013CT	D1013CT	\$86.00
130 to 160 WATTS (some 17" - 20" - 21" models)	\$86.00	B1016CT	J1016CT	D1016CT	\$86.00
160 to 190 WATTS (most 17" to 21" models)	Not Available for 6 V.	B1019CT	J1019CT	D1019CT	\$93.00
190 to 250 WATTS (larger sets)		B1025CPT	J1025CPT	D1025CPT	\$190.00
250 to 300 WATTS (larger sets)		B1030CPT	J1030CPT	D1030CPT	\$195.00

★ Other Carter Products ★



SUPER-DYNAMOTOR

For aircraft, marine, police and railroad communications. Input voltages range from 5.5 v. DC to 115 v. DC . . . outputs from 400 v. to 1000 v. DC. Specified by leading airlines, marine, and mobile radio manufacturers. Size 8 1/4" x 4 1/2". Weight 1 1/4 lbs.

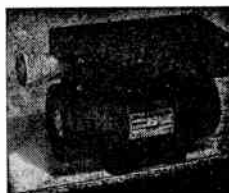

INDUCTOR ALTERNATOR

Provides mobile high frequency AC power (400 to 800 cycles), up to 150 watts, from DC source. Perfect for aircraft, geophysical, Government and laboratory research. Can also supply up to 400 v. DC plate voltage if necessary.



Write for Catalogs

Carter

Replacement Parts Reference Chart

The oldest name in Rotary Power Supplies for Mobile Radio

REPLACEMENT PARTS REFERENCE CHART

Use this handy chart for ordering the correct CARTER Replacement Dynamotor or Replacement parts. All parts guaranteed to conform to original manufacturer's specifications.

Mfg. Model No.	Frequency	Carter Model No.	List Price	Carter Armature No.	Armature List Price	Input Brushes & List Per Set	Output Brushes & List Per Set	Ball Bearings & List Per Each
Doolittle PFY-2 PFY-2A PFY-3 PFY-3A PFY-12	30-40 MC-FM 152-162 MC-FM	4726VS 4726VS	\$69.00 \$69.00	233-2 233-2	\$30.00 \$30.00	No. 7 \$1.20 No. 7 \$1.20	No. 2 80c No. 2 80c	37KVL \$2.50
Federal FT-125-B-25AZ FT-110-25AZ FT-110-50AZ	152-162 MC-FM 30-44 MC-FM 30-44 MC-FM	4037AS 5915AS 5925AS	\$71.40 \$63.00 \$73.50	179-2 252-2 261-2	\$30.00 \$30.00 \$30.00	No. 7 \$1.20 No. 7 \$1.20 No. 7 \$1.20	No. 2 80c No. 2 80c No. 2 80c	37KVL \$2.50
General Electric MC202 MC-1 MC-2 MC-3	152-162 MC-FM 30-44 MC-FM 30-44 MC-FM	MVS415 Transmitter MA251 Receiver 617V 624VS	\$61.50 \$56.50 \$68.00 \$71.19	360-4 300-6 279-2 309-2	\$27.25 \$26.00 \$30.00 \$30.00	No. 18 \$1.20 No. 23 \$1.20 No. 7 \$1.20 No. 7 \$1.20	No. 9 80c No. 9 80c No. 2 80c No. 2 80c	37KVL \$2.50
Harvey 505 506 542	30-44 MC-FM 152-162 MC-FM	620VS 620VS	\$70.00 \$70.00	307-2 307-2	\$30.00 \$30.00	No. 7 \$1.20 No. 7 \$1.20	No. 2 80c No. 2 80c	37KVL \$2.50
Kaar FM50X FM100X PTL-46X FM-175X	30-44 MC-FM 1600-6000 KC 152-162 MC-FM	6175VS early model 530VS late model VSF820 4232VS	\$69.00 \$70.00 \$98.00 \$98.00 \$69.83	278-2 360-2 360-2 231-2	\$30.00 \$40.00 \$40.00 \$30.00	No. 7 \$1.20 No. 30 \$1.20 No. 30 \$1.20 No. 7 \$1.20	No. 2 80c No. 14 80c No. 14 80c No. 2 80c	37KVL \$2.50 38KVL \$2.50 37KVL \$2.50
Mobile Communications (Taxi-Talkie) MFM-25-150 MFM-25-150B	150-170 MC-FM 150-170 MC-FM	450AS 520AS	\$67.00 \$67.00	175-2 208-2	\$30.00 \$30.00	No. 7 \$1.20 No. 7 \$1.20	No. 2 80c No. 2 80c	37KVL \$2.50
Motorola P8050 P8051 P8051 P8661 P8317 P8431	30-44 MC-FM 30-44 MC-FM 30-44 MC-FM 152-162 MC-FM	617V 624VS VVF630 VSF6237M 4228VS 4228VSC	\$68.00 \$71.19 \$91.00 \$95.00 \$67.73 \$69.30	279-2 309-2 279-2-2 301-2 207-2 195-2	\$30.00 \$30.00 \$40.00 \$40.00 \$30.00 \$30.00	No. 7 \$1.20 No. 7 \$1.20 No. 30-\$1.20 No. 25-\$1.20 No. 7 \$1.20	No. 2 80c No. 2 80c No. 14 80c No. 2 80c	37KVL \$2.50 38KVL \$2.50 37KVL \$2.50
RCA M1-7771A M1-31514 M1-7772A	30-44 MC-FM 152-162 MC-FM 30-44 MC-FM	6175VS 3732VS VSF627	\$69.00 \$69.30 \$90.00	278-2 176-2 274-2	\$30.00 \$30.00 \$40.00	No. 7 \$1.20 No. 7 \$1.20 No. 30 \$1.20	No. 2 80c No. 2 80c No. 14 80c	37KVL \$2.50 38KVL \$2.50
Radio Specialties Mfg. Co. 1096-1-1 1114-1147	520AS 520VS	520AS 520VS	\$67.00 \$68.00	208-2 231-2	\$30.00 30.00	No. 7 \$1.20	No. 2 80c	37KVL \$2.50
Wilcox Electric 358A	152-162 MC-FM	4228VS	\$67.73	207-2	\$30.00	No. 7 \$1.20	No. 2 80c	37KVL \$2.50

CARTER MOTOR COMPANY • CHICAGO 47, ILL.



VOLTAGE STABILIZERS

Standard Catalog Models

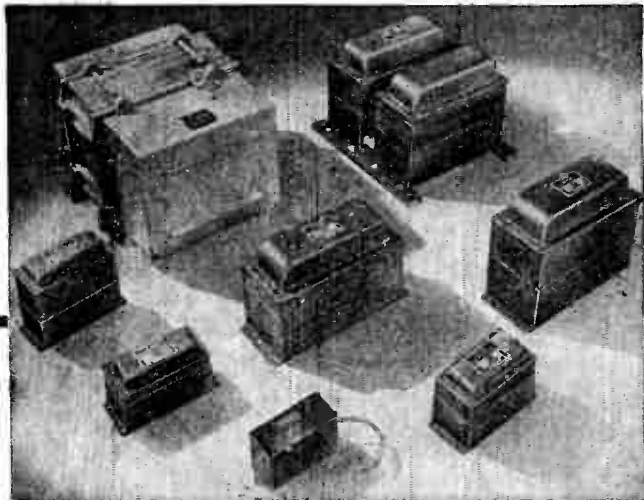
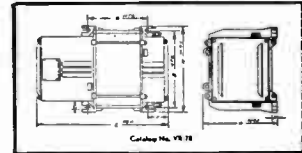
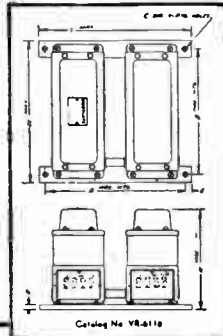
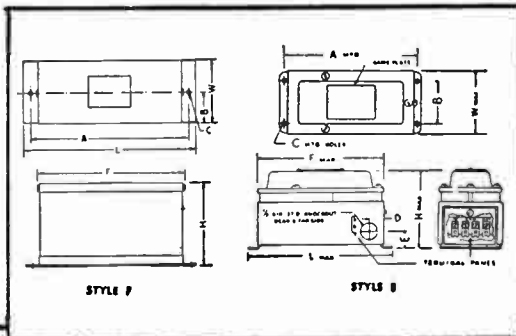

Photo shows typical catalog models: Upper left, style C, No. VR-7B (2000 watts); Upper right, style H, No. VR-6116 (1000 watts) and No. VR-6117 (2000 watts); Lower center, style F, No. VR-6110 (15 watts); all others, style E (rated 30 to 500 watts).



TESTS PROVE 10 POINTS OF RAYTHEON SUPERIORITY

1. Deliver accurate AC voltage within $\pm 1/2\%$
2. Stabilize output with more precision
3. Regulate better at full load
4. Hold up better under overload
5. Better no-load to full-load regulation
6. Accept wider input voltage range
7. Less voltage change as units heat up
8. Less change in output as frequencies fluctuate
9. Smaller, lighter, more compact; no moving parts
10. Cost less to operate

CATALOG NO.	OUTPUT CAP. WATTS	STYLE	DIMENSIONS IN INCHES										NET WEIGHT LBS.
			OVERALL			MOUNTING			LOCATIONS				
			L	W	H	A	B	C	D	E	F		
VR-6110	15	F	6 $\frac{1}{4}$	2 $\frac{1}{2}$	3	5 $\frac{1}{4}$	1 $\frac{1}{4}$	$\frac{1}{4}$ dia.	$\frac{5}{16}$	$\frac{3}{16}$	5 $\frac{3}{16}$	4	
VR-6101*	30	E	7 $\frac{1}{2}$	3 $\frac{3}{8}$	4 $\frac{1}{8}$	6 $\frac{3}{8}$	2 $\frac{1}{4}$	$\frac{7}{32} \times \frac{7}{32}$	$\frac{11}{16}$	$\frac{7}{8}$	6 $\frac{3}{16}$	5	
VR-6111	30	E	7 $\frac{1}{2}$	3 $\frac{3}{8}$	4 $\frac{1}{8}$	6 $\frac{3}{8}$	2 $\frac{1}{4}$	$\frac{7}{32} \times \frac{7}{32}$	$\frac{11}{16}$	$\frac{7}{8}$	6 $\frac{3}{16}$	5	
VR-6112	60	E	7 $\frac{1}{2}$	3 $\frac{3}{8}$	4 $\frac{1}{8}$	6 $\frac{3}{8}$	2 $\frac{1}{4}$	$\frac{7}{32} \times \frac{7}{32}$	$\frac{11}{16}$	$\frac{7}{8}$	6 $\frac{3}{16}$	8	
VR-6113	120	E	7 $\frac{1}{2}$	3 $\frac{3}{8}$	5 $\frac{15}{16}$	6 $\frac{3}{8}$	2 $\frac{1}{4}$	$\frac{7}{32} \times \frac{7}{32}$	$\frac{11}{16}$	$\frac{7}{8}$	6 $\frac{3}{16}$	14	
VR-6114	250	E	12 $\frac{3}{8}$	5	7 $\frac{3}{8}$	11 $\frac{1}{16}$	3 $\frac{1}{2}$	$\frac{7}{32} \times \frac{1}{16}$	$\frac{7}{8}$	1	11 $\frac{1}{16}$	25	
VR-6115	500	E	12 $\frac{3}{8}$	5	9 $\frac{1}{8}$	11 $\frac{1}{16}$	3 $\frac{1}{2}$	$\frac{7}{32} \times \frac{1}{16}$	$\frac{7}{8}$	1	11 $\frac{1}{16}$	45	
VR-6116	1000	H	14 $\frac{1}{16}$	13 $\frac{3}{16}$	9 $\frac{3}{8}$	12 $\frac{3}{8}$	11 $\frac{1}{16}$	$\frac{7}{16}$	$\frac{1}{2}$	$\frac{3}{16}$		92	
VR-6117	2000	H	36 $\frac{1}{4}$	14 $\frac{3}{8}$	10 $\frac{3}{8}$	34	12 $\frac{3}{16}$	$\frac{7}{16}$ dia.				200	
VR-7B	2000	C	16 $\frac{3}{8}$	14 $\frac{3}{8}$	12 $\frac{3}{8}$	8	13 $\frac{3}{8}$	$\frac{1}{2}$	1	2 $\frac{1}{16}$		200	
W-6710**	25	OPEN	7 $\frac{3}{8}$	3 $\frac{1}{8}$	3 $\frac{3}{8}$	7 $\frac{3}{16}$	1 $\frac{1}{2}$	$\frac{7}{32}$				4	

*Output 6.0 or 7.5 volts
 **Output 6.0 volts stabilized to $\pm 1/2\%$

Style E Models, VR-6101 to VR-6113 inclusive, available with card and plug; specify by adding "CP" to catalog number. For accessory card, plug and mounting plate on Model VR-6114 and VR-6115, specify "Assembly 51-590G2".

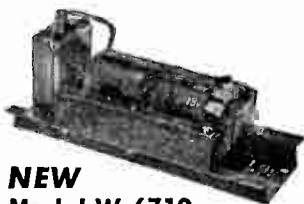

NEW Model W-6710
 OPEN TYPE CONSTRUCTION FOR CHASSIS MOUNTING

Insures constant 6 volts output at 25 watts, stabilized to $\pm 1/2\%$ from an input of 95 to 130 volts.

Raytheon Voltage Stabilizers can be incorporated into any equipment or used as an accessory. All models will operate on an input of 95 to 130 volts, 60 cycles, single phase with an output of 115 volts stabilized to $\pm 1/2\%$. The Catalog No. VR-7B rated at 2000 watts is a dual purpose unit and will operate on an input of 95 to 130 volts, single phase, with an output of 115 volts or on an input of 190 to 260 volts and an output of 230 volts. The new Model W-6710 supplies a steady 6-volt output at 25 watts, stabilized to $\pm 1/2\%$ from an input of 95 to 130 volts at 60 cycles.

The complete line of Raytheon Voltage Stabilizers is available through 155 authorized distributors. Special custom-built units, ranging from 5 to 10,000 watts are also available to meet special needs. Write for complete information.

NEW **RAYTHEON** 2KVA

Magnetic Amplifier

VOLTAGE STABILIZER

Among the many advantages offered by Magnetic Amplifier Control are: constant voltage despite line voltage and frequency changes, lower harmonic content, better no load to full load regulation, less cubic space required and ability to take heavy overload without damage. Employs selenium rectifiers and magnetic components in amplifier circuit — no filament type electron tubes and only one standard, long-life, readily available cold cathode voltage regulator tube. Voltage adjustment by potentiometer through screw driver slot in front panel. Write for complete information.

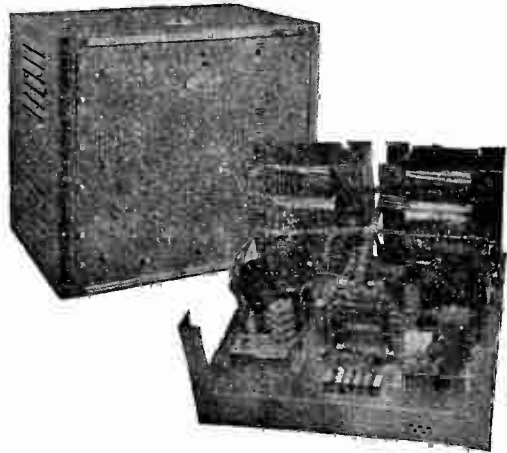

SPECIFICATIONS

- Input; 115 volts, $\pm 10\%$, 58-62 cycles, single phase.
- Output: 115 volts, 2000 va.
- Fixed load stabilized to $\pm 1/2\%$ for line change.
- Fixed load stabilized to $\pm 1\%$ for frequency change.
- No load to full load (85% power factor); 1% maximum.
- Temperature rise of components; 50°C maximum.
- Harmonics (at 60 cycles input); less than 5% total.
- Efficiency at full load (100% power factor); 90% minimum.
- Mounting: Bench, floor, wall or relay rack.



RECTIFILTER*

Battery Eliminator

*Reg. U. S. Pat. Off.



Here is the modern, economical and reliable way to obtain D.C. power direct from an A.C.

source. These never-failing battery eliminators operate entirely without moving parts.

Input 110-125 volts, 60 cycle, AC single phase

Catalog Number	DC Output		Full Load Output Volts	60 Cycle Output		Approximate Cabinet Size in Inches		
	Volts	Amps		Volts	Amps	High	Wide	Deep
RFR-1024-B	6	0.5	5.5	6-12-18-24AC	4.0	8 3/8	3 3/4	5 3/8
RFR-1027-BR	24	0.5	20	6-12-18-24AC	4.0	8 3/8	3 3/4	5 3/8
RFR-1044-GR	24	1.0	24	6-12-18-24-75-100AC	4.0	10 1/2	12 1/2	7 1/8
RFR-1040-AR	24	3.0	24	24V.DC	—	12 1/4	12 5/8	7 1/8
RFR-1042-AR	24	6.0	24	24V.DC	—	16 1/8	10 1/8	8 1/2

Other models available. Write for complete information.



MINIATURE PULSE TRANSFORMERS For Blocking Oscillator Use

These hermetically sealed, MIL-T-27 type pulse transformers are designed for universal blocking oscillator use at repetition rates from 50 to 5000 pps.

UX-7307A and UX-7350A are identical in electrical characteristics, having two windings for 1000 ohms impedance and two windings to

match 250 ohms. To cover a wider variety of applications, the windings are arranged differently in the two transformers.

These units are also available in octal type tube bases as UX-7307 and UX-7350. Bulletin DL-K-320 gives complete information including typical circuits. Write for it.



Pulse Width In Microseconds*	Rise Time In Microseconds	Drop	Front-Edge Overshoot	Trailing Edge Back Swing
0.25	.07	1%	4%	5%
0.50	.07	1%	4%	6%
1.00	.07	2%	4%	6%
2.00	.07	4%	4%	7%
5.00	.07	10%	4%	11%

*Measured at base of pulse

Electrical characteristics measured by a H-P#212A pulse generator and a Dumont #303 oscilloscope. Measurements made with secondary loaded with 1000 ohms. The transformers are tested in 1000 V.D.C., and the maximum voltage across the 1000 ohm windings is 300 volts peak.

UX-7307
UX-7307A
UX-7350
UX-7350A

RAYTHEON MANUFACTURING COMPANY

EQUIPMENT SALES DIVISION . DEPT. 6270-RM . WALTHAM 54, MASSACHUSETTS

DISTRICT OFFICES: BOSTON — NEW YORK — CLEVELAND — CHICAGO
NEW ORLEANS — LOS ANGELES (WILMINGTON) — SAN FRANCISCO — SEATTLE

the SUPERIOR ELECTRIC Co. . . .

including a complete line of **POWERSTAT**
to provide a continuously
from 150 VA



TYPE 10

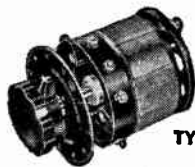

TYPE 20



TYPE 116

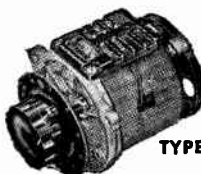

TYPE 116U



TYPE 2PF136

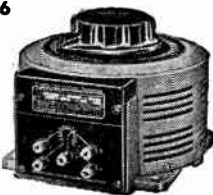

TYPE 136

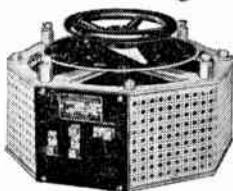

TYPE 1156

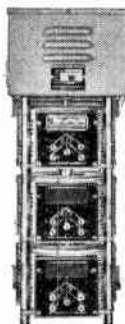

TYPE M136-3

TYPE MW 1156-6

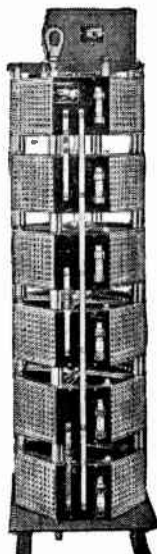

**SEND FOR POWERSTAT
BULLETIN P553G**

Line Voltage	Output Voltage	Maximum Output Amp.	Maximum Output KVA	Frequency	Type	Approx. Net	Weight Shipping	Motor Speeds
120	0-132	1.25	0.165	160	*10	1.8	3	
	0-140	3.0	0.42	160	*20	4	6	
	0-140	7.5	1.0	50/60	*116U	10	11	
	0-140	7.5	1.0	50/60	116	11	12	
	0-140	7.5	1.0	50/60	3PF116	11	12	
	0-140	7.5	1.0	50/60	3TF116	11	12	
	0-140	20.0	2.8	50/60	*136	22	25	5, 15, 30, 60
	0-140	20.0	2.8	50/60	*F136	22	25	5, 15, 30, 60
	0-140	20.0	2.8	50/60	*2PF136	23	26	
	0-140	20.0	2.8	50/60	*2TF136	23	26	
	0-140	20.0	2.8	50/60	*3PF136	23	26	
	0-140	20.0	2.8	50/60	*3TF136	23	26	
	0-140	40.0	5.6	50/60	*136-2P	47	53	5, 15, 30, 60
	0-140	45.0	6.3	50/60	1156	73	80	6, 14, 19, 45
0-140	45.0	6.3	50/60	F1156	74	81	6, 14, 19, 45	
0-140	90.0	12.6	50/60	1156-2P	150	170	6, 14, 19, 45	
0-140	135.0*	18.9	50/60	1156-3P	225	295	6, 14, 19, 45	
0-140	180.0	25.2	50/60	1156-4P	330	420	14, 19, 45	
0-140	270.0	37.8	50/60	1156-6P	500	600	14, 19, 45	
240	0-264	1.25	.33	160	*10-2S	4.5	5.0	
	0-280	3.0	.84	50/60	*216U	10	11	
	0-280	3.0	.84	50/60	216	11	12	
	0-280	3.0	.84	50/60	3PF216	11	12	
	0-280	3.0	.84	50/60	3TF216	11	12	
	0-280	7.5	2.1	50/60	*116U-2S	17	22	
	0-280	7.5	2.1	50/60	*116-2S	18	23	
	0-280	9.0	2.5	50/60	*236	22	25	5, 15, 30, 60
	0-280	9.0	2.5	50/60	*236	22	25	5, 15, 30, 60
	0-280	9.0	2.5	50/60	*2PF236	23	26	
	0-280	9.0	2.5	50/60	*2TF236	23	26	
	0-280	9.0	2.5	50/60	*3PF236	23	26	
	0-280	9.0	2.5	50/60	*3TF236	23	26	
	0-280	20.0	5.6	50/60	*136-2S	45	51	5, 15, 30, 60
0-280	28.0	7.8	50/60	1256	73	80	6, 14, 19, 45	
0-280	28.0	7.8	50/60	F1256	74	81	6, 14, 19, 45	
0-280	45.0	12.6	50/60	1156-2S	144	164	6, 14, 19, 45	
0-280	56.0	15.7	50/60	1256-2P	150	170	6, 14, 19, 45	
0-280	84.0	23.5	50/60	1256-3P	225	295	6, 14, 19, 45	
0-280	112.0	31.4	50/60	1256-4P	330	420	14, 19, 45	
0-280	168.0	47.0	50/60	1256-6P	500	600	14, 19, 45	
480	0-560	3.0	1.7	50/60	*216U-2S	17	22	
	0-560	3.0	1.7	50/60	*216-2S	18	23	
	0-560	9.0	5.0	50/60	*236-2S	45	51	5, 15, 30, 60
	0-560	28.0	15.7	50/60	1256-2S	144*	164	6, 14, 19, 45
	0-560	56.0	31.4	50/60	1256-4PS	330	420	14, 19, 45
0-560	84.0	47.0	50/60	1256-6PS	500	600	14, 19, 45	
Three Phase	0-132	1.25	.28	160	*10-2D	4.5	5.0	
	0-140	3.0	.73	160	*20-2D	17	22	
	0-140	7.5	1.8	50/60	*116U-2D	17	22	
	0-140	7.5	1.8	50/60	*116-2D	18	23	
	0-140	20.0	4.8	50/60	*136-2D	45	51	5, 15, 30, 60
	0-140	45.9	10.9	50/60	1156-2D	144	164	6, 14, 19, 45
	0-140	90.0	21.8	50/60	1156-4D	320	410	14, 19, 45
	0-140	135.0	32.7	50/60	1156-6D	490	590	14, 19, 45
240	0-240	1.25	.52	60	10L-3Y	7.0	8.0	
	0-240	3.0	1.2	60	20L-3Y	14.0	17.0	
	0-280	3.0	1.5	50/60	*216U-2D	17	22	
	0-280	3.0	1.5	50/60	*216-2D	18	23	
	0-280	7.5	3.6	160	*116U-3Y	26	36	
	0-280	7.5	3.6	160	*116-3Y	27	37	
	0-280	9.0	4.4	50/60	*136-2D	45	51	5, 15, 30, 60
	0-280	20.0	9.7	160	*136-3Y	68	77	5, 15, 30, 60
	0-280	28.0	13.6	50/60	1256-2D	144	164	6, 14, 19, 45
	0-280	45.0	18.7	50/60	1156L-3Y	215	280	6, 14, 19, 45
	0-280	56.0*	27.2	50/60	1256-4D	320	410	14, 19, 45
	0-280	84.0	40.7	50/60	1256-6D	490	590	14, 19, 45
0-240	90.0	37.4	50/60	1156L-6Y	500	600	14, 19, 45	
480	0-560	3.0	2.9	160	*216U-3Y	26	36	
	0-560	3.0	2.9	160	*216-3Y	27	37	
	0-560	9.0	8.7	160	*236-3Y	68	77	5, 15, 30, 60
	0-560	28.0	27.2	160	1256-3Y	215	280	6, 14, 19, 45
	0-560	56.0	54.3	160	1256-6Y	500	600	14, 19, 45

*These units are supplied with an "L" terminal which allows connecting in the field to limit the output voltage to the applied voltage. If "L" type connection is required on other models, the "L" must be included in the type number when ordering.

†When these POWERSTATS are "L" connected so that the output voltage does not exceed the applied voltage, the frequency range is 50/60 cycles.

One Source for Voltage Control Equipment

VARIABLE TRANSFORMERS adjustable source of a-c voltage to 100 KVA

efficient • accurate • dependable

POWERSTAT variable transformers are autotransformers of toroidal core design with a movable brush tap which is rotated to deliver any desired output voltage from zero to, or above, line voltage. Glass smooth commutator surfaces and advanced winding techniques assure smooth operation and permit adjustment to a fraction of a volt. Other important features include: excellent regulation, high efficiency, conservative ratings, zero waveform distortion and rugged mechanical construction.

A wide range of standard POWERSTAT variable transformers are available for 120, 240 and 480 volt, single and three phase operation. Both manually-operated and motor-driven types are offered. The rating chart lists some of the most-called-for standard POWERSTATS. Others — specifically designed to customer requirements—are available to fulfill each application. Consult us about your specific needs.

standard types for varied applications

POWERSTAT VARIABLE TRANSFORMERS for

OIL-COOLED OPERATION



TYPE 0-1126

By immersing a POWERSTAT in transformer oil, the rating above normal air operation is increased and duty in a corrosive atmosphere is possible. A standard line is offered in various ratings and sizes.

EXPLOSIVE ATMOSPHERES

TYPE X-1126

To provide safe operation in hazardous areas where a small arc or spark could cause an explosion, explosion-proof POWERSTATS are available. Standard models are approved by Underwriters' Laboratories for Class 1, Group D service.



HIGH CURRENT NEEDS LIMITED OUTPUT RANGE

TYPE 2106LC

Relatively large amounts of power can be controlled by a small POWERSTAT when used in conjunction with a fixed-ratio transformer. This combination is known as a POWERSTAT Line Corrector. It can be used to correct line voltage variations to maintain a specified output voltage and to supply a limited output voltage range. A multitude of ratings are available.



For complete information, ask your nearest distributor
the SUPERIOR ELECTRIC Co.

54 Clarke Avenue, Bristol, Connecticut

STABILINE automatic voltage regulators to maintain constant output voltage made in 2 distinct types to meet each need

TYPE IE (INSTANTANEOUS ELECTRONIC)

for the most exacting control

Type IE is completely electronic in operation with no moving parts. Providing instantaneous correction, it is ideal for laboratories, test lines, as a component of other equipment . . . and everywhere that the most exacting voltage control is required. At no load, full load or any intermediate stage, constant output voltage is maintained regardless of line fluctuations. The output voltage is held to within ± 0.1 volts of nominal for wide line variations and within ± 0.15 volts of nominal for any load current or load power factor change from .5 lagging to .9 leading. Waveform distortion never exceeds 3%. Standard types are listed below. Consult us about your specific requirements.



TYPE IE51002R

TYPE IE5101R

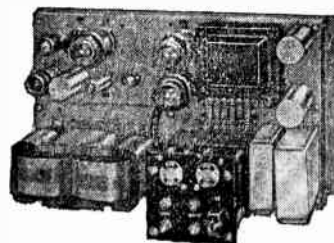

TYPE EM (ELECTRO MECHANICAL)

for large industrial loads . . . for applications requiring zero waveform distortion and high efficiency

Type EM is an electro-mechanical device with a very sensitive detector controlling a motor-driven POWERSTAT variable transformer and auxiliary transformer. While not instantaneous, Type EM corrects faster than most other automatic voltage regulators. Highly efficient in operation, it finds widest application in controlling large industrial loads and also in electronic equipment where zero waveform distortion is essential. Features include: complete insensitivity to the magnitude and power factor of the load, no effect on system power factor, no critical adjustments and adjustable output voltage. Standard types listed below.

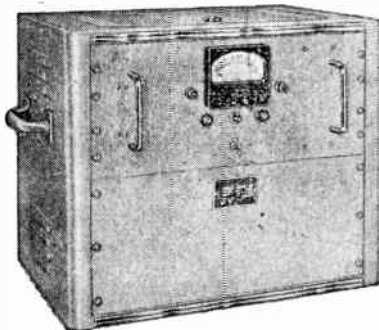

TYPE EM 4115

EM CONTROL CIRCUIT

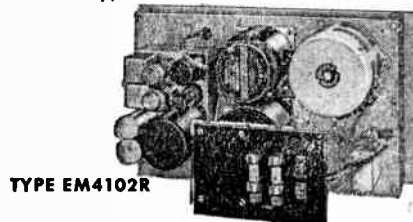
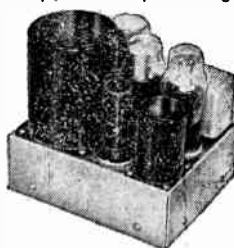

TYPE EM4102R

RATINGS TYPE IE

Input Voltage Range	Output Voltage Range	Frequency In Cycles	Load Range In Amperes	Load Power Factor Range	Rated Output KVA	Type
95-135	110-120	60 \pm 10%	0-2.2	.5 lagging	0.25	IE51002
95-135	110-120	60 \pm 10%	0-2.2		0.25	IE51002R
95-135	110-120	60 \pm 10%	0-4.5		0.5	IE51005
95-135	110-120	60 \pm 10%	0-4.5		0.5	IE51005R
95-135	110-120	60 \pm 10%	0-4.5		0.5	IE51005
95-135	170-240	50 \pm 10%	0-4.5	to .9 leading	0.5	IE51005R
195-255	220-240	50 \pm 10%	0-2.2		0.5	IE52005
195-255	220-240	50 \pm 10%	0-2.2		0.5	IE52005R
95-135	110-120	60 \pm 10%	0-8.5		1.0	IE5101
95-135	110-120	60 \pm 10%	0-8.5		1.0	IE5101R
95-135	110-120	50 \pm 10%	0-8.5	.9 leading	1.0	IE5101
95-135	110-120	50 \pm 10%	0-8.5		1.0	IE5101R
195-255	220-240	50 \pm 10%	0-4.5		1.0	IE5201
195-255	220-240	50 \pm 10%	0-4.5		1.0	IE5201R
95-135	110-120	60 \pm 10%	0-22.0		2.5	IE5102
95-135	110-120	60 \pm 10%	0-22.0		2.5	IE5102R
195-255	220-240	60 \pm 10%	0-11.0		2.5	IE5202
195-255	220-240	60 \pm 10%	0-11.0		2.5	IE5202R
195-255	220-240	50 \pm 10%	0-11.0		2.5	IE5202
195-255	220-240	50 \pm 10%	0-11.0		2.5	IE5202R
95-135	110-120	60 \pm 10%	0-43.5	5.0	IE5105	
195-255	220-240	60 \pm 10%	0-22.0	5.0	IE5205	

RATINGS TYPE EM

Nominal Output Voltage	Input Voltage Range	Output Voltage Range	Output Current (Amperes)	Output KVA	Type			
Single Phase 115	95-135	110-120	17.5	2.0	EM4102			
			52.0	6.0	EM4106			
			130.0	15.0	EM4115			
230	195-255	220-240	32.5	7.5	EM4207			
			120.0	27.5	EM4228			
460	400-520	420-460	15.0	6.6	EM4407			
			40.0	17.6	EM4418			
Three Phase 230	195-255	220-240	25.0	10.0	EM6210Y			
			38.0	15.0	EM6215Y			
			50.0	20.0	EM6220Y			
			113.0	45.0	EM6245Y			
			175.0	70.0	EM6270D			
			460	400-520	420-460	16.0	12.5	EM6412Y
						22.0	17.5	EM6417Y
						33.0	25.0	EM6425Y
						66.0	50.0	EM6450Y
						100.0	75.0	EM6475Y
131.0	100.0	EM64100Y						
420-500	420-460	16.0				12.5	EM6412Y	
		22.0				17.5	EM6417Y	

FOR COMPLETE INFORMATION, SEND FOR STABILINE BULLETIN S351

One Source for Voltage Control Equipment

VARICELL d-c power supplies

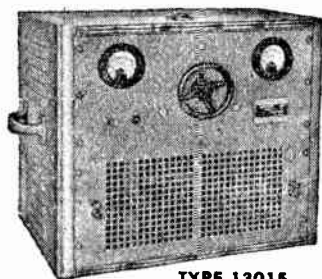

TYPE 13015

A VARIABLE RANGE OF STABILIZED AND REGULATED D-C VOLTAGES FROM AN A-C SOURCE

The ideal source of low d-c voltages, the VARICELL is simply plugged into any convenient, single phase a-c outlet supplying a nominal 115 volts at 60 cycles and it is ready to operate. Turning the handwheel provides any desired output voltage from 0 to 30 volts. Its load rating is 15 amperes. Any setting is unaffected by changes in line or load current. For any setting from 6 to 30 volts, R.M.S. ripple voltage never exceeds 0.1 volts, and stabilization and regulation is ± 0.25 volts.

FOR COMPLETE INFORMATION, SEND FOR VARICELL BULLETIN V1051

VOLTBOX a-c power supplies

A COMPACT, PORTABLE SOURCE OF VARIABLE A-C VOLTAGE

This is a handy instrument widely used in chemical, physical, electrical and other laboratories and in inspection, testing and plant maintenance departments. It eliminates the need for collecting a variable transformer, voltmeter and connection leads when tests involve variable a-c voltages. All necessary components are housed in a compact, aluminum case. By turning the "On-Off" switch to "On"; snapping the line-load switch to "Load" and rotating the knob, the desired voltage is available at the output receptacles and binding posts. Ratings are available to meet every requirement.

FOR COMPLETE INFORMATION, SEND FOR BULLETIN P553G

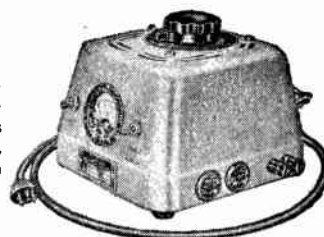

TYPE UC1M

superior 5-WAY binding posts

TYPE DF30RC

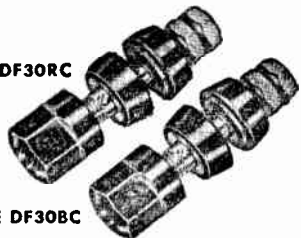

TYPE DF30BC

This versatile binding post offers 5 different methods of connection . . . permanent clamping, spade lug, clip-lead, banana plug, or looping and clamping. Ruggedly built of the finest materials it provides complete insulation, a current capacity of 30 amperes and a working voltage of 1,000 volts. Two available colors, red and black, provide circuit identification where required.

WRITE FOR BULLETIN BP652 DESCRIBING THE 5-WAY BINDING POSTS

SUPERIOR ELECTRIC — SPECIALISTS IN VOLTAGE CONTROL

Thoroughly familiar with every type of voltage control problem, The Superior Electric Company is well qualified to help with your specific requirements. We will be glad to recommend standard equipment exactly suited to your needs — or to engineer special types or new designs for unusual applications.

For complete information, ask your nearest distributor
the SUPERIOR ELECTRIC Co.

54 Clarke Avenue, Bristol, Connecticut

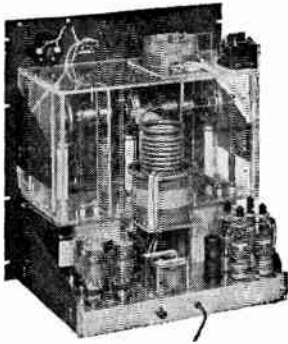

MODEL PN-60

REVERSIBLE POLARITY RF DC POWER SUPPLY

Polarity changes made on front panel. Continuously variable from 0 KV to 60 KV. Current output 1 milliamperere at 60 KV. Overall Dimensions 22½" x 21" x 15". Ideal for electrostatic paint spraying, capacitor charging and testing as well as many other uses.

PN-60 Complete with Meter.....\$675.00 Net

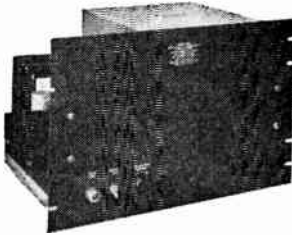
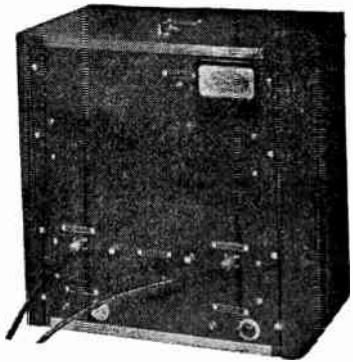

MODEL 2040 • 40 KV DC POWER SUPPLY

A ruggedly built power supply which is in constant use in laboratories and industrial plants throughout the world for condenser charging, electrostatic spraying and stress testing, etc. Nothing finer available at five times the price. Designed for constant use and will stand severe abuse. Available with either positive or negative 40 KV output. Voltage range of approx. 15 to 40 KV. The 15 to 40 KV variance in voltage is controlled through a knob on the front panel. If required for TV use, a voltage output of approx. 4 to 6 KV is available through a tap. Voltages supplied through a 4 ft. HV Safety Cable. Specify desired polarity when ordering.....\$136.90 Net
With HV meter installed in front panel.....\$50 additional



**MODEL LAB-40
CONTINUOUSLY VARIABLE REGULATED 25 to 40KV DC POWER SUPPLY**

Unit has a 4 to 6 KV focus tap for use with flying spot kin-scope recording tubes, etc. Regulations of 0.5% at 1 milliamperere. Available either with locking controls or standard knob.

With meter \$620 Net
Less Meter \$545 Net

MODEL LAB-30PN • REVERSIBLE POLARITY — Continuously Variable 1 to 30 KV

Regulated DC Power Supply with regulations of 0.5% at 1 milliamperere. Although rated at 1 ma., this unit is capable of 2 ma. operation within regulation specifications. This 16 tube unit is of the RF type consisting of a separate oscillator and buffer feeding the power oscillator into a doubler rectifier. Regulations accomplished through feedback into a DC amplifier plus simultaneous output control of the buffer. Polarity reversible from front panel. Standard Rack Model—19" wide x 12" high x 13" deep. Standard Bench Model—21" wide x 14" high x 15" deep.

With Meter \$670 Net — Less Meter \$595 Net

Model LAB-30 is a positive polarity output regulated High Voltage DC Power Supply with same electrical characteristics and dimensions as the LAB-30PN. Available in either positive or negative polarity.

With Meter \$570 Net — Less Meter \$495 Net

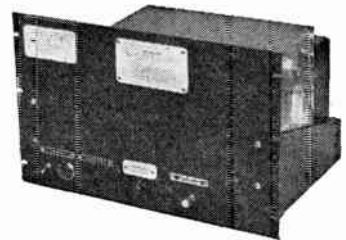

**MODEL 4575
4½ KV POWER SUPPLY**

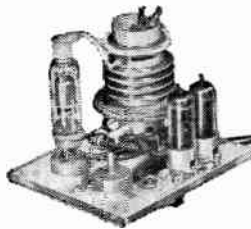

This compact, well designed, ruggedly built DC supply utilizes two 6AQ5 tubes as a parallel oscillator feeding a 1X2 rectifier tube. For an output voltage of 4½ KV DC at 1 milliamperere, the low voltage input requirement is 250 V at 50 milliampereres. By varying the DC input the output voltage can be varied from approx. 1 KV to 7½ KV. Dimensions: 5½" high x 5" deep x 4¼" wide. In completely enclosed metal housing (not shown). Less low voltage DC supply...\$32.50 Net

MODEL PN-30R • REVERSIBLE POLARITY CONTINUOUSLY VARIABLE 1-30 KV UNREGULATED DC POWER SUPPLY

A light, compact unit in wide use for insulation testing, precipitators and laboratory research. Polarity reversible from front panel. Current output — approx. 2 milliampereres at 20 KV; 250 microampereres at 30 KV. Input — 110V AC 60 cycles. Dimensions: 19" x 12¼" x 13"

With meter installed on front panel.....\$50 additional
UNIT SHOWN LESS FRONT PANEL

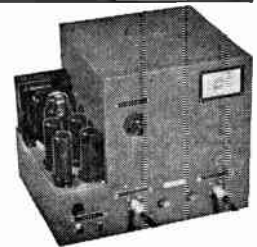

MODEL RG-30 • Continuously Variable 15-30 KV Regulated DC Power Supply

A high grade supply which incorporates a voltage tap in the range of 4 to 6 KV for use with 5WP15, 5TP4 and flying spot tubes. Regulations better than .5% at 1 milliamperere. In wide use for color tube development work, transcription recording systems. Power supply also available with focus and convergence voltage taps for RCA Tri-Color tubes at slight additional cost.

With meter installed on front panel.....\$50 additional

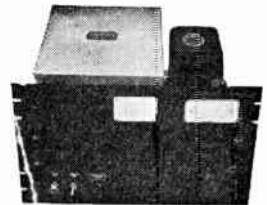

5 KV

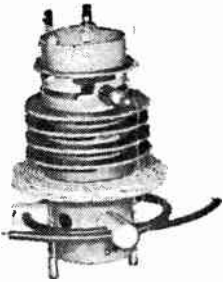

Secondary Height 3 1/2"
 Secondary Windings 1 3/4"
 Consisting of 4 Pie Windings
 Primary Diameter 2 1/4"
 Secondary Voltage Output..... 5 KV
 Secondary Current..... 2 Milliamperes
 Approx. Frequency..... 300 KC
\$4.80 Net

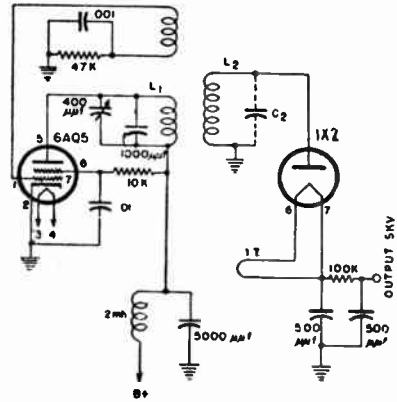

10-15 KV



Secondary Height 5 1/4"
 Secondary Windings 1 3/4"
 Consisting of 7 Pie Windings
 Diameter 2 1/2"
 Secondary Voltage Output... 10-15 KV
 Secondary Current..... 2 Milliamperes
 Approx. Frequency..... 175 KC
\$12.00 Net

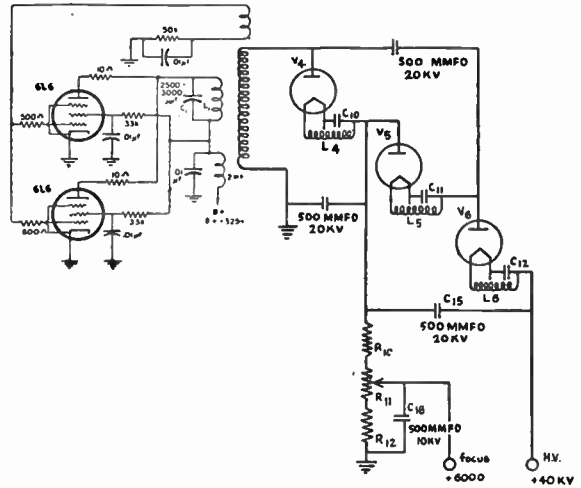

35 KV



Secondary Height 7"
 Secondary Windings 3" dia.
 Consisting of 10 Pie Windings
 Primary.....(separate from secondary)
 Height 4"
 Diameter 4 1/4"
 Secondary Voltage Output..... 35 KV
 Secondary Current..... 5 Milliamperes
 Approx. Frequency..... 70 KC
\$42.00 Net
 25KV—Same as 35 KV except
 Secondary Height 6"
\$36.00 Net

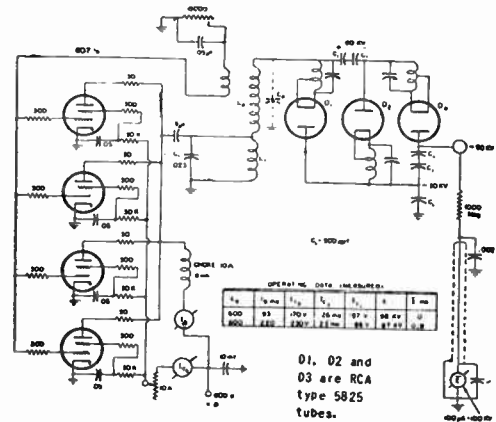

RF FILAMENT TRANSFORMERS

A self-resonant auto transformer for use with type 1B3 Rectifier tube.
 Will operate with Spellman HV coils.....

\$1.50

TUNING PADDER for Filament Transformer..... **0.58**

Perma-Power® Battery Eliminators

for 105-125V.,
50/60 cycle lines

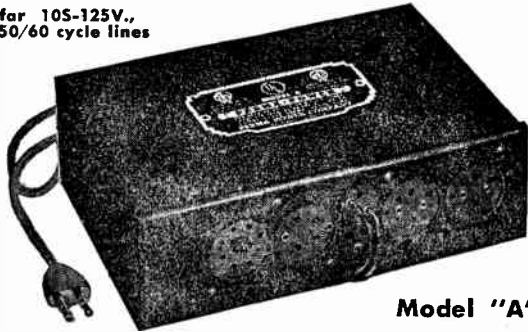

Model "A"

For 1½ volt radios with 4, 5 or 6 tubes. Designed to give constant power from varying line voltages. Maintains rated output under varying tube loads. Universal sockets for all battery plugs. Fits in back of battery radios as well as battery compartments of most portables.

Provides: "A" 1.45 Volts D.C. at 200 to 350 M.A. **STOCK No. A-101 Suggested List \$1895**
"B" 90 Volts D.C. at 13 M.A. **\$1895**
2½" x 4½" x 6¾" — 4 lbs.

Model "B" Battery Eliminator

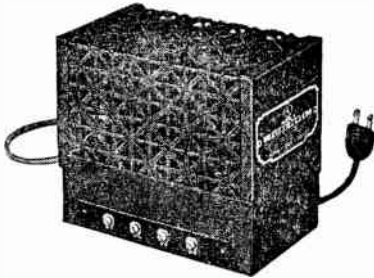

For 6-volt radios. Designed with separate outputs for the vibrator and the filaments eliminating vibrator disturbance assuring high fidelity radio performance. Often used as a trickle battery charger.

Provides: Two isolated sources of 6 Volts D.C. at 1½ amps, or when connected in parallel—3 amps.
3½" x 6½" x 5½" — 7 lbs.

STOCK No. A-201 Suggested List \$2345



Model "E" Battery Eliminator

For 2 volt radios with 4 to 8 tubes. Designed to supply "A" and "B" power under varying line voltages and loads. Provides hum-free

operation without distortion or "motor boating." Fits in back of battery radios as well as battery compartments of most portables.

Provides: "A" 2 Volts D.C. at 750 M.A. "B" 135 Volts D.C. at 25 M.A. tapped at 112 v, 90 v and 67 v. **STOCK No. A-301 Suggested List \$2075**
2¼" x 4¾" x 6-13/16" — 4 lbs.

UL APPROVED WITH 3 YEAR GUARANTEE!

Perma-Power® CO.
CHICAGO 25, ILLINOIS
Telephone: Uptown 8-6121

TV VOLTAGE REGULATOR



STOCK No. D-101

Suggested List Price

\$675

Engineered and designed to insure maximum performance of any television set by returning full height and width of picture when low line voltage distorts picture.

- Reduces tube failures — increases set sensitivity
- Eliminates intermittent sync and oscillator drift caused by low line voltage
- 300 watt rating . . . ample for most requirements on line voltage from 90 to 135 volts
- Automatically operated . . . turns on and off with set or appliance
- Selector switch permits boosting or lowering of voltage
- Simple external plug-in . . . 10 second installation aids over the counter sales
- Reduces low line or high line hazards to electrical equipment

Envelope stuffers available without charge

TV Insulated High Voltage Grid Cap Assembly



Black bakelite cap with molded corona guard . . . 10"—20KV dual wall polyethylene lead for ¼" or ⅜" caps.

STOCK No. M-101—¼" cap . . . Suggested list 40¢
STOCK No. M-102—⅜" cap . . . Suggested list 40¢



TV High Voltage Spring Clip Assembly

Heavy tension spring clip, tin-plated . . . 10" — 20KV dual wall polyethylene lead for ¼" or ⅜" caps.

STOCK No. M-103—¼" cap Suggested list 40¢
STOCK No. M-104—⅜" cap Suggested list 40¢



TV Replacement Socket

Our Perma-Power U.L. socket with 5 or 6 leads . . . 20" long, #22 U.L. wire . . . RMA colors.

STOCK No. L-501—five 20" leads . . . Suggested list 90¢
STOCK No. L-601—six 20" leads . . . Suggested list \$1.00

TV Tube Extension

Similar to Replacement Socket, but with 48" leads and the 6MI tube base. Use for set to good tube, or tube to good set.

STOCK No. L-604—six 48" leads . . . Suggested list \$2.15

"There is always something new being developed by Perma-Power"

HBC

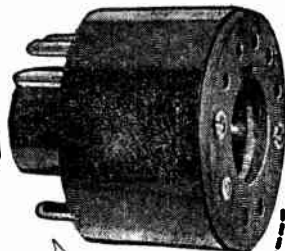

Horizontal BAR GENERATOR

A Neon Tube Relaxation Oscillator provides a series of equally spaced horizontal lines to indicate picture linearity.

STOCK No. B-101
Suggested
List Price
\$3.08

- PRECISE SETTING OF YOKE
- ACCURATE POSITIONING OF FOCUS COIL OR MAGNET
- QUICK ADJUSTMENT OF VERTICAL LINEARITY, HEIGHT & CENTERING

add increased brilliance to any TV picture tube.

"TV TUBE BRITENER"

STOCK No. C-101
Suggested
List

\$9.75

- Prolongs tube brilliance; fully automatic
- Isolates filament; relieves cathode-filament shorts.
- Works on all sets and all makes of sets with only one model
- Permanently plugged in into television set without wiring or soldering
- Less than 3 minutes to install
- Made to sell; packaged to sell
- Producing sales everywhere
- Standard R.M.A. warranty



Pat.
App.
For.

"There is always something new being developed by Perma-Power"

Perma-Power

UNIVERSAL

TV TUBE
BRITENER

STOCK No.
C-301

Suggested
List Price

\$4.45

Here is engineering at its peak! Use this unit for sets with parallel-wired or series-wired filaments; relieves cathode-filament short problems.

ONE UNIT FOR ALL SETS . . . AND TO RELIEVE CATHODE-FILAMENT SHORTS.



Isolation type transformer gives normal 6.3V to filament to relieve cathode-filament short problems or 7.8V to increase cathode emission and restore lost brightness. Simple switch allows quick selection . . . unique design allows operation as constant voltage (parallel wired sets) or constant current (series wired sets) transformer.



Get a
BRILLIANT
PICTURE

Suggested
List

\$3.45

STOCK
No. C-201

"C-BRITE"

- Brings out lost sharpness and detail
- Just plug it in and picture brightens
- Automatic . . . no switching or wiring
- NOW . . . all sets will have normal pictures easily and quickly
- Low price . . . many sales

NOW . . . in seconds have brighter television pictures, by easily installing C-BRITE. Designed for sets with parallel-wired filaments with magnetic or electrostatic focus tubes of any size, using the duo-decal base.

Perma-Power CO.

CHICAGO 25, ILLINOIS

Telephone: Uptown 8-6121

SO LA *Constant Voltage* TRANSFORMERS

SOLA Electric Co. • Chicago 50, Ill.

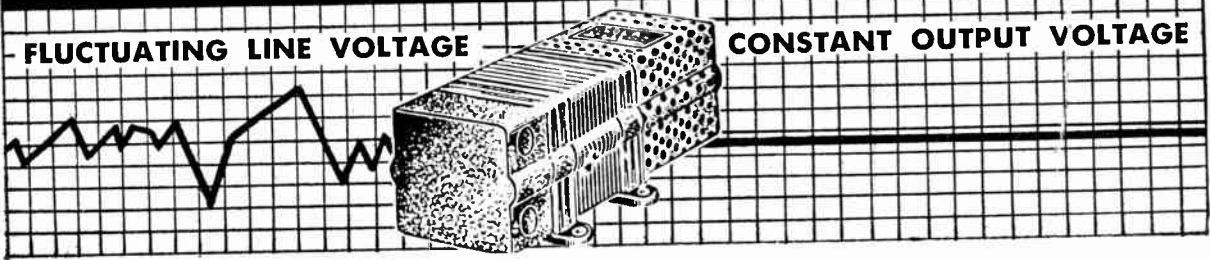

Automatic Instantaneous Voltage Regulation

SOLA Constant Voltage Transformers are static magnetic voltage regulators. They are designed to provide a constant output voltage which is unaffected by changes in input voltage. You will find, listed in the following pages, the widest range of ratings and types available from stock offered by any manufacturer.

In addition, CUSTOM DESIGNED UNITS can be manufactured in capacities from 1 V.A. to 25,000 V.A., to suit your individual specifications. When ordered in substantial quantities, they cost only slightly more than standard units of the same general size. Often, time and money can be saved by direct use or modification of a regulator from the several hundred special designs on file. Custom designs can include: SPECIAL VOLTAGE RATIOS, SPECIAL FREQUENCIES, COMPENSATION FOR FREQUENCY VARIATION, MULTIPLE OUTPUT VOLTAGES, THREE-PHASE SERVICE, and MILITARY SPECIFICATIONS.

SOLA Constant Voltage Transformers have eight distinct advantages over regulators which depend solely upon saturation of core materials for their regulating action, or electronic type regulators:

1. Response time, 1.5 cycles or less.
2. No moving or renewable parts . . . no manual adjustments.
3. Completely automatic continuous regulation.
4. Self-protecting against short circuits.
5. Current limiting characteristic protects load equipment from excessive fault currents.
6. Can often be substituted for conventional non-regulating transformers.
7. Relatively compact.
8. Provide isolation between input and output circuits.

For complete operational data write for Bulletin 4M-CV-200

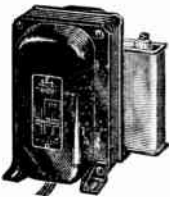

CONSTANT VOLTAGE TRANSFORMER FOR PLATE AND FILAMENT SUPPLY TYPE CVE

A single, compact source of filament and plate supply voltages . . . regulated to within $\pm 3\%$ or less with line voltage variations of 100-130 volts. Supplied with separate capacitor.

ELECTRICAL AND MECHANICAL SPECIFICATIONS: Input 100-130 v, 60 cycle

Catalog Number	D.C. Input Volts to Filter	FILAMENT WINDINGS		OVERALL DIMENSIONS IN INCHES			Shipping Weight
		6.3v	5.0v	Length	Width	Height	
7104	275v D.C. @ 50 M.A.	2.5 amps C.T.	2.0 amps	4 $\frac{1}{8}$	3 $\frac{3}{8}$	3 $\frac{5}{8}$	5
7106	385v D.C. @ 110 M.A.	3.0 amps C.T.	2.0 amps	4 $\frac{1}{8}$	3 $\frac{3}{8}$	4 $\frac{1}{8}$	8
7107	380v D.C. @ 250 M.A.	# 1: 4.0 amps # 2: 8.0 amps unregulated	3.0 amps	7	4 $\frac{1}{2}$	5	19

DATA ON STANDARD "CV" AND OTHER TYPES ON FOLLOWING PAGES

SPECIALIZED STANDARD TYPES

SOLA
ELECTRIC CO.

TYPES

ELECTRICAL and MECHANICAL SPECIFICATIONS

CONSTANT VOLTAGE TRANSFORMER WITH HARMONIC FILTER TYPE CVH

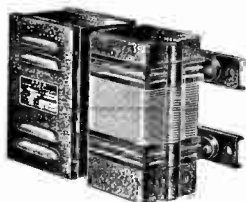

Incorporates harmonic neutralizer circuit . . . $\pm 1\%$ regulated . . . less than 3% harmonic distortion.

All models — Input 95-125 v, Output 115 v

Cat. No.	Cap. V.A.	DIMENSIONS IN INCHES					Ship'g Wght.
		A	B	C	E	F	
5003	60	11 $\frac{3}{4}$	4 $\frac{3}{16}$	4 $\frac{1}{2}$	10 $\frac{3}{4}$	2 $\frac{5}{8}$	22
5004	120	11	7 $\frac{1}{8}$	5 $\frac{7}{8}$	8 $\frac{3}{4}$	6 $\frac{1}{2}$	31
5005	250	8 $\frac{1}{2}$	16 $\frac{7}{8}$	6 $\frac{1}{4}$	3 $\frac{1}{2}$	15 $\frac{3}{8}$	60
5006	500	10 $\frac{3}{4}$	16 $\frac{7}{8}$	6 $\frac{1}{4}$	5 $\frac{1}{4}$	15 $\frac{3}{8}$	84
5008	1000	14 $\frac{1}{8}$	21 $\frac{1}{4}$	8 $\frac{3}{4}$	6 $\frac{3}{4}$	20	175
5010	2000	20 $\frac{3}{8}$	26 $\frac{1}{4}$	9 $\frac{5}{8}$	12 $\frac{1}{4}$	24 $\frac{1}{4}$	315

Transformers of catalog numbers 5003 and 5004 are now equipped with a primary cord and a secondary receptacle output for convenience in the laboratory. All other transformers are manufactured with knockout boxes.

ADJUSTABLE . . . REGULATED . . . A.C. VOLTAGE SUPPLY With Harmonic Filter TYPE CVL



One outlet regulated $\pm 1\%$ and adjustable from 0 to 130 volts. One outlet for fixed value 115 volts regulated $\pm 1\%$. Total harmonic distortion less than 3%. Regulating response 1.5 cycles or less. Self-protecting against short circuit. Portable for use in shop or laboratory.

Input 95-125 v; Output No. 1, 115 v; Output No. 2, 0-130 v

Cat. No.	Cap. V.A.	DIMENSIONS IN INCHES			Ship'g Wght.
		A	B	C	
50105	250	14	7 $\frac{1}{2}$	12 $\frac{5}{8}$	50
50106	500	15 $\frac{3}{4}$	7 $\frac{1}{2}$	13 $\frac{5}{8}$	75

CONSTANT VOLTAGE TRANSFORMER FOR TELEVISION RECEIVERS TYPE CVA



Voltage regulation for home TV Receivers eliminates flicker and distortion due to line voltage variations. Moderate price . . . plug-in type . . . regulation $\pm 3\%$ or less.

Input 95-130 v, Nominal Output Value in 115-120 v range.

Cat. No.	Cap. V.A.	DIMENSIONS IN INCHES			Ship'g Wght.
		A	B	C	
7201	180	7 $\frac{1}{4}$	8 $\frac{1}{4}$	4 $\frac{3}{4}$	21
7202	300	7 $\frac{1}{4}$	9 $\frac{1}{8}$	4 $\frac{3}{4}$	28

DIMENSIONS —

A: Overall Length; B: Overall Width; C: Overall Height; E & F: Mounting Dimensions

ILLUSTRATIONS FOR STANDARD TYPE "CV" UNITS ON RIGHT HAND PAGE

TYPE 1



TYPE 12



TYPE 2

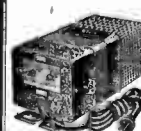

TYPE 21



TYPE 22

TYPE 3



TYPE 4



TYPE 5



TYPE 6

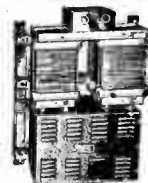

SOLA Electric Co. • Chicago 50, Ill.

STANDARD TYPE "CV"

SOLO *Constant Voltage* TRANSFORMERS

ELECTRICAL AND MECHANICAL SPECIFICATIONS

60 CYCLE, SINGLE PHASE

Catalog Number	Output Capacity in VA	VOLTAGE		Dimensions in Inches					Approx. Shipping Weight	
		Input Range	±1% Regulated Output	A	B	C	E	F		
TYPE 1										
30488	15	95-125	6.0	5 $\frac{1}{8}$	2 $\frac{5}{8}$	3 $\frac{1}{2}$	5 $\frac{1}{8}$	6	
30492	15	95-125	6.3	5 $\frac{1}{8}$	2 $\frac{5}{8}$	3 $\frac{1}{2}$	5 $\frac{1}{8}$	6	
30498	15	95-125	115.0	5 $\frac{1}{8}$	2 $\frac{5}{8}$	3 $\frac{1}{2}$	5 $\frac{1}{8}$	6	
TYPE 12										
301002	15	95-125	6.3	5 $\frac{1}{4}$	3 $\frac{1}{2}$	2 $\frac{1}{4}$	3	1 $\frac{1}{2}$	2 $\frac{1}{2}$	
301003	15	95-125	115.0	5 $\frac{1}{4}$	3 $\frac{1}{2}$	2 $\frac{1}{4}$	3	1 $\frac{1}{2}$	2 $\frac{1}{2}$	
TYPE 2										
30804	30	95-125	115.0	8 $\frac{1}{8}$	4 $\frac{1}{8}$	4 $\frac{3}{8}$	7 $\frac{7}{8}$	2 $\frac{3}{8}$	12	
30805	60	95-125	115.0	8 $\frac{1}{8}$	4 $\frac{1}{8}$	4 $\frac{3}{8}$	8 $\frac{1}{8}$	2 $\frac{3}{8}$	13	
30806	120	95-125	115.0	9 $\frac{3}{4}$	4 $\frac{1}{8}$	4 $\frac{3}{8}$	9	2 $\frac{3}{8}$	17	
30888	150	95-125	115.0	10 $\frac{1}{4}$	4 $\frac{1}{8}$	4 $\frac{3}{8}$	9 $\frac{1}{2}$	2 $\frac{3}{8}$	18	
TYPE 21										
30881	25	95-125	6.3	8 $\frac{1}{8}$	4 $\frac{1}{8}$	4 $\frac{3}{8}$	7 $\frac{1}{8}$	2 $\frac{3}{8}$	12	
30882	50	95-125	6.3	8 $\frac{1}{8}$	4 $\frac{1}{8}$	4 $\frac{3}{8}$	8 $\frac{1}{8}$	2 $\frac{3}{8}$	13	
TYPE 22										
30885	60	95-125	115.0	10 $\frac{3}{8}$	4 $\frac{1}{8}$	4 $\frac{3}{8}$	9 $\frac{5}{8}$	2 $\frac{3}{8}$	13	
30886	120	95-125	115.0	11 $\frac{1}{4}$	4 $\frac{1}{8}$	4 $\frac{3}{8}$	10 $\frac{1}{2}$	2 $\frac{3}{8}$	17	
TYPE 3										
30807	250	95-125	115.0	11 $\frac{5}{8}$	6 $\frac{1}{8}$	5 $\frac{5}{8}$	3 $\frac{1}{4}$	6 $\frac{1}{8}$	30	
30M807	250	190-250	115.0	11 $\frac{5}{8}$	6 $\frac{1}{8}$	5 $\frac{5}{8}$	3 $\frac{1}{4}$	6 $\frac{1}{8}$	30	
30808	500	95-125	115.0	14 $\frac{1}{2}$	6 $\frac{1}{8}$	5 $\frac{5}{8}$	5	6 $\frac{1}{8}$	40	
30M808	500	190-250	115.0	14 $\frac{1}{2}$	6 $\frac{1}{8}$	5 $\frac{5}{8}$	5	6 $\frac{1}{8}$	40	
TYPE 4										
30809	1000	95-125	115.0	19 $\frac{1}{8}$	9 $\frac{1}{2}$	7 $\frac{7}{8}$	6 $\frac{3}{4}$	8 $\frac{1}{2}$	110	
30M809	1000	190-250	115.0	19 $\frac{1}{8}$	9 $\frac{1}{2}$	7 $\frac{7}{8}$	6 $\frac{3}{4}$	8 $\frac{1}{2}$	110	
30811	2000	95-125	115.0	31 $\frac{1}{8}$	9 $\frac{1}{2}$	7 $\frac{7}{8}$	12 $\frac{1}{4}$	8 $\frac{1}{2}$	205	
30M811	2000	190-250	115.0	31 $\frac{1}{8}$	9 $\frac{1}{2}$	7 $\frac{7}{8}$	12 $\frac{1}{4}$	8 $\frac{1}{2}$	205	
30968	2000	190-250	230.0	30 $\frac{1}{8}$	9 $\frac{1}{2}$	7 $\frac{7}{8}$	12 $\frac{1}{4}$	8 $\frac{1}{2}$	205	
TYPE 5										
301706	3000	95-190—125-250	115.0	27 $\frac{1}{8}$	16 $\frac{1}{4}$	12	23 $\frac{3}{8}$	14 $\frac{1}{4}$	345	
301707	3000	190-380—250-500	230.0	27 $\frac{1}{8}$	16 $\frac{1}{4}$	12	23 $\frac{3}{8}$	14 $\frac{1}{4}$	345	
301704	4000	95-190—125-250	115.0	32 $\frac{1}{8}$	16 $\frac{1}{4}$	12	28 $\frac{3}{8}$	14 $\frac{1}{4}$	415	
301702	5000	95-190—125-250	115.0	39 $\frac{1}{8}$	16 $\frac{1}{4}$	12	34 $\frac{1}{2}$	14 $\frac{1}{4}$	485	
301703	5000	190-380—250-500	230.0	39 $\frac{1}{8}$	16 $\frac{1}{4}$	12	34 $\frac{1}{2}$	14 $\frac{1}{4}$	485	
TYPE 6										
301700	10,000	190/380-250/500	115.0	48 $\frac{1}{8}$	34 $\frac{1}{4}$	14	41 $\frac{1}{2}$	31 $\frac{1}{4}$	1025	
301701	10,000	190/380-250/500	230.0	48 $\frac{1}{8}$	34 $\frac{1}{4}$	14	41 $\frac{1}{2}$	31 $\frac{1}{4}$	1025	

DIMENSIONS — A: Overall Length; B: Overall Width; C: Overall Height; E & F: Mounting Dimensions

SOLO Electric Co. • Chicago 50, Ill.

Gothard CONVERTERS

Springfield, Illinois

DYNAMOTORS

GOTHARD DYNAMOTORS

The GOTHARD Model "GP-26" is especially designed and built for Mobile Transmitter applications, intermittent duty. Length 7 1/4", Diam. 3 1/2", Height 4", Weight 8 1/2 lbs.

INPUT		OUTPUT		Watts	Approx. Effic.	App. Reg.
Volts	Amps.	Volts	MA			
5.6	24	400	200	80	60%	17%
5.6	26	600	150	90	61%	18%
5.6	29	400	250	100	61%	19%
5.6	31	620	170	105	61%	20%
5.6	33	500	225	112	61%	21%
5.6	34	420	280	118	62%	22%
6.0	40	400	375	150	68%	25%

Prices upon request. Submit your special requirements to our engineers.

Also supplied for 12, 14, 24, 28, or 32 Volt input.

For continuous duty applications, Models GP-12, GP-17 and GP-26 cover wattage ratings from 20 to 80 Watts. Input voltages 6, 12, 24, or 32.

GP-12: Length 5 3/4", Diam. 3 1/2", Height 4", Weight 5 1/4 lbs.

GP-17: Length 6 1/4", Diam. 3 1/2", Height 4", Weight 6 lbs.

GP Models have steel mounting bases; width 4 1/8".

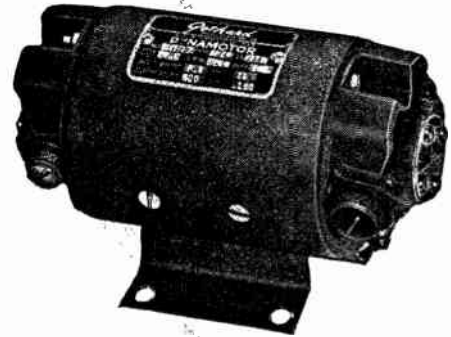

MODEL "GP-26" DYNAMOTOR



MODEL "SF-20" DYNAMOTOR

GOTHARD AIRCRAFT DYNAMOTORS

Frame Size	INPUT		OUTPUT		Length	Diam.	Weight
	Volts	Amps.	Volts	MA			
DS-12	12	2.6	250	60	4 3/4"	2 3/4"	2 7/8"
DS-17	12	3.6	250	90	5 1/4"	2 3/4"	3 7/8"
SP-12	12	4.0	250	100	6"	3 1/2"	4 3/4"
SP-17	12	5.2	300	125	6 1/2"	3 1/2"	5 1/4"
SP-22	12	6.4	400	125	7"	3 1/2"	6 1/2"
SF-20	12	8.4	400	150	6 3/4"	4"	8 1/2"
SF-25	12	10.	500	150	7 1/4"	4"	9 3/4"

Prices upon request. Submit your special requirements to our engineers.

Above ratings are continuous duty with temperature of 40°C.

Also supplied for 6, 14, 24, 28, or 32 Volt input. "SP" and "SF" dynamotors may be supplied in fan-ventilated construction as types "SPF" and "SFF". Prices upon request.

GOTHARD ROTARY CONVERTERS

TYPE "K" 3600 RPM Rated Output 110V AC 60 cycles 1 phase 0.90 p.f.

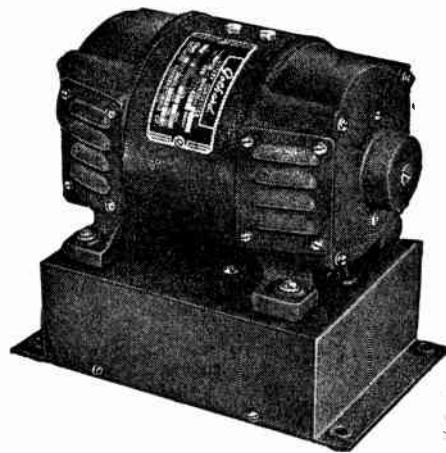

MODEL "AK-15" CONVERTER (With Filter)

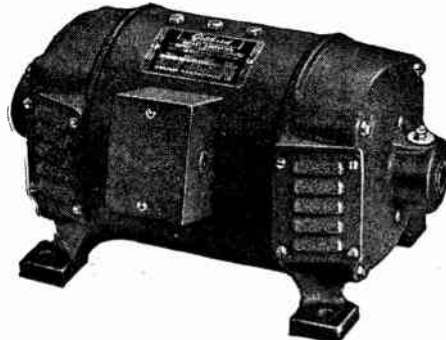

MODEL "BK-35" CONVERTER (Less Filter)

Model No.	Frame Size	Input		Output		Net Weights		List Prices	
		Volts	Amps.	VA at 0.90 pf	with Filter	Less Filter	with Filter	Less Filter	
6K11	AK-15	6	3.6	110	30	24	\$152.70	\$134.70	
12K11	AK-15	12	1.8	110	30	24	152.70	134.70	
12K16	AK-25	12	2.4	160	35	29	165.20	146.15	
12K30	BK-22	12	3.0	800	48	43	196.70	158.70	
24K11	AK-15	24	.9	110	30	24	152.70	134.70	
24K30	AK-25	24	1.94	800	48	43	196.70	158.70	
24K50	BK-35	24	3.4	500	56	51	232.10	194.10	
28K50	BK-35	28	2.6	500	56	51	232.10	194.10	
28K65	CK-35	28	3.5	850	79	74	333.60	284.30	
3K11	AK-15	32	6.2	110	30	24	142.70	125.90	
3K20	AK-25	32	1.4	200	35	29	154.40	136.60	
3K30	BK-22	32	1.4	800	48	43	183.80	148.30	
3K50	BK-35	32	2.2	500	56	51	216.90	181.40	
4K11	AK-15	48	4.4	110	30	24	152.70	134.70	
4K20	AK-25	48	7.0	200	35	29	165.20	146.15	
4K30	BK-22	48	9.7	800	48	43	196.70	158.70	
4K50	BK-35	48	15.2	500	56	51	232.10	194.10	
4K75	CK-35	48	22.7	750	79	74	333.60	284.30	
1K11	AK-15	115	1.8	110	30	24	142.70	125.90	
1K20	AK-25	115	3.0	200	35	29	154.40	136.60	
1K30	BK-22	115	4.2	800	48	43	183.80	148.30	
1K50	BK-35	115	6.6	500	56	51	216.90	181.40	
1K75	CK-35	115	9.4	750	79	74	311.80	265.70	
1K100	CK-35	115	12.4	1000	79	74	374.40	326.10	
1K125	CK-45	115	15.4	1250	87	80	394.40	346.10	
2K11	AK-15	230	.9	110	30	24	146.95	129.65	
2K20	AK-25	230	1.5	200	35	29	159.05	140.70	
2K30	BK-22	230	2.1	300	48	43	189.30	132.75	
2K50	BK-35	230	3.3	500	56	51	223.40	186.85	
2K75	CK-35	230	4.7	750	79	74	321.15	273.70	
2K100	CK-35	230	6.2	1000	79	74	385.60	335.90	

Ball Bearings and Filters are standard on all models. Unless ordered otherwise Converters are furnished with filter. Can be furnished with Marine Type Filter, 220V AC output, automatic frequency control, manual frequency control, 28, 48 or 64 volt input, 50 cycle output, other ratings not listed above. Prices and delivery on request.

PRICES

Prices of manufacturers and suppliers' products listed in **RADIO'S MASTER** are subject at all times to change without notice — they should not be considered final.

Get quick on-the-spot quotations from your distributor who subscribes to our perpetual up-to-the-minute **PRICING SERVICE**.



Official Pricing System of radio - electronic - television parts and equipment. Supported by the industry: distributors, manufacturers, and their sales representatives.

Loose-leaf, flexible binder. Contains over 1100 pages.

Published by
UNITED CATALOG PUBLISHERS, INC.
106-110 Lafayette Street
New York 13, N. Y.

DELIVERY

Delivery is often dependent on the availability of raw materials. So check with your distributor for delivery information.



STANCOR TRANSFORMERS AND RELATED COMPONENTS

TELEVISION COMPONENTS

This section contains only specific television components. Consult following Stancor pages for other audios, powers and chokes having extensive application in television, radio and electronics.

HORIZONTAL DEFLECTION AND HIGH VOLTAGE (FLYBACK) TRANSFORMERS

Stancor exact replacement flybacks are built from the set manufacturers' original specifications. They are exact electrical and physical duplicates of the units they are designed to replace. No circuit or chassis alteration is required for their installation.

Part No.	Approx. Anode Kv	Application	Mounting Type	Shpg. Wt. in Lbs.	List Price
A-8119	13-14	Exact replacement, RCA 211T5	HH	1.8	\$11.80
A-8127	9-10	Exact replacement, RCA 211T1 and 211T3	HH	1.8	9.85
A-8128	10-11	Similar to A-8127, for higher voltage applications. Exact replacement for Admiral 79C23-3, 79C28-1; Airline 22E42; Dumont 20-375, 20004261; Hoffman 5123, 5134, Majestic C9.240-1; Meek, Philharmonic, Teletone and many others	HO	1.8	10.90
A-8129	12-13	Conversion unit	HH	1.8	10.65
A-8130	10-14	Universal unit. Packed with six schematics showing connections for various circuits. Exact replacement G.E. 77J1 except where 6CD6 horizontal output tube is used	HG	0.9	10.00
A-8131	11-13	Exact replacement for Dumont, Capehart, Emerson, Packard-Bell, RCA and others using direct drive circuits	HR	0.5	6.50
A-8132	13-15	Exact replacement for Muntz TO-0031	HM	1.3	10.50
A-8133	12.5-15	Exact replacement for Admiral 79C30-1, 79C30-3	HA	1.0	10.50
A-8134	12.5-15	Exact replacement for Admiral 79C30-2, 79C30-4, 79C38-1, 79D38-1	HA	1.0	10.50
A-8135	13-15	Exact replacement for Admiral 79D41-1, 79D41-2, also replaces Sheraton Video products EL-106, EL-119, EL-119B	HB	1.2	10.75
A-8136	13-15	Exact replacement for Philharmonic 80-263, 80-265, 20-265-2, used in Apex, Ambassador, AMC, Brunswick, Pathe, Silvertone, also used in Airline, Jackson, Lafayette, Meek, Olympic, Starrett and many others	HP	1.2	10.00
A-8137	13-15	Exact replacement for Hoffman 5035	HC	1.2	10.00
A-8220	13-15	Exact replacement for Philco 32-8565, including terminal board components	HD	1.0	10.65
A-8221	13-15	Exact replacement for Philco 32-8555, with capacitor, resistor and choke coil on terminal board	HD	1.0	11.25
A-8222	13-15	Exact replacement for Philco 32-8533 and 32-8534 with capacitor, resistor and choke coil on terminal board	HD	1.0	10.70
A-8223	13-15	Exact replacement for Philco 32-8572, with choke coil on terminal board	HC	1.2	9.65
A-8224	13-15	Exact replacement for Motorola 24C711265, 24C71126A, 24C721290, with horizontal centering pot, variable gap width control and tube socket on terminal board	HE	1.5	13.10
A-8225	13-15	Exact replacement for Motorola 24K71213, with same components as A-8224	HE	1.3	13.10
A-8226	13-15	Exact replacement for Motorola 24K721301, 24K721301C, 24K721517C, with same components as A-8224	HE	1.3	13.10
A-8227	13-15	Exact replacement for Sylvania 241-0003	HJ	0.8	7.20
A-8228	13-15	Exact replacement for Sylvania 241-0005 and 241-0006	HJ	0.8	7.70
A-8229	13-15	Exact replacement for Sylvania 241-0007	HJ	0.9	8.10
A-8230	13-15	Exact replacement Air King, CBS-Columbia and Silvertone part numbers 10104, 10107, 10108, 10110, 10126 and 10135	HK	1.0	10.50
A-8231	13-15	Exact replacement for CBS-Columbia and Silvertone part numbers 10136, 10136B, 10137, 10138 and 10159	HK	1.0	10.50
A-8232	13-15	Exact replacement for Emerson 738067, 738068, 738069, 738073, 738074, 738075 and 738082	HL	1.0	10.50
A-8233	13-15	Exact replacement for RCA 76430 and 76795	HC	1.2	10.35
A-8234	13-15	Exact replacement for RCA 76501	HN	0.8	6.30
A-8235	13-15	Exact replacement for RCA 75519, 75585 and 76381	HN	0.8	6.65

DEFLECTION YOKES

All Stancor deflection yokes have ferrite cores and cosine distributed windings for anti-astigmatic focusing. All units with an "A" suffix have networks and extra long leads.

The networks have a capacitor across each half of the horizontal coils. There will

always be a capacitor across the "high" half of the yoke—regardless of circuit variations. Network rewiring is virtually eliminated.

All yokes have molded coil forms that automatically orient the coils to provide a minimum of "crosstalk." Shipping weight 1.0 lbs.

Part No.	Coil Inductance in Mh.		Coil Resistance in Ohms		Max. Scan.	Case Diam.	Unit Length	Mtg. Type	List Price
	Horizontal	Vertical	Horizontal	Vertical					
DY-1A	8.3	50	13.5	66	53°	3 1/8	3	DY	\$7.90
DY-2A	10.3	50	14.5	66	70°	3 1/8	2 1/4	DF	10.00
DY-7A	8.5	50	13.5	50	70°	3 1/8	2 1/4	DY	9.25
DY-8A	8.5	50	14.5	52.5	70°	3 1/8	2 1/4	DF	10.00
DY-9A	13.5	50	17.5	53.5	70°	3 1/8	2 1/4	DF	10.00
DY-10A	30.0	3.5	45	3.5	70°	3 1/8	2 1/4	DF	10.00
DY-11A	20.0	50	23	50	70°	3 1/8	2 1/4	DF	10.00
DY-12A	30.0	50	34	50	70°	3 1/8	2 1/4	DF	10.00

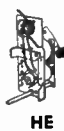



TELEVISION COMPONENTS

CHICAGO STANDARD TRANSFORMER CORPORATION

POWER TRANSFORMERS— All Primaries for 117V, 60 Cycle Operation

Part No.	Plate Supply	DCMA	Max DCMA#	Rect. Volts	Fil. Amps.	Other Fil. Volts	Fil. Amps.	Height Overall	Base Area	Mtg. Ctrs.	Mtg. Type	Shpg. Wt. in Lbs.	List Price
P-8158	117 ¹	200				6.3 6.3 6.3	4.25 4.0 2.0	3½	3¼ x 4½	2¼ x 3¼	M†	6.2	\$15.85
P-8338	117	280				6.3 6.3 6.3	9.5 0.6 1.2	4¼	3¼ x 4½	3¼ x 4¼	M†	8	16.00
P-8168	220-0-220 130-0-130	330 220		5.0	3.0	6.3† 6.3† or 12.6 CT†	6.5 6.5 6.5	4¾	3¼ x 4½	3 x 3¼	M†	10.5	28.85
P-8155	225-0-225	90	105	5.0	2.0	6.3	5.15	3¾	2½ x 3¾	2¼ x 2½	M	4.5	11.10
P-8353	265-0-265	300		5.0	6.0	12.6 CT	6.0	5¾	3¼ x 5¼	3 x 4	C3	12½	26.00
P-8334	275-0-275	305		5.0	5.0	6.3 6.3	8.5 1.2	5½	3¼ x 4½	3¼ x 4¼	M†	13	22.75
P-8167	280-0-280	400	450	5.0	6.0	6.3 6.3	4.5 8.5	6	3½ x 4¾	3¼ x 4¼	M†	13.0	28.50
P-8332	280-0-280	260		5.0	5.0	6.3 6.3 6.3	7.1 1.2 .9	4¾	3¼ x 4½	3¼ x 4¼	M†	11	20.75
P-8352	290-0-290	240		5.0	3.0	12.6 CT	5.25	4¾	3¼ x 4¾	3 x 3½	C	8½	19.85
P-8333	295-0-295	225		5.0 CT	3.0	6.3 6.3	11.4 .9	4¾	3¼ x 4½	3¼ x 4¼	M3†	10	19.50
P-8335	300-0-300	325		5.0	6.0	6.3 6.3	8.8 1.5	5	3¼ x 4½	3¼ x 4¼	M†	13	22.75
P-8164	300-0-300	225	250	5.0	3.0	6.3	9.0	4½	3¼ x 4½	2¼ x 3¼	M†	7.5	20.10
P-8331	310-0-310	240		5.0	3.0	6.3 6.3	6.4 3.0	4½	3¼ x 4½	3¼ x 4¼	M†	9	18.75
P-8337	315-0-315	225		5.0	3.0	6.3	8.25	4½	3¼ x 4½	3¼ x 4¼	M3	8½	20.10
P-8338	315-0-315	310		5.0	6.0	6.7 6.4	10.0 1.6	5½	3¼ x 4¾	3¼ x 3¾	M†	12½	20.40
P-8339	325-0-325	255		5.0	3.0	12.6 CT	5.25	4¾	3¼ x 5	3 x 3¾	C	8½	16.75
P-5059§	337.5-0-337.5	200	225	5.0 CT	3.0	6.3 CT	5.0	4¾	4¾ x 4	3 x 3¾	C	9.6	18.90
P-8166	340-0-340	330	360	5.0	6.0	6.3 6.3† 6.3† or 12.6 CT†	2.5 5.0 5.0 5.0	6	3½ x 4¾	3¼ x 4¼	M†	13.0	29.55
P-8345	350-0-350	215		5.0	3.0	6.3 6.3	9.0 1.2	5	3¼ x 4½	3¼ x 4¼	M†	11½	20.10
P-8165	350-0-350 220-0-220	180 70		5.0	3.0	6.3 6.3	2.0 10.0	4¾	3¼ x 4½	3 x 3¾	M†	11.0	26.90
P-8340	355-0-355	270		5.0	6.0	6.3 6.3 6.3	9.5 1.65 2.4	4½	3¼ x 4½	3¼ x 4¼	M†	12	21.20
P-8350	350-0-350	270		5.0	6.0	5.0 6.3 6.6	2 1.6 7.8	5¼	3¼ x 4½	3¼ x 4¼	M†	13	22.90
P-8341	360-0-360 220-0-220	175 110		5.0 5.0	3.0 2.0	12.6 CT	5.45	4¾	3¼ x 4¾	3 x 3½	C†	11	20.10
P-8160	358-0-358	185 65		5.0	3.0	6.45	12.0	4¾	3¼ x 4½	3 x 3¾	M	9.6	20.25
P-8349	360-0-360	260		5.0	6.0	5.0 6.3	2 8.85	5¼	3¼ x 4½	3¼ x 4¼	M†	13	27.90
P-8159	360-0-360	250	290	5.0	3.0	5.0 6.3 6.3	2.0 8.0 0.6	5½	3½ x 4¾	3¼ x 4¼	M†	10.0	23.50
P-8351	360-0-360	240		5.0	6.0	6.5	9.3	4¾	3¼ x 4½	3¼ x 4¼	M	10½	23.90
P-8343	360-0-360 220-0-220	220 110		5.0 5.0	3.2 2.0	12.8 CT	5.8	4¾	3¼ x 5¼	3 x 3¾	C	11½	20.50
P-8344§	365-0-365 200-0-200	170 84		5.0 5.0	3.2 2.0	12.6	4.25	4¾	3¼ x 4½	3 x 3¾	C	9	19.50
P-8342	365-0-365	260		5.0	6.0	6.3 6.3	8.85 1.2	5¼	3¼ x 4½	3¼ x 4¼	M†	13	20.10
P-8156	365-0-365	295	340	5.0	6.0	5.0 12.6 CT	2.0 5.0	6¾	3½ x 4¾	3¼ x 4¼	M†	16.5	29.15
P-8348	365-0-365	270		5.0	6.0	6.7	4.5	4¾	3¼ x 4½	3¼ x 4¼	M†	10	23.90
P-8163	370-0-370	190	225	5.0	3.0	6.3 6.3	7.75 1.2	5½	3½ x 4¾	3¼ x 4¼	M†	10.8	24.10
P-6315	370-0-370	275	310	5.0 CT	3.0	6.3 CT	7.0	4¾	3¼ x 4½	3 x 3¾	M	9.3	19.50
PM-8411	375-0-375	150		5.0	3.0	6.3 CT	4.5	3¾	3½ x 4½	2¼ x 3¾	M	5.8	12.70
P-8154	375-0-375	205	230	5.0	3.0	5.0 6.3	2.0 5.6	4¾	4¾ x 4½	3 x 3¾	M	9.1	18.50

†Loading to maximum DCMA will have no appreciable effect on the service or life of the transformer.
 ‡May be used as 6.3V windings or in series as 12.6V C.T.

§For use in voltage doubler circuits.

¶With copper shorting band to reduce external magnetic field.

‡Primary for 117/107 volts.

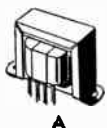

TELEVISION COMPONENTS

CHICAGO STANDARD TRANSFORMER CORPORATION



POWER TRANSFORMERS—ALL PRIMARIES FOR 117V, 60 CYCLE OPERATION—Continued

Part No.	Plate Supply AC Volts	DCMA	Max. DCMA#	Rect. Volts	Fil. Amps.	Other Fil. Volts	Fil. Amps.	Height Overall	Base Area	Mtg. Ctrs.	Mtg. Type	Shpg. Wt. in Lbs.	List Price
P-8171	375-0-375	225	250	5.0	3.0	6.3 6.3	2.0 9.0	5	3 3/4 x 4 1/2	3 x 3 3/4	M3†	10.5	23.60
P-8182	380-0-380	180	210	5.0 CT	3.0	6.3	9.0	5 1/2	4 1/8 x 3 3/16	2 3/4 x 3 3/16	M3†	9.0	19.25
P-8169	380-0-380	220	250	5.0	3.0	6.3 6.3† 6.3† 7.0	1.2 5.0 7.0	4 5/8	3 3/4 x 4 1/2	3 x 3 3/4	M†	10.5	23.65
P-8170	380-0-380	220	250	5.0	3.0	6.3 6.3† 6.3† 7.0	1.2 5.0 7.0	4 3/4	4 x 4 3/4	3 x 3 3/16	C	10.5	23.00
*P-8347	385-0-385	230		5.0	3.0	5 6.45 6.3	2 7.4 1.6	5 5/8	3 3/4 x 4 1/2	3 3/16 x 4 3/16	M†	13	\$28.25
P-8157	335-0-335 235-0-235	195 105		5.0 5.0	3.0 2.0	6.3 6.3 5.0	7.65 0.6 2.0	4 3/4	3 3/4 x 4 1/2	3 x 3 3/4	M	11.1	25.10
P-8181	385-0-385	230	270	5.0 5.0	3.0 2.0	6.3	9.0	5 1/8	3 13/16 x 4 3/4	3 3/16 x 4 1/16	M†	11.8	26.85
PM-8412	400-0-400	200		5.0	3.0	6.3 CT	5.0	3 7/8	3 3/4 x 4 1/2	3 x 3 3/4	M	8.2	14.30
*P-8346	400-0-400 330-0-300	180 180		5.0 5.0	3.0 3.0			4 5/8	3 3/4 x 4 3/4	3 x 3 1/2	C	11	24.50

†Loading to maximum DCMA will have no appreciable effect on the service or life of the transformer.

‡May be used as 6.3V windings or in series as 12.6 V C.T.

§For use in voltage doubler circuits.

¶With copper shorting band to reduce external magnetic field.

‡Primary for 117/107 volts

FILTER CHOKES

Part No.	At Rated DC Ma.	Inductance At 75 % Ma.	At 115 % Ma.	DC Res. in Ohms	RMS. V. Inaul.	Height Overall	Base Area	Mtg. Ctrs.	Mtg. Type	Shpg. Wt. in Lbs.	List Price
C-1646	5.0 hy. 200 ma.	7.0 hy.	3.7 hy.	90	5,000	4	3 1/4 x 3 3/8	2 1/2 x 2 3/8	C	4.5	\$9.00
C-1703	4.0 hy. 250 ma.	4.5 hy.	3.5 hy.	60	3,000	3 1/2	2 7/8 x 3 3/8	2 1/4 x 2 1/2	B	4.2	9.10
C-1709	9.0 hy. 85 ma.	10.5 hy.	7.5 hy.	250	1,500	2	3 1/4 x 2	2 13/16	A	1.4	3.40
C-1721	8.5 hy. 200 ma.	9.5 hy.	7.5 hy.	120	3,000	3 1/8	3 3/8 x 3	2 1/2 x 2 1/4	N	4.4	8.20
C-2303	2.5 hy. 130 ma.	3.0 hy.	2.1 hy.	100	2,000	2	3 1/4 x 1 3/4	2 13/16	A	1.0	3.10
C-2304	2.3 hy. 150 ma.	2.6 hy.	2.0 hy.	60	1,500	2	3 1/4 x 1 3/4	2 13/16	A	1.0	3.20
C-2309	3.0 hy. 150 ma.	3.6 hy.	2.5 hy.	90	2,000	2 1/4	3 3/4 x 2 1/4	3 1/8	A	1.7	3.85
C-2325	2.0 hy. 200 ma.	2.5 hy.	1.5 hy.	60	1,500	2 1/4	3 3/4 x 2 1/4	3 3/8	A	1.8	3.85
C-2326	1.0 hy. 300 ma.	1.5 hy.	0.6 hy.	43	1,500	2 1/4	3 3/4 x 2 1/4	3 3/8	A	1.7	4.35
C-2327	1.5 hy. 200 ma.	1.7 hy.	1.3 hy.	85	1,500	1 5/8	2 7/8 x 1 1/2	2 3/8	A	0.8	2.45
C-2328	0.8 hy. 375 ma.	1.0 hy.	0.65 hy.	25	1,500	2 1/4	3 3/4 x 2	3 3/8	A	1.5	5.05
C-2334	2.8 hy. 300 ma.	3.3 hy.	2.2 hy.	60	1,500	2 5/8	2 1/4 x 4	3 3/8	A	2.5	4.25

FILAMENT TRANSFORMERS

Part No.	Secondary Volts	Amps.	RMS. V. Insul.	Primary Volts	Height Overall	Base Area	Mounting Centers	Mtg. Type	Shpg. Wt. in Lbs.	List Price
P-3064	6.3 CT	6.0	2,500	117	3 1/8	2 1/2 x 2 7/8	2 x 2	B	2.4	\$6.25
P-6134	6.3 CT	1.2	2,500	117	1 5/8	2 7/8 x 1 5/8	2 3/8	A	0.8	2.90
P-6308	6.3 CT	10.0	2,500	117/107	3 3/8	2 7/8 x 2 3/4	2 1/4 x 2 3/8	N	3.4	7.50
P-8190	6.3	1.2	5,000	117	2	3 3/4 x 1 3/4	2 13/16	A	1.0	3.80
P-8191	6.3	1.2	5,000	6.3	2	3 3/4 x 1 3/4	2 13/16	A	1.0	4.10

VERTICAL BLOCKING-OSCILLATOR TRANSFORMERS

Part No.	Turns Ratio Pri./Sec.	Height Overall	Base Area	Mounting Centers	Mtg. Type	Shpg. Wt. in Lbs.	List Price
A-8111	1:4.2	1 1/2	1 1/2 x 2 1/2	2	A	0.4	\$2.70
A-8121	1:4.2	1 3/4	1 1/2 x 2 3/8	1 13/16	TD	0.4	3.45
A-8122	1:4.2	1 5/8	1 3/8 x 1 3/8	1 1/4	TS	0.3	4.20
A-8124	Sec. #1 1:0.48 Sec. #2 1:1	1 5/8	1 5/8 x 2 3/8	2 3/8	A	0.7	4.15
A-8125	1:4.2	1 3/8	2 3/8 x 1 1/4	1 3/4	A	0.4	2.70
A-8126	1:15	1 3/4	1 1/2 x 2	1 3/4	S	0.5	2.75

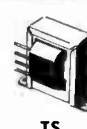
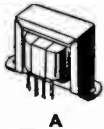



TELEVISION COMPONENTS

CHICAGO STANDARD TRANSFORMER CORPORATION

FOCUS COILS

Part No.	Resistance DC Ohms	Max. DC Ma.	Case Dimensions	Case Depth	Mounting Centers	Mtg. Type	Shpg. Wt. in Lbs.	List Price
FC-10	247	200	3 $\frac{1}{2}$ x 3 $\frac{1}{2}$	1 $\frac{3}{4}$	Two 8-32 Screws	FC	2.0	\$8.55
FC-11	470	140	4 $\frac{3}{4}$ Dia.	1 $\frac{1}{2}$	2 $\frac{1}{2}$ Radius—120° Apart	FO	3.2	10.90
FC-12	370	165	3 $\frac{1}{2}$ x 3 $\frac{1}{2}$	1 $\frac{3}{4}$	Two 8-32 Screws	FC	2.0	8.55

VERTICAL DEFLECTION OUTPUT TRANSFORMERS

Part No.	Turns Ratio Pri./Sec.	Primary Impedance—	D.C. Res. in Ohms Pri.	Sec.	Height Overall	Base Area	Mtg. Ctrs.	Mtg. Type	Shpt. Wt. in Lbs.	List Price
A-8112	10:1	18,000 ohms at 12 DCMA	1300	10	2	1 $\frac{1}{2}$ x 3 $\frac{1}{4}$	2 $\frac{1}{8}$	A	1.0	\$4.35
A-8113	8.8:1	16,500 ohms at 10 DCMA	700	12	2	1 $\frac{1}{2}$ x 3 $\frac{1}{4}$	2 $\frac{1}{8}$	A	1.0	4.45
A-8115	10:1	19,000 ohms at 13 DCMA	600	7	3 $\frac{1}{16}$	2 $\frac{1}{2}$ x 2 $\frac{1}{2}$	1 $\frac{1}{2}$ x 2	N	2.5	6.60
A-8116	10:1	18,000 ohms at 10 DCMA	525	7	3 $\frac{1}{16}$	2 $\frac{1}{2}$ x 2 $\frac{1}{2}$	1 $\frac{1}{2}$ x 1 $\frac{1}{2}$	N	2.2	6.05
A-8123§	11.4:1	17,000 ohms at 20 DCMA	1200	11	2	1 $\frac{1}{2}$ x 3 $\frac{1}{4}$	2 $\frac{1}{8}$	A	1.2	4.05
A-8140	44:1	11,000 ohms at 20 DCMA	400	0.3	3 $\frac{1}{16}$	2 $\frac{1}{2}$ x 2 $\frac{1}{2}$	1 $\frac{1}{2}$ x 2	N	2.5	6.85
A-8141§	18:1	30,000 ohms at 10 DCMA	1650	4.5	2 $\frac{1}{4}$	3 $\frac{1}{4}$ x 2 $\frac{1}{2}$	3 $\frac{1}{8}$	A	1.5	5.85
A-8142	8:1	19,000 ohms at 13 DCMA	540	10.5	2 $\frac{1}{2}$	2 $\frac{1}{4}$ x 3	2 $\frac{1}{2}$ x 1 $\frac{1}{2}$	N	2 $\frac{1}{2}$	5.10
*A-8143	10:1	14,000 ohms at 15 DCMA	625	14	2 $\frac{1}{4}$	2 $\frac{1}{4}$ x 3 $\frac{1}{8}$	3 $\frac{1}{8}$	A	2	4.35
*A-8144	9:1	9,500 ohms at 30 DCMA	540	15	2 $\frac{1}{4}$	1 $\frac{1}{2}$ x 3 $\frac{1}{8}$	3 $\frac{1}{8}$	A	1 $\frac{1}{2}$	3.85
*A-8145	9:1	11,000 ohms at 19 DCMA	540	14	2 $\frac{1}{2}$	2 $\frac{1}{4}$ x 2 $\frac{1}{2}$	—	N1	2	5.75
*A-8146§	6.9:1	6,000 ohms at 15 DCMA 4,700 ohms at 50 DCMA	375	10	2	1 $\frac{1}{2}$ x 3 $\frac{1}{4}$	2 $\frac{1}{8}$	A	1 $\frac{1}{2}$	4.00
*A-8147§	6:1	3,200 ohms at 40 DCMA	300	9	2	1 $\frac{1}{2}$ x 3 $\frac{1}{4}$	2 $\frac{1}{8}$	A	1	3.50
*A-8148§	8:1	6,000 ohms at 15 DCMA 4,700 ohms at 50 DCMA	375	6.5	2	1 $\frac{1}{2}$ x 3 $\frac{1}{4}$	2 $\frac{1}{8}$	A	1 $\frac{1}{2}$	4.25
*A-8149§	6.9:1	11,500 ohms at 20 DCMA	330	8.5	2	1 $\frac{1}{2}$ x 3 $\frac{1}{4}$	2 $\frac{1}{8}$	A	1	3.65

WIDTH AND LINEARITY CONTROLS

Part No.	Application	Inductance	Res. in Ohms	AGC Inductance	AGC Res. in Ohms	Mtg. Type	Shpg. Wt. in Lbs.	List Price
WC-1	Width coil	.050-.50 mh	0.53			WC	0.3	\$1.25
WC-2	Tapped Linearity Coil	.55-4.6 mh	8.3			WC	0.3	1.25
WC-4	Width coil	.170-.610 mh	1.0			WC	0.3	1.20
WC-5	Width Coil and/or Linearity Coil	4-39 mh	32	2.7-7.6 mh	19.5	WC	0.3	2.10
WC-6	Tapped Linearity Coil	1.3-4.1 mh	5.6			WC	0.3	1.30
*WC-7	Width coil	.5-3.5 mh	2.3			WC	0.3	1.25
*WC-8	Width coil	1.0-10.0 mh	8.0			WC	0.3	1.50
*WC-9	Width Coil with Keyed Winding	3.2-9 mh	28.0	.16-70 mh	1.0	WC	0.3	1.60
*WC-10	Width Coil With AGC	4.0-28 mh	32.0	2.6-7.5 mh	1.2	WC	0.3	1.75

HORIZONTAL BLOCKING-OSCILLATOR TRANSFORMERS

Part No.	Turns Ratio Pri./Sec.	Height Overall	Base Area	Mounting Centers	Mtg. Type	Shpg. Wt. in Lbs.	List Price
A-8110	2:1	1 $\frac{1}{2}$	1 $\frac{1}{2}$ x 2 $\frac{1}{2}$	2	A	0.4	\$3.05
A-8120	2:1	1 $\frac{1}{4}$	1 $\frac{1}{2}$ x 2 $\frac{1}{8}$	1 $\frac{1}{8}$	TD	0.4	4.30

TV BOOSTER TRANSFORMER

Part No.	Plate Supply AC Volts	DC MA	Filament Volts	Amps.	Height Overall	Base Area	Mtg. Ctrs.	Mtg. Type	Shpg. Wt. in Lbs.	List Price
P-8181	150 half wave	25	6.3	0.5	2	2 $\frac{1}{8}$ x 1 $\frac{1}{4}$	2	VE	0.8	\$4.35

*New Part Number. #Primary impedance measured at 30 V 60 cycle. §Autoformer type.



FO



FC

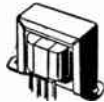

A



N

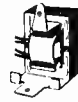

NI



TD



WC

HIGH FIDELITY TRANSFORMERS

CHICAGO STANDARD TRANSFORMER CORPORATION



AUDIO OUTPUT TRANSFORMERS

Part No.	Application	Max. Pri. DC	Max. Audio Watts	Height Overall	Base Area	Mtg. Ctrs.	Mtg. Type	Shpg. Wt. in Lbs.	List Price
A-2313	Single plate, 7,000 ohms, to 8 ohm voice coil	40 ma.	10	2	3 1/4 x 3 3/4	2 13/16	A	1.0	\$3.40
A-3303	Push-pull plates, 14,000 ohms, to 500/15/8/4 ohms line or voice coil	55 ma.	20	3 3/8	2 3/8 x 2 3/8	2 x 1 13/16	C	2.7	9.80
A-3330	Single plate, 2,000 ohms to 3.5 ohm voice coil	50 ma.	5	1 3/8	2 3/8 x 1 3/8	2	A	0.4	2.30
A-3332	Single plate, 2,000 ohms to 3.2 ohm voice coil	50 ma.	3	1 3/8	2 3/8 x 1	1 3/4	A	0.4	1.60
A-3823	Single or push-pull plates, 4,000-14,000 ohms, to voice coil	40 ma.	8	1 3/8	2 3/8 x 1 3/8	2 3/8	Q	0.7	3.10
A-3824	Single or push-pull plates, 6,000-10,000 ohms, to voice coil	75 ma.	8	2	3 1/4 x 2	2 13/16	Q	1.4	4.95
A-3825	Single plate, 1,500-4,500 ohms, to voice coil	75 ma.	8	2	3 1/4 x 1 3/8	2 13/16	Q	0.9	3.95
A-3830	Push-pull plates, 3,000-10,000 ohms, to voice coil	60 ma.	20	2 13/16	3 3/8 x 2 3/4	2 13/16	J	1.8	5.40
A-3849	Single plate, 1,500-10,000 ohms, to voice coil	55 ma.	10	1 3/8	2 3/8 x 1 3/8	2 3/8	Q	0.7	3.15
A-3850	Single or push-pull plates, 4,000-10,000 ohms, to voice coil	40 ma.	8	2	2 3/8 x 1 3/8	2	J	0.7	3.60
A-3852	Push-pull plates, 4,000-14,000 ohms, to voice coil	40 ma.	18	2 3/8	2 3/8 x 2	2 3/8	J	1.3	4.00
A-3856	Single or push-pull plates, 4,000-14,000 ohms, to voice coil	35 ma.	4	1 3/8	2 3/8 x 1 3/8	2	Q	0.4	2.90
A-3870	Push-pull plates, 4,000-14,000 ohms, to voice coil	50 ma. ca. 1/2	18	2	3 1/4 x 2	2 13/16	Q	1.3	4.95
A-3878	Single plate, 2,000 ohms, to 4 ohm voice coil	60 ma.	5	1 3/8	2 3/8 x 1 3/8	2	A	0.4	1.90
A-3877	Single plate, 5,000 ohms, to 4 ohm voice coil	40 ma.	5	1 3/8	2 3/8 x 1 3/8	2	A	0.4	2.00
A-3878	Single plate, 7,000 ohms, to 4 ohm voice coil	30 ma.	5	1 3/8	2 3/8 x 1 3/8	2	A	0.4	1.95
A-3879	Single plate, 10,000 ohms, to 4 ohm voice coil	30 ma.	5	1 3/8	2 3/8 x 1 3/8	2	A	0.4	1.90
A-3880	Push-pull plates, 4,000-14,000 ohms, to voice coil	40 ma.	15	2 1/4	3 3/4 x 2 3/4	3 3/8	Q	1.7	5.95
A-8114	Single plate, 7,600 ohms, to 3.2 ohm voice coil	32 ma.	5	1 3/8	2 3/8 x 1 3/8	2	A	0.4	2.65

CR TUBE BOOSTER

Part No.	Application	Shpg. Wt. in Lbs.	List Price
P-8192	Brightens CR tubes where dimming is due to low cathode emission. Has 15" leads for mounting anywhere in set. Plug-in type, no soldering	0.5	\$4.90

ISOLATION TESTING TRANSFORMER

Large enough to handle almost any television or radio receiver on test. Presents three standard receptacles, providing output voltages of 105, 115 and 125, with 117 volts AC from the line, for testing purposes

or may be employed to correct a high or low line voltage. Has electrostatic shield.

Part No.	Wattage	Primary Voltage	Secondary Voltage	Height Overall	Base Area	Mtg. Type	Shpg. Wt. in Lbs.	List Price
P-6415	350	117	105/115/125	5 3/8	4 1/2 x 5 1/2	KC	17.0	\$30.25

HIGH FIDELITY OUTPUT TRANSFORMERS

Better than ±1 db from 20 to 20,000 cps.

These Stancor output transformers combine the most advanced design and manufacturing practices to provide outstanding audio response at low cost. Maximum power level is conservatively rated at 50 watts. They are designed to match the most popular types of output tubes to speaker or line impedances.

Extensively interleaved "trifilar" windings, extremely tight coupling and careful electrical balance result in audio fidelity to please the most critical specialist. Inasmuch as elaborate shielding is not required at the audio output level, an inexpensive, but thoroughly practical, Type C mounting is used. Shipping weight is 6.5 lbs.

Part No.	Pri. Imp. (P-F) in Ohms	Sec. Imp. in Ohms	Max. Pri. D.C. Per Side	Audio Watts	Height Overall	Base Area	List Price
A-8050	1500	8, 16	200	50	4 1/8"	3 1/8" x 4 1/8"	\$20.45
A-8051	2500	8, 16	150	50	4 1/8"	3 1/8" x 4 1/8"	20.45
A-8052	3000	8, 16	175	50	4 1/8"	3 1/8" x 4 1/8"	20.45
A-8053	5000	8, 16	150	50	4 1/8"	3 1/8" x 4 1/8"	20.45
A-8054	9000	8, 16	100	50	4 1/8"	3 1/8" x 4 1/8"	20.45
A-8156	6800	8, 16	125	50	4 1/8"	3 1/8" x 4 1/8"	20.45
A-8060	1500	500	200	50	4 3/8"	3 1/8" x 4 1/8", 2 3/4" x 3 1/8"	20.45
A-8061	2500	500	150	50	4 3/8"	3 1/8" x 4 1/8"	20.45
A-8062	3000	500	175	50	4 3/8"	3 1/8" x 4 1/8"	20.45
A-8063	5000	500	150	50	4 3/8"	3 1/8" x 4 1/8"	20.45
A-8064	9000	500	100	50	4 3/8"	3 1/8" x 4 1/8"	20.45
A-8072†	7800	4, 8, 16	100	25	4 3/8"	3 1/8" x 4 1/8"	20.45
A-8066	6600	500	125	50	4 3/8"	3 1/8" x 4 1/8", 2 3/4" x 3 1/8"	25.00

*Where more than one secondary impedance is shown, only one value is to be used at any time.
†Primary provided with seven taps for Ultra-Linear application.



A



C



Q



J



KC



FS



FK



DRIVER TRANSFORMERS

CHICAGO STANDARD TRANSFORMER CORPORATION

SINGLE PLATE TO PUSH-PULL GRIDS

Part No.	Pri. Impedance in Ohms	Pri./1/2 Sec. Ratio	Core	Max. Pri. D.C.	Mtg.	Height Overall	Base Area	Shpg. Wt. in Lbs.	List Price
A-4713	10,000	2:1	5/8" x 5/8"	30 ma.	A	1 3/8"	2 3/8" x 1 1/4"	0.7	\$3.00
A-4752	10,000	2/1.5/1:1	3/4" x 3/4"	40 ma.	A	2"	3 1/4" x 1 3/4"	1.2	4.40
†A-4722	10,000	2:1	3/4" x 1"	30 ma.	TD	2 1/16"	2 3/4" x 2 1/16"	1.7	6.50
A-4292	10,000	2.5:1	5/8" x 5/8"	20 ma.	A	1 5/8"	2 1/8" x 1 1/2"	0.7	3.15
A-4723	10,000	3:1	5/8" x 5/8"	30 ma.	A	1 5/8"	2 3/8" x 1 1/2"	0.7	3.00
†A-4721	10,000 to 22,500	3/2:1	3/4" x 1"	25 ma.	TD	2 1/16"	2 3/4" x 2 1/16"	1.5	7.10
A-4210	1,500 to 5,000	3:1	1" x 1"	40 ma.	C	3 3/8"	2 3/4" x 2 3/8"	2.4	7.45
A-4702	1,500 to 5,000	5:1	1" x 1"	80 ma.	C	3 1/4"	2 5/8" x 2 3/8"	2.5	7.35

PUSH-PULL PLATES TO PUSH-PULL GRIDS

Part No.	Pri. Imp. (P.P.) in Ohms	Pri./1/2 Sec. Ratio	Core	Max. Pri. D.C.	Mtg.	Height Overall	Base Area	Shpg. Wt. in Lbs.	List Price
A-4208†	20,000 to 30,000	2.8:1	1" x 1"	15 ma.	C	3 1/8"	2 5/8" x 2 5/8"	2.5	8.35
†A-4712	20,000	3:1	5/8" x 5/8"	10 ma.	A	1 5/8"	2 1/8" x 1 1/2"	0.7	3.55
A-4701†	20,000	3:1	1" x 1"	25 ma.	C	3 1/8"	2 5/8" x 2 3/8"	2.7	9.60
A-4212	1,500 to 5,000	3.2:1	1" x 1"	50 ma.	C	3 1/8"	2 5/8" x 2 3/8"	2.5	7.80
A-4416†	3,000 to 10,000	5:1	1" x 1"	40 ma.	C	3 1/8"	2 5/8" x 2 3/8"	2.8	8.70
A-4703†	3,000 to 10,000	5:1	1 1/8" x 1 1/8"	95 ma.	C	3 3/8"	3" x 3 1/8"	3.7	9.50

POLY-PEDANCE DRIVER MULTI-TAPPED UNITS FOR USE IN CIRCUITS WHERE THE OPTIMUM RATIO CANNOT BE PREDETERMINED.

Driver circuit changes often require new transformers. Many times it is impossible to match correctly tubes involved with a specific transformer, with high distortion resulting. *Poly-Pedance* units solve that problem; three transformers with the maximum number of usable ratios will match the driver tubes to any Class B modulator grid circuit without exceeding the power capabilities of the driver tubes.

Part No.	Application and Ratio Pri./1/2 Sec.	Max. D.C.	Audio Watts	Mtg.	Height Overall	Base Area	Shpg. Wt. in Lbs.	List Price
A-4761	Driver to Class "B" Grids 1.25:1/ 1.4:1/ 1.6:1/ 1.8:1/ 2:1/ 2.2:1/ 2.4:1	Pri—150 ma. Sec—100 ma.	15	CD	3 1/8"	2 5/8" x 3 3/8"	3.4	\$16.65
A-4762	Driver to Class "B" Grids 2.6:1/ 3:1/ 3.2:1/ 3.4:1/ 4:1/ 4.5:1/ 5:1	Pri—150 ma. Sec—180 ma.	15	CD	3 1/8"	2 5/8" x 3 3/8"	2.7	15.70
A-4763	Driver to Class "B" Grids 1.25:1/ 1.5:1/ 1.75:1/ 2:1/ 2.25:1/ 3.2:1	Pri—225 ma. Sec—280 ma.	30	CD	3 5/8"	3" x 4"	4.3	19.45

POLY-PEDANCE LINE DRIVER MULTI-TAPPED UNIT TO MATCH ALL COMMON LINE IMPEDANCES TO GRID CIRCUIT OF MODULATOR OR CLASS "B" AMPLIFIER.

Designed with pie wound coils to assure low leakage inductance, low resistance and low capacity, these two units will easily match all common line impedances to any modulator grid circuit. Individually boxed with complete instructions.

Part No.	Application and Ratio Pri./1/2 Sec.	Max. D.C.	Audio Watts	Mtg.	Height Overall	Base Area	Shpg. Wt. in Lbs.	List Price
A-4765	Line to Grid 1:0.75/ 1:0.85/ 1:1/ 1:1.25/ 1:1.45/ 1:1.75/ 1:2/ 1:2.25/ 1:2.5/ 1:2.75/ 1:3.15	Pri—180 ma. Sec—100 ma.	15	CD	3 3/8"	2 5/8" x 3 3/8"	3.2	\$17.25

AUDIO CHOKES

Audio reactors are rated at 2 volts, 200 cycles, with maximum D.C. in windings. Tolerance of plus 15% is maintained on all ratings.

Part No.	Rated Inductance	Max. D.C.	D.C. Res. in Ohms	Test Volts	Core	Mtg.	Height Overall	Base Area	Shpg. Wt. in Lbs.	List Price
C-1003	16 hy at 50 ma.	50 ma.	580	1500	3/8" x 3/8"	A	2"	3 1/4" x 1 3/4"	1.1	2.45
C-2301	135 hy at 5 ma.	10 ma.	6500	1500	3/8" x 1"	TD	2 1/16"	2 3/4" x 2 3/8"	1.7	6.35

†These units have split secondaries for individual bias adjustment and/or use of inverse feedback.
‡To be removed from next catalog.



INPUT-INTERSTAGE

CHICAGO STANDARD TRANSFORMER CORPORATION



MICROPHONE OR LINE TO LINE

Part No.	Impedance In Ohms	Mtg.	Height Overall	Base Area	Shpg. Wt. In Lbs.	List Price
A-4350 ^f	Pri—500/333/200/125/50 Sec—500/333/200/125/50	Q	2"	3 1/4" x 1 3/4"	1.0	\$ 6.50
A-4407 ^{f†}	Pri—500/333/200/125/50 Sec—500/333/200/125/50	D	3 5/16"	2 5/8" x 3 1/4"	2.4	13.10

MICROPHONE PICKUP OR LINE TO GRID

Part No.	Application	Impedance in Ohms	Turns Ratio	Mtg.	Height Overall	Base Area	Shpg. Wt. in Lbs.	List Price
A-4705	S. B. Mic. to S. Grid	Pri—200/70 Sec—80,000	1:20	A	1 3/8"	2 3/8" x 1 1/2"	0.4	\$3.20
A-4706	S. B. Mic. to S. Grid	Pri—100 Sec—60,000	1:24.5	A	1 3/8"	2 3/8" x 1 1/2"	0.5	3.25
A-4708	D. B. Mic. to S. Grid	Pri—200 CT Sec—67,000	1:17	J	2"	2 3/8" x 1 5/8"	0.7	4.40
A-4742	S. B. Mic. to P.P. Grids	Pri—100 Sec—400,000 CT	1:64	S	2 1/16"	2 3/8" x 1 3/4"	1.2	4.70
A-4743	S. B. Mic. to P.P. Grids	Pri—100 Sec—400,000 CT	1:64	VE	2 1/16"	2 3/8" x 2 1/8"	1.2	6.45
*A-4747	S. B. Mic. or Low Imp. Line to S. Grid	Pri—10 Sec—1,300,000	1:137	VE	1 1/16"	1 1/8" x 1 1/4" 1 1/2"	0.5	3.60
A-4351 ^f	Mic. or Line to S. Grid	Pri—500/333/200/125/50 Sec—89,000	1:13.3	TD	2 11/16"	2 3/4" x 2 3/16"	1.4	6.95
A-4352 ^f	Mic. or Line to S. Grid	Pri—500/333/200/125/50 Sec—89,000	1:13.3	Q	2"	3 1/4" x 1 3/4"	1.0	6.05
†A-4726	Line and High Imp. to P.P. Grids	Pri—200 CT/60 and 2,500 Sec—100,000	1:22.4 1:6.3	TD	2 11/16"	2 3/4" x 2 3/16"	1.4	8.05
A-4709	Dynamic Mic. or Pickup to S. Grid	Pri—30/15/8/4 Sec—108,000	1:60	TD	2 11/16"	2 3/4" x 2 3/16"	1.7	7.80

INTERCOMMUNICATOR AND TRANSCEIVER

Part No.	Application	Impedance in Ohms	Mtg.	Height Overall	Base Area	Shpg. Wt. in Lbs.	List Price	
A-4744	Intercom. input	Pri—4 Sec—25,000		VE	1 3/8"	2 1/8" x 1 1/2"	0.5	\$2.80
A-4748	Intercom. input	Pri—45 or 50 Sec—50,000		A	1 3/8"	2 1/8" x 1 1/4" 1 3/4"	0.4	3.10
A-3833	Transceiver Input Mic. and Plate to Grid	Pri—200 and 5,000 Sec—60,000		A	1 5/8"	2 3/8" x 1 1/2"	0.7	4.30
A-3836	Transceiver Output. Plate to Low or High impedance phones	Pri—10,000 Sec—50 and 2,000		A	1 5/8"	2 3/8" x 1 1/2"	0.7	4.20

SINGLE PLATE TO SINGLE GRID—FOR 7,000-20,000 OHM PLATE IMPEDANCES

Part No.	Turns Ratio	Core	Max. Pri. D.C.	Mtg.	Height Overall	Base Area	Shpg. Wt. in Lbs.	List Price
A-53	1:3	1/2" x 1/2"	10 ma.	A	1 3/8"	2 3/8" x 1 1/2"	0.5	\$2.65

SINGLE PLATE TO PUSH-PULL GRIDS—FOR 7,000-15,000 OHM PLATE IMPEDANCES

A-52-C	1:2	1/2" x 1/2"	10 ma.	A	1 3/8"	2 3/8" x 1 3/8"	0.4	\$2.75
A-62-C	1:2	3/8" x 3/8"	10 ma.	A	1 5/8"	2 3/8" x 1 1/2"	0.7	3.10
A-4745	1:2	3/4" x 1"	10 ma.	TD	2 11/16"	2 3/4" x 2 3/16"	1.7	8.50
Recommended for use in super-regenerative circuits. Has a static shield between pri. and sec. windings.								
A-53-C	1:3	1/2" x 1/2"	10 ma.	A	1 3/8"	2 3/8" x 1 3/8"	0.5	2.70
A-63-C	1:3	5/8" x 5/8"	10 ma.	A	1 5/8"	2 3/8" x 1 1/2"	0.7	3.05
A-73-C	1:3	3/4" x 3/4"	10 ma.	A	2"	3 1/4" x 1 3/4"	1.0	3.80
A-4719	1:3	3/4" x 1"	10 ma.	TD	2 11/16"	2 3/4" x 2 3/16"	1.7	7.45
†A-83-C	1:3	3/8" x 3/8"	10 ma.	A	2 3/8"	3 3/4" x 2 3/4"	1.5	6.45
†A-103-C	1:3	1" x 1"	10 ma.	A	2 5/8"	4" x 2 3/4"	2.2	7.55
A-64-C	1:4	5/8" x 5/8"	10 ma.	A	2"	2 3/8" x 1 3/4"	0.7	3.65
A-4206 [§]	1:3.25	1" x 1"	15 ma.	C	3 1/8"	2 5/8" x 2 5/8"	2.5	9.85

MULTI-PURPOSE INTERSTAGE—SPLIT SECONDARIES May be used as a single plate to single grid, single plate to push-pull grid, or push-pull plate to push-pull grid interstate transformers. Overall ratios are 3:1, however, primaries are center-tapped and secondaries have split windings, thus providing ratios of 1:1, 3:1 and 6:1 in either step-up or step-down applications. † Has split secondary.

A-4774	1:3	3/4" x 3/4"	10 ma.	S	2 3/8"	2 3/8" x 1 3/8"	1.2	\$4.60
A-4773	1:3	3/4" x 1"	10 ma.	TD	2 11/16"	2 3/4" x 2 3/16"	1.7	7.80

PUSH-PULL PLATES TO PUSH-PULL GRIDS—FOR 7,000-15,000 OHM PLATE IMPEDANCES

A-4711	1:1	5/8" x 5/8"	10 ma.	A	1 5/8"	2 3/8" x 1 1/2"	0.7	\$3.65
A-4155	1:3	3/4" x 3/4"	10 ma.	L	2 1/16"	2 3/8" x 1 3/4"	1.0	6.55

PUSH-PULL PLATES TO PARALLEL OR PUSH-PULL GRIDS—FOR 7,000-20,000 OHM PLATE IMPEDANCES

A-4208	1:1.4	1" x 1"	15 ma.	C	3 3/8"	2 5/8" x 2 5/8"	2.5	\$8.35
†A-4777	1:1.5	1" x 1"	10 ma.	C	3 3/8"	2 5/8" x 2 5/8"	2.5	9.80

† Has a dual primary—when properly connected the 500 and 200 ohm sections are center tapped. § Has split secondary.
 † Has a static shield between primary and secondary windings. ‡ Designates part numbers to be removed from next catalog.

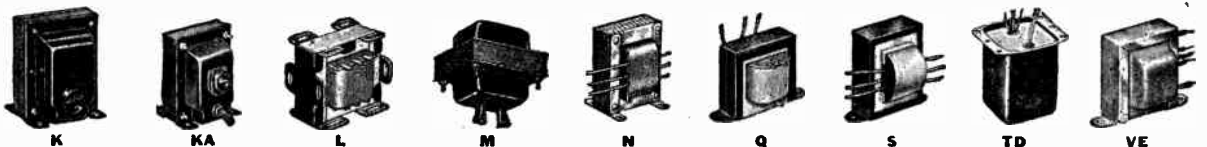



OUTPUT TRANSFORMERS

CHICAGO STANDARD TRANSFORMER CORPORATION

SINGLE PLATE TO VOICE COIL

Part No.	Application	Max. Pri. D.C.	Typical Output Tubes	Class	Audio Watts	Mtg.	Height Overall	Base Area	Shpg. Wt. in Lbs.	List Price
†A-3865	1,500 ohms to 6/4/2 ohms	55 ma.	48, 25B6, 25L6, 50L6	A	5	A	1 3/8"	2 3/8" x 1 3/8"	0.4	\$3.30
A-3332	2,000 ohms to 3.2 ohms	50 ma.	25B5, 25B6, 25L6, 35A5, 35L6, 50L6	A	3	A	1 3/8"	2 3/8" x 1"	0.4	1.60
A-3876	2,000 ohms to 4 ohms	60 ma.	2A3, 6A3, 6B4, 6V6, 6Y6, 25AC5, 25B5, 25B6, 25L6, 35A5, 35L6, 50L6	A	5	A	1 3/8"	2 3/8" x 1 3/8"	0.4	1.90
A-3328	4,000 ohms to 3.5 ohms	10 ma.	1S4, 3S4	A	3	A	1 3/8"	2 3/8" x 1"	0.4	2.05
A-2203	4,000 ohms to 8 ohms	40 ma.	43, 45, 48, 12A5, 25A6	A	5	A	1 3/8"	2 3/8" x 1 3/8"	0.7	3.70
A-3877	5,000 ohms to 4 ohms	40 ma.	43, 59, 6V6, 7C5, 25A5	A	5	A	1 3/8"	2 3/8" x 1 3/8"	0.4	2.00
A-3310	5,000 ohms to 500/15/8/4 ohms	55 ma.	45, 6L6, 6V6, 25A6, 25A7	A	20	C	3 3/8"	2 3/8" x 2 3/8"	2.5	8.05
A-3878	7,000 ohms to 4 ohms	30 ma.	20, 31, 33, 42, 2A5, 6AC5, 6B5, 6F6, 6K6, 6N6, 7B5	A	5	A	1 3/8"	2 3/8" x 1 3/8"	0.4	1.95
A-2313	7,000 ohms to 8 ohms	40 ma.	33, 41, 42, 47, 59, 89, 2A5, 6AC5, 6F6, 6K6, 6N6, 7B5	A	10	A	2"	3 1/4" x 1 3/4"	1.0	3.40
A-8114	7,600 ohms to 3.2 ohms	32 ma.	33, 41, 42, 47, 59, 89, 2A5, 6AC5, 6F6, 6K6, 6N6, 7B5	A	5	A	1 3/8"	2 3/8" x 1 3/8"	0.4	2.65
A-3329	8,000 ohms to 3.5 ohms	10 ma.	1C5-GT, 1G5-G, 1Q5-GT/G, 1S4, 3S4	A	3	A	1 3/8"	2 3/8" x 1"	0.4	1.90
A-3879	10,000 ohms to 4 ohms	30 ma.	1J6, 3C5, 6A4, 6G6, 6N7	A	5	A	1 3/8"	2 3/8" x 1 3/8"	0.4	1.90
A-3881	15,000 ohms to 4 ohms	10 ma.	1D8, 1E7, 1F4, 1F5, 1J6, 1T5, 6V7, 6Y7, 12A7	A	5	A	1 3/8"	2 3/8" x 1 3/8"	0.4	2.15
A-3327	25,000 ohms to 4 ohms	5 ma.	1A5, 1D8-GT, 1F4, 1F5-G, 1LA4, 1LB4, 1N6-G	A	5	A	1 3/8"	2 3/8" x 1 3/8"	0.4	2.45

PUSH-PULL PLATES TO VOICE COIL

†A-3306	P.P. Par. 2,500 ohms to 500/15/8/4 ohms	100 ma.	45, 48, 2A3, 25L6	AB	25	C	3 3/8"	3" x 3 1/8"	3.8	\$10.95
†A-3301	3,000 ohms to 500/15/8/4 ohms	55 ma.	48, 2A3, 6A3, 6B4, 25L6	AB	30	C	3 3/8"	3" x 3 1/8"	8.7	10.20
A-3802	3,800/3,300 to 500/250/8/4 ohms	250 ma.	45, 6L6, Par. 6L6	AB2, AB1	75	C	4 3/4"	4" x 3 3/8"	7.9	14.25
A-5528	4,000 ohms to 500/15/8/4 ohms	65 ma.	6Y6, 25LG	AB	8	C	3 3/8"	2 3/8" x 2 1/4"	1.9	5.00
A-3851§	4,400 ohms to 500/250/15/8/4 ohms	70 ma.	6L6	AB1	30	C	3 3/8"	3" x 3 1/8"	3.6	10.80
A-3872	5,000 ohms to 15/8/4 ohms	75 ma.	45, 2A3, 6A3, 6L6	AB	18	TD	2 1/8"	2 3/4" x 2 3/8"	1.7	7.00
A-3800	5,000 ohms to 500/250/15/8/4 ohms	80 ma.	45, 2A3, 6A3, 6L6	AB	30	C	3 3/8"	3" x 3 3/8"	3.7	8.70
A-3307	6,000 ohms to 500/15/8/4 ohms	100 ma.	46, 59, 42, 2A5, 6F6, Par. 53, 6A6, 6N7	B, AB2	30	C	3 3/8"	3" x 3 1/8"	3.5	11.30
A-3801	6,600 ohms to 500/250/15/8/4 ohms	150 ma.	6L6	AB1	35	C	4"	3 1/2" x 3 3/8"	5.8	10.45
A-3885	9,000 ohms to 500/250/15/8/4 ohms	150 ma.	6L6	AB1	35	C	4"	3 1/2" x 3 3/8"	4.5	12.70
A-3304	10,000/7,000 ohms to 500/15/8/4 ohms	60 ma.	45, 6V6, 6AC5	AB	25	C	3 3/8"	2 3/8" x 2 3/8"	2.7	9.65
A-3311	10,000 ohms to 500/15/8/4 ohms	70 ma.	6F6, 6V6, 6AC5	AB	25	C	3 3/8"	3" x 3 1/8"	3.5	9.10
A-3831	10,000 ohms to 8/4/2 ohms	40 ma.	30, 49	AB	5	A	1 3/8"	2" x 1 1/2"	0.7	3.35
A-3335	10,000 ohms to 6-8/3.2-4 ohms	40 ma.	10	S	2 3/8"	2 1/8"	2 1/8" x 1 3/4"	2 3/8"	1.0	4.40
A-2312	14,000 ohms to 4 ohms	40 ma.	33, 41, 42, 47, 49, 2A5, 6F6, 6K6, 7B5	AB	10	A	2"	3 1/4" x 1 3/4"	1.0	3.50
A-3496	14,000 ohms to 4 ohms	25 ma.	33, 41, 42, 47, 49, 2A5, 6F6, 6K6, 7B5	AB	5	A	1 3/8"	2 3/8" x 1 3/8"	0.4	3.20
A-3303	14,000 ohms to 500/15/8/4 ohms	55 ma.	41, 42, 47, 59, 89, 2A5, 6F6, 6K6, 7B5	AB	20	C	3 3/8"	2 3/8" x 2 3/8"	2.7	9.80
A-3857	25,000 ohms to 4 ohms	10 ma.	1F4, 1F5, 1J5, 1T5, 6G6, 12A7, 950	A	5	A	1 3/8"	2 3/8" x 1 3/8"	0.4	2.55

HUM-REDUCING TRANSFORMERS, Single Plate to Voice Coil

A-3330	‡2,000 ohms to 3.5 ohms	60 ma.	5	A	1 3/8"	2 3/8"	1 3/8" x 1 3/8"	2	0.4	\$2.30
A-3336	‡2,500 ohms to 3.5 ohms	50 ma.	5	A	1 3/8"	2 3/8"	1 3/8" x 1 3/8"	2	0.4	2.65

CRYSTAL RECORDER OUTPUT

Part No.	Application	Max. Pri. D.C.	Audio Watts	Core Size	Mtg.	Height Overall	Base Area	Shpg. Wt. in Lbs.	List Price
A-3853	Single 7,000 ohm plate to 70,000 ohm crystal cutter OR 4 ohm voice coil	35 ma.	5	3/4" x 3/4"	A	2"	3 1/4" x 1 3/4"	1.0	\$5.95
A-3854	Single 7,000 ohm plate to 70,000 ohm crystal cutter AND 4 ohm voice coil	35 ma.	10	3/8" x 3/8"	A	2 1/4"	3 3/4" x 2 1/4"	1.5	6.60
A-3859	Push-pull 10,000 ohm plates to 70,000 ohm crystal cutter OR 4 ohm voice coil	30 ma. ea.	5	3/4" x 3/4"	A	2"	3 1/4" x 1 3/4"	1.0	6.40
A-3860	Push-pull 10,000 ohm plates to 70,000 ohm crystal cutter AND 4 ohm voice coil	35 ma. ea.	10	3/8" x 3/8"	A	2 1/4"	3 3/4" x 2 1/4"	1.5	7.20

†Has tapped primary for use in hum-reducing circuit.

§This unit has a tertiary winding to provide 10% inverse feedback.

‡Designates part number to be removed from next catalog.

†Has a 4.5% primary tap.



CD



KA



L



M



N



Q



S



TD



WI-2

OUTPUT TRANSFORMERS



CHICAGO STANDARD TRANSFORMER CORPORATION

UNIVERSAL OUTPUT

Part No.	Application	Max. Pri. D.C.	Audio Watts	Mtg.	Height Overall	Base Area	Shpg. Wt. in Lbs.	List Price
A-3856	Single or Push-pull plates (4,000 to 14,000 ohms) to voice coil	35 ma.	4	Q	1 3/8"	2 3/8" x 1 3/8"	0.4	\$2.90
A-3822¶	Single plate (7,000 to 10,000 ohms) to voice coil	35 ma.	4	Q	1 3/8"	2 3/8" x 1 3/8"	0.4	2.75
A-3848§	Single plate (7,000 to 16,000 ohms) to voice coil	10 ma.	5	Q	1 3/8"	2 3/8" x 1 3/8"	0.4	3.90
A-3823	Single or Push-pull plates (4,000 to 14,000 ohms) to voice coil	40 ma.	8	Q	1 3/8"	2 3/8" x 1 1/2"	0.7	3.10
A-3850	Single or Push-pull plates (4,000 to 14,000 ohms) to voice coil	40 ma.	8	J	2"	2 3/8" x 1 1/2"	0.7	3.60
A-3825§	Single plate (1,500 to 4,500 ohms) to voice coil	75 ma.	8	Q	2"	3 1/4" x 1 5/8"	0.9	3.95
A-3824§	Single or Push-pull plates (6,000 to 10,000 ohms) to voice coil	75 ma.	8	Q	2"	3 1/4" x 2"	1.4	4.95
A-3849	Single plate (1,500 to 10,000 ohms) to voice coil	55 ma.	10	Q	1 3/8"	2 1/2" x 1 1/2"	0.7	3.15
A-3880	Push-pull plates (4,000 to 14,000 ohms) to voice coil	40 ma. ea. 1/2	15	Q	2 1/4"	3 3/4" x 2 1/4"	1.7	5.95
A-2855	Push-pull plates (4,000 to 14,000 ohms) to voice coil	50 ma. ea. 1/2	15	L	2 1/8"	2 5/8" x 1 3/4"	1.0	5.30
A-3890	Push-pull plates (4,000 to 14,000 ohms) to voice coil	50 ma. ea. 1/2	15	TD	2 1/8"	2 3/4" x 2 3/8"	1.5	8.15
A-3852	Push-pull plates (4,000 to 14,000 ohms) to voice coil	40 ma. ea. 1/2	18	J	2 3/8"	2 3/8" x 2"	1.3	4.00
A-3870	Push-pull plates (4,000 to 14,000 ohms) to voice coil	50 ma. ea. 1/2	18	Q	2"	3 1/4" x 2"	1.3	4.95
A-3830	Push-pull plates (3,000 to 10,000 ohms) to voice coil	60 ma. ea. 1/2	20	J	2 1/8"	3 3/8" x 2 1/4"	1.8	5.40

¶Secondary impedance 0.7, 1, 1.4, 2, 2.8, 4 ohms.

§Secondary impedance, 1, 2, 4 ohms.

TUBE TO LINE

Part No.	Application	Impedance in Ohms	Max. Pri. D.C.	Audio Watts	Mtg.	Height Overall	Base Area	Shpg. Wt. in Lbs.	List Price
A-3841	Single plate to line	Pri—7,000/6,000/5,000/4,000/2,500 Sec—500	60 ma.	10	J	2 1/8"	3 5/16" x 2 3/4"	1.5	\$7.50
A-3842	Push-pull plates to line	Pri—14,000/12,000/10,000/8,000 CT Sec—500	55 ma.	10	J	2 1/8"	3 5/16" x 2 3/4"	1.7	7.80
A-4770	Single plate to line	Pri—7,000/6,000/5,000/4,000/2,500 Sec—500	60 ma.	20	J	3 1/8"	3 5/8" x 2 3/4"	2.4	7.90
A-3250	Single plate or Push-pull plates to line	Pri—20,000/10,000/5,000 Pri—20,000 CT Sec—500/333/200/125/50	15 ma.	—	Q	2"	3 1/4" x 1 3/4"	1.0	4.95
A-3315	Single plate or Push-pull plates to line	Pri—20,000/10,000/5,000 Pri—20,000 CT Sec—500/333/200/125/50	35 ma.	—	D	3 3/16"	2 5/8" x 2 5/8"	2.7	11.30

LINE TO VOICE COIL

Part No.	Impedance in Ohms	Audio Watts	Mtg.	Height Overall	Base Area	Shpg. Wt. in Lbs.	List Price
A-8101	Pri—500 Sec—3.2/6-8	5	Q	1 3/8"	2 3/8" x 1 3/8"	0.4	\$2.20
A-3883	Pri—500 Sec—15/8/6/4	25	J	2 3/16"	2 1/2" x 1 3/8"	1.1	4.70
A-3882	Pri—500/333/250 Sec—15/8/4	25	D	3 3/16"	2 3/8" x 3 1/2"	2.4	9.30
A-3838	500/250/175/150/140/125/100/85/75/1 1/4"/0.7 This Unit is designed to operate one or more speakers in series across a 500 ohm line or to match unequal lines.	30	B	3 3/8"	2 1/2" x 2 1/4"	2.3	7.35
A-3818	Pri—1,500/1,000/500 Sec—15/8/4	25	J	3 3/8"	3 3/8" x 2 3/4"	2.2	5.45
A-7947	Pri—2,000/1,500/1,000/500 Sec—6 ohms	8	Q	1 3/8"	2 13/16" x 1 13/16"	0.7	3.20
A-7949	Pri—2,000/1,500/1,000/500 Sec—6-8 ohms	12	J	2 5/16"	2 7/8" x 1 13/16"	1.1	4.25
A-3820	Pri—2,000/1,500/1,000/500 Sec—15/8/4	40	D	4 5/16"	3 3/8" x 4 1/2"	5.0	15.20
A-8104	Pri—3,000/2,000/1,500/1,000/500 Sec—16/8/4	10	J	2 3/16"	2 13/16" x 1 3/4" 2 3/8"	1.5	6.10
A-3837	Line to Line or V. C. (Autoformer) Pri—500 Sec—8/4/2.65/2.35/ 2/1.5/0.7/0.5/0.3/0.2/0.1/0.05	15	J	2 3/16"	2 1/8" x 2"	1.4	5.50

This Unit is designed to operate one or more speakers in parallel across a 500 ohm line.

70.7 VOLT LINE TO VOICE COIL

Part No.	Power Steps in Watts	Impedance in Ohms	Mtg. Type	Height Overall	Base Area	Mtg. Ctrs.	Shpg. Wt. in Lbs.	List Price
A-8102	8/4/2/1/0.5	Pri—625/1,250/2,500/5,000/10,000 Sec—4/8/16	J	2"	1 3/8" x 2 1/8"	2"	0.7	\$4.50
A-8103	16/8/4/2/1/0.5	Pri—312.5/625/1,250/2,500/5,000/10,000 Sec—4/8/16	J	2 1/8"	2 1/4" x 3 1/4"	2 1/8"	1.5	6.30

LINE TO VOICE COIL—OUTDOOR TYPE

Part No.	Impedance in Ohms	Rated Watts	Mtg.	Mtg. Centers Can or Brkt.	Height Overall	Base Area†	Shpg. Wt. in Lbs.	List Price
A-3333	Pri—3,000/2,000/1,500/1,000/500 Sec—16/8/4	14	TW	2" x 3 3/32"	3 1/2"	3 1/2" x 3"	3.4	\$14.65
A-3334	Pri—3,000/2,000/1,500/1,000/500 Sec—16/8/4	25	TW	2" x 3 5/32"	3 1/2"	3 1/2" x 3"	3.5	17.75
20-337	Adapter Hardware Set							.55

For clamping Part Numbers A-3333 and A-3334 to the mounting bracket of a trumpet projector. Set consists of holding plate and four each of screws, nuts and lockwashers to secure transformer assembly to speaker bracket up to 2" wide.

†Dimensions with bracket.





POWER TRANSFORMERS

CHICAGO STANDARD TRANSFORMER CORPORATION

COMBINATION PLATE AND FILAMENT SUPPLY

POWER TRANSFORMERS TO PROVIDE APPROXIMATELY 260 VOLTS D.C. TO CONDENSER INPUT FILTER

Type and Part No.	Plate Supply A.C. Volts	D.C. Ma.	Rectifier Volts	Fil. Amps.	Other Volts	Windings Amps.	Base Area	Overall Height	Mtg. Centers	Shpg. Wt. in Lbs.	List Price
PC8401	235-0-235	40	5.0	2.0	6.3 CT	2.0	2 5/8" x 2 5/8"	3 3/16"	2" x 1 1/16"	2.2	\$ 6.75
PM8401							2 1/2" x 3"	2 3/8"	2" x 2 1/2"		
PC8402	240-0-240	55	5.0	2.0	6.3 CT	2.0	2 5/8" x 2 3/4"	3 3/16"	2" x 1 1/16"	2.4	7.50
PM8402							2 1/2" x 3"	2 3/4"	2" x 2 1/2"		
PC8403	250-0-250	70	5.0	2.0	6.3 CT	2.5	2 5/8" x 3 1/8"	3 3/16"	2" x 2 1/16"	3.2	8.40
PM8403							2 1/2" x 3"	3 3/8"	2" x 2 1/2"		
PC8404	260-0-260	90	5.0	2.0	6.3 CT	3.0	3" x 3 1/2"	3 3/8"	2 1/4" x 2 1/4"	4.0	9.45
PM8404							2 1/2" x 3 3/8"	3 3/8"	2 1/4" x 2 1/16"		
PC8405	270-0-270	120	5.0	3.0	6.3 CT	3.5	3 1/4" x 3 1/2"	4"	2 1/2" x 2 3/16"	4.9	10.45
PM8405							3 1/4" x 3 3/4"	3 1/4"	2 1/2" x 3 1/4"		

POWER TRANSFORMERS FOR USE WITH CHOKE INPUT FILTER, VR-TUBE REGULATED SUPPLY, SPEAKER FIELD IN FILTER, OR HIGHER VOLTAGE WITH CONDENSER INPUT FILTER

PC8406	325-0-325	40	5.0	2.0	6.3 CT	2.0	2 5/8" x 2 3/4"	3 3/16"	2" x 1 1/16"	2.4	\$ 6.90
PM8406							2 1/2" x 3"	2 3/4"	2" x 2 1/2"		
PC8407	325-0-325	55	5.0	2.0	6.3 CT	2.0	2 5/8" x 3 1/8"	3 3/16"	2" x 2 1/16"	3.2	7.60
PM8407							2 1/2" x 3"	3 1/8"	2" x 2 1/2"		
PC8422	325-0-325	50	5.0	3.0	6.3 CT	5.0	3 1/4" x 3 3/8"	4"	2 1/2" x 2 3/16"	5.8	13.45
PM8422							3 1/8" x 3 3/4"	3 3/4"	2 1/2" x 3 3/8"		
PC8408	340-0-340	70	5.0	2.0	6.3 CT	2.5	3" x 3 3/8"	3 5/8"	2 1/4" x 2 1/8"	3.8	8.60
PM8408							2 1/2" x 3 3/8"	3 1/2"	2 1/4" x 2 1/16"		
PC8409	350-0-350	90	5.0	2.0	6.3 CT	3.0	3" x 3 3/8"	3 5/8"	2 1/4" x 2 3/8"	4.5	9.60
PM8409							2 3/8" x 3 3/8"	3 3/4"	2 1/4" x 2 1/16"		
PC8410	360-0-360	120	5.0	3.0	6.3 CT	3.5	3 1/4" x 3 3/4"	4"	2 1/2" x 2 1/16"	5.5	10.60
PM8410							3 1/8" x 3 3/4"	3 3/4"	2 1/2" x 3 3/8"		
PC8411	375-0-375	150	5.0	3.0	6.3 CT	4.5	3 5/8" x 4"	4 1/8"	2 3/4" x 2 1/16"	5.8	12.70
PM8411							3 1/2" x 4 1/8"	3 7/8"	2 3/4" x 3 1/4"		
PC8412	400-0-400	200	5.0	3.0	6.3 CT	5.0	4" x 4"	4 3/4"	3" x 2 1/16"	8.2	14.30
PM8412							3 3/4" x 4 1/2"	3 7/8"	3" x 3 3/4"		
PC8413	400-0-400	250	5.0	4.0	6.3 CT	5.0	4" x 4 1/2"	4 3/4"	3" x 3 3/16"	10.0	17.95
PC8414	600-0-600	200	5.0	3.0	6.3	3.0	4" x 4"	4 3/4"	3" x 2 1/16"	8.3	18.05

POWER TRANSFORMERS FOR USE WITH 6AX5, 6X4, 6X5, OR SELENIUM RECTIFIERS

PS8415	125 1/2-wave	15	6.3	0.6	2 3/8" x 1 3/8"	2"	2"	0.7	\$ 3.15
PS8416	125-0-125	25	6.3	1.0	2 1/8" x 1 3/4"	2 3/16"	2 3/8"	1.0	3.95
*PA8421	125 1/2-wave	50	6.3	2.0	3 3/4" x 2 5/8"	2 1/4"	3 3/8"	1.5	5.25
PC8417	220-0-220	50	6.3	0.6	25.2	0.5	2 5/8" x 2 3/8"	3 3/16"	2" x 1 1/16"	2.2	7.40
PC8418	230-0-230	50	6.3	2.5	2 5/8" x 2 5/8"	3 3/16"	2" x 1 1/16"	2.2	6.55
PM8418							2 1/2" x 3"	2 3/8"	2" x 2 1/2"		
PC8419	240-0-240	70	6.3	3.0	2 5/8" x 2 7/8"	3 3/16"	2" x 1 1/16"	2.6	7.50
PM8419							2 1/2" x 3"	2 7/8"	2" x 2 1/2"		
PC8420	260-0-260	90	6.3	4.0	3" x 3 1/2"	3 3/8"	2" x 2 1/4"	3.5	8.35
PM8420							2 1/4" x 3 3/8"	3 1/2"	2 1/4" x 2 1/16"		

REPLACEMENT POWER TRANSFORMERS (Misc.)

Part No.	Plate Supply A.C. Volts	D.C. Ma.	Rectifier Filament Volts—Ampere	Other Windings Volts—Ampere	Mtg.	Height Overall	Base Area	Shpg. Wt. in Lbs.	List Price
P-6001	325-0-325	40	5.0 CT-2.0	2.5 CT-4.0	M	2 3/4"	2 1/2" x 3"	2.5	\$ 9.00
†P-6002	350-0-350	50	5.0 CT-2.0	2.5 CT-7.25	M	3 1/4"	2 1/2" x 3"	3.0	11.20
P-6348	240-0-240	60	...	6.3 CT-2.75	M	2 3/4"	2 3/16" x 2 11/16"	2.3	7.20
P-6003	350-0-350	70	5.0 CT-2.0	2.5 CT-9.0	M	3 1/4"	2 1/8" x 3 3/8"	3.7	12.80
P-6005	350-0-350	70	5.0 CT-3.0	2.5 CT-9.0 2.5 CT-3.5	M	4 1/4"	2 7/8" x 3 3/8"	4.8	8.75
†P-6009	275-0-275	70	5.0 CT-3.0	2.5 CT-10.5 5.0 C.T.-0.5	M	3 1/4"	2 1/8" x 3 3/8"	3.8	13.40
†P-4042	350-0-350	70	5.0-3.0	2.5 CT-3.5 2.5-7.5	C	4"	3 1/4" x 3"	3.8	13.45
P-4047	350-0-350	70	5.0-3.0	2.5 CT-9.0 6.3-3.0	C	4"	3 1/2" x 3"	3.8	12.70
P-6004	350-0-350	90	5.0 CT-3.0	2.5 CT-12.5	M	3"	3 1/8" x 3 3/4"	4.2	11.55

†Primary for 117/107 volts.

‡Designates part number to be removed from next catalog.

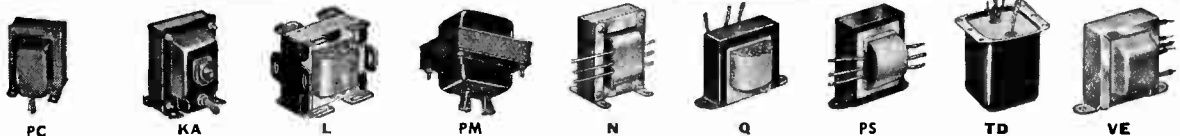

Radio's Master—19th Edition

Copyright by U. C. P., Inc.

Page N-10

TRADE DISCOUNT APPLIES TO LIST PRICES ONLY

POWER TRANSFORMERS



CHICAGO STANDARD TRANSFORMER CORPORATION

REPLACEMENT POWER TRANSFORMERS (Misc.)

Part No.	Plate Supply A.C. Volts	D.C. Ma.	Rectifier Filament Volts—Amperes	Other Windings Volts—Amperes	Mtg.	Height Overall	Base Area	Shpg. Wt. in Lbs.	List Price
P-4043	350-0-350	90	5.0-3.0	2.5 CT-3.5 2.5-9.0	C	4 $\frac{5}{16}$ "	3 $\frac{1}{8}$ " x 3 $\frac{3}{8}$ "	4.8	14.75
P-4048	350-0-350	90	5.0-3.0	2.5 CT-10.0 6.3-3.5	C	4 $\frac{5}{16}$ "	3 $\frac{1}{8}$ " x 3 $\frac{3}{8}$ "	5.2	14.20
P-6007	400-0-400	110	5.0 CT-3.0	2.5 CT-15.0 2.5 CT-3.5	M	3 $\frac{3}{8}$ "	3 $\frac{1}{8}$ " x 3 $\frac{3}{8}$ "	5.4	14.15
P-6006	350-0-350	120	5.0 CT-3.0	2.5 CT-12.5 2.5 CT-3.5	M	3 $\frac{3}{8}$ "	3 $\frac{1}{8}$ " x 3 $\frac{3}{8}$ "	5.5	14.95
P-3005	360-0-360 80 v. Bias	125	5.0 CT-3.0 5.0 CT-2.0	2.5 CT-10.0 6.3 CT-4.0	C	4 $\frac{3}{4}$ "	4" x 3 $\frac{7}{8}$ "	8.0	20.30
P-6143	440-0-440	130	5.0-3.0	6.3 CT-3.5	C	4 $\frac{5}{16}$ "	3 $\frac{1}{8}$ " x 3 $\frac{3}{8}$ "	7.0	15.25
P-4004#	400-0-400 80 v. Bias	175	5.0 CT-3.0	2.5-1.75 6.3 CT-2.5 6.3 CT-2.5	C	4 $\frac{3}{4}$ "	4" x 3 $\frac{7}{8}$ "	8.3	17.85
P-5059#	337.5-0-337.5	200	5.0 CT-3.0	6.3 CT-5.0	C	4 $\frac{3}{4}$ "	4" x 4 $\frac{1}{4}$ "	9.6	16.90
P-6315	370-0-370	275	5.0 CT-3.0	6.3 CT-7.0	M	4 $\frac{1}{4}$ "	3 $\frac{3}{4}$ " x 4 $\frac{1}{4}$ "	9.3	19.50

#Primary for 117/107 Volts.

!Designates part number to be removed from next catalog.

VIBRATOR TRANSFORMERS WITH 6 VOLT D.C. PRIMARY

Part No.	Secondary A.C. Volts	Secondary Volts	D.C. to Filter Milliamperes	Recommended Buffer Cap.	Mtg.	Height Overall	Base Area	Shpg. Wt. in Lbs.	List Price
P-6301	210-0-210	150	40	0.008 mfd.	S	2 $\frac{3}{8}$ "	2 $\frac{7}{8}$ " x 1 $\frac{1}{8}$ "	1.2	\$5.20
P-4060	210-0-240	225	40	0.008 mfd.	N	3 $\frac{1}{8}$ "	2 $\frac{1}{2}$ " x 2 $\frac{1}{2}$ "	2.5	6.75
P-4061	290-0-290	250	50	0.006 mfd.	N	3 $\frac{1}{8}$ "	2 $\frac{1}{2}$ " x 2 $\frac{1}{2}$ "	2.5	6.50
P-4062	300-0-300	260	65	0.006 mfd.	N	3 $\frac{1}{8}$ "	2 $\frac{1}{2}$ " x 2 $\frac{1}{2}$ "	2.3	7.15
P-4063	320-0-320	285	75	0.006 mfd.	N	3 $\frac{1}{8}$ "	2 $\frac{1}{2}$ " x 2 $\frac{3}{8}$ "	2.8	9.10
P-6131	370-0-370	330	100	0.007 mfd.	N	3 $\frac{1}{2}$ "	2 $\frac{3}{4}$ " x 2 $\frac{3}{4}$ "	3.5	10.05

VIBRATOR TRANSFORMER WITH 6 VOLT D.C. AND 117 VOLT A.C. PRIMARY

P-6166	350-0-350	—	135	—	C	4 $\frac{3}{4}$ "	4" x 3 $\frac{3}{8}$ "	6.9	\$16.85
---------------	-----------	---	-----	---	---	-------------------	------------------------	-----	----------------

Filament—6.3 volts at 2.25 Amps.

AUTO RADIO VIBRATOR TRANSFORMERS—EXACT DUPLICATE

Exact duplicate of mounting type used in original equipment.

Part No.	Original Part No.	Original Manufacture	D.C. Volts at Filter Input	D.C. Ma.	Recommended Buffer Cap.	Height Overall	Base Area	Shpg. Wt. in Lbs.	List Price
P-4064	7240519	United Motors (Delco)	280	65	0.015-0.015 mfd.	3 $\frac{1}{8}$ "	2 $\frac{3}{8}$ " x 2 $\frac{1}{16}$ "	2.5	\$11.75
P-4065	7255881	United Motors (Delco)	265	56	0.006 mfd.	4 $\frac{1}{16}$ "	2 $\frac{3}{8}$ " x 2 $\frac{1}{32}$ "	2.6	10.90
P-6470	140-111	Regal (5-tube univ. series)	145	50	0.009 mfd.	2 $\frac{1}{16}$ "	2 $\frac{1}{16}$ " x 2 $\frac{3}{16}$ "	1.4	7.65
P-6471	25B472533	Motorola (408, 508, etc.)	235	70	0.006 mfd.	3"	3 $\frac{3}{8}$ " x 2 $\frac{3}{16}$ "	2.0	7.60
P-6472	D 71014 C 217020 C 71014 25B70950	Colonial-Detrola No. 8072 Colonial-Bendix M1 Colonial-Motorola Motorola (405, 505, etc.)	270	56	0.007 mfd.	2 $\frac{5}{8}$ "	2 $\frac{1}{32}$ " x 2 $\frac{5}{32}$ "	2.0	7.60
P-6473	95-1073	Zenith	272	73	0.008 mfd.	3 $\frac{1}{16}$ "	2 $\frac{3}{8}$ " x 2 $\frac{1}{2}$ "	2.4	8.65
P-6474	95-1066	Zenith	240	52.5	0.008 mfd.	3 $\frac{1}{32}$ "	2 $\frac{3}{8}$ " x 2 $\frac{1}{2}$ "	2.2	7.90
P-6476	D 70267 C 70267	Colonial-Detrola No. 7070 Col.-Mot.-Det. No. 8030	220	53.5	0.008 mfd.	2 $\frac{5}{8}$ "	2 $\frac{1}{32}$ " x 2 $\frac{1}{32}$ "	2.0	7.80
P-6477	25C500189	Motorola	150	50	.03 mfd.	2"	1 $\frac{3}{8}$ " x 2 $\frac{1}{4}$ "	1.0	4.65
P-6478	25C501644	Motorola	225	70	.02 mfd.	2 $\frac{3}{4}$ "	2 $\frac{1}{16}$ " x 2 $\frac{5}{8}$ "	1.5	5.05
P-6479	65-0358	Philco	260	60	.005 mfd.	2 $\frac{1}{2}$ "	2 $\frac{3}{8}$ " x 3"	2.3	6.30
P-6480	65-0347	Philco	225	70	.0033 mfd.	2 $\frac{3}{16}$ "	2 $\frac{1}{4}$ " x 2 $\frac{5}{8}$ "	1.5	5.35
P-6481	32-8313-1	Philco	250	60	.0068 mfd.	2 $\frac{3}{4}$ "	2 $\frac{1}{16}$ " x 2 $\frac{5}{8}$ "	1.5	5.70
P-6483	VE-169	Farnsworth	240	50	.006	3 $\frac{1}{16}$ "	2 $\frac{1}{2}$ " x 2 $\frac{3}{8}$ "	2 $\frac{1}{2}$	7.90
P-6484	25B70950-E	Motorola	265	70	.007	3 $\frac{1}{16}$ "	2 $\frac{1}{2}$ " x 2 $\frac{3}{8}$ "	2 $\frac{1}{2}$	8.40
P-6485	95-1071	Zenith	240	70	.008	3 $\frac{1}{16}$ "	2 $\frac{1}{2}$ " x 2 $\frac{3}{8}$ "	2 $\frac{1}{2}$	8.70
P-6486	25C472586-C	Motorola	240	80	.007	3 $\frac{1}{2}$ "	2 $\frac{1}{8}$ " x 2 $\frac{3}{4}$ "	3 $\frac{1}{2}$	9.25
P-6487	25B-231303	Motorola	170	60	.007	2 $\frac{1}{16}$ "	2 $\frac{1}{16}$ " x 2 $\frac{3}{16}$ "	1 $\frac{3}{4}$	7.05
P-6488	25C-521454	Motorola	225	50	.007	2 $\frac{7}{8}$ "	2 $\frac{1}{16}$ " x 2 $\frac{3}{8}$ "	2	5.90





FILTER CHOKES

CHICAGO STANDARD TRANSFORMER CORPORATION

SMOOTHING CHOKES FOR D.C. POWER SUPPLIES.

Inductance varies with the amount of D.C. flowing through the coil, are rated at 10 volts, 60 cycles, with maximum D.C. in winding. therefore these units have been tested under uniform conditions. They Tolerance of plus 15% is maintained on all ratings.

Part No.	Induc.	Rating at Ma.	D.C.	D.C. Res. in Ohms	R.M.S. V. Insul.	Mtg.	Height Overall	Base Area	Shpg. Wt. in Lbs.	List Price
C-1515	20.0 hy.	at	15 ma.	900	1500	A	1 5/8"	2 7/8" x 1 1/2"	0.7	\$2.20
C-1706	4.5 hy.	at	50 ma.	300	1500	A	1 3/8"	2 3/8" x 1 3/8"	0.4	1.85
C-1707	7.0 hy.	at	50 ma.	500	1500	A	1 3/8"	2 3/8" x 1 3/8"	0.4	1.95
C-1003	16.0 hy.	at	50 ma.	580	1500	A	2"	3 1/4" x 1 3/8"	1.1	2.45
C-1708	13.0 hy.	at	65 ma.	500	1500	A	2"	3 1/4" x 1 3/8"	1.0	3.05
C-1355	8.0 hy.	at	75 ma.	290	1500	L	2 1/16"	2 5/8" x 1 3/4"	1.0	3.05
C-1002	15.0 hy.	at	75 ma.	400	1500	A	2 1/4"	3 3/4" x 2 1/4"	1.7	3.25
C-1420	16.0 hy.	at	80 ma.	360	1500	C	3 1/16"	3 1/2" x 2 5/8"	2.5	5.40
C-1709	8.0 hy.	at	85 ma.	250	1500	A	2"	3 3/4" x 2"	1.4	3.40
C-2305	5.0 hy.	at	100 ma.	300	1500	TD	2 1/16"	2 3/4" x 2 3/16"	1.5	4.70
C-1001	10.5 hy.	at	110 ma.	225	3000	A	2 5/8"	4" x 2 1/2"	2.3	4.45
C-2303	2.5 hy.	at	130 ma.	100	2000	A	2"	3 1/4" x 1 3/4"	1.0	3.10
C-1421	7.0 hy.	at	140 ma.	165	3000	C	3 1/16"	2 5/8" x 2 5/8"	2.5	6.15
C-2304	2.3 hy.	at	150 ma.	60	1500	A	2 1/8"	3 1/4" x 1 3/4"	1.0	3.20
C-2309	3.0 hy.	at	150 ma.	90	2000	A	2 1/4"	3 3/8" x 2 1/4"	1.7	3.85
C-1710	7.0 hy.	at	150 ma.	200	1500	A	2 3/8"	4" x 2 1/4"	2.2	4.95
C-1410	4.0 hy.	at	175 ma.	100	3000	C	3 1/16"	2 5/8" x 2 5/8"	2.4	6.30
C-2327	1.5 hy.	at	200 ma.	85	1500	A	1 9/8"	2 1/8" x 1 1/2"	0.8	2.45
C-1646	5.0 hy.	at	200 ma.	90	5000	C	4"	3 1/4" x 3 3/8"	4.5	9.00
C-1411	4.5 hy.	at	200 ma.	80	3000	C	3 5/8"	3" x 3 1/2"	3.5	7.15
C-1721	8.5 hy.	at	200 ma.	120	3000	N	3 1/8"	3 1/2" x 3"	4.4	8.20
C-1703	4.0 hy.	at	250 ma.	60	3000	B	3 1/2"	2 1/2" x 3 1/2"	4.2	9.10
C-1412	4.0 hy.	at	250 ma.	60	3000	C	3 3/8"	3" x 3 1/2"	4.3	10.45
C-1722	8.0 hy.	at	300 ma.	80	3000	N	4 3/8"	3 3/8" x 3 1/2"	7.3	13.60
C-2308	8.0 hy.	at	300 ma.	80	3000	C	4 3/4"	4" x 3 7/8"	7.8	13.75
C-1413	8.0 hy.	at	300 ma.	80	5000	D	4 3/8"	4" x 4 1/2"	7.8	13.75
C-2328	0.8 hy.	at	375 ma.	25	1500	A	2 1/2"	3 3/4" x 2"	1.5	5.05
C-1414	7.5 hy.	at	400 ma.	60	5000	D	4 3/8"	4" x 5 1/2"	11.8	19.80
C-1415	6.0 hy.	at	500 ma.	75	7500	FS	7 3/8"	6 1/8" x 7"	23.7	45.80

SWINGING CHOKES FOR INPUT SECTION OF D.C. POWER SUPPLIES.

Inductance varies with the amount of D.C. flowing through the coil, 10% of maximum D.C. in windings. therefore these units have been tested under uniform conditions. Tolerance of plus 15% is maintained on all ratings. Swinging chokes are rated at 10 volts, 60 cycles, from maximum to

Part No.	Min. Swg. Induc.	D.C. Res. in Ohms	Approx. Range of Induc. at D.C. Ma.	R.M.S. V. Insul.	Mtg.	Height Overall	Base Area	Shpg. Wt. in Lbs.	List Price	
C-1718	10 hy.	130	13.5-3.5 hy. at	15-150	2000	C	3 1/8"	2 5/8" x 2 1/2"	2.3	\$6.35
C-1400	10 hy.	100	12-2 at	17.5-175	3000	C	3 1/8"	2 5/8" x 2 5/8"	2.4	7.10
C-1401	10 hy.	80	12-2 at	20-200	3000	C	3 3/8"	3" x 3 3/8"	3.5	8.10
C-1645	10 hy.	90	12-2 at	20-200	5000	C	4"	3 1/2" x 3 3/8"	4.5	9.30
C-1702	10 hy.	60	12-2 at	25-250	3000	B	3 1/2"	2 3/8" x 3 3/8"	4.3	9.30
C-1402	10 hy.	60	12-2 at	25-250	3000	C	3 5/8"	3" x 3 3/8"	4.3	10.45
C-1720	16 hy.	80	20-4 at	30-300	3000	N	4 5/8"	3 3/4" x 3 1/2"	7.2	13.30
C-2307	16 hy.	80	20-4 at	30-300	3000	C	4 3/8"	4" x 3 3/8"	7.9	15.15
C-1403	16 hy.	80	20-4 at	30-300	5000	D	4 3/8"	4" x 4 1/2"	7.7	13.50
C-1404	14 hy.	60	17-3 at	40-400	5000	D	4 3/8"	4" x 5 1/2"	11.7	19.80
C-1405	12 hy.	75	16-4 at	50-500	7500	FS	7 3/8"	6 1/8" x 7"	24.3	40.70

SMOOTHING CHOKES FOR USE IN A.C.-D.C. POWER SUPPLIES.

Inductance varies with the amount of D.C. flowing through the coil, chokes are rated at 10 volts, 60 cycles, with maximum D.C. in windings therefore these units have been tested under uniform conditions. Filter Tolerance of plus 15% is maintained on all ratings.

Part No.	Induc.	Rating at Ma.	D.C.	D.C. Res. in Ohms	R.M.S. V. Insul.	Mtg.	Height Overall	Base Area	Shpg. Wt. in Lbs.	List Price
C-1080	3.5 hy.	at	50 ma.	200	1500	A	1 5/8"	2 7/8" x 1 1/2"	0.7	\$2.15
C-1325	5.0 hy.	at	50 ma.	250	1500	A	1 5/8"	2 7/8" x 1 1/2"	0.7	2.30
C-1277	7.0 hy.	at	50 ma.	300	1500	A	1 5/8"	2 7/8" x 1 1/2"	0.7	2.55
C-1723	4.5 hy.	at	50 ma.	325	1500	A	1 5/8"	2 3/8" x 1 3/8"	0.4	2.00
C-1227	7.0 hy.	at	50 ma.	350	1500	A	1 5/8"	2 7/8" x 1 1/2"	0.7	2.50
C-1279	8.5 hy.	at	50 ma.	400	1500	A	1 5/8"	2 7/8" x 1 1/2"	0.7	2.20
C-1333	8.0 hy.	at	50 ma.	450	1500	A	1 5/8"	2 7/8" x 1 1/2"	0.7	2.25
C-1215	9.0 hy.	at	50 ma.	500	1500	A	1 5/8"	2 7/8" x 1 1/2"	0.7	2.05

SPEAKER FIELD SUBSTITUTE CHOKES

Part No.	D.C. Resistance	Max. Current	Height Overall	Base Area	Mtg.	Shpg. Wt. in Lbs.	List Price
†C-2302	1750/1000/750/500 ohms 3000/2500/2250/2000/1500/500 ohms	60 ma. cont. or 75 ma. int. 40 ma. cont. or 55 ma. int.	3 1/2"	2 1/8" x 2 1/4"	N	3.1	\$9.15

†Designates part number to be removed from next catalog.

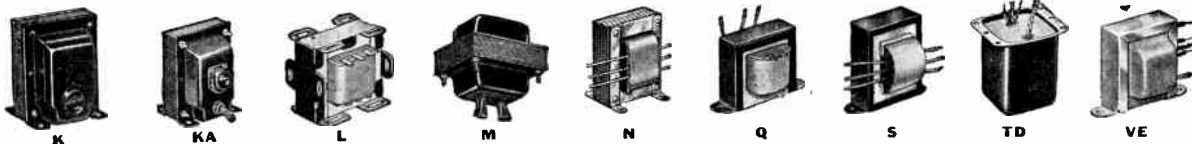

MODULATION TRANSFORMERS

CHICAGO STANDARD TRANSFORMER CORPORATION



PLATE MODULATION

Part No.	Impedance in Ohms	Max. D.C. Pri.	Ma. Tube Sec.	Typical Output Tubes	Class	Audio Watts	Mtg.	Height Overall	Base Area	Shpg. Wt. in Lbs.	List Price
A-3812	Pri—10,000 CT Sec—4,000	32	50	Sgl.—37, 38, 41, 1G5, 6K6 Sgl.—19, 1G6, 1J6, 6E6, 6G6, 6Z7 P.P.—30, 49, 1H4	A B	5	A	1 3/8"	2 3/8" x 1 1/2"	0.7	\$3.65
A-3871	Pri—4,500 Sec—8,500 #Secondary used as primary.	60	50	Sgl.—6L6, HY69 #Sgl.—6B5, 6F6, 6N6	A A	10	TD	2 11/16"	2 3/4" x 2 3/8"	1.4	6.65
†A-3873	Pri—8,500 CT Sec—8,000	100	100	Sgl.—6B5, 6F6, 6N6 P.P.—6L6, RK56, HY60	A AB	25	C	3 3/16"	2 5/8" x 3 3/8"	4.2	10.55
A-3845	Pri—10,000 CT Sec—8,000/6,500/5,000/3,000	100	100	Sgl. 53, 79, 6A6, 6N7, 6Y7 P.P.—42, 2A5, 6F6, 6V6	B AB2	25	C	3 3/16"	2 5/8" x 2 3/4"	2.8	8.35
†A-3835	Pri—5,000/3,000 CT Sec—10,000/8,350/5,350	80	100	P.P.—45, 50, 2A3, 6A3, 6A5, 6B4, 6L6	AB	25	C	4"	3 1/4" x 3 1/8"	4.0	11.30
†A-3868	Pri—6,600 CT Sec—12,000/10,000	100	70	P.P.—6L6	AB	35	C	3 3/16"	2 5/8" x 3 5/8"	4.0	10.95
A-3808	Pri—3,800/3,300 CT Sec—10,000/7,500/5,000/4,000	260	170	P.P.—6L6, 807, HY61, RK41 P.P. Par—6L6	AB2 AB1	60	D	4 3/4"	4" x 2 7/8"	7.7	18.75
†A-2907	Pri—8,000 CT Sec—12,500/9,000/6,800/ 5,000/3,300	200	150	P.P.—10, T20, TZ20, HY25, 46, 801, 825, 841	B	90	D	4 3/4"	4" x 5 1/4"	9.7	21.30
†A-2908	Pri—12,000/7,200 CT Sec—6,250/5,350/4,500/3,000	260	220	P.P.—RK18, T20, TZ20, HY25, RK31, 35T, 50T, 800, 801, 830B, 1623	B	120	D	4 3/4"	4" x 5 5/8"	9.7	22.90
A-3829	Pri—9,000/6,900 CT Sec—6,250/5,000/4,000/3,300	250	300	P.P.—RK12, HY25, 35T, HY40Z, T40, TZ40, 100TL, HK354, 756, 809, 830B	B	175	D	4 3/4"	4" x 6 1/8"	11.4	23.75

POLY-PEDANCE MODULATION MULTI-TAPPED UNITS TO PROPERLY MATCH THE OUTPUT OF THE MODULATOR STAGE TO THE MODULATED LOAD. WILL MATCH ALL COMMON IMPEDANCES OF CLASS "B" MODULATOR (2,000 to 20,000 OHMS) TO CLASS "C" LOAD IMPEDANCES OF 2,000 TO 20,000 OHMS.

The number of excellent transmitting tubes available is constantly increasing. R.F. applications, too, have increased and it is sometimes difficult to obtain the correct modulation transformer suitable for

matching some given modulator tubes or R.F. load. These units give an almost unlimited range in power and impedance ratings to assure a correct impedance match in all cases.

Part No.	Max. Watts	Max. D.C.	Mtg.	Height Overall	Base Area	Shpg. Wt. in Lbs.	List Price
A-3891	15	Pri—100 ma. Sec—100 ma.	D	3 3/8"	2 5/8" x 2 7/8"	2.5	\$13.60
A-3892	30	Pri—150 ma. Sec—150 ma.	D	4"	3 1/4" x 3 5/8"	4.3	17.20
A-3893	60	Pri—180 ma. Sec—180 ma.	D	4"	3 1/4" x 4 1/8"	6.2	18.60
A-3894	125	Pri—225 ma. Sec—225 ma.	D	4 3/4"	4" x 4 5/8"	9.4	22.50
A-3898	300	Pri—260 ma. Sec—260 ma.	FS	7 3/4"	7 3/8" x 8 1/8"	37.9	70.65
A-3899	600	Pri—500 ma. Sec—500 ma.	FS	11 1/4"	7 3/8" x 9"	70.0	140.70



TW



KA



L



M



N



Q



S



TD



W1-2



FILAMENT TRANSFORMERS

CHICAGO STANDARD TRANSFORMER CORPORATION

FILAMENT TRANSFORMERS WITH SINGLE SECONDARY

Part No.	Volts	Secondary Amperes	R.M.S. V. Insul.	Primary Volts†	Mtg.	Height Overall	Base Area	Shpg. Wt. in Lbs.	List Price
P-4026	2.5	1.5	2,500	117	A	1 3/8"	2 3/8" x 1 1/2"	0.7	\$3.60
P-4082	2.5 CT	2.5	2,500	117/107	TD	2 1/16"	2 3/4" x 2 3/16"	1.5	7.25
P-6133	2.5 CT	5.0	7,500	117	S	2 1/16"	3 3/16" x 2 1/4"	1.5	5.70
P-4083	2.5 CT	6.0	2,500	117/107	C	3 3/16"	2 3/8" x 2 3/8"	2.2	7.60
P-3024	2.5 CT	10.0	2,500	117/107	C	3 3/16"	2 3/8" x 2 3/8"	2.5	7.50
P-3060	2.5 CT	10.0	10,000	117	B	3 1/2"	2 1/2" x 2 1/2"	2.5	6.90
‡P-3025	2.5 CT	10.0	10,000	117/107	FA	5 1/8"	4 1/4" x 8 1/2"	10.7	22.35
P-3026	5.0 CT	3.0	2,500	117/107	C	3 3/16"	2 3/8" x 2 3/8"	2.4	7.50
P-4088	5.0 CT	3.0	2,500	117	B	3 3/8"	2 1/2" x 2 1/2"	1.8	5.45
*P-6467	5.0 CT	3.0	2,500	117	A	2	3 5/16" x 2" 2 13/16"	1.4	4.80
P-3062	5.0 CT	6.0	2,500	117	B	3 3/8"	2 1/2" x 2 1/2"	2.3	6.35
P-5000	5.0 CT	6.0	2,500	117/107	C	3 3/16"	2 3/8" x 2 3/8"	3.1	8.70
P-6135	5.0 CT	10.0	2,500	117	N	3 3/8"	2 1/2" x 2 3/8"	3.0	7.05
P-4086	5.0 CT	14.0	10,000	117/107	FA	5 1/8"	4 1/4" x 8 1/2"	12.3	25.45
P-6302	5.0 CT	22.0	10,000	117/107	FA	5 1/8"	4 1/4" x 8 1/2"	13.5	27.80
P-6468	5.0 CT	30.0	2,500	117/107	D	4 5/16"	3 1/8" x 3 3/8" 2 3/4" x 2 11/16"	4.3	16.25
P-6305	5.0 CT	30.0	10,000	117/107	FB	5 1/8"	4 1/4" x 10"	18.3	34.70
P-6137	5.25 CT	13.0	2,500	117	N	3 3/8"	3 1/4" x 3 3/4" 2 13/16"	5.2	11.60
P-6134	6.3 CT	1.2	3,000	117	A	1 3/8"	2 3/8" x 1 3/8"	0.8	2.90
P-8190	6.3	1.2	5,000	117	A	2	3 1/4" x 1 3/4" 2 13/16"	1.0	3.80
P-8191	6.3	1.2	5,000	6.3	A	2	3 1/4" x 1 3/4" 2 13/16"	1.0	4.10
P-5014	6.3 CT	3.0	2,500	117	B	3 3/8"	2 1/2" x 2 1/2"	2.0	5.15
P-6466	6.3 CT	3.0	2,500	117	A	2	3 5/16" x 2" 2 13/16"	1.4	4.65
P-4019	6.3 CT	4.0	2,500	117/107	C	3 3/16"	2 3/8" x 2 3/8"	2.7	7.20
P-3064	6.3 CT	6.0	2,500	117	B	3 3/8"	2 1/2" x 2 1/2"	2.4	6.25
P-4089	6.3 CT	6.0	2,500	117/107	C	3 3/8"	3" x 3 3/8"	3.5	8.25
P-6308	6.3 CT	10.0	2,500	117/107	N	3 1/2"	2 3/8" x 2 3/4"	3.4	7.50
P-6309	6.3 CT	20.0	2,500	117/107	N	4 3/8"	3 3/4" x 3"	6.7	14.20
P-5015	7.5 CT	4.0	2,500	117	B	3 3/8"	2 1/2" x 2 1/2"	2.7	6.35
P-4091	7.5 CT	5.0	2,500	117/107	C	3 3/8"	3" x 3"	3.4	10.05
P-6138	7.5 CT	8.0	2,500	117	N	3 3/8"	3 1/2" x 2 3/8"	4.7	9.20
P-5016	10.0 CT	4.0	2,500	117	B	3 3/2"	2 3/8" x 2 3/8"	3.3	7.65
P-4096	10.0 CT	5.0	2,500	117/107	C	4"	3 1/4" x 3 3/8"	4.0	9.10
P-6139	10.0 CT	8.0	2,500	117	N	3 3/8"	3 3/8" x 3 3/8"	4.9	9.30
P-4097	10.0 CT	8.0	2,500	117/107	C	4"	3 1/4" x 3 3/8"	5.2	10.10
P-5002	10.0 CT	12.0	7,500	117/107	FA	5 1/8"	4 1/4" x 8 1/2"	14.7	26.75
P-3020	11.0 CT	10.0	2,500	117/107	C	4 3/4"	4" x 3 1/2"	7.7	14.95
P-8130	12.6 CT	2.0	1,500	117	A	2"	3 3/4" x 2"	1.4	5.15
P-6469	25.2	1.0	1,500	117	A	2"	3 3/4" x 2"	1.4	4.90

FILAMENT TRANSFORMERS WITH MULTIPLE SECONDARY

P-6144	2.5 CT	3.5	2,500	117	C	3 3/8"	3" x 3 1/8"	3.7	\$11.70
	5.0 CT	3.0	2,500						
	6.3 CT	3.0	2,500						
P-6338	2.5	3.0	2,500	117	N	3 1/2"	2 3/8" x 2 3/8"	3.4	11.10
	5.0	3.0	2,500						
	6.3 CT	3.0	2,500						
P-5009	5.0 CT	3.0	2,500	117/107	C	4"	3 1/4" x 3 1/4"	4.5	13.35
	6.3 CT	6.0	2,500						
P-5008	5.0 CT	4.0	2,500	117/107	C	3 3/8"	3" x 3 3/8"	3.8	11.75
	6.3 CT	3.6	2,500						
P-4022	5.0 CT	6.0	2,500	117/107	C	4"	3 1/4" x 3 3/8"	4.8	12.55
	6.3 CT	6.0	2,500						
P-6333	5.0	3.0	2,500	117	B	3 1/2"	2 3/8" x 3 3/8"	4.7	12.90
	5.0	3.0	2,500						
	6.3 CT	4.0	2,500						
	7.5/6.3 CT	3.0	2,500						

TUBE CHECKER MULTI-TAPPED FILAMENT TRANSFORMER

Part No.	Secondary Volts	Primary Volts	Mtg.	Height Overall	Base Area	Shpg. Wt. in Lbs.	List Price
P-1834-3	1.1/ 1.4/ 1.5/ 2.0/ 2.5/ 3.0/ 3.3/ 5.0/ 6.3/ 7.0/ 7.5/ 12/ 25/ 30/ 35/ 50/ 70/ 85/ 110/ 117	125/115/105	A	2 5/8"	4" x 2"	2.4	\$14.20

†All primary windings for 60 cycle operation.

‡Designates part number to be removed from next catalog.

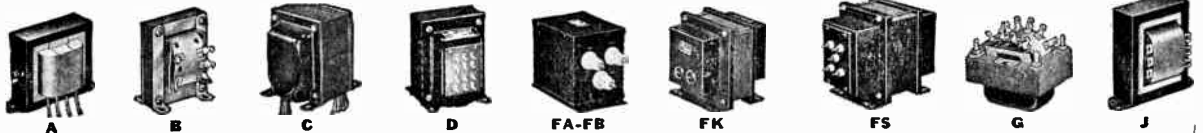

PLATE TRANSFORMERS



CHICAGO STANDARD TRANSFORMER CORPORATION

PLATE TRANSFORMERS

Part No.	D.C. Volts	Sec. A.C. Volts at Plate	D.C. CCS	Ma. ICAS	Pri. Volts	Mtg.	Height Overall	Base Area	Shpg. Wt. in Lbs.	List Price
P-8040	400 40	500/40-0-500	300	375	115	C	4 $\frac{3}{4}$ "	4" x 4 $\frac{1}{2}$ "	9.8	\$19.05
P-8041	500 400 40	615/520/40-0-520/615	250	310	115	C	4 $\frac{3}{4}$ "	4" x 5 $\frac{1}{8}$ "	13.6	20.65
P-8042	600 400 40	770/510/40-0-510/770	300	375	115	C	4 $\frac{3}{4}$ "	4" x 6 $\frac{1}{8}$ "	18.0	30.45
P-8043	750 600 40	950/750/40-0-750/950	300	375	115	FS	7 $\frac{5}{8}$ "	6 $\frac{1}{8}$ " x 8"	29.0	56.70
‡P-8045	1000 750	1225/850-0-850/1225	250	310	115	FS	7 $\frac{5}{8}$ "	6 $\frac{1}{8}$ " x 8"	28.5	61.00
P-8025	1000 750	1230/940-0-940/1230	400	500	115	FS	7 $\frac{5}{8}$ "	6 $\frac{1}{8}$ " x 8 $\frac{3}{4}$ "	35.0	71.95
P-8026	1250 1000	1475/1175-0-1175/1475	300	375	115	FS	7 $\frac{3}{4}$ "	7 $\frac{3}{8}$ " x 8 $\frac{1}{4}$ "	36.5	68.45
P-8027	1250 1000	1510/1210-0-1210/1510	500	625	115	FS	7 $\frac{3}{4}$ "	7 $\frac{3}{8}$ " x 9"	45.2	80.90
P-8028	1500 1250	1740/1460-0-1460/1740	300	375	115	FS	7 $\frac{3}{4}$ "	7 $\frac{3}{8}$ " x 8 $\frac{1}{2}$ "	38.7	72.45
P-8029	1500 1250	1775/1500-0-1500/1775	500	625	115-230	FS	11 $\frac{1}{4}$ "	7 $\frac{3}{8}$ " x 8 $\frac{3}{4}$ "	65.0	112.35
‡P-8030	1750 1500	2100/1800-0-1800/2100	300	375	115	FS	7 $\frac{3}{4}$ "	7 $\frac{3}{8}$ " x 9"	45.8	79.90
‡P-8031	1750 1500	2075/1775-0-1775/2075	500	625	115-230	FS	11 $\frac{1}{4}$ "	7 $\frac{3}{8}$ " x 8 $\frac{3}{4}$ "	65.5	110.60
‡P-8032	2000 1750	2400/2100-0-2100/2400	300	375	115	FS	7 $\frac{3}{4}$ "	7 $\frac{3}{8}$ " x 9 $\frac{1}{4}$ "	46.0	94.55
P-8033	2000 1750	2375/2065-0-2065/2375	500	625	115-230	FS	11 $\frac{1}{4}$ "	7 $\frac{3}{8}$ " x 9 $\frac{1}{4}$ "	77.0	138.35
P-8034	2500 2000	2900/2385-0-2385/2900	300	375	115-230	FS	11 $\frac{1}{4}$ "	7 $\frac{3}{8}$ " x 8 $\frac{3}{4}$ "	62.8	134.50
P-8035	2500 2000	2950/2375-0-2375/2950	500	575	115-230	FS	11 $\frac{1}{4}$ "	7 $\frac{3}{8}$ " x 9 $\frac{3}{4}$ "	80.0	146.90
‡P-9920	2500§ 2000	2980-0-2980 2450-0-2450	350 500	450 625	117	Y	9 $\frac{1}{8}$ "	11 $\frac{1}{8}$ " x 9 $\frac{3}{8}$ "	122.0	229.85

PLATE TRANSFORMERS—NEW FUNCTIONAL UNITS

No exposed terminals. Insulated leads provide protected routing to circuits. Simplified design offers ease of mounting and neat, convenient circuit wiring. No difficult cutouts needed. Each of these units is "all transformer," taking a minimum of chassis space. No bulky casing or protruding, "hot" terminals to increase mounting area.

D.C. output rated CCS at load terminals of single-section reactor-input filter, ICAS with single-section capacitor-input filter. Primaries for 117 volts, 60 cycles.

Type Part No.	Secondary A.C. Volts	D.C. Output Volts	Ma.	Type Filter	Rectifier	List Price
PC8301	415-0-415	300	200	Reactor Input	5U4G	\$12.05
		425	160	Capacitor Input	5U4G	
PC8302	515-0-515	385	235	Reactor Input	5U4G	15.45
		500	200	Capacitor Input	5R4GY	
PC8303	665-0-665	500	250	Reactor Input	5R4GY	19.55
		750	200	Capacitor Input	5R4GY	
PC8304	750-0-750	600	265	Reactor Input	2-5R4GY	21.90
		850	200	Capacitor Input	5R4GY	
PC8305	920-0-920	750	250	Reactor Input	2-5R4GY	22.85
		1000	200	Capacitor Input	5R4GY	
PC8306*	920-0-920	750	150	Reactor Input	5R4GY	23.20
		1100	125	Capacitor Input	5R4GY	
PC8306*	500-0-500	380	150	Reactor Input	5U4G	23.20
		550	125	Capacitor Input	5U4G	

D.C. output rated at load terminals of single-section, reactor-input filter with full-wave mercury-vapor rectification. Primaries for 117 volts, 60 cycles.

Type and Part No.	Secondary A.C. Volts	D.C. Volts	CCS	D.C. Ma. ICAS	List Price
PT8311	1200-0-1200	1000	225	280	\$25.20
PT8312	1200-0-1200	1000	325	405	41.70
PT8313	1475-0-1475	1250	250	310	39.95
PT8314	1790-0-1790	1500	225	280	46.10
PT8315	2065-0-2065	1750	200	250	46.50

BIAS SUPPLY TRANSFORMERS

Part No.	High Voltage Supply A.C. Volts at D.C. Milliamps.	Rectifier Fil. Volts—Amperes	Mtg.	Height Overall	Base Area	Shpg. Wt. in Lbs.	List Price
P-6317	200/170/130/90/0/90/130/170/200 @ 200 ma.	5.0 3.0	CD	4"	3 $\frac{1}{4}$ " x 3 $\frac{3}{8}$ "	4.9	\$17.20
P-6318	450/400/350/250/0/250/350/400/450 @ 200 ma.	5.0 3.0	CD	4 $\frac{5}{16}$ "	3 $\frac{3}{8}$ " x 4 $\frac{1}{8}$ "	7.0	19.55

All Primary Windings for 60 cycle operation. †Designates part number to be removed from next catalog.
§Output changed by means of tap on primary winding. Rating is for a single section choke input filter using a 6 mfd. condenser.



ISOLATION AND AUTOFORMERS

CHICAGO STANDARD TRANSFORMER CORPORATION

STRAIGHT ISOLATION—125/115/105 VOLTS TO 115 VOLTS.

Part No.	Wattage	Primary#	Secondary	Mtg.	Height Overall	Base Area	Shpg. Wt. in Lbs.	List Price
P-6160	100	125/115/105	115	KA	4 3/4"	4" x 3 5/8"	7.0	\$19.00
P-6161	250	125/115/105	115	KA	4 3/4"	4" x 5 3/8"	14.2	\$5.75
P-6298	500	125/115/105	115	FK	7 3/8"	6 1/2" x 7 1/8"	28.0	\$5.95
P-6125	1000	125/115/105	115	FK	7 3/8"	7 3/8" x 6 7/8"	34.8	\$7.35
P-6123	1500	125/115/105	115	FK	7 3/4"	7 3/8" x 8 1/2"	49.8	\$1.50

STEP-DOWN ISOLATION—250/230/210 VOLTS TO 115 VOLTS.

Part No.	Wattage	Primary#	Secondary	Mtg.	Height Overall	Base Area	Shpg. Wt. in Lbs.	List Price
P-6383	100	250/230/210	115	KA	4 3/4"	4" x 3 5/8"	7.3	\$20.80
P-6385	250	250/230/210	115	KA	4 3/4"	4" x 5 3/8"	14.2	\$3.70
P-6387	500	250/230/210	115	FK	7 3/8"	6 1/2" x 7 1/8"	29.5	\$7.75
P-6389	1000	250/230/210	115	FK	7 3/8"	7 3/8" x 6 7/8"	33.8	\$4.40
P-6390	1500	250/230/210	115	FK	7 3/4"	7 3/8" x 8 1/2"	50.3	\$2.95

ISOLATION TESTING TRANSFORMER

Part No.	Wattage	Primary#	Secondary	Mtg.	Height Overall	Base Area	Shpg. Wt. in Lbs.	List Price
P-6415	350	117	105/115/125	KC	5 3/8"	4 1/2" x 5 3/4"	17.0	\$30.25

Large enough to handle almost any television or radio receiver on test. Has three standard receptacles, providing output voltages of 105, 115 and 125, with 117 volts, A.C., from the line for testing purposes or for correction of high or low line voltage. Has electrostatic shield.

AUTOFORMERS

Part No.	Wattage	Primary#	Secondary	Mtg.	Height Overall	Base Area	Shpg. Wt. in Lbs.	List Price
P-6287	40	230	115	—	4 1/2"	3" Diam. can	2.7	\$ 9.50
P-5062	80	230	115	K	3 3/8"	3" x 3 1/4"	3.8	\$10.20
P-5063	100	230	115	K	4"	3 1/2" x 3 1/2"	4.5	\$11.55
P-5064	150	230	115	K	4 5/8"	3 3/8" x 3 5/8"	5.2	\$13.35
P-5065	300	230	115	K	4 3/4"	4" x 4 3/8"	8.8	\$17.60
P-6141	500	230	115	K	4 3/4"	4" x 5 3/8"	13.7	\$23.10
P-6124	1000	230	115	FK	7 3/8"	6 1/2" x 6 3/8"	24.5	\$50.30
P-6299	150	115	150/140/130/120/110/100/90	KA	4"	3 1/2" x 4 3/4"	6.0	\$19.05

Testing Autoformer—Designed especially for various service and test application. Incorporates a convenient tap switch to permit variable voltages from 90 to 150 volts. It may be used to apply an overload voltage to amplifiers, radio receivers, or other electronic devices being serviced, which will indicate and cause suspected parts to break down. Primary equipped with 6 ft. approved cord and plug. Secondary connected to female receptacle.

LINE ADJUSTING AUTOFORMERS

Stancor Line Adjusters permit operation of electrical devices at 115 volts when the supplied voltage is 65, 75, 90, 100, 115, 130 or 145. They are also useful for altering a 115 volt line above or below that level. The line adjuster input is correctable in seven steps by means of a selector switch and is accurately indicated by an output voltmeter. The meter has a convenient red-line marker at 115 volts on a 150 volt scale.

Type and Part No.	Va.*	Input Voltage 50-60 Cycle	Output Voltage	Height	Base Area	Shpg. Wt. in Lbs.	List Price
PV-6441	150	65/75/90/100/115/130/145	115	5 1/2"	3 1/2" x 5 3/8"	6.4	\$21.95
PV-6442	350	65/75/90/100/115/130/145	115	5 1/2"	3 3/8" x 6 1/8"	10.5	\$27.90
PV-6443	500	65/75/90/100/115/130/145	115	5 1/2"	3 3/8" x 6 7/8"	15.0	\$47.75
PV-6444	750	65/75/90/100/115/130/145	115	6 5/8"	4 1/2" x 8 3/8"	19.0	\$24.40

*Watts to pure resistive load. To other types of loads, multiply rating of line adjuster by power factor of load for actual wattage.
#All Primary Windings for 60 cycle operation.

CATHODE RAY TUBE POWER TRANSFORMERS

For use with type 2X2 rectifier tubes in a conventional half-wave voltage supply.

Part No.	Plate Supply A.C. Volts	Rectifier Filament D.C. Milliampers	Rectifier Filament Volts—Amperes	Other Windings Volts—Amperes	Mtg.	Height Overall	Base Area	Shpg. Wt. in Lbs.	List Price
P-8150	1,550 half-wave	1.5	2.5 1.75	...	TD	3 1/2"	3" x 2 1/2"	1.8	\$11.00
P-8151	2,400 half-wave	5.0	2.5 2.0	2.5 2.0	C	4 5/8"	3 3/8" x 3 3/4"	6.4	\$16.30

PHOTOFLASH POWER TRANSFORMER

Part No.	Application	Pri.	Sec.	Mtg. Type	Height Overall	Base Area	Mtg. Ctrs.	Shpg. Wt. in Lbs.	List Price
P-6425	For use in Sprague electronic flash circuits. See Sprague Electronic Flash Handbook C-703	105/115/125V. 60 cy.	Charges up to 1050 mfd. to 450 Volts D.C.	S	2 1/8"	2 1/8" x 2"	2 3/8"	1.4	\$5.25
P-6426	Trigger coil for use with 450V. flashtube. Replaces G.E. 86G41				3/4"	3/8" diam.		0.2	2.50

SPEAKER FIELD SUPPLY TRANSFORMER

Part No.	Plate Supply A.C. Volts	Rectifier Filament D.C. Milliampers	Rectifier Filament Volts—Amperes	Mtg.	Height Overall	Base Area	Shpg. Wt. in Lbs.	List Price
P-6146	120-0-120	250	5.0 3.0	C	4"	3 1/2" x 3 3/8"	4.2	\$11.75

All Primary Windings for 117 V-60 cycle operation unless otherwise indicated.

CONDENSER TESTER POWER TRANSFORMER

Part No.	Plate Supply A.C. Volts	Rectifier Filament D.C.-M.A.	Fil. Wdgs. Volts	Amps.	Overall Dimensions	Mtg. Type	Shpg. Wt. in Lbs.	List Price
P-6459	550 55	30 60	6.3 6.3	0.9 0.6	L 2 3/8" W 2 3/8" D 2 1/4"	Coil and Iron	1.4	\$8.20

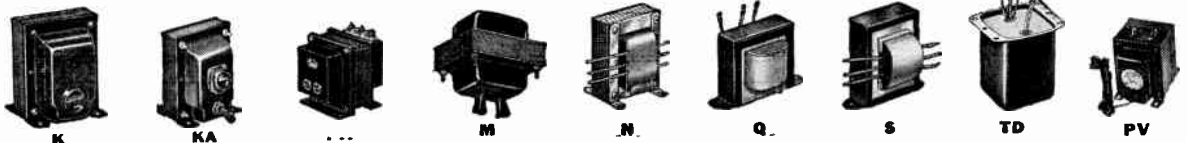

Radio's Master—19th Edition

Copyright by U. C. P. Inc.

TRIAD TRANSFORMER CORP.



MINIATURES

JAF SERIES — HERMETICALLY SEALED

These tiny transformers are hermetically sealed to MIL-T-27 requirements and are encased in standard military AF cans deep-drawn from "Trialloy" nickel alloy magnetic shielding material. Wide frequency range is consistently achieved by layer wound coils of extremely fine wire.

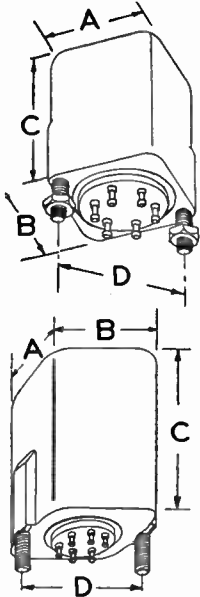

Type No.	List Price	Application	Impedance		Max. Level VU	Shielding db.	Freq. Resp.	Case No.
			Primary	Secondary				
JAF-1	\$16.00	Line or mike to grid.	600/250/50	5000	0	45	60-15000	AF
JAF-2	16.50	Line or mike to grid. Hi-gain.	600/250/50	250000	0	45	150-7000	AF
JAF-3	16.50	Line or mike to p.p. grids.	600/250/50	60000 C.T.	0	45	60-15000	AF
JAF-5	16.50	Dynamic mike or speaker VC to grid.	30/12/4	50000	0	45	60-1200	AF
JAF-11	15.50	Plate to grid.	15000	50000	10	45	60-15000	AF
JAF-12	16.00	Plate to p.p. grids.	15000	60000 C.T.	10	45	60-15000	AF
JAF-13	16.50	Plate to p.p. grids. DC in pri.	15000	95000 C.T.	10	45	350-7000	AF
JAF-14	16.50	Mike or line to grid.	200	1/2 megohm	0	45	350-5000	AF
JAF-15	16.50	Single plate to single grid.	15000	1 megohm	10	45	350-5000	AF
JAF-21	16.00	Plate to line.	15000	600/250/50	10	45	60-15000	AF
JAF-22	16.00	Plate to line. DC in pri.	15000	600/250/50	10	45	350-7000	AF
JAF-23	16.50	P.p. plates to line.	20000 C.T.	600/250/50	10	45	60-15000	AF
JAF-31	16.00	Line to line.	600/250/50	600/250/50	10	45	60-15000	AF
JAF-101	14.50	Coupling Reactor.	50 h.-1 Ma.			45		AF

Low frequency loss will result from DC in windings other than where specified.

MIL-T-27 Cases

	AF	AG	AH	AJ
A	3/4	1	1 1/8	1 3/8
B	3/4	1	1 1/8	1 3/8
C	1 1/8	1 3/8	1 3/4	2 3/8
D	* 1 1/2	1 3/4	1 3/4	1 3/4
F	5/8	3/4	7/8	7/8

Wt. 1 oz. 2 1/2 oz. 4 oz. 9 oz.
*4-40 studs

MINIATURE AUDIO — Uncased "Trijets"

Type No.	List Price	Application	Impedance		Max. Level-VU	Freq. Resp.
			Primary	Secondary		
T-1	\$ 5.90	Line or mike to grid.	600/250/50	50000	0	60-15000
T-2	6.00	Line or mike to grid. Hi-gain.	600/250/50	250000	0	100-5000
T-3	6.00	Line or mike to p.p. grids.	600/250/50	60000 C.T.	0	60-15000
T-5	5.90	Dynamic mike or speaker VC to grid.	30/12/4	50000	0	60-15000
T-11	5.85	Plate to grid.	15000	50000	10	60-15000
T-12	5.90	Plate to p.p. grids.	15000	60000 C.T.	10	60-15000
T-13	6.00	Plate to p.p. grids. DC in pri.	15000	95000 C.T.	10	350-7000
T-20	5.85	Plate to line.	15000	600/250/50	10	60-15000
T-21	5.85	Plate to line.	30000	50	10	60-15000
T-22	5.85	Plate to line. DC in pri.	15000	600/250/50	10	350-7000
T-23	6.00	P.p. plates to line.	20000 C.T.	600/250/50	10	60-15000
T-31	6.00	Line to line.	600/250/50	600/250/50	10	60-15000
T-101	5.35	Coupling Reactor.	50 henries @ 1 Ma.			

Low frequency loss will result from DC in windings other than where specified.

Hermetically Sealed — JO-SERIES

Type No.	List Price	Application	Impedance		Max. Level VU	Shielding db.	Freq. Resp.	Case No.
			Primary	Secondary				
JO-1	\$15.50	Line or mike to grid.	600/250/50	50000	0	45	50-15000	JOA
JO-2	16.00	Line or mike to grid. Hi-gain.	600/250/50	250000	0	45	150-7000	JOA
JO-3	16.00	Line or mike to p.p. grids.	600/250/50	60000 C.T.	0	45	50-15000	JOA
JO-5	16.00	Dynamic mike or speaker VC to grid.	30/12/4	50000	0	45	50-12000	JOA
JO-11	15.00	Plate to grid.	15000	60000	10	45	50-15000	JOB
JO-12	15.50	Plate to p.p. grids.	15000	60000 C.T.	10	45	50-15000	JOB
JO-13	16.00	Plate to p.p. grids. DC in pri.	15000	95000 C.T.	10	45	300-7000	JOB
JO-21	15.50	Plate to line.	15000	600/250/50	10	45	50-15000	JOB
JO-22	15.50	Plate to line. DC in pri.	15000	600/250/50	10	45	300-7000	JOB
JO-23	16.00	P.p. plates to line.	20000 C.T.	600/250/50	10	45	50-15000	JOB
JO-31	15.50	Line to line.	600/250/50	600/250/50	10	45	50-15000	JOB
JO-101	14.00	Coupling Reactor.	50 h.-2 Ma.			45		JOB

Low frequency loss will result from DC in windings other than where specified.

POWER OUTPUT to Line and VC. — Hermetically Sealed

Type No.	List Price	Application	Impedance		Max. Level Watts	Freq. Resp.	Case No.
			Primary	Secondary			
HS-71	\$16.00	Plate to line. DC in pri.	10000 (10 Ma.)	600/150	2	150-6000	AH
HS-73	18.30	Plate to line & VC. DC in pri.	5000 (40 Ma.)	4-8-16-250-500	5	150-6000	AJ
HS-75	20.40	P.p. plates to line & VC.	10000 C.T. (50 Ma. bal.)	4-8-16-250-500	10	150-6000	EB
*HS-77	25.70	P.p. plates to line & VC.	9000 C.T. (120 Ma. bal.)	4-8-16-250-500	25	150-6000	GA

*New item.



JO Series

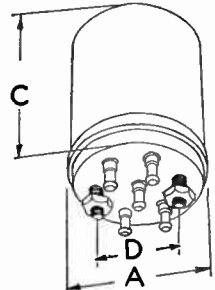

	JOA	JOB
A	1 1/8 dia.	1 1/8 dia.
B	Round	Round
C	1 1/8	1 3/8
D	7/8	7/8
F	7/8	7/8

Wt. 1 1/4 oz. 1 1/2 oz.



TRIAD TRANSFORMER CORP.

HERMETICALLY SEALED TRANSFORMERS

LOW LEVEL AUDIO Transformers

TRIAD low-level audio transformers have been adopted as standard by many manufacturers of the finest in audio equipment. No other transformers offer such wide frequency range and such effective magnetic shielding in such small size. Shielding up to 95 db. is attained by multiple "Trialloy" cases interleaved with heavy copper

shading rings. These transformers are solidly constructed, rigidly mounted with welded stainless steel studs, and hermetically sealed to MIL-T-27 specifications. Beautiful appearance, unmatched performance, long life, minimum size, are outstanding features of these quality transformers.

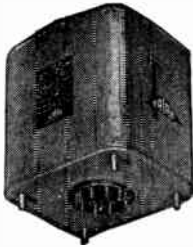

HS Series

AUDIO INPUT Transformers

Type No.	List Price	Application	Primary Impedance	Turn Ratio	Freq. Resp.	Max. Level VU	Shielding	Case No.
HS-1	\$38.50	Univ. line or mike to grid.	600 \ddagger /250 \ddagger / 150/62.5	1:11.3	20-20000	10	P-5	GP-4
HS-11	26.40	Same as above.					P-1	GP-2
HS-3	43.50	Univ. line or mike to p.p. class A grids.	600 \ddagger /250 \ddagger / 150/62.5	1:14 overall	20-20000	10	P-5	GP-5
HS-4	39.70	Same as above.					P-3	GP-4
HS-14	28.60	Same as above.					P-1	GP-3
HS-5	38.50	Dynamic mike to grid—Hi-gain.	30-50	1:65.7	50-10000	0	P-5	GP-4
HS-8	38.50	Line to p.p. class A grids—Hi-level.	600 \ddagger /250 \ddagger / 150/62.5	1:14 overall	20-20000	20	P-1	GP-4

\ddagger Balanced center tap available.

Low frequency loss will result from use of unbalanced DC in windings.

	GP-1	GP-2	GP-3
A	$\frac{3}{8}$	$1\frac{1}{8}$	$1\frac{1}{4}$
B	$1\frac{1}{8}$	$1\frac{1}{4}$	$1\frac{1}{2}$
Bw	$1\frac{1}{8}$	$1\frac{1}{4}$	$1\frac{1}{8}$
C	$1\frac{1}{4}$	$2\frac{1}{4}$	$2\frac{3}{8}$
D	$1\frac{1}{4}$	$1\frac{1}{2}$	$1\frac{1}{2}$
F	$\frac{3}{4}$	$\frac{3}{4}$	$\frac{1}{2}$
Wt.	3 oz.	$5\frac{1}{2}$ oz.	8 oz.

	GP-4	GP-5
A	$1\frac{1}{8}$	$1\frac{3}{8}$
B	$1\frac{3}{4}$	2
C	$2\frac{1}{2}$	$2\frac{3}{4}$
D	$1\frac{1}{2}$	$1\frac{1}{2}$
F	$\frac{1}{2}$	$\frac{1}{2}$
Wt.	12 oz.	17 oz.

AUDIO INTERSTAGE Transformers

Type No.	List Price	Application	Primary Impedance	Turn Ratio	Freq. Resp.	Max. Level Pri. Volts	Shielding	Case No.
HS-23	\$26.40	Single plate to single grid.	15000	1:2.7	20-20000	15	P-3	GP-4
HS-25	28.60	Single plate to p.p. class A grids.	15000	1:2.72 overall	20-20000	25	P-1	GP-4
HS-35	23.80	Single plate to p.p. class A grids.	15000	1:2.72 overall	20-20000	20	P-1	GP-2
HS-27	29.70	P.p. plates to p.p. class A grids.	20000/5000	1:1.72 overall	20-20000	50	P-1	GP-4
HS-29	38.50	Bridging-line to 1 or 2 grids.	20000/5000	1:2 overall	20-20000	20	P-5	GP-4
HSM-31	25.00	P.p. 6J5's or parallel-fed 6F6 triode to AB grids.	20000/5000	1:1 or 2:1	20-20000	240		FA

Low frequency loss will result from use of unbalanced DC in windings.

AUDIO LOW LEVEL OUTPUT, MIXING, MATCHING and BRIDGING Transformers

Type No.	List Price	Application	Impedance		Freq. Resp.	Max. Level VU	Shielding	Case No.
			Primary	Secondary				
HS-50	\$29.70	Plate to universal line.	15000	600 \ddagger /250 \ddagger / 150/62.5	20-20000	26	P-3	GP-4
HS-60	24.25	Plate to universal line.	15000	600 \ddagger /250 \ddagger / 150/62.5	20-20000	10	P-1	GP-2
*HS-61	27.50	Plate to universal line.—DC in pri.	15000 (5 Ma.)	600 \ddagger /250 \ddagger / 150/62.5	50-15000	20	P-1	GP-5
HS-52	32.50	P.p. plates to universal line.	20000/5000	600 \ddagger /250 \ddagger / 150/62.5	20-20000	26	P-1	GP-4
HS-54	38.50	Bridging, single or p.p. plates, to univ. line.	20000/5000	600 \ddagger /250 \ddagger / 150/62.5	20-20000	10	P-5	GP-4
HS-56	32.50	Universal line to universal line.	600 \ddagger /250 \ddagger / 150/62.5	600 \ddagger /250 \ddagger / 150/62.5	10-30000	20	P-3	GP-4
HS-66	27.50	Same as above.			10-30000	20	P-1	GP-3

*New item. \ddagger Balanced center tap available.

Low frequency loss will result from unbalanced DC in windings other than where specified.

FILTER REACTORS

Type No.	List Price	Current DC Ma.	Inductance Henries	Resistance Ohms	Test Voltage	Case No.
HSM-301	\$13.50	20	30	1000	1500	EA
HS-331	11.00	40	4	375	1500	AH
*HS-303	14.25	50	12	385	1500	EB
HS-333	11.50	70	3	225	1500	AJ
HSM-305	15.00	70	15	300	2500	GB
HS-335	12.00	120	3	150	1500	EB
HSM-307	17.50	120	15	185	2500	JB
HSM-309	18.00	150	9	115	2500	JB
HS-339	13.60	200	3	105	2000	FB
HSM-315	21.50	200	10	100	2500	JA
HS-341	14.60	300	2	48	2000	GB
HSM-319	28.00	300	10	85	2500	LA

*New item.

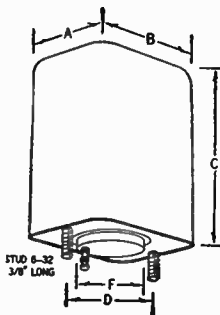

TRIAD TRANSFORMER CORP.



POWER COMPONENTS HERMETICALLY SEALED

TRIAD "HS" series power components are designed to meet the most stringent operating conditions in military and commercial service. They are hermetically sealed in heavy deep-drawn MIL standard cases, rigidly mounted with brazed stainless steel studs, liberally designed with highest quality materials, and beautifully finished in baked grey enamel. Both 50-60 cycle and 380-1500 cycle designs

meet all the requirements of the MIL-T-27 specification for Grade 1, Class A service. Among the qualification requirements are: 40°C maximum temperature rise, 10000 megohm insulation resistance, 10 day humidity and vibration cycle, alternate plus 85°C and minus 55°C temperature cycling. These are the finest transformers available!

Combined PLATE and FILAMENT Transformers Primary 115V—50/60 Cycle

Type No.	List Price	Plate Supply		Filaments	Case No.
		AC Volts	DC Ma.		
†HSM-201	\$21.00	500 C.T.	20	6.3 C.T.-2A.	GA
HSM-203	24.50	600 C.T.	50	6.3 C.T.-2.5A.-5-2A.	JB
HSM-205	27.50	700 C.T.	70	6.3 C.T.-3A.-5-3A.	JA
HSM-207	30.80	700 C.T.	120	6.3 C.T.-5A.-5-3A.	KA
HSM-211	37.50	700 C.T.-70 v. bias tap	150	6.3 C.T.-6A. 2.5 C.T.-5A.-5-3A.	LA
*HSM-212	39.00	1000/800 C.T.	150 (ch. input) 117 (cond. input)	6.3/5-4A.-6.3 C.T. 4A.-6.3V.-4A.	LA
HSM-215	43.00	800/700 C.T.-70 v. bias tap	200	6.3 C.T.-6A. 2.5 C.T.-10A.-5-6A.	MA
*HSM-216	45.00	1000/800 C.T.	200 (ch. input) 135 (cond. input)	6.3/5-4A. 6.3 C.T.-5A.-6.3-5A.	MA
HS-217	48.00	800/700 C.T.-70 v. bias tap	300	6.3 C.T.-8A. 2.5 C.T.-10A.-5-6A.	GP-15
*HSM-218	49.50	1000/800 C.T.	300 (ch. input) 235 (cond. input)	6.3/5-6A. 6.3 C.T.-6A.-6.3-6A.	GP-15
HSM-219	69.00	(115/230 pri.) 760/1600 C.T.	40/230 (ch. input)		GP-15

*New item. †Low flux density—for pre-amplifier service. All types electrostatically shielded.
GP-15 dimensions 4 3/4" x 5 7/8" x 6 5/8" high. Wt. approx. 22 lb.

Combined PLATE and FILAMENT Transformers Primary 115V—380/1500 Cycle

Type No.	List Price	Plate Supply		Filaments	Case No.
		AC Volts	DC Ma.		
HS-401	\$19.80	500 C.T.	40	6.3 C.T.-1A.-6.3-1A.	EB
HS-405	25.70	600 C.T.	70	6.3 C.T.-2A.-6.3-2A.-Δ6.3/5-2A.	GA
HS-407	30.80	600 C.T.	120	6.3 C.T.-3.5A.-6.3-3.5A.-Δ6.3/5-3A.	JB
HS-413	42.00	450 C.T.	200	6.3 C.T.-6A.-6.3-6A.-Δ6.3/5-4A.	JA
HS-415	42.00	800/600 C.T.	200	6.3 C.T.-6A.-6.3-6A.-Δ6.3/5-6A.	KB
HS-417	45.00	800/600 C.T.	300	6.3 C.T.-6A.-6.3-6A.-Δ6.3/5-6A.	LA

ΔTapped for 5 volt rectifier use. All types electrostatically shielded.

FILAMENT Transformers, 50-60 Cycle

Type No.	List Price	Primary Volts	Secondary		Insulation Test Voltage	Case No.
			Volts	Amperes		
HSM-223	\$13.50	115	6.3	0.6	1500	AJ
HSM-225	15.00	105-115-125	6.3 C.T.	2	2500	EA
HSM-227	21.80	105-115-125	\$6.3 C.T.-6.3	3-3	2500	GA
HSM-229	18.00	105-115-125	6.3 C.T.	8	2500	JB
*HS-236	24.75	105-115-125	\$12.6 C.T.-12.6	2-2	2500	JB
HSM-228	27.60	105-115-125	\$6.3 C.T.-6.3	6-6	2500	JA
HSM-231	22.50	105-115-125	6.3 C.T.-5 C.T.	5-3	2500	JB
*HS-232	27.50	105-115-125	2.5 C.T.	10	7500	HA
HSM-235	36.25	105-115-125	2.5 C.T.-10 C.T.	10-10	7500-2500	MA

*New item. †Series or parallel connections.

FILAMENT TRANSFORMERS, 380-1500 Cycle

Type No.	List Price	Primary Volts	Secondary		Insulation Test Voltage	Case No.
			Volts	Amperes		
HS-425	\$13.75	105-115-125	6.3 C.T.	2	1500	AJ
HS-427	19.40	105-115-125	6.3 C.T.	5	1500	EA
HS-433	21.20	105-115-125	Δ6.3 C.T.-6.3	5-5	2500	FA
HS-435	22.50	105-115-125	Δ6.3 C.T.-6.3-¶6.3/5	3.5-3.5-3	2000	FA
HS-441	28.00	105-115-125	45 C.T.-5-2.5 C.T.	10-10-10	2000-7500	HA
*HS-442	22.50	57.5-96-115-120 Single phase.	12.6 C.T. 12.6	2 2	1500	EA

Two HS-442's can be used, 115 volt 3 phase to 26 volt 2 phase, Scott-connected.

*New item †Series or parallel connection. ¶5 volt tap for filament type rectifiers.

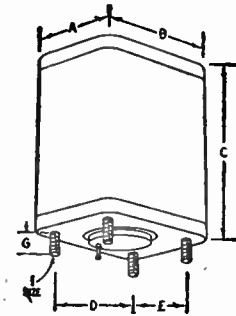

Avoid redesign—Use Triad HS and HSM transformers in military prototypes.

Since Triad HS and HSM series transformers use MIL-T-27 standard sizes, plus electrical and mechanical design to meet all MIL-T-27 requirements, equipment using these transformers need not be redesigned to submit for military approval. The basically good design factors which are necessary to meet MIL-T-27 standards for performance ensure longest life in any class of service.

These transformers are permanently marked with electrical and test data as specified in MIL-T-27. All are "Climateite" treated, use sturdy TRIAD terminals and are beautifully finished in grey enamel.

Standard MIL-T-27 Case Sizes

	EA	EB	FA	FB	GA	GB
A	1 1/4"	1 1/2"	2 1/4"	2 1/2"	2 3/4"	2 3/4"
B	1 1/4"	1 1/2"	2 1/4"	2 1/2"	2 3/4"	2 3/4"
C	2 1/4"	2 1/2"	3 1/4"	3 1/2"	3 3/4"	3 3/4"
D	1 1/2"	1 3/4"	1 3/4"	1 3/4"	2 1/4"	2 1/4"
E	1 1/4"	1 1/2"	1 1/2"	1 1/2"	1 3/4"	1 3/4"
G	3/4"	3/4"	3/4"	3/4"	3/4"	3/4"
I	6-32	6-32	6-32	6-32	6-32	6-32
Wt. lbs.	1	15 oz.	1 1/4"	1 1/4"	2	1 1/4"
	HA	HB	JA	JB	KA	KB
A	2 1/4"	2 1/4"	3 1/4"	3 1/4"	3 1/4"	3 1/4"
B	3 1/4"	3 1/4"	3 1/4"	3 1/4"	3 1/4"	3 1/4"
C	4 1/4"	3 1/4"	4 1/4"	3 1/4"	5 1/4"	4 1/4"
D	2 1/4"	2 1/4"	2 1/4"	2 1/4"	3	3
E	1 1/4"	1 1/4"	2 1/4"	2 1/4"	2 1/4"	2 1/4"
G	3/4"	3/4"	3/4"	3/4"	3/4"	3/4"
I	8-32	8-32	8-32	8-32	10-32	10-32
Wt. lbs.	2 1/4"	2 1/4"	4 1/4"	4	7 1/4"	7
	LA	LB	MA	MB	NA	NB
A	3 1/4"	3 1/4"	4	4	4 1/4"	4 1/4"
B	4 1/4"	4 1/4"	4 1/4"	4 1/4"	5 1/4"	5 1/4"
C	5 1/4"	4 1/4"	6	4 1/4"	5 1/4"	5 1/4"
D	3 1/4"	3 1/4"	3 1/4"	3 1/4"	4 1/4"	4 1/4"
E	2 1/4"	2 1/4"	3	3	3 1/4"	3 1/4"
G	3/4"	3/4"	3/4"	3/4"	3/4"	3/4"
I	10-32	10-32	10-32	10-32	10-32	10-32
Wt. lbs.	9 1/4"	8 1/4"	13 1/4"	12 1/4"	18	16



TRIAD TRANSFORMER CORP.

TOROIDS

TOROID COILS for WAVE FILTERS

The nearest practical approach to the perfect inductor of no resistance, no capacity, and infinite "Q," is made by winding on a pressed molybdenum-permalloy dust core of toroidal shape. Depending on size and composition of core materials, TRIAD Toroids will develop "Q's" of greater than 200, inductance values up to 25 Henries and stability with level, temperature and humidity almost beyond belief. Standard inductance tolerance is plus or minus 1%. Values of DC indicated as permissible will not reduce inductance values by more than 5%.

TRIAD Toroids are ordinarily encapsulated in translucent plastic material, but may be obtained in a hermetically sealed case if desired. When ordering Toroids to be hermetically sealed, they will be furnished in the cases shown in the margin. List prices shown are to be added to the list price of the unsealed types. When ordering hermetically sealed Toroids, order by the unsealed number, followed by the letters HS. Example: EA-1000-HS. Special inductors, made to your specifications as to inductance and "Q," may be ordered from the factory. Prices on request.

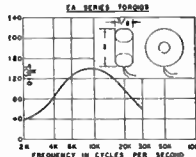

EA SERIES TOROIDS

Ind.	Type No.	List Price	Max. D.C.-Ma.
5 mh.	EA-005	\$ 8.20	270
7 mh.	EA-007	8.35	190
10 mh.	EA-010	8.50	130
15 mh.	EA-015	8.60	90
20 mh.	EA-020	8.70	67
40 mh.	EA-040	8.90	33
50 mh.	EA-050	8.95	27
70 mh.	EA-070	9.10	19
100 mh.	EA-100	9.25	13
200 mh.	EA-200	9.65	6
250 mh.	EA-250	9.75	5.4
500 mh.	EA-500	11.20	2.6
600 mh.	EA-600	11.40	2.2
700 mh.	EA-700	11.60	1.9
1 h.	EA-1000	11.85	1.3

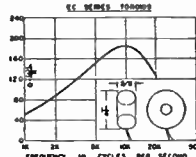

EC SERIES TOROIDS

Ind.	Type No.	List Price	Max. D.C.-Ma.
1 mh.	EC-001	\$ 8.65	650
2 mh.	EC-002	8.65	580
5 mh.	EC-005	8.65	500
7 mh.	EC-007	8.70	420
10 mh.	EC-010	8.80	380
15 mh.	EC-015	9.00	350
20 mh.	EC-020	9.25	300
40 mh.	EC-040	9.50	280
50 mh.	EC-050	9.60	250
70 mh.	EC-070	9.75	175
100 mh.	EC-100	9.90	125
200 mh.	EC-200	10.15	60
250 mh.	EC-250	10.25	50
500 mh.	EC-500	10.85	25
600 mh.	EC-600	11.40	20
700 mh.	EC-700	11.75	17.5
1.0 h.	EC-1000	12.50	12.5
1.5 h.	EC-1500	14.20	8
2.0 h.	EC-2000	15.00	6
4.0 h.	EC-4000	15.40	3
5.0 h.	EC-5000	15.80	2.5

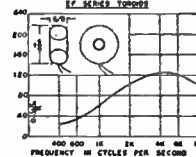

EF SERIES TOROIDS

Ind.	Type No.	List Price	Max. D.C.-Ma.
5 mh.	EF-005	\$ 9.00	1200
7 mh.	EF-007	9.10	1100
10 mh.	EF-010	9.25	1000
15 mh.	EF-015	9.45	850
20 mh.	EF-020	9.65	630
40 mh.	EF-040	9.85	310
50 mh.	EF-050	10.00	250
70 mh.	EF-070	10.20	180
100 mh.	EF-100	10.40	125
200 mh.	EF-200	10.70	60
250 mh.	EF-250	10.90	50
500 mh.	EF-500	11.00	25
600 mh.	EF-600	11.20	20
700 mh.	EF-700	11.35	18
1.0 h.	EF-1000	11.75	12
1.5 h.	EF-1500	12.40	8
2.0 h.	EF-2000	12.80	6
4.0 h.	EF-4000	13.75	3
5.0 h.	EF-5000	14.35	2.5
6.0 h.	EF-6000	14.85	2
7.0 h.	EF-7000	15.40	1.5
10.0 h.	EF-10000	16.20	1.0

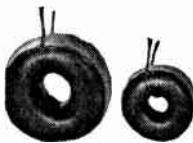

PL-6



PL-4



PL-5

These miniature blocking oscillator transformers are now in quantity production for manufacturers in a number of applications and with outstanding results. Their multiple winding construction makes them available for a variety of circuits and their fast rise time (.05 microseconds) makes them exceptionally useful. Positive hermetic sealing prevents deterioration of performance with time (absolutely necessary for long shelf life).

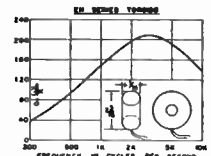

EH SERIES TOROIDS

Ind.	Type No.	List Price	Max. D.C.-Ma.
15 mh.	EH-015	\$23.40	1000
40 mh.	EH-040	24.00	400
100 mh.	EH-100	24.35	160
250 mh.	EH-250	24.75	65
600 mh.	EH-600	25.10	25
1.5 h.	EH-1500	26.00	10.5
4.0 h.	EH-4000	26.80	4
10.0 h.	EH-10000	27.85	1.5
25.0 h.	EH-25000	31.50	1.0

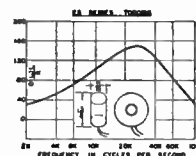

ES SERIES TOROIDS

Ind.	Type No.	List Price	Max. D.C.-Ma.
1 mh.	ES-001	\$12.00	800
2 mh.	ES-002	12.25	600
5 mh.	ES-005	12.60	400
7 mh.	ES-007	12.80	320
10 mh.	ES-010	12.90	250
20 mh.	ES-020	13.20	200
50 mh.	ES-050	13.45	160
70 mh.	ES-070	13.65	125
100 mh.	ES-100	14.00	100

PULSE

Type No.	List Price	Application
PL-4	\$15.00	2 equal windings. Pulse widths .35 to 1.2 microseconds. Duty cycle .05 max. Dimensions .4" dia. by .625" long.
PL-5	17.50	3 equal windings. Pulse widths .15 to .65 microseconds. Duty cycle .05 max. Dimensions .5" dia. by .68" long.
PL-6	15.00	3 equal windings. Pulse widths .15 to .65 microseconds. Duty cycle .05 max. Dimensions (Transformer only) 1/4" dia. by 3/4" long. Mounts with 8-32 x 1/2" stud.

TRIAD TRANSFORMER CORP.



HIGH FIDELITY OUTPUT TRANSFORMERS

Hermetically Sealed HIGH LEVEL OUTPUT

TRIAD "HS" Series Output Transformers represent the application of the most modern grain techniques in the design of fine audio equipment. Use of annealed grain-oriented core materials, combined with multiple interleaved coil structures, have resulted in an open circuit inductance to leakage inductance ratio of 10,000, representing a frequency

response range of better than 13 octaves. These transformers will deliver full rated power output within 1 db. from 7-50000 cycles. Full DC plate current can be carried through the primary windings, but every effort should be made to balance the two plates in push-pull circuits to obtain optimum results at the extreme low frequencies.

Type No.	List Price	Application	Impedance		Freq. Response	Max. Level-Watts	Case No.
			Primary	Secondary			
*HSM-79	\$25.00	Single 2A3, 6A3, 6B4, 6F6, 6V6, 6K6, 6AQ5, etc. (Unb. DC in pri.)	20000 C.T. (20 Ma.) or 5000 (40 Ma.)	16/8/4	50-25000	5	FA
*HSM-80	25.00	As above.	20000 C.T. (20 Ma.) or 5000 (40 Ma.)	500/250 C.T. or 125/62.5	50-25000	5	FA
HSM-81	30.50	P.p. 6V6's, etc. to V.C.	8000 Split pri.	16/8/4	7-50000	15	JB
HSM-82	30.50	As above—to line.	8000 C.T.	500/250/125	7-50000	15	JB
HSM-84	30.50	P.p. 2A3's, 6B4's, 6L6's, etc. to V.C.	5000 C.T.	16/8/4	7-50000	20	JB
HSM-85	30.50	As above—to line.	5000 C.T.	500/250/125	7-50000	20	JB
°HSM-189	39.50	P.p. KT-66's, 807's, etc. —for Williamson circuit.	10000/2500 Split pri.	16/8/4	7-50000	25	KB
°HSM-190	39.50	As above—to line.	10000/2500 Split pri.	500/250/125	7-50000	25	KB
HSM-87	35.80	AB, 6L6's, etc. to V.C.	9000 C.T.	16/8/4	7-50000	25	KB
HSM-88	35.80	As above—to line.	9000 C.T.	500/250/125	7-50000	25	KB
HSM-91	49.50	P.p. parallel 2A3's, 6L6's, etc. to V.C.	2500 C.T.	16/8/4	7-50000	50	LA
HSM-94	61.00	P.p. par. 6L6's to V.C.	4500 C.T.	16/8/4	7-50000	55	LA
HSM-95	61.00	As above—to line.	4500 C.T.	500/250/125	7-50000	55	LA
HS-97	115.00	P.p. 845's to line.	6600 C.T.	500/250/125	10-30000	125	Spec.
HS-101	35.80	Line to parallel lines—autoformer.		500/250/167/125/100/83/71	10-30000	30	Spec.
HS-103	30.50	Line to V.C.—autoformer.		500/16/8/4	10-30000	30	Spec.

*New item. °Williamson type circuit. Proper taps on primary for screen operation.

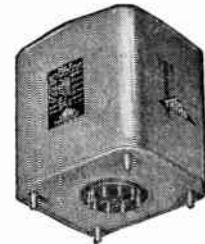

HS Series



Case A

HIGH LEVEL OUTPUT

The Triad high fidelity transformers in the group below afford a standard of performance exceeded only by the "HS" series outputs. These transformers have a frequency response linear within 1 db. from 20-20000. Feedback loops employing as high as 30 db. of negative feedback may be used.

Type No.	List Price	Application	Impedance		Output Watts	Case Dim.-Inches			Mtg. Dim.-Inches		Wt. Lbs.
			Primary	Secondary		H	W	D	MW	MD	
S-31A	\$12.00	P.p. 6V6, 45, etc.	8000 C.T.	4-8-16	15	3 1/8	2 5/8	3 3/8	2	2 5/8	3 1/2
S-32A	12.50	P.p. 6V6, 45, etc.	8000 C.T.	500/250/125	15	3 1/8	2 5/8	3 3/8	2	2 5/8	3 1/2
S-33A	12.00	P.p. 2A3, 6A5, 6B4, etc.	3000 C.T.	4-8-16	15	3 1/8	2 5/8	3 3/8	2	2 5/8	3 1/2
S-35A	13.00	P.p. 2A3, 6L6, etc.	5000 C.T.	4-8-16	20	3 1/8	2 5/8	3 3/8	2	2 7/8	4
S-36A	13.50	P.p. 2A3, 6L6, etc.	5000 C.T.	500/250/125	20	3 1/8	2 5/8	3 3/8	2	2 7/8	4
#S-148A	25.75	P.p. KT-66, 807, etc. triodes.	10000 C.T.	4-8-16	25	3 1/2	3	4 3/8	2 1/4	3 1/8	5 3/4
S-38A	16.70	P.p. 6L6, class AB.	9000 C.T.	4-8-16	25	3 1/2	3	4 3/8	2 1/4	3 1/8	5 3/4
S-39A	17.50	P.p. 6L6, class AB.	9000 C.T.	500/250/125	25	3 1/2	3	4 3/8	2 1/4	3 1/8	5 3/4
S-40A	16.70	P.p. par. 2A3, 6L6, etc.	2500 C.T.	4-8-16	30	3 1/2	3	4 3/8	2 1/4	3 1/8	5 3/4
S-42A	22.75	P.p. par. 6L6, class A.	4500 C.T.	4-8-16	50	4 1/4	3 3/8	4 3/4	2 3/4	3 7/8	9
S-45Z	5.65	70 v. line. Autoformer.	4000/2000/1000/500	4-8	10	2 5/8	3 1/8	2 1/4	2 1/8		1 3/4
S-46A	11.50	70 v. line. Autoformer.	2000/1000/500/250	4-8-16	20	3 1/8	2 5/8	3 3/8	2	2 5/8	4

#Williamson type circuit. Proper taps on primary for screen operation.

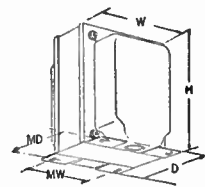
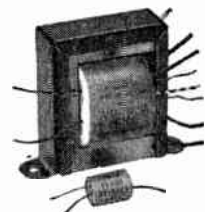

PHOTO-FLASH Transformers

Type No.	List Price	Application	Case Dim.-Ins.			Mtg. Dim.-Ins.		Wt. Lbs.
			H	W	D	MW	MD	
*V-30Z	\$ 6.00	From 115v-60 cycle line or 4 volt-180 cy. vibrator to 385 RMS @ 14 ma.	2 5/8	3 1/8	2 1/8	2 1/8		1 1/2
*PL-10	1.45	Trigger coil.	3/4		5/8			1 1/2 oz.

*New item.



V-30Z and PL-10



TRIAD TRANSFORMER CORP.

AMPLIFIER KITS

For High Fidelity Reproduction

HF-3—Preamplifier and Equalizer

A power amplifier such as our HF-18 or HF-40 will deliver outstanding reproduction when supplied with one volt or more of input, as from an AM or FM tuner. From a magnetic head additional gain is needed. In addition, frequency correction is necessary to equalize various recording styles and to correct for inherent deficiencies of the room and reproducer combination.

Features of the HF-3 are:

Adequate gain to drive an HF-40 or HF-18 from any commercial pickup or microphone.

Nine separate compensation networks to cover all standard recording systems now in use.

Equalization of low and high frequency gain up to 22 db., either of emphasis or of attenuation. (New type of tone control circuit.)

Completely self powered, with DC filament supply to insure minimum hum and noise background.

Aluminum chassis limits magnetic field distribution through chassis.

HF-3 KIT

Includes complete punched sectional aluminum chassis and complete assembly instructions, plus R-56A, A-75J and two C-1X transformers.

Net Weight, 5 pounds.

List Price \$32.80



HF18—"Williamson Type" All Triode Amplifier

The "Williamson Type" amplifier has a deserved reputation for quality of performance among high fidelity enthusiasts. Its quality is superb and its performance outstanding with extended frequency range and exceptionally low distortion.

With TRIAD transformers, the "Williamson" shows even wider frequency range with lower distortion. This unit is ideal where higher power is needed.

The output tubes may be operated as pentodes and the screens fed from taps on the output transformer. This will increase the output power to 22 watts with very little increase in distortion. The S-148-A, HSM-189 and HSM-190 transformers have the proper screen taps for this type of operation.

Features of the HF-18 are:

Full power output of 16.5 watts for triode operation or 20 watts for pentode operation from 12 to 60,000 cycles.

Frequency response linear from 7 cycles to 80 kc. within 0.2 db.

Distortion under 1/2% from 20 cycles to 45 kc.

Aluminum chassis limits magnetic field distribution through chassis.

Noise and hum approximately 80 db. down from maximum level.

HF-18 KIT

HF-18 kit includes a completely punched sectional aluminum chassis with complete assembly instructions, plus R-58A, C-14X, and S-148A transformers.

Net weight, 20 3/4 pounds.

List Price \$63.65

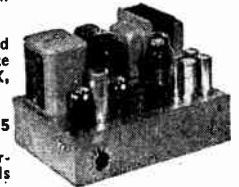

HF-12—10 Watt Power Amplifier Kit

The HF-12 is a complete amplifier with built-in preamplifier to accommodate all crystal and magnetic cartridges. It employs a new reactance type of tone control and a complete 9 point switch to afford compensation for all types of records in common use.

This kit is an improvement and elaboration of the original TRIAD HF-10 kit of which there are many thousands in use today and giving outstanding service.

This kit is a revision of the amplifier described in the article which appeared in the October 1953 issue of Radio and Television News, entitled "Improved Kappler Amplifier," by Charles P. Boegli.

Features of the HF-12 are:

Full 10 watts output from 20 cycles to 35,000 cycles.

Frequency response linear within 1 db. from 13 to 50,000 cycles.

Complete preamplifier tone control and record compensation for all standard recordings, on a single 8 x 12 chassis.

DC filament supply for preamplifier tubes. Aluminum chassis limits magnetic field distribution through chassis.

Noise and hum level down 68 db. below maximum full power output.

HF-12 KIT

The HF-12 kit includes a completely punched sectional aluminum chassis and complete assembly instructions, plus R-14A, C-13X, A-75J and S-31A transformers.

Net weight, 14 1/2 pounds.

List Price \$50.40

HF-12A KIT

Same as HF-12 kit, except HSM-81 hermetically sealed output transformer is used instead of the S-31A.

Net weight, 15 pounds.

List Price \$68.90

HF-12B KIT

Same as HF-12 kit, except S-32A output transformer is used. This kit will be used where line impedances are required of 500/250/125 ohms.

Net weight, 14 1/2 pounds.

List Price \$50.90

HF-12C KIT

Same as HF-12 kit, except HSM-82 hermetically sealed output transformer is used.

Net weight, 15 pounds.

List Price \$68.90



HF-18A KIT

Same as HF-18 kit, except HSM-189 hermetically sealed output transformer is used instead of S-148A transformer.

Net weight, 22 pounds.

List Price \$77.40

HF-18C KIT

Same as HF-18 kit, except HSM-190 hermetically sealed output transformer is used instead of the S-148A. The HSM-190 output transformer secondary matches 500/250/125 ohms.

Net weight, 22 pounds.

List Price \$77.40

HF-40—40 Watt Auditorium Amplifier

Improved amplifier techniques as exemplified in the HF-12 and HF-18 have seldom been applied to higher power units. However, peak powers in ordinary home listening often exceed the capacity of these amplifiers for short periods of time and increased power is desirable for those who desire the utmost in fidelity.

At least two manufacturers of "Stereophonic" sound for theatres have adapted this amplifier as standard for theater installation where the extreme stability made possible by the regulated power supply is of great value.

Features of the HF-40 are:

Regulated screen voltage and fixed bias voltage permit unchanged performance under wide variations in line voltage and loading.

Full power output of 40 watts from 20 to 40,000 cycles. Peak power of 55 watts available.

Frequency response 10 to 40,000 cycles within one db.

Distortion under 1% from 18 to 40,000 cycles at full power output.

Aluminum chassis limits magnetic field distribution through chassis.

Noise and hum down 75 db.

Net Weight, 35 1/2 pounds.

HF-40 KIT

HF-40 kit includes punched sectional aluminum chassis and complete instructions, plus R-46A, C-17X and S-42A transformers.

List Price \$78.35

HF-40A KIT

Same as HF-40 kit, except HSM-94 hermetically sealed output transformer is used instead of S-42A transformer.

Net weight, 35 3/4 pounds.

List Price \$116.60

HF-40C KIT

Same as HF-40 kit, except HSM-95 hermetically sealed output transformer is used instead of S-42A transformer.

Net weight, 35 3/4 pounds.

List Price \$116.60



TRIAD TRANSFORMER CORP.



POWER

Combined PLATE and FILAMENT Transformers Primary 115 Volts 50/60 Cycles

Type No.	List Price	Plate Supply		Rect. Fil.		Other Fil.		Case Dim.-Ins.			Mtg. Dim.-Ins.		Wt. Lbs.
		AC Volts	DC Ma.	Volts	Amp.	Volts	Amp.	H	W	D	MW	MD	
R-4A	\$ 6.25	500 C.T.	40			6.3 C.T.	2	2 3/4	2 3/8	2 3/4	1 1/2	1 7/8	1 3/4
R-4B	6.15	500 C.T.	40			6.3 C.T.	2	1 3/4	2 3/8	2 1/2	2 1/2	1 3/4	1 3/4
R-5A	7.35	600 C.T.	65			6.3 C.T.	2.7	3 1/2	2 3/8	2 3/8	2	1 7/8	2 3/4
R-5B	7.25	600 C.T.	65			6.3 C.T.	2.7	1 7/8	3	2 1/2	2 1/2	2	2 3/4
R-6A	7.50	480 C.T.	50	5	2	6.3 C.T.	2	3 1/2	2 3/8	2 3/8	2	1 7/8	2 3/4
R-6B	7.40	480 C.T.	50	5	2	6.3 C.T.	2	1 7/8	3	2 1/2	2 1/2	2	2 3/4
R-7A	7.90	600 C.T.	50	5	2	6.3 C.T.	2	3 1/2	2 3/8	2 3/8	2	1 7/8	2 3/4
R-7B	7.80	600 C.T.	50	5	2	6.3 C.T.	2	1 7/8	3	2 1/2	2 1/2	2	2 3/4
R-8A	8.80	500 C.T.	75	5	2	6.3 C.T.	2.5	3 1/2	2 3/8	3 1/8	2	2 3/8	3
R-8B	8.60	500 C.T.	75	5	2	6.3 C.T.	2.5	2 3/8	3	2 1/2	2 1/2	2	3
R-9A	9.20	600 C.T.	75	5	2	6.3 C.T.	3	3 1/2	3	3 3/8	2 1/4	2 1/8	3 1/2
R-9B	9.00	600 C.T.	75	5	2	6.3 C.T.	3	2 1/2	3 3/8	2 1/2	2 1/2	2 1/4	3 1/2
R-10A	10.50	525 C.T.	90	5	2	6.3 C.T.	5	3 1/2	3	3 3/8	2 1/4	2 1/2	4 1/2
R-10B	10.25	525 C.T.	90	5	2	6.3 C.T.	5	2 3/4	3 3/8	2 1/2	2 1/2	2 1/4	4 1/2
R-11A	10.25	700 C.T.	90	5	3	6.3 C.T.	3.5	3 1/2	3	3 3/8	2 1/4	2 5/8	4 1/4
R-11B	10.00	700 C.T.	90	5	3	6.3 C.T.	3.5	2 3/4	3 3/8	2 1/2	2 1/2	2 1/4	4 1/4
R-12A	10.50	550 C.T.	110	5	2	6.3 C.T.	5	4	3 1/4	3 3/8	2 1/2	2 3/4	4 1/2
R-12B	10.35	550 C.T.	110	5	2	6.3 C.T.	5	2 3/8	3 3/4	3 1/8	3 1/8	2 1/2	4 1/2
R-14A	11.50	700 C.T.	125	5	3	6.3 C.T.	4.5	4	3 1/4	3 1/2	2 1/2	2 1/2	6
R-14B	11.30	700 C.T.	125	5	3	6.3 C.T.	4.5	2 3/8	3 3/4	3 1/8	3 1/8	2 1/2	6
R-16A	13.75	700 C.T.	160	5	3	6.3 C.T.	5	4	3 1/4	4 1/2	2 1/2	3 3/8	7
R-16B	13.50	700 C.T.	160	5	3	6.3 C.T.	5	3 3/8	3 3/4	3 1/8	3 1/8	2 1/2	7
R-17A	16.25	750 C.T. 80 Tap	160	5	3	6.3 C.T. 2.5 C.T.	5 5	4 1/2	3 3/8	4 3/8	2 3/4	3 1/2	7 1/4
R-18A	16.50	750 C.T.	175	5	3	6.3 C.T.	8	4 1/2	3 3/8	4 1/2	2 3/4	3 3/8	8 1/2
R-18B	16.30	750 C.T.	175	5	3	6.3 C.T.	8	3 3/8	4 1/8	3 1/2	3 1/2	2 3/4	8 1/2
R-19A	19.00	750 C.T. 80 Tap	200	5	3	6.3 C.T. 2.5 C.T.	6 10	4 3/8	3 3/8	4 1/2	3	3 1/2	9 1/2
R-20A	16.25	700 C.T.	200	5	3	6.3 C.T.	8	4 1/2	3 3/8	4 1/2	2 3/4	3 3/8	8 1/2
R-20B	16.10	700 C.T.	200	5	3	6.3 C.T.	8	3 3/8	4 1/8	3 1/2	3 1/2	2 3/4	8 1/2
R-21A	17.60	800 C.T.	200	5	3	6.3 C.T.	6	4 1/2	3 3/8	5	2 3/4	4 1/8	9 1/4
R-21B	17.45	800 C.T.	200	5	3	6.3 C.T.	6	3 1/2	4 1/8	3 1/2	3 1/2	2 3/4	9 1/4
R-24A	22.50	800 C.T.	300	5	6	6.3 C.T.	6	4 3/8	3 3/8	5 3/4	3	4 1/2	14
R-24B	22.30	800 C.T.	300	5	6	6.3 C.T.	6	3 1/2	4 1/2	3 3/4	3 3/4	3	14
R-25A	36.00	800 C.T.	500	5	6	6.3 C.T.-6.3	3-7	5 3/8	4 1/2	5 3/4	3 1/2	4 3/4	19
R-58A	18.50	875 C.T.	185	5	3	6.3-6.3	4-3	4 3/8	3 3/8	4 1/2	3	3 3/8	9 1/2

PLATE POWER Transformers Primary 115 Volts 50/60 Cycles

Type No.	List Price	Secondary Volts		Sec. DC Ma.		Rect. Fil.	Case Dim.-Ins.			Mtg. Dim.-Ins.		Wt. Lbs.
		AC	DC	CCS	ICAS		H	W	D	MW	MD	
P-1A	\$ 9.20	440/220 C.T.	180/90	160	190	5V.-3A.	3 1/2	3	3 3/8	2 1/4	2 1/8	4
P-3A	12.50	600/300 C.T.	250/125	300	360	5V.-4A.	4	3 1/4	3 1/2	2 1/2	2 7/8	5 3/4
P-5A	16.75	1100 C.T.	400	250	310	5V.-4A.	4 3/8	3 3/8	4 1/4	3	3 1/2	9
P-7A	18.00	1235 C.T.	500	250	310	5V.-4A.	4 3/8	3 3/8	4 3/4	3	3 1/2	11
P-9A	33.00	1235 C.T.	500	500	600	5V.-6A.	5 3/8	4 1/2	5 3/4	3 1/2	4 3/4	19
P-11A	21.50	1455 C.T.	600	250	310		4 3/8	3 3/8	5	3	3 1/2	12
†P-13A	25.00	1780 C.T.	750	250	310		5 3/8	4 1/2	4 3/4	3 1/2	3 3/4	14
†P-14A	22.50	1780 C.T.	750/600	250	310		5 3/8	4 1/2	4 3/4	3 1/2	3 3/4	14
†P-15A	29.00	2340 C.T.	1000	250	310		5 3/8	4 1/2	5 1/4	3 1/2	4 1/4	17
†P-17A	38.50	2880 C.T.	1250	250	310		5 3/8	4 1/2	5 3/4	3 1/2	4 3/4	20
†P-16A	64.00	2430 C.T.	1000	500	600		6 1/2	5 1/2	6 1/2	4 1/4	4 1/2	31
†P-18A	72.00	2880 C.T.	1250	500	600		6 1/2	5 1/2	7	4 1/4	5	35
†P-20A	71.00	3300 C.T.	1500	350	425		6 1/2	5 1/2	7	4 1/4	5	35

†Plate leads out side of case for 866 rectifiers.

‡Tapped Pri. to produce the lower D.C. voltage.

For PREAMPLIFIERS, VTVM, Etc.

Type No.	List Price	Plate Supply		Filament Windings Volts and Amperes	Case Dim.-Ins.			Mtg. Dim.-Ins.		Lbs. Wt.
		AC Volts	DC Ma.		H	W	D	MW	MD	
*R-68A	\$ 9.50	800 C.T.	30	5V.-2A, 6.3-1.2A, 6.3-1.2A.	3 1/2	2 3/8	3 1/8	2 1/2	2	3
R-2C	4.75	135	15	6.3V.-.9A.	1 3/8	1 7/8	1 1/2		1 1/4	1
R-3A	6.15	500 C.T.	20	6.3 C.T.-2A.	2 3/4	2 3/8	2 3/8	1 1/2	1 3/4	1 3/4
R-29A	6.00	230 C.T.	40	6.3V.-1.5A.	2 3/4	2 3/8	2 1/2	1 1/2	1 5/8	1 3/4
R-30X	5.20	135	50	6.3V.-1.5A.	2 1/4	3 1/2	2 1/8	3 1/8		1 1/2
R-54X	4.75	115	15	6.3V.-.6A.	1 1/2	2 1/2	1 1/2	2 3/8		1/2
R-54A	6.85	130	20	0/15/22.5/30-.6A.	2 3/4	2 3/8	2 3/8	1 1/2	2	2

*New item.

TRIAD power components are liberally designed to best meet average design specifications and to ensure maximum utility for each design. All units are beautifully finished in baked grey enamel and have all connection data permanently marked on the case.

All types are "Climatite" treated, both coil and core, for protection against moisture and for elimination of lamination chatter. Although they are small in size, the high quality materials used keep losses to a minimum and hold temperature rise below 55° C. Only copper foil static shields, grounded to the case and core, are used. Leads are of a type approved by UL for high temperature operation.



Case A

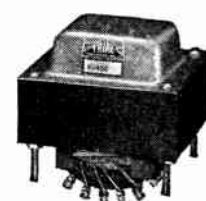
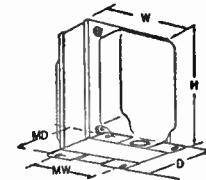

Case C



Case A
(Leads)



TRIAD TRANSFORMER CORP.

For CATHODE RAY TUBES

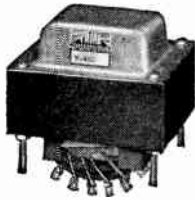

Case C

Type No.	List Price	Plate Supply		Filament Windings Volts and Amperes	Case Dim.-Ins.			Mtg. Dim.-Ins.			Wt. Lbs.
		AC Volts	DC Ma.		H	W	D	MW	MD	Ins.	
R-41C	\$23.15	440-0-440-1250	125/5	\$6.3V.-.6A. \$2.5V.-1.75A.	\$2.5V.-1.75A. 5V.-3A.	2 $\frac{3}{8}$	4 $\frac{1}{8}$	3 $\frac{1}{2}$	3 $\frac{1}{8}$	2 $\frac{3}{4}$	7 $\frac{1}{2}$
R-45C	16.50	400-0-400-800	30/5	\$6.3V.-.6A. 6.3 C.T.-3A. \$5V.-2A.	6.3V.-1A. 5V.-2A.	2 $\frac{3}{8}$	3 $\frac{3}{4}$	3 $\frac{1}{8}$	3 $\frac{1}{8}$	2 $\frac{1}{2}$	4 $\frac{1}{2}$
R-43C	13.80	1600	3	\$6.3/5/2.5V.-1A. \$6.3/5/2.5V.-3A.		2 $\frac{1}{2}$	3	2 $\frac{1}{2}$	2 $\frac{1}{2}$	2	3 $\frac{1}{2}$

§Statistically shielded and insulated for full plate voltage. °Insulated for full plate voltage.

For REGULATED POWER SUPPLIES

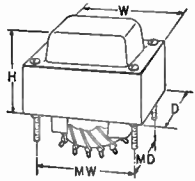

Case A

Type No.	List Price	Plate Supply		Filament Windings Volts and Amperes	Case Dim.-Ins.			Mtg. Dim.-Ins.			Wt. Lbs.
		AC Volts	DC Ma.		H	W	D	MW	MD	Ins.	
*R-70A	\$11.25	880 C.T.	75	6.3V.-.6A. 6.3V.-.9A.	4	3 $\frac{1}{4}$	3 $\frac{1}{8}$	2 $\frac{1}{8}$	2 $\frac{1}{2}$	4 $\frac{1}{2}$	
R-26A	21.50	880-720 C.T.	200	6.3 C.T.-8A. 6.3V.-1A.	4 $\frac{3}{4}$	3 $\frac{3}{8}$	4 $\frac{3}{4}$	3	3 $\frac{3}{8}$	12	
R-28A	32.50	1250 C.T.	300	6.3 C.T.-8A. 6.3V.-3A.	5 $\frac{3}{8}$	4 $\frac{1}{2}$	5 $\frac{7}{8}$	3 $\frac{1}{2}$	4 $\frac{3}{4}$	20	
R-46A	33.00	1250 C.T. 130 (Bias winding)	350 50	5V.-4A.	5 $\frac{3}{8}$	4 $\frac{1}{2}$	5 $\frac{7}{8}$	3 $\frac{1}{2}$	4 $\frac{3}{4}$	20	
R-46A will supply 550 V.D.C. using 2 5R4G rectifier tubes, choke input. Will also supply 130 V. for bias using Selenium rectifier. Sufficient filament windings to regulate screen voltages. See pages 11, HF-40 diagram.											
R-27A	45.00	1500 C.T.	400	5V.-6A.	5 $\frac{3}{8}$	4 $\frac{1}{2}$	7 $\frac{3}{8}$	3 $\frac{1}{2}$	6 $\frac{1}{4}$	30	

*New item.

CHOKES

SWINGING FILTER REACTORS

Type No.	List Price	Inductance Henries	Current Ma.	Resistance Ohms	Test Volts RMS	Case Dim.-Ins.			Mtg. Dim.-Ins.			Wt. Lbs.
						H	W	D	MW	MD	Ins.	
C-31A	\$ 8.20	25/5	20/200	150	2500	3 $\frac{1}{8}$	3	3 $\frac{3}{8}$	2 $\frac{1}{4}$	2 $\frac{3}{8}$	4 $\frac{1}{2}$	
C-33A	12.50	25/5	30/300	105	3000	4 $\frac{1}{8}$	3 $\frac{3}{8}$	4 $\frac{1}{4}$	2 $\frac{3}{4}$	3 $\frac{1}{8}$	7 $\frac{1}{4}$	
C-35A	16.00	20/4	40/400	60	3000	4 $\frac{3}{8}$	3 $\frac{3}{8}$	4 $\frac{1}{2}$	3	3 $\frac{1}{8}$	9 $\frac{1}{2}$	
C-39A	27.50	25/5	50/500	65	3000	5 $\frac{3}{8}$	4 $\frac{1}{2}$	5 $\frac{1}{4}$	3 $\frac{1}{2}$	4 $\frac{1}{4}$	17	

SMOOTHING FILTER REACTORS

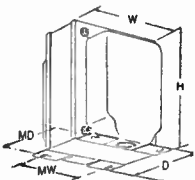

Case X

Type No.	List Price	Inductance Henries	Current Ma.	Resistance Ohms	Test Volts RMS	Case Dim.-Ins.			Mtg. Dim.-Ins.			Wt. Lbs.
						H	W	D	MW	MD	Ins.	
C-30X	\$ 2.50	50	15	3500	1500	1 $\frac{3}{8}$	2 $\frac{3}{8}$	1 $\frac{1}{2}$	2		$\frac{1}{2}$	
C-2X	1.70	2	15	70	1500	1 $\frac{1}{8}$	2 $\frac{1}{8}$	1 $\frac{1}{4}$	1 $\frac{3}{4}$		$\frac{1}{4}$	
C-1X	1.85	15	20	1000	1500	1 $\frac{1}{8}$	2 $\frac{1}{8}$	1 $\frac{1}{4}$	1 $\frac{3}{4}$		$\frac{1}{4}$	
C-3X	1.90	10	50	500	1500	1 $\frac{1}{8}$	2 $\frac{1}{8}$	1 $\frac{1}{2}$	2 $\frac{3}{8}$		$\frac{3}{4}$	
C-4X	1.90	4	50	360	1500	1 $\frac{3}{8}$	2 $\frac{3}{8}$	1 $\frac{3}{8}$	2		$\frac{1}{2}$	
C-6X	2.00	5	65	330	1500	1 $\frac{1}{8}$	2 $\frac{1}{8}$	1 $\frac{1}{2}$	2 $\frac{3}{8}$		$\frac{3}{4}$	
C-5X	2.75	12	75	400	1500	1 $\frac{1}{8}$	3 $\frac{1}{4}$	1 $\frac{7}{8}$	2 $\frac{1}{8}$		1	
C-8X	2.70	7	75	240	1500	1 $\frac{1}{8}$	3 $\frac{1}{4}$	1 $\frac{7}{8}$	2 $\frac{1}{8}$		1	
C-7X	3.00	10	90	270	1500	1 $\frac{1}{8}$	3 $\frac{1}{4}$	2	2 $\frac{1}{8}$		1 $\frac{1}{4}$	
C-9X	2.80	4	90	100	1500	1 $\frac{1}{8}$	3 $\frac{1}{4}$	1 $\frac{7}{8}$	2 $\frac{1}{8}$		1	
C-11X	3.60	6	110	160	1500	2 $\frac{1}{4}$	3 $\frac{1}{8}$	2 $\frac{1}{8}$	3 $\frac{1}{8}$		1 $\frac{1}{2}$	
C-10X	3.60	9	125	250	1500	2 $\frac{1}{4}$	3 $\frac{1}{8}$	2 $\frac{1}{8}$	3 $\frac{1}{8}$		1 $\frac{1}{2}$	
C-12X	4.00	6	160	165	1500	2 $\frac{1}{4}$	3 $\frac{1}{8}$	2 $\frac{1}{4}$	3 $\frac{1}{8}$		1 $\frac{3}{4}$	
C-12A	4.85	6	160	165	1500	2 $\frac{3}{4}$	2 $\frac{3}{8}$	2 $\frac{3}{8}$	1 $\frac{1}{8}$	1 $\frac{3}{4}$	1 $\frac{3}{4}$	
C-13X	3.90	3	160	75	1500	2 $\frac{1}{4}$	3 $\frac{1}{8}$	2 $\frac{1}{4}$	3 $\frac{1}{8}$		1 $\frac{3}{4}$	
C-14X	4.65	6	200	150	1500	2 $\frac{3}{8}$	4 $\frac{1}{8}$	2 $\frac{1}{2}$	3 $\frac{1}{8}$		2 $\frac{1}{4}$	
C-14A	5.85	6	200	150	1500	3 $\frac{1}{8}$	2 $\frac{3}{8}$	2 $\frac{3}{8}$	2	1 $\frac{7}{8}$	2 $\frac{1}{2}$	
C-16A	8.20	10	200	150	2500	3 $\frac{1}{8}$	3	3 $\frac{3}{8}$	2 $\frac{1}{4}$	2 $\frac{3}{8}$	4 $\frac{1}{4}$	
C-21X	3.75	1.5	225	65	1500	1 $\frac{1}{8}$	3 $\frac{1}{4}$	1 $\frac{7}{8}$	2 $\frac{1}{8}$		1	
C-15X	4.70	4	250	100	1500	2 $\frac{3}{8}$	4 $\frac{1}{8}$	2 $\frac{1}{2}$	3 $\frac{1}{8}$		2 $\frac{1}{4}$	
C-15A	5.90	4	250	100	1500	3 $\frac{1}{8}$	2 $\frac{3}{8}$	2 $\frac{3}{8}$	2	1 $\frac{7}{8}$	2 $\frac{1}{2}$	
C-23X	3.75	1.2	260	45	1500	1 $\frac{1}{8}$	3 $\frac{1}{4}$	2	2 $\frac{1}{8}$		1 $\frac{1}{4}$	
C-17X	3.75	1.5	300	40	1500	2 $\frac{1}{4}$	3 $\frac{1}{8}$	2 $\frac{1}{8}$	3 $\frac{1}{8}$		1 $\frac{1}{2}$	
C-18A	10.75	8	300	90	2500	4	3 $\frac{1}{4}$	3 $\frac{1}{8}$	2 $\frac{1}{2}$	2 $\frac{3}{8}$	6	
C-19A	13.00	10	300	105	3000	4 $\frac{1}{8}$	3 $\frac{3}{8}$	4 $\frac{1}{4}$	2 $\frac{3}{4}$	3 $\frac{3}{8}$	7 $\frac{1}{4}$	
C-25A	6.75	2.6	310	60	1500	3 $\frac{1}{8}$	2 $\frac{3}{8}$	3 $\frac{1}{8}$	2	2 $\frac{3}{8}$	3 $\frac{1}{2}$	
C-20A	16.00	8	400	60	3000	4 $\frac{3}{4}$	3 $\frac{7}{8}$	4 $\frac{1}{2}$	3	3 $\frac{1}{8}$	10 $\frac{1}{2}$	
C-22A	27.50	10	500	65	3000	5 $\frac{1}{8}$	4 $\frac{1}{2}$	5 $\frac{3}{8}$	3 $\frac{1}{2}$	4 $\frac{1}{4}$	17	
*C-40X	3.00	.32	600	10	1500	1 $\frac{1}{8}$	3 $\frac{1}{4}$	2	2 $\frac{1}{8}$		1 $\frac{1}{4}$	
C-48U	12.50	.08/.02	2.5/5A	.57/.143	1500	3 $\frac{3}{4}$	3 $\frac{1}{8}$	4	2 $\frac{1}{2}$	3	6 $\frac{1}{2}$	

*New item.

TRIAD TRANSFORMER CORP.



FILAMENT

FILAMENT Transformers, Single Secondary Primary 115 Volts 50-60 Cycles

Type No.	List Price	Secondary		Test Volts	Case Dim.-Inches			Mtg. Dim.-Inches		Wt. Lbs.
		Volts	Amperes		H	W	D	MW	MD	
F-1X	\$ 2.90	2.5 C.T.	3	1500	1 1/4	2 1/4	1 3/8	2 3/8		3/4
F-3X	4.25	2.5 C.T.	10	3000	2 1/4	3 1/4	2 1/4	3 1/8		1 3/4
F-5U	6.00	2.5 C.T.	10	7500	3	2 1/2	2 3/8	1 3/8	2	2
F-7X	4.00	5 C.T.	3	1500	1 1/4	3 1/4	2	2 1/4		1 1/4
F-8X	4.75	5 C.T.	6	1500	2 1/4	3 1/4	2 1/4	3 1/8		1 3/4
*F-9A	8.45	5.2 C.T.	13	1500	3 1/8	3	3 1/2	2 1/4	2 1/4	4
F-9U	8.00	5.2 C.T.	13	1500	3 3/8	2 1/4	3 3/8	2 1/4	2 3/8	3 3/4
F-11U	11.10	5.2 C.T.	24	1500	3 3/4	3 1/8	4	2 1/2	3	6 1/2
F-13X	2.75	6.3	.6	1500	1 3/8	2 3/8	1 3/8	2		1/2
F-14X	2.80	6.3 C.T.	1.2	1500	1 1/4	2 1/4	1 3/8	2 3/8		3/4
†F-52X	3.55	6.3	1.2	5000	1 1/4	3 1/4	1 7/8	2 1/4		1
†F-51X	3.95	6.3/5	2	5000	1 1/4	3 1/4	2	2 1/4		1 1/4
*†F-53X	6.00	6.3	4	5000	2 3/8	4 1/8	2 1/2	3 1/8		2 1/4
F-16X	4.15	6.3 C.T.	3	1500	1 1/4	3 1/4	2	2 1/4		1 1/4
F-18X	5.90	6.3 C.T.	6	1500	2 3/8	4 1/8	2 1/2	3 1/8		2 1/4
F-18A	7.25	6.3 C.T.	6	1500	3 1/8	2 3/8	2 3/8	2	1 7/8	2 1/2
F-21A	7.75	6.3 C.T.	10	1500	3 1/8	3	3 1/4	2 1/4	2	3 1/2
F-22A	13.50	6.3 C.T.	20	2000	4	3 1/4	4 1/8	2 1/2	3 1/8	7
F-23U	8.00	10 C.T.	7	1500	3 3/8	2 1/4	3 3/8	2 1/4	2 3/8	4
F-25X	3.90	12.6 C.T.	1.5	1500	1 1/4	3 1/4	2	2 1/4		1 1/4
F-40X	4.00	24	1	1500	1 1/4	3 1/4	2	2 1/4		1 1/4
†F-50X	3.85	Filament line transformer Pri. 6.3V/5V Sec. 6.3/5V 2A		5000	1 1/4	3 1/4	2	2 1/4		1 1/4

*New item. †Low capacity—High voltage for damper tube operation.



Case X

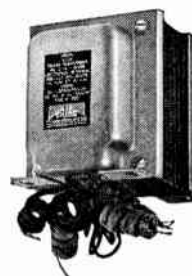
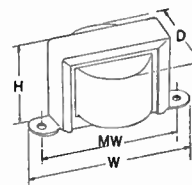

Case A

FILAMENT Transformers, Multiple Secondary

Primary 115 Volts 50-60 Cycles

Type No.	List Price	Secondary		Test Volts RMS	Case Dim.-Ins.			Mtg. Dim.-Ins.		Wt. Lbs.
		Volts and Amperes			H	W	D	MW	MD	
F-27U	\$10.85	10 C.T.-10A. 2.5 C.T.-10A.		1500 7500	4 1/8	3 1/8	3 1/2	2 3/4	2 1/2	6
F-30A	9.00	5 C.T.-3A. 6.3 C.T.-8A.		1500	3 1/8	3	3 3/8	2 1/4	2 1/8	3 3/4
F-32A	8.20	6.3 C.T.-3A.		1500	3 1/8	2 5/8	2 5/8	2	1 7/8	2 1/2
F-34A	8.75	6.3 C.T.-1.75A. 6.3V.-1.75A.		2500	3 1/8	2 3/8	3	2	2 3/8	3
F-36A	11.60	6.3 C.T.-3.5A. 6.3V.-3.5A.		2500	4	3 1/4	3 1/8	2 1/2	2 1/2	5
F-38A	13.20	6.3 C.T.-5A. 6.3V.-1A.-5V.-4A.		2500	4	3 1/4	3 1/4	2 1/2	2 3/4	5 1/2
*F-42A	8.90	12.6 C.T.-2A. 12.6-2.5A.		1500	3 1/8	3	3	2 1/4	2	3 1/4

*New item.

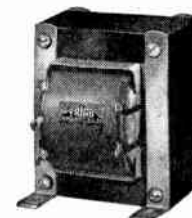
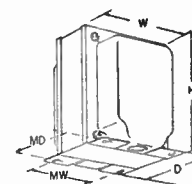

Case U

DRY DISK RECTIFIER Transformers

Primary 115 Volts 50-60 Cycles

Type No.	List Price	Secondary		Rectifier Circuit		Test Volts	Case Dim.-Ins.			Mtg. Dim.-Ins.		Wt. Lbs.
		AC Volts	Amperes	A Volts DC	B Volts DC		H	W	D	MW	MD	
F-47U	\$ 7.75	17-18	3	6-7	13-14	1500	3	2 1/2	2 7/8	1 3/8	2 1/2	2 1/2
F-48U	13.00	17-18	6	6-7	13-14	1500	3 3/4	3 1/8	3 3/8	2 1/2	2 5/8	5 1/4
F-49U	20.00	36-36	3-3	13	26	1500	4 1/2	3 3/4	4	3	3	9 1/2
*F-60U	8.25	6.5-13- 19.5-26	3 (Int.)			1500	3 3/8	2 1/4	3 1/8	2 1/4	2 1/8	3
*F-61U	14.50	24-27-30- 33-36	3			1500	3 3/4	3 1/8	3 3/8	2 1/2	2 5/8	5 1/4

*New item.

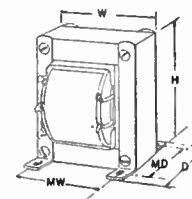



TRIAD TRANSFORMER CORP.

TELEVISION COMPONENTS

Replacement **POWER Transformers** — Combined Plate and Filament
Electrostatically Shielded — Primary 115 Volts 50-60 Cycles

Type No.	List Price	Plate Supply		Filaments		Case Dim.-Ins.			Mtg. Dim.-Ins.		Wt. Lbs.
		AC Volts	DC Ma.	Volts and Amperes		H	W	D	MW	MD	
R-31A	\$25.50	760 V.C.T.	320	5V.-6A.	12.6 C.T.-5A.	4 $\frac{3}{4}$	3 $\frac{7}{8}$	6	3	4 $\frac{7}{8}$	16
R-31BC	27.00					4 $\frac{1}{2}$	4 $\frac{1}{2}$	3 $\frac{3}{4}$	3 $\frac{3}{4}$	3	16
R-31A and R-31BC are designed for a great many of the 28 to 30 tube chassis where a 5V damper tube is used.											
R-32A	25.50	760 V.C.T.	320	5V.-6A.	12.6 V.C.T.-5A.	4 $\frac{3}{4}$	3 $\frac{7}{8}$	6	3	4 $\frac{7}{8}$	16
R-32A is designed for 28 to 30 tube chassis where a 6.3V damper tube is used.											
R-33A	23.50	775 V.C.T.	230	5V.-3A.	6.3V.-9A.	4 $\frac{3}{4}$	3 $\frac{7}{8}$	4 $\frac{3}{4}$	3	3 $\frac{5}{8}$	12
R-33BC	24.75				6.3V./5V.-2A.*	3 $\frac{7}{8}$	4 $\frac{1}{2}$	3 $\frac{3}{4}$	3 $\frac{3}{4}$	3	12
R-33A and R-33BC are designed to deliver 400 V into an 80 m.f.d. condenser using 5U4G rectifier. 6.3V or 5 V damper tube (low capacity).											
R-34A	21.50	750 V.C.T.	230	5V.-3A.	6.3V.-8.5A.	4 $\frac{3}{4}$	3 $\frac{7}{8}$	4 $\frac{3}{4}$	3	3 $\frac{5}{8}$	12
R-34A is designed to deliver 390 V into an 80 m.f.d. condenser using 5U4G rectifier. 6.3V damper tube.											
R-35A	23.50	725/340 V.C.T.	250	5V.-3A.	6.3V.-8A.	4 $\frac{3}{4}$	3 $\frac{7}{8}$	5 $\frac{1}{4}$	3	4 $\frac{1}{8}$	14
R-35BC	25.00				5V.-2A.	3 $\frac{1}{2}$	4 $\frac{1}{2}$	3 $\frac{3}{4}$	3 $\frac{3}{4}$	3	14
R-35A and R-35BC are designed to deliver 380 V DC into an 80 m.f.d. condenser out of a 5U4G rectifier and simultaneously delivering 200 V DC from the taps with a 5U4G rectifier, the accumulative current to be a maximum of 250 ma.											
R-36A	24.00	775 V.C.T.	275	5V.-6A.	6.3V.-8.5A.	4 $\frac{3}{4}$	3 $\frac{7}{8}$	5 $\frac{1}{4}$	3	4 $\frac{1}{8}$	14
R-36BC	25.25				6.3V.-1.2A.*	3 $\frac{1}{2}$	4 $\frac{1}{2}$	3 $\frac{3}{4}$	3 $\frac{3}{4}$	3	14
R-36A and R-36BC are designed to deliver 410 V into 80 m.f.d. condenser, using 2 5U4G tubes as rectifiers. 6.3V damper tube (low capacity).											
R-37BC	24.35	735 V.C.T.	275	5V.-6A.	6.3V.-8.5A.	3 $\frac{1}{2}$	4 $\frac{1}{2}$	3 $\frac{3}{4}$	3 $\frac{3}{4}$	3	13
R-37BC is designed for 380 V into filter condenser using 5U4G rectifier tubes. Either 6.3V or 5V damper tube (low capacity).											
R-38A	22.50	750 V.C.T.	225	5V.-3A.	6.3V.-10A.	4 $\frac{3}{4}$	3 $\frac{7}{8}$	4 $\frac{3}{4}$	3	3 $\frac{5}{8}$	12
R-38BC	23.75				6.3V.-1.2A.*	3 $\frac{7}{8}$	4 $\frac{1}{2}$	3 $\frac{3}{4}$	3 $\frac{3}{4}$	3	12
R-38A and R-38BC are designed to deliver 395 V into 80 m.f.d. condenser, using 5U4G rectifier. 6.3V damper tube (low capacity).											
R-39A	21.25	640 V.C.T.	225	5V.-3A.	6.3V.-10A.	4 $\frac{3}{4}$	3 $\frac{7}{8}$	4 $\frac{3}{4}$	3	3 $\frac{5}{8}$	12
R-39BC	22.50				6.3V.-1.2A.*	3 $\frac{7}{8}$	4 $\frac{1}{2}$	3 $\frac{3}{4}$	3 $\frac{3}{4}$	3	12
R-39A and R-39BC are designed to deliver 335 V into 60 m.f.d. condenser using 5U4G rectifier. 6.3V damper tube (low capacity).											
R-40A	27.00	780/440 V.C.T.	300	5V.-3A.	6.3V.-8.5A.	4 $\frac{3}{4}$	3 $\frac{7}{8}$	5 $\frac{1}{4}$	3	4 $\frac{1}{8}$	14
R-40BC	28.45				5V.-3A.	3 $\frac{1}{2}$	4 $\frac{1}{2}$	3 $\frac{3}{4}$	3 $\frac{3}{4}$	3	14
R-40A and R-40BC are designed to deliver 410 V to 80 m.f.d. filter using 5U4G tube and simultaneously delivering 235 V DC from the taps with suitable rectifier, and the accumulative current to be a maximum of 300 Ma.											
R-42A	21.30	675 V.C.T.	185	5V.-3A.	6.3V.-7A.	4 $\frac{3}{4}$	3 $\frac{7}{8}$	3 $\frac{7}{8}$	3	2 $\frac{3}{4}$	8
R-42BC	22.80				6.3V.-2A.*	2 $\frac{7}{8}$	4 $\frac{1}{2}$	3 $\frac{3}{4}$	3 $\frac{3}{4}$	3	8
R-42A and R-42BC are designed to deliver 350 V DC to 80 m.f.d. filter using 5U4G rectifier. 6.3V damper tube (low capacity).											
R-47BS	22.75	725 V.C.T.	225	5V.-3A.	6.3V.-10A.	3 $\frac{7}{8}$	4 $\frac{1}{2}$	3 $\frac{3}{4}$	3 $\frac{3}{4}$	3	12
Tube socket type, wired for 5U4G and designed to deliver 360 V into 80 m.f.d. condenser, low capacity damper tube winding.											
R-48BS	21.75	750 V.C.T.	180	5V.-3A.	6.3V.-9A.	3 $\frac{7}{8}$	4 $\frac{1}{2}$	3 $\frac{3}{4}$	3 $\frac{3}{4}$	3	12
Tube socket type, wired for 5U4G and designed to deliver 375 V into 80 m.f.d. condenser, low capacity damper tube winding.											
R-49BS	22.50	650 V.C.T.	240	5V.-3A.	6.3V.-9A.	3 $\frac{1}{2}$	4 $\frac{1}{2}$	3 $\frac{3}{4}$	3 $\frac{3}{4}$	3	13
6.3V.-1.2A.*											
*R-49BC	21.80										
Designed to deliver 325 V. into 80 m.f.d. condenser. low capacity damper tube winding.											
R-50A	27.50	790/650 V.C.T.	310	5V.-3A.	6.3V.-5A.	4 $\frac{3}{4}$	3 $\frac{7}{8}$	5 $\frac{1}{2}$	3	4 $\frac{3}{8}$	15
R-50BC	29.00				5V.-3A.	4 $\frac{1}{4}$	4 $\frac{1}{2}$	3 $\frac{3}{4}$	3 $\frac{3}{4}$	3	15
R-50A and R-50BC are designed to deliver 415 V to 80 m.f.d. filter using 5U4G rectifier tube and simultaneously delivering 340 V DC from the taps with suitable rectifier, the accumulative current to be a maximum of 310 Ma.											
R-60BC	23.75	460 V.C.T.	300	5V.-6A.	6.3V.-8A.	3 $\frac{7}{8}$	4 $\frac{1}{2}$	3 $\frac{3}{4}$	3 $\frac{3}{4}$	3	12
R-60BC is designed to deliver 250 V into an 80 m.f.d. condenser, using 2 rectifier tubes, low capacity damper tube winding.											
R-61BC	24.20	560 V.C.T.	275	5V.-6A.	6.3V.-6A.	3 $\frac{1}{2}$	4 $\frac{1}{2}$	3 $\frac{3}{4}$	3 $\frac{3}{4}$	3	14
6.3V.-1.2A.*											
R-61BC is designed to deliver 305 V into an 80 m.f.d. condenser, using 2 rectifier tubes, low capacity damper tube winding.											
R-62BC	24.00	700 V.C.T.	290	5V.-6A.	6.3V.-10A.	4 $\frac{1}{2}$	4 $\frac{1}{2}$	3 $\frac{3}{4}$	3 $\frac{3}{4}$	3	16
6.3V.-2.5A.											
6.3V.-1.2A.*											
R-62BC is designed to deliver 365 V into an 80 m.f.d. condenser, using 2 rectifier tubes, low capacity damper tube winding.											
R-63BC	19.50	131 V.	900		6.3V.-9A.	3 $\frac{1}{4}$	4 $\frac{1}{2}$	3 $\frac{3}{4}$	3 $\frac{3}{4}$	3	11
6.3V.-.6A.											
6.3V.-1.2A.											

131 V. winding designed for use in a voltage doubler circuit.

*New item. †Less than 100 m.m.f.d. capacity to ground and insulated for high voltage damper tube. Height of transformers in BC cases is measured from chassis line to top of case. Copper shading ring on all BC cases to reduce external magnetic field.

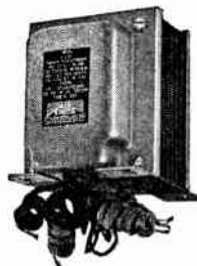

Case A

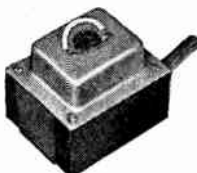
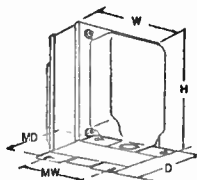

Case BS



Case BC



Case B

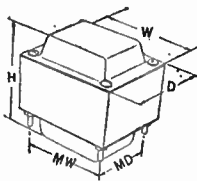

TRIAD TRANSFORMER CORP.



HORIZONTAL OUTPUT (FLYBACK) Transformers

Type No.	List Price	Application	Mtg. Type	Dim.-Inches			Wt. Lbs.
				H	W	D	
D-1	\$ 9.00	Delivers 12,000-14,000 anode volts from single 6BG6 or 6BQ6 driver and single HV rectifier. Ample deflection for 70° tubes.	Q	4	3	2 1/2	3/4
D-2	9.00	Autoformer type. Delivers 14,000 V. from 6BG6 or 6BQ6 driver and single HV rect. Sufficient for 70° tubes. Direct replacement for Hoffman 5143, 5144, 5146, 5148.	Q	4	3 1/2	3	3/4
D-11	9.65	Delivers 9,000 V. from single 6BG6 tube, and single HV rect. 53° operation. Replaces RCA 211T1, 211T3, matches Y-11, Y-12.	H	4 3/4	3 3/4	2 1/8	2
D-14	10.45	Delivers 14,000 volts from single 6BG6. Replaces GE 77J1. Universal matching of yokes.	P	4	2 1/2	2 3/4	3/4
D-15	10.45	Delivers 14,000 volts from single 6BG6. Has AGC circuit winding. Secondary tapped for Universal use. Matches Y12, Y17, Y21, Y22.	P	4	2 1/2	2 3/4	3/4
D-19	10.45	Delivers 14,000-16,000 V. Single driver, 70°, 17" to 24" tubes. Replaces RCA 225T1. Matches Y12, Y17, Y19, Y21, Y22.	P	4	2 1/2	2 3/4	3/4
DA-20	7.00	Delivers 13,000-14,000 V. Single driver, air core. Replaces RCA 74951 and Packard Bell 89432. Matches Y-20.	T	2 5/8	3	3	1/2
D-22	10.45	Delivers 16,000 V. Single driver, 70°, 17" to 24" tubes. 90KC De-Ringer. Replaces Packard Bell 89438-B. Matches Y-22.	P	4	2 1/2	2 3/4	3/4
D-24	10.45	Delivers 18,000 V. Single driver, 70°, 17" to 24" tubes. Matches Y-24.	P	4	2 1/2	2 3/4	3/4
D-26	10.00	Voltage doubler type. 20,000 V. for 70°-90° deflection. Replaces Hoffman 5033-2.	Q	4	3	2 1/2	3/4
D-27	10.00	Delivers 15,000 V. for sets using selenium rectifiers and single 6BQ6. Replaces Hoffman 5035.	Q	4	3	2 1/2	3/4
*D-28	10.00	Delivers 15,000 V., using single 6BQ6. Replaces Hoffman 5160.	QQ	4	3	2 1/2	3/4
D-31	11.00	Universal type, universal mounting, 16,000 V. using single driver all types, 70° deflection. Replaces RCA 231T1 plus low inductance tap for width coil. Can be used as auto transformer and with all yokes.	L	4 1/4	2 3/4	2 3/8	3/4
*D-32	10.75	Universal type, universal mounting. Supplies 13.5 KV to 15 KV from all driver tubes, has AGC or AFC tapped winding. Matches all yokes.	L	4 1/4	2 3/4	2 3/8	3/4
*D-33	10.00	Universal type, universal mtg. Supplies 12 KV to 14 KV from all driver tubes. Low inductance width coil tap, has AGC or AFC tapped winding similar to D-32, but lower impedance secondaries. Matches all yokes.	L	4 1/4	2 3/4	2 3/8	3/4
*D-35	11.00	Universal type, universal mtg. Supplies 14,000 V. from single drivers. Separated width coil winding. Replaces RCA 223T1, 224T1, 230T1 and 232T1. Matches all yokes.	L	4 1/4	2 3/4	2 3/8	3/4
*DA-36	3.50	Coil only, replaces Zenith part No. S-18567.	TT	2 1/4	2 1/4	1 1/2	1/4
*DA-37	3.50	Coil only, replaces Zenith part No. S-19032.	TT	2 1/4	2 1/4	1 1/2	1/4
*D-50	11.50	90° autoformer, designed especially for 90° deflection systems. 24", 27", 30" picture tubes. Matches Y-50 yoke.	P	4	2 1/4	2 3/4	3/4
*MB-10	.35	Universal mounting bracket designed for universal mounting on D-14, D-15, D-19, D-22, D-24 and D-50.	MB				1/8

*New item.

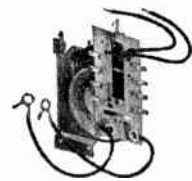

Type L



Type P

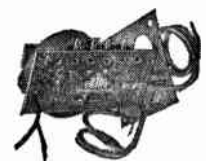

Type Q



Type TT



Type T



Type Y-11



Type Y-12



Type S

DEFLECTION YOKES

Type No.	List Price	Core	Construction	Inductance-mh.			Networks & Leads	Dim.-Inches		Wt. Lbs.
				Horiz.	Vert.	Defl.		Dia.	L.	
Y-11-1	\$ 8.75	Iron	Semi-cosine	8.3	50	53°	Yes	3 1/4	3	1 1/2
Y-12-1	10.25	Ferrite	Cosine	8.3	50	70°	Yes	3 1/4	2 5/8	1
Y-17	9.50	Ferrite	Cosine	13.5	41.5	70°	No	3 1/4	2 5/8	1
*Y-17-1	10.25	Ferrite	Cosine	13.5	41.5	70°	Yes	3 1/4	2 5/8	1
Y-19	9.50	Ferrite	Cosine	23	41.5	70°	No	3 1/4	2 5/8	1
*Y-19-1	10.25	Ferrite	Cosine	23	41.5	70°	Yes	3 1/4	2 5/8	1
*Y-20-1	10.25	Ferrite	Cosine	30	3.3	70°	Yes	3 1/4	2 5/8	1
*†Y-20-2	10.75	Ferrite	Cosine	30	3.3	70°	Yes	3 1/4	2 5/8	1 1/4
Y-21	9.50	Ferrite	Cosine	10.3	41.5	70°	No	3 1/4	2 5/8	1
*Y-21-1	10.25	Ferrite	Cosine	10.3	41.5	70°	Yes	3 1/4	2 5/8	1
Y-22	9.50	Ferrite	Cosine	18.5	42	70°	No	3 1/4	2 5/8	1
*Y-22-1	10.25	Ferrite	Cosine	18.5	42	70°	Yes	3 1/4	2 5/8	1
Y-24	9.50	Ferrite	Cosine	30	41.5	70°	No	3 1/4	2 5/8	1
*Y-50	18.00	Ferrite	Cosine	11	46	90°	No	4 3/4	2 1/2	2
*Y-50-1	19.00	Ferrite	Cosine	11	46	90°	Yes	4 3/4	2 1/2	2

*New item. †Replaces RCA 74952 with networks and leads attached to plug.

HORIZONTAL BLOCKING OSCILLATOR

Type No.	List Price	Application	Case Dim.-Inches			Mtg. Dim.-Inches		Wt. Lbs.
			H	W	D	MW	MD	
A-98X	\$ 2.75	Generates 15750 pulse.	1 7/8	2 1/8	1 1/4	1 3/4		1/4
A-98K	3.85	Generates 15750 pulse.	1 3/4	2 1/8	1 1/2	1 1/2		1/2



TRIAD TRANSFORMER CORP.

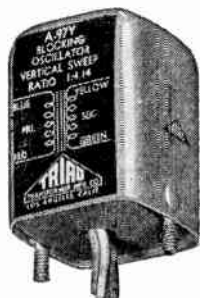

Case Y



Case K



Case X



Type WC



Case M

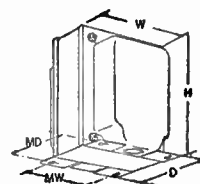

Case M
With Meter

VERTICAL BLOCKING OSCILLATOR

Type No.	List Price	Application	Ratio	Case Dim.-Inches			Mtg. Dim.-Inches		Wt. Lbs.
				H	W	D	MW	MD	
A-96X	\$ 3.75	Dumont type. 3 windings.	1:0.5 1:1	1 1/4	2 1/4	1 1/2	2 3/8		1/2
A-97X	2.75	Blocking oscillator transformer for vertical sweep.	1:4.14	1 1/8	2 1/8	1 1/4	1 3/4		1/4
A-97K	3.85	Same—Case K.	1:4.14	1 3/4	2 1/8	1 1/2	1 1/2		1/2
A-97Y	3.85	Same—Case V.	1:4.14	1 1/2	1 1/4	1 1/4	1 1/8		1/4
*A-95X	2.75	Blocking oscillator transformer for vertical sweep.	1:4.14	1 3/8	2 3/8	1 3/8	2		1/2

*New item.

VERTICAL OUTPUT Transformers

Type No.	List Price	Application	Turns Ratio	Case Dim.-Ins.			Mtg. Dim.-Ins.		Lbs. Wt.
				H	W	D	MW	MD	
A-99X	\$ 4.60	Vertical output transformer to couple output tube to vertical coils of deflection yoke. Matches all standard yokes except V-20.	10:1	2 1/4	3 1/4	2 1/8	3 1/8		1 1/2
A-101U	6.00	Same as above, except upright universal mounting.	10:1	3	2 1/2	2 1/4	1 5/8	1 7/8	2
A-102-X	3.80	Auto transformer type, 3 leads. Matches all yokes except V-20.	11.4:1	1 1/2	3 1/4	1 7/8	2 1/2		1
A-103X	4.65	Output transformer designed especially for V-20 yoke.	49:1	2 1/4	3 1/4	2 1/8	3 1/8		1 1/2
A-104X	5.00	Auto transformer type, 3 leads. Matches all standard yokes.	18:1	2 1/4	3 1/4	2 1/8	3 1/8		1 1/2
A-105X	5.00	Output transformer. Matches all standard yokes. May be used as auto transformer.	25:1	2 1/4	3 1/4	2 1/8	3 1/8		1 1/2
A-107X	6.50	Output transformer. Heavy duty type. Matches all standard yokes. May be used as auto transformer.	10:1	2 5/8	4 1/8	2 1/2	3 1/8		2 1/4
*A-108X	4.75	Output transformer. Matches all standard 70° and 90° yokes. May be used as auto transformer.	8:1	2 1/4	3 1/4	2 1/8	3 1/8		1 1/2
*A-109X	4.75	Output transformer. Matches all standard 70° and 90° yokes. May be used as auto transformer.	15:1	2 1/4	3 1/4	2 1/8	3 1/8		1 1/2
*A-110X	4.75	Auto transformer type, 3 leads. Designed especially for V-20 70° yoke.	44:1	2 1/4	3 1/4	2 1/8	3 1/8		1 1/2

*New item.

Width and Linearity COILS

Type No.	List Price	Application	Mtg. Type	Dim.-Inches			Wt. Lbs.
				H	W	D	
WC-11	\$ 2.50	Width control coil 3.6—30 mh. has primary and secondary winding, secondary tapped for AGC.	W	2	3/4	3/4	1/8
WC-12	1.65	Width and linearity coil, single winding, tapped, covers inductance range .8 to 15 mh.	W	2 3/8	5/8	5/8	1/8
*WC-13	1.60	Width coil, single winding, tapped, winding covers inductance range. 1 to 4 mh. Replaces RCA 208R1, 201R1 and 201R4.	W	2	5/8	5/8	1/8

*New item.

STEPDOWN Autotransformers

Type No.	List Price	V. A. Output	Input Volts	Output Volts	Case Dim.-Ins.			Mtg. Dim.-Ins.		Wt. Lbs.
					H	W	D	MW	MD	
N-1X	\$ 5.05	50	230	115	2 1/4	3 1/4	2 1/8	3 1/8	1 1/2	
N-3M	9.80	85	230	115	3 1/8	3	2 7/8	2 1/4	1 3/4	2 3/4
*N-4M	12.75	150	230	115	3 1/8	3	3 5/8	2 1/4	2 3/8	4 1/2
N-5M	14.30	250	230	115	4	3 1/4	4 1/8	2 1/2	3 1/8	6 3/4
N-7M	22.00	500	230	115	4 3/4	3 7/8	5	3	3 7/8	12
N-9M	40.25	1000	230	115	5 1/8	4 1/2	6 3/8	3 1/2	5 1/4	25
N-11M	67.20	2000	230	115	5 1/8	4 1/2	8 3/8	3 1/2	7 1/4	35
N-34X	8.15	150	95-105-115-125-135	115	2 5/8	4	2 1/2	3 1/8		2
bN-35M	18.50	350	Off-90-100-115-120-125-135	115	4 1/8	3 5/8	3 1/2	2 3/4	2 5/8	5 1/2
bN-50M	26.50	500	90 to 135	115	4 5/8	3 7/8	5 7/8	3	4 1/8	8

*New item. bM case with switch for primary voltage control and detachable cord.

POWER

For Vibrator Power Supply

Type No.	List Price	Primary Volts	Secondary		Case Dim.-Inches			Mtg. Dim.-Inches		Wt. Lbs.
			AC Volts	DC Ma	H	W	D	MW	MD	
V-1K	\$ 8.25	6-8	450 C.T.	40	3	2 1/8	2 3/8			2 1/4
V-3K	8.95	6-8	500 C.T.	50	3	2 1/2	2 5/8			2 1/2
V-5A	9.15	6-8	600 C.T.	75	3 1/8	2 5/8	2 7/8	2	1 7/8	2 1/2
V-7A	11.70	6-8	600 C.T.	100	3 1/8	3	3 1/4	2 1/4	2	3 1/2

TRIAD TRANSFORMER CORP.



ISOLATION Transformers

Type No.	List Price	V. A. Output	Input Volts	Output Volts	Case Dim.-Ins.			Mtg. Dim.-Ins.		Wt. Lbs.
					H	W	D	MW	MD	
N-51X	\$ 5.95	35	115	115	2 1/4	3 1/8	2 1/4	3 1/8	1 3/4	
N-53M	12.75	85	115	115	3 1/8	3	3 3/8	2 1/4	2 3/8	4 1/2
*N-54M	14.30	150	115	115	4	3 1/4	4 1/8	2 1/2	3 1/8	6 3/4
N-55M	25.30	250	115	115	4 3/4	3 7/8	5	3	3 7/8	12
N-57M	40.75	500	115	115	5 1/8	4 1/2	6 3/8	3 1/2	5 1/4	24
N-59M	67.20	1000	115	115	5 1/8	4 1/2	8 3/8	3 1/2	7 1/4	35
⊗N-60	130.00	2000	230/115	230/115	4 3/4	8 1/2	13 1/4	Spcl.		58

*New item. ⊗Special case.

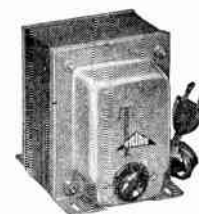

Case M

For AUTOMOBILE RADIO REPLACEMENT

Type No.	List Price	Primary Volts	Secondary		Replacement	Case Dim.-Ins.			Mtg. Dim.-Ins.		Wt. Lbs.
			AC Volts	DC Ma.		H	W	D	MW	MD	
V-11K	\$ 9.55	6-8	760 C.T.	65	Buick	3 5/8	2 3/8	2 3/4			2 1/2
V-12K	9.00	6-8	550 C.T.	55	Cadillac, Chevrolet, Firestone, Ford, Hudson, Kaiser, Motorola, Nash, Oldsmobile, Packard, Philco, Studebaker, Truetone.	2 5/8	2 3/4	2 1/4			2 1/2
V-13K	7.50	6-8	580 C.T.	70	Delco, Ford, Lincoln, Motorola, Philco, Pontiac.	3	2 1/2	2 3/8			3 1/2
V-16K	8.25	6-8	460 C.T.	50	Ford, Kaiser, MoPar, Philco, Truetone, Willys.	2 5/8	2 3/4	2 1/4			2 1/4
V-18X	6.15	6-8	580 C.T.	60	Chevrolet, MoPar, Oldsmobile, Pontiac, Silvertone.	2 1/4	3 1/8	2 1/4	3 1/8		1 3/4
*V-18K	8.25	6-8	580 C.T.	60		2 5/8	2 3/4	2 3/8			2 1/2
V-19A	5.65	6-8	320 C.T.	40	Automatic, Coronado, Philco, Regal, Studebaker.	2 3/4	2 3/8	2 3/8	1 1/8	1 5/8	1 3/4
V-20K	8.55	6-8	560 C.T.	50	Motorola, Truetone.	3	2 1/2	2 3/8			2 1/2

*New item.

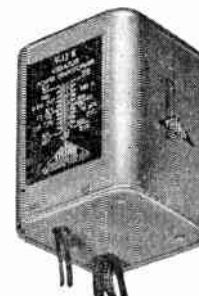

Case K

AUDIO

REPLACEMENT OUTPUT Transformers

TUBE to STANDARD VOICE COIL (3-4 Ohms)

Type No.	List Price	Primary		Impedance	DC Ma.	Audio Watts	Case Dim.-Ins.			Mtg. Dim.-Ins.		Wt. Lbs.
		Tubes Used					H	W	D	MW	MD	
*S-12X	\$ 1.75	25L6, 50L6, 35A5, 50B5, etc.		2500	50	2	1 7/8	2 1/8	1 1/4	1 3/4		1/4
S-1X	1.75	25L6, 50L6, 35A5, 50B5, 2A3, 6B4, etc.		2500	60	3	1 3/8	2 3/8	1 3/8	2		1/2
S-2X	1.85	2A3, 6A3, 6B4, 6Y6, 7A5, 25B6, 50L6.		2000	55	4	1 3/8	2 3/8	1 3/8	2		1/2
S-3X	1.80	6V6, 7C5, 6AQ5, 25A6, 71, etc.		5000	40	3	1 3/8	2 3/8	1 3/8	2		1/2
S-4X	2.95	2A3, 6B4, 6L6, 6U6, 12A5, 25L6, 50A5, 117N7.		3000	70	5	1 1/8	3 1/4	1 7/8	2 1/8		1
S-5Z	3.10	6V6, 7C5, 6AQ5, 25A6, 71, etc.		5000	50	5	2 1/4	2 7/8	1 7/8	2 3/8		1
S-5X	3.10	6V6, 7C5, 6AQ5, 25A6, 71, etc.		5000	50	5	1 1/8	3 1/4	1 7/8	2 1/8		1
S-6X	2.00	3B5, 6AQ5, 6A55, 25A6, 25A7, 35L6, 43, 117L7.		5000	35	2	1 1/8	2 1/8	1 1/4	1 3/4		1/4
S-7X	1.85	6K6, 7B5, 6F6, 1Q5, 31, 33, 41, 42, etc.		7500	40	3	1 3/8	2 3/8	1 3/8	2		1/2
S-8X	2.00	1C5, 1H4, 1Q5, 1S4, 3Q5, 3S4, 14A5, 25AC5.		8000	30	2	1 7/8	2 1/8	1 1/8	1 3/4		1/4
S-9Z	3.25	6K6, 7B5, 6F6, 1Q5, 31, 33, 41, 42, etc.		7500	50	5	2 1/4	2 7/8	1 7/8	2 3/8		1
S-9X	3.25	6K6, 7B5, 6F6, 1Q5, 31, 33, 41, 42, etc.		7500	50	5	1 1/8	3 1/4	1 7/8	2 1/8		1
S-11X	2.00	1J6, 3Q4, 3V4, 6AK6, 6AG7, etc.		10000	30	2	1 7/8	2 1/8	1 1/4	1 3/4		1/4
*S-11Z	2.00	1J6, 3Q4, 3V4, 6AK6, 6AG7, etc.		10000	30	2	1 3/8	1 7/8	1 1/4	1 1/2		1/4
S-13X	2.00	1A5, 1N6, 1LA4.		25000	10	2	1 7/8	2 1/8	1 1/4	1 3/4		1/4
S-15X	2.95	P.p.—6V6, 7C5, 6K6, 6F6, etc.		10000 C.T.	40	7	1 1/8	2 1/8	1 1/2	2 3/8		1/2
S-19Z	3.85	P.p.—6V6, 7C5, 6K6, 6F6, etc.		10000 C.T.	50	10	2 1/4	2 7/8	2	2 3/8		1 1/4
S-21A	5.60	P.p.—6V6, 7C5, 45, 6L6, etc.		8000 C.T.	50	15	2 3/4	2 3/8	2 1/2	1 1/8	1 5/8	1 3/4
S-23X	2.20	Line to VC. Autoformer.		50/3.2	0	3	1 7/8	2 1/8	1 1/4	1 3/4		1/4
S-26X	2.20	Line to VC. Autoformer.		500/50/3.2	0	4	1 7/8	2 1/8	1 1/4	1 3/4		1/4
*S-66X	2.25	Line to VC. Autoformer.		500 to 16/8/4	0	3	1 3/8	2 3/8	1 3/8	2		1/2
S-25Z	3.80	70 volt line to VC. Autoformer.		4000/2000/1000/500 to 4-8	0	10	2 1/4	2 7/8	1 7/8	2 3/8		1
S-58X	2.80	Line to line.		500/125 500/125 Split windings	0	2	1 7/8	2 1/8	1 1/4	1 3/4		1/4

*New item.



Case Z

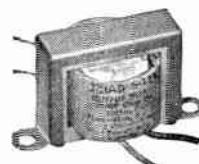

Case X

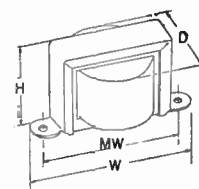

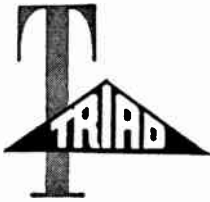

TRIAD TRANSFORMER CORP.

AUDIO

UNIVERSAL OUTPUT Transformers — Any Tube to Any Voice Coil



Case X

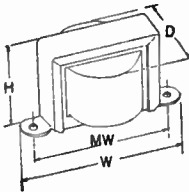

Type No.	List Price	Application	Pri. DC Ma.	Audio Watts	Case Dim.-Ins.			Mtg. Dim.-Ins.		Wt. Lbs.
					H	W	D	MW	MD	
S-51X	\$ 2.75	Single or p.p. plates (4,000 to 14,000 ohms) to VC.	35	5	1 $\frac{3}{8}$	2 $\frac{3}{8}$	1 $\frac{3}{8}$	2		$\frac{1}{2}$
S-53X	3.10	Single or p.p. plates (4,000 to 14,000 ohms) to VC.	40	8	1 $\frac{1}{2}$	2 $\frac{1}{2}$	1 $\frac{1}{2}$	2 $\frac{3}{8}$		$\frac{1}{2}$
S-55Z	4.15	Push-pull plates (4,000 to 14,000 ohms) to VC.	40 ea. side	10	2 $\frac{1}{4}$	2 $\frac{7}{8}$	1 $\frac{7}{8}$	2 $\frac{3}{8}$		1
S-55X	4.15	Push-pull plates (4,000 to 14,000 ohms) to VC.	40 ea. side	10	1 $\frac{1}{2}$	3 $\frac{1}{4}$	1 $\frac{7}{8}$	2 $\frac{1}{2}$		1
S-57Z	5.15	Push-pull plates (4,000 to 14,000 ohms) to VC.	50 ea. side	15	2 $\frac{5}{8}$	3 $\frac{1}{8}$	2 $\frac{1}{8}$	2 $\frac{1}{2}$		1 $\frac{1}{2}$

AUDIO COMPONENTS

This series of medium-priced audio components is designed to fill demands in public-address, amateur and replacement equipment. All items are designed to give an absolute maximum of performance possible in the size allowed. Workmanship and manufacturing techniques are identical with those used in the most expensive TRIAD transformers and only "Climatite" vacuum impregnation is used.

INPUT Transformers — Line or Microphone to Grid



Case Z

Type No.	List Price	Application	Frequency Response	Primary Impedance Ohms	Turn Ratio	Case Dim.-Ins.			Mtg. Dim.-Ins.		Wt. Lbs.
						H	W	D	MW	MD	
A-1X	\$ 2.75	Line or single button mike to grid.	300-3000	100	31.4	1 $\frac{1}{8}$	2 $\frac{1}{8}$	1 $\frac{1}{4}$	1 $\frac{3}{4}$		$\frac{1}{4}$
A-3X	3.00	Line or D.B. mike to grid.	300-3000	400 C.T.	15.8	1 $\frac{1}{8}$	2 $\frac{1}{8}$	1 $\frac{1}{4}$	1 $\frac{3}{4}$		$\frac{1}{4}$
A-5X	4.00	Single button mike to p.p. grids—Hi-gain.	300-3000	100	84	1 $\frac{1}{2}$	2 $\frac{1}{2}$	1 $\frac{1}{2}$	2 $\frac{3}{8}$		$\frac{1}{2}$
A-7J	6.50	Speaker V.C. (3.2 ohms) to grid. 45 db. shielding.	300-3000	3.2	124	1	1 $\frac{1}{8}$	1 $\frac{1}{8}$	1 $\frac{1}{8}$		$\frac{1}{8}$
A-9J	12.50	Line or mike to grid 45 db. shielding.	30-15000	600/250/50	12	1 $\frac{3}{4}$	1 $\frac{3}{8}$	1 $\frac{3}{8}$	$\frac{1}{2}$		$\frac{1}{4}$
A-10J	12.75	Line to grid. 45 db. shielding.	30-15000	600/150 Split windings for center tap.	10.1	1 $\frac{3}{4}$	1 $\frac{3}{8}$	1 $\frac{3}{8}$	$\frac{1}{2}$		$\frac{1}{4}$



Case J

SPECIAL TRANSCEIVER Transformers (Voice Frequencies)

Type No.	List Price	Application	Impedance-Ohms		Turn Ratio	Case Dim.-Ins.			Mtg. Dim.-Ins.		Wt. Lbs.
			Primary	Secondary		H	W	D	MW	MD	
A-21X	\$ 3.00	S.B. mike and plate to grid (2 pri.)	100	100000	1:1	1 $\frac{1}{8}$	2 $\frac{1}{8}$	1 $\frac{1}{4}$	1 $\frac{3}{4}$		$\frac{1}{4}$
A-23X	3.25	Tube to line and hi-impedance phones.	10000	50 and 2000	1:3	1 $\frac{3}{8}$	2 $\frac{3}{8}$	1 $\frac{3}{8}$	2		$\frac{1}{2}$

INTERSTAGE Transformers — Plate to Grid



Case A

Type No.	List Price	Application	Frequency Response	Impedance-Ohms		Ratio	Case Dim.-Ins.			Mtg. Dim.-Ins.		Wt. Lbs.
				Primary	Secondary		H	W	D	MW	MD	
A-31X	\$ 2.75	Plate to single or p.p. grids.	300-3000	10000	90000	1:3	1 $\frac{3}{8}$	2 $\frac{3}{8}$	1 $\frac{3}{8}$	2		$\frac{1}{2}$
A-33X	3.80	Plate to single or p.p. grids.	70-7000	10000	90000	1:3	1 $\frac{1}{2}$	3 $\frac{1}{4}$	1 $\frac{7}{8}$	2 $\frac{1}{2}$		1
*A-42Z	4.75	Multi-ratio single or p.p. plates to single or p.p. grids.	70-7000	15000 C.T. or 33750	135000 or 33750	1:1.5 1:3 1:6	2 $\frac{1}{4}$	2 $\frac{7}{8}$	2	2 $\frac{3}{8}$		1 $\frac{1}{4}$
A-35A	6.00	Plate to single or p.p. grids.	50-10000	10000	90000	1:3	2 $\frac{3}{4}$	2 $\frac{3}{8}$	2 $\frac{1}{2}$	1 $\frac{1}{2}$	1 $\frac{3}{8}$	1 $\frac{3}{4}$
A-39A	6.00	P.p. plates to p.p. grids.	50-10000	20000 C.T.	45000	1:1.5	2 $\frac{3}{4}$	2 $\frac{3}{8}$	2 $\frac{1}{2}$	1 $\frac{1}{2}$	1 $\frac{3}{8}$	1 $\frac{3}{4}$
A-40J	12.50	Parallel-fed 6J5 or 6SN7. Plate to p.p. grid. 45 db. shielding.	30-15000	15000	86000	1:2.76	1 $\frac{3}{4}$	1 $\frac{3}{8}$	1 $\frac{3}{8}$	$\frac{1}{2}$		$\frac{1}{4}$

*New item.

TRIAD TRANSFORMER CORP.



LOW LEVEL OUTPUT Transformers

Type No.	List Price	Application	Frequency Response	Primary Impedance	Ohms Secondary	Case Dim.-Ins.			Mtg. Dim.-Ins.		Wt. Lbs.
						H	W	D	MW	MD	
A-51X	\$ 2.50	Tube to line.	300-3000	7000	50	1 1/4	2 1/8	1 1/4	1 3/4		1/4
A-53X	3.45	Single or p.p. tubes to line.	70-7000	18000 C.T.	600/250/50	1 1/4	2 1/4	1 1/2	2 3/8		1/2
A-55J	12.50	Parallel-fed 6J5 or 6SN7 to line. 45 db. shielding.	30-15000	15000	600/250/50	1 3/4	1 3/8	1 3/8		1 1/2	1/4
A-65J	12.75	Parallel-fed 6J5 or 6SN7 to line. 45 db. shielding.	30-15000	15000	600/150 Split winding	1 3/4	1 3/8	1 3/8		1 1/2	1/4
A-57J	11.75	Line to line. 45 db. shielding.	30-15000	600/250/50	600/250/50	1 3/4	1 3/8	1 3/8		1 1/2	1/4
A-67J	12.00	Line to line. 45 db. shielding.	30-15000	600/150	600/150 —Split windings—	1 3/4	1 3/8	1 3/8		1 1/2	1/4



A-75J

EQUALIZING REACTORS

Type No.	List Price	Application	Ind.	D.C. Ma.	Res. Ohms	Case Dim.-Ins.			Mtg. Dim.-Ins.		Wt. Lbs.
						H	W	D	MW	MD	
**A-74J	\$ 9.10	Choke for cathode equalizer.	15	0	750	1 1/4	1 1/4	1 1/4	1 7/8		3/4
†A-75J	9.75	Choke for cathode equalizer.	15	0	300	1 3/4	1 3/8	1 3/8	3/8		1/4

**70 db. alloy shielding. †Humbucking and 45 db. shielding single hole mounting.

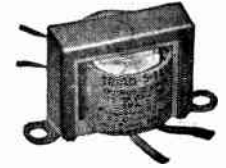

Case X

DRIVER Transformers

Type No.	List Price	Driver Tubes	Output Tubes	Frequency Response	Ratio Primary 1/2 Sec.	Primary D.C. Ma.	Case Dim.-Ins.			Mtg. Dim.-Ins.		Wt. Lbs.
							H	W	D	MW	MD	
A-81X	\$ 2.80	30, 1H4, etc.	P.p. 19, 30's, 1J6, etc.	300-3000	2.66:1	15	1 1/4	2 1/8	1 1/4	1 3/4		1/4
A-83X	3.35	6F6, 42, 45, etc.	P.p. 6L6, 6F6, 6V6, 807, etc.	70-7000	1.33:1	40	1 1/4	2 1/4	1 1/2	2 3/8		1/2
A-85X	3.75	6F6, 42, 45, etc.	P.p. 6L6, 6F6, 6V6, 807, etc.	50-10000	1.33:1	40	1 1/4	3 1/4	1 1/8	2 1/4		1
A-89A	8.70	P.p. plates to class B or AB grids—Universal 15 watt.	Any class B or AB tubes. 100-500 watts output.	50-10000	3.1 or 2.2:1	100 per side	3 1/4	2 3/8	2 3/8	2	1 7/8	2 3/4
A-91A	12.50	P.p. plates to class B or AB grids—Universal 30 watt.	Any class B or AB tubes. 400-1500 watts output.	50-10000	3.1 or 2.2:1	160 per side	3 1/4	3	3 1/2	2 1/4	2 1/4	4

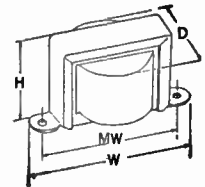

OUTPUT Transformers — Tube to Voice Coil and Line

Type No.	List Price	Primary		Secondary Imp.	DC Pri.	Audio Watts	Case Dim.-Ins.			Mtg. Dim.-Ins.		Wt. Lbs.
		Tubes	Impedance				H	W	D	MW	MD	
S-27A	\$ 6.80	2A3, 6A3, 6B4, 6L6, 6U6, 6Y6, 12A5, 25B6, 35B5, 50A5.	2500	4-8-16-500	80	8	2 3/4	2 3/8	2 1/2	1 1/4	1 3/8	1 3/4
S-28X	4.50	2A5, 6AC5, 6B5, 6F6, 6K6, 7B5, 14A5, 25AC5.	7500	4-8-16-500	40	5	1 1/4	3 1/4	1 3/8	2 1/4		1
S-29X	4.50	6AQ5, 6AS5, 6V6, 7C5, 25A6, 25B5, 25L6, 25N6, 35A5, 35L6.	5000	4-8-16-500	45	5	1 1/4	3 1/4	1 3/8	2 1/4		1
*S-22A	7.75	P.p. 2A3, 6B4, 6A5, 6L6, etc.	5000 C.T.	4-8-16-500	100 (bal.)	15	2 3/4	2 3/4	2 1/2	1 1/4	2	2 1/2
*S-24A	7.75	P.p. 6V6, 7C5, 6K6, 6F6, etc.	8000 C.T.	4-8-16-500	80 (bal.)	15	2 3/4	2 3/4	2 1/2	1 1/4	2	2 1/2

*New item.



Case A

MODULATION Transformers — Tube to RF Load

Type No.	List Price	Primary	Frequency Response	Secondary		Audio Ma. Watts	Case Dim.-Ins.			Mtg. Dim.-Ins.		Wt. Lbs.
				Impedance	Ma.		H	W	D	MW	MD	
M-1X	\$ 3.80	10000 C.T. for 19, 1J6, 6N7, 6A6, etc.	300-3000	5000-8000-10000	50	5	1 1/4	2 1/8	1 1/4	1 3/4		1/4
M-3X	5.60	10000 C.T. for 6N7, 6A6, 6F6's, etc.	300-3000	3000-5000-8000	100	20	2 1/4	3 1/4	2 1/8	3 1/8		1 1/2
M-7A	14.45	4250 C.T. for 807's	300-3000	3000-5000-8000	200	60	4 1/4	3 3/8	4	2 3/4	3 1/8	6 1/2
*M-8A	21.20	Multi-match.	300-3000	4000 to 20000	200	80	4 1/4	3 3/8	4 1/2	2 3/4	3 1/4	8
*M-12A	22.50	Multi-match.	300-3000	4000 to 20000	300	125	4 3/4	3 3/8	4 3/4	3	3 1/4	12

*Plate leads outside.

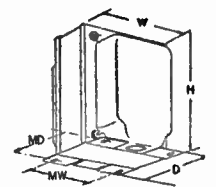

SNC QUALITY TRANSFORMERS Give OUTSTANDING PERFORMANCE!

Style AL Mtg. Style CL Mtg. Style BL Mtg.
Style DL Mtg. Style ET Mtg. Style FL Mtg.

Skillful Engineering, latest production techniques and highest quality materials . . . backed by careful workmanship, exacting step-by-step inspection and rigorous final testing . . . are combined in every SNC transformer to provide a quality product that gives MORE in dollar value.

AUDIO TRANSFORMERS—THE "ONE" SERIES

AUDIO INPUT

Type Number	Application	Impedance		Pri. Mils (D.C.)	Max. Turns Ratio	Frequency Characteristics—c. p. s.					Mtg. Style	Dimensions				Net Wt.	List Price
		Primary	Secondary			50	200	1M	5M	10M		A	B	C	D		
1P121	P.M. Speaker to Grid	4	100,000	0	1:58	-4.0	-1.0	0	0	0	BL	1-7/8	1-9/16	1-1/2	2	.5	3.58
1P124	S.B. Mic. to Sgl. or P.P. Grids	100	400,000 C.T.	50	1:63	-6.0	0	-2.0	-6.0	0	BL	1-7/8	1-9/16	1-1/2	2	.5	3.78
1P125	Low Z to Sgl. or P.P. Grids	50	100,000 C.T.	0	1:45	-3.0	0	0	0	0	BL	1-7/8	1-9/16	1-1/2	2	.5	3.40
1P128	Sgl. or D.B. Mic. or Line to Sgl. or P.P. Grids	200*/50	100,000 C.T.	50	1:45	-2.0	-0.3	0	-0.7	-2.0	DL	2-5/8	2-3/16	2-1/8	2-13/16	1.3	5.40
1P136	Line to Sgl. or P.P. Grids	500*/125	100,000 C.T.	0	1:28	-3.0	-0.4	0	-0.4	-1.5	DL	2-5/8	2-3/16	2-1/8	2-13/16	1.4	5.40
1P145	Sgl. or P.P. Plates to Line	20,000 C.T.	500*/125	8	12.6:1	-3.5	-1.0	0	0	0	DL	2-1/4	1-7/8	1-13/16	2-3/8	.9	4.45
1P152	Sgl. or P.P. Plates to Line	20,000 C.T.	200*/50	8	20:1	-4.0	-1.0	0	0	0	DL	2-1/4	1-7/8	1-13/16	2-3/8	.9	4.45
1P161	Line to Line	500	500*/125	0	2:1	-0.4	-0.1	0	-0.4	-1.0	DL	2-1/4	1-7/8	1-13/16	2-3/8	.9	4.00

*Indicates Balanced Center Tap

AUDIO INTERSTAGE

1P323	Sgl. Plate to Sgl. Grid	10,000	90,000	8	1:3	-5.0	-1.5	0	0	0	BL	1-7/8	1-9/16	1-1/2	2	.5	3.25
1P331	Sgl. Plate to P.P. Grids	10,000	90,000 C.T.	8	1:3	-6.0	-2.0	0	-1.0	BL	1-7/8	1-9/16	1-1/2	2	.5	3.50	
1P339	Sgl. Plate to P.P. Grids	10,000	90,000 C.T.	8	1:3	-3.0	-0.5	0	+0.1	BL	2-1/4	1-7/8	1-13/16	2-3/8	.9	3.98	
1P342	Sgl. Plate to P.P. Grids	10,000	90,000 C.T.	8	1:3	-2.5	-0.5	0	0	DL	2-5/8	2-3/16	2-1/8	2-13/16	1.5	5.05	
1P346	P.P. Plates to P.P. Grids	20,000 C.T.	45,000 C.T.	10	1:1.5	-1.0	-0.2	0	0	DL	2-5/8	2-3/16	2-1/8	2-13/16	1.5	5.20	
1P351	Universal	Universal		8	1:3	-2.0	-0.4	0	0	0	BL	2-1/4	1-7/8	1-13/16	2-3/8	.9	4.15
3P363	Sgl. Type 30 to 19, 1J5 or P.P. 30 Class B	10,000	7,000 C.T.	8	2.4:1	-0.5	0	0	-0.2	-1.0	BL	1-7/8	1-9/16	1-1/2	2	.5	2.80

TELEVISION REPLACEMENT (VERTICAL BLOCKING OSCILLATOR)

Type Number	Primary Inductance	Leakage Inductance	Turns Ratio	Mounting Style	Mounting	Dimensions				Net Wt.	List Price
						H	W	D	Ctrs.		
1P412	1.15 Hy. ±20%	.008 Hy. ±25-15%	1:42	Comp. Filled Case	Flange Studs	1-7/8	2-5/16	1-1/2	1-15/16	.5	3.60
1P416	1.15 Hy. ±20%	.008 Hy. ±25-15%	1:42	Comp. Filled Case	Flange Studs	1-5/8	1-3/16	1-3/16	1-13/64	.4	3.35

CHOKES AND REACTORS—THE "TWO" SERIES

AUDIO REACTORS

Type Number	D.C. Mils		Inductance				Insul. Test Voltage	D.C. Res.	Mtg. Style	Dimensions					Net Weight	List Price
	Nom.	Max.	0-D.C.	50% Nom. D.C.	Nom. D.C.	Max. D.C.				A	B	C	D	E		
2P123	5-0.5	15	550	—	300-500	80	2000	\$500	AL	1-7/8	2-1/4	1-5/8	2-13/16	.9	3.50	
2P124	5-0.5	15	550	—	300-500	80	2000	\$500	CL	1-7/8	2-1/4	1-3/4	2-13/16	.9	3.80	
2P126	35-15	45	65	—	25-35	20	2000	800	AL	1-7/8	2-1/4	1-5/8	2-13/16	.9	2.75	
2P127	35-15	45	65	—	25-35	20	2000	800	CL	1-7/8	2-1/4	1-3/4	2-13/16	.9	3.25	

FILTER AND SWINGING CHOKES

2P132	40	50	22	13	8	6	2000	450	AL	1-5/16	1-5/8	1-1/8	2	.3	1.80
2P135	65	80	18	11	8	7	2000	300	AL	1-9/16	1-7/8	1-3/8	2-3/8	.5	2.15
2P138	85	100	30	16	8	7	2000	350	AL	1-7/8	2-1/4	1-7/8	2-13/16	1.2	2.80
2P141	110	135	20	10.5	8	7	2000	250	BL	2-5/8	2-3/16	1-7/8	2-13/16	1.5	3.70
2P142	110	135	20	10.5	8	7	2000	200	DL	2-5/8	2-3/16	2-1/8	2-13/16	1.5	3.80
2P144	150	180	26	13	8	5.5	2000	190	BL	3	2-1/2	2-1/8	3-1/8	2.1	3.70
2P145	150	180	26	13	8	5.5	2000	190	GL	3-1/8	2-1/2	2-5/8	2	2.2	5.05
2P147	200	250	16	10	8	6.5	3500	110	GL	3-1/2	2-7/8	3-1/8	2-1/4	2	3.2
2P148	200-20	—	—	—	3-15	—	3500	110	GL	3-1/2	2-7/8	3-1/8	2-1/4	2	3.2
2P151	300	350	18	11	8	7	5000	75	GL	4-5/8	3-3/4	3-7/8	3	7.5	11.10
2P152	300-30	—	—	—	3-15	—	5000	75	GL	4-5/8	3-3/4	3-7/8	3	7.5	11.10
2P155	500	600	16	10	8	5.5	5000	55	HT	7-1/8	5-1/2	5-15/16	4-3/8	22.8	31.20
2P156	500-50	—	—	—	3-15	—	5000	55	HT	7-1/8	5-1/2	5-15/16	4-3/8	22.8	31.20

DRIVER TRANSFORMERS—THE "THREE" SERIES

Type Number	Primary Impedance	Watts	Ratio, Pri. to 1/2 Sec. or Sec. Z	Pri. D.C. Mils	Frequency Characteristics—c. p. s.					Mtg. Style	Dimensions					Net Wt.	List Price	
					50	200	1M	5M	10M		A	B	C	D	E			
3P323	6,000 C.T. to 10,000 C.T.	25	6, 5.5, 5:1	60	-0.5	0	0	0	-0.3	GL	3-1/8	2-1/2	2-5/8	2	1-11/16	2.3	11.30	
3P328	3,000 C.T. to 5,000 C.T.	25	6, 5.5, 5:1	60	-0.4	0	0	0	-0.1	GL	3-1/8	2-1/2	2-5/8	2	1-11/16	2.3	11.30	
3P334	6,000 C.T. to 10,000 C.T.	25	4.5, 4, 3.5:1	60	-1.0	-0.3	0	0	+0.6	GL	3-1/8	2-1/2	2-5/8	2	1-11/16	2.3	11.15	
3P338	3,000 C.T. to 5,000 C.T.	25	4.5, 4, 3.5:1	60	-1.7	-0.5	0	0	0	GL	3-1/8	2-1/2	2-5/8	2	1-11/16	2.3	11.35	
3P342	6,000 C.T. to 10,000 C.T.	25	3, 2, 1:1	60	-0.7	-0.1	0	0	+0.1	-0.4	GL	3-1/8	2-1/2	2-5/8	2	1-11/16	2.3	11.75
3P347	3,000 C.T. to 5,000 C.T.	25	3, 2, 1:1	60	-0.8	0	0	0	-0.2	GL	3-1/8	2-1/2	2-5/8	2	1-11/16	2.3	11.40	
3P353	6,000 C.T. to 10,000 C.T.	25	500 Ohms	60	-1.1	-0.3	0	0	+0.3	GL	3-1/8	2-1/2	2-5/8	2	1-11/16	2.3	11.40	
3P358	3,000 C.T. to 5,000 C.T.	25	500 Ohms	60	-0.9	-0.1	0	0	-0.4	-1.0	GL	3-1/8	2-1/2	2-5/8	2	1-11/16	2.3	11.40
3P363	10,000	5	2.4:1	10	-0.5	0	0	0	-0.2	-1.0	BL	1-7/8	1-9/16	1-1/2	2	.5	2.80	

See Page N-33 for Dimensional Illustrations.

SNC QUALITY TRANSFORMERS Give OUTSTANDING PERFORMANCE!

Style AL Mtg. Style CL Mtg. Style BL Mtg.
 Style DL Mtg. Style ET Mtg. Style FL Mtg.

DIMENSIONAL ILLUSTRATIONS

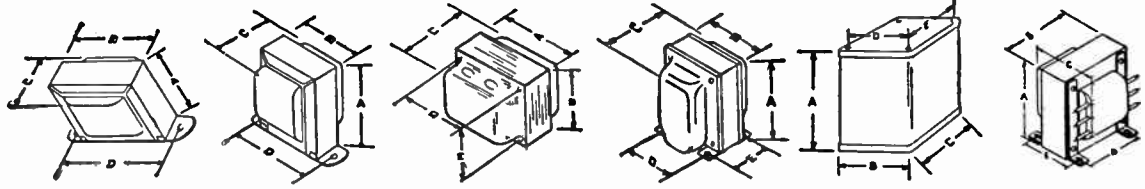

OUTPUT TRANSFORMERS—THE "SIX" SERIES

SPECIFIC DUTY REPLACEMENT TYPES—TUBE TO VOICE COIL

Type Number	Primary Imp.—Ohms	Pri. D.C. Mils	Sec. Z—Ohms	Watts	Mtg. Style	Dimensions				Net WL	List Price
						A	B	C	D		
6P306	Single 2,000 Plate	50	3-6	6	AL	1-5/16	1-5/8	1-1/2	2	.3	1.80
6P306	Single 4,000 Plate	35	3-6	6	AL	1-5/16	1-5/8	1-1/2	2	.3	1.80
6P312	Single or P.P. 7,500 Plates	35	3-6	6	AL	1-5/16	1-5/8	1-1/2	2	.3	2.40
6P316	Single or P.P. 10,000 Plates	35	3-6	6	AL	1-5/16	1-5/8	1-1/2	2	.3	2.40
6P319	Push-Pull 15,000 Plates	35	3-6	6	AL	1-5/16	1-5/8	1-1/2	2	.3	2.45
6P321	Push-Pull 20,000 Plates	30	3-6	6	AL	1-5/16	1-5/8	1-1/2	2	.3	2.45
6P325	Push-Pull 25,000 Plates	20	3-6	6	AL	1-5/16	1-5/8	1-1/2	2	.3	2.45

UNIVERSAL REPLACEMENT TYPES—TUBE TO VOICE COIL—TUBE TO LINE—LINE TO VOICE COIL

Type Number	Primary Imp.—Ohms	Pri. D.C. Mils	Sec. Z—Ohms	Watts	Mtg. Style	Dimensions				Net WL	List Price
						A	B	C	D		
6P165	Sgl. or P.P. 4M to 14M Plates	40	1.1 to 14	4	ATL	1-5/16	1-5/8	1-3/8	2	.3	2.80
6P166	Sgl. or P.P. 4M to 14M Plates	50	1.1 to 14	8	ATL	1-9/16	1-7/8	1-5/8	2-3/8	.5	2.80
6P167	Sgl. or P.P. 3M to 10M Plates	50	1.2 to 13	15	BTL	1-7/8	1-9/16	1-3/4	2	.5	3.50
6P169	Sgl. 1500 to 7M Plate	55	.8 to 19	10	ATL	1-9/16	1-7/8	1-5/8	2-3/8	.9	2.80
6P172	P.P. 3500 to 12M Plates	60	1.3 to 14	20	BTL	2-5/8	2-3/16	2-1/8	2-13/16	1.5	5.10
6P701	Single 2500 to 7500 Plate	45	165 to 1500	10	BTL	2-1/4	1-7/8	1-7/8	2-3/8	.9	4.45
6P710	P.P. 7500 to 15M Plates	45	250 to 1000	10	BTL	2-1/4	1-7/8	1-7/8	2-3/8	.9	5.85
6P714	Sgl. or P.P. 2500 to 12M Plates	45	150 to 2400	10	BTL	2-1/4	1-7/8	1-7/8	2-3/8	.9	5.30
6P717	125 to 500 Line	0	1 to 32	35	BTL	2-5/8	2-3/16	2-1/8	2-13/16	1.5	5.40
6P722	500 to 3M Line in 500-Ohm Steps	0	1.3 to 48	10	BTL	2-1/4	1-7/8	1-7/8	2-3/8	.9	5.10

AMPLIFIER AND EQUIPMENT TYPES—TUBE TO LINE AND VOICE COIL

Type Number	Primary Imp.—Ohms	Pri. D.C. Mils	Secondary Imp.—Ohms	Watts	Frequency Characteristics—c. p. s.					Mtg. Style	Dimensions					Net WL	List Price
					50	200	1M	5M	10M		A	B	C	D	E		
					6P726	P.P. 3300 or 3800 Plates	90	4-8-16-250-500	60		-0.3	0	0	+0.1	+0.5		
6P731	P.P. 4500 or 6800 Plates	90	4-8-16-250-500	60	-0.3	0	0	+0.2	0	GL	3-3/4	3-1/16	3-3/8	2-1/2	2-3/16	4.4	10.70
6P736	P.P. 5000 Plates	70	4-8-16-250-500	25	-0.9	-0.2	0	+0.2	+0.5	DL	2-5/8	2-3/16	2-1/8	2-13/16	1.5	7.20	
6P740	P.P. 4300 Plates	70	4-8-16-250-500	25	-0.9	-0.3	0	+0.3	+0.5	DL	2-5/8	2-3/16	2-1/8	2-13/16	1.5	7.20	
6P743	P.P. 6600 Plates	70	4-8-16-250-500	25	-0.7	-0.1	0	+0.2	+0.5	DL	2-5/8	2-3/16	2-1/8	2-13/16	1.5	7.20	
6P746	P.P. 8000 Plates	70	4-8-16-250-500	25	-0.7	-0.1	0	+0.1	+0.3	DL	2-5/8	2-3/16	2-1/8	2-13/16	1.5	7.20	
6P749	P.P. 10,000 Plates	60	4-8-16-250-500	25	-0.4	-0.1	0	+0.2	+0.3	DL	2-5/8	2-3/16	2-1/8	2-13/16	1.5	7.55	
6P752	Sgl. 2500 Plate	60	4-8-16-250-500	10	-3.0	-0.4	0	+0.3	+0.5	DL	2-1/4	1-7/8	2-1/8	2-3/8	1.0	5.70	

TELEVISION REPLACEMENT (VERTICAL DEFLECTION)

Type Number	Ratio Pri. to Sec.	Primary Imp.—Ohms	Leakage Inductance	Mounting Style	Dimensions					Net Wt.	List Price
					A	B	C	D	E		
6P860	10:1	19,800 Min.	0.33 My. Max.	B x L	3-3/16	2-3/4	2-9/16	1-19/32	2	2.2	6.78

MODULATION TRANSFORMERS—THE "FIVE" SERIES

SNC universal modulation transformers are specifically designed to provide maximum application possibilities per type. All units are provided with two identical secondary windings, permitting series or parallel operation. Changes in the ratio can be readily accomplished, when desired, without removing the unit from the chassis. Most units available in either air cooled or compound filled coils.

UNIVERSAL TYPES

Type Number	Watts	Primary Current Mils	Secondary Characteristics				Primary Impedance Ohms	Mtg. Style	Dimensions					Net Weight	List Price
			Series Sec.		Parallel Sec.				A	B	C	D	E		
			Impedance	Mils	Impedance	Mils									
SP341	15	60		50		100	3M to 8M	DL	2-5/8	2-3/16	2-3/8	2-13/16		1.5	9.00
SP346	50	80	2M to 18M	75	500 to 4500	150	3M to 15M	GTL	3-7/8	3-1/8	3-3/8	2-1/2	2-3/16	4	14.10
SP352	100	120	2M to 18M	100	500 to 4500	200	3M to 15M	GTL	4-5/8	3-3/4	3-7/8	3	2-13/16	9.7	22.50
SP354	200	200	2M to 18M	150	500 to 4500	300	3M to 15M	HT	7-1/8	5-1/2	5-15/16	4-3/8	4-13/16	32	51.60
SP355								JT							
SP357	300	250	2M to 18M	250	500 to 4500	500	3M to 15M	HT	7-1/8	6-1/2	7-1/4	5-3/8	6-1/8	41	62.40
SP358								JT							
SP363	500	300	2M to 18M	300	500 to 4500	600	3M to 15M	HT	10-3/4	6-1/2	7-1/4	5-3/8	6-1/8	51	126.80
SP364								JT							



NOTE
 Basic mounting types are classified as "A," "B," "C," "D," "E," "F," "G," "H," "J," and Bx.
 Explanation of Suffix Symbols
 L = Leads
 T = Lugs
 P = Cord and Plug
 SP = Switch, Cord and Plug

POWER TRANSFORMERS—THE "EIGHT" SERIES

All units conservatively rated for operation on either 50 or 60 cycles and contain an electrostatic shield between primary and all other windings
REPLACEMENT TYPES (6.3 Volt Heater Winding)

Type Number	Primary Voltage	R.M.S.—High Volt. Secondary	Pri. D.C. Mils.	Rectifier Filament	Heater Winding Center Tapped	Mtg. Style	Dimensions					Net WL	List Price
							A	B	C	D	E		
8P040	117	265-0-265	40	5V. @ 2A.	6.3V. @ 2A.	FL	3	2-1/2	3-3/4	2-1/2	2	2.3	5.40
8P055	117	300-0-300	55	5V. @ 2A.	6.3V. @ 2.5A.	FL	3	2-1/2	3-1/8	2-1/2	2	2.8	5.45
8P070	117	325-0-325	70	5V. @ 2A.	6.3V. @ 3A.	FL	3	2-1/2	3-1/2	2-1/2	2	3.2	6.90

HEAVY DUTY REPLACEMENT AND NEW EQUIPMENT TYPES (6.3 Volt Heater Winding)

Type Number	Primary Voltage	R.M.S.—High Volt. Secondary	Pri. D.C. Mils.	Rectifier Filament	Heater Winding Center Tapped	Mtg. Style	Dimensions					Net WL	List Price
							A	B	C	D	E		
8P180	117	265-0-265	40	5V. @ 2A.	6.3V. @ 2A.	FL	3	2-1/2	3-1/4	2-1/2	2	3.2	7.40
8P180G						GL	3-1/16	2-7/32	3-1/8	2	2-3/16		
8P183	117	300-0-300	50	5V. @ 2A.	6.3V. @ 2A.	FL	3-3/8	2-13/16	3-7/16	2-13/16	2-1/4	3.5	7.00
8P183G						GL	3-7/16	2-27/32	3-3/4	2-13/16	2-1/8		
8P186	117	325-0-325	60	5V. @ 2A.	6.3V. @ 3A.	FL	3-3/8	2-13/16	3-11/16	2-13/16	2-1/4	4.0	8.20
8P186G						GL	3-7/16	2-27/32	3-1/2	2-13/16	2-3/8		
8P189	117	350-0-350	70	5V. @ 3A.	6.3V. @ 3.5A.	FL	3-3/4	3-1/8	3-3/4	3-1/8	2-1/2	5.0	9.00
8P189G						GL	3-13/16	3-5/32	3-5/8	2-1/2	2-7/16		
8P192	117	350-0-350	90	5V. @ 3A.	6.3V. @ 4A.	FL	3-3/4	3-1/8	4	3-1/8	2-1/2	5.7	9.90
8P192G						GL	3-13/16	3-5/32	3-7/8	2-1/2	2-11/16		
8P194	117	375-0-375	110	5V. @ 3A.	6.3V. @ 4A.	FL	3-3/4	3-1/8	4-1/8	3-1/8	2-1/2	6.0	11.10
8P194G						GL	3-13/16	3-5/32	4	2-1/2	2-15/16		
8P196	117	350-0-350	150	5V. @ 3A.	6.3V. @ 4.8A.	FL	4-1/8	3-7/16	4-3/8	3-7/16	2-3/4	7.7	11.70
8P196G						GL	4-3/16	3-15/32	4-3/8	3-3/4	3-5/16		
8P199	117	400-0-400	70	5V. @ 3A.	6.3V. @ 3.5A.	FL	3-3/4	3-1/8	4	3-1/8	2-1/2	5.8	10.50
8P199G						GL	3-13/16	3-5/32	3-7/8	2-1/2	2-11/16		
8P202	117	450-0-450	200	5V. @ 3A.	6.3V. @ 5A.	FL	4-1/2	3-3/4	4-3/4	3-3/4	3	10.7	15.00
8P202G						GL	4-9/16	3-25/32	4-3/8	3	3-11/16		
8P205	117	450-0-450	325	5V. @ 6A.	6.3V. @ 8A.	HT	7-1/8	5-1/2	5-15/16	4-3/8	4-13/16	22.3	40.00
8P208	117	550-0-550	275	5V. @ 6A.	6.3V. @ 6A.	HT	7-1/8	5-1/2	5-15/16	4-3/8	4-13/16	23.3	40.00

REPLACEMENT TYPES (2.5 Volt Heater Winding)

8P287	117	350-0-350	70	5V. @ 3A.	2.5V. @ 6A.	FL	3-3/4	3-1/8	3-3/4	3-1/8	2-1/2	5.0	9.00
8P293	117	350-0-350	90	5V. @ 3A.	2.5V. @ 8A.	FL	3-3/4	3-1/8	4	3-1/8	2-1/2	6.6	9.00
8P295	117	350-0-350	150	5V. @ 3A.	2.5V. @ 12A.	FL	4-1/8	3-7/16	4-3/8	3-7/16	2-3/4	7.8	11.70

REPLACEMENT TYPES (Two 2.5 Volt Heater Windings)

8P487	117	350-0-350	70	5V. @ 3A.	No. 1 = 2.5V. @ 3.5A.	FL	3-3/4	3-1/8	4	3-1/8	2-1/2	5.8	10.00
8P487G					No. 2 = 2.5V. @ 8A.	GL	3-13/16	3-5/32	3-7/8	2-1/2	2-11/16		
8P494	117	375-0-375	110	5V. @ 3A.	No. 1 = 2.5V. @ 3.5A.	FL	3-3/4	3-1/8	4-1/4	3-1/8	2-1/2	6.2	11.00
8P494G					No. 2 = 2.5V. @ 10A.	GL	3-13/16	3-5/32	4-1/8	2-1/2	2-15/16		

GENERAL PURPOSE TYPES WITH CONVENIENT LUG TERMINALS (6.3 Volt Heater Winding)

Type Number	Primary Voltage	R.M.S.—High Volt. Secondary	Pri. D.C. Mils.	Rectifier Filament	Heater Winding Center Tapped	Mtg. Style	Dimensions					Net WL	List Price
							A	B	C	D	E		
8P382	117	300-0-300	50	5V. @ 2A.	6.3V. @ 2A.	ET	3-3/8	2-13/16	3-7/16	2-13/16	2-1/4	3.2	7.10
8P385	117	325-0-325	60	5V. @ 2A.	6.3V. @ 3A.	ET	3-3/8	2-13/16	3-11/16	2-13/16	2-1/4	4.0	7.60
8P388	117	350-0-350	70	5V. @ 3A.	6.3V. @ 3.5A.	ET	3-3/4	3-1/8	3-3/4	3-1/8	2-1/2	4.7	8.30

BIAS TYPES

8P510	117	40-0-40	25	5V. @ 2A.		CL	1-7/8	2-1/4	1-3/4	2-13/16		1.0	4.50
8P511	117	0-90-150-200-250	50	5V. @ 2A.		GL	3-1/16	2-7/32	2-5/8	2	1-11/16	2.0	6.55

VIBRATOR TYPES

8P610	6	225-0-225	40			AL	2-3/16	2-5/8	2	3-1/8		1.3	5.10
8P611	6	320-0-320	40			GL	3-1/16	2-7/32	2-1/2	2	1-9/16	2.1	6.10
8P612	6	390-0-390	60			GL	3-7/16	2-27/32	3-5/16	2-1/4	2-3/16	3.7	6.90

TELEVISION REPLACEMENT TYPES

8P003	117	375-0-375	210	5V. @ 3A.	No. 1-5V. @ 2A. No. 2-6.3V. @ 5.5A.	FL	4-1/2	3-3/4	4-3/4	3-3/4	3	10.7	17.75
8P005	117	235-0-235	90	5V. @ 2A.	8.3V. @ 5.5A.	FL	3-3/8	2-13/16	4	2-13/16	2-1/4	5.1	10.20
8P007	117	365-0-365	300	5V. @ 6A.	No. 1-12.8V. @ 5A. No. 2-5V. @ 2A.	FL	4-23/32	3-27/32	0-3/4	4-1/16	3-3/16	16.0	30.60

See Page N-33 for Dimensional Illustrations.



NOTE
 Basic mounting types are classified as "A," "B," "C," "D," "E," "F," "G," "H," "J," and Bx."

Explanation of Suffix Symbols
 L = Leads
 T = Lugs
 P = Cord and Plug
 SP = Switch, Cord and Plug

PLATE TRANSFORMERS—THE "SEVEN" SERIES

All SNC plate transformers have dual secondary ratings. Most units available in either air cooled or compound filled cases. All units contain electrostatic shields between primary and high voltage windings.

Type Number	Primary Voltage	Pri. V.A.	Secondary R.M.S. Voltage	D.C. Voltage From Filter*	D.C. Current	Mtg. Style	Dimensions					Net Wt.	List Price
							A	B	C	D	E		
7P530	115-230	220	920-0-920 or 740-0-740	750 or 600	200MA	GL	4-3/4	3-3/4	5-1/8	3	4-1/16	12	16.00
7P535 7P536	115-230	320	930-0-930 or 750-0-750	750 or 600	300MA	HT JT	7-1/8	5-1/2	5-15/16	4-3/8	4-13/16	22 30	42.00 48.00
7P542 7P543	115-230	530	1470-0-1470 or 1220-0-1220	1250 or 1000	300MA	HT JT	7-1/8	6-1/2	7-1/4	5-3/8	6-1/8	33 41	50.40 55.20
7P551 7P552	115-230	750	2050-0-2050 or 1740-0-1740	1750 or 1500	300MA	HT JT	7-1/8	6-1/2	7-1/4	5-3/8	6-1/8	43 51	54.00 66.00
7P557 7P558	115-230	1060	2880-0-2880 or 2350-0-2350	2500 or 2000	300MA	HT JT	10-3/4	6-1/2	7-1/4	5-3/8	6-1/8	53 69	74.40 89.40
7P563 7P564	115-230	1760	2900-0-2900 or 2370-0-2370	2500 or 2000	500MA	HT JT	10-3/4	9	7-1/4	7	5-13/16	96 126	108.00 150.00

*All units may be operated with simultaneous loads—provided the total D.C. current of the two loads does not exceed the rating listed.

FILAMENT TRANSFORMERS—THE "FOUR" SERIES

Most SNC Filament Transformers are constructed to provide two identical center tapped secondary windings and offer a minimum of three applications. They provide three-fold the number of possible applications of ordinary filament types. A few are single secondary units and are so designated. All have 117 V. 50/60 cycle primary.

Type Number	Applications			Test Voltage	Mtg. Style	Dimensions					Net Wt.	List Price
	Parallel Secondaries	Series Secondaries	Independent Identical Secondaries			A	B	C	D	E		
4P222	2.5V. C.T. @ 5 A.	5 V. C.T. @ 2.5 A.	Two of 2.5V. C.T. @ 2.5 A.	2000	BL	2-1/4	1-7/8	1-3/4	2-3/8		1.0	3.55
4P226*	2.5V. C.T. @ 10 A.*			7500	BL	3	2-1/2	2-3/8	3-1/8		2.0	5.50
4P227	2.5V. C.T. @ 10 A.	5 V. C.T. @ 5 A.	Two of 2.5V. C.T. @ 5 A.	2000	BL	2-5/8	2-3/16	2	2-13/16		1.5	4.80
4P234	2.5V. C.T. @ 15 A.	5 V. C.T. @ 7.5 A.	Two of 2.5V. C.T. @ 7.5 A.	2000	BL	3	2-1/2	2-1/4	3-1/8		2.2	5.70
4P239	5 V. C.T. @ 6.5A.	10 V. C.T. @ 3.25A.	Two of 5 V. C.T. @ 3.25A.	2000	BL	3	2-1/2	2-1/4	3-1/8		2.2	5.10
4P242*	5 V. C.T. @ 20 A.*			10000	BxL	4-1/8	3-7/16	2-3/4	2-3/4	2-1/8	4.6	10.20
4P243	5 V. C.T. @ 20 A.	10 V. C.T. @ 10 A.	Two of 5 V. C.T. @ 10 A.	2000	BxL	3-3/4	3-1/8	2-3/4	2-1/2	2-1/4	4.3	9.00
4P244*	6.3V. C.T. @ 0.6A.*			2000	BL	1-7/8	1-9/16	1-1/2	2		.6	3.50
4P245*	6.3V. C.T. @ 1.2A.*			2000	BL	1-7/8	1-9/16	1-5/8	2		.7	3.80
4P246	6.3V. C.T. @ 2 A.	12.6V. C.T. @ 1 A.	Two of 6.3V. C.T. @ 1 A.	2000	BL	2-1/4	1-7/8	1-3/4	2-3/8		1.0	4.20
4P251	6.3V. C.T. @ 6 A.	12.6V. C.T. @ 3 A.	Two of 6.3V. C.T. @ 3 A.	2000	BL	3	2-1/2	2-1/4	3-1/8		2.0	4.85
4P256	6.3V. C.T. @ 10 A.	12.6V. C.T. @ 5 A.	Two of 6.3V. C.T. @ 5 A.	2000	BxL	3-3/8	2-13/16	2-1/2	2-1/4	2-1/8	2.9	6.30
4P260	7.5V. C.T. @ 3 A.	15 V. C.T. @ 1.5 A.	Two of 7.5V. C.T. @ 1.5 A.	2000	BL	2-5/8	2-3/16	2	2-13/16		1.5	5.10
4P267	7.5V. C.T. @ 4.5A.	15 V. C.T. @ 2.3 A.	Two of 7.5V. C.T. @ 2.3 A.	2000	BL	3	2-1/2	2-1/4	3-1/8		2.0	6.30
4P272	11 V. C.T. @ 10 A.	22 V. C.T. @ 5 A.	Two of 11 V. C.T. @ 5 A.	2000	BxL	3-3/4	3-1/8	2-3/4	2-1/2	2-1/4	4.1	9.00

*Single secondary units

VOLTAGE CHANGER AND ISOLATION—THE "NINE" SERIES

All Units Have Primary Cord and Secondary Plug and Are For 50/60 Cycle Operation

VOLTAGE CHANGER (ISOLATION)

Type Number	Primary Voltage	Secondary Voltage	Capacity in V. A.	Mtg. Style	Dimensions					Net Wt.	List Price
					A	B	C	D	E		
9P707	220-250	110-125	75	GP	3-13/16	3-5/32	3-1/8	2-1/2	1-15/16	3.9	9.30
9P713	220-250	110-125	150	GP	4-9/16	3-25/32	3-7/8	3	2-13/16	8.0	13.80
9P718	220-250	110-125	350	HP	7-1/8	5-1/2	5-15/16	4-3/8	4-13/16	23.3	36.00

ISOLATION TYPES

9P721	110-250	110-250	150	GP	4-9/16	3-25/32	4-5/8	3	3-9/16	12.1	18.00
9P725	110-250	110-250	250	HP	7-1/8	5-1/2	5-15/16	4-3/8	4-13/16	23.3	29.40
9P728	110-250	110-250	500	HP	7-1/8	6-1/2	7-1/4	5-3/8	6-1/8	34.8	41.40

VOLTAGE ADJUSTMENT TYPES WITH TAP CHANGE SWITCH

9P732	95-130 in 5V. Steps	115	150	HSP	4-7/8	3-7/8	3-7/8	3-1/8	3-1/8	4.7	25.80
9P737	95-130 in 5V. Steps	115	250	HSP	5-3/8	4-3/8	4-1/4	3-5/8	3-1/2	8.0	33.80
9P739	80-130 in 5V. Steps	115	500	HSP	7-1/8	5-1/2	5-15/16	4-3/8	4-13/16	23.3	49.20

All list prices given are subject to regular trade discounts and may be changed without notice.

S N C MANUFACTURING CO., INC., OSHKOSH, WISCONSIN

See Page N-33 for Dimensional Illustrations.

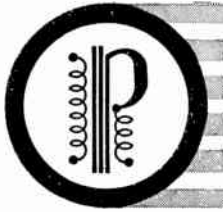

PEERLESS

ELECTRICAL PRODUCTS



DIVISION
9356 Santa Monica Blvd.
Beverly Hills, Calif.

161 Sixth Avenue
New York 13, N.Y.

CASE A



CASE D



CASE E



CASE F



CASE K



CASE L



CASE N



CASE Q



CASE X



Ⓢ New, Special Feature, item.
 ** All primaries are 117 V, 60 cycle.
 * All low-impedance windings of high-level output and impedance matching transformers may be worked into loads within $\pm 20\%$ of the rated impedance.
 † All transformers in this group are supplied with electro-static shield.

‡ Low flux-density core for preamplifiers.
 1 CCS—Continuous duty.
 2 ICAS—Intermittent duty (20% duty cycle).
 3 No center tap on second winding.
 ▲ Maximum operating level, 1 mw reference.
 ⊗ Choke input to filter.

• Impedance is total of two separate windings.
 ■ For RTMA standardized 70 volt line.
 ○ These units may also be used as bridging transformers. Complete application data in each packing box.

COMBINATION PLATE AND FILAMENT TRANSFORMERS ** †

Type Number	High Voltage Secondary		Filament Current, Amperes		Dimensions, Inches			Weight Lbs.	List Price
	AC Volts	DC MA.	5 V.	6.3 V. C.T.	Height	Depth	Width		
R-320-A	325-0-325	70	3.	3.	3 1/2	3 5/8	2 7/8	4	\$11.25
R-340-FⓈ	325-0-325	100	3.	5.	4 3/8	3 1/8	2 3/4	3 1/2	18.50
R-400-A	350-0-350	90	3.	4.	4 1/8	3 5/8	3 3/4	6 1/4	12.50
R-480-A	350-0-350	120	3.	5.	4	3 1/2	3 1/4	4	14.00
R-480-Q	350-0-350	120	3.	5.	5	4 1/8	4 1/8	8	27.40
R-482-A	350-0-350	120	3.	3.-3.	4	3 1/2	3 1/4	4	14.50
R-490-FⓈ	350-0-350	200	3.	6.	5 1/8	3 1/8	3 3/8	5 1/2	23.00
R-560-A	400-0-400	200	3.	6.	5	4 7/8	4 3/8	11 3/4	19.75
R-562-FⓈ	400-0-400	220	3.	6.	5 1/8	3 1/8	3 3/8	6 1/2	30.00
R-630-FⓈ	500-435-0-435-500 (Has 100 V tap for C bias)	225	3.	6.	5 3/8	4 1/8	3 1/8	8	37.50
R-800-A	400-0-400	300	4.	4.-5.	5	6 1/4	4 3/8	16 1/2	25.30

FILAMENT TRANSFORMERS

Type Number	Secondary Current, Amperes					Test Volts R.M.S.	Primary Volts 60 Cycle	Dimensions, Inches			Weight Lbs.	List Price
	2.5V. C.T.	5.V. C.T.	6.3V. C.T.	7.5V. C.T.	10.V. C.T.			Height	Depth	Width		
F-012-X			1.			2000	117	1 5/8	2 7/8	1 5/8	1/2	\$ 3.75
F-037-X			1-1 (2 Windings) ³			2000	117	2	3 1/2	2	1	10.90
F-073-X			2-2 (2 Windings) ³			2000	117	2 3/8	3 3/4	2 1/4	1 1/2	12.50
F-096-X	10					7500	117	2 5/8	4 1/4	2 1/2	2 1/8	9.00
F-139-E			8			2000	117	3 1/2	3 1/8	2 7/8	3 1/2	10.50
F-140-E					5	2000	117	3 1/2	3 1/8	2 7/8	3 1/2	10.50
F-155-E		15				10,000	117	3 7/8	3 1/2	3 1/4	6	24.00
F-168-E					10	2000	117	4 1/8	3 1/8	2 7/8	5 1/4	13.50
F-342-E					26	2000	117	4 5/8	4 1/2	3 7/8	11	25.50

SMOOTHING CHOKES

Type Number	Current D.C. MA.	Inductance Henrys	Resistance Ohms	Test Volts R.M.S.	Dimensions, Inches			Weight Lbs.	List Price
					Height	Depth	Width		
C-305-X	90	10	285	1500	2 3/8	3 3/4	2 1/4	1 1/2	\$ 3.40
C-315-X	225	3	80	1500	2 3/8	3 3/4	2 1/2	1 3/4	5.20
C-325-F	120	10	240	1500	3 1/4	3 1/8	2 3/4	2 3/4	11.75
C-325-X	120	10	240	1500	2 5/8	4 1/4	2 1/2	2 1/8	6.20
C-390-F	200	10	150	1500	4 1/8	3 1/8	3 3/8	6	15.80
C-445-A	250	10	110	2500	4 1/8	3 3/4	3 3/4	6 1/2	13.25

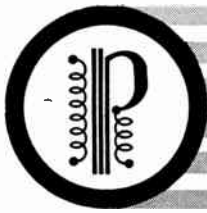

PEERLESS

ELECTRICAL PRODUCTS



9356 Santa Monica Blvd.
Beverly Hills, Calif.

161 Sixth Avenue
New York 13, N.Y.

INPUT TRANSFORMERS

Type Number	Descriptive Data	Impedance, Ohms		Turns Ratio	Freq. Range ± 1 db	Dimensions, Inches			Weight Lbs.	List Price
		Primary	Secondary			Height	Depth	Width		
K-007-X	Single-Button Mic. to 1 or 2 Grids.	100	700,000 C.T.	1:84	Voice	1 5/8	2 7/8	1 5/8	1/2	\$ 6.50
K-044-D low level	Line, Mixer, or Mic. to Sgls. Grid. Max. Level: -20 dbm Δ . 60 db Magnetic Shielding. Can be rotated in clamp ring for null. Has Electro-Static Shield. 6" Leads.	600-250 and 30-50	70,000		30 15,000	1 3/4	1 5/8	Round	1/2	19.00
K-049-D	Line, Mixer or Mic. to Single Grid. Max. Level: +8 dbm Δ . 30 db Magnetic Shielding.	500 C.T.-333 250-200 C.T. 125-50	60,000		20 20,000	2 7/8	1 3/4	1 3/4	1	21.50
K-049-Q	Same as K-049-D except 90 db Magnetic Shielding.	500 C.T.-333 250-200 C.T. 125-50	60,000		20 20,000	3 1/2	2 3/8	2 1/2	1 1/2	29.90
K-054-Q	Line, Mixer, or Mic. to 2 Grids. Max. Level: +18 dbm Δ . 30 db Shielding.	500 C.T.-333 250-200 C.T. 125-50	70,000 *		20 20,000	3 1/2	2 3/8	2 1/2	1 1/2	33.00
K-063-A high level	Line to P-P Grids. Max. Level: +42 dbm Δ .	500 C.T.-125	12,500 *		30 15,000	3 3/8	3	2 1/8	2 1/2	12.65

INTERSTAGE TRANSFORMERS

G-306-X	Single Plate to 1 or 2 Grids.	10,000	96,000 C.T.	1:3.1	100-5000	1 5/8	2 7/8	1 5/8	1/2	\$ 6.00
G-318-D	Sgls. Plate to Sgls. Grid. Max. Level: +8 dbm Δ . 30 db Magnetic Shielding.	10,000	60,000		20 20,000	2 7/8	1 3/4	1 3/4	1	17.85
G-322-Q	1 or 2 Plates to 2 Grids. Max. Level: +18 dbm Δ . 30 db Shielding.	20,000 *	70,000 *		20 20,000	3 1/2	2 3/8	2 1/2	1 1/2	29.90

IMPEDANCE MATCHING TRANSFORMERS

Type Number	Descriptive Data	Audio Watts Max.	70 V Line	Impedance, Ohms		Freq. Range ± 1 db	Dimensions, Inches			Weight Lbs.	List Price
				Primary	Secondary		Height	Depth	Width		
E-372-Q Repeat Coil	Electro-static Shield. 60 db Magnetic Shield.	+18 dbm Δ	—	500 C.T.-333 250-200 C.T. 125-50	500 C.T.-333 250-200 C.T. 125-50	20 20,000	3 1/2	2 3/8	2 1/2	1 1/2	\$27.50
E-374-X ■	Line to Spkr. Insertion Loss 0.6 db—1/4 watt tap for lines of 500 or less ohms.	4	1/4 - 1/2 3/8 - 1 2-4	10,000 C.T. 7500 5000 C.T. 2500-1250	16-12-8 4-2 *	30 15,000	2 3/8	3 3/8	2 1/4	1 3/4	11.75
E-377-X	Line to Speaker.	5	—	500	16-8	40-10,000	2	3 1/2	2	1	7.00
E-383-X ⊕ ■	Line to Spkr. Insertion Loss 0.6 db. 2 1/2 watt tap for lines of 500 or less ohms. Rated 20 watts 50-15,000 cps. 40 watts 150-15,000 cps.	10	1 1/4 - 2 1/2 3 1/2 - 5 10-20-40 (See Data)	4000 C.T. 2000 C.T. 1500 1000 C.T. 500-250-125	16-12-8 4-2 *	30 15,000	2 5/8	4 1/8	2 7/8	2 1/2	18.75
E-386-E ■	Line to Speaker. Insertion Loss 0.6 db. Max.	24	3-4 6-12 24	1600 C.T. 1200 800 C.T. 400-200	16-12-8 4-2*	30 15,000	3 3/8	3	3 1/4	4 1/4	18.50
E-392-E ■	Same Data as E-386-E.	64	8-11 16-32 64	625 C.T.-470 312 C.T.-156 78	16-12-8 4-2*	30 15,000	4 3/8	4 7/8	3 3/8	9	29.55

REACTOR EQUALIZING

Type Number	Descriptive Data	Res. Ohms	Ind. Henrys	D.C. MA		Dimensions, Inches			Weight Lbs.	List Price	
				Normal	Max.	Height	Depth	Width			
L-370-D	Low Pass Filter.	725	4	0	10	3/8	1 3/4	1 5/8	Round	3/8	\$10.55



PEERLESS

ELECTRICAL PRODUCTS



9356 Santa Monica Blvd.
Beverly Hills, Calif.

161 Sixth Avenue
New York 13, N.Y.

STANDARD OUTPUT TRANSFORMERS

Type Number	Descriptive Data	Freq. Range ±1 db	Impedance, Ohms Primary Secondary	Pri. DC MA. Max. Unbal.	Audio Watts	Dimensions, Inches Height Depth Width	Weight Lbs.	List Price
S-448-Q	Single or P-P plates to line. 30 db hum bucking.	20-20,000	20,000 C.T. 12,500 C.T. 5000-3125	500 C.T. 200 C.T.-333 250-125-50	15	2 +18 dbm▲	3 ½ 2 ¾ 2 ½	1 ½ \$26.10
S-508-A	P-P plates to speaker.	30-15,000	8000 C.T.	16-12-8-4	45	5 10	2 1 8 2 1 8 2 ¼	1 ¾ 11.00
S-510-F ⊕	P-P plates to speaker.	20-30,000	10,000 C.T. 8000 C.T.	16-8*	40	4 10	2 ¾ 2 ¾ 2 ½	2 17.00
S-516-A	P-P plates to speaker.	30-15,000	6600 C.T.	16-12-8-4	70	7 20	3 ½ 3 2 7 8	2 ½ 12.75
S-526-F ⊕	P-P plates to speaker.	20-30,000	6600 C.T. 5000 C.T.	16-8-4*	60	6 20	4 ¾ 3 7 8 2 ¾	3 21.00
S-532-A	P-P plates to speaker.	30-15,000	5000 C.T. 3000 C.T.	16-12-8-4	90	9 20	3 ½ 3 2 7 8	2 ½ 14.50
S-542-F ⊕	P-P plates to speaker.	20-30,000	5000 C.T. 4000 C.T.	16-8-4*	140	14 40	4 1 8 3 7 8 3 7 8	5 ½ 26.00
S-552-A ■	P-P plts. to spkr. or line.	30-15,000	3800 C.T. 3200 C.T.	380, 82 ½ 16-12-8-4-2	250	25 60	4 ¾ 4 ¾ 3 ¾	9 33.00

INPUT TRANSFORMERS (20-20 PLUS)

Type Number	Descriptive Data	Max. Level ▲	Impedance, Ohms Primary Secondary	Primary DC MA. Max. Unbal.	Dimensions, Inches Height Depth Width	Weight Lbs.	List Price
K-241-D ⊕	Frequency response, ±1 db: 10- 30,000 cps. Primary balanced to attenuate longitudinal cur- rents in excess of 50 db. Sec. may be used single ended or in P-P. Has 2 sec. windings with bal. cap. to grnd. Electrostatic shield is provided between pri. and sec. Has 90 db electromagnetic shielding. Insertion loss 1 ¼ db. Transformer will operate into open circuit or resistive load. Frequency resp. down less than 1 db at 15 KC, when operated into resistive load shunted with 120 MMFD, cap. High power rating makes transf. suitable for use as output transf.	+8	500-280- 125-31 70,000 • or 600-340- 150-37.5 84,000 •	0	2 ¾ 1 ½ 2	¾	\$42.00

OUTPUT TRANSFORMERS (20-20 PLUS)

Type Number	Descriptive Data	Max. Level ▲	Impedance, Ohms Primary Secondary	Primary DC MA. Max. Unbal.	Dimensions, Inches Height Depth Width	Weight Lbs.	List Price
S-217-D ⊕	Frequency response: ±1 db: 5- 65,000 cps. Pri. may be used single ended or P-P. Sec. wind- ings have bal. cap. to grnd. Has C.T. tertiary of 24.5 ohms which may be used for feedback or grnded, for electrostatic shield. Parallel feed is required. Astatic balance and electromagnetic shield provide approx. 50 db of sh'lding. Insertion loss 0.5 db. Transf. may be used as excellent input transf. to either single or P-P grids. When used this way, balanced low impedance winding provides excellent line termination.	+20 dbm	12,500 3125 600-300 150-75	25	0 3 ¾ 1 ½ 2	1 ¼	\$56.50

MATCHING TRANSFORMERS (20-20 PLUS)

Type Number	Descriptive Data	Max. Level ▲	Impedance, Ohms Primary Secondary	Primary DC MA. Max. Unbal.	Dimensions, Inches Height Depth Width	Weight Lbs.	List Price		
E-204-D ⊕	Frequency response: ±1 db: 5- 85,000 cps. Electrostatic shield. Astatic balance and electro- magnetic shield provide approx. 50 db magnetic shielding. Attenuates longitudinal currents 80 db in bal. circuit in freq. range up to 70,000 cps. Insertion loss 0.4 db.	+23 dbm	500 C.T. 125 C.T. or 600 C.T. 150 C.T.	500 C.T. 125 C.T. or 600 C.T. 150 C.T.	100	0 3 ¾ 1 ½ 2	1 ¼ \$56.50		
As a Hybrid Transformer	This precise matching transf. is an excellent hybrid unit for operation from two 250/300 ohm sources. Balancing resistor of approx. 125/150 ohms required in pri. circuit. For max. attenuation between sources the exact value of resistor should be determined from measurements made in circuit where transf. is used. Correct value will yield average attenuation of 27 to 30 db with a max. attenuation of approx. 50 db at some point between 500 cps and 1,000 cps.				Total Pri. Impedances, Ohms Pri. 1 Pri. 2 Sec. Max. Level ▲				
					500 or 600	250 or 300	250 or 300	500-125 or 600-150	+23 dbm

OUTPUT TRANSFORMERS (20-20 PLUS)

Type Number	Descriptive Data	Impedance, Ohms Primary Secondary	Max. Level ▲	Primary DC MA. Max. Unbal.	Dimensions, Inches Height Depth Width	Weight Lbs.	List Price
S-226-Q ⊕	Frequency response, ±1 db: 10- 100,000 cps. Power rating, at 15 cps., 10 watts; at 10 cps., 5 watts. Insertion loss 0.5 db. Can be used between half and double of rated impedances. For half impedances, power ratings are doubled. For doubled impedances, power ratings are halved. Sec. may be operated with one end, or C.T. grnded.	6600 C.T. 1650 C.T.	16, 12, 8, 4, 2 +43 dbm (20 watts) See Data	70	7 4 ¾ 3 7 8 3 7 8	3 ¾	\$38.00

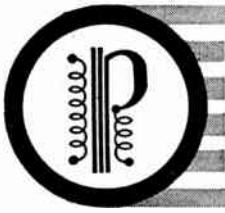

PEERLESS

ELECTRICAL PRODUCTS



DIVISION

9356 Santa Monica Blvd.
Beverly Hills, Calif.

161 Sixth Avenue
New York 13, N.Y.

OUTPUT TRANSFORMERS (20-20 PLUS) (Continued)

Type Number	Descriptive Data	Impedance, Ohms Primary Secondary	Max. Level ▲	Primary DC MA Max. Unbal.	Dimensions, Inches Height Depth Width	Weight Lbs.	List Price
S-256-Q ⊕	Same as S-226-Q, except: Power rating, at 15 cps., 20 watts; at 10 cps., 10 watts. Insertion loss, 0.4 db.	5000 C.T.	16, 12, 8, 4, 2	+46 dbm (10 watts) See Data	120 12	4 5/8 3 3/8 3 1/2	6 1/2 \$50.00
S-268-Q ⊕	Same as S-226-Q, except: Frequency response ±1 db: 8-80,000 cps. Power rating, at 15 cps., 40 watts; at 10 cps., 20 watts. Insertion loss, 0.3 db.	8000 C.T. 2000 C.T.	16, 12, 8, 4, 2	+49 dbm (80 watts) See Data	125 12 250 25	6 3/8 5 1/8 5 1/8	14 \$82.50

INPUT TRANSFORMERS (20-20)

K-221-Q ◊ Low Level	Sec. may be used single ended or in P-P—has two sec. windings with balanced capacitance to grd. Electro-static shield is provided between pri. and sec. Has 90 db electro-magnetic shield.	500-250-30 or 600-300-36	70,000* or 84,000*	—12 dbm	0	3 1/2 2 3/8 2 1/2	1 1/2 \$38.50
K-281-Q ◊ High Level	For P-P arrangement only—has two sec. windings with bal. cap. to grd.	500-220-125-56-14 or 600-265-150-67-17	30,000* or 36,000*	+38 dbm	0	4 5/8 3 3/8 3 1/2	5 1/2 59.85

INTERSTAGE TRANSFORMERS (20-20)

G-212-Q ◊ Low Level	Both pri. and sec. may be used single-ended or in P-P—has two sec. windings with bal. cap. to grd.—has 90 db electro-magnetic shield. parallel feed is recommended.	10,000 2,500	40,000 10,000	—12 dbm	5	0.5 3 1/2 2 3/8 2 1/2	1 1/2 \$40.00
G-252-Q ◊ Line Level	Same as G-212-Q except has 30 db electro-magnetic shield.	10,000 2,500	40,000 10,000	+23 dbm	10	1.0 4 1/8 3 3/8 3 1/8	2 3/8 57.00

OUTPUT TRANSFORMERS (20-20)

S-227-Q ◊ High Level	Sec. may be operated with one end grounded.	10,000 C.T.	16-8-4-2 *	+48 dbm (20 watts)	50	5 4 3/8 3 3/8 3 1/2	6 \$28.00
S-230-Q	Same as S-227-Q.	6600 C.T.	16-8-4-2 *	+43 dbm (20 watts)	70	7 4 5/8 3 3/8 3 1/2	6 27.50
S-240-Q	Same as S-227-Q.	5000 C.T.	16-8-4-2 *	+48 dbm (20 watts)	90	9 4 5/8 3 3/8 3 1/2	6 27.50
S-242-Q ■	Same as S-285-Q.	5000 C.T.	500-250-125-62 1/2	+43 dbm (20 watts)	90	9 4 5/8 3 3/8 3 1/2	6 28.00
S-245-Q	Same as S-227-Q.	3000 C.T.	16-8-4-2 *	+43 dbm (20 watts)	110	11 4 5/8 3 3/8 3 1/2	6 27.50
S-265-Q	Two center-tapped pri. for series or parallel. Sec. operated with one end grounded.	10,000 C.T. 2500 C.T.	16-8-4-2 *	+46 dbm (40 watts)	110 220	11 5 4 1/8 4 1/8	10 45.00
S-270-Q ■	Same as S-265-Q except sec. should be operated bal. to grd.	10,000 C.T. 2500 C.T.	500-250-125-62 1/2	+46 dbm (40 watts)	110 220	11 5 4 1/8 4 1/8	10 50.00

BRIDGING TRANSFORMERS (20-20)

Type Number	Descriptive Data	Impedance, Ohms		Unmatched Bridging 500/600 Ohm Line		Matched Bridging 500/600 Ohm Line		Resist. 2 Req. (1 watt)	Dimensions, Inches			Weight Lbs.	List Price
		Sec.	Pri.	Bridged Line Max. Level▲	Loss db	Bridged Line Max. Level▲	Loss db		Height	Depth	Width		
K-221-Q	Has electrostatic shield and 90 db electro-magnetic shield.	500/600 250/300	70,000	+9 dbm	21 1/2	+15 dbm	28 1/2	33,000	3 1/2	2 3/8	2 1/2	1 1/2	\$38.50
G-212-Q	Same data as K-221-Q.	40,000 10,000	10,000	+3 dbm	15 1/2	+8 dbm	21	7500	3 1/2	2 3/8	2 1/2	1 1/2	40.00
G-252-Q	Has electrostatic shield and 30 db electro-magnetic shield.	40,000 10,000	10,000	+36 dbm	+6 db (Gain)	+43 dbm	0	3600	4 3/8	3 3/8	3 1/8	2 3/8	57.00

IMPEDANCE MATCHING TRANSFORMERS (20-20)

Type Number	Descriptive Data	Impedance, Ohms Primary Secondary	Max. Level ▲	Primary DC MA Max. Unbal.	Watt Power RMA 70 V Line	Dimensions, Inches Height Depth Width	Weight Lbs.	List Price
E-214-Q	For use between line and spkr.	1000-500 250	16-12-8-4-2 *	+40 dbm (10 watts)	—	4 1/8 3 1/8 3 1/8	2 3/8	\$26.00
E-243-Q ■	Same as E-233-Q except insertion loss less than 1/2 db.	1000 C.T. 750 500 C.T. 250-125	16-12-8-4-2 *	+43 dbm (20 watts)	—	5-6 3/8-10-20	6	31.00

KENYON "T" LINE TRANSFORMERS

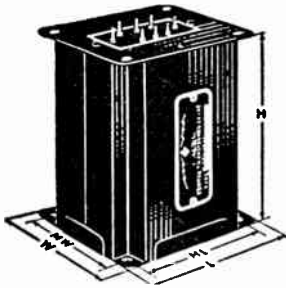

DIMENSIONS OF "T" LINE TRANSFORMERS

Case No.	MOUNTING DIMENSIONS		OVERALL DIMENSIONS		
	ML	MW	Length (L)	Width (W)	Height (H)
1A	2-1/32	1-9/16	2-7/16	2	27/8
2A	2 1/8	1-13/16	2 3/4	2 3/8	3-3/16
3A	2-7/16	1-13/16	3-1/16	2-9/16	3 5/8
4A	3 7/8	2-7/16	4 1/2	3	3 7/8
5A	4-5/16	3-3/16	5	3 3/8	5
5 1/2 A	4-5/16	3-27/32	5	4 1/2	5
6A	4-5/16	4 1/2	5	5 1/8	5
7A	5 1/2	4-5/16	6-5/16	5-3/16	6 3/8
8A	5 3/4	4-13/16	6-9/16	5-11/16	7 1/8
9A	6-15/16	5 3/4	7 3/4	6 5/8	7-3/16
10A	8 5/8	7-11/32	9 1/2	8 1/4	10 5/8

LOW IMPEDANCE SOURCE TO GRID TRANSFORMERS

Type No.	From	Primary Ohms	Secondary Ohms	Case No.	Weight lbs. ozs.	List Price
T-2 (Hum bucking type)	Any line	500-333-250-200-125-50	80,000 Single Grid	1A	1 1	\$11.75
T-3 (Hum bucking type)	Any line	500-333-250-200-125-50	80,000 P.P. Grids	1A	1 1	12.10
T-6 (Multiple Shielded)	Any line	500-333-250-200-125-50	20,000 Single Grid	1A	1 1	15.95

LINE-TRANSFORMERS — LINE TO LINE AND LINE TO VOICE COIL

Type No.	Primary Ohms	Secondary Ohms	Maximum Level	Case No.	Weight lbs. ozs.	List Price
T-26 (Hum bucking type)	500-333-250-200-125-50	500-333-250-200-125-50	+ 24 D.B.	1A	1 1	\$10.75
T-28	500-200	15-8-4	30 watts	4A	5 10	17.80

DRIVER TRANSFORMERS

Type No.	Primary to Match	Class AB or Class B Tubes	Ratio (pri. to 1/2 Sec.)	Case No.	Weight lbs. ozs.	List Price
T-251	Single 53, 6A6, 6N7, 56, 6C5	53, 6A6, 6N7	2.3:1	2A	1 14	\$ 9.75
T-252	Single 30, 49, 89	19, 30's, 49's	1.7:1	1A	1 13	8.40
T-255	P.P. 56, 6C5, 53, 6N7	6L6's	2.9:1	2A	1 14	10.55
T-271	P.P. 45's, 2A3's, 6F6's	6L6's, 809's, TZ40's	3.7:1	3A	2 13	13.65
T-264	7 Watts	{ Any Line or Single or Push }		3A	2 12	14.55
T-263	18 Watts	{ Pull Plates to Class B Grids }		4A	5 12	21.80

PREAMPLIFIER OUTPUT TRANSFORMERS

Type No.	From	Secondary Ohms	Case No.	Weight lbs. ozs.	List Price
T-101	Single 56, 76, 6C5	200-500	1A	1 4	\$ 8.35
T-102	P.P. 56, 76, 6C5	200-500	1A	1 4	8.90

OUTPUT TRANSFORMERS TO 500-200 OR 15-8-4 OHMS

Type No.	From	Primary Ohms	Case No.	Weight lbs. ozs.	List Price
T-104	Single 2A5, 6F6, 42, 47, 89	7,000	2A	1 14	\$11.20
T-105	Class "A," P.P. 2A5's, 6F6's, 42's, 47's, 89's	14,000	2A	2 14	12.15
T-301	Class "A," P.P. 6L6's, Class AB 45's, 2A3's	5,000 or 3,000	4A	4 5	17.95

Type No.	From	Case No.	Weight lbs. ozs.	List Price
T-108	Will match any set of Push-Pull or Push-Pull Parallel or a single plate to 500-200 or speaker voice-coils. Low impedance connection for speaker voice coils range from .5 to 25 ohms.	15 watts	3A	2 13
T-109		30 watts	4A	5 2

KEN-O-TAP MODULATION TRANSFORMERS

Type No.	Audio Watts	Class C. W. Sec.	Max. Pri. D.C.	Max. Sec. D.C.	Max D.C. Voltage	Primary Range Ohms	Secondary Range Ohms	Case No.	Weight lbs. ozs.	List Price
T-489	15	30	120	120	600	2000-20000	200-20000	3A	2 13	\$13.15
T-493	40	80	250	250	750	2000-20000	200-20000	4A	5 10	19.10
T-494	75	150	250	300	1250	2000-20000	200-20000	5A	9	25.95
T-441	125	250	250	250	1500	2000-20000	200-20000	6A	15 8	36.05
T-496	300	600	250	300	2500	500-18000	200-19000	8A	26 4	80.60
T-442	600	1200	400	400	3000	500-18000	200-19000	9A	45	90.10

FILAMENT TRANSFORMERS

Type No.	SECONDARY RATING				Case No.	Weight lbs. ozs.	List Price
T-365	10 V.-4 A. CT.				3A	2 13	\$11.55
T-361	10 V.-8 A. CT.						
T-384	10, 10.5, 11 V.-5 A. CT.						
T-386	6.3 V.-3 A. CT.	2000 V. Test	5 V.-4 A. CT.	2000 V. Test	3A	2 13	13.15
T-368	6.3 V.-4 A. CT.	2000 V. Test	6.3 V.-4 A. CT.	2000 V. Test			
T-376	5 V.-3 A.	2000 V. Test	6.3 V.-4 A. CT.	2000 V. Test			
T-377	5 V.-3 A.	2000 V. Test	5 V.-6 A.	2000 V. Test	4A	4 11	17.55
			6.3 V.-1 A. CT.	2000 V. Test	4A	5 10	18.10
			6.3 V.-5 A. CT.	2000 V. Test	5A	10 1	27.10

KENYON "T" LINE TRANSFORMERS

PLATE TRANSFORMERS DESIGNED FOR BOTH CONTINUOUS AND INTERMITTENT DUTY

Type No.	Primary Conn.	Volts		55°C. Rise MA Cont.	55°C. Rise 15 Min. On 15 Min. Off MA Int.	Case No.	Weight		List Price
		Secondary No. 1 D.C.	A.C.				lbs.	ozs.	
T-655	High	450	575-0-575	—	340	5A	10	1	\$26.30
	Low	350	460-0-460	250	375				
T-656	High	750	925-0-925	—	320	6A	15	9	40.30
	Low	600	740-0-740	270	360				
T-665	High	1250	1470-0-1470	—	270	7A	23	4	60.60
	Low	1000	1180-0-1180	200	300				
T-666		1250	1460-0-1460	280	350	8A	32	2	66.65
T-652	High	1750	2080-0-2080	—	450	9A	50	8	86.35
	Low	1500	1760-0-1760	320	500				
T-663		2000	2360-0-2360	350	500	10A	82		149.15
T-673	High	3000	3400-0-3400	—	400	10A	82		154.55
	Low	2500	2840-0-2840	425	500				
T-674	High	3000	3400-0-3400	—	800	Spec.	135		219.40
	Low	2500	2840-0-2840	850	1000				

Primaries on these items for 115/230 volt series-parallel connection.

REACTORS

Type No.	Inductance At Rated D.C.	Rated D.C. MA	D.C. Resistance	Insulation Test R.M.S.	Case No.	Weight lbs. ozs.	List Price	Type No.	Inductance At Rated D.C.	Rated D.C. MA	D.C. Resistance	Insulation Test R.M.S.	Case No.	Weight lbs. ozs.	List Price	
T-155	280	10	5200	1500	2A	2	\$ 8.80	T-178	10	400	90	5000	6A	15	2	\$35.15
T-156	30	25	800	1500	1A	1	6.65	T-177	11	500	90	5000	7A	21	1	47.85
T-157	10	50	200	1500	1A	1	6.45	T-161	7.5	600	50	5000	7A	21	4	46.40
T-153	20	90	360	1500	3A	2	9.65	T-180	10	500	60	7000	8A	26	4	61.55
T-154	12.5	165	220	1500	3A	3	11.00	T-181	5	1000	18	7000	9A	50		90.10
T-151	7.5	250	100	1500	4A	5	15.05	T-515	6/21	165/30	220	1500	3A	3	2	11.00
T-152	7	200	140	1500	3A	2	10.40	T-506	4/16	200/30	140	1500	3A	2	13	10.40
T-164	13	250	120	1500	5A	10	22.15	T-501	5/15	250/30	100	1500	4A	5	10	15.00
T-166	10	300	120	1500	5A	10	22.15	T-510	6/20	300/30	120	1500	5A	10	1	22.15
T-159	10	500	70	1500	6A	15	33.80	T-502	6/22	500/50	70	1500	6A	15	9	33.85
T-160	11	300	120	3000	5A	10	22.15	T-512	6/22	300/30	103	5000	5A	10	1	22.15
T-167	11	400	70	3000	6A	15	33.80	T-521	6/26	500/60	90	5000	7A	21	1	47.80
T-175	10	200	140	5000	4A	5	15.15	T-516	6/22	400/50	70	3000	6A	15	9	33.80
T-176	10	300	103	5000	5A	10	24.60									

OPERATING VOLTAGES FOR 1500 VOLT TEST — UP TO 600 VOLTS D.C.
OPERATING VOLTAGES FOR 3000 VOLT TEST — UP TO 1000 VOLTS D.C.

OPERATING VOLTAGES FOR 5000 VOLT TEST — UP TO 2000 VOLTS D.C.
OPERATING VOLTAGES FOR 7000 VOLT TEST — UP TO 3000 VOLTS D.C.

FILAMENT TRANSFORMERS

Type No.	Secondary Rating	Case No.	Weight lbs. ozs.	List Price
T-388	2.5, 5, 6.3 V.-3A	1A	1 7	\$ 8.75
T-352	2.5 V.-10 A. CT.	2A	1 14	9.55
T-360	2.5 V.-10 A. CT.	3A	2 13	11.70
T-389	2.5 V.-10 A. CT.	4A	4 14	16.80
T-354	5 V.-3 A. CT.	2A	1 14	9.35
T-390	5 V.-20 A. CT.	5 1/2A	11 9	27.05
T-382	5, 5.1, 5.25 V.-16 A. CT.	4A	5 10	18.90
T-351	6.3 V.-3 A. CT.	2A	1 14	9.10
T-378	6.3, 7.5 V.-7 A. CT.	3A	2 13	12.10
T-387	6.3, 6.45, 6.6 V.-8 A. CT.	3A	2 13	12.55
T-395	6.3 V.-20 A. CT.	5A	9	21.90
T-396	6.3 V.-30 A. CT.	5 1/2A	12	30.05
T-397	6.3 V.-12 A. CT.	4A	5 12	17.60

PLATE AND FILAMENT TRANSFORMERS

Type No.	High Voltage — Volts	Filament No. 1 Volts	Filament No. 1 A.M.A.	Filament No. 2 Volts	Filament No. 2 Amps	Filament No. 3 Volts	Filament No. 3 Amps	Filament No. 4 Volts	Filament No. 4 Amps	Case No.	Weight lbs. ozs.	List Price		
T-249*	235-0-235	20	6.3 C.T.	0.6	6.3 C.T.	0.9				2A	2	\$12.80		
T-245*	320-0-320	40	5	2	6.3 C.T.	2				3A	2	14.30		
T-205*	350-0-350	75	5	2	6.3 C.T.	3				4A	5	19.90		
T-222*	250-0-250	50	5	2	6.3 C.T.	2				3A	2	13.70		
T-206*	325-0-325	100	5	3	6.3 C.T.	3	6.3 C.T.	2		5A	9	27.05		
T-212	420-0-420	125	5	3	6.3 C.T.	3	2.5 C.T.	4		5A	9	27.15		
T-244*	425-0-425	165	5	3	6.3 C.T.	3	6.3 C.T.	3		6A	13	34.60		
T-213	520-110-0-520	180	5	3	2.5	3	6.3 C.T.	3	6.3 C.T.	3	5A	10	32.05	
T-215	360-125-0-360	200	5	3	2.5 C.T.	3	2.5 C.T.	10	6.3 C.T.	2.1	5A	10	32.15	
T-247	590-0-590	200	5	3	6.3 C.T.	3	6.3 C.T.	3		5A	12	33.10		
T-220*	125-0-125	200	5	3	6.3 C.T.	3	6.3 C.T.	3		4A	5	16.75		
T-246	625-0-625	250	5	3	6.3 C.T.	3	6.3 C.T.	2		6A	15	39.10		
T-223	600-0-600	300	5	3	6.3 C.T.	3	6.3 C.T.	2		6A	15	39.60		
T-221	High voltage secondary 520-390-105-390-520 to deliver 400 V. D.C. at 400 M.A. and 300 V. D.C. at 160 M.A.										7A	21	10	61.70
	Filament No. 1 5 V.-6A	Filament No. 2 5 V.-3A	Filament No. 3 2.5 V.-3A	Filament No. 4 6.3 V. C.T.-4A										

* Indicates unit designed for condenser input. All other units should be used choke input. If used with condenser input, the D.C. current rating of these items should be reduced to 70% of that specified.

POWER LINE AUTO TRANSFORMERS

Type No.	Input	Output	Volt-Amperes Capacity	Case No.	Weight lbs. ozs.	List Price
T-219	88 to 130 volts	115 volts	500	5A	10 1	\$30.00

All power transformers are designed for 115 volt, 50 to 60 cycle operation. For any other voltage 50 to 60 cycle operation add 25% to list prices. For 115 volt 25 cycle operation, add 60% to list prices. For any other voltage 25 cycle operation add 100% to list prices. Case sizes for 25 cycle application are different from those specified for standard 115 volt 50 to 60 cycle operations.

Prices and Specifications Subject to Change Without Notice

Adjust-A-Volt

VARIABLE TRANSFORMER

AUTO-TRANSFORMERS BENCH AND PANEL MOUNTINGS GANGED ASSEMBLIES

FOR CONTROL OF AC LINES
POWER, HEAT, SPEED AND LIGHT
SPECIFICATIONS FOR THESE
MODELS ON OPPOSITE PAGE



300BU



300B-3



500BU



500B



3000B



1500B



3PF1500B

ADJUST-A-VOLT FEATURES

- Smooth, continuous control
- No Wave-form distortion
- High efficiency
- Excellent Regulation
- 50/60 cycle operation
- Standard Mountings
- LoRes Commutator surface on all models

VARIABLE ISOLATION • ELECTROSTATICALLY SHIELDED • METERED • CASED

ISOLATION MODELS								
Type	Code	Input Voltage	Output Voltage	Amp Max.	Max. (V.A.)	Overall Dimensions	Shipping Weight (1 Unit)	Net Price
LR-5	LARKE	115	70-140	5.0	500	6 $\frac{3}{4}$ "x9 $\frac{1}{8}$ "x5"	27 lbs.	\$29.50
LR-10	LAMBE	115	70-140	10.0	1000	6 $\frac{3}{4}$ "x9 $\frac{1}{8}$ "x9"	40 lbs.	57.50
LR-22	LOOSE	230	70-140	5.0	500	6 $\frac{3}{4}$ "x9 $\frac{1}{8}$ "x5"	27 lbs.	31.50
LR-24	LOOKE	230	70-140	10.0	1000	6 $\frac{3}{4}$ "x9 $\frac{1}{8}$ "x9"	40 lbs.	61.50
METERED ISOLATION TRANSFORMER MODELS								
Type	Code	Input Voltage	Output Voltage	Amp Max.	Max. (V.A.)	Overall Dimensions	Shipping Weight (1 Unit)	Net Price
LRL-5	BARKE	115	0-140	5.0	500	6 $\frac{3}{4}$ "x9 $\frac{1}{8}$ "x6 $\frac{5}{8}$ "	29 lbs.	\$41.50
LRL-10	BAMBE	115	0-140	10.0	1000	6 $\frac{3}{4}$ "x9 $\frac{1}{8}$ "x9 $\frac{5}{8}$ "	42 lbs.	69.50
LRL-22	BOOSE	230	0-140	5.0	500	6 $\frac{3}{4}$ "x9 $\frac{1}{8}$ "x6 $\frac{5}{8}$ "	29 lbs.	43.50
LRL-24	BOOKE	230	0-140	10.0	1000	6 $\frac{3}{4}$ "x9 $\frac{1}{8}$ "x9 $\frac{5}{8}$ "	42 lbs.	73.50
UNMETERED AUTO-TRANSFORMER MODELS								
Type	Code	Input Voltage	Output Voltage	Amp Max.	Max. (V.A.)	Overall Dimensions	Shipping Weight (1 Unit)	Net Price
PA-3	NANNE	115	0-135	3.0	400	6 $\frac{1}{2}$ "x6 $\frac{1}{8}$ "x5 $\frac{1}{2}$ "	10 lbs.	\$18.75
METERED AUTO-TRANSFORMER MODELS								
Type	Code	Input Voltage	Output Voltage	Amp Max.	Max. (V.A.)	Overall Dimensions	Shipping Weight (1 Unit)	Net Price
MAL-7	QUALM	230	0-270	3.0	810	6 $\frac{3}{4}$ "x9 $\frac{1}{4}$ "x6 $\frac{1}{2}$ "	15 lbs.	\$49.50
PAL-7	PADDE	115	0-135	7.5	1000	6 $\frac{3}{4}$ "x9 $\frac{1}{4}$ "x6 $\frac{1}{2}$ "	15 lbs.	40.50
1500BD	LATTE	115	0-135	15.0	2000	8"x10 $\frac{3}{8}$ "x8 $\frac{1}{2}$ "	35 lbs.	64.00
1520BD	RALEN	230	0-270	9.0	2400	8"x10 $\frac{3}{8}$ "x8 $\frac{1}{2}$ "	35 lbs.	64.00
400-2400 CYCLE AUTO-TRANSFORMERS								
Type	Code	Input Voltage	Output Voltage	Amp Max.	Max. (V.A.)	Net Weight (1 Unit)	Shipping Weight (1 Unit)	Net Price
300BUH	HIFRE	115/115	0-115/0-135	3.0	340/400	1 $\frac{1}{2}$ lbs.	3 lbs.	On Request
500BUH	HICYC	115/115	0-115/0-135	7.5	860/1000	4 lbs.	6 lbs.	Request

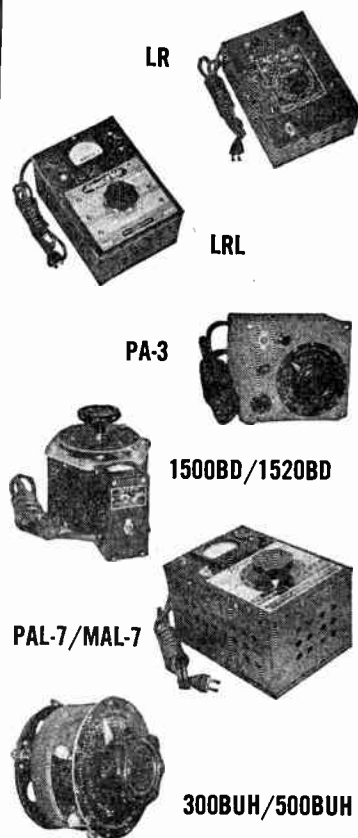

STANDARD ELECTRICAL PRODUCTS CO. • DAYTON, OHIO

WRITE FOR COMPLETE 18-PAGE ADJUST-A-VOLT CATALOG

ADJUST-A-VOLT SPECIFICATIONS AND APPLICATION INDEX

SINGLE PHASE

THREE PHASE

Input Volts	OUTPUT		Type	Description	Code Word	Approx. Wt. Lbs.		Net Price	
	Volts	Amp. Max.				KVA Max.	Net		Ship.
115	0-115 0-135	3.0 3.0	0.34 0.40	300BU	Uncased with terminal strip.	TREED	4	6	\$ 12.50
115	0-115 0-135	7.5 7.5	0.86 1.0	500B 500BU 3PF500B 3TF500B	With case, line cord-plug, input receptacle, switch and fuse. Uncased with terminal box. With case, 3 prong plug-cord, output receptacle, switch and fuse. With case, 3 prong twist blade plug-cord, output receptacle and fuse.	FEDEN FIVED PLEAD TELFE	11 10 11 11	12 11 12 12	\$ 23.00 18.00 30.00 30.00
115	0-115* 0-135	15.0 15.0	1.7 2.0	1500B F1500B 2PF1500B 3PF1500B 3TF1500B	With case and terminal board With case, fuse and terminal cover. With case, 2 prong plug-line cord, output receptacle and fuse. With case, 3 prong straight blade plug-cord, output receptacle and fuse. With case, 3 prong twist blade plug-cord, output receptacle and fuse.	TOODE FOODE POODE MOODE LOODE	21 21 22 22 22	25 25 26 26 26	\$ 46.00 50.00 56.00 56.00 56.00
115	0-115* 0-135	30.0 30.0	3.4 4.0	1500B-2 3000B 3000BU	2-gang, Parallel Circuit. With case and terminal cover. Without case and terminal cover.	DOUBE THIRT UTAH	43 23 22	50 27 26	\$ 96.00 55.00 49.00
115	0-115 0-155	60.0 60.0	6.9 8.0	3000B-2	2-gang, Parallel Circuit, requires paralleling Choke, Type 30L-1.	TOUBE	52	62	\$126.00
115	0-115 0-135	90.0 90.0	10.3 12.1	3000B-3	3-gang, Parallel Circuit, requires paralleling Chokes, 1 ea., Types 30L-1 and 30L-2.	MOUBE	79	83	\$182.00
230	0-230 0-270	3.0 3.0	0.69 0.81	520B 520BU	With case, line cord-plug, output receptacle, switch and fuse. Uncased with terminal box.	CRANY BRANY	11 10	12 11	\$ 26.00 20.00
115	0-270	3.0†	0.35	3PF520B 3TF520B	With case, 3 prong straight blade plug-cord, output receptacle and fuse. With case, 3 prong twist blade plug-cord, output receptacle and fuse.	PANNY TANNY	11 11	12 12	33.00 33.00
230	0-230 0-270	7.5 7.5	1.7 2.0	500B-2 500BU-2	2-gang, Series Circuit, cased. 2-gang, Series Circuit, uncased.	DEBEN UBBEN	22 21	25 25	\$ 49.00 44.00
230	0-230* 0-270	9.0 9.0	2.1 2.4	1520B F1520B	With case and terminal board. With case, fuse and terminal cover.	DANNY FANNY	21 21	25 25	\$ 46.00 50.00
115	0-270	9.0†	1.05	2PF1520B 3PF1520B 3TF1520B	With case, 2 prong plug-line cord, output receptacle and fuse—No switch. With case, 3 prong straight blade plug-cord, output receptacle and fuse—No switch. With case, 3 prong twist blade plug-cord, output receptacle and fuse—No switch.	MANNY CANNY JANNY	21 21 21	25 25 25	56.00 56.00 56.00
230	0-230* 0-270	15.0 15.0	3.4 4.0	1500B-2 F1500B-2	2-gang, Series Circuit. 2-gang, Series Circuit, fused output.	DOUBE JOODE	43 43	50 50	\$ 96.00 104.00
230	0-230* 0-270	18.0 18.0	4.1 4.8	1520B-2	2-gang, Parallel Circuit.	TWODE	43	50	\$ 96.00
115	0-270	18.0†	2.1						
230	0-230 0-270	12.0 12.0	2.8 3.2	3020B 3020BU	With case and terminal cover Without case and terminal cover	RANNY VOLTA	23 22	26 26	\$ 55.00 49.00
115	0-270	12.0†	1.4						
230	0-230 0-270	24.0 24.0	5.5 6.5	3020B-2	2-gang, Parallel Circuit, requires one paralleling Choke, Type 30L-1.	ZOAD	50	61	\$126.00
115	0-270	24.0†	2.8						
230	0-230 0-270	36.0 36.0	8.3 9.7	3020B-3	3-gang, Parallel Circuit, requires paralleling Chokes, 1 ea., Types 30L-1 and 30L-2.	ZOABA	75	88	\$182.00
115	0-270	36.0†	4.2						
460	0-460 0-540	3.0 3.0	1.4 1.6	520B-2 520BU-2	2-gang, Series Circuit. 2-gang, Series Circuit.	ZANNY VANNY	22 21	25 25	\$ 53.50 48.50
230	0-540	3.0†	0.7						
460	0-460* 0-540	9.0 9.0	4.1 4.9	1520B-2	2-gang, Series Circuit.	TWODE	43	50	\$ 96.00
230	0-540	9.0†	2.1						
460	0-460 0-540	12.0 12.0	5.5 6.5	3020B-2	2-gang, Series Circuit.	ZOAD	50	61	\$126.00
230	0-540	12.0†	2.8						
115	0-115 0-135	3.0 3.0	0.6 0.7	300BU-2	2-gang, Open Delta Circuit, uncased.	WREED	10	14	\$ 36.50
115	0-115 0-135	7.5 7.5	1.5 1.8	500B-2 500BU-2	2-gang, Open Delta Circuit, cased. 2-gang, Open Delta Circuit, uncased.	DEBEN UBBEN	22 21	25 25	\$ 49.00 44.00
115	0-115* 0-135	15.0 15.0	3.0 3.5	1500B-2	2-gang, Open Delta Circuit.	DOUBE	43	50	\$ 96.00
115	0-115 0-135	30.0 30.0	6.0 7.0	3000B-2	2-gang, Open Delta Circuit.	TOUBE	50	61	\$126.00
230	0-230* 0-270	3.0 3.0	1.2 1.4	300BU-3 520B-2 520BU-2	3-gang, Wye Circuit, uncased. 2-gang, Open Delta Circuit, cased. 2-gang, Open Delta Circuit, uncased.	MEADE ZANNY VANNY	14 22 21	20 25 25	\$ 58.75 \$ 53.50 48.50
115	0-270	3.0†	0.6						
230	0-230 0-270*	7.5 7.5	3.0 3.5	500B-3 500BU-3	3-gang, Wye Circuit, cased. 3-gang, Wye Circuit, uncased.	MEBEN ZUBEN	35 34	45 45	\$ 67.25 60.75
230	0-230* 0-270	9.0 9.0	3.6 4.2	1520B-2	2-gang, Open Delta Circuit.	TWODE	43	50	\$ 96.00
115	0-270	9.0†	1.8						
230	0-230* 0-270†	15.0 15.0	6.0 7.0	1500B-3	3-gang, Wye Circuit.	DOODE	65	75	\$147.00
230	0-230 0-270	12.0 12.0	4.8 5.6	3020B-2	2-gang, Open Delta Circuit.	ZOAD	50	61	\$126.00
115	0-270	12.0†	2.4						
230	0-230 0-270†	30.0 30.0	12.0 14.0	3000B-3	3-gang, Wye Circuit.	MOUBE	50	61	\$182.00
460	0-460 0-540†	3.0 3.0	2.4 2.8	520B-3 520BU-3	3-gang, Wye Circuit, cased. 3-gang, Wye Circuit, uncased.	TURN YURNE	35 34	45 45	\$ 75.25 68.25
230	0-540†	3.0†	1.2						
460	0-460* 0-540†	9.0 9.0	7.2 8.4	1520B-3	3-gang, Wye Circuit.	MORKE	65	75	\$147.00
230	0-540†	9.0†	3.6						
460	0-460 0-540†	12.0 12.0	9.6 11.2	3020B-3	3-gang, Wye Circuit.	ZOABA	70	82	\$182.00
230	0-540†	12.0†	4.8						

Over-voltage connection (0 to 17% above line voltage) or line voltage connection is available to the user by the type of connections made; however, line voltage connection on Types 1500B and 1520B must be specified.

* Ganged units of these types when connected for over-voltage operate from 60 cycle service only.

† Output current reduces to approx. 44% at full voltage.



TRANSFORMERS

STEP

DOWN

STEP

UP

ISOLATION AND LINE CORRECTION



FIG. 1



FIG. 2

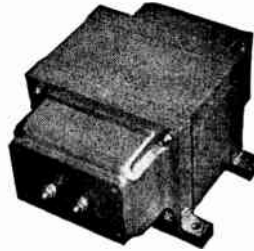

FIG. 3



FIG. 4

STEP-DOWN AUTOTRANSFORMERS

Input 220-240 V. 60 cy. Output 115 V. Pri. Cord and Plug Sec. Receptacle

Cat. No.	Code	Mount Fig. No.	Cap. in Watts	Input, Volts	Output, Volts	Cycles	Dimensions in Inches			Net Wt. in Lbs.	Net Price	Cat. No.
							H.	W.	D.			
SB-0075	STEBA	1	75	200/240	115	50/60	3 1/8"	2 5/8"	3 3/4"	3 1/2	\$ 5.40	SB-0075
SB-0150	STECA	1	150	200/240	115	50/60	3 3/8"	3 1/4"	3 5/8"	4 1/2	7.35	SB-0150
SB-0250	STEDA	1	250	200/240*	115	50/60	4 3/8"	3 3/8"	4 3/8"	8 1/2	9.60	SB-0250
SB-0500	STEFA	1	500	200/240*	115	50/60	4 3/4"	3 3/8"	6 1/8"	12 1/2	15.60	SB-0500
SB-1000	STEGA	3	1000	200/240*	115	50/60	4 1/2"	7 1/2"	9"	22 1/2	28.50	SB-1000
SB-2000	STELA	3	2000	200/240*	115	50/60	5 1/2"	8 5/8"	11 1/4"	40 1/2	47.40	SB-2000

* These models have primary taps of 200-220-240 Volts. Simply remove cover plate (see Figure 2) and connect to required taps.

TELEVISION LINE CORRECTION STEP-UP AUTOTRANSFORMERS

Models SU 100/105 Volt. Input. Models RU 200/210 Volt Input

All SU Models Boost Input 10 Volts. All RU Models Boost Input 20 Volts

SU-0100	SUBAT	1	100	100/110	110/120	50/60	3 1/8"	2 5/8"	2 7/8"	2 3/4	\$ 5.15	SU-0100
SU-0250	SUCAT	1	250	100/110	110/120	50/60	3 1/8"	2 5/8"	3 3/4"	3 3/4	7.35	SU-0250
SU-0500	SUDAT	1	500	100/110	110/120	50/60	3 3/8"	3 1/4"	3 1/4"	4 1/2	8.85	SU-0500
SU-1000	SUFAT	1	1000	100/110	110/120	50/60	4 3/8"	3 3/8"	4 3/8"	8 1/2	17.65	SU-1000
SU-2000	SUGAT	1	2000	100/110	110/120	50/60	4 3/8"	3 3/8"	5 5/8"	14 1/2	35.40	SU-2000
RU-0100	SREBA	1	100	200/210	220/230	50/60	3 1/8"	2 5/8"	2 7/8"	2 3/4	5.15	RU-0100
RU-0250	SRECA	1	250	200/210	220/230	50/60	3 3/8"	2 5/8"	3 3/4"	3 3/4	7.35	RU-0250
RU-0500	SREDA	1	500	200/210	220/230	50/60	3 3/8"	3 1/4"	3 3/4"	4 1/2	8.85	RU-0500
RU-1000	SREFA	1	1000	200/210	220/230	50/60	4 3/8"	3 3/8"	4 3/8"	8 1/2	17.65	RU-1000
RU-2000	SREGA	1	2000	200/210	220/230	50/60	4 3/8"	3 3/8"	5 5/8"	14 1/2	35.40	RU-2000

RADIO — ISOLATION TRANSFORMERS — TELEVISION

All Models 115 V. Input. 115 V. Output. Electrostatically Shielded.

SI-050	SICAR	1	50	115	115	50/60	3 1/8"	2 5/8"	3"	4 1/2	\$ 6.00	SI-050
SI-100	SICER	1	100	115	115	50/60	3 3/8"	3 3/8"	3 3/8"	7 1/4	11.70	SI-100
SI-250	SICOR	1	250	115	115	50/60	4 3/4"	3 3/8"	6 1/4"	14 1/2	21.00	SI-250

TELEVISION LINE VOLTAGE ADJUSTORS, METERED

8 Position Rotary Switch Corrects Low or High Line to 115 V. from 85-95-105-115-125-135 V-AUTOTRANSFORMER

LC-150	LABAD	4	150	85-135	115	50/60	6 1/2"	4 3/8"	5"	7 3/4	\$17.40	LC-150
LC-350	LAFAD	4	350	85-135	115	50/60	6 1/2"	4 3/8"	5"	10 1/4	21.00	LC-350
LC-500	LAJAD	4	500	85-135	115	50/60	6 1/2"	4 3/8"	5"	11 1/2	25.50	LC-500

STACO Transformers are compact and modern in design. Only the highest quality silicon lamination steel is used which assures cool operating transformers. Each coil is layer wound with the best quality enameled wires, each layer is insulated with heavy insulating material, each coil is varnished impregnated and high temperature baked. High Voltage Breakdown Test is performed on each coil and transformer in accordance with existing RMA Specs. This combination of high quality materials plus the finest workmanship is assurance of better and lasting performance at highest operating efficiency, yet costs no more than average.

Finishes: Mount type #1, Black baked enamel, Mount type #2, Black baked enamel, Mount type #3, Natural Buffed Aluminum, Mount type #4, Black Wrinkle baked enamel.

for
PRECISION

FREED TRANSFORMERS

for
QUALITY

HIGH FIDELITY COMPONENTS INPUT TRANSFORMERS

CASE DIMENSIONS NO. DC-2B

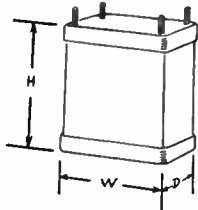

Mtg. Centers	Dimensions		
	W	D	H
2" x 1 3/4"	2 5/8"	2 1/4"	3 1/2"
Knockout	Mtg. Studs	Wgt.	
1 1/2" x 1 3/8"	8-32	3 lbs.	

L after case number indicates leads.
T after case number indicates terminals.

Modern high fidelity broadcasting and transcription apparatus require the utmost performance and reliability in the audio transformers used in their circuitry. The Freed "Quality Grade" audio transformers are wide band, high fidelity components featuring astatic construction, longitudinal balance, low harmonic distortion, uniform response, high efficiency, and constant impedance match throughout the audio frequency spectrum. Maximum neutralization of stray fields is accomplished by use of humbalanced coil structures and multiple alloy shielding. High fidelity is achieved on every tap of universal impedance winding without line reflection of transverse coupling.

All Quality Grade Components are thoroughly impregnated in a special non-hygroscopic varnish, and fully encapsulated in a moisture proof, high-melting point compound.

U-60 IMPEDANCES IN OHMS

2.5, 5, 10, 15, 20, 30, 40, 60

U-500 IMPEDANCES IN OHMS

50, 125, 200 CT, 250, 330, 500 CT.
125 and 500 ohms can be used for 150 and 600 ohms.

Catalog No.	Application	Impedance Ohms	Level	Maximum Power Level V.U.*	Ratio	Equivalent Shielding D.B.	Max. Pri. D.C. per Side Ma.	D.C. Unbalance Ma.	Freq. Response C.P.S.	Case Number
		Primary	Secondary							
QGA 1	Universal 500 ohm line to push-pull grids	U-500	100,000 split	+10	1:14.1	70	0	0	±1.0 DB 20-20,000	DC-2BT
QGA 2	Universal 500 ohm line to push-pull grids	U-500	100,000 split	+10	1:14.1	90	0	0	±1.0 DB 20-20,000	DC-2BT
QGA 3	Universal 500 ohm line to single or push-pull grids	U-500	60,000 split	+10	1:11	70	0	0	±1.0 DB 20-20,000	DC-2BT
QGA 4	Universal 500 ohm line to single or push-pull grids	U-500	60,000 split	+10	1:11	90	0	0	±1.0 DB 20-20,000	DC-2BT
QGA 5	Universal low impedance microphone, pickup or line to single or push-pull grids	U-60	60,000 split	+10	1:31.6	70	0	0	±1.0 DB 20-20,000	DC-2BT
QGA 6	Universal low impedance microphone, pickup or line to single or push-pull grids	U-60	60,000 split	+10	1:31.6	90	0	0	±1.0 DB 20-20,000	DC-2BT

HYBRID AND REPEAT COILS

CASE DIMENSIONS

Same as Input Transformers above

Catalog No.	Application	Impedance Ohms	Level	Maximum Power Level V.U.*	Ratio	Equivalent Shielding D.B.	Max. Pri. D.C. per Side Ma.	D.C. Unbalance Ma.	Freq. Response C.P.S.	Case Number
		Primary	Secondary							
QGA 7	Hybrid. Unbalanced 500/600 ohm lines to 600 ohms.	Total Pri 1200/1000 split 300/250 300/250	600/150 or 500/125 split	+10	1.41:1	70	0	0	±1.0 DB 20-20,000	DC-2BT
QGA 8	Hybrid. Balanced 500/600 ohm lines to 600 ohms. Longitudinal balance 70 DB	Total Pri 1200/1000 split 300/250C.T. 300/250C.T.	600/150 or 500/125 split	+10	1.41:1	70	0	0	±1.0 DB 20-20,000	DC-2BT
QGA 9	Hybrid. Unbalanced 500/600 ohm lines to triode plate. No D.C. in secondary.	Total Pri 1200/1000 split 300/250 300/250	15,000 or 12,500	+10	1:3.54	70	0	0	±1.0 DB 20-20,000	DC-2BT
QGA 10	Hybrid. Balanced 500/600 ohm lines to triode plate. No D.C. in secondary. Longitudinal balance 70 DB.	Total Pri 1200/1000 split 300/250C.T. 300/250C.T.	15,000 or 12,500	+10	1:3.54	70	0	0	±1.0 DB 20-20,000	DC-2BT
QGA 11	Repeat coil for low frequency ringing. Longitudinal balance 70 DB.	600/500 split	600/500 split Balanced	+10	1:1	90	0	0	±1.0 DB 20-20,000	DC-2BT

For Freed Precision Laboratory Test Instruments see Section G Page G-114 to 124

for
PRECISION

FREED TRANSFORMERS

for
QUALITY

HIGH FIDELITY COMPONENTS INTERSTAGE TRANSFORMERS

CASE DIMENSIONS

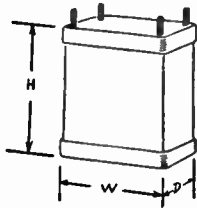

Case #	Mtg. Centers	Dimensions			Knockout	Mtg. Studs	Wgt.
		W	D	H			
DC-2A		2 5/8"	2 1/4"	3"	1 1/2" x 1 3/8"	8-32	3 lbs.
DC-4A	2 1/2" x 2 1/2"	3 1/8"	3"	3 3/4"	2" x 1 3/4"	8-32	4 1/2 lbs.

L after case number indicates leads.
T after case number indicates terminals.

Catalog No.	Application	Impedance Level Ohms		Maximum Power Level V.U.*	Ratio	Equiv- alent Shield- ing D.B.	Max. Pri. D.C. per Side Ma.	D.C. Un- bal- ance Ma.	Freq. Response C.P.S.	Case Number
		Primary	Secondary							
QGA 12	Bridging line to single or push-pull grids.	10,000	60,000 split	+10	1:2.45	70	0	0	±1.0 DB 20-20,000	DC-2B
QGA 13	Single 6C4, 6J5, 1/2 6SN7 triode to push-pull grids. Shunt feed.	15,000	60,000 split	+18	1:2	45	0	0	±1.0 DB 20-20,000	DC-2B
QGA 14	Single 6C4, 6J5, 1/2 6SN7 triode to push-pull grids.	15,000	60,000 split	+18	1:2	45	8	8	±1.0 DB 50-20,000	DC-2B
QGA 15	Push-pull triode plates to push-pull class A grids.	20,000 split	45,000 split	+25	1:1.5	30	8	0.5	±1.0 DB 20-20,000	DC-4AT

LOW LEVEL OUTPUT, MIXING, MATCHING TRANSFORMERS

CASE DIMENSIONS
See DC-2AT above

U-500 IMPEDANCES IN OHMS
50, 125, 200 CT, 250, 330, 500CT.
125 and 500 ohms can be used for 150 and 600 ohms

Catalog No.	Application	Impedance Level Ohms		Maximum Power Level V.U.*	Ratio	Equiv- alent Shield- ing D.B.	Max. Pri. D.C. per Side Ma.	D.C. Un- bal- ance Ma.	Freq. Response C.P.S.	Case Number
		Primary	Secondary							
QGA 16	Single plate or bridging line to Universal 500 ohm line. Shunt feed.	15,000	U-500	+18	5.5:1	70	0	0	±1.0 DB 20-20,000	DC-2B
QGA 17	Single plate to Universal 500 ohm line.	15,000	U-500	+18	5.5:1	70	8	8	±1.0 DB 50-20,000	DC-2B
QGA 18	Push-pull triode plates to Universal 500 ohm line.	20,000 C.T.	U-500	+25	6.3:1	70	8	0.5	±1.0 DB 20-20,000	DC-2B
QGA 19	Mixing, low impedance microphone or line to Universal 500 ohm line.	U-500	U-500	+12	1:1	70	0	0	±1.0 DB 20-20,000	DC-2B
QGA 20	Line level mixing and matching.	U-500	U-500	+30	1:1	70	0	0	±1.0 DB 20-20,000	DC-2B
QGA 21	High mu triode photo-cell to Universal 500 ohm line.	100,000	U-500	+12	14.1:1	70	0	0	±1.0 DB 20-20,000	DC-2B

For Freed Precision Laboratory Test Instruments see Section G Page G-114 to 124

for
PRECISION

FREED TRANSFORMERS

for
QUALITY

HIGH FIDELITY COMPONENTS DRIVER TRANSFORMERS

Catalog No.	Application	Primary Impedance Ohms	Maximum Power Level V.U.*	Turn Ratio Pri: 1/2 Sec.	Max. Pri. D.C. per Side Ma.	D.C. Unbalance Ma.	Frequency Response C.P.S.	Case Number
QGA 22	Universal 500 ohm line to Class B grids.	U-500	+40	1:1	0	0	±1.0 DB 20-20,000	DC-4AT
QGA 23	Push-pull 6J6, etc. to push-pull 2A3's, 6L6's, etc.	20,000 C.T.	+80	3.2:1	8	0.5	±1.0 DB 20-20,000	DC-2BT
QGA 24	Push-pull 2A3, 6B4 to push-pull 809, T2-40, 4/125A.	5,000 C.T.	+40	3.1:1	50	5	±1.0 DB 20-20,000	DC-4AT

HIGH LEVEL OUTPUT TRANSFORMERS TUBES TO LINE, TUBES TO VOICE COIL, LINE TO LINE, LINE TO VOICE COIL

Catalog No.	Application	Impedance Level Ohms		Maximum Power Level V.U.*	Ratio	Max. Pri. D.C. per Side Ma.	D.C. Unbalance Ma.	Frequency Response C.P.S.	Case Number
		Primary	Secondary						
QGA 25	PP 2A3, 6B4, 6L6, 800A, 275A to Universal 500 ohm line.	5,000 split	U-500	+42 (15 watts)	3.16:1	50	5	±0.5 DB 20-30,000	DC-5BT
QGA 26	As above to Universal voice coil.	5,000 split	U-16	+42	17.7:1	50	5	±0.5 DB 20-30,000	DC-5BT
QGA 27	Push-pull 6V6, 6AQ5, 7C5, 6N7 to Universal 500 ohm line.	8,000 split	U-500	+42	4:1	50	5	±0.5 DB 20-30,000	DC-5BT
QGA 28	As above to Universal voice coil.	8,000 split	U-16	+42	22.4:1	50	5	±0.5 DB 20-30,000	DC-5BT
QGA 29	P.P. 6F6, 6V6, 6AQ5, 7C5, 7B5, 6AR5, 6K6, 6L6 to Universal 500 ohm line.	10,000 split	U-500	+42	4.47:1	40	4	±0.5 DB 20-30,000	DC-5BT
QGA 30	As above to Universal voice coil.	10,000 split	U-16	+42	25:1	40	4	±0.5 DB 20-30,000	DC-5BT
QGA 31	PP 807, 1614, KT-66, (Williamson Amplifier) to Universal 500 ohm line.	10,000 split	U-500	+45.5 (36 watts)	4.47:1	50	5	±0.5 DB 20-30,000	DC-6AT
QGA 32	As above to Universal voice coil.	10,000 split	U-16	+45.5	25:1	50	5	±0.5 DB 20-30,000	DC-6AT
QGA 33	P.P. Parallel 2A3, 6A5G, 300A to Universal 500 ohm line.	2,500 split	U-500	+45.5	2.24:1	100	10	±0.5 DB 20-30,000	DC-6AT
QGA 34	As above to Universal voice coil.	2500 split	U-16	+45.5	12.5:1	100	10	±0.5 DB 20-30,000	DC-6AT
QGA 35	P.P. 6L6 or P.P. Parallel 6L6 to Universal 500 ohm line.	3800 split	U-500	+47 (50 watts)	2.75:1	130	13	±0.5 DB 20-30,000	DC-7BT
QGA 36	As above to Universal voice coil.	3800 split	U-16	+47	15.4:1	130	13	±0.5 DB 20-30,000	DC-7BT
QGA 37	High level multiple line to Universal voice coil.	U-500	U-16	+42	5.6:1	0	0	±0.5 DB 20-30,000	DC-5BT
QGA 38	High level multiple line to Universal voice coil.	U-500	U-16	+47	5.6:1	0	0	±0.5 DB 20-30,000	DC-7BT

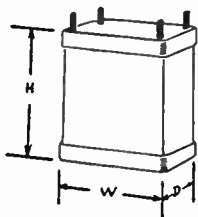

CASE DIMENSIONS

Case #	Mtg. Centers	Dimensions			Knockout	Mtg. Studs	Wgt.
		W	D	H			
DC-2B	2" x 1 3/4"	2 5/8"	2 1/4"	3 1/2"	1 1/2" x 1 3/8"	8-32	2 1/2
DC-4A	2 1/2" x 2 1/2"	3 1/8"	3"	3 3/4"	2" x 1 3/8"	8-32	4 1/2
DC-5B	3 1/8" x 2 5/8"	4 1/8"	3 1/2"	4 1/2"	2 1/2" x 2"	10-32	10
DC-6A	3 3/8" x 3"	5"	4 1/8"	4 7/8"	3" x 2 1/2"	10-32	15
DC-7B	4 3/8" x 3 3/8"	5 1/2"	5"	6 3/4"	3" x 2 1/2"	1/4-20	22

When supplied with leads: DC-L
When supplied with terminals: DC-T

U-16 IMPEDANCE IN OHMS
2, 4, 8, 12, 16

U-500 IMPEDANCES IN OHMS
50, 125, 200CT, 250, 330, 500CT.
125 and 500 ohms can be used for 150 and 600 ohms.

*A 70 volts level can be obtained for the following impedances:

500 ohms — 10 watts + 40 VU
330 ohms — 15 watts + 42 VU
250 ohms — 20 watts + 43 VU
200 ohms — 25 watts + 44 VU
125 ohms — 40 watts + 46 VU
50 ohms — 100 watts + 50 VU

For Freed Precision Laboratory Test Instruments see Section G Page G-114 to 124

for
PRECISION

FREED TRANSFORMERS

for
QUALITY

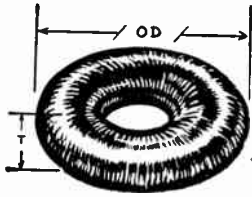

FREED TOROIDAL INDUCTORS

STANDARD TOLERANCE $\pm 1\%$

UNCASED DIMENSIONS		
Type	T	OD
TI-1	$1\frac{1}{8}$ "	$1\frac{1}{8}$ "
TI-2	$1\frac{1}{8}$ "	$1\frac{5}{8}$ "
TI-3	$\frac{3}{4}$ "	$1\frac{5}{8}$ "
TI-3A	1"	$2\frac{1}{8}$ "

CASE DIMENSIONS		
<p>DC CASE 8-32 Studs</p>		
Types TI-1, TI-2, TI-3		
H	W	D
$2\frac{1}{2}$ "	$2\frac{1}{8}$ "	$1\frac{1}{8}$ "
Mtg. Centers $1\frac{1}{2}$ " x $1\frac{1}{4}$ "		
TYPE TI-3A		
H	W	D
3"	$2\frac{5}{8}$ "	$2\frac{1}{4}$ "
Mtg. Centers 2" x $1\frac{3}{8}$ "		

<p>DT-3 CASE Types TI-1, TI-2, TI-3</p> <p>Length: $1\frac{3}{8}$" Width: $\frac{7}{8}$" Height: 2" Mounting: $\frac{7}{8}$" x $\frac{3}{32}$" Inserts: 6-32 Cutout: $\frac{3}{8}$" x $\frac{5}{8}$"</p>	
<p>DT-4 CASE Types TI-1, TI-2, TI-3</p> <p>Length: $2\frac{3}{4}$" Width: $1\frac{1}{8}$" Height: $2\frac{1}{8}$" Mtg.: $2\frac{1}{8}$" x $1\frac{1}{8}$" Studs: 8-32 Cutout: $\frac{3}{8}$" x $\frac{5}{8}$"</p>	
<p>DT-5 CASE Type TI-3AS</p> <p>Diameter: $1\frac{1}{8}$" Height: $1\frac{3}{8}$" Mtg.: $1\frac{1}{8}$" Inserts: 6-32 Cutout: $\frac{3}{8}$" x $1\frac{3}{8}$"</p>	

TYPE TI-1 STANDARD TOLERANCE $\pm 1\%$					
Frequency Range — Up to 15 KC Non-stabilized			Maximum Inductance — 20 MHY Maximum "Q" 185 @ 7.5 KC		
Cat. No. Uncased	Inductance Value	Cat. No. Uncased	Inductance Value	Cat. No. Uncased	Inductance Value
F-800	5 MHY	F-811	1000 MHY	F-822	4500 MHY
F-801	10 MHY	F-812	1250 MHY	F-823	5000 MHY
F-802	15 MHY	F-813	1500 MHY	F-824	6000 MHY
F-803	30 MHY	F-814	1750 MHY	F-825	7000 MHY
F-804	50 MHY	F-815	2000 MHY	F-826	8000 MHY
F-805	75 MHY	F-816	2250 MHY	F-827	9000 MHY
F-806	100 MHY	F-817	2500 MHY	F-828	10000 MHY
F-807	150 MHY	F-818	2750 MHY	F-829	15000 MHY
F-808	200 MHY	F-819	3000 MHY	F-830	20000 MHY
F-809	500 MHY	F-820	3500 MHY		
F-810	750 MHY	F-821	4000 MHY		

TYPE TI-2 ^s Available in following case types: DC, DT-3 and DT-5					
Frequency Range — Up to 75 KC Stabilized			Maximum Inductance — 500 MHY Maximum "Q" 270 @ 23 KC		
Cat. No. Uncased	Inductance Value	Cat. No. Uncased	Inductance Value	Cat. No. Uncased	Inductance Value
F-1800	1 MHY	F-1806	15 MHY	F-1812	200 MHY
F-1801	2 MHY	F-1807	30 MHY	F-1813	300 MHY
F-1802	3 MHY	F-1808	50 MHY	F-1814	400 MHY
F-1803	4 MHY	F-1809	75 MHY	F-1815	500 MHY
F-1804	5 MHY	F-1810	100 MHY		
F-1805	10 MHY	F-1811	150 MHY		

TYPE TI-3 ^s Available in following case types: DC, DT-3 and DT-5					
Frequency Range — Up to 200 KC Stabilized			Maximum Inductance — 10 MHY Maximum "Q" 280 @ 75 KC		
Cat. No. Uncased	Inductance Value	Cat. No. Uncased	Inductance Value	Cat. No. Uncased	Inductance Value
F-1846	.1 MHY	F-1850	.5 MHY	F-1854	4 MHY
F-1847	.2 MHY	F-1851	1 MHY	F-1855	5 MHY
F-1848	.3 MHY	F-1852	2 MHY	F-1845	7.5 MHY
F-1849	.4 MHY	F-1853	3 MHY	F-1844	10 MHY

TYPE TI-3A ^s Available in following case types: DC and DT-4					
Frequency Range — Up to 200 KC Stabilized			Maximum Inductance — 100 MHY Maximum "Q" 300 @ 37 KC		
Cat. No. Uncased	Inductance Value	Cat. No. Uncased	Inductance Value	Cat. No. Uncased	Inductance Value
F-1856	10 MHY	F-1859	30 MHY	F-1862	75 MHY
F-1857	15 MHY	F-1860	40 MHY		
F-1858	20 MHY	F-1861	50 MHY	F-1863	100 MHY

NOTE: When ordering Freed Inductors in Commercial Type Cases, add "C" to Catalog Number.
When ordering Hermetically Sealed units, add "H."
Freed Toroidal Inductors can also be supplied on special order to tolerances of closer than $\pm 1\%$.

For Freed Precision Laboratory Test Instruments see Section G Page G-114 to 124

for
PRECISION

FREED TRANSFORMERS

for
QUALITY

FREED TOROIDAL INDUCTORS

STANDARD TOLERANCE $\pm 1\%$

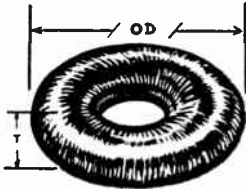

UNCASED DIMENSIONS

Type	T	OD
TI-4	5/8"	1 1/8"
TI-5*	3/8"	1"
TI-6	5/8"	1 1/8"
TI-7*	3/8"	1"

*Wedding Ring Size

CASE DIMENSIONS

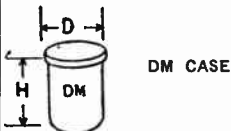

Types TI-4, TI-5, TI-6

Types TI-4 and TI-6
 H DM D
 1 1/2" 1 1/8" 1 1/8"
 Mtg. Centers 7/8"
 6-32 Inserts

Types TI-5 and TI-7
 H DM D
 1" 1" 1 1/8"
 Mtg. Centers 5/8"
 4-40 Inserts

DT-1 CASE Types TI-4, TI-7



Length: 1 1/8"
 Width: 1/2"
 Height: 1 3/8"
 Mtg.: 3/8"
 Inserts: 4/40"
 Cutout: 7/8" x 1/2"

DT-2 CASE Types TI-4, TI-6



Length: 1 3/8"
 Width: 3/4"
 Height: 1 3/8"
 Mtg.: 7/8" x 3/8"
 Inserts: 6-32
 Cutout: 5/8" x 5/8"

TYPES TI-4 & 4*

Available in following type cases: DM and DT-2

TYPE TI-4
 Frequency Range — Up to 15 KC
 Non-stabilized
 Maximum Inductance — 5 HY
 Maximum "Q" 175 @ 7.5 KC

TYPE TI-4s
 Frequency Range — Up to 15 KC
 Stabilized
 Maximum Inductance — 5 HY
 Maximum "Q" 175 @ 7.5 KC

Cat. No. Uncased	Inductance Value	Cat. No. Uncased	Inductance Value	Cat. No. Uncased	Inductance Value
F-850	5 MHY	F-860	400 MHY	F-870	2.00 HY
F-851	10 MHY	F-861	500 MHY	F-871	2.25 HY
F-852	15 MHY	F-862	600 MHY	F-872	2.50 HY
F-853	30 MHY	F-863	700 MHY	F-873	2.75 HY
F-854	50 MHY	F-864	800 MHY	F-874	3.00 HY
F-855	75 MHY	F-865	900 MHY	F-875	3.50 HY
F-856	100 MHY	F-866	1.00 HY	F-876	4.00 HY
F-857	150 MHY	F-867	1.25 HY	F-877	4.50 HY
F-858	200 MHY	F-868	1.50 HY	F-878	5.00 HY
F-859	300 MHY	F-869	1.75 HY		

TYPES TI-5 & 5*

Available in following type cases: DM and DT-1

TYPE TI-5
 Frequency Range — Up to 15 KC
 Non-stabilized
 Maximum Inductance — 2 HY
 Maximum "Q" 115 @ 10 KC

TYPE TI-5s
 Frequency Range — Up to 15 KC
 Stabilized
 Maximum Inductance — 2 HY
 Maximum "Q" 115 @ 10 KC

Cat. No. Uncased	Inductance Value	Cat. No. Uncased	Inductance Value	Cat. No. Uncased	Inductance Value
F-1700	5 MHY	F-1707	150 MHY	F-1714	800 MHY
F-1701	10 MHY	F-1708	200 MHY	F-1715	900 MHY
F-1702	15 MHY	F-1709	300 MHY	F-1716	1.00 HY
F-1703	30 MHY	F-1710	400 MHY	F-1717	1.25 HY
F-1704	50 MHY	F-1711	500 MHY	F-1718	1.50 HY
F-1705	75 MHY	F-1712	600 MHY	F-1719	1.75 HY
F-1706	100 MHY	F-1713	700 MHY	F-1720	2.00 HY

TYPES TI-6 & 6*

Available in following type cases: DM and DT-2

TYPE TI-6
 Frequency Range — Up to 75 KC
 Non-stabilized
 Maximum Inductance — 1 HY
 Maximum "Q" 250 @ 17 KC

TYPE TI-6s
 Frequency Range — Up to 75 KC
 Stabilized
 Maximum Inductance — 1 HY
 Maximum "Q" 250 @ 17 KC

Cat. No. Uncased	Inductance Value	Cat. No. Uncased	Inductance Value	Cat. No. Uncased	Inductance Value
F-1726	1 MHY	F-1732	10 MHY	F-1738	100 MHY
F-1727	2 MHY	F-1733	15 MHY	F-1739	150 MHY
F-1728	3 MHY	F-1734	20 MHY	F-1740	200 MHY
F-1729	4 MHY	F-1735	30 MHY	F-1741	250 MHY
F-1730	5 MHY	F-1736	50 MHY	F-1742	300 MHY
F-1731	7.5 MHY	F-1737	75 MHY	F-1743	500 MHY

TYPE TI-7

Available in following type cases: DM and DT-1

Frequency Range — Up to 75 KC
 Non-stabilized

Maximum Inductance — 200 MHY
 Maximum "Q" 170 @ 30 KC

Cat. No. Uncased	Inductance Value	Cat. No. Uncased	Inductance Value	Cat. No. Uncased	Inductance Value
F-1781	5 MHY	F-1787	10 MHY	F-1793	50 MHY
F-1782	1 MHY	F-1788	15 MHY	F-1794	75 MHY
F-1783	2 MHY	F-1789	20 MHY	F-1795	100 MHY
F-1784	3 MHY	F-1790	25 MHY	F-1796	150 MHY
F-1785	5 MHY	F-1791	30 MHY	F-1797	200 MHY
F-1786	7.5 MHY	F-1792	40 MHY		

For Freed Precision Laboratory Test Instruments see Section G Page G-114 to 124

for
PRECISION

FREED TRANSFORMERS

for
QUALITY

FREED TOROIDAL INDUCTORS

STANDARD TOLERANCE $\pm 1\%$

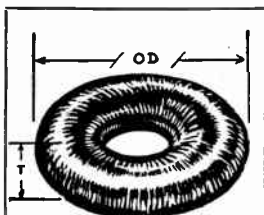

UNCASED DIMENSIONS

Type	T	OD
TI-8*	3/8"	1"
TI-9	1"	2 1/2"
TI-10	3/4"	1 3/4"
TI-11	1 1/8"	2 5/8"

*Wedding Ring Size

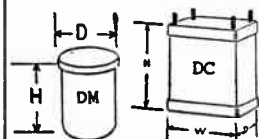

TYPE TI-8; DM CASE
H. 1", Mtg. Centers 3/8",
D. 1 1/8", Inserts 4-40

TYPE TI-9; DC CASE
H. 3", W. 2 3/4", D. 2 1/4"
Mtg. Centers 2"x1 3/4"

TYPE TI-10; DC CASE
H. 2 1/2", W. 2 1/8", D. 1 1/2"
Mtg. Centers 1 1/2"x1 1/4"

TYPE TI-11; DC CASE
(Commercial*)
H. 3 1/2", W. 2 5/8", D. 2 1/4"
Mtg. Centers 2"x1 3/4"

TYPE TI-11; DC CASE
HERMETICALLY SEALED
H. 3 3/8", W. 1 7/8", D. 3 3/8"
Mtg. Centers 2 1/2"x1"



DT-1 CASE

TYPE TI-8
Length: 1 1/8"
Width: 1/2"
Height: 1 3/8"
Mtg.: 3/4"
Screws: 4/40"
Cutout: 1/8"x1/2"



DT-3 CASE

TYPE TI-9
Length: 1 3/8"
Width: 7/8"
Height: 2"
Mtg.: 7/8"x3/32"
Inserts: 6-32
Cutout: 3/8"x5/8"



DT-4 CASE

TYPE TI-10
Length: 2 3/4"
Width: 1 3/8"
Height: 2 1/8"
Mtg.: 2 1/8"x1 1/8"
Studs: 8-32
Cutout: 3/8"x5/8"



DT-5 CASE

TYPE TI-10
Diameter: 1 1/8"
Height: 1 3/8"
Mtg.: 1 1/8"
Inserts: 6-32
Cutout: 3/8"x1 3/8"

TYPES TI-8 & 8^s

Available in following type cases: DM and DT-1

TYPE TI-8

Frequency Range — Up to 60 KC
Non-stabilized
Maximum Inductance — 100 MHY
Maximum "Q" 150 @ 50 KC

TYPE TI-8^s

Frequency Range — Up to 60 KC
Stabilized
Maximum Inductance — 100 MHY
Maximum "Q" 150 @ 50 KC

Cat. No. Uncased	Inductance Value	Cat. No. Uncased	Inductance Value	Cat. No. Uncased	Inductance Value
F-1821	.1 MHY	F-1828	3 MHY	F-1835	25 MHY
F-1822	.2 MHY	F-1829	4 MHY	F-1836	30 MHY
F-1823	.3 MHY	F-1830	5 MHY	F-1837	40 MHY
F-1824	.4 MHY	F-1831	7.5 MHY	F-1838	50 MHY
F-1825	.5 MHY	F-1832	10 MHY	F-1839	75 MHY
F-1826	1 MHY	F-1833	15 MHY	F-1840	100 MHY
F-1827	2 MHY	F-1834	20 MHY		

TYPE TI-9^s

Available in following type cases: DC and DT-4

Frequency Range — Up to 60 KC
Stabilized

Maximum Inductance — 500 MHY
Maximum "Q" 270 @ 17.5 KC

Cat. No. Uncased	Inductance Value	Cat. No. Uncased	Inductance Value	Cat. No. Uncased	Inductance Value
F-1554	1 MHY	F-1560	10 MHY	F-1566	150 MHY
F-1555	2 MHY	F-1561	15 MHY	F-1567	200 MHY
F-1556	3 MHY	F-1562	30 MHY	F-1568	300 MHY
F-1557	4 MHY	F-1563	50 MHY	F-1569	400 MHY
F-1558	5 MHY	F-1564	75 MHY	F-1570	500 MHY
F-1559	7.5 MHY	F-1565	100 MHY		

TYPE TI-10^s

Available in following type cases: DC, DT-3 and DT-5

Frequency Range — Up to 60 KC
Stabilized

Maximum Inductance — 200 MHY
Maximum "Q" 180 @ 40 KC

Cat. No. Uncased	Inductance Value	Cat. No. Uncased	Inductance Value	Cat. No. Uncased	Inductance Value
F-1579	1 MHY	F-1584	7.5 MHY	F-1589	75 MHY
F-1580	2 MHY	F-1585	10 MHY	F-1590	100 MHY
F-1581	3 MHY	F-1586	15 MHY	F-1591	150 MHY
F-1582	4 MHY	F-1587	30 MHY	F-1592	200 MHY
F-1583	5 MHY	F-1588	50 MHY		

TYPE TI-11^s

Available in following type cases: DC and DT-4

Frequency Range — Up to 15 KC
Stabilized

Maximum Inductance — 50 HY
Maximum "Q" 255 @ 4 KC

Cat. No. Uncased	Inductance Value	Cat. No. Uncased	Inductance Value	Cat. No. Uncased	Inductance Value
F-1747	1 MHY	F-1759	200 MHY	F-1771	4.50 HY
F-1748	2 MHY	F-1760	300 MHY	F-1772	5.00 HY
F-1749	3 MHY	F-1761	400 MHY	F-1773	7.50 HY
F-1750	4 MHY	F-1762	500 MHY	F-1774	10.00 HY
F-1751	5 MHY	F-1763	750 MHY	F-1775	15.00 HY
F-1752	10 MHY	F-1764	1.00 HY	F-1776	20.00 HY
F-1753	15 MHY	F-1765	1.50 HY	F-1777	25.00 HY
F-1754	30 MHY	F-1766	2.00 HY	F-1778	30.00 HY
F-1755	50 MHY	F-1767	2.50 HY	F-1779	40.00 HY
F-1756	75 MHY	F-1768	3.00 HY	F-1780	50.00 HY
F-1757	100 MHY	F-1769	3.50 HY		
F-1758	150 MHY	F-1770	4.00 HY		

NOTE: When ordering Freed Toroidal Inductors in Commercial Type Cases, add "C" to catalog number.
When ordering Hermetically Sealed units, add "H."

*Commercial type cases have Bakelite cover with solder lugs.

For Freed Precision Laboratory Test Instruments see Section G Page G-114 to 124

for
PRECISION

FREED TRANSFORMERS

for
QUALITY

FREED TOROIDAL INDUCTORS

STANDARD TOLERANCE $\pm 1\%$

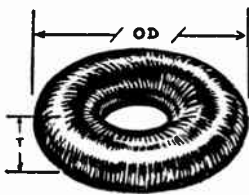

UNCASED DIMENSIONS

Type	T	OD
TI-12	$1\frac{1}{8}$ "	$2\frac{1}{8}$ "
TI-13	1"	$2\frac{1}{8}$ "

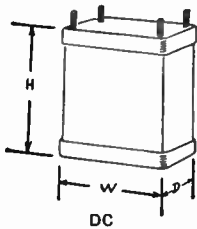

Types TI-12, TI-13

H	W	D
3"	$2\frac{3}{8}$ "	$2\frac{1}{4}$ "

Mtg. Centers $2" \times 1\frac{3}{8}"$
8-32 Studs



DT-4 CASE

Length: $2\frac{3}{4}"$
Width: $1\frac{1}{8}"$
Height: $2\frac{1}{8}"$
Mounting: $2\frac{1}{8}" \times 1\frac{1}{8}"$
Studs: 8-32
Cutout: $\frac{3}{8}" \times \frac{5}{8}"$

All Freed Toroidal Inductors can be supplied in tolerances of closer than $\pm 1\%$ on special order. . . Complete Toroid Catalog with curves for each unit is available on request. . . Jobbers and Engineers are urged to send for it.

TYPE TI-12

Frequency Range — Up to 15 KC
Non-stabilized

Maximum Inductance — 30 HY
Maximum "Q" 200 @ 5 KC

Cat. No. Uncased	Inductance Value
F-1655	1 MHY
F-1656	2 MHY
F-1657	3 MHY
F-1658	4 MHY
F-1659	5 MHY
F-1660	7.5 MHY
F-1661	10 MHY
F-1662	15 MHY
F-1663	30 MHY
F-1664	50 MHY
F-1665	75 MHY
F-1666	100 MHY
F-1667	150 MHY
F-1668	200 MHY
F-1669	300 MHY
F-1670	400 MHY
F-1671	500 MHY
F-1672	600 MHY
F-1673	750 MHY
F-1674	100 MHY

TYPE TI-12^s

Frequency Range — Up to 15 KC
Stabilized

Maximum Inductance — 30 HY
Maximum "Q" 200 @ 5 KC

Uncased Cat. No.	Value Inductance
F-1675	1.50 HY
F-1676	2.00 HY
F-1677	2.50 HY
F-1678	3.00 HY
F-1679	3.50 HY
F-1680	4.00 HY
F-1681	4.50 HY
F-1682	5.00 HY
F-1683	6.00 HY
F-1684	7.00 HY
F-1685	8.00 HY
F-1686	9.00 HY
F-1687	10.00 HY
F-1688	12.00 HY
F-1689	15.00 HY
F-1690	17.00 HY
F-1691	20.00 HY
F-1692	25.00 HY
F-1693	30.00 HY

TYPE TI-13^s

Available in case types: DC and DT-4

Frequency Range — Up to 75 KC
Non-stabilized

Maximum Inductance — 500 MHY
Maximum "Q" 340 @ 15 KC

Cat. No. Uncased	Inductance Value	Cat. No. Uncased	Inductance Value
F-1629	1 MHY	F-1638	50 MHY
F-1630	2 MHY	F-1639	75 MHY
F-1631	3 MHY	F-1640	100 MHY
F-1632	4 MHY	F-1641	150 MHY
F-1633	5 MHY	F-1642	200 MHY
F-1634	7.5 MHY	F-1643	300 MHY
F-1635	10 MHY	F-1644	400 MHY
F-1636	15 MHY	F-1645	500 MHY
F-1637	30 MHY		

NOTE: When ordering Freed Toroidal Inductors in Commercial Type cases, add "C" to catalog number.

When ordering Hermetically Sealed units, add "H."

For Freed Precision Laboratory Test Instruments see Section G Page G-114 to 124

for
PRECISION

FREED TRANSFORMERS

for
QUALITY

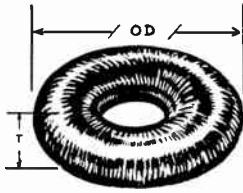

FREED TOROIDAL INDUCTORS

STANDARD TOLERANCE $\pm 2\%$

UNCASED DIMENSIONS		
Type	T	OD
TI-14	$\frac{3}{8}$ "	1"
TI-15*	$\frac{5}{8}$ "	1 $\frac{1}{8}$ "

*Wedding Ring Size

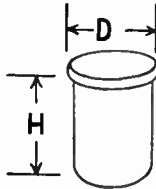

DIMENSIONS DM CASES

Type TI-14

H. 1" D. $1 \frac{1}{8}$ "
Mtg. $\frac{5}{8}$ " Inserts 4-40

Type TI-15*

H. $1 \frac{1}{2}$ " D. $1 \frac{3}{8}$ "
Mtg. $\frac{7}{8}$ " Inserts 4-40

DT-1 CASE



Length: $1 \frac{1}{8}$ "
Width: $\frac{1}{2}$ "
Height: $1 \frac{7}{8}$ "
Mtg.: $\frac{3}{4}$ "
Inserts: 4/40"
Cutout: $\frac{5}{16}$ " x $\frac{1}{2}$ "

Type TI-14

DT-2 CASE



Length: $1 \frac{3}{8}$ "
Width: $\frac{3}{4}$ "
Height: $1 \frac{3}{4}$ "
Mtg.: $\frac{7}{8}$ " x $\frac{3}{8}$ "
Screws: 6-32
Cutout: $\frac{3}{8}$ " x $\frac{5}{8}$ "

Type TI-15

TYPE TI-14^s

Available in following type cases: DM and DT-2

Temperature Stabilized

Frequency Range — Up to 50 KC

Maximum Inductance — 300 MHY

Maximum "Q" 140 @ 25 KC

Cat. No. Uncased	Inductance Value	Cat. No. Uncased	Inductance Value
F-1920	1 MHY	F-1929	30 MHY
F-1921	2 MHY	F-1930	50 MHY
F-1922	3 MHY	F-1931	75 MHY
F-1923	4 MHY	F-1932	100 MHY
F-1924	5 MHY	F-1933	150 MHY
F-1925	7.5 MHY	F-1934	200 MHY
F-1926	10 MHY	F-1935	250 MHY
F-1927	15 MHY	F-1936	300 MHY
F-1928	20 MHY		

TYPE TI-15^s

Available in following type cases: DM and DT-1

Temperature Stabilized

Frequency Range — Up to 50 KC

Maximum Inductance — 100 MHY

Maximum "Q" 140 @ 25 KC

Cat. No. Uncased	Inductance Value	Cat. No. Uncased	Inductance Value
F-1870	0.1 MHY	F-1880	7.5 MHY
F-1871	0.2 MHY	F-1881	10 MHY
F-1872	0.3 MHY	F-1882	15 MHY
F-1873	0.4 MHY	F-1883	20 MHY
F-1874	0.5 MHY	F-1884	25 MHY
F-1875	1 MHY	F-1885	30 MHY
F-1876	2 MHY	F-1886	40 MHY
F-1877	3 MHY	F-1887	50 MHY
F-1878	4 MHY	F-1888	75 MHY
F-1879	5 MHY	F-1889	100 MHY

NOTE: When ordering Freed Inductors in Commercial Type Cases, add "C" to Catalog Number.

When ordering Hermetically Sealed units, add "H."

Freed Toroidal Inductors can also be supplied on special order to tolerances of closer than $\pm 1\%$.

For Freed Precision Laboratory Test Instruments see Section G Page G-114 to 124

for
PRECISION

FREED TRANSFORMERS

for
QUALITY

FREED SUB-MINIATURE TOROIDAL INDUCTORS

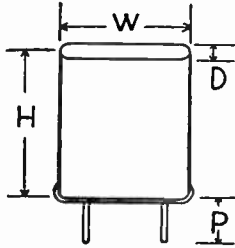

CASE DST-1

H.: $\frac{3}{8}$ "
W.: $\frac{1}{8}$ "
D.: $\frac{3}{8}$ "
P.: $\frac{1}{4}$ "

Pins fit $\frac{1}{2}$ "
crystal socket

Actual Size
Uncased



Outside Diameter $\frac{5}{8}$ "

Four types covering frequency ranges from 500 cycles to 200 Kc. Supplied uncased or in DST-1 cases.

TYPE TI-16		TYPE TI-17		TYPE TI-18		TYPE TI-19	
Frequency Range up to 15 KC Maximum Inductance 2 HY Non-stabilized		Frequency Range up to 60 KC Maximum Inductance 100 MHY Non-stabilized		Frequency Range up to 75 KC Maximum Inductance 100 MHY Non-stabilized		Frequency Range up to 200 KC Maximum Inductance 5 MHY Non-stabilized	
Catalog No. Uncased	Inductance Value	Catalog No. Uncased	Inductance Value	Catalog No. Uncased	Inductance Value	Catalog No. Uncased	Inductance Value
F-2050	1 MHY	F-2100	.1 MHY	F-2140	.1 MHY	F-2180	.1 MHY
F-2051	3 MHY	F-2101	.2 MHY	F-2141	.2 MHY	F-2181	.2 MHY
F-2052	5 MHY	F-2102	.3 MHY	F-2142	.3 MHY	F-2182	.3 MHY
F-2053	10 MHY	F-2103	.4 MHY	F-2143	.4 MHY	F-2183	.4 MHY
F-2054	15 MHY	F-2104	.5 MHY	F-2144	.5 MHY	F-2184	.5 MHY
F-2055	20 MHY	F-2105	1 MHY	F-2145	1 MHY	F-2185	.6 MHY
F-2056	50 MHY	F-2106	2 MHY	F-2146	2 MHY	F-2186	.7 MHY
F-2057	75 MHY	F-2107	3 MHY	F-2147	3 MHY	F-2187	.8 MHY
F-2058	100 MHY	F-2108	4 MHY	F-2148	4 MHY	F-2188	.9 MHY
F-2059	150 MHY	F-2109	5 MHY	F-2149	5 MHY	F-2189	1 MHY
F-2060	200 MHY	F-2110	7.5 MHY	F-2150	7.5 MHY	F-2190	2 MHY
F-2061	300 MHY	F-2111	10 MHY	F-2151	10 MHY	F-2191	3 MHY
F-2062	400 MHY	F-2112	15 MHY	F-2152	15 MHY	F-2192	4 MHY
F-2063	500 MHY	F-2113	20 MHY	F-2153	20 MHY	F-2193	5 MHY
F-2064	750 MHY	F-2114	30 MHY	F-2154	30 MHY		
F-2065	1.00 HY	F-2115	50 MHY	F-2155	50 MHY		
F-2066	1.25 HY	F-2116	75 MHY	F-2156	75 MHY		
F-2067	1.50 HY	F-2117	100 MHY	F-2157	100 MHY		
F-2068	1.75 HY						
F-2069	2.00 HY						

FREED MINIATURE TRANSISTOR TRANSFORMERS

These high quality miniature transformers are high efficiency audio transformers featuring hermetic sealing for maximum protection against electrolysis and corrosion of fine wires caused by moisture penetration. The units are constructed in accordance with MIL-T-27 Specifications.

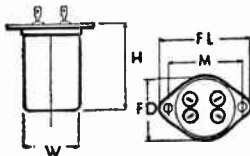

DM-15 CASE DIMENSIONS

FL: 1.375"
FD: 0.975"
W: 0.937"
H: 1.5"
M: 1.125"
Screws: 4-40
Cutout: 0.875"

Cat. No.	Impedance in Ohms Pri.	Ohms Sec.	Max. Power Level VU	Frequency Response Cps	Case No.
TMA- 1	500	500	+17	±1 db 200-15000	DM-15
TMA- 2	50K	500	+17	±2 db 300-15000	DM-15
TMA- 3	50000	6	+17	±2 db 300-15000	DM-15
TMA- 4	100K	1200 CT	+17	±3 db 300-15000	DM-15
TMA- 5	25K	1200 CT	+17	±2 db 200-15000	DM-15
TMA- 6	50K	1200 CT	+17	±2 db 200-15000	DM-15
TMA- 7	600/150	1200 CT	+17	±1 db 200-15000	DM-15
TMA- 8	25K	600	+17	±1 db 200-15000	DM-15
TMA- 9	4000 CT	600/150	+17	±1 db 200-15000	DM-15
TMA-10	2000	3.2	+17	±1 db 200-15000	DM-15
TMA-11	4000 CT	3.2	+17	±1 db 200-15000	DM-15

For Freed Precision Laboratory Test Instruments see Section G Page G-114 to 124

for
PRECISION

FREED TRANSFORMERS

for
QUALITY

NEW FREED CIRCUIT REVISES WILLIAMSON HI-FIDELITY AMPLIFIER FOR IMPROVED PERFORMANCE

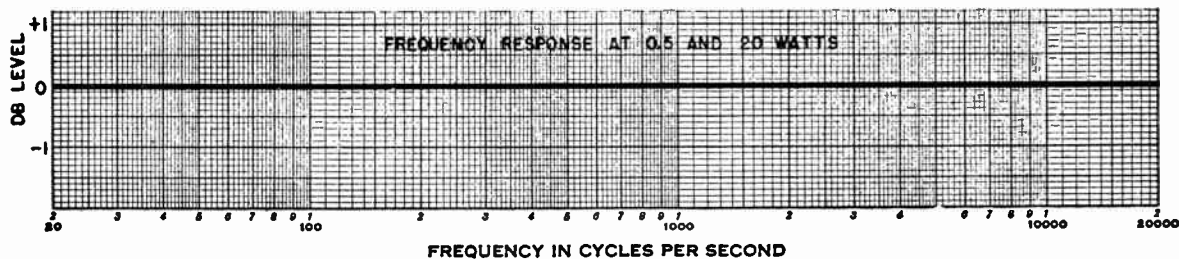

Freed ultra high fidelity amplifier with exceptional audio quality is now possible thru the use of specially designed high fidelity low cost Freed transformers and reactors; high fidelity output transformer KA-10, power transformer KP-10 and filter reactors KC-10 and KC-11.

Ask your Freed distributor or write for bulletin No. 5402. This bulletin contains detailed construction and performance characteristics of this unique amplifier.

FREED FILTERS

Freed Standard Filters are Hermetically Sealed miniature high performance components designed for both production and laboratory apparatus in the Communications and Electronic industry. In order to achieve attenuation requirements not obtainable with one single filter, one can combine several standard filters of different transmission characteristics.

Wide Band Pass characteristics are obtainable by combining low and high Pass Units. The astatic construction of inductive components together with special shielding reduces the hum pick-up of the standard filters. The standard filters are available in Low Pass, High Pass and Band Pass Filters.

LOW PASS FILTERS: The attenuation characteristics of Low Pass Filters are 6 db at cut-off frequency, 35 db at 1.5 cut-off frequency and 40 db at 2 cut-off frequency.

ILP—Interstage Low Pass Filter. Characteristic impedance 10,000 ohms.

LLP—Line Low Pass Filter. Characteristic Impedance 10,000 ohms.

HIGH PASS FILTERS: The attenuation characteristics of High Pass Filters are 6 db at cut-off frequency, 35 db and 40 db at 0.67 and 0.5 cut-off frequency.

IHP—Interstage High Pass Filter. Characteristic Impedance 10,000 ohms.

LHP—Line High Pass Filter. Characteristic Impedance 500-600 ohms.

BAND PASS FILTERS: The attenuation characteristics of Band Pass Filters are 2 db at plus or minus 3% of center frequency, 40 db at 0.5 and 2 center frequency. Special filters in all six types are available for any frequency from 300 to 20,000 cycles.

IBP—Interstage Band Pass Filter. Nominal input impedance —10,000 ohms. Nominal output impedance 5 megohms or grid of vacuum tube. Effective voltage step-up 2:1.

LBP—Line Band Pass Filter. Nominal input impedance 500-600 ohms. Nominal output impedance 5 megohms or grid of vacuum tube. Effective voltage gain 9:1.

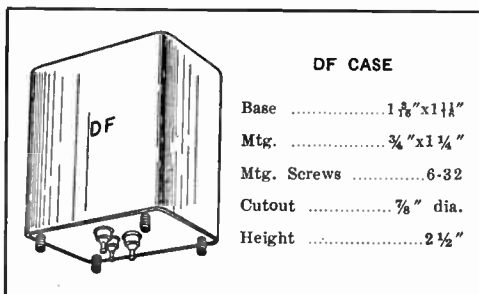

STOCK FILTERS

Frequency is indicated by numbers following filter designation:

ILP	1500	LLP	1500
ILP	2000	LLP	2000
ILP	2500	LLP	2500
ILP	3000	LLP	3000
IHP	300	LHP	300
IHP	400	LHP	400
IHP	1000	LHP	1000
IBP	400	LBP	400
IBP	1000	LBP	1000
IBP	3000	LBP	3000
IBP	10,000	LBP	10,000

For Freed Precision Laboratory Test Instruments see Section G Page G-114 to 124

for
PRECISION

FREED TRANSFORMERS

for
QUALITY

FREED MAGNETIC AMPLIFIERS

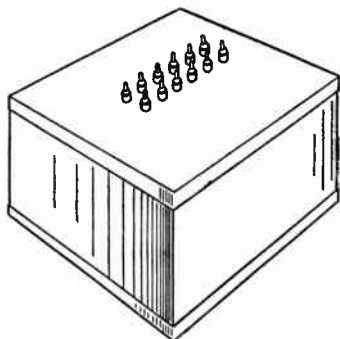

MAGNETIC AMPLIFIERS — SATURABLE TRANSFORMERS — SATURABLE REACTORS — FAST-RESPONSE MAGNETIC AMPLIFIERS — HIGH-TEMPERATURE MAGNETIC AMPLIFIERS — DRIFT-FREE MAGNETIC AMPLIFIERS

Freed Magnetic Amplifiers, Saturable Transformers and Reactors are designed for efficient operation and long life. They can be used in most applications that require reliable power amplifiers. The types of amplifiers listed below are designed to control AC servomotors.

Development facilities are available for the design of magnetic amplifiers to meet specific requirements. All standard units are hermetically sealed and meet MIL-T-27 Specifications.

SATURABLE TRANSFORMERS

Controlled with dual triode; plate supply can be either DC or AC; no rectifiers; AC or DC control signals.

PUSH-PULL MAGNETIC AMPLIFIERS

AC or DC control signals; high gain; may be used with magnetic or vacuum tube preamplifiers if needed.

FAST-RESPONSE MAGNETIC AMPLIFIERS

High gain; half-cycle per stage response time; AC or DC control signals; RC feedback networks for control system stabilization can be used directly; preamplifier not needed.

HIGH TEMPERATURE MAGNETIC AMPLIFIERS

Designed to operate in ambient temperatures as high as 200°C.; AC or DC control signals.

DRIFT-FREE MAGNETIC AMPLIFIERS

For rigid drift-free requirements of control systems; designed to meet specific requirements.

SATURABLE TRANSFORMERS

Single Phase Supply Voltage and Frequency	Full Power Output	Max. Voltage Output	Signal Req. for full output	Max. Power Gain	Typical Motor Load		FREED Catalog Number	
					Mfr. and Type No.	No Load Speed		
115V., 60 cps.	15 watts	115V. AC phase reversible	20 m.a. DC	30	Diehl FPE25-11	5.5 in.-oz.	3500 RPM	MAS-1
115V., 400 cps.	5 watts	115V. AC phase reversible	12 m.a. DC	25	Kearfott R110-2	1.5 in.-oz.	5300 RPM	MAS-2
115V., 400 cps.	10 watts	115V. AC phase reversible	12 m.a. DC	25	Kearfott R111-2	2.4 in.-oz.	5300 RPM	MAS-3
115V., 400 cps.	18 watts	115V. AC phase reversible	14 m.a. DC	57	Kearfott R112-2	2.8 in.-oz.	9800 RPM	MAS-4
115V., 400 cps.	2.7 watts	26V. AC phase reversible	10 m.a. DC	9	Kearfott R118	.32 in.-oz.	7200 RPM	MAS-5

PUSH-PULL MAGNETIC AMPLIFIERS

115V., 60 cps.	5 watts	115V. AC phase reversible	1.2 m.a. DC	5x10 ⁴	Kollsman 951-0160	0.57 in.-oz.	3450 RPM	MAP-1
115V., 60 cps.	15 watts	115V. AC phase reversible	1.6 m.a. DC	3.5x10 ⁴	Diehl FPE25-11	5.5 in.-oz.	3500 RPM	MAP-2
115V., 60 cps.	50 watts	115V. AC phase reversible	2 m.a. DC	2.5x10 ⁴	Diehl FPF49-9	20 in.-oz.	3500 RPM	MAP-3
115V., 60 cps.	175 watts	115V. AC phase reversible	2 m.a. DC	3x10 ⁵	Diehl FPF85-18-1	95 in.-oz.	3500 RPM	MAP-4
115V., 60 cps.	650 watts	115V. AC phase reversible	1.5 m.a. DC	1x10 ⁶	Diehl ZP105-2212-1	190 in.-oz.	3500 RPM	MAP-5
115V., 60 cps.	2000 watts	115V. AC phase reversible	50 m.a. DC	200	Diehl ZP43-2247-1	570 in.-oz.	3500 RPM	MAP-6
115V., 400 cps.	15 watts	115V. AC phase reversible	.55 m.a. DC	3.9x10 ⁵	Kearfott R112-2	2.8 in.-oz.	9800 RPM	MAP-7
115V., 400 cps.	50 watts	115V. AC phase reversible	1.75 m.a. DC	1x10 ⁴	Bendix CK-3000	14 in.-oz.	3700 RPM	MAP-8
115V., 400 cps.	140 watts	115V. AC phase reversible	3 m.a. DC	1x10 ⁵	Kearfott XW-14459	23 in.-oz.	10,500 RPM	MAP-9

FAST-RESPONSE MAGNETIC AMPLIFIERS

(Time of response: 2 cycles of power frequency for 100% response)

115V., 60 cps.	15 watts	115V. AC (Eff.) phase reversible	1V. AC or DC (10,000 ohms input impedance)	1.5x10 ⁵	Diehl FPE25-11	5.5 in.-oz.	3500 RPM	MAF-1
115V., 400 cps.	5 watts	57.5V. AC (Eff.) phase reversible	.1V. AC or DC (10,000 ohms input impedance)	5x10 ⁶	Kearfott R110-2	1.5 in.-oz.	5300 RPM	MAF-2
115V., 400 cps.	10 watts	57.5V. AC (Eff.) phase reversible	.1V. AC or DC (10,000 ohms input impedance)	1x10 ⁷	Kearfott R111-2	2.4 in.-oz.	5300 RPM	MAF-3
115V., 400 cps.	50 watts	115V. AC (Eff.) phase reversible	.1V. AC or DC (10,000 ohms input impedance)	5x10 ⁷	Bendix CK-3000	14 in.-oz.	3700 RPM	MAF-4

HIGH TEMPERATURE MAGNETIC AMPLIFIERS

115V., 60 cps.	15 watts	115V. AC phase reversible	1.6 m.a. DC	3.5x10 ⁴	Diehl FPE25-11	5.5 in.-oz.	3500 RPM	MAH-1
115V., 400 cps.	2.7 watts	26V. AC phase reversible	2 m.a. DC	1x10 ⁵	Kearfott R118	.32 in.-oz.	7200 RPM	MAH-2
115V., 400 cps.	5 watts	57.5V. AC phase reversible	2 m.a. DC	4x10 ⁵	Kearfott R110-2	1.5 in.-oz.	5300 RPM	MAH-3

For Freed Precision Laboratory Test Instruments see Section G Page G-114 to 124

for
PRECISION

FREED TRANSFORMERS

for
QUALITY

QUALITY GRADE HIGH Q REACTORS

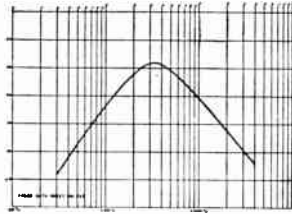
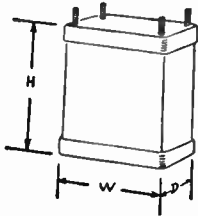

HIGH Q, LOW FREQUENCY REACTORS

Whenever there is need for a stable reactor with high Q at the lower audio frequencies, these reactors will be ideally suited. Units up to 400 henries can be supplied with inductance tolerance of $\pm 2\%$.

CASE DIMENSIONS

Case #	Mtg. Centers	Dimensions		
	W	D	H	
DC-2A	2" x 1 3/4"	2 5/8"	2 1/4"	3"
Knockout		Mtg.	Wgt.	
1 1/2" x 1 3/8"		8-32's	2 3/4"	

Catalog Number

QGC-1
QGC-2
QGC-3
QGC-4
QGC-5
QGC-6
QGC-7

Inductance In Henries

100
75
50
25
10
5
1

Case Size

DC-2AT
DC-2AT
DC-2AT
DC-2AT
DC-2AT
DC-2AT
DC-2AT

MILITARY PULSE TRANSFORMERS

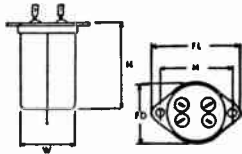

DM-12

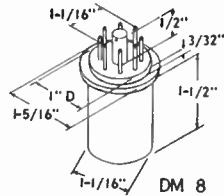

DM 8

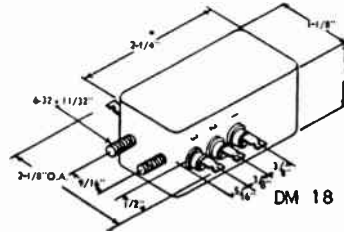

DM 18

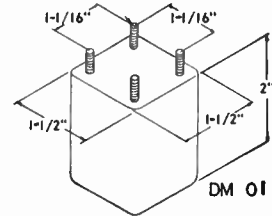

DM 01

CASE DIMENSIONS

CASE #	FL	FD	W	H	M	Screws	Cutout	Wgt.
DM-12	1 1/2	1 3/4	1 1/8	1 3/8	1 3/4	4-40	7/8	1.5 oz.
DM-8	Dimensions shown on drawing.							
DM-18	Dimensions shown on drawing.							
DM-01	Dimensions shown on drawing (knockout 1 1/4" diam.)							

HERMETICALLY SEALED PULSE TRANSFORMERS for use in blocking oscillators, low level interstage coupling, and modulator outputs. Made in accordance with MIL-T-27 specifications. These pulse transformers are designed for maximum power, efficiency and optimum pulse performance. Balanced coil structures permit series or parallel connection of windings for turn ratios other than unity. Pulse characteristics, voltages and impedance levels will depend upon interconnections made.

Catalog Number	Application	Pulse Voltage Kilovolts	Pulse Duration Microseconds	Duty Ratio	Test Voltage KV., RMS	Characteristic Impedance Ohms	Case Size
MPT-1	Blocking oscillator or interstage coupling.	0.25/0.25/0.25	0.2-1.0	.004	0.7	250	DM-12
MPT-2	Blocking oscillator or interstage coupling.	0.25/0.25	0.2-1.0	.004	0.7	250	DM-12
MPT-3	Blocking oscillator or interstage coupling.	0.5/0.5/0.5	0.2-1.5	.002	1.0	250	DM-18
MPT-4	Blocking oscillator or interstage coupling.	0.5/0.5	0.2-1.5	.002	1.0	250	DM-18
MPT-5	Blocking oscillator or interstage coupling.	0.5/0.5/0.5	0.5-2.0	.002	1.0	500	DM-12
MPT-6	Blocking oscillator or interstage coupling.	0.5/0.5	0.5-2.0	.002	1.0	500	DM-12
MPT-7	Blocking oscillator, interstage coupling or low power output.	0.7/0.7/0.7	0.5-1.5	.002	1.5	200	DM-18
MPT-8	Blocking oscillator, interstage coupling or low power output.	0.7/0.7	0.5-1.5	.002	1.5	200	DM-18
MPT-9	Blocking oscillator, interstage coupling or low power output.	1.0/1.0/1.0	0.7-3.5	.002	2.0	200	DM-18
MPT-10	Blocking oscillator, interstage coupling or low power output.	1.0/1.0	0.7-3.5	.002	2.0	200	DM-18
MPT-11	Blocking oscillator, interstage coupling or low power output.	1.0/1.0/1.0	1.0-5.0	.002	2.0	500	DM-01
MPT-12	Blocking oscillator, interstage coupling or low power output.	0.15/0.15 0.3/0.3	0.2-1.0	.004	0.7	700	DM-8

For Freed Precision Laboratory Test Instruments see Section G Page G-114 to 124

for
PRECISION

FREED TRANSFORMERS

for
QUALITY

STANDARD MILITARY AUDIO TRANSFORMERS

A group of hermetically sealed audio transformers designed in accordance with MIL-T-27 specifications. The functional characteristics of these transformers were established by the Armed Services.

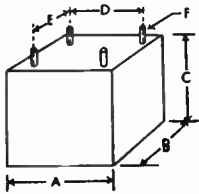

#AJ CASE DIMENSIONS

A	B	C	D	E	F
1 5/8"	1 5/8"	2 3/8"	1 1/8"	1 1/8"	6-32

Cat. No.	Application	Type Designation	Impedance Level in Ohms		Ratio	Max. Power Level V.U.	Pri. D.C. Per Side in MA	Max. D.C. Unbalance	Frequency Response	Case
			Primary	Secondary						
MGA 1	Transformer; interstage, single or P.P. plates to single or P.P. grids	TF1A15AJ0	10,000 CT	90,000 split and CT	1:3 overall	+15	10	10	±2 DB 300-10,000	AJ
MGA 2	Transformer; matching, 600 ohm line to voice coil	TF1A16AJ0	600 split	4, 8, 16	6.12:1 overall	+33	0	0	±2 DB 300-10,000	AJ
MGA 3	Transformer; input, 600 ohm line to single or P.P. grids	TF1A10AJ0	600 split	135,000 CT	1:15	+15	0	0	±2 DB 300-10,000	AJ
MGA 4	Transformer; matching, 600 ohm line to 600 ohm line	TF1A16AJ0	600 split	600 split	1:1	+15	0	0	±2 DB 300-10,000	AJ
MGA 5	Transformer; output, single plate 7600 ohm, 4800 ohm to 600 ohm line	TF1A13AJ0	7600 tap @ 4800	600 split	3.56:1	+33	40	40	±2 DB 300-10,000	AJ
MGA 6	Transformer; output, single plate 7600 ohm, 4800 ohm to voice coil	TF1A13AJ0	7600 tap @ 4800	4, 8, 16	21.8:1	+33	40	40	±2 DB 300-10,000	AJ
MGA 7	Transformer; output, single or P.P. plates to 600 ohm line	TF1A13AJ0	15,000 CT	600 split	5:1	+33	10	10	±2 DB 300-10,000	AJ
MGA 8	Transformer; output, P.P. plates to 600 ohm line	TF1A13AJ0	24,000 CT	600 split	6.32:1	+30	10	1	±2 DB 300-10,000	AJ
MGA 9	Transformer; output, P.P. plates to 600 ohm line	TF1A13AJ0	60,000 CT	600 split	10:1	+27	10	1	±2 DB 300-10,000	AJ

For Freed Precision Laboratory Test Instruments see Section G Page G-114 to 124

for
PRECISION

FREED TRANSFORMERS

for
QUALITY

PROFESSIONAL GRADE COMPONENTS MINIATURE AUDIO TRANSFORMERS

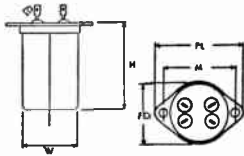

DM-12 CASE DIMENSIONS	
FL	1 1/2"
FD	1 3/8"
W	1 1/8"
H	1 3/8"
M	1 3/8"

These high quality, miniature transformers feature hermetic sealing for maximum protection from moisture penetration with subsequent electrolysis and corrosion of fine wires. While primarily intended for non-military equipment, these units are constructed in accordance with MIL-T-27 Specifications.

Catalog No.	Application	Impedance Level		Maximum Power Level V.U.*	Ratio	Equiv- alent Shield- ing D.B.	Max. Pri. D.C. per Side Ma.	D.C. Un- bal- ance Ma.	Frequency Response C.P.S.	Case Number
		Primary Ohms	Secondary							
PMA 1	Line or microphone to single or push-pull grids.	50/200/500	60,000 C.T.	+8	1:11		0	0	±2.0 DB 30-20,000	DM-12
PMA 2	Dynamic microphone or speaker voice coil to single or P.P. grid.	4/8	60,000 C.T.	+8	1:86.6		0	0	±2.0 DB 30-20,000	DM-12
PMA 3	Line or microphone to single or push-pull grids. Magnetically shielded.	50/200/500	60,000 C.T.	+8	1:11	30	0	0	±2.0 DB 30-20,000	DM-12
PMA 4	Single triode plate to single or push-pull grids.	15,000	60,000 C.T.	+8	1:2		0	0	±2 DB 30-10,000	DM-12
PMA 5	Single triode plate to push-pull grids.	15,000	60,000 C.T.	+8	1:2		2	2	±2 DB 200-10,000	DM-12
PMA 6	Single triode plate to multiple line.	15,000	50/200/500	+8	5.48:1		0	0	±2 DB 30-20,000	DM-12
PMA 7	Single triode plate to multiple line.	15,000	50/200/500	+8	5.48:1		2	2	±1 DB 200-10,000	DM-12
PMA 8	Push-pull triode plates to multiple line.	30,000 C.T.	50/200/500	+8	7.75:1		2	0.25	±2 DB 30-20,000	DM-12
PMA 9	Crystal mike or pickup to multiple line.	60,000	50/200/500	+8	11:1		0	0	±2 DB 30-20,000	DM-12
PMA 10	Mixing or matching.	50/200	50/200/500	+8	1:1.50		0	0	±2 DB 30-20,000	DM-12
PMA 11	Parallel Feed Reactor.	40 hy, 3 ma dc, 3500 ohms d.c. resistance								DM-12

*1 mw. reference level.

PROFESSIONAL GRADE AUDIO TRANSFORMERS

For popular priced high fidelity amplifiers, professional equipment and receivers, for home and public address service. Freed has developed this series of audio transformers using the latest design techniques and the best commercially available materials. Except for units carrying unbalanced direct current, the frequency response is better than ±1 DB from 30 to 15,000 cycles. All units feature excellent performance characteristics with minimum size and weight.

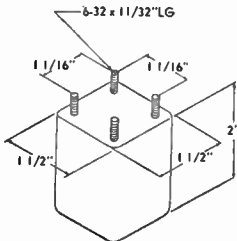

INPUT TRANSFORMERS

Mtg. Centers	DM-01 CASE DIMENSIONS			Knockout	Mtg. Studs	Wgt.	U-500 IMPEDANCES IN OHMS	
	W	H	W				H	
1 1/8" x 1 1/8"	1 1/2"	1 1/2"	2"	1 3/8" diam.	6-32	1/2	50, 125, 200CT, 250, 380, 500 CT.	125 and 500 ohms can be used for 150 and 60 ohms.

Catalog No.	Application	Impedance Level		Maximum Power Level V.U.*	Ratio	Equiv- alent Shield- ing D.B.	Max. Pri. D.C. per Side Ma.	D.C. Un- bal- ance Ma.	Frequency Response C.P.S.	Case Number
		Primary Ohms	Secondary							
PGA 1	Universal 500 ohm line to single grid.	U-500	50,000	+12	1:10	50	0	0	±1.0 DB 30-15,000	DM-01T
PGA 2	Universal 500 ohm line to push-pull grids.	U-500	60,000 split	+12	1:11	50	0	0	±1.0 DB 30-15,000	DM-01T
PGA 3	Universal 500 ohm line to push-pull grids.	U-500	100,000 split	+12	1:14.1	50	0	0	±1.0 DB 30-15,000	DM-01T
PGA 4	Bridging line to single grid.	10,000	60,000	+12	1:2.45	50	0	0	±1.0 DB 30-15,000	DM-01T
PGA 5	Bridging line to push-pull grids.	10,000	60,000 split	+12	1:2.45	50	0	0	±1.0 DB 30-15,000	DM-01T
PGA 6	Low level line matching.	U-500	U-500	+18	1:1	50	0	0	±1 DB	DM-01T

*1 mw. reference level.

For Freed Precision Laboratory Test Instruments see Section G Page G-114 to 124

for
PRECISION

FREED TRANSFORMERS

for
QUALITY

PROFESSIONAL GRADE COMPONENTS LOW LEVEL OUTPUT AND MIXING TRANSFORMERS

Cat. No.	Application	Impedance Level Ohms		Maximum Power Level V.U.* or Power in Watts	V.U.* Ratio	Max. Pri. D.C. Per Side Ma.	D.C. Unbalance Ma.	Frequency Response C.P.S.	Case Number
		Primary	Secondary						
PGA 7	Single triode plate to Universal 500 ohm line. Shunt feed.	15,000	U500	+18	5.48:1	0	0	±1.0 DB 30-15,000	DM-01T
PGA 8	Single triode plate to Universal 500 ohm line.	15,000	U500	+18	5.48:1	8	8	±1.0 DB 100-15,000	DM-01T
PGA 9	Push-pull triode plate to Universal 500 ohm line.	20,000 CT	U500	+30	6.32:1	8	0.5	±1.0 DB 30-15,000	DM-01T
PGA 10	Low level line matching.	U500	U500	+18	1:1	0	0	±1.0 DB 30-15,000	DM-01T

*1 mw. reference level.

U-500 IMPEDANCES IN OHMS 50, 125, 200 CT, 250, 330, 500 CT — 125 and 500 ohms can be used for 150 and 600 ohms

DRIVER TRANSFORMERS

Cat. No.	Application	Primary Impedance Ohms	Turn Ratio Pri: 1/2 Sec.	Max. Level V.U.*	Max. Pri. D.C. Per Side Ma.	D.C. Unbalance Ma.	Frequency Response C.P.S.	Case Number
PGA 12	Push-pull 6C4, 6SN7 triodes to push-pull 2A3, 6L6 grids.	20,000 C.T.	3.0:1	+30	10	0	±1.0 DB 30-15,000	DC-1AL
PGA 13	Push-pull 2A3, 6B4, 6A5G to push-pull 809, TZ-40, 4/125A	5,000 C.T.	3.2:1	+40	50	5	±1.0 DB 30-15,000	DC-2AL

U-500 IMPEDANCES IN OHMS 50, 125, 200 CT, 250, 330, 500 CT — 125 and 500 ohms can be used for 150 and 600 ohms

HIGH LEVEL OUTPUT TRANSFORMERS

CASE DIMENSIONS

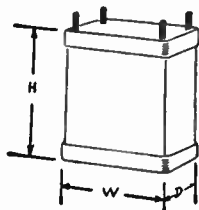

Case #	Mtg. Cent.	Dimensions					Mtg. Studs	Wgt.
		W	D	H	Knockout			
DC2AL	2 x 1 3/4	2 5/8	2 3/4	3	1 1/2 x 1 3/8	8-32	2 3/4	
DC2BL	2 x 1 3/4	2 5/8	2 3/4	3 1/2	1 1/2 x 1 3/8	8-32	3	
DC4AL	2 1/2 x 2 1/2	3 1/8	3	3 3/4	2 x 1 3/4	8-32	4 1/2	
DC5AL	3 1/2 x 2 5/8	4 1/8	3 1/2	3 3/4	2 1/2 x 2	10-32	9	
DC6AL	3 3/4 x 3	5	4 1/8	4 3/4	3 x 2 1/2	10-32	15	

L after case number indicates Leads.
T after case number indicates Terminals.

U-16 IMPEDANCES IN OHMS
2, 4, 8, 12, 16

U-500 IMPEDANCES IN OHMS
50, 125, 200CT, 250, 330, 500CT.
125 and 500 ohms can be used for 150 and 600 ohms.

A 70 volts level can be obtained for the following impedances:

500 ohms — 10 watts + 40 VU
330 ohms — 15 watts + 42 VU
250 ohms — 20 watts + 43 VU
200 ohms — 25 watts + 44 VU
125 ohms — 40 watts + 46 VU
50 ohms — 100 watts + 50 VU

Cat. No.	Application	Impedance Level Ohms		Maximum Power Level V.U.* or Power in Watts	V.U.* Ratio	Max. Pri. D.C. Per Side Ma.	D.C. Unbalance Ma.	Frequency Response C.P.S.	Case Number
		Primary	Secondary						
PGA 14	P.P. 6K6, 6AR5, 7B5 Class A to Universal voice coil.	12,000 C.T.	U16	+40 (10 watts)	27.4:1	40	4	±1.0 DB 30-15,000	DC-2BL
PGA 15	P.P. 6F6 Cl. AB ₂ , P.P. 6V6, 6AQ5, 7C5, 6L6 Cl. AB ₁ to Universal voice coil.	10,000 C.T.	U16	+43 (20 watts)	25:1	50	5	±1.0 DB 30-15,000	DC-4AL
PGA 16	P.P. 6L6 Cl. AB ₁ , self bias to Universal 500 ohm line.	9,000	U500	+44.8	4.23:1	50	5	±1.0 DB 30-15,000	DC-4AL
PGA 17	As above to Universal voice coil.	9,000	U16	+44.8	23.7:1	50	5	±1.0 DB 30-15,000	DC-4AL
PGA 18	P.P. 6N7 Cl. B, P.P. 6V6, 6AQ5, 7C5 Cl. AB ₁ to Universal voice coil.	8,000 C.T.	U16	+41.8 (15 watts)	22.3:1	45	5	±1.0 DB 30-15,000	DC-4AL
PGA 19	P.P. 6L6, fixed bias, Cl. AB ₁ to Universal 500 ohm line.	6,600 C.T.	U500	+44.8 (30 watts)	3.63:1	70	7	±1.0 DB 30-15,000	DC-4AL

*1 mw. reference level.

For Freed Precision Laboratory Test Instruments see Section G Page G-114 to 124

for
PRECISION

FREED TRANSFORMERS

for
QUALITY

PROFESSIONAL GRADE COMPONENTS HIGH LEVEL OUTPUT TRANSFORMERS

Continued from previous page — See same for case sizes

Cat. No.	Application	Impedance Level Ohms		Maximum Power Level V.U.* or Power in Watts Maximum	Ratio	Max. Pri. D.C. Per Side Ma.	D.C. Unbalance Ma.	Frequency Response C.P.S.	Case Number
		Primary	Secondary						
PGA 20	As above to Universal voice coil.	6600	U16	+44.8	20.3:1	70	7	±1.0 DB 30-15,000	DC-4AL
PGA 21	P.P. 6L6 Cl. A, P.P. 2A3, 6A5G, 6B4 self bias Par. 6V6 Cl. AB ₁ to Universal voice coil.	5000 C.T.	U16	+43	17.7:1	80	8	±1.0 DB 30-15,000	DC-4AL
PGA 22	P.P. Par 6L6 Cl. AB ₁ self bias P.P. 6L6 Cl. AB ₂ fixed bias PP807 Cl. AB ₂ to Universal 500 ohm line.	4000 C.T.	U500	+47 (50 watts)	2.83:1	100	10	±1.0 DB 30-15,000	DC-5AL
PGA 23	As above to Universal voice coil.	4000 C.T.	U16	+47	15.8:1	100	10	±1.0 DB 30-15,000	DC-5AL
PGA 24	P.P. 6A5G, 6B4, 2A3, fixed bias Universal voice coil.	3000 C.T.	U16	+41.8	13.7:1	75	7.5	±1.0 DB 30-15,000	DC-4AL
PGA 25	P.P. Par. 807 Cl. AB ₂ to Universal 500 ohm line.	2100 C.T.	U500	+51.8 (150 watts)	2.05:1	240	12	±1.0 DB 30-15,000	DC-6A
PGA 26	P.P. Par 2A3, 6A5G, fixed bias 6B4, 800A Cl. AB ₁ , P.P. Par 6L6 Cl. A to Universal 500 ohm line.	1500 C.T.	U500	+44.8	1.73:1	150	15	±1.0 DB 30-15,000	DC-4AL
PGA 27	As above to Universal voice coil.	1500 C.T.	U16	+44.8	9.7:1	150	15	±1.0 DB 30-15,000	DC-4AL
PGA 28	Matching line to Universal voice coil.	U500	U16	+44.8	5.6:1	0	0	±1.0 DB 30-15,000	DC-4AT
PGA 29	Matching line to Universal voice coil.	U500	U16	+47	5.6:1	0	0	±1.0 DB 30-15,000	DC-5AT
PGA 30	Matching line to Universal voice coil.	U500	U16	+50 (100 watts)	5.6:1	0	0	±1.0 DB 30-15,000	DC-6AT

*1 mw. reference level.

U-16 IMPEDANCES IN OHMS

2 ohms, 4 ohms, 8 ohms, 12 ohms, 16 ohms

U-500 IMPEDANCES IN OHMS

50, 125, 200 CT, 250, 330 500 CT

125 and 500 ohms can be used for 150 and 600 ohms

A 70 volts level can be obtained for the following impedances:

500 ohms	—	10 watts	+ 40 VU
330 ohms	—	15 watts	+ 42 VU
250 ohms	—	20 watts	+ 43 VU
200 ohms	—	25 watts	+ 44 VU
125 ohms	—	40 watts	+ 46 VU
50 ohms	—	120 watts	+ 51 VU

HIGH Q REACTORS

High Q Reactors for use in resonant wave traps and dynamic noise suppression circuits.

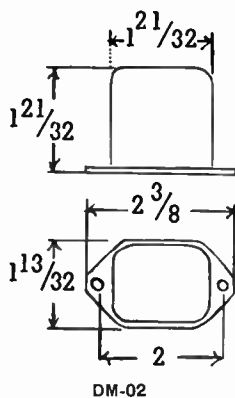

Cat. No.	Application	Rated Ind. in Henries	Q	Tuning Capacitor (Mf)	Case Size
PQC 1	60 cps resonant trap	14.00	10	.5	DM-02
PQC 2	400 cps resonant trap	1.58	15	.1	DM-02
PQC 3	1000 cps resonant trap	1.00	20	.025	DM-02
PQC 4	Dynamic noise suppression inductor	2.40	20 @ 4 KC		DM-02
PQC 5	Dynamic noise suppression inductor	2.00	20 @ 4 KC		DM-02
PQC 6	Dynamic noise suppression inductor	1.30	20 @ 4 KC		DM-02
PQC 7	Dynamic noise suppression inductor	.80	20 @ 4 KC		DM-02
PQC 8	Dynamic noise suppression inductor	.60	20 @ 4 KC		DM-02
PQC 9	Dynamic noise suppression inductor	.40	20 @ 4 KC		DM-02

For Freed Precision Laboratory Test Instruments see Section G Page G-114 to 124

for
PRECISION

FREED TRANSFORMERS

for
QUALITY

REACTORS—PROFESSIONAL GRADE COMPONENTS

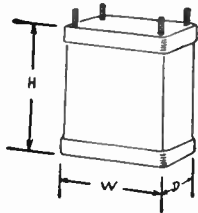

CASE DIMENSIONS

Case #	Mtg. Cent.	Dimensions			Mtg. Studs	Wgt.
		W	D	H		
DM-01	1 1/8 x 1 1/8	1 1/2	1 1/2	2	6-32	1/2
DC1A	1 1/2 x 1 1/4	2 1/8	1 1/8	2 1/2	8-32	1
DC2A	2 x 1 3/4	2 5/8	2 1/4	3	8-32	2 3/4
DC2B	2 x 1 3/4	2 5/8	2 1/4	3 1/2	8-32	3
DC4A	2 1/2 x 2 1/2	3 3/8	3	3 3/4	8-32	4 1/2
DC5B	3 1/8 x 2 5/8	4 1/8	3 1/2	4 1/2	10-32	10

Inductance measured at 50V, 60 cycles with rated direct current in the winding.

T following case number indicates Terminals.

L following case number indicates Leads.

Cat. No.	Inductance in Hy.	Rated Current D.C. Ma.	D.C. Resistance	Dielectric Test Voltage	Case Number
PGC 1	40	15	2000	1000	DM-01
PGC 2	12	40	400	1000	DC-1AL
PGC 3	8	50	300	1000	DC-1AL
PGC 4	20	50	425	2500	DC-2AL
PGC 5	10	70	250	2500	DC-2AL
PGC 6	6	100	160	2500	DC-2AL
PGC 7	6	150	115	2500	DC-2BL
PGC 8	10	150	160	2500	DC-4AL
PGC 9	5.5	200	95	2500	DC-4AL
PGC 10	10	200	150	2500	DC-4AL
PGC 11	10	250	135	2500	DC-5BL
PGC 12	8	300	95	2500	DC-5BL
PGC 13	7	400	60	2500	DC-5BL
Parallel Feed Audio Chokes					
PGC 14	100	10	3500	1000	DM-01L
PGC 15	30	50	650	1500	DC-2AL
PGC 16	400	1	6000	1000	DM-01L

SWINGING INPUT REACTORS

Cat. No.	Inductance in Hy.*	Rated Current D.C. Ma.	D.C. Resistance	Dielectric Test Voltage	Case Number
PGC 17	5 - 20	150	160	1500	DC-4AL
PGC 18	5 - 20	250	135	1500	DC-5BL
PGC 19	3 - 15	300	95	1500	DC-5BL
PGC 20	3 - 15	400	60	1500	DC-5BL

See Above

* Inductance values for 100% and 10% of rated Direct Current.

PROFESSIONAL GRADE POWER TRANSFORMERS

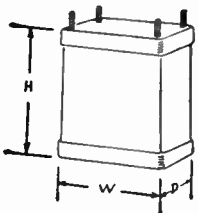

CASE DIMENSIONS

Case #	Mtg. Cent.	Dimensions			Mtg.	Wgt.
		W	D	H		
DC2B	2 x 1 3/4	2 5/8	2 1/4	3 1/2	8-32s	3
DC4A	2 1/2 x 2 1/2	3 3/8	3	3 3/4	8-32s	4 1/2
DC5A	3 1/8 x 2 5/8	4 1/8	3 1/2	3 7/8	10-32s	9
DC5B	3 1/8 x 2 5/8	4 1/8	3 1/2	4 1/2	10-32s	10
DC6A	3 3/4 x 3	5	4 1/8	4 7/8	10-32s	15
DC7B	4 3/8 x 3 3/8	5 1/2	5	6 3/4	1/4-20s	22

Fully impregnated and sealed in heavy gauge cases. Temperature rises range from 45° to 50°C.

All primaries designed for 115V/50-60 cycles. Available for 220V operation on special order.

T following case number indicates Terminals.

L following case number indicates Leads.

Cat. No.	Pri. Va	Hi Volt	Choke Input		Cond. Input		Rectifier	Fil. #1	Fil. #2	Case Number
			D.C. V.	D.C. Ma.	D.C. V.	D.C. Ma.				
PGP 1	15	440V. C.T.	Low flux density, hum-bucking. For Pre-amplifier service.	270	15	6X4	6.3 CT @ 0.6A.	6.3 @ 0.3A.	DC-2BL	
PGP 2	30	550V. C.T.	Low flux density, hum-bucking. For Pre-amplifier service.	310	35	6X4	6.3 CT @ 0.6A.	6.3 CT @ 0.9A.	DC-4AL	
PGP 3	45	500V. C.T.		270	40	6X4, 5Y3	5/6.3V @ 2A.	6.3 @ 2A.	DC-4AL	
PGP 4	57	600V. C.T.		330	50	6X4, 5Y3	5/6.3V @ 2A.	6.3 @ 2.5A.	DC-4AL	
PGP 5	64	650V. C.T.		370	50	6X4, 5Y3	5/6.3V @ 2A.	6.3 @ 3A.	DC-4AL	
PGP 6	73	600V. C.T.		320	70	6X4, 5Y3	5/6.3V @ 2A.	6.3 @ 3A.	DC-4AL	

For Freed Precision Laboratory Test Instruments see Section G Page G-114 to 124

for
PRECISION

FREED TRANSFORMERS

for
QUALITY

PROFESSIONAL GRADE POWER TRANSFORMERS

Continued from previous page — See same for case sizes

Cat. No.	Py Va	Hi Volt	Choke Input		Cond. Input		Bias Tap.	Rectifier	Fil. #1	Fil. #2	Fil. #3	Case Number
			D.C. V.	D.C. Ma.	D.C. V.	D.C. Ma.						
PGP 7	110	650V. C.T.	225	140	330	100		5Y3, 5U4	5 @ 3A.	6.3 @ 5A.		DC-5BL
PGP 8	76	700V. C.T.	260	100	385	70		5Y3	5 @ 2A.	6.3 @ 2.5A.		DC-5AL
PGP 9	108	700V. C.T.	250	125	370	90		5Y3, 5U4	5 @ 3A.	6.3 @ 5A.		DC-5BL
PGP 10	127	700V. C.T.	260	170	350	120		5U4	5 @ 3A.	6.3 @ 5A.		DC-5BL
PGP 11	146	700V. C.T.	260	210	350	150		5U4	5 @ 3A.	6.3 @ 5A.	6.3 @ 1A.	DC-6AL
PGP 12	207	800V. C.T.	295	280	400	200		5U4, 2-5Y3	5 @ 4A.	6.3 @ 6A.		DC-6AL
PGP 13	225	800V. C.T.	295	280	400	200	80	5U4, 2-5Y3	5 @ 4A.	6.3 @ 6A.	5/6.3 @ 2A.	DC-6AL
PGP 14	268	840V. C.T.	330	350	450	250	80	2-5U4	5 @ 6A.	6.3 @ 6A.	5/6.3 @ 2A.	DC-6AL
PGP 15	320	900V. C.T.	340	420	490	300	80	2-5U4	5 @ 6A.	6.3 @ 6A.	5/6.3 @ 2A.	DC-6AL
PGP 16	127	900V. C.T.	360	150				5U4	5 @ 3A.	6.3 @ 5A.		DC-6AL
PGP 17	150	900V. C.T.	350	200				5U4	5 @ 3A.	6.3 @ 5A.		DC-6AL
PGP 18	203	1100V. C.T.	400	250				5R4GY	5 @ 3A.	6.3 @ 5A.		DC-6AL
PGP 19	248	1100V. C.T.	420	300				2-5R4GY	5 @ 4A.	6.3 @ 7A.		DC-6AL
PGP 20	310	1280V. C.T.	480	350				2-5R4GY	5 @ 4A.	6.3 @ 7A.		DC-7BL

FILAMENT TRANSFORMERS

ALL PRIMARIES ARE FOR 115 V., 50/60 c.p.s.

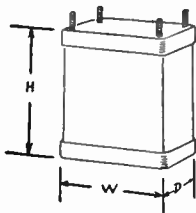

DC

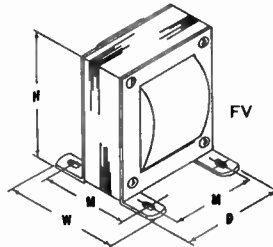

FV

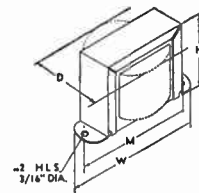

-2 H.L.S.
3/16" DIA.

CH

L after case number indicates Leads
T after case number indicates Terminals

Cat. No.	Secondary Voltage	Secondary Current Amps.	Secondary Test Voltage RMS	Case Size
TF 1	2.5 (C.T.)	7.5	1500	CH60
TF 2	2.5 (C.T.)	10	1500	CH70
TF 3	2.5 (C.T.)	5	7500	DC2BT
TF 4	2.5 (C.T.)	10	7500	DC4AT
TF 5	5.0 (C.T.)	4	1500	CH60
TF 6	5.0 (C.T.)	6	1500	CH70
TF 7	5.0 (C.T.)	10	1500	CH80
TF 8	5.0 (C.T.)	10	1500v	FV10
TF 9	5.0 (C.T.)	20	2500	FV30
TF 10	5.0 (C.T.)	20	10,000	DC6AT
TF 11	6.3 (C.T.)	1.35	1500	CH50
TF 12	6.3 (C.T.)	3	1500	CH60
TF 13	6.3 (C.T.)	5	1500	CH70
TF 14	6.3 (C.T.)	7	1500	FV12
TF 15	6.3 (C.T.)	10	1500	FV22
TF 16	10 (C.T.)	5	2500	CH80
TF 17	10 (C.T.)	5	2500	FV10
TF 18	10 (C.T.)	12		
	or	or	7500	DC5CT
	11 (C.T.)	11		
	(tapped primary)			
TF 19	12.6 (C.T.)	2	1500	CH62

CASE DIMENSIONS

Case #	Mtg. Cent.	Dimensions			Knockout	Mtg. Studs	Wgt.
		W	D	H			
DC2B2	2 x 1 3/4	2 3/8	2 1/4	3 1/2	1 1/2 x 1 3/8	8-32	3
DC4AT	2 1/2 x 2 1/2	3 1/8	3	3 3/4	2 x 1 3/8	8-32	4 1/2
DC5CT	3 1/8 x 2 3/8	4 1/8	3 1/2	4 7/8	2 1/2 x 2	10-32	12
DC6AT	3 3/4 x 3	5	4 1/8	4 7/8	3 x 2 1/2	10-32	15
FV10	2 x 2	2 1/2	2 1/2	3 1/8			2 1/2
FV12	2 x 2 1/8	2 1/2	2 3/8	3 1/8			2 3/4
FV22	2 3/8 x 2 1/4	2 3/8	2 7/8	3 7/8			4
FV30	2 1/2 x 2 1/4	3 1/8	3 3/4	3 1/8			5 1/2
CH50	2 3/8	2 3/8	1 3/4	1 1/2			3/4
CH60	2 3/8	3 3/4	2	2			1 1/2
CH62	2 3/8	3 3/4	2 1/2	2			1 3/4
CH70	3 1/8	3 1/8	2 1/4	2 1/8			2
CH80	3 7/8	4	2 5/8	2 3/8			2 3/4

For Freed Precision Laboratory Test Instruments see Section G Page G-114 to 124

for
PRECISION

FREED TRANSFORMERS

for
QUALITY

AUTO TRANSFORMERS

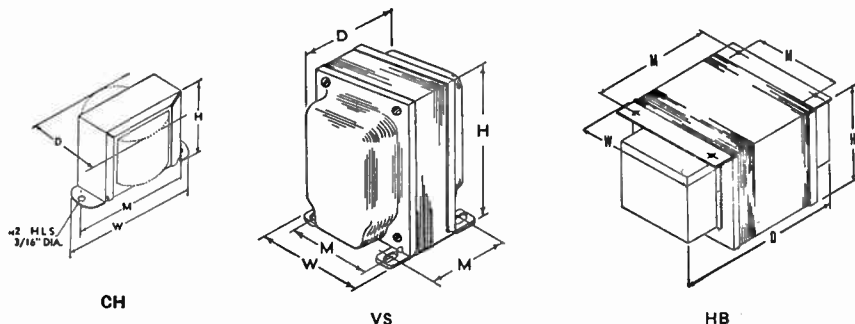

To be used as a step-down transformer. Equipped with standard receptacle and line cord.

CATALOG NUMBER	TRANSFORMATION	VA RATING	CASE SIZE
SDT 1*	230/115 V. 50/60 c.p.s.	25	CH-60
SDT 2*	230/115 V. 50/60 c.p.s.	50	CH-62
SDT 3	230/115 V. 50/60 c.p.s.	50	VS-300
SDT 4	230/115 V. 50/60 c.p.s.	100	VS-401
SDT 5	230/115 V. 50/60 c.p.s.	200	VS-501
SDT 6	230/115 V. 50/60 c.p.s.	300	VS-601
SDT 7	230/115 V. 50/60 c.p.s.	400	VS-604
SDT 8	230/115 V. 50/60 c.p.s.	500	VS-611
SDT 9	230/115 V. 50/60 c.p.s.	750	VS-706
SDT 10	230/115 V. 50/60 c.p.s.	1000	VS-718
SDT 11	230/115 V. 50/60 c.p.s.	1500	VS-728
SDT 12*	230/115 V. 50/60 c.p.s.	2000	HB-718
SDT 13*	230/115 V. 50/60 c.p.s.	2500	HB-728
SDT 14*	230/115 V. 50/60 c.p.s.	3000	HB-828
SDT 15*	230/115 V. 50/60 c.p.s.	5000	HB-920

*Supplied with leads without line cord and receptacle.

CASE DIMENSIONS

Case #	Mtg. Cent.	Dimensions			Wgt. (lbs.)
		W	D	H	
CH60	2 1/8	3 1/4	2	2	1 1/2
CH62	2 1/8	3 1/4	2 1/8	2	1 3/4
HB718	4 3/4 x 4 3/4	6 7/8	8 1/2	6 1/4	30
HB728	4 3/4 x 6	6 7/8	9 3/4	6 1/4	45
HB828	5 5/8 x 5 7/8	7 1/4	9 7/8	6 5/8	54
HB920	5 3/8 x 4 3/4	7 1/4	8 5/8	10	75
VS300	2 x 1 1/8	2 3/8	2 3/4	3 3/8	2 3/4
VS401	2 1/4 x 1 3/4	2 3/8	3	3 3/8	4 1/2
VS501	2 1/2 x 2 1/8	3 3/8	3 1/8	3 3/8	6 1/4
VS503	2 1/2 x 2 1/8	3 3/8	3 5/8	3 3/8	5 1/4
VS601	3 x 2 1/8	3 3/8	3 5/8	4 3/8	7 1/4
VS604	3 x 2 1/8	3 3/8	3 7/8	4 3/8	7 3/8
VS611	3 x 3 1/8	3 3/8	4 7/8	4 3/8	12
VS700	3 1/2 x 3 1/8	4 1/2	4 3/4	5 1/8	14
VS706	3 1/2 x 3 1/8	4 1/2	5 1/4	5 1/8	16
VS714	3 1/2 x 4 1/8	4 1/2	6 1/4	5 1/8	25
VS718	3 1/2 x 5 1/8	4 1/2	6 3/4	5 1/8	29
VS728	3 1/2 x 6 1/8	4 1/2	8	5 1/8	36

ISOLATION TRANSFORMERS

Electrostatic shield between primary and secondary. Equipped with standard receptacle and line cord.

CATALOG NUMBER	PRIMARY VOLTAGE 50/60 c.p.s.	SECONDARY VOLTAGE	VA RATING	CASE SIZE
IT 1	115	115	50	VS-401
IT 2	115	115	100	VS-508
IT 3	115	115	300	VS-700
IT 4	115	115	500	VS-714

For Freed Precision Laboratory Test Instruments see Section G Page G-114 to 124

for
PRECISION

FREED TRANSFORMERS

for
QUALITY

REPLACEMENT GRADE AUDIO TRANSFORMERS

CASE DIMENSIONS

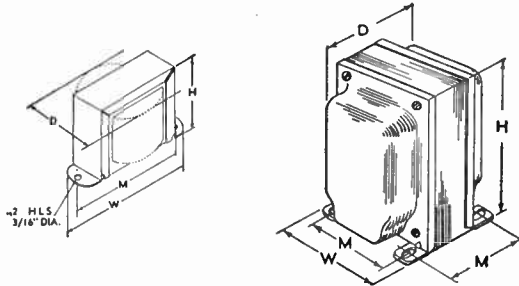

Case Number	Mtg. Centers	Dimensions			Wgt. (lbs.)
		W	D	H	
CH-40	2"	2 3/8"	1 5/8"	1 1/8"	1/2
CH-50	2 3/8"	2 1/8"	1 3/4"	1 1/8"	3/4
CH-60	2 1/8"	3 1/4"	2"	2"	1 1/2
CH-80	3 9/16"	4"	2 5/8"	2 5/8"	2 3/4
VS-100	1 1/2" x 1 7/8"	1 7/8"	2 1/4"	2 1/2"	1 1/2
VS-300	2" x 1 1/8"	2 1/8"	2 3/4"	3 3/8"	2 3/4

Catalog No.	Application	Impedance Ohms		Level Secondary	Max. Power Level V.U.* or Power in Watts	Ratio	Max. Pri. D.C. per Side Ma.	D.C. Un-balance Ma.	Freq. Response C.P.S.	Case Number
		Primary	Secondary							
RGA 1	Input; multiple line or double button mike to single or push-pull grids.	500 CT 200 CT	100.000 CT	+20	1:14.1	50	5	±2 DB 200-5000	CH-40	
RGA 2	Input; single button mike to single or push-pull grids.	100	100.000 CT	+20	1:31.6	50		±2 DB 200-5000	CH-40	
RGA 3	Input; voice coil to grid.	3.2	100.000	+20	1:17.9			±2 DB 200-5000	CH-40	
RGA 4	Mixing and matching line to line.	600 CT 500 CT 200 CT 150/125/50	600 CT 500 CT 200 CT 150/125/50	+20	1:1			±2 DB 100-5000	CH-40	
RGA 5	Interstage; single triode plate to single or P.P. grids.	10.000	90.000	+30	1:3	10		±2 DB 200-5000	CH-40	
RGA 6	Output; single plate to line or mixer.	10.000	600 CT 500 CT 200 CT 150/125/50	+30	4.8:1	10		±2 DB 200-5000	CH-40	
RGA 7	Output; Push-pull plate to line or mixer.	20.000 CT	600 CT 500 CT 200 CT 150/125/50	+30	6.32:1	10	1	±2 DB 200-5000	CH-40	
RGA 8	Output; plate to V.C. 6AL6, 6L6, 6Y6, 25B6, 25C6, 35A5, 35B5, 35C5, 50B5, 50C5, 50C6, 50L6, 117N7.	2500	3.2	5W		70		±3 DB 200-10000	CH-40	
RGA 9	Output; plate to V.C. 6V6, 6AQ5, 6AS5, 7C5.	5000	3.2	5W		50		±3 DB 200-10000	CH-40	
RGA 10	Output; plate to V.C. 6AR5, 6K6, 6V6, 7B5, 14A5, 3S4, 3U4, 3Q4, 3Q5, 3C5, 3A4.	10.000 or 7500	3.2	5W		30		±3 DB 200-10000	CH-40	
RGA 11	Output; P.P. plates to V.C. P.P. 6V6, PP6K6.	12.000 CT or 8000 CT	3.2	15W		50	5	±2 DB 200-8000	CH-60	

REPLACEMENT GRADE CHOKES

CATALOG No.	INDUCTANCE IN HENRIES	RATED CURRENT D.C. Ma.	D.C. RESISTANCE	DIELECTRIC TEST VOLTAGE	CASE No.
RGC 1	4	40	200	1000	CH-40
RGC 2	9	40	400	1000	CH-40
RGC 3	6	50	400	1000	CH-40
RGC 4	10	55	400	1500	CH-50
RGC 5	10	75	250	1500	CH-60
RGC 6	10	75	250	1500	VS-100
RGC 7	6	100	150	1500	CH-60
RGC 8	6	100	150	1500	VS-100
RGC 9	3.5	150	100	1500	CH-60
RGC 10	3.5	150	100	1500	VS-100
RGC 11	2	200	60	1500	CH-60
RGC 12	2	200	60	1500	VS-100
RGC 13	3.7	200	65	1500	CH-80
RGC 14	3.7	200	65	1500	VS-300
RGC 15	2.8	300	65	1500	CH-80
RGC 16	2.8	300	65	1500	VS-300

For Freed Precision Laboratory Test Instruments see Section G Page G-114 to 124

for
PRECISION

FREED TRANSFORMERS

for
QUALITY

REPLACEMENT GRADE POWER TRANSFORMERS

CASE DIMENSIONS

CASE #	MTG. CENTERS	DIMENSIONS			WGT. (lbs.)
		W	D	H	
VS-300	2" x 1 1/8"	2 1/8"	2 3/4"	3 3/8"	2 3/4
VS-303	2" x 1 1/8"	2 1/8"	3"	3 3/8"	3 1/2
VS-306	2" x 2 1/8"	2 1/8"	3 3/8"	3 3/8"	4 1/2
VS-307	2" x 2 7/8"	2 1/8"	3 3/4"	3 3/8"	4 3/4
VS-503	2 1/2" x 2 5/8"	3 3/8"	3 5/8"	3 1/2"	5 1/4
VS-505	2 1/2" x 2 5/8"	3 3/8"	3 7/8"	3 1/2"	6
VS-604	3" x 2 1/4"	3 1/2"	3 7/8"	4 1/8"	7 3/8
VS-605	3" x 2 1/8"	3 1/2"	4 1/8"	4 1/8"	8 3/4
VS-606	3" x 3 1/8"	3 1/2"	4 1/4"	4 1/8"	9 1/4
VS-609	3" x 3 1/8"	3 1/2"	4 5/8"	4 1/8"	11
VS-611	3" x 3 1/4"	3 1/2"	4 7/8"	4 1/8"	12
VS-612	3" x 3 1/2"	3 1/2"	5"	4 1/8"	13
VS-709	3 1/2" x 4 7/8"	4 1/2"	5 5/8"	5 1/4"	19
HS-300	2 1/2" x 2"	3"	2 1/2"	2 5/8"	2 3/4
HS-303	2 1/2" x 2"	3"	2 1/2"	2 7/8"	3 1/2
HS-306	2 1/2" x 2"	3"	2 1/2"	3 1/4"	4 1/2
HS-307	2 1/2" x 2"	3"	2 1/2"	3 3/8"	4 3/4
HS-503	3 1/8" x 2 1/8"	3 3/4"	3 1/8"	3 3/8"	5 1/4

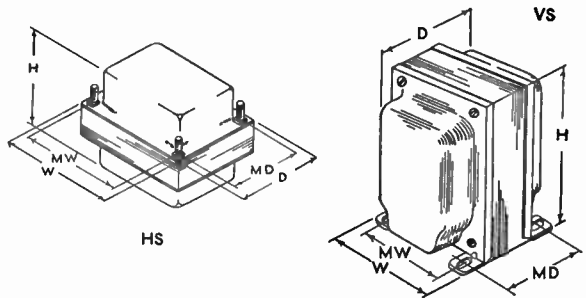

CASE DIMENSIONS

CASE #	MTG. CENTERS	DIMENSIONS			WGT. (lbs.)
		W	D	H	
HS-505	3 1/8" x 2 1/2"	3 3/4"	3 1/8"	3 5/8"	6
HS-604	3 3/4" x 3"	4 1/2"	3 3/4"	3 5/8"	7 3/8
HS-605	3 3/4" x 3"	4 1/2"	3 3/4"	3 7/8"	8 3/4
HS-606	3 3/4" x 3"	4 1/2"	3 3/4"	4"	9 1/4
HS-609	3 3/4" x 3"	4 1/2"	3 3/4"	4 3/8"	11
HS-611	3 3/4" x 3"	4 1/2"	3 3/4"	4 5/8"	12
HS-612	3 3/4" x 3"	4 1/2"	3 3/4"	4 3/4"	13
HS-709	4 3/8" x 3 1/2"	5 1/4"	4 3/8"	5 7/8"	19

All primaries designed for 115V/50-60 cycle operation. Available for 220 volt operation on special order.

Cat. No.	Py Va	Hi Volt	Choke Input		Cond. Input		Bias Tap.	Rectifier	Fil. #1	Fil. #2	Fil. #3	Case Number
			D.C. V.	D.C. Ma.	D.C. V.	D.C. Ma.						
RGP 1	45	500V. CT			270	40		6X4, 5Y3	5/6.3 @ 2A	6.3 @ 2A		VS300
RGP 2	"	"										HS300
RGP 3	57	600V. CT			330	50		6X4, 5Y3	5/6.3 @ 2A	6.3 @ 2.5A		VS303
RGP 4	"	"										HS303
RGP 5	64	650V. CT			370	50		6X4, 5Y3	5/6.3 @ 2A	6.3 @ 3A		VS306
RGP 6	"	"										HS306
RGP 7	73	600V. CT			320	70		6X4, 5Y3	5/6.3 @ 2A	6.3 @ 3A		VS307
RGP 8	"	"										HS307
RGP 9	110	650V. CT	225	140	330	100		5Y3, 5U4	5 @ 3A	6.3 @ 5A		VS503
RGP 10	"	"										HS503
RGP 11	76	700V. CT	260	100	385	70		5Y3	5 @ 2A	6.3 @ 8.5A		VS307
RGP 12	"	"										HS307
RGP 13	108	700V. CT	250	125	370	90		5Y3, 5U4	5 @ 3A	6.3 @ 5A		VS503
RGP 14	"	"										HS503
RGP 15	127	700V. CT	260	170	350	120		5U4	5 @ 3A	6.3 @ 5A		VS505
RGP 16	"	"										HS505
RGP 17	146	700V. CT	260	210	350	150		5U4	5 @ 3A	6.3 @ 5A	6.3 @ 1A	VS604
RGP 18	"	"										HS604
RGP 19	207	800V. CT	295	280	400	200		5U4, 2-5Y3	5 @ 4A	6.3 @ 6A		VS606
RGP 20	"	"										HS606
RGP 21	225	800V. CT	295	280	400	200	80V.	5U4, 2-5Y3	5 @ 4A	6.3 @ 6A	5/6.3 @ 2A	VS606
RGP 22	"	"										HS606
RGP 23	268	840V. CT	330	350	450	250	80V.	2-5U4	5 @ 6A	6.3 @ 6A	5/6.3 @ 2A	VS612
RGP 24	"	"										HS612
RGP 25	320	900V. CT	295	280	400	200	80V.	2-5U4	5 @ 6A	6.3 @ 6A	5/6.3 @ 2A	VS709
RGP 26	"	"										HS709
RGP 27	127	900V. CT	360	150				5U4	5 @ 3A	6.3 @ 5A		VS604
RGP 28	"	"										HS604
RGP 29	150	900V. CT	350	200				5U4	5 @ 3A	6.3 @ 5A		VS605
RGP 30	"	"										HS605
RGP 31	203	1100V. CT	400	250				5R4GY	5 @ 3A	6.3 @ 5A		VS611
RGP 32	"	"										HS611
RGP 33	248	1100V. CT	420	300				2-5R4GY	5 @ 4A	6.3 @ 7A		VS612
RGP 34	"	"										HS612
RGP 35	310	1280V. CT	480	350				2-5R4GY	5 @ 4A	6.3 @ 7A		VS709
RGP 36	"	"										HS709

For Freed Precision Laboratory Test Instruments see Section G Page G-114 to 124

for
PRECISION

FREED TRANSFORMERS

for
QUALITY

FREED TRANSFORMERS (CONT.)

TYPE TI-18	
Catalog No.	Net Price
F-2140	9.10
F-2141	9.10
F-2142	9.10
F-2143	9.10
F-2144	9.10
F-2145	9.10
F-2146	9.10
F-2147	9.10
F-2148	9.10
F-2149	9.10
F-2150	9.10
F-2151	9.20
F-2152	9.30
F-2153	9.50
F-2154	9.50
F-2155	9.70
F-2156	10.00
F-2157	10.20

MIL. PULSE TRANSFORMERS	
Catalog No.	Net Price
MPT-1	17.50
MPT-2	15.00
MPT-3	22.50
MPT-4	20.00
MPT-5	17.50
MPT-6	15.00
MPT-7	17.50
MPT-8	15.00
MPT-9	22.50
MPT-10	20.00
MPT-11	17.50
MPT-12	27.50

Low Level Output and Mixing Transformers	
Catalog No.	List Price†
PGA 7	16.00
PGA 8	17.00
PGA 9	16.00
PGA 10	16.00

Driver Transformers	
Catalog No.	List Price†
PGA 11	22.50
PGA 12	16.00
PGA 13	22.50

Parallel Feed Audio Chokes	
Catalog No.	List Price†
PGC 14	10.00
PGC 15	11.00
PGC 16	10.50

Swinging Input Reactors	
Catalog No.	List Price†
PGC 17	9.00
PGC 18	10.50
PGC 19	13.00
PGC 20	16.00

STEP-DOWN TRANSFORMERS	
Catalog No.	List Price†
SDT 1	3.25
SDT 2	3.75
SDT 3	7.50
SDT 4	10.20
SDT 5	11.55
SDT 6	14.70
SDT 7	18.40
SDT 8	20.05
SDT 9	26.75
SDT 10	37.60
SDT 11	55.00
SDT 12	66.00
SDT 18	77.00
SDT 14	89.35
SDT 15	105.00

Audio Transformers	
Catalog No.	List Price†
RG A 1	5.00
RG A 2	4.00
RG A 3	4.00
RG A 4	7.00
RG A 5	4.00
RG A 6	4.75
RG A 7	5.00
RG A 8	2.25
RG A 9	2.25
RG A 10	2.75
RG A 11	5.00

TYPE TI-19	
Catalog No.	Net Price
F-2180	8.30
F-2181	8.30
F-2182	8.30
F-2183	8.30
F-2184	8.30
F-2185	8.30
F-2186	8.30
F-2187	8.30
F-2188	8.30
F-2189	8.30
F-2190	8.30
F-2191	8.30
F-2192	8.30
F-2193	8.30

MILITARY AUDIO TRANSFORMERS	
Catalog No.	Net Price
MGA 1	12.50
MGA 2	12.50
MGA 3	12.50
MGA 4	12.50
MGA 5	12.50
MGA 6	12.50
MGA 7	12.50
MGA 8	12.50
MGA 9	12.50

High Level Output Transformers	
Catalog No.	List Price†
PGA 14	22.50*
PGA 15	23.75*
PGA 16	25.00*
PGA 17	25.00*
PGA 18	22.50*
PGA 19	25.00*
PGA 20	25.00*
PGA 21	23.75*
PGA 22	30.00*
PGA 23	30.00*
PGA 24	22.50*
PGA 25	50.00*
PGA 26	25.00*
PGA 27	25.00*
PGA 28	23.75*
PGA 29	27.50*
PGA 30	40.00*

Power Transformers	
Catalog No.	List Price†
PGP 1	12.50
PGP 2	18.50
PGP 3	4.00
PGP 4	9.50
PGP 5	10.00
PGP 6	11.00
PGP 7	12.50
PGP 8	11.75
PGP 9	12.50
PGP 10	14.00
PGP 11	19.00
PGP 12	22.50
PGP 13	25.00
PGP 14	30.00
PGP 15	35.00
PGP 16	16.00
PGP 17	18.50
PGP 18	25.00
PGP 19	30.00
PGP 20	37.50

ISOLATION TRANSFORMERS	
Catalog No.	List Price†
IT 1	10.00
IT 2	14.30
IT 3	36.10
IT 4	44.00

Power Transformers	
Catalog No.	List Price†
RGP 1	7.50
RGP 2	7.50
RGP 3	7.50
RGP 4	7.50
RGP 5	8.00
RGP 6	8.00
RGP 7	9.00
RGP 8	9.00
RGP 9	10.00
RGP 10	10.00
RGP 11	9.00
RGP 12	9.00
RGP 13	10.00
RGP 14	10.00
RGP 15	11.00
RGP 16	11.00
RGP 17	13.50
RGP 18	13.50
RGP 19	13.70
RGP 20	13.70
RGP 21	18.50
RGP 22	18.50
RGP 23	25.00
RGP 24	25.00
RGP 25	30.00
RGP 26	30.00
RGP 27	11.00
RGP 28	11.00
RGP 29	13.50
RGP 30	13.50
RGP 31	20.00
RGP 32	20.00
RGP 33	25.00
RGP 34	25.00
RGP 35	32.50
RGP 36	32.50

TRANSISTORS TRANSFORMERS	
Catalog No.	List Price
TMA 1	12.50
TMA 2	16.00
TMA 3	13.00
TMA 4	16.50
TMA 5	16.50
TMA 6	16.50
TMA 7	13.50
TMA 8	16.00
TMA 9	13.00
TMA 10	12.50
TMA 11	13.00

PROFESSIONAL GRADE COMPONENTS	
Miniature Audio Transformers	
Catalog No.	List Price†
PMA 1	16.50
PMA 2	13.50
PMA 3	19.00
PMA 4	13.50
PMA 5	13.50
PMA 6	16.50
PMA 7	16.50
PMA 8	16.50
PMA 9	16.50
PMA 10	15.50
PMA 11	12.00

High Q Reactors	
Catalog No.	List Price†
PQC 1	10.00
PQC 2	10.00
PQC 3	10.00
PQC 4	10.00
PQC 5	10.00
PQC 6	10.00
PQC 7	10.00
PQC 8	10.00
PQC 9	10.00

FILAMENT TRANSFORMERS	
Catalog No.	List Price†
TF 1	4.00
TF 2	4.50
TF 3	15.00
TF 4	18.50
TF 5	4.00
TF 6	5.50
TF 7	6.00
TF 8	6.40
TF 9	10.40
TF 10	24.00
TF 11	2.70
TF 12	4.00
TF 13	5.50
TF 14	6.60
TF 15	6.95
TF 16	6.00
TF 17	6.40
TF 18	24.00
TF 19	4.50

REPLACE-MENT GRADE COMPONENTS Chokes	
Catalog No.	List Price†
RGC 1	2.00
RGC 2	2.00
RGC 3	2.00
RGC 4	2.20
RGC 5	2.75
RGC 6	4.00
RGC 7	2.75
RGC 8	4.00
RGC 9	2.75
RGC 10	4.00
RGC 11	2.75
RGC 12	4.00
RGC 13	4.25
RGC 14	5.50
RGC 15	4.25
RGC 16	5.50

FREED FILTERS
Prices all filters: \$25.00 each net
Prices special filters: 800-20,000 cps. \$35.00 each net

HIGH Q REACTORS	
Catalog No.	Net Price
QGC 1	20.00 ea.
QGC 2	20.00 ea.
QGC 3	20.00 ea.
QGC 4	20.00 ea.
QGC 5	20.00 ea.
QGC 6	20.00 ea.
QGC 7	20.00 ea.

Input Transformers	
Catalog No.	List Price†
PGA 1	16.00
PGA 2	18.50
PGA 3	16.00
PGA 4	15.00
PGA 5	17.50
PGA 6	16.00

Filter Reactors	
Catalog No.	List Price†
PGC 1	6.50
PGC 2	7.00
PGC 3	7.00
PGC 4	7.50
PGC 5	7.50
PGC 6	7.50
PGC 7	8.00
PGC 8	9.00
PGC 9	9.00
PGC 10	9.50
PGC 11	10.50
PGC 12	13.00
PGC 13	16.00

Acrosound* Ultra-Linear*

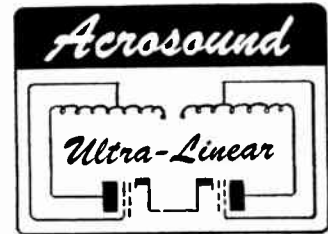

* Patent Pending

High Fidelity Output Transformers for Every Application!

CASE TYPE "A"
3 5/8 x 3 1/4 x 4 1/4
high

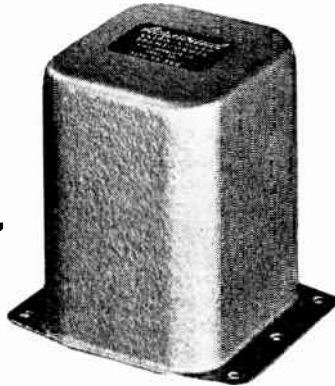

CASE TYPE "B"
4 x 4 5/8 x 5 3/8
high

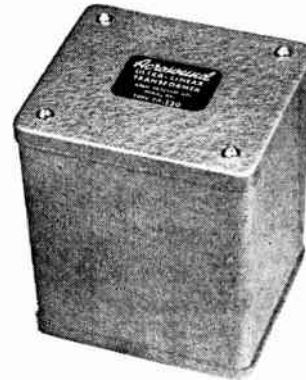

MODEL	IMPEDANCES*	POWER RATING	FREQUENCY RESPONSE	RATED PRIMARY CURRENT PER TUBE	PERMISSIBLE DC PRIMARY UNBALANCE	** CASE TYPE	WEIGHT	NET PRICE	APPLICATION
T0-230	3000 plate-to-plate 4, 8, 16 secondary	20 watts— 20 cps to 20 kc 40 watts— 30 cps to 15 kc	±1 db 10 cps to 40 kc	150 ma	20%	A	7 lbs.	\$14.50	For use with 6B4's or 2A3's fixed bias pp par. 6L6's, etc.
T0-250	5000 plate-to-plate 4, 8, 16 secondary	10 watts— 20 cps to 20 kc 20 watts— 30 cps to 15 kc	±1 db 10 cps to 40 kc	75 ma	10%	A	6 lbs.	11.75	For use with 6B4's or 2A3's self bias. 6L6's, class A, etc.
T0-270	10,000 plate-to-plate 4, 8, 16 secondary	10 watts— 20 cps to 20 kc 20 watts— 30 cps to 15 kc	±1 db 10 cps to 40 kc	75 ma	10%	A	6 lbs.	11.75	For use with 6V6's, 6K6's, etc.
T0-280	9000 plate-to-plate 4, 8, 16 secondary	20 watts— 20 cps to 20 kc 40 watts— 30 cps to 15 kc	±1 db 10 cps to 40 kc	75 ma	10%	A	7 lbs.	14.50	For use with 6L6's, class AB1
T0-290	12,000 plate-to-plate 4, 8, 16 secondary	20 watts— 20 cps to 20 kc 40 watts— 30 cps to 15 kc	±1 db 10 cps to 40 kc	75 ma	10%	A	7 lbs.	15.75	For use with triode connected 807's, or 5881's in Williamson type circuit
T0-300	6600 plate-to-plate 4, 8, 16 secondary	20 watts— 20 cps to 30 kc 40 watts— 30 cps to 20 kc	±1 db 10 cps to 100 kc	75 ma	15%	A	7 lbs.	24.75	For Ultra-Linear operation of KT-66's, 807's, 5881's, and Ultra-Linear conversion of Williamson type circuits
T0-310	8000 plate-to-plate 4, 8, 16 secondary	10 watts— 20 cps to 30 kc 20 watts— 30 cps to 20 kc	±1 db 10 cps to 100 kc	75 ma	10%	A	6 lbs.	18.75	For Ultra-Linear operation of 6V6's
T0-320	3500 plate-to-plate 4, 8, 16 secondary	10 watts— 20 cps to 30 kc 20 watts— 30 cps to 20 kc	±1 db 10 cps to 100 kc	75 ma	10%	A	6 lbs.	18.75	For Ultra-Linear operation of 6V6's
T0-330	3300 plate-to-plate 4, 8, 16 secondary	50 watts— 20 cps to 20 kc 100 watts— 30 cps to 15 kc	±1 db 10 cps to 100 kc	150 ma	15%	B	14 lbs.	39.75	For push pull parallel Ultra-Linear operation of KT-66's, 807's, etc.
T0-350	6600 plate-to-plate 4, 8, 16 secondary	100 watts— 20 cps to 20 kc	±1 db 7 cps to 70 kc	175 ma	10%	B	14 lbs.	49.50	For Ultra-Linear operation of 6L46 tubes using tertiary winding for screen connection.

* All models available with additional line winding (125 and 500 ohms) at extra cost of \$6.00 net for models with numbers up to T0-320 and \$10.00 net for models T0-330 and T0-350. Models with line winding are designated by model numbers ending in "5." For example, Model T0-300 with additional line winding is specified as T0-305.

** All cases are furnished in silver grey hammerloid finish. 10-inch color coded wire leads are brought out through case bottoms.

Case type "A" mounts with base flange. Case type "B" has provision for either top or bottom mounting.

ACRO PRODUCTS COMPANY

PHILADELPHIA 28, PA.

FERRANTI TRANSFORMERS

This group of transformers are hermetically sealed in standard Mil-T-27 case sizes, and are designed to meet the full requirements of the Mil-T-27 specification. They provide the highest standard of quality necessary for professional and military requirements.

The range includes the specific types stan-

dardized by the Armed Services Electro Standards Agency for universal military use, as well as a group of standard types for 400 cycle power supplies.

Use of these standard high quality components in experimental equipment will avoid the necessity for redesign for production.

Military Standard Filament Transformers *Input 105/115/125 Volts 50/60 Cycles*

Cat. No.	MIL Type	Military Standard #	Sec. Volts	Sec. Amps	Test Volts	Net Price	Case
FMF 20	TF1A01EB002	MS90016	2.5	3	2500	\$ 6.80	EB
FMF 21	TF1A01GB003	MS90017	2.5	10	2500	8.70	GB
FMF 22	TF1A01FB004	MS90018	5.0	3	2500	7.80	FB
FMF 23	TF1A01HB005	MS90019	5.0	10	2500	9.80	HB
FMF 24	TF1A01FB006	MS90020	6.3	2	2500	7.80	FB
FMF 25	TF1A01GB007	MS90021	6.3	5	2500	8.70	GE
FMF 26	TF1A01JB008	MS90022	6.3	10	2500	12.50	JB
FMF 27	TF1A01KB009	MS90023	6.3	20	2500	16.50	KB
FMF 28	TF1A01JB012	MS90024	2.5	10	10,000	14.50	JB
FMF 29	TF1A01KB013	MS90025	5.0	10	10,000	19.50	KB

Military Standard Plate and Filament Transformers *Input 105/115/125 Volts 50/60 Cycles Choke Input Filter*

Cat. No.	MIL Type	Military Standard #	FIL 1	FIL 2	Plate (RMS)	Current	Net Price	Case
FMP 30	TF1A03HA001	MS90026	6.3/5v 2a	6.3v 3a	200-100-0-100-200	.07A.DC	\$13.50	HA
FMP 31	TF1A03JB002	MS90027	6.3/5v 2a	6.3v 4a	325-0-325	.07A.DC	16.80	JB
FMP 32	TF1A03KB006	MS90028	5v 3a	6.3v 5a	325-0-325	.150A.DC	19.80	KB
FMP 33	TF1A03LB003	MS90029	5v 3a	6.3v 8a	400-0-400	.175A.DC	22.50	LB
FMP 34	TF1A03MB003	MS90030	5v 3a	6.3v 8a	450-0-450	.250A.DC	24.80	MB
FMP 35	TF1A03KB001	MS90031			350-0-350	.250A.DC	18.50	KB
FMP 36	TF1A02LB002	MS90032			550-0-550	.250A.DC	20.80	LB
FMP 37	TF1A02NB002	MS90036			800-0-800	.250A.DC	31.50	NB

400 Cycle Transformers

Filament Transformers

Input 115 Volts 380-1200 Cycles

Cat. No.	Sec. Volts	Sec. Amps.	Test Volts	Case	Net Price
FF 40	6.3 ct	2	1500	AJ	\$ 8.20
FF 41	6.3 ct	3	1500	EA	10.80
FF 42	6.3 ct	5	2500	FA	12.25
	6.3	5	2500		
FF 43	5/6.3	3	2500	EB	10.50
FF 44	5 ct	6	2500	EA	10.90
FF 45	2.5 ct	10	7500	HB	13.80

Plate and Filament Transformers

Input 115 Volts 380-1200 Cycles

Cat. No.	Plate RMS	DC Amps	Filaments	Case	Net Price
FP 40	250-0-250	.070	5/6.3V 2A 6.3Vct 3A	GB	\$14.50
FP 41	325-0-325	.120	5V 3A 6.3 ct 5A	JB	18.50
FP 42	400-0-400	.200	5 V 3A 6.3V 6A	KB	32.00
FP 43	350-0-350	.250	—	JB	16.80
FP 44	500-0-500	.250	—	KB	23.50

FERRANTI ELECTRIC, INC.

30 ROCKEFELLER PLAZA

NEW YORK 20, N. Y.



FERRANTI TRANSFORMERS

Terminal and Mounting Details

Standard Audio Transformers

All units are hermetically sealed in Mil-T-27 case size AJ and are designed to meet the full requirements of the Mil-T-27 specification

Use of these standard units in equipment at the experimental stage will avoid the necessity of redesign for production.

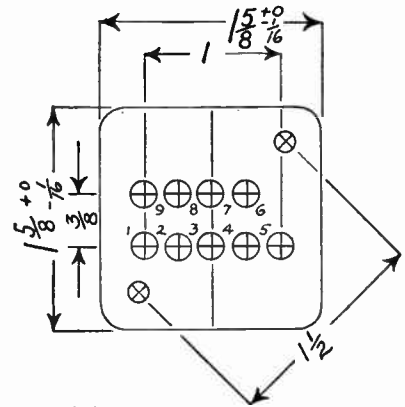

See dimension chart for AJ case details.

Cat. No	Function	Type Designation	Impedance Level Primary Secondary	Ratio	Max. Power Level V.U.	Pri. D.C. Per Side in MA	Max. D.C. Unbal- ance	Frequency Response	Net Price
FMA 10	Interstage, Single or P.P. plates to single or P.P. grids	TF1A15AJ0	10,000 CT 90,000 split and CT	1:3 overall	+15	10	10	±1 DB 300-10,000	\$11.80
FMA 11	Matching, 600 ohm line to voice coil	TF1A16AJ0	600 split 4,8,16	6,12:1 overall	+33	0	0	±1 DB 300-10,000	11.80
FMA 12	Input, 600 ohm line to single or P.P. grids	TF1A10AJ0	600 split 135,000 CT	1:15	+15	0	0	±2 DB 300-10,000	11.80
FMA 13	Matching 600 ohm line to 600 ohm line	TF1A16AJ0	600 split 600 split	1:1	+15	0	0	±1 DB 300-10,000	11.80
FMA 14	Output, single plate 7600 ohm or 4800 ohm to 600 ohm line	TF1A13AJ0	7600 top @ 4800 600 split	3,56:1	+33	40	40	±2 DB 300-10,000	11.80
FMA 15	Output, single plate 7600 ohm or 4800 ohm to voice coil	TF1A13AJ0	7600 top @ 4800 4,8,16	21.8:1	+33	40	40	±2 DB 300-10,000	11.80
FMA 16	Output single or P.P. plates to 600 ohm line	TF1A13AJ0	15,000 CT 600 split	5:1	+33	10	10	±1 DB 300-10,000	11.80
FMA 17	Output, P.P. plates to 600 ohm line	TF1A13AJ0	24,000 CT 600 split	6,32:1	+30	10	1	±1 DB 300-10,000	11.80
FMA 18	Output, P.P. plates to 600 ohm line	TF1A13AJ0	60,000 CT 600 split	10:1	+27	10	1	±2 DB 300-10,000	11.80

FERRANTI ELECTRIC, INC.

30 ROCKEFELLER PLAZA

NEW YORK 20, N. Y.



FERRANTI TRANSFORMERS

Filter Reactors

To match the power and audio transformers, these reactors are of the same high quality in design and construction, and are hermetically sealed in standard Mil-T-27 cases. Types particularly suitable for 400 cycle power supplies are included.

For 50-60 Cycle Power Supplies

Cat. No.	DC Amps	Inductance Henries	Resistance Ohms	Test Volts	Case	Net Price
FC 10	.020	30	1100	1500	AJ	\$ 6.50
FC 11	.070	15	345	2500	GB	7.40
FC 12	.150	10	135	2500	JB	9.20
FC 13	.200	8	105	2500	KB	11.50
FC 14	.300	10	100	2500	LB	15.40

For 400-Cycle Power Supplies

Cat. No.	DC Amps	Inductance Henries	Resistance Ohms	Test Volts	Case	Net Price
FC 40	.070	3	250	1500	AJ	\$ 6.50
FC 41	.120	3	170	2000	EB	7.20
FC 42	.200	3	125	2000	FB	8.70
FC 43	.250	3	75	2000	GB	9.20

Mil-T-27 Case and Mounting Dimensions

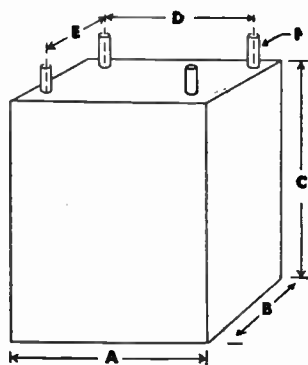

Case	A	B	C	D	E	F
AJ	1 $\frac{5}{8}$	1 $\frac{5}{8}$	2 $\frac{3}{8}$	See Previous Page		6-32
EA	1 $\frac{5}{8}$	1 $\frac{3}{8}$	2 $\frac{3}{4}$	1 $\frac{3}{8}$	1 $\frac{1}{4}$	6-32
EB	1 $\frac{5}{8}$	1 $\frac{3}{8}$	2 $\frac{1}{8}$	1 $\frac{3}{8}$	1 $\frac{1}{4}$	6-32
FA	2 $\frac{3}{8}$	2 $\frac{1}{8}$	3 $\frac{1}{8}$	1 $\frac{1}{8}$	1 $\frac{1}{8}$	6-32
FB	2 $\frac{3}{8}$	2 $\frac{1}{8}$	2 $\frac{1}{2}$	1 $\frac{1}{8}$	1 $\frac{1}{8}$	6-32
GB	2 $\frac{3}{4}$	2 $\frac{3}{8}$	2 $\frac{1}{2}$	2 $\frac{1}{8}$	1 $\frac{3}{4}$	6-32
HA	3 $\frac{1}{8}$	2 $\frac{3}{8}$	4 $\frac{1}{4}$	2 $\frac{1}{8}$	1 $\frac{5}{8}$	8-32
HB	3 $\frac{1}{8}$	2 $\frac{3}{8}$	3 $\frac{3}{8}$	2 $\frac{1}{8}$	1 $\frac{5}{8}$	8-32
JB	3 $\frac{1}{8}$	3 $\frac{1}{8}$	3 $\frac{3}{8}$	2 $\frac{3}{8}$	2 $\frac{1}{8}$	8-32
KB	3 $\frac{1}{8}$	3 $\frac{3}{8}$	4 $\frac{1}{8}$	3	2 $\frac{1}{8}$	10-32
LB	4 $\frac{1}{8}$	3 $\frac{1}{8}$	4 $\frac{1}{2}$	3 $\frac{3}{8}$	2 $\frac{1}{8}$	10-32
MB	4 $\frac{1}{8}$	4	4 $\frac{1}{8}$	3 $\frac{1}{8}$	3	$\frac{1}{4}$ -20
NB	5 $\frac{1}{8}$	4 $\frac{1}{8}$	5 $\frac{1}{2}$	4 $\frac{1}{8}$	3 $\frac{3}{8}$	$\frac{1}{4}$ -20

FERRANTI ELECTRIC, INC.

30 ROCKEFELLER PLAZA

NEW YORK 20, N. Y.





TRANSFORMERS

REPLACEMENT TRANSFORMERS

OUTPUT TRANSFORMERS Receiver Replacement Type

To couple the plate or plates of the output stage to the speaker voice coil. Sec. impedance—3.5 ohms.

Type No.	List Price	Tube	Class	Pri. Impedance	Pri. M.A.	Max. Watts	Mtg. Centers	Dimensions			Mtg.
								H.	W.	D.	
A-3025	\$1.65	7A5, 35A5, 35C5, 50C5, 32L7, 35L6, 50B5	A	2500	50	3	1 3/4	1 3/16	2 1/16	1 3/8	A
A-3026	1.65	6V6, 7C5, 25AC5, 35A5, 35B5, 35L6	A	5000	40	3	1 3/4	1 3/16	2 1/16	1 3/8	A
A-2927	1.75	Single 1C5-G, 1G5-G, 1G5, 1S4, 3Q4, 3Q5, 3S4, 6A4	A	8000	20	3	1 1/2	1 3/8	1 7/8	1	B
A-2928	1.90	Single 2A3, 6A3, 6B4, 6Y6, 25AC5, 25B6, 25N6, 25L6, 35A5, 35L6, 50L6, 48, 50B5, 35B5, 50A5	A	2000	60	5	2	1 3/8	2 3/8	1 1/4	A
A-3018	3.00	Single 6A3, 6L6, 6Y6, 7A5, 12A5, 25A6, 25B6, 25C6, 25L6, 50, 50A5, 50B5, 50C5, 50L6	A	3500	60	8	2 3/8	1 5/8	2 13/16	1 1/2	A
A-2930	2.00	Single 6V6, 7C5, 12A, 12A5, 25A6, 25A7, 35A5, 35L6, 31, 45, 50, 59	A	5000	40	5	2	1 3/8	2 3/8	1 1/4	A
A-3019	3.00	Single 6L6, 6V6, 6AQ5, 6AS5, 7C5, 25A6, 35A5, 35L6, 50	A	5000	50	8	2 3/8	1 5/8	2 13/16	1 1/2	A
A-2935	3.75	PP 6L6	A	5000 c.t.	150	18	2 13/16	2	3 1/4	1 3/8	A
A-2931	2.00	Single 2A5, 6AC5, 6B5, 6F6, 6K6, 6N6, 7B5, 20, 31, 42, 47, 50, 6V5	A	7000	30	5	2	1 3/8	2 3/8	1 1/4	A
A-3020	3.00	Single 2A5, 6AC5, 6AD7, 6AR5, 6B5, 6F6, 6K6, 6N6, 6Y7, 7B5, 12A6, 14A5, 41, 47	A	7000	40	8	2 3/8	1 5/8	2 13/16	1 1/2	A
A-2932	2.00	Single 1C5, 1Q5, 3C5, 6A4, 6G6, 6N7, 6R7, 12A, 38, 41, 49, 3V4	A	10000	30	5	2	1 3/8	2 3/8	1 1/4	A
A-2938	2.75	Single 19, 1G6, 1J6 PP 1H4, 30, 49	B	10000 c.t.	40	5	2	1 3/8	2 3/8	1 1/4	A
A-2936	3.00	PP 6AC5	B								
A-2933	2.20	PP 6V6, 7C5	AB1	10000 c.t.	75	10	2 3/8	1 5/8	2 13/16	1 1/2	A
A-2933	2.20	Single 1D8, 7B5, 6K6, 6G6	A	12000	10	5	2	1 3/8	2 3/8	1 1/4	A
A-3021	3.60	PP2A5, 6E6, 6K6 PP6AD7, 47, 49	A	14000 c.t.	35	12	2 13/16	2	3 1/4	1 3/8	A
A-2934	2.00	Single 6Y7, 6Z7, 79 Single 1D8, 1F4, 1F5, 1J5, 1T5, 6V7, 12A7, 85	B								
A-2937	2.50	Single 1A5, 1N6, 6V7, 85 PP 1E7, 1J5, 6G6, 3A4, 3V4	A	15000	10	5	2	1 3/8	2 3/8	1 1/4	A
A-3017	2.75	PP1A5, 1AC5, 1N6, 1LA4	A	25000 c.t.	10	5	2	1 3/8	2 3/8	1 1/4	A
A-3017	2.75	PP1A5, 1AC5, 1N6, 1LA4	A	50000 c.t.	10	5	2	1 3/8	2 3/8	1 1/4	A

FILTER TAPPED OUTPUT TRANSFORMERS Pri. has 3% and 6% Humbucking Taps Sec. Impedance 3-4 ohms



Type No.	List Price	Tube	Class	Pri. Impedance	Pri. M.A.	Max. Watts	Mtg. Centers	Dimensions			Mtg.
								H.	W.	D.	
A-3031	\$2.40	Single 2A3, 6A3, 7A5, 25L6, 35A5, 35B5, 35L6, 45, 50B5, 50L6	A	3000	50	5	2	1 3/8	2 3/8	1 1/4	A
A-3032	2.40	Single 6V6, 6B5, 7C5, 6F6	A	6000	40	5	2	1 3/8	2 3/8	1 1/4	A

SPECIAL OUTPUT TRANSFORMERS To Couple Push Pull Plates to Line or Voice Coil Sec. Impedance 2-4-8-15-250-500 ohms

Type No.	List Price	Tube	Class	Pri. Impedance	Pri. M.A. per Side	Max. Watts	Mtg. Centers	Dimensions			Mtg.
								H.	W.	D.	
A-3027	\$6.60	PP2A5, 6V6, 7C5, 19, 6F6 PP1H4G, 1J6, 6AC5, 49	A	10000 c.t.	45	15	2 13/16	2	3 1/4	1 3/4	F
A-3028	7.50	PP6L6 PP2A3	A1	5000 c.t.	70	20	3 1/8	2 3/16	3 11/16	2	F

All prices subject to trade discount, and change without notice.

Products of Merit

A
B
F



TRANSFORMERS

VERTICAL OUTPUT TRANSFORMER

Type No.	List Price	Turns Ratio Primary to Secondary	Mtg. Centers	Dimensions			Mtg. Type
				H.	W.	D.	
★A-3035	\$6.25	10:1	1 ¹³ / ₁₆ x 2	3 ¹ / ₈	2 ¹¹ / ₁₆	2 ¹ / ₂	EV
★A-3036	4.25	10:1	2 ¹³ / ₁₆	3 ¹ / ₄	2	2	A
★A-3037	4.25	11.4:1*	2 ¹³ / ₁₆	2	3 ¹ / ₄	1 ⁵ / ₈	A
★A-3038	5.50	10:1	3 ¹ / ₈	2 ¹ / ₄	3 ¹¹ / ₁₆	2 ¹ / ₄	A
★A-3039	5.50	18:1*	3 ¹ / ₈	2 ¹ / ₄	3 ¹¹ / ₁₆	2 ¹ / ₄	A
★A-3080	6.00	25:1, 50:1	3 ¹ / ₈	3	3 ³ / ₁₆	2 ¹ / ₄	B
★A-3081	6.50	30:1, 50:1*	3 ¹ / ₈	2 ¹ / ₄	3 ¹¹ / ₁₆	2 ¹ / ₄	A

★Indicates TV Replacements. *Auto Transformer.

DUAL PRIMARY OUTPUT TRANSFORMERS 3-4 ohms For Use with AC-DC Battery Portable Receivers—Sec. Impedance

Type No.	List Price	Tube	Class	Pri. Impedance	Pri. M.A.	Max. Watts	Mtg. Centers	Dimensions			Mtg.
								H.	W.	D.	
A-3029	\$2.40	Single 25AC5, 25B6, 25L6, 25N6, 35A5, 35B5, 35L6, 50A5, 50B5, 50L6 OR	A	2000 or	60 or	5	2	1 ³ / ₈	2 ³ / ₈	1 ¹ / ₄	A
A-3030	2.40	Single 1S4, 1Q5, 3Q4, 3Q5, 3V4 Single 25AC5, 25B6, 25L6, 25N6, 35A5, 35L6, 50A5, 50B5, 50L6 OR Single 1S4, 1Q5, 3Q4, 3Q5, 3V4	A A A	6000 2000 10000	10 60 10	5 2	2	1 ³ / ₈	2 ³ / ₈	1 ¹ / ₄	A

UNIVERSAL OUTPUT TRANSFORMERS To Provide Correct Coupling Between a Variety of Output Tubes and Any Speaker Voice Coil

Type No.	List Price	Tube	Ohms Impedance Pri.	Sec.	Pri. M.A.	Max. Watts	Mtg. Centers	Dimensions			Mtg.
								H.	W.	D.	
A-2900	\$2.75	Single or Push-pull	4000-7000-8000-10000-14000 c.t.	.17 to .32	35	4	2	1 ³ / ₈	2 ³ / ₈	1 ¹ / ₄	F
A-2901	3.00	Single or Push-pull	4000-7000-8000-10000-14000 c.t.	.17 to .32	40	8	2 ³ / ₈	1 ³ / ₈	2 ³ / ₈	1 ¹ / ₄	F
A-2902	3.00	Single	1500-2000-4000-5000-7000-10000	.1 to .40	55	10	2 ⁵ / ₈	1 ³ / ₈	2 ⁵ / ₈	1 ¹ / ₄	F
A-2903	2.60	Single	2000-4500-7000-10000	3.2	30	4	2	1 ³ / ₈	2 ³ / ₈	1 ¹ / ₄	F
A-2904	4.00	Single or Push-pull	4000-7000-8000-10000-14000 c.t.	.17 to .32	40	18	2 ³ / ₈	2 ³ / ₈	2 ³ / ₈	1 ¹ / ₄	F
A-2905	5.50	Single or Push-pull	3000-5000-7000-8000-10000 c.t.	.17 to .32	70	24	3 ¹ / ₈	2 ³ / ₈	3 ¹¹ / ₁₆	2 ³ / ₈	F
A-2998	2.50	Single	3500-5000-7000-10000	3.2	35	3	1 ³ / ₈	1 ³ / ₈	2 ³ / ₈	1 ¹ / ₄	F
A-2999	2.65	Single	12000-15000-18000-25000	3.2	10	3	1 ³ / ₈	1 ³ / ₈	2 ³ / ₈	1 ¹ / ₄	F

HEAVY DUTY OUTPUT TRANSFORMERS High Level Type to Couple to Line or Speaker. Sec. Impedance 4-8-15-250-500 ohms

Type No.	List Price	Tube	Class	Pri. Impedance	Pri. M.A. per Side	Max. Watts	Dimensions			Mtg.
							H.	W.	D.	
A-3127	\$ 6.50	Single 6L6, 2A3, 6A3, 6Y6	A	2500	80	8	3 ¹ / ₈	2 ⁵ / ₈	2 ¹ / ₂	D
A-3128	10.50	PP6V6, 6F6	AB ₁	8000 c.t.*	50	14	3 ¹ / ₂	2 ⁵ / ₈	3 ¹ / ₈	D
A-3129	10.50	PP6L6	AB ₁	4300 c.t.*	95	25	3 ¹ / ₂	2 ⁵ / ₈	3 ¹ / ₈	D
A-3130	10.50	PP6L6	AB ₁	6600 c.t.*	80	34	3 ¹ / ₈	3 ¹ / ₈	3 ¹ / ₈	D
A-3131	8.75	PP6L6, 6Y6, PP2A3, 6A3, 6B4, 45, PP6N7, 46	AB B	5000 c.t.	80	30	3 ¹ / ₂	2 ⁵ / ₈	3 ¹ / ₈	D
A-3132	8.75	PP6F6, 2A5, 7C5, Single 6N7, 6A6	AB ₂ B	10000 c.t.	40	25	3 ¹ / ₂	2 ⁵ / ₈	3 ¹ / ₈	D
A-3133	13.75	P.P. Par. 6L6. P.P. 807	AB ₁	3300 c.t.	240	55	4 ⁵ / ₈	3 ¹ / ₈	4	D†

* 10% Feedback Winding. † Mtg. Centers 3 x 2¹³/₁₆.

OUTPUT TRANSFORMERS—HIGH FIDELITY TYPE Frequency Response ± 1 DB 30-20000 Cycles

A-3100	\$19.00	PP2A3, 6A5G, 275A, 6A3, 6L6, etc.	5000 and 3000 c.t.	Sec. 4-8-16	20	3 ¹ / ₈	3 ³ / ₈	3 ⁵ / ₈	D
A-3101	19.00	PP6F6, 6L6, 6V6, etc.	10000 and 6600 c.t.		20	4 ¹ / ₄	3 ¹ / ₂	3 ³ / ₈	D

INPUT TRANSFORMERS For Coupling Microphone or Line to Single or Push-Pull Grids. Static Shielded.

Type No.	List Price	Ohms Impedance		Turns Ratio	Mtg. Centers	Dimensions			Mtg.
		Pri.	Sec.			H.	W.	D.	
A-2923	\$2.75	3.2	50000	1:125	2	1 ³ / ₈	2 ³ / ₈	1 ¹ / ₄	A
A-2918	4.50	100	400000 c.t.	1:64	2 ¹³ / ₁₆	2	3 ¹ / ₄	1 ⁵ / ₈	A
A-2919	4.50	200/50	100000	1:22	2 ¹³ / ₁₆	2	3 ¹ / ₄	1 ⁵ / ₈	A
A-2924	5.00	500/125	100000 c.t.	1:14	2 ¹³ / ₁₆	2	3 ¹ / ₄	1 ⁵ / ₈	A

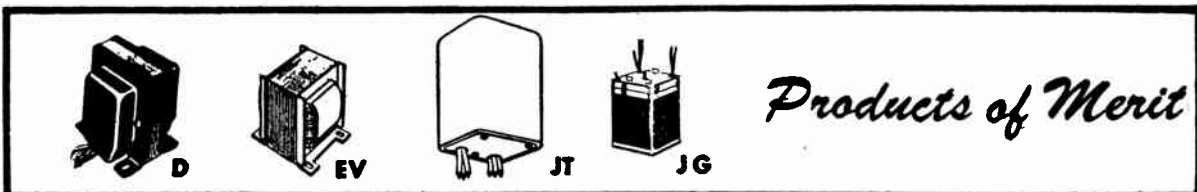



TRANSFORMERS

UNIVERSAL LINE TRANSFORMERS To Couple Various Line Impedances to a Voice Coil

Type No.	List Price	Ohms Impedance		Watts	Mtg. Centers	Dimensions			Mtg.
		Pri.	Sec.			H.	W.	D.	
A-2906	\$3.25	500-1000-1500-2000	3.2, 6-8	10	2 3/8	1 5/8	2 1/8	1 1/2	F
A-2907	5.20	500-1000-1500-2000	3.2, 6-8	18	2 3/8	2 1/8	2 1/8	1 1/2	G
A-2908	5.50	500-1000-1500-2000	6-8, 16	24	3 3/8	2 1/8	3 1/8	2 1/8	F
A-2909	3.00	45-50	3.2, 6-8	8	2	1 3/8	2 1/8	1 1/2	G
A-3005	2.25	500	3.2, 6-8	5	2	1 3/8	2 3/8	1 1/4	A

For Use With Constant 70.7V. Line as Recommended by the R.M.A. Rated Power is Furnished on Lowest Tap. Other Taps Provide Reduction in Power in Steps of 3DB.

A-3013	\$3.25	1000-2000-4000-8000-16000	3.5, 7	5	2	1 1/8	2 3/8	1 1/2	F
A-3014	4.00	500-1000-2000-4000-8000	4-8-16	10	2 3/8	1 3/8	2 1/8	1 1/2	G
A-3015	5.75	275-550-1100-2200-4400-8800	4-8-16	18	2 3/8	2 1/8	2 1/8	1 1/2	G
A-3016	6.25	210-420-840-1680-3360-6720	4-8-16	24	3 3/8	2 1/8	3 1/8	2 1/8	F

TUBE TO LINE TRANSFORMERS For Coupling Single or Push-Pull Plates to Line or Mixer

Type No.	List Price	Ohms Impedance		Pri. M.A.	Mtg. Centers	Dimensions			Mtg.
		Pri.	Sec.			H.	W.	D.	
A-2925	\$5.00	20000 c.t.	500/125	10	2 15/16	2	3 1/4	1 5/8	A
A-2926	5.00	20000 c.t.	200/50	10	2 15/16	2	3 1/4	1 5/8	A
†A-3023	5.00	5000-10000-20000 c.t.	500/333/200/125/50	15	2 15/16	2	3 1/4	1 5/8	F
†A-3024	11.00	5000-10000-20000 c.t.	500/333/200/125/50	50	2x1 15/16	3 3/8	2 3/8	2 3/8	DL

†20,000 ohm only center tapped.

INTERSTAGE TRANSFORMERS To Couple a Single Plate to a Single Grid

Type No.	List Price	Ohms Impedance		Turns Ratio	Pri. M.A.	Mtg. Centers	Dimensions			Mtg.
		Pri.	Sec.				H.	W.	D.	
A-2910	\$3.00	10000	90000	3:1	10	2	1 3/4	2 3/8	1 1/4	A
A-2911	3.00	10000	90000	3:1	10	2 3/8	1 5/8	2 1/8	1 1/2	A

To Couple a Single Plate to Push-Pull Grids

A-2914	\$2.75	10000	90000 c.t.	3:1	10	2	1 3/8	2 3/8	1 1/4	A
A-2915	3.00	10000	90000 c.t.	3:1	10	2 3/8	1 5/8	2 1/8	1 1/2	A
A-2916	3.75	10000	90000 c.t.	3:1	10	2 15/16	2	3 1/4	1 5/8	A

To Couple Push-Pull Plates to Push-Pull Grids

A-2912	\$4.50	10000 c.t.	90000*	3:1	10 per side	2 15/16	2	3 1/4	1 5/8	A
A-2913	3.60	20000 c.t.	20000 c.t.	1:1	10 per side	2 3/8	1 3/8	2 1/8	1 1/2	A
A-2917	4.50	20000 c.t.	45000 c.t.	1.5:1	10 per side	2 15/16	2	3 1/4	1 5/8	A

*Split secondary.

REPLACEMENT TYPE FILTER CHOKES Inductance Ratings are at 10 V. 60 cy. with Rated Current Flowing as Recommended by the R.M.A.

Type No.	List Price	Inductance Henries	Current Rating M.A.	DC Res. Ohms	Volts Insul.	Mtg. Centers	Dimensions			Mtg.
							H.	W.	D.	
★C-2973	\$1.75	1.5	10	95	1500	1 3/8	1 3/8	1 1/8	A	
★C-2994	2.25	1.5	200	90	1500	2 3/8	1 5/8	2 1/8	A	
C-2974	3.85	2.0	200	50	1500	2 15/16	3 1/4	1 5/8	A	
C-2977	2.20	4.5	50	200	1500	2 3/8	1 3/8	2 1/8	A	
C-2975	2.00	5.5	50	330	1500	2	1 5/8	2 3/8	A	
C-2976	2.00	8	40	500	1500	2	1 3/8	2 3/8	A	
★C-2995	3.00	8.0	100	375	1500	2 15/16	2	3 1/4	A	
C-2981	2.20	8.5	50	400	1500	2 3/8	1 3/8	2 1/8	A	
C-2985	2.20	20	15	900	1500	2 3/8	1 3/8	2 1/8	A	
C-2987	2.50	16	50	550	1500	2 15/16	2	3 1/4	A	
C-2990	3.30	13	75	400	1500	3 1/8	2 1/4	3 11/16	A	
★C-2991	4.40	2	250	53	2000	3 1/8	2 3/8	3 11/16	A	
C-2993	4.40	10.5	110	220	1500	3 1/8	2 3/8	4	A	
★C-2996	3.50	1.0	300	60	1500	3 1/8	2 1/4	3 11/16	A	

★Indicates TV replacements.

All prices subject to trade discount, and change without notice.

Products of Merit



F



DL



G



TRANSFORMERS

POWER TRANSFORMERS¹ Receiver Replacement Type — Primary for 115 V., 60 Cy. Leads R.M.A. Color Coded—Mtg. Fig. C

Type No.	List Price	H. V. Secondary			Rectifier		Fil. Wdgs.		Mtg. Centers	Dimensions		
		Volts	D.C.	M.A.	Volts	Amp.	Volts	Amp.		H.	W.	D.
*P-3045 *	\$5.00	120		50			6.3	2	3 1/8	2 1/16	2 5/8	2
*P-3046 *	3.25	150		25			6.3	2	2	2	2 1/2	1 3/4
P-3047	5.75	240-240		50			6.3	2.5	2	2 1/2	3	2
P-3048	7.75	260-260		90			6.3	4.7	2 x 2 1/2	2 1/2	3	2 1/2
P-2949	6.50	240-240		40	5	2	6.3	2	2 x 2 1/2	2 1/2	3	3 1/16
P-2958	6.50	240-240		50	5	2	6.3	2.6	2 x 2 1/2	2 1/2	3	2 1/2
P-3051	8.00	260-260		70	5	2	6.3	3	2 x 2 1/2	2 1/2	3	3
P-3052	9.00	280-280		90	5	2	6.3	5	2 1/4 x 2 1/8	2 1/8	3	3
P-2957	7.25	350-350		50	5	2	6.3	2.6	2 1/4 x 2 1/8	2 1/8	3 3/8	3 1/2
P-2966†	8.50	350-350		70	5	3	2.5	9	2 1/4 x 2 1/8	2 1/8	3 3/8	3
P-2967	10.75	350-350		90	5	3	2.5	3.5				
P-2968	13.00	400-400	110	5	3	3	2.5	12.5	2 1/4 x 3 1/8	3 1/8	3 3/4	4 1/16
P-2950	6.75	325-325	40	5	2	2	2.5	3.5	3 x 3 3/4	3 3/4	4 1/2	3 1/16
P-2951	7.75	325-325	70	5	3	3	6.3	2	2 x 2 1/2	2 1/2	3	2 7/8
P-2952	8.50	350-350	90	5	3	3	6.3	3.5	2 x 2 1/2	2 1/2	3	3 1/8
P-2953	9.75	350-350	120	5	3	3	6.3	4.7	2 1/4 x 2 1/8	2 1/8	3 3/8	3 3/8
P-2954	12.50	375-375	150	5	3	3	6.3	5	2 1/4 x 3 1/8	3 1/8	3 3/4	4 5/16
P-2955	14.00	400-400	200	5	3	3	6.3	5	3 x 3 3/4	3 3/4	4 1/2	4 1/8
P-2956	17.50	435-435	250	5	3	3	6.3	3	3 x 3 3/4	3 3/4	4 1/2	4 3/4
		(80-volt Bias Tap)		2.5	10		6.3	3				
*P-3071‡	22.50	360-360	180	5	3	3	6.3	1				
*P-3072	21.25	360-360	180	5	3	3	6.3	9	2 3/4 x 3 1/8	3 1/8	4 1/8	4 1/16
*P-3069‡	22.50	350-350	225	5	3	3	6.3	10	2 3/4 x 3 1/8	3 1/8	4 1/8	4 5/16
*P-3070	21.25	350-350	225	5	3	3	6.3	2.7	3 x 3 3/4	3 3/4	4 1/2	4 1/4
*P-3059	25.00	360-360	250	5	2	2	6.3	2.7				
*P-3063	22.50	360-360	250	5	3	3	6.3	9	3 x 3 3/4	3 3/4	4 1/2	5 1/8
				5	3	3	6.3	9	3 1/8 x 4 1/8	3 1/8	4 5/8	5 1/2
				5	3	3	6.3	1.2				
				5	2	2	6.3	1.5				
*P-3061	27.50	362-362	295	5	6	6	6.3	2.7	3 1/8 x 4 1/8	3 1/8	4 3/8	6 3/8
				5	3	3	12.6	5				
				5	3	3	6.3	2				
*P-3073‡	27.50	322-322	180	5	3	3	6.3	10	3 x 3 3/4	3 3/4	4 1/2	5
		205-205	70	5	3	3	6.3	2.7				
P-3053	25.00	375-375	170	5	3	3	6.3	7	3 x 3 3/4	3 3/4	4 1/2	5 5/8
		325-325	130	5	3	3	6.3	7*				
				5	3	3	6.3	2.7				
*P-3054	21.00	350-350	180	5	6	6	6.3	10	3 x 3 3/4	3 3/4	4 1/2	5 3/8
		220-220	70	5	6	6	6.3	2.7				
*P-3055	22.50	300-300	400	5	6	6	6.3	10	3 x 3 3/4	3 3/4	4 1/2	5 5/8
				5	3	3	6.3	4.5				
*P-3066	25.00	375-375	170	5	3	3	12.6	5	3 x 3 3/4	3 3/4	4 1/2	5 5/8
		325-325	130	5	3	3	6.3	2.6				
				5	3	3	6.3	2				
*P-3067	25.00	400-400	220	5	3	3	6.3	10	3 x 3 3/4	3 3/4	4 1/2	5 5/8
		212-212	90	5	3	3	6.3	2.6				
				5	3	3	6.3	9				
*P-3077	18.25	300-300	250	5	3	3	6.3	9	3 x 3 3/4	3 3/4	4 1/2	4 1/4
*P-3078	23.50	360-360	275	5	3	3	6.3	9	3 x 3 3/4	3 3/4	4 1/2	4 3/4
*P-3079	14.75	140 tap 117	300	5	3	3	6.3	9	3 x 3 3/4	3 3/4	4 1/2	3 3/4
*P-3076	24.00	270-270	300	5	3	3	6.3	6.5**	3 x 3 3/4	3 3/4	4 1/2	5
		180-180	200	5	3	3	6.3	6.5**				

* For use with Half-Wave Rectifier. † Replaces P2965.

‡ Socket Type. See Figure CS.o

† All TV Powers are Fully Flux and Static Shielded.

* Type A Mtg.

^ Shielded to meet Underwriters approval for pre-amp use.. Mtg B.

†Max. MA High Tap Only

‡Max MA Low Tap Only

**Can be used in series for 12.6 V.

P-3066	P-3067	P-3073	P-3076
320	300	220	435
340	340	325	500

TV ISOLATION FILAMENT TRANSFORMER Isolates damper tube from other filaments. Secondary insulated for 5000 V.

Type No.	List Price	Pri. Volts	Sec.		Mtg. Centers	Dimensions			Mtg.
			Volts	Amps.		H	W	D	
P-3097	\$3.70	6.3	12.6 or 6.3	1 1.2	2 1/8	1 7/8	3 1/4	2	A



Products of Merit



TRANSFORMERS

POWER TRANSFORMERS¹ Receiver Replacement Type—Primary for 115 V., 60 Cy. Leads R.M.A. Color Coded Fully Shielded Upright Mounting Type—Mtg. Fig. D

Type No.	List Price	H. V. Secondary		Rectifier		Fil. Wdgs.		Mtg. Centers	Dimensions		
		Volts	D.C. M.A.	Volts	Amp.	Volts	Amp.		H.	W.	D.
P-3147	\$6.00	240-240	50			6.3	2.5	2 x 1 ¹ / ₁₆	3 ¹ / ₈	2 ⁵ / ₈	2 ¹ / ₂
P-3148	7.00	260-260	90			6.3	4.7	2 x 2 ³ / ₁₆	3 ¹ / ₈	2 ⁵ / ₈	3 ¹ / ₂
P-3149	6.50	240-240	40	5	2	6.3 c.t.	2	2 x 1 ¹ / ₁₆	3 ¹ / ₈	2 ⁵ / ₈	2 ⁵ / ₈
P-3150	6.75	325-325	40	5	2	6.3 c.t.	2	2 x 1 ¹ / ₁₆	3 ¹ / ₈	2 ⁵ / ₈	2 ¹ / ₂
P-3154	8.75	275-275	50	5	2	6.3	2.6	2 x 2 ¹ / ₁₆	2 ¹ / ₂	4 ⁵ / ₈	2 ¹ / ₂
P-3160	7.50	350-350	50	5	2	6.3 c.t.	2.6	2 ¹ / ₄ x 1 ¹ / ₁₆	3 ¹ / ₈	2 ¹ / ₂	3 ¹ / ₄
P-3151	7.75	325-325	70	5	3	6.3 c.t.	3.5	2 ¹ / ₂ x 1 ¹ / ₁₆	3 ¹ / ₈	3 ¹ / ₈	3 ¹ / ₈
P-3152	8.50	350-350	90	5	3	6.3 c.t.	3.5	2 ³ / ₄ x 2 ⁵ / ₁₆	2 ¹ / ₂	4 ⁵ / ₈	2 ⁵ / ₈
P-3153	9.75	350-350	110	5	3	6.3 c.t.	4.5	3 ¹ / ₄ x 2 ¹ / ₁₆	4 ⁵ / ₈	3 ¹ / ₈	3 ¹ / ₄
P-3173	11.75	350-350	150	5	3	6.3	6.5	2 ¹ / ₂ x 2 ¹ / ₁₆	3 ¹ / ₈	3 ¹ / ₄	4 ¹ / ₂
P-3155	14.00	400-400	200	5	3	6.3 c.t.	5	3 x 3 ¹ / ₁₆	4 ⁵ / ₈	3 ¹ / ₈	4 ¹ / ₂
P-3156	17.50	435-435	250	5	3	6.3 c.t.	3	3 x 3 ¹ / ₁₆	4 ⁵ / ₈	3 ¹ / ₈	4 ¹ / ₂
★P-3165	18.75	(80-volt Bias Tap) 350-350	200	5	2	6.3 or 5	.6	3 x 3 ¹ / ₈	4 ⁵ / ₈	3 ¹ / ₄	5
★P-3169	27.00	†{390-390} {325-325}	160 130	5 5	3 3	6.3 6.3	8 4	3 x 3 ⁵ / ₈	4 ⁵ / ₈	3 ¹ / ₈	4 ¹ / ₂
★P-3166	31.50	400-400	300	5 5	3 6	12.6 c.t.	10	3 ¹ / ₂ x 4 ¹ / ₄	5 ¹ / ₂	4 ⁵ / ₈	5 ⁵ / ₈
★P-3174	40.00	†{450-450} {325-325}	240 200	5 5	3 3	6.3 6.3	6 6	3 ⁵ / ₈ x 3 ¹ / ₈	5 ¹ / ₈	4 ¹ / ₈	5 ⁵ / ₈
★P-3170	11.00	1750	2	2.5	2	6.3	.9	2 x 1 ¹ / ₁₆	3 ¹ / ₈	2 ⁵ / ₈	2 ¹ / ₂
★P-3171	14.50	2500	5	2.5	2	6.3 or 2.5	3	2 ¹ / ₂ x 2 ³ / ₁₆	3 ¹ / ₈	3 ¹ / ₈	3 ³ / ₈

¹All TV Powers are Fully Flux and Static Shielded.

†Max. M. A. High Tap Only P-3169: 270 P-3174: 400
Max. M.A. Low Tap Only P-3169: 290 P-3174: 430

FILAMENT TRANSFORMERS For Amplifier, Amateur, Industrial Use. Pri.: 115 Volts, 60 Cycles

Type No.	List Price	Sec. Volts	Sec. Amp.	Insulation Volts	Dimensions			Mtg.
					H.	W.	D.	
P-2939	\$4.00	2.5 c.t.	5	2500	2	3 ¹ / ₄	1 ⁵ / ₈	A
P-2940	6.00	2.5 c.t.	10	7500	3	3 ⁵ / ₈	2 ¹ / ₄	B
P-3042	6.50	2.5 c.t.	10	10000	2 ¹ / ₈	3 ⁵ / ₈	2 ¹ / ₄	EH
P-3040	4.50	5 c.t.	3	2500	2	3 ¹ / ₄	2 ⁵ / ₈	A
P-2941	5.25	5 c.t.	6	2500	2 ¹ / ₄	3 ¹¹ / ₁₆	1 ⁷ / ₈	A
P-2942	12.00	5 c.t.	15	10000	4 ¹ / ₂	3 ³ / ₄	3 ¹ / ₂	EV
P-2943	12.00	5 c.t.	30	2500	3 ³ / ₈	3 ³ / ₈	3	DL
P-2944	3.00	6.3 c.t.	1	2500	1 ⁵ / ₈	2 ¹ / ₂	1 ¹ / ₂	A
★P-3074	3.75	6.3	1.2	5000	2	3 ¹ / ₄	2	A
P-2945	3.60	6.3 c.t.	2	2500	2	3 ¹ / ₄	1 ⁵ / ₈	A
P-2946	4.50	6.3 c.t.	3	2500	2	3 ¹ / ₄	1 ¹ / ₈	A
P-2947	5.75	6.3 c.t.	6	2500	3	3 ⁵ / ₈	2 ¹ / ₄	B
P-2948	7.50	6.3 c.t.	10	2500	3 ¹ / ₁₆	2 ¹ / ₂	2 ¹ / ₂	EV
P-2960	5.50	7.5 c.t.	4	2500	2 ⁵ / ₈	3 ¹ / ₈	1 ⁵ / ₈	B
P-2961	7.15	6.3 c.t.	3	2500	3	3 ⁵ / ₈	2 ¹ / ₄	B
P-3041	7.15	5 c.t.	3	2500	2 ¹ / ₂	4	2 ¹ / ₈	A
		6.3 c.t.	3.6					
P-3143	9.00	7.5 c.t.	8	2500	3 ¹ / ₂	2 ¹ / ₂	3 ¹ / ₈	D
P-3145	9.00	10 c.t.	5	2500	3 ¹ / ₂	2 ¹ / ₂	3	D
P-3146	10.50	10 c.t.	10	3000	3 ¹ / ₈	3 ³ / ₈	3 ⁵ / ₈	D

TV CONVERSION—REPLACEMENT—IMPROVEMENT KIT

KIT No. 1000	\$25.25	1 EA. HVO-7, MDF-70, MWC-1 CONVERSION AND REPLACEMENT DATA INCLUDED
--------------	---------	---

POWER APPLICATIONS For Selenium Rectifiers, Pri. 115 Volts, 60 Cycles

Type No.	List Price	Sec. Volts	Sec. Amp.	Insulation Volts	Dimensions			Mtg.
					H.	W.	D.	
P-2959	\$ 4.75	12.6 c.t.	2	2500	2	3 ¹ / ₄	1 ⁷ / ₈	A
P-2962	4.75	25.2	1	2500	2	3 ¹ / ₄	1 ⁷ / ₈	A
P-2963	10.50	12.6	7	2500	3 ¹ / ₈	2 ⁵ / ₈	3 ¹ / ₂	D
		or						
		25.2	3.5					
P-3085	7.00	26 V. c.t.	3	2000	2 ¹ / ₂	3 ³ / ₈	2 ³ / ₄	EH
P-3086	20.00	104 V. c.t.	3	2000	4 ³ / ₈	5 ¹ / ₄	4 ¹ / ₄	EH
P-3087	38.00	78 V. tapped @ 26 & 52 V.	6	2000	5 ¹ / ₁₆	6 ¹ / ₈	5 ¹ / ₈	EH
P-3088	12.00	13 V.	12	2000	3 ⁷ / ₁₆	4 ¹ / ₈	3 ¹ / ₄	EH
P-3089	42.00	104 V. c.t.	6	2000	5 ¹ / ₁₆	6 ¹ / ₈	6 ⁵ / ₈	EH
P-3090	40.00	156 V. tapped at 130 V.	3	2000	5 ¹ / ₁₆	6 ¹ / ₈	5 ¹ / ₈	EH
P-3091	120.00	130 V. tapped at 104 V.	12	2000	7 ¹ / ₁₆	6 ¹ / ₃₂	7 ¹ / ₂	EH
P-3092	70.00	156 V.	6	2000	6 ¹ / ₃₂	7 ¹ / ₁₆	7	EH
*P-3093	27.00	36 V. c.t.	10	2000	4 ³ / ₈	5 ¹ / ₄	4 ³ / ₄	EH
*P-3094	50.00	72 V. c.t.	10	2000	6 ¹ / ₃₂	7 ¹ / ₁₆	5 ³ / ₄	EH

*Matches Selenium Rectifiers in Federal's "All Purpose" Assembly Kit.



TRANSFORMERS

VIBRATOR TRANSFORMERS For Operation From 6 V. Battery and Vibrator

Type No.	List Price	Sec. DC Volts to Filter	Sec. M.A.	Dimensions			Mtg.
				H.	W.	D.	
P-2969	\$5.25	150	40	2 1/4	2 1/8	1 3/8	B
P-2970	6.00	225	40	2 3/8	3 3/8	2 1/8	B
P-2971	6.50	250	50	2 3/8	3 1/8	2 1/8	B
P-2972	7.00	260	60	3	3 3/8	2 1/8	B
P-3068	5.00	260	60	2 3/8	2 3/8	1 7/8	C
P-4071	7.75	250	50	3	2 3/8	2 3/8	JT
†P-4076	7.50	265	55	3 1/4	2 3/8	2 3/8	JG
†P-4077	8.00	280	65	3 3/8	2 1/4	2 3/8	JT
P-4078	7.25	270	60	2 3/8	2 3/8	2 3/8	JT
P-4079	8.25	270	75	3 1/2	2 3/8	2 1/2	JT

★Indicates TV Replacement. †Has Built-in Hash Filter.

All prices subject to trade discount, and change without notice.

VIBRATOR TRANSFORMERS For Operation From 12V Battery and Vibrator

Type No.	List Price	Sec. DC Volts to Filter	Sec. M.A.	Dimensions			Mtg.
				H.	W.	D.	
P-2978	\$5.00	260	60	2 3/8	2 3/8	1 7/8	C
†P-4051	7.00	265	55	3 1/4	2 3/8	2 3/8	JG
†P-4052	7.50	280	65	3 3/8	2 1/4	2 3/8	JT

†Built-in hash filter.

BLOCKING OSCILLATOR TRANSFORMERS

Type No.	List Price	Turns Ratio Primary to Secondary	Mtg. Centers	Dimensions			Mtg. Type
				H.	W.	D.	
★A-3000 Vertical	\$2.65	1:4.2	2	1 3/8	2 3/8	1 1/4	A
★A-3001 Vertical	4.00	†	2 3/8	1 3/8	2 1/8	1 1/2	A
★A-4000 Vertical	3.25	1:4.2	2	1 3/8	2 3/8	1 1/2	J
★A-3002 Horizontal	3.00	2:1	1 15/16	1 3/8	2 3/8	1 1/4	A
★A-3003 Vertical	2.50	1:4.2	1 3/8	1 3/8	2 1/8	7/8	A
★A-3004 Vertical	2.75	1:15	1 3/8	1 3/8	2	1 1/2	B
★A-4002 Horizontal	3.75	2:1	1 3/4	1 3/8	2 3/8	1 1/2	J
★A-4003 Vertical	3.25	1:4.2	1 3/8	1 3/8	1 3/8	1 3/8	JL

†Pri./Sec. 1—1:2.08, Pri./Sec. 2—1:1.

HORIZONTAL SCAN CHOKE

Type No.	List Price	Description	Mtg. Centers	Dimensions			Mtg. Type
				H.	W.	D.	
(N) *C-2980	\$3.50	Exact Repl. Sylvania 241-0002	1 25/32	1 11/16	2	1 1/4	B

(N)—New item.

TV COMPONENTS

HORIZONTAL OUTPUT AND HI-VOLTAGE TRANSFORMERS

Type No.	List Price	Picture Tube	Equivalent Type	Mtg. Type
★HVO-3	\$ 8.00	7DP4—10 BP4 Etc.	RCA 211T1—211T3	M
HVO-5	10.00	16 AP4 Etc.	RCA 211T5	M
★HVO-X7*(Univ.Mtg.)	15.00	10" to 24"	GE 77J1 plus AGC-AFC	N
★HVO-7 (Univ. Mtg.)	12.00	10" to 24"	GE 77J1 plus AGC-AFC	N
★HVO-8	6.50	10" to 24"	Air Core	T
★HVO-9	10.00	17" to 24"	RCA 230T1	Exact Repl.
★HVO-10	10.00	10" to 21"	Fast retrace plus AGC-AFC	N
★HVO-11	9.00	10" to 19" Rnd.	Zenith under chassis	Exact Repl.
★HVO-12	10.00	10" to 20"	Motorola Replacement	Exact Repl.
★(N)*HVO-13	8.25	10" to 21"	Sylvania Replacement	Exact Repl.

(N)—New item.

★Indicates TV Replacement.

*"CORONA-FREE" Insulation.

WIDTH OR LINEARITY COILS

Type No.	List Price	Range	Resistance-Ohms.	Equivalent Type	Mtg. Type
★MWC-1†	\$2.25	4-29 M.H.	28.3—29.4	None	O
★MWC-2	1.10	2—4.0 M.H.	7.15	RCA 208R1, 201R1, 201R4	O
★MWC-3	1.90	20-60 M.H.	47.5	None	O
★MWC-4†	1.25	0.2—3 M.H.	7.12 Ohms	RCA 201R5	O
★MWC-5†	1.25	1—5 M.H.	6 Ohms	RCA 207R1, 209R1	O
★MWC-6	1.25	1.5—10 M.H.	8 Ohms	RCA 211R1, 213R1	O

†Secondary provided for AGC-AFC.

†Tapped.

★Indicates TV Replacement. *Split secondary. *Cosine-Ferrite core. All prices subject to trade discount, and change without notice.

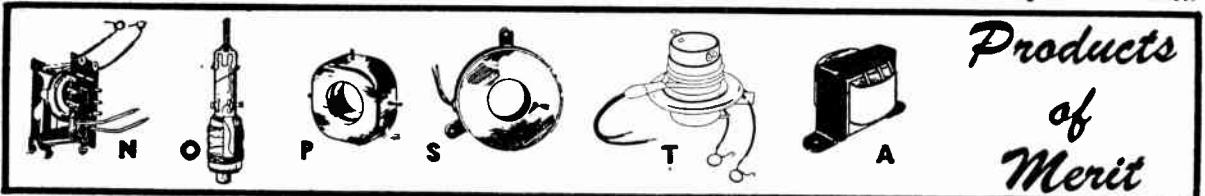

Products of Merit

Copyright by U. C. P., Inc.

TRADE DISCOUNT APPLIES TO LIST PRICES ONLY

Radio's Master—19th Edition

Page N-77



TRANSFORMERS

FOCUS COILS

Type No.	List Price	Tube Size	Dimensions-Depth	Equivalent Type	M.A.	DC. Res. Ohms	Mtg. Type
★MF-1*	\$8.25	10"-12"	1"-1 1/2"	202D1	100	247	S
★MF-2	11.00	16"	1"-3 1/2"	202D2	100	470	S
★MF-3*	8.25	10"-12"	1"-1 1/2"		100	360	S†
★MF-4	11.00	14"-20"	1"-3 1/2"		75	1000	S
★MF-5	11.00	14"-20"	1"-3 1/2"		75	1500	S

*Equipped with lugs on each side and universal mtg. plate.

DEFLECTION YOKES (With Network and Leads) Fig. R.

Type No.	List Price	Tube Size	Inductance		Def. Angle
			Horizontal	Vertical	
★MD-12	\$ 9.00	10"-16"	8 mh ± 10%	48 mh ± 10%	53°
★MD-13	9.00	10"-16"	30 mh ± 10%	48 mh ± 10%	53°
★MDF-70*	10.00	14"-24"	10 mh ± 10%	45 mh ± 10%	70°
★MDF-71*	10.00	14"-24"	30 mh ± 10%	50 mh ± 10%	70°
★MDF-72*	10.00	14"-24"	13 mh ± 10%	41 mh ± 10%	70°
★MDF-73*	10.00	14"-24"	19 mh ± 10%	40 mh ± 10%	70°
★MDF-74†*	10.00	14"-24"	28 mh ± 10%	3 mh ± 10%	70°
★MDF-90*	15.00	27"-30"	10 mh ± 10%	45 mh ± 10%	90°

*Cosine-Ferrite Core.

† Replaces MDI-30—Improved model.

LINE VOLTAGE REGULATORS To adjust line voltages of 65-75-90-100-115-130-145 volts, to 115 volts, 50/60 cycles. Equipped with voltmeter, line cord and plug, output receptacle, variable switch, and indicator light.

Type No.	List Price	Watts	Dimensions			Mtg.
			H.	W.	D.	
★P-3138	\$25.00	350	4 3/8	3 1/16	5 3/4	D
★P-3139	45.00	750	5 7/8	4 1/2	8 1/2	D

TV AUTOTRANSFORMER Provides TV picture tube booster voltage.

Type No.	List Price	Input Volts	Output		Mtg. Centers	Dimensions			Mtg.
			Volts	Amps.		H	W	D	
P-3098	\$2.75	6.3	12.6 taps at 9.45-6.3	1	2 3/8	1 1/2	2 1/16	1 1/4	A

INDUSTRIAL-AMATEUR

OUTDOOR TYPE UNIVERSAL LINE TRANSFORMER To Couple Various Line Impedances to a Voice Coil Universal Mounting Bracket

Type No.	List Price	Ohms Impedance		Watts	Mtg. Center Case	Dimensions			Mtg. Type
		Primary	Sec.			H.	W.	D.	
A-4040	\$11.00	250-500-1000-1500-2000	4-8-16	8	2 3/4 x 3 3/8	4 1/4	4 1/16	3 1/16	JO
A-4041	11.75	250-500-1000-1500-2000	4-8-16	12	2 3/4 x 3 3/8	4 1/4	4 1/16	3 1/16	JO
A-4042	16.25	250-500-1000-1500-2000	4-8-16	25	2 3/4 x 3 3/8	4 1/4	4 1/16	3 1/16	JO
A-4043	11.75	45-50	4-8	12	2 3/4 x 3 3/8	4 1/4	4 1/16	3 1/16	JO

DRIVER TRANSFORMERS To Couple Driver Plate to Amplifier Grids

Type No.	List Price	Driver	Output	Ratio, Pri. to 1/2 Sec.	Class	Pri. M.A.	Mtg. Centers	Dimensions			Mtg.
								H.	W.	D.	
A-2920	\$3.15	6C5, 11H4, 30, 49	Single 1J6, 19, Push-pull 30, 49	2.5:1	B	10	2 3/8	1 1/2	2 1/16	1 1/2	A
A-2921	4.40	6F6, 2A5, 42	PP6F6, 2A5, 6L6	1.7:1, 1.5:1, 1.3:1	AB	35	2 3/8	2	3 1/4	1 1/2	A
A-2922	5.25	6A6, 6C5, 6N7, 46	Single 6A6, 6N7, Push-pull 46	5:1, 4:1, 3:1, 2.5:1	B	20	2 3/8	2	3 1/4	1 1/2	A
A-3120	13.50	500 ohm line	Class B Grids 15 Watt Capacity		B	-----	2 1/2 x 2	3 3/8	2 3/8	3 3/8	DL
A-3121	15.25	500 ohm line	Class B Grids 30 Watt Capacity	1:1.75, 1:1.85, 1:1, 1:1.25, 1:1.45, 1:1.75, 1:2, 1:2.25, 1:2.5, 1:2.75, 1:3	B	-----	2 1/2 x 2 1/4	3 3/8	3	3 3/4	DL
A-3123	6.50	PP6A6, 53, PP6C5, 6N7, 6J5	PP6N7, 6A6, 53, PP6L6, T21	5:1*	B	15	2 x 1 1/16	3 1/2	2 3/8	2 3/8	D
A-3124	6.50	6F6, 46, 59, 2A5, 42	PP46, 59, PP6L6, 807	2.2:1	B	30	2 x 1 1/16	3 1/2	2 3/8	2 3/8	D
A-3125	9.25	6F6, 2A5, 47, 42	PP6L6	1.4:1*	B	40	2 1/4 x 2	3 1/2	2 3/8	3 1/2	D
A-3126	7.50	PP2A3, 6L6, 45, 6V6, 6F6	PP800, 203A, 811, 812, 812A, RK18, RK58, T20, TZ40, T55, 807, 809, 838, 845, 35, 100TH	2:1	B	40	2 x 1 1/16	3 1/2	2 3/8	2 3/8	D

★ Indicates TV Replacement. * Split secondary. * Cosine-Ferrite c. re.

All prices subject to trade discount, and changes without notice.

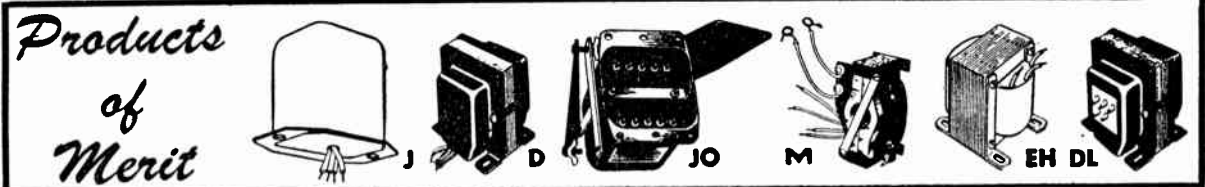



TRANSFORMERS

MODULATION TRANSFORMERS For Specific Applications

Type No.	List Price	Output Tubes	Ohms Impedance		Max. M.A.		Watts	Dimensions			Mtg.
			Pri.	Sec.	Pri.	Sec.		H.	W.	D.	
A-3008	\$4.00	6A6, 6N7, 53	10000 c.t.	4000-5000 7500-10000	70	60	10	2 1/4	2 1/8	2 1/8	B
A-3109	9.00	PP2A3, 6A3, 6B4, 6L6, 45, 46, 59	6000 c.t. 3800 c.t. 3000 c.t.	12000 5000-8000 10000	80	100	25	3 1/8	2 3/8	2 3/4	D
A-3110	15.00	PP6L6, 807, RK41, HY56, HY61, HK24	6600-3800 c.t.	4000-5000 7500-10000 12000	175	150	60	4 1/4	3 1/2	3 3/4	D
A-3113	23.00	PP 800, 809, TZ-40, T-55, HK-54, RK-31, HY-40, 811A, 807, 812A, 5514	15000-6900c.t.	3000-4000 5000-6000	250	300	175	4 5/8	3 3/16	5 5/8	D

UNIVERSAL MODULATION TRANSFORMERS Tapped Series-Parallel Coils Provide a Wide Range of Modulation Ratios

Type No.	List Price	Pri. Impedance	Pri. M.A. per Side	Sec. Impedance	Max. Sec. M.A. †	Watts	Dimensions			Mtg.
							H.	W.	D.	
A-3104	\$11.50	2000-20000	50	2000-20000	50/100	15	3 1/16	2 1/8	2 3/4	DL
A-3105	16.75	2000-20000	150	2000-20000	150/300	60	3 3/8	3 1/8	4 1/8	DL
A-3106	22.50	2000-20000	220	2000-20000	220/440	125	4 5/8	3 1/16	4 5/8	DL

‡Series/Parallel

PLATE TRANSFORMERS For Small Transmitters. DC Voltage Ratings are Approx. Values Obtained at Output of a 2 Section Choke Input Filter Using Mercury Vapor Rectifier Tubes. Pri. is for 115 V. 60 cy.

Type No.	List Price	Sec. Rms. Volts	Sec. DC Volts	DC Sec. M.A.	Dimensions			Mtg.
					H.	W.	D.	
P-3175	\$10.50	550-550	400	150	3 1/16	3	3 3/8	D
P-3157	14.50	660-660 †	500	250	4 1/8	3 13/16	4 3/8	D
P-3158	18.00	550-550 1080-1080	400 1000 †	125 150	4 5/8	3 13/16	5	D
P-3159	17.25	500-500 900-900	400 750	225	4 5/8	3 13/16	5 1/8	D
P-3167	43.00	800-800 1450-1450	600 1200	300	5 3/4	6 1/8	5	EH
P-3168	55.00	1175-1175 2100-2100	1000 1750	300	5 3/4	6 1/8	6	EH
P-4062	80.00	1800-1800 2900-2900 2385-2385	1500 2500 2000	300	8 1/2	6 1/2	6 1/16	H

†For dual operation with simultaneous use of both sec. ratings. †Has 40-volt bias tap.

FILTER CHOKES For Small Transmitter and Amplifier Applications

Type No.	List Price	Inductance Henries	Current Rating M.A.	DC Res. Ohms	Volts Insul.	Dimensions			Mtg.
						H.	W.	D.	
C-3192	\$5.00	15	85	325	1500	3 1/8	2 5/8	2 5/8	D
C-3193	5.00	10	110	200	1500	3 1/8	2 5/8	2 5/8	D
C-3194	6.00	12	150	230	1500	3 1/8	2 13/16	3 1/8	D
C-3195	8.75	15	150	180	2000	3 1/8	3 1/16	3 5/8	D
C-3196	7.00	5	200	80	1500	3 1/2	2 13/16	3 3/8	D

FILTER SMOOTHING CHOKES For Transmitter Power Supplies

C-3180	\$6.50	10	150	210	3000	3 1/8	2 5/8	2 3/4	D
C-3181	8.00	10	200	140	3000	3 1/2	2 13/16	3 1/2	D
C-3182	11.00	10	250	125	3000	3 1/8	3 1/16	3 3/4	D
C-3183	11.50	8	300	80	3000	3 1/8	3 1/16	3 3/4	D

FILTER INPUT OR SWINGING CHOKES

C-3187	\$6.50	4-16	150	210	3000	3 1/8	2 5/8	2 3/4	D
C-3188	8.00	4-16	200	140	3000	3 1/2	2 13/16	3 1/2	D
C-3189	11.00	4-16	250	125	3000	3 1/8	3 1/16	3 3/4	D
C-3190	11.50	3-14	300	80	3000	3 1/8	3 1/16	3 3/4	D

All prices subject to trade discount, and change without notice.

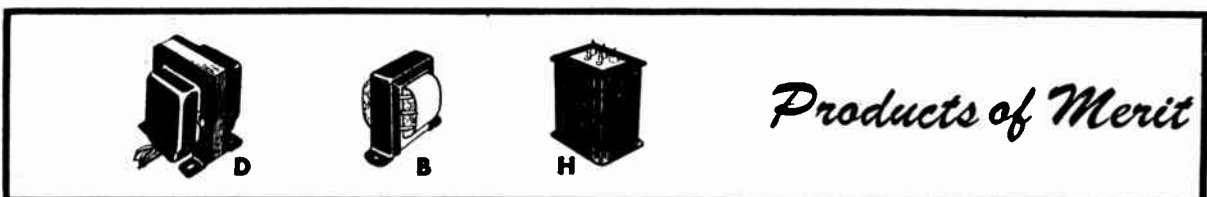



TRANSFORMERS

AC-DC VIBRATOR TRANSFORMER For Operation from 6 V. Battery and Vibrator or 115 V. 60 cy. Line

Type No.	List Price	H.V. Secondary		Filament		Dimensions			Mtg.
		DC Volts	MA	Volts	Amps	H.	W.	D.	
P-3176	\$15.00	306	160	6.3 or 5	3	4 3/8	3 13/16	4 1/4	D
P-3075	10.00	330	100	6.3	4.5	3 3/8	3 3/8	3 3/8	D

PHOTO-FLASH POWER TRANSFORMER Primary for 117 V. 60 Cy. Line or 4 V. Battery Vibrator (or Charger Winding)

Type No.	List Price	Secondary		Mtg. Centers	Dimensions			Mtg.
		AC Volts	DC M.A.		H.	W.	D.	
P-3065	\$8.00	1100	1.5	2 11/16	2 3/4	3 1/8	2	B

STEP-DOWN AUTOTRANSFORMERS Input 220-250 V. 60 cy. Output 110-125 V. Pri. Cord and Plug. Sec. Receptacle.

Type No.	List Price	Output Watts	Dimensions			Mtg.
			H.	W.	D.	
P-3161	\$10.00	80	3 1/2	2 15/16	3	D
P-3162	13.25	150	3 3/8	3 3/8	3 3/8	D
P-3163	17.75	250	4 3/8	3 13/16	4	D
P-3164	22.50	500	4 3/8	3 13/16	4 3/8	D
P-4065	50.00	1000	7 1/4	6 5/8	5 3/8	H

ISOLATION TRANSFORMERS Equipped with Pri. Cord and Plug—Sec. Standard Receptacles. Static Shielded

Type No.	List Price	Primary Volts	Secondary Volts	Watts	Dimensions			Mtg.
					H.	W.	D.	
P-3177	\$27.50	117	105-115-125	350	5 5/16	4 1/2	5 1/4	D

ISOLATION TRANSFORMERS To Provide Isolation Between Line and Associated Circuits. Primary for 50-60 Cy. Static Shielding Between Primary and Secondary.



Type No.	List Price	Primary Volts	Secondary Volts	Watts	Dimensions			Mtg.
					H.	W.	D.	
P-3096	\$ 7.25	117	117	40	3 1/8	2 3/8	2 3/8	B
P-3197	10.00	117	117	80	3 3/8	3 3/8	3 1/2	D

ISOLATION TRANSFORMERS Equipped with Line Cord and Standard Receptical

Type No.	List Price	Primary Volts	Secondary Volts	Watts	Dimensions			Mtg.
					H.	W.	D.	
P-3172	\$50.00	117	117	500	5 3/8	4 3/8	6 1/2	D
P-3198	18.75	117	117	100	4 1/4	3 3/8	3 3/4	D
P-3199	35.00	117	117	250	4 3/8	3 13/16	4 7/8	D

All prices subject to trade discount, and change without notice.

Products of Merit



IF-RF COILS

★ TELEVISION UNITS—IF Transformers—Permeability Tuned

Type No.	List Price	Function	Freq. MC.	Mtg. Centers	Dimensions	Mtg.
TV-100	\$2.75	1st Pix Amp.	25.3	3/8	3/8 x 3/8 x 2 1/8	A
TV-101	2.10	2nd Pix Amp.	22.3	3/8	3/8 x 3/8 x 2 1/8	A
TV-102	.80	3rd Pix Amp.	25.2	1/8 Hole	1/2 x 1 1/2	B
TV-103	.80	4th Pix Amp. (Detector)	23.4	1/8 Hole	1/2 x 1 1/2	B
TV-104	2.20	1st Sound (Amplifier)	21.25	3/8	3/8 x 3/8 x 2 1/8	A
TV-105	2.20	2nd Sound (Amplifier)	21.25	3/8	3/8 x 3/8 x 2 1/8	A
TV-106	2.60	Sound Discrim.	21.25	1 1/8	1 1/8 x 1 1/8 x 2 1/8	A
TV-107	2.75	Converter	21.8	3/8	3/8 x 3/8 x 2 1/8	A
TV-108	2.75	Input Amp.	4.5	1 1/8	1 1/8 x 1 1/8 x 2 1/8	A
TV-109	3.00	Sound Disc.	4.5	1 1/8	1 1/8 x 1 1/8 x 2 1/8	A
TV-110	3.30	Sound Ratio Det.	4.5	1 1/8	1 1/8 x 1 1/8 x 2 1/8	A
TV-111	3.30	Sound Ratio Det.	21.25	1 1/8	1 1/8 x 1 1/8 x 2 1/8	A
TV-112	1.00	Tunable Choke	21-25 MC	1/8	1/2 x 1 1/2	B
TV-113	2.75	Sound Amp.	4.5	Clip	3/4 x 3/4 x 2	K
TV-114	3.30	Sound Disc.	4.5	Clip	3/4 x 3/4 x 2	K
TV-115	3.30	Sound Ratio Det.	4.5	Clip	3/4 x 3/4 x 2	K
TV-116	1.75	Video IF (Transformer).	21-25 MC	1/8 Hole	1/2 x 1 1/2	B

TRAPS—Permeability Tuned

Type No.	List Price	Function	Freq. MC.	Mtg. Centers	Dimensions	Mtg.
TV-150	\$2.00	Cathode Trap*	21.25	1/8 Hole	1/2 O.D. x 1 1/2	B
TV-151	1.00	Sound Trap	4.5	1/8 Hole	1/2 O.D. x 1 1/2	B

*Includes Condenser.

HORIZONTAL "SYNC." TRANSFORMERS

Type No.	List Price	System	Mtg. Centers	Dimensions	Mtg.
TV-160	\$2.75	"Sync." Lock	1 1/8	1 1/8 x 1 1/8 x 2	C
TV-161	2.00	"Sync." Guide	1 1/8	1 1/8 x 1 1/8 x 2	C
TV-162	2.50	"Sync." Freq. and Phase	1 1/8	1 1/8 x 1 1/8 x 2	C
TV-163	2.00	Ringing Coil	1/8 Hole	1/2 x 1 1/2	B

ANTENNA COUPLING TRANSFORMERS

Type No.	List Price	Impedance Ratio	Mtg. Centers	Dimensions	Mtg.
TV-170	\$2.75	52/300 or 300/52	"L" Bracket	3/4 x 3/4 x 1 3/8	F
TV-171	2.75	72/300 or 300/72	"L" Bracket	3/4 x 3/4 x 1 3/8	F

PEAKING COILS

Type No.	List Price	Inductance Microhenries	Color Code	Shunt Resistor	Mtg.
TV-180	\$0.45	36	Black	—	E
TV-181	.45	93	Red	—	E
TV-182	.45	120	Blue	22K	E
TV-183	.45	180	White	39K	E
TV-184	.50	180	Yellow	—	E
TV-185	.50	250	Green	—	E
TV-189	.50	8	Orange	—	E
TV-186	.50	73	—	10 meg.	E
TV-187	.50	250	—	22K	E
TV-188	.50	500	—	10 meg.	E

HIGH-PASS FILTERS

Type No.	List Price	Line Impedance	Mtg. Centers	Dimensions	Mtg.
TV-210	\$5.50	72 Ohm	2 1/8	1 1/8 x 1 1/8 x 3 1/2	D
TV-211	5.50	300 Ohm	2 1/8	1 1/8 x 1 1/8 x 3 1/2	D

★ IF-RF television units prefix "TV."

WAVE TRAPS TV-FM

Type No.	List Price	Freq. Range	Mtg. Centers	Dimensions	Mtg.
TV-220	\$4.40	150-250 MC.	1 1/8	2 1/8	D
TV-221	4.40	75-150 MC.	1 1/8	2 1/8	D
TV-222	4.40	40- 80 MC.	1 1/8	2 1/8	D
TV-223	4.40	20- 40 MC.	1 1/8	2 1/8	D

HI-VOLT OSCILLATOR TRANSFORMERS

Type No.	List Price	Output Volts	Mtg. Centers	Dimensions	Mtg.
TV-230	\$ 8.25	To 4000	1 1/2	1 1/2 dia. x 3 3/4 high	H
TV-231	13.75	To 30000	2 1/2	2 1/2 dia. x 6 high	H

Products of Merit

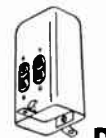



IF-RF COILS

FM

IF TRANSFORMERS (Permeability Tuned)

Type No.	List Price	Description	Freq.	Mtg. Centers	Dimensions	Mtg.
FM-250	\$3.30	Discriminator	10.7 MC.	1 1/4"	1 1/2" x 1 1/2" x 2 1/2"	A
FM-251	2.20	Amp. Interstage	10.7 MC.	1 1/4"	1 1/2" x 1 1/2" x 2 1/2"	A
FM-252	2.20	Ratio Detect.	10.7 MC.	1 1/4"	1 1/2" x 1 1/2" x 2 1/2"	A
FM-253	2.75	Disc.—Min.	10.7 MC.	Clip	3/4" x 3/4" x 2"	K
FM-254	3.30	Amp.—Min.	10.7 MC.	Clip	3/4" x 3/4" x 2"	K
FM-255	3.30	Ratio Det.—Min.	10.7 MC.	Clip	3/4" x 3/4" x 2"	K

ANTENNA—OSCILLATORS—RF (Slug Tuned)

Type No.	List Price	Description	Freq. MC.	Mtg. Centers	Dimensions	Mtg.
FM-280	\$2.20	Antenna	88-108	3/8" Hole	1/2" x 1 1/2"	B
FM-281	2.20	RF	88-108	3/8" Hole	1/2" x 1 1/2"	B
FM-282	2.20	Osc.	88-108	3/8" Hole	1/2" x 1 1/2"	B

BROADCAST

IF TRANSFORMERS (Capacity Tuned)

Type No.	List Price	Function	Freq.	Mtg. Centers	Dimensions	Mtg.
BC-300	\$2.50	Input	175 KC	1 1/8"	1 1/2" x 1 1/2" x 2 1/2"	I
BC-301	2.50	Interstage	175 KC	1 1/8"	1 1/2" x 1 1/2" x 2 1/2"	I
BC-302	2.50	Full Wave Output	175 KC	1 1/8"	1 1/2" x 1 1/2" x 2 1/2"	I
BC-303	2.50	Half Wave Output	175 KC	1 1/8"	1 1/2" x 1 1/2" x 2 1/2"	I
BC-304	2.20	Input	282 KC	1 1/8"	1 1/2" x 1 1/2" x 2 1/2"	I
BC-305	2.20	Interstage	282 KC	1 1/8"	1 1/2" x 1 1/2" x 2 1/2"	I
BC-306	2.20	Full Wave Output	282 KC	1 1/8"	1 1/2" x 1 1/2" x 2 1/2"	I
BC-307	2.20	Half Wave Output	282 KC	1 1/8"	1 1/2" x 1 1/2" x 2 1/2"	I
BC-308	2.20	Input	455 KC	1 1/8"	1 1/2" x 1 1/2" x 2 1/2"	I
BC-309	2.20	Interstage	455 KC	1 1/8"	1 1/2" x 1 1/2" x 2 1/2"	I
BC-310	2.20	Full Wave Output	455 KC	1 1/8"	1 1/2" x 1 1/2" x 2 1/2"	I
BC-311	2.20	Half Wave Output	455 KC	1 1/8"	1 1/2" x 1 1/2" x 2 1/2"	I
BC-312	2.20	Input	1500 KC	1 1/8"	1 1/2" x 1 1/2" x 2 1/2"	I
BC-313	2.20	Interstage	1500 KC	1 1/8"	1 1/2" x 1 1/2" x 2 1/2"	I
BC-314	2.20	Full Wave Output	1500 KC	1 1/8"	1 1/2" x 1 1/2" x 2 1/2"	I
BC-315	2.20	Half Wave Output	1500 KC	1 1/8"	1 1/2" x 1 1/2" x 2 1/2"	I

IF TRANSFORMERS (Iron Core—Capacity Tuned)

Type No.	List Price	Function	Freq.	Mtg. Centers	Dimensions	Mtg.
BC-330	\$3.30	Input	175 KC	1 1/8"	1 1/2" x 1 1/2" x 3 1/2"	I
BC-331	3.30	Interstage	175 KC	1 1/8"	1 1/2" x 1 1/2" x 3 1/2"	I
BC-332	3.30	Full Wave Output	175 KC	1 1/8"	1 1/2" x 1 1/2" x 3 1/2"	I
BC-333	3.30	Half Wave Output	175 KC	1 1/8"	1 1/2" x 1 1/2" x 3 1/2"	I
BC-334	2.75	Input	262 KC	1 1/8"	1 1/2" x 1 1/2" x 3 1/2"	I
BC-335	2.75	Interstage	262 KC	1 1/8"	1 1/2" x 1 1/2" x 3 1/2"	I
BC-336	2.75	Full Wave Output	262 KC	1 1/8"	1 1/2" x 1 1/2" x 3 1/2"	I
BC-337	2.75	Half Wave Output	262 KC	1 1/8"	1 1/2" x 1 1/2" x 3 1/2"	I
BC-338	2.75	Input	455 KC	1 1/8"	1 1/2" x 1 1/2" x 3 1/2"	I
BC-339	2.75	Interstage	455 KC	1 1/8"	1 1/2" x 1 1/2" x 3 1/2"	I
BC-340	2.75	Half Wave Output	455 KC	1 1/8"	1 1/2" x 1 1/2" x 3 1/2"	I
BC-341	2.75	Full Wave Output	455 KC	1 1/8"	1 1/2" x 1 1/2" x 3 1/2"	I

IF TRANSFORMERS (Capacity Tuned)

Type No.	List Price	Description	Freq.	Mtg. Centers	Dimensions	Mtg.
BC-360	\$2.20	Input Midget	175 KC	1 1/8"	1 1/2" x 1 1/2" x 2"	I
BC-361	2.20	Interstage—Midget	175 KC	1 1/8"	1 1/2" x 1 1/2" x 2"	I
BC-362	2.20	Full Wave—Midget	175 KC	1 1/8"	1 1/2" x 1 1/2" x 2"	I
BC-363	2.20	Half Wave—Midget	175 KC	1 1/8"	1 1/2" x 1 1/2" x 2"	I
BC-364	1.95	Input—Midget	262 KC	1 1/8"	1 1/2" x 1 1/2" x 2"	I
BC-365	1.95	Interstage—Midget	262 KC	1 1/8"	1 1/2" x 1 1/2" x 2"	I
BC-366	1.95	Full Wave—Midget	262 KC	1 1/8"	1 1/2" x 1 1/2" x 2"	I
BC-367	1.95	Half Wave—Midget	262 KC	1 1/8"	1 1/2" x 1 1/2" x 2"	I
BC-368	1.95	Input—Midget	455 KC	1 1/8"	1 1/2" x 1 1/2" x 2"	I
BC-369	1.95	Interstage—Midget	455 KC	1 1/8"	1 1/2" x 1 1/2" x 2"	I
BC-370	1.95	Full Wave—Midget	455 KC	1 1/8"	1 1/2" x 1 1/2" x 2"	I
BC-371	1.95	Half Wave—Midget	455 KC	1 1/8"	1 1/2" x 1 1/2" x 2"	I
BC-372	1.95	Output—Midget*	262 KC	1 1/8"	1 1/2" x 1 1/2" x 2"	I

*Includes output filter.

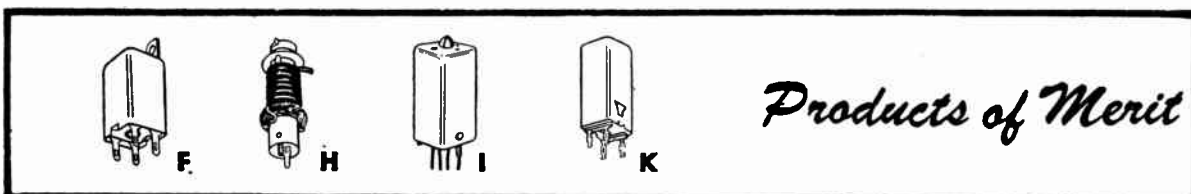

Products of Merit



IF-RF COILS

BROADCAST (Cont.)

IF TRANSFORMERS (Permeability Tuned)

Type No.	List Price	Description	Freq.	Mtg. Centers	Dimensions	Mtg.
BC-350	\$2.75	Input—Miniature	262 KC	3/4 3/4 3/4 3/4 Clip Clip	3/4 x 3/4 x 2	K
BC-351	2.75	Output—Miniature	262 KC			K
BC-352	2.40	Input—Miniature	455 KC			K
BC-353	2.40	Output—Miniature	455 KC			K
BC-354	2.65	Output—Miniature*	262 KC			K
BC-355	2.35	Output—Miniature*	455 KC			K

*Includes output filter.

IF TRANSFORMERS—Special

Type No.	List Price	Description	Freq.	Mtg.	Dimensions	Mtg.
BC-375	\$1.95	Cartwheel	455 KC	6-32 Screw	1 3/8 x 1 1/2	A
BC-376	2.75	Std. IF (Tweed Filter)	455 KC	1 3/8-Mtg. Center	1 3/8 x 1 3/8 x 2 1/2	
BC-377	4.75	AM-FM	455 KC-10.7 MC	1 1/8-Mtg. Center	1 1/8 x 1 1/8 x 2 1/2	

RF—ANTENNA—OSCILLATOR (Permeability Tuned) Univ. Replac.

Type No.	List Price	Description	Mtg.	Cond. Max.	Dimensions	Mtg.
BC-380	\$2.20	Antenna	L Bracket	250-450-MMF	7/8 Dia. x 2	B
BC-381	2.20	Oscillator*	L Bracket	250-450-MMF	7/8 Dia. x 2	B
BC-382	2.20	RF	L Bracket	250-450-MMF	7/8 Dia. x 2	B
BC-383	2.75	Antenna (Shielded)	1 3/8 Centers	250-450-MMF	1 3/8 x 1 3/8 x 2 1/2	A
BC-384	2.75	Oscillator* (Shielded)	1 3/8 Centers	250-450-MMF	1 3/8 x 1 3/8 x 2 1/2	A
BC-385	2.75	RF (Shielded)	1 3/8 Centers	250-450-MMF	1 3/8 x 1 3/8 x 2 1/2	A

*Used with any "IF" (100 to 550 KC) Tapped Pri. and Sec.

MINIATURE (IRON CORE) TYPE K

Type No.	List Price	Description	Operating Freq. KC	Cond. Size	Dimensions	Mtg.
BC-390	\$1.65	Antenna†	540-1700	365 MMF	3/4 x 3/4 x 2	Spring Clips Spring Clips Spring Clips
BC-391	1.65	RF	540-1700	365 MMF	3/4 x 3/4 x 2	
BC-392	1.65	Oscillators†	540-1700	365 MMF	3/4 x 3/4 x 2	

†Tapped Secondaries.

MIDGET—OSCILLATORS (Screw Mounting) (For use with 365 MMF Cond.)

Type No.	List Price	Description	Operating Freq.	Dimensions	Mtg.
BC-395	\$1.10	Oscillator	175 KC	1" Dia. x 1" High	L
BC-396	1.10	Oscillator	262 KC	1" Dia. x 1" High	L
BC-397	1.10	Oscillator	455 KC	1" Dia. x 1" High	L
BC-398	1.10	Oscillator (Autoformer)	175 KC	1" Dia. x 1" High	L
BC-399	1.10	Oscillator (Autoformer)	262 KC	1" Dia. x 1" High	L
BC-400	1.10	Oscillator (Autoformer)	455 KC	1" Dia. x 1" High	L

BEAT FREQUENCY OSCILLATORS (Capacity Tuned) Type M

Type No.	List Price	Frequency Range	IF Freq.	Dimensions	Mtg. Centers
BC-430	\$2.50	165-185 KC	175 KC	1 1/8 x 1 1/8 x 2 1/8	1 1/8
BC-481	2.50	250-275 KC	262 KC	1 1/8 x 1 1/8 x 2 1/8	1 1/8
BC-432	2.50	450-475 KC	455 KC	1 1/8 x 1 1/8 x 2 1/8	1 1/8
BC-433	2.50	500-550 KC	525 KC	1 1/8 x 1 1/8 x 2 1/8	1 1/8
BC-434	2.50	1500-1600 KC	1500 KC	1 1/8 x 1 1/8 x 2 1/8	1 1/8

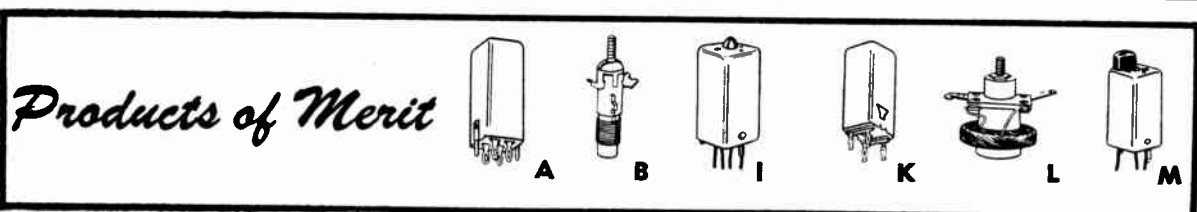

Products of Merit



IF-RF COILS

BROADCAST (Cont.)

TRF UNITS

Type No.	List Price	Description	Freq. Range	Dimensions	Mtg.
BC-410	\$1.00	Antenna†	540-1700 KC	1 3/8 Dia. x 2	N
BC-411	1.00	RF†	540-1700 KC	1 3/8 Dia. x 2	N
BC-412	.95	Antenna†	540-1700 KC	5/8 Dia. x 2 1/2	N
BC-413	.95	RF†	540-1700 KC	5/8 Dia. x 2 1/2	N
BC-414	.95	Band—Pass†	540-1700 KC	5/8 Dia. x 2 1/2	N
BC-415	1.25	Antenna (Shielded)	540-1700 KC	1 3/8 x 1 3/8 x 2 1/2	A
BC-416	1.25	RF (Shielded)	540-1700 KC	1 3/8 x 1 3/8 x 2 1/2	A
BC-417	1.25	Band—Pass (Shielded)	540-1700 KC	1 3/8 x 1 3/8 x 2 1/2	A

OSCILLATOR—Special

Type No.	List Price	Description	Freq.	Mtg. Center	Dimensions	Mtg.
BC-460	\$3.30	Phono—Osc.	540-700 KC	1 1/16	1 1/16 x 1 1/16 x 2 1/2	A

FILTERS

Type No.	List Price	Description	Voltage	Watts	Dimensions	Mtg.
BC-450	\$7.70	Appliance Type	115	550	2 1/4 x 2 1/4 x 4	O
BC-451	1.65	Fluorescent Light	220	20	1 1/2 Dia. x 1 1/2	P
BC-452	1.65	Fluorescent Light	220	40	1 1/2 Dia. x 1 1/2	P
BC-453	1.65	Fluorescent Light	220	80	1 1/2 Dia. x 1 1/2	P
BC-454	1.65	Fluorescent Light	220	160	1 1/2 Dia. x 1 1/2	P
BC-455	7.70	All-Wave Filter	115	150	2 1/4 x 2 1/4 x 4	O

CHOKES

UNSHIELDED AIR CORE*

Type No.	List Price	Inductance MH	Current M.A.	Resistance Ohms	Mtg.
BC-500	\$0.45	.25	125	8	R
BC-501	.45	.75	125	17	R
BC-502	.45	1.50	125	21	R
BC-503	.55	2.50	125	28	R
BC-504	.55	5.0	125	41	R
BC-505	.55	7.5	125	53	R
BC-506	.65	10.0	125	64	R
BC-507	.65	12.5	125	74	R
BC-508	.65	15.0	125	83	R
BC-509	.85	20.0	125	97	R
BC-510	.85	30.0	125	120	R
BC-511	1.10	60.0	100	175	R
BC-512	1.40	80.0	100	230	R

*Single Bolt Mtg. Dimen.—1 1/4 Dia. x 5/8.

SHIELDED AIR CORE*

Type No.	List Price	Inductance MH	Current M.A.	Resistance Ohms	Mtg.
BC-515	\$0.85	.5	125	10	S
BC-516	.85	1.0	125	17	S
BC-517	.95	2.5	125	30	S
BC-518	.95	5.0	125	49	S
BC-519	.95	7.5	125	61	S
BC-520	1.05	10.0	125	75	S
BC-521	1.20	25.0	125	125	S
BC-522	1.50	50.0	125	186	S

*1 1/4 Mtg. Centers Dimen.—1 1/4 Dia. x 1 1/2.

RF TYPE

Type No.	List Price	Inductance MH	Current M.A.	Resistance Ohms	Mtg.
BC-549	\$ 0.85	2.5	200	26	E
BC-550	66.00	100—BC-549 Bulk Packed			

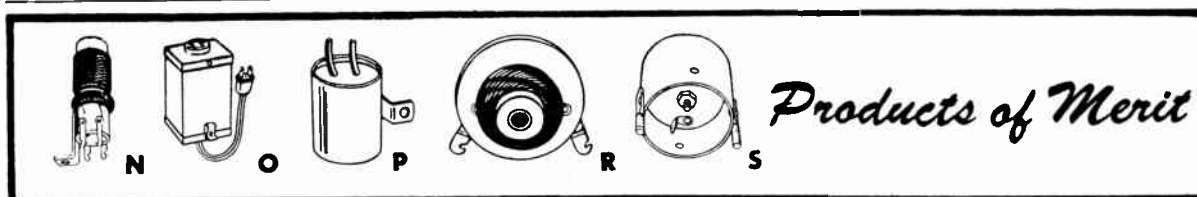



IF-RF COILS

CHOKES (Cont.)

UNSHIELDED IRON CORE*

Type No.	List Price	Inductance MH	Current M.A.	Resistance Ohms	Mtg.
BC-525	\$1.00	.5	125	6.8	R
BC-526	1.10	1.0	125	10.9	R
BC-527	1.15	2.5	125	19.5	R
BC-528	1.30	5.0	125	23.0	R
BC-529	1.40	7.5	125	37.0	R
BC-530	1.45	10.0	125	45.0	R
BC-531	1.75	25.0	100	78.0	R
BC-532	1.95	50.0	100	130.0	R
BC-533	2.20	75.0	100	172.0	R
BC-534	2.50	100.0	100	210.0	R
BC-535	2.75	150.0	100	268.0	R

*Single Bolt Mtg. Dimen. 1 1/8 Dia. x 5/8.

SHIELDED IRON CORE*

Type No.	List Price	Inductance MH	Current M.A.	Resistance Ohms	Mtg.
BC-538	\$1.40	.5	125	8.6	S
BC-539	1.50	1.0	125	11.5	S
BC-540	1.55	2.5	125	22.0	S
BC-541	1.70	5.0	125	31.0	S
BC-542	1.75	7.5	125	42.0	S
BC-543	1.80	10.0	125	47.0	S
BC-544	2.15	25.0	125	100.0	S
BC-545	2.30	50.0†	100	160.0	S
BC-546	2.60	75.0†	100	222.0	S
BC-547	2.85	100.0†	100	348.0	S
BC-548	3.15	150.0†	100	520.0	S

*1 1/8 Mtg. Centers Dimen. 1 1/4 Dia. x 1 1/8.

†1 1/8 Mtg. Centers Dimen. 1 1/8 Dia. x 1 1/8.

FILAMENT

Type No.	List Price	Inductance UH	Current Amps	Resistance Ohms	Mtg.
BC-537	\$0.70	10.0	8	.02	E

SHORT WAVE

IF TRANSFORMERS

Type No.	List Price	Description	Freq.	Mtg. Center	Dimensions	Mtg.
SW-600	\$2.20	Input	1400-1600	1 3/8	1 3/8 x 1 3/8 x 2 3/8	I
SW-601	2.20	Interstage	1400-1600	1 3/8	1 3/8 x 1 3/8 x 2 3/8	I
SW-602	2.20	Interstage (Miniature)	1400-1600	3/4	3/4 x 3/4 x 2	K
SW-603	2.20	Output (Miniature)	1400-1600	3/4	3/4 x 3/4 x 2	K
SW-604	2.20	Input Midget	1400-1600	1 1/8	1 1/8 x 1 1/8 x 2	I
SW-605	2.20	Interstage Midget	1400-1600	1 1/8	1 1/8 x 1 1/8 x 2	I
SW-606	2.20	Full Wave Output	1400-1600	1 1/8	1 1/8 x 1 1/8 x 2	I
SW-607	2.20	Half Wave Output	1400-1600	1 1/8	1 1/8 x 1 1/8 x 2	I

SW CHOKES





Type No.	List Price	Description	Ohms	Micro Henries	Dimensions	M.A.	Mtg.
SW-630	\$0.65	Choke	.07	2.5	3/4 Dia. x 1 1/2	200	P
SW-631	.65	Choke	.25	5.0	3/4 Dia. x 1 1/2	200	P

RF—ANTENNA—OSCILLATORS—Miniature Type

Type No.	List Price	Description	Freq.	Mtg.	Dimensions	Mtg.
SW-620	\$1.65	Antenna	2.1-6.3 MC	Clip	3/4 x 3/4 x 2	K
SW-621	1.65	RF	2.1-6.3 MC	Clip	3/4 x 3/4 x 2	K
SW-622	1.65	Oscillator*	2.1-6.3 MC	Clip	3/4 x 3/4 x 2	K

*1600 MMF Series pad.

Products of Merit

CHICAGO

MILITARY and NEW EQUIPMENT

AUDIO TRANSFORMERS

CHICAGO STANDARD TRANSFORMER CORPORATION



FULL FREQUENCY RANGE AUDIO TRANSFORMERS

Frequency Response within $\pm 1/2$ db, 30 to 15,000 Cycles

INPUT TRANSFORMERS

H-Type (Cat. No. BIH) and B-Type (Cat. No. BI) Mountings

Application	Impedance Primary—Secondary	Max. Power Level	Hum Shielding	Case Size	Wt. Lbs.	Cat. No.	List Price
Line to Single or P-P Grids	*Pri: 600/150 ohms CT *Sec: 50,000 ohms CT	+15 dbm.	-70 dbm.	13	1 1/2	BIH-1 BI-1	\$45.40 28.75
Line to Single or P-P Grids	*Pri: 600/150 ohms CT *Sec: 50,000 ohms CT	+15 dbm.	-90 dbm.	13	1 1/2	BIH-2 BI-2	59.85 36.75
Line bridging to P-P Grids	*Pri: 8,000/6,000 ohms CT *Sec: 50,000 ohms CT	+15 dbm.	-70 dbm.	13	1 1/2	BIH-3 BI-3	47.45 29.95
Line to Line	Pri: 600/150 ohms CT Sec: 600/150 ohms CT	+15 dbm.	-70 dbm.	13	1 1/2	BIH-4 BI-4	43.35 27.85
Line to Line	*Pri: 600/150 ohms CT *Sec: 600/150 ohms CT	+30 dbm.	-90 dbm.	18	3 1/4	BIH-5 BI-5	61.95 39.15
Interstage: P-P Plates to Sgl. or P-P Grids	*Pri: 20,000 ohms CT *Sec: 50,000 ohms CT	+15 dbm.	-70 dbm.	13	1 1/2	BIH-6 BI-6	45.40 28.75
Low Imped. Mike, Pickup, or Multiple Line to Grid	Pri: 50/150/250/600 *Sec: 50,000 ohms CT	+15 dbm.	-70 dbm.	13	1 1/2	BIH-7 BI-7	47.45 29.95
Single Plate to Push-Pull Grids	Pri: 10,000 ohms *Sec: 50,000 ohms CT	+15 dbm.	-70 dbm.	13	1 1/2	BIH-8 BI-8	45.40 28.75
Single Plate to Push-Pull Grids**	Pri: 10,000 ohms *Sec: 50,000 ohms CT	+15 dbm.	-70 dbm.	18	3 1/4	BIH-9 BI-9	53.70 19.35

B-TYPE MOUNTING

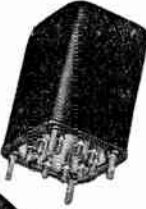

H-TYPE MOUNTING

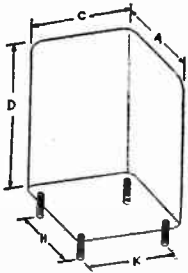

H & B TYPE MOUNTING DIMENSIONS

Case Size	Dimensions in Inches				
	A	C	D	H	K
8	1 1/2	1 1/2	3 1/2	1	1
9	1 1/2	1 1/2	2 1/2	1	1
12	2 1/4	2 1/4	2 1/4	1 1/2	1 3/8
13	2 1/4	2 1/4	2 1/4	1 1/2	1 3/8
14	2 1/2	2 1/2	3 1/2	1 1/2	1 1/2
15	2 1/2	2 1/2	3 1/2	2	1 1/2
16	2 1/2	2 1/2	3 1/2	2	1 1/2
17	2 1/2	2 1/2	3 1/2	2	1 1/2
18	3 1/4	3	3 1/2	2 1/2	2 1/8
19	3 1/4	3	3 1/2	2 1/2	2 1/8
20	3 1/2	3 1/2	4 1/2	2 1/2	2 1/8
21	3 1/2	3 1/2	4 1/2	2 1/2	2 1/8
22	4 1/2	4 1/2	5 1/2	3 1/2	3
24	5 1/2	4 1/2	6 1/2	3 1/2	3

HIGH Q CHOKES

For Dynamic Noise Suppression Circuits (S-Type Mounting)



Two efficient reactors, inductance values .8 and 2.4 henrys respectively, are designed for noise suppression circuits, but can be used in any tuned circuit requiring the given inductances. Inductance values accurate within -5% with up to 15 ma. d-c. Minimum Q of 20. Mounted in identical drawn steel cases.

Cat. No.	Inductance	List Price
NSI-1	.8 hy.	\$9.75
NSI-2	2.4 hy.	9.75

OUTPUT TRANSFORMERS

H-Type (Cat. No. BOH) and B-Type (Cat. No. BO) Mountings

Application	Impedance Primary—Secondary	Max. Power Level	Case Size	Wt. Lbs.	Cat. No.	List Price
Single Plate to Line	†Pri: 15,000 ohms *Sec: 600/150 ohms CT	+15 dbm. (22 mw)	14	2 1/2	BOH-1 BO-1	\$26.80 16.95
P-P Plates to Line	*Pri: 20,000 ohms CT *Sec: 600/150 ohms CT	+30 dbm. (1 watt)	16	3	BOH-2 BO-2	39.20 22.50
P-P Plates to Line	Pri: 5,000 ohms CT *Sec: 600/150 ohms CT	+40 dbm. (10 watts)	20	5 1/2	BOH-3 BO-3	35.10 22.15
P-P Plates to Line	Pri: 7,500 ohms CT *Sec: 600/150 ohms CT †	+43 dbm. (20 watts)	20	6	BOH-4 BO-4	37.10 23.50
P-P Plates to Line or Voice Coil	*Pri: 10,000 ohms CT *Sec: 600/16/8 ohms CT and 150/4 ohms	+37 dbm. (5 watts)	18	4	BOH-5 BO-5	49.50 27.20
P-P Plates to Voice Coil	Pri: 7,500 ohms CT Sec: 8/20 ohms †	+43 dbm. (20 watts)	20	6	BOH-6 BO-6	47.45 29.25
Line to Voice Coil	Pri: 600/150 ohms Sec: 8/20 ohms	+45 dbm. (30 watts)	20	6 1/2	BOH-7 BO-7	45.40 23.30
P-P Parallel Pl. to Line or Voice Coil	Pri: 1500 ohms CT *Sec: 600/16/8 ohms CT and 150/4 ohms	+45 dbm. (30 watts)	21	6 1/2	BOH-8 BO-8	61.95 30.80
P-P Plates to Line or Voice Coil	*Pri: 5000/3000 ohms CT *Sec: 600/16/8 ohms CT and 150/4 ohms	+42 dbm. (15 watts)	20	6	BOH-9 BO-9	45.40 28.75
P-P Low Level Plates to Line	Pri: 20,000 ohms CT *Sec: 600/150 ohms CT	+15 dbm. (22 mw)	13	1 1/2	BOH-10 BO-10	43.35 27.50
P-P Plates to Line or Voice Coil	*Pri: 3000/2500 ohms CT *Sec: 600/16/8 ohms CT and 150/4 ohms	+46 dbm. (40 watts)	22	9 1/2	BO-11	41.45
P-P Plates to Line or Voice Coil	Pri: 10,000 ohms CT Sec: 600/16/8 ohms	+40 dbm. (10 watts)	22	9	BO-12	29.75
P-P Plates to Voice Coil	Pri: 10,000 ohms Sec: 16 8 4 ohms	+43 dbm. (20 watts)	21	7	BO-13	29.75

*Split and balanced windings. †to 10 ma. D.C.

†Has tertiary winding to provide 15% inverse feedback.

**Has D.C. in primary; frequency response ± 2 db, 30-15,000 cycles.

DETAILS OF NEW EQUIPMENT LINE MOUNTINGS

H-TYPE MOUNTING—Hermetic sealing meets all MIL-T-27 specifications. Steel base cover is bonded into the case by deep-seal soldering. Terminals are hermetically sealed by unique rubber gasket—ceramic bushing construction. Units are stud mounted.

C-TYPE MOUNTING—Moisture-resistant compound surrounds coil and core. Ten-inch, RMA-color-coded leads, ends stripped and tinned for easy soldering. Flange-mounted drawn steel cases.

S-TYPE MOUNTING—Precision-fitted steel base-covers and terminal boards, plus compound filling, keep moisture out. Solder-ug terminals are clearly identified, easy to use. Drawn steel cases are flange-mounted.

B-TYPE MOUNTING—Steel bases are bonded into the drawn steel cases by deep-seal soldering to make units completely moisture proof. Stud-mounted cases take minimum chassis space. Convenient, compact, pin-type terminals.

BIAS TRANSFORMERS—Combination Plate and Filament—Primary 50-60 Cycles

Primary Volts	High Voltage Secondary		Rect. Volts	Fila. Amps.	H-Type Mounting		S-Type Mounting		C-Type Mounting	
	AC Volts	CT DC Ma.			Cat. No.	Case No. Price	Cat. No.	Case No. Price	Cat. No.	Case No. Price
115	180-160-140-120	150	5.0	3.0	1BH-150	19 \$26.80	1BS-150	19 \$16.95	1BC-150	18 \$10.75
230	180-160-140-120	150	5.0	3.0	2BH-150	19 26.25	2BS-150	19 16.60	2BC-150	18 10.50

CHICAGO

NEW EQUIPMENT AUDIO TRANSFORMERS



CHICAGO STANDARD TRANSFORMER CORPORATION

TRANSISTOR TRANSFORMERS

Here are the smallest iron core audio transformers ever built. They weigh less than 1/10 ounce and are no larger than the transistors they power. Write for Bulletin 462 showing typical circuit application.

These transformers are designed primarily for transistor audio application but they can be used wherever low power is involved. Useful range, below 1 mw level. They are constructed of extremely fine wire, wound on molded nylon bobbins, with special nickel alloy steel laminations. Mounting style is coil and iron only, type UM.

SPECIAL Chicago-Stancor ultra-miniature transistor transformers, designed and built to your requirements, can be supplied in quantities of five or more. Send your specifications for information on price and delivery.

Part No.	Application	Pri. Imp.	Sec. Imp.	Pri. DC Res.	Sec. DC Res.	Dimensions [§]	Weight in ounces	List Price
UM-110	Interstage	20,000	1,000	1675	285	1/4" x 3/8" x 3/8"	0.07	\$12.25
UM-111	Output or matching	1,000	50/60	120	9.0	3/8" x 3/8" x 3/8"	0.10	10.50
UM-112	High imp. mic. input	200,000	1,000	4000	195	3/8" x 3/8" x 3/8"	0.10	13.75
UM-113	Interstage	20,000	1,000	1350	205	3/8" x 3/8" x 3/8"	0.10	11.00
UM-114	Output or matching	500	50/60	70	9.0	3/8" x 3/8" x 3/8"	0.10	10.50

[§]Dimensions ±.015".

MINIATURE HIGH FIDELITY AUDIO TRANSFORMERS

Chicago-Stancor Tinytrans are miniature transformers made with nickel steel laminations. They have an exceptional frequency response for units of this size; ±1 db. 30-15,000 cps, Maximum level 0 db. Write for Bulletin 463 showing frequency response curves on these transformers.

These units are sealed and potted in 1/8" square, anodized aluminum cases with phenolic terminal boards. Total height, including terminals, is 1 1/4". The case has two 2-56 threaded inserts, 1/16" centers, for easy chassis mounting. The entire transformer weighs only 1.3 ounces.



Part No.	Application	Primary Impedance	Secondary Impedance	List Price
TT-11	Mic., pickup or line to single grid	50, 200/250, 500/600	50,000	\$14.15
TT-12	Mic., pickup or line to push-pull grids	50, 200/250, 500/600	50,000	14.75
TT-13	Dynamic mic. to single grid	7.5/30	50,000	13.45
TT-14	Single plate to single grid	15,000*	60,000	11.60

*No DC in primary.

PUBLIC ADDRESS RANGE TRANSFORMERS

Frequency Response within ± 1 db, 50 to 10,000 Cycles

Driver and output transformers in this CHICAGO series are designed for three general power levels to fit a wide range of application. Up-to-date secondary impedances match 600 or 150-ohm lines, 16, 8, and 4-ohm speakers.

(16/8/4-ohm taps also suitable for 20/6/3.2-ohm speakers.) Output transformers have tertiary windings for 10% inverse feedback that minimizes distortion and provides extra audio watts without loss of fidelity.

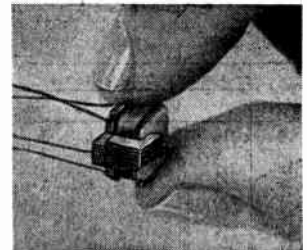

TYPE UM



H-TYPE MOUNTING



S-TYPE MOUNTING

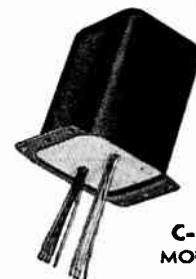

C-TYPE MOUNTING

DRIVERS H-Type (Cat. No. PHD), S-Type (Cat. No. PSD) and C-Type (Cat. No. PCD) Mountings

Application	Primary Impedance	Max. D.C. Pri.	Ratio, Pri. to 1/2 Sec.	Case Size	Wt. Lbs.	Cat. No.	List Price
P-P Plates to P-P Grids	20,000 ohms (Pri. CT)	10 ma.	3:1	14	2 1/4	PHD-10	\$15.00
						PSD-10	10.20
						PCD-10	7.00
P-P Plates to P-P Grids	20,000 ohms (Pri. CT)	25 ma.	3:1	15	2 1/4	PHD-25	14.45
						PSD-25	9.90
						PCD-25	6.65
P-P Plates to P-P Grids	5,000/10,000 ohms (Pri. CT)	100 ma.	5:1	18	4 1/2	PHD-100	24.75
						PSD-100	16.90
						PCD-100	11.95

OUTPUTS H-Type (Cat. No. PHO), S-Type (Cat. No. PSO) and C-Type (Cat. No. PCO) Mountings

Application	Impedances	Typical Output Tubes	Class	Max. Audio Watts	Max. D.C. Pri. CT	Case Size Wt.	Cat. No.	List Price
P-P Plates to Line or Voice Coil	Primary: 5,000 ohms, CT Secondary: * 600/150/16/8/4 ohms	6B4G, 6L6, 6V6, etc.	A ₁ AB	20	120 ma.	20: 6 1/2 lbs.	PHO-80	\$30.95
							PSO-80	21.25
							PCO-80	15.55
P-P Plates to Line or Voice Coil	Primary: 10,000 ohms, CT Secondary: * 600/150/16/8/4 ohms	6V6, 6F6, 6K6, etc.	AB, AB ₁	15	200 ma.	19: 5 lbs.	PHO-150	27.85
							PSO-150	19.00
							PCO-150	13.40
P-P Plates to Line or Voice Coil	Primary: 6,000 ohms, CT Secondary: * 600/150/16/8/4 ohms	Two 6L6's, Four 6V6's, or similar	B, AB ₂ †	30	250 ma.	22: 9 lbs.	PHO-200	34.60
							PSO-200	23.25
							PCO-200	17.60

*Has tertiary winding to provide 10% inverse feedback.

†For low distortion, use fixed bias.

CHICAGO

MILITARY STANDARD - 400 CYCLE POWER TRANSFORMERS FILTER REACTORS



CHICAGO STANDARD TRANSFORMER CORPORATION

MS (MILITARY STANDARD) POWER AND FILAMENT TRANSFORMERS



Case Type	Dimensions in Inches					Stud Size
	A	C	D	H	K	
EB	1 15/16	1 15/16	2 7/16	1 3/8	1 1/4	6-32
FB	2 3/4	2 1/16	2 1/8	1 11/16	1 1/8	6-32
GB	2 3/4	2 5/8	2 1/8	2 1/8	1 3/8	6-32
HB	3 1/16	2 5/8	3 3/16	2 19/64	1 55/64	8-32
HA	3 1/16	2 5/8	4 1/4	2 19/64	1 55/64	8-32
JB	3 1/16	3 1/16	3 7/8	2 5/8	2 1/8	8-32
KB	3 1/16	3 1/16	4 5/8	3	2 1/8	10-32
LB	4 1/16	3 1/16	4 5/8	3 5/16	2 1/16	10-32
MB	4 1/16	4 1/16	4 1/2	3 1/16	3	1 1/4-20
NB	5 1/16	4 5/16	5 1/2	4 1/16	3 5/16	1 1/4-20

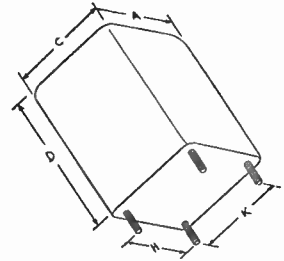

POWER TRANSFORMERS—Primary, 105/115/125 V.—Frequency, 54-65 Cycles

MIL-T-27 Classification	MIL-T-27 Part No.	High Voltage Secondary		D-C V Output	Rect. Fil.		Fil. No. 2		Wt. Lbs.	Case Size	Catalog Number	List Price
		A-C Volts	D-C Ma.		Volts	Amps	Volts	Amps				
TF1A03HA001	MS-90026	200-100-0-100-200	70	385	6.3/5	2	6.3	3	4	HA	PMS-70	\$24.50
TF1A03JB002	MS-90027	325-0-325	70	260	6.3/5	2	6.3	4	5	JB	PMS-70A	25.50
TF1A03KB006	MS-90028	325-0-325	150	245	6.3	5	5	3	7 1/4	KB	PMS-150	29.50
TF1A03LB003	MS-90029	400-0-400	175	318	5	3	6.3	8	10	LB	PMS-175	34.50
TF1A03MB004	MS-90030	450-0-450	250	345	5	3	6.3	8	13	MB	PMS-250	44.50
TF1A02KB001	MS-90031	350-0-350	250	255					7 1/2	KB	PMS-350	29.50
TF1A02LB002	MS-90032	550-0-550	250	419					11	LB	PMS-550	35.50
TF1A02NB003	MS-90036	800-0-800	250	640					16 1/2	NB	PMS-800	49.50

FILAMENT TRANSFORMERS—Primary, 105/115/125 V.—Frequency, 54-66 Cycles

MIL-T-27 Classification No.	MIL-T-27 Part No.	Secondary		Insulation Volts RMS	Wt. Lbs.	Case Size	Catalog Number	List Price
		Volts	Amps					
TF1A01EB002	MS-90016	2.5	3.0	2500	1 1/2	EB	FMS-23	\$14.75
TF1A01GB003	MS-90017	2.5	10	2500	2 1/2	GB	FMS-210	23.50
TF1A01FB004	MS-90018	5.0	3.0	2500	1 3/4	PB	FMS-53	16.21
TF1A01HB005	MS-90019	5.0	10	2500	4	HB	FMS-510	25.50
TF1A01FB006	MS-90020	6.3	2.0	2500	1 3/4	PB	FMS-62	15.50
TF1A01GB007	MS-90021	6.3	5.0	2500	2 3/4	HB	FMS-65	21.50
TF1A01JB008	MS-90022	6.3 CT	10	2500	5	JB	FMS-610	29.50
TF1A01KB009	MS-90023	6.3	20	2500	8	KB	FMS-620	36.50
TF1A01JB012	MS-90024	2.5	10	10000	4 3/4	JB	FMS-210H	27.50
TF1A01KB013	MS-90025	5.0	10	10000	7	KB	FMS-510H	35.00

400 CYCLE TRANSFORMERS AND REACTORS

POWER TRANSFORMERS (All Primaries 105/115/125 V., 380-1000 Cycles)



High Voltage Secondary	Rect. Fil.	Other Fil.		Case Size	Wt. Lbs.	Catalog Number	List Price		
		A. C. Volts	D.C. Ma.					Volts	Amps.
270-0-270	55	5.0	2	6.3 CT	2	12	1 1/2	4PHC-55	\$21.75
335-0-335	70	5.0	2	6.3 CT	3	13	1 3/4	4PHC-70	23.75
375-0-375	120	5.0	3	6.3 CT	4	17	2 1/2	4PHC-120	28.75
440-0-440	165	5.0	3	6.3	7.5				
				6.3	3				
				6.3	3				
				6.3	3				
450-0-450	200	5.0	2	6.3	0.6	20	6	4PHC-165	38.75
				6.3	4				
				6.3	4				
				6.3	0.6	20	5 3/4	4PHC-200A	41.75
550-370-75-0	300	5.0	6	6.3 CT	5				
75-370-550				6.3 CT	1	20	6 1/2	4-PHR-300	44.75

FILTER REACTORS

Inductance (henries)	Maximum D.C. Ma.	D.C. Resistance (Ohms)	Insulation Volts RMS	Case Size	Wt. Lbs.	Catalog Number	List Price
2.0	55	160	2,500	3	1 1/2	4RH-255	\$11.00
2.0	70	240	2,500	7	1 1/2	4RH-270	11.50
2.0	120	105	2,500	11	1	4RH-2120	12.00
2.0	165	80	2,500	12	1 1/2	4RH-2165	13.00
2.0	200	77	2,500	13	1 3/4	4RH-2200	13.50
2.0	300	49	2,500	16	3 1/4	4RH-2300	14.50

FILAMENT TRANSFORMERS (All Prim. 105/115/125 V., 380-1000 cycles)

Sec. Volts	Sec. Amps.	Insulation Volts RMS	Case Size	Wt. Lbs.	Catalog Number	List Price
6.3 CT	3	2,500	10	3/4	4FH-63	\$13.50
6.3 CT	5.5	2,500	11	1	4FH-65	18.50
6.3 CT	10	2,500	13	1 3/4	4FH-610	23.50
6.3 CT	20	2,500	15	2 1/2	4FH-620	29.50

CASE DIMENSIONS

Case Size	Dimensions in Inches					Studs
	A	C	D	H	K	
3	1 3/16	1 3/16	2	1 3/8	1 1/4	2 Studs
7	1 3/8	1 3/8	2	1 5/8	1 1/4	2 Studs
10	1 7/8	1 7/8	2 3/8	1 7/8	1 1/2	
11	1 7/8	1 7/8	2 3/8	1 7/8	1 1/2	
12	2 1/8	2 1/8	2 1/2	1 7/8	1 3/8	
12	2 1/8	2 1/8	2 1/2	1 7/8	1 3/8	
15	2 1/4	2 1/4	2 5/8	1 7/8	1 3/8	
16	2 1/2	2 1/2	3 1/8	2	1 3/8	
17	2 7/8	2 7/8	3 1/2	2	1 7/8	
17	2 7/8	2 7/8	3 1/2	2	1 7/8	
20	3 1/16	3 1/16	4 3/8	2 1/8	2 3/8	

CHICAGO

NEW EQUIPMENT AUDIO TRANSFORMERS



CHICAGO STANDARD TRANSFORMER CORPORATION

HF AND WF SERIES HIGH FIDELITY AUDIO TRANSFORMERS

HF Series

These units have a wide frequency response of 20 to 20,000 cps with ± 1 db. Correct design reduces harmonic and intermodulation distortion to a negligible amount. Balanced construction minimizes hum pickup. Chicago-Stancor impregnation insures long life. Cases are finished in gray enamel and have four threaded holes at each end for flush mounting. Stud-type terminals are plainly marked for easy identification.

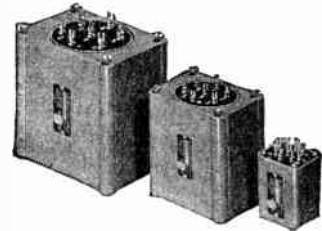

LOW IMPEDANCE TO GRID

Part No.	Application	Primary Imp/Ohms	Secondary Imp/Ohms	Max. Level	Hum-Pickup Reduction [†]	Mtg. \$	List Price
HF-20	Low Imp. Mic., Pickup, or Line to Grid	50, 125/150, 200, 250, 333, 500/600	60,000 overall, in two sections	15 db	-74 db	HF-1	\$32.50
HF-20X	Low Imp., Mic., Pickup, or Line to Grid	50, 125/150, 200, 250, 333, 500/600	50,000	14 db	-92 db [‡]	HF-1	41.60
HF-22	Low Imp. Mic., Pickup, or Line to P.P. Grids	50, 125/150, 200, 250, 333, 500/600	120,000 overall, in two sections	15 db	-74 db	HF-1	36.40
HF-22X	Low Imp. Mic., Pickup, or Line to P.P. Grids	50, 125/150, 200, 250, 333, 500/600	80,000 overall, in two sections	14 db	-92 db [‡]	HF-1	45.50

INTERSTAGE

HF-29	Sgl. Pl. to P.P. Grids—Split secondary	15,000	95,000 (Turn ratio 2.5:1 overall)	17 db	-50 db	HF-1	\$31.20
HF-31	Single Plate to P.P. Grids. Split pri. and sec.	15,000	135,000 (Turn ratio 3:1 overall)	14 db	-74 db	HF-1	31.20
HF-32	P.P. Plates to P.P. Grids. Split pri. and sec.	30,000 Plate to Plate	80,000 (Turn ratio 1.6:1 overall)	26 db	-50 db	HF-2	40.30

MIXING

HF-40	Low Imp. Mixer, Mic., Pickup, or Line to Line	50, 125/150, 200, 250, 333, 500/600	50, 125/150, 200, 250, 333, 500/600	17 db	-74 db	HF-1	\$32.50
-------	---	-------------------------------------	-------------------------------------	-------	--------	------	---------

OUTPUT

HF-65 [†]	P.P. 2A3's, 6L6's, etc. to Line or Voice Coil	3,000 or 5,000 Plate to Plate	1.2, 2.5, 5, 7.5, 10, 15, 20, 30, 50, 125, 200, 250, 333 or 500	20 watts	HF-2	\$36.40
HF-67 [†]	P.P. 2A3's, 6L6's, etc. to Voice Coil	3,000 or 5,000 Plate to Plate	30, 20, 15, 10, 7.5, 5, 2.5, 1.2	20 watts	HF-2	26.00
HF-68 [†]	P.P. Par. 2A3's, 6A5G's, 300A's, 6A3's to Line or Voice Coil	1,500 or 2,500 Plate to Plate	500, 333, 250, 200, 125, 50, 30, 20, 15, 10, 7.5, 5, 2.5, 1.2	40 watts	HF-3	65.00

§HF-1 Case: Shpg. wt., 3.0 lbs. Height overall, 3 $\frac{1}{4}$ ". Base area, 2 $\frac{1}{8}$ "x3 $\frac{1}{8}$ ". Mtg. ctrs., 1 $\frac{1}{8}$ "x2 $\frac{1}{8}$ ". HF-2 Case: Shpg. wt., 7.5 lbs. Height overall, 4 $\frac{3}{8}$ ". Base area, 3 $\frac{3}{8}$ "x4 $\frac{3}{8}$ ". Mtg. ctrs., 2 $\frac{1}{8}$ "x3 $\frac{1}{8}$ ". HF-3 Case: Shpg. wt., 15.0 lbs. Height overall, 4 $\frac{1}{8}$ ". Base area, 4 $\frac{1}{8}$ "x5 $\frac{3}{8}$ ". Mtg. ctrs.,

3 $\frac{3}{8}$ "x5 $\frac{1}{2}$ ".

[†]Response ± 1 db from 25 to 20,000 cps.
[‡]As compared to standard uncased units.
[§]Quadruple alloy magnetic shield.

WF Series

These units are of the same outstanding quality as the HF Series above, and, with the exception of two units, have a frequency response of 30–20,000 cps within ± 2 db. The WF-21 and WF-35 have a response within ± 2 db from 50–20,000 cps and have multiple alloy shields for

extremely low hum pickup. All WF units are cased in the WF-6 type cast case with phenolic terminal board and four tapped holes for flush mounting. Overall dimensions are 2" high with 1 $\frac{1}{2}$ " x 1 $\frac{1}{2}$ " base area. Mounting centers are 1 $\frac{3}{8}$ " x 1 $\frac{3}{8}$ ". Shipping weight is 0.6 lbs.

Part No.	Application	Primary Imp/Ohms	Secondary Imp/Ohms	List Price
----------	-------------	------------------	--------------------	------------

INPUT

WF-20	Low Imp. Mic., Pickup, or Line to Grid	50, 125/150, 200, 250, 333, 500/600	50,000	\$19.50
WF-21	Low Imp. Mic., Pickup, or L. to Sgl. or P.P. Grids	50, 200, 500	50,000	20.80
WF-22	Low Imp. Mic., Pickup, or Line to P.P. Grids	50, 125/150, 200, 250, 333, 500/600	80,000 overall, in two sections	19.50
WF-24	Dynamic Microphone to 1 or 2 Grids	30	50,000 overall, in two sections	17.70

INTERSTAGE

WF-26	Single Plate to Single Grid	15,000	60,000 (Turn ratio 2:1)	\$16.45
WF-28	Sgl. Pl. to 2 Grids. Can use split pri. for P.P. Pl.	15,000	80,000 overall (Turn ratio 2.3:1 overall)	18.20

LOW LEVEL OUTPUT

WF-34	Single Plate to Line	15,000	50, 125/150, 200, 250, 333, 500/600	\$19.50
WF-36	P.P. Low Level Plates to Line	30,000 Plate to Plate	50, 125/150, 200, 250, 333, 500/600	19.50
WF-35	Single Plate to Multiple Line Primary D.C. 8.0 ma. Response from 50–20,000 cps within ± 2 db	15,000	50, 125/150, 200, 250, 333, 500/600	18.20

MIXING

WF-30	Low Imp. Mixer, Mic., Pickup, or Line to Line	50, 125/150, 200, 250, 333, 500/600	50, 125/150, 200, 250, 333, 500/600	19.50
-------	---	-------------------------------------	-------------------------------------	-------

Radio's Master—19th Edition

Copyright by U. C. P., Inc.

TRADE DISCOUNT APPLIES TO LIST PRICES ONLY

Page N-90

CHICAGO

NEW EQUIPMENT

TRANSFORMERS and REACTORS

for Broadcast, Amateur and Industrial Application



CHICAGO STANDARD TRANSFORMER CORPORATION

LARGE CAPACITY TRANSFORMERS AND REACTORS For Broadcast, Communications and Industrial Use

DRIVER TRANSFORMERS

In:	Recommended Application: Tubes:	Ratio Pri./½ Sec.	Mtg. Case Type Size Lbs.	Cat. No.	List Price
250-Watt Transmitter	From two 2A3's, 6B4's, or similar P-P Plates to Class B 838's, 805's, 203-A's, etc.	3.5:1	B* 20 6½	BD-1	\$32.60
1-KW Transmitter	From four 2A3's, 6B4's, or similar P-P Plates to two 833-A's or similar P-P Grids	3:1	† 24 12¼	BD-2	40.00
5-KW Transmitter	From four 845's, two 152-TL's or similar P-P Plates to 891-R's or similar P-P Grids	3.5:1	BX 26 24	BD-3	55.75

†Similar to SX-Type mounting, but with screw terminals on a terminal board.
*B-Type mounting, but with screw terminals. See page N-55 for dimensions.

MODULATION TRANSFORMERS

Recommended Application In:	With:	Impedances (Pri. Plate to Plate)	Modulator Tubes	Mtg. Type Size Lbs.	Wt. Lbs.	Cat. No.	List Price
250-Watt Transmitter	Driver Transformer #BD-1	Pri: 7500 ohms CT Sec: 5000 ohms	203-A, 838 805, etc.	BX 26	25	BM-1	\$58.50
1-KW Transmitter	Driver Transformer #BD-2	Pri: 9000 ohms CT Sec: 7500 ohms	833-A, etc.	FS 84	175	BM-2	335.00
5-KW Transmitter	Driver Transformer #BD-2	Pri: 13500 ohms CT Sec: 10250 ohms	891-R, etc.	WC 1100		BM-3	777.00 (net)

MODULATION REACTORS

Recommended Application: In:	With:	Inductance	D.C. Ma.	Mtg. Type Size Lbs.	Wt. Lbs.	Cat. No.	List Price
250-Watt Transmitter	Mod. Transformer #BM-1	65 hy.	250	BX 28	41	BR-1	\$ 95.50
1-KW Transmitter	Mod. Transformer #BM-2	100 hy.	500	FS 81	165	BR-2	201.00
5-KW Transmitter	Mod. Transformer #BM-3	120 hy.	900	WC 1100		BR-3	652.08 (net)

PLATE TRANSFORMERS

Primary: Volts	Max. VA.	Secondary: A.C. Load Volts	D.C. Volts after Filter	D.C. Ma.	Mtg. Type Size Lbs.	Wt. Lbs.	Cat. No.	List Price
115-230	185	675-0-675 575-0-575	500 400	250	22 S	12	P-45	\$23.50
115-230	250	900-0-900 735-0-735	750 600	250	22 S	13½	P-67	28.00
115-230	310	1150-0-1150 870-0-870	1000 750	250	60 FS	37	P-107	69.50
115-230	360	1425-0-1425* 600-0-600	1250 400	150 200	24 S	26	P-1240	39.50
115-230	550	1710-0-1710 1430-0-1430	1500 1250	300	63 FS	43	P-1512	79.50
115-230	915	2820-0-2820 2260-0-2260	2500 2000	300	71 FS	71	P-2520	119.50
115-230	1600	2900-0-2900 2320-0-2320	2600 2100	500	64 FS	95	P-2126	149.50
115-230	1850	3450-0-3450 2850-0-2850	3000 2500	500	81 FS	137	P-3025	199.50
115-230	3050	4600-0-4600 4050-0-4050 3400-0-3400	4000 3500 3000	600	90 FS	150	P-4353	269.50

*Both secondaries may be rectified simultaneously.

FILTER REACTORS

Inductance in Henrys	Max. D.C. Ma.	D.C. Resistance, Ohms	Insulation Test Volts	Mtg. Type	Mtg. Size	Wt. Lbs.	Cat. No.	List Price
10	500	40	9,000	FS	62	35	R-105	\$57.50
10	300	40	7,500	SX	26	22	R-103	28.25
6	700	35	10,000	FS	61	35	R-67	56.50
6	500	35	9,000	FS	60	35	R-65	45.80
6	300	35	7,500	SX	24	16½	R-63	23.90

Splatter Chokes for High Level "Clipper" Filters

Can withstand high peak voltages. Has tapped windings to cover an inductance from .02 to 1.5 henries at relatively constant Q. Eliminates splatter, caused by heavy modulation; limits band width to 3,000 cycles, effectively increases "get through" ability of phone signals, and prevents negative peak clipping.

Type	D.C. Ma.	Insulation Volts	Inductance in Henrys	Mounting		List
				Type	Size	
SR-300	300	7,500	.02 to 1.5 Hy	BX	22	\$29.50
SR-500	500	10,000	.02 to 1.5 Hy	BX	24	31.50

Low Pass Filter No. LPF-1

For attenuating frequencies above 3,000 cycles in low level speech amplifiers. Operates out of a 15,000 ohm source, e.g., the plate of 8C5, 6J5, etc. when its 60,000 ohm secondary is connected to an equal impedance output. Operates at signal levels up to -8 db. Complete with operating instructions. S type mtg. Case size 13. (See pg. N-54).

List Price.....\$24.50

BX-TYPE MOUNTING

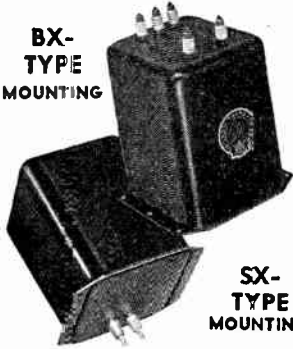

SX-TYPE MOUNTING

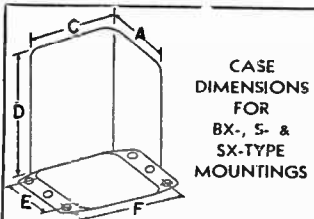

CASE DIMENSIONS FOR BX-, S- & SX-TYPE MOUNTINGS

Case Size	Dimensions in Inches					
	A	C	D	E	F	
22	4 5/16	4 1/8	5 5/8	2 1/2	4 3/4	
24	5 5/16	4 13/16	6 1/8	3 1/2	5 3/8	
26	6 2/16	5 1/4	7 1/8	4 1/4	6	
28	7 1/16	6 1/8	8 3/8	5	7	

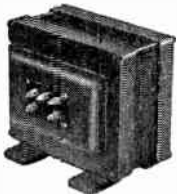

FS TYPE MOUNTING

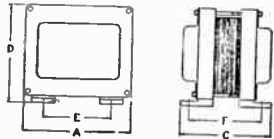

Size	Dimensions in Inches					
	A	D	E	F	C	
60	7 1/4	7	4 3/4	5 1/2	6 5/16	
61	7 1/4	7	4 3/4	5 1/2	6 7/8	
62	7 1/4	7	4 3/4	6 1/4	7 1/8	
63	7 1/4	7	4 3/4	6 1 1/16	7 1/8	
64	7 1/4	10	8 5/8	6	7 3/4	
65	7 1/4	7	4 3/4	6 7/8	7 13/16	
71	8 1/4	8 1/2	5 1/2	6 1/2	8 1/8	
81	11 1/2	10 1/2	7 1/2	8 1/4	10 1/4	
84	11 1/2	11 1/2	7 1/2	11 1/2	13 1/16	
90	13 1/2	12 3/4	9	8 3/4	10 5/8	

WC-TYPE MOUNTING



Overall Case Dimensions:
H—31½" W—26½" D—23½"

CHICAGO

REPLACEMENT TYPE

TRANSFORMERS and REACTORS

Premium Quality—Yet They Cost No More

CHICAGO STANDARD TRANSFORMER CORPORATION



POWER TRANSFORMERS—(Pri: 117 volts, 50/60 cycles)

6.3-VOLT FILAMENTS—VERTICAL SHIELD MOUNTING (V)

Catalog No.	High Voltage Secondary		Rectifier Filament Volts	Amps.	Other Filaments		Dimensions			Wt. Lbs.	List Price
	A.C. Volts	D.C. Ma.			Volts	Amps.	H	W	D		
PV-10S	250-0-250	10	6.3	1.2	6.3	0.6	2 1/4	2 7/8	2 1/2	1	\$ 7.50
PV-20S	250-0-250	20	6.3	1.2	6.3	0.6	2 3/8	3 1/16	2 1/4	1 1/2	8.00
PV-40	225-0-225	40	5	2	6.3 C-T	1	3 1/8	2 1/2	2 1/4	2 1/4	7.15
PV-50	325-0-325	50	5	3	6.3 C-T	2	3 3/4	2 7/8	3	3 3/4	8.05
PV-50A	117	50	5	3	6.3	1.75	2 3/8	3 1/16	2 1/4	1 1/2	6.80
PV-60	250-0-250	60	5	2	6.3 C-T	2	3 1/8	2 1/2	3	3	8.60
PV-70	350-0-350	70	5	3	6.3 C-T	3	4 1/8	3 1/8	3 1/8	4 1/2	9.25
PV-70A	300-0-300	70	5	3	6.3 C-T	3	3 3/4	2 7/8	3 1/8	4	9.15
PV-90	350-0-350	90	5	3	6.3 C-T	3.5	4 1/8	3 1/8	3 1/8	5 1/4	10.30
PV-100	350-0-350	100	5	3	6.3 C-T	5	4 1/8	3 3/4	3 3/4	7 1/2	10.65
PV-110	350-0-350	110	5	2	6.3 C-T	3	3 7/8	3 3/8	3 3/8	5 1/2	13.25
PV-120	300-0-300	120	5	3	6.3 C-T	5	4 1/8	3 1/8	3 3/4	5 3/4	10.85
PV-120A	350-0-350	120	5	3	6.3 C-T	4.5	4 1/8	3 1/8	3 1/16	6	11.95
PV-145	372-0-372	145	5	3	6.3 C-T	5	4 1/8	3 3/4	4	7 1/2	12.85
PV-200	400-0-400	200	5	4	6.3 C-T	5.5	4 7/8	3 3/4	4 1/4	9	15.00

V

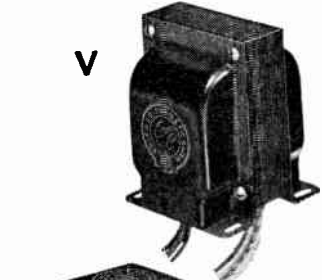

H

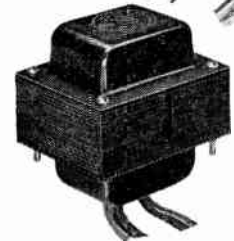

6.3-VOLT FILAMENTS—HORIZONTAL SHIELD MOUNTING (H)

Catalog No.	Secondary Volts	D.C. Ma.	Filament Volts	Amps.	Other Filaments	Dimensions			Wt. Lbs.	List Price			
						H	W	D					
PH-20S	250-0-250	20	6.3	1.2	6.3	0.6	2 3/8	2 3/8	2 3/16	1	\$8.35		
PH-40	250-0-250	40	5	2	6.3 C-T	1.6	3	3	2 1/2	2 1/2	7.40		
PH-50	250-0-250	50	5	2	6.3 C-T	2	3 1/2	3	2 1/2	3	7.50		
PH-50A	280-0-280	50	5	3	6.3	1.5	6.3	4.6	3 1/4	3	2 1/2	3 1/2	7.70
PH-70	300-0-300	70	5	3	6.3 C-T	3	3 1/2	3 3/8	2 1/2	4	8.40		
PH-70B	350-0-350	70	5	3	6.3 C-T	2.5	3 1/4	3	2 1/2	4 1/2	8.60		
PH-90	350-0-350	90	5	3	6.3 C-T	3.5	3 3/4	3 3/4	3 1/2	5 1/4	9.45		
PH-120	300-0-300	120	5	3	6.3 C-T	5	3 7/8	3 3/4	3 1/2	5 3/4	10.45		
PH-120B	350-0-350	120	5	3	6.3 C-T	4.5	3 7/8	3 3/4	3 1/2	6	10.60		
PH-145	372-0-372	145	5	3	6.3 C-T	5	3 7/8	4 1/2	3 3/4	7 1/2	12.70		
PH-200	350-0-350	200	5	3	6.3 C-T	6	4	4 1/2	3 3/4	8	14.30		

U

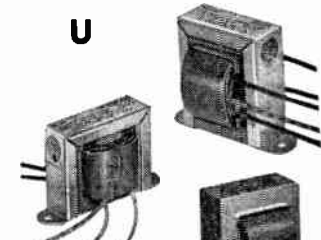

2.5-VOLT FILAMENTS—HORIZONTAL SHIELD MOUNTING (H)

Catalog No.	Secondary Volts	D.C. Ma.	Filament Volts	Amps.	Other Filaments	Dimensions			Wt. Lbs.	List Price	
						H	W	D			
PH-70A	325-0-325	70	5	3	2.5 C-T	9	3 3/8	3 3/4	3 1/8	4 1/2	\$12.80
PH-120A	325-0-325	120	5	3	2.5 C-T	12.5	3 3/8	4 1/4	3 1/2	6	14.95
					2.5 C-T	3.5	3 7/8	4 1/2	3 1/2	6	

FILAMENT TRANSFORMERS

Catalog No.	Secondary Volts	Amps.	Primary		Insulation Test Volts	Mounting Type	Dimensions			Wt. Lbs.	List Price
			Volts	Cycles			H	W	D		
FO-26	2.5 C-T	6	107/117	60	2000	U	2 5/8	2 7/8	1 7/8	1	\$4.20
FO-210H	2.5 C-T	10	107/117	60	7500	U	3	3 3/8	2 1/2	2 1/2	6.15
FO-53	5.0 C-T	3	107/117	60	2000	U	2 5/8	2 1/8	2	1	4.80
FO-56	5.0 C-T	6	107/117	60	2000	U	2 5/8	3 1/16	2	2	5.40
FO-513	5.0 C-T	13	107/117	60	2000	U*	3 3/8	2 1/2	2 1/2	4	7.50
FV-520H	5.0 C-T	20	117	50/60	10000	V	4 1/2	3 3/4	3 3/8	7	14.55
FV-530	5.0 C-T	30	117	50/60	2000	V	4 1/2	3 3/4	4	6	16.25
FO-615	6.3 C-T	1.5	107/117	60	2000	L	1 5/8	2 7/8	1 3/4	3/4	2.95
FO-63	6.3 C-T	3	107/117	60	2000	U	2 3/8	2 7/8	2	1 1/4	4.65
FO-66	6.3 C-T	6	107/117	60	2000	L	2 1/4	4 3/4	2 1/2	2	6.25
FO-610	6.3 C-T	10	107/117	60	2000	U*	3 3/8	2 1/8	2 3/4	3 1/4	7.50
FO-75	7.5 C-T	5	107/117	60	2000	U	3	3 3/8	2 1/2	2 1/4	7.20
FO-105	10 C-T	5	107/117	60	2000	FV	3 1/16	2 1/2	2 1/2	3	7.40
FV-1010	10 C-T	10	117	50/60	2000	V	3 3/4	3 3/8	3 1/16	5	10.10
FO-122	12.6 C-T	2	107/117	60	2000	L	2 3/8	3 1/16	2	1 1/2	5.15

*Universal mounting frames.

ISOLATION TRANSFORMERS



CHICAGO Isolation Transformers are designed for a dual purpose: (1) To supply 115 volts isolated from a line of above/below normal, or normal, voltage—primary switch sets for 125/115/105 volts, 50/60 cycles; or (2) For use in servicing to eliminate shock hazard, by isolating chassis ground from line ground (particularly important on "hot" AC-DC television sets). Also provide 125 and 105 volts on the secondary for locating doubtful tubes, etc.

FILTER REACTORS

Catalog No.	Inductance in Henries	Maximum D.C. Current Ma.	D.C. Resistance in Ohms	Insulation Test Volts	Mtg. Type	Dimensions			Wt. Lbs.	List Price
						H	W	D		
R-1230	12	30	400	2000	L	1 3/8	2 3/8	1 3/4	1/2	\$2.75
R-1240	12	40	400	2000	L	1 5/8	2 7/8	1 3/8	3/4	3.00
R-650	6	50	300	1500	L	1 5/8	2 7/8	1 3/8	3/4	1.95
R-1365	13	65	500	2000	L	2 1/4	3 3/4	2 1/4	1 1/2	3.05
R-885	8	85	250	2000	L	2 1/4	3 3/4	2 1/4	1 1/2	3.40
R-23110	23	110	250	2000	V	3 1/8	2 1/2	2 3/4	2 1/2	6.95
R-8120	8	120	350	1500	L	2 1/2	4	2	2 1/2	4.25
R-7150	7.5	150	160	2000	V	3 3/8	2 1/2	3 1/8	2 1/2	6.50
R-7200	8	200	125	3000	V	3 3/8	2 7/8	3 3/8	3 3/4	7.95
R-8300	8	300	60	3500	V	4 1/2	3 3/4	4	8	13.75

DRIVER TRANSFORMERS

Cat. No.	Typical Applications: From Driver Tubes To Output Tubes		Class	Ratio Primary: 1/2 Sec.	Max. Pri. D.C. Ma.	Mtg. Type	Dimensions			Wt. Lbs.	List Price
	H	W					D				
D-15	Single 30	P-P 19 or 30's	B	2.5-1	15	L	1 3/8	2 7/8	1 1/2	3/4	\$4.95
D-30	6C5, 6R7, or Triode 6F6	P-P 6L6's	AB	3:1	30	L	2	3 1/4	2 1/2	1	5.95
D-35	Triode Plate	P-P Grids		1:1, 1.5:1 or 2:1	35	L	2	3 1/4	1 7/8	1	4.50
D-40	6C5, 6R7, or Triode 6F6	P-P 6L6's	AB	3:1	40	V	8 1/2	2 1/2	2 1/2	2 1/2	7.00

Cat. No.	Capacity	List Price
IS-50	50 VA	\$12.75
IS-100	100 VA	19.75
IS-150	150 VA	23.50
IS-250	250 VA	27.75

CHICAGO

AUDIO TRANSFORMERS
CHICAGO STANDARD
TRANSFORMER CORPORATION



H-TYPE MOUNTING



S-TYPE MOUNTING



C-TYPE MOUNTING

MODULATION TRANSFORMER CMS-1

for Communications Transmitters

Freq. Range, 200 to 3,500 Cycles



Chicago's No. CMS-1 Modulation Transformer and matching Driver Transformer No. CDS-1, at right, are ideally suited for use in ham and commercial speech transmitters. No. CMS-1 will deliver 250-350 watts of Class B audio power from P-P 203A's, 211's, 805's, 75TL's, etc. to a Class C load with response variations not exceeding ± 1 db. over the stated frequency range. Primary impedances, 9000/6700 ohms ct; secondary, 8000/6000/4000 ohms. Case size 26. Wt., 22 lbs.

No. CMS-1.....List Price, \$49.50



MODULATION TRANSFORMER CMS-3

Delivers 500-750 watts of Class B audio power from 810's, 822's, etc. to a Class C load. Frequency response is within ± 1 db. over the stated voice range. Primary impedance, 18,000/12,000 ohms CT; secondary, 6,250 ohms. FS-Type mounting, size 65 (see page N-57). Wt. 43 lbs.

No. CMS-3.....List Price, \$89.50

COMMUNICATIONS RANGE AUDIO TRANSFORMERS

Frequency Response within ± 1 db, 200 to 3,500 Cycles

These transformers are specifically designed for use in receiving and transmitting equipment such as amateur, police, railroad, and aircraft types, where clear voice reproduction is desired.

INPUTS H-Type (Cat. No. CIH), S-Type (Cat. No. CIS) and C-Type (Cat. No. CIC) Mountings

Application	Impedances: Primary—Secondary	Case Size	Wt. Lbs.	Cat. No.	List Price
Low Level Line to Single or Push-Pull Grids	Pri: 600/150 ohms CT *Sec: 100,000 ohms CT	9	3/4	CIH-1 CIS-1 CIC-1	\$21.65 14.80 9.80
Low Level S. B. or D. B. Mike to Sgl. or P-P Grids	Pri: 125/50 ohms @ 80 ma. Sec. 125,000 ohms CT	9	3/4	CIH-2 CIS-2 CIC-2	14.35 8.50 5.35

*Split and balanced windings: may be used singly or push:pull.

OUTPUTS H-Type (Cat. No. COH), S-Type (Cat. No. COS) and C-Type (Cat. No. COC) Mountings

Application	Impedances: Pri.—Sec.	Typical Audio Tubes Class	Max. Case Watts	Max. Pri. D.C.	Case Size	Wt. Lbs.	Cat. No.	List Price
Sgl. P. to Line or Speaker	Pri.: 5000 ohms Sec. ohms: 600/150/16/8/4	6L6, 6V6, 25A6 A	5	55 ma.	14	2 1/4	COH-1 COS-1 COC-1	\$16.90 10.55 7.00
Sgl. Pl. to Line or Speaker	Pri: 8000 ohms Sec. ohms: 600/150/16/8/4	6F6, 6V6, 6K6 A	5	55 ma.	14	2 1/4	COH-2 COS-2 COC-2	19.30 10.85 7.00

DRIVER H-Type (Cat. No. CDH), S-Type (Cat. No. CDS) and C-Type (Cat. No. CDC) Mountings

Application	Primary Impedance	Max. D.C. Pri. CT	Ratio, Pri. to 1/2 Sec.	Case Size	Wt. Lbs.	Cat. No.	List Price
P-P Plates (2A3's, etc.) to P-P Grids	5,000 ohms (Pri. CT)	100 ma.	3:1	17	3 1/2	CDH-1 CDS-1 CDC-1	\$17.00 11.60 7.50

REPLACEMENT TYPE OUTPUT TRANSFORMERS

SINGLE PLATE TO VOICE COIL

Catalog No.	Application Typical Output Tubes	Ohms Impedance		Max. Primary D.C. Ma.	Max. Audio Watts	Mtg. Type	Dimensions			Wt. Lbs.	List Price
		Pri.	Sec.				H	W	D		
RO-2	25L6 35A5, 2A3, 6B4	2000	3 to 6	50	4	L	1 3/8	2 3/8	1 1/4	1/2	\$1.90
RO-3	25L6 (10-ohm tap on primary)	2000	3 to 6	50	4	L	3 3/8	2 3/8	1 3/8	1/2	2.60
RO-6	12A5, 25A6, 45, 71A	4000	4-8-15	40	10	L	2	3 1/4	1 3/8	1	3.70
RO-8	2A5, 25A6, 43	4500	3 to 6	35	5	L	1 3/8	2 3/8	1 1/4	1/2	2.00
RO-9	6V6, 25A7G, 30, 31, 50	5000	4-8-15	50	8	L	2	3 1/4	1 3/8	1	2.80
RO-11	1S4	6000	3 to 6	5	2	L	1 1/8	2 3/8	1 1/8	3/8	1.90
RO-13	7B5, 18, 31, 33, 42, 46, 47	7000	3 to 6	35	5	L	1 3/8	2 3/8	1 1/8	1/2	1.95
RO-16	1C5G, 1G5G, 1J6G, 6A4, 6A6	10000	3 to 6	30	5	L	1 3/8	2 3/8	1 1/8	1/2	1.95
RO-18	1A5G, 1E7G, 1N6G, 6V7G	25000	3 to 6	10	5	L	1 3/8	2 3/8	1 1/8	1/2	2.35

PUSH-PULL PLATES TO VOICE COIL

Catalog No.	P-P Tubes	Ohms Impedance	Max. Primary D.C. Ma.	Max. Audio Watts	Mtg. Type	Dimensions H	Dimensions W	Dimensions D	Wt. Lbs.	List Price	
RO-110	P-P 2A5, 6AC5G, 6A6, 6N7, 45	10000	4-8-15	80	12	U	2 3/8	2 3/8	1 3/8	1	\$3.70
RO-111	P-P 6B5, 6K6, 6N6G, 7B5, 31	14000	4-8-15	80	15	U	2 3/8	2 3/8	1 3/8	1	3.45
RO-113	P-P 1A5G, 1E7G, 1N6G, 6V7G	50000	3 to 6	20	8	L	1 3/8	2 3/8	1 1/2	5/8	4.00

UNIVERSAL TYPE—SINGLE PLATE TO VOICE COIL

Catalog No.	Range of Ohms Impedance		Primary D.C. Ma.	Max. Audio Watts	Mtg. Type	Dimensions			Wt. Lbs.	List Price
	Primary	Secondary				H	W	D		
RO-201	4000, 7000, or 100000	3 to 6	40	8	L	1 3/8	2 3/8	1 1/4	5/8	\$2.80

UNIVERSAL TYPE—SINGLE OR PUSH-PULL PLATES TO VOICE COIL

Catalog No.	Primary	Secondary	Max. Primary D.C. Ma.	Max. Audio Watts	Mtg. Type	Dimensions H	Dimensions W	Dimensions D	Wt. Lbs.	List Price
RO-301	2500 to 14000	2, 4, 6, 8, 15, etc.	30	4	L	1 3/8	2 3/8	1 3/8	1/2	\$2.85
RO-302	2500 to 15000	2, 4, 6, 8, 15	50	4	L	1 3/8	2 3/8	1 3/8	5/8	3.90
RO-303	2500 to 14000	2, 4, 6, 8, 15, etc.	40	8	L	1 3/8	2 3/8	1 3/8	5/8	3.10
RO-304	2500 to 13000	2, 4, 6, 8, 15	70	8	U	2	2 1/2	1 3/8	1 1/16	4.95
RO-305	2500 to 14000	2, 4, 6, 8, 15, etc.	60	12	L	2	3 1/4	2 3/8	1 1/2	5.75
RO-307	2500 to 14000	2, 4, 6, 8, 15, etc.	50	10	U	2 3/8	2 3/8	2 1/4	1	4.95

UNIVERSAL TYPE—PUSH-PULL PLATES (ONLY) TO VOICE COIL

Catalog No.	Primary	Secondary	Max. Primary D.C. Ma.	Max. Audio Watts	Mtg. Type	Dimensions H	Dimensions W	Dimensions D	Wt. Lbs.	List Price
RO-401	2500 to 13000	2, 4, 6, 8, 15	70	15	U	2 3/8	2 3/8	2 3/8	1 1/2	\$5.95

SPEAKER MATCHING TRANSFORMERS

Cat. No.	Application	Class	Ohms Impedance Pri. Sec.	Max. Primary D.C. Ma.	Ratio Sec.: Pri.	Mtg. Type	Dimensions H	Dimensions W	Dimensions D	Wt. Lbs.	List Price
SM-1	Sgl. Tube—500-1000-1500-2000	A	6 80	12	U	2 3/8	2 3/8	1 3/8	1	\$4.05	
SM-2	Sgl. Tube—2500-4000-6000-8000	A	6 80	12	U	2 3/8	2 3/8	1 3/8	1	5.85	
SM-3	Sgl. Tube—500-1000-1500-2000	A	6 60	5	U	1 3/8	2 3/8	1 3/8	3/4	2.50	

INTERSTAGE TRANSFORMERS

Cat. No.	Application	Class	Ohms Impedance Pri. Sec.	Max. Primary D.C. Ma.	Ratio Sec.: Pri.	Mtg. Type	Dimensions H	Dimensions W	Dimensions D	Wt. Lbs.	List Price
IN-10	S. Pl. to P-P Gds.	A	10000 160,000	10	4-1	L	2	3 1/4	1 3/4	1	\$5.95
IN-11	S. Pl. to P-P Gds.	A	10000 122,500	10	3.5:1	L	1 3/8	2 3/8	1 3/8	3/8	4.95
IN-13	S. Pl. to P-P Gds.	A	10000 90,000	10	3:1	L	2	3 1/4	1 3/8	1	5.10
IN-14	S. Pl. to P-P Gds.	A	10000 90,000	10	3:1	L	1 3/8	2 3/8	1 3/8	3/8	4.50
IN-15	P-P Pls. to P-P Gds.	A	10000 * 90,000	10	3:1	L	2	3 1/4	1 3/8	1	5.50
IN-16	Sgl. or P-P Input & Output	A			1:1, 3:1, or 6:1	L	2	3 1/4	2 1/4	1 1/2	6.50

*Universal type: center-tapped primary, split secondary.



TRANSFORMERS INDUSTRIAL - MILITARY - SPECIALTY

RADIO PRODUCTS CO., INC.

HUNTINGTON, INDIANA

A WHOLLY OWNED SUBSIDIARY OF NEWPORT STEEL CORPORATION

PULSE TRANSFORMERS... A FIELD PIONEERED and DEVELOPED BY UTAH

TYPE

Plate
Filament
Plate and Filament
Filter Reactors
Pulse
Audio

CONSTRUCTION

Core-and-Coil
Compound filled
Hypersil Loop
Hermetically
Sealed
Fosterite

APPLICATION

Radar
Guided Missile
Communications
Radio
Television
Sound Installation

Complete Fosterite Process—Varnish and Wax Impregnating

**33 MODELS OF THE MOST POPULAR PULSE
TRANSFORMERS IN STOCK—IMMEDIATE DELIVERY**

For Radio and Television Transformers—Line Matching—Impedance Matching
Write for Utah Catalog T 100

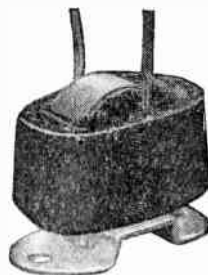

RIBBON CHOKE
Varnished
Actual Size

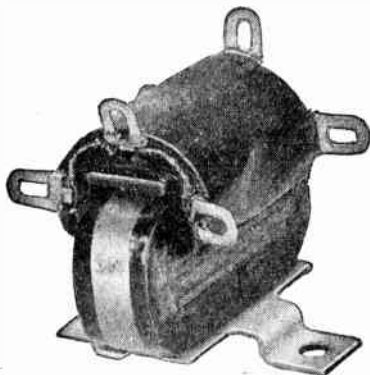

PULSE—Varnished
Actual Size

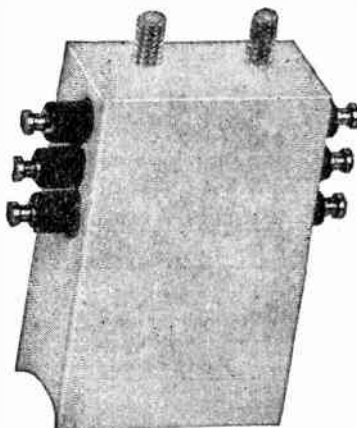

PULSE—Ceramic Terminals
Hermetically Sealed
Actual Size

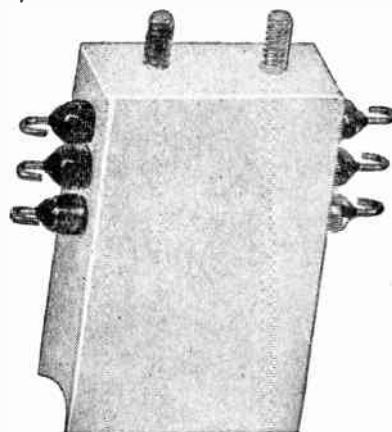

PULSE—Glass Bead Terminals
Hermetically Sealed
Actual Size

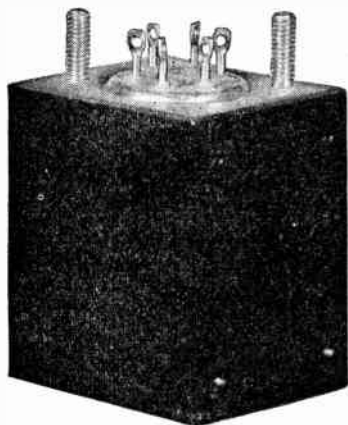

PULSE
Hermetically sealed

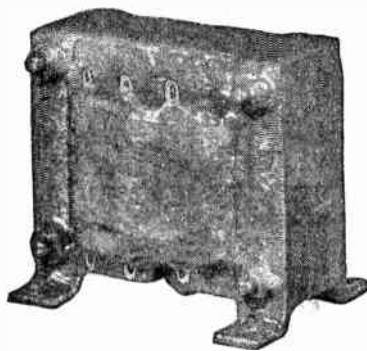

POWER PLATE
Fosterite

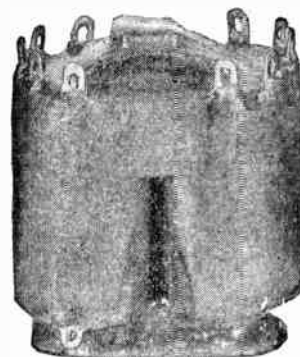

INTERSTAGE
Fosterite



THORDARSON

TRANSFORMER SPECIALISTS SINCE 1895

MT. CARMEL, ILL.

For a Complete Listing Ask for a Copy of Our Latest General Catalog



FGV



BAH



Z



RTV



RAV



GGV

AUDIO INPUT AND INTERSTAGE TRANSFORMERS

Type No.	List Price	Mtg.	Application	Ohms Impedance		Turns Ratio	Mtg. Centers	Dimensions			Wt. Lbs.
				Primary	Secondary			W.	D.	H.	
T-20A00	\$3.50	BAH	Line or mic to single or push-pull grids.....	600 Ct. 200 Ct.	60,000 Ct. 20,000 Ct.	1:10	2	2 3/8	1 1/4	1 1/8	1/2
T-20A01	6.00	FGV	Line or mic to single grid.....	50 600 Ct. 200 Ct.	20,000 Ct. 240,000 80,000	1:20	2 3/8	2 3/8	1 3/8	2 3/8	1 1/4
T-20A02	6.50	FGV	Line or mic to push-pull grids.....	50 600 Ct. 200 Ct.	80,000 240,000 Ct. 80,000 Ct.	1:20	2 3/8	2 3/8	1 3/8	2 3/8	1 1/4
T-20A03	5.00	BAH	Single plate and mic or line to grid.....	50 5,000 to 10,000	80,000 Ct. 100,000	1:3.25	2 3/8	2 1/8	1 3/8	1 3/8	3/4
T-20A04	3.00	BAH	Voice coil or mic to grid.....	200 3 to 6	250,000 38,400	1:80	2	2 3/8	1 1/4	1 1/8	1/2
T-20A05	15.00	RTV	Line or mic to single or push-pull grids..... (Hum-bucking coil and core—fully potted)	50 600 Ct. 200 Ct.	320,000 60,000 Ct. 20,000 Ct.	1:10	1 1/2 x 1 1/2	1 1/2	1 1/2	2	1/2
T-20A06	15.00	RTV	Line to Line..... (Hum-bucking coil and core—fully potted)	50 600 Ct. 200 Ct.	20,000 Ct. 600 Ct. 200 Ct.	1:1	1 1/2 x 1 1/2	1 1/2	1 1/2	2	1/2
T-20A40	30.00	Z	Microphone cable input transformer.....	50 Ct.	50 Ct.	1:31.6			1 Diam.	2 1/4	3/4
T-20A41	30.00	Z	Microphone cable input transformer.....	30 to 60 200 to 250	50,000 50,000	1:14.2			1 Diam.	2 1/4	3/4
T-20A29	4.00	BAV	Single or P.P. plate to single or P.P. grid..... Mixing Hi Imp. Outputs, Driver (2:1) etc.....	10,000 Ct. 15,000 Ct. 20,000 Ct.	10,000 Ct. 15,000 Ct. 20,000 Ct.	1:1:1:1	2	2 3/8	1 3/8	2	1/2
T-20A16	3.00	BAH	Single plate to single or push-pull grids.....	10,000	40,000 Ct.	1:2	8	2	2 3/8	1 1/4	1 1/8
T-20A17	6.50	RAV	Single plate to single or push-pull grids.....	10,000	40,000 Ct.	1:2	8	1 1/2	1 1/2	2	1/2
T-20A19	4.00	BAH	Single or push-pull plates to single or push-pull grids.....	10,000	40,000 Ct.	1:2	8	2 3/8	2 3/8	1 3/8	3/4
T-20A22	5.00	BAH	Single plate to single or push-pull grids.....	10,000	90,000 Ct.	1:3	8	2 7/8	3 1/4	2 1/4	1 1/2
T-20A23	6.50	FGV	Single plate to single or push-pull grids.....	10,000	90,000 Ct.	1:3	8	2 7/8	2 7/8	2 1/4	1 1/2
T-20A24	7.00	FGV	Push-pull plates to single or push-pull grids.....	20,000 Ct.	180,000 Ct.	1:3	8 Bal.	2 7/8	2 7/8	2 1/4	1 1/2
T-20A25	12.50	RTV	Single or push-pull plates to single or push-pull grids..... (Hum-bucking coil and core—fully potted)	Universal	Universal	1:1.41	8 Bal.	1 1/2 x 1 1/2	1 1/2	2	1/2
T-20A27	15.00	RTV	Single plate to single or push-pull grids.....	10,000 2,500	40,000 20,000	1:2			2 3/8 Diam.	3 3/8	2 3/8

TUBE TO LINE TRANSFORMERS (Low Level)

T-22S90	\$6.00	FGV	Single or push-pull plates to line.....	20,000 Ct.	500 Ct. or 125 to 200	..	8	2 3/8	2 3/8	1 3/8	2 3/8	1 1/4
T-22S92	12.50	RTV	Single or push-pull plates to line (Hum-bucking coil and core—fully potted)	20,000 Ct.	500 Ct. or 125 to 200	..	8	1 1/2 x 1 1/2	1 1/2	2	1/2	

DRIVER TRANSFORMERS

Type No.	List Price	Mtg.	Application	Turns Ratio		Pri. M.A.	Mtg. Centers	Dimensions			Wt. Lbs.
				Pri.-1/2 Sec.	Sec.			W.	D.	H.	
T-20D75	\$3.50	BAH	Single plate to push-pull Class B grids..... Primary 10,000 ohms—1H4-G or 30 to 19, etc.	2.4:1	5		2	2 3/8	1 1/4	1 3/8	1/2
T-20D76	3.50	BAH	Single plate to push-pull Class B grids..... Primary single 6N7 to Class B 6N7, etc.	5.2:1	15		2	2 3/8	1 1/4	1 3/8	1/2
T-20D77	5.50	FGV	Primary single 6F6 to PP 6F6, etc.....	2.5:1	30		2 3/8	2 3/8	2 1/4	2 3/8	1 1/2
T-20D78	8.50	GGV	Push-pull plates to push-pull grids..... Primary 6F6 triode to PP 6L6, etc.	4:1	40		2 x 1 1/4	2 3/8	2 1/4	3 1/8	2 1/2
T-20D79	7.00	FGV	Parallel or P-P parallel 6N7 to P-P parallel 6N7, etc.....	5.2:1	30		2 3/8	2 3/8	2 1/4	2 3/8	1 1/2
T-20D80	9.00	GGV	Push-pull 2A3 or 6A3 to 805-838, etc.....	3.2:1	100		2 x 1 1/4	2 3/8	2 1/4	3 1/8	2 1/2
T-20D81	12.00	GGV	Push-pull 845 to push-pull 805-833, etc.....	5:1	100		2 1/2 x 2 1/4	3 3/8	3 3/8	3 3/8	4 1/2
T-20D82	10.00	GGV	Push-pull plates to push-pull grids..... Push-pull 2A3-6F6, etc. to 805, etc.	5:1	100		2 x 1 1/4	2 3/8	2 1/4	3 1/8	2 1/2
T-20D83	38.00	PUV	20 watt 500 ohm line to Class B grids.....	4:1, 3.2:1	1:7.5, 1:8.5, 1:1.25, 1:1.4, 1:1.75, 1:2, 1:2.25, 1:2.5, 1:2.75, 1:3		1 1/2 x 4 3/8	3 3/8	4 3/8	4	8
T-20D84	22.00	GGV*	20 watt 500 ohm line to Class B grids.....	1:7.5, 1:8.5, 1:1.25, 1:1.4, 1:1.75, 1:2, 1:2.25, 1:2.5, 1:2.75, 1:3			2 1/2 x 2	3	3 3/8	3 3/8	3 3/8

*Terminal Board with Solder Lugs on Both Shields 20 Watts Capacity.

MODULATION TRANSFORMERS

Type No.	List Price	Mtg.	Capacity Watts	Primary Imp. Ohms	Secondary Imp. Ohms	Secondary Volts	M.A.	Primary Application	Mtg. Centers	Dimensions			Wt. Lbs.
										W.	D.	H.	
T-21M50	\$4.00	BAH	3	10,000 Ct.	4500	135	30	19, etc.	2	2 3/8	1 3/8	1 3/8	1/2
T-21M52	6.00	FGV	10	10,000 Ct.	4500/3750/3000	350	80	6N7, etc.	2	2 3/8	2 1/4	2 1/4	1 1/4
T-21M54	8.50	GGV	25	8,000 Ct.	4000	400	100	PP 6L6, etc.	2 x 1 1/4	2 3/8	2 1/4	3 1/8	2 3/8
T-21M56	16.50	GGV	75	10,000 Ct.	6600/3750	1250	200	TZ-20-809 etc.	2 1/2 x 2 1/4	3 3/8	4 3/8	3 3/8	6 3/8
T-21M58	31.00	KTV	100	15,000 Ct.	6250	1250	200	811-812, etc.	3 3/8 x 4 1/4	4 3/8	5 1/4	5 3/8	13

Copyright by U. C. P., Inc.

TRADE DISCOUNT APPLIES TO LIST PRICES ONLY

Radio's Master — 19th Edition

Page N-95

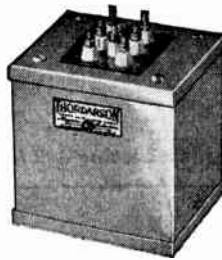
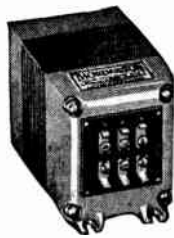

PUV

BHH

KTV

AGF

CAV

BAV

UNIVERSAL MULTI-MATCH MODULATION TRANSFORMERS

Type No.	List Price	Mtg.	Capacity Watts	Primary M.A. Each Side	Secondary Series	M.A. Parallel	Mtg. Centers	W.	Dimensions D.	H.	Wt. Lbs.
T-21M60	\$21.00	KTV	15	50	50	100	2 1/8 x 2 1/8	2 1/8	3 1/8	4	3 3/8
T-21M61	33.00	PUV	60	125	125	250	1 3/4 x 4 3/8	3 3/8	5 1/4	4	8 3/8
T-21M62	43.20	PUV	125	210	160	320	2 1/8 x 6 1/8	4 1/8	6 3/8	5 1/8	16 1/8
T-21M64	68.50	PUV	300	250	250	500	2 1/8 x 6 1/8	4 1/8	7 3/8	6	20
T-21M65	115.00	PUV	500	320	320	640	3 1/8 x 10	5 1/8	11	6 7/8	50
T-21M66	32.00	KTV	50	500 Ohm Line to R.F. Load—5000/6000/7000 8000/9000/10,000 Ohms—Max. Sec. D.C. 200 M.A.			3 1/4 x 3 3/4	4 1/8	5 1/8	5 1/8	11

VIBRATOR POWER TRANSFORMERS

Type No.	List Price	Mtg.	Primary	H.V. Secondary	Sec. No. 2	Mtg. Centers	Dimensions W. D. H.	Wt. Lbs.
T-22R25	\$7.50	TTV†	6-8 volts D.C.	160 volts D.C. at 40 M.A.		Exact Repl. 2 3/8	2 3/8 3	2
T-22R27	8.00	TTV†	6-8 volts D.C.	250 volts D.C. at 50 M.A.		Exact Repl. 2 3/8	2 3/8 3	2
T-22R20	8.00	CAV	6-8 volts D.C.	250 volts D.C. at 50 M.A.		2 x 1 3/4	2 1/8 2 1/8 3 1/8	2 1/2
T-22R22	9.00	CAV	6-8 volts D.C.	325 volts D.C. at 75 M.A.		2 x 2 1/8	2 1/8 3 3/8 3 1/8	3 1/2
T-22R24	16.50	GGV	117V. 60 cycle or 6-8 volts D.C.	325 volts D.C. at 135 M.A.	6.3 volts Ct. at 4.75 A.	3 x 3 1/8	3 1/8 4 3/8 4 3/8	8 3/4

OUTPUT TRANSFORMERS

Type No.	List Price	Mtg.	Application	Primary Imp. Ohms	Max. Prim. Per Side	D.C. M.A. Unbal.	Secondary Imp. Ohms	Power Watts	Mtg. Centers	Dimensions W. D. H.	Wt. Lbs.	
T-22S45	\$3.00	BAH	Single plate to voice coil....	1500 to 3000.....	..	55	3.2	3	2	2 3/8 1 1/4 1 3/8	1 1/2	
T-22S46	3.50	BAH	Single plate to voice coil....	3000 to 6000.....	..	35	3.2	3	2	2 3/8 1 1/4 1 3/8	1 1/2	
T-22S47	3.50	BAH	Single or push-pull plates to voice coil	6000 to 12000 Ct.	35	3.2	3	2	2 3/8 1 1/4 1 3/8	1 1/2	
T-22S48	3.50	BAH	Single or push-pull plates to voice coil	12000 to 25000 Ct. .	..	10	3.2	3	2	2 3/8 1 1/4 1 3/8	1 1/2	
T-22S56	5.00	BAH	Single or push-pull plates to voice coil	8000/10000 Ct.	50	3.2 to 4/6 to 8	8	2 1/8	3 1/4 1 3/4 2	1 1/4	
T-22S58	5.00	BAH	Single or push-pull plates to voice coil	5000/7000 Ct.	50	3.2 to 4/6 to 8	8	2 1/8	3 1/4 1 3/4 2	1 1/4	
T-22S60	5.00	BAH	Single or push-pull plates to voice coil	2500/4000 Ct.	60	3.2 to 4/6 to 8	8	2 1/8	3 1/4 1 3/4 2	1 1/4	
T-22S64	9.50	GGV	Single or push-pull plates to voice coil	10000 Ct.	50	3.2 to 4/6 to 8/15/250/500	25	2	x 1 1/8	2 1/8 2 1/8 3 3/8	2 1/2
T-22S66	9.50	GGV	Single or push-pull plates to voice coil	8000 Ct.	50	3.2 to 4/6 to 8/15/250/500	25	2	x 1 1/8	2 1/8 2 1/8 3 3/8	2 1/2
T-22S68	9.00	GGV	Single or push-pull plates to voice coil	6500 Ct.	70	3.2 to 4/6 to 8/15/250/500	25	2	x 1 1/8	2 1/8 2 1/8 3 3/8	2 1/2
T-22S70	9.00	GGV	Single or push-pull plates to voice coil	5000 Ct.	80	3.2 to 4/6 to 8/15/250/500	25	2	x 1 1/8	2 1/8 2 1/8 3 3/8	2 1/2
T-22S72	9.00	GGV	Single or push-pull plates to voice coil	3000 Ct.	90	3.2 to 4/6 to 8/15/250/500	25	2	x 1 1/8	2 1/8 2 1/8 3 3/8	2 1/2
T-22S78	13.00	GGV	Single or push-pull plates to voice coil	3300 Ct.	180	3.2 to 4/6 to 8/15/250/500	60	2 1/2 x 2 1/8	3 3/8 3 3/8 3 1/8	5 1/4	
T-22S74	8.00	BHH	Universal single or push-pull tubes to voice coil	14000/10000/8000/6000/5000/3000/2500 Ct.	..	80	60	25	3 1/8	4 2 1/2 2 1/8	2 1/2	
T-22S76	7.50	BHH	Universal single or push-pull tubes to line	14000/12000/10000/8000/5000/3000 Ct.	..	80	60	25	3 1/8	4 2 1/2 2 1/8	2 1/2	
T-22S80	5.50	BHH	Single line to voice coil.....	500 to 600.....	8	3 1/8	3 1/8 2 2 1/4	1 1/2	
T-22S82	8.50	BHH	Multiple lines to voice coil...	2000/1500/1000/500	25	3 1/8	4 2 3/4 2 1/8	2 1/4	
T-22S83	6.00	BAH	Multiple lines to voice coil...	2000/1500/1000/500	15	3 1/8	3 1/8 2 2 1/4	1 1/2	
T-22S84	5.50	BAH	Multiple lines to voice coil...	2000/1500/1000/500	5	2 1/8	3 1/4 1 3/4 2	1	
T-22S85	5.50	BAH	Multiple lines to voice coil...	2000/1500/1000/500	3	2 3/8	2 3/8 1 1/2 1 3/8	3/4	
T-22S62	5.00	BHH	Universal single plate to voice coil	4000/3000/2500/2000/1500	..	50	.1 to 29	8	2 1/8	3 1/4 2 2	1 1/4	
T-22S88	5.00	BAH	Universal single or push-pull plates to voice coil	14000 Ct./8000 Ct./3500/2000	..	50	10	8	2 1/8	3 1/4 1 3/4 2	1	
T-22S87	4.50	BAH	Universal single or push-pull plates to voice coil	14000 Ct./8000 Ct./3500/2000	..	50	10	6	2 3/8	2 3/8 1 1/2 1 3/8	3/4	
T-22S86	4.00	BAH	Universal single or push-pull plates to voice coil	14000 Ct./8000 Ct./3500/2000	..	50	10	3	2	2 3/8 1 1/4 1 3/8	1/2	

TELEVISION REPLACEMENT & EXPERIMENTAL POWER TRANSFORMERS

Type No.	List Price	Case Style	Secondary No. 1 A.C. Volts	Rect. Fil.	Class	Fil. No. 2	Fil. No. 3	Mtg. Centers	W.	Dimensions D. H.	Wt. Lbs.
T-22R40	\$18.00	GGV	1800	2 2.5V-1.8A	A	6.3V-6A Tapped at 2.5V-2.1A		2 1/2 x 2 1/8	3 3/8	3 3/8 3 1/8 4 3/8	4 3/4
TV-24R92	16.00	GGV	2400	10 2.5V-1.75A	A			2 3/4 x 2 1/8	3 3/8	3 3/8 3 1/8 4 3/8	5
TV-24R98	20.00	AGF	350-0-350	200 5V-2A 5V-3A	A	6.3V-7A		3 x 3 3/4	3 3/4	4 1/2 4 1/2 10 1/2	10 1/2



LINEAR STANDARD AUDIO TRANSFORMERS

LINEAR STANDARD AUDIO UNITS FEATURE:

UNIFORM FREQUENCY RESPONSE . . . at low frequencies, is effected through the use of HIPERM-ALLOY, a STABLE nickel iron alloy of very high initial permeability. Uniform high frequency response is the result of multiple section interleaved windings arranged in a semi-toroidal coil structure. This, plus special winding methods and insulations, assures a minimum of distributed capacity and leakage reactance.

UTC LINEAR STANDARD transformers are the ONLY audio units with a **GUARANTEED** uniform response . . . ± 1 DB from 20 to 20,000 cycles.

MINIMUM HUM PICKUP . . . is accomplished through the use of a hum balanced, semi-toroidal, coil structure which affords maximum neutralization of external fields. In addition, all units employ high conductivity outer case for maximum shielding. For very low level applications, units whose code numbers end in X employ multiple alloy shielding, making possible a transformer with extremely low inductive pickup.

NEGLECTIBLE WAVE FORM DISTORTION is a function of proper impedance matching, minimum phase shift, and low flux density. These elements have been given great attention in the design of Linear Standard units. It is interesting to note that an output transformer reasonably flat from 20 to 20,000 cycles may show serious distortions at 30 to 10,000 cycles. For this reason, UTC high level units have a frequency range better than guaranteed value, generally 7 cycles to 50,000 cycles (see page N-101).

MULTIPLE TAP WINDINGS . . . make possible a wide combination of impedance terminations without impairing fidelity or efficiency. Precision winding methods result in winding accuracy of .1% . . . perfect balance of inductance and capacity . . . exact impedance reflection.

DEPENDABILITY . . . is a function of external and internal structure. Linear Standard units are housed in rugged die cast cases of precise dimension with reversible mounting to permit above chassis or subchassis wiring. The solid terminal posts on low absorption bakelite are arranged in a circular layout so that a round chassis hole will clear all terminals. Coils are vacuum baked and impregnated. Semi-hermetic sealing is accomplished through the use of a high adhesion compound poured through the large opening opposite the terminal board after controlled preheating of the unit for full compound penetration.

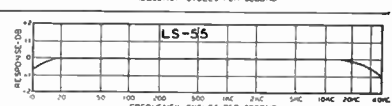
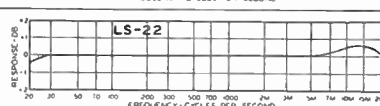
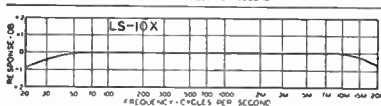
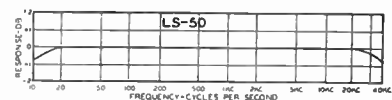
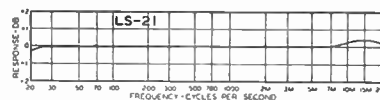
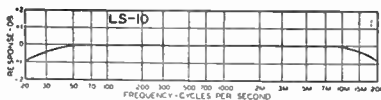

LOW IMPEDANCE TO GRID TRANSFORMERS

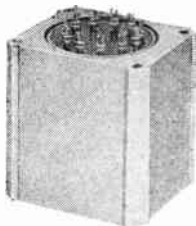

LS-1 CASE

Length 3 3/8"
 Width 2 5/8"
 Height 3 3/4"
 Mounting 1 1/4" x 2 1/4"
 Screws 6-32
 Cutout 1 7/8" dia.
 Unit Weight 3 lbs.

Type No.	Application	Primary Impedance	Secondary Impedance	± 1 db from	Max.† Level	Relative* hum	Unbal. DC in primy	Case No.
LS-10	Low impedance mike, pickup, or multiple line to grid	50, 125/150, 200, 250, 333, 500/600 ohms	60,000 ohms in two sections	20-20,000	+10 DB	-74 DB	.5 MA	LS-1
LS-10X	As above	As above	50,000 ohms	20-20,000	+10 DB	-92 DB-Q	.5 MA	LS-1
LS-12	Low impedance mike, pickup, or multiple line to push pull grids	50, 125/150, 200, 250, 333, 500/600 ohms	120,000 ohms overall, in two sections	20-20,000	+10 DB	-74 DB	.5 MA	LS-1
LS-12X	As above	As above	80,000 ohms overall, split	20-20,000	+10 DB	-92 DB-Q	.5 MA	LS-1
LS-14	Low impedance mike, pickup, or parallel mixer to grid	2.5, 5.5, 10, 15, 22, 30, 38, 60 ohms	60,000 ohms in two sections	20-20,000	+10 DB	-74 DB	.5 MA	LS-1
LS-14X	As above	As above	50,000 ohms	20-20,000	+10 DB	-92 DB-Q	.5 MA	LS-1
LS-15X	Three isolated lines or pads to one or two grids	30, 50, 200, 250 ohms each primary	60,000 ohms overall, in two sections	20-20,000	+10 DB	-92 DB-Q	.5 MA	LS-1
LS-18	High level multiple line to push pull grids	50, 125/150, 200, 250, 333, 500/600 ohms	50,000 ohms overall, in two sections	20-20,000	+20 DB	-50 DB	.5 MA	LS-2
LS-26	Bridging line to single or push pull grids	5,000 ohms	60,000 ohms in two sections	15-20,000	+15 DB	-74 DB	0 MA	LS-1



MIXING TRANSFORMERS

Type No.	Application	Primary Impedance	Secondary Impedance	± 1 db from	Max. † Level	Relative * hum	Unbal. DC in prim'y	Case No.
LS-30	Mixing, low impedance mike, pickup, or multiple line to multiple line	50, 125/150, 200, 250, 333, 500/600 ohms	50, 125/150, 200, 250, 333, 500/600 ohms	7-50,000	+15 DB	-74 DB	.5 MA	LS-1
LS-30X	As above	As above	As above	20-20,000	+15 DB	-92 DB-Q	.3 MA	LS-1
LS-31	Three isolated lines or pads to multiple line	30, 50, 200, 250 ohms each primary	50, 125/150, 200, 250, 333, 500/600 ohms	20-20,000	+15 DB	-74 DB	.5 MA	LS-1
LS-31X	As above	As above	As above	20-20,000	+14 DB	-92 DB-Q	.3 MA	LS-1
LS-32	Mixing, low impedance mike, pickup or parallel mixer to multiple line	2.5, 5, 5, 10, 15, 22, 30, 38, 60 ohms	50, 125/150, 200, 250, 333, 500/600 ohms	20-20,000	+15 DB	-74 DB	.5 MA	LS-1

INTERSTAGE AUDIO TRANSFORMERS

Type No.	Application	Primary Impedance	Secondary Impedance	± 1 db from	Max. † Level	Relative * hum	Unbal. DC in prim'y	Case No.
LS-19	Single plate to push pull grids like 2A3, 6L6, 5881 Split secondary	15,000 ohms	95,000 ohms 1.25:1 each side	20-20,000	+12 DB	-50 DB	0 MA	LS-1
LS-20	Single plate to single grid	15,000 ohms	60,000 ohms; 2:1 turn ratio	20-20,000	+10 DB	-74 DB	0 MA	LS-1
LS-21	Single plate to push pull grids. Split pri. and sec.	15,000 ohms	135,000 ohms; 3:1 overall	10-20,000	+10 DB	-74 DB	0 MA	LS-1
LS-40	Single plate to push pull grids. Split secondary	15,000 ohms	135,000 ohms; 3:1 overall	30-20,000	+12 DB	-74 DB	8 MA	LS-1
LS-22	Push pull plates to push pull grids. Split primary and secondary	30,000 ohms plate to plate	80,000 ohms; turn ratio 1.6:1 overall	20-20,000	+18 DB	-50 DB	.25 MA*	LS-2
LS-25	Push pull plates to push pull grids. Medium level. Split primary and sec.	30,000 ohms plate to plate	50,000 ohms; turn ratio 1.3:1 overall	20-20,000	+15 DB	-74 DB	1 MA	LS-1
LS-26	Bridging line to 1 or 2 grids	5000 ohms	60,000 in two sections	15-20,000	+15 DB	-74 DB	0 MA	LS-1

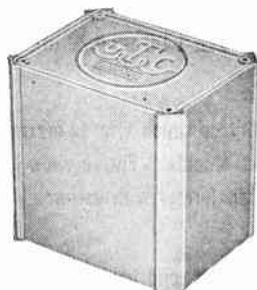

LS-2 CASE

Length	4 1/16"
Width	3 1/2"
Height	4 1/16"
Mounting	2 1/16" x 3 1/16"
Screws	.8-32
Cutout	2 3/4" dia.
Unit Weight	7.5 lbs.

PLATE, CRYSTAL, PHOTOCCELL, AND BRIDGING TO LINE TRANSFORMERS

Type No.	Application	Primary Impedance	Secondary Impedance	± 1 db from	Max. † Level	Relative * hum	Unbal. DC in prim'y	Case No.
LS-27	Single plate to multiple line	15,000 ohms	50, 125/150, 200, 250, 333, 500/600 cycles	30-15,000	+15 DB	-74 DB	8 MA	LS-1
LS-50	Single plate to multiple line	15,000 ohms	50, 125/150, 200, 250, 333, 500/600	10-40,000	+15 DB	-74 DB	0 MA	LS-1
LS-51	Push pull low level plates to multiple line	30,000 ohms plate to plate	50, 125/150, 200, 250, 333, 500/600	10-40,000	+16 DB	-74 DB	1 MA	LS-1
LS-38	Crystal microphone or pickup to multiple line, with internal equalizer	100,000 ohms	50, 125/150, 200, 250, 333, 500/600	Equalized for crystal	+10 DB	-74 DB	0 MA	LS-1
LS-38	Photocell, high-mu triode, diode or overbiased detector to multiple line	100,000 ohms	50, 125/150, 200, 250, 333, 500/600	20-20,000	+10 DB	-74 DB	0 MA	LS-1
LS-150	Bridging from 50 to 500 ohm line to line	4,000 ohms, bridging	50, 125/150, 200, 250, 333, 500/600	7-50,000	+15 DB	-74 DB	1 MA	LS-1
LS-151	Bridging from 50 to 500 ohm line to line	16,000 ohms, bridging	50, 125/150, 200, 250, 333, 500/600	7-50,000	+18 DB	-74 DB	1 MA	LS-1

HYBRID AND REPEAT COILS

Type No.	Application	Pri. and Sec. Impedances	± 1 db from	Max. Level	Hum Reduction	Max. Unbal. DC in Pri.	Case No.
LS-140	Line to line for isolating balanced and unbalanced circuits; balanced for maximum reduction cross talk (70 DB)	500/600 ohms split 500/600 ohms split	30-20,000	+10 DB	-92 DB Quadruple alloy shield	0 MA	LS-1
LS-141	Three sets of balanced windings for hybrid service, centertapped	500/600 ohms 500/600 ohms	30-15,000	+10 DB	-74 DB	0 MA	LS-1
LS-142	Line to line and to push pull grids for hybrid service	500/600 ohms 500/600 ohms 60,000 ohms	30-15,000	+10 DB	-74 DB	0 MA	LS-1
LS-143	High efficiency ring and talk repeat coil, for low frequency ringing	500/600 ohms 500/600 ohms	Efficient 15/12,000 cycles	+25 DB	-74 DB	5 MA	LS-2

DRIVER TRANSFORMERS

Type No.	Application	Primary Impedance	Ref. Sec. Impedance	± 1 db from	Max. Level	Max. Unbal. DC in Pri.	Case No.
LS-5	Driver, multiple line to class B 838's, 805's, ZB-120's, 203A's and similar tubes	50, 125, 200, 250, 333, 500/600 ohms	2,000 ohms; 1:2 overall turns ratio	20-20,000	+32 DB	5 MA	LS-2
LS-6	Driver, push pull 2A3's, etc., to push pull 845 or 211D grids	5,000 ohms plate to plate	2:25 primary impedance; turns ratio 1.5:1 overall	20-20,000	+32 DB	5 MA	LS-2
LS-7	Push pull 6C5, 6SN7, or similar plates to A 2A3's, 6L6's, 5881's	30,000 ohms plate to plate	.45 primary impedance turn ratio 1.5:1 Pri to Sec.	20-20,000	+25 DB	1 MA	LS-2
LS-47	Driver from push pull 2A3's, or similar to class B 838's, 203A's, 805's, or ZB120's	5,000 ohms plate to plate	.1 pri. impedance turns ratio, Pri./1/2 Sec. 3.2:1	20-20,000	+32 DB	5 MA	LS-2
LS-48	Driver transformer push pull 845's to 204 or 849 grids in class B	12,000 ohms plate to plate	.038 pri. impedance turns ratio, Pri./1/2 Sec. 5.1:1	20-20,000	+37 DB	15 MA	LS-3
LS-49	Push pull parallel 2A3, or similar tubes to four 838, 203A, 805, or ZB120 tubes	2,500 ohms plate to plate	Ratio Pri./1/2 Sec. 4:1 and 2.5:1	20-20,000	+37 DB	10 MA	LS-3



LS-3 CASE

Length	5 1/16"
Width	5"
Height	4 1/16"
Mounting	4 3/16" x 5 1/2"
Screws	10-24
Cutout	3 3/4" dia.
Unit Weight	15 lbs.

The values of unbalanced DC shown will affect approximately 1.5 DB loss at 30 cycles.

* Comparison of hum balanced unit with shielding to normal unshielded type.

Q Multiple alloy magnetic shield.

† 006 MW as ODB reference.



LS OUTPUT TRANSFORMERS THE FINEST

While the UTC Linear Standard line is generally designed for a flat response from 20 cycles to 20 Kc., a much wider response is required for output transformers. As is noted in the first curve below, typical UTC output transformers are down less than 1 dB at 10 cycles and less than 1 DB at 40 to 60 Kc. Because of this, a fine power output curve is possible. (Second curve.) The third figure below illustrates square waves obtained with the LS-63 transformer in a "Williamson" Amplifier Circuit. Of particular interest is the short rise time, which is far superior for UTC transformers than any standard make which we have measured.

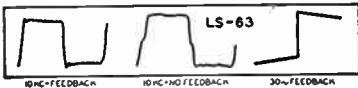
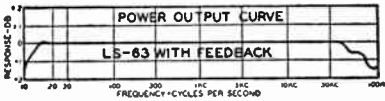
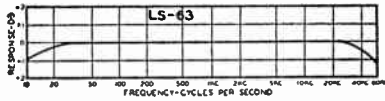

LS-6 CASE

Length15 3/4"
 Width13"
 Height24"
 Mounting Hole3/8" dia.
 Unit Weight350 lbs.

LS-7 CASE

Length20 3/8"
 Mounting7 7/8" x 14 1/8"
 Height18 1/2"
 Mounting11 1/8" x 19 3/8"
 Mounting Hole3/8" dia.
 Unit Weight500 lbs.
 Width17 3/4"

OUTPUT TRANSFORMERS TO LINE AND VOICE COIL

Type No.	Primary will match following typical tubes	Primary Impedance	Secondary Impedance	± 1 db from	Max. Level	Case No.
LS-52	Push pull 6AQ5, 6V6, 6L6, 5881	8,000 ohms	500, 333, 250, 200, 125, 50, 30, 20, 15, 10, 7.5, 5, 2.5, 1.2	7-50,000	15 watts	LS-2
LS-54	Same as above	8,000 ohms	30, 20, 15, 10, 7.5, 5, 2.5, 1.2	7-50,000	15 watts	LS-2
LS-55	Push pull 2A3's, 300B, 6L6's, 6AS7G, 6080, 6B4G, 350B	5,000 ohms plate to plate and 3,000 ohms plate to plate	500, 333, 250, 200, 125, 50, 30, 20, 15, 10, 7.5, 5, 2.5, 1.2	7-50,000	20 watts	LS-2
LS-57	Same as above	5,000 ohms plate to plate and 3,000 ohms plate to plate	30, 20, 15, 10, 7.5, 5, 2.5, 1.2	7-50,000	20 watts	LS-2
LS-58	Push pull parallel as above.	2,500 ohms plate to plate and 1,500 ohms plate to plate	500, 333, 250, 200, 125, 50, 30, 20, 15, 10, 7.5, 5, 2.5, 1.2	10-50,000	40 watts	LS-3
LS-60A	Push pull 2A3's, 6B4G's fixed bias, cathode follower drive, push pull parallel triode: 1614, 1626, 807, 5881, KT-66	4,600 ohms plate to plate	15, 10, 7.5, 5, 3.75, 2.5, 1.2	7-50,000	30 watts	LS-3
LS-62A	Same as above	As above	500, 125	7-50,000	30 watts	LS-3
LS-61	Push pull triode: 6AS7G, 6080, 6L6, 5881, KT-66, 807, 1614	10,000 ohms plate to plate and 6,000 ohms plate to plate	500, 333, 250, 200, 125, 50, 30, 20, 15, 10, 7.5, 5, 2.5, 1.2	7-50,000	15 watts	LS-2
LS-63	Same as above	10,000 ohms plate to plate and 6,000 ohms plate to plate	30, 20, 15, 10, 7.5, 5, 2.5, 1.2	7-50,000	15 watts	LS-2
LS-6L1	Self bias push pull 6L6's, 5881, KT-66, 6146 triode, 6149 triode	9,000 ohms plate to plate	500, 333, 250, 200, 125, 50, 30, 20, 15, 10, 7.5, 5, 2.5, 1.2	7-50,000	30 watts	LS-3
LS-6L3	Same as above	9,000 ohms plate to plate and	30, 20, 15, 10, 7.5, 5, 2.5, 1.2	7-50,000	30 watts	LS-3
LS-6L4	Push pull 6146, 6149, 6L6's fixed bias or push pull parallel 6L6's self bias	3,800 ohms plate to plate and 4,500 ohms plate to plate	500, 333, 250, 200, 125, 50, 30, 20, 15, 10, 7.5, 5, 2.5, 1.2	12-50,000	55 watts	LS-3

HIGH LEVEL MATCHING TRANSFORMERS

Type No.	Application	Primary Impedance	Secondary Impedance	± 1 db from	Max. Level	Case No.
LS-33	High level line matching	50, 125, 200, 250, 333, 500/600 ohms	1.2, 2.5, 5, 7.5, 10, 15, 20, 30, 50, 125, 200, 250, 333, 500/600	10-40,000	15 watts	LS-2
LS-34	High level line matching	50, 125, 200, 250, 333, 500/600 ohms	1.2, 2.5, 5, 7.5, 10, 15, 20, 30, 50, 125, 200, 250, 333, 500/600	10-40,000	30 watts	LS-3

OUTPUT TRANSFORMERS TO HIGH IMPEDANCE (RF) LOAD

Type No.	Primary will match following typical tubes	Primary Impedance	Secondary Impedance	± 1 db from	Max. Level	Case No.
LS-56	Push pull 2A3's, 6A5G's, 300B's, 6AS7, 6L6, 6080	5,000 ohms plate to plate and 3,000 ohms plate to plate	6000, 5000, 4000, 1800, 1500, 1000, 30, 20, 15, 10, 7.5, 5, 2.5, 1.2	10-50,000	20 watts	LS-2
LS-66	Class B 203A, 838, ZB120, 805	9,000 ohms plate to plate	5000, 4200, 4100, 3500, 3300, 2650, 2500, 2100, 1250, 600	10-50,000	260 watts	See Pg. N-102
LS-891	Class B 849, 833, 290TH	10,400 ohms plate to plate	4500, 4000, 3500, 2750, 2000	20-40,000	1000 watts	LS-6
LS-692	Class B push pull parallel 833's	4,750 ohms plate to plate	2500, 2000, 1750, 1500, 1250	20-40,000	2500 watts	LS-6

MODULATION REACTORS

Type No.	Application	Inductance	DC Current	DC Resistance	Insulation Test Voltage	Case No.
LS-102	Modulation reactor	50 hy	350 MA	250 ohms	5000	See Pg. N-102
LS-103	Modulation reactor	50 hy	500 MA	175 ohms	7500	See Pg. N-102
LS-104A	Modulation reactor	50 hy	1.3 amp	75 ohms	20000	LS-7
LS-106	Modulation reactor	50 hy	750 MA	120 ohms	10000	Spec.

*See dimension chart, page N-102



LINEAR STANDARD POWER EQUIPMENT

COMBINED PLATE AND FILAMENT TRANSFORMERS

In choosing power components for broadcast and commercial equipment, the first factor to be considered is dependability. Linear standard power components are very conservatively designed for maximum reliability. Designs provide for low temperature rise, 40°, and high insulation safety factors. Only the finest of materials and workmanship are used throughout.

The low power components of the Linear Standard series are housed in the familiar rectangular LS case with top or bottom mounting facilities. High power components are housed in end castings which completely protect the winding, while directly exposing the laminations for maximum heat transfer.

All units have a deep grey finish to obtain the highest heat radiation coefficient. Large components (up to 250 KVA) are housed in oil tanks.

Type No.	Typical Application	Pri. Volts 50/60 cycles	High Voltage	Filament Windings	Case No.
LS-180	For pre-amplifier service	110	225-0-225 15 MA	6.3 V.C.T.-2A 6.3 V.C.T.-6A	LS-1
LS-192	Power amplifier service	105, 115, 125	335-0-335 180 MA DC 60-0-60, 20 MA	5 V.-3A 6.3 V.C.T.-.75A 6.3 V.C.T.-5.25A	LS-3
LS-70	High power amplifier service	100, 105, 110, 115, 120, 125	425-375-0-375-425 200 MA 70-0-70 50 MA	5 V.C.T.-3A 5 V.C.T.-2A 2.5 V.C.T.-10A 6.3 V.C.T.-1A 6.3 V.C.T.-3A	LS-3
LS-72	For fixed or self bias 6L6's, 300A's	100, 105, 110, 115, 120, 125	525-450-0-450-525 250 MA 70-0-70 50 MA	5 V.C.T.-3A 2.5 V.C.T.-3A 2.5 V.C.T.-3A 6.3 V.C.T.-1A 6.3 V.C.T.-3A tapped at 5 V.C.T.-6A	LS-3
LS-74	For push pull parallel 6L6's, 2A3's, 6B4's	115	415-395-0-395-415 275 MA	5 V.-6A 6.3 V.C.T.-5A	LS-3

PLATE TRANSFORMERS*

Type No.	Application	Primary Voltage 50/60 cycles	High Voltage	Approximate DC Voltage Out of Filter	DC Current
LS-183	Class B 805 or push pull parallel 203A's, etc.	100, 110, 120, 220, 230, 240	1750-1500-0-1500- 1750	1500-1250	400 MA
LS-184	Class B 204A, 849, HF200, HF300, 250TH, HK354, 100TH, etc.	100, 110, 120, 220, 230, 240	3500-3000-2500-0- 2500-3000-3500	3000-2500-2100	500 MA
LS-185	For combined class B and class C stages as above	100, 110, 120, 220, 230, 240	3500-3000-2500-0- 2500-3000-3500	3000-2500-2100	1.2 amp.

FILAMENT TRANSFORMERS

Type No.	Application	Pri. Volts 50/60 cycles	Secondary Voltage	Insulation Test Voltage	Case No.
LS-80	866 rectifiers	100, 110, 120, 220, 230, 240	2.5 V.C.T.-10A	10,000	LS-3
LS-82	872 rectifiers	100, 110, 120, 220, 230, 240	5 V.C.T.-20A	10,000	LS-3
LS-84	203A, 845, etc. HF200, HF300	100, 110, 120, 220, 230, 240	10 V.C.T.-8A	2,500	LS-2
LS-88	6.3 volt tubes	105, 115, 125	6.3 V.C.T.-2A	2,500	LS-1
LS-120	866 Bridge rectifier	100, 110, 120, 220, 230, 240	2.5 V.C.T.-10A 2.5 V.C.T.-5A 2.5 V.C.T.-5A	12,000	LS-3
LS-121Y	872 Bridge rectifier	100, 110, 120, 220, 230, 240	5 V.C.T.-20A 5 V.C.T.-10A 5 V.C.T.-10A	12,000	*
LS-85	872A, 575 or 869 rectifiers	100, 110, 120, 220, 230, 240	5 V.C.T.-20A	35,000	*
LS-89A	Three 869 rectifiers	100, 110, 120, 220, 230, 240	5 V.C.T.-60A	35,000	*

LINEAR STANDARD FILTER, SWINGING, AND AUDIO CHOKES

(Inductance values are at D.C. current shown)

Type No.	L	W	H	Mtg.	WT.
LS-66	9 3/4	4 3/4	6 3/4	3 7/8 x 9 1/8	37
LS-73	9 1/2	4 3/4	6 3/4	3 7/8 x 8 7/8	34
LS-83	8 3/4	4 3/4	6 3/4	3 7/8 x 8 1/8	25
LS-89A	9 3/8	7	9	6 x 8 1/2 x 1 1/8	68
LS-96	10 1/4	4 3/4	6 3/4	3 7/8 x 9 5/8	40
LS-99	14 1/8	8 1/2	10 1/4	7 1/4 x 13 3/8	80
LS-102	9 3/4	4 3/4	6 3/4	3 7/8 x 9 5/8	37
LS-103	13 1/8	8 1/2	10 1/4	7 1/4 x 12 1/8	58
LS-105	13 1/8	8 1/2	10 1/4	7 1/4 x 12 1/8	58
LS-121Y	8 1/4	3 3/4	5 1/8	3 x 7 1/2 x 1 1/8	23
LS-181	9 3/4	4 3/4	6 3/4	3 7/8 x 9 5/8	37
LS-182	10 3/4	4 3/4	6 3/4	3 7/8 x 10 1/8	45
LS-183	15 1/2	10	13 1/4	8 1/2 x 14 1/2	70
LS-184	17 1/4	10	13 1/4	8 1/2 x 16 1/4	102
LS-185	23	10	13 1/4	8 1/2 x 22	230

Type No.	Application	Inductance	DC Current	DC Resistance	Insulation Test Voltage	Case No.
LS-90	Filter choke with hum bucking tap	Series-50 hy Parallel-12.5 hy	50 MA 100 MA	450 ohms 110 ohms	2000	LS-2
LS-91	Filter choke with hum bucking tap	Series-14 hy Parallel-3.5 hy	125 MA 250 MA	200 ohms 50 ohms	2000	LS-2
LS-92	Filter choke with hum bucking tap	Series-16 hy Parallel-4 hy	175 MA 350 MA	88 ohms 22 ohms	2500	LS-2
LS-93	Filter choke with hum bucking tap	Series-26 hy Parallel-6.5 hy	200 MA 400 MA	120 ohms 30 ohms	3500	LS-3
LS-950	Filter choke with hum bucking tap	Series-100 hy Parallel-25 hy	35 MA 70 MA	1000 ohms 250 ohms	1500	LS-2
LS-96	Filter choke with hum bucking tap	Series-20 hy Parallel-5 hy	500 MA 1 amp	90 ohms 22.5 ohms	7500	*
LS-980	Filter choke with hum bucking tap	Series-14 hy Parallel-3.5 hy	400 MA 800 MA	100 ohms 25 ohms	5000	LS-3
LS-98	Swinging choke	8-40 hy	400 MA	125 ohms	5000	LS-3
LS-99	Filter choke with hum bucking tap	Series-20 hy Parallel-5 hy	1 amp 2 amp	50 ohms 12.5 ohms	10000	*
LS-105	Swinging choke	8-40 hy	1 amp	50 ohms	10000	*

* See dimension chart, this page.



HIPERM ALLOY TRANSFORMERS

The UTC Hiperm alloy audio and power transformers are specifically designed for portable and compact service. While light in weight, neither dependability nor fidelity has been sacrificed. The frequency characteristic of the Hiperm alloy audio units is uniform from 30 to 20,000 cycles. They incorporate a Hiperm-alloy nickel iron core and hum balanced coil structure. The rugged die cast case is of high conductivity alloy finished in grey, arranged for mounting with the terminals either up or down. DC in Prim'y shown is maximum unbalanced.

LOW IMPEDANCE TO GRID AND MIXING TRANSFORMERS

Type No.	Application	Primary Imp. (ohms)	Secondary Impedance	± 1 db from	Max. Level	DC in Prim'y	Case No.
HA-100	Low impedance mike, pickup, or multiple line to grid	50, 125/150, 200, 250, 333, 500/600	60,000 ohms in two sections	30-20,000	+10 DB	.5 MA	H-1
HA-100X	Same as above but with tri-alloy internal shield to effect very low hum pickup						H-1
HA-101	Low impedance mike, pickup, or multiple line to P.P. grids	50, 125/150, 200, 250, 333, 500/600	120,000 ohms overall, split	30-20,000	+10 DB	.5 MA	H-1
HA-101X	As above but with tri-alloy internal shield to effect very low hum pickup		80,000 ohms overall, split	30-20,000	+10 DB	.5 MA	H-1
HA-103A	Low impedance mike, pickup, or parallel mixer to grid	2.5, 5.5, 10, 15, 22, 30, 38, 60	60,000 ohms in two sections	30-20,000	+10 DB	.5 MA	H-1
HA-108	Mixing, low impedance mike, pickup, or multiple line	50, 125/150, 200, 250, 333, 500/600	50, 125/150, 200, 250, 333, 500/600	20-50,000	+10 DB	.5 MA	H-1
HA-108X	Same as above but with tri-alloy internal shield to effect very low hum pickup						H-1
HA-130X	Three isolated lines or pads to one or two grids with tri-alloy internal shield	30, 50, 200, 250 each primary	60,000 ohms overall, in two sections	30-20,000	+10 DB	.5 MA	H-1



TYPE H-1 CASE

Length 2 3/8"
 Width 1 1/8"
 Height 3 1/8"
 Mounting 1 3/8" x 1 3/8"
 Screws 6-32
 Cutout 1 1/8" dia.
 Unit Weight 2 lbs.

INTERSTAGE AUDIO TRANSFORMERS

Type No.	Application	Primary Imp.	Secondary Impedance	± 1 db from	Max. Level	DC in Prim'y	Case No.
HA-104	Single plate to P.P. grids like 2A3, 6L6 (split secondary)	15,000 ohms	95,000 ohms 1.25:1	30-20,000	+12 DB	0 MA	H-1
HA-105	Single plate to single grid (split secondary)	15,000 ohms	60,000 ohms 2:1 turn ratio	30-20,000	+12 DB	0	H-1
HA-106	Single plate to push pull grids (split secondary)	15,000 ohms	135,000 ohms 3:1 ratio overall	30-20,000	+12 DB	0	H-1
HA-107	Push pull plates to push pull grids (split primary and secondary)	30,000 ohms plate to plate	80,000 ohms 1.6:1 turn ratio overall	30-20,000	+20 DB	.25 MA	H-2
HA-137	Push pull plates to push pull grids (split Pri. and Sec.)	30,000 ohms plate to plate	68,000 ohms 1.5:1 turn ratio	30-20,000	+12 DB	0	H-1

PLATE AND CRYSTAL TO LINE TRANSFORMERS

Type No.	Application	Primary Imp.	Secondary Imp. ohms	± 1 db from	Max. Level	DC in Prim'y	Case No.
HA-111	Crystal microphone or pickup, to multiple line	100,000 ohms	50, 125/150, 200, 250, 333, 500/600	30-20,000 measured with resistive source	+10 DB	0	H-1
HA-113	Single plate to multiple line	15,000 ohms	50, 125/150, 200, 250, 333, 500, 600	30-40,000	+12 DB	0 MA	H-1
HA-133	Single plate to multiple line (D.C. in Pri.)	15,000 ohms	50, 125/150, 200, 250, 333, 500, 600	30-40,000	+15 DB	8 MA	H-1
HA-114	Push pull low level plates to multiple line	30,000 ohms plate to plate	50, 125/150, 200, 250, 333, 500/600	30-40,000	+16 DB	1 MA	H-1
HA-134	Push pull 6B4's, 6L6, or 2A3's to line	5000/9400 ohms plate to plate	50, 125/150, 200, 250, 333, 500/600	10-50,000	+32 DB	5 MA	H-2
HA-135	Push pull 2A3's, etc. to voice coil	3000/5000 ohms plate to plate	30, 20, 15, 10, 7.5, 5, 2.5, 1.2	10-50,000	+34 DB	5 MA	H-2

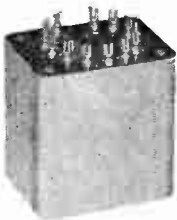

TYPE H-2 CASE

Length 3 3/8"
 Width 2 1/8"
 Height 3 1/2"
 Mounting 2" x 2 3/4"
 Screws 8-32
 Cutout 2 1/8" dia.
 Unit Weight 5 lbs.

POWER TRANSFORMERS AND CHOKES

Type No.	Application	Primary Voltage 50/60 cycles	High Voltage	Filament Windings	Case No.
HP-122	Pre-amp. power supply using 6X4, 6X5 rectifier	115	220-0-220 15 MA	6.3 V.C.T.-.6A 6.3 V.C.T.-1.2A	H-1
HP-123	Pre-amp. or tuner power supply using 6X4, 6X5 rectifier	115	275-0-275 35 MA	6.3 V.C.T.-.6A 6.3 V.C.T.-2A	H-2

Type No.	Application	Inductance	DC Current	DC Resistance	Test Voltage	Case No.
HC-115	Parallel feed and filter choke	Series-400 hy Parallel 100 hy	2.5 MA 5 MA	6000 ohms 1500 ohms	1500	H-1
HC-116	Parallel feed and filter choke	Series-600 hy Parallel-150 hy	8 MA 16 MA	3400 ohms 850 ohms	1500	H-2
HC-117	Parallel feed and filter choke	Series-200 hy Parallel-50 hy	15 MA 30 MA	3200 ohms 800 ohms	1500	H-1

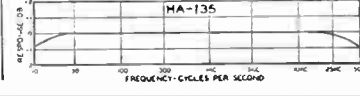
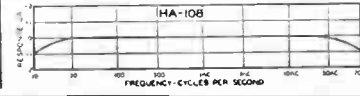
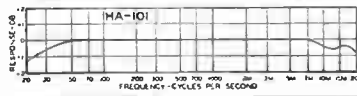
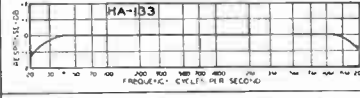
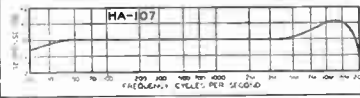
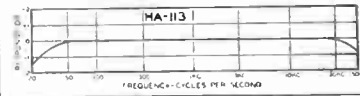
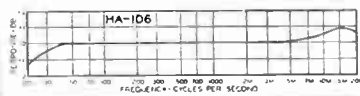



ULTRA COMPACT AUDIO UNITS

The UTC Ultra compact audio units are small and light in weight, ideally suited to remote amplifier and similar compact equipment. High fidelity is obtainable in all individual units, the frequency response being ± 2 DB from 30 to 20,000 cycles.

All units except those carrying DC in Primary employ a true hum balancing-coil structure, which combined with a high conductivity outer case, effects good inductive shielding. The die-cast case provides for top or bottom mounting. Maximum operating level $+7$ DB.

LOW IMPEDANCE TO GRID AND MIXING TRANSFORMERS

Type No.	Application	Primary Impedance	Secondary Impedance	± 2 db from
A-10	Low impedance mike, pickup, or multiple line to grid	50, 125/150, 200/250, 333, 500/600 ohms	50,000 ohms	20-20,000
A-11	Low impedance mike, pickup, or line to 1 or 2 grids	50, 200, 500	50,000 ohms	50-20,000 multiple alloy shield for extremely low hum pickup
A-12	Low impedance mike, pickup, or multiple line to push pull grids	50, 125/150, 200/250, 333, 500/600 ohms	80,000 ohms overall, in two sections	20-20,000
A-14	Dynamic microphone to one or two grids	30 ohms	50,000 ohms overall, in two sections	20-20,000
A-20	Mixing, low impedance mike, pickup, or multiple line to multiple line	50, 125/150, 200/250, 333, 500/600 ohms	50, 125/150, 200/250, 333, 500/600 ohms	10-50,000
A-21	Mixing, low impedance mike, pickup, or line to line	50, 200/250, 500/600	50, 200/250, 500/600	30-30,000 multiple alloy shield for extremely low hum pickup

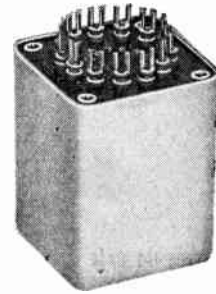

INTERSTAGE AUDIO TRANSFORMERS

Type No.	Application	Primary Impedance	Secondary Impedance	± 2 db from
A-16	Single plate to single grid	15,000 ohms	60,000 ohms, 2:1 turn ratio	20-20,000
A-17	Single plate to single grid 8 MA unbalanced D.C.	As above	As above	40-20,000
A-18	Single plate to two grids. Split primary, can also be used for P.P. plates	15,000 ohms	80,000 ohms overall, 2.3:1 turn ratio over-all	20-20,000
A-19	Single plate to two grids 8 MA unbalanced D.C.	15,000 ohms	80,000 ohms overall, 2.3:1 turn ratio over-all	40-20,000

TYPE A CASE

Length	1½"
Width	1½"
Height	2"
Mounting	1½" sq.
Screws	4-40
Cutout	1⅝" dia.
Unit Weight	½ lb.

PLATE AND CRYSTAL TO LINE TRANSFORMERS

Type No.	Application	Primary Impedance	Secondary Impedance	± 2 db from
A-24	Single plate to multiple line	15,000 ohms	50, 125/150, 200/250, 333, 500/600 ohms	20-40,000
A-25	Single plate to multiple line 8 MA unbalanced D.C.	15,000 ohms	50, 125/150, 200/250, 333, 500/600 ohms	40-20,000
A-26	Push pull low level plates to multiple line	30,000 ohms plate to plate	50, 125/150, 200/250, 333, 500/600 ohms	20-40,000
A-27	Crystal microphone to multiple line	100,000 ohms	50, 125/150, 200/250, 333, 500/600 ohms	30-20,000 measured with non inductive source
A-30	Audio choke, 250 henrys @ 5 MA 6000 ohms D.C., 65 henrys @ 10 MA 1500 ohms D.C. 450 henrys @ 0 MA			
A-32	Filter choke 60 henrys @ 15 MA 2000 ohms D.C., 15 henrys @ 30 MA 500 ohms D.C.			

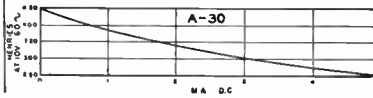
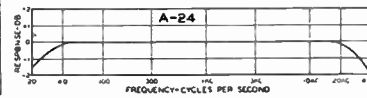
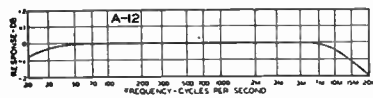
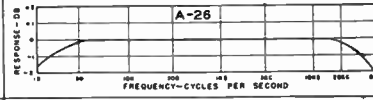
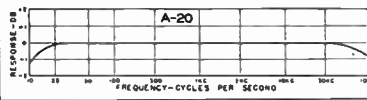
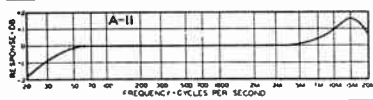
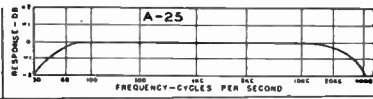
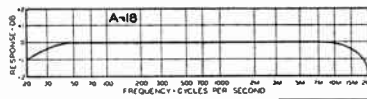
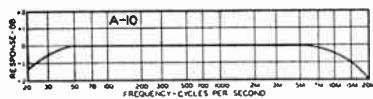



OUNCER AUDIO UNITS

STANDARD AND PLUG-IN TYPES

UTC OUNCER components represent the acme in compact quality transformers. These units, which weigh one ounce, are fully impregnated and sealed in a drawn aluminum housing $\frac{7}{8}$ " diameter . . . mounting opposite terminal board.

Ouncer items are ideal for portable broadcast, hearing aid, aircraft, concealed service, and similar applications. High fidelity characteristics are provided, uniform within approximately 1 DB from 30 to 20,000 cycles, except for O-14, O-15, and units carrying DC which are intended for voice frequencies. Maximum level 0 DB.

"P" series units are identical to the UTC OUNCER units but are sealed in bakelite housings with plug-in base to fit standard octal socket. While of submersion proof design, these units weigh but two ounces. Oversize pins in the base make it impossible to dislodge these units from their sockets.



OUNCER CASE

Dia. $\frac{7}{8}$ "
Ht. $1\frac{1}{4}$ "
Mtg. $\frac{1}{4}$ "
Scr. 2-56
Wt. 1 oz.



PLUG-IN CASE

Dia. $1\frac{1}{2}$ "
Ht. $1\frac{1}{2}$ "
Skt. St. Oct.
Wt. 2 oz.



O-16 CASE

Dia. $1\frac{1}{16}$ "
Ht. $1\frac{1}{2}$ "
Mtg. $1\frac{1}{2}$ "
Scr. 6-32
Wt. 3 oz.
Clamp ... $1\frac{1}{16}$ " x $1\frac{1}{8}$ "

OUNCER Type No.	Application	Pri. Imp.	Sec. Imp.	PLUG-IN Type No.
O-1	Mike, pickup or line to 1 grid	50, 200/250, 500/600	50,000	P-1
O-2	Mike, pickup or line to 2 grids	50, 200/250, 500/600	50,000	P-2
O-3	Dynamic mike to 1 grid	7.5/30	50,000	P-3
O-4	Single plate to 1 grid	15,000	60,000	P-4
O-5	Single plate to 1 grid, D.C. in Pri.	15,000	60,000	P-5
O-6	Single plate to 2 grids	15,000	95,000	P-6
O-7	Single plate to 2 grids, D.C. in Pri.	15,000	95,000	P-7
O-8	Single plate to line	15,000	50, 200/250, 500/600	P-8
O-9	Single plate to line, D.C. in Pri.	15,000	50, 200/250, 500/600	P-9
O-10	Push pull plates to line	30,000 ohms plate to plate	50, 200/250, 500/600	P-10
O-11	Crystal mike or pick-up to line	50,000	50, 200/250, 500/600	P-11
O-12	Mixing and matching	50, 200/250	50, 200/250, 500/600	P-12
O-13	Reactor, 300 Hys.—no D.C.; 50 Hys.—3 MA. D.C., 6000 ohms			P-13
O-14	50:1 mike or line to 1 grid	200	$\frac{1}{2}$ megohm	P-14
O-15	10:1 single plate to 1 grid	15,000	1 megohm	P-15
O-16	Mike or line to grid	250 C.T.	50,000	

This transformer provides very low hum pickup . . . employs two heavy gauge hyperalloy shields plus orientable mounting. Primary centertap is balanced to 1%. Can be used for 150, 200, 250, 500, or 600 ohm sources . . . 200:1 impedance ratio.

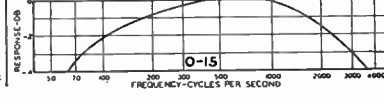
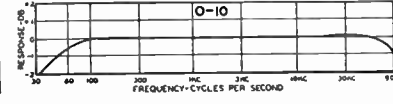
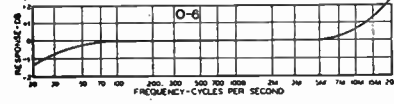
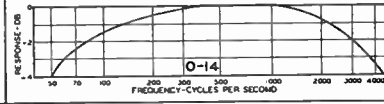
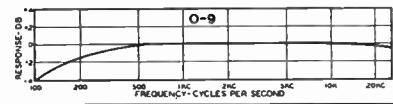
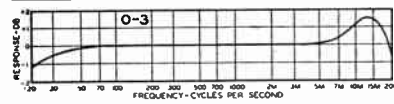
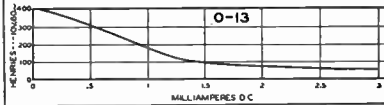
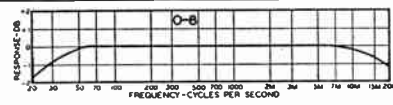
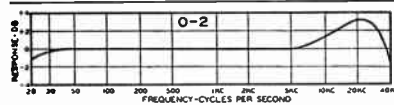
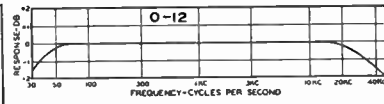
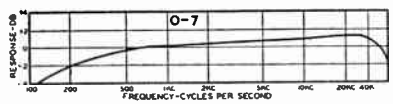
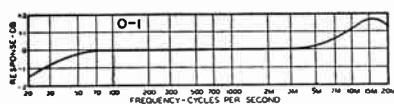

MICROPHONE CABLE TRANSFORMERS



UTC Cable transformers are designed to be inserted in the cable circuit, and are ruggedly constructed to withstand mechanical abuse. The cable connections (supplied less cable) are made through spring strain relief to terminal boards inside the end caps. $1\frac{1}{2}$ " diameter . . . $2\frac{1}{2}$ " long . . . $\frac{1}{2}$ lb.

Type MC-1—primary tapped 30/50 and 200/250 ohms, secondary to grid, standard fidelity.
Type MC-2—primary tapped 30/50 and 200/250 ohms, secondary to grid, high fidelity.



HERMETICALLY SEALED COMPONENTS

For over fifteen years UTC has been the largest supplier of transformer components for military applications, to customer specifications. Listed below are a number of types, to latest military specifications, which are now catalogued as UTC stock items.

Terminals on items H-20 through H-24 are neoprene-ceramic assemblies. All other units employ glass bead headers, but can be supplied with neoprene-ceramic terminals where required. For printed circuit use, wire terminals on glass header units can be straightened out without injury. Straight wire terminals available on production orders.

The frequency response ratings are based on military requirements. Actually, most of the units that do not carry DC are appreciably better in response than the range shown.

The level ratings are maximum level for reasonable distortion at the lowest frequency specified. For higher frequencies considerably higher levels are permissible.

The impedance ratings are listed in standard manner. Obviously, a transformer with a 15,000 ohm primary impedance can operate from a tube representing a source impedance of 7700 ohms, etc. In addition, transformers can be used for applications differing considerably from those shown, keeping in mind that impedance ratio is constant. Lower source impedance will improve response and level ratings . . . higher source impedance will reduce frequency range and level rating.

MINIATURE AUDIO UNITS . . . RCOF CASE

Type No.	Application	MIL Type	Pri. Imp. Ohms	Sec. Imp. Ohms	DC in Pri. MA	Response ± 2 db (Cyc.)	Max. level dbm
H-1	Mike, pickup, line to grid	TF1A10YY	50, 200 CT, 500 CT*	50,000	0	50-10,000	+ 5
H-2	Mike to grid	TF1A11YY	82	135,000	50	250-8,000	+21
H-3	Single plate to single grid	TF1A15YY	15,000	60,000	0	50-10,000	+ 6
H-4	Single plate to single grid, DC in Pri.	TF1A15YY	15,000	60,000	4	200-10,000	+14
H5	Single plate to P.P. grids	TF1A15YY	15,000	95,000 CT	0	50-10,000	+ 5
H-6	Single plate to P.P. grids, DC in Pri.	TF1A15YY	15,000	95,000 split	4	200-10,000	+11
H-7	Single or P.P. plates to line	TF1A13YY	20,000 CT	150/600	4	200-10,000	+21
H-8	Mixing and matching	TF1A16YY	150/600	600 CT	0	50-10,000	+ 8
H-9	82/41:1 input to grid	TF1A10YY	150/600	1 meg.	0	200-3,000 (4 db.)	+10
H-10	10:1 single plate to single grid	TF1A15YY	10,000	1 meg.	0	200-3,000 (4 db.)	+10
H-11	Reactor	TF1A20YY	300 Henries-0 DC, 50 Henries-3 Ma. DC, 6,000 Ohms.				



RCOF CASE

Length	1 $\frac{3}{4}$ "
Width	$\frac{1}{4}$ "
Height	1 $\frac{1}{2}$ "
Mounting	1 $\frac{1}{8}$ "
Screws	4-40 FIL.
Cutout	$\frac{7}{8}$ " Dia.
Unit Weight	1.5 oz.

COMPACT AUDIO UNITS . . . RC-50 CASE

Type No.	Application	MIL Type	Pri. Imp. Ohms	Sec. Imp. Ohms	DC in Pri. MA	Response ± 2 db (Cyc.)	Max. level dbm
H-19	Line to grid. Balanced, center tapped primary . . . 1:14 ratio. Multiple hi-permalloy (75 DB) shielding	TF1A10YY	250 CT 500 CT	50,000 100,000	0	30-20,000	+ 6
H-20	Single plate to 2 grids, can also be used for P.P. plates	TF1A15YY	15,000 split	80,000 split	0	30-20,000	+12
H-21	Single plate to P.P. grids, DC in Pri.	TF1A15YY	15,000	80,000 split	8	100-20,000	+23
H-22	Single plate to multiple line	TF1A13YY	15,000	50/200, 125/500**	8	50-20,000	+23
H-23	P.P. plates to multiple line	TF1A13YY	30,000 split	50/200, 125/500**	8 BAL.	30-20,000	+19
H-24	Reactor	TF1A20YY	450 Hys.-0 DC, 250 Hys.-5 Ma. DC, 6000 ohms 65 Hys.-10 Ma. DC, 1500 ohms				

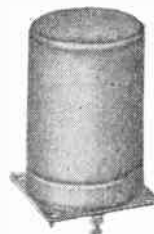

RC-50 CASE

Length	1 $\frac{1}{2}$ "
Width	1 $\frac{1}{8}$ "
Height	2 $\frac{1}{8}$ "
Mounting	1 $\frac{1}{8}$ "
Screws	#6-32
Cutout	1 $\frac{1}{2}$ " Dia.
Unit Weight	8 oz.

SUBMINIATURE AUDIO UNITS . . . SM CASE

Type No.	Application	MIL Type	Pri. Imp. Ohms	Sec. Imp. Ohms	DC in Pri. MA	Response ± 2 db (Cyc.)	Max. level dbm
H-30	Input to grid	TF1A10YY	50****	62,500	0	150-10,000	+13
H-31	Single plate to single grid, 3:1	TF1A15YY	10,000	90,000	0	300-10,000	+13
H-32	Single plate to line	TF1A13YY	10,000****	200	3	300-10,000	+13
H-33	Single plate to low impedance	TF1A13YY	30,000	50	1	300-10,000	+15
H-34	Single plate to low impedance	TF1A13YY	100,000	60	.5	300-10,000	+ 6
H-35	Reactor	TF1A20YY	100 Henries-0 DC, 50 Henries-1 Ma. DC, 4,400 ohms.				
H-36	Transistor Interstage	TF1A15YY	25,000	1,000	.5	300-10,000	+10



SM CASE

Length	1 $\frac{1}{4}$ "
Width	$\frac{1}{2}$ "
Height	2 $\frac{3}{8}$ "
Screw	4-40 FIL.
Unit Weight	8 oz.

HERMETICALLY SEALED FILTER CHOKES

Type No.	Induct. Hys.	at	MAX. DCMA	Induct. Hys.	at	DCMA	DC Res. Ohms	Ins. Test Volts RMS	Case†	Wt. Lbs.
H-60	10		80	15	55	280	2500	RC-75	2	
H-61	10		140	15	100	150	2500	RC-100	4	
H-62	10		180	12	150	150	2500	RC-112	6	
H-63	10		300	15	220	100	3500	RC-150	12	

† Dimensions on page N-112

- * 200 ohm termination can be used for 150 ohms or 250 ohms, 500 ohm termination can be used for 600 ohms.
- ** 200 ohm termination can be used for 150 ohms or 250 ohms, 125/500 ohm termination can be used for 150/600 ohms.
- *** can be used with higher source impedances, with corresponding reduction in frequency range. With 200 ohm source, secondary impedance becomes 250,000 ohms . . . loaded response is -4 db. at 300 cycles.
- **** Can be used for 500 ohm load . . . 25,000 ohm primary impedance . . . 1.5 Ma. DC.



HERMETICALLY SEALED PULSE TRANSFORMERS

Because of the wide variety of blocking oscillator, interstage, and modulator pulse applications, the bulk of UTC pulse transformers are designed to customer's specifications. Through versatile design, however, the stock pulse transformers listed below take care of most low level applications. The units are hermetically sealed and tested to MIL-T-27 Specifications. Wide ranges of pulse duration, loading, and level are obtainable by variations in the manner of connecting the balanced coil structure windings. An engineering sheet accompanies each unit, providing data for typical applications.

The H-40 and H-41 units employ identical windings suitable for different applications because of the manner in which the windings are brought out to the terminals. These units have two windings for 250 ohm impedance, and two windings for 1,000 ohm impedance. Pulse widths from .1 to 5 microseconds are realized with excellent fidelity. At 5 microsecond operation the maximum working voltages for the H-40 and H-41 are 175 volts peak for 250 ohms . . . 350 volts for 1,000 ohms. These voltages can be increased at lower pulse widths.

H-42 and H-43 are highly miniaturized hermetically sealed . . . MIL-T-27 units. They incorporate three equal windings capable of being inter-connected for wide versatility in blocking oscillator, interstage, and impedance matching service. The wound Hipermalloy core is uncut to effect maximum efficiency. Peak working voltage is 175 volts per winding.

Type No.	Description*	Pulse Width Microsec.	Ins. Test Volts RMS	Case
H-40	Two 250 ohm windings . . . two 1000 ohm windings	.1 to 5	1000	RCOF
H-41	Two 250 ohm windings . . . two 1000 ohm windings	.1 to 5	1000	RCOF
H-42	Three 250 ohm windings	.15 to .75	500	SM**
H-43	Three 500 ohm windings	.5 to 2	500	SM**

* Impedances shown are nominal, subject to wide variation with application
 **Mtg. screw is centered on large side of case.

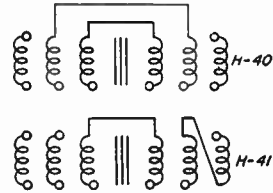

MAGNETIC AMPLIFIERS FOR SERVO MOTOR APPLICATIONS

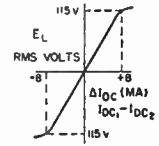
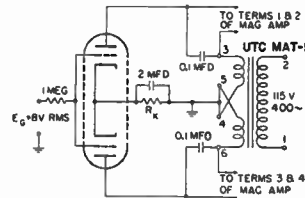
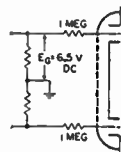
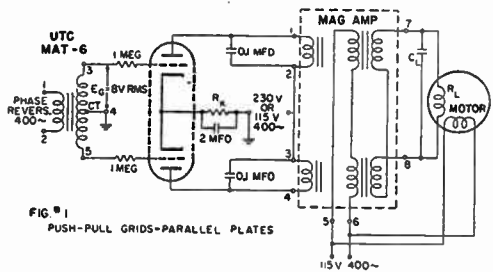

The MAT 1-4 Magnetic Amplifiers are exceptionally stable units designed for the control of 2 phase 400 cycle servo motors. They are compact . . . hermetically sealed . . . magnetically shielded . . . and meet MIL-T-27 and MIL-E-5400 Specifications. The output is sinusoidal, amplitude variable, and phase reversible. Control is provided by a dual triode such as a 12AU6 operating with a plate voltage of 115 volts, 400 cycles, or higher. The signal to the triode grids can be polarity reversible DC or phase reversible 400 cycles with or without suppressed carrier modulation. These units eliminate DC power requirements as well as temperature sensitive dry disc rectifiers. The high input impedance provides minimum loading on sensing elements and high power gain. Ringing at low load level has been reduced to a minimum through high internal damping factors. The power output figures are conservative . . . power gain of the MAGNETIC STRUCTURE is approximately 40 . . . response time approximately 7.5 milliseconds. The maximum null voltage is 3 volts RMS. For single phase supply voltage the load capacitor should effect 90° phase shift with motor load . . . for 3 phase, 30° phase shift. (The chart values shown are approximate.)

For AC signal control the circuit of Figure 1 is employed. For DC signal control Figure 2 applies. Figure 3 shows the use of a power transformer (MAT-5) which provides higher plate voltages and eliminates the input transformer (MAT-6). The typical response curve of Figure 4 applies to all units, the larger units feeding heavier loads.

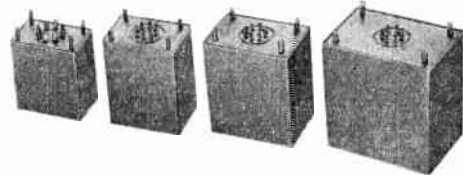

TYPE NO.	MAT-1	MAT-2	MAT-3	MAT-4
230 Volt Supply				
Power output	4 W.	8 W.	11 W.	18 W.
RL, ohms	3300	1600	1200	720
CL, mfd.	2	.3	.5	.7
115 Volt Supply				
Power output	2 W.	4 W.	6 W.	9 W.
RL, ohms	6500	3300	2200	1450
CL, mfd.	.13	.2	.3	.45
Reson. Freq.	40 cyc.	35 cyc.	35 cyc.	20 cyc.
Log-Decr.	.18	.23	.03	.65
Cont. Wdg. Res.	6200 ohms	8450 ohms	4750 ohms	5650 ohms
Case				
Length, in.	1 1/4	1 1/2	1 3/4	2 1/8
Width, in.	1 1/16	2 1/8	2 1/2	3 3/8
Height, in.	2 7/16	2 3/4	2 13/16	3 3/8
Mtg. Dim., in.	1 3/16 x 1 1/2	1 x 1 3/8	1 1/8 x 1 7/8	1 1/2 x 2 1/2
Screws	4-40	6-32	8-32	8-32
Cutout, in.	1	1	1	1
Unit Weight, lbs.	.67	1.1	1.7	2.75
MAT-5	115V.-400 cyc. to 460 VCT; provides 230V. 48 MA DC or 460V. 24 MA DC. RC-37 Case . . . 1 3/8 x 1 3/8 x 1 3/8 . . . 1/8 mtg. holes 1 1/8 x 1 1/8 . . . 6 oz.			
MAT-6	Input . . . 10,000 ohms pri. . . 1:15 C.T. ratio . . . phase shift under 1° . . . RCOF case.			



NEW "M" TYPE TOROIDS

MAXIMUM Q
MINIMUM SIZE

UTC Permalloy Dust Toroids have been the standard of the industry for over 15 years. The MQ series of coils provide the highest Q factor in their class (see curves below), with miniaturized dimensions. All units are hermetically sealed to MIL-T-27 Specifications

The stability is excellent. For the MQE-7 the inductance change is less than 1% for voltages from .1 to 3 volts. The MQA-13 change is less than 1% for applied voltages from .1 to 20 volts. The MQB-5 change is less than 1% for applied voltages from .1 to 50 volts. DC is permissible through the coil (values listed below). Inductance is virtually independent of frequency temperature and vibration.

Hum pickup is extremely low due to the toroidal winding structure, with windings uniformly spread over the core. The case is of high permeability, affording additional shielding such that close spacing of units can be effected, the coupling attenuation being approximately 80 DB.

Other values of inductance than those listed are available on special order at the price of the next higher listed value.

TYPICAL Q CURVES

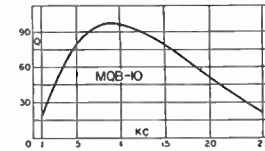
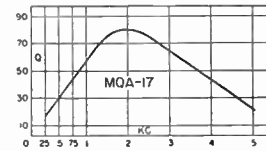
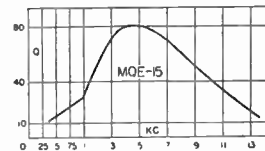
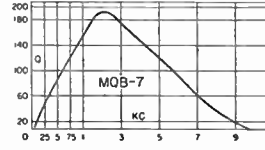
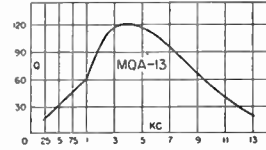
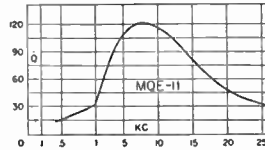
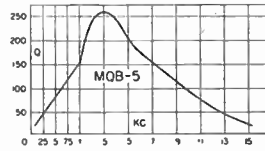
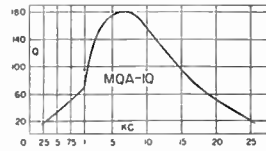
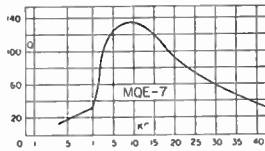
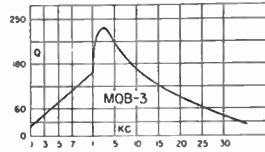
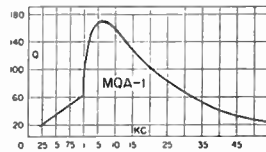
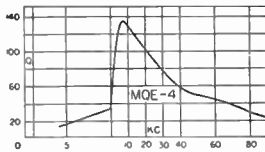

MQE CASE

Length 1 1/8"
Width 1/2"
Height 1 3/8"
Mounting 3/8"
Screws 4/40"
Cutout 5/16" x 1/2"
Unit Weight 1.5 oz.



MQA CASE

Length 1 1/2"
Width 1/4"
Height 1 1/2"
Mounting 7/8" x 1/2"
Screws 4/40"
Cutout 5/16" x 1/2"
Unit Weight 4 oz.

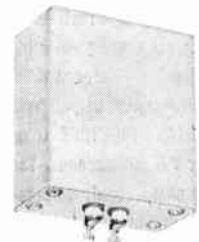

MQB CASE

Length 2 1/8"
Width 1 3/8"
Height 2 1/8"
Mounting 2 1/8" x 1 1/8"
Screws 6/32"
Cutout 7/8" x 1/2"
Unit Weight 14 oz.

MQE TYPES		
Type No.	Inductance	*DC Max.
MQE-1	7 mhy.	135
MQE-2	12 mhy.	100
MQE-3	20 mhy.	80
MQE-4	30 mhy.	65
MQE-5	50 mhy.	50
MQE-6	70 mhy.	40
MQE-7	100 mhy.	35
MQE-8	150 mhy.	30
MQE-9	25 hy.	22
MQE-10	.4 hy.	17
MQE-11	.6 hy.	14
MQE-12	.9 hy.	12
MQE-13	1.5 hy.	9
MQE-14	2 hy.	8
MQE-15	2.8 hy.	7.2

MQA TYPES		
Type No.	Inductance	*DC Max.
MQA-1	7 mhy.	250
MQA-2	12 mhy.	200
MQA-3	20 mhy.	150
MQA-4	30 mhy.	125
MQA-5	50 mhy.	100
MQA-6	70 mhy.	80
MQA-7	120 mhy.	60
MQA-8	.2 hy.	50
MQA-9	.3 hy.	40
MQA-10	.5 hy.	30
MQA-11	.7 hy.	25
MQA-12	1 hy.	20
MQA-13	1.5 hy.	17
MQA-14	2.5 hy.	13
MQA-15	4 hy.	10
MQA-16	6 hy.	9
MQA-17	10 hy.	7
MQA-18	15 hy.	5
MQA-19	22 hy.	4

MQB TYPES		
Type No.	Inductance	*DC Max.
MQB-1	10 mhy.	400
MQB-2	30 mhy.	250
MQB-3	70 mhy.	170
MQB-4	120 mhy.	120
MQB-5	.5 hy.	60
MQB-6	1 hy.	40
MQB-7	2 hy.	30
MQB-8	3.5 hy.	22
MQB-9	7.5 hy.	16
MQB-10	12 hy.	11
MQB-11	18 hy.	9
MQB-12	25 hy.	8

*This value of D.C. (MA) will drop the coil inductance 5%. Values of D.C. below this will show proportionately (linear) less inductance drop. For example, MQE-1 will drop 1/2% in L with 13.5 MA.



VARIABLE INDUCTORS

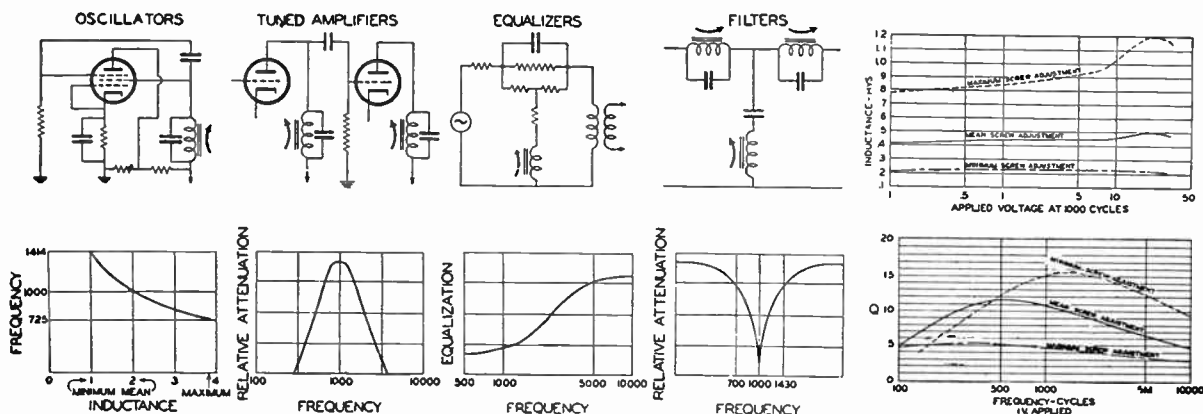

Type	Mean Hys.	DC MA*	Type	Mean Hys.	DC MA*
VIC-1	.0085	75	VIC-12	1.3	10
VIC-2	.013	60	VIC-13	2.2	8
VIC-3	.021	50	VIC-14	3.4	7
VIC-4	.034	40	VIC-15	5.4	6
VIC-5	.053	35	VIC-16	8.5	5
VIC-6	.084	30	VIC-17	13.	4
VIC-7	.13	25	VIC-18	21.	3.5
VIC-8	.21	21	VIC-19	33.	3
VIC-9	.34	18	VIC-20	52.	2
VIC-10	.54	15	VIC-21	83.	1.5
VIC-11	.85	12	VIC-22	130.	1

UTC type VIC variable inductors offer a revolutionary approach to the problem of tuned audio circuits. By adjusting a set screw in the side of the case, an inductance value of +85%, -45% from mean value is obtainable. Setting is positive. Effective Q for a wide frequency range and variation of inductance with applied AC voltage are shown on the illustrated curves, for a typical VIC unit.

The VIC inductor is housed in a rugged die cast case 1 1/2" long, 1 1/4" wide and 1 1/8" high with mounting centers on terminal board side 3/16" by 2 1/2". Weight is 5 1/2 oz.

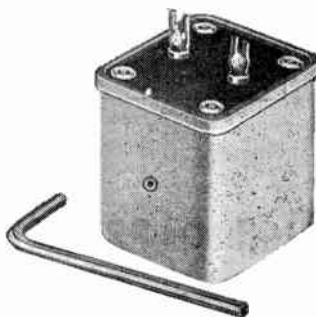

*DC MA shown is maximum recommended... will effect some reduction in inductance and Q.

UTC HERMETIC VARIABLE INDUCTORS

TYPE No.	Min. Hys.	Mean Hys.	Max. Hys.	DC* Ma
HVC-1	.002	.006	.025	100
HVC-2	.005	.015	.06	60
HVC-3	.011	.040	.15	40
HVC-4	.03	.1	.4	30
HVC-5	.07	.25	1.0	20
HVC-6	.2	.6	2.5	15
HVC-7	.5	1.5	6.0	10
HVC-8	1.1	4.0	15	7
HVC-9	3.0	10	40	5
HVC-10	7.0	25	100	3.5
HVC-11	20	60	250	2
HVC-12	50	150	600	1.5

UTC variable inductors have served as the ideal solution to many filter, oscillator, equalizer, and tuned amplifier problems—for over a decade. Extended development has now made possible the new HVC series of inductors with improved characteristics. They are hermetically sealed to MIL-T-27 specs... extremely compact... wider inductance range... higher Q's... lower and higher frequencies... superior voltage and temperature stability.

Adjustment of set screw in top of case permits changing inductance +300% +0 -70% of nominal value shown. Setting is positive. Effective Q for a wide frequency range and variation of inductance with applied AC voltage are shown on the illustrated curves, for a typical HVC unit. Case dimensions are 1 1/8" long, 2 1/2" wide 1 1/8" high. The two terminals and two 4/40 mounting studs are on opposite diagonals—1 1/8" spacing.

*DC MA shown is maximum recommended... will effect some reduction in inductance and Q.

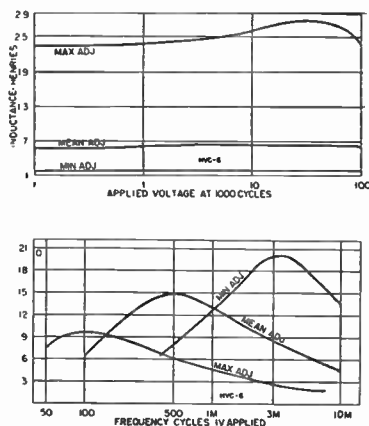
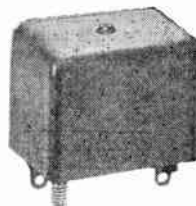



LOW FREQUENCY HIGH Q COILS

Permalloy dust toroids are not suited to providing high Q at low frequencies. The MQL series of laminated Hipermalloy coils were specifically designed for this class of service. The unique structure employed provides exceptional Q and stability. Inductance values are laboratory adjusted to 2% tolerance at 1 volt, 60 cycles. Stability with voltage is excellent, for MQL-3 inductance variation is less than 1% from .1 V to 1 V, 60 cycles. Temperature stability is exceptional, total inductance swing being less than 3.5% for the wide range of -55°C to $+85^{\circ}\text{C}$. A hum reducing lamination structure plus heavy Hipermalloy shielding provide very low hum pickup . . . 240 microvolts/gauss for MQL-3 series connected. Two identical windings brought out to four terminals permit series, parallel, center tapped, or transformer type connections.



MQL CASE

Base	1 1/4"
Height	2 1/2"
Mounting	1 1/2 x 1 1/2"
Screws	#6-32
Cutout	1 1/2" Dia.
Unit Weight	1 lb.

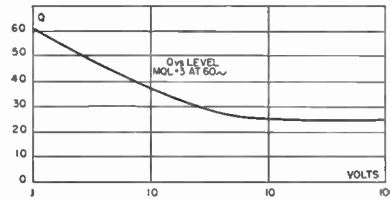
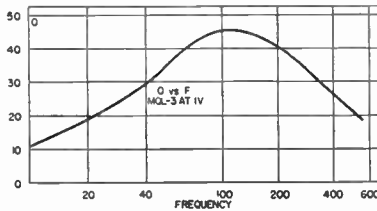

Type No.	Series Henries	Parallel Henries
MQL-1	10	2.5
MQL-2	20	5
MQL-3	200	50
MQL-4	400	100

HIGH Q PRECISION INDUCTANCE DECADES

UTC DI inductance decades are invaluable instruments for design and experimental work with tuned circuits, wave filters, and equalizers. They set new standards of Q, stability, frequency range, and convenience. The low hum pickup toroid coils employ a new permalloy dust core which, combined with special winding methods, provides very high Q, excellent voltage and temperature stability, and high self resonance frequency. The switch employed is a new low capacity type which lab tests have proven for low contact resistance after 100,000 operations. The inductance values are laboratory adjusted to better than 1% precision.

DI inductance decades are housed in a compact, rugged, die cast case with control on a sloping panel, ideally suiting these units to laboratory use. Ganging panels are available for mounting two, three, or four decades together. It is merely necessary to unscrew the four rubber feet at bottom of decade to attach to panel.

Type No.	Induct. Henries	Optimum Range	Max. Q	Max. ACMA	Ins. Test Volts RMS
DI-1	10 x .01	2-60 KC	200	500	500
DI-2	10 x .1	.25-20 KC	200	150	500
DI-3	10 x 1	.25-10 KC	200	50	500
DI-4	10 x 10	.2-1.5 KC	100	15	500

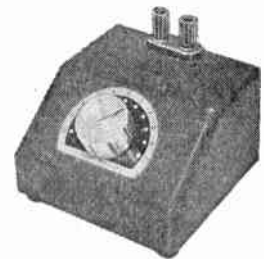

DI CASE

Length	4 1/2"
Width	4 3/4"
Height	2 3/4"
Weight	2 Lbs

DP-2	Gangs 2 decades
DP-3	Gangs 3 decades
DP-4	Gangs 4 decades

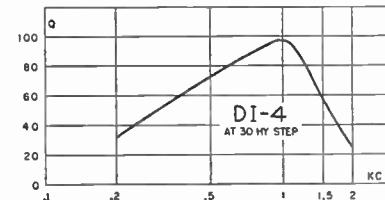
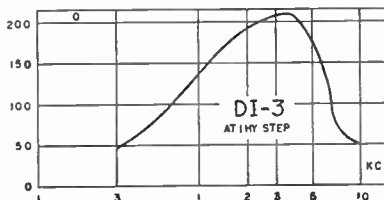
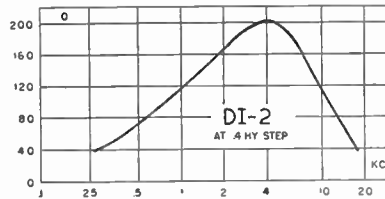
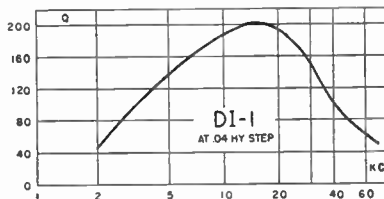



INTERSTAGE AND LINE FILTERS

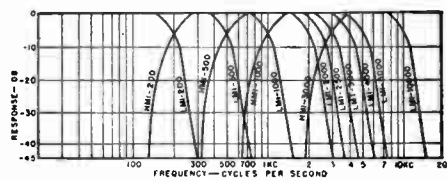
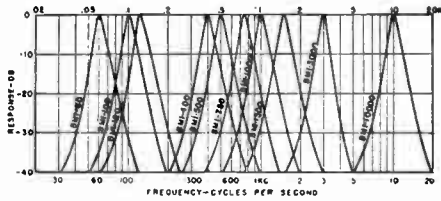
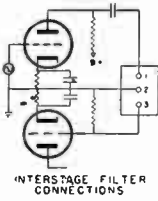

STOCK FREQUENCIES

(Number after letters is frequency)

BMI-60	LMI-2000
BMI-100	LMI-2500
BMI-120	LMI-3000
BMI-400	LMI-5000
BMI-500	LMI-10000
BMI-750	HML-200
BMI-1000	HML-500
BMI-1500	HML-1000
BMI-3000	BML-400
BMI-10000	BML-1000
HMI-200	LML-1000
HMI-500	LML-2000
HMI-1000	LML-2500
HMI-3000	LML-4000
LMI-200	LML-8000
LMI-500	LML-10000
LMI-1000	LML-12000

UTC standardized filters have been designed to take care of many present day filter requirements through stock units. The interstage type filters have a nominal impedance of 10,000 ohms, and lend themselves to effecting gain simultaneously with their frequency discrimination

BMI units (Band Pass) have 2:1 gain. They are sharply peaked, having approximately 2 DB attenuation at plus or minus 3% from center frequency and attenuation of 40 DB per octave as shown. Input 10,000 ohms, output to grid.

HMI units (High Pass) have a loss of less than 6 DB at cutoff frequency, and an attenuation of 35 DB at .67 cutoff frequency. Input and output 10,000 ohms.

LMI units (Low Pass) have a loss of less than 6 DB at cutoff frequency, and an attenuation of 35 DB at 1.5 cutoff frequency. Input and output 10,000 ohms.

HML (High Pass), and LML (Low Pass) filters are similar to the interstage filters, in all characteristics, except that they are intended for an input and output impedance of 500/600 ohms. BML (Band Pass) have input of 500/600 ohms, output to grid.

All of the standard filters are housed in hermetically sealed cases, shielded to reduce hum pickup to 150 MV per gauss at 60 cycles.

In addition to the stock filters listed, any of the six types are available as special units for any frequency from 100 to 12,000 cycles. Order by type followed by frequency, as LMI-2500, designating low pass interstage filter—2500 cycles cutoff frequency. These special units are priced at \$35.00 net



FILTER CASE M

Base	1 1/8" x 1 1/8"
Mtg.	3/4" x 1 1/4"
Mtg. Screws	6-32
Cutout	7/8" dia.
Height, BMI, LMI, BML	1 3/8"
Height, HMI, LML	2 1/2"
Weight	6 oz. and 9 oz

BROADCAST AND RECORDING EQUALIZERS AND FILTERS

500/600 ohms

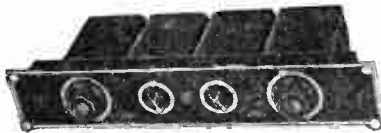

3AX UNIVERSAL EQUALIZER

The universal characteristics of the UTC 3AX equalizer have made it the most popular item for broadcast and recording equalization. This unique unit, with which most communications engineers are already familiar, is an accurately calibrated, quickly adjustable, combined low and high frequency equalizer. The low frequency controls include a switch for adjusting the maximum equalization frequency to 25, 50, or 100 cycles and a calibrated T-pad for exact adjustment of the amount of equalization. The high frequency portion of this unit includes a switch to set maximum equalization point at 4000, 6000, 8000, 10,000 or 15,000 cycles, and a similar calibrated control reading directly in DB. Equalization up to 25 DB available at any frequency selected.

Through a unique arrangement of compensating pads, changes in adjustment of the 3AX equalizer do not affect the apparent aural level. This permits changes in tone color, with negligible change in volume. Where rapid changeover is required in service from one line to another, or from recording to play back, it is merely necessary to predetermine the required setting. The actual adjustment of the controls can be taken care of almost instantaneously. The construction is of the depressed chassis, etched panel, rack mount type. Thoroughly shielded against inductive pickup with UTC Trialloy Shielding. Dimensions of panel 3 1/2" x 19" Depth 7 1/2" Weight 15 lbs.

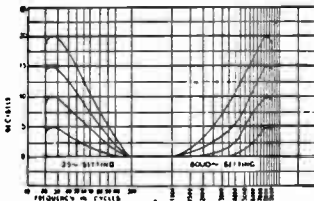

TYPICAL CURVES OBTAINABLE WITH 3A OR 3AX EQUALIZER

3A UNIVERSAL EQUALIZER

The 3A equalizer is identical to the 3AX described above, except that it does not incorporate the compensating pads for constant insertion loss. The insertion loss is roughly proportional to the amount of equalization employed. All other characteristics identical with the 3AX unit, this item weighs 10 lbs.

4C SOUND EFFECTS FILTER

The use of filters to obtain unusual sound effects is now finding wide application in broadcast technique. The Model 4C Filter was originally developed for one of the large broadcasting chains, and is now used extensively by most broadcast stations. Two controls are provided by the 5 1/4" x 19" panel, which is similar in appearance to the 3AX unit. The weight of the 4C unit is 20 lbs.

The low pass switch can be set for cutoff frequencies of 100, 250, 500, 1000, 2000, 3000, 4000, or 5000 cycles. The high pass switch has identical frequency points. The great number of cutoff frequencies provides for a wide latitude of tone control. If desired, though not normally necessary, external potentiometers may be inserted in the circuit for attenuation control.

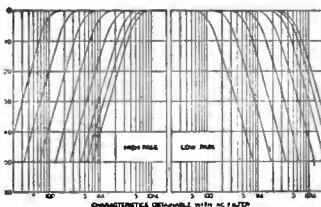



COMMERCIAL GRADE COMPONENTS

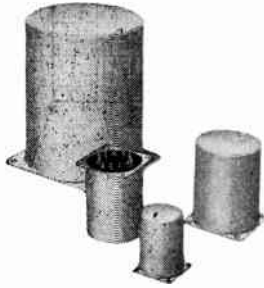

The commercial grade series of transformers incorporate conservative design and rugged construction to assure dependability under continuous service operation in industrial and commercial grade communication equipment. These units are mounted in uniform drawn cases finished in light grey enamel, and intended for chassis mounting. All items are poured with special sealing compound in addition to vacuum impregnation of coil structures. Type numbers are identical with the PA units except for the prefix "CG."

CG-134, 135 and 136 are of the hum-bucking type to assure low hum pick-up. All audio components are linear. $\pm 1\frac{1}{2}$ DB from 40 to 10,000 cycles (no unbalanced D.C.), except CVL and CVM units . . . 40 to 6000 cycles. Parallel feed low level interstage units with 50,000 ohms and .25 mfd. 200 ohm windings on input transformers are balanced and may be used for 150 to 250 ohm circuits.



INPUT, INTERSTAGE, MIXING AND LOW LEVEL OUTPUT TRANSFORMERS

Type No.	Application	Primary Impedance Ohms	Secondary Impedance Ohms	Case No.
CG-131	1 plate to 1 grid	15,000	135,000 3:1 ratio	RC-50
CG-132	1 plate to 2 grids	15,000	135,000 center-tapped 3:1 ratio overall	RC-62
CG-133	2 plates to 2 grids	30,000 P to P	80,000 overall 1.6:1 ratio overall	RC-75
CG-134	Line to 1 grid hum-bucking	50, 200, 500	80,000	RC-50
CG-135	Line to 2 grids hum-bucking	50, 200, 500	120,000 overall	RC-50
CG-235	Line to 1 or 2 grids, hum-bucking; multiple alloy shielded for low hum pickup	50, 200, 500 ohms	80,000 overall	RC-75
CG-136	Single plate and low impedance mike or line to 1 or 2 grids hum-bucking	15,000, 50, 200	80,000 overall	RC-62
CG-233	PP 6CS, 12AU7, similar triodes to AB 45's, 2A3's, 6L6's, etc.	30,000 P to P	25,000 overall .9:1 ratio overall	RC-87
CG-333	PP 6CS, 12AU7, similar triodes to fixed bias 6L6's	30,000 P to P	5,000 overall .4:1 ratio overall	RC-87
CG-433	PP 45, 2A3, similar tubes to fixed bias 2 or 4 6L6's	5,000 P to P	1,250 overall .5:1 ratio overall	RC-100
CG-137	Mixing	50, 200, 500	50, 200, 500	RC-50
CG-140	Triode plate to line	15,000	50, 200, 500	RC-50
CG-141	PP triode plates to line	30,000 P to P	50, 200, 500	RC-50

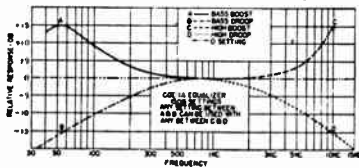

NEW UNIVERSAL INTERSTAGE EQUALIZER—CGE-1A

The UTC CGE-1A is the ideal device for any application where frequency response control is desired. Incorporating the latest developments in design and manufacture, this new unit provides the ultimate in control and flexibility. This equalizer is not a simple R-C tone control, but employs resonant circuits in a unique arrangement providing equalization characteristics unobtainable by conventional circuits. Designed to work from a low or medium impedance source (0 to 20,000 ohms) to a high impedance (500,000 ohms or open grid), the CGE-1A affords continuously variable equalization over a 30 DB range at either end of the spectrum, while introducing only 18 DB total insertion loss. (See curve above). Complete independence of high frequency and low frequency controls permits a wide variety of settings without affecting the over-all volume level. Because of its low insertion loss, this unit may be incorporated directly in many amplifiers. If existent gain is low, a single medium- μ triode stage will provide both proper gain and source impedance. The mechanical construction permits mounting with case on panel directly behind controls, or with case separated from controls and panel. An etched, calibrated panel is provided.

CGE-1A Panel Dim. 2 3/4" x 3 1/2" x 2 1/2" deep. Wt. 2 lbs.

DYNAMIC NOISE SUPPRESSION INDUCTOR

Incorporates two accurate High Q coils (.8 hy. and 2.4 hy.) for use in dynamic noise suppression circuits. Excellent circuit accompanies unit.
Type CG-50 RC-62 Case



COMMERCIAL GRADE CASE

Case No.	Base Dim. (Sq.)	Mounting Dim. (Sq.)	Height + 1/8, - 1/16	Cutout Dia.	Unit Weight (Lbs.)
RC-50	1 3/8	1 1/8	2 1/4	1 1/2	1/2
RC-62	1 1/2	1 1/2	2 1/2	1 1/2	1
RC-75	2 1/8	1 1/8	2 7/8	1 7/8	1 1/2
RC-87	2 1/8	2 1/2	3 1/4	2	2 1/2
RC-100	3	2 3/8	3 3/4	2 1/2	3 1/2
RC-112	3 1/8	2 1/8	4 1/8	2 7/8	5
RC-125	3 3/8	3	4 1/2	3	6 1/2
RC-150	4 1/2	3 1/8	5 1/2	3 3/4	11
RC-152	5 1/8	4 1/8	5 1/2	4	15 1/2
RC-175	5 3/4	4 7/8	7 1/8	4	22

OUTPUT TRANSFORMERS

Type No.	Imped. P. P. Ohms, Overall	Typical Tubes	Max. Watts	Case No.
CG-15	8,000	6F6 triode, 6V6	20	RC-100
CG-16	3,000/5,000	2A3, 6B4, 6AS7C, 6L6, 6080	20	RC-100
CG-19	6,000/10,000	6V6, Triode: 6L6, 5881	20	RC-100
CG-710	14,000/20,000	6K6, 7B5, 6AK6	20	RC-100
CG-2L6	9,000	6L6's, AB1, 5881	30	RC-125
CG-4L6	3,800/4,500	2-6L6's, AB2 or 4-6L6's AB1, 6146, 6149	55	RC-150

CG VARIMATCH OUTPUTS FOR P. A.

Universal units designed to match any tubes within the rated output power, to line or voice coil. Output impedance 500, 200, 50, 16, 8, 5, 3, 1.5 ohms Primary impedance 3000, 5000, 6000, 7000, 8000, 10,000, 14,000 ohms

Type No.	Audio Watts	Typical Tubes	Case No.
CVP-1	12	2A3, 25L6, 6V6, 6B4G, 6AQ5	RC-100
CVP-2	30	2A3, 6L6, 6V6, 807, 5881, 6B4G	RC-125
CVP-3	60	300B's, 6L6's, 801, 807, 1614, 5881, 1625	RC-150
CVP-4	125	807's, 4-6L6's, 845's, 4-1614's, 6146, 6149	RC-152
CVP-5	300	211, 242A's, 203A's, 838's, 4-845's, 2B-120's	RC-175

CG VARIMATCH LINE TO VOICE COIL TRANSFORMERS

The UTC VARIMATCH line to voice coil transformers will match any voice coil or group of voice coils to a 500 ohm line. More than 50 voice coil combinations can be obtained, as follows:

- 2, 4, 5, .62, 1, 1.25, 1.5, 2, 2.5, 3, 3.3, 3.8, 4, 4.5, 5, 5.5, 6, 6.25, 6.6, 7, 7.5, 8, 9, 10, 11, 12, 14, 15, 16, 18, 20, 25, 28, 30, 31, 40, 47, 50, 63, 69, 75

Where speakers are to be connected in groups to one transformer, it is preferable that parallel connection be used to eliminate the possibility of multiple resonance. If two speakers of different impedances are connected in parallel, the lower impedance speaker will develop greater power. If connected in series, the higher impedance speaker will develop greater power.

Type No.	Audio Watts	Primary Impedance	Secondary Impedance	Case No.
CVL-1	15	500 ohms	.2 to 75 ohms	RC-87
CVL-2	40	500 ohms	.2 to 75 ohms	RC-125
CVL-3	75	500 ohms	.2 to 75 ohms	RC-150

CG VARIMATCH LINE AUTOFORMERS

UTC Varimatch Line Autoformer will match one to ten 500 ohm lines or CVL windings to the 500 ohm output of an audio amplifier. The CVL-10 autoformer has impedances of 500, 250, 167, 125, 100, 83, 71, 62, 50 ohms.

Type No.	Audio Watts	Case No.
CVL-10	15	RC-87

COMMERCIAL GRADE COMPONENTS

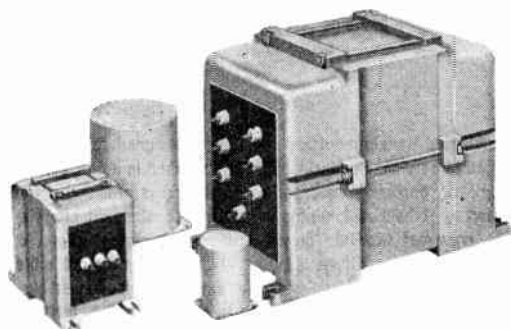

CG VARIMATCH MODULATION UNITS

Will match any modulator tubes to any RF load.

The ever increasing number of vacuum tubes available for audio and RF applications has increased the difficulty of obtaining transformers suitable for matching to the various correct tube loads. If a standard transformer having a limited impedance range is purchased and used for a specific purpose as the "nearest thing" available, comparatively high distortion is inevitable. While a 20% mismatch caused by such an occurrence does not represent a serious loss in power, it greatly reduces the undistorted power available from a class B modulator because optimum plate load is not reflected to the tubes. The UTC Varimatch transformer eliminates this difficulty through the use of a combination of tapped windings affording an extremely wide range in impedance matching. Designs provide that for any load impedance employed, full class C plate current can be carried by secondary winding.

Primary impedances from 500 to 20,000 ohms
Secondary impedances from 30,000 to 300 ohms

Type No.	Max. Audio Watts	Max. Class C Input	Typical Modulator Tubes	Case No.
CVM-0	12	25	2A3, 6B5G	RC-100
CVM-1	30	60	6V6, 2A3, 6L6, 807, 5881	RC-125
CVM-2	60	125	801, 6L6, 809, 4-46, T-20, 1608, 6146, 6149	RC-150
CVM-3	125	250	800, 807, 845, Tz-20, RK-30, 35-T	RC-152
CVM-4	300	600	50-T, 203A, 805, 838, T-55, ZB-120	RC-175
CVM-5	600	1200	805, HF-300, 204A, HK-354, 250TH	7x12x9H 60 lbs.

CG VARIMATCH DRIVER TRANSFORMERS

Type No.	Primary	Typical Output Tubes	Case No.
CG-51AX	All single tubes like: 6C5, 6C4, 12AU7, 45, 2A3	2A3, 45, 6L6	RC-87
CG-53AX	P. P. tube like: 45, 2A3, 6L6, 6B4	46, 4-46, 841, 210, 801, RK-18, 800, 203A, 838, 805, 50T, 830B	RC-112
CG-59AX	50, 200, 500 ohm line	805, 838, 203A, ZB-120, 100TH, 800, 55T, RK-18	RC-112
CG-238AX	4-2A3, 4-45, 4-50, 2-211A, 2-845	4-805's, 4-838's, 4-203A's, 2-204's, 2-849's, 2-HF300's, 2-HF200's, 2-250TH's, 2-450TH's	RC-150
CG-512	50, 200, 500 ohm line	2-250TH, 2-450TH, 2-HF200, 2-HF300, 2-204A, 2-849	RC-150

VARIPOWER AUTO-FORMERS

Type No.	Watts Output	Case No.	Designed for line voltage control, filament control and reduced power operation. Output voltage from 0 to 130 volts, 50/60 cycles. Varipower units permit control of filament voltage at the tube socket to within 2½% of desired value simultaneously with line voltage control and plate voltage control. Can be used to reduce or increase voltages on filament transformers. Taps at 25, 55, 75, 95, 100, 105, 110, 115, 120, 125 and 130 volts permit output voltages from 0 to 130 volts in 5 volt steps.
CVA-1	150	RC-112	
CVA-2	250	RC-125	
CVA-3	500	RC-150	
CVA-4	1000	RC-152	
CVA-5	2000	RC-175	

POWER AND BIAS TRANSFORMERS

Type No.	High Voltage	Primary 115 volts 50/60 cycles				Case No.	
		DC MA.	Fil. 1	Fil. 2	Fil. 3		
CG-422	435-365-0-365-435 125-0-125	125	5V-3A	5V-2A	6.3 VCT-3A	2.5 VCT-5A	RC-150
CG-428	500-0-500 80-0-80	250	5V-3A	5V-2A	6.3 VCT-4A	6.3 VCT-3A, tapped 2.5 VCT-3A	RC-152
CG-428	600-525-0-525-600	250	5V-3A	6.3 VCT-3-A	7.5 VCT-3A, tapped 6.3 VCT-4A		RC-152
CG-431	500-400-0-400-500 80-0-80	500	5V-6A	5V-2A	6.3 VCT-5A	6.3 VCT-3A	RC-175
CG-315	Tapped for any DC voltage from 15 to 100 volts within 6% — 250 MA						RC-125
CG-316	Tapped for any DC voltage from 75 to 400 volts within 6% — 250 MA						RC-152

Copyright by U. C. P., Inc.

(Refer to Page N-98 for UTC Prices)

UTC CG power transformers, Varimatch units and chokes are designed to A.I.E.E. commercial standards. Ratings are conservative for continuous duty. Designs provide temperature rise less than 55 degrees C. Units are tested for breakdown at twice maximum working voltage plus 1000 volts. Plate transformers are given a surge test of 250% normal voltage at 200 cycles. All items are vacuum impregnated and sealed with special insulating compound. The conservative design and manufacturing procedure of these units make them suitable for virtually all types of commercial equipment as well as ideally suited for quality amateur and public address service.

CG PLATE TRANSFORMERS

Primaries for 105, 115, 220, 230 volts, 50/60 cycles. For reduced power, secondary voltages can be reduced to half by using 220V. Pri. on 110 volts. These transformers may be used on 25 to 43 cycles if 220V. Pri. is used on 110 volts. Secondary voltage is simultaneously halved.

Type No.	High Voltage	OC Voltage	OC MA	Case No.
CG-300	625-515-0-515-625	500/400	200	RC-150
CG-301	580-530-300-0-300-530-580	475/425/250	420	RC-152
CG-302	950-750-0-750-950	760/610	360	RC-175
CG-303	1500-1235-400-0-400-1235-1500	1250/1000 300	260* 175	RC-175

* 300MA, if used without load on low voltage winding.

TYPE EC CASE UNITS

Type No.	High Voltage	DC Voltage	DC MA	L	W	H	WT. Lbs.
CG-304	1500-1235-0-1235-1500	1250/1000	800	15	8½	10½	100
CG-305	2400-1750-0-1750-2400	2000/1500	300	10½	4¾	6¾	50
CG-306	2400-1750-0-1750-2400	2000/1500	500	15	8½	10½	100
CG-307	3500-3000-2400-0-2400-3000-3500	3000/2500 2000	300	14½	8½	10¾	90
CG-308	3500-3000-2400-0-2400-3000-3500	3000/2500 2000	500	16½	8½	10¾	125
CG-309	3500-3000-2400-0-2400-3000-3500	3000/2500 2000	1000	21	10	13¾	185
CG-311	1500-1235-0-1235-1500	1250/1000	500	10½	4¾	6¾	50
CG-312	1800-1500-0-1500-1800	1500/1250	400	10½	4¾	6¾	50

FILTER CHOKES

INDUCTANCE SHOWN IS AT RATED DC MA

Type No.	Inductance Henrys	DC MA	DC Res. Ohms	Test Volts	Case No.
CG-40	10	200	110	1750	RC-112
CG-41	4-20	200	110	1750	RC-112
CG-44	30	100	400	1750	RC-100
CG-45	250	15	5000	1750	RC-87
CG-48C	75	50	2200	1750	RC-87
CG-100	12	150	110	2500	RC-125
CG-102	12	250	100	3000	RC-150
CG-104	10	350	90	5000	RC-152
CG-108	10	500	52	7000	RC-175
CG-15	10	1000	40	9000	11½x4¾x 6¾ H, 60 lb.

SWINGING INPUT CHOKES

INDUCTANCE SHOWN IS FROM 100% TO 10% OF RATED DC MA

Type No.	Inductance Henrys	DC MA	DC Res. Ohms	Test Volts	Case No.
CG-101	5-25	150	110	2500	RC-125
CG-103	5-25	250	100	3000	RC-150
CG-105	5-25	350	90	5000	RC-152
CG-109	5-25	500	52	7000	RC-175
CG-1C	5-25	1000	40	9000	11½x4¾x 6¾ H, 60 lb

FILAMENT TRANSFORMERS

Primary for 105, 115, 220, 230 volts, 50/60 cycles. These transformers may be used on 25 to 43 cycles if 220 volt primary is used on 110 volts. Secondary voltage is simultaneously reduced to half. * Two Windings.

Type No.	Sec. Volts C. T.	Sec. Amps.	Working Voltage	Test Voltage	Case No.
CG-33	6.3	4	500	2000	RC-75
CG-34	2½	10	2500	6000	RC-112
CG-120	2½	10	5000	11000	RC-125
CG-121	5	25	5000	11000	RC-150
CG-122	7.5/6.3	10	1500	4000	RC-125
CG-124	10	10	1500	4000	RC-150
CG-125	14/12/11	10	1500	4000	RC-150
CG-126	*14/11/10 14/11/10	10	1500	4000	RC-152

Radio's Master — 19th Edition

Page N-113



SPECIAL SERIES AUDIO TRANSFORMERS

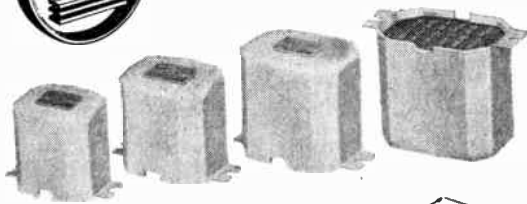

CASE SIZES

Type No.	H	W	D	M	Wt. Lbs.
G-1	1 7/8	2-13/16	1 3/4	2 3/8	1
G-2	2-5/16	3 3/8	1-15/16	2 7/8	1 1/2
G-3	2 1/2	3 3/4	2-5/32	3 1/4	2
G-4	2-15/16	4 1/8	2-5/16	3 3/8	3

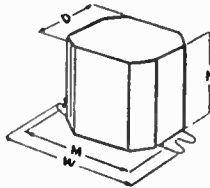

CLASS A INPUT TRANSFORMERS

Type No.	Application	Ratio	Case
S-1	1 plate* to 1 grid	3 1/2:1	G-2
S-2	1 plate* to 2 grids	2:1 4:1	G-2
S-3	1 plate* to 1 or 2 grids compact type	2:1	G-1
S-4	1 plate* to 2 grids wide range response	1:1	G-3
S-5	Single or double button mike or line to 1 grid hum-bucking type	16:1	G-2
S-6	Single or double button mike or line to 1 grid, compact type	16:1	G-1
S-7	Single plate* and carbon mike to one or two grids	3:1 16:1	G-2

* Will match tubes like 6J5, 6C4, 12AU7, etc. Can be used with high mu triodes with loss in low frequencies.

UNIVERSAL DRIVER TRANSFORMERS

(See Modulator chart for tube types)

Type No.	Application	Case
S-8	Single driver plate to pushpull grids	G-3
S-9	Pushpull driver plates to grids of class B tubes up to 400 watts output	G-4
S-10	Pushpull 56, 6C6 triode, 6C5, or similar plates to 45's, 2A3's or 6L6's, self or fixed bias	G-3

MATCHING TRANSFORMERS

Type No.	Application	Pri. Ohms	Sec. Ohms	Case
S-11	Single 6J5, 6C4, 12AU7 or similar tube to line	15,000	200/500	G-2
S-12	Line to speaker 15 watts	500, 2000, 4000	2, 4, 8, 15	G-2
S-13	Line to speaker 30 watts	500, 2000, 4000	2, 4, 8, 15	G-4

UNIVERSAL OUTPUT TRANSFORMERS TO LINE AND VOICE COIL

(Secondary Impedances: 500, 15, 8, 2 ohms)

Type No.	Primary Impedance	Typical Tubes	Class	Case
Single Tubes:				
S-14 10 W.	2500 ohms	2A3, 6B4, 6L6, 6Y6, 25L6, 35L6	A	G-2
	4000 ohms	6V6, 12A6	A	
	7000 ohms	6AC5, 6F6, 6K6, 7B5	A	
	10,000 ohms	1G5, 3C5, 6A4, 6N7	A	
P. P. Tubes:				
S-15 12 W.	4000 ohms	6Y6, 25L6	AB	G-2
	5000 ohms	2A3, 6B4, 6AS7	AB	
	10,000 ohms	1H4, 6AC5G, 6B5, 6A6, 6Y7	AB B	
S-16 30-W.	3000 ohms	2A3, 6B4, 25L6	AB	G-4
	6000 ohms	2A5, 6F6 triodes, 6AS7, 6A6, 6N7	AB B	
	9000/10000 ohms	2A5, 6AC5, 6B5, 6F6, 6L6, 6V6, 807-triode	AB	
S-17 55 W.	3800 ohms	6L6's	AB2	G-5
	4500/5000 ohms	4-6L6's 46, 1608, 809	AB1 B	

UNIVERSAL MODULATION TRANSFORMERS

Secondary carries class C current
Any modulator tubes to any RF load. (See chart)

Type No.	Audio Power	Case
S-18	12 watts	G-3
S-19	30 watts	G-4
S-20	55 watts	G-5
S-21	110 watts	G-7
S-22	250 watts	G-8

UTC Special Series transformers are specifically designed for amateur and popular-priced PA service. The Special units are finished in a rich, commercial type medium gray enamel. A recessed terminal strip is provided permitting above chassis or breadboard wiring in addition to standard chassis type wiring. The universal windings provided on driver, matching and output transformers assure a maximum of flexibility. Modulator output units will carry the DC current of the class C stage for any of the impedances available and will match practically any audio tubes to any RF load within the power rating of the transformer. Large components are housed in formed cases with top or bottom mounting. All units are vacuum impregnated—compound filled.

TYPICAL MODULATOR COMBINATIONS

S-18—12 WATTS MAX.

DRIVER TUBES: In the combinations shown below, typical suitable driver tubes are: 6C5, 6E6, 6N7, 6J5, 6C4, 12AU7, 6P5, 6J7-TR, 6SJ7-TR.

DRIVER Transf.	Sec. Term.	P.P. Tubes	Watts Output	MODULATOR STAGE P.P. Load	Plate Volts	Bias Volts	
S-2	G-G	6E6	1.6	14,000	250	27	
S-8	G-G	19, 1J6G	2.1	10,000	135	0	
S-8	G-G	49	3.5	12,000	180	0	
S-2	G-G	25L6	4	4,000	110	7.5	
S-8	G'-G'	627G	4.2	12,000	180	0	
S-2	G-G	6Y6G	7	4,000	135	13.5	
S-8	G-G	6Y7G	8	14,000	250	0	
S-8	G'-G'	6AC5G	8	10,000	250	0	
S-8	G'-G'	6A6, 6N6, 6N7	10	10,000	300	0	
S-2	G-G	2A3, 6A3, 6A5G, 6B4G	10	5,000	325	750 ohms	
S-8	G-G	45	10	5,000	275	770 ohms	
S-2	G-G	6AS7G	10	5,000	250	1,250 ohms	
SINGLE TUBES							
S-1	F-G	43, 45, 71A, 25A6, 25A7				4,000 ohms	
		46, 6V6				6,000 ohms	
		42, 46, 47, 49, 2A5, 6F6, 6B5				7,000 ohms	
		10, 41, 32, 6G6, 6K6				10,000 ohms	
		38, 12A7				14,000 ohms	

S-19—30 WATTS MAX.

(6J5, 6C4, 12AU7, etc. may be substituted for 6C5 tubes)

Tube or Tubes	DRIVER Transf.	Sec. Terms.	P.P. Tubes	Watts Output	P.P. Load	Plate Volts	Bias Volts
6C5	S-10	G-G	6V6	13	8,000	300	20
6C5	S-10	G-G	2A3, 6A3, 45, 6A5G, 6B4G	15	3,000	325	68
6C5	S-10	G-G	2A5, 6F6 Pentode AB	10	10,000	375	340 ohms
2A5	S-8	G-G	2A5, 6F6, triode AB	18	6,000	350	38
89	S-8	G'-G'	6A6, 6N6, 6N7	19	5,000	300	0
45	S-8	G-G	10, 1602	25	8,000	425	50
45	S-8	G'-G'	46	25	6,000	425	0
45	S-8	G'-G'	841	28	7,000	425	5
6C5	S-10	G-G	6L6 self bias	30	9,000	400	23

S-20—55 WATTS MAX.

P.P. Tubes	DRIVER Transf.	Sec. Terms.	P.P. Tubes	Watts O'tp't	MODULATOR STAGE P.P. Load	Plate Volts	Plate Tr'sf.	Bias Volts	Bias Tr'sf.
2A3	S-9	1-1	801	45	10000	600	S-45	75	S-51
2A3	S-9	3-3	1608	50	5000	425	S-44	15	S-51
2A3	S-9	1-1	T-20	50	8000	600	S-45	30	S-51
Single 45	S-8	G'-G'	4-46, 59	56	3000	425	S-44	0	
605	S-10	G-G	6L6, AB2	60	3800	400	S-39	25	S-51
6C5	S-10	G-G	4-6L6	60	4500	400	S-40	23	
2A3	S-9	3-3	809	60	5000	500	S-41	0	

SPECIAL SERIES POWER EQUIPMENT



UTC Special Series power supply components are designed specifically for amateur and popular-priced PA service. The ratings are based on such applications and recommended for ICAS intermittent use. For commercial application, GG or LS grade components should be employed. Tapped coil structures on power, and bias supply transformers afford maximum flexibility, permitting a given transformer to be used with many circuits and types of tubes. Stand by service should not be obtained by interrupting high voltage center tap.

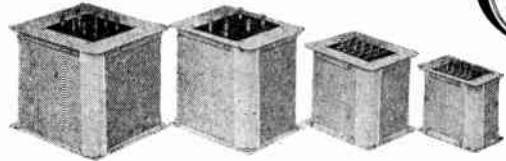

S-21—115 WATTS MAX.

P.P.-2A3 Driver S-9 Transf. Sec. Term.	P.P. Tubes	Watts Output	MODULATOR P.P. Load	STAGE Plate Volts	Plate Transf.	Bias Volts	Bias Trsf.
2-2	TZ-20	70	12000	800	S-46	0	
1-1	T-20	70	12000	800	S-46	40	S-51
*	845	75	4600	1000	S-47	175	S-52
1-1	807	80	6600	600	S-45	30	S-51
1-1	800, RK-30	100	12000	1000	S-47	55	S-51
3-3	809	100	8400	750	S-45	5	S-51
2-2	825	100	6600	850	S-46	30	S-51
2-2	TZ-40	100	6000	750	S-45	0	
2-2	T-756	100	7000	850	S-46	30	S-51
1-1	50-T	100	8000	1000	S-47	90	S-51
2-2	RK-18	100	12000	1000	S-47	50	S-51
1-1	HK-354	100	15000	1000	S-47	60	S-51
*	845	105	8800	1250	S-47	225	S-52
3-3	RK-31	110	14000	1000	S-47	0	
1-1	4-6L6	110	2000	400	S-44	25	S-51
2-2	35-T	115	11000	1000	S-47	30	S-51

* Reverse S-9 transformer using terminals 1-1 for plates and P-P. for grids.

S-22—250 WATTS MAX.

P.P.-2A3 Driver S-9 Transf. Sec. Term.	P.P. Tubes	Watts Output	MODULATOR P.P. Load	STAGE Plate Volts	Plate Transf.	Bias Volts	Bias Trsf.
3-3	RK-31	140	17000	1250	S-47	0	
*	50 T	250	20000	2000	S-50	180	S-52
2-2	TZ-40	175	6800	1000	S-47	0	
1-1	T-55	175	6900	1000	S-47	40	S-51
1-1	T-55	225	9400	1250	S-47	50	S-51
2-2	HF-100	250	12000	1500	S-49	52	S-51
2-2	100 TH	250	7200	1250	S-47	0	
5	100 TL	230	7200	1250	S-47	112	S-52
2-2	ZB-120	150	4800	750	S-45	0	
2-2	ZB-120	245	9000	1250	S-47	0	
*	HK-154	225	11400	1250	S-47	210	S-52
1-1	203 A	250	9000	1250	S-47	45	S-51
3-3	203 Z	200	6900	1000	S-47	0	
1-1	211	200	6900	1000	S-47	77	S-51
1-1	211	250	9000	1250	S-47	100	S-51
1-1	HK-354	220	15000	1500	S-49	100	S-51
2-2	808	190	12700	1250	S-47	15	S-51
2-2	830 B	175	7600	1000	S-47	35	S-51
2-2	838	250	9000	1250	S-47	0	

* Reverse S-9, using 2-2 for plates and P-P for grids.
 † Reverse S-9, using 1-1 for plates and P-P for grids.

FILAMENT TRANSFORMERS

Type No.	Primary Tapped Secondary Volts	105, 115 Volts—50/60 Cycles	Secondary Current	Insulation	Case No.
S-53	2.5 VCT	10 A.	1500 V.	G-3	
S-54	5 VCT	4 A.	2500 V.	G-3	
S-55	6.3 VCT	3 A.	1500 V.	G-3	
S-56	7.5 VCT	3 A.	1500 V.	G-3	
S-57	2.5 VCT	10 A.	10,000 V.	G-5	
S-58	2.5 VCT	20 A.	10,000 V.	G-5	
S-59	5 to 5.25 VCT	13 A.	5000 V.	G-5	
S-60	5 to 5.25 VCT	22 A.	10,000 V.	G-7	
S-61	7.5 VCT tapped 6.3 VCT	10 A.	3000 V.	G-5	
S-62	10 VCT	10 A.	3000 V.	G-5	
S-63	14 VCT tapped 12 VCT and 11 VCT	10 A.	5000 V.	G-7	

Type No.	Fil. 1	Fil. 2	Fil. 3	Insulation	Case No.
S-64	2.5 VCT-5A	2.5 VCT-5A	5 VCT-6A	3000 V.	G-5
S-65	2.5 VCT-5A	5 VCT-4A	6.3 VCT-3A	3000 V.	G-5
S-66	2.5 VCT-10A	7.5 VCT-6.5A		3000 V.	G-5
S-67	5 VCT-6A	6.3 VCT-5A		3000 V.	G-5
S-68	5 VCT-3A	6.3 VCT-4A	7.5 VCT-5A	3000 V.	G-5
S-69	6.3 VCT-3A	7.5 VCT-6.5A		3000 V.	G-5
S-70	6.3 VCT-5A	6.3 VCT-5A		3000 V.	G-5
S-71	2.5 VCT-6A	2.5 VCT-6A	2.5 VCT-12A	10000 V.	G-7
S-72	5 VCT-3A	5 VCT-3A	5 VCT-6A	5000 V.	G-5

Copyright by U. C. P., Inc.

CASE SIZES

Type No.	H	W	D	M	N	Wt. Lbs.
G-5	3 3/4	3 3/8	4 1/2	3 3/8	2-7/16	4 1/2
G-7	4 5/8	4 5/8	5 1/2	4-27/32	3-25/32	8
G-8	4 5/8	5 3/8	5 3/8	4-25/32	4 3/4	12
G-9	5 7/8	5 7/8	6 3/4	6-3/32	4-19/32	21
G-10	5 7/8	6 1/8	6 3/8	5-15/16	5-13/32	24
G-11	5 7/8	6 1/2	7 3/8	6-21/32	5-29/32	31
G-12	10 1/4	7 3/8	9 1/4	8 1/2	6 5/8	52

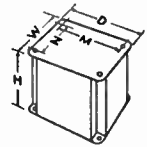

COMBINED PLATE AND FILAMENT UNITS

Primary 115 V.—50/60 Cycles

Type No.	Voltage	D.C. Voltages*	Rectifier Fil.	Fil. No. 1	Fil. No. 2	Case No.
S-39	490-400-0-400-490 175 Ma.	400/310	5 V.-3A	2.5 V.C.T.-6A	6.3 V.C.T. 4A	G-7
S-40	525-425-0-425-525 250 Ma.	400/310	5 V.-3A	6.3 V.C.T.-3A	6.3 V.C.T. 3A	G-7
S-41	600-0-600 200 Ma.	475	5 V.-3A	7.5 V. tapped 6.3 V.-3A	6.3 V.C.T. 2A	G-7
S-42	600-525-0-525-600 300 Ma.	480/400	5 V.-6A	7.5 V. tapped 6.3 V.-3A	6.3 V.C.T. 3A	G-8
S-43	525-0-525 450 Ma. 40-0-40, 200 Ma.	400	5 V.-3A 5 V.-6A	6.3 V.-3A -2A	6.3 V.C.T. 5A	G-9

* Based on two section filter, choke input.

PLATE TRANSFORMERS — BIAS TRANSFORMERS

Primary 115 V.—50/60 Cycles

Type No.	High Voltage	DC Voltages*	DC Current	Case No.
S-44	575-525-0-525-575	470/430	500 Ma.	G-9
S-45	900-750-0-750-900	750/620	200 Ma.	G-8
S-46	1000-750-0-750-1000	825/600	300 Ma.	G-9
S-47	1500-1250-1000-0-1000-1250-1500	1275/1050/825	300 Ma.	G-10
S-48	1500-1250-1000-0-1000-1250-1500	1300/1075/850	500 Ma.	G-11
S-49	2100-1800-1500-0-1500-1800-2100	1815/1540/1275	300 Ma.	G-11
S-50	3000-2500-0-2500-3000	2625/2175	300 Ma.	G-12
S-51	Will supply any bias voltage from 15 to 100 volts DC within approximately 6% of desired value.		200 Ma.	G-5
S-52	Will supply any bias voltage from 75 to 400 volts DC within approximately 6% of desired value.		200 Ma.	G-7

* Based on two section filter for 200 Ma. and 300 Ma. units, single section filter for 500 Ma. units, both choke input
 † 200 Ma. if used alone ‡ 300 Ma. if used alone

FILTER, SWINGING, AND AUDIO CHOKES

Type No.	Service	Inductance	Current	Resistance	Insulation	Case No.
S-23	Audio	450 Hy.	5 Ma.	5000 ohms	1500 V.	G-2
S-24	P.P. Choke	500 Hy. C.T.	3 Ma.	400 ohms	1500 V.	G-2
S-25	Filter	30 Hy.	30 Ma.	800 ohms	1500 V.	G-2
S-26	Filter	15 Hy.	60 Ma.	250 ohms	1500 V.	G-2
S-27	Filter	30 Hy.	75 Ma.	350 ohms	1500 V.	G-4
S-28	Filter	20 Hy.	100 Ma.	350 ohms	1500 V.	G-4
S-29	Filter	10 Hy.	175 Ma.	90 ohms	1500 V.	G-4
S-30	Swinging	5 25 Hy.	175 Ma.	90 ohms	1500 V.	G-4
S-31	Filter	20 Hy.	225 Ma.	100 ohms	2700 V.	G-5
S-32	Swinging	5 25 Hy.	225 Ma.	100 ohms	2700 V.	G-5
S-33	Filter	20 Hy.	300 Ma.	100 ohms	4000 V.	G-7
S-34	Swinging	5 25 Hy.	300 Ma.	100 ohms	4000 V.	G-7
S-35	Filter	20 Hy.	400 Ma.	60 ohms	5000 V.	G-8
S-36	Swinging	5 25 Hy.	400 Ma.	60 ohms	5000 V.	G-8
S-37	Filter	20 Hy.	550 Ma.	60 ohms	6000 V.	G-8
S-38	Swinging	5 25 Hy.	550 Ma.	60 ohms	6000 V.	G-8

Radio's Master — 19th Edition

(Refer to Page N-98 for UTC Prices)

Page N-115



REPLACEMENT TYPE COMPONENTS

UTC replacement type transformers (Pri. 117 V. 50/60 cycles) represent the culmination of years of development in this field. All units are low temperature rise, vacuum sealed against humidity with special impregnating materials to prevent corrosion and electrolysis. Shells and brackets are finished in attractive high lustre black enamel.

DOUBLE SHELL POWER TRANSFORMERS

Type No.	High V.	OC MA.	Rec. Fil.	Amp. Fil.	W	O	H	M	N	Wt. Lb.
R-101	275-0-275	50	5V-2A	6.3V CT-2.7A	3	2 1/2	2 3/4	2 1/2	2 1/16	2 1/2
R-102	350-0-350	70	5V-3A	6.3V CT-3A	3	2 1/2	3 3/4	2 1/2	2 1/16	3 1/2
R-103	350-0-350	90	5V-3A	6.3V CT-3.5A	3 3/4	2 7/8	3 3/4	2 13/16	2 1/4	4 1/2
R-104	350-0-350	120	5V-3A	6.3V CT-5A	3 3/4	3 1/8	3 3/4	3 3/4	2 1/2	5 1/2
R-105	385-0-385	160	5V-3A	6.3V CT-5A	3 3/4	3 1/8	3 7/8	3 3/4	2 1/2	7

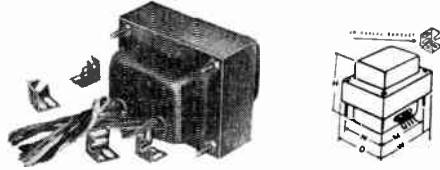

DOUBLE SHELL TYPE

SINGLE SHELL POWER TRANSFORMERS

Type No.	High V.	OC MA.	Rec. Fil.	Amp. Fil.	W	D	H	M	N	Wt. Lb.
R-106	300-0-300	50	5V-2A	6.3V CT-2.7A	3	2 1/2	3	2 1/2	2 1/16	2 1/2
R-107	350-0-350	70	5V-3A	6.3V CT-3A	3	2 1/2	3 3/4	2 1/2	2 1/16	3 1/2
R-108	350-0-350	120	5V-3A	6.3V CT-5A	3 3/4	3 1/8	3 3/4	3 3/4	2 1/2	5 1/2
R-109	400-0-400	200	5V-3A	6.3V CT-6A	4 1/2	3 3/4	4	3 3/4	3	8

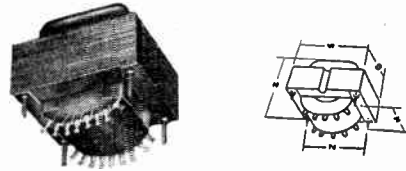

SINGLE SHELL TYPE

VERTICAL SHELL POWER TRANSFORMERS

Type No.	High V.	OC MA.	Rec. Fil.	Amp. Fil.	W	O	H	M	N	Wt. Lb.
R-110	300-0-300	50	5V-2A	6.3V CT-2.7A	2 1/2	2 1/2	3 1/4	2	1 3/4	2 1/2
R-111	350-0-350	70	5V-3A	6.3V CT-3A	2 1/2	3 1/8	3 1/4	2	2 3/8	3 1/2
R-112	350-0-350	120	5V-3A	6.3V CT-5A	3 1/4	3 3/8	4	2 1/2	2 1/2	5 1/2
R-113	400-0-400	200	5V-3A	6.3V CT-6A	3 3/4	4 1/4	4 5/8	3	3 1/8	8



VERTICAL SHELL TYPE

CHANNEL FRAME FILTER CHOKES

Inductance Shown is at Rated O.C.M.A.—Insulation Test: 1750 Volts

Type No.	Induct. Hys.	Current	Resistance Ohms	W	O	H	M	Lbs
R-55	6	40MA	300	2 1/2	1 3/8	1 3/8	2	1/2
R-14	8	40MA	250	2 7/8	1 3/8	1 11/16	2 3/8	3/4
R-15	12	30MA	450	2 7/8	1 3/8	1 11/16	2 3/8	3/4
R-16	15	30MA	630	2 7/8	1 3/8	1 11/16	2 3/8	3/4
R-17	20	40MA	850	3 1/8	1 5/8	2	2 13/16	1
R-18	8	80MA	250	3 1/8	1 5/8	2	2 13/16	1
R-19	14	100MA	450	3 3/4	1 3/4	2 5/8	3 1/8	1 1/2
R-20	5	200MA	90	4 1/8	2	2 5/8	3 1/8	2 1/2
R-21	3/15	200MA	90	4 1/8	2	2 5/8	3 1/8	2 1/2
R-22	120	5MA	4000	3 1/8	1 5/8	2	2 13/16	1

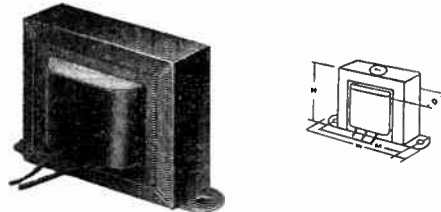

CHANNEL FRAME TYPE

FILAMENT TRANSFORMERS

CHANNEL FRAME TYPE
Pri. 115 V 50/60 Cycles—1500 V Breakdown

Type No	Secondary	Dimensions, Inches	W	H	M	Wt Lbs
FT-1	2.5 V.C.T.-3A	2 7/8	1 3/8	1 11/16	2 3/8	3/4
FT-2	6.3 V.C.T.-1.2A	2 7/8	1 3/8	1 11/16	2 3/8	3/4
FT-3	2.5 V.C.T.-6A	3 1/8	1 5/8	2	2 13/16	1
FT-4	6.3 V.C.T.-2.5A	3 1/8	1 5/8	2	2 13/16	1
FT-5	2.5 V.C.T.-10A	3 3/4	1 3/4	2 5/8	3 3/8	1 1/2
FT-6	5 V.C.T.-3A	3 3/4	1 3/4	2 5/8	3 3/8	1 1/2
FT-7	7.5 V.C.T.-3A	3 3/4	1 3/4	2 5/8	3 3/8	1 1/2
FT-8	6.3 V.C.T.-6A	4 1/8	2 1/4	2 5/8	3 3/8	2 1/2
FT-9	2.5 V.C.T.-10A 10000V. Test	4 1/8	2 1/4	2 5/8	3 3/8	2 1/2
FT-10	24V CT-2A or 12V-4A	4 1/8	2 1/4	2 5/8	3 3/8	2 1/2

CHANNEL FRAME AUDIO TRANSFORMERS

Type No.	Application	Description	W	O	Dimen., Ins.		M	Lbs.
R-33	1 plate to 1 grid	4:1 ratio	2 7/8	1 3/8	1 11/16	2 3/8	2 3/8	3/4
R-34	1 plate to 2 grids	2:1 ratio	2 7/8	1 3/8	1 11/16	2 3/8	2 3/8	3/4
R-35	Mike to 1 grid	17:1 ratio to Pri. C.T.	2 7/8	1 3/8	1 11/16	2 3/8	2 3/8	3/4
R-90	Intercomm speaker to grid	4 ohm to 40,000 ohm grid	2 1/2	1 3/8	1 3/8	2 1/8	2 1/8	1/2
R-58	5 watt Universal output	Any single tube to any voice coil, .1 to 30 ohms	2 1/2	1 3/8	1 3/8	2 1/8	2 1/8	1/2
R-38A	6 watt Universal	Any tubes up to 6 watts to any voice coil, .1 to 30 ohms	2 1/2	1 3/8	1 3/8	2 1/8	2 1/8	1/2
R-59	10 watt Universal	Any tubes up to 10 watts to any voice coil, .1 to 30 ohms	2 7/8	1 3/8	1 11/16	2 3/8	2 3/8	1/2
R-60	15 watt Universal	Any tubes up to 15 watts to any voice coil, .1 to 30 ohms	3 1/8	1 5/8	2	2 13/16	2 13/16	1
R-39	10 watt line Matching Transformer	250, 500, 1,500 ohms to 2, 8, 15 ohms	2 7/8	1 3/8	1 11/16	2 3/8	2 3/8	3/4
R-40	25 watt line Matching Transformer	250, 500, 1,500 ohms to 2, 8, 15 ohms	4 1/8	2 1/4	2 5/8	3 1/8	3 1/8	2 1/2



REPLACEMENT TYPE COMPONENTS

VARI-TRAN VOLTAGE ADJUSTERS

Input 115 volts 50/60 cycles. Output continually adjustable from 0-130 Volts through roller contact on exposed autotransformer winding. Regulation and efficiency are excellent, no wave form distortion. Output voltage is independent of load. Complete with line cord, switch, and receptacle . . . for loads up to 570 Watts . . . 5 A.



Type	Dimensions	Wt.
V-1-M with meter	4 7/8 x 9 7/8 x 3 3/8	14 lbs.
V-1 without meter	4 7/8 x 8 x 3 3/8	12 lbs.

EXPORT VOLTAGE ADAPTER

Complete with cord and plug and special locking switch providing for line voltages of 105, 115, 125, 135, 150, 210, 230, 250 volts; 42 to 60 cycles. Output voltage 115.

Type No.	Rating	Wgt. Lbs.
R-47	85 watts	4 1/2
R-48	150 watts	5 1/2



TV VOLTAGE REGULATOR

Complete with cord, plug, and special locking switch. Permits operation of 115 volt 50/60 cycle TV sets on line voltages of 85, 90, 95, 100, 105, 110, 120, 125 V.

Type No.	Rating	Wgt. Lbs.
R-49	350 watts	5

STEP DOWN AUTO-TRANSFORMERS

With 6 foot cord and female receptacle 220-240 to 110-120 Volts—50/60 Cycles

Type No.	Application	L	W	N	Wgt. Lbs.
R-41	85 watt capacity	2 3/4	2 3/4	3 1/4	4
R-42	125 watt capacity	3	3	3 1/2	5
R-43	175 watt capacity	3 1/4	3 1/4	3 3/4	5 1/2
R-44	250 watt capacity	3 3/4	3 1/4	3 3/4	6 1/2
R-45	500 watt capacity	4 1/8	3 3/4	4 1/2	12
R-46	1200 watt capacity	6 3/8	3 3/4	4 1/2	18
R-64	2500 watts, no cord	10 1/2	4 1/4	6 3/4	30



PHOTO FLASH TRANSFORMERS

Can be used for either standard (Anglo type) or trigger (Sylvania type) multiple flash bulbs. Circuit details included with transformer.

PF-1 Primary for 115 volts, 50/60 cycles. Secondaries for power supply delivering 2200 volts DC to condenser up to 100 Mfd. Compound sealed in G-3* case 2 1/2 x 2 3/4 (5% including flanges) x 2 1/2 inches high. Weight 2 lbs.

PF-2 For portable service. Primary tapped for 4 volt or 6 volt battery (full valve vibrator). Secondary for power supply delivering 2200 volts DC to condenser up to 60 Mfd. Compound sealed in G-3* case. Weight 2 lbs.

PF-3 Trigger Transformer 15 KV peak. 7/8 O.D x 3" long. Weight 2 Oz

PF-4 Dual Pri. for either 4V battery or 115V 50/60 cycles. Secondary for power supply delivering 900 volts DC to condenser up to 150 Mfd G-3* case, 2 Lb.

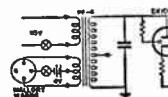
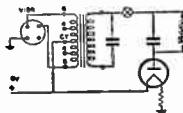
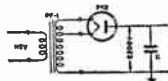

VOLTAGE BOOSTERS

The constantly increasing appliance load in home and office presents a serious low line voltage problem to which the UTC voltage booster is a perfect answer. These autotransformers are designed to operate from a 95 to 110 V. 50/60 cycle line. They boost the voltage 10%. The two ratings shown are ideal for TV sets and air conditioners. Complete with line cord and receptacle.



R-87

Type No.	Rating	L	W	N	Wgt. Lbs.
R-87	3A. 350 W.	3 3/4	2	2 3/4	2
R-88	18A. 2 KW.	3 3/4	4 1/4	4 1/2	12



R-88

ISOLATION TRANSFORMERS

Ideal for isolating line noise, AC-DC sets, etc. Excellent electrostatic shielding. 1500 volt breakdown test. Six foot cord and female receptacle.

Primary 110-120 volts, 50/60 cycles—Secondary 110-120 volts

Type No.	Rating	L	W	N	Wgt. Lbs.
R-72	40 watts	2 3/4	2 3/4	3 1/4	4
R-73	100 watts	3 3/4	3 1/4	3 3/4	6
R-74	250 watts	4 3/4	3 3/4	4 1/2	12
R-75	600 watts	6 3/4	3 3/4	4 1/2	20
R-76	1200 watts	8 3/4	4 1/2	5 3/4	30
R-77	2500 watts (no-cord)	12	7	9	70

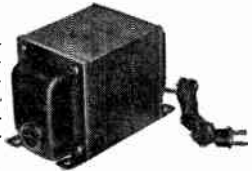

LINE VOLTAGE ADJUSTERS WITH METER

The perfect answer to abnormal or fluctuating line voltage. Adjust switch so that meter reads at red line and you know that your equipment is working at correct voltage.

These units combine a tapped auto-transformer with a switch and meter in a compact, rugged assembly.

The nine tap switch provides for line voltage of 60 to 140 volts on 115 volt output models and 160 to 240 volts on 230 volt output models.

All units are designed for 50/60 cycle service and come complete with 6 foot input cord and plug and outlet receptacle.



Type No.	Primary Voltages	Sec. Volts	Watts	L	W	N	Wgt. Lbs.
R-78	60, 70, 80, 90, 100, 110, 120, 130, 140	115	150	7	4	4 3/4	6
R-79	60, 70, 80, 90, 100, 110, 120, 130, 140	115	300	7	4	4 3/4	9
R-80	60, 70, 80, 90, 100, 110, 120, 130, 140	115	600	10 1/4	4	4 3/4	13
R-81	60, 70, 80, 90, 100, 110, 120, 130, 140	115	1200	10 1/4	4	4 3/4	21
R-83	160, 170, 180, 190, 200, 210, 220, 230, 240	230	150	7	4	4 3/4	6
R-84	160, 170, 180, 190, 200, 210, 220, 230, 240	230	300	7	4	4 3/4	9
R-85	160, 170, 180, 190, 200, 210, 220, 230, 240	230	600	10 1/4	4	4 3/4	13
R-86	160, 170, 180, 190, 200, 210, 220, 230, 240	230	1200	10 1/4	4	4 3/4	21

SIGNALLING AND CONTROL TRANSFORMERS

Primary 119-120 volts, 50/60 cycles—Secondary 4, 8, 12, 16, 20, 24 volts

High power transformers suitable for operating relays, sirens, horns, gongs, etc. from 115 V. 50/60 cycle line. These units have four secondary terminals providing 4, 8, 12, 16, 20 and 24 volt output. The volt ampere rating is based on the 24 volt secondary tap with corresponding reduction at the lower voltages. Underwriters' approved primary leads are employed, and screw-type binding posts.

Type No.	Watts	Overall Dimensions	Mfg. Dim.	Wgt. Lbs.
SC-3	50	3 x 3 1/2 x 3 3/4	1 7/8 x 2 1/4	3
SC-4	100	3 1/4 x 4 x 4	2 1/8 x 2 1/2	5
SC-5	250	4 x 5 x 4 1/4	3 1/4 x 3	10



*See Page N-114



SUBOUNCER UNITS

FOR HEARING AIDS...VEST POCKET RADIOS...MIDGET DEVICES

UTC Sub-Ouncer units fulfill an essential requirement for miniaturized components having relatively high efficiency and wide frequency response. Through the use of special nickel iron core materials and winding methods, these miniature units have performance and dependability characteristics far superior to any other comparable items. They are ideal for hearing aids, miniature radios, and other types of miniature electronic equipment.

The coils employ automatic layer windings of double Formex wire . . . in a molded Nylon bobbin. All insulation is of cellulose acetate. Four inch coded flexible leads are employed, securely anchored mechanically. No mounting facilities are provided, since this would preclude maximum flexibility in location. Units are vacuum impregnated and double (water proof) sealed. The curves below indicate the excellent frequency response available. Alternate curves are shown to indicate operating characteristics in various typical applications.

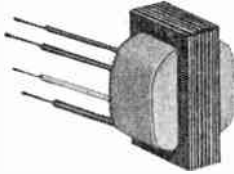

SUBOUNCER UNIT

Dimensions $\frac{3}{16}$ " x $\frac{5}{8}$ " x $\frac{7}{8}$ "
Weight03 lb.

Type	Application	Level	Pri. Imp.	D.C. in Pri.	Sec. Imp.	Pri. Res.	Sec. Res.
*S0-1	Input	+ 4 V.U.	200 50	0	250,000 62,500	16	2650
S0-2	Interstage/3:1	+ 4 V.U.	10,000	0	90,000	225	1850
*S0-3	Plate to Line	+ 20 V.U.	10,000 25,000	3 mil. 1.5 mil.	200 500	1300	30
S0-4	Output	+ 20 V.U.	30,000	1.0 mil.	50	1800	4.3
S0-5	Reactor 50 HY at 1 mil. O.C.	3000 ohms O.C. Res.					
S0-6	Output	+ 20 V.U.	100,000	.5 mil.	60	3250	3.8

*Impedance ratio is fixed, 1250:1 for S0-1, 1:50 for S0-3. Any impedance between the values shown may be employed.

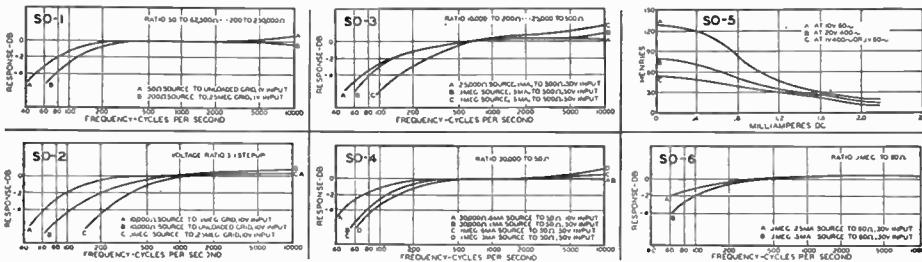

SUB-SUBOUNCER UNITS

FOR HEARING AIDS AND ULTRA-MINIATURE EQUIPMENT

UTC Sub-SubOuncer units have exceptionally high efficiency and frequency range in their ultra-miniature size. This has been effected through the use of specially selected Hiperm-Alloy core material and special winding methods. The constructional details are identical to those of the Sub-Ouncer units described above. The curves below show actual characteristics under typical conditions of application.

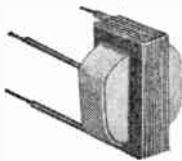

SUB-SUBOUNCER UNIT

Dimensions $\frac{7}{16}$ " x $\frac{3}{4}$ " x $\frac{5}{8}$ "
Weight02 lb.

Type	Application	Level	Pri. Imp.	MA D.C. in Pri.	Sec. Imp.	Pri. Res.	Sec. Res.
*SSO-1	Input	+ 4 V.U.	200 50	0	250,000 62,500	13.5	3700
SSO-2	Interstage/3:1	+ 4 V.U.	10,000	0.25	90,000	750	3250
*SSO-3	Plate to Line	+ 20 V.U.	10,000 25,000	3 1.5	200 500	2600	35
SSO-4	Output	+ 20 V.U.	30,000	1.0	50	2875	4.6
SSO-5	Reactor 50 HY at 1 mil. D.C.	4400 ohms O.C. Res.					
SSO-6	Output	+ 20 V.U.	100,000	.5	60	4700	3.3
SSO-7	Transistor Interstage	+ 10 V.U.	20,000 30,000	.5 .5	800 1,200	850	125

*Impedance ratio is fixed, 1250:1 for SSO-1, 1:50 for SSO-3. Any impedance between the values shown may be employed.

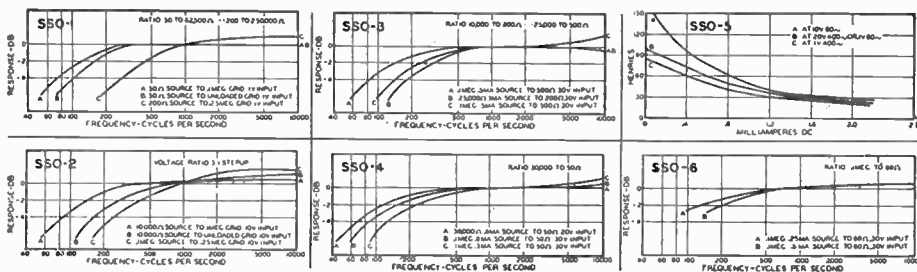



REVOLUTIONARY LINEAR STANDARD AMPLIFIER

NEW HEIGHT OF FIDELITY 20 WATTS...KIT FORM

The Linear Standard amplifier climaxes a project assigned to our audio engineering group a year ago. The problem was, why does a Williamson circuit amplifier which tests beautifully in the laboratory seem to have considerable distortion in actual use? It took a year to fully determine the nature and cause of these distortions and the positive corrective measures. This new amplifier not only provides for full frequency response over the audio range but, in addition, sets a new standard for minimum transient dirtortion.

An inherent weakness of the Williamson circuit lies in the fact that its negative feedback becomes positive at subsonic and supersonic frequencies. The resultant instability in use lends to parasitic oscillation at the high end and large subaudio cone excursions both of which produce substantial distortions. The Linear Standard Amplifier uses Multiple Loop Feedback and network stabilization to completely eliminate these instabilities. The oscillograms below show comparative performance. The flat frequency response and extremely low intermodulation distortion provided by 36 db feedback, are self evident from the curves shown.

In addition to providing an ideal amplifier electrically, considerable thought was given to its physical form. A number of points were considered extremely important: (1) Size should be minimum (power and audio on one chassis). (2) Each kit must have identical characteristics to lab model. (3) Rugged, reliable, structure is essential.

This resulted in a rather unique construction employing a printed circuit panel as large as the chassis with virtually all components pre-assembled and wired. The result is that each kit, which comes complete, including tubes and cover, can be fully pretested before shipment. Additional wiring involves only the connection of 17 leads to screw terminals for completion.

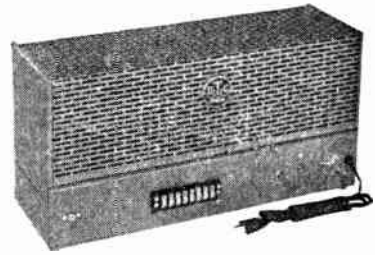

LINEAR STANDARD MLF AMPLIFIER

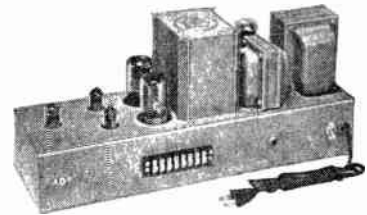

WITH COVER REMOVED

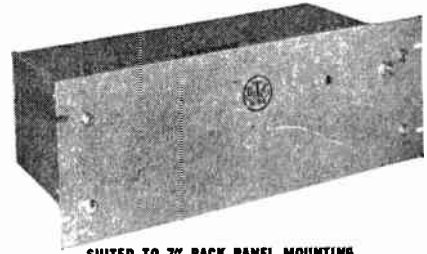

SUITED TO 7" RACK PANEL MOUNTING

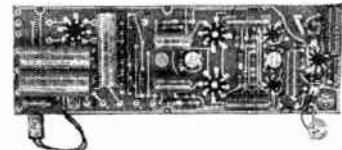

PRINTED CIRCUIT CONSTRUCTION

COMPARATIVE PERFORMANCE

LINEAR STANDARD

WILLIAMSON

Step function
(low frequency)
transient stability.

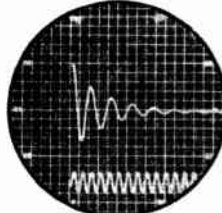
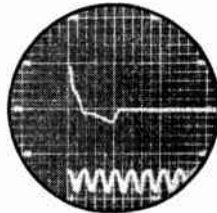

High frequency
oscillation stability.
Average speaker wiring
capacity.

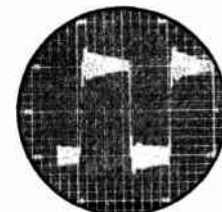
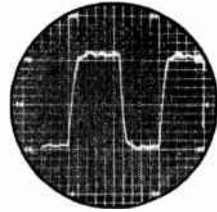

Overload recovery
transients.

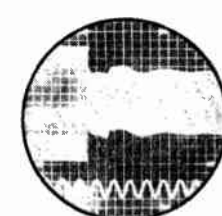
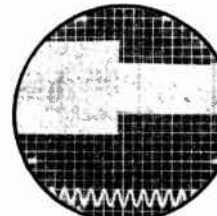

LINEAR STANDARD TYPE MLF AMPLIFIER SPECIFICATIONS . . .

Rated Power Output:	20 Watts
Intermodulation Distortion:	.07% -1W, 1%-20W
Frequency Response (controlled):	1 db 20 to 20,000 cycles
Hum & Noise Level:	80 db below rated output
Feedback:	36 db
Output impedances (not critical):	4, 8, 16 . . . also 2, 5, 10, 20, 30 ohms
Tubes:	1-12AX7, 2-6AU6, 2-5881, 1-5V4G
Dimensions & Weight:	5 1/4" x 8" x 17 1/4", 24 lbs.
Net Price:	\$108.00

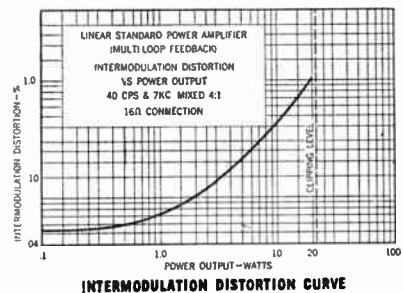
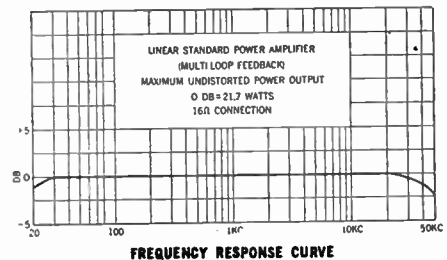

for like - new performance

Replace with original ROGERS TV DEFLECTION components HIGH VOLTAGE and HORIZONTAL OUTPUT TRANSFORMERS

Part No.	KV Output	Defl.	Description and Use	Deflection Yoke	Width Coil	Linearity Coil	List Price
EFR 85	12	70°	High efficiency for "630" type defl. CKTS. Same mtg. holes and terminals as 211T1, 211T3. Replaces 211T1, 211T3 with minor CKT changes, and has greater output. Can be supplied with 2 filament leads for doubler CKTS to replace 211T5.	PCM 85	QRC 102	QRC 106	\$9.50
EFR 88	15	70°	Regal 140-126, 140-138. GEM-JEWEL No. 64T3 exact replacement	PCM 85	QRC 102	QRC 106	9.50
EFR 90	15	70°	GEM-JEWEL No. 91T5 exact replacement	PCM 85	QRC 102	QRC 106	9.50
EFR 93	14.5	70°	VIDEO PRODUCTS No. ET-106 exact replacement also PHILHARMONIC and BRUNSWICK "630's"	PCM 85	QRC 102	QRC 106	9.50
EFR 96	14.5	70°	Similar to EFR 85 but with higher output KV. Conversion unit and general use in "630" type deflection CKTS.	PCM 85	QRC 102	QRC 106	9.50
EFR 101	13	70°	FADA 37.258, 37.255; CROSLEY AD151802, 153619 exact replacement	PCM 145	QRC 112	QRC 103	9.50
EFR 102	17	70°	FADA B37.264 exact replacement	PCM 145	QRC 112	ARC 103	10.00
EFR 106	14.5	70°	MAJESTIC C9.253, D9.259 exact replacement	PCM 145	QRC 104	QRC 104	9.50
EFR 112	14.5	70°	GE 77J1 for use in all GE type deflection CKTS.	PCM 145	QRC 104	QRC 104	9.50
EFR 118	14	70°	Direct drive, air core, auto transformer. RCA, EMERSON, CAPEHART, PACKARD BELL	PCM 303	QRC 110	QRC 106	6.50
EFR 125	14.5	70°	EMERSON No. 738056, 060, 064 exact replacement	PCM 303	QRC 110	QRC 104	9.50
EFR 126	15	70°	EMERSON No. 738067, 068, 069, 073, 074 exact replacement—newer models	PCM 175	QRC 110	none	9.50
EFR 128	14	70°	WESTINGHOUSE V10214, exact replacement	PCM 104	QRC 102	QRC 104	9.50
EFR 132	15	70°	WESTINGHOUSE V11548 exact replacement	PCM 204	QRC 102	QRC 106	9.50
EFR 138	12.5	70°	DeWALD No. 1120A, CROSLEY, JACKSON B 1675-13A, B 1676-13A exact replacement	PCM 85	QRC 102	QRC 106	9.50
EFR 142	12	70°	AC/DC Auto Transformer uses 100 V. B+	PCM 145	none	none	9.50
EFR 148	13	70°	ZENITH, earlier models, exact replacement	PCM 85	QRC 102	QRC 106	9.50
EFR 149	12	70°	ZENITH, later models, exact replacement	PCM 85	QRC 102	none	9.50
EFR 152	16	70°	RCA 230T1 exact replacement	PCM 144	QRC 109	QRC 110	10.00
EFR 153	16	70°	RCA 225T1 exact replacement. DUMONT 20008061	PCM 144	QRC 109	QRC 110	10.00
EFR 155	19	90°	RCA 235T1 exact replacement	PCM 2045	QRC 109	QRC 110	15.00
EFR 158	16	70°	OLYMPIC TR-2771 STROMBERG 161042, 161046 exact replacement	PCM 144	QRC 109	QRC 103	9.50
EFR 162	13	70°	SYLVANIA 241-0003 exact replacement	PCM 144	QRC 106	QRC 103	8.50
EFR 163	13	70°	SYLVANIA 241-0005, 6 exact replacement	PCM 144	QRC 107	QRC 103	8.50
EFR 164	13	70°	SYLVANIA 241-0007 exact replacement	PCM 204	QRC 112	QRC 103	8.50
EFR 167	14.5	70°	ADMIRAL 79C30-1, -3 exact replacement	PCM 144	QRC 103	QRC 103	10.00
EFR 168	14.0	70°	ADMIRAL 79C30-2, -4 exact replacement	PCM 144	QRC 103	QRC 103	10.00
EFR 169	15.0	70°	ADMIRAL 79D41-1 exact replacement	PCM 175	QRC 105	QRC 110	9.50
EFR 170	15.0	70°	ADMIRAL 79D41-2 exact replacement	PCM 175	QRC 105	QRC 110	9.50
EFR 175	12	70°	MOTOROLA 24K 792 753, 24K 700 588, 24C 792 596, 24K 701 099, 24C 701 134	PCM 305	—	—	9.50
EFR 177	16	70°	MOTOROLA 24C 711 265, 24C 721 290, 24K 722 126, 24K 721 301, 24K 711 266, 24K 730 692	PCM 243	—	—	11.50
EFR 178	16	70°	MOTOROLA 24K 702 975, 24K 711 937	PCM 243	—	—	11.50
EFR 181	13	66°	PHILCO No. 32-8428-2	PCM 144	—	—	9.50
EFR 182	13	66°	PHILCO No. 32-8453-3	PCM 105	—	—	12.50
EFR 183	13	66°	PHILCO No. 32-8509	PCM 105	—	—	12.50
EFR 184	13	70°	PHILCO No. 32-8509-2	PCM 105	—	—	12.50
EFR 185	13	70°	PHILCO No. 32-8534	PCM 144	—	—	9.50
EFR 186	15	70°	PHILCO No. 32-8555	PCM 305	none	none	9.50
EFR 187	14	70°	PHILCO No. 32-8565	PCM 305	none	none	9.50
EFR 190	16	70°	MUNTZ T0-0031 exact replacement	PCM 105	none	QRC 103	10.00
EFR 192	13	70°	CBS 10136, CROSLEY exact replacement	PCM 85	QRC 112	QRC 104	10.00
EFR 194	18	90°	MAGNAVOX 360552, 360557 exact replacement	PCM 1045	QRC 102	QRC 106	10.00

—: Do Not Make. none: Not in Circuit. All Transformers Include Complete Instructions For Installation.

COILS					DEFLECTION YOKES							
QRC Part No.	Description and Use	L (mh)		R (ohms)	List Price	Part No. PCM	Inductance (mh)		Resistance		Def. Angle	List Price
		min.	max.				Hor.	Vert.	Hor.	Vert.		
101	GE width coil with AGC winding	5	30	28	1.65	84	8.3	43	9.6	45	70°	\$9.00
102	RCA 201R4 width coil	.16	.65	1.2	.95	104	10.3	43	12.5	45	70°	9.00
103	Tapped linearity (RCA 207R1)	1.3	4.3	7.0	1.20	105	10.3	50	12.5	53	70°	9.00
104	GE width & lin. coils RLD-014	5	30	28	1.20	144	14.0	43	18.0	45	70°	9.00
105	QRC-102 with AGC/width winding	.16	.65	1.2	1.65	145	14.0	50	18.0	53	70°	9.00
106	RCA 201R3 Lin. Coil	3	9	28	1.20	175	17.5	50	21.5	53	70°	9.00
107	AFC coil	4	20	35	1.20	204	20.0	43	25.0	53	70°	9.00
108	RCA 211R1 width coil	1.65	9.2	8.8	1.20	243	24.0	3	28.5	3.2	70°	9.00
109	RCA 212R1 width coil	2.9	16	12	1.20	244	24.0	43	28.5	45	70°	9.00
110	RCA 213R1 lin. coil	1.5	8.3	8.3	1.20	245	24.0	50	28.5	53	70°	9.00
111	RCA 201R5 tap. lin. coil	.55	2.3	8.3	1.20	303	30.0	3	32	3.2	70°	9.00
112	Width coil	.5	2.5	2.5	1.00	305	30.0	50	32	53	70°	9.00
						1045	10.5	45	12	52	90°	15.00
						2045	20	45	28	52	90°	15.00

Each yoke supplied with color coded leads and matched network.

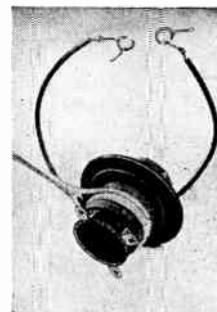
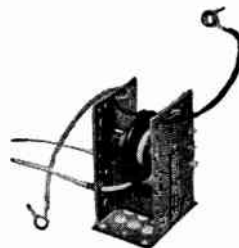
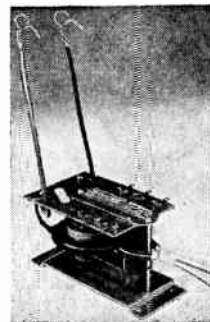

All ROGERS deflection components are individually packed—attractively packaged.

Prices subject to change without notice.

"the eye tells why"

ROGERS ELECTRONIC CORP. New York 12, N. Y.

CREST

LABORATORIES, INC.

84-11 Blvd.
Rockaway Beach 93, N. Y.

See additional transformer product listing under Microtran Co., division of Crest Laboratories Inc.



LVB-117 Line Voltage Booster

Engineered to safely and accurately restore required voltage to any TV set or electrical appliance. Insures full strength, width, and height of TV picture when low line voltage weakens and shrinks picture. Corrects low line voltage sync and oscillator drift troubles.

350 watt rating . . . ample for most requirements, restores line voltage of 90 through 135 volts to 117 volts output. Simple plug-in installation. Automatically operated . . . turns on and off with set or appliance. Multi-Tap Selector Switch and Calibrated Neon Indicator permit exact voltage boost. Overload Fuse Protection protects against unsafe line voltage increase.

Shipping weight: 4 lbs.

LIST PRICE \$1795

LVB "Jr" Economy Voltage Booster

Reliable budget priced unit. Single switch control . . . provides 10 volt boost, drop or straight-through line. 350 watt rating . . . simple plug-in installation.

Catalog No. 3021

Shipping weight: 3 lbs.

LIST PRICE ONLY \$675



Replacement Receiver Transformers

Designed to provide the serviceman with a series of transformers that require minimum investment to cover the most often required repair needs. Tube to 3.2 OHM voice coil.

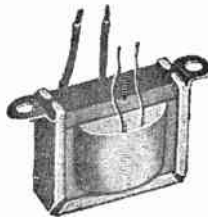

PART NO.	APPLICATION	PR. TRP	PR. MA.	MAX. WATTS	MTG. CENTERS	DIMENSIONS H W D	WT. LBS.	LIST PRICE
OP811	3267, 50CS, 35C3 70L7, 70A7, 50C6 7A5, 35A5	2500	50	5	1 3/4"	1" x 13/16" x 7/16"	.4	\$1.50
OP812	50L6 35L6 25L6	3500	40	5	1 7/8"	1" x 13/16" x 7/16"	.4	\$1.60
OP813	6W6, 6V6, 7C5 35A, 15A, 6AQ5 35A5, 25AC5	5000	40	5	1 3/4"	1" x 13/16" x 7/16"	.4	\$1.70
OP814	3V4, 3C5, 30A 1C5, 10S, 30S 1AC5	10,000	10	5	1 3/4"	1" x 13/16" x 7/16"	.4	\$1.80
OP815	6F6, 6K6, 7B5 6N6, 6B5 12A6	7500	33	5	2"	1 1/2" x 3/8" x 3/8"	.5	\$1.85
AB111	Vert. Block. 1:4.5 Oscillator ratio				2"	1 1/2" x 3/8" x 3/8"	.5	\$2.45

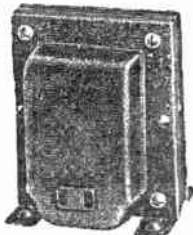

Step Down Auto Transformers

Equipped with secondary standard receptacle and primary 6 foot line cord. 240/220 V to 120/110 V 50/60 Cycles

Part No.	Application	Dimensions		Weight in lbs	List Price
		H	W		
M1556	100 Watt capacity	3 1/2"	2 1/8"	4	\$10.55
M1559	300 Watt capacity	3 3/4"	3 1/4"	7	14.30
M1558	500 Watt capacity	4 1/4"	3 3/4"	12	21.00
M1557	1000 Watt capacity	6 1/4"	4 1/2"	29	50.30



MICROTRAN

DIVISION OF CREST LABORATORIES INC.

miniature transformers

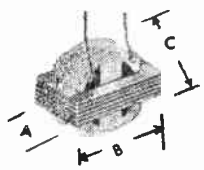
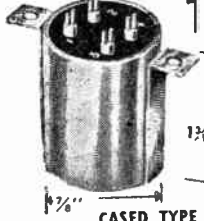
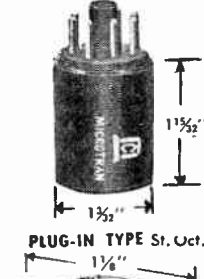
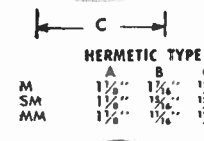
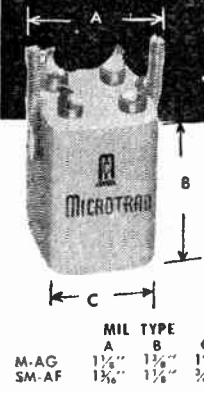

These ruggedized military type units were developed to meet demands of a growing miniaturization program.

All units shown are supplied from stock either hermetically sealed, potted, or open frame construction. Units are available in miniature, sub-miniature, micro-miniature, and veri-miniature sizes compatible with response, d.c. current, and power handled.

Hermetically sealed units can be obtained in MIL AF or AG cases with ceramic compression terminals or in compact cylindrical cans with glass bead terminals as shown. Open frame units are resin impregnated to provide thorough protection from adverse climatic conditions and are supplied with strongly anchored flexible 4" color coded leads.

MINIATURE TRANSFORMERS

PART NO.	MIL TYPE	APPLICATION	PRIMARY IMPED.	SEC. IMPED.	RES. ± 2 db.	LIST PRICE
M1	TF1A10YY	Mike pickup or line to 1 grid	50, 200, 600 C.T.	50,000	20-20,000	\$15.40
M2	TF1A10YY	Mike pickup or line to 2 grids	50, 200, 600 C.T.	50,000	20-10,000	15.40
M3	TF1A10YY	Dynamic mike to 1 grid	7.5, 30	50,000	20-20,000	14.30
M4	TF1A15YY	Single plate to 1 grid	15,000	60,000	20-15,000	12.10
M5	TF1A15YY	Single plate to 1 grid	15,000 4MA.D.C.	60,000	20-15,000	12.10
M6	TF1A15YY	Single plate to 2 grids	15,000	95,000	200-20,000	14.30
M7	TF1A15YY	Single plate to 2 grids	15,000 4MA.D.C.	95,000	20-15,000	14.30
MB	TF1A13YY	Single plate to line	15,000	50, 200, 600 C.T.	200-20,000	15.40
M9	TF1A13YY	Single plate to line	15,000 4MA.D.C.	50, 200, 600 C.T.	20-20,000	15.40
MM0	TF1A13YY	Push pull plates to line	30,000 ohms P.-P.	50, 200, 600 C.T.	150-20,000	15.40
M11	TF1A10YY	Crystal mike to line	50,000	50, 200, 600 C.T.	30-50,000	15.40
M12	TF1A16YY	Mixing and matching	50, 200	50, 200, 600 C.T.	20-20,000	15.40
M13	TF1A20YY	Reactor 300 HYS. - No. D.C.	50 HYS - 3MA. D.C.	6,000 ohms D.C. res.	30-40,000	14.30
M14	TF1A10YY	50: 1 mike or line to 1 grid	200	1/2 Megohm	80-3,000	11.00
M15	TF1A15YY	10: 1 single plate to 1 grid	10,000	1 Megohm	100-2,500	15.40

SUB MINIATURE TRANSFORMERS

PART NO.	MIL TYPE	APPLICATION	PRIMARY IMPED.	SEC. IMPED.	RES. ± 2 db.	LIST PRICE
SM1	TF1A10YY	Input	200, 50	250,000, 62,500	80-10,000	\$12.90
SM2	TF1A15YY	Interstage 3:1	10,000	90,000	100-10,000	12.90
SM3	TF1A13YY	Plate to line	10,000 3MA.	200	150-10,000	12.90
SM4	TF1A13YY	Output	30,000 1MA.D.C.	50	70-10,000	12.90
SM5	TF1A20YY	Reactor 50 HY 1 MA.	4,000 ohms.D.C. res.	60	100-10,000	10.90
SM6	TF1A13YY	Output	100,000 .5MA.D.C.	60	100-10,000	12.90

MICRO MINIATURE TRANSFORMERS

PART NO.	MIL TYPE	APPLICATION	PRIMARY IMPED.	SEC. IMPED.	RES. ± 2 db.	LIST PRICE
MM1	TF1A10YY	Input	200, 50	250,000, 62,500	200-10,000	\$12.90
MM2	TF1A15YY	Interstage 3:1	10,000	90,000	150-10,000	12.90
MM3	TF1A13YY	Plate to line	10,000 3MA.	200	150-10,000	12.90
MM4	TF1A13YY	Output	30,000 1MA.D.C.	50	150-10,000	12.90
MM5	TF1A20YY	Reactor 50 HY 1 MA.	3,500 ohms.D.C. res.	60	200-10,000	10.90
MM6	TF1A13YY	Output	100,000 .5MA.D.C.	60	200-10,000	12.90

TRANSISTOR TRANSFORMERS

PART NO.	MIL TYPE	APPLICATION	PRIMARY IMPED.	SEC. IMPED.	M	SM & MM	LIST PRICE
*T1	TF1A10YY	Input-Line to emitter	500	500			\$14.50
*T3	TF1A15YY	Interstage-collector to emitter	50,000	500			15.70
*T5	TF1A13YY	Output-collector to speaker	50,000	6			14.50
*T6	TF1A15YY	Collector to PP emitter	100,000	1200 C.T.			16.00
*T7	TF1A15YY	Collector to PP emitter	25,000	1200 C.T.			16.20
*T8	TF1A15YY	PP collector to PP emitter	50,000 C.T.	1200 C.T.			15.75
*T9	TF1A10YY	Line to PP emitter	600/150 C.T.	1200 C.T.			16.50
*T10	TF1A15YY	Collector to emitter	25,000	600			15.75
*T11	TF1A13YY	PP collector to line	4000 C.T.	600/150 C.T.			16.50
*T12	TF1A13YY	Collector to speaker	2K	3.4			15.70
*T13	TF1A13YY	PP collector to speaker	4K C.T.	3.4			16.00

VERI MINIATURE TRANSFORMERS

PART NO.	LEVEL MW	APPLICATION	PRIMARY IMPEDANCE	SECONDARY IMPEDANCE	PRI. D.C.R.	SEC. D.C.R.	LIST PRICE
VM1-F	30	Input	50	600 (1.5ma)	6	70	\$ 8.00
VM2-F	3	Input or Interstage	200K	600 (1.0ma)	2650	80	10.50
VM4-F	3	Input or Interstage	200K	1200 (.72ma)	2650	160	10.50
VM5-F	3	Interstage	50K	600 (1.0ma)	1500	60	9.25
VM7-F	30	Output	500 (3.5mo)	3.4	60	.5	8.00
VM8-F	30	Output	1250 (2.0ma)	3.4	115	.5	8.20
VM9-F	30	Output	1250 (2.0ma)	50	115	.6	8.20
VM11-F		Choke	20hy. (0ma)	12hy. (.5ma)	1000		7.25

(Frequency Response 200 to 10 KC.; weight .01 lbs.; open frame only)

*Add M prefix to denote Miniature size, SM for sub-miniature size, MM for micro-miniature size, VM for veri-miniature.

† Add: - AG suffix for miniature unit in MIL-AG can - AF suffix for sub-miniature unit in MIL-AF can - F suffix for unit supplied in open frame construction - P suffix for miniature size in plug in case - A suffix for miniature size in aluminum can.

List prices are shown only for Hermetic and veri-miniature units. Write for catalog giving complete prices and specifications.

See additional transformer and product listings under Crest Laboratories Inc.

GRAMER TRANSFORMER CORPORATION

presents

TRANSISTOR TRANSFORMER

TINYFORMERS

"The Most Efficient of All"



OPEN TYPE TINYFORMERS

Part numbers M1 thru M10

Preferred and specified as standard equipment by leading manufacturers of miniature electronic devices. Available in 7 types, each heat sealed in a cellulose acetate envelope, contained in fibreglass box with Chart Sheet that gives frequency in cycles, response in decibels and complete details.

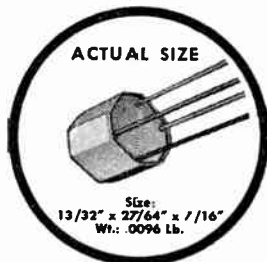

MU-METAL SHIELDED TINYFORMERS

Part numbers M1-S thru M7-S

Mu-Metal Shielded Tinyformers are for use in closely coupled or high gain circuits. Hum level can be reduced 18 to 20 db. Tiny size, extreme lightweight (104 per pound) are made possible by fine wire, precise nylon coil forms and high-nickel alloy high-Q cores. Supplied in satin finish with flexible color coded leads. The Mu-Metal Shielded Tinyformer is potted in a non-hydroscopic compound for excellent moisture and humidity-proof construction.

HERMETICALLY SEALED TINYFORMERS

Part numbers M1-H thru M7-H

Hermetically sealed to Mil-T-27, Grade 1, Class A. Glass sealed 1/8" high terminal construction.

Tinyformer is encased and sealed in metal container with a black satin finish. Mounts with one #3-48 stud, 3/16" long and is supplied with lock washer and nickel plated hex nut.



GRAMER TINYFORMER

transformers are designed for highest efficiency in transistor circuits. Tiny size and extreme lightweight are made possible by fine wires, precise nylon coil forms and high-nickel alloy high-Q cores. They are attractively packaged for quick sales.

OPEN TYPE PART NO	MU-METAL SHIELDED PART NO.	HERMETICALLY SEALED PART NO	TYPE	MATCH. IMPEDANCE		D.C. RESISTANCE	
				PRI.	SEC.	PRI.	SEC.
M 1	M 1-S	M 1-H	Interstage	20,000	1,000	1,150	175
M 2	M 2-S	M 2-H	Interstage	20,000	1,000	930	95
M 4	M 4-S	M 4-H	Output	600	50	66	7.7
M 5	M 5-S	M 5-H	Output	400	50	70	9.3
M 6	M 6-S	M 6-H	Input	200,000	1,000	2,600	135
M 7	M 7-S	M 7-H	Output	1,000	50/60	160	9
M 10	—	—	Choke	12 Hy.	O D.C.	830	

A Complete Line of Transformers up to 2 KVA; Toroids to Commercial or Military Specifications; I.F. and R.F. Coils and Transformers. See Your Distributor or Write for Details.



TRANSFORMER CORPORATION

2734 NORTH PULASKI ROAD · CHICAGO 39, ILLINOIS



TRANSFORMERS

For Electronic Equipment

MILITARY, INDUSTRIAL, & COMMERCIAL

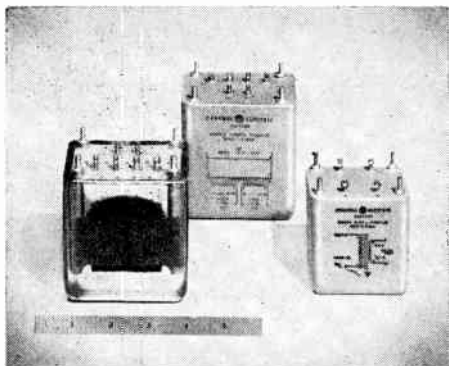

Cast-permafil transformers

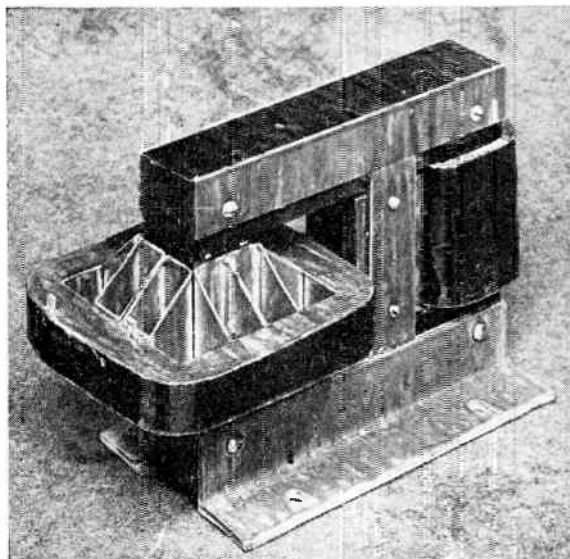

Special magnetron filament transformer

Plate
Filament
Plate and Filament
Filter Reactors
Pulse
Audio

in

Core-and-coil
Permafil
Cast-permafil
Compound-filled
Hermetic
Construction

for

Radar
Communication
Television and Radio
Transmitters
and Similar Equipment

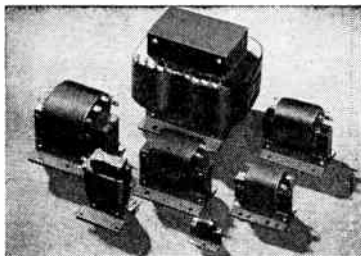

Permafil-type transformer

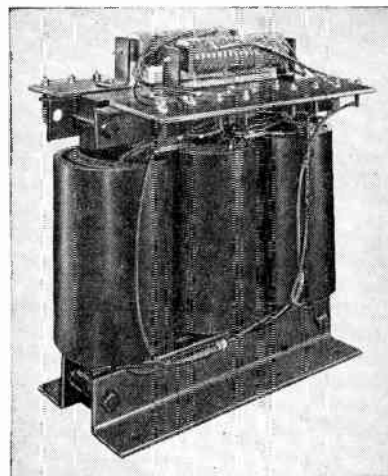

Core-and-coil assemblage for plate transformer
for use with rectifier, 33.3 kva

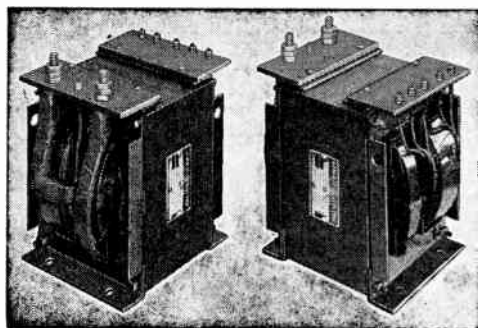

Heavy-duty, high-reactance filament transformers

The above illustrations show only a few of the transformers typical of this line. More complete information may be obtained by sending your request for details, along with specific requirements, to the nearest G-E Apparatus Sales Office.

DRY ELECTROLYTIC CAPACITORS

P. R. MALLORY & CO. INC.
MALLORY

P. R. MALLORY & CO., INC. - INDIANAPOLIS

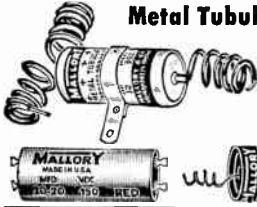

Metal Tubular Dry Electrolytic Capacitors

For filter and audio by-pass circuits. Sealed aluminum tube with external insulating sleeve. 3" bare, tinned-copper or insulated leads at each end, except TCS styles which have solder lugs. For use up to 85°C except types designated (†).

Single Section

Catalog Number	Cap. Mfd.	DC Wkg. Volts	Size Dia. Length	List Price
TC310	1000	3	1 5/16 x 1 3/4	\$1.70
TC605	500	6	1 3/8 x 1 3/4	1.55
TC610	1000	6	1 3/8 x 2	1.90
TC1502	200	15	1 3/8 x 1 1/2	1.40
TC1505	500	15	1 3/8 x 2	1.75
TC22	10	25	3/8 x 1 1/4	1.00
TC26	25	25	3/8 x 1 1/4	1.00
TC29	50	25	1 1/8 x 1 1/2	1.10
TC2501	100	25	1 1/8 x 1 3/4	1.35
TC2505	500	25	1 1/8 x 2 1/4	2.30
TC302	2	50	3/8 x 1 1/4	.90
TC30	5	50	3/8 x 1 1/4	1.00
TC31	1	50	3/8 x 1 1/4	.90
TC32	10	50	3/8 x 1 1/4	1.00
TC36	25	50	1 1/8 x 1 1/4	1.05
TC39	50	50	1 3/8 x 1 1/4	1.20
TC3501	100	50	1 3/8 x 2	1.40
TC40	5	150	3/8 x 1 1/4	1.40
TC41	8	150	1 1/8 x 1 1/4	1.05
TC42	10	150	1 1/8 x 1 1/4	1.05
TC43	12	150	1 1/8 x 1 1/2	1.10
TC44	16	150	1 1/8 x 1 1/2	1.15
TC45	20	150	1 3/8 x 1 1/2	1.20
TC47	30	150	1 3/8 x 1 1/2	1.30
TC48	40	150	1 3/8 x 1 3/4	1.35
TC49	50	150	1 3/8 x 1 3/4	1.40
TC492	80	150	1 3/8 x 2 1/4	1.60
TC495	150	150	1 1/8 x 2 3/8	1.90
TC50X	5	250	1 1/8 x 1 1/4	1.05
TC51	8	250	1 1/8 x 1 3/4	1.15
TC52	10	250	1 1/8 x 1 3/4	1.20
TC53	12	250	1 3/8 x 1 3/4	1.25
TC54	16	250	1 3/8 x 1 3/4	1.30
TC55	20	250	1 3/8 x 1 3/4	1.35
TC58	40	250	1 1/8 x 1 3/4	1.55
TC59	50	250	1 1/8 x 1 3/4	1.70
TC60	8	350	1 1/8 x 1 3/4	1.05
TC61	8	350	1 3/8 x 1 3/4	1.20
TC62	10	350	1 3/8 x 1 3/4	1.25
TC63	12	350	1 3/8 x 1 3/4	1.30
TC64	16	350	1 3/8 x 1 3/4	1.40
TC65	20	350	1 3/8 x 1 3/4	1.45
TC68	60	350	1 1/8 x 2 3/8	1.95
TC70	5	450	1 3/8 x 1 3/4	1.20
TC71	8	450	1 3/8 x 1 3/4	1.25
TC72	10	450	1 3/8 x 1 3/4	1.30
TC73	12	450	1 3/8 x 1 3/4	1.35
TC74	16	450	1 3/8 x 1 3/4	1.40
TC75	20	450	1 1/8 x 1 3/4	1.55
TC77	30	450	1 1/8 x 2 1/4	1.70
TC78	40	450	1 1/8 x 2 1/4	1.80
TC81	10	500	1 3/8 x 1 3/4	1.35
TC82	10	500	1 1/8 x 2 1 3/8	2.70
TC83	20	500	1 1/8 x 1 3/4	1.60
TC84	30	500	1 1/8 x 2 1/4	1.75
TC92	10	600	1 1/8 x 2 1 3/8	2.95
TC50025	250	50	1 1/8 x 2 1/4	1.75

Dual Common Negative

Catalog Number	Cap. Mfd.	DC Wkg. Volts	Size Dia. Length	List Price
TCD26	25-25	25	1 3/8 x 1 3/4	\$1.40
TCD45	20-20	150	1 3/8 x 2	1.65
TCD47	30-30	150	1 3/8 x 2	1.85
TCD48	40-40	150	1 1/8 x 2	1.75
TCD485	40-20	150	1 1/8 x 2	1.75
TCD49	50-50	150	1 1/8 x 2 1/4	2.10
TCD497	50-30	150	1 1/8 x 2 1/4	1.95
TCD498	80-50	150	1 1/8 x 2 1/4	1.95
ICD52	10-10	250	1 3/8 x 2	1.65
TCD55	20-20	250	1 1/8 x 2	1.85
TCD62	10-10	350	1 3/8 x 2	1.70
TCD65	20-20	350	1 1/8 x 3 3/8	2.25
TCD71	8-8	450	1 3/8 x 2	1.70
TCD72	10-10	450	1 1/8 x 2	1.85
TCD74	15-15	450	1 1/8 x 3 3/8	2.20
TCD75	20-20	450	1 1/8 x 3 3/8	2.50

Mallory Electrolytic Capacitors make excellent replacements in selenium rectifier power supply circuits.

Mallory Page 1

Dual Separate Section

Catalog Number	Cap. Mfd.	DC Wkg. Volts	Size Dia. Length	List Price
TCS44	15-15	150	1 3/8 x 2 3/4	\$2.00
TCS45	20-20	150	1 3/8 x 2 3/4	2.10
TCS47	30-30	150	1 1/8 x 2 3/4	2.25
TCS48	40-40	150	1 1/8 x 2 3/4	2.35
TCS505	70-70	175	1 1/8 x 3 3/4	3.60
TCS52	10-10	250	1 3/8 x 2 3/4	2.10
TCS55	20-20	250	1 3/8 x 2 3/4	2.35
TCS61	8-8	350	1 3/8 x 2 3/4	2.10
TCS64	15-15	350	1 1/8 x 2 3/4	2.75
TCS71	8-8	450	1 1/8 x 2 3/4	2.15
TCS74	15-15	450	1 1/8 x 2 3/4	2.75
TCS75	20-20	450	1 1/8 x 3 3/4	3.15



FP-WP Dry Electrolytic Capacitors

For use at ambient temperatures up to 85°C in filter and by-pass circuits in radio, TV and industrial electronics. Sealed in aluminum cans with twist-prong, lug construction. FP types have Mallory exclusive Fabricated Plates. WP have special etched plates. All feature low RF impedance and minimum coupling between sections. Separate anode terminals. Case is common cathode. For hardware, see page 11, Mallory Capacitors Section, of this catalog.

FP-WP—Singles

Catalog Number	Capacity Mfd.	Working Volts—DC	Size D L	List Price
WP510	.5Z/15750 cycles	3V	1 x 2	\$2.20
WP540	1.0Z/60 cycles	3V	1 3/8 x 3	4.00
WP505	10Z/30 cycles	3V	3/8 x 2	2.00
WP035	225	15	3/8 x 2	1.75
WP039	1000	15	1 x 2 1/2	2.55
WP041	2000	15	1 3/8 x 2 1/2	3.45
WP042	3000	15	1 3/8 x 3	3.50
WP052	40	25	3/8 x 2	1.35
WP055	100	25	1 x 2	1.60
WP057	500	25	1 x 2 1/2	2.55
WP059	1000	25	1 3/8 x 2	3.55
WP063	4	50	3/8 x 2	1.25
WP065	500	50	1 3/8 x 2	2.65
WP068	1500	50	1 3/8 x 4	3.85
FP113	30	150	3/8 x 2	1.55
FP116	100	150	1 x 2	1.65
FP118	150	150	1 x 2 1/2	2.00
FP117	150	150	1 x 3	2.15
FP119	300	150	1 3/8 x 3	2.80
FP125	15	250	3/8 x 2	1.55
FP135	30	350	1 x 2	1.90
FP137	50	350	1 x 2 1/4	2.10
FP138	80	350	1 3/8 x 2 1/2	2.85
FP140	125	350	1 3/8 x 3	3.95
FP142	10	450	3/8 x 2	1.55
FP143	15	450	1 x 2	1.70
FP144	20	450	1 x 2	1.80
FP145	30	450	1 x 2 1/4	1.95
FP146	40	450	1 x 2 1/4	2.05

FP-WP—DUALS

Catalog Number	Capacity Mfd.	Working Volts—DC	Size D L	List Price
FP149	80	450	1 3/8 x 2 1/2	\$3.05
WP204	250-1000	10-6	1 3/8 x 2	2.85
WP205	.5Z-2.5Z/15750C-60C	12-6V	1 3/8 x 4	3.60
WP200	1000-1000	15-15	1 3/8 x 2 1/2	4.40
WP206	50-150	150-25	1 x 2 1/2	2.20
FP208	20-20	150-150	1 x 2	1.70
FP210	30-30	150-150	1 x 2	1.85
FP211	40-20	150-150	1 x 2	1.80
FP212	40-40	150-150	1 x 2	1.90
FP213	50-30	150-150	1 x 2 1/2	2.00
FP214	50-50	150-150	1 x 2 1/2	2.15
FP214.5	75-75	150-150	1 3/8 x 2	2.60
FP216	80-40	150-150	1 x 3	2.30
FP215	125-100	150-150	1 3/8 x 2 1/2	3.40
FP216.1	200-5	150-150	1 3/8 x 2 1/2	2.75
FP216.3	200-150	150-150	1 3/8 x 4	3.75
FP216.4	200-200	150-150	1 3/8 x 4	4.00
FP217	20-20	250-250	1 x 2	1.90
FP221	40-40	250-250	1 x 3	2.50
FP217.7	150-150	250-250	1 3/8 x 4	5.15
FP217.9	75-75	300-300	1 3/8 x 3	3.80
FP218	120-20	300-300	1 3/8 x 3	4.00
FP225	15-15	350-350	1 x 2	2.25
FP227	20-20	350-350	1 x 2 1/2	2.30
FP227.3	30-30	350-350	1 x 3	2.90
FP227.6	80-80	350-350	1 3/8 x 4	4.70
FP229	35-100	400-50	1 x 3	2.60

See next page for additional values

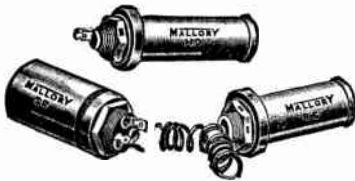

**Aluminum Can
Threaded Neck
Dry Electrolytic
Capacitors**

For replacement of wet and dry electrolytic capacitors. RS, RM and HS have flexible, insulated leads. HD and SR have solder lug anode connections; cathodes are connected to case.

Catalog Number	Capacity Mfd.	Volts DC	Size Dia. Length	List Price
RS207	30	250	1 x 3 1/2	\$2.05
RS212	8	450	1 1/4 x 3	2.20
RS213	8	450	1 x 2 3/4	2.20
RS214	12	450	1 1/4 x 3	2.40
RS215	12	450	1 x 2 3/4	2.40
RS216	16	450	1 x 3 1/2	2.45
RS217	16	450	1 1/4 x 3	2.45
RS219	20	450	1 1/4 x 3	2.70
RS223	30	450	1 1/4 x 3	3.00
RS224	40	450	1 1/4 x 3	3.15
HD684	10	450	1 x 3	2.30
HS691*	4	600	1 1/4 x 4	2.95
HS693*	8	600	1 1/4 x 4	3.15
HS696*	20	600	1 1/4 x 4 1/4	3.85
RM262	8-8	450	1 1/4 x 3	3.00
RM265	8-8-8	450	1 1/4 x 4 1/4	5.00
SR638	8-8	450	1 1/4 x 2 3/4	3.00
SR645	8-8	450	1 1/4 x 2 3/4	3.00

* Will operate at 85°C. Others operate at 65°C.



**Cardboard Tubular Dry
Electrolytic Capacitors**

Economical, cardboard tube, wax-sealed filter and by-pass units. Have flexible, insulated leads out one end except those marked (*) which have negative leads out opposite ends. All units (except TN111) are supplied with mounting strap; in addition all units marked (†) have special feet for vertical mounting.

Catalog Number	Capacity Mfd.	Volts DC	Size D L	List Price
Single Section				
ST595†	8	450	1 3/4 x 2 1/4	\$1.25
ST597†	16	450	7/8 x 2 3/4	1.40
ST598†	20	450	1 x 2 3/4	1.55
ST599†	30	450	1 x 3 1/4	1.70
ST645	60	450	1 3/4 x 3 3/4	2.35
ST845	80	450	1 3/4 x 4 3/4	2.80
Dual Common Negative				
TN111‡	10-10	25-25	5/8 x 1 3/4	\$1.40
2N501	250-1000	10-6	1 1/4 x 2 3/4	2.80
2N509*	20-20	150-150	3/4 x 2 1/2	1.65
2N513*	30-30	150-150	7/8 x 2 3/4	1.80
2N514*	40-20	150-150	7/8 x 2 1/2	1.75
2N511*	40-40	150-150	1 5/8 x 2 1/2	1.85
2N520*	50-30	150-150	1 5/8 x 2 3/4	1.95
2N521†	50-50	150-150	1 x 2 1/2	2.10
2N523	100-100	150-150	1 1/2 x 3 3/4	3.20
2N525	30-30	200-200	1 x 2 3/4	2.20
2N527	50-75	250-50	1 1/4 x 2 3/4	2.40
2N529	100-150	250-50	1 1/2 x 3 3/4	3.60
2N516*	8-8	250-250	7/8 x 2 1/4	1.60
2N531	40-40	300-300	1 1/2 x 3 3/4	2.95
2N533	40-50	450-50	1 1/2 x 3 3/4	2.50
2N535	30-60	450-300	1 1/4 x 3 3/4	3.20
2N518†	8-8	450-450	1 5/8 x 2 3/4	1.70
2N537	40-40	450-450	1 1/2 x 3 3/4	3.40
Dual Separate Section				
2S556†	30-30	150-150	1 x 2 3/4	\$2.25
2S567†	8-8	450-450	1 1/2 x 2 3/4	2.15
2S569†	16-16	450-450	1 1/4 x 3 3/4	2.80

Cardboard Tubular Dry Electrolytic Capacitors
(Continued from Preceding Column)

Catalog Number	Capacity Mfd.	Volts DC	Size D L	List Price
Triple Common Negative				
3N527*	20-20-20	150-150-25	1 5/8 x 2 1/4	\$2.05
3N533*	30-30-20	150-150-25	1 x 2 3/4	2.20
3N529	50-30-200	150-150-25	1 1/8 x 2 3/4	2.75
TN125*	20-10-10	150-150-150	3/8 x 2 3/4	2.00
3N528	20-20-20	150-150-150	1 3/8 x 2 3/4	2.15
TN129†	40-20-20	150-150-150	1 5/8 x 2 3/4	2.25
3N534	30-30-30	150-150-150	3/8 x 2 3/4	2.35
3N532	40-40-20	150-150-150	1 x 2 3/4	2.35
3N536	40-40-40	150-150-150	1 x 3	2.45
3N538	80-40-20	150-150-150	1 x 3 1/4	2.75
3N540	80-50-50	150-150-150	1 1/8 x 3 1/2	3.10
3N535	40-30-40	350-250-150	1 3/8 x 3 3/4	3.30
3N537	30-50-100	450-150-25	1 1/4 x 3 3/4	3.20
3N539	30-30-30	450-350-250	1 1/4 x 3 3/4	3.75
3N541	40-20-10	450-450-450	1 1/4 x 3 3/4	3.55

Triple Separate Section				
3S579†	8-8-20	450-450-25	1 1/8 x 2 3/4	\$2.65
3S584†	8-8-8	450-450-450	1 1/8 x 2 3/4	2.85

Quad Common Negative				
4N723	10-10-10-150	450-450-450-50	1 1/8 x 3 3/4	\$3.60
4N727	10-10-10-10	450-450-450-450	1 1/8 x 3 3/4	3.25

Quad Separate Section				
4S715†	16-16-10-10	150-150-25-25	1 1/4 x 2 3/4	\$3.25

‡ Has bare tinned leads out both ends.

**Plastic Cased High Capacity and Non-Polarized
Electrolytic Capacitors**



HC types are for use with dry disc rectifiers, in such applications as; movie equipment and electric fence power supplies. NP types are non-polarized for intermittent AC service.

Catalog Number	Capacity Mfd.	DC Wkg. Volts	Size D L	List Price
HC1020	2000	10	1 1/8 x 3 3/4	\$3.95
HC1040	4000	10	1 1/8 x 3 3/4	4.75
HC1060A*	6000	10	1 1/2 x 4 1/4	5.55
HC1520	2000	15	1 1/4 x 3 3/4	4.70
HC1540	4000	15	1 1/8 x 3 3/4	5.50
HC1560	6000	15	1 1/8 x 4 3/4	6.30
HC2510	1000	25	1 1/4 x 3 3/4	4.85
HC2520	2000	25	1 1/8 x 3 3/4	5.75
HC2540	4000	25	1 1/8 x 4 3/4	6.75
HC5005	500	50	1 1/4 x 3 3/4	3.90
HC5010	1000	50	1 1/8 x 3 3/4	6.40
HC5020	2000	50	1 1/8 x 4 3/4	8.75
HC15010	1000	150	2 1/4 x 4 3/4	10.50
HC20005	500	200	2 1/4 x 4 3/4	9.80
HC45003**	300	450	2 1/4 x 4 3/4	10.50
FF45052**	525	450	2 1/4 x 4 3/4	12.50
NP1225	200	125	1 1/8 x 4 3/4	5.00
NP1235	300	125	2 1/4 x 4 3/4	5.75
NP1255	500	125	2 1/4 x 4 3/4	7.50
NP3003	15	300	1 1/4 x 3 3/4	3.75
NP3014	100	300	1 1/8 x 4 3/4	6.75
NP3025	200	300	2 1/4 x 4 3/4	9.50
NP4505	50	450	1 1/8 x 3 3/4	7.50
NP4510	100	450	2 1/4 x 4 3/4	11.60

* This unit in Aluminum Case

** Designed for Photoflash Application



Silverlytic Subminiature Capacitors

Catalog Number	Capacity Mfd.	DC Wkg. Volts	Size D L	List Price
ALA-10A1	1	10	7/32 x 3/4	\$2.20
ALA-5A2	2	5	7/32 x 3/4	2.35
ALA-4A4	4	4	7/32 x 3/4	2.55

DRY ELECTROLYTIC AND PLASTIC TUBULAR CAPACITORS

P. R. MALLORY & CO., INC. - INDIANAPOLIS



Bathtub Dry Electrolytic Capacitors



Hermetically sealed for marine, aircraft and geophysical service. Will operate, without derating, from -40°F to 185°F. Have mounting flanges and solder lugs.

Catalog Number	Cap. Mfd.	DC Wkg. Volts	H	Size* W	L	Y	List Price
BS26	25	25	3/4	x 1	x 1 3/4	x 2 1/2	\$4.50
BS29	50	25	3/4	x 1	x 1 3/4	x 2 1/2	4.60
BS36	25	50	3/4	x 1	x 1 3/4	x 2 1/2	4.55
BS39	50	50	7/8	x 1	x 1 3/4	x 2 1/2	4.70
BS48	20	150	7/8	x 1	x 1 3/4	x 2 1/2	4.70
BS62	40	150	1	x 1 1/4	x 1 3/4	x 2 1/2	4.85
BS65	10	300	7/8	x 1	x 1 3/4	x 2 1/2	4.75
BS65	20	300	1 1/8	x 1 1/4	x 1 3/4	x 2 1/2	4.90
BS81	8	500	1	x 1 3/4	x 2	x 2 3/4	5.75
BS91	8	600	1	x 1 3/4	x 2	x 2 3/4	5.85

* H—Height; W—Width; L—Length; Y—Mounting Centers

AC Motor Starting Capacitors

PS type—round, moisture-proof, plastic case. For mounting accessories, see page 11, Mallory Capacitors section, this catalog.



Catalog Number	Mfd. New	Rating Old	Volts AC	Size D	L	List Price
PS2010*	20	20-24	110	1 7/16	x 2 3/4	\$2.05
PS2610*	26	26-30	110	1 7/16	x 2 3/4	2.10
PS3210*	32	32-36	110	1 7/16	x 2 3/4	2.10
PS3810*	38	38-42	110	1 7/16	x 2 3/4	2.10
PS4310*	43	43-48	110	1 7/16	x 2 3/4	2.10
PS5310	53	53-60	110	1 7/16	x 3 3/8	2.15
PS6410	64	64-72	110	1 7/16	x 3 3/8	2.25
PS7010	70	70-78	110	1 7/16	x 3 3/8	2.40
PS7510	75	75-84	110	1 7/16	x 3 3/8	2.55
PS8610	86	86-96	110	1 7/16	x 3 3/8	2.65
PS9710	97	97-107	110	1 7/16	x 3 3/8	2.80
PS10810	108	108-120	110	1 7/16	x 3 3/8	2.85
PS12410	124	124-138	110	1 7/16	x 3 3/8	2.95
PS13010	130	130-157	110	1 7/16	x 3 3/8	2.95
PS14510	145	145-162	110	1 7/16	x 3 3/8	3.20
PS16110	161	161-180	110	1 7/16	x 3 3/8	3.25
PS19410	194	194-216	110	1 7/16	x 3 3/8	3.90
PS20010*	200	200-220	110	1 3/8	x 3 3/8	3.90
PS21610	216	216-240	110	1 3/8	x 3 3/8	4.05
PS24310	243	243-270	110	1 3/8	x 3 3/8	4.70
PS27010	270	270-300	110	1 3/8	x 4 3/8	4.75
PS32410	324	324-360	110	1 3/8	x 4 3/8	5.40
PS34010	340	340-412	110	1 3/8	x 4 3/8	5.55
PS37810	378	378-420	110	2 1/8	x 4 3/8	6.00
PS40010	400	400-450	110	2 1/8	x 4 3/8	6.05
PS43010	430	430-485	110	2 1/8	x 4 3/8	6.95
PS48510	485	485-540	110	2 1/8	x 4 3/8	7.60
PS2520	25	25-30	220	1 7/16	x 3 3/8	4.60
PS3220	32	32-36	220	1 3/8	x 3 3/8	4.90
PS3820	38	38-42	220	1 3/8	x 3 3/8	5.30
PS4320	43	43-48	220	1 3/8	x 3 3/8	5.55
PS5320	53	53-60	220	1 3/8	x 3 3/8	5.75
PS6420	64	64-72	220	1 3/8	x 4 3/8	6.75
PS7020	70	70-78	220	2 1/8	x 4 3/8	7.00
PS7520	75	75-84	220	2 1/8	x 4 3/8	7.35
PS8620	86	86-96	220	2 1/8	x 4 3/8	7.65

* Cases will not accommodate PL caps and HB brackets.

AC Motor Running Capacitors

Have sealed metal cases. Non-inflammable oil impregnation. For continuous AC duty. Not suitable for DC. Capacity tolerance ±10%.



Catalog Number	Cap. Mfd.	Volts AC	Size Dia.	Length	List Price
RP-3301	1	330	1 3/8	x 1 1/2	\$4.20
RP-3302	2	330	1 3/8	x 3 3/16	5.20
RP-3303	3	330	2	x 2 3/8	5.55
RP-3304	4	330	2	x 2 3/8	6.20
RP-3305	5	330	2	x 3 3/8	6.80
RP-3306	6	330	2	x 3 3/8	7.50
RP-3307	7	330	2	x 4 3/8	7.90
RP-3308	8	330	2	x 5 1/8	8.35
RP-3310	10	330	2 1/2	x 4 3/16	9.55
RP-3312	12	330	2 1/2	x 5 1/16	10.90
RP-3315	15	330	2 1/2	x 6 1/16	13.80

Plascap®—Plastic Tubular Paper Capacitors



Have moisture-proof, plastic cases. Malleable-sealed leads, low power-factor and high insulation resistance. For use in bypass, coupling and auto set buffer circuits.

Catalog Number	Capacity Mfd.	Size Dia.	Length	List Price
400 Volts DC				
PT411	.01	3/8	x 1	\$0.25
PT412	.02	3/8	x 1 1/4	.25
PT4122	.022	3/8	x 1 1/4	.30
PT413	.03	7/16	x 1 1/4	.30
PT4133	.033	7/16	x 1 1/4	.30
PT4147	.047	1/2	x 1 1/4	.30
PT415	.05	1/2	x 1 1/4	.30
PT401	.1	1/2	x 1 1/2	.35
PT4015	.15	5/8	x 1 3/8	.40
PT402	.2	5/8	x 1 3/8	.45
PT4022	.22	5/8	x 1 3/8	.45
PT4025	.25	5/8	x 1 3/8	.45
PT4047	.47	3/4	x 2 1/4	.60
PT405	.5	3/4	x 2 1/4	.60
PT41	1.0	1 1/16	x 2 1/16	1.25

Catalog Number	Capacity Mfd.	Size Dia.	Length	List Price
600 Volts DC				
PT621	.001	5/16	x 1	\$0.25
PT622	.002	5/16	x 1	.25
PT6222	.0022	5/16	x 1	.25
PT623	.003	5/16	x 1	.25
PT6233	.0033	5/16	x 1	.25
PT624	.004	3/8	x 1	.25
PT6247	.0047	3/8	x 1	.25
PT625	.005	3/8	x 1	.25
PT626	.006	3/8	x 1	.25
PT611	.01	3/8	x 1 1/4	.30
PT6115	.015	3/8	x 1 1/4	.30
PT612	.02	7/16	x 1 1/4	.30
PT6122	.022	7/16	x 1 1/4	.30
PT613	.03	1/2	x 1 1/4	.35
PT6133	.033	1/2	x 1 1/4	.35
PT614	.04	1/2	x 1 1/2	.35
PT6147	.047	1/2	x 1 1/2	.40
PT615	.05	1/2	x 1 1/2	.40
PT616	.06	1/2	x 1 1/2	.40
PT601	.1	5/8	x 1 3/8	.45
PT602	.2	3/4	x 2 1/4	.70
PT6022	.22	3/4	x 2 1/4	.70
PT6025	.25	3/4	x 2 1/4	.70
PT6047	.47	7/8	x 2 1/16	.80
PT605	.5	7/8	x 2 1/16	.80
PT61	1.0	1	x 3	1.25

Catalog Number	Capacity Mfd.	Size Dia.	Length	List Price
1600 Volts DC				
PT1621	.001	3/8	x 1	\$0.55
PT1622	.002	3/8	x 1 1/4	.55
PT16222	.0022	3/8	x 1 1/4	.55
PT1623	.003	3/8	x 1 1/4	.55
PT16233	.0033	7/16	x 1 1/4	.55
PT1624	.004	7/16	x 1 1/4	.55
PT16247	.0047	7/16	x 1 1/4	.55
PT1625	.005	7/16	x 1 1/4	.55
PT1626	.006	1/2	x 1 1/4	.55
PT1627	.007	1/2	x 1 1/4	.55
PT16275	.0075	1/2	x 1 1/4	.55
PT1628	.008	1/2	x 1 1/4	.60
PT1611	.01	1/2	x 1 1/2	.60
PT16115	.015	5/8	x 1 3/8	.60
PT1612	.02	5/8	x 1 3/8	.60
PT16122	.022	5/8	x 1 3/8	.60
PT1613	.03	5/8	x 1 3/8	.60
PT1614	.04	3/4	x 2 1/4	.70
PT1615	.05	3/4	x 2 1/4	.70
PTD16115	.015-.015	5/8	x 1 3/8	.80

Capacitor Selector



For determining correct capacity to use in making replacements of defective motor starting capacitors which have lost their identity. For checking capacity ranges from 25 to 645 mfd. 110-125 VAC.

Catalog No. MSS-101 \$15.00 Net



**Metal Cased
Oil Impregnated
Paper Capacitors**

For vibrator buffer, coupling and other electronic circuits where highest quality, tubular-type capacitors are required. Mineral oil-impregnated, hermetically sealed, metal-cased tubulars with external insulating sleeves. 2% leads. For operation at 85°C.

Catalog Number	Capacity Mfd.	Working Volts DC	Size Dia. Length	List Price
OT101	.01	600	3/8 x 1 3/16	\$0.95
OT103	.02	600	3/8 x 1 3/16	1.05
OT106	.05	600	1 1/16 x 1 3/16	1.10
OT110	.1	600	1 1/16 x 1 1 1/16	1.25
OT113	.25	600	1 3/16 x 2 1/16	1.70
OT116	.5	600	1 1/16 x 2 1/4	2.20
OT301	.01	1000	3/8 x 1 3/16	1.10
OT303	.02	1000	1 1/16 x 1 3/16	1.20
OT306	.05	1000	1 1/16 x 2 3/16	1.30
OT310	.1	1000	1 3/16 x 2 3/16	1.50
OT370	.002	1600	3/8 x 1 3/16	1.20
OT377	.003	1600	3/8 x 1 3/16	1.20
OT371	.005	1600	3/8 x 1 3/16	1.20
OT372	.008	1600	3/8 x 1 3/16	1.20
OT373	.01	1600	1 1/16 x 1 3/16	1.20
OT375	.015	1600	1 1/16 x 1 1 1/16	1.25
OT376	.02	1600	1 1/16 x 1 1 1/16	1.30
OT378	.03	1600	1 1/16 x 2 3/16	1.30
OT379	.04	1600	1 1/16 x 2 3/16	1.30
OT380	.05	1600	1 1/16 x 2 7/16	1.40
OT458	.0025	2000	1 1/16 x 1 3/16	1.25
OT459	.005	2000	1 1/16 x 1 1 1/16	1.25
OT460	.0075	2000	1 1/16 x 1 3/16	1.25
OT461	.01	2000	1 1/16 x 1 3/16	1.25
OT462	.0125	2000	1 1/16 x 1 3/16	1.30
OT463	.015	2000	1 1/16 x 1 3/16	1.30
OT464	.02	2000	1 1/16 x 2	1.35
OT465	.03	2000	1 3/16 x 2	1.40
OT466	.04	2000	1 3/16 x 2 3/16	1.40
OT467	.05	2000	1 3/16 x 2 3/16	1.45



**Oil Impregnated Cardboard
Cased Tubular Paper
Capacitors**

Ideal for auto set buffer circuits.

Catalog Number	Capacity Mfd.	Working Volts DC	Size Dia. Length	List Price
OW635	.0005	6000	3/16 x 1 3/16	\$1.10
OW621	.001	6000	1 1/16 x 1 3/16	1.10
OW622	.002	6000	2 7/32 x 1 3/16	1.10
OW623	.003	6000	1 x 1 3/16	1.15
OW625	.005	6000	2 7/32 x 2 1/2	1.15
OW6275	.0075	6000	1 3/16 x 2 1/2	1.20
OW611	.01	6000	1 1/2 x 2 1/2	1.20
OW612	.02	6000	1 7/32 x 3	1.25
OW613	.03	6000	1 1/4 x 3 3/4	1.25
OW615	.05	6000	1 3/8 x 4 3/8	1.75

Packaged in Individual Display Carton with Mounting Strap.



Special Vibrator Buffer Capacitors

Intended for replacement of original vibrator buffer and hash suppressor capacitors of similar design.

Catalog Number	Capacity Mfd.	Working Volts DC	W	Size* L H	List Price
VB470	.0075	1600	3/16	5/8 x 3/8	\$1.10
VB471	.01	1600	3/16	5/8 x 3/8	1.15
VD491	.0008	1600	3/16	5/8 x 1 1/16	.65
VO480	.5	120	7/16	3/4 x 2 1/4	.65

* H—Height; W—Width; L—Length.

Miniature Metal Tubular Capacitors



For hearing aid, personal radio, and other uses where very small size tubulars are desirable. Wax impregnated (100 volt units) or oil impregnated (600 volt units) tubular capacitors in minute hermetically sealed metal tubes with insulating sleeve. Tinned copper leads.

Catalog Number	Capacity Mfd.	Working Volts DC	Size Dia. Length	List Price
MT105*	.001	100	3/32 x 1/2	\$0.90
MT107*	.002	100	3/32 x 1/2	.90
MT115*	.005	100	3/32 x 1/2	.90
MT125*	.01	100	1 3/64 x 1/2	.90
MT127*	.02	100	1 3/64 x 1 1/16	.95
MT135*	.05	100	1 3/64 x 1 1/16	.95
MT145*	.1	100	5/16 x 1 3/4	1.00
MT605†	.001	600	3/32 x 1 3/16	.95
MT607†	.002	600	3/32 x 1 3/16	.95
MT615†	.005	600	3/32 x 1 3/16	.95
MT625†	.01	600	2 1/64 x 1 3/16	.95

* Wax impregnated
† Oil impregnated

Automotive Noise Suppression Capacitors

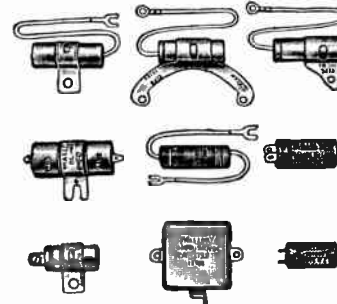

For suppressing radio interference emanating from auto generators, oil gauges, ammeters and other automotive, aircraft or marine equipment.

- AM—For ammeter and gauge suppression.
- FM—For Ford generator suppression.
- DL—For domelight suppression.
- RF—For vibrator hash suppression.
- CA—For general suppression in aircraft and marine applications.
- AS, AG—For generator, ammeter and contact spark suppression.

Top Row: AG Types; FM442; FM441
Center Row: DL445X; AM454; RF482
Bottom Row: AS types; CA275X; RF481

Wax impregnated cartridges assembled in various style housings. Type AG is hermetically sealed, provides low impedance and is ideal for extreme climatic conditions.

Catalog Number	Cap. Mfd.	Working Volts DC	Size D L	Signal Corps No.	List Price
RF481	.5	50	3/4 x 1 3/8		\$0.90
RF482	1.0	50	7/8 x 1 3/8		1.15
CA275X	4.0	50	2 x 2 x 1		3.00
AS125†	.01	100	.675 x 1 1/16	CA-432	1.20
AG442*	.05	100	3/8 x 1 1/4		.80
AG443	.05	100	7/16 x 1 3/16		1.00
AS145†	.1	100	.675 x 1 3/8	CA-442	1.40
AS165†	.25	100	3/4 x 1 1/2	CA-452	1.50
AS185†	.5	100	1 x 1 1/2	CA-462	1.75
FM441	.5	100	.675 x 1 3/8		.85
RF480	.5	100	1 3/16 x 1 1/16		.80
AG450	.5-.5	100	3/8 x 2		1.50
FM442	.5	160	.675 x 1 1/4		.65
AG444	.25	200	5/8 x 1 3/4		.60
DL445X	.4	200	1 x 2 3/8		2.25
AM454	.5	200	1 1/16 x 2		.65
AG451	.5	200	3/4 x 2		.65
AG453†	.5	200	3/4 x 2		1.50
AG452	1.0	200	1 x 2 3/16		.90
AS525†	.01	500 AC-DC	.675 x 1	CA-472	1.35
AS545†	.1	500 AC-DC	1 x 2 1/2	CA-482	1.60
AS565†	.25	500 AC-DC	1 x 2 1/2	CA-502	2.00

* For Midget Aircraft Motors.
† Has shielded lead.
‡ Also marked with Signal Corps Number as shown.

Steel-Cased, Oil-Filled Capacitors



For general use in aircraft, marine, geophysical and industrial electronic equipment where extreme dependability under severe conditions is desired. Oil impregnated, single, dual, and triple section units housed in rugged, hermetically sealed, hot-tinned steel cases. Single sections have two terminals. Dual section units have three terminals with left terminal common, and both are internally insulated from case. Triple units have three terminals with common ground to case. All terminals protrude in a row on one long side of case.

Catalog Number	Cap. Mfd.	Working Volts DC	Size*			List Price
			H	W	L X	
CB403	.25	400	3/4	7/8	1 3/4 x 2 1/4	\$2.25
CB404	.5	400	7/8	1	1 3/4 x 2 1/4	2.40
CB405	1.0	400	3/4	1 1/4	2 x 2 3/4	2.85
CB406	2.0	400	1 1/8	2	2 x 2 3/4	3.60
CB602	.1	600	3/4	7/8	1 1/4 x 2 1/4	2.65
CB603	.25	600	3/4	1	1 1/4 x 2 1/4	2.80
CB604	.5	600	7/8	1 1/4	1 3/4 x 2 1/4	3.00
CB605	1.0	600	7/8	1 3/4	2 x 2 3/4	3.40
CB1002	.1	1000	3/4	7/8	1 1/4 x 2 1/4	2.85
CB1003	.25	1000	3/4	1 1/4	1 3/4 x 2 1/4	2.95
CB1004	.5	1000	7/8	1 3/4	2 x 2 3/4	3.20
CBD403	.25-.25	400	3/4	1 1/4	1 3/4 x 2 1/4	3.25
CBD404	.5-.5	400	3/4	1 3/4	2 x 2 3/4	3.75
CBD602	.1-.1	600	3/4	7/8	1 1/4 x 2 1/4	3.35
CBT403	3X .25	400	3/4	1 3/4	2 x 2 3/4	4.00
CBT404	3X .5	400	1	1 3/4	2 x 2 3/4	4.75
CBT602	3X .1	600	7/8	1	1 1/4 x 2 1/4	3.80

* H—Height; W—Width; L—Length; X—Mounting Centers.

Uncased Wax Impregnated Capacitors

Designed for replacement of defective sections in large paper capacitor blocks. Wax-impregnated section enclosed in a paper tube wax dipped for moisture protection. Capacity tolerance +20% -10%.

Catalog Number	Cap. Mfd.	Working Volts DC	Size*			List Price
			W	L	H	
UB351	1	200	1/2	1 3/8	x 2 1/2	\$1.00
UB352	2	200	3/4	1 1/2	x 2 1/2	1.50
UB353	4	200	1 1/8	2 1/8	x 2 1/2	2.60
UB354	1	400	3/4	1 1/2	x 2 1/2	1.15
UB355	2	400	1	1 3/4	x 2 1/2	1.80
UB356	4	400	1 1/8	1 1/2	x 4 3/4	3.00
UB357	.5	600	1/2	1 1/2	x 2 1/2	1.05
UB358	1	600	3/4	1 1/2	x 2 1/2	1.40
UB359	2	600	1 1/8	2 1/8	x 2 1/2	2.10
UB364	4	600	1 1/8	1 1/2	x 4 3/4	3.90
UB362	1	1000	1 1/8	1 1/2	x 4 3/4	2.30
UB363	2	1000	1 1/8	1 1/2	x 4 3/4	3.80

* W—Width; L—Length; H—Height.

High Voltage Ceramic Capacitors—500 MMFD / 20KV WVDC



Designed for exact replacements as filters in high voltage circuits of television sets. The three capacitors have identical electrical characteristics and case styles, but differ in terminal arrangements. High quality ceramic dielectric materials and low loss plastic cases assure consistent operating results. Combinations of plain copper, internally threaded, slotted, or externally threaded studs are offered.

Catalog Number	Stud Description	List Price
HV-20035	Plain No. 6 copper, 1/2" long equipped with universal adapter	\$1.85
HV-20035A	(1) Internally threaded for 6-32 MS with .187 flat. (2) Externally threaded for 6-32 MS with .187 flat.	
HV-20035B	(1) Internally threaded for 6-32 MS with .187 flat.	1.85
	(2) No. 6 gauge with 7/16" slot.	1.85

Disc Ceramic Capacitors

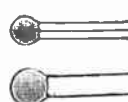

Small physical size, rugged construction, and excellent electrical characteristics. These unique capacitors are particularly suitable for replacement of molded mica and paper tubular units. They have dipped phenolic coating for maximum protection from moisture.

600 Working Volts DC

Catalog Number	Capacity (mfd)	Size Max. Dia.	List Price
DC-521	.001	1 9/32	\$0.25
DC-5215	.0015	1 9/32	.25
DC-522	.002	1 9/32	.30
DC-525	.005	1 9/32	.25
DC-511	.01	3/4	.25
DCD-521	.001-.001	1 9/32	.40
DCD-5215	.0015-.0015	1 9/32	.40
DCD-522	.002-.002	1 9/32	.40
DCD-524	.004-.004	3/4	.45

3000 Working Volts DC

Catalog Number	Capacity (mmfd.)	Size Max. Dia.	List Price
DC3054R7	4.7	3/8	\$0.50
DC3056R8	6.8	3/8	.50
DC3041	10	3/8	.50
DC30415	15	3/8	.50
DC30422	22	1 9/32	.50
DC30433	33	1 9/32	.50
DC30447	47	1 9/32	.50
DC30456	56	3/4	.50
DC30468	68	3/4	.50
DC3031	100	3/8	.55
DC30322	220	3/8	.60
DC30333	330	3/8	.60
DC30347	470	3/8	.65
DC30368	680	3/8	.75
DC3021	1000	1 9/32	.75
DC30215	1500	1 9/32	.85
DC30222	2200	3/4	1.05
DC30233	3300	3/4	1.25

6000 Working Volts DC

Catalog Number	Capacity (mmfd.)	Size Max. Dia.	List Price
DC6054R7	4.7	1 9/32	\$1.00
DC6056R8	6.8	3/4	1.00
DC6041	10	3/4	1.00
DC60415	15	1 9/32	1.00
DC60422	22	3/4	1.00
DC60318	180	1 9/32	1.00
DC60322	220	1 9/32	1.00
DC60333	330	3/4	1.00

Only Mallory can supply genuine Fabricated Plate (metallized cotton gauze) designed to operate at 185°F.

See pages 1 and 2, this section.

CERAMIC CAPACITORS

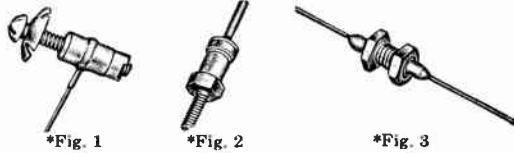

Mallory Ceramic Tubular Trimmers

Have high quality, silvered, steatite tubes; screw adjustment; low minimum capacitance and tinned-copper leads. 500 wkg. V. DC.

Cat. No.	mmfd	Length of Body	Fig. No.*	List Price
CT565A	.5-3	3/8"	1	\$0.50
CT565	.5-3	3/8"	1	.50
CT551	1-4	3/8"	1	.50
CT552	2-6	3/8"	1	.50

Stand-Off Ceramic Capacitors

Recommended for the dual purpose of by-passing R.F. current to ground, and of mechanically supporting other circuit elements. They are especially suited for VHF and UHF applications because of their low inductance and high resonant frequency.

Cat. No.	Cap. mmfd	Tolerance	Fig. No.*	List Price
SC-521	1000	20%	2	\$1.00
SC-535	500	20%	2	1.00

Feed-Thru Ceramic Capacitor

A well built, sturdy, feed-thru capacitor used to by-pass R.F. to ground in feed-thru applications. Wire terminals are rugged and will serve as tie points for several connections for supporting other circuit elements, and are sufficiently long for point-to-point wiring.

Cat. No.	Cap. mmfd	Tolerance	Fig. No.*	List Price
FC5215	1500	20%	3	\$1.00

Ceramic Trimmer Capacitors

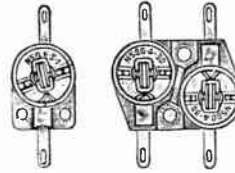

Small, electrically stable capacitors for use in high frequency FM-TV circuits. Each capacitor consists of fired silver electrodes on a ceramic rotor and base. They have a 360° rotor with a substantially constant capacity change and are completely sealed from dust and dirt. Single or dual units are available.

Solder type lugs at each end of capacitor.

Two clearance holes are provided in each capacitor for screw mounting.

Single Units—Overall size 2 1/2" x 2 7/8" x 3/8" thick.
Voltage Rating—600 VDC

Catalog No.	Cap. Range (mmfd)	Temperature Coefficient	List Price
ST-5515-Z	1.5 to 7	Zero	\$1.50
ST-553-Z	3 to 12	Zero	1.50
ST-554-N	4 to 30	Neg. 500 Parts/Million/°C.	1.50
ST-557-N	7 to 45	Neg. 500 Parts/Million/°C.	1.50

Dual Units—Overall size 1 1/4" x 3/8" x 3/8" thick.
Voltage Rating—600 VDC

Catalog No.	Cap. Range Each Section (mmfd)	Temperature Coefficient	List Price
DT-5515-Z	1.5 to 7	Zero	\$2.50
DT-553-Z	3 to 12	Zero	2.50
DT-554-N	4 to 30	Neg. 500 Parts/Million/°C.	2.50
DT-557-N	7 to 45	Neg. 500 Parts/Million/°C.	2.50

Fixed Ceramic Capacitors

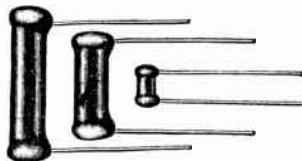

Mallory tubular, fixed, ceramic capacitors are manufactured in 3 types. UC is general purpose type for by-passing, coupling and other applications where a moderate capacitance change with temperature change can be tolerated. ZT is zero temperature type, the nominal capacitance of which remains substantially constant over a temperature variation from -55°C to 85°C. NT is negative temperature type with a negative coefficient of 750 parts/million/degrees C. These capacitors are supplied with a dipped phenolic insulation for protection against moisture and have radially placed bare, tinned-copper leads approximately 1/4" long.

Voltage Rating—600VDC.

General Purpose ±20% Tolerance			
Cat. No.	Capacity (mmfd)	Size*	List Price
UC-541	10	1	\$0.25
UC-5412	12	1	.25
UC-5415	15	1	.25
UC-5418	18	1	.25
UC-5422	22	1	.25
UC-5425	25	1	.25
UC-5427	27	1	.25
UC-5433	33	1	.25
UC-5439	39	1	.25
UC-5447	47	1	.25
UC-545	50	1	.25
UC-5456	56	1	.25
UC-5468	68	1	.25
UC-5475	75	1	.25
UC-531	100	1	.25
UC-5312	120	1	.25
UC-5315	150	1	.25
UC-532	200	1	.25
UC-5322	220	1	.25
UC-5325	250	1	.25
UC-5327	270	1	.25
UC-533	300	1	.25
UC-5333	330	1	.25
UC-5339	390	1	.25
UC-5347	470	1	.25
UC-535	500	1	.25
UC-5356	560	1	.25
UC-5368	680	1	.25
UC-5375	750	2	.25
UC-521	1000	2	.25
UC-5212	1200	2	.25
UC-5215	1500	2	.25
UC-5218	1800	3	.25
UC-522	2000	3	.25
UC-5222	2200	3	.25
UC-5225	2500	3	.25
UC-5227	2700	3	.25
UC-523	3000	3	.25
UC-5233	3300	3	.25
UC-5240	4000	3	.25
UC-5247	4700	3	.25
UC-525	5000	3	.30

Zero Temperature Coefficient ±10% Tolerance			
Cat. No.	Capacity (mmfd)	Size*	List Price
ZT-5675	.75	1	\$0.75
ZT-5515	1.5	1	.50
ZT-553	3	1	.50
ZT-5533	3.3	1	.50
ZT-5547	4.7	1	.50
ZT-555	5	1	.50
ZT-5568	6.8	1	.50
ZT-541	10	1	.50
ZT-542	20	1	.50
ZT-5425	25	2	.50
ZT-5433	33	2	.50
ZT-545	50	3	.55
ZT-5475	75	3	.55
ZT-531	100	3	.55
ZT-5315	150	4	.60
ZT-53175	175	4	.60

Negative Temperature Coefficient 750 Parts/Million/°C ±10% Tolerance			
Cat. No.	Capacity (mmfd)	Size*	List Price
NT-555	5	1	\$0.50
NT-541	10	1	.50
NT-5447	47	2	.50
NT-5475	75	3	.50
NT-531	100	3	.50

* SIZE CHART		
Sizes	Diameter	Length
1	.240	.460
2	.240	.710
3	.315	1.250
4	.415	1.213

NOISE FILTERS • CHOKE COILS

P. R. MALLORY & CO., INC. • INDIANAPOLIS

P. R. MALLORY & CO. Inc.
MALLORY

Mallory Noise Filters



Type X



Type W



Type Z



Type Z8A



Type LC



Type LB



For reducing or eliminating radio frequency interference caused by various electrical appliances.

Type W has dual capacitors housed in metal tubes. Common lead of capacitors connected to case, except WSP type which has shock-limiting capacitor from common lead to case. Designed for direct mounting. **Type X** has single and dual capacitors housed in round metal case, except X6 which is housed in rectangular plastic case. Designed for plug-in mounting. **Type Z**—Single and dual inductance-capacity filters housed in round metal container and designed for

insertion between appliance and electrical outlet. Types Z6 and Z8 have terminal for return lead to ground of appliance. **Type Z8A** designed for direct mounting and is equipped with 5" flexible leads. **Type LC**—combination inductance-capacity filter housed in rectangular metal case. Equipped with line cord and plug as well as outlet for appliance. **Type LB**—heavy duty choke-capacity, combination filters sealed in rectangular, standard, heavy-gauge metal cut-out boxes. Equipped with heavy, flexible insulated wire leads for splicing with house or motor wiring.

Catalog Number	Amps	Volts	Size	Intensity or Degree of Interference	Source of Interference	List Price
W7		110-220 AC-DC	7/8 x 2	Light	Compressors, Sewing Machines, Vacuum Cleaners	\$1.35
W9		115-220 AC-DC	1 x 3	Medium	Air-Conditioners, Dental Equipment, Fans, Signs	1.75
W11		115-220 AC-DC	1 1/8 x 3	Severe	Grinders, Thermostats, Motors	2.10
W79P		115-220 AC-DC	7/8 x 2	Light	Adding Machines, Cash Registers, Dishwashers	1.80
W99P		115-220 AC-DC	1 x 2 1/2	Medium	Vacuum Cleaners, Washing Machines	2.20
X1	5	110	1 1/8 x 1 1/4	Slight	Heating Pads, Radio Receivers	1.60
X3	5	110-220	1 1/8 x 2 3/16	Medium	Barber Clippers, Hair Dryers (small)	1.80
X5	5	110-220	1 1/8 x 2 3/16	Medium	Floor Polishers, Refrigerators	2.70
X6	15	125 AC-DC	1 1/4 x 2 x 1	Light	Electric Razors, Food Mixers and Grinders	1.60
X8D	15	125 AC-DC	1 1/4 x 2 x 1	Light	Electric Razors, Food Mixers and Grinders	9.60
Z2	3	110-220	1 1/8 x 2 1/16	Medium	Violet Ray, Radio Receivers, Barber Clippers	2.20
Z4	3	110-220	1 1/8 x 2 1/16	Severe	Heating Pads, Humidifiers (plug type)	2.50
Z6	3	110-220	1 1/8 x 3/4	Severe	Electric razors, Radio Receivers	3.60
Z8	3	110-220	1 1/8 x 3/4	Severe	Sewing Machines, Hair D yers (small)	3.60
Z8A	3	115-220 AC-DC	1 7/16 x 2 3/8	Severe	Fans (plug type) Vacuum Cleaners	3.00
LC5	5	115-220 AC-DC	2 1/16 x 3 1/16 x 3 3/16	Heavy	Air Conditioners, Cash Registers	11.25
LC10	10	115-220 AC-DC	2 1/16 x 3 1/16 x 3 3/16	Heavy	Dictating Machines, Ironing Machines	15.00
LB10	10	220	6 1/2 x 6 1/2 x 4	Heavy	Sign Flashers, Oil Burners, Neon Signs	17.50
LB20	20	220	10 1/4 x 10 1/4 x 6	Heavy	Stokers, Garbage Grinders, Fans, Compressors	47.50
LB40	40	220	12 x 10 1/4 x 6	Heavy	Motors, Sign Flashers	58.75
NF1-115	1	115 AC—500 DC	1 3/8 x 1 1/4 x 7/8		NF type filters are designed for professional-industrial noise filtering problems. May be used in such applications as; electric motors, lighting systems, make and break relay systems and fans. Should be installed and used exactly as suggested on applicable instruction sheets.	8.90
NF3-220	3	220 AC	2 x 1 3/8 x 1			13.20
NF5-115	5	115 AC—500 DC	2 x 1 3/8 x 7/8			7.30
NF10-115	10	115 AC—500 DC	2 x 2 x 1 1/8			9.75
NF15-220	15	220 AC	2 1/16 x 2 1/2 x 1 1/8			27.10
NF25-230	25	230 AC	2 x 2 x 1 1/4			12.10

MALLORY TYPE "K" VITREOUS WIRE-WOUND POWER RHEOSTATS AND POTENTIOMETERS

Hinged-spring contact arm; low contact resistance; low wear; easy cleaning and brush replacement; antibacklash characteristic.

See complete line Mallory page 4
Potentiometers, Rheostats, Resistors Section



Radio Frequency Choke Coil

General purpose radio frequency choke coils for all circuits. Hour-glass wound for low distributed capacity. Housed in compact insulating tubes. Two bare tinned copper wire leads, one at each end.

Catalog Number	Turns	Wire	Inductance* Microhenries	Size Dia. Length	List Price
RF581	90	16	25	1 x 1 1/2	\$0.60
RF582	55	16	12	1 x 1 3/16	.80
RF583	55	12	12	1 1/8 x 1 1/8	1.25

* Measured at 2.5 mc.

MALLORY PLASCAP!

Plastic tubular capacitor with Moisture-Proof Construction.

For complete description and listing see page 4, Mallory Capacitor section, this catalog.

Mica Receiver Capacitors



Designed for use in radio, TV and industrial electronic circuits. Made with carefully selected mica and foil. Phenolic case with RTMA color coding for identification.

Case Size— $\frac{7}{16}$ " x $2\frac{5}{32}$ " x $\frac{7}{32}$ "
with $\frac{1}{8}$ " Wire Leads

Voltage Rating
=500 VDC Working—1000 VDC Test

Capacity mmfd.	Standard Mica $\pm 20\%$ Cap. Tolerance		Silver Mica $\pm 10\%$ Cap. Tolerance		Silver Mica $\pm 2\%$ Cap. Tolerance	
	Catalog Number	List Price	Catalog Number	List Price	Catalog Number	List Price
5	MC205	\$0.25	MCB205	\$0.45		
10	MC215	.25	MCB215	.40	MCE215	\$0.50
25	MC220	.25	MCB220	.40	MCE220	.50
40	MC223	.20	MCB223	.40	MCE223	.50
50	MC225	.20	MCB225	.40	MCE225	.50
75	MC230	.20	MCB230	.40	MCE230	.50
100	MC235	.20	MCB235	.40	MCE235	.50
150	MC236	.20	MCB236	.45	MCE236	.55
200	MC237	.20	MCB237	.45	MCE237	.55
250	MC240	.25	MCB240	.45	MCE240	.55
300	MC241	.25	MCB241	.55	MCE241	.70
400	MC243	.25	MCB243	.65	MCE243	.80
500	MC245	.25	MCB245	.70	MCE245	.85
800	MC251	.25	MCB251	.95	MCE251	1.10
1000	MC255	.30	MCB255	1.10	MCE255	1.35
1500	MC256	.30				
500	MC445	.30	MCB445	.70	MCE445	.85
800	MC451	.30	MCB451	.95	MCE451	1.15
1500			MCB456	1.35	MCE456	1.65
2000	MC457	.40	MCB457	1.35	MCE457	1.65
2500	MC460	.45	MCB460	1.80	MCE460	2.20
3000	MC461	.50	MCB461	2.05	MCE461	2.45
4000	MC463	.55	MCB463	2.15	MCE463	2.60
5000	MC465	.60	MCB465	2.25	MCE465	2.70
6000	MC467	.75	MCB467	2.60	MCE467	3.15
7000	MC469	.90	MCB469	2.90	MCE469	3.50
8000	MC471	1.00	MCB471	3.20	MCE471	3.85
10000	MC475	1.20	MCB475	3.50	MCE475	4.20

Case Size— $1\frac{3}{16}$ " x $1\frac{3}{16}$ " x $\frac{5}{16}$ "
with $\frac{1}{8}$ " Wire Leads

Voltage Rating
=500 VDC Working—1000 VDC Test

Mica Transmitting Capacitors (Type MH)



For use in transmitting and power amplifier circuits. Made with accurately gauged, high-quality, India mica in molded phenolic case. Test volts are 200% of WVDC. Case size $1\frac{1}{8}$ " x $1\frac{1}{8}$ " (minus terminals).

High-Voltage Mica Capacitors for TV Replacement

$\pm 20\%$ Cap. Tolerance

Catalog Number	Capacity mmfd	Working Volts DC	W	Size L	H	List Price
MCP53R3	3.3	3000	$2\frac{5}{32}$ x $\frac{7}{16}$	x $\frac{7}{32}$.35
MCP550	5	3000	1 x $\frac{5}{8}$	x $1\frac{1}{32}$.35
MCP410	10	3000	1 x $\frac{5}{8}$	x $1\frac{1}{32}$.35
MCM422	22	2500	$2\frac{5}{32}$ x $\frac{7}{16}$	x $\frac{7}{32}$.30
MCM433	33	2500	$2\frac{5}{32}$ x $\frac{7}{16}$	x $\frac{7}{32}$.35
MCL420	20	2000	$2\frac{5}{32}$ x $\frac{7}{16}$	x $\frac{7}{32}$.35
MCL427	27	2000	$2\frac{5}{32}$ x $\frac{7}{16}$	x $\frac{7}{32}$.35
MCL443	43	2000	$2\frac{5}{32}$ x $\frac{7}{16}$	x $\frac{7}{32}$.35
MCL447	47	2000	$2\frac{5}{32}$ x $\frac{7}{16}$	x $\frac{7}{32}$.35
MCL450	50	2000	$2\frac{5}{32}$ x $\frac{7}{16}$	x $\frac{7}{32}$.40
MCL456	56	2000	$2\frac{5}{32}$ x $\frac{7}{16}$	x $\frac{7}{32}$.40
MCL428	62	2000	$2\frac{5}{32}$ x $\frac{7}{16}$	x $\frac{7}{32}$.40
MCL468	68	2000	$2\frac{5}{32}$ x $\frac{7}{16}$	x $\frac{7}{32}$.35
MCL482	82	2000	$2\frac{5}{32}$ x $\frac{7}{16}$	x $\frac{7}{32}$.40
MCL315	150	2000	$2\frac{5}{32}$ x $\frac{7}{16}$	x $\frac{7}{32}$.45
MCL320	200	2000	$2\frac{5}{32}$ x $\frac{7}{16}$	x $\frac{7}{32}$.60
MCL325	250	2000	$2\frac{5}{32}$ x $\frac{7}{16}$	x $\frac{7}{32}$.65
MCL330	300	2000	$2\frac{5}{32}$ x $\frac{7}{16}$	x $\frac{7}{32}$.70
MCL339	391	2000	$2\frac{5}{32}$ x $\frac{7}{16}$	x $\frac{7}{32}$.85
MCL347	470	2000	$1\frac{3}{16}$ x $1\frac{3}{16}$	x $1\frac{1}{32}$.90
MCL350	500	2000	$1\frac{3}{16}$ x $1\frac{3}{16}$	x $1\frac{1}{32}$.90
MCK475	75	1500	$2\frac{5}{32}$ x $\frac{7}{16}$	x $\frac{7}{32}$.30
MCK310	100	1500	$2\frac{5}{32}$ x $\frac{7}{16}$	x $\frac{7}{32}$.35
MCK315	150	1500	$2\frac{5}{32}$ x $\frac{7}{16}$	x $\frac{7}{32}$.35
MCK318	180	1500	$2\frac{5}{32}$ x $\frac{7}{16}$	x $\frac{7}{32}$.35
MCK322	220	1500	$2\frac{5}{32}$ x $\frac{7}{16}$	x $\frac{7}{32}$.40
MCK327	270	1500	$2\frac{5}{32}$ x $\frac{7}{16}$	x $\frac{7}{32}$.45
MCK333	330	1500	$2\frac{5}{32}$ x $\frac{7}{16}$	x $\frac{7}{32}$.50
MCK347	470	1500	$2\frac{5}{32}$ x $\frac{7}{16}$	x $\frac{7}{32}$.60
MCK368	680	1500	1 x $\frac{5}{8}$	x $1\frac{1}{32}$.65
MCK382	820	1500	1 x $\frac{5}{8}$	x $1\frac{1}{32}$.75
MCK210	1000	1500	1 x $\frac{5}{8}$	x $1\frac{1}{32}$.80
MCK215	1500	1500	1 x $\frac{5}{8}$	x $1\frac{1}{32}$		1.10
MCK220	2000	1500	1 x $\frac{5}{8}$	x $1\frac{1}{32}$		1.35
MCK224	2400	1500	1 x $\frac{5}{8}$	x $1\frac{1}{32}$		1.55

Catalog Number	Cap. Mfd.	Working Volts DC	Test Volts DC	Thick-ness	List Price
MH535	.0001	600	1200	$2\frac{3}{64}$	\$1.20
MH635	.0001	1200	2500	$2\frac{3}{64}$	1.55
MH735	.0001	2500	5000	$2\frac{3}{64}$	1.80
MH545	.0005	600	1200	$2\frac{3}{64}$	1.20
MH645	.0005	1200	2500	$2\frac{3}{64}$	1.55
MH745	.0005	2500	5000	$2\frac{3}{64}$	2.40
MH555	.001	600	1200	$2\frac{3}{64}$	1.20
MH655	.001	1200	2500	$2\frac{3}{64}$	1.80
MH755	.001	2500	5000	$2\frac{3}{64}$	2.80
MH557	.002	600	1200	$2\frac{3}{64}$	1.30
MH657	.002	1200	2500	$2\frac{3}{64}$	2.40
MH757	.002	2500	5000	$2\frac{3}{64}$	4.10
MH565	.005	600	1200	$2\frac{3}{64}$	1.50
MH665	.005	1200	2500	$2\frac{3}{64}$	3.30
MH765	.005	2500	5000	$2\frac{3}{64}$	6.25
MH575	.01	600	1200	$2\frac{3}{64}$	2.25
MH675	.01	1200	2500	$2\frac{3}{64}$	5.25
MH577	.02	600	1200	$2\frac{3}{64}$	3.05

**You can depend on
MALLORY CAPACITORS
Ask for them by name!**

MICA, OIL FILLED AND IMPREGNATED CAPACITORS

P. R. MALLORY & CO., INC. - INDIANAPOLIS



Mica Transmitting Capacitors (Type MX)

Ideal for amateur transmitting equipment. May also be used in coupling, tank and by-pass circuits at currents within specified rating.

Catalog Number	Cap. Mfd.	Test Volts DC	Max. Amps.	Freq. KC.	List Price
MX855	.001	12,500	9.0	15000	\$8.00
			10.0	7500	
			11.0	3750	
			12.0	1875	
MX857	.002	12,500	9.0	15000	11.00
			12.0	7500	
			13.0	3750	
			15.0	1875	
MX865	.005	10,000	10.0	15000	14.50
			13.0	7500	
			14.0	3750	
			15.0	1875	
MX875	.01	7,000	10.0	15000	15.25
			13.0	7500	
			15.0	3750	
			15.0	1875	
MX877	.02	3,500	10.0	15000	16.00
			13.0	7500	
			17.0	3750	
			17.0	1875	
MX885	.05	3,500	11.0	15000	18.50
			14.0	7500	
			16.0	3750	
			18.0	1875	
MX895	.1	2,000	11.0	15000	18.50
			14.0	7500	
			16.0	3750	
			18.0	1875	

Case Size: 4 1/16" x 2 3/8" x 2 1/8" (Minus Terminals).

Capacity tolerance ±20%.

Instructions for use of RETMA Color Code

Hold capacitor with arrow pointing to right. From left to right, the first dot shall always be white to indicate standard RETMA molded mica capacitor. The second and third dots become the first two significant figures in the capacitance. The second row is read from right to left. The lower right dot should be the multiplier. The lower second dot indicates the tolerance and the lower left dot indicates the class.

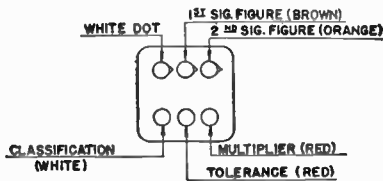

Example shown above = 1300 mmfd. ±2%, 500 V.W.

The key to color significance is as follows:

Color	Sig. Fig.	Mult.	Tol.	Class.*
Black	0	1	±20%	A
Brown	1	10		B
Red	2	100	± 2%	C
Orange	3	1000	± 3%	D
Yellow	4	10000		
Green	5		± 5%	
Blue	6			
Violet	7			
Gray	8			I
White	9			J
Gold		0.1		
Silver		0.01	±10%	

* Denotes various electrical characteristics.

Voltage ratings vary with capacitance as shown in RMA Specification—April, 1946.



Transmitting Capacitors (Type TX)

For radio, television, transmitting and all circuits requiring high voltage capacitors. Compact rectangular oil filled capacitors of sturdy construction. Capacity tolerance -10% +20%. Do not use on AC.

Catalog Number	Cap. Mfd.	Working Volts DC	W	Size* L	H	List Price
TX801	1	600	1	x 1 3/4	x 2 1/2	\$5.20
TX802	2	600	1	x 1 3/4	x 2 1/2	6.50
TX803	4	600	1	x 1 3/4	x 4 1/4	8.50
TX816	6	600	1 3/16	x 2 1/2	x 4 1/4	10.50
TX817	10	600	1 1/4	x 3 3/4	x 4 1/4	14.00
TX822	.5	1000	1	x 1 3/4	x 2 1/2	4.55
TX804	1	1000	1	x 1 3/4	x 2 1/2	5.70
TX805	2	1000	1	x 1 3/4	x 3 1/2	7.60
TX806	4	1000	1 3/16	x 2 1/2	x 4 1/4	9.60
TX824	6	1000	1 1/4	x 3 3/4	x 4 1/4	12.75
TX825	10	1000	1 3/4	x 3 3/4	x 4 1/4	15.50
TX807	1	1500	1	x 1 3/4	x 4 1/4	6.85
TX808	2	1500	1 3/16	x 2 1/2	x 4 1/4	9.50
TX809	4	1500	1 1/2	x 3 3/4	x 4 1/4	12.75
TX829	6	1500	1 3/4	x 3 3/4	x 4 1/4	15.75
TX830	10	1500	3 3/16	x 3 3/4	x 4 1/4	23.00
TX831	.25	2000	1	x 1 3/4	x 2 1/2	6.50
TX832	.5	2000	1	x 1 3/4	x 2 1/2	6.90
TX810	1	2000	1 3/16	x 2 1/2	x 3 1/2	8.40
TX811	2	2000	1 1/4	x 3 3/4	x 4 1/4	9.95
TX823	4	2000	2 1/4	x 3 3/4	x 4 1/4	13.75
TX833	6	2000	3 3/16	x 3 3/4	x 4 1/4	18.00
TX834	10	2000	4 1/8	x 3 3/4	x 4 1/4	28.50
TX812	1	2500	1 3/16	x 2 1/2	x 4 1/4	12.25
TX813	2	2500	1 1/4	x 3 3/4	x 4 1/4	20.00
TX835	.1	3000	1 3/16	x 2 1/2	x 4 1/4	12.75
TX836	.25	3000	1 3/16	x 2 1/2	x 3 1/2	14.00
TX837	.5	3000	1 3/16	x 2 1/2	x 4 1/4	15.50
TX814	1	3000	1 3/4	x 3 3/4	x 4 1/4	18.75
TX815	2	3000	3 3/16	x 3 3/4	x 4 1/4	23.25
TX838	4	3000	4 1/8	x 3 3/4	x 5 1/2	34.00
TX839	1	4000	2 1/4	x 3 3/4	x 4 1/4	34.00
TX827	2	4000	4 1/8	x 3 3/4	x 4 1/4	43.00
TX818	1	5000	5 1/4	x 3 1/2	x 5 1/2	39.00
TX819	2	5000	5 1/4	x 3 1/2	x 9	50.00
TX820	.5	6000	4 3/4	x 5 1/4	x 3 1/2	62.00
TX821	1	6000	3 1/16	x 4 1/16	x 6 1/16	77.00

* W—Width; L—Length; H—Height.



Transmitting Capacitors (Type TZ)

For filter and by-pass circuits in power amplifiers, television and transmitting equipment where compact round can units are desired. Capacity tolerance -10% +20%. Do not use on AC.

Catalog Number	Capacity Mfd.	Working Volts DC	Size Dia.	Height	List Price
TZ382	2.0	600	1 1/2	x 2 1/2	\$4.65
TZ383	4.0	600	1 1/2	x 4 1/4	6.20
TZ384	1.0	1000	1 1/2	x 2 1/2	4.30
TZ385	2.0	1000	1 1/2	x 4 1/4	5.45
TZ389	4.0	1000	2	x 4	7.25
TZ386	.5	1500	1 1/2	x 3 1/2	5.05
TZ387	1.0	1500	2	x 2 3/4	5.45
TZ388	2.0	1500	2	x 4	7.25
TZ390	1.0	2000	2	x 3 1/4	6.85
TZ391	2.0	2000	2	x 4 1/2	7.60

TERMINAL HEIGHTS

TX Capacitors	TZ Capacitors
600 through 2500V—1/4	600V—%
3000 through 4000V—1%	1 and 2 mfd at 1000V—%
5000 through 6000V—2 1/2	.5 and 1 mfd at 1500V—%
	4 mfd at 1000V—1%
	2 mfd at 1500V—1%
	1 mfd at 2000V—1%
	2 mfd at 2000V—1%

CAPACITOR HARDWARE

P. R. MALLORY & CO. INC.
MALLORY

P. R. MALLORY & CO. INC. - INDIANAPOLIS



Type TH—Special clips for horizontal mounting of any tubular or FP unit within the diameter range shown. Designed primarily to mount without tools under special chassis lances in original equipment; they may also be attached to chassis with 5-32 screw and nut in any 1/8" hole.

Type VR—Brackets for vertical mounting round units.

Cat. No.	Description	Size	List Price
TH-13	Spring clip for TC	3/8"	\$0.05
TH-15	Spring clip for TC	1/2 to 5/8"	.05
TH-17	Spring clip for TC	5/8 to 1 1/8"	.05
TH-19	Spring clip for TC and FP	3/4 to 1 3/8"	.05
TH-21	Spring clip for TC	3/8 to 1 3/8"	.05
TH-23	Spring clip for TC and FP	1 to 1 1/8"	.05
TH-25	Spring clip for TC and FP	1 1/2 to 1 7/8"	.10
VR-1	Clamp for vertical mounting	1 to 1 1/8"	.15
VR-3	Clamp for vertical mounting	1 3/8 to 1 7/8"	.15
VR-4	Clamp for vertical mounting	1 1/2 to 1 3/4"	.20
VR-6	Clamp for vertical mounting	1 3/4 to 1 7/8"	.25
VR-8	Clamp for vertical mounting	2 to 2 1/8"	.30
VR-10	Clamp for vertical mounting	2 1/2"	.35



Type "P" Hardware

Types PL and PL-A—Plastic end cap to protect terminals on HC, NP or P units when desired.

Type HB—Horizontal bracket for mounting HC, NP or P units, using end cap type PL or PLA.

Cat. No.	Description	Size	List Price
PL-3	Plastic end cap For "On Motor" mounting	1 7/8"	\$0.20
PL-6		1 3/8"	
PL-8		2 1/8"	
PL-3A	Plastic end cap For "Off Motor" mounting	1 7/8"	.20
PL-6A		1 3/8"	
PL-8A		2 1/8"	
HB-4	Horizontal bracket (plastic cases)	3"	.30
HB-8	Horizontal bracket (plastic cases)	4"	.35

Type "MSU," P, HC and NP Hardware

Catalog Number	Description	Size	List Price
115-1	Top Cap	1 3/8"	\$0.20
116-1	Top Cap	2"	
118-1	Bottom Cap	1 3/8"	.20
119-1	Bottom Cap	2"	.20
121-1	Bracket	1 3/8 x 3/4"	.35
122-1	Bracket	1 3/8 x 4/4"	.35
123-1	Bracket	2 x 3/8"	.35
124-1	Bracket	2 x 4/8"	.35

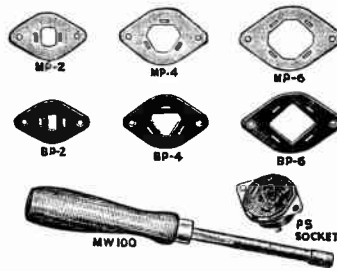

Type MP—Metal plates for grounded mounting of FP and WP capacitors.

Type BP—Phenolic plates for insulated mounting of FP and WP capacitors.

Type PS—Molded plastic sockets for plug-in mounting FP or WP capacitors. (Blank ear on capacitor should be removed to permit polarization with respect to socket.)

Type MW-100—Special wrench for twisting mounting ears on FP or WP capacitors.

Cat. No.	Description	Size	List Price
MP-2	Metal mounting wafer for FP	3/4"	\$0.05
MP-4	Metal mounting wafer for FP	1"	.05
MP-6	Metal mounting wafer for FP	1 3/8"	.05
BP-2	Phenolic mounting wafer for FP	3/4"	.05
BP-4	Phenolic mounting wafer for FP	1"	.05
BP-4A	Phenolic mounting wafer for FP (To mount 1" FP in chassis punched for 1 1/8" wafer)	1"	.05
BP-6	Phenolic mounting wafer for FP	1 3/8"	.05
PS-4	Plug-in socket for FP	1"	.70
PS-6	Plug-in socket for FP	1 3/8"	.90
PSC-4	Retainer clamp for PS-4 socket		.10
MW-100	Mounting wrench for FP		1.75

Recommended Replacements for Modified and Discontinued FP and WP Types

(as listed on pages 1 and 2, Mallory Capacitor Section, this catalog)

Old Catalog Number	Recommended Replacement	Old Catalog Number	Recommended Replacement
FP228	FP227.3	FP373	FP385
FP236	FP260	FP376*	FP396.2
FP246X	FP266	FP379*	FP385
FP313*	FP330	FP380	FP343.4†
FP316*	FP343.1	FP387	FP387.1
FP318*	FP319.5	FP389	FP375.8†
FP332	FP345.2†	FP390	FP376.1†
FP334*	FP333.8	FP391	FP391.1
FP339	FP345.8†	FP393	FP376.8†
FP342*	FP342.5	FP395	FP369.1†
FP344	FP344.5	FP416*	FP419.3
FP345	FP370†	FP418*	FP418.3
FP352	FP341.5†	FP420*	FP447
FP353	FP343.6	FP422	FP423.4
FP354	FP311.2†	FP425*	FP432.4
FP355	FP311.4†	FP427	FP422.1†
FP356	FP311.7†	FP457*	FP476
FP357	FP311.5†	FP465*	FP467
FP358	FP311.9†	FP471	FP476
FP360*	FP343.1	FP550*	FP245
FP363	FP320†	WP032	WP042
FP367	FP330.5†	WP302*	WP302.1
FP369	FP330.3†		

* Will be deleted from line when present stocks are exhausted.
† Change in catalog number only. No change in rating.



METAL-CLAD AND TANTALYTIC CAPACITORS

SUBMINIATURE METAL-CLAD TUBULAR CAPACITORS

Subminiature metal-clad tubular capacitors are available with Permafil solid dielectric for operation from -55°C to $+125^{\circ}\text{C}$, or with Pyranol* liquid dielectric for operation from -55°C to $+85^{\circ}\text{C}$, without derating. Silicone end seals of all-welded construction provide maximum resistance to thermal and physical shock and permit soldering up to the bushing without danger of seal damage. Butt-welded leads can be supplied either axially or at right angles. Permafil units combine small size and no liquid leakage with high insulation resistance and ability to withstand extreme temperature cycling. Pyranol units are 20 per cent smaller than comparable oil-filled capacitors.

Both types meet performance requirements of MIL-C-25A and can be supplied in standard case sizes in either tab or extended foil designs. Ratings range from .001 to $1.0\ \mu\text{f}$ in voltages of 100, 200, 300, 400, and 600 d-c working.

Write for Bulletin GEC-987.

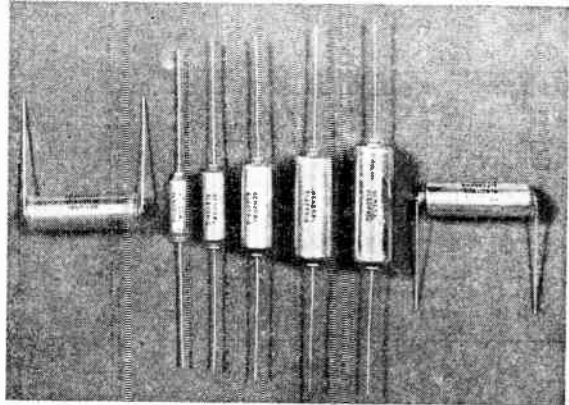

TANTALYTIC CAPACITORS FOR LOW-VOLTAGE USE

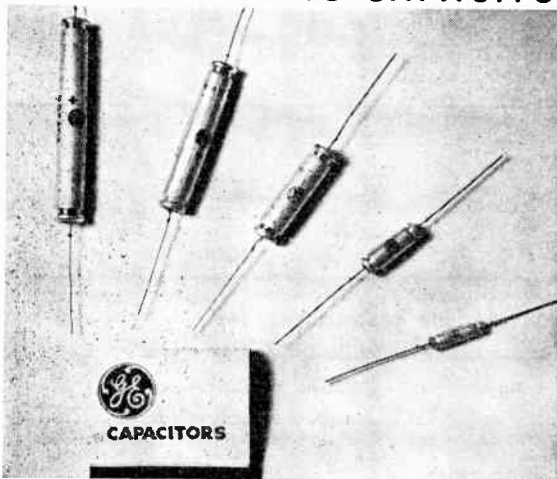

The Tantalum capacitor is designed for certain direct-current applications up to 150 WVDC where aluminum electrolytics and paper capacitors are not entirely satisfactory, and is suggested for use where superior characteristics and ultimate size reduction in the high quality electrolytic field are of prime importance.

This capacitor is a tantalum-electrode, electrolytic unit, similar in construction to an aluminum electrolytic capacitor, but smaller in size because of the characteristics of the tantalum. The Tantalum capacitor has lower leakage currents, longer shelf life, and a wider range of temperature operation (-55°C to $+85^{\circ}\text{C}$), without derating, than the conventional aluminum electrolytic capacitor. Tantalum capacitors, in a wide range of ratings, are currently being used in telephone equipment and military communication and ordnance equipment.

Write for Bulletin GEC-808.

MICRO-MINIATURE TANTALYTIC CAPACITORS

Micro-miniature Tantalum capacitors are designed for low-voltage d-c applications where long shelf life, electrical stability, and ultimate size reduction are of prime importance. Widely used in hearing aids and other subminiature assemblies employing transistors, micro-miniatures are rated as high as 4 volts, $8\ \mu\text{f}$ in the $\frac{1}{8}$ -inch case; higher ratings can be achieved in the $\frac{1}{2}$ -inch case. Capacitance tolerance for all units is $-0\% +100\%$.

The micro-miniature employs a tantalum anode enclosed in a silver case and impregnated with a nonacid electrolyte. A synthetic plug is roll-cripped into the end of the case and a solderable tin-coated nickel lead is lap-welded to the projecting tantalum anode lead. This permits connection up to the bushing. The case itself is the cathode and is equipped with a tin-coated nickel lead soldered to the case. The unit is of the polarized type.

Write for Bulletin GEA-6065.

*Registered trade-mark of General Electric Co.

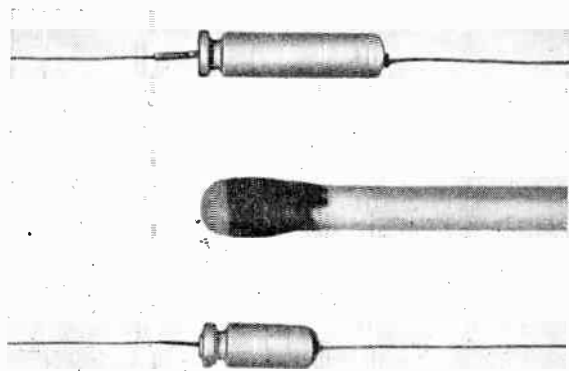



PYRANOL* CAPACITORS

*Registered trade-mark of General Electric Co.

CAPACITORS TO MEET MILITARY SPECIFICATION MIL-C-25A 100 to 12,500 Volts D-c — 0.01 to 15 Microfarads

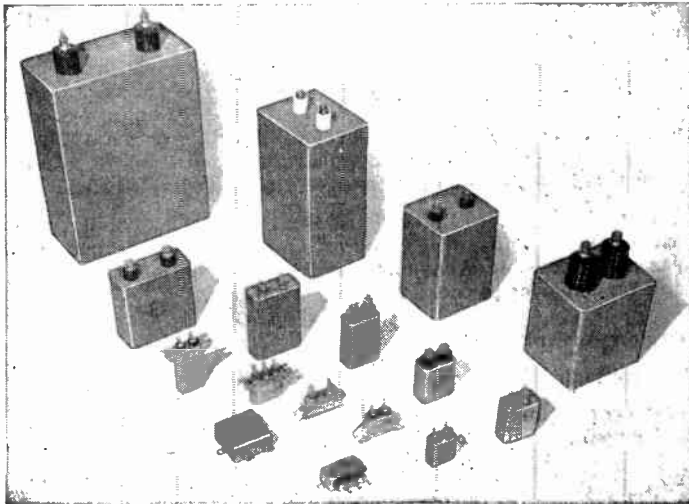

CP 53, 54—Bathtub style CP 70—Large Rectangular
CP 61, 63, 65, 67, 69—Miniature Rectangular

Intended primarily for feeder, by-pass, and blocking purposes, these units are qualified for applications where the alternating-current component of the impressed voltage is small with respect to the direct-current rating.

All case styles are available in Characteristics *D, E* and *F*. Single-section units are supplied with a capacitance tolerance of ± 10 per cent (*K*), and two- and three-section units with a capacitance tolerance of $+20$ per cent, -10 per cent (*V*). Spade-lug and footed mounting brackets are available for use with capacitors on which the mounting bracket is not an integral part.

In addition to their regular applications, these units may also be used at higher temperatures, with higher voltages for short-life applications, and with a-c voltages.

Write to the nearest G-E Apparatus Sales Office for Bulletin GEC-810.

ENERGY-STORAGE DISCHARGE CAPACITORS

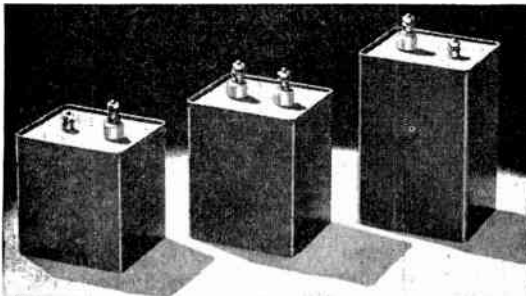

G-E light-duty energy-storage capacitors are made in a wide range of ratings to fit practically every requirement of high-speed flash photography, as well as home and industrial welders for light metals. Careful construction, high-quality materials, and skillful design contribute to long life and efficient operation. Write for Bulletin GEA-4646.

STANDARD RATINGS

Max. D-c volts	Capacitance, Microfarads	Max. D-c volts	Capacitance, Microfarads
2000	28	4000	50
		4000	100
2500	14	5000	25/50
		6000	55
3000	60	6000	25
3500	12.5		
4000	25/50		

CAPACITOR NETWORKS

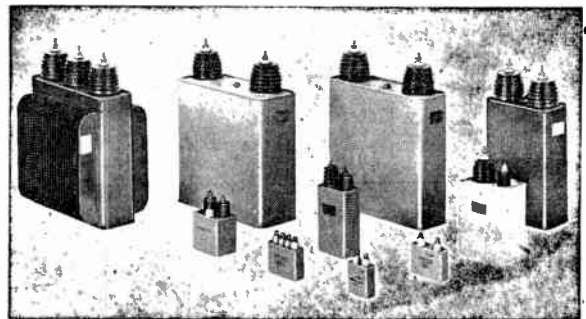

These capacitor networks are designed for radar and industrial equipment where the normal (exponential) capacitor discharge shape is not suitable and where an impulse having a definite energy content and duration is required.

General Electric pioneered in the development of mineral-oil-treated paper dielectric capacitor networks for air, sea, and land radar, and is a prime supplier for the government services. The products supplied vary from the miniature types in use with aircraft and guided missiles to the large designs for land-based radar.

Write for Bulletin GEA-4996.



PYRANOL* CAPACITORS

*Registered trade-mark of General Electric Co.

STANDARD COMMERCIAL TYPES

For A-c and D-c Applications — Fixed Paper-dielectric Capacitors

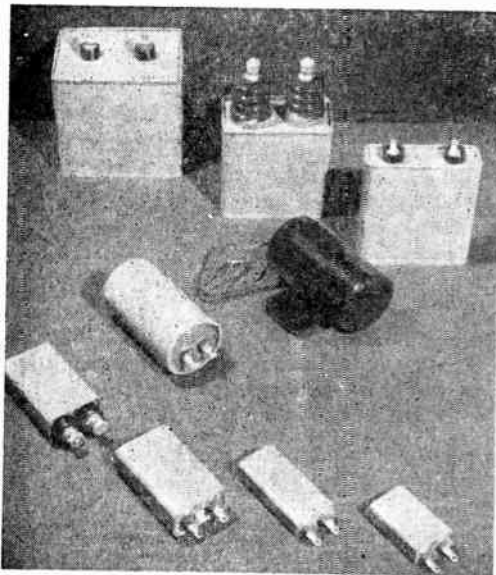

A-c/d-c dual-rated Pyranol capacitors for motors, controls, luminous-tube transformers, electronic equipments, and other applications will reduce inventories, simplify design problems, and increase standardization. Capacitors in the voltage ranges 236 through 660 volts, a-c, and 400 through 1500 volts, d-c, are now dual-rated and can be used for either a-c or d-c applications. Other a-c and d-c ratings available: 0.01 to 75 microfarads, 236 to 660 volts, a-c, and 400 to 100,000 volts, d-c.

Because of the high dielectric strength, high permittivity, and exceptional stability of Pyranol, its use as a treating material has made possible a capacitor which is much smaller in size, and far superior to those formerly available.

Design Advantages

- (1) Units are small and compact, because of the use of Pyranol.
- (2) A wide range of ratings is available in rectangular, cylindrical, and oval cases.
- (3) Three styles of mounting brackets are available and are supplied separate from the units. Units may be operated in any position.

Write to the nearest G-E Apparatus Sales Office for Bulletin GEC-809.

STANDARD RATING RANGE

Rated Voltage 60 Cycle.		Capacitance Ratings — Microfarads			
A-c	D-c	Case Style 60	Case Style 70	Fabricated Rectangular	Cylindrical Motor Line
236	400	2	4-16	—	—
330	—	—	—	1-50	1.2-12
330	600	0.25-1	1-50	—	—
440	—	—	—	28	—
440	1000	0.1-0.5	1-15	—	—
660	—	—	—	2-6	—
660	1500	0.01-0.05	1-15	—	—
—	2000-	—	—	—	—
—	100 000	—	0.05-75	—	—

Case Style 70

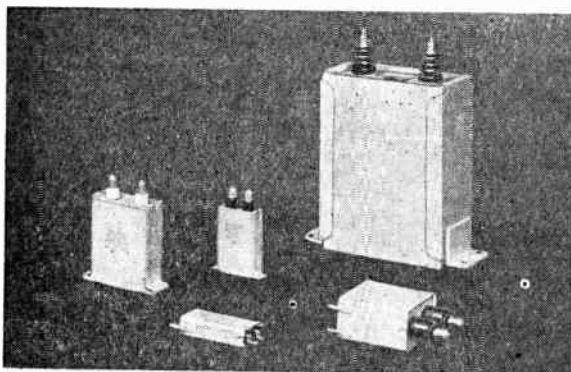

Case Style 70 units with various types of terminals and removable mounting brackets

These Pyranol fixed paper-dielectric capacitors in Case Style 70 are hermetically sealed in rectangular cases. This line includes standard ratings, ranging from very small units weighing only three ounces to large high-voltage units weighing up to 175 pounds.

All are of single-capacity construction, with a capacitance tolerance of ± 10 per cent. Cases are isolated and the two bushings are brought out through the cover. Units in 600-, 1000-, and 1500-volt ratings are available with either solder-lug terminals or with pillar-insulator terminals. All higher-voltage ratings have pillar-insulator terminals. These units may be operated in altitudes up to 7500 feet.

Up to 600 volts d-c, bushings with solder-lug terminals are made of G-E silicone; above this rating, they are of phenolic-cup construction. Bushings with pillar-



PYRANOL* CAPACITORS

*Registered trade-mark of General Electric Co.

Case Style 70 (Cont.)

insulator terminals are made of molded phenolic or porcelain of the highest quality. All bushings are thoroughly bonded to the container to provide a permanent liquid-tight seal.

All units can be supplied with removable mounting brackets. Both spade-lug and L-type are available. Brackets can be attached to either the top or the bottom of the units to permit upright or inverted mounting.

Write to the nearest G-E Apparatus Sales Office for Bulletin GEC-809.

STANDARD RATINGS

Nominal Direct Voltage Rating	Capacitance Ratings, Microfarads
2000	0.10, 0.25, 0.50, 1.0, 2.0, 4.0, 6.0, 8.0, 10.0, 12.0
2500	0.50, 1.0, 2.0, 4.0, 10.0, 20.0, 25.0, 55.0, 75.0
3000	0.10, 0.25, 0.50, 1.0, 2.0, 4.0, 8.0, 12.0, 20.0, 45.0, 60.0
4000	0.10, 0.25, 0.50, 1.0, 2.0, 4.0, 6.0, 7.0, 13.0, 20.0, 30.0
5000	0.05, 0.10, 0.25, 0.50, 1.0, 2.0, 4.0, 6.0, 8.0, 14.0, 18.0
6000	0.10, 1.0, 2.0, 4.0, 5.0, 10.0, 14.0
7500	0.10, 0.25, 0.50, 1.0, 2.0, 3.0, 7.0, 9.0
10,000	0.10, 0.25, 0.50, 1.0, 1.5, 2.0, 3.5, 5.0
12,500	0.05, 0.10, 0.25, 0.50, 0.75, 1.0, 1.2, 2.5, 3.3
15,000	0.25, 0.50, 0.75, 0.90, 1.75, 2.25*
20,000	0.15, 0.25, 0.50, 1.0, 1.25, 3.0
25,000	0.10, 0.25, 0.60, 1.0
30,000	0.25, 0.5, 0.75
40,000	0.10, 0.20, 0.25, 0.35
50,000	0.17, 0.25
75,000*	0.25
100,000*	0.125

*Mid-point connected to case.

Case Style 60

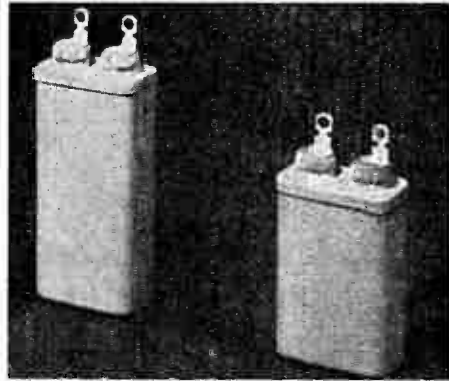

These small rectangular-case fixed-paper-dielectric units are of narrower width than the "bathtub" units, and will fit into a very restricted panel surface, where case height is not the limiting dimension. Removable-type mounting lugs are of very sturdy construction.

These units have solder-lug terminals, and are available in either single- or dual-section construction for all circuit diagrams.

The metallic containers are hermetically sealed, and of deep drawn construction.

Case Style 60 units have no brackets, but removable brackets of either the footed or spade-lug type can be supplied.

CAPACITORS FOR OSCILLATOR TANK CIRCUITS

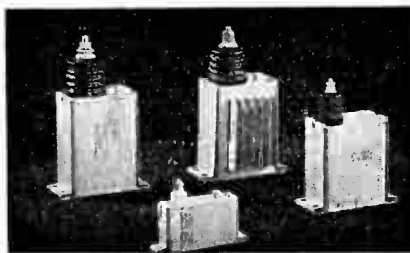

This line of fixed paper-dielectric capacitors has been developed primarily for grid and plate blocking service in the electronic oscillator circuits of high-frequency induction-heating equipments. They can also be used to advantage in other high-frequency oscillator circuits of a similar nature.

G-E high-voltage paper-dielectric capacitors are of relatively high capacitance (0.01 mu f) for high-frequency units, yet they are more economical than conventional high-frequency units of considerably smaller capacitance values. They can, therefore, be applied with savings in cost as well as reduced losses and lower voltage drop across the capacitor.

features

- Hermetically sealed in metallic cases.
- Single-bushing construction for minimum size.
- Removable mounting brackets.
- Internal lead connections arranged for minimum inductance.

Write for Bulletin GEA-4388.

STANDARD RATINGS

D-c Voltage Rating	Microfarad Rating
5000	0.01
15,000	0.01
20,000	0.01
20,000*	0.01

*With cooling fins for higher current-carrying capacity.
Capacitance tolerance $\pm 10\%$.

SPRAGUE CAPACITORS

ATOM[®] ELECTROLYTICS

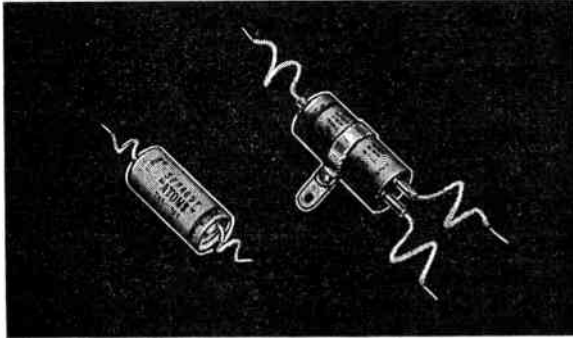

- The Smallest Dependable Dry Electrolytic—The Only Small Size Capacitor Designed For 85 °C (185 °F) operation In Voltages To 450 WVDC
- Whether For AC-DC Sets, Auto Radios, Home Radio-phono Combinations, Or TV Sets, The SPRAGUE Line Will Handle All Your Replacement Requirements—No Dual Inventory Problems
- Small Enough To Fit Anywhere, Work Anywhere
- Guaranteed To Have Low Leakage And Long Shelf Life
- Will Withstand High Temperatures, High Ripple Currents, High Surge Voltages

Mf	WVDC	Diam. x Length *	Cat. No.	List	Mf	WVDC	Diam. x Length *	Cat. No.	List
SINGLE UNITS									
50	6	3/8 x 1 1/4	TVA-1100	\$.95	10	250	3/16 x 1 1/16	TVA-1504	\$1.20
100	6	1/2 x 1 1/8	TVA-1101	1.20	12	250	3/16 x 1 1/16	TVA-1505	1.25
250	6	5/8 x 1 3/16	TVA-1102	1.35	16	250	3/8 x 1 1/16	TVA-1507	1.30
500	6	3/4 x 2 3/16	TVA-1103	1.55	20	250	1/4 x 1 1/16	TVA-1508	1.35
1000	6	1 1/16 x 2 3/16	TVA-1104	1.90	30	250	1 1/16 x 2 3/16	TVA-1510	1.45
1500	6	1 3/16 x 2 1 1/16	TVA-1105	2.10	40	250	3/4 x 2 3/16	TVA-1511	1.55
2000	6	1 5/16 x 2 1 1/16	TVA-1106	2.30	4	350	1/2 x 1 3/8	TVA-1601	1.05
100	12	3/16 x 1 3/16	TVA-1130	1.20	8	350	3/8 x 1 1 1/16	TVA-1603	1.20
250	12	3/8 x 1 1 1/16	TVA-1131	1.45	10	350	1 1/16 x 1 1 1/16	TVA-1604	1.25
500	12	3/4 x 1 1 1/16	TVA-1132	1.70	12	350	1 1/16 x 1 1 1/16	TVA-1605	1.30
1000	12	1 3/16 x 2 3/16	TVA-1133	2.25	16	350	3/4 x 1 1 1/16	TVA-1607	1.40
100	15	3/8 x 1 3/16	TVA-1160	1.25	20	350	13/16 x 1 1 1/16	TVA-1608	1.45
250	15	5/8 x 1 1 1/16	TVA-1161	1.55	30	350	13/16 x 2 3/16	TVA-1610	1.65
500	15	1 1/16 x 2 3/16	TVA-1162	1.75	40	350	3/8 x 2 7/16	TVA-1611	1.75
1000	15	7/8 x 2 3/16	TVA-1163	2.30	60	350	1 x 2 7/16	TVA-1613	1.95
2	25	3/8 x 1 1/4	TVA-1201	.90	2	450	3/16 x 1 3/8	TVA-1701	1.10
5	25	3/8 x 1 1/4	TVA-1203	1.00	4	450	3/16 x 1 1 1/16	TVA-1702	1.15
10	25	3/8 x 1 1/4	TVA-1204	1.00	8	450	1 1/16 x 1 1 1/16	TVA-1704	1.25
25	25	3/8 x 1 1/4	TVA-1205	1.00	10	450	1 1/16 x 1 1 1/16	TVA-1705	1.30
50	25	3/16 x 1 3/16	TVA-1206	1.10	12	450	3/4 x 1 1 1/16	TVA-1706	1.35
100	25	3/16 x 1 1 1/16	TVA-1207	1.35	16	450	3/4 x 2 3/16	TVA-1708	1.40
250	25	3/4 x 1 1 1/16	TVA-1208	1.70	20	450	3/4 x 2 3/16	TVA-1709	1.55
500	25	3/8 x 2 3/16	TVA-1209	2.30	30	450	3/8 x 2 3/16	TVA-1711	1.70
1	50	3/8 x 1 1/4	TVA-1300	.90	40	450	3/8 x 2 1 1/16	TVA-1712	1.80
2	50	3/8 x 1 1/4	TVA-1301	.90	50	450	3/8 x 3 3/16	TVA-1713	2.10
5	50	3/8 x 1 1/4	TVA-1303	1.00	80	450	1 x 3 1 1/16	TVA-1716	2.80
10	50	3/8 x 1 1/4	TVA-1304	1.00	10	475	3/4 x 1 1 1/16	TVA-1802	1.35
25	50	7/16 x 1 7/16	TVA-1306	1.05	20	475	3/8 x 2 3/16	TVA-1804	1.60
50	50	3/16 x 1 1 1/16	TVA-1308	1.20	8	500	3/8 x 1 1 1/16	TVA-1902	1.30
100	50	3/8 x 1 1 1/16	TVA-1310	1.40	16	500	1 1/16 x 2 3/16	TVA-1905	1.50
150	50	3/4 x 1 1 1/16	TVA-1311	1.55	20	500	1 x 2 3/16	TVA-1906	1.60
250	50	1 3/16 x 1 1 1/16	TVA-1312	1.75	DUAL UNITS				
4	150	3/8 x 1 1/4	TVA-1402	1.00	(COMMON NEGATIVE—3 LEADS)				
8	150	3/8 x 1 3/4	TVA-1405	1.05	10-10	25-25	3/8 x 1 3/16	TVA-2210	\$1.40
10	150	3/8 x 1 3/4	TVA-1406	1.05	10-10	50-50	3/8 x 1 3/16	TVA-2315	1.40
12	150	3/8 x 1 3/4	TVA-1407	1.10	8-8	150-150	3/8 x 1 3/16	TVA-2415	1.50
16	150	3/16 x 1 1 1/16	TVA-1409	1.15	16-16	150-150	3/8 x 1 3/16	TVA-2420	1.80
20	150	3/16 x 1 1 1/16	TVA-1410	1.20	20-12	150-150	3/8 x 1 3/16	TVA-2425	1.60
30	150	3/8 x 1 1 1/16	TVA-1412	1.30	20-20	150-150	3/8 x 1 3/16	TVA-2428	1.65
40	150	3/4 x 1 1 1/16	TVA-1413	1.35	30-20	150-150	3/8 x 1 1 1/16	TVA-2421	1.70
50	150	1 3/16 x 1 1 1/16	TVA-1414	1.40	30-30	150-150	3/8 x 1 1 1/16	TVA-2434	1.80
80	150	3/8 x 1 1 3/16	TVA-1418	1.60	40-20	150-150	3/8 x 1 1 1/16	TVA-2438	1.75
100	150	7/8 x 2 3/16	TVA-1420	1.75	40-30	150-150	3/8 x 1 1 3/16	TVA-2442	1.80
150	150	1 x 2 3/16	TVA-1422	1.90	40-40	150-150	3/8 x 1 1 3/16	TVA-2445	1.85
4	250	3/16 x 1 3/8	TVA-1501	1.00	50-30	150-150	3/8 x 1 1 3/16	TVA-2450	1.95
8	250	1/2 x 1 3/8	TVA-1503	1.15	50-50	150-150	3/8 x 2 3/16	TVA-2453	2.10

*Add 1/16" to diameter and 1/8" to length to allow for outer insulating tube.

SPRAGUE CAPACITORS

MF	WVDC	Diam. x Length*	Cat. No.	List
80-30	150-150	7/8 x 2 7/16	TVA-2460	\$2.20
20-20	250-250	7/8 x 1 11/16	TVA-2515	1.85
40-10	250-250	7/8 x 2 3/16	TVA-2520	2.05
80-10	250-250	1 1/16 x 3 3/16	TVA-2525	2.55
8-8	450-450	7/8 x 1 11/16	TVA-2720	1.70
10-10	450-450	7/8 x 1 11/16	TVA-2722	1.85
16-8	450-450	7/8 x 2 3/16	TVA-2725	2.00
20-20	450-450	7/8 x 2 3/16	TVA-2730	2.50
30-30	450-450	1 x 3 3/16	TVA-2735	3.00
40-40	450-450	1 x 3 11/16	TVA-2740	3.40

DUAL UNITS (SEPARATE SECTIONS—4 LEADS)

MF	WVDC	Diam. x Length*	Cat. No.	List
20-20	150-150	1 x 2 3/8	TU-220	2.05
40-20	150-150	1 1/16 x 2 3/8	TU-420	2.20
16-16	250-250	1 x 2 3/8	TU-216	2.20
8-8	450-450	1 1/16 x 3 3/8	TU-88	2.15
16-16	450-450	1 3/8 x 3 3/8	TU-1616	2.80

*Add 1/16" to diameter and 1/8" to length to allow for outer insulating tube.

MF	WVDC	Diam. x Length*	Cat. No.	List
TRIPLE UNITS				
20-20-20	150-150-25	7/8 x 1 7/16	TVA-3415	\$2.05
30-30-100	150-150-12	7/8 x 1 11/16	TVA-3419	2.30
40-30-20	150-150-25	7/8 x 1 11/16	TVA-3423	2.20
40-40-100	150-150-25	7/8 x 2 7/16	TVA-3427	2.45
50-30-20	150-150-25	7/8 x 2 3/16	TVA-3430	2.35
50-30-200	150-150-25	1 x 2 3/16	TVA-3433	2.75
50-50-20	150-150-25	1 5/16 x 2 3/16	TVA-3436	2.50
20-20-20	150-150-150	7/8 x 1 11/16	TVA-3440	2.20
30-30-30	150-150-150	7/8 x 2 3/16	TVA-3444	2.35
40-30-20	150-150-150	7/8 x 2 3/16	TVA-3448	2.35
40-40-40	150-150-150	1 x 2 7/16	TVA-3451	2.45
80-40-20	150-150-150	1 x 2 11/16	TVA-3455	2.75
12-12-20	450-450-25	1 x 2 7/8	TVA-3716	2.30

SCREWBASE ELECTROLYTICS

Type PLS—Capacitor sections have separate positive leads and common negative lead

Type LS—Positive terminal is lug connection, can is negative terminal

Type SC—For use where high peaks may occur . . . Lug connection is positive, can is negative

Type CL—Same as Type SC, but with can insulated from Sections . . . Separate positive and negative leads

Type WR—Designed to replace wet electrolytics . . . Will withstand extremely high A-C ripples . . . Has lug terminal

Type AP—For high voltage applications . . . Sections are connected in series . . . Insulated leads

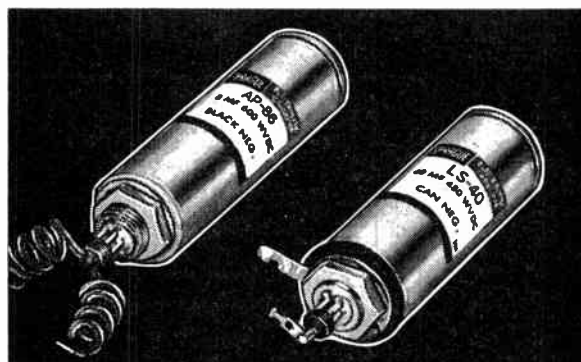

MF	Dia. x Length	Cat. No.	List
TYPE PLS—450 WVDC, 525 V Surge			
4	1 3/8 x 2 7/16	PLS-4	\$2.00
8	1 3/8 x 2 7/16	PLS-8	2.20
12	1 3/8 x 2 7/16	PLS-12	2.40
16	1 3/8 x 2 7/16	PLS-16	2.45
20	1 3/8 x 2 7/16	PLS-20	2.70
25	1 3/8 x 3 3/16	PLS-25	2.90
30	1 3/8 x 3 3/16	PLS-30	3.00
40	1 3/8 x 3 11/16	PLS-40	3.15
4+8	1 3/8 x 2 11/16	PLS-48	2.95
8+8	1 1/2 x 2 11/16	PLS-88	3.00
8+16	1 1/2 x 2 11/16	PLS-816	3.30
16+16	1 1/2 x 3 11/16	PLS-216	3.55
8+8+8	1 1/2 x 2 11/16	PLS-888	5.00

MF	Dia. x Length	Cat. No.	List
TYPE LS—450 WVDC, 525 V Surge			
8	1 3/8 x 2 11/16	LS-8	2.20
12	1 3/8 x 2 11/16	LS-12	2.40
16	1 3/8 x 2 11/16	LS-16	2.45
20	1 3/8 x 2 11/16	LS-20	2.70
25	1 3/8 x 3 3/16	LS-25	2.90
30	1 3/8 x 3 3/16	LS-30	3.00
40	1 3/8 x 3 11/16	LS-40	3.15
8+8	1 3/8 x 2 1/4	LS-88	3.00

MF	Dia. x Length	Cat. No.	List
TYPE SC—475 WVDC, 600 V Surge			
4	1 x 3 7/16	SC-4	\$2.55
8	1 3/8 x 4 7/16	SC-8	2.75
12	1 3/8 x 4 7/16	SC-12	2.95
16	1 1/2 x 4 7/16	SC-16	3.15
8+8	1 3/8 x 4 1/4	SC-88	4.10

MF	Dia. x Length	Cat. No.	List
TYPE CL—475 WVDC, 600 V Surge			
8	1 3/8 x 4 7/16	CL-8	2.75
16	1 1/2 x 4 7/16	CL-16	3.15
8+8	1 1/2 x 4 11/16	CL-88	4.10

MF	Dia. x Length	Cat. No.	List
TYPE WR—500 WVDC, 600 V Surge			
8	1 3/8 x 3 11/16	WR-8	2.85
16	1 3/8 x 4 7/16	WR-16	3.30
25	1 1/2 x 5 7/16	WR-25	3.75

MF	Dia. x Length	Cat. No.	List
TYPE AP—600 WVDC, 800 V Surge			
4	1 x 4 7/16	AP-46	2.95
8	1 3/8 x 4 7/16	AP-86	3.15
16	1 1/2 x 4 7/16	AP-16	3.75

All prices subject to change without notice.

TRADE DISCOUNT APPLIES TO LIST PRICES ONLY

3-54

Kadio's Master—19th Edition

Page P-17

SPRAGUE CAPACITORS

TVL TWIST-LOK* ELECTROLYTICS

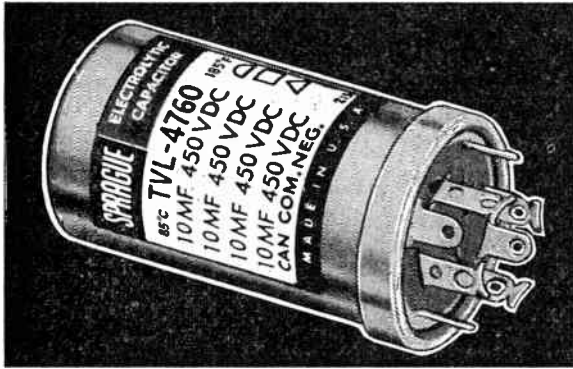

- Especially Designed for Tough TV and Radio Replacement Applications
- Hermetically Sealed in Aluminum Cans for Long Life and Dependable Performance
- Stand Up Under Extremely High Temperatures and High Surge Voltages as well as in High Ripple Selenium Rectifier Circuits
- Easy to Mount—A Twist of the Tabs Locks Unit Firmly in Place
- Furnished Complete with Bakelite and Metal Mounting Plates
- Designed for 85°C (185°F) Operation, Up to 450 Working Volts D-C

* Trademark

MF	WVDC	Diam. x Length	Cat. No.	List
SINGLE UNITS				
.5Ω@15.75 KC	3N.P.	1 x 2	TVL-1010	\$2.10
1Ω@60 CPS	3N.P.	1 3/8 x 2 1/2	TVL-1015	3.20
10Ω@30 CPS	3N.P.	3/4 x 2	TVL-1020	2.20
2000	6	1 3/8 x 2	TVL-1115	2.55
3000	10	1 3/8 x 2 1/2	TVL-1140	2.90
1000	15	1 x 2 1/2	TVL-1165	2.55
2000	15	1 3/8 x 2	TVL-1168	3.45
3000	15	1 3/8 x 3	TVL-1170	3.50
40	25	3/4 x 2	TVL-1210	1.35
100	25	3/4 x 2	TVL-1215	1.60
500	25	1 x 2	TVL-1220	2.55
1000	25	1 3/8 x 2	TVL-1230	3.55
150	50	3/4 x 2 1/2	TVL-1320	1.80
500	50	1 3/8 x 2 1/2	TVL-1330	2.65
20	150	1 x 2	TVL-1405	1.45
30	150	1 x 2	TVL-1408	1.55
40	150	1 x 2	TVL-1412	1.60
50	150	1 x 2	TVL-1415	1.65
80	150	1 x 2 1/2	TVL-1420	1.85
80	150	1 3/8 x 2	TVL-1421	1.85
100	150	1 x 2 1/2	TVL-1423	2.00
120	150	1 x 3 1/2	TVL-1425	2.15
140	150	1 x 3	TVL-1428	2.15
150	150	1 3/8 x 3	TVL-1430	2.15
200	150	1 3/8 x 4	TVL-1431	2.45
300	150	1 3/8 x 3 1/2	TVL-1434	2.80
40	200	1 x 2	TVL-1460	1.70
15	250	1 x 2	TVL-1505	1.55
20	250	1 x 2	TVL-1509	1.60
30	250	1 x 2	TVL-1516	1.70
40	250	1 x 2	TVL-1519	1.80
50	250	1 x 2 1/2	TVL-1522	1.95
60	250	1 x 3	TVL-1525	2.05
80	250	1 x 3 1/2	TVL-1530	2.15
100	250	1 x 3	TVL-1535	2.70
150	250	1 3/8 x 2 1/2	TVL-1540	3.10
15	300	1 x 2	TVL-1560	1.60
30	300	1 x 2	TVL-1563	1.75
50	300	1 x 2 1/2	TVL-1567	2.05
60	300	1 x 3	TVL-1570	2.10
80	300	1 x 3 1/2	TVL-1573	2.55
100	300	1 x 4	TVL-1578	2.90
125	300	1 3/8 x 3 1/2	TVL-1580	3.50
150	300	1 3/8 x 3 1/2	TVL-1584	3.50
30	350	1 x 2 1/2	TVL-1617	1.90

MF	WVDC	Diam. x Length	Cat. No.	List
40	350	1 x 2	TVL-1621	\$2.00
50	350	1 x 3	TVL-1622	2.10
80	350	1 3/8 x 3	TVL-1630	2.85
125	350	1 3/8 x 3 1/2	TVL-1638	3.95
10	400	1 x 2	TVL-1655	1.50
20	400	1 x 2	TVL-1660	1.75
80	400	1 3/8 x 3	TVL-1675	2.95
10	450	1 x 2	TVL-1705	1.55
15	450	1 x 2	TVL-1709	1.70
20	450	1 x 2	TVL-1714	1.80
30	450	1 x 2 1/2	TVL-1720	1.95
40	450	1 x 3	TVL-1725	2.05
80	450	1 3/8 x 2 1/2	TVL-1735	3.05
125	450	1 3/8 x 4	TVL-1760	3.85
30	475	1 x 3	TVL-1810	2.00
40	475	1 3/8 x 2	TVL-1820	2.50
90	475	1 3/8 x 3 1/2	TVL-1850	3.50
10	500	1 x 2	TVL-1940	1.70

DUAL UNITS

.5Ω@15.75 KC-		1 3/8 x 2	TVL-2010	3.60
2.5Ω@60 CPS		1 3/8 x 2	TVL-2010	3.60
1000-500	6 N.P.-6 N.P.	1 3/8 x 2	TVL-2120	3.90
250-1000	10-6	1 3/8 x 2	TVL-2140	2.85
1000-1000	15-15	1 x 3 1/2	TVL-2160	4.40
40-40	25-25	1 x 2	TVL-2210	1.60
150-50	25-25	1 x 2	TVL-2230	1.90
50-50	50-50	1 x 2	TVL-2320	1.70
50-500	150-5	1 x 3	TVL-2404	2.45
20-20	150-150	1 x 2	TVL-2415	1.70
30-15	150-150	1 x 2	TVL-2418	1.75
30-30	150-150	1 x 2	TVL-2422	1.85
40-20	150-150	1 x 2	TVL-2425	1.85
40-40	150-150	1 x 2 1/2	TVL-2428	1.90
50-30	150-150	1 x 2 1/2	TVL-2432	2.00
50-50	150-150	1 x 2 1/2	TVL-2435	2.15
60-60	150-150	1 x 3 1/2	TVL-2438	2.35
80-40	150-150	1 3/8 x 2 1/2	TVL-2442	2.30
200-5	150-150	1 3/8 x 3	TVL-2444	2.70
200-125	150-150	1 3/8 x 3 1/2	TVL-2445	3.75
200-200	150-150	1 3/8 x 4	TVL-2447	4.00
40-40	200-200	1 x 3	TVL-2460	2.30
40-25	250-25	1 x 2 1/2	TVL-2505	2.00
10-10	250-250	1 x 2	TVL-2510	1.70
20-20	250-250	1 x 2	TVL-2515	1.90
40-40	250-250	1 x 3 1/2	TVL-2520	2.50
150-150	250-250	1 3/8 x 4	TVL-2535	5.15
20-20	300-25	1 x 2	TVL-2555	1.85

SPRAGUE CAPACITORS

MF	WVDC	Diam. x Length	Cat. No.	List	MF	WVDC	Diam. x Length	Cat. No.	List
10-10	300-300	1 x 2	TVL-2565	\$1.75	70-70-20	250-250-50	1 3/8 x 3	TVL-3470	\$3.90
15-15	300-300	1 x 2	TVL-2568	1.90	100-10-40	200-200-50	1 3/8 x 2	TVL-3475	3.15
40-40	300-300	1 3/8 x 2 1/2	TVL-2575	3.00	15-15-20	250-250-25	1 x 2	TVL-3510	2.35
60-60	300-300	1 3/8 x 2 1/2	TVL-2579	3.40	30-30-20	250-250-25	1 x 3	TVL-3513	2.80
80-40	300-300	1 3/8 x 2 1/2	TVL-2582	3.55	40-20-10	250-250-150	1 3/8 x 2	TVL-3517	2.75
80-60	300-300	1 3/8 x 3 1/2	TVL-2584	3.70	80-80-60	250-250-200	1 3/8 x 3 1/2	TVL-3525	4.50
80-80	300-300	1 3/8 x 3 1/2	TVL-2585	4.05	15-15-10	250-250-250	1 x 2	TVL-3530	2.45
120-20	300-300	1 3/8 x 3 1/2	TVL-2588	4.00	30-15-10	250-250-250	1 x 2 1/2	TVL-3534	2.70
120-40	300-300	1 3/8 x 3 1/2	TVL-2589	4.35	40-20-20	250-250-250	1 x 3 1/2	TVL-3540	2.90
20-30	350-250	1 x 3	TVL-2615	2.30	100-60-20	300-150-25	1 3/8 x 3	TVL-3560	4.20
40-10	350-250	1 x 3	TVL-2617	2.45	100-60-20	300-250-250	1 3/8 x 4	TVL-3562	4.90
60-80	350-250	1 3/8 x 3 1/2	TVL-2618	3.45	200-60-20	300-250-250	1 3/8 x 4	TVL-3563	5.50
30-30	350-300	1 x 3 1/2	TVL-2621	2.65	20-20-20	300-300-25	1 x 2 1/2	TVL-3565	2.75
20-20	350-350	1 x 3	TVL-2626	2.30	40-15-20	300-300-25	1 x 3	TVL-3570	2.95
30-20	350-350	1 x 3 1/2	TVL-2627	2.60	40-20-20	300-300-25	1 3/8 x 2	TVL-3573	3.10
80-80	350-350	1 3/8 x 4	TVL-2635	4.70	100-10-60	300-300-50	1 3/8 x 2 1/2	TVL-3574	4.05
90-40	350-350	1 3/8 x 4	TVL-2637	4.30	200-20-10	300-300-100	1 3/8 x 4	TVL-3575	4.90
40-100	400-50	1 3/8 x 2	TVL-2653	2.70	10-10-15	300-300-250	1 x 2	TVL-3578	2.45
60-80	400-250	1 3/8 x 4	TVL-2657	3.90	10-10-10	300-300-300	1 x 2	TVL-3580	2.40
15-15	400-400	1 x 2 1/2	TVL-2660	2.25	80-40-40	300-300-300	1 3/8 x 3 1/2	TVL-3583	4.75
30-10	400-400	1 x 3	TVL-2663	2.35	120-50-40	300-300-300	1 3/8 x 4	TVL-3585	5.85
60-60	400-400	1 3/8 x 4	TVL-2668	4.40	4-100-40	350-25-25	1 x 2	TVL-3603	2.25
80-10	400-400	1 3/8 x 3 1/2	TVL-2672	3.40	10-50-100	350-150-50	1 x 3 1/2	TVL-3608	2.85
80-20	400-400	1 3/8 x 3	TVL-2673	3.65	125-5-100	350-200-75	1 3/8 x 3 1/2	TVL-3610	5.30
80-40	400-400	1 3/8 x 4	TVL-2675	4.10	20-30-20	350-250-25	1 x 3	TVL-3612	2.80
120-40	400-400	1 3/8 x 4	TVL-2679	5.25	30-20-10	350-250-250	1 x 3 1/2	TVL-3615	3.00
80-10	450-25	1 3/8 x 3	TVL-2705	3.40	20-40-10	350-300-150	1 x 3 1/2	TVL-3619	3.15
10-100	450-50	1 x 2 1/2	TVL-2708	2.05	30-30-20	350-300-25	1 x 3	TVL-3620	3.15
80-50	450-50	1 3/8 x 3	TVL-2710	3.50	40-20-10	350-300-200	1 3/8 x 2	TVL-3623	3.30
20-100	450-100	1 3/8 x 2	TVL-2713	2.90	10-10-20	350-350-25	1 x 2	TVL-3628	3.25
20-80	450-350	1 3/8 x 3 1/2	TVL-2730	3.65	30-20-100	350-350-75	1 3/8 x 2 1/2	TVL-3629	4.00
40-10	450-350	1 3/8 x 2 1/2	TVL-2735	2.60	15-10-20	350-350-25	1 x 2 1/2	TVL-3630	2.50
10-10	450-450	1 x 2	TVL-2750	1.90	15-15-20	350-350-25	1 x 2 1/2	TVL-3632	2.70
15-10	450-450	1 x 2 1/2	TVL-2752	2.25	20-5-30	350-350-25	1 x 2	TVL-3633	2.45
15-15	450-450	1 x 2 1/2	TVL-2753	2.25	20-10-20	350-350-25	1 x 2 1/2	TVL-3634	2.55
20-20	450-450	1 x 3	TVL-2755	2.55	30-20-20	350-350-25	1 x 3 1/2	TVL-3636	3.10
30-30	450-450	1 3/8 x 2 1/2	TVL-2759	3.05	10-5-30	350-350-50	1 x 2	TVL-3637	2.20
40-40	450-450	1 3/8 x 3	TVL-2764	3.45	10-5-150	350-350-50	1 x 3	TVL-3638	2.70
60-40	450-450	1 3/8 x 3 1/2	TVL-2770	3.95	60-40-20	350-350-350	1 3/8 x 4	TVL-3640	4.25
80-10	450-450	1 3/8 x 3	TVL-2776	3.60	80-60-60	350-350-350	1 3/8 x 4	TVL-3642	5.55
80-30	450-450	1 3/8 x 4	TVL-2777	4.20	90-40-20	350-350-350	1 3/8 x 4	TVL-3645	5.25
20-100	475-300	1 3/8 x 3 1/2	TVL-2810	3.95	60-40-20	400-300-25	1 3/8 x 3 1/2	TVL-3663	4.20
40-40	475-475	1 3/8 x 3	TVL-2830	4.30	10-40-10	400-300-150	1 3/8 x 2	TVL-3665	2.90
80-40	475-475	1 3/8 x 4	TVL-2850	5.05	10-50-30	400-350-25	1 x 3 1/2	TVL-3670	3.10
40-50	500-200	1 3/8 x 3	TVL-2920	3.35	100-10-20	400-350-50	1 3/8 x 3 1/2	TVL-3672	4.50
TRIPLE UNITS					100-10-40	400-400-25	1 x 3	TVL-3675	2.80
1500-1500-1500	3-3-3	1 x 3 1/2	TVL-3015	6.00	15-15-40	400-400-25	1 x 3	TVL-3678	2.85
20-20-20	25-25-25	1 x 2	TVL-3210	1.95	20-20-20	400-400-25	1 x 3	TVL-3682	2.65
40-40-40	25-25-25	1 x 2	TVL-3230	2.15	20-10-40	400-400-50	1 3/8 x 4	TVL-3684	5.25
30-30-30	50-50-50	1 x 2	TVL-3320	2.15	80-40-150	400-400-350	1 x 3	TVL-3687	2.70
20-250-100	150-15-15	1 3/8 x 2	TVL-3403	2.90	20-10-10	400-400-400	1 x 2 1/2	TVL-3690	2.40
100-50-25	150-50-25	1 x 3	TVL-3407	3.00	30-100-25	450-25-25	1 3/8 x 2	TVL-3703	2.95
30-20-100	150-150-6	1 x 2	TVL-3412	2.40	80-100-20	450-50-50	1 3/8 x 3	TVL-3704	4.25
20-20-20	150-150-25	1 x 2	TVL-3415	2.20	40-40-130	450-150-50	1 3/8 x 3	TVL-3706	3.70
30-20-20	150-150-25	1 x 2	TVL-3417	2.25	40-90-50	450-150-150	1 3/8 x 3	TVL-3708	4.00
30-30-20	150-150-25	1 x 2	TVL-3419	2.30	20-80-50	450-200-50	1 3/8 x 2 1/2	TVL-3709	3.40
40-20-20	150-150-25	1 x 2 1/2	TVL-3422	2.30	20-60-100	450-250-25	1 3/8 x 2 1/2	TVL-3711	3.65
40-30-20	150-150-25	1 x 2	TVL-3424	2.35	10-80-80	450-250-250	1 3/8 x 4	TVL-3712	4.15
40-30-25	150-150-25	1 x 2 1/2	TVL-3425	2.35	20-40-10	450-250-250	1 3/8 x 2	TVL-3713	3.15
50-30-100	150-150-25	1 x 3	TVL-3427	2.70	30-10-10	450-300-150	1 x 3	TVL-3714	2.95
50-50-20	150-150-25	1 x 3	TVL-3430	2.65	10-100-20	450-300-300	1 3/8 x 3	TVL-3715	4.35
20-20-20	150-150-150	1 x 2 1/2	TVL-3433	2.30	20-15-10	450-300-300	1 x 3 1/2	TVL-3716	2.85
30-30-10	150-150-150	1 x 2	TVL-3435	2.35	10-10-20	450-350-25	1 x 2 1/2	TVL-3719	2.30
40-20-20	150-150-150	1 x 2 1/2	TVL-3437	2.40	60-80-20	450-400-250	1 3/8 x 4	TVL-3720	5.45
40-40-40	150-150-150	1 x 3 1/2	TVL-3440	2.60	10-10-50	450-350-25	1 x 3	TVL-3721	2.40
50-50-50	150-150-150	1 x 3	TVL-3442	3.00	20-80-100	450-350-50	1 3/8 x 3 1/2	TVL-3722	4.50
80-80-80	150-150-150	1 3/8 x 3	TVL-3446	3.75	30-40-50	450-350-25	1 x 4	TVL-3723	3.70
120-80-40	150-150-150	1 3/8 x 3 1/2	TVL-3448	3.80	15-20-20	450-350-250	1 3/8 x 2	TVL-3724	2.95
200-100-60	150-150-150	1 3/8 x 3 1/2	TVL-3450	4.55	60-20-20	450-350-350	1 3/8 x 3 1/2	TVL-3725	4.30
					10-30-30	450-400-300	1 3/8 x 2 1/2	TVL-3726	3.35
					20-80-10	450-350-350	1 3/8 x 3	TVL-3727	4.25
					4-40-40	450-400-300	1 3/8 x 2 1/2	TVL-3728	4.60

All prices subject to change without notice.

TRADE DISCOUNT APPLIES TO LIST PRICES ONLY

Radio's Master - 19th Edition

Page P-19

SPRAGUE CAPACITORS

TVL TWIST-LOK ELECTROLYTICS, continued

MF	WVDC	Dia. x Length	Cat. No.	List	MF	WVDC	Dia. x Length	Cat. No.	List
10-10-10	450-450-25	1 x 2½	TVL-3729	\$2.40	40-40-20-10	300-300-300-300	1¾ x 3½	TVL-4579	\$4.55
10-10-20	450-450-25	1 x 2½	TVL-3731	2.40	60-40-10-10	300-300-300-300	1¾ x 2½	TVL-4583	4.55
15-15-20	450-450-25	1 x 3	TVL-3733	2.70					
20-10-20	450-450-25	1 x 3	TVL-3735	2.70	20-150-80-20	350-150-150-25	1¾ x 3	TVL-4603	4.55
20-15-20	450-450-25	1 x 3½	TVL-3737	2.90	20-100-100-10	350-200-200-100	1¾ x 4	TVL-4604	5.00
20-20-20	450-450-25	1 x 3	TVL-3739	3.05	40-40-20-20	350-300-300-25	1¾ x 3½	TVL-4605	4.50
30-30-20	450-450-25	1¾ x 2½	TVL-3741	3.55	40-10-100-25	350-350-25-25	1¾ x 2	TVL-4606	3.75
30-30-125	450-450-25	1¾ x 3	TVL-3743	3.95	60-4-100-40	350-350-25-25	1¾ x 2½	TVL-4607	3.80
80-10-125	450-450-25	1¾ x 3½	TVL-3745	4.45	60-40-60-20	350-350-200-150	1¾ x 3½	TVL-4609	5.05
80-40-100	450-450-25	1¾ x 4	TVL-3746	5.05	10-10-10-10	350-350-300-300	1¾ x 2	TVL-4612	3.10
10-10-40	450-450-50	1 x 2½	TVL-3749	2.50	20-10-5-10	350-350-350-25	1¾ x 2	TVL-4620	3.10
20-10-50	450-450-50	1 x 3	TVL-3751	2.85	40-20-5-10	350-350-350-25	1¾ x 2½	TVL-4621	3.80
30-15-150	450-450-50	1¾ x 3	TVL-3753	3.70	40-40-30-10	350-350-350-25	1¾ x 3	TVL-4622	4.95
40-10-40	450-450-50	1¾ x 2½	TVL-3754	3.25	90-30-5-100	350-350-350-75	1¾ x 3½	TVL-4625	6.15
60-40-75	450-450-50	1¾ x 4	TVL-3756	4.65	40-40-40-150	350-350-350-50	1¾ x 4	TVL-4628	5.65
80-20-100	450-450-50	1¾ x 4	TVL-3757	4.80	60-25-25-100	350-350-350-50	1¾ x 3½	TVL-4630	5.15
40-40-40	450-450-150	1¾ x 3½	TVL-3758	4.15	100-10-10-20	350-350-350-50	1¾ x 3½	TVL-4632	5.15
40-10-80	450-450-200	1¾ x 3	TVL-3761	3.90	100-40-30-50	350-350-350-50	1¾ x 4	TVL-4634	6.55
40-10-100	450-450-200	1¾ x 3½	TVL-3762	4.15					
40-40-60	450-450-200	1¾ x 3½	TVL-3763	4.45	40-120-10-150	400-250-250-50	1¾ x 4	TVL-4637	5.90
40-40-100	450-450-200	1¾ x 4	TVL-3764	4.95	10-100-10-100	400-300-75-25	1¾ x 3½	TVL-4638	4.70
15-10-120	450-450-300	1¾ x 3½	TVL-3765	4.70	30-40-50-200	400-300-250-150	1¾ x 4	TVL-4640	6.00
15-15-10	450-450-300	1 x 3½	TVL-3766	2.85	80-40-20-10	400-300-300-300	1¾ x 4	TVL-4641	5.55
15-5-15	450-450-350	1 x 3	TVL-3768	2.85	20-10-10-20	400-350-200-25	1¾ x 2	TVL-4652	3.20
20-20-60	450-450-350	1¾ x 3½	TVL-3770	5.05	40-10-80-10	400-350-250-250	1¾ x 4	TVL-4657	4.65
40-10-10	450-450-350	1¾ x 3	TVL-3772	3.30	80-40-10-10	400-350-350-25	1¾ x 4	TVL-4659	5.30
10-10-10	450-450-450	1 x 3	TVL-3776	2.60	10-10-25-25	400-400-25-25	1¾ x 2	TVL-4662	2.80
15-15-10	450-450-450	1 x 3½	TVL-3778	2.95	50-25-100-20	400-400-50-25	1¾ x 3	TVL-4663	4.65
20-20-20	450-450-450	1¾ x 2½	TVL-3780	3.60	10-10-40-10	400-400-200-50	1¾ x 2	TVL-4664	3.20
30-30-30	450-450-450	1¾ x 3½	TVL-3782	4.35	20-20-20-20	400-400-400-25	1¾ x 2½	TVL-4667	3.85
40-40-10	450-450-450	1¾ x 3½	TVL-3785	4.15	80-40-30-40	400-400-400-25	1¾ x 4	TVL-4670	5.95
40-40-20	450-450-450	1¾ x 3	TVL-3786	4.45	40-35-10-10	400-400-400-400	1¾ x 3	TVL-4673	4.45
40-40-40	450-450-450	1¾ x 3½	TVL-3787	4.90	80-10-10-10	400-400-400-400	1¾ x 3½	TVL-4675	4.70
60-20-20	450-450-450	1¾ x 3	TVL-3789	4.60	80-25-10-10	400-400-400-400	1¾ x 4	TVL-4680	5.25
60-30-10	450-450-450	1¾ x 3	TVL-3790	4.50					
80-40-10	450-450-450	1¾ x 4	TVL-3792	5.05					
10-100-40	475-200-50	1¾ x 2½	TVL-3800	3.35	10-80-40-100	450-200-200-50	1¾ x 3	TVL-4700	4.25
20-50-20	475-50-25	1 x 3	TVL-3801	2.75	20-80-20-50	450-200-200-50	1¾ x 3	TVL-4701	4.10
40-40-100	475-250-50	1¾ x 3	TVL-3802	4.30	40-40-40-20	450-250-250-25	1¾ x 3	TVL-4702	4.55
20-20-40	475-300-25	1¾ x 2	TVL-3805	3.10	10-40-40-100	450-300-250-50	1¾ x 3½	TVL-4703	4.40
40-80-10	475-300-300	1¾ x 3½	TVL-3806	4.80	10-100-20-20	450-300-300-200	1¾ x 3	TVL-4704	5.05
10-4-40	475-350-250	1¾ x 2	TVL-3807	2.75	10-10-60-100	450-300-200-50	1¾ x 3	TVL-4705	3.80
40-40-25	475-400-50	1¾ x 3	TVL-3813	4.30	10-100-10-20	450-350-350-25	1¾ x 3	TVL-4706	5.20
10-45-100	475-450-50	1¾ x 3	TVL-3815	3.65	10-60-40-25	450-350-350-25	1¾ x 4	TVL-4707	4.60
20-10-100	475-475-50	1¾ x 2	TVL-3817	3.25	20-15-15-20	450-350-350-25	1¾ x 2½	TVL-4708	3.80
20-20-60	475-475-400	1¾ x 3½	TVL-3820	4.80	5-60-50-20	450-400-350-25	1¾ x 3½	TVL-4709	5.05
10-10-10	475-475-475	1 x 3	TVL-3835	2.70	80-10-30-40	450-400-300-150	1¾ x 4	TVL-4710	5.25
30-30-20	475-475-475	1¾ x 3	TVL-3840	4.45	20-80-50-100	450-350-350-50	1¾ x 4	TVL-4711	6.00
40-30-30	475-475-475	1¾ x 4	TVL-3843	5.15	20-15-20-20	450-450-25-25	1¾ x 2	TVL-4712	3.45
20-40-100	500-300-25	1¾ x 2½	TVL-3908	3.60	10-10-60-100	450-450-200-50	1¾ x 3	TVL-4713	3.85
10-40-40	500-450-450	1¾ x 3½	TVL-3911	4.15	35-25-20-100	450-450-200-50	1¾ x 3	TVL-4714	4.65
					20-20-30-30	450-450-300-300	1¾ x 3½	TVL-4715	4.50
					10-10-10-50	450-450-300-25	1¾ x 2	TVL-4716	3.15
					40-10-35-10	450-450-350-350	1¾ x 3½	TVL-4718	4.60
					40-40-30-30	450-450-350-350	1¾ x 4	TVL-4720	5.90
					10-10-10-20	450-450-450-25	1¾ x 2	TVL-4723	3.15
					30-30-10-125	450-450-450-25	1¾ x 3	TVL-4725	4.70
					40-10-10-250	450-450-450-25	1¾ x 3	TVL-4726	4.70
					40-15-10-20	450-450-450-25	1¾ x 3	TVL-4729	4.10
					40-20-20-40	450-450-450-25	1¾ x 3	TVL-4732	4.65
					40-30-10-20	450-450-450-25	1¾ x 3½	TVL-4734	4.50
					40-40-10-20	450-450-450-25	1¾ x 3½	TVL-4736	4.70
					40-40-40-40	450-450-450-25	1¾ x 4	TVL-4739	5.50
					20-20-20-100	450-450-450-50	1¾ x 2½	TVL-4740	4.55
					30-30-15-30	450-450-450-50	1¾ x 3	TVL-4742	4.55
					40-40-10-25	450-450-450-50	1¾ x 3½	TVL-4745	4.70
					40-40-10-100	450-450-450-100	1¾ x 3½	TVL-4747	5.55
					10-10-10-10	450-450-450-150	1¾ x 2	TVL-4750	3.15
					60-10-10-20	450-450-450-150	1¾ x 3	TVL-4753	4.55
					35-35-10-10	450-450-450-200	1¾ x 3½	TVL-4755	4.60
					10-10-10-10	450-450-450-450	1¾ x 2	TVL-4760	3.35
					20-10-10-10	450-450-450-450	1¾ x 2½	TVL-4761	3.70
					20-20-20-20	450-450-450-450	1¾ x 3	TVL-4763	4.70
					30-15-15-15	450-450-450-450	1¾ x 3	TVL-4766	4.45
					30-30-15-10	450-450-450-450	1¾ x 3½	TVL-4769	4.70

QUADRUPLE UNITS

30-30-30-40	150-150-150-25	1¾ x 2	TVL-4415	3.10
40-40-30-20	150-150-150-25	1¾ x 2	TVL-4420	3.10
50-50-50-20	150-150-150-25	1¾ x 2	TVL-4425	3.55
60-60-10-60	150-150-150-25	1¾ x 2	TVL-4428	3.50
40-20-10-20	200-200-200-25	1¾ x 2	TVL-4470	3.20
100-40-10-100	250-250-250-50	1¾ x 3½	TVL-4516	5.15
80-60-40-20	250-250-250-150	1¾ x 4	TVL-4524	5.10
100-40-80-20	300-50-25-25	1¾ x 3	TVL-4555	4.55
10-200-140-30	300-150-150-150	1¾ x 3½	TVL-4559	5.10
100-10-200-30	300-300-150-150	1¾ x 4	TVL-4561	5.90
120-20-20-100	300-250-25-30	1¾ x 3½	TVL-4562	5.25
150-20-10-250	300-300-250-50	1¾ x 4	TVL-4564	6.05
10-10-10-20	300-300-300-25	1¾ x 2	TVL-4565	2.95
60-40-20-50	300-300-300-25	1¾ x 3½	TVL-4570	4.70
40-40-40-20	300-300-300-150	1¾ x 3	TVL-4575	4.90
40-20-10-10	300-300-300-300	1¾ x 2	TVL-4578	3.95

SPRAGUE CAPACITORS

MF	WVDC	Dia. x Length	Cat. No.	List
35-35-10-5	450-450-450-450	1 1/2 x 3 1/2	TVL-4771	\$4.60
40-40-30-30	450-450-450-450	1 1/2 x 4	TVL-4774	6.05
70-10-10-5	450-450-450-450	1 1/2 x 3	TVL-4780	4.75
20-40-100-80	475-300-50-25	1 1/2 x 3	TVL-4800	4.45
20-80-20-10	475-300-300-300	1 1/2 x 3 1/2	TVL-4801	5.00
10-100-10-100	475-300-300-25	1 1/2 x 3 1/2	TVL-4802	4.90
10-30-5-80	475-350-350-50	1 1/2 x 2 1/2	TVL-4803	3.70
10-40-100-10	475-400-50-25	1 1/2 x 2 1/2	TVL 4804	4.00
10-40-4-100	475-400-350-50	1 1/2 x 2 1/2	TVL-4805	4.05
10-10-80-50	475-450-200-60	1 1/2 x 3	TVL-4806	3.85
25-20-20-100	475-450-300-50	1 1/2 x 3	TVL-4809	4.60
10-60-30-125	475-450-400-50	1 1/2 x 4	TVL-4811	5.55
10-50-30-30	475-450-450-25	1 1/2 x 3	TVL-4813	4.75
15-15-80-40	475-475-300-50	1 1/2 x 3	TVL-4815	4.80
40-10-4-40	475-475-350-300	1 1/2 x 3	TVL-4817	4.95
10-5-80-40	475-475-450-50	1 1/2 x 3 1/2	TVL-4819	4.90

MF	WVDC	Dia. x Length	Cat. No.	List
40-20-10-10	475-475-475-25	1 1/2 x 3	TVL-4822	\$4.85
20-20-10-10	475-475-475-300	1 1/2 x 2 1/2	TVL-4826	4.30
50-30-10-20	475-475-475-300	1 1/2 x 3 1/2	TVL-4827	5.60
10-10-10-10	475-475-475-475	1 1/2 x 2	TVL-4830	3.50
40-20-10-10	475-475-475-475	1 1/2 x 3	TVL-4840	5.10

INSULATING TUBES

These closed-top black insulating sleeves are made of tightly fitting Kraftboard. Order with capacitors as required.

Cat. No.	Description	Cat. No.	Description
HKT-1	For 1" x 2" can	HKT-6	For 1 3/4" x 2 1/2" can
HKT-2	For 1" x 2 1/2" can	HKT-7	For 1 3/4" x 3" can
HKT-3	For 1" x 3" can	HKT-8	For 1 3/4" x 3 1/2" can
HKT-4	For 1" x 4" can	HKT-9	For 1 3/4" x 4" can
HKT-5	For 1 1/4" x 2" can		

PE OCTAL-BASE ELECTROLYTICS

MF	WVDC	Dia. x Length	Cat. No.	List
100	350	1 1/2 x 3	PE-1636	\$5.85
10	450	1 1/2 x 2 1/2	PE-1705	4.05
20	450	1 1/2 x 2 1/2	PE-1714	4.30
40	450	1 1/2 x 2 1/2	PE-1725	4.55
80	450	1 1/2 x 3 1/2	PE-1730	5.55
20-20	150-150	1 1/2 x 2 1/2	PE-2415	4.20
40-40	150-150	1 1/2 x 2 1/2	PE-2428	4.40
10-10	450-450	1 1/2 x 2 1/2	PE-2750	4.40
20-20	450-450	1 1/2 x 2 1/2	PE-2755	5.05
40-40	450-450	1 1/2 x 2 1/2	PE-2764	5.95
10-10-10	450-450-450	1 1/2 x 2 1/2	PE-3776	5.10
20-20-20	450-450-450	1 1/2 x 3	PE-3780	6.10
30-30-10-20	450-450-450-50	1 1/2 x 3 1/2	PE-4741	6.85

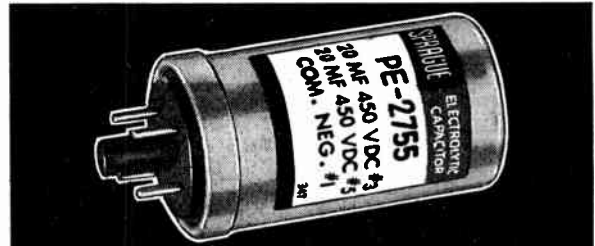

- For Broadcast Amplifiers, Police Radio, and Other Applications where Rapid Changing of Capacitors is Desired
- Will Fit Standard Octal Base Tube Sockets
- Hermetically Sealed in Metal Cans for Long Life
- Will Stand Up under High Temperatures, High Ripple Currents, High Surge Voltages

HLV HIGH CAPACITANCE ELECTROLYTICS



- Especially Designed for Filter Circuits in Motion Picture Amplifiers and Other Critical High Gain—Amplifier Equipment
- Compact Construction for Greater Utility
- Hermetically Sealed in Aluminum Cans
- Have Outer Insulating Cardboard Tube

MF	WVDC	Dia. x Length	Cat. No.	List
500	6	1 x 2 1/4	HLV-506	\$3.05
1000	6	1 1/2 x 2 1/4	HLV-106	3.40
1500	6	1 3/4 x 2 1/4	HLV-156	3.60
2000	6	1 3/4 x 3 1/4	HLV-206	3.80
500	12	1 1/2 x 2 1/4	HLV-5012	3.20
1000	12	1 3/4 x 2 1/4	HLV-1012	3.75
1500	12	1 3/4 x 2 1/4	HLV-1512	3.95
2000	12	1 3/4 x 3 1/4	HLV-2012	4.15
500	15	1 1/2 x 2 1/4	HLV-5015	3.25
1000	15	1 3/4 x 2 1/4	HLV-1015	3.80
1500	15	1 3/4 x 3 1/4	HLV-1515	4.00
2000	15	1 1/2 x 3 1/4	HLV-2015	4.70
500	25	1 1/2 x 2 1/4	HLV-525	3.80
1000	25	1 3/4 x 3 1/4	HLV-1025	4.80
2000	25	1 3/4 x 4 1/4	HLV-2025	5.75

SPRAGUE CAPACITORS

CERA-MITE* CERAMIC CAPACITORS

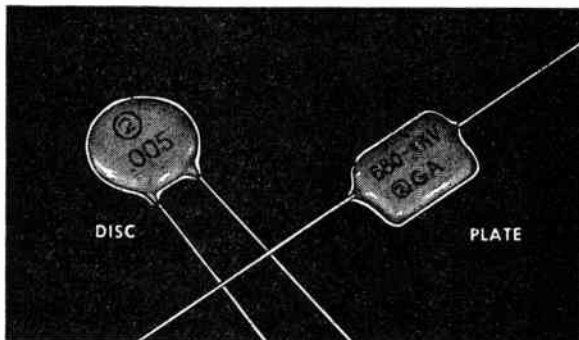

- Tiny, Tough, Dependable In Every Application
 - Low Self-inductance Of Silvered Flat-plate Design Means Very High By-pass Efficiency In All TV Circuits
 - Flat-plate Construction Permits Higher Self-resonant Frequency Than Tubular Ceramic Or Molded Mica Capacitors
 - Tough Moisture-proof Coating Protects Against Short-circuiting And Assures Good Performance Under Severe Conditions Of Humidity And Vibration
 - Cera-mite Capacitors Easily Fit Into Tight Spaces, Even Across Subminiature Tube Sockets
 - Designed For 85 °C (185 °F) Continuous Operation
- ★Trademark

GENERAL APPLICATION TYPES

- Excellent Where Temperature Coefficient Is Not Important, Such As By-pass and Coupling Applications
- Ideal For Replacing Older Types Of General Application Capacitors Such as Molded Micacs, Tubular Ceramics, and Paper Tubulars

MMF	Cat. No.	List	MMF	Cat. No.	List	MMF	Cat. No.	List	MMF	Cat. No.	List	MMF	Cat. No.	List
300 WVDC (plates) Std. Tolerance $\pm 20\%$			47	5GA-Q47	\$.25	4000	5GA-D4	\$.25	1000 WVDC (plates) Std. Tolerances: Type 10GAB-V47 ± 5 MMF, other types 10GAB $\pm 20\%$, types 10HKB MRC			3.3	15GAB-V33	\$.30
.022	3GAB-S22	.65	50	5GA-Q5	.25	4300	5GA-D43	.30	4.7	15GAB-V47	.30	6	15GAB-V6	.30
.047	3GAB-S47	.70	56	5GA-Q56	.25	4700	5GA-D47	.30	6	15GAB-V6	.30	7.5	15GAB-V75	.30
.1	3GAB-P1	.75	68	5GA-Q68	.25	5000	5GA-D5	.30	4.7	10GAB-V47	\$.30	10	15GAB-Q1	.30
.15	3GAB-P15	.80	75	5GA-Q75	.25	1000 WVDC (discs) Std. Tolerances: thru 680 MMF $\pm 10\%$, thru 3300 MMF $\pm 20\%$, thru 10,000 MMF MRC			10	10GAB-Q1	.30	12	15GAB-Q12	.30
400 WVDC (discs) Std. Tolerance $\pm 20\%$			82	5GA-Q82	.25	4.7	10GA-V47	\$.30	18	10GAB-Q18	.30	15	15GAB-Q15	.30
10	4GA-Q1	\$.25	91	5GA-Q91	.25	10	10GA-Q1	.30	22	10GAB-Q22	.30	18	15GAB-Q18	.30
15	4GA-Q15	.25	100	5GA-T1	.25	15	10GA-Q15	.30	25	10GAB-Q25	.30	20	15GAB-Q20	.30
22	4GA-Q22	.25	120	5GA-T12	.25	18	10GA-Q18	.30	33	10GAB-Q33	.30	22	15GAB-Q22	.30
33	4GA-Q33	.25	130	5GA-T13	.25	22	10GA-Q22	.30	39	10GAB-Q39	.30	33	15GAB-Q33	.30
47	4GA-Q47	.25	150	5GA-T15	.25	27	10GA-Q27	.30	47	10GAB-Q47	.30	47	15GAB-Q47	.30
68	4GA-Q68	.25	180	5GA-T18	.25	33	10GA-Q33	.30	68	10GAB-Q68	.30	56	15GAB-Q56	.30
100	4GA-T1	.25	200	5GA-T2	.25	39	10GA-Q39	.30	75	10GAB-Q75	.30	62	15GAB-Q62	.30
150	4GA-T15	.25	220	5GA-T22	.25	47	10GA-Q47	.30	82	10GAB-Q82	.30	68	15GAB-Q68	.30
220	4GA-T22	.25	250	5GA-T25	.25	68	10GA-Q68	.30	100	10GAB-T1	.30	82	15GAB-Q82	.35
330	4GA-T33	.25	270	5GA-T27	.25	75	10GA-Q75	.30	120	10GAB-T12	.30	100	15GAB-T1	.35
470	4GA-T47	.25	300	5GA-T3	.25	82	10GA-Q82	.30	150	10GAB-T15	.30	150	15GAB-T15	.35
500 WVDC (discs) Std. Tolerance $\pm 20\%$			330	5GA-T33	.25	100	10GA-T1	.30	180	10GAB-T18	.30	180	15GAB-T18	.35
5	5GA-V5	\$.25	350	5GA-T35	.25	120	10GA-T12	.30	200	10GAB-T2	.30	220	15GAB-T22	.35
6	5GA-V6	.25	360	5GA-T36	.25	150	10GA-T15	.30	220	10GAB-T22	.30	300	15GAB-T3	.35
7.5	5GA-V75	.25	390	5GA-T39	.25	180	10GA-T18	.30	250	10GAB-T25	.30	330	15GAB-T33	.35
8	5GA-V8	.25	400	5GA-T4	.25	200	10GA-T2	.30	270	10GAB-T27	.30	390	15GAB-T39	.35
10	5GA-Q1	.25	470	5GA-T47	.25	220	10GA-T22	.30	300	10GAB-T3	.30	390	15GAB-T39	.35
12	5GA-Q12	.25	500	5GA-T5	.25	250	10GA-T25	.30	330	10GAB-T33	.30	470	15GAB-T47	.35
15	5GA-Q15	.25	560	5GA-T56	.25	270	10GA-T27	.30	390	10GAB-T39	.30	500	10GAB-T5	.30
18	5GA-Q18	.25	600	5GA-T6	.25	300	10GA-T3	.30	470	10GAB-T47	.30	560	10GAB-T56	.50
20	5GA-Q2	.25	680	5GA-T68	.25	330	10GA-T33	.30	680	*10HKB-T68	.50	1000	*10HKB-D1	.50
22	5GA-Q22	.25	750	5GA-T75	.25	390	10GA-T39	.30	1000	*10HKB-D12	.50	1200	*10HKB-D12	.50
25	5GA-Q25	.25	800	5GA-T8	.25	470	10GA-T47	.30	1500	*10HKB-D15	.50	1500	*10HKB-D15	.50
27	5GA-Q27	.25	820	5GA-T82	.25	500	10GA-T5	.30	2200	*10HKB-D22	.50	2200	*10HKB-D22	.50
30	5GA-Q3	.25	1000	5GA-D1	.25	560	10GA-T56	.50	3300	*10HKB-D33	.50	3300	*10HKB-D33	.50
33	5GA-Q33	.25	1200	5GA-D12	.25	680	10GA-T68	.50	4700	*10HKB-D47	.50	4700	*10HKB-D47	.50
39	5GA-Q39	.25	1300	5GA-D13	.25	1000	10GA-D1	.50	.01 MF	*10HKB-S1	.60	1500 WVDC (plates) Std. Tolerances: thru 4.7 MMF ± 5 MMF, all others $\pm 20\%$		
			1500	5GA-D15	.25	1200	10GA-D12	.50	.015	*10HKB-S15	1.10			
			1600	5GA-D16	.25	1500	10GA-D15	.50	.022	*10HKB-S22	1.35			
			1800	5GA-D18	.25	2200	10GA-D22	.50						
			2000	5GA-D2	.25	3300	10GA-D33	.50						
			2200	5GA-D22	.25	4700	*10HK-D47	.50						
			2500	5GA-D25	.25	6800	*10HK-D68	.60						
			2700	5GA-D27	.25	10000	*10HK-S1	.60						
			3000	5GA-D3	.25									
			3300	5GA-D33	.25									
			3900	5GA-D39	.25									

SPRAGUE CAPACITORS

MMF	Cat. No.	List	MMF	Cat. No.	List	MMF	Cat. No.	List	MMF	Cat. No.	List	MMF	Cat. No.	List	
75	20GA-Q75	\$.35	30	20GAB-Q3	\$.35	30	30GA-Q3	\$.40	100	30GAB-T1	\$.40	18	60GAB-Q18	\$.50	
82	20GA-Q82	.35	33	20GAB-Q33	.35	39	30GA-Q39	.40	120	30GAB-T12	.40	20	60GAB-Q2	.50	
100	20GA-T1	.35	39	20GAB-Q39	.35	50	30GA-Q5	.40	150	30GAB-T15	.40	22	60GAB-Q22	.50	
120	20GA-T12	.35	47	20GAB-Q47	.35	60	30GA-Q6	.40	180	30GAB-T18	.40	30	60GAB-Q3	.50	
150	20GA-T15	.35	100	20GAB-T1	.35	68	30GA-Q68	.40	5000 WVDC (discs)			33	60GAB-Q33	.50	
180	20GA-T18	.35	150	20GAB-T15	.35	100	30GA-T1	.40	Std. Tolerances:			47	60GAB-Q47	.50	
200	20GA-T2	.35	200	20GAB-T2	.35	120	30GA-T12	.40	4.7 MMF ± 5 MMF,			100	*60HKB-T1	.50	
220	20GA-T22	.35	220	*20HKB-T22	.35	150	30GA-T15	.40	thru 22 MMF $\pm 10\%$,			470	*60HKB-T47	.65	
300	20GA-T3	.35	300	*20HKB-T3	.35	180	30GA-T18	.40	thru 500 MMF $\pm 20\%$			7500 WVDC (discs)			
330	20GA-T33	.35	500	*20HKB-T5	.35	200	30GA-T2	.40	4.7 50GA-V47			\$.45	Std. Tolerances:		
390	20GA-T39	.35	1000	*20HKB-D1	.55	220	30GA-T22	.40	10 50GA-Q1			\$.45	4.7 MMF ± 5 MMF,		
470	20GA-T47	.35	5000	*20HKB-D5	.70	250	30GA-T25	.40	22 50GA-Q22			\$.45	thru 18 MMF $\pm 10\%$,		
500	20GA-T5	.35	8000	*20HKB-D8	.70	270	30GA-T27	.40	47 50GA-Q47			\$.45	thru 470 MMF $\pm 20\%$		
1000	20GA-D1	.55	10000	*20HKB-S1	.70	300	30GA-T3	.40	100 50GA-T1			\$.45	4.7	75GA-V47	\$.50
4000	*20HK-D4	.55	3000 WVDC (discs)			3000 WVDC (plates)			330 50GA-T33			\$.55	8.2	75GA-V82	.50
5000	*20HK-D5	.70	Std. Tolerances:			Std. Tolerances:			500 50GA-T5			1.00	10	75GA-Q1	.50
6000	*20HK-D6	.70	1.5 MMF ± 25 MMF,			1.5 MMF ± 25 MMF,			6000 WVDC (plates)			12 75GA-Q12			.50
			4.7 MMF ± 5 MMF,			4.7 MMF ± 5 MMF,			Std. Tolerances:			15 75GA-Q15			.50
			thru 68 MMF $\pm 10\%$,			other types 30GAB $\pm 20\%$			4.7 MMF ± 5 MMF,			18 75GA-Q18			.50
			thru 500 MMF $\pm 20\%$						other types 60GAB $\pm 20\%$			20 75GA-Q2			.50
2000 WVDC (plates)			1.5 30GA-V15			4.7 30GA-V47			types 60HKB MRC			22 75GA-Q22			.50
Std. Tolerances:			4.7 30GA-Q1			10 30GA-Q1			5 20GAB-V5			30 75GA-Q3			.50
5 MMF $\pm .5$ MMF,			12 30GA-Q12			15 30GA-Q15			other types 20GAB $\pm 20\%$,			33 75GA-Q33			.50
types 20HKB MRC			15 30GA-Q15			40 30GAB-Q6			types 20HKB MRC			47 75GA-Q47			.50
			25 30GA-Q25			60 30GAB-Q68						56 75GA-Q56			.50
												100 75GA-T1			.50
												470 75GA-T47			.65

HIGH-K TYPES

- Designed Specifically for Minimum Capacitance Requirements
- Intended for By-pass and Coupling Applications where Additional Capacitance is Not Important
- Rated at 500 WVDC
- Units listed below are disc capacitors

MMF	Cat. No.	List	MMF	Cat. No.	List
SINGLE UNITS					
.015	5HK-S15	\$.40	.02	5HK-S2	.60
.02	5HK-S2	.60	.03	5HK-S3	.65
DUAL UNITS					
.001	5HK-D1	\$.25	2 x .001	5HK-2D1	\$.40
.0015	5HK-D15	.25	2 x .0015	5HK-2D15	.40
.002	5HK-D2	.25	2 x .002	5HK-2D2	.40
.0022	5HK-D22	.25	2 x .0022	5HK-2D22	.40
.0025	5HK-D25	.25	2 x .0025	5HK-2D25	.45
.0033	5HK-D33	.25	2 x .0033	5HK-2D33	.45
.004	5HK-D4	.25	2 x .004	5HK-2D4	.45
.0047	5HK-D47	.25	2 x .0047	5HK-2D47	.45
.005	5HK-D5	.25	2 x .005	5HK-2D5	.45
.0068	5HK-D68	.25	2 x .0068	5HK-2D68	.45
.01	5HK-S1	.30	2 x .01	5HK-2S1	.50
			2 x .02	5HK-2S2	.70

NPO TYPES

- Zero Temperature-coefficient Capacitors
- Used Where Capacitance Change with Temperature is Undesirable
- Superior to Silvered-mica Types in Stability, High "Q", and Insulation Resistance
- Rated at 500 WVDC
- Units listed below are discs, except those marked with a star (*), which are plate capacitors

MMF	Cat. No.	List	MMF	Cat. No.	List
1.0	*5TCCB-V1	\$.50	33	5TCC-Q33	\$.50
1.5	*5TCCB-V15	.50	39	5TCC-Q39	.55
2.2	*5TCCB-V22	.50	47	5TCC-Q47	.55
3.3	*5TCCB-V33	.50	50	5TCC-Q5	.55
4.7	*5TCCB-V47	.50	68	5TCC-Q68	.55
6.8	*5TCCB-V68	.50	75	5TCC-Q75	.55
			100	5TCC-T1	.55
10	5TCC-Q1	.50	120	5TCC-T12	.60
15	5TCC-Q15	.50	150	5TCC-T15	.60
20	5TCC-Q2	.50	175	5TCC-T175	.60
22	5TCC-Q22	.50	220	5TCC-T22	.70
25	5TCC-Q25	.50	270	5TCC-T27	.80

N750 TYPES

- Eliminate Frequency Drifts
- Negative Temp. Coefficient is 750 ppm/ $^{\circ}$ C.
- Rated at 500 V
- Starred (*) item is a Plate. All others are Discs

MMF	Cat. No.	List
5.0	*5TCCB-V5	\$.50
10	5TCC-Q1	.50
15	5TCC-Q15	.50
20	5TCC-Q2	.50
22	5TCC-Q22	.50
25	5TCC-Q25	.50
33	5TCC-Q33	.50
47	5TCC-Q47	.50
68	5TCC-Q68	.50
75	5TCC-Q75	.50
100	5TCC-T1	.50
120	5TCC-T12	.50
150	5TCC-T15	.50
175	5TCC-T175	.50
200	5TCC-T2	.50
220	5TCC-T22	.50
330	5TCC-T33	.50

BULPLATE® MULTIPLE CERAMICS



MFD.
1&2 .002 $\pm 10\%$
3&4 .00022 $\pm 50\%$
4&5 .00022 $\pm 50\%$
5&6 .005 $\pm 10\%$

Cat. No. 34C3

List, \$.75

- These Rugged Units Combine in One Compact Assembly All the Capacitors Used in One or More Stages of a Radio Circuit
- Fit Tight Spaces in Miniature Sets
- Rated at 500 WVDC, 1000 VDC Test

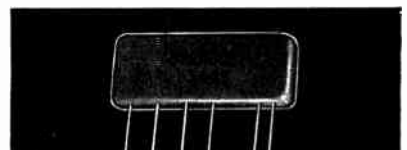

MFD.
1&2 .002 $\pm 10\%$
3&4 .00015 $\pm 100\%$
4&5 .005 MIN.
5&6 .0001 $\pm 75\%$
6&7 .005 $\pm 10\%$

Cat. No. 34C4

List, \$.90

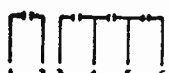

MFD.
1&2 .002 $\pm 10\%$
3&4 .005 MIN.
4&5 .0001 $\pm 25\%$
5&6 .005 $\pm 10\%$

Cat. No. 34C5

List, \$.75

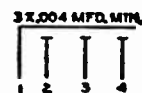

MFD.
3 x .004

Cat. No. 34C6

List, \$.65

All prices subject to change without notice

-3-54

*High-K Types

Radio's Master — 19th Edition

TRADE DISCOUNT APPLIES TO LIST PRICES ONLY

Page P-23

SPRAGUE CAPACITORS

BULPLATE® PRINTED CIRCUITS

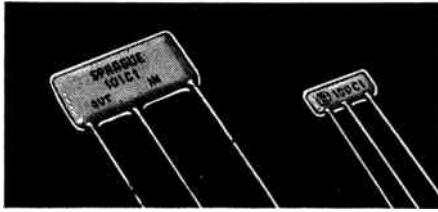

- Especially Designed to Save Space and Reduce Assembly Time
- Completed Unit is Protected by a Moisture-proof Coating
- A Combination of Resistors and Capacitors of Maximum Compactness
- Capacitors are rated at 500 volts d-c, 1000 volts test, while the maximum voltage to be applied across the resistors is 250 volts d-c; except on 100C1 where all elements are rated at 100 volts d-c.
- Integral Connections are "Printed" and Brought Out to External Leads Which Are Anchored to the Basic Ceramic Plate

VERTICAL INTEGRATOR

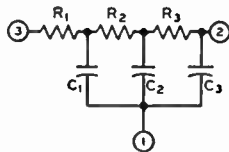

C ₁ (MF)	C ₂ , C ₃ (MF)	R ₁ (KΩ)	R ₂ , R ₃ (KΩ)	Old Cat. No.	Cat. No.	List Price
.0022	.0047	22	8.2	101C1	V-1	\$1.10

VERTICAL INTEGRATOR

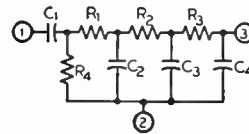

C ₁ (MF)	C ₂ (MF)	C ₃ , C ₄ (MF)	R ₁ , R ₄ (KΩ)	R ₂ , R ₃ (KΩ)	Cat. No.	List Price
.01	.002	.005	22	8.2	V-2	\$1.25

DIODE FILTER

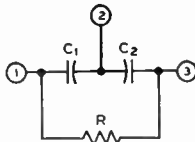

C ₁ (MMF)	C ₂ (MMF)	R (KΩ)	Old Cat. No.	Cat. No.	List Price
100	100	47	100C1	D-1	\$.60
150	150	47	—	D-2	.60
50	50	47	—	D-3	.60

AUDIO OUTPUT

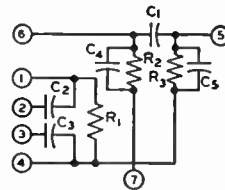

C ₁ (MF)	C ₂ (MF)	C ₃ (MMF)	C ₄ +C ₅ (MMF)	R ₁ (MΩ)	R ₂ , R ₃ (MΩ)	Old Cat. No.	Cat. No.	List Price
.0047	.0022	220	220	6.8	.47	103C4	DT-1	\$1.00
.005	.005	220	220	6.8	.47	—	DT-2	1.15

DECOUPLING FILTER

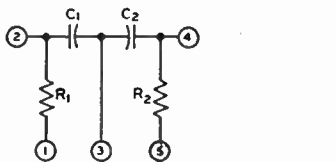

C ₁ (MF)	C ₂ (MF)	R ₁ (Ω)	R ₂ (Ω)	Cat. No.	List Price
.0047	.0047	1000	820	F-1	\$.85
.0047	.0047	220	1000	F-2	.85

TRIODE COUPLING

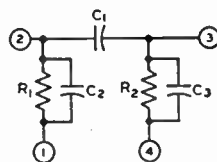

C ₁ (MF)	C ₂ +C ₃ (MMF)	R ₁ (MΩ)	R ₂ (MΩ)	Old Cat. No.	Cat. No.	List Price
.01	250	.5	.5	102C1	T-1	\$.75
.01	250	.25	.5	103C2	T-2	.75
.005	250	.5	.5	104C4	T-3	.70
.005	250	.25	.5	—	T-4	.70

PENTODE COUPLING

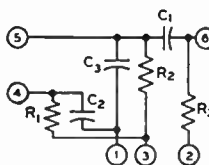

C ₁ (MF)	C ₂ (MF)	C ₃ (MMF)	R ₁ (MΩ)	R ₂ (MΩ)	R ₃ (Ω)	Old Cat. No.	Cat. No.	List Price
.0047	.0022	47	4.7	1.0	2.2	—	P-1	\$.90
.0047	.0047	100	4.7	1.0	2.2	103C3	P-2	.90
.002	.005	100	4.7	1.0	2.2	—	P-3	1.00

DETECTOR PENTODE COUPLING

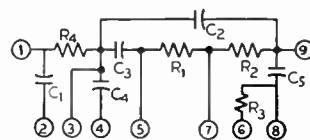

C ₁ (MF)	C ₂ , C ₃ (MMF)	C ₄ (MF)	C ₅ (MF)	R ₁ (MΩ)	R ₂ (MΩ)	R ₃ (MΩ)	R ₄ (MΩ)	Cat. No.	List Price
.002	150	.01	.005	4.7	1.0	3.3	10	DP-1	\$1.25

SPRAGUE CAPACITORS

BUTTON CERAMICS

MMF	Class	List	MMF	Class	List
TYPE 501C					
100	GA ± 20%	\$.70	470	MRC	\$.70
470	GA ± 20%	.70	1000	MRC	.70
1000	MRC	.70	TYPE 506C		
1500	MRC	.70	470	GA ± 20%	.75
TYPE 502C			1000	MRC	.75
10	SL	.65	1500	MRC	.75
22	SL	.65	TYPE 507C		
TYPE 503C			100	GA ± 20%	.90
100	GA ± 20%	.75	220	GA ± 20%	.90
470	GA ± 20%	.75	470	MRC	.90
1000	MRC	.75	680	MRC	.90
1500	MRC	.75	1000	MRC	.90
TYPE 505C			TYPE 508C		
100	GA ± 20%	.70	470	GA ± 20%	.95
220	GA ± 20%	.70	1000	MRC	.95
			1500	MRC	.95

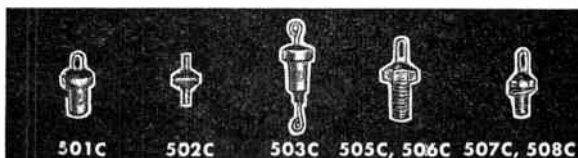

- Designed for Ultra-high-frequency TV Receivers and Electronic Equipment
- Flat Disc Design Means Low Self-inductance and High Self-resonant Frequency — Superior to Similar Units using Tubular Ceramic Elements
- Capacitor Element Sealed in Top of Ferrule or Screwhead with Plastic Resin
- 502C "shirt studs" are for u-h-f Coupling Applications in TV Sets
- 503C are Feed-thru Capacitors Intended for Filtering Leads thru Chassis—Ferrule Shank fits Standard Push Clip
- Stand-off Capacitors for By-pass Applications: 501C has Ferrule Shank to fit Standard push clip, 505C has Self-tapping 6-32 Thread, 507C has Standard 6-32 Thread, 506C has Self-tapping 10-32 Thread, 508C has Standard 10-32 Thread—All Screw-mounting Types Have Hexagon Heads
- Order by Type, Capacitance, Voltage, Class—Units Listed here are Rated at 500 WVDC

HI-VOLTAGE DOORKNOB CERAMICS

WITH INTERCHANGEABLE SCREW-IN TERMINALS TO FIT ALL TV SETS



- A New Idea in High Voltage Capacitor Design.
- Molded in Non-flammable, Moisture-resistant Thermosetting Plastic
- Molded Guard Rings Lengthen Surface Creepage Path

MMF	KV	Dia. x Length	Cat. No.	List
500	20	1 x 3/4	20DK-T5	\$1.85
500	30	1 1/4 x 1 1/4	30DK-T5	4.50

CUP CERAMICS

These precision capacitors are widely used in high stability r-f oscillators where frequency control is important. Tolerance on capacitance can be held to ± 1%, and on temperature coefficient to ± 10 ppm. Hermetically sealed construction and low self inductance are noteworthy as are high Q, capacitance stability, and retrace characteristics.



Available in 500, 1000, 1500 volt ratings for all standard temperature coefficients from P100 to N750. Write on company letterhead for complete details.

PRECISION TUBULARS

For exacting circuitry in electronic instrumentation and high stability oscillators. The same stacked disc construction as metal cup ceramics but with higher capacitance range.

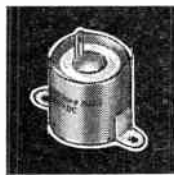

Hermetically sealed in plated metal tubes for moisture protection. Rated for -55° C to +85° C operation as are cup ceramics.

Available in ± 1% capacitance tolerances!

Available in 500, 1000, 1500 volt ratings for all standard temperature coefficients from P100 to N750. Write on company letterhead for complete details.

CERAMIC TRIMMERS

Widely used in precision circuitry where maximum stability is required. Unlike ordinary low cost trimmers, the special construction of these top-quality units prevents corrosion, permits mounting against chassis, and guarantees long, trouble-free life.

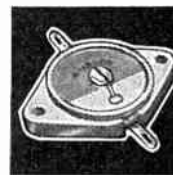

Write on letterhead for complete details.

MMF(Min.)	MMF(Max.)	Cat. No.	List
4	18	A08-006	\$10.00
5	30	A08-007	10.00
8	75	A08-001	10.00
10	110	A08-002	10.00

TV YOKE CAPACITOR REPLACEMENT KIT

- Capacitance in yoke applications is critical. Incorrect value produces distortion which only proper rating can correct.
- "Trial and error" method is often necessary to choose proper capacitor. This selection gives complete coverage of required fractional values between 33 and 82 mmf.

KIT CK-1 CONTENTS

Quantity	Cat. No.	MMF @ WVDC
2	20GA-Q33	33 @ 2000
5	20GA-Q39	39 @ 2000
5	20GA-Q47	47 @ 2000
10	20GA-Q56	56 @ 2000
2	20GA-Q62	62 @ 2000
5	20GA-Q68	68 @ 2000
2	20GA-Q75	75 @ 2000
5	20GA-Q82	82 @ 2000

These tiny but tough disc ceramic capacitors are small enough to fit easily inside any TV yoke assembly. They're excellent replacements for mica capacitors, which sometimes appear in original equipment.

Kit CK-1 \$12.60 List

SPRAGUE CAPACITORS

TELECAP[®] BLACK BEAUTY[®] MOLDED TUBULARS

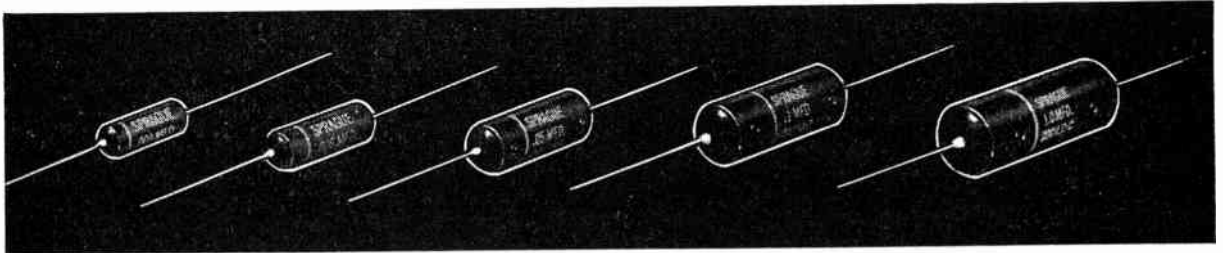

- Premium Quality at No Extra Cost
- Made Under Exclusive "Dry" Process, just like Costly Metal-Encased Oil Units
- Molded in Tough Bakelite Phenolic
- Non-Flammable Case
- Only Telecaps are Oil-impregnated in Ratings from 600 to 12,500 WVDC
- Extremely High Insulation Resistance
- Withstand Severe Heat, Moisture, Shock
- Designed for 85°C (185° F) Operation

MF	D. x L.	Cat. No.	List	MF	D. x L.	Cat. No.	List	MF	D. x L.	Cat. No.	List
200 WVDC				.0022	3/16 x 1	6TM-D22	\$.25	.022	1/2 x 1 1/2	10TM-S22	\$.50
.02	3/8 x 1 1/4	2TM-S2	\$.25	.0025	3/16 x 1	6TM-D25	.25	.03	1/2 x 1 1/2	10TM-S3	.50
.022	3/8 x 1 1/4	2TM-S22	.25	.003	3/16 x 1	6TM-D3	.25	.035	1/2 x 1 1/2	10TM-S35	.50
.047	3/8 x 1 1/4	2TM-S47	.25	.0033	3/16 x 1	6TM-D33	.25	.047	3/8 x 1 1/8	10TM-S47	.60
.05	3/8 x 1 1/4	2TM-S5	.25	.004	3/16 x 1	6TM-D4	.25	.05	3/8 x 1 1/8	10TM-S5	.60
.1	7/16 x 1 1/2	2TM-P1	.35	.0047	3/16 x 1	6TM-D47	.25	.068	3/8 x 1 1/8	10TM-S68	.65
.15	1/2 x 1 1/2	2TM-P15	.35	.005	3/8 x 1 1/4	6TM-D5	.25	.1	3/4 x 2 1/4	10TM-P1	.75
.22	5/8 x 1 1/8	2TM-P22	.40	.006	3/8 x 1 1/4	6TM-D6	.25	★ 1600 WVDC			
.25	5/8 x 1 1/8	2TM-P25	.40	.0068	3/8 x 1 1/4	6TM-D68	.30	.0005	3/8 x 1 1/4	MB-T5	.65
.47	5/8 x 1 1/8	2TM-P47	.60	.008	3/8 x 1 1/4	6TM-D8	.30	.001	3/8 x 1 1/4	MB-D1	.65
.5	5/8 x 1 1/8	2TM-P5	.60	.01	3/8 x 1 1/4	6TM-S1	.30	.0015	3/8 x 1 1/4	MB-D15	.65
1.0	3/4 x 2 1/4	2TM-M1	.90	.015	3/8 x 1 1/4	6TM-S15	.30	.002	3/8 x 1 1/4	MB-D2	.65
400 WVDC				.02	7/16 x 1 1/4	6TM-S2	.30	.0022	3/8 x 1 1/4	MB-D22	.65
.01	3/8 x 1	4TM-S1	.25	.022	7/16 x 1 1/4	6TM-S22	.30	.003	7/16 x 1 1/4	MB-D3	.65
.015	3/8 x 1 1/4	4TM-S15	.25	.03	7/16 x 1 1/4	6TM-S3	.35	.0033	7/16 x 1 1/4	MB-D33	.65
.02	3/8 x 1 1/4	4TM-S2	.25	.033	1/2 x 1 1/2	6TM-S33	.35	.004	7/16 x 1 1/4	MB-D4	.65
.022	3/8 x 1 1/4	4TM-S22	.25	.035	1/2 x 1 1/2	6TM-S35	.35	.0047	7/16 x 1 1/4	MB-D47	.65
.025	3/8 x 1 1/4	4TM-S25	.30	.04	1/2 x 1 1/2	6TM-S4	.35	.005	7/16 x 1 1/4	MB-D5	.65
.03	3/8 x 1 1/4	4TM-S3	.30	.047	1/2 x 1 1/2	6TM-S47	.40	.006	1/2 x 1 1/2	MB-D6	.65
.04	7/16 x 1 1/4	4TM-S4	.30	.05	1/2 x 1 1/2	6TM-S5	.40	.0068	1/2 x 1 1/2	MB-D68	.65
.047	7/16 x 1 1/4	4TM-S47	.30	.06	3/8 x 1 1/8	6TM-S6	.40	.007	1/2 x 1 1/2	MB-D7	.65
.05	7/16 x 1 1/4	4TM-S5	.30	.068	3/8 x 1 1/8	6TM-S68	.45	.0075	7/16 x 1 1/4	MB-D75	.65
.068	1/2 x 1 1/2	4TM-S68	.35	.1	5/8 x 1 1/8	6TM-P1	.45	.008	1/2 x 1 1/2	MB-D8	.65
.1	1/2 x 1 1/2	4TM-P1	.35	.15	3/4 x 2 1/4	6TM-P15	.50	.01	1/2 x 1 1/2	MB-S1	.70
.15	5/8 x 1 1/8	4TM-P15	.35	.2	3/4 x 2 1/4	6TM-P2	.55	.015	5/8 x 1 1/8	MB-S15	.70
.2	5/8 x 1 1/8	4TM-P2	.40	.22	3/4 x 2 1/4	6TM-P22	.55	.02	5/8 x 1 1/8	MB-S2	.70
.22	5/8 x 1 1/8	4TM-P22	.40	.25	3/4 x 2 1/4	6TM-P25	.55	.022	5/8 x 1 1/8	MB-S22	.70
.25	5/8 x 1 1/8	4TM-P25	.40	.5	1 x 2 3/8	6TM-P5	.80	.03	5/8 x 1 1/8	MB-S3	.70
.47	3/4 x 2 1/4	4TM-P47	.60	1.0	1 x 2 3/8	*TC-10	1.25	.04	3/4 x 2 1/4	MB-S4	.70
.5	3/4 x 2 1/4	4TM-P5	.60	1000 WVDC				.05	3/4 x 2 1/4	*TR-15	.70
				.0005	5/16 x 1	10TM-T5	.50	2 x .015	3/4 x 2	*TR-215	.80
				.001	5/16 x 1	10TM-D1	.50	6000 WVDC			
				.0015	5/16 x 1	10TM-D15	.50	.0005	1/2 x 1 1/2	TVM-356	1.35
				.002	5/16 x 1	10TM-D2	.50	.001	1/2 x 1 1/2	TVM-216	1.35
				.0022	5/16 x 1	10TM-D22	.50	.005	5/8 x 1 1/8	TVM-256	1.35
				.003	3/8 x 1 1/4	10TM-D3	.50	10,000 WVDC			
				.004	3/8 x 1 1/4	10TM-D4	.50	.0005	3/8 x 1 1/8	TVM-351	1.50
				.0047	3/8 x 1 1/4	10TM-D47	.50	12,500 WVDC			
				.005	3/8 x 1 1/4	10TM-D5	.50	.00025	5/8 x 1 1/8	12TVM-325	1.70
				.0068	3/8 x 1 1/4	10TM-D68	.50				
				.01	3/8 x 1 1/4	10TM-S1	.50				
				.015	7/16 x 1 1/4	10TM-S15	.50				
				.02	1/2 x 1 1/2	10TM-S2	.50				

*Supplied in waxed cardboard units pending completion of molds.

★ DESIGNED FOR BUFFER APPLICATIONS

SPRAGUE CAPACITORS

68P MIDGET® TUBULARS

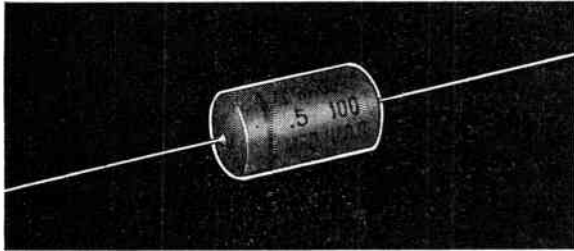

- Amazingly Small In Size Without Any Sacrifice In Performance — The Smallest Reliable Paper Tubular
- Will Fit Tight Spots In Pocket Radios, Auto Radios And Other Small Electronic Assemblies That Require High Temperature Operation, Good Humidity Performance, And Minimum Size At Moderate Cost
- Designed For 85°C (185°F) Operation

MF	Dia. x Length	Cat. No.	List
100 WVDC			
.25	1 ³ / ₃₂ x 1 ¹ / ₈	68P19	\$.70
.5	3 ¹ / ₈ x 1 ¹ / ₈	68P20	.80

200 WVDC			
.005	1 ⁴ / ₄ x 1 ¹ / ₁₆	68P11	.35
.006	1 ⁴ / ₄ x 1 ¹ / ₁₆	68P12	.35
.01	3 ¹ / ₃₂ x 1 ¹ / ₁₆	68P14	.40
.02	3 ¹ / ₃₂ x 1 ¹ / ₁₆	68P15	.45
.05	5 ¹ / ₁₆ x 1	68P16	.50
.1	1 ¹ / ₃₂ x 1	68P17	.60
.2	1 ¹ / ₃₂ x 1 ¹ / ₈	68P18	.65
.25	1 ¹ / ₃₂ x 1 ¹ / ₈	68P24	.70
.5	3 ¹ / ₈ x 1 ¹ / ₈	68P25	.80

400 WVDC			
.001	1 ⁴ / ₄ x 1 ¹ / ₁₆	68P1	.35
.003	1 ⁴ / ₄ x 1 ¹ / ₁₆	68P3	.35
.004	1 ⁴ / ₄ x 1 ¹ / ₁₆	68P4	.35
.005	1 ⁴ / ₄ x 1 ¹ / ₁₆	68P5	.35
.006	1 ⁴ / ₄ x 1 ¹ / ₁₆	68P6	.35
.01	5 ¹ / ₁₆ x 1 ¹ / ₁₆	68P8	.40
.02	5 ¹ / ₁₆ x 1	68P9	.45
.05	1 ¹ / ₃₂ x 1	68P10	.50
.1	1 ¹ / ₃₂ x 1 ¹ / ₈	68P21	.65
.2	3 ¹ / ₈ x 1 ¹ / ₈	68P38	.70
.25	3 ¹ / ₈ x 1 ¹ / ₈	68P22	.75
.5	3 ¹ / ₈ x 2 ¹ / ₁₆	68P23	.85

600 WVDC			
.001	1 ⁴ / ₄ x 1 ¹ / ₁₆	68P26	.35
.002	1 ⁴ / ₄ x 1 ¹ / ₁₆	68P27	.35
.003	3 ¹ / ₃₂ x 1 ¹ / ₁₆	68P28	.35
.004	3 ¹ / ₃₂ x 1 ¹ / ₁₆	68P29	.35
.005	3 ¹ / ₃₂ x 1 ¹ / ₁₆	68P30	.40
.006	5 ¹ / ₁₆ x 1 ¹ / ₁₆	68P31	.40
.008	5 ¹ / ₁₆ x 1	68P32	.40
.01	5 ¹ / ₁₆ x 1	68P33	.45
.02	1 ¹ / ₃₂ x 1	68P34	.50
.05	1 ¹ / ₃₂ x 1 ¹ / ₈	68P35	.55
.1	3 ¹ / ₈ x 1 ¹ / ₈	68P36	.70
.2	3 ¹ / ₈ x 1 ¹ / ₈	68P40	.80
.25	3 ¹ / ₈ x 2	68P37	.80

All prices subject to change without notice

HYPASS® CAPACITORS

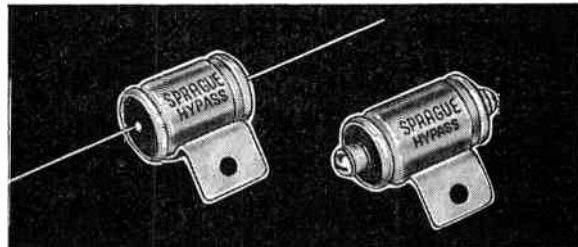

- Exclusive Sprague 3-terminal Network Feed-thru Capacitors
- Bypass V-H-F Currents Where Ordinary Capacitors are ineffective
- Suppress TVI from Short-wave Transmitters, Diathermy Machines, Electronic Heating Apparatus, etc.
- Eliminate Interference caused by Line-conducted Radiation Between Neighboring TV Sets
- Install Leads in Series with Circuit Being Filtered and Ground the Case

MF	WVDC	Dia. x Length	Cat. No.	List
.5	50	1 x 1 ¹ / ₁₆	*48P18	\$3.80
.1	250(VAC)	1 ¹ / ₁₆ x 1 ¹ / ₁₆	*48P9	2.60
.002	600	1 ⁴ / ₄ x 1 ¹ / ₁₆	46P12	2.15
.005	600	1 ⁴ / ₄ x 1 ¹ / ₁₆	46P8	2.15
.01	600	3 ¹ / ₁₆ x 1 ¹ / ₁₆	47P6	2.35
.1	600	1 ¹ / ₁₆ x 1 ¹ / ₁₆	*†80P3	2.95
.005	1000	3 ¹ / ₁₆ x 1 ¹ / ₁₆	47P12	2.40
.01	1000	3 ¹ / ₁₆ x 1 ¹ / ₁₆	47P13	2.60
.005	2500	1 x 1 ¹ / ₁₆	47P14	2.90
.01	2500	1 x 1 ¹ / ₁₆	47P15	3.10
.002	5000	1 x 1 ¹ / ₁₆	47P16	3.20

*Has female screw terminals
†Bulkhead mounting.

72P RESONANT CAPACITORS



PEP UP OLD RADIO SETS!

- Stabilize Any AC-DC "Squealer" Receiver
- Stop Self-oscillation, Permitting "On-the-nose" Alignment in a Jiffy
- Very Low Impedance at 465 KC Intermediate Frequency
- By-pass Unwanted I-F Signals
- Improve Set Performance

MF	WVDC	Dia. x Length	Cat. No.	List
.05	400	1 ¹ / ₂ x 1 ¹ / ₁₆	72P51	\$.50
.1	400	1 ¹ / ₂ x 1 ¹ / ₁₆	72P52	.65
.2	400	3 ¹ / ₁₆ x 1 ¹ / ₁₆	72P53	.70

3-54

Radio's Master — 19th Edition

TRADE DISCOUNT APPLIES TO LIST PRICES ONLY

Page P-27

SPRAGUE CAPACITORS

PX METAL-ENCASED TUBULARS



- Rubber-phenolic Compression Disc Seals Assure Positive Hermetic Closure
- Oil-Filled And Oil-Impregnated For Greater Dielectric Strength at Higher Temperatures
- A Product Of New Techniques, Materials, And Processes For Maximum Dependability Under Most Severe Operating Conditions
- Furnished With Insulating Kraftboard Outer Sleeve

MF	Dia. x Length	Cat. No.	List
600 WVDC			
.0001	1/2 x 1 1/4	PX-316	\$.95
.00025	1/2 x 1 1/4	PX-3256	.95
.0005	1/2 x 1 1/4	PX-356	.95
.001	1/2 x 1 1/4	PX-216	.95
.002	1/2 x 1 1/4	PX-226	.95
.003	1/2 x 1 1/4	PX-236	.95
.004	1/2 x 1 1/4	PX-246	.95
.005	1/2 x 1 1/4	PX-256	.95
.006	1/2 x 1 1/4	PX-266	.95
.007	1/2 x 1 1/4	PX-276	.95
.008	1/2 x 1 1/4	PX-286	.95
.009	1/2 x 1 1/4	PX-296	.95
.01	1/2 x 1 1/4	PX-116	.95
.02	1/2 x 1 1/4	PX-126	1.05
.03	3/8 x 1 3/8	PX-136	1.10
.04	3/8 x 1 3/8	PX-146	1.10
.05	3/8 x 1 3/8	PX-156	1.10
.06	1 1/16 x 1 3/8	PX-166	1.20
.08	1 1/16 x 1 3/8	PX-186	1.20
.1	1 1/16 x 1 3/8	PX-16	1.25
.25	1 3/16 x 2 13/16	PX-26	1.70
.5	1 1/16 x 2 13/16	PX-56	2.20
1.0	1 1/16 x 3 11/16	PX-106	3.00

MF	Dia. x Length	Cat. No.	List
.004	1 1/16 x 1 1/4	PX-241	\$1.10
.005	1 1/16 x 1 1/4	PX-251	1.10
.006	1 1/16 x 1 1/4	PX-261	1.10
.007	1 1/16 x 1 1/4	PX-271	1.10
.008	1 1/16 x 1 1/4	PX-281	1.10
.009	1 1/16 x 1 1/4	PX-291	1.10
.01	1 1/16 x 1 1/4	PX-111	1.10
.02	3/8 x 1 3/8	PX-121	1.20
.03	1 1/16 x 1 3/8	PX-131	1.20
.04	1 1/16 x 1 3/8	PX-141	1.20
.05	1 1/16 x 1 3/8	PX-151	1.30
.06	1 1/16 x 2	PX-161	1.35
.08	1 1/16 x 2	PX-181	1.40
.1	1 1/16 x 2	PX-11	1.50
.25	1 1/16 x 2 13/16	PX-21	2.00
.5	1 1/16 x 3 11/16	PX-51	2.85

MF	Dia. x Length	Cat. No.	List
1000 WVDC			
.0001	1 1/16 x 1 1/4	PX-311	1.10
.00025	1 1/16 x 1 1/4	PX-3251	1.10
.0005	1 1/16 x 1 1/4	PX-351	1.10
.001	1 1/16 x 1 1/4	PX-211	1.10
.002	1 1/16 x 1 1/4	PX-221	1.10
.003	1 1/16 x 1 1/4	PX-231	1.10

MF	Dia. x Length	Cat. No.	List
1500 WVDC			
.002	3/8 x 1 1/4	PX-2215	1.20
.005	3/8 x 1 1/4	PX-2515	1.20
.01	1 1/16 x 1 3/8	PX-1115	1.20
.02	1 1/16 x 1 3/8	PX-1215	1.30

MF	Dia. x Length	Cat. No.	List
2000 WVDC			
.0005	1 3/16 x 1 3/8	PX-352	1.25
.001	1 3/16 x 1 3/8	PX-212	1.25
.005	1 3/16 x 1 3/8	PX-252	1.25
.006	1 3/16 x 1 3/8	PX-262	1.25
.0075	1 3/16 x 1 3/8	PX-2752	1.25
.01	1 3/16 x 1 3/8	PX-112	1.25
.02	1 3/16 x 2 1/8	PX-122	1.35
.03	1 3/16 x 2 1/8	PX-132	1.40
.04	1 3/16 x 2 1/2	PX-142	1.40
.05	1 3/16 x 2 1/2	PX-152	1.45

PQ PHOTOFLASH CAPACITORS

DESIGNED EXPRESSLY FOR PHOTOFLASH USE

NOT COMPARABLE TO STANDARD HEAVY DUTY CAPACITORS SUCH AS THE CR TRANSMITTING TYPES

- Oil-Impregnated, Oil Filled
- Uniform Energy Storage
- Smallest Possible Construction with Maximum Dependability
- Hermetically Sealed
- High Insulation Resistance

MF	DC Peak*		Dimensions T. x W. x H.	Weight lbs.	Cat. No.	List Price
	Photoflash Volts	Watt/Sec. Total				
10	2500	31	2 1/4 x 3 3/4 x 4 1/2	1 3/4	PQ-2510	\$17.00
15	2500	47	3 3/16 x 3 3/4 x 4 9/8	2 1/2	PQ-2515	20.00
25	2500	78	4 7/16 x 3 3/4 x 5 1/4	4 1/4	PQ-2525	26.50
35	2500	109	4 7/16 x 3 3/4 x 7	6	PQ-2535	32.50
15	3000	67	3 3/16 x 3 3/4 x 4 7/8	3	PQ-315	24.50
25	4000	200	4 7/16 x 3 3/4 x 9 1/4	7 1/4	PQ-425	42.50

*Do not exceed Peak Voltage Rating under highest line voltage condition.

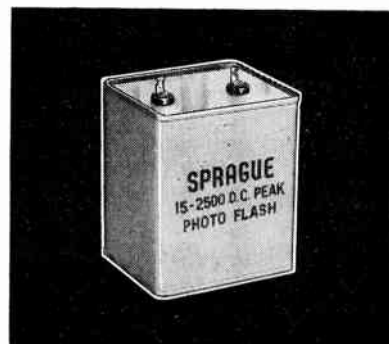

SPRAGUE CAPACITORS

CR RECTANGULAR OILS

- Capacitor Sections Hermetically Sealed In Ruggedly Constructed Rectangular Metal Cans
- Impregnated And Filled With KVO (Kilo Volt Oil), A Special Sprague Development
- Extremely High Insulation Resistance.
- Designed For Good Performance And Long Life, Even Under High Surge Voltages And High Ambient Temperatures.
- Terminals Have Universal Mounting Feature—Equipped With "Life-guard" Protective Caps

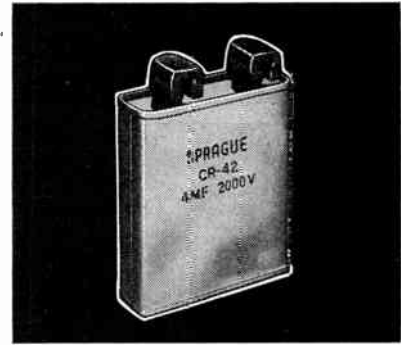

MF	WVDC	T. x W. x L	Cat. No.	List	MF	WVDC	T. x W. x L	Cat. No.	List
.5	600	1 1/16 x 1 13/16 x 2 1/4	CR-056	\$4.70	3.0	2000	1 1/4 x 3 3/4 x 4 3/4	CR-32	\$13.20
1.0	600	1 1/16 x 1 13/16 x 2 1/4	CR-16	5.80	4.0	2000	2 1/4 x 3 3/4 x 3 3/4	CR-42	15.15
2.0	600	1 1/16 x 1 13/16 x 2 3/4	CR-26	7.15	6.0	2000	3 3/16 x 3 3/4 x 4 1/2	CR-62	20.10
3.0	600	1 1/16 x 1 13/16 x 3 1/4	CR-36	8.25	10.0	2000	4 9/16 x 3 3/4 x 4 3/4	CR-102	30.55
4.0	600	1 3/16 x 2 1/2 x 3 1/2	CR-46	9.10	.1	2500	1 3/16 x 2 1/2 x 2 1/2	CR-0125	10.15
6.0	600	1 3/16 x 2 1/2 x 4 3/4	CR-66	11.30	.5	2500	1 1/4 x 3 3/4 x 3 3/4	CR-0525	11.55
8.0	600	1 1/4 x 3 3/4 x 3 3/4	CR-86	13.50	1.0	2500	1 3/4 x 3 3/4 x 3 1/4	CR-125	13.20
10.0	600	1 1/4 x 3 3/4 x 4 3/4	CR-106	15.15	2.0	2500	1 3/4 x 3 3/4 x 4 3/4	CR-225	21.45
.1	1000	1 1/16 x 1 13/16 x 1 5/8	CR-011	4.15	4.0	2500	4 9/16 x 3 3/4 x 4 3/4	CR-425	30.00
.25	1000	1 1/16 x 1 13/16 x 2 1/4	CR-0251	4.70	.1	3000	1 3/16 x 2 1/2 x 2 1/2	CR-013	14.05
.5	1000	1 1/16 x 1 13/16 x 2 1/4	CR-051	4.95	.25	3000	1 3/16 x 2 1/2 x 2 7/8	CR-0253	14.85
1.0	1000	1 1/16 x 1 13/16 x 2 1/4	CR-11	6.35	.5	3000	1 3/16 x 2 1/2 x 4 1/4	CR-053	16.80
2.0	1000	1 1/16 x 1 13/16 x 3 3/4	CR-21	8.25	1.0	3000	2 1/4 x 3 3/4 x 3 3/4	CR-13	20.10
4.0	1000	1 3/16 x 2 1/2 x 4 3/4	CR-41	10.45	2.0	3000	3 3/16 x 3 3/4 x 4 1/2	CR-23	25.05
8.0	1000	1 1/4 x 3 3/4 x 4 3/4	CR-81	15.15	4.0	3000	4 9/16 x 3 3/4 x 4 3/4	CR-43	36.85
10.0	1000	1 3/4 x 3 3/4 x 4 3/4	CR-101	16.80	.1	4000	2 1/4 x 3 3/4 x 2 3/4	CR-014	18.00
12.0	1000	2 1/4 x 3 3/4 x 4 1/2	CR-121	18.15	.25	4000	2 1/4 x 3 3/4 x 2 3/4	CR-0254	20.00
15.0	1000	2 1/2 x 3 3/4 x 4 3/4	CR-151	20.10	.5	4000	2 1/4 x 3 3/4 x 3 3/4	CR-054	23.00
.5	1500	1 1/16 x 1 13/16 x 2 3/4	CR-0515	6.35	1.0	4000	2 1/4 x 3 3/4 x 5 1/8	CR-14	29.00
1.0	1500	1 1/16 x 1 13/16 x 3 3/4	CR-115	7.45	2.0	4000	4 9/16 x 3 3/4 x 5 1/8	CR-24	39.00
2.0	1500	1 3/16 x 2 1/2 x 4 1/4	CR-215	10.20	.2	5000	1 3/4 x 3 3/4 x 3 3/4	CR-025	20.00
4.0	1500	1 1/4 x 3 3/4 x 4 3/4	CR-415	14.05	.5	5000	2 1/4 x 3 3/4 x 4 1/2	CR-055	25.00
5.0	1500	1 1/4 x 3 3/4 x 4 3/4	CR-515	15.15	1.0	5000	4 9/16 x 3 3/4 x 4 3/4	CR-15	34.00
8.0	1500	2 1/2 x 3 3/4 x 4 3/4	CR-815	20.90	2.0	5000	4 9/16 x 3 3/4 x 6	CR-25	52.00
10.0	1500	3 3/16 x 3 3/4 x 4 3/4	CR-1015	25.05	.1	6000	2 1/4 x 3 3/4 x 3 3/4	CR-0160	27.00
.1	2000	1 3/16 x 2 1/2 x 2 1/2	CR-012	6.60	.2	6000	1 3/4 x 3 3/4 x 4 1/4	CR-0260	30.00
.25	2000	1 3/16 x 2 1/2 x 2 1/2	CR-0252	7.15	1.0	6000	4 9/16 x 3 3/4 x 7 1/2	CR-160	49.00
.5	2000	1 3/16 x 2 1/2 x 2 7/8	CR-052	7.45	.1	7500	2 1/4 x 3 3/4 x 3 3/4	CR-0175	29.00
1.0	2000	1 3/16 x 2 1/2 x 3 1/2	CR-12	9.10	.2	7500	1 3/4 x 3 3/4 x 4 3/4	CR-0275	33.00
2.0	2000	1 1/4 x 3 3/4 x 4 1/4	CR-22	10.75					

PC SCREWBASE OILS

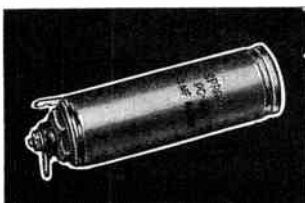

- Oil-impregnated
- Oil-filled
- Screwbase Can For Easy Single Hole Mounting
- Small Size—Will Fit Tight Spaces

MF	WVDC	Dia. x Length	Cat. No.	List
2	600	1 1/2 x 2 3/4	PC-26	\$5.40
3	600	1 1/2 x 3 1/2	PC-36	6.15
4	600	1 1/2 x 4 1/2	PC-46	7.10
1	1000	1 1/2 x 2 3/4	PC-11	5.00
2	1000	1 1/2 x 4 1/2	PC-21	6.30
0.5	1500	1 1/2 x 2 3/4	PC-515	5.85
1	1500	1 1/2 x 3 3/4	PC-115	6.30

CYLINDRICAL OT OILS



- Oil-impregnated, Oil-filled
- Hermetically Sealed
- Ceramic Terminals
- Rubber "Life-guard" Caps For Extra Protection

MF	WVDC	Dia. x Length	Cat. No.	List
2	600	2 x 2 15/32	OT-26	\$5.45
1	1000	2 x 2 15/32	OT-11	4.65
2	1000	2 x 3 3/32	OT-21	6.30
4	1000	2 x 5 3/32	OT-41	8.00
0.5	1500	2 x 2 15/32	OT-515	5.05
1	1500	2 x 2 21/32	OT-115	5.85
2	1500	2 x 4 15/32	OT-215	8.00
1	2000	2 x 4 3/32	OT-12	7.55
2	2000	2 1/2 x 4 15/32	OT-22	8.40
1	3000	2 1/2 x 4 23/32	OT-13	15.15

SPRAGUE CAPACITORS

BP BATHTUB CAPACITORS

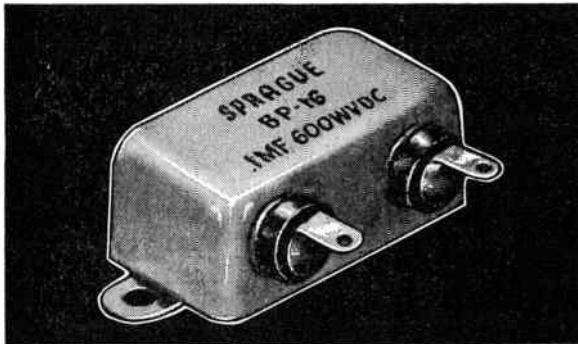

- For Applications Where Severe Operating Conditions Are Encountered
- Hermetically Sealed For Extra Protection Against Adverse Atmospheric Conditions
- Seamless Drawn Metal Can
- Oil-impregnated For Dependable Operation
- Convenient Mounting Ears Are Integral Part of Metal Container

MF	L. x W. x H.	Cat. No.	List
400 WVDC			
.1	1 ¹³ / ₁₆ x 1 x 3/4	BP-1	\$2.20
.25	1 ¹³ / ₁₆ x 1 x 3/4	BP-25	2.50
.5	1 ¹³ / ₁₆ x 1 x 7/8	BP-50	2.65
1.0	2 x 1 ³ / ₄ x 7/8	BP-10	3.15
.1 + .1	1 ¹³ / ₁₆ x 1 x 3/4	BP-21	3.30
.25 + .25	1 ¹³ / ₁₆ x 1 x 7/8	BP-225	3.60
.5 + .5	2 x 1 ³ / ₄ x 7/8	BP-250	4.15
.1 + .1 + .1	1 ¹³ / ₁₆ x 1 x 3/4	BP-31	4.00
600 WVDC			
.05	1 ¹³ / ₁₆ x 1 x 3/4	BP-56	2.90
.1	1 ¹³ / ₁₆ x 1 x 3/4	BP-16	2.95
.25	1 ¹³ / ₁₆ x 1 x 3/4	BP-256	3.10
.5	1 ¹³ / ₁₆ x 1 x 7/8	BP-506	3.30
1.0	2 x 1 ³ / ₄ x 7/8	BP-106	3.75
2.0	2 x 2 x 1 ¹ / ₈	BP-206	5.00
.05 + .05	1 ¹³ / ₁₆ x 1 x 3/4	BP-2056	3.65

MF	L. x W. x H.	Cat. No.	List
.1 + .1	1 ¹³ / ₁₆ x 1 x 3/4	BP-216	\$3.70
.25 + .25	1 ¹³ / ₁₆ x 1 x 7/8	BP-2256	3.75
.5 + .5	2 x 1 ³ / ₄ x 7/8	BP-2506	4.30
1.0 + 1.0	2 x 2 x 1 ¹ / ₈	BP-116	5.30
.1 + .1 + .1	1 ¹³ / ₁₆ x 1 x 3/4	BP-316	4.20
.25 + .25 + .25	2 x 1 ³ / ₄ x 7/8	BP-3256	4.75
.5 + .5 + .5	2 x 2 x 1 ¹ / ₈	BP-356	5.75
1000 WVDC			
.05	1 ¹³ / ₁₆ x 1 x 3/4	BP-51	3.05
.1	1 ¹³ / ₁₆ x 1 x 3/4	BP-11	3.15
.25	1 ¹³ / ₁₆ x 1 x 3/4	BP-251	3.25
.5	2 x 1 ³ / ₄ x 7/8	BP-501	3.55
1.0	2 x 2 x 1 ¹ / ₈	BP-101	4.40
.05 + .05	1 ¹³ / ₁₆ x 1 x 3/4	BP-2051	3.85
.1 + .1	1 ¹³ / ₁₆ x 1 x 3/4	BP-211	4.00
.25 + .25	2 x 1 ³ / ₄ x 7/8	BP-2251	4.20
.5 + .5	2 x 2 x 1 ¹ / ₈	BP-2501	5.45
.1 + .1 + .1	1 ¹³ / ₁₆ x 1 x 7/8	BP-311	4.60
.25 + .25 + .25	2 x 2 x 1 ¹ / ₈	BP-3251	5.50

HC HASH CAPACITORS

FOR AUTOMOBILE RADIOS

- HC-1—Braided Leads for Low R-F Resistance
- HC-2—Has Radial Side Leads
- HC-3—Has Flat Strap Leads for Minimum R-F Impedance

MF	WVDC	Size	Cat. No.	List
.5	120	7/16 x 3/4 x 2 (oval tube)	HC-1	\$.90
.5	120	5/16 x 3/4 x 2 (oval tube)	HC-2	.90
.5	120	3/4 x 1 ¹ / ₈ (round tube)	HC-3	1.10

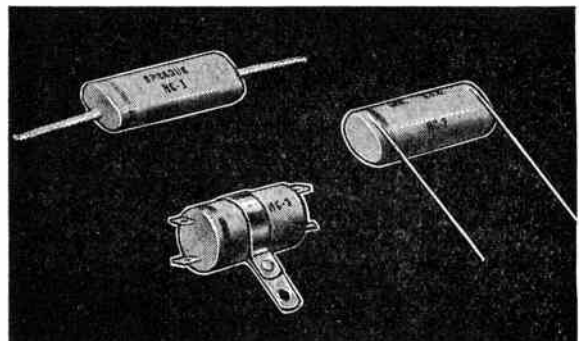

SPRAGUE CAPACITORS

AR & LR AUTO GENERATOR AND VIBRATOR TYPES

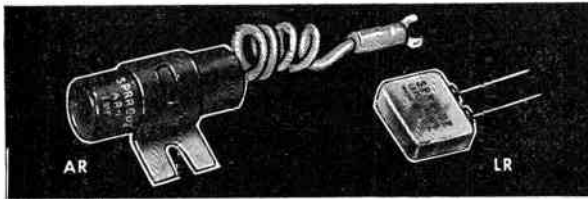

- Exceptionally Sturdy Design
- Withstand Bouncing and Vibration
- Oil-impregnated, Metal Encased
- Resist Heat and Humidity

MF	WVDC	Size	Cat. No.	List
AR (GENERATOR TYPES)				
1.0		1 x 2 $\frac{3}{16}$	AR-1	\$1.75
.5		1 $\frac{1}{16}$ x 1 $\frac{1}{8}$	AR-2	.90
.5+.5		1 x 2 $\frac{3}{16}$	AR-25	3.25
.5		1 $\frac{1}{16}$ x 1 $\frac{1}{8}$	AR-Ford	1.45
LR (VIBRATOR TYPES)				
.01	1600	1/4 x 3/8 x 1 1/16	LR-11	\$2.00
.02	1600	1/4 x 3/8 x 1 1/16	LR-12	2.90
.007	1600	1/4 x 3/8 x 1 1/16	LR-27	2.65

SPECIAL AUTO TYPES

Description and Cat. No.	MF	WVDC	D. x L.	List
Dome Light Filter				
DL-1	.2	200	1 x 2 $\frac{3}{16}$	\$4.20
Gas Gauge Filter				
GG-5	.05	200	7/16 x 1 $\frac{1}{2}$	1.20
Oil Gauge Filter				
OG-50	.25	200	1 $\frac{1}{16}$ x 1 $\frac{1}{8}$	1.40
Ford Replacement				
P-2077	.5	200	1 $\frac{1}{16}$ x 1 $\frac{1}{8}$	1.25
Ammeter Capacitor				
P-3402	.5	200	1 $\frac{1}{16}$ x 2	.90
Motorola Replacement				
P-2153	.0008+.0008	1000	3/4 x 1 $\frac{1}{8}$.80

INTERFERENCE FILTERS

FILTEROL[®] TYPES

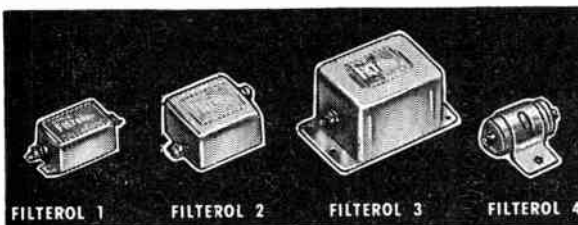

- Suppress Man-made Radio and TV Interference
- Small, Completely Self-contained
- Quickly, Easily Installed

Filterol Types 1, 2, and 3—Designed for connection in series with power supply lines to interference-producing devices . . . A 3-terminal network with the case as one terminal . . . The selected filter should have a rating higher than the continuous operating current of the offending device . . . A single Filterol connected to the high side of the line is usually sufficient . . . In severe cases a Filterol in each leg of the power line may be necessary . . . For three or four-wire systems, a Filterol in each wire is necessary.

Filterol Type 4—A new, exclusive Sprague development incorporating a Sprague HYPASS[®] Capacitor . . . Provides exceptionally high attenuation at frequencies above 5 megacycles . . . Intended for small devices with continuous current ratings up to 20 amperes.

Cat. No.	Amps.	Volts AC or DC	Size	List
Filterol 1	1	115	7/8 x 1 $\frac{1}{4}$ x 1 $\frac{3}{8}$	\$13.50
Filterol 2	10	115	1 $\frac{1}{8}$ x 2 x 2	14.80
Filterol 3	35	115	1 $\frac{7}{8}$ x 2 $\frac{3}{8}$ x 3 $\frac{3}{8}$	27.40
Filterol 4	20	115	1" dia. x 1 $\frac{1}{16}$ " long	3.05

IF TYPES

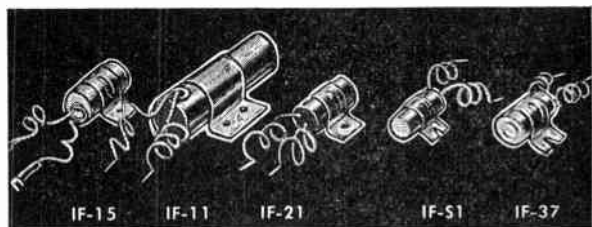

IF-15—TRIPLE-SECTION FILTER for all small motor-operated devices such as food and drink mixers, vacuum cleaners, fans, drills, etc. Especially designed to prevent accidental shocks from discharge of filter capacitors.

IF-11—DUAL HIGH-CAPACITY FILTER with completely enclosed safety construction. Designed for use on motors over 1 horsepower and up to 220 volts AC or DC. Also used on high-current arcing or sparking devices.

IF-21—COMPACT DUAL FILTER for use across brushes of fractional horsepower motors with the can grounded to motor frame. May also be used across line terminals of motors.

IF-S1—SINGLE SECTION 2-LEAD FILTER with can completely insulated. For use across make-and-break contacts, such as thermostats, circuit breakers, door-bells, buzzers, relays, etc.

IF-37—3-SECTION DELTA-CONNECTED FILTER especially designed for fluorescent fixtures. Only one IF-37 required for each offending fixture. Also effective on make-and-break governor-type motors. *Underwriters' Laboratories approved.*

Cat. No.	Volts AC or DC	Dia. x Length	List
IF-15	220	1 x 2 $\frac{3}{16}$	\$2.60
IF-11	220	1 $\frac{3}{8}$ x 3 $\frac{1}{2}$	7.80
IF-21	220	1 x 2 $\frac{3}{16}$	1.75
IF-S1	220	3/4 x 2 $\frac{1}{16}$	1.15
IF-37	220	1 x 2 $\frac{3}{16}$	2.25

All prices subject to change without notice

TRADE DISCOUNT APPLIES TO LIST PRICES ONLY

3-54 Radio's Master — 19th Edition

Page P-31

SPRAGUE CAPACITORS

MICA TYPES

- Each Mica Capacitor Section Receives a Radio Frequency Test Before Molding
- Careful Selection and Electrical Grading of Raw Mica Assures Maximum Quality
- Section Foils on Foil Micas are Connected to Terminals through Special Low-resistance R-F Bonds
- R-F Current Tested for Peak Ratings After Impregnation and Molding

TYPE MS & 1FM MICAS

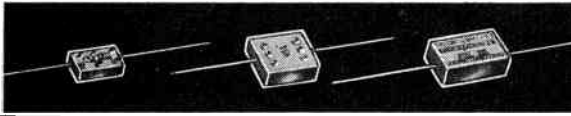

TYPE MS—SILVERED MICA
(Standard Capacity Tolerance $\pm 5\%$)

MF	Cat. No.	List
500 WVDC, 1000 V TEST		
.000005	MS-55	\$.45
.00001	MS-41	.40
.000015	MS-41.5	.40
.00002	MS-42	.40
.000025	MS-42.5	.40
.00003	MS-43	.40
.00004	MS-44	.40
.00005	MS-45	.40
.00006	MS-46	.40
.00007	MS-47	.40
.0001	MS-31	.40
.0002	MS-32	.45
.0003	MS-33	.55
.0004	MS-34	.65
.0005	MS-35	.70
.0006	MS-36	.80
.0007	MS-37	.85
.0008	MS-38	.95
.0009	MS-39	1.00
.001	MS-21	1.10
.002	MS-22	1.35
.003	MS-23	2.05
.004	MS-24	2.15
.005	MS-25	2.25
.006	MS-26	2.40
300 WVDC, 600 V TEST		
.007	MS-27	2.60
.008	MS-28	2.80
.009	MS-29	3.10
.01	MS-11	3.40
Catalog Nos.	L x W x T	
MS-55 through MS-35	$2\frac{1}{2} \times 1\frac{1}{2} \times \frac{1}{32}$	
MS-36 through MS-23	$2\frac{1}{2} \times 2\frac{1}{2} \times \frac{1}{32}$	
MS-24 through MS-28	$2\frac{1}{2} \times 2\frac{1}{2} \times \frac{1}{16}$	
MS-29 through MS-11	$1 \times \frac{3}{4} \times \frac{3}{16}$	

TYPE 1FM
(Standard Capacity Tolerance $\pm 20\%$)

MF	Cat. No.	List
500 WVDC, 1000 V TEST		
.00001	1FM-41	\$.25
.00002	1FM-42	.25
.00004	1FM-44	.25
.00005	1FM-45	.20
.000075	1FM-47.5	.20
.0001	1FM-31	.20
.00015	1FM-31.5	.20
.0002	1FM-32	.20
.00025	1FM-32.5	.25
.00035	1FM-33.5	.25
.0004	1FM-34	.25
.0005	1FM-35	.25
.0007	1FM-37	.25
.001	1FM-21	.30
.0015	1FM-21.5	.30
.002	1FM-22	.40
.003	1FM-23	.50
.004	1FM-24	.55
.005	1FM-25	.60
.006	1FM-26	.65
300 WVDC, 600 V TEST		
.007	1FM-27	\$.85
.008	1FM-28	1.00
.009	1FM-29	1.00
.01	1FM-11	1.20
Catalog Nos.	L x W x T	
1 FM-44 through 1 FM-35	$\frac{3}{4} \times 1\frac{1}{2} \times \frac{1}{32}$	
1 FM-37 through 1 FM-23	$\frac{3}{4} \times \frac{3}{4} \times \frac{1}{32}$	
1 FM-24 through 1 FM-28	$\frac{3}{4} \times \frac{3}{4} \times \frac{1}{16}$	
1 FM-29 through 1 FM-11	$1 \times \frac{3}{4} \times \frac{3}{16}$	

TYPES XFM, YFM & ZFM



(Standard Capacity Tolerance $\pm 10\%$)

MF	Cat. No.	List
XFM—600 WVDC, 1200 V TEST		
.00005	XFM-45	\$1.20
.0001	XFM-31	1.20
.0002	XFM-32	1.20
.00025	XFM-32.5	1.20
.0003	XFM-33	1.20
.0004	XFM-34	1.20
.0005	XFM-35	1.20
.001	XFM-21	1.20
.0015	XFM-21.5	1.20
.002	XFM-22	1.30
.0025	XFM-22.5	1.30
.003	XFM-23	1.45
.004	XFM-24	1.50
.005	XFM-25	1.55
.006	XFM-26	1.80
.007	XFM-27	1.85
.008	XFM-28	1.90
.01	XFM-11	2.15
.02	XFM-12	3.05
.03	XFM-13	4.45
Catalog Nos.	L x W x T	
XFM-45 thru XFM-11	$1\frac{1}{2} \times 1\frac{1}{2} \times \frac{1}{16}$	
XFM-12 thru XFM-13	$1\frac{1}{2} \times 1\frac{1}{2} \times \frac{3}{16}$	

TYPES 7FM, 8FM & 9FM



(Standard Capacity Tolerance $\pm 10\%$)

MF	Cat. No.	List
7FM—600 WVDC, 1200 V TEST		
.00005	7FM-45	\$1.45
.0001	7FM-31	1.45
.00015	7FM-31.5	1.45
.0002	7FM-32	1.45
.00025	7FM-32.5	1.45
.0005	7FM-35	1.45
.001	7FM-21	1.45
.002	7FM-22	1.65
.0025	7FM-22.5	1.70
.003	7FM-23	1.85
.004	7FM-24	2.00
.005	7FM-25	2.10
.006	7FM-26	2.20
.008	7FM-28	2.45
.01	7FM-11	2.80
.015	7FM-11.5	3.05
.02	7FM-12	3.55
.03	7FM-13	4.55
.04	7FM-14	5.85
.05	7FM-15	7.10
.06	7FM-16	8.05
Catalog Nos.	L x W x T	
7FM-45 thru 7FM-13	$1\frac{1}{2} \times 1\frac{1}{2} \times \frac{3}{16}$	
7FM-14 thru 7FM-16	$1\frac{1}{2} \times 1\frac{1}{2} \times \frac{3}{8}$	

TYPES 3AFM, 3BFM, & 3CFM



(Standard Capacity Tolerance $\pm 10\%$)

MF	Cat. No.	List
3AFM—300 WVDC, 600 V TEST		
.005	3AFM-25	\$.65
.006	3AFM-26	.70
.007	3AFM-27	.95
.008	3AFM-28	1.10
.01	3AFM-11	1.30
.015	3AFM-11.5	1.35
3BFM—500 WVDC, 1000 V TEST		
.0001	3BFM-31	.30
.0002	3BFM-32	.30
.00025	3BFM-32.5	.30
.0003	3BFM-33	.30
.0004	3BFM-34	.30
.0005	3BFM-35	.30
.001	3BFM-21	.35
.0015	3BFM-21.5	.35
Catalog Nos.	L x W x T	
3AFM Types	$1 \times \frac{3}{4} \times \frac{3}{16}$	
3BFM Types	$1 \times \frac{3}{4} \times \frac{3}{8}$	
3CFM Types	$1 \times \frac{3}{4} \times \frac{3}{4}$	

MF	Cat. No.	List
3CFM—1000 WVDC, 2000 V TEST		
.00005	3CFM-45	1.00
.0001	3CFM-31	1.00
.0002	3CFM-32	1.00
.00025	3CFM-32.5	1.00
.0003	3CFM-33	1.00
.0004	3CFM-34	1.00
.0005	3CFM-35	1.00
.001	3CFM-21	1.25
.0015	3CFM-21.5	1.50
.002	3CFM-22	1.50
.0025	3CFM-22.5	1.50
Catalog Nos.	L x W x T	
3AFM Types	$1 \times \frac{3}{4} \times \frac{3}{16}$	
3BFM Types	$1 \times \frac{3}{4} \times \frac{3}{8}$	
3CFM Types	$1 \times \frac{3}{4} \times \frac{3}{4}$	

MF	Cat. No.	List
YFM—1200 WVDC, 2500 V TEST		
.00005	YFM-45	1.60
.0001	YFM-31	1.60
.0002	YFM-32	1.60
.00025	YFM-32.5	1.60
.0003	YFM-33	1.60
.0004	YFM-34	1.60
.0005	YFM-35	1.60
.001	YFM-21	1.80
.0015	YFM-21.5	2.30
.002	YFM-22	2.40
.0025	YFM-22.5	2.80
.003	YFM-23	3.05
.004	YFM-24	3.05
.005	YFM-25	3.30
.006	YFM-26	3.30
.007	YFM-27	3.45
.008	YFM-28	3.85
.01	YFM-11	5.10
Catalog Nos.	L x W x T	
YFM-45 thru YFM-24	$1\frac{1}{2} \times 1\frac{1}{2} \times \frac{1}{16}$	
YFM-25 thru YFM-11	$1\frac{1}{2} \times 1\frac{1}{2} \times \frac{3}{16}$	

MF	Cat. No.	List
8FM—1200 WVDC, 2500 V TEST		
.00005	8FM-45	1.60
.0001	8FM-31	1.60
.00015	8FM-31.5	1.60
.0002	8FM-32	1.60
.00025	8FM-32.5	1.60
.0005	8FM-35	1.60
.001	8FM-21	1.90
.002	8FM-22	2.50
.0025	8FM-22.5	2.80
.003	8FM-23	2.95
.004	8FM-24	3.10
.005	8FM-25	3.30
.006	8FM-26	3.45
.008	8FM-28	4.10
.01	8FM-11	4.70
.015	8FM-11.5	5.80
.02	8FM-12	7.05
.025	8FM-12.5	7.90
.03	8FM-13	8.10
Catalog Nos.	L x W x T	
8FM-45 thru 8FM-11.5	$1\frac{1}{2} \times 1\frac{1}{2} \times \frac{3}{16}$	
8FM-12 thru 8FM-13	$1\frac{1}{2} \times 1\frac{1}{2} \times \frac{3}{8}$	

SPRAGUE CAPACITORS

TYPES 1MC & 2MC

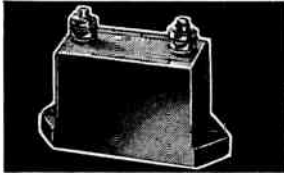

(Standard Capacity Tolerance $\pm 5\%$)

MF	VAC Peak	Cat. No.	List
TYPE 1MC			
.00005	3000	1MC-45	\$12.60
.0001	3000	1MC-31	12.60
.00015	3000	1MC-315	12.60
.0002	3000	1MC-32	12.60
.00025	3000	1MC-325	12.60
.0003	3000	1MC-33	12.60
.0004	3000	1MC-34	12.60
.0005	3000	1MC-35	12.60
.0006	3000	1MC-36	12.60
.0007	3000	1MC-37	12.60
.0008	3000	1MC-38	12.60
.001	3000	1MC-21	12.60
.0015	3000	1MC-215	12.60
.002	3000	1MC-22	12.60
.003	2000	1MC-23	12.60
.004	2000	1MC-24	12.60
.005	2000	1MC-25	12.60
.006	2000	1MC-26	12.60
.007	2000	1MC-27	12.60
.008	1500	1MC-28	12.60
.01	1000	1MC-11	12.60
.015	1000	1MC-115	12.60
.02	1000	1MC-12	14.30
.03	500	1MC-13	14.30
.04	500	1MC-14	14.30
.05	250	1MC-15	14.30
.1	250	1MC-1	15.10

1MC Dimensions $L \times W \times H$
 $2 \times 1\frac{1}{4} \times 1\frac{1}{2}$

MF	VAC Peak	Cat. No.	List
TYPE 2MC			
.00005	5000	2MC-45	17.30
.0001	5000	2MC-31	17.30
.00015	5000	2MC-315	17.30
.0002	5000	2MC-32	17.30
.00025	5000	2MC-325	17.30
.0003	5000	2MC-33	17.30
.0004	5000	2MC-34	17.30
.0005	5000	2MC-35	17.30
.0006	5000	2MC-36	17.30
.0007	5000	2MC-37	17.30
.0008	5000	2MC-38	17.30
.001	5000	2MC-21	17.30
.0015	5000	2MC-215	17.30
.002	5000	2MC-22	17.30
.003	3000	2MC-23	17.30
.004	3000	2MC-24	17.30
.005	3000	2MC-25	17.30
.006	3000	2MC-26	17.30
.007	3000	2MC-27	17.30
.008	2000	2MC-28	17.30
.01	2000	2MC-11	17.30
.015	2000	2MC-115	17.30
.02	2000	2MC-12	17.30
.03	1500	2MC-13	17.30
.04	1500	2MC-14	17.30
.05	1500	2MC-15	17.30
.06	1000	2MC-16	18.60
.07	1000	2MC-17	18.60
.08	500	2MC-18	19.20
.1	500	2MC-1	19.20

2MC Dimensions $L \times W \times H$
 $2\frac{1}{4} \times 1\frac{1}{4} \times 1\frac{1}{2}$

TYPES 1CC, 2CC, 3CC & 4CC

(Standard Capacity Tolerance $\pm 5\%$)

MF	Cat. No.	List
TYPE 1CC		
6000 VAC Peak		
.00005	1CC-45	\$38.20
.000075	1CC-475	40.00
.0001	1CC-31	40.60
.00015	1CC-315	40.60
.0002	1CC-32	40.60
.00025	1CC-325	40.60
.0003	1CC-33	44.35
.0004	1CC-34	44.35
.0005	1CC-35	46.65
.0006	1CC-36	46.65
.0007	1CC-37	46.65
.0008	1CC-38	46.65
.001	1CC-21	46.65
.0015	1CC-215	48.90
.002	1CC-22	48.90
.003	1CC-23	50.60
.004	1CC-24	50.60
4000 VAC Peak		
.005	1CC-25	50.60
.006	1CC-26	51.45
.007	1CC-27	51.45
.008	1CC-28	51.45
.01	1CC-11	51.45
3000 VAC Peak		
.015	1CC-115	51.45
2000 VAC Peak		
.02	1CC-12	51.45
.025	1CC-125	51.80
1500 VAC Peak		
.03	1CC-13	55.75
.04	1CC-14	58.50
.05	1CC-15	60.75
.06	1CC-16	62.80
1000 VAC Peak		
.07	1CC-17	64.25
.08	1CC-18	65.75
.1	1CC-1	68.50

1CC Dimensions $Dia. \times Height$
 $2\frac{1}{4} \times 2\frac{1}{2}$

MF	Cat. No.	List
TYPE 2CC		
10,000 VAC Peak		
.00005	2CC-45	65.55
.000075	2CC-475	65.55
.0001	2CC-31	65.55
.00015	2CC-315	65.55
.0002	2CC-32	65.55
.0003	2CC-33	65.55
.0004	2CC-34	65.55
.0005	2CC-35	65.55
.0006	2CC-36	65.55
.0007	2CC-37	65.55
.0008	2CC-38	65.55
.001	2CC-21	65.55
.0015	2CC-215	65.55
.002	2CC-22	65.55
8000 VAC Peak		
.003	2CC-23	65.55
.004	2CC-24	65.55
6000 VAC Peak		
.005	2CC-25	65.55
5000 VAC Peak		
.006	2CC-26	69.15
.007	2CC-27	69.15
.008	2CC-28	69.15
.01	2CC-11	69.15

MF	Cat. No.	List
4000 VAC Peak		
.015	2CC-115	\$ 69.15
3000 VAC Peak		
.02	2CC-12	69.15
.025	2CC-125	72.00
2000 VAC Peak		
.03	2CC-13	73.50
.04	2CC-14	77.80
.05	2CC-15	80.75
.06	2CC-16	83.00
1500 VAC Peak		
.07	2CC-17	85.00
.08	2CC-18	86.50
.1	2CC-1	90.00

2CC Dimensions $Dia. \times Height$
 $3\frac{1}{2} \times 3$

MF	Cat. No.	List
TYPE 3CC		
20,000 VAC Peak		
.00005	3CC-45	110.90
.000075	3CC-475	121.00
.0001	3CC-31	121.00
.00015	3CC-315	131.10
.0002	3CC-32	131.10
.0003	3CC-33	131.10
.0004	3CC-34	137.15
.0005	3CC-35	137.15
.0006	3CC-36	137.15
.0007	3CC-37	137.15
.0008	3CC-38	137.15
.001	3CC-21	141.15
15,000 VAC Peak		
.0015	3CC-215	143.20
.002	3CC-22	143.20
12,000 VAC Peak		
.003	3CC-23	151.25
.004	3CC-24	151.25

MF	Cat. No.	List
10,000 VAC Peak		
.005	3CC-25	151.25
.006	3CC-26	151.25
.007	3CC-27	151.25
.008	3CC-28	151.25
8000 VAC Peak		
.01	3CC-11	151.25
5000 VAC Peak		
.015	3CC-115	151.25
.02	3CC-12	151.25
3000 VAC Peak		
.025	3CC-125	151.25
.03	3CC-13	151.25
.04	3CC-14	151.25
.05	3CC-15	151.25
.06	3CC-16	158.50
2000 VAC Peak		
.07	3CC-17	164.00
.08	3CC-18	172.00
.1	3CC-1	182.00

3CC Dimensions $Dia. \times Height$
 5×4



(Standard Capacity Tolerance $\pm 5\%$)

MF	Cat. No.	List
TYPE 4CC		
30,000 VAC Peak		
.0001	4CC-31	\$210.30
.00015	4CC-315	210.30
.0002	4CC-32	221.16
.0003	4CC-33	221.16
.0004	4CC-34	221.16
.0005	4CC-35	221.16
.0006	4CC-36	221.16
.0007	4CC-37	221.16
.0008	4CC-38	221.16
.001	4CC-21	229.10
25,000 VAC Peak		
.0015	4CC-215	229.10
20,000 VAC Peak		
.002	4CC-22	229.10
.003	4CC-23	229.10
15,000 VAC Peak		
.004	4CC-24	234.35
.005	4CC-25	242.00
.006	4CC-26	252.25
.007	4CC-27	260.00
12,000 VAC Peak		
.008	4CC-28	260.00
.009	4CC-29	260.00
10,000 VAC Peak		
.01	4CC-11	272.44
8000 VAC Peak		
.015	4CC-115	272.44
6000 VAC Peak		
.02	4CC-12	272.44
.03	4CC-13	272.44
5000 VAC Peak		
.04	4CC-14	272.44
.05	4CC-15	272.44
.06	4CC-16	290.00
4000 VAC Peak		
.07	4CC-17	300.00
3000 VAC Peak		
.08	4CC-18	308.00
.1	4CC-1	326.00

4CC Dimensions $Dia. \times Height$
 $5 \times 5\frac{1}{2}$

SPRAGUE CAPACITORS

TO-4 TEL-OHMIKE® CAPACITOR-RESISTOR ANALYZER



PRICED SO YOU CAN AFFORD IT!

The handiest instrument you can buy! Modern service shops find it a must. Although moderately priced for radio and television repair shops, it offers you the quality and the accuracy required by the nation's outstanding laboratories.

The TO-4 comes complete with step-by-step instruction manual and capacitor guide.

- **CAPACITANCE BRIDGE** measures up to 2000 mf in five overlapping ranges. The special 1 mmf to 100 mmf range is exclusive with the Sprague Tel-Ohmike.
- **INSULATION RESISTANCE** directly read on large meter up to 20,000 megohms for paper, ceramic, and mica capacitors. No guessing with neon lamps.
- **LEAKAGE CURRENT** of electrolytics measured directly on meter, with exact rated voltage up to 600v. applied from continuously adjustable power supply. Two ranges: 0-6-60 ma. No guessing on eye-width or counting lamp blinks when you use a TO-4!
- **POWER FACTOR** of electrolytic capacitors measured by Wien Bridge up to 55% in three ranges.
- **RESISTANCE BRIDGE** measures from 2.5 ohms to 25 megohms at line frequency.
- **MAGIC-EYE TUBE** simplifies bridge balancing for capacitance, power factor, and resistance measurements.
- **PUSH-BUTTONS** for instant range selection, also discharge capacitors for safety automatically upon release.
- **MODERN CASE** finished in two-tone gray; measures 8 $\frac{7}{8}$ " high, 14 $\frac{5}{8}$ " wide, 6 $\frac{1}{8}$ " deep. Weight only 12 $\frac{1}{2}$ pounds.

MODEL TO-4.....115 VAC/50-60 cy.....\$73.50 net
Model TO-4X.....115-230 V/25-60 cy..... \$79.50 net

KT-1 KWIK-TEST® CAPACITOR CHECKER

An **IDEAL** supplement to the TO-4 Tel-Ohmike. With 75 to 100 capacitors in each set, here's a quick, easy way to check them all in a jiffy, for the KT-1 tests capacitors while they're wired in a set. **NO NEED TO REMOVE THEM FROM THE CIRCUIT!** The KT-1 instantly tells you whether or not a capacitor is open, shorted, or intermittent. This is the hottest thing we've ever offered to the service trade!

- Simply press a button and magic eye tube tells you if a capacitor is open, shorted, or intermittent.
- Checks by-pass, blocking, and coupling capacitors from 30 mmf to 2000 mmf, even when capacitor under test is wired in parallel with a resistance as low as 60 ohms. Capacitors between .1 mf and 2000 mf may be tested even when in parallel with resistance as low as 2 ohms.
- Sturdy steel case with medium gray wrinkle finish. Light gray front panel with clear black markings.
- Overall size of the KT-1 is 9" high x 6" wide x 5 $\frac{1}{4}$ " deep —Net weight, 6 lbs.

MODEL KT-1.....115 VAC/50-60 cy.....\$34.50 net
MODEL KT-1X.....115-230 V/25-60 cy..... 39.50 net

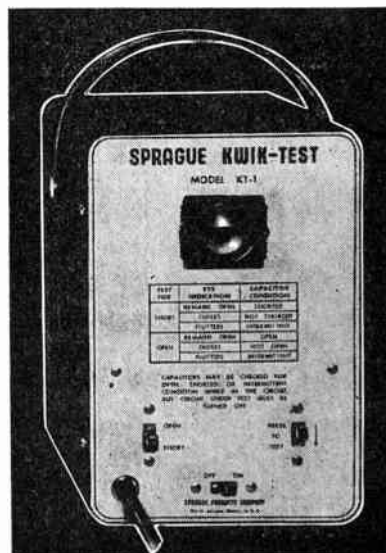

ARCO ELECTRONICS, INC.

EL-MENCO CAPACITORS

MINIATURE MICA CAPACITORS

"Smaller than your fingernail
but **SKY HIGH IN PERFORMANCE!**"

TYPE CM-15

TYPE DESIGNATION	CAP. MMF.	DC WKG. VOLTAGE	LIST PRICE
CM-15-C-010-M	1	500	\$0.50
CM-15-C-020-M	2	500	.50
CM-15-C-030-M	3	500	.50
CM-15-C-050-K	5	500	.40
CM-15-C-100-J	10	500	.40
CM-15-C-120-J	12	500	.40
CM-15-C-150-J	15	500	.40
CM-15-C-180-J	18	500	.40
CM-15-C-200-J	20	500	.40
CM-15-C-220-J	22	500	.40
CM-15-E-240-J	24	500	.40
CM-15-E-270-J	27	500	.40
CM-15-E-300-J	30	500	.40
CM-15-E-330-J	33	500	.40
CM-15-E-360-J	36	500	.40
CM-15-E-390-J	39	500	.40
CM-15-E-430-J	43	500	.40
CM-15-E-470-J	47	500	.40
CM-15-E-500-J	50	500	.40
CM-15-E-510-J	51	500	.40
CM-15-E-560-J	56	500	.40
CM-15-E-620-J	62	500	.40
CM-15-E-680-J	68	500	.40
CM-15-E-750-J	75	500	.40
CM-15-E-820-J	82	500	.45
CM-15-E-910-J	91	500	.45
CM-15-E-101-J	100	500	.45
CM-15-E-111-J	110	500	.45
CM-15-E-121-J	120	500	.45
CM-15-E-131-J	130	500	.45
CM-15-E-151-J	150	500	.45
CM-15-E-161-J	160	500	.50
CM-15-E-181-J	180	500	.50
CM-15-E-201-J	200	500	.50
CM-15-E-221-J	220	500	.55
CM-15-E-241-J	240	500	.55
CM-15-E-251-J	250	500	.55
CM-15-E-271-J	270	500	.60
CM-15-E-301-J	300	500	.60
CM-15-E-331-J	330	500	.65
CM-15-E-361-J	360	500	.70
CM-15-E-391-J	390	500	.70
CM-15-E-431-J	430	300	.75
CM-15-E-471-J	470	300	.80
CM-15-E-501-J	500	300	.80
CM-15-E-511-J	510	300	.80

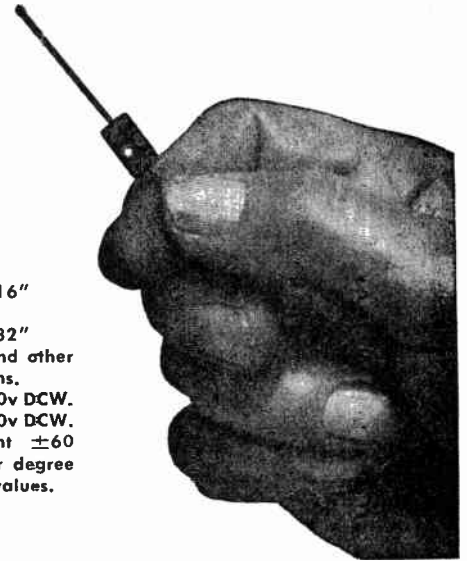

Actual Size
1-300 mmf.
9/32" x 1/2" x 3/16"
301-510 mmf.
9/32" x 1/2" x 7/32"
For Television, Radio and other
Electronic Applications.
1 - 420 mmf. cap. at 500v DCW.
1 - 510 mmf. cap. at 300v DCW.
Temperature Co-efficient ±60
parts per million per degree
C for most capacity values.
6-dot color coded.

Known the world over for their reliability under all operating conditions, EL-MENCO CAPACITORS are chosen by manufacturers who want successful performance and long life from their products.

EL-MENCO fixed mica dielectric capacitors are compact, precision made. Manufactured in accordance with American military standards to meet Army and Navy MIL-C-5A Specifications. All impregnated and MIL or RMA color coded. Standard specifications limits are shown.

Moulded in low loss bakelite, tested at double the working voltage. Tests for dielectric strength, insulation resistance, temperature co-efficient and capacitance drift, humidity and life tests according to MIL and RMA STANDARDS. All units are wax dipped for salt water immersion seal.

All the above are silver mica only. (Characteristic "E"). Standard Tolerance: ±5%. Closest Tolerance: ±.5 mmfd.

For low voltage circuitry, higher capacities are available at 100 VDCW rating.

ARCO ELECTRONICS, INC.

E L - M E N C O C A P A C I T O R S

MICA CAPACITORS

CM-19 & CM-20

TYPE DESIGNATION	CAP. MMF.	DC WKG. VOLTAGE	LIST PRICE	
			REGULAR MICA	SILVERED MICA
CM-20-050	5	500	\$0.30	\$0.40
CM-20-100	10	500	.30	.40
CM-20-120	12	500	.30	.40
CM-20-150	15	500	.30	.40
CM-20-180	18	500	.30	.40
CM-20-200	20	500	.30	.40
CM-20-220	22	500	.30	.40
CM-20-240	24	500	.30	.40
CM-20-270	27	500	.30	.40
CM-20-300	30	500	.30	.40
CM-20-330	33	500	.20	.40
CM-20-360	36	500	.20	.40
CM-20-390	39	500	.20	.40
CM-20-430	43	500	.20	.40
CM-20-470	47	500	.20	.40
CM-20-500	50	500	.20	.40
CM-20-510	51	500	.20	.40
CM-20-560	56	500	.20	.40
CM-20-620	62	500	.20	.40
CM-20-680	68	500	.20	.40
CM-20-750	75	500	.20	.40
CM-20-820	82	500	.20	.40
CM-20-910	91	500	.20	.40
CM-20-101	100	500	.20	.40
CM-20-111	110	500	.20	.45
CM-20-121	120	500	.20	.45
CM-20-131	130	500	.25	.45
CM-20-151	150	500	.25	.45
CM-20-161	160	500	.25	.45
CM-20-181	180	500	.25	.45
CM-20-201	200	500	.25	.45
CM-20-221	220	500	.25	.45
CM-20-241	240	500	.30	.55
CM-20-251	250	500	.30	.55
CM-20-271	270	500	.30	.55
CM-20-301	300	500	.30	.55
CM-20-331	330	500	.30	.55
CM-20-361	360	500	.30	.55
CM-20-391	390	500	.30	.65
CM-20-431	430	500	.30	.65
CM-20-471	470	500	.30	.70
CM-20-501	500	500	.30	.70
CM-20-511	510	500	.30	.70
CM-20-561	560	500	.35	.75
CM-20-621	620	500	.35	.75
CM-20-681	680	500	.35	.80
CM-20-751	750	500	.35	.80
CM-20-821	820	500	.40	.85
CM-20-911	910	500	.45	.85
CM-20-102	1000	500	.45	.90
CM-20-112	1100	500	.50	.90
CM-20-122	1200	500	.50	1.00
CM-20-132	1300	500	.50	1.00
CM-20-152	1500	500	.60	1.10
CM-20-162	1600	500	.60	1.10
CM-20-182	1800	500	.70	1.20
CM-20-202	2000	500	.75	1.30

For low voltage circuitry, higher capacities are available at 100 VDCW rating.

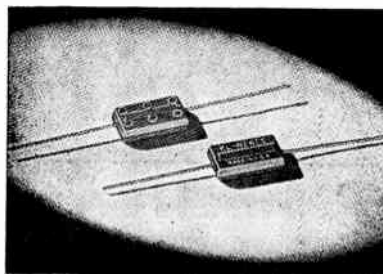

CM-19—11/16" x 7/16" x 7/32"
 CM-20—25/32" x 7/16" x 7/32"
 CM-25—7/16" x 1-7/64" x 7/32"

CM-25

TYPE DESIGNATION	CAP. MMF.	DC WKG. VOLTAGE	LIST PRICE	
			REGULAR MICA	SILVERED MICA
CM-25-510	51	500	\$0.25	\$0.40
CM-25-560	56	500	.25	.40
CM-25-620	62	500	.25	.40
CM-25-680	68	500	.25	.40
CM-25-750	75	500	.25	.40
CM-25-820	82	500	.25	.40
CM-25-910	91	500	.25	.40
CM-25-101	100	500	.25	.40
CM-25-111	110	500	.25	.45
CM-25-121	120	500	.25	.45
CM-25-131	130	500	.25	.45
CM-25-151	150	500	.25	.45
CM-25-161	160	500	.25	.45
CM-25-181	180	500	.25	.45
CM-25-201	200	500	.25	.45
CM-25-221	220	500	.25	.45
CM-25-241	240	500	.30	.55
CM-25-251	250	500	.30	.55
CM-25-271	270	500	.30	.55
CM-25-301	300	500	.30	.55
CM-25-331	330	500	.30	.55
CM-25-361	360	500	.30	.55
CM-25-391	390	500	.30	.65
CM-25-431	430	500	.30	.65
CM-25-471	470	500	.30	.70
CM-25-501	500	500	.30	.70
CM-25-511	510	500	.30	.70
CM-25-561	560	500	.35	.75
CM-25-621	620	500	.35	.80
CM-25-681	680	500	.35	.85
CM-25-751	750	500	.35	.90
CM-25-821	820	500	.40	.95
CM-25-911	910	500	.45	1.00
CM-25-102	1000	500	.45	1.10
CM-25-112	1100	500	.50	1.20
CM-25-122	1200	500	.50	1.30
CM-25-132	1300	500	.50	1.40
CM-25-152	1500	500	.60	1.50
CM-25-162	1600	500	.60	1.60
CM-25-182	1800	500	.70	1.70
CM-25-202	2000	500	.75	1.80

STANDARD TOLERANCES:

Regular mica $\pm 20\%$ (A and B Characteristics)
 For $\pm 10\%$ tolerance add 10% to list price.
 For $\pm 5\%$ tolerance add 25% to list price.
 Silvered Mica $\pm 5\%$ (C, D and E Characteristics)
 For $\pm 2\%$ tolerance add 15% to list price.
 For $\pm 1\%$ tolerance add 25% to list price.

NOTE:

CM19 capacitors available only up to 1000 mmf.
 CM20 and CM25 available to 2000 mmf.

ARCO ELECTRONICS, INC.

EL-MENCO CAPACITORS

MICA CAPACITORS

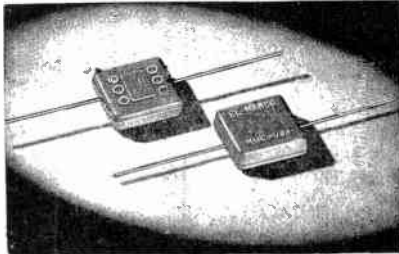

CM-30—13/16" x 13/16" x 9/32"
 CM-35—13/16" x 13/16" x 11/32"

CM-30

TYPE DESIGNATION	CAP. MMF.	DC WKG. VOLTAGE	LIST PRICE	
			REGULAR MICA	SILVERED MICA
CM-30-511	510	500	\$0.30	\$0.70
CM-30-561	560	500	.30	.75
CM-30-621	620	500	.30	.75
CM-30-681	680	500	.30	.80
CM-30-751	750	500	.30	.80
CM-30-821	820	500	.30	.85
CM-30-911	910	500	.30	.90
CM-30-102	1000	500	.35	1.00
CM-30-112	1100	500	.35	1.00
CM-30-122	1200	500	.35	1.15
CM-30-132	1300	500	.35	1.15
CM-30-152	1500	500	.40	1.25
CM-30-162	1600	500	.40	1.25
CM-30-182	1800	500	.45	1.25
CM-30-202	2000	500	.45	1.35
CM-30-222	2200	500	.45	1.35
CM-30-242	2400	500	.50	1.60
CM-30-252	2500	500	.50	1.60
CM-30-272	2700	500	.50	1.80
CM-30-302	3000	500	.60	1.90
CM-30-332	3300	500	.60	1.90
CM-30-362	3600	500	.60	2.00
CM-30-392	3900	500	.65	2.00
CM-30-432	4300	500	.65	2.10
CM-30-472	4700	500	.65	2.10
CM-30-502	5000	500	.70	2.15
CM-30-512	5100	500	.70	2.15
CM-30-562	5600	500	.70	2.25
CM-30-622	6200	500	.90	2.40

CM-35

CM-35-682	6800	300	\$0.95	\$2.65
CM-35-752	7500	300	1.00	2.80
CM-35-822	8200	300	1.15	3.00
CM-35-912	9100	300	1.15	3.20
CM-35-103	10000	300	1.40	3.50
CM-35-123	12000	300	1.60	4.25
CM-35-153	15000	300	2.00	5.00
CM-35-682	6800	500	1.05	2.90
CM-35-752	7500	500	1.15	3.05
CM-35-822	8200	500	1.30	3.30
CM-35-912	9100	500	1.30	3.50
CM-35-103	10000	500	1.55	3.85

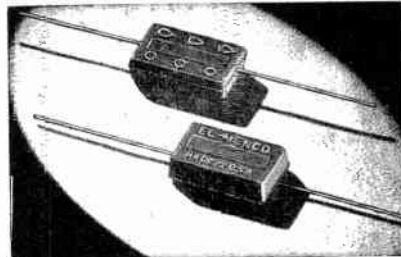

CM-40—1" x 5/8" x 11/32"
 CM-42—1 1/2" x 13/16" x 11/32"

CM-40

TYPE DESIGNATION	CAP. MMF.	DC WKG. VOLTAGE	LIST PRICE	
			REGULAR MICA	SILVERED MICA
CM-40-272	2700	500	.55	1.90
CM-40-302	3000	500	.60	2.05
CM-40-332	3300	500	.60	2.05
CM-40-362	3600	500	.65	2.10
CM-40-392	3900	500	.70	2.15
CM-40-432	4300	500	.70	2.15
CM-40-472	4700	500	.70	2.15
CM-40-502	5000	500	.75	2.25
CM-40-512	5100	500	.75	2.25
CM-40-562	5600	500	.75	2.50
CM-40-622	6200	500	1.05	2.90
CM-40-682	6800	500	1.15	3.30
CM-40-752	7500	500	1.40	3.65
CM-40-822	8200	500	1.40	3.85
CM-40-912	9100	500	1.40	4.40
CM-40-103	10000	500	1.70	4.40
CM-40-912	9100	300	1.30	4.00
CM-40-103	10000	300	1.50	4.00

ANNOUNCING A NEW MOLDED MICA EL-MENCO CAPACITOR

CM-42

A higher capacity molded mica which can be wired in directly without need of additional mounting facilities.

TYPE DESIGNATION	CAP. MMF.	DC WKG. VOLTAGE	LIST PRICE	
			REGULAR MICA	SILVERED MICA
CM-42-123	12000	500	\$1.80	\$3.90
CM-42-133	13000	500	1.95	4.20
CM-42-153	15000	500	2.20	4.80
CM-42-163	16000	500	2.30	5.10
CM-42-183	18000	500	2.60	5.70
CM-42-203	20000	500	2.80	6.30
CM-42-223	22000	500	3.00	6.90
CM-42-243	24000	500	3.30	7.50
CM-42-253	25000	500	3.40	7.80
CM-42-273	27000	300	3.10	7.50
CM-42-303	30000	300	3.40	7.80

STANDARD TOLERANCES

Regular mica $\pm 20\%$ (A and B Characteristics)

For $\pm 10\%$ tolerance add 10% to list price.

For $\pm 5\%$ tolerance add 25% to list price.

Silvered mica $\pm 5\%$ (C, D and E Characteristics)

For $\pm 2\%$ tolerance add 15% to list price.

For $\pm 1\%$ tolerance add 25% to list price.

ARCO ELECTRONICS, INC.

E L - M E N C O C A P A C I T O R S

TELEVISION • TRANSMITTING • INDUSTRIAL

HIGH VOLTAGE MICA CAPACITORS

DC WORKING VOLTAGES: FROM 1000 TO 2500 VOLTS
Molded in CM-20, CM-35 and CM-40 Cases

Demand for smaller units in higher voltages designed to meet the requirements for TELEVISION, POWER AMPLIFIERS, LOW POWER TRANSMITTERS, and various INDUSTRIAL Uses has increased. EL-MENCO designed and produced units listed below are especially adaptable to compact circuits where space is an important factor. Their acceptance has been overwhelming by the various manufacturers of TELEVISION RECEIVERS.

In many cases, these units will do the work of capacitors molded in CM-45, CM-50, and CM-55 cases without breaking down. NO SPECIAL MOUNTINGS ARE NECESSARY; just wire right into the circuit.

The capacitors are tested in low-loss bakelite and tested at double the branded voltage. They are tested for dielectric strength, insulation resistance, temperature coefficient, capacitance drift, susceptibility to humidity, and length of life, according to RCM Standards. All units are wax-dipped for protection against salt water immersion.

VCM-20						VCM-35 & VCM-40					
TYPE DESIGNATION	CAP. MMF.	5000 VDC TEST	4000 VDC TEST	3000 VDC TEST	2000 VDC TEST	TYPE DESIGNATION	CAP. MMF.	5000 VDC TEST	4000 VDC TEST	3000 VDC TEST	2000 VDC TEST
		2500 VDC WKG. LIST PRICE	2000 VDC WKG. LIST PRICE	1500 VDC WKG. LIST PRICE	1000 VDC WKG. LIST PRICE			2500 VDC WKG. LIST PRICE	2000 VDC WKG. LIST PRICE	1500 VDC WKG. LIST PRICE	1000 VDC WKG. LIST PRICE
VCM-20-B-050	5	\$0.35	\$0.35	\$0.35	\$0.30	VCM-35-B-241	240	\$0.60			
VCM-20-B-100	10	.35	.35	.35	.30	VCM-35-B-251	250	.60			
VCM-20-B-120	12	.35	.35	.35	.30	VCM-35-B-271	270	.60			
VCM-20-B-150	15	.35	.35	.35	.30	VCM-35-B-301	300	.65			
VCM-20-B-180	18	.35	.35	.35	.30	VCM-35-B-331	330	.65			
VCM-20-B-200	20	.35	.35	.35	.30	VCM-35-B-361	360	.75			
VCM-20-B-220	22	.35	.35	.35	.30	VCM-35-B-391	390	.80			
VCM-20-B-240	24	.35	.35	.35	.30	VCM-35-B-431	430	.80	\$0.65		
VCM-20-B-270	27	.35	.35	.35	.30	VCM-35-B-471	470	.80	.75		
VCM-20-B-300	30	.40	.35	.35	.30	VCM-35-B-501	500	.85	.75		
VCM-20-B-330	33	.40	.35	.35	.30	VCM-35-B-511	510	.85	.75		
VCM-20-B-360	36	.40	.35	.35	.30	VCM-35-B-561	560	.90	.75		
VCM-20-B-390	39	.40	.35	.35	.30	VCM-35-B-621	620	.95	.80		
VCM-20-B-430	43	.40	.35	.35	.30	VCM-35-B-681	680	1.05	.80	\$0.75	
VCM-20-B-470	47	.40	.35	.35	.30	VCM-35-B-821	820	1.15	.90	.85	
VCM-20-B-500	50	.40	.40	.35	.30	VCM-35-B-911	910	1.35	.95	.90	
VCM-20-B-510	51	.40	.40	.35	.30	VCM-35-B-102	1000	1.40	1.10	.90	
VCM-20-B-560	56	.40	.40	.35	.30	VCM-35-B-112	1100	1.40	1.15	.95	\$0.60
VCM-20-B-620	62	.40	.40	.35	.30	VCM-35-B-122	1200	1.50	1.20	1.10	.65
VCM-20-B-680	68	.45	.40	.35	.30	VCM-35-B-132	1800	1.65	1.30	1.15	.65
VCM-20-B-750	75	.50	.40	.35	.30	VCM-35-B-152	1500	1.85	1.45	1.30	.75
VCM-20-B-820	82	.50	.40	.35	.30	VCM-35-B-162	1600	2.00	1.50	1.30	.80
VCM-20-B-910	91	.50	.40	.40	.35	VCM-35-B-182	1800		1.70	1.45	.80
VCM-20-B-101	100	.55	.40	.40	.35	VCM-35-B-202	2000		1.80	1.60	.85
VCM-20-B-111	110	.60	.45	.40	.35	VCM-35-B-222	2200			1.70	.95
VCM-20-B-121	120	.60	.45	.40	.35	VCM-35-B-242	2400			1.80	1.05
VCM-20-B-131	130	.60	.45	.40	.35	VCM-35-B-272	2700				1.05
VCM-20-B-151	150	.65	.45	.40	.35	VCM-35-B-302	3000				1.15
VCM-20-B-161	160	.70	.50	.40	.35	VCM-35-B-332	3300				1.20
VCM-20-B-181	180	.70	.50	.40	.35	VCM-35-B-362	3600				1.35
VCM-20-B-201	200	.80	.60	.45	.40	VCM-35-B-392	3900				1.40
VCM-20-B-221	220	.85	.60	.45	.40	VCM-35-B-432	4300				1.50
VCM-20-B-241	240	.85	.65	.45	.40	VCM-35-B-472	4700				1.65
VCM-20-B-251	250		.65	.55	.40	VCM-35-B-502	5000				1.70
VCM-20-B-271	270		.65	.55	.40	VCM-35-B-512	5100				1.70
VCM-20-B-301	300		.70	.60	.45						
VCM-20-B-331	330		.80	.60	.45						
VCM-20-B-361	360		.80	.60	.45						
VCM-20-B-391	390		.85	.65	.45						
VCM-20-B-431	430			.65	.50						
VCM-20-B-471	470			.70	.50						
VCM-20-B-501	500			.70	.50						
VCM-20-B-511	510			.70	.50						
VCM-20-B-561	560			.80	.55						
VCM-20-B-621	620			.85	.55						
VCM-20-B-681	680				.60						
VCM-20-B-751	750				.60						
VCM-20-B-821	820				.65						
VCM-20-B-911	910				.70						
VCM-20-B-102	1000				.75						

All units supplied in "A" or "B" Characteristic at list price. Case Size Dimensions (See preceding pages for illustrations):
VCM-20— $\frac{1}{2}$ " x $\frac{1}{4}$ " x $\frac{1}{2}$ " VCM-35— $\frac{1}{2}$ " x $\frac{1}{4}$ " x $\frac{1}{2}$ "
Standard Tolerance: $\pm 20\%$. VCM-40—1" x $\frac{1}{2}$ " x $\frac{1}{2}$ "
Prices will be quoted for closer tolerances in "Silvered" mica upon request. TURN TO P-70 FOR INFORMATION ON OUR SPECIAL HI-VOLTAGE KIT.
Items listed also available in Silvered Mica. Prices quoted on request.

PLEASE SPECIFY VOLTAGE RATING WHEN ORDERING

ARCO ELECTRONICS, INC.

EL - M E N C O C A P A C I T O R S



**MINERAL OIL IMPREGNATION
NON-INDUCTIVE WINDING
SYNTHETIC RESIN END SEALS
STEATITE CASE**

PAPER TUBULAR CAPACITORS CP TYPE

EL-MENCO CP type paper tubular capacitors are sealed into STEATITE TUBES which serve to insulate the capacitor electrically as well as against moisture and heat. The capacitor insert is impregnated with MINERAL OIL, thereby assuring long life at 85° C operating conditions. This feature insures successful operation at the high ambient temperatures existing in small, compact enclosures.

The NON-INDUCTIVELY wound paper and foil units are sealed in the CERAMIC TUBES by means of baked SYNTHETIC RESIN END FILLS which cannot melt at any conceivable operating temperature. The end fills will not dissolve in wax, permitting the capacitors to be potted without damage to the insert. Leads are of tinned copper 2 1/4" long.

Many of the large TELEVISION, TRANSMITTER and HIGH VOLTAGE AMPLIFIER manufacturers have found these capacitors to be of highest quality. Breakdown tests have exceeded the required standards.

DIMENSIONS FOR CP TYPE CAPACITORS

	DIAMETER	LENGTH
CP-1	3/8"	1 1/8"
CP-2	3/8"	1 3/8"
CP-3	1/2"	1 3/8"
CP-5	3/8"	1 5/8"
CP-5	3/8"	2 1/8"
CP-6	1/2"	2 1/8"

STANDARD TOLERANCE ON ABOVE UNITS IS ± 20%.

CAPACITY MFD.	1000 WVDC		600 WVDC		400 WVDC		200 WVDC	
	PART NUMBER	LIST PRICE	PART NUMBER	LIST PRICE	PART NUMBER	LIST PRICE	PART NUMBER	LIST PRICE
.001	CP-1-102	\$0.30	CP-1-102	\$0.25				
.0015	CP-1-152	.30	CP-1-152	.25				
.02	CP-1-202	.30	CP-1-202	.25				
.0022	CP-1-222	.30	CP-1-222	.25				
.0025	CP-2-252	.30	CP-1-252	.25				
.008	CP-2-302	.30	CP-1-302	.25				
.0038	CP-2-332	.30	CP-1-332	.25				
.004	CP-2-402	.30	CP-1-402	.25				
.0047	CP-2-472	.35	CP-1-472	.25				
.005	CP-2-502	.35	CP-1-502	.25				
.006	CP-2-602	.35	CP-2-602	.25				
.0068	CP-2-682	.35	CP-2-682	.25				
.0075	CP-2-752	.35	CP-2-752	.30				
.01	CP-2-103	.40	CP-2-103	.30				
.015	CP-3-153	.40	CP-2-153	.30				
.02	CP-4-203	.40	CP-3-203	.30	CP-2-203	\$0.25		
.022	CP-4-223	.40	CP-3-223	.30	CP-2-223	.30		
.025	CP-4-253	.40	CP-4-253	.35	CP-3-253	.30		
.03	CP-4-303	.40	CP-4-303	.35	CP-3-303	.30		
.033	CP-4-333	.50	CP-4-333	.35	CP-3-333	.30		
.04	CP-4-403	.50	CP-4-403	.35	CP-4-403	.30		
.047	CP-4-473	.50	CP-4-473	.40	CP-4-473	.30		
.05	CP-4-503	.50	CP-4-503	.40	CP-4-503	.30		
.056	CP-4-563	.55	CP-5-563	.40	CP-4-563	.30		
.068			CP-5-683	.45	CP-4-683	.35		
.075			CP-5-753	.45	CP-4-753	.35		
.1			CP-5-104	.55	CP-4-104	.35	CP-4-104	\$0.35
.15			CP-5-154	.55	CP-5-154	.45	CP-5-204	.45
.22			CP-6-204	.65	CP-6-204	.55	CP-5-224	.45
.25			CP-6-224	.70	CP-6-224	.55	CP-5-254	.45
.33			CP-6-254	.70	CP-6-254	.55	CP-6-334	.55
.47							CP-6-474	.70
.5							CP-6-504	.70

PLEASE SPECIFY
VOLTAGE WHEN
ORDERING

TURN TO P-70
FOR INFORMATION
ON OUR SPECIAL
PAPER TUBULAR
KITS

ARCO ELECTRONICS, INC.

EL - M EN CO C A P A C I T O R S

Single and Dual PADDERS

EL-MENCO PADDING CONDENSERS have been acclaimed by engineers as the finest development in adjustable mica condensers.

The construction is such as to completely enclose and protect the delicate edges of the mica films, made of the finest quality clear India ruby mica.

The phosphor bronze adjusting plates assure permanent resilience and freedom from mechanical fatigue. All parts are heavily plated to resist corrosion.

TYPE 30

500 Volts DC Flash-Test — 250 WVDC

PART NUMBER	NUMBER OF PLATES	GUARANTEED RANGE		LIST PRICE
		At 1½ Inch Pounds Cap. Will Be More Than MMF.	At 2½ Turns Open Cap. Will Be Less Than MMF.	
302	2 Pl.	130	15	\$0.60
303	3 Pl.	340	65	.65
304	4 Pl.	560	100	.75
305	5 Pl.	760	190	.85
306	6 Pl.	970	275	.90
307	7 Pl.	1180	350	1.00
308	8 Pl.	1390	450	1.05
309	9 Pl.	1600	550	1.15
310	10 Pl.	1890	650	1.25
311	11 Pl.	2110	780	1.35
312	12 Pl.	2330	880	1.40
313	13 Pl.	2605	1150	1.50
314	14 Pl.	2830	1300	1.60
315	15 Pl.	3055	1400	1.65

Screw is insulated from top plate by mica washer. Above maximum capacity values are based on using 1½ to 1¾ Mil Mica films.

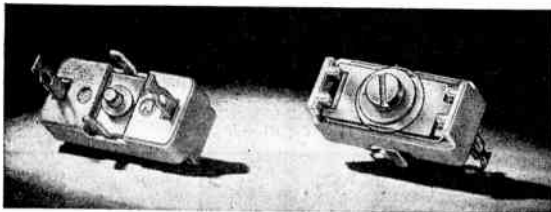

38

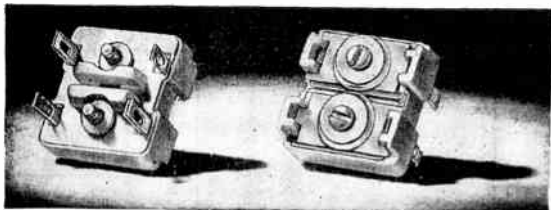

TYPE 50 DUAL PADDER
(will fit any size shield having dimensions exceeding 1-1/16" x 1-1/16")

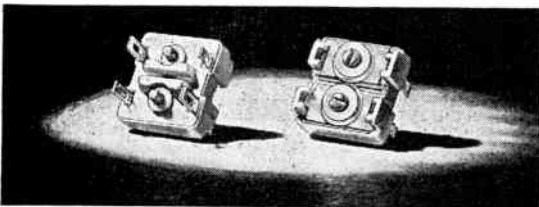

TYPE 60 DUAL PADDER
(will fit any size shield having dimensions exceeding ¾" x ¾")

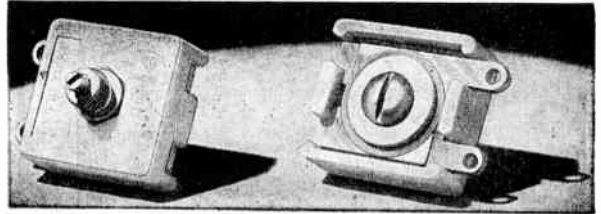

TYPE 30 AND TYPE 30-M PADDER 7/8" x 15/16"

TYPE 30-M

1000 Volts DC Flash-Test — 500 Working Volts DC

PART NUMBER	NUMBER OF PLATES	GUARANTEED RANGE		LIST PRICE
		At 1½ Inch Pounds Cap. Will Be More Than MMF.	At 2½ Turns Open Cap. Will Be Less Than MMF.	
302-M	2 Pl.	120	15	\$0.60
303-M	3 Pl.	320	65	.65
304-M	4 Pl.	500	100	.80
305-M	5 Pl.	690	180	.85
306-M	6 Pl.	880	265	.90
307-M	7 Pl.	1070	340	1.05
308-M	8 Pl.	1260	425	1.10
309-M	9 Pl.	1415	525	1.15
310-M	10 Pl.	1600	615	1.25
311-M	11 Pl.	1785	730	1.35
312-M	12 Pl.	1970	800	1.45
313-M	13 Pl.	2155	1000	1.50
314-M	14 Pl.	2340	1100	1.60
315-M	15 Pl.	2525	1200	1.70

Screw is insulated from top plate by mica washer. Above maximum capacity values are based on using 2 to 2¼ Mil Mica.

PART NUMBER	NUMBER OF PLATES	GUARANTEED RANGE		LIST PRICE
		At Tight Cap. Will Be More Than MMF.	At 2 Turns Open Cap. Will Be Less Than MMF.	
582	2 Pl.	80	7.5	\$0.40
583	3 Pl.	160	19	.45
584	4 Pl.	240	50	.50

← TYPE 58 Padder is a single variable trimmer section provided with a two-pronged staple mounting for attachment to bracket or chassis. Base is made of lowest loss steatite and the mica is India Ruby.

PART NUMBER	NUMBER OF PLATES	GUARANTEED RANGE		LIST PRICE
		At Tight Cap. Will Be More Than MMF.	At 2 Turns Open Cap. Will Be Less Than MMF.	
502	2 Pl.	80	7.5	\$0.60
503	3 Pl.	160	19	.70
504	4 Pl.	240	50	.80

← TYPE 50 Dual Padders provide two variable trimmers mounted on a single base. This unit is designed as a tuning component for I.F. transformers; and as such, may be snap-in mounted along with the transformer coil in any size shield having dimensions exceeding 1½" x 1½".

PART NUMBER	NUMBER OF PLATES	GUARANTEED RANGE		LIST PRICE
		At Tight Cap. Will Be More Than MMF.	At 2 Turns Open Cap. Will Be Less Than MMF.	
602	2 Pl.	55	7	\$0.50
603	3 Pl.	100	15	.60
604	4 Pl.	160	35	.70

← TYPE 60 Dual Padders provide two variable trimmers mounted on a single base. This unit is designed as a tuning component for I.F. transformers; and as such, may be snap-in mounted along with the transformer coil in any size shield having dimensions exceeding ¾" x ¾".

See Page P-41 for Mica Trimmer Capacitors

ARCO ELECTRONICS, INC.

E L - M E N C O C A P A C I T O R S

TRIMMERS

The base is made of the lowest dielectric loss ceramic material available and the mica is clear India Ruby.

The soldering lugs may be bent in any position without affecting capacity setting due to the rigid construction of adjusting plates.

EL-MENCO TRIMMING CONDENSERS are treated for resistance to humidity and for permanence of capacity setting.

Trimmers shown here are standard sizes and capacities.

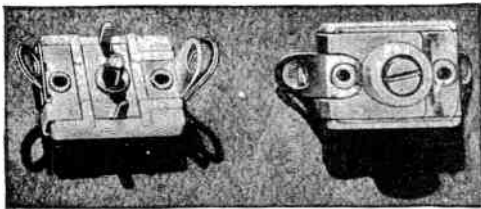

TYPE 46 STANDARD TRIMMER 3/4" x 5/8"

TYPE 46 — STANDARD TRIMMER

TYPE 46W	NUMBER PART	PLATES NUMBER OF	GUARANTEED RANGE		LIST PRICE
			At Tight Cap. Will Be More Than MMF.	At 3 Turns Oper. Cap. Will Be Less Than MMF.	
460	1 1/2 Pl.	15	1.5		\$0.35
461	1 3/4 Pl.	30	2.7		.35
462	2 Pl.	80	5		.40
463	3 Pl.	180	9		.45
464	4 Pl.	280	25		.50
465	5 Pl.	380	50		.55
466	6 Pl.	480	80		.60
467	7 Pl.	580	110		.70
468	8 Pl.	680	140		.75
469	9 Pl.	780	170		.80

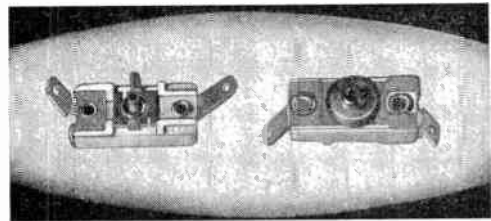

TYPE 42 MIDGET TRIMMER 3/8" x 3/4"

TYPE 42 — ANNOUNCING NEW MIDGET TRIMMER

TYPE 42	NUMBER PART	PLATES NUMBER OF	GUARANTEED RANGE		LIST PRICE
			At Tight Cap. Will Be More Than MMF.	At 3 Turns Open Cap. Will Be Less Than MMF.	
420	1 1/8 Pl.	12	1		\$0.40
421	1 1/4 Pl.	25	2		.40
422	2 Pl.	40	4		.40
423	3 Pl.	100	7		.45
424	4 Pl.	150	14		.50
425	5 Pl.	200	24		.60
426	6 Pl.	250	37		.65
427	7 Pl.	300	55		.70
428	8 Pl.	350	70		.80
429	9 Pl.	400	90		.85

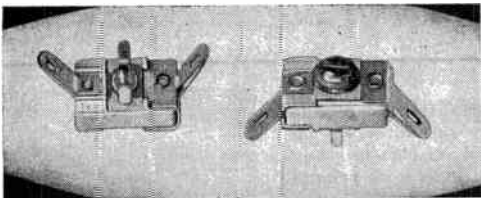

TYPE 40 MINIATURE TRIMMER 3/8" x 9/16"

TYPE 40 — ANNOUNCING NEW MINIATURE TRIMMER

TYPE 40	NUMBER PART	PLATES NUMBER OF	GUARANTEED RANGE		LIST PRICE
			At Tight Cap. Will Be More Than MMF.	At 3 Turns Open Cap. Will Be Less Than MMF.	
400	1 1/8 Pl.	7	0.9		\$0.40
402	2 Pl.	20	1.5		.45
403	3 Pl.	35	3		.50
404	4 Pl.	60	8		.55

**Metal Mounting Brackets
For These Trimmers Can Be
Supplied From Stock**

	LIST PRICE
Bracket for mounting 2 Trimmers	\$0.10
Bracket for mounting 3 Trimmers12
Bracket for mounting 4 Trimmers14
Bracket for mounting 5 Trimmers16
Bracket for mounting 6 Trimmers18

ARCO ELECTRONICS, INC.

E L - M E N C O C A P A C I T O R S

CERAMIC CAPACITORS

Use primarily for coupling and by-pass in RF and higher frequency circuits, ELMENCO ceramic capacitors are wax impregnated with low-loss phenolic coating. Insulation resistance far exceeds the 10,000 megohm minimum requirements. Voltage rating is 1500VDCT, 500VDCW. 90% relative humidity test for 100 hours. Radial leads are 1 1/4" minimum No. 22 tinned copper wire.

SILVER HIGH "K" DISC

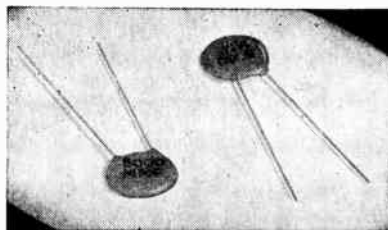

Reduced self-inductance due to flat design makes these units particularly adaptable to VHF applications.

Capacity and tolerance stamped on capacitor.

Maximum dimensions:

.575" diameter
.150" thickness

TYPE DESIGNATION	CAP. MMF.	LIST PRICE (MIN. GUAR. CAP.)	LIST PRICE (±20% TOL.)
CCD-102	1000	\$0.25	\$0.30
CCD-152	1500	.25	.30
CCD-202	2000	.25	.30
CCD-272	2700	.25	.35
CCD-332	3300	.25	.35
CCD-392	3900	.25	.35
CCD-472	4700	.25	.35
CCD-502	5000	.25	.40
CCD-682	6800	.25	.45
CCD-822	8200	.30	.50
CCD-103	10000	.30	.50
CCD-123	12000	.40	—

N-750 DISC

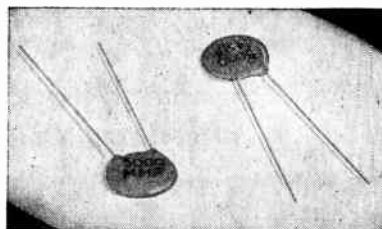

Negative temperature coefficient ceramics for compensation and reduction of temperature drift.

Capacity and tolerance stamped on capacitor.

Maximum dimensions:

.575" diameter
.150" thickness

TYPE DESIGNATION	CAP. MMF.	LIST PRICE (±20% TOL.)	LIST PRICE (±10% TOL.)
CCDN-470	47	\$0.40	\$0.50
CCDN-560	56	.40	.50
CCDN-620	62	.40	.50
CCDN-680	68	.40	.50
CCDN-750	75	.40	.50
CCDN-820	82	.40	.50
CCDN-101	100	.40	.50
CCDN-121	120	.40	.50
CCDN-151	150	.40	.50

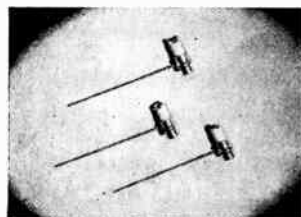

Adjustable ceramic trimmer capacitor for high frequency applications. Silvered Steatite tubes 5/8" in length provide capacity ranges listed below upon insertion of 0-32 screw.

VARIABLE CERAMIC TRIMMER

PART No.	CAP. RANGE MMF.	LIST PRICE
CV-1	0.5 - 3	\$0.35
CV-2	1 - 4	.35
CV-3	2 - 6	.35

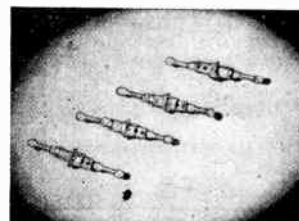

Compact rugged ceramic feed through capacitors are designed for high frequency coupling with a minimum of inductive reactance through elimination of wire leads. These units are three dot RMA coded and rated at 500VDCW.

FEED THRU CAPACITORS

PART No.	CAP. (MMF.) (Guar. Min. Val.)	LIST PRICE
CCF-501	500	\$0.40
CCF-102	1000	.40
CCF-152	1500	.40
CCF-202	2000	.40

ARCO ELECTRONICS, INC.

E L - M E N C O C A P A C I T O R S

ARCO CAPACITOR KITS

1000 VOLT PAPER TUBULAR CAPACITOR KIT

SPECIAL
KIT
LIST
PRICE **\$27.50**



This Kit contains 5 EACH of the following
PAPER TUBULAR CAPACITOR SIZES

PART NUMBER	CAPACITY MFD.	WORKING VOLTAGE
CP-1-102	.001	1000
CP-1-152	.0015	1000
CP-1-202	.002	1000
CP-1-252	.0025	1000
CP-2-302	.003	1000
CP-2-332	.0033	1000
CP-2-402	.004	1000
CP-2-472	.0047	1000
CP-2-502	.005	1000
CP-2-602	.006	1000
CP-2-752	.0075	1000
CP-3-103	.01	1000
CP-3-153	.015	1000
CP-4-203	.02	1000
CP-4-253	.025	1000
CP-5-353	.035	1000
CP-5-503	.05	1000

El-Menco CP type paper tubular capacitors are sealed in impervious steatite ceramic tubes through use of synthetic resin end fills which are waterproof and will not melt at any conceivable operating temperature. The non-inductively wound paper and foil inserts are mineral oil impregnated. This combination of fine quality material and construction insures long life at high ambient temperatures, indefinite shelf-life and trouble-free operation under the most adverse conditions.

STANDARD PAPER TUBULAR CAPACITOR KIT

SPECIAL KIT
LIST PRICE
\$37.50



This Kit contains 5 EACH of the following
PAPER TUBULAR CAPACITOR SIZES

PART NUMBER	CAPACITY MFD.	WORKING VOLTAGE
CP-1-102	.001	600
CP-1-152	.0015	600
CP-1-202	.002	600
CP-1-222	.0022	600
CP-1-252	.0025	600
CP-1-302	.003	600
CP-1-332	.0033	600
CP-1-402	.004	600
CP-1-472	.0047	600
CP-1-502	.005	600
CP-2-602	.006	600
CP-2-682	.0068	600
CP-2-752	.0075	600
CP-2-103	.01	600
CP-2-153	.015	600
CP-3-203	.02	600
CP-3-223	.022	600
CP-4-303	.03	600
CP-4-333	.033	600
CP-4-403	.04	600
CP-4-473	.047	600
CP-4-503	.05	600
CP-5-104	.1	600
CP-6-254	.25	400
CP-6-504	.5	200

CM20 HI VOLTAGE CAPACITOR KIT

This Kit contains 10 EACH of the following
HIGH VOLTAGE CAPACITORS, Tolerance $\pm 20\%$

CAP. MMF.	WKG. VOLT.	CAP. MMF.	WKG. VOLT.	CAP. MMF.	WKG. VOLT.
5	2500	56	2500	270	1500
10	2500	62	2500	300	1000
12	2500	68	2500	330	1000
15	2500	75	1500	360	1000
18	2500	82	1500	390	1000
20	2500	91	1500	430	1000
22	2500	100	1500	470	1000
24	2500	110	1500	500	1000
27	2500	120	1500	510	1000
30	2500	130	1500	560	1000
33	2500	150	1500	620	1000
36	2500	160	1500	680	1000
39	2500	180	1500	750	1000
43	2500	200	1500	820	1000
47	2500	220	1500	910	1000
50	2500	240	1500	1000	1000
51	2500	250	1500		

SPECIAL KIT
LIST PRICE
\$189.50



El-Menco High Voltage Capacitors are manufactured in accordance with MIL and RMA specifications for molded mica capacitors and are additionally designed to operate at higher voltages than normally expected of units of this size. They are ideally suited for use in high voltage, low power circuits, particularly where space requirements are an important factor. Axial wire leads provide simplicity of wiring through elimination of added mounting devices. All units are molded in low-loss phenolic cases and are wax-dipped for protection against salt-water immersion.

ARCO ELECTRONICS, INC.

EL - M E N C O C A P A C I T O R S



JAN-C-5 ELMENCO CAPACITOR KITS

All capacitors contained in these handy ARCO kits are ELMENCO, a name known world-wide for quality and dependability of performance, the finest products in their field.

SILVERED MICA KIT

This kit contains the complete range of ELMENCO silvered molded mica capacitors from 5 mmf. to 10,000 mmf. manufactured in accordance with JAN-C-5 specifications. All units are of letters "C", "D" or "E" characteristics as specified and letter "J" (5%) tolerance and are JAN color coded.

SPECIAL KIT \$325
LIST PRICE

PURCHASED INDIVIDUALLY THE TOTAL LIST PRICE VALUE OF THE CAPACITORS CONTAINED IN THIS KIT WOULD BE **\$38500**

THESE KITS CONTAIN FIVE EACH OF THE FOLLOWING ELMENCO MOLDED MICA CAPACITORS:

- 47 JAN capacity values CM20 case size, max. dim. 25/32 x 7/16 x 7/32", from 5 to 1000 mmf. 500VDCW.
- 12 JAN capacity values CM30 case size, max. dim. 13/16 x 13/16 x 9/32", from 1100 to 3300 mmf. 500VDCW.
- 7 JAN capacity values CM35 case size, max. dim. 13/16 x 13/16 x 11/32", from 3600 to 6200 mmf. 500VDCW.
- 5 JAN capacity values CM35 case size, max. dim. 13/16 x 13/16 x 11/32", from 6800 to 10,000 mmf. 300VDCW.

PER JAN-C-5 SPECIFICATIONS

REG. FOIL MICA KIT

SPECIAL KIT \$140
LIST PRICE

PURCHASED INDIVIDUALLY THE TOTAL LIST PRICE VALUE OF THE CAPACITORS CONTAINED IN THIS KIT WOULD BE **\$15840**



This kit contains the complete range of ELMENCO regular foil molded mica capacitors from 5 mmf. to 10,000 mmf. manufactured in accordance with JAN-C-5 specifications. All units are of the letter "B" characteristic and letter "K" (10%) tolerance and are JAN color coded.

ARCO ELECTRONICS, INC.

E L - M E N C O C A P A C I T O R S

CM-15 MINIATURE MICA CAPACITOR KIT

FOR EXPERIMENTAL WORK

Don't Get Caught Short...

ALWAYS HAVE THE CORRECT

CAPACITY ON HAND

This Handy Kit consists of 45 most commonly used Capacitors . . . five of each capacity as listed on page P-62 packed in individual tuck boxes, properly identified for permanent use.



SPECIAL KIT LIST PRICE ONLY \$90⁰⁰

THESE MINIATURES FIT INTO THE SMALLEST AREA CAPACITOR SIZE (9/32" x 1/2" x 3/16")

The complete set of capacitors amounts to \$113.00 at list prices. You get the entire set during this introductory offer, for only \$90.00.

COMPARE COST!

Type 46 Trimmer and Type 30 Padder Kits

A complete stock of trimmers and padders is provided in these compact, easily handled, and readily accessible kits. Always have a full line of El-Menco trimmers and padders available for immediate use.



TYPE 46 TRIMMER KIT

Provides a capacity range from 1 1/2 to 780 mmfd. Twenty-four units of each size available in type 46 trimmers (see P-41). The total list price for all units included in the kit is \$130.80. Yet you may have this complete kit for only

Special Kit List Price \$100.00



TYPE 30 PADDER KIT

Provides a capacity range from 15 to 3055 mmfd (30M:15 to 2525 mmfd.) Twelve units of each size available in type 30 or type 30M (see P-40). The total list price for all units included in the kit is \$191.40. Yet you may have this complete kit for only

Special Kit List Price \$145.00

INDUSTRIAL

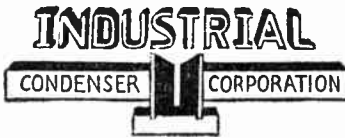

CONDENSER

TYPE "SA" OIL FILLED

Full information, including data on Pyroteen filled capacitors, available in Catalog 1083A.

1. INDCO OIL "A" IMPREGNATED AND FILLED—permitting efficient operation over widest range of temperatures.
2. HERMETICALLY SEALED CASE—is unaffected by time, humidity, or operating temperatures.
3. HIGHEST GRADE CONDENSER TISSUES—insure long uninterrupted life.
4. HIGH-GLAZE PORCELAIN INSULATORS—insure low moisture absorption and high terminal to case flash over.
5. CONSERVATIVELY RATED—safe for continuous operation at 10 per cent overload.
6. "SPACE SAVER" UNIVERSAL MOUNTING BRACKET—provides adjustable capacitor heights.
7. LEAD COATED STEEL CASE—is non-corrosive and lacquer finished.
8. TESTED FOUR TIMES BEFORE SHIPMENT—guarantees perfect product electrically, mechanically.

If riveted terminal construction is wanted in place of porcelain stand-off insulators add "R" to catalog number. For example, 6SA50 changes to 6SAR50. Submersion proof terminal construction to meet Army and Navy Specifications is optional; specify on order. Standard capacity tolerance plus or minus 10 per cent. Mounting brackets supplied in accordance with following catalog designations:

TYPE SA—No mounting brackets, TYPE SAU—"Space Saver" universal bracket, TYPE SAJ—Soldered vertical mounting bracket, Type SAL—Reversible mounting foot bracket, TYPE SAH—Re-

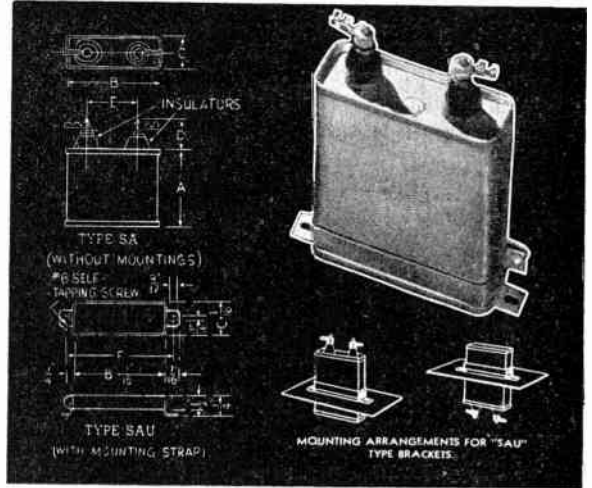

versible spade bolt bracket. For example: The 8mfd. 600V. type with "Space Saver" bracket has catalog number 6SAU800.

NOTE: To facilitate delivery we have standardized on container heights. In many cases units can be supplied in shorter containers if required.

600 V.D.C. WORKING									
Cat. No.	Cap. Mfd.	Dimensions in Inches							List Price
		A	B	C	D	E	F	H	
6SA50	.5	2 7/8	1 1/8	1 1/8	7/8	3/4	2 1/4	2 1/4	\$4.55
6SA100	1.0	2 7/8	1 1/8	1 1/8	7/8	3/4	2 1/4	2 1/4	5.85
6SA200	2.0	2 7/8	1 1/8	1 1/8	7/8	3/4	2 1/4	2 1/4	7.10
6SA400	4.0	4 1/4	2 1/2	1 1/8	7/8	1 1/8	3	3	9.20
6SA600	6.0	4 1/4	2 1/2	1 1/8	7/8	1 1/8	3	3	11.30
6SA800	8.0	4 1/4	2 1/2	1 1/8	7/8	1 1/8	4 3/8	4 3/8	13.35
6SA1000	10.0	4 1/4	2 1/2	1 1/8	7/8	1 1/8	4 3/8	4 3/8	15.00

1000 V.D.C. WORKING									
Cat. No.	Cap. Mfd.	Dimensions in Inches							List Price
		A	B	C	D	E	F	H	
10SA10	.1	2 7/8	1 1/8	1 1/8	7/8	3/4	2 1/4	2 1/4	4.20
10SA25	.25	2 7/8	1 1/8	1 1/8	7/8	3/4	2 1/4	2 1/4	4.55
10SA50	.5	2 7/8	1 1/8	1 1/8	7/8	3/4	2 1/4	2 1/4	5.00
10SA100	1.0	2 7/8	1 1/8	1 1/8	7/8	3/4	2 1/4	2 1/4	6.25
10SA200	2.0	4 1/4	2 1/2	1 1/8	7/8	1 1/8	3	3	8.35
10SA400	4.0	4 1/4	2 1/2	1 1/8	7/8	1 1/8	3	3	10.45
10SA600	6.0	4 1/4	2 1/2	1 1/8	7/8	1 1/8	4 3/8	4 3/8	14.05
10SA800	8.0	4 1/4	2 1/2	1 1/8	7/8	1 1/8	4 3/8	4 3/8	15.00
10SA1000	10.0	4 1/4	2 1/2	1 1/8	7/8	1 1/8	4 3/8	4 3/8	16.70

1500 V.D.C. WORKING									
Cat. No.	Cap. Mfd.	Dimensions in Inches							List Price
		A	B	C	D	E	F	H	
15SA50	.5	2 7/8	1 1/8	1 1/8	7/8	3/4	2 1/4	2 1/4	6.25
15SA100	1.0	4 1/4	2 1/2	1 1/8	7/8	1 1/8	3	3	7.55
15SA200	2.0	4 1/4	2 1/2	1 1/8	7/8	1 1/8	3	3	10.45
15SA400	4.0	4 1/4	2 1/2	1 1/8	7/8	1 1/8	4 3/8	4 3/8	13.90
15SA600	6.0	4 1/4	2 1/2	1 1/8	7/8	1 1/8	4 3/8	4 3/8	17.05

2000 V.D.C. WORKING									
Cat. No.	Cap. Mfd.	Dimensions in Inches							List Price
		A	B	C	D	E	F	H	
20SA10	.1	2 7/8	1 1/8	1 1/8	7/8	3/4	2 1/4	2 1/4	6.65
20SA25	.25	2 7/8	1 1/8	1 1/8	7/8	3/4	2 1/4	2 1/4	7.10

2000 V.D.C. WORKING (Continued)									
Cat. No.	Cap. Mfd.	Dimensions in Inches							List Price
		A	B	C	D	E	F	H	
20SA50	.5	2 7/8	1 1/8	1 1/8	7/8	3/4	2 1/4	2 1/4	\$7.55
20SA100	1.0	4 1/4	2 1/2	1 1/8	7/8	1 1/8	3	3	9.20
20SA200	2.0	4 1/4	2 1/2	1 1/8	7/8	1 1/8	3	3	10.85
20SA400	4.0	4 1/4	2 1/2	1 1/8	7/8	1 1/8	4 3/8	4 3/8	15.00
20SA600	6.0	4 1/4	2 1/2	1 1/8	7/8	1 1/8	4 3/8	4 3/8	19.65

2500 V.D.C. WORKING									
Cat. No.	Cap. Mfd.	Dimensions in Inches							List Price
		A	B	C	D	E	F	H	
25SA50	.5	4 1/4	2 1/2	1 1/8	7/8	1 1/8	4 3/8	4 3/8	11.70
25SA100	1.0	4 1/4	2 1/2	1 1/8	7/8	1 1/8	4 3/8	4 3/8	13.35
25SA200	2.0	4 1/4	2 1/2	1 1/8	7/8	1 1/8	4 3/8	4 3/8	21.55
25SA400	4.0	4 1/4	2 1/2	1 1/8	7/8	1 1/8	4 3/8	4 3/8	29.90

3000 V.D.C. WORKING									
Cat. No.	Cap. Mfd.	Dimensions in Inches							List Price
		A	B	C	D	E	F	H	
30SA10	.1	2 7/8	1 1/8	1 1/8	7/8	3/4	2 1/4	2 1/4	4.20
30SA25	.25	2 7/8	1 1/8	1 1/8	7/8	3/4	2 1/4	2 1/4	4.55
30SA50	.5	2 7/8	1 1/8	1 1/8	7/8	3/4	2 1/4	2 1/4	5.00
30SA100	1.0	2 7/8	1 1/8	1 1/8	7/8	3/4	2 1/4	2 1/4	6.25
30SA200	2.0	4 1/4	2 1/2	1 1/8	7/8	1 1/8	3	3	8.35
30SA400	4.0	4 1/4	2 1/2	1 1/8	7/8	1 1/8	3	3	10.45
30SA600	6.0	4 1/4	2 1/2	1 1/8	7/8	1 1/8	4 3/8	4 3/8	14.05
30SA1000	10.0	4 1/4	2 1/2	1 1/8	7/8	1 1/8	4 3/8	4 3/8	15.00

4000 V.D.C. WORKING									
Cat. No.	Cap. Mfd.	Dimensions in Inches							List Price
		A	B	C	D	E	F	H	
40SA10	.1	2 7/8	1 1/8	1 1/8	7/8	3/4	2 1/4	2 1/4	4.20
40SA25	.25	2 7/8	1 1/8	1 1/8	7/8	3/4	2 1/4	2 1/4	4.55
40SA50	.5	2 7/8	1 1/8	1 1/8	7/8	3/4	2 1/4	2 1/4	5.00
40SA100	1.0	2 7/8	1 1/8	1 1/8	7/8	3/4	2 1/4	2 1/4	6.25

5000 V.D.C. WORKING									
Cat. No.	Cap. Mfd.	Dimensions in Inches							List Price
		A	B	C	D	E	F	H	
50SA50	.5	4 1/4	2 1/2	1 1/8	7/8	1 1/8	4 3/8	4 3/8	33.45
50SA100	1.0	4 1/4	2 1/2	1 1/8	7/8	1 1/8	4 3/8	4 3/8	41.80

6000 V.D.C. WORKING									
Cat. No.	Cap. Mfd.	Dimensions in Inches							List Price
		A	B	C	D	E	F	H	
60SA50	.5	4 1/4	2 1/2	1 1/8	7/8	1 1/8	4 3/8	4 3/8	51.64
60SA100	1.0	4 1/4	2 1/2	1 1/8	7/8	1 1/8	4 3/8	4 3/8	83.55

TYPES "GA" and "HA" OIL FILLED

Full information, including data on Pyroteen filled capacitors, available in Catalog 1134.

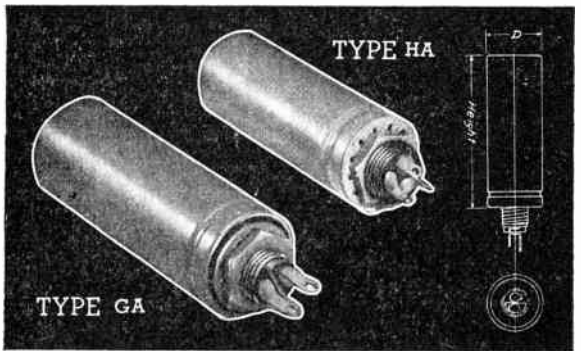

Types "GA" and "HA" are INDCO Oil "A" impregnated and filled. These capacitors fill a definite need where chassis space and ease of mounting are prime factors. Standard capacity tolerance: +20% -10%.

Moulded mounting neck is locked in the capacitor case and gasketed so that capacitor is hermetically sealed. Unless otherwise specified, capacitor case is insulated from terminals. Capacitors are supplied with solid nuts and lock washers for mounting.

Addition of the 8 mfd. (600 vdc.), dual 4 mfd. (600 vdc.), 4 mfd. (1000 vdc.), and similar units of the same case size, makes this series one of the most extensive in its class.

Catalog Number	Cap. Working Mfd.	V.D.C.	Case Size		Size of		List Price
			Dia.	Height	Mounting	Neck	
6GA200	2	600	1 1/2	2 7/8	3/8"	x 16 thread	\$4.55
6GA300	3	600	1 1/2	3 3/8	3/8"	x 16 thread	5.45
6GA400	4	600	1 1/2	4 1/2	3/8"	x 16 thread	6.25
6GA800	8	600	2	4 3/4	1"	x 14 thread	9.60
6GA2X400	4-4	600	2	4 3/4	1"	x 14 thread	10.10
10GA100	1	1000	1 1/2	2 7/8	3/8"	x 16 thread	4.20
10GA200	2	1000	1 1/2	4 1/2	3/8"	x 16 thread	5.45
10GA400	4	1000	2	4 3/4	1"	x 14 thread	8.00
10GA2X200	2-2	1000	2	4 3/4	1"	x 14 thread	8.60
15GA50	0.5	1500	1 1/2	2 7/8	3/8"	x 16 thread	5.00
15GA100	1	1500	1 1/2	4 1/2	3/8"	x 16 thread	5.45
15GA200	2	1500	2	4 3/4	1"	x 14 thread	7.75
6HA2X100	1.0-1.0	600	1 3/8	3 1/4	7/8"	x 16 thread	5.05
6HA2X50	.5-.5	600	1 3/8	2 7/8	7/8"	x 16 thread	4.75
10HA2X50	.5-.5	1000	1 3/8	2 7/8	7/8"	x 16 thread	5.05

TYPE "BA" OIL FILLED

Full information, including data on Pyroteen filled capacitors, available in Catalog 1083A

1. INDICO OIL "A" permits efficient operation of these compact units over the widest range of temperature.
2. HIGHEST GRADE CONDENSER TISSUE insures greater safety factor and longer life.
3. Specially PROCESSED RIVETED TERMINALS are designed to withstand total submersion in salt water and changes in temperature from 50° below zero Centigrade to 90° above zero Centigrade without loosening or losing their integrity.
4. CONDENSER MOUNTINGS form an integral part of these drawn shell containers insuring permanent and rigid fastenings.
5. NON-INDUCTIVELY WOUND for efficient operation over widest frequency range.
6. HERMETICALLY SEALED, they are unaffected by time, temperature or humidity.
7. CONSERVATIVELY RATED for safe and continuous uninterrupted operation at 10% above rated voltage for the lifetime of associated equipment.
8. Tested at twice the rated voltage between terminals and twice the rated voltage plus 1000 from each terminal to case.

Cat. No.	Cap. Mfd.	Dimensions in Inches					List Price
		L	W	H	M	O	
600 V. D. C. WORKING							
6BA05	.05	1 1/8	1	1 1/8	2 1/8	2 1/2	\$2.85
6BA10	.1	1 1/8	1	1 1/8	2 1/8	2 1/2	2.90
6BA25	.25	1 1/8	1	1 1/8	2 1/8	2 1/2	3.10
6BA50	.5	1 1/8	1	7/8	2 1/8	2 1/2	3.30
6BA100	1.0	2	1 3/4	7/8	2 1/8	2 3/4	3.75
6BA0505	.05-.05	1 1/8	1	1 1/8	2 1/8	2 1/2	3.65
6BA11	.1-1	1 1/8	1	1 1/8	2 1/8	2 1/2	3.70
6BA22	.25-.25	2	1 3/4	7/8	2 1/8	2 3/4	3.75
6BA55	.5-.5	2	1 3/4	7/8	2 1/8	2 3/4	4.30
6BA111	.1-1-1	1 1/8	1	1 1/8	2 1/8	2 1/2	4.20
6BA200	2.0	2	2	1 1/8	2 1/8	2 3/4	5.00
1000 V. D. C. WORKING							
10BA05	.05	1 1/8	1	1 1/8	2 1/8	2 1/2	3.05
10BA10	.1	1 1/8	1	1 1/8	2 1/8	2 1/2	3.15
10BA25	.25	1 1/8	1	1 1/8	2 1/8	2 1/2	3.25
10BA50	.5	2	1 3/4	7/8	2 1/8	2 3/4	3.50
10BA100	1.0	2	2	1 1/8	2 1/8	2 3/4	4.40
10BA0505	.05-.05	1 1/8	1	1 1/8	2 1/8	2 1/2	3.85
10BA11	.1-1	1 1/8	1	1 1/8	2 1/8	2 1/2	3.95
10BA22	.25-.25	2	1 3/4	7/8	2 1/8	2 3/4	4.20

Above units also available in 200 V. D. C., 400 V. D. C. and 1500 V. D. C. on request.

NOTICE—Most units are available with TERMINALS ON TOP, BOTTOM, OR ENDS. When ordering, add "T" for top terminals, "B" for terminals on bottom, or "E" for end terminals, i.e., 6BAT100 for terminals on top. Type "B" also available in WAX FILLED. When ordering, change catalog number A to W, i.e., 6BW100. If terminal position is not designated, side terminals are furnished. STANDARD CAPACITY tolerance of plus 20 per cent minus 10 per cent furnished on oil filled and wax filled units unless otherwise specified when ordering. Can be furnished in plus or minus 1 per cent capacity tolerance on special request.

ET SERIES ELECTROLYTIC CAPACITORS

Full information available in Catalog 1083A

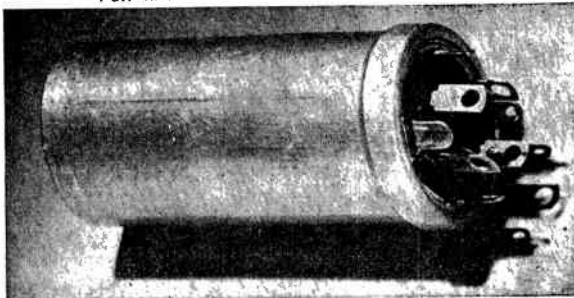

"ET" series capacitors have been designed for ease in installation and reliability. They are constructed to withstand the most severe operating conditions encountered in industrial and electronic equipment. Especially controlled manufacturing processes insure that the equipment in which these capacitors are used will function without interruption. Capacitors can be supplied for operation at temperatures ranging from minus 40 to plus 85 degrees Centigrade. Mounting is effected by inserting the capacitor through the slots in either the chassis or mounting plate, and twisting the mounting prongs 90 degrees.

Catalog Number	Cap. Mfd.	D.C. Voltage Working	D.C. Voltage Surge	Dim. in Ins. Diam.	Dim. in Ins. Lg.	List Price
52ET100	100	25	35	1	2	\$1.60
15ET30	30	150	225	1	2	1.55
15ET50	50	150	225	1	2	1.65
45ET10	10	450	550	1	2	1.55
45ET15	15	450	550	1	2	1.70
45ET20	20	450	550	1	2 1/2	1.80
45ET30	30	450	550	1	3	1.95
15ET2x20	20-20	150	225	1	2	1.70
15ET2x30	30-30	150	225	1	2	1.85
15ET2x50	50-50	150	225	1	3	2.15
30ET2x15	15-15	300	400	1	2	1.90
35ET3020	30-20	350	450	1	3	2.60
45ET2x10	10-10	450	550	1	2 1/2	1.90
45ET2x20	20-20	450	550	1 3/8	2 1/2	2.55
ET100	30-20/20	150/25	225/35	1	2	2.25
ET101	40-30/20	150/25	225/35	1	2 1/2	2.35
15ET3x20	20-20-20	150	225	1	2	2.30
ET102	40-20-20	150	225	1	2 1/2	2.40
15ET3x40	40-40-40	150	225	1	3	2.60
ET103	10-10/25	450/25	550/35	1	3	2.40
45ET3x10	10-10-10	450	550	1	3	2.60

TYPE "BE" ELECTROLYTICS

Full information available in Catalog 1083A

"BE" series electrolytic capacitors are designed to meet the growing need for small electrolytic capacitors in equipment where extreme reliability is required and where the capacitors are subject to the most adverse conditions of temperature and humidity. This series is designed similar to oil filled capacitors. They are hermetically sealed and will pass salt water immersion tests. Standard construction is with side terminals. Top and bottom terminals supplied on request.

Cat. No.	Cap. Mfd.	Volts	Dimen. in Inches				List Price
			L	W	H	M	
52BE10	10	25	1	1	1	2 1/8	\$2.70
52BE25	25	25	1	1	1	2 1/8	2.70
52BE50	50	25	1	1	1	2 1/8	2.80
05BE10	10	50	1	1	1	2 1/8	2.75
05BE25	25	50	1	1	1	2 1/8	2.75
J5BE50	50	50	1	1	1	2 1/8	3.00

Also available in other capacities in single and multiple sections up to 500 volts.

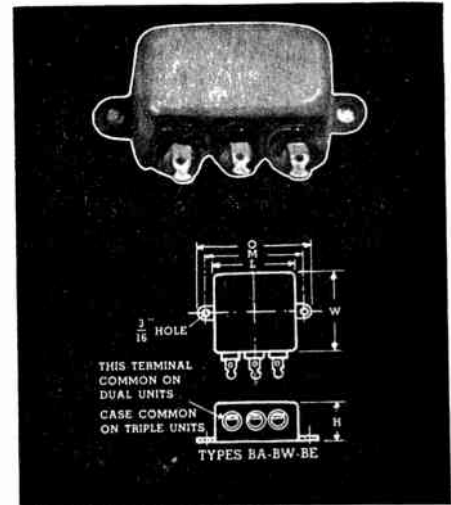

STABELEX "D" CAPACITORS

Technical Information Available in Catalog 1117A

Stabelex Capacitors represent a new series of capacitors being made available to industry for the first time.

Advancements in science and industry have created the need for capacitors having characteristics far superior to either laboratory type or commercial capacitors now available.

Advanced designs in equipment which have not been possible because of the unavailability of suitable capacitors have now become practical.

The Stabelex family of capacitors has been developed after a long period of research and has been made for special applications for quite some time. However, it is only now that these capacitors became available to industry.

Other Stabelex capacitors will be announced from time to time, each having its own special characteristics for use in applications for which they are most suited.

Suggested Applications

Input Capacitors	Computers
Coupling Capacitors	Filter Networks
RC Circuits	Radio Frequency Circuits
Meter Damping	Etc.

Many variations and special characteristics are possible with Stabelex capacitors that are not possible with any other type and it is, therefore, to the interest of the user to indicate, where possible, the application to which these capacitors will be put.

Catalog Number	Cap. Mfd.	Dimensions in Inches		List Price
		Dia.	Length	

600 VOLTS D.C. WORKING

6TY0005	.00005	1/2	1-1/16	\$ 2.40
6TY0001	.0001	1/2	1-1/16	2.40
6TY0005	.0005	1/2	1-1/16	2.40
6TY001	.001	1/2	1-1/16	2.40
6TY002	.002	1/2	1-1/16	2.40
6TY005	.005	1/2	1-1/16	2.40
6TY01	.01	5/8	1-1/2	2.30
6TY02	.02	5/8	1-1/2	2.40
6TY05	.05	3/4	2	2.80
6TY10	.1	1	2	3.50

400 VOLTS D.C. WORKING

4TY05	.05	5/8	1-1/2	2.60
4TY10	.1	3/4	2	2.80
4TY25	.25	1	2	3.60

Catalog Number	Cap. Mfd.	H	Dimensions in Inches		List Price
			L	W	

600 VOLTS D.C. WORKING

6SY50	0.5	4-1/8	1-13/16	1-1/16	\$15.50
6SY100	1.0	4-1/8	2-1/2	1-3/16	22.90
6SY200	2.0	4-1/8	3-3/4	1-1/4	33.40
6SY300	3.0	4-1/8	3-3/4	1-3/4	43.80
6SY400	4.0	5-1/8	3-3/4	1-3/4	51.20
6SY600	6.0	4-1/8	3-3/4	3-3/16	77.80
6SY800	8.0	5-1/8	3-3/4	3-3/16	92.80
6SY1000	10.0	5-1/8	3-3/4	4-9/16	113.70
6SY1200	12.0	5-1/8	3-3/4	4-9/16	129.30

400 VOLTS D.C. WORKING

4SY50	0.5	2-1/2	1-13/16	1-1/16	13.60
4SY100	1.0	4-1/8	1-13/16	1-1/16	15.20
4SY200	2.0	4-1/8	2-1/2	1-3/16	22.30
4SY300	3.0	5-1/8	2-1/2	1-3/16	25.90
4SY400	4.0	4-1/8	3-3/4	1-1/4	32.20
4SY600	6.0	4-1/8	3-3/4	1-3/4	41.60
4SY800	8.0	5-1/8	3-3/4	1-3/4	48.60
4SY1000	10.0	5-1/8	3-3/4	2-1/4	61.40
4SY1200	12.0	5-1/8	3-3/4	2-1/4	68.50
4SY1500	15.0	5-1/8	3-3/4	3-3/16	83.90
4SY2000	20.0	5-1/8	3-3/4	4-9/16	106.90
4SY2500	25.0	5-1/8	3-3/4	4-9/16	124.80

Catalog Number	Cap. Mfd.	L	Dimensions in Inches		List Price
			W	H	

600 VOLTS D.C. WORKING

6BY05	.05	1-13/16	1	13/16	\$ 5.80
6BY10	.1	1-13/16	1	13/16	6.10
6BY25	.25	2	1-3/4	7/8	7.70
6BY50	.5	2	2	1-1/8	10.10

400 VOLTS D.C. WORKING

4BY25	.25	2	1-3/4	7/8	6.50
4BY50	.5	2	1-3/4	7/8	7.50
4BY100	1.0	2	2	1-1/8	9.80

Catalog Number	Cap. Mfd.	L	Dimensions in Inches		List Price
			W	H	

600 VOLTS D.C. WORKING

6DY05	.05	1-5/16	23/32	1-5/16	\$ 6.70
6DL10	.1	1-5/16	23/32	1-15/16	7.00

400 VOLTS D.C. WORKING

4DY25	.25	1-5/16	23/32	1-15/16	8.30
-------	-----	--------	-------	---------	------

WITH MOUNTING NUT AND LOCKWASHER

Catalog Number	Cap. Mfd.	Working V.D.C.	Dimensions in Inches		List Price
			Dia.	Height	

6RY50	0.5	600	1 3/8	4	\$ 8.60
6RY100	1.0	600	1 1/2	5	12.60
4RY50	0.5	400	1 3/8	2 3/8	6.50
4RY100	1.0	400	1 3/8	4	8.30
4RY200	2.0	400	1 1/2	5	12.10

MIGHTY MIDGET METAL TUBULAR TYPE "MM" CAPACITORS

Full information available in Catalog 1083A



Type MM

An extremely popular type of condenser due to its exceptional high quality and midget size. Hermetically sealed in a small metal case and scientifically vented, to protect against adverse operating conditions of voltage, temperature and humidity. Container is insulated by a high grade tube which is spun over the ends of the can to eliminate shorts when wires are bent close to container. Easily mounted by their rigid wire leads.



Type SM

Type "SM" units are embedded in a high temperature wax and then sealed in a thoroughly impregnated cardboard tube, affording complete immunity to moisture penetration. New high voltage formation gives complete protection against surges and high peak voltages. The addition of the strap mounting bracket has proved favorable in its use due to its wide application in AC-DC and portable sets in the replacement field. The strap can be moved to the best mounting position and then bolted or soldered. Supplied with color-coded, Underwriters' Approved, rubber covered leads.

Catalog Number	Cap. Mfd.	W.V.	Peak Volts	Dimen. Dia. L.	List Price
MM406	100	10	15	1 1/8 x 1 1/2	\$1.20
MM407	250	10	15	1 1/8 x 2 3/8	1.45
MM408	500	10	15	1 1/8 x 2 3/8	2.30
MM409	750	10	15	1 1/8 x 2 3/8	3.00
MM400	5	25	35	1 1/8 x 1 1/2	1.00
MM401	10	25	35	1 1/8 x 1 1/2	1.00
MM402	25	25	35	1 1/8 x 1 1/2	1.00
MT403*†	10-10	25	35	1 1/8 x 2 3/8	1.40
MM410	250	25	35	1 1/8 x 2 3/8	1.70
MM411	500	25	35	1 1/8 x 2 3/8	2.30
MM404	10	50	75	1 1/8 x 1 1/2	1.00
MM405	25	50	75	1 1/8 x 1 1/2	1.05
MM412	100	50	75	1 1/8 x 2 3/8	1.40
MM413	200	50	75	1 1/8 x 2 3/8	2.00
MM414	300	50	75	1 1/8 x 2 3/8	2.75
MM360	8	150	225	1 1/8 x 1 1/2	1.05
MM368	12	150	225	1 1/8 x 1 1/2	1.10
MM361	16	150	225	1 1/8 x 1 1/2	1.15
MM362	20	150	225	1 1/8 x 2 3/8	1.20
MM369	30	150	225	1 1/8 x 2 3/8	1.30
MM363	40	150	225	1 1/8 x 2 3/8	1.35
MM373	60	150	225	1 1/8 x 2 3/8	1.50
MM374	80	150	225	1 1/8 x 2 3/8	1.60
MM370†	20-20	150	225	1 1/8 x 2 3/8	1.65
MM375†	30-30	150	225	1 1/8 x 2 3/8	1.80
MM376†	40-40	150	225	1 1/8 x 2 3/8	1.85
MM364	4	475	600	1 1/8 x 1 1/2	1.15
MM365	8	475	600	1 1/8 x 2 3/8	1.25
MM371	12	475	600	1 1/8 x 2 3/8	1.35
MM366	16	475	600	1 1/8 x 2 3/8	1.40
MM372	20	475	600	1 1/8 x 2 3/8	1.60
MM367†	8-8	475	600	1 1/8 x 2 3/8	1.70

*In Kraft tube with wax filled ends.

†3 leads.

"SM" TYPE

Catalog Number	Cap. Mfd.	W.V.	Peak Volts	Dimen. Dia. L.	List Price
SM605*	20-20	150	225	1 1/8 x 2 1/2	\$1.40
SM606†	20-20	150	225	1 x 2 1/2	2.15
SM601*	30-30	150	225	1 1/8 x 3	1.55
SM608*	40-40	150	225	1 x 3	1.75
SM607*	50-30	150	225	1 x 3	1.75
SM609†	30-20-20	150	225	1 x 3	2.05
SM604*	8-8	475	600	1 x 3	2.00
SM610*	40-20	150	225	1 1/8 x 3	1.55

*SM605, SM601, SM608, SM607, SM610: 3 leads.

†SM606, SM609: 4 leads.

TUBULAR PAPER CAPACITORS

Full information available in
Catalog 1083A



TYPE PT

INDUSTRIAL By-Pass Capacitors are non-inductively wound and designed for maximum efficiency up to the highest frequencies. The units themselves are completely impregnated and sealed with a special non-hygroscopic sealing compound, thus preventing moisture penetration under the most humid conditions.

Catalog Number	Capacity Mfd.	Working Volts D.C.	List Price
PT100	.0001	1000	\$0.45
PT101	.00025	1000	.45
PT102	.0005	1000	.45
PT103	.001	1000	.45
PT104	.002	1000	.45
PT105	.005	1000	.45
PT106	.006	1000	.45
PT107	.01	1000	.45
PT131	.001	600	.23
PT132	.002	600	.23
PT133	.005	600	.23
PT134	.006	600	.23
PT135	.01	600	.27
PT136	.02	600	.27
PT137	.03	600	.32
PT130	.04	600	.32
PT138	.05	600	.36
PT139	.1	600	.41
PT140	.25	600	.50
PT141	.5	600	.72
PT142	1.0	600	1.13
PT170	.01	400	.23
PT171	.02	400	.23
PT172	.05	400	.27
PT173	.1	400	.32
PT174	.25	400	.41
PT175	.5	400	.54
PT176	1.0	400	1.00
PT200	.02	200	.30
PT201	.05	200	.30
PT202	.1	200	.35
PT203	.25	200	.40
PT204	.5	200	.60
PT205	1.0	200	.90
PT260*	.005	200v	.65
PT261*	.0075	2000	.75
PT262*	.01	2000	.75
PT263*	.02	2000	.85
PT264	.015-.015	1600	.80

*Vibrator Capacitor

RADIO INTERFERENCE ELIMINATORS

Full information available in Catalog 1083A

INDUSTRIAL CONDENSER CORP. has made a special study of the suppression of noises caused by fluorescent lighting. No. 7249 capacitor is designed with three leads, two leads to be connected across the 110 volt line and the single lead to be grounded. No. 4219 is housed in a metal container and is self grounding. It is supplied with strap mounting for easy installation. No. 4252 is a flat type unit designed to mount on the ballast support of circline ballasts. The convenient mounting flap grounds the unit when the stem of the lamp is placed through the mounting hole.

Catalog Number	Dimensions in Inches	List Price
7249	3 1/4 x 1 3/8	\$1.30
4219	3/4 x 2	1.75
4252	2 1/2 x 5/8 x 1 1/2	1.95

AUTO GENERATOR CONDENSERS

ALSO AVAILABLE IN HERMETICALLY
SEALED SUBMERSION-PROOF CONSTRUCTION



TYPE F



TYPE G

Completely enclosed in a metal container to overcome severe operating conditions of temperature and humidity. Sturdily built to withstand constant vibration.

Cat. No.	Cap. Mfd.	List Price	Cat. No.	Cap. Mfd.	List Price
G325	.25	\$0.77	G328	1.0	\$1.15
G326	.5	.85	F330	.5	1.06



"BLUE BEAVER" ELECTROLYTIC TUBULARS

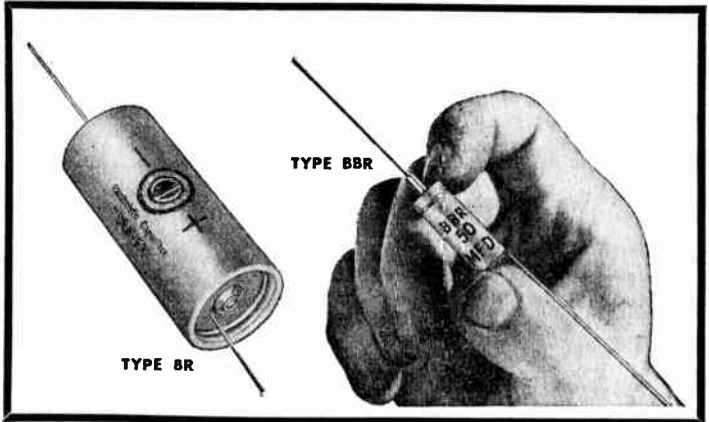
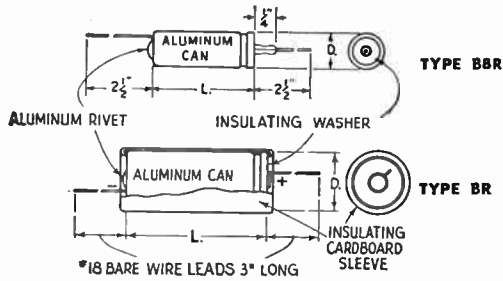

CD "Blue Beavers" have become the service industry's most popular tubular electrolytic—being DESIGNED EXPRESSLY AND EXCLUSIVELY FOR SERVICE REPLACEMENT APPLICATIONS. Type BR is the compact unit in aluminum can with cardboard outer sleeve. Fits neatly into the cramped quarters of a chassis—self-supported by means of rigid tinned copper leads. The larger sizes may be further supported by means of a metal strap. **NEGATIVE TERMINAL IS GROUNDED TO CAN.**
TEMPERATURE RANGE—to +85°C except 500 V. D.C., to +65°C.

BR Cat. No.	Cap. Mfd.	*Can Size—Inches Diam. x Length	List Price	Net Price
25 V. D.C.				
BR 102	10	5/8 x 1 1/16	\$1.00	\$.60
BR 202	20	5/8 x 1 1/16	1.00	.60
BR 252	25	5/8 x 1 1/16	1.00	.60
BR 502	50	5/8 x 1 1/16	1.10	.66
50 V. D.C.				
BR 550	5	5/8 x 1 1/16	1.00	.60
BR 105	10	5/8 x 1 1/16	1.00	.60
BR 205	20	5/8 x 1 1/16	1.00	.60
BR 255	25	5/8 x 1 1/16	1.05	.63
BR 505	50	5/8 x 1 1/16	1.20	.72
150 V. D.C.				
BR 415	4	5/8 x 1 1/16	1.00	.60
BR 815	8	5/8 x 1 1/16	1.05	.63
BR 1015	10	5/8 x 1 1/16	1.05	.63
BR 1215	12	5/8 x 1 1/16	1.10	.66
BR 1615	16	5/8 x 1 1/16	1.15	.69
BR 2015	20	5/8 x 1 1/16	1.20	.72
BR 2515	25	5/8 x 1 1/16	1.25	.75
BR 3015	30	5/8 x 1 1/16	1.30	.78
BR 4015	40	5/8 x 1 1/16	1.35	.81
BR 5015	50	5/8 x 1 1/16	1.40	.84
BR 6015	60	5/8 x 2	1.50	.90
BR 8015	80	5/8 x 2	1.60	.96
BR 10015	100	1 x 2 1/2	1.75	1.05
BR 15015	150	1 x 3	1.90	1.14
250 V. D.C.				
BR 425	4	5/8 x 1 1/16	1.00	.60
BR 825	8	5/8 x 1 1/16	1.15	.69
BR 1225	12	5/8 x 1 1/16	1.25	.75
BR 1625	16	5/8 x 1 1/16	1.30	.78
BR 2025	20	5/8 x 1 1/16	1.35	.81
BR 3025	30	5/8 x 1 1/16	1.45	.87
BR 4025	40	5/8 x 2	1.55	.93
BR 5025	50	1 x 2	1.70	1.02
BR 6025	60	1 x 2 1/2	1.80	1.08
350 V. D.C.				
BR 435	4	5/8 x 1 1/16	1.05	.63
BR 835	8	5/8 x 1 1/16	1.20	.72
BR 1235	12	5/8 x 1 1/16	1.30	.78
BR 1635	16	5/8 x 1 1/16	1.40	.84
BR 2035	20	5/8 x 1 1/16	1.45	.87
BR 3035	30	1 x 2	1.65	.99
BR 4035	40	1 x 2 1/2	1.75	1.05
BR 5035	50	1 x 2 1/2	1.85	1.11
450 V. D.C.				
BR 145	1	5/8 x 1 1/16	1.10	.66
BR 245	2	5/8 x 1 1/16	1.10	.66
BR 445	4	5/8 x 1 1/16	1.15	.69
BR 845	8	5/8 x 1 1/16	1.25	.75
BR 1045	10	5/8 x 1 1/16	1.30	.78
BR 1245	12	5/8 x 1 1/16	1.35	.81
BR 1645	16	5/8 x 2	1.40	.84
BR 2045	20	5/8 x 2	1.55	.93
BR 3045	30	1 x 2 1/2	1.70	1.02

BR Cat. No.	Cap. Mfd.	*Can Size—Inches Diam. x Length	List Price	Net Price
450 V. D.C.				
BR 4045	40	1 x 2 1/2	1.80	1.08
BR 6045	60	1 1/4 x 2 3/8	2.35	1.41
BR 8045	80	1 1/2 x 3 1/8	2.80	1.68
500 V. D.C.				
BR 450	4	3/4 x 1 11/16	1.20	.72
BR 850	8	3/4 x 1 11/16	1.30	.78
BR 1250	12	3/4 x 2	1.40	.84
BR 1650	16	1 x 2	1.50	.90
BR 2050	20	1 x 2	1.60	.96
BR 3050	30	1 x 2 1/2	1.75	1.05

*For Overall Size add 1/16" to Diam. and 3/16" to Length.

Type BBR "BLUE BEAVERS," miniature versions of the BR, are especially popular for those cramped and limited space installations in television receivers, hearing aids, miniature radios and other small assemblies. They are hermetically sealed in tubular aluminum containers and ideally suited to meet requirements in low voltage circuits. **NEGATIVE TERMINAL IS GROUNDED TO CAN.**

TEMPERATURE RANGE—to +85°C.

BBR Cat. No.	Cap. Mfd.	Can Size—Inches Diam. x Length	List Price	Net Price
3 Volts				
BBR 25-3	25	3/8 x 1 1/16	\$.85	\$.51
BBR 50-3	50	3/8 x 1 1/16	.95	.57
6 Volts				
BBR 5-6	5	3/8 x 1 1/16	.80	.48
BBR 25-6	25	3/8 x 1 1/16	.85	.51
BBR 50-6	50	3/8 x 1 1/16	.95	.57
BBR 100-6	100	1/2 x 1 1/16	1.20	.72
BBR 250-6	250	1/2 x 1 1/16	1.35	.81
15 Volts				
BBR 100-15	100	1/2 x 1 1/16	1.25	.75
25 Volts				
BBR 10-25	10	3/8 x 1 1/16	1.00	.60
BBR 20-25	20	3/8 x 1 1/16	1.00	.60
BBR 25-25	25	3/8 x 1 1/16	1.00	.60
BBR 50-25	50	1/2 x 1 1/16	1.10	.66
BBR 100-25	100	1/2 x 1 1/16	1.35	.81
50 Volts				
BBR 1-50	1	3/8 x 1 1/16	.90	.54
BBR 2-50	2	3/8 x 1 1/16	.90	.54
BBR 4-50	4	3/8 x 1 1/16	1.00	.60
BBR 5-50	5	3/8 x 1 1/16	1.00	.60
BBR 10-50	10	3/8 x 1 1/16	1.00	.60
BBR 25-50	25	1/2 x 1 1/16	1.05	.63
90 Volts				
BBR 10-90	10	1/2 x 1 1/16	1.10	.66
BBR 16-90	16	1/2 x 1 1/16	1.10	.66
150 Volts				
BBR 4-150	4	3/8 x 1 1/16	1.00	.60
BBR 8-150	8	1/2 x 1 1/16	1.05	.63
BBR 10-150	10	1/2 x 1 1/16	1.05	.63
BBR 12-150	12	1/2 x 1 1/16	1.10	.66
BBR 16-150	16	1/2 x 1 1/16	1.15	.69
BBR 20-150	20	1/2 x 1 1/16	1.20	.72
250 Volts				
BBR 4-250	4	1/2 x 1 1/16	1.00	.60
BBR 8-250	8	1/2 x 1 1/16	1.15	.69
BBR 12-250	12	1/2 x 1 1/16	1.25	.75



MULTI-SECTION TUBULAR ELECTROLYTICS

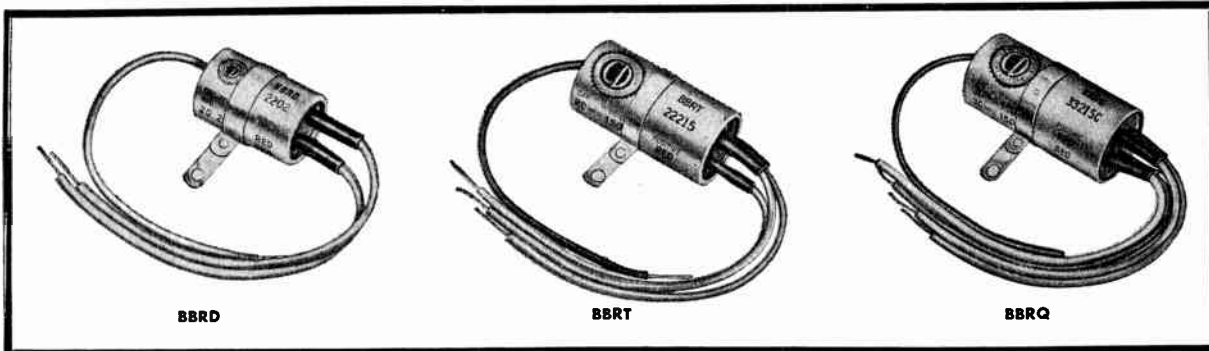

A new series of compact, tubular metal-cased, cardboard sleeved electrolytics—specially sealed against heat and humidity.

Featuring—

- Direct-to-terminal internal lead construction reduces possibility of shorts. (Pure aluminum wires crimped securely together with outer leads within aluminum stud terminals.)
- New high-insulation vinylite covered leads—generous 7 inches long.
- Sections sealed in aluminum tube for protection against moisture getting in, or electrolyte drying out.
- Wax impregnated cardboard outer insulation sleeve.
- Rubber diaphragm-type vent insures ideal vent action under all conditions.
- **IDEAL FOR OPERATION AT TEMPERATURES UP TO 85°C.**

BBRD—Dual Common Negative

BBRD Cat. No.	Cap. Mfd.	D.C. W. Volts	Can Size†—Inches Dia. x Lgth.	List Price	Net Price
BBRD 2202	20-20	25	3/4 x 1 1/16	\$1.40	\$.84
BBRD 115	10-10	50	3/4 x 1 1/16	1.40	.84
BBRD 2115	20-10	150	3/4 x 1 1/16	1.55	.93
BBRD 2215	20-20	150	3/4 x 1 1/16	1.65	.99
BBRD 3215	30-20	150	3/4 x 1 1/16	1.70	1.02
BBRD 3315	30-30	150	3/4 x 1 1/16	1.80	1.08
BBRD 4215	40-20	150	3/4 x 1 1/16	1.75	1.05
BBRD 4315	40-30	150	3/4 x 2	1.80	1.08
BBRD 4415	40-40	150	3/4 x 2	1.85	1.11
BBRD 5315	50-30	150	3/4 x 2	1.95	1.17
BBRD 5515	50-50	150	1 x 2	2.10	1.26
BBRD 8415	80-40	150	1 x 2 3/16	2.25	1.35
*BBRD 101015	100-100	150	1 x 3	3.20	1.92
BBRD 8D25	8-8	250	3/4 x 1 1/16	1.60	.96
BBRD 16825	16-8	250	3/4 x 2	1.70	1.02
BBRD 16825	16-16	250	3/4 x 2	1.80	1.08
BBRD 2225	20-20	250	1 x 1 1/16	1.85	1.11
BBRD 3325	30-30	250	1 x 2 3/16	2.25	1.35
*BBRD 7V225	75-20	250	1 x 3	2.60	1.56
BBRD 8D45	8-8	450	3/4 x 1 1/16	1.70	1.02
BBRD 16845	16-8	450	1 x 2 3/16	2.00	1.20
BBRD 16845	16-16	450	1 x 2 3/16	2.25	1.35
*BBRD 2245	20-20	450	1 x 3	3.50	1.90
*BBRD 3345	30-30	450	1 x 3 3/16	3.00	1.80
*BBRD 4445	40-40	450	1 x 4 3/16	3.40	2.04

BBRT—Triple-Common Negative

BBRT Cat. No.	Cap. Mfd.	D.C. W. Volts	Can† Size—Inches Dia. x Lgth.	List Price	Net Price
BBRT 22215	20-20-20	150	3/4 x 1 1/16	\$2.20	\$1.32
BBRT 32V215	30-25-20	150	3/4 x 2	2.25	1.35
BBRT 33315	30-30-30	150	1 x 2	2.35	1.41
BBRT 42215	40-20-20	150	1 x 1 1/16	2.25	1.35
BBRT 43215	40-30-20	150	1 x 2	2.35	1.41
BBRT 44215	40-40-20	150	1 x 2	2.35	1.41
BBRT 44415	40-40-40	150	1 x 2 3/16	2.45	1.47
*BBRT 84215	80-40-20	150	1 x 3	2.75	1.65
BBRT 2215C	20-20, 20	150, 25	3/4 x 1 1/16	2.05	1.23
BBRT 3315C	30-30, 20	150, 25	3/4 x 2	2.20	1.32
BBRT 4215C	40-20, 20	150, 25	1 x 1 1/16	2.15	1.29
BBRT 4315C	40-30, 20	150, 25	1 x 1 1/16	2.20	1.32

BBRT—Triple-Common Negative

BBRT Cat. No.	Cap. Mfd.	D.C. W. Volts	Can† Size—Inches Dia. x Lgth.	List Price	Net Price
BBRT 4415C	40-40, 20	150, 25	1 x 1 1/16	2.25	1.35
BBRT 4415X25	40-40, 250	150, 10	1 x 2 3/16	2.60	1.56
BBRT 5315C	50-30, 20	150, 25	1 x 1 1/16	2.35	1.41
BBRT 5515C	50-50, 20	150, 25	1 x 2 3/16	2.50	1.50
BBRT 8415C	80-40, 20	150, 25	1 x 2 1/2	2.65	1.59
BBRT 3215C10	30-20, 100	150, 25	1 x 2	2.35	1.41
BBRT 5315X20	50-30, 200	150, 10	1 x 2 3/16	2.55	1.53
BBRT 5315C10	50-30, 100	150, 25	1 x 2 3/16	2.45	1.47
*BBRT 5315C25	50-30, 250	150, 25	1 x 3	3.10	1.86
BBRT 8215C10	80-20, 100	150, 25	1 x 2 1/2	2.75	1.63
BBRT 2225C	20-20, 20	250, 25	1 x 2	2.25	1.35
BBRT 4225C	40-20, 20	250, 25	1 x 2 3/16	2.55	1.53
BBRT 4425C	40-40, 20	250, 25	1 x 2 1/16	2.90	1.74
*BBRT 7V4125	75-40-10	250	1 1/2 x 3	3.45	2.07
*BBRT 16745	16-16-16	450	1 1/2 x 3	3.10	1.86
*BBRT 2245C	20-20, 20	450, 25	1 x 3	2.90	1.74

BBRQ—Quadruple-Common Negative

BBRQ Cat. No.	Cap. Mfd.	D.C. W. Volts	Can† Size—Inches Dia. x Lgth.	List Price	Net Price
BBRQ 33215C	30-30-20, 20	150, 25	1 x 2	\$2.90	\$1.74
BBRQ 42215C	40-20-20, 20	150, 25	1 x 2	2.85	1.71
BBRQ 53215C	50-30-20, 20	150, 25	1 x 2 1/2	3.05	1.83
BBRQ 44315C	40-40-30, 20	150, 25	1 x 2 1/2	3.00	1.80
*BBRQ 55515C	50-50-50, 20	150, 25	1 x 3	3.45	2.07
*BBRQ 22245C	20-20-20, 20	450, 25	1 1/2 x 3 3/4	4.05	2.43

EDL—Dual Separate Section

Type EDL Capacitors are dual units in cardboard tube containers with wax-filled ends. Capacities, voltages and polarity of the leads are clearly defined by color coding stamped on the tube casing.

TEMPERATURE RANGE: to +65°C.

EDL Cat. No.	Cap. Mfd.	D.C. W. Volts	OVERALL Size—Inches Dia. x Lgth.	List Price	Net Price
*EDL 221555	20-20	150	1 5/8 x 2 3/4	\$1.65	\$ 1.99
*EDL 331555	30-30	150	1 x 2 3/4	1.80	1.08
*EDL 421555	40-20	150	1 x 2 3/4	1.75	1.03
*EDL 441555	40-40	150	1 1/4 x 2 3/4	1.85	1.11
*EDL 531555	50-30	150	1 1/4 x 2 3/4	1.95	1.17
*EDL 551555	50-50	150	1 1/4 x 3 1/4	2.10	1.26
*EDL 841555	80-40	150	1 3/4 x 3 3/4	2.25	1.33

†For OVERALL size on BBRD, BBRT and BBRQ, add 1/16" to Diam. and 3/16" to Length
All above Packed—5 Units per Carton, except those marked (*) which are Individual Carton Packed



HIGH-CAPACITY LOW-VOLTAGE ELECTROLYTICS

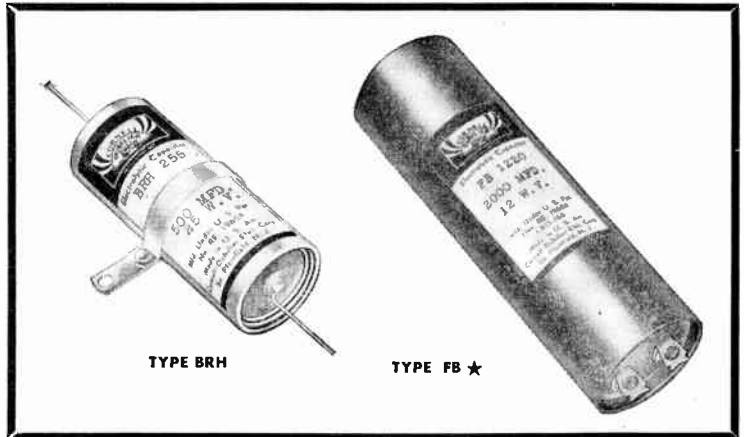
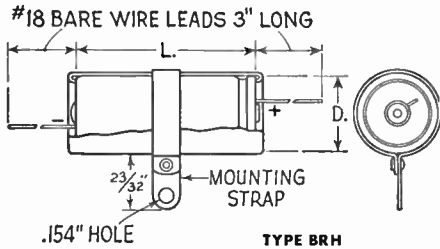

BRH compact tubular electrolytic capacitors are widely employed in portable radio power rectifying circuits, electric fence devices, telephone and D.C. timing circuits. Hermetically sealed in pure aluminum cans with an external cardboard insulating sleeve, these units are provided with metal mounting strap and bare wire leads for convenient wiring into any circuit assembly.

TEMPERATURE RANGE to +85°C.

BRH Cat. No.	Cap. Mfd.	Con† Size—Inches Diam. x Length	List Price	Net Price
6 D.C. W. Volts				
BRH 601	100	3/8 x 1 1/16	\$1.20	.72
BRH 6025	250	3/8 x 1 1/16	1.35	.81
BRH 605	500	3/4 x 1 11/16	1.55	.93
BRH 610	1000	7/8 x 2	1.90	1.14
BRH 620	2000	1 x 2 1/2	2.30	1.38
12 D.C. W. Volts				
BRH 121	100	3/8 x 1 1/16	1.20	.72
BRH 1225	250	3/4 x 1 11/16	1.45	.87
BRH 125	500	7/8 x 2	1.70	1.02
BRH 1210	1000	1 x 2	2.25	1.35
BRH 1220	2000	1 x 3	2.65	1.59
15 D.C. W. Volts				
BRH 151	100	3/8 x 1 1/16	1.25	.75
BRH 1525	250	3/4 x 1 11/16	1.55	.93
BRH 155	500	7/8 x 2	1.75	1.05
BRH 1510	1000	1 x 2	2.30	1.38
BRH 1520	2000	1 x 3	3.20	1.92
25 D.C. W. Volts				
BRH 251	100	3/8 x 1 1/16	1.35	.81
BRH 2525	250	3/4 x 1 11/16	1.70	1.02
BRH 255	500	1 x 2	2.30	1.38
50 D.C. W. Volts				
BRH 501	100	3/4 x 2	1.40	.84
BRH 5015	150	7/8 x 2	1.55	.93
BRH 5025	250	1 x 2	1.75	1.05
BRH 5050	500	1 x 3	2.40	1.44

†For Overall Size add 1/16" to Diam. and 3/16" to Length.

HIGH VOLTAGE TUBULAR ELECTROLYTICS

TEMPERATURE RANGE to +85°C.

BRHV Cat. No.	Cap. Mfd.	OVERALL Size—Inches Diam. x Length	List Price	Net Price
500 D.C. W. Volts				
BRHV 850	8	1 1/16 x 3 3/16	\$1.30	.78
BRHV 1050	10	1 1/8 x 3 3/16	1.35	.81
BRHV 1250	12	1 1/4 x 3 3/16	1.40	.84
BRHV 1650	16	1 3/8 x 3 3/16	1.50	.90
600 D.C. W. Volts				
BRHV 608	8	1 1/16 x 3 3/16	1.40	.84
BRHV 610	10	1 1/8 x 3 3/16	1.45	.87
BRHV 612	12	1 1/4 x 3 3/16	1.50	.90
BRHV 616	16	1 1/2 x 3 3/16	1.65	.99
700 D.C. W. Volts				
BRHV 708	8	1 1/16 x 3 3/16	1.50	.90
BRHV 710	10	1 1/8 x 3 3/16	1.55	.93
BRHV 712	12	1 1/4 x 3 11/16	1.60	.96
BRHV 716	16	1 1/2 x 4 3/16	1.75	1.05

★ When JAN-C-62 units must be supplied, order according to specific CE type designations.

Type FB capacitors in round cardboard sleeved aluminum cans are designed for high capacity, low voltage applications, and are especially popular as replacements in motion picture sound equipment, and other low voltage circuits.

TEMPERATURE RANGE to +85°C.

FB Cat. No.	Cap. Mfd.	D.C. W. Volts	Con†† Size—Inches Dia. x Lgth.	List Price	Net Price
FB 1005	500	10	1 3/8 x 2 3/8	\$3.10	\$1.86
FB 1010	1000	10	1 3/8 x 2 3/8	3.55	2.13
FB 1015	1500	10	1 3/8 x 2 3/8	3.75	2.25
FB 1020	2000	10	1 3/8 x 2 3/8	3.95	2.37
FB 1030	3000	10	1 3/8 x 3 3/8	4.35	2.61
FB 1040	4000	10	1 3/8 x 4 3/8	4.75	2.85
FB 1050	5000	10	1 1/2 x 4 3/8	5.15	3.09
FB 1060	6000	10	1 3/4 x 4 3/8	7.50	4.50
FB 1205	500	12	1 3/8 x 2 3/8	3.20	1.92
FB 1210	1000	12	1 3/8 x 2 3/8	3.75	2.25
FB 1215	1500	12	1 3/8 x 2 3/8	3.95	2.37
FB 1220	2000	12	1 3/8 x 3 3/8	4.15	2.49
FB 1225	2500	12	1 3/8 x 3 3/8	4.85	2.91
FB 1230	3000	12	1 3/8 x 4 3/8	5.05	3.03
FB 1240	4000	12	1 1/2 x 4 3/8	5.25	3.15
FB 1260	6000	12	2 x 4 3/8	9.35	5.61
FB 1505	500	15	1 3/8 x 2 3/8	3.25	1.95
FB 1510	1000	15	1 3/8 x 2 3/8	3.80	2.28
FB 1515	1500	15	1 3/8 x 2 3/8	4.00	2.40
FB 1520	2000	15	1 3/8 x 3 3/8	4.70	2.82
FB 1530	3000	15	1 3/8 x 4 3/8	5.15	3.09
FB 1540	4000	15	1 1/2 x 4 3/8	8.10	4.86
FB 1560	6000	15	2 x 4 3/8	10.00	6.00
FB 1805	500	18	1 3/8 x 2 3/8	3.00	1.80
FB 1810	1000	18	1 3/8 x 2 3/8	3.90	2.34
FB 1820	2000	18	1 3/8 x 3 3/8	4.90	2.94
FB 1840	4000	18	1 1/2 x 4 3/8	8.45	5.07
FB 2005	500	20	1 3/8 x 2 3/8	3.40	2.04
FB 2010	1000	20	1 3/8 x 3 3/8	4.10	2.46
FB 2020	2000	20	1 3/8 x 4 3/8	5.20	3.12
FB 2040	4000	20	2 x 4 3/8	8.75	5.25
FB 2505	500	25	1 3/8 x 2 3/8	3.55	2.13
FB 2510	1000	25	1 3/8 x 3 3/8	4.80	2.88
FB 2520	2000	25	1 3/8 x 4 3/8	5.75	3.45
FB 2530	3000	25	1 3/4 x 4 3/8	8.00	4.80
FB 2540	4000	25	2 x 4 3/8	9.50	5.70
FB 2550	5000	25	2 1/2 x 4 3/8	11.00	6.60
FB 3005	500	30	1 3/8 x 3 3/8	3.60	2.16
FB 3010	1000	30	1 3/8 x 4 3/8	4.90	2.94
FB 3020	2000	30	1 3/4 x 4 3/8	7.40	4.44
FB 3030	3000	30	2 x 4 3/8	8.95	5.37
FB 3040	4000	30	2 1/2 x 4 3/8	10.50	6.30
FB 3505	500	35	1 3/8 x 3 3/8	3.70	2.22
FB 3510	1000	35	1 3/8 x 4 3/8	5.00	3.00
FB 3520	2000	35	1 3/4 x 4 3/8	8.00	4.80
FB 3530	3000	35	2 x 4 3/8	9.50	5.70
FB 3540	4000	35	2 1/2 x 4 3/8	11.00	6.60
FB 4005	500	40	1 3/8 x 3 3/8	3.80	2.28
FB 4010	1000	40	1 3/8 x 4 3/8	6.50	3.90
FB 4020	2000	40	1 3/4 x 4 3/8	9.00	5.40
FB 4030	3000	40	2 x 4 3/8	10.50	6.30
FB 4040	4000	40	2 1/2 x 4 3/8	11.50	6.90
FB 5005	500	50	1 3/8 x 3 3/8	3.90	2.34
FB 5010	1000	50	1 3/8 x 4 3/8	7.00	4.20
FB 5020	2000	50	1 3/4 x 4 3/8	10.00	6.00
FB 5030	3000	50	2 x 4 3/8	11.50	6.90
FB 5040	4000	50	2 1/2 x 4 3/8	12.50	7.50

††For Overall Size add 1/16" to Diam. and 3/8" to Length.



UP, UPT & UPE TWIST-PRONG BASE ELECTROLYTICS

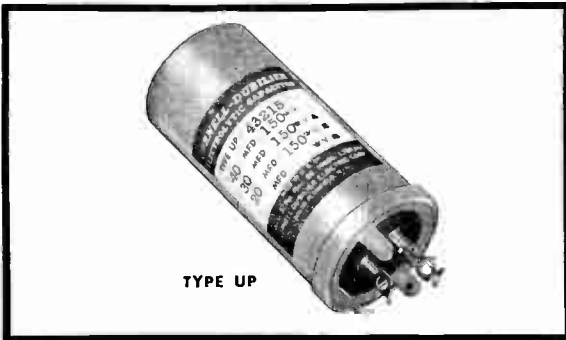

TYPE UP

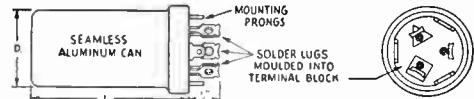

METAL WASHER - .025" THICK
BAKELITE WASHER - 1/8" THICK

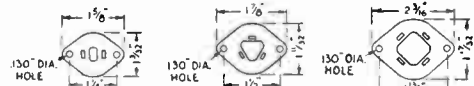

WASHER FOR 3/4" DIA. TYPE UP UNITS WASHER FOR 1" DIA. TYPE UP UNITS WASHER FOR 1 1/8" DIA. TYPE UP UNITS
DIMENSIONS OF METAL AND BAKELITE MOUNTING WASHERS

Types UP and UPT capacitors are small, conveniently-mounted, round can-type electrolytic units furnished with bakelite and metal mounting washers. Terminals are tinned for soldering. They are dependable in operation over wide temperature variations with minimum capacity change.

Units are especially designed for use in television, radio, amplifier and other equipment where extremely high temperatures, voltage surges and ripple currents are encountered. They are particularly popular as replacement capacitors for all standard television receivers. §

Type UPE units are designed for use in selenium rectifier circuits. When using selenium rectifiers in television, radio or other equipment, care must be taken to employ ONLY this type electrolytic capacitor and protective resistor—See page 10.

TEMP. RANGE: to incl. 475 V.D.C.W. + 85°C.
over 475 V.D.C.W. + 65°C.

Single Section

Cap., Volts	Rotational Stock No.	Cat. No.	Size—Ins. Dia. x Lgth.	List Price	Net Price
10Ω 30 CPS.	A001	UPT 102	3/4 x 2	\$2.00	\$1.20
.5Ω 15,750 CPS.	A002	UPT 100	1 x 2	2.20	1.36
1Ω 60 CPS.	A003	UPT 101	1 3/8 x 3	2.80	1.68
2000/6	A004	UPT 2M-6	1 3/8 x 2	2.55	1.53
3000/10	A005	UP 3M-10	1 3/8 x 2 1/2	2.90	1.74
1000/15	A006	UP 1M-15	1 x 2 1/2	2.55	1.53
2000/15	A007	UP 2M-15	1 3/8 x 2 1/2	3.45	2.07
3000/15	A008	UP 3M-15	1 3/8 x 3	3.52	2.11
40/25	A009	UP 40-25	3/4 x 2	1.35	.81
100/25	*A010	UP 100-25	3/4 x 2	1.60	.96
500/25	A011	UPT 103*	1 x 2 1/2	2.55	1.53
500/25	A012	UP 500-25	1 x 2	2.55	1.53
1000/25	A013	UP 1M-25	1 3/8 x 2	3.55	2.13
100/50	A014	UP 100-50	3/4 x 2	1.65	.99
150/50	A015	UP 150-50	1 x 2	1.80	1.08
500/50	A016	UP 500-50	1 3/8 x 2	2.65	1.59
1000/50	A017	UP 1M-50	1 3/8 x 3 3/8	3.75	2.25
30/150	A018	UP 3015	3/4 x 2	1.55	.93
40/150	A019	UP 4015	1 x 2	1.60	.96
50/150	A020	UP 5015	1 x 2	1.65	.99
60/150	A022	UP 6015	1 x 2	1.75	1.05
80/150	†A023	UPT 8015	1 x 2	1.85	1.11
100/150	†A024	UP 10015	1 x 2 1/2	2.00	1.20
120/150	A025	UPT 12015	1 3/8 x 2	2.10	1.26
150/150	†A026	UP 15015	1 x 3	2.15	1.29
20/250	A027	UP 2025	3/4 x 2	1.60	.96
30/250	A028	UP 3025	1 x 2	1.70	1.02
40/250	†A029	UP 4025	1 x 2	1.80	1.08
60/250	A030	UP 6025	1 x 2 1/2	2.05	1.23
80/250	A031	UP 8025	1 x 3	2.15	1.29

Single Section (Cont'd)

Cap., Volts	Rotational Stock No.	Cat. No.	Size—Ins. Dia. x Lgth.	List Price	Net Price
50/300	*A032	UP 5030	1 x 2 1/2	\$2.05	\$1.23
80/300	†A033	UP 8030	1 x 3	2.55	1.53
100/300	A034	UPT 10030	1 3/8 x 3	2.90	1.74
100/300	A035	UPT 104	1 x 3 3/8	2.90	1.74
15/350	*A036	UP 1535	1 x 2	1.65	.99
30/350	*A037	UP 3035	1 x 2	1.90	1.14
40/350	*A038	UP 4035	1 x 2 1/2	2.00	1.20
50/350	A039	UP 5035	1 x 3	2.10	1.26
80/350	†A040	UP 8035	1 3/8 x 2 1/2	2.85	1.71
125/350	†A041	UP 12535	1 3/8 x 3	3.65	2.19
80/400	*A042	UP 8040	1 3/8 x 3	2.95	1.77
10/450	A043	UP 1045	1 x 2	1.55	.93
10/450	A044	UP 1A157	3/4 x 2	1.55	.93
15/450	A045	UP 1545	1 x 2	1.70	1.02
20/450	A046	UP 2045	1 x 2	1.80	1.08
30/450	A047	UP 3045	1 x 2 1/2	1.95	1.17
40/450	A048	UPT 4045	1 x 3	2.05	1.23
50/450	A049	UP 5045	1 x 3 3/8	2.35	1.41
60/450	A050	UP 6045	1 3/8 x 2 1/2	2.60	1.56
80/450	A051	UP 8045	1 3/8 x 3	3.05	1.83
10/500	A052	UP 1050	1 x 2	1.60	.96
20/500	A053	UP 2050	1 x 2 1/2	1.85	1.11
25/500	A058	UP 2550	1 x 2 1/2	1.95	1.17
30/500	†A054	UP 3050	1 x 3	2.00	1.20
40/500	A055	UP 4050	1 x 3 3/8	2.50	1.50
80/500	A056	UP 8050	1 3/8 x 3 3/8	3.20	1.92
90/500	A057	UP 9050	1 3/8 x 3 3/8	3.50	2.10

Dual Section

Cap., Volts	Rotational Stock No.	Cat. No.	Size—Ins. Dia. x Lgth.	List Price	Net Price
.5Ω 15,750 CPS	B001	UPT 202	1 3/8 x 2	3.90	2.34
2.5Ω 60 CPS.	B002	UPT 203	1 3/8 x 2	3.85	2.31
1000-500/6 VNP	B003	UPT 201	1 x 3 3/8	4.40	2.64
1000-1000/15	B004	UP 11M-15	1 3/8 x 2 1/2	4.40	2.64
1000-1000/15	B005	UP 22-25	1 x 2	1.45	.87
20-20/25	B006	UP 44-25	1 x 2	1.60	.96
40-40/25	B007	UPT 205	1 x 2	1.90	1.14
150-50/25	B008	UP 55-50	1 x 2	1.70	1.02
50-50/50	†B009	UP 2215	1 x 2	1.70	1.02
20-20/150	B010	UP 3215	1 x 2	1.75	1.05
30-20/150	B011	UP 3315	1 x 2	1.85	1.11
30-30/150	B012	UP 4215	1 x 2	1.80	1.08
40-20/150	B013	UP 4315	1 x 2	1.85	1.11
40-30/150	†B014	UP 4415	1 x 2	1.90	1.14
40-40/150	B015	UP 5315	1 x 2	2.00	1.20
50-30/150	†B016	UP 5515	1 x 2 1/2	2.15	1.29

§ For application data on C-D types UP, UPT and UPE Capacitors ask your jobber for C-D TELEVISION REPLACEMENT GUIDE, No. TVR7.
† Superseded by equivalent ETCHED CATHODE Type UPE —See C-D catalog Page 10. • Recommend Stocking Next Higher Voltage Rating.



UP, UPT & UPE TWIST-PRONG BASE ELECTROLYTICS

Dual Section (Cont'd)

Dual Section (Cont'd)

Cap., Volts	Rotational Stock No.	Cal. No.	Size—Ins. Dia. x Lgth.	List Price	Net Price	Cap., Volts	Rotational Stock No.	Cal. No.	Size—Ins. Dia. x Lgth.	List Price	Net Price
75-75/150	B017	UP 75D15	1 x 3	\$2.60	\$1.56	20/450 20/25	B064	UP 2045C	1 x 2	\$2.00	\$1.20
80-40/150	B018	UP 8415	1 x 2½	2.30	1.38	20/450 100/25	B089	UP 2045C10	1 x 2½	2.20	1.32
200-5/150	B078	UPT 207	1½ x 2½	2.70	1.62	40/450 20/25	B065	UP 4045C	1 x 3	2.45	1.47
60-60/200	B019	UPT 6620	1½ x 2	2.55	1.53	40/450 50/50	B090	UPT 4045V5	1 x 3½	3.00	1.80
10-10/250	B020	UP 1125	1 x 2	1.70	1.02	80/450 20/25	B066	UP 8045C	1½ x 3	3.40	2.04
20-20/250	B021	UP 2225	1 x 2	1.90	1.14	10/450 100/50	B067	UPT 204	1½ x 2	2.05	1.23
30-30/250	B022	UP 3325	1 x 2½	2.30	1.38	20/450 80/350	B068	UPT 245-835	1½ x 3	3.65	2.19
40-20/250	B023	UP 4225	1 x 2½	2.20	1.32	20/450 100/100	B069	UPT 245-1010	1½ x 2	2.65	1.59
40-40/250	B024	UP 4425	1 x 3	2.55	1.53	30/450 40/150	B070	UPT 345-415	1½ x 2	2.50	1.50
150-150/250	B025	UPT 150D25	1½ x 4½	5.15	3.09	40/450 10/350	B071	UPT 445-135	1½ x 2	2.60	1.56
50-50/300	B026	UP 5530	1½ x 2½	3.35	2.01	80/450 50/50	B072	UPT 8045V5	1½ x 3	3.50	2.10
80-80/300	B027	UP 8830	1½ x 3	4.05	2.43	15/500 20/300	B073	UPT 15550-230	1 x 2½	2.30	1.38
120-20/300	B028	UPT 12230	1½ x 3	3.80	2.28	20/500 100/300	B074	UPT 250-1030	1½ x 3	3.95	2.37
120-40/300	B079	UPT 12430	1½ x 3½	4.35	2.61	40/500 50/200	B075	UPT 450-520	1½ x 2½	3.35	2.01
15-15/350	B029	UP 15D35	1 x 2	2.25	1.35	60/500 80/150	B076	UPT 650-815	1½ x 3½	3.75	2.25
20-20/350	B030	UP 2235	1 x 2½	2.30	1.38	80/500 50/50	B077	UPT 8050V5	1½ x 3½	3.80	2.28
30-30/350	B031	UP 3335	1 x 3	2.90	1.74						
50-30/350	B032	UP 5335	1½ x 2½	3.15	1.89						
80-80/350	B033	UPT 8835	1½ x 3½	4.70	2.82						
40-120/400	B080	UPT 213	1½ x 4½	4.75	2.85						
60-60/400	B034	UPT 6640	1½ x 3½	4.40	2.64						
80-10/400	B035	UP 8140	1½ x 3	3.40	2.04						
80-60/400	B081	UPT 8640	1½ x 3½	4.45	2.67						
4-4/450	B036	UPT 4D45	1 x 2	1.65	.99						
10-10/450	B037	UPT 1145	1 x 2	1.90	1.14						
15-10/450	B082	UPT 210	1 x 2½	2.05	1.23						
15-15/450	B038	UP 15D45	1 x 2½	2.25	1.35						
20-10/450	B039	UP 2145	1 x 2½	2.25	1.35						
20-20/450	B040	UP 2245	1 x 3	2.55	1.53						
30-10/450	B041	UPT 3145	1 x 3	2.50	1.50						
30-10/450	B042	UPT 206	1½ x 2	2.40	1.44						
30-30/450	B043	UP 3345	1½ x 2½	3.05	1.83						
40-5/450	B083	UPT 208	1 x 3	2.55	1.53						
40-20/450	B044	UP 4245	1½ x 2½	3.00	1.80						
40-40/450	B045	UPT 4445	1½ x 3	3.45	2.07						
60-20/450	B046	UPT 6245	1½ x 3	3.55	2.13						
60-60/450	B084	UPT 6645	1½ x 3½	4.50	2.70						
80-10/450	B047	UPT 8145	1½ x 3	3.60	2.16						
80-40/450	B048	UP 8445	1½ x 3½	4.35	2.61						
10-10/500	B049	UP 1150	1 x 2½	1.95	1.17						
20-20/500	B050	UP 2250	1½ x 2½	2.85	1.71						
25-40/500	B051	UPT 255450	1½ x 3	3.65	2.19						
30-10/500	B052	UPT 3150	1½ x 2½	2.60	1.56						
40-40/500	B053	UP 4450	1½ x 3½	4.30	2.58						
60-40/500	B054	UPT 6450	1½ x 3½	4.60	2.76						
250/10 1000/6	B055	UPT 200	1½ x 2	2.85	1.71						
40/150 150/25	B057	UP 4015C15	1 x 2	2.05	1.23						
40/150 20/50	B056	UP 4015V2	1 x 2	1.70	1.02						
50/150 500/5	B085	UPT 209	1 x 2½	2.45	1.47						
60/200 125/25	B086	UPT 212	1 x 3	2.40	1.44						
40/250 20/25	B058	UP 4025C	1 x 2	2.00	1.20						
50/250 100/50	B059	UPT 5025V10	1½ x 2	2.60	1.56						
100/250 150/50	B060	UPT 10025V15	1½ x 3	3.65	2.19						
80/300 100/50	B087	UPT 8030V10	1½ x 2½	3.15	1.89						
20/350 20/25	B061	UP 2035C	1 x 2	1.90	1.14						
20/350 100/75	B088	UPT 211	1 x 2½	2.25	1.35						
40/350 20/25	B062	UP 4035C	1 x 2½	2.35	1.41						
10/450 20/25	B063	UP 1045C	1 x 2	1.70	1.02						

Triple Section

20-20-20/25	C001	UPT 222-25	1 x 2	\$1.95	\$1.17
40-40-40/25	C002	UP 444-25	1 x 2	2.15	1.29
30-30-30/50	C003	UP 333-50	1 x 2	2.15	1.29
20-20-20/150	C004	UP 22215	1 x 2	2.35	1.41
30-30-10/150	C005	UP 33115	1 x 2	2.35	1.41
40-20-10/150	C006	UP 42115	1 x 2	2.35	1.41
40-20-20/150	C007	UP 42215	1 x 2	2.40	1.44
40-30-20/150	C008	UP 43215	1 x 2	2.50	1.50
40-40-40/150	C009	UP 44415	1 x 2½	2.60	1.56
40-70-40/150	C010	UP 47415	1 x 3	2.95	1.77
60-40-20/150	C011	UP 64215	1 x 2½	2.75	1.68
80-40-20/150	C012	UP 84215	1 x 2½	2.90	1.74
20-20-10/250	C013	UP 22125	1 x 2	2.50	1.50
30-20-10/250	C014	UP 32125	1 x 2½	2.70	1.62
40-20-10/250	C015	UPT 42125	1½ x 2	2.85	1.71
40-20-20/250	C016	UP 42225	1 x 3	2.90	1.74
80-80-60/250	C017	UPT 88625	1½ x 3½	4.90	2.94
20-80-10/300	C018	UPT 28130	1½ x 2½	3.80	2.28
60-20-10/300	C019	UPT 62130	1½ x 2½	3.45	2.07
80-40-40/300	C154	UPT 84430	1½ x 3	4.75	2.85
120-50-40/300	C020	UPT 125430	1½ x 4½	5.65	3.39
10-10-10/350	C021	UP 11135	1 x 2	2.40	1.44
20-20-10/350	C022	UP 22135	1 x 3	2.95	1.77
60-40-20/350	C023	UPT 64235	1½ x 3	4.25	2.55
60-40-40/350	C150	UPT 64435	1½ x 3½	4.70	2.82
10-10-10/450	C024	UP 11145	1 x 2½	2.60	1.56
15-15-10/450	C025	UP 15D145	1 x 3	2.95	1.77
20-10-10/450	C026	UP 21145	1 x 3	2.95	1.77
20-20-20/450	C027	UP 22245	1½ x 2½	3.60	2.16
30-20-20/450	C028	UP 32245	1½ x 3	3.85	2.31
30-30-20/450	C029	UPT 33245	1½ x 3	4.10	2.46
30-30-30/450	C030	UPT 33345	1½ x 3	4.35	2.61
30-60-10/450	C031	UPT 36145	1½ x 3½	4.50	2.70
40-10-10/450	C032	UPT 41145	1½ x 3	3.35	2.01
40-30-20/450	C033	UP 43245	1½ x 3	4.30	2.58
40-40-10/450	C034	UPT 44145	1½ x 3	4.15	2.49
40-40-20/450	C155	UPT 44245	1½ x 3½	4.45	2.67
40-40-40/450	C035	UPT 44445	1½ x 3½	4.90	2.94
60-20-20/450	C036	UPT 62245	1½ x 3½	4.60	2.76
80-40-20/450	C037	UPT 84245	1½ x 4½	5.40	3.24

§ For application data on C-D types UP, UPT and UPE Capacitors ask your jobber for C-D TELEVISION REPLACEMENT GUIDE, No. TVR7.

† Superseded by equivalent ETCHED CATHODE Type UPE — See C-D catalog Page 10.

* Recommend Stocking Next Higher Voltage Rating.



UP, UPT & UPE TWIST-PRONG BASE ELECTROLYTICS

Triple Section (Cont'd)

Triple Section (Cont'd)

Cap./Volts	Rotational Stock No.	Cat. No.	Size—Ins. Dia. x Lgth.	List Price	Net Price	Cap./Volts	Rotational Stock No.	Cat. No.	Size—Ins. Dia. x Lgth.	List Price	Net Price
40-30-30/475	C156	UPT 320	1 3/4 x 3 3/8	\$5.15	\$3.09	10-10/450 20/25	C091	UP 1145C	1 x 2	\$2.40	\$1.44
10-10-10/500	C038	UP 11150	1 x 3	2.70	1.62	10-10/450 40/50	C092	UPT 1145V4	1 x 2 1/2	2.50	1.50
30-20-20/500	C039	UPT 32250	1 3/8 x 3	4.20	2.52	10-10/450 50/100	C093	UPT 1145-510	1 3/8 x 2	2.65	1.59
40-10-10/500	C040	UP 41150	1 3/8 x 3	3.90	2.34	15-15/450 20/25	C094	UP 15D45C	1 x 2 1/2	2.75	1.65
40-40-10/500	C041	UPT 44150	1 3/8 x 3 3/8	5.05	3.03	15-15/450 10/300	*C095	UP 15D45-130	1 x 3	2.90	1.74
15-15/150 1200/1.5	C042	UP 4CJ69	1 x 2	3.05	1.83	20-10/450 20/25	C096	UP 2145C	1 x 2 1/2	2.75	1.65
20-20/150 20/25	C043	UP 2215C	1 x 2	2.20	1.32	20-10/450 50/50	C097	UPT 2145V5	1 x 3	2.85	1.71
20-20/150 100/10	C044	UP 2215X10	1 x 2	2.35	1.41	20-15/450 20/25	C098	UP 215545C	1 x 3	2.90	1.74
20-20/150 250/10	C045	UP 2215X25	1 x 2	2.60	1.56	20-20/450 20/25	C099	UP 2245C	1 x 3	3.05	1.83
30-30/150 20/25	C046	UP 3315C	1 x 2	2.35	1.41	20-20/450 100/50	C159	UPT 2245V10	1 3/8 x 2 1/2	3.50	2.10
30-30/150 200/10	C047	UP 3315X20	1 x 2	2.50	1.50	20-20/450 60/350	C100	UPT 2245-635	1 3/8 x 3	4.05	2.43
40-20/150 20/25	C048	UP 4215C	1 x 2	2.30	1.38	30-20/450 30/150	C101	UPT 3245-315	1 3/8 x 2 1/2	3.50	2.10
40-20/150 100/25	C049	UP 4215C10	1 x 2	2.50	1.50	30-30/450 20/25	C102	UPT 3345C	1 3/8 x 2 1/2	3.55	2.13
40-20/150 100/10	*C050	UP 4215X10	1 x 2	2.40	1.44	30-30/450 40/50	C103	UP 3345V4	1 3/8 x 3	3.65	2.19
40-20/150 200/25	C051	UP 4215C20	1 x 2 1/2	2.70	1.62	30-30/450 125/25	C160	UPT 322	1 3/8 x 3	3.95	2.37
40-20/150 200/10	*C052	UP 4215X20	1 x 2	2.50	1.50	35-25/450 100/50	C161	UPT 323	1 3/8 x 3	4.10	2.46
40-20/150 250/10	C053	UP 4215X25	1 x 2	2.70	1.62	40-10/450 100/50	C104	UPT 4145V10	1 3/8 x 3	3.55	2.13
40-30/150 20/25	C054	UP 4315C	1 x 2	2.35	1.41	40-10/450 80/200	C105	UPT 4145-820	1 3/8 x 3	3.90	2.34
40-40/150 20/25	C055	UP 4415C	1 x 2	2.40	1.44	40-20/450 20/25	C106	UP 4245C	1 3/8 x 2 1/2	3.50	2.10
50-30/150 20/25	C056	UP 5315C	1 x 2	2.50	1.50	40-40/450 20/25	C107	UP 4445C	1 3/8 x 3	3.95	2.37
50-30/150 100/25	C057	UP 5315C10	1 x 2 1/2	2.70	1.62	40-40/450 40/25	C108	UPT 4445C4	1 3/8 x 3	2.45	1.47
50-50/150 20/25	C058	UP 5515C	1 x 2 1/2	2.65	1.59	40-40/450 100/50	C109	UPT 4445V10	1 3/8 x 3 3/8	4.30	2.58
60-20/150 20/25	C059	UP 6215C	1 x 2	2.55	1.53	40-40/450 40/150	C110	UPT 4445-415	1 3/8 x 3 3/8	4.15	2.49
60-40/150 20/25	C060	UP 6415C	1 x 2 1/2	2.65	1.59	60-40/450 75/50	C162	UPT 324	1 3/8 x 3 3/8	4.65	2.79
80-40/150 20/25	C061	UP 8415C	1 x 2 1/2	2.80	1.68	80-10/450 125/25	C163	UPT 325	1 3/8 x 3 3/8	4.45	2.67
120-60/150 20/25	C062	UPT 12615C	1 3/8 x 2 1/2	3.35	2.01	80-20/450 100/50	C164	UPT 8245V10	1 3/8 x 4 1/8	4.80	2.88
30-20/200 20/25	C063	UP 3220C	1 x 2	2.55	1.53	80-40/450 100/25	C111	UPT 8445C10	1 3/8 x 4 1/8	5.10	3.06
40-80/200 100/50	C157	UPT 321	1 3/8 x 3	3.50	2.10	10-10/500 100/50	C112	UPT 1150V10	1 x 3	2.85	1.71
100-10/200 40/50	C064	UPT 10120V4	1 3/8 x 2	3.15	1.89	10-10/500 4/350	C113	UPT 318	1 x 2 1/2	2.50	1.50
15-15/250 20/25	C065	UP 15D25C	1 x 2	2.35	1.41	20-10/500 100/50	C115	UPT 2150V10	1 x 3 3/8	3.30	1.98
20-15/250 20/25	C066	UP 215525C	1 x 2	2.35	1.41	20-20/500 60/400	C116	UPT 2250-640	1 3/8 x 3 3/8	4.80	2.88
30-30/250 20/25	C067	UP 3325C	1 x 2 1/2	2.80	1.68	30-10/500 20/50	C117	UPT 3150V2	1 3/8 x 2 1/2	3.10	1.86
40-40/250 10/200	C158	UPT 4425-120	1 x 3	2.95	1.77	40-40/500 100/200	C118	UPT 4450-1020	1 3/8 x 4 1/8	5.85	3.51
70-70/250 20/50	C068	UPT 7725V2	1 3/8 x 3	3.90	2.34	100/100 50-25/25	C119	UPT 308	1 x 3	2.65	1.59
80-80/250 10/450	C069	UPT 8825-145	1 3/8 x 3 3/8	4.20	2.52	20/150 250-100/15	C120	UPT 310	1 3/8 x 2	2.90	1.74
10-10/300 15/250	C070	UPT 309	1 x 2	2.45	1.47	120/300 15-10/450	C121	UPT 305	1 3/8 x 3 3/8	4.50	2.70
20-20/300 20/25	*C071	UP 2230C	1 x 2	2.75	1.65	4/350 100-40/25	C165	UPT 326	1 x 2	2.25	1.35
30-30/300 25/50	C072	UP 3330V2	1 x 3	2.90	1.74	30/350 20-10/250	*C122	UP 335-2125	1 x 3	3.00	1.80
40-15/300 20/25	C073	UP 415530C	1 x 3	2.95	1.77	80/400 20-10/300	C123	UPT 840-2130	1 3/8 x 3 3/8	4.25	2.55
10-5/350 30/50	C153	UPT 319	1 x 2 1/2	2.55	1.53	10/450 20-10/25	C166	UPT 327	1 x 2	2.15	1.29
10-5/350 150/50	C074	UPT 316	1 x 3	2.70	1.62	20/450 40-10/250	C124	UPT 245-4125	1 3/8 x 2	3.15	1.89
10-10/350 20/25	*C075	UP 1135C	1 x 2	2.25	1.35	20/450 80-10/350	C167	UPT 245-8135	1 3/8 x 3 3/8	4.25	2.55
10-15/350 20/25	*C076	UP 115535C	1 x 2	2.50	1.50	30/450 100-25/25	C125	UPT 304	1 3/8 x 2	3.00	1.80
15-10/350 20/25	C077	UP 155135C	1 x 2	2.50	1.50	40/450 90-50/150	C126	UPT 445-9515	1 3/8 x 3	4.00	2.40
20-10/350 20/25	*C078	UP 2135C	1 x 2	2.55	1.53	60/450 40-20/350	C168	UPT 645-4235	1 3/8 x 3 3/8	4.60	2.76
20-10/350 5/250	C079	UP 4CJ66	1 x 2	2.55	1.53	80/450 100-20/50	C169	UPT 328	1 3/8 x 3 3/8	4.25	2.55
20-20/350 20/25	C080	UP 2235C	1 x 2 1/2	2.80	1.68	40/475 40-10/250	C170	UPT 329	1 3/8 x 2 1/2	4.00	2.40
30-10/350 20/25	C081	UP 3135C	1 x 2 1/2	2.85	1.71	40/475 80-10/300	C171	UPT 330	1 3/8 x 3 3/8	4.80	2.88
30-10/350 20/250	C082	UP 3135-225	1 x 3	3.05	1.83	40/475 20-20/450	C172	UPT 331	1 3/8 x 3	4.50	2.70
30-20/350 20/25	C083	UPT 3235C	1 x 3	3.10	1.86	10/500 80-10/150	C181	UPT 150-8115	1 x 3 3/8	2.85	1.71
30-30 350 20/25	C084	UP 3335C	1 3/8 x 2	3.40	2.04	40/150 25/25 130/15	C127	UPT 314	1 x 3	2.35	1.41
40-20/350 10/100	C085	UPT 4235-110	1 3/8 x 2	2.85	1.71	50/150 100 50 20/25	C173	UPT 332	1 x 3	2.85	1.71
20-40/350 10/150	C086	UPT 2435-115	1 x 3	3.20	1.92	80/250 40/150 50/50	C128	UPT 825-415V5	1 3/8 x 2 1/2	3.30	1.98
40-40/350 50/25	C087	UPT 4435C5	1 3/8 x 2 1/2	3.75	2.25	100/300 60/150 20/25	C129	UPT 1030-615C	1 3/8 x 3	4.20	2.52
30-10/400 150/50	*C088	UPT 3140V15	1 3/8 x 2 1/2	3.40	2.04	20/350 50/100 100/75	C130	UPT 307	1 x 3	3.10	1.86
80-40/400 150/50	C089	UPT 8440V15	1 3/8 x 3 3/8	5.15	3.09	30/350 30/300 20/25	C131	UP 335-330C	1 x 3	3.15	1.89
100-10/400 20/50	C152	UPT 10140V2	1 3/8 x 3 3/8	4.50	2.70	50/350 10/250 500/5	C132	UPT 302	1 3/8 x 2 1/2	3.60	2.16
15-5/450 15/350	C090	UP 6CJ68	1 x 3	2.85	1.71	10/400 50/350 30/25	C133	UPT 140-535C3	1 x 3	3.10	1.86

§ For application data on C-D types UP, UPT and UPE Capacitors ask your jobber for: C-D TELEVISION REPLACEMENT GUIDE, No. TVR7.
 † Superseded by equivalent ETCHED CATHODE Type UPE —See C-D catalog Page 10. * Recommend Stocking Next Higher Voltage Rating.



UP, UPT & UPE TWIST-PRONG BASE ELECTROLYTICS

Triple Section (Cont'd)

Cap./Volts	Rotational Stock No.	Cat. No.	Size—Ins. Dia. x Lgth.	List Price	Net Price
60/400 40/300 20/25	C134	UPT 640-430C	1½ x 3¾	\$4.20	\$2.52
10/450 50/150 100/25	C135	UPT 313	1 x 3	2.75	1.65
10/450 40/300 10/150	C136	UPT 306	1¾ x 2	3.10	1.86
10/450 40/350 100/50	C174	UPT 333	1¾ x 3¾	3.40	2.04
10/450 30/400 30/300	C137	UPT 301	1¾ x 2½	3.35	2.01
15/450 20/350 20/250	C138	UP 6CJ17	1 x 3	3.00	1.80
20/450 60/250 100/25	C139	UPT 312	1¾ x 2½	3.65	2.19
20/450 15/350 10/300	C140	UP 6CJ67	1 x 3	3.05	1.83
20/450 80/350 100/50	C141	UPT 317	1¾ x 3¾	4.50	2.70
30/450 40/350 50/25	C149	UPT 345-435C5	1 x 4½	3.70	2.22
30/450 50/400 40/25	C142	UPT 345-540C4	1¾ x 3	3.95	2.37
40/450 40/150 130/50	C143	UPT 300	1¾ x 3	3.65	2.19
40/450 100/150 50/50	C144	UPT 311	1¾ x 3	3.95	2.37
40/450 50/350 50/300	C175	UPT 334	1¾ x 4½	4.85	2.91
10/475 4/350 40/250	C176	UPT 335	1¾ x 2	2.75	1.65
20/475 50/50 20/25	C177	UPT 336	1 x 3	2.75	1.65
10/500 100/200 40/50	C145	UPT 315	1¾ x 2½	3.35	2.01
20/500 20/300 40/25	C146	UPT 250-230C4	1¾ x 2	3.10	1.86
40/500 40/250 100/50	C147	UPT 303	1¾ x 3	4.30	2.58
40/500 40/400 25/50	C148	UPT 450-440V2	1¾ x 3	4.30	2.58

Quadruple Section (Cont'd)

Cap./Volts	Rotational Stock No.	Cat. No.	Size—Ins. Dia. x Lgth.	List Price	Net Price
50-30-30/150 100/25	D028	UP 53315C10	1¾ x 2	\$3.45	\$2.07
50-50-50/150 20/25	D029	UP 55515C	1¾ x 2	3.55	2.13
60-40-20/150 200/10	D030	UP 64215X20	1¾ x 2	3.50	2.10
75-75-75/150 30/25	D031	UP 75T15C3	1¾ x 3	4.30	2.58
80-40-40/150 20/25	D032	UP 84415C	1¾ x 2	3.55	2.13
80-40-40/150 100/25	D033	UP 84415C10	1¾ x 2½	3.75	2.25
40-20-10/250 20/25	D034	UP 42125C	1¾ x 2	3.40	2.04
80-60-40/250 20/150	D035	UPT 86425-215	1¾ x 3¾	5.10	3.06
100-40-10/250 100/50	D036	UPT 415	1¾ x 3¾	5.15	3.09
40-40-40/300 20/150	D037	UPT 44430-215	1¾ x 3	4.90	2.94
60-40-20/300 50/25	D038	UPT 64230C5	1¾ x 3	4.70	2.82
10-10-10/350 20/25	D039	UP 11135C	1¾ x 2	2.95	1.77
15-15-15/350 50/50	D040	UPT 15T35V5	1¾ x 2	3.80	2.28
20-10-5/350 20/25	D041	UP 21535C	1¾ x 2	3.10	1.86
30-20-20/350 20/25	D042	UP 32235C	1¾ x 2½	4.10	2.46
40-20-20/350 20/25	D043	UP 44235C	1¾ x 3	4.70	2.82
40-20-20/350 25/25	D044	UPT 42235C	1¾ x 2½	4.25	2.55
40-30-10/350 50/50	D045	UPT 43135V5	1¾ x 3	4.40	2.64
40-40-40/350 40/25	D046	UPT 44435C4	1¾ x 3	5.20	3.12
40-40-40/350 150/50	D047	UPT 44435V15	1¾ x 3¾	5.70	3.42
20-10-10/400 25/25	D124	UPT 21140C	1¾ x 2	3.25	1.95
80-40-30/400 40/25	D125	UPT 84340C4	1¾ x 4½	5.95	3.57
10-10-10/450 20/25	D048	UPT 11145C	1¾ x 2	3.15	1.89
10-10-10/450 100/25	D049	UPT 11145C10	1¾ x 2	3.35	2.01
10-10-10/450 150/50	D050	UPT 11145V15	1¾ x 2½	3.70	2.22
15-10-10/450 20/25	D126	UPT 15S1145C	1¾ x 2	3.30	1.98
20-10-10/450 100/25	D051	UPT 21145C10	1¾ x 2	3.70	2.22
20-20-20/450 20/25	D052	UP 22245C	1¾ x 2½	4.15	2.49
20-20-20/450 100/50	D053	UPT 22245V10	1¾ x 3	4.55	2.73
30-15-15/450 40/25	D054	UP 315D45C4	1¾ x 2½	4.15	2.49
30-20-20/450 20/25	D055	UP 32245C	1¾ x 3	4.40	2.64
30-30-15/450 30/50	D056	UPT 400	1¾ x 3	4.15	2.49
30-30-15/450 100/50	D057	UPT 404	1¾ x 3¾	4.90	2.94
30-30-10/450 20/25	D058	UP 33145C	1¾ x 3	4.35	2.61
30-30-20/450 20/25	D059	UP 33245C	1¾ x 3	4.65	2.79
35-35-10/450 10/200	D103	UPT 434	1¾ x 3¾	4.60	2.76
40-10-10/450 250/25	D060	UPT 41145C25	1¾ x 3	4.25	2.55
40-10-10/450 40/300	D127	UPT 444	1¾ x 3¾	4.65	2.79
40-20-10/450 25/25	D061	UPT 42145C	1¾ x 3	4.25	2.55
40-20-10/450 100/50	D062	UPT 42145V10	1¾ x 3¾	4.65	2.79
40-20-20/450 20/25	D082	UPT 42245C	1¾ x 3	4.60	2.76
40-20-20/450 40/25	D063	UPT 42245C4	1¾ x 3	4.65	2.79
40-30-10/450 20/25	D064	UP 43145C	1¾ x 3	4.50	2.70
40-40-10/450 25/50	D065	UPT 44145V2	1¾ x 3¾	4.70	2.82
40-40-10/450 100/100	D066	UPT 403	1¾ x 3¾	5.35	3.21
40-40-10/450 100/350	D128	UPT 445	1¾ x 3¾	4.80	2.88
50-40-5/450 20/25	D129	UPT 446	1¾ x 3¾	4.80	2.88
60-10-10/450 20/150	D067	UPT 61145-215	1¾ x 3	4.60	2.76
40-10-20/475 10/25	D068	UPT 407	1¾ x 3	4.85	2.91
20-20-10/500 10/300	D069	UPT 22150-130	1¾ x 2½	4.30	2.58
50-30-10/500 20/300	D102	UPT 53150-230	1¾ x 3¾	5.60	3.36
10/300 200-140-30/150	D110	UPT 437	1¾ x 5	5.10	3.06
20/475 60-40-10/350	D130	UPT 447	1¾ x 3¾	5.20	3.12
20/500 80-20-10/300	D114	UPT 250-82130	1¾ x 3¾	5.00	3.00
20/300 150-150/150 100/30	D071	UPT 427	1¾ x 4½	5.30	3.18
15/350 80-40/200 200/25	D072	UPT 402	1¾ x 3	4.50	2.70
20/350 150-80/150 20/25	D106	UPT 430	1¾ x 3	4.55	2.73
40/350 50-20/150 80/50	D107	UPT 431	1¾ x 3	4.05	2.43

Quadruple Section

40-40-40-30/150	D001	UP 444315	1¾ x 2	\$3.35	\$2.01
40-20-10-10/300	D111	UPT 421130	1¾ x 2	3.95	2.37
40-40-20-10/300	D002	UPT 442130	1¾ x 2½	4.55	2.73
60-40-10-10/300	D112	UPT 641130	1¾ x 3¾	4.55	2.73
10-10-10-10/350	D003	UPT 111135	1¾ x 2	3.10	1.86
80-10-10-10/350	D004	UPT 811135	1¾ x 3¾	4.60	2.76
30-30-20-20/400	D005	UPT 332240	1¾ x 3	4.85	2.91
80-10-10-10/400	D118	UPT 811140	1¾ x 3¾	4.70	2.82
80-20-10-10/400	D006	UPT 821140	1¾ x 3¾	5.05	3.03
4-4-4-4/450	D007	UPT 4Q45	1¾ x 2	2.90	1.74
5-5-5-5/450	D008	UP 5Q45	1¾ x 2	3.00	1.80
10-10-10-5/450	O119	UPT 441	1¾ x 2	3.25	1.95
10-10-10-10/450	D009	UPT 111145	1¾ x 2	3.35	2.01
15-30-30-10/450	D010	UPT 15S33145	1¾ x 3	4.70	2.80
15-30-30-30/450	D011	UPT 15S33345	1¾ x 3¾	5.30	3.18
20-10-10-10/450	D012	UPT 211145	1¾ x 2½	3.70	2.22
20-20-20-20/450	D013	UPT 222245	1¾ x 3	4.70	2.82
30-15-15-15/450	D014	UPT 315T45	1¾ x 3	4.45	2.67
35-35-10-5/450	D015	UPT 420	1¾ x 3¾	4.65	2.79
40-10-10-10/450	D016	UP 411145	1¾ x 3	4.15	2.49
40-20-10-10/450	D017	UPT 421145	1¾ x 3	4.45	2.67
40-40-4-4/450	D120	UPT 442	1¾ x 3¾	4.65	2.79
40-40-20-20/450	D121	UPT 442245	1¾ x 4½	5.55	3.33
40-40-30-30/450	D122	UPT 443345	1¾ x 4½	6.05	3.63
70-10-10-5/450	D123	UPT 443	1¾ x 3¾	4.75	2.85
10-10-10-10/500	D018	UPT 111150	1¾ x 2	3.50	2.10
20-20-20/150 20/25	D019	UP 22215C	1¾ x 2	2.90	1.74
30-20-20/150 200/10	D020	UP 32215X20	1¾ x 2	3.10	1.86
30-30-30/150 40/25	D021	UP 33315C4	1¾ x 2	3.10	1.86
40-20-20/150 20/25	D022	UPT 42215C	1¾ x 2	2.95	1.77
40-40-20/150 200/10	D023	UP 44215X20	1¾ x 2	3.25	1.95
40-40-30/150 20/25	D024	UP 44315C	1¾ x 2	3.10	1.86
40-40-40/150 20/25	D025	UP 44415C	1¾ x 2	3.15	1.89
40-40-40/150 100/25	D026	UP 44415C10	1¾ x 2	3.35	2.01
40-40-40/150 160/25	D027	UP 44415C16	1¾ x 2	3.55	2.13

§ For application data on C-D types UP, UPT and UPE Capacitors ask your jobber for C-D TELEVISION REPLACEMENT GUIDE, No. TVR7.

† Superseded by equivalent ETCHED CATHODE Type UPE—See C-D catalog Page 10. • Recommend Stacking Next Higher Voltage Rating. ‡ Separate Section.



UP, UPT & UPE TWIST-PRONG BASE ELECTROLYTICS

Quadruple Section (Cont'd)

Cap./Volts	Rotational Stock No.	Cat. No.	Size—Ins. Dia. x Lgth.	List Price	Net Price
10/400 50-30/350 30/25	D073	UPT 428	1 3/8 x 3	\$4.40	\$2.64
80/400 40-10/350 10/25	D131	UPT 448	1 3/8 x 3 3/8	5.30	3.18
10/450 100-20/300 20/25	D108	UPT 435	1 3/8 x 3 3/8	4.90	2.94
10/450 100-20/300 20/200	D116	UPT 439	1 3/8 x 3 3/8	5.05	3.03
10/450 60-40/350 25/25	D074	UPT 424	1 3/8 x 3 3/8	4.60	2.76
10/450 100-10/350 20/25	D075	UPT 419	1 3/8 x 3 3/8	5.25	3.13
20/450 80-20/200 50/50	D076	UPT 421	1 3/8 x 3	4.15	2.49
20/450 80-50/350 100/50	D132	UPT 449	1 3/8 x 4 1/8	6.00	3.60
30/450 125-125/25 30/450	D078	UPT 409	1 3/8 x 3	4.90	2.94
30/450 40-40/350 10/200	D077	UPT 425	1 3/8 x 3 3/8	5.15	3.09
40/450 40-40/250 20/25	D133	UPT 445-4425C	1 3/8 x 3	4.55	2.73
10/500 100-30/300 100/25	D117	UPT 440	1 3/8 x 3 3/8	5.20	3.12
5-5/75 25/25 100/15	D134	UPT 450	1 3/8 x 2	2.65	1.59
5-5/400 50/300 80/250	D079	UPT 401	1 3/8 x 3	4.65	2.79
40-60/400 40/350 10/50	D080	UPT 429	1 3/8 x 3 3/8	5.75	3.45
10-10/450 60/200 100/50	D081	UPT 411	1 3/8 x 3	3.85	2.31
35-25/450 20/200 100/50	D104	UPT 433	1 3/8 x 3 3/8	4.65	2.79
10-5/475 80/450 40/50	D083	UPT 423	1 3/8 x 3 3/8	4.95	2.97
15-15/475 80/300 40/50	D084	UPT 417	1 3/8 x 3	4.80	2.88
40-10/475 4/350 40/300	D105	UPT 432	1 3/8 x 3	4.95	2.97
40-40/150 40-40/25	D085	UP 4415C44	1 3/8 x 2	3.05	1.83
40-40/150 100-100/25	D086	UP 4415CD10	1 3/8 x 2	3.35	2.01
100-10/300 200-30/150	D109	UPT 436	1 3/8 x 5	5.90	3.54
60-4/350 100-40/25	D135	UPT 451	1 3/8 x 2 1/2	3.80	2.28
40-10/400 80-10/250	D087	UPT 4140-8125	1 3/8 x 3 3/8	4.70	2.82
10-10/450 20-20/25	D088	UPT 1145CC	1 3/8 x 2	2.95	1.77
20-20/450 20-20/25	D089	UP 2245CC	1 3/8 x 2	3.60	2.16
20-20/450 30-30/350	D090	UP 2245-3335	1 3/8 x 3	5.05	3.03
30-10/450 150-30/50	D136	UPT 452	1 3/8 x 3	4.10	2.46
40-10/450 35-10/350	D091	UPT 408	1 3/8 x 3	4.60	2.76
40-20/450 80-10/350	D115	UPT 4245-8135	1 3/8 x 4 1/8	5.80	3.48
40-40/450 100-60/200	D137	UPT 453	1 3/8 x 4 1/8	6.05	3.63
40-40/450 30-30/350	D092	UPT 4445-3335	1 3/8 x 4 1/8	5.90	3.54
100/300 40/50 80-20/25	D070	UPT 414	1 3/8 x 2 1/2	4.55	2.73
20/400 50/350 80-40/25	D139	UPT 455	1 3/8 x 2 1/2	4.15	2.49
30/500 10/450 150-30/50	D113	UPT 438	1 3/8 x 3	4.20	2.52
120/300 20/250 20/25 100/50	D093	UPT 405	1 3/8 x 4 1/8	5.05	3.03
200/300 20/250 20/25 100/50	D094	UPT 406	1 3/8 x 5	5.45	3.27
20/350 40/300 10/150 250/50	D095	UPT 418	1 3/8 x 3	4.60	2.76
10/400 100/300 10/75 100/25	D138	UPT 454	1 3/8 x 3	4.45	2.67
10/450 80/300 40/250 100/50	D140	UPT 456	1 3/8 x 3 3/8	4.90	2.94
60/450 40/250 10/150 80/50	D141	UPT 457	1 3/8 x 3 3/8	4.80	2.88
80/450 10/400 30/300 40/150	D096	UPT 412	1 3/8 x 4 1/8	5.25	3.15
10/475 40/350 80/200 100/50	D101	UPT 426	1 3/8 x 3 3/8	4.80	2.88
10/475 40/400 100/50 10/25	D142	UPT 458	1 3/8 x 2 1/2	4.00	2.40
10/475 40/400 4/350 100/50	D143	UPT 459	1 3/8 x 2 1/2	4.05	2.43
10/475 10/450 80/200 50/60	D097	UPT 410	1 3/8 x 2 1/2	3.85	2.31
10/475 60/450 30/400 125/50	D098	UPT 413	1 3/8 x 4 1/8	5.45	3.27
20/475 40/300 100/50 80/25	D099	UPT 422	1 3/8 x 3	4.50	2.70
25/475 20/450 40/300 100/50	D100	UPT 416	1 3/8 x 3	4.95	2.97
40/475 40/250 50/150 80/50	D144	UPT 460	1 3/8 x 3 3/8	5.00	3.00

SELENIUM RECTIFIER CAPACITORS

Type UPE are etched anode and cathode units especially engineered to prevent capacity drop due to high ripple and surge currents normally encountered in selenium rectifier circuits. A protective series-resistor of approximately 50 ohms for a 100 ma. load, and at least 10 ohms for a 250 ma. load, should always be used to protect both the rectifier and filter capacitors. Use only type UPE in selenium rectifier circuits.

UPE Single Section Units

Cap./Volts	Rotational Stock No.	Cat. No.	Size—Ins. Dia. x Lgth.	List Price	Net Price
40/150	XA001	UPE 4015	3/4 x 2	\$1.60	\$.96
80/150	XA002	UPE 8015	1 x 2	1.85	1.11
100/150	XA003	UPE 10015	1 x 2 1/2	2.00	1.20
150/150	XA004	UPE 15015	1 x 3	2.15	1.29

UPE Single Section Units (Cont'd)

Cap./Volts	Rotational Stock No.	Cat. No.	Size—Ins. Dia. x Lgth.	List Price	Net Price
300/150	XA005	UPE 30015	1 3/8 x 3	\$2.80	\$1.68
80/200	XA006	UPE 8020	1 3/8 x 2	1.95	1.17
150/200	XA007	UPE 15020	1 3/8 x 2 1/2	2.80	1.68
40/250	XA008	UPE 4025	1 x 2	1.80	1.08
60/300	XA009	UPE 6030	1 x 2 1/2	2.10	1.26
80/300	XA010	UPE 8030	1 x 3	2.55	1.53
80/350	XA011	UPE 8035	1 3/8 x 2 1/2	2.85	1.71
125/350	XA012	UPE 12535	1 3/8 x 3	3.65	2.19
30/500	XA013	UPE 3050	1 x 3	2.00	1.20

UPE Dual Section Units

Cap./Volts	Rotational Stock No.	Cat. No.	Size—Ins. Dia. x Lgth.	List Price	Net Price
20-20/150	XB001	UPE 2215	1 x 2	\$1.70	\$1.02
40-40/150	XB002	UPE 4415	1 x 2	1.90	1.14
50-50/150	XB003	UPE 5515	1 x 2 1/2	2.15	1.29
80-40/150	XB004	UPE 8415	1 x 2 1/2	2.30	1.38
80-80/150	XB005	UPE 8815	1 3/8 x 2	2.65	1.59
100-100/150	XB006	UPE 101015	1 3/8 x 2 1/2	3.25	1.93
150-150/150	XB007	UPE 150D15	1 3/8 x 3	3.50	2.10
200-150/150	XB008	UPE 201515	1 3/8 x 3 3/8	3.75	2.23
200-200/150	XB009	UPE 202015	1 3/8 x 3 3/8	4.00	2.40
100-100/200	XB010	UPE 101020	1 3/8 x 3	3.50	2.10
40-40/250	XB011	UPE 4425	1 x 3	2.55	1.53
80-40/250	XB012	UPE 8425	1 3/8 x 2 1/2	3.00	1.80
40-40/300	XB013	UPE 4430	1 x 3	3.00	1.80
80-40/300	XB014	UPE 8430	1 3/8 x 2 1/2	3.55	2.13

UPE Triple Section Units

Cap./Volts	Rotational Stock No.	Cat. No.	Size—Ins. Dia. x Lgth.	List Price	Net Price
20-20-20/150	XC001	UPE 22215	1 x 2	\$2.35	\$1.41
40-20-20/150	XC002	UPE 42215	1 x 2	2.40	1.44
50-50-50/150	XC003	UPE 55515	1 x 3	3.00	1.80
80-80-80/150	XC004	UPE 88815	1 3/8 x 3	3.75	2.23
120-80-40/150	XC005	UPE 128415	1 3/8 x 3	3.70	2.22
20-20/150 20/25	XC006	UPE 2215C	1 x 2	2.20	1.32
40-20/150 20/25	XC007	UPE 4215C	1 x 2	2.30	1.38
40-40/150 20/25	XC008	UPE 4415C	1 x 2	2.40	1.44
80-30/150 300/25	XC012	UPE 8315C30	1 3/8 x 2 1/2	3.65	2.19
40-20/300 20/25	XC009	UPE 4230C	1 x 2 1/2	3.10	1.86
100/300 60-20/250	XC010	UPE 1030-6225	1 3/8 x 4 1/8	4.90	2.94
200/300 20-60/250	XC011	UPE 2030-2625	1 3/8 x 5	5.45	3.27

HARDWARE FOR TYPE UP, UPT & UPE CAPACITORS

Part No.	Item	Description	List Price	Net Price
22272	Wrench for	Mtg. Units	\$1.24	\$.74
19891	Bakelite Washer	For 3/4"	.07	.04
19884	Bakelite Washer	For 1"	.07	.04
19888	Bakelite Washer	For 1 3/8"	.07	.04
19890	Metal Washer	For 3/4"	.07	.04
19883	Metal Washer	For 1"	.07	.04
19887	Metal Washer	For 1 3/8"	.07	.04
21368-1	Mounting Clip	For 3/4"	.15	.09
21368-2	Mounting Clip	For 1"	.15	.09
21368-3	Mounting Clip	For 1 3/8"	.15	.09
28521-1	Insulating Tube	For 3/4" x 2"	.07	.04
28521-4	Insulating Tube	For 1" x 2"	.07	.04
28521-6	Insulating Tube	For 1" x 3"	.07	.04
28521-7	Insulating Tube	For 1 3/8" x 2"	.07	.04
28521-9	Insulating Tube	For 1 3/8" x 3"	.07	.04
30033	Bakelite Washer	For 1" in 1 3/8" Hole Mtg.	.07	.04
30036	Metal Washer	For 1" in 1 3/8" Hole Mtg.	.07	.04
28521-5	Insulating Tube	For 1" x 2 1/2"	.07	.04
28521-8	Insulating Tube	For 1 3/8" x 2 1/2"	.07	.04
28521-12	Insulating Tube	For 1 3/8" x 3 3/8"	.07	.04
28521-19	Insulating Tube	For 1" x 3 3/8"	.07	.04
28521-15	Insulating Tube	For 1 3/8" x 4 1/8"	.07	.04

§ For application data on C-D types UP, UPT and UPE Capacitors ask your jobber for C-D TELEVISION REPLACEMENT GUIDE, No. TVR7.
 • Recommend Stocking Next Higher Voltage Rating.



ROUND CAN-TYPE ELECTROLYTICS

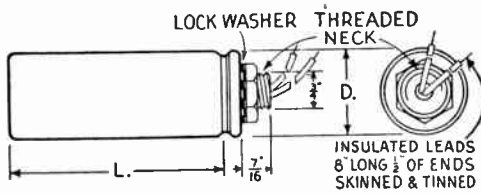
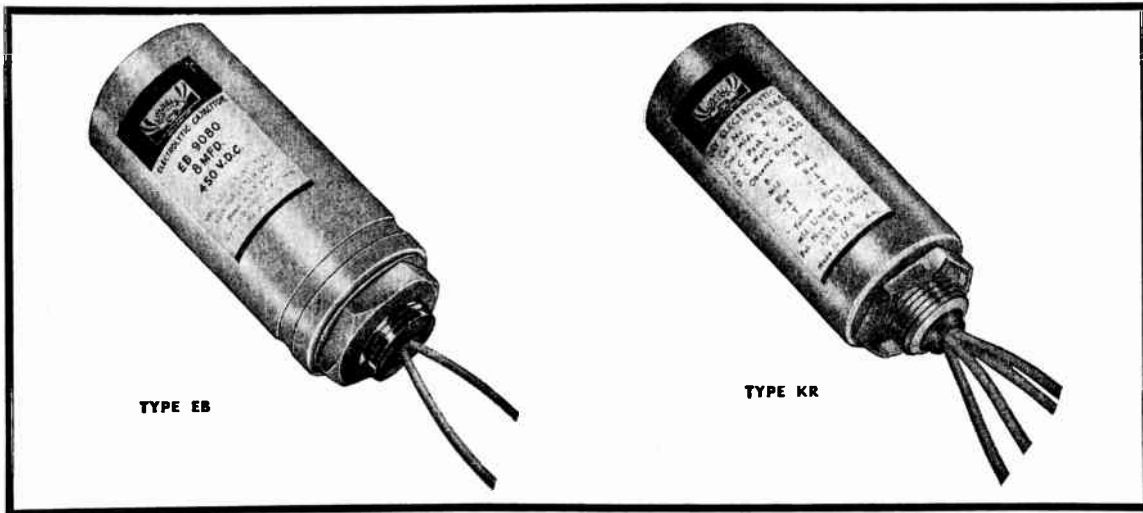

Type EB electrolytic capacitors are especially suited for replacement purposes in radio receivers to replace units of larger physical sizes. They are identical in mounting hole dimensions and general construction to Type WR capacitors except that they are provided with insulated color-coded wire leads 8" long. Bakelite threaded neck.

TYPE EB—450-VOLT D.C. WKG.
TEMPERATURE RANGE to +65°C.

EB Cat. No.	Cap. Mfd.	Size—Inches Dia. x Lgth.	List Price	Net Price
EB 9080	8	1 3/4 x 4 3/4	\$2.20	\$1.32
EB 9100	10	1 3/4 x 4 3/4	2.30	1.38
EB 9120	12	1 1/2 x 4 1/2	2.40	1.44
EB 9140	16	1 1/2 x 4 1/2	2.45	1.47
EB 9180	18	1 1/2 x 4 1/2	2.55	1.53
EB 9200	20	1 1/2 x 4 1/2	2.75	1.65
EB 8800	8-8	1 1/2 x 4 1/2	3.00	1.80

REPLACEMENTS FOR WET ELECTROLYTICS
TYPE WR—500-VOLT D.C.

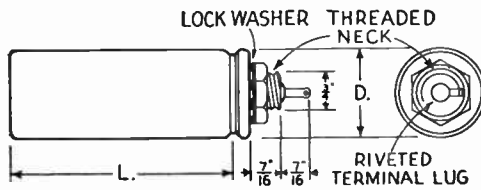

WET ELECTROLYTIC REPLACEMENT

TEMPERATURE RANGE to +65°C.

WR Cat. No.	Cap. Mfd.	Replacement for	Size—Ins. Dia. x Lgth.	List Price	Net Price
WR 10	10	4 to 12 mfd.	1 3/4 x 2 1/2	\$2.30	\$1.38
WR 20	20	16 to 20 mfd.	1 3/4 x 2 1/2	2.70	1.62
WR 30	30	20 to 30 mfd.	1 3/4 x 3 1/4	2.95	1.77
WR 40	40	30 to 40 mfd.	1 3/4 x 3 1/4	3.15	1.89

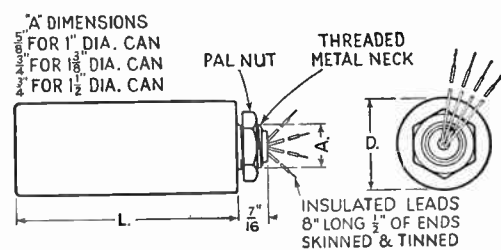

Types KR and KRC single-hole mounting units are compact etched foil type dry electrolytic capacitors furnished in round (inverted mounting) aluminum cans. Available in single, dual and triple sections with color-coded leads. Metal threaded neck.

TYPE KR
TEMPERATURE RANGE to +65°C.

KR Cat. No.	Cap. Mfd.	D.C. W. Volts	Size—Inches Dia. x Lgth.	List Price	Net Price
KR 504	4	450	1 x 2 1/2	\$2.05	\$1.23
KR 508	8	450	1 x 2 1/2	2.20	1.32
KR 512A	12	450	1 x 2 1/2	2.40	1.44
KR 516A	16	450	1 x 3 1/2	2.45	1.47
KR 520	20	450	1 3/4 x 2 1/2	2.75	1.65
KR 530	30	450	1 3/4 x 3 1/2	3.00	1.80
KR 540	40	450	1 3/4 x 4 3/4	3.15	1.89
KR 604C	4	600	1 3/4 x 3 1/2	2.95	1.77
KR 608C	8	600	1 3/4 x 4 3/4	3.15	1.89
KR 616C	16	600	1 3/4 x 4 3/4	3.75	2.25

Separate Section Units

KR 548A	4-8	450	1 3/4 x 3	\$3.70	\$2.22
KR 588A	8-8	450	1 3/4 x 3	3.75	2.25
KR 5816A	8-16	450	1 3/4 x 4 1/2	4.10	2.46
KR 5888A	8-8-8	450	1 3/4 x 4 1/2	6.25	3.75

Common Negative Units

KRC 548	4-8	450	1 x 3	\$2.95	\$1.77
KRC 588	8-8	450	1 3/4 x 2 1/2	3.00	1.80
KRC 5116	16-16	450	1 3/4 x 3 1/2	3.55	2.13
KRC 5220	20-20	450	1 3/4 x 4 3/4	3.80	2.28
KRC 5888	8-8-8	450	1 3/4 x 3 1/2	5.00	3.00



MOLDED TUBULAR CAPACITORS

"The CUB"



A New Champion!

tops in the field of molded tubular capacitors

C-D's Cub

The Cornell-Dubilier "CUB" is an *outstandingly superior* molded capacitor unequalled by any molded tubular heretofore developed. The "CUB" possesses characteristics that will meet the wide and demanding applications found in critical industrial, military and experimental electronic equipment.

This is the unit recommended for general replacement service.† Sold exclusively through C-D electronic parts Distributors.

The "CUB" is molded in extra hard, non-inflammable bakelite—tough, durable and exceptionally resistant to moisture, high temperature and shock.

The unit is processed by special vacuum—temperature—cycling impregnation—the 200 and 400 volt series are impregnated with HT compound and the 600 volt and up series are impregnated with oil (Dykanol "C").

In countless production test runs, the "CUB" has survived an average of 30 cycles of the punishing JAN and MIL Temperature and Immersion Cycling Test.

The "CUB" is dry assembly processed and sealed immediately after impregnation. This technique results in life long high insulation resistance, low power factor, and exceptional capacitance stability. Each unit is tested at several times its rated voltage to insure high dielectric strength.

At least a 50% greater resistance to humidity and a 15%-25% greater voltage breakdown over comparable molded tubulars, is built into the C-D "CUB".

Extra strong copper-weld leads eliminate breakage during assembly and throughout service life. The leads are solder sealed securely to the unit.

TEMP. RANGE: HT Compound —40°C to +90°C
Dykanol "C" —55°C to +100°C

THE CUB

CUB	Cat. No.	Cap. Mfd.	Size—Inches Dia. x Length	List Price	Net Price
200 V. D.C.					
CUB 252		.02	3/8 x 1	\$.25	\$.15
CUB 2547		.047	3/16 x 1 1/4	.25	.15
CUB 255		.05	3/16 x 1 1/4	.25	.15
CUB 2P1		.1	3/16 x 1 1/4	.35	.21
CUB 2P15		.15	3/16 x 1 1/2	.35	.21
CUB 2P22		.22	11/16 x 1 7/8	.40	.24
CUB 2P25		.25	11/16 x 1 7/8	.40	.24
CUB 2P47		.47	11/16 x 1 7/8	.60	.36
CUB 2P5		.5	11/16 x 1 7/8	.60	.36
CUB 2W1		1.0	1 x 2 1/4	.90	.54

† For units specially recommended in industrial applications see C-D Catalog Page 15 "BUDROC" Steatite-Cased Capacitors.

THE CUB

CUB	Cat. No.	Cap. Mfd.	Size—Inches Dia. x Length	List Price	Net Price
400 V. D.C.					
CUB 451		.01	3/8 x 1	\$.25	\$.15
CUB 452		.02	3/16 x 1 1/4	.25	.15
CUB 4522		.022	3/16 x 1 1/4	.25	.15
CUB 4547		.047	3/16 x 1 1/4	.30	.18
CUB 455		.05	3/16 x 1 1/4	.30	.18
CUB 4568		.068	3/16 x 1 1/2	.35	.21
CUB 4P1		.1	3/16 x 1 1/2	.35	.21
CUB 4P15		.15	11/16 x 1 7/8	.35	.21
CUB 4P22		.22	11/16 x 1 7/8	.40	.24
CUB 4P25		.25	11/16 x 1 7/8	.40	.24
CUB 4P47		.47	3/4 x 2 1/4	.60	.36
CUB 4P5		.5	3/4 x 2 1/4	.60	.36
*ST 4W1		1.0	1 x 2 1/4	.90	.54
600 V. D.C.					
CUB 6T1		.0001	3/8 x 1	\$.25	\$.15
CUB 6T25		.00025	3/8 x 1	.25	.15
CUB 6T4		.0004	3/8 x 1	.25	.15
CUB 6T5		.0005	3/8 x 1	.25	.15
CUB 6D1		.001	3/8 x 1	.25	.15
CUB 6D15		.0015	3/8 x 1	.25	.15
CUB 6D2		.002	3/8 x 1	.25	.15
CUB 6D22		.0022	3/8 x 1	.25	.15
CUB 6D3		.003	3/8 x 1	.25	.15
CUB 6D33		.0033	3/8 x 1	.25	.15
CUB 6D4		.004	3/8 x 1	.25	.15
CUB 6D47		.0047	3/8 x 1	.25	.15
CUB 6D5		.005	3/8 x 1	.25	.15
CUB 6D6		.006	3/8 x 1 1/4	.25	.15
CUB 6D68		.0068	3/16 x 1 1/4	.30	.18
CUB 6S1		.01	3/16 x 1 1/4	.30	.18
CUB 6S15		.015	3/16 x 1 1/4	.30	.18
CUB 6S2		.02	3/16 x 1 1/4	.30	.18
CUB 6S22		.022	3/16 x 1 1/4	.30	.18
CUB 6S3		.03	3/16 x 1 1/4	.35	.21
CUB 6S33		.033	3/16 x 1 1/2	.35	.21
CUB 6S4		.04	3/16 x 1 1/2	.35	.21
CUB 6S47		.047	3/16 x 1 1/2	.40	.24
CUB 6S5		.05	3/16 x 1 1/2	.40	.24
CUB 6S6		.06	11/16 x 1 7/8	.40	.24
CUB 6S68		.068	11/16 x 1 7/8	.40	.24
CUB 6P1		.1	11/16 x 1 7/8	.45	.27
CUB 6P2		.2	3/4 x 2 1/4	.55	.33
CUB 6P22		.22	3/4 x 2 1/4	.55	.33
CUB 6P25		.25	3/4 x 2 1/4	.55	.33
*ST 6P5		.5	1 x 2 1/4	.80	.48
1600 V. D.C.					
CUB 16T5		.0005	3/16 x 1 1/4	.65	.39
CUB 16D1		.001	3/16 x 1 1/4	.65	.39
CUB 16D15		.0015	3/16 x 1 1/4	.65	.39
CUB 16D2		.002	3/16 x 1 1/4	.65	.39
CUB 16D22		.0022	3/16 x 1 1/4	.65	.39
CUB 16D3		.003	3/16 x 1 1/4	.65	.39
CUB 16D33		.0033	3/16 x 1 1/4	.65	.39
CUB 16D4		.004	3/16 x 1 1/4	.65	.39
CUB 16D47		.0047	3/16 x 1 1/4	.65	.39
CUB 16D5		.005	3/16 x 1 1/4	.65	.39
CUB 16D6		.006	3/16 x 1 1/2	.65	.39
CUB 16D68		.0068	3/16 x 1 1/2	.65	.39
CUB 16D7		.007	3/16 x 1 1/2	.65	.39
CUB 16D75		.0075	3/16 x 1 1/2	.65	.39
CUB 16D8		.008	3/16 x 1 1/2	.65	.39
CUB 16S1		.01	3/16 x 1 1/2	.70	.42
CUB 16S15		.015	3/16 x 1 1/2	.70	.42
CUB 16S2		.02	11/16 x 1 7/8	.70	.42
CUB 16S22		.022	11/16 x 1 7/8	.70	.42
CUB 16S3		.03	11/16 x 1 7/8	.70	.42
CUB 16S4		.04	3/4 x 2 1/4	.70	.42
CUB 16S5		.05	3/4 x 2 1/4	.70	.42
6000 V. D.C.					
CUB 60T5		.0005	3/16 x 1 1/2	1.35	.81
CUB 60D1		.001	3/16 x 1 1/2	1.35	.81
CUB 60D5		.005	11/16 x 1 7/8	1.35	.81
10,000 V. D.C.					
CUB 100T5		.0005	11/16 x 1 7/8	1.50	.90
12,500 V. D.C.					
CUB 125T25		.00025	11/16 x 1 7/8	1.70	1.02

*Furnished as a "BUDROC" unit.



MOLDED MYLAR* TUBULARS

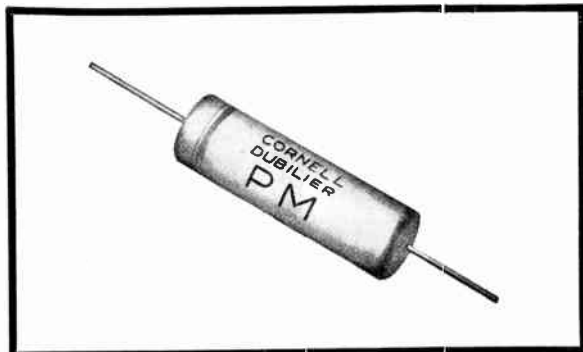

MYLAR* Polyester Film MOLDED TUBULAR CAPACITORS

Cornell-Dubilier's new PM SERIES of molded tubular capacitors are designed to meet the need for a rugged, high-temperature MOLDED unit. These are fabricated with the Du Pont Company's latest new dielectric material, "MYLAR" which maintains excellent electrical characteristics at temperatures up to +130°C. Over the temperature range of from -55°C to +100°C full rated voltage can be applied, and to +130°C voltage is derated only to 75%. Insulation resistance values are exceptionally high at any operating temperature and capacitance variation with thermal change is relatively small. The dielectric absorption and the power factor of the new capacitors is unusually low.

Non-inductive construction is employed with lead wires securely soldered to the extended foils, insuring low resistance connections and low radio frequency impedance. The durable thermosetting plastic case† construction holds copperweld lead wires and sections firmly in place to withstand extremes of handling, soldering temperatures, vibration and shock.

Standard sizes in 400, 600, 1000 and 1600 VDC ranges are listed in the accompanying table.

*DU PONT trade mark.
†Far metal-cased MYLAR tubulars—See Type TWM—Page 17.

TEMPERATURE RANGE: -55°C to +130°C.

PM Cat. No.	Cap. Mfd.	Dimensions—Inches Diameter x Length	List Price	Net Price
400 V. D.C.W.				
PM 451	.010	5/16 x 1	\$1.80	\$1.08
PM 4515	.015	3/8 x 1 1/4	1.80	1.08
PM 4522	.022	7/16 x 1 1/4	1.90	1.14
PM 4533	.033	7/16 x 1 1/4	1.90	1.14
PM 4547	.047	7/16 x 1 1/4	2.00	1.20
PM 4568	.068	1/2 x 1 1/2	2.10	1.26
PM 4P1	.10	1/2 x 1 1/2	2.30	1.38
PM 4P15	.15	5/8 x 1 5/8	2.40	1.44
PM 4P22	.22	5/8 x 1 7/8	2.50	1.50
PM 4P33	.33	11/16 x 1 15/16	2.70	1.62
PM 4P47	.47	3/4 x 2 1/4	2.90	1.74
PM 4P68	.68	1 x 2 1/8	3.30	1.98
PM 4W1	1.00	1 x 2 3/8	3.80	2.28
600 V. D.C.W.				
PM 6T5	.0005	5/16 x 1	1.80	1.08
PM 6D1	.0010	5/16 x 1	1.80	1.08
PM 6D15	.0015	5/16 x 1	1.80	1.08
PM 6D22	.0022	5/16 x 1	1.80	1.08
PM 6D33	.0033	5/16 x 1	1.80	1.08
PM 6D47	.0047	3/8 x 1 1/4	1.80	1.08
PM 6D68	.0068	3/8 x 1 1/4	1.80	1.08
PM 6S1	.010	3/8 x 1 1/4	1.90	1.14
PM 6S15	.015	3/8 x 1 1/4	1.90	1.14
PM 6S22	.022	7/16 x 1 1/4	2.00	1.20
PM 6S33	.033	7/16 x 1 1/4	2.10	1.26
PM 6S47	.047	7/16 x 1 1/4	2.30	1.38
PM 6S68	.068	9/16 x 1 5/8	2.40	1.44
PM 6P1	.10	5/8 x 1 7/8	2.50	1.50
PM 6P15	.15	11/16 x 1 15/16	2.70	1.62
PM 6P22	.22	3/4 x 2 1/4	2.90	1.74
PM 6P33	.33	1 x 2 1/8	3.30	1.98
PM 6P47	.47	1 x 2 3/8	3.80	2.28

PM Cat. No.	Cap. Mfd.	Dimensions—Inches Diameter x Length	List Price	Net Price
1600 V. D.C.W.				
PM 16D1	.0010	3/8 x 1 1/4	\$1.90	\$1.14
PM 16D15	.0015	3/8 x 1 1/4	1.90	1.14
PM 16D22	.0022	3/8 x 1 1/4	1.90	1.14
PM 16D33	.0033	3/8 x 1 1/4	2.00	1.20
PM 16D47	.0047	7/16 x 1 1/4	2.10	1.26
PM 16D68	.0068	1/2 x 1 1/2	2.10	1.26
PM 16S1	.010	1/2 x 1 1/2	2.20	1.32
PM 16S15	.015	1/2 x 1 1/2	2.30	1.38
PM 16S22	.022	5/8 x 1 5/8	2.40	1.44
PM 16S33	.033	5/8 x 1 5/8	2.50	1.50
PM 16S47	.047	11/16 x 1 15/16	2.70	1.62
PM 16S68	.068	3/4 x 2 1/4	3.00	1.80
PM 16P1	.10	1 x 2 1/8	3.50	2.10

"MINIROC"

MYLAR* Polyester Film

MINIATURE STEATITE-CASED CAPACITORS

(Identical in appearance to BUDROC — Illus. Page 15)

Cornell-Dubilier "MINIROC" type STM series capacitors are high quality tubular units in non-metallic (steatite) cases. They have exceptionally HIGH INSULATION RESISTANCE and are fully protected against moisture. Operating temperature ranges from -55°C. to 130°C. with no voltage derating required. These unusually fine characteristics are due to the use of MYLAR* Polyester Film dielectric, finest quality steatite cases, Polykane end-fill and C-D's painstaking processing. The C-D Polykane end-fill tightly bonds to the lead wires and steatite tubes preventing the entry of any moisture while at the same time locking the capacitor section and lead wires in place. Polykane will not soften, melt or flow at any operating temperature.

*DU PONT trade mark.

Temperature Range: -55°C to +130°C.

STM Cat. No.	Cap. Mfd.	Dimensions—Inches Diameter x Length	List Price	Net Price
100 V. D.C.W.				
STM 1D1	.001	.170 x 5/8	\$1.70	\$1.02
STM 1D15	.0015	.170 x 5/8	1.70	1.02
STM 1D22	.0022	.170 x 5/8	1.70	1.02
STM 1D33	.0033	.170 x 5/8	1.70	1.02
STM 1D47	.0047	.170 x 5/8	1.70	1.02
STM 1D68	.0068	.170 x 5/8	1.70	1.02
STM 1S1	.01	.170 x 5/8	1.70	1.02
STM 1S15	.015	.190 x 3/4	1.70	1.02
STM 1S22	.022	.190 x 1 1/16	1.70	1.02
STM 1S33	.033	1/4 x 1 1/16	1.70	1.02
STM 1S47	.047	1/4 x 1 1/16	1.80	1.08
STM 1S68	.068	5/16 x 1 1/16	1.90	1.14
STM 1P1	.10	5/16 x 1 1/16	2.10	1.26
400 V. D.C.W.				
STM 4D1	.001	.170 x 3/4	1.80	1.08
STM 4D15	.0015	.170 x 3/4	1.80	1.08
STM 4D22	.0022	.190 x 3/4	1.80	1.08
STM 4D33	.0033	.170 x 1 1/16	1.80	1.08
STM 4D47	.0047	.170 x 1 1/16	1.80	1.08
STM 4D68	.0068	.190 x 1 1/16	1.80	1.08
STM 4S1	.01	1/4 x 1 1/16	1.80	1.08
STM 4S15	.015	1/4 x 1 1/16	1.80	1.08
STM 4S22	.022	5/16 x 1 1/16	1.90	1.14
STM 4S33	.033	3/8 x 1 1/16	1.90	1.14
STM 4S47	.047	3/8 x 1 1/4	2.00	1.20
STM 4S68	.068	7/16 x 1 1/4	2.10	1.26
STM 4P1	.10	1/2 x 1 1/4	2.30	1.38
600 V. D.C.W.				
STM 6D1	.001	.170 x 3/4	1.80	1.08
STM 6D15	.0015	.190 x 3/4	1.80	1.08
STM 6D22	.0022	.190 x 1 1/16	1.80	1.08
STM 6D33	.0033	.190 x 1 1/16	1.80	1.08
STM 6D47	.0047	1/4 x 1 1/16	1.80	1.08
STM 6D68	.0068	1/4 x 1 1/16	1.80	1.08
STM 6S1	.01	5/16 x 1 1/16	1.90	1.14
STM 6S15	.015	5/16 x 1 1/16	1.90	1.14
STM 6S22	.022	3/8 x 1 1/16	2.00	1.20
STM 6S33	.033	3/8 x 1 1/4	2.10	1.26
STM 6S47	.047	7/16 x 1 1/4	2.30	1.38
STM 6S68	.068	1/2 x 1 1/2	2.40	1.44
STM 6P1	.10	5/16 x 1 1/2	2.50	1.50



"TINY-CHIEF" MOLDED PLASTIC CAPACITORS

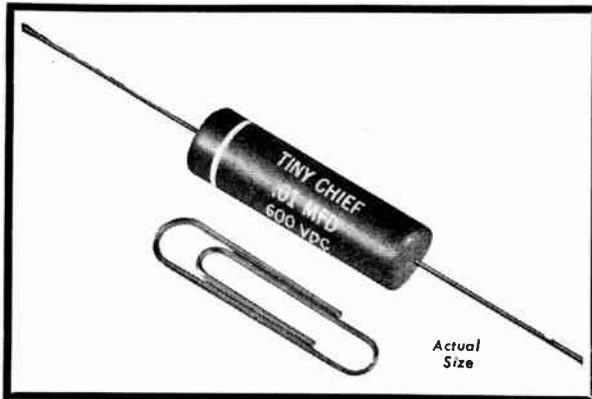

Cornell-Dubilier "TINY-CHIEFS" are small size all purpose capacitors molded in an extra hard thermosetting plastic which has all the qualities and electrical characteristics required for long lasting all-around satisfaction.

TEMPERATURE RANGE: $-40^{\circ}\text{C. to } +85^{\circ}\text{C.}$

PJ Cat. No.	Cap. Mfd.	Size—Inches Dia. & Length	List Price	Net Price
200 V. D.C.				
PJ 2S2	.02	$5/16 \times 1$	\$.25	\$.15
PJ 2S5	.05	$3/8 \times 1 1/4$.25	.15
PJ 2P1	.1	$7/8 \times 1 1/4$.35	.21
PJ 2P25	.25	$5/8 \times 1 3/8$.45	.27
PJ 2P5	.5	$5/8 \times 1 3/8$.60	.36
PJ 2W1	1.0	$3/4 \times 2 1/4$.90	.54
400 V. D.C.				
PJ 4S1	.01	$5/16 \times 1$.25	.15
PJ 4S2	.02	$3/8 \times 1 1/4$.25	.15
PJ 4S22	.022	$3/8 \times 1 1/4$.25	.15
PJ 4S47	.047	$7/8 \times 1 1/4$.30	.18
PJ 4S5	.05	$7/8 \times 1 1/4$.30	.18
PJ 4S68	.068	$7/8 \times 1 1/4$.35	.21
PJ 4P1	.1	$1/2 \times 1 1/2$.35	.21
PJ 4P15	.15	$5/8 \times 1 3/8$.35	.21
PJ 4P22	.22	$5/8 \times 1 3/8$.40	.24
PJ 4P25	.25	$3/4 \times 1 1/2$.45	.27
PJ 4P5	.5	$3/4 \times 2 1/4$.60	.36
PJ 4W1	1.0	$1 \times 2 3/4$.90	.54
600 V. D.C.				
PJ 6T25	.00025	$5/16 \times 1$.25	.15
PJ 6T5	.0005	$5/16 \times 1$.25	.15
PJ 6D1	.001	$5/16 \times 1$.25	.15
PJ 6D15	.0015	$5/16 \times 1$.25	.15
PJ 6D2	.002	$5/16 \times 1$.25	.15
PJ 6D22	.0022	$5/16 \times 1$.25	.15
PJ 6D3	.003	$5/16 \times 1$.25	.15
PJ 6D33	.0033	$5/16 \times 1$.25	.15
PJ 6D4	.004	$5/16 \times 1$.25	.15
PJ 6D47	.0047	$5/16 \times 1$.25	.15
PJ 6D5	.005	$5/16 \times 1$.25	.15
PJ 6D6	.006	$3/8 \times 1 1/4$.25	.15
PJ 6D68	.0068	$3/8 \times 1 1/4$.30	.18
PJ 6S1	.01	$3/8 \times 1 1/4$.30	.18
PJ 6S15	.015	$3/8 \times 1 1/4$.30	.18
PJ 6S2	.02	$7/8 \times 1 1/4$.30	.18
PJ 6S22	.022	$7/8 \times 1 1/4$.30	.18
PJ 6S25	.025	$7/8 \times 1 1/4$.30	.18
PJ 6S3	.03	$7/8 \times 1 1/4$.35	.21
PJ 6S4	.04	$1/2 \times 1 1/2$.35	.21
PJ 6S47	.047	$1/2 \times 1 1/2$.40	.24
PJ 6S5	.05	$1/2 \times 1 1/2$.40	.24
PJ 6S6	.06	$5/8 \times 1 3/8$.40	.24
PJ 6S68	.068	$5/8 \times 1 3/8$.40	.24
PJ 6P1	.1	$3/8 \times 1 3/8$.45	.27
PJ 6P25	.25	$3/4 \times 2 1/4$.55	.33
PJ 6P5	.5	$1 \times 2 3/4$.80	.48
1600 V. D.C.				
PJ 16D1	.001	$3/8 \times 1 1/4$.65	.39
PJ 16D15	.0015	$3/8 \times 1 1/4$.65	.39
PJ 16D2	.002	$3/8 \times 1 1/4$.65	.39
PJ 16D22	.0022	$3/8 \times 1 1/4$.65	.39
PJ 16D3	.003	$3/8 \times 1 1/4$.65	.39
PJ 16D33	.0033	$3/8 \times 1 1/4$.65	.39

METAL CASED DYKANOL PAPER CAPACITORS

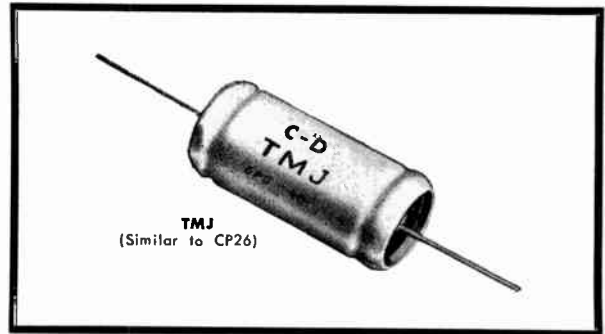

TYPE TMJ...4P

C-D type TMJ-4P is a non-magnetic metal-cased, ungrounded section, tubular paper capacitor, the body of which is covered with a non-hygrascopic plastic insulating tube. The unit is also available with a mounting strap* on request.

The TMJ is impregnated with Dykanol "C" (oil) and meets MIL-C-25A temperature characteristic "E".

STANDARD TOLERANCE: $\pm 20\%$

TEMPERATURE RANGE: $-55^{\circ}\text{C. to } +85^{\circ}\text{C.}$

TMJ Cat. No.	Cap. Mfd.	Body Dimensions Overall Dia. x Length	List Price	Net Price
600 VDCW				
TMJ 6D3-4P	.003	$1/2 \times 1 1/16$	\$1.30	\$.78
TMJ 6D6-4P	.006	$1/2 \times 1 1/16$	1.30	.78
TMJ 6S1-4P	.01	$1/2 \times 1 1/16$	1.30	.78
TMJ 6S2-4P	.02	$1/2 \times 1 1/16$	1.45	.87
TMJ 6S5-4P	.05	$1 1/16 \times 1 1/16$	1.55	.93
TMJ 6P1-4P	.10	$1 1/16 \times 2 1/16$	1.75	1.05
TMJ 6P25-4P	.25	$1 1/16 \times 2 1/16$	2.40	1.44
TMJ 6P5-4P	.50	$1 1/16 \times 2 1/16$	3.05	1.83
1000 VDCW				
TMJ 10D3-4P	.003	$1 1/16 \times 1 1/16$	1.55	.93
TMJ 10D6-4P	.006	$1 1/16 \times 1 1/16$	1.55	.93
TMJ 10S1-4P	.01	$1 1/16 \times 1 1/16$	1.55	.93
TMJ 10S2-4P	.02	$1 1/16 \times 1 1/16$	1.70	1.02
TMJ 10S5-4P	.05	$1 1/16 \times 1 1/16$	1.80	1.08
TMJ 10P1-4P	.10	$1 1/16 \times 2 1/16$	2.05	1.23
TMJ 10P25-4P	.25	$1 1/16 \times 2 1/16$	2.70	1.62
1600 VDCW				
TMJ 16D3-4P	.003	$1 1/16 \times 1 1/16$	1.70	1.02
TMJ 16D6-4P	.006	$1 1/16 \times 1 1/16$	1.70	1.02
TMJ 16S1-4P	.01	$1 1/16 \times 1 1/16$	1.70	1.02
TMJ 16S2-4P	.02	$1 1/16 \times 1 1/16$	1.80	1.08
TMJ 16S5-4P	.05	$1 1/16 \times 2 1/16$	1.95	1.17
TMJ 16P1-4P	.10	$1 1/16 \times 2 1/16$	2.55	1.53

*For unit with mounting strap, specify type as TMJ-6P (Ex. TMJ-6S1-6P).

PJ Cat. No.	Cap. Mfd.	Size—Inches Dia. & Length	List Price	Net Price
PJ 16D4	.004	$3/8 \times 1 1/4$	\$.65	\$.39
PJ 16D47	.0047	$3/8 \times 1 1/4$.65	.39
PJ 16D5	.005	$3/8 \times 1 1/4$.65	.39
PJ 16D55	.0055	$7/16 \times 1 1/4$.65	.39
PJ 16D6	.006	$7/16 \times 1 1/4$.65	.39
PJ 16D68	.0068	$7/16 \times 1 1/4$.65	.39
PJ 16D7	.007	$7/16 \times 1 1/4$.65	.39
PJ 16D75	.0075	$7/16 \times 1 1/4$.65	.39
PJ 16D8	.008	$7/16 \times 1 1/4$.65	.39
PJ 16S1	.01	$1/2 \times 1 1/2$.70	.42
PJ 16S15	.015	$1/2 \times 1 1/2$.70	.42
PJ 16S2	.02	$5/8 \times 1 3/8$.70	.42
PJ 16S25	.025	$5/8 \times 1 3/8$.70	.42
PJ 16S3	.03	$5/8 \times 1 3/8$.70	.42
PJ 16S4	.04	$5/8 \times 1 3/8$.70	.42



MINIATURE METAL-CASED TUBULARS "DEMICONS"

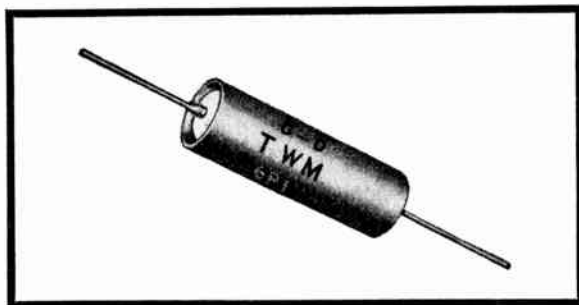
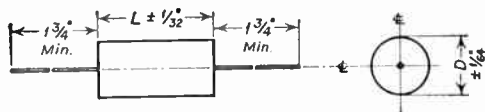

The Cornell-Dubilier series of "DEMICON" capacitors offer miniaturized tubular metal-cased units designed and processed to meet rigid and severe operating requirements particularly where space limitations are an important factor.

Unique and improved manufacturing processes have contributed to a product of unusual stability, dependability, and longevity, as attested to by field-test proven service over a long period of time.

Cornell-Dubilier DEMICONs are hermetically sealed in metal cases, with glass-to-metal seal terminals and are available in a wide variety of mounting styles, impregnants, tolerances, and internal construction. See Bulletins NB-147 and NB-151.

All Cornell-Dubilier DEMICONs will comply with applicable parts of Specifications JAN C-25 and MIL-C-25A.

The listings on this page cover the BASIC STYLE (illustrated) for types TWH, TWC, TWU, TWM.

STANDARD TOLERANCE: ± 20%.

TEMPERATURE RANGE:

TWH	High Temperature wax	— 40°C to + 85°C.
TWC	"Dykanol"	— 55°C to + 85°C.
TWU	"Dykanol U"	— 55°C to + 125°C.
TWM	"Mylar" polyester film	— 55°C to + 160°C.

PRICES shown below are for BASIC STYLE—UNGROUND.

*Registered Cornell-Dubilier trade mark.

**Registered Dupont trade mark.

"BASIC" STYLE UNGROUNDED

DEMICONS

TWH	Cat. No.	Cap. Mfd.	V.D.C.W.	Size—Inches Dia. x Length	List Price	Net Price
TWH 1D1	.001	100	.175 x 3/4	\$2.95	\$1.77	
TWH 1S1	.01	100	.175 x 3/4	3.00	1.80	
TWH 1P1	.1	100	.312 x 7/8	3.25	1.95	
TWH 1W1	1.0	100	.562 x 1 1/8	4.15	2.49	
TWH 2D1	.001	200	.235 x 3/4	3.05	1.83	
TWH 2S1	.01	200	.235 x 3/4	3.15	1.89	
TWH 2P1	.1	200	.312 x 7/8	3.40	2.04	
TWH 2W1	1.0	200	.562 x 1 1/8	4.25	2.55	
TWH 3D1	.001	300	.235 x 3/4	3.10	1.86	
TWH 3S1	.01	300	.235 x 3/4	3.20	1.92	
TWH 3P1	.1	300	.400 x 7/8	3.45	2.07	
TWH 3W1	1.0	300	.670 x 1 1/8	4.75	2.85	
TWH 4D1	.001	400	.235 x 3/4	3.15	1.89	
TWH 4S1	.01	400	.235 x 3/4	3.25	1.95	
TWH 4P1	.1	400	.400 x 1 1/8	3.50	2.10	
TWH 4W1	1.0	400	.750 x 2 1/8	5.00	3.00	

TWC	Cat. No.	Cap. Mfd.	V.D.C.W.	Size—Inches Dia. x Length	List Price	Net Price
TWC 1D1	.001	100	.175 x 3/4	\$3.30	\$1.98	
TWC 1S1	.01	100	.175 x 3/4	3.40	2.04	
TWC 1P1	.1	100	.312 x 7/8	3.70	2.22	
TWC 1W1	1.0	100	.562 x 1 1/8	4.85	2.91	
TWC 2D1	.001	200	.235 x 3/4	3.45	2.07	
TWC 2S1	.01	200	.235 x 3/4	3.55	2.13	
TWC 2P1	.1	200	.400 x 7/8	3.85	2.31	
TWC 2W1	1.0	200	.670 x 1 1/8	5.40	3.24	
TWC 3D1	.001	300	.235 x 3/4	3.50	2.10	
TWC 3S1	.01	300	.235 x 3/4	3.60	2.16	
TWC 3P1	.1	300	.400 x 1 1/8	3.90	2.34	
TWC 3W1	1.0	300	.750 x 2 1/8	5.75	3.45	
TWC 4D1	.001	400	.235 x 3/4	3.55	2.13	
TWC 4S1	.01	400	.235 x 3/4	3.65	2.19	
TWC 4P1	.1	400	.400 x 1 1/8	4.15	2.49	
TWC 4P68	.68	400	.750 x 2 1/8	5.75	3.45	
TWC 6D1	.001	600	.235 x 3/4	3.60	2.16	
TWC 6S1	.01	600	.312 x 7/8	3.75	2.25	
TWC 6P1	.1	600	.562 x 1 1/8	4.45	2.67	
TWC 6P47	.47	600	.750 x 2 1/8	5.80	3.48	
TWC 10D1	.001	1000	.400 x 7/8	4.10	2.46	
TWC 10S1	.01	1000	.400 x 7/8	4.25	2.55	
TWC 10P1	.1	1000	.562 x 1 1/8	5.00	3.00	
TWC 10P47	.47	1000	1.00 x 2 1/8	6.30	3.78	

DEMICONS

TWU	Cat. No.	Cap. Mfd.	V.D.C.W.	Size—Inches Dia. x Length	List Price	Net Price
TWU 1D1	.001	100	.175 x 3/4	\$4.13	\$2.48	
TWU 1S1	.01	100	.175 x 3/4	4.25	2.55	
TWU 1P1	.1	100	.312 x 7/8	4.63	2.78	
TWU 1W1	1.0	100	.562 x 1 1/8	6.06	3.64	
TWU 2D1	.001	200	.235 x 3/4	4.31	2.59	
TWU 2S1	.01	200	.235 x 3/4	4.44	2.66	
TWU 2P1	.1	200	.400 x 7/8	4.81	2.89	
TWU 2W1	1.0	200	.670 x 1 1/8	6.75	4.05	
TWU 3D1	.001	300	.235 x 3/4	4.38	2.63	
TWU 3S1	.01	300	.235 x 3/4	4.50	2.70	
TWU 3P1	.1	300	.400 x 1 1/8	4.88	2.93	
TWU 3W1	1.0	300	.750 x 2 1/8	7.19	4.31	
TWU 4D1	.001	400	.235 x 3/4	4.44	2.66	
TWU 4S1	.01	400	.235 x 3/4	4.56	2.74	
TWU 4P1	.1	400	.400 x 1 1/8	5.19	3.11	
TWU 4P68	.68	400	.750 x 2 1/8	7.19	4.31	
TWU 6D1	.001	600	.235 x 3/4	4.50	2.70	
TWU 6S1	.01	600	.312 x 7/8	4.69	2.81	
TWU 6P1	.1	600	.562 x 1 1/8	5.56	3.34	
TWU 6P47	.47	600	.750 x 2 1/8	7.25	4.35	
TWU 10D1	.001	1000	.400 x 7/8	5.13	3.08	
TWU 10S1	.01	1000	.400 x 7/8	5.31	3.19	
TWU 10P1	.1	1000	.562 x 1 1/8	6.25	3.75	
TWU 10P47	.47	1000	1.000 x 2 1/8	7.88	4.73	

TWM	Cat. No.	Cap. Mfd.	V.D.C.W.	Size—Inches Dia. x Length	List Price	Net Price
TWM 1S1	.01	100	.235 x 7/8	\$5.95	\$3.57	
TWM 1S22	.022	100	.312 x 7/8	6.10	3.66	
TWM 1S47	.047	100	.312 x 7/8	6.30	3.78	
TWM 1P1	.1	100	.400 x 7/8	6.50	3.90	
TWM 4D22	.0022	400	.235 x 7/8	6.20	3.72	
TWM 4S1	.01	400	.312 x 7/8	6.40	3.84	
TWM 4P1	.1	400	.562 x 1	7.25	4.35	
TWM 4W1	1.0	400	.750 x 2 1/2	10.50	6.30	
TWM 6D22	.0022	600	.235 x 7/8	6.30	3.78	
TWM 6S1	.01	600	.312 x 1	6.55	3.93	
TWM 6P1	.1	600	.562 x 1 1/8	7.80	4.68	
TWM 6W1	1.0	600	1.000 x 2 11/16	12.75	7.65	



DYKANOL TRANSMITTING CAPACITORS

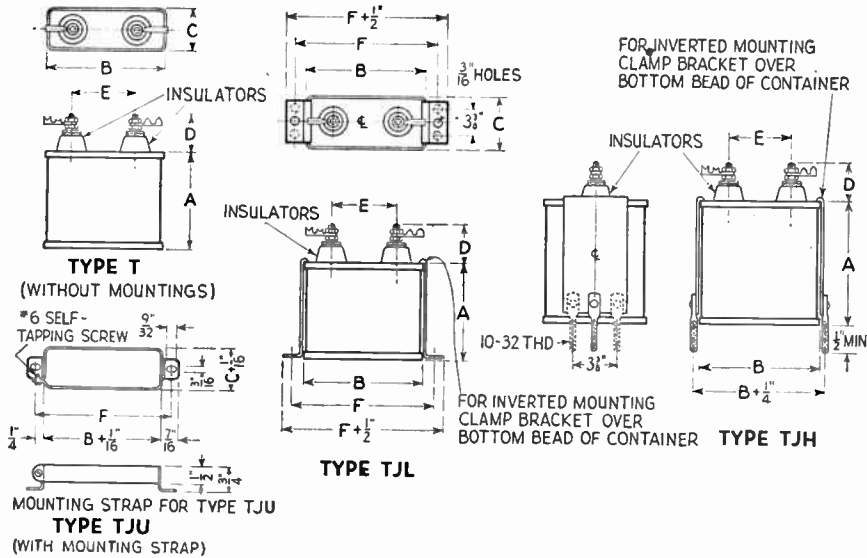

Prices below include mounting brackets or universal mounting strap when ordered according to these type numbers.

TYPE DESIGNATIONS—Type T (basic units) are without mountings. To order Types TJH, TJL or TJU with mountings as shown above, add letter symbols of type mountings desired to Cat. No. as follows:

TYPE T—(Basic unit) without mountings.

TYPE TJH—With screw spode-lug brackets.

TYPE TJL—With mounting foot brackets.

TYPE TJU—With universal mounting strap.

Prices below include mounting brackets or universal mounting strap when ordered according to these type numbers.

TEMPERATURE RANGE: -55°C to +85°C. STANDARD TOLERANCE: ±10%.

T Cat. No.	Cap. Mfd.	Dimensions—Inches						List Price	Net Price
		A	B	C	D	E	F		
600 V. D.C. Working									
T 6003	.5	2 1/4	1 1/4	1 1/4	3/4	1 1/4	2 1/4	\$4.70	\$2.82
T 6010	1	2 1/4	1 1/4	1 1/4	3/4	1 1/4	2 1/4	5.80	3.48
T 6020	2	2 1/4	1 1/4	1 1/4	3/4	1 1/4	2 1/4	7.15	4.29
T 6030	3	3 3/4	2 1/4	1 1/4	3/4	1 1/4	2 1/4	8.25	4.93
T 6040	4	3 3/4	2 1/4	1 1/4	3/4	1 1/4	2 1/4	9.10	5.27
T 6050	5	4 3/4	2 1/4	1 1/4	3/4	1 1/4	2 1/4	10.45	6.46
T 6060	6	4 3/4	2 1/4	1 1/4	3/4	1 1/4	2 1/4	11.30	6.78
T 6080	8	3 1/4	3 3/4	1 1/4	3/4	2	4 3/4	13.50	8.10
T 6100	10	4 3/4	3 3/4	1 1/4	3/4	2	4 3/4	15.15	9.09
1000 V. D.C. Working									
T 10001	.1	2	1 1/4	1 1/4	3/4	1 1/4	2 1/4	4.15	2.49
T 10002.5	.25	2 1/4	1 1/4	1 1/4	3/4	1 1/4	2 1/4	4.70	2.82
T 10005	.5	2 1/4	1 1/4	1 1/4	3/4	1 1/4	2 1/4	4.95	2.97
T 10010	1	2 1/4	1 1/4	1 1/4	3/4	1 1/4	2 1/4	6.35	3.81
T 10020	2	4	1 1/4	1 1/4	3/4	1 1/4	2 1/4	8.25	4.93
T 10030	3	3 1/4	2 1/4	1 1/4	3/4	1 1/4	3	9.65	5.79
T 10040	4	4 3/4	2 1/4	1 1/4	3/4	1 1/4	3	10.45	6.27
T 10050	5	3 1/4	3 3/4	1 1/4	3/4	2	4 3/4	12.65	7.59
T 10060	6	4 3/4	3 3/4	1 1/4	3/4	2	4 3/4	14.05	8.43
T 10080	8	4 3/4	3 3/4	1 1/4	3/4	2	4 3/4	15.15	9.09
T 10100	10	4 3/4	3 3/4	1 1/4	3/4	2	4 3/4	16.80	10.08
T 10120	12	3 1/4	3 3/4	2 1/4	3/4	2	4 3/4	18.15	10.89
T 10150	15	4 3/4	3 3/4	2 1/4	3/4	2	4 3/4	20.10	12.06
1500 V. D.C. Working									
T 15005	.5	2 3/4	1 1/4	1 1/4	3/4	1 1/4	2 1/4	6.35	3.81
T 15010	1	4	1 1/4	1 1/4	3/4	1 1/4	2 1/4	7.45	4.47
T 15020	2	4 1/2	2 1/4	1 1/4	3/4	1 1/4	3	10.20	6.12
T 15030	3	4 3/4	2 1/4	1 1/4	3/4	1 1/4	3	12.40	7.44
T 15040	4	4 3/4	3 3/4	1 1/4	3/4	2	4 3/4	14.05	8.43
T 15050	5	4 3/4	3 3/4	1 1/4	3/4	2	4 3/4	15.15	9.09
T 15060	6	4 3/4	3 3/4	1 1/4	3/4	2	4 3/4	17.05	10.23
T 15080	8	4 3/4	3 3/4	2 1/4	3/4	2	4 3/4	20.90	12.54
*T 15100	10	4 3/4	3 3/4	3 3/4	3/4	2	4 3/4	25.05	15.03
*T 15120	12	4 3/4	3 3/4	3 3/4	3/4	2	4 3/4	27.25	16.33
*T 15150	15	4 3/4	3 3/4	4 3/4	3/4	2	4 3/4	30.00	18.00

T Cat. No.	Cap. Mfd.	Dimensions—Inches						List Price	Net Price
		A	B	C	D	E	F		
2000 V. D.C. Working									
T 20001	.1	2 1/4	1 1/4	1 1/4	3/4	1 1/4	2 1/4	\$6.60	\$3.96
T 20002.5	.25	2 1/4	1 1/4	1 1/4	3/4	1 1/4	2 1/4	7.15	4.29
T 20005	.5	2 1/4	1 1/4	1 1/4	3/4	1 1/4	2 1/4	7.45	4.47
T 20010	1	3 3/4	2 1/4	1 1/4	3/4	1 1/4	2 1/4	9.10	5.46
T 20020	2	4	3 3/4	1 1/4	3/4	2	4 3/4	10.75	6.43
T 20030	3	4 3/4	3 3/4	1 1/4	3/4	2	4 3/4	13.20	7.92
T 20040	4	3 1/4	3 3/4	2 1/4	3/4	2	4 3/4	15.15	9.09
T 20050	5	4 3/4	3 3/4	2 1/4	3/4	2	4 3/4	16.80	10.08
*T 20060	6	4 3/4	3 3/4	3 3/4	3/4	2	4 3/4	20.10	12.06
*T 20080	8	4 3/4	3 3/4	3 3/4	3/4	2	4 3/4	25.05	15.03
*T 20100	10	4 3/4	3 3/4	4 3/4	3/4	2	4 3/4	30.55	18.33
*T 20120	12	5 3/4	3 3/4	4 3/4	3/4	2	4 3/4	33.30	19.98
2500 V. D.C. Working									
T 25005	.5	3 1/4	3 3/4	1 1/4	3/4	2	4 3/4	11.55	6.93
T 25010	1	3 3/4	3 3/4	1 1/4	3/4	2	4 3/4	13.20	7.92
T 25020	2	4 3/4	3 3/4	1 1/4	3/4	2	4 3/4	21.45	12.87
*T 25040	4	4	3 3/4	4 3/4	3/4	2	4 3/4	30.00	18.00
*T 25100A	10	6 3/4	3 3/4	4 3/4	3/4	2	4 3/4	75.10	43.06
3000 V. D.C. Working									
T 30001	.1	2	2 1/4	1 1/4	1 1/4	1 1/4	3	14.05	8.43
T 30002.5	.25	2 1/4	2 1/4	1 1/4	1 1/4	1 1/4	3	14.85	8.91
T 30005	.5	3 3/4	2 1/4	1 1/4	1 1/4	1 1/4	3	16.80	10.08
T 30010	1	3 1/4	3 3/4	2 1/4	1 1/4	2	4 3/4	20.10	12.06
*T 30020	2	4 1/4	3 3/4	3 3/4	1 1/4	2	4 3/4	25.05	15.03
*T 30040	4	4 3/4	3 3/4	4 3/4	3/4	2	4 3/4	36.85	22.11
4000 V. D.C. Working									
T 40001	.1	2 3/4	3 3/4	2 1/4	2	2	4 3/4	18.00	10.80
T 40002.5	.25	2 3/4	3 3/4	2 1/4	2	2	4 3/4	20.00	12.00
T 40005	.5	4	3 3/4	2 1/4	2	2	4 3/4	23.00	13.80
T 40010	1	5	3 3/4	2 1/4	2	2	4 3/4	29.00	17.40
*T 40020	2	5	3 3/4	4 3/4	2	2	4 3/4	39.00	23.40
*T 40040A	4	8	3 3/4	4 3/4	2	1 3/4	4 3/4	66.85	40.11
5000 V. D.C. Working									
T 50005	.5	4 1/4	3 3/4	2 1/4	2	2	4 3/4	25.00	15.00
*T 50010	1	4 1/4	3 3/4	4 3/4	2	2	4 3/4	34.00	20.40
*T 50020	2	6	3 3/4	4 3/4	2	2	4 3/4	52.00	31.20
6000 V. D.C. Working									
T 60001	.1	3 3/4	3 3/4	2 1/4	2	1 3/4	4 3/4	27.00	16.20
*T 60010A	1	8	3 3/4	4 3/4	2	1 3/4	4 3/4	49.00	29.40

NOTES—* Type TJU units are not furnished in these larger sizes.
 † Types TJL and TJH units furnished with two mounting holes or spade lugs 3/4" apart. All other units furnished with a single mounting hole or spade lug centered on each bracket.

For higher voltage units, from 6,000 to 25,000 v.d.c., write for data and prices on Type TK capacitors.

★ When JAN-C-25 units must be supplied, order according to specific CP type designations listed in C-D Paper Capacitor Catalog No. 400.

CORNELL



DUBILIER

COMPACT METALIZED-PAPER CAPACITORS

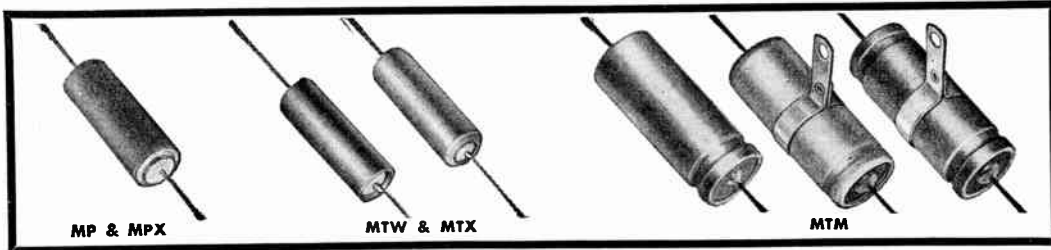

Cornell-Dubilier self-healing, metalized paper capacitors have better electrical characteristics and extra long service life. Units are light and compact.

"PUP" units have bare wire leads securely anchored in metal end-caps, wax-impregnated and dip-sealed against humidity. All units are extended foil—non-inductive wound for low impedance at high frequencies, have high insulation resistance, low power factor and small capacity change with temperature and life.

"METAPUPS" are one piece metal tubular cased, pressure sealed by spin-over on synthetic rubber gaskets.

"SEALPUPS" are a high quality metalized paper capacitor, designed for smallest size and positive seal against moisture. They are hermetically sealed in metal cases with solder—seal glass terminals. Especially recommended in military and commercial equipment where miniature size and light weight are paramount.

For further data on C-D metalized capacitors, write for Bulletins 142-3-4 and NB-152.

TEMPERATURE RANGE: -40°C to $+60^{\circ}\text{C}$.

"PUP" METAL END-CAP CARDBOARD TUBULARS

MP	Cat. No.	Cap. Mfd.	Voltage DCW	Size—Inches Diam. x Length	List Price	Net Price
MP 2S5		.05	200	$\frac{3}{8} \times \frac{5}{8}$	\$.65	\$3.39
MP 2P1		.1	200	$\frac{3}{8} \times \frac{5}{8}$.70	.42
MP 2P25		.25	200	$1\frac{1}{2} \times \frac{5}{8}$.90	.54
MP 2P5		.5	200	$1\frac{1}{2} \times 1\frac{1}{8}$	1.05	.63
MP 2W1		1.0	200	$\frac{9}{16} \times 1\frac{1}{8}$	1.30	.78
MP 2W2		2.0	200	$\frac{5}{8} \times 1\frac{3}{8}$	1.80	1.08
MP 4S5		.05	400	$1\frac{1}{2} \times \frac{5}{8}$.70	.42
MP 4P1		.1	400	$1\frac{1}{2} \times 1\frac{1}{8}$.80	.48
MP 4P25		.25	400	$\frac{9}{16} \times 1\frac{1}{8}$	1.00	.60
MP 4P5		.5	400	$\frac{5}{8} \times 1\frac{3}{8}$	1.15	.69
MP 4W1		1.0	400	$2\frac{3}{16} \times 2\frac{1}{8}$	1.60	.96
MP 6S1		.01	600	$\frac{3}{8} \times \frac{5}{8}$.70	.42
MP 6P1		.1	600	$1\frac{1}{2} \times 1\frac{1}{8}$.90	.54
MP 6P25		.25	600	$\frac{5}{8} \times 1\frac{1}{8}$	1.10	.66
MP 6P5		.5	600	$2\frac{3}{16} \times 1\frac{3}{8}$	1.45	.87
MP 6W1		1.0	600	$2\frac{3}{16} \times 2\frac{1}{8}$	1.80	1.08

TEMPERATURE RANGE: -55°C to $+95^{\circ}\text{C}$.

"METAPUP" ONE-PIECE METAL TUBULARS STYLE A (Ungrounded)

MTM	Cat. No.	Cap. Mfd.	Voltage DCW	Size—Inches Diam. x Length	* List Price	Net Price
MTM 2S5		.05	200	$\frac{3}{8} \times 1\frac{1}{16}$	\$1.90	\$1.14
MTM 2P1		.1	200	$\frac{7}{16} \times 1\frac{1}{16}$	1.95	1.17
MTM 2P25		.25	200	$\frac{1}{2} \times 1\frac{1}{16}$	2.10	1.26
MTM 2P5		.5	200	$\frac{1}{2} \times 1\frac{1}{4}$	2.20	1.32
MTM 2W1		1.0	200	$\frac{5}{8} \times 1\frac{7}{16}$	2.60	1.56
MTM 2W2		2.0	200	$\frac{5}{8} \times 1\frac{15}{16}$	3.10	1.86
MTM 4S5		.05	400	$\frac{7}{16} \times 1\frac{1}{16}$	1.95	1.17
MTM 4P1		.1	400	$\frac{7}{16} \times 1\frac{1}{4}$	2.10	1.26
MTM 4P25		.25	400	$\frac{3}{8} \times 1\frac{1}{4}$	2.30	1.38
MTM 4P5		.5	400	$\frac{5}{8} \times 1\frac{15}{16}$	2.50	1.50
MTM 4W1		1.0	400	$\frac{3}{4} \times 2\frac{7}{16}$	3.00	1.80
MTM 4W2		2.0	400	$1 \times 2\frac{7}{16}$	4.10	2.46
MTM 6S1		.01	600	$\frac{3}{8} \times 1\frac{1}{16}$	1.90	1.14
MTM 6P1		.1	600	$\frac{1}{2} \times 1\frac{7}{16}$	2.20	1.32
MTM 6P25		.25	600	$\frac{5}{8} \times 1\frac{1}{8}$	2.50	1.50
MTM 6P5		.5	600	$\frac{3}{4} \times 1\frac{15}{16}$	2.90	1.74
MTM 6W1		1.0	600	$1\frac{1}{8} \times 2\frac{7}{16}$	3.50	2.10
MTM 6W2		2.0	600	$1\frac{1}{4} \times 2\frac{7}{16}$	4.50	2.70

*DEDUCT 50¢ from List Price for Basic GROUNDED style.

TEMPERATURE RANGE: -55°C to $+95^{\circ}\text{C}$.

"SEALPUP" GLASS-METAL END-SEALED TUBULARS STYLE A (Ungrounded)

MTW	Cat. No.	Cap. Mfd.	Voltage DCW	Size—Inches Diam. x Length	* List Price	Net Price
MTW 2S5		.05	200	.235 x $\frac{3}{4}$	\$3.35	\$2.01
MTW 2P1		.1	200	.312 x $\frac{3}{4}$	3.45	2.07
MTW 2P25		.25	200	.312 x $1\frac{1}{16}$	3.90	2.34
MTW 2P5		.5	200	.400 x $1\frac{1}{16}$	4.50	2.70
MTW 2W1		1.0	200	.562 x $1\frac{1}{4}$	5.20	3.12
MTW 2W15		1.5	200	.562 x $1\frac{3}{4}$	5.90	3.54
MTW 2W2		2.0	200	.562 x $1\frac{3}{4}$	7.30	4.38
MTW 4S5		.05	400	.400 x $\frac{3}{4}$	3.60	2.16
MTW 4P1		.1	400	.400 x $1\frac{1}{16}$	3.80	2.28
MTW 4P25		.25	400	.562 x $1\frac{1}{16}$	4.45	2.67
MTW 4P5		.5	400	.562 x $1\frac{3}{4}$	5.35	3.21
MTW 4W1		1.0	400	.670 x $2\frac{1}{4}$	6.15	3.69
MTW 6S1		.01	600	.312 x $\frac{3}{4}$	3.40	2.04
MTW 6P1		.1	600	.500 x $1\frac{1}{4}$	4.15	2.49
MTW 6P25		.25	600	.670 x $1\frac{3}{8}$	5.00	3.00
MTW 6P5		.5	600	.750 x $1\frac{3}{4}$	6.35	3.81
MTW 6W1		1.0	600	.750 x $2\frac{1}{4}$	7.20	4.32

*DEDUCT 50¢ from List Price for Basic GROUNDED style.

CORNELL DUBILIER



HIGH TEMPERATURE Metalized-Paper CAPACITORS

- **POLYKANE-IMPREGNATED:** This impregnant insures excellent electrical properties over long service life.
- **MOISTURE RESISTANT:** MTX tubulars have the finest glass-to-metal solder seal terminals for maximum protection against moisture. MPX tubulars have POLYKANE-impregnated paper tubes, bonded securely to the POLYKANE fill. An external flash wax dip provides an increased moisture seal for extra long storage and service conditions under extremes of humidity.
- **NON-LEAKING:** "POLYKANE" is a solid thermosetting plastic that will not soften, crack, or leak at the maximum temperature. No oil or wax is used internally with these units.

MPX†—HIGH TEMPERATURE Paper-Cased TUBULARS

STANDARD TOLERANCE: ± 40 —20% to 1 mfd.
 ± 30 —20% over 1 mfd.
 TEMP. RANGE: —55°C to +130°C

MPX Cat. No.	Cap. Mfd.	Voltage DCW	Size—Inches Dia. x Length	List Price	Net Price
MPX 2S5	.05	200	1/4 x 13/16	\$1.60	\$.96
MPX 2P1	.10	200	5/16 x 13/16	1.75	1.05
MPX 2P25	.25	200	13/16 x 13/16	2.00	1.20
MPX 2P5	.50	200	13/16 x 1 1/8	2.50	1.50
MPX 2W1	1.0	200	3/8 x 1 3/16	3.00	1.80
MPX 2W2	2.0	200	3/8 x 1 1/2	4.00	2.40
MPX 4S5	.05	400	3/8 x 13/16	1.65	.99
MPX 4P1	.10	400	3/8 x 1 1/8	1.80	1.08
MPX 4P25	.25	400	3/8 x 1 3/16	2.10	1.26
MPX 4P5	.50	400	3/8 x 1 1/2	2.85	1.71
MPX 4W1	1.0	400	1 1/16 x 1 7/8	3.50	2.10
MPX 4W2	2.0	400	3/8 x 2 3/8	5.50	3.30
MPX 6S1	.01	600	1/4 x 13/16	1.45	.87
MPX 6P1	.10	600	1/4 x 1 1/8	1.90	1.14
MPX 6P25	.25	600	3/8 x 1 3/16	2.25	1.35
MPX 6P5	.50	600	13/16 x 1 1/2	3.00	1.80
MPX 6W1	1.0	600	13/16 x 1 7/8	4.00	2.40
MPX 6W2	2.0	600	1 x 2 3/8	6.00	3.60

†For High Temperature Metalized Paper Capacitors in "BATHUB" TYPE cases (Type SBX)—See Bulletin NB-152.

MTX†—HIGH TEMPERATURE Metal-Cased TUBULARS

STYLE BASIC (Ungrounded)
 STANDARD TOLERANCE: ± 40 —20% to 1 mfd.
 ± 30 —20% over 1 mfd.
 TEMP. RANGE: —55°C to +130°C

MTX Cat. No.	Cap. Mfd.	Voltage DCW	Size—Inches Diam. x Length	List Price	Net Price
MTX 2S5	.05	200	.235 x 13/16	\$3.90	\$2.34
MTX 2P1	.10	200	.312 x 13/16	3.95	2.37
MTX 2P25	.25	200	.312 x 1 1/8	4.50	2.70
MTX 2P5	.50	200	.400 x 1 1/8	5.20	3.12
MTX 2W1	1.0	200	.562 x 1 1/8	6.00	3.60
MTX 2W15	1.5	200	.562 x 1 13/16	6.75	4.05
MTX 2W2	2.0	200	.562 x 1 13/16	7.50	4.50
MTX 4S5	.05	400	.312 x 13/16	4.10	2.46
MTX 4P1	.10	400	.400 x 1 1/8	4.35	2.61
MTX 4P25	.25	400	.500 x 1 1/8	5.15	3.09
MTX 4P5	.50	400	.562 x 1 13/16	6.20	3.72
MTX 4W1	1.0	400	.670 x 2 3/16	7.50	4.50
MTX 6S1	.01	600	.312 x 13/16	3.85	2.31
MTX 6P1	.10	600	.400 x 1 1/8	4.80	2.88
MTX 6P25	.25	600	.562 x 1 13/16	5.75	3.45
MTX 6P5	.50	600	.670 x 1 13/16	7.25	4.35
MTX 6W1	1.0	600	.750 x 2 3/16	9.10	5.46

‡Other Styles available—See Bulletins NB-142, 3, 4 and NB-152.
 *DEDUCT 50¢ from List for Basic GROUNDED style.

"Super MICADON"

ENCAPSULATED Molded-Case MIDGET MICA CAPACITORS

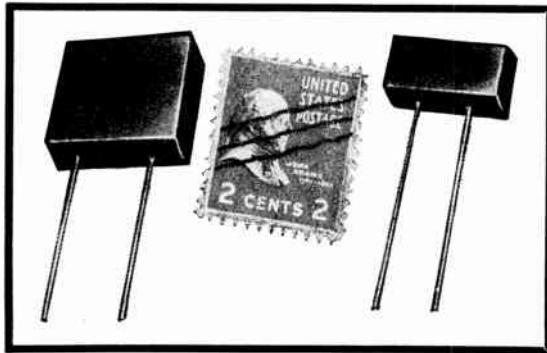

Cornell-Dubilier "SUPER MICADONS" represent an entirely new conception in Midget Mica Capacitor construction. The vastly improved design and construction of the new "SUPER MICADONS" (Types 1A and 5A) now makes it possible to produce miniature units of greatly increased capacitance and superior quality over conventional units of the same case size. SEE ENG. BULL. 155 FOR DETAILED DATA AND COMPLETE LISTINGS.

TYPE 1A

STD. TOL.: $\pm 5\%$ †. TEMP. RANGE: —55°C to +130°C.

Cat. No.	Cap. Mfds.	VDCW	List Price	Net Price
1A5D31	.0051	500	\$2.40	\$1.44
1A5D68	.0068	500	2.65	1.59
1A5D82	.0082	500	2.65	1.59
1A5S1	.01	500	2.65	1.59
1A5S15	.015	500	3.45	2.07
1A3S2	.02	300	4.00	2.40

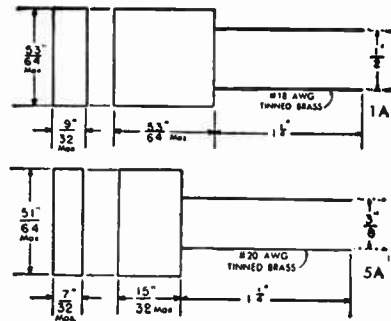

TYPE 5A

STD. TOL.: $\pm 5\%$ (or 1 MMFD., whichever is greater)†
 TEMP. RANGE: —55°C to +130°C

Cat. No.	Cap. Mfds.	VDCW	List Price	Net Price
5A5V5	.000005	500	\$.40	\$.36
5A5Q20	.00002	500	.40	.36
5A5Q33	.000033	500	.40	.36
5A5Q51	.000051	500	.40	.36
5A5T1	.0001	500	.40	.36
5A5T24	.00024	500	.40	.36
5A5T39	.00039	500	.70	.42
5A5T51	.00051	500	.75	.45
5A5T75	.00075	500	1.00	.60
5A5D1	.001	500	1.25	.75
5A5D15	.0015	500	1.70	1.02
5A5D2	.002	500	1.90	1.14
5A5D3	.003	500	2.40	1.44
5A3D39	.0039	300	2.50	1.50
5A3D51	.0051	300	2.65	1.59

† Tolerances to $\pm 1/2$ of 1% available on request. ‡ For $\pm 2\%$ Tol.—add 15% to List Price. For $\pm 1\%$ Tol.—add 25% to List Price. For $\pm 1/2$ of 1% Tol.—add 50% to List Price.

CORNELL



DUBILIER

MOLDED MIDGET "SILVER-MIKE" CAPACITORS

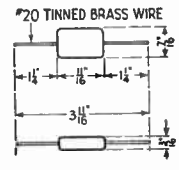
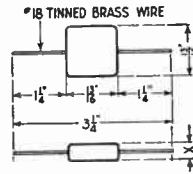
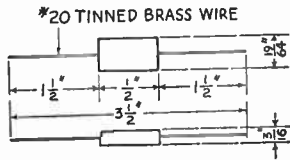
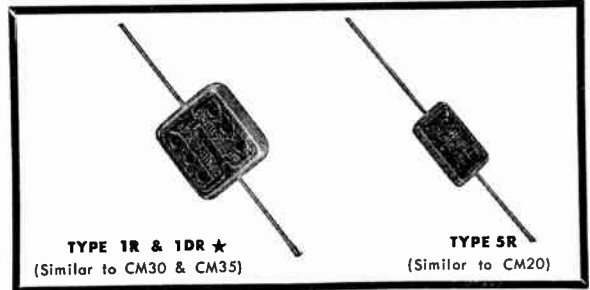
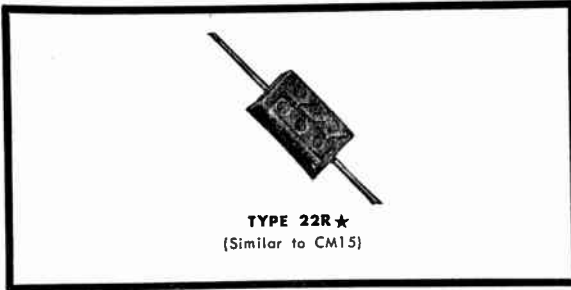

HIGH-STABILITY "SILVER-MIKE"★ UNITS

Type 22R miniature "Silver-Mike" capacitors are especially adapted for use in circuits where accuracy and stability of capacity is of prime importance. They are rated at 500 volts D.C.W. and tested at 1,000 volts D.C., molded in low-loss red plastic and fully protected against physical damage or changes in characteristics due to varying atmospheric conditions.

STANDARD TOLERANCE ±5%, but in no instance less than ±1mmf. For capacity Tolerance of: 20% deduct 10% from List; 10% deduct 5% from List; 3% add 10% to List; 2% add 15% to List; 1% add 25% to List.

TYPE 22R

22R	Cat. No.	Cap. Mfd.	List Price	Net Price
22R 5V2		.000002	\$.40	\$.24
22R 5V5		.000005	.40	.24
22R 5Q1		.00001	.40	.24
22R 5Q12		.000012	.40	.24
22R 5Q15		.000015	.40	.24
22R 5Q18		.000018	.40	.24
22R 5Q2		.00002	.40	.24
22R 5Q22		.000022	.40	.24
22R 5Q24		.000024	.40	.24
22R 5Q25		.000025	.40	.24
22R 5Q27		.000027	.40	.24
22R 5Q3		.00003	.40	.24
22R 5Q33		.000033	.40	.24
22R 5Q36		.000036	.40	.24
22R 5Q39		.000039	.40	.24
22R 5Q4		.00004	.40	.24
22R 5Q43		.000043	.40	.24
22R 5Q47		.000047	.40	.24
22R 5Q5		.00005	.40	.24
22R 5Q51		.000051	.40	.24
22R 5Q56		.000056	.40	.24
22R 5Q62		.000062	.40	.24
22R 5Q68		.000068	.40	.24
22R 5Q7		.00007	.40	.24
22R 5Q75		.000075	.40	.24
22R 5Q82		.000082	.40	.24
22R 5Q91		.000091	.40	.24
22R 5T1		.0001	.45	.27
22R 5T11		.00011	.45	.27
22R 5T12		.00012	.45	.27
22R 5T13		.00013	.45	.27
22R 5T15		.00015	.45	.27
22R 5T16		.00016	.45	.27
22R 5T18		.00018	.45	.27
22R 5T2		.0002	.45	.27
22R 5T22		.00022	.45	.27
22R 5T24		.00024	.45	.27
22R 5T25		.00025	.45	.27

Notes On Ordering 5R, 1R, 1DR Units

Standard capacity tolerance is 5%. Also available, on special order, in tolerance ratings of plus or minus 3%, add 10% to list prices, 2% add 15% to list prices and 1% add 25% to list prices, (or within 1 mmfd.—whichever is greater). All types can also be supplied in plus or minus 10% and 20% tolerances at lower prices.

*Reg. U.S. Pat. Off.

TYPE 1R - X- $\frac{1}{4}$ " THICK
TYPE 1DR - X- $\frac{1}{8}$ " THICK

TYPE 1R & 1DR

TYPE 5R

Types 1R, 1DR, and 5R "Silver-Mike" silvered mica capacitors are designed for use in high Q electronic circuits where frequency stability and minimum loss must be maintained. They are ideally suited for use in circuits where the LC product must be maintained constant, and particularly adapted for use in tuning IF transformers, push-button tuning circuits and other similar applications. Standard units are molded in low-loss red plastic.

Cap. Mfd.	500 V. D.C. W.—1000 V. D.C. T.			List Price	Net Price
	Type 5R Cat. No.	Type 1R Cat. No.	Type 1DR Cat. No.		
.00027	5R 5T27			\$.55	\$.33
.0003	5R 5T3			.55	.33
.00033	5R 5T33			.65	.39
.00036	5R 5T36			.65	.39
.00039	5R 5T39			.65	.39
.0004	5R 5T4			.70	.42
.00043	5R 5T43			.70	.42
.00047	5R 5T47			.70	.42
.0005	5R 5T5			.70	.42
.00051	5R 5T51			.85	.51
.00056		1R 5T56		.85	.51
.0006		1R 5T6		.85	.51
.00062		1R 5T62		.85	.51
.00068		1R 5T68		.85	.51
.0007		1R 5T7		.85	.51
.00075		1R 5T75		.95	.57
.0008		1R 5T8		.95	.57
.00082		1R 5T82		.95	.57
.0009		1R 5T9		1.00	.60
.00091		1R 5T91		1.00	.60
.001		1R 5D1		1.10	.66
.0011		1R 5D11		1.10	.66
.0012		1R 5D12		1.35	.81
.0013		1R 5D13		1.35	.81
.0015		1R 5D15		1.35	.81
.0016		1R 5D16		1.35	.81
.0018		1R 5D18		1.35	.81
.002		1R 5D2		1.35	.81
.0022		1R 5D22		1.80	1.08
.0024		1R 5D24		1.80	1.08
.0025		1R 5D25		1.80	1.08
.0027		1R 5D27		2.05	1.23
.003		1R 5D3		2.05	1.23
.0033		1R 5D33		2.05	1.23
.0036		1R 5D36		2.15	1.29
.0039		1R 5D39		2.15	1.29
.004		1R 5D4		2.15	1.29
.0043		1R 5D43		2.15	1.29
.0047		1R 5D47		2.25	1.35
.005		1DR 5D5		2.25	1.35
.0051		1DR 5D51		2.25	1.35
.0056		1DR 5D56		2.25	1.35
.0062		1DR 5D62		2.25	1.35
	300 V. D.C. W.—600 V. D.C. T.				
.0068		1DR 3D68		2.50	1.50
.007		1DR 3D7		2.50	1.50
.0075		1DR 3D75		2.50	1.50
		1DR 3D8		2.50	1.50
.008		1DR 3D82		2.50	1.50
.0082		1DR 3D9		2.50	1.50
.009		1DR 3D91		2.50	1.50
.0091		1DR 351		2.50	1.50
.01					

*When JAN-C-5 units must be supplied, order according to specific CM type designations listed in C-D Mica Bulletin—Series 422.



"TINMIKE" GENERAL PURPOSE Miniature DISC Ceramic Capacitors

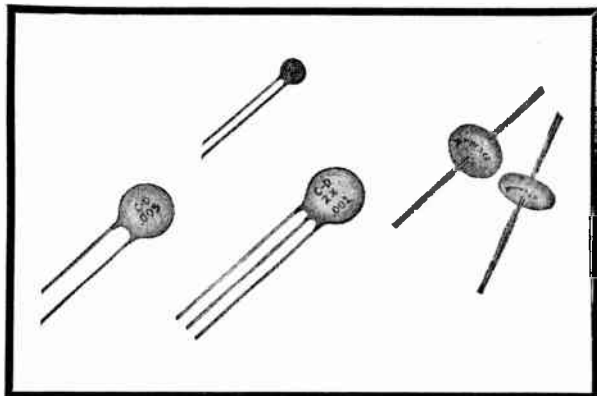

FEATURES OF "TINMIKE" DISC-TYPE CERAMIC CAPACITORS

- Small, space-saving and lightweight.
- Available in all popular capacities.
- Guaranteed minimum capacity tolerance.
- Adapted for wide variety of applications.
- Minimized eddy current losses due to construction.
- Low inductance, stable, dependable performance.
- Available with temperature compensating characteristics.

SINGLES:

TEMPERATURE RANGE: to +85°C.

TOLERANCE: GMC

(Guaranteed Minimum Capacity)

PACKAGED: 5 per envelope.

500 V. D.C. W.

DIMENSIONS:			
	D Max.	T Max.	
KO60 to KO69 incl.	1/4"	5/16"	
KO71	3/8"	5/16"	
KO72 to KO80 incl.	19/32"	5/16"	
KO81 to KO85 incl.	3/4"	5/16"	

Rotational Stock No.	Cap. Mmf.	List Price	Net Price
KO60	470		
KO61	500		
KO65	680		
KO67	820		
KO69	1000		
KO71	1500		
KO72	2000		
KO73	2200		
KO74	2500		
KO75	2700		
KO76	3000		
KO77	3300		
KO78	4000		
KO79	4700		
KO80	5000		
KO81	6800		
KO82	10000	\$.30	\$.18
KO85	20000	.60	.36

DUALS:

TEMPERATURE RANGE: to +85°C.

TOLERANCE: GMC

PACKAGED: 1 per envelope.

500 V. D.C. W.

DIMENSIONS:			
	D Max.	T Max.	
DKO69 to DKO74 incl.	19/32"	5/16"	
DKO76 to DKO82 incl.	3/4"	5/16"	

Rotational Stock No.	Cap. Mmf.	List Price	Net Price
DKO69	2X 1000	\$.40	\$.24
DKO71	2X 1500	.40	.24
DKO72	2X 2000	.40	.24
DKO73	2X 2200	.40	.24
DKO74	2X 2500	.45	.27
DKO76	2X 3000	.45	.27
DKO78	2X 4000	.45	.27
DKO79	2X 4700	.45	.27
DKO82	2X 10000	.50	.30

SINGLES:

TEMPERATURE RANGE: to +85°C.

TOLERANCE: ±20%

PACKAGED: 5 per envelope.

500 V. D.C. W.

DIMENSIONS:			
	D Max.	T Max.	
GO11 to GO28 incl.	1/4"	5/16"	
GO29 to GO42 incl.	3/8"	5/16"	
GO43 to GO67 incl.	19/32"	5/16"	
GO68 to GO71 incl.	3/4"	5/16"	

Rotational Stock No.	Cap. Mmf.	List Price	Net Price
GO11	5.0		
GO14	7.0		
GO15	8.0		
GO18	10		
GO19	12		
GO21	15		
GO22	18		
GO23	20		
GO24	22		
GO25	24		
GO26	25		
GO27	27		
GO28	30		
GO29	33		
GO31	39		
GO33	47		
GO34	50		
GO35	51		
GO36	56		
GO38	68		
GO39	75		
GO40	82		
GO42	100		
GO43	110		
GO44	120		
GO46	150		
GO49	180		
GO50	200		
GO51	220		
GO52	240		
GO53	250		
GO54	270		
GO55	300		
GO56	330		
GO57	360		
GO58	390		
GO59	420		
GO60	470		
GO61	500		
GO62	510		
GO63	560		
GO64	620		
GO65	680		
GO66	750		
GO67	820		
GO68	910		
GO69	1000		
GO70	1200		
GO71	1500		

ALL

.25 .15

ALL

.25 .15



"TINYMIKE" GENERAL PURPOSE Miniature DISC Ceramic Capacitors

TEMPERATURE RANGE: to +85°C.

TOLERANCE: to 2000 mmf. (incl.) ±20%
over 2000 mmf. GMC.

PACKAGED: 3 per envelope.

1000 V. D.C. W.

DIMENSIONS:		D Max.	T Max.
VV4.7 to VQ22 incl.		3/8"	5/32"
VQ33 to VT68 incl.		19/32"	5/32"
VD22 and VD33		19/32"	5/32"
VD1 and VD15 incl.		3/4"	5/32"
VD2, VD47 and VD68		3/4"	5/32"

Rotational Stock No.	Cap. Mmf.	List Price	Net Price
VV4.7	4.7	\$.30	\$.18
VV6.8	6.8	.30	.18
VQ1	10	.30	.18
VQ15	15	.30	.18
VQ22	22	.30	.18
VQ33	33	.30	.18
VQ47	47	.30	.18
VQ68	68	.30	.18
VT1	100	.30	.18
VT15	150	.30	.18
VT22	220	.30	.18
VT27	270	.30	.18
VT33	330	.30	.18
VT39	390	.30	.18
VT47	470	.30	.18
VT68	680	.50	.30
VD1	1000	.50	.30
VD15	1500	.50	.30
VD2	2000	.50	.30
VD22	2200	.50	.30
VD33	3300	.50	.30
VD47	4700	.50	.30
VD68	6800	.60	.36

TEMPERATURE RANGE: to +85°C.

TOLERANCE: ±20%.

PACKAGED: 3 per envelope.

1500 V. D.C. W.

DIMENSIONS:		D Max.	T Max.
MCV4.7 to MCQ15 incl.		3/8"	5/32"
MCQ22 to MCT47 incl.		19/32"	5/32"
MCT68 and MCD1 incl.		3/4"	5/32"

Rotational Stock No.	Cap. Mmf.	List Price	Net Price
MCV4.7	4.7	\$.30	\$.18
MCV6.8	6.8	.30	.18
MCQ1	10	.30	.18
MCQ15	15	.30	.18
MCQ22	22	.30	.18
MCQ33	33	.30	.18
MCQ47	47	.30	.18
MCQ68	68	.30	.18
MCT1	100	.35	.21
MCT15	150	.35	.21
MCT22	220	.40	.24
MCT33	330	.40	.24
MCT47	470	.45	.27
MCT68	680	.55	.33
MCD1	1000	.55	.33

TEMPERATURE RANGE: to +85°C.

TOLERANCE: to 1500 mmf. (incl.) ±20%
over 1500 mmf. GMC.

PACKAGED: 2 per envelope.

2000 V. D.C. W.

DIMENSIONS:		D Max.	T Max.
V2V47 to V2T27 incl.		3/8"	5/32"
V2T33 to V2T68 incl.		19/32"	5/32"
V2D2 and V2D22		19/32"	5/32"
V2D1, V2D15, V2D33, V2D47, V2D5		3/4"	5/32"

Rotational Stock No.	Cap. Mmf.	List Price	Net Price
V2V47	4.7	\$.35	\$.21
V2V68	6.8	.35	.21
V2Q1	10	.35	.21
V2Q15	15	.35	.21
V2Q22	22	.35	.21
V2Q33	33	.35	.21
V2Q47	47	.35	.21
V2Q68	68	.35	.21
V2T1	100	.35	.21
V2T15	150	.35	.21
V2T22	220	.35	.21
V2T27	270	.35	.21
V2T33	330	.35	.21
V2T39	390	.35	.21
V2T47	470	.35	.21
V2T68	680	.55	.33
V2D1	1000	.55	.33
V2D15	1500	.55	.33
V2D2	2000	.55	.33
V2D22	2200	.55	.33
V2D33	3300	.70	.42
V2D47	4700	.70	.42
V2D5	5000	.70	.42

TEMPERATURE RANGE: to +85°C.

TOLERANCE: to 1000 mmf. ±20%
over 1000 mmf. GMC.

PACKAGED: 2 per envelope.

3000 V. D.C. W.

DIMENSIONS:		D Max.	T Max.
V3V47 to V3T22 incl.		3/8"	7/32"
V3T27 to V3T47 incl.		19/32"	7/32"
V3D15		19/32"	7/32"
V3T68 and V3D1		3/4"	7/32"
V3D2 to V3D4 incl.		3/4"	7/32"

Rotational Stock No.	Cap. Mmf.	List Price	Net Price
V3V47	4.7	\$.40	\$.24
V3V68	6.8	.40	.24
V3Q1	10	.40	.24
V3Q15	15	.40	.24
V3Q22	22	.40	.24
V3Q33	33	.40	.24
V3Q47	47	.40	.24
V3Q68	68	.40	.24
V3T1	100	.40	.24
V3T15	150	.40	.24
V3T22	220	.40	.24
V3T27	270	.40	.24
V3T33	330	.40	.24
V3T39	390	.40	.24
V3T47	470	.40	.24
V3T68	680	.40	.24
V3D1	1000	.60	.36
V3D15	1500	.60	.36
V3D2	2000	.60	.36
V3D22	2200	.60	.36
V3D33	3300	.60	.36
V3D4	4000	.60	.36



"TINYMIKE" GENERAL PURPOSE Miniature DISC Ceramic Capacitors

TEMPERATURE RANGE: to +85°C.
TOLERANCE: ±20%.
PACKAGED: 2 per envelope.

5000 V. D.C. W.

Rotational Stock No.	Cap. Mmf.	List Price	Net Price	DIMENSIONS:	
				D Max.	T Max.
V5V47 and V5Q1				3/8"	1/4"
V5Q22 to V5T1 incl.				19/32"	1/4"
V5T22 to V5T47 incl.				3/4"	1/4"
V5V47	4.7	\$.45	\$.27		
V5Q1	10	.45	.27		
V5Q22	22	.45	.27		
V5Q47	47	.45	.27		
V5T1	100	.45	.27		
V5T22	220	.45	.27		
V5T33	330	.55	.33		
V5T47	470	1.00	.60		

Miniature DISC (Axial Leads) Ceramic Capacitors

TEMPERATURE RANGE: to +85°C.
TOLERANCE: ±20%.
PACKAGED: 2 per envelope.

6000 V. D.C. W.

Rotational Stock No.	Cap. Mmf.	List Price	Net Price	DIMENSIONS:	
				D Max.	T Max.
V6V47 to V6T1				19/32"	1/4"
V6V47	4.7				
V6Q1	10				
V6Q15	15				
V6Q22	22				
V6Q33	33				
V6Q47	47				
V6T1	100				

ALL
.50 .30

TEMPERATURE COMPENSATING CERAMIC DISCS

TEMPERATURE COEFFICIENTS: NPO (ZERO) and N750

TEMPERATURE RANGE: to +85°C.
TOLERANCE: ±10% or .5 MMF (whichever is greater)
PACKAGED: 3 per envelope.

500 V. D.C. W.

Rotational Stock No.	Cap. Mmf.	Rotational Stock No.	List Price	Net Price	DIMENSIONS:		
					D Max.	T Max.	
Z004 to Z016 incl.						1/4"	5/32"
NO11 to NO26 incl.						3/8"	5/32"
Z017 to Z022 incl.						19/32"	5/32"
NO27 to NO38 incl.						3/4"	5/32"
Z023 to Z033 incl.							
NO39 to NO48 incl.							
Z034 to Z040 incl.							
NO49 to NO54 incl.							
Z004	1.5						
Z005	2.0						
Z006	2.2						
Z007	3.0						
Z008	3.3						
Z009	4.0						
Z010	4.7						
Z011	5.0	NO11	ALL .50 .30				
Z012	6.0	NO12					
Z013	6.8	NO13					
Z014	7.0	NO14					
Z015	8.0	NO15					
Z016	8.2	NO16					
Z017	9.0	NO17					
Z018	10.0	NO18					
Z019	12.0	NO19					
Z020	13.0	NO20					

NPO Rotational Stock No.	Cap. Mmf.	N750 Rotational Stock No.	List Price	Net Price
Z021	15.0	NO21	ALL .50 .30	
Z022	18.0	NO22		
Z023	20.0	NO23		
Z024	22.0	NO24		
Z025	24.0	NO25		
Z026	25.0	NO26		
Z027	27.0	NO27		
Z028	30.0	NO28		
Z029	33.0	NO29		
Z030	36.0	NO30		.55 .33
Z031	39.0	NO31		
Z032	43.0	NO32		
Z033	47.0	NO33		
Z034	50.0	NO34		
Z035	51.0	NO35		
Z036	56.0	NO36		
Z037	62.0	NO37		
Z038	68.0	NO38		
Z039	75.0	NO39		
Z040	82.0	NO40	.50 .30	
	91	NO41	ALL .50 .30	
	100	NO42		
	110	NO43		
	120	NO44		
	130	NO45		
	150	NO46		
	160	NO47		
	175	NO48		
	180	NO49		
	200	NO50		
	220	NO51		
	240	NO52		
	270	NO53		
	300	NO54		



UNIVERSAL "MITYMIKE" HIGH VOLTAGE CERAMIC CAPACITORS

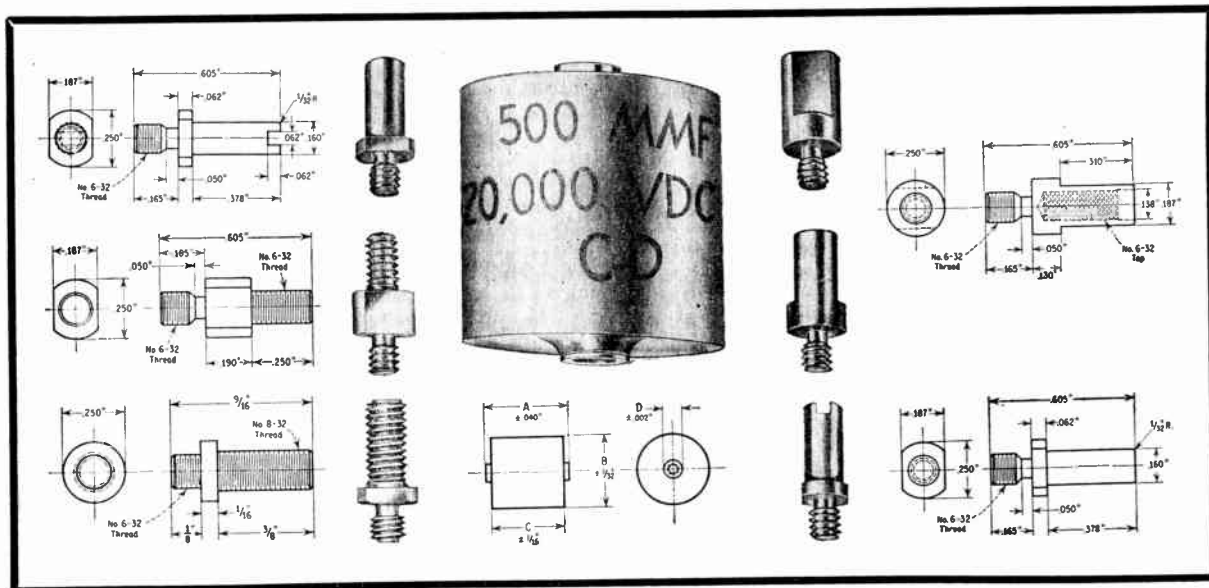

FEATURES OF "MITYMIKE" HIGH VOLTAGE CERAMIC CAPACITORS

- New, superior design and construction.
- High insulation resistance, low power factor.
- Generous factor of safety permits use at FULL rated voltage.
- Choice of terminal styles to meet all TV assembly requirements.

The C-D Universal Type MMU "MITYMIKE" is an entirely new and superior quality unit developed from extensive field experience over a long period. Weaknesses heretofore found in this type capacitor have been eliminated by C-D processing techniques.

Thus, the special quality encasing material forms a complete homogeneous bond between all elements and the ceramic dielectric. The permanent bond between the casing material and the ceramic element prevents formation of corona, hence preventing deterioration of the capacitor.

High purity silver electrodes are heat-bonded to the dielectric

STANDARD TOLERANCE: +50%, -20%

— and the silver-plated terminal studs in turn, firmly soldered direct to the electrodes.

A high degree of operating stability in service and extended life can be expected of the C-D MMU.

Six selected terminal styles are furnished with each body, permitting many combinations of terminals to cover a wide range of installation designs.

Because of the superior materials and quality construction of the MMU, a generous factor of safety is built into the "MITYMIKE", allowing operation at FULL RATED VOLTAGE.

Cat. No.	Cap. Mmfd.	VDCW	Flash Test	Body Size—Inches A x B x C x D	List Price	Net Price
MMU 20T5 MMU 30T5	500 500	20,000 30,000	30,000 40,000	1.068 x .950 x .937 x .250 1.381 x 1.375 x 1.250 x .250	\$1.85 4.50	\$1.11 2.70











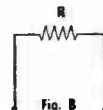

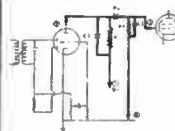

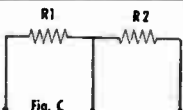

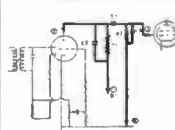

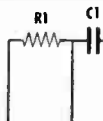

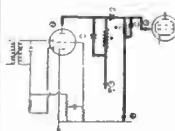

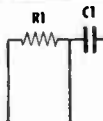

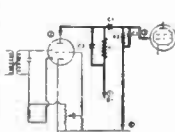

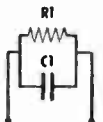

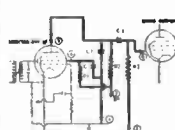

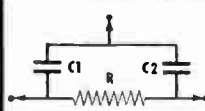
A 10,000 VDCW (MMU 10T5) unit is available on special order.

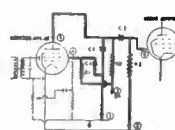

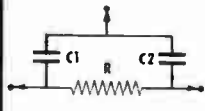

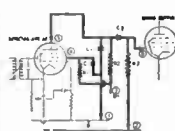

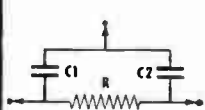

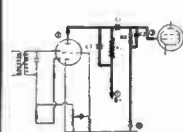

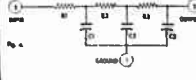

PRINTED ELECTRONIC CIRCUITS (P.E.C.)®

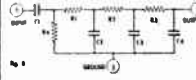

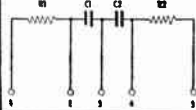

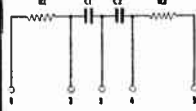



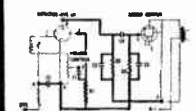

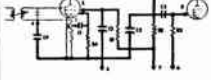
The term, "printed circuit," has come to be a catch-phrase to describe anything from a piece of tinfoil cemented on a plastic plate to a carbon-backed piece of adhesive tape. As the pioneer and leader in the field, we designate the true Printed ELECTRONIC Circuit as a complete circuit element . . . wiring, capacitors, and resistors. Centralab Printed ELECTRONIC Circuits offer a combination of resistors and

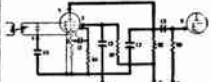
capacitors of ultra-compactness and permanence. No other modern development in electronic circuitry offers so many advantages in low-powered applications, such as small size, low assembly cost, and utmost reliability. There are 36,000,000 P.E.C.'s now in use — proof-positive that Centralab is the unquestioned leader in Printed Electronic Circuits.

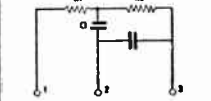
	 Fig. B	R=2 Meg.	PC-2 SINGLE RESISTOR \$.35 List			R ₁ =250K R ₂ =500K C ₁ =5000 mmf. C ₂ +C ₃ =250 mmf.	PC-71 MIDGET COUPLATE® \$.70 List
	 Fig. C	R ₁ =500K R ₂ =110K	PC-21 DUAL RESISTOR \$.50 List			R ₁ =500K R ₂ =500K C ₁ =.01 mfd. C ₂ +C ₃ =250 mmf.	PC-80 STANDARD COUPLATE® \$.75 List
		R ₁ =240K C ₁ =1000 mmf.	PC-30 RESISTOR-CAPACITOR \$.50 List			R ₁ =250K R ₂ =500K C ₁ =.01 mfd. C ₂ +C ₃ =250 mmf.	PC-81 STANDARD COUPLATE® \$.75 List
		R ₁ =1 Meg. C ₁ =1000 mmf.	PC-33 RESISTOR-CAPACITOR \$.50 List			R ₁ =500K R ₂ =500K C ₁ =.01 mfd. C ₂ +C ₃ =500 mmf.	PC-84 STANDARD COUPLATE® \$.75 List
		R ₁ =100K C ₁ =100 mmf.	PC-36 RESISTOR-CAPACITOR \$.50 List			R ₁ =4.7 Meg. R ₂ =1 Meg. R ₃ =2.2 Meg. C ₁ =5000 mmf. C ₂ =50 mmf. C ₃ =2000 mmf.	PC-90 PENTODE COUPLATE® \$.90 List
		R=47K C ₁ =100 mmf. C ₂ =100 mmf.	PC-50 FILPEC® \$.60 List			R ₁ =4.7 Meg. R ₂ =1 Meg. R ₃ =2.2 Meg. C ₁ =5000 mmf. C ₂ =100 mmf. C ₃ =5000 mmf.	PC-91 PENTODE COUPLATE® \$.90 List
		R=47K C ₁ =150 mmf. C ₂ =150 mmf.	PC-51 FILPEC® \$.60 List			R ₁ =4.7 Meg. R ₂ =1 Meg. R ₃ =2.2 Meg. C ₁ =5000 mmf. C ₂ =100 mmf. C ₃ =2000 mmf.	PC-92 PENTODE COUPLATE® \$1.00 List
		R=47K C ₁ =50 mmf. C ₂ =50 mmf.	PC-52 FILPEC® \$.60 List				
		R ₁ =500K R ₂ =500K C ₁ =5000 mmf. C ₂ +C ₃ =250 mmf.	PC-70 MIDGET COUPLATE® \$.70 List				

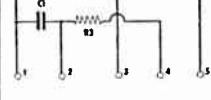

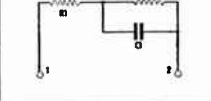
		<p>PC-100</p> <p>VERTICAL INTEGRATOR</p> <p>\$1.10 List</p> <p>$R_1=22K$ $R_2=8.2K$ $R_3=8.2K$ $C_1=2000$ mmf. $C_2=5000$ mmf. $C_3=5000$ mmf.</p>
		<p>PC-101</p> <p>VERTICAL INTEGRATOR</p> <p>\$1.25 List</p> <p>$R_1=22K$ $R_2=8.2K$ $R_3=8.2K$ $R_4=22K$ $C_1=.01$ mfd. $C_2=2000$ mmf. $C_3=5000$ mmf. $C_4=5000$ mmf.</p>
		<p>PC-110</p> <p>FILPLATE® FILTER PLATE</p> <p>\$.75 List</p> <p>$R_1=1000$ $R_2=820$ $C_1=.005$ mfd. $C_2=.005$ mfd.</p>
		<p>PC-111</p> <p>FILPLATE® FILTER PLATE</p> <p>\$.75 List</p> <p>$R_1=220$ $R_2=1000$ $C_1=.005$ mfd. $C_2=.005$ mfd.</p>
		<p>PC-150</p> <p>AUDET® OUTPUT STAGE</p> <p>\$1.00 List</p> <p>$R_1=6.8$ Meg. $R_2=470K$ $R_3=470K$ $C_1=2000$ mmf. $C_2=220$ mmf. $C_3+C_4=250$ mmf. $C_5=5000$ mmf.</p>
		<p>PC-151</p> <p>AUDET® OUTPUT STAGE</p> <p>\$1.15 List</p> <p>$R_1=6.8$ Meg. $R_2=470K$ $R_3=470K$ $C_1=5000$ mmf. $C_2=220$ mmf. $C_3+C_4=250$ mmf. $C_5=5000$ mmf. (Use for added bass response)</p>

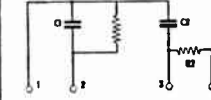
		<p>PC-160</p> <p>PENDET® PENTODE DETECTOR COUPLATE®</p> <p>\$1.25 List</p> <p>$R_1=4.7$ Meg. $R_2=1.0$ Meg. $R_3=3.3$ Meg. $R_4=10$ Meg. $C_1=.002$ mfd. $C_2=150$ mmf. $C_3=.01$ mfd. $C_4=150$ mmf. $C_5=.005$ mfd.</p>
		<p>PC-165</p> <p>PENDET® PENTODE DETECTOR COUPLATE®</p> <p>\$1.35 List</p> <p>$R_1=4.7$ Meg. $R_2=1.0$ Meg. $R_3=3.3$ Meg. $R_4=10$ Meg. $C_1=.002$ mfd. $C_2=150$ mmf. $C_3=.01$ mfd. $C_4=150$ mmf. $C_5=.005$ mfd. (To greatly reduce stray capacity effects)</p>
		<p>PC-176</p> <p>SPECIAL</p> <p>\$.75 List</p> <p>$R_1=82K$ $R_2=39K$ $C_1=.001$ mfd. $C_2=.002$ mfd.</p>
		<p>PC-177</p> <p>SPECIAL</p> <p>\$1.00 List</p> <p>$R_1=150K$ $R_2=47K$ $R_3=1$ Meg. $C_1=.01$ mfd.</p>
		<p>PC-178</p> <p>SPECIAL</p> <p>\$.75 List</p> <p>$R_1=15K$ $R_2=270K$ $C_1=150$ mmf.</p>
		<p>PC-179</p> <p>SPECIAL</p> <p>\$.90 List</p> <p>$R_1=150$ $R_2=220$ $C_1=.005$ mfd. $C_2=.005$ mfd.</p>

PRINTED ELECTRONIC CIRCUIT KITS

HANDY PLASTI-PAK NO. PCK-18

18 P.E.C. units . . . 9 of the most popular types . . . selected in ratio to usage. Packed in a hinged-lid Plasti-Pak, 8 1/2" x 4 1/4" x 1 1/4". You can use these 18 guaranteed P.E.C. units to replace 42 old-style resistors and 52 old-style capacitors. There is no extra charge for the container or the P.E.C. Guide enclosed.

Kit No. PCK-18 . . . List Price \$15.00
Net \$ 9.00



HANDY PLASTI-PAK NO. PCK-45

45 P.E.C. units . . . 21 P.E.C. types . . . in ratio of popularity and use. Packed in a hinged-lid Plasti-Pak, 8 1/2" x 4 1/4" x 1 1/4". These 45 widely-used circuit elements are equivalent to 106 ceramic-based resistors and 133 ceramic capacitors. No extra charge for the container or the P.E.C. Guide enclosed.

Kit No. PCK-45 . . . List Price \$40.00 — Net \$24.00

HANDY SHOP-PAK NO. PCK-110

110 P.E.C. units . . . 5 each of 22 widely-used types . . . the equivalent of 255 ceramic-based resistors, 305 ceramic capacitors. All P.E.C.'s are sealed in envelopes—clearly marked. Packed in blue, 8" x 6" x 6 3/8", four-drawer metal cabinet. New P.E.C. Guide helps you save time replacing old-style resistors and capacitors where the schematic calls for a similar capacity.

Kit No. PCK-110 . . . List Price \$93.00
Net \$55.80



MASTER KIT NO. PCK-220

220 P.E.C. units . . . 23 P.E.C. types . . . a master stock assortment of all active P.E.C. units in ratio to popularity and usage. Designed for the larger, progressive service engineer. Equivalent to a stock of 525 resistors and 620 capacitors. P.E.C.'s are guaranteed to be free of defects in materials and workmanship for one year. Packed in blue, four-drawer metal cabinet, 9 1/2" x 11 1/2" x 9 3/4". Cabinet and five P.E.C. Guides included free.

Kit No. PCK-220 . . . List Price \$193.00 — Net \$115.80



PRINTED ELECTRONIC CIRCUITS (P.E.C.) (Cont'd)

**TV ATTENUATOR SWITCH CAT. No. PCH-4
PRINTED ELECTRONIC CIRCUIT H PADS**

The Centralab PCH-4 Television Attenuator switch is designed as a service tool to determine the amount of attenuation required to secure best TV reception. It is also valuable for permanent installation in receivers. The switch incorporates Centralab's exclusive Printed Circuit TV H-Pads.



ADVANTAGES OF SWITCH

The switching arrangement makes it possible to attenuate each station as much or as little as necessary depending on daily conditions such as weather or existing interference, and allows for proper attenuation to balance two or more stations. Switching also eliminates the "hit-or-miss" method of installing H-Pads. Switch is installed in series with 300 ohm—twin-lead. PCH-4. List Price \$7.50

SEPARATE H-PADS
(Listed for Convenience)

Cat. No.	Attenuation Rating	Cat. No.	Attenuation Rating
PCH-10	10 db.	PCH-30	30 db.
PCH-20	20 db.	PCH-40	40 db.

List Price.....\$0.80 each
PCH-100 SET OF FOUR H-PADS
One each of the above, in plastic box.....List Price \$3.00



**ASK YOUR CENTRALAB DISTRIBUTOR
FOR PRINTED ELECTRONIC CIRCUIT
GUIDE NO. 3**

A practical working manual that saves you time and money. Shows circuit schematics that guide you in using P.E.C.'s to replace standard components. Gives other useful information.

STEATITE

Centralab has been producing fine ceramics since 1928 . . . primarily for its own use in fixed resistors, ceramic capacitors, switches, and more recently, printed electronic circuits. Often called upon by other manufacturers to produce many "standard" and custom designs, some very intricate. Centralab is the only ceramic manufacturer capable of producing many of these in quantity. All items listed are Grade L-5 Steatite, approved without limitation for Army and Navy use. Characteristics: Uniform, white appearance, high dielectric strength, exceedingly low loss at high frequencies, and strong mechanically. Impervious to moisture and common acids, will not warp, withstands high temperatures; harder than hardest quartz.

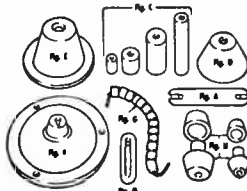

Length	1" DIAM.**	List Price	Length	3/4" DIAM.**	List Price
1 1/4"	X-28	\$0.18	3/4"	X-20	\$0.16
1 1/2"	X-29	.19	1 1/4"	X-21	.17
1 3/4"	X-30	.20	1 1/2"	X-22	.18
2"	X-31	.21	1 3/4"	X-23	.18
			2"	X-24	.19
Length	3/8" DIAM.**	List Price	Length	1" DIAM.**	List Price
3/8"	X-65	\$0.12	2 1/2"	X-25	.20
1/2"	X-48	.12	3"	X-26	.22
5/8"	X-50	.12	4"	X-27	.25
3/4"	X-52	.12			
1"	X-54	.12			
1 1/4"	X-56	.16	Length	1/4" DIAM.**	List Price
1 1/2"	X-58	.17	2 1/2"	X-32	\$0.23
2"	X-60	.17	3"	X-33	.28
2 1/4"	X-62	.18	4"	X-34	.33
			5"	X-35	.37

*5 per carton. **1 per carton.

SPREADERS—STRAIN INSULATORS

Deluxe Grade—Fig. A. Rounded and grooved. Packaged singly. Cat. No. O.A. Length Diam. Line Spacing List Price

X-1	2 3/4"	1/2"	2"	\$0.70
X-2	4"	3/4"	3"	1.00
X-3	6"	3/4"	5"	1.25

Standard Grade—Not illustrated. Square and rectangular bars. Packaged singly.

Cat. No.	O.A. Length	Size	Line Spacing	List Price
X-4	3"	1/2" x 3/8"	2"	\$0.15
X-5	5"	1/2" x 1/2"	4"	.25
X-6	7"	1/2" x 1/2"	6"	.45

Deluxe Aircraft Type Insulator—Fig. B. Fully glazed. Packaged singly. Cat. No. O.A. Length Diam. Line Spacing List Price

X-7	1 1/2"	17/32"	3/4"	\$0.65
-----	--------	--------	------	--------

STANDOFF OR PILLAR INSULATORS

See Figure C. Circumference glazed, tapped for screw sizes shown. "X" numbers below are catalog numbers.

1/4" DIAM.*		1/2" DIAM.**	
Length	#6-32 Thd.	Length	#6-32 Thd.
1/4"	X-63	1/2"	X-12
3/8"	X-64	3/4"	X-13
1/2"	X-8	1"	X-14
3/4"	X-9	1 1/4"	X-15
1"	X-10	1 1/2"	X-16
1 1/4"	X-11	2"	X-17
		2 1/2"	X-18
		3"	X-19

FEED-THROUGH INSULATORS

Glazed Surface—No hardware included. Packaged Singly.

Cat. No.	Fig.	Height	Base Diam.	Size	Max. Screw	List Price
X-36	D	7/8"	1 1/4"	10-32		\$0.25
X-37	D	1 1/8"	1 3/4"	1/4"-20		30
X-38	E	1 1/8"	2 1/2"	3/8"-16		1.50
X-39	F	1"	3 1/4"	8-32		1.50

FISH SPINE BEADS

See Fig. G. Four Beads will cover 1", or package of 100 covers 25" of buss wire. 5/16" O.D., 1/8" I.D. Packaged 100 per envelope. Cat. No. X-40 Carton of 100 Beads. List Price \$ 1.00
Cat. No. X-40G Giant 2 lb. pack (approx. 1200). List Price 10.00

THROUGH PANEL BUSHINGS

See Fig. H. Matched pairs of male and female bushings for feeding through chassis, panels, shields, racks or cases. No hardware included. Packaged one matched pair per carton.

Cat. No.	Top Pair Height	Max. Panel Diam.	Panel Hole	Panel Thickness	Max. Screw Size	List Price
X-41	1/4"	1/2"	5/16"	to 1/8"	6-32	\$0.30
X-42	7/32"	3/8"	7/16"	to 1/8"	8-32	.40
X-43	3/8"	1/2"	1/4"	to 3/16"	6-32	.35
X-44	3/8"	3/8"	3/8"	to 3/8"	8-32	.40
X-45	3/4"	1 1/8"	3/4"	to 3/8"	10-32	1.00
X-46	1 1/8"	1 1/4"	1/2"	to 2"	10-32	1.70

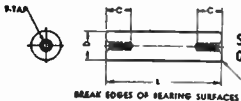

STYLES 01, 02, 03, 04

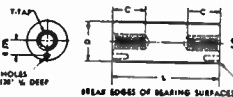

STYLE 05

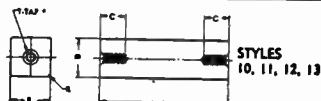

STYLES 10, 11, 12, 13

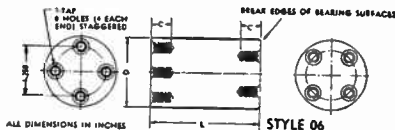

STYLE 06



STYLE 14

JAN CERAMIC STANDOFFS

Seven types of Style 01
Eight types of Style 02
Seven types of Style 03
Eight types of Style 04
Seven types of Style 05
Eight types of Style 06

Seven types of Style 10
Six types of Style 11
Seven types of Style 12
Five types of Style 13
Nine types of Style 14



Ask your Centralab distributor for bulletin 42-181 which completely lists JAN Ceramic Standoffs by type, part number, dimensions, minimum usable threads, and prices.

FOR MORE COMPLETE INFORMATION ON CRL COMPONENTS SEE YOUR DISTRIBUTOR

CERAMIC CAPACITORS

MOLDED DISC CERAMIC HI-KAPS® For Bypass, Coupling and General Applications



Molded disc ceramics feature highest available breakdown to ground, highest lead strength, and resistance to mechanical damage, closest tolerance. "MD's" can be placed directly against a chassis, or adjacent to high voltage leads without danger of flashover or breakdown. Low inductance makes these units highly efficient in high frequency circuits. They are not recommended for use in resonant or tuning applications. Voltage Rating: 1,000 V.D.C.W. to 5,000 mmf, 600 V.D.C.W. over 5,000 mmf. Maintain high capacity and stand up under +85° C. operation. Insulation — Molded Centrathene†, 2,500 V.D.C. breakdown to ground. Electrical properties constant to 3,000 megacycles. Insulation resistance of molding 300,000 megohms. Moisture absorption .005%. Power factor of molding .02%. Fungus resistant. Unaffected by ozone, salt water, any known acid, or solvent at room temperature. Will not become brittle at -55° C. Leads — No. 22 tinned copper 1½" long. All units one size — 11/16" diameter, 3/16" thick, maximum. Packaged — 5 units per polyethelene bag. 5 bags (25 units) per carton.

TYPE MD MOLDED DISC CERAMIC HI-KAPS®					
Cap. mmf.	Per Cent Tolerance	CRL Cat. No.	Cap. mmf.	Per Cent Tolerance	CRL Cat. No.
5	±10%	—MD-050	390	±10%	—MD-391
10	±10%	—MD-100	400	±10%	—MD-401
12	±10%	—MD-120	470	±10%	—MD-471
15	±10%	—MD-150	500	±10%	—MD-501
18	±10%	—MD-180	560	±10%	—MD-561
20	±10%	—MD-200	600	±10%	—MD-601
22	±10%	—MD-220	680	±10%	—MD-681
25	±20%	—MD-250	750	±20%	—MD-751
27	±10%	—MD-270	820	±20%	—MD-821
33	±10%	—MD-330	1,000	±20%	—MD-102
39	±10%	—MD-390	1,200	±20%	—MD-122
47	±10%	—MD-470	1,500	±20%	—MD-152
50	±10%	—MD-500	1,800	±20%	—MD-182
56	±10%	—MD-560	2,000	±20%	—MD-202
68	±10%	—MD-680	2,200	±20%	—MD-222
75	±10%	—MD-750	2,500	±20%	—MD-252
82	±10%	—MD-820	2,700	±20%	—MD-272
100	±10%	—MD-101	3,000	±20%	—MD-302
120	±10%	—MD-121	3,300	±20%	—MD-332
150	±10%	—MD-151	4,000	±20%	—MD-402
180	±10%	—MD-181	4,700	±20%	—MD-472
200	±10%	—MD-201	5,000	±20%	—MD-502
220	±10%	—MD-221	5,600	GMV	—MD-562
250	±10%	—MD-251	6,800	GMV	—MD-682
270	±10%	—MD-271	7,500	GMV	—MD-752
300	±10%	—MD-301	10,000	GMV	—MD-103
330	±10%	—MD-331			

List Price \$0.30 — \$1.50 per envelope of 5

TYPE DD16 BUFFERS

1600 V.D.C.W., 3000 V.D.C. Test — Originally designed for use in electric shavers, these units have wide acceptance for use as buffers in auto radio sets, as they are totally unaffected by heat, humidity or vibration.

Cap. mmf.	Cat. No.	Tolerance	Diam.	Thick	List Price
3,000	DD16-302	GMV	7/8"	5/32"	\$0.35
4,000	DD16-402	GMV	7/8"	5/32"	.35
5,000	DD16-502	GMV	7/8"	5/32"	.35
6,000	DD16-602	GMV	7/8"	5/32"	.35
7,000	DD16-702	GMV	7/8"	5/32"	.35
7,500	DD16-752	GMV	7/8"	5/32"	.35
8,000	DD16-802	GMV	7/8"	5/32"	.35
10,000	DD16-103	GMV	7/8"	5/32"	.35
15,000	DD16-153	—20%+80%	7/8"	1/4"	.60

Packaged 5 per envelope — 25 units per carton

HANDY PLASTI-PAK No. DDK-16 of 16 1600 V.D.C.W. Disc Hi-Kaps

Sixteen 1600 V.D.C.W. Disc HI-KAPS, two each of the eight most popular values used as buffers in auto radio sets.

Cap. mmf.	Quant.	Cat. No.	Cap. mmf.	Quant.	Cat. No.
3,000 mmf. (.003)	2	DD16-302	7,000 mmf. (.007)	2	DD16-702
4,000 mmf. (.004)	2	DD16-402	7,500 mmf. (.0075)	2	DD16-752
5,000 mmf. (.005)	2	DD16-502	8,000 mmf. (.008)	2	DD16-802
6,000 mmf. (.006)	2	DD16-602	10,000 mmf. (.01)	2	DD16-103

KIT No. DDK-16. List Price \$5.60

BC HI-KAP® TUBULARS

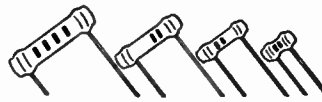

For by-pass, coupling and general use in AM, FM, TV, Audio, or other r.f. circuits. Double coating of Durez phenolic for extra protection. 85° C. plus operation. Tropicalized. 1200 volts D.C. test; 600 volts D.C. working. Packaged 5 per envelope (min.).

D6 SERIES BC HI-KAP® TUBULARS

Cap. mmf.	Cat. No.	Tolerance	Size	Cap. mmf.	Cat. No.	Tolerance	Size
3	D6-030	±5 mmf.	A	300	D6-301	±10%	A
5	D6-050	±10%	A	330	D6-331	±10%	A
10	D6-100	±10%	A	390	D6-391	±10%	B
12	D6-120	±10%	A	400	D6-401	±10%	B
15	D6-150	±10%	A	470	D6-471	±10%	B
18	D6-180	±10%	A	500	D6-501	±10%	B
20	D6-200	±10%	A	560	D6-561	±10%	B
22	D6-220	±10%	A	600	D6-601	±10%	B
25	D6-250	±10%	A	680	D6-681	±10%	B
27	D6-270	±10%	A	750	D6-751	±20%	A
33	D6-330	±10%	A	820	D6-821	±20%	A
39	D6-390	±10%	A	1,000	D6-102	±20%	A
40	D6-400	±10%	A	1,200	D6-122	±20%	B
47	D6-470	±10%	A	1,500	D6-152	±20%	B
50	D6-500	±10%	A	1,800	D6-182	±20%	B
56	D6-560	±10%	A	2,000	D6-202	±20%	B
68	D6-680	±10%	A	2,200	D6-222	±20%	B
75	D6-750	±10%	A	2,500	D6-252	GMV	B
82	D6-820	±10%	A	2,700	D6-272	GMV	B
91	D6-910	±10%	A	3,000	D6-302	GMV	B
100	D6-101	±10%	A	3,300	D6-332	GMV	C
120	D6-121	±10%	A	4,000	D6-402	GMV	C
150	D6-151	±10%	A	4,700	D6-472	GMV	C
180	D6-181	±10%	A	5,000	D6-502	GMV	D
200	D6-201	±10%	A	6,800	D6-682	GMV	D
220	D6-221	±10%	A	7,500	D6-752	GMV	D
250	D6-251	±10%	A	10,000	D6-103	GMV	D
270	D6-271	±10%	A				

List Price \$0.20 each — \$1.00 per envelope of 5
BODY DIMENSIONS — A=250" diam., .500" length — B=250" diam., .750" length — C=280" diam., .900" length — D=335" diam., 1.210" length.

TV-HI-VO KAPS®



Factory guaranteed exact replacement. Accepted standard for filter and bypass applications in TV high voltage power supplies. Brass cadmium terminals available in combinations shown below. Capacity tolerance —20% +50%.

Voltage D.C.W.	Cap. mmf.	CRL Cat. No.	Voltage D.C. Test	Terminals	List Price
10,000	500	TV1-501	20,000	2 Rod	\$1.50
10,000	500	TV2-501	20,000	1 Slot, 1 Tap	1.50
10,000	500	TV3-501	20,000	1 Tap, 1 Thread	1.50
20,000	500	TV1-502	40,000	2 Rod	1.50
20,000	500	TV2-502	40,000	1 Slot; 1 Tap	1.50
20,000	500	TV3-502	40,000	1 Tap, 1 Thread	1.50
20,000	500	TV4-502	40,000	2 Male Thread	1.50
20,000	500	TV5-502	40,000	2 Female Tap	1.50
20,000	500	TV7-502	40,000	1 8-32 thd., 1 6-32 thd.	1.50
30,000	500	TV1-503	48,000	2 Rod	3.00
30,000	500	TV8-503	48,000	2 Spec. 8-32 thd.	3.00

New ATTACHABLE TERMINAL HI-VO-KAP

Heavy threads prevent terminal breakage — 100% tested twice rated voltage.
TV-20 500 mmf. 20KVDC \$1.50 List
TERMINALS — List each \$0.10
Package of 5 (Min.) \$0.50

KIT TVK-25-5	each of the 5 terminals	LIST 2.50
KIT TVK-125-25	each of the 5 terminals	LIST 11.50
KIT TVK-5-50-5	TV-20's, 10 each terminal	NET 5.50

TX-1 Plain slotted rod
TX-2 6-32 Female Tap.
TX-3 6-32 Male Thd.
TX-4 Short 8-32 Male
TX-5 Long 8-32 Male



CERAMIC CAPACITORS (Cont'd)

TC TEMPERATURE COMPENSATING TUBULARS



Designed especially to limit frequency drift in r.f. circuits where temperature variations are prevalent. These capacitors are constructed with a ceramic body which changes capacities as the temperature varies. Use Centralab TC Hi-Kaps when servicing superhet receivers—replace older types in assillator and detector circuits in TV, AM and FM receivers. 1,200 volts D.C. test; 600 volts D.C. working.

TCZ TUBULAR HI-KAP®

All TC Hi-Kaps conform to JAN-C-20A specifications. NPO Units (JAN-CH-CJ-CK) which show zero capacitance change over temperature range —20° C. to +85° C.

Cap. mmf.	Tolerance	CRL Cat. No.	Size Type
.5	±.25 mmf.	TCZ-.5	CC20
.68	±.25 mmf.	TCZ-.68	CC20
1.0	±.25 mmf.	TCZ-1.0	CC20
1.5	±.25 mmf.	TCZ-1.5	CC20
2.2	±.25 mmf.	TCZ-2.2	CC20
3.3	±.25 mmf.	TCZ-3.3	CC20

List Price \$0.50 each

4.7	±.5 mmf.	TCZ-4.7	CC20
6.8	±.5 mmf.	TCZ-6.8	CC20
10	±.5 mmf.	TCZ-10	CC20
12	±.5 mmf.	TCZ-12	CC20
15	±.5 mmf.	TCZ-15	CC20
18	±.5 mmf.	TCZ-18	CC20
20	±.5 mmf.	TCZ-20	CC20

List Price \$0.50 each

22	±2 1/2%	TCZ-22	CC20
24	±2 1/2%	TCZ-24	CC20
25	±2 1/2%	TCZ-25	CC25
27	±2 1/2%	TCZ-27	CC25
30	±2 1/2%	TCZ-30	CC25
33	±2 1/2%	TCZ-33	CC25
36	±2 1/2%	TCZ-36	CC25
39	±2 1/2%	TCZ-39	CC25
43	±2 1/2%	TCZ-43	CC25
47	±2 1/2%	TCZ-47	CC25
50	±2 1/2%	TCZ-50	CC25
51	±2 1/2%	TCZ-51	CC25
56	±2 1/2%	TCZ-56	CC25
62	±2 1/2%	TCZ-62	CC32
68	±2 1/2%	TCZ-68	CC32
75	±2 1/2%	TCZ-75	CC32
82	±2 1/2%	TCZ-82	CC32
91	±2 1/2%	TCZ-91	CC32
100	±2 1/2%	TCZ-100	CC32
110	±5%	TCZ-110	CC32
120	±5%	TCZ-120	CC32
130	±5%	TCZ-130	CC35
150	±5%	TCZ-150	CC35
160	±5%	TCZ-160	CC35
180	±5%	TCZ-180	CC35
200	±5%	TCZ-200	CC45
220	±5%	TCZ-220	CC45
240	±5%	TCZ-240	CC45
270	±5%	TCZ-270	CC45
300	±5%	TCZ-300	CC45

List Price \$0.50 each

TCN TUBULAR HI-KAP®

N750 Units (JAN-UJ, UK) which show capacity change of minus 750 parts per million^{2a} per each degree C rise in temperature.

Cap. mmf.	Tolerance	CRL Cat. No.	Size Type
3.3	— .5 mmf.	TCN-3.3	CC20
5	— .5 mmf.	TCN-5	CC20
10	— .5 mmf.	TCN-10	CC20
12	— .5 mmf.	TCN-12	CC20
15	— .5 mmf.	TCN-15	CC20
18	— .5 mmf.	TCN-18	CC20
20	— .5 mmf.	TCN-20	CC20

List Price \$0.50 each

22	—2 1/2%	TCN-22	CC20
24	—2 1/2%	TCN-24	CC20
25	—2 1/2%	TCN-25	CC20
27	—2 1/2%	TCN-27	CC20
30	—2 1/2%	TCN-30	CC20
33	—2 1/2%	TCN-33	CC20
36	—2 1/2%	TCN-36	CC20
39	—2 1/2%	TCN-39	CC20
43	—2 1/2%	TCN-43	CC20
47	—2 1/2%	TCN-47	CC20
50	—2 1/2%	TCN-50	CC20
51	—2 1/2%	TCN-51	CC20
56	—2 1/2%	TCN-56	CC20
62	—2 1/2%	TCN-62	CC20
68	—2 1/2%	TCN-68	CC25
75	—2 1/2%	TCN-75	CC25
82	—2 1/2%	TCN-82	CC25
91	—2 1/2%	TCN-91	CC25
100	—2 1/2%	TCN-100	CC25
110	—5%	TCN-110	CC25
120	—5%	TCN-120	CC25
130	—5%	TCN-130	CC25
150	—5%	TCN-150	CC25
160	—5%	TCN-160	CC25
180	—5%	TCN-180	CC32
200	—5%	TCN-200	CC32
220	—5%	TCN-220	CC32
240	—5%	TCN-240	CC32
270	—5%	TCN-270	CC32
300	—5%	TCN-300	CC32
330	—5%	TCN-330	CC32
360	—5%	TCN-360	CC32
390	—5%	TCN-390	CC35
430	—5%	TCN-430	CC35
470	—5%	TCN-470	CC35
510	—5%	TCN-510	CC35
560	—5%	TCN-560	CC45
620	—5%	TCN-620	CC45
680	—5%	TCN-680	CC45
750	—5%	TCN-750	CC45

List Price \$0.50 each

BODY DIMENSIONS

Size	Diameter	Length
CC20	.200"	.400"
CC25	.200"	.690"
CC32	.225"	.860"
CC35	.285"	1.165"
CC45	.285"	1.625"

INTERMEDIATE TC TUBULARS
TYPES TCA AND TCL

The addition of Negative 330 and Negative 1500 TC Tubular Capacitors to the Centralab line increases the already complete selection and makes the CRL TC list the most useful and flexible of any stock manufacturer. Values most carefully selected from the most popular types in manufacturing usage. All units meet JAN specifications for military use. Color coded in compliance with RETMA and JAN specs. Intermediate values allow additional TC values without combining two or more standard capacitors. Packaged one per envelope with complete data, five envelopes per display carton.

TCA — N330 TC UNITS

Cap. mmf.	Tolerance	Cat. No.	Size Type
10	±5 mmf.	TCA-10	CC20
15	±2 1/2%	TCA-15	CC20
22	±2 1/2%	TCA-22	CC20
33	±2 1/2%	TCA-33	CC20
47	±2 1/2%	TCA-47	CC25
68	±2 1/2%	TCA-68	CC25
100	±2 1/2%	TCA-100	CC32

List Price Type TCA \$0.50 ea.

TCL — N1500 TC UNITS

Cap. mmf.	Tolerance	Cat. No.	Size Type
10	±5 mmf.	TCL-10	CC20
15	±2 1/2%	TCL-15	CC20
22	±2 1/2%	TCL-22	CC20
33	±2 1/2%	TCL-33	CC20
47	±2 1/2%	TCL-47	CC20
68	±2 1/2%	TCL-68	CC20
100	±2 1/2%	TCL-100	CC25

List Price Type TCL \$0.50 ea.

CERAMIC CAPACITOR KITS

PLASTI-PAK KIT NO. DDK-100 — 100 STANDARD DISC capacitors, 20 each of the five most popular values. Packed in handy plastic box List Price \$20.00

METAL KIT NO. DDK-200 — Comprehensive assortment of 200 STANDARD CERAMIC DISC capacitors of most generally used values. Packed in 4-drawer metal cabinet List Price \$40.00

PLASTI-PAK KIT NO. DK-100 — 100 BC TUBULARS, 20 each of the five most popular capacity values. Packed in handy plastic box List Price \$20.00

METAL KIT NO. DK-200 — Comprehensive assortment of 200 BC TUBULAR HI-KAPS of most generally used values. 600 V.D.C.W. Packed in 4-drawer metal cabinet List Price \$40.00

PLASTI-PAK KIT NO. MDK-40 — 40 MD DISC capacitors, 5 each of 8 most popular values. Handy plastic box List Price \$12.00

PLASTI-PAK KIT NO. MDK-100 — 100 MOLDED DISC ceramic capacitors, 20 each of the five most popular capacity values. Handy plastic box List Price \$30.00

METAL KIT NO. MDK-200 — Comprehensive assortment of 200 MOLDED DISC ceramic capacitors of most generally used values. 4-drawer metal cabinet List Price \$60.00

CERAMIC FEED-THRU HI-KAPS®
TYPES FT AND MFT

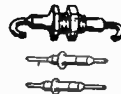

Type FT Feed-Thru or bushing mounted capacitor has been specifically designed and widely used in high frequency circuits where, in addition to feed thru, a capacity ground to either chassis or shield is desired. Lead inductance is virtually eliminated. Type MFT MINIATURE Eyelet Feed-Thru is a condensed version of the above units required in many new ultra-high frequency applications where space is at a premium. VOLTAGES—Both styles—500 V.D.C.W., 1,000 V.D.C. Test.

Cap. mmf.	CRL Cat. No.	Tolerance	Cap. mmf.	CRL Cat. No.	Tolerance
500	FT-500	±20%	50	MFT-50	±10%
1,000	FT-1,000	±20%	100	MFT-100	±10%
1,500	FT-1,500	—20% +50%	500	MFT-500	±20%
1,800	FT-1,800	—20% +50%	1,000	MFT-1,000	GMV
2,300	FT-2,300	—20% +50%			

List Price \$1.00 each

List Price \$0.50 each

TYPE DF FLAT-PLATE HI-KAP® CAPACITORS

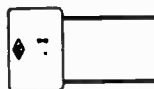

600 V.D.C.W., 1200 V.D.C. Test—Low mass weight, unusual thinness plus inherent Centralab ceramic capacitor stability and permanence make these units extremely popular for general replacement application.

Cap. mmf.	Cat. No.	Tolerance	Length	Height	Thick	List Price
5,000	DF-503**	GMV	1-9/32"	27/32"	3/32"	\$0.70
1,000	DF-104**	GMV	1-9/32"	27/32"	1/8"	.80

**Packaged 1 per envelope—5 units per carton.

CERAMIC CAPACITORS (Cont'd)

TRANSMITTING CAPACITORS



VOLTAGE—20,000 V.D.C.W., 30,000 V.D.C.T. R.F.
LOAD—30 amps or greater for 30° C. rise at 30 mc.
MOUNTING—Terminal ends tapped 10-32. DIMENSIONS—Overall length 2 7/8", diam. 2". Tolerance ±10%

Cap. mmf.	CRL Cat. No.	Temp. Coef.
50	8595-50Z	NPO
100	8595-100Z	NPO
250	8595-250N	N750
500	8595-500N	N2200

List Price \$75.00 each

Type 851 ceramic capacitors are high voltage units, held to ±10% tolerance. Size 1-9/32" diam. x 1-15/32". End terminal plates are center tapped 10-32. 851-200N 7500 V.D.C.W. — All others 15000 V.D.C.W.



Cap. mmf.	CRL Cat. No.	Temp. Coef.
25	851-25Z	NPO
50	851-50Z	NPO
100	851-100N	N750
200	851-200N	N750

List Price \$10.00 each

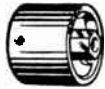

TYPES 850-858 5KV AND 7.5KV

Tolerance, ±10%. Dimensions, 13/16" diameter, 5/8" long. Mounting—S Series: 1/8" hex studs tapped 6-32 thd. SL Series: 17/32" solder lugs with 6-32 tapped hole.

Cap. mmf.	VDCW	Temp. Coef.	Cat. No. Studs	Cat. No. Lugs
25	7500	NPO	8505-25Z	8505L-25Z
50	7500	NPO	8505-50Z	8505L-50Z
50	7500	N750	8505-50N	8505L-50N
75	7500	N750	8505-75N	8505L-75N
100	5000	N750	8505-100N	8505L-100N
500	7500	Hi-K		8585-500
1000	7500	Hi-K		8585-1000

List Price \$3.00 each

SMALL HIGH VOLTAGE UNITS TYPES 853-853A, 854-854A, 855-855A

The three series which follow are exceedingly compact ceramic capacitors. 5000 V.D.C.W. Mounting is with axial screw type terminals tapped 2-56. Tolerance ±10%. Sizes: 853, 3/8" diam. x 1/2". 854, 7/8" diam. x 7/8". 855, 3/4" diam. x 3/4". Types 853, 854 and 855 also available with axial leads, 1/2" long, in place of screw terminals. For lead types, use same Cat. Nos., omitting "A". Same price.

Cap. mmf.	Cat. No.	Temp. Coef.	Cap. mmf.	Cat. No.	Temp. Coef.
10	853A-10Z	NPO	3	855A-3Z	NPO
20	853A-20Z	NPO	5	855A-5Z	NPO
20	853A-20N	N750	10	855A-10N	N750
40	853A-40N	N750			

List Price \$3.00 each

CERAMIC TRIMMER CAPACITORS

TYPE 827 MINIATURE MOLDED CERAMIC TRIMMER



Base, high grade phenolic. Two .120" diam. mounting holes spaced 3/8". Can be mounted on chassis through 3/32" diam. hole. Initial Insulation Resistance—10,000 megohms minimum. Body size: 17/32" x 3/4".

Cap. Range mmf.	CRL Cat. No.	Cap. Range mmf.	CRL Cat. No.
2.5 to 7	827A	5.0 to 50	827C
3.0 to 12	827B	8.0 to 50	827D

List Price \$1.00 each

TYPE 822 CERAMIC TRIMMER

Medium weight Steatite body. Numbers ending in Z are of zero temperature coefficient (NPO); those ending in N are negative temperature coefficient. Both rotor and stator plates are of metallic silver fired to ceramic rotor and stator. Mounting holes are clearance for No. 4 machine screws. Body size, approx. 27/32" x 21/32".



Cap. Range mmf.	CRL Cat. No.	JAN-C-81 Number	Cap. Range mmf.	CRL Cat. No.	JAN-C-81 Number
1.5 to 3	822-DZ	—	4.5 to 25.0	822-AZ	CV11A250
1.5 to 7	822-EZ	CV11A070	2.0 to 6.0	822-DN	CV11D060
2.0 to 7.5	822-CZ	—	4.0 to 30.0	822-EN	CV11D300
2.5 to 13.0	822-BZ	—	4.5 to 25.0	822-CN	—
3.0 to 12.0	822-FZ	CV11A120	7.0 to 45.0	822-BN	CV11D450
			8.0 to 50.0	822-AN	—

List Price \$1.50 each

TYPE 823 CERAMIC TRIMMER



A trimmer of highest quality. Medium heavy Steatite base. Numbers ending in Z are of zero temperature coefficient (NPO); those ending in N are of negative temperature coefficient. Both rotor and stator plates are of metallic silver fired to ceramic rotor and stator.

Mounting studs are set in the base, tapped 3/8" deep for 4-40 machine screws. Body size, approx. 1 1/4" x 1 1/2".

Cap. Range mmf.	CRL Cat. No.	JAN No.	Cap. Range mmf.	CRL Cat. No.	JAN No.
5.0 to 12.0	823-EZ	CV12A120	5.0 to 15.0	823-FN	CV12D150
6.0 to 25.0	823-DZ	CV12A250	8.0 to 25.0	823-EN	—
10.0 to 50.0	823-BZ	—	8.0 to 50.0	823-DN	CV12D500
12.0 to 60.0	823-AZ	CV12A620	10.0 to 100	823-BN	—
			20.0 to 125	823-AN	CV12D121

List Price \$2.50 each

TYPE 820 TRIMMER



Lightweight ceramic body. Stator plate metallic silver fired to ceramic body. Mounting bracket with 1/8" hole and locating fin. Body size, approx. 27/32" x 5/8".

Cap. range mmf.	Cat. No.	List Price
2.6 to 6	820-A	\$0.75
5 to 20	820-B	.75
7 to 35	820-C	.75

TYPE 829 TUBULAR CERAMIC TRIMMER



Special tiny, tubular trimmer, widely used in TV and FM applications. Ceramic body, .215" diameter.

Capacity Range mmf.	Body Length(B)	Cat. No.	List Price	Capacity Range mmf.	Body Length(B)	Cat. No.	List Price
1 to 3	1/2"	829-3	\$0.50	1 to 7.5	3/4"	829-7	\$0.60
1 to 4	1/2"	829-4	.50	1.5 to 10	3/4"	829-10	.60
1 to 6	3/8"	829-6	.50				

TYPE ZA & ZB—"ZIPPER" BUTTON-STYLED CERAMICS

This solder-sealed "Button-type" ceramic capacitor is an accurate, dependable, long-life replacement for old style mica "Buttons" . . . Zippers. Packaged—Singly—Five envelopes per carton. 500 V.D.C.W., 1,000 V.D.C. Flash Test.



TYPE ZA TAPPED GROUND TERMINAL CRL				TYPE ZB RIM TYPE FEED-THRU CRL			
Cap. mmf.	Cat. No.	Tolerance		Cap. mmf.	Cat. No.	Tolerance	
10	ZA-100	±10%		10	ZB-100	±10%	
15	ZA-150	±10%		15	ZB-150	±10%	
25	ZA-250	±10%		25	ZB-250	±10%	
33	ZA-330	±10%		33	ZB-330	±10%	
50	ZA-500	±10%		50	ZB-500	±10%	
75	ZA-750	±20%		75	ZB-750	±20%	
100	ZA-101	±20%		100	ZB-101	±20%	
150	ZA-151	±20%		150	ZB-151	±20%	
200	ZA-201	±20%		200	ZB-201	±20%	
250	ZA-251	±20%		250	ZB-251	±20%	
300	ZA-301	±20%		300	ZB-301	±20%	
400	ZA-401	±20%		400	ZB-401	±20%	
500	ZA-501	±20%		500	ZB-501	±20%	
600	ZA-601	±20%		600	ZB-601	±20%	
750	ZA-751	±20%		750	ZB-751	±20%	
1,000	ZA-102	GMV		1,000	ZB-102	GMV	

†Trade Mark

List Price \$1.25 each

TYPE S1 & S2 TUBULAR STANDOFF CAPACITORS

Designed for bypassing RF to ground in low power transmitter-exciter units, receivers and similar HF, UHF, and VHF circuits. Size—Type S1—3/8" maximum length. S2—7/8" maximum length. 500 V.D.C.W., 1,000 V.D.C. Flash Test.

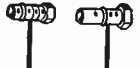

TYPE S1 CERAMIC STANDOFF CRL			TYPE S2 CERAMIC STANDOFF CRL		
Cap. mmf.	Cat. No.	Tolerance	Cap. mmf.	Cat. No.	Tolerance
50	S1-500	±10%	5,000	S2-502	±20%
100	S1-101	±10%	7,500	S2-752	GMV
250	S1-251	±10%	10,000	S2-103	-20% +80%
470	S1-471	±10%			
500	S1-501	±10%			
680	S1-681	±10%			
1,000	S1-102	±20%			
1,500	S1-152	±20%			
2,400	S1-242	±20%			
2,500	S1-252	±20%			

List Price \$0.60 each

List Price \$1.00 each
Type 950 High Accuracy (±1%) Capacitors available . . . See CRL Cat. 29

For prompt, excellent service see your
CENTRALAB DISTRIBUTOR
He has the "know-how" it takes
to help solve your problems.



CERAMIC CAPACITORS (Cont.)

1000 V.D.C.W. STANDARD DISC HI-KAPS®

- The most complete line of standard disc capacitors available.
- All units 1000 VDCW—100% tested at 2000 V.D.C.
- All units thru .005 mmf. built to Underwriters' Labs test specifications for use in A.C. lines.
- Close tolerances—smallest available sizes.
- Double coating of Durez phenolic insulation to give maximum breakdown strength.



CAP. mmf.	TOL.	DIAM.	CAT. NO.
3.3	±.5 mmf.	1/4"	DD-3R3
5	.5 mmf.	1/4"	DD-050
6.8	.5 mmf.	1/4"	DD-6R8
10	±10%	1/4"	DD-100
15	10%	1/4"	DD-150
20	10%	1/4"	DD-200
25	10%	1/4"	DD-250
33	10%	1/4"	DD-330
39	10%	1/4"	DD-390
47	10%	1/4"	DD-470
50	10%	1/4"	DD-500
56	10%	1/4"	DD-560
68	10%	1/4"	DD-680
75	10%	1/4"	DD-750
100	10%	1/4"	DD-101
120	10%	1/4"	DD-121
150	10%	1/4"	DD-151
180	10%	1/4"	DD-181
200	10%	1/4"	DD-201
220	±20%	1/4"	DD-221
250	20%	1/4"	DD-251
270	20%	1/4"	DD-271
300	20%	1/4"	DD-301
330	20%	1/4"	DD-331
390	20%	1/4"	DD-391
470	20%	1/4"	DD-471
500	20%	1/4"	DD-501
560	20%	1/4"	DD-561
680	20%	1/4"	DD-681
750	20%	1/4"	DD-751
800	20%	1/4"	DD-801
Mfd.			
.001	20%	3/8"	DD-102
.0015	20%	3/8"	DD-152
.002	20%	3/8"	DD-202
.003	20%	1/2"	DD-302
.0047	20%	1/2"	DD-472
.005	20%	1/2"	DD-5022†
.005	GMV	3/8"	DD-502
.01	20%	3/4"	DD-1032†
.01	GMV	3/4"	DD-103
.02(600VDCW)GMV		1/2"	DD-203†

LIST PRICE ALL ABOVE — \$0.20 each; \$1.00 package of 5 (min.)
Except †\$0.30 each, \$1.50 per 5.

List Price all above \$0.20 each — \$1.00 package of 5 except:

TYPE DD2 — DUAL DISCS

CAP. MFD.	TOL.	DIAM.	VDCW	CAT.NO.	LIST PRICE EACH
2 x .001	GMV	3/8"	600	DD2-102	\$0.40
2 x .0015	GMV	1/2"	600	DD2-152	.40
2 x .005	-20% +80%	1/2"	600	DD2-502	.45

TYPE DD3 — PATENTED SHIELDED DUAL DISC HI-KAPS®

CAP. MFD.	TOL.	DIAM.	VDCW	CAT.NO.	LIST PRICE EACH
2 x .001	GMV	3/8"	600	DD3-102	\$0.45
2 x .0015	GMV	3/8"	600	DD3-152	.45
2 x .002	GMV	1/2"	600	DD3-202	.45
2 x .005	GMV	1/2"	600	DD3-502	.50
2 x .01	GMV	3/8"	600	DD3-103	.50

3000-6000 V. HI-VO DISC CAPACITORS

These new units are highly efficient for bypass-coupling in high frequency circuits under conditions of extreme humidity or temperature.

- TEMPERATURE—Maintain high capacity and performance at 85° C.
- TOLERANCES—All units, ±20%.
- VOLTAGES—DD30 Series, 3000 VDCW, 6000 VDC Test.
DD60 Series, 6000 VDCW, 12,000 VDC Test.
- SIZES: (A) 1/2" x 5/8"; (B) 1/2" x 3/4"; (C) 1/2" x 7/8".



CAPACITY MMF.	CAT. NO. 3000 VDCW	SIZE	CAT. NO. 6000 VDCW	SIZE
4.7	DD30-4R7	(A)	DD60-4R7	(A)
6.8	DD30-6R8	(A)	DD60-6R8	(A)
8.2	DD30-8R2	(A)	DD60-8R2	(A)
10	DD30-100	(A)	DD60-100	(B)
12	DD30-120	(A)	DD60-120	(B)
15	DD30-150	(A)	DD60-150	(B)
22	DD30-220	(A)	DD60-220	(B)
25	DD30-250	(A)	DD60-250	(B)
27	DD30-270	(A)	DD60-270	(B)
30	—	(A)	DD60-300	(B)
33	DD30-330	(A)	DD60-330	(B)
39	DD30-390	(A)	DD60-390	(B)
47	DD30-470	(A)	DD60-470	(B)
50	DD30-500	(A)	DD60-500	(B)
56	DD30-560	(A)	DD60-560	(B)
68	DD30-680	(A)	DD60-680	(B)
75	DD30-750	(A)	DD60-750	(B)
82	DD30-820	(A)	DD60-820	(B)
100	DD30-101	(A)	DD60-101	(B)
120	DD30-121	(A)	DD60-121	(B)
150	DD30-151	(A)	DD60-151	(B)
180	DD30-181	(A)	DD60-181	(B)
200	DD30-201	(A)	DD60-201	(B)
220	DD30-221	(A)	DD60-221	(B)
250	DD30-251	(A)	DD60-251	(B)
270	DD30-271	(A)	DD60-271	(B)
300	DD30-301	(A)	DD60-301	(B)
330	DD30-331	(A)	DD60-331	(B)
390	DD30-391	(A)	DD60-391	(B)
400	DD30-401	(A)	DD60-401	(B)
470	DD30-471	(A)	DD60-471	(B)
500	DD30-501	(A)	DD60-501	(B)
560	DD30-561	(A)	DD60-561	(B)
680	DD30-681	(A)	DD60-681	(B)
750	DD30-751	(A)	DD60-751	(B)
1000	DD30-102	(A)	DD60-102	(B)
1200	DD30-122	(A)	DD60-122	(B)
1500	DD30-152	(A)	DD60-152	(B)
2000	DD30-202	(C)	—	—
2200	DD30-222	(C)	—	—
2500	DD30-252	(C)	—	—
2700	DD30-272	(C)	—	—
3000	DD30-302	(C)	—	—

LIST PRICES Each Env. of 5* Carton of 25
DD30 Series \$.40 \$2.00 \$10.00
DD60 Series .50 2.50 12.50

*Minimum Order Quantity.

MIN-KAP® MINIATURE DISCS

250 VDCW units for smaller voltage requirement applications (500 VDC test)—extremely small in size—3/8" diam. in high capacity values. Packages five per envelope (MIN.). Ideal for hearing aid, miniature radio, intercom, and experimental rigs.



CAP.	VDCW	THICKNESS	CAT. NO.	UNIT PRICE EACH
.005	250	.146"	DDM-502	\$.50
.01	250	.146"	DDM-103	.50
.02	250	.166"	DDM-203	.90
DUAL UNIT				
2x .01	250	.166"	DDM2-103	.90

SANGAMO CAPACITORS

ELECTROLYTIC CAPACITORS

TYPE MT-MTD-MTH

Chieftain

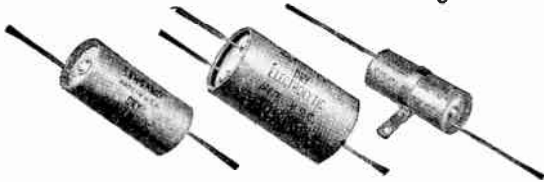

SANGAMO Type MT "Chieftain" electrolytics are especially designed for television and other electronic applications where operation at 85°C. temperatures is required. They are hermetically sealed in round aluminum containers which are encased in heavy insulating sleeves on which polarity is clearly indicated. Being small in physical size they are most popular where mounting in limited space is required — They will fit anywhere and can be mounted in almost any position. Double-thick paper spacers assure adequate breakdown characteristics and all sections are tightly held in place within the container. Multiple staking connects the terminal tabs to the electrodes and provides permanent low resistance contact throughout the life of the capacitor. Low voltage units utilize etched cathodes to maintain uniform capacity when they are subjected to combined conditions of heat and high ripple currents.

Catalog Number	Capacity mfd.	Single Units		List Price	Resale Net Price
		Working Volts D.C.	— Size — Dia. Len.		
MT-0210	10	25	5/8 x 1 1/8	\$1.00	\$0.60
MT-0225	25	25	5/8 x 1 1/8	1.00	.60
MT-0250	50	25	5/8 x 1 1/8	1.10	.66
MT-0510	10	50	5/8 x 1 1/8	1.00	.60
MT-0525	25	50	5/8 x 1 1/8	1.05	.63
MT-0550	50	50	5/8 x 1 1/8	1.20	.72
MT-1504	4	150	5/8 x 1 1/8	1.00	.60
MT-1508	8	150	5/8 x 1 1/8	1.05	.63
MT-1512	12	150	5/8 x 1 1/8	1.10	.66
MT-1516	16	150	5/8 x 1 1/8	1.15	.69
MT-1520	20	150	5/8 x 1 1/8	1.20	.72
MT-1530	30	150	5/8 x 1 1/8	1.30	.78
MT-1540	40	150	5/8 x 1 1/8	1.35	.81
MT-1550	50	150	5/8 x 1 1/8	1.40	.84
MT-2508	8	250	5/8 x 1 1/8	1.15	.69
MT-2512	12	250	5/8 x 1 1/8	1.25	.75
MT-2518	16	250	5/8 x 1 1/8	1.30	.78
MT-2520	20	250	5/8 x 1 1/8	1.35	.81
MT-2540	40	250	5/8 x 2 1/8	1.55	.93
MT-3508	8	350	5/8 x 1 1/8	1.20	.72
MT-3512	12	350	5/8 x 1 1/8	1.30	.78
MT-3516	16	350	5/8 x 1 1/8	1.40	.84
MT-4504	4	450	5/8 x 1 1/8	1.15	.69
MT-4508	8	450	5/8 x 1 1/8	1.25	.75
MT-4510	10	450	5/8 x 1 1/8	1.30	.78
MT-4512	12	450	5/8 x 1 1/8	1.35	.81
MT-4516	16	450	5/8 x 1 1/8	1.40	.84
MT-4520	20	450	5/8 x 1 1/8	1.55	.93
MT-4530	30	450	5/8 x 1 1/8	1.70	1.02
MT-4540	40	450	5/8 x 2 1/8	1.80	1.08

Catalog Number	Capacity mfd.	Dual Units		List Price	Resale Net Price
		Working Volts D.C.	— Size — Dia. Len.		
MTD-0210	10-10	25	7/8 x 1 1/8	\$1.40	\$0.84
MTD-0220	20-20	25	7/8 x 1 1/8	1.40	.84
MTD-1520	20-20	150	7/8 x 1 1/8	1.65	.99
MTD-1530	30-30	150	7/8 x 1 1/8	1.80	1.08
MTD-301	50-30	150	1 x 1 1/8	1.95	1.17
MTD-302	40-20	150	1 x 1 1/8	1.75	1.05
MTD-1540	40-40	150	1 x 1 1/8	1.85	1.11
MTD-1550	50-50	150	1 x 2 1/8	2.10	1.26
MTD-2520	20-20	250	1 x 1 1/2	1.85	1.11
MTD-3520	20-20	350	1 x 2 1/8	2.25	1.35
MTD-4508	8-8	450	1 7/8 x 1 1/8	1.70	1.02
MTD-4510	10-10	450	1 7/8 x 1 1/8	1.85	1.11
MTD-4520	20-20	450	1 7/8 x 2 1/8	2.50	1.50

NOTE: Packaging: 10, 25, or 50 capacitors per display carton.
NOTE: Diagram dimensions are for metal tubes. Add 1/8" to diameter and 1/8" to length for dimensions over cardboard insulating tubes.

Catalog Number	Capacity mfd.	Working Volts D.C.	— Size —		List Price	Resale Net Price
			Dia.	Len.		
MTH-0610	100	6	5/8 x 1 1/8		\$1.20	\$0.72
MTH-0625	250	6	5/8 x 1 1/8		1.35	.81
MTH-0650	500	8	5/8 x 2 1/8		1.55	.93
MTH-08100	1000	6	1 x 1 1/8		1.90	1.14
MTH-08150	1500	6	1 x 2 1/8		2.10	1.26
MTH-1210	100	12	5/8 x 1 1/8		1.20	.72
MTH-1225	250	12	5/8 x 1 1/8		1.45	.87
MTH-1250	500	12	5/8 x 2 1/8		1.70	1.02
MTH-1510	100	15	5/8 x 1 1/8		1.25	.75
MTH-1525	250	15	5/8 x 1 1/8		1.55	.93
MTH-1550	500	15	5/8 x 2 1/8		1.75	1.05
MTH-2510	100	25	5/8 x 1 1/8		1.35	.81
MTH-2525	250	25	5/8 x 1 1/8		1.70	1.02
MTH-2550	500	25	5/8 x 2 1/8		2.30	1.38
MTH-5010	100	50	7/8 x 1 1/8		1.40	.84

NOTE: Dimensions are for metal tubes. Add 1/8" to diameter and 1/8" to length for dimensions over cardboard insulating tube.
NOTE: Packaging: 10, 25, or 50 capacitors per display carton.

TYPE FM

Arrowhead



The SANGAMO Type FM "Arrowhead" electrolytic capacitors are similar in design to the Type MT "Chieftain" in every respect except leads. The Type FM is equipped with flexible, insulated wire leads and stud terminals eliminating the problem of crossed wires and the necessity for the use of insulating sleeves. They are much smaller than the wax-end filled types with insulated leads. The capacitors themselves are housed in round aluminum containers which are encased in heavy insulating sleeves. They are especially designed for the rugged television requirements where 85°C. operating temperatures are encountered.

Catalog Number	Capacity mfd.	Working Volts D.C.	— Size —		List Price	Resale Net Price
			Dia.	Len.		
FMD-0210	10-10	25	7/8 x 1 1/8		\$1.40	\$0.84
FMD-0510	10-10	50	7/8 x 1 1/8		1.40	.84
FMD-1520	20-20	150	7/8 x 1 1/8		1.65	.99
FMD-305	30-20	150	7/8 x 1 1/8		1.70	1.02
FMD-1530	30-30	150	7/8 x 1 1/8		1.80	1.08
FMD-302	40-20	150	1 x 1 1/8		1.75	1.05
FMD-304	40-30	150	1 x 1 1/8		1.80	1.08
FMD-1540	40-40	150	1 x 1 1/8		1.85	1.11
FMD-301	50-30	150	1 x 2 1/8		1.95	1.17
FMD-1550	50-50	150	1 x 2 1/8		2.10	1.26
FMD-4508	8-8	450	1 7/8 x 1 1/8		1.70	1.02
FMD-4515	8-15	450	1 7/8 x 1 1/8		2.00	1.20
FMD-4520	20-20	450	1 x 2 1/8		2.50	1.50

Catalog Number	Capacity mfd.	Working Volts D.C.	— Size —		List Price	Resale Net Price
			Dia.	Len.		
FMT-1520	20-20-20	150	7/8 x 1 1/8		\$2.20	\$1.32
FMT-1530	30-30-30	150	7/8 x 2 1/8		2.35	1.41
FMT-310	40-20-20	150	7/8 x 1 1/8		2.25	1.35
FMT-312	40-30-20	150	7/8 x 2 1/8		2.35	1.41
FMT-1540	40-40-40	150	1 x 2 1/8		2.45	1.47
FMT-315	50-30-20	150	1 x 2 1/8		2.45	1.47

NOTE: All units are supplied with mounting strap attached.
NOTE: Packaging: 10, 25, or 50 capacitors per display carton.
NOTE: Diagram dimensions are for metal tubes. Add 1/8" to diameter and 1/8" to length for dimensions over cardboard insulating tube.

TYPE MMT

MINIATURE TUBES



SANGAMO Type MMT miniature tubular electrolytic capacitors are designed for use in miniaturized equipment and are ideally suited to meet the precise operating requirements of low voltage circuits. They are small in physical size and are self supporting by means of strong bare finned copper wire leads. The Type MMT capacitors are contained in drawn aluminum tubes encased in a fitted cardboard insulating sleeve. Polarity of all units is clearly marked on the cardboard sleeve.

Catalog Number	Capacity mfd.	Working Volts D.C.	— Size —		List Price	Resale Net Price
			Dia.	Len.		
MMT-605	5	6	3/8 x 1 1/8		\$0.80	\$0.48
MMT-0505	5	50	3/8 x 1 1/8		1.00	.60
MMT-0210	10	25	3/8 x 1 1/8		1.00	.60
MMT-0510	10	50	3/8 x 1 1/8		1.00	.60
MMT-0220	20	25	3/8 x 1 1/8		1.00	.60
MMT-225	25	3	3/8 x 1 1/8		.85	.51
MMT-625	25	6	3/8 x 1 1/8		.85	.51
MMT-350	50	3	3/8 x 1 1/8		.95	.57
MMT-650	50	6	3/8 x 1 1/8		.95	.57
MMT-1505	5	150	3/8 x 1 1/8		1.00	.60
MMT-4501	1	450	3/8 x 1 1/8		1.00	.60

NOTE: Diagram dimensions are for metal tubes. Add 1/8 inch to diameter and 1/8 inch to length for dimensions over cardboard insulating tube.

SANGAMO CAPACITORS

ELECTROLYTIC CAPACITORS

TYPE CS

Tomahawk



The SANGAMO Type CS "Tomahawk" electrolytic capacitors are contained in wax-filled cardboard tubes with insulated leads approximately 8 inches in length extending from both ends of the unit. Capacity, voltage and polarity of each section is clearly indicated by color of the lead wires; coding information necessary to identify the individual sections is clearly stamped on the tube. Each unit is supplied with a mounting strap to facilitate mounting to the chassis.

Dual Common Negative Units

Catalog Number	Capacity mfd.	Working Volts D.C.	Size Dia. Len.	Net Price	Resale Net Price
CSD-0210	10-10	25	1/4 x 2 3/8	\$1.40	\$0.84
CSD-0510	10-10	50	1/4 x 2 3/8	1.40	.84
CSD-1508	8-8	150	1/4 x 2 3/8	1.50	.90
CSD-1516	16-16	150	1/4 x 2 1/2	1.80	1.08
CSD-1520	20-20	150	3/8 x 2 1/2	1.65	.99
CSD-500	30-30	150	3/8 x 2 1/2	1.70	1.02
CSD-1530	30-30	150	3/8 x 2 1/2	1.80	1.08
CSD-505	40-20	150	1 x 2 1/2	1.75	1.05
CSD-506	40-30	150	1 x 2 1/2	1.80	1.08
CSD-1540	40-40	150	1 x 2 1/2	1.85	1.11
CSD-512	50-30	150	1 x 2 1/2	1.95	1.17
CSD-1550	50-50	150	1 x 3	2.10	1.26
CSD-2516	16-16	250	1 x 2 1/2	1.75	1.05
CSD-4508	8-8	450	1 x 2 1/2	1.70	1.02
CSD-522	8-16	450	1 x 2 3/8	2.00	1.20
CSD-4520	20-20	450	1 x 3 3/8	2.50	1.50

Dual Separate Sections

Catalog Number	Capacity mfd.	Working Volts D.C.	Size Dia. Len.	Net Price	Resale Net Price
CS5-1520	20-20	150	1 x 2 1/2	\$2.05	\$1.23
CS5-4508	8-8	450	1 x 2 1/2	2.15	1.29
CS5-4516	16-16	450	1 1/4 x 3 3/8	2.80	1.68

Triple Common Negative Units

Catalog Number	Capacity mfd.	Working Volts D.C.	Size Dia. Len.	Net Price	Resale Net Price
CST-1520	20-20-20	150	1 x 2 3/8	\$2.20	\$1.32
CST-523	40-20-20	150	1 x 2 3/8	2.25	1.35
CST-524	40-30-20	150	1 x 2 3/8	2.35	1.41
CST-1540	40-40-40	150	1 x 3 3/8	2.45	1.47
CST-526	20-20-20	150-150-25	1 x 2 3/8	2.05	1.23
CST-527	40-20-20	150-150-25	1 x 2 3/8	2.15	1.29
CST-528	40-30-20	150-150-25	1 x 2 3/8	2.20	1.32
CST-532	50-30-20	150-150-25	1 x 2 3/8	2.35	1.41
CST-533	50-30-100	150-150-25	1 x 3 3/8	2.55	1.53
CST-534	80-40-20	150-150-25	1 x 3 3/8	2.60	1.56
CST-535	12-12-20	450-450-25	1 x 2 3/8	2.30	1.38
CST-537	20-20-20	450-450-25	1 1/4 x 3 3/8	2.90	1.74

NOTE: Packaging: 10, 25, or 50 per display carton.

COLOR CODE OF WIRE LEADS FOR TYPES FM, CS, AND SL CAPACITORS

Black..... Common negative
 Orange..... Positive, highest voltage or capacity
 Red..... Positive, next highest voltage or capacity
 Blue..... Positive, next highest voltage or capacity
 Yellow..... Positive, next highest voltage or capacity
 Brown..... Negative, in separate section unit

NOTE: Lead colors are determined by the rated working voltages. Where there are two or more sections of different voltages and the same capacity, the lead color will designate the voltage; with the same voltages and unequal capacities, the lead color will designate the capacity. If there are two sections with equal capacities and voltages the two lead wires will be in the same color.

NOTE: Based upon proposed R.T.M.A. Color code.

TYPE EM (MOTOR STARTING)

Trailblazer



The SANGAMO Type EM electrolytic capacitor is a standard universal replacement for all motor starter types presently in use, and its dimensions are comparable in every respect. The Type EML is provided with solder lug terminals, the Type EMS being equipped with screw types; otherwise the two units are identical in construction and operational characteristics. Insulating tubes are supplied with both types.

110 Volts A.C.

EML Catalog Number	Capacity, mfd. Range	Working Volts Nominal	Can Size, less insulating tube. Dia. Len.	List Price	Resale Net Price
EML-1120	20-24	20	1 3/8 x 3 1/4	\$2.05	\$1.43
EML-1126	26-30	26	1 3/8 x 3 1/4	2.10	1.47
EML-1132	32-36	32	1 5/8 x 3 1/4	2.10	1.47
EML-1138	38-42	38	1 5/8 x 3 3/8	2.10	1.47
EML-1143	43-48	43	1 5/8 x 3 3/8	2.10	1.47
EML-1153	53-60	53	1 5/8 x 3 3/8	2.15	1.50
EML-1164	64-72	64	1 5/8 x 3 3/8	2.25	1.57
EML-1170	70-78	70	1 5/8 x 3 3/8	2.30	1.61
EML-1175	75-84	75	1 5/8 x 3 3/8	2.30	1.61
EML-1186	86-96	86	1 5/8 x 3 3/8	2.60	1.82
EML-1197	97-107	97	1 5/8 x 3 3/8	2.65	1.85
EML-11108	108-120	108	1 5/8 x 3 3/8	2.85	1.99
EML-11124	124-138	124	1 5/8 x 3 3/8	2.95	2.06
EML-11145	145-162	145	1 5/8 x 3 3/8	3.20	2.24
EML-11161	161-180	161	1 5/8 x 4 1/4	3.25	2.27
EML-11161	161-180	161	2 x 3 3/8	3.25	2.27
EML-11189	189-216	189	2 x 3 3/8	3.75	2.62
EML-11216	216-240	216	2 x 3 3/8	4.05	2.83
EML-11243	243-270	243	2 x 3 3/8	4.70	3.29
EML-11270	270-300	270	2 x 4 1/4	4.75	3.32
EML-11324	324-360	324	2 x 4 1/4	5.40	3.78
EML-11378	378-420	378	2 x 4 1/4	6.00	4.20
EML-11400	400-480	400	2 x 4 1/4	6.05	4.23

220 Volts A.C.

EML Catalog Number	Capacity, mfd. Range	Working Volts Nominal	Can Size, less insulating tube. Dia. Len.	List Price	Resale Net Price
EML-2220	20-24	20	1 3/8 x 3 1/4	\$2.91	\$2.03
EML-2226	26-30	26	1 3/8 x 3 1/4	3.35	2.34
EML-2232	32-36	32	2 x 4 1/4	3.79	2.65
EML-2238	38-42	38	2 x 4 1/4	4.30	3.04
EML-2243	43-48	43	2 x 4 1/4	4.55	3.18
EML-2253	53-60	53	2 x 4 1/4	5.19	3.63

110 Volts A.C.

EMS Catalog Number	Capacity, mfd. Range	Working Volts Nominal	Can Size, less insulating tube. Dia. Len.	List Price	Resale Net Price
EMS-1120	20-24	20	1 3/8 x 3 1/4	\$2.05	\$1.43
EMS-1126	26-30	26	1 3/8 x 3 1/4	2.10	1.47
EMS-1132	32-36	32	1 5/8 x 3 1/4	2.10	1.47
EMS-1138	38-42	38	1 5/8 x 3 3/8	2.10	1.47
EMS-1143	43-48	43	1 5/8 x 3 3/8	2.10	1.47
EMS-1153	53-60	53	1 5/8 x 3 3/8	2.15	1.50
EMS-1164	64-72	64	1 5/8 x 3 3/8	2.25	1.57
EMS-1170	70-78	70	1 5/8 x 3 3/8	2.30	1.61
EMS-1175	75-84	75	1 5/8 x 3 3/8	2.30	1.61
EMS-1186	86-96	86	1 5/8 x 3 3/8	2.60	1.82
EMS-1197	97-107	97	1 5/8 x 3 3/8	2.65	1.85
EMS-11108	108-120	108	1 5/8 x 3 3/8	2.85	1.99
EMS-11124	124-138	124	1 5/8 x 3 3/8	2.95	2.06
EMS-11145	145-162	145	1 5/8 x 3 3/8	3.20	2.24
EMS-11161	161-180	161	1 5/8 x 4 1/4	3.25	2.27
EMS-11161	161-180	161	2 x 3 3/8	3.25	2.27
EMS-11189	189-216	189	2 x 3 3/8	3.75	2.62
EMS-11216	216-240	216	2 x 3 3/8	4.05	2.83
EMS-11243	243-270	243	2 x 4 1/4	4.70	3.29
EMS-11270	270-300	270	2 x 4 1/4	4.75	3.32
EMS-11324	324-360	324	2 x 4 1/4	5.40	3.78
EMS-11378	378-420	378	2 x 4 1/4	6.00	4.20
EMS-11400	400-480	400	2 x 4 1/4	6.05	4.23

220 Volts A.C.

EMS Catalog Number	Capacity, mfd. Range	Working Volts Nominal	Can Size, less insulating tube. Dia. Len.	List Price	Resale Net Price
EMS-2220	20-24	20	1 3/8 x 3 1/4	\$2.96	\$2.06
EMS-2226	26-30	26	1 3/8 x 3 1/4	3.40	2.37
EMS-2232	32-36	32	2 x 4 1/4	3.84	2.68
EMS-2238	38-42	38	2 x 4 1/4	4.35	3.04
EMS-2243	43-48	43	2 x 4 1/4	4.80	3.21
EMS-2253	53-60	53	2 x 4 1/4	5.24	3.66

NOTE: For insulating tube dimensions add 1/8" to the can diameter and 1/8" to the can length.

NOTE: Packaging: Individual display carton.

SANGAMO CAPACITORS

TYPE SL

wet electrolytics, the Designed primarily as replacements for Type SL electrolytic capacitors are assembled in round aluminum cans with threaded necks providing easy mounting to a chassis with the aid of a palnut which is supplied. The Type SL is completely insulated from the container, the negative connection being made to one of the insulated leads extending through the threaded neck of the can.



Single Section						
Catalog Number	Capacity mfd.	Wkg. Volts D.C.	— Size — Dia. Len.	List Price	Resale Net Price	
SL-2512	12	250	1 x 2 1/2	\$1.75	\$1.05	
SL-2525	25	250	1 x 3 1/2	1.95	1.1	
SL-4508	8	450	1 1/2 x 2 1/2	2.20	1.32	
SL-4512	12	450	1 1/2 x 3 1/2	2.40	1.44	
SL-4516	16	450	1 1/2 x 2 1/2	2.45	1.47	
SL-4520	20	450	1 1/2 x 2 1/2	2.70	1.62	
SL-4530	30	450	1 1/2 x 3 1/2	3.00	1.80	
SL-4540	40	450	1 1/2 x 4 1/4	3.15	1.89	

Common Negative Section						
Catalog Number	Capacity mfd.	Wkg. Volts D.C.	— Size — Dia. Len.	List Price	Resale Net Price	
SLD-4508	8-8	450	1 1/2 x 3 1/2	\$3.00	\$1.80	
SLD-4516	16-16	450	1 1/2 x 3 1/2	3.55	2.13	
SLT-4508	8-8-8	450	1 1/2 x 3 1/2	5.00	3.00	

High Voltage, Series Wound Sections

Catalog Number	Capacity mfd.	Wkg. Volts D.C.	— Size — Dia. Len.	List Price	Resale Net Price	
SL-6004	4	600	1 1/2 x 3 1/2	\$2.95	\$1.77	
SL-6008	8	600	1 1/2 x 4 1/4	3.15	1.89	
SL-6016	16	600	1 1/2 x 4 1/4	3.75	2.25	

TYPE TS

ideally suited for all applications where quick capacitor changes are required, the SANGAMO Type TS units are equipped with a

four-pin octal base mounting for use with standard octal base tube sockets. The special design of the bakelite octal base insures that the aluminum container will not contact the mounting surface and the connections to the brass pin terminals are imbedded in this bakelite base. The base pins are nickel-plated to prevent corrosion and insure good contact with the socket terminals.



Single Section						
Catalog Number	Capacity mfd.	Wkg. Volts D.C.	— Size — Dia. Len.	List Price	Resale Net Price	
TS-1520	20	150	1 1/2 x 2 1/2	\$3.95	\$2.37	
TS-1540	40	150	1 1/2 x 2 1/2	4.10	2.46	
TS-4510	10	450	1 1/2 x 2 1/2	4.05	2.43	
TS-4520	20	450	1 1/2 x 2 1/2	4.30	2.58	
TS-4540	40	450	1 1/2 x 2 1/2	4.55	2.73	
TS-4580	80	450	1 1/2 x 4 1/4	5.55	3.33	

Dual Sections

Catalog Number	Capacity mfd.	Wkg. Volts D.C.	— Size — Dia. Len.	List Price	Resale Net Price	
TSD-1520	20-20	150	1 1/2 x 2 1/2	\$4.20	\$2.52	
TSD-1540	40-40	150	1 1/2 x 2 1/2	4.40	2.64	
TSD-4510	10-10	450	1 1/2 x 2 1/2	4.40	2.64	
TSD-4520	20-20	450	1 1/2 x 2 1/2	5.05	3.03	

Multiple Sections

Catalog Number	Capacity mfd.	Wkg. Volts D.C.	— Size — Dia. Len.	List Price	Resale Net Price	
TST-4510	10-10-10	450	1 1/2 x 2 1/2	\$5.10	\$3.06	
TST-901	20-20-20	450-450-25	1 1/2 x 2 1/2	5.55	3.33	

NOTE: Not normally carried in stock. Available on special order only.
NOTE: Packaging: Individual display carton.

PAPER CAPACITORS

Telechief

PLASTIC MOLDED TUBULAR



The SANGAMO "Telechief" is molded in Sangamo HUMIDITITE to provide more stable capacity values, unsurpassed moisture resistance, excellent seal characteristics, and operation up to 85°C. temperature. Small in physical size, and rugged in construction, this tubular is especially adaptable to television, auto radio, small AC-DC set, and other uses. The leads are firmly imbedded in the hard plastic case and have been especially designed to resist breakage. The "Telechief" assures operating dependability under extremes of heat, humidity and physical stress.

Catalog Number	Capacity mfd.	Working Volts D.C.	— Size — Dia. Len.	List Price	Resale Net Price	
330221	.001	200	1/8 x 1	\$0.25	\$0.15	
330225	.005	200	1/8 x 1 1/2	.25	.15	
330211	.01	200	1/8 x 1 1/2	.25	.15	
330212	.02	200	1/8 x 1 1/2	.25	.15	
330217	.017	200	1/8 x 1 1/2	.30	.18	
330215	.05	200	1/8 x 1 1/2	.30	.18	
330201	.1	200	1/8 x 1 1/2	.35	.21	
330205	.15	200	1/8 x 1 1/2	.35	.21	
330202	.22	200	1/8 x 1 1/2	.40	.24	
330205	.25	200	1/8 x 2	.45	.27	
330207	.37	200	1/8 x 2	.60	.36	
330205	.5	200	1/8 x 2	.60	.36	
330210	1.0	200	1 x 2 1/2	.90	.54	
330421	.001	400	1/8 x 1	.25	.15	
330425	.005	400	1/8 x 1	.25	.15	
330411	.01	400	1/8 x 1 1/2	.25	.15	
330412	.02	400	1/8 x 1 1/2	.25	.15	
3304122	.022	400	1/8 x 1 1/2	.25	.15	
330417	.047	400	1/8 x 1 1/2	.30	.18	
330415	.05	400	1/8 x 1 1/2	.30	.18	
3304168	.068	400	1/8 x 1 1/2	.35	.21	
330401	.1	400	1/8 x 1 1/2	.35	.21	
330405	.15	400	1/8 x 2	.40	.24	
330402	.2	400	1/8 x 2	.40	.24	
3304022	.22	400	1/8 x 2	.45	.27	
3304025	.25	400	1/8 x 2	.60	.36	
330405	.5	400	1/8 x 2	.80	.48	
330410	1.0	400	1 1/2 x 2 1/2	.80	.48	
330635	.0005	600	1/8 x 1	\$0.25	\$0.15	
330621	.001	600	1/8 x 1	.25	.15	
3306215	.0015	600	1/8 x 1	.25	.15	
330622	.002	600	1/8 x 1	.25	.15	
3306222	.0022	600	1/8 x 1	.25	.15	
330623	.003	600	1/8 x 1	.25	.15	
330624	.004	600	1/8 x 1	.25	.15	
3306247	.0047	600	1/8 x 1	.25	.15	
330625	.005	600	1/8 x 1 1/2	.25	.15	
330626	.006	600	1/8 x 1 1/2	.25	.15	
3306268	.0068	600	1/8 x 1 1/2	.30	.18	
330611	.01	600	1/8 x 1 1/2	.30	.18	
3306115	.015	600	1/8 x 1 1/2	.30	.18	
330612	.02	600	1/8 x 1 1/2	.30	.18	
3306122	.022	600	1/8 x 1 1/2	.30	.18	
330613	.03	600	1/8 x 1 1/2	.35	.21	
330614	.04	600	1/8 x 1 1/2	.35	.21	
3306147	.047	600	1/8 x 1 1/2	.40	.24	
330615	.05	600	1/8 x 1 1/2	.40	.24	
330616	.06	600	1/8 x 1 1/2	.40	.24	
330601	.1	600	1/8 x 2	.45	.27	
330602	.2	600	1/8 x 2	.55	.33	
3306025	.25	600	1/8 x 2	.65	.39	
330605	.5	600	1 x 2 1/2	.80	.48	
330610	1.0	600	1 1/2 x 2 1/2	1.25	.75	

NOTE: Additional capacity values in the 200 and 400 volt ratings can be supplied on request.

NOTE: Packaging: 20, 50, or 100 per display carton.

NOTE: Standard capacity tolerance:
.005 mfd. +60% —25
.001 mfd. to .01 mfd. +60% —20
.01 mfd. to .15 mfd. ±20%
.15 mfd. and up. +20% —10

SANGAMO CAPACITORS

PAPER CAPACITORS

TYPE 50 *Pathfinder*



The Type 50 paper capacitors are primarily intended for bypass application. They are non-inductively wound, are supplied in fractional capacity values, and will provide efficient and continuous operation in R.F. and A.F. bypass, audio frequency coupling, and other A.C. circuits.

These units are impregnated and filled with mineral oil and may be operated under severe humidity conditions at temperatures up to +85°C.

600 W.V. D.C.

Catalog Number	Capacity mfd.	Dimensions — Inches			List Price	Resale Net Price
		L	W	H		
5006-.05	.05	1 1/8	1	3/4	\$2.90	\$1.74
5006-.1	.1	1 1/8	1	3/4	2.95	1.77
5006-.25	.25	1 1/8	1	3/4	3.10	1.86
5006-.5	.5	1 1/8	1	1	3.30	1.98
5006-1	1.0	2	1 1/4	3/4	3.75	2.25
5006-2	2.0*	2	2	1 1/4	5.00	3.00
5006-.05x2	.05-.05	1 1/8	1	3/4	3.65	2.19
5006-.1x2	.1-.1	1 1/8	1	3/4	3.70	2.22
5006-.25x2	.25-.25	1 1/8	1	3/4	3.75	2.25
5006-.5x2	.5-.5	2	1 1/4	3/4	4.30	2.58
5006-1x2	1.0-1.0*	2	2	1 1/4	5.30	3.18
5006-.1x3	.1-.1-1	1 1/8	1	3/4	4.20	2.52
5006-.25x3	.25-.25-.25	2	1 1/4	3/4	4.75	2.85
5006-.5x3	.5-.5-.5*	2	2	1 1/4	5.75	3.45

1000 W.V. D.C.

Catalog Number	Capacity mfd.	Dimensions — Inches			List Price	Resale Net Price
		L	W	H		
5010-.05	.05	1 1/8	1	3/4	\$3.05	\$1.83
5010-.1	.1	1 1/8	1	3/4	3.15	1.89
5010-.25	.25	1 1/8	1	3/4	3.25	1.95
5010-.5	.5	2	1 1/4	3/4	3.55	2.13
5010-1	1.0*	2	2	1 1/4	4.40	2.64
5010-.05x2	.05-.05	1 1/8	1	3/4	3.85	2.31
5010-.1x2	.1-.1	1 1/8	1	3/4	4.00	2.40
5010-.25x2	.25-.25	2	1 1/4	3/4	4.20	2.52
5010-.5x2	.5-.5*	2	2	1 1/4	5.45	3.27
5010-1x3	.1-.1-1	2	1 1/4	3/4	4.60	2.76
5010-.25x3	.25-.25-.25*	2	2	1 1/4	5.50	3.00

NOTE: *For bottom or top terminal, case size becomes 2" x 2" x 1 1/4"

NOTE: Packaging: Individual display carton.

NOTE: The above units built to comply with the electrical requirements of specification JAN-C-25 Style CP-53-54-55.

NOTE: Standard capacity tol. +20% —10%.

TYPE 62-64 *Scout*



The Types 62 and 64 SANGAMO non-inductively wound paper capacitors are impregnated and filled with mineral oil and are hermetically sealed in seamless drawn-steel cases. The mineral oil impregnant assures dependable service between the wide temperature limits of —55°C. and +85°C. Standard capacitors are supplied with top terminals and brackets for upright mounting. When bottom terminals and inverted mounting are required, add the letter "B" to the end of the catalog number.

TYPE 62 PAPER CAPACITORS 600 W.V. D.C.

Catalog Number	Capacity mfd.	Dimensions inldg. bracket			List Price	Resale Net Price
		L	W	H		
62B06-.01	.01	1 1/8	1	1 1/8	\$3.65	\$2.19
62B06-.05	.05	1 1/8	1	1 1/8	3.65	2.19
62B06-.1	.1	1 1/8	1	1 1/8	3.65	2.19
62B06-.25	.25	1 1/8	1	1 1/8	3.90	2.34
62C06-.5	.5	1 1/8	1 1/4	1 1/8	4.20	2.52
62A06-1.	1.0	1 1/8	2 1/4	1 1/8	4.65	2.79
62A06-2.	2.0	1 1/8	2 1/4	2 1/8	6.10	3.66

1000 W.V. D.C.

Catalog Number	Capacity mfd.	Dimensions inldg. bracket			List Price	Resale Net Price
		L	W	H		
62B10-.05	.05	1 1/8	1	1 1/8	\$3.75	\$2.25
62B10-.1	.1	1 1/8	1	1 1/8	4.00	2.40
62C10-.25	.25	1 1/8	1 1/4	1 1/8	4.20	2.52
62A10-.5	.5	1 1/8	2 1/4	1 1/8	4.45	2.67
62A10-1.	1.0	1 1/8	2 1/4	2 1/8	5.20	3.12

TYPE 64 PAPER CAPACITORS 600 W.V. D.C.

Catalog Number	Capacity mfd.	Dimensions inldg. bracket			List Price	Resale Net Price
		L	W	H		
64A06-.01	.01	2 1/8	1 1/4	2 1/8	\$3.55	\$2.13
64A06-.05	.05	2 1/8	1 1/4	2 1/8	3.55	2.13
64A06-.1	.1	2 1/8	1 1/4	2 1/8	3.55	2.13
64A06-.25	.25	2 1/8	1 1/4	2 1/8	3.85	2.31
64A06-.5	.5	2 1/8	1 1/4	2 1/8	4.10	2.46
64A06-1.	1.0	2 1/8	1 1/4	2 1/8	4.70	2.82
64A06-2.	2.0	1 1/8	1 1/4	2 1/8	6.05	3.63

1000 W.V. D.C.

Catalog Number	Capacity mfd.	Dimensions inldg. bracket			List Price	Resale Net Price
		L	W	H		
64A10-.05	.05	2 1/8	1 1/4	2 1/8	\$3.70	\$2.22
64A10-.1	.1	2 1/8	1 1/4	2 1/8	3.95	2.37
64A10-.25	.25	2 1/8	1 1/4	2 1/8	4.15	2.49
64A10-.5	.5	2 1/8	1 1/4	2 1/8	4.40	2.64
64A10-1.	1.0	1 1/8	1 1/4	2 1/8	5.15	3.09

NOTE: Not normally carried in stock. Available on special order only.

NOTE: Packaging: Individual display carton.

NOTE: The above units built to comply with the electrical requirements of specification JAN-C-25 Style CP-61-63-65-67-69.

TYPE 40-41 *Pueblo*



The SANGAMO Types 40 and 41 diacior impregnated and filled paper capacitors are ideal for use in high voltage filter applications.

Enclosed in aluminum containers, they facilitate convenient mounting to the chassis, an insulating washer and spade lug being provided for this purpose. In the Type 40 one connection is provided by an insulated terminal and the other is provided by the case. In the Type 41 both terminals are completely insulated from the case.

NOTE: These units built to comply with the electrical requirements of specification JAN-C-25 Style CP-40-41.

TYPE 40 PAPER CAPACITORS

Catalog Number	Capacity mfd.	Working Volts D.C.	— Size —		List Price	Resale Net Price
			Dia.	Len.		
4006-1	1.	600	1 1/2 x 1 1/4		\$3.85	\$2.31
4006-2	2.	600	1 1/2 x 2 3/8		4.60	2.76
4006-4	4.	600	1 1/2 x 3 3/8		6.30	3.78
4010-1	1.	1000	1 1/2 x 2 3/8		4.20	2.52
4010-2	2.	1000	1 1/2 x 3 3/8		5.45	3.27
4015-.25	.25	1500	1 1/2 x 1 1/4		4.85	2.91
4015-.5	.5	1500	1 1/2 x 2 3/8		5.00	3.00
4015-1.	1.	1500	1 1/2 x 3 3/8		5.45	3.27

TYPE 41 PAPER CAPACITORS

Catalog Number	Capacity mfd.	Working Volts D.C.	— Size —		List Price	Resale Net Price
			Dia.	Len.		
4106-1	1.	600	1 1/2 x 1 1/4		\$4.70	\$2.82
4106-2	2.	600	1 1/2 x 2 3/8		5.40	3.24
4106-4	4.	600	1 1/2 x 3 3/8		7.10	4.26
4110-1	1.	1000	1 1/2 x 2 3/8		5.00	3.00
4110-2	2.	1000	1 1/2 x 3 3/8		6.30	3.78
4115-.25	.25	1500	1 1/2 x 1 1/4		5.65	3.39
4115-.5	.5	1500	1 1/2 x 2 3/8		5.85	3.51
4115-1.	1.	1500	1 1/2 x 3 3/8		6.30	3.78

NOTE: Packaging: Individual display carton.

SANGAMO CAPACITORS

PAPER CAPACITORS

TYPE 71 *Seminole*

SANGAMO Type 71 diactor impregnated and filled paper capacitors have the advantage of light weight, and are smaller than the case size specified by JAN-C-25. Diactor* is a specially compounded, chemically purified chlorinated dielectric oil. This synthetic impregnant, whose characteristics can be controlled with great uniformity, possesses a high dielectric constant, high volume resistivity, low power factor, high dielectric strength, and is non-inflammable and non-explosive. Type A mounting brackets are supplied with each capacitor as standard equipment. If Type B or C brackets are required, they must be specified when ordering. Either composition rivet or stand-off porcelain terminals can be supplied, and the type desired should be specified.

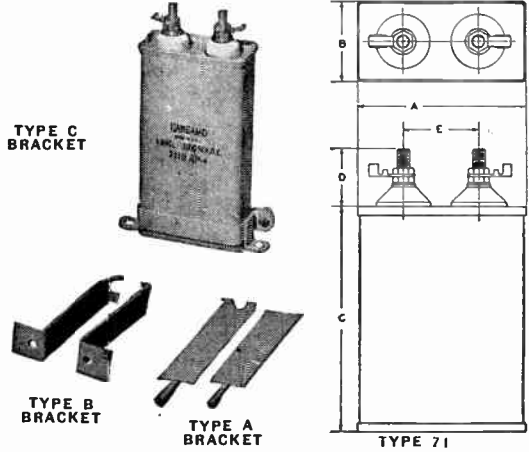

Catalog Number	Capacity mfd.	Dimensions — Inches						List Price	Resale Net Price
		A	B	C	D	E	F		
7106-.5	.5	1 3/8	1 3/8	1 5/8	2 1/8	2 1/8	\$4.70	\$2.82	
7106-1	1.	1 3/8	1 3/8	2 1/8	2 3/4	2 3/4	5.80	3.48	
7106-2	2.	1 3/8	1 3/8	2 3/8	3 1/4	3 1/4	7.15	4.29	
7106-4	4.	2 1/8	2 1/8	2 3/8	4 1/4	4 1/4	9.10	5.46	
7106-6	6.	2 3/8	2 3/8	3 1/8	5 1/4	5 1/4	11.30	6.78	
7106-8	8.	3 1/8	3 1/8	3 3/8	6 1/4	6 1/4	13.50	8.10	
7106-10	10.	3 3/8	3 3/8	4 1/8	7 1/4	7 1/4	15.15	9.09	

Catalog Number	Capacity mfd.	Dimensions — Inches						List Price	Resale Net Price
		A	B	C	D	E	F		
7110-.1	.1	1 3/8	1 3/8	1 5/8	2 1/8	2 1/8	\$4.15	\$2.49	
7110-.25	.25	1 3/8	1 3/8	1 5/8	2 3/4	2 3/4	4.70	2.82	
7110-.5	.5	1 3/8	1 3/8	2 1/8	3 1/4	3 1/4	4.95	2.97	
7100-1	1.	1 3/8	1 3/8	2 3/8	4 1/4	4 1/4	6.35	3.81	
7110-2	2.	1 3/8	1 3/8	3 1/8	5 1/4	5 1/4	8.25	4.95	
7110-4	4.	2 1/8	2 1/8	4 1/8	6 1/4	6 1/4	10.45	6.27	
7110-6	6.	3 1/8	3 1/8	4 3/8	7 1/4	7 1/4	14.05	8.43	
7110-8	8.	3 3/8	3 3/8	5 1/8	8 1/4	8 1/4	15.15	9.09	
7110-10	10.	3 3/8	3 3/8	5 3/8	9 1/4	9 1/4	16.80	10.08	
7110-12	12.	3 3/8	3 3/8	6 1/8	10 1/4	10 1/4	18.15	10.89	
7110-15	15.	3 3/8	3 3/8	6 3/8	11 1/4	11 1/4	20.10	12.06	

Catalog Number	Capacity mfd.	Dimensions — Inches						List Price	Resale Net Price
		A	B	C	D	E	F		
7115-.5	.5	1 3/8	1 3/8	2 1/8	3 1/4	3 1/4	\$6.35	\$3.81	
7115-1	1.	1 3/8	1 3/8	2 3/8	4 1/4	4 1/4	7.45	4.47	
7115-2	2.	2 1/8	2 1/8	3 1/8	5 1/4	5 1/4	10.45	6.27	
7115-4	4.	3 1/8	3 1/8	4 1/8	6 1/4	6 1/4	14.05	8.43	
7115-6	6.	3 3/8	3 3/8	5 1/8	7 1/4	7 1/4	17.05	10.23	
7115-8	8.	3 3/8	3 3/8	5 3/8	8 1/4	8 1/4	20.90	12.54	
7115-10	10.	3 3/8	3 3/8	6 1/8	9 1/4	9 1/4	25.05	15.03	
7115-12	12.	3 3/8	3 3/8	6 3/8	10 1/4	10 1/4	27.25	16.35	
7115-15	15.	3 3/8	3 3/8	7 1/8	11 1/4	11 1/4	30.00	18.00	

NOTE: Standard tolerance $\pm 10\%$.
NOTE: Brackets supplied at no extra cost.

Catalog Number	Capacity mfd.	Dimensions — Inches						List Price	Resale Net Price
		A	B	C	D	E	F		
7120-.1	.1	1 3/8	1 3/8	1 5/8	2 1/8	2 1/8	\$6.60	\$3.96	
7120-.25	.25	1 3/8	1 3/8	2 1/8	2 3/4	2 3/4	7.15	4.29	
7120-.5	.5	1 3/8	1 3/8	2 3/8	3 1/4	3 1/4	7.45	4.47	
7120-1	1.	2 1/8	2 1/8	3 1/8	4 1/4	4 1/4	9.10	5.46	
7120-2	2.	2 3/8	2 3/8	3 3/8	5 1/4	5 1/4	10.75	6.45	
7120-4	4.	3 1/8	3 1/8	4 1/8	6 1/4	6 1/4	15.15	9.09	
7120-6	6.	3 3/8	3 3/8	5 1/8	7 1/4	7 1/4	20.10	12.06	
7120-8	8.	3 3/8	3 3/8	5 3/8	8 1/4	8 1/4	25.05	15.03	
7120-10	10.	3 3/8	3 3/8	6 1/8	9 1/4	9 1/4	30.55	18.33	
7120-12	12.	3 3/8	3 3/8	6 3/8	10 1/4	10 1/4	33.30	19.98	

Catalog Number	Capacity mfd.	Dimensions — Inches						List Price	Resale Net Price
		A	B	C	D	E	F		
7125-.5	.5	2 1/8	2 1/8	2 3/8	3 1/4	3 1/4	\$11.55	\$6.93	
7125-1	1.	3 1/8	3 1/8	3 3/8	4 1/4	4 1/4	13.20	7.92	
7125-2	2.	3 3/8	3 3/8	4 1/8	5 1/4	5 1/4	21.45	12.87	
7125-4	4.	4 1/8	4 1/8	5 1/8	6 1/4	6 1/4	30.00	18.00	
7125-10	10.	5 3/8	5 3/8	6 3/8	7 1/4	7 1/4	75.10	45.06	

Catalog Number	Capacity mfd.	Dimensions — Inches						List Price	Resale Net Price
		A	B	C	D	E	F		
7130-.1	.1	2 1/8	2 1/8	2 3/8	3 1/4	3 1/4	\$14.05	\$8.43	
7130-.25	.25	2 1/8	2 1/8	2 3/8	3 1/4	3 1/4	14.85	8.91	
7130-.5	.5	2 1/8	2 1/8	3 1/8	3 1/4	3 1/4	16.80	10.08	
7130-1	1.	3 1/8	3 1/8	4 1/8	4 1/4	4 1/4	20.10	12.06	
7130-2	2.	3 3/8	3 3/8	4 3/8	5 1/4	5 1/4	25.05	15.03	
7130-4	4.	4 3/8	4 3/8	5 3/8	6 1/4	6 1/4	36.85	22.11	

TYPE 21 *Chippewa*



Hermetically sealed in metal tubes, the SANGAMO Type 21 paper capacitor is primarily designed for bypass and coupling applications. They are non-inductively wound; and, impregnated and filled with mineral oil assuring greatest stability of capacity and low power factor over the wide range of temperatures from -55°C . to $+85^{\circ}\text{C}$. These units are built to comply with the electrical requirements of Specification JAN-C-25 Style CP 25-26-27-28-29.

TYPE 21 METAL CASES MINERAL OIL PAPER CAPACITORS 600 W.V. D.C.

Catalog Number	Capacity mfd.	Size — Dia. Len.		List Price	Resale Net Price
		Dia.	Len.		
2106-.003	.003	1/4	1 1/8	\$0.95	\$0.57
2106-.006	.006	3/8	1 1/8	.95	.57
2106-.01	.01	1/2	1 1/8	1.05	.63
2106-.02	.02	3/4	1 1/8	1.10	.66
2106-.03	.03	7/8	1 1/8	1.10	.66
2106-.05	.05	1 1/8	1 1/8	1.25	.75
2106-.06	.06	1 1/8	1 1/8	1.70	1.02
2106-.1	.1	1 3/8	1 1/8	1.70	1.02
2106-.25	.25	2 1/8	2 1/8	2.20	1.32
2106-.5	.5	3 1/8	2 1/8		

1000 W.V. D.C.

Catalog Number	Capacity mfd.	Size — Dia. Len.		List Price	Resale Net Price
		Dia.	Len.		
2110-.006	.006	1/2	1 1/8	\$1.10	\$0.66
2110-.01	.01	3/4	1 1/8	1.10	.66
2110-.05	.05	3/4	1 1/8	1.30	.78
2110-.1	.1	1 1/8	2 1/8	1.50	.90
2110-.25	.25	1 3/8	2 1/8	2.30	1.38

1600 W.V. D.C.

Catalog Number	Capacity mfd.	Size — Dia. Len.		List Price	Resale Net Price
		Dia.	Len.		
2116-.0005	.0005	3/8	1 1/8	\$1.10	\$0.66
2116-.001	.001	3/8	1 1/8	1.10	.66
2116-.002	.002	3/8	1 1/8	1.10	.66
2116-.005	.005	3/8	1 1/8	1.20	.72
2116-.01	.01	3/8	1 1/8	1.20	.72
2116-.02	.02	3/8	1 1/8	1.30	.78
2116-.05	.05	3/8	2 1/8	1.30	.78
2116-.1	.1	1 1/8	2 1/8	2.10	1.26

2000 W.V. D.C.

Catalog Number	Capacity mfd.	Size — Dia. Len.		List Price	Resale Net Price
		Dia.	Len.		
2120-.0005	.0005	3/8	1 1/8	\$1.25	\$0.75
2120-.001	.001	3/8	1 1/8	1.25	.75
2120-.005	.005	3/8	1 1/8	1.25	.75
2120-.01	.01	3/8	1 1/8	1.25	.75
2120-.02	.02	3/8	1 1/8	1.30	.78
2120-.05	.05	3/8	2 1/8	1.45	.87

SANGAMO CAPACITORS

NEW MOLDING COMPOUND FOR SANGAMO WIRE LEAD MICAS

All SANGAMO wire-lead micas are molded in HUMIDITITE, a new molding compound developed by Sangamo, that gives them moisture resistance characteristics far superior to any others on the market. The standard moisture resistance test described in MIL-C-5A (proposed) Specification requires mica capacitors to offer at least 100 megohms of insulation resistance after ten 24-hour cycles in a humidity chamber at 90% to 95% relative humidity. The best competitive micas barely meet this requirement . . . but Sangamo HUMIDITITE Micras, under the same conditions, all tested in excess of 50,000 megohms! For additional information about HUMIDITITE, write for Engineering Bulletin No. TS-111.

TYPE RR

SILVERED MICA CAPACITORS

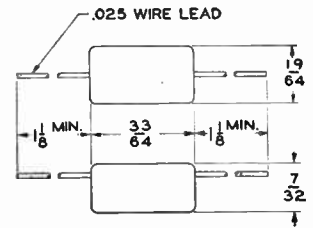

Catalog Number	Capacity Mfd.	Wkg. Volts D.C.
RR-1550	.000005	500
RR-1410	.00001	500
RR-1412	.000012	500
RR-1415	.000015	500
RR-1418	.000018	500
RR-1420	.00002	500
RR-1422	.000022	500
RR-1424	.000024	500
RR-1427	.000027	500
RR-1430	.00003	500
RR-1433	.000033	500
RR-1436	.000036	500
RR-1439	.000039	500
RR-1443	.000043	500
RR-1447	.000047	500
RR-1450	.00005	500
RR-1456	.000056	500
RR-1462	.000062	500
RR-1468	.000068	500

Catalog Number	Capacity Mfd.	Wkg. Volts D.C.
RR-1475	.000075	500
RR-1482	.000082	500
RR-1491	.000091	500
RR-1310	.0001	500
RR-1312	.00012	500
RR-1315	.00015	500
RR-1318	.00018	500
RR-1320	.0002	500
RR-1322	.00022	500
RR-1324	.00024	500
RR-1325	.00025	500
RR-1327	.00027	500
RR-1330	.0003	500
RR-1333	.00033	500
RR-1336	.00036	500
RR-1339	.00039	500
RR-06343	.00043	300
RR-06347	.00047	300
RR-06351	.00051	300

NOTE: Standard tolerance $\pm 5\%$, but in no instance less than ± 1 mmf.

NOTE: Capacitors are identified by color coding. Size of case prohibits stamping of ratings.

NOTE: Packaging: 10, 25, 50 or 100 per display carton.

TYPE K Mica Capacitor TYPE KR Silvered Mica

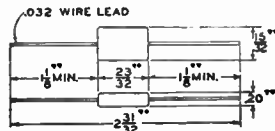

Catalog Number	Capacity Mfd.	List Price	Net Price
500 V.D.C. Working—1000 V.D.C. Test			
K-1550	.000005	\$0.25	\$0.15
K-1410	.00001	.25	.15
K-1415	.000015	.25	.15
K-1420	.00002	.25	.15
K-1425	.000025	.25	.15
K-1430	.00003	.25	.15
K-1439	.000039	.25	.15
K-1443	.000043	.20	.12
K-1450	.00005	.20	.12
K-1475	.000075	.20	.12
K-1310	.0001	.20	.12
K-1315	.00015	.20	.12
K-1320	.0002	.20	.12
K-1325	.00025	.25	.15
K-1330	.0003	.25	.15
K-1340	.0004	.25	.15
K-1350	.0005	.25	.15
K-1370	.0007	.35	.21
K-1380	.0008	.35	.21
K-1210	.001	.35	.21

Standard tolerance, $\pm 20\%$, B characteristic.

Inquiry should be directed to the factory as to the availability of capacities and voltages other than those listed.

Catalog Number	Capacity Mfd.	List Price	Net Price
500 V.D.C. Working—1000 V.D.C. Test			
KR-1550	.000005	\$0.45	\$0.27
KR-1410	.00001	.40	.24
KR-1415	.000015	.40	.24
KR-1420	.00002	.40	.24
KR-1425	.000025	.40	.24
KR-1430	.00003	.40	.24
KR-1439	.000039	.40	.24
KR-1443	.000043	.40	.24
KR-1450	.00005	.40	.24
KR-1475	.000075	.40	.24
KR-1310	.0001	.40	.24
KR-1315	.00015	.45	.27
KR-1320	.0002	.45	.27
KR-1325	.00025	.45	.27
KR-1330	.0003	.55	.33
KR-1340	.0004	.65	.39
KR-1350	.0005	.70	.42
KR-1370	.0007	.75	.45
KR-1380	.0008	.80	.48
KR-1210	.001	.90	.54

Standard tolerance, $\pm 5\%$, C characteristic.

TYPE C Mica Capacitor TYPE CR Silvered Mica

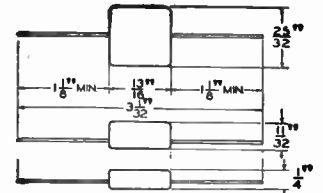

Catalog Number	Capacity Mfd.	List Price	Net Price
500 V.D.C. Working—1000 V.D.C. Test			
C-1350	.0005	\$0.25	\$0.15
C-1362	.00062	.25	.15
C-1375	.00075	.25	.15
C-1380	.0008	.25	.15
C-1390	.0009	.25	.15
C-1210	.001	.30	.18
C-1215	.0015	.30	.18
C-1220	.002	.40	.24
C-1225	.0025	.45	.27
*C-1230	.003	.50	.30
*C-1240	.004	.55	.33
*C-1250	.005	.60	.36
*C-1260	.006	.65	.39
300 V.D.C. Working—600 V.D.C. Test			
*C-06275	.0075	.90	.54
*C-06280	.008	1.00	.60
*C-06290	.009	1.00	.60
*C-06110	.01	1.20	.72

Standard tolerance, $\pm 20\%$, B characteristic. *Thickness $\frac{1}{16}$ "

Inquiry should be directed to the factory as to the availability of capacities and voltages other than those listed.

Catalog Number	Capacity Mfd.	List Price	Net Price
500 V.D.C. Working—1000 V.D.C. Test			
CR-1350	.0005	\$0.70	\$0.42
CR-1362	.00062	.80	.48
CR-1375	.00075	.85	.51
CR-1380	.0008	.95	.57
CR-1390	.0009	1.00	.60
CR-1210	.001	1.10	.66
CR-1215	.0015	1.35	.81
CR-1220	.002	1.35	.81
CR-1225	.0025	1.80	1.08
*CR-1230	.003	2.05	1.23
*CR-1240	.004	2.15	1.29
*CR-1250	.005	2.25	1.35
*CR-1260	.006	2.40	1.44
300 V.D.C. Working—600 V.D.C. Test			
*CR-06275	.0075	2.60	1.56
*CR-06280	.008	2.80	1.68
*CR-06290	.009	3.10	1.86
*CR-06110	.01	3.40	2.04

Standard tolerance, $\pm 5\%$, C characteristic. *Thickness $\frac{1}{16}$ "

SANGAMO CAPACITORS

High Voltage "Television" Mica Capacitors

These molded mica capacitors are specially designed for the high temperatures and voltages encountered in television applications. They may also be used in power amplifiers, low power transmitters and other industrial uses. They are fabricated with India ruby mica and are carefully tested to insure maximum performance under these difficult operating conditions.

TYPE C

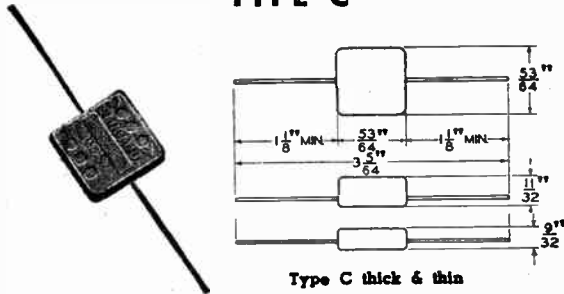

TYPE K



LIST PRICES

Catalog Number	Capacity Mfd.	LIST PRICES				
		6000 D.C. Test Working	5000 D.C. Test Working	4000 D.C. Test Working	3000 D.C. Test Working	2000 D.C. Test Working
C-312	.00012	\$0.50				
C-315	.00015	.55				
C-316	.00016	.60				
C-318	.00018	.60				
C-320	.0002	.65				
C-324	.00024	.70				
C-325	.00025	.70	\$0.55			
C-327	.00027	.70	.55			
C-330	.0003	.75	.60			
C-333	.00033	.80	.60			
C-336	.00036	.85	.65			
C-339	.00039	.90	.70			
C-343	.00043	1.00	.70	\$0.60		
C-347	.00047	1.05	.70	.65		
C-350	.0005	1.10	.75	.65		
C-351	.00051	1.10*	.75	.65		
C-356	.00056	1.20*	.80	.65		
C-362	.00062	1.25*	.85	.70		
C-368	.00068	1.35*	.90	.70	\$0.65	
C-382	.00082	1.55*	1.00*	.80	.75	
C-391	.00091	1.65*	1.10*	.85	.80	
C-210	.001	1.80*	1.20*	.95	.80	
C-211	.0011	1.80*	1.20*	1.00*	.85	\$0.55
C-212	.0012	1.95*	1.30*	1.05*	.95	.60
C-213	.0013	2.10*	1.40*	1.10*	1.00	.60
C-215	.0015	2.35*	1.60*	1.25*	1.10	.65
C-216	.0016		1.70*	1.30*	1.10	.70
C-218	.0018		1.85*	1.40*	1.25	.70
C-220	.002		2.05*	1.55*	1.35	.75
C-222	.0022			1.70*	1.40*	.85
C-224	.0024			1.85*	1.55*	.90
C-227	.0027			1.65*	.90*	
C-223	.003			1.75*	1.00*	
C-233	.0033				1.05*	

NOTE: When ordering, insert in blank space preceding catalog number, designation indicating test voltage requirements. For instance, C6812 means 6000 volts test; C5812 means 5000 volts test, etc.

NOTE: *Means thick case. See diagram above.

NOTE: Standard tolerance $\pm 20\%$, B characteristic. Prices will be supplied on request for closer tolerances or for silvered mica units.

NOTE: Standard trade discounts apply.

LIST PRICES

Catalog Number	Capacity Mfd.	LIST PRICES				
		6000 D.C. Test Working	5000 D.C. Test Working	4000 D.C. Test Working	3000 D.C. Test Working	2000 D.C. Test Working
K-550	.000005	\$0.30				
K-410	.00001	.30				
K-412	.000012	.30				
K-415	.000015	.35	\$0.30			
K-418	.000018	.35	.30			
K-420	.00002	.35	.30			
K-422	.000022	.35	.30			
K-424	.000024	.35	.30			
K-427	.000027	.35	.30			
K-430	.00003	.40	.35			
K-433	.000033	.40	.35			
K-436	.000036	.45	.35			
K-439	.000039	.45	.35			
K-443	.000043	.45	.35			
K-447	.000047	.45	.35	\$0.30		
K-450	.00005	.50	.35	.35		
K-451	.000051	.50	.35	.35		
K-456	.000056	.50	.35	.35		
K-462	.000062	.50	.35	.35		
K-468	.000068	.55	.40	.35		
K-475	.000075	.60	.45	.35	\$0.30	
K-482	.000082		.45	.35	.30	
K-491	.000091		.45	.35	.35	
K-310	.0001		.45	.35	.35	
K-311	.00011		.50	.40	.35	
K-312	.00012		.50	.40	.35	\$0.30
K-313	.00013		.50	.40	.35	.30
K-315	.00015		.55	.40	.35	.35
K-316	.00016		.60	.45	.35	.35
K-318	.00018		.60	.45	.35	.35
K-320	.0002		.50	.40	.35	
K-322	.00022		.50	.40	.35	
K-324	.00024		.55	.40	.35	
K-325	.00025		.55	.45	.40	
K-327	.00027		.55	.45	.40	
K-330	.0003			.60	.50	.40
K-333	.00033				.50	.40
K-336	.00036				.50	.40
K-339	.00039				.55	.40
K-343	.00043				.55	.45
K-347	.00047				.60	.45
K-350	.0005					.45
K-351	.00051					.45
K-356	.00056					.50
K-362	.00062					.50
K-368	.00068					.55

NOTE: When ordering, insert in blank space preceding catalog number, designation indicating test voltage requirements. For instance, K6550 means 6000 volt test; K5550 means 5000 volt test, etc.

NOTE: Standard tolerance $\pm 20\%$, B characteristic. Prices will be supplied on request for closer tolerances or for silvered mica units.

NOTE: Standard trade discounts apply.

SANGAMO CAPACITORS

TYPE A MICA CAPACITORS

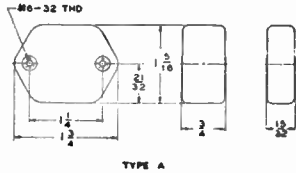

Catalog Number	Capacity Mfd.	List Price	Net Price
600 W.V.D.C.—1200 T.V.D.C.			
A-T1450	.00005	\$1.45	\$0.87
A-T1310	.0001	1.45	.87
A-T1315	.00015	1.45	.87
A-T1320	.0002	1.45	.87
A-T1325	.00025	1.45	.87
A-T1350	.0005	1.45	.87
A-T1210	.001	1.45	.87
A-T1220	.002	1.65	.99
A-T1225	.0025	1.70	1.02
A-T1230	.003	1.85	1.11
A-T1240	.004	2.00	1.20
A-T1250	.005	2.10	1.26
A-T1260	.006	2.20	1.32
A-T1280	.008	2.45	1.47
A-T1110	.01	2.80	1.68
A-T1115	.015	3.05	1.83
A-T1120	.02	3.55	2.13
A-T1125	.025	4.35	2.61
A-T1130	.03	4.55	2.73
A-K1140*	.04	5.85	3.51
A-K1150*	.05	7.10	4.26
A-K1160*	.06	8.05	4.83
1200 W.V.D.C.—2500 T.V.D.C.			
A-T2450	.00005	\$1.60	\$0.96
A-T2310	.0001	1.60	.96
A-T2315	.00015	1.60	.96
A-T2320	.0002	1.60	.96
A-T2325	.00025	1.60	.96

Catalog Number	Capacity Mfd.	List Price	Net Price
A-T2350	.0005	\$1.60	\$.96
A-T2210	.001	1.90	1.14
A-T2220	.002	2.50	1.50
A-T2225	.0025	2.80	1.68
A-T2300	.003	2.95	1.77
A-T2340	.004	3.10	1.86
A-T2350	.005	3.30	1.98
A-T2260	.006	3.45	2.07
A-T2280	.008	4.10	2.46
A-T2110	.01	4.70	2.82
A-K2115*	.015	5.80	3.48
A-K2125*	.02	7.05	4.23
A-K2125*	.025	7.90	4.74
A-K2130*	.03	8.10	4.86

Catalog Number	Capacity Mfd.	List Price	Net Price
2500 W.V.D.C.—5000 T.V.D.C.			
A-T5450	.00005	\$1.90	\$1.14
A-T5310	.0001	1.90	1.14
A-T5325	.00025	2.15	1.29
A-T5350	.0005	2.55	1.53
A-T5210	.001	2.90	1.74
A-T5220	.002	4.25	2.55
A-T5225	.0025	4.60	2.76
A-T5230	.003	5.10	3.06
A-T5240	.004	5.65	3.39
A-K5250*	.005	6.20	3.72
A-K5260*	.006	6.35	3.81
A-K5280*	.008	6.85	4.11
A-K5110*	.01	7.30	4.38
A-K5115*	.015	8.05	4.83

*Thickness 3/4" — Standard Insulators are available if desired. If .144" clearance holes are required, designate by adding letter "A" to Type No. (AA).

Standard tolerance $\pm 10\%$. B Characteristic, unless otherwise specified.

Inquiry should be directed to the factory as to the availability of capacities and voltages other than those listed above.

Prices subject to change without notice.

TYPE H MICA CAPACITORS

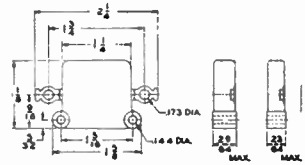

Catalog Number	Capacity Mfd.	List Price	Net Price
600 W.V.D.C.—1200 T.V.D.C.			
H-T1450	.00005	\$1.20	\$0.72
H-T1310	.0001	1.20	.72
H-T1320	.0002	1.20	.72
H-T1325	.00025	1.20	.72
H-T1330	.0003	1.20	.72
H-T1340	.0004	1.20	.72
H-T1350	.0005	1.20	.72
H-T1210	.001	1.20	.72
H-T1215	.0015	1.20	.72
H-T1220	.002	1.30	.78
H-T1225	.0025	1.30	.78
H-T1230	.003	1.45	.87
H-T1240	.004	1.50	.90
H-T1250	.005	1.55	.93
H-T1260	.006	1.80	1.08
H-T1270	.007	1.85	1.11
H-T1280	.008	1.90	1.14
H-T1110	.01	2.15	1.29
H-K1115*	.015	2.65	1.59
H-K1120*	.02	3.05	1.83
H-K1125*	.025	3.60	2.16
H-K1130*	.03	4.45	2.67
1200 W.V.D.C.—2500 T.V.D.C.			
H-T2450	.00005	\$1.60	\$0.96
H-T2310	.0001	1.60	.96
H-T2320	.0002	1.60	.96
H-T2325	.00025	1.60	.96

Catalog Number	Capacity Mfd.	List Price	Net Price
H-T2330	.0003	\$1.60	\$.96
H-T2340	.0004	1.60	.96
H-T2350	.0005	1.60	.96
H-T2210	.001	1.80	1.08
H-T2215	.0015	2.30	1.38
H-T2220	.002	2.40	1.44
H-T2225	.0025	2.80	1.68
H-T2230	.003	3.05	1.83
H-K2240*	.004	3.05	1.83
H-K2250*	.005	3.30	1.98
H-K2260*	.006	3.30	1.98
H-K2280*	.008	3.85	2.31
H-K2110*	.01	5.10	3.06

2500 W.V.D.C.—5000 T.V.D.C.

Catalog Number	Capacity Mfd.	List Price	Net Price
H-T5450	.00005	\$1.90	\$1.14
H-T5310	.0001	1.90	1.14
H-T5320	.0002	1.90	1.14
H-T5325	.00025	2.20	1.32
H-T5330	.0003	2.25	1.35
H-T5340	.0004	2.30	1.38
H-T5350	.0005	2.40	1.44
H-T5210	.001	2.80	1.68
H-T5215	.0015	3.55	2.13
H-K5220*	.002	4.15	2.49
H-K5230*	.003	4.90	2.94
H-K5240*	.004	5.65	3.39
H-K5250*	.005	6.40	3.84

*Thickness 29/64". For meter mounting bracket add letter "E" to Type designation; if assembled add 30 cents to list price; if unassembled add 20 cents and specify case size.

Standard tolerance $\pm 10\%$. B Characteristic, unless otherwise specified.

Inquiry should be directed to the factory as to the availability of capacities and voltages other than those listed above.

TYPE F1 MICA CAPACITORS

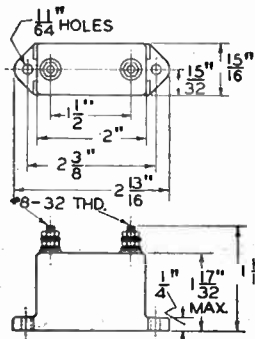

TYPE F1

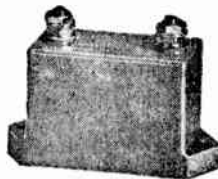

Types F1 and F2 capacitors, the smallest of the Sangamo line of transmitting types, possess a range of voltage and current ratings suitable for many applications. They are housed in low loss molded bakelite cases. The mica and foil sections are permanently clamped, vacuum impregnated, and installed in the case in such a manner as to provide stable characteristics and adequate moisture proofing.

TYPE F1 MICA CAPACITORS

Catalog Number	Capacity Mfd.	Peak Wkg. Volts	List Price	Net Price
F1-331	.0001	3000	\$12.60	\$7.56
F1-332	.0002	3000	12.60	7.56
F1-3325	.00025	3000	12.60	7.56
F1-335	.0005	3000	12.60	7.56
F1-321	.001	3000	12.60	7.56
F1-322	.002	3000	12.60	7.56
F1-223	.003	2000	12.60	7.56
F1-224	.004	2000	12.60	7.56
F1-225	.005	2000	12.60	7.56
F1-226	.006	2000	12.60	7.56
F1-1528	.008	1500	12.60	7.56
F1-111	.01	1000	12.60	7.56
F1-112	.02	1000	14.30	8.58
F1-0215	.05	250	14.30	8.58
F1-0201	.1	250	15.10	9.06

Standard tolerance $\pm 5\%$, B characteristic. Inquiry should be directed to the factory for availability of capacities and voltages other than those listed above. Prices subject to change without notice.

SANGAMO CAPACITORS

TYPE F2 MICA CAPACITORS

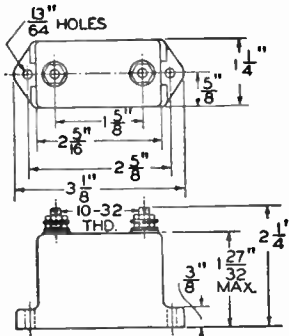

TYPE F2

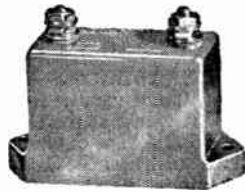

Types F1 and F2 capacitors, the smallest of the Sangamo lines of transmitting types, possess a range of voltage and current ratings suitable for many applications. They are housed in low loss molded bakelite cases. The mica and foil sections are permanently clamped, vacuum impregnated, and installed in the case in such a manner as to provide stable characteristics and adequate moisture proofing.

TYPE F2 MICA CAPACITORS

Catalog Number	Capacity Mfd.	Peak Wkg. Volts	List Price	Net Price
F2-531	.0001	5000	\$17.30	\$10.38
F2-5325	.00025	5000	17.30	10.38
F2-535	.0005	5000	17.30	10.38
F2-536	.0006	5000	17.30	10.38
F2-521	.001	5000	17.30	10.38
F2-522	.002	5000	17.30	10.38
F2-523	.003	5000	17.30	10.38
F2-325	.005	3000	17.30	10.38
F2-326	.006	3000	17.30	10.38
F2-211	.01	2000	17.30	10.38
F2-212	.02	2000	17.30	10.38
F2-1515	.05	1500	17.30	10.38
F2-0501	.1	500	19.20	11.52
F2-0202	.2	250	25.25	15.15
F2-02025	.25	250	27.90	16.74

Standard tolerance $\pm 5\%$, B characteristic. Inquiry should be directed to the factory for availability of capacities and voltages other than those listed above. Prices subject to change without notice.



TYPE G1

Catalog Number	Capacity Mfd.	Peak Wkg. Volts	List Price	Resale Net Price
G1-641	.00001	6000	\$35.45	\$21.27
G1-645	.00005	6000	38.20	22.92
G1-631	.0001	6000	40.60	24.36
G1-632	.0002	6000	40.60	24.36
G1-634	.0004	6000	44.35	26.61
G1-635	.0005	6000	46.65	27.99
G1-621	.001	6000	46.65	27.99
G1-6215	.0015	6000	48.90	29.34
G1-622	.002	6000	48.90	29.34
G1-623	.003	6000	50.60	30.36
G1-624	.004	6000	50.60	30.36
G1-625	.005	6000	50.60	30.36
G1-526	.006	5000	51.45	30.87
G1-511	.01	5000	51.45	30.87
G1-4115	.015	4000	51.45	30.87
G1-312	.02	3000	51.45	30.87

TYPE G2

Catalog Number	Capacity Mfd.	Peak Wkg. Volts	List Price	Resale Net Price
G2-1031	.0001	10000	\$65.55	\$39.33
G2-10315	.00015	10000	65.55	39.33
G2-1032	.0002	10000	65.55	39.33
G2-10325	.00025	10000	65.55	39.33
G2-1035	.0005	10000	65.55	39.33
G2-1021	.001	10000	65.55	39.33
G2-10212	.0012	10000	65.55	39.33
G2-10215	.0015	10000	65.55	39.33
G2-1022	.002	10000	65.55	39.33
G2-823	.003	8000	65.55	39.33
G2-824	.004	8000	65.55	39.33
G2-525	.005	5000	65.55	39.33
G2-526	.006	5000	69.15	41.49
G2-511	.01	5000	69.15	41.49
G2-4115	.015	4000	69.15	41.49
G2-312	.02	3000	69.15	41.49

Type G ceramic cased capacitors are intended for service where highest voltage and R.F. current ratings are required, such as in commercial transmitting or induction heating applications. All possible steps are taken in design and manufacturing operations to insure permanence of quality. Current ratings of these four sizes as well as detailed information on the Type G5 will be supplied upon request. Terminal plates are designed to permit any usual connecting or mounting practices.

Prices subject to change without notice.

SANGAMO ELECTRIC COMPANY · MARION, ILLINOIS

Copyright by U. C. P., Inc.

Net

Radio's Master—19th Edition

Page P-89

TYPES G1, G2, G3 AND G4 MICA CAPACITORS

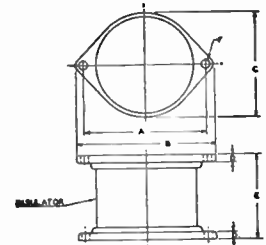

TYPE G1, 2, 3 and 4

TYPE G3

Catalog Number	Capacity Mfd.	Peak Wkg. Volts	List Price	Resale Net Price
G3-2045	.00005	20000	\$110.90	\$66.54
G3-2031	.0001	20000	121.00	72.60
G3-2032	.0002	20000	131.10	78.66
G3-20325	.00025	20000	131.10	78.66
G3-2033	.0003	20000	131.10	78.66
G3-2035	.0005	20000	137.15	82.29
G3-2038	.0008	20000	137.15	82.29
G3-2021	.001	20000	141.15	84.69
G3-15215	.0015	15000	143.20	85.92
G3-1522	.002	15000	143.20	85.92
G3-1523	.003	15000	151.25	90.75
G3-1524	.004	15000	151.25	90.75
G3-1025	.005	10000	151.25	90.75
G3-1026	.006	10000	151.25	90.75
G3-1028	.008	10000	151.25	90.75
G3-1011	.01	10000	151.25	90.75
G3-512	.02	5000	151.25	90.75
G3-313	.03	3000	151.25	90.75

TYPE G4

Catalog Number	Capacity Mfd.	Peak Wkg. Volts	List Price	Resale Net Price
G4-3043	.00003	30000	\$167.90	\$100.74
G4-3045	.00005	30000	167.90	100.74
G4-3031	.0001	30000	210.30	126.18
G4-30315	.00015	30000	210.30	126.18
G4-30325	.00025	30000	221.16	132.69
G4-3035	.0005	30000	221.16	132.69
G4-3038	.0008	30000	221.16	132.69
G4-3021	.001	30000	229.10	137.46
G4-2-215	.0015	25000	229.10	137.46
G4-2022	.002	20000	229.10	137.46
G4-2023	.003	20000	229.10	137.46
G4-2024	.004	20000	234.35	140.61
G4-1525	.005	15000	242.00	145.20
G4-1526	.006	15000	252.25	151.35
G4-1228	.008	12000	260.00	156.00
G4-1011	.01	10000	272.44	163.46
G4-612	.02	6000	272.44	163.46
G4-514	.04	5000	272.44	163.46

Standard tolerance $\pm 5\%$, B characteristic.

TYPE G MICA CAPACITOR DIMENSIONS — INCHES

Type	A	B	C	D	E	F
G1	3 1/4	3 1/8	2 1/8	1/4	2 1/2	1 1/2
G2	4 1/4	5	3 1/2	1/4	3	2.72
G3	5 5/8	6 1/2	5	3/8	4	3.77
G4	5 5/8	6 1/2	5	3/8	5 1/4	3.77
G5	8	9	6 3/4	1/2	10	4 1/2

Inquiry as to the availability of capacities and voltages other than those listed above should be directed to the factory.



ERIE GENERAL PURPOSE CERAMICONS®

TYPES GP1 — GP2 — GP3

ERIE CERAMICONS are small fixed capacitors consisting essentially of a ceramic dielectric with silver electrodes which are fired on at a very high temperature. Erie Ceramicons are outstanding because of their excellent high frequency characteristics, small size, rugged construction and availability in a wide range of capacity values.

GP1 CERAMICONS — The performance specifications of Type GP1 Ceramicons are identical with those of temperature compensating types of Ceramicons. A GP designation does allow the capacitor manufacturer added flexibility in selecting ceramic body. These capacitors meet performance specifications of RETMA Standard No. REC-107-A, Class 1, Characteristic U2.

GP2 CERAMICONS — The capacitance of GP2 Ceramicons will not vary more than + 10% or - 35% from + 25°C. value, as the temperature is varied from - 40°C. to + 85°C. These capacitors meet the performance specifications of RETMA Standard No. REC-107-A, Class 2, Characteristic Y5Y.

GP3 CERAMICONS — The capacitance of GP3 Ceramicons will not vary more than + 25% or - 50% from the 25°C. value, as the temperature is varied from + 10°C. to + 75°C. These capacitors meet the performance specifications of RETMA Standard No. REC-107-A, Class 2, Characteristic Z5Z.



DIMENSION SPECIFICATION CHART

Style	Length	Diameter	Leads	Insulation
K	.562"	.250"	Axial 1 1/4" Min.	Molded
L	.812"	.250"	Axial 1 1/4" Min.	Molded
333	1.250"	.315"	Radial 1 1/4" Min.	Dipped

"GP"® GENERAL PURPOSE CERAMICONS

are ideally suited for such applications as coupling and by-passing, in circuits where temperature coefficient is not important — in other words for all receiver applications except in frequency determining circuits. Working voltage — 600 volts D. C. Use Erie "GP" Ceramicons as replacements for molded mica and paper tubular capacitors.

Order by Catalog Number from Table Below

600 VDCW — STOCK ITEMS — ± 20% TOLERANCE

Catalog No.	Erie Part No.	Cap. MMF	Body Style
GP-5	GPIK-050	5	315 or K
GP-10	GPIK-100	10	315 or K
GP-12	GPIK-120	12	315 or K
GP-15	GPIK-150	15	315 or K
GP-18	GPIK-180	18	315 or K
GP-20	GPIK-200	20	315 or K
GP-22	GPIK-220	22	315 or K
GP-24	GPIK-240	24	315 or K
GP-25	GPIK-250	25	315 or K
GP-27	GPIK-270	27	315 or K
GP-30	GPIK-300	30	315 or K
GP-33	GPIK-330	33	315 or K
GP-39	GPIK-390	39	315 or K
GP-47	GPIK-470	47	315 or K
GP-50	GPIK-500	50	315 or K
GP-51	GPIK-510	51	315 or K
GP-56	GPIK-560	56	315 or K
GP-68	GPIK-680	68	315 or K
GP-75	GPIK-750	75	315 or K
GP-82	GPIK-820	82	315 or K
GP-100	GPIK-101	100	315 or K
GP-110	GP2K-111	110	315 or K
GP-120	GP2K-121	120	315 or K
GP-150	GP2K-151	150	315 or K
GP-180	GP2K-181	180	315 or K
GP-200	GP2K-201	200	315 or K
GP-220	GP2K-221	220	315 or K
GP-240	GP2K-241	240	315 or K
GP-250	GP2K-251	250	315 or K

Catalog No.	Erie Part No.	Cap. MMF	Body Style
GP-270	GP2K-271	270	315 or K
GP-300	GP2K-301	300	315 or K
GP-330	GP2K-331	330	315 or K
GP-360	GP2K-361	360	315 or K
GP-390	GP2K-391	390	315 or K
GP-470	GP2K-471	470	315 or K
GP-500	GP2K-501	500	315 or K
GP-510	GP2K-511	510	315 or K
GP-560	GP2K-561	560	315 or K
GP-680	GP2K-681	680	315 or K
GP-750	GP2L-751	750	316 or L
GP-820	GP2L-821	820	316 or L
GP-1,000	GP2L-102	1,000	316 or L
GP-1,200	GP2L-122	1,200	316 or L
GP-1,500	GP2L-152	1,500	316 or L
GP-1,800	GP2-333-182	1,800	333
GP-2,000	GP2-333-202	2,000	333
GP-2,200	GP2-333-222	2,200	333
GP-2,500	GP2-333-252	2,500	333
GP-2,700	GP2-333-272	2,700	333
GP-3,000	GP2-333-302	3,000	333
GP-3,300	GP2-333-332	3,300	333
GP-4,000	GP2-333-402	4,000	333
GP-4,700	GP2-333-472	4,700	333
GP-5,000	GP2-333-502	5,000	333
GP-5,600	GP3-333-562	5,600	333
GP-6,000	GP3-333-602	6,000	333
GP-6,800	GP3-333-682	6,800	333
GP-7,500	GP3-333-752	7,500	333
GP-10,000	GP3-333-103	10,000	333

Note: "Ceramicon" and "GP Ceramicon" are registered trade names and refer to ceramic dielectric capacitors manufactured only by Erie Resistor Corporation.



TEMPERATURE COMPENSATING CERAMICONS®

Erie Ceramicons are capacity-sensitive to temperature in varying pre-determined degrees, and because of this characteristic have found wide-spread application as temperature-compensating elements in circuits which must

be frequency-stabilized over wide temperature ranges. They are also manufactured with practically no thermal sensitivity for use in applications requiring a capacitor whose value is not affected by temperature.

NPO TEMPERATURE COEFFICIENT CERAMICONS®

NPO Temperature Coefficient Ceramicons are highly recommended for frequency determining applications where no capacity change with change in temperature is desired. "Q" for NPO Ceramicons above 30 mmf is 1000

or higher. Below 30 mmf "Q" decreases slightly as capacity decreases. Working voltage—600 volts D. C. Recommended as replacements for silver-mica capacitors.

Order by Catalog Number from Table Below

STOCK ITEMS — 600 VDCW

Catalog No.	Erie Part No.	Cap. MMF	Cap. Tol.	TC Tol.	Body Size
TCO-.5	NPOA-0R5	0.5	0.25 mmf	±250	301 or A
TCO-.68	NPOA-0R68	0.68	0.25 mmf	±250	301 or A
TCO-1	NPOA-010	1.0	0.25 mmf	±250	301 or A
TCO-1.5	NPOA-1R5	1.5	0.25 mmf	±250	301 or A
TCO-2.2	NPOA-2R2	2.2	0.25 mmf	±120	301 or A
TCO-3	NPOA-030	3.0	0.25 mmf	±120	301 or A
TCO-3.3	NPOA-3R3	3.3	0.5 mmf	±120	301 or A
TCO-4.7	NPOA-4R7	4.7	0.5 mmf	±60	301 or A
TCO-5	NPOA-050	5.0	0.5 mmf	±60	301 or A
TCO-6.8	NPOA-6R8	6.8	0.5 mmf	±60	301 or A
TCO-8.2	NPOA-8R2	8.2	0.5 mmf	±60	301 or A
TCO-10	NPOA-100	10	0.5 mmf	±30	301 or A
TCO-12	NPOK-120	12	0.5 mmf	±30	315 or K
TCO-15	NPOK-150	15	0.5 mmf	±30	315 or K
TCO-18	NPOK-180	18	0.5 mmf	±30	315 or K
TCO-20	NPOK-200	20	0.5 mmf	±30	315 or K
TCO-22	NPOK-220	22	5% mmf	±30	315 or K
TCO-24	NPOL-240	24	5% mmf	±30	316 or L
TCO-25	NPOL-250	25	5% mmf	±30	316 or L
TCO-27	NPOL-270	27	5% mmf	±30	316 or L
TCO-30	NPOL-300	30	5% mmf	±30	316 or L
TCO-33	NPOL-330	33	5% mmf	±30	316 or L
TCO-36	NPOL-360	36	5% mmf	±30	316 or L
TCO-39	NPOL-390	39	5% mmf	±30	316 or L

Catalog No.	Erie Part No.	Cap. MMF	Cap. Tol.	TC Tol.	Body Size
TCO-43	NPOL-430	43	5% mmf	±30	316 or L
TCO-47	NPO-338-470	47	5% mmf	±30	338
TCO-50	NPO-338-500	50	5% mmf	±30	338
TCO-51	NPO-338-510	51	5% mmf	±30	338
TCO-56	NPO-337-560	56	5% mmf	±30	337
TCO-62	NPO-337-620	62	5% mmf	±30	337
TCO-68	NPO-337-680	68	5% mmf	±30	337
TCO-75	NPO-337-750	75	5% mmf	±30	337
TCO-82	NPO-337-820	82	5% mmf	±30	337
TCO-91	NPO-337-910	91	5% mmf	±30	337
TCO-100	NPO-337-101	100	5% mmf	±30	337
TCO-110	NPO-333-111	110	5% mmf	±30	333
TCO-120	NPO-333-121	120	5% mmf	±30	333
TCO-130	NPO-333-131	130	5% mmf	±30	333
TCO-150	NPO-334-151	150	5% mmf	±30	334
TCO-160	NPO-334-161	160	5% mmf	±30	334
TCO-170	NPO-334-1750	175	5% mmf	±30	334
TCO-180	NPO-334-181	180	5% mmf	±30	334
TCO-200	NPO-334-201	200	5% mmf	±30	334
TCO-220	NPO-335-221	220	5% mmf	±30	335
TCO-240	NPO-335-241	240	5% mmf	±30	335
TCO-270	NPO-335-271	270	5% mmf	±30	335
TCO-300	NPO-335-301	300	5% mmf	±30	335

NEGATIVE TEMPERATURE COEFFICIENT CERAMICONS®

N330 and N750 units provide temperature compensation to eliminate drift. Positive and Negative Temperature Coefficient Ceramicons P100 through N1400 are available

on special order through your distributor. See table, Page 3 for other values and styles.

ERIE TUBULAR TYPE N330 CERAMICONS

Order by Catalog Number from Table Below

STOCK ITEMS — 600 VDCW

Catalog No.	Erie Part No.	Cap. MMF	Cap. Tol.	TC Tol.	Body Size
TC3-1	N330A-010	1.0	0.5 mmf	±250	301 or A
TC3-1.5	N330A-1R5	1.5	0.5 mmf	±250	301 or A
TC3-2.2	N330A-2R2	2.2	0.5 mmf	±120	301 or A
TC3-3.3	N330A-3R3	3.3	0.5 mmf	±120	301 or A
TC3-3.9	N330A-3R9	3.9	0.5 mmf	±120	301 or A
TC3-4.7	N330A-4R7	4.7	5% mmf	±60	301 or A
TC3-5.6	N330A-5R6	5.6	5% mmf	±60	301 or A
TC3-6.8	N330A-6R8	6.8	5% mmf	±60	301 or A
TC3-8.2	N330A-8R2	8.2	5% mmf	±60	301 or A
TC3-10	N330A-100	10	5% mmf	±60	301 or A
TC3-12	N330K-120	12	5% mmf	±60	315 or K
TC3-15	N330K-150	15	5% mmf	±60	315 or K
TC3-18	N330K-180	18	5% mmf	±60	315 or K
TC3-22	N330K-220	22	5% mmf	±60	315 or K
TC3-27	N330K-270	27	5% mmf	±60	315 or K

Catalog No.	Erie Part No.	Cap. MMF	Cap. Tol.	TC Tol.	Body Size
TC3-33	N330K-330	33	5% mmf	±60	315 or K
TC3-39	N330L-390	39	5% mmf	±60	316 or L
TC3-47	N330L-470	47	5% mmf	±60	316 or L
TC3-56	N330L-560	56	5% mmf	±60	316 or L
TC3-68	N330L-680	68	5% mmf	±60	316 or L
TC3-82	N330-338-820	82	5% mmf	±60	338
TC3-100	N330-337-101	100	5% mmf	±60	337
TC3-120	N330-337-121	120	5% mmf	±60	337
TC3-150	N330-337-151	150	5% mmf	±60	337
TC3-180	N330-333-181	180	5% mmf	±60	333
TC3-220	N330-334-221	220	5% mmf	±60	334
TC3-270	N330-334-271	270	5% mmf	±60	334
TC3-330	N330-334-331	330	5% mmf	±60	334
TC3-390	N330-335-391	390	5% mmf	±60	335
TC3-470	N330-335-471	470	5% mmf	±60	335



NEGATIVE TEMPERATURE COEFFICIENT CERAMICONS®

ERIE TUBULAR TYPE N750 CERAMICONS®

Order by Catalog Number from Table Below

STOCK ITEMS — 600 VDCW

Catalog No.	Erie Part No.	Cap. MMF	Cap. Tol.	TC Tol.	Body Size	Catalog No.	Erie Part No.	Cap. MMF	Cap. Tol.	TC Tol.	Body Size
TC7-33	N750A-3R3	3.3	0.5 mmf	± 120	301 or A	TC7-91	N750L-910	91	5%	± 120	316 or L
TC7-5	N750A-050	5	0.5 mmf	± 120	301 or A	TC7-100	N750L-101	100	5%	± 120	316 or L
TC7-10	N750A-100	10	0.5 mmf	± 120	301 or A	TC7-110	N750L-111	110	5%	± 120	316 or L
TC7-12	N750K-120	12	0.5 mmf	± 120	315 or K	TC7-120	N750L-121	120	5%	± 120	316 or L
TC7-15	N750K-150	15	0.5 mmf	± 120	315 or K	TC7-130	N750-337-131	130	5%	± 120	337
TC7-18	N750K-180	18	0.5 mmf	± 120	315 or K	TC7-150	N750-337-151	150	5%	± 120	337
TC7-20	N750K-200	20	0.5 mmf	± 120	315 or K	TC7-160	N750-337-161	160	5%	± 120	337
TC7-22	N750K-220	22	5%	± 120	315 or K	TC7-180	N750-337-181	180	5%	± 120	337
TC7-24	N750K-240	24	5%	± 120	315 or K	TC7-200	N750-337-201	200	5%	± 120	337
TC7-25	N750K-250	25	5%	± 120	315 or K	TC7-220	N750-337-221	220	5%	± 120	337
TC7-27	N750K-270	27	5%	± 120	315 or K	TC7-240	N750-337-241	240	5%	± 120	337
TC7-30	N750K-300	30	5%	± 120	315 or K	TC7-270	N750-337-271	270	5%	± 120	337
TC7-33	N750K-330	33	5%	± 120	315 or K	TC7-300	N750-333-301	300	5%	± 120	333
TC7-36	N750K-360	36	5%	± 120	315 or K	TC7-330	N750-333-331	330	5%	± 120	333
TC7-39	N750K-390	39	5%	± 120	315 or K	TC7-360	N750-333-361	360	5%	± 120	333
TC7-43	N750K-430	43	5%	± 120	315 or K	TC7-390	N750-334-391	390	5%	± 120	334
TC7-47	N750K-470	47	5%	± 120	315 or K	TC7-430	N750-334-431	430	5%	± 120	334
TC7-50	N750K-500	50	5%	± 120	315 or K	TC7-470	N750-334-471	470	5%	± 120	334
TC7-51	N750K-510	51	5%	± 120	315 or K	TC7-510	N750-334-511	510	5%	± 120	334
TC7-56	N750K-560	56	5%	± 120	315 or K	TC7-560	N750-334-561	560	5%	± 120	334
TC7-62	N750K-620	62	5%	± 120	315 or K	TC7-620	N750-335-621	620	5%	± 120	335
TC7-68	N750L-680	68	5%	± 120	316 or L	TC7-680	N750-335-681	680	5%	± 120	335
TC7-75	N750L-750	75	5%	± 120	316 or L	TC7-750	N750-335-751	750	5%	± 120	335
TC7-82	N750L-820	82	5%	± 120	316 or L						

PARALLELING TC AND CAPACITIES

A wide range of capacitance values and temperature coefficients can be obtained by using Erie NPO capacitors in parallel with either N330 or N750 units. The following

formulae are used in determining the capacitance of the various temperature compensating units that are required to obtain any desired temperature coefficient and capacitance:

- (Capacitance in MMF) (Temp. Coef. Required) = $\frac{750}{\text{Temp. Coef.}}$
Capacitance in MMF of the N750 unit to be used (use nearest standard capacitance value)
- (Total Capacitance Required) minus the value found in step 1 = capacitance in MMF of the NPO unit to be used.
- The total desired capacitance and temperature coefficient are obtained by connecting the units found in steps 1 and 2 in parallel.

*If an N330 unit is to be used in parallel with an NPO unit, substitute 330 for 750 in this equation.

CAPACITY RANGES IN MMF FOR TEMPERATURE COMPENSATING CERAMICONS® (AVAILABLE ON SPECIAL ORDER)

TEMPERATURE COEFFICIENT	K (or 315) 331 A (or 301)	L (or 316) 332 B (or 302)	M (or 317) 333 C (or 303)	334 D (or 304)	335 E (or 305)	336 F (or 306)	338 T (or 308)	337 S (or 307)
P100	0.75-12	13-23	24-69	70-107	108-164	165-212	13-28	29-56
P030	0.75-12	13-25	26-73	74-115	116-174	175-226	13-30	31-58
NPO	0.75-22	23-44	45-130	131-200	201-308	309-400	23-52	53-102
N030	0.75-23	24-45	46-133	134-210	211-317	318-420	24-54	55-105
N080	1.00-27	28-53	54-155	156-240	241-368	369-480	28-62	63-122
N150	1.00-30	31-60	61-176	177-275	276-420	421-545	31-71	72-140
N220	1.00-33	34-66	67-194	195-300	301-470	471-600	34-78	79-153
N330	1.00-37	38-73	74-215	216-334	335-510	511-665	38-87	88-170
N470	1.00-44	45-88	89-260	261-400	401-620	621-800	45-104	105-204
N750	1.50-62	63-120	121-360	361-560	561-840	841-1100	63-142	143-280
N1400	1.50-100*	101-198	199-580	581-910	911-1380	Not Available	101-234**	235-470

*For 350 volts D.C. working only above 82 MMF. **For 350 volts D.C. working only above 142 MMF. †Type 317 available on JAN-C-20A only.

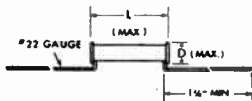

NON-INSULATED

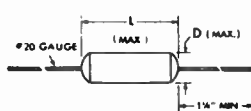

MOLDED INSULATED

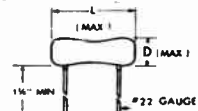

DIPPED PHENOLIC INSULATED

STYLE	301 or A	302 or B	308 or T	307 or S	303 or C	304 or D	305 or E	306 or F
RETMA	CC20	CC25	CC30	CC32	CC35	CC40	CC45	CC45
JAN	CC20	CC25	CC30	CC32	CC35	CC45	CC45	CC45
Dia. D	.200	.200	.230	.230	.265	.360	.360	.360
Length L	.400	.656	.460	.860	1.125	1.110	1.560	2.000

STYLE	315 or K	316 or L	317 or M*
RETMA/JAN	CC21	CC26	CC36
Dio D	250	250	.340
Length L	.562	.812	1.328

*Note Style M or 317 is no longer available commercially. It can be ordered only as CC36 to specification JAN-C-20A.

STYLE	331	332	338	337	333	334	335	336
RETMA	CC22	CC27	CC31	CC33	CC37	CC42	CC47	CC47
JAN	CC201	CC251	CC301	CC321	CC351	CC45	CC45	CC451
MIL	CK22	CK27			CK37			
Dio D	240	240	.312	.312	.315	.415	.415	.415
Length L	.460	.710	.550	.937	1.250	1.213	1.650	2.025

†Available on special order because of JAN overall dimensional limits. Specify either:
a. Thin phenolic dip, meeting exact JAN dimensions.
b. Standard insulating phenolic dip to dimensions shown above.



ERIE DISC CERAMICONS®

Erie Disc Ceramicons consist of a flat ceramic dielectric with silver fired onto the dielectric. Lead wires are firmly soldered to the silver electrodes, and the unit is given a

protective coating of phenolic. Low series inductance assures efficient high frequency operation.

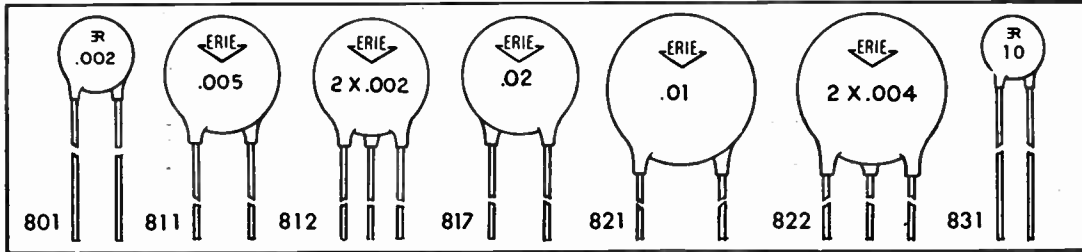

Order by Catalog Number from Table Below

600 VDCW — STOCK ITEMS — 1500 VDC TEST

Catalog No.	Erie Part No.	Capacity	Cop. Tol.	Body Size
ED-10	831-100	10 mmf	±20%	1/4" x 3/32"
ED-15	831-150	15 mmf	±20%	1/4" x 3/32"
ED-22	831-220	22 mmf	±20%	1/4" x 3/32"
ED-33	831-330	33 mmf	±20%	1/4" x 3/32"
ED-47	831-470	47 mmf	±20%	1/4" x 3/32"
ED-68	831-680	68 mmf	±20%	1/4" x 3/32"
ED-100	831-101	100 mmf	±20%	1/4" x 3/32"
ED-150	831-151	150 mmf	±20%	1/4" x 3/32"
ED-220	831-221	220 mmf	±20%	1/4" x 3/32"
ED-330	831-331	330 mmf	±20%	1/4" x 3/32"
ED-470	831-471	470 mmf	±20%	1/4" x 3/32"
ED-680	831-681	680 mmf	±20%	1/4" x 3/32"
ED-1000	801-.001	.001 mfd	gmV	3/8" x 3/32"
ED-1500	801-.0015	.0015 mfd	gmV	3/8" x 3/32"

Catalog No.	Erie Part No.	Capacity	Cop. Tol.	Body Size
ED-.002	801-.002	.002 mfd	gmV	3/8" x 3/32"
ED-.0022	811-.0022	.0022 mfd	±20%	1 1/2" x 3/32"
ED-.0033	811-.0033	.0033 mfd	+80% -20%	1 1/2" x 3/32"
ED-.0047	811-.0047	.0047 mfd	+80% -20%	1 1/2" x 3/32"
ED-.005	811-.005	.005 mfd	gmV	1 1/2" x 3/32"
ED-.0068	811-.0068	.0068 mfd	+80% -20%	1 1/2" x 3/32"
ED-.01	811-.01	.01 mfd	+80% -20%	1 1/2" x 3/32"
ED-.01	821-.01	.01 mfd	gmV	3/4" x 3/32"
ED-.02	821-.02	.02 mfd	+80% -20%	3/4" x 3/32"
ED2-.001	812-.001	2X.001 mfd	gmV	1 1/2" x 3/32"
ED2-.0015	812-.0015	2X.0015 mfd	gmV	1 1/2" x 3/32"
ED2-.002	812-.002	2X.002 mfd	gmV	1 1/2" x 3/32"
ED2-.003	822-.003	2X.003 mfd	gmV	3/4" x 3/32"
ED2-.004	822-.004	2X.004 mfd	gmV	3/4" x 3/32"

TEMPERATURE COMPENSATING DISC CERAMICONS®

Erie Temperature Compensating Disc Ceramicons in four sizes, 831, 801, 811, 821, offer all standard combinations of temperature coefficient and capacitance value. They are intended for circuit use requiring pronounced stability of capacitance, or exact temperature compensation, high "Q" and high insulation resistance. Each size is manu-

factured in standard coefficients P120 through N2100, providing capacitance values from 1.5 MMF to 725 MMF. These disc units are tested for conformance to Erie specifications that have applied to Tubular Ceramicons for many years. Further, they meet all requirements for RETMA REC-107A Class 1 ceramic capacitors.

CAPACITANCE RANGES IN MMF

(AVAILABLE ON SPECIAL ORDER)

Temperature Coefficient	Style 831	Style 801	Style 811	Style 821
P120	1.5-2.5	2.5-4	4-12	13-20
P100	2.5-6.5	7-10	11-29	30-54
P030	2.5-7	7-12	13-30	31-64
NPO	3-15	16-25	26-68	69-102
N030	4.7-16	17-26	27-70	71-105
N080	5-14	15-24	25-65	66-122
N150	6-16	17-27	28-74	75-139
N220	6.8-18	19-30	31-80	81-150
N330	7.5-20	21-33	34-90	91-170
N470	9-24	25-40	41-107	108-205
N750	12-32	33-55	56-147	148-280
N1400	20-66	67-115	116-300	Not Available
N2100	33-87	88-146	147-395	Not Available

Note: Disc Ceramicons are also supplied to broader, General Purpose, temperature coefficient limits:

GP(SL) — any nominal coefficient P100 through N750.

GP1 — any nominal coefficient P100 through N1400.



ERIE HIGH VOLTAGE DISC CERAMICONS®

Designed to employ the same basic diameters that have been standardized in 600 volt capacitors. Careful and detailed life testing has been accomplished over a long period of time to establish required dielectric thicknesses

to assure conservative ratings in the high voltage line. They differ in appearance from lower voltage units in having greater thickness, the degree of difference depending on voltage rating.

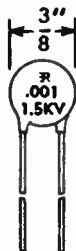

1R5KV-102



3KV-470



6KV-330

1500 VDCW — STOCK ITEMS — ± 20% TOLERANCE

Catalog No.	Erie Port No.	Capacity MMF	Size-Max. Dio.
HD15-4R7	1R5KV-4R7	4.7	3/8"
HD15-6R8	1R5KV-6R8	6.8	3/8"
HD15-10	1R5KV-100	10	3/8"
HD15-15	1R5KV-150	15	3/8"
HD15-22	1R5KV-220	22	3/8"
HD15-33	1R5KV-330	33	3/8"
HD15-47	1R5KV-470	47	1/2"
HD15-68	1R5KV-680	68	1/2"
HD15-100	1R5KV-101	100	1/2"
HD15-150	1R5KV-151	150	3/4"
HD15-180	1R5KV-181	180	3/4"

Catalog No.	Erie Port No.	Capacity MMF	Size-Max. Dio.
HD15-220	1R5KV-221	220	3/8"
HD15-330	1R5KV-331	330	3/8"
HD15-470	1R5KV-471	470	3/8"
HD15-680	1R5KV-681	680	3/8"
HD15-1000	1R5KV-102	1000	3/8"
HD15-1500	1R5KV-152	1500	1/2"
HD15-2200	1R5KV-222	2200	1/2"
HD15-3300	1R5KV-332	3300	1/2"
HD15-4700	1R5KV-472	4700	3/4"
HD15-5600	1R5KV-562	5600	3/4"
HD15-6200	1R5KV-622	6200	3/4"

3000 VDCW — STOCK ITEMS — ± 20% TOLERANCE

Catalog No.	Erie Port No.	Capacity MMF	Size-Max. Dio.
HD3-4R7	3KV-4R7	4.7	3/8"
HD3-6R8	3KV-6R8	6.8	3/8"
HD3-10	3KV-100	10	3/8"
HD3-15	3KV-150	15	3/8"
HD3-22	3KV-220	22	1/2"
HD3-33	3KV-330	33	1/2"
HD3-47	3KV-470	47	1/2"
HD3-56	3KV-560	56	3/4"
HD3-68	3KV-680	68	3/4"
HD3-100	3KV-101	100	3/4"

Catalog No.	Erie Port No.	Capacity MMF	Size-Max. Dio.
HD3-150	3KV-151	150	3/8"
HD3-220	3KV-221	220	3/8"
HD3-330	3KV-331	330	3/8"
HD3-470	3KV-471	470	3/8"
HD3-680	3KV-681	680	3/8"
HD3-1000	3KV-102	1000	1/2"
HD3-1500	3KV-152	1500	1/2"
HD3-2200	3KV-222	2200	3/4"
HD3-3300	3KV-332	3300	3/4"

6000 VDCW — STOCK ITEMS — ± 20% TOLERANCE

Catalog No.	Erie Port No.	Capacity MMF	Size-Max. Dio.
HD6-4R7	6KV-4R7	4.7	1/2"
HD6-6R8	6KV-6R8	6.8	3/4"
HD6-10	6KV-100	10	3/4"
HD6-15	6KV-150	15	1/2"
HD6-22	6KV-220	22	3/4"
HD6-33	6KV-330	33	3/4"

Catalog No.	Erie Port No.	Capacity MMF	Size-Max. Dio.
HD6-150	6KV-151	150	1/2"
HD6-180	6KV-181	180	3/4"
HD6-220	6KV-221	220	1/2"
HD6-330	6KV-331	330	3/4"
HD6-470	6KV-471	470	3/4"



ERIE UNIVERSAL 20 KV CERAMICON®

A highly universal 20 KV television power supply filter Ceramicon. Five types of terminals are available. By selecting the correct combinations of these, the correct replacement is provided for practically any existing receiver. Approved by leading TV manufacturers for replacement units.

Capacity of Style 413 is 500 MMF. Tolerance $\begin{matrix} + 50\% \\ - 20\% \end{matrix}$

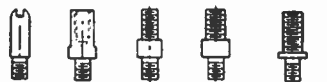

413-203 413-204 413-205 413-206-1 413-206-2

STYLE 413

Order by Part Number from Table Below

TERMINALS

Erie Part No.	Description
413-203	Slotted
413-204	Female — 6/32 Top
413-205	Male — 6/32 Thread
413-206-1	Male — 8/32 Thread — 1/4" — Long
413-206-2	Male — 8/32 Thread — 3/8" — Long

Terminals are packaged 5 of a type per bag.

CERAMICONS

Erie Part No.	Description
*413	Bulk — No Terminals
413-1	Single Box — 7 Terminals
413-6	Kit — 6 Bodies, 14 Terminals

*Does not include terminals, order them from terminal chart at left.



ERIE ELECTRONIC PRINTED CIRCUITS

Erie Resistor began the development of Printed Circuits in 1940. Since then the advantages of Printed Circuits have been amply demonstrated and Erie has made important contributions in the field. By bonding the complete or partial circuit to a ceramic base plate, the work of several capacitors and resistors may be combined in one installation unit. Erie Printed Circuits have simplified design and production problems for manufacturers of radio and television receivers, hearing aids, and other electronic products.

SPECIFICATIONS
INSULATION: Thermosetting dipped phenolic.
SIZE: Dimensions shown are maximum.
MARKING: ERIE trademark, part number, and lead numbers.
LEADS: Tinned copper wire, length $2\frac{1}{2} \pm \frac{1}{8}$.
CAPACITORS: 500 VDCW ... tolerance as marked.
RESISTORS: $\frac{1}{8}$ watt rated ... tolerance $\pm 20\%$.

ERIE DIODE FILTERS

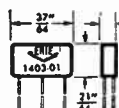

$R = 47K$
 $C_1 = 100 \text{ mmf}$
 $C_2 = 100 \text{ mmf}$
 Lead Wire # 24

1403-01

$R = 47K$
 $C_1 = 150 \text{ mmf}$
 $C_2 = 150 \text{ mmf}$
 Lead Wire # 24

1403-02

$R = 47K$
 $C_1 = 50 \text{ mmf}$
 $C_2 = 50 \text{ mmf}$
 Lead Wire # 24

1403-03

ERIE TRIODE PLATE COUPLERS

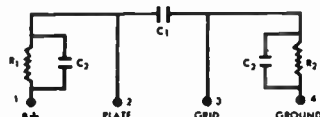
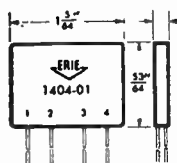

$R_1 = 500K$
 $R_2 = 500K$
 $C_1 = .01 \text{ mfd}$
 $C_2 + C_3 = 250 \text{ mmf}$
 Lead Wire # 22

1404-01

$R_1 = 250K$
 $R_2 = 500K$
 $C_1 = .01 \text{ mfd}$
 $C_2 + C_3 = 250 \text{ mmf}$
 Lead Wire # 22

1404-02

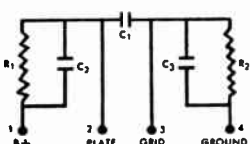
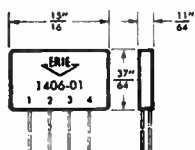

$R_1 = R_2 = 500K$
 $C_1 = .005 \text{ mfd}$
 $C_2 + C_3 = 250 \text{ mmf}$
 Lead Wire # 24

1406-01

$R_1 = 250K$
 $R_2 = 500K$
 $C_1 = .005 \text{ mfd}$
 $C_2 + C_3 = 250 \text{ mmf}$
 Lead Wire # 24

1406-02

ERIE VERTICAL INTEGRATOR

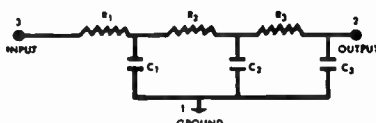
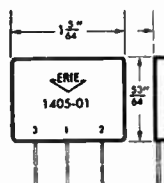

$R_1 = 22K$
 $R_2 = 8.2K$
 $R_3 = 8.2K$
 $C_1 = 2000 \text{ mmf}$
 $C_2 = 5000 \text{ mmf}$
 $C_3 = 5000 \text{ mmf}$
 Lead Wire # 22

1405-01

ERIE PENTODE PLATE COUPLERS

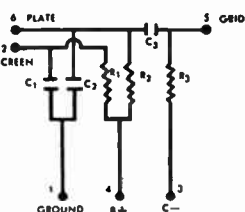
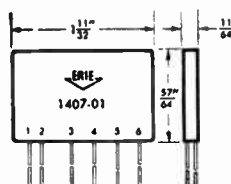

$R_1 = 4.7 \text{ megohm}$
 $R_2 = 1 \text{ megohm}$
 $R_3 = 2.2 \text{ megohm}$
 $C_1 = .005 \text{ mfd GMV}$
 $C_2 = 50 \text{ mmf}$
 $C_3 = .002 \text{ mfd}$
 Lead Wire # 22

1407-01

$R_1 = 4.7 \text{ megohm}$
 $R_2 = 1 \text{ megohm}$
 $R_3 = 2.2 \text{ megohm}$
 $C_1 = .005 \text{ mfd GMV}$
 $C_2 = 100 \text{ mmf}$
 $C_3 = .002 \text{ mfd}$
 Lead Wire # 22

1407-02

$R_1 = 4.7 \text{ megohm}$
 $R_2 = 1 \text{ megohm}$
 $R_3 = 2.2 \text{ megohm}$
 $C_1 = .005 \text{ mfd GMV}$
 $C_2 = 100 \text{ mmf}$
 $C_3 = .005 \text{ mfd}$
 Lead Wire # 22

1407-03

ERIE AUDIO OUTPUT CIRCUITS

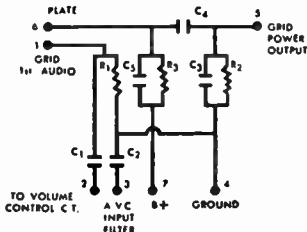
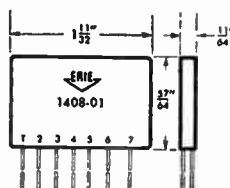

$R_1 = 6.8 \text{ megohm}$
 $R_2 = R_3 = 470K$
 $C_1 = .002 \text{ mfd}$
 $C_2 = 220 \text{ mmf}$
 $C_3 + C_4 = 250 \text{ mmf}$
 $C_4 = .005 \text{ mfd GMV}$
 Lead Wire # 22

1408-01

$R_1 = 6.8 \text{ megohm}$
 $R_2 = R_3 = 470K$
 $C_1 = .005 \text{ mfd}$
 $C_2 = 220 \text{ mmf}$
 $C_3 + C_4 = 250 \text{ mmf}$
 $C_4 = .005 \text{ mfd GMV}$
 Lead Wire # 22

1408-02

Order by Part Number from Table Below

Erie Part No.	Description	Dimensions
1403-01	Diode Filter	$3\frac{3}{64}'' \times 2\frac{1}{64}'' \times 1\frac{1}{64}''$
1403-02	Diode Filter	$3\frac{3}{64}'' \times 2\frac{1}{64}'' \times 1\frac{1}{64}''$
1403-03	Diode Filter	$3\frac{3}{64}'' \times 2\frac{1}{64}'' \times 1\frac{1}{64}''$
1406-01	Triode Plate Coupler	$1\frac{5}{16}'' \times 3\frac{3}{64}'' \times 1\frac{1}{64}''$
1406-02	Triode Plate Coupler	$1\frac{5}{16}'' \times 3\frac{3}{64}'' \times 1\frac{1}{64}''$
1404-01	Triode Plate Coupler	$1\frac{5}{16}'' \times 3\frac{3}{64}'' \times 1\frac{1}{64}''$
1404-02	Triode Plate Coupler	$1\frac{5}{16}'' \times 3\frac{3}{64}'' \times 1\frac{1}{64}''$

Erie Part No.	Description	Dimensions
1407-01	Pentode Plate Coupler	$1\frac{11}{32}'' \times 5\frac{3}{64}'' \times 1\frac{1}{64}''$
1407-02	Pentode Plate Coupler	$1\frac{11}{32}'' \times 5\frac{3}{64}'' \times 1\frac{1}{64}''$
1407-03	Pentode Plate Coupler	$1\frac{11}{32}'' \times 5\frac{3}{64}'' \times 1\frac{1}{64}''$
1405-01	Vertical Integrator	$1\frac{5}{16}'' \times 3\frac{3}{64}'' \times 1\frac{1}{64}''$
1408-01	Audio Output Coupler	$1\frac{11}{32}'' \times 5\frac{3}{64}'' \times 1\frac{1}{64}''$
1408-02	Audio Output Coupler	$1\frac{11}{32}'' \times 5\frac{3}{64}'' \times 1\frac{1}{64}''$

ERIE BUTTON® SILVER-MICA CAPACITORS



STYLE CB

These are midget silver-mica capacitors, for use where compact size, minimum series inductance, and high leakage resistance are essential. They offer high stability of capacitance over the full temperature range - 55°C to + 85°C. Erie button silver-mica capacitors are unmatched for V.H.F. and U.H.F. work. "Q" at 1 MC is not less than 1000 above 100 MMF; not less than 700 between 50 and 100 MMF; not less than 500 below 50 MMF. Type 370-CB has ring type metal shell with three soldering ears. High potential terminal at either end for feed-thru connection. Type 370-FA is fastened to chassis with 3-48 screw.

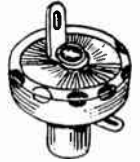

STYLE FA

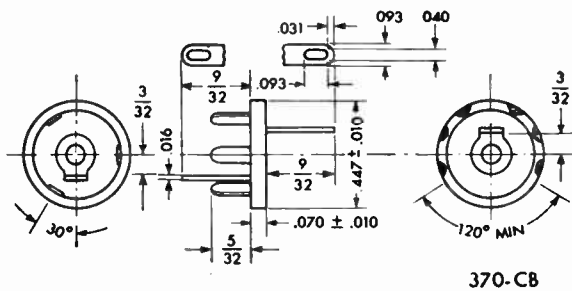

370-CB

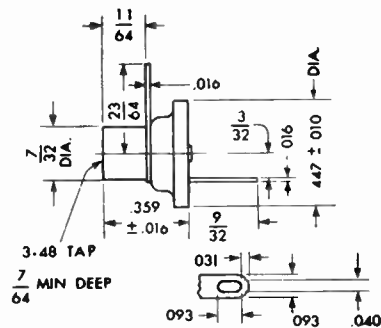

370-FA

Order by Part Number from Table Below

STOCK ITEMS — 500 VDCW

Part No. FA Styles	Part No. CB Styles	Cap. MMF	Tol.
370-FA-150K 370-FA-150J	370-CB-150K 370-CB-150J	15 15	10% 5%
370-FA-250K 370-FA-250J	370-CB-250K 370-CB-250J	25 25	10% 5%
370-FA-500K 370-FA-500J	370-CB-500K 370-CB-500J	50 50	10% 5%
370-FA-101K 370-FA-101J	370-CB-101K 370-CB-101J	100 100	10% 5%
370-FA-151K 370-FA-151J	370-CB-151K 370-CB-151J	150 150	10% 5%
370-FA-201K 370-FA-201J	370-CB-201K 370-CB-201J	200 200	10% 5%

Part No. FA Styles	Part No. CB Styles	Cap. MMF	Tol.
370-FA-251K 370-FA-251J	370-CB-251K 370-CB-251J	250 250	10% 5%
370-FA-301K 370-FA-301J	370-CB-301K 370-CB-301J	300 300	10% 5%
370-FA-401K 370-FA-401J	370-CB-401K 370-CB-401J	400 400	10% 5%
370-FA-501K 370-FA-501J	370-CB-501K 370-CB-501J	500 500	10% 5%
370-FA-751K 370-FA-751J	370-CB-751K 370-CB-751J	750 750	10% 5%
370-FA-102K 370-FA-102J	370-CB-102K 370-CB-102J	1000 1000	10% 5%

"Button" is a registered trade name of Erie Resistor Corporation



ERIE CERAMICON® TRIMMERS

These trimmers have been well known for years for their stability under the most exacting conditions. The top of the base and underside of the titanium dioxide rotor are lapped optically flat, thus eliminating air space variations with temperature. Fired silver electrodes are applied to top of base and rotor, so that capacity is changed by varying the

amount of overlap. Capacity change per degree of rotation is approximately constant, resulting in a smoothness of adjustment not possible with compression type trimmers, where the greater part of capacity change is concentrated close to one end of adjustment.



STYLE TS2A

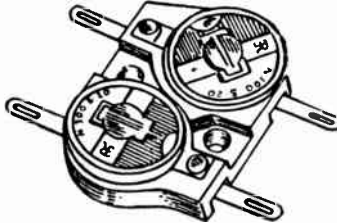

STYLE TD2A

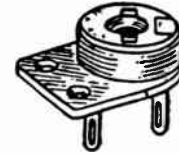

STYLE 557
Patented

Order by Catalog Number from Table Below
STOCK ITEMS — 500 VDCW

Catalog No.	Erie Part No.	Capacity Range (MMF)	Temperature Coefficient
TS-A	TS2A-1.5	1.5-7	NPO
TS-B	TS2A-3	3-12	NPO
TS-C	TS2A-4	4-30	N500
TS-D	TS2A-5	5-20	N300
TS-E	TS2A-7	7-45	N500
TD-A	TD2A-1.5	1.5-7	NPO
TD-B	TD2A-3	3-12	NPO
TD-C	TD2A-4	4-30	N500
TD-D	TD2A-5	5-20	N300
TD-E	TD2A-7	7-45	N500
557-A	557-1.5	1.5-7	NPO
557-B	557-3	3-12	NPO
557-F	557-5	5-25	NPO
557-G	557-5	5-30	N750
557-H	557-8	8-50	N750

ERIE TUBULAR TRIMMERS

These are compact, economical Tubular Trimmers that are ideal for applications calling for a low minimum capacity and a high ratio of maximum to minimum capacity. Styles 532 and 535 have molded plastic dielectric. Style 3115-01 and 3139-01 have ceramic dielectric.

Order by Catalog Number from Table Below

STOCK ITEMS — 500 VDCW

Catalog No.	Erie Part No.	Capacity Range (MMF)	Panel Thickness
532-A	532-08-0R5	0.5-5	.040" to .065"
532-B	532-10	1-8	.040" to .065"
535-C	535-0R7	0.7-3	up to .050"
3115-D	3115-01-0R5	0.5-3	.025" to .065"
3115-E	3115-01-10	1-4	.025" to .065"
3139-D	3139-01-0R5	0.5-3	.025" to .065"
3139-E	3139-01-10	1-4	.025" to .065"

STYLE 532



STYLE 535

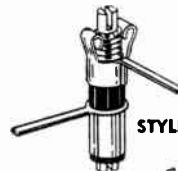

STYLE 3139-01

STYLE 3115-01



ERIE STAND-OFF CERAMICONS®

Stand-off Ceramicons, an original Erie development, are now widely used for the dual purposes of by-passing R.F. current to ground, and of mechanically supporting other circuit elements. They are especially suited for V.H.F. and U.H.F. applications, due to their low-inductance electrical paths and resultant high resonant frequency.

Order by Part Number from Table
500 VDCW — STOCK ITEMS — ± 20%

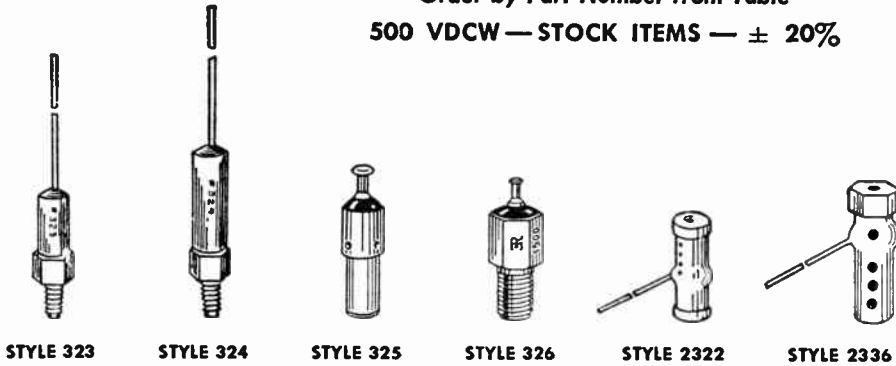

Erie Part No.	Capacity MMF
323-500	50
323-101	100
323-501	500
324-102	1000
324-152	1500
325-102	1000
325-152	1500
326-102	1000
326-152	1500
2322-152	1500
2322-252	2500
2336-152	1500
2336-252	2500
2336-502	5000

ERIE FEED-THRU CERAMICONS®

These very practical feed-thru capacitors are highly recommended for by-passing R.F. to ground in feed-thru applications. Wire terminals of Style 362 and hook type terminals of Style 327 are sufficiently rugged to serve as tie points for several connections, for supporting other circuit elements, and long enough for point to point wiring. Style 327 is hermetically sealed and ruggedized, and is primarily for military and similar commercial usage. Nut supplied.



Order by Part Number from Table Below
500 VDCW — STOCK ITEMS — ± 20%

Erie Part No.	Capacity MMF
327-102	1000
357-102	1000
362-152	1500

ERIE "HI-STAB" DEPOSITED CARBON RESISTORS



Order by Part Number from Table Below
1% — STOCK ITEMS — ½ WATT

Erie deposited carbon resistors are made by a process developed and perfected as a result of years of work in the laboratory of Erie Resistor Limited in England.

The Erie basic Style 155 resistor employs a highly stable resistance film that is applied in the form of carbon deposited at high temperature on the surface of a ceramic rod. Precise D.C. resistance values as close as 1% tolerance are produced by spiral cutting on the outside resistance film. This resistance rod then has axial leads firmly attached and the rod is encased in thermo-setting molded plastic insulation, a unique feature for resistors of this type.

Style 155 "Hi-Stab" resistor, rated at ½ watt, is designed to meet the requirements of Styles RN-15 and RN-20 as specified under MIL-R-10509A, and is available in resistances from 100 ohms to 470,000 ohms, tolerance of 5%, 2%, and 1%.

Erie Part No.	Resistance (Ohms) ½ Watt — ± 1%	Erie Part No.	Resistance (Ohms) ½ Watt — ± 1%
155-1000F	100	155-1002F	10,000
155-1500F	150	155-1502F	15,000
155-2200F	220	155-2202F	22,000
155-3300F	330	155-3302F	33,000
155-4700F	470	155-4702F	47,000
155-6800F	680	155-6802F	68,000
155-1001F	1,000	155-1003F	100,000
155-1501F	1,500	155-1503F	150,000
155-2201F	2,200	155-2203F	220,000
155-3301F	3,300	155-3303F	330,000
155-4701F	4,700	155-4703F	470,000
155-6801F	6,800		



Plastic Capacitors, Inc.

CHICAGO 47, ILL

- Mfrs. of
- Plastic Film Capacitors
 - Pulse Forming Networks
 - High Voltage Power Supplies

GLASSCAPS DC FILTER TYPES

ORLITE TYPE OF

Derated to 70% Nameplate Voltage for 85° C. Operation

Voltage Rated for Operation at 65° C.

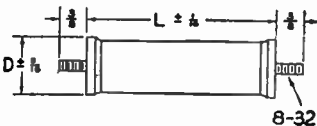

ORLITE TYPE OG

Voltage Rated for Operation at 85° C.

Part Number	Capacity MFD	Volts DC	Dimensions Lgth. Dia.	List Price
OF20-502	.005	2000	1 1/8 1/8	\$ 2.05
OF20-103	.01	2000	1 1/8 2.23	2.23
OF20-203	.02	2000	1 1/8 2.40	2.40
OF20-503	.05	2000	1 1/8 2.70	2.70
OF20-104	0.1	2000	2 1/4 3.05	3.05
OF20-254	0.25	2000	2 1/4 3.50	3.50
OF30-502	.005	3000	1 1/8 5.10	5.10
OF30-103	.01	3000	1 1/8 5.30	5.30
OF30-203	.02	3000	1 1/8 5.50	5.50
OF30-503	.05	3000	2 1/4 5.70	5.70
OF30-104	0.1	3000	1 1/8 6.00	6.00
OF30-254	0.25	3000	2 1/4 6.60	6.60
OF40-502	.005	4000	1 1/8 5.90	5.90
OF40-103	.01	4000	1 1/8 6.10	6.10
OF40-203	.02	4000	1 1/8 6.40	6.40
OF40-503	.05	4000	2 1/4 6.50	6.50
OF40-104	0.1	4000	2 1/4 7.40	7.40
OF40-254	0.25	4000	2 1/4 8.10	8.10
OF50-502	.005	5000	1 1/8 6.50	6.50
OF50-103	.01	5000	1 1/8 6.80	6.80
OF50-203	.02	5000	2 1/4 7.20	7.20
OF50-503	.05	5000	2 1/4 7.60	7.60
OF50-104	0.1	5000	2 1/4 8.50	8.50
OF50-254	0.25	5000	2 1/4 9.40	9.40
OF80-202	.002	8000	1 1/8 6.80	6.80
OF80-502	.005	8000	1 1/8 7.00	7.00
OF80-103	.01	8000	2 1/4 7.50	7.50
OF80-203	.02	8000	2 1/4 8.60	8.60
OF80-503	.05	8000	2 1/4 11.00	11.00
OF80-104	0.1	8000	2 1/4 12.50	12.50
OF100-102	.001	10 KV	1 1/8 7.20	7.20
OF100-202	.002	10 KV	1 1/8 7.40	7.40
OF100-502	.005	10 KV	1 1/8 8.50	8.50
OF100-103	.01	10 KV	2 1/4 9.20	9.20
OF100-203	.02	10 KV	2 1/4 11.40	11.40
OF100-503	.05	10 KV	2 1/4 14.60	14.60
OF100-603	.06	10 KV	2 1/4 15.50	15.50
OF150-102	.001	15 KV	2 1/4 13.80	13.80
OF150-202	.002	15 KV	2 1/4 14.60	14.60
OF150-502	.005	15 KV	2 1/4 17.00	17.00
OF150-103	.01	15 KV	3 1/8 20.00	20.00
OF150-203	.02	15 KV	4 1/4 22.00	22.00
OF150-503	.05	15 KV	7 1/8 26.00	26.00
OF200-501	.0005	20 KV	3 1/2 18.00	18.00
OF200-102	.001	20 KV	3 1/2 19.00	19.00
OF200-202	.002	20 KV	3 1/2 21.00	21.00
OF200-502	.005	20 KV	3 1/2 22.50	22.50
OF200-103	.01	20 KV	4 1/2 24.00	24.00
OF200-203	.02	20 KV	4 1/2 27.00	27.00
OF300-201	.0002	30 KV	4 1/8 21.00	21.00
OF300-501	.0005	30 KV	4 1/8 21.00	21.00
OF300-102	.001	30 KV	5 1/8 23.50	23.50
OF300-202	.002	30 KV	5 1/8 26.00	26.00
OF300-502	.005	30 KV	5 1/8 28.00	28.00
OF300-103	.01	30 KV	6 1/8 35.00	35.00
OF400-101	.0001	40 KV	5 3/8 22.50	22.50
OF400-201	.0002	40 KV	5 3/8 22.50	22.50
OF400-501	.0005	40 KV	5 3/8 22.50	22.50
OF400-102	.001	40 KV	6 3/8 26.00	26.00
OF400-202	.002	40 KV	6 3/8 28.00	28.00
OF400-502	.005	40 KV	6 3/8 33.00	33.00
OF500-101	.0001	50 KV	8 1/4 23.50	23.50
OF500-201	.0002	50 KV	8 1/4 23.50	23.50
OF500-501	.0005	50 KV	8 1/4 24.50	24.50
OF500-102	.001	50 KV	8 1/4 28.00	28.00
OF500-202	.002	50 KV	8 1/4 31.50	31.50
OF500-502	.005	50 KV	10 1/4 36.00	36.00
OF600-101	.0001	60 KV	10 1/4 24.50	24.50
OF600-201	.0002	60 KV	10 1/4 24.50	24.50
OF600-501	.0005	60 KV	10 1/4 28.00	28.00
OF600-102	.001	60 KV	10 1/4 34.00	34.00
OF600-202	.002	60 KV	10 1/4 36.00	36.00
OF600-502	.005	60 KV	11 1/4 41.50	41.50

Part Number	Capacity MFD	Volts DC	Dimensions Lgth. Dia.	List Price
OG6-103	.01	600	1 1/8 1 1/8	\$ 1.50
OG6-203	.02	600	1 1/8 1 1/8	1.60
OG6-503	.05	600	1 1/8 1 1/8	1.75
OG6-104	0.1	600	1 1/8 1 1/8	1.95
OG6-254	0.25	600	1 1/8 1 1/8	2.30
OG6-504	0.5	600	2 1/4 1 1/8	2.60
OG10-103	.01	1000	1 1/8 1 1/8	1.60
OG10-203	.02	1000	1 1/8 1 1/8	1.70
OG10-503	.05	1000	1 1/8 1 1/8	1.85
OG10-104	0.1	1000	1 1/8 1 1/8	2.15
OG10-254	0.25	1000	2 1/4 1 1/8	2.50
OG15-103	.01	1500	1 1/8 1 1/8	2.25
OG15-203	.02	1500	1 1/8 1 1/8	2.50
OG15-503	.05	1500	1 1/8 1 1/8	2.70
OG15-104	0.1	1500	1 1/8 1 1/8	3.20
OG15-254	0.25	1500	2 1/4 1 1/8	3.60
OG20-103	.01	2000	1 1/8 1 1/8	5.20
OG20-203	.02	2000	1 1/8 1 1/8	5.40
OG20-503	.05	2000	1 1/8 1 1/8	5.60
OG20-104	0.1	2000	1 1/8 1 1/8	6.00
OG20-254	0.25	2000	2 1/4 1 1/8	6.50
OG25-502	.005	2500	1 1/8 1 1/8	5.30
OG25-103	.01	2500	1 1/8 1 1/8	5.60
OG25-203	.02	2500	1 1/8 1 1/8	5.80
OG25-503	.05	2500	2 1/4 1 1/8	6.00
OG25-104	0.1	2500	2 1/4 1 1/8	6.50
OG25-254	0.25	2500	2 1/4 1 1/8	7.00
OG30-502	.005	3000	1 1/8 1 1/8	5.70
OG30-103	.01	3000	1 1/8 1 1/8	6.00
OG30-203	.02	3000	2 1/4 1 1/8	6.20
OG30-503	.05	3000	2 1/4 1 1/8	6.30
OG30-104	0.1	3000	2 1/4 1 1/8	7.00
OG30-254	0.25	3000	3 1/4 1 1/8	7.60

LUROL TYPE LF

Voltage Rated for Operation at 85° C.

Part Number	Capacity MFD	Volts DC	Dimensions Lgth. Dia.	List Price
LF4-503	.05	400	1 1/4 1 1/4	\$ 3.40
LF4-104	0.1	400	1 1/4 1 1/4	3.60
LF4-254	0.25	400	1 1/4 1 1/4	3.80
LF4-504	0.5	400	2 1/4 1 1/4	4.40
LF10-203	.02	1000	1 1/4 1 1/4	3.40
LF10-503	.05	1000	1 1/4 1 1/4	3.60
LF10-104	0.1	1000	2 1/4 1 1/4	3.80
LF10-254	0.25	1000	2 1/4 1 1/4	4.10
LF20-103	.01	2000	1 1/4 1 1/4	5.30
LF20-203	.02	2000	1 1/4 1 1/4	5.50
LF20-503	.05	2000	2 1/4 1 1/4	5.80
LF20-104	0.1	2000	2 1/4 1 1/4	6.30
LF20-254	0.25	2000	2 1/4 1 1/4	6.90
LF30-103	.01	3000	1 1/4 1 1/4	6.20
LF30-203	.02	3000	1 1/4 1 1/4	6.50
LF30-503	.05	3000	2 1/4 1 1/4	6.90
LF30-104	0.1	3000	2 1/4 1 1/4	7.30
LF30-254	0.25	3000	3 1/4 1 1/4	8.10
LF40-502	.005	4000	1 1/4 1 1/4	6.60
LF40-103	.01	4000	2 1/4 1 1/4	6.80
LF40-203	.02	4000	2 1/4 1 1/4	7.50
LF40-503	.05	4000	2 1/4 1 1/4	8.20
LF60-502	.005	6000	2 1/4 1 1/4	7.70
LF60-103	.01	6000	2 1/4 1 1/4	7.90
LF60-503	.05	6000	3 1/4 1 1/4	11.40
LF80-502	.005	8000	2 3/8 1 1/4	8.80
LF80-103	.01	8000	2 3/8 1 1/4	9.60
LF80-203	.02	8000	3 3/8 1 1/4	11.80
LF80-503	.05	8000	5 3/8 1 1/4	15.20
LF120-202	.002	12 KV	2 3/8 1 1/4	15.80
LF120-502	.005	12 KV	2 3/8 1 1/4	18.40
LF120-103	.01	12 KV	3 3/8 1 1/4	19.60
LF120-203	.02	12 KV	5 3/8 1 1/4	22.50

THE ABOVE ARE PARTIAL LISTINGS. OTHER VOLTAGES AND CAPACITANCES ARE AVAILABLE.



Plastic Capacitors, Inc.

CHICAGO 47, ILL

Mfrs. of
 • Plastic Film Capacitors
 • Fuse Fusing Networks
 • High Voltage Power Supplies

GLASSCAPS DC FILTER TYPES

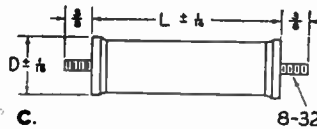

LUROL TYPE LG
Voltage Rated for Operation at 125° C.

Part Number	Capacity MFD	Volts DC	Dimensions Lgth. Dia.	List Price
LG7-203	.02	700	1 1/4	\$ 4.40
LG7-503	.05	700	1 1/4	4.60
LG7-104	0.1	700	2	4.80
LG7-254	0.25	700	2	5.20
LG10-203	.02	1000	1 1/4	6.50
LG10-503	.05	1000	2	6.80
LG10-104	0.1	1000	2	7.40
LG10-254	0.25	1000	2	8.20
LG15-203	.02	1500	1 1/4	8.10
LG15-503	.05	1500	2	8.70
LG15-104	0.1	1500	2	9.10
LG15-254	0.25	1500	3	9.60
LG20-103	.01	2000	2	8.10
LG20-203	.02	2000	2	8.70
LG20-503	.05	2000	2	9.40
LG20-104	0.1	2000	3	10.20
LG30-502	.005	3000	2	8.90
LG30-103	.01	3000	2	9.10
LG30-203	.02	3000	2	9.70
LG30-503	.05	3000	3	12.50
LG60-202	.002	6000	2 3/8	17.40
LG60-502	.005	6000	3 3/8	20.00
LG60-103	.01	6000	3 3/8	22.40
LG60-203	.02	6000	5 3/8	24.00
LG90-202	.002	9000	3 1/2	23.30
LG90-502	.005	9000	4 3/8	25.80
LG90-103	.01	9000	4 3/8	27.20
LG90-203	.02	9000	8 1/4	31.50
LG150-201	.0002	15 KV	5 3/8	27.70
LG150-501	.0005	15 KV	5 3/8	30.30
LG150-102	.001	15 KV	5 3/8	32.20
LG150-202	.002	15 KV	5 3/8	36.70

POLYSTYRENE TYPE PG

The Finest Capacitor for Computers and Standards

Part Number	Capacity MFD	Volts DC	Dimensions Lgth. Dia.	List Price
PG1-103	.01	100	1	\$ 4.60
PG1-203	.02	100	1	4.60
PG1-503	.05	100	1 3/8	6.30
PG1-104	0.1	100	1 3/8	8.30
PG1-254	0.25	100	1 3/8	10.50
PG1-504	0.5	100	2 1/2	12.60
PG1-105	1.0	100	3 1/2	15.38
PG2-502	.005	200	1	5.30
PG2-103	.01	200	1	5.30
PG2-203	.02	200	1	5.30
PG2-503	.05	200	1	7.50
PG2-104	0.1	200	1 3/8	9.20
PG2-254	0.25	200	1 3/8	11.50
PG2-504	0.5	200	2 1/2	13.20
PG4-502	.005	400	1	6.30
PG4-103	.01	400	1	6.30
PG4-203	.02	400	1 3/8	7.60
PG4-503	.05	400	1 3/8	9.60
PG4-104	0.1	400	2 1/2	12.00
PG4-254	0.25	400	3 1/2	14.50
PG6-102	.001	600	1	6.30
PG6-202	.002	600	1	6.30
PG6-502	.005	600	1	6.30
PG6-103	.01	600	1	6.80
PG6-203	.02	600	1	8.00
PG6-503	.05	600	1 1/2	10.60
PG6-104	0.1	600	1 1/2	13.20
PG10-102	.001	1000	1	7.60
PG10-202	.002	1000	1	8.60
PG10-502	.005	1000	1 3/8	9.80
PG10-103	.01	1000	1 3/8	10.60
PG10-203	.02	1000	1 3/8	11.60
PG10-503	.05	1000	3 1/2	12.40
PG10-104	0.1	1000	3 1/2	13.30
PG10-204	0.2	1000	3 1/2	14.40

RF AND PULSE GLASSCAPS

TRYLAR TYPE TF
Voltage Rated for Operation at 150° C.

Part Number	Capacity MFD	Volts DC	Peak Pulse Volts	Dimensions Lgth. Dia.	List Price
TF40-501	.0005	4000	3500	1 5/8	\$13.10
TF40-102	.001	4000	3500	1 5/8	13.10
TF40-202	.002	4000	3500	1 5/8	14.20
TF40-502	.005	4000	3500	1 5/8	15.40
TF40-103	.01	4000	3500	2 1/8	21.10
TF40-203	.02	4000	3500	2 1/8	24.20
TF60-101	.0001	6000	5000	2 1/8	15.20
TF60-201	.0002	6000	5000	2 1/8	15.20
TF60-501	.0005	6000	5000	2 1/8	15.20
TF60-102	.001	6000	5000	2 1/8	15.20
TF60-202	.002	6000	5000	2 1/8	16.80
TF60-502	.005	6000	5000	2 1/8	18.60
TF60-103	.01	6000	5000	2 1/8	24.10
TF80-101	.0001	8000	7000	2 3/8	16.10
TF80-201	.0002	8000	7000	2 3/8	16.10
TF80-501	.0005	8000	7000	2 3/8	16.10
TF80-102	.001	8000	7000	2 3/8	21.20
TF80-202	.002	8000	7000	2 3/8	22.40
TF80-502	.005	8000	7000	2 3/8	29.00
TF80-103	.01	8000	7000	3 3/8	36.90
TF120-101	.0001	12 KV	10 KV	3 1/8	16.90
TF120-201	.0002	12 KV	10 KV	3 1/8	16.90
TF120-501	.0005	12 KV	10 KV	3 1/8	16.90
TF120-102	.001	12 KV	10 KV	3 1/8	22.50
TF120-202	.002	12 KV	10 KV	3 1/8	29.70
TF120-502	.005	12 KV	10 KV	4 1/8	40.20
TF180-101	.0001	18 KV	15 KV	4 1/8	18.00
TF180-201	.0002	18 KV	15 KV	4 1/8	18.00
TF180-501	.0005	18 KV	15 KV	4 1/8	25.20
TF180-102	.001	18 KV	15 KV	5 1/8	35.20
TF180-202	.002	18 KV	15 KV	5 1/8	44.10

HYLON TYPE HG

Voltage Rated for Operation at 65° C.

Part Number	Capacity MFD	Volts DC	Peak Pulse Volts	Dimensions Lgth. Dia.	List Price
HG25-103	.01	2500	1500	1	\$ 6.50
HG25-203	.02	2500	1500	1 1/2	7.10
HG25-503	.05	2500	1500	2	8.60
HG25-104	0.1	2500	1500	2 1/2	11.40
HG35-502	.005	3500	2500	1	7.50
HG35-103	.01	3500	2500	1	8.10
HG35-203	.02	3500	2500	1 1/2	8.50
HG35-503	.05	3500	2500	2 1/2	11.60
HG50-502	.005	5000	3000	2	10.50
HG50-103	.01	5000	3000	2	11.50
HG50-203	.02	5000	3000	3	12.50
HG50-503	.05	5000	3000	6	18.50
HG70-202	.002	7000	5000	2	11.00
HG70-502	.005	7000	5000	2	14.20
HG70-103	.01	7000	5000	4	17.00
HG70-203	.02	7000	5000	4	18.60
HG100-102	.001	10 KV	7000	3	12.00
HG100-202	.002	10 KV	7000	3	13.50
HG100-502	.005	10 KV	7000	6	21.00
HG100-103	.01	10 KV	7000	6	24.00
HG140-102	.001	14 KV	10 KV	4	15.30
HG140-202	.002	14 KV	10 KV	4	20.00
HG140-502	.005	14 KV	10 KV	8	24.00
HG140-103	.01	14 KV	10 KV	8	27.00
HG200-201	.0002	20 KV	15 KV	5 3/8	17.00
HG200-501	.0005	20 KV	15 KV	5 3/8	20.00
HG200-102	.001	20 KV	15 KV	5 3/8	22.50
HG200-202	.002	20 KV	15 KV	5 3/8	24.50
HG250-201	.0002	25 KV	20 KV	7 1/4	20.00
HG250-501	.0005	25 KV	20 KV	7 1/4	25.00
HG250-102	.001	25 KV	20 KV	7 1/4	31.00
HG250-202	.002	25 KV	20 KV	7 1/4	35.00

OTHER VOLTAGES AND CAPACITANCES ARE AVAILABLE

STANDARD POWER PACKS

Model	Output KV	Output ma	Wdth.	Case Size Lgth.	Ht.	List Price
HV50-502	0 to 5.0	5.0	4 1/2	6 3/8	5 5/8	\$ 89.00
HV100-102	0 to 10	1.0	4 1/2	7 1/4	5	100.00
HV100-502	0 to 10	5.0	6	8 1/4	6 1/2	109.00
HV150-102	0 to 15	1.0	4 1/2	7 1/4	5	108.00
HV150-502	0 to 15	5.0	6	8 1/4	6 1/2	118.00
HV200-102	0 to 20	1.0	4 1/2	7 1/4	5 1/2	126.00
HV200-502	0 to 20	5.0	6	8 1/4	6 1/2	171.00
HV300-102	0 to 30	1.0	6 3/8	8 3/4	6	180.00
HV300-502	0 to 30	5.0	6 3/8	9	8 3/4	210.00
HV500-502	0 to 50	6.0	12 1/2	12 1/2	12 1/2	425.00
HV600-202	0 to 60	2.0	12 1/2	12 1/2	12 1/2	475.00
HV750-202	0 to 75	2.0	19	13	13	700.00



Plastic Capacitors, Inc.

CHICAGO 47, ILL

- Mfrs. of
- Plastic Film Capacitors
 - Pulse Forming Networks
 - High Voltage Power Supplies

CP 70 STYLE CONTAINER

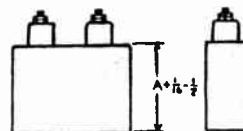

ORLITE TYPE OE Voltage Rated for Operation at 65° C.

Part Number	Volts DC	Capacity MFD	Case Size			List Price
			A	B	C	
OE20-105	2000	1.0	2 5/8	2 1/2	1 3/8	\$ 7.00
OE20-205	2000	2	3 3/8	2 1/2	1 3/8	8.10
OE20-405	2000	4	3 1/2	3 3/8	1 1/4	11.00
OE20-605	2000	6	4 3/4	3 3/8	1 3/4	15.50
OE30-105	3000	1.0	3 3/4	2 1/2	1 3/8	14.50
OE30-205	3000	2	4 3/8	3 3/8	1 1/4	18.40
OE30-405	3000	4	4 5/8	3 3/8	2 1/4	25.50
OE30-605	3000	6	5 3/8	4 3/8	3 3/4	45.00
OE40-105	4000	1.0	3 3/4	3 3/8	1 1/4	31.00
OE40-205	4000	2	4 3/8	3 3/8	1 3/8	38.50
OE40-405	4000	4	5 3/8	4 1/8	3 3/4	54.20
OE40-605	4000	6	6 3/8	4 1/8	3 3/4	69.80
OE50-105	5000	1.0	3 5/8	3 3/8	1 3/8	35.00
OE50-205	5000	2	4 1/2	3 3/8	2 1/4	44.30
OE50-405	5000	4	4 5/8	4 1/8	3 3/4	67.00
OE50-605	5000	6	6 3/8	4 1/8	3 3/4	94.00
OE60-105	6000	1.0	5	3 3/4	2 1/4	49.00
OE60-205	6000	2	5 1/2	4 1/8	3 3/4	65.00
OE60-405	6000	4	6 1/2	4 1/8	3 3/4	94.00
OE60-605	6000	6	7 1/2	5	4	130.00
OE75-105	7500	1.0	5	3 3/8	3 3/8	58.00
OE75-205	7500	2	7	4 1/8	3 3/4	78.00
OE75-405	7500	4	9 1/4	5	4	118.00
OE75-605	7500	6	11 1/4	5	4 1/4	157.00
OE100-105	10 KV	1.0	5 1/8	4 1/8	3 3/4	82.00
OE100-205	10 KV	2	9	4 1/8	3 3/4	105.00
OE100-405	10 KV	4	11	5	4	140.00
OE100-605	10 KV	6	13 1/4	5	4 1/4	178.00
OE150-254	15 KV	0.25	4 3/8	3 3/8	3 3/8	72.00
OE100-504	15 KV	0.5	7 3/8	4 1/8	3 3/4	116.00
OE150-105	15 KV	1.0	7	5	4	158.00
OE150-205	15 KV	2	13 1/8	5	4 1/4	189.00

ORLITE TYPE OC Derated to 75% Nameplate Voltage for 105° C. Operation Voltage Rated for Operation at 85° C.

Part Number	Volts DC	Capacity MFD	Case Size			List Price
			A	B	C	
OC6-105	600	1	2 1/8	1 3/4	1	\$ 4.50
OC6-205	600	2	3 3/8	1 3/4	1	5.40
OC6-405	600	4	3 3/8	2 1/2	1 3/8	6.70
OC6-605	600	6	4 3/4	2 1/2	1 7/8	8.60
OC10-105	1000	1	2 5/8	1 3/4	1	4.80
OC10-205	1000	2	4 3/8	1 3/4	1	6.50
OC10-405	1000	4	4 3/8	2 1/2	1 3/8	7.80
OC10-605	1000	6	4 3/8	3 3/8	1 1/2	10.10
OC15-105	1500	1.0	3 1/4	2 1/2	1 7/8	7.00
OC15-205	1500	2	3 3/8	3 3/4	1 1/4	8.10
OC15-405	1500	4	3 5/8	3 3/4	2 1/8	11.80
OC15-605	1500	6	3 5/8	3 3/4	3 7/8	15.60
OC20-105	2000	1.0	3 3/4	2 1/2	1 7/8	14.50
OC20-205	2000	2	4 3/8	3 3/8	1 1/4	18.50
OC20-405	2000	4	4 3/8	3 3/8	2 1/4	25.40
OC20-605	2000	6	5 3/8	4 1/8	3 3/4	32.00
OC25-105	2500	1.0	3 3/4	3 3/8	1 1/4	24.60
OC25-205	2500	2	4 3/8	3 3/8	1 3/8	29.60
OC25-405	2500	4	4 3/8	3 3/8	3 7/8	35.50
OC25-605	2500	6	4 3/8	4 1/8	3 3/8	40.60
OC30-105	3000	1.0	3 1/2	3 3/4	1 3/8	33.20
OC30-205	3000	2	4 3/8	3 3/8	2 1/4	39.50
OC30-405	3000	4	4 3/8	4 1/8	3 3/4	60.00
OC30-605	3000	6	6 3/8	4 1/8	3 3/8	73.50
OC50-254	5000	0.25	3 3/8	3 3/8	1 1/4	35.00
OC50-504	5000	0.5	4 3/8	3 3/8	1 3/8	42.00
OC50-105	5000	1.0	5	3 3/8	3 7/8	52.00
OC50-205	5000	2	7 1/8	4 1/8	3 3/8	65.00
OC75-504	7500	0.5	4 3/8	4 1/8	3 3/8	64.00
OC75-105	7500	1.0	7 3/8	4 1/8	3 3/8	105.00
OC75-205	7500	2	9 1/4	5	4	131.00
OC75-405	7500	4	9 1/4	13 1/2	4 1/4	182.00

LUROL TYPE LC Voltage Rated for Operation at 125° C.

Part Number	Volts DC	Capacity MFD	Case Size			List Price
			A	B	C	
LC3-205	300	2	2 1/8	1 3/4	1	\$ 10.60
LC3-405	300	4	3 1/4	1 3/4	1	13.40
LC3-605	300	6	3 1/4	2 1/2	1 3/8	16.60
LC3-805	300	8	3 5/8	3 3/8	1 1/4	22.00
LC7-105	700	1	2 5/8	1 3/4	1	14.20
LC7-205	700	2	2 5/8	2 1/2	1 3/8	17.50
LC7-405	700	4	4 1/8	2 1/2	1 7/8	26.20
LC7-605	700	6	4 1/8	3 3/8	1 1/4	35.50
LC7-805	700	8	5 3/8	3 3/8	2 1/4	45.60
LC10-504	1000	0.5	3	1 3/4	1	13.00
LC10-105	1000	1	2 7/8	2 1/2	1 7/8	16.50
LC10-205	1000	2	3 1/2	3 3/4	1 1/4	25.20
LC10-405	1000	4	3 1/2	3 3/4	2 1/4	41.30
LC10-605	1000	6	3 1/2	3 3/4	3 7/8	59.20
LC15-504	1500	0.5	2 7/8	2 1/2	1 3/8	16.20
LC15-105	1500	1	3 1/2	3 3/4	1 1/4	23.60
LC15-205	1500	2	3 1/2	3 3/4	2 1/4	40.60
LC15-405	1500	4	6 3/8	3 3/4	2 1/4	69.60
LC15-605	1500	6	6 3/8	3 3/4	3 7/8	104.00
LC20-504	2000	0.5	3	2 1/2	1 7/8	26.40
LC20-105	2000	1	3 3/4	3 3/4	2 1/4	42.60
LC20-205	2000	2	5 1/4	3 3/4	3 7/8	76.00
LC20-405	2000	4	6 1/2	4 1/8	3 3/4	131.00
LC30-254	3000	0.25	3 3/8	3 3/4	1 1/4	25.50
LC30-504	3000	0.5	3 3/8	3 3/4	2 1/4	42.70
LC30-105	3000	1	5 3/8	3 3/4	3 7/8	73.00
LC30-205	3000	2	6 3/8	4 1/8	3 3/4	124.50
LC40-104	4000	0.1	4	3 3/4	1 3/4	30.80
LC40-254	4000	0.25	4	3 3/4	2 1/4	47.50
LC40-504	4000	0.5	6 3/8	3 3/4	2 1/4	89.10
LC40-105	4000	1	7 3/8	4 1/8	3 3/4	137.60

POLYSTYRENE TYPE PC The Finest Capacitor for Computers and Standards

Part Number	Volts DC	Capacity MFD	Case Size			List Price
			A	B	C	
PC1-504	100	0.5	2 1/8	1 3/4	1	\$ 8.10
PC1-105	100	1.0	3	1 3/4	1	10.00
PC1-205	100	2	3	2 1/2	1 3/8	14.40
PC1-405	100	4	4	3 3/4	1 3/4	18.50
PC1-505	100	5	5 1/4	3 3/4	1 1/4	21.70
PC1-605	100	6	4	3 3/4	1 3/8	24.80
PC2-504	200	0.5	2 1/8	1 3/4	1	8.30
PC2-105	200	1.0	3	1 3/4	1	10.20
PC2-205	200	2	3	3 3/4	1 1/4	14.70
PC2-405	200	4	4	3 3/4	1 3/4	18.50
PC2-505	200	5	4	3 3/4	1 3/4	21.50
PC2-605	200	6	4	3 3/4	2 1/4	24.50
PC2-805	200	8	4	3 3/4	3 7/8	29.00
PC2-106	200	10	4	4 1/8	3 3/8	33.00
PC4-254	400	0.25	3	1 3/4	1	11.00
PC4-504	400	0.5	3	2 1/2	1 3/8	11.50
PC4-105	400	1.0	4	3 3/4	1 1/4	15.00
PC4-205	400	2	4	3 3/4	1 3/8	23.00
PC4-405	400	4	4	3 3/4	3 7/8	35.80
PC4-505	400	5	5 1/4	3 3/4	3 7/8	42.50
PC4-605	400	6	7 1/4	3 3/4	3 7/8	49.30
PC6-254	600	0.25	4	1 3/4	1	11.00
PC6-504	600	0.5	4	2 1/2	1 3/8	11.50
PC6-105	600	1.0	4 1/4	3 3/4	1 1/4	15.00
PC6-205	600	2	4 1/4	3 3/4	2 1/4	22.50
PC6-405	600	4	4 1/4	4 1/8	3 3/8	35.00
PS6-505	600	5	7 3/8	3 3/8	3 7/8	42.00
PC10-104	1000	0.1	2 1/8	1 3/4	1	9.70
PC10-254	1000	0.25	4	1 3/4	1	11.40
PC10-504	1000	0.5	4	2 1/2	1 3/8	15.30
PC10-105	1000	1.0	4	3 3/4	1 3/8	22.10
PC10-205	1000	2	4	3 3/4	3 7/8	34.70
PC10-405	1000	4	7 1/4	3 3/4	3 7/8	58.50

THE ABOVE ARE PARTIAL LISTINGS. OTHER VOLTAGES AND CAPACITIES ARE AVAILABLE.

AEROVOX TYPE P123WG CAPACITORS

Designed for —40 to 85°C. Operation, Wax Impregnated, Hermetically Sealed, Grounded Case, Glass Terminal End Seal, Tubular Capacitors.

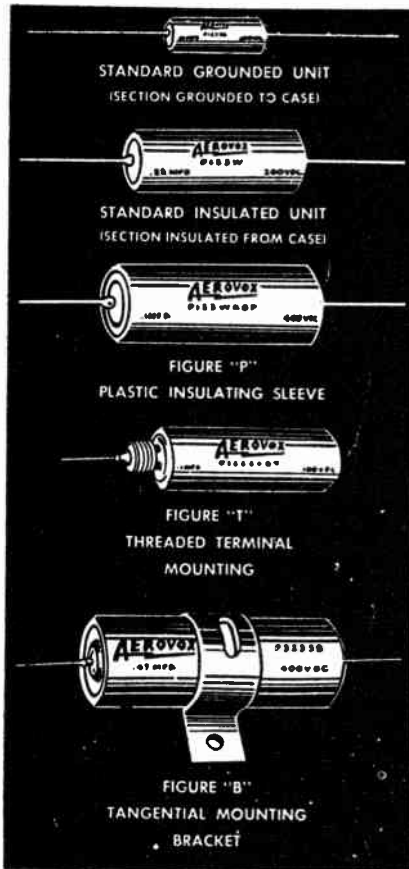

Capacity Rating Mfd.	100 VDC Size		200 VDC Size		300 VDC Size		400 VDC Size	
	D x L	List Pr.	D x L	List Pr.	D x L	List Pr.	D x L	List Pr.
.001	.175x	\$1.80	.235x	\$1.90	.235x	\$1.95	.235x	\$1.95
.0015	.175x	1.80	.235x	1.90	.235x	1.95	.235x	1.95
.0022	.175x	1.80	.235x	1.90	.235x	1.95	.235x	1.95
.0033	.175x	1.80	.235x	1.95	.235x	2.00	.235x	2.00
.0047	.175x	1.80	.235x	1.95	.235x	2.00	.235x	2.00
.0068	.175x	1.80	.235x	1.95	.235x	2.00	.235x	2.00
.01	.175x	1.85	.235x	2.00	.235x	2.05	.235x	2.05
.015	.175x	1.85	.235x	2.00	.235x	2.05	.235x	2.05
.022	.175x	1.85	.235x	2.00	.235x	2.05	.312x	2.10
.033	.195x	1.85	.235x	2.00	.312x	2.10	.312x	2.10
.047	.235x	1.90	.312x	2.05	.312x	2.10	.312x	2.10
.068	.312x	2.05	.312x	2.05	.312x	2.20	.400x	2.30
.1	.312x	2.05	.312x	2.20	.400x	2.25	.400x1/8	2.35
.15	.312x	2.10	.400x	2.25	.400x1/8	2.40	.400x1/8	2.50
.22	.400x1/8	2.10	.400x1/8	2.25	.400x1/8	2.55	.562x1/8	2.50
.33	.400x1/8	2.25	.400x1/8	2.50	.562x1/8	2.65	.562x1/8	2.85
.47	.400x1/8	2.35	.562x1/8	2.65	.562x1/8	2.80	.562x1/8	3.10
.68	.562x1/8	2.60	.562x1/8	2.80	.562x1/8	3.00	.670x1/8	3.55
1.0	.562x1/8	3.00	.562x1/8	3.05	.670x1/8	3.55	.750x2/8	3.85

- Standard Tolerance: ±20%.
for ±10% add 10% to list price.
for ±5% add 50% to list price.
- Insulated Construction: (For insulated construction omit "G" in designation and add 1/8 inch to length) add \$1.15 to list price.
- Plastic Insulating Sleeve: (For plastic insulating sleeve add "P" to designation and add .062 inch to diameter and 1/8 inch to length) add \$.20 to list price.
- Mounting Bracket: (For mounting bracket add "B" to designation) add \$.40 to list price.
- Threaded Terminal: (For threaded terminal mounting add "T" to designation) add \$.80 to list price.
- Screw-Stud Mounting: add \$.60 to list price.

AEROVOX TYPE P123WXG CAPACITORS

Designed for —40 to 85°C. Operation, Wax Impregnated, Hermetically Sealed, Grounded Case, Glass Terminal Seal, Tubular Capacitors with Extended-Foil Section Construction.

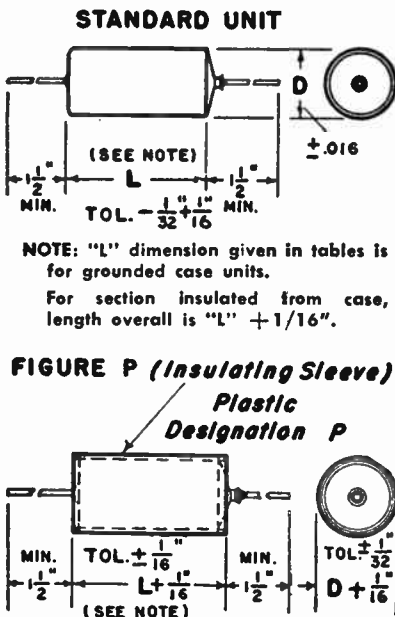

NOTE: "L" dimension given in tables is for grounded case units.
For section insulated from case, length overall is "L" + 1/16".

NOTE: "L" dimension given in tables is for metal case only of grounded unit.
Overall length is "L" + 1/16".
For section insulated from case, overall length is "L" + 1/8".

Capacity Rating Mfd.	100 VDC Size		200 VDC Size		300 VDC Size		400 VDC Size	
	D x L	List Pr.	D x L	List Pr.	D x L	List Pr.	D x L	List Pr.
.001	.175x	\$1.90	.235x	\$2.05	.235x	\$2.05	.235x	\$2.10
.0015	.175x	1.90	.235x	2.05	.235x	2.05	.235x	2.10
.0022	.175x	1.90	.235x	2.05	.235x	2.05	.235x	2.10
.0033	.175x	1.95	.235x	2.05	.235x	2.10	.235x	2.15
.0047	.175x	1.95	.235x	2.05	.235x	2.10	.235x	2.15
.0068	.175x	1.95	.235x	2.05	.235x	2.10	.312x	2.25
.01	.195x	2.00	.235x	2.10	.312x	2.25	.312x	2.30
.015	.235x	2.05	.312x	2.25	.312x	2.30	.312x	2.30
.022	.235x	2.05	.312x	2.25	.312x	2.30	.312x	2.30
.033	.312x	2.15	.312x	2.30	.312x	2.30	.400x	2.45
.047	.312x	2.20	.312x	2.35	.400x	2.40	.400x	2.45
.068	.312x	2.20	.400x	2.40	.400x	2.40	.400x1/8	2.50
.1	.400x	2.25	.400x	2.40	.400x1/8	2.55	.400x1/8	2.60
.15	.400x	2.30	.400x1/8	2.40	.400x1/8	2.70	.562x1/8	2.65
.22	.400x1/8	2.45	.400x1/8	2.60	.562x1/8	2.80	.562x1/8	3.00
.33	.400x1/8	2.50	.562x1/8	2.80	.562x1/8	2.95	.562x1/8	3.25
.47	.562x1/8	2.75	.562x1/8	2.95	.562x1/8	3.10	.670x1/8	3.70
.68	.562x1/8	3.10	.562x1/8	3.25	.670x1/8	3.70	.750x2/8	3.90
1.0	.562x1/8	3.40	.670x1/8	3.60	.750x2/8	3.95	1.000x2/8	*

*Price on request.

- Standard Tolerance: ±20%.
for ±10% add 10% to list price.
for ±5% add 50% to list price.
- Insulated Construction: (For insulated construction omit "G" in designation and add 1/8 inch to length) add \$1.20 to list price.
- Plastic Insulating Sleeve: (For plastic insulating sleeve add "P" to designation and add .062 inch to diameter and 1/8 inch to length) add \$.20 to list price.
- Mounting Bracket: (For mounting bracket add "B" to designation) add \$.40 to list price.
- Threaded Terminal: (For threaded terminal mounting stud add "T" to designation) add \$.80 to list price.
- Screw-Stud Mounting: add \$.60 to list price.

AEROVOX TYPES P123SG AND P323SG CAPACITORS

HYVOL "S" OIL IMPREGNATED

Aerovox Type P123SG Capacitors for -65°C. to +100°C. operation, and Aerovox Type P323SG Capacitors for -65°C. to +125°C. operation, Hermetically Sealed, Grounded Case, Glass Terminal Seal, Tubular Capacitors.

Capacity Rating Mfd.	100 VDC SIZE			200 VDC SIZE			300 VDC SIZE		
	Size D x L	List Price P123SG	List Price P323SG	Size D x L	List Price P123SG	List Price P323SG	Size D x L	List Price P123SG	List Price P323SG
.001	.175x	\$2.15	\$2.70	.235x	\$2.25	\$2.85	.235x	\$2.30	\$2.90
.0015	.175x	2.15	2.70	.235x	2.25	2.85	.235x	2.30	2.90
.0022	.175x	2.15	2.70	.235x	2.25	2.85	.235x	2.30	2.90
.0033	.175x	2.15	2.70	.235x	2.30	2.90	.235x	2.35	2.95
.0047	.175x	2.15	2.70	.235x	2.30	2.90	.235x	2.35	2.95
.0068	.175x	2.15	2.70	.235x	2.30	2.95	.235x	2.35	2.95
.01	.175x	2.20	2.75	.235x	2.35	2.95	.235x	2.40	3.00
.015	.175x	2.20	2.75	.235x	2.35	2.95	.235x	2.40	3.00
.022	.195x	2.25	2.80	.235x	2.35	2.95	.312x	2.55	3.20
.033	.235x	2.25	2.85	.312x	2.50	3.10	.312x	2.55	3.20
.047	.312x	2.45	3.05	.312x	2.55	3.20	.312x	2.60	3.25
.068	.312x	2.50	3.10	.312x	2.60	3.25	.400x	2.70	3.40
.1	.312x	2.50	3.15	.400x	2.65	3.35	.400x1	2.75	3.45
.15	.400x	2.55	3.20	.400x1	2.70	3.40	.400x1	2.90	3.60
.22	.400x1	2.65	3.30	.400x1	2.95	3.65	.562x1	3.20	4.00
.33	.400x1	2.80	3.50	.562x1	3.20	4.00	.562x1	3.45	4.35
.47	.562x1	3.15	3.90	.562x1	3.45	4.35	.562x1	3.70	4.60
.68	.562x1	3.40	4.25	.562x1	3.75	4.70	.670x1	4.20	5.25
1.0	.562x1	3.70	4.60	.670x1	4.25	5.30	.750x2	4.60	5.75

Capacity Rating Mfd.	400 VDC SIZE			600 VDC SIZE			1000 VDC SIZE		
	Size D x L	List Price P123SG	List Price P323SG	Size D x L	List Price P123SG	List Price P323SG	Size D x L	List Price	PRICES UPON REQUEST
.001	.235x	\$2.40	\$3.00	.235x	\$2.45	\$3.05	.400x		
.0015	.235x	2.40	3.00	.235x	2.45	3.05	.400x		
.0022	.235x	2.40	3.00	.235x	2.45	3.05	.400x		
.0033	.235x	2.45	3.05	.235x	2.50	3.10	.400x		
.0047	.235x	2.45	3.05	.235x	2.50	3.10	.400x		
.0068	.235x	2.45	3.05	.235x	2.50	3.10	.400x		
.01	.235x	2.50	3.10	.312x	2.60	3.25	.400x		
.015	.312x	2.60	3.25	.312x	2.65	3.30	.400x		
.022	.312x	2.60	3.25	.312x	2.70	3.35	.400x1		
.033	.312x	2.65	3.30	.400x	2.80	3.50	.400x1		
.047	.400x	2.75	3.45	.400x1	2.85	3.60	.562x1		
.068	.400x1	2.85	3.55	.400x1	3.05	3.80	.562x1		
.1	.400x1	3.00	3.70	.562x1	3.30	4.10	.562x1		
.15	.562x1	3.20	4.00	.562x1	3.45	4.30	.670x1		
.22	.562x1	3.45	4.35	.562x1	3.80	4.75	.750x2		
.33	.562x1	3.70	4.60	.670x1	4.35	5.40	.750x2		
.47	.670x1	4.70	5.25	.750x2	4.65	5.80	1.000x2		
.68	.750x2	4.55	5.70	1.000x1	*	*			
1.0	1.000x1	*	*	1.000x2	*	*			

* Price on request.

- Standard Tolerance: ±20%
for ±10% add 10% to list price.
for ±5% add 50% to list price.
- Insulated Construction: (For insulated construction omit "G" in designation and add 1/8 inch to length):
Type P123S—add \$1.15 to list price.
Type P323S—add \$1.45 to list price.

- Plastic Insulating Sleeve: (For plastic insulating sleeve add "P" to designation and add .062 inch to diameter and 1/8 inch to length): add \$.20 to list price.
- Mounting Bracket: add \$.40 to list price.
- Threaded Terminal: add \$.80 to list price.
- Screw-Stud Mounting: add \$.60 to list price.

LEAD WIRE DIAMETERS

Case Diameter	Nominal Lead Wire Diameter
.175 to .195	.020 to .025 inch
.235 to .312	.025 to .032 inch
.400 and up	.032 inch

BRACKET DIMENSIONS

D	A	H	E ± 1/32"	C ± 1/16"
.175	1/4	.144	.187	.312
.195	1/4	.144	.187	.312
.235	1/4	.144	.187	.312
.312	1/4	.144	.187	.312
.400	1/4	.144	.187	.312
.562	1/2	.156	.250	.487
.670	1/2	.156	.250	.487
.750	1/2	.156	.250	.487

This case style available only in .400" diameter and greater.

FIGURE T (Threaded Terminal Mounting)

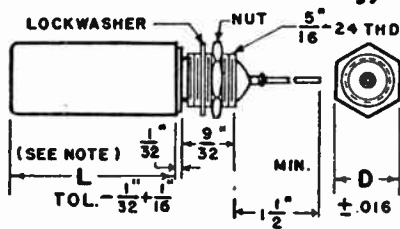

NOTE: "L" dimension given in tables is for grounded case units.

For section insulated from case, overall length is "L" + 1/16".

FIGURE B (Tangential Bracket)

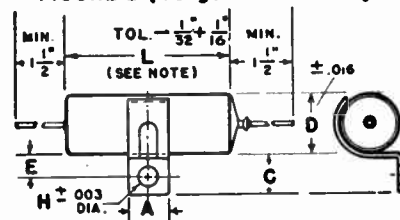

NOTE: "L" Dimensions given in tables is for grounded case units.

For section insulated from case, overall length is "L" + 1/16".

On grounded unit, ground lead wire is omitted.

AEROVOX TYPES P123SXG AND P323SXG CAPACITORS

Aerovox Type P123SXG Capacitors for -65°C. to +100°C. operation, and Aerovox Type P323SXG Capacitors for -65°C. to +125°C. operation, Hermetically Sealed, Grounded Case, Glass Terminal Seal, Tubular Capacitors with Extended-Foil Section Construction.

Capacity Rating Mfd.	100 VDC SIZE			200 VDC SIZE			300 VDC SIZE		
	Size D x L	List Price 123SXG	List Price 323SXG	Size D x L	List Price 123SXG	List Price 323SXG	Size D x L	List Price 123SXG	List Price 323SXG
.001	.175x 1/16	\$2.30	\$2.85	.235x 1/16	\$2.40	\$3.00	.235x 1/16	\$2.45	\$3.10
.0015	.175x 1/16	2.30	2.85	.235x 1/16	2.40	3.00	.235x 1/16	2.45	3.10
.0022	.175x 1/16	2.30	2.85	.235x 1/16	2.40	3.00	.235x 1/16	2.45	3.10
.0033	.175x 1/16	2.30	2.90	.235x 1/16	2.45	3.10	.235x 1/16	2.50	3.15
.0047	.175x 1/16	2.30	2.90	.235x 1/16	2.45	3.10	.235x 1/16	2.50	3.15
.0068	.195x 1/16	2.30	2.90	.235x 1/16	2.45	3.10	.235x 1/16	2.70	3.35
.01	.235x 1/16	2.40	3.00	.312x 1/16	2.65	3.30	.312x 1/16	2.70	3.40
.015	.235x 1/16	2.45	3.05	.312x 1/16	2.65	3.35	.312x 1/16	2.80	3.45
.022	.312x 1/16	2.55	3.20	.312x 1/16	2.70	3.35	.312x 1/16	2.80	3.50
.033	.312x 1/16	2.60	3.25	.312x 1/16	2.70	3.40	.400x 1/16	2.85	3.55
.047	.312x 1/16	2.60	3.25	.400x 1/16	2.80	3.50	.400x 1/16	2.85	3.60
.068	.400x 1/16	2.70	3.35	.400x 1/16	2.80	3.55	.400x1 1/16	2.90	3.60
.1	.400x 1/16	2.70	3.40	.400x1 1/16	2.85	3.55	.400x1 1/16	3.00	3.75
.15	.400x1 1/16	2.80	3.45	.400x1 1/16	3.05	3.85	.562x1 1/16	3.35	4.15
.22	.400x1 1/16	2.95	3.70	.562x1 1/16	3.35	4.15	.562x1 1/16	3.60	4.50
.33	.562x1 1/16	3.25	4.10	.562x1 1/16	3.60	4.50	.562x1 1/16	3.85	4.80
.47	.562x1 1/16	3.50	4.40	.562x1 1/16	3.90	4.85	.670x1 1/16	4.35	5.40
.68	.562x1 1/16	3.80	4.75	.670x1 1/16	4.35	5.40	.750x2 1/16	4.55	5.70
1.0	.670x1 1/16	4.35	5.40	.750x2 1/16	4.60	5.75	1.000x2 1/16	*	*

Capacity Rating Mfd.	400 VDC SIZE			600 VDC SIZE			1000 VDC SIZE		List Price
	Size D x L	List Price 123SXG	List Price 323SXG	Size D x L	List Price 123SXG	List Price 323SXG	Size D x L		
.001	.235x 1/16	\$2.50	\$3.15	.235x 1/16	\$2.55	\$3.20	.400x 1/16	PRICES UPON REQUEST	
.0015	.235x 1/16	2.50	3.15	.235x 1/16	2.55	3.20	.400x 1/16		
.0022	.235x 1/16	2.50	3.15	.235x 1/16	2.55	3.20	.400x 1/16		
.0033	.235x 1/16	2.55	3.20	.312x 1/16	2.75	3.40	.400x 1/16		
.0047	.312x 1/16	2.75	3.40	.312x 1/16	2.75	3.45	.400x 1/16		
.0068	.312x 1/16	2.75	3.45	.312x 1/16	2.80	3.45	.400x 1/16		
.01	.312x 1/16	2.80	3.45	.312x 1/16	2.80	3.50	.400x 1/16		
.015	.312x 1/16	2.80	3.50	.400x 1/16	2.95	3.70	.400x1 1/16		
.022	.400x 1/16	2.90	3.60	.400x 1/16	3.00	3.70	.400x1 1/16		
.033	.400x 1/16	2.90	3.65	.400x1 1/16	3.00	3.75	.562x1 1/16		
.047	.400x1 1/16	3.00	3.70	.400x1 1/16	3.15	3.95	.562x1 1/16		
.068	.400x1 1/16	3.10	3.90	.562x1 1/16	3.45	4.30	.562x1 1/16		
.1	.562x1 1/16	3.35	4.15	.562x1 1/16	3.60	4.50	.670x1 1/16		
.15	.562x1 1/16	3.60	4.50	.562x1 1/16	3.90	4.90	.670x1 1/16		
.22	.562x1 1/16	3.85	4.80	.670x1 1/16	4.45	5.60	.750x2 1/16		
.33	.670x1 1/16	4.35	5.40	.750x2 1/16	4.75	5.90	1.000x2 1/16		
.47	.750x2 1/16	4.65	5.80	.750x2 1/16	*	*	1.000x2 1/16		
.68	.750x2 1/16	*	*	1.000x2 1/16	*	*			
1.0	1.000x2 1/16	*	*	1.000x2 1/16	*	*			

* Price on request.

- Standard Tolerance: ±20%
for ±10% add 10% to list price.
for ±5% add 50% to list price.
- Insulated Construction: (For insulated construction omit "G" in designation and add 1/16 inch to length):
Type P123SX—add \$1.15 to list price.
Type P323SX—add \$1.45 to list price.
- Plastic Insulating Sleeve: (For plastic insulating sleeve add "I" to designation and add .062 to diameter and 1/16 inch to length): add \$.20 to list price.
- Mounting Bracket: add \$.40 to list price.
- Threaded Terminal: add \$.80 to list price.
- Screw-Stud Mounting: add \$.60 to list price.

LEAD WIRE DIAMETERS

Case Diameter	Nominal Lead Wire Diameter
.175 to .195	.020 to .025 inch
.235 to .312	.025 to .032 inch
.400 and up	.032 inch

BRACKET DIMENSIONS

D	A	H	E ± 1/32"	C ± 1/16"
.175	1/4	.144	.187	.312
.195	1/4	.144	.187	.312
.235	1/4	.144	.187	.312
.312	1/4	.144	.187	.312
.400	1/4	.144	.187	.312
.562	1/2	.156	.250	.437
.670	1/2	.156	.250	.437
.750	1/2	.156	.250	.437

This case style available only in .400" diameter and greater.

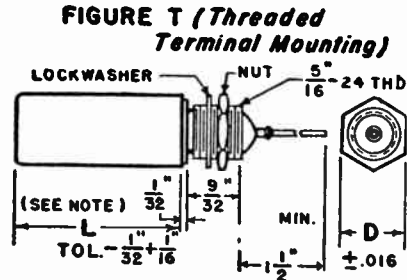

NOTE: "L" Dimensions given in tables is for grounded case units.

For section insulated from case, overall length is "L" + 1/16".

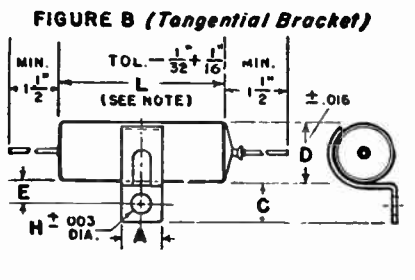

NOTE: "L" Dimensions given in tables is for grounded case units.

For section insulated from case, overall length is "L" + 1/16".

On grounded unit, ground lead wire is omitted.

TYPE AFH (85°C) TWIST-PRONG ELECTROLYTIC CAPACITORS



SINGLES

DUALS

TRIPLES

QUADS

AFH DUALS — (Continued)

AFH SINGLES				
CAT. NO.	CAP. MFD.	VOLT	SIZE	LIST
AFH 1-01	3000	10	1 3/8 x 3	\$2.90
AFH 1-02	1000	15	1x3	2.55
AFH 1-03	2000	15	1 3/8 x 3	3.45
AFH 1-04	3000	15	1 3/8 x 3	3.50
AFH 1-05	25	25	3/4 x 2	1.25
AFH 1-06	40	25	3/4 x 2	1.35
AFH 1-07	100	25	3/4 x 2	1.60
AFH 1-08	500	25	1 1/2 x 1/2	1.75
AFH 1-10	1000	25	1 3/8 x 2	3.55
AFH 1-11	100	50	3/4 x 2	1.65
AFH 1-12	150	50	3/4 x 2	1.80
AFH 1-13	500	50	1 3/8 x 2 1/2	2.65
AFH 1-14	1000	50	1 3/8 x 3 1/2	3.75
AFH 1-15	25	150	1x2	1.50
AFH 1-16	30	150	1x2	1.55
AFH 1-17	44	150	1x2	1.60
AFH 1-18	50	150	1x2	1.65
AFH 1-19	60	150	1x2	1.75
AFH 1-20	80	150	1x2	1.85
AFH 1-21	100	150	1x2	2.00
AFH 1-22	120	150	1x3	2.10
AFH 1-23	140	150	1x3	2.15
AFH 1-24	150	150	1x3	2.15
AFH 1-25	40	200	1x2	1.70
AFH 1-26	15	250	1x2	1.55
AFH 1-27	20	250	3/4 x 2	1.60
AFH 1-28	30	250	3/4 x 2	1.70
AFH 1-29	40	250	1x2	1.80
AFH 1-30	60	250	1x2 1/2	2.05
AFH 1-31	80	250	1x3	2.15
AFH 1-32	75	300	1x2	1.60
AFH 1-33	30	300	1x2	1.75
AFH 1-34	50	300	1x2 1/2	2.10
AFH 1-35	80	300	1x3	2.55
AFH 1-36	100	300	1x3 1/2	2.90
AFH 1-37	125	300	1 3/8 x 3	3.50
AFH 1-38	15	350	1x2	1.65
AFH 1-39	30	350	1x2	1.90
AFH 1-40	40	350	1x2 1/2	2.00
AFH 1-41	50	350	1x3	2.10
AFH 1-42	80	350	1 3/8 x 2 1/2	2.85
AFH 1-43	125	350	1 3/8 x 3	3.95
AFH 1-44	10	400	3/4 x 2	1.50
AFH 1-45	20	400	1x2	1.75
AFH 1-46	40	400	1 3/8 x 2	2.00
AFH 1-47	80	400	1 3/8 x 2 1/2	2.95
AFH 1-48	10	450	1x2	1.55
AFH 1-49	15	450	1x2	1.70
AFH 1-50	20	450	1x2	1.80
AFH 1-51	30	450	1x2 1/2	1.95
AFH 1-52	40	450	1x3	2.05
AFH 1-53	50	450	1x3	2.35
AFH 1-54	60	450	1 3/8 x 2 1/2	2.80
AFH 1-55	80	450	1 3/8 x 3	3.05
AFH 1-56	30	475	1x3	2.00
AFH 1-57	90	475	1 3/8 x 3 1/2	3.50
AFH 1-58	10	500	1x2	1.60
AFH 1-59	20	500	1x2 1/2	1.85
AFH 1-60	30	500	1x3	2.00
AFH 1-61	40	500	1x3 1/2	2.50
AFH 1-62	80	500	1 3/8 x 3	3.20
AFH 1-63	90	500	1 3/8 x 3 1/2	3.50
AFH 1-64	10	525	1x2	1.70
AFH 1-65	10 ohm-50 cps	3VNP	3/4 x 2	2.00
AFH 1-66	0.5 ohm-157.50 cps	3VNP	1x2	2.20
AFH 1-67	1 ohm-60 cps	3VNP	1 3/8 x 3	4.00

AFH DUALS

CAT. NO.	CAP. MFD.	VOLT	SIZE	LIST
AFH 2-02	1000-1000	15	1x3 1/2	\$4.40
AFH 2-03	20-20	25	1x2	1.45
AFH 2-04	40-40	25	1x2	1.60
AFH 2-05	150-50	25	1x2	1.90
AFH 2-06	50-50	50	1x2	1.70

CAT. NO.	CAP. MFD.	VOLT	SIZE	LIST
AFH 2-07	10-20	150	1x2	\$1.60
AFH 2-08	20-20	150	1x2	1.70
AFH 2-09	30-15	150	1x2	1.75
AFH 2-10	30-20	150	1x2	1.75
AFH 2-11	30-30	150	1x2	1.85
AFH 2-12	40-20	150	1x2	1.80
AFH 2-13	40-30	150	1x2	1.85
AFH 2-14	40-40	150	1x2	1.90
AFH 2-15	50-30	150	1x2	2.00
AFH 2-16	50-50	150	1x2 1/2	2.15
AFH 2-17	60-60	150	1x3	2.35
AFH 2-18	75-75	150	1x3	2.60
AFH 2-19	80-40	150	1x3	2.30
AFH 2-20	80-80	150	1 3/8 x 2	2.65
AFH 2-22	200-125	150	1 3/8 x 3	3.75
AFH 2-23	200-200	150	1 3/8 x 3	4.00
AFH 2-24	60-60	200	1 3/8 x 2	2.55
AFH 2-25	10-10	250	1x2	1.70
AFH 2-26	20-20	250	1x2	1.90
AFH 2-27	30-30	250	1x2 1/2	2.30
AFH 2-28	40-20	250	1x2 1/2	2.20
AFH 2-29	40-40	250	1x3	2.50
AFH 2-30	150-150	250	1 3/8 x 4	5.15
AFH 2-31	10-10	300	1x2	1.75
AFH 2-32	15-15	300	1x2	1.85
AFH 2-33	50-50	300	1 3/8 x 2 1/2	3.35
AFH 2-34	80-80	300	1 3/8 x 3	4.05
AFH 2-35	120-20	300	1 3/8 x 3 1/2	4.00
AFH 2-36	15-15	350	1x2	2.25
AFH 2-37	20-20	350	1x2 1/2	2.30
AFH 2-38	30-20	350	1x3	2.60
AFH 2-39	30-30	350	1x3	2.80
AFH 2-40	50-30	350	1 3/8 x 2 1/2	3.15
AFH 2-41	80-80	350	1 3/8 x 3 1/2	4.70
AFH 2-42	10-30	400	1x3	2.30
AFH 2-43	15-15	400	1x2 1/2	2.25
AFH 2-44	60-60	400	1 3/8 x 3 1/2	4.40
AFH 2-45	80-10	400	1 3/8 x 3	3.40
AFH 2-46	5-5	450	1x2	1.60
AFH 2-47	10-10	450	1x2	1.90
AFH 2-48	15-10	450	1x2 1/2	2.05
AFH 2-49	15-15	450	1x2 1/2	2.25
AFH 2-50	20-10	450	1x2 1/2	2.25
AFH 2-51	20-20	450	1x3	2.55
AFH 2-52	30-10	450	1x3	2.50
AFH 2-53	30-15	450	1 3/8 x 2	2.65
AFH 2-54	30-30	450	1 3/8 x 2	3.05
AFH 2-56	40-20	450	1 3/8 x 2 1/2	3.00
AFH 2-57	40-40	450	1 3/8 x 2 1/2	3.45
AFH 2-60	60-20	450	1 3/8 x 3	3.55
AFH 2-61	60-40	450	1 3/8 x 3 1/2	3.95
AFH 2-62	80-10	450	1 3/8 x 3	3.80
AFH 2-63	80-20	450	1 3/8 x 3 1/2	3.90
AFH 2-64	80-40	450	1 3/8 x 3 1/2	4.35
AFH 2-65	30-10	475	1 3/8 x 2	2.60
AFH 2-66	40-10	475	1 3/8 x 2 1/2	3.10
AFH 2-67	10-10	500	1x2 1/2	2.85
AFH 2-69	20-20	500	1 3/8 x 2 1/2	2.95
AFH 2-70	25-40	500	1 3/8 x 3	3.65
AFH 2-71	30-10	500	1 3/8 x 2 1/2	2.60
AFH 2-72	40-40	500	1 3/8 x 3	4.40
AFH 2-73	60-40	500	1 3/8 x 3 1/2	4.60
AFH 2-74	250-1000	10/6	1 3/8 x 2	2.85
AFH 2-75	250-2000	10/6	1 3/8 x 2	3.30
AFH 2-77	40-20	150/50	1x2	1.70
AFH 2-78	40-150	150/25	1x2	2.05
AFH 2-79	40-20	250/25	1x2	2.00
AFH 2-80	50-100	250/50	1 3/8 x 2	2.80
AFH 2-81	100-150	250/50	1 3/8 x 3	3.65
AFH 2-82	20-20	300/25	1x2	1.85
AFH 2-83	30-30	300/350	1x3	2.65
AFH 2-84	20-20	350/25	1x2	1.90
AFH 2-85	40-20	350/25	1x2 1/2	2.35
AFH 2-86	40-10	350/200	1 3/8 x 2	2.40
AFH 2-87	10-20	450/25	1x2	1.70
AFH 2-88	20-20	450/25	1x2	2.00
AFH 2-89	30-20	450/25	1x3	2.45
AFH 2-90	80-20	450/25	1 3/8 x 3	3.40
AFH 2-91	80-50	450/50	1 3/8 x 3	3.75
AFH 2-92	10-50	450/100	1 3/8 x 2	2.05
AFH 2-93	20-100	450/100	1 3/8 x 2	2.50
AFH 2-94	30-40	450/150	1 3/8 x 2	2.50
AFH 2-95	20-80	450/350	1 3/8 x 3	3.60
AFH 2-96	40-10	450/350	1 3/8 x 2	2.60
AFH 2-97	40-40	450/350	1 3/8 x 3	3.30
AFH 2-99	75-50	475/50	1 3/8 x 3	3.65
AFH 2-100	20-100	475/300	1 3/8 x 3	3.35
AFH 2-101	40-40	475/400	1 3/8 x 3	3.75
AFH 2-102	80-50	500/50	1 3/8 x 3 1/2	3.80
AFH 2-103	60-80	500/150	1 3/8 x 3	3.75
AFH 2-104	40-50	500/200	1 3/8 x 3	3.30
AFH 2-105	15-20	500/300	1 3/8 x 3 1/2	2.30
AFH 2-106	20-100	500/300	1 3/8 x 3	3.90
AFH 2-107	40-40	500/400	1 3/8 x 3	3.75
AFH 2-108	0.5 ohm-157.50 cps	12	1 3/8 x 2	3.60
	2.5 ohm-60 cps	6		

TYPE AFH (85°C) TWIST-PRONG ELECTROLYTIC CAPACITORS



AFH TRIPLES

CAT. NO.	CAP. MFD.	VOLT	SIZE	LIST
AFH 3-01	20-20-20	25	1x2	\$1.95
AFH 3-02	40-40-40	25	1x2	2.15
AFH 3-03	30-30-30	50	1x2	2.15
AFH 3-04	10-30-30	150	1x2	2.35
AFH 3-05	20-20-20	150	1x2	2.30
AFH 3-06	30-30-10	150	1x2	2.35
AFH 3-07	40-20-10	150	1x2	2.35
AFH 3-08	40-20-20	150	1x2	2.40
AFH 3-09	40-30-20	150	1x2	2.50
AFH 3-10	40-40-40	150	1x2 1/2	2.60
AFH 3-11	40-70-40	150	1x3	2.95
AFH 3-12	60-40-20	150	1x3	2.75
AFH 3-13	80-40-20	150	1x3	2.90
AFH 3-14	10-15-15	250	1x2	2.45
AFH 3-16	15-15-30	250	1x2	2.75
AFH 3-17	20-20-10	250	1x2	2.50
AFH 3-18	30-20-10	250	1x2 1/2	2.70
AFH 3-19	40-20-10	250	1x3	2.85
AFH 3-20	40-20-20	250	1x3	2.90
AFH 3-21	80-80-60	250	1 1/2 x 3	4.90
AFH 3-22	10-10-10	300	1x2	2.40
AFH 3-24	20-80-10	300	1 1/2 x 2 1/2	3.80
AFH 3-25	60-20-10	300	1 1/2 x 2	3.45
AFH 3-26	120-50-40	300	1 1/2 x 4	5.65
AFH 3-27	10-10-10	350	1x2 1/2	2.40
AFH 3-28	20-20-10	350	1x3	2.95
AFH 3-29	60-40-20	350	1 1/2 x 3 1/2	4.25
AFH 3-30	10-10-10	400	1x2 1/2	2.40
AFH 3-31	10-10-10	450	1x3	2.70
AFH 3-32	10-30-30	450	1 1/2 x 3	3.60
AFH 3-33	15-15-10	450	1x3	2.95
AFH 3-34	15-15-15	450	1x3	3.10
AFH 3-35	20-10-10	450	1x3	2.95
AFH 3-36	20-20-20	450	1 1/2 x 2 1/2	3.60
AFH 3-37	30-20-20	450	1 1/2 x 3	3.85
AFH 3-38	30-30-20	450	1 1/2 x 3	4.10
AFH 3-39	30-30-30	450	1 1/2 x 3	4.35
AFH 3-40	30-60-10	450	1 1/2 x 3 1/2	4.50
AFH 3-41	40-10-10	450	1 1/2 x 3	3.35
AFH 3-42	40-30-20	450	1 1/2 x 3	4.30
AFH 3-43	40-40-10	450	1 1/2 x 3	4.20
AFH 3-44	40-40-40	450	1 1/2 x 3 1/2	4.90
AFH 3-45	60-20-20	450	1 1/2 x 3 1/2	4.60
AFH 3-46	80-40-20	450	1 1/2 x 4	5.40
AFH 3-47	10-10-10	475	1x3	2.70
AFH 3-48	30-20-20	475	1 1/2 x 3	3.95
AFH 3-49	30-30-10	475	1 1/2 x 3	4.00
AFH 3-50	40-10-10	475	1 1/2 x 3	3.85
AFH 3-51	10-10-10	500	1x3	2.70
AFH 3-52	30-20-20	500	1 1/2 x 3	4.20
AFH 3-53	40-10-10	500	1 1/2 x 3	3.90
AFH 3-54	40-40-10	500	1 1/2 x 3 1/2	5.05
AFH 3-55	100/50-25	100/25	1x3	2.65
AFH 3-56	30-20/100	150/5	1x2	2.40
AFH 3-59	20-20/100	150/10	1x2	2.35
AFH 3-80	20-20/250	150/10	1x2	2.60
AFH 3-61	30-30/200	150/10	1x2 1/2	2.50
AFH 3-62	40-20/150	150/10	1x3	2.40
AFH 3-63	40-20/200	150/10	1x3	2.70
AFH 3-64	40-20/250	150/10	1x2 1/2	2.70
AFH 3-65	20/250-100	150/15	1 1/2 x 2	2.90
AFH 3-67	20-20/20	150/25	1x2	2.20
AFH 3-68	20-20/20	150/25	1x3	2.60
AFH 3-69	30-20/20	150/25	1x2	2.25
AFH 3-70	30-30/20	150/25	1x2	2.30
AFH 3-72	40-20/20	150/25	1x2	2.30
AFH 3-73	40-20/100	150/25	1x3	2.50
AFH 3-74	40-20/200	150/25	1x3	2.70
AFH 3-75	40-30/20	150/25	1x2 1/2	2.35
AFH 3-76	40-40/20	150/25	1x2 1/2	2.40
AFH 3-77	50-30/20	150/25	1x2 1/2	2.50
AFH 3-78	50-30/100	150/25	1x3	2.70
AFH 3-79	50-50/20	150/25	1x3	2.85
AFH 3-80	60-20/20	150/25	1x2	2.55
AFH 3-81	60-40/20	150/25	1x2 1/2	2.65
AFH 3-82	80-40/20	150/25	1x2 1/2	2.80
AFH 3-83	120-80/20	150/25	1 1/2 x 2 1/2	3.35
AFH 3-84	30-20/20	200/25	1x2	2.55
AFH 3-86	180-10/40	200/50	1 1/2 x 2	3.15
AFH 3-87	15-15/20	250/25	1x2	2.35
AFH 3-88	20-15/20	250/25	1x2	2.35
AFH 3-89	30-30/20	250/25	1x2 1/2	2.80
AFH 3-90	70-70/20	250/50	1 1/2 x 3	3.90
AFH 3-93	40-20/10	250/150	1 1/2 x 2	2.70

AFH TRIPLES — (Continued)

CAT. NO.	CAP. MFD.	VOLT	SIZE	LIST
AFH 3-95	10-20/30	250/350	1x3	\$3.00
AFH 3-98	80-80/10	250/450	1 1/2 x 3 1/2	4.20
AFH 3-97	20-20/20	300/25	1x2	2.75
AFH 3-98	40-15/20	300/25	1x2 1/2	2.95
AFH 3-99	30-30/25	300/50	1x3	2.90
AFH 3-100	40-40/20	300/150	1 1/2 x 2	3.60
AFH 3-101	10-10/15	300/250	1x2	2.45
AFH 3-102	120/15-10	300/450	1 1/2 x 3 1/2	4.50
AFH 3-103	10-10/20	350/25	1x2	2.25
AFH 3-104	15-10/20	350/25	1x2	2.50
AFH 3-105	15-15/20	350/25	1x2 1/2	2.70
AFH 3-108	20-10/20	350/25	1x2 1/2	2.55
AFH 3-107	20-20/20	350/25	1x2 1/2	2.80
AFH 3-108	30-10/20	350/25	1x2 1/2	3.05
AFH 3-109	30-20/20	350/25	1x3	3.10
AFH 3-110	30-30/20	350/25	1 1/2 x 2	3.40
AFH 3-111	40-40/50	350/25	1 1/2 x 2 1/2	3.75
AFH 3-112	10-5/150	350/50	1x3	2.70
AFH 3-113	40-20/10	350/100	1 1/2 x 2	2.85
AFH 3-114	40-40/10	350/150	1x3	3.20
AFH 3-113	20-10/5	350/250	1x2 1/2	2.55
AFH 3-116	30/20-10	350/250	1x3	3.00
AFH 3-117	30-10/20	350/250	1x3	3.05
AFH 3-119	15-15/40	400/25	1x2 1/2	2.80
AFH 3-120	20-20/20	400/25	1x3	2.65
AFH 3-121	30-10/150	400/50	1 1/2 x 3 1/2	3.40
AFH 3-122	80-40/150	400/50	1 1/2 x 4	5.15
AFH 3-123	80/20-10	400/300	1 1/2 x 3 1/2	4.25
AFH 3-124	10-10/10	450/25	1x2	2.35
AFH 3-125	10-10/20	450/25	1x2	2.40
AFH 3-126	10-20/20	450/25	1x3	2.70
AFH 3-127	15-15/20	450/25	1x3	2.70
AFH 3-128	20-15/20	450/25	1x3	2.90
AFH 3-129	20-20/20	450/25	1x3	3.35
AFH 3-130	30/100-25	450/25	1 1/2 x 3	2.85
AFH 3-131	30-30/20	450/25	1 1/2 x 2 1/2	3.55
AFH 3-132	40-20/20	450/25	1 1/2 x 2 1/2	3.50
AFH 3-133	40-40/20	450/25	1 1/2 x 3	3.85
AFH 3-134	40-40/40	450/25	1 1/2 x 3	3.95
AFH 3-135	80-40/100	450/25	1 1/2 x 4	5.10
AFH 3-136	10-10/40	450/50	1x2 1/2	2.95
AFH 3-137	20-10/40	450/50	1x3	2.80
AFH 3-138	20-10/50	450/50	1x3	2.85
AFH 3-139	20-20/40	450/50	1 1/2 x 3	3.65
AFH 3-140	40-10/100	450/50	1 1/2 x 3	4.30
AFH 3-141	40-40/80	450/50	1 1/2 x 3 1/2	4.10
AFH 3-142	40-40/100	450/50	1 1/2 x 3 1/2	4.30
AFH 3-143	10-10/30	450/100	1 1/2 x 2 1/2	2.85
AFH 3-144	30-20/30	450/150	1 1/2 x 2 1/2	3.50
AFH 3-145	40/90-50	450/150	1 1/2 x 3	3.95
AFH 3-146	40-10/80	450/150	1 1/2 x 3	3.75
AFH 3-147	40-40/40	450/150	1 1/2 x 3 1/2	4.10
AFH 3-148	40-10/80	450/200	1 1/2 x 3	3.90
AFH 3-149	20/40-10	450/250	1 1/2 x 2	3.15
AFH 3-150	15-15/10	450/300	1x3	2.85
AFH 3-151	20/15-10	450/300	1x3	2.85
AFH 3-152	15-5/15	450/350	1x3	2.85
AFH 3-153	20-20/60	450/350	1 1/2 x 3	4.05
AFH 3-154	40-10/10	450/350	1 1/2 x 2	3.30
AFH 3-155	40-40/10	450/500	1 1/2 x 3 1/2	4.15
AFH 3-156	10-10/100	500/50	1x3 1/2	2.65
AFH 3-157	20-10/100	500/50	1x4	3.30
AFH 3-158	30-10/20	500/50	1 1/2 x 2 1/2	3.10
AFH 3-159	40-40/100	500/200	1 1/2 x 4	5.85
AFH 3-160	10-10/5	500/350	1x2 1/2	2.50
AFH 3-181	20-20/60	500/400	1 1/2 x 3 1/2	4.80
AFH 3-162	40/25/130	150/25/15	1x3	3.30
AFH 3-164	80/40/50	250/150/50	1 1/2 x 3 1/2	3.35
AFH 3-185	100/60/20	300/150/25	1 1/2 x 3	4.20
AFH 3-166	20/50/100	350/100/75	1x3	3.10
AFH 3-167	10/50/100	350/150/50	1x3	2.85
AFH 3-168	50/10/500	350/250/5	1 1/2 x 2 1/2	3.60
AFH 3-169	30/30/20	350/300/25	1x3	3.15
AFH 3-171	60/40/20	400/300/25	1 1/2 x 3 1/2	4.20
AFH 3-172	10/40/10	400/300/150	1 1/2 x 2	2.90
AFH 3-173	55/50/80	400/300/250	1 1/2 x 3 1/2	5.35
AFH 3-174	10/50/30	400/350/25	1x3	3.10
AFH 3-175	10/50/100	450/150/25	1x3	2.75
AFH 3-176	40/40/130	450/150/50	1 1/2 x 3	3.75
AFH 3-177	40/100/50	450/150/50	1 1/2 x 3	3.95
AFH 3-178	20/60/100	450/250/25	1 1/2 x 2 1/2	3.65
AFH 3-179	10/40/10	450/300/150	1 1/2 x 2	3.10
AFH 3-180	10/10/20	450/350/25	1x2	2.30
AFH 3-182	20/80/100	450/350/50	1 1/2 x 3 1/2	4.50
AFH 3-183	15/20/20	450/350/250	1 1/2 x 2	2.95
AFH 3-184	20/15/10	450/350/300	1x3	3.05
AFH 3-186	30/50/40	450/400/25	1 1/2 x 3	3.90
AFH 3-187	10/30/30	450/400/300	1 1/2 x 2 1/2	3.35
AFH 3-188	10/100/40	475/200/50	1 1/2 x 2 1/2	3.30
AFH 3-189	20/20/40	475/300/25	1 1/2 x 2	3.05
AFH 3-190	40/40/25	475/400/50	1 1/2 x 3	4.30
AFH 3-191	10/100/40	500/200/50	1 1/2 x 2 1/2	3.35
AFH 3-192	40/40/100	500/250/50	1 1/2 x 3	4.30
AFH 3-193	20/20/40	500/300/25	1 1/2 x 2	3.10
AFH 3-194	40/40/25	500/400/50	1 1/2 x 3	4.30
AFH 3-195	80/20/20	500/500/25	1 1/2 x 3 1/2	8.65

TYPE AFH TWIST-PRONG ELECTROLYTIC CAP.

AFH QUADS

CAT. NO.	CAP. MFD.	VOLT	SIZE	LIST
AFH 4-01	40-40-40-30	150	1 1/2 x 2	\$3.35
AFH 4-02	40-40-20-10	300	1 1/2 x 2 1/2	4.55
AFH 4-03	10-10-10-10	350	1 1/2 x 2	3.10
AFH 4-05	80-10-10-10	350	1 1/2 x 3	4.55
AFH 4-06	30-30-20-20	400	1 1/2 x 3	4.85
AFH 4-07	80-20-10-10	400	1 1/2 x 3 1/2	5.05
AFH 4-09	5-5-5-5	450	1 1/2 x 2	3.00
AFH 4-10	10-10-10-10	450	1 1/2 x 2	3.35
AFH 4-11	15-30-30-10	450	1 1/2 x 3	4.70
AFH 4-12	15-30-30-30	450	1 1/2 x 4	5.30
AFH 4-13	20-10-10-10	450	1 1/2 x 2 1/2	3.70
AFH 4-14	20-20-20-20	450	1 1/2 x 2 1/2	4.70
AFH 4-15	30-15-15-15	450	1 1/2 x 3	4.45
AFH 4-16	35-35-10-5	450	1 1/2 x 3 1/2	4.65
AFH 4-17	40-10-10-10	450	1 1/2 x 3	4.15
AFH 4-18	40-20-10-10	450	1 1/2 x 3	4.45
AFH 4-19	10-10-10-10	475	1 1/2 x 2	3.50
AFH 4-20	10-10-10-10	500	1 1/2 x 2	3.50
AFH 4-21	30-20-20-200	150/10	1 1/2 x 2	3.15
AFH 4-22	40-40-20/200	150/10	1 1/2 x 2	3.25
AFH 4-23	60-40-20/200	150/10	1 1/2 x 2	3.50
AFH 4-24	10-20-60-20	150/25	1 1/2 x 2	3.10
AFH 4-25	20-20-20/20	150/25	1 1/2 x 2	2.90
AFH 4-26	30-30-30/40	150/25	1 1/2 x 2	3.10
AFH 4-27	40-20-20/20	150/25	1 1/2 x 2	2.95
AFH 4-28	40-40-30/20	150/25	1 1/2 x 2	3.10
AFH 4-29	40-40-40/20	150/25	1 1/2 x 2	3.15
AFH 4-30	40-40-40/40	150/25	1 1/2 x 2	3.05
AFH 4-31	40-40-40/100	150/25	1 1/2 x 2	3.35
AFH 4-32	40-40-40/180	150/25	1 1/2 x 2	3.55
AFH 4-33	40-40/100-100	150/25	1 1/2 x 2	3.35
AFH 4-34	50-30-30/100	150/25	1 1/2 x 2	3.45
AFH 4-35	50-50-50/20	150/25	1 1/2 x 2	3.55
AFH 4-36	75-75-75/30	150/25	1 1/2 x 3	4.30
AFH 4-37	80-40-40/20	150/25	1 1/2 x 2	3.55
AFH 4-38	80-40-40/100	150/25	1 1/2 x 2 1/2	3.75
AFH 4-39	40-20-10/20	200/25	1 1/2 x 2	3.20
AFH 4-40	40-20-10/30	250/25	1 1/2 x 2	3.40
AFH 4-41	100-40-10/100	250/50	1 1/2 x 3 1/2	5.15
AFH 4-42	60-60-40/20	250/150	1 1/2 x 3 1/2	5.10
AFH 4-43	10-10-10/20	300/25	1 1/2 x 2	2.95
AFH 4-44	40-20-20/25	300/25	1 1/2 x 2	4.00
AFH 4-45	40-40-20/20	300/25	1 1/2 x 3	4.40
AFH 4-46	60-40-20/50	300/25	1 1/2 x 3	4.65
AFH 4-47	40-40-40/20	300/150	1 1/2 x 3	4.90
AFH 4-48	10-10-10/20	350/25	1 1/2 x 2	2.95
AFH 4-49	20-10-5/20	350/25	1 1/2 x 2	3.10
AFH 4-50	30-20-20/20	350/25	1 1/2 x 2 1/2	4.10
AFH 4-51	40-20-20/25	350/25	1 1/2 x 2 1/2	4.25
AFH 4-52	40-40-20/20	350/25	1 1/2 x 3	4.70
AFH 4-53	40-40-40/40	350/25	1 1/2 x 3	5.20
AFH 4-54	15-15-15/50	350/50	1 1/2 x 2	3.80
AFH 4-55	40-30-10/50	350/50	1 1/2 x 3	4.40
AFH 4-56	40-40-40/150	350/50	1 1/2 x 3 1/2	5.70
AFH 4-57	20-20-20/20	400/25	1 1/2 x 2 1/2	3.85
AFH 4-58	40-10/80-10	400/250	1 1/2 x 3 1/2	4.70
AFH 4-59	10-10-10/20	450/25	1 1/2 x 2	3.15
AFH 4-60	10-10-10/25	450/25	1 1/2 x 2	3.15
AFH 4-61	10-10-10/100	450/25	1 1/2 x 2	3.35
AFH 4-62	10-10-10/150	450/50	1 1/2 x 2 1/2	3.70
AFH 4-63	10-10/20-20	450/25	1 1/2 x 2	2.95
AFH 4-65	20-10-10/100	450/25	1 1/2 x 2	3.70
AFH 4-66	20-15-20-20	450/25	1 1/2 x 2 1/2	3.55
AFH 4-67	20-20-20/20	450/25	1 1/2 x 2 1/2	4.15
AFH 4-68	30-15-15/40	450/25	1 1/2 x 2 1/2	4.15
AFH 4-69	30-20-20/20	450/25	1 1/2 x 3	4.40
AFH 4-70	30-30-10/20	450/25	1 1/2 x 3	4.35
AFH 4-71	30-30-20/20	450/25	1 1/2 x 3	4.65
AFH 4-72	40-10-10/250	450/25	1 1/2 x 3	4.65
AFH 4-73	40-10-10/300	450/25	1 1/2 x 3	4.85
AFH 4-74	40-15-10/25	450/25	1 1/2 x 3	4.05
AFH 4-75	40-20-10/20	450/25	1 1/2 x 3	4.25
AFH 4-76	40-20-20/20	450/25	1 1/2 x 3	4.60
AFH 4-77	40-20-20/40	450/25	1 1/2 x 3	4.65
AFH 4-78	40-30-10/20	450/25	1 1/2 x 3	4.50
AFH 4-79	40-40-20/20	450/25	1 1/2 x 3 1/2	5.00
AFH 4-80	20-20-20/100	450/50	1 1/2 x 3	4.55
AFH 4-81	30-30-15/30	450/50	1 1/2 x 3	4.55
AFH 4-82	30-30-15/100	450/50	1 1/2 x 3 1/2	4.90
AFH 4-83	40-20-10/100	450/50	1 1/2 x 3 1/2	4.60
AFH 4-84	40-40-10/20	450/50	1 1/2 x 3	4.70
AFH 4-85	40-40-10-30	450/50	1 1/2 x 3	4.50
AFH 4-86	60-10-10/20	450/50	1 1/2 x 3	4.55
AFH 4-87	40-40-10/100	450/100	1 1/2 x 3 1/2	5.35
AFH 4-88	60-10-10/20	450/150	1 1/2 x 3	4.60
AFH 4-89	20-20-30-30	450/300	1 1/2 x 3	4.50
AFH 4-91	20-30-30-30	450/350	1 1/2 x 3	5.05
AFH 4-92	40-10/35-10	450/350	1 1/2 x 3	4.60
AFH 4-93	40-40/30-30	450/350	1 1/2 x 4	5.90
AFH 4-94	40-10-20/10	475/25	1 1/2 x 3	4.65
AFH 4-95	20-20-10/10	500/300	1 1/2 x 2 1/2	4.30
AFH 4-96	50-30-10-20	500/300	1 1/2 x 4	5.80
AFH 4-97	100/40-80-20	300/50/25	1 1/2 x 2 1/2	4.55
AFH 4-99	15/80-40/200	350/200/25	1 1/2 x 3	4.50
AFH 4-100	40/40-20/20	350/300/25	1 1/2 x 3	4.50
AFH 4-101	5-5/50/80	400/300/250	1 1/2 x 3	4.65
AFH 4-102	10/50-30/30	400/350/25	1 1/2 x 3	4.70
AFH 4-103	40-60-40/10	400/350/50	1 1/2 x 3 1/2	5.75
AFH 4-104	40/10-80-10	400/350/20	1 1/2 x 3	4.65
AFH 4-105	30/125-125/30	450/25/450	1 1/2 x 3	8.55

AFH QUADS — (Continued)

CAT. NO.	CAP. MFD.	VOLT	SIZE	LIST
AFH 4-106	40/40/10-30	450/150/50	1 1/2 x 3	\$3.75
AFH 4-107	10-10/60/100	450/200/50	1 1/2 x 3	3.65
AFH 4-108	20/80-20/50	450/200/50	1 1/2 x 3	4.15
AFH 4-109	10/60-40/25	450/350/25	1 1/2 x 3 1/2	4.60
AFH 4-110	10/100-10/20	450/350/25	1 1/2 x 3 1/2	5.25
AFH 4-111	20/15-15/20	450/350/25	1 1/2 x 2	3.60
AFH 4-112	30/40-40/10	450/350/200	1 1/2 x 3 1/2	5.15
AFH 4-113	15-15/80/40	475/300/50	1 1/2 x 3	4.60
AFH 4-114	10-5/80/40	475/450/50	1 1/2 x 4	4.85
AFH 4-115	120/20/20/100	300/250/25/50	1 1/2 x 4	5.05
AFH 4-117	20/40/10/250	350/300/150/50	1 1/2 x 3	4.80
AFH 4-118	80/10/30/40	450/400/300/150	1 1/2 x 4	5.25
AFH 4-119	20/40/100/80	475/300/50/25	1 1/2 x 3	4.50
AFH 4-120	10/40/80/100	475/350/200/100	1 1/2 x 3 1/2	4.80
AFH 4-121	10/10/80/50	475/450/200/50	1 1/2 x 2 1/2	3.85
AFH 4-122	25/20/40/100	475/450/300/50	1 1/2 x 3 1/2	4.95
AFH 4-123	10/60/30/125	475/450/400/50	1 1/2 x 4	5.45

AFHS — TWIST-PRONG ELECTROLYTICS FOR SELENIUM-RECTIFIER CIRCUITS

Cat. No.	Voltage	Mfd.	Size	List
(SINGLES)				
AFHS 1-89	150	120	1 x 3	\$2.05
AFHS 1-70	150	140	1 x 3	2.10
AFHS 1-71	150	200	1 1/2 x 3 1/2	2.45
AFHS 1-72	150	300	1 1/2 x 3	2.80
AFHS 1-73	350	125	1 1/2 x 3	3.65
(DUALS)				
AFHS 2-109	150	200-5	1 1/2 x 2 1/2	2.70
AFHS 2-110	200	100-100	1 1/2 x 3	3.50
(TRIPLES)				
AFHS 3-198	150/10	100-80/200	1 1/2 x 2 1/2	3.60
AFHS 3-197	300/150	100/200-30	1 1/2 x 4	5.05
(QUADS)				
AFHS 4-124	150/25	40-70-40/25	1 1/2 x 2 1/2	3.45
AFHS 4-125	300/150	100-10/200-30	1 1/2 x 4	5.90



TYPE AEP PLUG-IN ELECTROLYTIC CAPACITORS

Quick change, hermetically sealed dry electrolytic. Plugs into standard octal socket for fast replacement or testing when continuous service is important. High capacity and ultra-compact, using etched foil in small can sizes. Non-corrosive aluminum internal construction throughout. Vented for safety.

Single Element Units

Type	Cap. Mfds.	VDCW	Dia. x Hgt.	List
AEP5A	25	25	1 1/8 x 2 1/2	\$3.75
AEP4D	20	150	1 1/8 x 2 1/2	3.95
AEP8D	40	150	1 1/8 x 2 1/2	4.10
AEP2J	10	450	1 1/8 x 2 1/2	4.05
AEP3J	15	450	1 1/8 x 2 1/2	4.20
AEP4J	20	450	1 1/8 x 2 1/2	4.30
AEP6J	30	450	1 1/8 x 2 1/2	4.45
AEP8J	40	450	1 1/8 x 2 1/2	4.55
AEP16J	80	450	1 1/8 x 3 1/2	5.55
AEP2L	10	600	1 1/8 x 4 1/2	4.20

Dual Element Units

Type	Cap. Mfds.	VDCW	Dia. x Hgt.	List
AEP44D	20-20	150	1 1/8 x 2 1/2	\$4.20
AEP88D	40-40	150	1 1/8 x 2 1/2	4.35
AEP22J	10-10	450	1 1/8 x 2 1/2	4.40
AEP44J	20-20	450	1 1/8 x 2 1/2	5.05
AEP88J	40-40	450	1 1/8 x 3	5.95

Triple Element Units

Type	Cap. Mfds.	VDCW	Dia. x Hgt.	List
AEP444D	20-20-20	150	1 1/8 x 2 1/2	\$4.80
AEP88D4A	40-40 x 150/20	25	1 1/8 x 2 1/2	4.85
AEP222J	10-10-10	450	1 1/8 x 2 1/2	5.10
AEP224A	10-10 x 450/20	25	1 1/8 x 2 1/2	4.85
AEP444A	20-20 x 450/20	25	1 1/8 x 2 1/2	5.55
AEP444J	20-20-20	450	1 1/8 x 3	6.10

Quadruple Element Units

Type	Cap. Mfds. x V.D.C.W.	Size—D. x H.	List
AEPG444D4A	20-20-20 x 150/20 x 25*	1 1/8 x 2 1/2	\$5.35
AEPG2222J	10-10-10-10 x 450	1 1/8 x 2 1/2	5.85
AEPG444J4A	20-20-20 x 450/20 x 25*	1 1/8 x 3	6.65

*Ground lug provided for cathode connection.



TYPE PRS • DANDEES • TUBULAR ALUMINUM CAN ELECTROLYTICS (85°C)

- Singles
- Duals
- Triples
- Quads

Tubular units encased in aluminum containers especially suited for compact assemblies. Single element units have solid wire leads. Dual, triple, and quad units are supplied with stranded wire leads and safety sleeves.

The higher voltage listings meet the new radio and electronic circuit potentials, particularly in cathode-ray applications like television receivers and oscillographs.

PRS units are normally supplied with etched foil, but plain foil is available. High-purity aluminum construction. Vented for excessive gas pressures.

SINGLE ELEMENT UNITS

Cap. Mfd.	V.D.C.W.	Size Diameter x Length	List
100	6	x 1 1/4	\$1.20
250	6	x 1 1/4	1.35
500	6	x 1 3/4	1.55
1000	6	x 2 1/4	1.90
1500	6	1 1/8 x 2 1/4	2.10
2000	6	1 1/8 x 2 3/4	2.30
100	12	x 1 1/4	1.20
250	12	x 1 3/4	1.45
500	12	x 2 1/4	1.70
1000	12	1 1/8 x 3 1/4	2.25
100	15	x 1 1/2	1.25
250	15	x 2 1/4	1.55
500	15	x 2 1/4	1.75
10	25	x 1 1/4	1.00
16	25	x 1 1/4	1.00
25	25	x 1 1/4	1.00
50	25	x 1 1/2	1.10
100	25	x 1 1/2	1.35
250	25	x 2 1/4	1.70
500	25	1 1/8 x 2 1/2	2.30
10	50	x 1 1/4	1.00
20	50	x 1 1/4	1.00
25	50	x 1 1/4	1.05
50	50	x 1 3/4	1.20
100	50	x 1 3/4	1.40
250	50	x 1 3/4	1.75
4	150	x 1 1/4	1.00
8	150	x 1 1/4	1.05
10	150	x 1 1/4	1.05
12	150	x 1 1/4	1.10
16	150	x 1 1/2	1.15
20	150	x 1 3/4	1.20
24	150	x 1 3/4	1.25
30	150	x 1 1/2	1.30
40	150	x 1 3/4	1.35
50	150	x 1 3/4	1.40
80	150	x 2 1/4	1.60
100	150	x 2 1/4	1.75
150	150	1 x 3	1.90
4	250	x 1 1/4	1.00
8	250	x 1 1/2	1.15
12	250	x 1 3/4	1.25
16	250	x 1 1/2	1.30
20	250	x 1 1/2	1.35
40	250	x 2 1/4	1.55
4	350	x 1 1/2	1.05
8	350	x 1 1/2	1.20
10	350	x 1 3/4	1.25
12	350	x 1 3/4	1.30
16	350	x 1 3/4	1.40
24	350	x 1 3/4	1.55
4	450	x 1 1/2	1.15
8	450	x 1 1/2	1.25
10	450	x 1 3/4	1.30
12	450	x 1 3/4	1.35
16	450	x 1 3/4	1.40
20	450	x 1 3/4	1.40
30	450	1 1/8 x 2 1/4	1.70
40	450	1 1/8 x 2 1/2	1.80
50	450	1 x 3	2.10
80	450	1 1/8 x 3 3/4	2.80
8	500	x 3 3/4	1.30
10	500	x 3 3/4	1.35
12	500	x 3 3/4	1.40
16	500	x 3 3/4	1.50
8	600	x 3 3/4	1.50
10	600	x 3 3/4	1.45
12	600	x 3 3/4	1.50
16	600	1 1/8 x 3 3/4	1.65
8	700	x 3 3/4	1.50
10	700	1 1/8 x 3 3/4	1.55
12	700	1 1/8 x 3 3/4	1.60
16	700	1 1/8 x 3 3/4	1.75

DUAL DANDEES Common (Dual-Element Units) Negative

Cap. Mfd.	V.D.C.W.	Size—Diameter x Length	List
10-10	25	x 1 1/4	\$1.40
10-10	50	x 1 1/2	1.40
8-8	150	x 1 3/4	1.50
8-16	150	x 2 1/4	1.55
20-20	150	x 1 3/4	1.65
20-30	150	x 2 1/4	1.70
20-40	150	x 1 3/4	1.75
30-30	150	x 1 3/4	1.80
30-40	150	x 2 1/4	1.80
30-50	150	x 2 1/4	1.95
40-40	150	x 2 1/4	1.80
40-80	150	x 2 3/4	2.20
50-50	150	x 2 1/4	2.10
80-40	150	x 2 1/4	2.25
100-100	150	1 x 3 1/4	3.20
8-8	200	x 1 3/4	1.50
8-16	200	x 2 1/4	1.60
16-16	200	x 1 3/4	1.70
30-30	200	x 2 1/4	2.15
8-16	250	x 1 3/4	1.65
10-10	250	x 1 3/4	1.65
16-16	250	x 2 1/4	1.70
20-20	250	x 2 1/4	1.85
30-30	250	x 2 1/4	2.25
8-8	450	x 2 1/4	1.70
8-16	450	x 2 1/4	2.00
10-10	450	x 2 1/4	1.85
16-16	450	1 1/8 x 2 1/4	2.25
20-20	450	1 1/8 x 3 1/4	2.50
*30-30	450	1 1/8 x 3 3/4	3.00
*40-20	450	1 1/8 x 3 3/4	2.95
*40-40	450	1 1/8 x 4	3.35

*Supplied in paper cases only.

TRIPLE DANDEES (Triple-Element Units)

Cap. Mfd.	V.D.C.W.	Size—Diameter x Length	List
20-20-20	150	x 1 3/4	\$2.20
30-20-10	150	x 1 3/4	2.15
30-30-30	150	x 2 1/4	2.35
40-20-20	150	x 2 1/4	2.25
40-40-20	150	x 2 1/4	2.35
40-40-40	150	1 1/8 x 2 1/4	2.45
50-30-10	150	x 2 1/4	2.35
50-30-20	150	1 1/8 x 2 1/4	2.45
80-40-20	150	1 1/8 x 2 1/2	2.75

TYPE PRS MULTIPLES (Common Negative)

Type	Cap. Mfd. x V.D.C.W.	Size—Dia. x Lgth.	List
PRS 64D20A	30-20 x 150 + 100 x 25	1 1/8 x 2 1/4	\$2.20
PRS 86D4A	40-30 x 150 + 20 x 25	1 1/8 x 2 1/4	2.20
PRS 106D20A	50-30 x 150 + 100 x 25	1 1/8 x 2 1/4	2.55
PRS 106D50A	50-30 x 150 + 250 x 25	1 1/8 x 2 1/4	3.10
PRS 1010D4A	50-50 x 150 + 20 x 25	1 1/8 x 2 1/4	2.50



TYPE PRS-B 150
150V.D.C.W. 200v Surge Peak

Cap. Mfd.	Can Size Dia. x Lgth.	List
20-20	1 x 2 1/2	\$2.05
20-40	1 x 3	2.20

TYPE HCLV



High capacity—low voltage units used in electric fence control and other applications requiring these capacity-voltage values. Unit supplied with outer insulating tube and mounting ring. External tube sizes indicated below.

**HIGH
CAPACITY
LOW
VOLTAGE**

TYPE PRS-B DUAL ELEMENT — 4 LEADS

Cap. Mfd.	Can Size Dia. x Lgth.	List
8-8	1 x 3	\$2.15
8-16	1 1/8 x 3 1/2	2.45
16-16	1 3/8 x 3 1/2	2.80

Cap. Mfd.	Can Size Dia. x Lgth.	List
8-16	1 x 2 1/2	2.10
16-16	1 x 3	2.20

Type HCLV12—12 V.D.C.W.

Cap. Mfd.	Size Dia. x Hght.	List
500	1 1/8 x 3	\$2.70
1000	1 1/8 x 3 1/2	3.25
2000	1 1/8 x 4 1/2	3.65
3000	2 1/8 x 4 1/2	4.55
4000	2 1/8 x 4 1/2	4.75

Type HCLV18—18 V.D.C.W.

Cap. Mfd.	Size Dia. x Hght.	List
500	1 1/8 x 3	3.00
1000	1 1/8 x 4 1/2	3.80
2000	1 1/8 x 4 1/2	4.75
4000	2 1/8 x 4 1/2	8.45

Type HCLV25—25 V.D.C.W.

Cap. Mfd.	Size Dia. x Hght.	List
500	1 1/8 x 3	3.30
1000	1 1/8 x 4 1/2	4.30
2000	2 1/8 x 3 1/2	5.25
3000	2 1/8 x 4 1/2	8.00
4000	2 1/8 x 4 1/2	9.50

Type HCLV50—50 V.D.C.W.

Cap. Mfd.	Size Dia. x Hght.	List
1000	2 1/8 x 3 1/2	6.50
2000	2 1/8 x 4 1/2	8.60

TYPE SRE BANTAM CAPACITORS



Tiniest Aerovox electrolytic. Handles full sized jobs, especially suitable for hearing aids, personal radios, screen

filter circuits and similar functions. Hermetically sealed, aluminum tube with waxed cardboard insulating jacket. New stud terminals with #18 gauge tinned copper wire leads.

Volts	Cap. Mfd.	Size	Length	List
3	100	3/8 x 1	1 1/8	\$1.10
3	200	3/8 x 1 1/8	1 3/8	1.15
3	300	1/2 x 1 1/8	1 3/8	1.30
3	500	1/2 x 1 1/8	1 5/8	1.40
6	50	3/8 x 1	1 1/8	.95
6	100	3/8 x 1 1/8	1 1/8	1.20
12	50	3/8 x 1 1/8	1 1/8	1.00
12	100	3/8 x 1 1/8	1 1/8	1.20
12	200	1/2 x 1 1/8	1 5/8	1.35
25	25	3/8 x 1	1 1/8	1.00
25	50	3/8 x 1 1/8	1 1/8	1.10
25	100	3/8 x 1 1/8	1 1/8	1.25
50	25	3/8 x 1	1 1/8	.95
50	50	3/8 x 1 1/8	1 1/8	1.00
50	10	3/8 x 1 1/8	1 1/8	1.00
50	15	3/8 x 1 1/8	1 1/8	1.00
50	25	3/8 x 1 1/8	1 1/8	1.05
150	10	3/8 x 1 1/8	1 1/8	1.00
150	15	3/8 x 1 1/8	1 1/8	1.05
150	25	3/8 x 1 1/8	1 1/8	1.15
150	50	1/2 x 1 1/8	1 5/8	1.25

REPLACEMENT FOR WET ELECTROLYTICS — TYPE WR



Dry electrolytic for replacement of wet electrolytic units. Furnished in round aluminum cans, the range of capacities covers most applications in standard radio receivers and other equipment originally using wet type electrolytic capacitors. 450 V.D.C.

Cap. Mfd.	Replacement For	Size	Hght.	List
10	1 to 12 mfd.	1 3/8 x 3	3	\$2.30
20	16 to 20 mfd.	1 3/8 x 3	3	2.70
30	20 to 30 mfd.	1 3/8 x 3	3	2.95
40	30 to 40 mfd.	1 3/8 x 3	3	3.15

TYPE BT



DRAWN-CASE "BATHTUB"

Designed for rigid mounting in minimum space. Extra sturdy construction, immersion proof.

Cap. Mfd.	TYPE BT500 500 V.D.C.W. L. x W. x H.	List
4	2 x 2 x 1 1/8	\$4.70
8	2 x 2 x 1 1/8	4.85
8	TYPE BT450 450 V.D.C.W.	4.25
12	1 3/4 x 1 x 1	4.75
16	1 3/4 x 1 1/4 x 1	5.00
16	2 x 1 3/4 x 1	
8	TYPE BT350 350 V.D.C.W.	3.70
12	1 3/4 x 1 x 3/8	4.20
16	1 3/4 x 1 x 3/8	4.40
20	1 3/4 x 1 1/4 x 1 1/8	4.60
8	TYPE BT150 150 V.D.C.W.	2.75
12	1 3/4 x 1 x 3/8	2.80
16	1 3/4 x 1 x 3/8	2.85
24	1 3/4 x 1 x 3/8	3.00
30	1 3/4 x 1 x 1	3.10
40	1 3/4 x 1 x 1	3.20
10	TYPE BT50 50 V.D.C.W.	2.65
25	1 3/4 x 1 x 3/8	2.75
50	1 3/4 x 1 x 3/8	3.00
10	TYPE BT25 25 V.D.C.W.	2.60
25	1 3/4 x 1 x 3/8	2.70
50	1 3/4 x 1 x 3/8	2.80

TYPE E



Upright or Inverted Mounting Capacitors

Can be mounted in any position with ring-type clamp provided with unit. Single or multiple elements. Two terminals on singles, three on dual, and 4 terminals on triple element units.

SINGLE ELEMENT

Cap. Mfds.	TYPE E475 475 V.D.C.W. 525 V. Surge Peak	Can Size	List
4	1 3/8 x 2 1/4		\$2.20
4	TYPE E450 450 V.D.C.W. 500 V. Surge Peak		
4	1 3/8 x 2 1/4		2.15
8	1 3/8 x 2 1/4		2.25
10	1 3/8 x 2 1/4		2.30
12	1 3/8 x 2 1/4		2.35
16	1 3/8 x 2 1/4		2.40
20	1 3/8 x 2 1/4		2.55
30	1 3/8 x 2 1/4		2.70
40	1 3/8 x 2 3/4		2.75
80	1 3/8 x 4 1/4		3.80

TYPE E50

Cap. Mfds.	50 V.D.C.W. 75 V. Single Peak	List
10	1 x 1 3/8	2.00
25	1 x 1 3/8	2.05

TYPE E25

Cap. Mfds.	25 V.D.C.W. 40 V. Surge Peak	List
10	1 x 1 3/8	2.00
25	1 x 1 3/8	2.00

DUAL ELEMENT

Cap. Mfds.	TYPE E450 450 V.D.C.W. 500 V. Surge Peak	List
8-8	1 3/8 x 2 1/4	3.25
8-16	1 3/8 x 2 1/4	3.50
10-10	1 3/8 x 2 1/4	3.35
12-12	1 3/8 x 2 1/4	3.45
16-16	1 3/8 x 2 3/4	3.80
20-20	1 3/8 x 2 3/4	4.05

TRIPLE ELEMENT

Cap. Mfds.	TYPE E450 450 V.D.C.W. 500 V. Surge Peak	List
8-8-8	1 3/8 x 2 1/4	3.90
10-10-10	1 3/8 x 2 1/4	4.10

TYPE GLS



Midget Screw- Mounting Wire- Lead Capacitors

Similar to Type GL. Smaller diameter cans and minimum length. Best for compact assemblies.

Cap. Mfds.	TYPE GLS450 SINGLE-ELEMENT 450 V.D.C.W. 500 V. Surge Peak	Can Size	List
4	1 x 2 3/8		\$2.00
8	1 x 2 1/8		2.20
12	1 x 3 3/4		2.40
16	1 x 3 3/4		2.45
8-8	TYPE GLS450 DOUBLE-ELEMENT	1 3/8 x 3	3.00
4	TYPE GLS250 SINGLE-ELEMENT 250 V.D.C.W. 300 V. Surge Peak		1.40
8	1 x 2 3/8		1.65
12	1 x 2 1/8		1.75
16	1 x 3 1/4		1.80

TYPE G



Insulated Screw-Mounting Capacitors

Hermetically-sealed aluminum can unit, threaded cover with hex nut and washer for convenient mounting on chassis. Washer can be used to insulate can from chassis. Terminals molded in cover. Cathode connection through terminal in cover.

Cap. Mfds.	TYPE G475 SINGLE ELEMENT 475 V.D.C.W. 525 V. Surge Peak	Can Size	List
4	1 3/8 x 2 1/4		\$2.20
8	1 3/8 x 2 1/4		2.30
4	TYPE G450 450 V.D.C.W. 500 V. Surge Peak		
4	1 3/8 x 2 1/4		2.15
8	1 3/8 x 2 1/4		2.25
10	1 3/8 x 2 1/4		2.30
12	1 3/8 x 2 1/4		2.35
16	1 3/8 x 2 1/4		2.40
20	1 3/8 x 2 1/4		2.55
30	1 3/8 x 2 1/4		2.70
40	1 3/8 x 2 3/4		2.75
80	1 3/8 x 4 1/4		2.80

TYPE G450 DUAL-ELEMENT

Cap. Mfds.	Can Size	List
8-8	1 3/8 x 2 1/4	3.25
8-16	1 3/8 x 2 1/4	3.50
10-10	1 3/8 x 2 1/4	3.35
12-12	1 3/8 x 2 1/4	3.45
16-16	1 3/8 x 2 3/4	3.80
20-20	1 3/8 x 2 3/4	4.05

TYPE GL SCREW-MOUNTING WIRE-LEAD CAPACITORS

Inverted mounting, aluminum can unit in single, double and triple elements. Two separate color-coded leads, 5" long brought out from each section. Convenient mounting with palnut and threaded neck.

Cap. Mfds.	TYPE GL600 SINGLE-ELEMENT 600 V.D.C.W. 750 V. Surge Peak	Can Size	List
4	1 3/8 x 4		\$2.95
8	1 3/8 x 4 1/2		3.15
16	1 3/8 x 4 1/2		3.75

Cap. Mfds.	TYPE GL475 SINGLE-ELEMENT 475 V.D. C. W. 525 V. Surge Peak	List
8	1 3/8 x 3	2.75
12	1 3/8 x 3	2.95
16	1 3/8 x 3	3.15

Cap. Mfds.	TYPE GL475 DUAL-ELEMENT	List
8-8	1 3/8 x 4	4.10

Cap. Mfds.	TYPE GL450 SINGLE-ELEMENT 450 V.D.C.W. 500 V. Surge Peak	List
4	1 3/8 x 3	2.00
8	1 3/8 x 3	2.20
10	1 3/8 x 3	2.30
12	1 3/8 x 3	2.40
16	1 3/8 x 3	2.45
20	1 3/8 x 3	2.75
30	1 3/8 x 3	3.00
40	1 3/8 x 3	3.15
80	1 3/8 x 4	4.90

Cap. Mfds.	TYPE GL450 DUAL-ELEMENT	List
8-8	1 3/8 x 4	3.00
8-16	1 3/8 x 4	3.30
10-10	1 3/8 x 4	3.10
12-12	1 3/8 x 4	3.20
16-16	1 3/8 x 4	3.55
20-20	1 3/8 x 4	3.80

Cap. Mfds.	TYPE GL450 TRIPLE-ELEMENT	List
8-8-8	1 3/8 x 4	5.00
10-10-10	1 3/8 x 4	5.30

DURANITE MOLDED TUBULAR CAPACITORS • TYPE P-88N

Toughest capacitors ever offered for radio-electronic equipment. DURANITE capacitors are entirely new—in design, impregnant, processing, and casing. New technique glove-fitting contact and seal throughout. DURANITE provides a permanent, non-varying, rock-hard casing, does not dry out, does not develop cracks or fissures. Pig-tail leads firmly imbedded, won't pull out, won't work loose. Moisture-proof; operate from sub zero to over 212°F. Exposure to temperatures of 250°F. will not impair life or performance, no deterioration on the shelf.

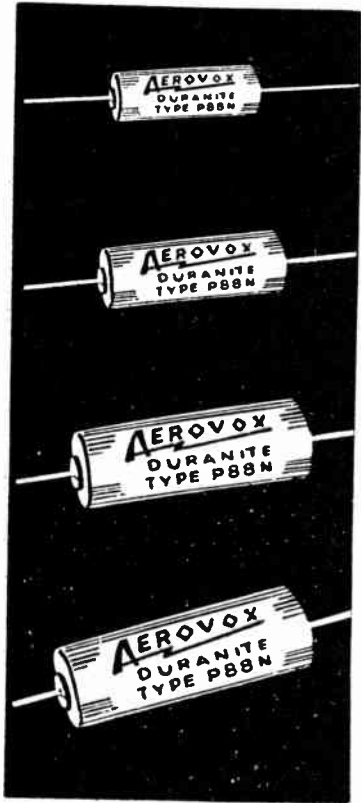

Mfds.	200 Volts		400 Volts		600 Volts		1000 Volts		1600 Volts	
	Size	List	Size	List	Size	List	Size	List	Size	List
.00025					A	\$.25				
.0004					A	.25				
.0005					A	.25				
.001					A	.25	A	\$.50	B	\$.60
.0015					A	.25	A	.50	B	.60
.002					A	.25	A	.50	B	.60
.0022					A	.25	A	.50	B	.60
.003					A	.25	B	.50	B	.60
.0033					A	.25	B	.50	B	.60
.004					A	.25	B	.50	B	.60
.0047					A	.25	B	.50	B	.60
.005					A	.25	B	.50	D	.60
.006					A	.25	B	.50	D	.60
.0068			A	\$.25	B	.25	B	.50	D	.60
.007			A	.25	B	.25	B	.50	D	.65
.0075					B	.25				.65
.008			A	.25	B	.30	B	.50	D	.65
.01					B	.30			E	.65
.015			A	.25	B	.30	B	.50		.65
.02			B	.25	B	.30	D	.50	E	.65
.022			B	.25	D	.30	E	.50	F	.65
.025			B	.30	D	.30	E	.50	F	.65
.03			B	.30	D	.35	E	.50	F	.65
.033			B	.30	D	.35	E	.50	F	.65
.04			B	.30	E	.35	E	.60	F	.70
.047			D	.30	E	.35	F	.60		
.05			D	.30	E	.35	F	.60		
.06			D	.30	E	.40	F	.60		
.068					F	.40				
.075					F	.40	F	.70		
.1			E	.35	F	.45				
.15			E	.35	F	.45				
.22			F	.40	G	.50				
.25			F	.40	G	.55				
.33			F	.40	G	.55				
.47			F	\$.50						
.5			F	.60						
.68			F	.60	G	.60	H	.80		
1.0					H	.90				

Size	Length x Dia.
A	1 1/4 x 1/8
B	1 3/8 x 1/8
C	1 1/2 x 1/8
D	1 3/4 x 1/8
E	1 7/8 x 1/8
F	2 x 1/8
G	2 1/4 x 1/8
H	2 1/2 x 1/8

AEROCON MINIATURE CAPACITORS • TYPE P-85N

Capacity Mfd.	TUBULAR SIZES — P-85N (Inches)			
	200 Volt	List Price	400 Volt	List Price
.00025	1/8 x 1/8	\$.35	1/8 x 1/8	\$.35
.0005	1/8 x 1/8	.35	1/8 x 1/8	.35
.001*	1/8 x 1/8	.35	1/8 x 1/8	.35
.0015*	1/8 x 1/8	.35	1/8 x 1/8	.35
.002	1/8 x 1/8	.35	1/8 x 1/8	.35
.0022*	1/8 x 1/8	.35	1/8 x 1/8	.35
.003	1/8 x 1/8	.35	1/8 x 1/8	.35
.0033*	1/8 x 1/8	.35	1/8 x 1/8	.35
.004	1/8 x 1/8	.35	1/8 x 1/8	.35
.0047*	1/8 x 1/8	.35	1/8 x 1/8	.35
.005	1/8 x 1/8	.35	1/8 x 1/8	.35
.0060	1/8 x 1/8	.35	1/8 x 1/8	.35
.0068*	1/8 x 1/8	.40	1/8 x 1/8	.40
.010*	1/8 x 1/8	.40	1/8 x 1/8	.45
.015*	1/8 x 1/8	.45	1/8 x 1/8	.45
.020	1/8 x 1/8	.45	1/8 x 1/8	.45
.022*	1/8 x 1/8	.45	1/8 x 1/8	.45
.03	1/8 x 1/8	.45	1/8 x 1/8	.45
.033*	1/8 x 1/8	.50	1/8 x 1/8	.50
.04	1/8 x 1/8	.50	1/8 x 1/8	.50
.047*	1/8 x 1/8	.50	1/8 x 1/8	.50
.05	1/8 x 1/8	.50	1/8 x 1/8	.50
.068*	1/8 x 1/8	.55	1/8 x 1/8	.55
.1*	1/8 x 1/8	.60	1/8 x 1/8	.65

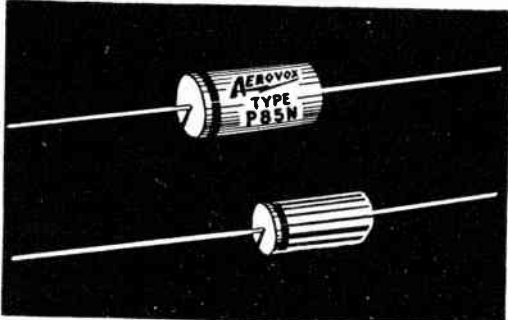

The new, tiny, Aerolene-impregnated tubular unit. Duranite endfill excludes humidity. Designed especially for personal radios, hearing aids and electronic assemblies requiring good performance and minimum size.

* Preferred Numbers
Note: Other capacities and voltage ranges available on special order.

Cap. Mfd.	100 VDCW	List Price
.25	.489 x 1/8	\$.70
.50	.645 x 1/8	.80

CAPACITORS AEROVOX RESISTORS

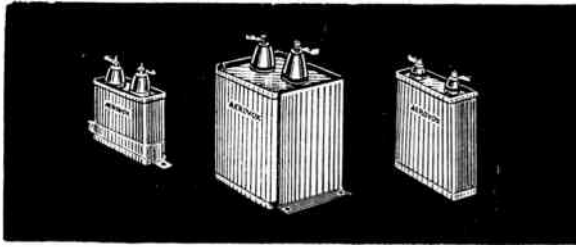

AEROVOX HYVOLS* • TYPE JP09

Immersion-proof in sturdy rectangular metal can. High-voltage screw type pillar terminals fitted with soldering lugs. Use of "HYVOL" allows exceptionally compact size for capacity, working voltage, and safety factor. Intended for heavy-duty continuous service in transmitters, amplifiers, etc. Type MB bracket is supplied unless otherwise specified, except on units with base sizes 3 3/4" x 3-3/16" and 3 3/4" x 4-9/16" where Type MS bracket is supplied. MSB is available for all types upon request.

600 VDCW			1000 VDCW			1500 VDCW			2000 VDCW			2500 VDCW		
Cap. Mfds	H. x W. x D.	List	H. x W. x D.	List	H. x W. x D.	List	H. x W. x D.	List	H. x W. x D.	List	H. x W. x D.	List		
.1			1 1/8 x 1 1/8 x 1 1/8	\$4.15			2 1/2 x 2 1/2 x 1 1/8	\$6.60						
.25			2 1/4 x 1 1/8 x 1 1/8	4.70			2 1/2 x 2 1/2 x 1 1/8	7.15						
.5		\$4.70	2 1/4 x 1 1/8 x 1 1/8	4.95	2 7/8 x 1 1/8 x 1 1/8	\$6.35	2 1/2 x 2 1/2 x 1 1/8	7.45	3 7/8 x 2 1/2 x 1 1/8	\$11.55				
1.0	2 1/4 x 1 1/8 x 1 1/8	5.80	2 1/4 x 1 1/8 x 1 1/8	6.35	3 3/8 x 1 1/8 x 1 1/8	7.45	2 1/2 x 2 1/2 x 1 1/8	9.10	3 7/8 x 3 3/8 x 1 1/8	13.20				
2.0	2 3/8 x 1 1/8 x 1 1/8	8.25	3 3/8 x 1 1/8 x 1 1/8	8.25	4 1/4 x 2 1/2 x 1 1/8	10.45	4 1/4 x 3 3/8 x 1 1/8	10.75	4 3/8 x 3 3/8 x 1 1/8	21.45				
3.0	2 3/8 x 1 1/8 x 1 1/8	8.25	3 3/8 x 2 1/2 x 1 1/8	9.65	4 3/8 x 2 1/2 x 1 1/8	12.40	4 3/8 x 3 3/8 x 1 1/8	13.20						
4.0	3 3/8 x 2 1/2 x 1 1/8	9.10	4 3/8 x 2 1/2 x 1 1/8	10.45	4 3/8 x 3 3/8 x 1 1/8	14.05	4 3/8 x 3 3/8 x 2 1/2 x 1 1/8	15.15	4 3/8 x 4 1/8 x 3 3/8	30.00				
5.0	4 3/8 x 2 1/2 x 1 1/8	10.45	4 3/8 x 3 3/8 x 1 1/8	12.65	4 3/8 x 3 3/8 x 1 1/8	15.15	4 3/8 x 3 3/8 x 2 1/2 x 1 1/8	16.80						
6.0	4 3/8 x 3 3/8 x 1 1/8	11.30	4 3/8 x 3 3/8 x 1 1/8	14.05	4 3/8 x 3 3/8 x 1 1/8	17.05	4 3/8 x 3 3/8 x 3 3/8	20.10						
8.0	4 3/8 x 3 3/8 x 1 1/8	13.50	4 3/8 x 3 3/8 x 1 1/8	15.15	4 3/8 x 3 3/8 x 1 1/8	20.90	5 1/8 x 3 3/8 x 3 3/8	25.05						
10.0	4 3/8 x 3 3/8 x 1 1/8	15.15	4 3/8 x 3 3/8 x 1 1/8	16.80	5 1/8 x 3 3/8 x 3 3/8	25.05	4 3/8 x 4 1/8 x 3 3/8	30.55						
12.0	4 3/8 x 3 3/8 x 1 1/8	16.70	4 3/8 x 3 3/8 x 2 1/2	18.15	4 3/8 x 3 3/8 x 2 1/2	27.25	5 1/8 x 4 1/8 x 3 3/8	33.30	7 x 4 1/8 x 3 3/8	75.10				
15.0	4 3/8 x 3 3/8 x 1 1/8	18.50	4 3/8 x 3 3/8 x 2 1/2	20.10	4 3/8 x 4 1/8 x 3 3/8	30.00	6 1/2 x 4 1/8 x 3 3/8	40.15						

3000 VDCW			4000 VDCW			5000 VDCW			6000 VDCW			7500 VDCW		
Cap. Mfds	H. x W. x D.	List	H. x W. x D.	List	H. x W. x D.	List	H. x W. x D.	List	H. x W. x D.	List	H. x W. x D.	List		
.1	2 7/8 x 2 1/2 x 1 1/8	\$14.05	2 3/4 x 3 3/8 x 2 1/4	\$25.05	2 3/4 x 3 3/8 x 2 1/4	\$26.70	3 3/8 x 2 1/4 x 3 3/8	\$33.55	3 3/8 x 3 3/8 x 2 1/4	\$47.30				
.25	2 7/8 x 2 1/2 x 1 1/8	14.85	2 3/4 x 3 3/8 x 2 1/4	26.40	2 3/4 x 3 3/8 x 2 1/4	30.25	3 3/8 x 2 1/4 x 4 1/8	41.80	3 3/8 x 4 1/8 x 2 3/8	50.05				
.5	4 1/8 x 2 1/2 x 1 1/8	16.80	3 7/8 x 3 3/8 x 2 1/4	30.00	4 1/8 x 3 3/8 x 2 1/4	33.30	4 3/8 x 3 3/8 x 4 1/8	47.30	5 1/8 x 4 1/8 x 3 3/8	54.20				
1.0	3 7/8 x 2 3/8 x 2 1/4	20.10	5 1/8 x 3 3/8 x 2 1/4	36.85	4 3/8 x 3 3/8 x 4 1/8	41.80	7 1/2 x 4 1/8 x 3 3/8	83.60						
2.0	4 1/8 x 3 3/8 x 3 3/8	25.05	5 1/8 x 4 1/8 x 3 3/8	46.75	6 x 3 3/8 x 4 1/8	53.65								
4.0	4 3/8 x 4 1/8 x 3 3/8	36.85	8 1/2 x 4 1/8 x 3 3/8	66.85										

COMPACT HYVOL* CAPACITORS • TYPE JP16CT

Mfd.	400 V			600 V			1000 V			600 V		
	List	List	List	List	List	List	List	List	List	List	List	
.01	1 1/8	\$2.85	1 1/8	\$2.90	1 1/8	\$3.10	2X .05	1 1/8	\$0.00			
.05	1 1/8	2.90	1 1/8	3.10	1 1/8	3.15	2X .1	1 1/8	0.00			
.1	1 1/8	3.15	1 1/8	3.20	1 1/8	3.25	2X .25	2	0.00			
.25	1 1/8	3.20	1 1/8	3.25	2	3.35	2X .5	2 1/2	0.00			
.5	1 1/8	3.25	2	3.35	2 1/2	3.65						
1.0	2	3.65	2 1/2	3.75								

Standard Width 1 1/8" — Depth 1 1/8"

Compact, immersion-proof unit, of minimum size and weight. Corrosion-proof metal container. Special immersion-proof terminals for severe atmospheric and climatic conditions. Type 16CT is standard, but Type 16CB (terminals on bottom) units also available.



COMPACT HYVOL* CAPACITORS • TYPE JP18CB

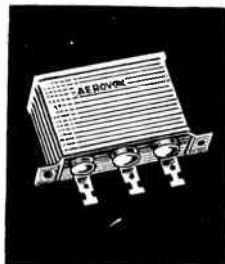

Compact, immersion-proof unit. Different base sizes make units adaptable for duals and triples. Even on single sections, different base sizes make units fit in particular applications where Type 16's do not fit. Type 18CB is standard, but Type 18CT (terminals on top) also available.

Mfd.	400 VOLT			SINGLE-ELEMENT 600 VOLT			1000 VOLT		
	List	List	List	List	List	List	List	List	
.05	1	\$3.15	1 1/8	\$3.20	1 1/8	\$3.35	1 1/8	\$3.35	
.1	1	3.25	1 1/8	3.35	1 1/8	3.45	1 1/2	3.45	
.25	1 1/8	3.35	1 1/2	3.45	1 1/2	3.70	2	3.65	
.5	1 1/2	3.45	2	3.70	2 1/2	4.00	2 1/2	3.85	
1.0	2 1/2	3.85							

Mfd.	DUAL-ELEMENT			TRIPLE-ELEMENT		
	List	List	List	List	List	List
.05	1 1/8	4.00	1 1/8	4.20	1 1/8	5.00
.1	1 1/8	4.15	1 1/2	4.30	1 1/2	5.95
.25	1 1/2	4.30	2	4.55	2 1/2	6.85
.5	2 1/2	4.70				
1.0						

Standard Width 1 3/4" — Depth 1 1/8"

BATHTUB CASE HYVOL CAPACITORS • TYPE JP30

SIZE: Length x Width x Height
SINGLE-ELEMENT

Mfd.	400 VOLT			600 VOLT			1000 VOLT		
	List	List	List	List	List	List	List	List	
.05	1 3/4 x 1 1/8 x 3/4	\$1.95	1 3/4 x 1 1/8 x 3/4	\$2.85	1 3/4 x 1 1/8 x 3/4	\$3.05	1 3/4 x 1 1/8 x 3/4	\$3.15	
.1	1 3/4 x 1 1/8 x 3/4	2.20	1 3/4 x 1 1/8 x 3/4	2.90	1 3/4 x 1 1/8 x 3/4	3.10	1 3/4 x 1 1/8 x 3/4	3.25	
.25	1 3/4 x 1 1/8 x 3/4	2.50	1 3/4 x 1 1/8 x 3/4	3.10	1 3/4 x 1 1/8 x 3/4	3.30	2 x 1 3/8 x 7/8	3.50	
.5	1 3/4 x 1 1/8 x 3/4	2.65	1 3/4 x 1 1/8 x 3/4	3.30	2 x 1 3/8 x 7/8	3.50	2 x 1 3/8 x 7/8	4.20	
.75	2 1/8 x 1 1/4 x 3/4	2.95	2 1/8 x 1 1/4 x 3/4	3.50	2 x 2 x 1 1/8	3.75	2 x 2 x 1 1/8	4.40	
1.0	2 1/8 x 1 1/4 x 3/4	3.15	2 x 2 x 1 1/8	3.75		5.00			
2.0	2 x 2 x 1 1/8	3.95							

Mfd.	DUAL-ELEMENT			TRIPLE-ELEMENT		
	List	List	List	List	List	List
.05	1 3/4 x 1 1/8 x 3/4	3.05	1 3/4 x 1 1/8 x 3/4	3.65	1 3/4 x 1 1/8 x 3/4	3.85
.1	1 3/4 x 1 1/8 x 3/4	3.30	1 3/4 x 1 1/8 x 3/4	3.70	1 3/4 x 1 1/8 x 3/4	3.95
.25	1 3/4 x 1 1/8 x 3/4	3.60	1 3/4 x 1 1/8 x 3/4	3.75	2 x 1 3/8 x 7/8	4.20
.5	2 x 1 3/8 x 7/8	4.15	2 x 1 3/8 x 7/8	4.30	2 x 2 x 1 1/8	5.45
1.0	2 x 2 x 1 1/8	4.95	2 x 2 x 1 1/8	5.30		

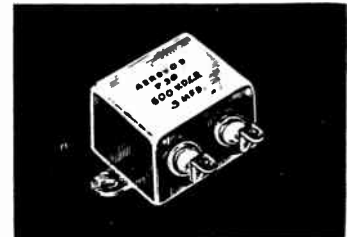

A compact superior-grade oil-impregnated, oil-filled, drawn-metal case capacitor. Hermetically sealed, immersion-proof. Built for severe operating conditions as in aircraft, police, broadcast, public address and other types of communications equipment. The AeroVox-designed terminals are constructed with "doublerubber bakelite" insulators permanently riveted to the case, and make a sturdy, absolutely immersion-proof assembly.

HIGH TEMPERATURE METALLIZED — PAPER CAPACITORS

Sizes given are D x L

Capacity	200 Volt		400 Volt		600 Volt	
	Size	List	Size	List	Size	List
.01	1 1/8 x 1 1/8	\$1.30	1 1/4 x 1 1/4	\$1.35	1 1/2 x 1 1/2	\$1.45
.02	1 1/8 x 1 1/8	1.40	1 1/4 x 1 1/4	1.45	1 1/2 x 1 1/2	1.55
.03	1 1/8 x 1 1/8	1.50	1 1/4 x 1 1/4	1.55	1 1/2 x 1 1/2	1.65
.05	1 1/8 x 1 1/8	1.60	1 1/4 x 1 1/4	1.65	1 1/2 x 1 1/2	1.75
.1	1 1/8 x 1 1/8	1.75	1 1/4 x 1 1/4	1.80	1 1/2 x 1 1/2	1.90
.25	1 1/8 x 1 1/8	2.00	1 1/4 x 1 1/4	2.10	1 1/2 x 1 1/2	2.25
.5	1 1/8 x 1 1/8	2.50	1 1/4 x 1 1/4	2.85	1 1/2 x 1 1/2	3.00
1.0	1 1/8 x 1 1/8	3.00	1 1/4 x 1 1/4	3.50	1 1/2 x 1 1/2	4.00
2.0	1 1/8 x 1 1/8	4.00	1 1/4 x 1 1/4	5.50	1 1/2 x 1 1/2	6.00

TYPE P92ZN

Aerovox type P92ZN Aerolene impregnated metallized paper capacitors are modified plastic tubular type, Duranite end-sealed capacitors in paper cases. Operating temperature range is -30°C to +100°C.



Standard Tolerances ±20%. For lower tolerances, ask for quotations.

TYPE P30ZN



HIGH TEMPERATURE METALLIZED — PAPER CAPACITORS

Sizes given are L x W x H

Capacity	200 Volt			List	400 Volt			List	600 Volt			List
	Size	Size	Size		Size	Size	Size		Size	Size	Size	
.1	1 3/4 x 1 3/4 x 1 3/4	x 1	x 3/4	\$5.75	1 3/4 x 1 3/4 x 1 3/4	x 1	x 3/4	\$7.00	1 3/4 x 1 3/4 x 1 3/4	x 1	x 3/4	\$8.00
.25	1 3/4 x 1 3/4 x 1 3/4	x 1	x 3/4	6.00	1 3/4 x 1 3/4 x 1 3/4	x 1	x 3/4	7.30	1 3/4 x 1 3/4 x 1 3/4	x 1	x 3/4	8.30
.5	1 3/4 x 1 3/4 x 1 3/4	x 1	x 3/4	6.25	1 3/4 x 1 3/4 x 1 3/4	x 1	x 3/4	7.60	1 3/4 x 1 3/4 x 1 3/4	x 1	x 3/4	8.75
1.0	1 3/4 x 1 3/4 x 1 3/4	x 1	x 3/4	6.75	1 3/4 x 1 3/4 x 1 3/4	x 1	x 3/4	8.20	1 3/4 x 1 3/4 x 1 3/4	x 1 1/4	x 3/4	9.50
2.0	1 3/4 x 1 3/4 x 1 3/4	x 1	x 3/4	7.80	1 3/4 x 1 3/4 x 1 3/4	x 1 3/4	x 3/4	9.50	2	x 2	x 1 1/4	11.00
3.0					1 3/4 x 1 3/4 x 1 3/4	x 1 3/4	x 3/4	11.00				13.25
4.0					1 3/4 x 1 3/4 x 1 3/4	x 2	x 1	12.20				
5.0					1 3/4 x 1 3/4 x 1 3/4	x 2	x 1 1/4	14.30				

Cap. Mfd.	150 Volt	List
3.0	1 3/4 x 1 x 7/8	\$9.00
4.0	1 3/4 x 1 x 7/8	9.80
5.0	1 3/4 x 1 x 7/8	11.20
6.0	1 3/4 x 1 1/4 x 7/8	12.40
8.0	2 x 2 x 1 1/4	14.70
10.0	2 x 2 x 1 1/4	17.20
12.0	2 x 2 x 1 1/4	19.60
15.0	2 x 2 x 1	23.50

Aerovox type P30ZN Aerolene impregnated metallized-paper capacitors housed in "bathtub" metal-cases with vitrified ceramic or glass terminal seals. Operating temperature range —55°C to +100°C at full rating with operation to +125°C at 75 per cent of voltage rating.

Standard Tolerances ±20%. For lower tolerances, ask for quotations.

TYPE P82 METALLIZED-PAPER CAPACITORS • CARDBOARD TUBES



Cap. Mfds.	200 V		List	400 V		List	600 V		List
	Size	Size		Size	Size		Size	Size	
.01	3/8 x 5/8	5/8	\$.60	3/8 x 5/8	5/8	\$.65	3/8 x 5/8	5/8	\$.70
.02	3/8 x 5/8	5/8	.60	3/8 x 5/8	5/8	.65	3/8 x 5/8	5/8	.70
.03	3/8 x 5/8	5/8	.60	3/8 x 5/8	5/8	.65	3/8 x 5/8	5/8	.80
.05	3/8 x 5/8	5/8	.65	3/8 x 5/8	5/8	.70	3/8 x 5/8	5/8	.80
.1	3/8 x 5/8	5/8	.70	3/8 x 1 1/8	5/8	.80	3/8 x 1 1/8	5/8	.90
.25	3/8 x 5/8	5/8	.90	3/8 x 1 1/8	5/8	1.00	3/8 x 1 1/8	5/8	1.10
.5	3/8 x 1 1/8	5/8	1.05	3/8 x 1 1/8	5/8	1.15	3/8 x 1 1/8	5/8	1.45
1.0	3/8 x 1 1/8	5/8	1.30	3/8 x 2 1/8	5/8	1.60	3/8 x 2 1/8	5/8	1.80
2.0	3/8 x 1 5/8	5/8	1.80						

TYPE P89ZXY • METALLIZED-PAPER CAPACITORS

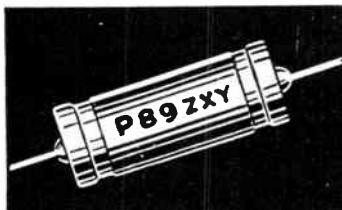

Cap. Mfds.	Size 200 V.D.C.		List	Size 400 V.D.C.		List	Size 600 V.D.C.		List
	Size	Size		Size	Size		Size	Size	
.01							3/8 x 1	\$1.40	
.02							3/8 x 1	1.45	
.03				3/8 x 1		\$1.40	3/8 x 1	1.50	
.05			\$1.40	3/8 x 1		1.45	3/8 x 1	1.55	
.1	1 1/4 x 1		1.45	3/8 x 1 1/8	5/8	1.60	3/8 x 1 1/8	1.70	
.25	1 1/4 x 1		1.60	3/8 x 1 1/8	5/8	1.80	3/8 x 1 1/8	2.00	
.5	1 1/4 x 1 1/8		1.70	3/8 x 2 1/8	5/8	2.00	3/8 x 2 1/8	2.40	
1.0	1 1/4 x 1 1/2		2.10	3/8 x 2 1/8	5/8	2.50	3/8 x 2 1/8	3.00	
2.0	5/8 x 2		2.60	1 x 2 1/2		3.60	1 1/4 x 2 3/4	4.00	

Tubular Aerolites in hermetically-sealed, metal cases. Hyvol K or M impregnated. Unique self-healing feature and Aerovox service-proven, double-rubber bakelite terminal seals. Ideal for extreme conditions and hard use. Tolerance ±20%.

Cap. Mfds.	Size 150 V.D.C.	List
3.0	3/8 x 2	\$3.40
4.0	3/8 x 2	4.35
6.0	1 x 2	5.30

Sizes shown are for flouting case without insulating tube.

METAL-CASED METALLIZED-PAPER CAPACITORS • TYPE P123ZG

Cap. Mfd.	200 V	List	400 V	List	600 V	List
.0005	.175 x 1/8	\$2.05	.235 x 7/8	\$2.10	.235 x 7/8	\$2.15
.001	.175 x 7/8	2.05	.235 x 7/8	2.10	.235 x 7/8	2.15
.002	.175 x 7/8	2.05	.235 x 7/8	2.10	.235 x 7/8	2.15
.003	.175 x 7/8	2.05	.235 x 7/8	2.10	.235 x 7/8	2.15
.005	.175 x 7/8	2.05	.235 x 7/8	2.10	.235 x 7/8	2.15
.01	.175 x 7/8	2.05	.235 x 7/8	2.15	.312 x 3/8	2.15
.015	.195 x 1/2	2.10	.235 x 3/8	2.15	.312 x 3/8	2.20
.02	.195 x 1/2	2.10	.235 x 3/8	2.15	.312 x 3/8	2.20
.033	.195 x 1/2	2.10	.235 x 3/8	2.15	.312 x 3/8	2.20
.022	.235 x 7/8	2.10	.312 x 3/8	2.20	.400 x 3/8	2.25
.040	.235 x 7/8	2.10	.312 x 3/8	2.20	.400 x 3/8	2.25
.047	.235 x 3/8	2.10	.400 x 3/8	2.20	.400 x 3/8	2.25
.050	.235 x 3/8	2.10	.400 x 3/8	2.25	.400 x 3/8	2.25
.068	.312 x 3/8	2.15	.400 x 1 1/8	2.25	.400 x 1 1/8	2.30
.10	.312 x 3/8	2.15	.400 x 1 1/8	2.45	.500 x 1 1/8	2.30
.15	.312 x 1 1/8	2.35	.500 x 1 1/8	2.45	.500 x 1 1/8	2.70
.2	.312 x 1 1/8	2.35	.500 x 1 1/8	2.45	.562 x 1 1/8	2.70
.22	.312 x 1 1/8	2.35	.562 x 1 1/8	2.45	.562 x 1 1/8	2.70
.25	.312 x 1 1/8	2.35	.562 x 1 1/8	2.75	.562 x 1 1/8	2.70
.33	.400 x 1 1/8	2.40	.562 x 1 1/8	2.75	.562 x 1 1/8	3.00
.47	.400 x 1 1/8	2.40	.562 x 1 1/8	2.75	.670 x 1 1/8	3.00
.50	.400 x 1 1/8	2.40	.562 x 1 1/8	3.05	.670 x 1 1/8	3.00
.68	.562 x 1 1/8	2.65	.670 x 1 1/8	3.05	.670 x 2 1/8	3.65
1.0	.562 x 1 1/8	2.65	.670 x 2 1/8	3.05	.750 x 2 1/8	3.65
1.5	.562 x 1 1/8	2.85				
2.0	.562 x 1 1/8	3.95				

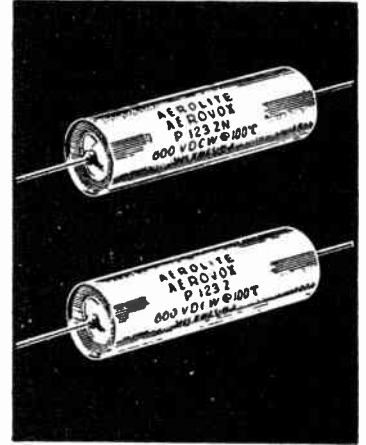

Ultra-compact, tiny capacitors in hermetically-sealed, metal cases. Bonded glass to metal terminal construction to minimize size. Can be supplied with Plastic insulating tubes. Std. Tolerance $\pm 20\%$.

HIGH TEMPERATURE METAL-CASED METALLIZED PAPER CAPACITORS • TYPE P123ZNG

Capacity	200 V	List	400 V	List	600 V	List
.0005	.175 x 7/8	\$2.95	.235 x 7/8	\$3.10	.235 x 7/8	\$3.15
.001	.175 x 7/8	2.95	.235 x 7/8	3.10	.235 x 7/8	3.15
.002	.175 x 7/8	2.95	.235 x 7/8	3.10	.235 x 7/8	3.15
.003	.175 x 7/8	3.00	.235 x 7/8	3.15	.235 x 7/8	3.25
.005	.175 x 7/8	3.00	.235 x 7/8	3.15	.235 x 7/8	3.25
.01	.175 x 7/8	3.10	.235 x 7/8	3.15	.312 x 3/8	3.25
.015	.195 x 1/2	3.15	.235 x 3/8	3.25	.312 x 3/8	3.30
.02	.195 x 1/2	3.15	.235 x 3/8	3.25	.312 x 3/8	3.30
.022	.195 x 1/2	3.15	.235 x 3/8	3.25	.312 x 3/8	3.30
.033	.235 x 7/8	3.15	.312 x 3/8	3.25	.400 x 3/8	3.30
.040	.235 x 7/8	3.15	.312 x 3/8	3.30	.400 x 3/8	3.40
.047	.235 x 7/8	3.15	.312 x 3/8	3.30	.400 x 3/8	3.40
.050	.235 x 7/8	3.15	.312 x 3/8	3.30	.400 x 3/8	3.40
.068	.312 x 3/8	3.25	.312 x 1 1/8	3.40	.400 x 1 1/8	3.45
.10	.312 x 3/8	3.25	.400 x 1 1/8	3.40	.400 x 1 1/8	3.45
.15	.312 x 1 1/8	3.55	.500 x 1 1/8	3.70	.500 x 1 1/8	4.05
.2	.312 x 1 1/8	3.55	.500 x 1 1/8	3.70	.562 x 1 1/8	4.05
.22	.312 x 1 1/8	3.55	.500 x 1 1/8	3.70	.562 x 1 1/8	4.05
.25	.312 x 1 1/8	3.55	.500 x 1 1/8	3.70	.562 x 1 1/8	4.05
.33	.400 x 1 1/8	3.60	.562 x 1 1/8	4.15	.562 x 1 1/8	4.50
.47	.400 x 1 1/8	3.60	.562 x 1 3/8	4.15	.670 x 1 3/8	4.50
.50	.400 x 1 1/8	3.60	.562 x 1 3/8	4.15	.670 x 1 3/8	4.50
.68	.500 x 1 1/8	4.00	.670 x 1 3/8	4.60	.670 x 1 3/8	5.50
1.00	.562 x 1 1/8	4.00	.670 x 2 1/8	4.60	.750 x 2 1/8	5.50
1.5	.562 x 1 1/8	5.95				
2.0	.562 x 1 1/8	5.95				

Aerovox type P123ZNG Aerolene impregnated metallized-paper capacitors housed in tubular metal cases with vitrified ceramic terminal seal. Operating temperature range -55°C to $+100^{\circ}\text{C}$ at full rating with operation to $+125^{\circ}\text{C}$ at 75 per cent of voltage rating.

FOR TYPE P123ZG AND P123ZNG

Standard tolerance .01 mfd and lower $\pm 25\%$. All others $\pm 20\%$

For $\pm 10\%$ add 50% to list

For $\pm 5\%$ add 100% to list

—For insulated section (insulating terminal at both ends) delete G in designation, add 1/8 inch to lengths listed above and add \$.50 to list

—For insulating sleeve add \$.15 to list, add suffix "P" to designation

—For mounting bracket add \$.15 to list, and add suffix "B" to designation

—For threaded terminal add \$.50 to list, and add suffix "T" to designation

TYPE P83Z MICROMINIATURES METALLIZED-PAPER CAPACITORS

Ultra-small, new metallized-dielectric capacitor particularly applicable in the electronic field to replace the low capacity paper units now being used. Hyvol K impregnated in humidity resistant molded thermo-plastic cases.

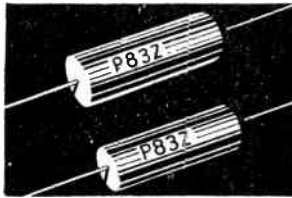

Cap. Mfd.	Voltage	Case Size (inches) Dia. x Lgth.	List
.004	200 VDC	3/16 x 7/16	\$.45
.005	200 VDC	3/16 x 7/16	.45
.01	200 VDC	3/16 x 7/16	.45
.02	200 VDC	3/16 x 7/16	.55
.04	200 VDC	3/16 x 7/16	.55
.00025	400 VDC	3/16 x 7/16	.45
.002	400 VDC	3/16 x 7/16	.45
.003	400 VDC	3/16 x 7/16	.45
.008	400 VDC	3/16 x 7/16	.55
.01	400 VDC	3/16 x 7/16	.55
.0005	600 VDC	3/16 x 7/16	.45
.0008	600 VDC	3/16 x 7/16	.45
.001	600 VDC	3/16 x 7/16	.45
.002	600 VDC	3/16 x 7/16	.55
.0022	600 VDC	3/16 x 7/16	.55
.0047	600 VDC	3/16 x 7/16	.55
.005	600 VDC	3/16 x 7/16	.55
.0068	600 VDC	3/16 x 7/16	.55

Standard Tolerance $\pm 25\%$
 for $\pm 20\%$ add 25% to list price
 for $\pm 10\%$ add 50% to list price

TYPE P30Z BATHTUBS METALLIZED-PAPER CAPACITORS

Aerolite Metallized-Paper capacitors. Hyvol K or M impregnated in bathtub, hermetically-sealed metal cases. Meets rigid JAN requirements for moisture immersion and vibration testing. Std. Tolerance $\pm 20\%$.

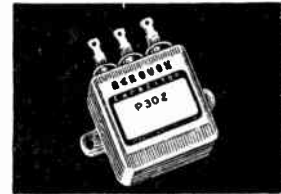

Cap. Mfds.	Volts	Size	List
.5	200	1 1/4 x 1 x 3/4	\$3.30
1.0	200	1 1/4 x 1 x 3/4	3.55
2.0	200	1 1/4 x 1 x 3/4	4.45
4.0	150	1 1/4 x 1 x 3/4	5.75
6.0	150	2 x 1 1/2 x 3/4	6.10
8.0	150	2 x 2 x 1	8.40
10.0	150	2 x 2 x 1 1/2	9.70
12.0	150	2 x 2 x 1 1/2	11.00
.25	400	1 1/4 x 1 x 3/4	3.35
.5	400	1 1/4 x 1 x 3/4	3.55
1.0	400	1 1/4 x 1 x 3/4	3.95
2.0	400	2 x 1 1/2 x 3/4	4.90
4.0	400	2 x 2 x 1 1/2	7.85
.1	600	1 1/4 x 1 x 3/4	3.50
.25	600	1 1/4 x 1 x 3/4	3.55
.5	600	1 1/4 x 1 x 3/4	4.25
1.0	600	1 1/4 x 1 1/4 x 3/4	4.90
2.0	600	2 x 2 x 1	6.25

Aerovox Motor-Starting Capacitors

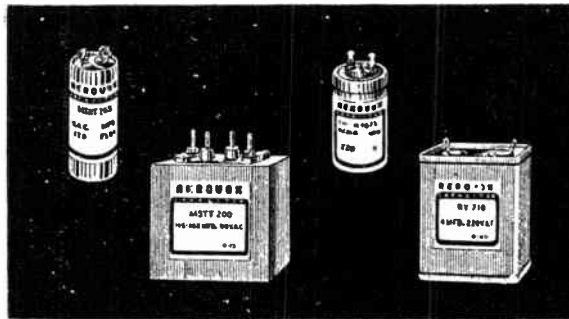

A TYPE FOR EVERY APPLICATION

Aerovox motor capacitors are available in two general categories:

- (1) Exact-Duplicate Replacements, precisely matching the mechanical and electrical features of the original equipment; and
- (2) Universal Replacements, for a minimum stock of numbers taking care of the maximum range of motor applications.

Exact-Duplicate Replacements do the "same-as-new" service job insisted upon by critical customers. Universal Replacements mean maximum convenience with minimum investment. And, of course, Aerovox also supplies the hardware, housings, caps, mountings

INTERFERENCE FILTERS

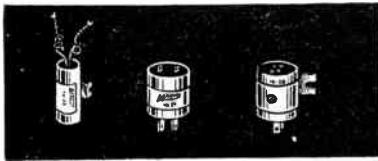

TYPE IN-23. Especially used for neon sign fixtures. Convenient mounting bracket. One filter for each fixture. Flexible leads. Also used on small motors. Size 1 x 2 1/4 inches. **List \$1.05**

TYPE IN-27. Simple, inexpensive, plug-in unit where interference is slight. Size 1 3/8 x 1 1/2 inches. **List \$1.50**

TYPE IN-28. For use where ground is at considerable distance. Most efficient when mounted on appliance. Bracket supplied. Size: 1 3/8 x 2 inches. **List \$2.00**

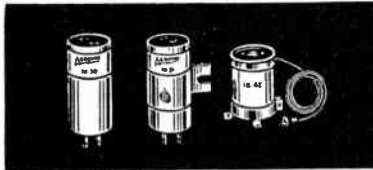

TYPE IN-29. Effective plug-in unit for local noise sources of variable character but strong intensity. Especially suited for shavers and other vibrating devices. Size: 1 3/8 x 3 inches. **List \$1.75**

TYPE IN-30. Similar to IN-29 but with greater inductance to handle more severe noise interference. Size: 1 3/8 x 3 inches. **List \$2.50**

TYPE IN-31. Bracket mounted unit with high inductance. Size: 1 3/8 x 3 inches. **List \$3.00**

TYPE IN-42. Heavy duty unit for serious interference from power transmission lines, etc. Plugs into outlet. Appliance or radio plugs into receptacle in filter. Mounting ring provided. Rating: 110/220 v. AC; 6 amps. Size: 2 1/2" dia. x 3 3/4". **List \$7.50**

UHF — INTERFERENCE FILTERS

These latest filter units provide maximum attenuation from 150 KC well up into the UHF range. And they are extra-rugged, extra-compact, extra-efficient, by any comparison with previous filters.

Primary applications are in r.f. noise suppression work in military or commercial aircraft and for vehicular low-voltage d.c. applications. Also, for special applications such as battery or low-voltage d.c. filters, for shield room applications, and for critical equipment.

Available in seven standard types meeting a wide variety of applications. For extraordinary requirements, special filters can be developed and built to your order.

Aerovox

Type	Amps.	VDC	Size (l. x w. x h.)	List
IN 148	2.0	150	1 3/8" x 1" x 7/8"	\$11.00
IN 150	3.0	150	1 1/8" x 1" x 1"	12.50
IN 151	5.0	150	1 1/8" x 1 1/4" x 1"	14.00
IN 152	10.0	150	2 1/8" x 1 1/4" x 1"	16.25
IN 153	25.0	150	2" x 2" x 1 1/8"	23.00
IN 156	40.0	150	5 1/8" x 1 1/8" x 1 1/8"	29.50
IN 154	100.0	150	3 1/8" x 2 1/8" x 2 3/8"	39.00

AEROVOX RESEARCH WORKER

A snappy, informative, practical engineering paper, issued monthly, the **AEROVOX RESEARCH WORKER** is free to servicemen, engineers, hams, and other interested radio workers. Ask your **AEROVOX** jobber how you may subscribe, or write direct.

INTERFERENCE ANALYZER
TYPE ANL-37

The Aerovox Filter Selector eliminates the guess work in determining the proper filter to use. Plugs between interfering device and outlet. Adjust selector switch until noise is eliminated or minimized. Dial then indicates type filter (IN27 thru IN42) to be used. Unit in handsome, sturdy metal cabinet. Compartment contains necessary attachment plugs and clips. Size: 5 1/2 x 5 1/2 x 8 inches.

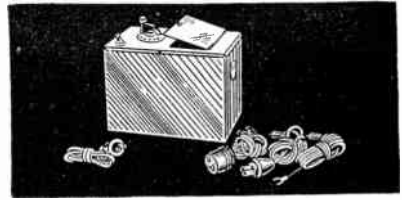

HEAVY DUTY INDUSTRIAL FILTERS

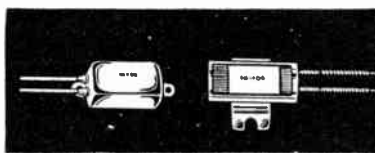
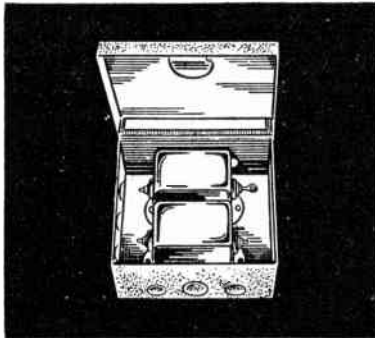

TYPE IN-105. Same as IN-104 except container is bathtub type metal can. Size: 1 3/8" x 1" x 3/4" high. **List \$1.25**

TYPE IN-106. Best filter for fluorescents. Balanced network. Especially suited for radio and television salesrooms. One unit per fixture in series where power leads enter. Metal container with four stranded wire leads. Rating: 125 v. AC or DC; 2.6 amps. Size: 1 7/8" x 3" x 1 1/8" high. **List \$3.80**

BUILT-IN FILTERS

High attenuation type, hermetically sealed units for use where severe interference is encountered and dependability is required. For permanently mounted applications. Aerovox special "Pi" type construction insures efficient radio noise reduction over low frequency broadcast, shortwave, and television bands. Suitable for Army-Navy or aircraft equipment where immersion and severe humidity tests must be met.

Aerovox Type	Maximum Voltage	Maximum Amperes	Size L x W x H	List
IN-101	125 VAC	1.5	2 7/8 x 1 1/4 x 3/4	\$ 3.75
IN-103	50 VDC	50	3 1/8 x 2 3/8 x 2 3/8	22.00
IN-110	250 VAC	5	2 x 2 x 1	7.50
IN-111	250 VAC	10	2 x 2 x 1 1/4	12.50
IN-112	250 VAC	30	3 1/8 x 2 3/8 x 2 3/8	22.00

Heavy duty, industrial-type interference filters consisting of one or more highly efficient radio noise filter elements. Enclosed in black painted steel surface cabinet for permanent installations of power equipment. One element per line. Cabinets meet Underwriters' requirements, and have standard knockouts. Rating: 250 v. AC — 25 to 60 cps. or 600 v. DC.

SINGLE-PHASE BALANCED NETWORK

Type	Max. Amps.	Elements	List
INB-104	5	1	\$12.50
INB-100	10	1	7.50
INB-101	30	1	27.50
INB-105	5	2	20.00
INB-102	10	2	30.00
INB-103	30	2	49.00

THREE-PHASE NETWORK

Type	Max. Amps.	Elements	List
INB-106	5	3	27.50
INB-107	10	3	42.50
INB-108	30	3	71.00

Other INB filters available for up to 200 amperes. Write for information.

TYPE IN-104. Small, inexpensive filter unit of low impedance, delta-connected capacitors. Connect one unit for each fluorescent light fixture or across line leads every eight feet in core lighting. Tubular with single hole mounting bracket. 6" stranded wire insulated leads. Can common for grounding. Rating: 125 v. AC or DC. Size: 1" dia. x 2 1/8". **List \$1.20**

TYPE IN-109. Balanced network filter for severe r-f noises from small appliances. Metal container and four insulated, stranded wire leads. Case common for grounding. Rating: 125 v. AC or DC; 2.5 amps. Size: 1 7/8" x 3" x 1 3/8" high. **List \$3.80**

TYPE IN-133. Hermetically sealed, metal cased unit — bracket mounted. Delta-connected capacitor combination for connecting across line. Excellent for use in areas near radio stations. 6" insulated stranded wire leads. Can common for grounding. Rating: 125 v. AC or DC. Size: 1 7/8" x 1 1/8" x 1 1/8" high. **List \$1.75**

For single wire unbalanced applications. For two wire filtering use one filter in each line. Filter case must be securely bonded to the filter appliance and ground for maximum efficiency. These filters when used on high-voltage AC should be used only on permanently grounded equipment.

AEROVOX R-F NOISE CAPACITANCE SUPPRESSORS

Type INA-116 Type INA-117 Type INA-118

These radio-noise suppression capacitors have been especially designed for use in military or commercial, aircraft and vehicular applications. Primary application is as an r-f bypass capacitor from line to ground in low voltage dc supply lines. Units are especially treated to assure extremely long, noise-free life. Operating temperature range is minus 55 degrees C to plus 95 degrees C. For full 150 volt rating the operating temperature range is minus 55 degrees C to plus 50 degrees C. Units may be used at operating voltages up to 120 vdc over a temperature range of minus 55 degrees C to plus 71 degrees C; and 60 vdc over a range of minus 55 degrees C to plus 95 degrees C.



Aerovox Type	Voltage	Max. Imped. at 150 Kc (Ohms)	Nom. Cap. Rating Mfd	Case Size	Mounting Centers	List
INA-117	150 VDC	.6	2.	1 3/8 x 1 x 3/4	2 3/8	\$ 6.00
INA-116	150 VDC	.3	4.	1 3/8 x 1 x 3/4	2 3/8	7.50
INA-118	150 VDC	.12	10.	2 x 2 x 7/8	2 3/8	10.00

**"POSTAGE-STAMP"
MOLDED-IN-BAKELITE MICA CAPACITORS**

Wide choice of designs, sizes, mountings, terminals offer the correct Aerovox unit for every application, as listed. Units built of selected mica and foil; molded bakelite casing impervious to moisture, heat, mechanical damage. Micrometer test for mica thickness maintains capacity values for long life. Capacity values indicated on units.

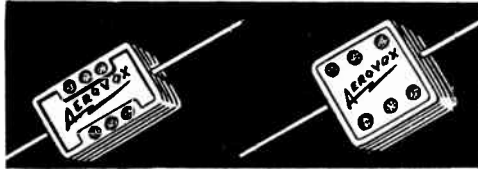

TYPE 1441W
Compact, with wire leads.

500 V.D.C.W.		1000 V.D.C.T.	
Cap. Mfd.	List	Cap. Mfd.	List
.0005	\$.25	.003	\$.50
.00075	.25	.004*	.55
.001	.30	.005*	.60
.0015	.30	.006*	.75
.002	.40	.007*	.90
.0025	.45	.008*	1.00

TYPE 1441WX
Compact, with wire leads.

300 V.D.C.W.		600 V.D.C.T.	
Cap. Mfd.	List	Cap. Mfd.	List
.004	\$.50	.008*	\$.90
.005	.55	.009*	1.00
.006	.70	.01*	1.10
.007*	.80		

Size: 1" x 5/8" x 3/8" Std. Tolerance ±20%
*Thickness 1/8"

TYPE 1467
Compact, with wire leads.

500 V.D.C.W.		1000 V.D.C.T.	
Cap. Mfd.	List	Cap. Mfd.	List
.0005	\$.25	.004	\$.55
.00075	.25	.005	.60
.001	.30	.006	.75
.0015	.30	.007*	.90
.002	.40	.008*	1.00
.0025	.45	.009*	1.10
.003	.50	.01*	1.20

TYPE 1467X
Compact, with wire leads.

300 V.D.C.W.		600 V.D.C.T.	
Cap. Mfd.	List	Cap. Mfd.	List
.007	\$.20	.013*	\$1.35
.008	.90	.014*	1.45
.01	1.10	.015*	1.55
.012*	1.25		

Std. Size: 3/4" x 3/4" x 3/8" Std. Tolerance ±20%
*Thickness 1/4"



TYPE 1468
Midget size with wire leads.

500 V.D.C.W.		1000 V.D.C.T.	
Cap. Mfd.	List	Cap. Mfd.	List
.000001	\$.25	.00025	\$.25
.000005	.25	.0003	.25
.00001	.25	.00035	.25
.000025	.25	.0004	.25
.00004	.20	.0005	.25
.00005	.20	.00075	.25
.000075	.20	.001	.30
.0001	.20		
.00015	.20		
.0002	.20		

Size: 1/4" x 3/4" x 1/8" Std. Tolerance ±20%

TYPE 1478
Midget size with wire leads.

500 V.D.C.W.		1000 V.D.C.T.	
Cap. Mfd.	List	Cap. Mfd.	List
.0005	\$.30	.0015	\$.45
.00075	.30	.002	.50
.001	.40		

Size: 1 1/8" x 7/8" x 1/8" Std. Tolerance ±20%
For Types 1441W, 1441WX, 1467, 1467X, 1468, 1478
For ±10% Tolerance add 10% to list price
For ±5% Tolerance add 25% to list price

PORCELAIN-CASED MICA CAPACITORS

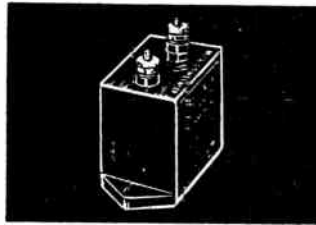

Ideal for high-frequency application. Glazed porcelain case, high temperature wax sealed. Heavy duty power terminals. Minimum power loss due to dielectric absorption. No heating at full load.

SIZE: 4" overall by 3" high; 3 1/2" between mounting holes.

TYPES 1991-1996

Cap.	DC Voltage Rating	Type	Max. Current Capacity—Amps.				List
			15 mc	7.5 mc	3750 kc	1875 kc	
.00005	12,500	1996	3	2.5	1.5	1	\$18.00
.0001	12,500	1996	5	4	3	2	18.00
.00025	12,500	1996	7	8	6	4	18.00
.0005	12,500	1996	8	9	8	7	18.00
	7,000	1994	7	8	6	4	14.85
.001	12,500	1996	9	10	11	12	18.00
	7,000	1994	8	9	10	8	16.10
.0015	3,500	1992	8	9	8	5	15.85
	12,500	1996	9	10	11	12	21.10
.002	7,000	1994	9	9	10	8	17.65
	5,000	1993	8	9	9	7	17.65
.0025	3,500	1992	8	9	8	5	15.85
	2,000	1991	7	8	8	5	15.85
.003	12,500	1996	9	12	13	15	25.00
	7,000	1994	9	9	10	10	21.10
.005	5,000	1993	8	9	9	8	18.80
	3,500	1992	8	8	9	7	18.60
.01	2,000	1991	7	8	8	6	18.60
	12,500	1996	9	12	13	15	31.00
.0015	7,000	1994	9	10	10	10	23.00
	5,000	1993	8	9	9	9	21.30
.002	3,500	1992	8	9	9	8	19.80
	2,000	1991	7	8	8	7	19.80
.003	10,000	1995	10	13	14	15	32.45
	7,000	1994	9	11	12	11	30.65
.005	5,000	1993	9	11	12	10	21.55
	3,500	1992	9	10	11	9	21.30
.01	2,000	1991	8	9	10	8	21.30
	7,000	1994	10	13	15	15	33.95
.015	5,000	1993	10	13	15	15	33.15
	3,500	1992	10	13	14	14	32.45
.02	2,000	1991	10	13	14	14	32.45
	3,500	1992	10	14	16	17	32.45
.025	2,000	1991	10	13	15	15	30.20
	3,500	1992	10	14	17	18	37.60
.05	2,000	1991	10	14	16	17	32.45
	1	2,000	1991	10	14	17	37.60

HI-VOLTAGE MOLDED-IN-BAKELITE MICA CAPACITORS

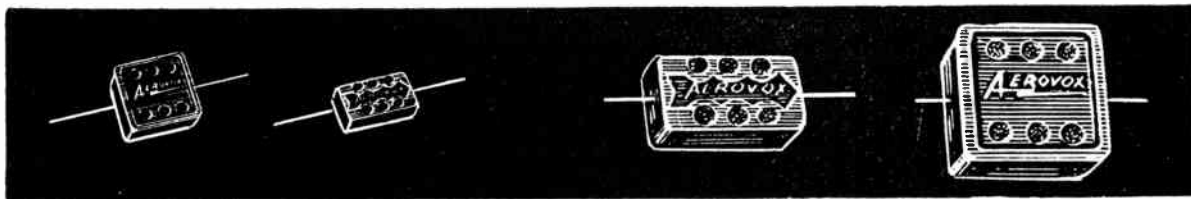

Designed especially for television, low-power transmitters, and power amplifier applications, these capacitors feature the highest voltages ever before available in these case sizes. They are furnished to meet characteristics A and B of the JAN specification. Standard tolerance is plus and minus 20% and they are tested to meet RETMA standards. Units are marked with capacity and working voltage and are tested at double the rated voltage to insure long life.

TYPE 1468LS-HV

Cap.	1000 VDCW 2000 VDCT List Price	1500 VDCW 3000 VDCT List Price	2000 VDCW 4000 VDCT List Price	2500 VDCW 5000 VDCT List Price
5	.30	.30	.35	.35
10	.30	.30	.35	.35
12	.30	.30	.35	.35
15	.30	.30	.35	.35
18	.30	.30	.35	.35
20	.30	.30	.35	.35
22	.30	.30	.35	.35
24	.30	.30	.35	.35
25	.30	.30	.35	.35
27	.30	.30	.35	.35
30	.30	.30	.35	.40
33	.30	.30	.35	.40
36	.30	.30	.35	.40
39	.30	.30	.35	.40
42	.30	.30	.35	.40
47	.30	.30	.35	.40
50	.30	.30	.40	.40
51	.30	.30	.40	.40
56	.30	.30	.40	.40
62	.30	.30	.40	.45
66	.30	.30	.40	.45
75	.30	.30	.40	.50
82	.30	.35	.40	.50
91	.35	.35	.40	.50
100	.35	.35	.40	.55
110	.35	.35	.45	.60
120	.35	.35	.45	.60
130	.35	.35	.45	.60
150	.35	.35	.45	.60
160	.35	.40	.50	.60
180	.35	.40	.50	.60
200	.40	.40	.60	.60
220	.40	.50	.60	.60
240	.40	.50	.65	.65
250	.40	.50	.65	.65
270	.40	.50	.65	.65
300	.45	.50	.65	.65
330	.45	.50	.65	.65
350	.45	.50	.65	.65
360	.45	.55	.65	.65
390	.45	.55	.65	.65
430	.50	.55	.65	.65
470	.50	.55	.65	.65
500	.50	.55	.65	.65
510	.50	.55	.65	.65
560	.55	.55	.65	.65
620	.55	.55	.65	.65

Standard Tolerance $\pm 20\%$
For $\pm 10\%$ Tolerance add 10% to List Price
For $\pm 5\%$ Tolerance add 25% to List Price
Nominal Size— $\frac{1}{2} \times \frac{1}{2} \times \frac{3}{16}$

TYPE 1467LS-HV

Cap.	List Price
150	.60
160	.60
180	.60
200	.60
220	.60
240	.60
250	.60
270	.60
300	.65
330	.65
360	.65
390	.65
430	.65
470	.65
500	.70
510	.75
560	.75
620	.75
680	.75
750	.80
820	.80
910	.85
1000	.85
1100	.90
1200	.95
1300	1.10
1500	1.15
1800	1.20
2000	1.30
2200	1.45
2400	1.50
2600	1.60
2700	1.60
2800	1.60
3000	1.70
3500	1.70
3900	1.70
4000	1.70
4200	1.70
4700	1.70
5000	1.70
5100	1.70

Standard Tolerance $\pm 20\%$
For $\pm 10\%$ Tolerance add 10% to List Price
For $\pm 5\%$ Tolerance add 25% to List Price
Nominal Size— $\frac{1}{2} \times \frac{1}{2} \times \frac{3}{16}$

Compact, precision made mica dielectric capacitors made in accordance with JAN specification C-5. These are the smallest mica capacitors listed in the JAN C-5 specification. All capacitors are molded in low-loss bakelite, impregnated and color-coded. They are tested to meet JAN requirements for dielectric strength, insulation resistance, temperature coefficient, capacitance drift, humidity and life test. ASEA approvals have been obtained and certificates of compliance can be furnished upon request.

Type 1468 and 1467 units are of the stacked mica and foil types and are made to meet the requirements of JAN characteristics A and B. Type 1469 and 1464 units are silvered-mica and are available in characteristics C, D, and E of the JAN specification.

TYPE 1468

Cap.	Characteristic A and B	List Price
5	CM20-90*	.30
10	CM20-100*	.30
12	CM20-120*	.30
15	CM20-150*	.30
18	CM20-180*	.30
20	CM20-200*	.30
22	CM20-220*	.30
24	CM20-240*	.30
27	CM20-270*	.30
30	CM20-300*	.30
33	CM20-330*	.30
36	CM20-360*	.30
39	CM20-390*	.30
43	CM20-430*	.20
47	CM20-470*	.20
50	CM20-500*	.20
51	CM20-510*	.20
56	CM20-560*	.20
62	CM20-620*	.20
66	CM20-660*	.20
75	CM20-750*	.20
82	CM20-820*	.20
91	CM20-910*	.20
100	CM20-1010*	.20
110	CM20-1111*	.20
120	CM20-121*	.20
130	CM20-131*	.25
150	CM20-151*	.25
160	CM20-161*	.25
180	CM20-181*	.25
200	CM20-201*	.25
220	CM20-221*	.25
240	CM20-241*	.30
250	CM20-251*	.30
270	CM20-271*	.30
300	CM20-30*	.30
330	CM20-331*	.30
360	CM20-361*	.30
390	CM20-391*	.30
430	CM20-431*	.30
470	CM20-471*	.30
500	CM20-501*	.30
510	CM20-511*	.30

TYPE 1467

Cap.	List Price
470	.30
510	.30
560	.30
620	.30
680	.30
750	.30
820	.30
910	.30
1000	.35
1100	.35
1200	.35
1300	.35
1500	.40
1600	.40
1800	.45
2000	.45
2200	.45
2400	.50
2500	.50
2700	.50
3000	.60
3300	.60
3600	.60
3900	.65
4300	.65
4700	.65
5000	.70
5100	.70
5600	.70
6200	.90
6800	.95
7500	1.00
8200	1.15
9100	1.15
10000	1.40

Standard Tolerances 1467 and 1468— $\pm 20\%$ (A & B Characteristics)

For $\pm 10\%$ Tolerance add 10% to List Price
For $\pm 5\%$ Tolerance add 25% to List Price
Nominal Size All CM20 Units— $\frac{1}{2} \times \frac{1}{2} \times \frac{3}{16}$
Nominal Size All CM30 Units— $\frac{1}{2} \times \frac{1}{2} \times \frac{3}{16}$
Nominal Size All CM35 Units— $\frac{1}{2} \times \frac{1}{2} \times \frac{3}{16}$
*Denotes those units as specifically listed Specification JAN-C-5 Working Voltage—500 VDCW up to and including 6200 mmf. 300 VDCW—above 6200 mmf.

TYPE 1469

Characteristic C, D and E	List Price
CM20-200*	.40
CM20-220*	.40
CM20-240*	.40
CM20-270*	.40
CM20-300*	.40
CM20-330*	.40
CM20-360*	.40
CM20-390*	.40
CM20-430*	.40
CM20-470*	.40
CM20-500*	.40
CM20-510*	.40
CM20-560*	.40
CM20-620*	.40
CM20-660*	.40
CM20-750*	.40
CM20-820*	.40
CM20-910*	.40
CM20-101*	.40
CM20-111*	.45
CM20-121*	.45
CM20-131*	.45
CM20-151*	.45
CM20-161*	.45
CM20-181*	.45
CM20-201*	.45
CM20-221*	.45
CM20-241*	.55
CM20-251*	.55
CM20-271*	.55
CM20-301*	.55
CM20-331*	.55
CM20-361*	.55
CM20-391*	.65
CM20-431*	.65
CM20-471*	.70
CM20-501*	.70
CM20-511*	.70

TYPE 1464

Characteristic C, D and E	List Price
CM30-471*	.70
CM30-511*	.70
CM30-561*	.75
CM30-621*	.80
CM30-681*	.85
CM30-751*	.90
CM30-821*	.95
CM30-911*	1.00
CM30-102*	1.10
CM30-112*	1.10
CM30-122*	1.25
CM30-132*	1.25
CM30-152*	1.35
CM30-162*	1.35
CM30-182*	1.35
CM30-202*	1.50
CM30-222*	1.50
CM30-242*	1.80
CM30-252*	1.80
CM30-272*	1.90
CM30-302*	2.05
CM30-332*	2.05
CM35-362*	2.10
CM35-392*	2.15
CM35-432*	2.15
CM35-472*	2.15
CM35-502*	2.25
CM35-512*	2.25
CM35-562*	2.50
CM35-622*	2.80
CM35-682*	3.00
CM35-752*	3.25
CM35-822*	3.50
CM35-912*	4.00
CM35-103*	4.00

Standard Tolerances 1464 and 1469— $\pm 5\%$ (C, D & E Characteristics)

For $\pm 2\%$ Tolerance add 15% to List Price
For $\pm 1\%$ Tolerance add 25% to List Price
Nominal Size All CM20 Units— $\frac{1}{2} \times \frac{1}{2} \times \frac{3}{16}$
Nominal Size All CM30 Units— $\frac{1}{2} \times \frac{1}{2} \times \frac{3}{16}$
Nominal Size All CM35 Units— $\frac{1}{2} \times \frac{1}{2} \times \frac{3}{16}$



TYPES 1650-1654

Heaviest-duty molded in bakelite mica capacitors of the AEROVOX line. Threaded mounting holes for round-head screw terminals or plain holes available. Add suffix A for plain holes. Types 1650, 1651, and 1652 are supplied in brown or low-loss bakelite. Types 1653L and 1654L in low-loss bakelite only.

TYPE 1650	
600 VDCW - 1000 VDCT	
350 VACW - 700 VACT	
Cap. Mfd.	List
.00005	\$1.45
.0001	1.45
.00025	1.45
.0003	1.45
.00035	1.45
.0004	1.45
.0005	1.45
.001	1.45
.0015	1.45
.002	1.65
.0025	1.70
.003	1.85
.004	2.00
.005	2.10
.006	2.20
.008	2.45
.01	2.80
.015	3.05
.02	3.55
.025	4.35
.03	4.55
.04*	5.85
.05*	7.10
.06*	8.05

TYPE 1651	
1200 VDCW - 2500 VDCT	
875 VACW - 1750 VACT	
Cap. Mfd.	List
.00005	\$1.60
.0001	1.60
.00025	1.60
.0003	1.60
.00035	1.60
.0004	1.60
.0005	1.60

TYPE 1651 (Con't)	
Cap. Mfd.	List
.001	\$1.90
.0015	2.25
.002	2.50
.0025	2.80
.003	2.95
.004	3.10
.005	3.30
.006	3.45
.008	4.10
.01	4.70
.015	5.80
.02	7.05
.025*	7.90
.03	8.10

TYPE 1652	
2500 VDCW - 5000 VDCT	
1750 VACW - 3500 VACT	
Cap. Mfd.	List
.00005	\$1.90
.000075	1.90
.0001	1.90
.00015	2.00
.0002	2.10
.00025	2.15
.0003	2.20
.00035	2.25
.0004	2.50
.0005	2.55
.001	2.90
.0015	3.90
.002	4.25
.0025	4.60
.003	5.10
.004	5.65
.005	6.20
.006	6.35
.008*	6.85
.01*	7.30

TYPE 1653L	
3750 VDCW - 7500 VDCT	
2625 VACW - 5250 VACT	
Cap. Mfd.	List
.00005	\$3.30
.000075	1.65
.0001	1.80
.00015	4.15
.0002	4.30
.00025	4.75
.0003	4.90
.00035	5.75
.0004	5.90
.0005	6.50
.001	7.70
.0015	10.10
.002	11.50
.0025	12.90
.003*	14.25

TYPE 1654L	
5000 VDCW - 10000 VDCT	
3500 VACW - 7000 VACT	
Cap. Mfd.	List
.00005	\$3.75
.000075	4.15
.0001	4.65
.00015	5.05
.0002	6.25
.00025	6.80
.0003	7.15
.00035	7.50
.0004	7.70
.0005	9.90
.001*	12.50

Standard Tolerance $\pm 10\%$
 For $\pm 5\%$ Tolerance add 15¢ to List Price
 For $\pm 2\%$ Tolerance add 40¢ to List Price
 Nominal Size — $1\frac{1}{8}" \times 1\frac{1}{8}" \times \frac{1}{16}"$
 *Thickness $\frac{3}{8}"$

Ceramic mounting insulators (specify "M") add 50¢ to List Price
 1650-54 Series furnished with 6-32 tapped holes for screw mounting — if plain hole desired specify "A" — no extra charge.



HIGH VOLTAGE MICAS

TYPES 1445-47

Designed with insulated mounting holes $1\frac{1}{8}"$ apart independent of soldering lugs
 Used to shunt meter windings, large or small meter-mounting brackets available.
 Specify by suffix (A) for large or (E) for small brackets.

TYPE 1445	
600 VDCW - 1000 DCT	
Cap. Mfd.	List
.00005	\$1.20
.0001	1.20
.00015	1.20
.0002	1.20
.00025	1.20
.0003	1.20
.00035	1.20
.0004	1.20
.0005	1.20
.001	1.20
.0015	1.20
.002	1.30
.0025	1.30
.003	1.45
.004	1.50
.005	1.55
.006	1.80
.008	1.90
.01	2.15
.015*	2.65
.02*	3.05
.025*	3.05
.03*	4.45
.04*	5.65

TYPE 1446	
1200 VDCW - 2500 VDCT	
Cap. Mfd.	List
.00005	\$1.60
.0001	1.60
.00015	1.60
.0002	1.60
.00025	1.60
.0003	1.60
.00035	1.60
.0004	1.60
.0005	1.60
.001	1.80
.0015	2.30
.002	2.40
.0025	2.80
.003	3.05
.004*	3.05
.005*	3.30
.006*	3.30
.008*	3.85
.01*	5.10
.015*	6.00

TYPE 1447	
2500 VDCW - 5000 VDCT	
Cap. Mfd.	List
.00005	\$1.90
.000075	1.90
.0001	1.90
.00015	1.90
.0002	1.90
.00025	2.20
.0003	2.25
.00035	2.25
.0004	2.30
.0005	2.40
.001	2.80
.0015	3.55
.002*	4.15
.0025*	4.60
.003*	4.90
.004*	5.65
.005*	6.40

Size: $1\frac{1}{8}" \times 1\frac{1}{8}" \times \frac{1}{16}"$

*Thickness $\frac{7}{8}"$

Standard Tolerance $\pm 10\%$
 For $\pm 5\%$ Tolerance add 15¢ to List For $\pm 2\%$ Tolerance add 40¢ to List

CAPACITORS **AEROVOX** RESISTORS

SILVERED MICA CAPACITORS

AEROVOX silvered mica units for most critical applications where precise capacity values are required. Encased in red low-loss bakelite. Similar in external appearance to standard bakelite molded mica units.

Available with temperature coefficient and retrace characteristics as defined by characteristics A to F inclusive of REC-115 and JAN-C-5 specifications for molded capacitors. Exceptionally high "Q." Mechanically protected against physical damage and changes in electrical characteristics due to varying atmospheric conditions. Wax impregnated externally. Ideal for circuits where inductance and capacity product must remain constant under all operating conditions.

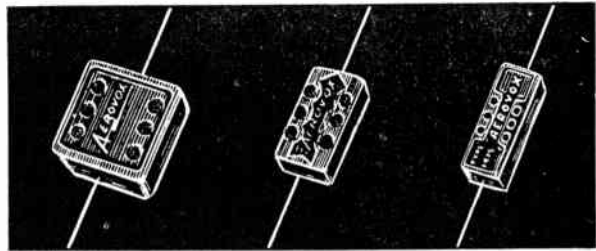

TYPE 1464 • 500 VDCW - 1000 VDCT				TYPE 1469 • 500 VDCW - 1000 VDCT				TYPE 1479 • 500 VDCW - 1000 VDCT			
Cap. Mfd.	List	Cap. Mfd.	List	Cap. Mfd.	List	Cap. Mfd.	List	Cap. Mfd.	List	Cap. Mfd.	List
.00075	\$.90	.0025	\$1.80	.000005	\$.45	.00015	\$.45	.0001	\$.40	.0005	\$.70
.0008	.95	.003	2.05	.00001	.40	.0002	.45	.00015	.45	.0007	.85
.0009	1.00	.004*	2.15	.000025	.40	.00025	.45	.0002	.45	.00075	.90
.001	1.10	.005*	2.25	.00004	.40	.0003	.55	.00025	.45	.0008	.95
.0015	1.35	.006*	2.25	.00005	.40	.00035	.60	.0003	.55	.0009	1.00
.002	1.35			.00007	.40	.0004	.65	.00035	.60	.001	1.10
TYPE 1464X • 300 VDCW - 600 VDCT				TYPE 1469 • 500 VDCW - 1000 VDCT				TYPE 1479 • 500 VDCW - 1000 VDCT			
.004	\$2.15	.007*	2.50	.000075	.40	.0005	.70	.0004	.65		
.005	2.25	.008*	2.50	.0001	.40						
.006	2.25	.01*	2.50								

Size: $\frac{3}{16}$ " x $\frac{3}{16}$ " x $\frac{3}{16}$ " provided with wire leads. Standard Tolerance $\pm 5\%$. *Thickness $\frac{1}{16}$ ".
 Size: $\frac{1}{8}$ " x $\frac{3}{16}$ " x $\frac{3}{16}$ " provided with wire leads. Maximum characteristic available F.
 For $\pm 2\%$ Tolerance add 15% to List — For $\pm 1\%$ Tolerance add 25% to List

AUTO-RADIO CAPACITORS

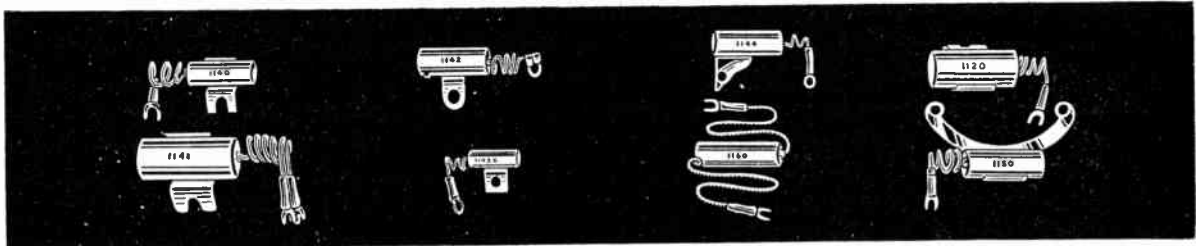

Car Generators					
Type 1120	1.0 Cap. Mfd.		\$1.75		
Type 1140	0.5 Cap. Mfd.		.90		
	Dual Element				
Type 1141	0.5-0.5 Cap. Mfd.		1.25		
Ford Auto Radios					
Type 1144	0.5 Cap. Mfd.		.90		
For 1936 Models					
Type 1150	0.5 Cap. Mfd.		.90		
Motorola Auto Radios					
Type 1466	.0008 Cap. Mfd.		\$.90		
Ammeter Condenser					
Type 1160	0.5 Cap. Mfd.		.90		
Gas Gage Filter Condenser					
Type 1143-G	0.05 Cap. Mfd.		.90		
Oil Gage Filter Condenser					
Type 1142-O	0.25 Cap. Mfd.		.90		



TYPE
VBC

VIBRATOR BUFFER CAPACITORS

Type	Cap. Mfd.	Size	List
VBC-2	.001	$\frac{7}{16}$ x $1\frac{1}{2}$	\$.50
VBC-3	.002	$\frac{7}{16}$ x $1\frac{1}{2}$.50
VBC-4	.0022	$\frac{7}{16}$ x $1\frac{1}{2}$.50
VBC-5	.003	$\frac{7}{16}$ x $1\frac{1}{2}$.50
VBC-6	.0033	$\frac{7}{16}$ x $1\frac{1}{2}$.50
VBC-7	.004	$\frac{7}{16}$ x $1\frac{1}{2}$.50
VBC-8	.0047	$\frac{7}{16}$ x $1\frac{1}{2}$.50
VBC-9	.005	$\frac{7}{16}$ x $1\frac{1}{2}$.50
VBC-22	.006	$\frac{7}{16}$ x $1\frac{1}{2}$.50
VBC-23	.006*	$\frac{7}{16}$ x $1\frac{1}{2}$.50
VBC-24	.007	$\frac{7}{16}$ x $1\frac{1}{2}$.55
VBC-25	.0075	$\frac{7}{16}$ x $1\frac{1}{2}$.55
VBC-26	.008	$\frac{7}{16}$ x $1\frac{1}{2}$.55
VBC-27	.01	$\frac{7}{16}$ x $1\frac{1}{2}$.55
VBC-28	.015	$\frac{7}{16}$ x $1\frac{1}{2}$.55
VBC-29	.02	$\frac{7}{16}$ x 2	.55
VBC-32	.025	$\frac{7}{16}$ x 2	.55
VBC-33	.03	$\frac{7}{16}$ x 2	.65
VBC-34	.05	$\frac{7}{16}$ x 2	.70
VBC-35	.015-.015	$\frac{7}{16}$ x 2	.80
VIBRATOR "HASH" CAPACITOR			
.5 Mfd.		100 Volts WVDC	VHC36 .50

AEROVOX RESEARCH WORKER

A snappy, informative, practical engineering paper, issued monthly, the **AEROVOX RESEARCH WORKER** is free to servicemen, engineers, hams, and other interested radio workers. Ask your **AEROVOX** jobber how you may subscribe, or write direct.

HI-Q DISK CERAMIC CAPACITORS

Hi-Q ceramic disk capacitors are available in a range of capacities from 10 mmf to 30,000 used for by-passing, blocking and coupling applications. They are sturdily constructed, precision tested, and moisture-proofed against high humidities. In many instances these Hi-Q disk capacitors offer advantages over the regular capacitors through their space saving features. Multiple capacities can be fabricated on single disks affording additional savings of space and installation costs. The silver electrodes are fired directly to the ceramic dielectric to assure low noise operation. They are coated with a non-hydroscopic phenolic and are impregnated with a micro-crystalline wax which protects the units from humidity and affords a sturdy construction.



**Bypass
and
Coupling**

Stock Items

BPD-GMV CAPACITOR 600 VDCW

Singles

Type	Cap.	Diam.	List Price
BPD	.00001	5/16	\$.25
BPD	.000015	5/16	.25
BPD	.000022	5/16	.25
BPD	.000025	5/16	.25
BPD	.000033	5/16	.25
BPD	.000047	5/16	.25
BPD	.00005	5/16	.25
BPD	.000068	5/16	.25
BPD	.0001	5/16	.25
BPD	.00012	5/16	.25
BPD	.00015	5/16	.25
BPD	.0002	5/16	.25
BPD	.00027	5/16	.25
BPD	.00033	5/16	.25
BPD	.00047	5/16	.25
BPD	.0005	5/16	.25
BPD	.00068	5/16	.25
BPD	.0008	5/16	.25
BPD	.001	5/16	.25
BPD	.0015	5/16	.25
BPD	.002	3/8	.25
BPD	.0022	3/8	.25
BPD	.0025*	7/16	.25
BPD	.0033	7/16	.25
BPD	.004	19/32	.25
BPD	.0047	19/32	.25
BPD	.005	19/32	.25
BPD	.0068*	11/16	.25
BPD	.01	3/4	.30
BPD	.015*	29/32	.40
BPD	.02*	29/32	.60
BPD	.03*	29/32	.65#

Duals and Triples

3PD2	2 x .001	19/32	.40
3PD2	2 x .0015	19/32	.40
3PD2	2 x .002	19/32	.40
3PD2	2 x .0022	19/32	.40
3PD2	2 x .003	3/4	.45
3PD2	2 x .004	3/4	.45
3PD2	2 x .0047	3/4	.45
3PD2	2 x .01*	3/4	.50
3PD2	2 x .02*	29/32	.70
3PD3	3 x .0015	3/4	.50
3PD3	3 x .002	3/4	.50

General Purpose

Hi-Q by-pass disks are fixed ceramic dielectric capacitors specifically suited for by-pass or coupling applications or for frequency discriminating circuits where Q and capacity stability are not of major importance. These disks are available in the capacities listed below, 10 mmf to 30,000 in tolerances as specified. The smallest possible standard disk has been used for each value of capacity.

Stock Items 600 VDCW

Type	Cap.	Diam.	List Price
DI-1	5*	5/16	\$.25
DI-1	10*	5/16	.25
DI-1	12*	5/16	.25
DI-1	15*	5/16	.25
DI-1	18*	5/16	.25
DI-1	20*	5/16	.25
DI-1	22*	5/16	.25
DI-1	25*	5/16	.25
DI-1	27*	5/16	.25
DI-1	30*	5/16	.25
DI-1	33*	5/16	.25
DI-1	39*	5/16	.25
DI-1	47*	5/16	.25
DI-1	59*	5/16	.25
DI-1	56*	5/16	.25
DI-2	68*	3/8	.25
DI-2	82*	3/8	.25
DI-2	100*	3/8	.25
DI-2	120*	3/8	.25
DI-2	150*	3/8	.25
DI-2	180*	3/8	.25
DI-2	200*	3/8	.25
DI-2	220*	3/8	.25
DI-2	250*	3/8	.25
DI-2	270*	3/8	.25
DI-2	300*	3/8	.25
DI-2	330*	3/8	.25
DI-2	390*	3/8	.25
DI-2	470*	3/8	.25
DI-2	500*	3/8	.25
DI-2	560*	3/8	.25
DI-2	680*	3/8	.25
DI-2	750*	3/8	.25
DI-4	1000*	19/32	.25
DI-4	1200*	19/32	.25
DI-4	1500*	19/32	.25
DI-4	1800*	19/32	.25
DI-4	2000*	19/32	.25
DI-4	2200*	19/32	.25
DI-5	2500*	11/16	.25
DI-5	2700*	11/16	.25
DI-5	3000*	11/16	.25
DI-5	3300*	11/16	.25
DI-7	4700*	29/32	.25
DI-7	5000*	29/32	.25
DI-7	5600*	29/32	.30
DI-5	#6800*	11/16	.30
DI-5	#7500*	11/16	.30
DI-6	#10000*	3/4	.30

*New.
#Tolerance +80% -20%.
Standard Tolerance ±20%.

TUBULAR and DISK CAPACITORS

PHYSICAL SIZES

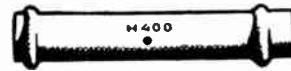

SI TUBULAR

Desig.	Size	Desig.	Size
SI-1	.284 x .437	SI-7	.275 x .875
SI-2	.234 x .687	SI-13	.234 x .468
SI-3	.312 x 1.250	SI-19	.312 x .937
SI-4	.375 x 1.098	SI-22	.280 x .750
SI-5	.375 x 1.600	SI-27	.275 x .500
SI-6	.375 x 1.968		



CI TUBULAR

Desig.	Size
CI-1	.250 x .562
CI-2	.250 x .812
CI-3	.340 x 1.320



DI DISK

Desig.	Size	Desig.	Diam
DI-1	.250 x .562	DI-1	5/16
DI-2	.250 x .812	DI-2	3/8
DI-3	.340 x 1.320	DI-3	7/16
DI-4		DI-4	19/32
DI-5		DI-5	11/16
DI-6		DI-6	3/4
DI-7		DI-7	29/32

VIBRATOR BUFFER CAPACITORS-GMV

Vibrator Buffer Capacitors — ceramic disks for use as buffers in car radios and similar equipment, compact, easily assembled, 1/4 the size of previous paper tubular types rated for 1600 VDCW GMV.



Stock Items — 1600 VDCW

Type	Cap.	Diam.	List Price
BCD-2	.001*	11/16	\$0.50
BCD-3	.002*	11/16	.50
BCD-4	.0022*	11/16	.50
BCD-5	.003*	11/16	.50
BCD-6	.0033*	11/16	.50
BCD-7	.004*	15/16	.50
BCD-8	.0047*	15/16	.50
BCD-9	.005*	15/16	.50
BCD-22	.006*	15/16	.50
BCD-23	.0068*	1	.50
BCD-24	.007*	1	.50
BCD-25	.0075*	1	.50
BCD-26	.008*	1	.50
BCD-27	.01*	1	.50

— New

HI-VOLTAGE DISK CAPACITORS

General Purpose



Hi-Q high voltage disk capacitors are available in many capacities and voltage ratings. These types offer many possible uses in TV circuits where voltages above 500 are necessary. They are the ideal units for dependable day-after-day service. Hi-Q has available numerous combinations of capacity, working voltages and physical sizes. These low cost units are manufactured to specific tolerances as listed.

Stock Items—1500 VDCW

Type	Cap.	Diam.	List Price	Type	Cap.	Diam.	List Price
HVD-15	4.7*	7/16	\$0.30	HVD-15	150*	7/16	\$0.35
HVD-15	6.8*	7/16	.30	HVD-15	180*	7/16	.35
HVD-15	10*	7/16	.30	HVD-15	220*	7/16	.40
HVD-15	15*	7/16	.30	HVD-15	270*	7/16	.40
HVD-15	22*	7/16	.30	HVD-15	330*	7/16	.40
HVD-15	33*	7/16	.30	HVD-15	390*	9/16	.45
HVD-15	47*	7/16	.30	HVD-15	470*	9/16	.45
HVD-15	68*	7/16	.30	HVD-15	680*	9/16	.55
HVD-15	100*	7/16	.35	HVD-15	1000*	9/16	.55

Type	Cap.	Diam.	List Price	Type	Cap.	Diam.	List Price
HVD-15	1500*	11/16	\$0.65	HVD-15	4700*	15/16	\$1.40
HVD-15	2200*	11/16	.85	HVD-15	5600*	15/16	1.60
HVD-15	3300*	11/16	1.05				

3000 VDCW

Type	Cap.	Diam.	List Price	Type	Cap.	Diam.	List Price
HVD-30	4.7*	9/16	\$0.50	HVD-30	180*	9/16	\$0.55
HVD-30	6.8*	9/16	.50	HVD-30	220*	9/16	.60
HVD-30	10*	9/16	.50	HVD-30	330*	9/16	.60
HVD-30	15*	9/16	.50	HVD-30	470*	9/16	.65
HVD-30	22*	9/16	.50	HVD-30	680*	9/16	.75
HVD-30	33*	9/16	.50	HVD-30	1000*	9/16	.75
HVD-30	47*	9/16	.50	HVD-30	1500*	9/16	.85
HVD-30	68*	9/16	.50	HVD-30	2200*	9/16	1.05
HVD-30	100*	9/16	.55	HVD-30	3300*	11/16	1.25
HVD-30	150*	9/16	.55				

6000 VDCW

Type	Cap.	Diam.	List Price	Type	Cap.	Diam.	List Price
HVD-60	4.7*	11/16	\$1.00	HVD-60	33*	11/16	\$1.00
HVD-60	6.8*	11/16	1.00	HVD-60	47*	11/16	1.00
HVD-60	10*	11/16	1.00	HVD-60	68*	11/16	1.00
HVD-60	15*	11/16	1.00	HVD-60	100*	11/16	1.00
HVD-60	18*	11/16	1.00	HVD-60	150*	11/16	1.00
HVD-60	22*	11/16	1.00	HVD-60	220*	11/16	1.00
HVD-60	30*	11/16	1.00	HVD-60	330*	11/16	1.00
HVD-60	80*	11/16	1.00	HVD-60	470*	11/16	1.00

*New. Tolerance — ±20% up to 1000, +80% -20% over 1000.

HI-Q TUBULAR CERAMIC CAPACITORS

Hi-Q general purpose tubular ceramic capacitors may be used for coupling, bypassing and filtering where frequency control is not critical (not to be confused with the Hi-Q line of close tolerance temperature compensating units). Available in two types (SI and CI) small in size, rugged construction and available in a wide range of capacity values.

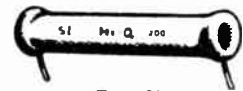

Type SI

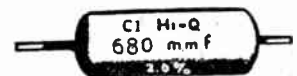

Stock Items—500 VDCW

Cap.	Size	List Price	Cap.	Size	List Price	Cap.	Size	List Price	Cap.	Size	List Price
5	SI-1	\$.25	5	CI-1	\$.25	330	SI-1	\$.25	20,000	SI-5 GMV	\$.30
10	SI-1	.25	10	CI-1	.25	360	SI-1	.25	25,000	SI-5 GMV	.50
12	SI-1	.25	12	CI-1	.25	390	SI-1	.25	30,000	SI-6 GMV	.50
15	SI-1	.25	15	CI-1	.25	470	SI-1	.25	33,000	SI-6 GMV	.50
18	SI-1	.25	18	CI-1	.25	500	SI-1	.25	330	CI-1	.25
20	SI-1	.25	20	CI-1	.25	510	SI-1	.25	360	CI-1	.25
22	SI-1	.25	22	CI-1	.25	560	SI-1	.25	390	CI-1	.25
24	SI-1	.25	24	CI-1	.25	680	SI-1	.25	470	CI-1	.25
25	SI-1	.25	25	CI-1	.25	750	SI-1	.25	500	CI-1	.25
27	SI-1	.25	27	CI-1	.25	*820	SI-1	.25	510	CI-1	.25
30	SI-1	.25	30	CI-1	.25	*910	SI-1	.25	560	CI-1	.25
33	SI-1	.25	33	CI-1	.25	1000	SI-1	.25	680	CI-1	.25
39	SI-1	.25	39	CI-1	.25	1200	SI-2	.25	750	CI-1	.25
47	SI-1	.25	47	CI-1	.25	1500	SI-2	.25	*820	CI-2	.25
50	SI-1	.25	50	CI-1	.25	1800	SI-2	.25	*910	CI-2	.25
51	SI-1	.25	51	CI-1	.25	2000	SI-2	.25	1000	CI-2	.25
56	SI-1	.25	56	CI-1	.25	2200	SI-7	.25	1200	CI-2	.25
68	SI-1	.25	68	CI-1	.25	2400	SI-7	.25	1500	CI-2	.25
75	SI-1	.25	75	CI-1	.25	2600	SI-7	.25	1800	CI-2	.25
82	SI-1	.25	82	CI-1	.25	2700	SI-7	.25	2000	CI-2	.25
*91	SI-1	.25	*91	CI-1	.25	3000	SI-19	.25	2200	CI-3	.25
100	SI-1	.25	100	CI-1	.25	3300	SI-19	.25	2400	CI-3	.25
110	SI-1	.25	110	CI-1	.25	4000	SI-19	.25	2500	CI-3	.25
120	SI-1	.25	120	CI-1	.25	4700	SI-3	.25	2700	CI-3	.25
150	SI-1	.25	150	CI-1	.25	5000	SI-3	.25	3000	CI-3	.25
180	SI-1	.25	180	CI-1	.25	5100	SI-3	.25	3300	CI-3	.25
200	SI-1	.25	200	CI-1	.25	*5600	SI-3	.25	4000	CI-3	.25
220	SI-1	.25	220	CI-1	.25	6000	SI-3	.25	4700	CI-3	.25
240	SI-1	.25	240	CI-1	.25	6800	SI-4	.25	5000	CI-3	.25
250	SI-1	.25	250	CI-1	.25	7500	SI-4	.25	5100	CI-3	.25
270	SI-1	.25	270	CI-1	.25	10,000	SI-5	.25	*5600	CI-3	.25
300	SI-1	.25	300	CI-1	.25	15,000	SI-6	.30	6000	CI-3	.25
						17,500	SI-6	.30			

*New Tolerance: ±20%

CAPACITORS **AEROVOX** RESISTORS

HI-Q TEMPERATURE COMPENSATING DISK CAPACITORS

The temperature coefficient of ceramic capacitors is an inherent characteristic of the ceramic body. By controlling this coefficient, the use of ceramics has been extended to countless applications in the electronic and communications fields. Temperature coefficient is determined by the ceramic mix and therefore certain tolerances are standardized. Following is a list of standard recommended tolerances used in this listing:

Temp. Coef.	Tolerance—PPM	Temp. Coef.	Tolerance—PPM
NPO	±30	N330	±500
N080	±30	N750	±100



The tolerances shown are maximum deviation. The actual average temperature coefficient usually runs close to nominal. Aerovox Hi-Q is the first to offer temperature compensating capacitors in both disk and tubular styles as stock items.

Hi-Q temperature compensating disks are specifically suited for resonant circuit applications or any other applications where high Q and stability of capacity are essential. They meet all specifications of RTMA Class 1 fixed ceramic dielectric capacitors. These disks are unusually suitable for limited space applications. These capacitors are available from stock in the capacity ranges and tolerances listed below.

Stock Items—500 VDCW

Type	Cap.	Diam.	List Price	Type	Cap.	Diam.	List Price	Type	Cap.	Diam.	List Price	Type	Cap.	Diam.	List Price
NPO-DI	3.0*	5/16	\$.50	NPO-DI	25*	7/16	\$.50	N750-DI	10*	5/16	\$.50	N750-DI	75*	7/16	\$.50
NPO-DI	3.3*	5/16	.50	NPO-DI	33*	19/32	.50	N750-DI	15*	5/16	.50	N750-DI	100*	19/32	.50
NPO-DI	4.7*	5/16	.50	NPO-DI	39*	19/32	.55	N750-DI	20*	5/16	.50	N750-DI	150*	19/32	.50
NPO-DI	5.0*	5/16	.50	NPO-DI	47*	19/32	.55	N750-DI	22*	5/16	.50	N750-DI	200*	11/16	.50
NPO-DI	6.8*	5/16	.50	NPO-DI	50*	19/32	.55	N750-DI	25*	5/16	.50	N750-DI	220*	11/16	.50
NPO-DI	8.2*	5/16	.50	NPO-DI	68*	11/16	.55	N750-DI	33*	5/16	.50	N750-DI	380*	29/32	.50
NPO-DI	10*	5/16	.50	NPO-DI	75*	11/16	.55	N750-DI	47*	3/8	.50	N750-DI	360*	29/32	.50
NPO-DI	15*	3/8	.50	NPO-DI	100*	3/4	.55	N750-DI	68*	7/16	.50	N750-DI	390*	29/32	.50
NPO-DI	20*	3/8	.50	NPO-DI	120*	29/32	.60					N750-DI	480*	29/32	.50
NPO-DI	22*	7/16	.50	NPO-DI	150*	29/32	.60								

*New Standard Tolerance: up to 10 mmf. ±5 mmf. above 10 mmf. ±10%

HI-Q TEMPERATURE COMPENSATING TUBULAR CAPACITORS



These tubular capacitors are precision designed for frequency determining applications where little or no capacity change with temperature is desired. Available in nominal capacities and tolerances which cover a complete range of applications.

Stock Items—500 VDCW

Type	Cap.	Size	List Price	Type	Cap.	Size	List Price
NPO-SI	1.0*	SI-1	\$.50	NPO-SI	39*	SI-2	\$.50
NPO-SI	1.5*	SI-1	.50	NPO-SI	47*	SI-2	.50
NPO-SI	2.2*	SI-1	.50	NPO-SI	50	SI-2	.50
NPO-SI	3.0	SI-1	.50	NPO-SI	56*	SI-7	.50
NPO-SI	3.3	SI-1	.50	NPO-SI	68*	SI-7	.50
NPO-SI	4.7	SI-1	.50	NPO-SI	75	SI-7	.50
NPO-SI	5.0	SI-1	.50	NPO-SI	100	SI-7	.50
NPO-SI	6.8	SI-1	.50	NPO-SI	120*	SI-19	.50
NPO-SI	8.2	SI-1	.50	NPO-SI	150	SI-3	.50
NPO-SI	10	SI-1	.50	NPO-SI	175	SI-4	.50
NPO-SI	15*	SI-1	.50	NPO-SI	180*	SI-4	.50
NPO-SI	20	SI-1	.50	NPO-SI	220*	SI-6	.50
NPO-SI	22*	SI-1	.50	NPO-SI	270*	SI-6	.50
NPO-SI	25	SI-13	.50				
NPO-SI	33	SI-13	.50				

*New Standard Tolerance: up to 10 mmf. ±5 mmf. above 10 mmf. ±10%

The zero temperature coefficient capacitor is the most stable ceramic commercial capacitor available.

When ordering the above units, designate type and MMFD fully. For example: NPO-SI-1-1.5 MMFD.

Stock Items—N750-500 VDCW

Type	Cap.	Size	List Price	Type	Cap.	Size	List Price
N750-SI	5	SI-1	\$.50	N750-SI	220*	SI-7	\$.50
N750-SI	10	SI-1	.50	N750-SI	270*	SI-7	.50
N750-SI	15*	SI-1	.50	N750-SI	330*	SI-3	.50
N750-SI	20*	SI-1	.50	N750-SI	360*	SI-3	.50
N750-SI	22*	SI-1	.50	N750-SI	390*	SI-3	.50
N750-SI	25*	SI-1	.50	N750-SI	480*	SI-4	.50
N750-SI	33*	SI-1	.50	N750-SI	470*	SI-4	.50
N750-SI	39*	SI-1	.50	N750-SI	510*	SI-4	.50
N750-SI	47	SI-1	.50	N750-SI	560*	SI-5	.50
N750-SI	56*	SI-1	.50	N750-SI	620*	SI-5	.50
N750-SI	68*	SI-1	.50	N750-SI	680*	SI-5	.50
N750-SI	75*	SI-13	.50	N750-SI	750*	SI-5	.50
N750-SI	100*	SI-2	.50				
N750-SI	120*	SI-7	.50				
N750-SI	150*	SI-7	.50				
N750-SI	200*	SI-7	.50				

*New

Standard Tolerance: up to 10 mmf. ±5 mmf. above 10 mmf. ±10%

Stock Items—500 VDCW

N080			Type	Cap.	Size	List Price
Type	Cap.	Size				
N080-SI	10	SI-1				\$.60
N080-SI	22	SI-1				.60
N080-SI	33	SI-13				.60
N080-SI	47	SI-27				.60
N080-SI	62	SI-27				.60

N330 ± 500 ppm

Type	Cap.	Type	Size	List Price
N330-SI	47 ±10%	1500 VDCW	SI-2	\$.50
N330-SI	56 ±10%	1500 VDCW	SI-2	.50

N330 — Deflection Yoke Capacitor for silvered mica capacitor replacement.

SI-TV HI-VOLTAGE CERAMIC CAPACITORS

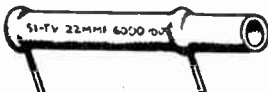

A recent addition to the already complete line of Aerovox Hi-Q Ceramic capacitors. Especially adapted to television applications this capacitor is available in two sizes. For capacities from 4.7 - mmf. to 22. mmf. the size is .280 x .750. For 24. mmf. to 60. mmf. the case size is .312 x 1.250. All units referred to here are 6000 Volts DCW.

Stock Items—6000 VDCW

Cap.	Size	List Price	Cap.	Size	List Price
4.7	SI-22	\$1.00	24	SI-3	\$1.00
8.2	SI-22	1.00	27	SI-3	1.00
12	SI-22	1.00	30	SI-3	1.00
15	SI-22	1.00	40*	SI-3	1.00
18	SI-22	1.00	47	SI-3	1.00
20	SI-22	1.00	50*	SI-3	1.00
22	SI-22	1.00	60*	SI-3	1.00

*New Tolerance: ±20%

HI-Q TUBULAR FEED-THRU CAPACITORS

Hi-Q Feed-Thru Capacitors provide means to transmit thru shields or ground potentials and simultaneously by-pass unwanted frequencies. A good mechanical connection is provided by the silver-plated bushing. These are excellent dependable units even under severe mechanical vibrations as in aircraft, missiles and automotive requirements. All units are flash tested at 1250 volts D.C.

Hi-Q Eyelet Feed-Thru Ceramic Capacitors provide the ultimate in miniaturization. They can be soldered directly to the chassis and provide excellent by-pass performance where space is critical. Especially recommended for use in UHF.



Eyelet Feed-Thru Type EF



Feed-Thru Type CFC



Feed-Thru Type CF

Stock Items — Feed-Thru 500 VDCW

Type	Cap.	Thread	List Price
CFC-1	500 mmf.*	12-28	\$1.00
	1000 mmf.*	12-28	1.00
	1500 mmf.*	12-28	1.00
CF-1	1500 mmf.	1/4 - 28	1.00
	1800 mmf.*	5/16 - 24	1.00
CF-2	2300 mmf.*	5/16 - 24	1.00
	3000 mmf.	5/16 - 24	1.00
	4000 mmf.	5/16 - 24	1.00
CF-4	7000 mmf.	5/16 - 24	1.00

Stock Items — Feed-Thru Eyelet Type - Miniature 500 VDCW

Cap.	Size	Type	Tol.	List Price
50*	CN-1**	EF	±10%	\$.50
100*	CN-1**	EF	±10%	.50
500*	CN-1**	EF	±20%	.50
1000*	CN-1**	EF	GMV	.50

*New
**Center conductor
Tolerance ±20%

HI-Q TUBULAR STAND-OFF CAPACITORS

Hi-Q stand-off capacitors are basically tubular, having as an integral part of their construction, a screw fixture for mounting to the chassis or common ground. Close coupling and their unique construction make them an excellent choice for by-passing high frequencies.

All units are coated with a high temperature enamel, stamped for capacity and supplied with mounting nut, if desired.

The MCS is a quick mounting type which permits high speed mechanical installation. The ceramic tube is enclosed in a cadmium-plated metal case with a specially developed end seal for protection against humidity and temperature changes.

All units are flash tested at 1250 volts D.C. The power factor is under 3% and the installation resistance is above 7500 megohms.

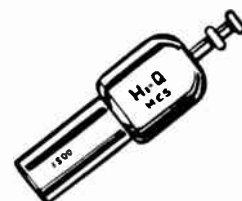

Type MCS



Type CS

Stock Items — 500 VDCW

Type	Capacity	List Price	Type	Capacity	List Price
CS-1A	50	\$.60	CS-2	3000	\$.60
CS-1A	100	.60	CS-3	4000	.60
CS-1A	500	.60	CS-4	7500	.60
CS-1B	1000	.60	CIS-1	50	.60
CS-1B	1500	.60	CIS-1	100	.60
*New			CIS-1	500	.60
Radial leads only			CIS-1	1000	.60
Tolerance: ±10% up to and including 500 mmf.			CIS-2	1500	.60
±20% above 500 mmf.			MCS	1500*	.70

HI-Q HIGH VOLTAGE "CARTWHEEL" CAPACITORS

Hi-Q high voltage "cartwheels" are thoroughly tested units capable of assuring dependable service while withstanding high voltages. This new universal type (UV) offers interchangeable terminals in 5 styles for use in filter and by-pass applications in TV high voltage power supplies.

TERMINAL HARDWARE

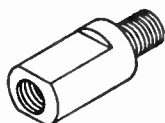

UV-3A



UV-4A



UV-2A



UV-6A



UV-1A

Stock Items — 500 MMF

Type	Volt.	Cap.	List Price
UV-501	10,000 VDCW	500 mmf.	\$1.40
UV-502	20,000 VDCW	500 mmf.	1.85
UV-503	30,000 VDCW	500 mmf.	4.50

Stock Items — Terminal Hardware

Type	List Price	Type	List Price
UV-1A	\$.10	UV-4A	\$.10
UV-2A	.10	UV-6A	.10
UV-3A	.10		

Hardware for Types UV-501 - 3 is included. Above prices are for EXTRA hardware.

PLANET MANUFACTURING CORPORATION

BLOOMFIELD, NEW JERSEY

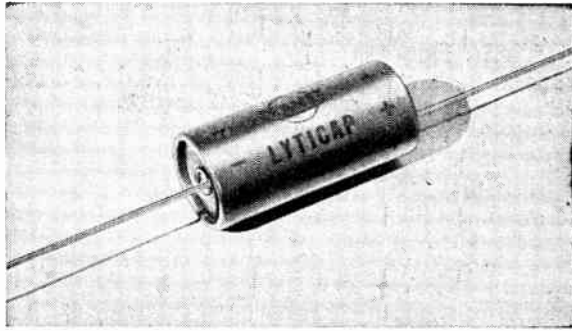

Universal Replacement Type Electrolytics

"LYTICAP" DRY ELECTROLYTICS

Hermetically sealed in aluminum tubes, covered with red kraftboard insulating jackets — tinned copper leads — dual capacitors (Type IL) have common negative, center mounting strap and insulated leads.

CAT. NO.	MFD.	SIZE*	LIST PRICE	DEALER NET
525 WVDC				
L- 8-525	8	7/8x2 1/8	\$1.30	\$.78
L-16-525	16	1x2 3/8	2.00	1.20
450 WVDC				
L- 4-450	4	5/8x1 5/8	1.15	.69
L- 8-450	8	3/4x1 5/8	1.25	.75
L-10-450	10	3/4x1 5/8	1.30	.78
L-12-450	12	7/8x1 5/8	1.35	.81
L-16-450	16	7/8x2 1/8	1.40	.84
L-20-450	20	1x2 1/8	1.55	.93
L-30-450	30	1x2 3/8	1.70	1.02
L-40-450	40	1x2 1/2	1.80	1.08
L-80-450	80	1 3/8x2 1/2	2.80	1.68
IL-2 x 8-450	8 + 8	7/8x2 1/8	1.70	1.02
IL-2x20-450	20+20	1x2 1/2	2.50	1.50
IL-2x30-450	30+30	1 1/4x2 1/2	3.00	1.80
IL-2x40-450	40+40	1 3/8x2 1/2	3.40	2.04
350 WVDC				
L- 8-350	8	3/4x1 5/8	1.20	.72
L-20-350	20	7/8x1 5/8	1.45	.87
L-40-350	40	1x2 1/8	1.75	1.05
250 WVDC				
L-10-250	10	5/8x1 5/8	1.15	.69
L-24-250	24	3/4x1 5/8	1.35	.81
150 WVDC				
L- 5-150	5	5/8x1 1/8	1.00	.60
L- 8-150	8	1/2x1 5/8	1.05	.63
L-10-150	10	1/2x1 5/8	1.05	.63
L-16-150	16	5/8x1 5/8	1.15	.69
L-20-150	20	5/8x1 5/8	1.20	.72

CAT. NO.	MFD.	SIZE*	LIST PRICE	DEALER NET
150 WVDC (Continued)				
L- 30-150	30	3/4x1 5/8	\$1.30	\$.78
L- 40-150	40	3/4x1 5/8	1.35	.81
L- 50-150	50	3/4x2 1/8	1.40	.84
L- 80-150	80	7/8x2 1/8	1.60	.96
L-150-150	150	1x2 1/8	2.10	1.26
IL-2x20-150	20+20	3/4x1 5/8	1.65	.99
IL-2x30-150	30+30	7/8x1 5/8	1.80	1.08
IL-4020-150	40+20	7/8x1 5/8	1.75	1.05
IL-2x40-150	40+40	7/8x2 1/8	1.85	1.11
IL-5030-150	50+30	7/8x2 1/8	1.95	1.17
IL-2x50-150	50+50	1x2 1/8	2.10	1.26
IL-8040-150	80+40	1x2 3/8	2.25	1.35
50 WVDC				
L- 5-50	5	5/8x1 1/8	1.00	.60
L-10-50	10	1/2x1 5/8	1.00	.60
L-25-50	25	1/2x1 5/8	1.05	.63
L-50-50	50	5/8x1 5/8	1.20	.72
L-100-50	100	3/4x1 5/8	1.40	.84
25 WVDC				
L-10-25	10	1/2x1 5/8	1.00	.60
L-25-25	25	1/2x1 5/8	1.00	.60
L-100-25	100	5/8x1 5/8	1.35	.81
L-250-25	250	7/8x2 1/8	1.70	1.02
L-500-25	500	1x2 3/8	2.30	1.38
6 WVDC				
L-1000-6	1000	7/8x2 1/8	1.90	1.14
L-2000-6	2000	1x2 3/8	2.40	1.44
3 WVDC				
L-1000-3	1000	7/8x2 1/8	1.80	1.08
L-1500-3	1500	7/8x2 1/8	2.40	1.44

*—Dimensions are for metal tubes. Add 1/16" to diameter and 1/8" to length for over-all dimensions over cardboard insulating tube.

Universal Replacement Type Electrolytics

"CT" DRY ELECTROLYTICS

Constructed in strong cardboard tubes, impregnated under pressure — long insulated leads of UL approved wire out both ends — mounting strap.

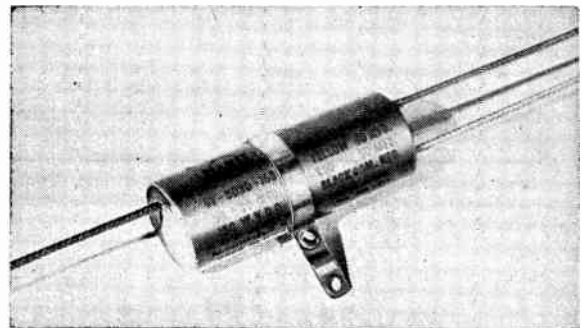

CAT NO.	MFD.	WVDC	SIZE	LIST PRICE	DEALER NET
DUAL UNITS — COMMON NEGATIVE					
CT-2x20-150	20+20	150	3/4x2 1/2	\$1.65	\$.99
CT-2x30-150	30+30	150	7/8x2 1/2	1.80	1.08
CT-4020-150	40+20	150	7/8x2 1/2	1.75	1.05
CT-2x40-150	40+40	150	1x2 1/2	1.85	1.11
CT-5030-150	50+30	150	1x2 1/2	1.95	1.17
CT-2x50-150	50+50	150	1x3	2.10	1.26

CAT NO.	MFD.	WVDC	SIZE	LIST PRICE	DEALER NET
DUAL UNITS — SEPARATE SECTIONS					
CT-2x20-150-SS	20+20	150	1x2 3/8	\$2.05	\$1.23
TRIPLE UNITS — COMMON NEGATIVE					
CT-403020-150	40+30+20	150	1x3	2.35	1.41
CT-302	30+20/ 20	150/25	1x2 1/2	2.10	1.26
CT-303	40+30/ 20	150/25	1x3	2.20	1.32
CT-304	50+50/ 20	150/25	1x3 1/4	2.50	1.50
CT-305	50+30/ 20	150/25	1x3	2.35	1.41

Copyright by U. C. P., Inc.

Net

Radio's Master — 19th Edition

All Prices Subject to Change Without Notice



PLASTICON DC RECTANGULARS

Mineral oil impregnated and filled. Hermetically sealed. Can be operated in any position, continuously at 10% over rated voltage up to +40° C. Tolerance 10%. Ambient temperature range -40° C. to +85° C. Insulators: Two ceramic type bushings for standard temperature range. Two soldered-in metallized glass insulators for extended temperature range. All DC rectangulars have 8-32 screw and hex nut terminals with removable hot-tinned solder lugs. Case: Rectangular base, lead coated steel with heavy finish of grey organic lacquer.

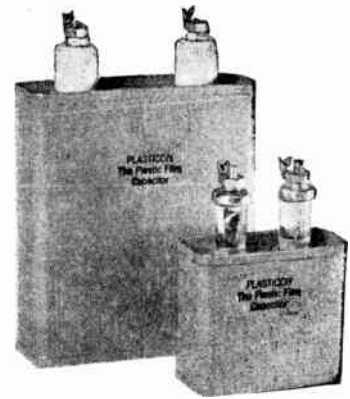

Mfr's. No.	Cap. Mfd.	Volts DC	Dimensions - Inches			Term. Height	Dist. Bet. Ter.	List
			Height	Width	Depth			
AOC6C1	1.0	600	2 1/8	1 3/8	1	1 1/8	1 1/8	\$ 4.49
AOC6C2	2.0	600	2 3/8	1 3/8	1	1 1/8	1 1/8	5.41
AOC6C4	4.0	600	3 1/2	2 1/2	1 1/8	1 1/8	1 1/8	6.73
AOC6C8	8.0	600	4	3 3/8	1 1/8	1 1/8	1 1/8	10.16
AOC6C10	10.0	600	4	3 3/8	1 1/8	1 1/8	1 1/8	11.42
AOC1M1	1.0	1000	2 3/8	1 3/8	1	1 1/8	1 1/8	4.82
AOC1M2	2.0	1000	3	2 1/2	1 1/8	1 1/8	1 1/8	6.47
AOC1M4	4.0	1000	4 5/8	2 1/2	1 1/8	1 1/8	1 1/8	7.85
AOC1M8	8.0	1000	4 5/8	3 3/8	1 1/8	1 1/8	1 1/8	11.09
AOC1M10	10.0	1000	4 5/8	3 3/8	2 1/8	1 1/8	1 1/8	12.80
AOC2M05	0.5	2000	2 3/8	1 3/8	1	1 1/8	1 1/8	5.81
AOC2M1	1.0	2000	4 1/2	1 3/8	1	1 1/8	1 1/8	7.06
AOC2M2	2.0	2000	3 1/2	3 3/8	1 1/8	1 1/8	1 1/8	8.18
AOC2M4	4.0	2000	3 1/2	3 3/8	2 1/8	1 1/8	1 1/8	11.09
AOC3M1	1.0	3000	4	2 1/2	1 1/8	1 1/8	1 1/8	14.52
AOC3M2	2.0	3000	4 5/8	3 3/8	1 1/8	1 1/8	1 1/8	18.48
AOC3M4	4.0	3000	4 5/8	3 3/8	2 1/8	1 1/8	1 1/8	25.54
AOC4M1	1.0	4000	4	3 3/8	1 1/8	1 1/8	1 1/8	33.00
AOC4M2	2.0	4000	4	3 3/8	1 1/8	1 1/8	1 1/8	39.60
AOC4M4	4.0	4000	4	3 3/8	4 1/8	1 1/8	1 1/8	60.53
AOC5M1	1.0	5000	4	3 3/8	1 1/8	1 1/8	1 1/8	39.60
AOC5M2	2.0	5000	3 1/2	3 3/8	4 1/8	1 1/8	1 1/8	49.50
AOC75C1	1.0	7500	3 1/2	3 3/8	4 1/8	2 1/8	1 1/8	59.40
AOC10M1	1.0	10000	4 5/8	3 3/8	4 1/8	2 1/8	1 1/8	105.60

PLASTICON DC OVALS

Mfr's. No.	Cap. Mfd.	Volts DC	Dimensions - Inches			Term. Height	Dist. Bet. Ter.	List Price
			Height	Width	Depth			
AOC06C2	2.0	600	2 3/8	2	1 1/8	3/8	1 1/8	\$5.28
AOC06C4	4.0	600	4	2	1 1/8	3/8	1 1/8	6.34
AOC01M1	1.0	1000	2 3/8	2	1 1/8	3/8	1	4.62
AOC01M2	2.0	1000	3 1/2	2	1 1/8	3/8	1 1/8	6.20
AOC03M01	0.1	3000	2 3/8	2	1 1/8	1 1/8	—	9.11
AOC05M01	0.1	5000	2 3/8	2	1 1/8	2	—	16.90
AOC05M025	0.25	5000	3 1/2	2	1 1/8	2 1/8	—	18.48
AOC05M05	0.5	5000	4 5/8	2	1 1/8	1	—	21.78
AOC08M005	0.05	8000	2 3/8	2	1 1/8	2 1/8	—	18.22
AOC08M01	0.1	8000	3 1/2	2	1 1/8	2 1/8	—	20.06
AOC010M005	0.05	10000	3 1/2	2	1 1/8	2 1/8	—	23.10

Same specifications as DC Rectangulars. Insulators: Two wet-process porcelain bushings on Types AOC06C, AOC01M & AOC02M. One ceramic bushing grounded on Types AOC03M, AOC05M, AOC08M and AOC010M. Case: Obround (flattened oval) cross section. Drawn or lock-seam lead coated steel with heavy finish of gray organic lacquer. Two right angle mounting foot brackets are provided as standard on all AOCO capacitors. Add 1/2" to depth to get mounting centers.



Condenser Products Company

MANUFACTURERS: Glassmikes • Plasticon Capacitors • HiVolt Power Supplies • Pulse Forming Networks



HiVolt POWER SUPPLIES

Where size and weight must
be kept to a minimum —

These hermetically-sealed, self-contained power supplies are designed for Hi Voltage low current DC for many applications. Our exclusive engineering techniques and oil-filled construction assure smaller, lighter, more flexible units.

APPLICATIONS:

- radiation counters
- spectrographic analyzers
- projection television sets
- dust and electrostatic precipitators
- oscilloscopes
- display tubes, etc.

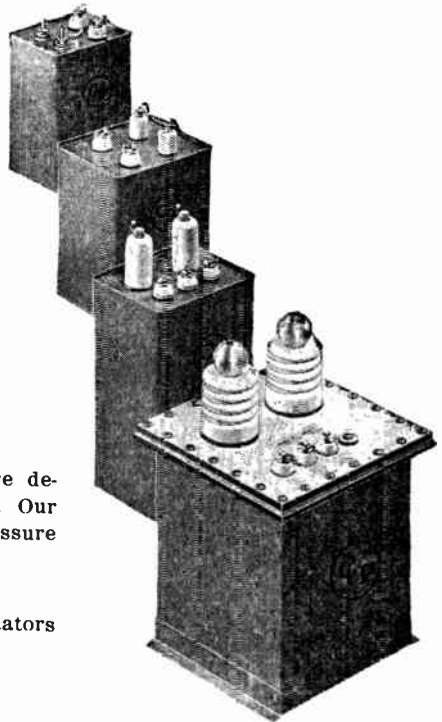

Model No.	Output Voltage	Rated Output Current	Max. Output Current	% Ripple at Rated Current	Case Size	Circuit	List Price
PS 2-2M60	2 KV DC	2.0 ma	5.0 ma	1.0	3 3/8 x 3 7/8 x 5 1/2	Half Wave	\$ 49.50
PS 5-3M60	5 KV DC	3.0 ma	5.0 ma	2.0	3 3/8 x 4 1/8 x 6	Half Wave	85.00
PS10-1M60	0-12 KV DC	1.5 ma	1.75 ma	2.0	3 3/8 x 4 1/8 x 8	Full Wave Doubler	115.00
PS15-1M60	0-15 KV DC	1.0 ma	1.75 ma	3.0	3 3/8 x 4 1/8 x 9	Full Wave Doubler	209.00
PS30-1M60D	0-30 KV DC	1.0 ma	1.75 ma	3.0	7 x 7 x 8 3/4	Full Wave Doubler	285.00
*PS50-2M60	0-50 KV DC	2.0 ma	4.0 ma	3.0	12 1/2 x 12 1/2 x 12 1/2	Full Wave Tripler	850.00
Others by Quotation							

- NOTES: *The PS 50 supply has a separate accessible compartment for the rectifier tubes.
1. HiVolt Supplies are rated at 118 V AC input, 60 cycles.
 2. HiVolt Supplies for 400 cycle operation are also available for aircraft use, built to military specifications.
 3. HiVolt Supplies are engineered for various applications. Send us your requirements.



LABORATORY GRADE PLASTICON CAPACITORS

Low dielectric absorption, .01-.02% residual. Low dissipation factor, .0002-.0003 at 1 MC. Constant Q and capacitance, from DC to 100 KC. High insulation resistance, 10¹² ohms/mfd. average. Negative temp.

coefficient, minus 400-500 ppm/°C. Rated voltage 500 V DC. Resistance and absorption readings taken at 200 V DC. 2% and 5% standard tolerances, 1% to order. Type LAG Glassmike style. Type LAC rectangular metal can.

No.	Mfd.	Dimensions	List Price 5% Tolerance
LAG101	.0001	1 1/8 x 1"	\$ 6.25
LAG201	.0002	1 1/8 x 1"	6.33
LAG501	.0005	1 1/8 x 1"	6.50
LAG102	.001	3/4 x 1"	6.67
LAG202	.002	3/4 x 1"	6.83
LAG502	.005	3/4 x 1"	7.25
LAG103	.01	3/4 x 1"	7.75
LAG203	.02	3/4 x 1"	8.50
LAG503	.05	1 3/8 x 1"	9.33
LAC104	.1	2 3/4 x 1 3/4 x 1"	12.83
LAC204	.2	2 3/4 x 2 1/2 x 1 3/8"	13.83
LAC504	.5	4 x 2 1/2 x 1 7/8"	15.83
LAC105	1.	4 3/4 x 3 3/4 x 1 1/4"	27.50
LAC205	2.	4 3/4 x 3 3/4 x 2 1/4"	40.83
LAC505	5.	6 x 4 1/8 x 3 3/4"	88.33



Condenser Products Company

MANUFACTURERS: Glassmikes • Plasticon Capacitors • HiVolt Power Supplies • Pulse Forming Networks

"Glassmike" PLASTICON CAPACITORS

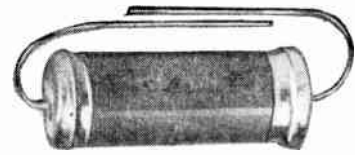
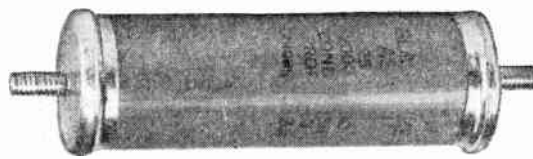

Type ASG

Type ASG are Plasticon A dielectric-silicone fluid impregnated capacitor elements in hermetically sealed glass tubes. Standard range —60°C to +85°C, extended range —60°C to +125°C with proper derating. The smallest and lightest high voltage capacitors made. Type ASG are ideal for DC and low frequency AC applications. All 19/32 diameter Glassmikes are supplied with pigtail leads.

Plasticon dielectric is superior to the finest linen or kraft condenser paper hitherto used. Plasticon is a thin plastic film, free from metallic particles or other foreign matter. Much higher tensile strength than paper and does not become brittle with age and heat. Not porous as paper and has higher breakdown voltage.

Cat. No.	Cap. Mfd.	Volts D.C.	Dimensions Dia. & Length	List Price
ASG103-6C	.01	600	1 1/8 x 1 3/8	\$1.50
ASG203-6C	.02	600	1 1/8 x 1 3/8	1.60
ASG303-6C	.03	600	1 1/8 x 1 3/8	1.60
ASG403-6C	.04	600	1 1/8 x 1 3/8	1.60
ASG503-6C	.05	600	1 1/8 x 1 3/8	1.75
ASG603-6C	.06	600	1 1/8 x 1 3/8	1.75
ASG753-6C	.075	600	1 1/8 x 1 3/8	1.75
ASG104-6C	.1	600	3/4 x 1 3/4	1.95
ASG204-6C	.2	600	1 1/8 x 1 3/4	2.15
ASG254-6C	.25	600	1 1/8 x 2 1/4	2.25
ASG304-6C	.3	600	1 1/8 x 1 3/4	2.35
ASG504-6C	.5	600	1 1/8 x 2 3/4	2.60
ASG105-6C	1.0	600	1 3/8 x 2	3.90
ASG502-1M	.005	1000	1 1/8 x 1 3/8	1.50
ASG103-1M	.01	1000	1 1/8 x 1 3/8	1.60
ASG203-1M	.02	1000	1 1/8 x 1 3/8	1.70
ASG503-1M	.05	1000	3/4 x 1 3/4	1.85
ASG104-1M	.1	1000	3/4 x 2 1/4	2.15
ASG254-1M	.25	1000	1 1/8 x 2 3/4	2.50
ASG504-1M	.5	1000	1 3/8 x 2 1/4	2.90
ASG202-2M	.002	2000	1 1/8 x 1 3/8	1.90
ASG502-2M	.005	2000	1 1/8 x 1 3/8	2.05
ASG103-2M	.01	2000	1 1/8 x 1 3/8	2.25
ASG203-2M	.02	2000	1 1/8 x 1 3/8	2.50
ASG503-2M	.05	2000	3/4 x 1 3/4	2.80
ASG104-2M	.1	2000	3/4 x 2 1/4	3.20
ASG254-2M	.25	2000	1 1/8 x 2 3/4	3.70
ASG504-2M	.5	2000	1 3/8 x 2	4.40
ASG102-3M	.001	3000	1 1/8 x 1 3/8	5.15
ASG202-3M	.002	3000	1 1/8 x 1 3/8	5.25
ASG502-3M	.005	3000	1 1/8 x 1 3/8	5.40
ASG103-3M	.01	3000	1 1/8 x 1 3/8	5.60
ASG203-3M	.02	3000	3/4 x 1 3/4	5.85
ASG503-3M	.05	3000	3/4 x 2 1/4	6.15
ASG104-3M	.1	3000	1 1/8 x 2 1/4	6.50
ASG254-3M	.25	3000	1 3/8 x 2	7.20
ASG102-4M	.001	4000	1 1/8 x 1 3/8	5.95
ASG202-4M	.002	4000	1 1/8 x 1 3/8	6.05
ASG502-4M	.005	4000	1 1/8 x 1 3/8	6.20
ASG103-4M	.01	4000	3/4 x 1 3/4	6.40
ASG203-4M	.02	4000	3/4 x 1 3/4	6.75
ASG503-4M	.05	4000	1 1/8 x 2	7.00
ASG104-4M	.1	4000	1 1/8 x 2	7.80
ASG102-5M	.001	5000	1 1/8 x 1 3/8	6.50
ASG202-5M	.002	5000	1 1/8 x 1 3/8	6.70
ASG502-5M	.005	5000	1 1/8 x 1 3/8	6.95
ASG103-5M	.01	5000	3/4 x 1 3/4	7.25
ASG203-5M	.02	5000	3/4 x 2 1/4	7.65
ASG503-5M	.05	5000	1 1/8 x 2 1/4	8.15
ASG104-5M	.1	5000	1 3/8 x 2 1/2	9.10

Cat. No.	Cap. Mfd.	Volts D.C.	Dimensions Dia. & Length	List Price
ASG501-8M	.0005	8000	1 1/8 x 1 3/8	\$7.00
ASG102-8M	.001	8000	1 1/8 x 1 3/8	7.00
ASG202-8M	.002	8000	1 1/8 x 1 3/8	7.25
ASG502-8M	.005	8000	3/4 x 1 3/4	7.55
ASG103-8M	.01	8000	3/4 x 2 1/4	8.15
ASG203-8M	.02	8000	3/4 x 2 1/4	9.25
ASG503-8M	.05	8000	1 3/8 x 2 1/4	11.50
ASG501-10M	.0005	10,000	1 1/8 x 1 3/8	7.30
ASG102-10M	.001	10,000	1 1/8 x 1 3/8	7.50
ASG202-10M	.002	10,000	1 1/8 x 1 3/8	7.80
ASG502-10M	.005	10,000	3/4 x 1 3/4	9.00
ASG103-10M	.01	10,000	3/4 x 2 1/4	10.50
ASG203-10M	.02	10,000	1 3/8 x 2 3/4	12.50
ASG303-10M	.03	10,000	1 3/8 x 2 3/4	15.00
ASG603-10M	.06	10,000	1 3/8 x 4 1/4	17.50
ASG501-15M	.0005	15,000	1 1/8 x 2 1/4	14.50
ASG102-15M	.001	15,000	3/4 x 2 1/4	14.80
ASG202-15M	.002	15,000	3/4 x 2 1/4	15.50
ASG502-15M	.005	15,000	1 1/8 x 2 3/4	18.00
ASG103-15M	.01	15,000	1 1/8 x 3 3/4	21.00
ASG203-15M	.02	15,000	1 3/8 x 4 1/2	25.00
ASG501-20M	.0005	20,000	1 1/8 x 3 1/2	19.50
ASG102-20M	.001	20,000	3/4 x 3 1/2	20.50
ASG202-20M	.002	20,000	1 1/8 x 3 1/2	22.00
ASG502-20M	.005	20,000	1 1/8 x 3 1/2	24.00
ASG103-20M	.01	20,000	1 3/8 x 4 1/2	26.00
ASG501-30M	.0005	30,000	1 1/8 x 4 1/8	22.50
ASG102-30M	.001	30,000	3/4 x 5	25.00
ASG202-30M	.002	30,000	1 3/8 x 4 1/4	28.00
ASG502-30M	.005	30,000	1 3/8 x 5	30.00
ASG501-40M	.0005	40,000	3/4 x 6 1/2	25.00
ASG102-40M	.001	40,000	1 1/8 x 6 1/2	29.00
ASG202-40M	.002	40,000	1 3/8 x 6 1/2	30.00
ASG501-50M	.0005	50,000	3/4 x 8 1/4	28.00
ASG102-50M	.001	50,000	1 1/8 x 8 1/4	34.00
ASG202-50M	.002	50,000	1 3/8 x 8 1/4	36.00
ASG502-50M	.005	50,000	1 5/8 x 10 1/4	44.00
ASG501-60M	.0005	60,000	3/4 x 11	32.00
ASG102-60M	.001	60,000	1 1/8 x 11	39.00

Other prices and values by quotation.



Condenser Products Company

MANUFACTURERS: Glassmikes • Plasticon Capacitors • HiVolt Power Supplies • Pulse Forming Networks



"Glassmike" PLASTICON CAPACITORS

Type LSC

LSG type capacitors have Plasticon L film-silicone fluid impregnant in Glassmike style case. Designed to compete with mica capacitors, the LSG capacitors are more applicable for Radio Frequency. Special beneficial features include greater safety factor, lower RF losses, more conveniently mounted, utilize less chassis space, impervious to moisture and smaller in overall volume.

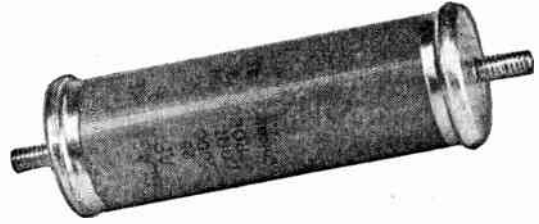

Part #	Size	Cap	Volts D.C.	List Price	Part #	Size	Cap	Volts D.C.	List Price	Part #	Size	Cap	Kilovolts D.C.	List Price
752-6C	1/8 x 1	.0075	600	\$4.17	753-35C	1 1/2 x 3	.075	3500	\$12.35	301-14M	3/4 x 4	.0003	14	\$12.85
103-6C	1/8 x 1	.01	600	4.50	104-35C	1 1/2 x 4	0.1	3500	13.65	401-14M	3/4 x 4	.0004	14	12.85
203-6C	1/8 x 1	.02	600	5.50	401-5M	1 1/2 x 2	.0004	5000	8.00	501-14M	3/4 x 4	.0005	14	12.85
253-6C	1/8 x 1 1/2	.025	600	5.50	501-5M	1 1/2 x 2	.0005	5000	8.00	601-14M	3/4 x 4	.0006	14	13.65
303-6C	1/8 x 1 1/2	.03	600	5.50	601-5M	1 1/2 x 2	.0006	5000	8.00	751-14M	1 1/2 x 4	.00075	14	15.35
403-6C	1/8 x 1 1/2	.04	600	5.50	751-5M	1 1/2 x 2	.00075	5000	8.85	102-14M	1 1/2 x 4	.001	14	15.35
503-6C	1/8 x 1 1/2	.05	600	5.50	102-5M	1 1/2 x 2	.001	5000	8.85	202-14M	1 1/2 x 4	.002	14	20.00
603-6C	1/8 x 1 1/2	.06	600	5.50	202-5M	1 1/2 x 2	.002	5000	9.65	252-14M	1 1/2 x 4	.0025	14	22.70
753-6C	1 1/8 x 1 1/2	.075	600	6.17	252-5M	1 1/2 x 2	.0025	5000	9.65	302-14M	1 1/2 x 4	.003	14	22.70
104-6C	1 1/8 x 1 1/2	0.1	600	6.17	302-5M	1 1/2 x 2	.003	5000	9.65	402-14M	1 1/2 x 4	.004	14	24.00
154-6C	1 1/8 x 1 1/2	0.15	600	7.00	402-5M	1 1/2 x 2	.004	5000	10.50	502-14M	1 1/2 x 4	.005	14	24.00
204-6C	1 1/8 x 2	0.2	600	7.00	502-5M	1 1/2 x 2	.005	5000	10.50	602-14M	1 1/2 x 4	.006	14	25.40
254-6C	1 1/8 x 2	0.25	600	7.33	602-5M	1 1/2 x 2	.006	5000	10.50	752-14M	1 1/2 x 4	.0075	14	27.50
304-6C	1 1/8 x 2	0.3	600	8.66	752-5M	1 1/2 x 2	.0075	5000	11.50	103-14M	1 1/2 x 4	.01	14	27.70
404-6C	1 1/8 x 2 1/2	0.4	600	8.85	103-5M	1 1/2 x 2	.01	5000	11.50	101-17M	1 1/2 x 4 3/4	.00017	17	14.00
504-6C	1 1/8 x 3	0.5	600	10.80	203-5M	1 1/2 x 3	.02	5000	12.50	201-17M	1 1/2 x 4 3/4	.0002	17	14.70
502-1M	1 1/8 x 1	.005	1000	5.00	253-5M	1 1/2 x 3	.025	5000	12.50	251-17M	1 1/2 x 4 3/4	.00025	17	14.70
602-1M	1 1/8 x 1	.006	1000	5.50	303-5M	1 1/2 x 4	.03	5000	15.00	301-17M	1 1/2 x 4 3/4	.0003	17	14.70
752-1M	1 1/8 x 1	.0075	1000	5.50	403-5M	1 1/2 x 4	.04	5000	16.70	401-17M	1 1/2 x 4 3/4	.0004	17	14.70
103-1M	1 1/8 x 1	.01	1000	5.50	503-5M	1 1/2 x 6	.05	5000	18.70	501-17M	1 1/2 x 4 3/4	.0005	17	16.00
203-1M	1 1/8 x 1 1/2	.02	1000	5.85	603-5M	1 1/2 x 6	.06	5000	20.70	601-17M	1 1/2 x 4 3/4	.0006	17	17.35
253-1M	1 1/8 x 1 1/2	.025	1000	5.85	753-5M	1 1/2 x 8	.075	5000	22.70	751-17M	1 1/2 x 4 3/4	.00075	17	19.00
303-1M	1 1/8 x 1 1/2	.03	1000	6.17	104-5M	1 1/2 x 8	0.1	5000	24.70	102-17M	1 1/2 x 4 3/4	.001	17	19.00
403-1M	1 1/8 x 1 1/2	.04	1000	6.85	301-7M	1 1/2 x 2	.0003	7000	8.15	202-17M	1 1/2 x 4 3/4	.002	17	21.85
503-1M	1 1/8 x 1 1/2	.05	1000	7.33	401-7M	1 1/2 x 2	.0004	7000	9.00	252-17M	1 1/2 x 4 3/4	.0025	17	21.85
603-1M	1 1/8 x 1 1/2	.06	1000	7.33	501-7M	1 1/2 x 2	.0005	7000	9.00	302-17M	1 1/2 x 5 3/4	.003	17	23.00
753-1M	1 1/8 x 1 1/2	.075	1000	7.33	601-7M	1 1/2 x 2	.0006	7000	9.00	402-17M	1 1/2 x 5 3/4	.004	17	25.90
104-1M	1 1/8 x 2	0.1	1000	8.00	751-7M	1 1/2 x 2	.00075	7000	9.00	502-17M	1 1/2 x 6 3/4	.005	17	29.00
154-1M	1 1/8 x 2	0.15	1000	9.50	102-7M	1 1/2 x 2	.001	7000	9.00	101-20M	1 1/2 x 5 3/4	.0001	20	16.00
204-1M	1 1/8 x 2	0.2	1000	10.80	202-7M	1 1/2 x 2	.002	7000	11.00	201-20M	1 1/2 x 5 3/4	.0002	20	17.00
254-1M	1 1/8 x 2 1/2	0.25	1000	11.00	252-7M	1 1/2 x 2	.0025	7000	11.85	251-20M	1 1/2 x 5 3/4	.00025	20	17.00
304-1M	1 1/8 x 3	0.3	1000	11.70	302-7M	1 1/2 x 2	.003	7000	11.85	301-20M	1 1/2 x 5 3/4	.0003	20	17.00
404-1M	1 1/8 x 3 1/2	0.4	1000	12.70	402-7M	1 1/2 x 2	.004	7000	12.35	401-20M	1 1/2 x 5 3/4	.0004	20	18.35
202-25C	1/8 x 1	.002	2500	5.1	502-7M	1 1/2 x 2	.005	7000	14.35	501-20M	1 1/2 x 5 3/4	.0005	20	20.15
252-25C	1/8 x 1	.0025	2500	5.50	602-7M	1 1/2 x 2	.006	7000	14.35	601-20M	1 1/2 x 5 3/4	.0006	20	20.15
302-25C	1/8 x 1	.003	2500	5.50	752-7M	1 1/2 x 4	.0075	7000	17.00	751-20M	1 1/2 x 5 3/4	.00075	20	22.65
402-25C	1/8 x 1	.004	2500	5.50	103-7M	1 1/2 x 4	.01	7000	18.65	102-20M	1 1/2 x 5 3/4	.001	20	22.65
502-25C	1/8 x 1	.005	2500	5.85	203-7M	1 1/2 x 4	.02	7000	21.30	202-20M	1 1/2 x 5 3/4	.002	20	24.50
602-25C	1/8 x 1	.006	2500	5.85	253-7M	1 1/2 x 6	.025	7000	21.30	252-20M	1 1/2 x 5 3/4	.0025	20	26.70
752-25C	1/8 x 1	.0075	2500	6.17	303-7M	1 1/2 x 6	.03	7000	23.00	302-20M	1 1/2 x 5 3/4	.003	20	28.70
103-25C	1 1/8 x 1	.01	2500	6.50	403-7M	1 1/2 x 8	.04	7000	23.00	402-20M	1 1/2 x 8 1/2	.004	20	30.20
203-25C	1 1/8 x 1 1/2	.02	2500	7.18	503-7M	1 1/2 x 8	.05	7000	23.00	750-25M	1 1/2 x 7 1/4	.00075	25	20.15
253-25C	1 1/8 x 1 1/2	.025	2500	7.18						101-25M	1 1/2 x 7 1/4	.001	25	21.70
303-25C	1 1/8 x 1 1/2	.03	2500	7.18						201-25M	1 1/2 x 7 1/4	.002	25	21.70
403-25C	1 1/8 x 2	.04	2500	8.00						251-25M	1 1/2 x 7 1/4	.0025	25	21.70
503-25C	1 1/8 x 2	.05	2500	8.68						301-25M	1 1/2 x 7 1/4	.003	25	21.70
603-25C	1 1/8 x 2	.06	2500	8.68						401-25M	1 1/2 x 7 1/4	.004	25	25.00
753-25C	1 1/8 x 2	.075	2500	10.40						501-25M	1 1/2 x 7 1/4	.005	25	25.00
104-25C	1 1/8 x 2 1/2	0.1	2500	11.70	201-10M	1 1/2 x 3	.0002	10	\$10.80	601-25M	1 1/2 x 7 1/4	.006	25	27.50
154-25C	1 1/8 x 3 1/2	0.15	2500	12.70	301-10M	1 1/2 x 3	.0003	10	11.00	751-25M	1 1/2 x 7 1/4	.00075	25	31.20
601-35C	1 1/8 x 1	.0006	3500	5.50	401-10M	1 1/2 x 3	.0004	10	11.00	102-25M	1 1/2 x 7 1/4	.001	25	31.20
751-35C	1 1/8 x 1	.00075	3500	5.85	501-10M	1 1/2 x 3	.0005	10	11.65	202-25M	1 1/2 x 7 1/4	.002	25	35.40
102-35C	1 1/8 x 1	.001	3500	5.85	751-10M	1 1/2 x 3	.00075	10	12.35	252-25M	1 1/2 x 9 1/2	.0025	25	45.00
202-35C	1 1/8 x 1	.002	3500	5.85	102-10M	1 1/2 x 3	.001	10	12.35	302-25M	1 1/2 x 9 1/2	.003	25	45.00
252-35C	1 1/8 x 1	.0025	3500	6.20	202-10M	1 1/2 x 3	.002	10	13.65	500-30M	1 1/2 x 9	.00005	30	23.70
302-35C	1 1/8 x 1	.003	3500	7.00	252-10M	1 1/2 x 3	.0025	10	15.35	600-30M	1 1/2 x 9	.00006	30	25.00
402-35C	1 1/8 x 1	.004	3500	7.00	302-10M	1 1/2 x 3	.003	10	15.35	750-30M	1 1/2 x 9	.0001	30	25.00
502-35C	1 1/8 x 1	.005	3500	7.50	402-10M	1 1/2 x 3	.004	10	17.65	101-30M	1 1/2 x 9	.00013	30	25.00
602-35C	1 1/8 x 1	.006	3500	7.50	502-10M	1 1/2 x 3	.005	10	21.30	201-30M	1 1/2 x 9	.0002	30	25.00
752-35C	1 1/8 x 1	.0075	3500	7.85	602-10M	1 1/2 x 6	.006	10	21.30	251-30M	1 1/2 x 9	.00025	30	30.70
103-35C	1 1/8 x 1	.01	3500	8.18	752-10M	1 1/2 x 6	.0075	10	24.00	301-30M	1 1/2 x 9	.0003	30	37.00
203-35C	1 1/8 x 1 1/2	.02	3500	8.50	103-10M	1 1/2 x 6	.01	10	24.00	401-30M	1 1/2 x 9	.0004	30	37.00
253-35C	1 1/8 x 1 1/2	.025	3500	8.67	203-10M	1 1/2 x 9	.01	10	27.70	501-30M	1 1/2 x 9	.0005	30	44.00
303-35C	1 1/8 x 2	.03	3500	10.80	253-10M	1 1/2 x 9	.025	10	27.70	601-30M	1 1/2 x 9	.0006	30	44.00
403-35C	1 1/8 x 2	.04	3500	10.80	303-10M	1 1/2 x 9	.05	10	27.70	751-30M	1 1/2 x 9	.00075	30	46.00
503-35C	1 1/8 x 2 1/2	.05	3500	11.65	403-10M	1 1/2 x 9	.1	10	27.70	102-30M	1 1/2 x 9	.001	30	50.00
603-35C	1 1/8 x 3	.06	3500	12.35	201-14M	1 1/2 x 4	.0001	14	12.85					
					251-14M	1 1/2 x 4	.00025	14	12.85					



Condenser Products Company

MANUFACTURERS: Glassmikes • Plasticon Capacitors • H-Volt Power Supplies • Pulse Forming Networks

Copyright by U. C. P., Inc.

TRADE DISCOUNT APPLIES TO LIST PRICES ONLY

Radio's Master 19th Edition

Page P-129

ASTRON

the
"streamlined" profit
line

ASTRON CORPORATION

255 GRANT AVENUE, E. NEWARK, NEW JERSEY

MINIMITE* TYPE MM

Miniature Metal-Cased Tubular Electrolytics

"SM"* Safety Margin Construction

- Hermetically sealed aluminum-cased tubulars. Small and light. Ideal for under-chassis mounting in compact, tight assemblies.
- Designed to withstand high surge voltages and high ripple currents. Stable capacitance characteristics. Long service life.
- Exceptionally low leakage. Terminal tab connections provide permanent low-resistance contact for life of the unit.
- Outer insulating tube. Duals have centered mounting strap, and 3 leads (common negative).
- #20 bare wire leads, 3" long.
- Widely specified for original equipment and as popular replacements with quality-minded servicemen.

SINGLE MINIMITE (2 leads)

Cat. No.	Cap. Mf.	WVDC	† Dia x L.	List Price
MM-500-6	500	6	3/8 x 1 1/2	\$1.55
MM-1000-6	1000	6	7/8 x 2 1/2	1.90
MM-500-15	500	15	7/8 x 2 1/2	1.75
MM-1000-15	1000	15	1 x 2 1/2	2.30
MM-10-25	10	25	1/2 x 1 1/2	1.00
MM-25-25	25	25	1/2 x 1 1/2	1.00
MM-50-25	50	25	5/8 x 1 1/2	1.10
MM-100-25	100	25	5/8 x 1 1/2	1.35
MM-250-25	250	25	7/8 x 1 1/2	1.70
MM-500-25	500	25	1 x 2 1/2	2.40
MM-4-50	4	50	1/2 x 1 1/2	.95
MM-10-50	10	50	1/2 x 1 1/2	1.00
MM-25-50	25	50	5/8 x 1 1/2	1.00
MM-50-50	50	50	5/8 x 1 1/2	1.20
MM-100-50	100	50	5/8 x 1 1/2	1.40
MM-4-150	4	150	7/8 x 1 1/2	1.00
MM-8-150	8	150	7/8 x 1 1/2	1.05
MM-16-150	16	150	5/8 x 1 1/2	1.15
MM-20-150	20	150	5/8 x 1 1/2	1.20
MM-30-150	30	150	5/8 x 1 1/2	1.30
MM-40-150	40	150	5/8 x 1 1/2	1.35
MM-50-150	50	150	7/8 x 1 1/2	1.40
MM-80-150	80	150	7/8 x 2 1/2	1.60
MM-100-150	100	150	7/8 x 2 1/2	1.75
MM-150-150	150	150	1 x 2 1/2	1.90
MM-8-250	8	250	5/8 x 1 1/2	1.15
MM-16-250	16	250	5/8 x 1 1/2	1.30
MM-20-250	20	250	5/8 x 1 1/2	1.35
MM-40-250	40	250	7/8 x 1 1/2	1.55
MM-8-350	8	350	5/8 x 1 1/2	1.20
MM-10-350	10	350	5/8 x 1 1/2	1.25
MM-20-350	20	350	7/8 x 1 1/2	1.45
MM-4-450	4	450	5/8 x 1 1/2	1.15
MM-8-450	8	450	5/8 x 1 1/2	1.25
MM-10-450	10	450	5/8 x 1 1/2	1.30
MM-12-450	12	450	7/8 x 1 1/2	1.35
MM-16-450	16	450	7/8 x 1 1/2	1.40
MM-20-450	20	450	7/8 x 2 1/2	1.55
MM-30-450	30	450	1 x 2 1/2	1.70
MM-40-450	40	450	1 x 2 1/2	1.80
MM-80-450	80	450	1 1/2 x 2 1/2	2.80
MM-8-500	8	500	7/8 x 2 1/2	1.30
MM-16-500	16	500	1 x 2 1/2	1.50
MM-20-500	20	500	1 x 2 1/2	1.60

*DUAL MINIMITE (3 leads, Common Negative)

MM-2x20-150	20+20	150	5/8 x 1 1/2	\$1.55
MM-2x30-150	30+30	150	7/8 x 1 1/2	1.80
MM-2x40-150	40+40	150	7/8 x 2 1/2	1.85
MM-5030-150	50+30	150	7/8 x 2 1/2	1.95
MM-2x50-150	50+50	150	7/8 x 2 1/2	2.10
MM-8040-150	80+40	150	1 x 2 1/2	2.20
MM-2x8-450	8+8	450	7/8 x 1 1/2	1.70
MM-2x10-450	10+10	450	7/8 x 2 1/2	1.85
MM-16x-450	16+8	450	1 x 2 1/2	1.95
MM-2x16-450	16+16	450	1 x 2 1/2	2.25
MM-2x20-450	20+20	450	1 x 2 1/2	2.50

† Dimensions are for metal tubes. Add 1/8" to diameter and 1/4" to length for dimensions over cardboard insulating tubes.

* Supplied with radial mounting strap.

*TRADE MARK

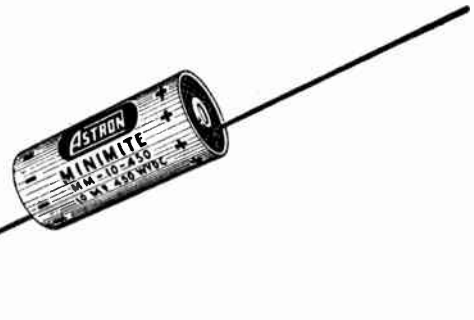

*TRADE MARK

TYPE ES

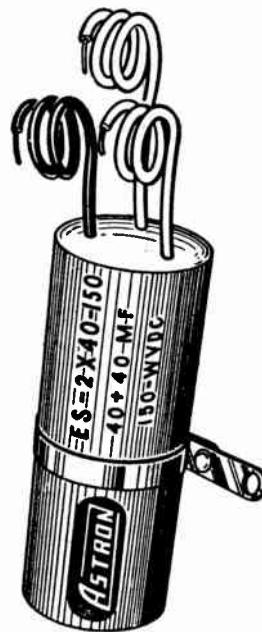

Cardboard-Cased Electrolytics

- ASTRON-improved design. Long service life. Electrically and mechanically superior to similar-appearing units.
- Dual and triple-section units. Can be used in place of costlier metal-can types of equal rating in television, radio, radio-phonos and other equipment. 65°C. operation.
- Sections wrapped in plastic film. Lasting protection from moisture, humidity, severest climatic conditions. High-melting-point wax fill.
- Centered radial mounting strap. Plastic insulated wire leads, 6" long. Color coding on tubes.
- Overall wax coating for added protection against moisture and humidity.

DUAL UNITS (Common Negative)

Cat. No.	Cap. Mf./WVDC	D. x L.	List Price
ESD-155	20+20/150	5/8 x 2 1/2	\$1.85
ESD-160	30+30/150	7/8 x 2 1/2	1.80
ESD-165	40+40/150	1 x 2 1/2	1.85
ESD-170	50+30/150	1 x 2 1/2	1.95
ESD-175	50+50/150	1 x 3	2.10
ESD-190	80+40/150	1 1/2 x 3	2.25
ESD-255	20+20/250	7/8 x 2 1/2	1.85
ESD-455	20+20/450	1 1/2 x 3 1/2	2.50

TRIPLE UNITS (Common Negative)

Cat. No.	Cap. Mf./WVDC	D. x L.	List Price
EST-555	20+20+20/150	1 x 2 1/2	\$2.20
EST-570	40+30+20/150	1 x 2 1/2	2.35
EST-575	40+40+20/150	1 x 3	2.35
EST-585	80+40+20/150	1 x 3 1/2	2.40
EST-595	80+40+20/150	1 1/2 x 3 1/2	2.50
EST-810	40+10/150+20/25	1 x 2 1/2	1.95
EST-620	40+30/150+20/25	1 x 2 1/2	2.30
EST-625	40+40/150+40/25	1 x 3 1/2	2.40
EST-640	50+30/150+100/25	1 x 3 1/2	2.50
EST-855	50+30/150+200/10	1 x 3 1/2	2.55

ASTRON

the
"streamlined" profit
line

ASTRON CORPORATION

255 GRANT AVENUE, E. NEWARK, NEW JERSEY

TYPE EY

Twist-Prong Electrolytics

"SM" Safety Margin Construction

- Widest choice of singles, and dual, triple and quadruple capacitance-voltage combinations in smallest practical aluminum can sizes.
- Ideal for replacement in television, radio and other high quality electronic equipment where high ripple and high surge voltages are encountered.
- Hermetically sealed. Designed for 85°C. operation.
- Quick, easy, firm mounting through chassis slots or slotted plates for insulated or grounded connection. Mounting prong ring serves as common negative terminal.
- Terminal coding clearly stamped on container.
- Individually packaged for the service trade, including metal and phenolic mounting plates.



SINGLE UNITS

Cat. No.	Cap. Mf./WVDC	Dia x Length	Price
EYS-100	1000/15	1 x3	\$2.55
EYS-105	2000/15	1 1/2 x3	3.45
EYS-115	100/25	1 x2	1.80
EYS-120	500/25	1 x3	2.35
EYS-125	1000/25	1 1/2 x3	3.55
EYS-130	500/50	1 1/2 x2 1/2	2.65
EYS-135	50/150	1 x2	1.65
EYS-140	80/150	1 x2	1.85
EYS-145	100/150	1 x2	2.00
EYS-150	120/150	1 x2 1/2	2.10
EYS-155	140/150	1 x3	2.15
EYS-160	150/150	1 x3	2.15
EYS-162	300/150	1 1/2 x3 1/2	2.80
EYS-165	15/250	1 x2	1.55
EYS-170	30/250	1 x2	1.70
EYS-175	40/250	1 x2	1.80
EYS-180	60/250	1 x2 1/2	2.05
EYS-185	80/250	1 x3	2.15
EYS-190	150/250	1 1/2 x2 1/2	3.10
EYS-195	30/350	1 x2	1.90
EYS-200	40/350	1 x2 1/2	2.00
EYS-205	50/350	1 x3	2.10
EYS-215	80/350	1 1/2 x2 1/2	2.85
EYS-220	125/350	1 1/2 x3	3.65
EYS-225	80/400	1 1/2 x2 1/2	2.95
EYS-230	10/450	1 x2	1.55
EYS-235	30/450	1 x2	1.75
EYS-240	40/450	1 x2 1/2	1.95
EYS-245	60/450	1 x3	2.05
EYS-250	80/450	1 1/2 x3	2.00
EYS-255	30/475	1 x3	2.00
EYS-260	40/475	1 1/2 x2	2.50
EYS-265	90/475	1 1/2 x3 1/2	3.50

TRIPLE UNITS

Cat. No.	Cap. Mf./WVDC	Dia x Length	Price
EYT-1000	40-40-40/25	1 x2	\$2.15
EYT-1005	40-20-20/150	1 x2	2.40
EYT-1010	40-40-40/150	1 x2 1/2	2.60
EYT-1015	50-50-50/150	1 x3	3.00
EYT-1020	40-20-10/250	1 x2 1/2	2.85
EYT-1025	60-40-20/350	1 1/2 x3	4.25
EYT-1030	10-10-10/450	1 x3	2.60
EYT-1035	20-10-10/450	1 x3	2.95
EYT-1040	20-20-20/450	1 1/2 x3	3.80
EYT-1045	30-30-30/450	1 1/2 x3 1/2	4.35
EYT-1046	40-10-10/450	1 1/2 x2 1/2	3.60
EYT-1050	40-20-10/450	1 1/2 x3 1/2	4.15
EYT-1055	40-40-40/450	1 1/2 x4	4.90
EYT-1060	60-30-10/450	1 1/2 x3 1/2	4.50
EYT-1065	80-40-20/450	1 1/2 x4 1/2	5.40
EYT-1070	10-10-10/475	1 x3	2.70
EYT-1075	30-30-20/475	1 1/2 x3 1/2	4.40
EYT-1080	10-10-10/500	1 x3 1/2	2.70
EYT-1085	40-20/150+20/25	1 x2	2.50
EYT-1087	40-20/150+100/25	1 x2 1/2	2.60
EYT-1089	50-30/150+30/25	1 x2	2.60
EYT-1090	50-50/150+20/25	1 x2 1/2	2.70
EYT-1095	120-60/150+20/25	1 1/2 x2 1/2	3.30
EYT-1100	100-10/200+40/50	1 1/2 x2	3.10
EYT-1105	40-20/250+10/150	1 1/2 x2 1/2	2.75
EYT-1110	70-70/250+20/50	1 1/2 x2 1/2	3.90
EYT-1115	10-10/300+15/250	1 x2	2.45
EYT-1120	10-5/350+150/50	1 x3	2.70
EYT-1125	15-15/350+20/25	1 x2 1/2	2.50
EYT-1130	30-20/350+20/25	1 x3	3.10
EYT-1135	30-30/350+20/25	1 x3	3.10
EYT-1140	30-30/350+50/50	1 1/2 x2 1/2	3.50
EYT-1145	40-20/350+10/100	1 1/2 x2	2.80
EYT-1150	40-40/350+50/25	1 1/2 x2 1/2	3.70
EYT-1155	10-10/450+20/25	1 x2 1/2	2.40
EYT-1160	10-10/450+40/50	1 x2	2.75
EYT-1165	20-10/450+50/50	1 x3	2.85
EYT-1170	20-20/450+20/25	1 x3 1/2	3.10
EYT-1175	20-20/450+60/350	1 1/2 x3 1/2	4.00
EYT-1180	30-30/450+20/25	1 1/2 x2 1/2	3.50
EYT-1185	30-30/450+40/50	1 1/2 x3	3.65
EYT-1190	40-10/450+80/200	1 1/2 x3	3.90
EYT-1195	40-10/450+100/200	1 1/2 x3 1/2	4.10
EYT-1200	40-10/450+10/350	1 1/2 x2 1/2	3.30
EYT-1205	40-20/450+25/50	1 1/2 x3	3.40
EYT-1210	40-40/450+20/25	1 1/2 x3 1/2	3.95
EYT-1215	40-40/450+40/25	1 1/2 x3 1/2	4.00
EYT-1220	40-40/450+60/150	1 1/2 x3 1/2	4.15
EYT-1225	40-40/450+100/200	1 1/2 x4	4.95
EYT-1240	80-40/450+100/25	1 1/2 x4 1/2	5.90
EYT-1245	20-20/475+60/400	1 1/2 x4	4.80
EYT-1250	10-10/500+4/350	1 x3	2.50
EYT-1255	10-10/500+100/50	1 x3 1/2	2.85
EYT-1260	30-10/500+20/50	1 1/2 x2 1/2	3.10
EYT-1265	80/400+20-10/300	1 1/2 x3 1/2	4.25
EYT-1270	20/450+40-10/250	1 1/2 x2	3.00
EYT-1275	30/450+100-25/25	1 1/2 x3 1/2	4.00
EYT-1280	40/450+90-50/150	1 1/2 x3 1/2	4.00
EYT-1285	20-350+30/250+20/25	1 x2 1/2	2.80
EYT-1290	100/300+60/150+20/25	1 1/2 x2 1/2	2.85
EYT-1295	10/350+50/150+100/50	1 x3	3.15
EYT-1310	20/350+40/300+10/150	1 x3	3.15
EYT-1315	30/350+30/300+20/25	1 x3	3.30
EYT-1320	40/350+20/300+10/200	1 1/2 x2	3.30
EYT-1325	60/400+40/300+20/25	1 1/2 x3	4.20
EYT-1327	10/450+30/400+30/300	1 1/2 x2 1/2	3.35
EYT-1330	20/450+60/250+100/25	1 1/2 x2 1/2	3.65
EYT-1335	20/450+80/350+100/50	1 1/2 x3 1/2	4.50
EYT-1340	40/450+10/150+130/50	1 1/2 x2 1/2	3.85
EYT-1345	10/475+100/200+40/50	1 1/2 x2 1/2	3.35
EYT-1350	20/500+20/300+40/25	1 1/2 x2 1/2	3.10
EYT-1355	40/500+40/250+100/50	1 1/2 x3 1/2	3.75

DUAL UNITS

Cat. No.	Cap. Mf./WVDC	Dia x Length	Price
EYD-500	1000-1000/15	1 1/2 x3	\$4.40
EYD-505	150-50/25	1 x2	1.75
EYD-510	90-30/150	1 x2	1.75
EYD-515	50-50/150	1 x2 1/2	1.95
EYD-520	200-200/150	1 1/2 x3 1/2	4.00
EYD-525	20-20/250	1 x2	1.90
EYD-530	40-40/250	1 x2 1/2	2.50
EYD-540	80-80/300	1 1/2 x3 1/2	4.05
EYD-545	120-20/300	1 1/2 x3	3.80
EYD-550	15-15/350	1 x2	2.25
EYD-555	20-20/350	1 x2 1/2	2.35
EYD-560	80-80/350	1 1/2 x3 1/2	4.70
EYD-565	10-10/450	1 x2	1.90
EYD-565	30-30/450	1 x3	2.55
EYD-575	30-30/450	1 1/2 x3 1/2	3.05
EYD-580	40-40/450	1 1/2 x3	3.45
EYD-585	40-40/450	1 1/2 x4	4.35
EYD-590	80-10/450	1 1/2 x3 1/2	4.30
EYD-600	20-20/500	1 1/2 x2 1/2	2.85
EYD-605	40-40/500	1 1/2 x2	4.40
EYD-610	40-40/500	1 1/2 x2	2.85
EYD-615	250/10+1000/6	1 1/2 x2	2.30
EYD-620	20/350+30/250	1 x2 1/2	2.00
EYD-625	60/350+80/250	1 1/2 x3	3.45
EYD-630	20/450+20/25	1 x2 1/2	2.00
EYD-635	20/450+100/100	1 1/2 x2 1/2	2.65
EYD-640	20/450+80/350	1 1/2 x3	3.65
EYD-645	30/450+40/150	1 1/2 x2	2.50
EYD-650	40/450+20/25	1 x3 1/2	2.40
EYD-655	40/450+10/350	1 1/2 x2 1/2	2.60
EYD-660	80/450+50/50	1 1/2 x3	3.50
EYD-665	20/475+100/300	1 1/2 x3 1/2	3.95
EYD-670	40/500+50/200	1 1/2 x3 1/2	3.35
EYD-675	40/500+50/200	1 1/2 x3 1/2	3.35

*TRADE MARK

Copyright by U. C. P., Inc.

TRADE DISCOUNT APPLIES TO LIST PRICES ONLY

Radio's Master — 19th Edition

Page P-131

ASTRON

the
"streamlined" profit
line

ASTRON CORPORATION

255 GRANT AVENUE, E. NEWARK, NEW JERSEY

QUADRUPLE UNITS

Cat. No.	Cap. Mf./WVDC	Dia x Length	Price
EYQ-2000	40-40-20-10/300	1 3/8 x 2 1/2	\$4.55
EYQ-2005	30-30-20-20/400	1 3/8 x 3 1/2	4.85
EYQ-2010	80-10-10-10/100	1 3/8 x 1 1/2	4.70
EYQ-2015	10-10-10-10/450	1 3/8 x 2	3.35
EYQ-2020	20-10-10-10/450	1 3/8 x 2 1/2	3.70
EYQ-2025	20-20-20-20/450	1 3/8 x 3	4.70
EYQ-2030	30-15-15-15/150	1 3/8 x 3	4.45
EYQ-2035	30-30-15-10/450	1 3/8 x 3 1/2	4.70
EYQ-2040	10-20-10-10/450	1 3/8 x 3	4.45
EYQ-2045	10-10-10-10/475	1 3/8 x 2	3.50
EYQ-2050	40-20-10-10/175	1 3/8 x 3 1/2	5.10
EYQ-2055	10-40-40/150+ 20/25	1 3/8 x 2	3.15
EYQ-2060	80-60-40/250+ 20/150	1 3/8 x 3	5.10
EYQ-2065	100-40-10/250+100/50	1 3/8 x 3	5.15
EYQ-2070	60-40-20/300+ 50/25	1 3/8 x 2 1/2	4.70
EYQ-2075	40-40-10/300+ 20/150	1 3/8 x 2 1/2	4.90
EYQ-2080	40-20-20/350+ 25/25	1 3/8 x 2 1/2	4.25
EYQ-2085	40-10-40/350+ 40/25	1 3/8 x 3	5.20
EYQ-2090	40-10-40/350+150/50	1 3/8 x 3 1/2	5.70
EYQ-2095	20-20-20/400+ 20/25	1 3/8 x 2 1/2	3.85
EYQ-2105	10-10-10/450+ 20/25	1 3/8 x 2	3.15
EYQ-2110	10-10-10/450+ 10/150	1 3/8 x 2 1/2	3.15
EYQ-2115	20-10-10/450+100/25	1 3/8 x 2 1/2	3.70
EYQ-2120	20-20-20/450+ 20/25	1 3/8 x 2 1/2	4.15
EYQ-2125	20-20-20/450+100/50	1 3/8 x 3	4.55
EYQ-2130	30-30-15/450+ 30/50	1 3/8 x 3	4.15
EYQ-2135	30-30-20/450+ 20/25	1 3/8 x 3 1/2	4.65
EYQ-2140	40-10-10/450+250/25	1 3/8 x 3 1/2	4.25
EYQ-2145	40-10-10/450+ 10/350	1 3/8 x 3	3.90
EYQ-2150	10-15-10/450+ 20/25	1 3/8 x 3	4.10
EYQ-2153	40-20-20/450+ 20/25	1 3/8 x 3 1/2	4.60
EYQ-2155	40-20-20/450+ 10/25	1 3/8 x 3 1/2	4.65
EYQ-2160	40-30-10/450+ 20/25	1 3/8 x 3	4.60
EYQ-2163	10-40-10/450+100/100	1 3/8 x 4	5.35
EYQ-2165	40-40-40/450+ 25/50	1 3/8 x 1	4.70
EYQ-2170	60-10-10/450+ 20/150	1 3/8 x 3 1/2	4.60
EYQ-2175	20-20-10/475+ 20/300	1 3/8 x 3	4.30
EYQ-2180	10-20-10/475+ 10/25	1 3/8 x 3 1/2	4.85
EYQ-2185	40-10/400+ 80/10/250	1 3/8 x 3 1/2	4.70
EYQ-2190	10-10/450+ 20-20/25	1 3/8 x 2	2.95
EYQ-2195	20-20/450+ 20-20/25	1 3/8 x 2	3.60
EYQ-2197	10-10/450+ 35-10/350	1 3/8 x 4	5.50
EYQ-2200	40-10/450+ 30-30/350	1 3/8 x 1 1/2	5.90
EYQ-2205	10-5/475+ 80/150+ 40/50	1 3/8 x 4	4.95
EYQ-2210	15-15/475+ 80/300+ 40/50	1 3/8 x 3 1/2	4.80
EYQ-2220	10/450+ 60-40/350+ 25/25	1 3/8 x 3 1/2	4.60
EYQ-2222	10/450+100-10/350+ 20/25	1 3/8 x 3 1/2	5.25
EYQ-2225	20/150+ 80-20/200+ 50/50	1 3/8 x 3	4.15
EYQ-2235	100/300+ 40/50 +80-20/25	1 3/8 x 3	4.50
EYQ-2240	120/300+20/250+100/50 + 20/25	1 3/8 x 3 1/2	5.05
EYQ-2245	200/300+20/250+100/50 + 20/25	1 3/8 x 1 1/2	5.45
EYQ-2250	10/450+10/300+ 60/200+100/50	1 3/8 x 2 1/2	3.80
EYQ-2255	20/450+20/100+ 20/350+ 20/25	1 3/8 x 3	3.80
EYQ-2260	80/450+10/100+ 30/300+ 40/150	1 3/8 x 1 1/2	5.25
EYQ-2265	10/475+10/450+ 80/200+ 50/60	1 3/8 x 3	3.85
EYQ-2270	10/475+60/450+ 30/100+125/50	1 3/8 x 1	5.45
EYQ-2275	20/475+40/300+100/50 + 80/25	1 3/8 x 3	4.50
EYQ-2280	25/475+20/150+ 40/300+100/50	1 3/8 x 3 1/2	4.95

ACCESSORIES FOR TYPE EY

Part Number	Item	Description	List Price
EYP-2	Phenolic Mtg. Plate	for 1" can	\$0.07
EYP-4	Phenolic Mtg. Plate	for 1 3/8" can	.07
EYP-1	Metal Mtg. Plate	for 1" can	.07
EYP-3	Metal Mtg. Plate	for 1 3/8" can	.07
EYP-101	Insulating Tube	1" x 2 1/2"	.15
EYP-102	Insulating Tube	1" x 3"	.15
EYP-103	Insulating Tube	1" x 3 1/2"	.15
EYP-104	Insulating Tube	1" x 3 1/2"	.15
EYP-201	Insulating Tube	1 3/8" x 2"	.15
EYP-202	Insulating Tube	1 3/8" x 2 1/2"	.15
EYP-203	Insulating Tube	1 3/8" x 3"	.15
EYP-204	Insulating Tube	1 3/8" x 3 1/2"	.15
EYP-205	Insulating Tube	1 3/8" x 4"	.15
EYP-206	Insulating Tube	1 3/8" x 4 1/2"	.15



TYPE E

Metal Screw-Base Electrolytics

"SM" Safety Margin Construction

- Popular aluminum can type with threaded neck and palmot for easy, convenient mounting.
- Recommended as original units or replacements for other can-type wet or dry electrolytics using chassis hole mounting.
- Capacitor sections insulated from can. Separate positive and negative color-coded lead for each section. Section in high-voltage units (400 vdw) are series-connected to assure long service life.
- Plastic insulated leads, 6" long. Stripped and tinned ends.
- ASTRON-improved terminal construction. Excellent protection against moisture. Suitable for use in tropical, hot, humid and other severe climates.

SINGLE UNITS (2 leads)

Cat. No.	Mf	WVDC	D. x L.	Price
E-8-450	8	450	1 3/8 x 3 1/2	\$2.20
E-12-450	12	450	1 3/8 x 3 1/2	2.40
E-16-450	16	450	1 3/8 x 3 1/2	2.45
E-20-450	20	450	1 3/8 x 3 1/2	2.75
E-30-450	30	450	1 3/8 x 3 1/2	3.00
E-40-450	40	450	1 3/8 x 3 1/2	3.15

High-Voltage Series Wound Units

Cat. No.	Mf.	WVDC	D. x L.	Price
E-4-600	4	600	1 3/8 x 3 1/2	2.95
E-8-600	8	600	1 3/8 x 3 1/2	3.15
E-16-600	16	600	1 3/8 x 3 1/2	3.75

DUAL UNITS (4 leads) and TRIPLE UNITS (6 leads)

Cat. No.	Mf.	WVDC	D. x L.	Price
E-2x8-450	8+8	450	1 3/8 x 3 1/2	3.00
E-2x16-450	16+16	450	1 3/8 x 3 1/2	3.55
E-3x8-450	8+8+8	450	1 3/8 x 3 1/2	5.00

*TRADE MARK

ASTRON

the
"streamlined" profit
line

©1951

ASTRON CORPORATION

255 GRANT AVENUE, E. NEWARK, NEW JERSEY

BLUE-POINT* TYPE BP-Molded Plastic Tubulars

85°C. Operation



ASTRON BLUE-POINT Type BP capacitors are the finest all-purpose molded plastic paper tubulars ever made.

They are designed for continuous operation at temperatures up to 85°C. without voltage derating. The famous BLUE-POINT seal makes them unsurpassed for dependability in television, radio, and a wide variety of applications where a combination of small size, excellent capacitance-temperature stability and resistance to vibration and moisture are prime requisites.

ASTRON BLUE-POINT capacitors give equally dependable and unvaried performance under all climatic conditions including tropical, hot and humid climates.

Due to solid thermosetting impregnant, BLUE POINTS show highly stable capacitance characteristics; also low power factor and high insulation resistance over the entire temperature range -55°C. to +85°C. Capacitance change at 25°C. is less than ±5% over the entire temperature range. The 400-volt and 600-volt units can be operated at 125°C. when derated to a voltage equal to 60% of their 85°C. rating.

The ASTRON-developed BLUE-POINT seal and molding process (patent pending) is completely new and revolutionary in the capacitor art.

The BLUE-POINT actually bonds itself to the plastic seal and the wire leads to form the tightest seal ever produced against moisture and humidity and the severest climatic conditions. Both the seal and shell are completely resistant to soldering iron heat.

ASTRON BLUE-POINT capacitors are identified by their distinctive yellow plastic case and are clearly marked with rated voltage, capacitance and outside foil location.

Cat. No.	Cap. Mf.	Dia. x Length	List Price
----------	----------	---------------	------------

200 VOLTS DC WORKING

BP-2-01	.01	3/8 x 1	\$0.25
BP-2-02	.02	3/8 x 1	.25
BP-2-05†	.05	3/8 x 1 1/4	.25
BP-2-1†	.1	1/8 x 1 1/4	.35
BP-2-2	.2	3/8 x 1 7/8	.45
BP-2-25	.25	3/8 x 1 7/8	.45
BP-2-5†	.5	3/8 x 1 7/8	.60

400 VOLTS DC WORKING

BP-4-01	.01	3/8 x 1	.25
BP-4-02	.02	3/8 x 1 1/4	.25
BP-4-03	.03	1/8 x 1 1/4	.30
BP-4-05†	.05	1/8 x 1 1/4	.30
BP-4-1	.1	1/2 x 1 5/8	.35
BP-4-2	.2	3/8 x 1 7/8	.40
BP-4-25	.25	3/8 x 1 7/8	.45

600 VOLTS DC WORKING

BP-6-001	.001	3/8 x 1	.25
BP-6-0015	.0015	3/8 x 1	.25
BP-6-002	.002	3/8 x 1	.25
BP-6-0022	.0022	3/8 x 1	.25
BP-6-003	.003	3/8 x 1	.25
BP-6-004	.004	3/8 x 1	.25
BP-6-0047	.0047	3/8 x 1	.25
BP-6-005	.005	3/8 x 1	.25
BP-6-006	.006	3/8 x 1	.25
BP-6-01	.01	3/8 x 1 1/4	.30
BP-6-015	.015	3/8 x 1 1/4	.30
BP-6-02	.02	1/8 x 1 1/4	.30
BP-6-022	.022	1/8 x 1 1/4	.30
BP-6-03	.03	1/2 x 1 5/8	.35
BP-6-04	.04	1/2 x 1 5/8	.35
BP-6-047	.047	1/2 x 1 5/8	.40
BP-6-05	.05	1/2 x 1 5/8	.40
BP-6-08	.08	5/8 x 1 7/8	.40
BP-6-1	.1	5/8 x 1 7/8	.45

1600 VOLTS DC WORKING

BP-16-001	.001	3/8 x 1 1/4	.55
BP-16-002	.002	3/8 x 1 1/4	.55
BP-16-003	.003	3/8 x 1 1/4	.55
BP-16-004	.004	3/8 x 1 1/4	.55
BP-16-005	.005	1/8 x 1 1/4	.55
BP-16-006	.006	1/8 x 1 1/4	.55
BP-16-007	.007	1/8 x 1 1/4	.60
BP-16-008	.008	1/2 x 1 5/8	.60
BP-16-01	.01	1/2 x 1 5/8	.60
BP-16-015	.015	1/2 x 1 5/8	.60
BP-16-02	.02	5/8 x 1 7/8	.60
BP-16-03	.03	5/8 x 1 7/8	.60

†Wax impregnated

CAPACITANCE TOLERANCES

Nominal Capacitance	Capacitance Tolerance
.001 mfd	+60% -25%
.002 mfd	+40% -20%
.01 mfd	+20% -20%
.11 mfd	+20% -10%

*TRADE MARK

Copyright by U. C. P., Inc.

TRADE DISCOUNT APPLIES TO LIST PRICES ONLY

Radio's Master — 19th Edition

Page P-133

ASTRON

the
"streamlined" profit
line

ASTRON CORPORATION

255 GRANT AVENUE, E. NEWARK, NEW JERSEY

TYPE AM

Molded Paper Tubulars
85°C. Operation

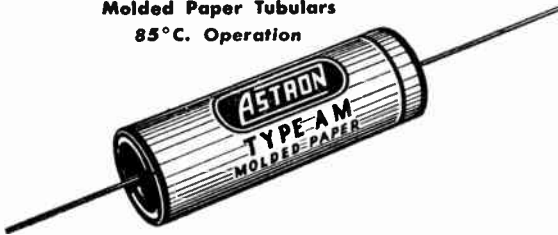

- Pressure molded units. Sealed terminal connections. Long, trouble-free service.
- Smaller than conventional paper tubular types. Better humidity and heat seal — in molded units at no extra cost.
- Ideal as original units or replacements in television, radio, radio-phonos and other commercial applications.
- Operation at temperatures up to 85°C.
- Leads 2" long. Individually tested and fully guaranteed. Attractive red label for easy identification.

200 VOLTS DC WORKING

Cat. No.	Cap. Mf.	Dia. x Length	Price
AM-2-01	.01	3/8 x 1	\$0.25
AM-2-02	.02	3/8 x 1	.25
AM-2-05	.05	3/8 x 1 1/8	.25
AM-2-1	.1	1/2 x 1 1/8	.35
AM-2-2	.2	5/8 x 1 1/8	.45
AM-2-25	.25	5/8 x 1 1/8	.45
AM-2-5	.5	5/8 x 1 1/8	.60

400 VOLTS DC WORKING

AM-4-01	.01	3/8 x 1	.25
AM-4-02	.02	3/8 x 1 1/8	.25
AM-4-05	.05	1/2 x 1 1/8	.30
AM-4-1	.1	1/2 x 1 5/8	.35
AM-4-2	.2	5/8 x 1 1/8	.40
AM-4-25	.25	5/8 x 1 1/8	.45
AM-4-5*	.5	3/4 x 2 1/4	.60

600 VOLTS DC WORKING

AM-6-001	.001	3/8 x 1	.25
AM-6-002	.002	3/8 x 1	.25
AM-6-003	.003	3/8 x 1	.25
AM-6-004	.004	3/8 x 1	.25
AM-6-005	.005	3/8 x 1	.25
AM-6-006	.006	3/8 x 1	.25
AM-6-01	.01	3/8 x 1 1/8	.30
AM-6-02	.02	1/2 x 1 1/8	.35
AM-6-03	.03	1/2 x 1 5/8	.35
AM-6-05	.05	1/2 x 1 5/8	.40
AM-6-08	.08	5/8 x 1 1/8	.40
AM-6-1	.1	5/8 x 1 1/8	.45
AM-6-25*	.25	3/4 x 2 1/4	.55
AM-6-5*	.5	1 x 2 1/8	.80

1600 VOLTS DC WORKING

AM-16-001	.001	3/8 x 1 1/8	.55
AM-16-002	.002	3/8 x 1 1/8	.55
AM-16-003	.003	3/8 x 1 1/8	.55
AM-16-005	.005	1/2 x 1 1/8	.55
AM-16-006	.006	1/2 x 1 1/8	.55
AM-16-008	.008	1/2 x 1 5/8	.60
AM-16-01	.01	1/2 x 1 5/8	.60
AM-16-015	.015	1/2 x 1 5/8	.60
AM-16-02	.02	5/8 x 1 1/8	.60
AM-16-03	.03	5/8 x 1 1/8	.60

* Supplied in tubular kraftboard containers with plastic end fill.

CAPACITANCE TOLERANCES

Nominal Capacitance	Capacitance Tolerance
.001 mfd — .0019 mfd	+60% —25%
.002 mfd — .009 mfd	+40% —20%
.01 mfd — .1 mfd	+20% —20%
.1 mfd — .5 mfd	+20% —10%

TYPE ARMF

Oil-Filled Metal Tubulars
85°C. Operation

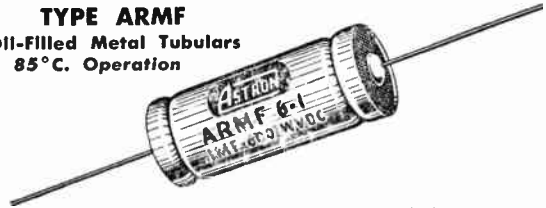

- Non-inductively wound. Mineral oil impregnated and filled. Hermetically sealed.
- Excellent capacitance stability and low power factor over entire temperature range —55°C. to +85°C.
- Units listed are internally insulated from case. Also available with capacitor section grounded to case (Type ARMG) and in accordance with all Specification MIL-C-25A Styles CP25-26-27-28-29.
- Wire leads 1 1/2" long. Standard capacitance tolerance ±20%.

CAPACITOR SECTION INSULATED FROM CASE:

ARMF (MIL Style CP25): Sizes and list prices as shown.

ARMFP (MIL Style CP26): Basic ARMF with plastic outer sleeve (P) for insulated body. Add 3/8" to length and 3/8" to diameter. Add 15¢ to ARMF list prices.

ARMFY (MIL Style CP27): Basic ARMF with riveted radial mounting strap "Y" on un-insulated body. Case sizes as listed. Add 10¢ to ARMF list prices.

ARMFPY (MIL Style CP28): Basic ARMF with plastic outer sleeve (P) and riveted radial mounting strap "Y". Add 3/8" to length, 3/8" to diameter. Add 25¢ to ARMF list prices.

ARMFA (MIL Style CP29): Basic ARMF with tangential soldered-on mounting bracket "A". Case sizes as listed. Add 40¢ to ARMF list prices.

CAPACITOR SECTION GROUNDED TO CASE:

ARMG (MIL Style CP25): Deduct 1/8" from length of ARMF sizes listed. Uninsulated body. Same list prices as ARMF.

ARMGP (MIL Style CP26): Basic ARMG with plastic outer sleeve (P) for insulated body. Add 3/8" to length and diameter of ARMF sizes listed. Add 15¢ to ARMF list prices.

ARMGY (MIL Style CP27): Basic ARMG with riveted radial mounting strap "Y" on un-insulated body. Deduct 1/8" from length of ARMF sizes listed. Add 10¢ to ARMF list prices.

ARMGPY (MIL Style CP28): Basic ARMG with plastic outer sleeve (P) and riveted radial mounting strap "Y". Add 3/8" to diameter and length of ARMF sizes listed. Add 25¢ to ARMF list prices.

ARMGA (MIL Style CP29): Basic ARMG with tangential soldered-on mounting bracket "A". Deduct 1/8" from length of ARMF sizes listed. Add 40¢ to ARMF list prices.

Cat. No.	Cap. Mf.	Dia x Length	List Price
----------	----------	--------------	------------

200 VOLTS DC WORKING

ARMF-2-1	.1	5/8 x 1 1/8	\$1.30
ARMF-2-25	.25	3/4 x 2 1/8	1.60
ARMF-2-5	.5	1 x 2 1/8	1.90

600 VOLTS DC WORKING

ARMF-6-003	.003	1/2 x 1 1/8	1.00
ARMF-6-006	.006	1/2 x 1 1/8	1.05
ARMF-6-01	.01	1/2 x 1 1/8	1.05
ARMF-6-02	.02	1/2 x 1 1/8	1.15
ARMF-6-05	.05	5/8 x 1 1/2	1.25
ARMF-6-1	.1	5/8 x 1 1/8	1.40
ARMF-6-25	.25	1 x 2 1/8	1.90
ARMF-6-5	.5	1 x 2 1/8	2.45

1000 VOLTS DC WORKING

ARMF-10-003	.003	5/8 x 1 1/8	1.10
ARMF-10-006	.006	5/8 x 1 1/8	1.15
ARMF-10-01	.01	5/8 x 1 1/8	1.25
ARMF-10-02	.02	5/8 x 1 1/8	1.35
ARMF-10-05	.05	3/4 x 1 1/2	1.45
ARMF-10-1	.1	1 x 1 1/8	1.65
ARMF-10-25	.25	1 x 2 1/8	1.90

1500 VOLTS DC WORKING

ARMF-15-003	.003	1 x 1 1/8	1.50
ARMF-15-006	.006	1 x 1 1/8	1.50
ARMF-15-01	.01	1 x 1 1/8	1.50
ARMF-15-02	.02	1 x 1 1/8	1.60
ARMF-15-05	.05	1 x 1 1/8	1.70
ARMF-15-1	.1	1 x 2 1/8	2.10

CAPACITANCE TOLERANCE: ±20% (M).

ASTRON

the
"streamlined" profit
line

ASTRON CORPORATION

255 GRANT AVENUE, E. NEWARK, NEW JERSEY

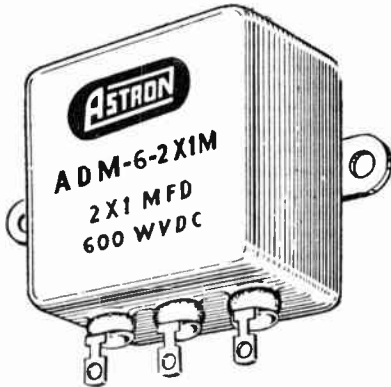

TYPE ADM

Bathtub Paper Capacitors 85°C. Operation

- Non-inductively wound. Mineral oil impregnated and filled. Hermetically sealed.
- Operating temperature range —55°C. to +85°C.
- Built to comply with strict requirements of MIL-C-25A. Silicone rubber compression-seal lug terminals. Completely immersion-proof.

- Single units have two terminals; duals have three terminals (one common); triple units have three terminals (case common).
- Standard position of Type ADM terminals is on side (MIL-C-25A Style CP53). Available also with terminals on top (ASTRON Type ADMT or MIL Style CP54) and bottom terminals (ASTRON Type ADMB or MIL Style CP55).
- Cap. Tolerance: ±20%.

Cat. No.	Cap. Mf.	L. x W. x H.	Mtg. Ctr.	List Price
100 VOLTS DC WORKING				
ADM-1-1M	1.0	1 1/8 x1 x 3/8	2 3/8	\$3.15
ADM-1-2M	2.0	2 x1 3/4 x 3/8	2 3/8	4.50
ADM-1-4M	4.0	2 x2 x1 1/8	2 3/8	6.40
200 VOLTS DC WORKING				
ADM-2-5	.5	1 1/8 x1 x 3/8	2 1/8	2.45
ADM-2-1M	1.0	2 x1 3/4 x 3/8	2 3/8	3.00
ADM-2-2M	2.0	2 x2 x1	2 3/8	3.95
400 VOLTS DC WORKING				
ADM-4-5	.5	1 1/8 x1 x 3/8	2 1/8	2.65
ADM-4-1M	1.0	2 x1 3/4 x 3/8	2 3/8	3.15
ADM-4-3x5	.5-.5-.5	2 x2 x1 1/8	2 3/8	4.50
600 VOLTS DC WORKING				
ADM-6-05	.05	1 x1 x 3/8	2 1/8	2.60
ADM-6-1	.1	1 x1 x 3/8	2 1/8	2.65
ADM-6-25	.25	1 x1 x 3/8	2 1/8	2.80
ADM-6-5	.5	1 x1 x1	2 1/8	3.00
ADM-6-1M	1.0	2 x1 3/4 x1	2 3/8	3.40
ADM-6-2M	2.0	2 x2 x1 1/8*	2 3/8	4.55
ADM-6-2x05	.05-.05	1 x1 x 3/8	2 1/8	3.30
ADM-6-2x1	.1-.1	1 x1 x 3/8	2 1/8	3.35
ADM-6-2x25	.25-.25	1 x1 x1	2 1/8	3.40
ADM-6-2x5	.5-.5	2 x1 3/4 x1	2 3/8	3.90
ADM-6-2x1M	1.0-1.0	2 x2 x1 1/8*	2 3/8	4.80
ADM-6-3x05	.05-.05-.05	1 x1 x 3/8	2 1/8	3.45
ADM-6-3x1	.1-.1-.1	1 x1 x 3/8	2 1/8	3.80
ADM-6-3x25	.25-.25-.25	2 x1 3/4 x 3/8	2 3/8	4.30
ADM-6-3x5	.5-.5-.5	2 x2 x1 1/8*	2 3/8	5.20
1000 VOLTS DC WORKING				
ADM-10-05	.05	1 x1 x 3/8	2 1/8	2.75
ADM-10-1	.1	1 x1 x 3/8	2 1/8	2.85
ADM-10-25	.25	1 x1 x 3/8	2 1/8	2.95
ADM-10-5	.5	2 x1 3/4 x 3/8	2 3/8	3.20
ADM-10-1M	1.0	2 x2 x1 1/8*	2 3/8	4.00
ADM-10-2x05	.05-.05	1 x1 x 3/8	2 1/8	3.50
ADM-10-2x1	.1-.1	1 x1 x 3/8	2 1/8	3.60
ADM-10-2x25	.25-.25	2 x1 3/4 x 3/8	2 3/8	3.80
ADM-10-2x5	.5-.5	2 x2 x1 1/8*	2 3/8	4.95
ADM-10-3x05	.05-.05-.05	1 x1 x 3/8	2 1/8	4.00
ADM-10-3x1	.1-.1-.1	2 x1 3/4 x 3/8	2 3/8	4.15
ADM-10-3x25	.25-.25-.25	2 x2 x1 1/8*	2 3/8	5.00

* For top or bottom terminals, case height is 1 1/4".



METEOR* TYPE ADZ Bathtub Capacitors

125°C. Operation

- Designed for operation at temperatures up to 125°C. without voltage derating.
- Excellent capacitance stability, less than 5% change over entire range —65°C. to +125°C. achieved by use of ASTRON - developed X-250* impregnant.
- Temperature characteristics exceed MIL specifications for Characteristic K.

- Compact sizes in handy, easy-mounting bathtub cases. (Glas-to-metal sealed lug-type terminals. Positive immersion proof seal.
- Standard position of terminals is on side (ASTRON Type ADZ or MIL Style CP53). Available also with terminals on top (ASTRON Type ADZT or MIL Style CP54); bottom terminals (ASTRON Type ADZB or MIL Style CP55).
- Standard Capacitance Tolerance: ±20%.

Cat. No.	Cap. Mf.	L. x W. x H.	Mtg. Ctr.	List Price
200 VOLTS DC WORKING				
ADZ-2-5	.5	1 1/8 x1 x 3/8	2 1/8	\$5.45
ADZ-2-1M	1.0	2 x1 3/4 x 3/8	2 3/8	5.85
ADZ-2-2M	2.0	2 x2 x1	2 3/8	7.40
400 VOLTS DC WORKING				
ADZ-4-05	.05	1 1/8 x1 x 3/8	2 1/8	4.50
ADZ-4-1	.1	1 1/8 x1 x 3/8	2 1/8	4.80
ADZ-4-25	.25	1 1/8 x1 x 3/8	2 1/8	5.20
ADZ-4-5	.5	1 1/8 x1 x 3/8	2 1/8	5.90
ADZ-4-1M	1.0	2 x1 3/4 x 3/8	2 3/8	6.80
600 VOLTS DC WORKING				
ADZ-6-05	.05	1 1/8 x1 x 3/8	2 1/8	5.10
ADZ-6-1	.1	1 1/8 x1 x 3/8	2 1/8	5.80
ADZ-6-25	.25	1 1/8 x1 x 3/8	2 1/8	5.90
ADZ-6-5	.5	1 1/8 x1 x1	2 1/8	7.05
ADZ-6-1M	1.0	2 x1 3/4 x1	2 3/8	7.95
ADZ-6-2M	2.0	2 x2 x1 1/8;	2 3/8	9.50

CAPACITANCE TOLERANCE: ±20% (M). Other tolerances are available.

Case height (C dimension) is 1 1/4" for top terminals (ADZT) or bottom terminals (ADZB).

*TRADE MARK

ASTRON

the
"streamlined" profit
line

ASTRON CORPORATION

255 GRANT AVENUE, E. NEWARK, NEW JERSEY

METEOR* SUBMINIATURE PAPER CAPACITORS

For 125°C. Operation without voltage derating

- Amazingly small sizes, compact and light weight units.
- Highly dependable operation at temperatures up to 125°C. without voltage derating.
- Exceptional capacitance stability, less than 5% change, over entire temperature range of -65°C. to +125°C. due to use of ASTRON-developed high-temperature impregnant X-250*.
- High insulation resistance, low power factor, unusually low resonance loss. High test voltage indicates extra margin of safety in operation.
- Built to exceed stringent requirements of Specification MIL-C-25A for Styles CP04-05-08-09-10-11 (ASTRON Types AQ, TQF, and variations); and Styles CP53-54-55, Characteristic K (ASTRON Type ADZ, bathtub).
- Positive hermetic closure of the metal cases is assured by glass-to-metal solder seal terminals.
- Tubulars supplied in a variety of construction and mounting styles to meet your specific needs: extended foil or inserted tab; capacitor section grounded to case or insulated from case; plastic outer sleeve; with soldered-on tangential or L-type bracket; screw neck mounting style; or stud-base mounting style.

METEOR* TYPE AQ Glass-to-Metal Sealed SUBMINIATURE TUBULARS

- No voltage derating necessary over entire operating temperature range -65°C. to +125°C.
- Extended foil, non-inductively wound construction offers extremely small size and lowest possible resonant losses in low and high voltage applications.
- Excellent capacitance-temperature stability, long life.
- Available in a variety of construction styles to meet your specific needs, as follows:

CAPACITOR SECTION GROUNDED TO CASE (Glass-to-Metal terminal at one end):

- AQ (MIL Style CP08):** Basic unit. Sizes and list prices as shown. Uninsulated body.
- AQP (MIL Style CP09):** Basic AQ unit with plastic outer sleeve (P) for insulated body. Add $\frac{1}{8}$ " to diameter and length of AQ sizes listed. Add 15¢ to AQ list prices.
- AQ-A:** Basic AQ unit with soldered-on tangential mounting bracket "A" on uninsulated body. Case sizes as listed for AQ. Add 40¢ to AQ list prices.
- AQ-B:** Basic AQ unit with soldered-on L-type bracket "B" on uninsulated body. Case sizes as listed for AQ. Add 40¢ to AQ list prices.
- AQS:** Screw neck mounting type. Uninsulated body. Available in same ratings as AQ. Minimum case diameter .400". Add 80¢ to AQ list prices.
- AQV:** Stud base mounting type. Uninsulated body. Available in same ratings and case sizes as AQ. Add 60¢ to AQ list prices.

CAPACITOR SECTION INSULATED FROM CASE (Glass-to-Metal terminal both ends):

- AQF (MIL Style CP08):** Basic unit in "floating" construction. Add $\frac{1}{8}$ " to length of AQ sizes listed. Uninsulated body. Add \$1.00 to AQ list prices.
- AQFP (MIL Style CP09):** Basic AQF unit with plastic outer sleeve (P) for insulated body. Add $\frac{1}{8}$ " to diameter and $\frac{1}{8}$ " to length of AQ sizes listed. Add \$1.15 to AQ list prices.
- AQF-A:** Basic AQF unit with soldered-on tangential mounting bracket "A" on uninsulated body. Add $\frac{1}{8}$ " to length of AQ sizes listed. Add \$1.10 to AQ list prices.
- AQF-B:** Basic AQF unit with soldered-on L-type bracket "B" on uninsulated body. Add $\frac{1}{8}$ " to AQ sizes listed. Add \$1.40 to AQ list prices.
- AQFS:** Screw neck mounting type. Uninsulated body. Available in same ratings as AQ. Minimum case diameter is .400". Add $\frac{1}{8}$ " to case length of AQ sizes listed. Add \$1.80 to AQ list prices.

*TRADE MARK

Cat. No.	Cap. Mf.	Dia. x Length	List Price	300 VOLTS DC WORKING			
				AQ-3-0022	.0022	.235x $\frac{1}{8}$	2.80
				100 VOLTS DC WORKING			
AQ-1-0033	.0033	.235x $\frac{1}{8}$	\$2.70	AQ-3-0033	.0033	.235x $\frac{1}{8}$	2.90
AQ-1-0047	.0047	.235x $\frac{1}{8}$	2.80	AQ-3-0047	.0047	.235x $\frac{1}{8}$	3.05
AQ-1-01	.01	.235x $\frac{1}{8}$	2.95	AQ-3-01	.01	.312x $\frac{1}{8}$	3.20
AQ-1-015	.015	.235x $\frac{1}{8}$	2.95	AQ-3-015	.015	.312x $\frac{1}{8}$	3.20
AQ-1-022	.022	.312x $\frac{1}{8}$	3.00	AQ-3-022	.022	.312x $\frac{1}{8}$	3.25
AQ-1-033	.033	.312x $\frac{1}{8}$	3.05	AQ-3-033	.033	.400x $\frac{1}{8}$	3.30
AQ-1-047	.047	.312x $\frac{1}{8}$	3.15	AQ-3-047	.047	.400x $\frac{1}{8}$	3.35
AQ-1-068	.068	.400x $\frac{1}{8}$	3.20	AQ-3-068	.068	.400x1 $\frac{1}{8}$	3.40
AQ-1-1	.1	.400x $\frac{1}{8}$	3.20	AQ-3-1	.1	.400x1 $\frac{1}{8}$	3.45
AQ-1-15	.15	.400x1 $\frac{1}{8}$	3.40	AQ-3-15	.15	.562x1 $\frac{1}{8}$	3.60
AQ-1-22	.22	.400x1 $\frac{1}{8}$	3.50	AQ-3-22	.22	.562x1 $\frac{1}{8}$	3.75
AQ-1-27	.27	.562x1 $\frac{1}{8}$	3.60	AQ-3-27	.27	.562x1 $\frac{1}{8}$	4.25
AQ-1-33	.33	.562x1 $\frac{1}{8}$	4.00	AQ-3-33	.33	.562x1 $\frac{1}{8}$	4.35
AQ-1-47	.47	.562x1 $\frac{1}{8}$	4.15	AQ-3-47	.47	.670x1 $\frac{1}{8}$	4.50
AQ-1-56	.56	.562x1 $\frac{1}{8}$	4.30	AQ-3-56	.56	.750x2 $\frac{1}{8}$	4.60
AQ-1-68	.68	.562x1 $\frac{1}{8}$	4.60	AQ-3-68	.68	.750x2 $\frac{1}{8}$	5.10
AQ-1-1M	1.0	.670x1 $\frac{1}{8}$	4.85				
				400 VOLTS DC WORKING			
AQ-2-0022	.0022	.235x $\frac{1}{8}$	2.70	AQ-4-0022	.0022	.235x $\frac{1}{8}$.95
AQ-2-0033	.0033	.235x $\frac{1}{8}$	2.80	AQ-4-0033	.0033	.235x $\frac{1}{8}$	3.05
AQ-2-0047	.0047	.235x $\frac{1}{8}$	2.95	AQ-4-0047	.0047	.312x $\frac{1}{8}$	3.15
AQ-2-0068	.0068	.235x $\frac{1}{8}$	3.00	AQ-4-0068	.0068	.312x $\frac{1}{8}$	3.25
AQ-2-01	.01	.312x $\frac{1}{8}$	3.10	AQ-4-01	.01	.312x $\frac{1}{8}$	3.30
AQ-2-015	.015	.312x $\frac{1}{8}$	3.10	AQ-4-015	.015	.312x $\frac{1}{8}$	3.30
AQ-2-022	.022	.312x $\frac{1}{8}$	3.20	AQ-4-022	.022	.400x $\frac{1}{8}$	3.35
AQ-2-033	.033	.312x $\frac{1}{8}$	3.20	AQ-4-033	.033	.400x $\frac{1}{8}$	3.40
AQ-2-047	.047	.400x $\frac{1}{8}$	3.25	AQ-4-047	.047	.400x1 $\frac{1}{8}$	3.45
AQ-2-056	.056	.400x $\frac{1}{8}$	3.30	AQ-4-068	.068	.400x1 $\frac{1}{8}$	3.50
AQ-2-068	.068	.400x $\frac{1}{8}$	3.30	AQ-4-1	.1	.562x1 $\frac{1}{8}$	3.55
AQ-2-1	.1	.400x1 $\frac{1}{8}$	3.35	AQ-4-15	.15	.562x1 $\frac{1}{8}$	3.75
AQ-2-15	.15	.400x1 $\frac{1}{8}$	3.50	AQ-4-22	.22	.562x1 $\frac{1}{8}$	3.85
AQ-2-22	.22	.562x1 $\frac{1}{8}$	3.65	AQ-4-27	.27	.670x1 $\frac{1}{8}$	4.55
AQ-2-27	.27	.562x1 $\frac{1}{8}$	3.75	AQ-4-33	.33	.670x1 $\frac{1}{8}$	4.65
AQ-2-33	.33	.562x1 $\frac{1}{8}$	3.95	AQ-4-47	.47	.750x2 $\frac{1}{8}$	4.75
AQ-2-47	.47	.562x1 $\frac{1}{8}$	4.25				
AQ-2-56	.56	.670x1 $\frac{1}{8}$	4.50	600 VOLTS DC WORKING			
AQ-2-68	.68	.670x1 $\frac{1}{8}$	4.90	AQ-6-0022	.0022	.235x $\frac{1}{8}$	3.00
AQ-2-1M	1.0	.750x2 $\frac{1}{8}$	5.25	AQ-6-0033	.0033	.312x $\frac{1}{8}$	3.10
				AQ-6-0047	.0047	.312x $\frac{1}{8}$	3.20
				AQ-6-0068	.0068	.312x $\frac{1}{8}$	3.30
				AQ-6-01	.01	.312x $\frac{1}{8}$	3.35
				AQ-6-015	.015	.400x $\frac{1}{8}$	3.35
				AQ-6-022	.022	.400x $\frac{1}{8}$	3.40
				AQ-6-033	.033	.400x1 $\frac{1}{8}$	3.45
				AQ-6-047	.047	.400x1 $\frac{1}{8}$	3.50
				AQ-6-068	.068	.562x1 $\frac{1}{8}$	3.65
				AQ-6-1	.1	.562x1 $\frac{1}{8}$	3.75
				AQ-6-15	.15	.562x1 $\frac{1}{8}$	3.85
				AQ-6-22	.22	.670x1 $\frac{1}{8}$	4.35
				AQ-6-27	.27	.750x2 $\frac{1}{8}$	4.50
				AQ-6-33	.33	.750x2 $\frac{1}{8}$	4.90
				AQ-6-47	.47	.750x2 $\frac{1}{8}$	5.25

Standard Tolerance $\pm 20\%$.

ASTRON

the
"streamlined" profit
line

ASTRON CORPORATION

255 GRANT AVENUE, E. NEWARK, NEW JERSEY

METEOR* TYPE TQF

125°C. Operation

Glass-to-Metal Sealed
SUBMINIATURE TUBULARS



- Inserted tab construction provides smallest paper-foil capacitors available. Ideal where resonant losses are secondary to small size.
- No voltage derating necessary over entire operating temperature range —65°C. to +125°C.
- Excellent capacitance stability over entire temperature range.
- Available in a variety of construction styles to meet your specific needs, as follows:

CAPACITOR SECTION INSULATED FROM CASE (Glass-to-Metal terminal both ends):

TQF (MIL Style CP04): Basic unit in "floating" construction. Sizes and list prices as shown. Uninsulated body.

TQFP (MIL Style CP05): Basic TQF unit with plastic outer sleeve (P) for insulated body. Add $\frac{1}{8}$ " to diameter and length of TQF sizes listed. Add 15¢ to list price.

TQF-A (MIL Style CP10): Basic TQF unit with soldered-on tangential mounting bracket "A" on uninsulated body. Case sizes as listed for TQF. Add 40¢ to TQF list prices.

TQF-B: Basic TQF unit with soldered-on L-type mounting bracket "B" on uninsulated body. Case sizes as listed for TQF. Add 40¢ to TQF list prices.

TQFS (MIL Style CP11): Screw neck mounting type. Uninsulated body. Available in same ratings as TQF. Minimum case diameter is .100". Add 80¢ to TQF list prices.

CAPACITOR SECTION GROUNDED TO CASE (Glass-to-Metal terminal at one end):

TQ (MIL Style CP04): Basic grounded unit. Deduct $\frac{1}{8}$ " from length of TQF sizes listed. Uninsulated body. Deduct \$1.00 from TQF list prices.

TQP (MIL Style CP05): Basic TQ unit with plastic outer sleeve (P) for insulated body. Add $\frac{1}{8}$ " to diameter of TQF sizes listed. Deduct 85¢ from TQF list prices.

TQ-A (MIL Style CP10): Basic TQ unit with soldered-on tangential mounting bracket "A" on uninsulated body. Deduct $\frac{1}{8}$ " from length of TQF sizes listed. Deduct 60¢ from TQF list prices.

TQ-B: Basic TQ unit with soldered-on L-type mounting bracket "B" on uninsulated body. Deduct $\frac{1}{8}$ " from length of TQF sizes listed. Deduct 60¢ from TQF list prices.

TQS (MIL Style CP11): Screw neck mounting type. Uninsulated body. Available in same ratings as TQF listed. Minimum case diameter .100". Deduct $\frac{1}{8}$ " from length of TQF sizes listed. Deduct 20¢ from TQF list prices.

TQV: Stud base mounting type. Uninsulated body. Available in same ratings as TQF listed. Deduct $\frac{1}{8}$ " from TQF sizes. Deduct 40¢ from TQF list prices.

*TRADE MARK

Cat. No.	Cap. Mf.	Dia. x Length	List Price	400 VOLTS DC WORKING			
100 VOLTS DC WORKING				TQF-4-001	.001	.235x $\frac{3}{8}$	3.30
TQF-1-027	.027	.235x $\frac{3}{8}$	\$3.60	TQF-4-0015	.0015	.235x $\frac{3}{8}$	3.40
TQF-1-033	.033	.235x $\frac{3}{8}$	3.60	TQF-4-0022	.0022	.235x $\frac{3}{8}$	3.50
TQF-1-047	.047	.312x $\frac{3}{8}$	3.70	TQF-4-0033	.0033	.235x $\frac{3}{8}$	3.60
TQF-1-068	.068	.312x $\frac{3}{8}$	3.75	TQF-4-0047	.0047	.235x $\frac{3}{8}$	3.70
TQF-1-1	.1	.312x $\frac{3}{8}$	3.75	TQF-4-0068	.0068	.235x $\frac{3}{8}$	3.80
TQF-1-15	.15	.400x $\frac{3}{8}$	3.90	TQF-4-01	.01	.235x $\frac{3}{8}$	3.85
TQF-1-22	.22	.400x1 $\frac{1}{2}$	4.00	TQF-4-015	.015	.235x $\frac{3}{8}$	3.85
TQF-1-27	.27	.400x1 $\frac{3}{8}$	4.10	TQF-4-022	.022	.312x $\frac{3}{8}$	3.85
TQF-1-33	.33	.400x1 $\frac{3}{8}$	4.40	TQF-4-027	.027	.312x $\frac{3}{8}$	3.85
TQF-1-47	.47	.562x1 $\frac{1}{2}$	4.55	TQF-4-033	.033	.312x $\frac{3}{8}$	3.90
TQF-1-68	.68	.562x1 $\frac{3}{8}$	4.95	TQF-4-047	.047	.400x $\frac{3}{8}$	3.95
TQF-1-1M	1.0	.562x1 $\frac{1}{2}$	5.15	TQF-4-068	.068	.400x1 $\frac{1}{2}$	4.00
200 VOLTS DC WORKING				TQF-4-1	.1	.400x1 $\frac{1}{2}$	4.05
TQF-2-01	.01	.235x $\frac{3}{8}$	3.65	TQF-4-15	.15	.562x1 $\frac{1}{2}$	4.20
TQF-2-015	.015	.235x $\frac{3}{8}$	3.65	TQF-4-22	.22	.562x1 $\frac{3}{8}$	4.30
TQF-2-022	.022	.235x $\frac{3}{8}$	3.70	TQF-4-27	.27	.562x1 $\frac{3}{8}$	4.90
TQF-2-027	.027	.312x $\frac{3}{8}$	3.70	TQF-4-33	.33	.562x1 $\frac{3}{8}$	4.95
TQF-2-033	.033	.312x $\frac{3}{8}$	3.75	TQF-4-47	.47	.670x1 $\frac{1}{2}$	5.05
TQF-2-047	.047	.312x $\frac{3}{8}$	3.80	TQF-4-56	.56	.750x2 $\frac{1}{2}$	5.20
TQF-2-068	.068	.312x $\frac{3}{8}$	3.85	TQF-4-68	.68	.750x2 $\frac{1}{2}$	5.50
TQF-2-1	.1	.400x $\frac{3}{8}$	3.85	TQF-4-1M	1.0	1 x1 $\frac{1}{2}$	6.10
TQF-2-15	.15	.400x1 $\frac{1}{2}$	4.00	600 VOLTS DC WORKING			
TQF-2-22	.22	.400x1 $\frac{3}{8}$	4.10	TQF-6-0047	.0047	.235x $\frac{3}{8}$	3.75
TQF-2-27	.27	.562x1 $\frac{1}{2}$	4.20	TQF-6-0068	.0068	.235x $\frac{3}{8}$	3.85
TQF-2-33	.33	.562x1 $\frac{1}{2}$	4.40	TQF-6-01	.01	.312x $\frac{3}{8}$	3.85
TQF-2-47	.47	.562x1 $\frac{3}{8}$	4.65	TQF-6-015	.015	.312x $\frac{3}{8}$	3.85
TQF-2-68	.68	.562x1 $\frac{3}{8}$	5.20	TQF-6-022	.022	.312x $\frac{3}{8}$	3.90
TQF-2-1M	1.0	.670x1 $\frac{1}{2}$	5.50	TQF-6-027	.027	.400x $\frac{3}{8}$	3.90
300 VOLTS DC WORKING				TQF-6-033	.033	.400x $\frac{3}{8}$	3.95
TQF-3-0068	.0068	.235x $\frac{3}{8}$	3.75	TQF-6-047	.047	.400x1 $\frac{1}{2}$	4.00
TQF-3-01	.01	.235x $\frac{3}{8}$	3.75	TQF-6-068	.068	.400x1 $\frac{3}{8}$	4.10
TQF-3-015	.015	.235x $\frac{3}{8}$	3.75	TQF-6-1	.1	.562x1 $\frac{1}{2}$	4.20
TQF-3-022	.022	.312x $\frac{3}{8}$	3.80	TQF-6-15	.15	.562x1 $\frac{1}{2}$	4.30
TQF-3-027	.027	.312x $\frac{3}{8}$	3.80	TQF-6-22	.22	.562x1 $\frac{3}{8}$	4.70
TQF-3-033	.033	.312x $\frac{3}{8}$	3.85	TQF-6-27	.27	.670x1 $\frac{1}{2}$	4.85
TQF-3-047	.047	.312x $\frac{3}{8}$	3.85	TQF-6-33	.33	.670x1 $\frac{3}{8}$	5.20
TQF-3-068	.068	.400x $\frac{3}{8}$	3.90	TQF-6-47	.47	.750x2 $\frac{1}{2}$	5.50
EQF-3-1	.1	.400x1 $\frac{1}{2}$	3.95	Standard Tolerance $\pm 20\%$.			
TQF-3-15	.15	.400x1 $\frac{3}{8}$	4.10				
EQF-3-22	.22	.562x1 $\frac{1}{2}$	4.20				
TQF-3-27	.27	.562x1 $\frac{1}{2}$	4.65				
TQF-3-33	.33	.562x1 $\frac{3}{8}$	4.70				
TQF-3-47	.47	.562x1 $\frac{3}{8}$	4.85				
TQF-3-68	.68	.670x1 $\frac{1}{2}$	5.35				
TQF-3-1M	1.0	.750x2 $\frac{1}{2}$	5.90				

ASTRON

the
"streamlined" profit
line

ASTRON CORPORATION

255 GRANT AVENUE, E. NEWARK, NEW JERSEY

METALITE®

Metallized Paper Capacitors for 65°C. and 85°C. Operation

METALITE CAPACITORS

Feature:

- Ultra-compact sizes. Light weight. Ideal for miniaturization applications, and portable, mobile and airborne equipment.
- As much as 75% reduction in size over conventional paper-foil capacitors.
- Self-healing — the ability to withstand high dielectric stresses. METALITE capacitors can be subjected to momentary overvoltages and surges over and over again without danger of permanent failure.
- Temperature Range (Metal cased units) -65°C. to +85°C.; (cardboard cased Type ML) -55°C. to +65°C.
- Excellent RF characteristics. Low RF impedance due to small sizes and short current path. Low power factor.
- Wide variety of applications: RF and audio bypass circuits, noise suppression filters and systems, instruments, and various types of communication equipment where small size, light weight and the self-healing feature are especially desirable characteristics to meet specific circuit requirements.
- Interchangeability with standard paper-foil capacitor designs when operated within published ratings and circuit requirements.

METALITE® TYPE MQC

85°C. Operation



Glass-to-Metal Sealed SUBMINIATURE TUBULARS

- Smallest paper capacitor type available.
- Temperature Range —65°C. to +85°C.
- Non-inductively wound. Mineral wax impregnated and filled. Tinned, non-ferrous metal cases.
- Capacitor section grounded to case (Type MQC) with glass-to-metal terminal at one end. Available also with capacitor section insulated from case (Type MQCF) with glass-to-metal terminal at each end.
- Lead length 1 3/4" minimum. Standard capacitance tolerance: ±20%.

CAPACITOR SECTION GROUNDED TO CASE (Glass-to-metal terminal at one end):

- MQC:** Basic unit. Uninsulated body. Sizes and list prices as shown.
- MQCF:** Basic MQC unit with plastic outer sleeve (P) for insulated body. Add 3/8" to diameter and length of MQC sizes listed. Add 15¢ to MQC list prices.
- MQC-A:** Basic MQC unit with soldered-on tangential mounting bracket "A" on uninsulated body. Case sizes as listed for MQC. Add 40¢ to MQC list prices.
- MQC-B:** Basic MQC unit with soldered-on L-type bracket "B" on uninsulated body. Case sizes as listed for MQC. Add 40¢ to MQC list prices.
- MQCS:** Screw neck mounting type. Uninsulated body. Available in same ratings as MQC. Minimum case diameter .400". Add 50¢ to MQC list prices.
- MQV:** Stud base mounting type. Uninsulated body. Available in same ratings and case sizes as MQC. Add 60¢ to MQC list prices.

CAPACITOR SECTION INSULATED FROM CASE (Glass-to-metal terminal each end):

- MQCF:** Basic unit in "floating" construction. Add 3/8" to length of MQC sizes listed. Uninsulated body. Add 50¢ to MQC list prices.
- MQCF-P:** Basic MQCF unit with plastic outer sleeve (P) for insulated body. Add 3/8" to diameter and 1/4" to length of MQC sizes listed. Add 65¢ to MQC list prices.
- MQCF-A:** Basic MQCF unit with soldered-on tangential mounting bracket "A" on uninsulated body. Add 3/8" to length of MQC sizes listed. Add 90¢ to MQC list prices.
- MQCF-B:** Basic MQCF unit with soldered-on L-type bracket "B" on uninsulated body. Add 3/8" to length of MQC sizes listed. Add 90¢ to MQC list prices.
- MQCFS:** Screw neck mounting type. Uninsulated body. Available in same ratings as MQC. Minimum case diameter .400". Add 3/8" to case length of MQC sizes listed. Add \$1.00 to MQC list prices.

Cat. No.	Cap. Mf.	Dia. x Length	List Price
150 VOLTS DC WORKING			
MQC-1.5-4M	4.0	1 x 1 3/4"	5.00
MQC-1.5-6M	6.0	1 x 1 3/4"	5.85
MQC-1.5-8M	8.0	1 x 2 1/4"	6.65
200 VOLTS DC WORKING			
MQC-2-01	.01	.235x 3/8"	\$2.05
MQC-2-02	.02	.235x 3/8"	2.10
MQC-2-033	.033	.235x 3/8"	2.10
MQC-2-04	.04	.235x 3/8"	2.10
MQC-2-05	.05	.235x 3/8"	2.10
MQC-2-1	.1	.312x 3/8"	2.15
MQC-2-15	.15	.400x 3/8"	2.20
MQC-2-2	.2	.400x 3/8"	2.30
MQC-2-25	.25	.400x 3/8"	2.35
MQC-2-33	.33	.400x1 1/8"	2.40
MQC-2-5	.5	.400x1 1/8"	2.40
MQC-2-68	.68	.562x1 1/2"	2.55
MQC-2-1M	1.0	.562x1 1/2"	2.65
MQC-2-1.5M	1.5	.562x1 1/2"	2.85
MQC-2-2M	2.0	.562x1 1/2"	3.95
400 VOLTS DC WORKING			
MQC-4-01	.01	.235x 3/8"	2.10
MQC-4-02	.02	.235x 3/8"	2.15
MQC-4-03	.03	.312x 3/8"	2.15
MQC-4-04	.04	.312x1 1/8"	2.20
MQC-4-05	.05	.312x1 1/8"	2.20
MQC-4-1	.1	.400x1 1/8"	2.25
MQC-4-15	.15	.562x1 1/8"	2.35
MQC-4-2	.2	.562x1 1/8"	2.40
MQC-4-25	.25	.562x1 1/8"	2.45
MQC-4-33	.33	.562x1 1/2"	2.55
MQC-4-5	.5	.562x1 1/2"	2.75
MQC-4-68	.68	.670x1 1/2"	2.95
MQC-4-1M	1.0	.670x2 1/4"	3.05
MQC-4-1.5M	1.5	1 x 2 1/4"	4.10
MQC-4-2M	2.0	1 x 2 1/4"	4.65
MQC-4-4M	4.0	1 1/2 x 2 1/4"	6.85
600 VOLTS DC WORKING			
MQC-6-01	.01	.235x 3/8"	2.15
MQC-6-015	.015	.312x 3/8"	2.15
MQC-6-02	.02	.312x 3/8"	2.15
MQC-6-03	.03	.312x 3/8"	2.20
MQC-6-04	.04	.312x1 1/8"	2.25
MQC-6-05	.05	.312x1 1/8"	2.25
MQC-6-1	.1	.400x1 1/8"	2.30
MQC-6-15	.15	.562x1 1/8"	2.45
MQC-6-22	.22	.562x1 1/8"	2.65
MQC-6-25	.25	.562x1 1/2"	2.70
MQC-6-33	.33	.670x1 1/4"	2.85
MQC-6-5	.5	.670x1 1/2"	3.00
MQC-6-68	.68	.670x2 1/4"	3.45
MQC-6-1M	1.0	.750x2 1/4"	3.65
MQC-6-2M	2.0	1 x 2 1/4"	5.15
STANDARD CAPACITANCE TOLERANCE: ±20%.			

METALITE® TYPE ML

Cardboard Tubulars

65°C. Operation



- Temperature Range —55°C. to +65°C.
- Microcrystalline hydrocarbon wax impregnated.
- Sturdy, wax-impregnated cardboard tubes. Strong terminal connections, metal end caps. Units can be point-to-point connected and supported by own leads.
- Wire leads 1 1/2" long.
- Overall mineral wax coating for added protection against moisture and humidity.
- Standard capacitance tolerance: —20% +30%.

Cat. No.	Cap. Mf.	Dia. x Length	List Price
200 VOLTS DC WORKING			
ML-2-01	.01	3/8 x 5/8"	\$0.65
ML-2-02	.02	3/8 x 5/8"	.65
ML-2-03	.03	3/8 x 5/8"	.65
ML-2-05	.05	3/8 x 5/8"	.65
ML-2-1	.1	3/8 x 5/8"	.70
ML-2-25	.25	3/8 x 5/8"	.90
ML-2-5	.5	3/8 x 1 1/8"	1.05
ML-2-1M	1.0	1/2 x 1 1/2"	1.30
ML-2-2M	2.0	5/8 x 1 1/2"	1.80
400 VOLTS DC WORKING			
ML-4-01	.01	3/8 x 5/8"	.70
ML-4-02	.02	3/8 x 5/8"	.70
ML-4-03	.03	3/8 x 5/8"	.70
ML-4-05	.05	3/8 x 5/8"	.70
ML-4-1	.1	3/8 x 1 1/8"	.80
ML-4-25	.25	3/8 x 1 1/8"	1.00
ML-4-5	.5	3/8 x 1 1/2"	1.15
ML-4-1M	1.0	3/8 x 2 1/4"	1.60
600 VOLTS DC WORKING			
ML-6-01	.01	3/8 x 5/8"	.70
ML-6-02	.02	3/8 x 5/8"	.70
ML-6-03	.03	3/8 x 5/8"	.80
ML-6-05	.05	3/8 x 5/8"	.80
ML-6-1	.1	3/8 x 1 1/8"	.90
ML-6-25	.25	3/8 x 1 1/8"	1.10
ML-6-5	.5	3/8 x 1 1/2"	1.45
ML-6-1M	1.0	3/8 x 2 1/4"	1.80
STANDARD CAPACITANCE TOLERANCE: —20% +30%.			

ASTRON

the
"streamlined" profit
line

ASTRON CORPORATION

255 GRANT AVENUE, E. NEWARK, NEW JERSEY

METALITE® TYPE MRF

Metal Cased Tubulars
85°C. Operation

- Temperature Range —85°C. to +85°C.
- Mineral wax impregnated and filled.
- Hermetically sealed. Neoprene-phenolic end discs.
- Type MRF supplied with capacitor section insulated from case. Also available with section grounded to case (Type MRG).
- Lead length 1 3/4" minimum.
- Standard capacitance tolerance: ±20%.



CAPACITOR SECTION INSULATED FROM CASE:

MRF: Basic unit. Sizes and list prices as shown.
MRF-P: Basic MRF unit with plastic outer sleeve (P). Add 15¢ to length and 1/8" to diameter of MRF listed. Add 15¢ to MRF list prices.
MRF-Y: Basic MRF unit with riveted radial mounting strap "Y". Case sizes as listed for MRF. Add 10¢ to MRF list prices.
MRF-Y-P: Basic MRF unit with riveted radial mounting strap "Y" over plastic insulating sleeve (P). Add 15¢ to length and 1/8" to diameter of MRF listed. Add 25¢ to MRF list prices.
MRF-A: Basic MRF unit with tangential soldered-on mounting bracket "A". Case sizes as listed for MRF. Add 40¢ to MRF list prices.

CAPACITOR SECTION GROUNDED TO CASE:

MRG: Basic style in grounded construction. Deduct 10¢ from MRF sizes listed. Add 10¢ to MRF list prices.
MRG-Y: Basic MRG unit with riveted radial mounting strap "Y". Deduct 10¢ from MRF sizes listed. Add 10¢ to MRF list prices.
MRG-Y-P: Basic MRG unit with riveted radial mounting strap "Y" over plastic insulating sleeve (P). Add 15¢ to length and 1/8" to diameter of MRF listed. Add 25¢ to MRF list prices.
MRG-A: Basic MRG unit with tangential soldered-on mounting bracket "A". Deduct 10¢ from length of MRF sizes listed. Add 40¢ to MRF list prices.

150 VOLTS DC WORKING

Cat. No.	Cap. Mf.	L. x W. x H.	Mtg. Ctr.	List Price
MRF-1.5-4M	4.0	1 x 1 1/4 x 1 1/4	2 1/2	4.35
MRF-1.5-6M	6.0	1 x 1 1/4 x 1 1/4	2 1/2	5.30
MRF-1.5-8M	8.0	1 1/2 x 1 1/4 x 1 1/4	2 1/2	6.10
MRF-1.5-10M	10.0	1 1/2 x 1 1/4 x 1 1/4	2 1/2	7.20

Cat. No.	Cap. Mf.	Dia. x Length	List Price
200 VOLTS DC WORKING			
MRF-2-05	.05	3/8 x 7/8	\$1.40
MRF-2-1	.1	1/2 x 7/8	1.45
MRF-2-25	.25	1/2 x 7/8	1.60
MRF-2-5	.5	1/2 x 1 1/8	1.70
MRF-2-1M	1.0	.670 x 1 1/8	2.10
MRF-2-2M	2.0	.670 x 1 1/8	2.60

400 VOLTS DC WORKING

MRF-4-03	.03	3/8 x 7/8	1.35
MRF-4-05	.05	1/2 x 7/8	1.45
MRF-4-1	.1	1/2 x 1 1/8	1.60
MRF-4-25	.25	.670 x 1 1/8	1.80
MRF-4-5	.5	.670 x 1 1/8	2.00
MRF-4-1M	1.0	1 x 2 1/8	2.50
MRF-4-2M	2.0	1 x 2 1/8	3.60
MRF-4-3M	3.0	1 1/8 x 2 1/8	4.80
MRF-4-4M	4.0	1 1/4 x 2 1/8	5.90

600 VOLTS DC WORKING

MRF-6-01	.01	3/8 x 7/8	1.35
MRF-6-02	.02	1/2 x 7/8	1.45
MRF-6-03	.03	1/2 x 7/8	1.50
MRF-6-05	.05	1/2 x 7/8	1.55
MRF-6-1	.1	1/2 x 1 1/8	1.70
MRF-6-2	.2	.670 x 1 1/8	1.90
MRF-6-25	.25	.670 x 1 1/8	2.00
MRF-6-5	.5	.670 x 1 1/8	2.40
MRF-6-1M	1.0	1 x 2 1/8	3.00
MRF-6-2M	2.0	1 1/8 x 2 1/8	4.00
MRF-6-3M	3.0	1 1/4 x 2 1/8	5.30

Standard capacitance tolerance: ±20%.
Other tolerances are available.

- Units meet MIL tests for moisture resistance, thermal cycle immersion and vibration.
- Single units have two terminals; dual units have three terminals, one terminal common negative.
- Standard position of terminals on side. Also available with terminals on top (Type MDT) or bottom (Type MDB).
- Standard capacitance tolerance: ±20%.
- Compact sizes. Light weight. Up to 75% reduction in sizes over conventional paper-foil capacitors.
- Temperature Range —85°C. to +85°C.
- Space-saving metallized paper dielectric makes possible wider choice of high capacitance ratings than ever before obtainable in bathtub cases.
- Hermetically sealed. Silicone rubber compression seal lug terminals.

METALITE® TYPE MD

Bathtub Capacitors
85°C. Operation

Cat. No.	Cap. Mf.	L. x W. x H.	Mtg. Ctr.	List Price
400 VOLTS DC WORKING				
MD-4-25	.25	1 3/8 x 1 x 3/4	2 1/2	3.35
MD-4-5	.5	1 3/8 x 1 x 3/4	2 1/2	3.55
MD-4-1M	1.0	1 3/8 x 1 x 3/4	2 1/2	3.95
MD-4-2M	2.0	2 x 1 3/8 x 7/8	2 3/8	4.90
MD-4-4M	4.0	2 x 2 x 1 1/2	2 3/8	7.85
MD-4-6M	6.0	2 x 2 x 1 1/2	2 3/8	9.50
MD-4-2x5	.5-.5	1 3/8 x 1 x 3/4	2 1/2	4.35
MD-4-2x1M	1.0-1.0	2 x 1 3/8 x 7/8	2 3/8	5.50
MD-4-2x2M	2.0-2.0	2 x 2 x 1 1/2	2 3/8	8.10

600 VOLTS DC WORKING

MD-6-1	.1	1 3/8 x 1 x 3/4	2 1/2	3.50
MD-6-25	.25	1 3/8 x 1 x 3/4	2 1/2	3.55
MD-6-5	.5	1 3/8 x 1 x 3/4	2 1/2	4.25
MD-6-1M	1.0	1 3/8 x 1 1/4 x 3/4	2 1/2	4.90
MD-6-2M	2.0	2 x 2 x 1	2 3/8	6.25
MD-6-3M	3.0	2 x 2 x 1 1/2	2 3/8	7.75
MD-6-4M	4.0	2 x 2 x 1 1/2	2 3/8	9.75
MD-6-2x25	.25-.25	1 3/8 x 1 x 3/4	2 1/2	4.95
MD-6-2x5	.5-.5	1 3/8 x 1 1/4 x 3/4	2 1/2	5.70
MD-6-2x1M	1.0-1.0	2 x 2 x 1	2 3/8	6.60

STANDARD CAPACITANCE TOLERANCE: ±20%.

Cat. No.	Cap. Mf.	L. x W. x H.	Mtg. Ctr.	List Price
200 VOLTS DC WORKING				
MD-2-5	.5	1 3/8 x 1 x 3/4	2 1/2	\$3.30
MD-2-1M	1.0	1 3/8 x 1 x 3/4	2 1/2	3.55
MD-2-2M	2.0	1 3/8 x 1 x 3/4	2 1/2	4.45
MD-2-2x1M	1.0-1.0	1 3/8 x 1 x 3/4	2 1/2	5.00
MD-2-2x2M	2.0-2.0	1 3/8 x 1 x 3/4	2 1/2	6.30
150 VOLTS DC WORKING				
MD-1.5-4M	4.0	1 3/8 x 1 x 3/4	2 1/2	5.75
MD-1.5-6M	6.0	2 x 1 3/8 x 7/8	2 3/8	6.10
MD-1.5-8M	8.0	2 x 2 x 1 1/2	2 3/8	8.40
MD-1.5-10M	10.0	2 x 2 x 1 1/2	2 3/8	9.70
MD-1.5-12M	12.0	2 x 2 x 1 1/2	2 3/8	11.00
MD-1.5-16M	16.0	2 x 2 x 1 1/2	2 3/8	13.50
MD-1.5-18M	18.0	2 x 2 x 1 1/2	2 3/8	15.00
MD-1.5-2x4M	4.0-4.0	2 x 2 x 1 1/2	2 3/8	9.00
MD-1.5-2x6M	6.0-6.0	2 x 2 x 1 1/2	2 3/8	11.50

Cat. No.	Cap. Mf.	L. x W. x H.	Mtg. Ctr.	List Price
100 VOLTS DC WORKING				
MXJ-1-100M	100.0	3 3/4 x 1 3/4 x 4 1/4	4	\$98.50
200 VOLTS DC WORKING				
MXJ-1.5-4M	4.0	1 3/8 x 1 x 3/4	2	14.00
MXJ-1.5-10M	10.0	1 3/8 x 1 1/2 x 3/4	2	20.75
MXJ-1.5-12M	12.0	1 3/8 x 1 1/2 x 3/4	2	22.00
MXJ-1.5-15M	15.0	1 3/8 x 1 3/4 x 3/4	2	26.75
MXJ-1.5-20M	20.0	1 3/8 x 1 3/4 x 3/4	2	31.50
MXJ-1.5-25M	25.0	2 x 1 1/2 x 3/4	2	37.00
MXJ-1.5-30M	30.0	2 x 1 1/2 x 3/4	2	42.00
MXJ-1.5-50M	50.0	2 x 1 1/2 x 3/4	2	59.00
400 VOLTS DC WORKING				
MXJ-4-2M	2.0	1 3/8 x 1 1/2 x 3/4	2	14.00
MXJ-4-4M	4.0	1 3/8 x 1 1/2 x 3/4	2	19.00
MXJ-4-6M	6.0	1 3/8 x 1 3/4 x 3/4	2	23.25
MXJ-4-8M	8.0	1 3/8 x 1 3/4 x 3/4	2	27.25
MXJ-4-10M	10.0	2 x 1 1/2 x 3/4	2	30.50
MXJ-4-20M	20.0	2 x 1 1/2 x 3/4	2	50.50
MXJ-4-30M	30.0	3 x 1 1/2 x 3/4	4	63.50

- Most extensive range of capacitance ratings ever offered in Style CP70 cases.
- Temperature range —85°C. to +85°C.
- Mineral wax impregnated and filled.
- Hermetically sealed. Silicone rubber compression seal lug terminals. Units meet MIL tests for moisture resistance, thermal cycle immersion and vibration.
- Spade bolt "J" brackets supplied with each unit for convenient, rigid mounting.
- Standard capacitance tolerance: ±20%.

600 VOLTS DC WORKING

MXJ-6-1M	1.0	1 3/8 x 1 x 3/4	2	13.75
MXJ-6-2M	2.0	2 x 1 1/2 x 3/4	2	18.75
MXJ-6-4M	4.0	1 3/8 x 1 1/2 x 3/4	2	22.90
MXJ-6-6M	6.0	1 3/8 x 1 1/2 x 3/4	2	26.25
MXJ-6-8M	8.0	2 x 1 1/2 x 3/4	2	30.45
MXJ-6-10M	10.0	2 x 1 1/2 x 3/4	2	34.35
MXJ-6-15M	15.0	3 x 1 1/2 x 3/4	4	41.50
MXJ-6-20M	20.0	3 x 1 1/2 x 3/4	4	56.20

STANDARD CAPACITANCE TOLERANCE: ±20%. Other tolerances are available.

METALITE® TYPE MXJ

In Ternplate Cases
85°C. Operation



ASTRON

the
"streamlined" profit
line

ASTRON CORPORATION

255 GRANT AVENUE, E. NEWARK, NEW JERSEY

METALITE[®] HY-MET^{*} High Temperature Metallized Paper Capacitors for 100°C. and 125°C. Operation

HY-MET CAPACITORS

Feature:

- Temperature Range (Metal cased units) -65°C. to +125°C.; (cardboard cased Type MLL) -55°C. to +100°C.
- Exceptionally small, ultra-compact sizes and light weight for given ratings. As much as 75% reduction in size over conventional paper-foil types.
- Self-heating; ability to withstand high dielectric stresses. HY-MET capacitors can be subjected to momentary over-voltages and surges over and over again without danger of permanent failure.
- Extremely low RF impedance due to small size and short current path. Excellent RF characteristics.
- Solid thermosetting impregnant provides high dielectric strength, improved insulation resistance over conventional metallized paper capacitors and permits high temperature operation.
- Hermetically sealed cases. Glass-to-metal sealed terminals (except cardboard tubular Type MLL).
- Wide variety of applications in communications equipment, instruments, noise suppression filters and systems where small size, light weight, self-healing feature and high temperature operation are prerequisites.
- Interchangeability with standard paper-foil capacitor designs when operated within published ratings and circuit requirements.

METALITE[®] HY-MET^{*}

TYPE MLL

Cardboard Tubulars
85°C. Operation



- Sturdy cardboard cased units. Temperature Range -55° to +100°C. Solid thermosetting impregnant.
- Exceptional strength. Metal end caps. Units can be point-to-point connected and supported by own leads. Leads 1/4" minimum length.
- Overall mineral wax coat provides added protection against moisture and humidity.
- Standard capacitance tolerance: -20% +30%.

Cat. No.	Cap. Mf.	Dia. x Length	List Price
200 VOLTS DC WORKING			
MLL-2-01	.01	3/8 x 5/8	\$1.00
MLL-2-02	.02	3/8 x 5/8	1.00
MLL-2-03	.03	3/8 x 5/8	1.00
MLL-2-05	.05	3/8 x 5/8	1.00
MLL-2-1	.1	3/8 x 5/8	1.05
MLL-2-25	.25	1/2 x 1 1/4	1.35
MLL-2-5	.5	1/2 x 1 1/4	1.60
MLL-2-1M	1.0	1/2 x 1 1/4	1.95
MLL-2-2M	2.0	5/8 x 1 5/8	2.70
400 VOLTS DC WORKING			
MLL-4-01	.01	3/8 x 5/8	1.05
MLL-4-02	.02	3/8 x 5/8	1.05
MLL-4-03	.03	3/8 x 5/8	1.05
MLL-4-05	.05	1/2 x 1 1/4	1.05
MLL-4-1	.1	1/2 x 1 1/4	1.20
MLL-4-25	.25	1/2 x 1 1/4	1.50
MLL-4-5	.5	5/8 x 1 5/8	1.75
MLL-4-1M	1.0	3/4 x 2 1/8	2.40
600 VOLTS DC WORKING			
MLL-6-01	.01	3/8 x 5/8	1.05
MLL-6-02	.02	3/8 x 5/8	1.05
MLL-6-03	.03	3/8 x 5/8	1.20
MLL-6-05	.05	1/2 x 1 1/4	1.20
MLL-6-1	.1	1/2 x 1 1/4	1.35
MLL-6-25	.25	5/8 x 1 5/8	1.65
MLL-6-5	.5	5/8 x 1 5/8	2.20
MLL-6-1M	1.0	3/4 x 2 1/8	2.70

CAPACITANCE TOLERANCE:
-20% +30%.
*TRADE MARK

METALITE[®] HY-MET^{*}

TYPE MQL

125°C. Operation



Glass-to-Metal Sealed SUBMINIATURE TUBULARS

- Smallest paper capacitors available for the given ratings.
- Solid thermosetting impregnant. Temperature Range -65°C. to +125°C.
- Tinned, non-ferrous metal cases. Hermetically sealed.
- Non-inductively wound. Capacitor section grounded to case, glass-to-metal seal terminal at one end. Available also with section insulated from case with glass-to-metal terminal at each end (Type MQLF).

CAPACITOR SECTION GROUNDED TO CASE (Glass-to-metal terminal at one end):

MQL: Basic unit. Uninsulated body. Sizes and list prices as shown.

MQLP: Basic MQL unit with plastic outer sleeve (P) for insulated body. Add 1/8" to diameter and length of MQL sizes listed. Add 15¢ to MQL list prices.

MQL-A: Basic MQL unit with soldered-on tangential mounting bracket "A" on uninsulated body. Case sizes as listed for MQL. Add 10¢ to MQL list prices.

MQL-B: Basic MQL unit with soldered-on L-type bracket "B" on uninsulated body. Case sizes as listed for MQL. Add 40¢ to MQL list prices.

MQLS: Screw neck mounting type. Uninsulated body. Available in same ratings as MQL. Minimum case diameter .400". Add 50¢ to MQL list prices.

MQLV: Stud base mounting type. Uninsulated body. Same ratings and case sizes as MQL. Add 60¢ to MQL list prices.

CAPACITOR SECTION INSULATED FROM CASE (Glass-to-metal terminal each end):

MQLF: Basic unit in "floating" construction.

Add 1/8" to length of MQL sizes listed. Uninsulated body. Add 50¢ to MQL list prices.

MQLFP: Basic MQLF unit with plastic outer sleeve (P) for insulated body. Add 1/8" to diameter and 1/8" to length of MQL sizes listed. Add 65¢ to MQL list prices.

MQLF-A: Basic MQLFP unit with soldered-on tangential mounting bracket "A" on uninsulated body. Add 1/8" to length of MQL sizes listed. Add 90¢ to MQL list prices.

MQLF-B: Basic MQLFP unit with soldered-on L-type bracket "B" on uninsulated body. Add 1/8" to length of MQL sizes listed. Add 90¢ to MQL list prices.

MQLFS: Screw neck mounting type. Uninsulated body. Same ratings as MQL. Minimum case diameter .400". Add 1/8" to case length of MQL sizes listed. Add \$1.00 to MQL list prices.

*TRADE MARK

Cat. No.	Cap. Mf.	Dia. x Length	List Price
200 VOLTS DC WORKING			
MQL-2-01	.01	.235x 3/8	\$3.10
MQL-2-022	.022	.235x 3/8	3.15
MQL-2-033	.033	.235x 3/8	3.15
MQL-2-047	.047	.235x 3/8	3.15
MQL-2-05	.05	.235x 3/8	3.15
MQL-2-068	.068	.312x 3/8	3.25
MQL-2-1	.1	.312x 3/8	3.25
MQL-2-15	.15	.312x1 1/8	3.30
MQL-2-22	.22	.312x1 1/8	3.45
MQL-2-25	.25	.312x1 1/8	3.55
MQL-2-33	.33	.400x1 1/8	3.55
MQL-2-47	.47	.400x1 1/8	3.60
MQL-2-5	.5	.400x1 1/8	3.60
MQL-2-68	.68	.500x1 1/8	3.75
MQL-2-1M	1.0	.562x1 1/2	4.00
MQL-2-2M	2.0	.562x1 1/2	5.95
150 VOLTS DC WORKING			
MQL-1.5-4M	4.0	1 x1 3/4	7.00
MQL-1.5-6M	6.0	1 x1 3/4	8.20
MQL-1.5-8M	8.0	1 x2 1/4	9.35
400 VOLTS DC WORKING			
MQL-4-01	.01	.235x 3/8	3.15
MQL-4-022	.022	.235x 3/8	3.25
MQL-4-033	.033	.312x 3/8	3.25
MQL-4-047	.047	.312x1 1/8	3.30
MQL-4-05	.05	.312x1 1/8	3.30
MQL-4-068	.068	.400x1 1/8	3.35
MQL-4-1	.1	.400x1 1/8	3.40
MQL-4-22	.22	.500x1 1/8	3.60
MQL-4-25	.25	.500x1 1/8	3.70
MQL-4-33	.33	.562x1 1/4	3.85
MQL-4-47	.47	.562x1 1/4	4.10
MQL-4-5	.5	.562x1 1/4	4.10
MQL-4-68	.68	.670x1 3/4	4.45
MQL-4-1M	1.0	.670x2 1/4	4.60
MQL-4-2M	2.0	1 x2 1/4	7.00
600 VOLTS DC WORKING			
MQL-6-01	.01	.235x 3/8	3.25
MQL-6-022	.022	.312x 3/8	3.30
MQL-6-033	.033	.400x 3/8	3.35
MQL-6-047	.047	.400x 3/8	3.40
MQL-6-05	.05	.400x 3/8	3.40
MQL-6-068	.068	.400x1 1/8	3.40
MQL-6-1	.1	.400x1 1/8	3.45
MQL-6-15	.15	.500x1 1/8	3.65
MQL-6-22	.22	.562x1 1/4	3.80
MQL-6-25	.25	.562x1 1/4	4.05
MQL-6-33	.33	.562x1 3/4	4.35
MQL-6-47	.47	.670x1 3/4	4.50
MQL-6-5	.5	.670x1 3/4	4.50
MQL-6-68	.68	.670x2 1/4	5.00
MQL-6-1M	1.0	.750x2 3/4	5.45
MQL-6-2M	2.0	1 x2 3/4	7.75

STANDARD CAPACITANCE TOLERANCE:
±20%. Other tolerances are available.

ASTRON

the
"streamlined" profit
line

ASTRON CORPORATION

255 GRANT AVENUE, E. NEWARK, NEW JERSEY

125°C. Operation

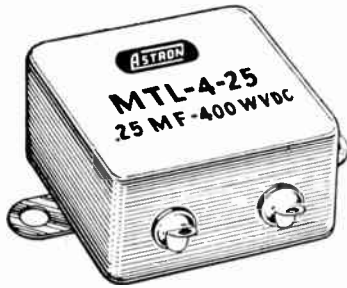

METALITE® HY-MET* TYPE MTL

- Subminiature Bathhtub Capacitors**
- Popular, handy bathtub case in tiny 1 1/8" x 1" base size and minimum case heights.
 - Solid thermosetting impregnant enables operation up to 125°C. Temperature Range —65°C. to +125°C.
 - Excellent RF characteristics due to non-inductive extended foil construction and extremely small capacitor sections.
 - Ideal for all types of miniaturized equipment and tight assemblies to meet extreme minimum weight and size, long life, and high temperature operation requirements.
 - Hermetically sealed. Glass-to-metal sealed lug terminals.
 - Capacitance tolerance: ±20%.

Cat. No.	Cap. Mf.	L. x W. x H.	List Price
200 VOLTS DC WORKING			
MTL-2-1	.1	1 1/8 x 1 x 1/2	\$4.35
MTL-2-25	.25	1 1/8 x 1 x 1/2	4.65
MTL-2-5	.5	1 1/8 x 1 x 1/2	5.45
MTL-2-1M	1.0	1 1/8 x 1 x 1/2	5.85
MTL-2-2M	2.0	1 1/8 x 1 x 1/2	7.40
400 VOLTS DC WORKING			
MTL-4-1	.1	1 1/8 x 1 x 1/2	5.35
MTL-4-25	.25	1 1/8 x 1 x 1/2	5.55
MTL-4-5	.5	1 1/8 x 1 x 1/2	5.90
600 VOLTS DC WORKING			
MTL-6-1	.1	1 1/8 x 1 x 1/2	5.80
MTL-6-25	.25	1 1/8 x 1 x 1/2	5.90
MTL-6-5	.5	1 1/8 x 1 x 1/2	7.05

STANDARD CAPACITANCE TOLERANCE: ±20%. Other tolerances are available.

METALITE® HY-MET* TYPE MDL Bathhtub Capacitors — 125°C. Operation



- *TRADE MARK
- Higher capacitance ratings than ever before offered in same size MIL Style CP53-55 cases in conventional paper-foil types.
 - Solid thermosetting plastic impregnant enables operation to 125°C. Temperature Range —65°C. to +125°C.
 - Hermetically sealed. Lug type glass-to-metal sealed terminals.
 - Standard position of terminals is on side. Can be supplied with top terminals (Type MDLT) or bottom terminals (Type MDLB).
 - Standard capacitance tolerance: ±20%.

Cat. No.	Cap. Mf.	L. x W. x H.	List Price
200 VOLTS DC WORKING			
MDL-2-1	.1	1 3/4 x 1 x 3/4	\$ 3.95
MDL-2-25	.25	1 3/4 x 1 x 3/4	4.25
MDL-2-5	.5	1 3/4 x 1 x 3/4	4.95
MDL-2-1M	1.0	1 3/4 x 1 x 3/4	5.35
MDL-2-2M	2.0	1 3/4 x 1 x 3/4	6.70
150 VOLTS DC WORKING			
MDL-1.5-3M	3.0	1 3/4 x 1 x 7/8	8.10
MDL-1.5-4M	4.0	1 3/4 x 1 x 7/8	8.65
MDL-1.5-5M	5.0	1 3/4 x 1 x 7/8	8.95
MDL-1.5-6M	6.0	1 3/4 x 1 1/4 x 7/8	9.15
MDL-1.5-8M	8.0	2 x 1 3/4 x 3/4	12.60
MDL-1.5-10M	10.0	2 x 1 3/4 x 3/4	14.55
MDL-1.5-12M	12.0	2 x 2 x 7/8	16.50
MDL-1.5-15M	15.0	2 x 2 x 1	19.85
MDL-1.5-18M	18.0	2 x 2 x 1 1/4	22.50
MDL-1.5-20M	20.0	2 x 2 x 1 1/2	25.10
400 VOLTS DC WORKING			
MDL-4-1	.1	1 3/4 x 1 x 3/4	4.85
MDL-4-25	.25	1 3/4 x 1 x 3/4	5.05
MDL-4-5	.5	1 3/4 x 1 x 3/4	5.35
MDL-4-1M	1.0	1 3/4 x 1 x 3/4	5.95
MDL-4-2M	2.0	2 x 1 3/4 x 3/8	7.35
MDL-4-3M	3.0	2 x 1 3/4 x 3/8	9.75
MDL-4-4M	4.0	2 x 2 x 1	11.80
MDL-4-5M	5.0	2 x 2 x 1 1/4	13.20
MDL-4-6M	6.0	2 x 2 x 1 1/2	14.00
600 VOLTS DC WORKING			
MDL-6-1	.1	1 3/4 x 1 x 3/4	5.25
MDL-6-25	.25	1 3/4 x 1 x 3/4	5.35
MDL-6-5	.5	1 3/4 x 1 x 3/4	6.40
MDL-6-1M	1.0	1 3/4 x 1 1/4 x 7/8	7.35
MDL-6-2M	2.0	2 x 2 x 7/8	9.40
MDL-6-3M	3.0	2 x 2 x 1 1/8	11.65
MDL-6-4M	4.0	2 x 2 x 1 1/4	14.65

STANDARD CAPACITANCE TOLERANCE: ±20%. Other tolerances are available.

METALITE® HY-MET* TYPE MEL 125°C. Operation Compact Seamless Cases

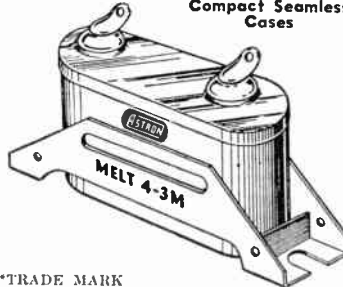

- *TRADE MARK
- High-temperature, high-capacitance, single and dual units designed to fit tight, narrow chassis space.
 - Higher capacitance than ever before achieved in MIL Style CP67-69 containers due to use of space saving metallized paper sections.
 - Temperature Range —65°C. to +125°C. due to use of solid thermosetting impregnant.
 - Hermetically sealed. Glass-to-metal sealed lug terminals. Convenient bracket mounting.
 - Single units have two terminals; dual units have three terminals (one common negative).
 - Standard style is Type MELT (with top terminals) for mounting on chassis surface, for through-the-chassis terminal connections, with terminals on bottom, specify Type MELB.
 - Capacitance tolerance: ±20%.

Cat. No.	Cap. Mf.	L. x W. x H.	Price
SINGLE UNITS — 2 terminals			
200 VOLTS DC WORKING			
MELT-2-2M	2.0	1.788x.619x1	\$ 7.45
150 VOLTS DC WORKING			
MELT-1.5-3M	3.0	1.788x.619x1 1/2	8.75
MELT-1.5-4M	4.0	1.788x.619x2	9.65
MELT-1.5-6M	6.0	1.788x.619x2 1/2	11.85
400 VOLTS DC WORKING			
MELT-4-5	.5	1.788x.619x1	6.60
MELT-4-1M	1.0	1.788x.619x1 1/2	8.00
MELT-4-2M	2.0	1.788x.619x2 1/2	10.20
MELT-4-3M	3.0	1.788x.619x2 3/4	12.40
600 VOLTS DC WORKING			
MELT-6-5	.5	1.788x.619x1	7.15
MELT-6-1M	1.0	1.788x.619x1 3/4	8.80
MELT-6-2M	2.0	1.788x.619x2 1/2	12.10
DUAL UNITS — 3 terminals			
200 VOLTS DC WORKING			
MELT-2-2x1M	1.0-1.0	1.788x.619x1	8.25
MELT-2-2x2M	2.0-2.0	1.788x.619x2	10.75
400 VOLTS DC WORKING			
MELT-4-2x1M	1.0-1.0	1.788x.619x2 1/2	11.10
600 VOLTS DC WORKING			
MELT-6-2x1M	1.0-1.0	1.788x.619x2 3/4	13.75

CAPACITANCE TOLERANCE: ±20%.
*Add ⚡ to height for bracket.

METALITE® HY-MET* TYPE MXLJ 125°C. Operation in Terneplate Cases



- *TRADE MARK
- Higher capacitance than ever before achieved in MIL Style CP70 cases, due to use of metallized paper sections.
 - Temperature range —65°C. to +125°C. due to use of solid thermosetting impregnant.
 - Hermetically sealed. Glass-to-metal sealed lug terminals.
 - Exceptionally small sizes for the given ratings. Size reductions of 50% to 75% over equal ratings in conventional paper-foil units.
 - Spade bolt "J" brackets supplied with each unit for convenient, rigid mounting.
 - Standard capacitance tolerance: ±20%.

Cat. No.	Cap. Mf.	L. x W. x H.	List Price
150 VOLTS DC WORKING			
MXLJ-1.5-4M	4.0	1 3/4 x 1 x 1 1/8	\$15.30
MXLJ-1.5-10M	10.0	1 3/4 x 1 x 2 5/8	22.75
MXLJ-1.5-12M	12.0	1 3/4 x 1 x 2 3/8	24.10
MXLJ-1.5-15M	15.0	1 3/4 x 1 x 3 3/8	29.35
MXLJ-1.5-20M	20.0	1 3/4 x 1 x 4 3/8	34.55
MXLJ-1.5-25M	25.0	2 1/2 x 1 1/8 x 3 3/8	40.60
MXLJ-1.5-30M	30.0	2 1/2 x 1 1/8 x 3 3/8	46.10
MXLJ-1.5-50M	50.0	2 1/2 x 1 1/8 x 4 3/8	64.80
400 VOLTS DC WORKING			
MXLJ-4-2M	2.0	1 3/4 x 1 x 2 1/8	15.30
MXLJ-4-4M	4.0	1 3/4 x 1 x 2 3/8	20.80
MXLJ-4-6M	6.0	1 3/4 x 1 x 3 3/8	25.50
MXLJ-4-8M	8.0	1 3/4 x 1 x 4 3/8	29.90
MXLJ-4-10M	10.0	2 1/2 x 1 1/8 x 3 3/8	33.45
MXLJ-4-20M	20.0	2 1/2 x 1 1/8 x 4 3/8	55.45
MXLJ-4-30M	30.0	3 3/4 x 1 1/8 x 4 3/8	69.75
600 VOLTS DC WORKING			
MXLJ-6-1M	1.0	1 3/4 x 1 x 1 1/8	15.05
MXLJ-6-2M	2.0	1 3/4 x 1 x 2 3/8	18.35
MXLJ-6-4M	4.0	1 3/4 x 1 x 3 3/8	25.10
MXLJ-6-6M	6.0	1 3/4 x 1 x 4 3/8	28.80
MXLJ-6-8M	8.0	2 1/2 x 1 1/8 x 3 3/8	33.40
MXLJ-6-10M	10.0	2 1/2 x 1 1/8 x 4 3/8	37.70
MXLJ-6-15M	15.0	3 3/4 x 1 1/8 x 4 3/8	45.55
MXLJ-6-20M	20.0	3 3/4 x 1 1/8 x 4 3/8	61.70

STANDARD CAPACITANCE TOLERANCE: ±20%. Other tolerances are available.

Copyright by U. C. P., Inc.

Radio's Master — 19th Edition

TRADE DISCOUNT APPLIES TO LIST PRICES ONLY

Page P-141



MINIATURE PLASTIC FILM CAPACITORS

Electronic Fabricators, Inc.

Electronic Fabricators, Inc. manufactures EFCON Capacitors in standard production with tolerances of $\pm 5\%$, $\pm 2\%$, and $\pm 1\%$!

Type MH (Metal Case, Hermetically Sealed) and Type MC (Cardboard Tube) are EFCON Capacitors using DuPont Company's moisture-proof "Mylar"* polyester film. The use of "Mylar" results in high stability over an extended temperature range (-60°C to $+125^{\circ}\text{C}$) without de-
*DuPont Trademark

rating and provides high insulation resistance together with low dielectric absorption.

EFCON, Type MH Capacitors are hermetically sealed with glass-to-metal, solder-sealed terminals. Both Type MH and Type MC are production tested to withstand a D.C. voltage of 250% of rated voltage at 25°C between terminals. Type MH is also tested between terminal and case.



TYPE MH HERMETICALLY SEALED Temperature Range -60°C to $+125^{\circ}\text{C}$

CATALOG NUMBER	CAP. MFD.	SIZE D x L	LIST PRICE
200 D.C. Working Volts			
MH-1002-2C-5	.010	.235x1-1/16	\$4.26
MH-1202-2C-5	.012	.235x1-1/16	4.29
MH-1502-2C-5	.015	.235x1-1/16	4.29
MH-1802-2C-5	.018	.235x1-1/16	4.29
MH-2202-2C-5	.022	.235x1-1/16	4.29
MH-2702-2C-5	.027	.235x1-1/16	4.32
MH-3302-2C-5	.033	.235x1-1/16	4.32
MH-3902-2C-5	.039	.312x1-1/16	4.38
MH-4702-2C-5	.047	.312x1-1/16	4.38
MH-5002-2C-5	.050	.312x1-1/16	4.38
MH-5602-2C-5	.056	.312x1-1/16	4.38
MH-6802-2C-5	.068	.312x1-1/16	4.41
MH-8202-2C-5	.082	.312x1-1/16	4.44
MH-1003-2C-5	.10	.312x1-1/16	4.47
MH-1203-2C-5	.12	.400x1-1/16	4.68
MH-1503-2C-5	.15	.400x1-1/16	4.74
MH-1803-2C-5	.18	.400x1-1/16	4.80
MH-2203-2C-5	.22	.562x1-1/16	4.86
MH-2503-2C-5	.25	.562x1-1/16	4.89
MH-2703-2C-5	.27	.562x1-1/16	4.92
MH-3303-2C-5	.33	.562x1-1/16	5.16
MH-3903-2C-5	.39	.562x1-1/16	5.25
MH-4703-2C-5	.47	.562x1-7/16	5.52
MH-5003-2C-5	.50	.562x1-7/16	5.55
MH-5603-2C-5	.56	.562x1-7/16	5.64
MH-6803-2C-5	.68	.670x1-7/16	5.82
MH-8203-2C-5	.82	.670x1-7/16	6.42
MH-1004-2C-5	1.00	.670x1-13/16	6.69
MH-1004-2C-5	1.00	.750x1-7/16	6.69
400 D.C. Working Volts			
MH-1002-4C-5	.010	.235x1-1/16	\$4.73
MH-1202-4C-5	.012	.235x1-1/16	4.77
MH-1502-4C-5	.015	.312x1-1/16	4.77
MH-1802-4C-5	.018	.312x1-1/16	4.77
MH-2202-4C-5	.022	.312x1-1/16	4.77
MH-2702-4C-5	.027	.312x1-1/16	4.80
MH-3302-4C-5	.033	.312x1-1/16	4.80
MH-3902-4C-5	.039	.400x1-1/16	4.87
MH-4702-4C-5	.047	.400x1-1/16	4.87
MH-5002-4C-5	.050	.400x1-1/16	4.87
MH-5602-4C-5	.056	.400x1-1/16	4.87
MH-6802-4C-5	.068	.400x1-7/16	4.90
MH-8202-4C-5	.082	.400x1-7/16	4.93
MH-1003-4C-5	.10	.562x1-1/16	4.97
MH-1203-4C-5	.12	.562x1-1/16	5.20
MH-1503-4C-5	.15	.562x1-7/16	5.27
MH-1803-4C-5	.18	.562x1-7/16	5.33
MH-2203-4C-5	.22	.562x1-7/16	5.40
MH-2503-4C-5	.25	.562x1-13/16	5.43
MH-2703-4C-5	.27	.562x1-13/16	5.47
MH-3303-4C-5	.33	.670x1-13/16	5.73
MH-3903-4C-5	.39	.670x1-13/16	5.83
MH-4703-4C-5	.47	.670x1-13/16	6.13
MH-5003-4C-5	.50	.750x1-13/16	6.17
MH-5603-4C-5	.56	.750x1-13/16	6.27
MH-6803-4C-5	.68	.750x1-13/16	6.47
MH-8203-4C-5	.82	1" x1-13/16	7.13
MH-1004-4C-5	1.00	1" x1-13/16	7.43

TYPE MC CARDBOARD TUBE Temperature Range -60°C to $+85^{\circ}\text{C}$

CATALOG NUMBER	CAP. MFD.	SIZE D x L	LIST PRICE
200 D.C. Working Volts			
MC-1002-2C-5	.010	3/16x1-1/8	\$2.17
MC-3502-2C-5	.035	1/4x1-1/8	2.22
MC-6502-2C-5	.065	1/4x1-1/8	2.28
MC-8502-2C-5	.085	5/16x1-1/8	2.34
MC-1003-2C-5	.10	5/16x1-1/8	2.40
MC-1503-2C-5	.15	3/8x1-1/8	2.49
MC-2003-2C-5	.20	3/8x1-1/8	2.58
MC-2503-2C-5	.25	7/16x1-1/8	2.67
MC-3003-2C-5	.30	15/32x1-1/8	2.79
MC-3503-2C-5	.35	1/2x1-1/8	2.91
MC-4003-2C-5	.40	7/16x1-3/8	3.03
MC-4503-2C-5	.45	15/32x1-3/8	3.15
MC-5003-2C-5	.50	15/32x1-3/8	3.30
MC-6003-2C-5	.60	1/2x1-3/8	3.51
MC-7003-2C-5	.70	9/16x1-3/8	3.72
MC-8003-2C-5	.80	5/8x1-3/8	3.93
MC-9003-2C-5	.90	9/16x1-13/16	4.14
MC-1004-2C-5	1.00	9/16x1-13/16	4.38
MC-1004-2C-5	1.00	11/16x1-3/8	4.38
400 D.C. Working Volts			
MC-1002-4C-5	.010	3/16x1-1/8	\$2.40
MC-3502-4C-5	.035	5/16x1-1/8	2.47
MC-6502-4C-5	.065	3/8x1-1/8	2.53
MC-8502-4C-5	.085	3/8x1-3/8	2.60
MC-1003-4C-5	.10	15/32x1-1/8	2.67
MC-1503-4C-5	.15	9/16x1-1/8	2.77
MC-2003-4C-5	.20	1/2x1-3/8	2.87
MC-2503-4C-5	.25	9/16x1-3/8	2.97
MC-3003-4C-5	.30	5/8x1-3/8	3.10
MC-3503-4C-5	.35	5/8x1-13/16	3.23
MC-4003-4C-5	.40	5/8x1-13/16	3.37
MC-4503-4C-5	.45	5/8x1-13/16	3.50
MC-5003-4C-5	.50	11/16x1-13/16	3.67
MC-6003-4C-5	.60	3/4x1-13/16	3.90
MC-7003-4C-5	.70	7/8x1-13/16	4.13
MC-8003-4C-5	.80	1" x1-13/16	4.37
MC-9003-4C-5	.90	1" x1-13/16	4.60
MC-1004-4C-5	1.00	1" x1-13/16	4.87

Prices quoted are $\pm 5\%$ Tolerance
For $\pm 20\%$ tolerance — add 10%
For $\pm 1\%$ tolerance — add 20%
600 D.C. Working Volts are available
from standard production.

Special sizes and voltage can be supplied
on request or to specification.

Write for brochure giving temperature characteristic curves for capacitance change, power factor and insulation resistance over temperature range -60°C to $+160^{\circ}\text{C}$, plus test data and general characteristics.

Electronic Fabricators, Inc. also manufactures EFCON, Type S, molded silvered mica capacitors.

Round Shaft Midgetrols

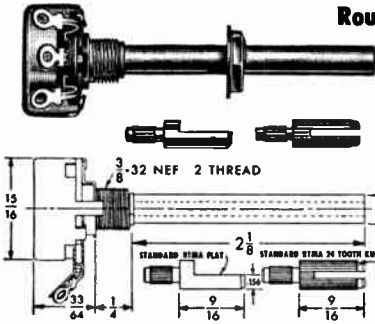

Compact, 1/16" diameter carbon element control. Used in industrial electronic equipment; also, in control circuits of television sets, home radios, auto radios and audio amplifiers. AC-DC power switches are available which may be attached quickly and permanently. Has 2 1/2" long, 1/4" round brass shaft. 2 shaft-end knob adaptors for knurled, push-on knobs, and one hex nut furnished. List Price \$1.25 each.



Dual Midgetrol Volume Controls and Accessories

Mallory Midgetrol Volume Control Parts and Accessories enable the serviceman to duplicate the physical and electrical characteristics of hundreds of Concentric Shaft Dual Carbon Controls, Single Shaft Dual Carbon Controls and Concentric Shaft Dual Wire-Wound Carbon control combinations for fast replacement in TV, home and auto radio sets. Supplied as separate front and rear control sections, these parts are easy to assemble, practical and economical, and eliminate delays while waiting delivery of manufacturer's original controls. UF is 1/16" diameter carbon front section; UR is 1/16" carbon rear section; WF is wire-wound front section. A kit of standard assembly parts is supplied with each front section. For accessory fittings and switches, see page 2, Mallory Resistors and Controls Section, this catalog. Average mounting depth behind panel for a carbon dual is 1 1/2"; with switch, is 1 3/4".

Cat. No.	Ohms	Taper†	Cat. No.	Ohms	Taper†
U3	1M	2	U40	100M	2
U4	1M	4	U41	100M	4
U5	1500	2	U415	125M	4
U6	2M	4	U42	150M	1
U7	2500	2	U43	200M	4
U8	3M	4	U44	250M	1
U12	5M	1	U45	250M	2
U14	5M	4	U46	250M	4
U18	10M	1	U48	500M	1
U19	10M	2	U50	500M	4
U20	10M	4	U51	750M	1
U21	15M	1	U53	1 Meg.	1
U22	15M	2	U54	1 Meg.	4
U24	20M	1	U155	1.5 Meg.	4
U26	20M	4	U55	2 Meg.	1
U28	25M	2	U56	2 Meg.	4
U29	25M	4	U255	2.5 Meg.	4
U33	50M	1	U57	3 Meg.	1
U34	50M	2	U59	3 Meg.	4
U35	50M	4	U65	5 Meg.	1
U36	75M	1	U67	5 Meg.	4
U39	100M	1	U82	10 Meg.	4

† See Explanation of Mallory Tapers, page 2, Mallory Resistors and Controls section, this catalog.

Single Tapped Midgetrols—List Price \$1.85 Each

Cat. No.	Ohms	Tap At	Cat. No.	Ohms	Tap At
UT-420	250M	50M	UT-443	1 Meg.	450M
UT-425	350M	70M	UT-450	2 Meg.	125M
UT-429	500M	50M	UT-448	2 Meg.	250M
UT-427	500M	100M	UT-454	2 Meg.	400M
UT-430	500M	150M	UT-449	2 Meg.	600M
UT-431	500M	225M	UT-451	2 Meg.	900M
UT-440	1 Meg.	200M	UT-457	3 Meg.	900M
UT-438	1 Meg.	300M			

Double Tapped Midgetrols—List Price \$1.85 Each

Catalog Number	Overall Resistance	Tap Resistance	
		Tap 1	Tap 2
UDT-283	500M	100M	200M
UDT-289	1 Meg.	250M	500M
UDT-291	1.5 Meg.	225M	500M
UDT-295	2.25 Meg.	250M	500M
UDT-296	2.25 Meg.	500M	1 Meg.

Two Watt Wire-Wound Front Sections

Catalog Number	Res. Ohms	List Price	Catalog Number	Res. Ohms	List Price
WF32	300	\$2.10	WF152-T52	1500†	\$2.50
WF751	750	2.10	WF23	2000	2.10
WF751-T251	750*	2.50	WF252†	2500	2.10
WF751-T52	750‡	2.50	WF252-T23	2500	2.50
WF13	1000	2.10	WF33	3000	2.10
WF13-T251	1000*	2.50	WF53	5000	2.10
WF152	1500	2.10	WF73	7000	2.10

* Tapped at 250 ohms. † Tapped at 500 ohms.
‡ Tapped at 2000 ohms.

Front Section List Price—\$2.00 Catalog Number	Rear Section List Price—\$1.00 Catalog Number	Resistance Ohms	Taper†
UF13L	UR13L	1000	4
UF13R		1000	2
UF152L	UR152L	1500	4
UF152R		1500	2
UF23L	UR23L	2000	4
UF23R		2000	2
UF252L		2500	4
UF252R		2500	2
UF33L		3000	4
UF33R		3000	2
	UR352L	3500	4
UF53R	UR53R	5000	2
UF53L	UR53L	5000	4
UF73R		7000	2
	UR14R	10M	2
UF14L	UR14L	10M	4
UF253R		25M	2
UF253L	UR253L	25M	4
UF34A		30M	1
UF54A		50M	1
UF64L	UR54L	50M	4
UF753L		75M	4
UF15A		100M	1
UF15R	UR15R	100M	2
UF18L	UR15L	100M	4
UF254A	UR254A	250M	1
UF254L	UR254L	250M	4
	UR354A	350M	1
UF55A	UR55A	500M	1
UF55R		500M	2
UF55L	UR55L	500M	4
UF16A	UR16A	500M	1
UF16L	UR16L	1 Meg.	1
UF155A		1 Meg.	4
UF26A		1.5 Meg.	1
UF26L	UR26A	2 Meg.	1
UF255L	UR255L	2 Meg.	4
	UR36A	2.5 Meg.	4
	UR56L	3 Meg.	1
		5 Meg.	4
UF46A		4 Meg.	1
UF106L		10 Meg.	1

† See Explanation of Mallory Tapers, page 2.

Tapped Sections

Front Section List Price—\$2.25 Catalog Number	Rear Section List Price—\$1.25 Catalog Number	Resistance Ohms	Tapped at
UF751-T52		750	500
UF252-T52		2500	500
UF252-T23		2500	2000
UF254-T753	UR254-T753	250M	75M
	UR354-T74	350M	70M
UF55-T54	UR55-T54	500M	50M
	UR55-T154	500M	150M
UF55-T254	UR55-T254	500M	250M
	UR16-T1253	1 Meg.	125M
UF16-T25	UR16-T25	1 Meg.	200M
UF16-T154		1 Meg.	150M
	UR16-T254	1 Meg.	250M
UF16-T35	UR16-T35	1 Meg.	300M
	UR26-T25	2 Meg.	200M
UF26-T55		2 Meg.	500M
		2 Meg.	900M
	UR26-T95		

For Midgetrol accessory parts, see Page 2, Mallory Resistors and Controls Section, this catalog.

Midgetrol Accessory Parts

- DS-35**—Flatted split knurl shaft end. Special for Zenith. List Price **\$0.45**
- DS-36**—Special 3" extension shaft for tubular shaft Midgetrols and 2-watt, wire-wound controls. Also used for coupling a front and rear section together to make a single-shaft, dual control for oscilloscope and other push-pull amplifier service. Packaged with the DS-36 are two shaft-end knob adaptors, one knurled and slotted, one flatted. List Price **\$0.45**
- DS-37**— $\frac{3}{16}$ " diameter shafts for use with round-shaft Midgetrols to accommodate knobs requiring $\frac{3}{16}$ " shaft. List Price **\$0.45**
- EB-158**—Special bushing. $\frac{7}{16}$ "-28 thread, $1\frac{1}{16}$ " long with $\frac{3}{8}$ " milled double flat. List Price **\$0.60**
- EB-214**—Special bushing: $\frac{1}{2}$ "-28 thread, $2\frac{3}{16}$ " long with .403 milled flat. List Price **\$0.60**



Attachable Midgetrol Switches

Cat. No.	Description	List Price
US-26	Single Pole—Single Throw	\$0.60
US-26T	Single Pole—Single Throw (with dummy terminal)	.75
US-27	Double Pole—Single Throw	.75
US-28	Single Pole—Double Throw	.75

Explanation of Mallory Tapers

Taper Number 1 is a modified logarithmic left hand taper in the carbon type of control and an approximation to this logarithmic taper in the wire-wound type. This taper should always be used in shunt circuits, as in usual antenna and audio circuits, or where only the center and left hand terminals are used.

Taper Number 2 is a right hand logarithmic taper in the carbon and an approximation in the wire-wound type. Used in series circuits, as in cathode voltage controls, or where only the center and right hand terminals are used.

Taper Number 4 is a linear taper. Strictly speaking it is not a "taper" although commonly referred to as such. A linear "taper" is used wherever a control should be such that voltage change is proportional to the degree of rotation.

Taper Number 7 is made only in the wire-wound type of control and is a form of left hand taper. This taper is desirable for the antenna shunt plus bias control, wherein greater attenuation is obtained by increasing the bias voltage. The slight left taper then suffices to gradually reduce the signal to zero volume by the shunting action in the antenna circuit.

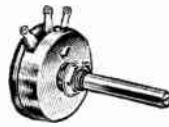
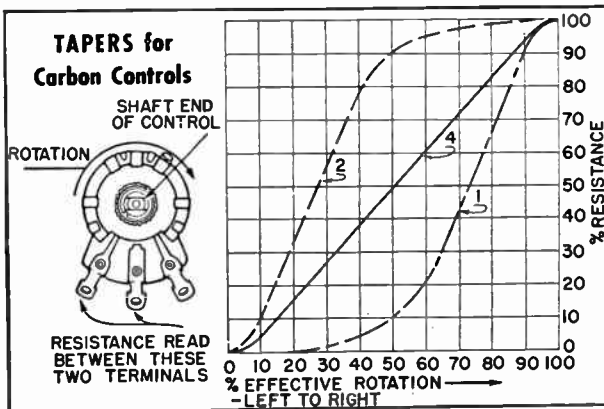

TV Focus Controls

These $1\frac{1}{8}$ " diameter units are designed especially for focus control replacement in TV sets. They are 4 watt, wire-wound, and have a special taper. One control, plus accessories and complete instructions per display carton.

Catalog Number	Ohms Resistance (Maximum)	Type Element	Shaft Length	List Price
TVF140	1500	WW	2"	\$1.85
TVF143	2500	WW	2"	1.85

Television and Special Application Midgetrols

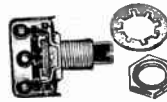

For use as exact replacement. Meet physical and electrical requirements for special applications. Equipped with fixed, knurled and screw driver-slotted phenolic shafts, $\frac{1}{4}$ " in diameter and $\frac{1}{4}$ " long. List Price **\$1.50** each

Cat. No.	Ohms	Cat. No.	Ohms
SU-6	1500	SU-46	250M
SU-8	3M	SU-50	500M
SU-14	5M	SU-54	1 Meg.
SU-20	10M	SU-56	2 Meg.
SU-29	25M	SU-56S	2.5 Meg.
SU-35	50M	SU-59	3 Meg.
SU-41	100M	SU-67	5 Meg.

All SU-No. 4—Linear Taper. (see Explanation of Mallory Tapers, page 2, Mallory Resistors and Controls section, this catalog).



Theater Speaker Controls

Designed for use with Motiograph, Simplex, International and other outdoor theater motion picture equipment. Quality constructed with pig-tail rotor connections and corrosion-resistant finish to assure long, noise-free life. Housed in $1\frac{1}{8}$ " diameter metal case. Mounting nut supplied.

Cat. No.	Description	List Price
TSA-10	4-Ohm I. Pad	\$2.00
TSA-35	35-ohm Potentiometer	1.50
TSA-6	6-ohm Potentiometer	1.50

T and L Pad Attenuators

High quality attenuators having a peak audio rating of 15 watts and a continuous DC dissipation rating of 4 watts. Packaged with instructions, 366 knob, 395 dial plate and hex nut.



"T" Pad Attenuators List Price \$4.25 each Catalog Number	"L" Pad Attenuators List Price \$3.75 each Catalog Number	Ohms Impedance
T2	L2	2
T4	L4	4
T6	L6	6
T8	L8	8
T15	L15	15
T50	L50	50
T100	L100	100
T200	L200	200
T250	L250	250
T500	L500	500
T600	L600	600
T1000	L1000	1000
T2000	L2000	2000
T3000	L3000	3000
	L4000	4000

Two Watt Wire-Wound TV and Industrial Potentiometers

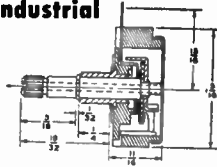

For replacement of positioning, hold and focus controls in TV. Also ideal for industrial circuits up to 1500 volts AC. Completely enclosed in 1/16" diameter phenolic case. Thumb-knurled 1/4" diameter, 5/16" long, screw driver, slotted, insulated shaft. All have linear resistance change.

For special 3" extension shaft, DS-36, see page 2, Mallory Resistors and Controls Section, this catalog.

Catalog Number	Total Ohms	List Price
R20L	20	\$1.25
R20CT	20	1.85
R25L	25	1.25
R30L	30	1.25
R30CT	30	1.85
R50L	50	1.25
R100L	100	1.25
R250L	250	1.25
R500L	500	1.25
R1000L	1000	1.40
R1500L	1500	1.40
R2500L	2500	1.40
R3000L	3000	1.40
R5000L	5000	1.40
R7500L	7500	1.50
R10ML	10000	1.50
R15ML	15000	1.50
R20ML	20000	1.50

All R type are linear No. 4 taper (see Explanation of Mallory Tapers, page 2, Mallory Resistors and Controls section, this catalog).

Attachable Switches for Above Controls

Cat. No.	Description	List Price
US30	Single Pole-Single Throw	\$0.60
US32	Double Pole-Single Throw	.75

Two Watt Wire-Wound Potentiometers and Rheostats

1/16" diameter. 1/4" diameter by 3/8" long shaft with screw driver slot. For use in test and special instruments, bias control and bridge circuits. Has grounded contact arm. Rheostat has "open" or "off" position—all have linear No. 4 taper (see Explanation of Mallory Tapers, page 2, Mallory Resistors and Controls section, this catalog).

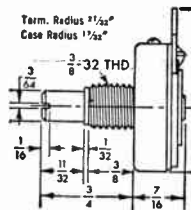

For Dial plate 393, see page 5, Mallory Resistors and Controls Section, this catalog.

Potentiometer		Rheostat			
Catalog Number	List Price	Catalog Number	List Price	Ohms	Cap. in Amperes
C6P	\$1.50	C6R	\$1.25	6	.58
C10P	1.50	C10R	1.25	10	.45
C15P	1.50	C15R	1.25	15	.37
C20P	1.50	C20R	1.25	20	.32
C30P	1.50	C30R	1.25	30	.26
C40P	1.50	C40R	1.25	40	.22
C50P	1.50	C50R	1.25	50	.2
C100P	1.50	C100R	1.25	100	.14
C200P	1.50			200	.1
C400P	1.50			400	.07
C1MP	1.75			1M	.045
C3MP	1.75			3M	.025
C5MP	2.00			5M	.02
C6MP	2.00			6M	.018
C10MP	2.00			10M	.014
C15MP	2.00			15M	.011

Four Watt Wire-Wound Potentiometers and Rheostats

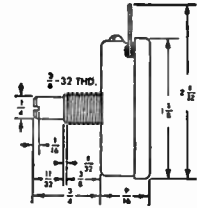

Four-watt, wire-wound controls designed especially for low voltage TV, test equipment, industrial and electronic applications. These controls are supplied with a 3/8" long bushing and have 1/4" round knurled screw driver slotted shafts 3/8" long. Overall case diameter is 1". Mounting radius, including solder lugs, is 1 1/4" and mounting depth is 3/4". Rheostat styles have "off" position. All have linear resistance change and insulated shaft. For Dial Plate No. 395, see page 4, Mallory Resistors and Controls Section, this catalog.

Potentiometer		Rheostat*			
Catalog Number	List Price	Catalog Number	List Price	Ohms	Cap. in Amperes
M1PK	\$1.50	M05RK	\$1.25	1/2	2.80
		M1RK	1.25	1	2.00
		M2RK	1.25	2	1.4
M3PK	1.50	M3RK	1.25	3	1.15
		M4RK	1.25	4	1.0
M6PK	1.50	M6RK	1.25	6	.82
M10PK	1.50	M10RK	1.25	10	.63
M15PK	1.50	M15RK	1.25	15	.52
M20PK	1.50	M20RK	1.25	20	.45
M25PK	1.50	M25RK	1.25	25	.40
M30PK	1.50	M30RK	1.25	30	.37
M40PK	1.50	M40RK	1.25	40	.32
M50PK	1.50	M50RK	1.25	50	.28
M60PK	1.50	M60RK	1.25	60	.26
M75PK	1.50	M75RK	1.25	75	.23
M100PK	1.50	M100RK	1.25	100	.20
M200PK	1.50			200	.14
M400PK	1.50			400	.10
M500PK	1.50			500	.09
M600PK	1.50			600	.082
M1MPK	1.75			1M	.063
M2MPK	1.75			2M	.045
M3MPK	1.75			3M	.037
M4MPK	1.75			4M	.032
M5MPK	1.75			5M	.028
M10MPK	2.00			10M	.020
M15MPK	2.00			15M	.016
M20MPK	2.00			20M	.014
M25MPK	2.00			25M	.013
M50MPK	2.40			50M	.009
M70MPK	2.40			70M	.0075

*"Open" or "Off" position counter-clockwise.

Center Tapped Potentiometer

Catalog Number	List Price	Ohms	Cap. in Amperes
MT10PK	\$2.25	10	.63
MT20PK	2.25	20	.45
MT30PK	2.25	30	.37

Seven Watt Wire-Wound Potentiometers

Has 7-watt dissipation, grounded contact arm and linear resistance change. Metal case is 2 3/8" diameter, 3/4" deep. Shaft is 1/4" diameter and 3/8" long with screw driver slot. For Dial plate No. 399, see page 5, Mallory Resistors and Controls Section, this catalog.

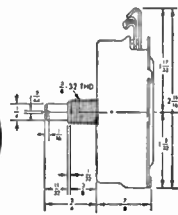

Catalog Number	Ohms	Capacity in Amperes	List Price
E5MP	5M	.042	\$3.80
E10MP	10M	.03	4.05
E20MP	20M	.021	4.20
E25MP	25M	.019	4.25
E50MP	50M	.0135	4.30
E75MP	75M	.011	4.45
E100MP	100M	.0095	4.55
E125MP	125M	.0085	4.55
E150MP	150M	.0078	4.65

POWER RHEOSTATS

P. R. MALLORY & CO. INC.
MALLORY

P. R. MALLORY & CO., INC. - INDIANAPOLIS

Type "K" Vitreoous Wire-Wound Power Rheostats and Potentiometers



Mallory Power Rheostats and Potentiometers are used with Battery Chargers, Blue Print Machines, Dental and Medical Equipment, Fans, Film Printers, Generators, Motion Picture Projectors, Motors and other applications where it is desired to vary a stable current. Mallory Power Rheostats and Potentiometers are constructed by uniformly winding resistance wire into position and applying a protective coating of vitreoous enamel. The element contact arm is hinged and under constant pressure to insure proper contact with the element at all times. Wattage ratings of 75, 225 and 500 are available, in addition to those below. A knob and dial plate are supplied with each rheostat.

Type 25K—25 Watts Outside Diameter—1 1/16" Angle of Rotation—295°

Cat. No.	Ohms	Max. Current Amps.	Steps (Approx.)	List Price
25K1P	1	5.000	28	\$7.00
25K2P	2	3.540	28	8.20
25K3P	3	2.880	53	8.20
25K3P	6	2.040	51	8.20
25K8P	8	1.770	56	6.20
25K10P	10	1.580	54	6.20
25K15P	15	1.290	88	6.20
25K25P	25	1.000	117	6.20
25K35P	35	.845	129	6.20
25K50P	50	.707	149	8.20
25K75P	75	.575	174	8.20
25K100P	100	.500	184	6.20
25K125P	125	.447	187	6.20
25K175P	175	.378	178	8.20
25K250P	250	.316	200	8.20
25K350P	350	.267	227	8.20
25K500P	500	.222	256	8.20
25K750P	750	.182	303	6.20
25K1000P	1000	.155	318	7.00
25K1500P	1500	.129	310	7.00
25K2500P	2500	.100	405	7.00
25K3500P	3500	.084	432	7.40
25K5000P	5000	.070	471	7.40

Type 50K—50 Watts Outside Diameter—2 1/32" Angle of Rotation—300°

Cat. No.	Ohms	Max. Current Amps.	Steps (Approx.)	List Price
50K.5P	.5	10.00	25	\$7.80
50K1P	1	7.07	37	7.80
50K2P	2	5.00	42	7.80
50K4P	4	3.54	66	7.00
50K8P	6	2.89	79	7.00
50K8P	8	2.50	84	7.00
50K12P	12	2.04	100	7.00
50K18P	16	1.76	106	7.00
50K22P	22	1.50	145	7.00
50K35P	35	1.19	145	7.00
50K50P	50	1.00	163	7.00
50K80P	80	.79	210	7.00
50K125P	125	.63	204	7.00
50K180P	150	.58	244	7.00
50K225P	225	.47	298	7.00
50K300P	300	.41	268	7.00
50K500P	500	.32	205	7.00
50K800P	800	.25	363	7.40
50K1000P	1000	.22	354	7.40
50K1600P	1600	.176	449	7.40
50K2500P	2500	.14	455	7.40
50K3500P	3500	.12	500	7.80
50K5000P	5000	.10	550	7.80
50K8000P	8000	.08	690	7.80

Type 100K—100 Watts Outside Diameter—3 1/8" Angle of Rotation—300°

Cat. No.	Ohms	Max. Current Amps.	Steps (Approx.)	List Price
100K.5P	.5	14.20	30	\$11.70
100K1P	1	10.00	40	11.70
100K2P	2	7.07	42	11.70
100K3P	3	5.77	56	11.70
100K5P	5	4.47	59	11.70
100K7.5P	7.5	3.65	96	10.95
100K10P	10	3.16	101	10.95
100K18P	16	2.50	128	10.95
100K25P	25	2.00	160	10.95
100K50P	50	1.41	200	10.95
100K75P	75	1.15	240	10.95
100K100P	100	1.00	250	10.95
100K200P	200	.71	315	10.95
100K300P	300	.58	302	10.95
100K400P	400	.50	316	10.95
100K500P	500	.45	342	10.95
100K750P	750	.37	406	10.95
100K1000P	1000	.32	435	11.70
100K1500P	1500	.26	520	11.70
100K2000P	2000	.22	544	11.70
100K2500P	2500	.20	535	11.70
100K5000P	5000	.14	692	12.45
100K7500P	7500	.12	820	13.25
100K10000P	10000	.10	840	14.00

Type 150K—150 Watts Outside Diameter—4 1/32" Angle of Rotation—305°

Cat. No.	Ohms	Max. Current Amps.	Steps (Approx.)	List Price
150K.5P	.5	17.30	31	\$14.85
150K1P	1	12.30	38	14.85
150K2P	2	8.66	51	14.85
150K3P	3	7.07	73	14.85
150K5P	5	5.48	77	14.85
150K7.5P	7.5	4.47	70	14.85
150K10P	10	3.87	145	14.00
150K15P	15	3.16	138	14.00
150K25P	25	2.45	142	14.00
150K35P	35	2.07	198	14.00
150K50P	50	1.73	182	14.00
150K75P	75	1.41	218	14.00
150K100P	100	1.22	229	14.00
150K150P	150	1.00	276	14.00
150K200P	200	.87	289	14.00
150K250P	250	.77	360	14.00
150K350P	350	.66	350	14.00
150K500P	500	.55	400	14.00
150K750P	750	.45	460	14.85
150K1250P	1250	.35	490	14.85
150K1800P	1800	.290	555	15.60
150K2250P	2250	.26	547	15.60
150K3000P	3000	.22	729	15.60
150K4500P	4500	.18	689	16.35
150K7500P	7500	.14	930	17.15
150K10000P	10000	.12	980	18.70

Type 300K—300 Watts Outside Diameter—6 1/16" Angle of Rotation—315°

Cat. No.	Ohms	Max. Current Amps.	Steps (Approx.)	List Price
300K1P	1	17.30	48	\$21.05
300K2P	2	12.25	60	21.05
300K3P	3	10.00	64	21.05
300K4P	4	8.66	80	21.05
300K5P	5	7.75	80	21.05
300K7.5P	7.5	6.32	100	21.05
300K10P	10	5.48	139	21.05
300K15P	15	4.47	128	21.05
300K25P	25	3.46	182	21.05
300K50P	50	2.45	228	21.05
300K75P	75	2.00	271	21.05
300K100P	100	1.73	287	21.05
300K150P	150	1.41	338	21.05
300K200P	200	1.22	361	21.05
300K300P	300	1.00	427	21.05
300K400P	400	.87	460	21.05
300K700P	700	.66	555	21.05
300K900P	900	.58	564	21.05
300K1200P	1200	.50	605	21.05
300K1500P	1500	.45	755	21.05
300K1750P	1750	.41	691	21.05
300K2500P	2500	.35	785	21.05

Order by wattage and resistance. For example: A 25-watt 100 ohm unit is indicated by 25K100P. A 100-watt 12 ohm unit is 100K12P. Or, a 50-watt .5 ohm unit is 50K.5P . . . etc.



Mercury "A" Batteries



Provide up to 4 times energy-volume ratio of other types of batteries. Ideal for use in portable electronic equipment, etc. Perform under wide range of adverse weather and humidity conditions. No need for rotation or rest periods. Uniform and optimum discharge voltage throughout long service life. 1.34 volts. Button height .058".

"A" Battery	Diam. (Inches)	Height (Inches)	Volume (Cu. In.)	Weight (Oz.)	Capacity (MAH)	Max. Drain (Ma.)
RM1000	.625	.650	.20	.43	1000	100
RM3000	.973	.650	.50	.93	2000	60
RM4000	1.187	.650	.72	1.60	3200	80
RM1200	.625	1.950	.60	1.40	3600	250
RM4010	.465	1.140	.18	.40	800	100
RM6250T	.606	.225	.07	.14	200	20
RM5020	.538	1.950	.44	1.05	2400	200

Mallory Power-Pak Batteries

Catalog Number	Description	Nominal Voltage	Capacity MAH
302100*	Old Style Geophysical	1.34	9,600
302108	Martin Aircraft E-746206	5.3	3,200
302125	Home Fire Alarm	5.2	2,000
302157	SU-10 Radiation Detector "A"	1.34	36,000
302158	SU-10 Radiation Detector "B"	†	1,000
302189	Navy Transceiver	9-130	3,200
302240	Martin F746210	24	2,000
302249	Radiation Detector	6.7	250
302250	Radiation Detector	9.4	250
302268	Navy Mark of Computer	4.0	3,600
302271	Air Force Multimeter	1.3-12	3,600-250
302425	Mallory Standard	45	250
302435	Radiation Detector	6.7	250
302437	Radiation Detector	9.4	250
302462	CBS Transmitter "B" Supply	96.4	1,000
302463*	New Style Geophysical	1.34	18,000
302464	New Style Geophysical	6.7	3,600
302465	New Style Geophysical	45	1,000
302475	Double "C" Photoflash Cartridge	2.7	3,600
302478	Minifon Recorder	9	2,300
302604	Signal "C" Radiation Detector	5.2	250
RM-42	Std. "D" Size Cell	1.34	14,000
RM-42-T	Std. "D" Cell with Tabs	1.34	14,000

* Replaceable by RM-42

† "B" Voltage 45-22.5 "C" Voltage 5.2-2.6

Cat. No.	Cap. (MAH)	Diam. (Inches)	Height (Inches)	No Load Voltage	Weight (Ozs.)	Max. Drain (Ma.)
TR-115	250	.650	1.295	6.7	.73	20
TR-132	1000	.655	1.305	2.6	.90	100
TR-133	1000	.655	1.960	4.0	1.40	100
TR-152	350	.480	1.125	2.6	.42	40
		Size L W H				
TR-120	800	.980	.505	1.227	2.6	.91
TR-140	1600	.980	.505	1.227	1.3	.91

Mallory Military Batteries

Catalog Number	Description	Nominal Voltage	Capacity (MAH)	Max. Drain (Ma.)
BA-1051/U	Transceiver "B" Battery	64	650	JAN Spec.
BA-1277/U	SU-10 Military Radiation. For civilian use, substitute 302157	1.34	38,400	
BA-1278/U	SU-10 Military Radiation. For civilian use, substitute 302158	†	650	
BA-1293/U	Military Bias Battery	4	650	JAN Spec.

Shafts—Couplers—Bushings—Dial Plates



Cat. No.	Description	List Price
EC240	For coupling two 1/4" shafts or 1/4" and 3/16" (D)	\$0.75
EB247	3/8" Extension Bushing (F)	.25
UB241	Panel Bushing for 1/4" shaft (G)	.95
178	1/2" and 3/16" Wrench (H)	.75
RS242	4" long x 1/4" diameter x 1/32" flat (K)	.40
RS243	4" long x 1/4" diameter x 1/32" flat (J)	.40
RS244	4" long x 3/16" diameter x 1/64" flat (L)	.40
RS245	2" long x 1/4" diameter x slotted 1/32" (M)	.45
369	0-100 All Rheostats and Potentiometers (compromise scale) 2 1/4" (N)	.25
391	Increase Volume—All Rheostats and Potentiometers—1 1/2" (N)	.15
393	0-10 For "C" Type Rheostats and Potentiometers—2 1/4" (N)	.25
395	0-10 For Standard Wire-Wound Controls with Plain cover; also "M" Type Rheostats and Potentiometers—2 1/4" (N)	.25
396	0-10 For Standard Wire-Wound Controls with switch type cover—2 1/4" (N)	.25
397	0-10 For Standard Carbon Controls with Plain cover—2 1/4" (N)	.25
398	0-10 For Standard Carbon Controls with switch type cover—2 1/4" (N)	.25
399	0-10 For "E" Type Potentiometers—2 1/4" (N)	.25

Mallory Page 5

Yard-Ohm Resistance Kits

Each Yard-Ohm Kit consists of the following: 1 yard spiral wound resistance wire; 1 yard insulated braid; 24 spiral wire leads. The kit is available in eight resistance values. Dissipation—all types: 1/2 watt per inch.

List Price \$0.75 each

Catalog Number	Resistance Value (Ohms per Inch)	Carrying Capacity in Amperes	Catalog Number	Resistance Value (Ohms per Inch)	Carrying Capacity in Amperes
YO-1	1	.707	YO-50	50	.100
YO-5	5	.315	YO-100	100	.071
YO-10	10	.223	YO-250	250	.044
YO-25	25	.141	YO-500	500	.031

Adjustable Mounting Brackets

Cat. No.	Description	List Price
RB248	1 3/4" Mounting Centers (A)	\$0.25
RB249	2 1/2" Mounting Centers (B)	.25
RB254	Universal	.25

VITREOUS ENAMEL RESISTORS

P. R. MALLORY & CO., INC. - INDIANAPOLIS



Mallory Fixed and Adjustable Vitreous Enamel Resistors



Wire-wound, covered with a special, vitreous, non-alkaline, non-hygroscopic enamel coating which assures exceptional sealing and permanence of electrical characteristics. Adjust-

able types equipped with slider. 5 and 10 watt sizes have tinned-copper leads. All others supplied with mounting feet.

Fixed Types

Type HHJ-5 Watt Rating Tube Size 3/16" x 1"

Resistance Ohms						
1	10	40	250	700	1250	3500
1.5	12	50	300	750	1500	4000
2	15	75	350	800	1750	4500
3	20	100	400	900	2000	5000
4	25	125	450	1000	2250	
5	30	150	500	1100	2500	
7.5	35	200	600	1200	3000	

Ohms	List Price
1 Thru 1000	\$0.67
1100 Thru 5000	.75

Type 1HJ-10 Watt Rating Tube Size 3/16" x 1 3/4"

Resistance Ohms						
1	25	225	800	2500	8500	18000
2	30	250	900	3000	10000	20000
3	35	300	1000	3500	11000	22500
4	40	350	1100	4000	12000	25000
5	50	400	1200	4500	12500	30000
7.5	75	450	1250	5000	13500	35000
10	100	500	1500	6000	14300	40000
12	125	600	1750	7000	15000	45000
15	150	700	2000	7500	16000	50000
20	200	750	2250	8000	17500	

Ohms	List Price
1 Thru 1000	\$0.75
1100 Thru 5000	.80
6000 Thru 10000	.92
11000 Thru 20000	1.03
22500 Thru 50000	1.11

Type 2HJ-20 Watt Rating Tube Size 3/16" x 2"

Resistance Ohms						
5	100	500	2000	4000	12500	40000
10	150	750	2250	4500	15000	50000
15	200	1000	2500	5000	20000	75000
25	250	1250	2750	6000	25000	100000
50	300	1500	3000	7500	30000	
75	400	1750	3500	10000	35000	

Ohms	List Price
5 Thru 1000	\$0.95
1250 Thru 5000	.97
6000 Thru 10000	1.12
12500 Thru 20000	1.20
25000 Thru 40000	1.37
50000	1.50
75000 Thru 100000	1.75

Type 5HJ-50 Watt Rating Tube Size 3/16" x 4"

Resistance Ohms						
10	250	1500	7500	20000	50000	
25	500	2000	10000	25000	75000	
50	750	2500	12500	30000	100000	
100	1000	5000	15000	40000		

Ohms	List Price
10 Thru 5000	\$1.75
7500 Thru 10000	1.92
12500 Thru 20000	2.12
25000 Thru 40000	2.33
50000	2.58
75000	2.92
100000	3.20

Type 10HJ-100 Watt Rating Tube Size 3/8" x 6 1/2"

Resistance Ohms						
25	500	2000	10000	25000	50000	
50	750	2500	15000	30000	75000	
100	1000	5000	20000	40000	100000	
250	1500	7500				

Ohms	List Price
25 Thru 1000	\$2.48
1500 Thru 5000	2.53
7500 Thru 10000	2.70
15000 Thru 20000	2.97
25000 Thru 40000	3.26
50000	3.37
75000	3.58
100000	3.80

Type 20HJ-200 Watt Rating Tube Size 1/8" x 10 1/2"

Resistance Ohms						
25	100	750	2000	5000	20000	50000
50	250	1000	2500	7500	30000	75000
75	500	1500	3000	10000	40000	100000

Ohms	List Price
25 Thru 1000	\$3.29
1500 Thru 5000	3.34
7500 Thru 10000	3.54
20000	3.75
30000 Thru 40000	3.90
50000	4.03
75000	4.25
100000	4.53

Adjustable Types

Type 1AV-10 Watt Rating Tube Size 3/16" x 1 3/4"

Resistance Ohms						
1	15	150	500	1500	4000	8000
2	20	200	600	2000	4500	8500
3	25	250	750	2250	5000	9000
5	50	300	800	2500	6000	10000
7.5	75	350	1000	3000	7000	
10	100	400	1250	3500	7500	

Ohms	List Price
1 Thru 1000	\$1.47
1100 Thru 5000	1.53
6000 Thru 10000	1.63

Type 2AV-25 Watt Rating Tube Size 3/16" x 2"

Resistance Ohms						
1	25	200	750	2500	6000	20000
3	50	250	1000	3000	7500	25000
5	75	300	1250	3500	10000	
10	100	400	1500	4000	12000	
15	150	500	2000	5000	15000	

Ohms	List Price
1 Thru 1000	\$1.84
1250 Thru 5000	1.88
6000 Thru 10000	2.03
12000 Thru 20000	2.08
25000	2.28

Type 5AV-50 Watt Rating Tube Size 3/16" x 4"

Resistance Ohms						
5	75	250	1500	4000	15000	40000
10	100	500	2000	5000	20000	50000
25	150	750	2500	7500	25000	
50	200	1000	3000	10000	30000	

Ohms	List Price
5 Thru 1000	\$2.37
1500 Thru 5000	2.47
7500 Thru 10000	2.63
15000 Thru 20000	2.83
25000 Thru 40000	3.08
50000	3.31

Type 10AV-100 Watt Rating Tube Size 3/8" x 6 1/2"

Resistance Ohms						
50	2000	5000	15000	30000	50000	
100	2500	7500	20000	35000	75000	
500	3000	10000	25000	40000		
1000	4000					

Ohms	List Price
50 Thru 1000	\$3.55
2000 Thru 5000	3.67
7500 Thru 10000	3.87
15000 Thru 20000	4.12
25000 Thru 40000	4.37
50000	4.57
75000	4.75

Type 20AV-200 Watt Rating Tube Size 1/8" x 10 1/2"

Resistance Ohms						
50	1000	2500	20000	50000		
100	1500	5000	25000	75000		
500	2000	10000	30000			

Ohms	List Price
50 Thru 1000	\$4.37
1500 Thru 5000	4.45
10000	4.70
20000	4.92
25000 Thru 30000	5.03
50000	5.17
75000	5.42

Types HS and DC Deposited Carbon Resistors

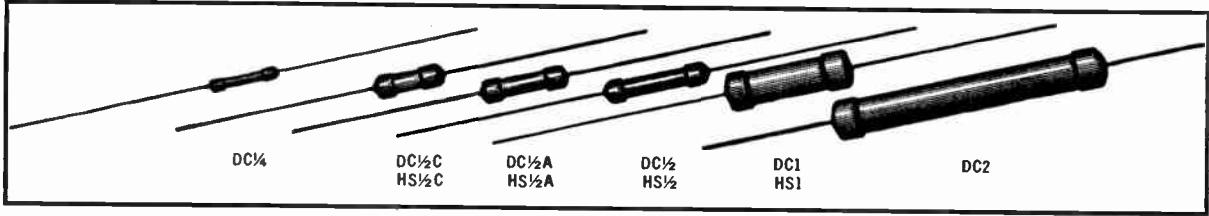

(Resistors illustrated are approximately 1/3 actual size)

Type DC ± 1% Deposited Carbon Precision Resistors

Mallory Deposited Carbon Precision Resistors are designed primarily as low-cost replacements for expensive wire-wound resistors in high-quality laboratory instruments. Their unique operating characteristics also make them ideal for replacement or substitution in all radio, television, electronic, or electric circuitry where stability, close tolerance, low-noise, and low inductance are desired. Average shelf life change will not exceed 1/4% per year. One thousand hour load life test indicates a maximum change not exceeding ± 1%.

These resistors are formed of pure, crystalline-carbon particles deposited on specially compounded ceramic. Each Mallory Deposited Carbon Resistor is equipped with 1/2" tinned copper, axially-placed leads rigidly attached to silver plated brass end-caps. Baked moisture-resistant insulation is incorporated in construction for protection against humidity. Each resistor is calibrated at a nominal temperature of 25°C. and each has a negative temperature coefficient range of approximately .03% for low resistance values, through .08% for resistances exceeding 1 megohm.

Each unit is inspected according to requirements of accepted government specifications, and each is marked with resistance value, type and tolerance, except the smaller types which have a separate label.

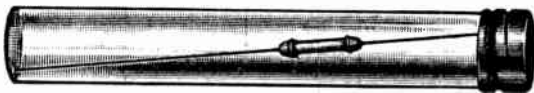

All DC Types are packaged in this dust-free plastic tube, assuring adequate physical protection.

Cat. No.	Wattage	Working Volts	Size (in inches) Dia. Length	Standard Value Resistance Range	List Price
DC 1/4	.25	300	3/32 x 1 1/32	50 ohms—1 Meg.	\$.50
DC 1/2	.50	500	1/16 x 1 1/16	70 ohms—5 Meg.	.67
DC 1/2 A	.50	350	1/16 x 1 9/32	41 ohms—2.2 Meg.	.67
DC 1/2 C	.50	350	1/16 x 1 9/32	20 ohms—1.1 Meg.	.67
DC 1	1.00	500	3/32 x 1 1/16	41 ohms—4.5 Meg. 5.0 Meg.	1.00 1.10
DC 2	2.00	750	3/32 x 2 1/16	120 ohms—10 Meg.	1.20

Each of the six DC types is available in the following resistance values, within resistance ranges shown in the table above:

Ohms	Ohms	Ohms	Ohms	Ohms	Ohms
50	1000	7.5 K	40.0 K	225.0 K	1.0 Meg.
100	1500	10.0 K	50.0 K	250.0 K	1.5 Meg.
200	2000	12.5 K	60.0 K	300.0 K	2.0 Meg.
250	2200	15.0 K	75.0 K	400.0 K	2.5 Meg.
300	2500	20.0 K	100.0 K	500.0 K	5.0 Meg.
400	3.0 K	22.5 K	125.0 K	600.0 K	10.0 Meg.
500	3.5 K	25.0 K	150.0 K	750.0 K	
600	4.0 K	30.0 K	175.0 K	900.0 K	
700	5.0 K	35.0 K	200.0 K		

When ordering specify type and resistance value desired.

Type HS Hi-Stability Deposited Carbon Resistors

For the first time the well-known advantages of high-stability, low inductance, and small size of Mallory Deposited Carbon Resistors are available at moderate cost for use in many commercial applications where accuracy of resistance is of less importance than the consistency of operation over long periods of time and through many changes of temperature. Average shelf life change will not exceed 1/4% per year. One thousand hour load life test indicates a maximum change not exceeding ± 1%.

Television servicemen, laboratory technicians, and model shop engineers, in particular, will find these resistors ideal for critical television and other oscillator circuits where constancy of resistance is of utmost importance. The electrical and mechanical characteristics of HS types are exactly the same as similar DC types, with exception of the resistance tolerance which has been increased to ± 10% of the nominal value. The same quality and temperature coefficient, as featured in the DC types, is maintained throughout.

Cat. No.	Wattage	Working Volts	Size (in inches) Dia. Length	Standard Value Resistance Range	List Price
HS 1/2	.50	500	1 1/64 x 1 3/16	47 ohms—8.2 Meg.	\$0.35
HS 1/2 A	.50	350	1 1/64 x 1 9/32	10 ohms—3.3 Meg.	.40
HS 1/2 C	.50	350	1 1/64 x 1 9/32	10 ohms—1.2 Meg.	.45
HS 1	1.00	500	3/32 x 1 1/16	100 ohms—10 Meg.	.50

Each of the four HS types is available in the following RTMA resistance values, within resistance ranges shown in the chart above:

Ohms	Ohms	Ohms	Ohms	Ohms	Ohms
10	100	1 K	10 K	100 K	1 Meg.
12	120	1.2 K	12 K	120 K	1.2 Meg.
15	150	1.5 K	15 K	150 K	1.5 Meg.
18	180	1.8 K	18 K	180 K	1.8 Meg.
22	220	2.2 K	22 K	220 K	2.2 Meg.
27	270	2.7 K	27 K	270 K	2.7 Meg.
33	330	3.3 K	33 K	330 K	3.3 Meg.
39	390	3.9 K	39 K	390 K	3.9 Meg.
47	470	4.7 K	47 K	470 K	4.7 Meg.
56	560	5.6 K	56 K	560 K	5.6 Meg.
68	680	6.8 K	68 K	680 K	6.8 Meg.
82	820	8.2 K	82 K	820 K	8.2 Meg. 10 Meg.

When ordering specify type and resistance value desired.

SPECIAL ORDERS

— Made to Your Specifications

Mallory Deposited Carbon Precision Resistors are also available in DC types made to exact customer specifications requiring a wider range of resistance values from 2 ohms to 50 megohms. DC type resistors are also available in hermetically sealed types and with special coatings or sleeves.



INSULATED RESISTORS

TYPE BT FIXED COMPOSITION CARBON RESISTORS



More IRC Filament Type BT Resistors are used in the electronic industry than any other brand of fixed composition resistors. For original equipment, IRC BT's are by far the leading choice of Electronic Engineers. For replacement, Service Technicians favor IRC BT's over all other brands combined.

IRC's exclusive filament-type resistance element is combined with superior construction features to provide a stable resistor of extremely low operating temperature and excellent power dissipation in a compact, light weight, fully insulated unit.

COLOR CODING AND STAMPING

Resistance values are clearly indicated by standard RETMA Color Code. All resistors in Distributor Packages, except BTR, are individually stamped with value and wattage.

IRC TYPE NUMBER	BTR	BTS	BTA	BTB	BW-1/2	BW-1	BW-2
Element Style	Carbon Filament	Carbon Filament	Carbon Filament	Carbon Filament	Wire Wound	Wire Wound	Wire Wound
Equivalent MIL TYPE	RC09	RC20	RC30	RC41	RU3 Max. 470 ohms	RU4 Max. 2200 ohms	RU6 Max. 3300 ohms
MIL CHARACTERISTICS	BE, BF	BE, BF, GF	BE, BF		B	B	
Rating in Watts 40° Ambient	1/4	1/2	1	2	1/2	1	2
Minimum Resistance	82 Ohms	10 Ohms	100 Ohms	330 Ohms	0.24 Ohm	0.47 Ohm	1.0 Ohm
Maximum Resistance	22 Meg.	22 Meg.	22 Meg.	22 Meg.	820 Ohms	5100 Ohms	8200 Ohms
Rated Voltage	250V	350V	500V	500V			
Dimensions (Fig. 1)							
A—Body Length	1 1/8"	1 3/8"	1 3/8"	1 1/4"	5/8"	1 1/4"	1 3/4"
B—Body Diameter	3/8"	1/2"	1/2"	1/4"	1/8"	1/4"	2 1/64"
C—Lead Length	1 1/2 ± 1/8"	1 1/2 ± 1/8"	1 1/2 ± 1/8"	1 1/2 ± 1/8"	1 1/2 ± 1/8"	1 1/2 ± 1/8"	1 1/2 ± 1/8"
D—Lead Diameter	.028"	.032"	.040"	.043"	.032"	.036"	.036"
List Price							
10% Tolerance	\$0.20	\$0.20	\$0.30	\$0.38	\$0.20	\$0.30	\$0.38
5% Tolerance	\$0.38	\$0.38	\$0.58	\$0.75	\$0.38	\$0.58	\$0.75

NOTE: Consult your IRC Distributor for prices in lots of 100 and over per item.

Figure 1
Dimensions

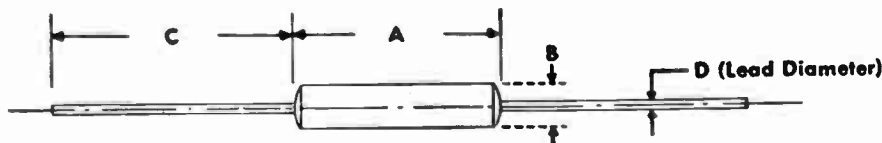

TYPE BW INSULATED WIRE WOUND RESISTORS



Type BW's are exceptionally stable, inexpensive wire wound resistors for low range requirements. These small, completely insulated units are similar in appearance to insulated composition resistors but are readily identified by the double width of the first color code band.

The wire element is uniformly and tightly wound on an insulated core. Tinned, solid wire leads are keyed to the element by a specially designed terminal. Leads are anchored inside the insulation and cannot turn or pull loose.



INSULATED RESISTORS

STANDARD STOCK VALUES

BT and BW Insulated Resistors are available in RETMA Ranges within the maximum and minimum values for each type. Stock values are listed below.

STANDARD VALUES AT ±10% TOLERANCE

OHM	OHMS	OHMS	OHMS	OHMS	OHMS	OHMS	MEGS	MEGS
—	1.0	10	100	1,000	10K	100K	1.0	10
—	1.2	12	120	1,200	12K	120K	1.2	12
—	1.5	15	150	1,500	15K	150K	1.5	15
—	1.8	18	180	1,800	18K	180K	1.8	18
—	2.2	22	220	2,200	22K	220K	2.2	22
0.27	2.7	27	270	2,700	27K	270K	2.7	—
0.33	3.3	33	330	3,300	33K	330K	3.3	—
0.39	3.9	39	390	3,900	39K	390K	3.9	—
0.47	4.7	47	470	4,700	47K	470K	4.7	—
0.56	5.6	56	560	5,600	56K	560K	5.6	—
0.68	6.8	68	680	6,800	68K	680K	6.8	—
0.82	8.2	82	820	8,200	82K	820K	8.2	—

STANDARD VALUES AT ±5% TOLERANCE

OHM	OHMS	OHMS	OHMS	OHMS	OHMS	OHMS	MEGS	MEGS
—	1.0	10	100	1,000	10K	100K	1.0	10
—	1.1	11	110	1,100	11K	110K	1.1	11
—	1.2	12	120	1,200	12K	120K	1.2	12
—	1.3	13	130	1,300	13K	130K	1.3	13
—	1.5	15	150	1,500	15K	150K	1.5	15
—	1.6	16	160	1,600	16K	160K	1.6	16
—	1.8	18	180	1,800	18K	180K	1.8	18
—	2.0	20	200	2,000	20K	200K	2.0	20
—	2.2	22	220	2,200	22K	220K	2.2	22
0.24	2.4	24	240	2,400	24K	240K	2.4	—
0.27	2.7	27	270	2,700	27K	270K	2.7	—
0.30	3.0	30	300	3,000	30K	300K	3.0	—
0.33	3.3	33	330	3,300	33K	330K	3.3	—
0.36	3.6	36	360	3,600	36K	360K	3.6	—
0.39	3.9	39	390	3,900	39K	390K	3.9	—
0.43	4.3	43	430	4,300	43K	430K	4.3	—
0.47	4.7	47	470	4,700	47K	470K	4.7	—
0.51	5.1	51	510	5,100	51K	510K	5.1	—
0.56	5.6	56	560	5,600	56K	560K	5.6	—
0.62	6.2	62	620	6,200	62K	620K	6.2	—
0.68	6.8	68	680	6,800	68K	680K	6.8	—
0.75	7.5	75	750	7,500	75K	750K	7.5	—
0.82	8.2	82	820	8,200	82K	820K	8.2	—
0.91	9.1	91	910	9,100	91K	910K	9.1	—



RESIST-O-CABINETS and RESIST-O-KITS

ALL METAL RESIST-O-CABINETS



In 3 popular resistor assortments including ranges most widely used in TV (shown by asterisk*).

4 "non-spill" drawers with 28 identified compartments. Attractive blue, yellow and silver finish. Designed for stacking. Cabinets measure 5 3/8" x 5 1/8" x 10 3/4".

1/2 WATT ASSORTMENT #4 100 BW-1/2 and BTS 1/2 Watt Resistors. List Price \$20.00.		1 WATT ASSORTMENT #5 83 BW-1 and BTA 1 Watt Resistors. List Price \$24.90.		COMBINATION ASSORTMENT #6 91 Insulated Resistors and Type DCF Tolerance Precistors. List Price \$28.50.				
QUANTITY	RANGE	QUANTITY	RANGE	RANGE	1/2 WATT	1 WATT	2 WATT	DCF
2	47 ohms	2	47 ohms	47 ohms	1	1	1	—
3	100 ohms	2	100 ohms	100 ohms	1	1	1	—
2	220 ohms	2	150 ohms	150 ohms	1	1	—	—
2	270 ohms	2	220 ohms	220 ohms	1	1	—	—
3	470 ohms*	2	270 ohms	270 ohms	1	1	—	—
6	1,000 ohms*	2	470 ohms	470 ohms	1*	1	1	—
2	1,500 ohms	5	1,000 ohms*	1,000 ohms	3*	2*	—	1
2	2,200 ohms*	2	1,500 ohms	1,500 ohms	1	1	—	—
2	2,700 ohms*	3	2,200 ohms	2,200 ohms	1*	1	—	—
3	3,300 ohms*	2	2,700 ohms	2,700 ohms	1*	1	—	—
5	4,700 ohms*	2	3,300 ohms*	3,300 ohms	1*	1*	—	—
5	10K ohms*	3	4,700 ohms*	4,700 ohms	2*	1*	1	—
3	22K ohms*	5	10K ohms*	10K ohms	2*	2*	1*	1
3	27K ohms*	2	15K ohms*	15K ohms	1	1*	—	—
3	33K ohms*	3	22K ohms*	22K ohms	1*	1*	1*	—
6	47K ohms*	5	27K ohms*	27K ohms	1*	2*	—	—
2	56K ohms*	2	33K ohms*	33K ohms	1*	1*	—	—
2	68K ohms*	2	39K ohms*	39K ohms	1	1*	—	—
6	100K ohms*	5	47K ohms*	47K ohms	3*	2*	1*	—
5	220K ohms*	2	68K ohms*	68K ohms	1*	1*	—	—
6	270K ohms*	5	100K ohms*	100K ohms	2*	2*	—	1
3	330K ohms*	2	150K ohms	150K ohms	1	1	—	—
6	470K ohms*	2	220K ohms	220K ohms	2*	1	—	—
6	1.0 meg*	5	270K ohms	270K ohms	3*	1	—	—
5	2.2 meg*	5	470K ohms	470K ohms	3*	2	—	—
2	3.3 meg	5	1.0 meg*	1.0 meg	3*	2*	—	1
3	4.7 meg*	2	2.2 meg	2.2 meg	2*	1	—	—
2	10.0 meg	2	4.7 meg	4.7 meg	1*	1	—	—
				5.0 meg	—	—	—	1

RESIST-O-KITS



ALL METAL

Handy pocket-size metal kit of 1/2 or 1 watt BT Resistors. 10 compartments; lid snaps securely shut. Ranges marked on each resistor in Kit. Ideal for service calls. List Price \$9.00

1/2 WATT ASSORTMENT #7

45 BTS 1/2 Watt Resistors

*indicates popular TV ranges.

QUANTITY	RANGE
4	1,000 ohms*
3	4,700 ohms*
4	10K ohms*
5	47K ohms*
6	100K ohms*
3	220K ohms*
5	270K ohms*
6	470K ohms*
5	1.0 meg*
4	2.2 meg*

1 WATT ASSORTMENT #8

30 BTA 1 Watt Resistors

*indicates popular TV ranges.

QUANTITY	RANGE
4	1,000 ohms*
2	2,200 ohms
2	4,700 ohms*
3	10K ohms*
2	27K ohms*
4	47K ohms*
4	100K ohms
2	270K ohms
4	470K ohms
3	1.0 meg*

TYPE Q VOLUME CONTROL CABINET

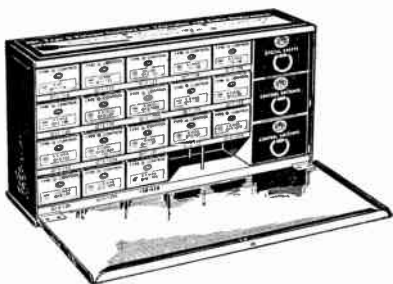

Stocked with 18 new Type Q Controls plus switches and special shafts—for handling over 90% of all AM, FM and TV Single Carbon Control replacements. Individually marked compartments contain controls—3 special drawers hold shafts, switches and spare parts. Everything neat, protected, there when you want it. No charge for sturdy metal cabinet; you pay only for its contents.

CONTENTS—Contains one each of the following Q Controls: Q11-116, Q11-123, Q13-123, Q11-128, Q13-128, Q11-130, Q13-130, Q13-130X, Q11-133, Q13-133X, Q11-137, Q13-137, Q13-137X, Q13-139, Q13-139X, Q18-139X; and two type Q13-133 controls. Also included are six 76-1 Switches and five Special Shafts. **LIST PRICE \$30.90**

CONCENTRIKIT STOCK CABINET ASSORTMENT #14



Wide-coverage, low cost dealer stock of CONCENTRIKIT parts. Provides coverage of 404 concentric dual listings (equivalent of 188 different concentric duals)—TV coverage which would require dealer investment of \$403.44 in factory-assembled controls.

CONTENTS—Contains 30 selected Base-Elements, 34 Exact Duplicate Shafts, 4 K-2 CONCENTRIKITS and 3 Switches. Provides "less-than-a-minute" assembly without shaft modification.

Assortment #14 is contained in sturdy IRC four-drawer all-metal stock cabinet. 28 compartments are prominently labeled as to contents. Cabinet stacks with IRC Resist-O-Cabinets. Full replacement data on stock coverage is included.

COVERAGE — Supplies replacement coverage among 77 Trade Names including RCA, Emerson, Admiral, Philco, Crosley, G.E. and many other widely sold makes. **LIST PRICE \$44.60**



REPLACEMENT CONTROL KITS

IRC CONCENTRIPAKS

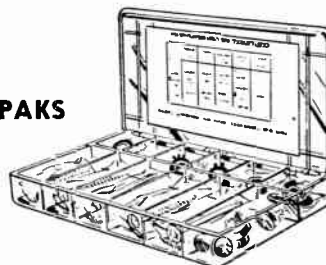

IRC CONCENTRIPAKS are practical assortments of IRC CONCENTRIKITS, Base-Elements, Exact Duplicate Shafts and Switches selected from the concentric dual requirements of specific brands of TV sets. CONCENTRIPAKS afford wide coverage of replacement needs at a fraction of the cost of factory-assembled controls.

Contained in an extra heavy plastic stock box with 11 compartments and sturdy hinged top, each CONCENTRIPAK includes complete replacement data for the parts included, showing manufacturer's part and stock numbers, IRC parts required for control assembly, pricing guide. List of contents is in easy-to-use chart form. CONCENTRIKIT parts included feature "less-than-a-minute" assembly without filing, slotting, soldering or cutting of shafts.

CONCENTRIPAK—KC-1 FOR PHILCO

Replaces any one of 13 Philco concentric duals plus 21 specific controls of 18 other widely sold makes — TV coverage which would require dealer investment of \$25.62 in factory-assembled controls.

Contains both K-2 and K-3 CONCENTRIKITS, 9 selected Base-Elements, 18 Exact Duplicate Shafts and Switch, and replacement data.

LIST PRICE \$17.00

CONCENTRIPAK—KC-2 FOR RCA

Replaces any one of 14 RCA concentric dual controls plus 38 part number listings among 17 other makes—coverage which would require dealer investment of \$30.36 in factory-assembled controls.

Contains K-2 CONCENTRIKIT, 10 selected Base-Elements, 8 special Replacement Shafts and Switch, and complete replacement data.

LIST PRICE \$12.40

CONCENTRIPAK—KC-3 FOR ADMIRAL

Replaces any one of 14 Admiral concentric dual controls plus additional controls for Packard-Bell, Sparton and Stromberg-Carlson — TV coverage which would require dealer investment of \$30.00 in factory-assembled controls.

Contains K-2 CONCENTRIKIT, 10 selected Base-Elements, 8 Special Replacement Shafts, and 2 Switches. Replacement data included.

LIST PRICE \$13.00



TYPE Q VOLUME CONTROLS



RADIO-TV TECHNICIANS'

TYPE Q VOLUME CONTROL

IRC's Type Q Control is the basic control for all set servicing. It is carefully engineered to meet most replacement requirements with a minimum stock.

The quality appearance and "cushioned turn" of the Q Control assure customer satisfaction. Easier installation and dependable performance provide more profitable servicing.

KNOB MASTER STANDARD FIXED SHAFT

Standard shaft is knurled, flatted and slotted and fits most knobs without alteration. For knurled or spring type push-on knobs, cut to length. For over-size, worn or web type knobs, split shaft slot lengthwise and spread ends. For positioned knobs, bend down control locating pins and rotate control base for correct knob position.

1/4" LONG BUSHING

Shorter bushing and compact 1/8" design suit Q Controls to all small sets, yet handle large set needs as well.

7 STANDARD TAPERS FOR Q CONTROLS

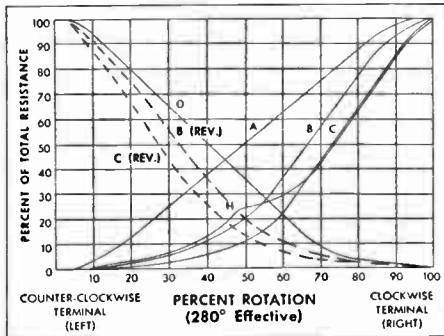

A — For potentiometer or rheostat where uniform resistance change is required.

B — Semi-logarithmic curve for tone control or audio circuit control.

B Reverse — Semi-logarithmic curve — reverse taper for use in contrast and picture control circuits in television.

C — Logarithmic curve for audio circuit control or antenna shunt control.

C Reverse — Semi-logarithmic curve — reverse taper for use in contrast and picture control circuits in television.

D — Tapered at both ends to provide control of grid bias and antenna circuit. Used where control of grid bias is important in controlling volume.

H — Tapped logarithmic curve for audio level control for automatic bass compensation.

93 VALUES FOR COMPLETE COVERAGE

RESISTANCE OHMS	TAP	IRC STOCK No.	TAPER
250	—	Q11-201	A
500	—	Q11-103	A
750	—	Q11-105	A
750	—	Q17-105	B (Rev)
750	250	Q17-105X	Spec
1000	—	Q11-108	A
1000	—	Q17-108	B (Rev)
1500	—	Q11-109	A
1500	—	Q17-109	C (Rev)
2000	—	Q11-110	A
2500	—	Q13-111	C
2500	—	Q17-111	C (Rev)
3000	—	Q11-112	A
3000	—	Q17-112	C (Rev)
5000	—	Q11-114	A
5000	—	Q13-114	C
5000	—	Q17-114	C (Rev)
7500	—	Q11-115	A
10K	—	Q11-116	A
10K	—	Q13-116	O
10K	—	Q14-116	D
10K	—	Q17-116	C (Rev)
15K	5K-10K	Q13-118XX	Spec
15K	5K	Q17-118X	Spec
15K	5K-10K	Q17-118XX	Spec
20K	—	Q11-119	A
20K	—	Q16-119	Spec
25K	—	Q11-120	A
25K	—	Q13-120	C
25K	—	Q14-120	D
30K	—	Q11-121	A
35K	—	Q11-122	A
50K	—	Q11-123	A
50K	—	Q13-123	O
50K	—	Q14-123	D
75K	—	Q11-125	A
100K	—	Q11-128	A
100K	—	Q13-128	C
125K	—	Q11-228	A
150K	—	Q13-328	C
150K	19K-38K	Q17-328XX	Spec
200K	—	Q11-129	A
250K	—	Q11-130	A
250K	—	Q13-130	O
250K	125K	Q13-130X	Spec
250K	60K	Q18-130X	H
250K	60K-120K	Q18-130XX	Spec
300K	—	Q11-131	A
350K	—	Q13-132	C
350K	35K	Q17-132X	Spec
350K	75K	Q18-132X	H
500K	—	Q11-133	A
500K	—	Q13-133	C
500K	125K	Q13-133X	H
500K	—	Q14-133	D
500K	—	Q17-133	C (Rev)
500K	25K	Q17-133X	Spec
500K	50K	Q18-133X	Spec
300K	—	Q11-131	A
500K	250K	Q19-133X	Spec
500K	100K-200K	Q18-133XX	Spec
600K	—	Q11-134	A
750K	—	Q11-136	A
1.0 Meg	—	Q11-137	A
1.0 Meg	—	Q13-137	C
1.0 Meg	250K	Q13-137X	H
1.0 Meg	—	Q14-137	D
1.0 Meg	35K	Q17-137X	Spec
1.0 Meg	50K-100K	Q17-137XX	Spec
1.0 Meg	100K	Q18-137X	Spec
1.0 Meg	250K-500K	Q18-137XX	Spec
1.0 Meg	500K	Q19-137X	Spec
1.0 Meg	500K	QVC-539X	Spec
1.5 Meg	—	Q11-138	A
1.5 Meg	250K	Q13-138X	Spec
2.0 Meg	—	Q11-139	A
2.0 Meg	—	Q13-139	C
2.0 Meg	500K	Q13-139X	H
2.0 Meg	500K-1.0 Meg	Q13-139XX	Spec
2.0 Meg	—	Q17-139	C (Rev)
2.0 Meg	150K	Q17-139X	Spec
2.0 Meg	1.0 Meg	Q18-139X	Spec
2.0 Meg	250K-500K	Q18-139XX	Spec
2.5 Meg	50K	Q19-139X	Spec
3.0 Meg	—	Q11-239	A
3.0 Meg	—	Q11-140	A
3.0 Meg	—	Q13-140	C
3.0 Meg	—	Q17-140	C (Rev)
5.0 Meg	—	Q11-141	A
5.0 Meg	—	Q12-141	Spec
5.0 Meg	—	Q13-141	C
5.0 Meg	—	Q17-141	C (Rev)
7.5 Meg	—	Q11-142	A
10.0 Meg	—	Q11-143	A

Plain Controls	List
Tapped Controls	\$1.25
	1.85

TAB MOUNT CONTROLS

Many recent TV sets use Tab Mount Controls. These are single controls without switch. They differ from standard controls in that bushing is omitted and mounting to chassis is made with two heavy twist-type mounting tabs.

IRC TAB-MOUNT KITS

Since assembly of Tab-Mount Controls is so simple, IRC supplies three 3-Part Tab-Mount Kits which will assemble with any standard plain or tapped IRC Base-Element to provide satisfactory Tab-Mount Controls. Each TM Kit includes a Tab-type Ground Plate, a control cover and a finger-knurled and screw-driver slotted shaft of appropriate length for universal replacement. Packaged with instruction sheet but without necessary Base-Element.

TM-1—IRC Tab-Mount Kit—Shaft $\frac{1}{4}$ " long. List Price \$0.60

TM-2—IRC Tab-Mount Kit—Shaft $\frac{5}{8}$ " long. List Price \$0.60

TM-3—IRC Tab-Mount Kit—Shaft 1" long. List Price \$0.60

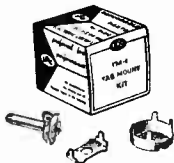

Q CONTROL ACCESSORIES

IRC SWITCHES

The Type 76 Switch is designed and produced by IRC. It is supplied in two types: 76-1 Single Pole Single Throw, and 76-2 Double Pole Single Throw. Switch is specially engineered for the Q Control with matching blue Bakelite enclosure. It attaches easily and quickly, and for added convenience, the one-piece terminals have elongated holes. List Price \$0.60

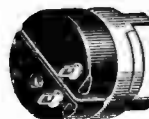

16 INTERCHANGEABLE FIXED SHAFTS FOR Q CONTROLS



AQ

Knob Master Shaft. Same as supplied in Type Q Controls. Flatted, grooved and knurled. 3" long. List Price \$0.50



BQ

Slotted or tongued. For remote control cables. Includes $\frac{7}{8}$ " and $1\frac{1}{8}$ " guide funnels and tongue. Approximately $3\frac{1}{2}$ " long from mounting face. $\frac{1}{8}$ " diameter. List Price \$0.45



GQ

Specially slotted with hole in bottom. For Philco sets. Slot $\frac{1}{8}$ " x $\frac{1}{8}$ " deep. Approximately $1\frac{1}{8}$ " long from mounting face when installed in control. $\frac{1}{4}$ " diameter. List Price \$0.30



HQ

Flatted, with groove for dial plate. For Delco, RCA, Sears-Roebuck and Westinghouse sets. $\frac{3}{8}$ " deep flat. $\frac{1}{4}$ " deep groove. Approximately $1\frac{1}{8}$ " long from mounting face. $\frac{1}{4}$ " diameter. List Price \$0.30



JQ

$\frac{1}{8}$ " diameter with .105" flat. For Zenith models where shaft must operate inside another shaft. Approximately $4\frac{1}{8}$ " long from mounting face. List Price \$0.45



KQ

Special $\frac{1}{8}$ " round with two concentric holes in end. For Motorola sets. Approximately $1\frac{3}{8}$ " long from mounting face. List Price \$0.30



LQ

Short flat with groove and threaded hole in end. For Belmont and Montgomery-Ward sets. $\frac{3}{8}$ " deep flat. $\frac{3}{8}$ " deep groove. Approximately $1\frac{1}{2}$ " long from mounting face. $\frac{1}{4}$ " diameter. List Price \$0.35



MQ

Special double-flat, threaded for $\frac{3}{8}$ " on end. For Belmont, Montgomery-Ward and Wells-Gardner sets. Has two concentric holes in end, the smaller being threaded. Approximately $1\frac{1}{2}$ " long from mounting face. List Price \$0.45



NQ

Universal $\frac{7}{8}$ " flatted and slotted shaft. Slot milled entire length of shaft except for thin web. Approximately 4" long from mounting face. List Price \$0.45



PQ

Universal $\frac{1}{4}$ " full-round shaft approximately 3" long from mounting face. For $\frac{1}{4}$ " or $\frac{3}{8}$ " bushings. $\frac{3}{8}$ " bushing included. List Price \$0.35



RQ

Very short screw-driver slot shaft. Slot, $\frac{1}{8}$ " x $\frac{1}{8}$ ". Approximately $\frac{1}{2}$ " long from mounting face. $\frac{1}{4}$ " diameter. For $\frac{3}{8}$ " bushing only. Bushing included. List Price \$0.35



SQ

Combination finger knurl and screw-driver slot. Shaft knurled at end for $\frac{1}{8}$ ". Screw-driver slot in end, $\frac{3}{4}$ " x $\frac{1}{8}$ ". $\frac{1}{4}$ " diameter. Approximately $\frac{3}{4}$ " long from mounting face. List Price \$0.30



TQ

Insulated shaft for use in television. Drive arm and shaft of insulating material. Used without retainer ring. 3" long from mounting face. Easily cut to required length. $\frac{1}{4}$ " diameter. CANNOT BE USED WITH SWITCH. List Price \$0.60



UQ

Identical with BQ Shaft except for addition of friction clutch-drive arm. Used for remote control as in auto radios. List Price \$0.60



VQ

Special tongued shaft—1" long from mounting face, tongue $\frac{1}{8}$ " wide, $\frac{1}{8}$ " long, .050" thick. For Magnavox TV Receivers. List Price \$0.35



WQ

Special tongued shaft— $1\frac{1}{8}$ " long from mounting face, tongue $\frac{1}{4}$ " wide, $\frac{1}{2}$ " long, .062" thick. For Zenith TV Receivers. List Price \$0.35

FOR QUICK, EASY CONVERSION TO "SPECIALS" WITH FIXED SHAFT SECURITY

This feature adapts the Q Control to a "special" in 6 easy steps. (1) Remove control cover by bending up tabs. (2) Remove Resilient Retainer Ring with knife or pointed tool. (3) Remove standard shaft from control base. (4) Insert special shaft in base. (5) Roll new Ring into shaft groove. (6) Replace cover (or add switch).

IRC INTERCHANGEABLE FIXED SHAFTS ARE INDIVIDUALLY PACKAGED with complete instructions and extra Resilient Retainer Ring.



Q CONTROL ACCESSORIES

ASSEMBLE YOUR OWN STANDARD OR SPECIAL IRC Q CONTROLS

For those who would like to use their IRC Base-Element stock for assembly of standard controls, the component parts are available. Plain Q Control assemblies with 1-Base-Element, 1-Interchangeable Fixed Shaft, 1-QCB Bushing and 1-QCC Cover. Switch type Q control assemblies with 1-Base-Element, 1-Interchangeable Fixed Shaft, 1-QCB Bushing and 1 of either 76-1 or 76-2 Switch.

QCB-BUSHING— $\frac{3}{8}$ "-32 thread, $\frac{1}{4}$ " long. Pkg. of 5.
List Price \$0.30

QCC-COVER—For plain or tapped controls. Pkg. of 5.
List Price \$0.45

IRC VOLUME CONTROL GROUNDING LUG—Same as supplied with IRC Type Q Controls. Fits $\frac{3}{8}$ " bushing. Lug length from hole center— $1\frac{1}{8}$ ". Type QCL Grounding Lugs. Pkg. of 5.
List Price \$0.17

STANDARD Q CONTROL LOCKNUT—Hex nut for $\frac{3}{8}$ "-32 thread. $\frac{3}{8}$ " across flats. Type QCN. Pkg. of 10.
List Price \$0.25

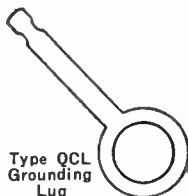

Type QCL Grounding Lug

EXTENSION SHAFTS



These attach to regular shafts, thus extending length to any needed size. They frequently make it possible to use standard controls for "special" jobs.

Type	Dimensions
Shaft 441.....	4" x $\frac{1}{4}$ " dia. x $\frac{3}{32}$ " flat
Shaft 442.....	4" x $\frac{1}{4}$ " dia. x $\frac{3}{32}$ " flat
Shaft 443.....	4" x $\frac{7}{8}$ " dia. x $\frac{3}{32}$ " flat
Shaft 444.....	8" x $\frac{1}{4}$ " dia. x $\frac{3}{32}$ " flat for 4" lengths

List Price \$0.40

PLAIN OR INSULATED SHAFT COUPLERS

For use with standard controls to meet special shaft requirements. Two set screws give rigid connection.

TYPE C2—Insulated coupler for use with square type shaft used by Motorola.

TYPE C3—Plain coupler to couple $\frac{1}{4}$ " shafts; insert allows coupling of $\frac{1}{4}$ " shaft to $\frac{3}{8}$ " shaft.

List Price \$0.30

SLEEVE BUSHINGS

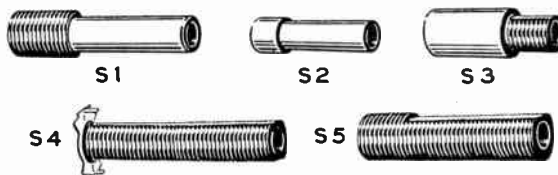

TYPE S1—For use with standard controls. List Price \$0.45

TYPE S2—To provide bearing for switching mechanism. List Price \$0.30

TYPE S3—For use with standard controls to set control back from chassis or mounting bracket. $1\frac{1}{2}$ "— $\frac{1}{2}$ " dia. for 1" unthd. — $\frac{3}{8}$ " dia. for $\frac{1}{2}$ ", $\frac{3}{8}$ "—32 thd.—.344 flat. List Price \$0.60

TYPE S4—For use with concentric duals to provide $\frac{1}{16}$ " dia. bushing. $1\frac{1}{2}$ "— $\frac{7}{8}$ "—28 thd. full length—.375 dbl. flat. List Price \$0.60

TYPE S5—For use with standard controls to provide $\frac{1}{2}$ " dia. bushing, $2\frac{1}{4}$ "— $\frac{1}{2}$ "—28 thd. full length—.437 flat. List Price \$0.60

SPECIAL PURPOSE CONTROLS

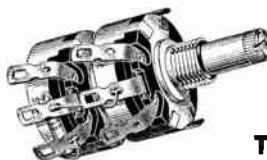

Type QJ-3 TV ATTENUATOR

- Reduces overloading effects on TV sets in strong signal areas.
- Diminishes interstation interference caused by nearby or powerful stations.
- Minimizes buzz due to high signal level in intercarrier systems.
- Permits easy adjustment of signal RIGHT AT SET.
- Frequently prevents mismatch of antenna load to set.

IRC's QJ-3 TV Attenuator permits ready adjustment of signal input to TV sets. In most cases, it corrects or substantially reduces such conditions as:—Adjacent channel interference, background picture on weaker stations, poor definition, picture and sound breakover. Also useful in service work—duplicating fringe area signals when shop is near strong local station. List Price \$3.30

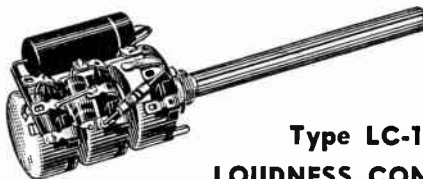

Type LC-1 LOUDNESS CONTROL

A continuously compensated control that boosts lows and highs as volume is decreased—maintains depth and brilliance even at whisper level. Type LC-1 replaces makeshift compensating units—tapped volume controls, stepped-type loudness controls, bass and treble boost circuits. Automatically maintains proper balance of all frequencies in the audio spectrum at any listening level. Simplicity itself—as easy to wire into an audio circuit as any standard three-terminal volume control. Complete instructions included, showing applications. Type 76-1 or 76-2 switch can be added to this control. List Price \$9.95

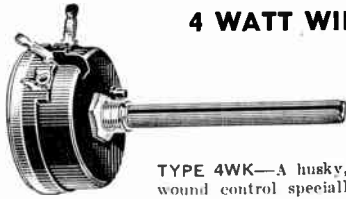

4 WATT WIRE WOUNDS

TYPE 4WK—A husky, universal 4-watt wire-wound control specially designed for TV replacements. Equipped with IRC Knob Master

Shaft—knurled, flatted and grooved to fit most knob requirements without modification except for cutting to length. Diameter $1\frac{1}{4}$ " depth behind panel $\frac{1}{8}$ ", bushing $\frac{1}{4}$ ", shaft length 3".

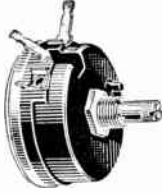

TYPE 4WS—Identical to Type 4WK except equipped with short, knurled and slotted shaft. Designed for replacement without shaft alteration of TV controls mounted at chassis rear or under front panel concealment. Dimensions same as Type 4WK except $\frac{5}{8}$ " shaft length.

HIGH VOLTAGE CONTROLS

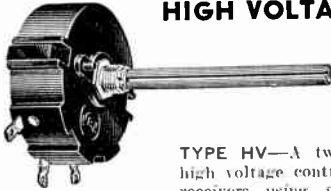

TYPE HV—A two-watt carbon element high voltage control for use in television receivers using picture tubes requiring electrostatic focus. Equipped with Knob Master Shaft. Diameter $2\frac{1}{4}$ " depth behind panel $\frac{3}{8}$ ", bushing $\frac{1}{4}$ ", shaft length 3".

TYPE 4WK

Control No.	Ohms	Taper	List Price
4WK-1G	10	Linear	\$2.00
4WK-20	20	"	2.00
4WK-30	30	"	2.00
4WK-50	50	"	2.00
4WK-100	100	"	2.00
4WK-200	200	"	2.00
4WK-300	300	"	2.00
4WK-400	400	"	2.00
4WK-500	500	"	2.00
4WK-600	600	"	2.00
4WK-650	650	"	2.00
4WK-750	750	"	2.00
4WK-750R	750	R. H. Log	2.20
4WK-1000	1000	Linear	2.00
4WK-1350	1350	"	2.00
4WK-1500	1500	"	2.00
4WK-1500L	1500	L. H. Log	2.20
4WK-2000	2000	Linear	2.00
4WK-2500	2500	"	2.00
4WK-3000	3000	"	2.00
4WK-5000	5000	"	2.00
4WK-6000	6000	"	2.00
4WK-7500	7500	"	2.00
4WK-10000	10K	"	2.35
4WK-15000	15K	"	2.35
4WK-20000	20K	"	2.35
4WK-25000	25K	"	2.35

TYPE 4WS

4WS-25	25	Linear	\$2.00
4WS-250	250	"	2.00
4WS-500	500	"	2.00
4WS-1000	1000	"	2.00
4WS-1500	1500	"	2.00
4WS-2000	2000	"	2.00
4WS-2250	2250	"	2.00
4WS-2500	2500	"	2.00
4WS-3000	3000	"	2.00
4WS-4000	4000	"	2.00
4WS-5000	5000	"	2.00

TYPE HV

HV-15	15 Meg.	Linear	\$3.00
HV-25	25 Meg.	"	3.00



WIRE WOUND AND HV CONTROLS

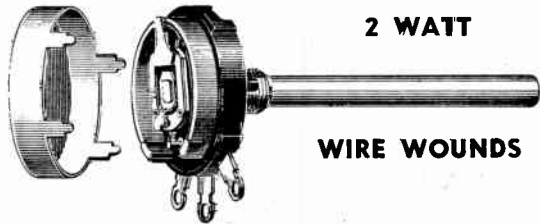

2 WATT

WIRE WOUNDS

TYPE W—Tight, uniform winding assures utmost accuracy, dependability and uniform resistance change. Diameter $1\frac{1}{4}$ " depth behind panel $\frac{3}{8}$ ", full round $\frac{1}{4}$ " shaft 3" long from control face.

TYPE WK—Identical to Type W except provided with Knob Master Shaft for both knurled and flatted knobs in TV sets. Accommodates W Switches. $\frac{1}{4}$ " long bushing; shaft 3" long from mounting face.

TV CENTERING CONTROLS—Same as Type W but center tapped for television.

TYPES W AND WK

Control No.	Resistance Ohms	Max. Current (Amps.)	Control No.	Resistance Ohms	Max. Current (Amps.)
W-2	2	1.000	W-750	750	.052
W-3	3	.815	*WK-750L	750	.052
W-5	5	.630	*WK-750R	750	.052
W-6	6	.560	W-1000	1000	.045
W-8	8	.500	WK-1000	1000	.045
W-10	10	.450	WK-1500	1500	.036
W-15	15	.370	W-2000	2000	.032
W-20	20	.320	WK-2000	2000	.032
W-25	25	.285	WK-2500	2500	.028
W-30	30	.260	*WK-2500R	2500	.028
W-40	40	.225	W-3000	3000	.026
W-50	50	.200	WK-3000	3000	.026
W-60	60	.183	W-4000	4000	.022
W-75	75	.164	W-5000	5000	.020
W-100	100	.142	*WK-5000	5000	.020
W-200	200	.100	W-7500	7500	.016
WK-250	250	.089	*WK-7500	7500	.016
W-300	300	.083	W-10000	10K	.014
W-400	400	.071	WK-10000	10K	.014
W-500	500	.063	*WK-12500	12.5K	.012

*New controls required for TV replacement.

TV CENTERING CONTROLS

Control No.	Resistance Ohms	Center Tapped At
W10X5	10	5 ohms
W20X10	20	10 ohms
W30X15	30	15 ohms
W50X25	50	25 ohms

TYPE W SWITCHES

Type No.	Description
51	S.P., S.T.
52	D.P., S.T.
53	S. P., D.T.
54	3 Point
55	4 Point
56	S.P., D.T. at clockwise position
57	S.P., S.T. with dummy lug

PRICES

	List Price
W —Control, plain	\$1.25
W —Control, center tapped	1.85
WK —Control, plain	1.25
W —Switch No. 51	.60
W —Switches 52 thru 57	.75



TELEVISION CONTROLS

FACTORY-ASSEMBLED EXACT DUPLICATE CONCENTRIC DUALS

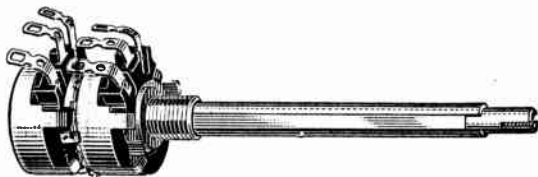

For Service Technicians who prefer factory-assembled controls, IRC provides a complete line of over 500 Factory-Assembled Exact Duplicate TV Concentric Duals. Both Carbon and Wire Wound Element types are included to meet the needs of over 5500 TV sets.

PART NUMBER MANUAL (Form S012C) provides complete cross-reference from manufacturers' Part or Stock Numbers.

Net 15¢

**MECHANICAL FIT
AND ELECTRICAL OPERATION
DOUBLE-MONEY-BACK GUARANTEED!**

IRC TV Concentric Duals—both Factory-Assembled Exact Duplicates and Universal Concentrikits — are double-money back GUARANTEED! Mechanical and electrical specifications are all based on set manufacturers' procurement prints. Resistance values are matched; tapers are closely followed; shaft lengths are never less than manufacturers' nominal, never more than $\frac{3}{32}$ " longer.

NEW, SIMPLIFIED IRC CONCENTRIKITS AND EXACT DUPLICATE SHAFTS



GIVE "LESS-THAN-A-MINUTE" ASSEMBLY OF TV CONCENTRIC DUAL CONTROLS

Here's the outstanding development in TV Concentric Dual replacements—a universal stock of parts which assemble into Exact Duplicate Controls in less-than-a-minute! Makes practical wide coverage of special TV Controls with a low cost stock of parts. Reduces obsolescence. Permits faster, more efficient and more profitable servicing.

FOUR NEW IRC CONCENTRIKITS of simplified, improved design plus new IRC Exact Duplicate Shafts and a greatly expanded selection of Base-Elements provide exceptionally wide coverage, including wire-wound-carbon combinations.

NO FILING OR CUTTING OF SHAFTS. IRC Exact Duplicate Shafts are ready for assembly into completed concentric duals. No alterations are required! No special tools needed!

PARTS NEEDED FOR ASSEMBLY. Each control requires only 2 base elements, a pair of shafts and a switch (when needed), in addition to CONCENTRIKIT. IRC's **PART NUMBER MANUAL** (Form S012—15¢ Net) supplies complete listing of parts needed for each manufacturer's part number.

K-2 CONCENTRIKIT. For assembly of concentric duals having 2 carbon sections. Contain 4 parts: Panel Cover, Rear Cover, Bushing and Mounting Nut. Assembly instructions included. Requires following additional parts, depending upon specification desired:

- 2—Base-Elements (Type B)
- 1—Outer Shaft (Types P1 or P2)
- 1—Inner Shaft (Types R1, R2, R3 or R4)
- 1—Switch—when needed (Types 76-1 or 76-2)

KS-2 Universal Shaft Kit may be used with K-2 CONCENTRIKIT in place of Exact Duplicate Outer and Inner Shafts.

List Price \$0.80

K-3 CONCENTRIKIT. For assembly of concentric duals having wire-wound panel section and carbon rear section. Contains 4 parts: Panel Cover, Rear Cover, Ground Plate and Mounting Nut. Assembly instructions included. Requires additional parts, depending upon specification desired, as follows:

- 1—Panel Base-Element (Type W)
- 1—Rear Base-Element (Type B)
- 1—Outer Shaft (Types P3 or P4)
- 1—Inner Shaft (Types R1, R2, R3 or R4)
- 1—Switch—when needed (Types 76-1 or 76-2)

KS-3 Universal Shaft Kit may be used with K-3 CONCENTRIKIT in place of Exact Duplicate Outer and Inner Shafts.

List Price \$0.80

K-4 CONCENTRIKIT. For assembly of concentric duals having 2 carbon sections. Contains 4 parts: Panel Cover, Rear Cover, SPECIAL BUSHING FOR MOTOROLA, and Mounting Nut. Assembly instructions included. Requires same additional parts, depending upon specification desired, as listed for K-2 Concentrikits.

List Price \$0.90

K-5 CONCENTRIKIT. Use, contents and additional parts required are the same as listed for K-2 Concentrikits, except SPECIAL $\frac{1}{4}$ " LONG BUSHING FOR HALLICRAFTERS is included.

List Price \$0.80

IRC Base-Elements are a revolutionary advance in concentric dual replacement. A relatively small stock at low investment provides wide coverage of electrical requirements of many concentric duals. Each unit is a complete molded control base with element, terminals and collector ring installed. There are no loose parts.

Two types of Base-Elements are available: Type B for panel or rear carbon sections and Type W for wire-wound panel sections.

Two Base-Elements are required for each concentric dual.



CONCENTRIKIT BASE ELEMENTS



BASE ELEMENT STOCK VALUES

OHMS	TAP	STOCK No.	TAPER	OHMS	TAP	STOCK No.	TAPER
300		*B11-102	A	500K		B11-133	A
500		*B11-103	A	500K		B13-133	C
750		*B11-105	A	500K	125K	B13-133X	C
750		*B17-105	B (Rev)	500K	75K	B15-133X	Spec
750	250	B17-105X	Spec	500K		*B17-133	C (Rev.)
1000		B11-108	A	500K	50K	B18-133X	Spec
1060		*B17-108	B (Rev)	500K	250K	B19-133X	Spec
1000	150	*B17-108X	Spec	500K	180K	B20-133X	Spec
1200		*B17-208	C (Rev)	1.0 Meg		B11-137	A
1500		B11-109	A	1.0 Meg		B13-137	C
1500		*B17-109	O (Rev)	1.0 Meg	250K	B13-137X	H
1500	187 & 375	*B17-109XX	Spec	1.0 Meg		B17-137	C (Rev.)
2000		B11-110	A	1.0 Meg	35K	*B17-137X	Spec
2000		B17-110	C (Rev)	1.0 Meg	100K	B18-137X	Spec
2000	550	B17-110X	Spec	1.0 Meg	250K-50CK	B18-137XX	Spec
2000	250 & 500	B17-110XX	Spec	1.0 Meg	500K	B19-137X	Spec
2500		B17-111	C (Rev)	1.5 Meg		B11-138	A
2500	500	B17-111X	Spec	2.0 Meg		B11-139	A
2500	625	*B27-111X	Spec	2.0 Meg		B13-139	C
3000		B11-112	A	2.0 Meg	500K	B13-139X	H
3000		B17-112	C (Rev)	2.0 Meg	500K-1.0 Meg	*B13-139XX	Spec
5000		B11-114	A	2.0 Meg		B17-139	C (Rev.)
5000		B17-114	C (Rev)	2.0 Meg	1.0 Meg	B18-139X	Spec
5000	1000	B17-114X	Spec	2.0 Meg	250K-50*K	B18-139XX	Spec
7500		B11-115	A	2.5 Meg		B11-239	A
10K		B11-116	A	3.0 Meg		B11-140	A
10K		*B13-116	O	3.0 Meg		B13-140	O
10K		B17-116	C (Rev)	3.0 Meg	900K	*B13-140X	Spec
11.5K		B17-117	C (Rev)	3.0 Meg	1.5 Meg	B18-140X	Spec
15K	5000 & 10K	*B13-118XX	Spec	5.0 Meg		*B11-141	A
20K		B11-119	A	5.0 Meg		B12-141	Spec
25K		B11-120	A	5.0 Meg		B13-141	C
25K		B13-120	C	5.0 Meg		*B17-141	C (Rev.)
30K		B11-121	A	250 Ohms		*W11-201	Linear
35K		B11-122	A	300 Ohms		W11-102	Linear
50K		B11-123	A	750 Ohms		*W11-105	Linear
75K		B11-125	A	750 Ohms		*W13-105	LH Log
100K		B11-128	A	750 Ohms		W17-105	RH Log
100K		B17-128	C (Rev)	750 Ohms	250	W17-105X	Spec
125K		B11-228	A	1000 Ohms		W11-108	Linear
200K		B11-129	A	1500 Ohms		*W11-109	Linear
250K		B11-130	A	1500 Ohms	500	W17-109X	Spec
250K		B13-130	C	2000 Ohms		W11-110	Linear
250K	125K	B13-130X	Spec	2500 Ohms		W11-111	Linear
250K	60K	B18-130X	H	2500 Ohms		W17-111	RH Log
300K		B11-131	A	3000 Ohms		W11-112	Linear
350K		B13-132	C	3000 Ohms		W17-112	RH Log
350K	35K	B17-132X	Spec	5000 Ohms		W11-114	Linear
350K	75K	B18-132X	H	5000 Ohms		W17-114	RH Log
				10K		W11-116	Linear
				10K		†*WR11-116	Linear

* New items required for TV replacement.

† Rear base element for concentric dual where both elements are wire wound. Necessary hardware included.

BASE ELEMENTS

TYPE	List Price
Plain Base-Elements	\$0.50
Tapped Base-Elements	1.10
WR11-116	1.30

SWITCHES

TYPE	List Price
76-1 S.P.S.T.	\$0.60
76-2 D.P.S.T.60



CONCENTRIKIT EXACT DUPLICATE SHAFTS

Save time—be assured of accurate fit! IRC now provides a complete line of Exact Duplicate Shafts for CONCENTRIKIT—factory-tailored for dependable mechanical fit. No filing, slotting, soldering or cutting required!

Many shafts are flatted as well as slotted to provide wider replacement coverage. Each shaft is a complete assembly, including contactor. Factory-lubricated, packaged in cellophane and in individual carton.

DEPENDABLE MECHANICAL FIT FOR YOUR TV REPLACEMENTS

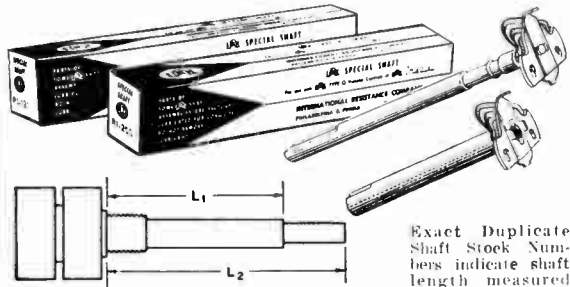

Exact Duplicate Shaft Stock Numbers indicate shaft length measured from mounting face

when installed in control (L_1 is Outer Shaft length; L_2 is Inner Shaft length). First digit is number of whole inches in shaft length; remaining two digits indicate number of additional 32nds of an inch. Thus, P1-210 has shaft lengths of 2-10/32" or 2-5/16". Exception is Inner Shafts when used with K-3 CONCENTRIKIT where 3/32" should be subtracted to determine shaft length.

SHAFT TYPES

TYPE P1 OUTER SHAFTS. 1/4" WIDE SLOT & 1/8" LONG FLAT FOR Q BASE-ELEMENT
TYPE P2 OUTER SHAFTS. 3/8" WIDE SLOT & FLAT 1/8" LONG FOR Q BASE-ELEMENT
TYPE P3 OUTER SHAFTS. 1/4" WIDE SLOT & FLAT 1/8" LONG FOR W BASE-ELEMENT
TYPE P4 OUTER SHAFTS. 1/4" WIDE SLOT & FLAT 3/8" LONG FOR W BASE-ELEMENT
TYPE P5 OUTER SHAFTS. 1/4" WIDE SLOT & FLAT 1/8" LONG FOR W BASE-ELEMENT
TYPE P6 OUTER SHAFTS. 1/4" WIDE SLOT & FLAT 1/8" LONG FOR Q BASE-ELEMENT
TYPE P7 OUTER SHAFTS. 1/20" WIDE SLOT & FLAT 1/8" LONG FOR Q BASE-ELEMENT
TYPE P8 OUTER SHAFTS FULL ROUND. 1/8" KNURLED BAND ON END FOR W BASE-ELEMENT

TYPE P9 OUTER SHAFTS FULL ROUND. 1/8" KNURLED BAND ON END FOR Q BASE-ELEMENT
TYPE P10 OUTER SHAFTS. 1/4" WIDE SLOT & 1/8" LONG FLAT FOR Q BASE-ELEMENT
TYPE R1 INNER SHAFTS. .187" DIAMETER SLOTTED WITH 1/2" LONG FLAT
TYPE R2 INNER SHAFTS. .202" DIAMETER SLOTTED WITH 1/2" LONG FLAT
TYPE R3 INNER SHAFTS. .190" DIAMETER 20 TOOTH SPLIT KNURL (ZENITH)
TYPE R4 INNER SHAFTS. .180" DIAMETER ROUND & SLOTTED (MOTOROLA)
TYPE R5 INNER SHAFTS. .187" DIAMETER —REAR EXTENSION TYPE (RCA)
TYPE R6 INNER SHAFTS. .202" DIAMETER —REAR EXTENSION TYPE (DUMONT)

TYPE R7 INNER SHAFT. .189" DIAMETER 18 TOOTH SPLIT KNURL (ZENITH)
TYPE R8 INNER SHAFT. .187" SLOTTED & FLATTED 1/2" LONG FOR W REAR ELEMENT
TYPE R9 INNER SHAFT. .187" DIAMETER SLOTTED 5/8" LONG FLAT
TYPE R10 INNER SHAFT. .187" DIAMETER FULL ROUND WITH 1/8" KNURLED BAND ON END FOR W REAR ELEMENT
TYPE R11 INNER SHAFT. .187" DIAMETER FULL ROUND 1/8" KNURLED END
TYPE R12 INNER SHAFT. .202" DIAMETER 3/8" WIDE KNURLED BAND ON END
TYPE R13 INNER SHAFTS. .180" DIAMETER, ROUNDED & SLOTTED 5/8" DEEP (MOTOROLA)
TYPE R14 INNER SHAFTS. .202" DIAMETER, SLOTTED WITH 5/8" LONG FLAT

STANDARD STOCK SHAFTS

Stock No.	Shaft Length	Stock No.	Shaft Length	Stock No.	Shaft Length	Stock No.	Shaft Length	Stock No.	Shaft Length
P1-017	1 1/2"	P2-118	1 1/8"	*P6-202	2 1/8"	R1-326	3 1/2"	R3-204	2 1/8"
P1-020	1 5/8"	P2-128	1 3/8"	*P6-218	2 1/4"	R1-417	4 1/8"	R3-223	2 3/8"
*P1-024	1 3/4"	P2-200	2"	*P6-224	2 1/2"	R1-420	4 5/8"		
P1-028	1 7/8"	P2-209	2 1/16"	*P7-206	2 1/8"			*R4-106	1 3/8"
P1-102	1 1/4"	P2-214	2 1/8"	*P8-020	2 1/8"	R2-103	1 3/16"	R4-210	2 3/16"
P1-106	1 1/8"	P2-218	2 1/8"	*P9-104	1 1/8"	*R2-105	1 1/16"	R4-212	2 3/16"
P1-109	1 3/8"	P2-222	2 1/8"	*P9-112	1 3/8"	R2-110	1 1/16"	*R4-221	2 3/16"
P1-112	1 1/8"	P2-226	2 1/8"	*P9-116	1 1/2"	R2-115	1 1/16"	R4-226	2 3/16"
P1-114	1 1/8"			*P9-124	1 3/4"	R2-117	1 1/8"	R4-228	2 3/16"
*P1-116	1 1/8"	P3-100	1"	*P10-225	2 3/8"	R2-119	1 1/8"	*R4-306	3 3/8"
*P1-118	1 1/8"	P3-104	1 1/8"	*P10-308	3 3/4"	R2-124	1 3/8"	*R4-322	3 3/8"
P1-121	1 1/8"	P3-106	1 1/8"	R1-024	1 1/8"	R2-127	1 3/8"		
*P1-123	1 1/8"	P3-111	1 1/8"	R1-028	1 1/8"	R2-131	1 3/8"	*R5-215	2 1/8"
P1-126	1 1/8"	P3-114	1 1/8"	R1-111	1 1/8"	*R2-200	2 1/8"	*R6-208	2 1/4"
P1-128	1 1/8"	P3-116	1 1/8"	R1-115	1 1/8"	R2-204	2 1/8"	*R7-212	2 3/8"
P1-200	2"	P3-118	1 1/8"	R1-118	1 1/8"	R2-206	2 1/8"	*R8-213	2 3/8"
*P1-204	2 1/8"	P3-121	1 1/8"	R1-122	1 1/8"	*R2-209	2 1/8"	*R9-208	2 1/4"
*P1-206	2 1/8"	P3-123	1 1/8"	R1-126	1 1/8"	R2-212	2 1/8"	*R9-222	2 3/8"
P1-210	2 1/8"	P3-127	1 1/8"	R1-130	1 1/8"	R2-216	2 1/8"	*R9-314	3 3/8"
P1-212	2 1/8"	*P3-129	1 1/8"	R1-202	2 1/8"	R2-218	2 1/8"		
P1-216	2 1/2"	P3-131	1 1/8"	R1-205	2 2/8"	*R2-220	2 1/8"	*R10-028	7/8"
P1-220	2 2/8"	P3-203	2 2/8"	R1-207	2 2/8"	R2-222	2 1/8"	*R11-031	1 1/8"
P1-224	2 2/8"	P3-208	2 2/8"	*R1-209	2 2/8"	R2-226	2 1/8"	*R11-112	1 3/8"
*P1-229	2 2/8"	*P3-210	2 2/8"	R1-210	2 2/8"	R2-230	2 1/8"	*R11-124	1 3/8"
*P1-300	3"	*P3-212	2 2/8"	R1-212	2 2/8"	*R2-300	3 1/8"	*R11-200	2"
*P1-302	3 1/8"	*P3-214	2 2/8"	R1-216	2 2/8"	R2-306	3 1/8"		
*P1-304	3 1/8"	*P3-223	2 2/8"	R1-218	2 2/8"	*R2-308	3 1/8"	*R12-108	1 1/4"
*P1-306	3 1/8"	*P3-226	2 2/8"	R1-220	2 2/8"	R2-310	3 1/8"	*R12-122	1 1/4"
*P1-308	3 1/8"	*P3-400	4 1/8"	R1-223	2 2/8"	*R2-312	3 1/8"	*R12-129	1 1/4"
*P1-310	3 1/8"	*P3-405	4 3/8"	R1-226	2 2/8"	R2-314	3 1/8"	*R12-131	1 1/4"
*P1-314	3 1/8"			R1-228	2 2/8"	R2-322	3 1/8"		
*P1-325	3 1/8"	P4-124	1 3/4"	R1-300	3 1/8"	*R2-329	3 1/8"	*R13-316	3 1/4"
P1-400	4"	*P5-206	1 1/4"	R1-304	3 1/8"	R2-401	4 5/8"	*R13-331	3 1/4"
P1-405	4 5/8"			R1-308	3 1/8"	R2-420	4 5/8"	*R14-302	3 1/4"
P2-031	1 3/8"	*P6-112	1 3/8"	*R1-312	3 3/8"	*R2-426	4 11/16"	*R14-414	4 1/8"
P2-116	1 1/2"	*P6-122	1 1/2"	*R1-316	3 3/8"	*R2-429	4 11/16"	*R14-426	4 1/8"

* New items required for TV replacement.

LIST PRICE \$0.60

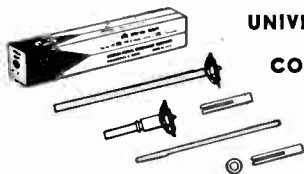

UNIVERSAL SHAFTS FOR CONCENTRIKIT

For use with CONCENTRIKITS in place of Exact Duplicate Shafts. Requires shaft modification to desired specification. KS-2 Shaft Kit is for controls in which both sections are carbon. Use with K-2, K-4 or K-5 CONCENTRIKIT.

KS-3 Shaft Kit is for controls in which panel section is wire-wound and rear section is carbon. Use with K-3 CONCENTRIKIT.

KS-2 or KS-3

LIST PRICE \$1.20

SINGLE CONTROLS



TYPE PQ



TYPE RQ

IRC Distributor Controls for Industry offer commercial users a wide selection of resistance values and two industrial shaft types. Shafts are fixed. This combination of wide selection of values and speedy Distributor delivery holds many advantages for industrial purchasers. These Industrial Controls are adaptations of the new, compact $\frac{1}{8}$ " Q Control. Power rating is $\frac{1}{2}$ watt, 500 volts maximum. Electrical rotation is the same with or without switch. $\frac{3}{8}$ " bushing is brass and held to close tolerance for snug shaft fit.

Terminals are heavily tinned for easy soldering, and may be bent without becoming noisy. Two locating lugs are provided, either or both of which may be bent down if not needed. Molded base. Both Types PQ and RQ are supplied in standard tapers.

TYPE PQ. Full round $\frac{1}{4}$ " shaft, approximately 3" from mounting face, with $\frac{3}{8}$ " long bushing. Available in 33 stock values as shown. Regular IRC stock numbers are used with prefix PQ.

LIST \$1.25

TYPE RQ. Very short screw-driver slot shaft, $\frac{1}{4}$ " diameter and approximately $\frac{1}{2}$ " long from mounting face with $\frac{3}{8}$ " long bushing. Available in 33 values as shown. Regular IRC stock numbers are used with prefix RQ.

LIST \$1.25

STANDARD VALUES

TYPE PQ	TYPE RQ	RESISTANCE IN OHMS	TAPER
PQ11-103	RQ11-103	500	A
PQ11-108	RQ11-108	1000	A
PQ11-110	RQ11-110	2000	A
PQ11-112	RQ11-112	3000	A
PQ11-114	RQ11-114	5000	A
PQ11-115	RQ11-115	7500	A
PQ11-116	RQ11-116	10K	A
PQ13-116	RQ13-116	10K	C
PQ14-116	RQ14-116	10K	D
PQ11-119	RQ11-119	20K	A
PQ11-120	RQ11-120	25K	A
PQ14-120	RQ14-120	25K	D
PQ11-121	RQ11-121	30K	A
PQ11-123	RQ11-123	50K	A
PQ13-123	RQ13-123	50K	C
PQ14-123	RQ14-123	50K	D
PQ11-128	RQ11-128	100K	A
PQ13-128	RQ13-128	100K	C
PQ11-129	RQ11-129	200K	A
PQ11-130	RQ11-130	250K	A
PQ13-130	RQ13-130	250K	C
PQ11-133	RQ11-133	500K	A
PQ13-133	RQ13-133	500K	C
PQ11-137	RQ11-137	1.0 meg	A
PQ13-137	RQ13-137	1.0 meg	C
PQ11-138	RQ11-138	1.5 meg	A
PQ11-139	RQ11-139	2.0 meg	A
PQ13-139	RQ13-139	2.0 meg	C
PQ11-239	RQ11-239	2.5 meg	A
PQ11-140	RQ11-140	3.0 meg	A
PQ13-140	RQ13-140	3.0 meg	C
PQ11-141	RQ11-141	5.0 meg	A
PQ11-143	RQ11-143	10.0 meg	A

Taper A is linear. Taper C is logarithmic.
Taper D is reverse curve for control of bias.



DISTRIBUTOR CONTROLS FOR INDUSTRY

DUALS AND TRIPLES

IRC Type PQ and RQ Industrial Controls are supplied as single controls. Dual Control and Triple Control combinations are available by adding IRC MULTISECTIONS.



MULTISECTIONS

IRC MULTISECTIONS are complete control sections that can be added like a switch to any Q, PQ or RQ Control. With these units, the Radio Technician or Engineer is provided with an endless variety of dual, triple or even quadruple controls. Duals assembled from IRC MULTISECTIONS will accommodate Type 7F switches. Available in a selection of 22 values, as shown in following table. Each MULTISECTION adds $\frac{1}{8}$ " to basic control.

STOCK VALUES

RESISTANCE IN OHMS	TAPER	IRC STOCK NO.
500	A	M11-103
1000	A	M11-108
2000	A	M11-110
5000	A	M11-114
10K	A	M11-116
25K	A	M11-120
30K	A	M11-121
50K	A	M11-123
100K	A	M11-128
100K	O	M13-128
250K	A	M11-130
250K	O	M13-130
500K	A	M11-133
500K	C	M13-133
1.0 Meg	A	M11-137
1.0 Meg	C	M13-137
2.0 Meg	A	M11-139
2.0 Meg	O	M13-139
3.0 Meg	A	M13-140
3.0 Meg	C (Rev.)	M17-140
5.0 Meg	A	M11-141
10.0 Meg	A	M11-143

MULTISECTION DIMENSIONS

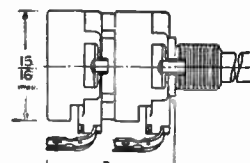

DUAL CONTROL

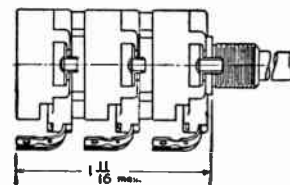

TRIPLE CONTROL



FIXED POWER WIRE WOUND RESISTORS

IRC Power Wire Wounds are rugged resistors specially engineered for dependable heavy-duty performance. They are supplied in a variety of power ratings, resistance values, sizes and terminal types. In addition to the conventional tubular types, IRC also supplies: 4 watt completely insulated Type PW-4 with axial leads, and two new high temperature resistors rated at 7 and 10 watts. Type PW-7 and PW-10 are fully insulated in rectangular ceramic cases and have axial leads.



STOCK VALUES AND LIST PRICES

	Ohms	PW4 4 watts	PW7 7 watts	PW10 10 watts	1 3/4 A 10 watts	2D 20 watts	4 1/2 E 50 watts	6 1/2 E 80 watts	6 1/2 H 100 watts	10 1/2 H 200 watts
TYPE PW-4 4 WATTS 21/64" dia. by 1 1/4" long. Axial leads.	1	\$0.49	\$0.52	\$0.55	\$0.75	\$0.95	\$2.25	—	\$3.37	\$4.53
	2	.49	.52	.55	.75	—	2.25	—	3.37	4.53
	3	.49	.52	.55	.75	—	2.25	—	3.37	4.53
	4	.49	.52	.55	.75	—	2.25	—	3.37	4.53
TYPE PW-7 7 WATTS 3/8" by 1 1/8" by 1-25/64" long. Axial leads.	4	.49	.52	.55	.75	.95	1.63	\$2.00	2.42	3.22
	5	.49	.52	.55	.75	.95	1.63	2.00	2.42	3.22
	7.5	—	—	—	.75	—	—	—	—	—
	10	.49	.52	.55	.75	.95	1.63	2.00	2.42	3.22
	15	.49	.52	.55	.75	.95	1.63	2.00	2.42	3.22
	20	.49	.52	.55	.75	.95	1.63	2.00	2.42	3.22
TYPE PW-10 10 WATTS 3/8" by 1 1/8" by 1 7/8" long. Axial leads.	25	.49	.52	.55	.75	.95	1.63	2.00	2.42	3.22
	30	—	—	—	.75	—	—	—	—	—
	35	—	—	—	.75	—	—	—	—	—
	40	—	—	—	.75	—	—	—	—	—
	50	.49	.52	.55	.75	.95	1.63	2.00	2.42	3.22
	75	.49	.52	.55	.75	.95	1.63	2.00	2.42	3.22
	100	.49	.52	.55	.75	.95	1.63	2.00	2.42	3.22
	125	—	—	—	.75	—	—	—	—	—
	150	.49	.52	.55	.75	.95	1.63	2.00	2.42	3.22
	200	.49	.52	.55	.75	.95	1.63	2.00	2.42	3.22
TYPE 1 3/4" 10 WATTS 1 1/8" dia. by 1 3/4" long. Accommodate Z0 brackets (not in- cluded, 12c list).	225	.49	.52	.55	.75	.95	1.63	2.00	2.42	3.22
	250	.49	.52	.55	.75	.95	1.63	2.00	2.42	3.22
	300	.49	.52	.55	.75	.95	—	—	—	—
	350	—	—	—	.75	.95	—	—	—	—
	400	—	—	—	.75	.95	—	—	—	—
	450	—	—	—	.75	.95	—	—	—	—
	500	.49	.52	.55	.75	.95	1.63	2.00	2.42	3.22
	600	—	—	—	.75	.95	—	—	—	—
	700	—	—	—	.75	.95	—	—	—	—
	800	.49	.52	.55	.75	.95	1.63	2.00	2.42	3.22
TYPE 2D 20 WATTS 3/8" dia. by 2" long. Accommodate Z1 brackets (not in- cluded, 12c list).	1,000	.49	.52	.55	.75	.95	1.63	2.00	2.42	3.22
	1,100	—	—	—	.80	.97	—	—	—	—
	1,200	—	—	—	.80	.97	—	—	—	—
	1,250	.49	.52	.55	.80	.97	—	—	2.53	—
	1,500	.49	.52	.55	.80	.97	1.75	2.08	2.53	3.30
	1,750	—	—	—	.80	.97	—	—	—	—
TYPE 4 1/2 E 50 WATTS 3/8" dia. by 4 1/2" long. Supplied with Z2 brackets.	2,000	.49	.52	.55	.80	.97	1.75	2.08	2.53	3.30
	2,250	—	—	—	.80	.97	—	—	—	—
	2,500	.49	.52	.55	.80	.97	1.75	2.08	2.53	3.30
	3,000	.49	.52	.55	.80	.97	1.75	2.08	2.53	3.30
	3,500	—	—	—	.80	.97	—	—	—	—
	4,000	.49	.52	.55	.80	.97	1.75	2.08	—	—
TYPE 6 1/2 E 80 WATTS 3/8" dia. by 6 1/2" long. Supplied with Z3 brackets.	4,500	—	—	—	.80	.97	—	—	—	—
	5,000	.49	.52	.55	.80	.97	1.75	2.08	2.53	3.30
	6,000	—	—	—	.92	1.12	1.92	2.25	—	—
	7,000	—	—	—	.92	1.12	1.92	—	—	—
	7,500	.49	—	.55	.92	1.12	1.92	2.25	2.70	3.53
	8,000	—	—	—	.92	1.12	1.92	2.25	—	—
TYPE 6 1/2 H 100 WATTS 1 1/8" dia. by 6 1/2" long. Supplied with Z3 brackets.	8,200	.49	—	.55	—	—	—	—	—	—
	8,500	—	—	—	.92	1.12	—	—	—	—
	9,000	—	—	—	.92	1.12	—	—	—	—
	10K	—	—	—	.92	1.12	1.92	2.25	2.70	3.53
	11K	—	—	—	1.03	1.20	—	—	—	—
	12K	—	—	—	1.03	1.20	2.08	—	—	—
	12.5K	—	—	—	1.03	1.20	2.08	—	—	—
	15K	—	—	—	1.03	1.20	2.08	2.45	2.97	3.77
	20K	—	—	—	1.03	1.20	2.08	2.45	2.97	3.77
	25K	—	—	—	1.08	1.37	2.33	2.78	3.20	3.90
TYPE 10 1/2 H 200 WATTS 1 1/2" dia. by 10 1/2" long. Supplied with Z3 brackets.	30K	—	—	—	—	1.37	2.33	2.78	3.20	3.90
	35K	—	—	—	—	1.37	2.33	—	—	—
	40K	—	—	—	—	1.37	2.33	2.78	3.20	3.90
	50K	—	—	—	—	1.58	2.58	2.87	3.37	4.03
	60K	—	—	—	—	—	2.58	2.87	3.37	4.03
	75K	—	—	—	—	—	2.92	3.22	3.58	4.25
	—	—	—	—	—	—	—	—	—	—
	100K	—	—	—	—	—	3.20	3.58	3.80	4.53

IRC Power Wire Wounds are designed for continuous operation at full rated power. Derating is unnecessary even for the highest stock values. IRC Power Wire Wounds are full size, thus capable of efficiently handling greater wattage. Cooler performance assures longer resistor life, and safeguards critical components mounted adjacently. Clear, permanent markings show type, size, wattage, and resistance value; markings improve in legibility with temperature rise. Terminals are tin plated for easy soldering.



ADJUSTABLE POWER WIRE WOUND RESISTORS

TYPE 6 1/2 HA

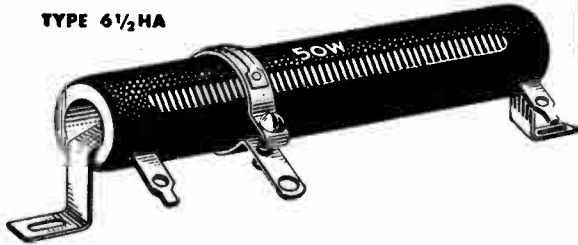

TYPE 1 3/4 AA

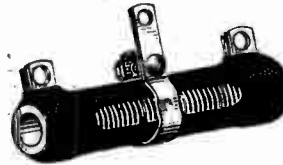

STOCK VALUES AND LIST PRICES

Ohms	1 3/4 AA 10 watts	2 1/2 DA 25 watts	4 1/2 EA 50 watts	6 1/2 EA 80 watts	6 1/2 HA 100 watts	10 1/2 HA 200 watts
1	\$1.47	\$1.87	\$3.00	\$3.53	\$4.53	\$5.67
2	1.47	1.87	3.00	3.53	4.53	5.67
3	1.47	1.87	3.00	3.53	4.53	5.67
4	—	—	3.00	3.53	4.53	5.67
5	1.47	1.87	2.37	2.75	3.58	4.37
7.5	1.47	1.87	—	—	—	—
10	1.47	1.87	2.37	2.75	3.58	4.37
15	1.47	1.87	—	—	—	—
20	1.47	1.87	—	—	—	—
25	1.47	1.87	2.37	2.75	3.58	4.37
50	1.47	1.87	2.37	2.75	3.58	4.37
75	1.47	1.87	2.37	—	—	—
100	1.47	1.87	2.37	2.75	3.58	4.37
150	1.47	1.87	2.37	—	—	—
200	1.47	1.87	2.37	2.75	3.58	4.37
250	1.47	1.87	2.37	2.75	3.58	4.37
300	1.47	1.87	2.37	2.75	—	—
400	1.47	1.87	2.37	2.75	3.58	—
500	1.47	1.87	2.37	2.75	3.58	4.37
750	1.47	1.87	2.37	2.75	3.58	—
800	1.47	1.87	2.37	2.75	—	—
1,000	1.47	1.87	2.37	2.75	3.58	4.37
1,250	1.53	1.88	2.47	2.83	—	—
1,500	1.53	1.88	2.47	2.83	3.67	4.45
2,000	1.53	1.88	2.47	2.83	3.67	4.45
2,250	1.53	1.88	2.47	2.83	—	—
2,500	1.53	1.88	2.47	2.83	3.67	4.45
3,000	1.53	1.88	2.47	2.83	3.67	4.45
3,500	1.53	1.88	2.47	2.83	—	—
4,000	1.53	1.88	2.47	2.83	3.67	—
4,500	1.53	1.88	2.47	2.83	—	—
5,000	1.53	1.88	2.47	2.83	3.67	4.45
6,000	1.63	2.03	2.63	3.00	3.87	—
7,000	1.63	2.03	2.63	3.00	—	—
7,500	1.63	2.03	2.63	3.00	3.87	—
8,000	1.63	2.03	2.63	3.00	3.87	—
9,000	1.63	2.03	2.63	3.00	—	—
10K	1.63	2.03	2.63	3.00	3.87	4.70
12K	—	2.08	2.83	3.20	—	—
15K	—	2.08	2.83	3.20	4.12	4.92
20K	—	2.08	2.83	3.20	4.12	4.92
25K	—	2.28	3.08	3.53	4.37	5.03
30K	—	—	3.08	3.53	4.37	5.03
35K	—	—	—	3.53	—	—
40K	—	—	3.08	3.53	4.37	5.03
45K	—	—	—	3.62	—	—
50K	—	—	3.30	3.62	4.53	5.17
60K	—	—	3.30	3.62	4.53	5.17
75K	—	—	3.67	—	4.75	5.42
80K	—	—	3.67	3.97	—	—
100K	—	—	3.92	4.33	4.95	5.67

TYPE 1 3/4 AA
10 WATTS
1/8" dia. by 1 3/4" long.
Accommodate Z0
brackets (not included,
12c list).

TYPE 2 1/2 DA
25 WATTS
1/8" dia. by 2 1/2" long.
Supplied with Z1
brackets.

TYPE 4 1/2 EA
50 WATTS
3/16" dia. by 4 1/2" long.
Supplied with Z2
brackets.

TYPE 6 1/2 EA
80 WATTS
3/16" dia. by 6 1/2" long.
Supplied with Z2
brackets.

TYPE 6 1/2 HA
100 WATTS
1 1/8" dia. by 6 1/2" long.
Supplied with Z3
brackets.

TYPE 10 1/2 HA
200 WATTS
1 3/8" dia. by 10 1/2"
long. Supplied with Z3
brackets.

STANDARD TERMINALS

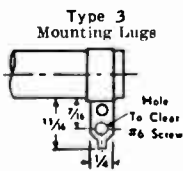

For 6 1/2 HA, 6 1/2 HA,
10 1/2 HA, 10 1/2 HA

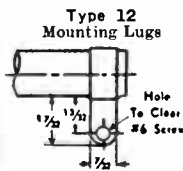

For 4 1/2 EA, 4 1/2 EA, 6 1/2 EA,
6 1/2 EA

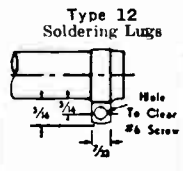

For 1 3/4 AA, 2 1/2 DA

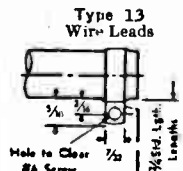

For 1 3/4 AA, 2D

BRACKETS: Bracket holes are for 8-32 screws.



TYPE X BANDS

Type "X" bands are furnished for 2 1/2 DA, 4 1/2 EA, 6 1/2 EA, 6 1/2 HA and 10 1/2 HA. Type 1 3/4 AA, because of its small size, is furnished with special adjustable band.

Resistor	Band	List
2 1/2 DA	X2	\$.25
4 1/2 EA, 6 1/2 EA	X3	\$.25
6 1/2 EA, 10 1/2 HA	X4	\$.42
1 3/4 AA	SPECIAL BAND A	.25



PRECISION WIRE WOUND RESISTORS

IRC Precision Wire Wound Resistors surpass MIL-R-93A Specifications. MIL and JAN Style equivalents are shown below.

Improved ceramic winding forms have high insulating qualities, high mechanical strength and low coefficient of expansion. Improved winding technique, developed by IRC, eliminates shorted turns or strains in the winding. Improved insulation provides greater humidity protection and contributes to longer trouble-free service. Improved lug and lead terminals assure perfect electrical connections without strain on the windings, and are easily soldered.

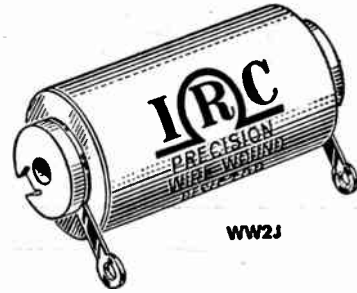

IRC TYPE No.	WW2J	WW3J	WW4J	WW5J	WW8J	WW10J	WW11J
MIL-R-93A Type	RB19	RB16	RB17	RB18	RB15	—	RB16
Old JAN Type	RB14	RB11	RB12	RB13	RB10	—	RB11
Rating in Watts 40°C. Ambient 85°C. Ambient	2.00 1.00	.50 .35	1.00 .50	1.00 .50	.50 .25	.25 .15	.50 .35
Maximum Volts	2000	400	700	1000	250	150	500
No. of Sections	8	2	4	4	1	1	2
Minimum Resistance	0.1 Ohm	0.1 Ohm	0.1 Ohm	0.1 Ohm	0.1 Ohm	10 Ohms	0.1 Ohm
Max. Resistance (MIL) E Characteristic	4.0 Meg.	185K Ohms	300K Ohms	750K Ohms	185K Ohms		300K Ohms
Maximum Resistance (Commercial)	12.0 Meg.	850K Ohms	2.0 Meg.	4.5 Meg.	850K Ohms	120K Ohms	1.0 Meg.
Dimensions (See Figs. 1 & 2)							
A Dimension	2 3/8"	9/16"	1"	1 1/4"	3 3/8"	3 3/8"	3 3/8"
B Dimension	3 3/8"	3 3/8"	3 3/8"	3 3/8"	3 3/8"	3 3/8"	3 3/8"
C Dimension	1 3/8"	3/8"	3 3/8"	3 3/8"	1"	3 3/8"	7/8"
D Dimension	3 3/8"	5/8"	5/8"	5/8"	5/8"	—	5/8"
E Dimension	—	—	—	—	—	2"	—

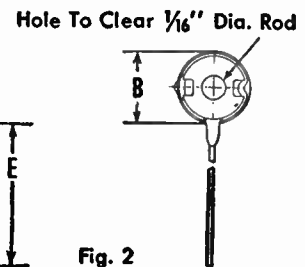
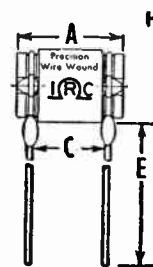
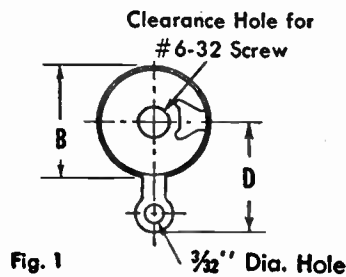
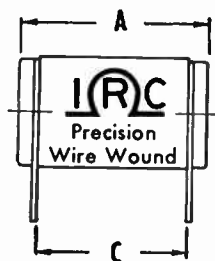

IRC offers a complete line of redesigned Precision Wire Wound Resistors. These improved units are fully interchangeable with earlier types, while providing higher standards of performance plus new sizes and terminals.

All IRC Precisions, except Type WW10J, are furnished with rugged lug terminals for soldered connections. Type WW10J has wire lead terminals 2" long.

All Types except WW8J and WW10J are wound with adjacent sections in opposite directions. This provides windings of low residual inductance, and windings that have little coupling effect from other parts of the circuit. Type WW8J, with single section, is wound non-inductively. Type WW10J has a single section winding, but inductance is minimized by the comparatively small size of this unit.



PRECISION WIRE WOUND RESISTORS



WW3J



WW8J



WW11J

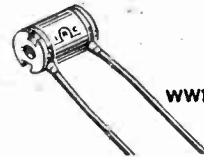

WW10J

TYPE WW2J

Stock Resistance Values	List Price	Stock Resistance Values	List Price	Stock Resistance Values	List Price	Stock Resistance Values	List Price
600K Ohms	\$6.00	900K Ohms	\$13.80	1.5 Megohms	\$21.04	2.5 Megohms	30.92
750K Ohms	6.00	1.0 Megohm	13.80	2.0 Megohms	25.41		

TYPE WW3J

Stock Resistance Values	List Price	Stock Resistance Values	List Price	Stock Resistance Values	List Price	Stock Resistance Values	List Price
0.1 Ohm	\$ 2.97	300 Ohms	\$ 1.75	7,500 Ohms	\$ 2.05	60K Ohms	\$ 2.05
0.2 Ohm	2.97	500 Ohms	1.75	10 K Ohms	2.05	75K Ohms	2.58
0.5 Ohm	2.45	1,000 Ohms	1.75	12.5K Ohms	2.05	100K Ohms	2.58
1.0 Ohm	2.45	1,500 Ohms	1.75	15 K Ohms	2.05	125K Ohms	3.05
5 Ohms	2.28	2,000 Ohms	1.75	20 K Ohms	2.05	150K Ohms	3.55
10 Ohms	2.28	2,500 Ohms	1.75	22.5K Ohms	2.05	175K Ohms	3.55
25 Ohms	2.28	3,000 Ohms	1.75	25 K Ohms	2.05	200K Ohms	2.97
50 Ohms	2.28	3,500 Ohms	1.75	30 K Ohms	2.05	225K Ohms	2.97
100 Ohms	1.75	4,000 Ohms	1.75	40 K Ohms	2.05		
200 Ohms	1.75	5,000 Ohms	1.75	46 K Ohms	2.05		
250 Ohms	1.75			50 K Ohms	2.05		

TYPE WW4J

Stock Resistance Values	List Price	Stock Resistance Values	List Price	Stock Resistance Values	List Price	Stock Resistance Values	List Price
0.1 Ohm	\$ 3.16	500 Ohms	\$ 1.95	12.5K Ohms	\$ 2.22	100K Ohms	\$ 2.87
0.2 Ohm	3.16	1,000 Ohms	1.95	15 K Ohms	2.22	125K Ohms	3.30
0.5 Ohm	2.74	1,500 Ohms	1.95	20 K Ohms	2.22	150K Ohms	3.60
1.0 Ohm	2.38	2,000 Ohms	1.95	22.5K Ohms	2.22	175K Ohms	3.67
5 Ohms	2.38	2,500 Ohms	1.95	25 K Ohms	2.22	200K Ohms	3.67
10 Ohms	2.38	3,000 Ohms	2.22	30 K Ohms	2.87	225K Ohms	4.45
25 Ohms	2.38	3,500 Ohms	2.22	40 K Ohms	2.87	250K Ohms	4.45
50 Ohms	2.38	4,000 Ohms	2.22	50 K Ohms	2.87	300K Ohms	4.45
100 Ohms	1.95	5,000 Ohms	2.22	60 K Ohms	2.87	400K Ohms	4.53
200 Ohms	1.95	7,500 Ohms	2.22	75 K Ohms	2.87	500K Ohms	5.25
250 Ohms	1.95						
300 Ohms	1.95	10K Ohms	2.22				

TYPE WW5J

Stock Resistance Values	List Price	Stock Resistance Values	List Price	Stock Resistance Values	List Price	Stock Resistance Values	List Price
600K Ohms	\$ 8.50	750K Ohms	\$10.00	900K Ohms	\$ 8.92	1.0 Megohm	\$10.84

TYPE WW10J

Stock Resistance Values	List Price	Stock Resistance Values	List Price	Stock Resistance Values	List Price	Stock Resistance Values	List Price
10 Ohms	\$ 2.03	1,000 Ohms	\$ 1.63	7,500 Ohms	\$ 1.78	40K Ohms	\$ 2.17
25 Ohms	1.63	1,500 Ohms	1.63	10K Ohms	1.78	50K Ohms	2.17
50 Ohms	1.63	2,000 Ohms	1.78	12.5K Ohms	1.97	60K Ohms	2.37
100 Ohms	1.63	2,500 Ohms	1.78	15K Ohms	1.95	75K Ohms	2.53
200 Ohms	1.63	3,000 Ohms	1.78	20K Ohms	1.95	100K Ohms	2.53
250 Ohms	1.63	3,500 Ohms	1.78	25 K Ohms	1.95		
300 Ohms	1.63	4,000 Ohms	1.78	30K Ohms	1.95		
500 Ohms	1.63	5,000 Ohms	1.78				

SPECIAL VALUES: For non-stock values, use price of next higher listed value. Request prices on WW8J and WW11J from Distributor.

MINIMUM RESISTANCE VALUES FOR SPECIAL RESISTANCE TOLERANCES

SPECIAL TOLERANCE	WW2J—WW3J—WW4J WW5J—WW8J—WW11J		WW10J	PRICING
	1 Ohm & Over	5 Ohms & Over		
±1.0% TOLERANCE IS STANDARD	±0.5%	5 Ohms & Over	50 Ohms & Over	Add 5% to above prices
	±0.25%	10 Ohms & Over	100 Ohms & Over	Add 10% to above prices
	±0.1%		100 Ohms & Over	Add 25% to above prices



CLOSE TOLERANCE PRECISTORS

TYPE DC DEPOSITED CARBON RESISTORS

1% ACCURACY

PRECISION PACKAGED

1/2, 1 and 2 WATTS

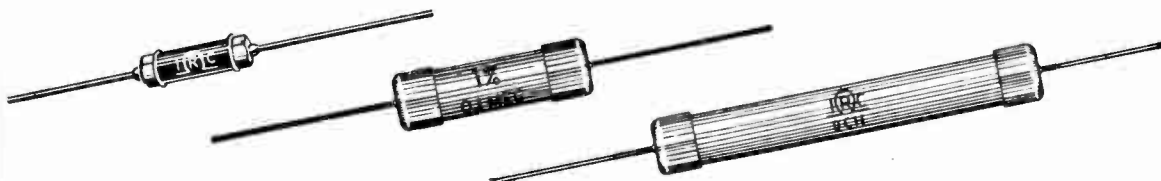

IRC Deposited Carbon Precision Resistors offer a unique combination of close tolerance, stability and economy. Pure crystalline carbon is bonded to selected ceramic cores to produce a resistor ideally suited to the requirements of instrumentation, advanced electronics and critical television circuits.

Deposited Carbon Precistors provide a combination of characteristics not found in any other resistor type. The wide range of values, accuracy, high stability, low voltage coefficient, excellent frequency characteristics, predictable temperature characteristics, high voltage rating, low noise level and small size of PRECISTORS make them superior for many popular applications.

IRC Type DC Deposited Carbon Precistors are available in three sizes: 1/2 watt (body size $\frac{1}{8}'' \times \frac{3}{32}''$), 1 watt (body size $\frac{1}{8}'' \times \frac{1}{8}''$), and 2 watts (body size $2\frac{1}{16}'' \times \frac{3}{32}''$). Accuracy $\pm 1\%$ (25°C).

For complete protection against scratches, jars and surface injury IRC PRECISTORS are factory packed in capped plastic tubes. This special precision packaging also safeguards these close tolerance resistors against excessive handling.



STOCK VALUES

TYPE DCC — 1/2 WATT

Ohms	Ohms	Ohms	Ohms	Ohms	Megohms
—	100	1,000	10K	100K	1.0
—	110	1,100	11K	110K	1.1
—	120	1,200	12K	120K	1.2
—	130	1,300	13K	130K	1.3
—	150	1,500	15K	150K	1.5
—	160	1,600	16K	160K	1.6
—	180	1,800	18K	180K	1.8
—	200	2,000	20K	200K	2.0
—	220	2,200	22K	220K	—
—	240	2,400	24K	240K	—
—	270	2,700	27K	270K	—
—	300	3,000	30K	300K	—
—	330	3,300	33K	330K	—
—	360	3,600	36K	360K	—
—	390	3,900	39K	390K	—
—	430	4,300	43K	430K	—
—	470	4,700	47K	470K	—
51	510	5,100	51K	510K	—
56	560	5,600	56K	560K	—
62	620	6,200	62K	620K	—
68	680	6,800	68K	680K	—
75	750	7,500	75K	750K	—
82	820	8,200	82K	820K	—
91	910	9,100	91K	910K	—

All values Type DCC
List Price
(51 ohms to 2.0 meg.).....\$0.67

TYPE DCF — 1 WATT

Ohms	Ohms	Ohms	Ohms	Megohms
100	1,000	10K	100K	1.0
150	1,500	15K	150K	1.5
200	2,000	20K	200K	2.0
250	2,500	25K	250K	2.5
300	3,000	30K	300K	3.0
400	4,000	40K	400K	4.0
500	5,000	50K	500K	5.0

List Price
Type DCF (100 ohms to 5.0 meg.).....\$1.00
Type DCF (over 5 meg. to 10.0 meg.).... 1.10

TYPE DCH — 2 WATTS

Ohms	Megohms	Megohms	Megohms
500K	1.0	2.5	15.0
—	1.5	3.0	20.0
—	2.0	5.0	—
—	2.2	10.0	—

List Price
Type DCH (200 ohms to 10.0 meg.).....\$1.20
Type DCH (over 10.0 meg. to 20.0 meg.).. 1.30

**MOLDED
BORON - CARBON
PRECISTORS
1% ACCURACY
1/2 WATT**



**CLOSE TOLERANCE
PRECISTORS**

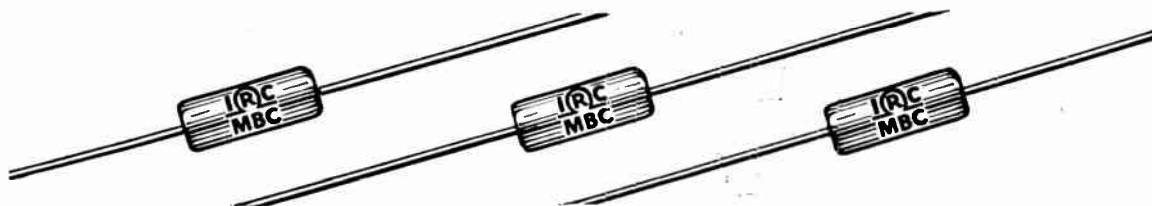

TYPE MBC

IRC's Molded Boron-Carbon Precistor is a precision film type resistor that incorporates the added advantages of a fully insulated unit. The molded plastic housing provides complete mechanical protection, and minimizes the effect of moisture. Because of its greater heat dissipating capacity, load life characteristics for the Type MBC are improved over those of either boron or deposited carbon unmolded units.

APPLICATIONS

Type MBC Molded Boron-Carbons are particularly suited for applications where unmolded boron or deposited carbon units cannot be used due to the risk of mechanical damage to their coating, insulation breakdown, or high moisture change.

SPECIFICATIONS

WATTAGE RATING: 1/2 watt at 40°C. ambient (per MIL-R-10509A), derated to 0 at 120°C.

RESISTANCE VALUES: 10 ohms to 510K ohms.

TOLERANCE: Standard tolerance is 1%.

IDENTIFICATION: Housing is distinctive green plastic. Type designation, resistance value and tolerance are stamped on each unit.

DIMENSIONS:

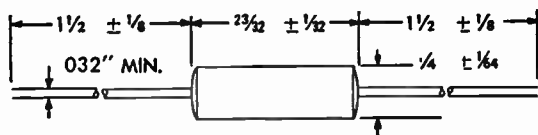

STANDARD STOCK VALUES

Ohms	Ohms	Ohms	Ohms	Ohms
10	100	1,000	10K	100K
11	110	1,100	11K	110K
12	120	1,200	12K	120K
13	130	1,300	13K	130K
15	150	1,500	15K	150K
16	160	1,600	16K	160K
18	180	1,800	18K	180K
20	200	2,000	20K	200K
22	220	2,200	22K	220K
24	240	2,400	24K	240K
27	270	2,700	27K	270K
30	300	3,000	30K	300K
33	330	3,300	33K	330K
36	360	3,600	36K	360K
39	390	3,900	39K	390K
43	430	4,300	43K	430K
47	470	4,700	47K	470K
51	510	5,100	51K	510K
56	560	5,600	56K	—
62	620	6,200	62K	—
68	680	6,800	68K	—
75	750	7,500	75K	—
82	820	8,200	82K	—
91	910	9,100	91K	—

	List Price
Standard Values and Tolerance	\$1.00
Special Values and Tolerances	2.00

TYPE BOC. 1/2 watt unmolded Boron-Carbon Precistors, designated Type BOC are available on special order.



GERMANIUM & SELENIUM DIODES

GERMANIUM DIODES

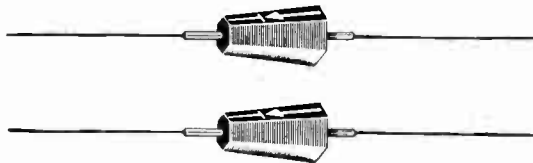

IRC Germanium Diodes are point contact crystal rectifiers designed and assembled in such a manner as to give a low cost unit of dependable service and long life. The units are protected against humidity by the molded housing and an electrically inert material which fills the entire cavity, sealing out moisture and protecting against severe mechanical shock.

Hot tin dipped mounting pins and leads make it ideal for either clip or solder mounting. Polarity is indicated by the tapered shape which shows the direction of current flow at a glance.

STANDARD TYPES

Stock No.	Minimum Forward @ 1V (MA)	Maximum Reverse Current (Micro-amps)	†Average Rectified Current (MA Max)	‡Mini- mum Reverse Volts	Maxi- mum Continuous Reverse Operating Volts	List Price
1N34	5.0	50 (-10V), 800 (-50V)	50	75	60	\$1.50
1N34A	5.0	30 (-10V), 500 (-50V)	50	75	60	1.65
1N38	3.0	6 (-3V), 625 (-100V)	50	120	100	2.90
1N38A	4.0	5 (-3V), 500 (-100V)	50	120	100	3.65
1N48	4.0	833 (-50V)	50	85	70	1.10
1N51	2.5	1,667 (-50V)	25	50	40	.85
1N52	4.0	150 (-50V)	50	85	70	2.15
1N54	5.0	10 (-10V)	50	75	35	1.75
1N54A	5.0	7 (-10V), 100 (-50V)	50	75	50	2.40
1N58	4.0	800 (-100V)	50	120	100	2.40
1N58A	4.0	600 (-100V)	50	120	100	3.00
1N60	Minimum of 1.8V peak to peak in 40MC test circuit			—	—	1.25
1N63	4.0	50 (-50V)	50	125	100	4.85
1N64	Minimum of 100 μA in 44MC test circuit			—	20	.75
1N65	2.5	200 (-50V)	50	85	70	1.10
*1N69	5.0	50 (-10V), 850 (-50V)	40	75	60	1.50
	Rectification efficiency: 35% minimum in 100MC test circuit					
*1N70	3.0	25 (-10V), 300 (-50V)	30	125	100	4.00
1N72	Noise figure as a mixer better than 15DB @ 750MC with 43.5MC IF circuit with noise bandwidth of 3MC and a noise figure of 4DB					
						1.60
*1N81	3.0	10 (-10V)	30	50	40	3.25
1N110	Noise figure as a mixer better than 12DB @ 750MC with 43.5MC-IF circuit having a noise bandwidth of 3MC and a noise figure of 4DB					
						1.43

*JAN Types

†Average half-wave rectified current at 60 cps and 25°C

‡For zero dynamic resistance

DIMENSIONS

Overall body dimensions approximately .250" diameter by .435" long. Axial leads 1½". Illustrations above are actual size.

MICROSTAK SELENIUM DIODES

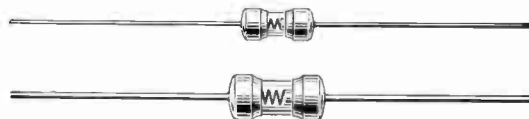

Type GA Microstak Diodes for use in low current circuits where very high back resistance and low forward resistance are required. Miniature selenium cells with outstanding performance characteristics, they are ideal for such applications as A. V. C., switching, blocking and bias supplies. Design and small size give high frequency performance not found in conventional cells — tests prove their successful performance in circuit applications up to 1 megacycle. Hermetically sealed to assure stable operation under high humidity, dust, fumes and changing pressures.

Dimensions: (Type 6GA1) Length of leads — 1½". Body length — .450". Diameter — .145". (Type 9GA1) Length of leads — 1½". Body length — .500". Diameter — .210".

TYPE 6GA1

Stock No. 6GA1-2B. Minimum forward current (at 2 V.D.C.) is 0.5 M.A. and corresponding resistance, 4000 ohms. Maximum inverse current (at 20 V.D.C.) is 20 microamperes and corresponding resistance, 1 megohm. Peak inverse volts —36. Continuous inverse volts —22. Maximum A.C. input (RMS volts with resistive load only) —26. Temperature range is —55°C to +90°C. Shunt capacitance — approximately 25 mmf (measured with two plates back-to-back on 1000 cycle bridge).

List \$1.67

Stock No. 6GA1-3C. Minimum forward current (at 2 V.D.C.) is 1 M.A. and corresponding resistance, 2000 ohms. Maximum inverse current (at 20 V.D.C.) is 10 microamperes and corresponding resistance, 2 megohms.

List \$2.25

TYPE 9GA1

Stock No. 9GA1-2B. Characteristics are the same as the 6GA1-2B.

List \$1.50

Stock No. 9GA1-3C. Characteristics are the same as the 6GA1-3C.

List \$2.04

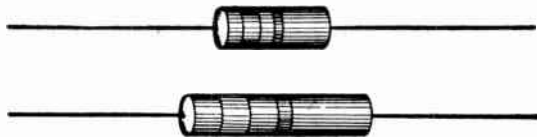

IRC Insulated Chokes are available in two sizes designated as types CLA and CL-1. Both types are fully insulated in molded phenolic housings for full protection against high humidity. The insulated housing also guards the winding from abrasion and physical damage, and prevents any possibility of shorting to chassis. Color coded for easy identification.

The wide range of size and characteristic combinations available permits accurate replacement with respect to space and electrical requirements.

TYPE CLA LIST 35c each
 TYPE CL-1 LIST 35c each

TYPE CLA

Inductance (Micro-henrys)	Approximate "Q" at Frequencies (Mc)	D. C. Resistance (Ohms)	Approximate Self-Resonant Frequency (Mc)	Current Rating (Milliamperes) (1)* (2)*	
.47	30 @ 12	.22 ± 30%	305	1400	2100
.51	30 @ 11	.25 ± 30%	290	1300	2000
.56	30 @ 11	.26 ± 30%	275	1300	1900
.62	29 @ 11	.34 ± 30%	265	1100	1700
.68	29 @ 10	.37 ± 30%	250	1100	1600
.75	28 @ 10	.38 ± 30%	240	1000	1600
.82	27 @ 9	.49 ± 30%	230	950	1400
.91	26 @ 9	.51 ± 30%	215	900	1400
1.0	26 @ 9	.66 ± 30%	205	800	1200
1.1	25 @ 8	.67 ± 30%	200	800	1200
1.2	24 @ 8	.68 ± 20%	190	800	1200
1.3	24 @ 8	.88 ± 20%	180	700	1050
1.5	23 @ 7	.94 ± 20%	170	650	1000
1.6	22 @ 7	1.2 ± 20%	165	600	900
1.8	22 @ 7	1.3 ± 20%	155	550	850
2.0	21 @ 6	1.4 ± 20%	145	550	850
2.2	20 @ 6	1.8 ± 20%	140	475	700
2.4	19 @ 5	1.9 ± 20%	135	475	700
2.7	19 @ 5	2.0 ± 20%	125	475	700
3.0	18 @ 5	2.6 ± 20%	120	400	600
3.3	18 @ 5	2.8 ± 20%	115	400	550

CHOKE CABINETS

For efficient stocking, the handy bench supply of IRC Insulated Chokes is available in a 4-drawer all-metal cabinet. Same size as Resist-O-Cabinets and can be stacked with them. Each value is contained in an individual identified compartment. Cabinet contains 5 of each value — totaling 140 chokes in a full range of values and 2 sizes. No extra charge for the Choke Cabinet.



LIST \$49.00



INSULATED CHOKES

TYPE CL-1

Inductance (Micro-henrys)	Approximate "Q" at Frequencies (Mc)	D. C. Resistance (Ohms)	Approximate Self-Resonant Frequency (Mc)	Current Rating (Milliamperes) (1)* (2)*	
.47	35 @ 12	.14 ± 30%	330	1850	2900
.51	34 @ 11	.15 ± 30%	315	1800	2800
.56	34 @ 11	.16 ± 30%	300	1750	2700
.62	33 @ 10	.16 ± 30%	285	1750	2700
.68	33 @ 10	.22 ± 30%	275	1500	2300
.75	33 @ 10	.23 ± 30%	260	1450	2300
.82	32 @ 9	.29 ± 30%	250	1300	2000
.91	32 @ 9	.31 ± 30%	235	1250	1950
1.0	32 @ 9	.33 ± 30%	225	1200	1900
1.1	31 @ 8	.40 ± 30%	215	1100	1700
1.2	31 @ 8	.40 ± 20%	205	1100	1700
1.3	30 @ 8	.42 ± 20%	195	1050	1700
1.5	29 @ 7	.56 ± 20%	185	950	1450
1.6	29 @ 7	.59 ± 20%	180	900	1400
1.8	28 @ 7	.77 ± 20%	170	800	1250
2.0	27 @ 6	.82 ± 20%	160	750	1200
2.2	26 @ 6	.87 ± 20%	150	750	1150
2.4	25 @ 6	1.1 ± 20%	145	650	1050
2.7	25 @ 5	1.2 ± 20%	135	600	1000
3.0	24 @ 5	1.6 ± 20%	130	550	850
3.3	24 @ 5	1.7 ± 20%	125	500	850
3.6	23 @ 5	1.7 ± 20%	120	500	850
3.9	23 @ 4.5	2.3 ± 20%	115	450	750
4.3	22 @ 4.5	2.4 ± 20%	110	450	700
4.7	22 @ 4.0	2.5 ± 20%	105	450	700
5.1	21 @ 4.0	3.3 ± 20%	100	375	600
5.6	21 @ 4.0	3.4 ± 20%	95	375	600
6.2	20 @ 3.5	3.6 ± 20%	80	375	600
6.8	20 @ 3.5	4.7 ± 20%	86	325	550
7.5	19 @ 3.5	5.0 ± 20%	82	300	525
8.2	18 @ 3.0	5.2 ± 20%	79	300	500
9.1	18 @ 3.0	7.2 ± 20%	75	250	425
10	17 @ 3.0	7.5 ± 20%	71	250	425

* (1) Current which will cause resistance to increase approximately 10% due to temperature coefficient of copper wire.

* (2) Current which will cause resistance to increase approximately 25% due to temperature coefficient of copper wire.

DIMENSIONS

TYPE CLA—Body diameter ¼" by ¾" long; 1 ½" leads.
 TYPE CL-1—Body diameter ¼" by 1 ¼" long; 1 ½" leads.

PRODUCTS OF
"The House of Resistors"



CLAROSTAT MFG. Co., Inc.
DOVER NEW HAMPSHIRE
TWX 275U Tel. DOVER 975

T.M.

COMPOSITION-ELEMENT CONTROLS

These "Pick-A-Shaft" and "Ad-A-Switch" controls will take any of the shafts listed on page R-30 including High Voltage Coupler and insulated shaft. Your choice of any one of the 12 shafts listed, (this does not include insulated shaft) with each control. "AT" controls use "SWA" Switches and "A47F" controls use "SWE" Switches, both shown on page R-30. "AM" controls use "SWA" switches while "A47" controls use "SWE" switches, both shown on page R-30. Tolerances for these controls are in accordance with RETMA standards; Overall resistance tolerance of plus/minus 20% for all values up to and including 100K ohms; Plus/minus 30% for all values above 100K ohms.

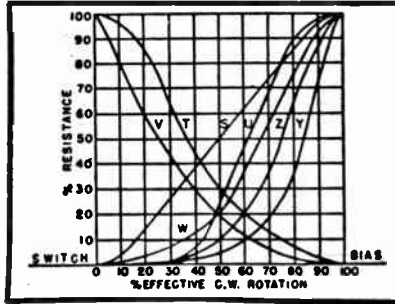

Graph Explanation:

- Taper S—Straight or uniform resistance change with rotation.
- Taper T—Right-hand 30% resistance at 50% of C.C.W. rotation.
- Taper U—Left-hand 1% resistance at 33 1/3% of C.W. rotation.
- Taper V—Right-hand 20% resistance at 50% of C.C.W. rotation.
- Taper W—Left-hand 20% resistance at 50% of C.W. rotation.
- Taper Z—Left-hand (Log. audio) 10% resistance at 50% of C.W. rotation.
- Taper Y—Left-hand 5% resistance at 50% of C.W. rotation.

SERIES "AT" and "A47F" 1/2 WATT TAPPED CONTROLS



SERIES A47F
(INDUSTRIAL)
SERIES 47F



SERIES AT
(INDUSTRIAL)
SERIES 37F

"AT" controls have taps 1, 2, and 3 located at 37 1/2%, 50%, and 62 1/2% of rotation respectively. "A47F" controls have taps 1 and 3 located at 30% and 70% of rotation respectively. These controls are available with factory-assembled shafts at no extra charge by omitting the prefix "A" from the catalog number and designating the type of shaft desired when ordering. Example: T-95 with KSS-3 shaft, or 47F-200K with FS-3 shaft.

Cat. No.	Cat. No.	Res. Ohms	Tap No. 1	Tap No. 2	Tap No. 3
AT-25		50K		25K	
AT-38	A47F-200K	200K		25K	100K
AT-39		250K		25K	
AT-42		250K		125K	
AT-43	A47F-250K	250K			50K
AT-44		250K	60K		125K
AT-45		350K	30K	60K	
AT-60	A47F-350K	350K	75K	25K	
AT-70		500K		75K	
AT-78		500K		100K	
AT-80	A47F-500K	500K			100K
AT-81	A47F1-500K	500K	25K		
AT-82	A47F2-500K	500K			200K
AT-88		500K		50K	
AT-90		500K		250K	
AT-92		500K	100K		300K
AT-98	A47F-1 Meg.	1 Meg.	250K		
AT-101		1 Meg.		50K	
AT-102		1 Meg.	100K		500K
AT-103		1 Meg.		100K	
AT-109		1 Meg.		225K	
AT-110		1 Meg.		170K	
AT-111	A47F1-1 Meg.	1 Meg.			200K
AT-112		1 Meg.		500K	
AT-95		1.5 Meg.	250K		500K
AT-125		1.5 Meg.		350K	
AT-114		2 Meg.		100K	
AT-115		2 Meg.		500K	
AT-116		2 Meg.		1 Meg.	
AT-118	A47F-2 Meg.	2 Meg.	20K		
AT-119		2 Meg.		200K	
AT-120		2 Meg.		400K	
AT-121		2 Meg.	250K		500K
AT-124	A47F1-2 Meg.	2 Meg.	5,000		
AT-126		2 Meg.	200K		400K
AT-129	A47F2-2 Meg.	2 Meg.	15K		
AT-123		2.5 Meg.	250K		500K
AT-128		4 Meg.		500K	

LIST PRICE \$1.85

Standard Packing 10 per Carton. For Power Switch, see listing on page R-10.

*Trade Mark

SERIES "AM" and "A47" 1/2 WATT CONTROLS

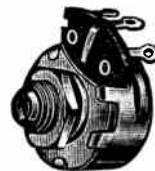

SERIES A47
(INDUSTRIAL)
SERIES 47

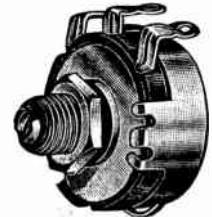

SERIES AM
(INDUSTRIAL)
SERIES 37

These controls are available with factory assembled shafts at no extra charge by omitting the prefix "A" from the catalog number and designating type of shaft desired when ordering. Example: M-60-Z with FS-3 Shaft, or 47-100K-S with FKS-1/4 shaft.

Cat. No.	Cat. No.	R. O. T.	Cat. No.	Cat. No.	R. O. T.
AM-5-S	A47-500-S	500 S	AM-45-W	A47-50K-W	50K W
AM-8-S	A47-1,000-S	1,000 S	AM-46-Z	A47-50K-Z	50K Z
AM-11-S	A47-2,000-S	2,000 S	AM-47-S	A47-75K-S	75K S
AM-15-S	A47-3,000-S	3,000 S	AM-48-V	A47-75K-V	75K V
AM-80-S	A47-4,000-S	4,000 S	AM-49-S	A47-100K-S	100K S
AM-19-S	A47-5,000-S	5,000 S	AM-51-Z	A47-100K-Z	100K Z
AM-20-U		5,000 U	AM-52-S	A47-200K-S	200K S
AM-23-S	A47-7,500-S	7,500 S	AM-55-S	A47-250K-S	250K S
AM-27-S	A47-10K-S	10K S	AM-64-Z	A47-250K-Z	250K Z
AM-29-U		10K U	AM-57-S	A47-300K-S	300K S
AM-30-V	A47-10K-V	10K V	AM-58-S	A47-500K-S	500K S
AM-31-W	A47-10K-W	10K W	AM-59-Y		500K Y
AM-81-Z	A47-10K-Z	10K Z	AM-60-Z	A47-500K-Z	500K Z
AM-32-S	A47-15K-S	15K S	AM-79-Z	A47-750K-Z	750K Z
AM-33-U		15K U	AM-61-S	A47-1 Meg-S	1 Meg. S
AM-34-V	A47-15K-V	15K V	AM-83-Z	A47-1 Meg-Z	1 Meg. Z
AM-35-W	A47-15K-W	15K W	AM-83-S	A47-2 Meg-S	2 Meg. S
AM-36-S	A47-20K-S	20K S	AM-66-Z	A47-2 Meg-Z	2 Meg. Z
AM-37-U		20K U	AM-84-S	A47-2.5 Meg-S	2.5 Meg. S
AM-40-S	A47-25K-S	25K S	AM-67-Z	A47-3 Meg-Z	3 Meg. Z
AM-41-W	A47-25K-W	25K W	AM-68-Z	A47-4 Meg-Z	4 Meg. Z
AM-72-V	A47-25K-V	25K V	AM-85-S	A47-5 Meg-S	5 Meg. S
AM-42-S	A47-30K-S	30K S	AM-69-Z	A47-5 Meg-Z	5 Meg. Z
AM-43-S	A47-40K-S	40K S	AM-86-S	A47-7.5 Meg-S	7.5 Meg. S
AM-44-S	A47-50K-S	50K S	AM-99-Z	A47-10 Meg-Z	10 Meg. Z

LIST PRICE \$1.25

Standard Packing 10 per Carton.

For Power Switch, see listing on page R-10.

SERIES "DC" 1/2-WATT DUAL CONTROLS

These composition element controls are ganged together so that both are operated by a single shaft in corresponding rotation. They have a 2 1/4" fixed milled shaft. Tolerances are in accordance with RETMA standards; Overall resistance tolerance of plus/minus 20% for all values up to and including 100K ohms; Plus/minus 30% for all values above 100K ohms. These controls use "SWA" switches. Other combinations of ohmage available. Prices and information upon request.

Cat. No.	Panel	Tap.	Rear Tap.	Cat. No.	Panel	Tap.	Rear Tap.
DC-34-S	10K S	25K S		DC-8-Z	250K Z	500K Z	500K Z
DC-23-S	10K S	50K S		DC-10-Z	500K Z	500K Z	
DC-5-S	50K S	50K S		DC-11-Z	1 Meg. Z	1 Meg. Z	
DC-6-Z	100K Z	100K Z		DC-35-S	1 Meg. S	1 Meg. S	
DC-29-S	250K S	250K S		DC-36-S	2 Meg. S	2 Meg. S	
				DC-37-S	5 Meg. S	5 Meg. S	

LIST PRICE \$3.10

Standard Packing: Individual Carton. For Power Switch, see listing on page R-10.



TM

WIRE-WOUND CONTROLS

These are "Pick-A-Shaft"* controls which take any one of 12 shafts listed on page R-30, including High Voltage Coupler and insulated shaft. Your choice of any one of the 12 shafts listed (this does not include insulated shaft) with each control. Tolerances of these controls are in accordance with RETMA standards. Overall resistance

tolerance of plus/minus 10% for all values. All controls are linear. Available with factory-assembled shafts at no extra charge, by omitting the prefix "A" from the catalog number and designating the type of shaft desired when ordering. Example: 43-500 with FKS-1/4 shaft, or 438-10K with FS-3 shaft and SPST switch.

SERIES "A43" and "A43S" 2-WATT CONTROLS



SERIES A43
(INDUSTRIAL)
SERIES 43



SERIES A43S
(INDUSTRIAL)
SERIES 43S

"A43" is without switch, while "A43S" has factory-attached switch. When ordering "A43S" controls, specify type of switch. See general note above regarding choice of shaft.

Without Switch Cat. No.	With Switch Cat. No.	Res. Ohms	Without Switch Cat. No.	With Switch Cat. No.	Res. Ohms
A43-5	A43S-5	5	A43-400	A43S-400	400
A43-10	A43S-10	10	A43-500	A43S-500	500
A43-20	A43S-20	20	A43-750	A43S-750	750
A43-25	A43S-25	25	A43-1,000	A43S-1,000	1,000
A43-30	A43S-30	30	A43-1,500	A43S-1,500	1,500
A43-40	A43S-40	40	A43-2,000	A43S-2,000	2,000
A43-50	A43S-50	50	A43-2,500	A43S-2,500	2,500
A43-75	A43S-75	75	A43-3,000	A43S-3,000	3,000
A43-100	A43S-100	100	A43-4,000	A43S-4,000	4,000
A43-150	A43S-150	150	A43-5,000	A43S-5,000	5,000
A43-200	A43S-200	200	A43-7,500	A43S-7,500	7,500
A43-300	A43S-300	300	A43-10K	A43S-10K	10K

LIST PRICE \$1.25 (Without Switch) — \$2.00 (With Switch)
Standard Packing: 10 per Carton.

SERIES "A58" and "A58S" 3-WATT CONTROLS

"A58" is without switch, while "A58S" has factory-attached switch. When ordering "A58S" controls, specify type of switch. Available with factory-assembled shafts, at no extra charge, by omitting prefix "A" from catalog number, and designating type of shaft desired when ordering. Example: 58-50K with KSS-3 shaft, or 58S-25K with RS-3 shaft and DPST switch.

Without Switch Cat. No.	Res. Ohms	List Price	Without Switch Cat. No.	Res. Ohms	List Price
A58-1	1	\$1.25	A58-3,000	3,000	1.25
A58-2	2	1.25	A58-5,000	5,000	1.25
A58-4	4	1.25	A58-7,500	7,500	1.25
A58-6	6	1.25	A58-10K	10K	1.25
A58-10	10	1.25	A58-15K	15K	1.60
A58-15	15	1.25	A58-20K	20K	1.60
A58-20	20	1.25	A58-25K	25K	1.60
A58-25	25	1.25	A58-30K	30K	2.25
A58-30	30	1.25	A58-40K	40K	2.25
A58-40	40	1.25	A58-50K	50K	2.25
A58-50	50	1.25			
A58-60	60	1.25			
A58-75	75	1.25			
A58-100	100	1.25			
A58-200	200	1.25			
A58-300	300	1.25			
A58-400	400	1.25			
A58-500	500	1.25			
A58-750	750	1.25			
A58-1,000	1,000	1.25			
A58-1,500	1,500	1.25			
A58-2,000	2,000	1.25			
A58-2,500	2,500	1.25			

Standard Packing: 10 per Carton.

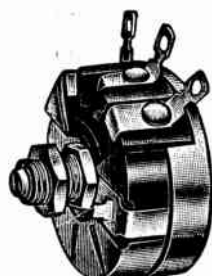

SERIES A58
(INDUSTRIAL)
SERIES 58

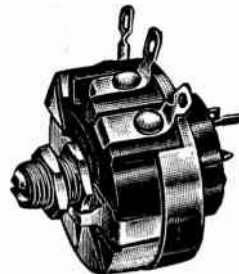

SERIES A58S
(INDUSTRIAL)
SERIES 58S

With Switch Cat. No.	Res. Ohms	List Price	With Switch Cat. No.	Res. Ohms	List Price
A58S-50	50	2.00	A58S-1,500	1,500	2.00
A58S-60	60	2.00	A58S-2,000	2,000	2.00
A58S-75	75	2.00	A58S-2,500	2,500	2.00
A58S-100	100	2.00	A58S-3,000	3,000	2.00
A58S-200	200	2.00	A58S-5,000	5,000	2.00
A58S-300	300	2.00	A58S-7,500	7,500	2.00
A58S-400	400	2.00	A58S-10K	10K	2.00
A58S-500	500	2.00	A58S-15K	15K	2.35
A58S-750	750	2.00	A58S-20K	20K	2.35
A58S-1,000	1,000	2.00	A58S-25K	25K	2.35
			A58S-30K	30K	3.00
			A58S-40K	40K	3.00
			A58S-50K	50K	3.00

Standard Packing: 10 per Carton.

SERIES "A10" and "A10S" 4-WATT CONTROLS

"A10" is without switch, while "A10S" has factory-attached switch. When ordering "A10S" controls, specify type of switch. Also available with factory-assembled shaft at no extra charge, by omitting prefix "A" from catalog number. See above for examples.

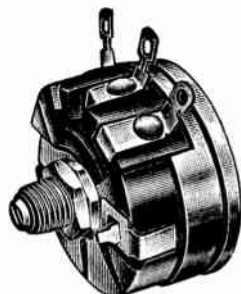

SERIES A10
(INDUSTRIAL)
SERIES 10

Without Switch Cat. No.	With Switch Cat. No.	Res. Ohms	Without Switch List Price	With Switch List Price	Without Switch Cat. No.	With Switch Cat. No.	Res. Ohms	Without Switch List Price	With Switch List Price
A10-1	A10S-1	1	\$1.85	\$2.60	A10-500	A10S-500	500	1.85	2.60
A10-2	A10S-2	2	1.85	2.60	A10-750	A10S-750	750	1.85	2.60
A10-4	A10S-4	4	1.85	2.60	A10-1,000	A10S-1,000	1,000	1.85	2.60
A10-6	A10S-6	6	1.85	2.60	A10-1,500	A10S-1,500	1,500	1.85	2.60
A10-10	A10S-10	10	1.85	2.60	A10-2,000	A10S-2,000	2,000	1.85	2.60
A10-15	A10S-15	15	1.85	2.60	A10-2,500	A10S-2,500	2,500	1.85	2.60
A10-20	A10S-20	20	1.85	2.60	A10-3,000	A10S-3,000	3,000	1.85	2.60
A10-25	A10S-25	25	1.85	2.60	A10-5,000	A10S-5,000	5,000	1.85	2.60
A10-30	A10S-30	30	1.85	2.60	A10-7,500	A10S-7,500	7,000	1.85	2.60
A10-40	A10S-40	40	1.85	2.60	A10-10K	A10S-10K	10K	1.85	2.60
A10-50	A10S-50	50	1.85	2.60	A10-15K	A10S-15K	15K	2.20	2.95
A10-60	A10S-60	60	1.85	2.60	A10-20K	A10S-20K	20K	2.20	2.95
A10-75	A10S-75	75	1.85	2.60	A10-25K	A10S-25K	25K	2.20	2.95
A10-100	A10S-100	100	1.85	2.60	A10-30K	A10S-30K	30K	2.85	3.60
A10-200	A10S-200	200	1.85	2.60	A10-40K	A10S-40K	40K	2.85	3.60
A10-300	A10S-300	300	1.85	2.60	A10-50K	A10S-50K	50K	2.85	3.60
A10-400	A10S-400	400	1.85	2.60	A10-75K	A10S-75K	75K	3.50	4.25
					A10-100K	A10S-100K	100K	3.50	4.25

*Trade Mark

Standard Packing: 10 per Carton.

PRODUCTS OF
"The House of Resistors"



CLAROSTAT MFG. Co., Inc.
DOVER NEW HAMPSHIRE
TWX 275U Tel. DOVER 975

T.M.

SHAFTS and SWITCHES • BALLASTS • REGULATORS

SHAFTS FOR "PICK-A-SHAFT"* CONTROLS

For use with all Clarostat "Pick-A-Shaft"* controls, either carbon or wire-wound. Your choice of shaft furnished with each control.

- (1) SS 3/8" length—(Male) to take female fitting.
- (2) RS-2—Round shaft, 2" long.
- (3) RS-3—Round shaft 3/8" dia., 3" long.
- (4) KSS-3—Knurled, split shaft, 3" long.
- (5) RS-5—Round shaft, 5" long.
- (6) FS-5—Flatted shaft, 5" long.
- (7) KSS-5—Knurled, split shaft, 5" long.
- (8) FS-3—Flatted shaft, 3" long.
- (9) RN-3—Round shaft, 3" long.
- (10) DFS-1/2—Double flatted Philco Type, 1/2" long.
- (11) FKS-1/4—Fine knurled flatted shaft, 1/4" long.
- (12) KFS-3—Knurled flatted shaft, 3" long.

List Price, Each Shaft \$0.30

HIGH VOLTAGE COUPLER

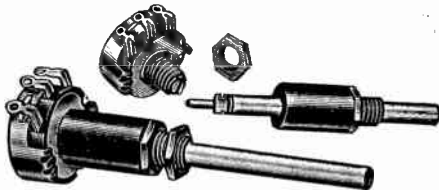

High-voltage shaft unit for operation up to 10K volts. Attaches to any Clarostat "Pick-A-Shaft" control, composition-element or wire-wound. Also available as a factory-attached unit on order. For example: "M-58-S" unit with factory-attached high voltage coupler, order as an "M-58-S-HVC." Manufacturers' Series 37 - 1/2 meg.-S-HVC.

Cat. No.		List Price
59-186	Spacer and Bushing Assembly	\$1.00
RN-3	Non-Metallic Shaft Round 3" long	1.00

SERIES "SWA" SWITCHES FOR "AD-A-SWITCH"* CONTROLS

For use with AM, M, AT, T, and DC controls. Rated 3 amperes at 125 volts. A.C. Underwriters' Laboratories approved.

Cat. No.	Wiring	List Price
SWA	Single Pole Single Throw	\$0.60
SWA-1	Three Way No "Off" Position S.P.D.T.	.75
SWA-2	Double Pole Single Throw	.75
SWA-4	Four Wire (to Control A, B, and C Voltages)	.75
SWA-5	S.P.S.T. (reverse action)	.75
SWA-6	S.P.S.T. with dummy lug	.75



Standard Packing: 10 per Carton.

SERIES "SWE" SWITCHES FOR "AD-A-SWITCH"* CONTROLS

For use with "A47" and "A47F" controls. Underwriters' Laboratories approved.

Cat. No.	Wiring	List Price
SWE-12	S.P.S.T. — Single Pole Single Throw, 5A.-125V. A.C.	\$0.60
SWE-20	D.P.S.T. — Double Pole Single Throw, 3A.-125V. A.C.	.75
SWE-21	Mod. D.P.S.T. one pole on, one off, or with Jumper S.P.D.T., 3A.-125V. A.C.-D.C.	.75

U. S. Pat. 2,642,506 Standard Packing: 10 per Carton.



ROTARY SWITCHES

* Molded phenolic case. Underwriters approved. Rated 1 amp, 250 volt; 3 amp, 125 volt. The physical dimensions of the switch are as follows:

Diameter 1 3/8", body depth 3/8", lug protrusion 1/4", locking projection on a 1/2" radius, rotation for actuation 30 degrees. All standard stock numbers have 3/8" bushing, 1 1/2" shaft.



Cat. No.	Switch Description	List Price
8590	Single Pole Single-Throw	\$0.60
8591	Single Pole Bussing Lug	.75
8592	Double Pole Single Throw	.75
8593	Single Pole Double Throw	.75
8594	Single Pole Reversed Action	.75
8595	Four Wire Single Throw	.75

Standard packing: Individual Carton.

UNIVERSAL BALLAST

Universal replacements for most standard tube types. Replacing tube types as listed below.

Universal Tube No.	Replaces AC-DC Tubes Beg. with Letters	Having Numbers From	Ending in Letter
10-23-A	BK, BL, K, L, M	10 to 23	A, B, C, D
10-23-E	BK, BL, K, L, M	10 to 23	E
10-23-F	BK, BL, K, L, M	10 to 23	F, G, H
23-55-A	BK, BL, K, L, M	23 to 55	A, B, C, D
23-55-E	BK, BL, K, L, M	23 to 55	E
23-55-F	BK, BL, K, L, M	23 to 55	F, G, H
60-92-A	BK, BL, K, L, M	60 to 92	A, B, C, D
60-92-E	BK, BL, K, L, M	60 to 92	E
60-92-F	BK, BL, K, L, M	60 to 92	F, G, H
92-105-A	BK, BL, K, L, M	92 to 105	A, B, C, D

LIST PRICE \$2.25

Standard Packing: Individual Carton.



STANDARD BALLAST

Exact replacements for resistor tube types.

Cat. No.	Cat. No.	Cat. No.	Cat. No.	Cat. No.	Cat. No.
BK-29-B	BM-49-B	K-49-H	K-80-B	L-49-D	M-80-B
BK-29-D	BM-55-B	K-55-A	K-82-B	L-49-H	M-86892-9
BK-32-D	K-26J218	K-55-B	K-86-B	L-55-B	10-610
BK-36-D	K-36-D	K-55-C	K-90-A	L-55-CJ	100-37
BK-36-H	K-42-A	K-55-CPR	K-90-B	L-55-CPR	100-70
BK-42-B	K-42-AJ	K-55-D	K-92-A	L-55-C	100-76
BK-42-C	K-42-B	K-55-H	L-42-B	L-55-D	100-77
BK-49-C	K-42-C	K-67-A	L-42-C	M-30-H	100-79
BK-49-B	K-42-D	K-67-B	L-42-D	M-42-B	115-78
BK-55-B	K-49-A	K-67-BJ	L-49-A	M-49-B	5459
BK-67-BJ	K-49-B	K-72-B	L-49-B	M-55-B	28602
BL-42-D	K-49-C	K-74-B	L-49-C	M-55-H	43X106

LIST PRICE \$1.50

Standard Packing: Individual Carton.

TELEVISION BALLAST

Specific TV receiver tube-type ballasts.

Motorola 17A470303	Belmont B9M 16067	Pilot 35-37
Motorola 17A485459	Belmont B9M 16534	Emerson 397021*
Telehone TBR102D	Belmont B9M 15822	Emerson 397022*
Telehone TBR103D	Belmont B9M 17571	Emerson 397023*
Telehone TBR104D	Belmont B9M 18941	Emerson 397036*
	Stewart Warner ST-507300	

LIST PRICE \$4.00

except 397036* LIST \$2.00

Standard Packing: Individual Carton.

*These units act as protective fuses and are therefore expendable.

LINE VOLTAGE REGULATORS

A protective unit designed to prevent line voltage surges from reaching radio or TV receivers. Will reduce surges up to 140 volts down to approximately 110 volts. Plugs in outlet and provides outlet for receiver. Available as follows:

Type	Watts	For Use with Sets Consuming	Dia.	Lgth.	List Price
TVA	300	200 to 300 watts	1 3/8"	1 3/4"	\$2.50
TVB	375	300 to 375 watts	1 3/8"	3 3/4"	3.00

Standard Packing—10 (ten) per carton

FOR RADIO RECEIVERS

Type	Watts	For Use with Receivers Consuming	No. of Tubes Used
O	50	Up to 60 watts	4
A	100	60 to 100 watts	5, 6, 7
B	150	100 to 150 watts	8, 9, 10
C	200	150 to 200 watts	11, 12
D	250	200 to 250 watts	2 Type 50
E	100	60 to 100 watts	

*Note: For use with 220-volt receivers

LIST PRICE \$2.50

Standard Packing—10 (ten) per carton



*Trade Mark

PRODUCTS OF
"The House of Resistors"



CLAROSTAT MFG. Co., Inc.
DOVER NEW HAMPSHIRE
TWX 275U Tel. DOVER 975

TM



POWER RHEOSTATS

Clarostat Power Rheostats maintain their full power rating at settings, as low as, one third rotation without excessive temperature rise. Standard overall resistance tolerance plus/minus 10%. Closer tolerances are available upon special order.

The metal cored winding is embedded in a cold-setting, inorganic cement and is thereby bonded to the ceramic body. Unit mounts through a single hole. A locking pin is provided for rear panel mounting.

SERIES 25 — 25-WATT

Cat. No.	Total Res. Ohms	Max. Cur. at Total Res. Amps.	Max. Cur. Up to 1/3 Res. Amps.	List Price
25-1	1	5.000	7.500	\$5.85
25-2	2	3.536	5.304	5.20
25-3	3	2.887	4.330	5.20
25-6	6	2.041	3.062	5.20
25-8	8	1.768	2.652	5.20
25-10	10	1.581	2.372	5.20
25-15	15	1.291	1.936	5.20
25-25	25	1.000	1.500	5.20
25-35	35	.845	1.268	5.20
25-50	50	.707	1.061	5.20
25-75	75	.577	.866	5.20
25-100	100	.500	.750	5.20
25-125	125	.447	.671	5.20
25-175	175	.378	.567	5.20
25-250	250	.316	.474	5.20
25-350	350	.267	.401	5.20
25-500	500	.224	.335	5.20
25-750	750	.183	.274	5.20
25-1,000	1,000	.158	.237	5.85
25-1,500	1,500	.129	.194	5.85
25-2,500	2,500	.100	.150	5.85
25-3,500	3,500	.085	.127	6.20
25-5,000	5,000	.071	.107	6.50

Standard Packing: Individual Carton.

SERIES 50 — 50-WATT

Cat. No.	Total Res. Ohms	Max. Cur. at Total Res. Amps.	Max. Cur. Up to 1/3 Res. Amps.	List Price
50-0.5	0.5	10.000	15.000	\$6.50
50-1	1	7.071	10.607	6.50
50-2	2	5.000	7.500	6.50
50-4	4	3.536	5.304	5.85
50-6	6	2.887	4.330	5.85
50-8	8	2.500	3.750	5.85
50-12	12	2.041	3.062	5.85
50-16	16	1.768	2.652	5.85
50-22	22	1.508	2.261	5.85
50-35	35	1.195	1.798	5.85
50-50	50	1.000	1.500	5.85
50-80	80	.791	1.186	5.85
50-125	125	.632	.949	5.85
50-150	150	.577	.866	5.85
50-225	225	.471	.707	5.85
50-300	300	.408	.612	5.85
50-500	500	.316	.474	5.85
50-800	800	.250	.375	6.20
50-1,000	1,000	.224	.335	6.20
50-1,600	1,600	.177	.265	6.20
50-2,500	2,500	.141	.212	6.20
50-3,500	3,500	.120	.179	6.50
50-5,000	5,000	.100	.150	7.50
50-8,000	8,000	.079	.118	7.80
50-10K	10K	.071	.106	8.00

Standard Packing: Individual Carton.

AIRCRAFT-TYPE POWER RHEOSTATS

Basically the same unit as the 25 and 50 watt Power Rheostats, mechanically and electrically. Unit is encased in metal housing rendering it explosion-proof and moisture resistant.

Terminals are screw-type lugs plated to prevent corrosion. 25- and 50-watt power rheostats when encased in metal housing, are derated 50%.



SERIES AN-3155-25 (25-WATT)

Cat. No.	Resistance	List Price
AN-3155-25-10	10 ohms	\$7.25
AN-3155-25-11	11 ohms	7.25
AN-3155-25-15	15 ohms	7.25
AN-3155-25-25	25 ohms	7.25
AN-3155-25-50	50 ohms	7.25
AN-3155-25-75	75 ohms	7.25
AN-3155-25-100	100 ohms	7.25
AN-3155-25-200	200 ohms	8.50

Prices include AN-3220—2 knob.
Standard Packing: Individual Carton.

SERIES AN-3155-50 (50-WATT)

Cat. No.	Resistance	List Price
AN-3155-50-5	5 ohms	\$8.50
AN-3155-50-8	8 ohms	8.50
AN-3155-50-10	10 ohms	8.50
AN-3155-50-25	25 ohms	8.25
AN-3155-50-30	30 ohms	8.25
AN-3155-50-50	50 ohms	8.25
AN-3155-50-75	75 ohms	8.25
AN-3155-50-100	100 ohms	8.25
AN-3155-50-150	150 ohms	9.25
AN-3155-50-200	200 ohms	9.25

Prices include AN-3220—2 knob.
Standard Packing: Individual Carton.

RTV - IZE!

No need to guess, experiment, cultivate trouble, when replacing TV controls. Clarostat provides the most complete data — the CLAROSTAT TV CONTROL REPLACEMENT MANUAL — and supplements.

Clarostat provides standard replacements where feasible, and exact-duplicate replacements where essential. Your Clarostat distributor can supply the Manual — and the replacements.

SERIES 39 "HUMDINGER" WIRE-WOUND CONTROLS



Compact. Inexpensive. 2-watt rating. Screwdriver adjusted by slot in drive plate. Mounting ears. For hum balance, centering, hold and locking, linearity, AGC sensitivity, etc.

LIST PRICE \$0.60

Standard Packing: 10 per Carton.

Cat. No.	Total Res. Ohms	Min. Res. Ohms	Cat. No.	Total Res. Ohms	Min. Res. Ohms	Cat. No.	Total Res. Ohms	Min. Res. Ohms
39-5	5	—	39-300	300	—	39-1000	1,000	—
39-8	8	—	39-500	500	—	39-1000-100	1,000	100
39-50	50	—	39-500-100	500	100	39-2000	2,000	—
39-75	75	—	39-600	600	—	39-2000-100	2,000	100
39-100	100	—	39-650	650	—	39-3000	3,000	—
39-125	125	—	39-700	700	—	39-3000-700	3,000	700
39-150	150	—	39-700-200	700	200	39-4000	4,000	—
39-200	200	—	39-800	800	—	39-4000-350	4,000	350
			39-800-50	800	50	39-4000-1000	4,000	1,000

*Reg. U. S. Pat. Off.

PRODUCTS OF
"The House of Resistors"



CLAROSTAT MFG. Co., Inc.
DOVER NEW HAMPSHIRE
TWX 275U Tel. DOVER 975

TM

SOUND-SYSTEM CONTROLS

For proper control of volume and tone alike, Clarostat offers a choice of several controls, such as L- and T-pads, output attenuators, and individual-speaker volume controls as used for drive-in theatre instal-

lations. These are not ordinary radio controls but rather sound-system controls designed and built for critical requirements.

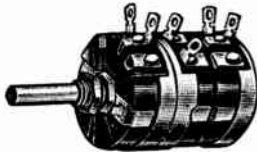

CONSTANT-IMPEDANCE CONTROLS

Self-compensating volume controls known as L-pads and T-pads for use in sound systems. Rated at 2½ watts DC, but will handle up to 10 watts audio. Continuous range from 0.5 to 30 decibels attenuation in 90% rotation. Last 10% affords infinite attenuation. With Clarostat constant-impedance L-pads and T-pads the input and output impedances of associated circuits can be kept within the limits of a constant required value.



U. S. Pat. 2,434,248

CIT
Cat. No.
CIT-4
CIT-6
CIT-8
CIT-15
CIT-50
CIT-100

CIL
Cat. No.
CIL-4
CIL-6
CIL-8
CIL-15
CIL-50
CIL-100

Res. Ohms
4
6
8
15
50
100

CIT
Cat. No.
CIT-200
CIT-250
CIT-500
CIT-600
CIT-1,000
CIT-2,000

CIL
Cat. No.
CIL-200
CIL-250
CIL-500
CIL-600
CIL-1,000
CIL-2,000

Res. Ohms
200
250
500
600
1,000
2,000

CIT—LIST PRICE \$4.25

CIL—LIST PRICE \$3.75

Standard Packing: Individual Carton.

CONSTANT IMPEDANCE OUTPUT ATTENUATORS

Series "CIB" rated at 10 watts, but will handle up to 30 watts in audio circuit. Linear attenuation provided in 3 decibel steps up to 24db, then 30db followed by infinity. Equipped with dial plate and bar knob. One-hole mounting, ⅜" bushing diameter. 1" shaft. This control has been developed to meet the need for a constant-impedance attenuator capable of handling considerable power without measurable insertion loss. Recommended as an output level control for power amplifiers, or as an input attenuator for individual or for a group of speakers in a public address system.



Cat. No.
CIB-6
CIB-8
CIB-15
CIB-50

Res. Ohms	Cat. No.
6	CIB-200
8	CIB-250
15	CIB-500
50	CIB-600

Res. Ohms
200
250
500
600

NET PRICE \$6.50

Standard Packing: Individual Carton.

SPECIAL DRIVE-IN THEATRE L-PAD

To meet the needs of the drive-in theatres where individual control of the speakers is required, a special 8 ohm L-Pad is now being offered. A single unit contains two separate windings of 5 ohms and 40 ohms. ⅜"-32 bushing, ⅝" long. 1½" round shaft.

Cat. No. CM8727
List Price \$2.75
Standard Packing:
Individual Carton.



MINIATURIZED CONTROLS COMPOSITION ELEMENT CONTROLS—Series 48

Composition element control rated at 0.2 watt. Diameter ⅝". Low-loss phenolic housing. ⅜" round shaft, ½" long. ¼" x 32 NEF-2 mounting bushing ⅜" long. Mounting nut ⅜" x ⅜" across flat. Available as dual combinations.

Also available with split-locking bushing as Series 48-9. Screwdriver slot shaft ⅜" diameter x ⅜" long. Split-locking bushing holds control at pre-determined setting by means of jam nut. Locking bushing ¼" x 32 NEF-2, ⅜" long.

Mechanical and electrical rotation of 300°. Linear and taper values available as listed below.

RESISTANCE VALUES AND TOLERANCES

Ohmage	Plus/minus	RESISTANCE VALUES AND TOLERANCES		Standard 10% C.W. taper	
		Ohmage	Plus/minus	Ohmage	Plus/minus
2.5 meg.	30%	25K	20%	2.5 meg.	30%
1 meg.	30%	10K	20%	1 meg.	30%
500K	30%	5,000	20%	500K	30%
250K	30%	2,500	20%	250K	30%
100K	20%	1,000	20%	100K	20%
50K	20%			50K	20%
				25K	20%
				10K	20%

When ordering, request Series 48, or 48-9, plus the ohmage. For example: Series 48-250K (with split-locking bushing order as Series 48-9—250K.) Dual combinations available as Series D48. Any combination of ohmages within range specified may be obtained on order. PRICE: Due to the special nature of these units, prices and specific information will be sent upon request.

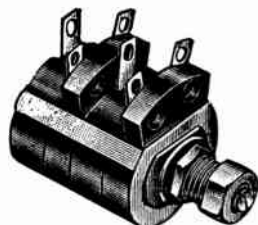

WIRE-WOUND — SERIES 49

Wire-wound controls with a power rating of 1.5 watts. ⅜" diameter low-loss phenolic housing. Linear taper resistance through 300° mechanical and electrical rotation. Breakdown between metal mounting surface and element or terminal, greater than 1,000 Volts AC.

Bushing ¼" x 32 NEF-2, ⅜" long. ⅜" diameter round shaft, ½" long. Hexagon mounting nut ⅜" thick x ⅜" across flat.

Also available as Series 49-9 incorporating screwdriver slotted shaft with split-locking bushing. Split bushing ¼" x 32 NEF-2, ⅜" long. Shaft length of ⅜".

Dual combinations available as Series D49. Any combination of ohmages within range specified below may be obtained on order.

Series 49, 49-9, and D49 are available in any ohmage from 10 ohms to 20K.

PRICE: Due to the special nature of these units, prices and specific information will be sent upon request.

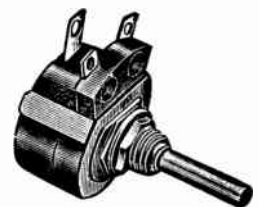

Pat. Pending

Radio's Master — 19th Edition

Page R-32

TRADE DISCOUNT APPLIES TO LIST PRICES ONLY

Copyright by U. C. P., Inc.

PRODUCTS OF
"The House of Resistors"



CLAROSTAT MFG. Co., Inc.
DOVER NEW HAMPSHIRE
TWX 275U Tel. DOVER 975

TM

C-LINE CONTROLS

A new line of composition-element and wire-wound controls designed specifically for industrial, laboratory, and other semi-critical applications. The new "C-line" controls are deluxe versions, mechanically and electrically, of the popular Clarostat Series 37, composition element; Series 43, wire-wound; Series 58, wire-wound; Series 10, wire-wound controls.

All exposed metal parts of the "C-line" controls have corrosion-resistant finishes. Terminals have suitable finish for ease of soldering. Covers are close-fitting with no cut-outs, resulting in practically a dust-proof, moisture-proof control. Units are in sealed dustproof plastic bags, packaged in the standard Clarostat cartons. In this manner, controls retain factory fresh appearance and performance even through an extended shelf-life.

Designated as the "C-line" Controls, these latest additions to the Clarostat line are of factory-assembled, fixed-shaft type. They are available with either a 1 1/8" round, nickel plated shaft, or a 1/2" screwdriver slot-type shaft with split locking bushing.

The C1 designation indicates a 1 1/8" round shaft beyond bushing; 3/8" long bushing with 3/32-NEF-2 thread. The C2 designation is a 1/2" screwdriver slotted shaft with a 1/2" split locking bushing. One nickel plated machined hexagon mounting nut and one internal lock washer supplied with all units. All C2 units are supplied with one nickel plated machined hexagon locking nut.

All "C-line" controls are available as follows on special order:

- (1) Switches available for all "C-line" controls.
- (2) Other ohmage not listed as standard catalog numbers.
- (3) Other tapers not listed as standard catalog numbers.
- (4) Other bushings and shaft lengths not listed as standard catalog items.
- (5) As dual combinations. Prices and delivery information on request.

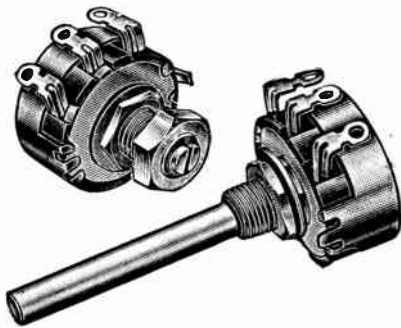

SERIES "37C1" and "37C2" 1-WATT CONTROLS

Electrical tolerances are plus/minus 10% for all values up to and including 100,000 ohms, and plus/minus 20% for values above 100,000 ohms up to 10 megohms. All controls rated 1 watt.

37C1 Cat. No.	37C2 Cat. No.	Res. Ohms	Taper	37C1 Cat. No.	37C2 Cat. No.	Res. Ohms	Taper
37C1-500-S	37C2-500-S	500	N	37C1-100K-Z	37C2-100K-Z	100K	Z
37C1-1000-S	37C2-1000-S	1000	S	37C1-200K-S	37C2-200K-S	200K	S
37C1-2000-S	37C2-2000-S	2000	N	37C1-250K-S	37C2-250K-S	250K	S
37C1-3000-S	37C2-3000-S	3000	N	37C1-250K-Z	37C2-250K-Z	250K	Z
37C1-4000-S	37C2-4000-S	4000	N	37C1-300K-S	37C2-300K-S	300K	S
37C1-5000-S	37C2-5000-S	5000	N	37C1-500K-S	37C2-500K-S	500K	N
37C1-10K-S	37C2-10K-S	10K	N	37C1-500K-Z	37C2-500K-Z	500K	Z
37C1-15K-S	37C2-15K-S	15K	N	37C1-1 Meg-S	37C2-1 Meg-S	1 Meg	S
37C1-20K-S	37C2-20K-S	20K	N	37C1-1 Meg-Z	37C2-1 Meg-Z	1 Meg	Z
37C1-25K-S	37C2-25K-S	25K	N	37C1-2 Meg-S	37C2-2 Meg-S	2 Meg	S
37C1-30K-S	37C2-30K-S	30K	N	37C1-2 Meg-Z	37C2-2 Meg-Z	2 Meg	Z
37C1-40K-S	37C2-40K-S	40K	N	37C1-2.5 Meg-S	37C2-2.5 Meg-S	2.5 Meg	S
37C1-50K-S	37C2-50K-S	50K	S	37C1-5 Meg-S	37C2-5 Meg-S	5 Meg	S
37C1-75K-S	37C2-75K-S	75K	N	37C1-10 Meg-Z	37C2-10 Meg-Z	10 Meg	Z
37C1-100K-S	37C2-100K-S	100K	S				

LIST PRICES: 37C1—\$1.85

37C2—\$3.10

SERIES "43C1" and "43C2" 2-WATT CONTROLS

Electrical tolerance is plus/minus 5% for all ohmage. Independent linearity is to plus/minus 2%. All controls rated 2 watts.

43C1 Cat. No.	43C2 Cat. No.	Res. Ohms	43C1 Cat. No.	43C2 Cat. No.	Res. Ohms	43C1 Cat. No.	43C2 Cat. No.	Res. Ohms
43C1-5	43C2-5	5	43C1-200	43C2-200	200	43C1-4000	43C2-4000	4000
43C1-10	43C2-10	10	43C1-300	43C2-300	300	43C1-5000	43C2-5000	5000
43C1-20	43C2-20	20	43C1-400	43C2-400	400	43C1-7500	43C2-7500	7500
43C1-25	43C2-25	25	43C1-500	43C2-500	500	43C1-10K	43C2-10K	10K
43C1-30	43C2-30	30	43C1-750	43C2-750	750	43C1-15K	43C2-15K	15K
43C1-40	43C2-40	40	43C1-1000	43C2-1000	1000	43C1-20K	43C2-20K	20K
43C1-50	43C2-50	50	43C1-1500	43C2-1500	1500	43C1-25K	43C2-25K	25K
43C1-75	43C2-75	75	43C1-2000	43C2-2000	2000	43C1-30K	43C2-30K	30K
43C1-100	43C2-100	100	43C1-2500	43C2-2500	2500	43C1-40K	43C2-40K	40K
43C1-150	43C2-150	150	43C1-3000	43C2-3000	3000	43C1-50K	43C2-50K	50K

LIST PRICES

43C1-5 to 43C1-10K \$1.85
43C1-15K to 43C1-25K 2.50
43C1-30K to 43C1-50K 2.85

43C2-5 to 43C2-10K \$3.10
43C2-15K to 43C2-25K 3.50
43C2-30K to 43C2-50K 4.25

SERIES "58C1" and "58C2" 3-WATT CONTROLS

Electrical tolerance is plus/minus 5% for all ohmage. Independent linearity is to plus/minus 1%. All controls rated 3 watts.

58C1 Cat. No.	58C2 Cat. No.	Res. Ohms	58C1 Cat. No.	58C2 Cat. No.	Res. Ohms	58C1 Cat. No.	58C2 Cat. No.	Res. Ohms
58C1-1	58C2-1	1	58C1-60	58C2-60	60	58C1-2500	58C2-2500	2500
58C1-2	58C2-2	2	58C1-75	58C2-75	75	58C1-3000	58C2-3000	3000
58C1-4	58C2-4	4	58C1-100	58C2-100	100	58C1-5000	58C2-5000	5000
58C1-6	58C2-6	6	58C1-200	58C2-200	200	58C1-7500	58C2-7500	7500
58C1-10	58C2-10	10	58C1-300	58C2-300	300	58C1-10K	58C2-10K	10K
58C1-15	58C2-15	15	58C1-400	58C2-400	400	58C1-15K	58C2-15K	15K
58C1-20	58C2-20	20	58C1-500	58C2-500	500	58C1-20K	58C2-20K	20K
58C1-25	58C2-25	25	58C1-750	58C2-750	750	58C1-25K	58C2-25K	25K
58C1-30	58C2-30	30	58C1-1000	58C2-1000	1000	58C1-30K	58C2-30K	30K
58C1-40	58C2-40	40	58C1-1500	58C2-1500	1500	58C1-40K	58C2-40K	40K
58C1-50	58C2-50	50	58C1-2000	58C2-2000	2000	58C1-50K	58C2-50K	50K

LIST PRICES

58C1-1 to 58C1-10K \$1.85
58C1-15K to 58C1-25K 2.50
58C1-30K to 58C1-50K 2.85

58C2-1 to 58C2-10K \$3.10
58C2-15K to 58C2-25K 3.50
58C2-30K to 58C2-50K 4.25



SERIES "10C1" and "10C2" 4-WATT CONTROLS

Electrical tolerance is plus/minus 5% for all ohmage. Independent linearity is to plus/minus 1%. All controls rated 4 watts. 1 to 50K ohms available on special order. Prices and information upon request.

10C1—Cat. No.	10C2—Cat. No.	Res. Ohms
10C1-75K	10C2-75K	75K
10C1-100K	10C2-100K	100K

LIST PRICES

10C1.....\$4.10 10C2.....\$5.50

*TM



"GREENOHM"* FIXED WIRE-WOUND RESISTORS

Wire-wound resistors for most rugged applications. Will withstand tremendous overloads and temperature changes without changes in resistance values or appearance. Wire windings on high-grade ceramic and coated with special inorganic cement. In accordance with RETMA standards; overall tolerances are $\pm 5\%$ for resistors of 50 Ω and higher. For resistors of 49.9 Ω and lower, overall tolerances are $\pm 10\%$.

- SERIES PR-5-F**—Rated 5 watts. $\frac{1}{8}$ " dia. by 1" long. Lead wires and tinned lugs. Standard Packing—10 per carton.
- SERIES AC-10-F**—Rated 10 watts. $\frac{1}{8}$ " dia. by 1 $\frac{3}{4}$ " long. Lead wires and tinned lugs. Standard Packing—10 per carton.
- SERIES AC-20-K**—Rated 20 watts. $\frac{3}{8}$ " dia. by 2" long. Lead wires and tinned lugs. Standard Packing—5 per carton.
- SERIES A-25-K**—Rated 25 watts. $\frac{3}{8}$ " dia. by 2 $\frac{1}{2}$ " long. Supplied with mounting brackets. Standard Packing—Individually Boxed.
- SERIES K-40-N**—Rated 40 watts. $\frac{3}{4}$ " dia. by 3 $\frac{1}{2}$ " long. Supplied with mounting brackets. Standard Packing—Individually Boxed.
- SERIES K-50-N**—Rated 50 watts. $\frac{3}{4}$ " dia. by 4 $\frac{1}{2}$ " long. Supplied with mounting brackets. Standard Packing—Individually Boxed.
- SERIES K-80-N**—Rated 80 watts. $\frac{3}{4}$ " dia. by 6 $\frac{1}{2}$ " long. Supplied with mounting brackets. Standard Packing—Individually Boxed.

"GREENOHM JR." SERIES C4GJ—Inexpensive ceramic-case resistors. Wire-wound on spun glass fiber core. Cement-filled ceramic case. Rated 5 watts. $\frac{1}{8}$ " dia. by 1" long. 1 $\frac{1}{2}$ " axial pigtail leads. Standard Pack—10 per carton.



"GREENOHM JR." SERIES C7GJ—Same construction as Series C4GJ. Rated 10 watts. $\frac{1}{8}$ " dia. by 1 $\frac{3}{4}$ " long. Standard Packing—10 per carton.

- SERIES K-100-W**—Rated 100 watts. 1 $\frac{1}{8}$ " dia. by 6 $\frac{1}{2}$ " long. Supplied with mounting brackets. Standard Packing—Individually Boxed.
- SERIES K-160-W**—Rated 160 watts. 1 $\frac{1}{8}$ " dia. by 8 $\frac{1}{2}$ " long. Supplied with mounting brackets. Standard Packing—Individually Boxed.
- SERIES K-200-W**—Rated 200 watts. 1 $\frac{1}{8}$ " dia. by 10 $\frac{1}{2}$ " long. Supplied with mounting brackets. Standard Packing—Individually Boxed.

"GREENOHM" AND "GREENOHM JR."* FIXED WIRE-WOUND RESISTORS

Res. Ohms	List Price PR-5-F	List Price C4GJ	List Price C7GJ	List Price AC-10-F	List Price AC-20-K	List Price A-25-K	List Price K-40-N	List Price K-50-N	List Price K-80-N	List Price K-100-W	List Price K-160-W	List Price K-200-W
1	\$0.50	\$0.55	\$0.55	\$0.55	\$0.75
2	.50	.55	.55	.5575
3	.50	.55	.55	.5575
4	.50	.55	.55	.55
5	.50	.55	.55	.55
7.5	.50	.55	.55	.55	\$0.65	.75	\$0.90	\$1.10	\$1.25	\$1.75	\$2.25	\$2.50
10	.50	.55	.55	.55	.65	.75	.90	1.10	1.25	1.75	2.25	2.50
12	.50	.55	.55	.55
15	.50	.55	.55	.5575	.90
20	.50	.55	.55	.5575	.90
25	.50	.55	.55	.55	.65	.75	.90	1.10	1.25	1.75	2.25	2.50
30	.50	.55	.55	.55
35	.50	.55	.55	.55
40	.50	.55	.55	.55
50	.50	.55	.55	.55	.65	.75	.90	1.10	1.25	1.75	2.25	2.50
75	.50	.55	.55	.55	.65	.75	.90	1.10	1.25	1.75	2.25	2.50
100	.50	.55	.55	.55	.65	.75	.90	1.10	1.25	1.75	2.25	2.50
125	.50	.55	.55	.5590
150	.50	.55	.55	.55	.65	.75	.90	1.10	1.25	1.75	2.25	2.50
200	.50	.55	.55	.55	.65	.75	.90	1.10	1.25	1.75	2.25	2.50
225	.50	.55	.55	.55
250	.50	.55	.55	.55	.65	.75	.90	1.10	1.25	1.75	2.25	2.50
300	.50	.55	.55	.55	.65	.75	.90	1.10	1.25	1.75	2.25	2.50
350	.50	.55	.55	.55	.65	.75	.90	1.10	1.25	1.75	2.25	2.50
400	.50	.55	.55	.55	.65	.75	.90	1.10	1.25	1.75	2.25	2.50
450	.50	.55	.55	.55
500	.50	.55	.55	.55	.65	.75	.90	1.10	1.25	1.75	2.25	2.50
600	.50	.55	.55	.55
65065
700	.50	.55	.55	.55	.65
750	.50	.55	.55	.55	.65	.75	.90	1.10	1.25	1.75	2.25	2.50
800	.50	.55	.55	.55	.65	.75
85065
900	.50	.55	.55	.55
1000	.50	.55	.55	.55	.65	.75	.90	1.10	1.25	1.75	2.25	2.50
1100	.50
1200	.5065
1250	.5065	.75	1.10	1.25	1.75	2.25	2.50
1500	.5065	.75	.90	1.10	1.25	1.75	2.25	2.50
1750	.5055	.55	.65
185065
2000	.50	.55	.55	.55	.65	.75	.90	1.10	1.25	1.75	2.25	2.50
2250	.5055	.55	.65	.75	1.10	1.25	1.75	2.25	2.50
2500	.5055	.55	.65	.75	.90	1.10	1.25	1.75	2.25	2.50
275065
3000	.50	.55	.55	.55	.65	.75	.90	1.10	1.25	1.85	2.25	2.50
3500	.5065	.75	1.10	1.25	1.85	2.25	2.50
4000	.50	.55	.55	.55	.65	.75	.90	1.10	1.25	1.85	2.25	2.50
4500	.5065	.75	1.10	1.25	1.95	2.25	2.50
5000	.5065	.75	.90	1.10	1.25	1.95	2.25	2.50
6000	.5065	.85	1.00	1.35	1.50	1.95	2.25	2.50
7000	.5055	.55	.65	.85
7500	.5065	.85	1.00	1.35	1.50	1.95	2.25	2.50
8000	.5055	.55	.65	.85	1.35	1.50	1.95	2.25	2.50
8500	.5055	1.00
9000	.5055	.55	.65	.85	1.35	1.50	1.95	2.25	2.50
10K	.5055	.65	.85	1.00	1.35	1.50	1.95	2.25	2.50
11K55
12K5585	1.35	1.50	1.95	2.30	2.75
12.5K55	.65	1.00	1.35	1.50	1.95	2.35	2.85
13.5K55
14.5K55
15K55	.65	.85	1.00	1.35	1.50	1.95	2.65	3.00
16K55
17.5K55

* Reg. U. S. Pat. Off.

PRODUCTS OF

"The House of Resistors"

CLAROSTAT



CLAROSTAT MFG. Co., Inc.
DOVER NEW HAMPSHIRE
TWX 275U Tel. DOVER 975

"GREENOHM"* FIXED WIRE-WOUND RESISTORS

(CONT'D FROM PREVIOUS PAGE)

Res. Ohms	List Price PR-5-F	List Price C4GJ	List Price C7GJ	List Price AC-10-F	List Price AC-20-K	List Price A-25-K	List Price K-40-N	List Price K-50-N	List Price K-80-N	List Price K-100-W	List Price K-160-W	List Price K-200-W
18K55
20K55	.85	1.00	\$1.00	\$1.35	\$1.50	\$1.95	\$2.65	\$3.00
22.5K55
25K55	.85	1.00	1.00	1.35	1.50	1.95	2.65	3.00
30K55	.85	1.00	1.20	1.70	1.75	2.50	2.65	3.00
35K55	.85	1.00	1.20	1.70	1.75	2.50	2.65	3.00
40K55	.85	1.00	1.20	1.70	1.75	2.50	2.65	3.00
45K85	1.00
50K55	.85	1.00	1.20	1.70	1.75	2.50	2.65	3.00
55K	1.10
60K	1.10	1.15	1.20	1.70	2.00	2.75	3.00	3.00
65K	1.10
70K	1.10	1.25	1.20	1.70	2.00	2.75	3.00	3.00
75K	1.10	1.30	1.70	2.00	2.75	3.00	3.00
80K	1.10	1.35	1.20	1.70	2.10	2.85	3.00	3.00
85K	1.10	1.50
90K	1.10	1.60	1.20
95K	1.10
100K	1.10	1.75	1.20	1.70	2.25	3.00	3.00	3.00
125K	1.40	2.00	3.10	3.20	3.75
150K	1.40	2.25	3.25	3.50	3.75
175K	1.50	2.25	3.35
200K	1.60	3.00	3.75

"GREENOHM"* ADJUSTABLE WIRE-WOUND RESISTORS



Same electrical and mechanical construction as "Greenohm" fixed resistors. Incorporates sliding band for tapping any desired resistance. Slider band tightened by means of screw at desired setting. In accordance with RETMA standards, overall tolerances are $\pm 10\%$.

SERIES AC-10-FA—Rated 10 watts. $\frac{3}{8}$ " dia. by $1\frac{1}{2}$ " long. Lead wires and tinned lugs. Standard Packing—10 per carton. Extra Slider Band: \$0.10 each.

SERIES A-25-KA—Rated 25 watts. $\frac{3}{8}$ " dia. by $2\frac{1}{2}$ " long. Tinned lugs. Supplied with mounting brackets. Standard Packing—Individually Boxed. Extra Slider Band: \$0.25 each.

SERIES K-50-NA—Rated 50 watts. $\frac{3}{4}$ " dia. by $4\frac{1}{2}$ " long. Supplied with mounting brackets. Standard Packing—Individually Boxed. Extra Slider Band: \$0.25 each.

SERIES K-80-NA—Rated 80 watts. $\frac{3}{4}$ " dia. by $6\frac{1}{2}$ " long. Supplied with mounting brackets. Standard Packing—Individually Boxed. Extra Slider Band: \$0.25 each.

SERIES K-100-WA—Rated 100 watts. $1\frac{1}{8}$ " dia. by $6\frac{1}{2}$ " long. Supplied with mounting brackets. Standard Packing—Individually Boxed. Extra Slider Band: \$0.25 each.

SERIES K-160-WA—Rated 160 watts. $1\frac{1}{8}$ " dia. by $8\frac{1}{2}$ " long. Supplied with mounting brackets. Standard Packing—Individually Boxed. Extra Slider Band: \$0.25 each.

SERIES K-200-WA—Rated 200 watts. $1\frac{1}{8}$ " dia. by $10\frac{1}{2}$ " long. Supplied with mounting brackets. Standard Packing—Individually Boxed. Extra Slider Band: \$0.25 each.

Res. Ohms	Series AC-10-FA List Price	Series A-25-KA List Price	Series K-50-NA List Price	Series K-80-NA List Price	Series K-100-WA List Price	Series K-160-WA List Price	Series K-200-WA List Price
1	\$0.85	\$0.95
2	.85	.95
3	.85	.95
5	.85	.95	\$1.50	\$1.75	\$2.00	\$2.50	\$3.00
7.5	.85	.95
10	.85	.95	1.50	1.75	2.00	2.50	3.00
15	.85	.95	1.50	1.75	2.00	2.50	3.00
20	.85	.95	1.50	1.75	2.00	2.50	3.00
25	.85	.95	1.50	1.75	2.00	2.50	3.00
50	.85	.95	1.50	1.75	2.00	2.50	3.00
75	.85	.95	1.50	1.75	2.00	2.50	3.00
100	.85	.95	1.50	1.75	2.00	2.50	3.00
150	.85	.95	1.50	1.75	2.00	2.50	3.00
200	.85	.95	1.50	1.75	2.00	2.50	3.00
250	.85	.95	1.50	1.75	2.00	2.50	3.00
300	.85	.95	1.50	1.75	2.00	2.50	3.00
350	.85	.95	1.50	1.75	2.00	2.50	3.00
400	.85	.95	1.50	1.75	2.00	2.50	3.00
500	.85	.95	1.50	1.75	2.00	2.50	3.00
600	.85	.95
750	.85	.95	1.50	1.75	2.00	2.50	3.00
800	.85	.95
1000	.85	.95	1.50	1.75	2.00	2.50	3.00
1250	.85	.95	1.50	1.75	2.00	2.50	3.00
1500	.85	.95	1.50	1.75	2.00	2.50	3.00
2000	.85	.95	1.50	1.75	2.00	2.50	3.00
2250	.85	.95
2500	.85	.95	1.50	1.75	2.00	2.50	3.00
3000	.85	.95	1.50	1.75	2.00	2.50	3.00
3500	.85	.95	1.50	1.75	2.25	2.50	3.00
4000	.85	.95	1.50	1.75	2.25	2.50	3.00
4500	.85	.95	1.50	1.75	2.25	2.50	3.00
5000	.85	.95	1.50	1.75	2.25	2.65	3.25
6000	.85	1.10	1.75	2.00	2.25	2.65	3.25
7000	.85	1.10	1.75	2.00	2.25	2.65	3.25
7500	.85	1.10	1.75	2.00	2.25	2.65	3.25
8000	.85	1.10	1.75	2.00	2.25	2.65	3.25
8500	.85
9000	.85	1.10	1.75	2.00	2.25	2.65	3.25
10K	.85	1.10	1.75	2.00	2.25	2.65	3.25
12K	1.10	1.75	2.00	2.25	2.90	3.50
15K	1.10	1.75	2.00	2.25	3.25	3.75
20K	1.25	1.75	2.00	2.25	3.25	3.75
25K	1.25	1.75	2.00	2.25	3.25	3.75
30K	2.00	2.25	2.75	3.25	3.75
35K	2.00	2.25	2.75	3.25	3.75
40K	2.00	2.25	2.75	3.25	3.75
45K	2.00	2.25	2.75	3.25	3.75
50K	1.50	2.00	2.25	2.75	3.25	3.75
60K	2.50	2.75	3.00	3.25	3.75
75K	2.50	2.75	3.00	3.25	3.75
80K	2.50	2.75	3.50	3.75	4.25
100K	2.50	2.75	3.50	3.75	4.25
125K	3.50	4.25
150K	3.75	4.25

* Reg. U. S. Pat. Off.

TM

"GLASOHM"* FLEXIBLE RESISTORS

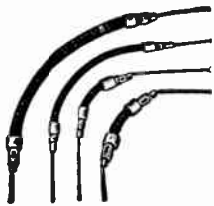

Fixed wire-wound resistors on glass fibre core with flexible woven glass filter casing. Made up to any length on order. A substitute for a wide range of carbon resistors. Standard types 1" long with 2" pigtail leads, 1/8" dia. RETMA color coded. RETMA overall tolerances are plus/minus 10%.

LIST PRICE \$0.30
 Standard Packing: 10 per carton.

Cat. No.	Ohms	Cat. No.	Ohms	Cat. No.	Ohms	Cat. No.	Ohms
FYG5	5	FYG75	75	FYG350	350	FYG850	850
FYG10	10	FYG100	100	FYG375	375	FYG900	900
FYG15	15	FYG125	125	FYG400	400	FYG1000	1000
FYG25	25	FYG150	150	FYG500	500	FYG1250	1250
FYG35	35	FYG200	200	FYG600	600	FYG1500	1500
FYG40	40	FYG225	225	FYG700	700	FYG1600	1600
FYG50	50	FYG250	250	FYG750	750	FYG1750	1750
FYG60	60	FYG300	300	FYG800	800	FYG2000	2000

"GREENOHM"* RESISTOR KIT

Wall Card holding 20 most popular sized 10-watt "Greenohm" resistors. As units are removed, value appears on card for reordering. Metal clips afford easy mounting of units replaced. Dimensions: 10 1/2" x 12".

Wall card contains Wire-Wound Fixed Power Resistors as follows:

Cat. No. GK-1.....LIST PRICE \$11.00

1 each	25 ohms
1 each	250 ohms
2 each	500 ohms
1 each	750 ohms
2 each	1,000 ohms
1 each	1,250 ohms
1 each	1,500 ohms
1 each	2,000 ohms
1 each	2,500 ohms
2 each	5,000 ohms
1 each	7,500 ohms
2 each	10K ohms
1 each	12.5K ohms
2 each	15K ohms
1 each	25K ohms

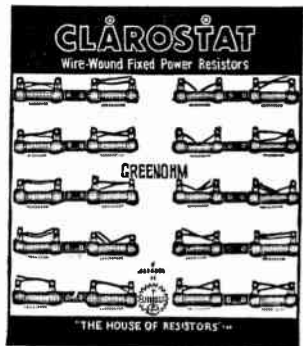

POWER RESISTOR DECADE BOX



The Resistance Decade Box Model No. 240B allows changing resistance at a flip of the switch in a working circuit. Any value obtainable from 1 ohm to 999,999 in steps of one ohm and at a maximum power rating of 225 watts using a maximum of 1000 volts D.C. or 660 volts A.C.

Resistance changing switches are of the type that prevents a resistance breakdown between steps, thus protecting delicate meters and measuring instruments in the circuit. Pointer knobs indicate at a glance the resistance value being used.

Clarostat "Greenohm" resistors are used

throughout. These are inorganic-cement-coated wire-wound power resistors. The resistors are mounted on rigid metal supports. A baffle plate separating the resistor bank from the switch assembly protects the latter against heat.

The heavy-gauge metal case is finished in frosted gray wrinkle, with an etched black-and-aluminum front panel. 13 in. long; 8 1/2 in. deep; 5 3/4 in. high. Weight, 11 lbs.

SUGGESTED USES: Resistance determination. Load Resistance. Meter Multiplier. Calibrating Meters. Providing any desired ohmage as a universal power resistor.

Decade No.	Maximum Current Ratings:	Resistance Tolerance	Decade No.	Maximum Current Ratings:	Resistance Tolerance
Decade No. 1	5 amp.	5%	Decade No. 4	.15 amp.	2%
Decade No. 2	1.5 amp.	2%	Decade No. 5	.05 amp.	2%
Decade No. 3	.5 amp.	2%	Decade No. 6	.005 amp.	2%

NET PRICE.....\$90.00



U. S. Pat.
2,552,342

TV TUBE BEAM BENDERS

Available in either single or double magnet types. Spring collar provides mounting on tube neck. No screws to tighten.



SINGLE MAGNET TYPE TV-2

For all tubes requiring only one bend in beam, either electromagnetic or electrostatic, as listed below:

ELECTROMAGNETIC				ELECTROSTATIC		
12QP4	16KP4	17UP4	21WP4	12YP4	17RP4	21DP4
12RP4	16TP4	17YP4	21ZP4	14QP4	17SP4	21FP4
12UP4B	16UP4	19AP4	22AP4	14HP4	17TP4	21GP4
12WP4	16VP4	19DP4	24AP4	16ABP4	17VP4	21KP4
14CP4	16YP4	19EP4	24CP4	16ACP4	19QP4	21MP4
14EP4	16ZP4	19GP4	27EP4	16AEP4	20FP4	21XP4
14FP4	17AP4	19JP4	27GP4	17AP4	20GP4	21YP4
15DP4	17BP4	20CP4	27LP4	17GP4	20HP4	24BP4
B1014P4	17CP4	20DP4	27NP4	17HP4	20JP4	24DP4
16FP4	17JP4	21AP4	27RP4	17KP4	20LP4	27AP4
16GP4	17QP4	21EP4	30BP4	17LP4	20MP4	

LIST PRICE \$2.00

Standard Packing: Individual Carton.

*Reg. U. S. Pat. Off.

DOUBLE MAGNET TYPE TV-3

For all tubes requiring two bends in beam, such as following types:

10BP4	14DP4	16LP4
10EP4	15CP4	16MP4
10MP4	16AP4	16QP4
12LP4	16CP4	16RP4
12TP4	16DP4	16SP4
12UP4	16EP4	16WP4
12VP4	16HP4	16XP4
14BP4	16JP4	

LIST PRICE \$3.00

Standard Packing: Individual Carton.



TYPE 25R



TYPE 50R

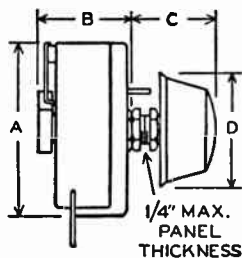
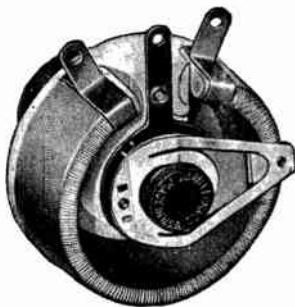

DIMENSION SKETCH

SEE DIMENSIONS HEADING EACH TABLE

25-Watt — 50-Watt

The Ward Leonard 25-watt (Type 25R) and 50-watt (Type 50R) Type Rheostats are especially suited for use in electronic and electrical circuits where gradual and positive resistance change is essential. Balanced contact arms, self-lubricating metal graphite contact shoes, and no backlash in the drive shaft combine to assure uniform contact pressure and smooth operation.

Standard shaft length for back-of-board mounting on 1/4" panel.

25 WATTS TYPE 25R				50 WATTS TYPE 50R			
Dimensions: A-1 13/16" B-1 1/8"				Dimensions: A-2 1/16" B-1 1/8"			
C-1" D-1 1/8"				C-1 1/8" D-1 1/8"			
Current M.A.	Approx. No. of Steps	List Price	Ohms	Current M.A.	Approx. No. of Steps	List Price	
5000	27	\$7.03	1	7070	49	\$7.81	
3540	27	6.22	2	5000	49	7.81	
2880	27	6.22	3				
			4	3540	59	7.03	
2040	81	6.22	6	2880	108	7.03	
1770	90	6.22	8	2500	113	7.03	
1580	90	6.22	10	2230	150	7.03	
1280	103	6.22	15	1810	150	7.03	
1000	103	6.22	25	1415	188	7.03	
840	108	6.22	35	1190	119	7.03	
707	137	6.22	50	1000	188	7.03	
574	137	6.22	75	812	188	7.03	
500	171	6.22	100	707	225	7.03	
407	171	6.22	150	574	225	7.03	
316	240	6.22	250	447	300	7.03	
267	274	6.22	350	374	338	7.03	
223	308	6.22	500	316	375	7.03	
181	308	6.22	750	256	450	7.39	
158	390	7.03	1000	223	450	7.39	
128	376	7.03	1500	181	570	7.39	
100	520	7.03	2500	141	570	7.39	
84	520	7.39	3500	119	713	7.81	
70	520	7.39	5000	100	713	7.81	
			7500	81	855	7.81	
			10000	70	998	7.81	

The Ring Rheostats shown on this page are standard values and sizes carried in stock at our factory and by our Distributors. Information concerning Rheostats of special construction available on request.

100-Watt — 150-Watt

The Ward Leonard 100-watt (Type 100R) and 150-watt (Type 150R) Ring Type Rheostats are of sturdy construction for electrical applications, such as control of fractional h.p. motors, rectifiers, voltage regulators, and some electronic circuits, such as filament and battery control.

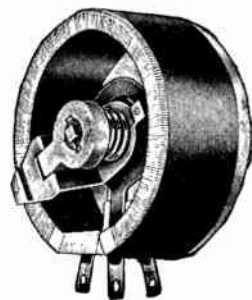

TYPE 100R



TYPE 150R



For Correct Current Control Use Ward Leonard

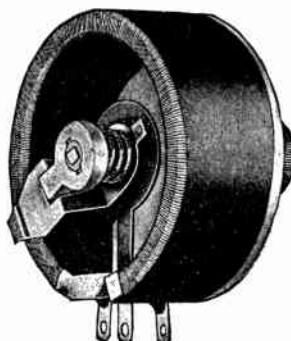

100 WATTS TYPE 100R				150 WATTS TYPE 150R			
Dimensions: A-3 5/8" B-1 1/4"				Dimensions: A-3 13/16" B-2"			
C-1 1/8" D-1 1/2"				C-1 1/8" D-1 1/2"			
Current M.A.	Approx. No. of Steps	List Price	Ohms	Current M.A.	Approx. No. of Steps	List Price	
10000	41	\$11.70	1	12240	43	\$14.83	
7070	41	11.70	2	8660	43	14.83	
5740	72	11.70	3	7070	54	14.83	
4470	82	11.70	5	5470	107	14.83	
3640	82	10.95	7.5	4470	107	14.83	
3160	72	10.95	10	3870	107	14.03	
2560	156	10.95	15	3160	107	14.03	
2000	196	10.95	25	2440	204	14.03	
1415	274	10.95	50	1730	245	14.03	
1150	313	10.95	75	1415	286	14.03	
1000	274	10.95	100	1224	367	14.03	
707	313	10.95	200	866	326	14.03	
574	353	10.95	300	707	408	14.03	
500	392	10.95	400	612	408	14.03	
447	392	10.95	500	547	489	14.03	
364	464	10.95	750	447	489	14.83	
316	470	11.70	1000	387	620	14.83	
223	595	11.70	2000	273	775	15.81	
200	744	11.70	2500	244	775	15.81	
141	893	12.47	5000	173	930	16.36	
115	893	13.28	7500	141	1240	17.17	
100	1041	14.03	10000	122	1240	18.72	

Copyright by U. C. P., Inc.

TRADE DISCOUNT APPLIES TO LIST PRICES ONLY

Radio's Master — 19th Edition

Page R-37



CONTROLS

BLUE SHAFT RADIOHMS®



The most widely accepted line of 15/16" diameter carbon-type controls, constructed to meet exacting

radio, television, and industrial standards. Switch types are tested to assure instant, smooth, positive operation. Blue, anodized aluminum shafts, 3" long with universal mill. Rating 1/2 watt. Type BSK units have 2 1/8" brass split-knurl shafts. Switches are universal DPST, easily wired for SPST or 3-wire use.

Ohm. Max. Resistance	Taper or Tap	Cat. No. Plain	Cat. No. w/Switch	List Price Plain	List Price w/Switch
500	C1	B-4	B-4-S	\$1.25	\$1.75
1,000	C1	B-5	B-5-S	.125	.175
2,000	C1	B-6	B-6-S	.125	.175
2,500	C1	B-7	B-7-S	.125	.175
3,000	C1	B-8	B-8-S	.125	.175
5,000	C1	B-10	B-10-S	.125	.175
5,000	C2	B-11	B-11-S	.125	.175
5,000	C5	B-12	B-12-S	.125	.175
6,500	C1	B-13	B-13-S	.125	.175
10,000	C1	B-14	B-14-S	.125	.175
10,000	C2	B-15	B-15-S	.125	.175
10,000	C4	B-18	B-18-S	.125	.175
10,000	C5	B-17	B-17-S	.125	.175
10,000	C6	B-16	B-16-S	.125	.175
15,000	C6	B-20	B-20-S	.125	.175
20,000	C1	B-22	B-22-S	.125	.175
20,000	C5	B-23	B-23-S	.125	.175
20,000	C6	B-24	B-24-S	.125	.175
25,000	C1	B-26	B-26-S	.125	.175
25,000	C5	B-27	B-27-S	.125	.175
25,000	C6	B-28	B-28-S	.125	.175
50,000	C1	B-31	B-31-S	.125	.175
50,000	C2	B-32	B-32-S	.125	.175
50,000	25K	BT-33	BT-33-S	.85	2.35
75,000	C1	B-35	B-35-S	.125	.175
100,000	C1	B-40	B-40-S	.125	.175
100,000	C2	B-41	B-41-S	.125	.175
150,000	C2	B-44	B-44-S	.125	.175
200,000	C1	B-46	B-46-S	.125	.175
250,000	C1	B-50	B-50-S	.125	.175
250,000	C2	B-51	B-51-S	.125	.175
250,000	C5	B-52	B-52-S	.125	.175
250,000	125K	BT-53	BT-53-S	.85	2.35
250,000	75K	BT-55	BT-55-S	.85	2.35
350,000	70K	BT-57	BT-57-S	.85	2.35
1/2 meg.	C1	B-59	B-59-S	.125	.175
1/2 meg.	C2	B-60	B-60-S	1.00	1.50
1/2 meg.	C4	B-58	B-58-S	.125	.175
1/2 meg.	C5	B-61	B-61-S	.125	.175
1/2 meg.	C7	B-617	B-617-S	.125	.175
1/2 meg.	50K	BT-63	BT-63-S	.85	2.35
1/2 meg.	100K	BT-66	BT-66-S	.85	2.35
1/2 meg.	150K	BT-67	BT-67-S	.85	2.35
1/2 meg.	250K	BT-65	BT-65-S	.85	2.35
1 meg.	C1	B-69	B-69-S	.125	.175
1 meg.	C2	B-70	B-70-S	1.00	1.50
1 meg.	C4	B-744	B-744-S	.125	.175
1 meg.	C5	B-68	B-68-S	.125	.175
1 meg.	C7	B-697	B-697-S	.125	.175
1 meg.	100K	BT-74	BT-74-S	.85	2.35
1 meg.	200K	BT-72	BT-72-S	.85	2.35
1 meg.	300K	BT-73	BT-73-S	.85	2.35
1 meg.	1/2 meg.(50%)	BT-71	BT-71-S	.85	2.35
1 meg.	1/2 meg.(62%)	BT-7417	BT-7417-S	.85	2.35
2 mgs.	C1	B-75	B-75-S	.125	.175
2 mgs.	C2	B-76	B-76-S	.125	.175
2 mgs.	C5	B-77	B-77-S	.125	.175
2 mgs.	200K	BT-81	BT-81-S	.85	2.35
2 mgs.	400K	BT-79	BT-79-S	.85	2.35
2 mgs.	600K	BT-80	BT-80-S	.85	2.35
2 mgs.	1 meg.(50%)	BT-78	BT-78-S	.85	2.35
2 mgs.	1 meg.(62%)	BT-82	BT-82-S	.85	2.35
2 1/2 mgs.	C1	B-83	B-83-S	.125	.175
3 mgs.	C1	B-84	B-84-S	.125	.175
3 mgs.	C2	B-85	B-85-S	.125	.175
4 mgs.	C1	B-86	B-86-S	.125	.175
5 mgs.	C1	B-87	B-87-S	.125	.175
7 mgs.	C7	B-89	B-89-S	.125	.175
10 mgs.	C1	B-98	B-98-S	.125	.175
250,000	C2	BSK-51	BSK-51-S	1.10	1.60
1/2 meg.	C2	BSK-60	BSK-60-S	1.10	1.60
1/2 meg.	100K	BTSK-66	BTSK-66-S	.85	2.35
1/2 meg.	150K	BTSK-67	BTSK-67-S	.85	2.35
1 meg.	C2	BSK-70	BSK-70-S	1.10	1.60
1 meg.	200K	BTSK-72	BTSK-72-S	.85	2.35

FASTATCH† SWITCHES

TYPE KB—For field attachment to plain Type B and AB controls bearing blue and white label. Easiest switch on the market to install. Rated 5 amps. 125 V.A.C., underwriters approved. Packaged 1 per carton.

Type	Cat. No.	List Price
SPST	KB-1	\$0.50
DPST	KB-2	.60
SPDT	KB-3	.75
SPST 8 amp A.C.	KB-4	.85

†Trade Mark

TYPE "AB" ADASHAFT RADIOHMS®

SELECT THE CONTROL

ADD-A-SHAFT TO MEET YOUR NEEDS

Adashaft Controls are now built in the popular Model "B"—15/16" construction. The basic control unit is constructed with a patented stub shaft . . . usable just this way in many cases as a short, screwdriver slotted unit. A selection of nine basic shaft types are available, ranging from 3/8" to 10" in length, including auto types, insulating nylon and many others. This original, patented Centralab construction permits instant locking . . . resulting in a solid, integral, well aligned unit. There is no price premium on Adashaft . . . you pay for exactly what you need. After adding the required shaft, the units may be



converted to switch type with the new "Fastatch"† type KB line switches. All "AB" characteristics same as Model B. Packaged—singly including all data.

Ohms Max. Resistance	Taper or Tap	CRL Cat. No.	Ohms Max. Resistance	Taper or Tap	CRL Cat. No.
200	C1	AB-2	250,000	125K(62%)	ABT-56
500	C1	AB-4	350,000	70K	ABT-57
750	C5	AB-415	1/2 meg.	C1	AB-59
1,000	C1	AB-5	1/2 meg.	C2	AB-60
1,000	C5	AB-505	1/2 meg.	C4	AB-58
1,500	C5	AB-515	1/2 meg.	C5	AB-61
2,000	C1	AB-6	1/2 meg.	C6	AB-616
2,500	C1	AB-7	1/2 meg.	C7	AB-617
2,500	C5	AB-705	1/2 meg.	50K(37%)	ABT-62
3,000	C1	AB-8	1/2 meg.	50K(50%)	ABT-63
4,000	C1	AB-9	1/2 meg.	100K	ABT-66
5,000	C1	AB-10	1/2 meg.	150K	ABT-67
5,000	C2	AB-11	1/2 meg.	250K(50%)	ABT-65
5,000	C5	AB-12	1/2 meg.	250K(62%)	ABT-64
6,500	C1	AB-13	1 meg.	C1	AB-69
10,000	C1	AB-14	1 meg.	C2	AB-70
10,000	C2	AB-15	1 meg.	C4	AB-744
10,000	C4	AB-18	1 meg.	C5	AB-68
10,000	C5	AB-17	1 meg.	C7	AB-697
10,000	C6	AB-16	1 meg.	500K	ABT-71
15,000	C5	AB-19	1 meg.	200K	ABT-72
15,000	C6	AB-20	1 meg.	300K	ABT-73
20,000	C1	AB-22	1 meg.	500K	ABT-74
20,000	C5	AB-23	1 meg.	100K	ABT-7417
20,000	C6	AB-24	2 mgs.	C1	AB-75
25,000	C1	AB-26	2 mgs.	C2	AB-76
25,000	C4	AB-29	2 mgs.	C5	AB-77
25,000	C5	AB-27	2 mgs.	200K	ABT-81
25,000	C6	AB-28	2 mgs.	400K	ABT-79
50,000	C1	AB-31	2 mgs.	600K	ABT-80
50,000	C2	AB-32	2 mgs. 1 meg.(50%)	ABT-78	
50,000	C5	AB-34	2 mgs. 1 meg.(62%)	ABT-82	
50,000	25K	ABT-33	2 1/2 mgs. C1	AB-83	
75,000	C1	AB-35	3 mgs.	C1	AB-84
75,000	C5	AB-36	3 mgs.	C2	AB-85
100,000	C1	AB-40	3 mgs.	C5	AB-855
100,000	C2	AB-41	3 mgs.	300K	ABT-8515
100,000	50K	ABT-39	(50% Rot.)		
150,000	C2	AB-44	3 mgs. 300K	ABT-8517	
200,000	C1	AB-46	(37% Rot.)		
200,000	100K	ABT-47	4 mgs. C1	AB-86	
250,000	C1	AB-50	4 mgs. C2	AB-862	
250,000	C2	AB-51	5 mgs. C1	AB-87	
250,000	C5	AB-52	5 mgs. C2	AB-88	
250,000	50K	ABT-54	7 mgs. C7	AB-89	
250,000	75K	ABT-55	10 mgs. C1	AB-98	
250,000	125K(50%)	ABT-53			

AB 60 and AS 70	List Price \$0.95
All other AB units	List Price \$1.10
All ABT units	List Price \$1.70



CONTROLS (Cont'd)

DUAL TAPPED AB ADASHAFTS

Ohms Max.	Cat. No.	Taps — Ohms	Ohms Max.	Cat. No.	Taps — Ohms
15K	ABT-154	5K and 10K	1 meg.	ABT-165	200K and 500K
250,000	ABT-155	50K and 125K	1.5 megs.	ABT-167	250K and 500K
250,000	ABT-156	41K and 82K	2 megs.	ABT-174	250K and 500K
500,000	ABT-159	82K and 165K	2 megs.	ABT-175	400K and 1 meg.
500,000	ABT-160	100K and 250K	2.5 megs.	ABT-176	300K and 625K
1 meg.	ABT-164	165K and 330K			

LIST PRICE ON ALL ABOVE ITEMS.....\$1.70 EA.

HANDY-ADASHAFT KIT

14 AB Adashaft controls, 17 shafts and couplers, and 6-"KB" switches CAT. No. AB-100. List Price \$22.30

ADASHAFT SHAFTS—COUPLERS—SHAFT EXTENSIONS

Cat. No.	Description	List Price
AK-1	Fingertip knurl and screwdriver slot 3/8" long from bushing	\$.15
AK-2	1-9/16" long from bushing, with .078"-wide slot	.20
AK-3	Universal fluted mill full length, 3" long from bushing	.15
AK-4	Split knurl shaft 3-7/8" long from bushing	.25
AK-5	3" from bushing auto type with guide funnel	.55
AK-6	6" from bushing auto type with guide funnel	.65
AK-8	3/16" diameter, full round, 2-1/8" long from bushing	.30
AK-9	1/4" diameter, full round, 2-1/8" long from bushing	.30
AK-10	10" long from bushing, with flat mill .216" x 4-5/16"	.30
AK-16	Coupler adaptable to 1/4" and 1/4" or 1/4" and 3/16" shafts	.40
AK-19	Insulating nylon, 2-1/16" long from bushing	.55
AK-21	Shaft extension 4" long, 1/4" diam., .218" flat	.40
AK-22	Shaft extension 4" long, 1/4" diam., .154" flat	.40
AK-23	Shaft extension 4" long, 3/16" diam., .172" flat	.40
AK-24	1/4" diameter, full round, 3/8" from bushing	.15
AK-25	1/4" diameter, flattened to .218", 3/8" from bushing	.15

MODEL "BB" TWIN RADIOHMS®



Two tandem-mounted Model B 15/16"-diameter Radiohms operated by a single shaft. Specifications same as Model B Blue Shaft Radiohms. Shaft 3" from 3/8"-long bushing, universal fluted mill full length. 1 per carton.

FRONT SECTION		REAR SECTION		CRL Cat. No.
Ohms Max. Resistance	Taper	Ohms Max. Resistance	Taper	
10,000	C1	25,000	C1	BB-1001
10,000	C1	50,000	C1	BB-1011
10,000	C2	50,000	C1	BB-101
10,000	C4	25,000	C3	BB-100
50,000	C1	50,000	C1	BB-1051
50,000	C3	50,000	C3	BB-105
100,000	C1	100,000	C1	BB-1021
100,000	C2	100,000	C2	BB-102
250,000	C1	250,000	C1	BB-1031
250,000	C2	250,000	C2	BB-103
500,000	C1	500,000	C1	BB-1041
500,000	C2	500,000	C2	BB-104
1 meg.	C1	1 meg.	C1	BB-102
1 meg.	C2	1 meg.	C2	BB-107
2 megs.	C1	2 megs.	C1	BB-110
5 megs.	C1	5 megs.	C1	BB-112

List Price.....\$2.50 ea.

MODEL "SVP" FOUR WATT WIREWOUND LINEAR TAPER

1-25/32" diam., 31/32" deep. Not available in switch types.

SVP-982 to SVP-990	3/8" fingertip knurl and slot shaft	List Price
SVP-991 to SVP-996 <td>2 1/4" full length split knurl shaft</td> <td>2.35</td>	2 1/4" full length split knurl shaft	2.35
SVP-997 to SVP-999 <td>3" full length mill shaft</td> <td>2.25</td>	3" full length mill shaft	2.25

Ohms Resistance	Cat. No.	Cat. No.	Cat. No.
	3/8" Shaft	Sp. Knurl	3" Shaft
25	SVP-982	—	—
100	SVP-983	—	—
200	SVP-984	—	SVP-997
400	—	SVP-991	—
500	SVP-985	—	—
600	—	SVP-992	—
750	SVP-986	—	—
1000	—	SVP-993	—
1500	—	SVP-994	—
2000	—	—	SVP-998
2200	SVP-987	—	—
2500	SVP-988	—	—
5000	SVP-989	—	SVP-999
7500	SVP-990	—	—
10000	—	SVP-995	—
20000	—	SVP-996	—

HANDY PLASTI-PAKS

12 UNITS — MODELS B AND BSK IN PLASTIC BOXES

Popular 1/2 and 1 Meg. Audio taper Model B Blue shaft controls furnished in plastic kits of 12 controls each. The hinged lid kit is 8 1/4" x 4 1/4" x 1 1/4" deep. The following six assortments are available.

Cat. No.	Description	List Price
BP-1	PAK-12 Cat. No. B-60 plain controls, 1/2 Megohm, C2 Audio taper	\$12.00
BP-2	PAK-12 Cat. No. B-70 plain controls, 1 Megohm, C2 Audio taper	12.00
BP-3	PAK-12 Cat. No. B-60-S switch type controls, 1/2 Megohm, C2 Audio taper	18.00
BP-4	PAK-12 Cat. No. B-70-S switch type controls, 1 Megohm, C2 Audio taper	18.00
BP-9	PAK-2 Cat. No. B-60 plain, 1/2 Megohm—C2; 5 Cat. No. B-60-S switch, 1/2 Megohm—C2; 2 Cat. No. B-70 plain, 1 Megohm—C2; 3 Cat. No. B-70-S switch, 1 Megohm—C2	16.00
BP-12	PAK SNAP-TITE RADIOHMS. List	\$9.00
1 Bx—10 (5K—C1)	1 Bx—83 (2 1/2 Meg—C1)	
1 Bx—40 (100K—C1)	1 Bx—84 (3 Meg—C1)	
2 Bx—59 (500K—C1)	2 Bx—31 (50K—C1)	
1 Bx—742 (1 1/2 Meg—C1)	1 Bx—46 (200K—C1)	
1 Bx—75 (2 Meg—C1)	1 Bx—69 (1 Meg—C1)	

B-A AND B-B METAL CABINET

KITS OF 22 CONTROLS

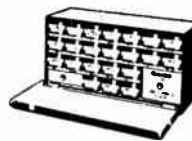

Two assortments of popular Model B Blue Shaft Controls are furnished in handy, useful cabinets at no price premium. The B-A Kit contains values you use every day. Half and one Megohm, audio taper units only. The B-B Kit contains fifteen different types . . . the fifteen controls most often used in radio and television service. The kits contain no slow movers.

KIT DEAL B-A

22 Controls—Values You Use Every Day

PLAIN TYPE				SWITCH TYPE			
Quan.	Cat. No.	Ohms Resist.	Taper	Quan.	Cat. No.	Ohms Resist.	Taper
3	B-60	1/2 meg.	C2	5	B-60-S	1/2 meg.	C2
2	B-70	1 meg.	C2	3	B-70-S	1 meg.	C2
2	BSK-60	1/2 meg.	C2	3	BSK-60-S	1/2 meg.	C2
2	BSK-70	1 meg.	C2	2	BSK-70-S	1 meg.	C2

Plus one metal cabinet.....List Price \$29.40

KIT DEAL B-B

22 Controls—15 Types Most Used in Radio and TV

PLAIN TYPE				SWITCH TYPE			
Quan.	Cat. No.	Ohms Resist.	Taper	Quan.	Cat. No.	Ohms Resist.	Taper
1	B-5	1,000	C1	3	B-60-S	1/2 meg.	C2
1	B-10	5,000	C1	1	BSK-60-S	1/2 meg.	C2
1	B-26	25,000	C1	2	B-70-S	1 meg.	C2
2	B-31	50,000	C1	1	BT-80-S	2 megs.-T-600K	C13
2	B-40	100,000	C1				
1	B-59	500,000	C1				
2	B-69	1 meg.	C1				
1	B-75	2 megs.	C1				
2	B-83	2.5 megs.	C1	1	KB-1		SPST
1	B-84	3 megs.	C1	1	KB-2		DPST
1	B-87	5 megs.	C1	1	KB-3		SPDT

Plus one metal cabinet.....List Price \$32.55

CONTROLS (Cont'd)

MODEL "A" 1 WATT PATENTED NON-RUBBING CONTACT CONTROLS



Wall type resistor element provides one-third longer effective resistor length assuring low noise level, closer taper tolerance, double load carrying ability. Patented non-rubbing contact

eliminates all friction between resistance element and contacting member assuring accuracy . . . the resistance strip CAN'T wear out.

Ohms Max. Resistance	Taper	Cat. No.	Ohms Max. Resistance	Taper	Cat. No.
500	C1	A-100	500,000	C1	A-128
1,000	C1	A-101	500,000	C2	A-130
2,000	C1	A-102	1 meg.	C1	A-232
5,000	C1	A-105	1 meg.	C2	A-132
10,000	C1	A-108	2 megs.	C1	A-233
25,000	C1	A-115	2 megs.	C2	A-133
50,000	C1	A-118	3 megs.	C1	A-234
50,000	C2	A-119	3 megs.	C2	A-134
100,000	C1	A-122	5 megs.	C1	A-249
100,000	C2	A-123	5 megs.	C2	A-149
250,000	C1	A-227	10 megs.	C1	A-250
250,000	C2	A-227	10 megs.	C2	A-150

List Price.....\$1.75 ea.

SWITCHES FOR MODEL "A" AND "V" CONTROLS

Attachable switch "covers" are rated at 3 amps. 125 V.A.C.



TYPE	CAT. NO.	LIST PRICE
SPST	K-10	\$0.60
SPDT	K-11	.75
DPST	K-12	.75

MODEL "V" AND "VK" WIREWOUND RADIOHMS® 3 WATT LINEAR TAPER

Model "V" smooth action wirewound controls are regularly furnished without switches. Attachable switches are available, as listed above 1-7/16" diameter, 9/16" depth behind mounting surface. Shafts: "V"—3" fluted mill; "VK"—3/8" fingertip knurl and slot. "VK" series not adaptable to switch type.

Ohms Resistance	Cat. No. "V"	Cat. No. "VK"	Ohms Resistance	Cat. No. "V"	Cat. No. "VK"
2	V-100	—	200	V-123	VK-123
4	V-102	—	300	V-125	VK-125
6	V-104	—	400	V-126	VK-126
8	V-106	—	500	V-127	VK-127
10	V-108	—	750	V-128	—
15	V-109	—	1000	V-129	VK-129
20	V-110	VK-110	1500	V-130	VK-130
25	V-111	VK-111	2000	V-131	VK-131
30	V-112	VK-112	2500	V-132	VK-132
40	V-114	—	3000	V-133	VK-133
50	V-116	VK-116	4000	V-134	VK-134
60	V-117	VK-117	5000	V-135	VK-135
75	V-118	—	7500	V-136	—
100	V-121	VK-121	10000	V-137	VK-137

List Price.....\$1.85 ea.

STANDARD RESISTANCE TAPERS

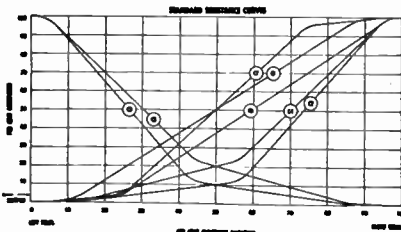

SNAP-TITE* REPLACEMENT CONTROL For speed-servicing of "hidden" volume controls



The revolutionary new Centralab control with amazing time-saving features:

- SNAP-TITE is installed by just pushing it into the chassis mounting hole. It holds itself in place.
- No tools needed for mounting; no nuts, lockwashers, or any other hardware. A clean, fast replacement.
- Six spring clips grip the panel for positive, non-twist mounting.
- Replaces any standard control type. (One or two locating lugs.)
- Shaft is molded, high-strength polystyrene, fingertip knurled and slotted for screwdriver adjustment. Extends 1/2" from face of mounting surface.

The ten values below will replace 75% of current rear-end or "hidden" television controls:

Max. Resistance	Taper	Cat. No.	Max. Resistance	Taper	Cat. No.
5000	C1	8X-10	1 meg.	C1	BX-69
50K	C1	8X-31	1 1/2 megs.	C1	BX-72
100K	C1	8X-40	2 megs.	C1	BX-75
200K	C1	8X-46	2 1/2 megs.	C1	BX-83
500K	C1	8X-59	3 megs.	C1	BX-84

List Price.....\$1.75 each

*Trademark

THE COMPENTROL †



The COMPENTROL is a volume control and special Printed Electronic Circuit network designed to better reproduce the apparent bass and treble response of amplifiers, radio, and television sets when volume is at low level. For use in radio sets (5 or more tube AC or DC), audio amplifiers, or phono combinations.

Resistance	Type	Cat. No.
1/2 meg.	Plain Type	C1-60
1/2 meg.	Switch Type	C1-60-S
1 meg.	Plain Type	C1-70
1 meg.	Switch Type	C1-70-S

User Net Price—Plain.....\$2.50 ea. Switch.....\$3.00 ea.

SENIOR COMPENTROL WITH LEVEL-SET



There's nothing else like it. Lets you control bass and treble compensation to your own tastes — not possible with any other compensated volume control. A universal unit that replaces any value without additional amplification. Special knobs furnished.

Cat. No. C2-100.....Net Price \$4.50 †Trademark

MODEL "SVT" CENTER TAPPED WIREWOUND RADIOHMS®

Tapped at 50% rotation—otherwise similar electrically to Model "V" Wirewound Linear Taper. Furnished with 3/8" fingertip knurl and screwdriver slot shaft. Units are not adaptable to switches.

Ohms Resistance	Tap Resistance	Cat. No.
20	10	SVT-901
30	15	SVT-902
40	20	SVT-903
50	25	SVT-904

List Prices.....\$2.45 ea.

SERIES MX CONTROLS — DELTA T TYPE

For use in equipment where it may be necessary to maintain an impedance match. Not adapted for switches. Rating, 1 watt. Shaft, 1 1/8" long from end of 3/8" bushing. Diameter, 1-7/16" x 1-1/16" depth. Packaged singly.

Resistance Ohms	Cat. No.
50	MX-146
200	MX-147
500	MX-148
600	MX-149

List Price.....\$5.00 ea.



CONTROLS (Cont'd)

MODEL B16 RADIOHM®



This tiny control is smaller than a dime, virtually a watch makers' production job. The noise level is exceptionally low. In the switch types, the switches are built entirely within the unit. 5/16" diameter without knob, 23/32" with knob. 1/4" total thickness, including knob. Rating, 1/10 watt.

Ohms Max. Resistance	Taper	Cat. No. Plain	Cat. No. with Switch
500,000	C2	B16-118	B16-218
1 meg.	C2	B16-120	B16-220
2 megs.	C2	B16-122	B16-222
3 megs.	C2	B16-124	B16-224
5 megs.	C2	B16-128	B16-228

List Price—Plain.....\$2.50 ea. With Switch.....\$4.00 ea.

NEW FASTATCH*
DUAL CONCENTRIC CONTROL SYSTEM

No tools needed . . .

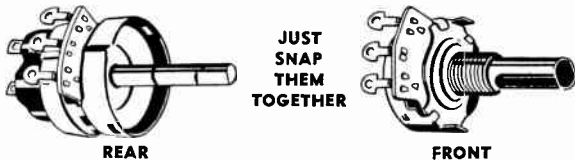

Centralab's new system of dual concentric control replacement saves stocking and availability "headaches" for radio, black-and-white and color television controls. The unit is ideal also for manufacturers and laboratories that need special dual concentric controls. Nothing to bend, no tools required for assembly. Built with extremely popular, patented "Fastatch" construction, these controls are completely guaranteed by Centralab against defects in workmanship.

- Fastatch Duals are completely assembled, tested, and guaranteed front and rear units, not "put-together" controls. You don't do the manufacturer's work.
- No extra tools needed — the units snap together.
- Closely held tolerances, some more critical than original manufacturers' specifications, insure perfect fit and operation of front to rear, inner to outer shafts.
- Precision made front and rear controls are stocked separately. Instead of 400 units, just 126 cover all current and FUTURE dual concentric specifications.
- By checking popularity listings of Fastatch Duals, a small stock of controls for popular sets in your area can be maintained. With a minimum investment, you can have the correct dual control for any replacement needed.

FASTATCH DUAL FRONT UNIT

Outer shaft is 3-5/16" long from mounting surface, with double-fluted mill . . . brass for quick cutting to proper length. Use for single or double flat or round shaft. Scores make cutting for single or double slot easy.



FASTATCH DUAL — REAR UNIT

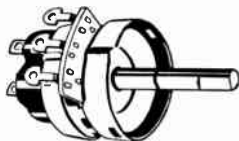

Distinctive blue aluminum inner shaft is 3 3/4" long from mounting surface. Easily cut to proper length. Diameter, 3/16" with .156" flat. Fits .187" or .202" flat shaft knob — spring adapter furnished for other knob types convert to switch type with type KB switches listed on page R-40. Front and rear units.

List Price \$1.60 — F or R

Max. Resist.	Taper or Tap	Front Unit	Rear Unit
300	C1	FI- 0	—
500	C1	FI- 1	—
750	C1	FI- 2	—
750	C5	F3- 2	—
750	500	FI- 3	—
1000	C1	FI- 4	R2- 4
1000	C5	FI- 5	R2- 5
1500	C1	FI- 6	R2- 6
1500	C5	FI- 7	R2- 7
1500	187 and 375	FI- 8	—
2000	C1	FI- 9	R2- 9
2000	C5	FI-10	R2-10
2000	1500	FI-11	—
2000	250 and 500	F3-11	—
2500	C1	FI-12	—
2500	C2	—	R2-13
2500	C3	—	R2-14
2500	C5	FI-15	—
2500	500	FI-16	—
2500	625	FI-17	—
3500	C5	—	R2-18
5000	C1	FI-19	R2-19
5000	C3	FI-20	—
5000	C5	FI-21	—
7500	C1	—	R2-22
10K	C1	FI-23	R2-23
10K	C2	FI-24	—
10K	C5	FI-25	R2-25
15K	5K and 10K	FI-26	—
25K	C1	FI-27	R2-27
35K	C1	FI-28	—
50K	C1	FI-29	R2-29
75K	C1	FI-30	R2-30
100K	C1	FI-31	R2-31
125K	C1	FI-32	R2-32
200K	C1	FI-33	R2-33
250K	C1	FI-34	R2-34
250K	C2	—	R2-35
250K	C4	—	R2-36
250K	C5	FI-37	R2-37
330K	66K	—	R2-38
350K	C2	FI-39	—
500K	C1	FI-40	R2-40
500K	C2	FI-41	R2-41
500K	C4	FI-42	R2-42
500K	100K	FI-44	R2-44
500K	150K	—	R2-45
500K	250K	—	R2-46
500K	50K	FI-47	R2-47
500K	150K	—	R2-48
750K	C7	FI-49	—
850K	C1	FI-50	—
1 meg.	C1	FI-51	R2-51
1 meg.	C2	FI-52	R2-52
1 meg.	C3	FI-53	R2-53
1 meg.	C4	FI-54	R2-54
1 meg.	C7	FI-55	—
1 meg.	500K	—	R2-56
1 meg.	200K	—	R2-57
1 meg.	250K	—	R2-58
1 meg.	300K	FI-59	R2-59
1 meg.	500K	—	R2-60
1 meg.	100K	—	R2-61
1 meg.	300K	—	R2-62
1 meg.	200K and 500K	FI-63	—
1 1/2 meg.	C1	FI-64	R2-64
1 1/2 meg.	C7	FI-65	—
1 1/2 meg.	250K and 500K	—	R2-66
2 megs.	C1	FI-67	R2-67
2 megs.	C2	FI-68	R2-68
2 megs.	C4	FI-69	—
2 megs.	C5	—	R2-70
2 megs.	C7	FI-71	—
2 megs.	1 meg.	—	R2-72
2 megs.	400K	FI-73	R2-73
2 megs.	200K	FI-74	R2-74
2 megs.	600K	—	R4-74
2 megs.	1 meg.	FI-75	R2-75
2 1/2 megs.	C1	FI-76	R2-76
2 1/2 megs.	C7	FI-77	R2-77
3 megs.	C1	FI-78	R2-78
3 megs.	C2	FI-79	R2-79
3 megs.	1 1/2 meg.	—	R2-80
3 megs.	900K	FI-81	R2-81
4 megs.	C7	FI-82	—
5 megs.	C7	FI-83	R2-83
5 megs.	C3	—	R2-84



NOBLELOY RESISTORS

"Nobleloy" METAL FILM RESISTORS

Trade Mark Reg

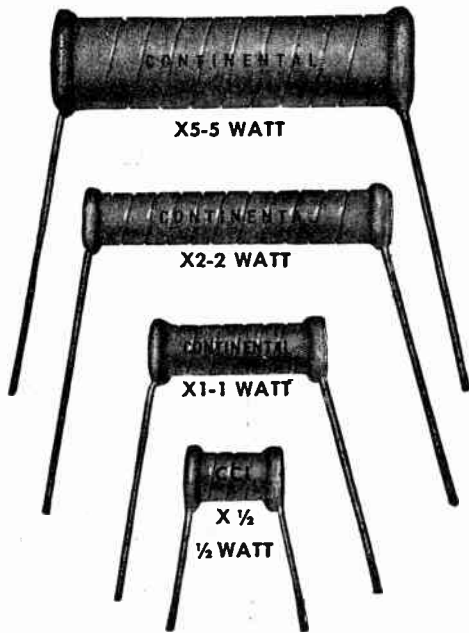

NF TYPE



NF—Continental "Nobleloy" type NF is a metal film miniature precision resistor. Metallic resistance element is deposited on a low loss ceramic carrier. A layer of vitreous enamel protects metal film against unusual atmosphere conditions. Axial leads are firmly fastened to silver contact bands. Initial accuracy and high stability make these resistors best suited for critical applications. Primarily designed to meet MIL-R-10509A specifications. Color coded to RETMA standard values.

X—Continental "Nobleloy" type X metal film resistors have radial leads firmly affixed to extremely low resistance metal contact films to reduce contact resistance. This type of design with hollow center permits greater heat radiation to withstand overloads, and possesses excellent resistance stability under adverse operating conditions. Resistance and tolerance are marked on each unit. Coated with a gray colored enamel.

PX—Continental "Nobleloy" type PX metal film resistors are constructed the same as type X. A different improved alloy resistance film is employed to allow for better temperature coefficient. Resistance and tolerance are marked on each unit. Coated with an orange colored enamel.

Type	Wattage	Resistance Range	Voltage	List Price		
				½% Tol.	1% Tol.	5% Tol.
X½	½ Watt	1 ohm to 1 megohm	350	—	\$.80	\$.70
		1.1 megohm to 5 megohm	350	—	1.05	.95
X1	1 Watt	1 ohm to 1 megohm	500	—	1.00	.90
		1.1 megohm to 10 megohm	500	—	1.30	1.15
X2	2 Watt	2 ohm to 1 megohm	750	—	1.25	1.10
		1.1 megohm to 20 megohm	750	—	1.65	1.50
X5	5 Watt	3 ohm to 1 megohm	1000	—	1.50	1.35
		1.1 megohm to 30 megohm	1000	—	2.00	1.80
PX½	½ Watt	1 ohm to 1 megohm	350	\$1.10	.90	.75
PX1	1 Watt	1 ohm to 1 megohm	500	1.30	1.10	1.00
PX2	2 Watt	2 ohm to 1 megohm	750	1.75	1.40	1.25
PX5	5 Watt	3 ohm to 1 megohm	1000	2.10	1.65	1.50

No. 18 AWG Tinned Copper Leads 1½" long.

NF½	½ Watt	1 ohm to 1 megohm	350	—	.80	.70
		1.1 megohm to 3 megohm	350	—	1.05	.95

No. 20 AWG Tinned Copper Leads 1½" long.

CONTINENTAL CARBON, INC.



COMPOSITION AND WIRE WOUND RESISTORS

"CARBOMITE" TYPE M COMPOSITION RESISTORS

Trade Mark Reg.

(Actual size as illustrated)

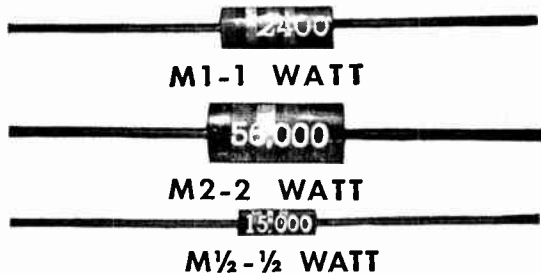

Meet JAN-R-11 Specifications
Low Noise Level Small Size Insulated

Continental's "CARBOMITE" type M resistors are manufactured by the most exacting standards to produce a stable and rugged resistor capable of operating at maximum efficiency in any circuit. All resistors are marked with resistance in addition to the RETMA code. Standard packages are 10 and 50 per item in all three sizes. They are also available in the NEW "RESIST-O-FILE" package consisting of five resistors of a value and size mounted on a 3 x 5 indexed file card. These resistors mounted on a card are coded as MR. They are available in standard boxes of 10 cards per value.

Type	Wattage	Size		Resistance Range	List Prices	
		L	D		5% Tol.	10% Tol.
M $\frac{1}{2}$ or MR $\frac{1}{2}$	$\frac{1}{2}$ Watt	$\frac{3}{8}$	$9/64$	10 ohms to 22 megohms	\$0.33	\$0.17
M1 or MR1	1 Watt	$9/16$	$7/32$	2.7 ohms to 22 megohms	.50	.25
M2 or MR2	2 Watt	$11/16$	$5/16$	10 ohms to 22 megohms	.66	.33

RESIST-O-FILE CABINETS

Resist-O-File type MR (carded resistors) are available in a handy assortment contained in a 3 x 5 card cabinet. Each cabinet contains the most popular resistance values used.

CODE MC $\frac{1}{2}$, $\frac{1}{2}$ Watt, (200 resistors) 1 card each of: 10 ohms, 15, 22, 33, 47, 68, 100, 150, 220, 330, 470, 680, 1000, 1500, 2200, 3300, 4700, 6800, 10K, 15K, 22K, 33K, 47K, 68K, 150K, 220K, 330K, 680K, 1.5 Meg, 2.2 Meg, 3.3 Meg, 4.7 Meg, 6.8 Meg, and 10 Meg. 2 cards each of 100K, 470K and 1 Meg.

CODE MC1, 1 Watt, (200 resistors) same values and quantities as code MC $\frac{1}{2}$ assortment.

CODE MC2, 2 Watt, (150 Resistors) 1 card each of: 10 ohms, 15, 22, 47, 68, 100, 150, 220, 330, 470, 680, 1000, 1500, 2200, 3300, 4700, 6800, 10K, 15K, 22K, 33K, 47K, 68K, 100K, 150K, 220K, 330K, 470K, 680K, and 1 Meg.

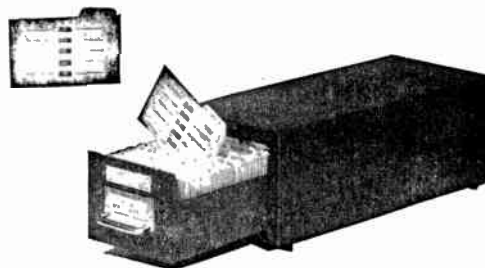

Code	List Price
MC $\frac{1}{2}$	\$34.00
MC1	50.00
MC2	49.50

The cabinet is furnished free, you pay for the resistors only. Shipping weight 8 lbs.

"WM" TYPE WIRE WOUND RESISTORS

Resistance Wire Molded in Bakelite Axial Leads
Soldered Connections RETMA Color Coded

Continental type WM resistors are wound evenly to prevent shorting of turns. A minimum of .0015 inch wire is used for the winding. The terminals are securely and permanently connected to the winding. They are resistant to moisture. The WM resistor is recommended for circuits requiring very low resistance which is not ordinarily available in the carbon style. Packaged in boxes of 10 or 50 each.

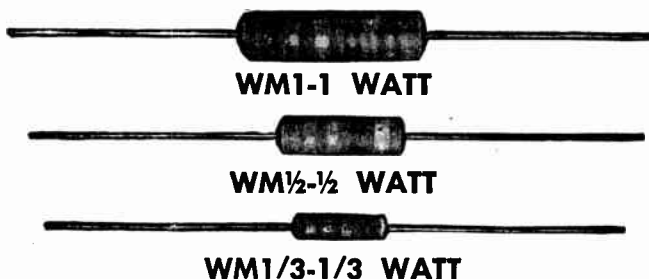

Type	Wattage	Size		Resistance Range	List Prices	
		L	D		5% Tol.	10% Tol.
WM $\frac{1}{3}$	$\frac{1}{3}$ Watt	$7/16$	$\times \frac{1}{8}$.47 ohm to 10 ohms	\$0.30	\$0.25
WM $\frac{1}{2}$	$\frac{1}{2}$ Watt	$\frac{5}{8}$	$\times 7/32$.47 ohm to 10 ohms	.33	.28
WM1	1 Watt	1	$\times 9/32$.47 ohm to 10 ohms	.40	.35

CONTINENTAL CARBON, INC.

Copyright by U. C. P., Inc.

Radio's Master — 19th Edition

TRADE DISCOUNT APPLIES TO LIST PRICES ONLY

Page R-45



AUTO RADIO SUPPRESSORS

CONTINENTAL SUPPRESSORS have been subjected to years of laboratory development and actual road service. They effectively remove noise interference from spark discharge at the plugs and high-tension distributor — yet do not in any way affect the motor car ignition system.

They have mechanical strength to stand the most severe service. The resistance value of 10,000 ohms has been scientifically determined. Sparking across the terminals is eliminated by careful shaping of the electrodes and cases.

The S-19, S-21 and S-23 Suppressors are equipped with a removable terminal nut for spade type mountings.



S19



S 21



S 20 A



S 23



C 11.

T 24

SPARK PLUG SUPPRESSORS,

S-19, S-20A, S-21 and S-23.....each \$0.30

DISTRIBUTOR SUPPRESSORS,

C-11 and T-25each .30

List Price

GENERATOR CONDENSERS

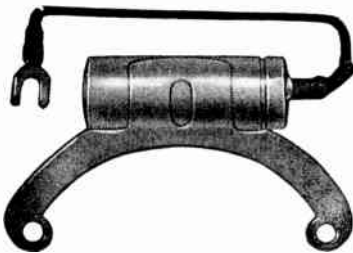

GB05F



GB05

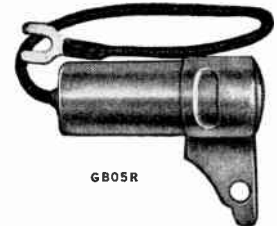

GB05R

Type	Application	Capacity	Size	List Price
GB025	Generator and coil	.25 mfd.	2 1/8" x 3/4"	\$0.60
GB05	Generator and coil	.5 mfd.	2 1/8" x 3/4"	.75
GB05F	Ford V-8 coil 1936 Models	.5 mfd.	2 1/8" x 3/4"	1.00
GB05R	Ford Generator and coil Latest Models	.5 mfd.	2 1/8" x 3/4"	1.00

OIL BURNER SUPPRESSORS



OB15



OB15A



OB15B

Type	List Price
OB15 with Rajah Terminal.....	\$1.80
OB15A	1.40
OB15B	1.40
OB15C	1.40



OB15C

CONTINENTAL CARBON, INC.

LECTROHM

INCORPORATED • 5560 NORTHWEST HIGHWAY, CHICAGO 30, ILLINOIS

VITREOUS ENAMELED RESISTORS

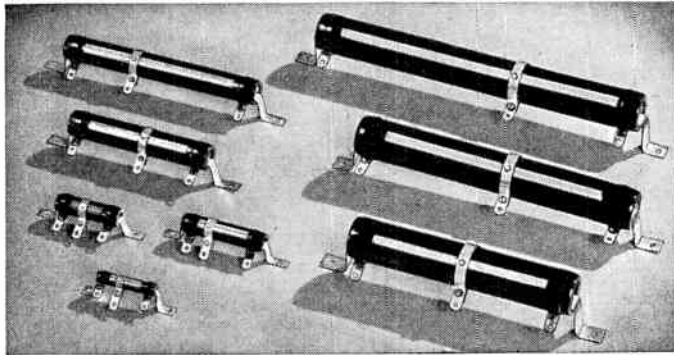

Adjustable Wire-Wound Types

The same high quality and construction are used for LECTROHM Adjustable Resistors as are incorporated in LECTROHM fixed units.

These resistors are used for replacing voltage dividers in radio receivers, for radio transmitter power supply, and for general experimental work.

TYPE 1 1/4 EV—10-WATT

DIMENSIONS..... $\frac{5}{16}$ " x $\frac{3}{16}$ " x $1\frac{3}{4}$ "
 TERMINALS.....Lug Type
 MAXIMUM RESISTANCE.....10,000 ohms
 MOUNTING BRACKET.....Centers $2\frac{1}{4}$ "

Res. Ohms	Max. M.A.	List Price	Res. Ohms	Max. M.A.	List Price
1	3150	\$1.47	750	115	\$1.47
2	2230	1.47	800	111	1.47
3	1825	1.47	1000	100	1.47
5	1415	1.47	1250	89	1.53
7.5	1155	1.47	1500	79	1.53
10	1000	1.47	2000	69	1.53
15	815	1.47	2250	64	1.53
20	707	1.47	2500	61	1.53
25	630	1.47	3000	56	1.53
50	447	1.47	3500	51	1.53
75	365	1.47	4000	47	1.53
100	315	1.47	4500	44	1.53
150	258	1.47	5000	40	1.53
200	223	1.47	6000	36	1.63
250	200	1.47	7000	33	1.63
300	182	1.47	7500	32	1.63
350	169	1.47	8000	31	1.63
400	158	1.47	8500	30	1.63
500	141	1.47	10000	24	1.63
600	129	1.47			

TYPE 2SV—25-WATT

DIMENSIONS..... $\frac{9}{16}$ " x $\frac{1}{8}$ " x 2"
 TERMINALS.....Solder Lug
 MAXIMUM RESISTANCE.....25,000 ohms
 MOUNTING BRACKET.....Centers $2\frac{7}{8}$ "

Res. Ohms	Max. M.A.	List Price	Res. Ohms	Max. M.A.	List Price
1	5000	\$1.87	1000	158	\$1.87
3	2890	1.87	1250	141	1.88
5	2240	1.87	1500	129	1.88
10	1580	1.87	2000	112	1.88
15	1290	1.87	2500	100	1.88
25	1000	1.87	3000	91	1.88
50	707	1.87	3500	84	1.88
75	575	1.87	4000	79	1.88
100	500	1.87	5000	71	1.88
150	400	1.87	6000	64	2.03
200	353	1.87	7500	57	2.03
250	316	1.87	10000	50	2.03
300	288	1.87	12000	44	2.08
400	250	1.87	15000	26	2.08
500	224	1.87	20000	22	2.08
750	182	1.87	25000	20	2.28

TYPE 4 1/2 MV—50-WATT

DIMENSIONS..... $\frac{3}{4}$ " x $\frac{1}{2}$ " x $4\frac{1}{2}$ "
 TERMINALS.....Solder Lugs
 MAXIMUM RESISTANCE.....100,000 ohms
 MOUNTING BRACKET.....Centers $5\frac{1}{2}$ "

Res. Ohms	Max. M.A.	List Price	Res. Ohms	Max. M.A.	List Price
5	3160	\$2.37	3000	129	\$2.47
10	2230	2.37	4000	112	2.47
25	1410	2.37	5000	100	2.47
50	1000	2.37	7500	81	2.63
75	816	2.37	10000	70	2.63
100	707	2.37	12000	64	2.83
150	577	2.37	15000	57	2.83
200	500	2.37	20000	50	2.83
250	447	2.37	25000	44	3.08
300	408	2.37	30000	41	3.08
400	354	2.37	40000	35	3.08
500	316	2.37	50000	20	3.30
750	258	2.37	60000	18	3.30
1000	224	2.37	75000	17	3.67
1500	182	2.47	80000	16	3.67
2000	158	2.47	100000	14	3.92
2500	141	2.47			

TYPE 6 1/2 MV—80-WATT

DIMENSIONS..... $\frac{3}{4}$ " x $\frac{1}{2}$ " x $6\frac{1}{2}$ "
 TERMINALS.....Solder Lugs
 MAXIMUM RESISTANCE.....100,000 ohms
 MOUNTING BRACKET.....Centers $7\frac{1}{2}$ "

Res. Ohms	Max. M.A.	List Price	Res. Ohms	Max. M.A.	List Price
10	2830	\$2.75	3500	152	\$2.83
15	2310	2.75	5000	126	2.83
25	1790	2.75	7500	103	3.00
50	1265	2.75	10000	89	3.00
100	894	2.75	15000	73	3.20
250	566	2.75	20000	63	3.20
300	517	2.75	25000	57	3.53
400	495	2.75	30000	51	3.53
500	400	2.75	40000	44	3.53
750	327	2.75	50000	25	3.62
1000	283	2.75	60000	23	3.62
1500	231	2.83	75000	21	3.97
2000	200	2.83	80000	20	3.97
2500	179	2.83	100000	18	4.33

TYPE 6 1/2 KV—100-WATT

DIMENSIONS..... $1\frac{1}{8}$ " x $\frac{3}{4}$ " x $6\frac{1}{2}$ "
 TERMINALS.....Solder Lugs
 MAXIMUM RESISTANCE.....100,000 ohms
 MOUNTING BRACKET.....Centers $7\frac{1}{2}$ "

Res. Ohms	Max. M.A.	List Price	Res. Ohms	Max. M.A.	List Price
50	1413	\$3.58	15000	81	\$4.12
100	1000	3.58	20000	70	4.12
500	447	3.58	25000	63	4.37
1000	316	3.58	30000	57	4.37
2000	223	3.67	35000	53	4.37
3000	182	3.67	40000	50	4.37
4000	158	3.67	50000	44	4.53
5000	141	3.67	75000	23	4.75
7500	115	3.67	100000	20	4.95
10000	100	3.87			

TYPE 8 1/2 KV—160-WATT

DIMENSIONS..... $1\frac{1}{8}$ " x $\frac{3}{4}$ " x $8\frac{1}{2}$ "
 TERMINALS.....Solder Lugs
 MAXIMUM RESISTANCE.....100,000 ohms
 MOUNTING BRACKET.....Centers $9\frac{1}{2}$ "

Res. Ohms	Max. M.A.	List Price	Res. Ohms	Max. M.A.	List Price
5	5660	\$5.33	10000	126	\$4.44
10	4000	4.14	15000	103	4.69
25	2530	4.14	20000	89	4.69
50	1788	4.14	25000	80	4.81
100	1266	4.14	30000	73	4.81
500	566	4.14	40000	55	4.81
1000	400	4.14	50000	43	4.94
2500	253	4.19	75000	27	5.17
5000	179	4.19	100000	18	5.44

TYPE 10 1/2 KV—200-WATT

DIMENSIONS..... $1\frac{1}{8}$ " x $\frac{3}{4}$ " x $10\frac{1}{2}$ "
 TERMINALS.....Solder Lugs
 MAXIMUM RESISTANCE.....100,000 ohms
 MOUNTING BRACKET.....Centers $11\frac{1}{2}$ "

Res. Ohms	Max. M.A.	List Price	Res. Ohms	Max. M.A.	List Price
50	2000	\$4.37	10000	141	\$4.70
100	1414	4.37	20000	100	4.92
500	632	4.37	25000	89	5.03
1000	447	4.37	30000	81	5.03
1500	361	4.45	50000	63	5.17
2000	316	4.45	75000	51	5.42
2500	283	4.45	100000	28	5.67
5000	200	4.45			

Mounting brackets and one band are furnished with all adjustable types.

ADJUSTABLE LUGS

Diameter of Resistor	List Price
$\frac{3}{8}$ "	\$0.25
$\frac{1}{2}$ "	.25
$\frac{3}{4}$ "	.42
$1\frac{1}{4}$ "	.42

Screw-Driver Type

LECTROHM

INCORPORATED • 5560 NORTHWEST HIGHWAY, CHICAGO 30, ILLINOIS

VITREOUS ENAMELED RESISTORS Fixed Wire-Wound Types

LECTROHM Resistors are manufactured from the highest quality materials obtainable and are rated according to RTMA standards. They are rugged, dependable, accurate—quality components that will give long, trouble-free service. Mounting brackets available for 10, 20, 50, 80, 100, 160 and 200 watt units.

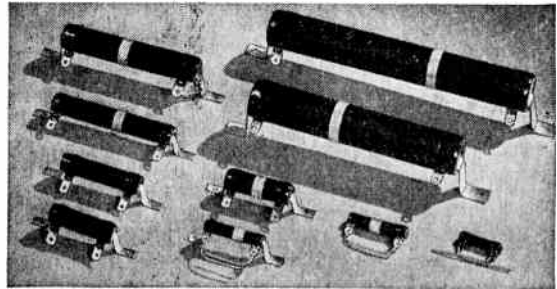

TYPE 1¼L—5-WATT

DIMENSIONS..... ¼" x ⅜" x 1½"					
TERMINALS..... Pig Tail					
MAXIMUM RESISTANCE..... 10,000 ohms					
MOUNTING BRACKET..... No Mounting Brackets					
Res. Ohms	Max. M.A.	List Price	Res. Ohms	Max. M.A.	List Price
1	2240	\$0.67	300	129	\$0.67
2	1580	.67	350	119	.87
4	1290	.67	400	111	.67
4	1110	.67	500	100	.67
5	1000	.67	600	91	.67
10	707	.67	700	84	.67
15	575	.67	750	81	.67
20	500	.67	800	79	.67
25	447	.67	900	74	.67
30	408	.67	1000	70	.67
35	374	.67	1100	64	.72
40	346	.67	1200	60	.72
50	316	.67	1250	59	.72
75	258	.67	1500	54	.72
100	222	.67	1750	50	.72
125	200	.67	2000	44	.72
150	182	.67	2500	40	.72
200	158	.67	3000	36	.72
225	149	.67	4000	31	.72
250	141	.67	5000	28	.72

TYPE 1¼E—10-WATT

DIMENSIONS..... ⅝" x ⅝" x 1¾"					
TERMINALS..... Pig Tail					
MAXIMUM RESISTANCE..... 40,000 ohms					
MOUNTING BRACKET..... No Mounting Brackets					
Res. Ohms	Max. M.A.	List Price	Res. Ohms	Max. M.A.	List Price
1	3150	\$0.75	1500	79	\$0.80
2	2230	.75	1750	74	.80
3	1825	.75	2000	69	.80
5	1415	.75	2250	64	.80
7.5	1155	.75	2500	61	.80
10	1000	.75	3000	56	.80
15	815	.75	3500	51	.80
20	707	.75	4000	47	.80
25	630	.75	4500	44	.80
50	447	.75	5000	40	.80
75	365	.75	6000	36	.92
100	315	.75	7000	33	.92
150	258	.75	7500	32	.92
200	223	.75	8000	31	.92
250	200	.75	8500	30	.92
300	182	.75	10000	24	.92
350	169	.75	12000	20	1.03
400	158	.75	12500	20	1.03
500	141	.75	15000	18	1.03
600	129	.75	17500	17	1.03
700	119	.75	18000	16	1.03
750	115	.75	20000	15	1.03
800	111	.75	22500	15	1.08
900	105	.75	25000	14	1.08
1000	100	.75	30000	8	1.22
1200	91	.80	40000	7	1.22
1250	89	.80			

LECTROHM R. F. PLATE CHOKES (1000 Milliamps.)



Type	RFC-1	RFC-2	RFC-3	RFC-4
Amateur				20, 40
Band Meters	5	10 & 20	20 & 40	80 & 160
Microhenries	5.4	35	95	220
D. C. Ohms	0.85	2	5	9
Len. Overall	1¾"	3"	6"	6¾"
Diameter	¼"	⅝"	⅞"	¾"
List Price	\$0.33	\$1.04	\$1.56	\$2.15

TYPE 2R—20-WATT

DIMENSIONS..... ½" x ⅝" x 2"					
TERMINALS..... Solder Lug					
MAXIMUM RESISTANCE..... 100,000 ohms					
MOUNTING BRACKET..... Centers 2 7/8"					
Res. Ohms	Max. M.A.	List Price	Res. Ohms	Max. M.A.	List Price
5	2000	\$0.95	1100	134	\$0.97
10	1414	.95	1250	126	.97
15	1153	.95	1500	115	.97
20	1000	.95	2000	100	.97
25	894	.95	2500	89	.97
40	707	.95	3000	81	.97
50	633	.95	4000	70	.97
60	574	.95	5000	63	.97
75	517	.95	6000	57	1.12
100	448	.95	7000	53	1.12
125	400	.95	7500	51	1.12
150	365	.95	8000	50	1.12
200	316	.95	10000	43	1.12
250	283	.95	12500	39	1.20
300	258	.95	15000	30	1.20
350	238	.95	20000	24	1.20
400	223	.95	25000	21	1.37
500	200	.95	30000	21	1.37
600	182	.95	35000	18	1.37
700	169	.95	40000	17	1.37
750	163	.95	45000	13	1.58
800	158	.95	50000	11	1.58
1000	141	.95			

TYPE 4¼M—50-WATT

DIMENSIONS..... ¾" x ⅝" x 4½"					
TERMINALS..... Solder Lugs					
MAXIMUM RESISTANCE..... 100,000 ohms					
MOUNTING BRACKET..... Centers 5 1/2"					
Res. Ohms	Max. M.A.	List Price	Res. Ohms	Max. M.A.	List Price
5	3165	\$1.63	6000	85	\$1.92
10	2250	1.63	7000	78	1.92
25	1590	1.63	7500	77	1.92
50	1000	1.63	8000	75	1.92
100	700	1.63	10000	66	1.92
200	500	1.83	12000	63	2.08
250	440	1.83	12500	60	2.08
500	300	1.63	15000	56	2.08
750	250	1.63	20000	48	2.08
1000	215	1.63	25000	43	2.33
1500	175	1.75	30000	39	2.33
2000	155	1.75	40000	34	2.33
2500	135	1.75	50000	30	2.58
3000	120	1.75	60000	28	2.92
4000	105	1.75	75000	25	2.92
5000	95	1.75	100000	21	2.92

TYPE 6¼M—80-WATT

DIMENSIONS..... ¾" x ½" x 6½"					
TERMINALS..... Solder Lugs					
MAXIMUM RESISTANCE..... 100,000 ohms					
MOUNTING BRACKET..... Centers 7 1/2"					
Res. Ohms	Max. M.A.	List Price	Res. Ohms	Max. M.A.	List Price
5	4000	\$2.00	5000	122	\$2.08
10	2730	2.00	6000	112	2.25
25	1730	2.00	7500	100	2.25
50	1220	2.00	8000	98	2.25
100	865	2.00	10000	86	2.25
200	612	2.00	15000	70	2.45
250	545	2.00	20000	61	2.45
500	387	2.00	25000	55	2.78
750	316	2.00	30000	50	2.78
1000	274	2.00	40000	43	2.87
1500	223	2.08	50000	39	2.87
3000	193	2.08	60000	35	3.22
2500	173	2.08	75000	31	3.22
3000	158	2.08	100000	27	3.58
4000	137	2.08			

TYPE 6½K—100-WATT

DIMENSIONS..... 1½" x ¾" x 6½"					
TERMINALS..... Solder Lugs					
MAXIMUM RESISTANCE..... 100,000 ohms					
MOUNTING BRACKET..... Centers 7 1/2"					
Res. Ohms	Max. M.A.	List Price	Res. Ohms	Max. M.A.	List Price
25	2000	\$2.42	3000	180	\$2.53
50	1414	2.42	5000	140	2.53
75	1155	2.42	7500	115	2.70
100	1100	2.42	10000	100	2.70
150	815	2.42	15000	80	2.97
250	632	2.42	20000	70	2.97
500	447	2.42	25000	63	3.20
750	365	2.42	30000	58	3.20
1000	315	2.42	40000	50	3.20
1250	280	2.53	50000	44	3.37
1500	250	2.53	60000	41	3.37
2000	220	2.53	75000	36	3.58
2500	200	2.53	100000	31	3.58

TYPE 8½K—160-WATT

DIMENSIONS..... 1½" x ¾" x 8½"					
TERMINALS..... Solder Lugs					
MAXIMUM RESISTANCE..... 100,000 ohms					
MOUNTING BRACKET..... Centers 9 1/2"					
Res. Ohms	Max. M.A.	List Price	Res. Ohms	Max. M.A.	List Price
5	5660	\$4.16	4500	185	\$3.04
10	4000	2.98	5000	180	3.04
25	2530	2.98	7500	145	3.30
50	1788	2.98	10000	125	3.30
75	1460	2.98	15000	105	3.54
100	1260	2.98	20000	90	3.54
200	900	2.98	25000	80	3.64
500	570	2.98	30000	67	3.64
1000	400	2.98	35000	57	3.64
1500	330	3.04	40000	50	3.64
2000	280	3.04	50000	40	3.76
2500	250	3.04	60000	33	3.76
3000	230	3.04	70000	28	3.76
3500	215	3.04	80000	25	4.03
4000	200	3.04	100000	20	4.26

TYPE 10½K—200-WATT

DIMENSIONS..... 1½" x ¾" x 10½"					
TERMINALS..... Solder Lugs					
MAXIMUM RESISTANCE..... 100,000 ohms					
MOUNTING BRACKET..... Centers 11 1/2"					
Res. Ohms	Max. M.A.	List Price	Res. Ohms	Max. M.A.	List Price
5	6310	\$4.53	4500	210	\$3.30
10	4470	3.22	5000	200	3.30
25	2830	3.22	7500	165	3.53
50	2000	3.22	10000	140	3.53
75	1635	3.22	15000	115	3.77
100	1400	3.22	20000	100	3.77
250	990	3.22	25000	90	3.90
500	630	3.22	30000	82	3.90
1000	450	3.22	35000	71	3.90
1500	365	3.30	40000	62	3.90
2000	315	3.30	50000	50	4.03
2500	280	3.30	60000	42	4.03
3000	260	3.30	75000	33	4.25
3500	240	3.30	100000	25	4.25
4000	225	3.30			

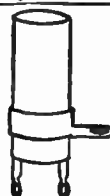

ALSO AVAILABLE
Upright and axial lead
designs

LECTROHM

INCORPORATED • 5560 NORTHWEST HIGHWAY, CHICAGO 30, ILLINOIS

LECTROHM IS CREATING NEW DESIGNS AND MATERIALS IN WIRE WOUND RESISTORS FOR NEW ASSEMBLY METHODS

In addition to supplying the electronics industry with a superior vitreous enameled wire-wound power resistors in the familiar sizes and ratings, LECTROHM is producing whole new groups of types, each designed to solve a special problem. Miniaturization and printed circuit restrictions in space and ventilation no longer are complicated by conventional power re-

sistor size standards. New coating materials and winding methods developed by LECTROHM permit an infinite variety of configurations yet retain operating and life characteristics expected of the finest grade vitreous enameled types. LECTROHM engineers will fit the resistor size and shape to your design.

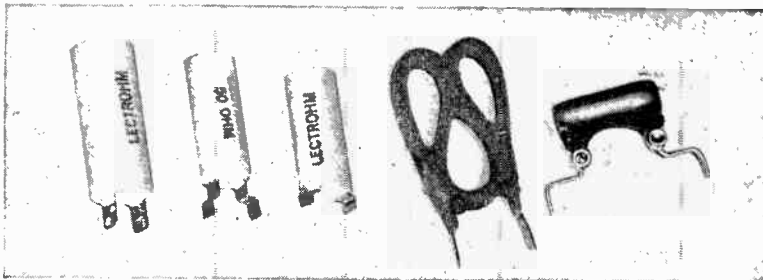

TYPICAL LECTROHMS FOR PRINTED CIRCUITS

Other styles quickly designed for your individual space limitations.

3 to 25 watts. 10 to 25,000 Ohms.

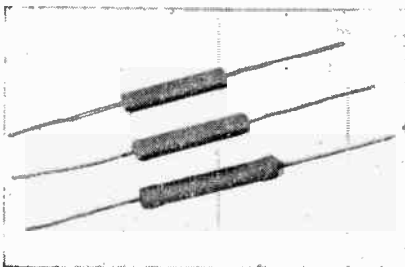

LECTROHM AXIAL LEAD WIREWOUNDS

For added convenience in mounting in many types of assembly.

1 to 10 watts. 10 to 25,000 Ohms.

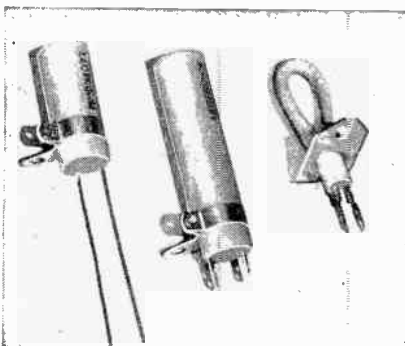

LECTROHM ABOVE CHASSIS TYPE

More efficient use of space designed to eliminate heat beneath the chassis. LECTROHM engineers will create resistors to fit your available space.

5 to 25 watts. 10 to 15,000 Ohms.

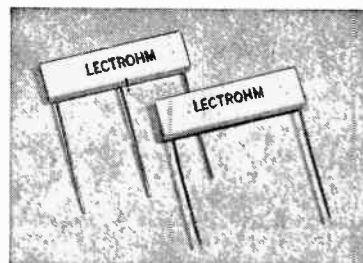

NEW LECTROHMS FOR UTMOST ECONOMY

Competing in price with sand coated types, but offering a new standard of moisture resistance and long life performance.

5 to 20 watts. 10 to 15,000 Ohms.

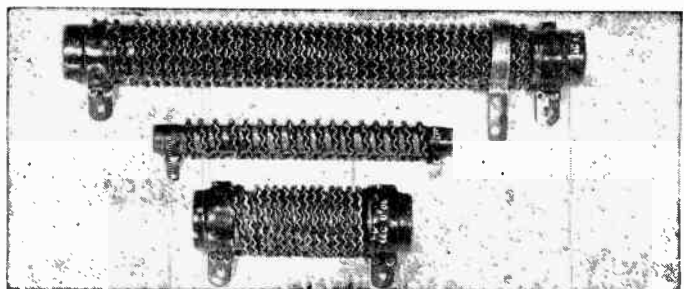

RIB-ON-EDGE LECTROHM (STANDARD SIZES AND VALUES)

155 to 420 watts. .06 to 22 Ohms.



VITREOUS ENAMELED LECTROHM-FERRULE TYPE (STANDARD SIZES AND VALUES)

13 to 190 watts. To 100,000 Ohms.

SHALLCROSS MANUFACTURING CO.

COLLINGDALE, PENNSYLVANIA

ELECTRICAL INSTRUMENTS
RESISTORS
VARIABLE ATTENUATORS
SWITCHES

SHALLCROSS DECADE RESISTANCE BOXES

The large assortment and wide range of resistance available makes the Shallcross line of Resistance Boxes unique in the instrument

field. They are used extensively as laboratory standards, AC and DC Bridge and ratio arms, voltage dividers, etc.

Accuracy adjustment of Resistors as follows:
 0.1 ohm..... 1% 1. ohm..... 0.25% all others..... 0.1%

No.	No. Dials	Ohm Steps	Ohms Total Resistance	Price	No.	No. Dials	Ohm Steps	Ohms Total Resistance	Price
543	1	0.1	1	\$22.00	821	3	10	11,100	\$60.00
544	1	1.0	10	22.00	822	3	100	111,000	63.00
545	1	10	100	22.00	823	3	1,000	1,110,000	77.00
546	1	100	1,000	22.00	824	3	10,000	11,100,000	120.00
547	1	1,000	10,000	24.00	825	4	1	11,110	77.00
548	1	10,000	100,000	26.00	826	4	10	111,100	79.00
549	1	100,000	1,000,000	36.00	827	4	100	1,111,000	92.00
550	1	1,000,000	10,000,000	66.00	828	4	1,000	11,110,000	139.00
817	3	.01	11.1	60.00	8285	5	0.1	11,111	94.00
817A	4	.01	111.1	75.00	829	5	1	111,110	101.00
817B	5	.01	1,111.1	94.00	830	5	10	1,111,100	113.00
818	3	0.1	111	51.00	831	5	100	11,111,000	155.00
819	4	0.1	1,111	71.00	832	6	1	1,111,110	121.00
820	3	1	1,110	56.00	833	6	10	11,111,100	169.00

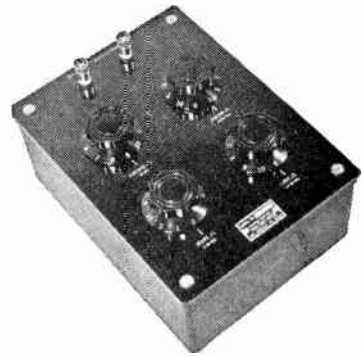

UNMOUNTED DECADE RESISTANCES

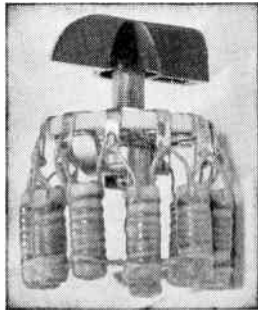

In response to a demand from engineers, manufacturers and physicists who design and construct their own electrical measuring instruments, we have made the Shallcross Unmounted Decade Resistances available. They are of the same construction as those used in the popular Shallcross Resistance Decades described above and consist of ten Shallcross Resistors mounted on a ceramic instrument switch.

SPECIFICATIONS

Type No.	Total Resistance Ohms	Unit Resistance Ohms	Switch No.	Accuracy	*Price
435	1.0	.1	4485-S	1.0%	\$12.00
436	10	1.0	4485-B	0.25%	13.25
437	100	10	4485-B	0.1	13.25
438	1,000	100	4485-B	0.1	15.00
439	10,000	1,000	4485-B	0.1	16.00
440	100,000	10,000	4485-B	0.1	18.50
441	1 Meg.	100,000	4485-B	0.1	32.50
442	10 Meg.	1 Meg.	4485-B	0.1	60.00

* Does not include knob or dial.

MOUNTING: Single 3/8" Hole Mounting—Panels up to 3/16" Thick. All of the above are available with aluminum dust cover, shield, and isolated shaft at \$3.00 additional.

Knob #1916-1 (illustrated): \$0.25 additional and aluminum dial 0-10 #1522-1 \$0.70 additional.

SHALLCROSS No. 6100 FAULT LOCATION WHEATSTONE BRIDGE

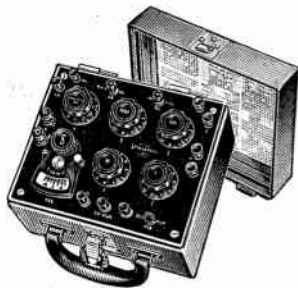

Resistance range 1 ohm to 1.011 megohms

SPECIFICATIONS

APPLICATIONS—Measures resistance from 1 ohm to 1 megohm. Locates grounds, crosses, opens, and shorts by Murray, Varley, Hilborn, or Fisher Loop and Capacitance tests.

ACCURACY—Overall $\pm 0.1\% + 0.01$ ohm; Ratio resistors $\pm 0.05\%$; All others $\pm 0.1\%$.

RHEOSTAT ARM—Four decades. 10,110 ohms in 1 ohm steps. Can also be used as a resistance box.

GALVANOMETER—Rugged Shallcross galvanometer is built-in. Sensitivity 1 micro-amp. per mm scale division.

SWITCHES—Shallcross molded phenolic instrument switches. Pure nickel contacts, beryllium copper brushes.

CASE—Light weight aluminum carrying-type case with battery compartment and removal lid.

DIMENSIONS—Length 8 3/8", width 7 3/8", height 5 3/8".

WEIGHT—Approx. 8 lbs. **PRICE**—\$175.00.

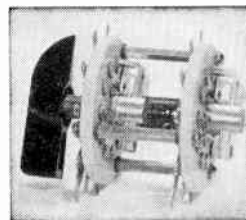

SHALLCROSS ROTARY SELECTOR SWITCHES

Like other Shallcross instrument components, these Rotary Selector Switches are designed to cover a very wide field of application in both shorting and non-shorting types, and can be modified to control a variety of circuits. Details on any type for practically any application on request. Suffixes B and

S denote Brass and Silver contacts and contact arms. Write for Specification Sheet SS-6.

SPECIFICATIONS

Poles	Positions	Contact Spacing	Contact Plate Material	Type Number		*List Price
				Shorting	Non-Shorting	
1	11	32.7°	Steatite	4605-B	4610-B	\$ 4.25
2	11	32.7°	Steatite	4620-B	4615-B	9.50
1	11	32.7°	Steatite	4605-S	4610-S	4.50
2	11	32.7°	Steatite	4620-S	4615-S	10.00
1	12	30°	Bakelite	5550-B	5620-B	4.95
1	12	30°	Bakelite	5550-S	5620-S	5.25
1	15	24°	Steatite	5610-B	4225-B	5.55
2	15	24°	Steatite	5615-B	4980-B	12.50
1	15	24°	Steatite	5610-S	4225-S	6.00
2	15	24°	Steatite	5615-S	4980-S	13.50
1	18	20°	Steatite	5155-B	5625-B	6.50
1	18	20°	Steatite	5155-S	5625-S	7.00
1	24	15°	Bakelite	5630-B	5570-B	9.50
1	24	15°	Bakelite	5630-S	5570-S	10.00
1	36	10°	Bakelite	10054-S	28.00
1	40	8.8°	Melamine	10,055	35.00
1	60	6°	Bakelite	10061-S	30.00

* Does not include knob or dial.

**ELECTRICAL
INSTRUMENTS**

RESISTORS

**VARIABLE
ATTENUATORS**

SWITCHES

SHALLCROSS MANUFACTURING CO.
COLLINGDALE, PENNSYLVANIA

SHALLCROSS AUDIO ATTENUATORS

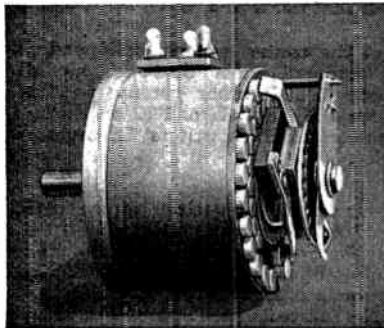

SHALLCROSS
ATTENUATOR
NO.
420-2B2

SHALLCROSS
ATTENUATOR
NO.
C720-2A3

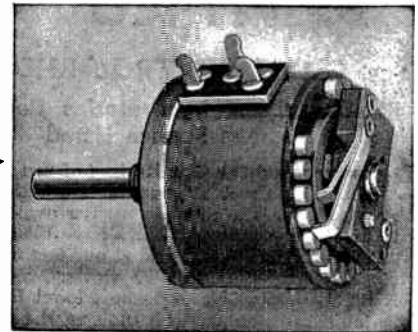

These Shallcross Features Mean

- ✓ BETTER PERFORMANCE
- ✓ BIGGER VALUE

- ✓ Off position attenuation well in excess of 100 db.
- ✓ 25% to 50% fewer soldered joints.
- ✓ Noise level ratings that are factual. (130 db or more below zero level).
- ✓ Non-inductive Shallcross precision resistors used throughout assure flat attenuation to and beyond 30 kc.
- ✓ Types and sizes engineered for all needs. Attenuation accuracies of 1%, resistor accuracies of 0.1%, on special order.

Shallcross Audio Attenuators are available in either variable or fixed units, the former often being referred to as a "control" and the latter, as a "pad".

Controls are available with as few as 5 steps or as many as 52 steps with an attenuation as small as 0.1 db per step. The total attenuation for a single control does not exceed 125 db since such high attenuation approaches the noise level of the switching mechanism.

The complete story of Shallcross attenuators may be found in Shallcross Engineering Bulletin #4, copies of which are available on request. Specifications and prices are given below for a few of the most popular variable attenuators.

IMPEDANCE: 150, 500, 250/500, 600 ohms, except potentiometers, which are 100,000 and 250,000 ohms.

RESISTORS: All non-inductively wirewound, $\pm 5\%$ tolerance, except types preceded with "C", which are composition selected to $\pm 5\%$.

ATTENUATION: Increases for counter-clockwise rotation of knob end of shaft.

FREQUENCY RESPONSE: Flat over entire audio range.

SWITCH MECHANISM: Multi-leaf wiper arms, collector rings and contacts available in tarnish resistant silver alloy or brass. Noise level -130 db.

DETENT: Indexing mechanism available on any unit for \$0.75 list. Back of panel depth is then increased $\frac{3}{16}$ ".

DIALS: \$1.50 list each additional.

KNOBS (VA-16906): \$0.60 list each additional.

120-2A3
\$ 9.50 silver
10.50 brass

Ladder attenuator, 20 steps, 2 db per step, tapered on last 3 steps to off. MOUNTING: single hole, $\frac{3}{16}$ "-32 threaded bushing or two hole, 6-32 screws, $\frac{1}{4}$ " centers. DIMENSIONS: $1\frac{3}{4}$ " diameter, $1\frac{3}{4}$ " back of panel depth. CONTACT SPACING: 15°.

C720-2A3
\$ 9.50 silver
10.50 brass

Potentiometer, 20 steps, 2 db per step, tapered on last 3 steps to off. MOUNTING: single hole, $\frac{3}{16}$ "-32 threaded bushing or two hole, 6-32 screws, $\frac{1}{4}$ " centers. DIMENSIONS: $1\frac{3}{4}$ " diameter, $1\frac{3}{4}$ " back of panel depth. CONTACT SPACING: 15°.

132-1.5B3
\$16.50 silver
18.00 brass

Ladder attenuator, 32 steps, 1.5 db per step, tapered on last 3 steps to off. MOUNTING: two hole, 6-32 or 8-32 screws, $\frac{1}{4}$ " or $\frac{1}{2}$ " centers. DIMENSIONS: $2\frac{1}{2}$ " diameter, $1\frac{3}{4}$ " back of panel depth. CONTACT SPACING: 10°.

430-1C1
\$29.00 silver
27.00 brass

Bridged T attenuator, 30 steps, 1 db. per step, 30 db total. MOUNTING: two hole, 6-32 or 8-32 screws, $\frac{1}{4}$ " or $\frac{1}{2}$ " centers. DIMENSIONS: $2\frac{1}{2}$ " diameter, $1\frac{3}{4}$ " back of panel depth. CONTACT SPACING: $11\frac{1}{4}$ °.

430-1.5C3
\$29.00 silver
27.00 brass

Bridged T attenuator, 30 steps, 1.5 db per step tapered on last 5 steps to off. MOUNTING: two hole 6-32 or 8-32 screws, $\frac{1}{4}$ " or $\frac{1}{2}$ " centers. DIMENSIONS: $2\frac{1}{2}$ " diameter, $1\frac{3}{4}$ " back of panel depth. CONTACT SPACING: $11\frac{1}{4}$ °.

420-2B2
\$21.50 silver

Bridged T attenuator, 20 steps, 2 db per step, attenuation linear with off on last step. MOUNTING: two hole, 8-32 or 6-32 screws, $\frac{1}{4}$ " or $\frac{1}{2}$ " centers. DIMENSIONS: $2\frac{1}{2}$ " diameter, $1\frac{3}{4}$ " back of panel depth. CONTACT SPACING: 15°.

C820-2B2
\$21.50 silver

Dual potentiometer, each section 20 steps, 2 db per step, attenuation linear with off on last step. MOUNTING: two hole, 6-32 or 8-32 screws, $\frac{1}{4}$ " or $\frac{1}{2}$ " centers. DIMENSIONS: $2\frac{1}{2}$ " diameter, $1\frac{3}{4}$ " back of panel depth. CONTACT SPACING: 15°.

SHALLCROSS V.U. METER RANGE EXTENDING ATTENUATORS

IMPEDANCE: Available with input impedances of 3900-7100-7500 ohms. Output impedance is 3900 ohms to match Weston Type 30B or General Electric Type DO 61 V.U. meters.

TOLERANCE: $\pm 1\%$ except "C" types which are $\pm 5\%$.

INSERTION LOSS: Zero.

DETENT: All units supplied with indexing mechanism; back of panel depth includes detent.

C35-4A4
\$16.00 silver
15.00 brass

T attenuator, 0, +4 to +20 V.U., 5 steps, 4 V.U. per step. MOUNTING: single hole, $\frac{3}{16}$ "-32 threaded bushing. DIMENSIONS: $1\frac{3}{4}$ " diameter, $2\frac{1}{16}$ " back of panel depth. CONTACT SPACING: 30°.

C35-4A5
\$16.00 silver
15.00 brass

T attenuator, 0, +4 to +16 V.U., and OFF, 5 steps, 4 V.U. per step. MOUNTING: single hole, $\frac{3}{16}$ "-32 threaded bushing. DIMENSIONS: $1\frac{3}{4}$ " diameter, $2\frac{1}{16}$ " back of panel depth. CONTACT SPACING: 30°.

320-2C4
\$31.50 silver

T attenuator, +4 to +44 V.U., 20 steps, 2 V.U. per step. MOUNTING: two hole, 8-32 screws, $\frac{1}{2}$ " centers. DIMENSIONS: $2\frac{1}{4}$ " diameter, $2\frac{1}{16}$ " back of panel depth. CONTACT SPACING: 15°.

320-2C5
\$31.50 silver

T attenuator, +4 to +42 V.U. and OFF, 20 steps, 2 V.U. per step. MOUNTING: two hole, 8-32 screws, $\frac{1}{2}$ " centers. DIMENSIONS: $2\frac{1}{4}$ " diameter, $2\frac{1}{16}$ " back of panel depth. CONTACT SPACING: 15°.

412-2B4
\$22.50 silver

Bridged T attenuator, +4 to +28 V.U., 12 steps, 2 V.U. per step. MOUNTING: two hole, 8-32 screws, $\frac{1}{4}$ " centers. DIMENSIONS: $2\frac{1}{2}$ " diameter, $2\frac{1}{16}$ " back of panel depth. CONTACT SPACING: 12°.

412-2B5
\$22.50 silver

Bridged T attenuator, +4 to +26 V.U. and OFF, 12 steps, 2 V.U. per step. MOUNTING: two hole, 8-32 screws, $\frac{1}{4}$ " centers. DIMENSIONS: $2\frac{1}{2}$ " diameter, $2\frac{1}{16}$ " back of panel depth. CONTACT SPACING: 12°.

VITREOUS ENAMELED RHEOSTATS

CLOSE CONTROL RHEOSTATS

Underwriters' Laboratories Reexamination Service Listed

For many years the Ohmite line of ten wirewound, vitreous enameled rheostats, ranging from 25 to 1000 watts in size, has been the most extensive available to industry. Six of the most popular sizes have been carried in stock by Ohmite Distributors and at our factory. Now, the other four sizes, the Model G, 75 watts; Model P, 225 watts; Model T, 750 watts; and the Model U, 1000 watts are available from stock, thus making the entire line of ten sizes quickly obtainable for design and production needs and for emergencies.

FEATURES OF CONSTRUCTION: Ohmite rheostats are designed to produce permanently smooth, close control. The construction is all ceramic and metal; there is nothing to smoke, char, shrink, or shift. All models have insulated shafts with provision to keep the rheostat from turning on the panel. The resistance wire is wound over a solid ceramic core. Each turn is a separate resistance step and is locked against shifting by vitreous enamel. The core and base are also bonded by vitreous enamel. The pivoted universal-action-mounted contact brush is of copper-graphite or silver-graphite on the heavier current rheostats. It rides upon a large flat surface and assures perfect contact without wear on the wire. Pressure

at the contact and at the center lead are independent. The construction is patented under U. S. Patent No. 1,942,495 and Re-issue 19607; other patents pending. Ohmite Rheostat Models H, J, K, L, and N, all marked Series A, are listed under the Underwriters' Laboratories Reexamination Service.

RATING: The current carrying capacities shown in the tables are for use in *free air*; when units are enclosed, these currents should be reduced possibly as much as 30% to 50%, depending upon the degree of ventilation. The rated current will cause the rheostat to dissipate its rated wattage when the full resistance is in the circuit.

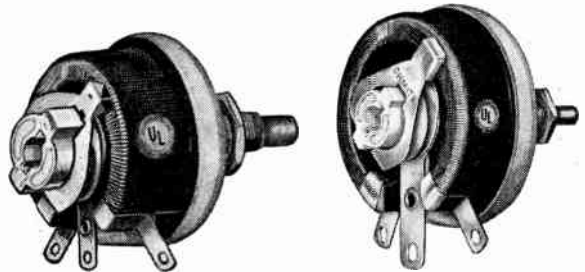

Model "H"

Models "J", "G" and "K"

MODEL "H", Series A — 25 WATT

Diameter $1\frac{1}{8}$ "—Depth behind panel $1\frac{3}{8}$ "—Shaft $\frac{1}{4}$ " diameter. Rotation 295°—Mounting for panels up to $\frac{1}{4}$ " by means of $\frac{3}{8}$ "-32 Bushing and Hex. Nut—Non-turn lug requires $\frac{1}{8}$ " hole $\frac{1}{2}$ " below center of shaft—Stock No. 5150 Knob Supplied.

Stock No.	Total Ohms	Max. Amps.	List Price	Stock No.	Total Ohms	Max. Amps.	List Price
0140	1	5.000	\$7.03	0152	125	.445	\$6.22
0141	2	3.540	6.22	0153	175	.375	6.22
0142	3	2.880	6.22	0154	250	.316	6.22
0143	6	2.040	6.22	0155	350	.267	6.22
0144	8	1.770	6.22	0156	500	.222	6.22
0145	10	1.580	6.22	0157	750	.182	6.22
0146	15	1.290	6.22	0158	1,000	.155	7.03
0147	25	1.000	6.22	0159	1,500	.129	7.03
0148	35	.845	6.22	0160	2,500	.100	7.03
0149	50	.707	6.22	0161	3,500	.084	7.39
0150	75	.575	6.22	0162	5,000	.070	7.39
0151	100	.500	6.22				

MODEL "G" — 75 WATT

Diameter $2\frac{3}{4}$ "—Depth behind panel $1\frac{3}{4}$ "—Shaft $\frac{1}{4}$ " Diameter. Rotation 300°—Mounting for panels up to $\frac{1}{4}$ " by means of $\frac{3}{8}$ "-32 Bushing and Hex. Nut—Non-turn lug requires $\frac{1}{8}$ " hole $\frac{1}{2}$ " below center of shaft—Stock No. 5150 Knob Supplied.

Stock No.	Total Ohms	Max. Amps.	List Price	Stock No.	Total Ohms	Max. Amps.	List Price
1100	0.5	12.300	\$10.57	1112	200	.612	\$9.72
1101	1	8.660	10.57	1113	300	.500	9.72
1102	2	6.120	10.57	1114	400	.433	9.72
1103	3	5.000	10.57	1115	500	.388	9.72
1104	5	3.880	9.72	1116	750	.316	10.57
1105	7.5	3.160	9.72	1117	1,000	.274	10.57
1106	10	2.740	9.72	1118	1,500	.224	10.57
1107	16	2.170	9.72	1119	2,000	.194	10.57
1108	25	1.730	9.72	1120	2,500	.173	10.57
1109	50	1.230	9.72	1121	5,000	.123	11.28
1110	75	1.000	9.72	1122	7,500	.100	12.12
1111	100	.866	9.72	1123	10,000	.087	12.12

MODEL "J", Series A — 50 WATT

Diameter $2\frac{1}{8}$ "—Depth behind panel $1\frac{3}{8}$ "—Shaft $\frac{1}{4}$ " Diameter. Rotation 300°—Mounting for panels up to $\frac{1}{4}$ " by means of $\frac{3}{8}$ "-32 Bushing and Hex Nut—Non-turn lug requires $\frac{1}{8}$ " hole $\frac{1}{2}$ " below center of shaft—Stock No. 5150 Knob Supplied.

Stock No.	Total Ohms	Max. Amps.	List Price	Stock No.	Total Ohms	Max. Amps.	List Price
0308	0.5	10.000	\$7.81	0321	150	.575	\$7.03
0309	1	7.070	7.81	0322	225	.470	7.03
0310	2	5.000	7.81	0323	300	.408	7.03
0311	4	3.530	7.03	0324	500	.316	7.03
0312	6	2.880	7.03	0325	800	.250	7.39
0313	8	2.500	7.03	0326	1,000	.224	7.39
0314	12	2.040	7.03	0327	1,600	.176	7.39
0315	16	1.760	7.03	0328	2,500	.141	7.39
0316	22	1.500	7.03	0329	3,500	.119	7.81
0317	35	1.190	7.03	0330	5,000	.100	7.81
0318	50	1.000	7.03	0331	8,000	.079	7.81
0319	80	.790	7.03	0332	10,000	.070	7.81
0320	125	.630	7.03				

MODEL "K", Series A — 100 WATT

Diameter $3\frac{1}{8}$ "—Depth behind panel $1\frac{3}{4}$ "—Shaft $\frac{1}{4}$ " Diameter. Rotation 300°—Mounting for panels up to $\frac{1}{4}$ " by means of $\frac{3}{8}$ "-32 Bushing and Hex. Nut—Non-turn lug requires $\frac{1}{8}$ " hole $\frac{1}{2}$ " below center of shaft—Stock No. 5150 Knob Supplied.

Stock No.	Total Ohms	Max. Amps.	List Price	Stock No.	Total Ohms	Max. Amps.	List Price
0440	0.5	14.100	\$11.70	0452	200	.707	\$10.95
0441	1	10.000	11.70	0453	300	.575	10.95
0442	2	7.070	11.70	0454	400	.500	10.95
0443	3	5.750	11.70	0455	500	.447	10.95
0444	5	4.470	11.70	0456	750	.365	10.95
0445	7.5	3.650	10.95	0457	1,000	.316	11.70
0446	10	3.160	10.95	0458	1,500	.258	11.70
0447	16	2.500	10.95	0459	2,000	.224	11.70
0448	25	2.000	10.95	0460	2,500	.200	11.70
0449	50	1.410	10.95	0461	5,000	.141	12.47
0450	75	1.150	10.95	0462	7,500	.115	13.28
0451	100	1.000	10.95	0463	10,000	.100	14.03

BE RIGHT WITH OHMITE

RHEOSTATS
RESISTORS
SWITCHES
CHOKES

VITREOUS ENAMELED RHEOSTATS



Model "L"

MODEL "L", Series A - 150 WATT

Diameter 4"—Depth behind panel 2"—Shaft 1/4" Diameter. Rotation 300°—Mounting for panels up to 1/4", 3/8"-32 Bushing and Hex. Nut or two 10-32 x 3/4" flat head screws, mounting centers 7/8" each side of center of shaft on line perpendicular to center terminal.—Stock No. 5150 Knob Supplied.

Stock No.	Total Ohms	Max. Amps.	List Price	Stock No.	Total Ohms	Max. Amps.	List Price
0524	0.5	17.300	\$14.83	0537	150	1.000	\$14.03
0525	1	12.300	14.83	0538	200	.865	14.03
0526	2	8.650	14.83	0539	250	.775	14.03
0527	3	7.070	14.83	0540	350	.655	14.03
0528	5	5.480	14.83	0541	500	.548	14.03
0529	7.5	4.470	14.83	0542	750	.447	14.83
0530	10	3.880	14.03	0543	1,250	.346	14.83
0531	15	3.613	14.03	0544	1,800	.288	15.61
0532	25	2.450	14.03	0545	2,250	.259	15.61
0533	35	2.070	14.03	0546	3,000	.224	15.61
0534	50	1.735	14.03	0547	4,500	.182	16.36
0535	75	1.415	14.03	0548	7,500	.141	17.17
0536	100	1.225	14.03	0549	10,000	.122	18.72

MODEL "P" - 225 WATT

Diameter 5"—Depth behind panel 2 1/8"—Shaft 3/8" Diameter. Rotation 310°—Mounting for panels up to 1 1/2", two 1/4"-20 x 1 1/2" flat head screws, mounting centers 7/8" each side of center of shaft on center line of cross-bar.—Stock No. 5105 Knob Supplied. Three 8-32 Terminal Screws, Nuts and Washers are supplied.

Stock No.	Total Ohms	Max. Amps.	List Price	Stock No.	Total Ohms	Max. Amps.	List Price
1250	1	15.000	\$19.43	1261	100	1.500	\$19.43
1251	2	10.600	19.43	1262	150	1.220	19.43
1252	3	8.660	19.43	1263	200	1.060	19.43
1253	4	7.500	19.43	1264	300	.866	19.43
1254	5	6.710	19.43	1265	400	.750	19.43
1255	7.5	5.490	19.43	1266	700	.567	19.43
1256	10	4.740	19.43	1267	900	.500	19.43
1257	15	3.870	19.43	1268	1,200	.433	19.43
1258	25	3.000	19.43	1269	1,500	.387	19.43
1259	50	2.120	19.43	1270	1,750	.358	19.43
1260	75	1.730	19.43	1271	2,500	.300	19.43

MODEL "N", Series A - 300 WATT

Diameter 6"—Depth behind panel 2 3/8"—Shaft 3/8" Diameter. Rotation 315°—Mounting for panels up to 1 1/4", two 1/4"-20 x 1 1/2" flat head screws, mounting centers 1 1/8" each side of center of shaft on center line of cross-bar.—Stock No. 5105 Knob Supplied. Three 8-32 Terminal Screws, Nuts and Washers are supplied.

Stock No.	Total Ohms	Max. Amps.	List Price	Stock No.	Total Ohms	Max. Amps.	List Price
0650	1	17.320	\$21.06	0661	100	1.730	\$21.06
0651	2	12.240	21.06	0662	150	1.410	21.06
0652	3	10.000	21.06	0663	200	1.220	21.06
0653	4	8.660	21.06	0664	300	1.000	21.06
0654	5	7.750	21.06	0665	400	.866	21.06
0655	7.5	6.320	21.06	0666	700	.655	21.06
0656	10	5.480	21.06	0667	900	.578	21.06
0657	15	4.470	21.06	0668	1,200	.500	21.06
0658	25	3.460	21.06	0669	1,500	.447	21.06
0659	50	2.450	21.06	0670	1,750	.414	21.06
0660	75	2.000	21.06	0671	2,500	.346	21.06



Models "N" and "R"
("P", "T" and "U" Similar)

MODEL "R" - 500 WATT

Diameter 8"—Depth behind panel 2 1/8"—Shaft 3/8" Diameter. Rotation 325°—Mounting for panels up to 1 1/4", two 1/4"-20 x 1 1/2" flat head screws, mounting centers 1 1/2" each side of center of shaft on center line of cross-bar.—Stock No. 5105 Knob Supplied. Three 8-32 Terminal Screws, Nuts and Washers are supplied.

Stock No.	Total Ohms	Max. Amps.	List Price	Stock No.	Total Ohms	Max. Amps.	List Price
0849	1.0	22.300	\$30.45	0872	50	3.160	\$30.45
0850	1.5	18.200	30.45	0861	80	2.520	30.45
0851	2	15.800	30.45	0862	125	2.000	30.45
0852	2.5	14.100	30.45	0863	175	1.690	30.45
0853	3	12.900	30.45	0864	250	1.410	30.45
0854	4	11.200	30.45	0865	325	1.240	30.45
0855	5	10.000	30.45	0866	500	1.000	30.45
0856	8	7.900	30.45	0867	750	.817	30.45
0857	12.5	6.300	30.45	0868	1,000	.707	30.45
0858	16	5.600	30.45	0869	1,500	.577	30.45
0859	25	4.470	30.45	0870	2,000	.500	30.45
0860	40	3.540	30.45	0871	2,500	.447	30.45

MODEL "T" - 750 WATT

Diameter 10"—Depth behind panel 3"—Shaft 3/8" Diameter. Rotation 330°—Mounting for panels up to 1 1/4", two 1/4"-20 x 1 1/2" flat head screws, mounting centers 1 1/8" each side of center of shaft on center line of cross-bar.—Stock No. 5105 Knob Supplied. Three 8-32 Terminal Screws, Nuts and Washers are supplied.

Stock No.	Total Ohms	Max. Amps.	List Price	Stock No.	Total Ohms	Max. Amps.	List Price
1300	1	27.400	\$42.97	1312	50	3.870	\$42.97
1301	1.5	22.300	42.97	1313	80	3.060	42.97
1302	2	19.400	42.97	1314	100	2.740	42.97
1303	2.5	17.300	42.97	1315	160	2.170	42.97
1304	3	15.800	42.97	1316	200	1.940	42.97
1305	4	13.600	42.97	1317	300	1.580	42.97
1306	5	12.200	42.97	1318	400	1.370	42.97
1307	8	9.650	42.97	1319	600	1.117	42.97
1308	10	8.650	42.97	1320	750	1.000	42.97
1309	12.5	7.750	42.97	1321	1,200	.791	42.97
1310	16	6.820	42.97	1322	1,800	.646	42.97
1311	25	5.470	42.97	1323	2,500	.547	42.97

MODEL "U" - 1000 WATT

Diameter 12"—Depth behind panel 3"—Shaft 3/8" Diameter. Rotation 335°—Mounting for panels up to 1 1/4", two 1/4"-20 x 1 1/2" flat head screws, mounting centers 3" each side of center of shaft on center line of cross-bar.—Stock No. 5105 Knob Supplied. Three 8-32 Terminal Screws, Nuts and Washers are supplied.

Stock No.	Total Ohms	Max. Amps.	List Price	Stock No.	Total Ohms	Max. Amps.	List Price
1450	1	31.600	\$50.22	1462	50	4.470	\$50.22
1451	1.5	25.800	50.22	1463	75	3.650	50.22
1452	2	22.400	50.22	1464	100	3.160	50.22
1453	2.5	20.000	50.22	1465	175	2.390	50.22
1454	3	18.300	50.22	1466	225	2.110	50.22
1455	4	15.800	50.22	1467	300	1.830	50.22
1456	5	14.100	50.22	1468	400	1.580	50.22
1457	8	11.200	50.22	1469	500	1.410	50.22
1458	10	10.000	50.22	1470	750	1.150	50.22
1459	12.5	8.950	50.22	1471	1,000	1.000	50.22
1460	16	7.900	50.22	1472	1,500	.816	50.22
1461	25	6.330	50.22	1473	2,500	.633	50.22

BE RIGHT WITH OHMITE

RHEOSTATS
RESISTORS
SWITCHES
CHOKES

OHMITE "LITTLE DEVIL"® RESISTORS



Ohmite "Little Devils" are full 1/2 Watt, 1 Watt and 2 Watt Insulated Composition Resistors and can be used at their full wattage ratings at 70° C. (158° F.) ambient temperature. They meet requirements of specification JAN-R-11.

"LITTLE DEVILS" are available from stock in 1/2, 1 and 2 watt sizes with ±5% or ±10% tolerance. The standard RMA values, 10 ohms to 22 megohms can be furnished. In the 1 watt size, ±10% tolerance values as low as 2.7 ohms are available from stock.

Stocked in RETMA Values ±5% or ±10% Tolerance

(Figures in bold type are ±10% RETMA values. All values except (*) available in ±5% tolerance.)

Ohms	Ohms	Ohms	Ohms	Megs.
*2.7	110	2,400	51,000	1.1
*3.3	120	2,700	56,000	1.2
*3.9	130	3,000	62,000	1.3
*4.7	150	3,300	68,000	1.5
*5.6	160	3,600	75,000	1.6
*6.8	180	3,900	82,000	1.8
*8.2	200	4,300	91,000	2.0
10	220	4,700	MEGS	2.2
11	240	5,100	0.1	2.4
12	270	5,600	0.11	2.7
13	300	6,200	0.12	3.0
15	330	6,800	0.13	3.3
16	360	7,500	0.15	3.6
18	390	8,200	0.16	3.9
20	430	9,100	0.18	4.3
22	470	10,000	0.20	4.7
24	510	11,000	0.22	5.1
27	560	12,000	0.24	5.6
30	620	13,000	0.27	6.2
33	680	15,000	0.30	6.8
36	750	16,000	0.33	7.5
39	820	18,000	0.36	8.2
43	910	20,000	0.39	9.1
47	1,000	22,000	0.43	10.0
51	1,100	24,000	0.47	11.0
56	1,200	27,000	0.51	12.0
62	1,300	30,000	0.56	13.0
68	1,500	33,000	0.62	15.0
75	1,600	36,000	0.68	16.0
82	1,800	39,000	0.75	18.0
91	2,000	43,000	0.82	20.0
100	2,200	47,000	0.91	22.0
			1.0	

*1 Watt Size Only. ±10% tolerance.

Type	Size Lgth. Diam.	Max. Volts	List Price ±10%	List Price ±5%
1/2 Watt	3/8" 3/4"	350	17c	33c
1 Watt	1/2" 5/8"	500	25c	50c 10 Ohms and up
2 Watt	3/4" 1"	1,000	33c	66c

Popular OHMITE "BROWN DEVIL"® RESISTORS



5 Watt—1" x 5/16" Core Size

Ohms	Mils.	Ohms	Mils.	Ohms	Mils.
1	2,236	125	200	1,250	63
1.5	1,820	150	182	1,500	57
2	1,580	200	158	1,750	53
3	1,290	225	149	2,000	49
4	1,120	250	141	2,250	46
5	1,000	300	129	2,500	44
7.5	818	350	120	3,000	39
10	707	400	112	3,500	36
12	645	450	105	4,000	33
15	575	500	100	4,500	31
20	500	600	91	5,000	29
25	447	700	84	6,000	26
30	408	750	81	7,000	24
35	378	800	79	7,500	22
40	353	900	74	8,000	21
50	316	1,000	70	9,000	19
75	258	1,100	67	10,000	18
100	224	1,200	64		

List Price, 1 thru 1,000 ohms.....\$0.67
List Price, 1,100 thru 5,000 ohms..... .72
List Price, 6,000 thru 10,000 ohms..... .78

10 Watt—1 3/4" x 5/16" Core Size

Ohms	Mils.	Ohms	Mils.	Ohms	Mils.
1	3,160	350	169	6,000	38
2	2,235	400	158	7,000	34
3	1,825	450	149	7,500	32
4	1,580	500	141	8,000	31
5	1,414	600	129	8,500	29
7.5	1,155	700	119	10,000	26
10	1,000	750	115	11,000	24
12	910	800	111	12,000	23
15	816	900	105	12,500	22
20	707	1,000	100	13,500	21
25	632	1,100	95	14,300	20
30	575	1,200	91	15,000	19
35	535	1,250	89	16,000	18
40	500	1,500	79	17,500	17
50	447	1,750	74	18,000	17
75	365	2,000	69	20,000	16
100	316	2,250	64	22,500	15
125	283	2,500	63	25,000	14
150	258	3,000	56	30,000	12
200	223	3,500	51	35,000	10
225	217	4,000	47	40,000	9
250	200	4,500	45	45,000	8
300	182	5,000	43	50,000	7

List Price, 1 thru 1,000 ohms.....\$0.75
List Price, 1,100 thru 5,000 ohms..... .80
List Price, 6,000 thru 10,000 ohms..... .92
List Price, 11,000 thru 20,000 ohms..... 1.03
List Price, 22,500 & 25,000 ohms..... 1.08
List Price, 30,000 thru 50,000 ohms..... 1.22

10 WATT DIVIDOHM® ADJUSTABLE RESISTORS

Core Size 1 3/4" x 5/8"			Mounting Centers 2 1/4"		
Adjustable Res.			Adjustable Res.		
Res. Ohms	Max. Mils.	Stock No.	Res. Ohms	Max. Mils.	Stock No.
1	3,150	1001	75	365	1011
2	2,235	1002	100	316	1012
3	1,825	1003	150	258	1013
5	1,415	1004	200	223	1014
7.5	1,155	1005	250	200	1015
10	1,000	1006	300	182	1016
15	816	1007	350	169	1017
20	707	1008	400	158	1018
25	632	1009	500	141	1019
50	447	1010	600	129	1020

WITH WELDED TERMINALS

High quality, small size, wire-wound resistors ideal for voltage dropping, bias units, bleeders, etc. They're extra-sturdy, all-ceramic, vitreous enameled. These all-welded construction units have welded high-strength alloy terminals. For perfect electrical connection, the resistance wire is welded to the terminal. They give time-proved protection against shock, vibration, heat and humidity. Their long record of continuous trouble-free service—their wide use in all climates of the world—prove their complete reliability and economy. All units can be conveniently mounted by means of their 1 1/2" tinned wire leads.

20 Watt—2" x 7/16" Core Size

Ohms	Mils.	Ohms	Mils.	Ohms	Mils.
5	2,000	1,250	126	12,500	35
10	1,414	1,500	115	15,000	30
25	894	1,750	107	20,000	24
50	632	1,850	104	25,000	20
75	516	2,000	100	30,000	17
100	447	2,250	94	35,000	15
150	365	2,400	91	40,000	14
200	316	2,500	89	45,000	13
250	283	2,750	85	50,000	12
300	258	3,000	81	55,000	10
350	239	3,500	75	60,000	9
400	223	4,000	70	65,000	8
500	200	4,500	66	70,000	7
650	175	5,000	63	75,000	7
700	169	6,000	57	80,000	7
750	163	7,000	53	85,000	6
800	158	7,500	51	90,000	6
850	153	8,000	50	95,000	6
1,000	141	9,000	47	100,000	6
1,200	129	10,000	43		

List Price, 5 thru 1,000 ohms.....\$0.95
List Price, 1,200 thru 5,000 ohms..... .97
List Price, 6,000 thru 10,000 ohms..... 1.12
List Price, 12,500 thru 20,000 ohms..... 1.20
List Price, 25,000 thru 40,000 ohms..... 1.37
List Price, 45,000 thru 60,000 ohms..... 1.58
List Price, 65,000 thru 80,000 ohms..... 1.83
List Price, 85,000 thru 100,000 ohms..... 2.11

BE RIGHT WITH OHMITE

RHEOSTATS
RESISTORS
SWITCHES
CHOKES

OHMITE VITREOUS ENAMELED FIXED AND DIVIDOHM® RESISTORS



25 WATTS Core Size 2"x3/16" Mounting Centers 2 3/4"

Res. Ohms	Max. Mils.	Fixed Resist.		Adj. Resist.	
		Stock No.	List Price	Stock No.	List Price
1	5,000	0200J	\$0.97	0360	\$1.87
2	3,535	0200K	.97	0360B	1.87
3	2,885	0200L	.97	0361	1.87
5	2,235	0200A	.97	0362	1.87
7.5	1,825			0362B	1.87
10	1,580	0200B	.97	0363	1.87
15	1,290	0200R	.97	0364	1.87
20	1,117			0364B	1.87
25	1,000	0200C	.97	0365	1.87
50	707	0200D	.97	0366	1.87
75	577	0200E	.97	0367	1.87
100	500	0200F	.97	0368	1.87
150	408	0200G	.97	0369	1.87
200	353	0200H	.97	0370	1.87
250	316	0201	.97	0371	1.87
300	288			0371B	1.87
400	250			0371C	1.87
500	223	0202	.97	0372	1.87
750	182	0203	.97	0373	1.87
800	176	0204	.97	0374	1.87
1,000	158	0205	.97	0375	1.87
1,250	141			0375B	1.88
1,500	129	0206	1.03	0376	1.88
2,000	111	0207	1.03	0377	1.88
2,500	105			0377B	1.88
3,000	100	0208	1.03	0378	1.88
3,500	91	0209	1.03	0379	1.88
4,000	84	0210	1.03	0380	1.88
4,500	79	0211	1.03	0381	1.88
5,000	74			0381B	1.88
5,000	70	0212	1.03	0382	1.88
6,000	64	0213	1.14	0383	2.03
7,000	60			0383B	2.03
7,200	59			0383C	2.03
7,500	57	0214	1.14	0384	2.03
8,000	55			0384B	2.03
9,000	52			0384C	2.03
10,000	50	0215	1.14	0385	2.03
12,000	42	0216	1.19	0386	2.08
15,000	34	0217	1.19	0387	2.08
20,000	26	0218	1.19	0388	2.08
25,000	21	0219	1.36	0389	2.28
40,000	14	0222	1.36		
50,000	12	0224	1.56		
100,000	7	0229	2.11		

100 WATTS Core Size 6 1/2"x3/8" Mounting Centers 7 3/4"

Res. Ohms	Max. Mils.	Fixed Resist.		Adj. Resist.	
		Stock No.	List Price	Stock No.	List Price
5	4,470	0600A	\$2.42	0956	\$3.58
10	3,160	0600B	2.42	0957	3.58
25	2,000	0601	2.42	0958	3.58
50	1,414	0602	2.42	0959	3.58
75	1,153	0603	2.42		
100	1,000	0604	2.42	0960	3.58
150	816	0605	2.42		
250	632	0606	2.42	0960B	3.58
500	447	0607	2.42	0961	3.58
750	365	0608	2.42		
1,000	316	0609	2.42	0962	3.58
1,500	258	0610	2.53	0962B	3.67
2,000	223	0611	2.53		
2,500	200	0612	2.53	0963	3.67
3,000	182	0613	2.53		
5,000	141	0614	2.53	0964	3.67
7,500	115	0615	2.70		
10,000	100	0616	2.70	0965	3.87
15,000	81	0617	2.97	0966	4.12
20,000	70	0618	2.97	0967	4.12
25,000	53	0619	3.20	0968	4.37
30,000	47	0620	3.20	0969	4.37
40,000	36	0621	3.20	0970	4.37
50,000	29	0622	3.37	0971	4.53
60,000	24	0623	3.37		
75,000	19	0624	3.58	0972	4.75
100,000	15	0625	3.80	0973	4.95

50 WATTS Core Size 4"x3/16" Mounting Centers 4 3/4"

Res. Ohms	Max. Mils.	Fixed Resist.		Adj. Resist.	
		Stock No.	List Price	Stock No.	List Price
5	3,160	0400A	\$1.63	0560	\$2.37
10	2,235	0400B	1.63	0561	2.37
25	1,414	0400C	1.63	0562	2.37
50	1,000	0400D	1.63	0563	2.37
75	816	0400E	1.63	0564	2.37
100	707	0400F	1.63	0565	2.37
150	577	0400G	1.63	0566	2.37
200	500	0400H	1.63	0567	2.37
250	447	0401	1.63	0568	2.37
300	408			0568B	2.37
400	353			0568C	2.37
500	316	0402	1.63	0569	2.37
750	258	0403	1.63	0570	2.37
1,000	223	0405	1.63	0572	2.37
1,250	200			0572B	2.47
1,500	182	0406	1.75	0573	2.47
2,000	158	0407	1.75	0574	2.47
2,500	141	0408	1.75	0575	2.47
3,000	129	0409	1.75	0576	2.47
3,500	119			0576B	2.47
4,000	111	0410	1.75	0577	2.47
4,500	105			0577B	2.47
5,000	100	0411	1.75	0578	2.47
6,000	91			0578B	2.63
7,000	84			0578C	2.63
7,500	81	0412	1.92	0579	2.63
8,000	79	0413	1.92	0580	2.63
9,000	74			0580B	2.63
10,000	70	0414	1.92	0581	2.63
12,000	64	0415	2.08	0582	2.83
15,000	57	0416	2.08	0583	2.83
20,000	48	0417	2.08	0584	2.83
25,000	41	0418	2.33	0585	3.08
30,000	36			0586	3.08
35,000	32	0419	2.33		
40,000	28			0587	3.08
50,000	23	0420	2.58	0588	3.30
60,000	19			0589	3.30
75,000	16	0421	2.92		
80,000	15			0590	3.67
100,000	12	0422	3.20	0591	3.92

160 WATTS Core Size 8 1/2"x1 1/8" Mounting Centers 9 3/8"

Res. Ohms	Max. Mils.	Fixed Resist.		Adj. Resist.	
		Stock No.	List Price	Stock No.	List Price
5	5,660	0700A	\$4.16	1156	\$5.33
10	4,000	0700B	2.98	1157	4.14
25	2,530	0701	2.98	1158	4.14
50	1,788	0702	2.98	1159	4.14
75	1,460	0703	2.98		
100	1,265	0704	2.98	1160	4.14
150	1,032	0705	2.98		
250	800	0706	2.98	1160B	4.14
500	566	0707	2.98	1161	4.14
750	462	0708	2.98		
1,000	400	0709	2.98	1162	4.14
1,500	326	0710	3.04	1162B	4.19
2,000	283	0711	3.04		
2,500	253	0712	3.04	1163	4.19
3,000	231	0713	3.04		
5,000	179	0714	3.04	1164	4.19
7,500	146	0715	3.30		
10,000	126	0716	3.30	1165	4.44
15,000	103	0717	3.54	1166	4.69
20,000	89	0718	3.54	1167	4.69
25,000	80	0719	3.64	1168	4.81
30,000	67	0720	3.64	1169	4.81
40,000	50	0721	3.64	1170	4.81
50,000	40	0722	3.76	1171	4.94
60,000	34	0723	3.76		
75,000	27	0724	4.03	1172	5.17
100,000	21	0725	4.26	1173	5.44

These all-welded construction resistors have welded high-strength alloy terminals. For perfect electrical connection, the resistance wire is welded to the terminal. Units are wire-wound on ceramic cores and protected by Ohmite Vitreous Enamel. Furnished with mounting brackets and on DIVIDOHM with one adjustable lug.

75 WATTS Core Size 6"x3/16" Mounting Centers 6 3/4"

Res. Ohms	Max. Mils.	Adjustable Res.		Res. Ohms	Max. Mils.	Adjustable Res.	
		Stock No.	List Price			Stock No.	List Price
5	3,870	0769		5,000	122	0783	
10	2,735	0770		6,000	111	0783B	
15	2,236	0771		7,000	103	0783C	
25	1,732	0772		7,500	100	0784	
50	1,224	0773		8,000	96	0784B	
100	866	0774		9,000	91	0784C	
200	612	0774B		10,000	86	0785	
250	547	0775		12,000	79	0785B	
300	500	0775B		15,000	70	0786	
400	433	0775C		20,000	61	0787	
500	387	0776		25,000	49	0788	
750	316	0777		30,000	42	0789	
1,000	273	0778		35,000	36	0790	
1,250	245	0778B		40,000	32	0791	
1,500	223	0779		45,000	29	0792	
2,000	193	0780		50,000	26	0793	
2,500	173	0781		60,000	22	0794	
3,000	158	0781B		80,000	17	0795	
3,500	146	0782		100,000	13	0796	
4,000	136	0782B					

List Price, 5 thru 1,000 ohms \$2.75
List Price, 1,250 thru 5,000 ohms 2.83
List Price, 6,000 thru 10,000 ohms 3.00
List Price, 12,000 thru 20,000 ohms 3.20
List Price, 25,000 thru 40,000 ohms 3.53
List Price, 45,000 thru 60,000 ohms 3.62
List Price, 80,000 ohms 3.97
List Price, 100,000 ohms 4.33

200 WATTS Core Size 10 1/2"x1 1/8" Mounting Centers 11 3/8"

Res. Ohms	Max. Mils.	Fixed Resist.		Adj. Resist.	
		Stock No.	List Price	Stock No.	List Price
5	6,320	0900A	\$4.53	1356	\$5.67
10	4,470	0900B	3.22	1357	4.37
25	2,828	0901	3.22	1358	4.37
50	2,000	0902	3.22	1359	4.37
75	1,635	0903	3.22		
100	1,414	0904	3.22	1360	4.37
150	1,153	0905	3.22		
250	894	0906	3.22	1360B	4.37
500	632	0907	3.22	1361	4.37
750	516	0908	3.22		
1,000	447	0909	3.22	1362	4.37
1,500	365	0910	3.30	1362B	4.45
2,000	316	0911	3.30		
2,500	283	0912	3.30	1363	4.45
3,000	258	0913	3.30		
5,000	200	0914	3.30	1364	4.45
7,500	163	0915	3.53		
10,000	141	0916	3.53	1365	4.70
15,000	115	0917	3.77	1366	4.92
20,000	100	0918	3.77	1367	4.92
25,000	80	0919	3.90	1368	5.03
30,000	81	0920	3.90	1369	5.03
40,000	61	0921	3.90	1370	5.03
50,000	49	0922	4.03	1371	5.17
60					

BE RIGHT WITH OHMITE

RHEOSTATS
RESISTORS
SWITCHES
CHOKES

OHMITE R.F. PLATE CHOKES

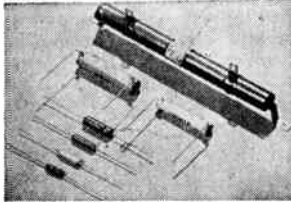

This series of seven Ohmite single layer wound solenoid radio frequency plate chokes covers the entire frequency range of 3 to 520 megacycles. The four highest frequency chokes are wound on low power factor plastic cores while the other three units

are wound on steatite tubes. Windings are insulated and protected by a moisture-proof coating. The single layer winding is designed to avoid adverse harmonic effects within the recommended operating range and also prevents breakdown from high r.f. potentials.

Stock Number	Operating Range Megacycles	Micro-henries	Core Dimensions	List Price
Z-7	3 to 20 Mc.	84.0	6" x 3/16"	\$1.56
Z-14	7 to 35 Mc.	44.0	2" x 1/8"	.68
Z-28	20 to 60 Mc.	21.0	1 3/4" x 5/16"	.44
Z-50	35 to 110 Mc.	7.0	1 1/2" x 5/16"	.33
Z-144	80 to 200 Mc.	1.8	3/4" x 3/16"	.33
Z-235	160 to 350 Mc.	0.84	3/4" x 3/16"	.33
Z-460	320 to 520 Mc.	0.20	1/2" x 3/16"	.33

Non-magnetic Brackets Furnished with Z-7. The Z-14 and Z-28 are rated at 600 ma. All others 1000 ma.

2 WATT MOLDED COMPOSITION POTENTIOMETER - TYPE AB

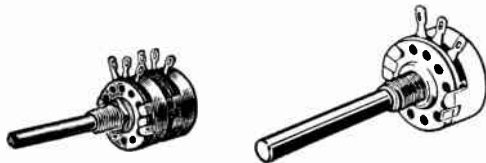

The Type AB Potentiometer is an exceptionally high quality unit designed especially for industrial, laboratory, radio service and other uses where reliability is particularly important. Because the resistor element is molded, the unit has an exceptionally large safety factor. The power rating of 2 watts is unusual for a unit of such small size. The unit has a very low noise level and low voltage coefficient. It will pass the Army-Navy 200 hour salt spray test, specification AN-QQ-S-91. The single unit is 1-1/16" diameter and extends 9/16" behind the panel. The dual unit extends 1-3/16" behind the panel. The 2" long round shaft (including the 3/8" long mounting bushing) is available from stock on potentiometers with all three resistance tapers and on the dual unit. The screw-driver shaft with locking-nut is available from stock on the linear taper units only. A SPST switch, to be attached to the back of the control, can be supplied extra.



For more complete information on OHMITE PRODUCTS, ask for Ohmite Stock Catalog.

LITTLE DEVIL® RESISTOR ASSORTMENTS FOR SERVICE USE



Serviceman's assortments of 150 Ohmite "Little Devil," 1/2-watt, or 125, 1-watt or 2-watt insulated composition resistors, in the 40 values (10 ohms to 10 megohms) most frequently used by servicemen. The assortment is offered at the price of the resistors alone—the cabinet is furnished without extra cost! Cabinet is only 9" long, 4 3/4" high, and 5 1/4" deep.

resistors alone—the cabinet is furnished without extra cost! Cabinet is only 9" long, 4 3/4" high, and 5 1/4" deep.

Assortment	Stock No.	Quantity of Resistors	Wattages	Net Price
SERVICE ±10% tolerance (40 resistance values)	CAB-10	150	1/2 watt	\$15.00
	CAB-2	125	1 watt	13.75
	CAB-3	125	2 watt	25.00

NEW OHM'S LAW CALCULATOR

Redesigned! This new, improved version of the famous Ohmite Ohm's Law Calculator — popular the world over with servicemen, engineers and students — now has scales for solving parallel resistance problems, AND a standard slide rule. More useful than ever! With one setting of the slide the calculator gives the answer to any Ohm's Law problem—reading directly in ohms, volts, amperes, and watts. Three of the new scales on the back provide a quick, one-setting means of solving parallel resistance problems. The slide rule scales will multiply, divide, find squares, and square roots.

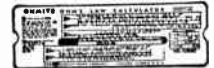

Ohm's Law Calculator (Cardboard)Net Price \$0.25
Ohm's Law Calculator (Plastic)Net Price 1.50

Total Resistance ±10% Except as Noted	Resistance Rotation Characteristics (Taper)				
	LINEAR			Type A Clockwise Log. Stock No.	Type B Counterclock. Log. Stock No.
	Type U 2" Shaft Stock No.	Type LU Locking Shaft Stock No.	Type U Dual Unit Stock No.		
50 Ohms	CU 5001	CLU 5001			
100 Ohms	CU 1011	CLU 1011			
250 Ohms	CU 2511	CLU 2511			
500 Ohms	CU 5011	CLU 5011			
1,000 Ohms	CU 1021	CLU 1021			
2,500 Ohms	CU 2521	CLU 2521			
5,000 Ohms	CU 5021	CLU 5021			
10,000 Ohms	CU 1031	CLU 1031	CCU 1031	CB 1031	
25,000 Ohms	CU 2531	CLU 2531	CCU 2531	CB 2531	
50,000 Ohms	CU 5031	CLU 5031	CCU 5031	CB 5031	
.10 Meg.	CU 1041	CLU 1041	CCU 1041		
.25 Meg.	CU 2541	CLU 2541	CCU 2541	CA 1041	
.5 Meg.	CU 5041	CLU 5041	CCU 5041	CA 2541	
1.0 Meg. ±20%	CU 1052	CLU 1052	CCU 1052	CA 5041	
2.5 Meg. ±20%	CU 2552	CLU 2552		CA 1052	
5.0 Meg. ±20%	CU 5052	CLU 5052		CA 2552	

Stock No. CU PotentiometerList Price \$3.25
Stock Nos. CA and CB PotentiometerList Price 3.75
Stock No. CLU PotentiometerList Price 4.25
Stock No. CCU Dual PotentiometerList Price 9.75
Stock No. CS-1, Switch only for above unit (supplied unmounted) .List Price 1.10

SPRAGUE RESISTORS

KOOLOHM[®] WIRE-WOUND RESISTORS

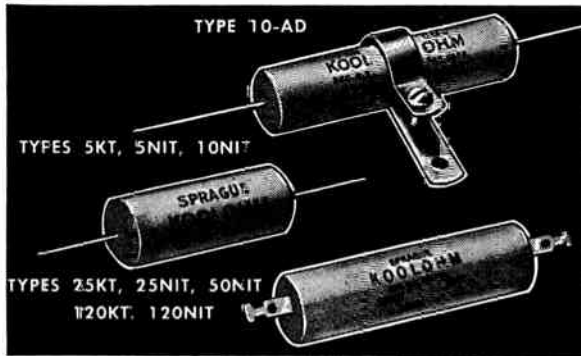

- Wound with wire which is insulated before winding with a flexible ceramic coating. This coating is impervious to heat as high as 1000°C.
- Each resistor is "tropicalized" by a glazed ceramic outer coating and new type end seals which offer complete protection against moisture or any other climatic conditions
- May be mounted anywhere—even flat against chassis or grounded parts
- Extremely high insulation resistance—10,000 volts from surface of ceramic jacket to inner resistance elements
- Insulated wire permits winding higher values in layers, which means much smaller physical sizes for each wattage rating
- Insulated wire permits true "non-inductive" wound designs

NOTE: ALL NIT TYPES ARE NON-INDUCTIVE

5 WATTS TYPES 5 KT & 5 NIT 1 1/2" dia. x 1 1/2" long				
5 KT List	Ohms	Max. Ma.	Max. Volts	5 NIT List
\$.65	5	1000	5.00	\$1.00
.65	10	707	7.07	1.00
.65	15	587	8.67	1.00
.65	20	500	10	1.00
.65	25	446	11	1.00
.65	30	406	12	1.00
.65	40	354	14	1.00
.65	50	316	15	1.00
.65	75	258	19	1.00
.65	100	224	22	1.00
.65	150	183	27	1.00
.65	200	158	31	1.00
.65	250	141	35	1.00
.65	300	129	38	1.00
.65	400	112	44	1.00
.65	500	100	50	1.00
.65	600	91	54	1.00
.65	700	84	59	1.00
.65	800	79	63	1.00
.65	900	74	67	1.00
.70	1000	70	70	1.00
.70	1250	63	79	1.15
.70	1500	57	86	1.15
.70	1750	53	93	1.15
.70	2000	50	100	1.15
.70	2500	44	112	1.25
.70	3000	40	123	1.25
.70	4000	35	141	1.25
.70	5000	31	158	1.30
.80	6000	28	173	**
.80	7000	26	187	**
.80	7500	25	194	**
.80	8000	25	200	**
.80	9000	23	212	**
.80	10000	22	224	**
.90	12500	20	250	**
.90	14000	18	265	**
.95	15000	18	274	**
.95	20000	15	333	**
1.10	25000	14	354	**
1.20	30000	13	387	**
1.40	35000	12	418	**
1.50	40000	11	447	**

10 WATTS TYPES 10 KT & 10 NIT 1 1/2" dia. x 1 1/2" long				
10 KT List	Ohms	Max. Ma.	Max. Volts	10 NIT List
\$.75	5	1414	7.07	\$1.00
.75	10	1000	10	1.00
.75	15	830	12.3	1.00
.75	20	707	14.1	1.00

10 WATTS ADJUSTABLE† TYPE 10-AD 1 1/2" dia. x 1 1/2" long				
Ohms	Max. Ma.	Max. Volts	List	
10	1000	10	\$1.45	
25	630	15.8	1.45	
50	447	22.4	1.45	
100	316	31.6	1.45	
150	259	38.7	1.45	
200	223	44.6	1.45	
250	200	50	1.45	
300	182	54.7	1.45	
400	158	63.3	1.45	

25 WATTS TYPES 25 KT & 25 NIT 2 1/2" dia. x 2 1/2" long				
25 KT List	Ohms	Max. Ma.	Max. Volts	25 NIT List
\$1.45	5	2.23	11	\$ 1.85
1.30	10	1.58	15	1.85
1.30	25	1.0	25	1.85
1.30	50	.707	35	1.85
1.30	75	.577	43	1.85
1.30	100	.500	50	1.85
1.30	150	.408	61	1.85
1.30	200	.353	70	1.85
1.30	250	.316	79	1.85
1.30	500	.223	111	1.85
1.35	600	.204	122	1.85
1.35	750	.182	137	1.85
1.35	1000	.158	158	1.85
1.35	1500	.129	193	2.00
1.35	2000	.111	223	2.00
1.35	2500	.100	250	2.00
1.45	3000	.091	273	2.40
1.45	4000	.079	316	2.40
1.45	5000	.070	353	2.40
1.45	7500	.057	432	2.40
1.50	10000	.050	500	2.75
1.55	12000	.046	548	2.75
1.55	15000	.041	612	2.75
1.65	20000	.035	707	3.10
1.80	25000	.032	790	3.40
2.00	40000	.025	1000	**
2.20	50000	.022	1118	**
2.85	75000	.018	1370	**
3.55	100000	.016	1580	**

50 WATTS TYPES 50 KT & 50 NIT 3 1/2" dia. x 4" long				
50 KT List	Ohms	Max. Ma.	Max. Volts	50 NIT List
\$1.95	5	3.16	15	\$ 3.10
1.95	10	2.23	22	3.10
1.95	25	1.41	35	3.10

120 WATTS TYPES 120 KT & 120 NIT 1 1/4" Dia. x 8 1/2" long				
120 KT List	Ohms	Max. Ma.	Max. Volts	120 NIT List
\$7.75	5	4.9	24.5	\$9.40
7.75	10	3.46	34.6	9.40
7.75	25	2.18	54.6	9.40
7.75	50	1.54	77.4	9.40
7.75	75	1.26	94.8	9.40
7.75	100	1.09	109.5	9.40
7.75	150	.884	134	9.40
7.75	200	.775	155	9.40
7.75	250	.692	173	9.40
7.75	300	.624	191	9.40
7.75	390	.574	211	9.40
7.75	500	.490	245	9.40
7.75	600	.446	268	9.40
7.75	750	.400	300	9.40
7.75	1000	.346	346	9.40
7.75	1500	.282	424	9.40
7.75	2000	.245	490	9.40
7.75	2500	.219	548	9.40
7.75	3000	.200	600	9.40
7.75	5000	.154	774	9.40
8.00	7500	.126	948	10.00
8.00	10000	.109	1095	10.00
8.00	15000	.089	1340	10.00
8.00	20000	.077	1550	10.00
8.00	25000	.069	1733	10.00
8.00	50000	.049	2450	10.00
8.00	75000	.040	3000	**
8.00	100000	.034	3460	**

*KT Types only

†Adjustable Resistors are not tropicalized

★New addition to line.



DALE PRODUCTS, INC.

COLUMBUS, NEBRASKA U. S. A.



Miniature POWER RESISTORS

Carefully designed and skillfully made for electronic and allied industries, these miniature power resistors are completely welded from terminal to terminal. They are coated with a special Silicone material, embedded in an anodized aluminum housing designed for maximum heat dissipation, and are impervious to moisture. They are ruggedly built for long life service under the most adverse operating conditions.

DIMENSIONS OF RH AND B TYPES

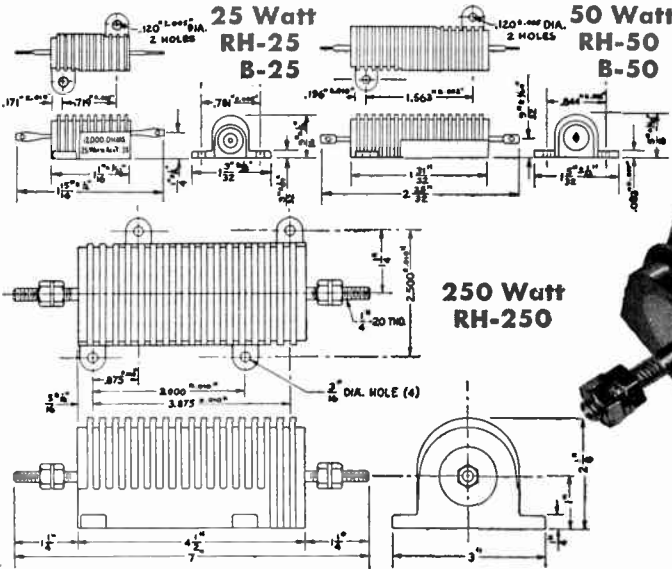

ACTUAL SIZE

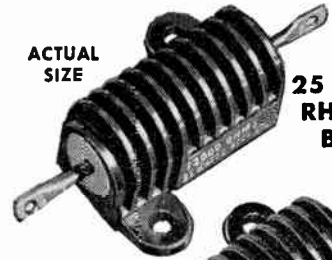

25 Watt
RH-25
B-25

ACTUAL SIZE



50 Watt
RH-50
B-50

SHOWN IN REDUCED SIZE

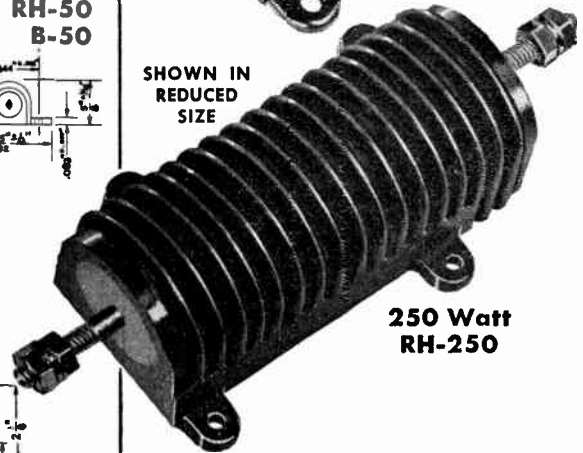

250 Watt
RH-250



Power Resistors are the answer to that space problem because it is true POWER in MIN-IATURE. Carefully crafted in every respect, DALOHM Miniature Power Resistors are designed to give trouble-free performance under all conditions.

- Tolerances from 0.05% to 10%.
- RH and RS Types made in accordance to applicable JAN and MIL Specifications.
- Resistance ranges up to 55,000 ohms.
- T.C. 0.00002/ Deg. C.

Packed and sealed in plastic tubes for your protection.



CS Types — standard package 10 to the carton.

2 Watt

RS-2

CS-2

5 Watt

RS-5

CS-5

10 Watt

RS-10

CS-10

DIMENSIONS OF RS & CS TYPES

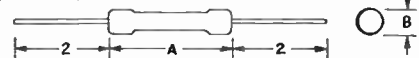

Part No.	Full Wattage Rating	Nom. Dimensions	
		A	B
RS-2 CS-2	2	$\frac{3}{8}'' \pm 1/16''$	$\frac{1}{4}'' \pm 1/32''$
RS-5 CS-5	5	$\frac{7}{8}'' \pm 1/16''$	$5/16'' \pm 1/32''$
RS-10 CS-10	10	$1 \frac{25}{32}'' \pm 1/16''$	$\frac{3}{8}'' \pm 1/32''$

DALE PRODUCTS, INC.

COLUMBUS, NEBRASKA U. S. A.



HERMETIC SEAL — RUGGEDIZED DEPOSITED CARBON PRECISION RESISTORS

The ultimate in precision under ALL conditions

- Completely sealed.
- Fully insulated.
- Non-Hydroscopic.
- Thermal Shock Proof.
- Ultra-high-frequency.
- Ruggedized construction.

DALOHM hermetic sealed ruggedized precision resistors are produced under most exacting methods of quality control. They are completely solder sealed in a newly developed envelope of non-hydroscopic ceramic. Ideally suited for use in U.H.F. equipment where only the optimum of quality may be tolerated. Ruggedized for incorporation into "snap-in" component clips. Production tested for resistance to thermal shock, salt-water immersion and humidity.



HERMETIC SEAL
RUGGEDIZED PRECISION
RESISTORS ARE AVAILABLE
IN THREE WATTAGE
RATINGS, IN RESISTANCE
RANGES TO 200 MEGOHMS

Standard Tolerance $\pm 1\%$

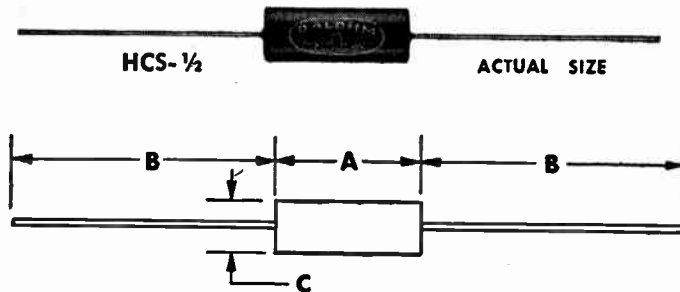

TYPE	DIMENSIONS			RESISTANCE RANGE
	A	B	C	
HCS-1/2	$\frac{3}{4}'' \pm \frac{1}{32}''$	$1\frac{3}{8}'' \pm \frac{1}{8}''$	$.280'' \pm .010''$	1 Ohm to 2 Megohms
HC-1	$1\frac{1}{8}'' \pm \frac{1}{32}''$	$1\frac{3}{8}'' \pm \frac{1}{8}''$	$.390'' \pm .010''$	1 Ohm to 10 Megohms
HC-2	$2\frac{1}{4}'' \pm \frac{1}{32}''$	$1\frac{3}{8}'' \pm \frac{1}{8}''$	$.390'' \pm .010''$	1 Ohm to 200 Megohms

CONFORM TO APPLICABLE JAN AND MIL SPECIFICATIONS

Your requests for samples and quotations are cordially invited

In Canada: Teletronics Corp., Ltd., Toronto and Montreal

Export Dept.: Pan-Mar Corporation, 1270 Broadway, New York 1, New York



DEPOSITED CARBON RESISTORS

FOR EXCEPTIONAL ACCURACY IN ANY LOW-HIGH RESISTANCE RANGE

Dalohm deposited carbon resistors are manufactured under a licensed agreement with Western Electric. The matchless stability and accuracy of these precision resistors are the result of years of intensive research and development. Dalohm deposited carbon resistors are manufactured by depositing pure carbon in crystalline form which is bonded to a selected ceramic core. They are intended for circuits calling for the accuracy and stability of wire wound resistors such as instrumentation, advanced electronics and critical television circuits but with the marked economy of carbon resistors.

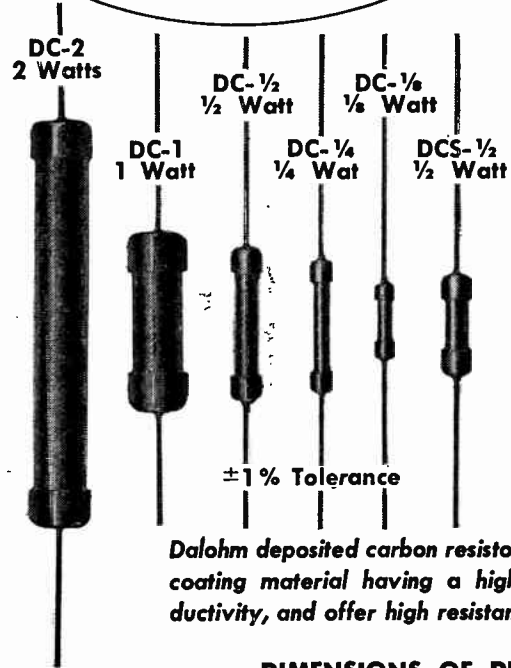

Dalohm deposited carbon resistors are sealed from moisture by special silicone coating material having a high dielectric strength, excellent thermal conductivity, and offer high resistance to abrasion.

DIMENSIONS OF DEPOSITED CARBON RESISTORS

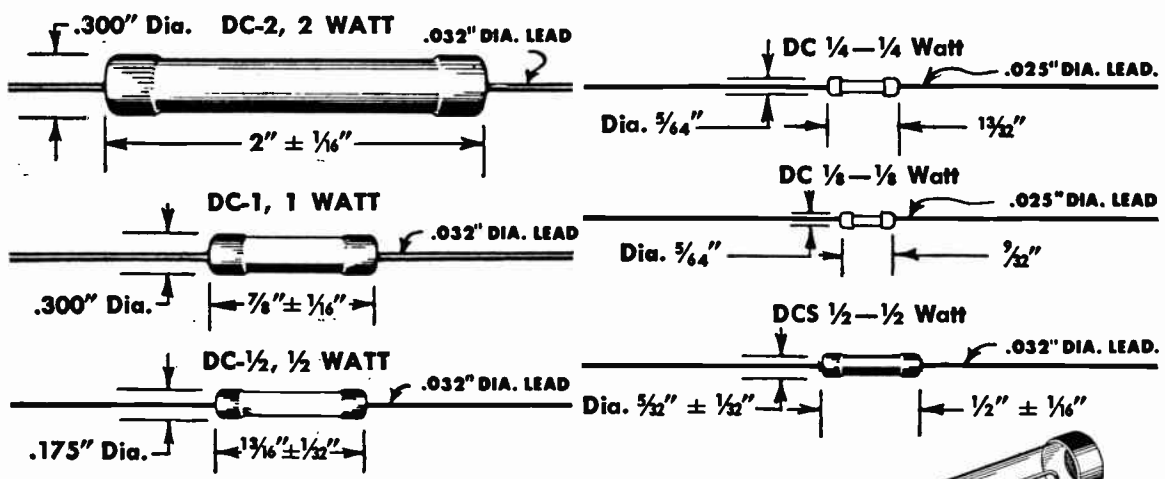

LIST PRICE

DC-2 (2 Watts)\$1.20
DC-1 (1 Watt) 1.00
DC-1/2 (1/2 Watt) 1.00
DC-1/4 (1/4 Watt) 1.00
DC-1/8 (1/8 Watt) 1.00
DCS-1/2 (1/2 Watt) 1.00

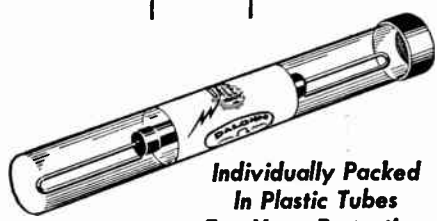

*Individually Packed
In Plastic Tubes
For Your Protection.*



DALE PRODUCTS, INC.

COLUMBUS, NEBRASKA U.S.A.

Made to withstand the utmost in SHOCK conditions

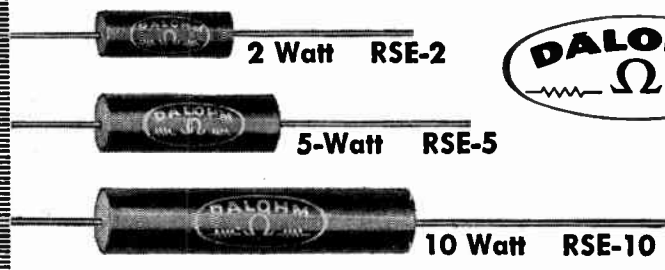

"RUGGEDIZED" RSE-Type Miniature POWER RESISTORS

DALOHM "Ruggedized" Precision Power Resistors not only answer the space problem, but the shock problem. They are designed for trouble-free performance under the most exacting and demanding conditions.

RSE-Type resistors are sealed in Silicone and housed in black metal tubing. (Suggested mounting clip: Atlas E-E Corp.) RSE-Type resistors have same tolerances and T.C. as RS Types.

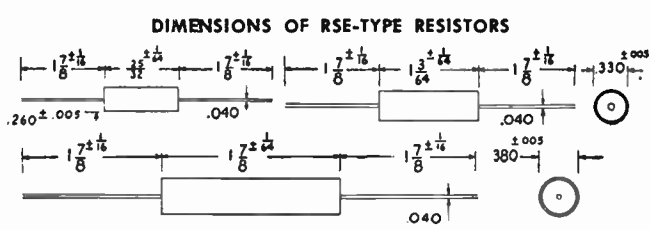

EPOXY ENCAPSULATED LIGHT WEIGHT WIRE WOUND PRECISION RESISTORS exceed applicable JAN and MIL specifications

STANDARD TOLERANCE $\pm 1\%$.
TOLERANCES AS LOW AS $\pm .05\%$
CAN BE HAD ON SPECIAL ORDER.
TEMP. COEF. $0.00002 / ^\circ C$.

Dale engineers and chemists have compounded a chemically inert material making possible these light weight precision resistors that surpass the requirements of applicable JAN and MIL specifications.

In addition to these resistors being completely impervious to the penetrating effects of salt ions, humidity, moisture, and corrosive gases and vapors, this new material in which the Dalohm precision wire wound resistors are encased has very high dielectric strength and due to its coefficient of expansion matching that of wire itself, it eliminates the possibility of distorted windings and shorted turns which are quite common in other types of resistors.

The superior quality of Dalohm precision wire wound resistors is assured through thorough testing, temperature cycling, salt water immersion, humidity, and overload tests. These are without a doubt the precision resistors for dependable and long life operation under the most adverse conditions.

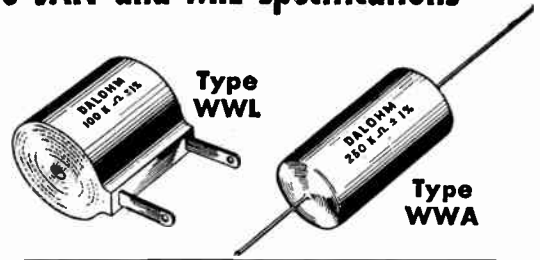

LUG TYPE WWL			
TYPE	DIAM.	LENGTH	MOUNTING SCREW SIZE
WWL-1	.575	.520	6
WWL-2	.575	.625	6
WWL-3	.575	1.02	6
WWL-4	.575	1.54	6
WWL-5	.575	2.04	6

AXIAL LEAD TYPE WWA			
TYPE	DIAM.	LENGTH	LEAD WIRE SIZE
WWA-1	.525	.520	22 AWG
WWA-2	.525	.625	22 AWG
WWA-3	.525	1.02	22 AWG
WWA-4	.525	1.54	22 AWG
WWA-5	.525	2.04	22 AWG

AVAILABLE IN RESISTANCE VALUES FROM 0.05 OHMS TO 3 MEGOHMS.
OTHER CASE SIZES AND STYLES AVAILABLE. ALL PRICES QUOTED ON REQUEST.

In Canada: Teletronics Corp., Ltd., Toronto and Montreal

Export Dept.: Pan-Mar Corporation, 1270 Broadway, New York 1, New York



NEWARK • NEW JERSEY

VITREOUS ENAMELED RHEOSTATS

Insulated shafts and mounting bushings

Type A-25 — Will withstand rugged treatment under the most adverse conditions. It has unusually smooth mechanical operation. The terminals, made of strong corrosion resistant alloy, are permanently welded to the winding form. The wound ring is made an integral part of the refractory base by vitreous enamel. The phosphor bronze actuating arm, with its graphite brush, gives smoothest action and excellent electrical control. Shafts are insulated. Three terminals permit either potentiometer or rheostat use; and our new high temperature gray enamel gives an added safety factor.

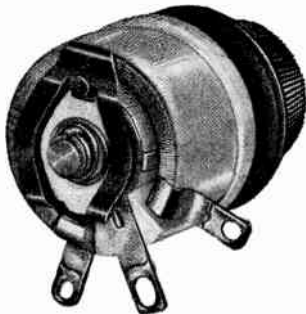

Types H-50, H-100, H-150 — These are our newest rheostats and they will give longer service and greater protection. They are designed for use under extremes of humidity and abnormal atmospheric conditions. The unique "buss bar" type brush automatically adjusts tension for complete, continuous contact. It eliminates backlash and prevents binding. It assures perfect contact with the entire winding surface. Our new high-temperature gray enamel bonding gives you an increased safety factor and better overall service. These improved rheostats are designed to comply with current standards of: (a) Military Specifications JAN-R-22. (b) R.T. M.A. (c) N.E.M.A. (d) "listed by Underwriters Laboratories, Inc."

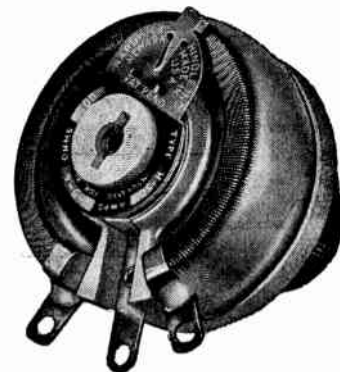

TABLES OF SIZES AND RATINGS OF RHEOSTATS

TYPE A-25 25 WATT RHEOSTAT					TYPE H-50 50 WATT RHEOSTAT					TYPE H-100 100 WATT RHEOSTAT					TYPE H-150 150 WATT RHEOSTAT				
Stock No.	Total Ohms	Max. Amps.	Approx. No. Steps	List Price	Stock No.	Total Ohms	Max. Amps.	Approx. No. Steps	List Price	Stock No.	Total Ohms	Max. Amps.	Approx. No. Steps	List Price	Stock No.	Total Ohms	Max. Amps.	Approx. No. Steps	List Price
0201	0.50	7.06	17	\$7.39	0301	0.50	10.0	25	\$7.81	0401	0.50	14.2	30	\$11.70	0501	0.50	17.30	26	\$14.83
0202	0.75	5.77	17	7.39	0302	0.75	8.16	25	7.81	0402	0.75	11.6	30	11.70	0502	0.75	14.10	30	14.83
0203	1.0	5.00	17	7.03	0303	1.0	7.06	52	7.81	0403	1.0	10.0	30	11.70	0503	1.00	12.25	40	14.83
0204	1.5	4.08	34	7.03	0304	1.5	5.77	52	7.81	0404	1.5	8.16	30	11.70	0504	1.5	10.00	37	14.83
0205	2.5	3.16	34	6.22	0305	2.5	4.48	52	7.03	0405	2.5	6.34	54	11.70	0505	2.5	7.75	39	14.83
0206	5.0	2.22	34	6.22	0306	5.0	3.16	52	7.03	0406	5.0	4.48	54	11.70	0506	5.0	5.48	79	14.83
0207	7.5	1.82	34	6.22	0307	7.5	2.58	52	7.03	0407	7.5	3.66	54	10.95	0507	7.5	4.47	75	14.83
0208	10	1.58	90	6.22	0308	10	2.22	98	7.03	0408	10	3.16	54	10.95	0508	10	3.88	77	14.03
0209	15	1.29	90	6.22	0309	15	1.82	98	7.03	0409	15	2.58	112	10.95	0509	15	3.16	151	14.03
0210	25	1.00	100	6.22	0310	25	1.41	98	7.03	0410	25	2.00	108	10.95	0510	25	2.45	151	14.03
0211	50	0.706	100	6.22	0311	50	1.00	129	7.03	0411	50	1.42	127	10.95	0511	50	1.73	192	14.03
0212	75	0.577	135	6.22	0312	75	0.816	153	7.03	0412	75	1.16	151	10.95	0512	75	1.41	224	14.03
0213	100	0.500	112	6.22	0313	100	0.706	157	7.03	0413	100	1.00	160	10.95	0513	100	1.22	204	14.03
0214	150	0.408	146	6.22	0314	150	0.577	187	7.03	0514	150	0.816	190	10.95	0514	150	1.00	280	14.03
0215	250	0.316	146	6.22	0315	250	0.448	258	7.03	0415	250	0.634	250	10.95	0515	250	0.775	252	14.03
0216	500	0.222	180	6.22	0316	500	0.316	308	7.03	0416	500	0.448	302	10.95	0516	500	0.548	362	14.03
0217	750	0.182	214	6.22	0317	750	0.258	294	7.39	0417	750	0.366	303	10.95	0517	750	0.447	378	14.83
0218	1000	0.158	248	7.03	0318	1000	0.222	390	7.39	0418	1000	0.316	317	11.70	0518	1000	0.388	398	14.83
0219	1500	0.129	292	7.03	0319	1500	0.182	364	7.39	0419	1500	0.258	375	11.70	0519	1500	0.316	483	15.61
					0320	2500	0.141	485	7.39	0420	2500	0.200	494	11.70	0520	2500	0.245	635	15.61
					0321	5000	0.100	590	7.81	0421	5000	0.141	640	12.47	0521	5000	0.173	790	16.36
					0322	7500	0.082	714	7.81	0422	7500	0.115	760	13.28	0522	7500	0.141	940	17.17
					0323	10000	0.070	750	7.81	0423	10000	0.100	740	14.03	0523	10000	0.122	1020	18.72

*Thru all or any part of winding.
Diameter of base: 1 7/8".
Depth behind panel: 1 1/2".
Mounting: Single hole for 3/8" bushing.
Shaft: 1/4" diameter, projecting 1/2" beyond bushing.
Standard Bushing: Will take panels up to 1/4".
Mechanical Rotation: 285 degrees.
Non-Turn Feature: Standard position as shown. Changed on request.
Terminals: Holes for No. 4 screw.

*Thru all or any part of winding.
Diameter of base: 2 3/8".
Depth behind panel: 1 7/8".
Mounting: Single hole for 3/8"-32 bushing.
Shaft: 1/4" diameter, projecting 1/2" beyond bushing.
Standard Bushing: Will take panels up to 1/4".
Mechanical Rotation: 300 degrees.
Non-Turn Feature: Standard position as shown. Changed on request.
Furnished with or without knob.
Terminals: Holes for No. 8 screw.

*Thru all or any part of winding.
Diameter of base: 3 1/8".
Depth behind panel: 1 3/4".
Mounting: Single hole for 3/8"-32 bushing.
Shaft: 1/4" diameter, projecting 1/2" beyond bushing.
Standard Bushing: Will take panels up to 1/4".
Mechanical Rotation: 300 degrees.
Non-Turn Feature: Standard position as shown. Changed on request.
Furnished with or without knob.
Terminals: Holes for No. 8 screw.

*Thru all or any part of winding.
Diameter of base: 4".
Depth behind panel: 1 3/4".
Mounting: Two holes as shown 10-32 x 5/8" screws furnished.
Shaft: 1/4" diameter, projecting 1/2" beyond bushing.
Standard Bushing: Will take panels up to 1/4".
Mechanical Rotation: 300 degrees.
Non-Turn Feature: For single hole mounting supplied on request.
Furnished with or without knob.
Terminals: Holes for No. 8 screw.

RATING—current ratings shown for all Rheostats are for use in free air. When units are enclosed values should be reduced about 50%.

Data on non-stock Rheostats—special shafts and bushings; values intermediate to those listed; tapered windings; tandem assemblies, etc., furnished upon request.



HARDWICK-HINDLE INC.



NEWARK • NEW JERSEY

BLUE RIBBON RESISTORS

TABLE OF RATINGS

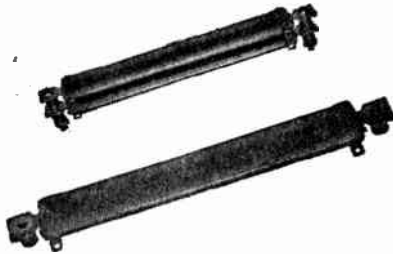

Blue Ribbon resistors differ from tubular resistors in that they are wound on an elliptical core. An aluminum bar through the center insures more even distribution of heat, avoiding hot spots.

Our gray enamel eliminates crazing which results in failure of the resistive element due to moisture penetration from humidity, salt and other severe atmospheric conditions.

Mounting studs—corrosion and rust resistant—peened to the ends of the thru-bar conduct heat to the mounting surface. You can stack two or more units. Our method of fastening the tube to the thru-bar prevents loosening.

In comparison with tubular units of equivalent wattage rating these resistors offer outstanding advantages: • Higher wattage rating per unit space requirement. • Reduction in space requirement. • Simple sturdy mounting, single or stacked. • 1/4" weight. • Lower inductance.

Designed for and manufactured in accordance with JAN-R-26A specifications.

TYPE 1 1/4" B 30 Watt Rating* Mounting Centers 2"				TYPE 2" B 40 Watt Rating* Mounting Centers 2 3/4"				TYPE 3 1/2" B 55 Watt Rating* Mounting Centers 4 1/4"				TYPE 6" B 75 Watt Rating* Mounting Centers 6 3/4"			
Stock No.	Ohms	Max. Milli-Amps.	List Price	Stock No.	Ohms	Max. Milli-Amps.	List Price	Stock No.	Ohms	Max. Milli-Amps.	List Price	Stock No.	Ohms	Max. Milli-Amps.	List Price
B101	5	2450	\$1.92	B201	5	2830	\$2.01	B301	5	3320	\$2.32	B601	5	3880	\$2.88
B102	10	1730	1.92	B202	10	2000	2.01	B302	10	2350	2.32	B602	10	2750	2.88
B103	15	1410	1.92	B203	15	1640	2.01	B303	15	1920	2.32	B603	15	2240	2.88
B104	25	1090	1.92	B204	25	1260	2.01	B304	25	1480	2.32	B604	25	1730	2.88
B105	50	770	1.92	B205	50	890	2.01	B305	50	1050	2.32	B605	50	1220	2.88
B106	100	550	1.92	B206	100	630	2.01	B306	100	740	2.32	B606	100	860	2.88
B107	150	440	1.92	B207	150	510	2.01	B307	150	600	2.32	B607	150	710	2.88
B108	250	340	1.92	B208	250	400	2.01	B308	250	470	2.32	B608	250	550	2.88
B109	500	245	1.92	B209	500	283	2.01	B309	500	332	2.32	B609	500	388	2.88
B110	1000	173	1.92	B210	1000	200	2.01	B310	1000	235	2.32	B610	1000	275	2.88
B111	1500	141	1.92	B211	1500	164	2.01	B311	1500	192	2.32	B611	1500	224	2.88
B112	2500	109	1.92	B212	2500	126	2.01	B312	2500	148	2.32	B612	2500	173	2.88
B113	5000	77	2.06	B213	5000	89	2.15	B313	5000	105	2.45	B613	5000	122	3.02
B114	10000	55	2.10	B214	10000	63	2.42	B314	10000	74	2.72	B614	10000	86	3.26
				B215	15000	51	2.52	B315	15000	60	2.83	B615	15000	71	3.38
								B316	25000	47	3.10	B616	25000	55	3.67
												B617	50000	39	4.12

*This rating based on a maximum temperature rise of 300 degrees C. with the Resistor mounted horizontally on a 10" x 10" x .040" steel plate supported horizontally 1/2" above a wooden surface.

When Resistors are mounted on a non-metallic base the nominal watt rating should be reduced by approximately 15%.

10 and 20 WATT FIXED VITREOUS ENAMELED RESISTORS

Designed for radio service and replacement use—conservatively rated—wound upon Steatite Tube—combination lug and pigtail terminal connections. Vitreous

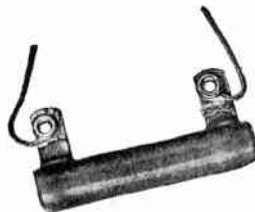

enamel insulation, insures proof against moisture. 10 watt and 20 watt sizes, in the range of resistance values shown.

TABLE OF RATINGS

10 WATT 1 1/4" Long x 5/16" O.D.				20 WATT 2" Long x 1/2" O.D.											
Stock No.	Ohms	Max. Milli-Amps.	List Price	Stock No.	Ohms	Max. Milli-Amps.	List Price	Stock No.	Ohms	Max. Milli-Amps.	List Price	Stock No.	Ohms	Max. Milli-Amps.	List Price
A101	1	3160	\$.75	A116	750	115	\$.75	A201	5	2000	\$.95	A216	2000	100	\$.97
A102	3	1825	.75	A117	1000	100	.75	A202	10	1415	.95	A217	2500	89	.97
A103	5	1415	.75	A118	1250	89	.80	A203	25	895	.95	A218	3000	81	.97
A104	7.5	1150	.75	A119	1500	81	.80	A204	50	633	.95	A219	4000	71	.97
A105	10	1000	.75	A120	2000	70	.80	A205	75	517	.95	A220	5000	63	.97
A106	15	815	.75	A121	2500	63	.80	A206	100	447	.95	A221	6000	57	1.12
A107	25	630	.75	A122	3000	58	.80	A207	150	375	.95	A222	7500	51	1.12
A108	50	450	.75	A123	4000	50	.80	A208	200	316	.95	A223	10000	44	1.12
A109	75	365	.75	A124	5000	45	.80	A209	250	282	.95	A224	12500	40	1.20
A110	100	315	.75	A125	7500	36	.92	A210	400	224	.95	A225	15000	37	1.20
A111	150	260	.75	A126	10000	31	.92	A211	500	200	.95	A226	25000	15	1.37
A112	200	225	.75	A127	12500	16	1.03	A212	750	163	.95	A227	35000	13	1.37
A113	250	200	.75	A128	15000	14	1.03	A213	1000	141	.95	A228	40000	12	1.37
A114	400	158	.75	A129	20000	12	1.03	A214	1250	126	.97	A229	50000	11	1.58
A115	500	142	.75	A130	25000	11	1.08	A215	1500	115	.97				



GIRARD - HOPKINS RESISTORS - CAPACITORS

HIGH QUALITY, FIXED
COMPOSITION RESISTORS

CUSTOM MANUFACTURED
PAPER DIELECTRIC CAPACITORS

5% AND 10% TOLERANCE — 1/2 - 1 - 2 WATT RATINGS

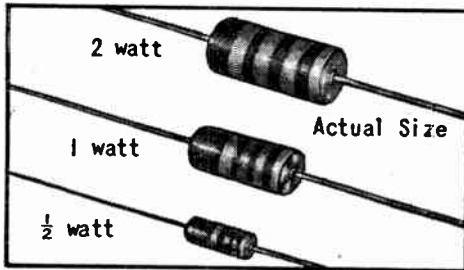

G-H fixed composition resistors are of the highest quality and combine the desirable features of great mechanical strength, permanent electrical characteristics and minimum physical size for a given wattage rating. Leads are differentially tempered to prevent sharp bends near the resistor body while still permitting ready forming to fit a particular arrangement.

G-H resistors are supplied in convenient packages having a perforated top section which permits the tops to hinge, (as shown in the illustration) or to be removed entirely. Since each resistor is held in an upright position by a honeycomb section within the lower portion of the box, the leads of all resistors remaining within a given container are exposed to view. Resistance value and tolerance indication are clearly marked on sides and top cover of the container. These features greatly facilitate stock location and stock control checking.

G-H maintains a complete stock of 5% and 10% tolerance resistors in all wattage ratings to insure rapid delivery on all orders.

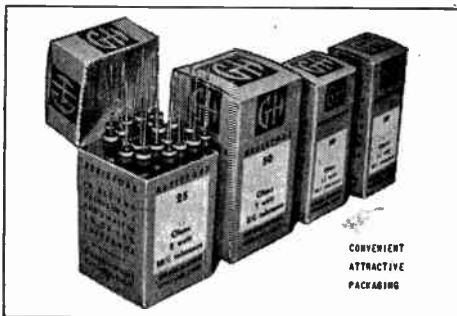

CONVENIENT
ATTRACTIVE
PACKAGING

All Standard RTMA Values

5% TOLERANCE One-half, one and two watt ratings.

Standard packages:		One-half and one watt...50 per package		Two watt.....25 per package		
10	82	680	5600	47,000	390,000	3.3 meg.
11	91	750	6200	51,000	430,000	3.6 "
12	100	820	6800	56,000	470,000	3.9 "
13	110	910	7500	62,000	510,000	4.3 "
15	120	1000	8200	68,000	560,000	4.7 "
16	130	1100	9100	75,000	620,000	5.1 "
18	150	1200	10,000	82,000	680,000	5.6 "
20	160	1300	11,000	91,000	750,000	6.2 "
22	180	1500	12,000	100,000	820,000	6.8 "
24	200	1600	13,000	110,000	910,000	7.5 "
27	220	1800	15,000	120,000	1.0 meg.	8.2 "
30	240	2000	16,000	130,000	1.1 "	9.1 "
33	270	2200	18,000	150,000	1.2 "	10.0 "
36	300	2400	20,000	160,000	1.3 "	11.0 "
39	330	2700	22,000	180,000	1.5 "	12.0 "
43	360	3000	24,000	200,000	1.6 "	13.0 "
47	390	3300	27,000	220,000	1.8 "	15.0 "
51	430	3600	30,000	240,000	2.0 "	16.0 "
56	470	3900	33,000	270,000	2.2 "	18.0 "
62	510	4300	36,000	300,000	2.4 "	20.0 "
68	560	4700	39,000	330,000	2.7 "	22.0 "
75	620	5100	43,000	360,000	3.0 "	

10% TOLERANCE

One-half, one and two watt ratings.

10	120	1500	18,000	220,000	2.7 meg.	Available in 1 watt 10% toler- ance only,
12	150	1800	22,000	270,000	3.3 "	
15	180	2200	27,000	330,000	3.9 "	
18	220	2700	33,000	390,000	4.7 "	
22	270	3300	39,000	470,000	5.6 "	
27	330	3900	47,000	560,000	6.8 "	
33	390	4700	56,000	680,000	8.2 "	
39	470	5600	68,000	820,000	10.0 "	
47	560	6800	82,000	1.0 meg.	12.0 "	
56	680	8200	100,000	1.2 "	15.0 "	
68	820	10,000	120,000	1.5 "	18.0 "	
82	1000	12,000	150,000	1.8 "	22.0 "	
100	1200	15,000	180,000	2.2 "		

Standard packages: { One-half and one watt...50 per package
Two watt.....25 per package

PAPER DIELECTRIC CAPACITORS

Custom manufactured to customers specifications. Can be supplied in any practical capacity, working voltage and tolerance. Containers and terminal arrangements may be in accordance with customers drawings.

Capacitors can be manufactured for AC or DC operation . . . impregnated with Wax, Tensoil, or in the stable, highly superior oil impregnant, G-H PERMANOL. Your inquiries are invited.

GIRARD-HOPKINS

1000 - 40TH AVENUE, OAKLAND, CALIF.

ATLAS RESISTOR CO.

PHILADELPHIA, PENNA.

DIV. OF PHILADELPHIA ELECTRONICS, INC.

FIXED PACK WOUND

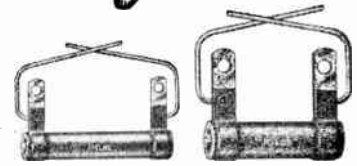

5 WATT

10 WATT

5 WATT

LIST PRICE \$0.50
1" x 5/16"

MOUNT BY WIRE LEADS

Ohms	Ohms
1	350
1.5	400
2	450
3	500
4	600
5	700
7.5	750
10	800
12	900
15	1000
20	1100
25	1200
30	1250
35	1500
40	1750
50	2000
75	2250
100	2500
125	3000
150	3500
200	4000
250	4500
300	5000

10 WATT

LIST PRICE \$0.55
1 3/4" x 5/16"

MOUNT BY WIRE LEADS

Ohms	Ohms	Ohms
1	350	7500
1.5	400	8000
2	450	8500
3	500	9000
4	600	10000
5	700	11000
7.5	750	12000
10	800	12500
12	900	13500
15	1000	14300
20	1100	15000
25	1200	16000
30	1250	17500
35	1500	18000
40	1750	20000
50	2000	22500
75	2250	25000
100	2500	30000
125	3000	35000
150	3500	40000
200	4000	45000
250	4500	50000
300	5000	
	7000	

20 WATT

2" x 9/16"

MOUNT BY WIRE LEADS

	List Price
1 to 15,000 ohms.....	\$0.65
20,000 to 50,000 ohms.....	.85
55,000 to 100,000 ohms.....	1.10

25 WATT

2 1/2" x 9/16"

MOUNTING BRACKETS

	List Price
1 to 5,000 ohms.....	\$0.75
6,000 to 15,000 ohms.....	.85
20,000 to 50,000 ohms.....	1.00
60,000 ohms.....	1.15
70,000 ohms.....	1.25
75,000 ohms.....	1.30
80,000 ohms.....	1.35
85,000 ohms.....	1.50
90,000 ohms.....	1.60
100,000 ohms.....	1.75



25 WATT

50 WATT

4 1/2" x 3/4"

MOUNTING BRACKETS

	List Price
1 to 5,000 ohms.....	\$1.10
6,000 to 25,000 ohms.....	1.35
26,000 to 100,000 ohms.....	1.75



100 WATT

6 1/2" x 1 1/8"

MOUNTING BRACKETS

	List Price
5 to 2,500 ohms.....	\$1.75
3,000 to 4,000 ohms.....	1.85
4,500 to 25,000 ohms.....	1.95
30,000 to 50,000 ohms.....	2.50
60,000 to 75,000 ohms.....	2.75
80,000 to 100,000 ohms.....	3.00

160 WATT

8 1/2" x 1 1/8"

MOUNTING BRACKETS

	List Price
5 to 10,000 ohms.....	\$2.25
11,000 to 15,000 ohms.....	2.35
20,000 to 50,000 ohms.....	2.65
60,000 to 100,000 ohms.....	3.00

200 WATT

10 1/2" x 1 1/8"

MOUNTING BRACKETS

	List Price
5 to 10,000 ohms.....	\$2.50
12,000 to 14,000 ohms.....	2.80
15,000 to 100,000 ohms.....	3.00

ATLAS RESISTOR CO.

PHILADELPHIA, PENNA.

DIV. OF PHILADELPHIA ELECTRONICS, INC.

ADJUSTABLE



10 WATTS

1 3/4" x 3/8"

MOUNTING BRACKETS
LIST PRICE \$0.85

Ohms	Ohms
1	750
2	800
3	1000
5	1250
7.5	1500
10	2000
15	2500
20	3000
25	3500
50	4000
75	4500
100	5000
150	6000
200	7000
250	7500
300	8000
350	8500
400	9000
500	10000
600	

EXTRA SLIDER BANDS
\$0.10 Each

25 WATTS

2 1/2" x 9/16"

MOUNTING BRACKETS

	List Price
1 to 5,000 ohms.....	\$0.95
6,000 to 15,000 ohms.....	1.10
16,000 to 25,000 ohms.....	1.50
26,000 to 50,000 ohms.....	1.50

EXTRA SLIDER BANDS
\$0.25 Each



10 WATT



25 WATT

50 WATTS

4 1/2" x 3/4"

MOUNTING BRACKETS

	List Price
1 to 5,000 ohms.....	\$1.50
6,000 to 25,000 ohms.....	1.75
26,000 to 50,000 ohms.....	2.00
51,000 to 100,000 ohms.....	2.50

EXTRA SLIDER BANDS
\$0.25 Each

80 WATTS

6 1/2" x 3/4"

MOUNTING BRACKETS

	List Price
1 to 5,000 ohms.....	\$1.75
6,000 to 25,000 ohms.....	2.00
26,000 to 50,000 ohms.....	2.25
51,000 to 100,000 ohms.....	2.50

EXTRA SLIDER BANDS
\$0.25 Each

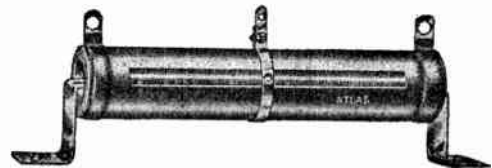

50 WATTS



200 WATTS

100 WATTS

6 1/2" x 1 1/8"

MOUNTING BRACKETS

	List Price
5 to 2,500 ohms.....	\$2.00
2,600 to 25,000 ohms.....	2.25
26,000 to 50,000 ohms.....	2.75
51,000 to 75,000 ohms.....	3.00
76,000 to 100,000 ohms.....	3.50

EXTRA SLIDER BANDS
\$0.25 Each

160 WATTS

8 1/2" x 1 1/8"

MOUNTING BRACKETS

	List Price
5 to 5,000 ohms.....	\$2.50
6,000 to 10,000 ohms.....	2.65
11,000 to 14,000 ohms.....	2.90
15,000 to 60,000 ohms.....	3.25
61,000 to 100,000 ohms.....	3.75

EXTRA SLIDER BANDS
\$0.25 Each

200 WATTS

10 1/2" x 1 1/8"

MOUNTING BRACKETS

	List Price
100 to 4,500 ohms.....	\$3.00
5,000 to 10,000 ohms.....	3.25
11,000 to 14,000 ohms.....	3.50
15,000 to 50,000 ohms.....	3.75
51,000 to 100,000 ohms.....	4.25

EXTRA SLIDER BANDS
\$0.25 Each



VITREOUS ENAMELED RESISTORS

• FIXED • ADJUSTABLE • TRU-RIB

Our new, modern plant occupies 80,000 square feet devoted to producing the finest power rheostats and wire wound resistors available. If you need a rheostat or resistor, whether it be right from stock or to your specifications, we assure you of courteous service, prompt delivery and quality merchandise.

10 WATT—TYPE FRL-10

FIXED		
OHMS	MILLIAMPS	VOLTS
1	3160	3.1
1.5	2580	3.8
2	2230	4.4
3	1820	5.4
4	1580	6.3
5	1410	7.0
7.5	1150	8.6
10	1000	10
12	914	11
15	816	12
20	707	14
25	631	16
30	577	17
35	535	19
40	500	20
50	447	22
75	366	27
100	316	31
125	283	35
150	254	38
200	223	44
225	211	47
250	200	50
300	182	54
350	169	59
400	158	63
450	149	67
500	141	70
600	129	77
700	120	84
750	115	86
800	112	89
900	105	94
1000	100	100
1100	96	104
1200	91	109
1250	89	111
1500	82	123
1750	76	133
2000	71	142
2250	67	151
2500	63	158
3000	57	171
3500	53	185
4000	50	200
4500	47	212
5000	45	225
6000	41	246
7000	38	266
7500	36	270
8000	35	280
8500	34	289
9000	33	297
10,000	30	300
11,000	27	300
12,000	25	300
12,500	24	300
13,500	22	300
14,300	21	300
15,000	20	300
16,000	19	300
17,500	17	300
18,000	16	300

25 WATT—TYPE FR-25

OHMS	FIXED		50% RATING AMPS
	VOLTS	AMPS	
1	5.0	5.000	3.535
2	7.0	3.535	2.500
3	8.6	2.885	2.040
4	10	2.500	1.770
5	11	2.236	1.580
10	15	1.580	1.118
15	19	1.291	.914
25	25	1.000	.707
50	35	.707	.500
75	43	.577	.408
100	50	.500	.353
150	61	.408	.289
200	70	.353	.250
250	79	.316	.223
300	86	.289	.204
400	100	.250	.177
500	111	.223	.158
750	136	.182	.129
800	141	.177	.125
850	145	.171	.121
1000	158	.158	.111
1250	176	.141	.100
1500	198	.129	.091
2000	222	.111	.079
2500	250	.100	.070
3000	273	.091	.064
3500	294	.084	.058
4000	316	.079	.056
5000	350	.070	.050
6000	384	.064	.045
7500	427	.057	.040
10,000	500	.050	.035
12,000	505	.042	.029
15,000	510	.034	.024
20,000	520	.026	.018
25,000	530	.022	.014
30,000	540	.018	.012
35,000	550	.016	.010
40,000	560	.014	.009
50,000	585	.012	.008
60,000	610	.010	.007
70,000	630	.009	.006
75,000	635	.008	.005
80,000	640	.008	.005
100,000	700	.007	.005

Free air rating to 10,000 Ohms at 25 Watts

10 WATT—TYPE AR-10

OHMS	ADJUSTABLE		50% RATING AMPS
	VOLTS	AMPS	
1	3.1	3.160	2.230
2	4.4	2.230	1.580
3	5.4	1.820	1.290
5	7.0	1.410	1.000
7.5	8.6	1.150	.816
10	10	1.000	.707
15	12	.816	.576
20	14	.707	.500
25	16	.631	.447
50	22	.447	.316
75	27	.365	.258
100	31	.316	.223
150	38	.254	.182
200	44	.223	.158
250	50	.200	.141
300	54	.182	.129
350	59	.169	.119

10 WATT (Continued)

400	63	.158	.112
500	70	.141	.100
600	77	.129	.091
750	86	.115	.081
800	89	.112	.079
1000	100	.100	.071
1250	111	.089	.063
1500	123	.082	.058
2000	142	.071	.050
2250	151	.067	.047
2500	158	.063	.045
3000	171	.057	.041
3500	185	.053	.038
4000	200	.050	.035
4500	212	.047	.033
5000	225	.045	.032
6000	246	.041	.029
7000	226	.038	.027
7500	270	.036	.026
8000	280	.035	.025
8500	289	.034	.024
9000	297	.033	.023
10,000	300	.030	.022

25 WATT—TYPE AR-25

OHMS	ADJUSTABLE		50% RATING AMPS
	VOLTS	AMPS	
1	5.0	5.000	3.535
2	7.0	3.535	2.500
3	8.6	2.885	2.040
5	11	2.236	1.580
7.5	13	1.825	1.290
10	15	1.580	1.118
15	19	1.291	.914
20	22	1.117	.790
25	25	1.000	.707
50	35	.707	.500
75	43	.577	.408
100	50	.500	.353
150	61	.408	.289
200	70	.353	.250
250	79	.316	.223
300	86	.289	.204
400	100	.250	.177
500	111	.223	.158
750	136	.182	.129
800	141	.177	.125
850	145	.171	.121
1000	158	.158	.111
1250	176	.141	.100
1500	198	.129	.091
2000	222	.111	.079
2250	236	.106	.074
2500	250	.100	.070
3000	273	.091	.064
3500	294	.084	.058
4000	316	.079	.056
4500	332	.074	.052
5000	350	.070	.050
6000	384	.064	.045
7000	420	.060	.042
7200	425	.059	.041
7500	427	.057	.040
8000	440	.055	.039
9000	468	.052	.037
10,000	500	.050	.035
12,000	505	.042	.029
15,000	510	.034	.024
20,000	520	.026	.018
25,000	530	.022	.014

You are guaranteed to receive 24 hour delivery as we maintain jobber stock items!



SPECIAL RESISTORS

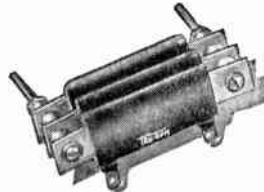
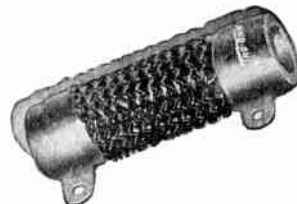

Now Available — 25 watt — 50 watt — 75 watt — 100 watt — 150 watt — Power Rheostats — ready for shipment from stock; special features available to meet your requirements.

Mfd. by TRU-OHM PRODUCTS, DIVISION OF MODEL ENG. & MFG. INC. • General Sales Office: Chicago 18, Ill.



POWER RHEOSTATS

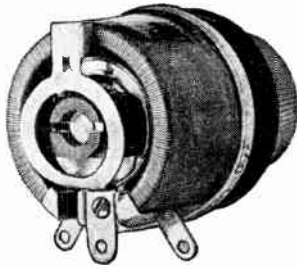

TYPE R-25 — 25 WATTS

Cat. No.	Resistance	Max. Amps.	Approx. Steps
100	1	5.000	26
101	2	3.540	28
102	3	2.880	44
103	6	2.040	50
104	8	1.770	54
105	10	1.680	60
106	15	1.290	78
107	25	1.000	80
108	35	.845	100
109	50	.707	105
110	75	.575	120
111	100	.500	140
112	125	.445	145
113	175	.375	153
114	250	.316	170
115	350	.267	180
116	500	.222	215
117	750	.182	230
118	1000	.155	270
119	1500	.129	325
120	2500	.100	410
121	3500	.084	440
122	5000	.070	480

CONSTRUCTION

The TRU-OHM power rheostat will provide smooth variation of resistance under the most severe operating conditions. The all ceramic-metal construction insures dependable service even at extreme operating temperatures. An extra deep core, on which the resistance wire is toroidally wound, means a more conservative power rating.

Types R-50, 75, 100 and 150 have an exclusive torsion spring assembly which provides uniform pressure of the contact brush against the winding at all times. Current flows from the brush through a flexible shunt wire to a large size slip ring. Positive, low-wear contact is maintained against the center terminal by an adequate compression spring. Back lash in the rotating assembly is reduced to a minimum by means of the design. A positive stop is provided at the extremes of rotation entirely independent of the contact arm assembly.

SPECIAL FEATURES

TRU-OHM rheostats are available with many extras such as off positions, screw driver control, shaft assemblies for special mounting conditions, etc. Prompt engineering service is available for all special requirements. Knobs furnished upon request.

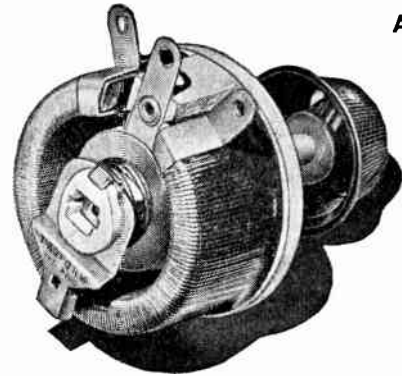

TYPE R-50 — 50 WATTS

Cat. No.	Resistance	Max. Amps.	Approx. Steps
200	0.5	10.000	22
201	1	7.070	36
202	2	5.000	38
203	4	3.540	38
204	6	2.880	75
205	8	2.500	70
206	12	2.040	80
207	16	1.760	90
208	22	1.500	95
209	35	1.190	120
210	50	1.100	120
211	80	.790	135
212	125	.630	185
213	150	.574	175
214	225	.470	215
215	300	.408	225
216	500	.316	295
217	800	.250	360
218	1000	.223	375
219	1600	.176	465
220	2500	.141	560
221	3500	.119	585
222	5000	.100	600
223	8000	.079	710
224	10,000	.070	720

Also ready for Immediate Shipment

TYPE R-75 →
75 Watts

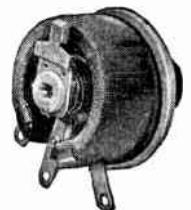

← TYPE R-100
100 Watts

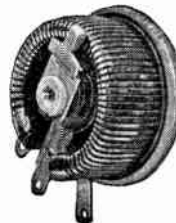

TYPE R-150 →
150 Watts

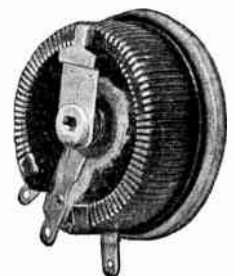

You are guaranteed to receive 24 hour delivery as we maintain jobber stock items!

**Mfd. by TRU-OHM PRODUCTS DIVISION OF MODEL ENG. & MFG. INC.
General Sales Office: Chicago 18, Ill.**

SLIDE OHM WIRE-WOUND VITREOUS-ENAMELED ADJUSTABLE RESISTORS

Slideohm Resistors are for use in any application where it is necessary or desirable to have one or more intermediate resistance values; or in circuits that need to be changed from time to time to meet varying electrical conditions. Slideohm Resistors are built of the highest grade low temperature coefficient materials, and are coated with tough crazeless Vitreous Enamel.

Adjustable resistors combining adjustment to any resistance value within unit's range, with positive, permanent, non-fluctuating qualities of wire-wound resistor. Each Slideohm Resistor is provided with horizontal mounting brackets and one adjustable contact slider.

25 WATTS

Ohms	Current m. a.	List Price
1	5000	\$1.85
2	3535	1.85
3	2890	1.85
5	2230	1.85
7	1825	1.85
10	1580	1.85
15	1290	1.85
20	1115	1.85
25	1000	1.85
50	710	1.85
75	580	1.85
100	500	1.85
150	410	1.85
200	354	1.85
250	315	1.85
300	289	1.85
400	250	1.85
500	224	1.85
750	182	1.85
800	177	1.85
850	170	1.85
1000	158	1.85

Type 952

Ohms	Current m. a.	List Price
1250	140	\$1.90
1500	129	1.90
2000	112	1.90
2250	105	1.90
2500	100	1.90
3000	90	1.90
3500	85	1.90
4000	80	1.90
4500	74	1.90
5000	70	1.90
6000	65	2.05
7000	57	2.05
7200	56	2.05
7500	53	2.05
8000	50	2.05
8500	47	2.05
9000	44	2.05
10000	40	2.05
12000	33	2.10
15000	27	2.10
20000	20	2.10
25000	16	2.30

50 WATTS

Ohms	Current m. a.	List Price
1	7070	\$3.00
2	5000	3.00
3	4080	3.00
4	3535	3.00
5	3160	3.00
10	2235	3.00
25	1415	3.00
50	1000	3.00
75	815	3.00
100	707	3.00
150	575	3.00
200	500	3.00
250	445	3.00
300	408	3.00
400	353	3.00
500	316	3.00
750	258	3.00
800	250	3.00
1000	224	3.00
1250	200	2.45
1500	180	2.45
2000	160	2.45
2250	150	2.45
2500	141	2.45

Type 954

Ohms	Current m. a.	List Price
3000	130	\$2.45
3500	120	2.45
4000	110	2.45
4500	105	2.45
5000	100	2.45
6000	91	2.65
7000	85	2.65
7200	83	2.65
7500	82	2.65
8000	79	2.65
9000	75	2.65
10000	71	2.65
12000	64	2.85
15000	58	2.85
20000	48	2.85
25000	40	3.10
30000	33	3.10
40000	25	3.10
50000	20	3.30
60000	17	3.30
75000	13	3.60
80000	12	3.60
100000	10	3.90

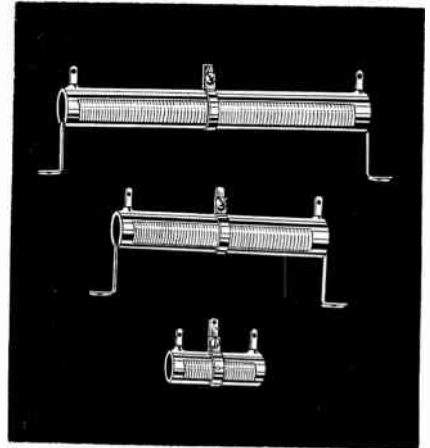

WATT RATINGS

Nominal Watt ratings for Slideohm Resistors apply when the entire resistor is in the circuit. For most practical purposes the watt rating for each part of the resistor is approximately proportional to the amount of the resistance that is in the circuit.

Mounting brackets are furnished with all Slideohm Resistors.

Price of resistor includes brackets and one adjustable band.

80 WATTS

Ohms	Current m. a.	List Price
1	8660	\$3.55
2	6120	3.55
3	5000	3.55
4	4330	3.55
5	3870	3.55
10	2740	3.55
15	2235	3.55
25	1730	3.55
50	1220	3.55
75	1000	3.55
100	866	3.55
200	612	3.55
250	550	3.55
300	500	3.55
400	433	3.55
500	387	3.55
750	315	3.55
800	305	3.55
1000	274	3.55
1250	245	2.85
1500	224	2.85
2000	195	2.85
2250	183	2.85
2500	173	2.85

Type 956

Ohms	Current m. a.	List Price
3000	158	\$2.85
3500	146	2.85
4000	137	2.85
4500	129	2.85
5000	122	2.85
6000	111	3.00
7000	103	3.00
7200	102	3.00
7500	100	3.00
8000	97	3.00
9000	91	3.00
10000	87	3.00
15000	71	3.15
20000	61	3.15
25000	50	3.50
30000	43	3.50
35000	37	3.50
40000	33	3.60
45000	30	3.60
50000	25	3.60
60000	21	3.95
70000	19	3.95
80000	19	3.95
100000	15	4.35

100 WATTS

Ohms	Current m. a.	List Price
1	10000	\$4.55
2	7070	4.55
3	5770	4.55
4	5000	3.60
5	4470	3.60
10	3160	3.60
25	2000	3.60
50	1410	3.60
100	1000	3.60
200	707	3.60
250	630	3.60
400	500	3.60
500	447	3.60
750	385	3.60
1000	316	3.60
1500	260	3.65
2000	225	3.65

Type 957

Ohms	Current m. a.	List Price
2500	200	\$3.65
3000	180	3.65
4000	160	3.65
4500	150	3.65
5000	141	3.65
6000	130	3.85
7500	115	3.85
10000	100	3.85
15000	80	4.10
20000	70	4.10
25000	60	4.35
30000	50	4.35
40000	37	4.35
50000	30	4.55
60000	25	4.55
75000	20	4.75
100000	15	4.95

ADJUSTABLE BANDS

One screw-driver type adjustable band terminal is supplied with each "Slideohm" resistor. Order additional bands, screw-driver or knob type as illustrated by resistor type number for which band is to be used.



200 WATTS

Ohms	Current m. a.	List Price
7	6320	\$5.65
10	4470	4.35
25	2825	4.35
75	2000	4.35
100	1414	4.35
250	900	4.35
500	632	4.35
1000	447	4.35
1500	365	4.45
2000	315	4.45
2500	282	4.45
3000	260	4.45
3500	240	4.45
4000	225	4.45

Type 958

Current List	Ohms	Current List
4.45	4500	210
4.45	5000	200
4.45	7500	163
4.70	10000	141
4.90	15000	115
4.90	20000	100
5.05	25000	90
5.05	30000	82
5.05	40000	62
5.15	50000	50
5.15	60000	42
5.40	75000	33
5.65	100000	25

Resistor Rating	Size of Resistor	SCREW DRIVER TYPE Cat. No.	TYPE List	BAKELITE KNOB TYPE Cat. No.	TYPE List
25 Watt	2" x 5/8"	RB 25	\$.25	BB 25	\$.35
50 Watt	4 1/2" x 3/4"	RB 80	.25	BB 50	.35
80 Watt	6 1/2" x 3/4"	RB 80	.25	BB 80	.35
100 Watt	6 1/2" x 1 1/8"	RB 100	.42	BB 100	.47
200 Watt	10 1/2" x 1 1/8"	RB 200	.42	BB 200	.47

WIRE-WOUND VITREOUS ENAMELED FIXED RESISTORS

TYPES 931-933

Compact genuine wire-wound, vitreous-enamel. Correctly designed, highest quality materials used throughout. Note these features:

1. Crack-proof refractory tubing for the support. Adequate heat dissipation.
2. Quality resistance wire precisely spaced, tension wound.
3. Copper terminal band clamped to tubing. Wire ends wrapped and brazed around raised ear.
4. Heavy vitreous-enamel coating for permanent seal against moisture, oxidation and mechanical damage.
5. Pig-tail of stiff wire 2 in. long soldered to terminal band for positive, non-breakable connection.

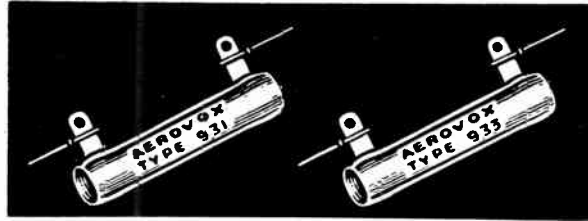

10 Watts Type 931

Ohms	Current m. a.	List Price
1	3160	\$.75
1.5	2580	.75
2	2235	.75
3	1825	.75
4	1580	.75
5	1415	.75
7.5	1155	.75
10	1000	.75
12	913	.75
15	815	.75
20	707	.75
25	630	.75
30	577	.75
35	534	.75
40	500	.75
50	450	.75
75	365	.75
100	316	.75
125	283	.75
150	258	.75
200	224	.75
225	211	.75
250	200	.75
300	182	.75
350	169	.75
400	158	.75
450	149	.75
500	142	.75
600	129	.75
700	120	.75
750	115	.75
800	110	.75
900	105	.75
1000	100	.75
1100	95	.80
1200	91	.80

10 Watts Type 931

Ohms	Current m. a.	List Price
1250	89	\$.80
1500	81	.80
1750	75	.80
2000	70	.80
2250	66	.80
2500	63	.80
3000	58	.80
3500	53	.80
4000	50	.80
4500	47	.80
5000	45	.80
6000	41	.90
7000	38	.90
7500	36	.90
8000	35	.90
8500	34	.90
9000	33	.90
10000	30	.90
11000	27	1.05
12000	25	1.05
12500	24	1.05
13500	22	1.05
14300	21	1.05
15000	20	1.05
16000	19	1.05
17500	17	1.05
18000	16	1.05
20000	15	1.05
22500	13	1.10
25000	12	1.10
30000	*13	1.20
35000	*12	1.20
40000	*11	1.20
45000	*10.5	1.20
50000	*10	1.20

*Operated at low temp., rated at 5 watts.

20 Watts Type 933

Ohms	Current m. a.	List Price
1	4480	\$.95
3	2580	.95
5	2000	.95
10	1410	.95
15	1150	.95
25	900	.95
50	630	.95
75	510	.95
100	450	.95
150	365	.95
175	340	.95
200	320	.95
250	285	.95
300	258	.95
350	240	.95
400	220	.95
500	200	.95
650	175	.95
700	169	.95
750	160	.95
800	155	.95
850	153	.95
1000	141	.95
1200	130	.95
1250	125	.95
1500	115	.95
1750	107	.95
1850	104	.95
2000	100	.95
2250	94	.95
2400	91	.95
2500	90	.95
2750	85	.95
3000	80	.95
3500	76	.95
4000	70	.95

20 Watts Type 933

Ohms	Current m. a.	List Price
4500	67	\$.95
5000	63	.95
6000	55	1.10
7000	53	1.10
7500	51	1.10
8000	50	1.10
10000	40	1.10
12500	32	1.20
15000	27	1.20
20000	20	1.20
25000	16	1.35
30000	13	1.35
35000	11	1.35
40000	10	1.35
45000	9	1.60
50000	8	1.60
55000	7	1.60
60000	†10.8	1.60
65000	†10.5	1.85
70000	†10.0	1.85
75000	†9.5	1.85
80000	†9.9	1.85
85000	†9.1	2.10
90000	†8.8	2.10
95000	†8.6	2.10
100000	†8.4	2.10

†Operated at low temp., rated at 7 watts.

INSULATED MOLDED CARBON RESISTORS

TYPES 1097-1098

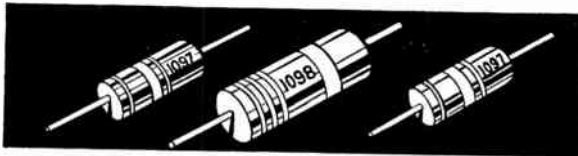

Small, noiseless, vibration-proof. Crack-proof molded casing around molded carbon resistance element. Tinned copper pig-tail leads 2 in. long. Resists humidity effects. Ideal for AVC circuits, high-gain amplifiers. RTMA color-coded; stamped with resistance value. Precision tested. Standard tolerance $\pm 10\%$.

TYPE 1097— $\frac{1}{2}$ Watt-Size: $\frac{3}{16}$ " x $\frac{3}{8}$ " lg.....List \$0.17

TYPE 1098—1 Watt-Size: $\frac{1}{4}$ " x $\frac{3}{4}$ " lg.....List \$0.25

TYPE 1099—2 Watt-Size: $\frac{3}{8}$ " x 1 $\frac{1}{2}$ " lg.....List \$0.33

JOBBERS' STOCK IN PREFERRED RTMA RANGES

Ohms	Ohms	Ohms	Ohms	Ohms	Megs	Megs	Megs
10	68	470	3,300	22,000	0.1	0.68	4.7
12	82	560	3,900	27,000	0.12	0.82	5.6
15	100	680	4,700	33,000	0.15	1.0	6.8
18	120	820	5,600	39,000	0.18	1.2	8.2
22	150	1,000	6,800	47,000	0.22	1.5	10.0
27	180	1,200	8,200	56,000	0.27	1.8	12.0
33	220	1,500	10,000	68,000	0.33	2.2	15.0
39	270	1,800	12,000	82,000	0.39	2.7	18.0
47	330	2,200	15,000		0.47	3.3	22.0
56	390	2,700	18,000		0.56	3.9	

CAPACITORS **AEROVOX** RESISTORS

HERMETICALLY-SEALED *Carbofilm* RESISTORS

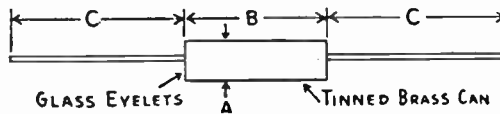

*Type	A	B	C	Standard Min. Ohms	Standard Max. Megohms	Standard Peak Volts**
CPH 1/2	0.312" ± .005	3/8" ± 1/32"	#20 gauge x 1 1/8"	90	2.5	350
CPH -1	0.400" ± .005	1 1/8" ± 1/32"	#20 gauge x 1 1/8"	100	5	500
CPH -2	0.400" ± .005	2 1/4" ± 1/32"	#20 gauge x 1 1/8"	150	15	750

No Mil-R-10509 Specifications for Hermetically-Sealed units.

*Numerals signify wattage.

**Provided wattage rating is not exceeded.

TOLERANCE	CPH 1/2	CPH 1	CPH 2	TOLERANCE	CPH 1/2	CPH 1	CPH 2	TOLERANCE	CPH 1/2	CPH 1	CPH 2
± 1%	1/2 Watt	1 Watt	2 Watt	± 1%	1/2 Watt	1 Watt	2 Watt	± 1%	1/2 Watt	1 Watt	2 Watt
Ohms	List	List	List	Ohms	List	List	List	Ohms	List	List	List
100	\$3.00	\$3.25	\$3.50	7000	\$3.00	\$3.25	\$3.50	0.450	\$3.00	\$3.25	\$3.50
120	3.00	3.25	3.50	*7450	3.00	3.25	3.50	0.500	3.00	3.25	3.50
130	3.00	3.25	3.50	7500	3.00	3.25	3.50	0.550	3.00	3.25	3.50
150	3.00	3.25	3.50	8000	3.00	3.25	3.50	0.600	3.00	3.25	3.50
175	3.00	3.25	3.50	8500	3.00	3.25	3.50	0.650	3.00	3.25	3.50
200	3.00	3.25	3.50	*8950	3.00	3.25	3.50	0.700	3.00	3.25	3.50
225	3.00	3.25	3.50	9000	3.00	3.25	3.50	0.750	3.00	3.25	3.50
250	3.00	3.25	3.50	*9950	3.00	3.25	3.50	0.800	3.00	3.25	3.50
300	3.00	3.25	3.50	10,000	3.00	3.25	3.50	0.850	3.00	3.25	3.50
350	3.00	3.25	3.50	12,000	3.00	3.25	3.50	0.900	3.00	3.25	3.50
400	3.00	3.25	3.50	12,500	3.00	3.25	3.50	1.0	3.00	3.25	3.50
450	3.00	3.25	3.50	*13,500	3.00	3.25	3.50	1.2	3.00	3.25	3.50
500	3.00	3.25	3.50	15,000	3.00	3.25	3.50	1.25	3.00	3.25	3.50
550	3.00	3.25	3.50	17,500	3.00	3.25	3.50	1.5	3.00	3.25	3.50
600	3.00	3.25	3.50	20,000	3.00	3.25	3.50	2.0	3.00	3.25	3.50
650	3.00	3.25	3.50	22,500	3.00	3.25	3.50	2.225	3.00	3.25	3.50
750	3.00	3.25	3.50	25,000	3.00	3.25	3.50	2.5	3.00	3.25	3.50
800	3.00	3.25	3.50	30,000	3.00	3.25	3.50	3.0	3.00	3.25	3.50
850	3.00	3.25	3.50	40,000	3.00	3.25	3.50	3.5	3.00	3.25	3.50
900	3.00	3.25	3.50	45,000	3.00	3.25	3.50	4.0	3.00	3.25	3.50
1000	3.00	3.25	3.50	50,000	3.00	3.25	3.50	4.5	3.00	3.25	3.50
1200	3.00	3.25	3.50	55,000	3.00	3.25	3.50	5.0	3.00	3.25	3.50
1250	3.00	3.25	3.50	60,000	3.00	3.25	3.50	5.5	3.00	3.25	3.50
*1450	3.00	3.25	3.50	65,000	3.00	3.25	3.50	6.0	3.00	3.25	3.50
1500	3.00	3.25	3.50	70,000	3.00	3.25	3.50	6.5	3.00	3.25	3.50
1750	3.00	3.25	3.50	75,000	3.00	3.25	3.50	7.0	3.00	3.25	3.50
2000	3.00	3.25	3.50	80,000	3.00	3.25	3.50	7.5	3.00	3.25	3.50
2250	3.00	3.25	3.50	85,000	3.00	3.25	3.50	8.0	3.00	3.25	3.50
2500	3.00	3.25	3.50	90,000	3.00	3.25	3.50	8.5	3.00	3.25	3.50
*2950	3.00	3.25	3.50					9.0	3.00	3.25	3.50
3000	3.00	3.25	3.50	Megohms				10.0	3.00	3.25	3.50
3500	3.00	3.25	3.50	0.10	3.00	3.25	3.50	12.5	3.00	3.25	3.50
4000	3.00	3.25	3.50	0.125	3.00	3.25	3.50	15.	3.00	3.25	3.50
*4450	3.00	3.25	3.50	0.150	3.00	3.25	3.50				
4500	3.00	3.25	3.50	0.175	3.00	3.25	3.50				
5000	3.00	3.25	3.50	0.200	3.00	3.25	3.50				
5500	3.00	3.25	3.50	0.225	3.00	3.25	3.50				
*5950	3.00	3.25	3.50	0.250	3.00	3.25	3.50				
6000	3.00	3.25	3.50	0.300	3.00	3.25	3.50				
6500	3.00	3.25	3.50	0.350	3.00	3.25	3.50				
				0.400	3.00	3.25	3.50				

*Meter multiplier resistance values—
other odd values can be ordered as
specials.

CAPACITORS **AEROVOX** RESISTORS

AEROVOX *Carbofilm* RESISTORS

PRECISION RESISTORS MADE WITH MATCHLESS ACCURACY

Made under licensed agreement with Western Electric, these precision resistors are the result of years of intensive research in developing components with extreme accuracy and stability. Carbofilm resistors are intended for circuits calling for the accuracy and stability of wire-wound resistors with the marked economy of carbon resistors. They serve a real need in test equipment and laboratory instruments. All in all, Carbofilm resistors meet the requirements of accuracy, stability and economy.

The Carbofilm resistors are a carbon deposit type and are available in the following standard or jobber stock sizes with the resistance value shown in the listing.

Packed and sealed in plastic tubes for your protection.

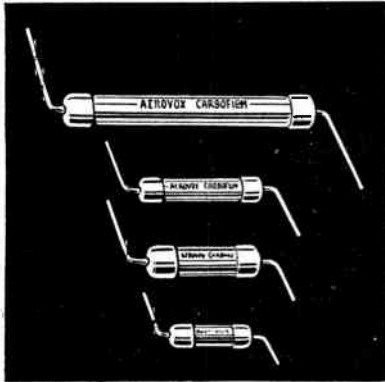

STANDARD NUMBERS

Carbofilm Resistors are available in the following standard or jobber-stocked sizes, and in the resistance values shown in the listings:

Type	Sizes	Min. Ohms	Max. Megohms	Peak Volts*
CP-1/2 watt	0.280D x 1/4" L	100	5	1500
CPL-1/2 watt	0.280D x 1/2" L	5,100,000	7.5	2000
CP-1 watt	0.293D x 1/2" L	100	15	2500
CP-2 watt	0.293D x 2 1/4" L	100	100	6000

* Provided wattage rating is not exceeded.

TOLERANCE ±1% Ohms	CP 1/2 Watt ±1% List	CP 1 Watt ±1% List	CP 2 Watt ±1% List	TOLERANCE ±1% Ohms	CP 1/2 Watt ±1% List	CP 1 Watt ±1% List	CP 2 Watt ±1% List	TOLERANCE ±1% Ohms	CP 1/2 Watt ±1% List	CP 1 Watt ±1% List	CP 2 Watt ±1% List	TOLERANCE ±1% Megohms	CP 1/2 Watt ±1% List	CP 1 Watt ±1% List	CP 2 Watt ±1% List
100	\$0.65	\$0.95	\$1.20	3000	\$0.65	\$0.95	\$1.20	51,000	\$0.65	\$0.95	\$1.20	1.0	\$0.65	\$0.95	\$1.20
110	.65	.95	1.20	3300	.65	.95	1.20	55,000	.65	.95	1.20	1.1	.65	1.00	1.20
120	.65	.95	1.20	3500	.65	.95	1.20	56,000	.65	.95	1.20	1.2	.65	1.00	1.20
130	.65	.95	1.20	3600	.65	.95	1.20	60,000	.65	.95	1.20	1.25	.65	1.00	1.20
150	.65	.95	1.20	3900	.65	.95	1.20	62,000	.65	.95	1.20	1.5	.65	1.00	1.20
175	.65	.95	1.20	4000	.65	.95	1.20	65,000	.65	.95	1.20	1.8	.65	1.00	1.20
180	.65	.95	1.20	4300	.65	.95	1.20	68,000	.65	.95	1.20	2.0	.65	1.00	1.20
200	.65	.95	1.20	4450	.65	.95	1.20	70,000	.65	.95	1.20	2.2	.65	1.00	1.20
220	.65	.95	1.20	4500	.65	.95	1.20	75,000	.65	.95	1.20	2.225	.65	1.00	1.20
235	.65	.95	1.20	4700	.65	.95	1.20	80,000	.65	.95	1.20	2.4	.65	1.00	1.20
240	.65	.95	1.20	5000	.65	.95	1.20	82,000	.65	.95	1.20	2.5	.65	1.00	1.20
250	.65	.95	1.20	5100	.65	.95	1.20	85,000	.65	.95	1.20	2.7	.65	1.00	1.20
270	.65	.95	1.20	5500	.65	.95	1.20	90,000	.65	.95	1.20	3.0	.65	1.00	1.20
300	.65	.95	1.20	5600	.65	.95	1.20	91,000	.65	.95	1.20	3.3	.65	1.00	1.20
330	.65	.95	1.20	5950	.65	.95	1.20	100,000	.65	.95	1.20	3.5	.65	1.00	1.20
350	.65	.95	1.20	6000	.65	.95	1.20	110,000	.65	.95	1.20	3.6	.65	1.00	1.20
360	.65	.95	1.20	6200	.65	.95	1.20	120,000	.65	.95	1.20	3.9	.65	1.00	1.20
390	.65	.95	1.20	6500	.65	.95	1.20	125,000	.65	.95	1.20	4.0	.65	1.00	1.20
400	.65	.95	1.20	6800	.65	.95	1.20	150,000	.65	.95	1.20	4.3	.65	1.00	1.20
480	.65	.95	1.20	7000	.65	.95	1.20	175,000	.65	.95	1.20	4.5	.65	1.00	1.20
450	.65	.95	1.20	7450	.65	.95	1.20	180,000	.65	.95	1.20	4.7	.65	1.00	1.20
470	.65	.95	1.20	7500	.65	.95	1.20	200,000	.65	.95	1.20	5.0*	.65	1.00	1.20
500	.65	.95	1.20	8000	.65	.95	1.20	220,000	.65	.95	1.20	5.1	.75	1.10	1.20
510	.65	.95	1.20	8200	.65	.95	1.20	225,000	.65	.95	1.20	5.5	.75	1.10	1.20
550	.65	.95	1.20	8500	.65	.95	1.20	240,000	.65	.95	1.20	5.6	.75	1.10	1.20
560	.65	.95	1.20	8950	.65	.95	1.20	250,000	.65	.95	1.20	6.0	.75	1.10	1.20
600	.65	.95	1.20	9000	.65	.95	1.20	270,000	.65	.95	1.20	6.2	.75	1.10	1.20
620	.65	.95	1.20	9100	.65	.95	1.20	300,000	.65	.95	1.20	6.5	.75	1.10	1.20
650	.65	.95	1.20	9950	.65	.95	1.20	330,000	.65	.95	1.20	6.8	.75	1.10	1.20
680	.65	.95	1.20	10,000	.65	.95	1.20	350,000	.65	.95	1.20	7.0	.75	1.10	1.20
750	.65	.95	1.20	11,000	.65	.95	1.20	360,000	.65	.95	1.20	7.5	.75	1.10	1.20
800	.65	.95	1.20	12,000	.65	.95	1.20	390,000	.65	.95	1.20	8.0	.75	1.10	1.20
820	.65	.95	1.20	12,500	.65	.95	1.20	400,000	.65	.95	1.20	8.2	.75	1.10	1.20
850	.65	.95	1.20	13,500	.65	.95	1.20	430,000	.65	.95	1.20	8.5	.75	1.10	1.20
900	.65	.95	1.20	15,000	.65	.95	1.20	450,000	.65	.95	1.20	9.0	.75	1.10	1.20
910	.65	.95	1.20	17,500	.65	.95	1.20	470,000	.65	.95	1.20	9.1	.75	1.10	1.20
1000	.65	.95	1.20	18,000	.65	.95	1.20	500,000	.65	.95	1.20	10.0	.75	1.10	1.20
1100	.65	.95	1.20	20,000	.65	.95	1.20	510,000	.65	.95	1.20	12.0	.75	1.10	1.30
1200	.65	.95	1.20	22,000	.65	.95	1.20	550,000	.65	.95	1.20	12.5	.75	1.10	1.30
1250	.65	.95	1.20	22,500	.65	.95	1.20	560,000	.65	.95	1.20	15.0	.75	1.10	1.30
1300	.65	.95	1.20	24,000	.65	.95	1.20	600,000	.65	.95	1.20	18.0	.75	1.10	1.30
1450	.65	.95	1.20	25,000	.65	.95	1.20	620,000	.65	.95	1.20	20.0	.75	1.10	1.30
1500	.65	.95	1.20	27,000	.65	.95	1.20	650,000	.65	.95	1.20	22.0	.75	1.10	1.75
1750	.65	.95	1.20	30,000	.65	.95	1.20	680,000	.65	.95	1.20	25.0	.75	1.10	1.75
1800	.65	.95	1.20	33,000	.65	.95	1.20	700,000	.65	.95	1.20	27.0	.75	1.10	2.00
2000	.65	.95	1.20	36,000	.65	.95	1.20	750,000	.65	.95	1.20	33.0	.75	1.10	2.00
2200	.65	.95	1.20	39,000	.65	.95	1.20	800,000	.65	.95	1.20	36.0	.75	1.10	2.00
2250	.65	.95	1.20	40,000	.65	.95	1.20	820,000	.65	.95	1.20	39.0	.75	1.10	2.00
2400	.65	.95	1.20	43,000	.65	.95	1.20	850,000	.65	.95	1.20	43.0	.75	1.10	2.00
2500	.65	.95	1.20	45,000	.65	.95	1.20	900,000	.65	.95	1.20	47.0	.75	1.10	2.00
2700	.65	.95	1.20	47,000	.65	.95	1.20	910,000	.65	.95	1.20	50.0	.75	1.10	2.00
2950	.65	.95	1.20	50,000	.65	.95	1.20					100.0*	.75	1.10	5.00

NOTE: Prices on special values are 2X next highest standard value.

*Furnished in ±2% tolerance only

WIRT CO.

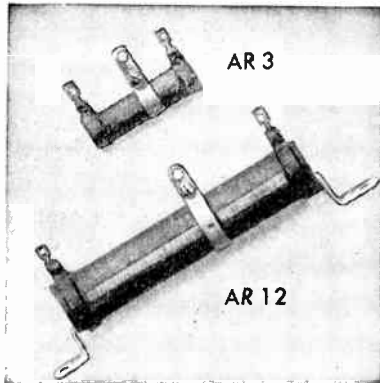

WIRE WOUND ADJUSTABLE RESISTORS

WIRT Adjustable Resistors are space wound on low loss ceramic tubes to which the resistance wire is bonded, resulting in dependability and long life. Protection of the windings is afforded by the PHENOCOTE covering which is described fully on the preceding page. One adjustable Slider Band, screw driver type, is furnished as standard. Bakelite knob type bands can be furnished on special order at slightly higher prices as shown below.

These bands are made with small contact buttons located on the inside of the band so that a number of taps may be made without shorting out excessive resistance.

TABLE OF SPECIFICATIONS OF ADJUSTABLE RESISTORS

Cat. No.	Watts	Sizes Phys.	Resistance Limits (Ohms)	List Price (Ea.)	Accessories			Mounting Centers	Packing
					Terminals	Brackets Mounting	Slider Bands		
AR 3	10	3/8" x 1 3/4"	1 to 10000	\$0.98	Soldering Lugs	None	1	Individual
AR 7	25	3/4" x 2"	1 to 5000	1.24	Soldering Lugs	2	1	3"	Individual
			6000 to 15000	1.43					
			20000 to 25000	1.56					
AR 12	50	3/4" x 4"	5 to 5000	1.95	Soldering Lugs	2	1	5"	Individual
			7000 to 25000	2.15					
			30000 to 50000	2.47					
			60000 to 100000	2.86					
AR 15	75	3/4" x 6"	10 to 5000	2.54	Soldering Lugs	2	1	7"	Individual
			7500 to 25000	2.86					
			30000 to 50000	3.25					
			60000 to 100000	3.58					
AR 19	100	1 1/8" x 6 1/2"	5 to 10000	2.86	Soldering Lugs	2	1	7"	Individual
			15000 to 50000	3.25					
			75000 to 100000	3.90					
AR 22	160	1 1/8" x 8 1/2"	5 to 10000	3.25	Soldering Lugs	2	1	9"	Individual
			15000 to 50000	4.15					
			60000 to 100000	4.65					
AR 23	200	1 1/8" x 10 1/2"	5 to 10000	4.29	Soldering Lugs	2	1	11"	Individual
			15000 to 100000	5.01					

SLIDE SWITCHES & CONTROLS

Various types of slide switches are also available as well as a line of wire wound potentiometers and rheostats in both standard and miniature sizes.

Write for our complete catalog.

WIRT CO.

WIRE WOUND FIXED RESISTORS

To satisfy the most exacting needs of the Radio and Electronic Industries, Wirt Fixed Wire-wound Resistors are regularly furnished in PHENOCOTE protective coatings, developed and steadily improved over a period of many years in the Wirt Laboratories. The resistor wire is space wound on low loss ceramic tubes. The PHENOCOTE covering is an exclusive organic cement coating offering maximum protection to the resistance winding against the detrimental effects of moisture, humidity and electrolysis. Absolutely inert chemically, it will not effect the most delicate windings. It is particularly recommended for fine wire sizes and all applications where the maximum temperature of the unit will not exceed 300° F. These Resistors are universally used in the Radio, Electronic, Instrument, Public Address and Test Equipment fields.

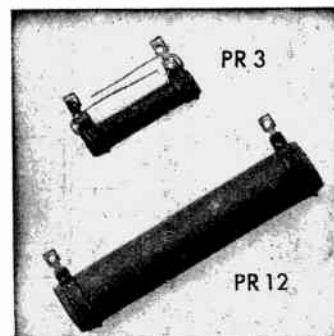

TABLE OF SPECIFICATIONS OF FIXED RESISTORS

Cat. No.	Watts	Sizes Phys.	Resistance Limits (Ohms)	List Price (Ea.)	Accessories Terminals	Mounting Brackets	Mounting Centers	Packing
PR 1	5	3/8"x1"	1 to 10000	\$0.53	Soldering Lugs & Wire Leads	None	10 to a box
PR 3	10	3/8"x1 3/4"	1 to 10000	.59	Soldering Lugs & Wire Leads	None	10 to a box
			11 to 25000	.65				
PR 4	20	1/2"x2"	5 to 15000	.91	Soldering Lugs & Wire Leads	None	10 to a box
			16000 to 50000	1.11				
			51000 to 100000	1.43				
PR 12	50	3/4"x4"	5 to 5000	1.56	Soldering Lugs	2	5"	Individual
			5100 to 25000	1.82				
			26000 to 100000	2.08				
PR 19	100	1 1/8"x6 1/2"	5 to 5000	2.15	Soldering Lugs	2	7"	Individual
			5100 to 25000	2.54				
			26000 to 50000	2.86				
			51000 to 75000	3.25				
PR 22	160	1 1/8"x8 1/2"	5 to 10000	2.86	Soldering Lugs	2	9"	Individual
			11000 to 50000	3.43				
			51000 to 100000	3.86				
PR 23	200	1 1/8"x10 1/2"	5 to 10000	3.58	Soldering Lugs	2	11"	Individual
			11000 to 100000	4.29				

When ordering state: Quantity, Catalogue Number and Resistance Value.

BALLAST TUBE FOR AUTOMATIC REGULATION OF CURRENT AND VOLTAGE



T9 BULB

AUTOMATIC REGULATION

WHAT IT IS! AMPERITE is an automatic "rheostat" designed to keep the current in a circuit at a definite value, e.g., 0.5 amps. Should the supply voltage increase, the AMPERITE will automatically increase in resistance to take up the increase in supply voltage. Since AMPERITE is a constant current device, it can only be used on a fixed load.

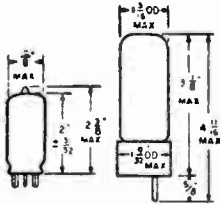

SIZES:

- T-5 1/2 L. Miniature. O.D. 1 1/8"; seated height, 2 3/8"
- T-6 1/2 L. Miniature. O.D. 1 3/8"; seated height, 2 3/8"
- T-9 Octal base. O.D. 1 1/8"; seated height, 3"

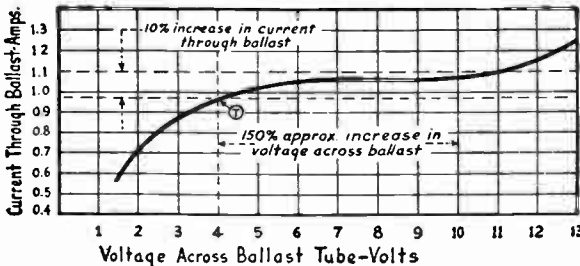

⑦ = Threshold Current & Voltage

CHARACTERISTIC CURVE

Characteristic curve of a typical Amperite. Approximate curve of any other Amperite can be obtained by multiplying or dividing the current or voltage scale by any number.

We strongly recommend that you send us your specifications on special problems, and let us recommend the BALLAST TUBE you need.

AMPERITE NUMBERING SYSTEM

In general, the AMPERITE number approximately denotes the current—voltage threshold value:

AMPERITE NUMBER	3-4	3H4	10-7	12-11	12H11
THRESHOLD CURRENT	0.3	0.35	1.0	1.2	1.25
THRESHOLD VOLTAGE	4.0	4.0	7.0	11.0	11.0

SPECIAL BALLAST TUBES

List \$3.00 — Dealer Cost \$1.80

D6-1E	1H20	3V1	4A10	6-3	**7HTF3	9A10	12-3
*D6T4	1H22	3-7	4-12	6-4	**7HTF4	9-11	12-4
**D6TK7	**2TK7	*3T7	4H3	6-4A	7H4	10T1	12-7
*D6T11	2A10	**3TF7	4H4	6-4R	7H4R	**10TF2	12A10
**D6TF10	2A12	3A10	**4HTF4	*GT4	7H7	10-3	13-11
**D6TF30	2A20	3-11	**4HTF7	**GT4	7H11	10-1A	13-4
D7-20	*2HT2	*3T11	4H10	6-7	**8TF2	10-4R	15-2
D7H4	2H4	3TF11	4H11	**6TF7	8-3B	10-4C	15-4
*D7HT4	*2HT4	**3TF12	5E1	6-8B	8-4	10-4D	16-4
*D7HT11	**2HT11	3-14	**5TF2	6A10	8A10	10-4E	17-3
1A10	2H10	8-16	5-4	6-11	**9TF2	10A12	20-3
*1TF10	3-2	3A20	**5TF4	6-12	9-3	10A12	20-4
1-15	*3T2	3-SN4	5A10	6-13	9-4	10-25	22-4
*1HT2	**3TF2	3-50A	5-11	6A15	9-1A	11-3	24-3
1H4	**3TK2	3H-1-7	5-16	6-26	9-7	11-4	31-2
*1HT4	3-4	3H4	5H3	6H4	9-8	11A10	35-4
1H10	*3T4	**3HTF4	5H4	**8HTF4		11-11	40-6E
*1HTF10	*3T4A	3H11	5H10	6H6			41-7E
*1HT11	**3TF4A	3H-25	5H11	7-4			55-1
*1HTF11	*3TF4			**7TF4			55-4
	**3TFV4			7A10			
				7-11			
				**7HTF2			

124A—List \$10.00

*T denotes T5 1/2 bulb-7 pin miniature, e.g., 3T4.
 **TF denotes T6 1/2 bulb-9 pin miniature, e.g., 3TF4.
 Base Wiring: Octal, 7 and 9 pin miniature—prongs 2-7.

ADVANTAGES

Light . . . Compact . . . No Moving Parts (Will withstand vibrations of 10G min.) . . . Hermetically Sealed (Not affected by altitude or humidity changes) . . . Can Be Changed as Easily as a Radio Tube . . . Operates Equally Well on AC or DC . . . Inexpensive.

CAPACITIES AVAILABLE

Current values of 60 ma. to 5 amps; threshold voltage 0.4 to 40 V. Maximum dissipation per AMPERITE 50w per tube (ST19 bulb). Any number of AMPERITES with the same voltage range can be operated in parallel. AMPERITES should not be used in series.

AMBIENT EFFECTS

Variations of -50° to +70° C. will change the current of an AMPERITE approximately ±2% on the regulating portion of the curve.

LIFE EXPECTANCY

Average life 2000 hours prox.; if AMPERITE filament is operated at black temperature—average life 5000 hours prox., depending on use.

AGEING

AMPERITE Ballast Tubes may change approximately up to 3% in current if aged for 4 to 8 hours, at maximum voltage. They will change very little thereafter.

POWER SUPPLIES

We strongly recommend, for any particular application, to fill and return one of our special problem sheets (ASP 343) and permit us to recommend the most suitable AMPERITE.

Power Supply	Dry Cells	6 Volts	12 Volts	26 Volts	115-Volts
Variation	2.2-3.0V	5.5-7.5V	10.0-14.0V	22.0-30.0V	105-125V
Desired on load	1.8-2.0V	3.9-4.1V	6.1- 6.4V	17.5-18.5V	90- 95V
Required on AMPERITE	0.4-1.0V	1.0-3.4V	3.9- 7.6V	4.5-11.5V	15- 30V
Current Variation	.29-.32a	.29-.31a	.29-.31a	.29-.32a	.29-.32a

The above chart shows the maximum load voltage for the given supply to obtain 2% regulation on load. Better regulation is obtainable by increasing the voltage across the AMPERITE. In general, the higher the percent of the supply voltage taken by the AMPERITE, the better the regulation.

ALPHA WIRE CORPORATION

SHIELDED MULTIPLE CONDUCTOR CABLE

GENERAL PURPOSE: For indoor permanent or portable P.A. systems, photo electric cell circuits, sound recording and auto radios.
TINNED SHIELD OVERALL

No.	Cond.	Size	Strand	O.D.	Standard Put-Up	Alternate Put-Ups		
1256	2	20	10/30	.215"	100'	250'	500'	1000'
1256V	2	20	10/30	.155"	100'	250'	500'	1000'
1257	3	20	10/30	.245"	100'	250'	500'	1000'
1257V	3	20	10/30	.170"	100'	250'	500'	1000'
1258	4	20	10/30	.270"	100'	250'	500'	1000'
1259V	2	18	16/30	.195"	100'	250'	500'	1000'
1260V	2	16	26/30	.215"	100'	250'	500'	1000'
1260/14	2	14	41/30	.240"	100'	250'	500'	1000'

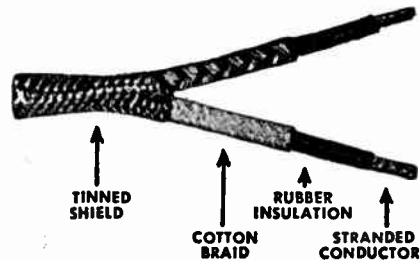

COTTON BRAID OVER SHIELD

1262	2	20	10/30	.225"	100'	250'	500'	1000'
1262V	2	20	10/30	.190"	100'	250'	500'	1000'
1263	3	20	10/30	.240"	100'	250'	500'	1000'
1264	4	20	10/30	.275"	100'	250'	500'	1000'

Construction: Nos. 1256-7-8: Each conductor stranded tinned copper, 1/64" rubber, waxed cotton braid, color coded, conductors twisted, tinned copper shield overall.

Construction: Nos. 1256V, 1257V, 1259V, 1260V, 1260/14: Each conductor stranded tinned copper, 1/64" plastic, color coded, conductors twisted, tinned copper shield overall.

Nos. 1262-3-4: Same as Nos. 1256-7-8 plus cotton braid over shield.

No. 1262V: Same as No. 1256V plus cotton braid over shield.

For alternate put-ups use code: D=250 ft., E=500 ft., F=1000 ft.

SHIELDED DUPLEX SPEAKER CABLE

GENERAL PURPOSE: For P.A. systems, photo-electric cell circuits, master control sound systems, etc.
TINNED SHIELD OVERALL

No.	Cond.	Size	Strand	O.D.	Standard Put-up	Alternate Put-up
1265	2	18	16/30	.250"	500'	1000'

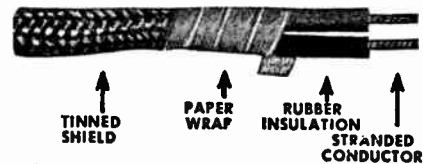

WAXED COTTON BRAID OVER SHIELD

1266	2	18	16/30	.280"	500'	1000'
------	---	----	-------	-------	------	-------

Construction: No. 1265: Two conductors 18-16/30 stranded tinned copper, 1/32" "Hi-Tension" rubber, color coded, conductors twisted, paper wrap, close tinned copper shield overall.

Construction: No. 1266 same as No. 1265 except with waxed cotton braid over shield.

For alternate put-up use code: F=1000 ft.

SHIELDED TRANSMISSION LINE

GENERAL PURPOSE: For broadcast, public address and sound systems, inter-communication systems, short wave, etc.
TINNED SHIELD OVERALL

No.	Cond.	Size	O.D.	Standard Put-up	Alternate Put-up
1267/22	2	22 Solid	.175"	500'	1000'
1267	2	20 Solid	.135"	500'	1000'
1267V	2	20 Solid	.145"	500'	1000'
1267/18	2	18 Solid	.150"	500'	1000'



WAXED COTTON BRAID OVER SHIELD

1268	2	20 Solid	.165"	500'	1000'
1268V	2	20 Solid	.175"	500'	1000'

Construction: Nos. 1267/22, 1267, 1267/18: Two conductors solid tinned enameled copper, insulated, color coded, conductors twisted, close copper shield overall.

Construction: No. 1267V: Two conductors 20 AWDG solid tinned copper, 1/64" plastic, color coded, conductors twisted, close copper shield overall.

No. 1268: Same as No. 1267 plus waxed cotton braid over shield.

No. 1268V: Same as No. 1267V plus waxed cotton braid over shield.

For alternate put-up use code: F=1000 ft.

SHIELDED AUDIO CABLE

(PLASTIC JACKET)

GENERAL PURPOSE: For broadcast, public address and sound systems, inter-communication systems, short wave, and for any installation where a cable is required to eliminate interference and cross talk.

No.	Cond.	Size	Strand	O.D.	Standard Put-up	Alternate Put-up
1736	2	22	7/30	.160"	500'	1000'
1762	2	22 Solid	—	.155"	500'	1000'
1775	2	22 Solid	—	.150"	500'	1000'

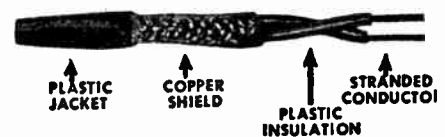

Construction: No. 1736: Two conductors 22-7/30 stranded tinned copper, plastic insulated, color coded, twisted, braided copper shield, plastic jacket overall.

Construction: No. 1762: Two conductors 22 AWG solid tinned enameled copper, cotton insulated, color coded, conductors twisted; 22 AWG solid tinned copper ground wire; braided copper shield, plastic jacket overall.

No. 1775—Same as No. 1736 except 22 AWG solid conductors and 22 AWG solid tinned copper wire under shield parallel to twisted pair.

For alternate put-up use code: F=1000 ft.

ALPHA WIRE CORPORATION

CRYSTAL MICROPHONE CABLE

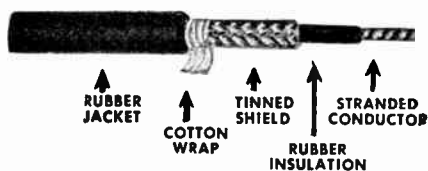

GENERAL PURPOSE: Low loss design for use with crystal, ribbon, dynamic and velocity microphones, photo-electric cells. Use No. 1248 FOR LAPEL MICROPHONES and phonograph pickups.

No.	Size	Strand	Capacity Per Ft.	O.D.	Standard Put-up	Alternate Put-ups		
1248	20	26/34	40 mmf.	.175"	100'	250'	500'	1000'
1249	20	26/34	30 mmf.	.245"	100'	250'	500'	1000'
1249/18	18	41/34	45 mmf.	.250"	100'	250'	500'	1000'

Construction: Single conductor, extra flexible stranded tinned copper, cotton serve, insulated with special low loss SIC rubber compound, braided tinned copper shield, cotton serve, tough black rubber jacket overall.

For alternate put-up use code: D=250 ft., E=500 ft., F=1000 ft.

SHIELDED MICROPHONE CABLE

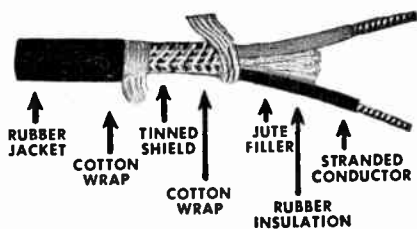

GENERAL PURPOSE: Adaptable for all indoor and outdoor crystal, carbon and condenser microphones as well as public address systems.

No.	Cond.	Size	Capacity Per Ft.	O.D.	Standard Put-up	Alternate Put-ups		
1250	2	20	70 mmf.	.290"	100'	250'	500'	1000'
1250/18	2	18	75 mmf.	.300"	100'	250'	500'	1000'
1251	3	20	65 mmf.	.305"	100'	250'	500'	1000'
1251/18	3	18	65 mmf.	.355"	100'	250'	500'	1000'
1252	4	20	65 mmf.	.345"	100'	250'	500'	1000'
1253	5	20	60 mmf.	.350"	100'	250'	500'	1000'
1254	6	20	60 mmf.	.375"	100'	250'	500'	1000'
1254/18	6	18	60 mmf.	.430"	100'	250'	500'	1000'
1255	7	20	60 mmf.	.380"	100'	250'	500'	1000'
1255/8	8	20	60 mmf.	.400"	100'	250'	500'	1000'

Construction: Each conductor, extra flexible stranded tinned copper, cotton wrap, .020" "Hi-Tension" low capacity rubber, color coded, conductors twisted, braided tinned copper shield, cotton wrap, tough black rubber jacket overall.

For alternate put-up use code: D=250 ft., E=500 ft., F=1000 ft.

PLASTIC MICROPHONE CABLE SINGLE CONDUCTOR

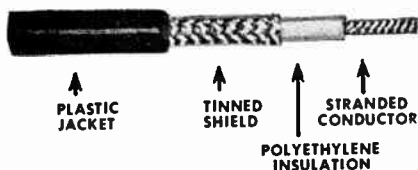

GENERAL PURPOSE: For use with all lapel, crystal, ribbon and other impedance microphones. Use No. 1703 for LAPEL MICROPHONES. Use No. 1704 and No. 1706 for CRYSTAL, RIBBON and other IMPEDANCE MICROPHONES.

No.	Size	Strand	Capacity Per Ft.	O.D.	Standard Put-up	Alternate Put-up		
1703	24	7/32	38 mmf.	.145"	500'	100'	250'	1000'
1704	24	10/34	25 mmf.	.200"	500'	100'	250'	1000'
1706	20	26/34	39 mmf.	.175"	500'	100'	250'	1000'

Construction:

Single conductor flexible stranded tinned copper, polyethylene insulation, braided tinned copper shield, plastic jacket overall.

TWO CONDUCTOR

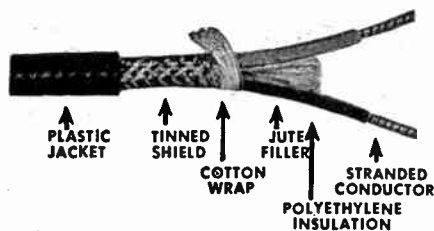

GENERAL PURPOSE: For use with carbon and other low impedance microphones.

No.	Cond.	Size	Strand	Capacity Per Ft.	O.D.	Standard Put-up	Alternate Put-ups	
1710	2	22	16/34	32 mmf.	.235"	500'	100'	250'

Construction:

Two conductors 22-16/34 flexible stranded tinned copper, polyethylene insulation, color coded, conductors twisted, cushioned with fillers, cotton wrap, braided tinned copper shield, plastic jacket overall.

For alternate put-ups use code: Q=100 ft., D=250 ft., F=1000 ft.

ALPHA WIRE CORPORATION

PLASTIC INTER-COMMUNICATION CABLE

4 CONDUCTORS (2 Shielded—2 Unshielded)

GENERAL PURPOSE: This cable is designed for general wiring from station to station where a shielded twisted pair is essential to eliminate cross talk.

No.	Cond.	Size	Strand	O.D.	Standard Put-up	Alternate Put-up
1243/4	4	22	7/30	.315"	500'	1000'

Construction: Four conductors 22-7/30 tinned copper, vinyl plastic insulation, color coded; tinned copper shield over two conductors, two conductors unshielded; plastic jacket overall.

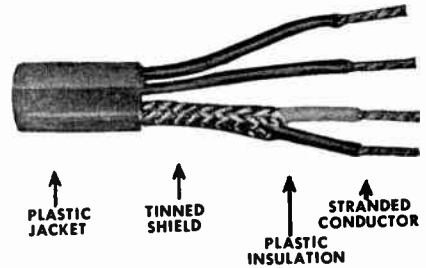

3 CONDUCTORS (1 Shielded—2 Unshielded)

GENERAL PURPOSE: This cable is designed for general wiring from station to station where a shielded single conductor is essential to eliminate cross talk.

No.	Cond.	Size	Strand	O.D.	Standard Put-up	Alternate Put-up
1242	3	22	7/30	.170"	500'	1000'
1243	3	22	7/30	.215"	500'	1000'

Construction: Three conductors 22-7/30 tinned copper, vinyl plastic insulation, color coded; tinned copper shield over one conductor, two conductors unshielded; cotton braid overall (No. 1242), or plastic jacket overall (No. 1243).

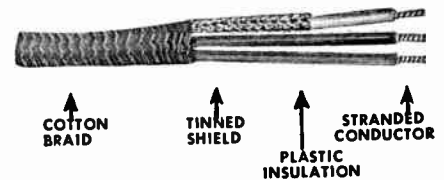

For alternate put-up use code: F=1000 ft.

SHIELDED TWISTED PAIR CABLE

GENERAL PURPOSE: Where small diameter is required for sound recording, photo electric cell circuits, public address systems, etc.

No.	Cond.	Size	Strand	O.D.	Standard Put-up
1261	2	24	16/36	.115"	1000'

Construction: Two conductors 24-16/36 extra flexible tinned copper, 1/64" vinyl insulation, color coded, conductors twisted, very fine tinned copper shield overall.

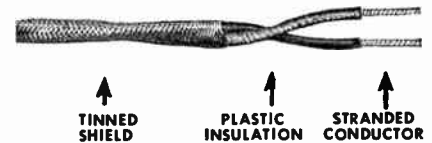

ARMORED DUPLEX SPEAKER CABLE

GENERAL PURPOSE: For P.A. systems, oil burner installations, automotive wiring, etc.

No.	Cond.	Size	Strand	O.D.	Standard Put-up	Alternate Put-up
1272	2	18	16/30	.132" x .182"	500'	1000'

Construction: Two conductors parallel, 18-16/30 stranded tinned copper, rubber insulated, color coded, lacquered cotton braid, galvanized steel armor overall.

For alternate put-up use code: F=1000 ft.

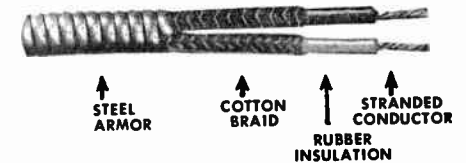

SHIELDED PHONO AND GRID WIRE

GENERAL PURPOSE: Extreme flexibility and limpness make this an ideal wire for phonograph pick-up arm cable and grid wire.

No.	Cond.	Size	Strand	Insulation	O.D.	Standard Put-up	Alternate Put-up
1200	1	24	16/36	.010"	.080"	1000'	100'
1201	1	24	16/36	.010"	.095"	1000'	100'
1202	2	24	16/36	.010"	.115"	1000'	—

Construction: No. 1200—Single conductor 24-16/36 extra flexible stranded tinned copper, vinyl plastic insulation, fine close tinned copper shield overall.
No. 1201 same as No. 1200 plus cotton braid over shield.
No. 1202 same as No. 1200 except two conductors with shield overall.

For alternate put-ups use code: Q=100 ft.



ALPHA WIRE CORPORATION

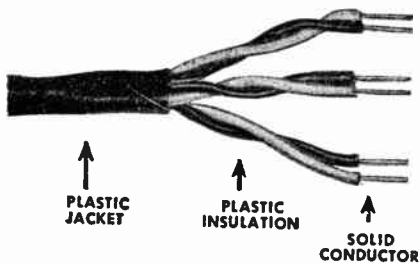

↑
PLASTIC JACKET

↑
PLASTIC INSULATION

↑
SOLID CONDUCTOR

Construction:

Each conductor 22 AWG tinned copper, plastic insulation, conductors color coded, twisted into pairs, plastic jacket overall.

For alternate put-up use code: Q=100 ft.

PLASTIC COMMUNICATION CABLE

(TWISTED PAIRS)

GENERAL PURPOSE: For use in connecting intercommunication systems, annunciators, telephones and wherever a multiple circuit hook-up is required.

SOLID CONDUCTORS

No.	Pairs	Cond.	Size	O.D.	Standard Put-up	Alternate Put-up
1300	1	2	22 Solid	.145"	1000'	100'
1302	2	4	22 Solid	.205"	1000'	100'
1304	3	6	22 Solid	.215"	1000'	100'
1307	6	12	22 Solid	.250"	1000'	100'
1308	10	20	22 Solid	.320"	1000'	100'
1309	15	26	22 Solid	.360"	1000'	100'
1310	16	32	22 Solid	.405"	1000'	100'
1312	26	52	22 Solid	.475"	1000'	100'

STRANDED CONDUCTORS

No.	Pairs	Cond.	Size	Strand	O.D.	Standard Put-up	Alternate Put-up
1316	1	2	22	7/30	.135"	1000'	100'
1317	2	4	22	7/30	.190"	1000'	100'
1318	3	6	22	7/30	.225"	1000'	100'
1319	4	8	22	7/30	.235"	1000'	100'
1320	5	10	22	7/30	.245"	1000'	100'
1322	6	12	22	7/30	.260"	1000'	100'



↑
COTTON BRAID

↑
PLASTIC INSULATION

↑
STRANDED CONDUCTOR

Construction:

Each conductor 20-10/30 stranded tinned copper, 1/64" thermo-plastic insulation, color coded, conductors twisted, brown cotton braid overall.

Alternate put-up use code:

D=250 ft., E=500 ft., F=1000 ft.

MULTI-CONDUCTOR FLEXIBLE CABLE

(COTTON BRAID)

GENERAL PURPOSE: For connecting speakers, analyzers, remote control units, P.A. systems or wherever a multiple circuit hook-up is required.

No.	Cond.	Size	Strand	O.D.	Standard Put-up	Alternate Put-up
1182	2	20	10/30	.135"	100'	250' 500' 1000'
1183	3	20	10/30	.170"	100'	250' 500' 1000'
1184	4	20	10/30	.180"	100'	250' 500' 1000'
1185	5	20	10/30	.205"	100'	250' 500' 1000'
1186	6	20	10/30	.225"	100'	250' 500' 1000'
1187	7	20	10/30	.240"	100'	250' 500' 1000'
1188	8	20	10/30	.255"	100'	250' 500' 1000'
1189	9	20	10/30	.275"	100'	250' 500' 1000'
1190	10	20	10/30	.310"	100'	250' 500' 1000'
1192	12	20	10/30	.340"	100'	250' 500' 1000'



↑
COTTON BRAID

↑
PLASTIC INSULATION

↑
SOLID CONDUCTOR

Construction:

Each conductor 18 AWG solid bare copper wire, thermoplastic insulation, color coded, conductors twisted, waxed cotton braid overall.

INTER-COMMUNICATION CABLE

(BRAIDED)

GENERAL PURPOSE: Designed for interior use for connecting inter-communication systems, annunciators, thermostat controls of oil burners, air conditioners, etc.

No.	Cond.	Size	O.D.	Standard Put-up
1274	2	18 Solid	.150"	500'
1275	3	18 Solid	.165"	500'
1275/4	4	18 Solid	.180"	500'
1275/5	5	18 Solid	.200"	500'
1275/6	6	18 Solid	.220"	500'

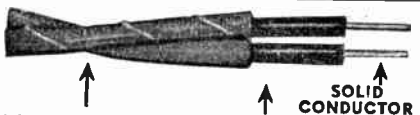

↑
WEATHERPROOF COTTON BRAID

↑
RUBBER INSULATION

↑
SOLID CONDUCTOR

Construction:

Nos. 1279, 1280: Each conductor 19 AWG solid tinned copper, 1/64" telephone compound rubber, heavy cotton braid (ridged for polarity) with specially treated compound to make it weather-proof for resistance against rain, snow, hail and cold.

Nos. 1279V, 1280V: Each conductor 19 AWG solid tinned copper, .024" plastic insulation (ridged for polarity), conductors twisted.

OUTDOOR INTER-COMMUNICATION WIRE

GENERAL PURPOSE: For outdoor and indoor use or in any damp location, for connecting communication systems, telephones, etc.

No.	Cond.	Size	O.D.	Standard Put-up
1279	2	19 Solid	.255"	500'
1279V	2	19 Solid	.165"	500'
1280	3	19 Solid	.275"	500'
1280V	3	19 Solid	.175"	500'

ALPHA WIRE CORPORATION

BRAIDED COMMUNICATION CABLE

(TWISTED PAIRS)

GENERAL PURPOSE: For interior use designed for connecting inter-communication systems, annunciators, telephones, etc.

No.	Pairs	Cond.	Size	O.D.	Standard Put-up	Alternate Put-up
1276/2	2	4	22 Solid	.185"	1000'	100'
1276/3	3	6	22 Solid	.210"	1000'	100'
1276	6	12	22 Solid	.240"	1000'	100'
1277	10	20	22 Solid	.300"	1000'	100'
1277/13	13	26	22 Solid	.360"	1000'	100'
1277/15	16	32	22 Solid	.380"	1000'	100'
1277/25	26	52	22 Solid	.445"	1000'	100'
1277/50	51	102	22 Solid	.650"	1000'	—

Construction: Each conductor 22 AWG solid tinned copper wire, two reverse serves paraffined, color coded, conductors twisted into pairs, then covered with an impregnated double paper wrap, and overall a cotton braid saturated with a moisture-proof, flame retarding, rodent-proof compound.

For alternate put-up use code: Q=100 ft.

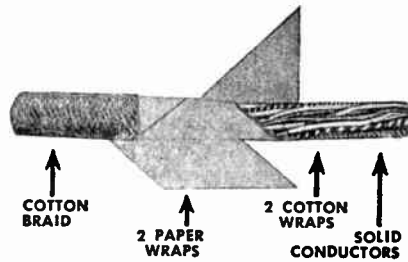

LEAD-COVERED COMMUNICATION CABLE

(TWISTED PAIRS)

GENERAL PURPOSE: For use indoors, outdoors, underground and in pipes for connecting inter-communication systems, annunciators, telephones, etc.

No.	Pairs	Cond.	Size	O.D.	Standard Put-up
1289	6	12	22 Solid	.375"	1000'
1291	10	20	22 Solid	.450"	1000'
1293	16	32	22 Solid	.510"	1000'
1295	26	52	22 Solid	.560"	1000'

Construction: Similar to Braided Communication Cable above, but with lead antimony sheath instead of cotton braid over the twisted pairs.

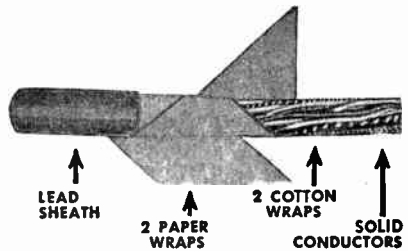

LEAD SHEATHED CABLE

GENERAL PURPOSE: For P.A. systems, communications, traffic control, mines, railroads and many other uses where severe moisture conditions are encountered. For all outdoor use including underground and underwater.

No.	Cond.	Size	O.D.	Standard Put-up
1271	2	19 Solid	.325"	1000'

Construction:

Two conductors 19 AWG solid tinned copper, 1/32" "Hi-Tension" rubber, color coded, conductors twisted, pure lead sheath overall.

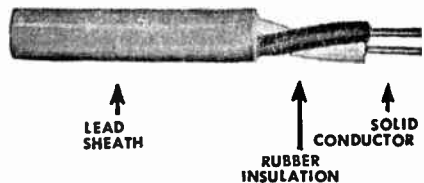

PLASTIC INTER-COMMUNICATION WIRE

GENERAL PURPOSE: For connecting sound and inter-communication systems, general audio hook-up, etc.

No.	Cond.	Size	O.D.	Standard Put-up	Alternate Put-up
1793	2	22 Solid	.125"	500'	1000'
1794	3	22 Solid	.130"	500'	1000'

Construction:

Conductors 22 AWG solid tinned copper, plastic insulation, color coded, conductors twisted, plastic jacket overall.

For alternate put-up use code: F=1000 ft.

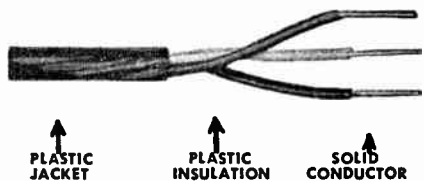

INDOOR INTER-COMMUNICATION WIRE

GENERAL PURPOSE: For connecting sound and communication systems, telephones, etc.

No.	Cond.	Size	O.D.	Standard Put-up
1269	2	22 Solid	.115"	500'
1270	3	22 Solid	.125"	500'

Construction:

Conductors 22 AWG solid copper, plastic insulated, color coded, conductors twisted.



ALPHA WIRE CORPORATION

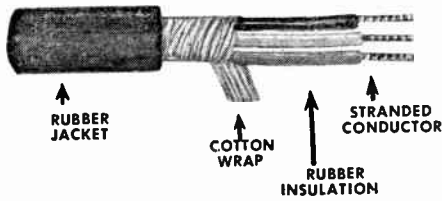

MULTI-CONDUCTOR FLEXIBLE CABLE

(RUBBER JACKETED)

GENERAL PURPOSE: For indoor and outdoor speakers, permanent or portable P.A. systems, sound recording and auto radios.

Construction:

Each conductor 20-26/34 extra flexible stranded tinned copper, cotton wrap, 1/32" "Hi-Tension" rubber, color coded, conductors twisted, cushioned with cotton fillers, cotton wrap, tough black rubber jacket overall.

For alternate put-ups use code:
D=250 ft., E=500 ft., F=1000 ft.

No.	Cond.	Size	Strand	O.D.	Standard Put-up	Alternate Put-up	
1244	2	20	26/34	.250"	100'	250'	500' 1000'
1245	3	20	26/34	.285"	100'	250'	500' 1000'
1246	4	20	26/34	.305"	100'	250'	500' 1000'
1247	5	20	26/34	.335"	100'	250'	500' 1000'
1247/6	6	20	26/34	.355"	100'	250'	500' 1000'
1247/8	8	20	26/34	.395"	100'	250'	500' 1000'

RUBBER SHEATHED SERVICE CORD

(UNDERWRITERS APPROVED)

GENERAL PURPOSE: For amplifiers, sound systems, speakers, vacuum cleaners, electric tools, washing machines, refrigerators, appliances, trouble lights, garage lamps or wherever a rough usage power line is required.

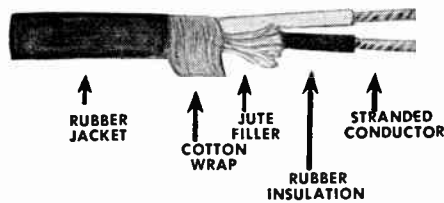

Construction:

Each conductor stranded bare copper, cotton separator, 1/32" rubber, color coded, conductors twisted, cushioned with jute fillers, 40% tough rubber jacket overall.

No.	Cond.	Size	Type	Current Carrying Capacity	Voltage Rating	O.D.	Standard Put-up
1951	2	18	SV	5 amps	300	.250"	250'
1952	2	18	SJ	5 amps	300	.310"	250'
1952/3	3	18	SJ	5 amps	300	.345"	250'
1953	2	16	SJ	7 amps	300	.340"	250'
1953/3	3	16	SJ	7 amps	300	.375"	250'
1954	2	18	S	5 amps	600	.390"	250'
1955	2	16	S	7 amps	600	.410"	250'
1956	2	14	S	15 amps	600	.540"	250'
1957	2	12	S	20 amps	600	.605"	250'
1958	2	10	S	25 amps	600	.640"	250'

Available with Additional Conductors. Also other sizes.

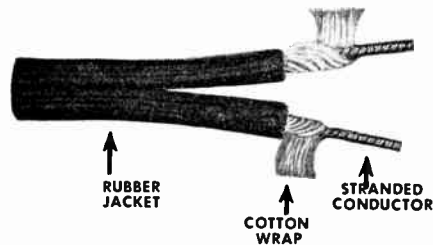

E-Z STRIP LAMP CORD—TYPE POSJ

(UNDERWRITERS APPROVED)

GENERAL PURPOSE: For line cord on radios, lamps, electric clocks, food mixers and other small instruments and appliances.

Construction:

Two conductors parallel, 18-41/34 extra flexible bare copper, color coded, cotton serve, 40% tough rubber jacket overall. Slit in jacket to permit "E-Z" separation.

No.	Cond.	Size	Strand	O.D.	Standard Put-up
1966	2	18	41/34	.235" x .130"	100'
1967	2	18	41/34	.235" x .130"	250'



TWISTED PAIR TRANSMISSION LINE

(WEATHERPROOF BRAID)

GENERAL PURPOSE: For inter-com hook-up. Also suitable for low loss coupling between antenna and receiver as doublet style twisted lead-in.

Construction:

Two conductors stranded tinned copper, "Hi-Tension" rubber, color coded, conductors twisted, cotton braid overall, saturated weather-proof finish.

No.	Cond.	Size	Strand	O.D.	Standard Put-up
1146	2	22	7/30	.175"	500'
1135	2	18	16/30	.190"	500'

ALPHA WIRE CORPORATION

KINKLESS TEST LEAD WIRE

GENERAL PURPOSE: As test leads in analyzers, oscillators and all other types of testing apparatus or wherever an EXTRA FLEXIBLE insulated wire is required.

No.	Size	Strand	Insul.	Voltage Breakdown (60 Cycles)	O.D.	Standard Put-up	Alternate Put-up
1633	20	41/36	3/64"	10,000	.140"	100'	—
1635	20	41/36	3/64"	10,000	.140"	500'	1000'
1636	18	65/36	3/64"	12,000	.150"	500'	1000'
1636Q	18	65/36	3/64"	12,000	.150"	100'	—

HEAVY DUTY TYPE

GENERAL PURPOSE: For television, therapeutic equipment, analyzers, oscillators, etc., or wherever a heavy duty EXTRA FLEXIBLE high voltage line is required.

No.	Size	Strand	Insul.	Voltage Breakdown (60 Cycles)	O.D.	Standard Put-up	Alternate Put-up
1637	18	65/36	7/64"	22,000	.245"	100'	—
1638	18	65/36	7/64"	22,000	.245"	500'	1000'

HI-VOLTAGE & CATHODE RAY WIRE

GENERAL PURPOSE: This wire is designed for high-voltage leads for all applications, especially for cathode ray tubes in television receivers and oscilloscopes. This wire has high dielectric strength and is resistant to heat, flame, and moisture.

No.	Size	Strand	Insul.	Voltage Rating	O.D.	Standard Put-up	Alternate Put-up
1642	20	10/30	4/64"	20,000	.175"	100'	500' 1000'

DIATHERMY CABLE

GENERAL PURPOSE: Its extreme flexibility and tough rubber jacket give it long life. This cable is used as a lead on therapy apparatus, charging cable, battery lead, underground cable, etc.

No.	Size	Strand	Insulation	O.D.	Standard Put-up
1623	14	104/34	3/64"	.300"	100'
1625	14	104/34	3/64"	.300"	1000'

RG—COAXIAL CABLE

GENERAL PURPOSE: For radio frequency applications wherever a low capacitance shielded cable is required.

No.	Type	Size	Strand	Capacitance Per Ft.	O.D.	Standard Put-up
1803	RG-8/U	13	7/21 Bare Copper	29.5 mmf.	.405"	500'
1806	RG-11/U	18	7/26 Tinned Copper	20.5 mmf.	.405"	500'
1825	RG-58/U	20	Solid Bare Copper	28.5 mmf.	.195"	500'
1827	RG-59/U	22	Solid Copperweld	21.0 mmf.	.242"	500'



Construction:

Single conductor extra flexible tinned soft annealed copper, concentric strand, cotton wrap, 3/64" "Super Hi-Tension" rubber, satin finish.

STOCK COLORS:
Red, Black

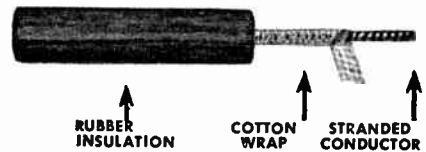

Construction:

Single conductor 18-65/36 extra flexible tinned soft annealed copper, concentric strand, cotton wrap, 7/64" "Super Hi-Tension" rubber, satin finish.

STOCK COLORS:
Red, Black

For alternate put-up use code: F=1000 ft.



Construction:

Single conductor 20-10/30 stranded tinned copper, special polyethylene insulation.

For alternate put-ups use code:
E=500 ft., F=1000 ft.

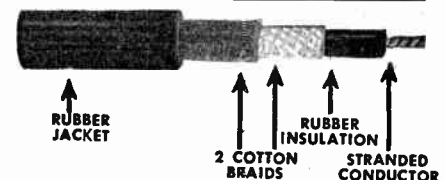

Construction:

Single conductor 14-104/34 copper, paper serve, 3/64" ASTM performance grade rubber, double cotton braid, .040" oil resistant neoprene rubber jacket.

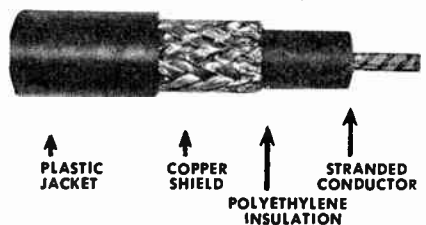

Construction:

Single conductor, polyethylene insulation, braided copper shield, plastic jacket overall.

ALPHA WIRE CORPORATION

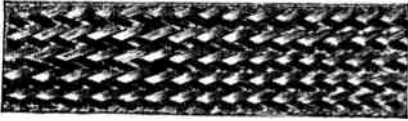

FLEXIBLE TINNED COPPER

Construction:

Composed of very fine soft annealed tinned copper wires braided and rolled flat.

For alternate put-ups use code:

Q=100 ft., D=250 ft., E=500 ft., F=1000 ft.

TINNED COPPER SHIELDING

GENERAL PURPOSE: For shielding speaker leads, lead-ins, amplifier wires, auto radio installations. Also for bonding.

No.	Sizes of Wires	I.D.	Standard Put-up	Alternate Put-ups			
				100'	250'	500'	1000'
1229	36 AWG	1/8"	50'	100'	250'	500'	1000'
1230	36 AWG	3/16"	50'	100'	250'	500'	1000'
1231	36 AWG	1/4"	50'	100'	250'	500'	1000'
1232	36 AWG	3/8"	50'	100'	250'	500'	1000'
1233/2	36 AWG	1/2"	50'	100'	250'	500'	1000'
1233	36 AWG	5/8"	50'	100'	250'	500'	1000'
1234	36 AWG	3/4"	50'	100'	250'	500'	1000'
1235	36 AWG	1"	50'	100'	250'	500'	1000'



FLEXIBLE TINNED COPPER

Construction:

Composed of very fine soft annealed tinned copper wires braided and rolled flat.

For alternate put-up use code:

E=500 ft.

BRAIDED TINNED COPPER

GENERAL PURPOSE: For shielding small sizes of insulated wire, flexible leads, and in hook-ups wherever a small size uninsulated extremely flexible wire is needed.

No.	Sizes of Wires	Approx. Width	Standard Put-up	Alternate Put-up	
				1000'	500'
1222	36 AWG	1/32"	1000'	500'	
1223	36 AWG	1/16"	1000'	500'	
1224	36 AWG	3/64"	1000'	500'	



TINNED SHIELD
LACQUERED BRAID
LOW LOSS INSULATION
STRANDED CONDUCTOR

Construction:

Single conductor stranded tinned copper, low loss insulation, highly lacquered braid, close tinned copper shield overall.

Construction:

Single conductor stranded tinned copper, low loss insulation, close tinned copper shield, plastic jacket overall.

For alternate put-ups use code:

E=500 ft., Q=100 ft.

SHIELDED HOOK-UP AND LEAD-IN WIRE

GENERAL PURPOSE: To reduce interference caused by motors, high tension wires, x-ray machines or other apparatus that radiates electrical impulses. Ideal for grid-lead use.

No.	Size	Strand	O.D.	Alternate Put-ups		
				Standard Put-up	500'	100'
1194/22	22	7/30	.105"	1000'	500'	100'
1194	20	10/30	.110"	1000'	500'	100'
1196	18	16/30	.145"	1000'	500'	100'
1197	16	26/30	.160"	1000'	500'	100'
1198	14	41/30	.180"	1000'	500'	100'
1199	12	19/25	.210"	1000'	500'	100'
1199/10	10	19/23	.220"	1000'	500'	100'

PLASTIC JACKETED

No.	Size	Strand	O.D.	Alternate Put-ups		
				Standard Put-up	500'	100'
1208	24	7/32	.150"	1000'	500'	100'
1210	20	26/34	.170"	1000'	500'	100'



TINNED SHIELD
LACQUERED BRAID
STRANDED CONDUCTOR
HEAVY INSULATION

Construction:

Single conductor 20-10/30 stranded tinned copper, heavy low loss insulation, white braid, tinned copper shield overall.

For alternate put-ups use code:

D=250 ft., E=500 ft., F=1000 ft.

SHIELDED LOW LOSS CABLE

GENERAL PURPOSE: For auto radio, lead-ins, short wave receivers and for grid leads in the input stages of P.A. amplifiers.

No.	Size	Strand	O.D.	Alternate Put-ups		
				Standard Put-up	250'	500'
1241	20	10/30	.225"	100'	250'	500'

ALPHA WIRE CORPORATION

HI-TEMP PLASTIC WIRE

GENERAL PURPOSE: For hook-up wherever small size and/or high temperature (105°C) is required especially in miniaturization of electronic equipment, etc.

†UNSHIELDED				
No.	Size	Strand	O.D.	Standard Put-up
1607	28	7/36	.035"	1000'
1608	27	7/35	.040"	1000'

SHIELDED				
No.	Size	Strand	O.D.	Standard Put-up
1334	28	7/36	.060"	1000'
1337	24	16/36	.080"	1000'

†STOCK COLORS

- | | | | | |
|-----------|------------|-----------|------------|------------|
| (1) Black | (3) Green | (5) Blue | (7) White | (9) Purple |
| (2) Red | (4) Yellow | (6) Brown | (8) Orange | (10) Slate |

Available to order in additional sizes, solid colors and tracer combinations.



- ↑
TINNED
SHIELD
- ↑
PLASTIC
INSULATION
- ↑
STRAINED
CONDUCTOR

Construction:

Single conductor stranded tinned copper, plastic insulation (105°C) overall.

Construction:

Single conductor stranded tinned copper, plastic insulation (105°C), fine braided tinned copper shield overall.

"CL" PUSHBACK WIRE

GENERAL PURPOSE: Pushback hook-up wire in various bright colors for circuit identification; radio, radar, electronics, electrical toys, etc.

STRAINED Voltage Breakdown (60 Cycles)						
No.	Size	Strand	Voltage Breakdown (60 Cycles)	O.D.	Standard Put-up	†Stock Colors
1460	22	7/30	1000	.065"	1000'	1 thru 8
1460Q	22	7/30	1000	.065"	100'	1 thru 8
1461	20	10/30	1000	.070"	1000'	1 thru 8
1461Q	20	10/30	1000	.070"	100'	1 thru 8
1462	18	16/30	1000	.082"	1000'	1 thru 8
1462Q	18	16/30	1000	.082"	100'	1 thru 8
1463	16	26/30	1000	.093"	1000'	1 and 2
1463Q	16	26/30	1000	.093"	100'	1 and 2
1464	14	41/30	1000	.105"	1000'	1 and 2
1464Q	14	41/30	1000	.105"	100'	1 and 2

SOLID

1465	22	Solid	1000	.060"	1000'	1 thru 8
1465Q	22	Solid	1000	.060"	100'	1 thru 8
1466	20	Solid	1000	.065"	1000'	1 thru 8
1466Q	20	Solid	1000	.065"	100'	1 thru 8
1467	18	Solid	1000	.075"	1000'	1 thru 8
1467Q	18	Solid	1000	.075"	100'	1 thru 8
1468	16	Solid	1000	.085"	1000'	1 and 2
1468Q	16	Solid	1000	.085"	100'	1 and 2
1469	14	Solid	1000	.095"	1000'	1 and 2
1469Q	14	Solid	1000	.095"	100'	1 and 2



- ↑
COTTON
BRAID
- ↑
CELLULOSE
ACETATE
WRAP
- ↑
STRAINED
CONDUCTOR

Construction:

Single conductor stranded and solid tinned copper, heavy wrap of cellulose acetate, cotton braid with flame-retarding lacquer.

†STOCK COLORS

- | | | |
|-----------|------------|------------|
| (1) Black | (3) Green | (5) Blue |
| (2) Red | (4) Yellow | (6) Brown |
| (7) White | | (8) Orange |

Available to order in additional sizes, solid colors and tracer combinations.

LACQUERED HOOK-UP AND LEAD-IN WIRE

GENERAL PURPOSE: For point to point soldering connections on transformers, amplifiers, panel hook-up, etc., where a low loss dielectric is required. It is not a pushback wire but will strip easily.

No.	Size	Strand	Insulation	Voltage Breakdown (60 Cycles)	O.D.	Standard Put-up	†Stock Colors
1513	20	10/30	1/64"	7000	.090"	100'	1 thru 7
1515	20	10/30	1/64"	7000	.090"	500'	1 thru 7
1533	18	16/30	1/32"	8500	.125"	100'	1 thru 7
1535	18	16/30	1/32"	8500	.125"	500'	1 thru 7
1543	16	26/30	1/32"	8500	.140"	100'	1 and 2
1545	16	26/30	1/32"	8500	.140"	500'	1 and 2
1546	14	41/30	1/32"	8500	.170"	500'	1 and 2
1546Q	14	41/30	1/32"	8500	.170"	100'	1 and 2
1547	12	19/25	1/32"	8500	.190"	500'	1 and 2
1547Q	12	19/25	1/32"	8500	.190"	100'	1 and 2
1548	10	19/23	1/32"	8500	.208"	500'	1 and 2
1548Q	10	19/23	1/32"	8500	.208"	100'	1 and 2



- ↑
COTTON
BRAID
- ↑
RUBBER
INSULATION
- ↑
STRAINED
CONDUCTOR

Construction:

Single conductor stranded tinned copper, free stripping insulation, single braid highly lacquered.

†STOCK COLORS

- | | | |
|-----------|------------|-----------|
| (1) Black | (3) Green | (5) Blue |
| (2) Red | (4) Yellow | (6) Brown |
| (7) White | | |

Available to order in additional sizes, solid colors and tracer combinations.

ALPHA WIRE CORPORATION

TYPE SRIR—PLASTIC HOOK-UP WIRE (JAN-C-76) (1000 VOLT)

GENERAL PURPOSE: Electronic Devices Radio Transmitters Lighting and Power
Aircraft Instruments Radar Receivers Rectifiers



CONSTRUCTION: Single conductor, stranded and solid tinned copper with thermoplastic insulation. FUNGUS PROOF.

CHARACTERISTICS: High Dielectric Strength • Stability at High Temperatures • Flexibility at Low Temperatures Resistant to: Acids, Alkalis, Oil, Flame, Moisture.

***COLOR CODE:** 0 — Black, 1 — Brown, 2 — Red, 3 — Orange, 4 — Yellow, 5 — Green, 6 — Blue, 7 — Purple, 8 — Slate, 9 — White.

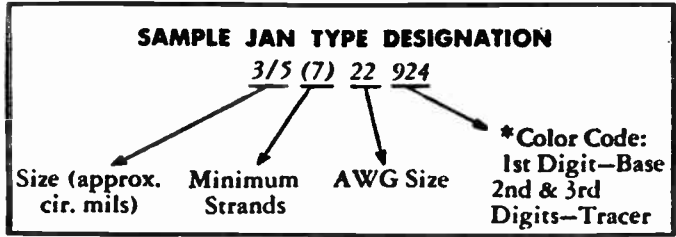

STRANDED

No.	JAN-C-76 Type Designation	Size	Strand	Insulation	Voltage Breakdown (60 Cycles)	O.D.	Standard Put-up	†Stock Colors
1550	2/5(7)-24	24	7/32	1/64"	8000	.059"	1000'	1 thru 13
1550Q	2/5(7)-24	24	7/32	1/64"	8000	.059"	100'	1 thru 13
1551	3/5(7)-22	22	7/30	1/64"	8000	.064"	1000'	1 thru 22
1552	3/5(7)-22	22	7/30	1/64"	8000	.064"	100'	1 thru 22
1553	1(10)-20	20	10/30	1/64"	8000	.073"	1000'	1 thru 22
1554	1(10)-20	20	10/30	1/64"	8000	.073"	100'	1 thru 22
1555	1½(16)-18	18	16/30	1/64"	8000	.084"	1000'	1 thru 22
1556	1½(16)-18	18	16/30	1/64"	8000	.084"	100'	1 thru 22
1557	2½(26)-16	16	26/30	1/64"	8000	.095"	1000'	1 thru 22
1558	2½(26)-16	16	26/30	1/64"	8000	.095"	100'	1 thru 22
1559	4(41)-14	14	41/30	1/64"	12000	.107"	1000'	1 thru 13
1559Q	4(41)-14	14	41/30	1/64"	12000	.107"	100'	1 thru 13
1560	6(65)-12	12	65/30	1/64"	12000	.120"	1000'	1 thru 3
1560Q	6(65)-12	12	65/30	1/64"	12000	.120"	100'	1 thru 3
1560/10	9(105)-10	10	105/30	1/64"	12000	.180"	1000'	1
1560/10Q	9(105)-10	10	105/30	1/64"	12000	.180"	100'	1
1560/8	17(133)-8	8	133/29	1/64"	12000	.240"	1000'	1
1560/8Q	17(133)-8	8	133/29	1/64"	12000	.240"	100'	1

SOLID

1561	3/5(1)-22	22	1	1/64"	8000	.060"	1000'	1 thru 13
1562	3/5(1)-22	22	1	1/64"	8000	.060"	100'	1 thru 13
1563	1(1)-20	20	1	1/64"	8000	.066"	1000'	1 thru 13
1564	1(1)-20	20	1	1/64"	8000	.066"	100'	1 thru 13
1565	1½(1)-18	18	1	1/64"	8000	.074"	1000'	1 thru 10
1566	1½(1)-18	18	1	1/64"	8000	.074"	100'	1 thru 10

TYPE SRHV — PLASTIC HOOK-UP WIRE (JAN-C-76) (2500 VOLT)

1571	3/5(7)-22	22	7/30	1/32"	12000	.095"	1000'	1 thru 3
1572	3/5(7)-22	22	7/30	1/32"	12000	.095"	100'	1 thru 3
1573	1(10)-20	20	10/30	1/32"	12000	.105"	1000'	1 thru 3
1574	1(10)-20	20	10/30	1/32"	12000	.105"	100'	1 thru 3
1575	1½(16)-18	18	16/30	1/32"	12000	.115"	1000'	1 thru 3
1576	1½(16)-18	18	16/30	1/32"	12000	.115"	100'	1 thru 3

†SRIR AND SRHV STOCK COLORS

- | | | | | |
|------------|----------------|----------------|-------------------|-------------------|
| (1) White | (6) Light Blue | (10) Purple | (14) White/Black | (18) White/Blue |
| (2) Black | (7) Brown | (11) Tan | (15) White/Red | (19) White/Brown |
| (3) Red | (8) Orange | (12) Pink | (16) White/Green | (20) White/Orange |
| (4) Green | (9) Slate | (13) Dark Blue | (17) White/Yellow | (21) White/Slate |
| (5) Yellow | | | | (22) White/Purple |

Also available to order in additional sizes, solid colors and tracer combinations.

ALPHA WIRE CORPORATION

TYPE SRIR—GLASS BRAID HOOK-UP WIRE (JAN-C-76) (1000 VOLT)

GENERAL PURPOSE: For hook-up where secondary insulation is required on SRIR wire in electronic devices, aircraft instruments, radio, radar, transmitters, receivers, etc.

Construction: Single conductor stranded tinned copper, thermoplastic insulation, glass braid, lacquered.



↑ GLASS BRAID
↑ PLASTIC INSULATION
↑ STRANDED CONDUCTOR

No.	JAN-C-76 Type Designation	Size	Strand	Insulation	Voltage Breakdown (60 Cycles)	O.D.	Standard Put-up	Stock Colors
1590	3/5(7)-C-22	22	7/30	1/64"	8000	.085"	1000'	1 thru 10
1590Q	3/5(7)-C-22	22	7/30	1/64"	8000	.085"	100'	1 thru 10
1591	1(10)-C-20	20	10/30	1/64"	8000	.095"	1000'	1 thru 10
1591Q	1(10)-C-20	20	10/30	1/64"	8000	.095"	100'	1 thru 10
1592	1½(16)-C-18	18	16/30	1/64"	8000	.110"	1000'	1 thru 10
1592Q	1½(16)-C-18	18	16/30	1/64"	8000	.110"	100'	1 thru 10
1593	2½(26)-C-16	16	26/30	1/64"	8000	.125"	1000'	1 thru 10
1593Q	2½(26)-C-16	16	26/30	1/64"	8000	.125"	100'	1 thru 10
1594	4(41)-C-14	14	41/30	1/64"	12000	.145"	1000'	1 thru 7
1594Q	4(41)-C-14	14	41/30	1/64"	12000	.145"	100'	1 thru 7
1595	6(65)-C-12	12	65/30	1/64"	12000	.165"	1000'	1 thru 3
1595Q	6(65)-C-12	12	65/30	1/64"	12000	.165"	100'	1 thru 3
1596	9(105)-C-10	10	105/30	1/64"	12000	.190"	1000'	1
1596Q	9(105)-C-10	10	105/30	1/64"	12000	.190"	100'	1
1597	17(133)-C-8	8	133/29	1/64"	12000	.280"	1000'	1
1597Q	17(133)-C-8	8	133/29	1/64"	12000	.280"	100'	1

STOCK COLORS

- | | | | | |
|-----------------|-----------------|------------------|------------------|-------------------|
| (1) White | (3) White/Red | (5) White/Yellow | (7) White/Brown | (9) White/Slate |
| (2) White/Black | (4) White/Green | (6) White/Blue | (8) White/Orange | (10) White/Purple |

Also available to order in additional sizes, solid colors and tracer combinations.

TYPE SRIR—SHIELDED HOOK-UP WIRE (JAN-C-76) (1000 VOLT)

GENERAL PURPOSE: For use when a shielded wire is required in electronic devices, aircraft instruments, radio, radar, transmitters, receivers, etc.

Construction: Single conductor stranded tinned copper, thermoplastic insulation, braided tinned copper shield overall.



↑ TINNED SHIELD
↑ PLASTIC INSULATION
↑ STRANDED CONDUCTOR

No.	JAN-C-76 Type Designation	Size	Strand	Insulation	Voltage Breakdown (60 Cycles)	O.D.	Standard Put-up
1351	3/5(7)-22	22	7/30	1/64"	8000	.090"	1000'
1352	1(10)-20	20	10/30	1/64"	8000	.100"	1000'
1353	1½(16)-18	18	16/30	1/64"	8000	.110"	1000'
1354	2½(26)-16	16	26/30	1/64"	8000	.125"	1000'

Also available to order in additional sizes and multiple conductors.

ALPHA WIRE CORPORATION

TYPE WL HOOK-UP WIRE (JAN-C-76) (600 VOLT)

GENERAL PURPOSE:

Electronic Devices
Aircraft Instruments

Radio
Radar

Transmitters
Receivers

Lighting and Power
Rectifiers



↑
GLASS BRAID

↑
PLASTIC INSULATION

↑
STRANDED CONDUCTOR

CONSTRUCTION:

Single conductor stranded tinned copper with thermoplastic insulation, lacquered cotton or glass braid, or nylon jacket. FUNGUS PROOF.

CHARACTERISTICS:

Stability at High Temperatures • Flexibility at Low Temperatures • Resistant to: Flame, Moisture

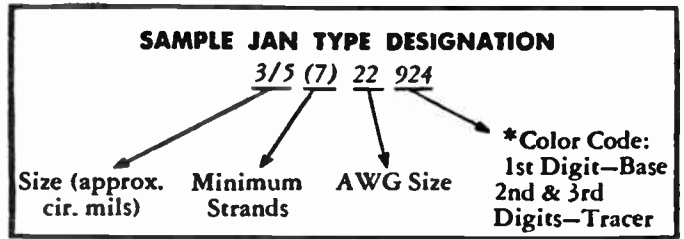

*COLOR CODE

0—Black 2—Red 4—Yellow 6—Blue 8—Slate
1—Brown 3—Orange 5—Green 7—Purple 9—White

COTTON BRAID

No.	JAN-C-76 Type Designation	Size	Strand	Insulation	Voltage Breakdown (60 Cycles)	O.D.	Standard Put-up	†Stock Colors
1480	3/5(7)-22	22	7/30	1/64"	5000	.090"	1000'	1 thru 10
1480Q	3/5(7)-22	22	7/30	1/64"	5000	.090"	100'	1 thru 10
1481	1(10)-20	20	10/30	1/64"	5000	.100"	1000'	1 thru 10
1481Q	1(10)-20	20	10/30	1/64"	5000	.100"	100'	1 thru 10
1482	1½(16)-18	18	16/30	1/64"	5000	.115"	1000'	1 thru 10
1482Q	1½(16)-18	18	16/30	1/64"	5000	.115"	100'	1 thru 10
1483	2½(26)-16	16	26/30	1/64"	5000	.130"	1000'	1 thru 10
1483Q	2½(26)-16	16	26/30	1/64"	5000	.130"	100'	1 thru 10
1484	4(41)-14	14	41/30	1/64"	5000	.150"	1000'	1 thru 3
1484Q	4(41)-14	14	41/30	1/64"	5000	.150"	100'	1 thru 3
1485	6(65)-12	12	65/30	1/64"	5000	.170"	1000'	1 thru 3
1485Q	6(65)-12	12	65/30	1/64"	5000	.170"	100'	1 thru 3

†STOCK COLORS

(1) White (3) Red (5) Yellow (7) Brown (9) Slate
(2) Black (4) Green (6) Blue (8) Orange (10) Purple

Also available to order in additional sizes, solid colors and tracer combinations.

GLASS BRAID

1490	3/5(7)-22	22	7/30	1/64"	5000	.085"	1000'	1 thru 10
1490Q	3/5(7)-22	22	7/30	1/64"	5000	.085"	100'	1 thru 10
1491	1(10)-20	20	10/30	1/64"	5000	.095"	1000'	1 thru 10
1491Q	1(10)-20	20	10/30	1/64"	5000	.095"	100'	1 thru 10
1492	1½(16)-18	18	16/30	1/64"	5000	.110"	1000'	1 thru 10
1492Q	1½(16)-18	18	16/30	1/64"	5000	.110"	100'	1 thru 10
1493	2½(26)-16	16	26/30	1/64"	5000	.125"	1000'	1 thru 10
1493Q	2½(26)-16	16	26/30	1/64"	5000	.125"	100'	1 thru 10
1494	4(41)-14	14	41/30	1/64"	5000	.145"	1000'	1 thru 7
1494Q	4(41)-14	14	41/30	1/64"	5000	.145"	100'	1 thru 7
1495	6(65)-12	12	65/30	1/64"	5000	.165"	1000'	1 thru 3
1495Q	6(65)-12	12	65/30	1/64"	5000	.165"	100'	1 thru 3
1496	9(105)-10	10	105/30	1/64"	5000	.190"	1000'	1
1496Q	9(105)-10	10	105/30	1/64"	5000	.190"	100'	1
1497	17(133)- 8	8	133/29	1/64"	5000	.280"	1000'	1
1497Q	17(133)- 8	8	133/29	1/64"	5000	.280"	100'	1

†STOCK COLORS

(1) White (3) White/Red (5) White/Yellow (7) White/Brown (9) White/Slate
(2) White/Black (4) White/Green (6) White/Blue (8) White/Orange (10) White/Purple

Also available to order in additional sizes, solid colors and tracer combinations.

ALPHA WIRE CORPORATION

TYPE WL HOOK-UP WIRE (JAN-C-76) (600 VOLT)

(Continued)

NYLON JACKET

No.	JAN-C-76 Type Designation	Size	Strand	Insulation	Voltage Breakdown (60 Cycles)	O.D.	Standard Put-up	†Stock Colors
1504	3/5(7)-22	22	7/30	1/64"	5000	.075"	1000'	1 thru 10
1504Q	3/5(7)-22	22	7/30	1/64"	5000	.075"	100'	1 thru 10
1505	1(10)-20	20	10/30	1/64"	5000	.085"	1000'	1 thru 10
1505Q	1(10)-20	20	10/30	1/64"	5000	.085"	100'	1 thru 10
1506	1½(16)-18	18	16/30	1/64"	5000	.095"	1000'	1 thru 10
1506Q	1½(16)-18	18	16/30	1/64"	5000	.095"	100'	1 thru 10
1507	2½(26)-16	16	26/30	1/64"	5000	.105"	1000'	1 thru 10
1507Q	2½(26)-16	16	26/30	1/64"	5000	.105"	100'	1 thru 10
1508	4(41)-14	14	41/30	1/64"	5000	.128"	1000'	1 thru 3
1508Q	4(41)-14	14	41/30	1/64"	5000	.128"	100'	1 thru 3
1509	6(65)-12	12	65/30	1/64"	5000	.147"	1000'	1
1509Q	6(65)-12	12	65/30	1/64"	5000	.147"	100'	1

†STOCK COLORS

(1) White (2) Black (3) Red (4) Green (5) Yellow (6) Blue (7) Brown (8) Orange (9) Slate (10) Purple

Also available to order in additional sizes, solid colors and tracer combinations.

MIL-W-5086 WIRE & MIL-C-7078 CABLE (Aircraft Type)

GENERAL PURPOSE: For applications requiring single conductor, 600 volt insulated, aircraft electrical wire resistant to: abrasion, moisture, cold, heat, flame, fungus, oil, salt water.

UNSHIELDED (MIL-W-5086)

No.	Wire Designation	Strand	O.D.	Standard Put-up
1381	AN-22	19/34	.085"	1000'
1382	AN-20	19/32	.095"	1000'
1383	AN-18	19/30	.105"	1000'
1384	AN-16	19/29	.115"	1000'

SHIELDED (MIL-C-7078)

No.	Wire Designation	Strand	O.D.	Standard Put-up
1391	AN-22	19/34	.110"	1000'
1392	AN-20	19/32	.120"	1000'
1393	AN-18	19/30	.130"	1000'
1394	AN-16	19/29	.150"	1000'



↑
 NYLON
 JACKET

↑
 PLASTIC
 INSULATION

↑
 STRANDED
 CONDUCTOR

Construction:
Single conductor stranded tinned copper, plastic insulation, nylon jacket overall.

Construction:
Single conductor stranded tinned copper, plastic insulation, nylon jacket, braided tinned copper shield overall.

Also available to order in additional sizes and multiple conductors.

7 MM LACQUERED CABLE (UNSHIELDED)

GENERAL PURPOSE: For high voltage leads in television receivers, cathode-ray tubes, oscilloscopes, automotive, etc.

No.	Size	Strand	Insul.	O.D.	Standard Put-up	Alternate Put-ups	Alternate Put-ups
1981	16	19/29	3/32"	.275"	100'	250'	500' 1000'

(SHIELDED)

GENERAL PURPOSE: For automotive and aircraft ignition systems requiring grounding to overcome interference.

No.	Size	Strand	Insul.	O.D.	Standard Put-up	Alternate Put-ups	Alternate Put-ups
1193	16	19/29	3/32"	.300"	100'	250'	500' 1000'



↑
 COTTON
 BRAID

↑
 RUBBER
 INSULATION

↑
 STRANDED
 CONDUCTOR

Construction:
Single conductor 16-19/29 stranded tinned copper, rubber insulated, cotton braid highly lacquered.

Construction:
Single conductor 16-19/29 stranded tinned copper, rubber insulated, cotton braid highly lacquered, tinned copper shield overall.

For alternate put-ups use code:
D=250 ft., E=500 ft., F=1000 ft.

LACQUERED PRIMARY WIRE

GENERAL PURPOSE: For automobile head, tail, side, dashboard lamps, horn, spotlight, instrument leads and general high voltage and primary voltage applications.

No.	Size	Strand	Insul.	O.D.	Standard Put-up	Alternate Put-ups	Alternate Put-ups
1991	18	16/30	1/32"	.125"	100'	250'	500' 1000'
1995	16	26/30	1/32"	.140"	100'	250'	500' 1000'
1997	14	41/30	1/32"	.170"	100'	250'	500' 1000'
1999	12	19/25	1/32"	.190"	100'	250'	500' 1000'
1983	10	19/23	1/32"	.208"	100'	250'	500' 1000'



↑
 COTTON
 BRAID

↑
 RUBBER
 INSULATION

↑
 STRANDED
 CONDUCTOR

Construction:
Single conductor stranded soft annealed tinned copper, insulated with rubber, highly lacquered braid. Oil, heat, and moisture resistant.

STOCK COLORS:

Red, Black

For alternate put-ups use code:
D=250 ft., E=500 ft., F=1000 ft.

ALPHA WIRE CORPORATION

TINNED COPPER WIRE

GENERAL PURPOSE: Winding of coils, antennas, point to point, bus bar, etc.

Construction: Pure electrolytic copper properly annealed and tinned for quick soldering.

STRANDED					
No.	Size	Strand	Circular Mills	O.D.	Standard Put-up
194	14 AWG	7/22	4496.8	.075"	1000'
196	18 AWG	16/30	1608.0	.045"	1000'
197	20 AWG	10/30	1005	.037"	1000'
198	22 AWG	7/30	703.5	.030"	1000'

SOLID (Bus Bar)

No.	Size	Circular Mills	O.D.	Standard Put-up
292	10 AWG	10380	.103"	1000'
289	12 AWG	6530	.082"	1000'
286	14 AWG	4107	.065"	1000'
295	16 AWG	2583	.051"	1000'
296	18 AWG	1624	.040"	1000'
297	20 AWG	1022	.033"	1000'
298	22 AWG	642.4	.025"	1000'
299	24 AWG	404.0	.020"	1000'
299/1	26 AWG	254.1	.016"	1000'
299/2	28 AWG	159.8	.013"	1000'
299/3	30 AWG	100.5	.010"	1000'

BRONZE AERIAL WIRE

GENERAL PURPOSE: Recommended especially for ship, short wave and transmitting aerials where high tensile strength is required.

Construction: 7 strands Bronze.

No.	Size	Strand	Breaking Strength	O.D.	Standard Put-up
1160	14	7/22	420 Lbs.	.075"	500'
1161	12	7/20	650 Lbs.	.100"	500'
1163	10	7/18	1000 Lbs.	.122"	500'
1164	8	7/16	1600 Lbs.	.150"	500'
1165	6	7/14	2140 Lbs.	.190"	500'
1166	4	7/12	3670 Lbs.	.240"	500'



DIAL CABLE

PHOSPHOR BRONZE

Construction: 42 strands (6x7x.004) genuine phosphor bronze wire with a linen center for extra flexibility.

No.	Tensile Strength	O.D.	Standard Put-up
1692	50 lbs.	.036"	500'

BRAIDED LINEN

Construction: Composed of a very strong linen center over which is a smooth black braid.

No.	Tensile Strength	O.D.	Standard Put-up
1696	40 lbs.	.057"	500'
1699	22.5 lbs.	.036"	500'
1700E	18 lbs.	.027"	500'



AC-DC ANTENNA WIRE

GENERAL PURPOSE: Ideal replacement wire for universal midjets, indoor aerials and loop antennas.

Construction:

Single conductor 24-16/36 extra flexible bare copper, covered with dark brown cotton braid or plastic insulation.

No.	Type	Size	Strand	O.D.	Standard Put-up
1281	Cotton	24	16/36	.050"	25' Disc
1281V	Plastic	24	16/36	.047"	25' Disc
1284	Cotton	24	16/36	.050"	1000' Spl.
1284V	Plastic	24	16/36	.047"	1000' Spl.



ALPHA E-Z STRIP LINE CORD

(UNDERWRITERS APPROVED)

GENERAL PURPOSE: This is the modern and ideal power supply cord for replacement on radios, lamps, fans, etc.

Construction:

E-Z strip rubber parallel cord (Type POSJ) with small unbreakable soft rubber attachment plug. Free end stripped and tinned ready to attach. Also available in other lengths.

No.	Conductors	Size	Strand	O.D.	Length
2106	2	18	41/34	.235" x .130"	6'
2109	2	18	41/34	.235" x .130"	9'
2112	2	18	41/34	.235" x .130"	12'

ALPHA WIRE CORPORATION

SERVICESPPOOL ASSORTMENT

General Purpose: Designed for quality wiring in radio, television, phonographs, audio equipment, instruments and electronic devices.

PLASTIC HOOK-UP WIRE

NO.	SIZE	INSULATION	O.D.	PUT-UP
453	20 Stranded	Plastic	.073"	25 Ft. Spl.
463	20 Solid	Plastic	.066"	25 Ft. Spl.

Stock Colors: White, Black, Red, Green, Yellow, Blue.

TINNED COPPER (BUS-BAR)

NO.	SIZE	CIRCULAR MILS	O.D.	PUT-UP
497	20 Solid	1022.0	.033"	50 Ft. Spl.

TEST LEAD WIRE

NO.	SIZE	INSULATION	O.D.	PUT-UP
435	20 Stranded	Rubber	.135"	10 Ft. Spl.

Stock Colors: Black and Red.

DIAL CABLE

NO.	TYPE	TENSILE STRENGTH	O.D.	PUT-UP
492	Bronze	50.0 lbs.	.036"	10 Ft. Spl.
499	Nylon	22.5 lbs.	.036"	15 Ft. Spl.

PHONO WIRE

NO.	SIZE	INSULATION	SHIELD	O.D.	PUT-UP
400	24 Stranded	Plastic	Tinned Copper	.080"	10 Ft. Spl.

FREE DISPLAY upon request with every 12 boxes

Make your own decision! Choose only those items which satisfy your own specific needs.

Packaged as Follows:

INDIVIDUAL ITEMS

- No. 400: 6 Spools per box.
- No. 435: 6 Spools of each individual color per box.
- No. 453: 6 Spools of each individual color per box.
- No. 463: 6 Spools of each individual color per box.
- No. 492: 6 Spools per box.
- No. 497: 6 Spools per box.
- No. 499: 6 Spools per box.

ASSORTED ITEMS

- No. 425A: 6 Spools per box (One each 400, 435 Red, 435 Black, 492, 497, 499)
- No. 453A: 6 Spools per box (One each White, Black, Red, Green, Yellow, Blue)
- No. 463A: 6 Spools per box (One each White, Black, Red, Green, Yellow, Blue)



ALPHA WIRE CORPORATION

NOTE: USEFUL INFORMATION FOR ORDERING

- All tests on specifications are approximate and subject to normal manufacturing tolerances.
- Lengths other than those regularly listed can be furnished.
- Other wires and cables made to specifications.
- Use the following symbols alongside catalog number for other than standard put-ups.

COILS	COILS	COILS	SPOOLS	SPOOLS	SPOOLS
25 Ft.....H	100 Ft.....K	500 Ft.....B	25 Ft.....N	100 Ft.....Q	250 Ft.....D
50 Ft.....Z	150 Ft.....L	1000 Ft.....C	50 Ft.....T	150 Ft.....R	500 Ft.....E
75 Ft.....J	200 Ft.....M	250 Ft.....A	75 Ft.....P	200 Ft.....S	1000 Ft.....F

G — LONGER LENGTHS ON SPOOLS OR REELS

The constant development of new and improved designs and manufacturing processes results in continually changing specifications. In every case where Alpha wires shipped are different in specifications from those shown in this catalog, an improvement will be noted.

Cat. No.	List Price	Cat. No.	List Price	Cat. No.	List Price	Cat. No.	List Price	Cat. No.	List Price	Cat. No.	List Price	Cat. No.	List Price
194	\$ 52.50	1222	\$42.50	1277	\$315.00	1482	\$39.00	1564*	\$ 1.75	1595Q	\$ 15.38	1803	\$136.25
196	18.75	1223	45.00	1277/13	385.00	1482Q	4.25	1565*	19.50	1596	197.50	1806	124.75
197	15.00	1224	46.25	1277/15	437.50	1483	53.75	1566*	2.25	1596Q	20.38	1825	48.13
198	11.88	1229	2.45	1277/25	700.00	1483Q	5.75	1567*	30.00	1597	304.38	1827	56.25
286	23.75	1230	3.13	1277/50	1725.00	1484	75.00	1569*	45.63	1597Q	31.08	1951	23.13
289	35.00	1231	3.88	1279	31.25	1484Q	7.88	1571*	21.25	1607	13.50	1952	30.00
292	52.50	1232	6.25	1279V	21.25	1485	122.50	1572*	2.50	1608	14.13	1952/3	42.50
295	16.25	1233	8.75	1280	46.88	1485Q	12.88	1573*	28.13	1623	19.38	1953	37.50
296	13.00	1233/2	8.25	1280V	31.25	1490	29.00	1574*	3-20	1625	187.50	1953/3	53.75
297	8.00	1234	18.75	1281	.40	1490Q	3.25	1575*	39.00	1633	3.80	1954	41.88
298	5.25	1235	20.00	1281V	.38	1491	32.00	1576*	4.28	1635	17.75	1955	51.25
299	6.00	1241	12.50	1284	11.25	1491Q	3.50	1577*	51.75	1636	24.25	1956	85.00
299/1	5.50	1242	43.75	1284V	7.50	1492	40.00	1579*	76.00	1636Q	5.10	1957	118.75
299/2	5.00	1243	43.75	1289	550.00	1492Q	4.38	1581*	18.75	1637	8.50	1958	162.50
299/3	4.88	1243/4	56.25	1291	725.00	1493	55.00	1583*	22.75	1638	39.25	1964	.15
400	.65	1244	11.25	1293	807.50	1493Q	5.88	1585*	34.00	1642	7.00	1966	6.13
425A	3.75	1245	13.75	1295	1155.00	1494	77.50	1587*	45.75	1692	18.75	1967	14.00
435	.65	1245/18	18.75	1300	35.00	1494Q	8.13	1589*	72.00	1696	17.50	1981	12.50
453A	3.75	1246	17.25	1302	63.75	1495	140.00	1590	32.50	1699	16.88	1983	12.88
453A	.65	1246/18	23.75	1304	90.00	1495Q	14.63	1590Q	3.50	1700E	13.50	1991	4.25
463A	3.75	1247	20.25	1307	150.00	1496	187.50	1591	36.25	1703	32.50	1995	5.75
463	.65	1247/6	25.75	1308	240.00	1496Q	19.38	1591Q	3.88	1704	45.00	1997	7.88
492	.65	1247/8	33.50	1309	321.25	1497	297.00	1592	45.00	1706	45.00	1999	11.13
497	.65	1248	9.75	1310	375.00	1497Q	30.75	1592Q	4.75	1710	67.50	2091	21.38
499	.65	1249	12.25	1312	600.00	1504	28.00	1593	61.25	1736	38.75	2106	.50
1114	15.00	1249/18	14.75	1316	40.00	1504Q	3.13	1593Q	6.50	1762	41.13	2109	.65
1114E	8.13	1250	14.88	1317	70.00	1505	31.50	1594	85.00	1775	36.25	2112	.80
1131	17.25	1250/18	19.50	1318	110.00	1505Q	3.50	1594Q	9.00	1793	35.00	2126	.70
1135	35.00	1251	19.00	1319	145.00	1506	39.50	1595	147.50	1794	55.00		
1146	24.38	1251/18	30.00	1320	180.00	1506Q	4.25						
1150	41.25	1252	22.00	1322	225.00	1507	55.00						
1150/3	50.00	1253	25.50	1334	60.00	1507Q	5.88						
1156/4	62.50	1254	29.50	1337	55.00	1508	76.25						
1150/5	77.50	1254/18	49.50	1351	52.50	1508Q	8.00						
1151	37.50	1255	34.00	1352	55.00	1509	137.50						
1152	35.00	1255/8	40.00	1353	60.00	1509Q	14.13						
1157	112.50	1256	9.75	1354	75.00	1513	3.63						
1160	26.25	1256V	7.25	1381	35.00	1515	16.50						
1161	45.00	1257	13.50	1382	40.00	1533	4.25						
1163	50.00	1257V	11.00	1383	50.00	1535	19.50						
1164	70.00	1258	17.00	1384	64.38	1543	5.75						
1165	112.50	1259V	9.50	1391	80.00	1545	26.88						
1166	172.50	1260V	17.25	1392	87.50	1546	37.50						
1168	25.00	12 0/14	19.00	1393	100.00	1546Q	7.88						
1169	16.25	1261	68.75	1304	132.50	1547	52.50						
1170	1.75	1262	11.50	1460	18.75	1547Q	11.13						
1182	5.25	1262V	9.50	1460Q	2.13	1548	61.25						
1183	7.75	1263	16.25	1461	21.88	1548Q	12.88						
1184	10.00	1264	19.75	1461Q	2.45	1550*	14.75						
1185	12.25	1265	58.75	1462	27.50	1550Q*	1.73						
1186	14.25	1266	67.50	1462Q	3.00	1551*	15.25						
1187	16.00	1267	30.00	1463	37.25	1552*	1.78						
1188	17.75	1267V	28.75	1463Q	4.00	1553*	18.75						
1189	20.50	1267/18	35.88	1464	49.50	1554*	2.13						
1190	23.00	126 7/22	24.50	1464Q	5.25	1555*	23.75						
1192	28.50	1268	41.25	1465	17.25	1556*	2.63						
1193	17.25	1268V	36.88	1465Q	1.98	1557*	34.75						
1194/22	57.50	1269	16.25	1466	19.75	1558*	3.75						
1194	61.25	1270	24.38	1466Q	2.25	1559*	52.50						
1196	70.00	1271	230.00	1467	24.75	1559Q*	5.63						
1197	82.50	1272	51.25	1467Q	2.75	1560*	90.00						
1198	112.50	1274	25.00	1468	32.00	1560Q*	9.63						
1199	187.50	1275	31.25	1468Q	3.50	1560/10*	150.00						
1199/10	245.00	1275/4	43.75	1469	43.00	1560/10Q*	15.63						
1200	46.25	1275/5	57.50	1469Q	4.63	1560/8	280.50						
1201	56.25	1275/6	73.75	1400	27.25	1560/8Q	28.68						
1202	68.75	1276/2	105.00	1480Q	3.00	1561*	12.50						
1208	65.00	1276/3	125.00	1481	31.25	1562*	1.50						
1210	90.00	1276	230.00	1481Q	3.50	1563*	15.00						

FLEXIBLE VARNISHED TUBING AND SLEEVING

Size	Approx. I.D.	Radio Tubing (Soaghetti) 4000 Volts List Price per 100 ft.	Saturated Steeving 800 Volts List Price per 100 ft.	Magneto Tubing 7000 Volts List Price per 100 ft.
24	.020"	\$6.13	\$3.75	\$6.00
20	.034"	6.25	3.75	6.00
19	.038"	6.50	3.88	6.25
18	.042"	6.63	4.00	6.50
17	.047"	7.00	4.25	6.63
16	.053"	7.25	4.50	7.13
15	.059"	7.50	4.75	7.50
14	.066"	7.88	5.00	7.88
13	.076"	8.25	5.25	8.25
12	.085"	9.13	5.63	8.63
11	.095"	9.75	6.00	9.38
10	.106"	10.50	6.38	10.38
9	.118"	11.00	6.75	11.25
8	.133"	11.75	7.13	11.88
7	.148"	12.63	7.50	13.00
6	.166"	13.75	7.88	14.25
5	.186"	15.38	8.25	15.38
4	.208"	16.88	8.63	16.75
3	.234"	18.38	9.75	18.00
2	.263"	17.25	10.88	19.38
1	.294"	19.50	12.00	20.63
0	.330"	23.25	13.88	24.75
3/8 in.	.375"	28.13	18.25	31.00
1/2 in.	.438"	33.63	22.00	35.13
5/8 in.	.500"	38.88	24.63	41.25
3/4 in.	.625"	47.50	28.13	47.50
7/8 in.	.750"	54.75	34.50	54.75
1 in.	.875"	59.00	38.00	59.00
	1.000"	74.00	47.75	74.00

*For Striped Tracers, add to List Price \$1.88 per 1,000 Feet.

ALL PRICES AND SPECIFICATIONS SUBJECT TO CHANGE WITHOUT NOTICE.

Belden

ELECTRONIC WIRES & CABLES

microphone cables plastic microphone cable

Performance and long service life are the outstanding features of Belden Microphone Cables. They are resistant to physical abuse, aging, and moisture. In addition, Belden Microphone Cables have low capacitance, high insulation resistance, and low attenuation at audio frequencies.



8411

Trade Number

25' Coiled & cartoned
100' Spool
500' Spool

25 A.W.G.

3x33 copper & 4x33 steel stranded tinned conductor
Cellulose yarn braid
Polyethylene plastic insulation
Tinned copper braid shield
Chrome vinyl plastic jacket
.144" Nom. Diam
Nom. Capacitance — 34 mm/ft

General Description

For high impedance lapel microphones.



8401

25' Coiled & cartoned
50' Coiled & cartoned
100' Spool
500' Spool

25 A.W.G.

3x33 copper & 4x33 steel stranded tinned conductor
Cellulose yarn braid
Polyethylene plastic insulation
Tinned copper braid shield
Chrome vinyl plastic jacket
.200" Nom. Diam
Nom. Capacitance — 25 mm/ft

For crystal, ribbon, and other high impedance microphones.



8422

25' Coiled & cartoned
50' Coiled & cartoned
100' Spool
500' Spool

22 A.W.G.

16x34 stranded tinned copper conductor
Polyethylene plastic insulation
2 conductors cabled with fillers:
Black and White
Rayon braid
Tinned copper braid shield
Chrome vinyl plastic jacket
.231" Nom. Diam
Nom. Capacitance — 32 mm/ft between one conductor and remaining conductor connected to shield

For all low impedance microphones.



8410

25' Coiled & cartoned
50' Coiled & cartoned
100' Spool
500' Spool

25 A.W.G.

3x33 copper & 4x33 steel stranded tinned conductor
Rubber insulation
Cellulose yarn braid
Rubber insulation
Rayon braid
Tinned copper braid shield
Rayon wrap
Black rubber jacket
.245" Nom. Diam
Nom. Capacitance — 33 mm/ft

For crystal, ribbon, and other high impedance microphones.



8412

25' Coiled & cartoned
50' Coiled & cartoned
100' Spool
500' Spool

20 A.W.G.

26x34 stranded tinned copper conductor
Cotton wrap
Rubber insulation
2 conductors cabled with fillers: Black and White
Rayon braid
Tinned copper braid shield
Cotton wrap
Black rubber jacket
.268" Nom. Diam
Nom. Capacitance — 69 mm/ft between one conductor and remaining conductor connected to shield

For all low impedance microphones.

microphone cables rubber microphone cable



8428

Trade Number

100' Spool
500' Spool

18 A.W.G.

41x34 stranded tinned copper conductor
Cotton wrap
Rubber insulation
2 conductors cabled with fillers: Black and White
Rayon braid
Tinned copper braid shield
Cotton wrap
Black rubber jacket
.295" Nom. Diam
Nom. Capacitance — 80 mm/ft between one conductor and remaining conductor connected to shield

General Description

Heavy-duty studio cable.



8423

50' Coiled & cartoned
250' Spool
500' Spool

20 A.W.G.

26x34 stranded tinned copper conductor
Cotton wrap
3 conductors cabled:
Black, Red, White
Rayon braid
Tinned copper braid shield
Cotton wrap
Black rubber jacket
.277" Nom. Diam
Nom. Capacitance — 85 mm/ft between one conductor and remaining conductors connected to shield

For all low impedance microphones.



8424

50' Coiled & cartoned
250' Spool

20 A.W.G.

26x34 stranded tinned copper conductor
Cotton wrap
Rubber insulation
4 conductors cabled:
Black, Green, Red, White
Rayon braid
Tinned copper braid shield
Cotton wrap
Black rubber jacket
.295" Nom. Diam
Nom. Capacitance — 95 mm/ft between one conductor and remaining conductors connected to shield

For all low impedance microphones.



8452

100' Spool
500' Spool

18 A.W.G.

41x34 stranded bare copper conductor
Cotton wrap
1/64" rubber insulation
2 conductors cabled with fillers:
Black and White
Cotton wrap
1/32" black rubber jacket
.245" Nom. Diam

Underwriters' Type SV



8472

100' Spool
250' Spool

18 A.W.G.

41x34 stranded bare copper conductor
Cotton wrap
1/32" rubber insulation
2 conductors cabled with fillers:
Black and White
Cotton wrap
1/32" black rubber jacket
.295" Nom. Diam

Underwriters' Type SJ



8453

100' Spool
500' Spool

18 A.W.G.

41x34 stranded bare copper conductor
Cotton wrap
1/64" rubber insulation
3 conductors cabled with fillers:
Black, Green, White
Cotton wrap
1/32" black rubber jacket
.265" Nom. Diam





Underwriters' Type SJ

multiple conductor cables rubber-jacketed portable cord



Belden multiple conductor cables are developed for long service life, excellent mechanical and electrical characteristics, and uniform quality. These cables are used for a multitude of applications, including power and interconnecting cords on radio receivers, electronic devices, speakers, analyzer test equipment, remote control circuits, and pre-talk microphone circuits.

BELDEN ELECTRONIC WIRES & CABLES

multiple conductor cables rubber-jacketed portable cord







			
Trade Number 8454	Trade Number 8455	Trade Number 8462	Trade Number 8888
100' Spool 500' Spool	100' Spool 250' Spool	100' Spool 250' Spool	250' Spool
18 A.W.G.	22 A.W.G.	18 A.W.G.	18 A.W.G.
General Description 41x34 stranded bare copper conductor Cotton wrap 1/64" rubber insulation 4 conductors cabled: Black, Brown, Red, White Cotton wrap 1/32" black rubber jacket .265" Nom. Diam	General Description 16x34 stranded bare copper conductor Cotton wrap 1/64" rubber insulation 18 A.W.G. 41x34 stranded bare copper conductor Cotton wrap 1/64" rubber insulation 6 conductors cabled with fillers: 3 — 22 A.W.G.: Brown, Green, White 2 — 18 A.W.G.: Black, Red Cotton wrap 1/32" black rubber jacket .280" Nom. Diam	General Description 41x34 stranded bare copper conductor Cotton wrap (one conductor white; one conductor black) 2 conductors parallel: Brown rubber insulation and jacket integral .123" x .223" Nom. Diam Underwriters' Type SP-1 (POSJ-64)	General Description 41x34 stranded — one bare and one tinned copper conductor 2 conductors parallel: White vinyl plastic insulation and jacket integral .114" x .231" Nom. Diam Underwriters' Type SPT-1 (POT-64)

shielded



		
Trade Number 8425	Trade Number 8426	Trade Number 8427
50' Spool 250' Spool	50' Spool 250' Spool	50' Spool 250' Spool
20 A.W.G.	20 A.W.G.	20 A.W.G.
General Description 26x34 stranded tinned copper conductor Cotton wrap .020" rubber insulation 6 conductors cabled: Black, Blue, Green, Red, White Rayon braid Tinned copper braid shield Cotton wrap .040" black rubber jacket .323" Nom. Diam Interconnecting power cable for all electronic uses.	General Description 26x34 stranded tinned copper conductor Cotton wrap .020" rubber insulation 6 conductors cabled: Black, Blue, Brown, Green, Red, White Rayon braid Tinned copper braid shield Cotton wrap .040" black rubber jacket .349" Nom. Diam Interconnecting power cable for all electronic uses.	General Description 26x34 stranded tinned copper conductor Cotton wrap .020" rubber insulation 7 conductors cabled: Black, Blue, Brown, Green, Red, White, Yellow Rayon braid Tinned copper braid shield Cotton wrap .040" black rubber jacket .360" Nom. Diam Interconnecting power cable for all electronic uses.

intercommunicating and sound system cables shielded







The vinyl plastic jacket of Belden Intercommunication System Cable is tubed for greater flexibility and fast, easy stripping.

					
Trade Number 8734	Trade Number 8735	Trade Number 8737	Trade Number 8738	Trade Number 8739	Trade Number 8732
100' Spool 500' Spool	100' Spool 500' Spool	100' Spool 500' Spool	100' Spool 500' Spool 1000' Spool	100' Spool 500' Spool 1000' Spool	100' Spool 500' Spool
22 A.W.G.	22 A.W.G.	22 A.W.G.	22 A.W.G.	22 A.W.G.	22 A.W.G.
General Description 7x30 stranded tinned copper conductor .015" vinyl plastic insulation 3 conductors cabled: Black, Red, White White conductor, tinned copper braid shield Black & Red conductors, unshielded .020" tubed gray vinyl plastic jacket .190" Nom. Diam For Station-to-station and Extension Wiring (Shielded)	General Description 7x30 stranded tinned copper conductor .015" vinyl plastic insulation 3 conductors cabled Black, Red, White Tinned copper braid shield .020" tubed gray vinyl plastic jacket 200" Nom. Diam	General Description 7x30 stranded tinned copper conductor .015" vinyl plastic insulation 2 conductors cabled Black and Red Tinned copper braid shield .020" tubed gray vinyl plastic jacket .180" Nom. Diam	General Description Tinned copper conductor, solid .015" vinyl plastic insulation 2 conductors cabled Black and Red Tinned copper braid shield .135" Nom. Diam	General Description Tinned copper conductor or, solid .015" vinyl plastic insulation 2 conductors cabled Black and Red Tinned copper braid shield .020" tubed gray vinyl plastic jacket .170" Nom. Diam	General Description 7x30 stranded tinned copper conductor .015" polyethylene insulation 2 pair cabled (4 conductors) Color coded: Black and White One pair tinned copper braid shield One pair unshielded .020" tubed gray vinyl plastic jacket .188" x .276" Nom. Diam

unshielded





	
Trade Number 8740	Trade Number 8741
100' Spool 500' Spool 1000' Spool	100' Spool 500' Spool 1000' Spool
22 A.W.G.	22 A.W.G.
General Description Tinned copper conductor, solid .015" vinyl plastic insulation 1 pair cabled (2 conductors) Color coded: 1 (See listing) .020" tubed gray vinyl plastic jacket .145" Nom. Diam	General Description Tinned copper conductor, solid .015" vinyl plastic insulation 2 pair cabled (4 conductors) Color coded: 1 through 2 (See listing) .020" tubed gray vinyl plastic jacket .190" Nom. Diam

intercommunicating and sound system cables unshielded

					
Trade Number 8742	Trade Number 8743	Trade Number 8744	Trade Number 8753	Trade Number 8745	Trade Number 8746
100' Spool 500' Spool 1000' Spool	100' Spool 500' Spool	100' Spool 500' Spool	100' Spool 500' Non-returnable Crates Reel	100' Spool 500' Non-returnable Crates Reel	100' Spool 500' Non-returnable Crates Reel
22 A.W.G.	22 A.W.G.	22 A.W.G.	22 A.W.G.	22 A.W.G.	22 A.W.G.
General Description Tinned copper conductor, solid .015" vinyl plastic insulation 3 pair cabled (6 conductors) Color coded: 1 through 3 (See listing) .020" tubed gray vinyl plastic jacket .230" Nom. Diam	General Description Tinned copper conductor, solid .010" vinyl plastic insulation 6 pair cabled (12 conductors) Color coded: 1 through 6 (See listing) .020" tubed gray vinyl plastic jacket .265" Nom. Diam	General Description Tinned copper conductor, solid .010" vinyl plastic insulation 9 pair cabled (18 conductors) Color coded: 1 through 9 (See listing) .020" tubed gray vinyl plastic jacket .330" Nom. Diam	General Description Tinned copper conductor, solid .010" vinyl plastic insulation 11 pair cabled (22 conductors) Color coded: 1 through 11 (See listing) .020" tubed gray vinyl plastic jacket .360" Nom. Diam	General Description Tinned copper conductor, solid .010" vinyl plastic insulation 16 pair cabled (32 conductors) Color coded: 1 through 16 (See listing) .025" tubed gray vinyl plastic jacket .390" Nom. Diam	General Description Tinned copper conductor, solid .010" vinyl plastic insulation 27 pair cabled (54 conductors) Color coded: 1 through 27 (See listing) .025" tubed gray vinyl plastic jacket .510" Nom. Diam

BELDEN ELECTRONIC WIRES & CABLES

intercommunicating and sound system cables unshielded

			
Trade Number 8747	Trade Number 8748	Trade Number 8749	Trade Number 8750
100' Spool 500' Spool 22 A.W.G.	100' Spool 500' Non-returnable Crate Reel 22 A.W.G.	100' Spool 500' Non-returnable Crate Reel 22 A.W.G.	100' Spool 500' Returnable Reel 22 A.W.G.
General Description 7x30 stranded tinned copper conductor .010" vinyl plastic insulation 6 pair cabled (12 conductors) Color coded: 1 through 6 (See listing) .020" tubed gray vinyl plastic jacket .310" Nom. Diam	General Description 7x30 stranded tinned copper conductor .010" vinyl plastic insulation 9 pair cabled (18 conductors) Color coded: 1 through 9 (See listing) .020" tubed gray vinyl plastic jacket .355" Nom. Diam	General Description 7x30 stranded tinned copper conductor .010" vinyl plastic insulation 15 pair cabled (30 conductors) Color coded: 1 through 15 (See listing) .025" tubed gray vinyl plastic jacket .460" Nom. Diam	General Description 7x30 stranded tinned copper conductor .010" vinyl plastic insulation 27 pair cabled (54 conductors) Color coded: 1 through 27 (See listing) .025" tubed gray vinyl plastic jacket .580" Nom. Diam





paired intercom cables color code listing

Belden Intercom Cables are color coded for easy identification. In the description of Intercom Cables, color coding of the pairs is identified by the number shown in the following list:



Pair Number	Color Combination	Pair Number	Color Combination
1	Black paired with Red	15	Green paired with White
2	Black paired with White	16	Green paired with Brown
3	Black paired with Green	17	Green paired with Orange
4	Black paired with Blue	18	Green paired with Yellow
5	Black paired with Brown	19	White paired with Blue
6	Black paired with Yellow	20	White paired with Brown
7	Black paired with Orange	21	White paired with Orange
8	Red paired with Green	22	White paired with Yellow
9	Red paired with White	23	Blue paired with Brown
10	Red paired with Blue	24	Blue paired with Orange
11	Red paired with Yellow	25	Blue paired with Yellow
12	Red paired with Brown	26	Brown paired with Orange
13	Red paired with Orange	27	Brown paired with Yellow
14	Green paired with Blue		

intercommunicating and sound system cables plastic-insulated cable

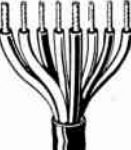

Flexible, lightweight, and small diameter. Applications include control, annunciator, and communication circuits.

				
Trade Number 8443	Trade Number 8444	Trade Number 8445	Trade Number 8446	Trade Number 8447
100' Spool 500' Spool 22 A.W.G.	100' Spool 500' Spool 22 A.W.G.	100' Spool 500' Spool 22 A.W.G.	100' Spool 500' Spool 22 A.W.G.	100' Spool 500' Spool 22 A.W.G.
General Description 7x30 stranded tinned copper conductor .010" vinyl plastic insulation 3 conductors cabled: Black, Green, Red .020" tubed gray vinyl plastic jacket .140" Nom. Diam	General Description 7x30 stranded tinned copper conductor .010" vinyl plastic insulation 4 conductors cabled: Black, Green, Red, White .020" tubed gray vinyl plastic jacket .158" Nom. Diam	General Description 7x30 stranded tinned copper conductor .010" vinyl plastic insulation 5 conductors cabled: Black, Brown, Green, Red, White .020" tubed gray vinyl plastic jacket .170" Nom. Diam	General Description 7x30 stranded tinned copper conductor .010" vinyl plastic insulation 18 A.W.G. 16x30 stranded tinned copper conductor .018" vinyl plastic insulation 6 conductors cabled: 4 — 22 A.W.G.: Brown, Blue, Green, White 2 — 18 A.W.G.: Black, Red .020" tubed gray vinyl plastic jacket .212" Nom. Diam	General Description 7x30 stranded tinned copper conductor .010" vinyl plastic insulation 18 A.W.G. 16x30 stranded tinned copper conductor .018" vinyl plastic insulation 7 conductors cabled: 5 — 22 A.W.G.: Blue, Brown, Green, Orange, White 2 — 18 A.W.G.: Black, Red .020" tubed gray vinyl plastic jacket .230" Nom. Diam

intercommunicating and sound system cables plastic-insulated cable







	
Trade Number 8448	Trade Number 8449
100' Spool 500' Spool 22 A.W.G.	100' Spool 500' Spool 22 A.W.G.
General Description 7x30 stranded tinned copper conductor .010" vinyl plastic insulation 18 A.W.G. 16x30 stranded tinned copper conductor .018" vinyl plastic insulation 8 conductors cabled: 6 — 22 A.W.G.: Blue, Brown, Green, Orange, White, Yellow 2 — 18 A.W.G.: Black, Red .020" tubed gray vinyl plastic jacket .235" Nom. Diam	General Description 7x30 stranded tinned copper conductor .010" vinyl plastic insulation 18 A.W.G. 16x30 stranded tinned copper conductor .018" vinyl plastic insulation 9 conductors cabled: 7 — 22 A.W.G.: Blue, Brown, Green, Orange, Purple, White, Yellow 2 — 18 A.W.G.: Black, Red .020" tubed gray vinyl plastic jacket .245" Nom. Diam

P.A. and sound system cables



		
Trade Number 8782	Trade Number 8785	Trade Number 8783
500' Spool 1000' Spool 24 A.W.G.	500' Spool 22 A.W.G.	500' Spool 20 A.W.G.
General Description 7x32 stranded — 1 bare copper conductor and 1 tinned copper conductor 2 conductors parallel Gray vinyl plastic insulation .058"x.115" Nom. Diam Juke Box Speaker Cable.	General Description 7x30 stranded tinned copper conductor .015" vinyl plastic insulation 5 conductors cabled: 3 conductors Black, Green, Red, with overall tinned copper braid shield 2 conductors Blue & Yellow twisted pair, unshielded .020" tubed gray vinyl plastic jacket .195"x.300" Nom. Diam	General Description 10x30 stranded tinned copper conductor .020" vinyl plastic insulation 16 A.W.G. 26x30 stranded tinned copper conductor .020" vinyl plastic insulation 3 conductors cabled: 1 — 20 A.W.G.: Blue 2 — 16 A.W.G.: Green, Orange .020" tubed strame vinyl plastic jacket .240" Nom. Diam Juke Box Control Cable.

BELDEN ELECTRONIC WIRES & CABLES



P.A. and sound system cables

Trade Number	8799	8432	8433	8482	8483	8789	8204
							
	100' Spool 500' Spool 1000' Spool	100' Spool 500' Spool 1000' Spool	100' Spool 500' Spool	1000' Spool	1000' Spool	100' Spool 500' Spool 1000' Spool	100' Spool 500' Spool 1000' Spool
	18 A.W.G.	20 A.W.G.	20 A.W.G.	19 A.W.G.	19 A.W.G.	18 A.W.G.	18 A.W.G.
General Description	Bare copper conductor, solid Enameled Cotton wrap Cotton braid waxed 2 conductors cabled: Black and White Tinned copper braid shield .165" Nom. Diam	10x30 stranded tinned copper conductor Paper wrap .015" rubber insulation Cotton braid Lacquer coating 2 conductors cabled: Black and Red Tinned copper braid shield .215" Nom. Diam	10x30 stranded tinned copper conductor Paper wrap .015" rubber insulation Cotton braid Lacquer coating 3 conductors cabled: Black, Red, Yellow Tinned copper braid shield .230" Nom. Diam	Bare copper conductor, solid .015" vinyl plastic insulation 2 conductors cabled Brown and Tan .115" Nom. Diam	Bare copper conductor, solid .015" vinyl plastic insulation 3 conductors cabled Brown, Gray, Tan .132" Nom. Diam	7x26 stranded tinned copper conductor .020" vinyl plastic insulation 2 conductors cabled: Black and White Tinned copper braid shield .180" Nom. Diam	7x26 stranded tinned copper conductor Cotton wrap Low-loss rubber insulation 2 conductors cabled: Red and White White cotton braid treated with weather-resistant compound .220" Nom. Diam
	P.A. Cable Amplifier to Speaker Broadcast Control Cable.						For extension speakers.

P.A. and sound system cables

Trade Number	8209	8208	8205
			
	500' Spool 1000' Spool	500' Spool 1000' Non-returnable Crate Reel	500' Spool 1000' Spool
	18 A.W.G.	18 A.W.G.	22 A.W.G.
General Description	7x26 stranded tinned copper conductor Cotton wrap Low-loss rubber insulation 2 conductors cabled: Red and White Paper wrap Tinned copper braid shield White cotton braid treated with weather-resistant compound .235" Nom. Diam	7x26 stranded tinned copper conductor Cotton wrap Low-loss rubber insulation 2 conductors cabled: Red and White Paper wrap Tinned copper braid shield .020" tubed gray vinyl plastic jacket .260" Nom. Diam	7x30 stranded tinned copper conductor Rubber insulation 2 conductors cabled: Black and Red Black cotton braid, treated with weather-resistant compound .165" Nom. Diam
	For long runs in extension speaker installations.	For extension speakers.	For extension speaker and control circuits.





broadcast audio cables

Trade Number	8437	8438	8439
			
	100' Spool 500' Spool 1000' Spool	100' Spool 500' Spool 1000' Spool	100' Spool 500' Spool 1000' Spool
	22 A.W.G.	20 A.W.G.	20 A.W.G.
General Description	Tinned copper conductor, solid Enameled Heavy cellulose acetate yarn wrap Cotton braid waxed 2 conductors cabled: Black and Red Tinned copper braid shield 22 A.W.G. tinned solid copper wire parallel to twisted pair under shield .025" tubed black vinyl plastic jacket .210" Nom. Diam	Tinned copper conductor, solid Enameled Cotton wrap Cotton braid waxed 2 conductors cabled: Blue and Red Tinned copper braid shield .140" Nom. Diam	Tinned copper conductor, solid Heavy cellulose acetate yarn wrap Cellulose acetate yarn braid Lacquer coating 2 conductors cabled: Black and Red Tinned copper braid shield .150" Nom. Diam
	Belden Audio Broadcast Cables are designed to provide the maximum performance from your equipment. High insulation resistance, adequate shielding, and correct twisting of the conductors assure clear, quiet operation free from cross talk. The vinyl plastic jackets of Belden Audio Broadcast Cables are tubed for greater flexibility and fast, easy stripping.		

broadcast audio cables





Trade Number	8440
	
	100' Spool 500' Spool 1000' Spool
	22 A.W.G.
General Description	Tinned copper conductor, solid Enameled Cotton wrap Cotton braid waxed 2 conductors cabled: Black and Red Tinned copper spiral wrapped shield 22 A.W.G. tinned solid copper wire parallel to twisted pair under shield .025" tubed gray vinyl plastic jacket .195" Nom. Diam

antenna rotor cables



Trade Number	8464	8484	8485	8488
				
	100' Coils in counter dispenser 500' Spool 1000' Spool	100' Spool 500' Spool 1000' Spool	100' Spool 500' Spool 1000' Spool	100' Spool 500' Spool 1000' Spool
	20 A.W.G.	20 A.W.G.	20 A.W.G.	22 A.W.G.
General Description	7x28 stranded bare copper conductor 4 conductors parallel Gray vinyl plastic insulation One outer conductor tinned for polarity .070"x.390" Nom. Diam	7x28 stranded bare copper conductor .010" vinyl plastic insulation 4 conductors parallel: Black, Green, Red, and White .015" tubed gray vinyl plastic jacket .170" Nom. Diam	7x28 stranded bare copper conductor .010" vinyl plastic insulation 5 conductors parallel: Black, Green, Red, White, and Yellow .015" tubed gray vinyl plastic jacket .180" Nom. Diam	7x30 stranded bare copper conductor .010" vinyl plastic insulation 8 conductors cabled: Black, Blue, Brown, Green, Orange, Red, White, and Yellow .020" tubed gray vinyl plastic jacket .208" Nom. Diam

BELDEN ELECTRONIC WIRES & CABLES

transmission line cables

				
Trade Number	8222	8224	8225	8230
	100' Spooled & cartoned 500' Spool	100' Spool 500' Spool	100' Coils in counter dispenser 500' Spool 1000' Spool	100' Coils in counter dispenser 500' Spool 1000' Spool
General Description	20 A.W.G. 7x28 stranded bare copper conductor 2 conductors parallel Brown polyethylene plastic insulation .075" x .128" Nom. Diam Nom. Attenuation — 7.7 db/100 ft at 100 mc 11.0 db/100 ft at 200 mc 13.6 db/100 ft at 300 mc 15.9 db/100 ft at 400 mc Nom. Impedance — 72 ohms Velocity of propagation — 69% Nom. Capacitance — 20.3 mmf/ft	20 A.W.G. 7x28 stranded bare copper conductor 2 conductors parallel Brown polyethylene plastic insulation .075" x .162" Nom. Diam Nom. Attenuation — 2.8 db/100 ft at 100 mc 4.2 db/100 ft at 200 mc 5.4 db/100 ft at 300 mc 6.4 db/100 ft at 400 mc Nom. Impedance — 150 ohms Velocity of propagation — 76% Nom. Capacitance — 9.0 mmf/ft	20 A.W.G. 7x28 stranded bare copper conductor 2 conductors parallel Brown polyethylene plastic insulation .077" x .400" Nom. Diam Nom. Attenuation — 1.1 db/100 ft at 100 mc 1.7 db/100 ft at 200 mc 2.2 db/100 ft at 300 mc 2.7 db/100 ft at 400 mc Nom. Impedance — 300 ohms Velocity of propagation — 85% Nom. Capacitance — 4.6 mmf/ft	20 A.W.G. 7x28 stranded "Weldohm®" annealed copper coated steel wire 2 conductors parallel Brown polyethylene plastic insulation .072" x .400" Nom. Diam Nom. Attenuation — 1.1 db/100 ft at 100 mc 1.7 db/100 ft at 200 mc 2.2 db/100 ft at 300 mc 2.7 db/100 ft at 400 mc Nom. Impedance — 300 ohms Velocity of propagation — 85% Nom. Capacitance — 4.6 mmf/ft
	For use with receiving antenna at high frequencies.	For use with receiving antenna, matching transformer, and experimental applications at high frequencies.	For use with television and FM receiving antenna. Especially low losses at high frequencies.	Greater service life in TV installations requiring long runs from receiving antennas. Has over 2½ times the flex-life and over 1½ times the breaking strength of the equivalent in copper.





transmission line cables

		
Trade Number	8275 CELLULINE®	8235
	100' Coils in counter dispenser 500' Non-returnable Crate Reel 1000' Non-returnable Crate Reel	100' Spool 500' Spool
General Description	20 A.W.G. 7x28 stranded "Weldohm®" annealed copper-coated steel wire 2 conductors parallel Brown polyethylene plastic jacket with inert gas filled uni-cellular polyethylene core .300" Nom. Diam round .356" Nom. Diam over conductor insulation Nom. Attenuation — 1.05 db/100 ft at 100 mc 2.12 db/100 ft at 300 mc 2.9 db/100 ft at 400 mc 3.62 db/100 ft at 700 mc 4.3 db/100 ft at 900 mc Nom. Impedance — 300 ohms Velocity of propagation — 80% Nom. Capacitance — 4.6 mmf/ft	20 A.W.G. 7x28 stranded "Weldohm®" copper coated steel wire 2 conductors parallel Brown polyethylene plastic insulation .185" x .520" Nom. Diam Nom. Attenuation — 1.1 db/100 ft at 100 mc 1.73 db/100 ft at 200 mc 2.28 db/100 ft at 300 mc 2.74 db/100 ft at 400 mc 3.18 db/100 ft at 500 mc 3.7 db/100 ft at 700 mc 4.5 db/100 ft at 900 mc Nom. Impedance — 300 ohms Velocity of propagation — 77% Nom. Capacitance — 5.0 mmf/ft
	Lowest losses at UHF and VHF frequencies. A stable and efficient cable — water — sun wind — abrasion-resistant. No end seal required.	Greater service life in TV installations requiring long runs from receiving antennas. Has over 2½ times the flex-life and over 1½ times the breaking strength of the equivalent in copper.

RGU transmission line cables

	
Trade Number	8264
	100' Spool 500' Spool 1000' Non-returnable Crate Reel
General Description	16 A.W.G. Silver coated copper conductor, solid Polyethylene plastic insulation Silver coated copper, double braid shield Gray plastic jacket .332" Nom. Diam Nom. Attenuation — 2.40 db/100 ft at 100 mc 3.50 db/100 ft at 200 mc 5.25 db/100 ft at 400 mc Nom. Impedance — 50 ohms Nom. Velocity of propagation — 66% Nom. Capacitance — 29 mmf/ft
	Belden RGU Cables can be furnished on special order with Type II-A Noncontaminating Jacket. *Not stock — manufactured to special order — See price sheet for minimum run order requirements.

RGU transmission line cables

					
Trade Number	★ 8253	★ 8265	8237	★ 8246	8242
	100' Spool 500' Spool 1000' Non-returnable Crate Reel	100' Spool 500' Non-returnable Crate Reel 1000' Returnable Reel	100' Spool 500' Non-returnable Crate Reel 1000' Returnable Reel	100' Spool 500' Non-returnable Crate Reel 1000' Returnable Reel	100' Spool 500' Non-returnable Crate Reel 1000' Returnable Reel
General Description	21 A.W.G. Bare "Copperweld" conductor, solid Polyethylene plastic insulation Silver coated copper, braid shield Bare copper braid shield Gray plastic jacket .332" Nom. Diam Nom. Attenuation — 2.85 db/100 ft at 100 mc 3.85 db/100 ft at 200 mc 5.60 db/100 ft at 400 mc Nom. Impedance — 76 ohms Nom. Velocity of propagation — 66% Nom. Capacitance — 20 mmf/ft.	19 A.W.G. Bare copper conductor, solid Semi-solid polyethylene plastic insulation Bare copper braid shield Black vinyl plastic jacket 370" Nom. Diam Nom. Attenuation — 2.00 db/100 ft at 100 mc 3.00 db/100 ft at 200 mc 4.40 db/100 ft at 400 mc Nom. Impedance — 97 ohms Nom. Velocity of propagation — 66% Nom. Capacitance — 12.5 mmf/ft	13 A.W.G. 7x21 stranded bare copper conductor Polyethylene plastic insulation Bare copper braid shield Black vinyl plastic jacket 405" Nom. Diam Nom. Attenuation — 2.10 db/100 ft at 100 mc 3.30 db/100 ft at 200 mc 4.50 db/100 ft at 400 mc Nom. Impedance — 52 ohms Nom. Velocity of propagation — 66% Nom. Capacitance — 29.5 mmf/ft	13 A.W.G. 7x21 stranded silver coated copper conductor Polyethylene plastic insulation Silver coated copper, double braid shield Gray plastic jacket .420" Nom. Diam Nom. Attenuation — 2.10 db/100 ft at 100 mc 3.30 db/100 ft at 200 mc 4.50 db/100 ft at 400 mc Nom. Impedance — 51 ohms Nom. Velocity of propagation — 66% Nom. Capacitance — 30 mmf/ft	13 A.W.G. 7x21 stranded silver coated copper conductor Polyethylene plastic insulation Silver coated copper braid shield Gray plastic jacket .420" Nom. Diam Nom. Attenuation — 2.10 db/100 ft at 100 mc 3.30 db/100 ft at 200 mc 4.50 db/100 ft at 400 mc Nom. Impedance — 51 ohms Nom. Velocity of propagation — 66% Nom. Capacitance — 30.0 mmf/ft

BELDEN ELECTRONIC WIRES & CABLES

RGU transmission line cables

Belden RGU Cables can be furnished on special order with Type II-A Noncontaminating Jacket.
 *Not stock — manufactured to special order — See price sheet for minimum run order requirements.



RG-10/U
★ 8247

Trade Number
100' Spool
500' Non-returnable Crate Reel
1000' Returnable Reel
13 A.W.G.

General Description
7x21 stranded bare copper conductor
Polyethylene plastic insulation
Bare copper braid shield
Gray plastic jacket
Aluminum braid armor
.475" Nom. Diam
Nom. Attenuation —
2.10 db/100 ft at 100 mc
3.30 db/100 ft at 200 mc
4.50 db/100 ft at 400 mc
Nom. Impedance — 52 ohms
Nom. Velocity of propagation — 66%
Nom. Capacitance — 29.5 mm/ft



RG-11/U
8238

Trade Number
100' Spool
500' Non-returnable Crate Reel
1000' Returnable Reel
18 A.W.G.

General Description
7x26 stranded tinned copper conductor
Polyethylene plastic insulation
Bare copper braid shield
Black vinyl plastic jacket
.405" Nom. Diam
Nom. Attenuation —
1.90 db/100 ft at 100 mc
2.85 db/100 ft at 200 mc
4.35 db/100 ft at 400 mc
Nom. Impedance — 75 ohms
Nom. Velocity of propagation — 66%
Nom. Capacitance — 20.5 mm/ft



RG-12/U
★ 8248

Trade Number
100' Spool
500' Non-returnable Crate Reel
1000' Returnable Reel
18 A.W.G.

General Description
7x26 stranded tinned copper conductor
Polyethylene plastic insulation
Bare copper braid shield
Gray plastic jacket
Aluminum braid armor
.475" Nom. Diam
Nom. Attenuation —
1.90 db/100 ft at 100 mc
2.85 db/100 ft at 200 mc
4.35 db/100 ft at 400 mc
Nom. Impedance — 75 ohms
Nom. Velocity of propagation — 66%
Nom. Capacitance — 20.5 mm/ft



RG-13/U
★ 8250

Trade Number
100' Spool
500' Non-returnable Crate Reel
1000' Returnable Reel
18 A.W.G.

General Description
7x26 stranded tinned copper conductor
Polyethylene plastic insulation
Bare copper, double braid shield
Black vinyl plastic jacket
.420" Nom. Diam
Nom. Attenuation —
1.90 db/100 ft at 100 mc
2.85 db/100 ft at 200 mc
4.35 db/100 ft at 400 mc
Nom. Impedance — 74 ohms
Nom. Velocity of propagation — 66%
Nom. Capacitance — 20.5 mm/ft



RG-21/U
★ 8243

Trade Number
100' Spool
500' Spool
1000' Non-returnable Crate Reel
16 A.W.G.

General Description
High resistance conductor, solid
Polyethylene plastic insulation
Silver coated copper, double braid shield
Gray plastic jacket
.332" Nom. Diam
Nom. Attenuation —
14.50 db/100 ft at 100 mc
20.50 db/100 ft at 200 mc
29.00 db/100 ft at 400 mc
Nom. Impedance — 53 ohms
Nom. Velocity of propagation — 66%
Nom. Capacitance — 29.0 mm/ft

RGU transmission line cables



RG-22A/U
8260

Trade Number
100' Spool
500' Non-returnable Crate Reel
1000' Returnable Reel
18 A.W.G.

General Description
7x.0152" stranded bare copper conductor
Polyethylene plastic insulation
2 conductors cabled
Core jacket polyethylene plastic
Tinned copper, double braid shield
Gray plastic jacket
.420" Nom. Diam
Nom. Attenuation —
4.00 db/100 ft at 100 mc
5.50 db/100 ft at 200 mc
8.50 db/100 ft at 400 mc
Nom. Impedance — 95 ohms
Nom. Velocity of propagation — 66%
Nom. Capacitance — 16 mm/ft



RG-29/U
8244

Trade Number
100' Spool
500' Spool
1000' Spool
20 A.W.G.

General Description
Bare copper conductor, solid
Polyethylene plastic insulation
Tinned copper braid shield
Clear polyethylene plastic jacket
.172" Nom. Diam
Nom. Attenuation —
4.10 db/100 ft at 100 mc
6.20 db/100 ft at 200 mc
9.50 db/100 ft at 400 mc
Nom. Impedance — 53.5 ohms
Nom. Velocity of propagation — 66%
Nom. Capacitance — 28.5 mm/ft



RG-42/U
★ 8249

Trade Number
100' Spool
500' Spool
1000' Non-returnable Crate Reel
21 A.W.G.

General Description
High resistance conductor, solid
Polyethylene plastic insulation
Silver coated copper, double braid shield
Gray plastic jacket
.342" Nom. Diam
Nom. Attenuation —
17.00 db/100 ft at 100 mc
24.00 db/100 ft at 200 mc
34.00 db/100 ft at 400 mc
Nom. Impedance — 78 ohms
Nom. Velocity of propagation — 66%
Nom. Capacitance — 20 mm/ft



RG-54A/U
8239

Trade Number
100' Spool
500' Spool
1000' Non-returnable Crate Reel
18 A.W.G.

General Description
7x.0152" bare copper conductor
stranded
Polyethylene plastic insulation
Tinned copper braid shield
Clear polyethylene plastic jacket
.250" Nom. Diam
Nom. Attenuation —
3.10 db/100 ft at 100 mc
4.40 db/100 ft at 200 mc
6.70 db/100 ft at 400 mc
Nom. Impedance — 58 ohms
Velocity of propagation — 66%
Nom. Capacitance — 26.5 mm/ft



RG-55/U
8245

Trade Number
100' Spool
500' Spool
1000' Spool
20 A.W.G.

General Description
Bare copper conductor, solid
Polyethylene plastic insulation
Tinned copper, double braid shield
Clear polyethylene plastic jacket
.206" Nom. Diam
Nom. Attenuation —
4.10 db/100 ft at 100 mc
6.20 db/100 ft at 200 mc
9.50 db/100 ft at 400 mc
Nom. Impedance — 53.5 ohms
Velocity of propagation — 66%
Nom. Capacitance — 28.5 mm/ft

RGU transmission line cables



RG-58A/U
8259

Trade Number
100' Spool
500' Spool
1000' Spool
20 A.W.G.

General Description
19x.0068" tinned copper conductor
stranded
Polyethylene plastic insulation
Tinned copper braid shield
Black vinyl plastic jacket
.195" Nom. Diam
Nom. Attenuation —
5.30 db/100 ft at 100 mc
8.20 db/100 ft at 200 mc
12.60 db/100 ft at 400 mc
Nom. Impedance — 50 ohms
Velocity of propagation — 66%
Nom. Capacitance — 29 mm/ft



RG-58/U
8240

Trade Number
100' Spool
500' Spool
1000' Spool
20 A.W.G.

General Description
Bare copper conductor, solid
Polyethylene plastic insulation
Tinned copper braid shield
Black vinyl plastic jacket
.195" Nom. Diam
Nom. Attenuation —
4.10 db/100 ft at 100 mc
6.20 db/100 ft at 200 mc
9.50 db/100 ft at 400 mc
Nom. Impedance — 53.5 ohms
Velocity of propagation — 66%
Nom. Capacitance — 28.5 mm/ft



RG-59/U
8241

Trade Number
100' Spool
500' Spool
1000' Non-returnable Crate Reel
22 A.W.G.

General Description
Bare "Copperweld" conductor, solid
Polyethylene plastic insulation
Bare copper braid shield
Black vinyl plastic jacket
.242" Nom. Diam
Nom. Attenuation —
3.75 db/100 ft at 100 mc
5.60 db/100 ft at 200 mc
8.30 db/100 ft at 400 mc
Nom. Impedance — 73 ohms
Velocity of propagation — 66%
Nom. Capacitance — 21.0 mm/ft



RG-62/U
8254

Trade Number
100' Spool
500' Spool
1000' Non-returnable Crate Reel
22 A.W.G.

General Description
Bare "Copperweld" conductor, solid
Semi-solid polyethylene plastic insulation
Bare copper braid shield
Black vinyl plastic jacket
.242" Nom. Diam
Nom. Attenuation —
3.10 db/100 ft at 100 mc
4.40 db/100 ft at 200 mc
6.30 db/100 ft at 400 mc
Nom. Impedance — 83 ohms
Velocity of propagation — 84%
Nom. Capacitance — 13.5 mm/ft



RG-63/U
★ 8255

Trade Number
100' Spool
500' Non-returnable Crate Reel
1000' Returnable Reel
22 A.W.G.

General Description
Bare "Copperweld" conductor, solid
Semi-solid polyethylene plastic insulation
Bare copper braid shield
Black vinyl plastic jacket
.405" Nom. Diam
Nom. Attenuation —
2.00 db/100 ft at 100 mc
2.90 db/100 ft at 200 mc
4.20 db/100 ft at 400 mc
Nom. Impedance — 125 ohms
Velocity of propagation — 84%
Nom. Capacitance — 10 mm/ft

BELDEN ELECTRONIC WIRES & CABLES

RGU transmission line cables

Belden RGU Cables can be furnished on special order with Type II-A Noncontaminating Jacket.
***Not stock** — manufactured to special order — See price sheet for minimum run order requirements.

Trade Number	Image	Trade Number	Image	Trade Number	Image	Trade Number	Image	
RG-71/U 8257		RG-79/U ★ 8256		RG-83/U ★ 8252		RG-108/U ★ 8266		
100' Spool 500' Spool 1000' Non-returnable Crate Reel		100' Spool 500' Non-returnable Crate Reel 1000' Returnable Reel		100' Spool 500' Non-returnable Crate Reel 1000' Returnable Reel		100' Spool 500' Spool 1000' Spool		
22 A.W.G.		22 A.W.G.		10 A.W.G.		20 A.W.G.		
Bare "Copperweld" conductor, solid Semi-solid polyethylene plastic insulation Tinned copper, double braid shield Clear polyethylene plastic jacket .250" Nom. Diam Nom. Attenuation — 3.10 db/100 ft at 100 mc 4.40 db/100 ft at 200 mc 6.30 db/100 ft at 400 mc Nom. Impedance — 93 ohms Velocity of propagation — 84% Nom. Capacitance — 13.5 mm/ft		Bare "Copperweld" conductor, solid Semi-solid polyethylene plastic insulation Bare copper braid shield Black vinyl plastic jacket Aluminum braid armor .475" Nom. Diam Nom. Attenuation — 2.00 db/100 ft at 100 mc 2.90 db/100 ft at 200 mc 4.20 db/100 ft at 400 mc Nom. Impedance — 125 ohms Velocity of propagation — 84% Nom. Capacitance — 10 mm/ft		Bare copper conductor, solid Polyethylene plastic insulation Bare copper braid shield Black vinyl plastic jacket Black vinyl plastic jacket .405" Nom. Diam Nom. Attenuation — 3.40 db/100 ft at 100 mc 4.40 db/100 ft at 200 mc 7.00 db/100 ft at 400 mc Nom. Impedance — 35 ohms Velocity of propagation — 66% Nom. Capacitance — 44 mm/ft		7x28 tinned copper conductor stranded Polyethylene plastic insulation 2 conductors cabled (one conductor bare copper for coding) Tinned copper braid shield Gray plastic jacket .230" Nom. Diam Nom. Attenuation — — db/100 ft at 100 mc — db/100 ft at 200 mc 32.00 db/100 ft at 400 mc Nom. Impedance — 76 ohms Velocity of propagation — 66% Nom. Capacitance — 24.5 mm/ft		7x.0152" bare copper conductor stranded Polyethylene plastic insulation 2 conductors cabled Core jacket polyethylene plastic Tinned copper, double braid shield Gray plastic jacket Aluminum braid armor .490" Nom. Diam Nom. Attenuation — 4.00 db/100 ft at 100 mc 5.30 db/100 ft at 200 mc 8.50 db/100 ft at 400 mc Nom. Impedance — 95 ohms Velocity of propagation — 68% Nom. Capacitance — 16 mm/ft

instrument and lead wires photoelectric cell cable

Trade Number	Image	Trade Number
50' Spool 100' Spool 500' Non-returnable Crate Reel		8282
13 conductor TV eye cable		
9 conductors 22 A.W.G. 7x30 tinned stranded copper conductor .010" vinyl plastic insulation Black, Blue, Brown, Green, Orange, Purple, Red, White, Yellow		
2 conductors 18 A.W.G. 16x30 tinned stranded copper conductor .018" vinyl plastic insulation 2 conductors paired Black and Red		
1 conductor RG 58a/u cable (Belden 8259)		
1 conductor RG 59/u type cable		
.040" tubed gray vinyl plastic jacket .470" Nom. Diam		

phonograph pickup arm cable

Trade Number	Image	Trade Number	Image
15' Packaged on card (5 cards in carton) 100' Spool 500' Spool		8431	
24 A.W.G.			
16x36 stranded tinned copper conductor .015" rubber insulation Tinned copper braid shield Brown, fine cotton braid .095" Nom. Diam			
25' Packaged on card (5 cards in carton) 500' Spooled & cartoned		8014	
25 A.W.G.			
13x36 stranded tinned copper conductor .010" chrome vinyl plastic insulation .044" Nom. Diam			

Especially designed for use as phonograph pickup arm cable. Extreme flexibility and limeness with small diameter are very important features of this cable.

hook-up and lead wires

cellulose braid lacquered (used on r-f circuits where low-loss properties are required)

Trade Number	Image	Trade Number	Image	Trade Number	Image	Trade Number	Image
25' Coiled & cartoned 100' Spooled & cartoned 1000' Spool		8941		25' Coiled & cartoned 100' Spooled & cartoned 1000' Spool		8945	
20 A.W.G.				25' Coiled & cartoned 100' Spooled & cartoned 1000' Spool			
Tinned copper conductor, solid Heavy cellulose acetate yarn wrap Cellulose acetate yarn braid Fungus-resistant lacquer coating Colors: Black, Blue, Brown, Green, Orange, Red, White, Yellow .072" Nom. Diam Nom. *d-c Ins. Res. per ft — 200 megohms Nom. **breakdown voltage — 1000 volts				20 A.W.G.			
16x30 tinned copper conductor stranded Heavy cellulose acetate yarn wrap Cellulose acetate yarn braid Fungus-resistant lacquer coating Colors: Black, Blue, Brown, Green, Orange, Red, White, Yellow .078" Nom. Diam Nom. *d-c Ins. Res. per ft — 200 megohms Nom. **breakdown voltage — 1000 volts				18 A.W.G.			
16x30 tinned copper conductor stranded Heavy cellulose acetate yarn wrap Cellulose acetate yarn braid Fungus-resistant lacquer coating Colors: Black, Blue, Green, Red, White, Yellow .087" Nom. Diam Nom. *d-c Ins. Res. per ft — 200 megohms Nom. **breakdown voltage — 1000 volts				25' Coiled & cartoned 100' Spooled & cartoned 1000' Spool			
26x30 stranded tinned copper conductor Heavy cellulose acetate yarn wrap Cellulose acetate yarn braid Fungus-resistant lacquer coating Colors: Black, Green, Red .095" Nom. Diam Nom. *d-c Ins. Res. — 200 megohms/ft Nom. **breakdown voltage — 1000 volts				16 A.W.G.			
41x30 stranded tinned copper conductor Heavy cellulose acetate yarn wrap Cellulose acetate yarn braid Fungus-resistant lacquer coating Colors: Black, Red .115" Nom. Diam Nom. *d-c Ins. Res. — 200 megohms/ft Nom. **breakdown voltage — 1000 volts				14 A.W.G.			

*Measurements for d-c insulation resistance made with a megohm bridge at 300 volts on specimens in mercury after subjection to 90% relative humidity and 100F for 24 hours.
 **Measurements for insulation breakdowns were made on specimens in mercury by applications of gradually increasing 60-cycle a-c potential.





BELDEN ELECTRONIC WIRES & CABLES

hook-up and lead wires





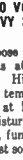

R-F push-back wire

CELLULOSE ACETATE BRAID WAXED

Used on r-f circuits where low-loss properties are required.

					
Trade Number	8841	8839	8844	8918	8530
General Description	100' Spooled & cartoned 1000' Spool 20 A.W.G. Tinned copper conductor, solid Two cellulose acetate yarn braids waxed Colors: Black, Blue, Green, Red, all with White Tracer .067" Nom. Diam Nom. *d-c Ins. Res. — 1000 megohms/ft Nom. **breakdown voltage — 1000 volts	100' Spooled & cartoned 1000' Spool 20 A.W.G. 10x30 stranded tinned copper conductor Two cellulose acetate yarn braids waxed Colors: Black, Blue, Green, Red, all with White Tracer .072" Nom. Diam Nom. *d-c Ins. Res. — 1000 megohms/ft Nom. **breakdown voltage — 1000 volts	100' Spooled & cartoned 1000' Spool 18 A.W.G. 16x30 stranded tinned copper conductor Two cellulose acetate yarn braids waxed Colors: Black, Blue, Green, Red, all with White Tracer .092" Nom. Diam Nom. *d-c Ins. Res. — 1000 megohms/ft Nom. **breakdown voltage — 1000 volts	250' Spool 1000' Spool 18 A.W.G. 16x30 stranded tinned copper conductor .031" vinyl thermoplastic insulation Colors: Black, Green, Red, Yellow .112" Nom. Diam Nom. *d-c Ins. Res. — 5000 megohms/ft Nom. **breakdown voltage — 12,000 volts	TYPE SR1R—1000 VOLT JOINT ARMY-NAVY SPECIFICATIONS JAN-C-76 General purpose hook-up wire for applications at 1000 volts RMs or less. High dielectric strength, High temperature stability, low moisture absorption, flame resistant, fungus resistant, resistant to most solvents. SR1R 3/5 (1) 22*** 100' Spooled & cartoned 1000' Spool 22 A.W.G. Tinned copper conductor, solid .018" vinyl thermoplastic insulation .062" Nom. Diam Colors: Black, Brown, Red, Orange, Yellow, Green, Blue, Violet, Gray, White Nom. *d-c Ins. Res. — megohms/ft Nom. **breakdown voltage — volts

hook-up and lead wires thermoplastic insulated





								
Trade Number	8529	8524	8523	8522	8864	8865		
General Description	SR1R 1 (1) 20*** 100' Spooled & cartoned 1000' Spool 20 A.W.G. Tinned copper conductor, solid .018" vinyl thermoplastic insulation .069" Nom. Diam Colors: Black, Brown, Red, Orange, Yellow, Green, Blue, Violet, Gray, White Nom. *d-c Ins. Res. — megohms/ft Nom. **breakdown voltage — volts	SR1R 3/5 (7) 22*** 100' Spooled & cartoned 1000' Spool 22 A.W.G. 7x30 stranded tinned copper conductor .018" vinyl thermoplastic insulation .066" Nom. Diam Colors: Black, Brown, Red, Orange, Yellow, Green, Blue, Violet, Gray, White Nom. *d-c Ins. Res. — megohms/ft Nom. **breakdown voltage — volts	SR1R 1 (7) 20*** 100' Spooled & cartoned 1000' Spool 20 A.W.G. 10x30 stranded tinned copper conductor .018" vinyl thermoplastic insulation .075" Nom. Diam Colors: Black, Brown, Red, Orange, Yellow, Green, Blue, Violet, Gray, White Nom. *d-c Ins. Res. — megohms/ft Nom. **breakdown voltage — volts	SR1R 1 1/2 (7) 18*** 100' Spooled & cartoned 1000' Spool 18 A.W.G. 16x30 stranded tinned copper conductor .020" vinyl thermoplastic insulation .087" Nom. Diam Colors: Black, Brown, Red, Orange, Yellow, Green, Blue, Violet, Gray, White Nom. *d-c Ins. Res. — megohms/ft Nom. **breakdown voltage — volts	Contents: 6—25' Coils 8941. Size 20 solid; cellulose acetate wrap and braid laquered One each Black, Blue, Green, Red, White, and Yellow.	Contents: 6—25' Coils 8943. Size 20 flexible; cellulose acetate wrap and braid laquered. One each Black, Blue, Green, Red, White, and Yellow.		
	***Type Designation Government Specification Hook-up Wire will be shown as follows:		SR1R Type	3/5 Size approximate circular mils in thousands	7 minimum strands	22 A.W.G. size	00 color code first digit is body color, second digit is tracer or auxiliary color	
	Colors:		0 Black	4 Yellow	8 Gray (slate)	1 Brown	5 Green	9 White
			2 Red	6 Blue		3 Orange	7 Violet (purple)	

hook-up wire display assortments



hook-up and lead wires rubber-insulated push-back

General-use hook-up wire and leads for transformers, speakers, and controls in audio and power circuits.

				
Trade Number	8837	8838	8833	8885
General Description	100' Spooled & cartoned 1000' Spool 20 A.W.G. Tinned copper conductor, solid Cotton wrap .010" unvulcanized rubber insulation Cellulose acetate yarn braid Fungus-resistant lacquer coating Colors: Black, Blue, Green, Red, Yellow .075" Nom. Diam Nom. *d-c Ins. Res. — 2000 megohms/ft Nom. **breakdown voltage — 2000 volts	100' Spooled & cartoned 1000' Spool 20 A.W.G. 10x30 stranded tinned copper conductor Cotton wrap .010" unvulcanized rubber insulation Cellulose acetate yarn braid Fungus-resistant lacquer coating Colors: Black, Blue, Green, Red, Yellow .081" Nom. Diam Nom. *d-c Ins. Res. — 2000 megohms/ft Nom. **breakdown voltage — 2000 volts	100' Spool 1000' Spool 18 A.W.G. 16x30 stranded tinned copper conductor Paper wrap .031" rubber insulation Cellulose acetate yarn braid Fungus-resistant lacquer coating Colors: Black, Blue, Green, Red, Yellow .135" Nom. Diam Nom. *d-c Ins. Res. — 10,000 megohms/ft Nom. **breakdown voltage — 8000 volts	25' Coiled & cartoned 100' Spooled & cartoned 500' Spool 20 A.W.G. 10x30 stranded tinned copper conductor .015" rubber insulation Cellulose acetate yarn braid Fungus-resistant lacquer coating Tinned copper braid shield .117" Nom. Diam Nom. *d-c Ins. Res. — 5000 megohms/ft Nom. **breakdown voltage — 4000 volts Used in circuits where shielded grid return is required and to shield a circuit conductor from stray fields.

* Measurements for d-c insulation resistance made with a megohm bridge at 300 volts on specimens in mercury after subjection to 90% relative humidity and 110F for 24 hours.
** Measurements for insulation breakdown wire made on specimens in mercury by application of gradually increasing 60-cycle a-c potential.

BELDEN ELECTRONIC WIRES & CABLES

hook-up and lead wires

high-voltage and cathode-ray tube lead cable

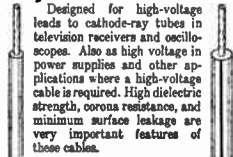

Designed for high-voltage leads to cathode-ray tubes in television receivers and oscilloscopes. Also as high voltage in power supplies and other applications where a high-voltage cable is required. High dielectric strength, corona resistance, and minimum surface leakage are very important features of these cables.

Trade Number	8869	8868
100' Spool		100' Spool
20 A.W.G.		20 A.W.G.
General Description	7x28 stranded tinned copper conductor .035" flame retardant polyethylene plastic insulation Color: White .108" Nom. Diam Puncture voltage 32,000 volts Suggested Working Voltage 10,000 volts	7x28 stranded tinned copper conductor .065" flame retardant polyethylene plastic insulation Color: White with Red Stripe .168" Nom. Diam Puncture voltage 54,000 volts Suggested Working Voltage 20,000 volts

test prod wire

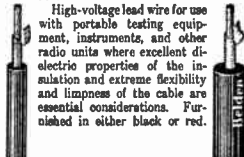

High-voltage lead wire for use with portable testing equipment, instruments, and other radio units where excellent dielectric properties of the insulation and extreme flexibility and limppness of the cable are essential considerations. Furnished in either black or red.

Trade Number	8899	8898
14' Coiled & cartoned (7' Black and 7' Red)		100' Spool
100' Spool		500' Spool
500' Spool		1000' Spool
18 A.W.G.		18 A.W.G.
General Description	65x36 stranded tinned copper conductor Cotton wrap .043" rubber insulation Colors: Black, Red .140" Nom. Diam Puncture voltage 20,000 volts Suggested Working Voltage 5,000 volts	65x36 stranded tinned copper conductor Cotton wrap .088" rubber insulation Colors: Black, Red .230" Nom. Diam Puncture voltage 29,000 volts Suggested Working Voltage 10,000 volts

aerial wire indoor aerial wire (EXTRA FLEXIBLE)



Trade Number	8014
25' Packaged on card (5 cards in carton)	
500' Spooled & cartoned	
18 A.W.G.	
General Description	13x36 stranded tinned copper conductor .010" ethylene vinyl plastic insulation .044" Nom. Diam

aerial wire

stranded bare copper



Trade Number	8000	8002
50' Coil		50' Coil
75' Coil		75' Coil
100' Coil		100' Coil
1000' Spool		1000' Spool
General Description	7x22 stranded bare copper conductor	7x24 stranded bare copper conductor

solid Beldenamel



Trade Number	8004	8009
100' Coiled & cartoned		100' Coiled & cartoned
200' Spool		500' Spool
500' Spool		1000' Spool
14 A.W.G.		14 A.W.G.
General Description	Beldenamel	Beldenamel

Belden • bus bar wire

solid tinned copper

Trade Number	8011	8012	8013
100' Coiled & cartoned		100' Coiled & cartoned	100' Coiled & cartoned
12 A.W.G.		14 A.W.G.	16 A.W.G.
General Description	Tinned copper wire, solid	Tinned copper wire, solid	Tinned copper wire, solid

bus bar wire

solid aluminum TV grounding wire



Trade Number	8018
50' Coiled in series of 10 coils	
500' Spool	
1000' Spool	
8 A.W.G.	
General Description	Aluminum wire, soft annealed 500' and 1000' spools are marked at 100' intervals for easy measuring.

power supply cord

Trade Number	8874
6' Cord — Cartoned	
18 A.W.G.	
General Description	Brown Type SP-1. Extra-flexible all-rubber parallel lamp cord with Belden molded-on all-rubber connector and Belden unbreakable soft rubber plug. Television Power Supply Connector Cord Original equipment on most television sets. Consult Cord Set Catalog for other replacements and extensions.

litz wire

Trade Number	8817
100' Spool	
5x44 Celenamel conductor	
Wrap of nylon	
.008" Nom. Diam	
General Description	For rewinding antenna primaries and for hand-wound r-f coils.

lead-in wire

Trade Number	8200	8206
100' Spool		250' Spool
500' Spool		18 A.W.G.
1000' Spool		General Description
18 A.W.G.		7x27 stranded tinned copper conductor .040" rubber insulation Tinned copper braid shield .155" Nom. Diam
General Description	7x27 stranded tinned copper conductor .040" rubber insulation .120" Nom. Diam	

voice coil lead wire



Trade Number	8127
18' Packaged on card (5 cards in carton)	
25 A.W.G.	
General Description	32x40 braided bare copper wire .024" Nom. Diam

BELDEN ELECTRONIC WIRES & CABLES

aircraft, marine, and auto radio wires and shielding

Belden supplies a complete line of auto radio wires and shielding to handle every wire requirement in installation and servicing. In installations of this type, the use of the correct wire is particularly important. Applications are indicated in the listings below.

Trade Number	8667	8665	8677	8675	8673	8833
	100' Spool	100' Spool	100' Spool 500' Spool	100' Spool 500' Spool	100' Spool 500' Spool	100' Spool 1000' Spool
	16 A.W.G.	19 A.W.G.	16 A.W.G.	14 A.W.G.	12 A.W.G.	18 A.W.G.
General Description	19x29 stranded tinned copper conductor Rubber insulation Cotton braid Lacquer coating Color: Black .280" Nom. Diam	7x.013" stranded stainless steel alloy conductor Rubber insulation Glass yarn web braid Neoprene jacket Tinned copper braid shield Black neoprene jacket .365" Nom. Diam Nom. Capacitance — 33.0 mmf/ft	19x29 stranded tinned copper conductor Vinyl plastic insulation One black and one white conductor parallel Chrome vinyl plastic jacket .189" x .276" Nom. Diam	19x27 stranded tinned copper conductor Vinyl plastic insulation One black and one white conductor parallel Chrome vinyl plastic jacket .189" x .326" Nom. Diam	19x25 stranded tinned copper conductor Vinyl plastic insulation One black and one white conductor parallel Chrome vinyl plastic jacket .214" x .376" Nom. Diam	16x30 stranded tinned copper conductor Paper wrap Rubber insulation Cellulose acetate yarn braid Lacquer coating Colors: Black, Blue, Green, Red, Yellow .136" Nom. Diam
	High-voltage ignition cable.	Shielded high-voltage ignition cable.	Duplex weatherproof cable.	Duplex weatherproof cable.	Duplex weatherproof cable.	Heavy-duty hook-up wire.

aircraft, marine, and auto radio wires and shielding

Trade Number	8652	8651	8650	8656	8660	8668	8661
	100' Spool	100' Spool	100' Spool	100' Spool	50' Spooled & cartoned 250' Spool	50' Spooled & cartoned 250' Spool	50' Spooled & cartoned 250' Spool
	16 A.W.G.	14 A.W.G.	12 A.W.G.	16 A.W.G.			
General Description	19x29 stranded tinned copper conductor Cellophane wrap Rubber insulation Cotton braid Lacquer coating Color: Black with one White Tracer .140" Nom. Diam	19x27 stranded tinned copper conductor Cellophane wrap Rubber insulation Cotton braid Lacquer coating Color: Green with two White Tracers .170" Nom. Diam	19x25 stranded tinned copper conductor Cellophane wrap Rubber insulation Cotton braid Lacquer coating Color: Red with three White Tracers .200" Nom. Diam	19x29 stranded tinned copper conductor Cellophane wrap Rubber insulation Cotton braid Blue lacquer coating Tinned copper braid shield .170" Nom. Diam	96x34 braided tinned copper Braided in tubing form 1/8" ID Nom. Diam For shielding and bending.	120x34 braided tinned copper Braided in tubing form 11/64" ID Nom. Diam For shielding and bending.	192x34 braided tinned copper Braided in tubing form 3/8" ID Nom. Diam For shielding and bending.
	Heavy-duty hook-up wire.	Heavy-duty hook-up wire.	Heavy-duty hook-up wire.	Shielded heavy-duty hook-up wire.			

aircraft, marine, and auto radio wires and shielding

Trade Number	8669	8662
	50' Spool 250' Spool	50' Spool 250' Spool
General Description	336x34 braided tinned copper conductor Braided in tubing form 1/4" ID Nom. Diam For shielding and bending.	576x34 braided tinned copper conductor Braided in tubing form 25/32" ID Nom. Diam For shielding and bending.

magnet wire

Nylclad magnet wire combines the most desirable features of Formvar with the well-known toughness and solvent resistance of Nylon enamel.

For difficult and exacting windings, these plus values may represent the difference between low and high rejections.

Nylclad will out-perform all other A.I.E.E., Class A, film-coated wires

with respect to: (1) ability to withstand winding abuse and forming operations; (2) resistance to the solvent action of insulating varnishes and all types of thinners; (3) resistance to softening at elevated temperatures; (4) solvent crazing; (5) windability.

Other types of Belden Magnet Wires available are Beldenamel, Single Cotenam, and Single Nyltex-enamel.



BELDENAMEL					NYLCLAD					SINGLE COTENAMEL					
Size	Turns per Linear Inch	Turns per Square Inch	Approx. Length in Foot 1/2-Lb Spool	1-Lb Spool	Size	Turns per Linear Inch	Turns per Square Inch	Approx. Length in Foot 1/2-Lb Spool	1-Lb Spool	Size	Turns per Linear Inch	Turns per Square Inch	Approx. Length in Foot 1/2-Lb Spool	1-Lb Spool	
11	15.2	231	...	90	14	14.9	222	...	79	14	14.1	199	...	39	73
16	19.1	365	...	62	15	18.6	316	...	125	16	17.4	303	...	61	123
18	23.9	671	...	100	18	23.2	538	...	190	18	21.4	458	...	97	195
20	29.9	894	...	150	20	28.9	825	...	316	19	23.6	657	...	151	244
22	37.4	1399	...	250	22	36.0	1294	...	503	20	26.1	681	...	241	481
24	46.9	2200	...	400	24	44.7	1998	...	809	24	38.6	1490	...	376	752
26	59.0	3481	...	628	26	55.7	3102	...	1264	25	42.3	1799	...	442	942
28	73.8	5448	...	1010	28	69.4	4816	...	2001	28	55.1	3038	...	616	1332
30	92.2	8501	...	1610	30	86.2	7430	...	3167	30	64.7	4199	...	710	1420
32	114.0	12996	...	2540	32	106.0	11238	...	5023	32	74.6	5565	...	1090	2180
34	144.0	20736	...	4080	34	133.0	17689	...	7962	34	86.6	7500	...	1608	...
36	180.0	32400	...	6400	36	167.0	27899	...	12618	36	97.8	9529	...	2125	...
38	225.0	50625	...	10700	38	206.0	42436	...	20004	38	161	25600	...	4275	...
40	290.0	84100	...	18050	40	263.0	69189	...	31886	39	179	32000	...	5600	...
										40	192	38900	...	6900	...

BELDEN • Price List

Belden Trade Number	Unit Package and Length**	Suggested List Price Each	Belden Trade Number	Unit Package and Length**	Suggested List Price Each	Belden Trade Number	Unit Package and Length**	Suggested List Price Each	Belden Trade Number	Unit Package and Length**	Suggested List Price Each	Belden Trade Number	Unit Package and Length**	Suggested List Price Each
1701B		1.47	8243	100'	.43'	8426	50'	11.75	8488	1000'	.08'	8750	500'	.61'
1701K		1.57	8243	500'	.43'	8426	250'	.24'	8650	100'	.10'	8753	100'	.23'
1702B		1.67	8243	1000'	.43'	8427	50'	12.60	8651	100'	.08'	8753	500'	.23'
1702K		1.77	8244	100'	.08'	8427	250'	.255'	8652	100'	.06'	8782	500'	.02'
1705B		1.34	8244	500'	.08'	8428	100'	.15'	8656	100'	.085'	8782	1000'	.02'
1705K		1.44	8244	1000'	.08'	8428	500'	.15'	8660	50'	.05'	8783	500'	.10'
1725K		.63	8245	100'	.13'	8431	15'	.90'	8660	250'	.05'	8799	100'	.065'
1735K		.77	8245	500'	.13'	8431	100'	.045'	8661	50'	.05'	8799	500'	.065'
1749B		.61	8245	1000'	.13'	8431	500'	.045'	8661	250'	.075'	8799	1000'	.065'
1749K		.73	8246	100'	.65'	8432	100'	.085'	8662	50'	.23'	8817	100'	.45
1750B		1.00	8246	500'	.65'	8432	500'	.085'	8662	250'	.23'	8833†	100'	.035'
1750K		1.18	8246	1000'	.65'	8433	1000'	.085'	8665	100'	.23'	8833†	1000'	.035'
1752K		1.54	8247	100'	.44'	8433	100'	.11'	8667	100'	.14'	8837†	100'	.03'
1754B		.73	8247	500'	.44'	8433	500'	.11'	8668	50'	.06'	8837†	1000'	.03'
1754K		.87	8247	1000'	.44'	8437	100'	.085'	8668	250'	.06'	8838†	100'	.03'
1756K		1.61	8248	100'	.43'	8437	500'	.085'	8669	50'	.16'	8838†	1000'	.03'
1765B		.47	8248	500'	.43'	8437	1000'	.085'	8669	250'	.16'	8839†	100'	.03'
1777K		.91	8248	1000'	.43'	8438	100'	.06'	8673	100'	.23'	8839†	1000'	.03'
1790K		7.31	8249	100'	.41'	8438	500'	.06'	8673	500'	.23'	8841†	100'	.03'
1792K		9.08	8249	500'	.41'	8438	1000'	.06'	8675	100'	.175'	8841†	1000'	.03'
1795K		4.63	8249	1000'	.41'	8439	100'	.07'	8675	500'	.175'	8844†	100'	.03'
8000	50'	1.15	8250	100'	.33'	8439	500'	.07'	8677	100'	.13'	8864	1000'	.03'
8000	75'	1.70	8250	500'	.33'	8439	1000'	.07'	8677	500'	.13'	8864		3.45
8000	100'	2.15	8250	1000'	.33'	8440	100'	.085'	8732	100'	.09'	8865		3.72
8000	1000'	20.00	8251	100'	.24'	8440	500'	.085'	8732	500'	.09'	8868	100'	.055'
8002	50'	.83	8251	500'	.24'	8440	1000'	.085'	8734	100'	.10'	8869	100'	.03'
8002	75'	1.15	8251	1000'	.24'	8443	100'	.04'	8734	500'	.10'	8874		.90
8002	100'	1.45	8252	100'	.29'	8443	500'	.04'	8735	100'	.105'	8885	25'	1.45
8002	1000'	13.15	8252	500'	.29'	8444	100'	.05'	8735	500'	.105'	8885	100'	.045'
8008	100'	3.05	8252	1000'	.29'	8444	500'	.05'	8737	100'	.08'	8885	500'	.045'
8008	200'	5.90	8253	100'	.30'	8445	100'	.06'	8737	500'	.08'	8888	250'	.05'
8008	500'	14.15	8253	500'	.30'	8445	500'	.06'	8738	100'	.045'	8898†	100'	.055'
8009	100'	2.15	8253	1000'	.30'	8446	100'	.095'	8738	500'	.045'	8898†	500'	.055'
8009	500'	9.50	8254	100'	.13'	8446	500'	.095'	8738	1000'	.045'	8899†	14'	.62'
8011	100'	3.50	8254	500'	.13'	8447	100'	.10'	8739	100'	.065'	8899†	100'	.035'
8012	100'	2.40	8254	1000'	.13'	8447	500'	.10'	8739	500'	.065'	8899†	500'	.035'
8013	100'	1.65	8255	100'	.27'	8448	500'	.11'	8739	1000'	.065'	8899†	1000'	.035'
8014	25'	.40	8255	500'	.27'	8448	100'	.11'	8740	100'	.035'	8901†	100'	.015'
8014	500'	0.15'	8255	1000'	.27'	8449	100'	.12'	8740	500'	.035'	8901†	1000'	.015'
8018	50'	1.40	8256	100'	.40'	8449	500'	.12'	8740	1000'	.035'	8905†	100'	.015'
8018	100'	2.50	8256	500'	.40'	8452	100'	.07'	8741	100'	.065'	8905†	1000'	.015'
8018	500'	12.50	8256	1000'	.40'	8452	500'	.07'	8741	500'	.065'	8913†	100'	.02'
8018	1000'	22.50	8257	100'	.18'	8452	1000'	.085'	8741	1000'	.065'	8913†	1000'	.02'
8127	10'	.35	8257	500'	.18'	8453	500'	.085'	8742	100'	.09'	8918†	250'	.02'
8200	100'	.02'	8257	1000'	.18'	8454	100'	.10'	8742	500'	.09'	8918†	1000'	.02'
8200	500'	.02'	8258	100'	.64'	8454	500'	.10'	8742	1000'	.09'	8938†	100'	.04'
8200	1000'	.02'	8258	500'	.64'	8455	100'	.11'	8743	100'	.115'	8938†	500'	.04'
8204	500'	.05'	8258	1000'	.64'	8455	100'	.11'	8743	500'	.115'	8941†	25'	.58
8204	1000'	.05'	8259	100'	.085'	8455	250'	.11'	8744	100'	.175'	8941†	100'	.02'
8205	500'	.035'	8259	500'	.085'	8462	100'	.045'	8744	500'	.175'	8941†	1000'	.02'
8205	1000'	.035'	8259	1000'	.085'	8462	250'	.045'	8745	100'	.30'	8942†	100'	.03'
8208	250'	.05'	8260	100'	.45'	8464-CD-100*		5.15	8745	500'	.30'	8942†	1000'	.03'
8208	500'	.11'	8260	500'	.45'	8464	500'	.05'	8746	100'	.49'	8943†	25'	.62
8208	1000'	.11'	8260	1000'	.45'	8464	1000'	.05'	8746	500'	.49'	8943†	100'	.02'
8209	500'	.10'	8264	100'	.41'	8472	250'	.105'	8747	100'	.16'	8943†	1000'	.02'
8209	1000'	.10'	8264	500'	.41'	8483	1000'	.02'	8747	500'	.16'	8945†	25'	.70
8221	100'	.11'	8264	1000'	.41'	8484	100'	5.25	8748	100'	.23'	8945†	100'	.025'
8222	100'	.025'	8265	100'	.24'	8484	500'	.055'	8748*	500'	.23'	8945†	1000'	.025'
8222	500'	.025'	8265	500'	.24'	8484	1000'	.055'	8749	100'	.36'	8947†	25'	.73
8224	100'	.035'	8265	1000'	.24'	8485	100'	6.50	8749*	500'	.36'	8947†	100'	.025'
8224	500'	.035'	8266	100'	.12'	8485	500'	.065'	8750	100'	.61'	8947†	1000'	.025'
8225-CD-100*		3.65	8266	500'	.12'	8485	1000'	.065'						
8225	100'	.04'	8266	1000'	.12'	8488	100'	8.15						
8225	500'	.04'	8275	CD-100*	8.75	8488	500'	.08'						
8225	1000'	.04'	8275	CR-500*	.09'									
8227	100'	.16'	8275	CR-1000*	.09'									
8227	250'	.16'	8282	CS-50*	.45'									
8230-CD-100*		3.65	8282	CS-100*	.45'									
8230	100'	.04'	8282	CR-500*	.45'									
8230	500'	.04'	8401	25'	2.50									
8230	1000'	.04'	8401	50'	4.75									
8235	100'	.09'	8401	100'	.095'									
8235	500'	.09'	8401	500'	.095'									
8236	100'	.22'	8410	25'	3.40									
8236	500'	.22'	8410	50'	6.40									
8236	1000'	.22'	8410	100'	.12'									
8237	100'	.28'	8410	500'	.12'									
8237	500'	.28'	8411	25'	2.15									
8237	1000'	.28'	8411	100'	.075'									
8238	100'	.26'	8411	500'	.075'									
8238	500'	.26'	8412	25'	3.15									
8238	1000'	.26'	8412	50'	6.25									
8239	100'	.125'	8412	100'	.125'									
8239	500'	.125'	8412	500'	.125'									
8239	1000'	.125'	8422	25'	3.25									
8240	100'	.085'	8422	50'	6.15									
8240	500'	.085'	8422	100'	.12'									
8240	1000'	.085'	8422	500'	.12'									
8241	100'	.11'	8423	50'	7.25									
8241	500'	.11'	8423	250'	.14'									
8241	1000'	.11'	8423	500'	.14'									
8242	100'	.52'	8424	50'	8.40									
8242	500'	.52'	8424	250'	.16'									
8242	1000'	.52'	8425	50'	9.50									
			8425	250'	.19'									

*10-100 ft. coils in a Counter Dispenser.
 †Specify Color. All prices subject to change without notice.
 **Please indicate length desired, immediately following trade number, when more than one length is listed under the same trade number.
 *New item.

BELDENM&L MAGNET WIRE			SINGLE COTENAM&L MAGNET WIRE			SINGLE NYLTEX- ENAM&L MAGNET WIRE		HNC NYLCLAD	
Size	1/4 lb. Spools List Price	1/2 lb. Spools List Price	Size	1/4 lb. Spools List Price	1 lb. Spools List Price	Size	1/4 lb. Spools List Price	Size	1 lb. Spools List Price
14	—	\$1.03	14	—	\$1.15	14	—	14	\$2.05
16	—	1.03	16	—	1.20	16	—	16	2.10
18	—	1.03	17	—	—	17	—	18	2.13
20	—	1.08	18	—	1.30	18	—	20	2.25
22	—	1.10	19	—	—	19	—	22	2.30
24	—	1.18	20	—	1.40	20	—	24	2.53
26	—	1.23	22	—	1.48	22	—	26	2.68
28	\$.73	1.28	24	—	1.65	24	—	28	2.88
30	.75	1.33	25	—	—	25	—	30	3.08
32	.78	1.38	26	\$.95	1.78	26	—	32	3.40
34	.83	1.48	28	1.05	1.98	28	—	34	3.



Products

**SPECIAL PURPOSE
INSULATED WIRE**

THE WILLIAM

AND CO., INC., WILLIMANTIC, CONN.

MINIATURIZATION WIRE

Specially developed for use in electronic equipment within the range of -55°C to $+105^{\circ}\text{C}$, and maximum operating voltage of 600 volts rms. This wire is ideal for use in miniaturized equipment as both hook-up wire and lead wire for transformers, chokes and other components, where space is at a premium and operating temperatures are high. Available in both standard and flexible . . . in solid colors or candy striped with 1, 2 or 3 tracers

The primary insulation is Turbo 540, an extruded polyvinyl chloride compound that is resistant to the effects of water, oils, aircraft engine fuels, hydraulic fluids, ethylene glycol, alcohol, dilute acids, alkalis and fungus. Over the primary insulation there is an extruded jacket of nylon to give added mechanical protection and abrasion resistance.

Brand Part No.	Approx. AWG	Stranding	Nom. Cir. Mil Area	Pri. Ins. Min. Wall	Nylon Min. Wall	Max. O.D.	Nom. lbs./M'
MM300607N	30	7/38	110	0.006	0.002	0.035	0.8
MM270607N	27	7/35	221	0.006	0.002	0.040	1.1
MO2606N	26	Solid	254	0.006	0.002	0.040	1.6
MO2406N	24	Solid	404	0.006	0.002	0.048	2.0
MM240619N	24	19/36	475	0.006	0.002	0.048	2.2
MM240607N	24	7/32	442	0.006	0.002	0.048	2.1
MO2207N	22	Solid	642	0.007	0.003	0.058	2.9
MM220719N	22	19/34	754	0.007	0.003	0.058	3.3
MM220707N	22	7/30	707	0.007	0.003	0.058	3.2
MO2007N	20	Solid	1020	0.007	0.003	0.068	4.3
MM200719N	20	19/32	1200	0.007	0.003	0.068	5.0
MM200707N	20	7/28	1120	0.007	0.003	0.068	4.7
MO1807N	18	Solid	1620	0.007	0.003	0.079	6.5
MM180719N	18	19/30	1920	0.007	0.003	0.079	7.5
MM180707N	18	7/26	1780	0.007	0.003	0.079	7.1
MO1607N	16	Solid	2580	0.007	0.003	0.088	9.7
MM160719N	16	19/29	2410	0.007	0.003	0.088	9.4
MO1408N	14	Solid	4110	0.008	0.003	0.103	14.0
MM140819N	14	19/27	3840	0.008	0.003	0.103	14.5
MM120819N	12	19/25	6080	0.008	0.004	0.126	22.5

MIL-W-16878

Approx. AWG Size	Stranding	TYPE B			TYPE C			TYPE D		
		Min. O.D.	Max. O.D.	Brand Pt. No.	Min. O.D.	Max. O.D.	Brand Pt. No.	Min. O.D.	Max. O.D.	Brand Pt. No.
30	7/38	.030	.036	HH300907	—	—	—	—	—	—
28	7/36	.031	.037	HH280907	—	—	—	—	—	—
26	7/34	.035	.041	HH261007	—	—	—	—	—	—
24	7/32	.040	.047	HH241007	.054	.062	HH241707	.075	.090	HH243107
22	7/30	.046	.053	HH221007	.060	.068	HH221707	.081	.096	HH223107
20	7/28	.054	.061	HH201007	.068	.076	HH201707	.089	.104	HH203107
18	7/26	—	.070	HH181007	.078	.086	HH181707	.098	.114	HH183107
16	19/29	—	—	—	.087	.095	HH161719	.110	.125	HH163119
14	19/27	—	—	—	.101	.109	HH141719	.122	.137	HH143119
12	19/25	—	—	—	—	—	—	.155	.170	HH123719
10	37/26	—	—	—	—	—	—	.174	.189	HH103737
8	133/29	—	—	—	—	—	—	2.39	.254	HH0840133

TRANSMISSION LINES AND CABLES

Efficient TV and FM Reception depends on the right cable lead-in. With every installation of a TV or FM set and antenna make sure that you are selling trouble-free, efficient transmission lines. It's the *important link* that insures customer satisfaction. TURBO BRAND Transmission Lines and Cables are furnished in three basic types to fit every specific installation need. Tops in transmission insures tops in reception.

TURBO TUBULAR TWIN LEAD 300 OHM (Cat. #1010)

Turbo Tubular Twin Lead is suitable for connecting UHF and VHF Antennae to TV and FM receivers. Its tubular construction contains and protects the concentrated field of energy. It reduces signal losses to a minimum. Sun-proof, brown colored insulation. Highly effective against conditions of high humidity.

TURBO RIBBON-TYPE TWIN LEAD 300 OHM OVAL TYPE (Cat. #1004)

Specially recommended for VHF reception in strong signal areas. For outdoor use, it is furnished with 7/28 conductor and .065" web thickness to resist rain, snow, dirt or salt deposits, minimizing impedance and preserving electrical efficiency.

TURBO COAXIAL LINES

Made especially for use in indoor antennae and for wiring inside the chassis of TV and FM receivers. It is flat with the twin conductors on either edge, and is extremely flexible. This cable uses a 7/30 conductor and a .040" web thickness. Inside the chassis short lengths are used to conduct the signal between circuits.

ROTATOR CABLE (Cat. #1014)

The use of Coaxial Lines for carrying signals from the antenna to the TV receiver has the distinct advantage that this type of lead-in is not affected by atmospheric conditions at any time.

4 conductor ribbon cable for antenna rotator use is also available from stock on 1,000 ft. put-ups — specify Turbo #1014. A complete line of multi-conductor jacketed cables for intercommunication and control circuits are available.



**GENERAL PURPOSE
HOOK-UP WIRE**

THE WILLIAM

BRAND

AND CO., INC., WILLIMANTIC, CONN.

**TURBOTHERM "60" Radio and Instrument Hook-Up Wire
to Specification JAN-C-76**

The conductor can be furnished in either solid or stranded tinned copper wire. The primary insulation is an extruded polyvinyl chloride compound that is resistant to the effects of water, oils, aircraft engine fuels, hydraulic fluids, ethylene glycol, alcohol, dilute acids, alkalis and fungus. This wire has excellent electrical properties.

Type WL wire is designed for general purpose applications at 600 Volts rms or less. It is normally furnished with an extruded nylon jacket over the primary insulation.

Type SRIR is designed for general purpose applications at 1000 Volts rms or less. It is normally furnished without an outer covering.

Type SRHV is designed for general purpose applications at 2500 Volts rms or less. It is normally furnished without an outer covering.

These wires can be furnished in all solid colors of vinyl insulation or up to 3 colored spiral tracers on a white background. Other colors with spiral tracers can be furnished but their use is not recommended.

Approx. AWG	Stranding	TYPE WL			TYPE SRIR			TYPE SRHV		
		With Nylon Jacket			Without Covering			Without Covering		
		Max. O.D.	Nom. Lbs./M'	Brand Part No.	Nom. O.D.	Nom. Lbs./M'	Brand Part No.	Nom. O.D.	Nom. Lbs./M'	Brand Part No.
24	Solid	0.064	2.33	602412N	0.055	2.35	602417	0.086	4.47	602433
24	7/32	0.068	2.66	66241207N	0.058	2.64	66241707	0.090	4.8	66243307
24	16/36	0.068	2.53	66241216N	0.058	2.6	66241716	0.090	4.67	66243316
22	Solid	0.069	3.24	602212N	0.060	3.3	602217	0.092	5.59	602233
22	7/30	0.075	3.71	66221207N	0.065	3.71	66221707	0.097	6.13	66223307
22	16/34	0.075	3.5	66221216N	0.065	3.5	66221716	0.097	5.92	66223316
20	Solid	0.076	4.61	602012N	0.067	4.66	602017	0.098	7.07	602033
20	7/28	0.082	5.22	66201207N	0.073	5.28	66201707	0.105	7.91	66203307
20	19/32	0.084	5.66	66201219N	0.074	5.6	66201719	0.107	8.31	66203319
18	Solid	0.084	6.67	601812N	0.076	6.81	601817	0.107	9.48	601833
18	7/26	0.092	7.6	66181207N	0.083	7.67	66181707	0.115	10.65	66183307
18	19/30	0.094	8.2	66181219N	0.086	8.2	66181719	0.118	11.13	66183319
16	Solid	0.097	10.01	601612N	0.087	10.17	601617	0.118	13.07	601633
16	19/29	0.101	9.98	66161319N	0.093	10.01	66161719	0.124	13.19	66163319
16	26/30	0.104	10.69	66161226N	0.098	10.93	66161726	0.128	13.94	66163326
14	Solid	0.111	15.21	601414N	0.103	15.38	601417	0.132	18.47	601433
14	19/27	0.118	15.27	66141419N	0.110	15.37	66141719	0.138	18.28	66143319
14	41/30	0.124	16.1	66141441N	0.118	16.74	66141741	0.144	19.59	66143341
12	19/25	0.138	23.16	66121419N	0.131	23.52	66121719	0.157	26.5	66123319
12	65/30	0.141	24.28	66121265N	0.140	25.52	66121765	0.163	28.17	66123365

TUBING

"TURBO 117"

A flexible silicone rubber, bonded to a glass braid. Temperature Range -100°F to +500°F. NEMA — Class "H" Rating. Available in the following grades.

Grade	NEMA Designation	50% Relative Humidity		96% Relative Humidity	
		Average	Minimum	Average	Minimum
		A-1	H-A-1	7000	5000
B-1	H-B-1	4000	2500	2000	1250
C-1	H-C-1	2500	1500	—	—
C-2	H-C-2	1500	800	—	—
C-3	H-C-3	—	—	—	—

"TURBOTUF"

A flexible vinyl coated glass braid. Temperature range -45°C to +125°C. NEMA — Class "B" Rating. Available in the following grades.

Grade	NEMA Designation	50% Relative Humidity		96% Relative Humidity	
		Average	Minimum	Average	Minimum
		A-1	B-A-1	7000	5000
B-1	B-B-1	4000	2500	2000	1250
C-1	B-C-1	2500	1500	—	—



**GENERAL PURPOSE
HOOK-UP WIRE**

THE WILLIAM

BRAND

AND CO., INC., WILLIMANTIC, CONN.

HOOK-UP WIRE FOR RADIO & TELEVISION INDUSTRY

Except as noted, the following wires are approved by Underwriters' Laboratories, Inc., for operation at indicated temperatures.

Typical strandings are shown. Others are available on special order.

* Underwriters' Approved only with cotton, rayon or glass overbraid. See NOTE.

** Not covered by Underwriters' Standards.

*** Underwriters Approved only with glass overbraid. See NOTE.

Approx. AWG Size	Stranding	Min. Ave. Ins. Thickness	Nom. Plastic O.D.	80°C Brand Pt. No.	90°C Brand Pt. No.	105°C Brand Pt. No.
26	Solid	0.016	0.050	802616	902616*	502616***
26	10/36	0.016	0.052	88261610	99261610*	55261610***
24	Solid	0.016	0.054	802416	902416*	502416***
24	7/32	0.016	0.057	88241607	99241607*	55241607***
22	Solid	0.016	0.059	802216	902216*	502216***
22	7/30	0.016	0.065	88221607	99221607*	55221607***
20	Solid	0.016	0.067	802016	902016*	502016***
20	10/30	0.016	0.071	88201610	99201610*	55201610***
18	Solid	0.016	0.074	801816	901816*	501816***
18	16/30	0.016	0.080	88181616	99181616*	55181616***
16	Solid	0.016	0.086	801616	901616*	501616***
16	26/30	0.016	0.095	88161626	99161626*	55161626***
14	41/30	0.016	0.112	88141641**	99141641**	55141641**
26	Solid	0.031	0.080	802631	902631	502631
26	10/36	0.031	0.084	88263110	99263110	55263110
24	Solid	0.031	0.084	802431	902431	502431
24	7/32	0.031	0.088	88243107	99243107	55243107
22	Solid	0.031	0.089	802231	902231	502231
22	7/30	0.031	0.094	88223107	99223107	55223107
20	Solid	0.031	0.096	802031	902031	502031
20	10/30	0.031	0.102	88203110	99203110	55203110
18	Solid	0.031	0.104	801831	901831	501831
18	16/30	0.031	0.111	88183116	99183116	55183116
16	Solid	0.031	0.115	801631	901631	501631
16	26/30	0.031	0.126	88163126	99163126	55163126
14	Solid	0.031	0.129	801431	901431	501431
14	41/30	0.031	0.142	88143141	99143141	55143141
12	65/30	0.031	0.162	88123165	99123165	55123165

NOTE — All wire available with an overbraid. Add suffix to Part No. to indicate required overbraid.

Overbraid	Suffix	Approximate O.D. Increase
Cotton	"C"	0.030
Rayon	"R"	0.015
Glass	"G"	0.015

OTHER FAMOUS TURBO INSULATING PRODUCTS

- TURBOZONE** — Low temperature plastic tubing
- TURBOLEX** — General purpose plastic tubing
- TURBO "PE"** — High frequency plastic tubing
- TURBOTHERM 1DS** — High temperature (105°C) plastic tubing
- TURBOTRANS 1DS** — Special high temperature (105°C) plastic tubing
- PLASBRAID** — Overbraided polyvinyl tubing
- TURBOSIL** — High temperature (200°C) silicone varnish impregnated glass-braid tubing
- TURBO MARKERS** — Long-life slip-on identification markers for electrical uses
- TURBO INSULATED WIRES**
- TURBO WIRE MARKERS**
- TURBO EXTRUDED TUBING**
- TURBO GLASS SLEEVING AND TUBING**
- TURBO VARNISHED SATURATED SLEEVING & TUBING**
- TURBO CAMBRIC CLOTHS, TAPES, PAPERS**
- TURBO MICA**



BIRNBACH TOGGLE SWITCHES

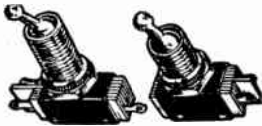

A very small, high grade UL approved switch. Well adapted for use on small motors, radio and electronic devices. Rated at 3 amps. at 125 volts. Mfd. by H. & H. for Birnbach. SPST Switches rated at 3 amps 250 volts, 6 amps 125 volts. Switches nickel plated and supplied with ring and mounting nut. Laminated type.

Cat. No.	Description	Shank Length	Std. Pkge.
6200	SPST	15/32"	25
6201	SPST	3/4"	25
6202	SPDT	15/32"	25
6203	SPDT	3/4"	25
6204	DPST	15/32"	25
6205	DPST	3/4"	25
6206	DPDT	15/32"	25
6207	DPDT	3/4"	25
6208	ON-OFF Toggle Switch	Plates Only	10

BIRNBACH BAT HANDLE TOGGLE SWITCHES



Available in nickel-plated finish and supplied with ring and mounting nut. Made by H. & H. for Birnbach. Rated at 3 amps 125 volts. SPST switches rated at 3 amps 250 volts, 6 amps 125 volts. Laminated type. UL approved.

Cat. No.	Description	Shank Length	Std. Pkge.
6220	SPST	15/32"	25
6221	SPDT	15/32"	25
6222	DPST	15/32"	25
6223	DPDT	15/32"	25

BIRNBACH POWER SWITCH

DPST switch rated at 12 amps at 125 volts per pole. When a single pole switch is required, the rating can be doubled. The push button power switch has the same rating. Primarily intended as a safety switch to be used as an interlock connection on doors of dangerous high voltage devices. Mfd. by H. & H. for Birnbach. UL approved.

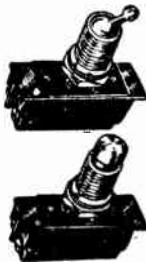

Cat. No.	Description	Std. Pkge.
6225	Toggle Switch	25
6226	Push Button Switch	25

SMALL APPLIANCE SWITCH



Rated high—3 amps. at 250 volts; 6 amps. at 125 volts. Small molded compact switch 15/32" shank; brass nickel plated with solder lugs and complete with hex nut and ring. One hole mounting. UL approved.

Cat. No.	Descrip.	Std. Pkge.
6244	SPST	25

CANOPY SWITCH

Has a 3 amp., 125 volts; 1 amp., 250 volts rating. 6" leads. CSA approved.



Cat. No.	Std. Pkge.
6249	Canopy Switch . . . 50

HEAVY DUTY POWER SWITCH



Recommended for use in transmitters, amplifiers, movie equipment and motors where heavy currents are carried. Made by H. & H. for Birnbach. Nickel plated and rated 10 amps., 125 volts. Neutral off in center position. Mounting sleeve diam. 3/4". UL approved.

Cat. No.	Description	Size	Std. Pkge.
6227	DPDT	2"x1 1/4"x 7/8"	25
6228	3PDT	2"x2 1/4"x1"	25
6229	4PDT	2"x2 3/4"x1"	10

BIRNBACH DPDT CENTER OFF SWITCH



Rated at 1 amp., 125 volts. Has lug terminal with bat handle. 15/32" diam. shaft, nickel plated.

6243	St. Pkge.	25
------	-----------	----

BIRNBACH PUSH BUTTON SWITCH Momentary Contact

Made by H. & H. for Birnbach. Slow make and quick break. Laminated type with solder lugs. Has 9/16" slotted sleeve, 15/32" diam. Complete with 1 hex nut and one knurled nut. Rated 1 amp., 125 volts. UL approved. Nickel plated.



Cat. No.	Description	Std. Pkge.
6224	Two Circuit	25
6230	SPST Normally Closed, Push to Break	25
6231	DPST Normally Open, Push to Make	25
6232	Button Only, Red or Black	20

MOMENTARY PUSH BUTTON SWITCH



Molded momentary push button switch with solder lugs. Rated at 1 amp., 125 volts. With 15/32" shank. Normally OFF—push to make. Nickel plated.

Cat. No.	Description	Std. Pkge.
6233	SPST	25
6234	SPDT	25
6235	DPST	25
6236	DPDT	25

BIRNBACH SLIDE LEVER SWITCH



Popular for phonographs, tone controls, auto lights, test instruments. Rated at 4 amps., 125 volts A.C. 1/2" wide by 1 1/4" long. Mounting centers 1 1/4".

Cat. No.	Description	Std. Pkge.
6245	SPST	25
6246	SPDT	25
6247	DPST	25
6248	DPDT	25

BIRNBACH ROTARY SWITCHES



Made by H. & H. for Birnbach. Rated at 1 amp., 250 volts; 3 amps., 125 volts. Nickel plated and supplied with mounting nut. UL approved.

Cat. No.	Description	Shank Length	Overall Length of Shaft Incl. Shank	Std. Pkge.
6210	SPST	3/8"	1 1/2"	25
6211	SPST	1/2"	2 1/2"	25
6212	SPDT	3/8"	1 1/2"	25
6213	SPDT	1/2"	2 1/2"	25
6214	DPST	3/8"	1 1/2"	25
6215	DPST	1/2"	2 1/2"	25
6216	DPDT	3/8"	1 1/2"	25
6217	DPDT	1/2"	2 1/2"	25

BIRNBACH KNIFE SWITCHES



Made of special nickel-plated spring brass on a rugged base. Screw terminals located conveniently for easy connections in circuit. Two mounting holes.

Cat. No.	Description	Std. Pkge.
6100	SPST	25
6102	SPDT	20
6103	DPST	10
6104	DPDT	10
6105	TPDT	10

BIRNBACH MOLDED BAT HANDLE TOGGLE SWITCHES

Meets Joint Army and Navy Specifications

JAN-S-23

Made by H. & H. for Birnbach. They meet all Joint Army and Navy Specifications JAN-S-23. Molded with 3/8" Shank length they have back connected lugs and have a bat handle. Maintained contact.



Cat. No.	A.W.S. No.	Description	Shank Length	Std. Pkg.
6250	ST-12-A	SPST	3/8"	25
6251	ST-12-D	SPDT	3/8"	25
6252	ST-22-K	DPST	3/8"	25
6253	ST-22-N	DPDT	3/8"	25

BAT HANDLE "CENTER-OFF" SWITCHES



Molded bakelite case, made by H. & H. three-position center off. Solder lugs. Rated at 3 amps, 250 volts; 6 amps, 125 volts.

Cat. No.	Description	Shank Length	Std. Pkge.
6261	SPDT	15/32"	25
6263	DPDT	15/32"	25

BAKELITE MOLDED MOMENTARY CONTACT SWITCH

Made by H. & H. for Birnbach. Rated at 3 amps., 250 volts; 6 amps, 125 volts. Molded with 15/32" diam. Has momentary contact bat handle. Circuit normally OFF. Used on intercoms. UL approved.



Cat. No.	Description	Shank Length	Std. Pkge.
6241	SPST	15/32"	25
6242	DPDT	15/32"	25

PHONO ATTACHMENT PLUG

To be used with recording and reproducing equipment, record players, etc. Large hole in cap for coaxial cable and extra long pin for new type jacks.



Cat. No.	Std. Pkge.
248	Phono Plug (Long Pin) 100
248S	Phono Plug (Short Pin) 100

PHONO JACK



Designed to fit No. 248 Plug. Positive grip, single prong. Mounted on 3/8" bakelite. 3/8" mounting centers.

Cat. No.	Std. Pkge.
249	Phono Jack 100

DUAL PHONO JACK



Used on phono players and recording units, etc., where dual application is needed.

Mounted on 3/8" bakelite. Double mounting holes are spaced 1/2" x 1 1/8". 3/8" center to center of jacks.

Cat. No.	Std. Pkge.
T250	Dual Phono Jack 100

Birnbach

GOV'T. SPECIFICATION HOOKUP WIRE JAN-C-76 SRIR — SRIR SHIELDED — SRHV 105° C. UL APPROVED

TYPE SRIR — 1000-VOLT (Fungus Proof)

The following items meet all requirements of Army-Navy joint specifications JAN-C-76 Type SRIR for thermoplastic plain resin construction where highest resistance to fungus growth is required. Has high dielectric strength, high temperature stability, low temperature flexibility, low moisture absorption, high flame resistance; resists all common solvents.

SPEC. JAN-C-76

Cat. No.	Spool	Size AWG	JAN-C-76 Type Designation*	Conductor Construction	Nom. Wall	Nom. DC Ins. Res./Ft. - Megs	Nom. Break-down Voltage 60 Cycles	O.D.
7024	1000'	24	2 5(16)-24	16/36	.015"	5000	8000	.054"
7024-1	100'	24	2 5(16)-24	16/36	.015"	5000	8000	.054"
7001	1000'	22	3 5(7)-22	7/30	.017"	5000	8000	.069"
7001-1	100'	22	3 5(7)-22	7/30	.017"	5000	8000	.069"
7003	1000'	20	1 (10)-20	10/30	.017"	5000	8000	.077"
7003-1	100'	20	1 (10)-20	10/30	.017"	5000	8000	.077"
7005	1000'	18	1-1/2 (16)-18	16/30	.017"	5000	8000	.077"
7005-1	100'	18	1-1/2 (16)-18	16/30	.017"	5000	8000	.086"
7007	1000'	16	2-1/2 (26)-16	26/30	.017"	5000	8000	.086"
7007-1	100'	16	2-1/2 (26)-16	26/30	.017"	5000	8000	.098"
7009	1000'	14	4 (41)-14	41/30	.033"	7500	12000	.098"
7009-1	100'	14	4 (41)-14	41/30	.033"	7500	12000	.148"
7011	1000'	12	6 (65)-12	65/30	.033"	7500	12000	.148"
7011-1	100'	12	6 (65)-12	65/30	.033"	7500	12000	.171"
7015-1	100'	8	17(133)-8	133/29	.051"	7500	12000	.171"

SOLID

7000	1000'	22	3 5(1)-22	.0253 Solid	.017"	5000	8000	.064"
7000-1	100'	22	3 5(1)-22	.0253 Solid	.017"	5000	8000	.064"
7002	1000'	20	1(1)-20	.032 Solid	.017"	5000	8000	.071"
7002-1	100'	20	1(1)-20	.032 Solid	.017"	5000	8000	.071"
7004	1000'	18	1-1/2(1)-18	.0403 Solid	.017"	5000	8000	.079"
7004-1	100'	18	1-1/2(1)-18	.0403 Solid	.017"	5000	8000	.079"

COLORS:

Black	Green	White
Brown	Blue	Dark Blue
Red	Violet (Purple)	Pink
Orange	Gray (Slate)	Tan
Yellow		

In addition to the standard colors we can furnish #7001†, #7003† and #7005† in the following spiral Tracer Colors (Add "S" to Catalog Number):
Wh/Black Wh/red Wh/yellow Wh/blue Wh/gray
Wh/brown Wh/orange Wh/green Wh/purple
†Add \$3.00 to List Price for Single Spiral Tracer Wire.

TYPE SRIR — SHIELDED — Spec. JAN-C-76 HOOK-UP WIRE SHIELDED (TINNED COPPER)

Cat. No.	Spool	Size AWG	JAN-C-76 Type Designation*	Stranding	Nom. Wall	Diam.
7074	1000'	24	2 5(16)-24	16/36	.015"	.076"
7072	1000'	22	3 5(7)-22	7/30	.017"	.089"
7070	1000'	20	1(10)-20	10/30	.017"	.097"
7068	1000'	18	1-1/2(16)-18	16/30	.017"	.106"
7067	1000'	16	2-1/2(26)-16	26/30	.017"	.118"

COLORS: Black White Red Yellow Brown Green Blue

TYPE SRHV (THERMOPLASTIC) HOOK-UP WIRE STRANDED

Cat. No.	Spool	Size AWG	JAN-C-76 Type Designation*	Stranding	Nom. Wall	Nom. DC Ins. Res. Meg/Ft	Nom. Breakdown Volt. 60 Cycles	Max. Diam. (Inches)
7322	1000'	22	3 5(7)-22	7/30	.033	7500	12000	.105
7322-1	100'	22	3 5(7)-22	7/30	.033	7500	12000	.105
7320	1000'	20	1(10)-20	10/30	.033	7500	12000	.113
7320-1	100'	20	1(10)-20	10/30	.033	7500	12000	.113
7318	1000'	18	1-1/2(16)-18	16/30	.033	7500	12000	.122
7318-1	100'	18	1-1/2(16)-18	16/30	.033	7500	12000	.122
7316	1000'	16	2-1/2(26)-16	26/30	.033	7500	12000	.134
7316-1	100'	16	2-1/2(26)-16	26/30	.033	7500	12000	.134
7314	1000'	14	4(41)-14	41/30	.033	7500	12000	.152
7314-1	100'	14	4(41)-14	41/30	.033	7500	12000	.152
7312	1000'	12	6(65)-12	65/30	.033	7500	12000	.172
7312-1	100'	12	6(65)-12	65/30	.033	7500	12000	.172

COLORS: Black Brown Red Orange Yellow Green Blue Purple Gray White

BIRNBACH THERMOPLASTIC INSULATED HOOK-UP WIRE 105° C. — 600-VOLT RATING UL APPROVED

Especially designed for the chassis, sub chassis wiring of radio and television receivers and transmitters inside or outside the chassis. UL approved for 105°C. (221°F.) operating temperature. Has high electrical characteristics. All wires are annealed tinned copper.

Cat. No.	Spool	AWG	Stranding	Nom. Wall	Volt. Breakdown	DC Ins. Res. Megs/Ft.	Max. O.D. Inches
7201	1000'	22	7/30	.032	18000	5000	.100
7201-1	100'	22	7/30	.032	18000	5000	.100
7203	1000'	20	10/30	.032	18000	5000	.104
7203-1	100'	20	10/30	.032	18000	5000	.104
7205	1000'	18	16/30	.032	18000	5000	.112
7205-1	100'	18	16/30	.032	18000	5000	.112
7207	1000'	16	26/30	.032	18000	5000	.129
7207-1	100'	16	26/30	.032	18000	5000	.129
7202	1000'	22	Solid	.032	18000	5000	.095
7202-1	100'	22	Solid	.032	18000	5000	.095
7204	1000'	20	Solid	.032	18000	5000	.102
7204-1	100'	20	Solid	.032	18000	5000	.102

COLORS: Black Red Green Yellow Blue Brown White Orange Gray Purple

Birnbach

GOV'T. SPECIFICATION HOOKUP WIRE JAN-C-76 WL — NYLON JACKET — GLASS BRAID HIGH VOLTAGE CRT LEAD WIRE

JAN TYPE of DESIGNATION * SAMPLE

(For all Government Specification HOOKUP WIRES on this page and preceding page.)

3/5	(7)	22	90
SIZE (Approx. Cir. Mils)	MINIMUM STRANDS	AWG SIZE	COLOR CODE
0. BLACK	3. ORANGE		1st Digit Rep.
1. BROWN	4. YELLOW		2nd Digit Rep.
2. RED	5. GREEN		resents Tracer
	6. BLUE		resents Tracer
	7. VIOLET (purple)		resents Tracer
	8. GRAY (slate)		
	9. WHITE		

Hookup Wire with no outer covering shall be designated by the letter "U".
Hookup Wire with an outer covering, either braid or jacket, shall be designated by the letter "C".

AIRCRAFT WIRE

MIL-W-5086

(Supersedes AN-J-C-48A)

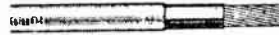

Construction: Tinned Copper Polyvinyl Chloride Ins. Extruded Nylon Jacket Overall.

Cat. No.	Spool	Size AWG	Stranding	O.D.
7351	1000'	22	19/34	.085"
7353	1000'	20	19/32	.095"
7355	1000'	18	19/30	.104"
7357	1000'	16	19/28	.115"

MIL-C-7078

(Supersedes AN-C-168)



Same as MIL-W-5086, but with tinned copper shield overall.

Cat. No.	Spool	Size AWG	O.D.
7371	1000'	22	.110"
7372	1000'	20	.120"
7373	1000'	18	.129"
7374	1000'	16	.139"

Available in White.

TYPE WL — EXTRUDED NYLON JACKET HOOK-UP WIRE (Fungus Proof)



SPEC. JAN-C-76

Cat. No.	Spool	Size AWG	JAN-C-76 Type Designation*	Stranding	Nom. Wall	Nom. DC Ins. Res. Meg/Ft	Nom. Breakdown Volt. 60 Cycles	Max. Diam. (Inches)
7224	1000'	24	2 5(16)-24	16/36	.012"	1000	5000	.067
7224-1	100'	24	2 5(16)-24	16/36	.012"	1000	5000	.067
7222	1000'	22	3 5(7)-22	7/30	.012"	1000	5000	.073
7222-1	100'	22	3 5(7)-22	7/30	.012"	1000	5000	.073
7220	1000'	20	1(7)-20	7/28	.012"	1000	5000	.081
7220-1	100'	20	1(7)-20	7/28	.012"	1000	5000	.081
7218	1000'	18	1 1/2(7)-18	7/26	.013"	1000	5000	.092
7218-1	100'	18	1 1/2(7)-18	7/26	.013"	1000	5000	.092
7216	1000'	16	2 1/2(19)-16	19/29	.015"	1000	5000	.108
7216-1	100'	16	2 1/2(19)-16	19/29	.015"	1000	5000	.108
7214	1000'	14	4(19)-14	19/27	.018"	1000	5000	.132
7214-1	100'	14	4(19)-14	19/27	.018"	1000	5000	.132
7212	1000'	12	6(19)-12	19/25	.018"	1000	5000	.152
7212-1	100'	12	6(19)-12	19/25	.018"	1000	5000	.152
7210	1000'	10	9(37)-10	37/26	.020"	1000	5000	.179
7210-1	100'	10	9(37)-10	37/26	.020"	1000	5000	.179

COLORS:

White	Orange	Purple	Wh/Red	Wh/Blue	Wh/Black/Yellow	Wh/Bk/Orange
Black	Yellow	Gray	Wh/Orange	Wh/Purple	Wh/Bk/Blue	Wh/Bk/Brown
Brown	Green	Wh/Black	Wh/Yellow	Wh/Gray	Wm/Bk/Green	Wh/Bk/Gray
Red	Blue	Wh/Brown	Wh/Green	Wh/Bk/Red		

IN ADDITION Sizes 7218, 7220, 7222 can be furnished in red/black and black/white.

SPEC. JAN-C-76

TYPE WL GLASS BRAID — 600-VOLT (Fungus Proof)



Extensively used on electronic devices, aircraft instruments, lighting and power, transmitters, radar, etc. Constructed of one conductor, stranded copper tinned, high heat vinyl insulation, glass braid with a heavily lacquered coating which is fungus proof and flame resistant.

Cat. No.	Spool	Size AWG	JAN-C-76 Type Designation*	Stranding	Nom. Wall	Nom. DC Ins. Res./Ft. - Megs	Nom. Break-down Voltage 60 Cycles	O.D.
7022	1000'	22	3 5(7)-22	7/30	.012"	1000	5000	.077"
7022-1	100'	22	3 5(7)-22	7/30	.012"	1000	5000	.077"
7020	1000'	20	1(10)-20	10/30	.012"	1000	5000	.085"
7020-1	100'	20	1(10)-20	10/30	.012"	1000	5000	.085"
7018	1000'	18	1 1/2(16)-18	16/30	.013"	1000	5000	.096"
7018-1	100'	18	1 1/2(16)-18	16/30	.013"	1000	5000	.096"
7016	1000'	16	2 1/2(26)-16	26/30	.015"	1000	5000	.112"
7016-1	100'	16	2 1/2(26)-16	26/30	.015"	1000	5000	.112"

COLORS:

White	Orange	Purple	White/Red	White/Blue	White/Black/Yellow	White/Black/Orange
Black	Yellow	Gray	White/Orange	White/Purple	White/Black/Blue	White/Black/Brown
Brown	Green	White/Black	White/Yellow	White/Black/Red	White/Black/Green	White/Black/Gray
Red	Blue	White/Brown	White/Green			

HIGH VOLTAGE & CATHODE-RAY TUBE LEAD CABLE



This High Voltage and Cathode Ray Tube Lead Wire is approved for 10,000, 20,000, and 40,000 volt applications. It is made of RULAN (flame retarding type Polyethylene) which is high heat resistant and moisture resistant. Approved by A.S.T.M. It has a dielectric constant of 2.7 and a power factor of .002. Available in white.

Cat. No.	Spool	Size	Stranding	Nom. Wall	DC Voltage	Max. DC Voltage	Approx. O.D.
7402	1000'	20	10/30	.046"	10,000	10,000	.125
7402-1	100'	20	10/30	.046"	10,000	10,000	.125
7412	1000'	20	10/30	.068"	20,000	20,000	.169
7412-1	100'	20	10/30	.068"	20,000	20,000	.169
7418	1000'	18	16/30	.047"	10,000	10,000	.135
7418-1	100'	18	16/30	.047"	10,000	10,000	.135
7428	1000'	18	16/30	.069"	20,000	20,000	.179
7428-1	100'	18	16/30	.069"	20,000	20,000	.179
7448	1000'	18	16/30	.095"	40,000	40,000	.231
7448-1	100'	18	16/30	.095"	40,000	40,000	.231



BIRNBACH BIRNTEX SLIPBACK WIRE

This wire is constructed of quality materials and carefully insulated with a cotton wrap over which a cotton braid is closely woven, and then saturated with paraffin. Pushes back easily.

COLORS: Black, Red, Blue, Yellow, Green, White, Brown, Yellow.

SOLID

Cat. No.	Put-up Ft.	Size	Strands	Puncture V. 60 Cy.	AC	O.D.
70	25 Coil	22	Solid	1500	.060	
72	100 Spool	22	Solid	1500	.060	
74	500 Spool	22	Solid	1500	.060	
76	1000 Spool	22	Solid	1500	.060	
80	25 Coil	20	Solid	1500	.065	
84	100 Spool	20	Solid	1500	.065	
88	500 Spool	20	Solid	1500	.065	
92	1000 Spool	20	Solid	1500	.065	
82	25 Coil	18	Solid	1500	.075	
86	100 Spool	18	Solid	1500	.075	
90	500 Spool	18	Solid	1500	.075	
94	1000 Spool	18	Solid	1500	.075	

STRANDED

71	25 Coil	22	7/30	1500	.065	
73	100 Spool	22	7/30	1500	.065	
75	500 Spool	22	7/30	1500	.065	
77	1000 Spool	22	7/30	1500	.065	
81	25 Coil	20	10/30	1500	.070	
85	100 Spool	20	10/30	1500	.070	
89	500 Spool	20	10/30	1500	.070	
93	1000 Spool	20	10/30	1500	.070	
83	25 Coil	18	16/30	1500	.080	
87	100 Spool	18	16/30	1500	.080	
91	500 Spool	18	16/30	1500	.080	
95	1000 Spool	18	16/30	1500	.080	

BIRNBACH KINKLESS TEST LEAD WIRE

An extremely flexible wire with a wall of abrasion resisting live rubber that will not kink or break down in service under rough usage and repeated bendings. Has found wide use in laboratory test equipment, analyzers, oscillators, etc.

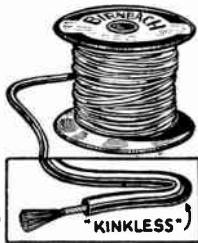

Cat. No.	Spool Ft.	Size	Strand- ing	Insul.	Breakdown 60 Cycles	O.D.
61	100	20	41/36	3/64	12,000	.140
62	500	20	41/36	3/64	12,000	.140
66	100	18	66/36	3/64	12,000	.150
67	500	18	66/36	3/64	12,000	.150

High Voltage Kinkless Test Lead Wire

68	100	18	66/36	5/64	16,500	.210
69	500	18	66/36	5/64	16,500	.210

COLORS: Red and Black

VARNISHED CAMBRIC WIRE



Widely used in automotive wiring because of oil and waterproof construction. Consists of tinned stranded conductor with two layers of varnished cambric over which a lacquered cotton braid is woven.

Cat. No.	Spool Ft.	Size	Stranding	Puncture V.	O.D.
3420	100	20	10/30	1000	.094
3418	100	18	16/30	1000	.097
3416	100	16	26/30	1000	.108

BIRNBACH RADEX SLIPBACK HOOKUP WIRE

It has a cotton serve with double cotton braid overall, and dipped into paraffin. This construction will not cause the cotton insulation to fray or bunch up when pushed back. It has a high dielectric strength and will withstand all climatic changes without breakdown.



SOLID

Cat. No.	Put-up Ft.	Size	Strands	Puncture V. 60 Cy.	AC	O.D.
280	25 Coil	20	Solid	2000	.090	
380	100 Spool	20	Solid	2000	.090	
480	500 Spool	20	Solid	2000	.090	
580	1000 Spool	20	Solid	2000	.090	
282	25 Coil	18	Solid	2100	.098	
382	100 Spool	18	Solid	2100	.098	
482	500 Spool	18	Solid	2100	.098	
582	1000 Spool	18	Solid	2100	.098	
284	25 Coil	16	Solid	2100	.108	
384	100 Spool	16	Solid	2100	.108	
484	500 Spool	16	Solid	2100	.108	
584	1000 Spool	16	Solid	2100	.108	
286	25 Coil	14	Solid	2100	.122	
386	100 Spool	14	Solid	2100	.122	
486	500 Spool	14	Solid	2100	.122	
586	1000 Spool	14	Solid	2100	.122	
288	25 Coil	12	Solid	2200	.135	
388	100 Spool	12	Solid	2200	.135	
488	500 Spool	12	Solid	2200	.135	
588	1000 Spool	12	Solid	2200	.135	

STRANDED

281	25 Coil	20	10/30	2100	.093	
381	100 Spool	20	10/30	2100	.093	
481	500 Spool	20	10/30	2100	.093	
581	1000 Spool	20	10/30	2100	.093	
283	25 Coil	18	16/30	2200	.103	
383	100 Spool	18	16/30	2200	.103	
483	500 Spool	18	16/30	2200	.103	
583	1000 Spool	18	16/30	2200	.103	
285	25 Coil	16	26/30	2200	.118	
385	100 Spool	16	26/30	2200	.118	
485	500 Spool	16	26/30	2200	.118	
585	1000 Spool	16	26/30	2200	.118	
287	25 Coil	14	41/30	2200	.135	
387	100 Spool	14	41/30	2200	.135	
487	500 Spool	14	41/30	2200	.135	
587	1000 Spool	14	41/30	2200	.135	
289	25 Coil	12	65/30	2300	.155	
389	100 Spool	12	65/30	2300	.155	
489	500 Spool	12	65/30	2300	.155	
589	1000 Spool	12	65/30	2300	.155	

COLORS: Black, Red, Blue, Yellow, Green, White, Brown, Orange.

RAYON BRAID LACQUERED WIRE



Constructed of stranded tinned copper with heavy wall of live rubber over which is woven a rayon braid and a high gloss lacquered finish over braid. Easy to solder and strip.

Cat. No.	Spool Ft.	Size	Strand- ing	Insul.	Volts Res.	DC Ins. Ft.	Punc. Res. Ft.
3425	25	18	16/30	1/32	9000	460	.125
3450	50	18	16/30	1/32	9000	460	.125
3460	100	18	16/30	1/32	9000	460	.125
3500	500	18	16/30	1/32	9000	460	.125

BIRNBACH HI VOLTAGE LACQUERED PRIMARY WIRE



Recommended for use as leads for wiring high voltage devices, auto head, tail, dashboard, lamps, horns, spotlight, instrument leads and for all primary voltage applications. Constructed of soft drawn, tinned copper, with a wall of rubber and covered with a highly lacquered cotton braid, making it oil, heat and moisture resistant.

Cat. No.	Spool Ft.	Size	Strand- ing	Insul.	Puncture V.	O.D.
2818	100	18	16/30	1/32	9500	.125
2816	100	16	26/30	1/32	9500	.140
2814	100	14	41/30	1/32	9500	.170
2812	100	12	19/25	1/32	9500	.190
2810	100	10	19/23	1/32	9500	.208

BIRNBACH SPECIAL SPOOL ASSORTMENT



FREE DISPLAY

One Display is given with each initial order for 100 spools. Each Display made of strong, reinforced steel, mahogany crackle finish with attractive 3 color Display at top. Space provided to indicate YOUR resale price. Extra Display Racks available.

Cat. No.	Ft.	Size	Type
3000	65	22	Solid Pushback
3001	55	20	Solid Pushback
3002	45	18	Solid Pushback
3003	35	16	Solid Pushback
3004	30	14	Solid Pushback
3005	55	22	Stranded Pushback
3006	45	20	Stranded Pushback
3007	40	18	Stranded Pushback
3008	30	16	Stranded Pushback
3009	20	11	Stranded Pushback
3010	50	18	Colored Rubber
3011	35	16	Colored Rubber
3012	30	14	Stranded Leadin
3013	60	18	Solid Leadin
3014	65	18	Stranded Leadin
3015	35	18	Stranded Lacquered
3016	75	18	Brown & White AC-DC Wire
3017	30	18	Kinkless Wire
3018	20	18	Twisted Lamp Cord
3019	35	18	Single Fix. Wire
3020	15	18	Parallel Silk
3021	15	18	Blk. Whit. Brn Zip Cord
3022	100	18	Solid Tinned
3023	75	18	Hell Wire
3024	15	20	Phono Pickup Wire

STRANDED COLORED RUBBER WIRE



Annealed stranded tinned copper conductors with a cotton wrap, and insulated with a special grade of non-cracking live colored rubber compound. It strips readily.

Cat. No.	Ft.	Size	Strand- ing	Carrying Capacity Amps.	Punct. Volt. 60 Cy.	O.D.
1225	1000	18-1/64	16/30	3	5500	.087
446	50	16-1/32	26/30	6	8000	.135
1440	100	16-1/32	26/30	6	8000	.135
2440	500	16-1/32	26/30	6	8000	.135

COLORS: Red, Black, White, Brown, Green

FILAMENT WIRE (High Amperage)

782	25	14-1/32	26/28	15	8500	.148
786	500	14-1/32	26/28	15	8500	.148
784	25	12-3/64	41/28	20	12,000	.190
787	500	12-3/64	41/28	20	12,000	.190

COLORS: Red and Black

RG59/U-72 OHM COAXIAL CABLE



Low impedance assures efficient transfer of energy with negligible interference from local noise, auto ignition and other electrical disturbances.

Attenuation—D.B. per 100 ft.

IOMC	30MC	100MC	300MC	400MC	3000MC
1.0	2.0	3.8	7.0	8.9	29

Nominal Impedance 72
Nominal Capacitance MMF/Ft. 21

Cat. No.	Spool	Length	Pkgs.
907	100 ft. spool		10
908	250 ft. spool		4
909	500 ft. spool		4
910	1000 ft. reel		1



BIRNBACH RUBBER SHIELDED MICROPHONE CABLE

Used for indoor and outdoor crystal, carbon and condenser mikes and for all sound systems. Consists of extra flexible tinned copper conductors, each insulated with a wall of .022 low capacity rubber, color coded, twisted, cotton fillers, braided tinned copper shielding, cotton wrap with a tough weatherproof black rubber jacket overall which will withstand hard and rough usage.



Microphone Cable Color Coding Chart
 1—Black; 2—White; 3—Red; 4—Green;
 5—Yellow; 6—Blue; 7—Brown; 8—Orange

Cap. Bet. Shield Cap. and Bet.

Cat. No.	Spool No.	Ft.	Conds.	Size	Strand- ing	Cond. mmmf	O.D.	
772	100	2	20	.26/34	.50	.40	.280	
772	250	2	20	.26/34	.50	.40	.280	
772	18	100	2	.18	.41/34	.55	.45	.300
773	100	3	20	.26/34	.55	.38	.290	
773	18	100	3	.18	.41/34	.60	.38	.350
1773	250	3	20	.26/34	.55	.38	.290	
774	100	4	20	.26/34	.60	.30	.300	
1774	250	4	20	.26/34	.60	.30	.300	
775	100	5	20	.26/34	.60	.31	.330	
1775	250	5	20	.26/34	.60	.31	.330	
776	100	6	20	.26/34	.60	.30	.350	
1776	250	6	20	.26/34	.60	.30	.350	
777	100	7	20	.26/34	.60	.30	.365	
1777	250	7	20	.26/34	.60	.30	.365	
778	100	8	20	.26/34	.60	.30	.390	

LONGER LENGTHS AVAILABLE

BIRNBACH RUBBER MULTIPLE CONDUCTOR CABLES



(Not Shielded)

Used for permanent or portable PA systems, sound recording, indoor and outdoor speakers where it will stand up under all weather conditions and rough usage. Consists of No. 20 Stranded 26/34 flexible tinned copper cotton wrap, .022 low capacity rubber color coded, twisted, cotton filler, cotton wrap with a tough rubber jacket overall.

MULTIPLE CABLE COLOR CODING CHART
 1—Black; 2—White; 3—Red; 4—Green;
 5—Yellow; 6—Blue; 7—Brown; 8—Orange

Cap. Bet. Conds.

Cat. No.	Spool No.	Ft.	Conds.	Size	Stranding	mmf	O.D.
788	100	2	20	.26/34	.22	.275	
789	250	2	20	.26/34	.22	.275	
789	100	3	20	.26/34	.20	.285	
791	250	3	20	.26/34	.20	.285	
792	100	4	20	.26/34	.18	.305	
793	250	4	20	.26/34	.18	.305	
794	100	5	20	.26/34	.16	.335	
795	250	5	20	.26/34	.16	.335	
796	100	6	20	.26/34	.15	.355	
797	250	6	20	.26/34	.15	.355	
798	100	7	20	.26/34	.15	.370	
749	100	8	20	.26/34	.14	.395	

LONGER LENGTHS AVAILABLE

BIRNBACH RUBBER SERVICE CORD



Heavy Duty U.L. Approved

For power line requirement where rough usage is indicated as for amplifiers, speakers, vacuum cleaners, tools, refrigerators, washing machines, trouble lights, etc. All color coded. Underwriters approved.

Amp. Volt Rat- ing

Cat. No.	Spool No.	Ft.	Cds	Size	Type	Rat- ing	O.D.
701	250	2	18	.SV	41/34	7	.300
574	250	2	18	.SJ	41/34	7	.300
578	250	2	16	.SJ	65/34	10	.300
702	250	2	18	.S	41/34	7	.300
703	250	2	16	.S	65/34	10	.300
704	250	2	14	.S	41/30	15	.600
705	250	2	12	.S	65/30	20	.600

Longer lengths and additional conductors also available.

CRYSTAL MICROPHONE CABLE



Used with crystal, dynamic, velocity, ribbon microphones, and photoelectric cells. Birnbach No. 870 used widely for lapel microphones and phono pickups. Constructed of extra flexible, stranded, tinned copper, cotton serve—insulated with new low loss rubber compound, braided tinned copper shield cotton serve and covered with tough black rubber jacket.

Cap. Bet. Shield Cap. and Bet.

Cat. No.	Spool No.	Ft.	Conds.	Size	Strand- ing	Cond. mmmf	O.D.
870	100	1	20	.26/34	.40	.175	
1870	250	1	20	.26/34	.40	.175	
872	100	1	20	.26/34	.30	.245	
1872	250	1	20	.26/34	.30	.245	

LONGER LENGTHS AVAILABLE

BIRNBACH MULTIPLE CONDUCTOR FLEXIBLE CABLE



(Cotton Braid Overall)

Constructed of individual 1/64 rubber wall No. 20 stranded, tinned cotton braid; color coded; conductors twisted and with a closely woven brown cotton braid overall. Used widely for P.A. systems, analyzers, remote control units, etc.

COLOR CODING CHART
 1—Black, 2—White, 3—Red, 4—Green,
 5—Orange, 6—Blue, 7—Brown,
 8—Yellow, 9—White/Black Tracer
 10—Red/Black Tracer,
 11—Green/Black Tracer
 12—Orange/Black Tracer

Cat. No.	Spool No.	Ft.	Conds.	Size	Stranding	Rubber Insul.	O.D.
172	100	2	20	.10/30	.1/64	.205	
173	100	3	20	.10/30	.1/64	.245	
174	100	4	20	.10/30	.1/64	.265	
175	100	5	20	.10/30	.1/64	.290	
176	100	6	20	.10/30	.1/64	.310	
177	100	7	20	.10/30	.1/64	.325	
178	100	8	20	.10/30	.1/64	.350	
179	100	9	20	.10/30	.1/64	.395	
180	100	10	20	.10/30	.1/64	.425	
182	100	12	20	.10/30	.1/64	.440	

LONGER LENGTHS AVAILABLE

MULTIPLE CONDUCTOR THERMOPLASTIC CABLE



(Cotton Braid Overall)

Constructed of individual No. 22 stranded tinned copper, 1/64 thermoplastic insulation, color coded; conductors twisted with brown cotton braid overall. Used widely for P.A. systems, remote control units, multiple circuit hookups and whenever a small diameter cable is indicated.

COLOR CODING CHART
 1—Black, 2—White, 3—Red, 4—Green,
 5—Orange, 6—Blue, 7—Brown,
 8—Yellow, 9—Purple, 10—Pink,
 11—Gray, 12—Dk. Blue.

Cat. No.	Spool No.	Ft.	Conds.	Size	Stranding	Thermoplastic Insul.	O.D.
263	100	3	22	.7/30	.1/64	.165	
264	100	4	22	.7/30	.1/64	.175	
265	100	5	22	.7/30	.1/64	.200	
266	100	6	22	.7/30	.1/64	.215	
267	100	7	22	.7/30	.1/64	.235	
268	100	8	22	.7/30	.1/64	.250	
269	100	9	22	.7/30	.1/64	.265	
270	100	10	22	.7/30	.1/64	.300	
272	100	12	22	.7/30	.1/64	.330	

LONGER LENGTHS AVAILABLE

BIRNBACH SHIELDED MULTI-CONDUCTOR CABLE



THERMOPLASTIC INSULATION TINNED SHIELD OVERALL 500 FT. SPOOLS

Cap./Ft. and Bet. Cond. Cap./Ft.

Cat. No.	No. of Conds.	Size	Strand- ing	Ins. Shield	Cond. O.D.		
972S	2	.20	.10/30	.1/64	.50	.28	.170
973S	3	.20	.10/30	.1/64	.48	.21	.192

WAXED COTTON BRAID OVER SHIELD

Cat. No.	No. of Conds.	Size	Strand- ing	Ins. Shield	Cond. O.D.		
972B	2	.20	.10/30	.1/64	.50	.28	.180

LONGER LENGTHS AVAILABLE

BIRNBACH SHIELDED TWO WIRE SPEAKER CABLE



Used widely for master control sound systems, photo electric circuits, public address systems, etc. The No. 972A consists of 2 conductors twisted No. 18—16/30 tinned copper with a 1/32" wall of color coded low capacity rubber with paper wrap covering the two conductors and a closely woven tinned copper shield overall. The No. 1972A has same construction as the 972A with a waxed cotton braid over the shield.

COLOR CODING CHART
 1—Black; 2—Red

TINNED SHIELD OVERALL 500 FT. SPOOLS

Cat. No.	No. of Conds.	Size	Strand- ing	Ins. Shield	Cond. O.D.		
972A	2	.18	.16/30	.1/32	.65	.23	.250

Tinned Shield with Cotton Braid Overall

Cat. No.	No. of Conds.	Size	Strand- ing	Ins. Shield	Cond. O.D.		
1972A	2	.18	.16/30	.1/32	.65	.23	.275

LONGER LENGTHS AVAILABLE

BIRNBACH SHIELDED MULTI-CONDUCTOR CABLE



(Tinned Braid Overall)

Consists of No. 20, 10/30 flexible tinned copper with 1/64" rubber wall, color coded cotton braid, twisted, with tinned copper shield woven over cable. Generally used indoors to prevent interference pickup on P.A. systems, recording equipment, photo electric circuits, etc. 100 Ft. Spools.

Cap./Ft. and Bet. Cond. Cap./Ft.

Cat. No.	No. of Conds.	Size	Strand- ing	Ins. Shield	Cond. O.D.		
972	2	.20	.10/30	.1/64	.60	.32	.215
973	3	.20	.10/30	.1/64	.55	.30	.220
974	4	.20	.10/30	.1/64	.48	.28	.250
975	5	.20	.10/30	.1/64	.45	.23	.280
976	6	.20	.10/30	.1/64	.40	.20	.315
977	7	.20	.10/30	.1/64	.40	.20	.350
978	8	.20	.10/30	.1/64	.35	.20	.350

LONGER LENGTHS AVAILABLE

COLOR CODING CHART
 1—Black, 2—Red, 3—White, 4—Green,
 5—Brown, 6—Yellow, 7—Blue, 8—Orange

SHIELDED MULTIPLE CONDUCTOR CABLE

(Cotton Braid Overall)

Constructed of individual tinned stranded copper with a 1/64" wall of rubber covered with a colored cotton braid. A tinned copper shield follows and a brown cotton braid covers this cable. 100 Ft. Spools.

Cap./Ft. and Bet. Cond. Cap./Ft.

Cat. No.	No. of Conds.	Size	Strand- ing	Ins. Shield	Cond. O.D.		
1972	2	.20	.10/30	.1/64	.60	.32	.225
1973	3	.20	.10/30	.1/64	.55	.30	.230
1974	4	.20	.10/30	.1/64	.45	.23	.290
1975	5	.20	.10/30	.1/64	.40	.20	.300
1976	6	.20	.10/30	.1/64	.40	.20	.300

LONGER LENGTHS AVAILABLE

COLOR CODING CHART
 1—Black, 2—Red, 3—White, 4—Green,
 5—Brown, 6—Yellow, 7—Blue, 8—Orange

BIRNBACH DIATHERMY CABLE



Especially designed for use with electrotherapy apparatus, charging cable battery lead and underground cable. It is made of size No. 14 stranded double cotton braid and with an extremely flexible special grade of tough, live rubber jacket.

Cat. No.	Spool No.	Ft.	Conds.	Size	Stranding	O.D.
756	100	1	14	.14	.104/34	.300
757	1000	1	14	.14	.104/34	.300



SHIELDED TWISTED PAIR CABLE



Consists of two conductors #24, 16/36 tinned copper, twisted with .015 vinyl insulation color coded and with tinned copper shield overall. For public address systems, phono pickups, sound recording and various electronic circuits. COLOR CODE: Red and Black.

Cat. No.	Spool No.	Ft.	Conds.	Size	Stranding	Insu.	O.D.
826	1000	2	2	24	16/36	.015	1.15

INTER-COM CABLE 3 CONDUCTORS



1 Shielded
2 Unshielded

Used for single shielded wire in station to station wiring in order to eliminate cross talk. Consists of 3 conductors #22 stranded tinned copper wire with vinyl insulation, color coded and twisted— one conductor with tinned copper shield, the other two unshielded; with cotton braid overall.

Cat. No.	Spool No.	Ft.	Conds.	Size	Stranding	Insu.	O.D.
923	500	3	3	22	7/30	.155	

SHIELDED TWISTED PAIR



Cat. No. 822 and 824 are constructed of solid enameled wire with a cotton wrap, color coded cotton braid, twisted pair waxed and bare copper braid woven overall. Cat. No. 825 is composed of two conductors #20 solid tinned copper enamel braid, cotton wrap waxed; color coded and twisted with a bare copper braid shield overall.

Cat. No.	Spool No.	Ft.	Conds.	Size	Stranding	Insu.	O.D.
822	500	2	2	22	Solid	.125	
824	500	2	2	19	Solid	.145	
825	500	2	2	20	Solid	.135	

ARMORED SPEAKER CABLE



Constructed of 2 conductor parallel #18—16/30

ed tinned copper 1/64" wall rubber, color coded cotton braid lacquered, and spiral steel armor overall.

Cat. No.	Spool No.	Ft.	Size	Stranding	Insu.	O.D.
1111	250	18	18	16/30	.155	2.10
1112	500	18	18	16/30	.155	2.10
1113	1000	18	18	16/30	.155	2.10

BIRNBACH SERVICE LINE CORD



Underwriters Approved

Constructed of all rubber parallel UL approved wire with rubber plug on one end and with the other end stripped, tinned and banded ready for use. Available in black and brown.

Cat. No.	Ft.
816	8
817	7 1/2
819	10



BIRNBACH HEAVY DUTY SERVICE CORD

UL APPROVED

A heavy rubber jacketed cable, Underwriters Approved for replacement in refrigerators, washing machines and electrical appliances. Cat. Nos. 309 and 312 consist of 2 No. 18 S.V. Stranded Conductors with a soft rubber plug at one end; the other end is stripped and tinned ready for use. Cat. No. 248 consists of 8 ft. 2 Cond. No. 16 S.J. all rubber banded, stripped and tinned with all rubber plug.

Cat. No.	Conds.	Ft.	Type	Stranding	O.D.
348	2	8	SJ	65/84	.325
309	2	9	SV	41/34	.250
312	2	12	SV	41/34	.250

TINNED COPPER SHIELDING



Very flexible, slides over wires and cables. For bonding, shielding in aircraft, auto radio, etc. Size of wires #36 AWG.

Cat. No.	Inside Diam.	Flattened	Spool
855	1/16"		50 ft.
858	1/8"		50 ft.
859	3/16"		50 ft.
863	1/4"		50 ft.
864	3/8"		50 ft.
868	1/2"		50 ft.
865	5/8"		50 ft.
857	2 5/32"		50 ft.
856	1"		50 ft.

BARE

860	1/4"	50 ft.
-----	------	--------

LONGER LENGTHS AVAILABLE

7MM HIGH TENSION CABLE



UNSHIELDED

Useful in reducing interference from auto secondary circuits. Also used as photoelectric cell leads, high voltage leads in television receivers, cathode-ray tubes, etc. Single conductor #18 stranded rubber insulation with cotton braid and heavy coats of lacquer.

Cat. No.	Spool	Size	Stranding	O.D.
1600	100 Ft.	16	19/29	.275

LONGER LENGTHS AVAILABLE

7MM SHIELDED SECONDARY WIRE

Used for auto and aircraft ignition systems where grounding is necessary for effective elimination of interference. Same construction as #1600 with a shielded, tinned copper braid overall.

Cat. No.	Spool	Size	Stranding	O.D.
781	100 Ft.	16	19/29	.295

LONGER LENGTHS AVAILABLE

BIRNBACH PHONO PICKUP WIRE



EXTRA FLEXIBLE

Where small diameter, limpness and extreme flexibility is necessary as for use on phono pickup arms and grid wire. Constructed of #24 gauge flexible stranded copper wire with rubber insulation and a close tinned copper braid shield overall. No. 1825 and 1825M have same construction with fine brown cotton braid over shield.

Cat. No.	Spool	Size	Stranding	Insu.	O.D.
1824	500	24	18/36	.015	.080
1824M	1000	24	18/36	.015	.080
1825	500	24	14/38	.015	.095
1825M	1000	24	16/36	.015	.095

PHONO PICKUP WIRE

Used on phono pickup arms and grid leads where extreme flexibility is not of paramount importance. Constructed of #22—7/30 tinned copper wire with 1/64 wall of vinyl plastic insulation and a closely woven tinned copper shield overall.

Cat. No.	Spool	Size	Stranding	Insu.	O.D.
1822	100	22	7/30	1/64	.090
1822B	500	22	7/30	1/64	.090
1822C	1000	22	7/30	1/64	.090

COMMERCIAL TYPE TWISTED PAIR



(Transmission Line)

Used for low loss transmission line between receiver and antenna as doublet lead-in wire and for intercom setup. Consists of two wires with 1/32" wall rubber color coded with a cotton braided weather-proof finish overall.

Cat. No.	Spool	No. of Conds.	Gauge	Stranding	Insu.
951	100	2	22	7/30	.132
952	500	2	22	7/30	.132
919	500	2	18	16/30	.132
920	1000	2	18	16/30	.132

Cat. No.	Cap. Bet. Conds.	Size of KC	O.D.
951	21.8 mmf.	3.75	.200
952	21.8 mmf.	3.75	.200
919	21.8 mmf.	3.75	.225
920	21.8 mmf.	3.75	.225

SHIELDED GRID LEAD WIRE



High insulation of this wire will reduce loss in shielded grid circuits. Tinned copper stranded wire with rubber insulation, lacquered cotton braid with closely woven tinned copper shield overall.

Cat. No.	Spool	Ft.	Size	Stranding	Insu.	Under-shield	Cap/Ft.	O.D.
820	100	20	10/30	.085	.70	.140		
818	100	18	16/30	.085	.75	.150		

LONGER LENGTHS AVAILABLE

SHIELDED HOOK-UP AND LEAD-IN WIRE



Used to prevent and reduce interference caused by motors, high tension wires, X-ray machines and man-made static. Consists of stranded tinned copper, a wall of low loss life rubber over which is woven a tinned copper shield.

Cat. No.	Spool	Ft.	Size	Stranding	Insu.	Cap/Ft.	O.D.
810	500	20	10/30	1/64	.105	.095	
809	100	18	16/30	1/64	.125	.125	
803	250	18	16/30	1/64	.125	.125	
851	100	16	26/30	1/32	.90	.145	
802	250	16	26/30	1/32	.90	.145	
806	100	14	19/27	3/64	.85	.185	
801	250	14	19/27	3/64	.95	.185	

SHIELDED VARNISHED CAMBRIC WIRE



Used where an oil and water resistant wire with a shielded covering is required. Constructed of tinned stranded conductor with 2 layers of varnished cambric and a lacquered cotton braid with a tinned copper shield overall.

Cat. No.	Spool	Ft.	Size	Stranding	Cap/Ft.	O.D.
1820	100	20	10/30	.100	.125	
1818	100	18	16/30	.102	.131	
1800	100	16	26/30	.142	.145	

ANTENNA CONTROL ROTOR CABLE



Four Conductor has ribbed Polyethylene construction to facilitate making of connections in compact housings and control boxes. Separates like zip wire cable has one tinned conductor for coding identity. 4 conductors No. 7/28 stranded.

Five conductor is color coded and twisted with round plastic jacket overall. 5 cond. No. 20 - 7/28 stranded.

Eight Conductor is color coded and twisted with round plastic jacket overall as used widely for Radiart. 8 cond. No. 22 - 7/30 stranded.

1874A	500 ft. spool	4 cond.	Flat Rotor Cable
1874	1000 ft. spool	4 cond.	Flat Rotor Cable
1875A	500 ft. spool	5 cond.	Round Rotor Cable
1875	1000 ft. spool	5 cond.	Round Rotor Cable
1878A	500 ft. spool	8 cond.	Round Rotor Cable
1878	1000 ft. spool	8 cond.	Round Rotor Cable

POSJ ALL RUBBER LAMP CORD



(Underwriters Approved)

An all purpose approved, very flexible rubber covered parallel cord which is easily separated by slit in jacket; has color coded cotton serve.

Cat. No.	Spool	Ft.	Conds.	Size	Stranding	O.D.
570	100	2	18	41/34	.135	.235
572	250	2	18	41/34	.135	.235
573	500	2	18	41/34	.135	.235

COLORS: Brown, Black, Ivory



BARE, TINNED and ENAMELED COPPER WIRE

Coil Lead, Jumper Cable
Ft. Spool

1622	7/30 (22 B&S)	1000
1620	10/30 (20 B&S)	1000
1618	16/30 (18 B&S)	1000

Stranded Bare Copper Wire
Cat. No.

493	7/20	100 ft. coil
1640	7/22 (14 B&S)	75 ft. coil
1670	100 ft. coil	
1639	1000 ft. spool	
1643	7/23 (15 B&S)	75 ft. coil
1673	100 ft. coil	
1634	1000 ft. spool	
1646	7/24 (16 B&S)	75 ft. coil
1680	100 ft. coil	
1647	1000 ft. spool	
647	7/26	75 ft. coil
681	100 ft. coil	
1648	1000 ft. spool	
740	7/27	75 ft. coil
700	100 ft. coil	
1741	1000 ft. spool	

Stranded Tinned Cop. Wire
Cat. No.

495	7/20	100 ft. coil
1641	7/22 (14 B&S)	75 ft. coil
1671	100 ft. coil	
1638	1000 ft. spool	
1644	7/23 (15 B&S)	75 ft. coil
1674	100 ft. coil	
1633	1000 ft. spool	
1697	7/24 (16 B&S)	75 ft. coil
1696	100 ft. coil	
1628	1000 ft. spool	

Solid Tinned Copper Wire
SOFT DAWN

1433	No. 8	100 ft. coil
	No. 10	
1401	50 ft. coil	
1402	100 ft. coil	
1403	1000 ft. spool	
	No. 12	
1405	50 ft. coil	
1406	100 ft. coil	
1407	1000 ft. spool	
	No. 14	
1409	50 ft. coil	
1410	100 ft. coil	
1411	1000 ft. spool	
	No. 16	
1413	50 ft. coil	
1414	100 ft. coil	
1415	1000 ft. spool	
	No. 18	
1417	50 ft. coil	
1418	100 ft. coil	
1419	1000 ft. spool	
	No. 20	
1421	50 ft. coil	
1422	100 ft. coil	
1423	1000 ft. spool	
	No. 22	
1434	1000 ft. spool	

Silicon Bronze
Twice the strength of copper. Used extensively on Master Antenna Systems, airports, ships, where strength and resistance to the elements are important.

Cat. No.	Ft.	Size	Tensile Strength
529	100	7/12	3670 lbs.
528	100	7/14	2140 lbs.
527	100	7/18	1600 lbs.
499	100	7/18	1000 lbs.
524	100	7/20	650 lbs.
528	100	7/22	420 lbs.

LONGER LENGTHS AVAILABLE

Stranded Enamel Copper Wire
Cat. No.

	7/22 (14 B&S)	
1642	75 ft. coil	
1672	100 ft. coil	
1637	1000 ft. spool	
	7/23 (15 B&S)	
1645	75 ft. coil	
1675	100 ft. coil	
1631	1000 ft. spool	
	7/24 (16 B&S)	
1683	75 ft. coil	
1682	100 ft. coil	
1627	1000 ft. spool	

Solid Enamel Copper Wire
Cat. No.

	No. 10	
697	50 ft. coil	
497	100 ft. coil	
1497	1000 ft. spool	
	No. 12	
292	50 ft. coil	
492	100 ft. coil	
492-A	150 ft. coil	
492-B	200 ft. coil	
1492	1000 ft. spool	
	No. 14	
290	50 ft. coil	
490	100 ft. coil	
490-A	150 ft. coil	
490-B	200 ft. coil	
1490	1000 ft. spool	

Solid Bare Copper Wire
SOFT DRAWN

	No. 10	
1561	50 ft. coil	
1562	100 ft. coil	
1563	1000 ft. spool	
	No. 12	
1565	50 ft. coil	
1566	100 ft. coil	
1567	1000 ft. spool	
	No. 14	
1569	50 ft. coil	
1570	100 ft. coil	
1571	1000 ft. spool	
	No. 16	
1573	50 ft. coil	
1574	100 ft. coil	
1575	1000 ft. spool	



Birnbach Tinned Bus Bar Wire

For hooking up all types of transmitters, especially ultra short wave equipment. All Bus Wire is made of hard drawn copper, tinned, straightened, and cut 2 ft. lengths. (100 to Std. Pkg.)

Cat. No.

2010	10 Round
2012	12 Square
2013	12 Square
2014	14 Square
2015	14 Round
2016	16 Round

Birnbach MAGNET WIRE



PLAIN ENAMEL

Size B&S	1/4 lb. Spool Ft.	1/2 lb. Spool Ft.	1 lb. Spool Ft.
10	8	16	32
12	12	25	50
14	20	40	80
16	32	64	128
18	50	100	201
20	80	160	320
22	127	254	508
24	201	403	806
26	320	640	1280
28	507	1015	2030
30	805	1610	3220
32	1282	2564	5128
34	2037	4075	8150
36	3221	6443	12887
38	5132	10248	20492
40	8143	16286	32573

SOLID TINNED (Soft Drawn)

Size B&S	1/4 lb. Spool Ft.	1/2 lb. Spool Ft.	1 lb. Spool Ft.
10	8	16	32
12	12	25	50
14	20	40	80
16	32	65	126
18	50	100	201
20	80	160	320
22	127	254	508
24	201	403	806
26	320	640	1280
28	507	1015	2030
30	805	1610	3220
32	1282	2564	5128
34	2037	4075	8150
36	3221	6443	12887
38	5132	10248	20492
40	8143	16286	32573

DOUBLE COTTON

Size B&S	1/4 lb. Spool Ft.	1/2 lb. Spool Ft.	1 lb. Spool Ft.
10	8	24	32
12	12	24	48
14	20	40	80
16	49	97	194
18	78	157	314
20	119	238	477
22	184	369	739
24	284	568	1136
26	435	871	1742
28	641	1283	2569
30	976	1953	3906
32	1365	2735	5470
34	1827	3654	7309
36	2738	5476	10952
38	3405	6811	13628

DOUBLE SILK

Size B&S	1/4 lb. Spool Ft.	1/2 lb. Spool Ft.	1 lb. Spool Ft.
12	12	24	49
14	19	39	78
16	31	62	125
18	49	99	198
20	78	157	314
22	123	247	495
24	195	390	781
26	303	606	1212
28	478	956	1912
30	739	1479	2958
32	1136	2272	4545
34	1712	3421	6849
36	2551	5102	10204
38	3770	7541	15082
40	5040	10080	20161

BIRNBACH MAGNET and TINNED WIRE SPECIAL SPOOLS

Attractive Spools, even sizes from 10 to 40 inclusive in Double Cotton, Plain Enamel, Double Silk and Solid Tinned. This display on the counter is a Silent Salesman bringing you real profits the year around.

FREE DISPLAY

One Display Given with each initial order of 100 spools. Display made of strong, reinforced steel. Mahogany crackle finish. 3-color display at top. Space for YOUR resale price. Extra Display Rack available.

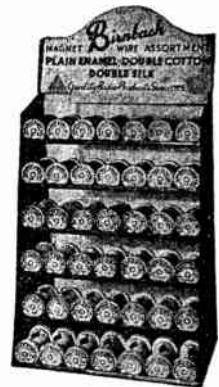

Length of Wire of Special Spools

Size B&S	Plain Enamel Ft.	Double Cotton Ft.	Double Silk Ft.	Solid Tinned Ft.
10	11	—	—	15
12	15	9	—	20
14	26	20	11	34
16	34	54	19	56
18	56	44	23	86
20	86	56	29	118
22	112	75	37	150
24	184	97	56	184
26	214	116	71	244
28	401	131	90	461
30	525	158	112	525
32	675	180	124	675
34	900	195	131	900
36	1275	240	142	1275
38	1725	240	116	1725
40	1950	265	125	1950



BIRNBACH BIRACO TUBING (Extruded Vinyl)



Synthetic plastic tubing especially designed for electronic and electrical insulation work. Extremely flexible and high resistance to abrasion. Has high dielectric strength, average 10,000 volts and high tensile strength. Will not support combustion, soften up to 257°F. or crack at -75°F. Its dielectric strength: 1100 volts per mil at room temperature when dry and 1000 volts per mil when wet. Impervious to water, oil, alkalies, alcohol, solvents, etc. Meets all ASTM specs.

Cat. No.	100-Ft. Spools B&S Gauge Size No.	Approx. I.D.
313BC	20	.034
314BC	18	.042
315BC	16	.053
316BC	14	.066
317BC	12	.085
318BC	10	.106
325BC	8	.135
326BC	6	.166
319BC	4	.208
320BC	2	.263
321BC	Coll 5/16	.3125
322BC	Coll 3/8	.375
323BC	Coll 1/2	.500
324BC	Coll 5/8	.625

Also Available in 36" Lengths
COLORS: Black, Red, Green, White, Yellow, Blue, Brown, Orange and Clear.

BIRNBACH VARNISHED TUBING (Radio & Electronic Grade)



Constructed of high quality rayon braid with heavy coatings of varnish applied. The inside is also coated for easy insertion of stranded wires. It is impervious to oil, acid and water. Extremely flexible; it will not crack after aging. Average dielectric strength 5000 volts. Meets all ASTM and VTA No. B-1 Specifications.

Cat. No.	100-Ft. Spools B&S Gauge Size No.	Approx. I.D.
291VC	20	.034
293VC	18	.042
294VC	16	.053
295VC	14	.066
300VC	12	.085
307VC	10	.106
301VC	8	.135
302VC	6	.166
305VC	4	.208
306VC	2	.263
303VC	Coll 5/16	.3125
304VC	Coll 3/8	.375
299VC	Coll 1/2	.500
296VC	Coll 5/8	.625

*Also Available in 30" Lengths
**Also Available in 36" Lengths
COLORS: Black, Red, Green, Yellow, Blue, Brown, Orange, White.

BIRNBACH DIAL CABLE 42-STRAND PHOSPHOR BRONZE



Finest phosphor bronze wire over a linen thread center. Due to its high tensile strength, it will not stretch.

Cat. No.	(.040 Diameter)
1025	25 ft. Spool
1050	50 ft. Spool
1051	100 ft. Spool
1052	1000 ft. Spool

BRAIDED PHOSPHOR BRONZE DIAL CABLE (Light — .025 Diameter)

Cat. No.	(.025 Diameter)
1053	25 ft. Spool
1054	50 ft. Spool
1055	100 ft. Spool
1056	1000 ft. Spool

All of the quality cables are constructed of the finest Nylon Braid, over a fiberglass core. They are pre-stretched and chemically treated to prevent stretching and slipping. Has maximum resistance to abrasion.

EXTRA THIN NYLON DIAL CABLE (.025 Diameter)

Cat. No.	(.025 Diameter)
4025	25 ft. Spool
4050	50 ft. Spool
4051	100 ft. Spool
4052	1000 ft. Spool

Used on Motorola, RCA, GE, etc. Is extra thin!

REGULAR THIN NYLON CORD (.028 Diameter)

The most popular of all dial cords.

Cat. No.	(.028 Diameter)
2025	25 ft. Spool
2050	50 ft. Spool
2051	100 ft. Spool
2052	1000 ft. Spool

LIGHT NYLON DIAL CORD (.040 Diameter)

Used extensively in RCA, Philco, Majestic, Wells Gardner, etc.

Cat. No.	(.040 Diameter)
3025	25 ft. Spool
3050	50 ft. Spool
3051	100 ft. Spool
3052	1000 ft. Spool

HEAVY DUTY NYLON DIAL CORD (.062 Diameter)

Cat. No.	(.062 Diameter)
1057	25 ft. Spool
1058	50 ft. Spool
1059	100 ft. Spool
1060	1000 ft. Spool

As used on models of Philco, Majestic, Brunswick, etc.

TUBING IN HANDY SPOOLS



Both the Biraco Extruded Vinyl Tubing and Varnished Tubing are now available on convenient spools, in special length spools and 100-ft. spools in a variety of assorted colors. It is a perfect item for servicemen, laboratories and for manufacturing purposes.



BIRNBACH BIRACO TUBING (Extruded Vinyl)

Cat. No.	B&S Gauge Size No.	Approx. I.D.	Length Spool
313B	20	.034	25 Ft.
314B	18	.042	25 Ft.
315B	16	.053	25 Ft.
316B	14	.066	25 Ft.
317B	12	.085	25 Ft.
325B	10	.106	15 Ft.
318B	8	.135	15 Ft.
326B	6	.166	15 Ft.
319B	4	.208	10 Ft.
320B	2	.263	10 Ft.
313BC	20	.034	100 Ft.
314BC	18	.042	100 Ft.
315BC	16	.053	100 Ft.
316BC	14	.066	100 Ft.
317BC	12	.085	100 Ft.
325BC	10	.106	100 Ft.
318BC	8	.135	100 Ft.
326BC	6	.166	100 Ft.
319BC	4	.208	100 Ft.
320BC	2	.263	100 Ft.
321BC	5/16	.3125	100 Ft.
322BC	3/8	.375	100 Ft.
323BC	1/2	.500	100 Ft.
324BC	5/8	.625	100 Ft.

COLORS: Red, Black, Green, White, Yellow, Blue, Brown, Clear and Orange.

BIRNBACH VARNISHED TUBING (Radio and Electronic Grade)

Cat. No.	B&S Gauge Size No.	Approx. I.D.	Length Spool
291V	20	.034	25 Ft.
293V	18	.042	25 Ft.
294V	16	.053	25 Ft.
295V	14	.066	25 Ft.
300V	12	.085	25 Ft.
307V	10	.106	20 Ft.
301V	8	.135	15 Ft.
302V	6	.166	10 Ft.
305V	4	.208	10 Ft.
306V	2	.263	10 Ft.
291VC	20	.034	100 Ft.
293VC	18	.042	100 Ft.
294VC	16	.053	100 Ft.
295VC	14	.066	100 Ft.
300VC	12	.085	100 Ft.
307VC	10	.106	100 Ft.
301VC	8	.135	100 Ft.
302VC	6	.166	100 Ft.
305VC	4	.208	100 Ft.
306VC	2	.263	100 Ft.
303VC	5/16	.3125	100 Ft.
304VC	3/8	.375	100 Ft.
299VC	1/2	.500	100 Ft.
296VC	5/8	.625	100 Ft.

COLORS: Black, Red, Green, White, Yellow, Blue, Brown, and Orange.

MALE RUBBER PLUGS

Brass prongs. Rated 15 amps at 125 Volts. 3/8" hole.

St. Pkge.

814—Rubber Male Plug.....100



INSULATED STAPLES

Essential for securing lead-in, ground, and other wires for installation.



Cat. No. St. Pkge.

R100—Plain Staples. 100 to box.....1000

D50—Plain Staples. 50 to box.....1000



COPPER STRAP CLAMP

Will takes 3/4" to 2" pipe. Made of copper with Birnbach clip riveted and soldered to strap. Complete with nut and bolt.
Cat. No. 600.....St. Pkge. 50

BIRNBACH WIRE WINDING and MEASURING OUTFIT



Consists of a Folding Reel, Measuring Machine, and a Wire Winder. This outfit is shipped complete, ready to assemble. It registers up to 1000 feet, and is accurate, simple to use, and time saving. Very compact, this unit can be easily set up on counter, table or bench.

Cat. No.	Shpg. Wt.
7401.....Complete Outfit.....	23 lbs.
7401-M.....Metric System Machine.....	25 lbs.

BIRNBACH COPPERWELD ENAMEL ANTENNA WIRE



PURE COPPER WELDED TO CORE ENAMEL

Steel core covered with copper and heavily enameled. Will not elongate because of its high tensile strength which is several times that of enameled copper wire. It has low R.F. resistance and is ideal for transmitting doublet and directional antenna systems as it will maintain the frequency characteristics of the antenna because of its stretchless qualities.

Cat. No.	Size B&S	Available in Following Footages:
710	.10	100 ft. coils; 250 ft., 500 ft., 1000 ft., 2500 ft. spools
712	.12	
714	.14	
Specify Length Desired Next to Cat. No.		
Size B&S	Ft. per Lb.	Tensile Strength
10	3 1/2	1130 lbs.
12	5 1/2	720 lbs.
14	8 1/2	400 lbs.



BIRNBACH INSULATED PHONE TIP (SCRULOK)



1" long, 5/16" dia. Connection is made by threading wire through the Scrulok threaded bushing (see drawing).

COLORS: Red, Black, Green, Blue and Yellow.
Cat. No. Std. Pkg.
412—Scrulok Pin Tip, 1-9/16" Long.....50
418—Scrulok Pin Tip, 1-15/16" Long.....50

INSULATED Solderless PHONE TIPS



They have insulated handles 3/4" dia. by 1" long fitted to solderless phone tips. The wire can be easily attached by threading through the hole in the handle and tightening the knurled nut.

COLORS: Red, Black, Green, Blue and Yellow.
Cat. No. Std. Pkg.
409—Insulated Sr. Solderless Tip
2 3/4" Long.....50
415—Insulated Jr. Solderless Tip
1-13/16" Long.....50

No. 407 INSULATED TIP JACK



7/16" insulated top; mounts in a 5/16" dia. hole. The specially designed bronze springs hold the phone tip tight and straight.

COLORS: Red, Black, Yellow, Green.
Cat. No. Std. Pkg.
407—Insulated Phone Tip Jack...100

No. 330 INSULATED NEEDLE POINT PLUG



The insulated sleeve is 3/4" long. Positive contact is assured with the sharp needle point phone tip. Body of plug accommodates all standard banana type plugs; easily pierces insulation.

Available in Black or Red.

Cat. No. Std. Pkg.
330—Insulated Needlepoint Plug.....50

No. 331 INSULATED PHONE TIP PLUG



Plugs into all standard phone tip jacks. The 3/4" long insulated sleeve is designed to accommodate all standard banana type plugs. Overall length 1 1/2". Available in Black, Red, Yellow and Green.

Cat. No. Std. Pkg.
331—Insulated Phone Tip Plug.....50
331A—Tip Only.....50

No. 332 INSULATED SPADE LUG



Sleeve measures 3/4" long by 3/8" diameter. Barrel accommodates all standard banana type plugs. Available in Red or Black.

Cat. No. Std. Pkg.
332—Insulated Spade Lug.....50
332A—Spade Only.....50



TEST CLIPS

The No. 27-C is a solid copper clip with a brass screw designed for high frequency work.

Cat. No.	Length	Jaw Spread	Std. Pkg.
27—Pee Wee	1 1/4"	3/8"	50
28—Midget	2"	3/8"	50
29—Medium	2 3/4"	1"	50
30—Large	4"	1 1/4"	50
27C—Pee Wee Copper	1 1/2"	7/8"	50
27R—Rubber Sleeve—Red or Black			50

No. 404 INSULATED BANANA PLUG



It has the Scrulok solderless connection and the non-collapsible special alloy springs assembled on a pin preventing collapse of the plug spring. The handle is made of phenolic resin and is 3/4" wide by 1" long.

COLORS: Red, Black, Yellow, Blue and Green.
Cat. No. 404.....Std. Pkg. 50

No. 404B SPRING BANANA PLUG



Same construction as No. 404 above except with small side screw for wire connection.

COLORS: Red, Black, Yellow, Blue and Green.
Cat. No. 404B.....Std. Pkg. 50

No. 604 BANANA PLUG



Solid brass nickel-plated, with the end slotted. Cast phenolic handle is 1" long by 3/4" dia. and is held on by the screw that secures wire to plug.

COLORS: Red, Black, Yellow, Green and Blue.
Cat. No. 604.....Std. Pkg. 50

No. 341 INSULATED BANANA PLUG



This plug consists of our No. 404A plug with a larger handle 1 3/4" long by 3/4" dia. Used on therapeutic apparatus and test equipment. Overall length 2 3/4".

COLORS: Red or Black.
Cat. No. 341.....Std. Pkg. 50



No. 392 INSULATED GIANT PLUG

No projecting edges are exposed.

Connection is made by soldering into the hole at the end of the threaded shank of the plug. Handle is 1 3/4" long by 3/4" dia.; length overall 3".

COLORS: Red or Black.

Cat. No. 392.....Std. Pkg. 50

No. 342 HARD RUBBER INSULATED GIANT PLUG



Designed for use with diathermy cables. It has a 3/4" dia. hole in the handle to take the largest cable. Polished black hard rubber. The handle is 3" long by 3/4" dia. Overall length is 4 1/2".

COLORS: Red or Black

Cat. No. 342.....Std. Pkg. 50

No. 605 HANDLE JACK



Consists of a banana jack inside an insulated sleeve. Connection is made by soldering to the end of the jack. Handle is made of cast phenolic resin 3/4" dia. by 1 1/4" long.

COLORS: Red, Black, Yellow and Green.
Cat. No. 605.....Std. Pkg. 50

Nos. 391 and 406 INSULATED BANANA JACKS



3/4" dia. insulated head admits all of the exposed metal part of the metal plug when inserted. Mounts in a 5/16" dia. hole on a panel up to 3/8" thick. No. 406 Jack has a 7/16" dia. insulated top. It fits into 5/16" dia. hole and takes up to a 3/4" panel. Both with insulating shoulder washer, nut and lug.

Cat. No. Std. Pkg.
391—Insulated Jack—Red,
Black, Yellow, Green...50
406—Insulated Jack—Red,
Black, Yellow, Blue,
Green.....50

No. 393 INSULATED GIANT JACK



Designed to leave no metal part exposed on the panel. The 3/4" dia. brass nickel plated sleeve has a 10-32 threaded hole at the end permitting a connection at the end of the jack or to the lug under the head. Either assembly available complete with nut, insulating shoulder washer, lock-washer and lug. Length overall 1 3/4".

COLORS: Red or Black.

Cat. No. Std. Pkg.
393—Insulated Giant Jack
lug under head.....50
393A—Insulated Giant Jack
lug at end.....50

No. 333 INSULATED COMBINATION JACK



Accommodates all standard plugs of the phone tip or banana type construction. 3/4" hole mounting in panels up to 3/8" thick. Overall length 1 3/4". Supplied complete with insulating shoulder, washer and nut. Insulated head comes in following colors: Black, Red, Green or Yellow.

Cat. No. 333.....Std. Pkg. 50

No. 310 INSULATED ALLIGATOR CLIP



Steel nickel plated. The insulated handle is 3/4" dia. and 3/4" long and 2 1/4" overall and comes in Red or Black.

Cat. No. 310.....Std. Pkg. 50

No. 334 ALLIGATOR CLIP WITH PHONE TIP JACK



1" long insulated handle houses a tip jack that accommodates all standard phone tip plugs. Overall length 2 3/4".

COLORS: Red or Black.
Cat. No. 334.....Std. Pkg. 50

No. 335 ALLIGATOR CLIP COMBINATION JACK



Insulated alligator clip is composed of a combination jack in rear for both standard phone tip plugs and banana plugs. 1-9/16" length of handle. Overall length 3". Available in Red or Black.

Cat. No. 335.....Std. Pkg. 50



HEAVY DUTY HIGH VOLTAGE TEST LEADS

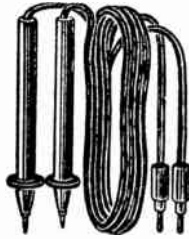

Safely tests up to 15,000 volts. High dielectric strength and no leakage resistance. Has low voltage drop. Prods and tip handles are made of black and red bakelite with special tip for application. Cable constructed of No. 18-66 3/4 tinned copper with heavy duty rubber wall. Prods are 6" long and 1/2" dia. and have a protective rugged tip. The other end has 1 1/4 x 1/2" dia. bakelite prods. All prods and cable color coded. The leads are 60" long.

Cat. No. 562—Heavy Duty High Voltage Test Leads... 10 Std. Pkg.

BAKELITE PENCIL TYPE TEST LEADS (SCRULOK)

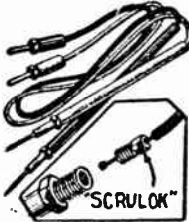

Red and black bakelite handles, 6" long and 5/16" in dia. and red and black bakelite insulated phone tips. Heavy kinkless wire is used together with the Birnbach Scrulok system of solderless wire connection. The Universal needle and phone tip prod have the same dimensions as the standard phone tip and are useful for piercing in insulation without damage.

Cat. No. 408—Bakelite Pencil Type Test Lead... 10 Std. Pkg.
439—Needlepoint Prod Tip for Replacement... 10

DELUXE TEST LEADS



Constructed with 5" long cast phenolic red and black handles with removable needlepoint chucks or solderless tips. Black and red heavy kinkless instrument 18" long is used to connect the prods with the insulated red and black cast phenolic solderless tip.

Cat. No. 560—Solderless Prod. Solderless Tip... 25 Std. Pkg.
561—Needlepoint Prod. Solderless Tip... 25

NEEDLEPOINT TEST LEADS



These test leads have 4" red and black insulated handles. A needlepoint chuck is fitted to the handle. Needles can be replaced when broken simply by loosening the knurled collar. Length overall 50".

Cat. No. 420—Needlepoint Phone Tip Test Leads... 25 Std. Pkg.
421—Needlepoint Spade Lug Test Leads... 25

STANDARD TEST LEADS



A Sr. solderless phone tip is fitted to a red and black insulated handle 4" long. This permits replacement of wire when broken. The wire is secured by tightening the knurled nut. Length overall 50".

Cat. No. 422—Solderless Phone Tip Test Leads... 25 Std. Pkg.
423—Solderless Spade Lug Test Leads... 25

PHONE TIPS



The 402 is 1" in overall length and fits all standard phone tip jacks. Hole is drilled for 7/64", length of barrel is 1/2". Brass, nickel plated.

Cat. No. 402—Phone Tip... 100 Std. Pkg.
402A—Larger Diameter... 100

HEAVY DUTY HIGH VOLTAGE BAKELITE TEST PROD HANDLES



Same as used on No. 562. 8" long and 1/4" dia. with finer guard control. The rear of the prod can accommodate 1N 34 crystal and condenser for use as an RF probe. Tips are heavy brass with nickel plating. Available in Red and Black.

Cat. No.	Handle Length	Handle Width	Overall Length
559	6"	1/4"	6-15/16"
558	1 1/2"	1/2"	2 1/4"



No. 411 BAKELITE PENCIL TEST PRODS

These prods have the Birnbach Scrulok solderless needlepoint tips. They are made of bakelite and are 6" long and 5/16" dia. The connection is made by threading the wire through the handle and securing to the needlepoint tip by locking the Scrulok. The tip is then screwed into the handle. Available in Red or Black.

Cat. No. 411—Bakelite Pencil Test Prods... 12 Std. Pkg.

NEEDLEPOINT TEST PROD



A threaded shank needlepoint chuck is threaded into the end of handle. Made of highly polished cast phenolic handle. Available in Red or Black.

Cat. No.	Handle Length	Std. Pkg.
344	4"	50
345	5"	50

SCRULOK NEEDLEPOINT TEST PROD



These insulated prods have the Scrulok solderless system of wire connection. Wire is easily attached with out soldering. An extra heavy needle is fitted into the tip.

Cat. No. 417—4" Handle... 50 Std. Pkg.
418—5" Handle... 50

SOLDERLESS TEST PROD



Made of highly polished cast phenolic resin. A solderless phone tip is threaded at end permitting replacement of tip. Available in Red or Black.

Cat. No.	Handle Length	Std. Pkg.
410	4"	50
343	5"	50

SOLDERLESS PHONE TIPS



These phone tips are milled of solid brass and nickel plated. Designed for easy insertion of the wire.

Cat. No.	Std. Pkg.
23—Junior	100
24—Senior	100



No. 26 PHONE TIP JACK

Milled of brass nickel plated. The bronze springs are made to hold the phone tip tight and straight. Mounts in a 1/4" dia. hole.

Cat. No. 26... 100 Std. Pkg.

BIRNBACH GIANT PLUGS



The Giant Plugs are intended for use where heavy current is used. They are rated at 25 amps. The long life nickel silver alloy spring is secured over a pin preventing a collapse of the spring and also maintaining the full spring action of the spring when inserted into the jack. The No. 398A plug has a hole in the thread shank to permit soldering to it. It is used extensively on diathermy electrode pad cables.

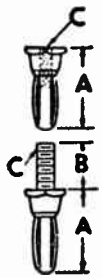

Cat. No.	Std. Pkg.	A	B	C
396... Plug	25	1-5/32	—	10-32
397... Plug	25	1-7/16	—	3/4-20
398... Plug	25	1-5/32	3/8	1/4-28
398A... Plug	25	1-5/32	3/8	1/4-28

BIRNBACH GIANT JACKS



Carefully milled with the central hole being reamed to size to insure a tight and wobble free fit with all Giant Plugs. The No. 394 and No. 399A have a 10-32 thread tapped at the end permitting connection to be made there with the use of a screw and lug. Made of brass and nickel-plated. Complete with nut and lug.

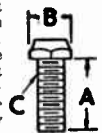

Cat. No.	Std. Pkg.	A	B	C
394... Jack	25	1-1/16	3/8	3/4-24
395... Jack	25	11/16	3/4	3/4-24
399... Jack	25	3/4	3/4	1/2-20
399A... Jack	25	1 1/4	3/4	1/2-20

BIRNBACH BANANA PLUGS



Large area of contact is one of the outstanding features of these jacks and plugs. The No. 400 series of plugs have a nickel silver contact spring secured over a full length central pin, making these plugs non-collapsible and assuring a low resistance contact. Capacity 5 Amperes.



Cat. No.	Std. Pkg.	A	B	C
400... Plug	100	3/8	3/4	6-32
401... Plug	100	31/32	—	6-32
404A... Plug	100	3/4	3/4	1/4-28

BIRNBACH No. 403 BANANA JACK



Accurately milled. Precision reamed hole helps maintain the tight and smooth action of the plug. Brass nickel plated. With nut and lug.

Cat. No.	Std. Pkg.	A	B	C
403... 100	100	3/8	3/4	1/4-28



No. 31 ALLIGATOR CLIP

Cat. No.	Length	Std. Pkg.
31-R	2"	50
31-R	Insulators for #31, Red or Black	50



BIRNBACH TINNED TERMINAL LUGS

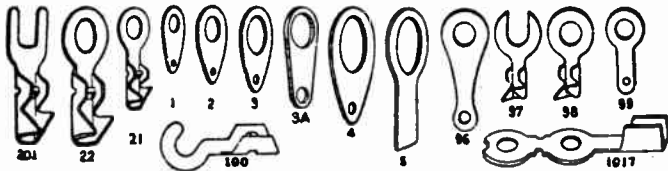

Cat. No.	Hole for Screw	Length In.	Std. Pkg.
1	6	17/32	1000
2	10	5/8	1000
3	1/4	5/8	1000
3A	1/4	13/16	1000
4	3/8	7/8	1000
5	1/2	1-3/16	1000
21	10	13/16	1000
22	1/4	1-1/8	1000
201	8	13/16	1000
96	6-8-10	7/8	1000
97	8	5/8	1000
98	6-8-10	11/16	1000
99	4-6-8	11/16	1000
100	10	7/8	1000
1017 (TV)	10	13/16	1000

BIRNBACH LUGS IN PACKAGES



Cat. No.	Quan. in Env.	Lug No.	Cat. No.	Quan. in Env.
1-50	50	1	1-100	100
2-50	50	2	2-100	100
3-50	50	3	3-100	100
21-35	35	21	21-100	100
22-15	15	22	22-100	100
201-35	35	201	201-100	100
96-40	40	96	96-100	100
97-40	40	97	97-100	100
98-35	35	98	98-100	100
99-35	35	99	99-100	100
100-20	20	100	100-100	100
1017-10	10	1017	1017-100	100

FOLD-OVER SOLDERLESS TERMINAL LUGS

Use this lug for easy, positive vibration-proof terminal connections at antenna mast and for permanent connections at receiver. Simply lay bare wire into groove and fold over. No special tools necessary. For No. 10 hole.



Cat. No.	Quan. in Pkgs.	St. Carton
1017-10	10 (Envelope)	25 Pkgs.
1017-50	50 (Envelope)	25 Pkgs.
1017-100	100 (Envelope)	12 Pkgs.
1017-1000	1000 (Box)	10 Pkgs.

BIRNBACH LOCKING TYPE TERMINAL LUGS

Brass Electro Plated

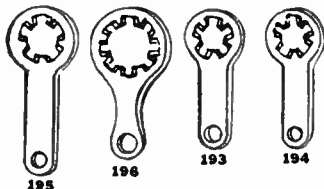

Cat. No.	Hole for Screw	Thickness	Std. Pkg.
193	4	.020"	1000
194	6	.020"	1000
193	8	.020"	1000
195	1/4"	.020"	1000

TAPPED ANGLE BRACKET

Steel cadmium plated. 1/4" by 3/8". One plain .165 hole and one 8/32 tapped hole.

Cat. No.	Std. Pkg.
1120	100

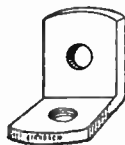

BRASS AND STEEL ANGLES

Cat. No.	Material	Size	Std. Pkg.
1121	Brass N.P.	1/2" x 1/2"	100
1122	Brass N.P.	3/8" x 3/8"	100
1123	Steel H.T.	3/4" x 3/4"	100
1124	Steel H.T.	1" x 1 1/2"	100

BIRNBACH LUG TERMINAL STRIPS

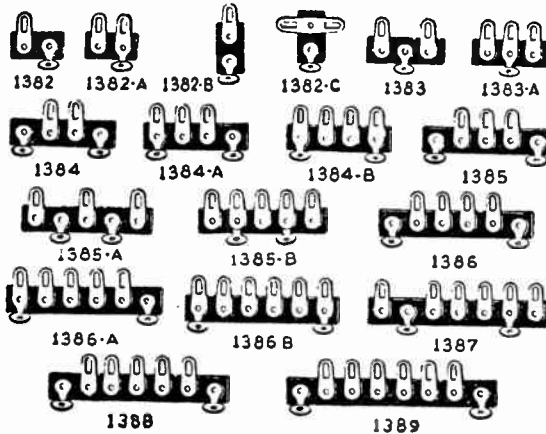

Cat. No.	Std. Pkg.	Cat. No.	Std. Pkg.
1382	100	1385	100
1382A	100	1385A	100
1382B	100	1385B	100
1382C	100	1386	100
1383	100	1386A	100
1383A	100	1386B	100
1384	100	1387	100
1384A	100	1388-5 Ter., 2 grds.	100
1384B	100	1389-6 Ter., 2 grds.	100

BIRNBACH BAKELITE TERMINAL STRIPS

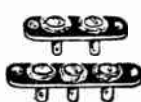

Terminals are made of brass and cadmium plated. Terminals are mounted on 1/16" bakelite. 7, 8, 9 and 10 terminals are mounted on 3/32" bakelite. All terminals are space 7/16" center to center.

PLAIN		MARKED	
Cat. No.	Mtg. Terminals Center	Cat. No.	Terminals Marked
1372	2...1-A"	1260	2; A-G
1373	3...1-3/4"	1261	2; Output
1374	4...2-A"	1262	2; Input
1375	5...2-3/4"	1263	3; 1-2-3
1376	6...3-3/4"	1264	4; 1-2-3-4
1377	7...3-1/2"	1265	5; 1-2-3-4-5
1378	8...3-1/4"	1266	6; 1-2-3-4-5-6
1379	9...4-A"		
1380	10...4-1/2"		

TERMINAL STRIPS 2 POST

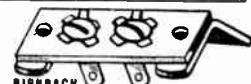

Excellent mounting for twin lead transmission lines. Brass hot tinned lugs spaced 1/4" center to center. 1/8" mounting center.

Cat. No. T16	Std. Pkg.
T16	50

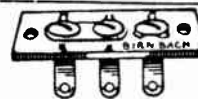

BIRNBACH 3 POST

A synchronizing lock strip for RCA type television receivers. Brass hot tinned lugs. Spaced 3/8" center to center. Mounting center 1 1/8".

Cat. No. T16A	Std. Pkg.
T16A	50



FUSE MOUNT BASE

Protects high voltage and similar type circuits. Takes 3 AG auto fuse. 1/8" bakelite.

Cat. No. T15	Std. Pkg.
T15	50



ROUND HEAD MACHINE SCREWS

Standard Package 1000

STEEL NICKEL PLATED			BRASS NICKEL PLATED		
Cat. No.	Size		Cat. No.	Size	
6300	2-56 x $\frac{3}{8}$		6400	4-36 x $\frac{1}{4}$	$\frac{1}{8}$ %
6301	2-56 x $\frac{7}{8}$		6401	4-36 x $\frac{3}{8}$	$\frac{1}{2}$ %
6302	2-56 x $\frac{1}{2}$		6402	4-36 x $\frac{1}{2}$	$\frac{1}{2}$ %
6303	3-48 x $\frac{1}{2}$		6403	4-36 x $\frac{1}{2}$	$\frac{1}{2}$ %
6304	4-36 x $\frac{1}{2}$		6404	4-36 x 1	$\frac{1}{2}$ %
6305	4-36 x $\frac{3}{8}$		6312	4-40 x $\frac{1}{4}$	$\frac{1}{8}$ %
6306	4-36 x $\frac{1}{2}$		6313	4-40 x $\frac{1}{2}$	$\frac{1}{2}$ %
6307	4-40 x $\frac{1}{2}$		6314	4-40 x $\frac{1}{2}$	$\frac{1}{2}$ %
6308	4-40 x $\frac{1}{2}$		6315	4-40 x $\frac{1}{2}$	$\frac{1}{2}$ %
6309	4-40 x $\frac{1}{2}$				
6420	6-32 x $\frac{1}{4}$		6405	6-32 x $\frac{1}{4}$	$\frac{1}{4}$ %
6421	6-32 x $\frac{3}{8}$		6406	6-32 x $\frac{1}{2}$	$\frac{1}{2}$ %
6422	6-32 x $\frac{1}{2}$		6407	6-32 x $\frac{3}{8}$	$\frac{3}{8}$ %
6423	6-32 x $\frac{1}{2}$		6408	6-32 x $\frac{1}{2}$	$\frac{1}{2}$ %
6424	6-32 x $\frac{1}{2}$		6409	6-32 x $\frac{1}{2}$	$\frac{1}{2}$ %
6425	6-32 x 1		6410	6-32 x 1	$\frac{1}{2}$ %
6426	8-32 x $\frac{3}{8}$		6411	6-32 x 1 $\frac{1}{4}$	$\frac{1}{4}$ %
6427	8-32 x $\frac{1}{2}$		6412	6-32 x 1 $\frac{1}{2}$	$\frac{1}{2}$ %
6428	8-32 x $\frac{1}{2}$		6413	8-32 x $\frac{1}{2}$	$\frac{1}{2}$ %
6429	8-32 x $\frac{3}{8}$		6414	8-32 x $\frac{1}{2}$	$\frac{1}{2}$ %
6430	8-32 x $\frac{1}{2}$		6415	8-32 x $\frac{1}{2}$	$\frac{1}{2}$ %
6431	8-32 x 1		6416	8-32 x 1	$\frac{1}{2}$ %
6432	8-32 x 1 $\frac{1}{2}$		6417	8-32 x 1	$\frac{1}{2}$ %
6433	10-32 x $\frac{1}{4}$		6418	8-32 x 1	$\frac{1}{2}$ %
6434	10-32 x $\frac{3}{8}$				
6435	10-32 x $\frac{1}{2}$		6316	10-32 x $\frac{1}{4}$	$\frac{1}{4}$ %
6436	10-32 x $\frac{3}{8}$		6317	10-32 x $\frac{1}{2}$	$\frac{1}{2}$ %
6437	10-32 x $\frac{1}{2}$		6318	10-32 x $\frac{3}{8}$	$\frac{3}{8}$ %
6438	10-32 x 1		6319	10-32 x $\frac{1}{2}$	$\frac{1}{2}$ %
6439	10-32 x 1 $\frac{1}{2}$		6320	10-32 x 1	$\frac{1}{2}$ %
6310	$\frac{1}{4}$ -20 x 1 $\frac{1}{2}$				
6311	$\frac{1}{4}$ -20 x 2 $\frac{1}{2}$				



BINDING HEAD MACHINE SCREWS

Steel Nickel Plated

Cat. No.	Size	Std. Pkg.
6321	6-32 x $\frac{1}{4}$	1000
6322	6-32 x $\frac{3}{8}$	1000
6323	6-32 x $\frac{1}{2}$	1000
6324	8-32 x $\frac{1}{2}$	1000
6325	8-32 x $\frac{1}{2}$	1000
6326	8-32 x $\frac{1}{2}$	1000

OVAL HEAD RACK SCREWS

Steel Nickel Plated

Widely used for mounting panels on racks and cabinets. Screws are nickel-plated brass.



Cat. No.	Size	Std. Pkg.
6600	6-32 x $\frac{1}{4}$	100
6601	6-32 x $\frac{3}{8}$	100
6602	6-32 x $\frac{1}{2}$	100
6603	6-32 x $\frac{1}{2}$	100
6604	8-32 x $\frac{1}{2}$	100
6605	8-32 x $\frac{1}{2}$	100
6606	8-32 x $\frac{1}{2}$	100
6607	8-32 x 1	100
6608	10-32 x $\frac{1}{4}$	100
6609	10-32 x $\frac{1}{2}$	100
6610	10-32 x $\frac{3}{8}$	100
6611	10-32 x $\frac{1}{2}$	100
6611-A	10-32 x 1	100



ORNAMENTAL HEAD SCREWS

Steel—Statuary Bronze Finish

Cat. No.	Size	Std. Pkg.
6327	6-32 x $\frac{3}{8}$	1000
6328	6-32 x 1	1000
6329	8-32 x 1 $\frac{1}{2}$	1000



WING NUTS

High quality brass nickel plated wing nut used extensively on portable and test instruments.

Cat. No.	Thread	Std. Pkg.
6	6-32	100
8	8-32	100
10	10-32	100
11	$\frac{1}{4}$ -20	100

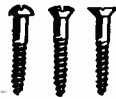

BRASS AND STEEL WOOD SCREWS

Round, Flat and Oval Heads

BRASS NICKEL PLATED				STEEL NICKEL PLATED			
Cat. No.	Size	Std. Pkg.		Cat. No.	Size	Std. Pkg.	
6460	$\frac{5}{16}$ x #4	144		6470	$\frac{5}{16}$ x #4	144	
6461	$\frac{1}{2}$ x #4	144		6471	$\frac{3}{8}$ x #4	144	
6462	$\frac{5}{16}$ x #5	144		6472	$\frac{5}{8}$ x #5	144	
6463	$\frac{1}{2}$ x #5	144		6473	$\frac{3}{8}$ x #5	144	
6464	$\frac{1}{2}$ x #6	144		6474	1 x #6	144	
6465	1 $\frac{1}{2}$ x #6	144		6475	1 $\frac{1}{2}$ x #6	144	
6466	1 $\frac{1}{2}$ x #6	144		6476	1 $\frac{1}{2}$ x #6	144	
				6477	$\frac{1}{2}$ x #8	144	
				6478	$\frac{3}{8}$ x #8	144	



BIRNBACH SHEET METAL SELF TAPPING SCREWS

Steel Cadmium Plated
TYPE A — SHARP POINT

Cat. No.	Size	Std. Pkg.
6500	#4 x $\frac{1}{4}$	144
6501	#6 x $\frac{1}{4}$	144
6502	#6 x $\frac{3}{8}$	144
6503	#6 x $\frac{1}{2}$	144
6504	#6 x $\frac{3}{4}$	144
6540	#8 x $\frac{1}{4}$	144
6541	#8 x $\frac{3}{8}$	144
6505	#8 x 1	144
6542	#10 x $\frac{1}{4}$	144
6543	#10 x $\frac{3}{8}$	144
6506	#10 x $\frac{1}{2}$	144
6507	#10 x 1	144



BIRNBACH HEX HEAD SELF TAPPING SCREWS

TYPE B — BLUNT POINT SLOTTED
Steel Cadmium Plated

Cat. No.	Size	Std. Pkg.	Cat. No.	Size	Std. Pkg.
6510	#6 x $\frac{3}{8}$	144	6515	#8 x $\frac{1}{2}$	144
6511	#6 x $\frac{1}{2}$	144	6516	#8 x $\frac{3}{4}$	144
6512	#6 x $\frac{3}{4}$	144	6517	#8 x 1	144
6513	#8 x $\frac{1}{2}$	144	6518	#10 x $\frac{1}{2}$	144
6514	#8 x $\frac{3}{8}$	144	6519	#10 x 1	144



HEXAGON STEEL MACHINE SCREW NUTS

Nickel Plated

Cat. No.	Thread	Width across Flats	Thickness	Std. Pkg.
6330	2-56	3/16"	1/16"	1000
6331	3-18	3/16"	1/16"	1000
6332	4-36	1/4"	3/32"	1000
6333	4-40	1/4"	3/32"	1000
6448	6-32	1/4"	3/32"	1000
6449	6-32	5/16"	7/64"	1000
6334	8-32	1/4"	3/32"	1000
6450	8-32	5/16"	7/64"	1000
6335	10-32	3/8"	1/8"	1000
6336	$\frac{1}{4}$ -20	7/16"	3/16"	1000



HEXAGON MACHINE SCREW NUTS

BRASS—NICKEL PLATED

Cat. No.	Thread	Width across Flats	Thickness	Std. Pkg.
6440	4-38	1/4"	3/32"	1000
6442	4-40	1/4"	3/32"	1000
6441	6-32	1/4"	5/64"	1000
6443	6-32	5/16"	7/64"	1000
8444	8-32	11/32"	1/8"	1000
6445	10-32	5/16"	7/64"	1000
6446	10-32	3/8"	1/8"	1000
6447	$\frac{1}{4}$ -20	7/16"	1/8"	1000



BIRNBACH TUBE CLAMPS

Desirable when mounting resonant lines or elements of directive beam antennas. Made of hard drawn aluminum. The 5/16", 3/8" and 1/2" have holes for No. 10 screw and the 3/8" and 1" dia. clamps have holes for 1/4" bolts.

Cat. No.	To Fit Tube	Std. Pkg.
51—Clamp	$\frac{1}{4}$ " Dia.	100
52—Clamp	$\frac{3}{8}$ " Dia.	100
53—Clamp	$\frac{1}{2}$ " Dia.	100
54—Clamp	$\frac{3}{8}$ " Dia.	100
55—Clamp	$\frac{1}{2}$ " Dia.	50
57—Clamp	$\frac{3}{8}$ " Dia.	50
56—Clamp	1" Dia.	50

BIRNBACH CABLE CLAMPS

Standard Package of 100



Cat. No.	To Fit Cable	L.	W.	Hole
1153	$\frac{1}{8}$ "	$\frac{7}{8}$ "	$\frac{1}{4}$ "	4
1154	$\frac{1}{8}$ "	$\frac{1}{2}$ "	$\frac{3}{8}$ "	6
1155	$\frac{3}{8}$ "	$\frac{1}{2}$ "	$\frac{3}{8}$ "	6
1156	$\frac{1}{2}$ "	$\frac{1}{2}$ "	$\frac{3}{8}$ "	6
1157	$\frac{3}{8}$ "	1"	$\frac{3}{8}$ "	10



FINISHING RACK WASHERS

Brass Nickel Plated

Cat. No.	Size	Std. Pkg.
6612	6-32 Cup Washer	100
6613	8-32 Cup Washer	100
6614	10-32 Cup Washer	100



BIRNBACH BRASS NICKEL PLATED FLAT WASHERS

Cat. No.	Fits Screw No.	Hole Size	O.D.	Thickness	Std. Pkg.
6478	4	.118"	.9/32"	.025"	1000
6480A	6	.145"	5/16"	.025"	1000
6480	6	.145"	3/8"	.025"	1000
6481	8	.172"	3/8"	.032"	1000
6482	10	.203"	7/16"	.036"	1000
6483	$\frac{1}{4}$ -20	.265"	9/16"	.040"	1000



STEEL KANTLINK LOCKWASHERS

Cat. No.	Screw Size	O.D.	Thickness	Std. Pkg.
6484	4	3/16"	1/32"	1000
6485	6	15/64"	1/32"	1000
6486	8	15/64"	.025"	1000
6487	10	5/16"	.050"	1000
6488	$\frac{1}{4}$	7/16"	5/64"	1000



SHAKEPROOF LOCKWASHERS

INTERNAL TEETH

Cat. No.	Screw Size	Std. Pkg.
6355	2	1000
6356	3	1000
6357	4	1000
6490	6	1000
6491	8	1000
6492	10	1000
6493	$\frac{1}{4}$	1000
6494	$\frac{3}{8}$	1000



SHAKEPROOF LOCKWASHERS

EXTERNAL TEETH

Cat. No.	Screw Size	Std. Pkg.
6358	4	1000
6359	6	1000
6360	8	1000
6361	10	1000
6362	$\frac{1}{4}$	1000
6363	$\frac{3}{8}$	1000



BIRNBACH SPEED NUTS TEMPERED STEEL PARKERIZED

These speed nuts are self locking and help reduce assembly time. They prevent loosening from vibration, eliminate need of washers and stand up under abuse. For use with machine screws.

Cat. No.	Thread Size	Length	Width	Thickness	Std. Pkg.
6350	4-36	3/8"	1/4"	.012"	1000
6351	6-32	7/16"	9/16"	.017"	1000
6352	8-32	1/2"	5/16"	.017"	1000
6353	10-24	3/8"	3/8"	.022"	1000
6354	1/4-20	3/4"	1/2"	.025"	1000



BIRNBACH SPEED NUTS TEMPERED STEEL PARKERIZED For use with sheet metal screws.

Cat. No.	Thread Size	Length	Width	Thickness	Std. Pkg.
6350A	4A	3/8"	1/4"	.028"	1000
6351A	6A	1/2"	5/16"	.025"	1000
6352A	8A	5/8"	13/32"	.028"	1000
6353A	10A	3/4"	1/2"	.031"	1000
6354A	14A	7/8"	9/16"	.037"	1000

BIRNBACH FRONT PANEL BEARING

Cadmium plated brass for panels up to 3/4" in thickness and for 1/4" dia. shafts. The No. 551 and No. 552 are complete assemblies of the No. 550 and 1/4" dia. brass shaft cadmium plated.

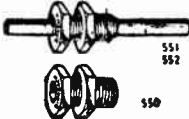

Cat. No.	Description	Std. Pkg.
550	Front Panel Bearing	50
551	Front Panel Bearing, 1/4" shaft, 3" long	50
552	Front Panel Bearing, 1/4" shaft, 6" long	25

BIRNBACH FLEXIBLE SHAFTS

With couplings and these flexible shafts, locations can be made with ease on an offset and angles up to 90 degrees. The flexible shafts are made of phosphor bronze and fitted into 1/4" dia. hubs.

Cat. No.	Description	Std. Pkg.
553	Flexible Shaft 3" long	25
554	Flexible Shaft 6" long	25

BIRNBACH SPRING WIRE CLIPS

They will hold a wire up to No. 10 B&S Gauge in a secure contact. All clips are brass nickel plated.

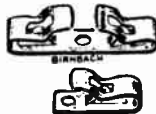

Cat. No.	Length	Width	Hole	Std. Pkg.
32A	Spring Clip, 3/4"	3/8"	6	100
32	Spring Clip, 1"	3/8"	10	100
33	Twin Clip, 1 1/4"	3/8"	10	50

6 PIECE SCREW DRIVER SET

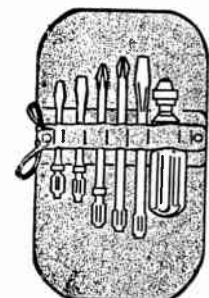

Unbreakable, shock-proof, non-inflammable amber handle, with flange aluminum screw chuck. Blades hardened, tempered and fully polished. For most TV and Radio work.

Blade Size	Description	Std. Pkg.
1	Cabinet Blade x 3/4"	100
1	Mechanic Blade x 3/4"	100
1	Recessed Head (#1) Blade x 4/4"	100
1	Recessed Head (#2) Blade x 4/4"	100
1	Amber Handle with Chuck	100

All in attractive leatherette case. Wt. 5 lbs. Cat. No. 3618. Std. Pkg. 12

BRASS BUSHING AND SPACERS

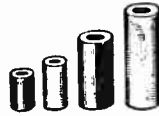

For raising sub panels, chassis, condensers, transformers, etc. Hole will accommodate a No. 6 or No. 8 screw.

For No. 6			1/4" O.D.	For No. 8		
Cat. No.	Std. Pkg.	Length	Cat. No.	Std. Pkg.	Length	
1125	100	1/4"	1130	100	1/4"	
1126	100	3/8"	1131	100	3/8"	
1127	100	1/2"	1132	100	1/2"	
1128	100	3/4"	1133	100	3/4"	
1129	100	1"	1134	100	1"	
3/8" O.D.						
1135	100	1/4"	1140	100	1/4"	
1136	100	3/8"	1141	100	3/8"	
1137	100	1/2"	1142	100	1/2"	
1138	100	3/4"	1143	100	3/4"	
1139	100	1"	1144	100	1"	

INSULATED BUSHINGS & SPACERS

For No. 6			1/4" O.D.	For No. 8		
Cat. No.	Std. Pkg.	Length	Cat. No.	Std. Pkg.	Length	
1145	100	1/4"	1149	100	1/4"	
1146	100	3/8"	1150	100	3/8"	
1147	100	1/2"	1151	100	1/2"	
1148	100	3/4"	1152	100	3/4"	



SHAFT COUPLINGS, REDUCERS AND EXTENDERS

By the use of these units all 1/4" and 3/8" dia. shafts and knobs can be assembled together. The insulated units are for use where electrical isolation is desired. Furnished complete with set screws shown.

SHAFT COUPLINGS

Brass No.	Insul. No.	Shaft A	Hole B
534	634	1/4"	1/4"
535	635	3/8"	3/8"
536	636	1/2"	1/2"
537	637	3/4"	3/4"

COUPLINGS

Brass No.	Insul. No.	Shaft A	Hole B
531	631	1/4"	1/4"
532	632	3/8"	3/8"
533	633	1/2"	1/2"

EXTENDERS

Length	538 Brass	539 Insul.
1 1/4"	1 1/4"	1 1/4"
Hole I.D.	1/4"	1/4"
Shaft O.D.	1/4"	1/4"

BRASS SHAFING

No.	Dia.	Length
540	1/4"	6"
541	3/8"	12"
542	1/2"	8"

FIBRE SHAFING

No.	Dia.	Length
543	1/4"	6"
544	3/8"	12"
545	1/2"	8"

RATCHET HANDLE SCREW DRIVER SET

6 piece set. Same as above but with ratchet amber handle. (3 way: left, right and rigid). Weight: 5 lbs.

Cat. No.	Std. Pkg.
3619	12

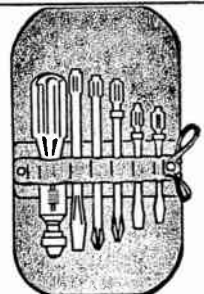

TRANSMITTING TUBE SOCKETS



50-Watt socket has extra heavy side wiping phosphor bronze contact spring with the filament spring having a double contact to safely carry the heavy current.

Std. Pkg.	Description
434-50	Watt.....25
435-10	Watt.....25

AIRPLANE INSULATORS

Used on mobile and aircraft and also with guy wire on TV installations. Shaped for the least air resistance; have very high tensile strength and low loss. Nos. 473 and 474 made of white glazed low absorption porcelain. No. 472 made of wetprocess glazed brown porcelain.



Cat. No.	Description	Std. Pkg.
472-2 1/4"	(brown)	25
473-2"	(white)	100
474-1 1/2"	(white)	100

LEADIN INSULATORS



Each cone 2 3/4" high, made of low absorption, vitrified glazed porcelain. The Nos. 4237 and 4238 have insulating bushings to insulate rod that goes through the wall. 2 bushings are included. 1/4" complete insulation of the threaded rod of any length in multiples of 1/4". Complete with brass nickel plated hardware and lead and cork washers to permit water-tight seal.

Cat. No.	Description	Std. Pkg.
4235	10" Rod	10
4236	15" Rod	10
4237	10" Rod with bushings	10
4238	15" Rod with bushings	10

BEE-HIVE STANDOFF



Base measures 2" dia. with 3 holes on a 1 1/2" circle, for No. 6 screws. Complete with 12-24 nickel plated brass screw and nuts. No. 766J has a No. 403 Jack. Available white or brown glaze.

Cat. No.	Hardware	Std. Pkg.
766	Standoff Insulator, 12-24 Screw	10
766J	Jack Type, No. 403 Jack	10

PORCELAIN TUBES

To bring a lead-in into a building, 3/4" diameter hole required.

Cat. No.	Length	Std. Pkg.
42	2"	100
43	3"	100
44	4"	100
46	6"	100
48	8"	100

BIRNBACH THREADED RODS

These brass nickel plated threaded rods are standard parts of our insulator assemblies.

Cat. No.	Length	Thread	Std. Pkg.
16	4"	1/4-20	1000
17	5 1/2"	3/8-20	1000
18	10"	1/2-20	1000
113	15"	3/4-20	1000
114	1 1/2"	10-32	1000
115	1 3/4"	10-32	1000
116	2"	10-32	1000
117	2 1/2"	10-32	1000
118	3"	8-32	1000
119	3"	6-32	1000
15	2"	6-32	1000



BIRNBACH STEATITE PILLARS

(Without Hardware)



In many constructions, these unmounted threaded steatite pillars will facilitate assembly because of the one hole mounting and parallel mounting surfaces. They are made of glazed Steatite with threaded holes on both sides.

Cat. No.	Height	Dia.	Threaded Hole	Std. Pkg.
443	1/4"	1/2"	6-32	100
444	3/8"	1/2"	6-32	100
445	1"	1/2"	6-32	100
446	1 1/2"	1/2"	6-32	100
447	2 1/2"	1/2"	6-32	100
448	2 1/2"	3/4"	1/4-20	50
449	4"	3/4"	1/4-20	50

BIRNBACH STEATITE PILLARS

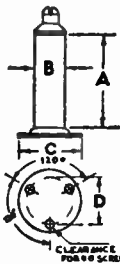

Have great tensile strength with extremely low losses at very high frequencies. Tapped on both ends; supplied with nickel plated mounting base and top hardware.

Cat. No.	Height	Std. Pkg.	Base Dimen.	Base Dia.	Hardware
450	1"	10	1/2" x 1/2"	7/8"	6-32
450J	1"	10	1/2" x 1/2"	7/8"	403 Jack
451	1 1/2"	10	1/2" x 1/2"	7/8"	6-32
451J	1 1/2"	10	1/2" x 1/2"	7/8"	403 Jack
452	2 1/2"	10	1/2" x 1/2"	7/8"	6-32
452J	2 1/2"	10	1/2" x 1/2"	7/8"	403 Jack
453	3 1/2"	5	3/4" x 1/2"	1 1/8"	1/4-20
453J	3 1/2"	5	3/4" x 1/2"	1 1/8"	395 Jack
454	4"	5	3/4" x 1/2"	1 1/8"	1/4-20
454J	4"	5	3/4" x 1/2"	1 1/8"	395 Jack

BIRNBACH STEATITE BUTTON



This specially designed steatite button is intended for use to simplify wiring and to be used as a binding post or a binding post insulator or as a standoff insulator. Attention is called to the uniqueness of the design which prevents either section of the insulator from turning in respect to the special screw. The specially designed screw locks both sections.

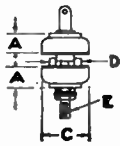

Cat. No.	Std. Pkg.	Dimensions
457	25	A: 5/16", C: 3/8", D: 1/2", E: 6-32

"LUCITE" FEEDTHRU INSULATORS



These feedthru insulators are ideal for bringing high frequency leads thru a panel. They are made of genuine DuPont Lucite. Because of its low loss at high frequency, it is well adapted to insulated elements of high frequency circuits. The 1/2" dia. insulators have brass nickel plated 6-32 hardware and the 3/8" dia. insulators, 10-32 hardware.

Cat. No.	Height Above Panel	Insulator Dia.	Mtg. Hole	Bottom Height	Std. Pkg.
377	1/4"	1/2"	6-32	1/4"	25
378	1/2"	1/2"	6-32	1/4"	25
379	1"	1/2"	6-32	1/4"	25
475	1 1/2"	1/2"	6-32	1/4"	25
476	2"	1/2"	6-32	1/4"	25

CONE STANDOFF INSULATORS (STEATITE)



All heights except the No. 430 are available with a Jack or a threaded hole top. Complete with screws, metal and cork washers.



Cat. No.	Height	Std. Pkg.	Base Dimensions	Threaded Holes
430	1/4"	100	3/8" x 3/8"	6-32
431	1"	50	1/2" x 1/2"	8-32
431J	1"	50	1/2" x 1/2"	403 Jack
432	1 1/2"	50	1/2" x 1/2"	10-32
432J	1 1/2"	50	1/2" x 1/2"	403 Jack
433	2 1/2"	25	1/2" x 1/2"	1/4-20
433J	2 1/2"	25	1/2" x 1/2"	395 Jack

Mounting Hole: No. 430—5/32"; 431 & 431J—3/16"; 432 & 432J—7/32"; 433 & 433J—9/32"

BIRNBACH STANDOFF INSULATORS

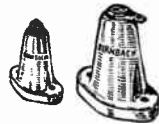

Highly vitrified low absorption glazed porcelain. No washers are necessary for mounting except No. 405 and No. 966. All brass nickel plated hardware is supplied.

Cat. No.	Height	Std. Pkg.	Base Dimensions	Mtg. Holes
405	1/4"	100	1/2" x 1/2"	6-32
965	1"	50	1 1/4" x 1 1/4"	6-32
966	1"	50	1 1/4" x 1 1/4"	6-32
966J	1"	50	1 1/4" x 1 1/4"	403 Jack
866	1 1/2"	25	1 1/4" x 1 1/4"	1/4-20
866J	1 1/2"	25	1 1/4" x 1 1/4"	395 Jack
866SJ	1 1/2"	25	1 1/4" x 1 1/4"	395 Jack
4275	2 1/2"	10	2 1/2" x 2 1/2"	1/4-20
4275J	2 1/2"	10	2 1/2" x 2 1/2"	394 Jack
4450	4 1/2"	5	3 1/2" x 3 1/2"	1/4-20
4450J	4 1/2"	5	3 1/2" x 3 1/2"	394 Jack

Hardware: No. 405—6-32; 965 & 966—8-32; 866 & 866J—No. 403 Jack; 866—10-32; 866SJ, 4275J & 4450J—No. 395 Jack; 4275 & 4450—1/4-20.

BIRNBACH METAL BASE INSULATORS



No. 867



No. 4176

Extremely long leakage paths due to the corrugated surface is one of the important characteristics. Made from high tensile strength low absorption porcelain smoothly glazed all over. Supplied with nickel plated brass screws and nuts and cadmium plated drawn steel bases.



Cat. No.	Height	Std. Pkg.	Base Dimension	Mounting Screw
867	1 1/2"	25	1 1/8" x 1 1/8"	1/4-20
867J	1 1/2"	25	1 1/8" x 1 1/8"	394 Jack
4176	2 1/2"	10	1 1/8" x 1 1/8"	4 #10
4176J	2 1/2"	10	1 1/8" x 1 1/8"	4 #10
4451	4 1/2"	5	2 1/2" x 2 1/2"	4 #10
4451J	4 1/2"	5	2 1/2" x 2 1/2"	4 #10

Hardware: No. 867—10-32; 867J—No. 403 Jack; 4176 & 4451—1/4-20; 4176J & 4451J—No. 395 Jack.

BIRNBACH LUCITE SPREADERS



DuPont Lucite rod which has a very low loss at radio frequencies. Very low water absorption. Holes are drilled to take a No. 12 wire. A screw at the end of the spreader locks the wire in position.

Cat. No.	Wire Spacing	Std. Pkg.
466	2"	25
437	4"	25
438	6"	25

BIRNBACH LUCITE RODS

Cat. No.	Length	Dia.	Cat. No.	Length
455	12"	1/4"	455A	48"
459	12"	3/8"	459A	48"
460	12"	1/2"	460A	48"
461	12"	3/4"	461A	48"

BIRNBACH FEEDTHRU INSULATORS

Made of highly vitrified, low absorption porcelain smoothly glazed. Long insulating sleeves on the lower part of the insulator. Brass nickel plated hardware.



Cat. No.	Height	Std. Pkg.	Dimensions	Mtg. Hole	Hardware
478	1/4"	50	1/2" x 1/2"	6-32	100
478J	1/4"	25	1/2" x 1/2"	6-32	10-32
478J	1/4"	25	1/2" x 1/2"	6-32	403 Jack
4125	1 1/2"	25	1 1/2" x 1 1/2"	6-32	10-32
4125J	1 1/2"	25	1 1/2" x 1 1/2"	6-32	403 Jack
4234	2 1/2"	10	2 1/2" x 2 1/2"	1/4-20	1/4-20
4175	2 1/2"	10	1 1/2" x 1 1/2"	1/4-20	1/4-20
4175J	2 1/2"	10	1 1/2" x 1 1/2"	1/4-20	394 Jack

BIRNBACH CORRUGATED FEEDTHRU INSULATORS

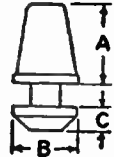
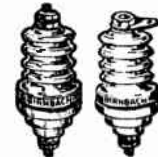

Have more than twice the leakage path of the straight type because of increased surface of the corrugations. Brass nickel plated hardware and cork mounting washers supplied.

Cat. No.	Height	Std. Pkg.	Dimensions	Mtg. Hole	Hardware
479	1 1/2"	25	1 1/2" x 1 1/2"	6-32	10-32
479J	1 1/2"	25	1 1/2" x 1 1/2"	6-32	403 Jack
4276	2 1/2"	10	1 1/2" x 1 1/2"	1/4-20	1/4-20
4276J	2 1/2"	10	1 1/2" x 1 1/2"	1/4-20	394 Jack
4452	4 1/2"	5	2 1/2" x 2 1/2"	1/4-20	1/4-20
4452J	4 1/2"	5	2 1/2" x 2 1/2"	1/4-20	394 Jack

BIRNBACH HIGH VOLTAGE FEEDTHRU INSULATOR

High dielectric and mechanical strength. The extra long leakage path is made possible by the corrugations on the top insulator. The bottom sleeve tapers from a base dia. of 1-3/16".

Cat. No.	H. Dia.	Std. Base	Mtg. Hole	Hardware
4233	1 1/2"	1.0	2" x 1 1/4"	1/4-20

BIRNBACH ANTENNA INSULATORS



470—7 inch 471—12 inch



Cat. No.	Std. Pkg.	Center Insulator
468	4 1/2"	long 10
668	4 1/2"	long 25
470	7"	long 10
471	12"	long 5

BIRNBACH FEEDER SPREADERS

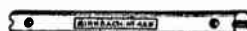

Cat. No.	Std. Pkg.	Dimensions
462	25	3/8" x 1/2"
464	25	3/8" x 1/2"
469	25	3/8" x 1/2"

STEATITE AIRPLANE INSULATORS



It is 1 1/2" long and 1/2" diameter. 463.....Std. Pkg. 25



Hi-Voltage Anode Cap with Lead



Dependable protection from high voltages found on cathode ray tubes. Supplied with 18" lead.

Cat. No. T14—Hi-Volt Anode Cap with Lead... 25 St. Pkge.
For RCA, G.E., and Sylvania Tubes.

TELEVISION SAFETY CORD



6 Ft. UL approved. Plugs into No. 813.
815—TV Safety Cord..... St. Pkge. 100

MALE AC INTERLOCK PLUG



Designed to mount on TV receiver cabinet and serves as socket for Safety Cord No. 815.

813—AO Interlock Plug
St. Pkge. 100

CLEAR VINYL TUBING FOR TV

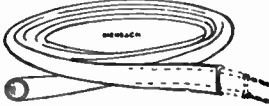

For 300 ohm line. Protects it from grounding when going over corners and eaves of buildings. Waterproofs line and eliminates loss of signal.

Cat. No. 321BC..... 100 ft. coils..... 8 St. Pkge.

HALF-MOON DUO-DECAL SOCKET



For CR Television tubes. Solid moulded black bakelite provides 100% insulation around clip and lead. Multi-colored lead-in wires. 19" leads supplied.

Cat. No. T20—Duo-Decal Socket... 25 St. Pkge.

UNIVERSAL ALL WAVE KIT



The No. 149 All Wave Antenna Kit is designed for efficient operation with all types of receivers.

List of Parts:

- 2—30 ft. coils 7/24 bare copper aerial wire
- 1—50 ft. coil Stranded Transmission Cable
- 1—Transfer unit
- 2—Porcelain Insulators
- 2—All Wave Lead-in Strip
- 1—Ground Clamp
- 2—Glazed Nailit Knobs

The above completely assembled for simple installation.

Cat. No. 149—Universal All Wave Kit..... 24 St. Pkge.

BIRNBACH IGNITION FILTERS

Completely eliminate all ignition and high tension circuit interference. Copper wound inductance accounts for the low resistance of 120 ohms for the Ignition Filter. Due to the low resistance of these filters, less gasoline is consumed than when high resistance filters are used.

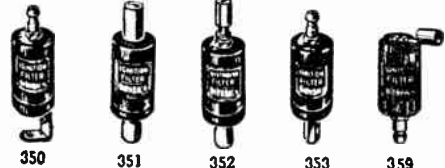

Cat. No. Std. Pkge.
350—Ignition Filter (Bracket Type)..... 25
351—Ignition Filter (Cable Type)..... 25
352—Distributor Filter 10
353—Ignition Filter (Screw Type)..... 25
359—Ignition Filter (Slip-on Type)..... 25

SPEAKER EXTENSION CORDS

These extension cords are constructed of stranded annealed copper wire insulated with rubber over which a brown mercerized cotton braid is closely woven. Complete with easily attached bakelite connector.



Cat. No. Std. Pkge.
166..... 10 ft. Cord
120..... 20 ft. Cord
151..... Bakelite Extension Cord Connector Only

SPEAKER CORDS



Stranded wire, insulated with rubber, with closely woven brown mercerized cotton overall.

Cat. No. Std. Pkge.
102..... 5 ft. with Pin Tips on both ends
103..... 5 ft. with Pin and Spade Tips
106..... 5 ft. with Pin and Eye Tips
413..... 10 ft. with Pin and Eye Tips

BIRNBACH ANTENNA KITS



Cat. No. 503 — AERIAL KIT

- 75 ft. 7/24 Copper Wire
- 35 ft. R.C. Lead-in Wire
- 1—No. 650 Lightning Arrestor
- 1—No. 600 Ground Clamp
- 1—No. 611 Lead-in Strip
- 2—No. 668 Porcelain Insulators
- 2—No. 669 Glazed Nailit Knobs
- 2—No. 665 Galvanized Screw Eyes

Std. Pkg. 24 Weight 65 lbs.

AC-DC RESISTANCE CORDS



Consists of a line cord into which a third element has been incorporated. The voltage dropping resistor reduces the voltage to that needed for the filament of the tubes. The 135, 160, 180 and 200-ohm cords can also be used for single light 20 and 15-watt fluorescent fixtures. All 6-ft. long, color coded with tinned leads and all rubber plugs. All individually boxed.

Cat. No.	Cord Rating	Sets Having Following Tubes:
35	135 ohm	2525-43-4 (6.3 volt tubes)
38	160 ohm	2525-43-3 (6.3 volt tubes)
34	180 ohm	12Z3-43-4 (6.3 volt tubes)
49	200 ohm	2525-43-2 (6.3 volt tubes)
37	220 ohm	12Z3-43-3 (6.3 volt tubes)
41	250 ohm	12Z3-43-2 (6.3 volt tubes)
38	290 ohm	12Z3 -3 (6.3 volt tubes)
45	300 ohm	12Z3 -3 (6.3 volt tubes)
39	330 ohm	-4 (6.3 volt tubes)
40	350 ohm	12Z3 -2 (6.3 volt tubes)
47	390 ohm	12Z3 -1 (6.3 volt tubes)
58	560 ohm	-2 (6.3 volt tubes)
59	960 ohm	For 3-way portables, AC-DC battery sets
125	220-110 volt.	Wherever 4523 rectifier is used (All pocket type radios)

HEADSET PHONE CORDS



These cords are closely woven and are very durable and strong. Standard cords listed match practically all headsets manufactured.

Cat. No. Std. Pkge.
104..... 5 ft. with Pin Tips on both ends
105..... 5 ft. with Pin and Spade Tips
107..... 5 ft. with Pin and Eye Tips
108..... 8 ft. with Pin and Eye Tips
109..... 10 ft. with Pin and Eye Tips

BIRNBACH GLASS INSULATORS



Made of crystal clear glass and have a smooth surface which prevents dirt or ice from collecting.

Cat. No. 00—3"..... Std. Pkg. 100

Birnbach PRICE LIST

NUMERICALLY ARRANGED BY CATALOG NUMBER
See BIRNBACH Pages S-31 thru S-45

Cat. No.	List Price	Cat. No.	List Price	Cat. No.	List Price	Cat. No.	List Price	Cat. No.	List Price	Cat. No.	List Price	Cat. No.	List Price
00	\$11.00/C	11	17.50/C	27-C	.21/Ea.	39	1.40/Ea.	55	.40/Ea.	74	11.55/Ea.	91	17.60/Ea.
1-50	.80/Ea.	15	7.00/C	27-R	.195/Ea.	40	1.40/Ea.	58	.50/Ea.	75	14.00/Ea.	92	24.20/Ea.
1-100	1.20/Ea.	16	.25/Ea.	28	.11/Ea.	41	1.40/Ea.	57	.50/Ea.	78	\$21.50/Ea.	93	27.00/Ea.
1-1000	9.75/M	17	.55/Ea.	29	.17/Ea.	42	7.00/C	58	1.50/Ea.	77	24.25/Ea.	94	29.50/Ea.
2-50	.80/Ea.	18	1.00/Ea.	30	.30/Ea.	43	8.00/C	59	1.80/Ea.	80	.70/Ea.	95	33.00/Ea.
2-100	1.20/Ea.	21-35	.80/Ea.	31	.15/Ea.	44	10.00/C	81	4.90/Ea.	81	.77/Ea.	96-40	.60/Ea.
2-1000	9.75/M	21-100	1.50/Ea.	31-R	.22/Ea.	45	1.40/Ea.	82	24.00/Ea.	82	.83/Ea.	96-100	1.15/Ea.
3-50	.60/Ea.	21-1000	12.50/M	32	\$2.50/C	46	14.00/C	86	6.00/Ea.	83	.90/Ea.	96-1000	10.75/M
3-1000	9.75/M	22-15	.60/Ea.	32-A	2.25/C	47	1.40/Ea.	87	27.50/Ea.	84	2.75/Ea.	97-40	.60/Ea.
3-1000	1.20/Ea.	22-100	3.20/Ea.	33	10.50/C	48	\$2.50/C	88	7.75/Ea.	85	3.05/Ea.	97-100	1.20/Ea.
3A-1000	9.75/M	22-1000	29.50/M	34	1.40/Ea.	49	1.40/Ea.	69	38.00/Ea.	88	3.30/Ea.	97-1000	10.75/M
4-1000	37.50/M	23	15.00/C	35	1.40/Ea.	51	.25/Ea.	70	.80/Ea.	87	3.60/Ea.	98-35	.60/Ea.
5-1000	50.00/M	24	15.00/C	36	1.40/Ea.	52	.25/Ea.	71	.70/Ea.	88	13.75/Ea.	98-100	1.50/Ea.
6	12.00/C	26	15.00/C	37	1.40/Ea.	53	.25/Ea.	72	2.36/Ea.	89	15.50/Ea.	98-1000	12.50/M
8	12.50/C	27	.11/Ea.	38	1.40/Ea.	54	.25/Ea.	73	2.75/Ea.	90	15.70/Ea.	99-35	.60/Ea.

Cat. No.	List Price	Cat. No.	List Price	Cat. No.	List Price	Cat. No.	List Price	Cat. No.	List Price	Cat. No.	List Price	Cat. No.	List Price
99-100	1.40/Ea.	295-V	1.80/Ea.	384	4.30/Ea.	485	23.65/Ea.	712-2500	116.00/Ea.	977	38.50/Ea.	1411	24.50/Ea.
99-1000	12.50/M	295-VC	7.00/Ea.	385	4.75/Ea.	486	28.40/Ea.	714-100	3.05/Ea.	978	44.00/Ea.	1413	1.15/Ea.
100-20	.60/Ea.	296 (36")	1.75/Ea.	386	5.80/Ea.	487	27.50/Ea.	714-250	7.50/Ea.	1017	35.00/M	1414	2.00/Ea.
100-100	2.25/Ea.	296-VC	50.00/Ea.	387	6.90/Ea.	488	44.00/Ea.	714-500	15.00/Ea.	1017-10	.60/Ea.	1415	19.00/Ea.
100-1000	20.00/M	297	.45/Ea.	388	9.35/Ea.	489	48.50/Ea.	714-1000	29.00/Ea.	1017-50	1.95/Ea.	1417	1.85/Ea.
102	.90/Ea.	298	.50/Ea.	389	9.90/Ea.	490	2.75/Ea.	714-2500	71.00/Ea.	1017-100	3.85/Ea.	1418	1.55/Ea.
103	.90/Ea.	299 (36")	1.45/Ea.	391	.22/Ea.	490-A	4.13/Ea.	740	.88/Ea.	1017-1000	35.00/M	1419	15.30/Ea.
104	1.50/Ea.	299-VC	42.50/Ea.	392	.70/Ea.	490-B	5.50/Ea.	749	35.00/Ea.	1025	1.35/Ea.	1421	1.40/Ea.
105	1.50/Ea.	300	.19/Ea.	393	.65/Ea.	492	4.30/Ea.	756	21.00/Ea.	1050	2.50/Ea.	1422	1.40/Ea.
106	.90/Ea.	300-V	1.95/Ea.	393-A	.65/Ea.	492-A	6.45/Ea.	757	18.75/Ea.	1051	4.50/Ea.	1423	9.90/Ea.
107	1.50/Ea.	300-VC	7.65/Ea.	394	.45/Ea.	492-B	8.60/Ea.	766	\$.50/Ea.	1052	37.00/Ea.	1433	15.40/Ea.
108	\$1.90/Ea.	301	.35/Ea.	395	.45/Ea.	493	4.15/Ea.	766-J	.75/Ea.	1053	.75/Ea.	1434	8.25/Ea.
109	2.75/Ea.	301-V	1.75/Ea.	396	.45/Ea.	495	5.35/Ea.	768	.70/Ea.	1054	1.40/Ea.	1440	4.70/Ea.
113	1.10/Ea.	301-VC	10.00/Ea.	397	.50/Ea.	497	6.60/Ea.	769	1.40/Ea.	1055	2.75/Ea.	1490	27.50/Ea.
114	10.00/C	302	.35/Ea.	398	.50/Ea.	499	11.80/Ea.	770	2.50/Ea.	1056	21.00/Ea.	1492	42.90/Ea.
115	11.00/C	302-V	1.25/Ea.	398-A	.45/Ea.	501	3.60/Ea.	771	16.75/Ea.	1057	1.45/Ea.	1497	67.10/Ea.
116	12.00/C	302-VC	11.00/Ea.	399	.45/Ea.	503	3.35/Ea.	772	16.75/Ea.	1058	2.80/Ea.	1516	28.50/Ea.
117	25.00/C	303	.65/Ea.	399-A	.50/Ea.	505	2.90/Ea.	772/18	21.00/Ea.	1059	5.00/Ea.	1518	1.20/Ea.
118	22.50/C	303-VC	\$25.00/Ea.	400	.20/Ea.	516	2.00/Ea.	773	21.75/Ea.	1060	40.00/Ea.	1519	2.30/Ea.
119	20.00/C	304 (36")	.90/Ea.	401	.20/Ea.	518	17.50/Ea.	773/18	27.00/Ea.	1101	4.20/Ea.	1520	11.00/Ea.
120	2.75/Ea.	304-VC	30.00/Ea.	402	4.00/C	519	3.80/Ea.	774	24.00/Ea.	1111	30.00/Ea.	1526	1.40/Ea.
125	2.50/Ea.	305-V	1.50/Ea.	402-A	5.00/C	520	2.25/Ea.	775	27.50/Ea.	1112	57.50/Ea.	1527	2.70/Ea.
131	7.50/Ea.	305-VC	14.00/Ea.	403	.15/Ea.	522	4.25/Ea.	776	32.00/Ea.	1113	115.00/Ea.	1528	13.00/Ea.
149	.80/Ea.	306-V	1.70/Ea.	404	.30/Ea.	523	20.00/Ea.	777	35.00/Ea.	1120	5.00/C	1542	12.50/Ea.
154	7.00/Ea.	306-VC	16.00/Ea.	404-A	.27/Ea.	524	6.95/Ea.	778	45.00/Ea.	1121	2.80/C	1543	4.25/Ea.
155	7.00/Ea.	307	.30/Ea.	404-B	.40/Ea.	526	6.65/Ea.	781	20.00/Ea.	1122	5.50/C	1544	20.00/Ea.
156	4.50/Ea.	307-V	11.80/Ea.	405	1.10/Ea.	527	16.65/Ea.	782	1.40/Ea.	1123	2.20/C	1545	25.00/Ea.
157	4.50/Ea.	307-VC	9.00/Ea.	406	.20/Ea.	528	22.50/Ea.	784	1.95/Ea.	1124	2.20/C	1548	22.50/Ea.
158	12.00/Ea.	309	1.70/Ea.	407	.20/Ea.	529	34.25/Ea.	786	27.50/Ea.	1125	5.00/C	1549	18.00/Ea.
160	4.25/Ea.	310	25.00/C	408	3.00/C	531	.25/Ea.	787	38.50/Ea.	1126	6.50/C	1550	3.75/Ea.
161	4.85/Ea.	312	1.90/Ea.	409	.23/Ea.	532	.25/Ea.	788	13.00/Ea.	1127	8.00/C	1553	25.00/Ea.
164	.40/Ea.	313	.17/Ea.	410	.50/Ea.	533	.25/Ea.	789	31.75/Ea.	1128	9.50/C	1561	3.35/Ea.
166	2.00/Ea.	313-B	.75/Ea.	411	1.20/Ea.	534	5.34	790	15.50/Ea.	1129	11.00/C	1562	6.80/Ea.
172	10.50/Ea.	313-BC	2.75/Ea.	412	.30/Ea.	535	2.25/Ea.	791	37.50/Ea.	1130	5.00/C	1563	60.50/Ea.
173	14.25/Ea.	314	.17/Ea.	413	1.50/Ea.	536	.25/Ea.	792	18.75/Ea.	1131	6.50/C	1565	2.00/Ea.
174	17.80/Ea.	314-B	.75/Ea.	415	.23/Ea.	537	.25/Ea.	793	45.75/Ea.	1132	8.00/C	1566	4.00/Ea.
175	22.00/Ea.	314-BC	2.75/Ea.	417	.50/Ea.	538	.30/Ea.	794	22.00/Ea.	1133	9.50/C	1587	36.75/Ea.
176	26.00/Ea.	315	.18/Ea.	418	.55/Ea.	539	\$.30	795	11.00/Ea.	1134	14.00/C	1569	1.40/Ea.
177	31.00/Ea.	315-B	.75/Ea.	419	.35/Ea.	540	.30/Ea.	796	27.50/Ea.	1135	8.00/C	1570	2.75/Ea.
178	37.00/Ea.	315-BC	2.75/Ea.	420	1.30/Ea.	541	.60/Ea.	797	65.00/Ea.	1136	9.50/C	1571	26.50/Ea.
179	45.00/Ea.	316	.21/Ea.	421	1.30/Ea.	542	.45/Ea.	798	29.00/Ea.	1137	11.00/C	1573	.95/Ea.
180	53.00/Ea.	316-B	.80/Ea.	422	1.30/Ea.	543	.25/Ea.	799	20.00/Ea.	1138	12.50/C	1574	1.60/Ea.
182	61.00/Ea.	316-BC	3.00/Ea.	423	1.30/Ea.	544	.50/Ea.	800	27.50/Ea.	1139	14.00/C	1575	14.80/Ea.
193	14.00/M	317	.19/Ea.	430	.32/Ea.	545	.50/Ea.	801	35.00/Ea.	1140	8.00/C	1600	15.40/Ea.
194	14.00/M	317-B	.80/Ea.	431	.40/Ea.	550	.25/Ea.	802	24.00/Ea.	1141	9.50/C	1618	15.40/Ea.
195	14.00/M	317-BC	3.00/Ea.	431-J	.48/Ea.	551	.50/Ea.	803	18.25/Ea.	1142	11.00/C	1620	9.90/Ea.
196	18.00/M	318	.40/Ea.	432	.72/Ea.	552	.60/Ea.	806	15.00/Ea.	1143	12.50/C	1622	7.70/Ea.
201-35	.60/Ea.	318-B	.75/Ea.	432-J	\$.95/Ea.	553	.90/Ea.	809	8.00/Ea.	1144	14.00/C	1627	19.85/Ea.
201-100	1.40/Ea.	318-BC	4.70/Ea.	433	1.40/Ea.	554	1.30/Ea.	810	35.00/Ea.	1145	6.00/C	1628	18.30/Ea.
201-1000	12.50/M	319	.45/Ea.	433-J	1.70/Ea.	555	2.20/Ea.	813	20.00/C	1146	6.75/C	1631	24.40/Ea.
220	8.50/Ea.	319-B	.75/Ea.	434	2.35/Ea.	558	.85/Ea.	814	15.00/C	1147	7.00/C	1633	22.95/Ea.
220-A	\$6.75/Ea.	319-BC	6.75/Ea.	435	1.85/Ea.	559	1.30/Ea.	815	.80/Ea.	1148	9.00/C	1634	19.00/Ea.
236-FC1	5.50/Ea.	320	.50/Ea.	436	.60/Ea.	560	2.25/Ea.	816	.55/Ea.	1149	6.00/C	1637	29.95/Ea.
237-FC1	9.25/Ea.	320-B	.75/Ea.	437	.85/Ea.	561	2.25/Ea.	817	.70/Ea.	1150	6.75/C	1638	26.25/Ea.
238-FC1	15.40/Ea.	320-BC	6.75/Ea.	438	.75/Ea.	562	6.00/Ea.	818	12.00/Ea.	1151	7.00/C	1639	23.70/Ea.
239-FC2	6.20/Ea.	321	.60/Ea.	439	.35/Ea.	566	40.00/Ea.	819	.75/Ea.	1152	9.00/C	1640	1.80/Ea.
240-FC2	9.75/Ea.	321-BC	8.50/Ea.	440	2.35/Ea.	568	30.00/Ea.	820	10.50/Ea.	1153	1.50/C	1641	2.25/Ea.
241-FC2	16.00/Ea.	322	.65/Ea.	443	.15/Ea.	570	6.25/Ea.	822	40.00/Ea.	1154	1.80/C	1642	1.80/Ea.
242-MC1	5.50/Ea.	322-BC	\$14.00/Ea.	444	.17/Ea.	572	15.50/Ea.	824	47.50/Ea.	1155	2.00/C	1643	1.48/Ea.
243-MC1	9.25/Ea.	323	1.00/Ea.	445	.17/Ea.	573	28.00/Ea.	825	45.00/Ea.	1156	2.25/C	1644	1.70/Ea.
244-MC1	15.40/Ea.	323-BC	22.50/Ea.	446	.18/Ea.	574	31.50/Ea.	826	75.00/Ea.	1157	2.50/C	1645	1.90/Ea.
245-MFC	6.20/Ea.	324	1.10/Ea.	447	.20/Ea.	578	37.50/Ea.	851	9.50/Ea.	1220-A	12.50/Ea.	1646	1.20/Ea.
246-MFC	9.25/Ea.	324-BC	27.50/Ea.	448	.28/Ea.	580	29.00/Ea.	855-50'	3.50/Ea.	1225	25.00/Ea.	1647	15.50/Ea.
247-MFC	16.70/Ea.	325	.35/Ea.	449	.32/Ea.	581	32.00/Ea.	856-50'	20.00/Ea.	1260	.23/Ea.	1648	10.75/Ea.
248	10.00/C	325-B	.75/Ea.	450	.56/Ea.	582	33.60/Ea.	857-50'	17.50/Ea.	1261	.23/Ea.	1670	2.42/Ea.
248-B	10.00/C	325-BC	4.40/Ea.	450-J	.67/Ea.	583	36.00/Ea.	858-50'	3.50/Ea.	1262	.23/Ea.	1671	2.70/Ea.
249	14.00/C	326	.40/Ea.	451	.67/Ea.	584	38.50/Ea.	859-50'	3.75/Ea.	1263	.40/Ea.	1672	3.15/Ea.
249-A	18.00/C	326-B	.75/Ea.	451-J	.72/Ea.	585	44.00/Ea.	860-50'	4.00/Ea.	1264	.45/Ea.	1673	1.92/Ea.
250	4.60/Ea.	326-BC	5.00/Ea.	452	.72/Ea.	586	48.50/Ea.	863-50'	4.75/Ea.	1265	.56/Ea.	1674	2.30/Ea.
251	8.00/Ea.	330	25.00/C	452-J	.95/Ea.	587	55.00/Ea.	864-50'	6.75/Ea.	1266	.62/Ea.	1675	2.42/Ea.
252	12.85/Ea.	331	25.00/C	453	1.30/Ea.	588	87.00/Ea.	865-50'	10.75/Ea.	1372	-.15/Ea.	1680	1.60/Ea.
255	4.25/Ea.	331-A	13.00/C	453-J	1.50/Ea.	589	96.50/Ea.	866-50'	.23/Ea.	1373	-.21/Ea.	1682	2.00/Ea.
256	7.25/Ea.	332	18.00/C	454	1.70/Ea.	600	8.00	866-J	.30/Ea.	1374	.26/Ea.	1683	1.60/Ea.
257	12.50/Ea.	332-A	20.00/M	454-J	1.75/Ea.	604	.25/Ea.	866-SJ	.70/Ea.	1375	-.37/Ea.	1696	1.82/Ea.
263	8.50/Ea.	333	25.00/C	455	1.00/Ea.	605	.35/Ea.	867	.35/Ea.	1376	.37/Ea.	1697	1.50/Ea.
284	11.00/Ea.	334	50.00/C	455-A	4.00/Ea.	619	2.80/Ea.	867-J	.45/Ea.	1377	-.42/Ea.	1718	42.00/Ea.
285	13.25/Ea.	335	60.00/C	457	.35/Ea.	625	.23/Ea.	868-50'	10.75/Ea.	1378	-.47/Ea.	1741	11.00/Ea.
286	15.50/Ea.	340	11.00/C	458	.25/Ea.	626	.56/Ea.	870	11.25/Ea.	1379	.52/Ea.	1772	40.00/Ea.
287	17.50/Ea.	341	.60/Ea.	459	1.50/Ea.	628	.28/Ea.	872	13.50/Ea.	1380	.57/Ea.	1773	\$50.00/Ea.
288	19.50/Ea.	342	2.50/Ea.	459-A	6.00/Ea.	629	8.50/C	907	14.00/Ea.	1382	3.50/C	1774	56.00/Ea.
269	22.50/Ea.	343	.55/Ea.	460	2.00/Ea.	631	.25/Ea.	908	32.00/Ea.	1382-A	4.00/C	1775	67.50/Ea.
270	25.00/Ea.	344	.50/Ea.	460-A	8.00/Ea.	632	.25/Ea.	909	63.20/Ea.	1382-B	4.00/C	1776	80.00/Ea.
272	31.00/Ea.	345	.55/Ea.	461	3.75/Ea.	633	.25/Ea.	910	125.00/Ea.	1382-C	4.00/C	1777	87.50/Ea.
280	\$.80/Ea.	348	2.00/Ea.	461-A	15.00/Ea.	634	.25/Ea.	919	42.50/Ea.	1383	5.00/C	1800	13.25/Ea.
281	.90/Ea.												

Birnbach PRICE LIST NUMERICALLY ARRANGED BY CATALOG NUMBER

Cat. No.	List Price	Cat. No.	List Price	Cat. No.	List Price	Cat. No.	List Price	Cat. No.	List Price	Size	Ft.	List Price	Size	Ft.	List Price		
1975	30.00/Ea.	5075	.30/Ea.	6318	24.00/M	6477	4.35/Gr.	7046	4.75/Ea.	PLAIN ENAMEL MAGNET WIRE ¼ Lb. Spools				DOUBLE SILK MAGNET WIRE ¼ Lb. Spools			
1976	35.00/Ea.	5076	.30/Ea.	6319	30.00/M	6478	3.00/Gr.	7047	2.25/Ea.								
2010	12.10/Ea.	5080	.30/Ea.	6320	36.00/M	6479	5.50/M	7048	25.00/C								
2012	9.90/Ea.	5081	.35/Ea.	6321	6.50/M	6480	5.50/M	7052	1.10/Ea.								
2013	8.55/Ea.	5085	.30/Ea.	6322	7.00/M	6480-A	5.50/M	7053	1.50/Ea.								
2014	7.70/Ea.	5086	.35/Ea.	6323	7.50/M	6481	6.75/M	7054	2.75/Ea.								
2015	8.35/Ea.	5090	.30/Ea.	6324	8.50/M	6482	7.50/M	7055	3.00/Ea.								
2016	5.25/Ea.	5091	.32/Ea.	6325	8.85/M	6483	25.00/Gr.	7056	1.25/Ea.								
2025	1.35/Ea.	5095	.36/Ea.	6326	9.60/M	6484	4.95/M	7066	1.50/Ea.								
2050	2.50/Ea.	5096	.35/Ea.	6327	9.30/M	6485	4.85/M	7067	10.00/Ea.								
2051	4.50/Ea.	5105	.55/Ea.	6328	9.90/M	6486	5.50/M	7068	70.00/Ea.								
2052	28.00/Ea.	5108	.45/Ea.	6329	11.70/M	6487	5.20/M	7070	62.50/Ea.								
2339	15.00/Ea.	5110-5111	.40/Ea.	6330	8.20/M	6488	7.50/M	7072	36.00/Ea.								
2331	3.25/Ea.	5115	.80/Ea.	6331	8.20/M	6491	5.50/M	7074	50.00/Ea.								
2440	19.00/Ea.	5130 to 5134	.30/Ea.	6332	7.80/M	6490	5.50/M	7085	2.70/Ea.								
2810	14.50/Ea.	5140	.30/Ea.	6333	7.80/M	6492	5.75/M	7087	2.70/Ea.								
2812	9.85/Ea.	5141	.35/Ea.	6334	8.70/M	6493	7.15/M	7201	22.50/Ea.								
2814	6.80/Ea.	5142	.35/Ea.	6335	9.60/M	6494	12.65/Gr.	7201-I	2.60/Ea.								
2816	5.50/Ea.	5143	.40/Ea.	6336	22.80/M	6500	1.70/Gr.	7202	21.50/Ea.								
2818	4.85/Ea.	5160	.23/Ea.	6337	27.50/M	6501	1.85/Gr.	7202-I	2.50/Ea.								
3000 to 3024	1.55/Ea.	5161	.25/Ea.	6338	35.00/M	6502	1.70/Gr.	1 ½ Lb. Spools									
3025	1.35/Ea.	5165-86	.30/Ea.	6339	35.00/M	6503	1.80/Gr.					7203	25.50/Ea.				
3050	2.50/Ea.	5171	.30/Ea.	6340	10.00/M	6504	2.00/Gr.					7203-I	3.00/Ea.				
3051	4.50/Ea.	5180	.25/Ea.	6341	10.00/M	6505	2.90/Gr.					7204	22.50/Ea.				
3052	28.00/Ea.	5181	.30/Ea.	6351-A	10.00/M	6507	3.25/Gr.					7204-I	2.60/Ea.				
3416	10.00/Ea.	5185	.30/Ea.	6352-A	10.00/M	6510	1.70/Gr.					7205	34.00/Ea.				
3418	7.50/Ea.	5190	.17/Ea.	6353	11.00/M	6511	1.80/Gr.					7205-I	3.80/Ea.				
3420	6.00/Ea.	5191	.17/Ea.	6353-A	11.00/M	6512	2.00/Gr.					7207	47.50/Ea.				
3425	1.25/Ea.	5195	.30/Ea.	6354	13.50/M	6513	2.00/Gr.					7207-I	5.50/Ea.				
3450	2.50/Ea.	5200	.25/Ea.	6354-A	13.50/M	6514	2.00/Gr.					7210	100.00/Ea.				
3460	5.00/Ea.	5201	.25/Ea.	6355	8.25/M	6515	2.15/Gr.					7210-I	18.00/Ea.				
3600	22.50/Ea.	6000	4.90/Ea.	6356	7.70/M	6516	2.65/Gr.	7212	90.00/Ea.								
3618	2.35/Ea.	6100	.50/Ea.	6357	7.70/M	6517	2.80/Gr.	7212-I	10.00/Ea.								
3619	2.75/Ea.	6102	.60/Ea.	6357	7.70/M	6518	2.60/Gr.	7214	65.00/M								
4000 to 4008	9.00/M	6103	.85/Ea.	6358	5.50/M	6519	3.25/Gr.	7214-I	7.50/Ea.								
4007 to 4013	10.00/M	6104	.85/Ea.	6359	5.50/M	6525 to 6534	1.55/C	7216	32.50/M								
4014	11.25/M	6105	3.00/Ea.	6360	5.75/M	6535	2.00/Gr.	7216-I	8.00/Ea.								
4015 to 4019	12.25/M	6200	.80/Ea.	6361	3.75/M	6541	2.15/Gr.	7218	37.50/M								
4020-21	13.50/M	6201	1.10/Ea.	6362	7.15/M	6542	2.50/Gr.	7218-I	4.25/Ea.								
4022-23	28.00/M	6202	1.10/Ea.	6363	12.65/M	6543	2.80/Gr.	7220	28.00/M								
4025	.85/Ea.	6203	1.30/Ea.	6364	7.50/M	6544	2.80/Gr.	7220-I	3.25/Ea.								
4026	.75/Ea.	6204	1.55/Ea.	6401	8.10/M	6600	1.05/C	7222	26.00/M								
4027	1.75/Ea.	6205	1.75/Ea.	6402	10.50/M	6601	1.40/C	7222-I	3.00/Ea.								
4028	.85/Ea.	6206	1.75/Ea.	6403	11.50/M	6602	1.80/C	7224	27.00/M								
4050	1.60/Ea.	6207	2.00/Ea.	6404	16.00/M	6603	\$1.80/C	7224-I	3.25/Ea.								
4051	2.80/Ea.	6208	6.00/C	6405	16.00/M	6604	1.45/C	7312	607.50/M								
4052	25.00/Ea.	6210	1.25/Ea.	6406	11.90/M	6605	1.85/C	7312-I	11.50/Ea.								
4125	.40/Ea.	6211	1.30/Ea.	6407	13.50/M	6608	2.30/C	7314	62.50/M								
4125-J	.45/Ea.	6212	1.40/Ea.	6408	16.20/M	6607	2.70/C	7314-I	6.75/Ea.								
4175	.90/Ea.	6213	1.60/Ea.	6409	\$19.80/M	6608	1.85/C	7316	32.50/M								
4175-J	1.30/Ea.	6214	1.75/Ea.	6410	20.00/M	6609	2.40/C	7316-I	5.75/Ea.								
4176	.62/Ea.	6215	1.25/Ea.	6411	23.00/M	6610	2.65/Gr.	7318	38.00/M								
4178	.80/Ea.	6216	2.00/Ea.	6412	26.50/M	6611	3.00/Gr.	7318-I	4.20/Ea.								
4233	.90/Ea.	6217	2.25/Ea.	6413	14.70/M	6611-A	3.60/C	7320	30.00/M								
4234	1.00/Ea.	6220	\$.80	6414	16.60/M	6612	1.10/C	7320-I	3.25/Ea.								
4235	\$2.25/Ea.	6221	1.10/Ea.	6415	18.50/M	6613	1.25/C	7322	25.00/M								
4236	2.50/Ea.	6222	1.55/Ea.	6416	20.30/M	6614	1.40/C	7322-I	2.50/Ea.								
4237	2.75/Ea.	6223	1.75/Ea.	6418	27.50/M	7000	13.75/Ea.	7322-II	2.75/Ea.								
4238	3.50/Ea.	6224	1.40/Ea.	6420	6.50/M	7000-I	1.50/Ea.	7400	675.00/Ea.								
4275	.80/Ea.	6225	2.50/Ea.	6421	7.00/M	7001	17.00/Ea.	7400D	45.00/Ea.								
4275-J	1.00/Ea.	6226	3.00/Ea.	6422	7.50/M	7001S	20.00/M	7401	138.90/Ea.								
4276	1.15/Ea.	6227	7.25/Ea.	6423	8.00/M	7001-I	1.85/Ea.	7401-M	188.90/Ea.								
4278	1.35/Ea.	6228	12.00/Ea.	6424	8.75/M	7001-IS	2.15/Ea.	7402	40.00/M								
4450	1.50/Ea.	6229	14.75/Ea.	6425	8.75/M	7002	16.75/Ea.	7402-I	40.00/M								
4451	.92/Ea.	6230	1.00/Ea.	6426	9.75/M	7002-I	1.80/Ea.	7402-II	4.50/Ea.								
4451-J	1.30/Ea.	6231	2.77/Ea.	6427	8.30/M	7003	21.50/Ea.	7412	54.00/M								
4452	2.00/Ea.	6232	.35/Ea.	6428	8.75/M	7003S	30.00/Ea.	7412-I	6.00/Ea.								
5000	1.10/Ea.	6233	.85/Ea.	6429	9.60/M	7003-I	2.30/Ea.	7418	55.00/M								
5002	1.35/Ea.	6234	1.00/Ea.	6430	10.00/M	7003-IS	2.60/Ea.	7418-I	6.10/Ea.								
5003	1.70/Ea.	6235	1.20/Ea.	6431	11.00/M	7004	21.25/Ea.	7428	85.00/M								
5005	1.05/Ea.	6236	1.55/Ea.	6432	12.85/M	7004-I	2.25/Ea.	7428-I	9.00/Ea.								
5006	1.35/Ea.	6241	1.75/Ea.	6433	14.65/M	7005	26.00/Ea.	7448	129.50/M								
5007	1.05/Ea.	6242	2.70/Ea.	6434	10.85/M	7005-I	2.75/Ea.	7448-I	13.50/Ea.								
5008	1.45/Ea.	6243	1.50/Ea.	6435	11.20/M	7005-S	4.50/M	D-50	4.50/M								
5009	1.70/Ea.	6244	.75/Ea.	6436	12.50/M	(1000) 29.00	R-100	4.50/M									
5010	3.30/Ea.	6245	.21/Ea.	6437	13.25/M	7005-IS	(100) 3.05	T-6	20.00/Ea.								
5011	3.30/Ea.	6246	.22/Ea.	6438	15.00/M	7007	37.50/Ea.	T-7	.50/Ea.								
5012	4.75/Ea.	6247	.38/Ea.	6439	19.15/M	7009	3.90/Ea.	T-9	15.00/Ea.								
5013	4.75/Ea.	6248	.38/Ea.	6439	19.15/M	7009	56.50/Ea.	T-11	30.00/Ea.								
5013-5018	.75/Ea.	6249	.50/Ea.	6440	10.30/M	7009-I	5.80/Ea.	T-12	15.00/Ea.								
5017-5018	.75/Ea.	6250	1.80/Ea.	6441	14.70/M	7011	100.00/Ea.	T-14	70.00/Ea.								
5040	.23/Ea.	6251	2.10/Ea.	6442	10.30/M	7011-I	10.15/Ea.	T-14A	80.00/Ea.								
5041	.23/Ea.	6252	2.60/Ea.	6443	16.05/M	7015-I	30.00/Ea.	T-15	25.00/Ea.								
5042	.24/Ea.	6253	2.77/Ea.	6444	17.05/M	7016	55.00/Ea.	T-16	25.00/Ea.								
5043	.24/Ea.	6261	2.00/Ea.	6445	17.10/M	7016-I	5.70/Ea.	T-16A	.25/Ea.								
5044	.24/Ea.	6263	2.60/Ea.	6448	18.10/M	7018	44.55/Ea.	T-20	.80/Ea.								
5045	.24/Ea.	6300	5.25/M	6447	35.00/M	7018-I	2.65/Ea.	T-105-14	9.45/Ea.								
5046	.24/Ea.	6301	5.80/M	6448	7.80/M	7020	37.50/Ea.	T-105-16	11.25/Ea.								
5047	.24/Ea.	6302	5.35/M	6449	8.65/M	7020-I	3.90/Ea.	T-105-16R	11.95/Ea.								
5048	.24/Ea.	6303	7.00/M	8450	9.60/M	7022	32.00/Ea.	1 Lb. Spools									
5049	.24/Ea.	6304	5.80/M	8460	11.20/M	7022-I	3.35/Ea.					T-105-17	12.95/Ea.				
5050	.24/Ea.	6305	5.80/M	8461	12.50/M	7024	17.25/Ea.					T-105-19R	18.50/Ea.				
5051	.24/Ea.	6306	5.80/M	8462	13.25/M	7024-I	1.85/Ea.					T-105-20	18.85/Ea.				
5052	.24/Ea.	6307	6.40/M	8463	15.00/M	7026-FM	2.75/Ea.					T-105-21	20.00/Ea.				
5053	.24/Ea.	6308	8.40/M	8464	16.05/M	7027	3.50/Ea.					T-110	1.25/Ea.				
5054	.24/Ea.	6309	8.40/M	8465	17.10/M	7027-HF	2.50/Ea.					T-250	20.00/C				
5055	.24/Ea.	6310	29.05/M	8466	6.95/Gr.	7031	7.75/Gr.					T-250-A	22.00/C				
5056	.24/Ea.	6311	49.50/M	8467	8.55/Gr.	7034	8.55/Gr.					SPECIAL SPOOLS Magnet Wire \$.84/Ea. Solid Tinned .84/Ea.					
5057	.24/Ea.	6312	8.50/M	8470	2.75/Gr.	7035	.25/Ea.										
5058	.24/Ea.	6313	9.00/M	8471	2.95/Gr.	7039	11.00/C										
5059	.24/Ea.	6314	9.75/M	8472	3.10/Gr.	7040	20.00/C										
5060	.24/Ea.	6315	12.00/M	8473	3.25/Gr.	7041	15.00/C										
5061	.24/Ea.	6316	19.00/M	8474	3.40/Gr.	7042	22.50/C										
5062	.24/Ea.	6317	22.50/M	8475	3.60/Gr.	7044	18.00/C										
5063	.24/Ea.	6318	22.50/M	8476	4.00/Gr.	7045	28.00/C										
5064	.24/Ea.	6319	22.50/M	8477	4.00/Gr.	7045	28.00/C										
5065	.24/Ea.	6320	22.50/M	8478	4.00/Gr.	7045	28.00/C										
5066	.24/Ea.	6321	22.50/M	8479	4.00/Gr.	7045	28.00/C										

Where wire is shipped on returnable spools or reels a deposit covering same will be required. No credit will be allowed for returnable reels and spools unless returned prepaid within 12 months from date of shipment. All deposit spools and reels are billed separately on invoice and not included in price of materials sold. ALL PRICES SUBJECT TO CHANGE WITHOUT NOTICE

ANACONDA FOAM POLYETHYLENE TRANSMISSION LINE

The finest all-purpose VHF UHF line in use today. Actual results under the most adverse conditions have proven beyond doubt that this line will withstand salt air, moisture, extremes of heat and cold and other factors that cause rapid deterioration and signal loss in other types of transmission lines. No sealing is necessary with this foam-line as moisture cannot penetrate the cellular construction of this cable. High strength 22 Ga. solid copper-weld conductors are imbedded deep in the insulation concentrating the field of energy **INSIDE THE CABLE**. Cable is very light, 100 feet weighing slightly over 2 lbs. Developed through the combined efforts of Anaconda and RCA, acknowledged leaders in television cable research and development. Cable size is approximately .450 x .350.

CAT. NO.

1592 TYPE ATV-270 FOAM-LINE 100 TO 999 FT.

1590 TYPE ATV-270 FOAM-LINE 1000 FT OR MORE

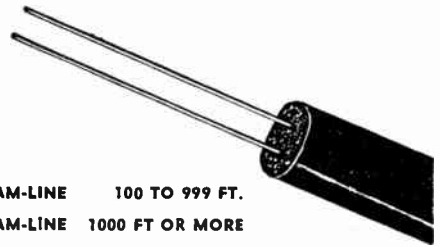

COLUMBIA TELEVISION TRANSMISSION LINES



Columbia now offers several types of exceptional quality TV lines at moderate prices. Virgin Polyethylene and clean bright conductors assure best results in all TV installations. All cables have a smooth polished finish that will effectively shed dirt and moisture.

CAT. NO.

45 MIL 22 GA 7/30 TELEVISION LINE .045 x .350
1008 100 FT. COIL
1010 1000 FT. SPOOL

55 MIL 20 GA 7/28 TELEVISION LINE .055 x .385
1053 100 FT. COIL
1055 1000 FT. SPOOL

70 MIL 20 GA 7/28 TELEVISION LINE .070 x .390
1068 100 FT. COIL
1070 1000 FT. SPOOL

70 MIL 20 GA 7/28 TELEVISION LINE .070 x .390
High Strength COPPERWELD Conductors
3068 100 FT. COIL
3070 1000 FT. SPOOL

80 MIL 20 GA 7/28 TELEVISION LINE .080 x .395
1078 100 FT. COIL
1080 1000 FT. SPOOL

100 MIL 20 GA 7/28 TELEVISION LINE .100 x .430
1002 100 FT. COIL
1004 1000 FT. SPOOL

PLASTIC MICROPHONE CABLE

Here are two types of microphone cable that are always in demand from jobbers stock. Tough plastic insulation provides resistance to abrasion, moisture and aging. Excellent for other uses requiring small diameter shielded flexible cables.

CAT. NO.

1316 **LAPEL MICROPHONE CABLE**
22 GA. Stranded .130 O.D. Black Plastic Jacket
250 FT. SPOOL

1318 **CRYSTAL MICROPHONE CABLE**
22 GA. Stranded .180 O.D. Black Plastic Jacket
250 FT. SPOOL

MICROPHONE CABLE



Single and multi-conductor microphone cables for crystal and ribbon microphones, photo-electric cells, public address systems etc. All cable made with low loss compounds and extra flexible copper conductors. Closely woven T/C shield under tough wear resistant jacket. Low capacitance between shield and conductor.

MULTI PAIRED INTERCOM CABLES



For use in Intercom Systems as station to station wiring, the cables listed below will handle most installations. Each conductor is 22 ga. solid soft drawn copper and has an .010 wall of durable color coded plastic. Each pair is individually twisted and pairs are covered overall with an adequate plastic jacket.

CAT. NO.

4012	3 PAIR	PLASTIC INTERCOM CABLE	100 FT.
4014	3 PAIR	PLASTIC INTERCOM CABLE	500 FT.
4016	7 PAIR	PLASTIC INTERCOM CABLE	100 FT.
4018	7 PAIR	PLASTIC INTERCOM CABLE	500 FT.
4020	11 PAIR	PLASTIC INTERCOM CABLE	100 FT.
4022	11 PAIR	PLASTIC INTERCOM CABLE	500 FT.
4024	15 PAIR	PLASTIC INTERCOM CABLE	100 FT.
4026	15 PAIR	PLASTIC INTERCOM CABLE	500 FT.
4028	25 PAIR	PLASTIC INTERCOM CABLE	100 FT.
4030	25 PAIR	PLASTIC INTERCOM CABLE	500 FT.

NOTE: Longer lengths of this cable are available. Please specify length desired when ordering.

HOOKUP WIRE ASSORTMENT

Here is an unusual item sure to be appreciated by every serviceman. No need now to have odd lengths of hookup wire scattered all over the service bench. Six 100 foot individual spools of 300 volt plastic insulated hookup wire are held rigidly on a metal shaft enabling the serviceman or experimenter to mount all six spools directly over or anywhere on a bench. Six different colors in each assortment. Available in 22, 20 and 18 Ga. —both solid and stranded.

CAT. NO.

1710	6-100 FT. SPOOLS	22 GA. SOLID
1715	6-100 FT. SPOOLS	22 GA. STRANDED
1720	6-100 FT. SPOOLS	20 GA. SOLID
1725	6-100 FT. SPOOLS	20 GA. STRANDED
1730	6-100 FT. SPOOLS	18 GA. SOLID
1735	6-100 FT. SPOOLS	18 GA. STRANDED

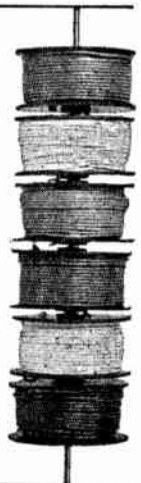

CAT. NO.

CAT. NO.			APPROX. O D
1300	1 CONDUCTOR	SHIELDED	100 FT. SPOOL.....260
1302	2 CONDUCTOR	SHIELDED	100 FT. SPOOL.....280
1304	3 CONDUCTOR	SHIELDED	100 FT. SPOOL.....285
1306	4 CONDUCTOR	SHIELDED	100 FT. SPOOL.....300
1308	5 CONDUCTOR	SHIELDED	100 FT. SPOOL.....330
1310	6 CONDUCTOR	SHIELDED	100 FT. SPOOL.....350
1312	7 CONDUCTOR	SHIELDED	100 FT. SPOOL.....365



DELUXE TELEVISION SERVICE LITE

This newly designed service lite is one of the finest items in our entire line of television service accessories. Has a 2 1/4 inch highly polished aluminum reflector and wide opening spring clamp that will permit this lite to be attached almost anywhere inside the television cabinet leaving both hands free to work. Lower part of clamp has rubber covering that will hold firmly wherever it is placed. Comes complete with 7 1/2 watt 110 Volt bulb and six foot parallel plastic cord with unbreakable male plug for attaching to baseboard or into service block on our all purpose Television Service Cord. Display card furnished with orders for 25 or more lites.

CAT. NO. **185** DELUXE TELEVISION SERVICE LITE



STEEL GUY WIRE

Columbia offers a complete line of galvanized steel guy wire for all antenna installations. This wire has high tensile strength and is weatherproof, rustproof and stretch proof.

CAT. NO.

- | | |
|-------------|---|
| 1222 | 4/20 GALVANIZED STEEL WIRE |
| 1232 | 1 DOZEN 50 FT. INTERCONNECTED COILS
1000 FOOT SPOOLS |
| 1220 | 6/20 GALVANIZED STEEL WIRE |
| 1230 | 1 DOZEN 50 FT. INTERCONNECTED COILS
1000 FOOT SPOOLS |
| 1208 | 6/18 GALVANIZED STEEL WIRE |
| 1210 | 1 DOZEN 50 FT. INTERCONNECTED COILS
500 FOOT SPOOLS |

ALUMINUM GROUND WIRE



Light strong solid wire now being used as a grounding wire in television. Amateur and many other antenna installations. This aluminum wire can also be used as antenna wire replacing solid copper wire with excellent results.

CAT. NO.

- | | | |
|-------------|--------------------|----------------------------|
| 1264 | 100 FT. COIL..... | 14 GA. SOLID ALUMINUM WIRE |
| 1266 | 500 FT. COIL..... | 14 GA. SOLID ALUMINUM WIRE |
| 1268 | 1000 FT. COIL..... | 14 GA. SOLID ALUMINUM WIRE |
| 1270 | 100 FT. COIL..... | 10 GA. SOLID ALUMINUM WIRE |
| 1272 | 500 FT. COIL..... | 10 GA. SOLID ALUMINUM WIRE |
| 1274 | 1000 FT. COIL..... | 10 GA. SOLID ALUMINUM WIRE |
| 1276 | 100 FT. COIL..... | 8 GA. SOLID ALUMINUM WIRE |
| 1278 | 500 FT. COIL..... | 8 GA. SOLID ALUMINUM WIRE |
| 1280 | 1000 FT. COIL..... | 8 GA. SOLID ALUMINUM WIRE |
| 1296 | 50 FT. COIL..... | 6 GA. SOLID ALUMINUM WIRE |
| 1294 | 100 FT. COIL..... | 6 GA. SOLID ALUMINUM WIRE |
| 1292 | 500 FT. COIL..... | 6 GA. SOLID ALUMINUM WIRE |
| 1290 | 1000 FT. COIL..... | 6 GA. SOLID ALUMINUM WIRE |

TWO CONDUCTOR SPEAKER CABLE



Flexible stranded conductors twisted with tinned copper shield overall. For public address and intercom systems together with many other applications.

CAT. NO.

- | | | |
|-------------|---|---------|
| 2698 | 100 FT. SPOOLS..... | 18 STR. |
| | 1/64 DURABLE PLASTIC INSULATION
CLOSELY WOVEN T/C SHIELD OVERALL | |

WRITE FOR COPY OF COMPLETELY ILLUSTRATED CATALOG!

Columbia 

ROTATOR CABLE

The four types of rotator cable listed below are for use with most antenna rotators in use today. Weather resistant polyethylene and plastic are used exclusively in the manufacture of these cables.

20 GA. Stranded 4 Conductor polyethylene insulated flat rotator cable has one tinned copper conductor for easy identification.

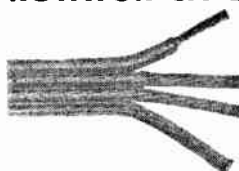

Cat. No.

- | | |
|-------------|-----------------|
| 1112 | 500 Ft. Spools |
| 1114 | 1000 Ft. Spools |



Cat. No.

- | | |
|-------------|-----------------|
| 1116 | 500 Ft. Spools |
| 1118 | 1000 Ft. Spools |

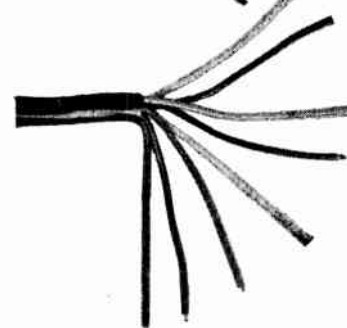

Cat. No.

- | | |
|-------------|-----------------|
| 1122 | 500 Ft. Spools |
| 1124 | 1000 Ft. Spools |

22 GA. Stranded 8 Conductor rotator cable, twisted color coded plastic conductors with plastic jacket overall.

Cat. No.

- | | |
|-------------|-----------------|
| 1128 | 500 Ft. Spools |
| 1130 | 1000 Ft. Spools |

MULTI CONDUCTOR CABLES

Small diameter flexible cable for many applications requiring the use of cables with three to ten conductors. All cables with four conductors and over have two 18 GA. stranded wires for power circuits. Tough vinyl plastic is used as insulation on inner conductors as well as the outside jacket. Cables are color coded for easy identifications.



CAT. NO.

- | | | | |
|-------------|--------------------|-------------|----------------|
| 4060 | 3 CONDUCTOR CABLE | 22 GA. STR. | 250 FT. SPOOL |
| 4062 | 3 CONDUCTOR CABLE | 22 GA. STR. | 1000 FT. SPOOL |
| 4066 | 4 CONDUCTOR CABLE | 2-22 GA. | 250 FT. SPOOL |
| 4068 | 4 CONDUCTOR CABLE | 2-18 GA. | 1000 FT. SPOOL |
| 4072 | 6 CONDUCTOR CABLE | 4-22 GA. | 250 FT. SPOOL |
| 4074 | 6 CONDUCTOR CABLE | 2-18 GA. | 1000 FT. REEL |
| 4078 | 8 CONDUCTOR CABLE | 6-22 GA. | 250 FT. SPOOL |
| 4080 | 8 CONDUCTOR CABLE | 2-18 GA. | 1000 FT. REEL |
| 4084 | 10 CONDUCTOR CABLE | 8-22 GA. | 250 FT. SPOOL |
| 4086 | 10 CONDUCTOR CABLE | 2-18 GA. | 1000 FT. REEL |

GROUND RODS



Heavy copper plated ground rods in three sizes to take care of all requirements. Pointed end assures ease of driving rod in ground with little effort. Unique designed clamp is simple in construction, yet will hold ground wire firmly against any movement, insuring positive contact at all times. All parts are attached permanently and cannot be lost or mislaid.

CAT. NO.

- | | | |
|------------|--|-----------------------|
| 965 | FOUR FT. 3/8" DIAMETER COPPER PLATED GROUND ROD | PACKED 25 TO A BUNDLE |
| 967 | SIX FT. 3/8" DIAMETER COPPER PLATED GROUND ROD | PACKED 25 TO A BUNDLE |
| 969 | EIGHT FT. 1/2" DIAMETER COPPER PLATED GROUND ROD | PACKED 12 TO A BUNDLE |

COLUMBIA WIRE & SUPPLY CO. · Chicago, Ill.



Military Types A ROME CABLE PRODUCT

Thermoplastic Insulated Military Type Hook-up Wire

Comply to Joint Army-Navy Specification JAN-C-76 and manufactured under specific approval of the Armed Services Electro Standards Agency (ASESA). Impervious to oils, acids, alkalis, moisture and flame and possessing unusually high dielectric strength.

ALL OTHER SIZES CAN BE SUPPLIED PER JAN-C-76 SPECIFICATIONS

TYPE SRIR		PER JAN-C-76 SPECIFICATIONS					DIAMETER (INCHES)		LIST PRICE EACH
CAT. No.	JAN-C-76 TYPE DESIGNATION	SIZE	STRANDING	LENGTH	INSULATION THICKNESS	No Outer Covering	Lacquered Glass Braid		
707	SRIR-3/5(1)-22	No. 22	Solid	1000 ft. spool	.017"	.066	.081	\$ 9.75	
717	SRIR-1(1)-20	No. 20	Solid	1000 ft. spool	.017"	.073	.088	10.35	
727	SRIR-1 1/2(1)-18	No. 18	Solid	1000 ft. spool	.017"	.081	.096	14.65	
737	SRIR-3/5(7)-22	No. 22	7x30	1000 ft. spool	.017"	.071	.086	10.25	
747	SRIR-1(7)-20	No. 20	10x30	1000 ft. spool	.017"	.079	.094	12.45	
757	SRIR-1 1/2(7)-18	No. 18	16x30	1000 ft. spool	.017"	.088	.103	15.45	

TYPE SRHV		PER JAN-C-76 SPECIFICATIONS					DIAMETER (INCHES)		LIST PRICE EACH
CAT. No.	JAN-C-76 TYPE DESIGNATION	SIZE	STRANDING	LENGTH	INSULATION THICKNESS	No Outer Covering	Lacquered Glass Braid		
637	SRHV-3/5(1)-22	No. 22	Solid	1000 ft. spool	.033	.100	.115	\$13.30	
642	SRHV-1(1)-20	No. 20	Solid	1000 ft. spool	.033	.107	.122	15.35	
647	SRHV-1 1/2(1)-18	No. 18	Solid	1000 ft. spool	.033	.115	.130	20.00	
667	SRHV-3/5(7)-22	No. 22	7x30	1000 ft. spool	.033	.105	.120	15.75	
672	SRHV-1(7)-20	No. 20	10x30	1000 ft. spool	.033	.113	.128	17.50	
677	SRHV-1 1/2(7)-18	No. 18	16x30	1000 ft. spool	.033	.122	.137	21.60	

COLORS: Black, Brown, Dark Blue, Green, Light Blue, Orange, Pink, Purple, Red, Slate, Tan, White, Yellow.

Rome Synthinol A ROME CABLE PRODUCT

THERMOPLASTIC INSULATED HOOK-UP WIRE

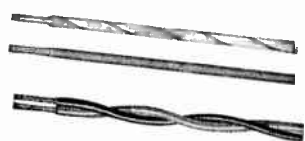

Rome Synthinol is a polyvinyl chloride type of thermoplastic insulation impervious to oils, acids, alkalis, moisture and flame, and possessing unusually high dielectric strength. Colors are of gem-like permanency. Approved by Underwriters' Laboratories where exposed to temperatures not exceeding 80° Centigrade or where exposed to oil at temperatures not exceeding 60° Centigrade with ratings at 300 and 600 volts as indicated below. The Underwriters' approval seal appears on every factory length reel of Rome Synthinol.

Conductors: Annealed tinned solid or stranded copper conforming to A.S.T.M. Specification B 33 and/or Underwriters' Standards. In order to provide maximum flexibility and prevent unraveling of the strands, a short lay stranding is used as follows:
 No. 22 Awg. .33" max. No. 30 Awg. .50" max.
Insulation: Rome Synthinol—Approved by and conforming to Underwriters' requirements and the performance specifications of A.S.T.M. D 734. Available in solid colors or with a surface applied contrasting colored spiral stripe.

U/L Voltage Rating—300 Volts Max. Single and Two-Conductor Twisted Cable: Color Coded

Rome Synthinol is specially designed for the chassis and sub-chassis wiring of radio and television receivers and transmitters as well as all other types of electronic equipment. It has physical and electrical characteristics of unusual permanency.

Typical Test Results
 Breakdown Voltage: 1/64" Synthinol over 10000 volts
 1/32" Synthinol over 18000 volts
 Insulation Resistance: 1/32" Synthinol over 5000 megohms feet

Cat. No.	Size Awg.	Stranding	Nom. Ins. Thickness Inches	Volts	Max. Dia. Inches	Length	List Price
801	22	Solid	1/64	300	.065	25' Carton	\$ 0.39
803	22	Solid	1/64	300	.065	100' Carton	1.39
805	22	Solid	1/64	300	.065	500' Spool	5.95
807	22	Solid	1/64	300	.063	1000' Spool	10.15
811	20	Solid	1/64	300	.071	25' Carton	.45
813	20	Solid	1/64	300	.071	100' Carton	2.00
815	20	Solid	1/64	300	.071	500' Spool	6.65
817	20	Solid	1/64	300	.071	1000' Spool	13.18
841	18	Solid	1/64	300	.080	25' Carton	5.57
842	18	Solid	1/64	300	.080	100' Carton	2.04
843	18	Solid	1/64	300	.080	500' Spool	9.22
844	18	Solid	1/64	300	.080	1000' Spool	17.37
821	22	7 x No. 30	1/64	300	.069	25' Carton	.45
823	22	7 x No. 30	1/64	300	.069	100' Carton	2.00
825	22	7 x No. 30	1/64	300	.069	500' Spool	6.65
827	22	7 x No. 30	1/64	300	.069	1000' Spool	13.18
831	20	10 x No. 30	1/64	300	.078	25' Carton	.55
833	20	10 x No. 30	1/64	300	.078	100' Carton	1.84
835	20	10 x No. 30	1/64	300	.078	500' Spool	8.48
837	20	10 x No. 30	1/64	300	.078	1000' Spool	15.44
846	18	16 x No. 30	1/64	300	.085	25' Carton	.61
847	18	16 x No. 30	1/64	300	.085	100' Carton	2.15
848	18	16 x No. 30	1/64	300	.085	500' Spool	9.72
849	18	16 x No. 30	1/64	300	.085	1000' Spool	18.56
851	22	Solid	1/32	600	.097	25' Carton	.51

COLORS: Black, Brown, Light Blue, Dark Blue, Green, Orange, Pink, Purple, Red, Slate, Tan, White, Yellow.

Rome Hi-Temp A ROME CABLE PRODUCT

RUBBER INSULATED HOOK-UP WIRE



The result of extensive laboratory development and proved by a decade of service—Rome Hi-Temp is offered for radio and electronic circuits where resistance to moisture and heat is required.

SPECIFICATIONS

Conductors: Annealed tinned, solid or stranded copper conforming to A.S.T.M. Specification B 33 and/or Underwriters' Standards.

In order to provide maximum flexibility and prevent unraveling of the strands a short lay stranding is used as follows:

No. 22 Awg. .33 inch max.
 No. 20 Awg. .50 inch max.

Insulation: Rome Hi-Temp—a high quality, free-stripping heat-resistant rubber insulation approved by Underwriters' Laboratories.

Typical Test Results

Breakdown Voltage (1/32" Hi-Temp) 10500 volts
 Insulation Resistance Over 10000 megohms feet
 *Only factory length reels are furnished with U/L's labels.

Cat. No.	Size No.	Stranding No.	Length	Insulation Thickness	Diameter	List Price Each
901	22	Solid	25 ft. carton	1/32"	.075"	\$0.44
903	22	Solid	100 ft. carton	1/32"		1.65
905	22	Solid	500 ft. spool	1/32"		6.56
907	22	Solid	1000 ft. spool	1/32"		12.70
911	20	Solid	25 ft. carton	1/32"	.086"	.50
913	20	Solid	100 ft. carton	1/32"		1.79
915	20	Solid	500 ft. spool	1/32"		7.40
917	20	Solid	1000 ft. spool	1/32"		14.30
921	22	7 x 30	25 ft. carton	1/32"	.085"	.50
923	22	7 x 30	100 ft. carton	1/32"		1.79
925	22	7 x 30	500 ft. spool	1/32"		7.40
927	22	7 x 30	1000 ft. spool	1/32"		14.30
931	20	10 x 30	25 ft. carton	1/32"	.090"	.62
933	20	10 x 30	100 ft. carton	1/32"		2.04
935	20	10 x 30	500 ft. spool	1/32"		9.07
937	20	10 x 30	1000 ft. spool	1/32"		16.95

U/L Voltage Rating—300 Volts Maximum
 Colors: Black, Blue, Brown, Green, Orange, Pink, Red, Slate, White, Yellow

TELEVISION CABLE . . . Transmission Cables

NOMINAL ELECTRICAL PROPERTIES

No.	Type	Length	Size & Stranding	Specifications and General Applications	Nominal Diam. (in.)	Frequency (mc)	Attenuation Per 100 ft.	Impedance (ohms)	Velocity of Propagation (%)	Capacitance Per Ft. (mmf)	List Price Each
4500	2 cond.	500 ft.	22	Both conductors bare copper; flexible stranding; conductors parallel; insulated with polyethylene. USE: Receiving antenna at high frequencies.	.055	50	.72	300	85	4.6	\$82.00
		Spool	7x30		x	100	1.1				
					.400	200	1.7				
						300	1.7				
						400	2.7				
						500	3.1				
4503	2 cond.	500 ft.	20	Same as 4500	.072	Same	Same	300	85	4.6	28.50
		Spool	7x28		x	as	as	as	as	as	
					.400	4500	4500				
4507	3 cond.	500 ft.	20	Two bare, one tinned copper conductor; flexible stranding; conductors parallel; polyethylene insulation. USE: Same as 4501, but third conductor may be used for ground or other purposes.	.072	Same	Same	300	85	4.6	32.25
		Spool	7x28		x	as	as	as	as	as	
					.400	4500	4500				
4508	4 cond.	500 ft.	22	Same as 4503 except three conductors bare copper, one conductor tinned. Amber polyethylene plastic insulation overall is semi-transparent for easy conductor identification and is grooved between conductors for ease of separation and stripping. USE: Rotor Aerials.	.072	Same	Same	300	85	4.6	30.75
		Spool	7x30		x	as	as	as	as	as	
					.345	4500	4500				
4509	4 cond.	500 ft.	20	Same as 4508	.072	Same	Same	300	85	4.6	33.00
		Spool	7x28		x	as	as	as	as	as	
					.400	4500	4500				
4516	5 cond.	500 ft.	20	Same as 4508 except four conductors bare copper, one conductor tinned copper. USE: Rotor Aerials.	.072	Same	Same	300	85	4.6	40.90
		Spool	7x28		x	as	as	as	as	as	
					.355	4500	4500				
4517	5 cond.	500 ft.	20	Same as 4516	.090	Same	Same	300	85	4.6	44.00
		Spool	7x28		x	as	as	as	as	as	
					.400	4500	4500				
4515	4 cond.	500 ft.	22	Tinned copper conductors. .010" thermoplastic insulation over each conductor with jacket overall. USE: Rotor Aerials.	.160						36.85
		Spool	7x30								
4518	5 cond.	500 ft.	22	Same as 4515	.170						45.00
		Spool	7x30								
4521	8 cond.	500 ft.	22	Same as 4515	.205						45.00
		Spool	7x30								

TELEVISION CABLE . . . Transmission Cables

NOMINAL ELECTRICAL PROPERTIES

No.	Type	Length	Size & Stranding	Specifications and General Applications	Nominal Diam. (in.)	Frequency (mc)	Attenuation Per 100 ft.	Impedance (ohms)	Velocity of Propagation (%)	Capacitance Per Ft. (mmf)	List Price Each
	4401	1 cond. 100 ft. Spool	22 solid	Bare copper, solid; black vinyl plastic jacket; bare copper braid shield; polyethylene plastic insulation.	.242	100 200 300 400	3.75 5.60 7.10 8.30	73	66	21.0	\$ 7.65
	4403	1 cond. 500 ft. Spool	22 solid	Same as 4401	.242	Same as 4401	Same as 4401	73	66	21.0	71.50
	4405	1 cond. 100 ft. Spool	20 solid	Bare copper, solid; black vinyl plastic jacket; tinned copper braid shield; polyethylene plastic insulation.	.195	100 200 300 400	4.10 6.20 8.00 9.50	53.5	66	28.5	7.35
	4407	1 cond. 500 ft. Spool	20 solid	Same as 4405	.195	Same as 4405	Same as 4405	53.5	66	28.5	59.35
	4415	1 cond. 100 ft. Spool	13 7x21	Bare copper; flexible stranding; black vinyl plastic jacket; bare copper braid shield; polyethylene plastic insulation.	.405	100 200 300 400	2.10 3.30 4.10 4.50	52	66	29.5	18.50
	4417	1 cond. 500 ft. Spool	13 7x21	Same as 4415	.405	Same as 4415	Same as 4415	52	66	29.5	173.75
	4419	1 cond. 100 ft. Spool	18 7x26	Tinned copper; flexible stranding; bare copper braid shield; black vinyl plastic jacket; polyethylene plastic insulation.	.405	100 200 300 400	1.90 2.85 3.60 4.35	75	66	20.5	17.35
	4421	1 cond. 500 ft. Spool	18 7x26	Same as 4419	.405	Same as 4419	Same as 4419	75	66	20.5	163.75
	4523	2 cond. Heavy Spool	500 ft. 7x26	Conductors bare copper; flexible stranding; conductors run parallel; polyethylene insulation. USE: TV and FM receiving antenna. Especially designed for use in TV fringe areas. Also adapted to use with low-power transmitting antenna.							
	4527	2 cond. round Spool	500 ft. 20 7x28	Copperweld conductors; tubular design protects against exterior hazards. USE: For UHF and VHF.	.350	30 60 100 200 400 500 700 900	.63 .93 1.25 1.82 2.7 3.0 3.6 4.2	300	84	5.6	48.00
	4529	2 cond. oval Spool	500 ft. 20 7x28	Same as 4527	.200 .400	Same as 4527	Same as 4527	Same as 4527	Same as 4527	Same as 4527	48.00



CONTROL PANEL INTERCOM CABLE

SPECIFICATIONS: Tinned copper; vinylite plastic insulation; wires twisted together; closely woven braided tinned copper shield.

TYPE No.	TYPE	LENGTH	SIZE	STRANDING	INSULATION THICKNESS (Inches)	FINISHED O.D. (Inches)	LIST PRICE EACH
1468	2 conductors	100 ft.	22	Solid	.010	.110	\$ 5.25
1469	3 conductors	100 ft.	22	Solid	.010	.145	6.70



LEAD COVERED CABLE

For freedom from interference, corrosion and dampness.

SPECIFICATIONS: Tinned copper wire; heavy rubber insulation and cotton braid; heavy lead sheath.

TYPE No.	TYPE	LENGTH	SIZE	STRANDING	INSULATION THICKNESS (Inches)	FINISHED O.D. (Inches)	LIST PRICE EACH
1453	2 conductors	100 ft.	18	Solid	1/32	.240 x .200	\$21.50
1454	3 conductors	100 ft.	18	Solid	1/32	.420	37.50



INTERCOMMUNICATING AND SOUND SYSTEM CABLES PAIRED CONDUCTORS

No.	Type	Length	Size & Stranding	Specifications and General Applications	Nominal Diameter (in.)	List Price	Color Coding for Intercom Cables
5201	1 Pr.-2 Condr.	100 ft. Spool	22 Solid	Cabled, .020" gray vinyl plastic Jacket overall	.145	\$ 2.50	PAIRED INTERCOMMUNICATING CABLES COLOR CODING Identification is simple with Consolidated Intercom Cables because they are all color coded. See chart below. Pair Color Combination 1 Black paired with red 2 Black paired with white 3 Black paired with green 4 Black paired with blue 5 Black paired with brown 6 Black paired with yellow 7 Black paired with orange 8 Red paired with green 9 Red paired with white
5202	1 Pr.-2 Condr.	500 ft. Spool	22 Solid	Same as 5201	.145	25.00	
5205	2 Pr.-4 Condr.	100 ft. Spool	22 Solid	Same as 5201	.190	4.65	
5206	2 Pr.-4 Condr.	500 ft. Spool	22 Solid	Same as 5201	.190	46.50	
5211	3 Pr.-6 Condr.	100 ft. Spool	22 Solid	Same as 5201	.230	5.90	
5212	3 Pr.-6 Condr.	500 ft. Spool	22 Solid	Same as 5201	.230	59.00	
5221	5 Pr.-10 Condr.	100 ft. Spool	22 Solid	Same as 5201	.250	8.80	
5222	5 Pr.-10 Condr.	500 ft. Spool	22 Solid	Same as 5201	.250	88.00	
5226	6 Pr.-12 Condr.	100 ft. Spool	22 Solid	Same as 5201	.265	9.25	
5227	6 Pr.-12 Condr.	500 ft. Spool	22 Solid	Same as 5201	.265	92.50	
5231	7 Pr.-14 Condr.	100 ft. Spool	22 Solid	Same as 5201	.280	13.30	
5232	7 Pr.-14 Condr.	500 ft. Spool	22 Solid	Same as 5201	.280	133.00	
5236	8 Pr.-16 Condr.	100 ft. Spool	22 Solid	Same as 5201	.300	13.80	
5237	8 Pr.-16 Condr.	500 ft. Spool	22 Solid	Same as 5201	.300	138.00	
5241	9 Pr.-18 Condr.	100 ft. Spool	22 Solid	Same as 5201	.320	14.15	
5242	9 Pr.-18 Condr.	500 ft. Spool	22 Solid	Same as 5201	.320	141.50	

MULTIPLE CONDUCTORS

No.	Type	Length	Size & Stranding	Specifications and General Applications	Nominal Diameter (in.)	List Price	Color Coding for Intercom Cables
5401	3 Condr.	100 ft. Spool	22-7x30	Cabled, .020" gray vinyl plastic Jacket overall	.140	\$ 3.00	Black, green, red
5402	3 Condr.	500 ft. Spool	22-7x30	Same as 5401	.140	30.00	Same as 5401
5406	4 Condr.	100 ft. Spool	22-7x30	Same as 5401	.158	3.70	Black, green, red, white
5407	4 Condr.	500 ft. Spool	22-7x30	Same as 5401	.158	37.00	Same as 5407
5411	5 Condr.	100 ft. Spool	22-7x30	Same as 5401	.170	4.50	Black, brown, green, red, white
5412	5 Condr.	500 ft. Spool	22-7x30	Same as 5401	.170	45.00	Same as 5411
5416	6 Condr.	100 ft. Spool	22-7x30	Same as 5401	.212	7.15	Black, blue, brown, green, red, white
5417	6 Condr.	500 ft. Spool	22-7x30	Same as 5401	.212	71.50	Same as 5416
5421	7 Condr.	100 ft. Spool	22-7x30	Same as 5401	.230	7.70	Black, blue, brown, green, orange, red, white
5422	7 Condr.	500 ft. Spool	22-7x30	Same as 5401	.230	77.00	Same as 5421
5426	8 Condr.	100 ft. Spool	22-7x30	Same as 5401	.235	8.25	Black, blue, brown, green, orange, red, white, yellow
5427	8 Condr.	500 ft. Spool	22-7x30	Same as 5401	.235	82.50	Same as 5426
5431	9 Condr.	100 ft. Spool	22-7x30	Same as 5401	.245	9.00	Black, blue, brown, green, orange, purple, red, white, yellow
5432	9 Condr.	500 ft. Spool	22-7x30	Same as 5401	.245	90.00	Same as 5431

ARMORED SPEAKER CABLE — For severe use, chafing, etc.

SPECIFICATIONS: Flexible copper conductors mounted parallel each covered with cotton serve and 1/64 wall of live rubber; overall wrap of galvanized steel armor



TYPE NO.	LENGTH	SIZE	STRANDING	INSULATION THICKNESS	FINISHED O.D. (Inches)	LIST PRICE EACH
1458	2 Conductors	100 ft.	18	16 x 30	1/64	233 x .155 \$9.00

PHONOGRAPH PICK-UP-ARM CABLE

SPECIFICATIONS: Tinned copper; flexible stranding; vinylite plastic insulation—SHIELDED.



TYPE No.	LENGTH	SIZE	STRANDING	INSULATION THICKNESS	FINISHED O.D. (Inches)	LIST PRICE EACH
1470	100 ft.	23	20 x .005	.010	.070	\$3.60

MICROPHONE CABLE

On 100 ft. spools—Conductor color chart: 1—Black; 2—White; 3—Red; 4—Green; 5—Yellow; 6—Blue; 7—Brown.



SHIELDED: Weatherproof rubber jacket for all microphone or weatherproof extension work. (Longer continuous lengths if desired.)

TYPE No.	TYPE	SIZE	SPECIAL USE	SPECIFICATIONS	STRANDING	FINISHED O.D. (Inches)	NOMINAL CAPACITY per ft. (mmf)	LIST PRICE
1459	1 conductor	20	Lapel microphone	Tinned copper wire; covered with cotton serve and wall of live colored rubber insulation; then covered with second cotton serve, closely woven tinned copper shield, another cotton serve, and a heavy live rubber overall jacket.	26 x 34	.175	40.	\$10.15 each
1460	1 conductor	20	Crystal microphone	Tinned copper, glass yarn serve; wall of live rubber; tinned copper braid shield; rubber jacket overall.	26 x 34	.240	38.	10.50 each
1462	2 conductor	20	Carbon microphones	Same as 1549; color coded.	26 x 34	.280	63.	11.35 each
1463	3 conductor	20	Carbon microphones	Same as 1549; color coded.	26 x 34	.290	.54	12.75 each
1464	4 conductor	20	Carbon microphones	Same as 1549; color coded.	26 x 34	.300	.33	16.85 each
1465	5 conductor	20	Carbon microphones	Same as 1549; color coded.	26 x 34	.340	.32	19.00 each
1466	6 conductor	20	Carbon microphones	Same as 1549; color coded.	26 x 34	.350	.82	24.70 each
1467	7 conductor	20	Carbon microphones	Same as 1549; color coded.	26 x 34	.370	.30	25.90 each





CATHODE-RAY TUBE LEAD CABLE

Flame Retardant Polyethylene Plastic Insulation

For high voltage leads to cathode-ray tubes in television receivers, oscilloscopes, power supplies and other uses requiring a high-voltage cable. Special features: minimum surface leakage, corona resistance and high dielectric strength.

No.	Length Package & Color	Size	Specifications	Stranding	Insulation Thickness (Inches)	Finished O.D. (Inches)	List Price Each
4601	100 ft. Spool Red with two white tracers	20	Extra flexible tinned copper wire; red cellulose acetate yarn braid with 2 white tracers; lacquer coating.	7 x 28	.035	.136	\$2.80
4611	100 ft. Spool Red	20	Same as No. 4601 except heavier insulation; solid red braid.	7 x 28	.065	.198	\$4.80

PHONOGRAPH MULTIPLE CABLE

	TYPE No.	LENGTH	SIZE	SPECIAL USE	SPECIFICATIONS	STRANDING	FINISHED O.D. (Inches)	LIST PRICE EACH
	5030	500 ft.	2-16 28-22	Connections between commercial electric phonographs (juke boxes) and record selectors.	1 cond. No. 16 gauge bare copper wire with 1/64" black vinylite insulation. 1 cond. No. 16 gauge solid bare copper wire with 1/64" red vinylite insulation. 14 condrs. No. 22 gauge solid bare copper wire with .010" vinylite insulation, all individually color coded. 14 condrs. No. 22 gauge tinned copper wire with a .010" vinylite insulation, all individually color coded. All condrs. grouped into cable form with a tight spiral cotton wrapping and with a heavy black vinylite jacket over-all.	Solid		\$382.00
	5103	1,000 ft.	3-22	Connections for commercial electric phonographs and record selectors.	3 condrs. No. 22 with 1/64" thermoplastic insulation, all individually color coded. All conductors grouped into cable form with a treated cotton braid overall lacquered.	7 x 30	.125	44.25
	5113	1,000 ft.	2-16 1-18	Connections for commercial electric phonographs and record selectors.	2 condrs. No. 16 1/32" thermoplastic insulation, all individually color coded. All conductors grouped into cable form with a treated brown cotton braid overall lacquered.	2-26 x 30 1-16 x 30	.165	105.70
	5123	1000 ft.	2-16 1-18	Same as 5030	Same as 5113, but with silver plastic jacket.	2-26 x 30 1-16 x 30	.165	77.75
	5135	1000 ft.	22 5 condr.	Same as 5030	5 cond. No. 22 with 1/64" thermoplastic insulation; 3 cond. twisted together with a braided tinned copper shield; 2 cond. twisted; all cond. grouped into cable form with a brown cotton braid overall.	5-7 x 30	.225	99.75



MULTI-COLOR CABLES

for intercom and p.a. systems

CONDUCTOR COLOR CHART (colored rubber): 1st—Red; 2nd—Black; 3rd—Blue; 4th—Green; 5th—Brown; 6th—Yellow; 7th—White; 8th—Tan; 9th—Pink; 10th—Gray; 11th—Purple; 12th—Orange.



FLEXIBLE COTTON BRAIDED

For speakers, testers, battery hook-up, etc. (longer continuous lengths if desired).

SPECIFICATION: Tinned flexible copper; cotton sleeve; live colored rubber insulation; bunched individual conductors; heavy brown cotton braid over-all; color coded.

TYPE No.	TYPE	LENGTH	SIZE	STRANDING	INSULATION THICKNESS (Inches)	FINISHED O.D. (Inches)	LIST PRICE EACH
1481	1 conductor	100 ft.	20	10 x 30	1/64	.150	\$ 4.15
1482	2 conductor	100 ft.	20	10 x 30	1/64	.175	5.60
1483	3 conductor	100 ft.	20	10 x 30	1/64	.200	7.75
1484	4 conductor	100 ft.	20	10 x 30	1/64	.275	9.65
1485	5 conductor	100 ft.	20	10 x 30	1/64	.250	11.60
1486	6 conductor	100 ft.	20	10 x 30	1/64	.260	14.45
1487	7 conductor	100 ft.	20	10 x 30	1/64	.275	16.60
1488	8 conductor	100 ft.	20	10 x 30	1/64	.300	22.45
1489	9 conductor	100 ft.	20	10 x 30	1/64	.310	23.25
1490	10 conductor	100 ft.	20	10 x 30	1/64	.325	25.30
1494	11 conductor	100 ft.	20	10 x 30	1/64	.335	27.20
1495	12 conductor	100 ft.	20	10 x 30	1/64	.350	33.80

ANALYZER CABLE

SPECIFICATIONS: Extra flexible tinned copper; rubber covered; color coded; Brown cotton braid overall.

1456	8 conductors	100 ft.	2-14 6-18	41 x 30 16 x 30	1/64	.300	\$26.30
1457	9 conductors	100 ft.	2-14 7-18	41 x 30 16 x 30	1/64	.320	27.50



TINNED COPPER SHIELDED

For radio, auto and electrical work.

SPECIFICATIONS: Extra flexible; tinned copper stranded; cotton serve; live color-coded rubber insulation; cotton serve over all conductors; tinned shielded overall braid.

1471	1 conductor	100 ft.	18	16 x 30	1/64	.110	\$ 6.60
1472	2 conductors	100 ft.	20	10 x 30	1/64	.190	8.50
1473	3 conductors	100 ft.	20	10 x 30	1/64	.200	11.00
1474	4 conductors	100 ft.	20	10 x 30	1/64	.220	14.45
1475	5 conductors	100 ft.	20	10 x 30	1/64	.235	17.05
1476	6 conductors	100 ft.	20	10 x 30	1/64	.250	21.00
1477	7 conductors	100 ft.	20	10 x 30	1/64	.265	25.30

FORMVAR WIRE—No. 2000

Covered with the new, tough, abrasion-resisting film. Takes up less space. Has these important qualities: No danger from stretching and bending during assembly. Tough at higher temperature. Resists abrasion better. Stable under heat aging. Does not fail after 2 hours at 105° C. Completely insoluble to petroleum solvents. Adequate acid and alkali resistance. Constant dielectric properties. Infinite resistance to water and moisture.

Use Single Formvar for low voltage coils, Heavy Formvar to replace Enamel Paper, Enamel Cotton, Enamel Silk, Double Cotton and Double Silk.
ON PROTECTA-SLEEVE SPOOLS.

Single Formvar Magnet Wire				Heavy Formvar Magnet Wire			
Size	1/4 Lb.	1/2 Lb.	1 Lb.	Size	1/4 Lb.	1/2 Lb.	1 Lb.
14	\$0.66	\$1.12	\$2.07	14	\$0.73	\$1.24	\$2.27
15	.66	1.20	2.10	15	.73	1.34	2.33
16	.75	1.25	2.14	16	.84	1.39	2.35
17	.75	1.30	2.15	17	.84	1.44	2.37
18	.75	1.34	2.17	18	.84	1.47	2.39
19	.83	1.39	2.23	19	.92	1.52	2.45
20	.83	1.40	2.25	20	.92	1.54	2.51
21	.83	1.42	2.27	21	.92	1.55	2.61
22	.83	1.45	2.36	22	.92	1.60	2.80
23	.89	1.49	2.42	23	.97	1.64	2.87
24	.90	1.50	2.80	24	1.00	1.65	4.22
25	.97	1.65	2.92	25	1.15	1.97	3.50
26	.99	1.65	3.05	26	1.19	1.98	3.64
27	1.05	1.74	3.20	27	1.25	2.07	3.84
28	1.10	1.80	3.37	28	1.34	2.15	4.04
29	1.14	1.87	3.46	29	1.37	2.22	4.14
30	1.20	1.95	3.52	30	1.44	2.34	4.22
31	1.34	2.02	3.67	31	1.67	2.52	4.58
32	1.35	2.10	3.75	32	1.69	2.63	4.67
33	1.42	2.25	3.95	33	1.77	2.81	4.94
34	1.50	2.55	4.12	34	1.87	3.19	5.16
35	1.64	2.81	4.70	35	1.85	3.46	5.50
36	1.92	3.00	5.26	36	2.39	3.75	6.38
37	2.17	3.37	6.00	37	2.72	4.20	7.50
38	2.55	3.75	6.76	38	3.17	4.69	8.45
39	2.80	4.50	7.50	39	3.50	5.64	9.38
40	3.75	5.64	9.00	40	4.69	7.04	11.27

COPPER WIRE—No. 2000



ON PROTECTA-SLEEVE SPOOLS

Handy convenient way to stock small quantities of wire. Prevents wire from matting or tangling. Supplied on spools as shown and in heavier weights.

Bare Copper Wire				Tinned Copper Wire			
Size	1/4 Lb.	1/2 Lb.	1 Lb.	Size	1/4 Lb.	1/2 Lb.	1 Lb.
14	\$0.53	\$0.97	\$1.54	14	\$0.67	\$1.13	\$1.75
15	.57	1.00	1.60	15	.73	1.27	1.92
16	.60	1.10	1.83	16	.80	1.40	2.00
17	.52	1.12	1.87	17	.84	1.44	2.03
18	.63	1.14	1.90	18	.87	1.47	2.08
19	.65	1.17	1.95	19	.90	1.50	2.12
20	.67	1.20	2.00	20	.94	1.53	2.14
21	.68	1.22	2.07	21	.95	1.53	2.24
22	.70	1.24	2.14	22	.97	1.57	2.30
23	.70	1.27	2.17	23	.98	1.58	2.34
24	.70	1.30	2.20	24	1.00	1.60	2.37
25	.72	1.30	2.20	25	1.00	1.60	2.37
26	.73	1.34	2.27	26	1.00	1.60	2.37
27	.75	1.37	2.30	27	1.05	1.67	2.64
28	.77	1.40	2.40	28	1.10	1.75	2.90
29	.77	1.42	2.47	29	1.13	1.84	2.94
30	.77	1.44	2.47	30	1.17	1.92	2.97
31	.77	1.44	2.47	31	1.20	2.00	3.10
32	.77	1.44	2.60	32	1.24	2.09	3.10
33	.78	1.47	2.68	33	1.27	2.17	3.19
34	.80	1.50	2.77	34	1.30	2.25	3.27
35	.82	1.55	2.90	35	1.32	2.30	3.40
36	.84	1.60	3.04	36	1.34	2.34	3.54
37	.92	1.75	3.16	37	1.36	2.42	3.72
38	1.00	1.90	3.40	38	1.38	2.50	3.90
39	1.02	1.97	3.45	39	1.39	2.59	3.95
40	1.04	2.04	3.50	40	1.40	2.67	4.00

MAGNET WIRE



Popular, profitable specialty wire packaged for easy selling in radio - electrical, department, specialty and hardware stores. Wide variety of sizes and insulations. Keeps stock in perfect order, always saleable. For all wire pages S-49 to 56.

Supplied on Spool as Shown and in Heavier Weights.

Here is a handy and convenient way to stock small quantities of wire. It prevents wire from matting or tangling. The sleeve is accurately made and can be readily slipped out of the way when any length of wire is desired.

PROTECTA-SLEEVE SPOOLS

DOUBLE COTTON COVERED				PLAIN ENAMEL				SINGLE COTTON ENAMEL				SINGLE SILK ENAMEL			
Size	1/4 lb.	1/2 lb.	1 lb.	Size	1/4 lb.	1/2 lb.	1 lb.	Size	1/4 lb.	1/2 lb.	1 lb.	Size	1/4 lb.	1/2 lb.	1 lb.
14	\$0.55	\$0.95	\$1.87	14	\$0.45	\$0.75	\$1.39	14	\$0.57	\$1.10	\$1.95	14			
15	.58	1.00	1.95	15	.45	.80	1.46	15	.58	1.10	2.00	15			
16	.60	1.05	2.00	16	.50	.84	1.42	16	.60	1.15	2.05	16	\$0.84	\$1.35	\$2.50
17	.60	1.10	2.05	17	.50	.87	1.44	17	.63	1.18	2.09	17	.85	1.45	2.75
18	.65	1.15	2.28	18	.50	.89	1.45	18	.65	1.25	2.10	18	.88	1.50	2.89
19	.65	1.25	2.34	19	.55	.92	1.49	19	.67	1.28	2.14	19	.90	1.60	3.00
20	.65	1.25	2.34	20	.55	.94	1.50	20	.68	1.34	2.19	20	.94	1.65	3.14
21	.77	1.34	2.64	21	.55	.95	1.59	21	.70	1.39	2.26	21	.96	1.70	3.25
22	.82	1.39	2.64	22	.55	.97	1.70	22	.73	1.43	2.30	22	1.00	1.75	3.39
23	.88	1.50	2.75	23	.58	.99	1.75	23	.78	1.50	2.38	23	1.05	1.87	3.50
24	.94	1.60	3.00	24	.60	1.00	1.87	24	.84	1.55	2.50	24	1.10	1.90	3.64
25	.95	1.65	3.14	25	.65	1.10	1.95	25	.85	1.63	2.63	25	1.18	2.00	3.75
26	1.00	1.75	3.39	26	.65	1.10	2.03	26	.90	1.70	2.75	26	1.20	2.20	4.14
27	1.15	1.89	3.64	27	.70	1.15	2.14	27	1.00	1.75	2.89	27	1.30	2.39	4.50
28	1.20	2.14	4.00	28	.73	1.20	2.25	28	1.05	1.80	3.00	28	1.40	2.50	4.67
29	1.30	2.39	4.50	29	.75	1.25	2.30	29	1.10	1.95	3.14	29	1.54	2.89	5.25
30	1.32	2.50	4.75	30	.80	1.30	2.35	30	1.15	2.04	3.39	30	1.65	3.05	5.80
31	1.50	2.75	5.00	31	.89	1.35	2.45	31	1.25	2.25	3.64	31	1.87	3.39	6.65
32	1.75	3.00	5.64	32	.90	1.40	2.50	32	1.39	2.50	4.00	32	2.20	4.00	7.25
33	1.89	3.37	6.25	33	.95	1.50	2.65	33	1.60	3.00	4.50	33	2.50	4.39	8.25
34	2.14	3.89	7.00	34	1.00	1.70	2.75	34	1.80	3.14	5.00	34	2.70	4.89	9.25
35	2.39	4.25	7.50	35	1.09	1.84	3.14	35	2.14	3.64	5.64	35	2.80	5.25	10.06
36	2.75	4.89	8.65	36	1.29	2.00	3.50	36	2.40	4.14	6.50	36	3.14	5.90	11.40
37	2.25	6.25	11.40	37	1.45	2.25	4.00	37	3.20	5.64	10.25	37	3.75	7.15	14.00
38	4.75	8.65	16.50	38	1.70	2.50	4.50	38	4.00	7.25	12.00	38	4.39	8.65	16.00
39	6.00	11.50	20.00	39	1.87	3.00	5.00	39	5.00	8.75	15.25	39	5.39	10.25	20.00
40	8.00	15.00	28.15	40	2.50	3.75	6.00	40	6.41	12.25	19.00	40	6.75	13.00	25.00



STA-PUT PUSHBACK HOOK-UP WIRE

STRIPS AND REMAINS BACK FOR CLEAN TERMINAL
 Seven colors for each: Black, blue, brown, green, red, yellow, white. Be sure to specify color when ordering.
 Every unit packaged in handsome 3-color display carton for easy merchandising by dealer.

SPECIFICATIONS: Tinned copper conductor; cotton serve and cotton braid through paraffin impregnation.

TYPE No.	SIZE	LENGTH	STRANDING	FINISHED O.D.	LIST PRICE
1048	18	25 ft. carton	16 x 30	.072	\$0.55 each
1049	18	100 ft. carton	16 x 30	.072	1.90 each
1050	18	1000 ft. spool	16 x 30	.072	19.00 each
1091	22	25 ft. carton	7 x 30	.066	.38 each
1092	22	100 ft. carton	7 x 30	.066	1.20 each
1093	22	1000 ft. spool	7 x 30	.066	11.20 each
1101	20	25 ft. carton	10 x 30	.068	.48 each
1102	20	100 ft. carton	10 x 30	.068	1.67 each
1103	20	1000 ft. spool	10 x 30	.068	13.70 each
1045	18	25 ft. carton	Solid	.070	.47 each
1046	18	100 ft. carton	Solid	.070	1.67 each
1047	18	1000 ft. spool	Solid	.070	16.50 each
1096	22	25 ft. carton	Solid	.065	.37 each
1097	22	100 ft. carton	Solid	.065	1.15 each
1098	22	1000 ft. spool	Solid	.065	10.50 each
1106	30	25 ft. carton	Solid	.067	.45 each
1107	20	100 ft. carton	Solid	.067	1.65 each
1108	20	1000 ft. spool	Solid	.067	12.50 each



HI-Q LO-LOSS PUSHBACK HOOK-UP WIRE

High efficiency wire ideal for use where high conductivity with negligible loss is essential. 3-color display carton. Real pushback — insulation will not creep. R.M.A. color coded.

SPECIFICATIONS: Tinned pure copper serve of cellulose acetate yarn; cotton braid overall with high gloss lacquer.

TYPE No.	SIZE	LENGTH	STRANDING	FINISHED O.D.	LIST PRICE
1051	22	25 ft. carton	7 x 30	.065	\$1.05 each
1052	22	100 ft. carton	7 x 30	.065	2.75 each
1053	22	1000 ft. spool	7 x 30	.065	12.00 each
1056	20	25 ft. carton	10 x 30	.066	1.07 each
1057	20	100 ft. carton	10 x 30	.066	2.90 each
1058	20	1000 ft. spool	10 x 30	.066	23.65 each
1061	22	25 ft. carton	Solid	.064	.70 each
1062	22	100 ft. carton	Solid	.064	2.47 each
1063	22	1000 ft. spool	Solid	.064	18.40 each
1066	20	25 ft. carton	Solid	.065	.94 each
1067	20	100 ft. carton	Solid	.065	3.20 each
1068	20	1000 ft. spool	Solid	.065	23.50 each



AERIAL WIRE . . . Copper and Bronze

Special, attractive three-color cartons help to make this wire easier for customers to buy, easier for your dealers to sell. Supplied at slight additional cost.



SOLID ENAMELED

No. 3851.	50 ft. coil,	14 Solid Enamel
No. 3852.	75 ft. coil,	14 Solid Enamel
No. 3853.	100 ft. coil,	14 Solid Enamel
No. 3854.	1000 ft. coil,	14 Solid Enamel
No. 3861.	50 ft. coil,	12 Solid Enamel
No. 3862.	75 ft. coil,	12 Solid Enamel
No. 3863.	100 ft. coil,	12 Solid Enamel
No. 3864.	1000 ft. spool,	12 Solid Enamel
No. 3871.	50 ft. coil,	10 Solid Enamel
No. 3872.	75 ft. coil,	10 Solid Enamel
No. 3873.	100 ft. coil,	10 Solid Enamel
No. 3874.	1000 ft. spool,	10 Solid Enamel

AERIAL AND BUS BAR SOLID TINNED

No. 3815.	1000 ft. spool,	16 Solid Tinned
No. 3816.	1000 ft. spool,	18 Solid Tinned
No. 3817.	1000 ft. spool,	20 Solid Tinned
No. 3818.	1000 ft. spool,	22 Solid Tinned
No. 3819.	1000 ft. spool,	24 Solid Tinned
No. 3821.	50 ft. coil,	14 Solid Tinned
No. 3822.	75 ft. coil,	14 Solid Tinned
No. 3823.	100 ft. coil,	14 Solid Tinned
No. 3824.	1000 ft. spool,	14 Solid Tinned
No. 3831.	50 ft. coil,	12 Solid Tinned
No. 3832.	75 ft. coil,	12 Solid Tinned
No. 3833.	100 ft. coil,	12 Solid Tinned
No. 3834.	1000 ft. spool,	12 Solid Tinned
No. 3841.	50 ft. coil,	10 Solid Tinned
No. 3842.	75 ft. coil,	10 Solid Tinned
No. 3843.	100 ft. coil,	10 Solid Tinned
No. 3844.	1000 ft. spool,	10 Solid Tinned

SOLID BARE

No. 3786.	50 ft. coil,	12 Solid Bare
No. 3787.	75 ft. coil,	12 Solid Bare
No. 3788.	100 ft. coil,	12 Solid Bare
No. 3789.	1000 ft. spool,	12 Solid Bare
No. 3791.	50 ft. coil,	10 Solid Bare
No. 3792.	75 ft. coil,	10 Solid Bare
No. 3793.	100 ft. coil,	10 Solid Bare
No. 3794.	1000 ft. spool,	10 Solid Bare
No. 3801.	50 ft. coil,	15 Solid Bare
No. 3802.	75 ft. coil,	15 Solid Bare
No. 3803.	100 ft. coil,	15 Solid Bare
No. 3804.	1000 ft. spool,	15 Solid Bare
No. 3811.	50 ft. coil,	14 Solid Bare
No. 3812.	75 ft. coil,	14 Solid Bare
No. 3813.	100 ft. coil,	14 Solid Bare
No. 3814.	1000 ft. spool,	14 Solid Bare

BARE STRANDED

No. 3501.	50 ft. coil,	7x26 Bare
No. 3502.	75 ft. coil,	7x26 Bare
No. 3503.	100 ft. coil,	7x26 Bare
No. 3504.	1000 ft. spool,	7x26 Bare
No. 3511.	50 ft. coil,	7x25 Bare
No. 3512.	75 ft. coil,	7x25 Bare
No. 3513.	100 ft. coil,	7x25 Bare
No. 3514.	1000 ft. spool,	7x25 Bare
No. 3521.	50 ft. coil,	7x24 Bare
No. 3522.	75 ft. coil,	7x24 Bare
No. 3523.	100 ft. coil,	7x25 Bare
No. 3524.	1000 ft. spool,	7x25 Bare
No. 3531.	50 ft. coil,	7x23 Bare
No. 3532.	75 ft. coil,	7x23 Bare
No. 3533.	100 ft. coil,	7x23 Bare
No. 3534.	1000 ft. spool,	7x23 Bare
No. 3541.	50 ft. coil,	7x0242 Bare
No. 3542.	75 ft. coil,	7x0242 Bare
No. 3543.	100 ft. coil,	7x0242 Bare
No. 3544.	1000 ft. spool,	7x0242 Bare
No. 3551.	50 ft. coil,	7x22 Bare
No. 3552.	75 ft. coil,	7x22 Bare
No. 3553.	100 ft. coil,	7x22 Bare
No. 3554.	1000 ft. spool,	7x22 Bare
No. 3561.	50 ft. coil,	7x20 Bare
No. 3562.	75 ft. coil,	7x20 Bare
No. 3563.	100 ft. coil,	7x20 Bare
No. 3564.	1000 ft. spool,	7x20 Bare

TINNED STRANDED

No. 3601.	50 ft. coil,	7x26 Tinned
No. 3602.	75 ft. coil,	7x26 Tinned
No. 3603.	100 ft. coil,	7x26 Tinned
No. 3604.	1000 ft. spool,	7x26 Tinned
No. 3611.	50 ft. coil,	7x25 Tinned
No. 3612.	75 ft. coil,	7x25 Tinned
No. 3613.	100 ft. coil,	7x25 Tinned
No. 3614.	1000 ft. spool,	7x25 Tinned
No. 3621.	50 ft. coil,	7x24 Tinned
No. 3622.	75 ft. coil,	7x24 Tinned
No. 3623.	100 ft. coil,	7x24 Tinned
No. 3624.	1000 ft. spool,	7x24 Tinned
No. 3631.	50 ft. coil,	7x23 Tinned
No. 3632.	75 ft. coil,	7x23 Tinned
No. 3633.	100 ft. coil,	7x23 Tinned
No. 3634.	1000 ft. spool,	7x23 Tinned
No. 3641.	50 ft. coil,	7x0242 Tinned
No. 3642.	75 ft. coil,	7x0242 Tinned
No. 3643.	100 ft. coil,	7x0242 Tinned
No. 3644.	1000 ft. spool,	7x0242 Tinned
No. 3651.	50 ft. coil,	7x22 Tinned
No. 3652.	75 ft. coil,	7x22 Tinned
No. 3653.	100 ft. coil,	7x22 Tinned
No. 3654.	1000 ft. spool,	7x22 Tinned
No. 3661.	50 ft. coil,	7x20 Tinned
No. 3662.	75 ft. coil,	7x20 Tinned
No. 3663.	100 ft. coil,	7x20 Tinned
No. 3664.	1000 ft. coil,	7x20 Tinned

AERIAL WIRE . . . Phosphor Bronze

Recommended for short wave and transmitting aerials
Tested and used by Army and Navy
Amazing improvement for reception and transmission

No. 3401.	50 ft. coil,	7x26 Phosphor Bronze
No. 3402.	75 ft. coil,	7x26 Phosphor Bronze
No. 3403.	100 ft. coil,	7x26 Phosphor Bronze
No. 3404.	1000 ft. spool,	7x26 Phosphor Bronze
No. 3421.	50 ft. coil,	7x24 Phosphor Bronze
No. 3422.	75 ft. coil,	7x24 Phosphor Bronze
No. 3423.	100 ft. coil,	7x24 Phosphor Bronze
No. 3424.	1000 ft. spool,	7x24 Phosphor Bronze

Phosphor bronze is recognized as the most efficient, practical wire obtainable for short wave and transmitting aerials. It will not stretch or sag and is super-inductive.

No. 3451.	50 ft. coil,	7x22 Phosphor Bronze
No. 3452.	75 ft. coil,	7x22 Phosphor Bronze
No. 3453.	100 ft. coil,	7x22 Phosphor Bronze
No. 3454.	1000 ft. spool,	7x22 Phosphor Bronze
No. 3461.	50 ft. coil,	7x20 Phosphor Bronze
No. 3462.	75 ft. coil,	7x20 Phosphor Bronze
No. 3463.	100 ft. coil,	7x20 Phosphor Bronze
No. 3464.	1000 ft. spool,	7x20 Phosphor Bronze

TEST PROD WIRE



A specially constructed high grade wire for use on laboratory test equipment, bench analyzers, etc.

No.	Length Package & Color	Size	Specifications	Stranding	Insulation Thickness (Inches)	Finished O.D. (Inches)	List Price Each	No.	Length Package & Color	Size	Specifications	Stranding	Insulation Thickness (Inches)	Finished O.D. (Inches)	List Price Each
1001	100 ft. Spool Black Red	20	Extra flexible tinned copper wire with red or black live rubber insulation 5000 Volts	41x36	.043	.130	\$ 2.25	1006	100 ft. Spool Black Red	18	Same as No. 1001 10,000 Volts	65x36	.088	.230	4.30
1002	250 ft. Spool Black Red	20	Same as No. 1001 5000 Volts	41x36	.043	.130	5.60	1007	250 ft. Spool Black Red	18	Same as No. 1001 10,000 Volts	65x36	.088	.230	10.75
1003	1000 ft. Spool Black Red	20	Same as No. 1001 5000 Volts	41x36	.043	.130	21.00	1008	500 ft. Spool Black Red	18	Same as No. 1001 10,000 Volts	65x36	.088	.230	20.00
								1009	1000 ft. Spool Black Red	18	Same as No. 1001 10,000 Volts	65x36	.088	.230	40.00

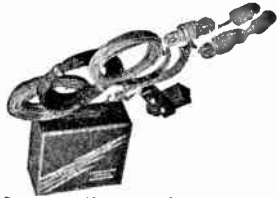

AERIAL KITS for Every Radio Receiver

Consolidated Aerial Kits are made up with the same painstaking care that has always featured our assemblies. All materials and parts are of highest standard and are guaranteed as to Length, Weight, Size and Count as to

Spectrum. If your needs are not answered in the stock listings below, write us regarding your special requirements.

50 FOOT SERIES

- No. 506—**THE PRICE LEADER**
50 feet 7x26 Bare Copper Aerial Wire; 25 feet No. 16 Rubber Covered Lead-in Wire; 1 Adjustable Ground Clamp; 2 Porcelain Insulators; 2 Porcelain Nail Knobs; 1 Window Lead-in Strip; Installation Instructions. **\$1.37 each**
- No. 507—Contains 1 Underwriter Approved Lightning Arrestor, otherwise same as No. 506. **1.72 each**
- No. 501—**A SUPER VALUE**
50 feet 7x26 Bare Copper Aerial Wire; 35 feet No. 16 Rubber Covered Lead-in Wire; 1 Adjustable Ground Clamp; 2 Porcelain Insulators; 2 Porcelain Nail Knobs; 1 Window Lead-in Strip; Installation Instructions. **1.44 each**
- No. 502—Contains 1 Underwriter Approved Lightning Arrestor, otherwise same as No. 501. **1.78 each**
- No. 512—**DE LUXE AERIAL**
50 feet 7x22 Enamel Aerial Wire; 35 feet No. 16 Rubber Covered Lead-in Wire; 1 Underwriter Approved Lightning Arrestor; 2 Large Glass Insulators; 1 Shur Grip Ground Clamp; 1 Duco Window Lead-in Strip; 2 Porcelain Nail Knobs; Installation Instructions. **2.62 each**

60 FOOT SERIES

- No. 516—**PRICE KIT**—Contains 60 feet 7x26 Bare Copper Aerial Wire, otherwise same as No. 501. **1.57 each**
- No. 517—Contains 60 feet 7x26 Bare Copper Aerial Wire, 1 Underwriter Approved Lightning Arrestor, otherwise same as No. 501. **1.94 each**
- No. 518 **AERIAL**—Contains 60 feet 7x22 Enamel Aerial Wire, otherwise same as No. 512. **2.87 each**

75 FOOT SERIES

- No. 531—**75 FOOT SPECIAL**
75 feet 7x26 Bare Copper Aerial Wire; 25 feet No. 16 Rubber Covered Lead-in Wire; 1 Adjustable Ground Clamp; 2 Porcelain Insulators; 2 Porcelain Nail Knobs; 1 Window Lead-in Strip; Installation Instructions. **1.72 each**
- No. 532—Contains 1 Underwriter Approved Lightning Arrestor, otherwise same as No. 531. **2.07 each**
- No. 522—**SUPERFINE AERIAL**
75 feet 7x24 Enameled Aerial Wire; 25 feet No. 16 Rubber Covered Lead-in Wire; 1 Underwriter Approved Lightning Arrestor; 2 Large Glass Insulators; 1 Shur Grip Gound Clamp; 1 Duco Window Lead-in Strip; 2 Porcelain Nail Knobs; Installation Instructions. **2.82 each**

100 FOOT SERIES

- No. 541—**EXTRA VALUE**
100 feet 7x26 Bare Copper Aerial Wire; 25 feet No. 16 Rubber Covered Lead-in Wire; 1 Adjustable Ground Clamp; 2 Porcelain Insulators; 2 Porcelain Nail Knobs; 1 Window Lead-in Strip; Installation Instructions. **1.87 each**
- No. 542—Contains Underwriter Approved Lightning Arrestor, otherwise same as No. 541. **2.22 each**
- No. 551—Contains 100 feet 7x24 Copper Aerial Wire, otherwise same as No. 541. **2.03 each**
- No. 552—Contains 100 feet 7x24 Aerial Wire; 1 Underwriter Approved Lightning Arrestor, otherwise same as No. 541. **3.20 each**



RESISTANCE LINE CORDS for AC-DC Radio Sets

The cords have a wide market for replacement on AC-DC radios with worn out cords; also on those formerly having hot resistance. Consists of a 6 foot cord with red and black rubber covered line cord wires and an asbestos covered resistance having separate terminal braid. Consolidated cords have an exclusive tinned copper terminal on the resistance cord that can be soldered. Colored cotton tracer designates ohmage.

VOLTAGE DATA

The table and example below indicate tube voltages and how to determine proper cord. Check the voltages of each tube in the voltage table. Add all voltages together, allowing 10% variation, plus or minus.

TUBE VOLTAGES	EXAMPLE: Radio Contains
6.3 volt tubes: 36, 37, 38, 39, 77, 78, 6B7, KR1, 6D6, 6C6, 6A7, 6F7.	1 77 tube—voltage 6.3 1 78 tube—voltage 6.3 1 43 tube—voltage 25. 1 25Z5 tube—voltage 25.
12 volt tubes: 12Z3, 12A5.	Total voltage 62.6
25 volt tubes: 25Z3, 43.	Radio uses 160 ohm cord. List Price
No. 2401 135 ohms—Blue	\$ 1.05 ea.
No. 2413 150 ohms—Blue and Red—Cross tracer.....	1.05 ea.
No. 2402 160 ohms—Red	1.05 ea.
No. 2412 180 ohms—Blue and White—Cross tracer.....	1.05 ea.
No. 2411 200 ohms—Red and White—Cross tracer.....	1.05 ea.
No. 2403 220 ohms—Grey	1.05 ea.
No. 2410 250 ohms—Red and Green—Cross tracer.....	1.05 ea.
No. 2409 280 ohms—White and Green—Cross tracer.....	1.05 ea.
No. 2404 290 ohms—White	1.05 ea.
No. 2408 310 ohms—Yellow and Green—Cross tracer.....	1.05 ea.
No. 2405 330 ohms—Yellow	1.05 ea.
No. 2407 350 ohms—Yellow and Red—Cross tracer.....	1.05 ea.
No. 2406 360 ohms—Green	1.05 ea.
No. 2414 525 ohms—Grey and White—Cross tracer.....	1.05 ea.
No. 2415 30 ohms Per Ft.—100 Ft. Spools.....	13.75
No. 2421 60 ohms Per Ft.—100 Ft. Spools.....	13.75



VOLTAGE REDUCER CORD SETS

No. 2451

The Consolidated Voltage Reducer Cord Set can be used anywhere that it is necessary to reduce line voltage from 220 volts to 110 volts for radios, electric clocks, household appliances, electric dry shavers, etc. It has a special built-in resistor which reduces 220 volts AC or DC to 110 volts without any additional devices. It comes as a 6 foot cord with dark brown glazed cotton covering. Packed in attractive two-color box.

- No. 2451—American male plug with American female receptacle.....\$1.90
- No. 2452—English male plug with American female receptacle..... 2.40
- No. 2453—French male plug with American female receptacle..... 2.40

ELECTRICAL CORDAGES

HANDYCORD CENTERSTRIP

The perfect Lamp and Utility Cord.



Colors: Black, Brown, White.

- No. 4071 No. 18 1/64 ft. Spools **\$37.50M**
- No. 4072 250 ft. Spools **35.00M**

APPROVED PARALLEL SILK CORD



- No. 4066 No. 18 1/64 100 ft. Spools **\$37.50M**
- No. 4067 No. 18 1/64 250 ft. Spools **35.00M**

HEATER CORD



- No. 4086 No. 16 100 ft. Spools..... **\$73.65M**
- No. 4087 No. 16 250 ft. Spools..... **69.75M**
- No. 4091 No. 18 100 ft. Spools..... **63.50M**
- No. 4092 No. 18 250 ft. Spools..... **59.25M**

TWISTED COTTON CORD



- No. 4101 No. 20 1/64 Black 100 ft. Spools..... **\$35.75M**
- No. 4102 No. 20 1/64 Black 250 ft. Spools..... **32.90M**
- No. 4106 No. 18 1/64 Black 100 ft. Spools..... **41.00M**
- No. 4107 No. 18 1/64 Black 250 ft. Spools..... **37.90M**
- No. 4111 No. 18 1/32 Black 100 ft. Spools..... **54.35M**
- No. 4112 No. 18 1/32 Black 250 ft. Spools..... **51.00M**
- No. 4116 No. 18 1/64 Gr. & Yel. 100 ft. Spools..... **41.00M**
- No. 4117 No. 18 1/64 Gr. & Yel. 250 ft. Spools..... **37.90M**
- No. 4121 No. 18 1/32 Gr. & Yel. 100 ft. Spools..... **54.35M**
- No. 4122 No. 18 1/32 Gr. & Yel. 250 ft. Spools..... **51.00M**

ALL RUBBER SERVICE CORD



- No. 4151 280 O.D. No. 18-2 Cond. 100 ft. Spools..... **\$57.00M**
- No. 4152 280 O.D. No. 18-2 Cond. 250 ft. Spools..... **55.00M**
- No. 4156 380 O.D. No. 18-2 Cond. 100 ft. Spools..... **71.50M**
- No. 4157 380 O.D. No. 18-2 Cond. 250 ft. Spools..... **68.00M**
- No. 4161 380 O.D. No. 16-2 Cond. 100 ft. Spools..... **76.50M**
- No. 4162 380 O.D. No. 16-2 Cond. 250 ft. Spools..... **73.50M**



Radio & TV Wire Products

microphone cables

Cornish Microphone Cables are available in plastic and rubber insulations. Plastic cables utilize polyethylene insulation on the conductor with outer vinyl plastic jacket. They are designed for low capacitance, high insulation resistance, low attenuation; and withstand severe service under all operating conditions.

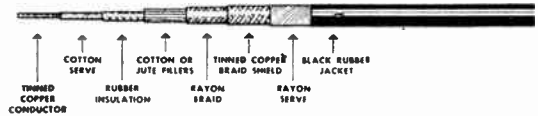
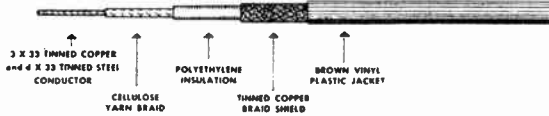

PLASTIC MICROPHONE CABLE								
Catalog Number	AWG Size	Number of Strands	Nominal Outside Diameter Inches	Nominal Capacitance Per Ft. MMF	Standard Put-Up	Standard Shipping Pkg.	Approx. Wght. Lbs./M Ft.	List Price Per M Ft.
2411	25/1	7/33	.144	37	500' Spool	1 Spool	15	55.00
2401	25/1	7/33	.200	25	500' Spool	1 Spool	25	70.00

RUBBER MICROPHONE CABLE								
Catalog Number	AWG Size	Number of Strands	Nominal Outside Diameter Inches	Nominal Capacitance Per Ft. MMF	Standard Put-Up	Standard Shipping Pkg.	Approx. Wght. Lbs./M Ft.	List Price Per M Ft.
2101	20/1	26/34	.260	32*	500' Spool	1 Spool	49	92.00
2152	20/2	26/34	.280	68*	500' Spool	1 Spool	54	115.00
2153	20/3	26/34	.280	85*	500' Spool	1 Spool	59	132.50
2154	20/4	26/34	.305	95*	500' Spool	1 Spool	72	157.50
2182	18/2	41/34	.295	80*	500' Spool	1 Spool	60	147.50
2160	20/1	26/34	.175	34*	500' Spool	1 Spool	25	78.25

*Between one conductor and remaining conductors connected to shield.

antenna control cables

Cornish Antenna Control Cables are available in polyethylene and vinyl plastic insulations in a varied range of conductors to adequately meet all installation problems encountered. Flat and round constructions are furnished in brown colored outer insulation.



Catalog Number	AWG Size	Number of Strands	Thickness Conductor Insulation Inch	Nominal Outside Dimension Inch	Standard Put-Up	Standard Shipping Pkg.	Approx. Wght. Lbs./M Ft.	List Price Per M Ft.
510	20/4	7/28	—	.075x.350	1000' Spool	1 Spool	20	39.40
514	20/4	7/28	.010	.170	1000' Spool	1 Spool	24	46.25
515	20/5	7/28	.010	.180	1000' Spool	1 Spool	30	61.25
518	22/8	7/30	.015	.205	1000' Spool	1 Spool	34	71.25

t-v lead-in cables

Cornish TV Lead-in Cables are furnished only in pure virgin polyethylene insulation to insure long life under severe operating conditions and are designed so that only exceptionally low losses at high frequencies are experienced. They are available with pure copper or copperweld conductors. Copperweld 300 Ohm lead-in cable has 1 1/2 times the tensile strength of copper and has approximately 2 1/2 times greater flexing life. It insures long service life in TV aerial installations requiring long runs.

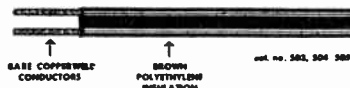

Catalog Number	AWG Size	Number of Strands	Nominal Outside Diameter Inch	Frequency (MC)	Attenuation Per 100 Ft. (Decibels)	Impedance (Ohms)	Capacitance Per Ft. (MMF)	Standard Put-Up Pkg.	Approx. Wght. Lbs./M Ft.	List Price Per M Ft.
500	20/2	7/28	.052 x .400	100	1.1	300	4.6	1000' Spool	17	26.25
501	20/2	7/28	.072 x .400	200	1.7	300	4.6	1000' Spool	18	32.80
502	20/2	7/28	.100 x .400	300	2.2	300	4.6	1000' Spool	20	37.50
				400	2.7					
503	20/2	7/28	.052 x .400	100	1.1	300	4.6	1000' Spool	17	26.25
504	20/2	7/28	.072 x .400	200	1.7	300	4.6	1000' Spool	18	32.80
505	20/2	7/28	.100 x .400	300	2.2	300	4.6	1000' Spool	20	37.50
				400	2.7					
520	20/2	7/28	.320 x .460	100	1.25	300	4.65	500' Spool	28	55.00
499	22/2	7/50	.040 x .360			300	4.6	1000' Spool	12	20.00

RG/U coaxial transmission cables

Cornish RG/U Coaxial Transmission Cables are available in two basic constructions, namely RG-11/U, Catalog No. 522 and RG-59/U, Catalog No. 521. They are designed for use as communication cables and television antenna lead-in cable. These cables are available, normally, from factory stock. Other special RG/U constructions can be furnished to special order providing quantities required constitute an economical manufacturing run.

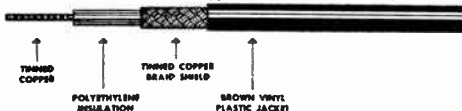

Catalog Number	AWG Size	Number of Strands	Nom. Outside Diam. Inch	Frequency (MMC)	Atten. per 100 Ft. (Decibels)	Impedance (Ohms)	Capacitance per M Ft. (MMF)	Standard Put-Up	Standard Shipping Pkg.	Approx. Wght. Per M Ft. Lbs.	List Price Per M Ft.
521	22/1	Solid	.245	100	3.75	73	21	500 Ft. Spool	1 Spool	43	91.25
RG-59/U			200	5.60							
			400	8.30							
522	18/1	7/26	.405	100	1.90	75	20.5	500 Ft. Spool	1 Spool	98	185.00
RG-11/U			200	2.85							
			400	4.35							

Note: All Cornish Wire and Cable is available in put-ups other than those listed, ask for current price schedule.



Radio & TV Wire Products

braided tinned copper tubular shielding



Catalog Number	Number of Strands	Nom. Outside Diameter Inch	Standard Put-Up	Standard Shipping Pkg.	Approx. Wght. Lbs./M Ft.	List Price Per M Ft.
1110	14 x 33	.250	250' Spool	1 Spool	19	62.50

test lead wire

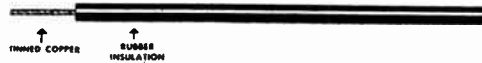

Catalog Number	AWG Size	Number of Strands	Jacket Insulation Inch	Nominal Outside Diameter Inch	Suggested Voltage Rating	Available Standard Put-Up	Standard Shipping Pkgs.	Approx. Wght. Lbs./M Ft.	List Price Per M Ft.
1142	18	65/36	.044	.140	5000	100' Spool	4 Spools	15	32.50
1142	18	65/36	.044	.140	5000	500' Spool	1 Spool	15	26.75
1142	18	65/36	.044	.140	5000	1000' Spool	1 Spool	15	26.75

STANDARD COLORS:—Red and Black.

intercommunication cable

Cornish Intercommunication and Sound Cables are made in various constructions utilizing plastic insulation for both conductors and jacket. Where installation conditions dictate, Cornish shielded cables are recommended.

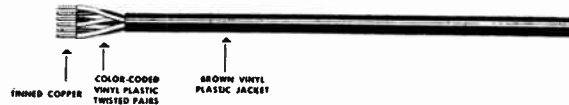

Catalog Number	AWG Size	Number of Strands	Number of Pairs	Thick. Conductor Insulation Inch	Thickness Jacket Insulation Inch	Nominal Outside Diameter Inch	Standard Put-Up	Standard Shipping Pkg.	Approx. Wght. Lbs./M Ft.	List Price Per M Ft.
1240	22/2	Solid	1	.015	.015	.145	500' Spool	1 Spool	14	31.25
1241	22/4	Solid	2	.015	.015	.205	500' Spool	1 Spool	22	53.75
1242	22/6	Solid	3	.015	.015	.230	500' Spool	1 Spool	29	76.25
1243	22/12	Solid	6	.015	.015	.265	500' Spool	1 Spool	42	102.50
1244	22/18	Solid	9	.015	.015	.320	500' Spool	1 Spool	68	152.50
1245	22/30	Solid	15	.015	.015	.380	500' Spool	1 Coil	105	262.50

plastic insulated cable

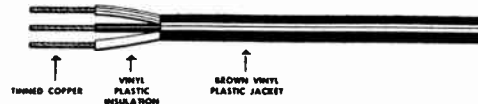

Catalog Number	AWG Size	Number of Strands	Thick. Conductor Insulation Inch	Thickness Jacket Insulation Inch	Nominal Outside Diameter Inch	Standard Put-Up	Standard Shipping Pkg.	Approx. Wght. Lbs./M Ft.	List Price Per M Ft.
1223	22/3	7/30	.015	.015	.140	500' Spool	1 Spool	14	35.00
1224	22/4	7/30	.015	.015	.160	500' Spool	1 Spool	20	42.50
1832	18/2	Solid	.015	No Jacket	.115	500' Spool	4 Spools	13	20.50
1833	18/3	Solid	.015	No Jacket	.135	500' Spool	4 Spools	20	30.75

shielded intercommunication cable



Catalog Number	AWG Size	Number of Strands	Thickness Conductor Insulation Inch	Tinned Copper Shielding	Nominal Outside Diameter Inch	Standard Put-Up	Standard Shipping Pkg.	Approx. Wght. Lbs./M Ft.	List Price Per M Ft.
1230	20/2	10/30	.015	#34	.163	1000 ft.	2	22	57.50
1238	18/2	16/30	.015	#34	.228	1000 ft.	2	35	66.25
1233	20/3	10/30	.015	#34	.230	500 ft.	2	42	97.50

lead-in wire

Cornish Lead-in wire is recommended for use from the outdoor antenna to the radio set.



Catalog Number	AWG Size	Number of Strands	Thickness Conductor Insulation Inch	Nominal Outside Diameter Inch	Standard Put-Up	Standard Shipping Package	Approx. Weight Lbs./M Ft.	List Price Per M Ft.
303	18/1	16/30	1/32	.115	1000' Spool	1 Spool	8	20.00
304	16/1	26/30	1/32	.130	1000' Spool	1 Spool	12	25.00

aerial wire

BARE COPPER

Catalog Number	AWG Size	Number of Strands	Jacket Insulation Inch	Nominal Outside Diameter Inch	Suggested Voltage Rating	Available Standard Put-Up	Standard Shipping Packages	Approx. Wght. Lbs./M Ft.	List Price Per M Ft.
42A	16	7/24	Bare	.060	—	75' Coil	50	8.5	1,150.00

no flame-corr hook-up wire



Catalog Number	AWG Size	Number of Strands	Nominal Outside Diameter Inches	Voltage Break-Down Nominal Volts	Available Standard Put-Ups	*Standard Shipping Package	Approx. Weight Lbs./M Ft.	List Price Per M Ft.
1084	18	16/30	.110	7400	100' Spool 1000' Spool	10	9	38.60 35.50
1085	20	10/30	.102	7400	100' Spool 1000' Spool	10	7	32.10 29.00
1086	22	7/30	.091	7400	100' Spool 1000' Spool	10	6	27.90 24.80
1079	18	Solid	103	7400	100' Spool 1000' Spool	10	9	35.90 32.80
1080	20	Solid	.095	7400	100' Spool 1000' Spool	10	6	29.40 26.30
1081	22	Solid	.091	7400	100' Spool 1000' Spool	10	5	26.10 23.00

STANDARD COLORS:—Black, Red, Green, Yellow, Blue, Brown, Orange, Slate, White and tracer combinations of base colors.

*100 Ft. Spool put-ups furnished in assorted colors.



Radio & TV Wire Products

cor-lac push back wire



Catalog Number	AWG Size	Number of Strands	Nominal Outside Diameter Inches	Voltage Break-Down Nominal Volts	Available Standard Put-Ups	*Standard Shipping Package	Approx. Weight Lbs./M Ft.	List Price Per M Ft.
648	18	16/30	.092	3100	100' Spool 1000' Spool	10 1	9	25.60 22.50 20.60
649	20	10/30	.072	3100	100' Spool 1000' Spool	10 1	6	17.50 14.30
650	22	7/30	.062	3100	100' Spool 1000' Spool	10 1	4	23.00 18.75
642	18	Solid	.092	3100	100' Spool 1000' Spool	10 1	8	19.75 18.75
644	20	Solid	.071	3100	100' Spool 1000' Spool	10 1	5	15.60 15.75
645	22	Solid	.061	3100	100' Spool 1000' Spool	10 1	4	12.60

STANDARD COLORS:—Black, Red, Green, Yellow, Blue, Brown, Orange, Slate, White and tracer combinations of base colors.
 *100 Ft. Spool put-ups furnished in assorted colors.

plastic-cor hook-up wire



Catalog Number	AWG Size	Number of Strands	Nominal Outside Diameter Inches	Voltage Break-Down Nominal Volts	Available Standard Put-Ups	*Standard Shipping Package	Approx. Weight Lbs./M Ft.	List Price Per M Ft.
1307	18	16/30	.108	22,000	100' Spool 1000' Spool	10 1	11	26.10 23.00 21.75
1308	20	10/30	.097	22,000	100' Spool 1000' Spool	10 1	10	18.60 19.75
1309	22	7/30	.092	22,000	100' Spool 1000' Spool	10 1	9	16.60 24.75
1301	18	Solid	.105	22,000	100' Spool 1000' Spool	10 1	11	21.10 19.50
1202	20	Solid	.094	22,000	100' Spool 1000' Spool	10 1	10	16.30 16.60
1303	22	Solid	.089	22,000	100' Spool 1000' Spool	10 1	9	13.50

STANDARD COLORS:—Black, Red, Green, Yellow, Brown, Tan, Blue, Orange and White.
 *100 Ft. Spool put-ups furnished in assorted colors.

flexible and portable cords

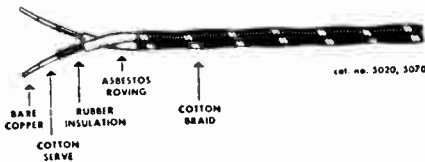
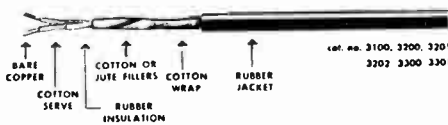

Catalog Number	AWG Size	UL Type	Number of Strands	Insulation Cond. In.	Thickness Jacket In.	Nominal Outside Diameter Inch	Current Carrying Capacity Amp.	Standard Put-Up	Standard Shipping Pkg.	Approx. Wght. Lbs./M Ft.	List Price Per M Ft.
3000	18/2	SP-1	41/34	2/64	—	.120x225	7	250' Spool	4 Spools	22	31.25
3001	18/2	SP-2	41/34	3/64	—	.150x285	7	250' Spool	4 Spools	36	45.60
3003	16/2	SP-2	65/34	3/64	—	.170x320	10	250' Spool	4 Spools	50	63.75
3010	18/2	SPT-1	41/34	2/64	—	.120x225	7	250' Spool	4 Spools	23	27.50
3011	18/2	SPT-2	41/34	3/64	—	.150x285	7	250' Spool	4 Spools	33	43.10
3012	16/2	SPT-2	65/34	3/64	—	.170x320	10	250' Spool	4 Spools	45	63.75
3100	18/2	SV	41/34	1/64	2/64	.250	7	250' Spool	4 Spools	42	62.50
3200	18/2	SJ	41/34	2/64	2/64	.305	7	250' Spool	4 Spools	54	70.00
3201	18/3	SJ	41/34	2/64	2/64	.345	7	250' Spool	4 Spools	73	103.50
3202	18/4	SJ	41/34	2/64	2/64	.360	5.6	250' Spool	1 Spool	96	150.40
3300	18/2	SJ	16/30	2/64	2/64	.305	7	250' Spool	4 Spools	54	65.00
3301	18/3	SJ	16/30	2/64	2/64	.345	7	250' Spool	4 Spools	73	97.40
5020	18/2	HPD	41/34	2/64	—	.274	10	250' Spool	4 Spools	32	62.50
5070	16/2	HPD	65/34	2/64	—	.301	15	250' Spool	4 Spools	42	75.00

Note: All Cornish Wire and Cable is available in put-ups other than those listed, ask for current price schedule.



Radio & TV Wire Products

replacement and extension cord sets

DESCRIPTION

18/2 SP-1 Brown with Cornish Molded-On Male Plug and Molded-On =185TV Connector UL Flag Label

SUGGESTED USE

Television Power Supply Cord for use on original equipment or as a replacement cord set.



DESCRIPTION

18/2 SP-1 Brown with Cornish Molded-On Male Plug, Appliance end slit 2 inches. Conductor stripped 1 inch. Hanked UL Flag Label

SUGGESTED USE

Replacement Cord-set for radios, record players, lamps and small appliances.



DESCRIPTION

18/2 5V Black with Cornish Molded-On Male Plug. Appliance end jacket removed 2 inches. Conductors stripped 1 inch. Hanked UL Flag Label

SUGGESTED USE

Replacement Cord-set for food mixers, test equipment and small appliances.

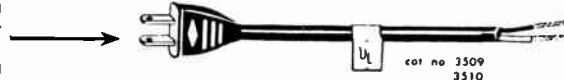

DESCRIPTION

18/2 16/30 SJ Black with Cornish Molded-On Plug Appliance end jacket removed 2 inches. Conductors stripped 1 inch. Hanked UL Flag Label

SUGGESTED USE

Replacement Cord set for electric tools, small motors and general use.



DESCRIPTION

18/2 SP-1 Brown with Cornish Molded-On Plug and soft molded rubber cube tap - UL Blue Flag Label.

SUGGESTED USE

Extension Cord set for office and household use.



DESCRIPTION

18/2 16/30 SJ Black with Cornish Molded-On Male Plug and Cornish Molded-On Female Connector Coiled and bared.

SUGGESTED USE

Extension Cord set for outdoor and heavy duty use.

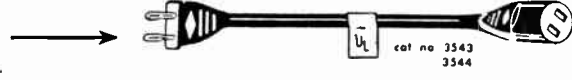

DESCRIPTION

16/2 Glazed Cotton HPD Replacement Heater Cord with Cornish Molded-On Plug and with crotch and conductors wrapped 3 inches with asbestos thread and conductors bared 1/2 inch. Hanked, Green Flag Label.

SUGGESTED USE

For electric irons and other heating devices.



DESCRIPTION

18/2 SP-1 Brown with Cornish Molded-On Male Plug and Molded-On =190 Connector

*Not UL Approved.

SUGGESTED USE

Television Power Supply "Cheater" Cord for sale to and use by authorized television servicemen.



Catalog Number	Length	Standard Put-Up	Standard Shipping Pkg.	Wght. Standard Shipping Pkg.	List Price Per M Cords	Catalog Number	Length	Standard Put-Up	Standard Shipping Pkg.	Wght. Standard Shipping Pkg.	List Price Per M Cords
3185	6 Feet	100	100	19	565.00	3580	6 Feet	100	100	24	825.00
3189	9 Feet	100	100	25	670.00	3581	9 Feet	100	100	32	937.50
3500	6 Feet	100	100	18	345.00	3582	12 Feet	100	100	38	1,037.50
3501	10 Feet	100	100	26	480.00	5520	7 Feet	100	100	30	1,070.00
3509	6 Feet	100	100	28	665.00	3543	15 Feet	1	20	23	1,775.00
3510	10 Feet	50	50	23	952.50	3544	25 Feet	1	20	33	2,787.50
3519	6 Feet	50	50	19	680.00	3190*	6 Feet	100	100	19	565.00
3520	10 Feet	50	50	28	977.50	3191*	9 Feet	100	100	25	670.00

phonograph pick-up arm cable

This cable is designed specifically for use as phonograph pick-up arm cable. The conductor, being stranded from #36 AWG wire, is very flexible. The overall diameter of the wire is quite small and cable is devoid of stiffness.

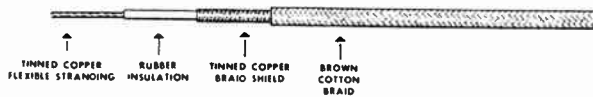

Catalog Number	AWG Size	Number of Strands	Thick. Conductor Insulation Inch	Tinned Copper Shielding	Nom. Outside Diameter Inch	Outer Braid	Standard Put-Up	Standard Shipping Package	Approx. Wght. Lbs./M Ft.	List Price Per M Ft.
1250	24/1	16/36	.015	#36	.095	Overall	100' Spool	4 Spools	7	38.75
1251	24/1	16/36	.015	#36	.080	None	100' Spool	4 Spools	6	31.25

high voltage and cathode-ray tube lead wire

This cable is designed for high voltage applications such as leads to cathode-ray tubes in television receivers and oscilloscopes. It has a high dielectric strength, corona resistance, and minimum surface leakage.

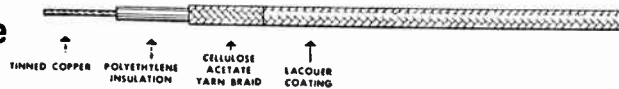

Catalog Number	AWG Size	Number of Strands	Nominal Outside Diameter Inch	Suggested Voltage Rating	Color Outer Braid	Available Standard Put-Ups	Standard Shipping Package	Approx. Wght. Lbs./M Ft.	List Price Per M Ft.
1248	20/1	10/30	.136	10,000	Red with 2 White Tracers	{ 100' Spool 1000' Spool }	{ 4 Spools 1 Spool }	14	{ 57.50 53.75 }
1249	20/1	10/30	.198	20,000	Solid Red	{ 100' Spool 1000' Spool }	{ 4 Spools 1 Spool }	24	{ 77.50 72.50 }

Note: All Cornish Wire and Cable is available in put-ups other than those listed, ask for current price schedule.

PROVED DEPENDABILITY

Copperweld[®] NON-RUSTING

GROUND RODS and CLAMPS

FOR RADIO AND TELEVISION

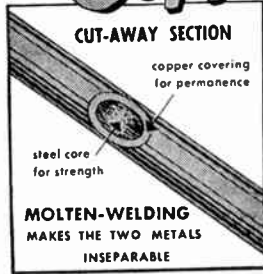

Copperweld Ground Rods and Clamps provide the reliable grounding protection necessary for successful performance, elimination of interference and safe operation of radio and television equipment. The rugged steel core gives the stiffness you need for easy driving. High conductance and lasting protection against corrosion are provided by the heavy molten-welded copper covering.

Millions of Copperweld Ground Rods are rendering permanent grounding protection. You're **SAFE** when you use Copperweld—the only Molten-Welded Ground Rods. They give you **PROVED dependability**—**PROVED economy**—**PROVED longer service**.

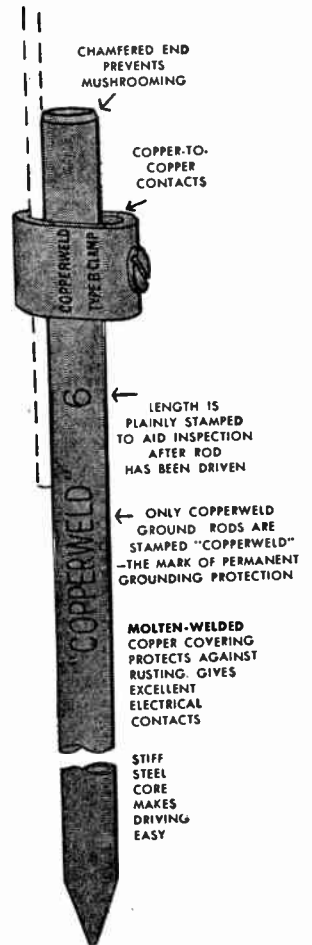

CONVENIENT CONTAINER-PACKAGE

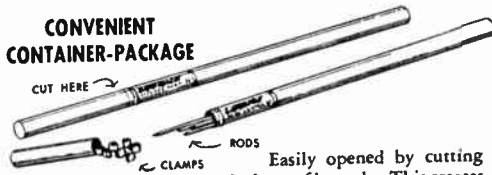

Easily opened by cutting the heavy fiber tube. This creates a bin for the rods and a convenient container for the clamps

SPECIFICATIONS

Catalog Number	Size	Pounds Per 100 Pcs.	Pcs. Per Package
RT 34	3/8" x 4'	142	25
RT 36	3/8" x 6'	212	25
RT 38	3/8" x 8'	277	20
RT 45	1/2" x 5'	320	10
RT 46	1/2" x 6'	385	10
RT 48	1/2" x 8'	505	10

Above weights include clamps.

COPPERWELD GUY STRAND



Ideal for guying radio and television antenna masts and towers. It provides greater safety, permanent high strength and rust proof construction for the life of the antenna. Furnished in two sizes, 3 No. 18 (breaking strength 550 Lbs.) and 3 No. 14 (breaking strength 1000 Lbs.). Lengths of 100', 200', 250', 500' and 1000' are available.



COPPERWELD GROUNDING WIRE

Used to connect antenna mast to ground rod. Annealed for easy handling. Available in two sizes, No. 8 Awg and No. 10 Awg. Coils are furnished in various lengths ranging from 50 to 500 ft.



COPPERWELD ANTENNA WIRE

Preferred for many years by professionals and amateurs. Because of its high strength, it maintains a fixed length. Furnished in 4 sizes, No. 10 Awg, No. 12 Awg, No. 14 Awg, and No. 18 Awg, in coil lengths of 100, 250, 500, 1000 and 3000 feet—bare and insulated. Sizes 10, 12 and 14 available with Polyvinylchloride (PVC) Insulation.

Copperweld is also used for television twin-lead wire, coaxial cable, resistor and condenser pigtails, radio tube parts and various allied components manufactured and sold by other companies.

Additional information available upon request.

COPPERWELD STEEL COMPANY
GLASSPORT, PA.

TV Lead-in Cables by *Federal*

Transmission Lines for Every Television Application — by America's Leading Manufacturer of Solid Dielectric HF Cables

TV-1185 All-Channel Tubular TV Line — 300 ohms

"Pipeline" of the Air 

For the Finest VHF, UHF

The new TV-1185 is more durable, more flexible, more efficient. Smaller in O.D.—it fits all stand-off brackets and lightning arrestors, holds its shape going around sharp angle edges. TV-1185, with its

"silver" polyethylene insulation, is highly resistant to sunlight, heat, moisture, salt spray, and other deposits. The energy field stays within the sheath . . . for very low loss . . . more constant impedance.

Federal Code No.	Nominal Impedance Ohms	Nominal Attenuation DB per 100 feet							List Price per ft.
		10 Mc	50 Mc	100 Mc	200 Mc	400 Mc	500 Mc	1000 Mc	
TV-1185	300	0.80	0.76	1.15	1.75	2.6	3.0	4.5	\$0.06½
TV-1184	300	0.31	0.84	1.28	1.95	3.0	3.4	5.2	.03

Federal's "BIG 5" of Community TV



K-14 Ultra Low-Loss 72-Ohm Cable

Shielded cable for use as main transmission line in community TV and other distribution systems. Outstanding for lowest line loss, long cable runs and fewer amplifiers required.



RG-11/U Coaxial 75-Ohm Low-Loss TV Lead-In Cable

Community system secondary lead-in. Also used with unbalanced input TV receivers in low signal strength areas.



Community system tap-off lead-in. Also used with unbalanced input TV receivers where top-quality installation is essential.

Non-radiating TV Cables (Used with K-14)



K-125 Coaxial 72-Ohm TV Lead-In Cable (Formerly SP-75)

Double-shielded and double-jacketed to protect community TV systems from signal leakage. Where radiation exists, Federal's K-125 alternates for Federal's RG-11/U as secondary lead-in.



K-126 Coaxial 73-Ohm TV Lead-In Cable (Formerly SP-76)

Double-shielded and double-jacketed. Where radiation exists, K-126 alternates for Federal's RG-59/U as tap-off lead-in.

Federal Code No.	Nominal Impedance Ohms	Attenuation DB/100 ft.			List Price per ft.
		50 Mc	100 Mc	200 Mc	
K-14	72	.57	.90	1.42	\$0.92
RG-11/U	75	1.4	2.15	3.2	.20
RG-59/U	73	2.7	4.0	5.7	.10
K-125	72	1.5	2.15	3.2	.35
K-126	73	2.7	4.0	5.7	.19
TV-1182	300	.84	1.25	1.9	.04
K-111	300	2.4	3.4	4.6	.21
RG-8/U	52	1.35	2.1	3.1	.21



TV-1182 "Silver" Heavy-Duty TV Line 300-Ohms

Insulated with Federal's "Silver" polyethylene — the revolutionary development that provides greater resistance to weather, heat and sunlight. Unchanging electrical and physical characteristics assure long, trouble-free service.



K-111 Shielded 300-Ohm TV Lead-In

Shielded and balanced TV lead-in that minimizes "snow," "ghosts" and electrical noise due to transmission line pick-up. For use in high signal strength, high noise level areas.



RG-8/U Coaxial 52-Ohm TV Lead-In Cable

Characteristics and quality proved in every installation where this type low-loss cable is indicated. For special applications and experimental work.

RG Type	Impedance Ohms	Capacitance per ft. Micro-Farads	ATTENUATION DB/100 ft.				Jacket O.D. Mils	Weight per M ft. (Lbs.)	Inner Conductor		List Price per ft.
			50 Mc	100 Mc	200 Mc	400 Mc			Mat.	Strands	
6/U	76	20	1.8	2.9	4.3	6.5	339	74	CuW	1	\$0.34
17/U	52	29.5	.60	.95	1.5	2.4	835	446	Cu	1	1.01
58A/U	53.5	28.5	4.1	6.2	9.2	14.0	200	24	Cu	1	.11
63/U	125	10.0	1.4	2.0	2.9	4.1	415	78	CuW	1	.20
71/U	93	13.5	1.9	2.7	3.9	5.8	238	37	CuW	1	.21

Intelin* H-F Cables, manufactured by Federal Telephone and Radio Company, are available in a complete line for all electronic requirements.

Consult your local Federal Distributor or write to Federal direct

*Trade Mark



the sensational



At last . . . a precision instrument that brings radio and TV listening pleasure to the hard of hearing without raising the normal loudspeaker volume. And perfect for normal hearing folks who want to watch TV or listen to radio without any sound to disturb others.

ADAPHONE is easily attached to any TV or radio set. List Price is \$19.95 complete. Literature and counter displays available. Sold through jobbers only. Write today for details.

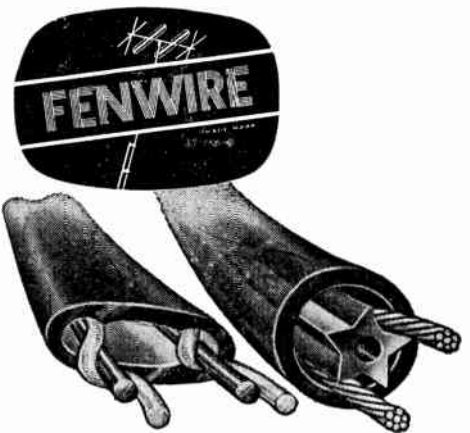

FENTUBE-AIRSPACED*

300-OHM OVAL TUBULAR LINE

Better because NO dielectric between conductors, nor contact between conductors and wall. Performance not affected by outside atmospheric changes.

TWISTUBE*

300-OHM ROUND TRANPOSED SEMI-AIRSPACED TUBULAR LINE

Better because besides being airspaced, it is the *only* transposed transmission line created to reduce interference pickup.

*U. S. and British Patents Pending

Your best source for:

- TUBULAR WIRES
- JUMBO FOAMLINE
- TWIN LEAD-IN WIRES
- OPEN WIRE LINES
- ROTOR WIRES
- MIKE CABLES
- COAXIAL CABLES
- **Tuf-Guy** GUY WIRE

FIRST CHOICE by SERVICEMEN
because FENWIRE is BEST by TEST

Sold through jobbers only

FENTON COMPANY

New York 4, N. Y.

WRITE FOR LITERATURE AND SAMPLE



The GUY WIRE that is spot-marked every 10 feet for easy measuring

Imperial RADAR AND WIRE CORPORATION

NEW YORK 66, N. Y.

... first to present complete line of GUY WIRE!

- STEEL
- ALUMINUM
- COPPERWELD



Cat. No.	Description	No Strands	Gauge	Standard Packing	Aver. Wgt. per M Ft.	Overall Diam.	Strength Test	Strength Yield	List Price
GWE 6/21	Heavy galvanized steel, half hard temper	6	21	10-100 ft. coils 1-1000 ft. spool	15 3/4 lbs.	.090	385 lbs. p.s.i.	4% per C ft.	7.90 per M
GW 6/20	Heavy galvanized steel, half hard temper	6	20	10-100 ft. coils 1-1000 ft. spool	19 lbs.	.100	465 lbs. p.s.i.	3.6% per C ft.	8.25 per M
GW 6/19	Heavy galvanized steel, half hard temper	6	19	10-100 ft. coils 1-1000 ft. spool	26 3/4 lbs.	.115	520 lbs. p.s.i.	3.2% per C ft.	11.25 per M
GW 6/18	Heavy galvanized steel, half hard temper	6	18	10-100 ft. coils 1-1000 ft. spool	33 lbs. 8 oz.	.127	675 lbs. p.s.i.	3% per C ft.	12.60 per M
AL 7/17	EC quality aluminum aircraft temper	7	17	10-100 ft. coils 1-1000 ft. spool	13 lbs. 7 oz.	.140	640 lbs. p.s.i.	4.5% per C ft.	29.25 per M
ASL 7/17	EC quality aluminum aircraft temper with triple coated single steel core	6 alum. 1 steel	17 17	10-100 ft. coils 1-1000 ft. spool	16 lbs.	.140	685 lbs. p.s.i.	3.5% per C ft.	27.25 per M
CO 6/20	Copperweld—30% copper over steel core, non-rust half hard temper	6	20	10-100 ft. coils 1-1000 ft. spool	19 lbs.	.102	600 lbs. p.s.i.	2.7% per C ft.	28.25 per M
CO 6/18	Copperweld—30% copper over steel core, non-rust half hard temper	6	18	10-100 ft. coils 1-1000 ft. spool	34 lbs.	.129	1100 lbs. p.s.i.	2.5% per C ft.	37.50 per M

All of the above guy wire items also available in 50 foot coils, 500 foot metal spools, or 1000 foot wooden reels, at a small additional charge — wire also stranded to your specifications. All guy wire shipped F.O.B. factory, New York City — specify type of coils or spools when ordering.

SINGLE STRAND WIRE ON SPOOLS

Cat. No.	Description	Gauge	Diam.	Temper	Aver. Wt. per M Ft.	Strength Test	List Price
RP-1000	1 M ft. spool 30% Copperweld	12	.0519	Annealed	18 lbs.	350 lbs. p.s.i.	21.50 per spool
SP-1000	1 M ft. spool 30% Copperweld	18	.0409	Unannealed	4.5 lbs.	185 lbs. p.s.i.	8.00 per spool
SP-2500	2500 ft. spool 30% Copperweld	18	.0409	Unannealed	4.5 lbs.	185 lbs. p.s.i.	13.80 per spool
DP-1000	1 M ft. spool 30% Copperweld	20	.035	Annealed	3 lbs.	135 lbs. p.s.i.	6.25 per spool
CFR-1000	1 M ft. spool Farmvar coated Copperweld	20	.035	Annealed	3.2 lbs.	135 lbs. p.s.i.	7.40 per spool
GF-1000	1 M ft. spool galvanized steel	20	.035	Half-Hard	3 lbs.	120 lbs. p.s.i.	4.65 per spool
GP-1000	1 M ft. spool galvanized steel	18	.0409	Half-Hard	4.5 lbs.	175 lbs. p.s.i.	5.50 per spool
AP-1000	1M ft. spool aluminum EC quality	17	.0478	Half-Hard	1.9 lbs.	110 lbs. p.s.i.	8.00 per spool
FP-1000	1 M ft. spool Farmvar coated pure copper	18	.0409	Unannealed	4.6 lbs.	105 lbs. p.s.i.	10.00 per spool
FR-1000	1 M ft. spool Farmvar coated pure copper	20	.035	Unannealed	3.2 lbs.	85 lbs. p.s.i.	7.65 per spool

All above wire supplied on 500 foot spools at small additional charge — also various other sizes and types — write factory for information.

We also manufacture foam and other types of insulated wires.

Write to factory for complete details and catalog.

Imperial



RADAR AND WIRE CORPORATION

NEW YORK 66, N. Y.

HI-GAIN, LO-LOSS LEAD-IN WIRE, FOR EVERY AREA AND PURPOSE

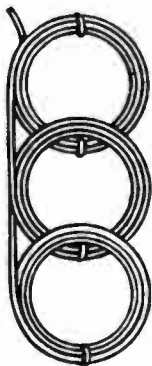
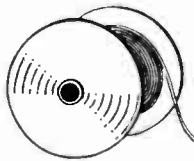
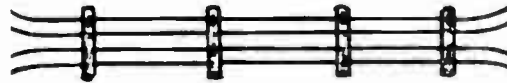
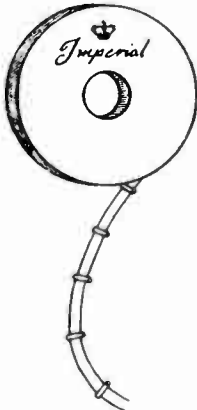

GROUND WIRE



TRANSMISSION LINE ATTENUATION			
TYPE	100	500	1000
250-275 Ohm Open	0.4	0.8	1.8
450 Ohm Open	0.4	0.8	1.1
300 Ohm Tubular	1.2	3.2	5.0
	1.5	3.6	5.1
	1.5	3.6	5.0
	1.1	2.4	4.0
Various	1.1	2.6	4.2
Other	1.2	2.6	4.7
Competitors	1.0	—	—
Lines	1.3	—	—
Tested	1.0	3.2	4.3
	0.7	2.5	—

HI-GAIN, LO-LOSS OPEN LEAD WIRE

Cat. No.	Description	Impedance	Material	Spooling	Standard Packing	Approx. Wgt. per M Ft.	List Price per M Ft.
DA 6	Extra heavy open lead-in for use by amateurs, or in areas with high winds or other signal difficulties	600 ohms	12 ga. Copperweld (30% copper) with 1/4" dia. Poly insulators 6" apart	100 ft., 250 ft., & 500 ft. spools	10-100 ft. 4-250 ft. 5-500 ft.	46 lbs.	68.75
CDA 6		600 ohms	14 ga. Copperweld (30% copper) with 1/4" dia. Poly insulators 6" apart	100 ft., 250 ft., & 500 ft. spools	10-100 ft. 4-250 ft. 5-500 ft.	33 lbs.	58.75
AD 6	Standard open lead-in for use in normal areas	450 ohms	18 ga. Copperweld (30% copper) with 1/4" dia. Poly insulators 6" apart	100 ft., 250 ft., & 500 ft. spools	10-100 ft. 4-250 ft. 5-500 ft.	18 lbs.	32.50
FAD 6	Same as AD-6, but Formvar insulated Copperweld	450 ohms	18 ga. Formvar insulated Copperweld (30% copper) with 1/4" dia. Poly insulators 6" apart	100 ft., 250 ft., & 500 ft. spools	10-100 ft. 4-250 ft. 5-500 ft.	18 1/2 lbs.	38.15
FO 6	Same as AD-6, but Formvar insulated pure copper	450 ohms	18 ga. Formvar insulated pure copper with 1/4" dia. Poly insulators 6" apart	100 ft., 250 ft., & 500 ft. spools	10-100 ft. 4-250 ft. 5-500 ft.	18 lbs.	43.75
UHD 4 1/2	Narrow-spaced open lead-in for UHF or VHF—especially efficient for short runs	275 ohms	18 ga. Copperweld (30% copper) with 1/4" dia. Poly insulators 4 1/2" apart	100 ft., 250 ft., & 500 ft. spools	10-100 ft. 10-250 ft. 5-500 ft.	12 1/2 lbs.	36.25
UH 4	Same as UHD 4 1/2, but Formvar insulated pure copper	275 ohms	20 ga. Formvar insulated pure copper with 1/4" dia. Poly insulators 4" apart	100 ft., & 250 ft. spools only	10-100 ft. 10-250 ft.	13 lbs.	43.75
4 DA	4 conductor open lead-in for areas with both UHF & VHF, or stations in opposite directions—especially adaptable for long runs	2-275 ohm prs., 2-375 ohm prs., or 1-450 ohm pr., and 1-275 ohm pr.	18 ga. copperweld (30% copper) with 1/4" Poly insulators spaced 5" apart	100 ft., 250 ft., & 500 ft. spools	10-100 ft. 4-250 ft. 5-500 ft.	26 lbs.	57.40

All Open Wire Items Prepaid East of the Mississippi in quantities of 10M feet or more.

COMPLETE LINE OF GROUND WIRE

ALUMINUM GROUND WIRE, DEAD SOFT FINISH featuring REYNOLDS EC-O ALUMINUM

Cat. No.	Description	Gauge	Diam.	Temper	Aver. Wt. per M Ft.	Standard Packing	List Price
AG-6	Special Soft Aluminum for Protective Grounding of Masts. Will Meet All Code Specifications.	6	.1640	Dead Soft	24 lbs. 2 oz.	10-100 ft. coils 1-1000 ft. spool	27.50 per M
AG-8		8	.1285	Dead Soft	15 lbs. 2 oz.	10-100 ft. coils 1-1000 ft. spool	17.50 per M
AG-10		10	.1019	Dead Soft	9 lbs. 6 oz.	10-100 ft. coils 1-1000 ft. spool	16.00 per M
AG-11		11	.091	Dead Soft	7 lbs. 6 oz.	10-100 ft. coils 1-1000 ft. spool	13.50 per M

Aluminum ground wire also available on 500 foot spools or 50 foot coils at a small additional charge — all types of aluminum wire spooled or coiled to your specifications.

All ground wire shipped F.O.B. factory, New York City — specify type of coils or spools when ordering.

We also manufacture foam and other types of insulated wires.

Write to factory for complete details and catalog.

Imperial



RADAR AND WIRE CORPORATION

NEW YORK 66, N. Y.

COMPLETE LINE OF GROUND RODS, AND GROUND CLAMPS

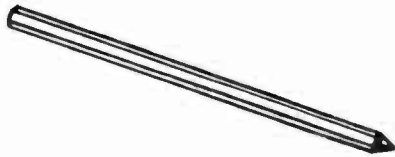

GROUND RODS MADE OF ALUMINUM, PURE COPPER, AND COPPER CAPED

Cat. No.	Description	Diameter	Length	Weight per 25	Standard Packing	List Price
SGR 4	Double copper plated steel with hand rubbed oil finish and fine turned point	1 1/32"	4 ft.	32 lbs.	25	.73 Each
SGR 6		1 1/32"	6 ft.	48 lbs.	25	1.08 Each
CGR 4		3/8"	4 ft.	35 lbs.	25	.80 Each
CGR 6		3/8"	6 ft.	55 lbs.	25	1.23 Each
CGR 8		3/8"	8 ft.	70 lbs.	25	1.63 Each
GR 4	Solid aluminum, special hard drawn 635T alloy, fine turned point	3/8"	4 ft.	14 lbs.	25	1.05 Each
GR 6		3/8"	6 ft.	20 lbs.	25	1.55 Each
GR 8		3/8"	8 ft.	28 lbs.	25	2.13 Each
CC 4	Solid copper with fine turned point	3/8"	4 ft.	43 lbs.	25	3.45 Each
CC 6		3/8"	6 ft.	63 lbs.	25	4.75 Each
GG 4	Hot dipped galvanized steel with fine turned point	3/8"	4 ft.	38 lbs.	25	.95 Each
GG 6		3/8"	6 ft.	57 lbs.	25	1.33 Each
DR 4	Hot dipped galvanized steel with fine turned point	1/2"	4 ft.	68 lbs.	25	1.50 Each
DR 6		1/2"	6 ft.	102 lbs.	25	2.38 Each
DR 8		1/2"	8 ft.	135 lbs.	25	3.25 Each
CDC 4	Solid copper with fine turned point	1/2"	4 ft.	76 lbs.	25	5.25 Each
CDC 6		1/2"	6 ft.	114 lbs.	25	7.00 Each
CDC 8		1/2"	8 ft.	152 lbs.	25	8.50 Each

All above rods shipped complete with clamps No. RMC as described below, boxed separately, F.O.B. factory, New York City. Special rods made to specifications.



GROUND MAST CLAMP

GROUND ROD CLAMP



Cat. No.	Description	Standard Packing	Weight per 100	List Price
GMC	Brass alloy mast clamp	100 to carton	19 lbs.	.60 Each
RMC	Aluminum casting rod clamp	100 to carton	3 1/2 lbs.	.20 Each

We also manufacture foam and other types of insulated wires.

Write to factory for complete details and catalog.



NATIONAL

WIRE & CABLE CORPORATION

136 SAN FERNANDO ROAD, LOS ANGELES • PHONE Capitol 1-2171

"JAN-spec" WIRES

WIRES TO GOVERNMENT SPECIFICATION

ARMY • NAVY • AIR FORCE

JAN-C-76 — MIL — ANJ-C-48A

TYPE SRIR HOOK-UP WIRE



Construction: Tinned copper-stranded or solid. Nominal insulation thickness, .015" Thermoplastic. Rating 1000 VOLTS (working). Temperatures -40C to +60C.

Sizes: 28 to 6. Colors: all NEMA standard colors. Tracers on solid colors also available.

Catalog No. 100.

TYPE SRIR GLASS BRAID



Construction: Tinned copper with thermoplastic insulation and braided glass and flame resisting lacquer finish over all. Temperature rating, -40C to +60C.

Sizes: 28 to 6. All standard NEMA color coding and also available with tracers on solid colors.

Catalog No. 101.

TYPE WL — NYLON — HOOK-UP WIRE



Construction: Tinned copper stranded or solid. Nominal insulation thickness .010" Thermoplastic with .005" extruded nylon. Rating 600 VOLTS (working). Temperature rating -40C to +60C.

Sizes: 28 to 6. Colors: bright standard NEMA colors, also tracers on solid colors.

Catalog No. 102.

TYPE SRHV HOOK-UP WIRE



Construction: Tinned copper, stranded or solid. Nominal insulation .031" Thermoplastic. Rating 2500 VOLTS (working). Temperature rating, -40C to +60C.

Sizes: 28 to 6. Colors: all standard NEMA colors, also available tracers on solid colors.

Catalog No. 103.

TYPE MIL-W-16878



Construction: Tinned copper, stranded or solid. Nominal insulation Thermoplastic, with or without nylon jacket. Types A, B, C and D.

Sizes and Colors: all sizes and colors and tracers.

Catalog No. 120.

TYPE SRRF HOOK-UP WIRE R. F. INSULATED



Construction: Tinned copper stranded, polyethylene insulated with or without glass braid. Rating 1000 VOLTS (working).

Sizes: 24 to 6. Colors: all NEMA standard colors, also tracer on solid colors. For use in radio frequency circuits.

Catalog No. 105.

NATIONAL — LARGEST ELECTRONICS AND AIRCRAFT WIRE AND CABLE INVENTORY WEST OF CHICAGO!

NATIONAL

WIRE & CABLE CORPORATION

136 SAN FERNANDO ROAD, LOS ANGELES • PHONE CAptol 1-2171



AIRCRAFT WIRE

TYPE ANJC — 48-A — Aircraft power and lighting cable

Construction: Flexible tinned copper, vinyl insulation with cotton braid with fungicidal treatment. Flame resisting lacquer finish. Low Tension: 600 VOLTS (working).

Sizes: 22 to 4/0. Colors: White.

Catalog No. 200.



TYPE AN-C-168

Construction: Flexible tinned copper, vinyl insulation with cotton braid with fungicidal treatment. Flame resisting lacquer finish. Tinned copper braid shield. Low Tension: 600 VOLTS (working).

Sizes: 22 to 4/0. Colors: White.

Catalog No. 201.



TYPE MIL-W 5086 & MIL-W 5274A AIRCRAFT, power and lighting cables. TYPE 1

Construction: Tinned copper stranded, synthetic resin insulation with nylon jacket. Rating 600 VOLTS (working).

Sizes: all standard gauges. Color: White.

Catalog No. 202.



TYPE MIL-C-7078

Construction: Tinned copper stranded, synthetic resin insulation with nylon jacket and tinned copper shield. Rating 600 VOLTS (working).

Sizes: all standard gauges. Color: White.

Catalog No. 203.



TYPE 2

Construction: Tinned copper stranded, synthetic resin insulation plus glass braid, plus synthetic insulation with overall nylon jacket. Rating 600 VOLTS (working).

Sizes: all standard gauges. Colors: White.

Catalog No. 204.



TYPE MIL-C-7078

Construction: Tinned copper stranded, synthetic resin insulation plus glass braid, plus synthetic insulation with overall nylon jacket and tinned copper shield. Rating 600 VOLTS (working).

Sizes: all standard gauges. Colors: White.

Catalog No. 205.



NATIONAL — LARGEST ELECTRONICS AND AIRCRAFT WIRE AND CABLE INVENTORY WEST OF CHICAGO!



NATIONAL

WIRE & CABLE CORPORATION

136 SAN FERNANDO ROAD, LOS ANGELES • PHONE CApitol 1-2171

MICROPHONE CABLE AND INTERCOM CABLE

PLASTIC JACKETED MICROPHONE CABLE — one conductor



Construction: General purpose, low loss, poly insulated, tinned copper shield, stranded one conductor, overall poly jacket, nominal capacitance per foot: 32 mmf.

Size: Outside diameter .130".

Catalog No. 600/1.

PLASTIC JACKETED MICROPHONE CABLE — two conductor



Construction: General purpose, low loss, poly insulated, tinned copper shield. Stranded, twisted two conductor with filler. Nominal capacitance per foot between conductors 18 mmf.

Size: Outside diameter .225".

Catalog No. 601/2.

RUBBER JACKETED MICROPHONE CABLE



Construction: Extra flexible stranded tinned copper conductors, cotton serve between conductor and insulation and between shield and outer jacket. Braided tinned copper shield, covered with tough rubber outer jacket. For use indoor and outdoor.

Sizes: 20 gauge stranded tinned copper, available from one conductor to eight conductors.

Catalog No. 603/1-8.

SHIELDED AUDIO TRANSMISSION LINE



Construction: Solid two conductor thermoplastic insulated twisted pair, color coded with braided shield with thermoplastic jacket overall.

Catalog No. 604.

INTERCOM CABLE



Construction: Twisted pairs, one to fifty-one pairs, twenty-two gauge solid copper, thermoplastic insulation, overall thermoplastic jacket or overall treated cotton braid.

Catalog No. 605.

NATIONAL — LARGEST ELECTRONICS AND AIRCRAFT WIRE AND CABLE INVENTORY WEST OF CHICAGO!

NATIONAL

WIRE & CABLE CORPORATION

136 SAN FERNANDO ROAD, LOS ANGELES • PHONE CApitol 1-2171

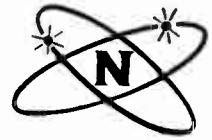

GENERAL PURPOSE MULTI CONDUCTOR CONTROL CABLES MICROPHONE CABLE AND INTERCOM CABLE (Continued)

MULTI CONDUCTOR CONTROL CABLE

General purpose control cable, up to thirty or more conductor, with or without shielded members, or overall shield, etc., with plastic or tough rubber overall jacket.

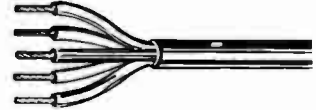

CO-AXIAL CABLES

Standard co-axial cables carried in stock RG 7/U, 8/U, 9/AU, 11/U, 17/U, 34/U, 58/U, 58/AU, 59/U, 62/U, etc.



IMMEDIATE DELIVERY FROM WAREHOUSE STOCKS

INSULITE VINYL INSULATION TUBING

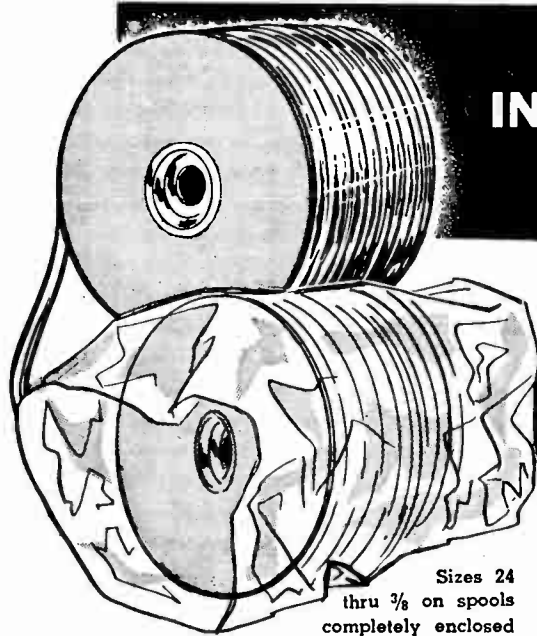

Qualified under
Spec. MIL-I-7444 U.S.A.F.
MIL-I-631A
MIL-I-7444A

Sizes 24 thru $\frac{3}{8}$ on spools completely enclosed in plastic wrapping.
Sizes $\frac{7}{16}$ " thru $2\frac{1}{2}$ " in coils. GP — general purpose Insulite qualified under spec. MIL-I-631A, Type F, Form U, Grade A, Classes I and II, Categories 1 and 2.

ABOUT INSULITE

Insulite, commercial and specification grade Vinyl tubing is manufactured from only the highest quality materials. Extreme care in preparing the compound formulations assures product uniformity. The most modern of plants, complete with compounding facilities and controlled extrusion techniques, together with modern inspection equipment provides rigid physical and visual inspection on each length of tubing, assuring a finished product fully guaranteed against defective workmanship and materials. A product development laboratory is engaged in constant research to provide you with the finest in tubing.

PHYSICAL PROPERTIES

Property	MIL-I-7444	MIL-I-631A
Specific Gravity	1.21	1.23
Tensile Strength	2800 PSI	2700 PSI
Ultimate Elongation	350%	340%
Water Absorption*	0.2%	—
Cold Bend	-55°C	-30°C
Dielectric Strength (.025 wall)	875 V.P.M.	1032 V.P.M.
Flame Resistance	**	**
Approx. Durometer Hardness (Shore "A")	66	86

* Weight increase after 24 hours at 77°F

** Self-Extinguishing

POLYSTYRENE ROD — TUBING — SHEET

For radio and electronic applications, because of its very low loss factor at ultra high frequencies, Polystyrene is the ideal material for insulators, coil forms, shields, etc. It has excellent arc resistance, is non-tracking and has splendid insulating properties. Because its water absorption is practically zero it has excellent dimensional stability.

POLYSTYRENE ROD — Transparent

Available in 12" or 48" lengths

Catalog Number	Diameter	Net Price	
		12" lgth.	48" lgth.
JB-100	1/8"	\$.03	\$.12
JB-101	3/16"	.07	.28
JB-102	1/4"	.12	.48
JB-103	5/16"	.18	.72
JB-104	3/8"	.26	1.04
JB-105	7/16"	.36	1.44
JB-106	1/2"	.48	1.92
JB-107	5/8"	.72	2.88
JB-108	3/4"	1.00	4.00
JB-109	7/8"	1.42	5.68
JB-110	1"	1.90	7.60
JB-111	1 1/8"	2.50	10.00
JB-112	1 1/4"	3.00	12.00
JB-113	1 3/8"	3.60	14.40
JB-114	1 1/2"	4.30	17.20
JB-116	1 3/4"	6.00	24.00
JB-118	2"	7.50	30.00

POLYSTYRENE SHEET

The following sheets are all crystal clear with smooth surfaces fully protected against abrasion by masking paper on both sides.

Catalog Number	Thickness	Sheet Size	Net Price
JB-125	1/16"	12" x 12"	\$3.50
JB-126	3/32"	12" x 12"	3.75
JB-127	1/8"	12" x 12"	4.25
JB-128	3/16"	12" x 12"	5.00
JB-129	1/4"	12" x 12"	5.75
JB-245	1/16"	12" x 24"	6.85
JB-246	3/32"	12" x 24"	7.25
JB-247	1/8"	12" x 24"	8.35
JB-248	3/16"	12" x 24"	9.90
JB-249	1/4"	12" x 24"	11.35
JB-300	1/32"	20" x 20"	9.20
JB-301	1/16"	24" x 24"	11.15
JB-302	3/32"	24" x 24"	11.85
JB-303	1/8"	24" x 24"	13.60
JB-304	3/16"	24" x 24"	16.25
JB-305	1/4"	24" x 24"	18.60
JB-306	5/16"	20" x 20"	16.85
JB-308	3/8"	20" x 20"	18.75
JB-309	3/8"	24" x 24"	27.65
JB-310	1/2"	20" x 20"	25.00
JB-311	1/2"	24" x 24"	36.10
JB-312	5/8"	20" x 20"	40.00
JB-313	3/4"	20" x 20"	47.75
JB-314	1"	20" x 20"	64.75

POLYSTYRENE TUBING — Satin Finish

Available in 12" or 48" lengths.

Catalog Number	O.D.	I.D.	Net Price	
			12" lgth.	48" lgth.
JB-201	1/4"	1/8"	\$.10	\$.40
JB-202	5/16"	3/16"	.14	.56
JB-203	3/8"	1/4"	.18	.72
JB-205	1/2"	3/8"	.26	1.04
JB-206	5/8"	1/2"	.32	1.28
JB-207	3/4"	5/8"	.40	1.60
JB-208	1"	7/8"	.56	2.24
JB-220	1 1/2"	1 1/4"	1.50	6.00
JB-222	2"	1 3/4"	2.20	8.80

JULIUS BLUM & CO., INC.

Serving Industry
Since 1910

Porcelain Product's TELEVISION & RADIO INSULATORS

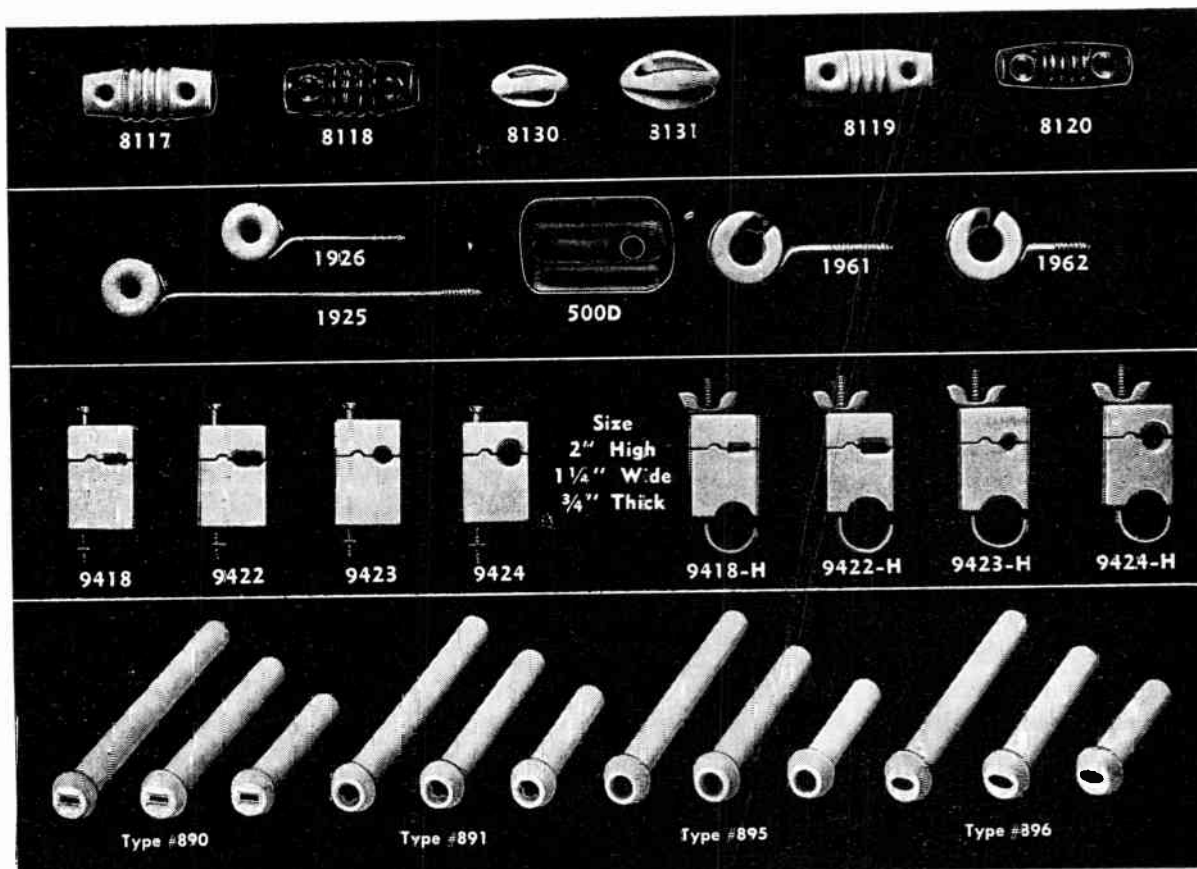

TV-FM LEAD-IN TUBES

Provide essential insulation and neatness of appearance for lead-ins going through walls, partitions, etc.

Type #890 Tubes —

Handles the conventional $\frac{3}{8}$ " wide 300 Ohm common flat lead-ins. Outside diameter $\frac{1}{2}$ ": use a $\frac{3}{4}$ " drill.

Type #891 Tubes —

UHF Tubes with the round holes, two slots or key-ways, for Amphelox Cable #14-271 or equivalent. Outside diameter $\frac{1}{2}$ ": use a $\frac{3}{4}$ " drill.

Type #895 Tubes —

For the round (but hollow) UHF cable equivalent to Federal's Rand Tubular UHF. Outside diameter $\frac{1}{2}$ ": use a $\frac{3}{4}$ " drill.

Type #896 Tubes —

For oval UHF cable made under many trade names and numbers. Examples: Belden #8235. The wide oval hole requires a larger outside diameter. Outside diameter $\frac{3}{4}$ ": use $\frac{1}{2}$ " drill.

Length	Wt. per M	Length	Wt. per M
4"	143 Lbs.	8"	275 Lbs.
5"	175 Lbs.	10"	330 Lbs.
6"	210 Lbs.		

TV-FM LEAD-IN SUPPORTS

The perfect insulator. Easy to install. Holds lead-in positively and rigidly. Size — 2" high, 1-1/4" wide, 3/4" wide. Supports lead-in 1-7/16" from surface. Weight 170 lbs. per M.

SCREW TYPE

No.	Description	No.	Description
No. 9418	For light-weight 3/8" wide flat 300 Ohm twin lead-in.	No. 9418-H	Hook type
No. 9422	For heavy-weight 1/2" wide oval 300 Ohm twin lead-in.	No. 9422-H	Hook type
No. 9423	For 1/4" round 72 Ohm Coaxial Cable.	No. 9423-H	Hook type
No. 9424	For 3/8" round Coaxial Cable	No. 9424-H	Hook type

ANTENNA INSULATORS

Made of highest quality electrical Porcelain. Pressure molded to assure dense strong body. Glazed.

No. 8117 — Round, White glaze. Size 2-1/2" long, 1" diameter, 1/4" holes. Weight 146 Lbs. per M.

No. 8118 — Same as No. 8117 but brown glaze. Weight 146 Lbs. per M.

No. 8119 — Oval, White glaze. Size 2-2" long, 1" diameter, 1/4" holes. Weight 130 Lbs. per M.

No. 8120 — Same as No. 8119 but brown glaze. Weight 130 Lbs. per M.

No. 8130 — Small airplane type, oval, white glaze. Size 1-3/8" long, 7/8" diameter, 7/32" holes. Weight 60 Lbs. per M.

No. 8131 — Large airplane type, oval, white, glaze. Size 2" long, 1-1/8" diameter, 9/32" holes. Weight 90 Lbs. per M.

No. 500D — Strain type, brown glaze. Size 2-1/8" long, 1-9/16" diameter, 3/8" holes. Weight 250 Lbs. per M.

INSULATED SCREW EYES

No. 1925 — Seven and one-quarter inches long over-all. White glaze insulator with 5/16" hole. Weight 110 Lbs. per M.

No. 1926 — Same as No. 1925 but 3" long over-all. Weight 90 Lbs. per M.

No. 1961 — Split bridle-ring type. Insulator has diagonal slot 1/4" wide to facilitate quick threading of conductor. Over-all length 3-5/16". White glaze insulator has 5/8" hole. Weight 100 Lbs. per M.

No. 1962 — Same as No. 1961 but 2-5/8" long over-all. Weight 90 Lbs. per M.

PORCELAIN PRODUCTS, INC.

FINDLAY, OHIO

Copyright by U. C. P., Inc.

Radio's Master — 19th Edition

Page 5-73

VHF-COMplete
SPECTRUM
ANTENNAS

"CONICAL V-BEAMS"

ALL-ALUMINUM
CONSTRUCTION

MODEL NO.		Units in St'd. Carton	Ship. Wt. Lbs.	List Price
MONARCH SERIES				
K2X-TV	Single bay	2	8	12.60
K4X-TV	Two bay stack	1	9	25.21
K8X-TV	Four bay stack	1	18	53.11
METEOR "E-Z-RIG" SERIES				
ME-2X	Single bay	2	8	12.60
ME-4X	Two bay stack	1	8.5	25.21
ME-8X	Four bay stack	1	19	53.11
UNIVERSAL SERIES				
U2X-TV	Single bay	2	7.5	9.30
U4X-TV	Two bay stack	1 or 3	8:22	19.94
U8X-TV	Four bay stack	1	18	43.89
UNIVERSAL "CUSTOMIZED" SERIES				
Two bay stacks:				
U4X-TVC	Channels 2 or 3	1	8.5	21.33
U4X-TVC	Channels 4, 5, or 6	1	8.5	21.05
U4X-TVC	Channels 7 or 8	1	8.5	20.77
U4X-TVC	Channels 9, 10, 11, 12 or 13	1	8.5	20.50
LOW FREQUENCY SERIES				
4X-TVS	DeLuxe 1/2-Wave	1	9	28.80
M4X-TVS	Metro 1/2-Wave	1	8.5	22.57
VANGUARD SERIES				
4 Element Radiator; 2 El. Reflector				
VU2X-6	Single bay	3	9.5	7.22
VU4X-12	Two bay stack	4	20	15.28
6 Element Radiator; 2 El. Reflector				
VU2X-8	Single bay	3	10	7.92
VU4X-16	Two bay stack	4	22	16.83
CONICAL-V-BEAM SERIES				
4 Element Radiator; 2 El. Reflector				
CH2X-6	Single bay	3	10	6.66
CH4X-12	Two bay stack	3	20	14.16
CH8X-24	Four bay stack	1	13	31.80
4 Element Radiator; 4 El. Reflector				
CH2X-8	Single bay	3	10.5	7.22
CH4X-16	Two bay stack	3	21	15.28
CH8X-32	Four bay stack	1	14	34.03
"CLOVER-V-BEAM" SERIES				
CLV	E-Z-Rig Clover	4	5	5.95



K8X-TV

Has "Hi-V" reflector. All elements are hardware factory mounted and captivated. Combines hurricane design and high-speed-assembly. Solid rod elements insure low wind resistance and long life. Has cylindrical dipole reflector.

DESCRIPTIVE NOTES

Has "Hi-V" reflector. Specify whether solid or doweled tubular elements preferred. Eight plug-in rods and two stubs per bay permit multiplicity of radiator and reflector configurations. Quality of workmanship and rugged construction is second to none—finest Conical-V Beam built. "If the K8X-TV does not provide a usable signal, TV reception is impossible or impractical."

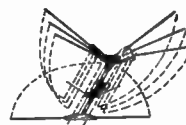

ME-2X

With "Hi-V" reflector. Specify whether solid or doweled tubular elements preferred. Shipped with 8 plug-in rods per multi-arrangement bay. This, and completely aluminum construction, makes the "Universal" an outstanding value.



U4X-TV

Receive all channels. Same antenna as "Universal" except center elements cut to peak at any channel specified, without destroying the antenna's broad band characteristics. Has "Hi-V" reflector.

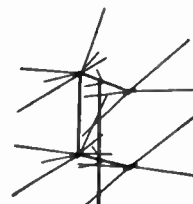

U4X-TVC

Special 1/2-wave stacking and other design details gives this antenna optimum performance on Channels 2 to 6. Eight solid or doweled tubular elements. All-aluminum construction on both "Metro" and the "DeLuxe." "DeLuxe" has hurricane design.

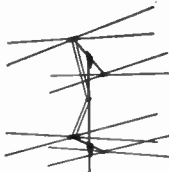

4X-TVS

Solid or doweled tubular elements. Supplied with 6 elements (or 8, for the 2X-8). Has straight dipole reflector. Offers Conical-V-Beam performance at very low cost.



VU2X-8

7/32" D. solid duraluminum rod, or doweled tubular elements. Six supplied in the 2X-6 type; eight elements, in the 2X-8 type. Both types feature "Universal" style "butterfly" element brackets, at each end of the crossarm, facilitating several radiator and reflector arrangements.

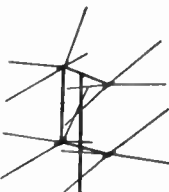

CH4X-16

Requires no rotator to pick up signal from front or back. Transposition bar stacking gives vertically narrow, noise-free reception lobes. Tough closed loops yield lightly in high winds, but have no tendency to snap off.

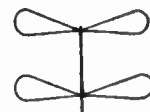

CLV

"Conical-V-Beams" are produced under re-issue Pat. No. 23,346, and Canadian Pat. No. 500436 and in England Pat. No. 691485.

AMERICA'S LARGEST MANUFACTURER OF "CONICAL-V-BEAMS"



UHF-VHF ANTENNAS

**ALL-ALUMINUM
CONSTRUCTION**

MODEL NO.		Units in Std. Carton	Ship. Wt. Lbs.	List Price
DUO-BAND (UNIVERSAL) "CONICAL-V-BEAM"				
#420	Single bay	2	10	12.08
#440	Two bay stack	1	10.5	25.50
#440S	Two bay stack-low frequency	1	11	28.16
#480	Four bay stack	1	22	55.00
DUO-BAND "CONICAL-V-BEAM"				
#520	Single bay	2	6	10.98
#540	Two bay stack	1	7	23.30
#540S	Two bay stack-low frequency	1	7.5	25.95
#580	Four bay stack	1	15	50.61
DUO-BAND (METEOR) "CONICAL-V-BEAM"				
#320	Single bay	2	9	13.48
#340	Two bay stack	1	10.5	28.30
#380	Four bay stack	1	21	60.60
DUO-BAND MODIFICATION KIT				
#410	For single bay	4	5	3.95
#414	For two bay stack	4	9	7.90
"BAT WING" Indoor				
BW-1		24	35	5.95

DESCRIPTIVE NOTES

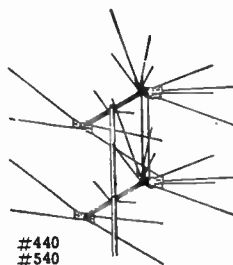

UHF-VHF at same cone apex. No filler losses. Electronic and mechanical excellence equal to the "Meteor Duo-Band." Solid or tubular elements, with famous Telrex plug-in design. All aluminum.

Single lead-in. Practical Channel 2 to 83 performance at lowest cost. Solid or tubular elements. All aluminum.

Sensational UHF-VHF gain and directivity. Solid rod elements. "E-Z rig" construction combines super-strength with speedy-assembly. All aluminum. Finest DUO-BAND "Conical-V-Beam."

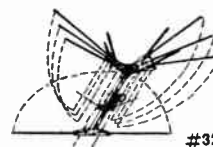

#320

Adds exceptional UHF pickup, converting all Conical-V-Beams to "Duo-Bands." VHF performance completely unimpaired by addition of UHF.



#410

Top-of-set. "Conical-V-Beam" type wings are adjustable so that their forward tilt gives maximum signal. Excellent for UHF, too.



BW-1

UHF ANTENNAS

"BOW TIE"				
#750	Single bay	1 or 2	2.4	7.50
#755	Two bay stack	1	3.5	15.00
SERIES 80 ULTRA-HI "CONICAL-V-BEAM"				
#81	Single bay on 5-spline reflector	1	2	4.25
#82	Two bay stack on 10-spline reflector	1	3	7.95
#84	Four bay stack on 17-spline reflector	1	5	14.95
#82P-10	Two bay stack with Parabolic extensions.	1	5	18.70
#84P-10	Four bay stack with Parabolic extensions.	1	6	25.69
#89	CORNER REFLECTOR	1	3	12.95

Superior performance of Telrex Bow-Ties is due to their forward, "Conical-V-Beam"-type, tilt. Has pre-assembled spline reflector for maximum signal pick-up.

Lightweight, ruggedized construction . . . withstands gale winds. This series has solid rod spline reflector elements permanently mounted by means of a special clamping process which eliminates screws and nuts.

Ultra sensitive stacked array with excellent directivity for clean, snowfree, ghost-free reception.

Compacted, lightweight unit covers full UHF range at highest signal-to-noise ratio! — AT LOW COST!

Tuned spline parabolic reflector assures maximum gain and reflector action for ghost-free, reflection-free reception and minimum wind resistance.

Powerful stacked parabolic UHF array, with #84 as its nucleus. Also includes two #810 parabolic reflectors, increasing energy by approximately 30%.

Designed for all channel UHF reception. Precision built — yet reasonable in price. Provides high gain, sharp directivity, easy installation, excellent over-all performance.



#755

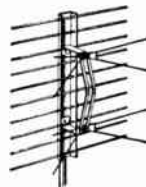

#82



#84

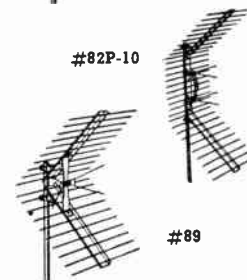

#82P-10

#89

AMERICA'S LARGEST MANUFACTURER OF "CONICAL-V-BEAMS"



UHF ANTENNAS

MODEL NO.	Units in St'd. Carton	Ship. Wt. Lbs.	List Price
SERIES 70 "BOW TIE"			
#71 Single bay Bow-Tie on 5-spline reflector	1	2.5	5.75
#72 Two bay stacked Bow-Tie on 10-spline reflector	1	3.5	10.75
#74 Four bay stacked Bow-Tie on 17-spline reflector	1	5.5	19.95
#79 CORNER REFLECTOR	1	3.5	14.45
PARABOLIC MODIFICATION KIT For Models 81, 82, 84, 71, 72, 74			
#805 (Two 5-spline reflectors)	1	3.5	6.25
#810 (Two 10-spline reflectors)	1	3	10.75

DESCRIPTIVE NOTES

Superior performance of Telrex Bow-Ties is due to their forward, "Conical-V-Beam"-type, tilt. Has pre-assembled spline reflector for maximum signal pick-up,

Full-wave Stacked "Bow-Ties" provide Lo-angle concentrated vertical lobe for peak sensitivity, fidelity and ghost-free reception with highest signal-to-noise ratio. A practical solution to your UHF problem.

Simply attach antenna assembly to screen reflector, secure to mast and connect downlead.

Designed for all channel UHF reception. Precision-built — yet reasonable in price. Provides high gain, sharp directivity, easy installation, excellent over-all performance.

Spline reflectors give exceptionally efficient parabolic performance. Special bracket automatically assures optimum position on any mast.

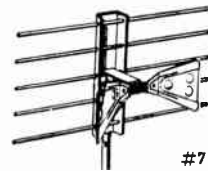

#71

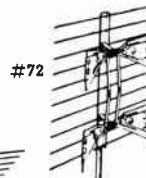

#72



#74



#79

VHF - SINGLE CHANNEL ANTENNAS

ALL-ALUMINUM
CONSTRUCTION

5 ELEMENT YAGI

Precision Cut for Single Channel Emphasis
Single bay:

Y5X-1 for Ch. 2 or 3	1	8	16.19
Y5X-1 for Ch. 4, 5, 6	1	7	15.28
Y5X-1 for Ch. 7 to 13	2	6	7.63
Two bay stacks:			
Y5X-2 for Ch. 2 or 3	1	17	37.08
Y5X-2 for Ch. 4, 5, 6	1	15	35.25
Y5X2 for Ch. 7 to 13	1	6	16.10

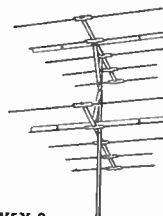

Y5X-2

5 elements, single driven for creditable performance with outstanding economy. High impedance folded dipoles found on all Telrex Yagis result in perfect 300 ohm impedance match. No standing waves.

Specify channel when ordering.

"FISHBONE JR."

Precision Cut for Single Channel Emphasis
Single bay:

Y6X-1 for Ch. 2 or 3	1	10	21.41
Y6X-1 for Ch. 4, 5, 6, or FM	1	8.5	19.68
Y6X-1 for Ch. 7 to 13	2	9	8.35
Two bay stacks:			
Y6X-2 for Ch. 2 or 3	1	21	46.00
Y6X-2 for Ch. 4, 5, 6, or FM	1	18	42.55
Y6X-2 for Ch. 7 to 13	1	10	18.06

6 elements, twin-driven. Outperforms most ten element, single-driven Yagis! Like all Telrex Yagis, these Yagis are Precision Engineered for reception of a single channel (which must be specified when ordering) to secure all the gains of which Yagi designs are capable.

Specify channel when ordering.

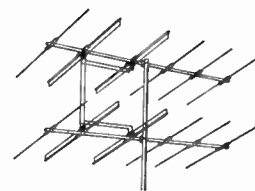

Y6X-2

"FISHBONE"

Precision Cut for Single Channel Emphasis
Single bay:

FBT-1 for Ch. 4 or 5	1	14	33.50
FBT-1 for Ch. 6	1	13	32.35
FBT-1 for Ch. 7 to 13	1	4	13.35
Two bay stacks:			
1/2 wave stacked for optimum performance.			
FBT-2 for Ch. 7 to 13	2	8.0	27.55





FBT-1

10 elements, twin-driven. Outperforms any other Yagi! Despite its exceptional gain and front-to-back ratio, has full channel band-pass. Completely pre-assembled, like all Telrex Yagis. All aluminum.

Specify channel when ordering.

AMERICA'S LARGEST MANUFACTURER OF "CONICAL-V-BEAMS"

**VHF - DUAL CHANNEL ANTENNAS ALL-ALUMINUM
CONSTRUCTION**

MODEL NO.	Units in St'd. Carton	Ship. Wt. Lbs.	List Price	DESCRIPTIVE NOTES
DUAL CHANNEL "FISHBONE JR." DY6X-1 for Ch. 4 and 5	1	8.5	19.68	 6 elements. Twin-driven, 135" quadrature fed, phased radiators, supply superior reception of both Channels 4 and 5. Not simply a "compromise design." DY6X-1
DUAL CHANNEL "FISHBONE" DFBT-1 for Ch. 4 and 5	1	14	33.50	 Each of the 10 elements contributes gain to Channels 4 and 5. No "scenic" elements. All the features of the DY6X-1 plus 4 additional working elements make this the ultimate in dual-channel antennas. DFBT-1

PRE-TUNED "BEAMED POWER-PERFECT MATCHED" ARRAYS
"PRECISION TUNED" . . . "MATCHED" AND "CALIBRATED" FOR "TOP PERFORMANCE"

	Model No.	Ship. Wt. Lbs.	Net Price
5-EL. 2-METER ARRAY 11.2 db gain, 30° beam-width, 20 db F/B	250	8	45.00
"TWIN-FIVE" 10-ELEMENT (Half-Wave Stacked 5 Element Arrays) 14.4 db gain, 30° beam-width when horizontally polarized, 26° beam-width when vertically polarized	255	18	90.00
3-EL. 10-METER ARRAY 8.9 db gain, 30° beam-width, 26 db F/B, 8'5" boom	303	19	77.50
3-EL. 15-METER ARRAY 8.9 db gain, 30° beam-width, 26 db F/B, 12'5" x 3" boom	153	41	110.00
5-EL. 15-METER ARRAY 11.2 db gain, 26° beam-width, 28 db F/B, 24'6" x 3" boom	155	74	210.00
2-EL. 20-METER ARRAY 5.6 db gain, 50° beam-width, 20 db F/B, 6'4" x 3" boom	502	31	97.00
3-EL. 20-METER ARRAY 8.9 db gain, 30° beam-width, 26 db F/B, 16'3" x 3" boom	503	61	120.00
4-EL. 20-METER ARRAY 9.7 db gain, 28° beam-width, 27 db F/B, 24' x 3" boom	504	71	185.00
5-EL. 20-METER ARRAY 11.2 db gain, 26° beam-width, 30 db F/B, 32'4" x 3" boom	505	95	240.00

Export Packing (Wood Crating) \$17.00 additional, net.

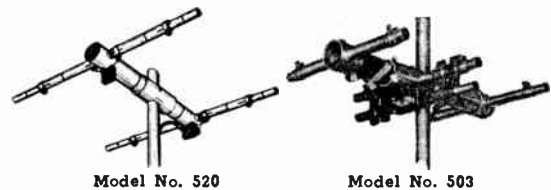

Telrex "Beamed Power-Perfect Match" Arrays are fully integrated units combining really practical structures with built-in performance that assures "Top man on the frequency" results at your site . . . without endless "cut and try" hacksaw engineering.

Every Telrex 2, 6, 10, 15, 20, and 40 meter Array is a professionally designed, precision manufactured communications array which is accurately tuned, then calibrated for optimum gain, perfect match and a balanced uni-lobe pattern that puts your signal out in front where you want it!

A feature of every Telrex "Beamed Power" Array is the Telrex designed coaxial balun and "T" transformer which permits optimum coaxial line coupling and insures a broad band resistive match, and a completely cold transmission line for pattern symmetry, highest s/n and signal to interference ratios, and minimum TVI.

2-EL. 20 METER PRE-TUNED "MINI-BEAM"

Compact size 2" x 82" boom; 2½" center reinforcing section; 1¾" mounting hole; reflector 20-ft., driven element 19 ft., gain 4.6 db; F/B 15 db.

Model No. 520 Wt. 11 lbs. Net \$77.50

AMERICA'S LARGEST MANUFACTURER OF "CONICAL-V-BEAMS"

WARD TV Antennas

WARD'S DYMON-VANE CONICAL

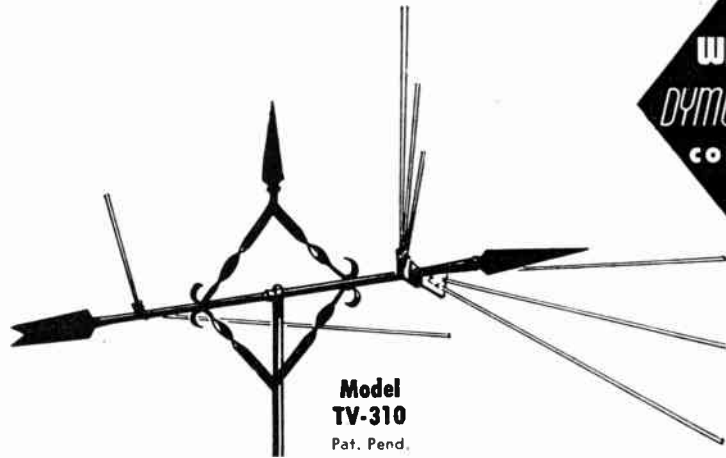

**Model
TV-310**

Pat. Pend.

WARD'S Dymon-vane is one of the new WARD Tele-vane TV Antennas. Tele-vanes, the newest concept in TV antennas, are designed to add beauty to the housetop and to make any owner proud to own one. With its black wrought iron appearance, the Dymon-vane has a weather-vane look that enhances the appearance of any home.

The Dymon-vane is an 8 element conical for VHF channels 2 through 13 in metropolitan areas, cross-

arm 1" O.D. Permatube with flat black finish. Both models are new fold-up design with parabolic principle reflector and preassembled for easier installation.

Model TV-310—Single Bay. Individually packed. Shipping wgt. 15 lbs. ea. 6 units standard quantity.

Model TV-315—Double Bay. Individually packed. Shipping wgt. 28 lbs. ea. 3 units standard quantity.

Model TV-77—Stacking Kit for stacking 2 two-bay units into 4-bay unit.

WARD'S CIRCLE-VANE YAGI

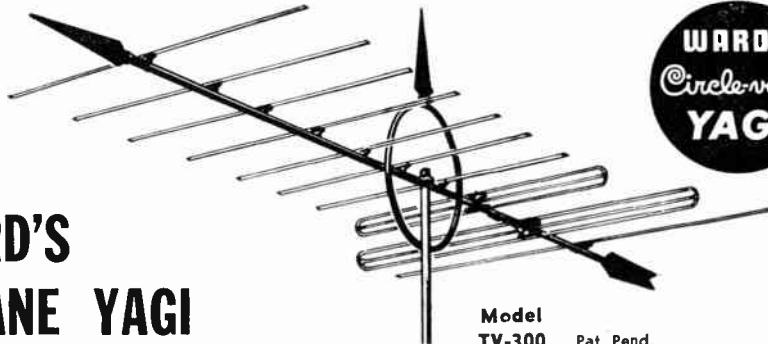

**Model
TV-300**

Pat. Pend.

Another of the Tele-vane TV Antennas designed to add beauty to the home is Ward's Circle-vane Yagi. The Circle-vane is a 10 element double driven VHF antenna for use on channels 2 through 6 in areas where gain and directivity pattern are important. Crossarm is 1 1/2" O.D. Permatube with flat black

finish with elements of 1/2" aluminum. Antenna comes with 3 major sub-assemblies with elements attached and folded for easy assembly.

Model TV-300—Individually packed. Shipping wgt. 35 lbs. ea. 3 units standard quantity.

WARD'S PARA-CON

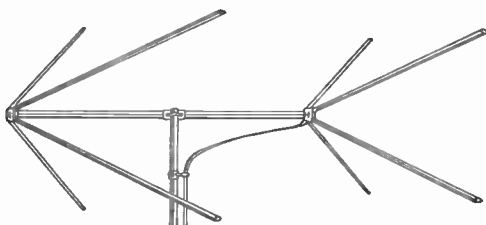

Combines parabolic and conical principles to assure maximum picture clarity and concentration of weak signals. Rugged aluminum elements. . . . heavy duty cross arm . . . molded plastic insulators.

Model TVA-62—Single bay . . . bulk packed . . . 6 units standard quantity.

Model TVA-63—Single bay . . . individually packed . . . 6 units standard quantity.

Model TVSA-66—Double bay . . . bulk packed . . . 3 units standard quantity.

Model TVSA-67—Double bay . . . individually packed . . . 3 units standard quantity.

Model
TV-132

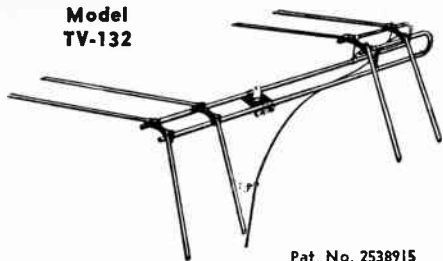

Pat. No. 2538915

WARD'S TROMBONE

Designed for high gain on all channels—UHF and VHF. 8 elements properly spaced and streamline in design. Engineered for sharp directivity, 300 ohm impedance match and low VSWR. Completely preassembled.

Model TV-132—Single Bay . . . individually packed . . . shipping wgt. 5 lbs. ea. . . . 6 units standard quantity.

Model TVS-142—Double Bay . . . individually packed . . . shipping wgt. 11 lbs. ea. . . . 3 units standard quantity.

Model TVS-161—Triple Bay . . . individually packed . . . shipping wgt. 16½ lbs. ea. . . . 3 units standard quantity.

WARD'S U-VEE

Designed to permit elements to be assembled at 3 different angles, as indicated, depending on areas in which located and channels desired. All aluminum construction, light, rugged. Completely preassembled.

Model TV-130—Single Bay . . . individually packed . . . shipping wgt. 3 lbs. ea. . . . 6 units standard quantity.

Model TVS-141—Stacked Model . . . shipping wgt. 7 lbs. ea. . . . 3 units standard quantity.

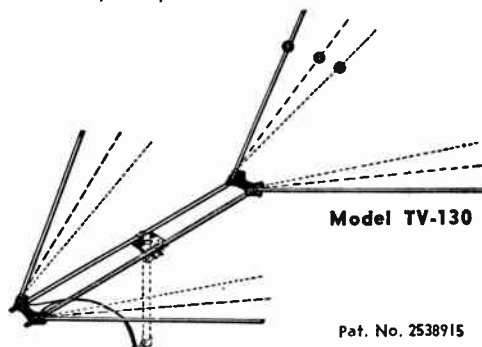

Model TV-130

Pat. No. 2538915

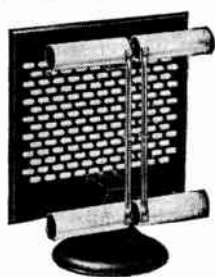

Model TV-215

WARD'S UHF Indoor Can-Can

An attractive item in either black wrought iron and bronze finish, or all bronze finish with brown base, the Indoor Can-Can is equivalent to stacked bow ties electrically. Ideal for auxiliary antenna wherever UHF has been added. Completely preassembled with lead.

Model TV-215—Black and Bronze finish . . . individually packed . . . shipping wgt. 3½ lbs. ea. . . . 6 units standard quantity.

Model TV-216—Bronze finish with brown base . . . individually packed . . . shipping wgt. 3½ lbs. ea. . . . 6 units standard quantity.

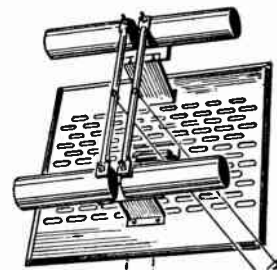

Model TV-202

WARD'S CAN-CAN

For either new UHF installation or as an auxiliary UHF antenna, the Can-Can is designed for reception for the entire UHF band. Compact, sturdy all-aluminum construction. . . . Completely preassembled. Individually packed . . . shipping wgt. 2 lbs. ea. . . . 6 units standard quantity.

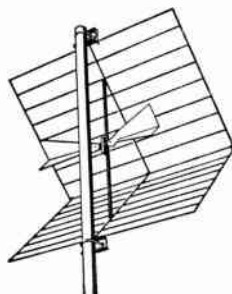

WARD'S Corner Reflector

Designed for suburban and semi-fringe areas, the Corner Reflector is ruggedly constructed to eliminate picture flutter, ghosts and vibration. Completely preassembled. Individually packed . . . shipping wgt. 4 lbs. ea. . . . 6 units standard quantity.

Model TV-203

WARD'S UHF Bow Tie Antenna

The only bow tie antenna with adjustable screen, easily spaced to favor stations in any area, for best possible local reception. Insulators have been eliminated and "free space" terminals incorporated to provide higher gain and flatter response across the UHF band — all possibility of picture deterioration and antenna shorting eliminated.

All Aluminum Construction . . . Completely preassembled . . . Rugged Design.

Model TV-189—Single Bay . . . individually packed . . . shipping wgt. 2½ lbs. ea. . . . 6 units standard quantity.

Model TVS-191—Double Bay . . . individually packed . . . shipping wgt. 5 lbs. ea. . . . 3 units standard quantity.

Model TV-190—Stacking Kit.

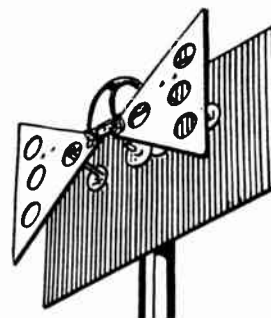

Model TV-189

WARD TV Accessories

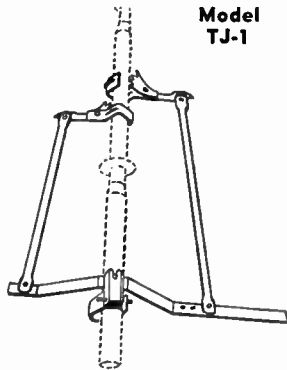

Model TJ-1

WARD'S TOWER JACK

TOWER JACK makes erecting telescopic masts a one-man job . . . just mount antennas on top section and raise away. Handles any 2 to 5 section mast from 1 1/4" to 2 1/4" in diameter. Easy to carry from job to job.

Model TJ-1—Shipping wgt. 11 lbs. . . . 3 units standard quantity.

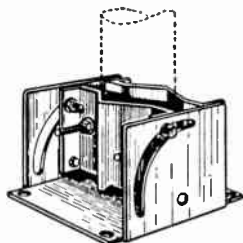

Model C-34

WARD'S ANTENNA BASES

All Ward Bases are weather-proofed, easy to mount on outside walls or pitched or flat roofs:

Model C-34—Heavy Duty Base for any telescopic masts 1 1/4" to 2 1/4" O.D.

Model C-14—Self Supporting Base for 1 1/4" O.D. . . . Individually packed . . . shipping wgt. 1 1/2 lbs. ea. . . . 6 units standard quantity.



Model DX-1

WARD Diplexer

The foolproof, waterproof, dependable, Ward Diplexer can be used either outside to connect a UHF and VHF antenna to one transmission line or inside to connect one transmission line to the VHF-UHF terminals of a TV set. Permits use of a single lead-in and eliminates switches.

ZIP-HI

Telescoping Mast

Zip-Hi mast comes in 2, 3, 4 or 5 sections . . . cannot collapse during installation . . . O.D. ranging from 1 1/4" to 2 1/4" . . . self-locking guy-rings . . . constructed of Permatube with durable plastic coating. Shipped collapsed with guy-rings and all hardware.

Model ME-20—2 sections

Model ME-30—3 sections

Model ME-40—4 sections

Model ME-50—5 sections

3 units of a size standard quantity.



WARD Auto Aerials

SIDE COWL MOUNTS

Two stanchions for sturdy installation. Smartly designed insulators with chrome caps. Conversion kit for torpedo bodies included.

LONG RANGER

Special sensitivity for low signal strength areas. Two stanchion, triple chrome plated, rattle-proof.

Four sections, extends to 100"

36" Elektran Cable

EZ-on installation

Model SC-8—Individually packed, 12 to a master carton, 22 lbs. Individual weight, 1 lb. 10 oz.

SKY QUEEN

Smartly styled for side mounting. Rugged construction. Finest quality heavy duty brass tubing, with corrosion-free triple chrome plate. Rattle-proof.

Three sections, extends to 66"

36" Elektran Cable

EZ-on installation

Model SC-6—Individually packed 12 to a master carton, 17 lbs. Individual weight, 1 lb. 5 oz.

MASTER

Model SC-3A—12 to a master carton, 13 lbs. Individual weight, 1 lb.



World Famous WARD
Exclusive Patented

EIGHT-BALL

Non-Disappearing

TOP COWL OR FENDER MOUNTS

Completely installed from the outside in 5 minutes . . . at any desired angle. Fits any car. Rugged construction. Completely rattle-proof. Smart appearance. The universal, most popular auto aerial.



Three sections; adjustable from 56" to 22"
36" Elektran Cable

Model TCF-3B—Individually packed, 12 to master carton. 14 lbs. Individual weight 1 lb.

Model TCF-2B—Same as Model TCF-3B with only two sections.

Model TCF-3C—Same as Model TCF-3B with 54" lead.



WARD Auto Aerials

PHANTOM

Disappearing

A disappearing antenna — 100% shielded against engine noises. Includes Eight-Ball for easy, smart installation plus popular disappearing feature for attractive built-in appearance.

Three sections, 56" to 3½" when collapsed.
36" Elektran Cable

Universal mounting bracket for sturdy installation

Model DCF-3—Individually packed, 12 to master carton, 17 lbs. Individual weight 1 lb.

Model DCF-3A—Same as Model DCF-3 with 54" lead.



MAJORETTE

A new, top-quality aerial priced to meet the keenest competition. 3 Sections extend to 56". Triple chromed on Admiralty Brass. Ward's exclusive 8-Ball top cowl or fender mount. Genuine Elektran lead cable. Quickly and easily installed from outside.

Model TA-3—36" lead

Model TB-3—54" lead



EACH MODEL COMPLETE WITH A WARD ELEKTRAN LEAD CABLE

Made of the finest insulating materials—Polyethylene, wire shield braid, oil and abrasion-proof vinylite.

WARD'S exclusive lead connector fitting provides an easy coaxial connection, 100% shielded. Bayonet adapter for pin plug included so lead will fit every car radio.



Model C-B (12 inches)
Model C-9 (18 inches)
Model C-12 (24 inches)

Provides additional lead length required for fender installation.

Covered by one or more of the following Patent Numbers:
104968, 119160, 2152316,
2251889, 2252671,
2269947, 2366634.

DEALER DISPLAY RACK →

Colorful and compact in black wrought iron with yellow, white and black sign, Ward's new permanent display rack will "dress-up" any show room. For practical "see-it" demonstrations, an aerial can be mounted on the side of the rack.

Model WDD-1—Contains 3 TCF-3B and 3 TCF-3C assortment.

Model WDD-2—Contains 6 TCF-3C assortment.

Model WDD-3—Contains 6 TCF-3B assortment.



Here is a handsome, colorful display to catch the eye, create interest and make sales . . . on your counter or in your windows. Available at your distributors.

Put this business builder to work for YOU. Identify yourself with the world's oldest, largest, exclusive manufacturer of antennas.

Model WCD-3



← JOBBER DISPLAY RACK

Here's the modern way to store, as well as display, the Ward Auto Aerial line. This beautiful permanent black wrought iron and expanded metal rack with yellow, white and black trimmings will attract every eye . . . and will sell more aerials for you.

Model WJD-1 — Contains 24 TCF-3B and 12 TCF-3C assortment.

Model WJD-2 — Contains 36 TCF-3C assortment.

Model WJD-3 — Contains 36 TCF-3B assortment.





by WARD

BUILT FOR RIGOROUS SERVICE

UNIVERSAL SWIVEL MOUNTS

Antennas built for the hardest mobile use. Separate components may be combined to meet any requirements. These rear-mounting Transmitting Antennas are designed for the 25-45 mc. services. Base mounts in such a way as to allow the whip rod to be held vertically regardless of contour of vehicle body.

← SPP-3B

SINGLE ROD

Special Alloy Whip Rod of maximum resilience and durability. 84" Single rod for use in the range of 30 to 45 mcs. Non-Cor-roding, stainless steel tapered for proper stress distribution. Base Adapter threaded $\frac{3}{8}$ "-24 to permit mounting on SPP-3 Base or SPP-3A Spring.

Individually packed. Approx. wt.: 2 1/2 lbs.

SPP-12 →

ADJUSTABLE 2-SECTION ROD

Adjustable Rod. Telescopes from 85" to 103" and is equipped with a locking device that permits removal of the whip rod and replacement at the exact previous length. Heavy wall, hard drawn brass tubing — threaded $\frac{3}{8}$ "-24 to fit either SPP-3 Base or SPP-3A Spring. See SPP-3B for Rod description.

Ind. packed. Approx. weight: 2 lbs. 10 oz.

SPP-3

SWIVEL BASE

Swivel base for mounting at any desired point. Half balls of cast aluminum tapped $\frac{3}{8}$ "-24 to accept whip rods and shock springs. Insulator of black bakelite — rubber gaskets — steel back-up plate. All screws are Allen Head type with wrenches supplied.

Individually packed. Approx. wt.: 1 lb. 10 oz.



SPP-3A

SHOCK MOUNTING SPRING

This sturdy spring is used to lessen damage to the whip rod. A flexible lead through the center of the spring maintains constant electrical impedance through the spring assembly. $\frac{3}{8}$ "-24 stud on one end — $\frac{3}{8}$ "-24 tapped hole on opposite end — approximately 6" in height — made of oil tempered wire.

Individually packed. Approx. wt.: 2 lbs. 3 oz.



NEW 10 METER MOBILE TRANSMITTING ANTENNA NEEDS BUT 1 HOLE FOR INSTALLATION!

Ward's SPP-143 transmitting antenna can be installed on cowl, fender or flat rear deck of any automobile without the necessity of drilling a series of unsightly holes. It is developed to use one 15/16" hole, that can easily be plugged or used to mount a Ward B-Ball standard broadcast antenna. The short, standard 55 1/2" rod reduces damage from overhead constructions.

MODEL SPP-143



NEW POLICE TRANSMITTING ANTENNA → GIVES COMPLETE DISGUISE TO DETECTIVE CARS

To any criminal a long whip antenna is a police car giveaway. To achieve complete disguise, Ward engineered a standard automotive aerial to withstand transmitting currents and permanently fix the rod length.

MODEL SPPB-71

MOTORCYCLE MOUNTS

These Antennas are designed for use on motorcycles and are built to withstand the rugged service and high vibration of vehicle. Rod is electrically short but can be used on all frequencies. 40" rod of same material as SPP-3B — 1/4"-20 mounting stud in insulator for mounting to motorcycle. Flexible base of rubber to allow movement when rod is bent — Model SPP-6 with safety ring tip — Model SPP-6A with stainless steel ball tip — no lead supplied. Individually packed. Approx. weight: 1 lb. 5 oz.

Model SPP-6—Ring Tip (Illustrated)

Model SPP-6A—Ball Tip (Not Shown)

← ROOF TOP MOUNT

Developed for roof top mountings in 30 to 45 Megacycle range. Advantages of this type of antenna are that directional effects caused by car body shielding of antenna are avoided. Base is designed to be used with the SPP-3B rod which is sold separately. This unit consists of all components of Universal Swivel Mounts except that half-balls are replaced by SPP-3A Spring fastened permanently to insulator. No lead supplied.

Individually packed. Approximate weight: 3 lbs.

Model SPP-26 Base

ROOF TOP ANTENNA →

This model is designed for taxicabs, police services, and others using the 140 to 165 Megacycles frequencies. Installed entirely from the outside of vehicle — 12 ft. length of RG-58/U coaxial cable attached permanently to antenna. Whip rod is replaceable.

Individually packed. Approximate weight: 1 lb.

Model SPP-18

Many More Models for Every Need — Write or See Your Distributor for Catalog.

WARD PRODUCTS CORPORATION
DIVISION OF THE GABRIEL COMPANY

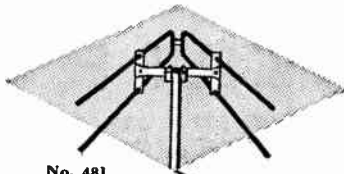

No. 481
UHF-VHF Dual-V

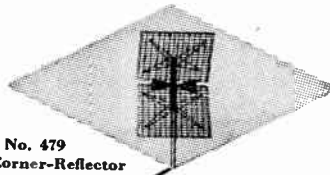

No. 479
UHF Corner-Reflector

5 NEW *Brach* QUALITY-ENGINEERED UHF ANTENNAS

*the right
uhf antenna
for every locality!*

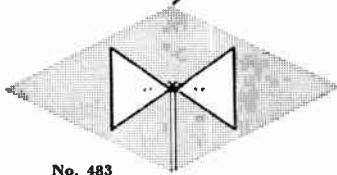

No. 483
UHF Bow Tie

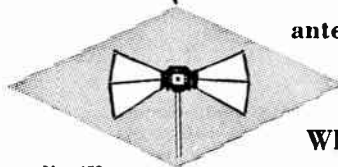

No. 452
UHF-VHF Bow Tie V

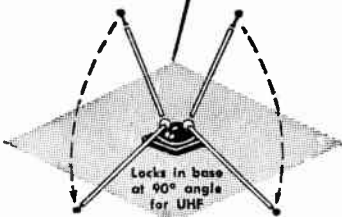

No. 482
UHF-VHF Indoor

Brach electronic engineers, who successfully pioneered and developed VHF antennas and Mul-Tel, now proudly present the newest in UHF—5 quality-engineered UHF antennas! Each is designed to solve specific UHF antenna problems.

When you sell Brach, you sell *the ultimate* in quality, reception, and service. Write for FREE booklet "How to Select UHF Antennas".



Division of
General Bronze Corp.

MANUFACTURING CORP.
Quality-Engineered TV & Radio Products
200 Central Ave. • Newark 4, N. J.

- ROTATORS
- VIBRATORS
- AUTO AERIALS
- TV ANTENNAS
- POWER SUPPLIES



THE **RADIART** CORPORATION
CLEVELAND 2, OHIO

AUTO AERIALS



- Exclusive "Static Muffer" Ball
- 18-8 Stainless Steel Rod
- "Super-Chrome" Finish On High Tensile Strength Brass Mast
- SPEE-DEE ASSEMBLY
- Extra Long Fill 42" Polyethylene Lead-In

Here is the outstanding new auto aerial that has everything. Full 30 degree mast adjustment so that it fits all body and fender contours. And the new installation design makes it a snappy 1, 2, 3 assembly without even looking under the fender.

TWO INSULATOR SIDE MOUNT TYPES

Sturdy high quality construction throughout. Brilliant chromed brass masts with stainless steel rods. Wedge type adaptor furnished, with 36" polyethylene lead-in.

MODEL 2S, 43" extended, 2 sections. 10 per master carton, 9 pounds

MODEL 3S, 63" extended, 3 sections. 10 per master carton, 13 1/4 pounds

MODEL 4S, 92" extended, 3 sections. 10 per master carton, 17 1/2 pounds



DISAPPEARING MOUNT

A handsome addition to any car. Collapses to 6 inches and extends to 60 inches. Fits either fender or cowl and features the exclusive "O" ring seal around the mast that prevents water from entering inside the aerial. Only one 1/8" mounting hole required.

MODEL 3D, 60" extended. 3 sections, 2 pounds each

10 per master carton weighing 19 pounds.



MODEL 8 BE SPEE-DEE

DELUXE MODEL 4BX3

Three section design extends to 59 1/2".

- Brilliant long lasting chrome finished mast and spacer cap
- Full length quality 36" polyethylene waterproof lead-in
- Only one half inch mounting hole required

SUPERIOR STANDARD MODEL 4BX2

Two section design extends to 43".

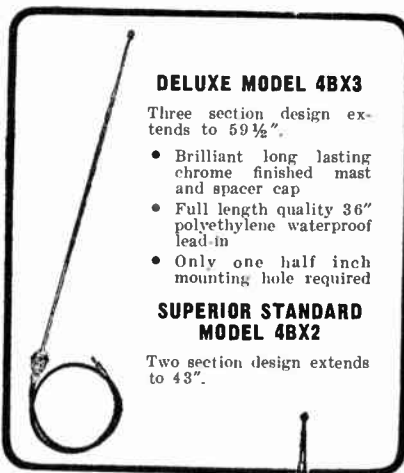

MODEL 8 BD HI-BALL

- Fast installation . . . 5 minutes
- 30 degree mast adjustment fits all body and fender contours
- "18-8" Stainless steel rod
- Fits any car radio, bayonet lead-in adaptor included

A favorite with dealers and service-men everywhere. Fast assembly and outstanding performance make it a great value.

Also Model 8BDL with 48" lead-in.

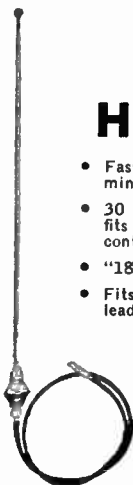

BATTERY POWER

Here is the ideal, compact efficient unit for testing and demonstrating auto radios. Smooth DC power, 6 or 12 volts, from the 110 volt 60 cycle AC line.

Model — 110 BA12

Output: 6V DC @ 20A
12V DC @ 10A

Size: 7 3/4 x 13 x 8 1/2

Weight lbs.: 24 1/2



- ROTATORS
- VIBRATORS
- AUTO AERIALS
- TV ANTENNAS
- POWER SUPPLIES



THE RADIART CORPORATION
CLEVELAND 2, OHIO

RADIART TV ANTENNAS

VHF ANTENNAS

the "ULTAMATIC"
TV Antenna
UM 213

Perfectly synchronized for both monochromatic and color TV. The best performing antenna on the market.

the true conical
Model K-8
TV Antenna

Rugged and sturdy beyond any ordinary requirement, available in single or double bays.

the popular
Model V-8
TV Antenna

Here is the most economical 4 stacked antenna for all channel reception.

the "LAZY X"
Conical
TV Antennas

Uniformly good all channel reception. LZX, single, LZX-2, double stacked, LZX-4 with four bays.

the famous
SUPER-VEE
TV Antenna

Here is the only all channel antenna with sharp directivity on all channels.

the
10 YG YAGI

A ten element yagi for any channel . . . the best performing antenna of its type.

combination
UHF and VHF
TV Antenna
UVS-6

A new antenna of conical design for all channel reception, requires no network.

the budget antenna
Model S-6

Here is a conical antenna . . . the best budget conical to be had.

UHF ANTENNAS

UW-2
UW-4
and
UW-8

Three models, single, double or quadruple stacked designs for peak UHF reception.

indoor
UHF antennas
the UW-1-2
and **UW-1-3**

The same fine principle adapted for indoor use.

the UC-1
and **UC-2**

The new corner reflector type UHF antenna.

the UBT-1

An improved version of the "bow-tie" antenna . . . for UHF TV reception.

the original
Model U-4
TV Antenna

Here is the original design . . . often copied but never duplicated

the YAGI
for UHF
6YGU

Here is a yagi type antenna for UHF reception . . . for all channels.

ACCESSORIES

for FM reception
92 FM and 93 FM

Two superior quality antennas for truest high fidelity FM reception.

AK-85 Chimney Mount

The famous "Spee-Dee" chimney mount, faster and sturdier.

TA-5 Lightning Arrestor

Here is the midget that does the work of a giant. Many features of superiority.

Model UAK-4 Filter Network

Here is the most efficient network . . . not just a circuit . . . but an electronic device.

the new
VU-1
TV Antenna
Combination

For peak performance on all channels . . . both UHF and VHF.

- * ROTATORS
- * VIBRATORS
- * AUTO AERIALS
- * TV ANTENNAS
- * POWER SUPPLIES



THE **RADIART CORPORATION**
CLEVELAND 2, OHIO

MODEL TR-4 . . . the complete rotor with handsome modern design cabinet with **METER** control dial . . . **USES FOUR WIRE CABLE.**

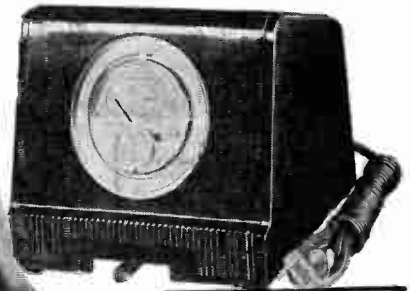
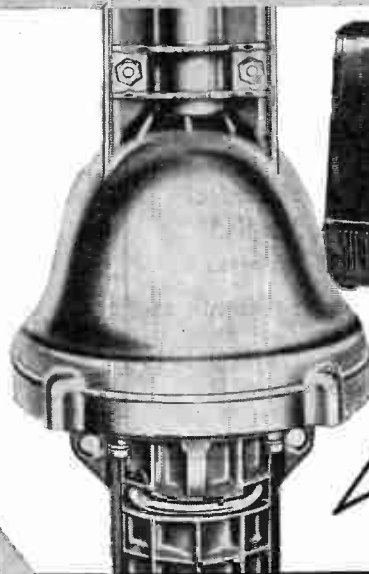

TR-4

- * Handles heavier loads with ease . . . as much as 150 pounds
- * Streamlined weather-proof design, durable sturdy construction
- * 12 heavy duty ball bearings in two 6½" ball bearing races
- * Heavily reinforced die cast housing
- * Heavy duty precision gears
- * Positive stop at end of rotation . . . WITH BRAKE THAT ELIMINATES COASTING
- * Reversible clamps will handle ⅞" to 2" O.D. masts
- * Heavy duty motor—reverses instantly
- * Mast, tower or platform mounting
- * 3 heavy duty guy wire lugs
- * Completely weather-sealed . . . factory lubricated for life

the old favorite . . .
still the most powerful TV Rotors,
enough power to turn any TV array

C • D • R ROTORS

MODEL TR-2 . . . the complete rotor with "Compass Control" dial cabinet with illuminated "perfect Pattern" dial, uses 8 wire cable.

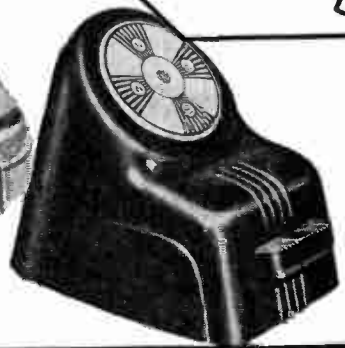
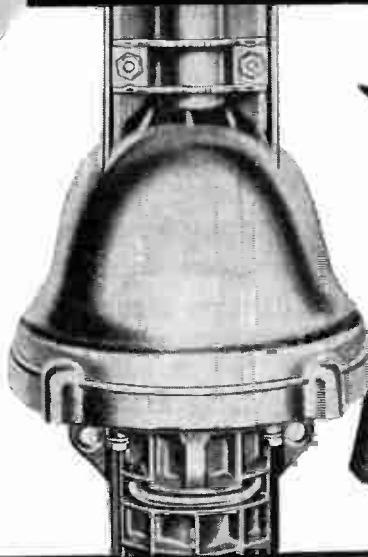

TR-2

- * ROTATORS
- * VIBRATORS
- * AUTO AERIALS
- * TV ANTENNAS
- * POWER SUPPLIES



THE **RADIART CORPORATION**
CLEVELAND 2, OHIO

in a class by itself

C•D•R

ROTORS

TR-11 and TR-12

- * Quick Mounting Antenna Mast Collet
- * Speedy Installation . . . no loose parts to assemble
- * Takes Antenna Masts up to 1½" OD —self-centering saw tooth clamps
- * Instantly Reversible . . . makes complete revolution in 45 seconds
- * Instant Locking . . . WILL NOT DRIFT
- * Modern Design Offers Minimum Wind Resistance
- * High Strength with Low Weight
- * Fits Standard Towers
- * Completely Weather-Sealed
- * Mahogany or Blonde Finish

MODEL TR-12 . . . complete rotor including THRUST BEARING and handsome modern design cabinet featuring METER CONTROL DIAL with finger-tip lever . . . uses 4 wire cable.

MODEL TR-11 . . . Same as TR-12 without thrust bearing.

THRUST BEARING



Accessory MODEL TA-6, heavy duty bearing for side thrust . . . has six precision bearings . . . non-corrosive, water-proof, weather-proof. No kit needed to install.

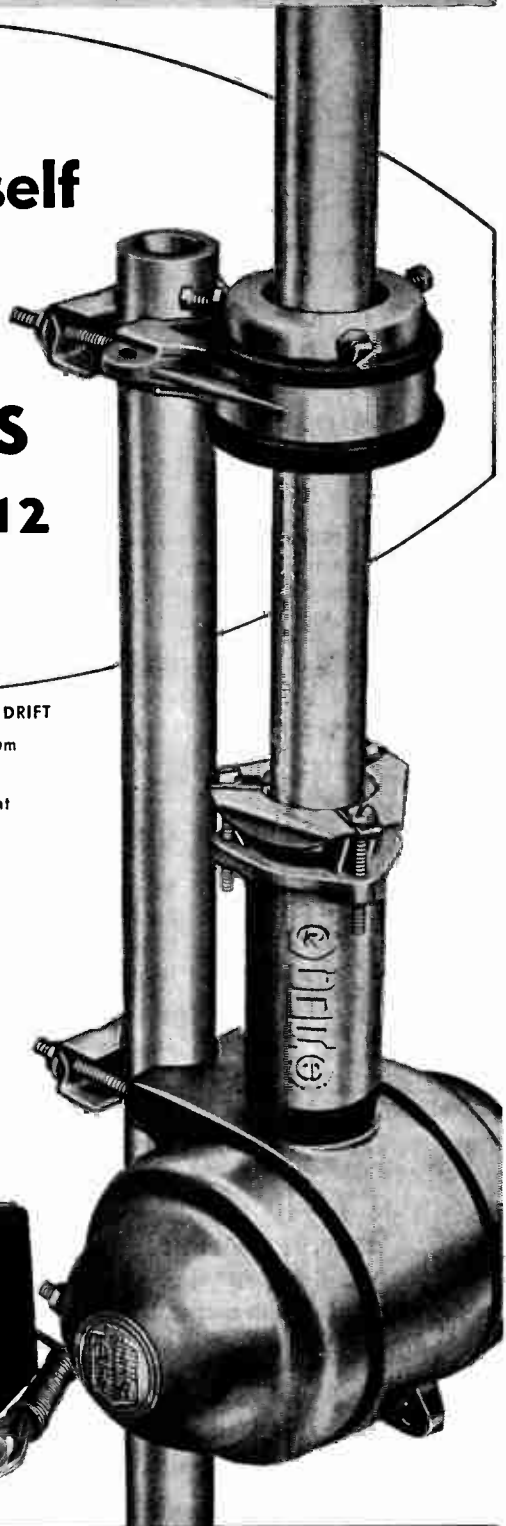
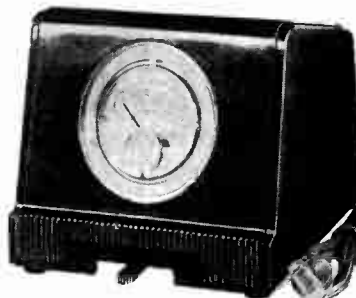

**NEW!
VHF & UHF-VHF**



**OUTDOOR
TV ANTENNA**

WITH "QUICK RIG" — "B" CONSTRUCTION

E-Z-BEE

**Featuring the NEW, Matchless
"B" Construction**

**Designed for
HIGHEST GAIN
in Fringe Areas and
QUICK, EASY INSTALLATION**

The SPICO E-Z-BEE outdoor antenna has proven itself, under rigorous testing conditions, that it will outperform and outlast all others.

Opens as easily as an umbrella—no screws, no tools needed!

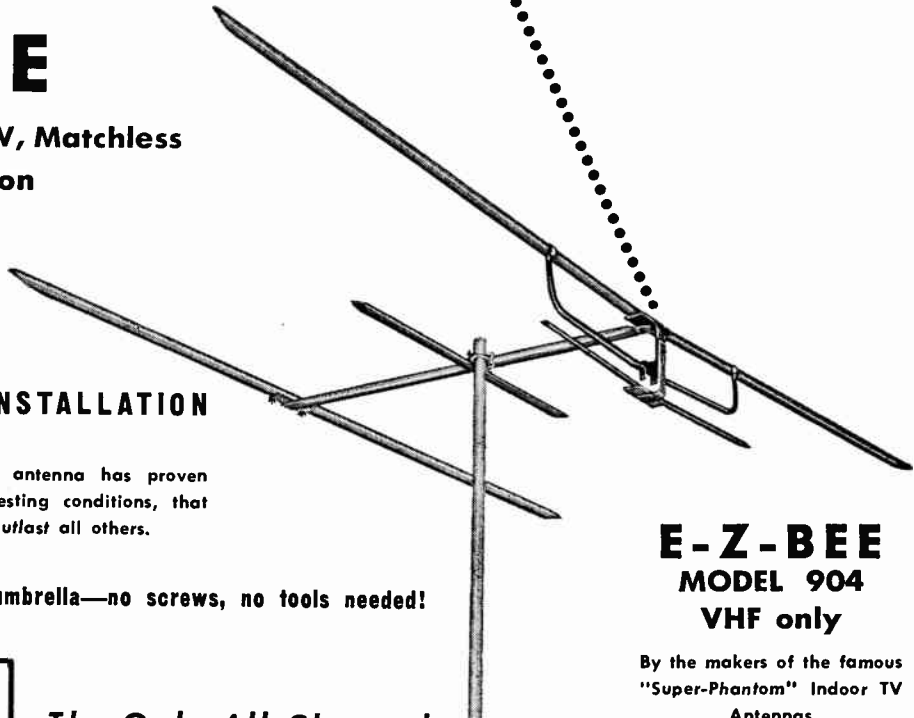

**E-Z-BEE
MODEL 904
VHF only**

By the makers of the famous
"Super-Phantom" Indoor TV
Antennas



Quick rig for permanent installation within minutes. Pre-assembled, foldaway, individually boxed.

**The Only All-Channel
VHF Outdoor Antenna with ALL these features:**

- | | |
|--|--|
| Unique "B" construction | Quick-rig, pre-assembled foldaway for E-Z installation |
| Forward resonator section | Non-corrosive construction |
| Mid-band parasitic resonator | May be stacked in any number of bays |
| Narrow beam width eliminates interference and ghosts | Elements securely held and positioned |
| High gain throughout all channels | Uni-directional |
| All aluminum, eliminates electrolytic action | High front-to-back ratio |

Model 904 (illustrated) for **VHF** and **COLOR**.....List **\$16.95**

Model 904U—Available with attached bowtie for **UHF, VHF** and **COLOR**

SPICO, the industry's fastest selling TV antenna line, makes the "E-Z-BEE" another money maker for you. Unique "B" construction eliminates stacking of extra bays in most locations . . . permanent installation in minutes. Weatherproof to withstand all conditions. Customers' satisfaction guaranteed.

Sold only through SPICO Authorized Distributors

SPIRLING PRODUCTS CO., INC.

NOW! FAMOUS **Spico** UHF-VHF INDOOR TV ANTENNAS



FOR ALL CHANNELS — 2 through 83 — UHF, VHF and **COLOR**

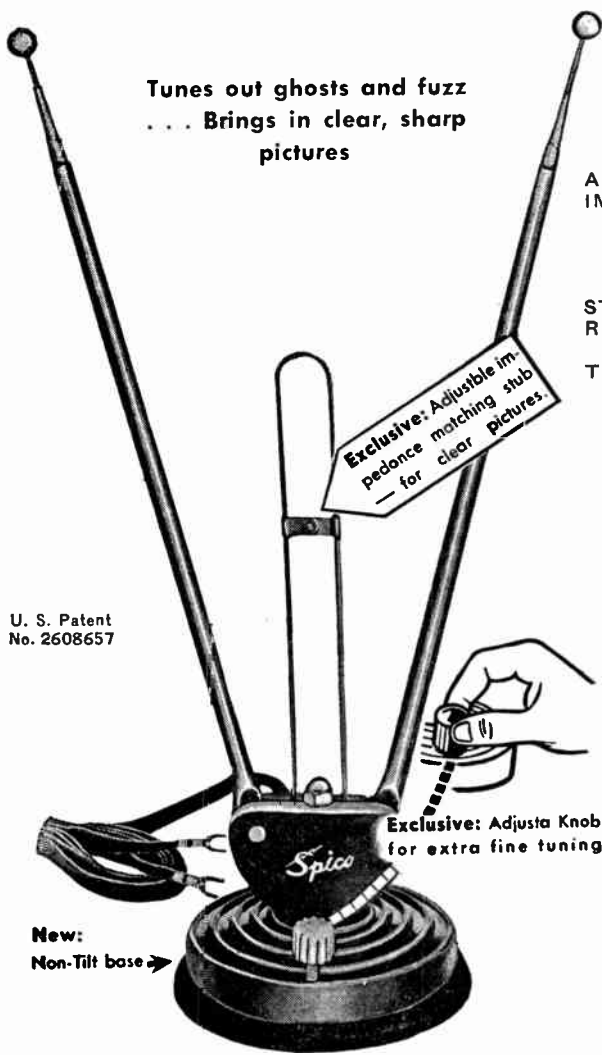

Tunes out ghosts and fuzz
... Brings in clear, sharp pictures

Exclusive: Adjustable impedance matching stub — for clear pictures.

Exclusive: Adjusta Knob for extra fine tuning

U. S. Patent No. 2608657

New: Non-Tilt base

MODEL TV-503

Super-Phantom for VHF and COLOR

(as illustrated)List **\$8.95**

GUARANTEED to outperform wherever Indoor Antennas Are Used!

The great **SPICO Super-Phantom** indoor antennas that are breaking sales records wherever TV is received

Super-Phantom EXCLUSIVES!

ADJUSTA-KNOB for pin-point tuning.

IMPEDANCE MATCHING STUB: Theoretically most sets are 300 ohm, yet, many vary + or -50 to 110 ohms. With the SPICO shorting bar impedance is matched perfectly for each set, thus no loss or mismatch.

STEADY, CLEAR PICTURE with maximum gain.

RUSTPROOF: Nickel plated brass tubing assures permanent, clear contacts between telescopic dipoles.

TILT-PROOF: New, heavy base will not tip nor tilt at any angle of dipoles—in protected, glistening bakelite—completely concealed wiring.

MODEL UV-506

Super-Phantom

for VHF, UHF and COLOR (as illustrated at right with specially designed UHF inductance coupler for maximum reception on all channels, 2 through 83) List **\$9.95**

MODEL U-505

Strato

for UHF and COLOR only (as illustrated at right with UHF inductance coupler, 6 1/4" fixed dipoles, 1/4 wave length. Engineered and calibrated for all UHF channels 14 through 83) List **\$8.95**



Model UV-506
Model U-505

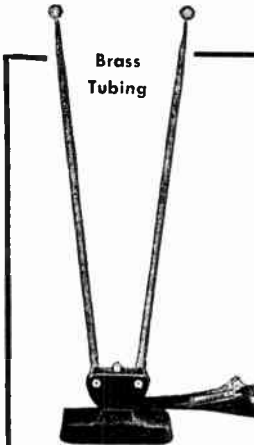

Indoor-Jenna

MODEL TV-8

only SPICO can make this UNCONDITIONAL GUARANTEE

UNBREAKABLE RUSTPROOF • TILT-PROOF

Sturdy construction, handsome appearance, factory warranty enclosed with each unit.

Lowest Prices Ever!
Patent Pending

Guaranteed for Life of Set!

SPIRLING PRODUCTS CO., INC. Sold only thru authorized SPICO distributors.

ANTENNAS *Master Mobile* MOUNTS

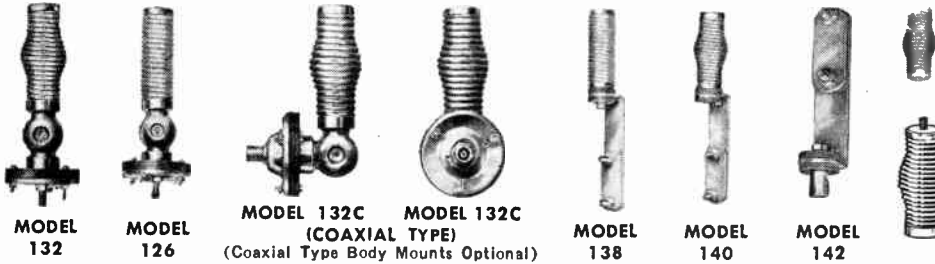

100 Reg.
Separate Springs
for Antenna Mounts

100X Heavy Duty
100W Heavy Duty

	Net
100—Regular	\$4.50
100-X—Heavy Duty	5.50
100SS—Stainless Steel	6.95
100XSS—Heavy Duty Stainless Steel	7.95
100WX	5.50

MOUNT SPECIFICATIONS

(All types are topped for 1/8" Stud Fitting on Antenna End. Shipping Weight Approx. 3 lbs.)

126	or 126C*	Body Mount—Straight Spring—Swivel Base	\$ 8.75
126X*	or 126XC*	Body Mount—Heavy Duty—Straight Spring—Swivel Base	9.40
132	or 132C	Body Mount—Double Tapered—Spring Swivel Base	8.75
132X	or 132XC	Body Mount—Heavy Duty—Double Tapered—Spring Swivel Base	9.85
132SS*	or 132SSC*	Body Mount—Special Stainless	12.95
132XSS*	or 132XSSC*	Body Mount—H.D. Special Stainless	14.95
138		Bumper Mount—Straight Spring	6.95
138X		Bumper Mount—Heavy Duty—Straight Spring	7.65
140		Bumper Mount—Double Tapered Spring	6.95
140X		Bumper Mount—Heavy Duty—Double Tapered Spring	7.95
140SS		Bumper Mount—Special Stainless	9.65
140XSS		Bumper Mount—Special Heavy Duty Stainless	10.95
142		Bumper Mount—Less Spring, with Insulators for Direct Mounting by Series 100 Ant. or 92 Ext. and 106 Antenna	3.95

*Coax Type
X—Heavy Duty

SS—Special Stainless
XC—Heavy Duty Coax

XSS—Heavy Duty Special Stainless
XSSC—Heavy Duty Special Stainless Coax

SILICON-CHROME WHIP ANTENNA

NEW 9 SERIES—with 3/8" Threaded Studs

Model No.	Overall Length	Net Price
9-60T	60"	\$2.97
9-72T	72"	3.24
9-84T	84"	3.30
9-86T	86"	3.60
9-96T	96"	3.75

NEW 8 SERIES—without Studs

Model No.	Overall Length	Net Price
8-60	60"	\$2.82
8-72	72"	3.07
8-84	84"	3.13
8-86	86"	3.42
8-96	96"	3.55

WHIP ANTENNA SPECIFICATIONS

MODEL	Overall Length	Base Specifications	Net Price
100-60S	60"	Threaded 3/8" Stud to fit all Mounts	\$4.95
100-72S	72"	Threaded 3/8" Stud to fit all Mounts	4.95
100-78S	78"	Threaded 3/8" Stud to fit all Mounts	5.00
100-86S	86"	Threaded 3/8" Stud to fit all Mounts	5.15
100-90S	90"	Threaded 3/8" Stud to fit all Mounts	5.20
100-96S	96"	Threaded 3/8" Stud to fit all Mounts	5.25
106-60S	60"	Plain End 7/8" Dia. (Fits Model 92 Ext.)	4.15
106-72S	72"	Plain End 7/8" Dia. (Fits Model 92 Ext.)	4.15
106-78S	78"	Plain End 7/8" Dia. (Fits Model 92 Ext.)	4.20
106-86S	86"	Plain End 7/8" Dia. (Fits Model 92 Ext.)	4.35
106-90S	90"	Plain End 7/8" Dia. (Fits Model 92 Ext.)	4.40
106-96S	96"	Plain End 7/8" Dia. (Fits Model 92 Ext.)	4.50

ALL BAND
MOBILE
ANTENNA

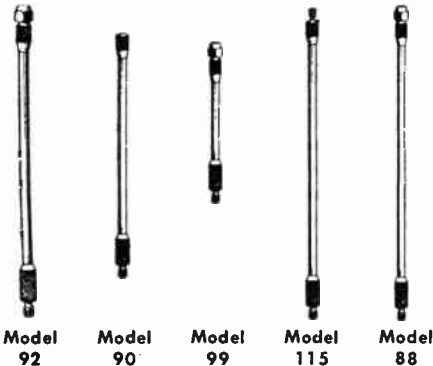

Model	Overall Length	Description	Net Price
92	36"	Lower Section for all Band Antennas	\$4.95
88	36"	In Chrome Plate	6.45
90	26"	Extension for 100 Series Whips	3.95
99	8"	Extension for 106 Series Whips	3.50
94	36 1/4"	Extension for 106 Series Whips	4.95
92	18 1/4"	Tenna-juster for Whip Adjustment on AB/W Antenna	1.95
115	36"	Extension for Models No. 114 and No. 214	4.25

New Model No. 132-J Junior Body Mount—Same design as our standard No. 132 Master Mount but of slightly less size. Built to approved Master specifications for quality of materials, workmanship and finish. Attractive priced at only.....\$4.17

Model No. 132-JC—Same as above with Coax Connector....Only \$5.17

New Model No. 140-J Junior Bumper Mount—Same design as our standard No. 140 Master Mount but of slightly less size yet of same high quality spring construction and finish. Competitively priced at an attractive Net of only.....\$4.17

Coaxial Conversion Kit—No. 118 fits No. 132 and No. 118J fits No. 132J Models.....Net \$1.00

MASTER ALL-BAND ANTENNAS

Model	Length	Coil	Net Price
AB/W20	20 Meter	Coil	\$11.50
AB/W40	40 Meter	Coil	11.50
AB/W75	75 Meter	Coil	11.50
AB/W160	160 Meter	Coil	16.95

EXTRA COILS

Model	Coil	Net Price
M-20	Coil	\$3.95
M-40	Coil	3.95
M-75	Coil	3.95
M-160	Coil	7.95
M-2374 KC	Coil	6.75
M-2738 KC	Coil	6.75
M-2768 KC	Coil	6.75
M-4507.5 KC	Coil	5.75
M-4585 KC	Coil	5.75
M-4325 KC	Coil	5.75

CIVIL AIR PATROL ANTENNA

Model	Net Price
4507.5, 4585, 4325 KC	\$13.95
2374, 2738, 2768 KC	14.95

ORDER FROM YOUR JOBBER TODAY!

Master Mobile Mounts, Inc.

P. O. BOX 1817 · LOS ANGELES 36, CALIFORNIA
WAREHOUSE AND SHIPPING ADDRESS: 1306 BOND STREET

ANTENNAS

Master Mobile

MOUNTS

NEW

INCREASE YOUR QSO AND DX QUOTAS WITH...

HY "Q" ANTENNA COILS...

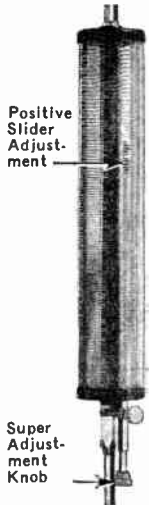

MASTER HY "Q" ALL-BANDER MODEL No. "666"

Master Mobile presents the greatest advancement in antenna coils in a decade... fully enclosed, the variably-spaced **NON-LINEAR** adjustable slide antenna coil with built-in Hy-Q!

Because it maintains a fairly constant "Q" over 4 lower ham bands, this coil will operate with a minimum of losses... meaning more QSO's on less power. Positive action, non-quivering slider contact assures steady signals that will stay put. Simple, one-shot tuning for any band. The ideal for that mobile rig of yours. Get it!

NET **\$14.95** EA.

NEW HY "Q" COILS AIR-WOUND



Ar Spaced Coil Winding • Protective Coated Coils Highest "Q" Possible • Weather Sealed • Extremely Lightweight

MASTER MOBILE is first again with the finest tried and tested coil. The new MASTER HY "Q" Antenna Coils are approved first in reception, finest by comparison. Never in mobile communication history have coils of such sensitivity been manufactured. Master HY "Q" Coils deliver more QSO's and greater DX with universal satisfaction wherever used.

Master HY "Q" Coils are products of advance research and are especially engineered to provide the highest possible "Q" consistent with good design. HY "Q" Coils are compact, extremely rugged, yet lightweight... Glyptol coated air spaced coil winding insures the finest transmission and reception.

GO MOBILE WITH MASTER HY "Q" COILS... NET **\$6.95** EA.

HY "Q" C.A.P. ANTENNAS

HY "Q" C.A.P. 2374 KC.	HY "Q" C.A.P. Antenna with choice of one (1) HY "Q"	Net \$17.15
HY "Q" C.A.P. 2738 KC.	C.A.P. Coil according to frequency desired.	Net 17.15
HY "Q" C.A.P. 2768 KC.		Net 17.15
HY "Q" C.A.P. 4507.5 KC.		Net 14.95
HY "Q" C.A.P. 4585 KC.		Net 14.95
HY "Q" C.A.P. 4325 KC.		Net 14.95

HY "Q" C.A.P. COILS

HY "Q" 2374 KC.	(Additional HY "Q" C.A.P. coils to be used with HY "Q" C.A.P. Antennas according to frequency desired. These coils are interchangeable.)	Net \$ 8.95
HY "Q" 2738 KC.		Net 8.95
HY "Q" 2768 KC.		Net 8.95
HY "Q" 4507.5 KC.		Net 7.95
HY "Q" 4585 KC.		Net 7.95
HY "Q" 4325 KC.		Net 7.95
HY "Q" 160 Meters		Net 12.95

2 METER ANTENNAS — FIXED • MOBILE

GROUND PLANE ANTENNA

Model 300—Master DeLuxe... NEW!... brings in that DX for you. Outperforms any type of vertical dipole. "Drooping" Type Ground Plane plus four straight radials to give a low angle of radiation for general coverage. It gives an almost perfect circle radiation pattern. Ideal for (D) and defense nets. Covers complete Amateur Band with excellent Broad Band characteristics. Other frequencies as specified. Matches 52 ohm coaxial cable through threaded coaxial fitting at end. Straight radials are adjustable (up or down) for purpose of eliminating standing waves on transmission lines. For medium or low-powered transmitters. Sturdily built of finest alloys to withstand corrosion, high winds and extreme icing. With 36" length of 1/2" pipe for mounting purposes. Standard mounting facilities can be secured locally.

Model 300... Amateur's Net \$12.95
MB-1—Mounting Bracket... Net 1.00

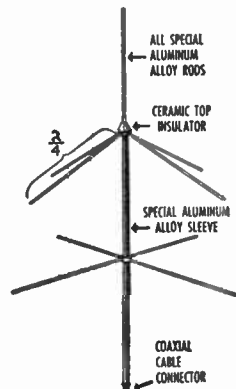

Model GP-4 — Four "Drooping" Radials for perfect match to 52 ohm coax cable. Complete amateur band coverage. Specify other frequencies. Attaches to Mast with 1" Bolts. (Bolts and Mounting Brackets furnished. Also attachable to side of building. Sturdy with special alloys, to withstand corrosion and extreme weather.

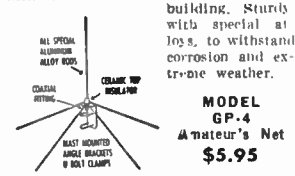

MODEL GP-4 Amateur's Net \$5.95

TWO METER COAX ANTENNAS

No. 214—MASTER DELUXE... ruggedly constructed, vertically polarized, frequency range 140 to 170 MC. completely waterproofed. Highly polished chrome enhances appearance of any vehicle. Furnished with 10 ft. of 72 Ohm Coax Cable. Type 1—On side with 2 brackets furnished. \$15.95
Type 2 — Master Mount (No. 132X or 140X)—Mounts sold separately. Complete \$17.45
Adjustable mounting—adjusts to 17".

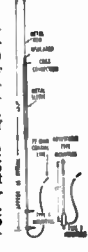

2 METER STANDARD MODEL

No. 114 COAX VHF ANTENNA — At a popular price! For OPEN TYPE VEHICLES using 140 MC to 165 MC. Mounts any convenient place with standard Master Mounts. Baked enamel finish. With 10 ft. Coax Cable and 18" Adjustable Section. Net, Only \$9.95

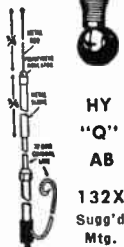

HY "Q" AB 132X Sugg'd Mtg. \$13.95

No. 613



No. 613—NEW IMPROVED MASTER VHF ROOF TOP ANTENNA. This new high performance antenna features an improved type positive-lock coaxial connector. Designed for police, fire, taxi cabs and amateurs using 140 MC to 165 MC. Stainless steel wire with threaded fitting. Easily changed without disturbing mounting. Comes with 10 ft. coax cable. Net \$4.95

No. 113—MOBILE ROOF TOP ANTENNA without De Luxe Connection... Net 3.96
No. 117—Extra Antenna for No. 113 and No. 114... Net .97
No. 116—Extra Antenna for No. 214 and No. 613... Net 1.70

Master Mobile Mounts, Inc.
P. O. BOX 1817 • LOS ANGELES 36, CALIFORNIA
WAREHOUSE AND SHIPPING ADDRESS: 1306 BOND STREET

HY-LITE ANTENNAS for any installation

Any antenna problem can be solved with the use of the proper HY-LITE model. There is a unit for every purpose and every job. Single channel and all-band antennae are available for local, medium, and fringe areas. HY-LITE units are made of tubing that is specifically manufactured for use in antennae. Combined with HY-LITE time proven methods of construction, this tubing is made into units that will give unequalled reception and long life.

HY-LITE END FIRE ARRAYS

MODEL D. V., 2-13

Versatile local and semi-fringe unit. Stacked for fringe area. Features simplicity of installation.



MODEL C. V., 2-13, UHF

Advanced all channel End-Fire Conical high uniform gains fringe area unit. Stacked for more gain.

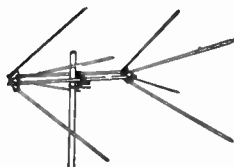

HY-LITE CONICAL TV ANTENNAS

MODEL X6R2, 2-13

6-Element Insert, Dipole. Pre-assembled Reflector.

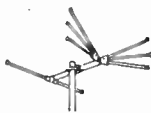

MODEL X6HR2, 2-13

All Band-High Gain Two Elements Peaked for High Band.



MODEL X4R2, 2-13

4-Element Dipole Pre-assembled Reflector.



HY-LITE "YAGI"

The HY-LITE "YAGI" is designed for signal reception on a specific channel. The important feature of the "YAGI" type antenna for TV receivers is the directional characteristic. This affords greater discrimination against unwanted interfering signals and at the same time gives better reception to the TV Signal the "YAGI" is designed to receive. Specify channel when ordering.

MODEL 10Y #14-B3 YAGI

Peaked for top efficiency on a single channel. Made in 10 elements and designated by 10Y #14 for channel 14, etc. Made in 5 elements and designated by 5Y #14 etc. Order by channel. (Pre-assembled.)

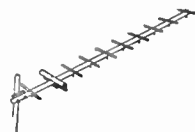

MODEL 5Y

5-Element Yagi. Pre-assembled, Elements Pre-aligned.



MODEL BY

8-Element Yagi. Low Band supplied with extra boom Cross-Arm as shown.



MODEL 10Y

10-Element Yagi. Low Band supplied with extra Boom Cross-Arm as shown.



YAGI MODELS FOR UHF AVAILABLE

HY-LITE SNAP OUTS

MODEL BHF, 7-13

High Band Folded Dipole & Reflector Pre-assembled.

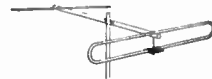

MODEL S030, 2-5 & S030-6

Low Band Folded Dipole & Reflector.



MODEL S070, 2-6

Low Band Straight Dipole & Reflector Pre-assembled for Low Impedance Lead.



MODEL S070 BHF, 2-13

Folded High with Straight Low.



MODEL S030 BHF, 2-13

Folded High with Folded Low Dipoles with Reflectors.



MODEL S040, 2-13

In-Line High & Low.



MODEL S040-D, 2-13

In-Line High & Low Additional Director for High Band.



HY-LITE UHF ANTENNAS

MODEL UFDV "DOODLE-VEE"

High gain - ALL BAND UHF. Available, Double or four bay. All aluminum snap-out assembly, including "Q" Bars.



MODEL UFBT

UHF Bow tie with grid bar reflector - all band - High gain - Broad band. Available for stacking with "Q" Bars. Completely pre-assembled.

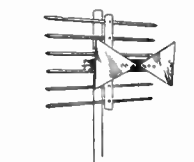

MODEL UF170 "BAR-GAIN"

High gain broad band uniform UHF response. Top grade aluminum, pre-assembled.

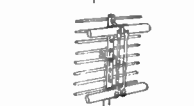

HY-LITE FM ANTENNAS

MODEL FM 30

Folded Dipole & Reflector.



MODEL Y FM

High Gain Directional F.M. Antenna for Areas with Weak Signal.



MANUFACTURERS OF THE FAMOUS HY-LITE AMATEUR BEAM ANTENNAS

IT PAYS to play the winner!

FOR PROFIT AND PERFORMANCE SPECIFY RADION... IT PAYS!

Radion products give you high-profit volume sales. They are designed to save time and manpower... to be as all-purpose as possible to simplify your inventories. They are quality-built to minimize service problems. That's why Radion products are recognized and preferred by jobbers, dealers and customers alike!

REMEMBER RADION...

- First to build the indoor VHF antenna... still far ahead in sales!
- First to bring you the lightning arrestor that fits all twin leads, mounts anywhere!
- First with a smart, compact indoor UHF antenna!
- First with a compact, all-channel VHF-UHF indoor antenna!
- First with the amazing 16-lb. portable VHF-UHF Field Strength Meter!

It's leadership in design, in quality, in profit that makes Radion the winner. That's why it pays YOU to play the winner... Radion!

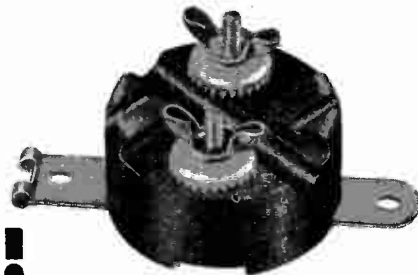

LA-75
Lightning Arrester
\$1.35 list



BULLSEYE
UHF Antenna
\$4.95 list

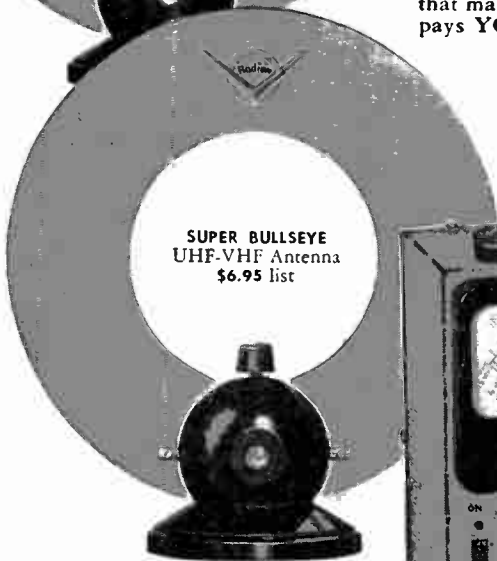

SUPER BULLSEYE
UHF-VHF Antenna
\$6.95 list

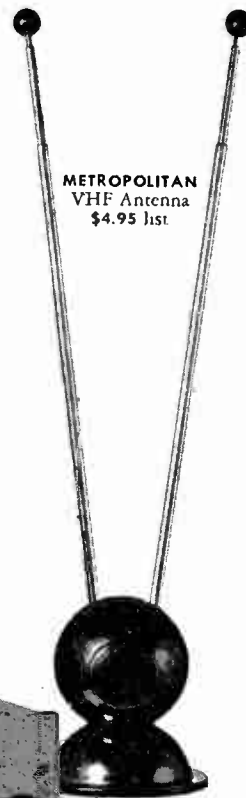

METROPOLITAN
VHF Antenna
\$4.95 list



FSM 5000
Field Strength Meter
\$97.50 dealer set

Radion

THE RADION CORPORATION

1130 WEST WISCONSIN AVENUE • CHICAGO 14, ILLINOIS • MO 4-4617



C-D TV ANTENNAS

SUPERIOR DESIGN • QUICKLY INSTALLED • TROUBLE-FREE PERFORMANCE

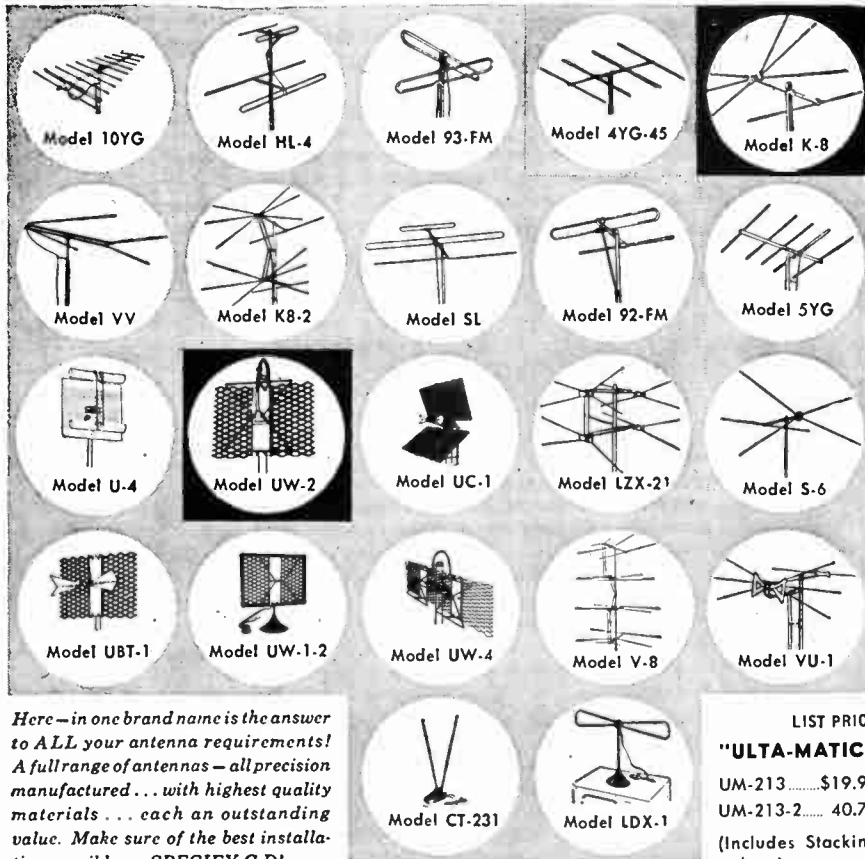

Here—in one brand name is the answer to ALL your antenna requirements! A full range of antennas—all precision manufactured... with highest quality materials... each an outstanding value. Make sure of the best installation possible... SPECIFY C-D!

TYPE	LIST PRICE
QUICK RIG CONICAL	
K-8	\$16.95
K8-2	34.95
"LAZY-X" CONICAL	
LZX	\$ 6.95
LZX-M	8.85
LZX-MA	9.95
Stacked "Lazy-X"	
LZX-2L	\$14.95
LZX-2	16.95
LZX-4	33.25
"Bulk Packed"	
LZX-6B	\$40.65
LZX-6BE	34.95
LZX-6BQ	43.60
ALL-ALUMINUM SERIES	
LZX-AA	\$ 8.30
LZX-2LAA	17.75

TYPE	LIST PRICE
SUPERIOR CONICAL	
S-6	\$ 5.80
Conical Stacking Bars	
AK-50	\$ 1.00
AK-51	3.40
AK-54	1.65
"SUPER-VEE"	
VV	\$ 8.75
VV-2	20.30
VEE-EIGHT ANTENNA	
V-8	\$41.50
"SUPER-VEE" STACKING BARS	
3AK-73-1	\$ 9.00
SUPERIOR GROUP	
SL-4	\$12.75
SL-4L	9.30
STACKING BARS FOR "STRATE-LINE"	
AK-57	\$ 1.65

TYPE	LIST PRICE
"HI-LO" SUPERIOR LINE	
HL-4	\$12.75
HL-4S	11.60
HL-4L	9.30
L-4M	7.75
L-4L	7.00

INDOOR ANTENNAS	
LDX-1	\$ 5.95
CT-231	4.35
CT-331	5.25

"YAGI" ANTENNAS	
5YG-2	\$12.95
5YG-3	12.60
5YG-4	11.75
5YG-5	10.95
5YG-6	10.45
5YG-7 (thru 13)	5.75
4YG-45	15.95

TEN ELEMENT "YAGI"	
10YG-2	\$29.95
10YG-3	28.95
10YG-4	26.95
10YG-5	25.95
10YG-6	23.75
10YG-7 (thru 13)	13.25

STACKING BARS FOR "YAGI" ANTENNAS (Specify channel)	
AK84-(2 to 6)	\$ 4.00
AK84-(7 to 13)	5.20

"UHF" ANTENNAS	
U-4	\$ 7.50
UW-2	5.95
UW-4	9.95
UW-8	18.95
UC-1	12.95
UC-2	10.95
UBT-1	5.25

UHF "YAGI" ANTENNAS	
6YG-Series	\$ 4.77

(Stacking bars are included in all the above listed models of UHF antennas.)

"UHF-VHF" COMBINATION	
UV-S6	\$ 7.50

"DELUXE" FM ANTENNAS	
92FM	\$15.65
93FM	16.35

TV ACCESSORIES ANTENNA MOUNTING EQUIPMENT	
--	--

AK-31	\$ 0.75
AK-85	3.95
AK-95	5.95

STAND-OFF INSULATORS	
AMX-122	\$ 0.10
ASA-279	.25

LIGHTNING ARRESTERS	
TA-5	\$1.25 ea.
TA-5WS	1.35 ea.
TA-5BP	1.25 ea.

For detailed description of antennas refer to C-D Catalog CF-902.

CORNELL



DUBILIER

CAPACITORS—ROTATORS—VIBRATORS—AUTO, TV & FM ANTENNAS—CONVERTORS

C★D★R ROTORS

The Ultimate in Heavy Duty Rotors

Complete with modern cabinet and meter-control dial.. uses 4 wire cable.

- Handles heavier loads with ease...as much as 150 pounds • Streamlined weather-proof design...durable sturdy construction • 12 heavy duty ball bearings in two 6½" ball bearing races • Heavily reinforced die cast housing • Heavy duty precision gears • Positive stop at end of rotation • Reversible clamps will handle 7/8" to 2" masts • Heavy duty motor—reverses instantly • Mast, tower or platform mounting • 3 heavy duty guy wire lugs • Completely weather-sealed — factory lubricated for life • Available in mahogany or blonde finish cabinet.

THE NEW TR-4

TR-4... the de-luxe HEAVY DUTY rotor complete with modern design meter control dial cabinet, using 4 wire cable

\$48.95

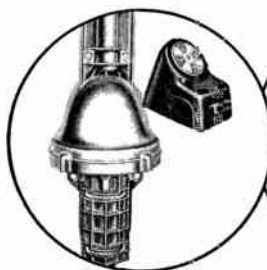
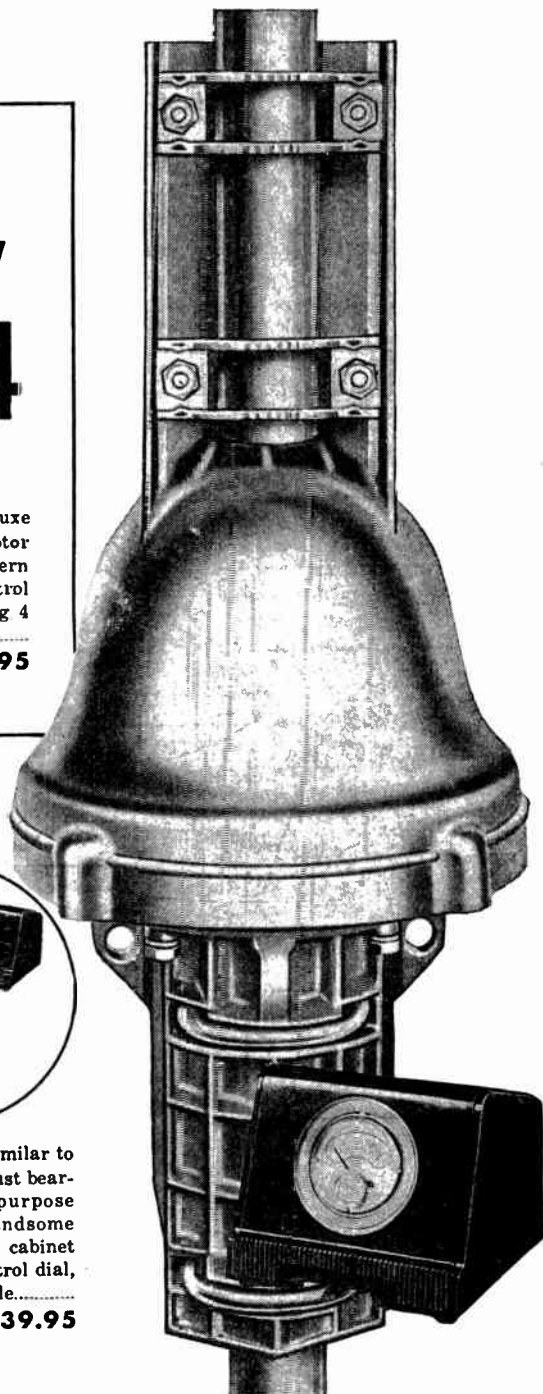

TR-2... the heavy-duty rotor, (similar to TR-4) complete with "Compass Control" cabinet and illuminated "perfect pattern" dial, 8 wire cable.....

\$44.95

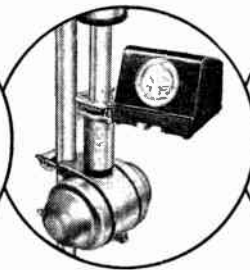

TR-12... a special combination value consisting of complete rotor, including thrust bearing ... handsome modern design cabinet with meter control dial, 4 wire cable

\$42.95

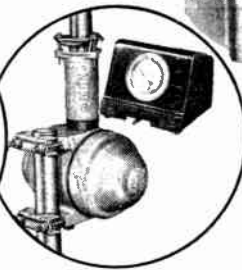

TR-11... (Similar to TR-12, less thrust bearing), the all-purpose rotor with handsome modern design cabinet with meter control dial, uses 4 wire cable.....

\$39.95

CORNELL



DUBILIER

CAPACITORS — ROTATORS — VIBRATORS — AUTO, TV & FM ANTENNAS — CONVERTORS

Brand New!

The Fastest Mounting.. Best Performing Auto Aerial on the Market!

- ★ Speedy One Man Installation
 - ★ 30' Mast Adjustment
- Fits All Body and Fender Contours*

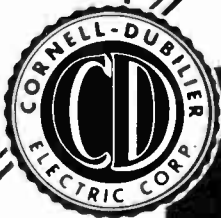
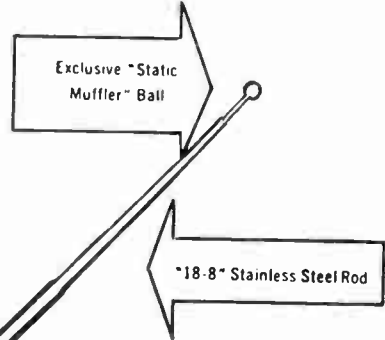

CORNELL-DUBILIER
Spee-Dee
MODEL 8BE
AUTO AERIAL

"Super Chrome" Finish on High Tensile Strength Brass Mast

Spee-Dee Assembly

Beautiful Chromed Metal Top Spacer and Cap Nuts (All Upper Mounting Hardware is Chrome on NICKEL)

Extra Long Full 42" Polyethylene Lead-In

EASY 1-2-3 INSTALLATION

Here is the outstanding new auto aerial and it has everything! Handsome in appearance... outstanding in performance... and a new design that is a snappy one, two, three, installation... WITHOUT EVEN LOOKING UNDER THE FENDER!

\$4.95
List ...

STANDARD
MODEL CT-231
TWO SECTION RODS
EXTENDABLE 20 1/4" to 37 1/2"
12 per master carton
Shipping weight 18 lbs.
LIST PRICE \$4.35 EACH



DELUXE
MODEL CT-331
THREE SECTION CHROME RODS
RODS EXTENDABLE 16 1/4" to 43 1/4"
12 per master carton
Shipping weight 19 lbs.
LIST PRICE \$5.25 EACH

The New . . .

Hi-Lo UHF-VHF

Spiral Indoor Antenna

Model 202

Peak performance for
Indoor UHF and VHF
TV reception

Channels
2-83

\$995 LIST PRICE
Complete with Lead

Takes only seconds to install . . . receives clear pictures immediately, tuned to high or low TV channels. No switches or rods to adjust. 20 inches high, 32 inches wide. Gleaming gold tone appearance with smart bakelite base and aluminum bars. Modern design blends with any furniture.

Best TV Reception . . .



Hi-Lo Spiral - Tenna Indoor Antenna

- The one and only original Spiral-Tenna
- Nothing to adjust
- Receive clear pictures immediately
- Tuned to high or low TV channels
- Blends with all furniture
- Installed in a few seconds
- Smart bakelite base, aluminum bars, gleaming gold appearance

Channels
2-13

Peak Performance
for Indoor TV Reception.

Model 101

\$995 LIST PRICE

Complete with Lead



Amazing
New . . .

Channels
14-83

Hi-Lo TWIN ARROW

Indoor UHF Antenna

Covers complete UHF band —Twin arrows may be adjusted for local areas. Has luxurious gold tone upright and crossbar with light-weight plastic base. Designed to blend with any furniture. Takes only a short time to install.

\$595 LIST PRICE

Model
303

Complete with Lead

U.S. Pat. No. 2,495,579
Canadian Pat. 1951
Other Pats. Pending

Mfd. By **Hi-Lo** TV Antenna Corporation
Chicago 13, Illinois

Copyright by U. C. P., Inc.

TRADE DISCOUNT APPLIES TO LIST PRICES ONLY

Radio's Master — 19th Edition

Page S-97



Miller



TELEVISION CO.

Manufacturers of the

Selection of Antennas

- AN ANTENNA FOR EVERY NEED.
- 400 MODELS TO CHOOSE FROM.
- 1,500,000 ANTENNAS PRODUCED SINCE 1948.

V.H.F. FRINGE AREA (SINGLE CHANNEL YAGIS)

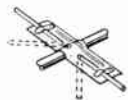
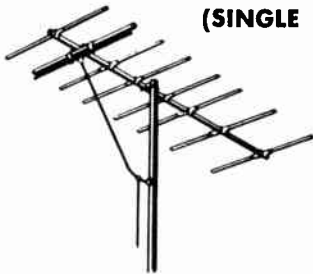

SNAP-IN-CLIP

8TC6

8 element T match Yagi \$16.00

LIST
PRICE

U.H.F. NORMAL AREA, BROAD BAND

A Corner Reflector that
Opens Like a Book



CR200

1/4" tubing reflector screen 7.65

LIST
PRICE



U.H.F.-V.H.F. COMBINATION CHANNELS 2 to 83

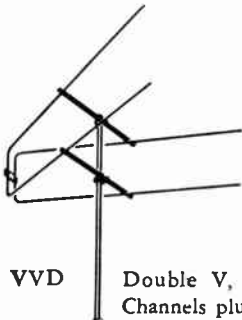

VVD

Double V, Deluxe, all U.H.F.
Channels plus Hi Band U.H.F. . . . 4.60

LIST
PRICE

V.H.F. FRINGE AREA (MULTI-CHANNEL YAGIS)

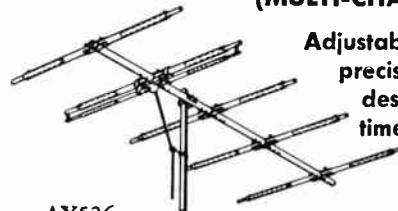

Adjustable Yagi permits
precise setting to the
desired channel at
time of installation

AY526

5 element, adjustable Yagi, channels 2 to 6. 12.00

LIST
PRICE

MODEL D-60 TUBE REACTIVATOR



C.R.T. Checker
and re-activator
Dealer's net,
\$89.50

AUTOMOBILE AERIALS



TC100 Del.

Top cowl, 3 section telescoping
chrome plated brass tubing,
55" extended length, 24" col-
lapsed length, single hole
mount 4.20

LIST
PRICE

• FULL FREIGHT ALLOWED • UNCONDITIONAL GUARANTEE • IMMEDIATE DELIVERY

MILLER TELEVISION CO., Burbank, California



Miller



TELEVISION CO.

Manufacturers of the

Selection of Antennas

- AN ANTENNA FOR EVERY NEED.
- 400 MODELS TO CHOOSE FROM.
- 1,500,000 ANTENNAS PRODUCED SINCE 1948.

V.H.F. NORMAL AREA, BROAD BAND (CONICALS)

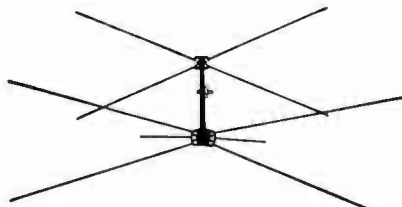

C64 Del. 6 dipoles, 4 reflectors 6.00

LIST PRICE

V.H.F. FRINGE AREA, BROAD BAND

(YAGI—CONICALS)
CHANNELS 2 to 13

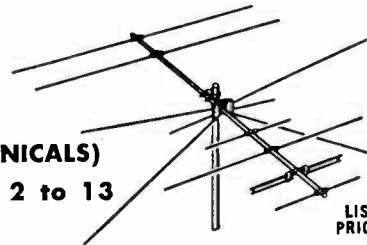

YC100
Yagi combined with single conical, pre-assembled, doweled and crimped elements 9.75

LIST PRICE

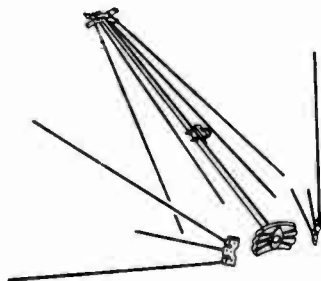

C6P4P Del. 6 pre-assembled dipoles, 4 pre-assembled reflectors 6.54

LIST PRICE

V.H.F. FRINGE AREA, BROAD BAND (REFLECTOR SCREENS)

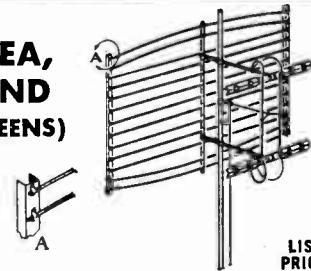

FRM300 Del.
* Radar screen, pre-assembled with snap-in clips 34.95

LIST PRICE

*Triangular dipoles with hi impact insulators

V.H.F. WEATHER VANE SERIES

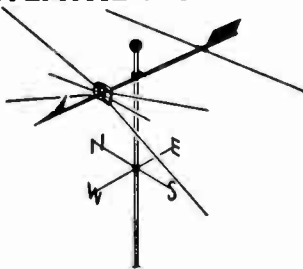

WVC Conical, channels 2 to 13 favoring 2 to 6 12.00

LIST PRICE

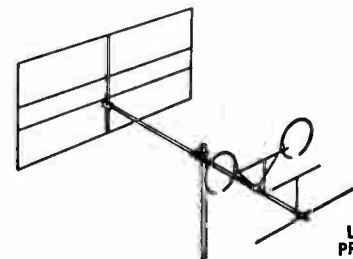

BF200
Another Miller first. Patent pending. Bi-Focal with reflector screen. Highest gain of all reflector screen types 35.95

LIST PRICE

• FULL FREIGHT ALLOWED • UNCONDITIONAL GUARANTEE • IMMEDIATE DELIVERY

MILLER TELEVISION CO., Burbank, California



RADELCO AERIALS

RADELCO "BAR-X" CONICAL ANTENNA

with the ORIGINAL High Channel Director Bar

King of the Conicals!

Director Bar definitely improves performance on high channels where reception is most difficult.

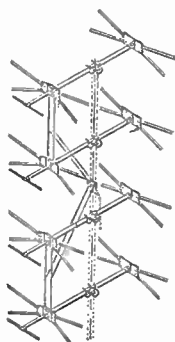
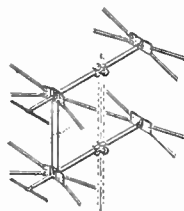

Heavy duty construction thruout. Rugged 1" cross boom. Aluminum elements specially engineered to reduce vibration and noise. All boom fittings are pre-assembled.

SINGLE STACK consists of single Bar-X array. U-bolt mounting. Fits mast up to 1 1/2".

Model	List	Pkg.	Ship. Wt.
RS-751	\$7.65	4	20 lbs.

DOUBLE STACK consists of 2 bays, complete with jumper bars.

Model	List	Pkg.	Ship. Wt.
RS-752	\$16.15	4	38 1/2 lbs.

QUAD STACK consists of 4 bays complete with all linking bars and terminal block.

Model	List	Pkg.	Ship. Wt.
RS-754	\$35.85	1	20 lbs.

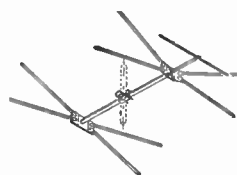

RADELCO DOUBLE STAR ANTENNA KITS

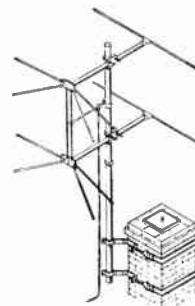

**SAVE TIME!
SAVE MONEY!**

Made of finest materials and designed for trouble-free performance. Elements are tight butt seam aluminum tubing, reinforced with wood dowels. U-bolt mounting takes up to 1 1/2" mast. Heavy gauge steel fittings with thick zinc plating. Mounting plates, U-bolts and saddle assembly are attached to boom before shipping.

REAL LOW PRICES!

SINGLE STACK

Model	List	Pkg.	Ship. Wt.
RK-901	\$10.95	4	39 1/2 lbs.

DOUBLE STACK

Model	List	Pkg.	Ship. Wt.
RK-902	\$19.30	2	31 1/2 lbs.

RADELCO RS-800 SERIES OF CONICAL ANTENNAS

Pre-assembled with wing nuts to assure quick, easy installation. Made of finest materials and designed for trouble-free performance. Elements are tight butt seam aluminum tubing, reinforced with wood dowels to eliminate vibration and breakage. Ends are crimp closed to prevent whistling. Rugged cross boom pre-assembled. U-bolt mounting will take up to 1 1/2" mast. All fittings are of heavy gauge steel with thick zinc plating.

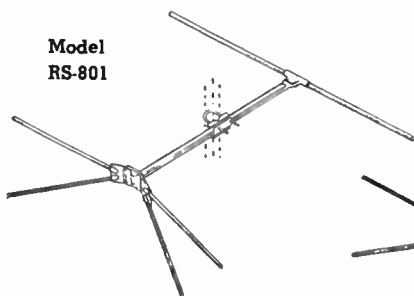

Model RS-801

X-TYPE CONICAL WITH STRAIGHT REFLECTOR

One of the greatest values offered today in Conical antennas. Packed in bulk, 4 to a carton.

Model	List	Pkg.	Ship. Wt.
RS-801	\$ 4.85	4	12 1/2 lbs.

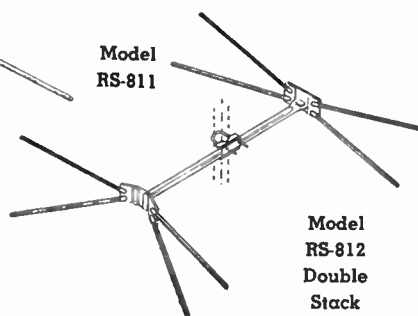

Model RS-811

X-TYPE CONICAL WITH X-REFLECTOR

Packed in bulk, 4 to a carton.

Model	List	Pkg.	Ship. Wt.
RS-811	\$ 5.90	4	15 1/2 lbs.

Double stacked array with jumper bars. In bulk, 2 double arrays per carton.

Model	List	Pkg.	Ship. Wt.
RS-812	\$12.80	2	16 lbs.

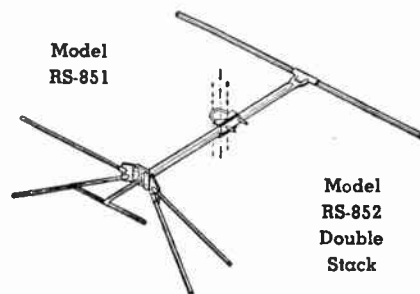

Model RS-851

Model RS-852 Double Stack

BAR-X CONICAL WITH STRAIGHT REFLECTOR

Equipped with hi-channel director bar. Packed in bulk, 4 to a carton.

Model	List	Pkg.	Ship. Wt.
RS-851	\$ 5.60	4	14 lbs.

Double stacked array with jumper bars. In bulk, 2 double arrays per carton.

Model	List	Pkg.	Ship. Wt.
RS-852	\$12.05	2	14 1/2 lbs.



RADELCO AERIALS

RADELCO IMPERIAL LINE OF AREA-CUSTOMIZED YAGIS

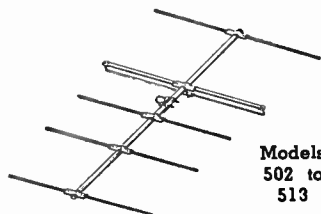

Models
502 to
513

FIVE ELEMENT YAGI

The ideal aerial for extreme fringe areas. Custom cut. Five heavy-duty aluminum elements pre-assembled on rugged 1" boom. U-bolt mounting assembly takes up to 1½" mast.

Model	Chan.	Mc.	List
YS-502	2	54-60	\$12.30
YS-503	3	60-66	11.65
YS-504	4	66-72	10.90
YS-505	5	76-82	10.25
YS-506	6	82-88	9.45
YS-507	7	174-180	7.15
YS-508	8	180-186	7.15
YS-509	9	186-192	7.15
YS-510	10	192-198	7.15
YS-511	11	198-204	7.15
YS-512	12	204-210	7.15
YS-513	13	210-216	7.15

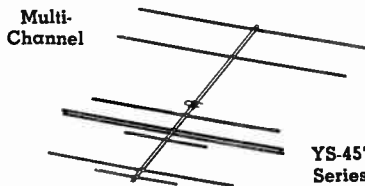

Multi-Channel

YS-457
Series

SEVEN ELEMENT YAGI

These new Radelco 7 and 8 element Yagis are the first, true Yagis to be developed for a combination of low and high band VHF channels. Each antenna is area-customized and designed to provide high peak gain on the channels indicated. Its phenomenal front to back ratio cuts out ghosts and positively reduces picture snow. Matches 300 ohm line. Ideal for fringe areas.

Model	Channels	List
YS-457	4, 5, 7	\$13.05
YS-457-A	4 and 5	13.05
YS-457-B	5 and 7	13.05

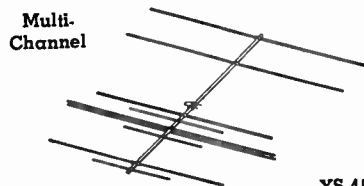

Multi-Channel

YS-458
Series

EIGHT ELEMENT YAGI

Operation description same as Model YS-457. Durably built for long service and trouble-free performance. Aluminum elements are carefully cut for finest picture reception. U-bolt takes up to 1½" mast.

Model	Channels	List
YS-458	4, 5, 8	\$14.30
YS-458-A	4 and 5	14.30
YS-458-B	5 and 8	14.30
YS-458-C	4, 5, 9	14.30
YS-458-D	4 and 9	14.30
YS-458-E	5 and 9	14.30
YS-458-F	4, 5, 10	14.30
YS-458-G	4 and 10	14.30
YS-458-H	5 and 10	14.30
YS-458-I	4, 5, 11	14.30
YS-458-J	4 and 11	14.30
YS-458-K	5 and 11	14.30

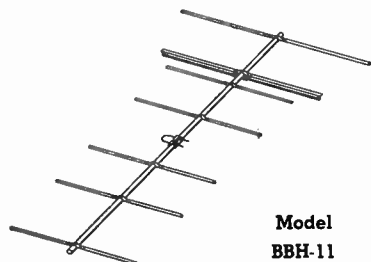

Model
BBH-11

BROAD BAND HI-CHANNEL YAGI

Designed by Radelco to provide clearer, sharper TV pictures on all 7 high band VHF channels. Definitely superior to any broad band Yagi on the market. Ideal antenna for any area having two or more high band stations. Makes possible smaller inventory by reducing number of models to be stocked. Quality built and engineered by Radelco. Packed 4 to a bundle. Ship Wt. 20 lbs.

Model	Channels	List
BBH-11	7 thru 13	\$10.20

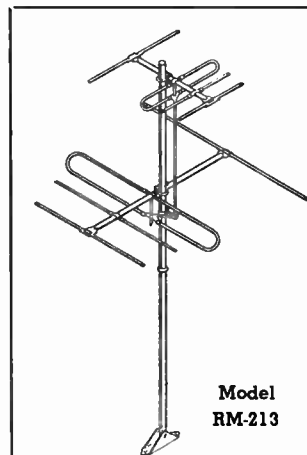

Model
RM-213

TOPPER New Dual YAGI

Separately Orienting All-Channel VHF Antenna

The perfect antenna for areas where stations are NOT in the same direction. Fills all reception requirements, provides "true" Yagi performance on all 12 VHF channels. Complete with two 5-ft. mast sections, swivel base, guy ring, clamp-type Stand-off insulator, jumper harness and arrays. Package of 4 — 40 lbs.

Model	Channels	List
RM-213	2 thru 13	\$16.25

Model
RS-206
RS-217

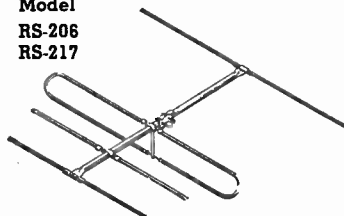

ALSO AVAILABLE
AS SEPARATE ARRAYS

Low Band Yagi Array

Model	Channels	List
RS-206	2 thru 6	\$ 8.25

High Band Yagi Array

Model	Channels	List
RS-713	7 thru 13	\$ 3.95



RADELCO AERIALS

RADELCO UHF-VHF ANTENNAS

Designed with Tomorrow in Mind!

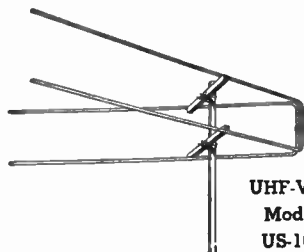

UHF-VHF
Model
US-102

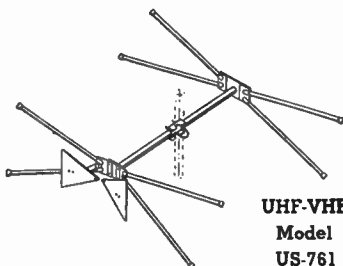

UHF-VHF
Model
US-761

UHF
Model
US-151

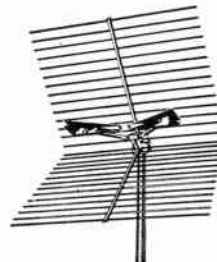

TWIN-V ALL-CHANNEL ANTENNA

A big favorite wherever used. Gain increases with increasing frequency. This means that it compensates for the greater transmission losses at the high frequency end of the band. Matches 300 ohm line. Completely pre-assembled.

Model US-102 Double Stack as shown 2 to a carton
List (less mast) \$4.35

Model US-102A Double Stack as shown 1 to a carton
List (less mast) \$4.83

Model US-104 Quad Stack with jumper bars
List (less mast) \$9.30

BOW-X ALL-CHANNEL CONICAL

Combines all the best features of the Conical, plus the added advantages of the Bow-Tie to provide exceptional performance on both UHF and VHF channels. UHF elements are isolated from VHF elements by a metallic insulator. Single transmission line to set for both UHF and VHF signals. Covers all channels from 2 thru 83. Packed 4 to a bundle.

Model	Stack	List	Wt.
US-761	Single	\$ 8.65	23½ lbs.
US-762	Double	18.20	39½ lbs.

UHF CORNER REFLECTOR

Provides clearest TV pictures under most difficult conditions. Superb high gain, extremely directive, broad band antenna. Engineered to eliminate ghost problems and reject interference. Easy to install, opens like a book. Covers all UHF channels. Mounts in front of mast. Takes up to 1½" mast. Shipped 4 to a bundle.

Model	List	Ship. Wt.
US-151	\$7.45	4 - 16½ lbs.

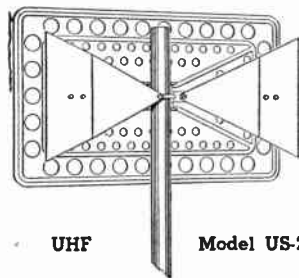

UHF Model US-201

BONANZA ALL-WEATHER ANTENNA

Works equally well in both wet and dry weather. All aluminum, all metallic construction with no plastic insulators to absorb moisture and weaken signals. Works perfectly, even in the dampest coastal locations. Shipped 4 to a bundle.

Model	Stack	List	Wt.
US-201	Single	\$ 3.95	4- 6 lbs.
US-202	Double	8.25	4-10 lbs.

New RADELCO R-122 LIGHTNING ARRESTOR



Takes Flat, Oval, Round and Open Cables

Precision carbon resistors bleed off static charges. Breakdown gap provides ground path for lightning surges. Positive piercing contacts eliminate stripping of insulation and provide perfect electrical path, regardless of variation in width or thickness of insulation.

50 to Carton List **90c**

RADELCO UHF-VHF INDOOR ANTENNA

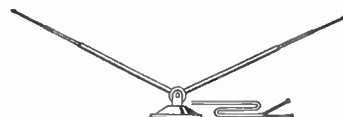

High quality antenna, attractively designed to harmonize with all room furnishings. 3 sections of satin plated masts, extend to 45". Heavily weighted base has smooth finished lacquered surface. Included 5-ft. lead with terminals.

Model	Pkg. - Ship. Wt.	List
VT-3A	20 - 20 lbs.	\$5.75



REGAL TUBE — Specially Developed for TV Masting

16 gauge cold rolled strip steel, Fosbonded inside and out to prevent rust indefinitely. Finished with a baked, plastic-coat enamel. Ten 10-ft. sections to a carton.

Model	Pkg. - Ship. Wt.	List
FJ-10	10 Len. - 76 lbs.	\$3.50



RADELCO AERIALS

AMERICA'S FINEST LINE OF AUTO ANTENNAS



MONARCH
Cowl-Fender

Model MH-3—Ball-joint metal mounting base, adjustable from flat to 30°. Base sufficiently large to cover largest holes. Lovely chrome finish. Waterproof construction. Holds angular adjustment permanently. 36" cable.

Model	Sec.	List
MH-3	3-57"	\$5.80
MH-3A	3-70"	6.40



ROTOLOK
Cowl-Fender

Model CO-3A — Easy mounting, all tightening outside. Half-inch mounting hole. Chrome-plated mounting base. Exclusive VISE-LOCK eliminates clumsy braces. Fits any fender or top cowl. 36" Radar type cable.

Model	Sec.	List
CO-3A	3-57"	\$5.30



CHAMPION
Side Cowl

Model CS-3 — A competitively priced aerial built to RADELCO's high quality standard. Chrome-plated brass tubing. Shielded polyethylene cable with silver cover. Screw-on connector and chrome capped insulators.

Model	Sec.	List
CS-3	3.66"	\$4.15



CONCEALED
Cowl-Fender

Model FD-3, 3A — Chrome-plated all-metal adjustable mounting base. Strong, non-crushable! Waterproof, electrically efficient, guaranteed trouble free. 48" Radar cable.

Model	Sec.	List
FD-3	3-4"-55"	\$7.65
FD-3A	3-9"-68"	8.15



"SCREW BALL"
Cowl-Fender

New, entirely different! Installed entirely from outside by only one man. The screw portion of the assembly assures quick and economical installation. The ball portion provides angular adjustment for every type of fender or cowl contour.

Model	Sec.	List
EZ-2	2-49"	\$3.55
EZ-3	3-57"	5.10



DELUXE
Side Cowl

Model RAD-3, 4, 5 — Built to superior quality standards. Automotive specification chrome-plate. Low loss 100% shielded 36" Radar cable with screw-on connectors.

Model	Sec.	List
RAD-3	3-70"	\$5.60
RAD-4	4-92"	6.60
RAD-5	5-112"	7.65



BUICK
Replacement
Mast

Mast for roof aerials on all Buicks from year 1940 to present models. Built to Radelco's high quality standards.

Model	List	Sec.	Lth.
B-448	\$2.85	4	45"



FORD
Replacement
Mast

For 1941, 42, 46, 47 Ford-Mercury Roof Antennas that operate behind windshield center post. A high quality replacement.

Model	List	Sec.	Lth.
F-254	\$2.30	2	54"

COMMUNICATION ANTENNAS

**BUILT FOR HARDEST MOBILE USE . . .
EACH AN OUTSTANDING VALUE!**



MB-1

SWIVEL BASE. Has adjustable split-ball with positive locking feature to maintain angular adjustment at all times. Black bakelite insulator mounting plate with moisture-proof rubber gasket. Heavy steel backup plate.

Model MB-1	List \$4.55	Ship Wt. 8½ lbs.	Pkg. 10
-------------------	-------------	------------------	---------

SWIVEL BASE AND SPRING. Responds instantly upon contact with overhead obstructions. 3/8" threaded fitting on end of spring.

Model	List	Ship. Wt.	Pkg.
MB-2	\$6.60	18½ lbs.	10
MB-2H (heavy duty spring)	7.65	22 lbs.	10

SPRING TEMPERED STEEL MASTS. Chrome silicon steel, can be bent 90° and still return to original vertical position. Fits any standard base.

Model	List	Lth.	Ship. Wt.	Pkg.
MM-40F Motorcycle Mast	\$5.40	40"	3 lbs.	10
MM-60 Mobile Mast	5.40	60"	5 lbs.	10
MM-72 Mobile Mast	5.40	72"	7½ lbs.	10
MM-84 Mobile Mast	5.65	84"	9¼ lbs.	10
MM-96 Mobile Mast	6.40	96"	10 lbs.	10

BASE SPRINGS. Oil tempered, tightly coiled heavy spring steel. Model MBS-1 is a regular strength spring. Model MBS-2 is a heavy duty spring for heavier masts.

Model	List	Ship. Wt.	Pkg.
MBS-1	\$2.30	20 lbs.	10
MBS-2	3.30	22½ lbs.	10

RADELCO Coaxial Connectors

Made to meet JAN and Signal Corps specifications. Insulators are of Durez mica material to assure long, satisfactory service. Each item shipped 50 to a carton.

Model	Item	List
PL-259	Coaxial Connector	\$.75
PL-258	Junction for use with PL-259	1.10
UG-106-U	Shield Cap	.25
SO-239	Coaxial Socket Receptacle	.85
UG-175-U	Cable Plug Reducer for RG-58-U	.25
UG-176-U	Cable Plug Reducer for RG-59-U	.25

BROAD-BAND VHF TRAPPER

TRAPPER CO-LINEAR YAGI—Cat. No. 1880

The most revolutionary antenna introduced in years. This one antenna model meets all VHF reception needs in primary, medium, medium-fringe and fringe areas plus UHF in primary areas. Exclusive Taco trapper wave-trap design makes possible a high-gain, yet neat, streamlined antenna. No larger than ordinary 5-element antenna. Packed 2 to a carton for convenience.

ALSO AVAILABLE Catalog No. 1882—Two stacked kit.
Catalog No. 1884—Four stacked kit.

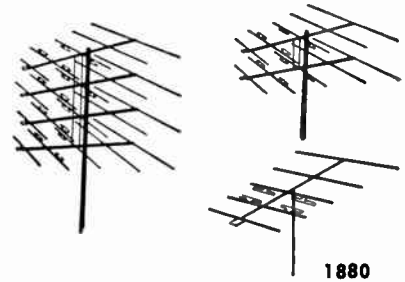

1880

HIGH-GAIN VHF TELEVISION ANTENNAS

LOW-BAND SINGLE CHANNEL

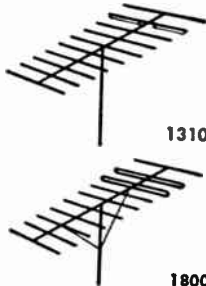

1310

1800

TEN-ELEMENT TWO-DIAMETER YAGI—Cat. No. 1310 ()

Eight directors and one reflector provide excellent front-to-back ratio and directivity for noise rejection. Two-diameter driven dipole matches 300-ohm transmission line for maximum energy transfer. May be stacked for increased performance. Cat. No. 1312 () 2-bay stacking lines also available.

5-ELEMENT YAGI—Cat. No. 1325 ()

An economical antenna for use in medium to medium-fringe installations. Two-diameter driven element provides 300-ohm terminal impedance. Cat. No. 1327 () 2-bay stacking lines also available.

10-ELEMENT TWIN-DRIVEN YAGI—Cat. No. 1800 ()

Features the patented Taco twin-driven principle whereby two folded dipoles are driven in parallel for higher gain and improved terminal impedance. Extremely high front-to-back ratio and sharp directivity for outstanding signal-to-noise ratio. Cat. No. 1802 () 2-bay stacking lines also available.



1325

HIGH-BAND SINGLE CHANNEL

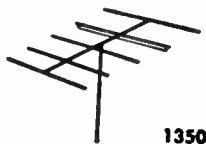

1350

10-ELEMENT YAGI—Cat. No. 1850 ()

Provides extra gain for fringe area installations on selected high-band channel. Excellent directivity and front-to-back ratio. Two-diameter driven element provides optimum match for 300-ohm transmission line. Ideal for use with Taco Supercharger. Also available as stacked array, Cat. No. 1851 ().

5-ELEMENT YAGI—Cat. No. 1350 ()

Designed for high-band single channel reception in medium and fringe areas. Provides the basic advantages of the yagi design along with low cost. Used extensively in metropolitan areas where noise rejection is desired. Also available is Cat. No. 1351 stacked array.

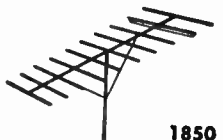

1850

LOW-BAND MULTI-CHANNEL

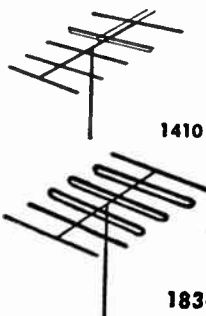

1410

1836

BAZOOKA-TUNED YAGI—Cat. No. 1410 (—)

Used where high gain is desired on two low-band channels. (Available in following combinations: (2 and 6); (3 and 6); (4 and 5); (4 and 6). Bazooka tuning device maintains sharp tuning necessary for high gain.

TRIPLE-DRIVEN BROAD-BAND YAGI—Cat. No. 1836

Designed to meet the needs for a high-gain antenna in areas where channels 3 through 6 are operating. Triple-Driven feature provides high-gain and sharp directivity. Terminal impedance matches 300-ohm transmission line. Stacking Kit, No. 1842, for 2 stack installations.

TRIPLE-DRIVEN BROAD-BAND YAGI—Cat. No. 1840

Receives all low-band channels from 2 through 6. Perfect mechanical balance plus extreme ruggedness lends this antenna to areas receiving stations from many directions through use of mechanical rotor. Good front-to-back ratio minimizes adjacent and co-channel interference. Stacking Kit, No. 1842 for two stack installations.



1840

HIGH-BAND MULTI-CHANNEL

BAZOOKA-TUNED HIGH-BAND YAGI—Cat. No. 1860

Bazooka-tuning element broad-bands the basic ten-element yagi design providing excellent gain and directivity on high-band channels 7 through 13. Designed for use in fringe area installations. May be used in combination with Taco low-band antennas to a single transmission line by the use of Taco Hi-Lo Magi-Mix unit described on opposite page. Cat. No. 1862 () 2-bay stacking lines also available.

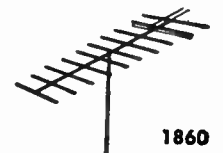

1860

HIGH-GAIN UHF TELEVISION ANTENNAS

BROAD-BAND, BOW-TIE, CHANNELS 14 THRU 83

For complete coverage of the entire UHF band, the open bow-tie developed by Taco has no rival. Proved in every demonstration to outperform all others by wide margins. Open design minimizes vibration. Multiple stacking, coupled by factory designed phasing lines, provide excellent gain. Screen-type reflector and large frontal area of this four stack Bow-Tie saves time in hunting for touchy "hot spots." Kralastic insulators assure top dielectric quality and mechanical strength.

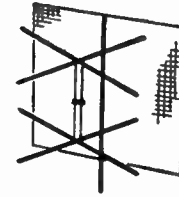

3032



3034

Cat. No. 3006C is designed to mount on top of existing mast or below VHF antenna by clamping to mast section.

Cat. No. 3034A is designed for mounting to existing mast. Light weight and ease of assembly are salient features.

Cat. No. 3035 Horizontal Stacking Kit for either 3006C or 3034A antenna provides improved pick-up.
Cat. No. 3032 Dual Bow-Tie with Screen Grid Reflector.

BROAD-BAND UHF YAGIS

UHF GRID YAGI—Cat. No. 3015

The first television antenna to be offered to the trade that is an all-aluminum, all-welded assembly. No assembled parts to corrode or loosen. Perfect electrical and mechanical union for life of installation. Grid Reflector plus 8 directors provide sharp directivity and high front-to-back ratio. Choice of single, double, or four-stacked arrays make this model ideal for use in any UHF installation. Available in five models covering the following channels: (14-29); (21-26); (30-50); (41-63); (56-83). Special models are available for any local needs.

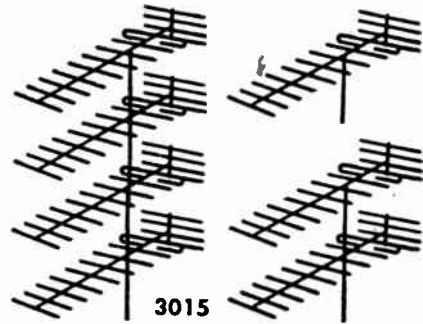

3015

SELECTRONIC SWITCH

Cat. No. 873

Cat. No. 873 — Double-pole, triple throw switch. Ideal for use in switching antennas at receiver. Extremely low-loss. Matches 300-ohm impedance. May also be used in audio systems, or for store TV demonstrations.

MAGI-MIX COUPLERS

Magi-Mix coupling devices incorporating low loss high "Q" coils and mounted in weatherproof, easy to attach plastic housings, are available in various types . . .

- to couple VHF high-band and VHF low-band to a single down lead.
- for coupling UHF and VHF antennas to a single transmission line.
- a triple duty unit for coupling high-band VHF, low-band VHF and UHF antennas into a single transmission line.
- a UHF model for coupling two UHF antennas (channels 14 thru 42) and (58 thru 83) into a single UHF transmission line.

MULTI-SET COUPLERS

Cat. Nos. 820-2, 3, and 4—Two or more television receivers may be operated from a single antenna installation through use of these couplers. Available in two, three and four set models, all employ the low loss high "Q" design inherent in Taco Magi-Mix Couplers, etc.

SPECIALIZED ANTENNA SYSTEMS

Technical Appliance Corporation maintains the most complete antenna engineering staff, laboratory and testing grounds in the country. As a result, Taco has been called upon to design, develop and manufacture the most critical antennas for both the military and civilian markets for specialized applications.

Technical Appliance Corporation enjoys the distinction of being the oldest television and radio antenna manufacturer in the United States. The experience gained over the years in practical antenna engineering is apparent in all Taco designs. In addition to experience, the Taco laboratory is equipped with the latest antenna testing instruments and facilities. The engineering department is constantly growing as young engineers are added to the staff, bringing with them new ideas that are combined with the unparalleled experience of the older engineers in the laboratory.

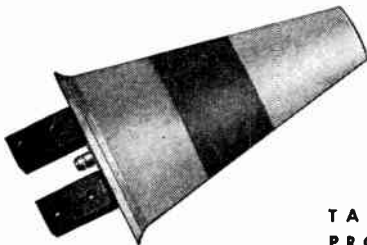

Production-wise, Taco offers equipment not usually found in an ordinary television antenna manufacturing setup. Such equipment includes high-precision machine tools, a fully equipped tool and die shop, aluminum welding equipment and a complete metal-finishing department. Whatever your antenna requirements—Taco is your best choice.

TACO MAINTAINS THE FINEST ENGINEERING AND PRODUCTION FACILITIES IN THE ANTENNA INDUSTRY

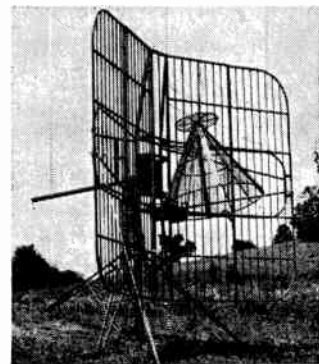

TECHNICAL APPLIANCE CORPORATION • SHERBURNE, NEW YORK



NEMCO

NATIONAL ELECTRONIC MANUFACTURING CORP.
186 GRANITE STREET
MANCHESTER, NEW HAMPSHIRE

NEMCO HOME AND MAST ANTENNAS

*A series of mast and window antennas
for a variety of installations*

HOME ANTENNAS

WINDOW ANTENNAS FOR APARTMENTS, HOMES, HOTELS, OFFICE BUILDINGS

Adjustable base brackets permit setting in any position for best reception. Completely assembled with insulator; lead-in strip and mounting flange. Antenna constructed of sturdy brass plated tubing-telescopic joints.

No. NM 74—3 Sections. Extends to 96" List \$4.85
No. NM 76—4 Sections. Extends to 12 ft. List 7.45

MAST ANTENNAS

COMPLETE MAST ANTENNAS FOR HOMES

Includes all accessories for complete installation — brackets; approved lightning arrester, lead-in wire, etc. Antenna made of nickel plated Admiralty brass. Easily installed on roof, gable, window pipe or cornice with accompanying universal brackets.

No. NM 70—4 Sections. Extends to 12 ft. List \$6.95

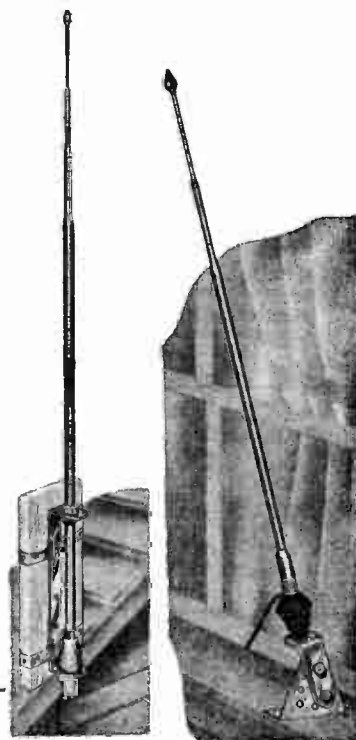

NEMCO COMPLETE AERIAL KITS

Contains the highest quality accessories to assure maximum reception. Each kit is attractively boxed in handsome colorful package for quick sale.

NATIONAL KIT: Includes 100 ft. 7/26 Aerial Wire. Approved Lightning Arrester. Ground Clamp. Lead-in Strip. 2 Porcelain Insulators.

No. NK 900 List \$1.90

JUNIOR KIT: Includes 100 ft. 7/26 Aerial Wire. 30 ft. Insulated Lead-in Wire. 2 Porcelain Insulators. Lead-in Strip. Ground Clamp.

No. NK 902 List \$1.55

Special Antenna Kits Made to Order.

NEMCO 7 STRAND AERIAL WIRE

7 strand wire composed of 4 strand copper tinned No. 26 and 3 strand Monel metal No. 26. Greater tensile strength — will not sag or stretch.

No. NK 955—7/26 Gauge—100 ft. coil List \$0.70

NEMCO LEAD-IN WIRE — HEAVY DUTY No. 20

Stranded copper tinned wire No. 20 — Rubber insulation. Heavy weatherproof braiding. Used by U. S. Army and Navy. An excellent heavy duty wire.

No. NK 940— 50 ft. coil List \$1.25 coil | No. NK 942— 500 ft. coil List \$12.00 coil
No. NK 941—100 ft. coil List 2.50 coil | No. NK 943—1000 ft. coil List 24.00 coil



LIGHTNING ARRESTER



Black glazed porcelain. Measures $3\frac{3}{4}$ " x $1\frac{3}{8}$ ". Weatherproof and non-grounding. Approved by Underwriters' Laboratories.

No. NK 910 List \$0.45

NEMCO "NAIL-IT" KNOB



Glazed porcelain. Will not crack or absorb moisture.

No. NK 922 List \$0.17

WINDOW LEAD-IN STRIP



Ends soldered to convenient clips for firm contact. Flexible strip, $\frac{1}{2}$ " wide; insulated covering.

No. NK 914 List \$0.22

PORCELAIN INSULATOR



Glazed porcelain. Will not crack or absorb moisture.

No. NK 920 List \$0.15

NEMCO GROUND CLAMP

Flexible plated metal. Adjustable screw permits clamping to ground rod or pipe of varying diameters from $\frac{3}{8}$ " to $2\frac{1}{2}$ ".



No. NK 916 List \$0.15

STRAIN INSULATOR

Glazed ceramic strain insulator featuring low moisture absorption and high dielectric strength. Particularly suitable for outdoor antenna installations. Length: $1\frac{1}{2}$ "; Diam.: $1\frac{1}{8}$ "; Wire Hole: $\frac{5}{16}$ " diam.; Distance between holes: $\frac{5}{8}$ ".



No. NTV 1775 List \$0.20



NEMCO

NATIONAL ELECTRONIC MANUFACTURING CORP.
186 GRANITE STREET
MANCHESTER, NEW HAMPSHIRE

NEMCO UNIVERSAL "Ball-Tenna"

The auto radio antenna that's breaking sales records all over the country

MOUNTED ENTIRELY FROM THE OUTSIDE!

Here's the revolutionary antenna that may be installed anywhere on a car (old or new). The unique design of the Ball-Tenna permits it to be mounted on Side Cowl; Top Fender; Roof; Top Cowl; Rear of car.

Eliminates Huge Inventories • Slow Movers
Beautifully styled for maximum sales appeal. Blends with car contour. Lustre-chromed. Includes 36" lead.

No. NSF 26—2 Section 49"List \$4.95
No. NSF 27—3 Section 62"List 5.95

"Ball-Tenna" DISPLAY



FREE!
All-Metal Display
Fully-Mounted
Pay only for Aerials
No. ND 9
List \$11.90



FREE! ALL-METAL DISPLAY

Colorful all-metal display. Measures 14" x 16". Pay only for following fully mounted antennas:

No. NSF 27
Ball-Tenna 3 Sec.
No. NCS 8
Side Cowl
No. NF 32
Concealed
No. NCP 63
Side Cowl
No. ND 7
List \$23.70

NEMCO AUTO ANTENNAS . . . THE STANDARD OF THE INDUSTRY

Precision Engineered . . . Rugged Construction . . . Competitively Priced
Includes 36" polyethylene weather-proof shielded loom cable

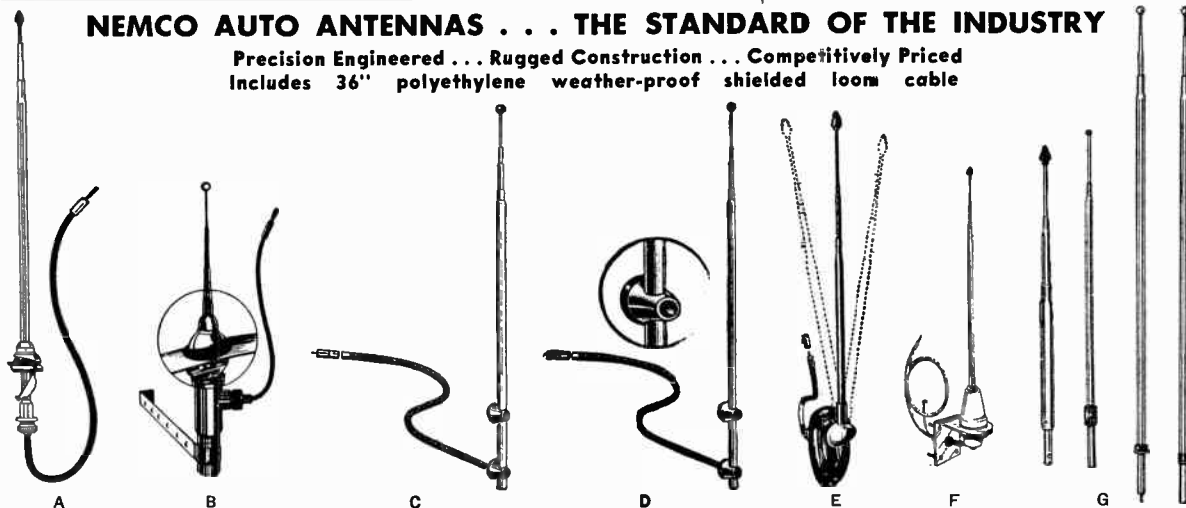

A — FENDER AND COWL MOUNT TYPE
The "Dubl-Qwik" features special multi-angle mount. Mounted entirely from the outside.
No. List
NT 40—3 Sec. Extends to 60"\$5.95
NT 43—4 Sec. Extends to 88" 7.25

B — CONCEALED TYPE
Collapsible disappearing type; vision-free.
No. NF 32 List \$7.45
3 Sec. Adjustable 6 1/2" to 56"
No. NF 37 List \$8.25
4 Sec. Adjustable 7 1/2" to 56"

C — SIDE COWL TYPE
Popularly priced. Durable construction.
No. List
NCS 8—3 Sec. Extends to 63"\$3.45
NC 51—3 Sec. Extends to 68" 5.00
NC 4—3 Sec. Extends to 93" 5.50
NC 5—4 Sec. Extends to 100" 6.75

D — SIDE COWL TYPE
Chrome-capped insulator for modern cars. Heavy duty tubing.
No. List
NCP 61—3 Sec. Extends to 38"\$5.50
NCP 62—4 Sec. Extends to 78" 5.50
NCP 63—4 Sec. Extends to 100" 6.95

E — "ROCKER" TYPE
Swivel antenna for flat or convex surfaces.
No. NS 12 List \$5.25
F — "HOT ROD" REAR MOUNT TYPE
POLICE-COMMUNICATION TYPE
Includes 3 ft. lead-in cable.
No. List
NP 80—3 Sec. Extends to 96"\$7.45
G — REPLACEMENT ANTENNA ASSEMBLIES
No. List
NA 1500—For Buick, Hudson, Packard \$2.95
NA 1501—For Ford Cars 2.95
NA 1504—For Oldsmobile Cars 3.95
NA 1506—For Pontiac Cars 3.95

NEMCO COMMUNICATION AERIALS

NEMCO ROOF TOP ANTENNAS

A 2-meter highly efficient mobile antenna of the latest design. Covers the 140 to 165 Megacycle frequency range.

Designed especially for roof-top installation, these antennas are suitable for taxicab, commercial, police, fire, amateur and other mobile applications.

Provides excellent reception. Special rubber gasket and lock-nut affords waterproof protection. The sturdy stainless steel rod is flexible and durable; has static discharge tip. Includes 11 ft. RG-58/U antenna cable.

No. NC 83List \$4.93



NEMCO "WHIP" ANTENNA Communication Aerial

Ruggedly made for rugged use. Designed for all types of mobile application, including police, fire, ambulance, amateur, etc.

MULTI-ANGLE BASE AND SPRING: The heavy base features vari-angle design which permits locking mast in vertical position despite car contours. Moisture proof gasket assures long service. The oil-tempered heavy steel spring prevents damage to mast from low hanging obstructions; absorbs heavy shocks, vibrations. Mast fits into 3/8" threaded fitting on spring end.

STEEL MAST: The "Whip" mast is made of heavy spring-tempered steel, 96" long . . . high tensile strength. Resists 90 degree bends. Weather resistant finish.

No. List
NC 86 Multi-Angle Base and Spring\$7.98
NC 87 96" "Whip" Mast 7.42
NL 730 11 foot Antenna cable 5.35
NC 89 Base-Mast Combination15.40





NEMCO

NATIONAL ELECTRONIC MANUFACTURING CORP.
186 GRANITE STREET
MANCHESTER, NEW HAMPSHIRE

THE NEMCO-MATIC

The electrically operated, completely automatic auto-antenna

OFFERS LONG, TROUBLE-FREE SERVICE
SUITABLE FOR ALL CARS
GUARANTEED LONG-LIFE OPERATION

The NEMCO-MATIC is a concealed type aerial that extends from 14" to 60".

A FLICK OF THE SWITCH AND IT LOWERS OR RAISES ITSELF

Powered by its own rugged motor that provides smooth uninterrupted lowering or raising action by remote control. Operating switch may be placed at any convenient location.

TAMPER-PROOF: Switch may be concealed or hooked into ignition system. Fully shielded sturdy molded housing; weatherproof. Includes 36" low-loss cable.

No. NF 55 List \$34.95



THE INDUSTRY'S MOST COMPLETE LINE OF AUTO ANTENNA LEADS A NEMCO ANTENNA FOR EVERY TYPE OF CAR . . . FOR EVERY PURPOSE

REPLACEMENT LEADS

Guaranteed "Hi-Q" low-loss design. Weather-proof insulation. Maximum reception.

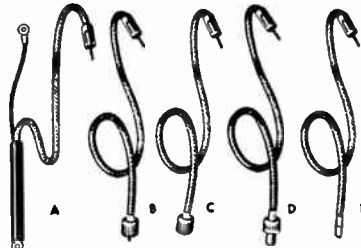

No.	Type	Length	Description	List
NL 700	B	36"	For All Side Cowl Antennas except NCS 8	\$1.40
NL 701	B	48"	Same as above	1.75
NL 700B	C	36"	For NCS 8, NT 981, C 66	1.40
NL 734	C	11 ft.	Same as above	3.50
NL 724	D	36"	NF 32, NF 37, NT 40, NT 43, NP 55, NSF 26, NSF 27	1.40
NL 727	D	48"	Same as above	1.75
NL 735	D	11 ft.	Same as above	4.00
NL 736	D	15 ft.	Same as above	5.75
NL 730	A	8 ft.	For Model NP 80, NP 81 and "Whip" Antennas	2.50
NL 710	A	11 ft.	Same as above	3.50
NL 731	A	15 ft.	Same as above	6.00

UNIVERSAL EXTENSION LEADS

No.	Length	Description	List
NL 715	12"	Extension	\$0.85
NL 716	18"	Extension	1.05
NL 717	24"	Extension	1.20
NL 718	36"	Extension	1.50
NL 721	11 ft.	Extension	4.00
NL 722	15 ft.	Extension	6.00

WIRE-WOUND SUPPRESSORS

Does not cut down speed of car, nor alter intensity of ignition spark because of very low D.C. resistance (30 ohms). Sealed permanently into heat-resistant and moisture-proof bakelite cases. Winding inductance sets up high reactance against ignition-noise frequencies, and suppresses interference.

No. NW 200—For spark plug List \$0.75
No. NW 201—Slip-on type List .75
No. NW 202—For Distributor List .75



MASTER DIST. CARBON SUPPRESSOR — 10,000 OHMS

For use on new type cars where only one suppressor is needed. Master Suppressor is guaranteed to eliminate all motor noise — making unnecessary the use of individual suppressors.

No. NS 300 List \$0.85



UNIVERSAL GENERATOR CONDENSER

Of universal application. Special bracket permits use on generators needing end installing, such as Fords, etc. Minus bracket, serves for all other type generators.

No. NS 505—.5 mfd. List \$1.15



PRE-WIRED JUMBO FUSE HOLDER

Suitable for 3.A.G. 20 amp. or SFE 14 amp. fuse. Eliminates necessity of soldering when changing fuse holder. Wire is merely severed, stripped and placed in line.

No. NA 620 List \$0.80



ELBOW SHAPED CARBON SUPPRESSOR

Auto ignition suppressor of the elbow type. Hermetically sealed molded-in-bakelite. Machined brass metal parts.

No. NR 108 List \$0.35



WHEEL HUB STATIC ELIMINATOR

Without back plate. Installed in hub caps of front wheel, it eliminates noises caused by static pick-up.

No. NH 401 List \$0.18



NOISE ELIMINATOR KITS

Each Kit contains complete accessories for a particular type of car . . . carbon type suppressors, condensers for ignition, spark plugs, etc.

No. NK 800 List per Kit \$4.21

For all Ford Cars to 1938

No. NK 801 List per Kit \$4.35

For all Ford Cars 1939 to current

No. NK 802 List per Kit \$3.75

For all 6 cylinder cars (except Ford)

No. NK 803 List per Kit \$4.25

For all 8 cylinder cars (except Ford)



Attractively packaged in special, colorful counter display unit. Installation instructions included. Each display contains 6 Kits of one type.

UNIVERSAL WIRE WOUND SUPPRESSOR KIT

For ALL types of cars. Includes wire wound suppressors for distributor and spark plug, dome light or ammeter condenser; universal type generator condenser; front wheel static pick-up suppressors; copper braid, etc. for complete noise-free installation. Full instructions.

No. NK 812—For all 6 cylinder cars List \$5.95 per Kit

No. NK 813—For all 8 cylinder cars List \$6.95 per Kit

CARBON TYPE SUPPRESSORS

Hermetically sealed carbon resistor is molded bakelite. Machined brass parts. Constant resistance values guaranteed. Impervious to oil, heat and moisture.



E No. NR 100—Slip-on. Fits all cars List \$0.35

E No. NR 101—Slip-on, For Ford cars only List .35

A No. NR 102—Knurled nut and bracket design List .35

B No. NR 103—Distributor Model List .35

C No. NR 104—Distributor brush type for 1934-36 model cars List .40

C No. NR 105—Distributor brush type for 1937 to current models List .40

D No. NR 106—Spark plug type. All cars List .35

D No. NR 107—Spark plug type. Ford Cars (20,000 ohms) List .35

F No. NR 109—Cable Type Suppressor List .35

DOME LIGHT AND GENERATOR SILENCER

For by-passing ammeter, dome light or generator.

No. NS 500—1/4 mfd. List \$0.70



NEMCO GENERATOR SILENCERS

Heavy duty generator type for effective elimination of intensive noise.

No. NS 501—.5 mfd. List \$0.95

No. NS 512—1 mfd. List 1.25

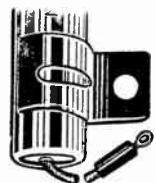

FORD V-8 CONDENSER
1939-41 models.
Capacity 1/2 mfd.
No. NS 502 List \$0.95

FORD V-8 NOISE SILENCER
1942 and later models.
.5 mfd.
List \$0.95





NEMCO

NATIONAL ELECTRONIC MANUFACTURING CORP.
186 GRANITE STREET
MANCHESTER, NEW HAMPSHIRE

UHF-VHF CONICAL

WITH FILTER

For medium fringe area. Includes printed circuit interaction filter with SINGLE TRANSMISSION LINE.

ALL-ALUMINUM Tubing of 3/8" diameter; firmly braced. Factory pre-assembled.

No. NTV 2147—Single List \$17.08
No. NTV 2148—Stacked List 34.71

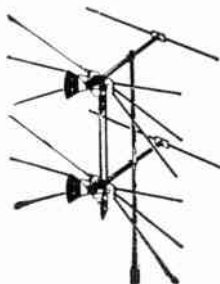

UHF CORNEF REFLECTOR

Exceptional db gain for maximum performance. Features weather-resistant construction. Pre-assembled for easy installation.

No. NTV 2213—Single List \$11.80
No. NTV 2214—Stacked List 24.30

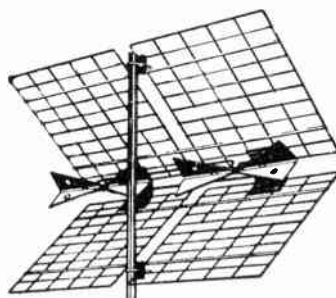

UHF "BOW-TIE"

WITH REFLECTOR

Offers outstanding UHF reception. For medium and maximum signal strength localities. Vibration-free. Pre-assembled for easy installation.

No. NTV 2230—Single..... List \$ 6.00
No. NTV 2231—Stacked.....List 11.69

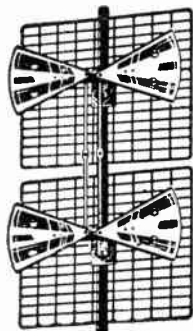

WINDOW ANTENNA

Latest conical type. Made of sturdy steel and 3/8" aluminum; sealed ends. Provides horizontal or vertical positioning. Steel mast measures 2 1/2 feet in length. 1 inch in diameter. Window clamp (1" diam.) is adjustable . . . spans 30 to 50 inches for almost any wood or casement window frame. Easily installed.

NO. NTV 1656—Conical Type List \$10.69
NTV 1658—UHF-VHF Type List 20.13

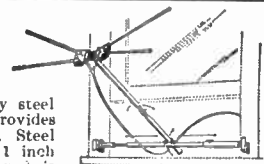

UHF YAGI

A broad-band YAGI Antenna for areas demanding super high-gain. Rigidly braced.

No. *NTV 2215 List \$7.25
*Specify channel when ordering



INDOOR PORTABLE ANTENNA

(Pat. No. 158679)
All-Channel Reception
For All Television Receivers

- Features
- ✓ BRASS DIPOLES
 - ✓ Complete adjustability
 - ✓ Tilt-free Base
 - ✓ Quick Installation
 - ✓ Include 300 ohm connecting lead and open end mounting lugs.
- TELESCOP DELUXE
No. 3 Section List \$3.75
NTV 1790B List \$3.75
- TELESCOP JUNIOR
No. 2 Section List \$3.47
NTV 1789 List \$3.47



SEND FOR
COMPLETE
PRICE LIST
COVERING E-Z
TV PACKAGED
KITS SHOWN
BELOW

NEMCO'S E-Z TV KITS OFFER BETTER RECEPTION — HIGHER PROFITS

ORDER EITHER ONE OF THESE THEN SPECIFY DESIRED KIT UHF-VHF ANTENNAS by NUMBER for COMPLETE PACKAGED UNIT

NTV 2203
THE "SUPER HI-V"

High gain in medium fringe areas. 8 driven elements for sharp directivity and less interference. Simple installation.

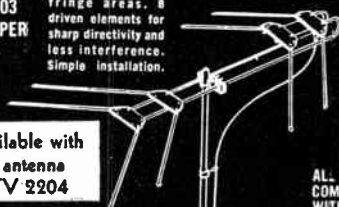

Also available with stacked antenna
No. NTV 2204

NTV 2147

Features printed circuit filter with single UHF-VHF transmission line. Straight line reflector for maximum gain. Vented fins for less wind resistance.

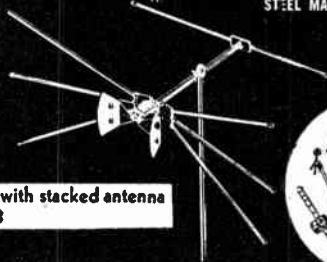

Also available with stacked antenna
No. NTV 2148

ALL KITS COMPLETE WITH 5 FT STEEL MAST



KIT A

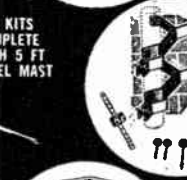

KIT B



KIT C

HERE'S THE FASTEST SELLING ECONOMY KIT ON THE MARKET!

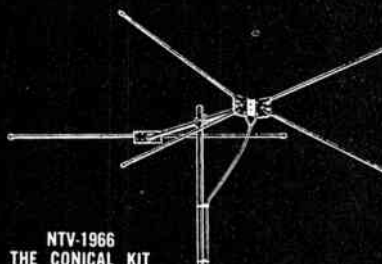

NTV-1966
THE CONICAL KIT

General purpose all-channel Kit. Includes conical antenna, steel mast, lead-in wire, guy wire, lightning arrester and accessories as illustrated.

Also available with stacked antenna.
Kit No. NTV 1967

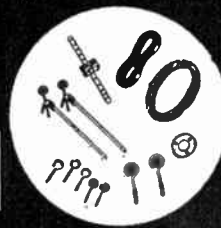



NEMCO

NATIONAL ELECTRONIC MANUFACTURING CORP.
186 GRANITE STREET
MANCHESTER, NEW HAMPSHIRE

UHF-VHF UNIVERSAL STAND-OFFS

ALL-PURPOSE STAND-OFFS

All-purpose, for UHF-VHF flat, oval or round lead-ins. Low-loss polyethylene insulation minimizes signal strength loss.

No.	List
NTV 1760—3 1/2" L.	\$5.00 C
NTV 1761—7" L.	8.05 C

LOK-STRAP STAND-OFF

T-Type stand-off with special adjustable metal strap. All-purpose, for UHF-VHF flat, oval or round lead-ins. Assures firm grip. For masts up to 2 3/4" diam. For double lead-ins.

No.	List
NTV 1791—3 1/2" Stand-off	\$33.32 C
NTV 1792—7" Stand-off	38.88 C

MAST STAND-OFF

For quick and easy set-up. Assures sway-free line. All-purpose, for UHF-VHF flat, oval or round lead-ins. Polyethylene insert. Adjustable strap with self-locking feature permits use on masts up to 2 3/4" diam.

No.	List
NTV 1787—3 1/2" Stand-off	\$15.83 C
NTV 1788—7" Stand-off	19.72 C

SNAP-ON MAST STAND-OFF

For UHF-VHF flat, oval or round lead-ins. Easily snaps on mast. Low-loss polyethylene insert. For 1 1/4" Mast.

No.	List
NTV 1793—3 1/2" Stand-off	\$10.00 C

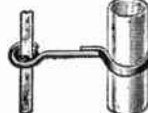

DOUBLE POLE DOUBLE THROW SWITCHES

Ideal for television needs. Black bakelite base is 2 3/4" x 1 7/8".



No.
NTV 1840 List \$1.50

Same as above with POR-CELAIN Base.

No.
NTV 1844 List \$0.97

DUAL TWIN LEAD CONNECTOR

Fully-insulated, low-loss plastic, solderless connection for 300 ohm twin-lead. Permits rapid connecting or disconnecting of set to two separate leads.



No. NTV 1758 List \$0.89 Set

TV LINE CLIP

A convenient three-way, small-size line clip that requires no soldering. Easily attached. Ideal for connecting UHF converters and boosters.



No. NTV 1870 List \$0.50

ANTENNA WALL BRACKETS

A useful antenna accessory where a vertical wall installation is desired. Offers a tight-gripping clamping action. Suitable for masts from 3/8" to 1 1/2" in diameter. Made of weather-resistant plated heavy gauge steel.

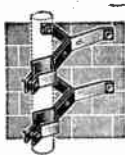

No.
NTV 1710 List \$3.40

MULTI-POSITION MOUNTING BRACKET

Provides many mounting positions on either roof-top, roof-side or side-wall. Maximum adjustability; cadmium plated steel.



No.	List
NTV 1730—For masts up to 1 1/2" d. (Offsets to 8")	\$ 7.64
NTV 1732—For masts up to 2" d. (Offsets to 12")	11.80

MULTIPLE ANGLE ANTENNA BASE



Offers rigid support; adjustable in three positions for maximum antenna direction. Cadmium plated, sturdy steel complete with hardware. For sidewall or flat mounting. For masts up to 1 1/2" diameter.

No. NTV 1722 List \$0.81

NEMCO TURNBUCKLES



Sturdy, steel turnbuckles that afford balanced tension of supporting wires. Especially suitable for antenna guy wires. Assure slack-free, rigid support.

No.	List
NTV 1772—3" (closed)	\$0.22
NTV 1773—5" (closed)	.31
NTV 1774—7 1/2" (closed)	.81

NEMCO GROUND RODS



Rugged copper-plated steel rods that provide direct-to-earth ground. Has pointed end for easy driving. Includes screw clamp capable of holding No. 4 to 14 gauge wire.

No.	List
NTV 2001—4 ft.	\$1.25
NTV 2002—8 ft.	2.47

THE NEMCO "REDI-MOUNT"

A fast-installing chimney antenna mount. One piece sections require minimum handling. Heavy gauge steel. Steel strapping is perforated. Convenient—easy to install. Sections may be spread for greater support.

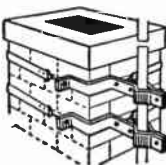

No.
NTV 1724 List \$2.50

GUY WIRE CLAMP



Ideal for set-ups requiring guy-wire support. May be located at any position on antenna mast for maximum rigidity. This rugged adjustable steel clamp is suitable for masts ranging from 3/8" to 1 1/4" diameters. Includes nuts and lock-washers.

No. NTV 1735 List \$0.42

UHF - VHF LIGHTNING ARRESTER

U/L Approved

A single lightning arrester that is designed for BOTH VHF 300 OHM-LEAD-IN and UHF TUBULAR TYPE TRANSMISSION LINE. Made of molded phenolic; non-ferrous plated hardware. No insulation stripping necessary.

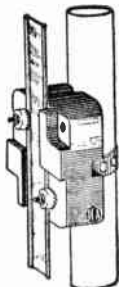

No. NTV 1852	List \$1.25
Includes metal strap for indoor use.	
No. NTV 1851	List \$1.00
For outdoor use.	

"DUBL-SET" ANTENNA COUPLER

Permits operation of two TV sets with 300 ohm input from a single antenna. Allows simultaneous operation with no interference from either set; no loss in signal strength. Easy to install. Soldering unnecessary. Ideal for two set homes, apartments, etc.



No. NTV 2245 List \$5.53

"MULTI-SET" ANTENNA COUPLER

Three or four TV receivers (of 300 ohm input) may be used simultaneously connected to a single antenna with no inter-action interference or signal strength loss. Designed for apartments or multi-set installations. Simple to install. Soldering unnecessary.



No. NTV 2246 List \$7.08

HIGH PASS FILTER

A highly efficient filter for the elimination of television reception disturbances caused by such noise generators as electric shavers, diathermy machines, etc. May be installed at the set or source of disturbance. Easy to install. . . . no soldering required.



No. NTV 2242 List \$5.50

PRINTED CIRCUIT FILTER

Nemco's printed circuit inter-action filter permits combining a UHF antenna with a VHF type, requiring but a single transmission line. Has three sets of terminals, fully sealed in thermal-resistant plastic case that may be quickly and easily added to antenna cross-arm.



No. NTV 2240 List \$4.72

Web Wip[®] MOBILE ANTENNAS and Accessories

MILITARY—MARINE—POLICE—FIRE—AIRCRAFT
AMATEUR—C-D—COMMERCIAL

WEBSTER (WEB-WIP) Band-spanner MOBILE ANTENNA

The Webster "Band-spanner" is essentially an effective, Center-loaded Antenna with the loading inductor wound directly on the upper portion of the fiber glass support column. This inductor has sufficient turns to permit resonance at the lowest frequency band, (75 meters) with the particular top whip used. A unique Webster design allows a portion of each coil turn to be internally exposed. A top whip of fixed length is arranged to push down or pull up from the inside of the loading section. This whip has a circular contactor affixed to its lower end and this contact establishes positive electrical connection between the bottom end of the whip and the internally-exposed loading coil turns. The whip may, by merely raising or lowering it plunger-fashion, be "Tapped" on any desired portion of the loading inductor. This type of continuous adjustment of the loading inductor permits exact antenna resonance to be achieved anywhere within a given band, minimizes loading problems, assures most efficient operation. The contact arrangement is self-cleaning and tends to firmly hold the whip at any pre-set position. The overall effect is neat, streamlined, mechanically sound and sturdy.

Suggested resale price 29.50

EXTENSION COLUMNS

Extension columns to increase the height of Band-spanner or WEB-WIP single frequency antennas are available. Consists of a fiber glass support column (with interior conductor), 36" in length provided with standard 3/8-24 SAE thread fittings on top and bottom. Two or more such columns may be combined if desired.

Suggested resale price 9.40 ea.

WEB-DUCTOR

A variable inductor arranged to fit between antenna column and mount. Sturdy, wound on phenolic material with weatherproof plastic coil covering. Ideal for base loading adjustments or antenna coupling to coax line. Standard 3/8-24 threads, female tap, male bottom.

Suggested resale price \$12.00

COMMERCIAL-TYPE WEB-WIPS

Commercial-type, high quality whips with extreme flexibility yet will not fatigue or take permanent set under extreme flexure. Bonded-on fiber glass covering . . . insulated . . . weather-proof. Standard lengths are listed but these whips can be provided in any practical length on special order.

STANDARD LENGTHS—60", 72", 78", 90", 96". Suggested resale price \$12.00

MOTORCYCLE RECEIVING ANTENNA—30". Suggested resale price \$8.00

WEBSTER—"TIARE" ANTENNA

A center-loaded antenna for use in marine or other fixed or mobile services where a full length quarter wave vertical antenna is not feasible. The "Tiare" is time-tried-and-proven with thousands of units giving outstanding performance on boats of many different types. The antenna has an overall height of 24 feet and the construction throughout will stand up under motion of the craft as well as heavy weather. The antenna is completely waterproof! Bottom support column is heavy-wall, water resistant aircraft aluminum, anodized and sealed with a most durable plastic coating. Upper loading section is also completely sealed and is watertight. Top whip has a highly flexible, bonded-on fiber glass covering and the whip design is such that it can be subjected to extreme flexure without fatigue or permanent set. Antenna comes with rugged, insulating mounts of die-cast, high impact bakelite. Holding bolts and wing nuts are bronze. Marine model covers 2-3 mcs. Models in other ranges are available on special order.

Suggested resale price \$54.50

Webster also manufactures other antenna models suitable for motorboats, yachts, etc. . . Full information upon request.

WEB-WIP SINGLE FREQUENCY MOBILE ANTENNA

The WEB-WIP single frequency antenna is designed specifically for vehicular mounting or for small boats or aircraft. This antenna incorporates numerous mechanical features found only in the well-known WEBSTER "TIARE" marine antenna. Notable in this regard is the overall weatherproof construction and the thorough and complete protection of all metallic parts. The lower support column of the WEB-WIP center-loaded mobile antenna is an extremely sturdy but light-weight fiber glass tube. This column permits ample flexure to take up shock but prevents excessive sway at high vehicular speeds. The center loading section is wound directly on the upper portion of the fiber glass column and is protected by an external plastic covering. The top whip secures to the upper end of the loading section by a standard screw thread fitting and may be removed readily. This top whip incorporates many of the design features of the WEB high quality, military and commercial whips. It is flexible enough to bend into a complete half circle yet is sufficiently rigid to prevent excessive sway while the vehicle is in motion. A bonded-on, highly flexible fiber glass jacket provides complete protection against weather. Both whip and support column have chrome plated brass fittings and the standard 3/8 thread utilized permits mounting on any standard type of base mount.

The WEB-WIP antenna is available for any spot frequency from 1500 kcs to 30 mcs. Prices and further information upon request.

A COMPLETE LINE OF ANTENNA MOUNTS AND HARDWARE

Write for details.

All prices subject to change without notice.

DEALERS: WRITE FOR UNIT AND QUANTITY DISCOUNT INFORMATION.

WEBSTER MANUFACTURING CO.
Mill Valley, California

WEB-WIP

"TIARE"

now . . . the *Shakespeare* "Wonderod"

Fiberglas antenna . . . with these

Length
60" to 90"

Net Price
\$7.74

— price includes $\frac{3}{8}$ " — 24 chrome-plated brass fitting at base and smooth, rounded tip. Larger ball at tip and special base fittings available on request. Rods are white Fiberglas. Special colors available on quantity orders.

NOTE: The best impedance match requires a somewhat shorter "Wonderod" antennae than is required with solid steel.

POSITIVE "WONDEROD" ADVANTAGES:

- Will not corrode — excellent weathering properties
 - Will not take a set
 - Light weight, reduces bumping on spring-mount
 - Exceptionally high flexural strength
 - High impact strength
 - Excellent insulation even at high frequencies
- Reduces hazard of operating under live wires, around sub-stations, etc.

PAT. APPLIED FOR

New "Wonderod" is a Fiberglas reinforced antennae for mobile radio equipment . . . made by the pioneer manufacturer of Fiberglas fishing rods. Thoroughly tested under extreme conditions, for commercial and private installations. STOCK SIZES READILY AVAILABLE. *Inquiries Solicited for Custom-Built Antennae. Mounts available.*

. . . Excellent performance . . . excellent weathering . . . tough enough to take the hard knocks a police antennae encounters. That's the report of CAPT. TEE HUTTO, commanding officer of South Carolina Highway Patrol, whose "Wonderod" antennae has withstood every test known to a police officer.

COLUMBIA PRODUCTS COMPANY

P.O. Box 5207, Columbia, South Carolina

a division of

the *Shakespeare* Company

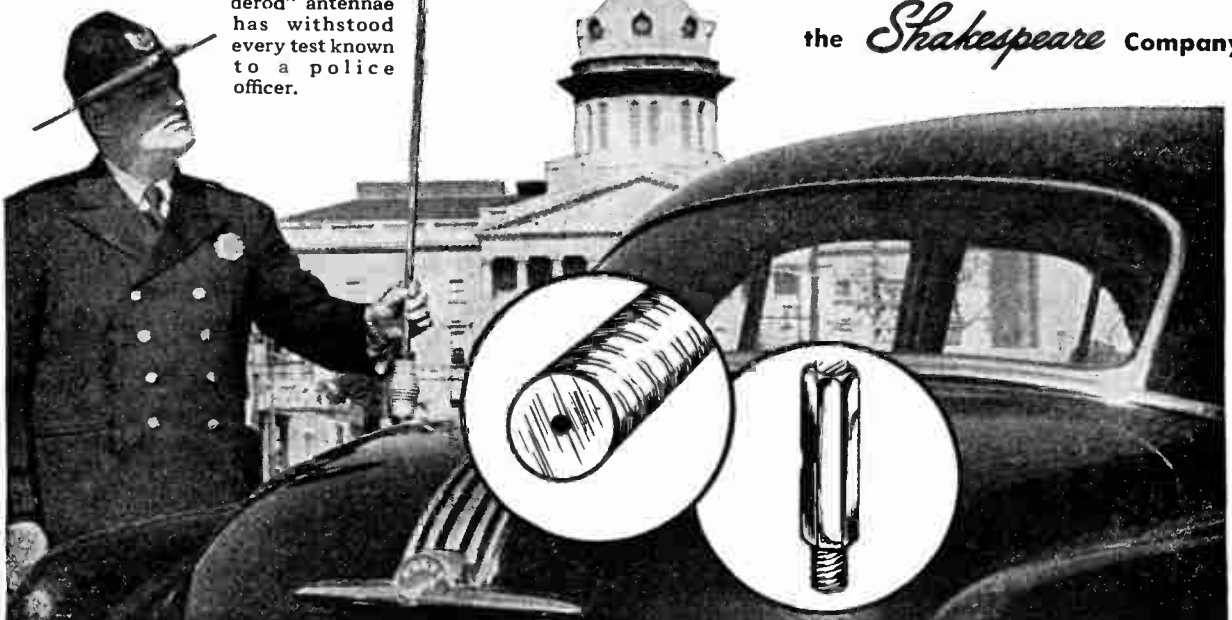

JERROLD

DE-SNOWER CONNECTORS

PREAMPLIFIERS ACCESSORIES

JERROLD Proudly Announces The DE-SNOWER

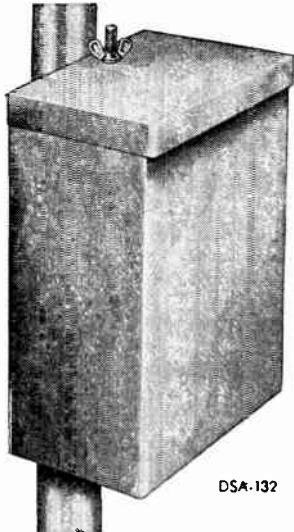

DSA-132

JERROLD now makes available for Custom Home Installations professional equipment, tested and proven in over 80% of all Community Antenna Systems throughout the country—at prices only slightly higher than ordinary boosters.

- GAIN: 25 db Channels 2 to 13
- FREQUENCY RESPONSE: ± 1 db Channels 2 to 13. Flat for COLOR!
- SIGNAL-TO-NOISE RATIO: 6 db Channels 2 to 6, 7.5 db Channels 7-13
- ANTENNA MOUNTED: Brings your tuner to the antenna! The only way to step up gain of modern cascode tuners without stepping up snow! Power supply mounts on back of receiver.
- SINGLE CABLE OPERATION: One coax cable carries 24 volt power up to preamplifier, signal down to receiver.
- BUILT TO PROFESSIONAL STANDARDS: Automatic ON-OFF switch or, for cold or humid climates, continuous 24-hour operation.
- POWER SUPPLY: Input, 117 Volts 60 Cycles, Output to preamp, 24-28 Volts
- "IRIDITE" weatherproof finish on preamplifier.

MODEL DSA-132 Channels 2 to 13
 Inputs: One 2 to 6 and one 7 to 13 antenna or one 2 to 13 antenna, 72 Ω or 300 Ω .
 Output: 72 Ω or 300 Ω . 0.1 volt/channel, 0.5 composite
 Tube Complement 3-6BQ7-A, 1-6AK5, 1-6C86
 Size: Preamplifier 5"x5"x10 1/4" overall.
 Power Supply 2 1/2"x5 1/2"x7 1/4" overall.
 Shipping Wt: 12 lbs. List Price \$109.50

MODEL DSA-62 Channels 2 to 6
 Inputs: One 2 to 6 antenna, 72 Ω or 300 Ω .
 Outputs: 72 Ω or 300 Ω . 0.1 volt/channel, 0.5 composite
 Tube Complement: 1-6BQ7-A, 1-6C86
 Size: Preamplifier 2 1/2"x5"x10 1/4" overall.
 Power Supply 2 1/2"x5"x6 1/4" overall.
 Shipping Wt: 7 1/2 lbs. List Price \$82.50

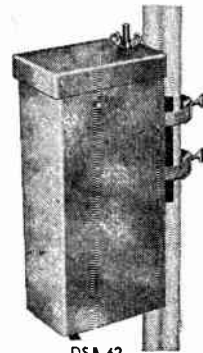

DSA-62



POWER SUPPLY

R. F. ATTENUATOR PADS

3, 6, 10, 20 or 30 db attenuation in 72 Ω line. Accuracy $\pm 2\%$ from 0-250 MC. V.S.W.R. 1.05. Rated at 500 mw C.W. Packed complete with screws and connectors.

PD-3,6,10,20,30 Pads. Each \$6.66 List



WALL TERMINAL UNIT

Matches TV receiver (300 or 72 Ω) to 72 Ω line. Attractive Ivory plastic molded box. Screw terminals. Mounting screws included.

1201 Wall Terminal. Each \$2.08 List



MATCHING TRANSFORMER

72 Ω to 300 Ω . Matches TV receivers to 72 Ω coax. 5 to 6 db voltage step-up, 50-250 MC. AC-DC isolation. V.S.W.R. 1.48. Steel radiation-proof case Packed complete, with screws and connectors.

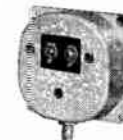

T-372 Transformer. Each 5.00 List.

SOLDERLESS CO-AXIAL CONNECTORS



MALE CONNECTOR—For RG-59/U. Mates with C-61 Receptacle, C-81, C-101 or C-5911 Adapters. Individually packed. Full instructions.
 C-51 Connector. Each \$.80 List

FEED-THROUGH ADAPTER—Chassis or cabinet mounting. Connects C-1113 (PL-259) to C-51, C-52 or C-56. Individually packed. Full instructions.
 C-5911 Adapter. Each \$3.50 List



HEAVY DUTY ADAPTER—Takes RG-11/U or RG-8/U. Packed with one C-51 connector for RG-59/U cable. Full instructions.
 C-101 Adapter. Each \$2.50 List

MALE CONNECTOR—For RG-59/U or double-shielded equivalents. Mates with C-61 receptacle. Requires Crimping Tool PL-52. Individually packed. Full instructions.
 C-52 Connector. Each \$.80 List



FEMALE RECEPTACLE—Chassis mounting. Mates with C-51, C-52 or C-56 Connectors. Threaded stem is 3/8" long. Individually packed.
 C-61 Receptacle. Each \$.80 List

MALE CONNECTOR—For RG-6/U cable. Mates with C-61 Receptacle, C-81, C-101 or C-5911 Adapters. Requires Crimping Tool PL-52. Individually packed. Full instructions.
 C-56 Connector. Each \$1.03 List



CABLE JUNCTION—Mates with C-51, C-52 or C-56 Connectors for RG-6/U, RG-59/U or double-shielded equivalents. Individually packed.
 C-81 Adapter. Each \$1.00 List

CRIMPING TOOL—Attaches C-52 and C-56 Connectors to cable. Forms a connection that withstands 350 lbs. of pull. Individually packed.

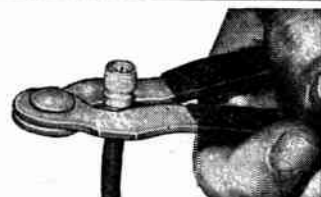

MALE CONNECTOR—For RG-11/U, RG-13/U or double-shielded equivalents. Requires soldering. Individually packed. Full Instructions.
 C-1113 (PL-259). Each \$1.00 List

PL-52 Each \$2.92 List

N A J E S C O I N C .

NATIONAL JERROLD EQUIPMENT SALES COMPANY

RMS

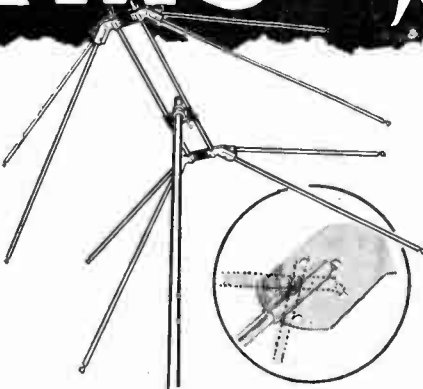

All Band (2-83) ADJUSTABLE CONICAL V
Model AAV-100
\$15.74 List Packed individually

Adjust any one or all 8 of the elements for efficient reception on uhf, vhf and uhf-vhf. Elements at 45° for uhf; 60°—uhf-vhf; 90° and 180°—vhf . . . and still an end-fire array. Adapts itself for your own specific problem. Deluxe construction features dowel-reinforcement of elements and Q-bars at the mast attachment — plus double u-bolt mast attachment. Fully preassembled.

2-bay Model AAV-200 with stacking bars **\$32.87 List**
 4-bay Model AAV-400 with harness assembly **\$70.06 List**

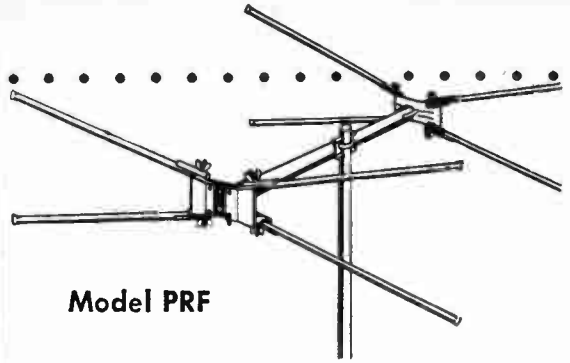

Model PRF

ALL PREASSEMBLED ECONOMY CONICAL:

A ruggedly constructed 4-front, four-back completely pre-assembled conical. Elements are 3/8" aluminum with pinched ends; are secured to extremely rugged triple-cadmium-plated brackets. With standard 36" length aluminum or steel crossarm. Aluminum crossarm dowel-reinforced at U-bolt and at both ends.

ALUMINUM CROSSARM

MODEL NO.	LIST PRICE	DESCRIPTION	STD. PKG.
PRF-1	\$ 6.30	single bay	6
PRF-2*	15.90	2-bay	3
PRF-4**	29.63	4-bay	1

STEEL CROSSARM

PRF-1S	\$ 6.00	single bay	6
PRF-2S*	13.43	2-bay	3
PRF-4S**	28.40	4-bay	1

*includes stacking bars **includes harness assembly
 Also available as PRF-1D with specially designed high-frequency director—
\$8.02 list.

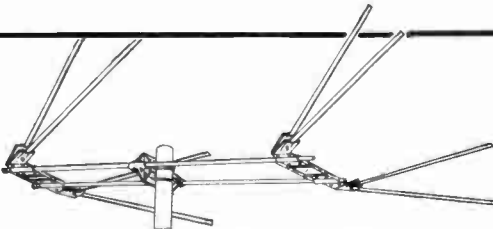

CONICAL V FRINGE LEADER SR.
Model CVA-500 \$13.33 List 4 to carton
 Same design as AAV-100 but elements not adjustable.

2-bay Model CVA2-500 with stacking bars **\$28.00 List**
 4-bay Model CVA4-500 with harness assembly **\$60.50 List**

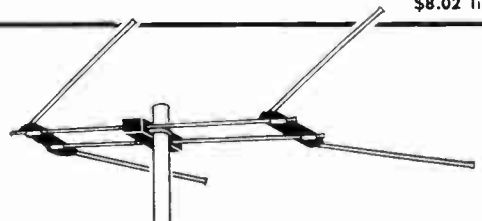

FRINGE LEADER JR. V. ANTENNA
Model EVA-100 \$5.40 List 4 to carton
 4 element end-fire array, ideal for urban and semi-fringe area. Completely preassembled. Similar in design to UVA series, but elements not adjustable.

2-bay Model EVA-200 with stacking bars **\$12.20 List**
 4-bay Model EVA-400 with harness assembly **\$28.70 List**



the renown **RMS LA-3**
\$1.00 list

lightning arrester and static charge eliminator . . . all in one! Takes twin lead and open line; mounts flat or to the mast. UL approved. High conductivity, corrosion resistant contact hardware throughout.

UHF Lightning Arrester LA-UH3
\$1.48 list

incorporates specially designed filter networks to effectively isolate r.f. from ground potential so that the arrester operates to discharge static and lightning. Takes regular twin lead, oval and tubular lead, 375 ohm and 450 ohm open line. UL approved. High conductivity, corrosion resistant contact hardware used throughout. Can be mounted flat, or to mast.

**THE
YAGI
LEADERS
OF THE
INDUSTRY**

Completely preassembled —
3/8" aluminum elements with
sealed ends; crossarm of 1"
aluminum dowel-reinforced
at U-bolt — step-up type
transformer element.

Low-band models feature unique steel brace
RMS 5 - 8 - 10 element Yagis

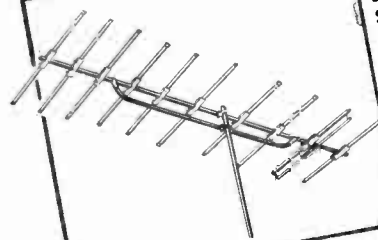
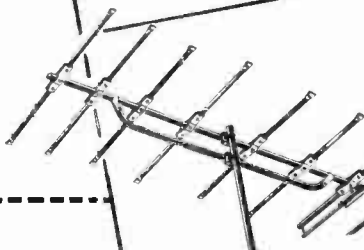
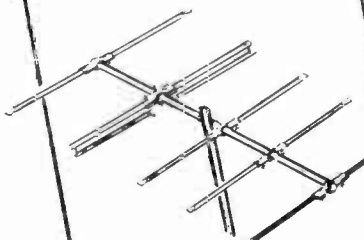

Model No.	Chan. No.	List Price
STY-2	2	\$18.15
STY-3	3	15.74
STY-4	4	14.94
STY-5	5	14.23
STY-6	6	13.11
TY-7	7	7.62
TY-8	8	7.62
TY-9	9	7.62
TY-10	10	7.62
TY-11	11	7.62
TY-12	12	7.62
TY-13	13	7.62

Model No.	Chan. No.	List Price
STYL8-2	2	\$24.69
STYL8-3	3	23.15
STYL8-4	4	22.38
STYL8-5	5	21.60
STYL8-6	6	20.83
TYL8-7	7	13.12
TYL8-8	8	13.12
TYL8-9	9	13.12
TYL8-10	10	13.12
TYL8-11	11	13.12
TYL8-12	12	13.12
TYL8-13	13	13.12

Model No.	Chan. No.	List Price
STYL10-2	2	\$30.86
STYL10-3	3	29.32
STYL10-4	4	27.77
STYL10-5	5	26.23
STYL10-6	6	24.39
TYL10-7	7	14.81
TYL10-8	8	14.81
TYL10-9	9	14.81
TYL10-10	10	14.81
TYL10-11	11	14.81
TYL10-12	12	14.81
TYL10-13	13	14.81

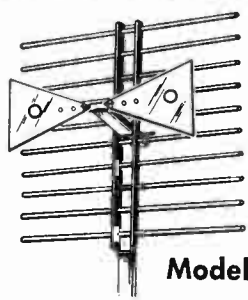

Model LBT-25

- Universally accepted for uhf areas — excellent gain over channels 14-83.
- Reflector is not wire mesh but actually tuned elements — eliminates ghost pickup.
- Greater air gap around signal takeoff points acts to prevent shorting due to excessive rains.
- Bow Tie elements fold back on crossarm for protection during shipping . . . swivel out for speedy installation.

Model	Chan. No.	List	Description
LBT-10	14-83	\$2.75	Bow Tie & Crossarm with reflector
LBT-25	14-83	\$3.55	Bow Tie & Crossarm with reflector

**K-38
NEVATIP
UHF-
VHF**

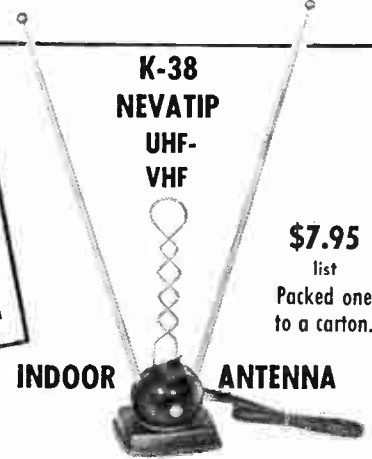

\$7.95
list
Packed one to a carton.

INDOOR ANTENNA

. . . designed with 6 position switch which selects the proper elements for UHF or VHF reception. K-38 stereoscopic indoor antenna engineered with NEVATIP base and polished brass 3 section elements. Supplied with 5 ft. of twin lead.

Also available as KN-38 with nickel plated elements at \$8.95 list



SN-350
10¢ list

***U-35**
.05¢ list

***MC-3**
20¢ list

*other models available in machine and wood screw types.

**NEW . . . RMS Lightning Arrestor Model UL-5
75¢ List**

Here's performance combined with economy! Capable of accommodating UHF & VHF transmission lines, the all new Model UL-5 is UNIVERSAL . . . engineered to utilize either oval, tubular, open or twin lead transmission lines.

Incorporating a self-tapping screw that is part of the unit, the RMS UL-5 Lightning Arrestor is practically automatic . . . a simple twist of the wrist and it engages itself into location.

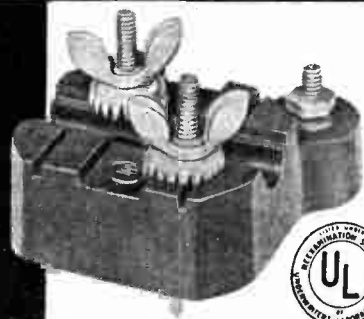

Other quality features that make the RMS UL-5 your best buy!

- Brass wing nuts instead of ordinary hexagon nuts
- Piercing type contacts (no stripping of transmission line required)
- Solid brass components on all electrical circuits
- Form fitting cut-outs to bind transmission line in place
- APPROVED BY UNDERWRITERS' LABORATORIES

NO ROTORMOTOR-YET ALL DIRECTION UHF-VHF RECEPTION

53 CLAIMS GRANTED IN 5 U. S. PATENTS

- #2,585,670
- #2,609,503
- #2,625,655
- #2,644,091
- #2,661,423

OTHERS PENDING



Guaranteed
60 mi UHF
60 mi VHF

UP TO

LIST PRICE
\$36.75
SEE YOUR
JOBBER

10 TIMES MORE POWERFUL
THAN ALL OTHER ANTENNAS
Solves Your Problem in Your Area

Guaranteed
40 mi UHF
40 mi VHF

LIST PRICE
\$24.50
SEE YOUR
JOBBER

Guaranteed
100 mi VHF
30 mi UHF

LIST PRICE
\$43.50
SEE YOUR
JOBBER

The Super 60 is the general purpose model for conditions prevailing in most communities today. Within a short time 15 to 20 UHF-VHF stations will be on the air within a 60 mile radius of every fair sized community. With the installation of the Super 60, you are improving your present reception in all directions and you are ready for the future.

The Suburban 40 has been developed for suburban areas where the stations are closer and trouble with distance is less of a problem — but the advantage of all direction all channel reception is necessary. A low priced high quality antenna for the present and the future.

Here is the real go-getter of the All Channel family. The Ultra 150 reaches out of long distances on VHF and gives you a bright, clear picture 150 miles and more. This antenna has solved the problem for thousands throughout the country where long range reception was otherwise impossible.

**9 POSITION
ELECTRONIC
ORIENTATION
SWITCH**

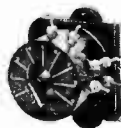

PRICE INCLUDES

Antenna arrays - necessary stacking bars - 9 position switch - switch-to-set coupler - necessary hook-up harness - 7 1/2" stand-offs. Individually boxed in mailable carton.

Yes, we said YOUR area. With the FCC allocating over 2,000 new TV Stations covering 12 VHF and 70 UHF channels, your area is due to change and you will require an antenna able to receive both UHF and VHF channels from all directions. All Channel Antenna Corp. has just the antenna to fill your needs and money back guaranteed to positively bring you at your location, clearer, sharper, pictures than any combination of present day antennas using expensive rotor motors, boosters, etc. With a flick of the 9 position electronic beam selector switch, any station in any area is instantly brought in on any TV set clearer and sharper.

NEW POLYMICALENE
4 CONDUCTOR TRANSMISSION LINE

- Low Loss External Air Dielectric
- Matched Impedance
- Eliminates End Sealing
- Eliminates Condensation
- Up to 50% Less Loss Than Tubular When Wet
- Easily Spiraled
- No Breaking or Shorting
- Patents Pending - T. M. Reg.

While antenna reception is guaranteed as specified, perfect pictures have been consistently received from 2 to 3 times these distances.

ALL CHANNEL ANTENNA CORP.
47-39 49th Street, Woodside 77, N. Y. EXeter 2-1336



CROWN[®]

ANTENNA ROTATOR



A PROVEN TOP PERFORMER

CHECK THE NEW, EXCLUSIVE FEATURES!

Gears—Brass and steel machine cut gears set to within .002". Final gear is 3" in diameter and $\frac{3}{16}$ " thick, has own roller ball thrust bearing.

Housing — Reinforced — High strength aluminum casting, not affected by extreme temperature changes.

Brake — Automatic brake releases only when motor is energized. Prevents coasting and windmilling. Permits use of a spur gear drive which increases delivered torque.

Terminals — Readily accessible. Standard terminal screws permit 4 wire hook-up to be made with screw driver only.

Bearing—Built in roller ball thrust bearing. 175 pounds weight capacity without additional accessories.

Direction Indicator—A tele-metering indication system. A complete unit within itself, hermetically sealed. Not a rheostat device.

Motor—Lifetime lubricated capacitor motor.

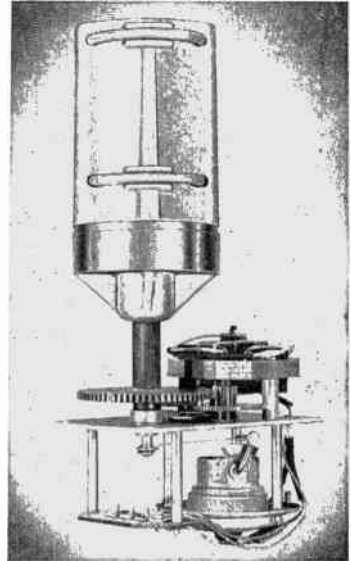

SPECIFICATIONS

- | | |
|---|------------------------------|
| 1. 115 Volts 25 or 60 Cycle AC | 6. Shipping Weight 11 Lbs. |
| 2. 30 Watts AC Input | 7. 4 Conductor Installation |
| 3. Gear Ratio 3000 to 1 | 8. 365° Rotation, 60 Seconds |
| 4. 175 Lbs. Wt. Capacity | |
| 5. Antenna Mast from $\frac{3}{4}$ " up to 2" | |

UL and Canadian Standards Association listed.

CROWN COMPASS INDICATOR

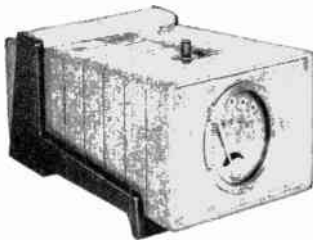

Constant Indication — No need to rotate antenna to obtain a reading. Needle does not fluctuate . . . stays steady and accurate. Is easily observed and accurately read.

Automatic Voltage Compensation — Line voltage variations do not interfere with the indicating accuracy. No need to calibrate or adjust.

Finger Tip Switch — One switch controls antenna in either direction.

Dial — Compass indicating type. Illuminated for easy reading.

Control Box — Beautiful mahogany Bakelite.

Off and On Switch—Located next to dial. Electrically safe, push button type.

CROWN Roller-Bearing GUY RING

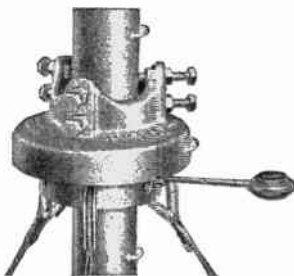

- Cast aluminum construction. Alloy used has extra high corrosion resistance rating.
- Weather-proof . . . no danger of freeze-ups due to unique outside casting design.
- Roller-bearing equipped for easy turning.
- Stand-off insulator furnished as standard equipment . . . tapped hole for fast installation, can be used with maximum of 6 guy wires.

- Fits any mast up to 1 $\frac{3}{4}$ " O.D. Furnished complete with 6 bolts, 12 locking nuts, and 3 guy wire thimbles.
- Shipping weight approximately 2 pounds.
- Bearing lubrication will not freeze at 50°F. below zero or melt at 200°F.
- Can be used with the Crown Antenna Rotator where the rotator is mounted at the base of the antenna mast.



CROWN[®] CONTROLS Co., Inc.

NEW BREMEN,
OHIO

Subsidiary—Crown Controls Manufacturing Co., Ltd., Kitchner, Ontario

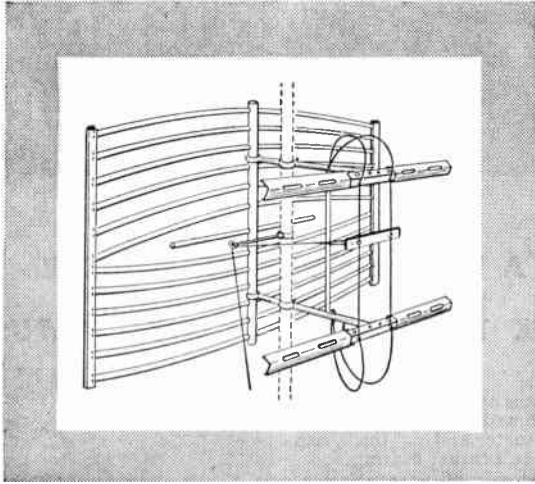

New Improved DAVIS SUPER-VISION TELEVISION ANTENNA WIND TESTED And WEATHERIZED



• THE ORIGINAL TELEVISION ANTENNA
SOLD WITH A MONEY-BACK GUARANTEE

Unbeatable for Fringe Area

LIST PRICE

\$39.95

Less Mast

With the Newly
Designed
**ELECTRONIC
DIPOLE
SEPARATORS**
(as illustrated)

features...

1. Excellent for fringe area and DX receiving and broad band receiving and high gain on all channels — 2 through 13.
2. Ghost problems reduced or eliminated due to excellent pattern.
3. Clearer pictures up to 125 miles or more from the station.
4. Provides 10 DB or more gain on high channels where gain is most needed.
5. Has excellent front to back ratio on all channels. Eliminates co-channel interference.
6. Minimizes interference: Airplane Flutter — Diathermy and Ignition — F.M. — Neon Signs — X-Ray — Industrial — Etc.
7. Eliminates double stacked arrays, and out-performs 2 bay yagis on low band and 4 bay yagis on high channels.
8. Only one transmission line necessary.
9. No worry over possible channel changes on either high or low channels.
10. It can be tipped without tilting the mast — to take advantage of the horizontal wave lengths.
11. Can be used with an Antenna Rotor.

SUMMARIZING THE PERFORMANCE CHARACTERISTICS: The excellent gain pattern and line match are outstanding on all of the high channels and very good on all of the low channels.

PACKED: One to a corrugated shipping carton.

SHIPPING WEIGHT: 12 lbs. Complete with Assembly Instructions.

Design Patent Pending — U.S. & Foreign Countries

ANTENNA SIZE:

6' 2" High (less mast), 8' Wide, 4' Deep

DAVIS ELECTRONICS

MANUFACTURERS OF V.H.F. AND U.H.F. ANTENNAS
Backed By Over A Quarter Century of Experience

FACTORIES IN: BURBANK, CALIF., CHICAGO, ILL., and SILVER SPRING, MD.

IT SELLS BEST

BECAUSE IT PERFORMS BEST

This type antenna is now being used by the largest TV service organizations for all their fringe area installations.

Leading TV manufacturers, who operate their own service departments, have found the Super-Vision to be the only antenna which fits into their rough installations to eliminate ghost and DX problems.

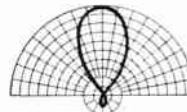

LOW BAND PATTERN

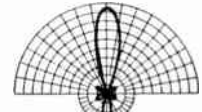

CHANNEL 7

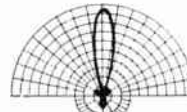

CHANNEL 8, 9, & 10

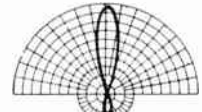

CHANNEL 11, 12, & 13

TWO MODELS:

Standard
and Zip-Rig



WALDOM Electronic

Duo-Tenna



NEW . . . SENSATIONAL TV DISTRIBUTION AMPLIFIER

Permits operation of **TWO** TV receivers from **ONE** antenna at same time. (VHF-UHF).

WITH BOOST IN SIGNAL STRENGTH

THE *Duo-Tenna* as an electronic amplifier, also gives you booster effect, improving picture quality in "fringe" as well as metropolitan areas.

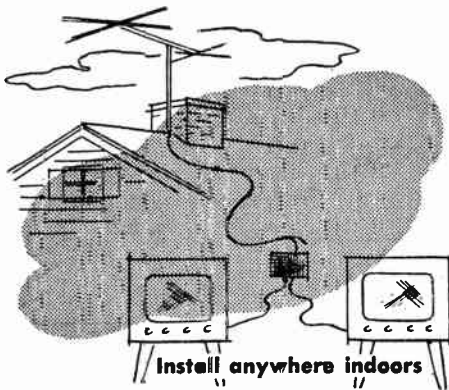

- A stronger signal to both sets than if each set were connected separately to its own antenna.
- Boost in signal strength improves noise and "snow" conditions which may exist in TV receivers. Amplification and isolation design of Duo-tenna insures against radiation interference between sets.
- Exclusive UHF distribution input. Immediately converts two sets to UHF reception with a single UHF converter.
- Exceptionally broad band width of Duo-tenna makes it ideal for reception of color telecasts.
- Eliminates unsightly addition of a second antenna. Saves expense of second antenna, accessories and installation labor.
- Easy to install. Complete instructions included.
- Factory guaranteed for complete satisfaction.

SPECIFICATIONS

SIZE: 8" x 5½" x 2¼". Attractive gray hammertone metal cabinet. Mount on back of one set, or place wherever convenient to both sets.

TUBES: Two 6BK7A.

GAIN: Between 1 db. and 5 db. (as function of channel) with less than 1 db. variation over any one channel.

PERFORMANCE: Signal delivered to each set is an average of 3 db. better than the signal available from the average antenna. A theoretically ideal non-electronic coupler introduces a loss of 3 db. at each set (if both are tuned to the same channel). The Duo-tenna performs an average of 3 db. better than separate antennae. It does a minimum of 6 db. better than a non-electronic coupling device.

INPUTS: VHF Antenna, 300 ohms. UHF Converter (Channel 5 or 6), 300 ohms.

OUTPUTS: Two 300 ohm twin-lead connections to TV sets.

POWER CONSUMPTION: 110-120 Volts, AC only, 20 Watts.

Complete with tubes and full instructions

MODEL DA-2000: LIST PRICE **\$39.50**

Price slightly higher west of Rockies and in Canada.

WALDOM Electronic Duo-tenna is the perfect answer to two-television set homes. You save cost and installation of second antenna, and gain in signal strength and performance.

The Duo-tenna features a new, unique circuit design which actually provides two separate and independent broad-band amplifiers (one for each TV set). In effect, it combines two broad-band boosters into one inexpensive unit. Should one amplifier fail, the other will continue, completely unaffected by failure of the first.

WALDOM ELECTRONICS INC., Chicago, Illinois
Electronic Components and Cname Products



CHANNEL MASTER CORP.

the CHAMPION

Extraordinary power on VHF and UHF!

2-Bay array gives:

- 11-13 db High Band gain on VHF
- 6½-7½ db Low Band gain on VHF
- Excellent performance on UHF

Channel Master's CHAMPION is the first antenna to employ the "Tri-Pole," a unique new Broad Band dipole system, in which the Low Band dipole provides exceptional Low Band gain, and also functions as THREE half-wave dipoles tied together, in phase, on the Low Band. The result: spectacular gain on VHF, excellent performance on UHF.

Model No.	Description
325	Single-Bay
325-2	2-Bay
325-4	4-Bay

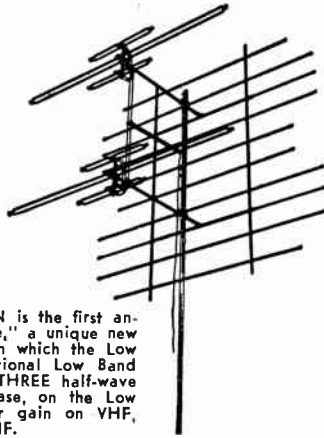

the SUPER CHAMP

model no. 325-6

- Features wide-spaced "Tri-Pole" assemblies, and new connecting harness.
- Gives from 1½ to 3 db MORE Low Band gain, and 1 db MORE High Band gain than the stacked CHAMPION, model no. 325-2.
- Provides extraordinary VHF-UHF reception at GREATER DISTANCES than has ever before been possible.

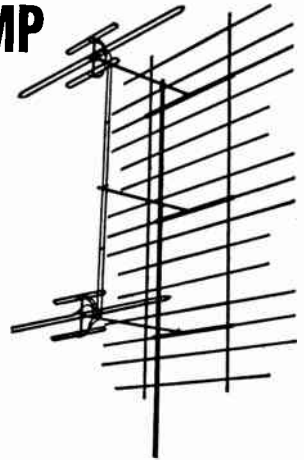

Conversion Kit

model no. 325-7

For converting stacked 2-Bay CHAMPIONS into Super Champs.

CHANNEL MASTER - - the most complete line of TV antennas!

VHF

DUAL-FLECTOR

Model No. 310
Broad Band VHF antenna



CONE-FLECTOR

Model No. 708
All-channel VHF antenna



SUPER FAN

The original fan antenna, covers channels 2-13.



Seamless Tubing

Model No.	Description
313	Super Fan
313-2	Stacked Super Fan
313-4	4-Bay Super Fan

Butted Tubing

Model No.	Description
713	Super Fan
713-2	Stacked Super Fan
713-4	4-Bay Super Fan

TWIN VEE

Model No. 315
For all-channel VHF reception.



HI-LO FOLD-FLECTOR

Model No. 322
For primary signal areas; broad band.



TRI-CONE

Good Broad Band reception. X-type reflector: 716 series
Straight-bar reflector: 717 series



GLOBE TROTTER

Model No. 321
All-channel VHF fringe area coverage.
All-channel UHF primary area coverage.



ULTRA FAN

Model No. 413
For VHF-UHF reception, covers channels 2 through 83.



5-ELEMENT Z-MATCH YAGIS

600 series
Gain: 9 db single, 12 db stacked.
Single-channel Yagis. Perfect 300 ohm match, single or stacked.



Z-MATCH YAGIS

Feature high gain impedance-matching system.
Model No. Description
626—Covers channels 2, 3, 4, 5, 6
646—Covers channels 4, 5 and 6



BIG 10 Z-MATCH YAGIS

Series 1000
Gain: 12 db single, 14½ db stacked. World's most powerful single-channel fringe-area Yagis.



FUTURAMIC YAGIS

Series 1100
Most powerful fringe area Broad Band antennas.



CHALLENGER 5-ELEMENT YAGIS

Feature transformer-type folded dipole.
Low Band: 550 Series
High Band: 500 Series



CHALLENGER TWIN-TUNED YAGIS

Peaked for two channels.
Model No. Description
525 Channels 2 and 5
536 Channels 3 and 6
545 Channels 4 and 5



CHALLENGER 10-ELEMENT YAGIS

Series 1500
Single-channel, high gain antennas.



CHALLENGER BROAD BAND YAGIS

Feature Channel Master's famous quality construction at low prices. Provide powerful fringe area reception. Low Band Yagi, Model No. 1526. Covers channels 2 thru 6. 7 elements, 3 driven dipoles.



HIGH BAND YAGI

Model No. 1573
Covers channels 7 thru 13. 10 elements, transformer-type dipole.



CHALLENGER CONICAL

Model No. 718 (X-type reflector)
Model No. 719 (Straight-bar reflector)
Low priced conical antennas.



INTER-ACTION FILTERS

Tie separate antennas together for use with single transmission line.



Tenna Tie

Model No. 9033A
VHF only



Ultra-Tie

Model No. 9034
VHF-UHF. Combines two separate antennas.



Triple-Tie

Model No. 9035
VHF-UHF. Combines up to three separate antennas.



UHF

DELTA-WELD YAGIS

Model No. 400—10-element Yagi
Model No. 420—"Sweet 16"—world's first 16-element Yagi.
Custom-cut; wide band element welded to crossarm.



ECONO-VEE

Model No. 411
For secondary and fringe UHF areas, primary VHF areas.



TWIN CORNER REFLECTOR

Model No. 406
The most powerful Broad Band UHF antenna.

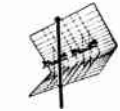

CORNER REFLECTOR

Model No. 409
Fringe area Broad Band UHF antenna, with optional 2-way mounting.



BOW-FLECTOR

Model No. 408
Gain:
To 10 db single,
To 12½ db stacked.



ULTRA-DAPTER

Model No. 414
Instantly converts all Super Fans in high gain VHF-UHF antennas.

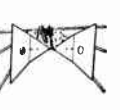

THE WORLD'S LARGEST MANUFACTURER OF TV ANTENNAS



Blaco ADJUSTABLE GROUND CLAMPS

TV OR FM INSTALLATION ACCESSORIES

The exclusive "Original Adjustable Idea" intermediate tightening screw draws up slack as it chafes the pipe—bores through rust, dirt and scale, and at the same time contracts band around pipe or ground rod. The band around the pipe is a means of support for the screw and is not a part of the circuit. OVER 41,000,000 BLACO GROUND CLAMPS HAVE BEEN MANUFACTURED BY US SINCE 1904.

Use low amperage clamps for grounding telephones, lightning protectors, radios, alarm systems, electric fences, signaling devices, appliances, TV and FM antennas, and similar circuits. Use high amperage clamps for grounding electrical equipment, conduits, armored cable, metal surface wiring raceways, alarm systems, communications equipment, and similar circuits. Not for grounding neutral of wiring systems.

Part A-1E is same as Part A-1 except shield is furnished. A-1 equal to Signal Corps Clamp TM-106, Part 6Z1906, Navy G-17-C-9612. B-1 equal to Navy G-17-C-9610, and AT&T AT-6751. T-1 equal to Signal Corps 5B3350, and AT&T AT-6751. May also be used on $\frac{3}{8}$ " and $\frac{1}{2}$ " ground rod by cutting off band at soldered nut and between pin. Put tightening screw through hole in band. Two or more low amperage type clamps may be linked together to encircle all sizes of pipe.

B-1 and T-1—For all telephone, radio and signal circuit station grounds. The design principles of this clamp are field-proven to maintain high pressure contact and maximum conductivity to joint. Clamps are adjustable for grounding to iron or copper pipe. Sometimes called a Station Ground Clamp. Made only of copper and brass materials. When installed shield fits between tightening screw and pipe. Furnished with $\frac{3}{8}$ " hex brass tightening screw and $\frac{1}{8}$ " hex brass lock nut. A socket wrench is available from the manufacturer for installing B-1 or T-1.

3SL, 4SL, 5SL, 6SL Clamps consist of a flexible perforated pure copper band, which encircles the pipe. A boss raised on the flat end of the removable solderless connector fits into band holes to give a clean and smooth contact surface. Tightening screw with lock nut is threaded through the boss and assures a perfect ground. All parts are identical in design and construction, the only difference is the thickness of copper band, and size of outside dia. (or I.P.S.) a clamp will fit. Solderless connector takes ground wire up to No. 4 AWG. Pure copper band $\frac{3}{8}$ " wide is properly tempered making it easy to wrap around the pipe.

STAND-OFF STRAPS—Strap has all the physical features of our BLACO A-1, B-1 and T-1 ground clamps. They are made from copper or plated steel. Illustrated at right, less hardware (screw, nut, washer). Stand-off is used to tighten band around pipe.

REA APPROVAL—Blaco Parts B-1, T-1, O, and A-1E (A-1 with shield added) are REA approved and are listed in the "Suggested List of Materials Suitable for Use on REA Borrowers' Telephone Systems."

BLACO GROUND CLAMPS GIVE YOU THESE ADVANTAGES AND HIDDEN VALUES:

- * Sizes for $\frac{3}{8}$ " - 3" Pipe (I.P.S.)
- * Positive Contact
- * Simple Design and Construction
- * Vibration Proof
- * Sizes for $\frac{5}{8}$ " - $3\frac{1}{4}$ " O.D.
- * Soldering Not Required
- * Attached in One Minute
- * Foolproof — Low Cost
- * Adjustable — Universal
- * Trouble Free Service

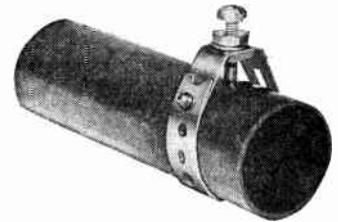

BLACO
Parts A-1, A-1S, 8, 7S, 7

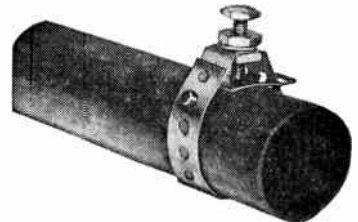

BLACO
Parts B-1, T-1



BLACO
Parts 3SL, 4SL, 5SL, 6SL

GROUND CLAMPS — LIST PRICES

Part Number	Dia. Inside	Pipe Size Range Outside	Band Specifications		Type Amp. Circuit	Packing		Carton Wt. Lbs.	List Price Each
			Material	Wide Thick		Box	Carton		
A-1	$\frac{3}{8}$ " - $1\frac{1}{4}$ "	$\frac{5}{8}$ " - $1\frac{1}{2}$ "	Copper	$\frac{1}{2}$ - .025"	Low	100	500	22	\$.18
A-1E			Copper	$\frac{1}{2}$ - .025"	Low	50	250	15	.22
A-1S			Plated Steel	$\frac{1}{2}$ - .020"	Low	100	500	20	.18
B-1			Copper	$\frac{1}{2}$ - .025"	Low	50	250	15	.27
T-1			Tinned Copper	$\frac{1}{2}$ - .025"	Low	50	250	15	.28
3SL	& Bx. Cable,		Copper	$\frac{3}{8}$ - .025"	High	50	250	24	.44
5SL	Conduit		Copper	$\frac{3}{8}$ - .050"	High	50	250	30	.56
7S	$\frac{3}{8}$ " - 2"	$\frac{5}{8}$ " - $2\frac{1}{2}$ "	Plated Steel	$\frac{1}{2}$ - .020"	Low	100	500	25	.21
7			Copper	$\frac{1}{2}$ - .025"	Low	100	500	29	.21
8			Plated Steel	$\frac{3}{8}$ - .020"	Low	100	500	24	.21
O	$\frac{3}{8}$ " and $\frac{1}{2}$ " Rod		Copper	$\frac{1}{2}$ - .025"	Low	200	1000	30	.17
2	$\frac{3}{8}$ " - 3"	$\frac{5}{8}$ " - $3\frac{1}{4}$ "	Copper	$\frac{1}{2}$ - .025"	Low	100	500	36	.24
2S			Plated Steel	$\frac{1}{2}$ - .020"	Low	100	500	28	.24
4SL	& Bx. Cable,		Copper	$\frac{3}{8}$ - .025"	High	50	250	34	.54
6SL	Conduit		Copper	$\frac{3}{8}$ - .050"	High	50	250	50	.66

STRAPS — LIST PRICES

Part Number	Dia. Inside	Pipe Size Range Outside	Band Specifications		Box	Packing Carton	Weight Lbs.	List Price Each
			Material	Wide Thick				
A-1H	$\frac{3}{8}$ " - $1\frac{1}{4}$ "	$\frac{5}{8}$ " - $1\frac{1}{2}$ "	Copper	$\frac{1}{2}$ - .025"	200	1000	31	\$.16
A-1SH			Plated Steel	$\frac{1}{2}$ - .020"	200	1000	25	.16
7SH	$\frac{3}{8}$ " - 2"	$\frac{5}{8}$ " - $2\frac{1}{2}$ "	Plated Steel	$\frac{1}{2}$ - .020"	200	1000	43	.19
7H			Copper	$\frac{1}{2}$ - .025"	200	1000	51	.19
2H	$\frac{3}{8}$ " - 3"	$\frac{5}{8}$ " - $3\frac{1}{4}$ "	Copper	$\frac{1}{2}$ - .025"	200	1000	59	.22
2SH			Plated Steel	$\frac{1}{2}$ - .020"	200	1000	42	.22

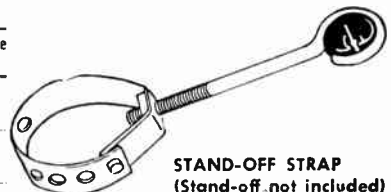

STAND-OFF STRAP
(Stand-off not included)



ROYALTEL ACCESSORIES

ROYAL'S GILINE Winch

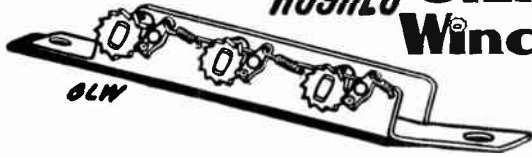

Designed to simplify and make safe the securing of guy wire lines. The Giline Winch is mounted with one Bolt. The channels and ratchets are made of 12 ga. steel, with drums of heavy steel rods, oil electrogalvanized. It is foolproof, in that the cotter pins lock firmly in place against the ratchet pawls. A turn of the wrench gives proper tension to the Guy Lines.

SHIPPING WEIGHT 1 LB.

GLW LIST PRICE \$2.78

ROLLED EDGE GUY RING & Separate Guy Ring Collar



1. Royal's Rolled Edge Guy Ring eliminates danger of guy line being cut by a sharp ring edge.

REGR 118 Fits 1-3/16" O.D. Mast 15-lb./c. 35.00c

REGR 125 Fits 1-1/4" O.D. Mast 15-lb./c. 40.00c

REGR 131 Fits 1-5/16" O.D. Mast 15-lb./c. 45.00c

2. Royal's Guy Ring Collar permits placement of guy ring anywhere along the mast. Together they furnish added strength and safety at any point on the mast.

GRC 125 Fits 1-3/16" and 1-1/4" O.D. Mast 9-lb./c. 50.00c

GRC 131 Fits 1-5/16" O.D. Mast 9-lb./c. 55.00c

All Royal Guy Rings and Collars are electrogalvanized against corrosion and rust, and are made of heavy 16 ga. steel.

Royal Mast Bases

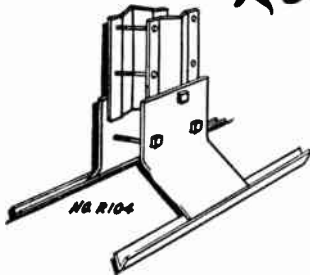

R104 Base Ideal for Tile or Peaked Roof
Fits 1-1/4" to 2-1/2" Masts
Weight 4.7 List Price \$5.15

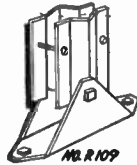

R109 All Angle Base
Fits 1-1/4" to 2-1/4" Masts
Weight 1.7 List Price 2.64

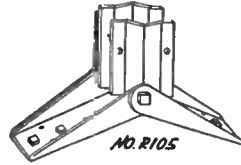

R105 Adjustable Peaked Roof Base
Fits 1-1/4" to 2-1/4" Masts
Weight 1.5 List Price \$3.47



R111 Small All Angle Base
Fits 1" to 1-1/4" Masts
Weight 0.4 List Price \$.85

ALL BASES ARE HEAVY GAUGE GALVANIZED STEEL

List Price	30.00c	28.00c	22.00c	18.00c	16.00c	15.00c	14.00c	12.00c	10.00c
	RGR 218 Fits 2-3/16" O.D.	RGR 200 Fits 2" O.D.	RGR 175 Fits 1-3/4" O.D.	RGR 150 Fits 1-1/2" O.D.	RGR 131 Fits 1-5/16" O.D.	RGR 125 Fits 1-1/4" O.D.	RGR 118 Fits 1-3/16" O.D.	RGR 100 Fits 1" O.D.	RGR 93 Fits 15/16" O.D.

Royal Guy Rings

All Rings are made of heavy 14 gauge steel and are electrogalvanized against corrosion and rust

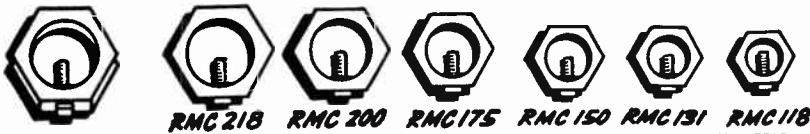

Royal Mast Clamps

RMC	Fits	O.D. Mast Section	LIST PRICE
RMC118	Fits 1-3/16"	O.D. Mast Section	\$.69
RMC131	Fits 1-5/16"	O.D. Mast Section	.83
RMC150	Fits 1-1/2"	O.D. Mast Section	.97
RMC175	Fits 1-3/4"	O.D. Mast Section	1.11
RMC200	Fits 2"	O.D. Mast Section	1.25
RMC218	Fits 2-3/16"	O.D. Mast Section	1.39
RMC237	Fits 2-3/8"	O.D. Mast Section	1.67

All Royal Clamps are complete with 5/16"x1" bolt and nut and are electrogalvanized against corrosion and rust

A TREMENDOUS TIME SAVER



ROYAL'S PRECUT GUYWIRE
with specially designed hook
Available in precut lengths for 30, 40, 50 and 60 foot mast installations.
Made up of standard 6/20 galvanized wire

Royal TELEVISION SUPPLY and Manufacturing Co.

PREMAX ALUMINUM ANTENNAS

Premax Telescoping Adjustable Aluminum Antennas for marine, mobile, amateur and commercial installations are built up of specially-drawn, seamless, tempered aluminum tubing, engineered to withstand wind velocities up to 60 m.p.h. Secure collet locking device.

No.	Description	Ext'd Lgth.	Col'd Lgth.	Base O.D.	Base I.D.	Wgt. Lbs.
AL-312	2-Sec. Tele.	12'4"	6'4"	.500"	.334"	1 1/2
AL-518	3-Sec. Tele.	18'5"	6'4"	.750"	.584"	3
AL-324	4-Sec. Tele.	24'4"	6'4"	1.000"	.834"	5
AL-530	5-Sec. Tele.	30'0"	6'5"	1.250"	1.084"	7
AL-535	6-Sec. Tele.	35'8"	6'5"	1.500"	1.310"	12

PREMAX STEEL ANTENNAS

These are low-cost, adjustable Antennas for amateur, commercial, municipal, Civil Defense and other installations. Made of high-tensile, copper-nickel steel tubing, heavily cadmium plated and resistant to corrosion. Fully telescoping and adjustable. In 5 lengths.

No.	Description	Ext'd Lgth.	Col'd Lgth.	Base O.D.	Base I.D.	Wgt. Lbs.
112-M	2-Sec. Tele	11'8"	6'0"	.656"	.556"	4
318-M	3-Sec. Tele.	17'3"	6'2"	.875"	.775"	7
224-M	4-Sec. Tele.	22'9"	6'3"	1.063"	.963"	11
130-M	5-Sec. Tele.	28'3"	6'4"	1.250"	1.150"	15
136-M	6-Sec. Tele.	33'9"	6'5"	1.500"	1.400"	20

STAINLESS STEEL ANTENNAS

Stainless Steel Antennas made of a special grade of tubing, hard-drawn for tensile and yield strength. Fully telescoping and adjustable. Polished finish. Secure locking device. Fine for marine use.

No.	Description	Ext'd Lgth.	Col'd Lgth.	Base O.D.	Base I.D.	Wgt. Lbs.
SS-1118	3-Sec.	18'4"	6'3"	.750"	.680"	6
SS-1124	4-Sec.	24'3"	6'3"	1.000"	.900"	9
SS-1130	5-Sec.	30'0"	6'4"	1.250"	1.120"	13
SS-1135	6-Sec.	35'7"	6'4"	1.500"	1.370"	19

TAPER WHIP ANTENNAS

Type E—1/4" base, taper-ground to 3/2" tip for high flexibility and strength. Easily cut to exact frequency. In Chrome Silicon Steel, cadmium-plated, or in Stainless Steel with polished finish. Fits any Premax Mounting.

Length Overall	Chrome-Silicon Steel	Stainless Steel
60"	EC-660	ES-760
72"	EC-672	ES-772
84"	EC-684	ES-784
96"	EC-696	ES-796

TYPE A WHIP ANTENNAS

Type A—Made of sections of varying diameters, securely joined into a solid taper-tapered Whip 1/4" at the base and 1/8" at the tip. In high-carbon, oil-tempered steel, cadmium-plated, or in polished stainless steel. The finest low-cost antenna you can buy.

Length Overall	Stainless Steel	Cadmium-Plated Steel
60"	AS-160	AC-160
72"	AS-172	AC-172
84"	AS-184	AC-184
96"	AS-196	AC-196

Type E

GROUND RODS

For All Radio and Television Installations

Practical and efficient Ground Rods, costing so little that it doesn't pay to fuss with makeshifts! Of smooth, hard-drawn steel, chisel-pointed for easy driving and heavily copper-plated for rust prevention and to insure clean electrical contact. 4' to 8' lengths in 3/8", 1/2" and 5/8" with screw clamp (illustrated) or in 6' and 8' lengths in pigtail wire, drilled hole or plain style, 1/2" and 5/8" only.

Size	Screw Clamp	Hole	Pigtail	Plain
3/8"x4'	J-64
3/8"x6'	J-66
3/8"x8'	J-68
1/2"x6'	G-86	H-86	P-86	X-86
1/2"x8'	G-88	H-88	P-88	X-88
5/8"x6'	G-106	H-106	P-106	X-106
5/8"x8'	G-108	H-108	P-108	X-108

PREMAX MOUNTINGS

BASE MOUNTINGS



Type 1—Galvanized malleable iron or chrome plated brass hardware with heavy-duty porcelain cones. 7" to 9" height to post base. Wt. 8 lbs. Available for all Premax Vertical Antennas. Specify antenna number or post diameter. This is also available in hinge post type.



Type 2—Light design with brown glazed porcelain and removable top post. In steel only. Height to post base 6". For Premax Antennas up to 24". Specify Antenna number or post diameter.

DECK OR ROOF MOUNTING



Type 6—6" flange in galvanized malleable iron with studs and bolts for 1/2" to 6" deck. Lead-thru construction permits connections below roof or deck. Height to post base 3" to 5". Weight 11 1/2 lbs. Available for all Premax Antennas. Specify Antenna number or post diameter.

TYPE 10-C MOUNTING CLAMP



Type 10-C Mounting Clamp has porcelain split bushing in stamped steel frame. Height to center 2". Wt. 3/4 lb. Sizes to fit 3/8", 1/2", 5/8" and 1" only.

TYPE 10-S STANDOFF INSULATOR



Type 10-S is a heavy-duty insulator in chrome-plated bronze with brown glazed porcelain. Solid or hinged clamp. Height to center about 4 1/2". Wt. 3 lbs. Available in sizes to fit 3/8" to 1 1/2" tube diameter.

TYPE 13-S STANDOFF INSULATOR



Type 13-S—In heavy cast aluminum or brass, plain or chrome-plated, with brown glazed porcelain, 3" diameter. Height to center 4 3/4". Wt. 2 lbs. In sizes to fit 3/4" to 1 1/2". Specify size and material; also whether solid or hinge cap.

SERIES C CENTER-LOADED MARINE ANTENNAS

Center-Loaded Collapsible Marine Antenna for 2 to 3 mc. with power gain of 6 db. Two telescoping base sections with top whip. Extended length 17 ft., collapsing to 7 ft. In aluminum, monel and stainless. Fits standard Premax Mountings shown on preceding page.

No.	Type	Base O.D.	Base I.D.	Wt. Lbs.
CLA-619	Aluminum	1.000"	.834"	5
CLM-519	Monel	.893"	.799"	7
CLS-1119	Stainless	1.000"	.902"	7

SERIES B LOW-COST CENTER-LOADED ANTENNAS FOR MOBILE AND MARINE

Center-Loaded Whip-Type Antennas consist of a standard base section or spring-type on which is mounted a special Premax coil. The top is a taper-ground stainless steel whip 6 ft. in length, giving a total overall height of 9 ft. Various coils are available or the standard 75-meter coil can be adapted by shorting out turns on the coil. Antennas can be used with any of the Standard Premax Mountings shown below, or will fit any $\frac{3}{8}$ "x24-thread mounting.

Frequency	Type BX Less Spring	Type BS With Spring	Coil Only
14,000 kc. (20M.)	BXS-14	BSS-14	B-14
2374 kc. (CAP)	BXS-23	BSS-23	B-23
3105 kc. (APT)	BXS-31	BSS-31	B-31
3800 kc. (75M)	BXS-38	BSS-38	B-38
4325 kc. (CAP)	BXS-43	BSS-43	B-43
4585 kc. (CAP)	BXS-46	BSS-46	B-46
2000 to 3000 kc. (Marine)	BXS-25	BSS-25	B-25

CIVIL DEFENSE, PUBLIC SERVICE, FIRE, POLICE ANTENNAS 100 TO 162 MEGACYCLES

FCDA is insisting on adequate communications in Civil Defense and cities everywhere are installing RACES equipment that calls for outstanding ground plane and UHF Antennas. Premax meets this need with several profitable numbers to cover this new market.

GROUND PLANE ANTENNAS

For point-to-point installations, Premax has two VHF Antennas: The Style GP-3 which has elements of heavily-plated spring steel with skirt wires that can be bent down to any angle to match coax cable. Mounting is within a water-proof housing that fits standard



GP-314

$\frac{1}{4}$ " pipe. Cable carries down thru pipe. Style GP-314 for 144 Mc. For 2 meter and CD. Style GP-312 for 108 to 120 Mc. For aircraft and CAP. Style GP-315 for 152 to 162 Mc. For police and taxi.

ADJUSTABLE GROUND PLANE ANTENNAS

Another low-cost type Ground Plane Antenna is adjustable from 20 to 40 mc. or 40 to 60 mc. Standing wave ratio matching to 52-ohm line is 1.07 to 1.13 and to 72-ohm line is 1.27 to 1.23 depending on type of transformer cable. All-aluminum construction employing adjustable tubular elements. Style GP-430—Adjustable 20 to 40 Mc. Style GP-450—Adjustable 40 to 60 Mc.

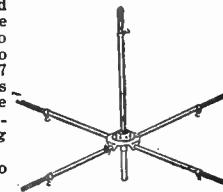

GP-430

CAR-TOP OR MOBILE ANTENNAS

Premax Mobile or Car-Top Antennas are made of heavily-plated, highly-tempered spring steel wire in elements of precise diameters and lengths. Mountings are well insulated and so designed that one man can install them through a single small hole in a car roof.

STYLE CD-114 for 144 mc. For 2-meter amateur and CD. Porcelain insulator. One man installation thru $\frac{1}{2}$ " rooftop hole.

STYLE CD-112 for 108 to 120 mc. For aircraft and CAP. Similar to CD-114.

STYLE CD-115 for 152 to 162 mc. For police and taxi. Similar to CD-114.



CD-114

EMERGENCY TYPE

STYLE CD-214 for 144 mc. Emergency type with rubber suction cup base. No hole required. Can be installed in matter of seconds. Ideal for CD.

STYLE CD-215 for 152 to 162 mc. For police and taxi. Similar to CD-214.

STYLE CD-212 for 108 to 120 mc. For aircraft and CAP. Similar to CD-214.



CD-214

MOBILE

For $\frac{1}{4}$ " Diam. Whips

TYPE R-2 — Universal Mounting. Solid aluminum split-ball can be adjusted to any angle. Has shielded coax connection.

TYPE RS-2—Similar to the above except has spring as shown under Type SA-1.

TYPE S-1 — Spring Mounting, heavy-duty spring, bakelite insulation with rubber gasket and steel back-plate with shielded co-ax fitting. Ht. 5".

TYPE SA-1 — Spring Adaptor (similar to Type S-1 and RS-2 which can be attached to Type K, L, TA, CA or NA Mounting. Ht. 4 $\frac{1}{2}$ ". Dia. 1 $\frac{1}{2}$ ".

TYPE F—30° Adjustable Mounting for fender, cowl or gravel pan. Chrome-plated brass with bakelite insulation.



TYPE SA-1



TYPE F



TYPE NA-1



TYPE L-1

MOUNTINGS

or Any $\frac{3}{8}$ " - 24 Male Thread

TYPE NA-1 — Bumper Mounting with ceramic cone insulator and steel bracket.

TYPE L-1 — Bumper Mounting, 2 pairs ceramic cone insulators with steel bracket. 10" adjustment.

TYPE XL — Panel Mounting, similar to L-1 less bumper bracket.

TYPE K-1 — Bumper Mounting, ceramic cone insulators, cadmium-plated brackets; 10" height adjustment.

TYPE TA — Trunk or Panel Mounting; ceramic cone insulators, cadmium-plated brackets. Fits any contour surface. 10" adjustment.

TYPE CA — "Chain Style" Bumper Mounting. Clamps on any bumper with 1" clearance; no drilling; theft-proof.



TYPE K-1



TYPE TA



TYPE CA

SERIES C



TYPE R-2



TYPE RS-2



TYPE S-1

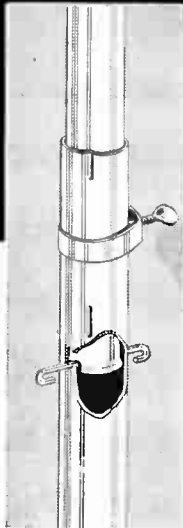

BAKER

TOWERS FOR TELEVISION

NEW HEAVY GAUGE TELESCOPING MASTS

New mast joint requires a minimum of hardware, has 6" overlap for added strength and rigidity. Heavy gauge J & L Permatube construction. Free-floating cupped guy washer included—will not bind mast even if a ladder is placed against it.

No.	Height	Wt.	List Price	Dealer
20 CM	20' two section mast	25	11.25	6.75
30 CM	30' three section mast	30	16.25	9.75
31 CM	1 FM roof mount with 30' mast	35	24.95	14.97

MODEL 40TK-B

Complete 40' installation including 010TK and the new 30 CM telescoping mast described above. Base fits all roofs, self contained permanent ladder, two sturdy cast iron mast clamps adjustable to mast diameters 1" to 2", and guy washers. New Baker mast joint is simple, rigid and requires a minimum of hardware. Heavily galvanized. Built to withstand 80 mile wind. Shipped flat with major assembly done at factory.

Tower No.	Height	Wt.	List Price	Dealer
40TK-B	40' (10' tower & 30' mast)	85	49.50	29.70

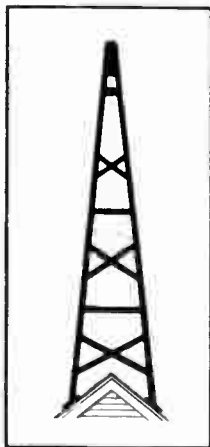

BAKER TOWERS

3, 5 and 10 foot models. All steel parts heavily galvanized. Folded flat for shipment and easy to store. Major assembly done at factory. Fits any pitch roof and uses any mast up to 2".

No.	Height	Wt.	List	Dealer
010TK	10' tower	50	33.00	19.80
05TK	5' tower	25	17.95	11.20
03TK	3' tower	16	9.90	5.95

J & L PERMA-TUBE FITTED END MASTS

Economical rust and corrosion resistant masts in three lengths. Fitted joint makes mast strong and rigid.

No.	Height	Wt.	
15 AM	10' 1 1/4" 16GA.	120	(14 masts per carton)
16 AM	10' 1 1/4" 18GA.	90	(14 masts per carton)
7 AM	5' 1 1/4" 18GA.	90	(28 masts per carton)

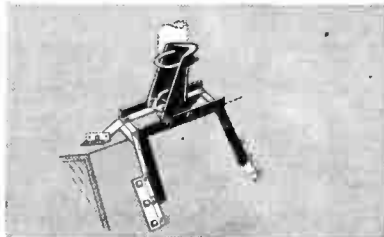

MODEL 1 FM ROOF MOUNT

Fits any roof. Sturdy casting and two U bolts clamp firmly to base of mast, diameter 1" to 2". Built strong enough to support mast temporarily without guys during erection.

No.	Wt.	List	Dealer
1 FM	50 (5 mounts per carton)	7.95	4.77

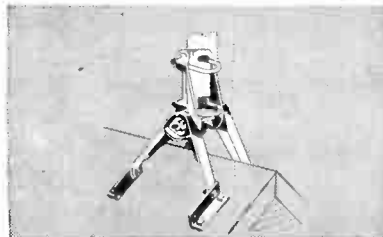

MODEL 2 FM ROOF MOUNT

Inexpensive roof mount fits any pitch roof and will hold up to 1 3/4" mast. Double rock up design makes erection easy—one man job. Snaps into vertical position.

No.	Wt.	List	Dealer
2 FM	70 (15 mounts per carton)	3.95	2.37

HARDWARE

Heavy duty guy washers for 3 or 4 guys. Can be used with standard thimbles. Plated for rust resistance.

No.	Size	Price
120 AM	1 1/2"	8.00 per 100
110 AM	1 1/4"	8.00 per 100

BAKER MANUFACTURING COMPANY

Prices and specifications subject to change without notice.

new, improved

JONTZ TV INSTALLATION ACCESSORIES

Sturdy, long-lasting . . . easy to erect and service

model 200 SELF-SUPPORTING TOWER

50-ft. self-supporting tower assures maximum safety with no guy wires. Constructed of highest quality rust-resistant 1" 14-ga. steel tubing. Tested to withstand wind loads up to 100 mph. Additional height up to 150 ft. by using guys every 30 feet.

	Recom- mended List	Recom- mended Dlrs. Net	Ship. mended Wt. Lbs.
50' Tower, complete with foundation mountings	\$129.75	\$82.50	200
10' Top sections, including foundation mountings	28.75	18.50	40
10' Mid sections	25.25	16.00	40
20' Gim poles for erection (2" Tubing)		8.75	24

model 400 SELF-SUPPORTING TOWER

Slash your freight rates with Model 400! Occupies 40% less shipping space, as sections are constructed to ship nested. 50-ft. self-supporting tower withstands high wind loads . . . constructed of heavy duty 1 1/2" 14-ga. tubing, with 16-ga. steps.

	Recom- mended List	Recom- mended Dlrs. Net	Ship. mended Wt. Lbs.
50' Tower, complete with foundation mountings	\$134.95	\$89.95	240
10' Top sections, No. 400D, complete with foundation mtgs.			58
10' Mid sections No. 400C			43
10' Reducing sections — No. 400B			43
10' Bottom sections — No. 400A			48

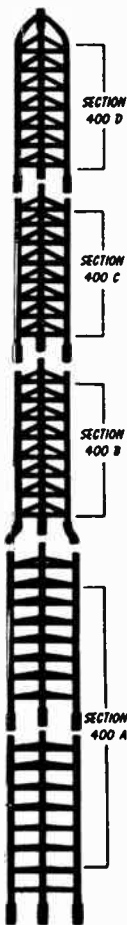

KWICK-UP GALVANIZED TELESCOPING MASTS

Constructed of heavy-weight rust-resistant 1 1/2" 16-ga. steel tubing . . . hot-dip galvanized. Sturdy, well-built, non-twisting masts for any location. Shipped in special protective cartons. Complete with All Hardware and Base.

	Recom- mended List	Recom- mended Dlrs. Net	Ship. mended Wt. Lbs.
Model 120, 20'	\$13.85	\$ 8.35	22
Model 130, 30'	20.15	12.10	33
Model 140, 40'	28.50	17.10	46
Model 150, 50'	34.30	20.60	52
Model 150A, 50'	38.90	23.35	61
Deduct 40¢ Per Unit If Wanted Without Base.			

model 240

LIGHT SELF-SUPPORTING TOWER
40-ft. light self-supporting tower withstands high wind loads. Ten-foot sections are constructed of 1" 16-ga. tubing, with 1 1/2" 12-ga. joints. Additional height up to 150 feet by using guys every 20 feet.

	Recom- mended List	Recom- mended Dlrs. Net	Ship. mended Wt. Lbs.
40' Tower, complete with foundation mountings	\$88.95	\$55.95	150
10' Top sections, including foundation mountings			45
10' Mid sections			35

model 100

LIGHT GUYED TOWER
30-ft. tubular steel tower, heavily zinc-plated with additional chromate dip for extra rust-resistance. Section ends made with slip joints . . . eliminates bolting. Additional height up to 100 feet.

	Recom- mended List	Recom- mended Dlrs. Net	Ship. mended Wt. Lbs.
30' Tower, complete with base	\$69.95	\$44.65	80
10' Top sections	20.95	12.95	22
10' Mid sections	19.15	12.50	22
Base plates	10.70	6.70	14
20' Gim poles for erection (1 1/4" Tubing)		8.75	20

ROOF MOUNTS

GUY RINGS

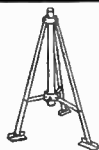

MITEY-MITE TOWER

Models 300 and 500
For both UHF and VHF antennas; receives 1" to 1 1/2" masts. No guy wires necessary; just bolt mounting feet to any pitch roof. Shipped folded completely assembled.

	Ship. Wt. Lbs.
Model 300, 3' high	7
Model 500, 5' high	10

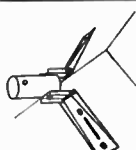

MODELS "U-S" NO. 1, 2, AND 3

Nos. 1 and 2: For any pitch roof. Cut your inventory on bases to a minimum. "U-S" No. 1 receives masts up through 1 1/2" O.D., "U-S" No. 2 for masts up through 2" O.D.
No. 3: Universal swivel-type quality base mount permits erection from any angle at any position. Receives masts up through 2" O.D.

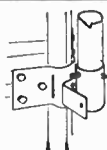

MODEL A-S APEX MOUNT

4-way swivel mount for any type of installation, whether flat surface, peak roof, or corner mounting. Receives masts up to 2 1/4" tubing.

	Recom- mended List	Recom- mended Dlrs. Net	Ship. mended Wt. Lbs.
Model A-S, each	\$ 2.15	\$ 1.35	3
Model U-S #1, each	1.55	.95	2 1/2
Model U-S #2, each	1.95	1.25	2 1/2
Model U-S #3, each	2.30	1.45	3

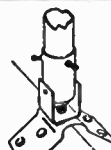

New, improved guy rings with shoulders. Handy ring may be used with either 3 or 4 wires. 3 3/8" O.D., with your choice of 5 I.D.'s: 1", 1 1/4", 1 1/2", 1 3/4", and 2"

ALL SIZES, each	Recom- mended List	Recom- mended Dlrs. Net	Ship. mended Wt. Lbs.
	\$.15	\$.10	14

All prices subject to change without notice.

Model A-S, each	\$ 2.15	\$ 1.35	3
Model U-S #1, each	1.55	.95	2 1/2
Model U-S #2, each	1.95	1.25	2 1/2
Model U-S #3, each	2.30	1.45	3

DIRECT INQUIRIES TO:

JONTZ MANUFACTURING COMPANY



Thank You!

When writing for additional
information or when ordering
from sources of supply listed
in this book, please mention

RADIO'S MASTER

Argos

PRODUCTS COMPANY

*Craftsmanship
in Cabinets*



NEW HI-FI TUNER CABINETS

Give added beauty to your high-fidelity installation with handsome new Argos cabinets. Designed for finest surroundings, yet economically priced. Will accommodate most every tuner or amplifier on market.

Sleek modern design with extended top and tapered front. Extra heavy mahogany or blonde leatherette over sturdy plywood. Blonde model uses especially attractive new pattern. Carefully constructed throughout with "Craftsmanship in Cabinets."
Size: 10 1/4 x 17 x 13 1/2 in. Front panels shipped blank. 4-page instruction folder. Shipping weight: 8 1/2 lbs.
UC-1—State Mahogany or Blonde, same price. List \$24.00 — Net \$14.40
MATCHING CABINETS also available for record player (inside dimensions 9 1/2 x 16 1/2 x 14 in.); also matching console cabinets for 12-in. or 15-in. speaker, using either bass reflex, Jensen duette, or woofer-tweeter system. Ask your distributor for latest information.

DELUXE SPEAKER CABINET

Designed for the finest surroundings. Picture-frame front is hand-rubbed 1 x 2 1/2 in. solid hardwood. Top and sides are 1/2-in. 5-ply wood, covered with matching leatherette. Plastic grille cloth. Acoustic padding. Size 23 3/4" w., 30" h., 14 1/8" deep. 15" spkr. mounting screws installed; also reducing ring with screws for 12" spkr. Specify Mahogany or Blonde, same price. DBR—Ship. wt. 35 lbs. List \$75.00 — Net \$45.00

BASS REFLEX CABINETS

Same high quality as above, without picture-frame front. 1/2-in. 5-ply wood; brown mahogany leatherette. Acoustic lining. Plastic grille cloth. Spkr. mounting screws in place.
BR-12—20" w., 30" h., 12 1/2" d. Ship. wt. 31 lbs. List \$44.50 — Net \$26.70
BR-15—23 3/8" w., 30" h., 14" d. Ship. wt. 35 lbs. List \$49.50 — Net \$29.70

CORNER WALL BAFFLES

Corner location often aims sound better, is less conspicuous. Heavy wood construction, bass reflex design and acoustic lining for richer tone than ordinarily obtained in baffles. Plastic grille; pyroxylin-coated leatherette.

Mahogany or Blonde, Same Price
CB-8—For 8" Speaker. 12 3/4 x 14 1/4 x 6 1/2 in. Shipping Weight 5 lbs. List \$9.25 — Net \$5.55
CB-12—For 12" Speaker. 17 3/4 x 20 1/2 x 9 in. Shipping Weight 9 lbs. List \$15.50 — Net \$9.30

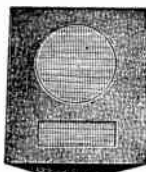

WALL BAFFLES

Same fine craftsmanship as above. Heavy construction, reinforced for extra strength. Plastic grille; Pyroxylin coated leatherette. Packed 2 in carton. Shipping weight per carton of two in the order listed below: 2 1/2, 3, 5 1/2, 7, and 10 lbs.

Mahogany or Blonde, Same Price

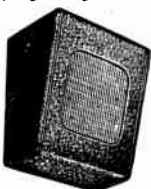

Part No.	Speaker	Width, Height, Depth	List Price	Dir. Net
WB-4/5	4-5 in.	6x6 1/2 x 3 3/4 in.	\$3.90	\$2.34
WB-6	6 in.	7 1/4 x 8 1/2 x 5 in.	4.40	2.64
WB-8	8 in.	9 1/2 x 10 1/4 x 6 3/8 in.	4.90	2.94
WB-10	10 in.	11 1/2 x 12 1/2 x 6 3/8 in.	5.80	3.48
WB-12	12 in.	13 1/2 x 14 1/4 x 9 in.	7.75	4.65

SOUND CADDY

Highly serviceable portable case. Accommodates two 12-in. speakers with space below for most amplifiers (with turn-table) up to 30 watts. Amplifier bolts to mounting board. Mahogany leatherette 17" wide by 23" high by 13" deep.
SC-1—Shipping Weight 22 lbs. — Net \$19.50



RECORD CHANGER CASE

Sturdily built for long dependable service. Handsome mahogany leatherette with brass-finish hardware (also corner hardware, not shown). Clearance above mounting board 6 1/2 in. Size 16 1/2" square by 11 1/2"; inside 3/4" less.
PC-1A—Shipping Weight 16 lbs. — Net \$12.60



THE NEW Carry-all tube caddy

COUNTS and CARRIES Your TUBES

Specially designed for the television serviceman. Makes work easier and quicker — and YOU more efficient. Holds up to 262 receiving-type tubes, plus TOOLS and METER. You TAKE INVENTORY AT A GLANCE. Missing cartons easily spotted. Shop owners say the Tube Caddy PAYS FOR ITSELF IN 3 WEEKS time. Their men are checked in and out faster, and always arrive on the job with the tubes they need. This means more calls per day, and lower cost per call. Moreover, customers recognize their service is up-to-the-minute, with every aid available for faster, more efficient repair. Heavy two-tone gray scuff-resistant leatherette with handsome brass finish hardware. Solidly built for long service.
TC-4—Size 8 x 15 x 21 in. Shipping Weight 16 lbs. — Net \$13.95

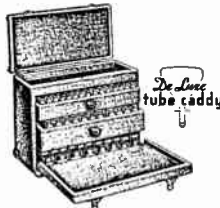

DELUXE TUBE CADDY

Combines drawers with convenient top tray for TOOLS and METER. Holds up to 225 tubes. Heavy two-tone gray leatherette, etc., same high quality as above. Stay hinges support top cover; slip-out hinges on front cover with clips for data sheets or mirror (not furnished).
TC-3—Size 18 x 14 1/2 x 9 1/4 in. Shipping weight 16 lbs. — Net \$14.95

ORIGINAL "TUBE CADDY"

Holds up to 249 tubes without a single inch of waste space. Prized possession of thousands of TV servicemen. Drawer partitions removable to accommodate TOOLS and METER. Brown leatherette. Slip-out hinges, etc. Size 20 x 13 1/2 x 9 inches.
TC-1B—Ship. Wt. 16 lbs. — Net \$13.50



TUBE CADDY "JUNIOR"

Companion piece to larger units above. Same work-saving features in 3/5rds the size and weight. Easy to carry. Holds up to 143 tubes, or less with TOOLS and METER. Brown leatherette, slip-out hinges on cover, etc. Handy size 15 1/2 x 13 x 8 in.
TC-2—Ship. Wt. 13 lbs. — Net \$7.75

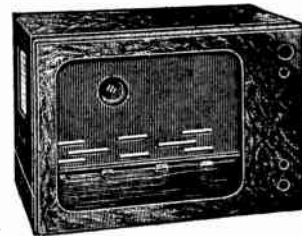
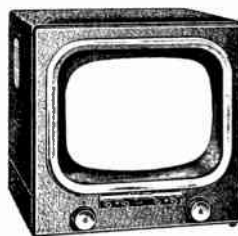

TV CABINETS For All Popular TV Chassis

16" to 27" Tube — Mahogany or Blonde, Same Price
Convert your TV chassis into a complete set with minimum cost. Exceptionally well built Argos cabinets fit finest surroundings. Richly grained pyroxylin coated leatherette—Mahogany or Blonde, same price. Rugged construction with 3/8" 3-ply sides and 1/2" 5-ply bottom. Speaker grille is woven plastic. Fin-shanked bolts for speaker.

ARGOS #	Tube Size	Chassis (see footnotes)	Ship. Wt.	Dir. Net*
TV-1RC	16-17 Rect.	Craftsmen, a	25 lbs.	\$32.92
TV-21RC	21 Rect.	Craftsmen, a	28 lbs.	36.86
TV-24RC	24 Rd./27 Rect.	Craftsmen, a	40 lbs.	50.40
TV-24RCR	24 Rect.	Craftsmen, a, d	45 lbs.	57.70
TV-27RCR	27 Rect.	Craftsmen, a, d	45 lbs.	57.70
TV-24RCRT	24 Rect.	Craftsmen, a, c, d	45 lbs.	57.70
TV-27RCRT	27 Rect.	Craftsmen, a, c, d	45 lbs.	57.70
TV-3PT	16 Rd./20 Rect.	630 type, b	28 lbs.	34.97
TV-21PT	21 Rect.	630 type, a	28 lbs.	36.86
TV-24PT	24 Rd./27 Rect.	630 type, a	40 lbs.	50.40
TV-24PTU	24 Rd./27 Rect.	630 type, b	40 lbs.	48.51
TV-24/27R	24 or 27 Rect.	630 type, a, c	45 lbs.	59.85

a — All holes cut, ready for chassis to slide in. b — Blank front panel. c — Mounting board furnished for sidewinder chassis. d — Remote control.

ALL ARGOS PRODUCTS equipment is sold only through Parts Jobbers. The name Argos stands for craftsmanship in cabinetry. Prices slightly higher West of Rockies.

MALLORY MODEL 88 UHF CONVERTER



The Mallory Model 88 UHF Converter expands the receiving capability of any conventional VHF television set to include reception of all UHF stations located within the signal range.

Designed for continuous tuning, this UHF converter insures a compatible balance of inductance and capacitance over the entire, tuning spectrum from 470 to 890 megacycles with a single control.

The smooth and easy operation of the Model 88 Converter is the result of many years of Mallory research in the field of variable inductance tuning devices. This program has resulted in the successful combination of modern circuit techniques required for converting conventional UHF signals to intermediate channels. The Model 88 will result in added television entertainment, through wider program selection, from the conventional television receiver.

The Model 88 Converter is equipped with a built-in UHF antenna which permits installation without the need for special tools or technical skills.

To simplify the operation of this unit even further, a 3-position, "master control" switch is located on the panel to assure rapid selection of:

- (a) UHF station tuning.
- (b) Normal operation of the VHF set.
- (c) Switching VHF set and converter off and on.

Complete installation and operating instructions and warranty are included with each unit.

Catalog No. Model 88

List Price \$34.95

DETAILED SPECIFICATIONS

Tuning Range: The tuning range of the Model 88 extends from 470 to 890 megacycles in a continuous, unbroken sweep of the tuning dial. This permits accurate tuning of all UHF TV channels without the addition of strips, coils, or band switches. The Mallory Converter is constantly tuned for operation in all areas of television reception.

Tube Complement: 6AF4/6T4 Oscillator; 6CB6 I.F. Amplifier; Selenium Rectifier; and a 1N72 UHF Diode Detector.

Circuitry: Three tuned circuits are employed in the UHF range to provide antenna pre-selection as well as the oscillator-mixer tuning function. These circuits are controlled manually by means of a single shaft actuated from the front panel of the converter. A 6CB6 amplifier, operating at a mean of 82 megacycles, is part of the Model 88. It provides additional amplification at the converter I.F. (either VHF channel 5 or 6). A combination change-over and AC on-off switch is provided to permit quick selection of either VHF or UHF stations from the front panel of the instrument.

Antenna Input Impedance: 300 ohms nominal.

Output Impedance: 300 ohms.

Stability: Oscillator drift and instability in the Model 88 are reduced to a negligible factor by the omission of all mechanically unstable parts, such as; air-tuned condensers, long leads, switches, and coil strips. Thermal sensitive parts are mounted away from heat producing components such as the I.F. and power supply tubes. The Model 88 stabilizes after approximately 1 minute when used with inter-carrier VHF TV sets, and after 3 to 5 minutes when employed with split-circuit sets.

Dial Mechanism: The dial is a slide-rule type, calibrated in TV channels 14 through 82. Full coverage of the entire tuning range is accomplished with approximately 7.5 turns of the tuning knob. Numerals indicating calibration are in gold on glass, and extend approximately 4" across the face of the instrument.

Power Supply: The Model 88 is designed for 117 volt, 60 cycle operation. The power supply consists of a transformer, a selenium rectifier, and a resistance-capacitance filter. Approximately 25 watts of power are required for operation.

Cabinet: Cabinet is attractive and of compact modern design. Measures 7½" wide, 4⅞" deep, and 5¾" high. Bottom of cabinet has felt pads to prevent marring of furniture.

Weight: Approximately 3¼ lbs.

THE MALLORY UHF INDUCTUNER*

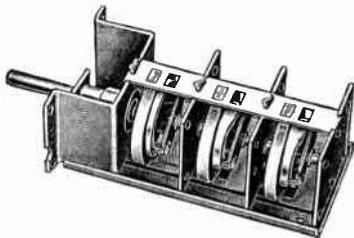

The Mallory UHF Inductuner, the result of years of research by P. R. Mallory & Co. Inc. in variable-inductance tuning of resonant circuits, is a compact assembly of variable inductances available in three sections. It will tune continuously the UHF range of television channels from 470 to 890 megacycles when used with proper circuitry.

Features of the UHF Inductuner include: reduction in overall capacitance while maintaining the same compact case as used for the Spiral Tuner; complete shielding between sections; shaping of the various sections for oscillator tracking at an I.F. of 82 Mc.; rugged contacts, and positive, uni-control coverage in 270° of rotation.

Additional information is available on request.

Catalog No.	Dimensions	List Price
8313	4 1/8 x 2 x 2 1/8	\$15.00

* Inductuner—Registered trade mark for Mallory variable inductance tuning devices. Pat. Applied For.

SPIRAL TUNERS • GRID BIAS CELLS

P. R. MALLORY & CO., INC. • INDIANAPOLIS

P. R. MALLORY & CO. Inc.
MALLORY

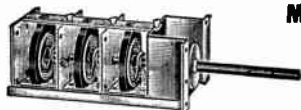

Mallory Spiral Inductuner*

The two, three and four gang Spiral Inductuners* are variable inductance tuning devices designed to provide efficient front-end tuning in deluxe television and FM receivers and boosters.

When used in conjunction with suitable tubes and a minimum of circuit wiring, these Inductuners assure accurate, noise-free and continuous tuning of the entire frequency spectrum from 52 through 216 megacycles. The Inductuner eliminates the need for band switches, plug-in coils, turret coil assemblies or complicated circuit wiring when used for this purpose.

Tuning is accomplished in all models by means of a single 1/4" shaft to vary the inductance of each of the inductors simultaneously from the front of the equipment using the Inductuner. Automatic stops at the maximum and minimum inductance positions are provided to prevent damage to the inductors.

The individual coils have a maximum inductance of .985 uh and a minimum inductance of .025 uh. Total shaft turns are 5.925 ± .060-.000. Each Inductuner has a 2 1/2" shaft—1/4" diameter.

Model 8302 is ideal for use in a TV booster (see schematic diagram below). Models 8303 or 8304 are suitable for TV front-end service.

Catalog No.	No. of Gangs	Dimensions†	List Price
8302	2	3 9/16 x 2 x 2 1/8	\$12.00
8303	3	4 1/16 x 2 x 2 1/8	15.00
8304	4	5 7/8 x 2 x 2 1/8	18.00

† Excluding lugs and shaft.

* Inductuner—Registered trade mark for Mallory variable inductance tuning devices. Manufactured and sold under one or more of the following Paul Ware and Mallory patents: 2,163,644, 2,163,645, 2,163,646, 2,163,647, 2,260,877, 2,377,789, 2,377,790, 2,399,060, 2,405,890, 2,443,020, 2,443,822, 2,505,178, 2,540,863, 2,666,906. Other patents applied for.

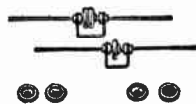

Grid Bias Cells

Mallory Grid Bias Cells are small acorn-shaped, self-contained devices. The metal container or cup is the negative electrode. The black disc is the positive electrode.

The principal use of Mallory Grid Bias Cells is in the biasing of the first audio amplifier tube in modern high-gain receivers. The bias cell does not need to be by-passed to ground.

The no-current potential of the cells is within plus or minus 10% of their rated voltage. The cells are strictly potential or voltage cells for biasing class "A" amplifier tubes and should not be used for biasing power tubes or oscillators, or for any circuit where direct current may flow through, or be drawn from, the cells.

The cells may be used at temperatures from 0°F to 140°F. The voltage of the cells remains reasonably constant throughout this wide temperature range. Whenever possible, place the bias cells in the coolest location. The cells exhibit no change in characteristics when exposed to a relative humidity of 90% at 120°F.

Mallory Grid Bias Cells are non-reactive at audio frequencies. The DC resistance of the cell ranges between 10,000 and 40,000 ohms. The cells do not cause noise.

Cat. No.	Description	List Price
BC-3	1 1/2-volt Grid Bias Cell (packed 10 to box)	\$0.45
BC-4	1 1/2-volt Grid Bias Cell (packed 10 to box) With mounting stud	
BC-5	1 3/4-volt Grid Bias Cell (packed 10 to box)	.70
BC-6	1 3/4-volt Grid Bias Cell (packed 10 to box) With mounting stud	.45
GB15	Cell Clip, 1-cell capacity for BC-2 or 2-cell holding capacity for BC-3 or BC-5	.70
GB16	Cell Clip, 2-cell capacity for BC-2 or 4-cell holding capacity for BC-3 or BC-5	.15
GB17	Cell Clip, 1-cell capacity for BC-3	.15

Two-Gang Spiral Inductuner Booster for TV, FM and General Purpose Tuning

Continuous Range: 54 to 216 Mc.

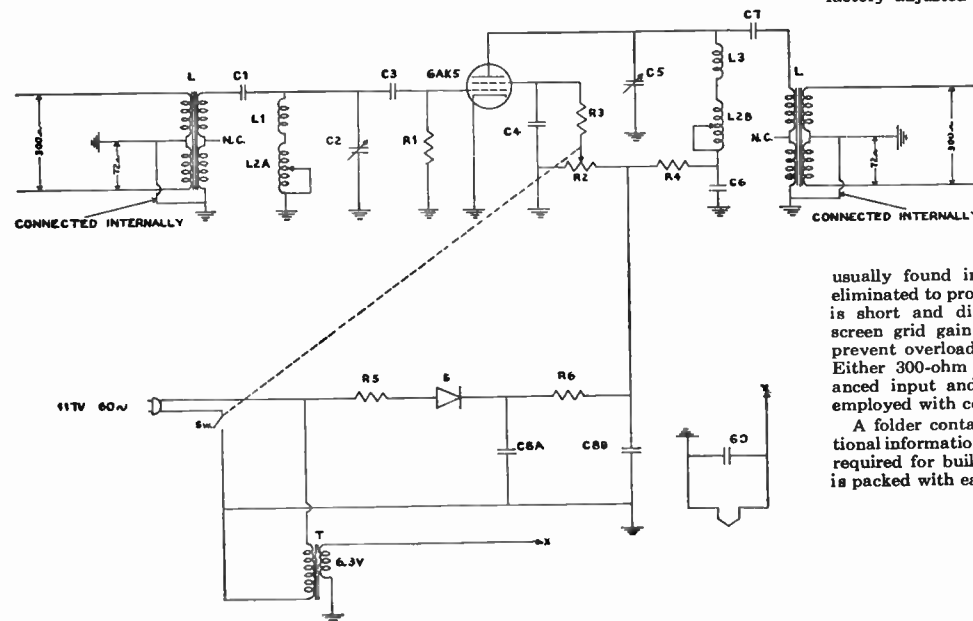

At the left is a schematic diagram of a full-coverage, TV booster employing the Mallory No. 8302 2-gang Spiral Inductuner. This TV booster is entirely practical and suitable for home-shop construction by the average technician. The Inductuner supplies all the essentials required for tuning in one, compact, factory-adjusted unit, thus providing simplified construction.

No tuning condensers, band switches or plug-in coils are needed. Possible errors usually attendant with hand-wound coils and unknown tolerances of tuning condensers are completely avoided.

The proven efficiency and high gain of a 6AK5 tube has been utilized to the fullest extent. The antenna changeover switch usually found in booster circuits has been eliminated to provide vital R.F. wiring, which is short and direct. An infinitely variable screen grid gain control has been added to prevent overloading by strong, local signals. Either 300-ohm balanced or 72-ohm unbalanced input and output feed lines may be employed with comparable results.

A folder containing detailed and constructional information, plus a listing of components required for building an Inductuner booster, is packed with each No. 8302 Inductuner.

NO FINER CHOICE THAN

Electro-Voice

PRECISION ELECTRONIC

BOOSTERS

VHF TV • FM • VHF TV

TENNA-TOP

ANTENNA-MOUNTED TV BOOSTER

Low Noise • All Channel • Self-tuning • Permits Long Lead-Ins

Mounts at antenna, ahead of lead-in. Amplifies only wanted TV signals, NOT local noise picked up by lead-in. Completely automatic, fully electronic. NO manual tuning necessary. Exclusive EV broadband circuit assures uniform high gain across entire band width. Tapped power transformer in junction box permits satisfactory operation with long lead-ins. Use of high quality wire allows lengths up to 3000'. Extremely stable, no signal drift, no limiting peaks. Easy to install. Single lead-in carries power up, brings amplified TV signal down. Uses all-band or separate hi and low channel antennas. Amplifier unit is rugged, weather-proof, trouble-free. Easily mounted on mast. Junction control box easily hidden in TV set.

Model 3010 SUPER-TENNA TOP. Uses four tubes for two separate high and low band 2-stage amplifiers. Input and output 150-300 ohms. Booster unit 7 $\frac{1}{4}$ " x 7 $\frac{3}{8}$ " x 6" in rugged, moisture-proofed housing. Junction control box 6 $\frac{3}{4}$ " x 3 $\frac{3}{8}$ " x 4 $\frac{1}{2}$ " finished in gray hammertone. For 105-125 volts, 50-60 cycles AC. Complete with four 6J6 tubes, mounting brackets, and plug-in cord. Shipping weight 11 lbs.

List Price\$88.00

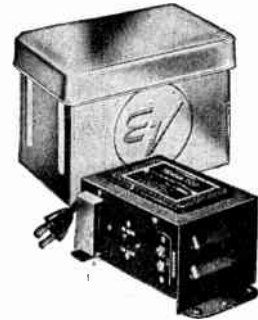

3010

MODEL 3400 UHF TV BOOSTER

High Gain • Increased Sensitivity • Micrometer Type Tuning

Again EV creative engineering contributes a major advance in ultra high frequency electronic research with the production of the Model 3400 UHF TV Booster. If you are located in a UHF fringe area the Model 3400 will enable UHF reception equal to that in primary areas. The use of a special push-pull grounded grid circuit provides a substantial increase in sensitivity, improved signal-to-noise ratio and reduced "off frequency" interference. Exclusive micrometer type tuning system permits smooth, precision tuning over the entire UHF range, channels 14 through 83. As a result of careful, thorough UHF engineering, the performance, stability and ease of tuning of the Model 3400 UHF Booster compares favorably with the finest VHF boosters.

Model 3400 UHF BOOSTER. Employs two 6AJ4 RF amplifiers in a push-pull grounded grid circuit with silver plated, distributed constant resonant system. Frequency range, 470 mc to 890 mc. 300-ohm input and output impedance. For 105-125 volt, 60 cycle AC. 19 watts power consumption. Attractive metal cabinet finished in rich, warm brown. 7 $\frac{3}{4}$ " wide, 5 $\frac{1}{4}$ " high, 6 $\frac{1}{4}$ " deep. Shipping weight 5 $\frac{1}{2}$ lbs.

List Price\$44.78



3400

MODEL 3005 FM BOOSTER

Fully Automatic • High Gain • Broadband

The lasting pleasure of fine FM music under all conditions is made possible with the Model 3005 FM Booster. No more "lost programs" in difficult city locations or in outlying low-signal areas. Utilizing a special design high-gain circuit, this all-electronic broadband booster takes full advantage of all FM features without compromise. Extends the useful range of FM reception; clearly brings in stations not possible before. Increases signal strength over 10 times (20 db) uniformly throughout the entire FM spectrum from 88 to 108 mc. Thermal relay permits FM booster to be turned "on" and "off" by the receiver without any circuit modifications. Completely automatic, no tuning or adjustment required; simple to install.

Model 3005 FM BOOSTER. Uses two dual triode tubes in a highly developed, low internal noise circuit. 300-ohm input and output. For 105-125 volt, 60 cycles AC. Automatic switch actuated by sets consuming between 40 and 250 watts. Sturdy metal two-tone gray case. Vertical mounting brackets included; rubber feet. 5 $\frac{1}{2}$ " x 4" x 5 $\frac{3}{8}$ ". Complete with tubes and plug-in cord. Shipping weight 3 lbs.

List Price\$45.00



3005



products for BETTER TELEVISION

by BLONDER-TONGUE LABORATORIES, INC., Westfield, N. J.

The B-T Add-A-Unit SYSTEM

A Successful Plan for Low Cost, Easy-to-Install Master TV Systems for VHF and UHF. Through the use of B-T Units, virtually every known TV problem can be dealt with. And the system is so flexible that it can serve the needs of 1 or 2 or even 2000 sets . . . without outside engineering assistance.

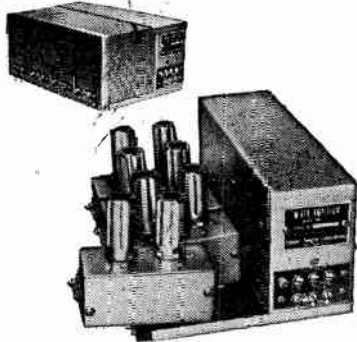

B-T MIXER AMPLIFIER Model MA4-1

TV signal mixer with built-in power supply. Has 4 receptacles for plug-in, single-channel (VHF) amplifier strips (CS-1) or UHF conversion strips (UC-1), plus one through line.
Model MA4-1. Basic chassis and power supply less plug-in strips.
List Price \$52.50

Model CS-1. Single channel amplifier strip specify VHF channel.
List Price \$21.50

Model UC-1. UHF conversion strip (occupies space of two CS-1). Converts specified UHF channel to specified VHF channel. Specify UHF and VHF channels.
List Price \$69.50

B - T TELEVISION ACCESSORIES

Precision engineered and individually tested for performance and impedance match. For Master Systems and individual installations.

WEATHER-PROOF HOUSING

Model WH-1. For outdoor installation of any B-T Unit. Has universal mounting bracket for mast, roof, etc. Size: 9 3/4" x 7" x 5 3/4".
List Price \$17.50

LINE LOSS EQUALIZER

Model LLE-1. Compensates for differential signal loss in 1000 feet of RG/11U or 500 feet of RG/59U. Attenuates gradually from 1 db. on Channel 13 to 17 db. on Channel 2.
List Price \$9.50

MATCHING TRANSFORMER

Model MT-1. Provides precise impedance match of 75 ohm (unbalanced) and 300 ohm (balanced) lines.
List Price \$6.50

RESISTOR OUTLET BOX

Model RO1-A. Permits TV tap-off from any 75-ohm line to 75 or 300-ohm receiver. Provides 17 db. isolation with only .5 db. insertion loss. Passes UHF as well as VHF.
List Price \$5.50

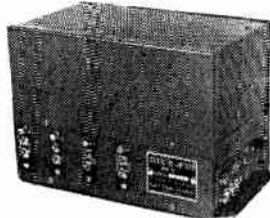

B-T DISTRIBUTION AMPLIFIERS

Model DAE-1. Eight TV receiver outlets and one through line. For multiple set distribution systems. Gain control. Full isolation, with no loss at receiver terminals.
List Price \$87.50

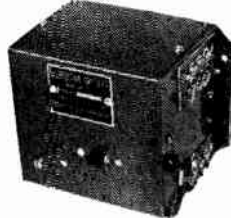

Model DA2-1. Two TV receiver outlets and one through line. For multiple set distribution systems. Full isolation, with no loss at receiver terminals.
List Price \$39.50



B-T ALL-CHANNEL AMPLIFIER COMMERCIAL ANTENSIFIER

Model CA-1. All-channel VHF amplification in excess of 27 db. Gain control. Ideal line amplifier for master TV systems or as deluxe pre-amplifier.
List Price \$77.50

LINE SPLITTERS (Couplers)

Model LS4-1. Divides one 75 ohm line into four 75 ohm lines. List Price.....\$7.50

Model LS4-2. Divides one 300 ohm line into four 75 ohm lines. List Price.....\$7.50

Model LS4-3. Divides one 75 ohm line into four 300 ohm lines. List Price.....\$7.50

Model LS4-4. Divides one 300 ohm line into four 300 ohm lines. List Price.....\$7.50

REMOTE CONTROL

Model RC-1. For automatic 'on/off' operation of any B-T Unit, or other unit drawing up to .5 amp. at 117v. AC. Complete with relay, indicator light, and fuses.
List Price \$19.50

ATTENUATOR

Model AT-1. Provides 0 to 42 db. attenuation on all VHF channels in 6 db. steps. 75 ohm and 75 and 300 ohm terminals.
List Price \$12.50

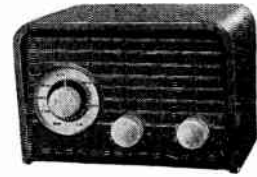

B-T ULTRAVERTER Model BTU-2 All Channel UHF Converter

For highest quality UHF reception on all VHF TV sets. Automatic "ON-OFF." Output to TV set on Channels 5 and 6. Selector switch for VHF and UHF Antennas. High gain, low noise conversion. Dual-speed tuning. Employs original B-T Ultratuner. Tubes: 6T4, 6AB4 and Germanium Diode. Fully shielded. Complete with power supply. Provides maximum performance in weak signal locations. Attractive cabinet styling.

List Price \$39.95



B-T UHF CONVERTER Model 99

A low cost, high quality, all-channel UHF Converter. Has tuned input that tracks with oscillator, for effective rejection of spurious signals, and suppression of oscillator radiation. Thermally compensated oscillator provides drift-free performance. Precise impedance match. Maximum signal conversion. Attractive styrene cabinet. Requires no VHF Channel switching. One knob tuning. Output is received on VHF Channel 4, 5 or 6.

List Price \$19.95

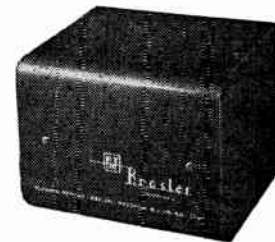

B-T BOOSTER Model HA-3

Fully Automatic with Gain in Excess of 16 db on All VHF Channels

Automatic 'on/off' operation with TV set. Requires no tuning or bandswitching. Operates automatically across the entire VHF band. Can be used with UHF converters. All-triode, cascaded, push-pull circuit (3 6J6) assures lowest possible noise factor. Attenuator switch prevent overloads.

List Price \$39.50

FREE INSTALLATION MANUAL AND CATALOG ON REQUEST

Bogen TELEVISION ACCESSORIES

UHF or VHF—if T.V. reception is unsatisfactory due to fringe area location or other cause—try one of the

Bogen "proof in the picture" units described below, unmatched for engineering, performance and value.

UHF Big 3

"G-Line" Transmission Line A single-wire line impervious to effects of rain, salt spray, soot, and swinging of line. Insures good reception in any kind of weather. No intermediate supports are needed. G-Line also substantially extends range of UHF reception due to exceptional low-loss qualities (only 6 db loss for 500').

Does not pick up noise. Electronic "launchers" at antenna (illustration at right) and at set (outside window) set up the mode of transmission and confine field to small area around the wire. Order "GL" kit, which includes 2 launchers, 150' of the special insulated wire, 2 brackets.

List Price: \$43.75

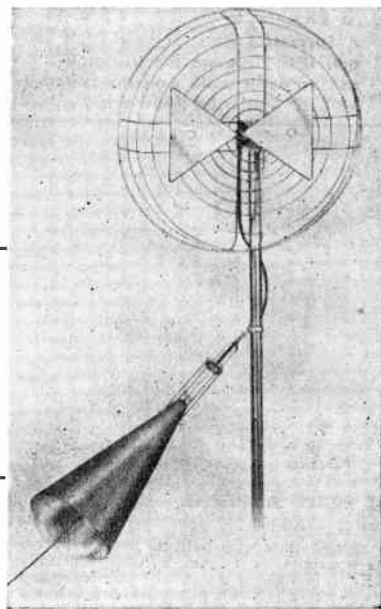

G-Line



UHB

"UHB" Booster

Provides optimum reception through UHF channels 14 to 83, tunes continuously, delivers a gain of 13½ db at low frequencies, an 8 db gain at the high end. Proportionately, the noise figure is extremely good—from 11 db to 15 db from low to high. Brings in fringe areas, cuts down "snow" effectively. Brown steel cabinet.

List Price: \$41.00



UCT-1

"UCT-1" Converter

Approximately 6 db lower signal-to-noise ratio than competitive converters! Connects easily to any VHF set for reception of all 70 UHF channels. Single-knob tuning. Completely self-contained and compact in design. Brown plastic cabinet.

List Price: \$42.50

VHF Boosters

"BB1-A" Tunable Booster

The tunable booster proved in hundreds of thousands of installations. A precision-tooled gear assembly provides the ultimate in smooth control. One knob tunes continuously from Channel 2 to 13. Separate 6J6 triodes operate in independent push-pull circuits. When the set is turned on the BB1-A turns on automatically. When the set is turned off the booster shuts off automatically. BB1-A in brown plastic cabinet. List Price: \$32.50

BB1-B in blonde plastic cabinet. List Price: \$33.50



BB1-A

"AMB-1" Broad Band Antenna Mounted Booster

A two-unit automatic booster. The AMPLIFIER mounts to the antenna quickly, easily and positively with the Bogen "strap-mount." The four tube cascade circuit provides an average 16 db gain increase for all channels. The CONTROL UNIT mounts at the rear of or inside the television receiver and turns on and off automatically with the set. It is equipped with a tapped transformer to compensate for different lengths of twin lead. Power is fed to the amplifier and the amplified signal is returned to the set over the same twin lead.

List Price: \$79.50

"BIB-1" Broad Band Set Located Booster

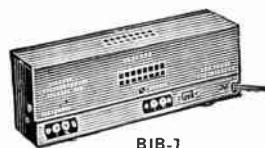

BIB-1

Completely automatic broad band booster designed to mount behind the set or inside it. Once installed it will provide improved picture and sound on all channels without being touched. It turns on and off automatically with the T.V. receiver. Its four tube cascade, push-pull circuit provides an average 18 db gain for all channels and a noise figure of 10, assurance of improved picture and reduced "snow." List Price: \$55.50

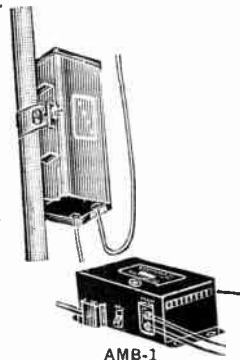

AMB-1

"TVC" Voltage Compensator

A tapped transformer to assure full size horizontal drive and reduces picture width or when high line voltage threatens set life. Will deliver 117 volts to any T.V. receiver drawing up to 350 watts. Equipped with calibrated switch to select available primary line voltage: 100 V, 105 V, 110 V, 115 V, 120 V, 125 V.

List Price: \$18.00

PRICES APPROXIMATELY 5% HIGHER WEST OF THE ROCKIES

• ALL PRICES SUBJECT TO CHANGE WITHOUT NOTICE

For further information see your distributor, or write or telephone:

DAVID BOGEN CO., INC. • 29 Ninth Avenue • New York 14, N. Y. • ORegon 5-6565

Radio's Master — 19th Edition

Copyright by U. C. P., Inc.

Regency

Every Regency Product Outsells All Other Competitive Items Combined



DB-550

DB-550 REGENCY CASCADE VHF BOOSTER

Two-Stage Model with twice as much gain and low noise. Superior performance. Single tuning knob . . . large, easy to read numbers. Designed especially for use with CASCADE front ends. **Only \$37.50 List Price**



VB-1

VB-1 REGENCY VOLTAGE BOOSTER

The answer to low line voltage problems. Get full power potential and peak performance from your TV set or any electrical device drawing 350 watts or less. This manually operated autotransformer maintains full 117 volt power supply. Insures full size TV picture when low line voltage shrinks picture size. **\$19.95 List Price**



POWER SUPPLY

HF-1000 REGENCY PROFESSIONAL HIGH FIDELITY EQUIPMENT FOR THE HOME

For those who can afford the finest. To meet the requirements of discriminating music lovers, the Regency Professional High Fidelity Ensemble for the Home has been developed and built . . . without regard to cost. Exceptional care and research have gone into the unusual flexibility of the extraordinary controls . . . which allow precise adjustments, not only for the source of the sound but for the particular room acoustic and individual psycho-acoustics. An utterly new concept in appearance, as well as luxury listening, the gold and black ensemble is designed with such striking simplicity that it need not be housed in a cabinet. REGENCY guarantees these units forever against defects in material and workmanship. **\$1000.00 Audiophile Net**

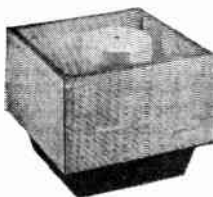

POWER AMPLIFIER



PRE-AMPLIFIER



HP-45

HP-45 REGENCY HIGH PASS FILTER

Here is an effective High Pass Filter to suppress television interference. It is a constant "K" type filter with a cut-off frequency of approximately 45 mc in a 300 ohm balanced line. Signals above 55 mc are passed through the filter without loss.

Amateur Net, only \$0.99

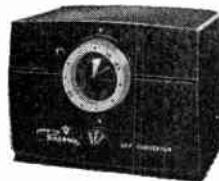

RC-53

RC-53 REGENCY UHF CONVERTER

The fastest moving converter because of its low price, high quality, and in addition, provides conversion from all UHF channels to a wide selection of VHF channels. A convenient AC outlet is provided for control of the TV set by means of the OFF-ON switch. Unexcelled performance. Housed in an attractive bakelite cabinet.

List Price \$19.95



DB-98A

DB-98A REGENCY FM BOOSTER

This compact booster brings in the full glory of FM sound even when you live miles from the transmitter. Just plug it in—then settle back and enjoy luxury listening such as you've never before experienced. 88-108 MC. Push-pull amplifier. Attractive plastic cabinet harmonizes with any style radio.

\$29.95 List Price

HF-150 REGENCY HIGH FIDELITY AUDIO AMPLIFIER

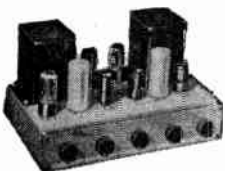

HF-150

A sensationally priced quality high fidelity amplifier with output to cover 99% of all applications. Frequency range from 20 cycles to 40,000 cycles. Five controls on the HF-150 demonstrates its real flexibility. Bass and on-off switch—treble—loudness control—level control—record compensation and input selector. Handsome gold anodized aluminum chassis makes it unnecessary to hide.

\$99.50 Audiophile Net

RT-700 REGENCY CHAIRSIDE TELEVISION CONTROL

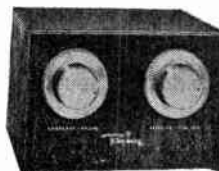

RT-700

Regency puts an end to "jack-in-the-box" televiewing with this easily installed Remote Control. It works on as much as 100 ft. of cable. Permits running cable around room periphery. Changes channels, controls contrast, and adjusts volume from where the picture is viewed. **\$69.95 List Price**

Ask your Regency representative about the Regency HI-FI distribution plan.

I.D.E.A., INC., Regency Division • Indianapolis, Indiana

Millions of TV Set Owners are your prospects for New and improved STANDARD TUNERS

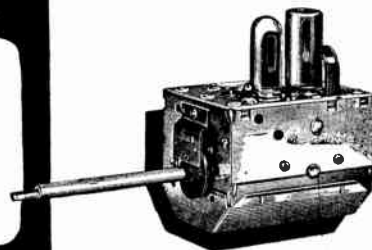

The Standard Tuner is the most widely used "front end" in the television industry . . .

now performing in more than 11,000,000 sets representing 40 per cent of the market.

Standard tuners are specified by 75 nationally known manufacturers because of proved dependability, superior gain and easy conversion to UHF.

SUPER CASCODE TUNER, TV-2232*

Dealer, \$24.50 List, \$34.50

Standard super cascode tuner TV-2232 receives signals at further distances than the original cascode tuner, making it your most effective tuner replacement in fringe areas.

SPECIFICATIONS

R.F. AMPLIFIER.....	6BQ7
OSCILLATOR MIXER.....	6J6
POWER SUPPLY.....	135 Volts 250 Volts 6.3 Volts
GAIN.....	Gain ratio low channels 80-100 times Gain ratio high channels 40-50 times
NOISE FACTOR.....	7.0DB low channels 8.1DB high channels
IMAGE REJECTION.....	55DB or greater on all channels
I.F. REJECTION.....	60DB or greater on all channels
DETENT SHAFT LENGTH.....	5 $\frac{3}{8}$ "
FINE TUNING SHAFT LENGTH.....	4 $\frac{1}{4}$ "

*This tuner I.F. is nominally set at 22.3mc at the factory but can be adjusted to any frequency within the range of 19-26mc. Also available in the 41 mc range.

PENTODE TUNER, TV-1532

Dealer, \$22.95 List, \$32.50

Standard pentode tuner No. TV-1532, completely redesigned for top performance, is your ideal replacement where signals are stronger.

SPECIFICATIONS

R.F. AMPLIFIER.....	6CB6
OSCILLATOR MIXER.....	6J6
POWER SUPPLY.....	130 Volts 6.3 Volts
GAIN.....	Low Channels 60DB High Channels 50DB
NOISE FACTOR.....	10.5DB Low Channels 12.5DB High Channels
IMAGE REJECTION.....	50DB High Channels 60DB Low Channels
I.F. REJECTION.....	60DB MIN.
DETENT SHAFT LENGTH.....	5 $\frac{3}{8}$ "
FINE TUNING SHAFT LENGTH.....	4 $\frac{1}{4}$ "

**END YOUR TV TUNER SMALL
PARTS PROBLEM
With the
STANDARD TUNER
REPLACEMENT PARTS
KIT No. 1011**

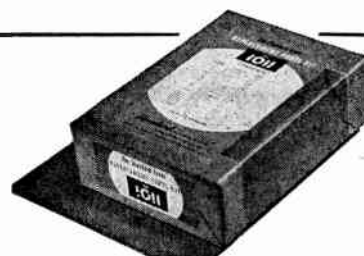

Get 104 small, hard-to-find parts in this convenient, low-cost kit . . . now available from your jobber.

Dealer price, \$22.50

See column 7 of parts price list for identity and quantity of parts in kit.

SIMPLE, LOW-COST CONVERSION TO UHF



STANDARD UHF CHANNEL STRIPS

Dealer, \$7.50 List, \$11.25

TV TUNER SERIES COIL SERIES

When ordering, give channel number and coil series letter. Use the accompanying guide:	200, 300, 1000	F-G
	1500	H
	2000	K
	2200	Q
	3000	M
	3100	R
	4200	Q
	4000, 4400	Q-R
	6000, 6500, 8000	U

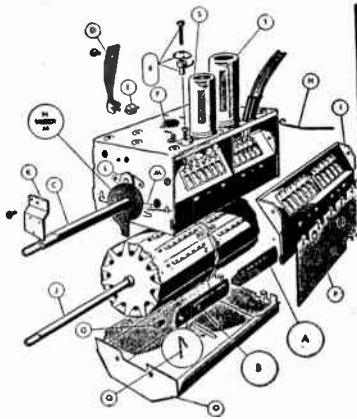

PARTS IDENTIFICATION and PRICE LIST STANDARD TUNERS

EXPLODED
VIEW

REFERENCES	DESCRIPTION	TV-200 Series Part No.	TV-1500 Series Part No.	TV-2000 Series Part No.	TV-2200 Series Part No.	Parts in Replacement Kit No. 1011	Suggested Dealer Each	List Each
A	Antenna Coil	31M-012-2F thru 13F	31M-012-2H thru 13H	31M-012-2K thru 13K	31M-012-2Q thru 13Q	None	\$1.14	\$1.90
B	Oscillator Coil	31M-112-2F thru 13F	31M-112-2H thru 13H	31M-112-2K thru 13K	31M-112-2Q thru 13Q	None	1.50	2.50
C	Fine Tuning Assembly	31A-066-22	31A-066-22	31A-066-22	31A-066-22	4	.63	1.05
D	Detent Spring	31B-005	31B-005	31B-005	31B-005	10	.06	.10
E	Roller	31B-016	31B-016	31B-016	31B-016	5	.06	.10
F	I.F. Coil Assembly	31A-082	31A-078	31A-078	31A-078	3*	.78	1.30
No Reference	Sound Trap Assembly	31A-067				1	2.65	4.00
G	Oscillator Tuning Slug	31B-015	31B-015	31B-015	31B-015	6	.09	.15
H	Retainer Spring (Drum)	31B-030	31B-030	31B-030	31B-030	6	.06	.10
I	Contact Plate and Bracket Assembly	31B-278	31B-278	31B-278	31B-278	1	2.25	3.75
J	Coil Support Assembly	31B-203-22	31B-203-22	31B-203-22	31B-203-22	1	2.70	4.50
K	Fine Tuner Ground Plate	31B-012	31B-012	31B-012	31B-012	2	.12	.20
L	a. Fine Tuner Ceramic Disc } b. Mounting Bracket }	31B-252 } 31B-021 }	31B-252 } 31B-021 }	31B-252 } 31B-021 }	31B-252 } 31B-021 }	5	.15	.25
M	Fine Tuner Tension Spring	31B-008	31B-008	31B-008	31B-008	6	.06	.10
N	Washer, Fiber	11D-022	11D-022	11D-022	11D-022	6	.06	.10
O	Shield, Bottom Cover		31B-103	31B-103	31B-103	None	.36	.60
P	Shield, Side Cover		31B-143	31B-143	31B-143	None	.12	.20
Q	Oscillator Slug Retainer Spring	31A-010	31A-010	31A-010	31A-010	6	.03	.05
No Reference	Trimmer Kit (Antenna)	31B-207	31B-207	31B-207	31B-207	5	.21	.35
R	Trimmer Kit (All others)	31B-206	31B-206	31B-206	31B-206	5	.21	.35
S	Shield, Oscillator Tube	16S-006	16S-006	16S-006	16S-006	None	.09	.15
T	Shield, R.F. Tube	16S-006	16S-006	16S-004	16S-004	None	.09	.15
No Reference	Sound Take-Off Coil (necessary when using tuner in split sound circuits)		XM-752	XM-752	XM-752	2	1.14	1.90
No Reference	Condensers							
	10 mmf ±5% N750	13L8U-100D	—	13L8U-100D	—	5	.15	.25
	10 mmf ±10% NPO	—	13L8C-100K	—	13L8C-100K	5	.15	.25
	120 mmf ±5% N750	13D-045	—	13D-045	—	5	.15	.25
	120 mmf ±10%	—	13L8D-121K	—	—	5	.15	.25
	1000 mmf GMV	13L8X-102Z	13L8X-102Z	13L8X-102Z	13L8X-102Z	5	.15	.25
	47 mmf ±10% N1400	—	—	—	13L8Q-470K	5	.15	.25
No Reference	UHF Coil Strips					None	7.50	11.25

*1-31A-082 and 2-31A-078

For all series of The Standard Tuner: Part No. 31G-200
(Includes one oscillator and one antenna coil)

Standard

COIL PRODUCTS CO., INC.

CHICAGO • LOS ANGELES • BANGOR, MICH. • NO. DIGHTON, MASS.

Export Agent: *Rocke International Corporation*, 13 E. 40th Street, New York City

Granco

UHF CONVERTERS • TUNERS • TEST EQUIPMENT

GRANCO PRODUCTS INC.

36-17 20th Avenue
Long Island City 5, N.Y.

COAXIAL TUNING • PRESELECTION • AMPLIFICATION

The superior performance of Granco UHF converters and tuners is due to these Granco features . . .

COAXIAL TUNING: Most efficient UHF tuning system known. Extreme mechanical and electrical precision. No wiper contacts. Continuous tuning over entire UHF band. Highest stability.

FINE TUNING: No "on-again off-again" tuning with Granco. No slipping past desired channel, especially with weak signals. Instead, fine tuning is simple and positive with high-ratio tuning knob. "On-the-button" tuning assured without need for "safecracker's touch."

PRESELECTION: Rejects unwanted signals and spurious interference. Only the desired signal tuned in. A "must" in areas with two or more channels, either UHF or VHF.

AMPLIFICATION: Low-loss tuning and associated circuitry, plus high-gain amplification of tuned-in channel, means cleaner, brighter, more enjoyable pictures.

WORKS WITH ANY TV SET: The Granco UHF Converter feeds a 300-ohm input to any VHF television set tuned to Channel 5 or 6. Selector switch instantly provides for UHF or VHF reception.

FITS THE REQUIREMENTS: With four models to choose from, Granco meets the requirements of every purse and purpose. No need to pay more than necessary for entirely satisfactory results in any area or location.

"CHALLENGER" Series SLU

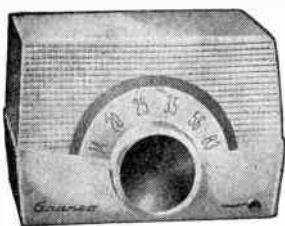

- More converter, less cost
- All-channel continuous tuning
- Two-cavity coaxial tuner
- Smart styling for modern decor
- Fine tuning; preselection; stability

No other UHF converter in this price class — or other makes costing up to \$10 more — can match the performance of the "Challenger." Works with indoor antenna in usual locations. Smart modern styling — plastic cabinet, large gilt-center tuning knob, semi-circular tuning dial, easily-read channel designations, selector-switch knob. Positively — and ready to meet any challenge — the SLU "Challenger" stands for most converter for least cost.

MODEL SLU "CHALLENGER": Complete with tubes (6AF4 oscillator, 6CB6 I.F. amplifier, IN72 crystal mixer). Individually packaged in corrugated carton, with instructions. LIST PRICE: Mahogany, \$24.95; sand, \$27.95.

"SUPER" Series MTU



- Greatest gain for weakest signals
- Three-cavity coaxial continuous tuner
- High-ratio tuning knob
- Cascode amplification
- High-power two-unit chassis

Combining outstanding performance with smartest styling. Meets esthetic requirements of the fastidious housewife, while performance meets the rigid demands of the advanced TV fan. The logical converter in areas where signal strength is low and where distance is great. Model MTU will work where other converters do not perform at all. Two-unit chassis, with complete power supply including vacuum-tube rectifier and three-cavity coaxial tuner. Exceptionally smart appearance — metal cabinet in simulated mahogany (or blond at slightly higher price) set off by gold-framed panel with quadrilled upper half. Large gilt-center tuning indicator, and smaller concentric knob for precision tuning and selector-switch.

MODEL MTU "SUPER": Complete with tubes (6BQ7A cascode amplifier, IN82 low-noise silicon diode, 6X4 vacuum-tube rectifier, 6AF4 oscillator). Individually packaged in corrugated carton, with instructions. LIST PRICE: Mahogany, \$39.95; blond, \$42.95.

"STAR" Series LCU



- Greater gain for weaker signals
- Two-cavity coaxial tuner
- All-wave continuous tuning
- Conservative-styled cabinet
- Fine tuning; preselection; stability

A further refined and restyled "Star" (Model LCU) of which tens of thousands are in daily use. Ideal in weaker-signal areas or locations where greater gain is desirable. The best performer of any UHF converter in its class. Smartly styled cabinet in mottled mahogany plastic (blond optional at slightly higher price).

MODEL LCU "STAR": Complete with tubes (6AF4 oscillator, 6CB6 I.F. amplifier, IN72 crystal mixer). Individually packaged in corrugated carton, with instructions. LIST PRICE: Mahogany, \$29.95; blond, \$32.95.

"DELUXE" Series DUC



- Finest wood cabinet
- In mahogany or blond
- High-power two-unit chassis
- Cascode amplification
- Three-cavity coaxial tuner
- Superlative sensitivity, selectivity, gain

The ultimate in performance and rich appearance. Housed in handsome wood cabinet finished in mahogany or blond. Gold-finished corrugated-motif shadow-box frame for recessed slide-rule dial. Two gilt-center dials for tuning and selector-switch. Styling in such excellent taste that it "belongs" with the most elaborate TV console. Two-unit high-power chassis, with power supply including vacuum-tube rectifier, and three-cavity continuous all-wave coaxial tuner. Superlative sensitivity, selectivity and gain.

MODEL DUC "DELUXE": Complete with tubes (6BQ7A cascode amplifier, IN82 low-noise silicon diode, 6X4 vacuum-tube rectifier, 6AF4 oscillator). Individually packaged in corrugated carton, with instructions. LIST PRICE: Mahogany, \$49.95; blonde, \$52.95.

Granco

UHF CONVERTERS • TUNERS • TEST EQUIPMENT

GRANCO UHF HIDEAWAY TUNERS *

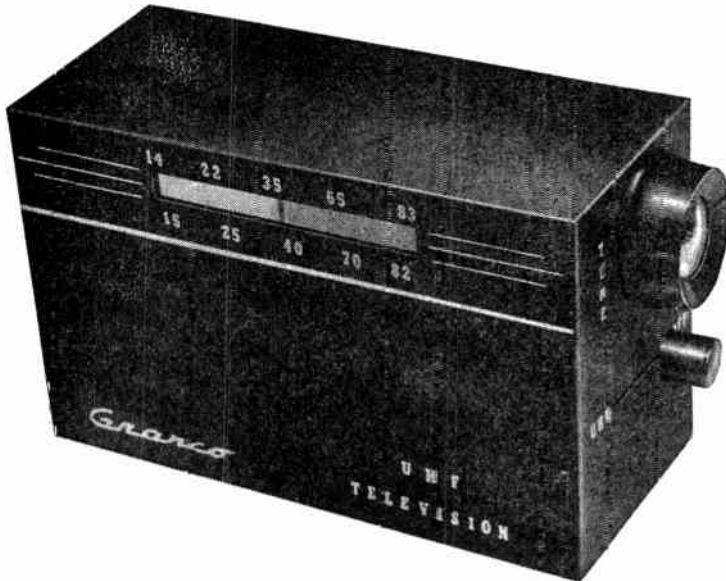

- Complete UHF converter in metal casing
- Mounts at rear or on top of TV cabinet
- Provides continuous coverage of UHF band
- Two-cavity coaxial tuning
- Preselection for clean interference-free pictures
- High sensitivity
- High signal-to-noise ratio

*Patent applied for.

Easiest, cheapest, neatest concealed UHF conversion job. Installed without pulling out heavy chassis; without fussing with turret tuner; without realignment bothers; without getting interference from adjacent channels.

Yet the Hideaway provides continuous high-ratio tuning over entire UHF band; high signal-to-noise ratio; preselection for clean interference-free pictures; high sensitivity.

Neat metal cabinet mounts at rear right of TV cabinet, with slide-rule dial showing, and with tuning knob and selector switch at right of cabinet. So small, it attaches to any TV set (mounting brackets supplied). So simple, it works on indoor antenna in most localities. So inexpensive, that even the oldest traders rate this UHF conversion. So necessary, that even the brand new TV set needs it when UHF stations come along. Also, it can be used as a top-of-cabinet converter.

Available in three different models for three different operating requirements and in corresponding price ranges:

MODEL HT-1 — The price leader. Yet a complete coaxial tuned UHF converter. Takes minimum power from TV set, with simple socket connections. Ample sensitivity in most UHF areas. Preselection means clean pictures with minimum "snow." Cuts out interference in areas with two or more VHF or UHF stations. On-the-button tuning. LIST: \$15.95

MODEL HT-2 — Self-powered. Otherwise same fine features as HT-1. No need to make any power connections inside the TV set. Just connect with TV set and antenna. LIST: \$18.95

MODEL HT-3 — Self-powered, plus additional low-noise amplification. Ideal in weak signal areas. A wonderful buy for those who want superior UHF performance. LIST: \$21.95

GRANCO UHF SIGNAL-GAIN GENERATOR

Type SU-200 Granco UHF Signal-Gain Generator, is a new type of instrument for UHF television areas,

with more versatility and usefulness than any other similar instrument within at least twice the price.

THE SU-200 FEATURES...

- Coaxial tuning elements
- Accurate tuning over entire UHF band
- Calibration in both frequency and channel numbers
- Balanced detector meter circuit and gain control
- Simple operation for quick measurements

APPLICATIONS...

1. Measures gain, tracking, calibration accuracy and range of UHF tuners, converters, antennas, strips, boosters, and receivers.
2. Acts as a signal power source for various types of measuring equipment, such as VHF bridges and slotted line.
3. Ideally suited for development, production, and communication testing.



SPECIFICATIONS...

Frequency Range: 440-910 mc $\pm 2\%$ in a single direct-reading tuning range.

Output: CW

Spurious Frequency: None

Leakage: Negligible

Output Voltage: 2 volts available across 50-ohm unbalanced or 300-ohm balanced termination.

Cables: 1. 3-foot cable with 300-ohm balanced pad termination.
2. 3-foot cable with 50-ohm unbalanced termination.
3. 3-foot twin lead cable.

VHF Input Impedance: 300 ohms balanced.

VHF Detector Sensitivity: 200 MV with VHF gain control set at .5 and meter pointer at midscale.

UHF Output Terminal: BNC Panel Jack type UG 291/U.

VHF Input Terminal: 300-ohm twin lead receptable.

Controls: Meter switch — UHF output — VHF input UHF output control — varies from 0 to 2 volts.

VHF gain control — measures gain in db and voltage -6 db to +12 db -.5 to 5.

Dimensions: 10 1/4" high x 8 1/2" wide x 8" deep.

Weight: 5 pounds.

AC Input: 117 volts 60 cycles 30 watts.

Price: \$99.50 (Dealer's Net).

OAK AUXILIARY SPEAKER SWITCH

ESSENTIAL IN CARS or with REMOTE TV or JUKEBOX SPEAKERS

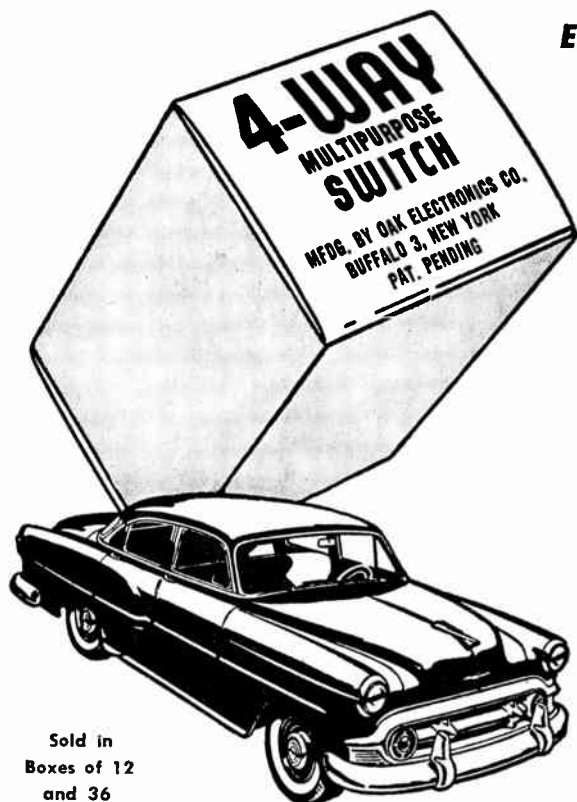

Sold in Boxes of 12 and 36

Does all that the old style 3 way rear seat speaker switch could do . . . Plus: the advantage of the best impedance match to the radio at any volume setting used . . . Plus: sound distribution as you want it.

Either speaker can be made the louder, by the flip of a switch, while both continue to play together.

4 SWITCH POSITIONS

- Front Speaker
- Rear Speaker
- Both Speakers In Parallel
- Both Speakers In Series

LIST PRICE

\$1.50

Patent Pending

—TENNALOOP—

The Neatest little BIG VALUE package. TENNALOOP is a tiny antenna made possible in this size and form by the use of a ferrite-magnetic core. No longer is it necessary to use the old-fashioned 'loop' antenna.

\$.95 LIST PRICE

"Tennaloop" is "all" directional

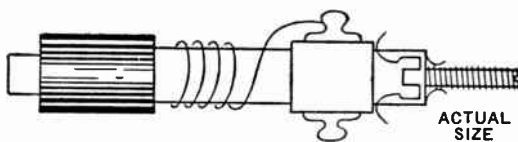

Greater — Selectivity-Sensitivity
Compact — Durable — Efficient

Continuous Tuning on All VHF-TV and FM Channels.

HIGHEST GAIN of any Booster

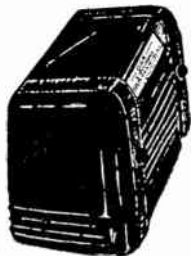

Front Knob Controls Gain

Erases GHOSTS when carefully tuned to induce opposite phase line reflections

OAK TV-FM BOOSTER

Comparative Reading of Boosters FEATURES

FEATURES	BOOSTER						
	OAK BOOSTER	A	B	C	D	E	F
Automatic On-Off	Yes	Yes	Yes	No	No	No	No
Variable Bandwidth	Yes	No	No	No	No	No	No
Amplifies FM	Yes	No	No	No	No	No	No
75 to 300 Input & Output	Yes	Yes	Yes	No	No	No	Yes
Variable Sensitivity	Yes	No	No	No	No	No	No
Highest Gain 2-6	Yes	No	No	No	No	No	No
Highest Gain 7-13	Yes	No	No	No	No	No	No
Square Wave Type Band Pass Characteristic	Yes	Yes	No	Yes	No	Yes	No

No untuned booster is rated, as performance is not equal to any tunable booster.

OAK BOOSTER **\$39.95**

OAK ELECTRONICS COMPANY • BUFFALO 3, NEW YORK

TRANSFORMERS

**Thousands of TV
SERVICEMEN depend on**

RAM



**ORIGINAL SERVICE
REPLACEMENTS**

DEFLECTION YOKES

CAT. NO.	INDUCTANCE		D. C. RESIST.		LIST
	HORIZ.	VERT.	HORIZ.	VERT.	
Y70108	8.3	50 MH	9.5 ohms	60.0 ohms	9.00
Y70P08	8.3	50	9.5	60.0	10.00
Y70P08/43	8.3	43	9.5	48.0	10.00
Y70P10	10.0	50	10.0	60.0	10.00
Y70P10/43	10.00	43	10.0	48.0	10.00
Y70P12	12.0	50	16.0	52.0	10.00
Y70P14	14.0	60	14.5	60.0	10.00
Y70P14/43	14.0	43	14.5	48.0	10.00
Y70P14/3	14.0	3.0	23.0	3.3	10.50
Y70P17	15.0	50.0	20.0	60.0	10.00
Y70P17/43	15.0	43.0	21.0	48.0	10.00
Y70P20/43	20.0	43.0	22.0	48.0	10.00
Y70P25	25.0	50.0	27.0	60.0	10.00
Y70P25/3	25.0	3.3	27.0	4.0	10.50
Y70P30	30.0	50.0	35.0	60.0	10.00
Y70P30/3	30.0	3.3	36.0	4.0	10.50
Y70P30/3	30.0	3.3	35.0	4.0	11.20

LINEARITY & WIDTH COILS

CAT. NO.	MILLIHENRIES	OHMS	LIST
201R1A	.05 - .5 MH	.53	1.00
201R3A	5 - 40 MH	32.0	1.25
201R4	.17 - .61 MH	1.0	1.00
201R5A	.55 - 4.6 MH	8.3	1.25
201R10	3.5 - 29.5 MH	30.0	1.25
201R11	PRI. .16 - .7 MH SEC. 3.2 - 9 MH	1.0 28.0	1.75
201R12	1.3 - 4.1 MH	5.6	1.25
201R13A	.5 - 3.5 MH	2.3	1.25
201R14	PRI. 2.6 - 7.5 MH SEC. 4.0 - 28.0 MH	20.0 32.0	1.75
201R15	1.0 - 10.0 MH	8.0	1.50
201R16	2.5 - 16.0 MH	8.2	1.50
201R17	.17 - 1.8 MH 8.0 - 50.0 MH	2.3 23.0	2.25
201R18	.17 - 1.8 MH	2.3	1.50
201R19	3.0 MH	16.0	2.25

CAT. NO.	MTG.	KV	OPERATING CONDIT.		DIRECT REPL. & DESCRIPTION	LIST
			B + SUPPLY	BOOST		
X032	A	13.0	325	510	High efficiency - 630 circuits	10.00
X035	A	14.5	325	525	Similar to X032-higher voltage	10.00
X036	A	10.5	320	420	RCA 211T1, 211T3	10.00
X045	B	14.0	320	450	GE7711 and GE circuits	10.00
X047	C	13.0	325	510	Crosley, DeWald, Jackson	10.00
X048	C	12.0	300	470	DuMont #20005021	10.50
X049	C	13.0	350	510	Spartan, Pads, Crosley	10.50
X050	A or C	13.0	325	510	Philharmonic, Airline, Silvertone	10.50
X051	B	16.0	230	460	Majestic #C9.253.D9.258; GE RTO-101. RTO-104,109	10.50
X053	A	15.0	325	510	Regal #140-126 Jewel #91T5A	10.00
X054	A	13.0	250	515	CBS, Silvertone # A 10126	20.00
X064	C	14.0	230	480	Emerson # 738056, 60, 64	10.50
X065	C	16.0	230	480	Emerson # 738057, 68, 69, 73, 74	10.50
X066	A	14.0	325	510	Airline, Silvertone, CBS, Olympic	10.00
X068	P	10.0	270	350	RCA, Emerson, Magnavox, Packard Bell	6.50
X069	B	16.0	300	500	Stromberg Carlson #161042, Olympic	11.50
X070	D	13.0	325	510	Zenith	10.00
X071	E	14.5	360	460	Admiral # 79C30-1,-3	10.50
X072	E	13.0	280	400	Admiral # 79C30-2,-4	10.50
X073	D	11.0	325	510	Zenith	10.00
X074	I	16.0	280	475	RCA 225T1, Hallicratter, Silvertone, Arvin, Hoffman	10.00
X075	A	14.0	325	510	CBS # 10136, Firestone	10.50
X076	A	16.0	280	500	Muntz # 70-0031	10.00
X077	A	13.0	325	500	RCA 211T5 Voltage Doubler	10.00
X078	G	13.0	325	500	Travler # TVX 104, 106	9.00
X079	G	13.0	325	500	Travler # TVX 107, 108, 109	9.00
X080	I	18.0	280	475	RCA #78795, Hoffman #5035, 5049, 5155, 5160	10.00
X081	C	14.0	325	510	Westinghouse # V9804-1	10.50
X082	C	15.0	325	510	Westinghouse # W10214-1	9.00
X083	G	13.5	125	310	Sylvania # 241-0003	9.00
X084	G	13.0	125	310	Sylvania # 241-0005, '6	9.00
X085	G	13.0	125	310	Sylvania # 241-0007	9.00
X086	O	15.0	310	510	Philco # 32-8428-2	10.00
X087	H	13.0	310	510	Philco # 32-8453-3	14.00
X088	H	13.0	310	510	Philco # 32-8509	14.00
X089	H	13.0	310	510	Philco # 32-8509-2	14.00
X090	G	13.0	240	410	Philco # 32-8534	10.00
X091	E	15.0	230	350	Philco # 32-8555	10.00
X092	G	14.0	250	320	Philco # 32-8565	11.50
X093	C	20.0	280	530	Magnavox #360552, 360577, 360593	11.50
X094	I	18.0	320	675	RCA #235T1, CBS#9C-10155, Stromberg Carlson #461045	11.50
X096	A	12.0	250	480	Magnavox #320061	11.80
X097	C	18.0	260	-	Magnavox #360561	11.80
X098	I	17.0	280	540	Magnavox #360580	11.50
X099	J	15.0	300	520	Parnsworth #650220, 650285	11.50
X100	K	16.5	230	350	Philco # 32-8572	11.00
X102	L	17.5	250	450	Admiral # 79D41-1,-2	11.50
X103	M	10.0	240	-	Motorola # 24C790184, 24K791974	11.50
X104	N	14.0	240	530	Motorola #24C701134, 710626, 792596.0, #24K700558, 701069, 792753	11.50
X105	O	16.0	266	660	Motorola #24C701552, 711652, 701636	13.25
X106	N	16.5	266	490	Motorola #24C711265, A: 721290, 730689; 24K702975, 711266, 711837, 712193, 720615, 721301, C: 721517, C: 722126, 722700, 730690, 91, 92, 902, 3, 4	13.25

VERTICAL SCANNING OUTPUT TRANSFORMERS

RAM #	TURNS RATIO PRI/SEC.	PRIMARY IMPEDANCE	MOUNTING TYPE	MOUNTING CENTERS	DIMENSIONS			SHIPPING lbs. WEIGHT	LIST
					H	W	D		
V301	10:1	19,000Ω 13MADC	V1	1 19/32 x 2	3 1/16	2 1/2	2 1/2	2 1/8	6.00
V302	8:1	19,000Ω 13MADC	V2	2 3/8 x 1 5/8	2 9/16	2 7/8	2 1/4	2 1/2	5.00
V303	8:1	19,000Ω 13MADC	V1	1 19/32 x 2	3 1/16	2 1/2	2 1/4	2 1/2	5.75
V304	10:1	18,000Ω 10MADC	V1	1 19/32 x 1 1/2	3 1/16	2 1/2	2 1/4	2 1/2	4.25
V305	10:1	14,000Ω 15MADC	V3	2 1/8	2 1/4	3 9/16	3 1/16	2 1/4	6.25
V306	44.6:1	11,250Ω 15MADC	V1	1 19/32 x 1 7/8	3 1/16	2 1/2	2 3/8	2 1/4	6.50
V307	9:1	11,000Ω 19MADC	V4	Spl. Frame	2 9/16	2 3/16	2 1/4	2 1/4	4.25
V308	11:1	15,000Ω 19MADC	V4	2 13/16	2	3 1/4	1 1/4	1 1/4	4.75
V309	10:1	13,000Ω 22MADC	V3	2 13/16	2	3 1/4	2	1 1/4	4.75
V310	10:1	13,000Ω 15MADC	V3	3 1/2	2 1/2	4	2 1/4	2 1/2	6.00
V311	10:1	18,000Ω 10MADC	V1	1 19/32 x 1 5/8	3 1/16	2 1/2	2 1/8	2 1/2	5.00
V312	18:1	27,500Ω 10MADC	V3	3 1/8	2 1/4	3 3/4	3 1/4	1 1/2	5.75
V313	11.4:1	17,000Ω 20MADC	V3	2 13/16	2	3 1/4	1 5/8	1	4.25

VERTICAL BLOCKING OSCILLATOR TRANSFORMERS

RAM #	TURNS RATIO PRI/SEC.	MOUNTING TYPE	MOUNTING CENTER	DIMENSIONS			SHIPPING lbs. WEIGHT	LIST
				H	W	D		
V401	1:4.2	V5	1 15/16	2 1/8	2 1/4	1 17/32	1	3.25
V402	1:4.2	V6	1 7/32	1 25/32	1 5/32	1 5/32	1/2	4.00
V403	1:4	V5	2	1 21/32	2 3/8	1 13/32	1	3.50
V404	1:1.5	V3	2	1 11/32	2 3/8	1 3/8	1/2	3.00
V405	1:4.2	V3	1 3/4	1 1/8	2 1/16	1 3/8	1/2	2.75

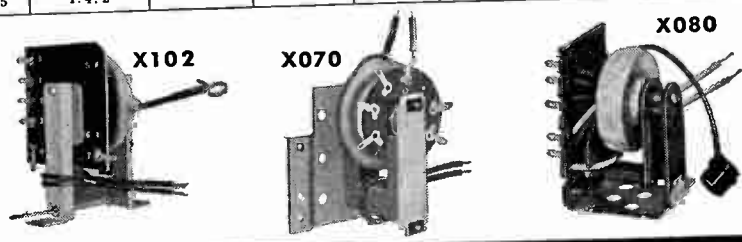
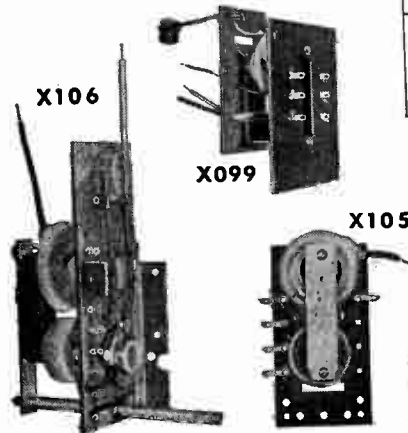

RAM ELECTRONICS SALES CO., IRVINGTON, NEW YORK

ALLIANCE TV PRODUCTS

ALLIANCE TENNA-ROTORS • UHF CONVERTERS • BOOSTERS

ALLIANCE TENNA-ROTOR

The Alliance Tenna-Rotor, available in three models illustrated below, is a TV or FM antenna rotator. Designed to rotate all conventional type antennas. It consists of a fully enclosed electrically driven rotor into which the antenna center-post is clamped. Four-conductor "zip" cable connects rotator with plastic control case placed near receiver, which plugs into any 60 cycle 110-volt AC house circuit. A selector switch controls rotation clockwise or counter-clockwise to point antenna in any direction for optimum reception.

Alliance Tenna-Rotor reduces interference, improves quality of picture, eliminates ghosts, aids fringe reception. It is especially useful in multi-station areas and wherever there are signals from the more critical UHF stations. Will add distance to your reception.

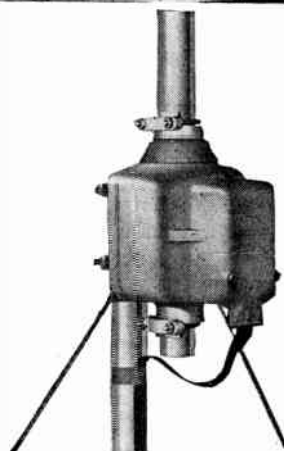

ROTATOR UNIT

*Most Widely Advertised
Rotor on the Market*

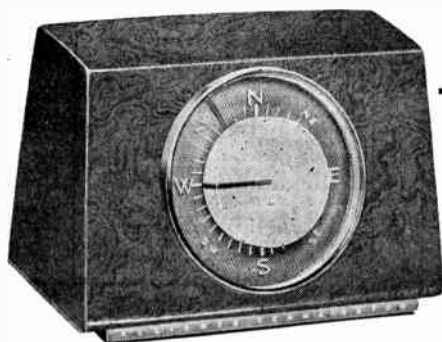

Model U-83 Automatic

List Price\$34.95

FULLY AUTOMATIC MODEL U-83

"SET IT AND FORGET IT"

This deluxe Model U-83 is the only fully automatic rotator on the market.

BEAUTIFUL NEW STYLING

Simply set the pointer — antenna automatically turns by itself and stops at the direction shown on the indicator dial. New styling plus the exclusive automatic feature makes Model U-83 the ultimate in rotators!

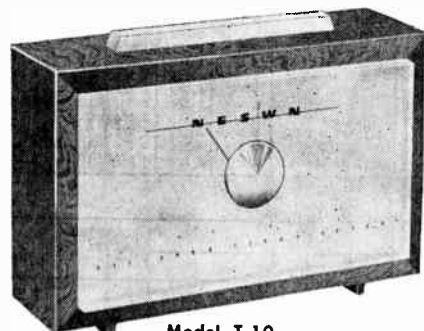

Model T-10

List Price\$29.95

MODEL T-10

This finger-tip electrically controlled Alliance Tenna-Rotor is noted for extreme accuracy, compactness and smart styling. Pressing attractive tilt bar controls rotator and a pointer on the control case dial shows compass direction to which antenna is pointed.

Both new Model Alliance Tenna-Rotors, the U-83 automatic, and the T-10, have increased speed of rotation and incorporate features that make for faster installation, trouble-free operation and unsurpassed performance. The new rotator unit has double-action magnetic anti-drift brake plus smoother synchronization with control units. Alliance Tenna-Rotors are pre-sold through TV advertising!

MODEL F-4

Model F-4 has a three-position selector switch to control the rotator. Throwing switch to right or left rotates rotor shaft clockwise or counter-clockwise through a complete 360 degree arc. Center OFF position enables operator to select exact position for "peak" reception! A screen illuminates to tell when limit of travel in either direction is reached.

More Than 2,000,000 Alliance Tenna-Rotors Are In Use!



Model F-4

List Price\$24.95

ALLIANCE MANUFACTURING COMPANY • Alliance, Ohio

Radio's Master — 19th Edition

Page T-14

TRADE DISCOUNT APPLIES TO LIST PRICES ONLY

Copyright by U. C. P., Inc.

ALLIANCE TV PRODUCTS

ALLIANCE TENNA-ROTORS • UHF CONVERTERS • BOOSTERS



Model BY-90

List Price\$29.95

ALLIANCE UHF CONVERTER

Alliance UHF Converter, a proved, dependable, quality Converter that's built to last!

Model BY-90, the Alliance UHF Converter, covers all channels — both UHF and VHF, when connected with any VHF receiver. Requires only a few minutes to install without the need for special tools or technical skill. A three-position "master-control" switch on panel assures UHF station tuning — normal operation of the VHF set — on-off switching of Converter and set. This Converter is noted for outstanding selectivity and gain to provide superior picture quality. An excellent performer in fringe areas or where a UHF signal strength is weak.

ALLIANCE CASCAMATIC AUTOMATIC TV BOOSTER

Model BB-2 Alliance Cascamatic is a fully automatic television booster, is pre-tuned to all VHF channels and features the "California" circuit. The Cascamatic mounts out of sight on back of the set and requires no manual control because it turns on and off automatically, with the set. Equipped with three tubes. Affords excellent high gain reception — especially useful in fringe areas. Quickly installed.



Model BB-2

Alliance Cascamatic Booster

List Price\$29.95

ALLIANCE TENNA-SCOPE TV BOOSTER

Model BB-1 Alliance Tenna-Scope is a popular TV Booster for all VHF channels. Manually controlled, it permits critical tuning to each channel. Features an automatic "on-off" switch so that set may be used with or without the booster in the circuit, has unusual high channel reception characteristics — amplifies picture and sound uniformly — is an excellent performer in TV fringe and suburban areas.



Model BB-1

Alliance Tenna-Scope

List Price\$24.95



Model TBB

List Price...\$4.95

ALLIANCE THRUST BEARING BRACKET

The Alliance Thrust Bearing Bracket, accessory to Alliance Tenna-Rator, is made to provide added support for all heavier conventional type antennas. Used with Alliance Tenna-Rator, it makes an ideal installation. Especially suited for multibay and stacked array an-

tenna types. The Thrust Bearing takes the weight off the rotor unit and transfers it to the ground. It assures extra rigid support and maximum resistance to high winds.

For catalogue sheets, folders and more detailed information of Alliance Converters, Boosters and Tenna-Rotors, write the factory.

ALLIANCE MANUFACTURING COMPANY • Alliance, Ohio



RCA ELECTRONIC COMPONENTS

TELEVISION PARTS



A



B



C



D



E

DEFLECTING YOKES (For Use with Kinescopes)

Horiz. Coils		Vertical Coils		For Kinescopes				
In-ductance mh	DC Resistance ohms	In-ductance mh	DC Resistance ohms	Typical Type	Horizontal Deflection Angle	Mtg. Fig.	RCA Type	Sugg'd List Price
8.3	13.5	50	64.6	10BP4-A	50-57°	A	201 D12	\$ 9.00
8.3	14	50	68	12KP4-A	52°	B	201 D2	15.55
8.4	11.5	55	70	10BP4-A	50-57°	A	207 D1	10.00
10.3	13.2	41.5	48.7	16GP4-B	66-70°	A	206 D1	10.00
11.7	14.7	46.3	42.6	16RP4	90°	A	219 D1	22.25
12.5	17.4	50	68.8	10BP4-A	50-57°	A	205 D1	10.00
13.3	18.2	41	48	16GP4-B	66-70°	A	209 D1	10.00
13.3	23.5	41	48	16GP4-B	66-70°	A	211 D2*	10.00
18.5	26.5	42	48	21AP4	66-70°	A	222 D1*	10.00
28.5	56	3.3	3.3	16GP4-B	66-70°	A	214 D1*	10.50

*Supplied with color-coded leads, damping and neutralizing elements.

DEFLECTING YOKES (For Use with Camera Tubes)

Horizontal Coils		Vertical Coils		For Camera Tubes				
In-ductance mh	DC Resistance ohms	In-ductance mh	DC Resistance ohms	Typical Type	Mtg. Fig.	RCA Type	Sugg'd User Price	
0.9	3.5	50	161	6198	C	216 D1	\$50.00	
2.25	9	25	100	1850-A	—	201 D76	105.00	
5.5	19	28.3	34	5820, 5826	—	210 D1	186.50	
5.5	19	28	68	2F21, 1699	—	201 D77	89.00	
8	12	50	62	5WP15, 5ZP16	B	212 D1	21.50	

HORIZONTAL-OUTPUT TRANSFORMERS

For Cathode-Ray or Camera Tubes	Description	Mtg. Fig.	RCA Type	Sugg'd List Price
5TP4	For use in TV receivers, studio cameras, and video-signal generators. Multi-tapped secondary winding to facilitate the matching of circuit impedances.	H	204T1	\$22.25
5WP11, 5WP15				
5ZP16				
10BP4-A, 16AP4-A				
5820, 5826				
10BP4-A, 16AP4-A		D	204T3	13.35
6198		L	233T1	16.95†

†Suggested User Price

WIDTH/AGC CONTROL

Width (Primary Winding)			AGC (Secondary Winding)*			Mtg. Fig.	RCA Type	Sugg'd List Price
Induct. Min. mh	Induct. Max. mh	DC Resistance ohms	Induct. Min. mh	Induct. Max. mh	DC Resistance ohms			
1.75	10.5	9	9.8	26.0	47	J	214R1	\$1.75

*Tapped off-center.

HORIZONTAL-OUTPUT AND HIGH-VOLTAGE TRANSFORMERS

DC Output Voltage No Load kv	For Cathode-Ray or Camera Tubes		Mtg. Fig.	RCA Type	Sugg'd List Price
	Typical Tube Type	Horizontal Deflection Angle			
8.75	10BP4-A	50°-57°	D	211T3*	\$10.00
9	10BP4-A, 12LP4-A	50°-57°	D	211T1*	10.00
10 to 15	10 to 21-inch kinescopes	50°-70°	E	231T1*	10.00
10 to 16	10 to 21-inch kinescopes	50°-70°	E	232T1†	10.50
14	16GP4-B, 16RP4	66°-70°	F	223T1†	10.00
14	14CP4, 17BP4-A	66°-70°	F	224T1†	10.00
16	17CP4, 20CP4	66°-70°	F	225T1†	11.50
18	19AP4, 21AP4	66°-70°	F	230T1†	10.00
18	27MP4	to 90°	F	235T1†	11.50
33	5TP4, 5ZP16	40°-50°	G	211T2*	21.10

*Isolated-Secondary type. †Auto-transformer type.

HORIZONTAL LINEARITY CONTROLS

Inductance Range		DC Resistance ohms	Mounting Fig.	RCA Type	Sugg'd List Price
Min. mh	Max. mh				
0.55	2.3	8.3	J	201R5	\$1.25
1.3	4.1	5.6	J	209R1	1.25
1.3	4.3	7.0	J	207R1	1.25
1.5	8.3	8.3	J	213R1	1.25
5.5	20	36	J	201R3	1.25

WIDTH CONTROLS

Inductance Range		DC Resistance ohms	Mounting Fig.	RCA Type	Sugg'd List Price
Min. mh	Max. mh				
0.054	0.245	0.53	J	201R1	\$1.00
0.085	0.240	0.34	K	201R2	2.30
0.17	0.61	1.0	J	201R4	1.00
0.47	1.7	2.6	J	206R1	1.25
1.65	9.2	8.8	J	211R1	1.50
2.9	16.0	12.0	J	212R1	1.50
3.9	22.0	17.6	J	215R1	1.25

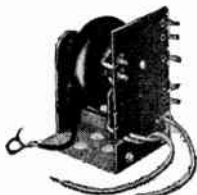

F



G



H



J



K

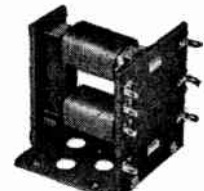

L

RCA ELECTRONIC COMPONENTS

TELEVISION PARTS

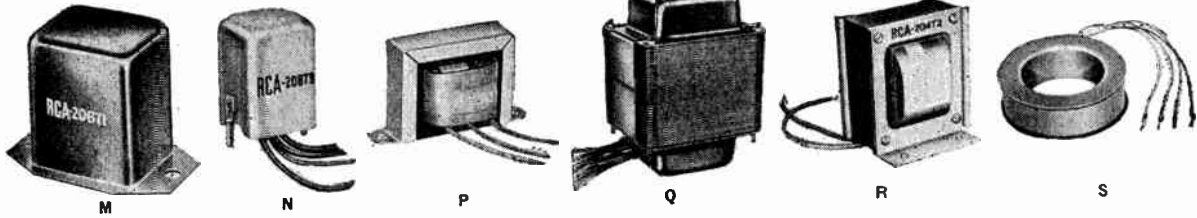

HORIZONTAL-BLOCKING-OSCILLATOR TRANSFORMERS

Turns Ratio Primary/ Secondary	DC Resistance		Inductance Primary Henries	Mounting Fig.	RCA Type	Sugg'd List Price
	Primary ohms	Secondary ohms				
1:2	3.5	8.5	0.016	M	208T1	\$4.35
1:2	3.5	8.5	0.016	M	208T3	3.05

VERTICAL-BLOCKING-OSCILLATOR TRANSFORMERS

Turns Ratio Primary/ Secondary	DC Resistance		Inductance Primary Henries	Mounting Fig.	RCA Type	Sugg'd List Price
	Primary ohms	Secondary ohms				
1:4:2	244	1310	1.15	M	208T2	\$3.25
1:4:2	244	1310	1.15	N	208T9	4.00
1:4:2	208	1060	1.15	P	209T1	2.75

VERTICAL-DEFLECTION-OUTPUT TRANSFORMERS

Turns Ratio Primary/ Secondary	DC Resistance		Inductance Primary ohms	Mounting Fig.	RCA Type	Sugg'd List Price
	Primary ohms	Secondary ohms				
3:1	700	70	11000	P	234T1	\$3.65†
10:1	521	6.9	18000	R	204T9	5.50
10:1	590	6.9	19000	R	204T2	6.00
11.4:1	1200	11	17000	P	222T1	4.25
18:1	1600	4.4	27000	P	226T1	5.75

†Suggested User Price

HORIZONTAL SYNC-DISCRIMINATOR TRANSFORMERS

DC Resistance		Inductance at 1000 cps				Mtg. Fig.	RCA Type	Sugg'd List Price
Terminals A-C ohms	Terminals D-F ohms	Terminals A-C		Terminals D-F				
		Max. mh	Min. mh	Max. mh	Min. mh			
42.3	44.0	9.0	5.0	10.0	5.5	Y	208T8	\$2.45

FOCUSING AND ALIGNMENT COILS

DC Resistance ohms	DC Current ma	For Cathode-Ray or Camera Tubes		Mtg. Fig.	RCA Type	Sugg'd List Price
		Typical Tube Type	Anode Voltage kv			
140	40	6198	—	S	218D1*	\$26.00†
150	30	5820, 5826	—	—	204D75*	43.50†
247	120	10BP4-A, 12LP4-A	10	T	202D1	8.35
385	60	6198	—	V	217D1	42.50†
	90	14EP4	12			
470	100	16GP4-B	12	W	202D2	12.25
	104	17CP4	14			
2000	75	5820, 5826	—	—	202D75	116.00†

†Suggested User Price

ION-TRAP MAGNETS

Description	Mtg. Fig.	RCA Type	Sugg'd List Price
Double pole, field-coil type. DC current rating, 200 ma.	—	203D1	\$6.50
Double-pole, ring-shaped permanent magnet, "universal" type. Field strength: large magnet, 55 gauss; small magnet, 15 gauss. The RCA-203D3 can be used as a single-pole magnet by removing the small ring-shaped magnet.	Z	203D3	2.10

HORIZONTAL OSCILLATOR AND SYNC-STABILIZER COILS

DC Resistance		Inductance at 1000 cps				Mtg. Fig.	RCA Type	Sugg'd List Price
Terminals A-F ohms	Terminals C-D ohms	Terminals A-F		Terminals C-D				
		Max. mh	Min. mh	Max. mh	Min. mh			
117	—	38.0	21.0	—	—	Y	203R1	\$1.90
81	47	33.0	13.5	11.0	7.75	Y	205R1	2.40

POWER TRANSFORMERS*

PRIMARY WINDING Current amps	Plate Winding		Filament #1 Voltage volts	Current amp	Filament #2 Voltage volts	Current amp	Filament #3 Voltage volts	Current amp	Mounting Fig.	RCA Type	Sugg'd List Price
	Full-Load Voltage volts	Max. DC Current amps									
2.75	724/362	0.295	5	6	12.6/6.3	5/10	5.0	2.0	Q	201T6	\$28.90
2.20	770/385	0.230	5	3	6.3	9.0	5.0	2.0	Q	201T7	23.35
2.18	720/360	0.250	5	3	6.3	8.0	5.0	2.0	Q	201T8†	21.10
2.48	730/365	0.260	5	6	6.3	8.85	5.0	2.0	Q	201T9	23.35
2.48	730/365	0.260	5	6	6.3	8.85	6.3	1.2	Q	201T10	23.35

*For 117-volt, 60-cycle operation. †Type 201T8 has an additional filament winding; 6.3 volts 0.6 ampere.

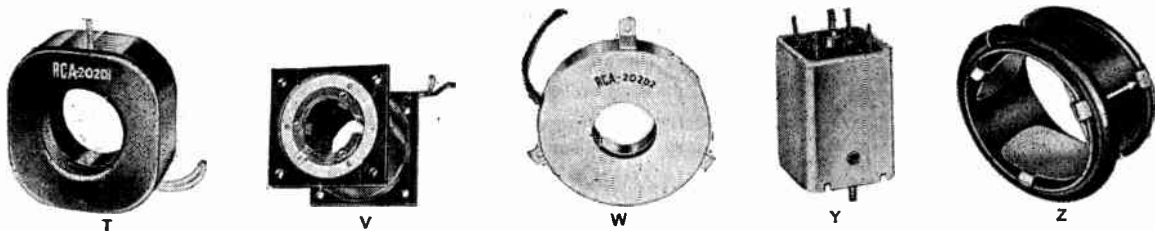

RCA SERVICE PARTS

54 KEY PARTS FOR RCA VICTOR TELEVISION AND PHONOGRAPHS



RCA Stock No.	Part Description	Suggested Price Each	
		List	Dealer
CARTRIDGES			
70338	78 RPM	\$ 7.00	\$ 4.20
74067	45 RPM	6.40	3.84
75575	45 RPM	6.40	3.84
77779	33 1/2 /45/78 RPM	9.20	5.52

CONTROLS			
71440	Height	1.20	.72
71441	Linearity	1.20	.72
71442	Focus	1.80	1.08
75215	Horizontal and Vertical Hold	2.95	1.77
75216	Picture and Brightness	3.00	1.80
75513	Volume and Tone	3.75	2.25
75514	Picture and Brightness	4.00	2.40
75516	Width	1.10	.66
76441	Width	1.95	1.15
76442	Linearity	1.35	.81
76444	AGC	2.10	1.25
76445	Picture	1.75	1.05
76483	Linearity	1.10	.66
76484	Width	2.40	1.45
76803	Volume and On/Off Switch	1.55	.93
77641	Brightness	3.55	2.15
77655	Brightness	4.40	2.65
78208	Picture and Volume	3.85	2.30

STYLII			
72345	78 RPM	2.00	1.20
74068	45 RPM	1.50	.90
75497	78 RPM	1.50	.90
75770	45 RPM	2.25	1.35
77899	33 1/2 /45 RPM	1.95	1.15

RCA Stock No.	Part Description	Suggested Price Each	
		List	Dealer
SELENIUM RECTIFIERS			
75221	Selenium	\$ 3.10	\$ 1.86
76452	Selenium	3.80	2.28

SPEAKERS			
*74974	12" Speaker	11.50	6.90

TRANSFORMERS AND COILS			
73591	Antenna-Matching Coil	2.00	1.20
74144	Vertical-Blocking-Oscillator	3.00	1.80
74586	Power	23.50	14.10
74588	Horizontal-Output and High-Voltage	16.50	9.90
74950	Vertical-Deflection-Output	5.50	3.30
74951	Horizontal-Output and High-Voltage	6.25	3.75
75212	IF	2.50	1.50
75213	Horizontal-Oscillator	2.50	1.50
75508	Power	22.00	13.20
75519	Horizontal-Output and High-Voltage	6.00	3.60
75520	Audio-Output	2.40	1.44
75645	Power	24.50	14.70
76440	Horizontal-Oscillator	3.00	1.80
76501	Horizontal-Output and High-Voltage	11.90	7.15
76795	Horizontal-Output and High Voltage	10.00	6.00
76980	IF	1.45	.87
76981	IF	3.35	2.00
76984	Power	29.00	17.40
77112	IF	3.85	2.30
77635	Power	22.75	13.65
78201	Horizontal-Output and High-Voltage	16.65	10.00

YOKES			
74952	Deflecting Yoke	9.80	5.88
76653	Deflecting Yoke	17.10	10.25
77697	Reflecting Yoke	12.00	7.20

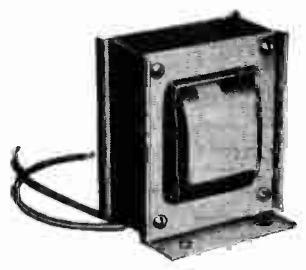
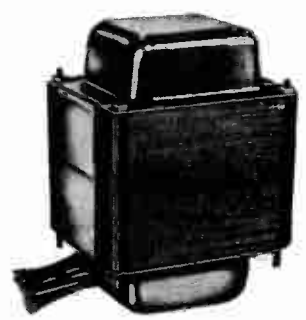

**When Servicing
RCA VICTOR
Instruments
Use GENUINE
RCA SERVICE PARTS**

- You Save 5 Ways:**
- Direct Mechanical Fit
 - Exact Circuit Replacement
 - Less Installation Time
 - Eliminates Need for Extra Parts
 - Original Performance Assured



This is only a partial listing of genuine RCA service parts that you may order. These are the top volume numbers that you should stock. Ask your RCA Distributor salesman for further details.
*Subject to Federal Excise Tax, included in prices shown.
ALL PRICES SUBJECT TO CHANGE OR WITHDRAWAL WITHOUT NOTICE.



KENCO

TELEVISION ANTENNA
MOUNTS
AND ACCESSORIES

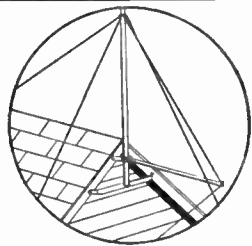

SKY STRUT

Made of tubular steel—welded construction, 40" long. Built-in cable clamp on outer end of strut locks guy wire in place giving rigid support to mast. Weather resistant finish.

Model 40S.....List \$3.95



LAG SCREWS

(Zinc Plated)

1/4 x 1 1/2	1/4 x 1 1/2	1/4 x 2
1/4 x 2 1/2	1/4 x 3	1/4 x 1 1/2
5/8 x 1 1/2	5/8 x 3	5/8 x 1 1/2
		5/8 x 3

Special low prices.
Write for quotations.

EXPANSION SHIELD

Dia. of Lag	List
1/4"	\$15.00 per 100
5/8"	18.00 per 100

U-BOLT

Mast Joiner

Easily joins two masts up to 1 1/2" o.d. Heavy zinc plate.

List \$0.30 ea.



J & L PERMA TUBE

10 ft. lengths

1 1/4 o.d. x .035 (20 gage)	
plain end	
1 1/4 o.d. x .049 (18 gage)	fitted joint
1 1/4 o.d. x .064 (16 gage)	fitted joint
1 1/2 o.d. x .049 (18 gage)	fitted joint



NEW PARAPET MOUNT

Gives positive anchorage to apartment house walls without damage to building. Shipped assembled. Hot dip galvanized.

Model	List
106	\$11.95

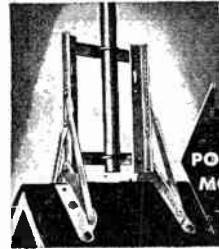

ALL POSITION MOUNTS

A strong, self supporting mount for peak, slope, sidewall corner or flat mountings. Heavy zinc plate.

Model	List
105 Masts up to 1 1/2" o.d.	\$5.35
101 Masts up to 2" o.d.	7.98



KENCO EAVE MOUNTS

Easily mounted on hanging rafters or trim boards of eave. Ideal for buildings with extended roofs. Hot dip galvanized. Available in 3 sizes

Model	List
122 22" eave mount	\$3.45
128 28" eave mount	4.50
148 48" eave mount	5.95

SNAP-IN CHIMNEY MOUNTS

Snap-in feature eliminates holding of mast while applying hardware. Carriage bolts throughout—for easy installation.

Model	List
4C Galvanized bands	\$2.93
4C-SS Stainless bands	4.45

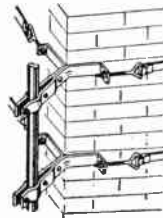

CHIMNEY MOUNT (Z TYPE)

Made of heavy gage steel. One piece construction, zinc plated. Square corners provide snug fit.

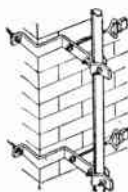

Model	List
3C Galvanized bands	\$2.22
3C-SS Stainless bands	3.55

MINUTE MOUNT

ONE PIECE CHIMNEY MOUNT

Exclusive Y construction on offsets for maximum strength. Bearing feet top and bottom prevent rocking on irregular chimneys. Snap-in feature holds mast while applying hardware. Carriage bolts throughout. One piece welded construction. Heavy gage steel—hot dipped galvanized. 12 ft. stainless steel band and stainless steel seals. 3-Easy-slide corner guards for uniform tightening and protection of bands. Model 5C-SS List \$5.69

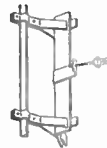

REPLACEMENT KIT

Stainless Steel Strap

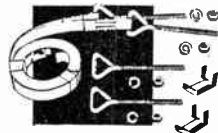

You get: 2-12 ft. stainless steel straps, 2 stainless steel seals, 2 stainless E-Z seals, 1 heavily plated triangular eyebolts, lockwashers & nuts. Model 1RK List \$3.00

SNAP-IN WALL BRACKETS

Available in 7" - 12" - 18" - 24" Sizes
Snap-in feature eliminates holding of mast while applying hardware. Carriage bolts throughout. Heavy gage steel, zinc plated.

Model	List
7W-7" (less tripod legs)	\$2.15
7W-1-7" (1 tripod leg)	2.45
7W-2-7" (2 tripod legs)	2.75
12W-12" (less tripod legs)	3.89
12W-1-12" (1 tripod leg)	4.25



Model	List
12W-2-12" (2 tripod legs)	\$4.65
18W-1-18" (1 tripod leg)	5.50
18W-2-18" (2 tripod legs)	5.95
24W-2-24" (2 tripod legs)	6.95

ALUMINUM SNAP-IN WALL BRACKET

Made of heavy gage high strength aluminum alloy. Snap-in feature eliminates holding of mast while applying hardware. Carriage bolts throughout.

Model	List
6W-AL-6" (less tripod leg)	\$2.15
6W1-AL-6" (1 tripod leg)	2.45
6W2-AL-6" (2 tripod legs)	\$2.75

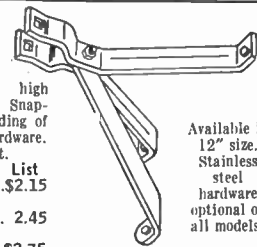

Available in 12" size. Stainless steel hardware optional on all models.



STAINLESS STEEL STRAPPING

Heavy 3/4" stainless steel strapping. 100 ft. lengths. (Ind. boxed) List \$10

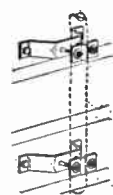

2" WALL BRACKET

Heaviest bracket made, 3/8" x 1 1/4" steel. Locking nuts in front of bracket for easy installation. Hot dip galvanized.

Model	List
2W	\$1.85

ALL KENCO ITEMS AVAILABLE AT COMPETITIVE PRICES!

KENWOOD ENGINEERING CO., INC.
KENILWORTH, NEW JERSEY

CREST

LABORATORIES, INC.

84-11 Blvd.
Rockaway Beach 93, N. Y.

These are a group of service essentials expertly engineered for proven performance. Each specifically suited to perform a vital job in the conversion, repair and realignment of TV equipment and electronic devices. Most all are modular plug-in units for ease and speed of application.

Universal Coil Kit

Saves valuable service and development time . . . minimizes inventory problems, eliminates difficulty in obtaining hard-to-get exact replacements

For Video Peaking . . . IF Circuits. Eight coils cover a range from 1 to 590 uh. Q-Max impregnation.

Extra terminal for tappoint convenience.

Spring clip mounting: designed for 5/16" chassis whale.

Full data enclosed on L min., L max., Q's, R, C distrib., Freq. self-res.

INDIVIDUAL CALIBRATION CHARTS permit approximate adjustment to required inductance value without test equipment. Individually packaged in 8 labeled plastic containers.



Single Set Replacements Available as follows:

Coils	L min.	L. max	List Price*
#200-1	1	2.7 uh	\$1.00
#200-2	2.4	7.6 uh	\$1.00
#200-3	6.6	20.0 uh	\$1.00
#200-4	16.0	55.0 uh	\$1.00
#200-5	33	110	\$1.08
#200-6	74	225	\$1.08
#200-7	100	310	\$1.08
#200-8	200	590	\$1.08

Complete Kit Model 200K. Shipping weight per kit: 6 oz. LIST PRICE \$795

UHF Multi-Channel Converter

Peaked for single channel application

Tuneable to receive any single channel within 15 channel range without use of instruments. Shipped pre-tuned for specified channel range. Single control provides simple on-off and VHF-UHF changeover.

- Designed for use with 300 ohms UHF antenna input. Connects directly to antenna input terminals of VHF TV set. Does not alter VHF reception
- Uses double tuned silver plated hi-Q preselector circuitry for maximum gain, noise figure and selectivity.
- Fundamental oscillator provides superior tuning stability and reduces interference susceptibility.
- Housed in attractive mahogany hammeroid case: 5" x 4" x 2".
- Obtains its power through octal adaptor that plugs into receiver audio output tube.
- Model UHF 10B available at same price. Supplied complete as above but with 7 pin #10B miniature adaptor plug.

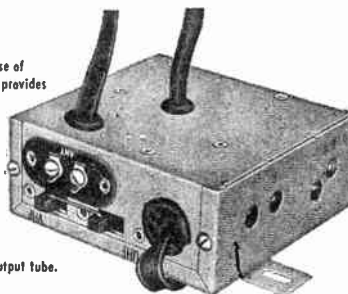

Model UHF 10A LIST PRICE \$1595

7 pin adaptor Plug #10B . . . \$2.30 List Price

Shipping weight: 1 1/4 lbs.

TV Bar Generator

Produces bar pattern on TV screen

Portable lightweight unit that provides servicemen with the Bar Generator for on the spot linearity adjustments.

- Vest pocket size . . . stows conveniently in tool box.
- Can be used when no stations are on the air.
- Produces horizontal or vertical bars.
- Adjustable number of vertical and horizontal bars.
- Simple adaptor plug-in unit . . . fits picture tube.
- No tools required for this 10-second installation.

Model MA-4

Shipping weight: 1 lb.



LIST PRICE \$1825

Picture Tube Rejuvenator



Renews CRT brightness . . . restores picture brilliance for a year or more. Corrects old, dim picture tubes that are failing, due to low cathode emission or interelement leakage. Simple plug-in unit, no wiring, no soldering, available for any type tube; turns on and off with set.

Model	Description	List Price
Model 48-B	for use with Magnetic or Electro-static picture tubes; parallel wired sets	\$2.10
Model 49-C	for use with Standard focus CRT; parallel wired sets	\$1.80
Model 50-D	for use with Magnetic or Electro-static focus CRT; series wired sets	\$2.10
Model 51-E	Heavy duty isolation transformer for use with tubes having cathode leakage . . . useable on Magnetic or electro-static CRT; parallel wired sets	\$2.30
Model 52	Tapped to provide adjustable boost. Usage same as Model 48-B (if space permits use copy of model 48-B)	\$3.85

These units are Resin treated, and incorporate other improvements that insure cool operation and freedom from hum or buzz
Shipping weight: 6 oz.

MA4-AC Self-Powered Bar Generator

Completely self-powered unit, that obtains its operating voltage from the wall outlet. Similar in size and weight to the MA-4. The MA4-AC is useable with all TV sets. A unique pocket size bar generator capable of providing an adjustable number of horizontal and vertical bars. Simple plug-in installation.

Shipping weight: 1 1/2 lbs.

LIST PRICE \$2480



VIDAIRE • VIDAIRE • VIDAIRE

Vidaire

FIL-TEST



WAVE TRAP METER

Accurately Determines Line Filter or Antenna Wave Trap Within Seconds.

- Eliminates installing individual filters or wave traps.
- Eliminates hours of trouble-shooting TV!
- Reduces service-man's inventory of filters and traps.

Vidaire

FIL-TRAN WAVE TRAPS

- Reduces effects of interfering signals.
- High Q coils used for high efficiency.
- Removes most picture-sound interference from amateur radio, foreign broadcasts, diathermy, etc.



5 Models
15 to 160 MC

LINE FILTER



4 MODELS AVAILABLE

Vidaire

- Reduces, eliminates effects of interfering signals thru line of TV or radio.
- Completely shielded, prevents stray signal pick-up.
- Low pass filters — no tuning adjustments necessary.

Vidaire

KINE-TEST

- Accurately determines if picture tube is bad.
- Simultaneously checks filament voltage, bias voltage, first anode voltage, video signal at picture tube socket.



COUNTER DISPLAY CARDS AVAILABLE ON ALL ITEMS

TV ACCESSORIES

C.R.T. EXTENSION



For use with all picture tubes:

- Model SE-3 — 36" long, 6-wire
- Model SE-4 — 72" long, 6-wire

For use with magnetic focus tubes only:

- Model SE-1 — 36" long, 5-wire
- Model SE-2 — 72" long, 5-wire

ANODE EXTENSION



- Model AE-1 — 36" long
- Model AE-2 — 72" long

For maximum hard wear. Rated for minimum of 25,000 volts breakdown.



YOKE EXTENSION

- Model YE-1 — 36" long
- Model YE-2 — 72" long

A handy extension for many late type TV receivers.

HI-FI PUSH PULL SOUND AMPLIFIER



Model A-130

Flat within 1.5 db from 80-20,000 cycles. Adds beautiful tone quality to most TV and radio receivers.

Output matched for most Hi-Fi speakers.

Tubes: 1-6J5GT, 2-6K6GT.

Simple installation, remove output tube and insert plug.

Push-pull amplifier adds new, glorious tone to TV and radio sets utilizing one sound output tube.

VIDAIRE • VIDAIRE • VIDAIRE

Vidaire

ELIM-A-TRACE



VERTICAL RETRACE LINE ELIMINATOR

- Eliminates vertical retrace lines in picture when brightness control is turned up.
- Makes picture viewable on weak picture tubes.
- View picture without strain in fringe areas.

Vidaire

TEL-ATTEN

- Eliminates overloading due to strong signals.
- Reduces buzz in intercarrier sets.
- 1000 to 1 change in signal reaching antenna posts.
- Vernier adjustment for all signal areas.



SIGNAL ATTENUATOR

KINE-LITE



C.R.T. REJUVENATOR

Vidaire

- Renews brilliance and contrast of picture.
- Prolongs life of old picture tubes.
- Two connecting plugs.
- No soldering necessary.

Vidaire

TELE-COUPLER

- Permits use of one antenna with two TV sets.
- Reduces effects of local oscillator radiation from one TV set to another.
- Filter action reduces interference of IF frequencies.

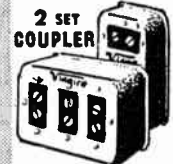

CATALOGUE BROCHURE PRICES ON REQUEST



- Manufacturers of:
- ELECTRONIC DEVICES
 - TV AMPLIFIERS
 - TV COLOR EQUIPMENT

Vidaire ELECTRONICS MFG. CO.

Executive Offices and Plant
LYNBROOK • NEW YORK

**WEATHER-PROOF TV LEAD-IN
 ENTRANCE DEVICES • LOW LOSS
 TV SOCKETS • SWITCHES • ETC.**

ROOF-THRU

Polystyrene bushing and copper flashing provides direct roof entrance of TV transmission line. Permits shorter lead-in, protects line from exposure to weather and eliminates messy wires on side of house. Model 624 also accommodates rotator cable.



Cat. 624 ROOF-THRU for flat line.
 List Price \$5.84

Cat. 623 ROOF-THRU for tubular line.
 List Price \$5.84

WALL-FEED

Installs under eave of house to bring lead-in into attic. Completely weather-proof. For any popular 300 ohm line. Also ideal for use in house trailer. Supplied with neoprene gasket and wood screws. Brown or ivory.



Cat. 626 WALL-FEED List Price \$1.26

Cat. 626-PK WALL-FEED with Universal TV Socket and mating Plugs List Price \$2.31

WALL-THRU

For any wall up to 13" thick. Completely weather-proof polystyrene bushing for all popular types line. Outside plate provides anchor point for open-wire line. Rubber grommet supplied for tight weather seal. Universal TV Socket may be mounted on inside plate. In brown or ivory.

Cat. 625 WALL-THRU List Price \$1.95

Cat. 625-PK WALL-THRU with Universal TV Socket and mating Plugs List Price \$3.00

3-WAY TV ANTENNA SWITCH

Ideal UHF/VHF antenna selector switch. Low loss rotary type making silver-to-silver contacts. In ivory or brown polystyrene case. Solderless, easy to install. Extension knob supplied for easy access when mounted behind set.

Cat. F-20 3-WAY TV ANTENNA SWITCH List Price \$3.75

DUAL-MATCH 2-SET COUPLER

Efficient, compact bridging-pad coupler permits 2-set operation from one TV antenna without interaction. May be installed outside in semi-protected area. Solderless connections to 300 ohm line. In sturdy polystyrene case.

Cat. 902 DUAL-MATCH 2-SET COUPLER List Price \$3.95

FLUSH TV SOCKETS

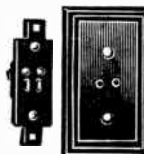

SINGLE LEAD-IN. For installations requiring single line and not utilizing rotator. Low loss, constant impedance socket with attractive ivory or brown wall plate. Solderless. Install with Cat. F-9, Mounting Brackets, Cat. F-8, Plaster Ring, or standard outlet box.

Cat. F-1 SINGLE FLUSH SOCKET List Price \$1.67

Cat. F-1PK SINGLE FLUSH SOCKET with mating Plug and Mounting Brackets List Price \$1.95

DUAL LEAD-IN SOCKET (Not illus.) Similar to F-1, above, but provides terminations for two separate lead-in lines.

Cat. F-11 DUAL FLUSH SOCKET List Price \$2.09

Cat. F-11PK DUAL FLUSH SOCKET with mating Plug and Mounting Brackets List Price \$2.67



COMB. ROTATOR CABLE & TV LEAD-IN FLUSH SOCKETS. Provides plug-in termination for one lead-in line plus polarized connection of rotator cable. Multi-wire socket takes appropriate line plug, following page.

Cat. F-14 COMB. SOCKET for 4-WIRE CABLE..... List Price \$2.09

Cat. F-14PK Above, with necessary mating Plugs, mounting hardware List Price \$3.51

Cat. F-155 COMB. SOCKET FOR 5-WIRE CABLE List Price \$2.09

Cat. F-155PK Above, with necessary mating Plugs and mounting hardware List Price \$3.51

Cat. F-18 COMB. SOCKET FOR 8-WIRE CABLE..... List Price \$2.25

Cat. F-18PK Above, with necessary mating Plugs and mounting hardware List Price \$3.60



SOCKET-SWITCH. Single lead-in socket with 3-way rotary antenna switch. Constant impedance, low loss. Brown or ivory.

Cat. F-10 SOCKET SWITCH List Price \$3.75

Cat. F-10PK Above, with mating Plug and mounting hardware. List Price \$4.40

WALL PLATE SOCKET

No wall opening required to install this attractive TV lead-in socket. Mount on wall or baseboard with wood screws supplied. In brown or ivory polystyrene.

Cat. F-2 WALL PLATE SOCKET..... List Price \$1.35

Cat. F-2PK Above, with mating Plug. List Price \$1.65



UNIVERSAL TV SOCKETS

Compact molded polystyrene terminal socket or line tap for single TV lead-in. Mounts on wall, baseboard, metal chassis or direct on Wall-Thru. Constant impedance, low loss. In brown or ivory. With wood screws.

Cat. 343 UNIVERSAL TV SOCKET List Price \$. 80

Cat. 343-PK Above, with mating Plug List Price \$1.05

Cat. 344 Similar to No. 343, above, but with male pins. List Price \$. 80

Cat. 344-PK Above, with mating Line Socket..... List Price \$1.05



LOW LOSS TRANSMISSION LINE CONNECTORS • SPLICERS • MULTI-WIRE CONNECTORS • CRYSTAL HOLDER SOCKETS AND ADAPTERS

UNIVERSAL TRANSMISSION LINE PLUG

Solderless constant impedance 300 ohm transmission line plug. Mates with all MOSLEY Transmission Line Sockets. Precision molded polystyrene. Plated brass pins, set screws. Phosphor bronze contact strips.



Cat. 301 TRANSMISSION LINE PLUG
List Price \$.30

TRANSMISSION LINE SOCKET

Constant impedance 300 ohm transmission line socket for use where mounted socket not feasible. Made of same low loss materials as Plug, above. Mates with Cat. 301 Plug, Cat. 304 Input Adapter, below, and with Cat. 344 TV Receptacle. Solderless.



Cat. 311 TRANSMISSION LINE SOCKET.....List Price \$.30

POLARIZED TRANSMISSION LINE CONNECTORS

Maintains impedance and polarity when used to connect 300 ohm transmission line. Made of low loss materials. Solderless. Use in pairs.

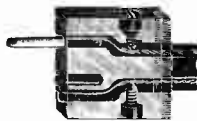

Cat. 321 POLARIZED TRANSMISSION LINE CONNECTORS
List Price, per pair \$.50

INPUT ADAPTER

Ideal plug-in connector for TV and FM sets, boosters, etc. Attaches to screws on antenna terminal strip of set. Mates with Cat. 311 Line Socket. Solderless.



Cat. 304 INPUT ADAPTER.....List Price \$.30



TUBULAR TO FLAT TRANSMISSION LINE SPLICER

Solderless, constant impedance splicer for connecting round or oval 300 ohm line to standard flat line. Slot in splicer wall permits moisture to escape eliminating drip loop in tubular line. Molded polystyrene with non-ferrous set screws.
Cat. 29-S TUBULAR TO FLAT LINE SPLICER.....List Price \$.20



FLAT LINE SPLICER

Low loss, constant impedance splicer for joining sections of standard 300 ohm flat transmission line. Molded polystyrene with non-ferrous set screws. Solderless.

Cat. 27-S FLAT LINE SPLICERList Price \$.18

ROTATOR CABLE CONNECTORS

LINE PLUGS



Compact, polarized molded polystyrene plugs for many low voltage uses. Mate with appropriate Flush, Line or Base Socket. No individual set screws. Solderless. Plated brass pins. For flat or round cable. In brown or ivory.

Cat. 374 4-WIRE PLUGList Price \$.75
Cat. 375 5-WIRE PLUGList Price \$.81
Cat. 378 8-WIRE PLUGList Price \$1.00

LINE SOCKETS

Polarized line sockets to mate with above Plugs. Solderless. No individual set screws. Phosphor bronze contact strips. In brown or ivory.



Cat. 364 4-WIRE LINE SOCKETList Price \$.96
Cat. 365 5-WIRE LINE SOCKETList Price \$1.03
Cat. 368 8-WIRE LINE SOCKETList Price \$1.25

BASE SOCKETS

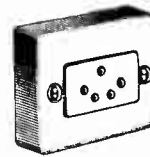

Compact, sturdy polarized sockets for mounting on wall, baseboard or metal chassis. Highest quality construction. Molded polystyrene with phosphor bronze contacts. In brown or ivory. Wood screws supplied.

Cat. 354 4-WIRE BASE SOCKETList Price \$1.37
Cat. 355 5-WIRE BASE SOCKETList Price \$1.50
Cat. 358 8-WIRE BASE SOCKETList Price \$1.75

CRYSTAL HOLDER SOCKETS and ADAPTERS



SINGLE CRYSTAL HOLDER SOCKET takes .095" dia. pins spaced 1/2". Molded high temperature polystyrene with phosphor bronze one piece contacts and solder lugs. Mounts behind chassis or panel up to 1/8" thick. Punching template and mounting brass machine screw supplied.

Cat. 500 CRYSTAL HOLDER SOCKETList Price \$.35
Cat. 53 3-GANG SOCKET for 1/2" spaced small pin crystal holders. Acrylic plasticList Price \$1.08
Cat. 56 6-GANG SOCKET for 1/2" spaced small pin crystal holders. Acrylic plasticList Price \$2.08



Cat. 5-75 CRYSTAL HOLDER ADAPTER takes small pin 1/2" spaced holder and plugs into 3/4" spaced sockets or in any 5 or 6 prong socket.
List Price \$.58

Cat. 75-5 CRYSTAL HOLDER ADAPTER receives pin spaced 3/4" and plugs into standard 1/2" spaced sockets or octal sockets.
List Price \$.58

The MOSLEY Transmission Line Accessories listed on this, and preceding pages, are designed to fulfill the exacting requirements of present day television installations. Materials used include only those possessing low loss characteristics while careful engineering attention

assures that the line impedance be maintained wherever MOSLEY Accessories are used.

Convenience of facility and attractive appearance combine to make MOSLEY TV Accessories completely acceptable to all television set owners.

The NEW MOSLEY "ORIENTOR"

For Fast, Accurate Orientation of Any UHF/VHF Television Antenna

The Mosley "Orientor" is an isolation device that enables the installer on the roof to utilize the television transmission line to bring the video signal back up to him where it can be read in relative value by means of an ordinary volt-ohmmeter. When using the Orientor, it is not necessary that an extra man be stationed at the TV set to relay information to the installer adjusting the antenna.

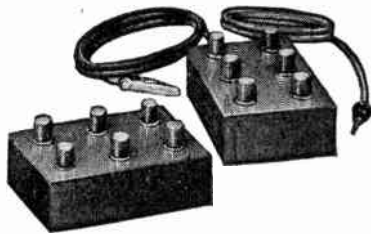

Other advantages include:

- Eliminates need of expensive instruments!
- Use with any inexpensive, portable VOM!
- Requires no power!
- Pocket size — easy to carry
- No special tools needed!
- Sturdy-made for years of service!

Catalog 903 "Orientor" complete with set of leads, less meter.

Dealer Net \$7.50

SPECIAL TV WIRING ACCESSORIES FOR NEW CONSTRUCTION

Here are two new Mosley products designed especially to facilitate roughing-in television transmission line in new homes and other buildings. These products, for the first time, provide builders with components engineered for TV.

MOSLEY TV CONDUIT

Special polyethylene Conduit for TV will not introduce signal losses. 3/4" inside diameter. Flexible, easy to install. In 25', 50' and 100' coils.

Cat. 80-25 Cat. 80-50 Cat. 80-100

Dealer Net \$.15 per foot



MOSLEY PLASTER RING

Provides secure, rigid support for MOSLEY TV Outlet Sockets without signal loss. Use instead of electrical outlet box. For plaster thickness up to 1 1/2". Mounts easily and quickly to wood studding.

Cat. F-8 PLASTER RING

Dealer Net \$.24 each

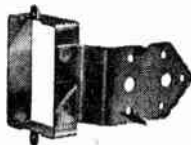

NO BROKEN LEADS

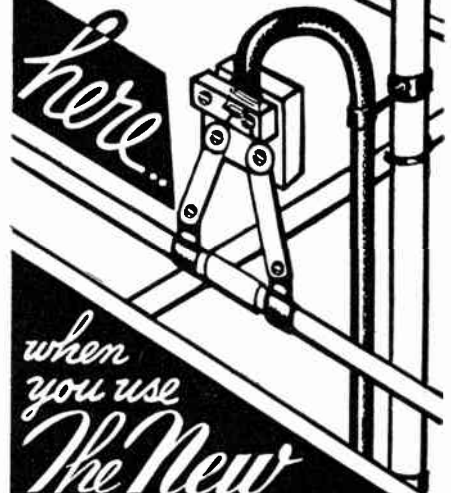

when you use
The New
MOSLEY
"Y-Jay"

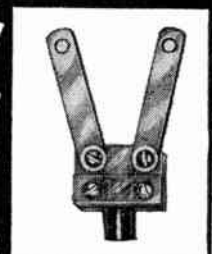

LIST PRICE \$.80

PATENT APPLIED FOR

- Low Loss, Permanent Connections Of Transmission Line and Phasing Strips To TV Antenna Elements!
- For UHF and VHF Antennas!
- For All Types Transmission Line!
- Eliminates Roof-top Soldering Jobs!
- Quick — Easy to Install!
- Available In Two Sizes To Fit All Antennas!

CATALOG 263-S For all UHF Antennas and most VHF Yagis, Conicals, Inline, and other type antennas where distance between terminals is 4" or less.

CATALOG 263-L For TRIO Zig-Zag, and other antennas where distance between terminals is 6" or less.

The
Famous

South River

Quality Line of Antenna
Mounting Accessories

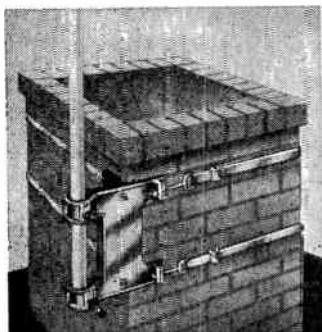

**CHIMNEY MOUNT
ANTENNA BASE**

(U.S. Pat. 2482575)
(Can. Pat. 463261)

****Model SR-10A\$6.50**
Model SR-10A ST (with stainless steel banding) .. \$8.40

One-piece chimney mount of aircraft type aluminum. Mounts by means of **galvanized steel strapping. Exclusive "Kwik Klip" provides convenient means of fastening loose end of banding. Will accommodate any size tube from 1/2"-1 1/2" O.D. Complete with all necessary installation hardware.

Model SP-12A Two-Piece Mount for High Masts..\$6.50
Model SP-12A ST (with stainless steel banding)\$8.40

CHIMNEY MOUNTS

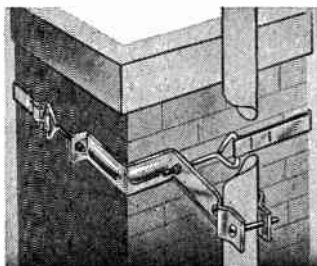

THRIFT MOUNT

(U.S. Pat. 2482575)
(Can. Pat. 463261)

Model T-15\$2.50
Model T-15 ST (with stainless steel banding) ... \$4.25

One-piece embossed, heavy gauge steel, hot-dip galvanized. Accommodates masts to 1 1/2" O.D. **NOTE:** Model T-15 consists of 2 brackets, one of which is shown on illustration.

*South River Metal Products Co., Inc., are the inventors and original manufacturers of the chimney mount antenna base. All other chimney mounts using a pliable band are infringements of Patent No. 2482575.

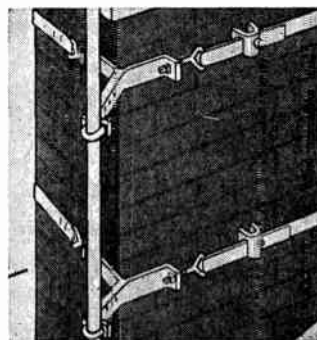

**DUO-MOUNT
ANTENNA BASE**

(U.S. Pat. 2482575)
(Can. Pat. 463261)

Model DM-36\$3.95
Model DM-36 ST (with stainless steel banding) ... \$5.00
Model DM-LKK (same as DM-36 but without "Kwik-Klip")\$3.50
Model DM-LKK ST (with stainless steel banding)\$4.75

Two-piece mount of alloy steel rivet construction, finished in a hot-dip, everlasting, galvanized finish. Specially designed "U" bolts accommodate masts from 3/8"-1 1/2" O.D. Exclusive "Kwik Klip" feature provides convenient means of fastening loose end of banding.

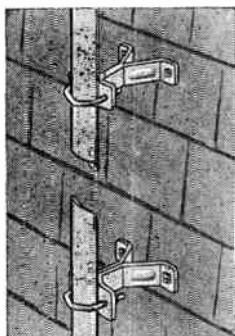

3" WALL BRACKET

Model WB-3\$2.00

Made of aluminum, embossed for extra strength. Accommodates masts up to 1 1/2" O.D. Complete with installation hardware.

WALL BRACKETS

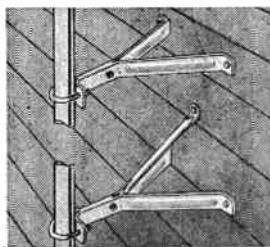

12" WALL BRACKET

Model WB-6 (6")\$2.50
Model WB-12 (12") .. 4.20
Model WB-15 (15") .. 4.50
Model WB-18 (18") .. 4.85
Model WB-24 (24") .. 6.50

Constructed of heavy-gauge, embossed steel, hot-dip galvanized for an everlasting, rust-proof finish. Complete with installation hardware.

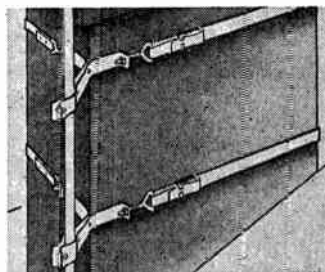

**"SNAP-IN" TYPE
CHIMNEY MOUNT**

(U.S. Pat. 2482575)
(Can. Pat. 463261)

Model SN-50\$3.50
A heavy-gauge steel, hot-dipped galvanized. Rounded wide-flared lips on mast holder facilitate antenna mounting. Has two 12' lengths of galvanized strapping. Also available with heavy-gauge **STAINLESS STEEL** strapping.
Model SN-50-ST\$4.75

South River Metal Products Co., Inc.

PIIONEER MANUFACTURER AND OUTSTANDING PRODUCER OF THE FINEST LINE OF ANTENNA MOUNTING ACCESSORIES IN THE TELEVISION INDUSTRY

The
Famous

South River

Quality Line of Antenna
Mounting Accessories

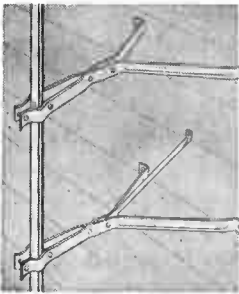

12" WALL BRACKET
(Snap-In Type)
Model SN-12
\$4.00

Features snap-in type mast holder permitting the mast to be held temporarily while screws are tightened. Hot-dip galvanized. With hardware. Available in 6", 12", 15", 18" and 24" sizes.

- Model SN-6\$2.50
- Model SN-15 4.40
- Model SN-18 4.75
- Model SN-24 6.25

Extra support legs available for use with unusually high and heavy masts.

WALL BRACKETS (Cont'd)

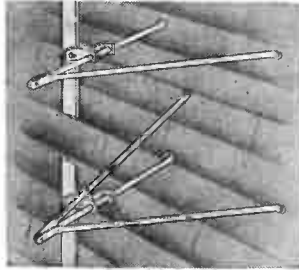

ADJUSTABLE WALL BRACKET

Model WB-18A\$6.50

All aluminum tubular construction. Adjusting slides are made of one-piece aluminum extrusions. Fits all size masts up to 1 1/2" O.D. Complete with installation hardware.

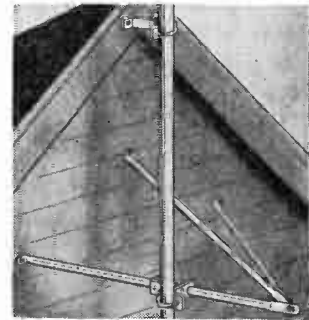

COMBINATION ADJUSTABLE WALL BRACKET

Model WB3-18A\$4.50

All aluminum construction. Eave bracket is of extruded aluminum as is the slide of the tubular adjusting wall bracket. Accommodates masts up to 1 1/2" O.D. Furnished complete with all necessary hardware.

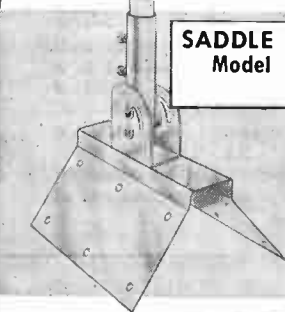

SADDLE MOUNT
Model PM-10
\$4.20

ROOF MOUNTS

Mounts on roof peak without using screws. One man can hold the base in place while another man "walks the mast up" to a vertical position at which point the mast socket drops and locks into place. Accommodates masts up to 1 1/2" O.D. Complete with installation hardware. Assembled.

Model PM-10 LM accommodates masts up to 2" O.D.\$4.75

PEAK & FLAT ROOF MOUNT

Model PFM-30 \$2.85

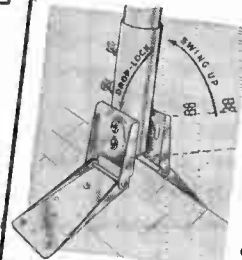

A well-constructed, low-priced, roof mounting featuring the exclusive South River drop lock, mast socket. Assembled for easy installation on either peak, flat or pitched roofs. Accommodates masts to 1 1/2" O.D. Complete with installation hardware.

Model PFM-30 LM accommodates masts up to 2" O.D.\$3.50

All Steel Adjustable Wall Bracket

Model ST-18A
\$7.50

Consists of 2 heavy-gauge embossed steel, rugged braced brackets, fully adjustable, permitting an 18" clearance under eave. Hot-dip galvanized to prevent corrosion and rust streaking. Bottom bracket supplied with embossed steel bracing leg. Features unique U bolt and plate sliding type mast clamp. Hardware includes lag screws and mounting.

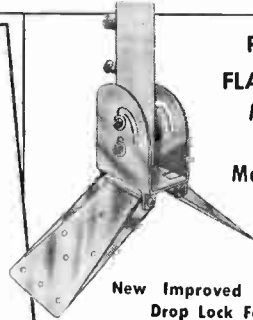

PEAK & FLAT ROOF MOUNT

Model PFM-1
\$2.95

New Improved Model with Drop Lock Feature

Heavy-gauge steel, embossed for extra strength. Adjustable flaps permit mounting on any type roof. Mast socket can be "walked up" to the vertical position at which point it drops and locks securely. Permits one man roof installations.

MODEL PFM-1 LM available to accommodate masts up to 2" O.D.\$3.50. Assembled.

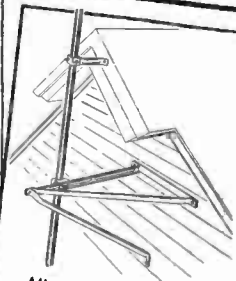

Combination Steel Adjustable Wall Bracket
Model ST3-18A
\$6.25

All steel construction; hot-dip galvanized for lasting rust resistance. Rugged 18" lower bracket features embossed steel bracing leg, is fully adjustable to enable vertical mast mounting under eave. 3" embossed clamp permits use of Spintite for nut tightening. Accommodates masts up to 1 1/2" O.D. Complete with installation hardware and lag screws.

South River Metal Products Co., Inc.

PIONEER MANUFACTURER AND OUTSTANDING PRODUCER OF THE FINEST LINE OF ANTENNA MOUNTING ACCESSORIES IN THE TELEVISION INDUSTRY

The
Famous

South River

Quality Line of Antenna
Mounting Accessories

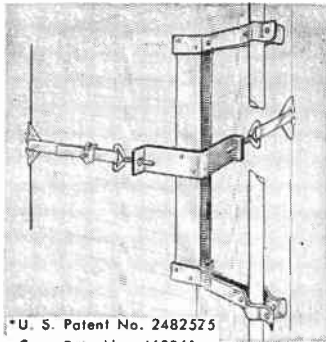

*U. S. Patent No. 2482575
Can. Pat. No. 463261

CHIMNEY UNI-MOUNT

Model UM-1\$6.80

Constructed of embossed heavy-gauge steel, riveted for extra strength. Hot-dip galvanized for lasting weather-proof finish. Features: snap-in mast holders with flared lips. 18" spacing between mast holders provides rigid support. Available with heavy-gauge, stainless-steel strap, Kwik-Klip Banding Closure and clever new Chimney Corner Guards.

EAVE MOUNT

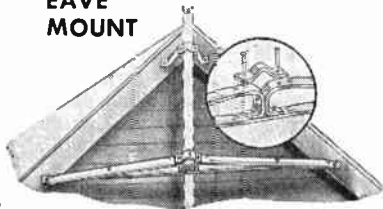

Model EM-1\$4.50

Constructed of heavy-gauge steel, embossed for extra strength and hot-dip galvanized for lasting, rust-proof finish. Unique bridge-type truss construction of lower-bracket provides extra strength and rigidity. 48" spread provides proper spacing between brackets insuring perfect mechanical support. Complete with installation hardware.

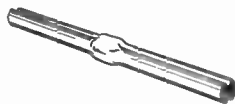

MAST COUPLER

For connecting 2 masts. Heavy-gauge steel hot-dip galvanized, for 1 1/4" O.D. masts \$1.00

ROOF MOUNTINGS

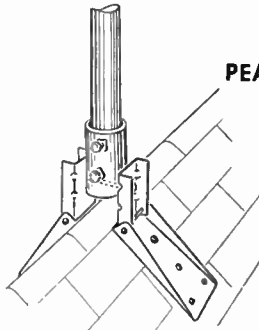

PEAK FLAT ROOF MOUNT

Model
PFM-90
\$2.25

Accommodates masts up to 1 1/2" O.D. Heavy single pin pivotal mast holder. Complete with 2 mast securing bolts and jam nuts. Heavily plated for rust resistance. Embossed for extra strength. Economy priced.

Also available for 2" mast PFM-90LM \$2.65

UNIVERSAL ROOF MOUNT

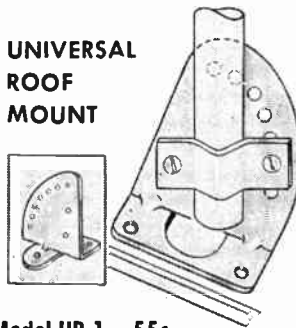

Model UR-1—55c

Constructed of heavy-gauge steel. Will accommodate masts up to 1 1/2" O.D.

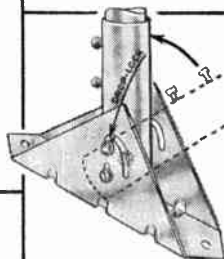

ROOF MOUNT

Model RM-15
\$2.40

New Improved
Model with
Drop Lock
Feature

Heavy-gauge steel, embossed at all critical points and heavily plated for rust resistance. Mast socket can be "walked up" to vertical position at which point it drops and locks securely. Accommodates masts to 1 1/2" O.D. Assembled.

Model RM-20 for 2" masts.....\$2.95

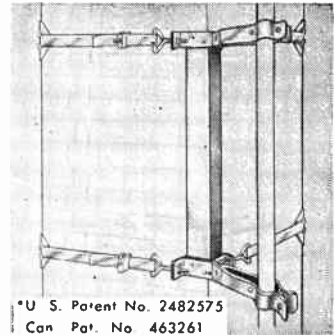

*U. S. Patent No. 2482575
Can. Pat. No. 463261

CHIMNEY UNI-MOUNT

Model UM-2ST\$7.60

With 2 heavy-gauge, stainless steel straps, complete with all of the other features listed for UM-1. For extra heavy installations utilizing antenna rotator.

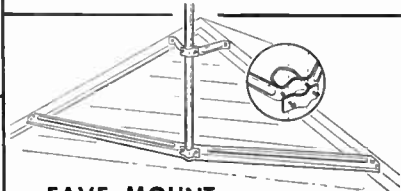

EAVE MOUNT

Model EM-48—\$5.95

ONE PIECE CONSTRUCTION of heavy-gauge steel, embossed, galvanized for lasting rust-proof finish. Unique construction of lower bracket provides extra strength and rigidity. Extended lip provides mast support during installation. Generous 48" spread bracket provides proper spacing between brackets, insuring perfect mechanical support. 3" embossed steel upper bracket features U bolt and clamp for Spintite fastening. Complete with installation hardware.

Also available with 60" spread. EM-60\$7.25

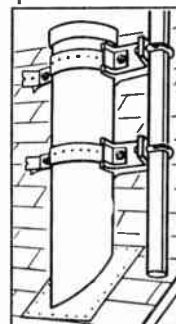

DUO-PIPE MOUNT

Model P-1..\$2.50

Of extruded aluminum; fits all size masts up to 1 1/2" O.D. Positive adjustment for all size pipes up to 6" in diameter. Complete with installation hardware.

Also available with stainless steel straps. P-1ST\$2.95

South River Metal Products Co., Inc.

PIONEER MANUFACTURER AND OUTSTANDING PRODUCER OF THE FINEST LINE OF ANTENNA MOUNTING ACCESSORIES IN THE TELEVISION INDUSTRY

The
Famous

South River

Quality Line of Antenna
Mounting Accessories

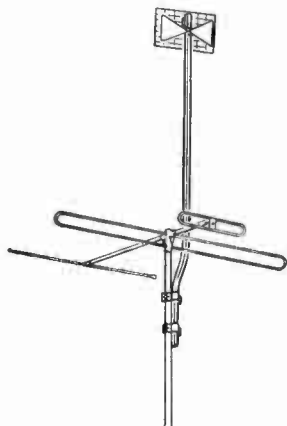

**ULTRA-HIGH FREQUENCY
ANTENNA MOUNTING
ADAPTERS**

Model UHM-1\$3.00

Mounts UHF antenna without disturbing present installation. Fastens quickly to present mast with 2 sets of clamps provided. Of magnesium; extends 5' ABOVE present antenna.

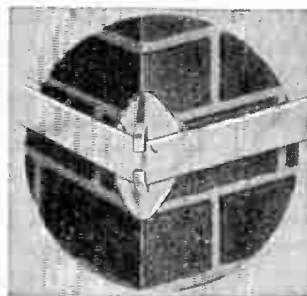

CORNER GUARD

Box of six.....49c

An exclusive South River device for protecting, strengthening, and safeguarding chimney and strapping. Prevents chipping of chimney. Permits uniform tightening of banding. Safeguards mounting equipment. Guards snap in behind banding.

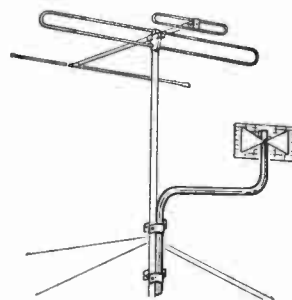

**ULTRA-HIGH FREQUENCY
ANTENNA MOUNTING
ADAPTERS**

Model UHM-2\$3.00

Permits mounting of UHF antenna BELOW present antenna installation, 30" from mast. Fastens quickly to present mast with 2 sets of clamps provided. Of magnesium.



GUY RING

Model GR-5
17c

Heavy-gauge steel stamping, embossed. Accommodates either 3 or 4 guy wires on even spacings. Fits 1 1/4" O.D. mast. Heavily plated for rust protection.

Standard Package: 25
Also available GR-6 for 1 3/8" masts 25c
GR-7 for 1 1/2" masts.....25c

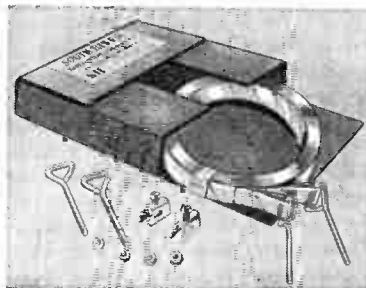

**CHIMNEY MOUNT REPLACEMENT
BANDING KITS**

Universal — may be used with any chimney antenna mount.

KIT A 12' galvanized.....\$1.70
KIT C 12' stainless.....\$3.25

Hardware identical to XL Kits

For Extra Large Chimneys

KIT XL-"G" 18' galvanized steel \$2.30
KIT XL-"ST" 18' stainless steel..\$4.40

Kits consist of:

- 2—18" x 3/4" STRAPS with eyebolts attached
- 2—Eyebolts Unattached
- 4—Nuts to Fit Eyebolts
- 2—KWIK KLIP Strapping Fasteners.

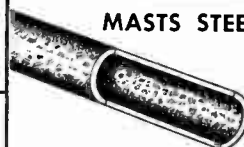

MASTS STEEL TUBING

Hot-Dip
Galvanized
Inside
and Outside!

Another FIRST in the industry . . . 20, 18 and 16 gauge steel tubing, hot-dip galvanized INSIDE AND OUTSIDE . . . overall protection affords long life, increases resistance of steel to the extremes of salt air and industrial atmospheric corrasions. Hot-dip galvanizing is the only experience-proven rust resistant finish known. Available in swedged 5' and 10' lengths, 10 to a bundle, in 1/4" and 1/2" dia.

Also available: Aluminum tubing, 63S-T6, special tough structural alloy, .054 wall by 1/4" dia., 5' and 10' lengths. Plain or swedged end.

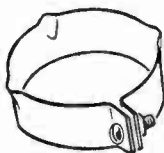

**GUY RING
SUPPORT**

MODEL RS-5
30c

Mast clamp for supporting floating Guy Ring Model GR-5. Fits 1 1/4" mast.

Standard Carton: 25

**Stronger,
Tighter—Twist
GUY WIRE**



Does the best installation job . . . South River's new hot-dip galvanized guy wire is carefully drawn with a strong, tight twist for extra durability under stress — provides tensile strength up to 70,000 lbs. per square inch. 18 gauge or GENUINE 20 gauge, both available in either 4 or 6 strands. 1,000' metal spool, or continuous loops of 50' and 100'.

South River Metal Products Co., Inc.

PIONEER MANUFACTURER AND OUTSTANDING PRODUCER OF THE FINEST LINE OF ANTENNA MOUNTING ACCESSORIES IN THE TELEVISION INDUSTRY

The
Famous

South River

Quality Line of Antenna
Mounting Accessories



3 1/2" Screw Eyes..\$.05
5 1/2" Screw Eyes..\$.06
7 1/2" Screw Eyes..\$.07
4" Mach. Screw..\$.06

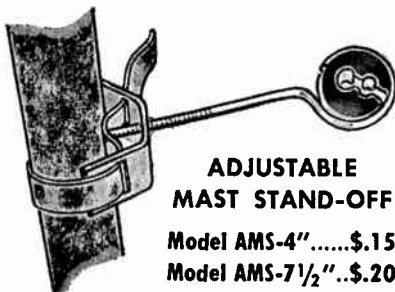

**ADJUSTABLE
MAST STAND-OFF**
Model AMS-4".....\$.15
Model AMS-7 1/2" ..\$.20

Duplex stand-offs also available.
Write for complete catalog.

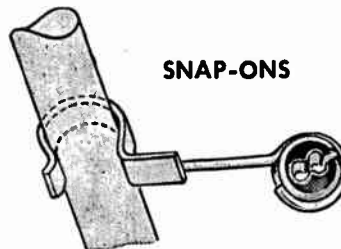

SNAP-ONS

Model SO-1 1/4".....\$.10
Model SO-1 3/8".....\$.12
Model SO-1 1/2".....\$.12

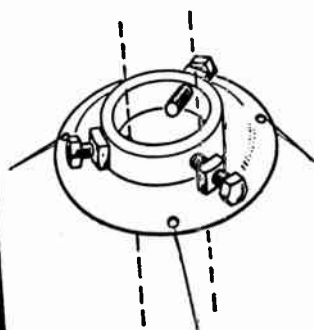

GUY RING
Model GR-1 \$1.25

Of heavy gauge, galvanized steel, embossed for extra strength. Set screws provide positive fit for all masts ranging from 1" O.D. to 2" O.D. Complete with installation hardware.

GROUND ROD
Model GND 4'-6'-8'

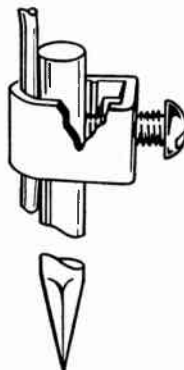

Made of tough, 3/8" O.D., steel rod, pointed on one end. Furnished with either copper or hot-dip galvanized finish. The extruded aluminum wire clamp provides a simple means of attaching all sizes of ground lead wire up to 1/4" O.D. Available in 4', 6' and 8' lengths.

Model GND-4CP-4'
copper plated.....\$1.00
Model GND-6CP-6'
copper plated..... 1.50
Model GND-4HD-4'
hot-dip galv.....\$1.15
Model GND-6HD-6'
hot-dip galv..... 1.60
Model GND-8HD-8'
hot-dip galv..... 2.20

GUY WIRE CLAMP

Model GC-1 30¢
Clamps on mast with a sure grip . . . 12 holes provided for guy wire attachment. Accommodates masts to 1 1/2" O.D.

Model GC-2 35¢
Similar to Model GC-1 with 2 eyebolts for guy wire attachment.

Model GC-3 45¢
Accommodates mast to 2" O.D. Features 3 eyebolts for guy wire attachment.

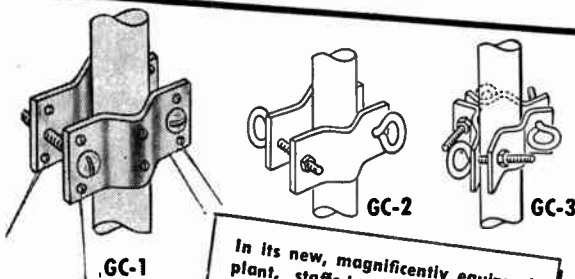

In its new, magnificently equipped plant, staffed with specialists in the production of its line, SOUTH RIVER is ready to supply you with the finest of antenna mounting materials.

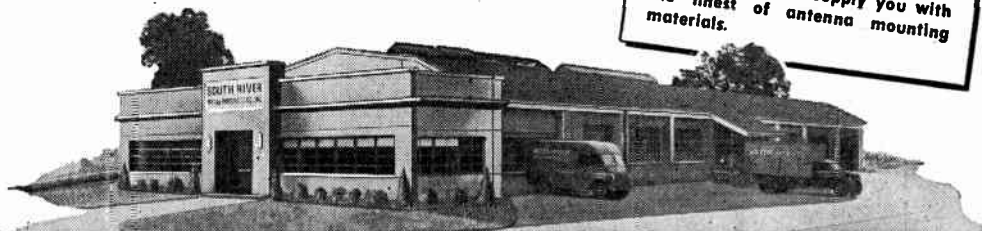

South River Metal Products Co., Inc.

PIONEER MANUFACTURER AND OUTSTANDING PRODUCER OF THE FINEST LINE OF ANTENNA MOUNTING ACCESSORIES IN THE TELEVISION INDUSTRY

engineered
precision



PENN TELEVISION PRODUCTS CO.

engineered
precision engineered
precision engineered
precision engineered
precision engineered
precision engineered
precision

TELEVISION ACCESSORIES



BMA-138

Sturdy Universal Base Mount, made of "PENNALLOY"—strong, weather-resistant. Patented bearing locks in any position with turn of Hex Head Bolt. Patented tongue supports masts up to 2" O.D. Individually boxed—12 to master carton. Shipping Wt. 22 lbs. List Price \$4.25 ea. Set of 1 1/2" wood screws \$.25 additional

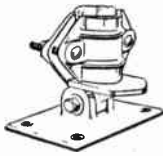

BMA-136

Universal Base Mount, made of "PENNALLOY"—strong, weather-resistant. Patented bearing locks in any position with turn of Hex Head Bolt. Patented tongue supports masts up to 1 1/2" O.D. Individually Boxed 20 to master carton. Shipping Weight 22 lbs. List Price \$3.55 ea. Set of 1 1/2" wood screws \$.17 additional

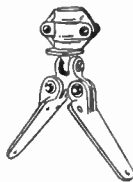

PRA-148

Universal Peak Roof Mount, made of "PENNALLOY"—strong, weather-resistant. Patented bearings lock at any angle with turn of Hex Head Bolts. Patented tongue supports masts up to 2" O.D. Individually boxed 12 to master carton. Shipping Weight 21 lbs. List Price \$5.25 ea. Set of 1 1/2" wood screws \$.25 additional

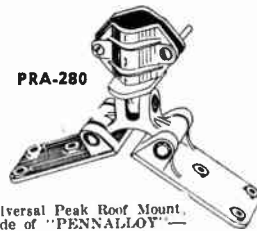

PRA-280

Universal Peak Roof Mount, made of "PENNALLOY"—strong, weather-resistant. Patented bearings lock at any angle with pitch of roof, with turn of Hex Head bolts. Patented tongue supports masts up to 2" O.D. Individually boxed 12 to master carton. Shipping Wt. 28 lbs. List Price \$6.95 ea. Set of 1 1/2" wood screws \$.25 additional

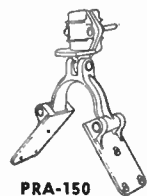

PRA-150

Universal Peak Roof Mount, arches over crown tile. Made of "PENNALLOY"—strong, weather-resistant. Patented bearings lock at any angle and pitch of roof with turn of Hex Head bolts. Patented tongue supports masts up to 2" O.D. Individually boxed 12 to master carton. Shipping Weight 35 lbs. List Price \$6.95 ea. Set of 1 1/2" wood screws \$.25 additional



BMA-192

Economy cast aluminum Base Mount. Takes up to 1 1/2" O.D. Masts. Packed in bulk—24 to master carton. Shipping Wt. 20 1/2 lbs. List Price \$1.90 ea.

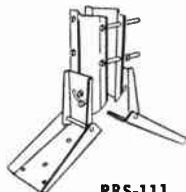

PRS-111

Heavy duty, easy-to-use Peak Roof Mount. Allows tall masts to be swung up along peak of roof. Takes masts up to 2" O.D. Heavy gauge steel, zinc plated, Lusteron dipped. Packed in bulk. 24 to Master Carton. Shipping Weight 60 lbs. List Price \$2.50

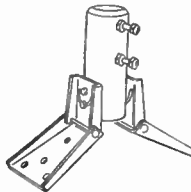

PR-7255

Same as PRS-111 except that PR-7255 has pipe in place of clamp that will take up to 1 1/2" O.D. masts. Packed in bulk. 24 to master carton. Shipping Weight 60 lbs. List Price \$2.75

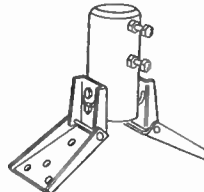

PR-7256

Same as PR-7255 except that PR-7256 has pipe that will take up to 2" O.D. masts. Packed in bulk. 24 to master carton. Shipping Weight 62 lbs. List Price \$3.25

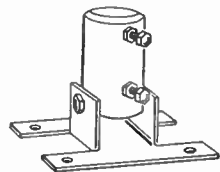

BM-7254

Heavy duty economy swing-up base mount for flat or slant roofs. Heavy gauge steel, zinc plated, Lusteron dipped. Fits up to 1 1/2" O.D. masts. Packed in bulk. 24 to master carton. Ship. Wt. 29 lbs. List Price \$1.50

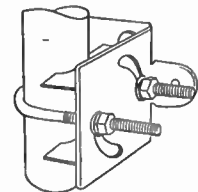

BM-133

Adjustable Base Mount. Rotates easily to fit flat, slope roofs and side walls. Made of heavy plated gauge steel. Packed in bulk, 50 to master carton. Shipping Weight 23 lbs. List Price \$.55 ea.

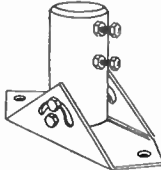

BM-7253

Economy swing-up base mount for flat or slant roofs. Heavy gauge steel, zinc plated, Lusteron dipped. Fits masts up to 1 1/2" O.D. Packed in bulk. 48 to master carton. Ship. Wt. 37 lbs. List Price \$1.30

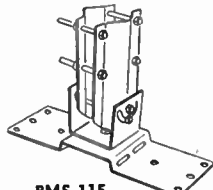

BMS-115

Versatile extra-heavy base mount. Heavy gauge steel—flat roofs, ridges, walls. Easily bent to fit any shape. "I" shape clamp fastens to mast from any angle. Can be rotated. Fits masts up to 2" O.D. Zinc plated, Lusteron dipped. Packed in bulk. 24 to master carton. Ship. Wt. 60 lbs. List Price \$2.75

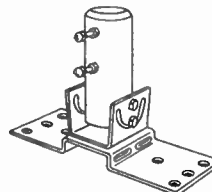

BM-7257

Same as BMS-115 except that BM-7257 has pipe in place of clamp to accommodate masts up to 1 1/2" O.D. Packed in bulk. 24 to master carton. Shipping Weight 60 lbs. List Price \$2.95

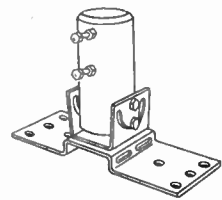

BM-7258

Same as BM-7257 except that BM-7258 accommodates masts up to 2" O.D. Packed in bulk. 24 to master carton. Shipping Wt. 62 lbs. List Price \$3.45



MCA-743

Universal Mast Coupler, made of "PENNALLOY"—strong, weather-resistant. Couples mast sections up to 1 1/2" O.D. Set screws fasten coupler securely. Patented floating guy wire ring permits orientation while mast is permanently guyed. Individually boxed 12 to master carton. Shipping Wt. 11 1/2 lbs. List Price \$3.50 ea.

floating guy wire ring permits orientation while mast is permanently guyed. Individually boxed 12 to master carton. Shipping Wt. 11 1/2 lbs. List Price \$3.50 ea.

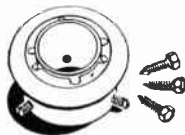

GRA-140

Patented Floating Guy Wire Ring and Collar, made of "PENNALLOY"—strong, weather-resistant. Permits orientation of masts while permanently guyed. Lubricated. Fits masts up to 1 1/2" O.D. Included for your choice—8 headless set screws—3 hex head set screws. Individually boxed—24 to master carton. Shipping Weight 8 1/2 lbs. List Price \$1.80 ea.

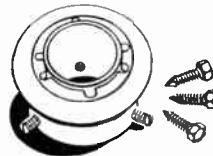

GRA-141

Same as GRA-140, except that GRA-141 takes up to 1 1/2" O.D. mast. Individually boxed—24 to master carton. Shipping Weight 11 lbs. List Price \$1.90 ea.

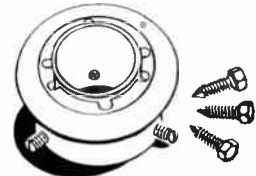

GRA-142

Same as GRA-140, except that GRA-142 takes up to 2" O.D. masts. Individually boxed—24 to master carton. Shipping Weight 15 lbs. List Price \$2.50 ea.

precision engineered
precision engineered
precision engineered
precision engineered
precision engineered
precision engineered
precision engineered

TELEVISION ACCESSORIES

PENN TELEVISION PRODUCTS CO.

precision
engineered

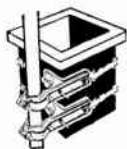

CMA-500

Pair of Chimney Mounts, made of "PENNALLOY" — strong, weather-resistant. Two 12 ft. lengths of galvanized strapping. 6 corner brackets. Eyebolts permanently sealed at one end of strapping. Seals for opposite end of straps easily fastened. Mounts hold masts up to 2" O.D. Complete with heavy plated hardware. Individually boxed—12 to master carton. Shipping Weight 49 lbs. List Price \$6.95 pair

CMA-500 S.S.

Same as CMA-500, except CMA-500S.S. has stainless steel strapping and seals. Individually boxed 12 to master carton. Shipping Wt. 49 lbs. List Price \$8.95 pr.

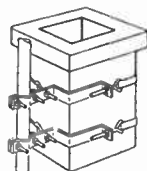

Z-3

A pair of Chimney Brackets for economy installations. Two 10 ft. lengths of 3/4" galvanized strap, complete with hardware and galvanized EZ seals. Zinc plated. Lusteron dipped. Individually boxed, 24 to master carton. Shipping Wt. 60 lbs. List Price \$2.25

Z-4SS

Same as Z-3 except that Z-4SS has two 11 ft. lengths 3/4" x .015 stainless steel strap. Complete with hardware and stainless steel EZ seals. Individually boxed. 24 to master carton. Shipping Weight 60 lbs. List Price \$3.25

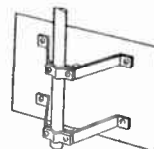

WB-4

A pair of economy close wall mounting Brackets. 4" clearance. Extra-heavy gauge steel, complete with hardware. Zinc plated. Lusteron dipped. Individually boxed. 48 to master carton. Shipping Weight 60 lbs. List Price \$8.00

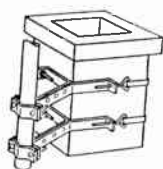

"Y" TYPE CHIMNEY MOUNTS

Cat. No.	Finish	Strapping	Complete Hardware and EZ Seals	Std. Pack.	Ship. Weight	List Price
CMS-XXX	Zinc Plated	2-11' lengths 3/4" Galv.	Galv. EZ Seals	12	41 lbs.	\$3.00
CMS-222	Hot Dip Galv.	2-12' lengths 3/4" Galv.	Galv. EZ Seals	12	41 lbs.	3.25
CMS-333SS	Hot Dip Galv.	2-12' lengths 3/4" x .020 St. St.	St. St. EZ Seals	12	41 lbs.	4.75
CMS-444SS	Hot Dip Galv.	2-12' lengths 3/4" x .015 St. St.	St. St. EZ Seals	12	41 lbs.	4.35
CMS-666SS	Zinc Plated	2-12' lengths 3/4" x .015 St. St.	St. St. EZ Seals	12	41 lbs.	3.95

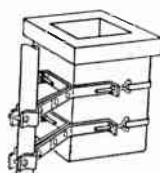

SNAP-IN TYPE CHIMNEY MOUNTS

Cat. No.	Finish	Strapping	Complete Hardware and EZ Seals	Std. Pack.	Ship. Weight	List Price
CMS-OXO	Zinc Plated	2-11' lengths 3/4" Galv.	Galv. EZ Seals	12	41 lbs.	\$3.00
CMS-020	Hot Dip Galv.	2-12' lengths 3/4" Galv.	Galv. EZ Seals	12	41 lbs.	3.25
CMS-030SS	Hot Dip Galv.	2-12' lengths 3/4" x .020 St. St.	St. St. EZ Seals	12	41 lbs.	4.75
CMS-040SS	Hot Dip Galv.	2-12' lengths 3/4" x .015 St. St.	St. St. EZ Seals	12	41 lbs.	4.35
CMS-060SS	Plated Zinc	2-12' lengths 3/4" x .015 St. St.	St. St. EZ Seals	12	41 lbs.	3.95

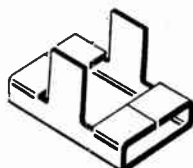

GS-24

EZ Seals. Galvanized. Fits 3/4" strapping. Easy to use. Packed in bulk—100 to carton. Shipping Weight 2 lbs. List Price \$.06 ea.

SS-25

EZ Seals. Stainless steel. Fits 3/4" strapping. Easy to use. Packed in bulk—100 to carton. Shipping Wt. 2 lbs. List Price \$.18 ea.

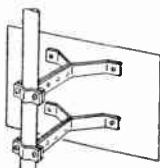

WB-8

A pair of sturdy Wall Brackets. 8" clearance. Extra-heavy gauge steel, complete with hardware. Zinc, plated. Lusteron dipped. Individually boxed, 12 to master carton. Shipping Weight 27 lbs. List Price \$1.95

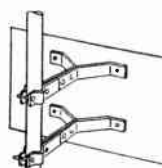

WB-SN

A pair of easy - to - use Snap-in Wall Brackets. 8" clearance. Extra-heavy gauge steel, complete with hardware. Zinc plated. Lusteron dipped. Individually boxed, 12 to master carton. Ship. Wt. 25 lbs. List Price \$1.95



12015

12 ft. lengths of 3/4" Stainless Steel Strap Replacement Kit for Chimney Mounts. Individually boxed—12 to carton. Shipping Weight 16 1/2 lbs. List Price \$2.75 ea.



SE-23

Heavy plated, welded triangular eyebolts, same as used for Chimney Mounts. Complete with lockwasher and hex nut. Packed in bulk—100 to carton. Shipping Weight 7 lbs.

List Price \$10 ea.



MK-29

"PENNALLOY" tube cap fits 1 1/4" tubing; prevents wind howls, rain and snow accumulation in mast tubing. Packed in bulk—100 to carton. Shipping Weight 7 lbs. List Price \$.20 ea.



3/4" ROLLS OF STEEL STRAPPING

Cat. No.	Strapping	Gauge	Ft. per Roll	Std. Pack. Rolls	Ship. Weight	List Price Per Roll
#10015	Stain. Steel	3/4" x .015	100'	6	26 lbs.	\$9.00
CSS-28	Stain. Steel	3/4" x .020	100'	6	35 lbs.	11.80
#05015	Stain. Steel	3/4" x .015	50'	12	23 lbs.	4.50
#02515	Stain. Steel	3/4" x .015	25'	25	24 1/2 lbs.	2.25
CSG-27	Galvanized	3/4"	100'	6	35 lbs.	4.60
#2750	Galvanized	3/4"	50'	25	50 lbs.	2.30

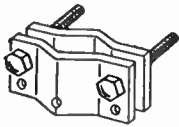
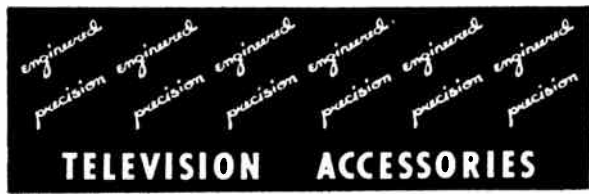

GW-134

Guy Wire Clamp, easy to fasten to mast, for attaching guy wires. Extra-heavy gauge steel, zinc plated, Lusteron dipped. Packed in bulk, 100 to master carton. Shipping weight 30 lbs.

List Price \$.35 ea.

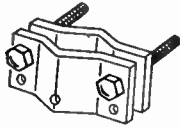

GW-134A

Same as GW-134, except that GW-134A is made of heavy but stock aluminum. No rust. Packed in bulk, 100 to master carton. Shipping Weight 13 1/2 lbs.

List Price \$.40 ea.



GW-137

Guy Wire Clamp with 2 heavy eyebolts, easy to fasten to mast, for attaching guy wires. Extra-heavy gauge steel, zinc plated, Lusteron dipped. Packed in bulk, 100 to master carton. Shipping Weight 35 lbs.

List Price \$.45 ea.



GW-139

Same as GW-137, except that GW-139 has 3 heavy eyebolts. Packed in bulk, 100 to master carton. Shipping Weight 51 lbs.

List Price \$.60 ea.



No. 153

"Pennalloy" universal Collar for holding guy wire rings. 3 cone point set screws to easily and securely fasten collar to mast. Fits masts up to 1 3/8" O.D. Guy Wire Rings rest on collar. Packed in individual cellophane bags. 100 to master carton. Shipping Weight 8 lbs.

List Price \$.47 ea.



GW-135

Heavy gauge steel Guy Wire Ring with plated rolled edge. Fits 1 1/4" O.D. masts. Packed in bulk, 100 to master carton. Shipping Weight 13 3/4 lbs.

List Price \$.42 ea.

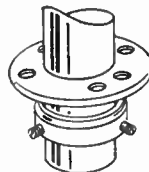

No. 143

Economy floating guy wire Ring and Collar. "Pennalloy" collar with 3 cone point set screws, ring made of heavy gauge steel. Takes up to 1 1/4" O.D. masts. Zinc plated, Lusteron dipped. Packed in individual cellophane bags. 100 to master carton. Shipping Weight 21 lbs.

List Price \$.89



GT-30

Guy Wire Thimble made of aluminum with plated U-bolt and hex nuts. Swift, vise-like tightening and joining of guy wires insures permanent grip. Packed in bulk, 100 to carton. Shipping Weight 7 lbs.

List Price \$.25 ea.

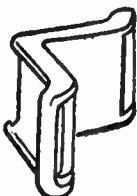

AC-26

"PENNALLOY" Corner Protector. Fits 3/4" strapping. Permits uniform tightening of strapping. Protects chimney corners. No rust. Packed 6 to cellophane bag. 17 bags (102 pieces) to carton. Shipping Weight 4 lbs.

List Price \$.17 ea.

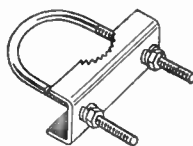

UC-22

"U" Bolts with Clamp. Ideal mast clamp assembly to fasten cross bar to mast. Serrated edges to prevent turning on mast. Zinc plated, Lusteron dipped. Packed in bulk, 100 to master carton. Shipping Weight 18 lbs.

List Price \$.33 ea.

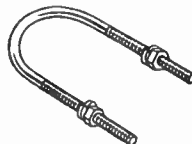

UC-21

"U" Bolt, length 3 3/4", will take pipe up to 1 1/2" O.D. Zinc plated. Complete with lockwashers and nuts. Packed in bulk, 100 to master carton. Shipping Weight 15 lbs.

List Price \$.17



STAINLESS STEEL MAST STAND-OFF INSULATORS

All Stainless Steel TV Mast Stand-offs, Screw Eye, Bracket, Rivet, 9" Strapping. No Rust. Precision close fit thread—can't strip. Genuine Polyethylene inserts—one type for 300 ohm flat lead-in (VHF), specify **FLAT**; one type for tubular lead-in (UHF), specify **UNIVERSAL**. For UHF-VHF.

Cat. No.	Size	Std. Pack.	Ship. Weight	List Price
S0S-49	3 1/2"	100	10 lbs.	\$.22 ea.
S0S-59	5 1/2"	100	12 lbs.	.28 ea.
S0S-79	7 1/2"	100	14 lbs.	.35 ea.



TURNBUCKLES

Cat. No.	Description	Closed	Open	Std. Pack.	Ship. Weight	List Price
8501	Alum. Body—Plated Steel Screws	3 3/8"	4 5/8"	100	3 1/4 lbs.	\$.027
8502	Alum. Body—Plated Steel Screws	4"	5 5/8"	100	5 lbs.	.28
8503	Alum. Body—Plated Steel Screws	4 1/2"	6 3/8"	100	7 lbs.	.30
8504	Alum. Body—Plated Steel Screws	5 1/2"	7 5/8"	100	11 lbs.	.45
8505	Alum. Body—Plated Steel Screws	6 3/4"	9 1/4"	100	20 1/2 lbs.	.70
8506	Alum. Body—Plated Steel Screws	7 1/2"	10 1/2"	100	27 lbs.	.95
8507	Alum. Body—Alum. Screw, No Rust	7 1/2"	10 1/2"	100	22 lbs.	1.15



ALUMINUM WOOD-SCREW STAND-OFF INSULATORS

All Aluminum Wood Screw Eye, No Rust. Sturdy, everlasting with genuine Polyethylene inserts for UHF-VHF. One type for 300 ohm flat lead-in (VHF), specify **FLAT**; one type for tubular lead-in (UHF), specify **UNIVERSAL**.

Cat. No.	Size	Std. Pack.	Ship. Weight	List Price
ASO-35	3 1/2"	100	1 3/4 lbs.	\$.09 ea.
ASO-55	5 1/2"	100	2 1/2 lbs.	.12 ea.
ASO-75	7 1/2"	100	3 lbs.	.15 ea.

engineered precision engineered precision engineered precision engineered precision engineered precision engineered precision

TELEVISION ACCESSORIES

PENN TELEVISION PRODUCTS CO.



TS-551 HILOSWITCH

2-position Antenna Switch for easily and correctly switching any 2 antennas in any combination of UHF, VHF, FM, to a receiver. Efficient also for switching any 2 receivers to 1 antenna. Easy to install - cuts installation time - no soldering - positive contacts - minimum leakage. Individually boxed, 12 to master carton. Shipping Weight 3 1/2 lbs.

List Price \$2.75 ea.

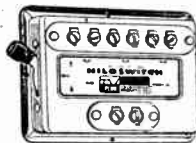

TS-587 HILOSWITCH

3-position Antenna Switch for easily and correctly switching any 2 or 3 antennas in any combination of UHF, VHF, FM, to a receiver. Efficient also for switching any 3 receivers to 1 antenna. Easy to install - cuts installation time - no soldering - positive contacts - minimum leakage. Individually boxed, 12 to master carton. Shipping Weight 4 lbs.

List Price \$3.75 ea.



TC-313 TWINTENA

2-Set Coupler designed to permit simultaneous operation, under suitable conditions, of 2 TV receivers from a common antenna. Utilizes matched resistance elements only; therefore does not affect impedance characteristics of transmission line. Result: bandpass response of line remains essentially uniform. Reduces oscillator radiation. Easy to install - no soldering - positive contacts - minimum leakage. Individually boxed, 12 to master carton. Shipping Weight 3 1/2 lbs.

List Price \$3.95



TC-374 TWINTENA

DeLuxe 2-Set Coupler designed to permit simultaneous operation under suitable conditions, of 2 TV receivers from a common antenna. Utilizes

matched coils only; therefore cannot affect impedance characteristics of transmission. Result: bandpass response of line remains essentially uniform. Reduces oscillator radiation. Easy to install - no soldering - positive contacts - minimum leakage. Individually boxed, 12 to master carton. Ship. Wt. 3 1/2 lbs. List Price \$4.95 ea.



"PENNUE" MODEL WT-39

An FM-TV Interference Eliminator for FM band interference. Adjusts to give clear vision, uncluttered sound. Easily installed. Packed 12 on display card. 1 card to carton. Shipping Weight 3 lbs.

List Price \$1.98 ea.



No. 412 ATTENUATOR

3-position Attenuator. Quickly evaluates and corrects signal overload problems. Can be used as: Trouble shooting tool and permanent home installation. Trouble Shooting Tool: Serviceman uses it to quickly check which channels are operating at too high a level. Permanent Home Installation: Used to adjust levels on any channel. Operation simple - results amazing. Individually boxed, 12 to master carton. Shipping Weight 4 lbs.

List Price \$4.95



No. 77 E 2-SET COUPLER

Economy 2-set Coupler designed to permit simultaneous operation, under suitable conditions, of 2 TV receivers from common antenna. Individually boxed, 12 to master carton. Shipping Weight 3 lbs.

List Price \$1.75



TS-127 JR. HILOSWITCH

Economy 2-position switch for easily and correctly switching any 2 antennas in any combination of UHF, VHF, FM, to a receiver. Easy to install, no soldering, positive contacts. Individually boxed, 24 to master carton. Ship. Wt. 4 lbs.

List Price \$1.95

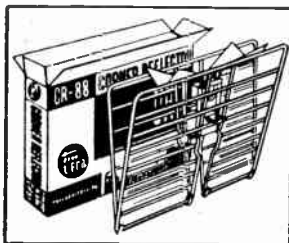

1. Take preassembled unit from carton.

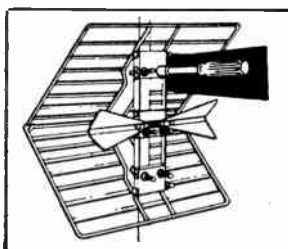

3. Tighten THREE U-BOLTS to permanently secure Antenna to mast.

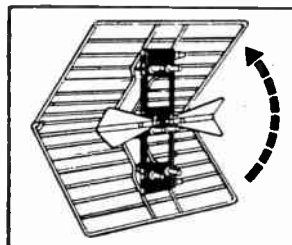

2. Snap open Antenna.

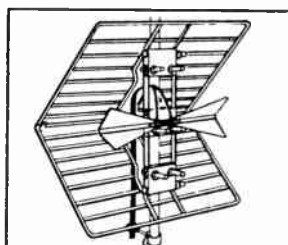

4. Simply attach lead-in line to terminals of driven element.

CR-88

An improved corner reflector designed to cut installation time in half and to end 99% of future maintenance problems.

Better than three extra hands when making installations on windy rooftops . . . Just zip out the sturdy, light-weight pre-assembled unit from carton . . . snap open reflector . . . tighten three U bolts on mast . . . attach feed line . . . and there you have it!

Imagine freedom of both hands without the acrobatics generally needed in the installation of other antennas. PENN TELEVISION PRODUCTS' CORNER REFLECTOR is balanced so perfectly that the weight of ice loads will always be evenly distributed. There are absolutely NO loosely packed parts to lose since everything is COMPLETE on the one unit.

These superior features have made PENN TELEVISION PRODUCTS COMPANY justly proud of their newest and finest achievement in the U.H.F. field.

CORNER REFLECTOR



TELEVISION ACCESSORIES



NEW BUD FILTERS TO REDUCE OR ELIMINATE TELEVISION INTERFERENCE

The sources of television interference are most often short wave broadcasting stations, amateur radio transmitting stations, diathermy equipment, X-ray equipment, automotive ignition noises

or similar sources. The basic problem of eliminating this interference is that of rejection of the signals received from these sources.



LF-601 LOW PASS FILTER

Interference to television receiver reception caused by transmissions from an amateur station can be caused by harmonics or by shock from the transmitter. The shock from the transmitter fundamental can be cured at the television receiver with a Bud HF-600 high pass filter. Harmonics can be greatly reduced or eliminated at the transmitter by use of a Bud LF-601 low pass filter.

The LF-601 high attenuation low pass filter has the following characteristics:

1. Minimum attenuation of 86 decibels on all frequencies above 54 megacycles and a minimum of 93 decibels above 70 megacycles.
2. Maximum rejection is adjustable from 55 to 90 megacycles. This tunable feature provides two slots at least 100 decibels down.
3. The cut-off frequency is 42 megacycles.
4. The unit will easily handle a full kilowatt modulated on a reasonably flat line.

5. The insertion loss is less than one DB.
6. Since the design of this filter provides an adjustable feature, the unit can be used with either 52 ohm or 72 ohm coax.
7. Each inductance is in an individually shielded compartment.
8. All capacitors used are variable.

LF-601

Dealer Cost \$13.50

WIRELESS PHONO OSCILLATOR WO-6A



This compact unit is designed to enable any standard record player to be easily converted to wireless operation. Record reproduction is then possible through a regular radio receiver without the necessity of cumbersome inter-connecting wires. Installation is simple according to the complete instructions furnished with each unit.

The circuit incorporated in the Wireless Oscillator is of such design that faithful reproduction is assured. The unit comes completely wired and tested including tubes and is finished in black enamel. Operates from 115 volts AC or DC. Frequency range is approximately 1100-2150 K.C. Actual weight 1 lb.

WO-6A

Dealer Cost \$9.00

HF-600 HIGH PASS FILTER



The HF-600 high pass filter is designed to have a cut off frequency at 42 megacycles, thus this filter rejects signals from 0 to 42 megacycles. It is within this range that the majority of signals causing interference would be received. Since there is no attenuation above 42 megacycles, picture strength or quality is not affected.

This unit is easily installed and complete installation instructions are included. The filter is housed in an attractive aluminum case 3 1/4" x 2 3/4" x 1 3/4".

HF-600.....Dealer Cost \$3.57

ADJUSTABLE CHIMNEY MOUNTS

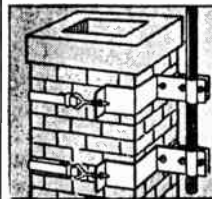

Very easy to install on any size chimney without use of special tools. The NEW BUD STRAP CLAMP simplifies and speeds up installation. A rugged antenna installation is assured.

The Twin Mounts design allows unlimited spacing between the brackets, thus providing maximum strength.

AM-86—Heavy Duty Chimney Mounts—Made from 1/2" steel—2 1/2" wide enabling the overlapping of more than one brick and can be used to support any size antenna mast from 7/8" to 1 1/2" diameter.

AM-88 — Economy Model Chimney Mount — Construction and design same as AM-86 except for the width of the bracket which is 1 1/4". Also made from 1/2" steel and will support mast up to 1-5/16" in diameter. These chimney mounts are supplied complete with 24 feet of strapping, and all necessary hardware. The brackets are finished by painting with a black rust-resisting paint and all hardware is plated, assuring a long lasting installation.

AM-86.....Dealer Cost \$2.10

AM-88.....Dealer Cost \$1.60

COMBINATION ANTENNA MOUNT

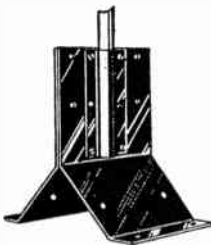

This new Combination Mount is the latest addition to Bud's complete line of television antenna mounts for every location . . . to meet any condition.

Made of two sheets of extra heavy gauge, tough steel, the upright portion is welded together for a permanent bond. Spread portion is accurately formed for peak or wall installation. Sturdy construction guarantees permanent, trouble-free mast installation.

The Combination Mount has a baked, black enamel finish to prevent rust. Furnished complete with plated mounting hardware. Will accommodate up to 1 1/4" mast.

AM-83.....Dealer Cost \$1.50

GUYING CLAMPS and MAST COUPLERS

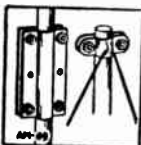

GT-68 Guytie—A vise grip clamp to hold guy wire at any point.

AM-66 Mast Coupling — Used to extend antenna height.

GT-68.....Dealer Cost \$3.33

AM-66.....Dealer Cost \$6.00

HEAVY DUTY WALL MOUNTING BRACKET

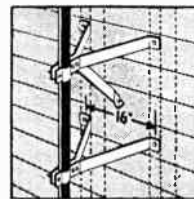

For an installation requiring maximum strength and weather resistance. The 16" spacing on the wall allows lag bolts to enter 2 x 4 joists under the wall siding, making a solid support for the antenna. Made of 1/2" steel 2" wide. Painted with a black rust-resisting paint. A steel brace is furnished for use as a brace on the upper bracket and permits the supporting of heavy television antenna. Brackets are adjustable to accommodate masts 1 1/2" in diameter. The AM-60 will allow a 12" space between the mast and the wall. The AM-89 will separate the mast from the wall by a space of 16". Supplied complete with lag screws and all other hardware.

AM-60Dealer Cost \$3.00

AM-89Dealer Cost \$3.60

Only a few of many BUD Products are shown. For complete catalog, write BUD RADIO, INC., 2118 E. 55th St., Cleveland, Ohio



R. L. Drake Company

Television Interference Filters



High Pass Filters

300 ohms optimum impedance

LIST

- TV-300-HP For very high attenuation at all I.F. Bands below 50 Mc. Very low insertion loss at both UHF and VHF TV channels \$ 5.95
- TV-72-HP Same as above for 72 ohm input..... 5.95
- TV-300-50HP For use on sets with 20 Mc I.F.'s 4.95
- UHF-300-HP For use at UHF Input Only. Very high attenuation at all Intermediate Frequencies below 350 Mc. Low insertion loss at UHF 3.25



Band Rejectors

300 ohms optimum impedance

- TV-300-45T Peak attenuation adjustable 40 to 46 MC. Low insertion loss at adjacent TV channels 3.25
- TV-300-FMT Same as above—adjustable 88 to 108 Mc .. 3.25

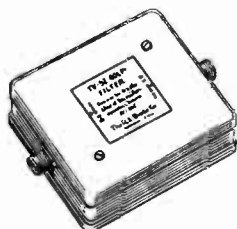

Low Pass Filters

1 Kw. rating

- TV-52-20LP 52 ohms impedance, attenuates all frequencies above 20 Mc. 12.95*
- TV-52-40LP 52 ohms impedance, attenuates all frequencies above 44.5 Mc. 12.95*
- TV-300-LP Same as TV-52-40LP except 300 ohms 12.95*

*AMATEUR NET



Half Wave Filters

300 ohms, 1 Kw. rating

- TV-300-10HW For 10 and 11 Meter Band use 10.95*
- TV-300-20HW For 20 Meter Band use 10.95*

The above Half Wave Filters will attenuate all harmonics from the band for which it is designed.

*AMATEUR NET

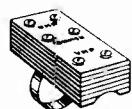

"Tenna-Mix" Crossover Network

"TENNA-MIX" Lumped constants filter type for combining UHF and VHF TV inputs or antennas. Low loss

Available Soon

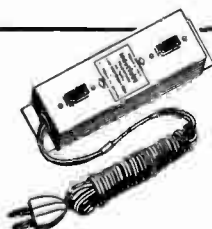

"Inductube" Power Line Filter

LN-5 500 Watt rating AC-DC, dielectric loss type constant "K" Filter. Attenuation increases as frequency increases. Very good filter action at UHF and VHF frequencies. For use on either the receiver or the interference source .. 9.70



MODEL 5TV4
Replaces 5U4G

"B" PLUS BOOSTER

FOR MORE HEIGHT, WIDTH AND GAIN
Simply by pulling a tube and replacing with a "B" Plus Booster you add 30-40 volts to low voltage supply, provide more height, width and gain for a full size picture even where there is low line voltage or weak tubes.

- Extra power for converted sets
- Extra gain for fringe areas
- Extra life to dual purpose vertical tube in set
- Built-in delay to protect TV set

SPECIFICATIONS

Filament Voltage	5 volts	LIST PRICE \$6.60 ea.
Filament Current	3 amperes	
Peak Inverse Plate Voltage	1550 max. volts	
Peak Plate Current per plate	1.0 max. amperes	
DC Output Current	2.25 max. ma	



- Brightens old picture tubes
- Easy to plug in — permanent hookup
- Completely automatic
- Works on any 10" to 30" picture tube
- Adds up to one year or more to tube life
- Guaranteed — or your money refunded

TV picture tube booster

MODEL W-2 For TV picture tubes with filaments in parallel circuits	MODEL W-3 For TV picture tubes with filaments in series circuits	MODEL W-4 1. For picture tubes with cathode to filament shorts 2. For electrostatic focus type picture tube. 3. For picture tubes with filaments in parallel circuits
--	--	---

LIST PRICES

W-2	\$2.65
W-3	2.90
W-4	3.70



POWDERED IRON CORES

7 ASSORTED CORES
4.5 to 30 MC.



MODEL PS-10 IRON CORE KIT

REPLACES 80% OF THE FOLLOWING:

Sound Discriminator	Horizontal Oscillator
Radio Detector	Horizontal Frequency
Sound IF	Horizontal Lack
Video IF	Horizontal Discriminator
Video Peaking Coil	Linearity Coil
Width Coil	

LIST PRICE \$0.95 per kit

PLUG-IN MODEL 10-V

LINE BOOSTER

Corrects dull picture, insufficient height, insufficient width . . . DUE TO LOW LINE VOLTAGE

- Automatically increases line voltage 10%
- Constant duty 300 watts
- No on-off switch needed — leave attached
- Less than one mill current drain with no load
- No temperature increase under rated load
- 99% efficient operation

SPECIFICATIONS

Model No.	10-V	LIST PRICE \$13.25
Output Capacity in VA	300	
Input Volts	90-115	
Output Volts	100-127	
Dimensions	3 1/2" x 3 1/4" x 4"	



WISSER

Electronic Contact CLEANER & LUBRICANT

- Cleans Contact Points and Tuners Instantly
- Lubricates Tuners and Controls
- Eliminates Noises and Scratches
- Restores Carbon Controls
- Longer lasting protection for Radio-TV equipment

THE SCIENTIFIC FORMULA . . . THAT CLEANS AND LUBRICATES!
USE EITHER METHOD TO APPLY — Squeeze Bottle or Brush Bottle — supplied with each qt. con. Spout provided.

with 2 REFILL DISPENSERS FREE!

- 1 Squeeze Bottle
- 1 Glass Bottle with brush

LIST PRICE (with free bottles) \$4.80
Quart Con



Rubber Base SPEAKER CEMENT

CONE RECONDITIONER

REPAIRS: Cracks • Punctures • Weak Edges
This is a rubber based product especially made for use on paper speaker cones. It corrects the brittleness which results from use and age and repairs damaged cones, which would require replacement. It does not leave a hard crusty surface. Use WTV cement for all your paper cone repairs. Save time and work of replacement and improve tone quality. Comes in 2 oz. brush applicator bottle.

RESTORES SPEAKER CONES TO FULL TONE RANGE . . . like new!

LIST PRICE
2 OZ. BOTTLE WITH BRUSH APPLICATOR . . . \$0.95



WORKMAN TV INC.

309 QUEEN ANNE ROAD, TEANECK, N.J.
TEANECK 6-0200

Manufacturers of Guaranteed Electronic Products

Long Life Non-Inductive High Voltage Filter Resistor

3.5 WATTS

for Doubler Circuits

2 Megohms

COMPOSITION CARBON BAR . . . not a carbon film.

LIST PRICE \$0.85 ea.



Genuine Top Grain Cowhide

SPECKIT CASE

Combination Eyeglasses and Tool Holder for the Shirt Pocket!

A safe, firm holder for eyeglasses or sunglasses while you are working. A heavy gauge covered spring clip holds the Speckit in your work shirt pocket securely even when you are active. Front compartments hold pens, pencils, small tools, screwdrivers and other items you need regularly. Glass compartment holds gently and firmly to your glasses while you bend and move. Will fit an automobile sunvisor or on trouser belt as well. Heavy duty stitching for long life.

PRICE \$2.00
Dealer Net



Temperature Sensitive

Filament Resistors

for G. E. TELEVISION
100% REPLACEMENT FOR ALL G. E. SETS

Every G.E. model number is listed on the up-to-date easy to read instruction sheet. Next to the model number it is indicated whether to use one resistor from the kit, or both resistors in either series or parallel combination.

MODEL FR2 KIT
Use the Model FR2 Kit for: Motorola - Hoffman - Sears Pathe - Telatone (In Canada - G.E. - R.C.A. Marconi)

LIST PRICE \$2.40 per kit





TELEVISION HARDWARE

TELEVISION ANTENNAS UHF TYPES

TELCO "GOLDEN GRID" STANDARD BUTTERFLY ANTENNA



Features the famed Telco "Wishbone" Insulator that prevents shorting. "Golden Grid" plating protects from rust.

No. A-9001 List \$2.95

TELCO "GOLDEN GRID" STANDARD CORNER REFLECTOR ANTENNA



Front mounting style with Telco "Wishbone" Insulator. Assembled. High 14 db. gain. Front-to-back ratio 15-1.

No. A-9002 List \$7.45

TELCO "GOLDEN GRID" STANDARD BUTTERFLY ANTENNA—Assembled



Same as 9001, only pre-assembled for quick installation. Ideal for high power local areas.

No. A-9003 List \$3.50

TELCO "GOLDEN GRID" TWO-STACK DOUBLE TIE ANTENNA



Double bow tie antenna fastened to one grid. "Wishbone" Insulator. "Golden Grid" plating. Up to 12.5 db. gain.

No. A-9004 List \$6.75

TELCO "GOLDEN GRID" DELUXE CORNER REFLECTOR ANTENNA



Highly directive corner style completely assembled. Features "Wishbone" Insulator. Rigid, vibration-proof. 16 db. gain.

No. A-8984 List \$8.95

TELCO "BOW TIE" FOUR-WAY WINDOW-TENNA

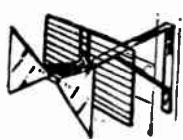

Ideal for homes, apartments, hotels, offices. Easy to install, swings any direction. No mast needed. Bracket, hardware included.

No. A-9056 List \$7.25

TELCO "DOUBLE V" UHF-VHF WINDOW-TENNA

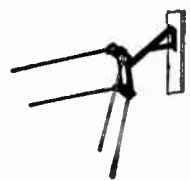

For window installations everywhere. Adjustable approximately 120° (VHF) to 160° (UHF) when mounted against wall or flat surface.

No. A-9057 List \$8.95

TELCO "GOLDEN GRID" DELUXE BUTTERFLY ANTENNA

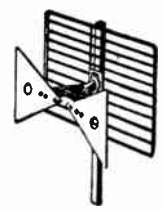

Very high gain model for all channels. Completely assembled, ready to install. Exclusive Telco "Wishbone" Insulator. Heavy, vibration-proof.

No. A-8965 List \$4.95

TELCO "GOLDEN HALO" INDOOR UHF ANTENNA



Gold plated, attractive, highly efficient indoor UHF model. Walnut color base.

No. A-9000 List \$3.95

TELCO UNIVERSAL ANTENNAS

TELCO "DOUBLE V" UHF-VHF ANTENNA

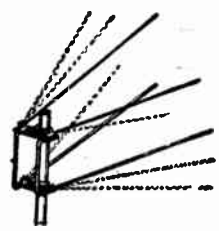

Highly directional stacked-V style, adjustable for UHF-VHF or combined UHF-VHF. 50°-70°-90°. Strong, easy to install.

No. A-9010 List \$5.95

TELCO UHF-VHF CONICAL ANTENNA

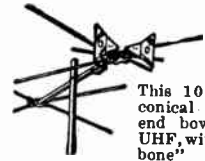

This 10-element conical has front end bow tie for UHF, with "Wishbone" Insulator. Coupler for single lead transmission line.

No. A-8981 List \$8.95



TELEVISION HARDWARE MFG. CO. ROCKFORD, ILL., U.S.A.
DIVISION OF GENERAL CEMENT MFG. CO., ROCKFORD, ILL., U.S.A.





TELEVISION HARDWARE

TELEVISION ANTENNAS CONICAL TYPES

TELCO MASTER LINE VHF CONICAL ANTENNA Single Bay



Ten elements for all-channel coverage, cross bar assembled for fast installation. Aluminum cross arm with unbreakable styron insulator.

No.	List
8700 10-Element, 1-Bay.....	\$7.00
8700-6S 6-Element, 1-Bay.....	5.90
8700-8S 8-Element, 1-Bay.....	6.50

TELCO MASTER LINE VHF CONICAL ANTENNA Two Bay



Same features as 8700, but two-bay style. All hardware double plated for long life, long protection against rust.

No.	List
8702 10-Element, 2-Bay.....	\$14.75
8702-6S 6-Element, 2-Bay.....	12.55
8702-8S 8-Element, 2-Bay.....	13.75

TELCO SUPER CONICAL VHF "FLYING GOOSE" ANTENNA

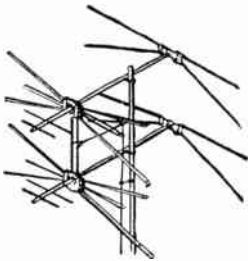

All the features of the 8700 series, plus double director for exceptionally high gain on channels 7 to 13.

No.	List
A-230 10-Element, 1-Bay.....	\$ 7.85
A-232 10-Element, 2-Bay.....	16.45

UHF CAN-TENNA INDOOR ANTENNA

"New High Gain Indoor Antenna"

Here is an attractive, compact Indoor Antenna that can be placed on top of the TV set and will give excellent performance in primary signal areas over the entire UHF band.

Attractive gold color finish. Supplied complete with lead wires ready to use. Individually boxed.

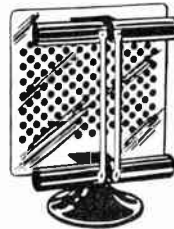

No.	List
A-350 UHF Can-tenna.....	\$7.75

TELCO CAN-TENNA UHF OUTDOOR ANTENNA

Very efficient high gain UHF antenna covers the complete UHF Band of 70 channels.

Basically, it's a 2-element array with a full reflector. It has gain up to 9.25 db, and is excellent for ghost suppression.

Comes completely assembled, ready to install. Mounts on mast up to 1 1/2" O.D.

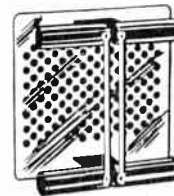

No.	List
A-352 Outdoor Can-tenna.....	\$6.75

(Supplied less mast and wire)

TELCO VHF-UHF TV LIGHTNING ARRESTOR



All weather, Underwriters' approved lightning arrestor. For 300-ohm and 450-ohm open line. Easy to connect, no wires to strip.

No.	List
8640	\$1.00

TELCO UNIVERSAL UHF-VHF LIGHTNING ARRESTOR



Protects all lines: UHF, VHF, hollow, oval, square, open line, etc. Underwriters' approved for both indoor-outdoor use. Easy to install.

No.	List
8642	\$1.25



TELEVISION HARDWARE MFG. CO. ROCKFORD, ILL., U.S.A.
DIVISION OF GENERAL CEMENT MFG. CO., ROCKFORD, ILL., U.S.A.





TELEVISION HARDWARE

TELCO TV STAND-OFFS are made with genuine Polyethylene inserts and heavy gauge screw eyes. Supplied in three styles of inserts to take all VHF and UHF lead-ins; specify by letter indicated after part number.

UHF B — Universal Type



The B type is as universal as can be made for Hollow and Tubular Lines, Round Lines, Flat Lines, Double Barrel Lines, etc. When this type is wanted use Suffix "B" after Telco or G-C part number.

VHF Standard Type



Most Popular Standard Insulator For VHF

For 300 ohm Flat Line, Open Lines, Small Oval Lines and RGU Co-Ax Line. Order by Telco or G-C exact part number — use no suffix.

UHF - VHF X Type



For UHF and VHF Type X is made with an extra large round hole for extra large special Co-Ax Lines. When this type is wanted use suffix "X" after Telco or G-C part number.

WOOD SCREW TYPE



No.	Size	List
8027	3 1/2" lg.	\$ 4.45C
8027SS	3 1/2" lg.	40.00M
8028	5 1/2" lg.	8.00C
8029	7 1/2" lg.	9.00C
8030	12" lg.	.18 ea.

MACHINE SCREW TYPE



No.	Size	List
8031	3 1/2" lg.	\$ 6.00C
8032	5 1/2" lg.	8.00C
8035	7 1/2" lg.	9.00C

DUPLEX INLINE TYPE



No.	Size	List
8225	7 1/2" lg. Wood Screw	\$0.25 ea.
8226	7 1/2" lg. 10/32 Machine Screw	.25 ea.

DUPLEX T-TYPE



No.	Size	List
8509	7 1/2" lg. Wood Screw	\$0.25 ea.
8810	7 1/2" lg. 10/32 Machine Screw	.25 ea.

TELCO TV STAND-OFF "EYE OPENER" TOOL



Makes stand-off installation easier. Opens inserts, closes them tight.

No. 8450 List \$1.25

GUY WIRE CLAMP-ON TYPE

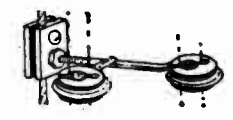

No.	Size	List
8255	3 1/2" lg. Single	\$0.19 ea.
8256	7 1/2" lg. Duplex Inline	.30 ea.

EAVE TYPE



Clamps on eaves, brackets and mounts.

No.	Size	List
8811	3 1/2" lg. Single	\$0.35 ea.
8812	7 1/2" lg. Duplex Inline	.40 ea.
8815	7 1/2" lg. Duplex T-Type	.40 ea.

NAIL-IN TYPE



No.	Size	List
8343	3 1/2" lg.	\$9.00C

(100 pack carton)

TELCO MAST STRAPS ONLY



Same as supplied with 8253, 8257, 8258.

No.	Size	List
8251	Standard for masts to 2 1/2"	\$16.00C
8252	Extra long for masts to 5"	18.00C

TELCO "KANT-STRIP" 3-WAY MAST STAND-OFF



Extruded "kant-strip" threads. With any type of insert, 7 1/2" long.

No.	Material	List
8395	Galvanized Strap	\$0.45 ea.
8396	Stainless Steel Strap	.50 ea.

TELCO "KANT-STRIP" MAST STAND-OFF



Galvanized 9" Strap

No.	Size	List
8253	3 1/2" Single	\$0.19 ea.
8254	5 1/2" Single	.22 ea.
8257	7 1/2" Single	.25 ea.

Stainless Steel 9" Strap

No.	Size	List
8353	3 1/2" Single	.25 ea.
8354	5 1/2" Single	.30 ea.
8357	7 1/2" Single	.35 ea.

TELCO "KANT-STRIP" MAST STAND-OFF



Galvanized Strap

No.	Size	List
8258	7 1/2" Duplex Inline	\$0.30 ea.
8259	7 1/2" Duplex T-Type	.30 ea.

Stainless Steel Strap

No.	Size	List
8358	7 1/2" Duplex Inline	.35 ea.
8359	7 1/2" Duplex T-Type	.35 ea.

TELCO TV INSERTS



Four types for all popular TV lead wires as pictured. Made of high grade, low-loss polyethylene materials. Available to fit all types of wires and cables.

No.	Type	List
8025	Regular Standard Type	\$2.65 C
8025-B	Universal UHF Type-B	2.65 C
8025-X	Co-Ax Type-X	\$2.65 C
EZ-8025	New Universal EZ Insulator	\$4.15 C

TELCO 3-WAY STAND-OFF



For neater 3-line installations. Zinc plated to prevent rust.

No.	Material	List
8397	7 1/2" Wood Screw	\$0.35 ea.
8398	7 1/2" Machine Screw	.35 ea.

SNAP-ON MAST TYPE



Extra wide reinforced band, stays put.

No.	Size	List
8797	For 1" masts	\$0.10 ea.
8798	For 1 1/4" masts	.10 ea.

TELCO NEW E-Z "SWING IN" UHF-VHF TV STAND-OFFS



TELCO'S new E-Z Stand-Off line is designed to keep all types of lead-in wire away from any metal ring, thereby cutting down transmission loss, standing waves and the possibility of shorts at certain frequencies. Each E-Z Stand-Off comes pre-assembled, ready for use. Solid Polyethylene insulator . . . 33 Stand-Off styles.

E-Z STAND-OFFS Wood Screw Type



No.	Size	Each
EZ8027	3 1/2"	\$0.08
EZ8028	5 1/2"	.09
EZ8029	7 1/2"	.10
EZ8225	7 1/2"	.28

Double Inline

No.	Size	Each
EZ8809	7 1/2"	.28

Double T-Type

No.	Size	Each
EZ8397	7 1/2"	.40

Triple Type

E-Z STAND-OFFS Machine Screw Type



No.	Size	Each
EZ8031	3 1/2"	\$0.08
EZ8032	5 1/2"	.09
EZ8035	7 1/2"	.10
EZ8226	7 1/2"	.28

Double Inline

No.	Size	Each
EZ8810	7 1/2"	.28

Double T-Type

No.	Size	Each
EZ8398	7 1/2"	.40

Triple Type

Galvanized Straps



No.	Size	Each
EZ8253	3 1/2"	\$0.21
EZ8254	5 1/2"	.24
EZ8257	7 1/2"	.25
EZ8258	7 1/2"	.35

Double Inline

No.	Size	Each
EZ8259	7 1/2"	.35

Double T-Type

No.	Size	Each
EZ8395	7 1/2"	.50

Triple Type

E-Z "KANT STRIP" MAST STAND-OFFS



Stainless Steel Straps

No.	Size	Each
EZ8353	3 1/2"	\$0.25
EZ8354	5 1/2"	.28
EZ8357	7 1/2"	.30
EZ8358	7 1/2"	.40

Double Inline

No.	Size	Each
EZ8359	7 1/2"	.40

Double T-Type

No.	Size	Each
EZ8396	7 1/2"	.55

Triple Type

E-Z MAST SNAP-ON STAND-OFFS



No.	Size	Each
EZ8797	3 1/2" (for 1 1/4" Mast)	\$0.15
EZ8795	7 1/2" (for 1 1/4" Mast)	.22
EZ8796	7 1/2" (for 1 1/4" Mast)	.33

E-Z GUY WIRE AND EAVE CLAMP STAND-OFFS



No.	Size	Each
EZ8255	3 1/2" Single Guy Wire	\$0.25
EZ8256	7 1/2" Duplex Inline Guy Wire	.35
EZ8811	3 1/2" Single Eave Type	.45
EZ8813	7 1/2" Single Eave Type	.50
EZ8812	7 1/2" Double Inline Eave Type	.80
EZ8815	7 1/2" Double T-Type Eave Type	.60



TELEVISION HARDWARE MFG. CO. ROCKFORD, ILL., U.S.A.
DIVISION OF GENERAL CEMENT MFG. CO., ROCKFORD, ILL., U.S.A.





TELEVISION HARDWARE

TELEVISION ROOF MOUNTS



DELUXE ALUMINUM BRACKET
For masts to 1 1/4".
No. 8000.....List \$5.75



ALL-PURPOSE MOUNT
For masts to 1 3/4".
No. 8575.....List \$2.75



ALL-ANGLE MAST MOUNT
For masts to 1 3/4".
No. 8620.....List \$0.55



SLOTTED SWING-UP MOUNT
For masts to 1 3/4".
No. 8800.....List \$0.55



PIVOT MOUNT BASE
For masts to 1 3/4".
No. 8621.....List \$0.40



PIVOT MOUNT BASE
For masts to 1 3/4".
No. 8921.....List \$0.55
For masts to 2 1/4".
No. 8922.....List \$0.55



PIVOT SWING MOUNT
For masts to 1 1/4".
No. 8622.....List \$0.65



SWING-UP JR. MOUNT
For masts to 1 3/4".
No. 8626.....List \$2.95
For masts to 2".
No. 8627.....List \$3.25



HEAVY DUTY RIDGE MOUNT
For masts to 1 3/4".
No. 8630.....List \$3.25
For masts to 2".
No. 8632.....List \$3.75



NEW UNIVERSAL HEAVY DUTY MOUNT
For masts to 2".
No. 8635.....List \$4.95



FITZ-ALL MOUNT
For masts to 2".
No. 8804.....List \$2.95
No. 8792 Base only.....List 2.75



HINGED TYPE RIDGE MOUNT
For masts to 1 1/2".
No. 9021.....List \$1.95
For masts to 2".
No. 9022.....List \$2.75



UNIVERSAL RIDGE MOUNT
For masts to 1 1/2".
No. 8906.....List \$1.95
For masts to 2".
No. 8907.....List \$2.75

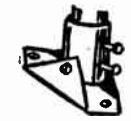

UNIVERSAL TILT MOUNT
For masts to 1 1/2".
No. 8908.....List \$1.35
For masts to 2".
No. 8909.....List \$2.15

TV WALL MOUNTS

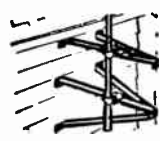

DELUXE ADJUSTABLE WALL MOUNT
1" to 19" clearance. For masts to 1 1/2" dia.
No. 8230.....List \$5.95

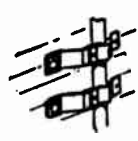

CLOSE WALL MOUNT
For masts to 1 3/4" dia.
No. 8302 2 1/4" clearance \$1.35
8304 4" clearance 1.50



SNAP-IN WALL MOUNT
For masts to 1 3/4" dia.
No. 8306 6" clearance \$2.00
8308 8" clearance 3.25

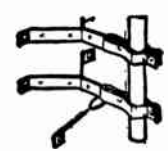

MASTER DELUXE SNAP-IN WALL MOUNT
For Masts to 1 3/4" dia.
No. 8312 12" clearance \$3.50
8318 18" clearance 4.50
8324 24" clearance 6.10

TV CHIMNEY MOUNTS



STANDARD CHIMNEY QUICK MOUNT
For masts to 1 3/4".
No. 8005 List \$2.25
Galvanized straps
9025 \$3.50
Stainless steel straps



DELUXE ALUMINUM CHIMNEY MOUNT
For masts to 1 3/4".
Stainless steel straps.
No. 8001 \$6.75



SNAP-IN CHIMNEY MOUNT
For masts to 1 3/4".
Stainless straps.
4" clearance
No. 8930 List \$3.95



SNAP-IN CHIMNEY MOUNT
For masts to 1 3/4".
Galvanized straps.
No. 8610 List \$2.85



CHIMNEY STRAPPING REPAIR KIT
Galvanized strapping and hardware.
No. 8931 List \$1.75



CHIMNEY STRAPPING REPAIR KIT
Stainless steel strapping and hardware.
No. 8932 List \$3.00



TELEVISION HARDWARE MFG. CO. ROCKFORD, ILL., U.S.A.
DIVISION OF GENERAL CEMENT MFG. CO., ROCKFORD, ILL., U.S.A.





TELEVISION HARDWARE

VENT MOUNTS



Double rust-proofed vent mounts. Simple, easy to use.

No.		List
8802	2" to 4" vents	\$2.25
8803	4" to 6" vents	2.25

PEAK AND MAST MOUNTS



PEAK MOUNT

30" Lower Support
For masts to 1 3/4".

No. 8625.....List \$3.95



PEAK MOUNT

48" Lower Support
For masts to 1 3/4".

No. 8933.....List \$5.95



GROUND-UP PEAK MOUNT

48" Lower Support

No. 8934.....List \$6.50



TELCO 3-WAY SHORTY TV KLIP

Handy line klip for straight, side or RCA plug-in types. No soldering.

No. 8899.....List \$0.35



TELCO UHF UNIVERSAL MOUNTING BAR

For mounting UHF antennas on present VHF installations.

No. 8977.....List \$1.65



TELCO UNIVERSAL TV LEAD-IN TUBE

For all lead-in styles. Low-loss material, weather-proof seal. Fits 3/4" hole, up to 16" wall.

No. 8958 Brown List \$1.95
No. 8958-I Ivory List 1.95



TELCO 2-SET TV COUPLER

Couples two sets to one antenna. Use on UHF and VHF networks.

No. 8920.....List \$3.50



TELCO 3-WAY TV LINE KLIP

Deluxe style, used three ways—straight, side or plug-in type (RCA sets).

No. 8744.....List \$0.35



TELCO FLOATING GUY RINGS

No.	Mast Size	Ring I.D.	List
8055	3/4"-1"	1 1/8"	\$0.22
8313	1 1/8"	1 3/4"	.24
8314	1 1/4"	1 3/8"	.24
8315	1 3/4"	1 1/2"	.24
8316	1 1/2"	1 5/8"	.24
8316-A	1 3/4"	1 3/4"	.24
8317	2"	2 3/8"	.24



TELCO 3-WAY GUY WIRE CLAMP

Fits masts to 2 1/2".

No. 8911.....List \$0.50



TELCO GUY WIRE CLAMP

For masts to 1 1/2".

No. 8372.....List \$0.30



TELCO GUY WIRE CLAMP

Fits masts to 1 1/2". Screw eyes for easy fastening.

No. 8939.....List \$0.40



TELCO DELUXE FLOATING GUY RING

Cast aluminum, for masts to 2".

No. 8650.....List \$2.95



TELCO UHF PORCELAIN TUBES

For UHF hollow oval line. Fits 3/4" hole.

No. 8964	4" long	List \$0.30
No. 8966	6" long	List .50
No. 8968	8" long	List .60



TELCO CABLE CLAMPS

Galvanized, easy to install.

No.		List
8131	Standard size	\$0.25
8133	Small size	.25



TELCO TURNBUCKLES

No.	Closed	Open	List
8056	3 3/8"	4 5/8"	\$18.05C
8057	4"	5 5/8"	20.15C
8058	4 1/2"	6 5/8"	20.85C
8365	5 1/2"	7 5/8"	25.70C
8366	6 3/4"	9 1/4"	43.05C
8367	7 1/2"	10 1/4"	62.50C



TELCO SCREW EYES

No.	Length	List
8078	1"	\$0.05
8342	3"	.10
8486	5"	.11
9027	7"	.15



TELCO 300-OHM SOLDERLESS TV WIRE TERMINALS

No soldering, quick and easy to use.

No.		List
8633-C	Standard size	\$3.65C
9029-C	Large size	3.65C



TELCO GROUND RODS

Heavy copper plated, smooth swaged point for easy driving. Complete with clamp.

No.		List
8929	4' long x 3/8" dia.	\$1.35
9016	6' long x 3/8" dia.	1.75
9017	8' long x 1/2" dia.	3.85



TELEVISION HARDWARE MFG. CO. ROCKFORD, ILL., U.S.A.
DIVISION OF GENERAL CEMENT MFG. CO., ROCKFORD, ILL., U.S.A.



Bliley FOR 24 YEARS

...the dependable source
for **AMATEUR CRYSTALS**

TYPE CCO-2L CODE NO. E16A

Famous **BLILEY "PACKAGED" OSCILLATOR**
FOR 2-6-10-11 METERS; FOR USE WITH
7-9 mc CRYSTALS

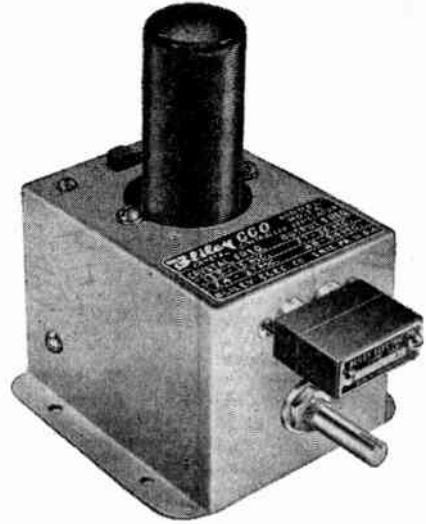

AMATEUR FREQUENCIES • CRYSTAL FILTERS • STANDARD FREQUENCIES				
CODE	TYPE	APPLICATION	TOLERANCE	PRICE
E10	KV3	reference frequency 100 kc	±.005%	\$ 8.50
E11	MS433	reference frequency 1000 kc	±.005%	17.00
E11A	MC9	marker frequency 1000 kc	±.05%	8.00
E13	MC9	13.6275 mc (multiplier to 27.255 mc) CITIZEN'S RADIO SERVICE (CLASS "C")	±.04%	5.50
E13A	SR10	27.255 mc (3rd overtone crystal) CITIZEN'S RADIO SERVICE (CLASS "C")	±.04%	5.50
E14	CF3	455 kc—456 kc—465 kc Single Signal Filters	±5 kc	5.00
E15	CF6	455 kc—456 kc—465 kc Single Signal Filters	±5 kc	4.50
AMATEUR FREQUENCIES AND PACKAGED OSCILLATORS				
E16A	CCO-2L	packaged oscillator for 2-6-10-11 meters; for use with 7-9 mc crystals	11.95
E17	AX2	1800-1825 kc; 1875-1900 kc; 1900-1925 kc; 1975-2000 kc	*	3.75
E18	AX2	3500-4000 kc	*	2.95
E19	AX2	7000-7425 kc; 8000-9000 kc	*	2.95
*Note: We will supply to integral spot frequencies (no fractions) as ordered; calibration ± 500 cycles in factory test oscillator.				
E20	AX2	14-14.5 mc	±10 kc	3.95
SPOT FREQUENCIES FOR NET OPERATION				
E22	MC9	3 mc-12 mc experimental frequencies	±.03%	6.50
E22A	SR10	12 mc-27.5 mc experimental frequencies	±.03%	8.50



SR10

CODE NO. E22A E13A



KV3

CODE NO. E10



MS433

CODE NO. E11



MC9

CODE NO. E11A E13 E22



CF3

CODE NO. E14



CF6

CODE NO. E15



AX2

CODE NO. 17 THRU 20

DIMENSIONS

CODE	TYPE	LENGTH	WIDTH	THICKNESS	PIN SIZE	PIN SPACE
E10	KV3	1 3/8"	1 3/8" (dia.)093"	.486"
E11	MS433	1 3/8"	1 3/8" (dia.)093"	OCTAL
E11A	MC9	1 1/4"	1 3/8"	3/16"	.093"	.486"
E13	MC9	1 1/4"	1 3/8"	3/16"	.093"	.486"
E13A	SR10	3/4"	3/4"	1 1/2"	.093"	.486"
E14	CF3	1 1/2"	1 3/8"	3/4"	.125"	.750"
E15	CF6	1 3/8"	1 3/8"	.695"
E16A	CCO-2L	2 1/4"	3 1/4"	3"
E17	AX2	1 5/8"	1 1/8"	3/16"	.093"	.486"
E18	AX2	1 5/8"	1 1/8"	3/16"	.093"	.486"
E19	AX2	1 5/8"	1 1/8"	3/16"	.093"	.486"
E20	AX2	1 5/8"	1 1/8"	3/16"	.093"	.486"
E22	MC9	1 1/4"	1 3/8"	3/16"	.093"	.486"
E22A	SR10	3/4"	3/4"	1 1/2"	.093"	.486"

BLILEY ELECTRIC CO., UNION STATION BUILDING, ERIE, PA.

Bliley CRYSTALS FOR: TV SERVICE • SHIP-TO-SHORE

DIATHERMY • SINGLE SIGNAL FILTERS • CITIZEN'S BAND *and* EXPERIMENTAL



SR 10
CODE NO. E2 E4
E13A E22A
LENGTH: 3/64"
WIDTH: 3/8"
THICK.: 1/32"
PIN SIZE: .093"
PIN SPACE: .486"



MC9
CODE NO. E3 E8 E9
E11A E13 E22
LENGTH: 1 1/4"
WIDTH: 1 3/8"
THICK.: 3/16"
PIN SIZE: .093"
PIN SPACE: .486"



MC7
CODE NO.: E5
LENGTH: 1 3/64"
WIDTH: 1 1/2"
THICK.: 2 1/2"
PIN SIZE: .125"
PIN SPACE: .750"



SR5
CODE NO.: E6
LENGTH: 1 1/4"
WIDTH: 1 3/8"
THICK.: 3/16"
PIN SIZE: .125"
PIN SPACE: .500"

NOTE: Prices Are Based On "Standard" Specifications As Shown. Quotations Will Be Made On Any Special Requirements.

TV SERVICE CRYSTALS, SOUND AND PICTURE CHANNEL MARKERS (Sub-Multiple Frequencies $\pm 0.5\%$)						
CODE	TYPE	CHANNEL NO.	CHAN. FREQ. (mc)	SOUND CHAN. (mc)	CRYS. FREQ. (kc)	PRICE
E2	SR10	2	54.60	59.75	19916.666	\$6.95
E2	SR10	3	60.66	65.75	16437.500	6.95
E2	SR10	4	66.72	71.75	17937.500	6.95
E2	SR10	5	76.82	81.75	16350.000	6.95
E2	SR10	6	82.88	87.75	17550.000	6.95
E2	SR10	7	174-180	179.75	17975.000	6.95
E2	SR10	8	180-186	185.75	18575.000	6.95
E2	SR10	9	186-192	191.75	19175.000	6.95
E2	SR10	10	192-198	197.75	19775.000	6.95
E2	SR10	11	198-204	203.75	18522.727	6.95
E2	SR10	12	204-210	209.75	19068.181	6.95
E2	SR10	13	210-216	215.75	19613.636	6.95
E4	SR10	SPECIFY	SPECIFY	PICTURE CHANNEL	RANGE 15-27.5 mc	8.50

PRICES AND SPECIFICATIONS SUBJECT TO CHANGE WITHOUT NOTICE

TV SERVICE CRYSTALS, I-F ALIGNMENT AND TAP FREQUENCIES					
CODE	TYPE	FREQUENCIES	TOLERANCE	APPLICATION	PRICE
E3	MC9	4.5 mc	$\pm 0.02\%$	intercarrier	\$3.95
E4	SR10	15-27.5 mc	$\pm 0.05\%$	video, sound i-f alignment; trap frequencies	8.50
E8	MC9	5.0 mc	$\pm 0.02\%$	signal generator	3.95
E9	MC9	10.7 mc	$\pm 0.05\%$	FM—i-f alignment	3.95

SHIP-TO-SHORE

CODE	TYPE	APPLICATION	TOLERANCE	PRICE
E5	MC7	radiotelephone 2-3.5 mc	$\pm 0.02\%$	\$7.50
E6	SR5	radiotelephone 2-3.5 mc	$\pm 0.02\%$	\$7.50
E7	SR8	radiotelephone 2-3.5 mc	$\pm 0.02\%$	\$7.50

For **EASY FAST**
TV SERVICING
Select
BLILEY CRYSTALS

STANDARD FREQUENCIES

CODE	TYPE	APPLICATION	TOLERANCE	PRICE
E10	KV3	reference frequency 100 kc	$\pm 0.005\%$	\$ 8.50
E11	MS433	reference frequency 1000 kc	$\pm 0.005\%$	17.00
E11A	MC9	marker frequency 1000 kc	$\pm 0.05\%$	8.00

BLILEY ELECTRIC CO.
UNION STATION BLDG., ERIE, PA.

DIATHERMY, SINGLE SIGNAL FILTERS, CITIZEN'S RADIO SERVICE (CLASS C) AND EXPERIMENTAL

CODE	TYPE	APPLICATION	TOLERANCE	PRICE
E13	MC9	13.560 mc (multiplies to 27.12 mc) Diathermy 13.6275 mc (multiplies to 27.255 mc) Citizens	$\pm 0.04\%$	\$5.50
E13A	SR10	27.12 mc Diathermy; 27.255 mc Citizens (3rd overtone crystals)	$\pm 0.04\%$	5.50
E14	CF3	455 kc-456 kc-465 kc Single Signal Filter	± 5 kc	5.00
E15	CF6	455 kc-456 kc-465 kc Single Signal Filter	± 5 kc	4.50
E22	MC9	3-12 mc experimental frequencies	$\pm 0.03\%$	6.50
E22A	SR10	12-27.5 mc experimental frequencies	$\pm 0.03\%$	8.50



SR8
CODE NO.: E7
LENGTH: 1 1/4"
WIDTH: 1 1/2"
THICK.: 3/16"
PIN SIZE: .093"
PIN SPACE: .486"



KV3
CODE NO.: E10
LENGTH: 1 1/2"
WIDTH: 1 3/8" (dia.)
PIN SIZE: .093"
PIN SPACE: .486"



MS433
CODE NO.: E11
LENGTH: 1 3/8"
WIDTH: 1 3/8" (dia.)
PIN SIZE: .093"
PIN SPACE: OCTAL



CF3
CODE NO.: E14
LENGTH: 1 1/2"
WIDTH: 1 3/8"
THICK.: 3/16"
PIN SIZE: .125"
PIN SPACE: .750"



CF6
CODE NO.: E15
LENGTH: 1 3/8"
WIDTH: 1 3/8"
THICK.: .695"

PR Crystals

Since 1934

USE **PR** AND KNOW WHERE YOU ARE

COMMERCIAL TYPES—SPECIFICATIONS

Type	Frequency Range	Pin Spacing	Pin Diameter	Height Above Pins	Width	Depth
Z-1 Fundamental	900 Kc. to 12000 Kc.	.486"	.093"	1-3/16"	13/16"	7/16"
Z-1 Harmonic	12001 Kc. to 30000 Kc.	.486"	.093"	1-3/16"	13/16"	7/16"
*Z-1A Fundamental	500 Kc. to 2000 Kc.	3/4"	.125"	1 1/8"	1 1/8"	1/2"
Z-1B Fundamental	1000 Kc. to 12000 Kc.	3/4"	.125"	1 1/8"	1-3/16"	1/2"
Z-1B Harmonic	12001 Kc. to 30000 Kc.	3/4"	.125"	1 1/8"	1-3/16"	1/2"
Z-1D Same as Z-1	Same as Z-1	1/2"	.125"	1-3/16"	13/16"	7/16"
Z-1E Same as Z-1	Same as Z-1	1/2"	.125"	1 1/4"	1 1/8"	7/16"
Z-1H Single or dual unit Fundamental	500 Kc. to 12000 Kc.	3-Pin W.E.	.157"	2-1/16"	1-19/32"	1-3/16"
Z-1K Same as Z-1A except has .157" dia. pins	500 Kc. to 12000 Kc.	3/4"	.157"	1 1/8"	1 1/8"	1/2"
Z-1M Fundamental	1000 Kc. to 10000 Kc.	7/8"	Std. Banana	2-3/32"	1-19/32"	3/4"
Z-1R Fundamental	500 Kc. to 1600 Kc.	1/2"	.093"	1 1/4"	1-3/32"	7/16"
Z-4 Fundamental	1601 Kc. to 12000 Kc.	3/4"	.125"	.650"	Diameter	.995"
Z-4 Harmonic	12001 Kc. to 30000 Kc.	3/4"	.125"	.650"	Diameter	.995"
Z-7 Fundamental	Same as Z-1 Fundamental	3/4"	Std. Banana	1.660"	1.192"	.518"
Z-8 Fundamental	500 Kc. to 1600 Kc.	3/4"	1/8"	1 3/4"	1-9/16"	1-11/16"
Z-9 Fundamental	1000 Kc. to 15000 Kc.	1/2"	.050"	.758"	.720"	.309"
Z-9A Harmonic	15001 Kc. to 35000 Kc.	1/2"	.050"	.758"	.720"	.309"
E-1 Fundamental	500 Kc. to 7000 Kc.	Interchangeable with FT-164 and AC-95				

* Can be Supplied with Standard Banana Pins.



Z-1



Z-1A



Z-1B



Z-9

Every PR Crystal is Guaranteed Unconditionally,
by the Makers of Fine Crystals Since 1934.

PETERSEN RADIO Company, Inc., 2800 W. Broadway, Council Bluffs, Iowa

PR Crystals

Since 1934

USE **PR** AND KNOW WHERE YOU ARE

PRICE LIST

Effective February 1, 1954
Subject to Change Without Notice

ALL CRYSTALS ON THIS
PAGE ARE SCHEDULE B



FOR AMATEUR SERVICE



Z-2 and Z-3 Crystals are supplied only in the following bands and calibrated integral kilocycles only, no fractions.

TYPE	FREQUENCY RANGE	PRICE	TYPE	FREQUENCY RANGE	PRICE
Z-2	1800 to 1825 Kc.	\$2.95	Z-3	12000 to 12333 Kc.	\$3.95
	1875 to 1900 Kc.			12500 to 13500 Kc.	
	1900 to 1925 Kc.			13480 to 13615 Kc.	
	1975 to 2000 Kc.			14000 to 14850 Kc.	
	3500 to 4000 Kc.				
	6250 to 6750 Kc.				
	6740 to 6807 Kc.				
	7900 to 7425 Kc.				
	8800 to 8222 Kc.				
	8334 to 9000 Kc.				
9000 to 9250 Kc.					

All amateur crystals calibrated plus or minus 500 cycles, except 160 meters, which are plus or minus 250 cycles.

SPECIAL CRYSTALS

Type Z-1, AIRCRAFT

3023.5 Kc., .005% \$4.95

VHF Type Z-9A

For LEAR, NARCO and similar equipment operating in the 121 Mc. region, requiring crystals in 30 Mc. range. Each \$7.50

Type Z-1, MARS and CAP

Calibrated to .005%
Official assigned transmitter frequencies in the range.
1500 to 10000 Kc. \$4.95

Type Z-9A Radio Controlled Objects

No license required for power up to 5 watts input.
27.255 Mc., .04% \$5.00

Type 2XP

Suitable for converters, experimental, etc. Same holder dimensions as Type Z-2.
1600 to 12000 Kc. ±5 Kc. \$3.95
12001 to 25000 Kc. ±10 Kc. \$5.00

ACCESSORIES

Single Sockets 30c
Dual Sockets 35c
Adapters, to adapt Z-1 and Z-2 to 3/4" Socket 35c

Type Z-1, TV Marker Crystals

Channels 2 through 13 \$7.00
4.5 Mc. Intercarrier, .01% \$3.95
5.0 Mc. Signal Generator, .01% \$3.95
10.7 Mc. FM, IF, .01% \$3.95

BROADCAST CRYSTALS REGRINDING SERVICE

Any Frequency, 550 to 1600 Kc. \$20.00

PETERSEN RADIO Company, Inc., 2800 W. Broadway, Council Bluffs, Iowa

MONITOR

Crystals

EIGHT MILLION CRYSTALS SINCE 1931

---- COMMERCIAL TYPES ----

Type	Pins		Approximate Dimensions in Inches			Nominal Freq. Range
	Diam. inches	Spacing inches	Height	Width	Thickness	
MC-1	.125*	.750***	1.375	1.187	.532	1-30 MC
MC-2	.125	.750	.625	1.375 diam.		2.5-25 MC
MC-5	3 Pin	W. E.	2.093	1.593	1.187	80-5000 KC
MC-6	.050**	.486	.765	.750	.343	2-75 MC
MC-10	(Coxial	.062 pins ext.	.250)	.5625 diam.	.555 long	15-75 MC
MC-11	.125*	.750***	1.687	1.562	.687	1-5 MC
MC-11W	.125*	.750***	1.687	1.562	.687	80-200 KC
MC-11V	Variable	— Same as MC-11 —			.750	.5-4.5 KC
MC-13	.050**	.486	1.516	.750	.343	20-250 KC
MC-14	.050**	.486	.574	.750	.343	4-15 MC
MC-15	.093	octal	2 max.	1.250 Dia.	Max.	15-500 KC
MC-20A	.093	.486	1.187	1.125	.437	2-10 MC
MC-20B	.125	.500	1.187	1.125	.437	2-10 MC
MC-20C	.125	.750	1.187	1.125	.437	2-10 MC
MC-34W	.125*	.750	1.625	1.375	.500	100-1000 KC
MC-96	.050**	.486	.765	.750	.343	5-75 MC
MC-241	.093	.486	1.100	1.125	.437	200-1000 KC
MC-243	.093**	.486	1.125	.8125	.437	2.5-50 MC

*Also available with Banana Pins or .125 Pins.

**Also furnished with Wire Leads or .093 Pins.

***Also available in other Pin spacings.



MC-6



MC-1



MC-13



MC-96



RM OVEN

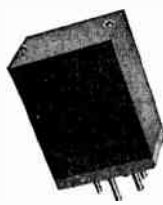

MTC-6S OVEN



MC-15



MC-20

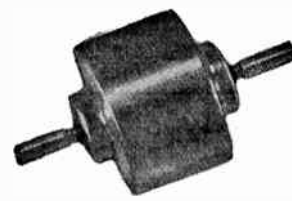

MC-10

OVENS FOR TEMPERATURE CONTROLLED CRYSTAL UNITS

MONITOR manufactures a wide variety of ovens for temperature-controlled crystal units. Two typical examples are illustrated above. Units are available which will accommodate one or more of a large number of holder types. Heaters are normally furnished for either 6, 12 or 24 volt operation, but special values can be furnished.

MONITOR ovens feature an hermetically-sealed thermostat and will maintain very close temperature control over a wide range of ambient temperatures.

Write or call for specific data.



MC-11V

MONITOR PRODUCTS COMPANY

815 FREMONT AVENUE

SOUTH PASADENA, CALIFORNIA

Pyramid 1-1174

JAMES KNIGHTS COMPANY, Sandwich, Ill.

Crystals

for the critical

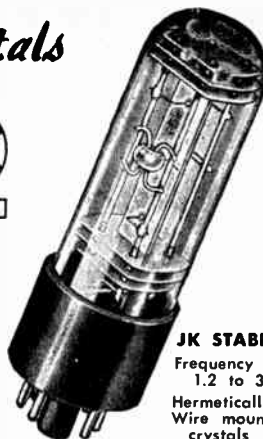

JK STABILIZED G-9, G-9J

Frequency range 1 KC to 300 KC and 1.2 to 30 MC

Hermetically sealed glass holder
Wire mounted, gold or silver plated crystals

6V6GT envelope, octal base
MIL HC-15/U

Write for engineering bulletins Nos. 9 and 14 and H-300-20JA Spec.



JK STABILIZED H-7

Frequency Range 3 to 16 mc
Holder material black phenolic
Pressure mounting, stainless steel electrodes

Water and Dust Proof
Military type FT243 holder,
CAATC No. 3R1-1

JK STABILIZED G-12

Frequency range 99 to 180 kc with high stability GT cut for frequency standard use.

Also 550 to 1500 kc for high stability.

F.C.C. Approved for broadcast transmitter use without temperature control. Write for specifications H-300-097B and engineering bulletin No. 13.



JK STABILIZED H-18

Frequency range 80 kc to 2 mc
Hermetically sealed metal holder
Wire mounted, plated crystals

H18 has octal base, H18-L has 2 pins 1/8" dia. on 3/4" centers, M-18-5 has standard 5 pin tube base.



JK STABILIZED H-4

Frequency Range 1800 kc to 16 mc
Holder Material Black Phenolic
Pressure Mounting, Stainless Steel Electrodes

Water and Dust Proof
Military Type HC1/U Holder
Write for engineering bulletins Nos. 2 and 8.



JK STABILIZED H-9

Frequency Range 85 to 300 KC
Holder base Black Phenolic
Holder can Anodized aluminum
Wire mounted plated crystal
Water and Dust proof
Especially light and compact.



JK STABILIZED HEAT JKO-9

Holds two type H17 units (Military HC6/U)

Normal temperature $75^{\circ} \pm 5^{\circ}\text{C}$.

Ambient range - 55 to 70°C .

Heater 6.3 volts, under 1 amp.

Standard octal base



H-17

JK STABILIZED H-17

Frequency Range 200 to 500 kc and 1 to 75 mc

Hermetically sealed metal holders
Wire mounted, plated crystals

Two type H-17 holders fit octal socket
H-17 is military type HC6/U, CAATC No. 3R1-3



JK STABILIZED BROADCAST UNIT JK57M & JK87M

Frequency range 400 kc to 1750 kc adjustable $\pm .01\%$

Normal temperature $60^{\circ}\text{C} \pm 2^{\circ}\text{C}$ (adjustable $\pm 10^{\circ}\text{C}$)

Ambient range for 60°C operation, -20 to $+58^{\circ}\text{C}$

Heater 6.3 volts at 1 1/2 amp

JK57M has standard 5 pin base, JK87M has octal base

Low temperature coefficient plate will stay within FCC tolerance during warmup from normal room temperature

F.C.C. approved for broadcast use. JK57MT & JK87MT have thermometer



JK STABILIZED HEAT JKO7, JKO7E

Will hold any JK type crystal except H-6, H-18T and H-19
Normal operating temperature $50^{\circ}\text{C} \pm 2^{\circ}\text{C}$

Will hold temperature as much as 75°C above the ambient.
Supplied complete with Johnson No. 237 socket.

JKO-7E has sealed-in-glass thermostat for greater precision and longer life. Available as JKO7 or JKO7E with 6.3 volt 10 watt heater or 115 volt 12 watt heater on either model
Ideal for frequency standards and broadcast (FM & TV) FCC approved.

VALPEY

Quartz Crystals



TYPE VR6

Hermetically sealed in compact metal case, 1500 Kc to 75.0 Mc frequency range. (Jan type HC-6/u) Pin is .050" diameter, spaced .486".



TYPE CM1

Fixed air gap, 850 to 20,000 Kc frequency range. Available in standard 3/4" and G.R. 3/4", 5/8" 7/8" or .850" spaced pins.



TYPE CBC-0

Frequency range 60 to 10,000 Kc. Available with 6, 8, or 10 volts, ± 1/2 degree C. temperature stability. Standard 5-prong socket.

TYPE VD5

Frequency range 1,000 to 6,000 Kc. Single or dual crystals. Mounts in special 3-prong socket, pin diameter .562", spaced .500" x .8125"



TYPE XL100

Exact 100 Kc., used extensively in frequency standards. Mounts in 3/4" crystal socket or standard 5-prong socket.

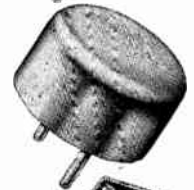

TYPE CM5

Frequency range 1,500 to 30,000 Kc. Fixed air gap, standard .486" x .093" or standard octal socket.



TYPE DFS

Features separate 100 and 1,000 Kc. crystals in one mounting, with accuracy ±.005% over range of -10°C to +60°C when used in recommended circuits.



TYPE VDO

Frequency range 1,000 to 10,000 Kc. Single or dual crystals with 6 volt oven ± 1/2 degree temperature stability. Mounts in standard 5-prong socket.



APPLICATION	TYPE	FREQUENCIES	TOLERANCE	PRICE
Commercial or Military (Jan HC-6/u)	VR6	1.5 to 2.0 Mc	.005%	\$15.00
	VR6	2.0 to 30.0 Mc	.005%	9.50
	VR6	30.0 to 75.0 Mc	.005%	15.00
Commercial or Military (Jan Spec.)	CM1 & CM5	1.5 to 30.0 Mc	.005%	9.50
	CM1	1.5 to 30.0 Mc	.005%	9.50
Marine	CM1	2.0 to 3.2 Mc	.01%	6.00
Marine	CM5	2.0 to 3.2 Mc	.01%	6.00
Marine	VD5	2.0 to 3.2 Mc Dual Crystal	.01%	19.00
Standard	XL100	100 Kc	.005%	6.95
Standard	DFS	100 — 1,000 Kc Dual Crystal	.005%	8.95
Close Frequency Oven	VDO	1.0 to 30.0 Mc	.002%	16.00
Broadcast and Close Frequency Oven	CBC-0	60 Kc to 10.0 Mc	.002%	65.00
Amateur	CM5	160M Bands	±1 Kc	3.75
		3.5 to 4.0 Mc	±1 Kc	2.80
		7.0 to 7.4 Mc	±1 Kc	2.80
		8.0 to 8.222 Mc	±1 Kc	2.80
		14.0 to 14.8 Mc	±5 Kc	3.50
		12.0 to 12.3 Mc	±5 Kc	3.50
		24.0 to 24.666 Mc	±5 Kc	3.95
		25.0 to 27.00 Mc	±5 Kc	3.95
		28.5 to 29.7 Mc	±5 Kc	3.95

For additional details on these and other types, request Catalog QC-FE.



VALPEY

Crystal CORPORATION

HOLLISTON, MASS

CRAFTSMANSHIP IN CRYSTALS SINCE 1931

American Beauty

ELECTRIC SOLDERING IRONS

Embodied in these Electric Soldering Irons are features of construction and design that specialized experience—since 1894—has demonstrated to be desirable for efficient and lasting service. Hundreds of thousands are in use throughout the world in a wide variety of manufacturing plants; in service, maintenance and repair shops; Army and Navy Services; in telephone, telegraph, radio and TV stations. Because of their proven efficiency and durability, they are preferred by those who measure the value of a tool by the service it renders.

No. 3138 Designed primarily for production and maintenance in radio, telephone, telegraph, ignition, switchboard and telephone installation work and similar industrial applications.

No. 3158 For the same purpose as the No. 3138 but for work requiring an iron of greater capacity.

No. 3178 For use on still heavier work; for light commutators, service and production work. A very useful iron for general purposes.

No. 3198 For heavy work of all kinds. Supplies a large volume of heat at high temperature. Used by manufacturers in many different lines; for shop, service, production work, etc.

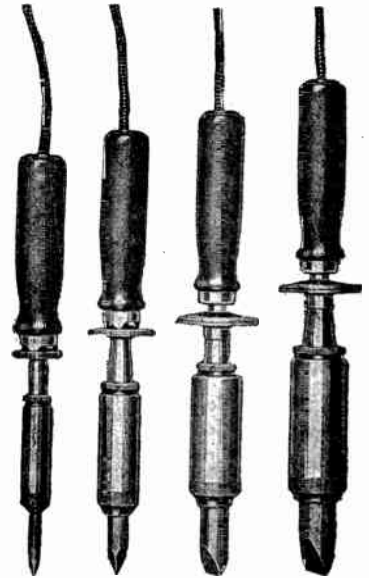

3138 3158 3178 3198

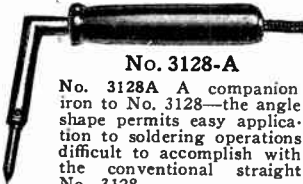

No. 3128-A
No. 3128A A companion iron to No. 3128—the angle shape permits easy application to soldering operations difficult to accomplish with the conventional straight No. 3128.



No. 3128 For servicing TV, electronic and radio equipment and similar light work.

SPECIFICATIONS

Available in standard voltages and for 32 volts. No. 3138 also made for 6, 12, 24 and 64 volts. All irons can be equipped with three-conductor cord, one wire grounded, at slight additional charge. Separate heat-insulating stand supplied with each iron.

Cat. No.	Diameter of Tip	Watts	Net Weight	Length Over All	Casing Diameter	Approx. Ship. Wt.	List Price Each	Net Price Each (Less than 6)	Net Price Each (6 or more)
3128	1/4"	60	7 1/2 oz.	12 1/4"	3/8"	1 lb.	\$5.50	\$3.67	\$3.51
3128-A	1/4"	60	10 oz.	—	3/8"	1 lb.	6.00	4.00	3.83
3138	3/8"	100	16 oz.	12 7/8"	7/8"	2 lbs.	8.75	5.83	5.58
(3138 is made also in 130- and 150-watt input.)									
3158	5/8"	200	28 oz.	13 3/8"	1 1/4"	3 lbs.	10.25	6.83	6.53
3178	7/8"	300	42 oz.	14 3/8"	1 1/2"	4 lbs.	13.50	9.00	8.61
3198	1 1/8"	550	60 oz.	15 "	1 3/4"	5 3/4 lbs.	17.50	11.66	11.16



**Amer. B'ty
Bantam El.
Solder. Irons**

For light or intricate soldering operations. Long life element—Replaceable plug type tip. Perfectly balanced for conventional or pencil type usage. Stainless steel shell and low wattage insures cool handle. Ideally suited for production use on small soldering operations.

Cat. No.	Tip Diam.	List	Net (Less than 6)	Net (6 or more)
3118	1/8"	30	9 1/4"	\$5.00 \$3.33 \$3.19
3120	3/8"	30	9 1/4"	5.00 3.33 3.19



**Amer. B'ty
Element. in. Tip
El. Solder. Iron**

A new, more efficient soldering iron for production line purposes. Element imbedded in tip insures minimum heat loss, quicker initial heating and pick-up, more efficient use of heat with a saving in time and money. Furnished only with Iron Plated or Eternalloy Plated tips.

Cat. No.	Tip Diam.	List	Net (Less than 6)	Net (6 or more)
3438	3/8" Iron Plated	100	13 1/4"	\$11.00 \$7.33 \$7.02
3438EP	3/8" Eternalloy Plated	100	13 1/4"	12.00 7.99 7.66

American Beauty COPPER TIPS

American Beauty Copper Tips are made from commercially pure, drawn bar copper rod and are heavily nicked to resist corrosion and oxidation. Tips are available from 1/8" to 1 1/8" in diameter. Standard shaped tips with which various models are equipped are shown in illustration but pyramidal, instead of chisel type, and vice versa can be supplied when so specified without additional charge. For No. 3138 a special long, semi-chisel shaped tip (No. 3738-S) can be supplied for telephone, switchboard, television and radio work. All tips shown at right can be supplied either iron-plated or eternalloy-plated—for extra long life—at additional cost. For iron-plate add the suffix "IP" to catalog numbers indicated or "EP" for eternalloy-plate.

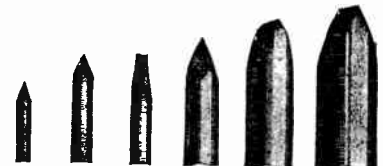

3728 for Iron 3128
3738 for Iron 3138
3738S for Iron 3138
3758 for Iron 3158
3778 for Iron 3178
3798 for Iron 3198



American Beauty TEMPERATURE REGULATING STAND

For use on (AC) Alternating Current Only

This is a thermostatically controlled device for the regulation of the temperature of an Electric Soldering Iron while at rest. Through an adjustment on bottom of stand the thermostat may be set for maintenance of any desired heat—from very low, or warm, to full working temperature. It is designed for use with Electric Soldering Irons from 80 to 660 watts input and on circuits up to 240 volts. Not recommended for Nos. 3118, 3120, 3128, 3128A, 3438, and 3438E,P.

Cat. No.	Net Weight	List Price	Net Price
475	27 oz.	\$6.25	\$4.41



ELECTRIC SOLDERING IRONS

Equipped with a flexible 6 ft. approved Neoprene rubber heater cord, which is oil-resistant, abrasion-resistant and heat-resistant, as well as water-proof and kink-free. Nickel-chromium replaceable heating elements, insulated with finest mica obtainable, protected by rugged outer housing. Replaceable tips. Standard voltages 110/120, 121/130, 220/250. Also available at \$1.00 extra list in any other voltage from 6 to 250, including 6, 12, 24, 32 and 55 volts. OPERATE IDENTICALLY ON A.C. OR D.C., ANY CYCLE.



All prices subject to change without notice.

All prices F.O.B. Roselle Park, N. J.

PLUG TIP IRONS



No. P-25A—Smallest Full-fledged Industrial Iron. Weight (less cord) only 3 oz. Length only 8". For extremely light soldering on finest wires, delicate instruments, jewelry, etc. Can also be furnished in higher wattages. 25 Watts. Tip dia., $\frac{1}{8}$ ". Ship wt., $\frac{1}{2}$ lb. Price \$5.00



No. P-26—Same size and for same work as P-25A, but where larger tip is required. Can be furnished in higher wattages. 30 Watts. Tip dia., $\frac{1}{8}$ ". Ship wt., $\frac{1}{2}$ lb. Price \$5.00



No. P-30—Very light soldering on fine wire and delicate instruments. Extra $\frac{1}{8}$ " dia. tip furnished with each iron. Also available in 50 or 60 watts. Specify watts when ordering. 40 Watts. Tip dia., $\frac{1}{8}$ ". Ship. wt., $\frac{3}{8}$ lb. Price \$5.25



No. P-70—Medium light soldering on telephone and radio apparatus. 80 Watts. Tip dia., $\frac{3}{8}$ ". Ship wt., 1 $\frac{1}{8}$ lb. Price \$7.50



No. P-100—A high speed tool for telephone, radio. Also home use. 100 Watts. Tip dia., $\frac{3}{8}$ ". Ship wt., 1 $\frac{1}{8}$ lbs. Price \$8.25



No. P-125—Light tinware, toys, typewriter type bars, small cans. 130 Watts. Tip dia., $\frac{3}{8}$ ". Ship wt., 1 $\frac{1}{8}$ lbs. Price \$9.75



No. P-150—Extra high speed iron for TV production, etc. 150 Watts. Tip dia., $\frac{3}{8}$ ". Ship wt., 1 $\frac{1}{2}$ lbs. Price \$9.00



No. P-151—Same use as No. P-150, but where larger tip is required. 175 Watts. Tip dia., $\frac{1}{2}$ ". Ship wt., 1 $\frac{1}{2}$ lbs. Price \$9.50



No. P-200—Medium tinware, small cans, small motors, organ pipes. 200 Watts. Tip dia., $\frac{3}{8}$ ". Ship wt., 2 $\frac{3}{8}$ lbs. Price \$10.00



No. P-250—Same use as No. P-200, but where greater speed is required. 250 Watts. Tip dia., $\frac{3}{8}$ ". Ship wt., 2 $\frac{3}{8}$ lbs. Price \$11.50



No. P-300—Large cans, roofs, auto radiators, gutters, refrigerators. 300 Watts. Tip dia., $\frac{3}{8}$ ". Ship wt., 3 lbs. Price \$13.25



No. P-550—Auto bodies, roofs, heavy armatures, tinsmiths. 550 Watts. Tip dia., 1 $\frac{1}{8}$ ". Ship wt., 4 $\frac{3}{8}$ lbs. Price \$17.50



SCREW TIP IRONS



No. 50—Light soldering on radio, telephone and electrical apparatus. 50 Watts. Tip dia., $\frac{1}{8}$ ". Ship wt., 1 lb. Price \$5.25



No. 60—Medium light soldering on telephone and radio apparatus. 60 Watts. Tip dia., $\frac{1}{2}$ ". Ship wt., 1 $\frac{1}{8}$ lbs. Price \$7.50



No. 85—Average soldering on telephone and radio. For home use. 90 Watts. Tip dia., $\frac{1}{2}$ ". Ship wt., 1 $\frac{1}{8}$ lbs. Price \$8.25



No. 120—A high speed iron. Light tinware, toys, typewriter type bars. 120 Watts. Tip dia., $\frac{3}{8}$ ". Ship wt., 1 $\frac{1}{8}$ lb. Price \$9.00



No. 130—Same use as No. 120, but where larger tip is required. 130 Watts. Tip dia., $\frac{7}{8}$ ". Ship wt., 1 $\frac{1}{2}$ lbs. Price \$10.00



No. 170—Medium tinware, small cans, small motors, organ pipes. 175 Watts. Tip dia., 1". Ship wt., 2 $\frac{1}{4}$ lbs. Price \$11.25



No. 225—Medium tinware, large cans, auto repairs, metal patterns. 250 Watts. Tip dia., 1 $\frac{1}{8}$ ". Ship wt., 2 $\frac{3}{8}$ lbs. Price \$13.25



No. 350—Large cans, roofs, auto radiators, gutters, refrigerators. 350 Watts. Tip dia., 1 $\frac{1}{8}$ ". Ship wt., 3 $\frac{1}{2}$ lbs. Price \$15.00



No. 500—Auto bodies, roofs, heavy armatures, tinsmiths. 500 Watts. Tip dia. 1 $\frac{1}{8}$ ". Ship wt., 4 $\frac{3}{8}$ lbs. Price \$17.00



No. 700—Continuous extra heavy duty soldering of very large armatures, etc. Where more heat is required use two irons alternately. 700 Watts. Tip dia., 1 $\frac{1}{8}$ ". Ship wt., 5 $\frac{3}{8}$ lbs. Price \$32.00



QUICK-HEATING BATTERY IRON

CONNECT THIS IRON TO EITHER 6 OR 12 VOLTS
Developed as a Standard Battery Iron for Armed Forces

No. 612—200 Watts. Tip dia., $\frac{7}{16}$ ". Price \$17.60
Length, 12 $\frac{1}{2}$ ". Wt. (less cord) 1 lb. Ship wt., 2 $\frac{3}{8}$ lbs.

For: Planes • Trucks • Cars • Tractors • Boats • Steam Shovels • etc.

Ready to Use in 20 Seconds.

Also for remote places in industrial plants where battery equipment is available.

Will do three times heavier work than the size indicates because element is embedded in tip, yet tip is small enough for finest soldering.

Switch in handle controls heat.

See Bulletin No. 612 for Further Details

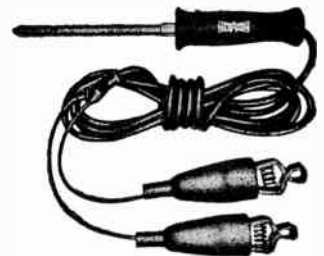



SPECIAL-PURPOSE FAST-PRODUCTION-LINE SOLDERING IRONS

Types Listed Below Have Been Developed Specifically for Soldering of TV Sets, Electronics and Communication Equipment Instruments, etc.—and Are Popular on Production Lines of Leading Producers (Both Conveyor Belt Lines and Sub-assemblies).

SUPER-POWERED IRONS HIGHER SPEED WITH SMALLER TIPS

Tip Dia.	Watts	Cat. No.	Ship Wt.	Price
1/4"	100	P-114	1 3/4 lbs.	\$ 8.25
1/4"	150	P-154 (shown)	1 3/2 lbs.	\$ 9.00
3/8"	200	P-214 (shown)	2 3/4 lbs.	\$10.00
3/8"	200	P-238	2 1/4 lbs.	\$10.00
1/2"	200	P-212	2 1/4 lbs.	\$10.00
3/8"	300	P-388A	2 3/4 lbs.	\$13.25

SOLDER FASTER WITH LOWER TIP COST! For example, Cat. P-214 has more speed than conventional 200 watt iron, but takes 1/4" tip instead of 3/8" (only 3/4 the copper). Widely used on production-line-soldering of TV sets, etc., where small-diameter, high-powered tips get into close quarters, and extra-fast-soldering prevents burning of insulation.

See Bulletin No. P-154 for Further Details

HATCHET TYPE IRONS PERFECT BALANCE—LESS FATIGUE—BETTER SOLDERED JOINTS FOR INACCESSIBLE PLACES

One of the most popular production line soldering irons. For same use as Plug Tip irons of equal wattage shown on opposite page. Replaceable elements and tips.

80 Watts 3/8" Tip		Ship Wt., 1 3/4 lbs. Price \$9.50
100 Watts 3/8" Tip		Ship Wt., 1 1/2 lbs. Price \$10.25
150 Watts 3/8" Tip		Ship Wt., 1 1/4 lbs. Price \$11.00
175 Watts 1/2" Tip		Ship Wt., 1 1/2 lbs. Price \$11.50
200 Watts 3/8" Tip		Ship Wt., 2 1/4 lbs. Price \$12.00
300 Watts 3/8" Tip		Ship Wt., 3 lbs. Price \$15.25

See Bulletin 70H for Further Details

INSTRUMENT SOLDERING IRONS

FOR FAST SOLDERING OF SMALL CONNECTIONS
EFFORTLESS TO USE — OUTPERFORM LARGER IRONS

Three distinct styles to choose from—SUPER-PENCIL, BANTAMWEIGHT HATCHET or PIN-POINT. All three types have same soldering efficiency and capacity and differ only in method of holding.

More powerful than wattage rating indicates. Tiny tips outperform irons with larger tips and higher wattage. Light weight reduces operator fatigue. Nickel-chromium mica-wound elements. Element, tip and housing all made of special alloys to increase efficiency. Engineered for maximum performance. No transformer or other cumbersome and expensive equipment required.

For constant duty precision soldering of instruments, sub-assemblies, small electronic devices, jewelry and all light or intricate electrical connections.

SUPER-PENCIL IRONS

HOT TIP — COOL HANDLE

Length 7 3/4"		25* Watts	3/8" Tip	Ship Wt., 1/2 lb. Price \$5.00
Length 7 3/4"		30* Watts	3/16" Tip	Ship Wt., 1/2 lb. Price \$5.00

*Can also be furnished in higher wattages.

All the advantages of a soldering pencil but a full-fledged industrial soldering iron with tip and element as separate parts and both individually replaceable. Cool, comfortable handle. Tiny tips outperform irons with larger tips and higher wattages. Weighs only 2 oz. See Bulletin 25S for Further Details.

BANTAMWEIGHT HATCHET IRONS

PERFECT BALANCE—LESS FATIGUE—BETTER SOLDERED JOINTS FOR INACCESSIBLE PLACES

	No. 25H Price \$5.50 25* Watts 3/8" Tip Ship Wt., 1/2 lb.		No. 26H Price \$5.50 30* Watts 3/16" Tip Ship Wt., 1/2 lb.
--	--	--	---

*Can also be furnished in higher wattages.

The same iron as Super-Pencil except in hatchet type—the same tiny tips out-perform larger tips and irons with higher wattages. Weighs only 3 oz.

See Bulletin 25H for Further Details

PIN-POINT SOLDERING IRONS

FOR PIN-POINT ACCURACY ON PRECISION SOLDERING
(These two items also listed on page 2)

Ship Wt., 1/2 lb. Length 8"		25* Watts	1/8" Tip	Price \$5.00
Ship Wt., 1/2 lb. Length 8"		30* Watts	3/16" Tip	Price \$5.00

*Can also be furnished in higher wattages.

The same iron as Super-Pencil except with conventional handle and longer case for soldering in tight places. The same tiny tips out-perform irons with larger tips and higher wattages. Weighs only 3 oz.

See Bulletin P-25 for Further Details

FEATHERWEIGHT HATCHET IRON

So light its weight is hardly noticeable (5 1/2 ozs. less cord), but more powerful than the wattage rating indicates. Hatchet design makes iron effortless to use. No transformer or other cumbersome and expensive equipment required. At 60 Watts has successfully replaced irons up to 100 Watts in many instances.

	No. 30H.....Price \$5.75
Pat. Pending	40, 50, or 60 Watts (Specify watts). Both 1/4" and 1/8" dia. tips furnished with each iron. Ship Weight: 1/2 lb.

See Bulletin No. 30H for Further Details



SOLDERMASTER Royal Blue Line ELECTRIC SOLDERING IRONS



GENERAL INFORMATION—Replaceable elements. Best grade of Madagascar mica for insulation. No. 55B has brass-sheathed cartridge element. Best grade nickel-chrome resistance wire. Replaceable hard drawn copper tips. All one piece swaged cases

gun metal finish. Equipped with 6 ft. Underwriters' Approved heater cord, rubber plug. Continental or English type plug 25c extra list. Stand for resting iron furnished.

VOLTAGES 110/120 220/250 A.C. or D.C., ANY CYCLE
SPECIFY VOLTAGE WHEN ORDERING

SCREW TIP IRONS



No. 55B—For light soldering, radio apparatus, etc. 55 Watts. Tip diam., $\frac{7}{8}$ ". Ship. wt., 13 oz. each \$3.00



No. 76B—For light work, electrical instruments, etc. 75 Watts. Tip diam., $\frac{1}{2}$ ". Ship. wt., 15 oz. each \$5.00



No. 100B—Same as No. 76B except used where more speed is required and heavier work is done. For home use. 90 Watts. Tip diam., $\frac{1}{2}$ ". Ship. wt., 16 oz. each \$5.50



No. 150B—Ideal size for garage and repair work. For home use. 170 Watts. Tip diam., $\frac{3}{8}$ ". Ship wt., 24 oz. each \$7.50



No. 300B—For heavy steel metal, auto radiators, etc. 275 Watts. Tip diam., $1\frac{1}{8}$ ". Ship wt., 38 oz. each \$10.50

PLUG TIP IRONS



No. 71B—For light work, radio repairs, etc. 75 Watts. Tip diam., $\frac{3}{8}$ ". Ship. wt., 16 oz. each \$5.00



No. 101B—For same work as No. 71B, but where more speed is required or heavier work is done. For home use. 100 Watts. Tip diam., $\frac{3}{8}$ ". Ship wt., 18 oz. each \$5.50



No. 121B—High speed iron for radio and electrical repairs. 125 Watts. Tip diam., $\frac{3}{8}$ ". Ship wt., $1\frac{3}{4}$ lbs. each \$6.50



No. 201B—For same work as No. 150B, except where plug tip is desired. 200 Watts. Tip diam., $\frac{3}{8}$ ". Ship wt., 34 oz. each \$8.50



No. 301B—For same work as No. 300B, except where plug tip is desired. 300 Watts. Tip diam., $\frac{3}{8}$ ". Ship wt., 46 oz. each \$10.50

DISPLAYS

Increase your sales with these silent salesmen. Irons securely mounted, but readily removable for sale. Individually packed in cartons ready for shipment. Catalog number and wattage shown on front of display. Complete catalog information and price list on back.

SCROLL TYPE DISPLAY

Striking, Modernistic, All Metal Panel



No. 1B DISPLAY Illustrated

Size 15" x 17 $\frac{1}{2}$ " (Nos. 1B, 2B, and 3B also same size)

This Display Panel Also Furnished With
Five or Seven Irons (See Below)

	Ship. Wt.	List Price
No. 1B—Nine Iron with Nos. 55B, 76B, 100B, 150B, 300B, 71B, 101B, 201B, 301B...	20 lbs.	\$61.00
No. 2B—Seven Iron with Nos. 55B, 76B, 100B, 150B, 300B, 71B, 101B.....	17 lbs.	42.00
No. 3B—Five Iron with Nos. 55B, 76B, 100B, 150B, 300B.....	15 lbs.	31.50
No. 4B—Five Iron with Nos. 71B, 101B, 121B, 201B, 301B.....	16 lbs.	36.00

ATTRACTIVE THREE COLOR CARDBOARD DISPLAY



This same display card also furnished with No. 5B and No. 5DB, but mounted with irons listed below.

No. 6B DISPLAY Illustrated

Size 12" x 16 $\frac{1}{2}$ "
(Nos. 5B, 5DB also same size)

	Ship. Wt.	List Price
No. 5B—Three Iron with Nos. 55B, 76B, 100B...	4 lbs.	\$13.50
No. 5DB—Three Iron with Nos. 55B, 100B, 150B on display and 2 No. 55B and 1 No. 100B for stock.....	8 lbs.	27.50
No. 6B—Three Iron with Nos. 71B, 101B, 121B....	5 lbs.	17.00

ESICO

REG. U. S. PAT. OFF.

ELECTRIC SOLDERING IRONS FOR HOME, PROFESSIONAL MECHANIC AND FACTORY

● GREEN LABEL LINE

For intermittent duty. Meets all requirements of the home craftsman.



No. 415—List \$2.15— $\frac{3}{8}$ " Tip—55 Watts



No. 416—List \$3.25— $\frac{1}{4}$ " Tip—60 Watts



No. 417—List \$4.35— $\frac{3}{8}$ " Tip—100 Watts



No. 418—List \$5.45— $\frac{1}{2}$ " Tip—130 Watts

● ORANGE LABEL LINE

For Professional Mechanics—light or heavy soldering where iron must withstand operation for eight hour periods or more on frequent occasions.



No. 62—List \$5.45— $\frac{1}{4}$ " Tip—60 Watts



No. 63—List \$6.55— $\frac{3}{8}$ " Tip—100 Watts



No. 64—List \$7.65— $\frac{1}{2}$ " Tip—130 Watts



No. 65—List \$8.75— $\frac{5}{8}$ " Tip—200 Watts



No. 67—List \$9.85— $\frac{7}{8}$ " Tip—300 Watts



No. 69—List \$12.05— $1\frac{1}{8}$ " Tip—500 Watts

● RED LABEL LINE

For Production Line Continuous Operations. These irons are of most rugged construction.



No. 38—List \$7.65— $\frac{3}{8}$ " Tip—100 Watts



No. 58—List \$9.85— $\frac{5}{8}$ " Tip—200 Watts



No. 78—List \$12.05— $\frac{7}{8}$ " Tip—300 Watts



No. 98—List \$14.25— $1\frac{1}{8}$ " Tip—550 Watts

FOR FASTER SOLDERING... LONGER IRON LIFE

MAINTAINS DESIRED IRON TEMPERATURE BETWEEN JOBS • PREVENTS OVERHEATING
SAVES ELECTRIC CURRENT • ADJUSTABLE TO ANY SIZE IRON
SAVES TIME • NO LONG WARM-UP PERIOD

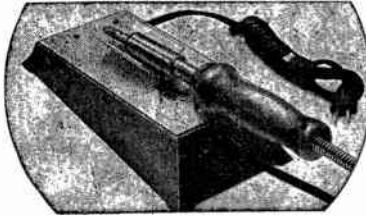

A practical, time and money saving device which accurately regulates and maintains soldering iron temperature between jobs. Lengthens iron life by reducing tip oxidation and amalgamation of tip with solder which increases with over-heating.

When placed on stand, iron rests in a copper cradle which conducts heat of iron and actuates a bimetal to open or close a switch. Temperature is easily regulated by an adjusting slide at bottom of stand. As iron is removed from stand, full current is instantly supplied. Stem rest adjustable to accommodate various lengths of irons. Stand is a heavy gray iron casting—stays firmly fixed without being fastened.

● SOLDERING POTS

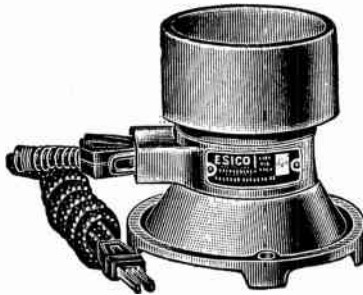

Ruggedly constructed, cast iron pots for production work. Elements are easily replaced even while pots are hot.

Net Price

Cat. No. 12— $1\frac{1}{2}$ " dia. Cap.	
$\frac{3}{4}$ lbs.	\$ 4.95
Cat. No. 36— $2\frac{1}{2}$ " dia. Cap.	
$2\frac{1}{4}$ lbs.	6.05
Cat. No. 60— $3\frac{1}{2}$ " dia. Cap.	
$3\frac{3}{4}$ lbs.	7.15

● SPOT SOLDERING MACHINE

Model "F" is a treadle operated machine which feeds solder forward as the iron moves away from the work. Suitable for spot soldering where a mechanical connection has first been made. Net price\$16.50

Model "N" is a treadle operated machine for the advancement of the iron, but without a solder feed attachment. Net price.....\$8.25

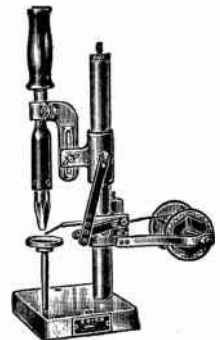

● GLUE POTS

The catalogue No. 700 Glue Pot is of two quart capacity. It is the water jacket type and has a gasket sealed element and thermostat completely protected from moisture. Thermostat is normally set at 150 degrees for use with glue, but can be set at various temperatures for use with wax, etc. Net price\$20.35

ELECTRIC SOLDERING IRON CO., INC.

Copyright by U. C. P., Inc.

TRADE DISCOUNT APPLIES TO LIST PRICES ONLY

Radio's Master—19th Edition

Page U-5



SOLDERING IRONS

Equipped with Long-life Calrod* Heaters
 FOR MANUFACTURING AND SERVICE OF
 RADIO AND ELECTRONIC EQUIPMENT

*Registered trade-mark of General Electric Co.

ASK YOUR G-E DISTRIBUTOR FOR A COPY OF BULLETIN GEA-4519.

- **HIGH-SPEED SOLDERING.** You can solder as fast and continuously as the nature of the work will allow.
- **UNIFORM PERFORMANCE.** Operating characteristics remain constant day after day. No appreciable decrease in efficiency even after months of service.
- **EASY, LOW-COST REPAIR.** Assembling and disassembling are easy.
- **LONG LIFE AND LOW MAINTENANCE.** Life is lengthened, and over-all costs are kept low because sturdy construction obviates need of frequent repairs.
- **THEY NEED NOT BE RETURNED TO THE FACTORY FOR REPAIR.** Irons can be repaired on the job without special tools or skill.

LIGHTWEIGHT INDUSTRIAL IRONS

(Approved by Underwriters' Laboratories)



Soldering Iron, Including Tip and Heater Assembly						Tip and Heater		Tip Only†		
Cat. No.	Rating		Tip Dia. in Inches	List Price, Each‡	Standard Package Quantity	Cat. No.	List Price, Each‡	Cat. No.	Size in Inches	List Price, Each‡
	Volts	Watts								
6A273	120	60	1/4	\$11.40	6	6A300	\$5.60	326A964P21	1/4	\$1.60
6A283	120	60	3/8	11.40	6	6A301	5.60	326A964P22	3/8	1.60

†Tips must be brazed on. See instructions included with irons.
 ‡Mfr's suggested retail price.

INDUSTRIAL SOLDERING IRONS

For light, high-speed soldering, such as assembly of radios, telephones, switchboards, appliances, meters, and instruments, and installation and repair of wiring and wiring devices and ignition. Also, for medium, intermittent soldering on tinware, wiring, plumbing, and smithing. Excellent general-purpose iron for service and repairs, for shop and farm.



Fig. 1. Industrial soldering iron, 6A161 and 6A162 series

Fig. 2. Cutaway view of industrial soldering iron, 6A161 and 6A162 series

3/8-in. 1/2-in. 1/2-in. short long

Soldering Iron, Less Tip				Renewal Heater		Interchangeable Tips				
Cat. No.	Rating		List Price, Each‡	Standard Package Quantity	Cat. No.	List Price, Each‡	Cat. No.	Size, inches	Type	List Price, Each‡
	Volts	Watts								
6A161 and 6A162 Series (Fig. 1 and 2)										
6A161	115	75	\$12.00	6	6A31	\$3.70	Note: All of the interchangeable tips listed below will fit any iron in the 6A161 and 6A162 series.			
6A161G3	230	75	12.00	6	6A31G3	3.70				
6A162	115	100	12.00	6	6A32	3.70	6851732P21	3/8	Calorized	\$0.80
6A162G2	230	100	12.00	6	6A32G3	3.70	6851732P22	3/8	Ironclad	1.50
6A162G6	115	110	12.00	6	7C342	3.70	6808345AAP2	1/2 short	Calorized	.80
6A162G30	230	110	12.00	6	7C249	3.70	6851775P21	1/2 short	Ironclad	1.50
6A162G3	115	125	12.00	6	8A88	3.70	6808345AAP3	1/2 long	Calorized	1.40
6A162G8	230	125	12.00	6	7A76G21	3.70	6851775P22	1/2 long	Ironclad	2.85
							9817171P22	13/64	Ironclad	1.50

‡Mfr's suggested retail price.



SOLDERING IRONS

Equipped with Long-life Calrod* Heaters

FOR MANUFACTURING AND SERVICE OF RADIO AND ELECTRONIC EQUIPMENT

*Registered trade-mark of General Electric Co.

ASK YOUR G-E DISTRIBUTOR FOR A COPY OF BULLETIN GEA-4519.

MIDGET SOLDERING IRONS

APPLICATION

This 8-inch, 1¾-ounce featherweight iron for close-quarter soldering with pin-point precision is used where conventional irons might cause damage . . . be clumsy to handle . . . be more expensive to operate. The Midget literally goes places with greater efficiency and less power . . . with no sacrifice in heat or speed. With its fingertip operation, this iron will help make an expert out of any solderer in a short time.

The Midget has Ironclad copper tips either ¼-, ⅜- or ½-inch diameter, as desired.

THIS MIDGET DOES A BIG JOB IN

- Boosting Production Rates
- Increasing Operator Efficiency
- Cutting Down Employee Fatigue
- Saving on Repair and Maintenance
- Reducing Rejects
- Manufacturing and Repairing:
 - Radios and other electronic equipment
 - Meters
 - Instruments
 - Jewelry
 - Appliances

. . . and many other products requiring precision soldering

RATING: 6 VOLTS, 25 WATTS

Soldering Iron, Including Tip and Heater Assembly	Cat. No.	Price†
⅜-in. Ironclad copper tip (pyramid-shaped)	6A212	\$6.90
¼-in. Ironclad copper tip (chisel-shaped)	6A210	6.90
⅝-in. Ironclad copper tip (pyramid-shaped)	6A214	6.90
⅜-in. Renewal tip and heater assembly only	6A213	3.60
¼-in. Renewal tip and heater assembly only	6A211	3.60
⅝-in. Renewal tip and heater assembly only	6A215	3.60

Net weight iron less cord 1¾ oz.
 Net weight iron including cord 5 oz.
 Shipping weight complete iron 8 oz.

Standard package consists of 6 irons of one tip size. Tip and heater assemblies can be purchased in any quantities.



Disassembled view of midget soldering iron



¼-in. dia tip, Cat. No. 6A210

SPECIAL TRANSFORMERS (OPTIONAL) FOR G-E MIDGET SOLDERING IRONS

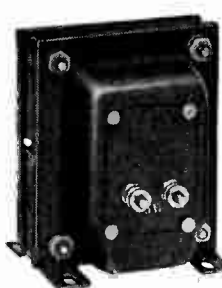

Single-tap, Cat. No. 6A362

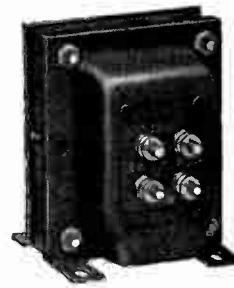

Four-tap, Cat. No. 6A364

Specially designed 115-volt transformers are available as optional equipment in two types:

1. Single-tap 115/6 volts—for use where only one soldering heat is required
2. Four-tap 115/6.3/6/5.7/5.4 volts — gives wide range of heats (from 25 to 35 watts) for close temperature control of tips

Transformers are small, lightweight, but sturdy. Their 6-foot extension cords can be plugged in any 115-volt a-c circuit.

Description	Cat. No.	Price†
Single-tap	6A362	\$5.70
Four-tap	6A364	7.60

Publication Reference GEA-4519

THE MIDGET OFFERS MAJOR ADVANTAGES

Low-cost soldering—Solders more efficiently, using only approximately one-fourth wattage normally used.

Fingertip operation—Only 8 inches long, weighs but 1¾ ounces. Styled for fingertip grip.

Quick, continuous heat—Famous G-E Calrod heater built into Ironclad copper tip for rapid heat transfer.

Easy renewal—Ironclad tip and heater assembly can be replaced as a unit merely by unscrewing from handle.

Long life, low maintenance—Low voltage permits use of heavy, long-lasting nickel-chromium resistance wire. Less maintenance is required with long-lasting Ironclad copper tip.

† Manufacturers' suggested retail price.

KWIKHEAT THERMOSTATIC SOLDERING IRONS

Built-in Vanatta Automatic Thermostat

KWIKHEAT TYPE NO. 200

HOT IN 80 SECONDS
150 Watts — 115 Volts AC Only

Weight of Iron with Tip 7½ oz.
Shipping Weight per Iron with ⅜" x ¼" Dia. Tip and resting stand 1 lb. 2 oz.
Length of Iron with ⅜" x ¼" Dia. Tip 12¾"
Length of Heater Cord 6 ft.

HOT IN 80 SECONDS
List Price

Iron complete with tip \$7.75
Replacement Elements 3.15
Tip ⅜" x ¼" Dia. Pyramid Point55

CHECK THESE ADVANTAGES

KWIKHEAT JR. has been designed to meet the demand by the electronics industry for a lighter and smaller PRODUCTION tool. The element is readily replaced in the field by use of screwdriver, pliers, and small punch or nail.

CORROSION RESISTANT
Core assembly and outer shell are made of STAINLESS STEEL.

HOT IN 80 SECONDS

The watt density of the heating element is very high and completely controlled by the thermostat.

TEMPERATURE

While the thermostat is preset at the factory, two standard temperatures are available—Standby Irons, used for intermittent bench work, servicing, and engineering, set at 700°F; PRODUCTION Irons, used for constant high speed soldering, set at 800°F.

TIPS

Tips, plunger type ⅜" x ¼" diameter x 4" long, plated to reduce corrosion. It is advisable to keep tips inserted completely in the cavity of the element for complete temperature control.



PLUNGER TYPE TIP

KWIKHEAT TYPE NO. 300

HOT IN 90 SECONDS
225 Watts — 115 or 230 Volts AC Only

Weight of Iron with Standard No. 1 Tip 14 oz.
Shipping Weight per Iron with No. 1 Tip and resting stand 1½ lb.
Length of Iron with No. 1 Tip 13"
Length of Heater Cord 6 ft.

HOT IN 90 SECONDS
List Price

Iron complete with tip \$12.25
Available in other AC Voltages add .75
Available with 3 Conductor Cord add 2.50
Replacement Elements 8.60
Tips, any style 1.50

TEMPERATURE

The Kwikheat Element can be set at the factory to any desired tip temperature between 275° and 875° F. Additional charges for this service:

1 to 49 \$1.00 ea.
50 to 9950 ea.
100 or more standard price

CORROSION RESISTANT

Tips and core are forged of tellurium copper alloy and plated for resistance to corrosion.

HOT IN 90 SECONDS

Kwikheat Thermostatically controlled soldering irons are the only irons containing built-in thermostats, allowing a much greater watt density with less radiation of heat.

TEMPERATURES ARE PRE-SET

The use of recently developed alloys have permitted the increase of thermostat temperatures with reduced creep.

WHEN IRONS ARE TO BE USED FOR HEAVY OR HIGH SPEED SOLDERING — SPECIFY A PRODUCTION IRON.

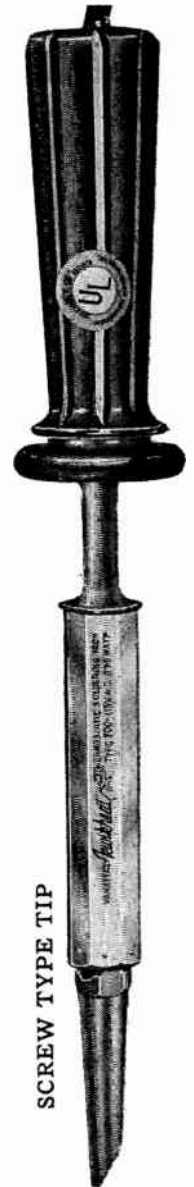

SCREW TYPE TIP

#20 ANTIFREEZE COMPOUND

A lubricant for all soldering iron tips. Prevent sticking, increases conductivity between tip and core.

Please contact your jobber for trade discounts.

6 INTERCHANGEABLE TIPS FOR TYPE 300

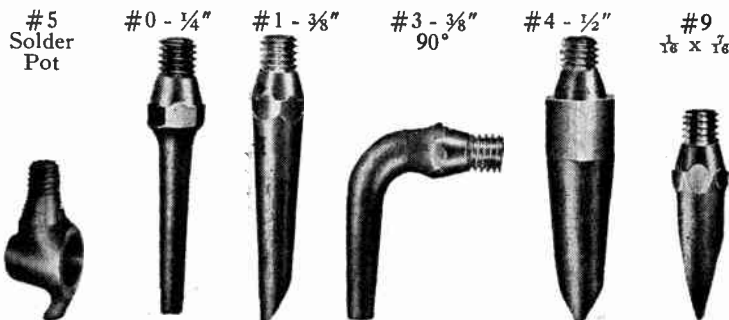

KWIKHEAT MFG. CO.

Glendale 4, California

WELLER SOLDERING GUNS

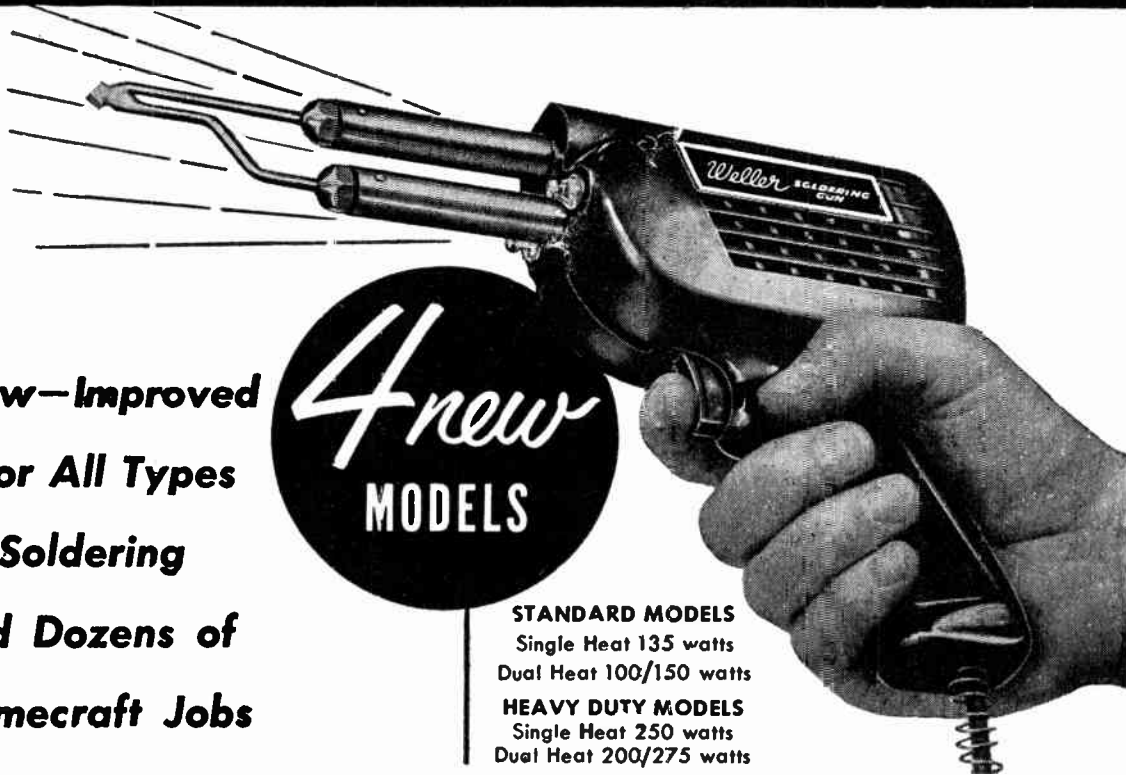

**New—Improved
—for All Types
of Soldering
and Dozens of
Homecraft Jobs**

STANDARD MODELS
Single Heat 135 watts
Dual Heat 100/150 watts
HEAVY DUTY MODELS
Single Heat 250 watts
Dual Heat 200/275 watts

- **INSTANT HEAT.** No wasted time or current. Weller Guns pay for themselves in a few months.
- **DUAL HEAT SAVES TIME AND MONEY.** Tip life greatly increased by using high heat only when necessary. Switch instantly to high or low heat as job requires.
- **EXCLUSIVE TIP-GRIP.** Wiping action of tip-fastening nut eliminates contact resistance and oxidation. Assures full constant heat.
- **DUAL SPOTLIGHTS ON ALL MODELS.** Locate work quickly—even in dark corners.
- **HIGH-IMPACT HOUSING—PERFECT BALANCE.** Rugged Hycar phenolic plastic housing protects against damage. Streamlined design and built-in transformer give pistol balance and soldering convenience.
- **SLIDES EASILY INTO TIGHT SPACES.** Longer reach slips easily between wiring—handles difficult, deep-corner jobs with ease. Speeds work and ends damage to insulation.
- **LOW-COST, REPLACEABLE WELLERTIPS.** Change tips in a jiffy. Chisel shape for faster heat transfer.

U.S. Pat. No. RE-23619, Other Pat. Pending.

Printed in U.S.A.

Weller Better From Grip to Tip
SOLDERING GUNS

LIGHT DUTY MODELS

MODEL	WATTS	NET PRICE	
S-400	SINGLE HEAT 135	\$8.95	SOLDERING TIP Sturditip No. 7135—Pkg. 2—25c net
			SMOOTHING TIP No. 6120 (with nuts) 35c each net
D-440	DUAL HEAT 100/150	\$10.95	CUTTING TIP No. 6110 (with nuts) 35c each net

HEAVY DUTY MODELS

MODEL	WATTS	NET PRICE	
S-500	SINGLE HEAT 250	\$9.95	SOLDERING TIP Rigidtip No. 7250—Pkg. 2—35c net
			SMOOTHING TIP No. 6140 (with nuts) 35c each net
D-550	DUAL HEAT 200/275	\$11.95	CUTTING TIP No. 6130 (with nuts) 35c each net

All Models for 60 Cycles, 120 V. AC Only

The Finest Tools for the Finest Craftsmen

VULCAN

ELECTRIC SOLDERING TOOLS

High-powered Soldering Tools, designed for fast soldering, with low operating cost. Tips are of finest forged copper. The "Hang" or balance good mechanics appreciate, plus light weight. Cool handles of selected birch, shaped to fit the hand. 6 ft. heater cord, with unbreakable rubber plug. Fireproof terminals. Heating elements easily replaced. Operate equally well on AC or DC.

Pygmy PENCIL TYPE



A very efficient tool for fine soldering of instruments, meters, gauges, small radios, etc. or any spots where space is cramped or there is little clearance. The cool, tapering wood handle permits "writing grip." Flexible coil also assures coolness. Equipped with approved cord and unbreakable rubber plug. Standard tip is 1/4" but 3/8" or 1/2" tips are available, as well as special tips, bent to any angle or in various shapes.

Cat. No.	Watts	Tip	Weight	Length	List
Pygmy	25	1/4"	7 oz.	8 1/4"	\$4.50

SOLDERING TOOL HOLDER

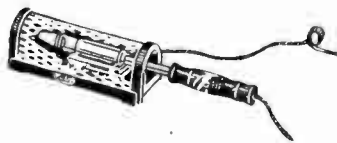

Holds and guards the Soldering Tool and keeps the tip at soldering temperature as long as it remains in the holder. Has a cord and attached plug cap for connection to current and a receptacle for plugging in the Tool. A convenient adjusting screw sets the Holder thermostat to maintain proper temperature. AC or DC
 No. 2100 without thermostat \$4.00 list
 No. 2100T with thermostat \$6.50 list

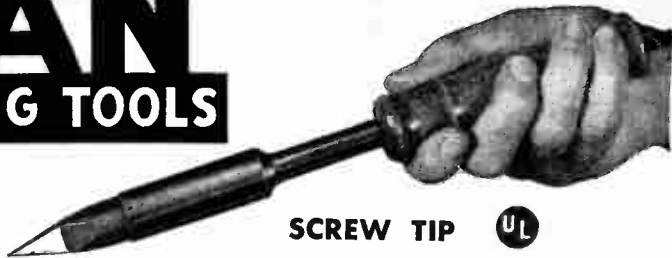

SCREW TIP

CAT. No.	WATTS	TIP	LIST
20	50	3/16"	\$6.25
30	60	1/2"	7.50
40	90	1/2"	8.50
50	130	7/8"	9.50
60	175	1"	10.75
70	220	1 1/8"	12.50
80	310	1 3/8"	14.50
90	430	1 5/8"	16.50
900	700	1 3/4"	29.50

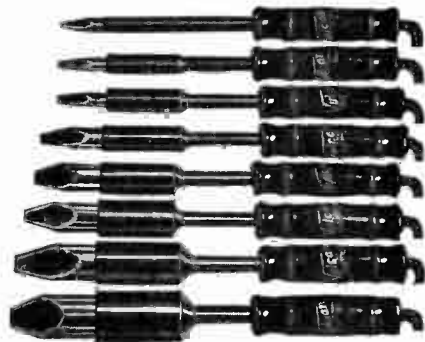

PLUG TIP — All parts replaceable

CAT. No.	WATTS	TIP	LIST
* 25	50	1/4"	\$5.50
35	100	3/8"	7.75
453	150	3/8"	8.50
45	150	1/2"	8.50
55	200	5/8"	9.75
75	300	7/8"	13.00

*Heating element replaceable at Factory only.



ELECTRIC SOLDER POTS



Both single and three-temperature Pots in a variety of sizes and wattages, all with cord and plug approved at Underwriters' Laboratories.

CAT. No.	WATTS			CAPACITY SOLDER APPROXIMATE	LIST
	HIGH	MEDIUM	LOW		
1700	200	120	80	1 1/4 lbs.	\$20.90
1702	250	150	100	5 lbs.	24.20
1704	500	250	125	10 lbs.	27.80
1600	150	Single Heat		14 oz.	7.65
1606	350	Single Heat		3 lbs.	8.45
1701	250	Single Heat		4 lbs.	16.25
1703	200	Single Heat		14 oz.	11.85

Other sizes up to 6000 watts, single heat.

"DUREVER" Soldering Tips are pure forged copper, shaped to your favorite style, with a special metal coating that will preserve the original shape of the tip by protecting the copper from corrosion and oxidation. Will outlast copper tips, cannot amalgamate with solder, do away with the necessity for dressing or filing. Can be readily tinned without filing and hold their original shape. Circular on request.

VULCAN ELECTRIC CO

ELECTRIC SOLDERING TOOLS · SOLDER POTS · GLUE POTS · BRANDING IRONS · HEATING UNITS

VULCAN ELECTRIC SOLDERING TOOLS JACKSON

**LOW PRICE
LONG DISCOUNT**

Jackson "Standard" Electric Soldering Irons are scientifically designed for that "balanced feel" which reduces fatigue. All elements used in Jackson Standard Irons are made of the finest quality nichrome wire, wound on precision machined steel cores and insulated with selected high grade amber mica. Equipped with 6 ft. approved heater cords and plugs. Stand included with every iron.



STANDARD SCREW TYPE — Gun Metal Finish

CAT. No.	WATTS	TIP	LIST
141	85	7/16"	\$4.20
142	100	5/8"	5.50
0142	125	3/4"	6.25
144	150	3/4"	7.50
143	225	7/8"	9.00
210	350	1 1/8"	9.75



STANDARD PLUNGER TYPE (Plug Tip) — Gun Metal Finish

CAT. No.	WATTS	TIP	LIST
149	85	5/16"	\$4.20
145	100	3/8"	5.50
0145	125	3/8"	6.25
146	150	1/2"	7.50
147	225	5/8"	9.00
148	350	1 1/8"	9.75



DE-LUXE ELECTRIC SOLDERING PENCIL

A soldering pencil for all light work such as Radio, Television, Jewelry, Instruments and Electronics. Handle is cork-filled composition, 100% air cooled: 1/2" steel tubing, perforated for air cooling. Element is wound on a steel core, for efficient heating. High grade mica and nichrome wire. Underwriters approved 6 ft. rubber cord and plug.

CAT. No.	WATTS	VOLTS	TIP	LENGTH	WEIGHT	LIST
230D	25	115	1/4"	7"	3 oz.	\$2.65



STANDARD ELECTRIC SOLDERING PENCIL

Wood handle, rich black finish with cork sleeve. 1/8" steel tubing gun metal finish. Element is wound on steel core. High grade mica and nichrome wire. 6 ft. rubber cord and plug.

CAT. No.	WATTS	VOLTS	TIP	LENGTH	WEIGHT	LIST
230	25	115	1/4"	7"	3 oz.	\$2.20
231	40	115	3/8"	8"	4 oz.	3.95



COMET — SCREW TIP



Comet Irons are equipped with a 6 ft. approved Heater Cord and Plug. Heating element is made of high quality Nichrome Wire, wound with mica on a core. Handles are black finish. All irons are packed one in a box, stand included. 50 to a standard shipping container. All irons are made for 115 volts. If higher voltage is desired, there will be a slight extra charge.

CAT. No.	WATTS	TIP	LIST
65 S	65	1/2"	\$3.00
85 S	85	5/8"	3.50
100 S	100	3/4"	3.95
125 S	125	7/8"	4.75



COMET — PLUNGER (PLUG) TIP



CAT. No.	WATTS	TIP	LIST
65 P	65	1/4"	\$2.20
85 P	85	5/16"	2.60
100 P	100	3/8"	3.25
125 P	125	7/16"	3.95

VULCAN ELECTRIC CO

ELECTRIC SOLDERING TOOLS · SOLDER POTS · GLUE POTS · BRANDING IRONS · HEATING UNITS



2 NEW Lenk WINNERS

Lenk

INSTANT **I H** HEAT
Soldering Iron



- INSTANT SOLDERING** for Radio, TV, Laboratory and Service Men!
- MELTS SOLDER** in 3½ seconds!
- PERFECT BALANCE** for working comfort!
- ADJUSTABLE SWIVEL-TIP** permits any angle soldering!
- SPECIAL ALLOY TIP** for increased resistance to oxidation and wear!
- AUTOMATICALLY FOCUSED LIGHT** always follows work!

Model No. 501 180 watts, 110 volts A.C.
Packed in counter display carton
12 Cartons to case . . . 35 lbs.
List Price \$9.95

Lenk

PENCIL TYPE
Industrial
Soldering Iron



- MINIATURE DESIGN** for fast continuous production of precision work. TV, Radio, Electronic Components, etc.
- 2 TIPS** ⅛" Tip-standard ¼" Tip extra
- FEATHER-LIGHT** — only 2 oz.!
- COMPACT** — only 7½" over-all!
- PLATED TIPS** resist corrosion!
- FAST HEATING** — brass core element!
- EXTRA RUGGED** — stainless steel construction!
- EXTRA COOL** — cooling fins, plastic handle!
- BALANCED** — easy to handle, fatigue-reducing!

Model No. 251 25 watts
Packed 12 to a case . . . 4 lbs.
List Price \$4.00

Model No. 256 40 watts
Packed 12 to a case . . . 4 lbs.
List Price \$5.00

The
Lenk
Mfg. Company
30 Cummington St.
BOSTON 15, MASS.

Distributors' Choice For Over 35 Years

when there's a soldering job to be done... remember the line

Ungar DOES A BETTER JOB

the world's most versatile line of **ELECTRIC SOLDERING TOOLS**

On the job, doing a better job, you'll find this famed family of versatile soldering tools everywhere... on production lines and in home workshops... in service organizations and testing labs.

The Ungar Electric Pencil Handle with its series of interchangeable Soldering Tips has been deliberately designed to reach into those hard-to-get-at soldering points, speed soldering production and to replace the big, bulky soldering irons that promote fatigue and add costly man hours to overhead. No wonder the industry calls them "Ungar's Little Angels".

NO. 776 UNGAR PENCIL HANDLE for use with all Ungar thread-in tips

Feather-light, less than 5-inches long. Extra length brass shell firmly engages all threads, keeps heating unit tight; spring action rivet assures positive contact; extra flexible cord protected with molded rubber sleeve prevents wear; cooler handle of durable molded plastic, perfectly balanced; form-fit cork grip keeps handle tilted at 10 degree angle, eliminates need for extra handle-rest, keeps hot tip point up, away from bench surface; ceramic insulation for double safety. Underwriters' listed (110-120V., 37½ Watts).

No. 776 Handle & Cord Set only \$1.15 ea.



INTERCHANGEABLE TIPS for every soldering need



No. 331 Elkaloy Pencil Tiplet, 15c ea.

No. 1235 Hi-Heat Thread-In Unit, 37½ watts, \$1.35



No. 535 Thread-In Unit, 23½ watts, \$1.10 ea.



No. 332 Elkaloy Offset Pencil Tiplet, 15c ea.



No. 333 Elkaloy Chisel Tiplet, 15c ea.



No. 536 Tellurium Pyramid Tip, 20-watts, \$1.10 ea.



No. 539 Tellurium Chisel Tip, 20-watts, \$1.10 ea.



No. 1239 Hi-Heat Chisel Tip, 37½-watts, \$1.35 ea.



No. 2336 Hi-Heat Pyramid Tip, 37½-watts, \$1.35 ea.



No. 540 - Combination of #267 Heating Unit and #122 Brass Knife Tip for Plastics - 20-watts, \$1.10 ea. No. 267 - 85c ea. No. 122 - 25c ea.

We sell only through authorized distributors. Please contact your nearest Radio Parts, Electrical, Hardware or Mill Supply House for discounts and further information.

Ungar ELECTRIC TOOLS, INC.

P. O. BOX 312, VENICE, CALIFORNIA



Copyright by U. C. P., Inc.

TRADE DISCOUNT APPLIES TO LIST PRICES ONLY

Radio's Master — 19th Edition

Page U-13



WASSCO ELECTRIC PRODUCTS CORP.,
JOLIET, ILLINOIS

RESISTANCE SOLDERING EQUIPMENT

FOR THAT "HARD TO SOLDER" GROUNDING LUG ON CHASSIS—FOR ANY TOUGH SOLDER JOB—WHERE INSTANT INTENSE HEAT IS NEEDED TO SOLDER HEAVIER PARTS—OR ON DELICATE WORK WHERE PROLONGED HEATING WOULD BURN OR MELT SURROUNDING INSULATION—TO ABSOLUTELY ELIMINATE "COLD" SOLDERING JOINTS.

EVERY PLANT, LABORATORY AND SERVICE ORGANIZATION SHOULD HAVE AT LEAST ONE SET OF WASSCO RESISTANCE SOLDERING EQUIPMENT.

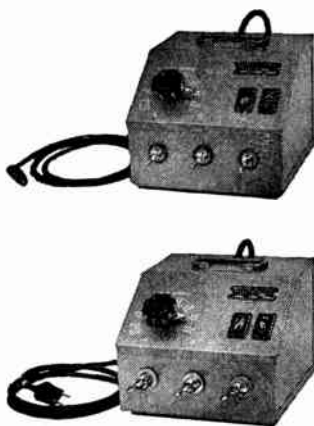

Wassco Glo-Melt Power Units shown above have the exclusive 24 heat feature. Very efficient on largest down to most delicate, small soldering job. Transformers have extra iron and copper for hard repetitive service. Cases are steel, ventilated and finished in attractive gray hammerloid. Snap switch, pilot light and five foot cord.

Model 105-B-2—500 watts $\frac{1}{4}$ " output terminals, uses "Standard" attachments. 115 volt 50-60 cyc..... **\$44.00**
230 volt 50-60 cyc..... **47.00**

Model 105-C1—1000 watts $\frac{3}{8}$ " output terminals, uses "Heavy Duty" attachments. 115 volt 50-60 cyc..... **\$52.00**
230 volt 50-60 cyc..... **56.00**

Model 105-D1—2500 watts $\frac{1}{2}$ " output terminals, uses "Heavy Duty" attachments. This unit not illustrated.
115 volt 50-60 cyc..... **\$78.00**
230 volt 50-60 cyc..... **83.00**



"Standard" Handpiece and Ground Lead attachment set. Handpiece uses $\frac{1}{4}$ " Carbon Tip straight out or at angle. Sturdy comfortable handle and cooling fins. Leads are extra flexible #10 cable 5 ft. long. One Carbon Tip is included.

Cat. #10529..... **\$6.75**



"Heavy Duty" Handpiece and Ground Lead attachment set. Handpiece uses $\frac{1}{2}$ " Carbon Tip at angle. Sturdy comfortable handle and cooling fins. Leads are extra flexible #6 cable 5 ft long. One Carbon Tip included.

Cat. #10533..... **\$12.75**



"Pencil" Handpiece and Ground Lead attachment set. Handpieces use either $\frac{1}{8}$ " or $\frac{1}{16}$ " Carbon Tips. Are 5" long x $\frac{3}{8}$ " diam., weigh $\frac{1}{2}$ ounce. For sensitive, precision soldering of all kinds. One Carbon Tip included. Leads are #10 cable 5 ft. long.

Cat. #10530 for $\frac{1}{8}$ " Carbon Tip..... **\$6.25**
Cat. #10531 for $\frac{1}{16}$ " Carbon Tip..... **6.25**



Wassco Carbon Tips are a tough high resistance, special analysis carbon and must be used with our equipment for best results. Standard length is 3 inches.

Cat. #10524..... $\frac{1}{8}$ "..... **\$0.18**
#10525..... $\frac{3}{16}$ "..... **.18**
#10526..... $\frac{1}{4}$ "..... **.22**
#10527..... $\frac{3}{8}$ "..... **.28**
#10534..... $\frac{1}{2}$ "..... **.35**

MANY SPECIAL PURPOSE SOLDERING ATTACHMENTS AND DEVICES ARE ALSO AVAILABLE, PARTICULARLY FOR HIGH PRODUCTION.



TECHNICAL ADVANTAGES

ERSIN FLUX

Ersin Flux is exclusive to Multicore and will not be found in any other solder. It is a high grade, water white rosin, homogeneously activated.

Ersin Flux has a vigorous fluxing action and possesses the non-corrosive and protective features of the original rosin. Soldered joints made with Ersin Flux do not corrode even after prolonged exposure to any degree of humidity. Ersin Flux reduces the surface tension of molten solder, causing it to wet metals rapidly, increasing speed of operation with resultant production economies.

Free from objectionable odor. Non-toxic in use. Leaves nothing but pure rosin on the work after soldering, and may be used wherever plain rosin is specified.

**ONLY SOLDER MADE WITH
NON-CORROSIVE, EXTRA-ACTIVE
ERSIN FLUX!**

MULTICORE SOLDER

Five separate cores of flux eliminate possibility of no flux in a portion of the wire, which may occur in single cored solder. Guaranteed continuity of the flux stream prevents "dry" joints, i.e., those having high electrical resistance.

Although there are five cores of flux in Multicore, the total percentage of flux to solder is less than many single cored solders.

Very rapid melting results from the multiple core construction which provides thinner walls of solder than are found in the same gauge single cored solder. Multicore's unique properties make perfect joints possible on difficult metals and alloys, even if oxidized.

Ability to tin rapidly produces perfect joints with less solder. Greater coverage per pound.

Standard Wire Gauge	Diam. in Inches	Diam. in M/ms.	Approximate Number of Feet per lb. ALLOY					
			Tin content is shown first					
			60/40	50/50	45/55	40/60	30/70	20/80
10	.128	3.251	24.5	23.6	23.3	22.7	21.6	20.8
12	.104	2.643	37.2	35.7	35.2	34.6	32.7	31.5
13	.092	2.337	47.5	45.6	45	44	41.9	40.4
14	.080	2.032	62.8	60.2	59.4	58	55.2	53.2
16	.064	1.626	98	94.3	93	91	86.5	83.4
18	.048	1.219	174.5	167	165	161	154	148
19	.040	1.016	251	241	238	232	221	212
20	.036	.914	310	298	294	287	273	263
22	.028	.711	512	492	486	474	452	436

ALLOY Tin/Lead	B.S. Grade	MULTICORE Color Code	MELTING TEMPERATURES Solidus of all these alloys is 183° C.-361° F.		Recommended bit temperature	
			° C. Liquidus	° F.	° C.	° F.
60/40	K	Red	189	372	229	444
50/50	F	Yellow	214	417	254	489
45/55	(M)	Crimson/Buf	225	437	265	509
40/60	G	Green	232	450	272	522
30/70	J	White	255	491	295	563
20/80	—	Purple	275	527	315	599



"GENALEX" 2729 TUBE
A low hum, low microphonic, voltage amplifying Audio Pentode, expressly designed for use in high quality, high gain audio preamplifier and equalizer stages. Fits standard 9 pin miniature socket.

The KT66 is a versatile power tetrode with a number of useful applications. It may be used in the output stage of an audio-frequency power amplifier, either tetrode-connected for maximum sensitivity and power output, or triode-connected for high quality working. In transmitting circuits using frequencies up to 30 Mc/s it may also be used as an oscillator or as a radio frequency amplifier.
A high slope, indirectly heated beam tetrode, the KT66 is suitable for either single or push-pull audio operation and may be employed as a beam tetrode with aligned grids.



May be formed to Loudspeaker Grilles for radio and television sets, Machinery Guards, Window Display Backgrounds and Figures, Chair Seats and Hampers, Truck Bodies, Fire Screens, Lockers, Air Filters, Walkways, Flying Trays, and many other items, as well as Air Conditioner Grilles, Ventilator Grilles, Shelves, Trays, Storage Bins, and Home Accessories.

"Expamet" may be cut, formed and shaped easily without use of special tools. American aluminum specification 2S. It has also been manufactured from sheets conforming to 3S and 52S. Twelve standard sizes of mesh from 1/8" to 6" shortway of mesh.

BRITISH INDUSTRIES CORPORATION · NEW YORK 13, N. Y.

Copyright by U. C. P., Inc.

Radio's Master — 19th Edition

Page U-15

Two famous KESTER FLUX-CORE SOLDERS



KESTER "RESIN-FIVE" CORE SOLDER

Formulated especially for Radio and TV; will easily solder such metals as brass, zinc and ferrous alloys. It is non-corrosive and non-conductive.



KESTER PLASTIC ROSIN-CORE SOLDER

The most widely used solder in the TV and radio field. All Kester Solders are made from the finest tin and lead available.

- ★ Kester Plastic Rosin-Core Solder
- ★ Kester "Resin-Five" Core Solder
- ★ Kester "44" Resin-Core Solder
- ★ Kester Radio Solder
- ★ Kester Acid-Core Solder
- ★ Kester "A" Flux-Core Solder
- ★ Kester Nosput Flux-Core Solder
- ★ Kester Knorust Flux-Core Solder
- ★ Specialized Flux-Core Solders
- ★ Solid Wire and Bar Solders
- ★ Kester "Solderforms," Rings, Pellets, Washers, Unusual Shapes
- ★ External Rosin Soldering Fluxes
- ★ Other Fluxes
- ★ Kester Soldering Iron Brackets

For Peak Soldering Efficiency, It's Kester!

Kester offers every conceivable type of Solder product. Strand sizes as small as .008" diameter in Flux-Core Solder, unusual alloys and varying Flux contents or Core sizes.

A Technical Service for Manufacturers

If you are not getting peak efficiency or have a specific problem in your soldering operations, take advantage of the facilities of Kester's Technical Department. . . . It costs you nothing.

STANDARD FOR THE TV AND RADIO FIELD



KESTER SOLDER COMPANY



No. 41 • Electricians' Diagonal Pliers —

Hardened and tempered in oil. Narrow nose for radio and electrical work.

Size 4 in. 5 in. 6 in.
List Price **\$2.34 \$2.62 \$3.08**

Can be furnished with insulation stripper.

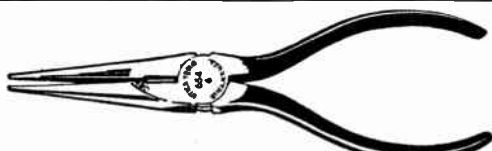

No. 654 • Utica Long Needle Nose Side Cutting Pliers

This is a long, fine, spring-tempered nose, side-cutting pliers, drop forged and with hand-honed cutting knives.

Size 6 in. 7 in.
List Price **\$3.00 \$3.50**

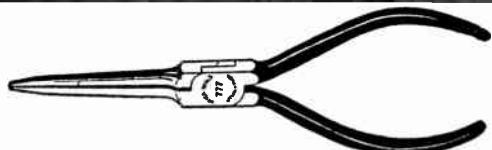

No. 777 • Utica Long Needle Nose Pliers

This pliers has a long, half-round, spring-tempered nose for very fine work in assembling small electrical apparatus.

Size 6 inches
List Price **\$2.64**

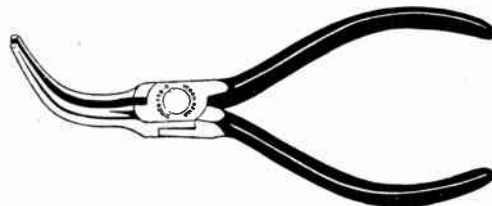

No. 776 • Curved Needle Nose Pliers —

This is a long curved spring-tempered Needle Nose Pliers for use in deep and narrow places. It may be used without turning or twisting the hand in the assembling of small fixtures, electrical apparatus, etc.

Size 6 inches
List Price **\$3.00**



No. 82 • Utica Chain Nose Wiring Pliers

This is a special Radio Repair Man's Pliers having a chain nose for those who prefer this type of construction.

Size 8 inches
List Price **\$2.80**

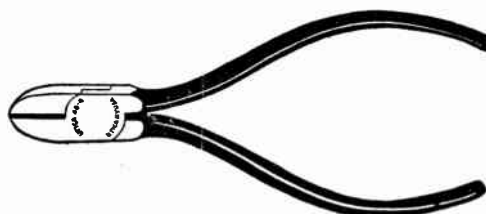

No. 46 • Midget Diagonal Pliers

A small Diagonal for radio and electrical work. Hand honed edges with a slim nose for use in cramped quarters.

Size 4 inches
List Price **\$2.50**



No. 896 • Utica Radio Pliers

This is a General Radio Repair Man's Pliers. It has a center cutter and flat scored nose for looping and bending.

Size 6 inches
List Price **\$3.60**

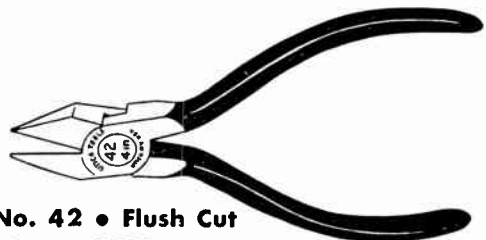

No. 42 • Flush Cut Diagonal Pliers

This is a Custom-built pliers designed for flush cutting in confined spaces. Can be furnished with spring in handle.

Size 4 inches
List Price **\$4.80**

NEW
VACO
Individually Tested
PLIERS

- Milled jaws for sure grip
- Hand honed side cutters
- Fitted grip handles
- Unconditional factory guarantee

24 Popular Styles from Which to Choose

Short Needle Nose Plier with Cutter

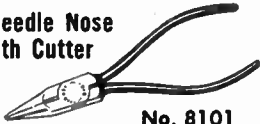

No. 8101 5"

This plier is intended for general use where a short nose is desired for getting into difficult places

Long Needle Nose Plier with Cutter

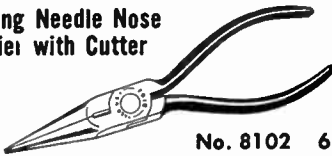

No. 8102 6"
No. 8103 7"

An exceptional handy and useful plier, well proportioned with long thin nose, designed for reaching into tight places

Curved Needle Nose Plier

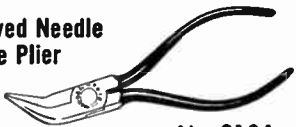

No. 8104 6"

A long, bent, thin nose plier. The angle is arranged to give full clearance and prevent skinning of knuckles.

Long Nose Plier

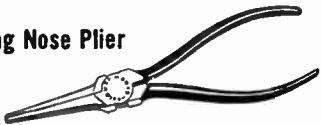

No. 8105 6"

Newly designed long nose plier suitable for working in confined places.

Long Reach Needle Nose Plier

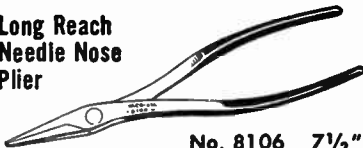

No. 8106 7 1/2"

Has long, thin, sure-grip jaws to reach into places where fingers and ordinary pliers will not go.

Diagonal Cutting Plier

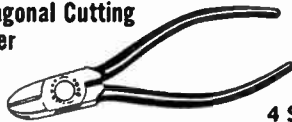

4 Sizes

No. 8201 4 1/2" No. 8203 6"
No. 8202 5" No. 8204 7 1/2"

Specially designed for electricians, radio and TV service men and automotive mechanics. Powerful jaws cut close and quickly

Heavy Duty Diagonal Cutting Plier

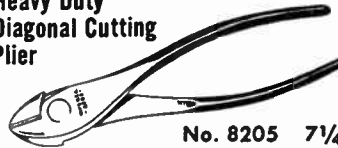

No. 8205 7 1/4"

One of the most powerful diagonal pliers made. Long handles give a 20 to 1 ratio of leverage to cut with minimum effort.

Heavy Duty Linemen's Side Cutting Plier



No. 8301 6 1/4"
No. 8302 7 1/2" No. 8303 8 3/4"

One of the most popular pliers in use today. Has extra powerful leverage and reinforced cutting knives.

Heavy Duty Slip Joint Plier



No. 8401 6 1/2"
No. 8402 8"

A top quality slip joint combination plier. Has all the quality features of higher priced cutting pliers at modest cost.

Heavy Duty Slip Joint Plier with Cutter



No. 8403 7 1/2"

This plier incorporates the best features of a regular side cutter with the versatility of a slip joint combination plier.

Long Flat Nose Plier with Cutter

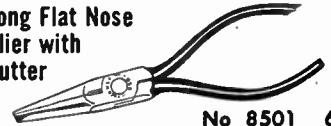

No. 8501 6"

Extra long, wide, flat nose makes this an especially useful tool. Plier is tempered so jaw will not spring under pressure

Long Flat Nose Plier

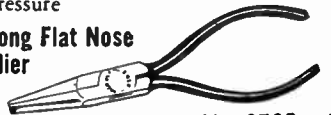

No. 8502 6"

Same as No. 8501 except supplied without cutter

Long Reach Flat Nose Plier



No. 8503 7 1/2"

Fitted with duckbill type jaws wider and heavier than those of the ordinary flat nose for firmer gripping service.

VACGRUV Adjustable Ignition Plier Wrench, Chrome Plated



No. 8601 5"

Especially designed 3-position jaws accommodate small to medium large nuts, bolts, etc. Fine for delicate radio and TV work.

VACGRUV Adjustable Plier Wrench, Chrome Plated



No. 8602 6"
No. 8603 8"

Built to provide an especially secure grip on medium to large bolts, nuts, pipes, etc. 3-position jaws open to 3/8", 3/4", respectively

VACGRUV Adjustable Plier Wrench, Chrome Plated



No. 8604 10"

A general purpose, heavy duty tool with 3-position jaws that open to 1 1/8". Doubles as pipe wrench, gripping plier and hand vise.

VACO PRODUCTS CO., 317 E. Ontario St., Chicago 11, Illinois

Warehouse Branches in Principal Cities
In Canada: Vaco-Lynn Products (of Canada) Ltd.

VACO

BREAK-PROOF
SHOCK-PROOF

Screw Drivers

- Chrome Vanadium Steel Blades
- Fire-Safe Ambery Shock and Break-Proof Handles

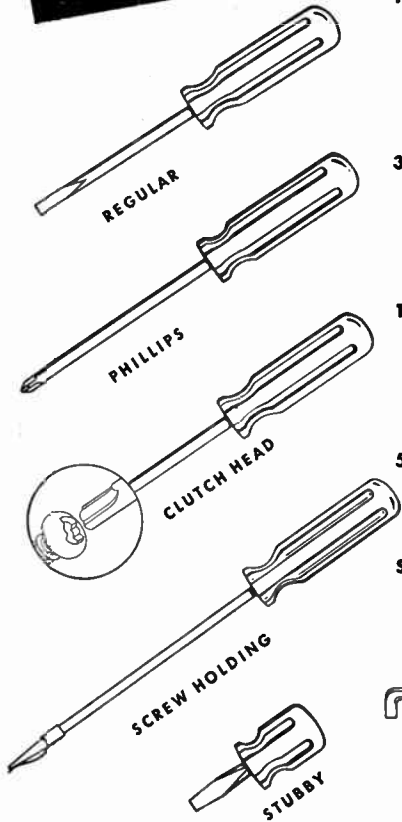

1/8" Cabinet Style—Round Blades

Stock Number	Blade Diameter and Length
A 216-4	1/8"x4"
A 216-6	1/8"x6"
A 216-8	1/8"x8"
A 216-10	1/8"x10"

3/16" Cabinet Style—Round Blades

Stock Number	Blade Diameter and Length
A 316-4	3/16"x4"
A 316-5	3/16"x5"
A 316-6	3/16"x6"
A 316-8	3/16"x8"
A 316-10	3/16"x10"

1/4" General Service—Round Blades

Stock Number	Blade Diameter and Length
A 416-4	1/4"x4"
A 416-5	1/4"x5"
A 416-6	1/4"x6"
A 416-8	1/4"x8"
A 416-10	1/4"x10"

5/16" Heavy Duty—Round Blades

Stock Number	Blade Diameter and Length
A 516-6	5/16"x6"
A 516-8	5/16"x8"
A 516-10	5/16"x10"

Stubbys

A 132	1/4"x1-1/4"
A 135	5/16"x1-3/4"

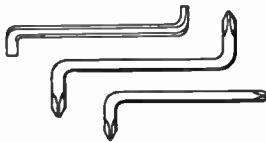

Offset Screw Drivers

Stock No.	Type	Blade
VO 1	Regular	5/32"x3"
VO 2	Regular	1/4"x4"
P 120	Phillips	#1 point one end, #2 point other end
P 111	Phillips	#1 point both ends
P 222	Phillips	#2 point both ends

Phillips Drivers

Stock Number	Point No. and Length	Blade Diam. and Length
P 01	0	1/8"x2-1/2"
P 1	1	3/16"x3"
P 2	2	1/4"x4"
P 3	3	5/16"x6"
P 5 (Stub)	2	1/4"x1-3/4"
P 6 (Stub)	1	3/16"x1-1/4"
P 12 (Pocket Clip)	1	1/8"x2-1/2"

Clutch Head Drivers

Stock Number	Bit Point Diameter and Blade Length
CH 43	1/8"x3"
CH 54	5/32"x4-1/4"
CH 64	3/16"x4-1/4"
CH 86	1/4"x6"
CH 106	5/16"x6"

Stub Styles

CH 51	5/32"x1-1/2"
CH 61	3/16"x1-1/2"

Screw Holding Drivers

Stock Number	Blade Diam. & Length
OK 23	1/8"x3"
OK 24	1/8"x4"
OK 26	1/8"x6"
OK 28	1/8"x8"
OK 34	3/16"x4"
OK 36	3/16"x6"
OK 38	3/16"x8"

NUT DRIVERS

S 700

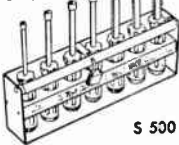

S 500



Wall or Bench Stand Nut Driver Sets . . . 3/16" to 1/2"

Stock No.	Contains:
S 700	7 Nut Drivers, Color Coded Handles
S 500	5 Standard Nut Drivers

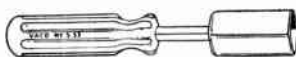

Electrolytic Condenser Nut Wrenches

Stock No.	Takes Size:
S 32	31/32"
S 34	1"
S 36	1-5/32"

Deluxe Super Hard Nut Drivers (Color Coded)

Stock No.	Hexagon Size (Across Flats)	Overall Length	Color Code
S 61	3/16"	6-3/4"	Brown
S 82	1/4"	6-3/4"	Red
S 103	5/16"	6-3/4"	Green
S 114	11/32"	6-3/4"	Ivory
S 125	3/8"	6-3/4"	Blue
S 146	7/16"	6-3/4"	Orange
S 167	1/2"	6-3/4"	Yellow

All Hollow Shaft Nut Drivers

Stock No.	Hexagon Size (Across Flats)	Handle Diam. and Length	Overall Length
S 160	1/2"	1"x3-5/8"	7"
S 180	9/16"	1"x3-5/8"	7"

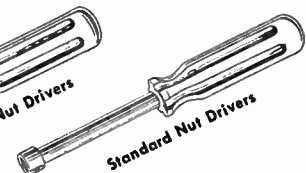
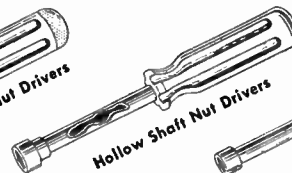
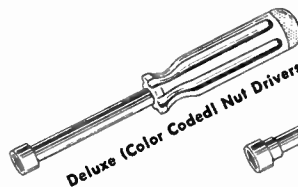

Standard Extra Hard Nut Drivers

Stock Number	Hexagon Size (Across Flats)	Overall Length
S 5	5/32"	6-3/4"
S 6	3/16"	6-3/4"
S 7	7/32"	6-3/4"
S 8	1/4"	6-3/4"
S 9	9/32"	6-3/4"
S 10	5/16"	6-3/4"
S 11	11/32"	6-3/4"
S 12	3/8"	6-3/4"
S 14	7/16"	6-3/4"
S 15	15/32"	6-3/4"
S 16	1/2"	6-3/4"

Extra Large Size

S 17	17/32"	8"
S 18	9/16"	8"
S 19	19/32"	8"
S 20	5/8"	8"

Beryllium Copper Drivers



Round Blade, Non-Spark, Non-Magnetic

Stock Number	Blade Diameter and Length
VB 26	1/8"x6"
VB 210	1/8"x10"
VB 38	3/16"x8"
VB 46	1/4"x6"
VB 48	1/4"x8"

Insulated Blade Screw Drivers



VR 241	1/8"x4"
VR 261	1/8"x6"
VR 281	1/8"x8"
VR 361	3/16"x6"
VR 381	3/16"x8"

Non-Metallic Radio and TV Aligners



Bone Fiber Blade

AT 55	5/32"x5"
AT 510	5/32"x10"

Non-Magnetic Metal Tip Radio and TV Aligner



Stock Number	Body Size	Bit Diameter	Capacitance
AT 45	3/8"x5-1/2"	3/16"	Slight

Neon Light Screw Drivers

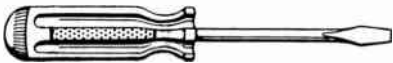

Stock Number	Blade Diameter and Length
AN 44	1/4"x4"
AN 2 (Pocket Clip)	1/8"x3"

Duplex "Reversible" Drivers

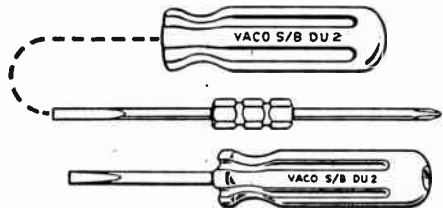

Stock Number	Blade Size and Type
DU 2	No. 1 Phillips, One End 3/16" Regular, Other End
DUH 4	No. 2 Phillips, One End 1/4" Regular, Other End
DUP 12	No. 1 Phillips, One End No. 2 Phillips, Other End

VACO RADIO and TV KITS



ZBX 51

ZBX 51 Screw Driver Kit

A fine, all-purpose kit of interchangeable regular and Phillips blades that fit same handle. 6" extension makes 10 combinations possible. In durable leatherette bag.



ZSX 61

ZSX 61 Nut Driver Kit

A most versatile and complete hexagon wrench kit for radio, television or any other work requiring speedy nut setting. All sockets are super hard for maximum utility and long life. 6" extension makes 10 blade lengths possible. In handy leatherette tool roll.



ZA 70

ZA 70 Allen Driver Kit

This useful kit consists of 6 hexagon drivers, handle and bag. Will service hexagon recessed opening screws Nos. 4, 5, 6, 8, 10, 1/4", 5/16" and 3/8". Each bit is extra long and may ground back as wear occurs.



ZU 75

ZU 75 Universal Driver Kit

Here is a kit that is universal in its applications since it will serve all three types of the most popular screws in use today—regular slotted, Phillips, and clutch head. All popular size blades are included—3/16" and 1/4" for regular slotted screws; No. 1 and No. 2 Phillips; 5/32" x 3/16" clutch head.

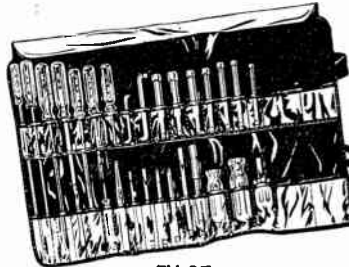

TV 27

27-Piece TV and Radio Kit

NO. TV 27 KIT—Contains practically every hand tool necessary for television and radio work, plus extra pockets for pliers and other personal tools according to individual preferences. Contains one each of the following: ZH 1 medium duty handle; ZH 2 heavy duty handle; ZX 56 extension; A 132 1/4" stub; 1/4", 3/16", 1/8" regular bits; No. 1 Phillips and No. 2 Phillips bits; 3/16", 1/4", 5/16", 11/32", 3/8", 7/16" and 1/2" hex. wrenches; AT 45 metal tip aligner; AT 116-2 3/32" pocket clip; P 01 #0 Phillips thin blade; OK 24 1/8" screw holding; VR 261 1/8" insulated blade; OK 38 3/16" screw holding; VR 381 3/16" insulated blade; VB 210 1/8" x 10" non-magnetic adjuster; AT 510 5/32" fiber aligner; VO 2 medium offset; VO 1 small offset.



RT 14

14-Piece TV and Radio Kit

NO. RT 14 KIT—Here's a handy, convenient kit for radio and TV service men. Contains nut drivers, Phillips and regular drivers, plus ZH 2 heavy duty handle and famous Vaco 6" extension which doubles the usefulness of each driver. In durable leatherette tool roll.

VACO PRODUCTS CO., 317 E. Ontario St., Chicago 11, Illinois

Warehouse Branches in Principal Cities

In Canada: Vaco-Lynn Products (of Canada) Ltd.

LYNN Lightning Solderless Terminals by VACO

Wide Assortment of Solderless Terminals for General Use, Radio and TV

No. 2195 Service Kit

A GENERAL PURPOSE ELECTRICAL, RADIO AND TV KIT containing everything needed for making clean, fast, trouble-free electrical connections. No soldering! No fuss or muss! Kit includes . . . No. 1900 Crimping Tool and Terminals Nos. 2300, 2301, 2302, 2400, 2401, 2402, 2600, 2601, 2602, and 3300 . . . all in a clear plastic box with tight-fitting lid. Individual bins marked with terminal stock number cards.

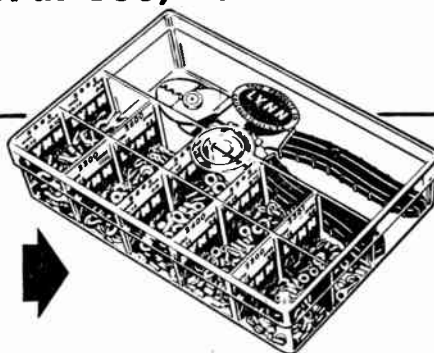

No. 1900 Crimping Tool

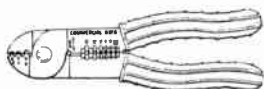

No solder . . . no iron . . . no heating . . . a perfect connection every time with this tool and Lynn Lightning Solderless Terminals by Vaco! Crimping tool has wire cutters, indenting die, wire-stripping die, shock-proof, slip-proof plastic handle sleeves. For No. 22 to No. 10 gauge wire.

Only 3 SIMPLE STEPS and Terminal Is On



1. Cut Wire. Use the wire cutter built into the crimping tool to cut wire proper length.



2. Strip Wire. Insert end of wire into proper wire stripping opening, close jaws, rotate tool one-half turn, then pull insulation off wire.



3. Crimp Terminal. Insert stripped portion of wire into terminal barrel, place barrel in proper crimping nest with seam directly opposite crimping tooth and close tool like pliers.

Extra long barrel on terminal provides easy crimp and perfect contact. Only ONE crimp necessary. Barrel always remains round.

Quick Reference Chart for Easy Terminal Identification

RING TONGUE TERMINALS

No. 2300 Hole Dio. — 5/32" Stud Size — 4 - 6 Wire Size — 22 - 16	No. 2301 Hole Dio. — 5/32" Stud Size — 4 - 6 Wire Size — 22 - 16	No. 2302 Hole Dio. — 13/64" Stud Size — 8 - 10 Wire Size — 22 - 16	No. 2303 Hole Dio. — 17/64" Stud Size — 12 - 1/4 Wire Size — 22 - 16	No. 2304 Hole Dio. — 13/32" Stud Size — 3/8 Wire Size — 22 - 16	No. 2400 Hole Dio. — 5/32" Stud Size — 4 - 6 Wire Size — 16 - 14	No. 2401 Hole Dio. — 5/32" Stud Size — 4 - 6 Wire Size — 16 - 14
No. 2402 Hole Dio. — 13/64" Stud Size — 8 - 10 Wire Size — 16 - 14	No. 2403 Hole Dio. — 17/64" Stud Size — 12 - 1/4 Wire Size — 16 - 14	No. 2404 Hole Dio. — 13/32" Stud Size — 3/8 Wire Size — 16 - 14	No. 2502 Hole Dio. — 13/64" Stud Size — 8 - 10 Wire Size — 12 - 10	No. 2503 Hole Dio. — 17/64" Stud Size — 12 - 1/4 Wire Size — 12 - 10	No. 2504 Hole Dio. — 13/32" Stud Size — 3/8 Wire Size — 12 - 10	

SPADE TONGUE TERMINALS

No. 2600 Slot Dio. — 5/32" Stud Size — 4 - 6 Wire Size — 22 - 16	No. 2601 Slot Dio. — 5/32" Stud Size — 4 - 6 Wire Size — 16 - 14	No. 2602 Slot Dio. — 13/64" Stud Size — 8 - 10 Wire Size — 16 - 14	No. 2702 Slot Dio. — 13/64" Stud Size — 8 - 10 Wire Size — 12 - 10

FLAG TYPE TERMINALS

No. 2802 Hole Dio. — 13/64" Stud Size — 8 - 10 Wire Size — 22 - 16	No. 2902 Hole Dio. — 13/64" Stud Size — 8 - 10 Wire Size — 16 - 14	No. 3002 Hole Dio. — 13/64" Stud Size — 8 - 10 Wire Size — 12 - 10

HOOK TYPE TERMINAL

No. 3300 Slot Dio. — 5/32" Stud Size — 4 - 6 Wire Size — 22 - 16

BUTT CONNECTORS

No. 3101 Wire Size — 22 - 16	No. 3102 Wire Size — 16 - 14	No. 3103 Wire Size — 12 - 10

CONVENIENT \$ PAK



All Lynn Lightning Terminals are available in convenient \$ Paks. When any of the "bins" of the service kit are empty, user merely purchases a refill just right for replacing stock. Refill Paks are well marked for trouble-free handling, and designed with "window" for easy identification.

BULK PAK



Also available in bulk-packed 250 pieces to a package, 4 packages to master carton of 1,000.

VACO PRODUCTS CO. • 317 East Ontario Street • Chicago 11, Illinois, U.S.A.

Quality

XCELITE

Tools

REG. TRADE MARK

**FOR PINPOINT
FOCALIZER
ADJUSTMENT**

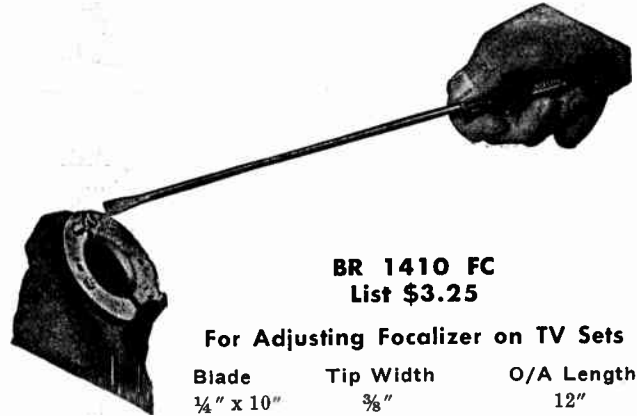

BR 1410 FC
List \$3.25

For Adjusting Focalizer on TV Sets

Blade	Tip Width	O/A Length
1/4" x 10"	3/8"	12"

XCELITE

BERYLLIUM-COPPER SCREWDRIVERS

- Non-magnetic — no disturbance to television image
- Blade needs no continual regrinding as with fibre or plastic
- Better fatigue resistance than steel
- Long 10" shanks to reach into chassis — wide tapered blade to fit adjustment screw snugly

Other Beryllium Copper Sizes

BR186	1/8" x 6	List \$1.25
BR1810	1/8" x 10	List 1.35
BR3168	1/8" x 8	List 2.20
BR146	1/4" x 6	List 2.75
BR148	1/4" x 8	List 2.95

ROUND BLADES



Number	Size Blade	List	Weight Box of 10
**R-3322	3/32" x 2"	\$0.30	1/2 lb.
*R-3323	3/32" x 3"	.40	1/2 lb.
*R-3324	3/32" x 4"	.40	1/2 lb.
**R-181	1/8" x 2"	.30	1/2 lb.
*R-183	1/8" x 3"	.40	1/2 lb.
*R-184 1/2	1/8" x 4"	.40	1/2 lb.
R-182	1/8" x 2"	.50	1/2 lb.
††R-184	1/8" x 4"	.55	1/2 lb.
††R-186	1/8" x 6"	.60	3/4 lb.
††R-188	1/8" x 8"	.70	1 lb.
††R-1810	1/8" x 10"	.80	1 lb.
R-5323	5/32" x 3"	.65	1 lb.
R-5324	5/32" x 4"	.65	1 lb.
R-5325	5/32" x 5"	.65	1 lb.
R-5328	5/32" x 8"	.80	1 1/4 lb.
R-3163	1/8" x 3"	.75	1 1/2 lb.
R-3164	1/8" x 4"	.80	1 1/2 lb.
R-3166	1/8" x 6"	.95	1 3/4 lb.
R-3168	1/8" x 8"	1.00	1 3/4 lb.
R-31610	1/8" x 10"	1.15	2 lb.
R-142	1/4" x 2"	.95	1 3/4 lb.
R-144	1/4" x 4"	1.00	2 lb.
R-146	1/4" x 6"	1.05	2 1/4 lb.
R-148	1/4" x 8"	1.15	2 1/2 lb.
R-1410	1/4" x 10"	1.25	2 3/4 lb.
R-5164	1/8" x 4"	1.25	2 1/2 lb.
R-5166	1/8" x 6"	1.35	3 1/2 lb.
R-5168	1/8" x 8"	1.45	4 lb.

4 ea.
on 332
Display
4 ea.
used on
#12 Dis-
play

- **24 of this number used on # 24 display.
- *These numbers have 1/2" dia. handles.
- ††These numbers have 3/4" dia. handles. For insulated blades any size add 35 cents to list price.

SQUARE BLADES



Number	Size Blade	List	Weight Box of 10
S-183	1/8" x 3"	\$0.60	1/2 lb.
S-184	1/8" x 4"	.60	1/2 lb.
S-185	1/8" x 5"	.60	1/2 lb.
S-3163	1/8" x 3"	.90	1 3/4 lb.
S-3164	1/8" x 4"	.95	1 3/4 lb.
S-3166	1/8" x 6"	1.10	2 lb.
S-3168	1/8" x 8"	1.20	2 lb.
S-31610	1/8" x 10"	1.30	2 1/4 lb.
S-142	1/4" x 2"	1.10	1 3/4 lb.
S-144	1/4" x 4"	1.15	2 lb.
S-146	1/4" x 6"	1.20	2 1/2 lb.
S-148	1/4" x 8"	1.35	3 lb.
S-5162	1/8" x 2"	1.15	2 lb.
S-5164	1/8" x 4"	1.35	3 1/4 lb.
S-5166	1/8" x 6"	1.45	3 3/4 lb.
S-5168	1/8" x 8"	1.55	4 1/4 lb.
S-51610	1/8" x 10"	1.70	4 3/4 lb.
S-51612	1/8" x 12"	1.85	5 1/4 lb.
S-388	3/8" x 2"	1.90	6 lb.
††S-3812	3/8" x 12"	2.75	1 1/4 lb.
††S-3818	3/8" x 18"	3.00	1 1/4 lb.
††S-7166	1/8" x 6"	2.25	1 1/4 lb.
††S-71612	1/8" x 12"	2.75	1 1/4 lb.
††S-71618	1/8" x 18"	3.00	1 1/4 lb.
S-1424	1/4" x 24"	2.50	1 1/4 lb.

1
in
box

Stubbies

S-3161	1/8" x 1"	\$0.65	3/8 lb.
S-141	1/4" x 1"	.75	1 1/4 lb.
S-5161	1/8" x 1"	.75	1/4 lb.

††Large double grip handles.

Quality

XCELITE

Tools

REG. TRADE MARK



Inset shows how wedging action of screwdriver tip holds screw.

SCREW HOLDERS



Slips up the shaft out of the way when not in use.

A Revolutionary Screw Holder that works on YOUR screwdriver.

No. 99-71 REAMER



Super Hard and Super Tough. The 99-71 Reamer is designed to fit the 99-1 Handle. Intended for use on wood, plastic or sheet metal. Reams from 1/8" to 3/8".

- No. 99-71 —Reamer only \$1.65 List
- No. 99-71H—Complete with detachable handle..... \$2.65 List

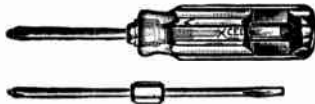

INDIVIDUAL Blade Combinations

(Please Order by Number)

- No. 1—No. 1 Phillips and 1/8" Xcelite
- No. 2—No. 2 Phillips and 1/4" Xcelite
- No. 3—No. 3 Phillips and 3/8" Xcelite

COMPLETE

(Regular Type) List Price

BLADES ONLY

(Regular Type) List Price

- No. CR1.....\$1.90
- No. CR2.....1.90
- No. CR3.....1.90
- No. RB1.....\$1.05
- No. RB2.....1.05
- No. RB3.....1.05

HANDLES ONLY

- No. 25 Regular.....\$0.85

STUBBY TYPE

"Combination-Detachable" Screwdrivers



COMPLETE

(Stubby Type)

BLADES ONLY

(Stubby Type)

- No. CS1.....\$1.70
- No. CS2.....1.70
- No. SB1.....\$0.90
- No. SB2......90

HANDLES ONLY

- No. 26 Stubby.....\$0.80

Made from tempered spring steel. This new device holds, starts and removes screws in hard-to-reach places.

- SH2—For 1/8" Round Shank Screwdrivers.....25c List
- SH4—For 1/4" Round Shank Screwdrivers.....25c List

ROLL KIT Combinations

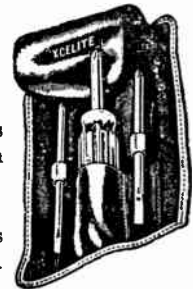

No. CK-3 . . . \$4.70 List. Contains RB-1, RB-2, RB3 and Combination Handle.

No. CK-2 . . . \$3.65 List. Contains RB-1, RB2 and Combination Handle.

Xcelite-Phillips

No.	Point Size	Length Blade	Diameter Blade	Box of Ten Weight	List Price
X-108	1	6"	1/8"	1 1/2 lbs.	\$1.15
X-101	1	3"	1/8"	1 1/4 lbs.	1.05
X-102	2	4"	1/4"	2 lbs.	1.35
X-103	3	6"	1/8"	3 1/2 lbs.	1.80
X-104	4	8"	3/8"	5 1/4 lbs.	2.25
X-1010	1	10"	1/8"	2 lbs.	1.60
X-1020	2	10"	1/4"	3 lbs.	1.80

SHORT STUBBY TYPE

SX-101	1	1/8"	7/8 lbs.	1.00
X-102	2	1/4"	1 1/4 lbs.	1.10

POCKET CLIP STYLE

P12S	0	2"	1/8"	1/2 lb.	.50
------	---	----	------	---------	-----



XCELITE Clutch Head Screwdrivers

Type G No.	Type A No.	Size	Diameter Blade	Length Blade	List Price Each
G-3324	—	3/32"	1/8"	4"	\$1.20
G-183	A-183	1/8"	1/8"	3"	1.20
G-5324	A-5324	3/32"	1/4"	4"	1.32
G-3164	A-3164	1/8"	1/4"	4"	1.32
G-146	A-146	1/4"	1/4"	6"	1.75
G-5166	A-5166	1/8"	3/8"	6"	2.15

Note: Both above types are the same size and the same price. Order by Number.

Quality

XCELITE

Tools

REG. TRADE MARK

ALL NUT DRIVERS and NUT DRIVER SETS NOW WITH COLOR CODED HANDLES



6" Overall Length

Number	Handle Color	Hex Opening	List
6	Black	7/8"	\$0.95
7	Brown	7/8"	.95
8	Red	7/8"	.95
9	Orange	7/8"	.95
10	Yellow	7/8"	.95
11	Green	7/8"	.95
12	Blue	7/8"	.95
14	Brown	7/8"	1.25
16	Red	7/8"	1.25

9" Overall Length

Number	Handle Color	Hex Opening	List
A-6	Black	7/8"	\$1.15
A-7	Brown	7/8"	1.15
A-8	Red	7/8"	1.15
A-9	Orange	7/8"	1.15
A-10	Yellow	7/8"	1.15
A-11	Green	7/8"	1.15
A-12	Blue	7/8"	1.15
A-14	Brown	7/8"	1.50
A-16	Red	7/8"	1.50

STUBBIES

3 1/4" Overall Length

Number	Handle Color	Hex Opening	List
S-8	Red	1/4"	\$0.80
S-10	Yellow	3/8"	.80
S-12	Blue	3/8"	.80

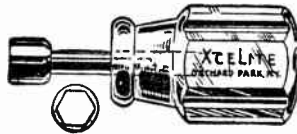

HOLLOW SHAFT NUT DRIVERS



No. and Length Overall	Hex Open.	Handle Color	Depth of Hole	List	Insulated List
HS-8 6"	1/4"	Red	5"	\$1.25	\$1.60
HS-10 6"	3/8"	Yellow	5"	1.25	1.60
HS-11 6"	3/8"	Green	5"	1.25	1.60
HS-12 6"	3/8"	Blue	5"	1.25	1.60
HS-14 7"	1/2"	Brown	5"	1.40	1.75
HS-16 7"	1/2"	Red	5"	1.45	1.80
HS-18 7"	1/2"	Orange	5"	1.50	1.85
HS-20 7"	1/2"	Yellow	5"	1.75	2.10

No. 99 PR MULTI-PURPOSE SET

CONTENTS

- 99-1 Multi-Purpose Handle
- 99-82 Reversible Phillips Blade
- 99-81 Screwdriver Blade
- 99-6-7-8-9-10-11-12-14-16

Nut Drivers

ACCESSORIES

- 99-71 1/8" to 1/8" Reamer
- 99-83 Reversible Reed and Prince Blade

Number	Description	List
99	Comb. Set in Metal Box	Temp. Disc.
99-PR	Comb. Set in Plastic Roll	\$11.95
99-1	Handle	1.00
99-6 through 99-12	Nut Drivers	.75
99-14	Nut Driver	1.00
99-16	Nut Driver	1.00
99-71	Reamer	1.65
99-81	Reversible Screw Driver	1.25
99-82	Reversible Phillips	1.25
99-83	Reversible Reed & Prince	1.25

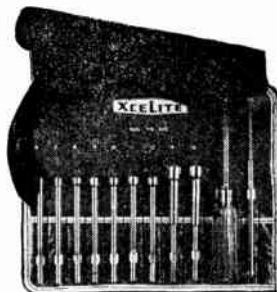

No. 127 Set

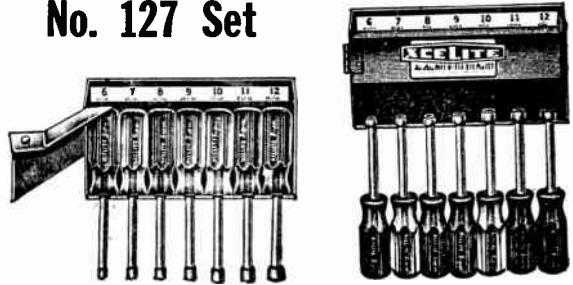

- COLORED HANDLES FLASH SIZE!
- NEW LARGER HANDLES — BRIGHTER COLORS
- Set contains Nos. 6, 7, 8, 9, 10, 11, and 12. Furnished in either full polished or chrome finish.
- Sturdy metal holder in red wrinkle finish.

Individual Drivers, Polished	\$0.95
Chrome	1.05
No. 127—Polished Finish	7.85
No. 127C—Chrome Plated	8.75
No. 77—Nutdriver Set. Same as 127 Set, except in Yellow Plastic Carrying Kit.	
No. 77—Polished Finish	7.85
No. 77C—Chrome Plated	8.75

NO. 137 NUT DRIVER SET

Consisting of:

No.	Handle Color	Hex Open.	Pol.	Chr.	List
6	Black	7/8"	\$.95	\$1.05	
8	Red	1/4"	.95	1.05	
10	Yellow	1/8"	.95	1.05	
11	Green	1/4"	.95	1.05	
12	Blue	3/8"	.95	1.05	
HS-16	Red	1/2"	1.45	1.60	
HS-18	Orange	1/8"	1.50	1.65	



No. 137—Polished Finish	\$8.95
No. 137C—Chrome Plated	9.95

NO. 17 NUT DRIVER SET

Colored Handles — Highly Polished Blades

Consisting of:

No.	Handle Color	Hex Opening
6	Black	1/4"
7	Brown	3/8"
8	Red	1/4"
9	Orange	3/8"
10	Yellow	1/8"
11	Green	1/4"
12	Blue	3/8"

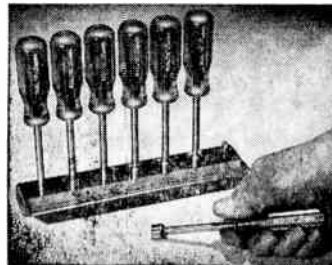

No. 17
Polished Finish
\$7.20

No. 17C
Chrome Plated
\$8.10

Quality

XCELITE

Tools

REG. TRADE MARK

XCELITE QUALITY PLIERS

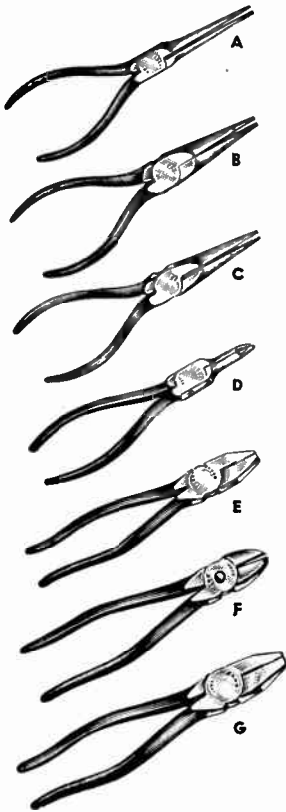

No. 56 6-in. Needle Nose Plier (Fig. A)—Long slim jaws permit entry of this plier where a regular long nose plier won't work. Weight per pkg. of 6, 1 1/4 lbs. **\$270**

No. 52 Long Nose Plier (Without Side Cutters) (Fig. B)—Long perfectly matching tips are ideal for gripping and twisting in awkward places. Weight per pkg. of 6, 2 lbs. **\$240**

No. 51 Long Nose Plier (With Side Cutters) (Fig. C)—The same rugged strength and long reach as No. 52 Long Nose Plier above plus side cutters. Weight per pkg. of 6, 2 lbs. **\$310**

No. 58 Radio and TV Plier (Fig. D)—Designed for radio and TV servicemen. Extreme tip for gripping with sharp cutting edges 1/4 in. back from tip. Invaluable in many applications. Weight per pkg. of 6, 2 1/2 lbs. **\$370**

No. 60 6-in. Side Cutting Plier (Fig. E)—This plier has the "just right" size required for most side cutting operations. Serrated upper and lower jaws for gripping and hand honed cutting edges. Weight per pkg. of 6, 3 1/2 lbs. **\$270**

No. 67 7-in. Diagonal Plier (Fig. F)—A rugged plier with all the leverage required for even the heaviest applications. Hand honed cutting edges stand up under tough cutting conditions. Weight per pkg. of 6, 3 1/2 lbs. **\$340**

No. 68 8-in. Side Cutting Plier (Fig. G)—The big brother to No. 60 above. Designed for the man-sized big job where heavy grip and leverage is needed. Ideal for cutting heavy wire. Weight per pkg. of 6, 5 lbs. **\$340**

No. 54 Midget 4-in. Diagonal Plier (Fig. H)—The ideal plier for close quarter work. For servicemen, electricians and hobbyists. Weight per pkg. of 6, 1 lb. **\$260**

No. 49 Shear Action Snips (Fig. I)—Shear action permits trimming of small leads where diagonal cutting pliers can't go. Weight per pkg. of 6, 1 lb. **\$310**

No. 55 5-in. Diagonal Plier (Fig. J)—Ideal for most cutting needs. Hand honed cutting edges cut through medium wire with ease. Weight per pkg. of 6, 1 1/2 lbs. **\$270**

No. 66 6-in. Diagonal Plier (Fig. K)—An all purpose plier heavier than No. 55 above. Small enough for most jobs, but it has a grip for the tough ones. Weight per pkg. of 6, 2 1/2 lbs. **\$310**

No. 59 Chain Nose Electricians Plier (Fig. L)—Long reach and high leverage are combined. Slim enough to go into a small space, rugged enough to stand the pressure for tough electrical jobs. Weight per pkg. of 6, 2 1/2 lbs. **\$290**

No. 64 10-in. Standoff Insulator Plier (Fig. M)—Grooving on lower jaw and recess in upper jaw make this the ideal tool for opening and closing standoff insulators. Forged ribbed lock design for strength plus high leverage. **\$350**

No. 64 10-in. Standoff Insulator Plier—List Price

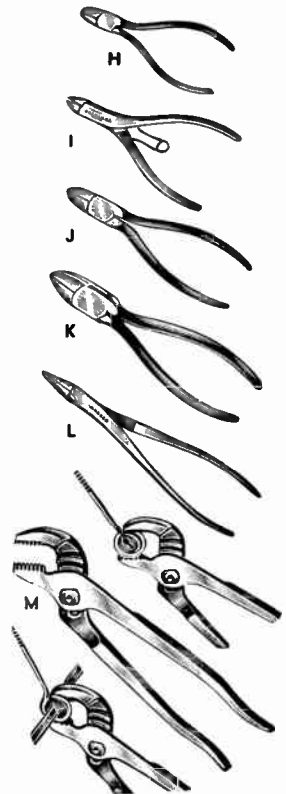

No. 63 10-in. Utility Plier (not illustrated)—Same as No. 64 except without grooving on lower jaw or recessing on upper jaw.

LIST PRICE \$2.95



- BETTER GRIP! Movable jaws has wide bearing surface!
- THIN PATTERN designed by mechanics for mechanics to get into hard-to-reach places!
- EASY TURNING KNURL for quick adjustment.
- AN IDEAL TOOL for securing antenna mounts!
- STRONG! Drop forged from chrome alloy steel!

No.	Size	Wgt. Box of 6	List
44	4"	7/8 lb.	\$2.05
46	6"	2 lbs.	2.10
48	8"	3 3/4 lbs.	2.40
40-10	10"	6 lbs.	3.15
40-12	12"	9 lbs.	4.55

No. 50 5-in. Ignition Plier (Fig. N)—Narrow head. Three slip joint adjustments. Chrome plated.



LIST PRICE \$1.50

No. 53 6-in. Water Pump Plier (Fig. O). A husky all purpose plier with three slip joint positions, serrated jaws. Chrome plated.



LIST PRICE \$1.80



KRAEUTER

The choice of skilled mechanics



"GRIPTITE" COMBINATION PLIERS

The finest quality combination pliers, designed for heavy duty. Wire cutting notch.

No.	Length	Finish	Wt. per doz.	List Each
356	5½ in.	Full Nickel	3½ lbs.	\$1.95
356	6 in.	Full Nickel	5¼ lbs.	2.20
356	8 in.	Full Nickel	8¾ lbs.	2.75
356	10 in.	Full Nickel	14 lbs.	3.30



THIN NOSE COMBINATION PLIERS

The tapered jaws and thin nose will reach and grip objects in confined areas. With wire cutters.

No.	Length	Finish	Wt. per doz.	List Each
40	6 in.	Nickel Plated	4¼ lbs.	\$1.65



TONGUE-N-GROOVE JOINT PLIERS

Forged fins and grooves. Five parallel adjustments, with working capacity ranging from ⅜" to 1½".

No.	Length	Finish	Wt. per doz.	List Each
710	10 in.	Polished	9 lbs.	\$2.85



IGNITION PLIERS

Very narrow head, serrated gripping teeth and well shaped handle grips. Three slip joint positions.

No.	Length	Finish	Wt. per doz.	List Each
643	5 in.	Blue Temper	1 lb.	\$1.90



ELECTRICIANS' SIDE CUTTING PLIERS

Used extensively in electric wiring. Very popular with mechanics on production and general repair work.

No.	Length	Finish	Wt. per doz.	List Each
1830	4 in.	Blue Temper	1½ lbs.	\$2.35
1830	5 in.	Blue Temper	2¼ lbs.	2.50
1830	6½ in.	Blue Temper	4¾ lbs.	2.75
1830	7 in.	Blue Temper	6¾ lbs.	3.00
1830	8 in.	Blue Temper	8¼ lbs.	3.40



SHORT JAW DUCK BILL PLIERS

Short flat nose — long handles, for greater leverage. Milled jaws. Inside length 1¾" tapering to flat nose.

No.	Length	Finish	Wt. per doz.	List Each
51	8 in.	Blue Temper	5 lbs.	\$2.70



Short pointed nose, long handles for added leverage. Milled jaws, inside length 1¾" tapering to ⅛" at points.

No.	Length	Finish	Wt. per doz.	List Each
61	8 in.	Blue Temper	4¾ lbs.	\$2.80



The long handles provide maximum reach for the slender jaws to cut small wires in confined work areas.

No.	Length	Finish	Wt. per doz.	List Each
71	8 in.	Blue Temper	4¾ lbs.	\$3.75

THIS IS ONLY A PARTIAL LISTING OF KRAEUTER TOOLS . . . SEND FOR CATALOG



KRAEUTER

The choice of skilled mechanics

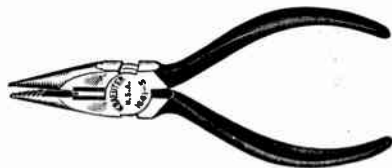

SHORT CHAIN NEEDLE NOSE PLIERS

Short nose, extra leverage. Used for wiring switches and other open electrical work.

No.	Length	Finish	Wt. per doz.	List Each
1641	5 in.	Blue Temper	2 3/4 lbs.	\$2.60
1643	Same without Cutter		2 3/4 lbs.	2.20



LONG CHAIN NEEDLE NOSE PLIERS

Used extensively in radio and TV manufacture and repair. Switchboard, fixture, and appliance wiring.

No.	Length	Finish	Wt. per doz.	List Each
1661	6 in.	Blue Temper	3 1/2 lbs.	\$3.00
1671	Same without Cutter		3 1/2 lbs.	2.35



EXTRA LONG CHAIN NOSE PLIERS

Extra long reach, narrow pointed nose. Length of jaw 2 3/4". For production and repair work.

No.	Length	Finish	Wt. per doz.	List Each
1781	7 in.	Blue Temper	3 3/4 lbs.	\$3.40
1771	Same without Cutter		3 3/4 lbs.	2.60



RADIO AND IGNITION NOSE CUTTING PLIERS

Designed to reach into tight spots and grip or cut small wires. Useful in precision wiring where ordinary pliers are too bulky.

No.	Length	Finish	Wt. per doz.	List Each
1663	8 in.	Blue Temper	3 1/4 lbs.	\$3.10

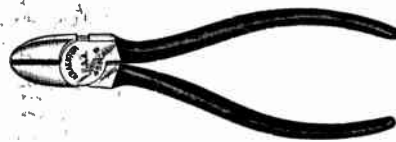

DIAGONAL "OBLIQUE" CUTTING PLIERS

Especially made for close cutting in radio, TV, telephone and ignition manufacturing and repair.

No.	Size	Finish	Wt. per doz.	List Each
4501	4 1/2 in.	Blue Temper	1 1/2 lbs.	\$2.35
	5 in.	" "	2 3/4 lbs.	2.65
	6 in.	" "	3 3/4 lbs.	3.00



WIRE STRIPPING DIAGONAL CUTTING PLIERS

Narrow head and notched cutters for stripping fine wire .062 diameter. Spring in handle for fast cutting.

No.	Length	Finish	Wt. per doz.	List Each
2612	6 1/2 in.	Blue Temper	3 lbs.	\$3.40



"HIGH POWER" DIAGONAL CUTTING PLIERS

Joint is close to end of cutter for added leverage and easier cutting.

No.	Length	Finish	Wt. per doz.	List Each
4610	5 in.	Blue Temper	2 1/4 lbs.	\$2.60
4610	7 in.	Blue Temper	5 3/4 lbs.	3.00



7-IN. DIAGONAL CUTTING PLIERS WITH FULL-FASHIONED HANDLES

Well balanced, with handles providing proper leverage and comfort for continuous cutting.

No.	Length	Finish	Wt. per doz.	List Each
4502	7 in.	Blue Temper	6 lbs.	\$3.30

THIS IS ONLY A PARTIAL LISTING OF KRAEUTER TOOLS

SEND FOR CATALOG



KRAEUTER

The choice of skilled mechanics

PRECISION LINE

Fine, small jewelers pliers, matched in size and handle shape for accurate and exacting work. Drop forged from selected tool steel, accurately machined, and carefully heat treated. Extensively used in the manufacture and repair of radio, TV, instruments, etc. FULL POLISHED FINISH.

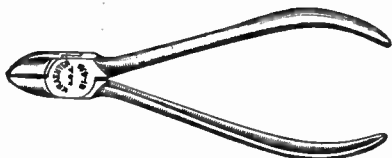

JEWELERS' DIAGONAL CUTTING PLIERS

No.	Size	Finish	Wt. per doz.	List Each
81	4½"	Full Polished	1 lb.	\$3.00

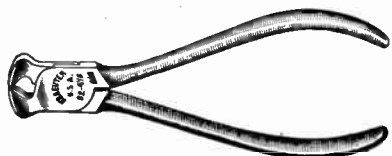

JEWELERS' END CUTTING NIPPERS

No.	Size	Finish	Wt. per doz.	List Each
82	4½"	Full Polished	1½ lbs.	\$3.60

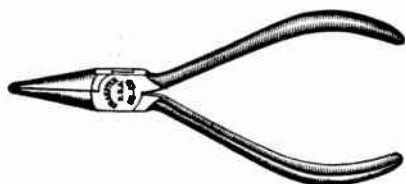

JEWELERS' CHAIN NOSE PLIERS

No.	Size	Finish	Wt. per doz.	List Each
83	4½"	Full Polished	1¼ lbs.	\$2.90

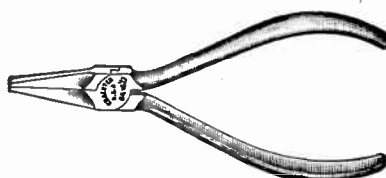

JEWELERS' FLAT NOSE PLIERS

No.	Size	Finish	Wt. per doz.	List Each
84	4½"	Full Polished	1½ lbs.	\$3.00

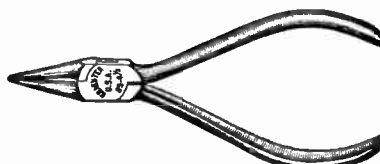

JEWELERS' ROUND NOSE ROUND JAW PLIERS

No.	Size	Finish	Wt. per doz.	List Each
85	4½"	Full Polished	1¼ lbs.	\$3.00

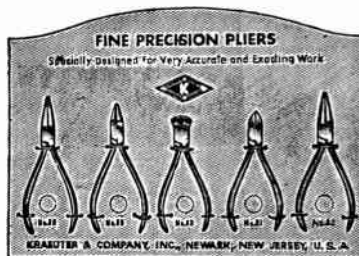

NO. 88 COUNTER DISPLAY

Size 12½" x 8¾" with easel back
One each of Nos. 81, 82, 83, 84, 85.



COMBINATION PATTERN SNIP

Cuts straight and curved shapes in metal, etc.

No.	Length	Cut	Wt. ea.	List Each
13	7 in.	1½ in.	5½ oz.	\$3.00



ALLOY STEEL ADJUSTABLE WRENCH THIN PATTERN — SMOOTH ACTION

No.	Length	Cap.	Wt. per doz.	List Each
31	4"	½"	1¼ lbs.	\$2.00
31	6"	¾"	3½ lbs.	2.00
31	8"	1⅛"	6½ lbs.	2.30
31	10"	1½"	11 lbs.	3.00
31	12"	1⅞"	18 lbs.	4.40

THIS IS ONLY A PARTIAL LISTING OF KRAEUTER TOOLS

SEND FOR CATALOG



KRAEUTER

The choice of skilled mechanics

PROFESSIONAL LINE

SPECIAL NEEDLE POINT PLIERS • FULL POLISHED FINISH

Designed for light, fine professional work. The special needle points make them invaluable where delicate adjustments have to be made. Nose of these pliers not guaranteed.

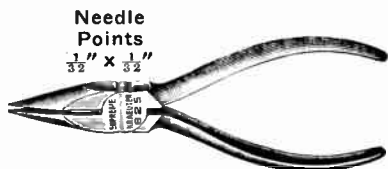

MEDIUM NOSE NEEDLE POINT PLIERS

No.	Length	Finish	Wt. per doz.	List Each
825	5 in.	Full Polished	2 1/4 lbs.	\$3.25
835	Same	without cutter		2.75

LONG NOSE NEEDLE POINT PLIERS

No.	Length	Finish	Wt. per doz.	List Each
826	6 in.	Full Polished	3 lbs.	\$3.50
836	Same	without cutter		3.00

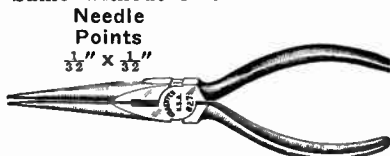

EXTRA LONG NOSE NEEDLE POINT PLIERS

No.	Length	Finish	Wt. per doz.	List Each
827	7 in.	Full Polished	3 3/4 lbs.	\$3.90
837	Same	without cutter	3 3/4 lbs.	3.40



NEEDLE POINT DIAGONAL CUTTING PLIERS

No.	Length	Finish	Wt. per doz.	List Each
5601	4 1/2 in.	Full Polished	2 lbs.	\$3.00
5601	5 in.	Full Polished	2 3/4 lbs.	3.20
5601	6 in.	Full Polished	3 3/4 lbs.	3.60



NEEDLE POINT DIAGONAL CUTTING PLIERS

No.	Length	Finish	Wt. per doz.	List Each
5612	6 1/2 in.	Full Polished	3 lbs.	\$4.00

(With Stripping Notch)

PLIERS WITH SPRING IN HANDLE

Available for most pliers, replaceable leaf spring keeps pliers in open position, ready to work. Can be provided separately or in combination with cushion grips described below. Effectively used to increase efficiency and reduce wrist fatigue on the production line. Additional, List Each \$0.30

LEATHER TOOL POUCHES

Five pockets, with tape holder. Stitched with 7-cord top quality linen hot wax thread, locked to solid leather back with steel rivets. Pockets made of pliable form-fitting Russet Leather. Designed for the radio and TV serviceman to carry pliers, screwdrivers, tape, and other small tools. No. 711 Tool Holster List Each \$4.65

CUSHION GRIP HANDLES

For extra comfort on the production line, most pliers can be provided with dipped red plastic handles. Additional, List Each \$0.40

SAFETY GRIPS

Available to fit most pliers. Knurled, easily applied, non-explosive, molded to snugly fit handles. List Each Pair
 6" Size \$0.65
 7" Size \$0.70
 8" Size \$0.75

THIS IS ONLY A PARTIAL LISTING OF KRAEUTER TOOLS SEND FOR CATALOG

KLEIN top quality PLIERS!

NEW SMALL PATTERNS

Price Includes Leaf Spring

LONG NOSE PLIER Extremely slim pattern with knurled jaws for positive grip. Size 5½-in.

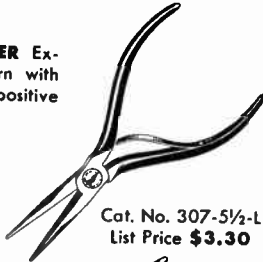

Cat. No. 307-5½-L
List Price \$3.30

CHAIN NOSE PLIER Has a very fine knurl that will not damage soft wire. Available without knurl to order. Size 5-in.



Cat. No. 317-5-L
List Price \$3.55

TRANSVERSE END CUTTING PLIER Permits a clean flush cut where ordinary oblique or end cutters are too bulky. Size 6-in.

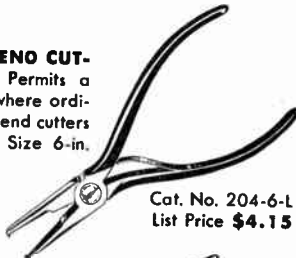

Cat. No. 204-6-L
List Price \$4.15

OBLIQUE CUTTING PLIER For cutting small wires and trimming. Entire length of knives works flush against cutting surface. Sizes 5 and 6-in.



Cat. No. 210-5-L
List Price \$3.60
Cat. No. 210-6-L
List Price \$3.65

LIGHTWEIGHT CUTTING PLIER Has extremely narrow head. Entire length of knives works flush against cutting surface. Size 5-in.

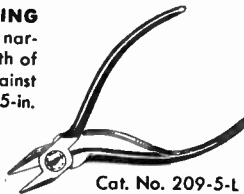

Cat. No. 209-5-L
List Price \$4.05

DUCK BILL PLIER Has jaws wide enough to hold small springs, yet small enough to form wire in confined space. Size 5½-in.

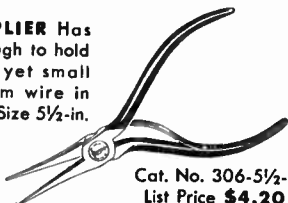

Cat. No. 306-5½-L
List Price \$4.20

Klein Pliers are hammer forged from high-grade steel, individually fitted, tempered, adjusted and tested. All patterns available with tempered steel leaf spring. Prices on request.

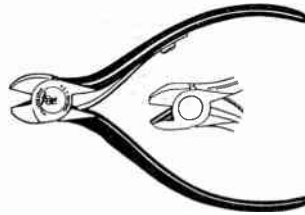

SHEARING PLIER Specially designed plier shears through tungsten filaments, music wire, springs and other hard wire. No adjustment or sharpening needed. Size 5-in.
Cat. No. 053-L
List Price \$3.50

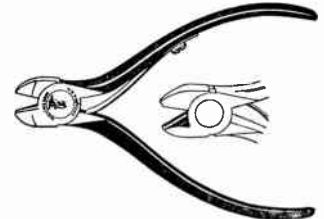

PRINTED CIRCUIT PLIER Cuts and crimps in one operation. Crimped wire ends hold loose parts in position for dip soldering. Size 5-in.
Cat. No. 052-L
List Price \$3.50



OBLIQUE CUTTING PLIER Ideal for light cutting in confined places. Measures exactly 5-in. long.
Cat. No. 245-5
List Price \$3.00



OBLIQUE CUTTING PLIER Has narrow head with knives accurately fitted for close, clean cut. Sizes 5 and 6-in.
Cat. No. 202-5 202-6
List Price \$3.00 \$3.15



LONG CURVED NOSE PLIER Designed to give full clearance and prevent skinning of knuckles. Size 6-in.
Cat. No. 302-6
List Price \$3.35



LONG NOSE, SIDE-CUTTING PLIER Has same features as 301 series, but with cutting knives. Jaws taper to 3/32-in. round point. Sizes 5, 6 and 7-in. For plier without cutters, specify 301 series. 303-6 plier has 1/16-in. point.
Cat. No. 203-5 203-6 203-7
List Price \$3.10 \$3.25 \$3.40
Cat. No. 301-5 301-6 301-7 303-6
List Price \$2.65 \$2.75 \$2.95 \$2.75



DUCK BILL PLIER WITH CUTTERS Wide jaws give firm grip. Specify 304-6 for plier without cutters. Size 6-in.
Cat. No. 205-6 304-6
List Price \$3.40 \$2.90



CHAIN NOSE PLIER WITH CUTTERS Made in 6-in. size only. Specify 317 series for 5 and 6-in. sizes without cutters.
Cat. No. 217-6 317-5 317-6
List Price \$3.25 \$3.20 \$2.75



SIDE CUTTING PLIER, N. E. TYPE "Streamlined" pattern with full clearance back of knife permitting use on insulated wire. Sizes 5, 6, 7, 8 and 9-in.
Cat. No. 201-5-NE 201-6-NE
List Price \$3.25 \$3.60
201-7-NE 201-8-NE 201-9-NE
\$4.05 \$4.85 \$5.10



LONG NOSE PLIER Has ¼-in. cutters ¼ in. from point for cutting deep in confined places. Size 6-in.
Cat. No. 301-6-P
List Price \$4.00



Mathias **KLEIN** & Sons
Established 1857
3200 BELMONT AVE. CHICAGO 18, ILL.

THE *Moody Kit* CIRCUIT

A five stage set designed to **DETECT** troubles to **MODULATE** the temper of the technician and considerably **AMPLIFY** his efficiency.

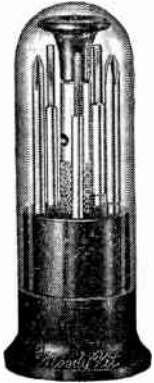

THE PA-5 MOODY KIT SET Contains No. 0 and No. 1 Phillips drivers, No. 4, No. 6 and No. 8 Allen type wrenches. These fit interchangeably into swivel top, chuck type handle with torque hole to set fastenings up tight. List \$2.50 each.



THE BW-5 MOODY KIT Contains five tiny socket wrenches sizes $\frac{3}{16}$ " hex., $\frac{3}{32}$ " hex., $\frac{1}{8}$ " hex., $\frac{1}{16}$ " hex., $\frac{3}{32}$ " hex. The handle of set is magnetized so it will hold tiny nuts, thus nuts may be easily removed from or inserted into recessed hard-to-get-at places. List \$3.95 each.



THE SC-5 MOODY KIT Tiny screw driver set; blade sizes .040", .055", .070", .080", .100", all properly heat treated; perfect for getting at those recessed small screws in electrical work. List \$1.79 each.



THE SH-2 SCREW HOLDING MOODY KIT — screw driver contains two lengths of No. 100 blades. Each blade can take the spring steel clip that holds tiny screws better than fingers. Can be used on all delicate instruments that might otherwise be affected by magnetic screw drivers. List \$1.25 each.

THE MS-2 MOODY DOUBLE-END SCRIBER

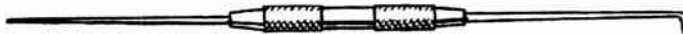

The **RIGHT** tool for marking metal for close tolerance cutting or drilling. It's a must in every electrical technician's set of tools. List 40c each.

Get to know this line of tiny tools. Stock them — they hold a terrific profit potential for you. Ask your jobber to get a Moody catalog for you.



GREENLEE KNOCKOUT PUNCHES AND CUTTERS

Greenlee Tool Co., Rockford, Illinois

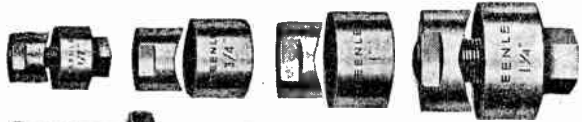

NO. 735 KNOCKOUT PUNCH SET

Designed primarily for the electrical trade to permit fast, easy enlarging of knockouts and cutting of holes for conduit in metal boxes and cabinets. Also excellent for automobile work where holes are needed for heater pipes and other accessories. Simply insert the tool in a knockout or small drilled hole and give the screw a few turns with an ordinary wrench. No. 735 set has four punches for cutting $\frac{7}{8}$, $1\frac{3}{32}$, $1\frac{11}{32}$, $1\frac{11}{16}$ -inch holes for $\frac{1}{2}$, $\frac{3}{4}$, 1, $1\frac{1}{4}$ -inch conduit. Set is neatly packed in leather case illustrated. The $\frac{1}{2}$ -inch punch will cut a $\frac{7}{8}$ -inch hole for $\frac{1}{2}$ -inch conduit where no standard knockout is provided when a $\frac{7}{16}$ hole is drilled.

Heavy Duty Drive for $\frac{1}{2}$ " Punch

To increase length of service of the $\frac{1}{2}$ -inch Knockout Punch in cutting $\frac{7}{8}$ -inch holes in heavier-gauge sheet metals, the No. KR5 Drive Screw with No. KR4 Drive Nut illustrated is recommended.



NO. 737 KNOCKOUT PUNCH SET

Similar to the No. 735 set, but consists of only two punches for cutting holes to accommodate $1\frac{1}{2}$ " and 2" conduit. Packed in leather case.



NOS. 738 AND 739 KNOCKOUT PUNCHES

For cutting holes to accommodate $2\frac{1}{2}$ " and 3" conduit. Design is similar to that of smaller GREENLEE Knockout Punches.

insert in a knockout or drilled hole and turn drive nut with an ordinary wrench. Packed and sold individually.

NOS. 741 AND 742 KNOCKOUT PUNCHES

For quickly making smooth openings for $3\frac{1}{2}$ " and 4" conduit. Hole is clean, no filing of burrs necessary. Operation is similar to that of other GREENLEE Knockout Punches. Simply insert in hole for 1" conduit and turn drive nut with an ordinary wrench.

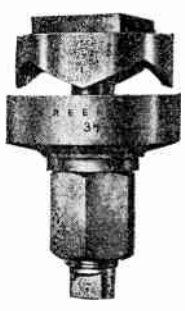

No. 740 Knockout Cutter

Companion tool to GREENLEE Knockout Punches. Enlarges knockouts to take $1\frac{1}{2}$, 2, $2\frac{1}{2}$ and 3-inch conduit. Operation is simple since an ordinary wrench drives the tool. Cutting is done by the drive action of two wheel cutters. Special discs

can be furnished for cutting odd sizes of holes from $1\frac{1}{8}$ to $3\frac{1}{2}$ -inch diameter. Packed in leather case.



NO. 7646 HYDRAULIC KNOCKOUT PUNCH DRIVER

A powerful portable hydraulic unit for driving all GREENLEE Knockout Punches. Also drives GREENLEE Radio Chassis Punches using $\frac{3}{8}$ " or larger drive screws. Quickly, easily cuts holes in 10-gauge metal. Excellent for use in tight places. Packed in metal case. List price complete, \$96.00. Weight, 20 lbs.

KNOCKOUT PUNCHES — LIST PRICES AND WEIGHTS (WTS. IN LBS.)

No.	Description	Hole Size	Price	Weight
No. 735	Knockout Punch Set		\$11.00	2½
KR1	½" Conduit Punch	¾"	1.40	⅞
KR2	½" Conduit Die	¾"	.70	⅞
KR3	¾" x 1½" Drive Screw		.30	⅞
K11	¾" Conduit Punch	1⅜"	1.60	⅞
K12	¾" Conduit Die	1⅜"	.90	⅞
K13	1" Conduit Punch	1-11/32"	1.85	⅞
K14	1" Conduit Die	1-11/32"	1.05	⅞
K15	1¼" Conduit Punch	1⅞"	2.10	⅞
K16	1¼" Conduit Die	1⅞"	1.15	⅞
KR17	¾" x 2¼" Drive Screw		.40	⅞
KR4	Heavy Duty Drive Nut		.40	⅞
KR5	Heavy Duty Drive Screw		.85	⅞
No. 737	Knockout Punch Set Complete		\$11.00	3½
K21	1½" Conduit Punch	1⅞"	2.55	⅞
K22	1½" Conduit Die	1⅞"	2.20	⅞
K23	2" Conduit Punch	2⅜"	3.50	⅞
K24	2" Conduit Die	2⅜"	2.75	1
KR25	¾" x 3" Drive Screw		.55	⅞
No. 738	Knockout Punch Complete		\$15.50	4½
K31	2½" Conduit Punch	2⅞"	6.00	1⅜
K32	2½" Conduit Die	2⅞"	5.50	1⅜
K34	Drive Nut		1.50	½
K35	¾" x 5¾" Drive Screw		3.00	⅞
No. 739	Knockout Punch Complete		\$21.00	6½
K34	Drive Nut		1.50	½
K35	¾" x 5¾" Drive Screw		3.00	⅞
K37	3" Conduit Punch	3½"	8.90	2½
K38	3" Conduit Die	3½"	8.25	2½
No. 741	Knockout Punch Complete		\$43.00	10¾
K41	3½" Conduit Die	4"	15.50	3¾
K42	3½" Conduit Punch	4"	20.00	3
K44	Drive Nut		2.20	1¼
K45	1½" x 6¾" Drive Screw		6.60	2¼
K46	Bushing		2.50	¾
No. 742	Knockout Punch Complete		\$53.00	12¾
K44	Drive Nut		2.20	1¼
K45	1½" x 6¾" Drive Screw		6.60	2¼
K46	Bushing		2.50	¾
K47	4" Conduit Punch	4½"	26.50	4½
K48	4" Conduit Die	4½"	20.00	3½
No. 740	Knockout Cutter Complete		\$16.50	4¾
K51	Lock Screw (2)		.35	⅞
K52	Wheel Cutter (2)		.60	⅞
K53	Feed Nut		.30	⅞
K54	1⅞" dia. Disc		.75	⅞
K55	2⅜" dia. Disc		.90	⅞
K56	2⅞" dia. Disc		1.10	⅞
K57	3½" dia. Disc		1.30	⅞
K58	Body		6.00	1¾
K59	Center Shaft		.90	½
K60	Drive Nut		.90	⅞
K61	Retainer Screw (2)		.50	⅞
K62	Cutter Bushing (2)		.30	⅞
K63	Cutter Support (2)		.70	⅞
K64	Key Washer		.30	⅞
K65	Woodruff Key		.10	⅞

Radio's Master — 19th Edition



RADIO CHASSIS PUNCHES

ROUND, SQUARE, "KEY" AND "D" TYPES

Greenlee Tool Co., Rockford, Illinois

No. 730 ROUND PUNCH



No. 730

Swiftly cuts clean, accurate holes in radio chassis for sockets, switches, controls and other equipment. Operates simply with an ordinary wrench for drive power. Just insert in a small drilled hole and turn drive screw. No reaming or filing. Hole is smooth, perfect. Seventeen sizes from 1/2" to 2 1/4" diameter.

No. 731 SQUARE PUNCH



No. 731

Cuts square or oblong openings as desired. Available in three sizes for making 5/8", 3/4" and 1" square holes. Drive screw fits into 1/2" hole, which can be drilled or made with 1/2" No. 730 Greenlee Round Punch. Operates with an ordinary wrench for drive power. Individually packed.

No. 732 "KEY" PUNCH



No. 732

Quickly, easily cuts holes for keyed radio sockets. Operates on same principle as other Greenlee Radio Chassis Punches. An ordinary wrench supplies the drive power. In four sizes to make openings of 1 1/16", 1 11/64", 1 17/64", 1 21/64". Drive screw fits into 1/2" hole. Individually packed.

No. 733 "D" PUNCH



No. 733

Simplifies and speeds the work of making "D" shaped openings for high-frequency, miniature tube sockets and other equipment using this type opening. Available in 1/2" and 5/8" sizes. Operates on same principle as other Greenlee Radio Chassis Punches with an ordinary wrench supplying the drive power. Drive screw fits into 3/8" drilled hole. Individually packed.

NO. 730 RADIO PUNCHES — LIST PRICES AND WEIGHTS (WTS. IN LBS.)

	Price	Weight
1/2" Round Radio Chassis Punch Complete..	\$2.40	1/8
R1 1/2" Punch	1.40	1/8
R2 1/2" Die70	1/8
R3 1/4" Screw30	1/8
5/8" Round Radio Chassis Punch Complete..	2.40	1/8
R5 5/8" Punch	1.40	1/8
R6 5/8" Die70	1/8
R3 1/4" Screw30	1/8
3/4" Round Radio Chassis Punch Complete..	2.40	1/8
R7 3/4" Punch	1.40	1/8
R8 3/4" Die70	1/8
KR3 3/4" Screw30	1/8
7/8" Round Radio Chassis Punch Complete..	2.40	1/8
KR1 7/8" Punch	1.40	1/8
KR2 7/8" Die70	1/8
KR3 3/4" Screw30	1/8
1" Round Radio Chassis Punch Complete..	2.60	6/16
R11 1" Punch	1.50	1/2
R12 1" Die80	1/2
R13 3/8" Screw30	1/2
1 1/16" Round Radio Chassis Punch Complete..	2.75	1/2
R15 1 1/16" Punch	1.60	1/2
R16 1 1/16" Die85	1/2
R13 3/8" Screw30	1/2
1 1/8" Round Radio Chassis Punch Complete..	2.75	1/2
R17 1 1/8" Punch	1.60	1/2
R18 1 1/8" Die85	1/2
R13 3/8" Screw30	1/2
1 1/4" Round Radio Chassis Punch Complete..	2.75	1/2
R19 1 1/4" Punch	1.60	1/2
R20 1 1/4" Die85	1/2
R13 3/8" Screw30	1/2
1 1/2" Round Radio Chassis Punch Complete..	2.75	1/2
R21 1 1/2" Punch	1.60	1/2
R22 1 1/2" Die85	1/2
R13 3/8" Screw30	1/2
1 3/8" Round Radio Chassis Punch Complete..	2.75	1/2
R23 1 3/8" Punch	1.60	1/2
R24 1 3/8" Die85	1/2
R13 3/8" Screw30	1/2
1 5/8" Round Radio Chassis Punch Complete..	3.15	5/8
R25 1 5/8" Punch	1.85	5/8
R26 1 5/8" Die	1.00	5/8
R13 3/8" Screw30	5/8
1 7/8" Round Radio Chassis Punch Complete..	3.55	7/8
R27 1 7/8" Punch	2.10	7/8
R28 1 7/8" Die	1.15	7/8
R13 3/8" Screw30	7/8
1 3/4" Round Radio Chassis Punch Complete..	4.10	1 1/8
R29 1 3/4" Punch	2.40	1 1/8
R30 1 3/4" Die	1.30	1 1/8
KR17 3/4" x 2 1/4" Screw40	3/8
1 3/4" Round Radio Chassis Punch Complete..	4.65	1 1/4
R31 1 3/4" Punch	2.70	3/8
R32 1 3/4" Die	1.55	1/2
KR17 3/4" x 2 1/4" Screw40	3/8
1 7/8" Round Radio Chassis Punch Complete..	5.80	1 5/8
R33 1 7/8" Punch	3.00	5/8
R34 1 7/8" Die	2.25	5/8
KR25 3/4" x 3" Drive Screw55	1/8
2" Round Radio Chassis Punch Complete..	6.25	1 1/2
R35 2" Punch	3.20	5/8

NO. 730 RADIO PUNCHES (CONT.)

	Price	Weight
R36 2" Die	2.50	1 1/2
KR25 3/4" x 3" Screw55	1/8
2 1/4" Round Radio Chassis Punch Complete..	6.80	2 3/8
R37 2 1/4" Punch	3.50	3/4
R38 2 1/4" Die	2.75	1 1/8
KR25 3/4" Screw55	1/8

NO. 731 SQUARE RADIO PUNCHES — LIST PRICES AND WEIGHTS (WTS. IN LBS.)

	Price	Weight
5/8" Square Radio Chassis Punch Complete..	\$3.70	1/8
R51 5/8" Square Punch	1.60	1/8
R52 5/8" Square Die	1.25	1/8
R53 31/64" Drive Screw65	1/8
R54 Drive Nut20	1/8
3/4" Square Radio Chassis Punch Complete..	4.30	3/8
R55 3/4" Square Punch	1.85	1/8
R56 3/4" Square Die	1.50	1/8
R57 31/64" Drive Screw75	1/8
R54 Drive Nut20	1/8
1" Square Radio Chassis Punch Complete..	5.00	5/8
R59 1" Square Punch	2.00	1/8
R60 1" Square Die	1.70	1/8
R61 31/64" Drive Screw	1.10	1/8
R54 Drive Nut20	1/8

NO. 732 "KEY" RADIO PUNCHES — LIST PRICES AND WEIGHTS (WTS. IN LBS.)

	Price	Weight
1 1/8" Radio Chassis Key Punch Complete..	\$4.15	1/8
R71 1 1/8" Key Punch	1.70	1/8
R72 1 1/8" Key Die	1.10	1/8
R73 31/64" Drive Screw	1.15	1/8
R54 Drive Nut20	1/8
1 1/16" Radio Chassis Key Punch Complete..	4.45	1 1/8
R75 1-11/64" Key Punch	1.75	1/8
R76 1-11/64" Key Die	1.25	1/8
R77 31/64" Drive Screw	1.25	1/4
R54 Drive Nut20	1/8
1-17/64" Radio Chassis Key Punch Complete..	4.75	3/4
R79 1-17/64" Key Punch	1.90	1/4
R80 1-17/64" Key Die	1.30	1/8
R81 31/64" Drive Screw	1.35	1/8
R54 Drive Nut20	1/8
1-21/64" Radio Chassis Key Punch Complete..	5.00	3/4
R83 1-21/64" Key Punch	2.00	1/4
R84 1-21/64" Key Die	1.40	1/8
R85 31/64" Drive Screw	1.40	1/8
R54 Drive Nut20	1/8

NO. 733 "D" RADIO PUNCHES — LIST PRICES AND WEIGHTS (WTS. IN LBS.)

	Price	Weight
1/2" Radio Chassis "D" Punch Complete..	\$3.90	1/8
R91 1/2" "D" Punch	1.70	1/8
R92 1/2" "D" Die	1.10	1/8
R93 5/8" Drive Screw85	1/8
R94 Drive Nut25	1/8
5/8" Radio Chassis "D" Punch Complete..	4.15	1/8
R95 5/8" "D" Punch	1.75	1/8
R96 5/8" "D" Die	1.25	1/8
R97 5/8" Drive Screw90	1/8
R94 Drive Nut25	1/8

SAVE TIME...EFFORT...
AND EQUIPMENT!
WITH
Equipto AURORA, ILLINOIS
ELECTRONIC CHASSIS
and
TEST EQUIPMENT STAND

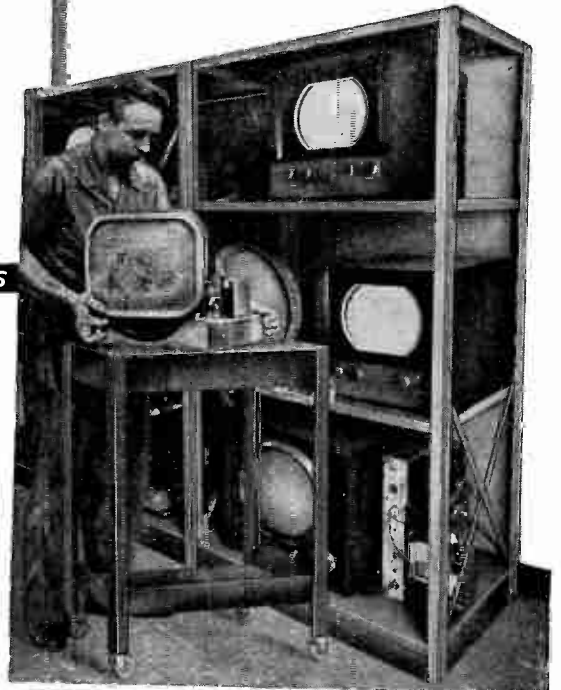

Here's the ideal unit to hold heavy test-
ing equipment. It has a rugged all-steel
construction and is the right height for
full working convenience. It rolls noise-
lessly on big 2½" rubber wheels. Use it
also as a hand truck for transporting
chassis or other heavy equipment. Fin-
ished in olive green, polymerized shock-
resistant enamel. Available without
wheels if desired.

DIMENSIONS & PRICES

No. 710 w/o wheels	18" x 24" x 31"	\$12.12
with wheels	18" x 24" x 34"	13.77
No. 711 with wheels and pressed wood top	18" x 24" x 34"	15.27

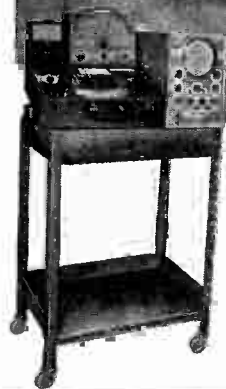

Above illustrations show
the No. 710 Stand used as
hand truck for transport-
ing heavy chassis. Ad-
joining illustration shows
it used for holding heavy
testing equipment.

No. 710

Equipto AURORA ILLINOIS

LITTLE GEM[®] DRAWER CABINET FOR TINY PARTS

EVEN THE SMALLEST PARTS CAN'T GET SHUFFLED OR LOST!



NO. 1
\$890

OUTSTANDING FEATURES

Here's unexcelled convenience and storage capacity for small parts, Equipto's LITTLE GEM[®]. No. 1 Unit—3 1/4" high x 11" deep x 11" wide—shown at left, consists of two 1 1/2" high drawers in a one-piece frame. Each drawer is furnished with 8 dividers, providing for 24 adjustable compartments. Adding extra dividers makes possible a total of 28 compartments per drawer or a total of 56 compartments per unit. There's nothing like it on the market. Check the list of features below:

Most efficient drawer ever conceived for tiny parts storage

Use individually, stack, or insert in shelving.

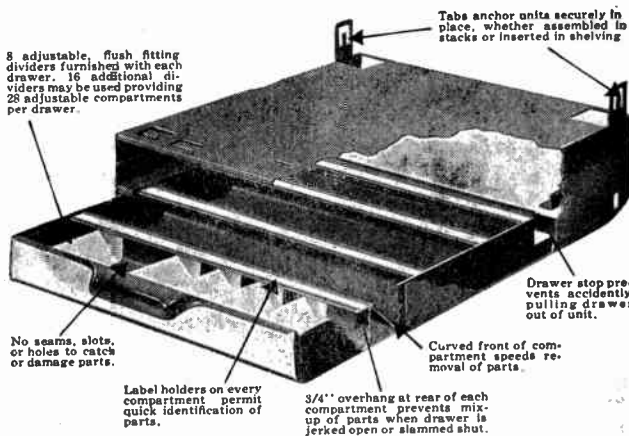

NO. 1



NO. 12



NO. 2



NO. 14

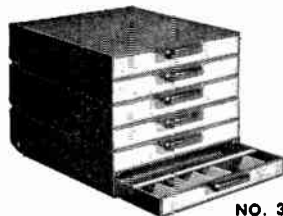

NO. 3



NO. 10



NO. 13

service counters



No. 88—Front View; No. 88—Service Side



No. 68

MODEL NO.	DIMENSIONS	DRAWERS		TOTAL COMPT'S		PRICE
		LITTLE GEM [®]	NO. 8505	AS FURN.	MAX. CAP.	
1	11 1/4" x 3 1/4" x 12" deep	2		24	56	\$ 6.95
2	11 1/4" x 6 1/2" x 12" deep	4		48	112	\$13.90
3	11 1/4" x 9 3/4" x 12" deep	6		72	168	\$20.85
9	23 1/4" x 9 1/2" x 12" deep	4	4	60	124	\$24.33
10	23 1/4" x 9 1/2" x 12" deep	8		96	224	\$34.31
12	34" x 13 1/4" x 12" deep	4	14	90	154	\$34.93
13	34" x 13 1/4" x 12" deep	8	10	126	254	\$44.91
14	34" x 13 1/4" x 12" deep	12	6	162	354	\$54.89

Extra dividers for Little Gem[®] Drawer..... .08 ea.
Extra dividers for 8505 Drawers..... .09 ea.

*Trade Mark Patent Pending

Size 36"x28"x39" high. Counters have reinforced 16 gauge tops—also suitable for benches and packing tables.

Closed Type No. 88 is a counter complete with backs and sides. **\$31.85**

No. 89 is the same except with one end panel only, as where two counters stand side by side. **\$28.45**

Open Type No. 68—Sway braces provided where required. **\$19.95**



"HAZ-BIN, JR" HAS EVERYTHING!

THE HANDIEST CABINET EVER MADE FOR STORING ELECTRONICS PARTS!

What a relief! No more frantic searching for misplaced items. You'll say it's just what you've always wanted. Store electronics parts—free from dust and dirt—and where they can be found instantly. Contents visible: Lifetime guaranteed, crystal-clear plastic drawers. Strong, all-steel cabinet has individual drawer guides, baked-on, silver-gray hammerloid finish. Furnished complete with index cards, removable lengthwise and crosswise drawer dividers, rubber feet. Testimonials from hundreds of users in the electronics field say "it solved small parts storage problems." Drawer size same in all models—2¾" wide x 1-7/16" deep x 5/8" long. Safety catch anchors open drawers, prevents spilling.

Model	Made in 10 Sizes:	Dimensions			Net Price
		High	Wide	Deep	
J-128	128 drawer	30 1/2"	25 1/8"	6"	\$55.95
J-96	96 drawer	22 1/2"	25 1/8"	6"	42.95
J-64	64 drawer	15 1/8"	25 1/8"	6"	24.95
J-48	48 drawer	22 1/2"	12 1/2"	6"	20.95
J-32	32 drawer	15 1/8"	12 1/2"	6"	12.95
J-24	24 drawer	12 1/8"	12 1/2"	6"	9.95
J-20	20 drawer	10 1/8"	12 1/2"	6"	7.95
J-16	16 drawer	8 1/8"	12 1/2"	6"	6.95
J-12	12 drawer	6 1/8"	12 1/2"	6"	5.95
J-8	8 drawer	4"	12 1/2"	6"	4.25
J-32-SD	24 plastic drawers and 1 large steel drawer (5 7/8" long x 3 3/8" deep x 11 1/8" wide)....	15 1/4"	12 1/2"	6"	12.95
C32	Carrying Case for J-32 or J-32-SD				7.95
C-16	Carrying Case for J-16				6.95



J-48 — 48 DRAWERS
(144 Compartments)



J-128 — 128 DRAWERS
(384 Compartments)

J-24 — 24 DRAWERS
(72 Compartments)

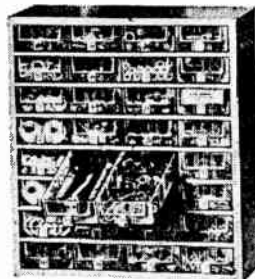
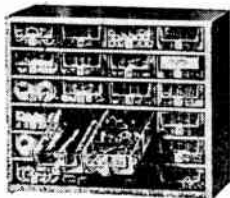

J-32 — 32 DRAWERS
(96 Compartments)

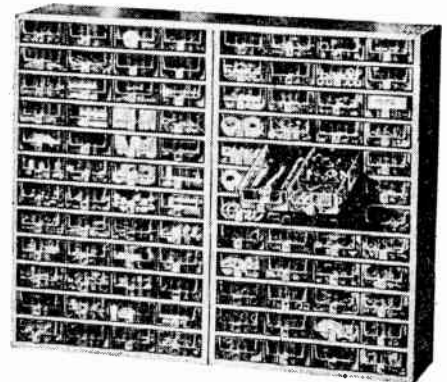

J-96 — 96 DRAWERS
(288 Compartments)



J-16 — 16 DRAWERS
(48 Compartments)

J-12 12 DRAWERS
(36 Compartments)

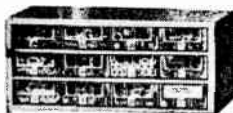

J-8 — 8 DRAWERS
(24 Compartments)

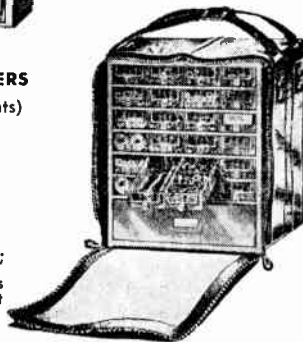

C-32
Carrying Case
Illustrated
With J-32-SD Cabinet

Carrying Cases make On-the-job Service Easy

Makes your small parts case easily portable. Carrying cases made of Textileather's "TOLEX" . . . 100 pound test construction. All vital parts reinforced for long service. Metal studs protect bottoms.

FREE ILLUSTRATED FOLDER ON CABINETS
WITH LARGER SIZE DRAWERS
(10¾" L x 2¾" W x 2⅞" D)

AKRO-MILS, INC.

P. O. BOX 989-RM

AKRON, OHIO

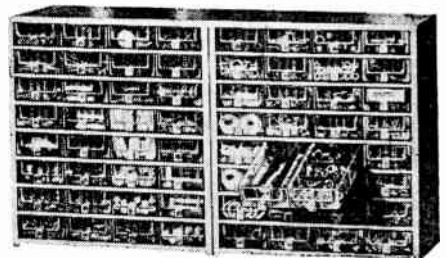

J-64 — 64 DRAWERS
(192 Compartments)

SNAP-ON DRAWER CO. MORROW, OHIO

YOU make up your own small parts cabinet to exactly fit **YOUR NEEDS** with . . .

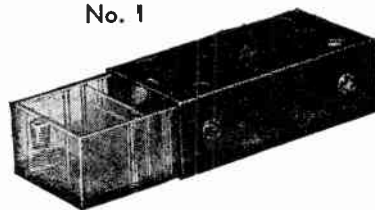

No. 1

PLASTIC
& STEEL

SMALL— $6\frac{1}{8}'' \times 3\frac{1}{8}'' \times 1\frac{7}{8}''$

No. 1. "SMALL" Snap-On Drawer, including one No. 1D Divider, net price.....\$0.54
 No. 1BP. Base Plate net price......30
 No. 1D. Divider, net price......03

- **MODERN** Light weight, functional in design.
- **EFFICIENT** Parts are quickly, easily located.
- **PRACTICAL** You build to suit your needs.
- **SELECTIVE** You have a choice of three sizes.
- **ECONOMICAL** You buy only what you actually need.
- **CONVENIENT** When you need more room.
- **SO SIMPLE** Just snap on another SNAP-ON DRAWER.

● The sturdy, steel shells of the SNAP-ON DRAWER snap together on sides, top and bottom, with duplicate shells to form a strong metal cabinet. No tools required. Just place the metal buttons of one shell directly over the holes in the adjacent shell and snap the buttons into place, one at a time.

If you wish to change the position of a drawer, the shells can be readily pried apart with a knife blade and rearranged. Finished in GUN-METAL GRAY.

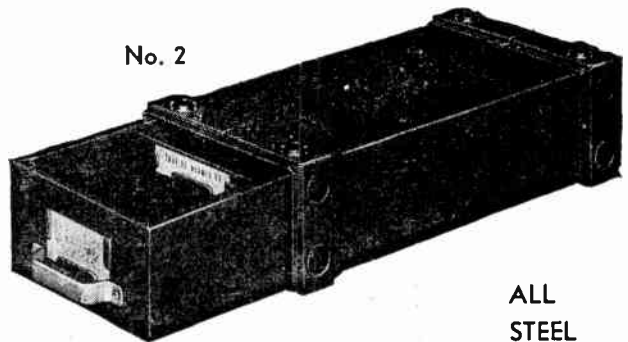

No. 2

ALL
STEEL

JUNIOR— $11\frac{3}{4}'' \times 5\frac{1}{8}'' \times 2\frac{1}{2}''$

No. 2. "JUNIOR" Snap-On Drawer, including one No. 2D Divider, net price.....\$2.70
 No. 2D. Divider, net price......12

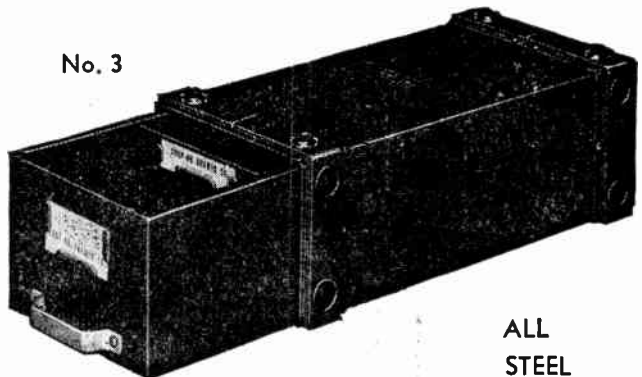

No. 3

ALL
STEEL

SENIOR— $11\frac{3}{4}'' \times 5\frac{1}{8}'' \times 3\frac{1}{2}''$

No. 3. "SENIOR" Snap-On Drawer, including one No. 3D Divider, net price.....\$3.00

No. 3D. Divider, net price......12½

Pierceway

Trade Mark Reg. U. S. Pat. Off.

PACKAGED WIRE SYSTEMS

...is the **BEST** way to **EXTRA** outlets!

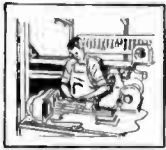

FACTORIES



OFFICES

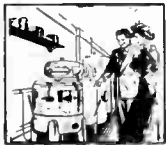

STORES



HOMES



FARMS

Wherever the need arises for extra outlets for power and light, there is a *Pierceway* Packaged Wire System to fill that need. Designed for quick, easy installation, and safe, dependable performance, *Pierceway* systems are available in either the handsome and durable rigid duct type, or the simple-to-install *Pierceway, Jr.* system.

Both *Pierceway* Packaged Wire Systems are the result of exacting design and stringent manufacturing procedure, backed by years of experience in the electrical field.

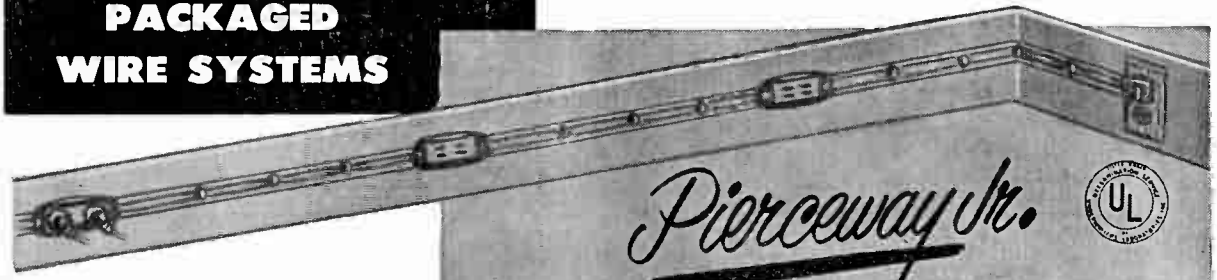

Pierceway Jr.



FLEXIBLE PLASTIC WIRING SYSTEMS

All you need is a hammer to install this electric outlet system at a new low cost per outlet. Each system comes complete in its own package, and includes plastic-topped upholsterer's tacks. Can be quickly removed and re-used in another location.

Pierceway, Jr. comes in two sizes: 6-ft. with 3 duplex outlets and 1 cord cap; 12-ft. system has 3 lamp-holders, 1 duplex outlet and 1 cord cap.



Pierceway



PLASTIC DUCT WIRING SYSTEMS

Packaged in three lengths: 4-foot system with 6 outlets; 6-foot, 8-inch system with 10 outlets; 9-foot, 4-inch system with 14 outlets. With relatively few parts, this *Pierceway* rigid duct system, can easily be taken apart and quickly reassembled to meet any change in requirements. *Pierceway* Packaged Wire Systems are made in both 2-wire and 3-wire systems, with a choice of end-feed or back-feed connection. Complete and ready to install, with copper conductors built in as an integral part of each section.

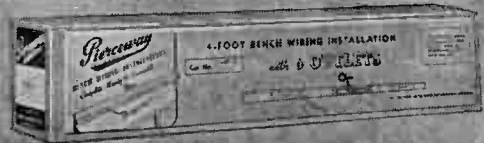

WRITE FOR CATALOG AND PRICE LISTS

CLIFTON CONDUIT (TENNESSEE) INC.

Pierceway DIVISION

General Offices: 75 Montgomery Street, Jersey City 2, N. J. Factory: 1278 Orgill Avenue, Memphis 6, Tenn.

INDUSTRIAL SAFETY BELT



• TOOL HOLSTERS • TOOL BELTS



No. 24

No. 24 TOOL HOLSTER

Similar to electrician holster except side pockets not attached, making the overall dimensions 5 x 9 inches.

**No. 24 List
\$4.00 each**

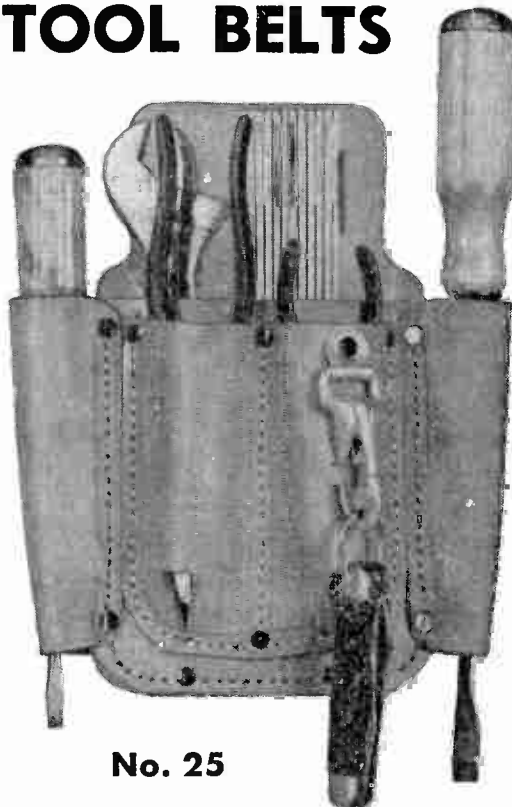

No. 25

No. 25 ELECTRICIAN HOLSTER 5 POCKETS

Stitched with seven cord top quality linen hot wax thread, locked to solid leather back with steel rivets. Pockets made of pliable form fitting Russet Leather.

Special designed snap allows knife to be removed by use of a one hand upward motion. Overall dimensions are: 8 x 9 inches.

No. 25 List Price \$5.00 each (Without Tools)



No. 23

No. 23

Similar to overall dimensions of tool holster No. 24. One pocket. Dimensions are small enough to insert in pocket of trousers.

**No. 23 List
\$3.00 each**

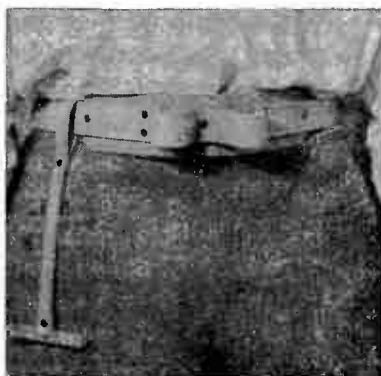

No. 1, 2, 3 TOOL BELT

Extra heavy quality leather. Two strong loops formed for heavy tools. Latigo thong tape carrier attached. Steel rivets anchor tested buckle to belt. Three sizes, No. 1, 30 to 38; No. 2, 40, to 46; No. 3, 46 to 52.

List Price \$3.50

TYPE CB 101

\$29.50



A TV TEST PATTERN ANYTIME!

Modulates TV Signal Generator or Connects Direct to Video Amplifier. Gives horizontal or vertical lines. Checks linearity, width and height of TV picture. Complete with operating instructions.

ADJUSTABLE COILS



TYPE V-2
\$4.50 per KIT

FOR COLOR TV VIDEO PEAKING IF CIRCUITS RF CHOKE

HANDY CALIBRATED COIL KIT

Range 1-1000 uhs Individual Curve Sheet for each coil. Complete data on Lmin, Lmax, Q, Resonant Frequency, R and C.

\$1.25 each



PLASTIK-707 ACRYLIC SPRAY

Insulates Antenna Connections High Voltage Components; Reduces Corona; Prevents Corrosion and Rust. IN PRESSURIZED 12 oz. CAN.

TYPE T1
2" x 2" x 2"

LIST \$3.95

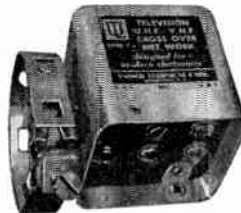

UHF-VHF CROSS-OVER NETWORK

Isolates UHF ant. from VHF ant. Two Antennas on Single Transmission Line.

TYPE F-1 300 0

LIST \$4.95



TELEVISION INTERFERENCE FILTER

EFFICIENT 3-SECTION HI-PASS. Attenuates All Frequencies from 0 to 50 MC. Cuts out Amateur, Diathermy, Auto Ignition, etc. Connects between Antenna and Receiver.

SIZE 2" x 2" x 2"



MICRO-ADJUSTABLE LOOPS

For Small Radios HIGH-Q gives better sensitivity and selectivity. Ind. 180 to 250 uhs. Complete with mounting bracket and instructions.

TYPE HQ

LIST \$.95 each

TYPE R1

LIST \$3.15



TWO-RECEIVER TV COUPLER

ALLOWS USE OF TWO TV RECEIVERS ON ONE ANTENNA. No Switches — No Adjustments. No effect on impedance of transmission line.

KLIPZON TEST PRODS \$1.95

TYPE A TEST PRODS WITH SELF-HOLOING POINTS

KLIPZON \$2.95

TYPE S SHIELDED, LOW LOSS, LOW CAP. PROBE

KLIPZON \$2.50

TYPE H JUMBO PRODS FOR LARGE CONDUCTORS

\$4.35

KLIPZON

TYPE V & G FOR VTVM-TYPE C FOR VOM

TYPE P KLIPZONS FOR PANEL MOUNTING

TYPE B KLIPZON MINI-PROD CONNECTOR

TYPE M KLIPZON MINI-PROD ADAPTOR

TYPE A1 KLIPZON TEST PROD HANDLE TENITE—4 3/4" LONG 50¢ ea.

TYPE M-I KLIPZON JUMBO PROD HANDLE 40¢ ea.

TYPE J KLIPZON JUMBO PROD ADAPTOR 25¢ ea.

TYPE L KLIPZON LONGIE ADAPTOR 35¢ ea.

TYPE T KLIPZON ALLIGATOR ADAPTOR 32¢ ea.

TYPE Q KLIPZON BANANA PLUG ADAPTOR 30¢ ea.

TYPE R KLIPZON BANANA PLUG CONNECTOR 44¢ ea.

TYPE KK \$4.95

The KLIPZON TEST PROD AND ADAPTOR KIT

Self-Assembling Probes! MODERN - EFFICIENT - CONVENIENT - FREES BOTH HANDS - ADAPTS TEST PRODS TO ALL TYPES OF CIRCUITS

A Handy, Compact Test Outfit. Adapts all types of prods to all circuits. Roll-up type with securing cord. Consists of:

1 TYPE A Klipzon Test Prods and Leads,
2 TYPE T, 2 TYPE Q, 2 TYPE R, 2 TYPE L, 2 TYPE J ADAPTORs.



GENERAL CEMENT

TV • RADIO CHEMICALS

ALL CHEMICALS AVAILABLE
IN LARGER SIZE CONTAINERS!

Ask your distributor
for large, complete

**G-C CATALOG
FREE!**

or write direct!



G-C RADIO-TV SERVICE CEMENT



The best Cement for repairing radios and speakers. Excellent for repairing and replacing torn cones. Vibration-proof, water-proof and fast drying. Brushes attached.

No.		List
30-2	2-oz.	\$0.65
34-2	Tube	.60

G-C RUBBER TO METAL DIAL DRIVE CEMENT



For cementing rubber drives to shafts, rubber mountings, gaskets, hose, weather stripping, for radio, refrigerators, autos, etc.

No.		List
35-2	2-oz.	\$0.65
35-3	Tube	.65

G-C BAKELITE CEMENT



For cementing bakelite to bakelite and bakelite to other materials. For repairing knobs, cabinets, panels, for inserts in moldings, attaching labels to plastics, etc. Brush attached.

No.		List
32-2	2-oz.	\$0.85

G-C VINYLITE CEMENT



Clear transparent adhesive, air drying. For cementing metals, plastics, paper, leather, etc. Used also as thermoplastic cement for non-porous materials. Sets on cooling. Brush attached.

No.		List
58-2	2-oz.	\$0.65

G-C HOUSEHOLD & MODEL CEMENT



Best cement for model makers, household, and office use. For airplanes, railroads, ships, toys, etc. Will cement wood, paper, plastics, metal, china, ceramics, etc. Fast drying, water-proof. Brush attached.

No.		List
45-2	2-oz.	\$0.50
45-3	Tube	.50

G-C FABRIC TO METAL CEMENT



For cementing cloth and felt to metal or plastics. Best for grille cloth, phono turntable felts, upholstering, fabrics, etc. Fast drying, water-proof.

No.		List
22-2	2-oz.	\$0.65

G-C WOOD GLUE



New white resin water-proof glue for radio cabinets, furniture, chairs, etc. Will not injure finish. Extra strong.

No.		List
39-2	2-oz.	\$0.65

G-C PLI-O-BOND CEMENT



Sticks anything to anything. Cold setting, rubber-like, thermoplastic cement that dries rapidly with a flexible and very strong bond. For iron, steel, plastics, glass, cloth, plastic fabrics, etc.

No.		List
43-2	2-oz.	\$0.65

G-C ELECTRICAL AND RESISTOR CEMENT



Heat-proof cement, hardens like porcelain. Same as on resistors, flat irons, etc.

No.		List
27-2	2-oz.	\$0.65

G-C ACRYLIC CEMENT



Welds and cements lucite, plexiglas, and other acrylic materials. Strong, fast drying. Brush attached.

No.		List
40-2	2-oz.	\$0.65

G-C NE-O-PRENE CEMENT



New G-C cement for cementing Neoprene rubber to Neoprene or Neoprene to other materials, such as metals, wood, paper, etc. Easy to use, fast drying.

No.		List
52-2	2-oz.	\$0.65

G-C LABEL CEMENT



Sticks labels to anything—metal, glass, wood, tin, bakelite, plastics, etc. Good for cementing labels to bins, racks, water-proofing labels, etc.

No.		List
46-2	2-oz.	\$0.65

G-C CEMENT SAMPLER KIT



What kind of cement shall I use? Get this kit and experiment with all types of cements available. Cements for all applications included so you can try them yourself for your application. 10—2-oz. bottles in Kit.

No.		List
345	Kit	\$8.25

G-C CEMENT THINNER



Made of same solvents as G-C Service Cement. Best thinner for all cements.

No.		List
28-2	2-oz.	\$0.55

G-C RADIO SERVICE SOLVENT



Best Solvent for loosening cement on speaker cones, frames, etc. Will dissolve all cements on speakers. Brush attached.

No.		List
31-2	2-oz.	\$0.55

G-C LACQUER THINNER



Will thin all lacquers, lacquer enamels, telephone black or gray, touch-up lacquers, airplane dopes, model cements, etc.

No.		List
29-2	2-oz.	\$0.55

G-C No. 67 PAINT THINNER



For Ruf-Koat, Krome-Koat, B-K Cement, Insulating Varnish, Rubber Cements, and ordinary paints.

No.		List
67-2	2-oz.	\$0.55

G-C PLASTIC CEMENT



For cementing broken plastic cabinets, knobs, dial and crystal assemblies, grille cloth, etc. Fast drying. Brush attached.

No.		List
32-2A	2-oz.	\$0.65

G-C TV TENNA-KOAT



Clear plastic coating to minimize TV antenna corrosion, maintain strong signal. Also coat lead connections, retard moisture. Apply with brush. Fast drying.

No.	List
24-2	2-oz. \$0.65

G-C TELEVISION CHEMICAL KIT



Complete kit of essential chemicals needed for TV set servicing. Saves time and money. Handy metal box contains 9 chemicals such as Corona Dope, Tube-Koat, Tenna-Koat, De-Ox-Id, Lens Cleaner, etc.

No.	List
904	Kit \$9.50

G-C TELEVISION HIGH VOLTAGE CORONA DOPE



Used by manufacturers and servicemen to prevent corona shorts on high voltage circuits in Television sets. Easy to apply, air-drying. It has very excellent high voltage insulating qualities.

No.	List
47-2	2-oz. \$1.20

G-C TV LENS & TUBE CLEANER



Specially prepared for cleaning TV lenses and CR tubes. Eliminates finger marks and spots, restores sharp, clear picture. Good item to sell every TV set owner.

No.	List
216-2	2-oz. \$0.60

G-C SILVER PRINT



Same "Pure Silver" compound as used by manufacturers in Printed Circuit design. You need G-C Silver Print to repair those Printed Circuits, to touch up the circuit around eyelets, rivets, parts, etc. Also handy for experimenters, engineers, laboratories, etc.

No.	List
21-2	1-Troy oz. \$7.75

G-C LIQUIDOPE



All wave nitrocellulose base dope for coils. Air dries fast to tough film that insures toughness and firmness. Use for sealing, doping, supporting coils, etc.

No.	List
36-2	2-oz. \$0.65

G-C ELECTRONIC HYPO-DERMIC NEEDLE INJECTOR



A handy applicator on the hypodermic principle; for injecting cleaners and oils into tight places. Supplied with 2-oz. bottle.

No.	List
8383	Hypodermic Needle \$0.75

G-C RADIO CHASSIS CLEANER



Clean the chassis and make extra money on every repair job. Satisfy your customer. For radio chassis, panels, testers, etc. Non-explosive cleaner.

No.	List
123-8	8-oz. \$0.95



GENERAL CEMENT TV • RADIO CHEMICALS

G-C TELEVISION TUBE KOAT

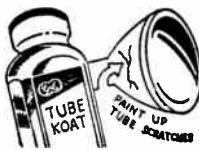

A black conductive coating for outside of glass TV tubes and for interior of cabinets to ground high potential, built up for TV tubes.

No.	List
49-2	2-oz. \$0.95

NEW G-C RED-X CORONA DOPE



Prevent corona shorts on high voltage TV circuits with this all-new G-C product. Easy to apply. Air dries faster. Excellent high voltage insulating qualities.

No.	List
50-2	2-oz. \$1.20

G-C MAG-NETIK HEAD CLEANER



Cleans tape and wire recorder head mechanisms. Does not leave scum or film. Should be used regularly for best recordings.

No.	List
53-1	1-oz. bottle \$0.85
53-2	2-oz. bottle 1.60

G-C FUNGUS VARNISH



Used on radio equipment and instruments to insulate and prevent fungus growth in moist or humid climates. Air dry, brush or spray.

No.	List
57-2	2-oz. \$0.65

G-C INSULATING & DIPPING VARNISH



For treating field coils, noisy or buzzing transformers and chokes. Air dries to a tough insulating film. Can be brushed or dipped.

No.	List
56-2	2-oz. \$0.65

G-C DE-OX-ID KIT



"Ideal for Television Controls"

Handy kit contains 2-oz. of De-Ox-Id and hypodermic injector in box.

No.	List
8460	Kit \$1.65

G-C GRAFOLINE



Noiseless lubricant for air exposed switch contacts, rheostats, relays, wire volume controls, tube prongs, etc. Increases current capacity of switch controls. Cleans also.

No.	List
120-2	2-oz. \$0.65



G-C TV SPRA-KLEEN

Pressurized electrical contact cleaner and lubricant. Fast, easy to use, no spillage. Saves removing chassis or parts.

No.	List
8666	6-oz. \$1.67

G-C NO-NOIZ TV CONTACT & DETENT CLEANER



New secret ingredients dissolve corrosion and oxidation on contacts, stops noise on contacts, volume controls, tuners, detents, switches, relays, etc.

No.	List
51-1	1-oz. bottle \$0.85
51-2	2-oz. bottle with Applicator 1.60

G-C SILICONE COMPOUND



"The miracle moisture and water-proofing compound for Television and FM"

A permanent water-proofing material for TV and FM leads.

No.	List
8100	1-oz. Tube \$1.65

G-C Q-DOPE & Q-DOPE THINNER



Liquid polystyrene low loss coil dope for RF, UHF, and VHF components. Performs -70°F. to 160°F.

No.	List
37-2	2-oz. \$0.60
41-2	Thinner 2-oz. .55

G-C DE-OX-ID



"Television Contact Cleaner" Liquid chemical for all electronic contacts and controls. It cleans, lubricates, and preserves. Recommended for volume and tone controls, relay contacts, push-buttons, etc. Dissolves corrosion and oxidation.

No.	List
19-1	1-oz. \$0.85
19-2	2-oz. 1.60

G-C RED ELECTRONIC CONTACT CLEANER



The best and only all-purpose cleaner. Dissolves the dirt and removes corrosion. Leaves protective film on contacts to prevent corrosion.

No.	List
210-2	2-oz. \$0.55

G-C VINYL PLASTIC FABRIC CEMENT



Made for cementing vinyl plastic sheets together. Ideal for vinyl insulating tubings, patching plastic raincoats, etc. Dries fast.

No.	List
16-2	2-oz. bottle \$0.65



GENERAL CEMENT

TV • RADIO CHEMICALS

It's

G - C

for All TV!

G-C LUBE-REX



Lubriplate—white lubricant for push buttons, phonographs, Philco mystery controls, guns, fishing reels, dials, etc. Prevents corrosion, repels water.

No.		List
1206	2-oz. Tube	\$0.65
1209	2-oz. Bottle	.65

G-C CONTACT & CRYSTAL CLEANER



Extra pure cleaner. Fast drying for cleaning contacts and crystals. Will not injure delicate parts.

No.		List
127-2	2-oz.	\$0.55

G-C COIL DOPE KIT



For high frequency coils, ultra low loss. Contains 2-oz. bottle Polystyrene Q-Dope, 2-oz. Thinner, and 2 brushes. The best!

No.		List
888	Kit	\$1.10

G-C RUF-KOAT WRINKLE VARNISH

Air Dry or Bake



The only finish that will air dry and give professional wrinkle job without baking. Same as used by leading mfrs. Apply and let dry. Colors: Black, Gray, Brown. (Specify Color.)

No.		List
60-2	2-oz.	\$0.65
60-X-4	Ruf-Koat Undercoat 4-oz.	1.10

G-C KRYSTAL KOAT CRYSTAL LACQUER



Makes beautiful floral pattern when dry. Strictly air drying. For chassis, panels, decorations on metal, etc. Colors: Black, Gray. (Specify Color.)

No.		List
63-2	2-oz.	\$0.65

G-C DIAL LITE COLOR KIT



Long lasting coloring for dials, signals, lamps, panels, hobby work, etc. Red, Green, Blue, Amber, Purple and Solvent in kit.

No.		List
66-5	Kit - 5 small bottles	\$1.00
66-6	Kit - 6 small bottles	1.20
66-2	2-oz. (Specify Color)	.65

G-C CARBON CONTROL CLEANER



Fix noisy carbon controls without taking apart. Just squirt cleaner along shaft and job is done. Save money. Applicator supplied.

No.		List
212-2	2-oz.	\$0.65

G-C CONTACT DOPE



Ideal cleaner and lubricant for switches, controls and contacts. Resists corrosion and oxidation. Eliminates noise.

No.		List
121-3	Tube	\$0.45
121-4	2-oz.	.65

G-C SPIRIT VARNISH



Fast drying walnut spirit varnish for touching up nicks and scratches. Will not raise the finish.

No.		List
161-2	2-oz.	\$0.65

G-C ROOF-SEEL COMPOUND



Seals holes in roofs, eliminates call-backs on roof antenna installations. Inexpensive, easy to use.

No.		List
18-16	Pint Can	\$1.00

G-C KROME-KOAT ALUMINUM PAINT



Fast drying, ready mixed, leaves chrome-like finish. For PA equipment, speakers, chassis, towers, antennas, etc.

No.		List
61-2	2-oz.	\$0.65

G-C CHEMICAL LABORATORY



Complete assortment of 20 popular radio chemicals and cements in 2-oz. bottles put up on steel rack. Very neat for radio bench and home work shop. Steel rack FREE.

No.		List
997	Lab	\$12.75

G-C CARBON-X



New improved formula. Fix those old noisy carbon controls, touch up noisy spots on worn controls. Brush in bottle.

No.		List
1205	2-oz.	\$1.20

G-C CARBON TETRA-CHLORIDE



100% pure for cleaning and degreasing electrical contacts, controls, motors. Absolutely safe—will not burn. Also kills bugs, roaches, etc.

No.		List
211-2	2-oz.	\$0.55

G-C PENETRATING STAIN



Spirit type stain, penetrates and will not injure finish. Cover scratches, dents, darken corners on cabinets, etc. Walnut and Mahogany. Specify.

No.		List
162-2	2-oz.	\$0.55

G-C TELEPHONE BLACK OR GRAY



High grade lacquer enamel covers well, dries fast. Black is satin ebony finish similar to telephones. Gray is pleasing shade. For panels, racks, parts, etc. (Specify Color.)

No.		List
62-2	2-oz.	\$0.65

G-C RMA COLOR CODING KIT



Complete kit of all standard RMA colors to code resistors, condensers, parts, etc. Chart included. Ten bottles.

No.		List
677	Kit	\$2.15

G-C DELUXE CHEMICAL LAB



Practical larger laboratory of popular chemicals and cements to fit needs of average shop—2-oz., 4-oz., and 8-oz. bottles. Larger bottles of more popular items. Steel rack is FREE.

No.		List
998	Lab	\$17.45

Ask Your Distributor for Complete G-C Catalog

FREE . . . or Write Direct!

**It's
G-C
for All TV!**

**GE GENERAL CEMENT
TV • RADIO CHEMICALS**

G-C POWER SPRAY-KOAT

No brush — no muss — no fuss. Your choice of eight fine finishes in handy spray containers. Just press the special nozzle cap. Aluminum: Coat and protect antenna masts, speakers, PA equipment, etc.; dries to bright, chrome-like finish. Plastic: Corrosion-proof antennas, connectors, all metals, etc.; dries fast, transparent. Cover 100 square feet approximately.



No.		List
8660	Aluminum	\$1.79
8665	Plastic, clear	1.79
8754	Gray	1.79
8755	Black	1.79
8756	Brown	1.79
8757	White	1.79
8758	Gold	1.79
8759	Coppertone	1.79

G-C DIAL OIL



For lubricating dials, drives, and fine mechanisms. Long lasting.

No.		List
1245	4 oz.	\$0.50

**G-C NON-STICK
IRON TIP COMPOUND**



Prevents soldering iron tips from burning into iron. Saves your iron and tips.

No.		List
1201	2 oz.	\$0.65

G-C LIQUID SOLDER FLUX



Non-corrosive flux for radio and electrical work. Solders faster, smoother.

No.		List
42-2	2 oz.	\$0.65

G-C SOLDERING PASTE



The best non-corrosive paste for radio and electrical work. Solders faster and smoother.

No.		List
1207	2 oz. can	\$0.45

G-C STRIP-X



Strips enamel from magnet wire. Dip wire in and wipe insulation off—ready for soldering.

No.		List
26-2	2 oz.	\$0.65

**G-C NON-SLIP COMPOUNDS
Powder Compound**



For dial cords, pulleys, belts. Prevents slipping.

No.		List
1210	2 ozs.	\$0.55

Liquid

Penetrating liquid shrinks fibers, prevents slipping on dial cord and belts.

No.		List
1215	2 oz.	\$0.65

G-C RECORD-LIFE LUBRICANT



Simply wipe record with "Record-Life" and the needle will glide over the record smoothly. Prevents record and needle wear; also eliminates noises and scratching sounds. Use also for making records.

No.		List
125-2	2 oz.	\$0.65

G-C REK-O-DOPE



Required lubricant when recording and cutting records. All purpose, it cools, cleans, lubricates, and hardens grooves when cut. Rek-O-Dope will give better tone and longer life.

No.		List
126-2	2 oz.	\$0.65

G-C STA-PUT

PHONO-GEAR LUBRICANT



New "Sta-Put" lubricant for phonomotors, gears, shafts, etc. Will not run or drip-it "Stays-Put." Recommended by RCA, G-E, and others.

No.		List
1223	Tube	\$0.65
122-2	2 oz.	.65

G-C "RECO" STATIC CHASER



Developed specially for vinylite records, it eliminates static electricity on plastic records and keeps records dust free. Also stops crackling and static discharge noises. Simply wipe it on and the job is done. Can be used on any type records.

No.		List
48-2	2 oz.	\$0.75

G-C PORCELAIN GLAZE



Fills in nicks and dents on porcelain and duco refrigerators, sinks, washing machines, etc. Fill in and let dry.

No.		List
911	2 oz.	\$0.75

**G-C SPEAKER CONE
RECONDITIONER**



Apply to old dried out cones to restore plasticizer and bring back original tones.

No.		List
25-8	8 oz.	\$1.00

G-C TV LINE SEAL for UHF and VHF



Outdoor special acrylic sealer for sealing TV wires, terminals, screws, antennas, TV Lines, etc. Seal it with G-C TV Line Seal and forget it. It will avoid trouble as it seals and prevents corrosion and loosening of contacts, screws, etc.

No.		List
17-2	2 oz. Line Seal	\$0.65



GENERAL CEMENT

CABINET REPAIR MATERIALS

G-C LUMINOUS KITS



Complete kits of luminous paint that glows in the dark. Many uses in shop and home. See it at night. Easy to use — apply and let dry.

No. List
184-C DeLuxe Kit contains Powder, Mix-Coat, Top Coat and Brush. \$3.25

G-C FRENCH VARNISH



Used by craftsmen to repair furniture and blend in the finish. Can be applied with pad, brush or spray. Dries fast.

No. List
160-2 2 oz. \$0.65

G-C FRENCH EMULSION



Best pad lubricant to use with French Varnish Polishing Method.

No. List
164-4 4 oz. \$0.85

G-C RUBBING OIL



Rub down newly finished or repaired cabinets to produce rich satin sheen finish.

No. List
163-16 16 oz. \$0.95

G-C SCRATCH REMOVER POLISHES



Dark
Polish contains stains to remove scratches. Sell to housewives.

No. List
92-2 2 oz. \$0.50

Light
For light woods; polishes and removes scratches at same time. Popular with housewives.

No. List
93-2 2 oz. \$0.50

G-C CREME-O-WAX POLISH



White non-staining hard wax base polish produces a hard glossy finish. Excellent for radios, pianos, refrigerators, furniture, etc.

No. List
95-2 2 oz. \$0.50

G-C PORCELAIN PATCH STICK



Made for white porcelain refrigerators, sinks, ranges, fixtures, etc. Simply melt into nick and smooth off.

No. List
908 Stick \$0.50

G-C SHELLAC STICKS



High grade sticks for filling dents and nicks in wood cabinets and furniture. Sticks 7" long.

No.	List	No.	List
929 Lt. Walnut	\$0.55	979 Dk. Oak	\$0.55
930 Dk. Walnut	.55	980 Transparent	.55
933 Black	.55	981 Lt. Transparent	.55
934 White	.55	982 Walnut	.55
935 Maple	.55	983 Mahogany	.55
978 Lt. Oak	.55	984 Blonde Maple	.55

G-C SHELLAC STICK KIT



Handy assortment of 10 colors to take care of any shade of wood. Same as in G-C Kits.

No. List
925 Kit \$2.25

G-C MAGIC SCRATCH KIT

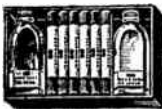

Combination of 6 shades fillers and light and dark scratch fluid. Easy to use on emergency jobs.

No. List
915 Kit \$1.65

G-C GENERAL SCRATCH STICK



Removes scratches. Simply run over scratches and they will disappear. Handy to carry in your pocket or tool box for emergency repairs. Also sell to housewives.

No. List
909 Scratch Stik \$0.50

NEW G-C DIAL CORD DRESSING STICK

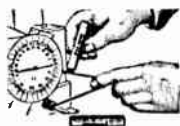

A new, easy way to treat slipping cords on dial mechanisms. Simply rub the stick on cord and job is done! Prevents and stops slipping. Carry a stick with you and save time.

No. List
1212 Dressing Stick \$0.25

G-C SCRATCH REMOVER LIQUID



New liquid! Removes scratches instantly. Simply wipe over scratches. Handy to have in tool box.

No. List
917 2 oz. \$0.55

**SPECIAL PRICES TO QUANTITY USERS . . .
ASK YOUR G-C DISTRIBUTOR FOR
COMPLETE INFORMATION AND PRICES.**

G-C FLOCK BLOWER GUN



It's easy to apply flock and be sure to get a good job with the G-C Patented Gun. Gun can also be used for dusting and cleaning.

No.	List
180-3 Gun	\$4.80
180-4N35
Cleaning Nozzle for Gun	



GENERAL CEMENT CABINET REPAIR KITS GRILLE CLOTH

G-C MASTER DELUXE CABINET REPAIR KIT



Complete cabinet repair kit in a permanent metal box. All finishes are spirit soluble and will not cut or damage surrounding finishes on cabinets, etc. Kit contains 10 shellac sticks, alcohol lamp, French varnishes, rubbing felt and sandpaper, polish, directions, etc.

No.	List
900 Kit	\$10.95

G-C MASTER CABINET TOUCH-UP KIT



A complete, fast touch-up kit for repairing scratches and dents. Works on wood and plastic cabinets. The spirit finishes will not cut into the adjoining surface or injure surrounding finish. Contains French varnish, emulsion, colored enamels, stains, polishes, and filler. Sandpaper, steel wool, rubbing cloth and directions included. Brushes attached to caps of all finish bottles. Put up in metal box.

No.	List
907 Kit	\$4.75

G-C FELT KOAT FLOCK KIT



New G-C kit with special blower gun. Distributes flock evenly and applies a thick velvet-like coat. Kit is complete with gun, brown and ivory flock, brown and ivory undercoat, thinner, brush, etc. Gives professional job on turntables, cabinets, grilles, tool boxes, toys, signs, etc. Has thousands of applications.

No.	List
180-2 Kit	\$12.95

G-C FELT-KOAT FLOCK



Genuine Rayon Flock, $\frac{1}{8}$ " length fibers accurately cut, give beautiful even finish. One pound covers approximately 90 sq. ft. Colors: Brown, Taupe, Blue, Black, Ivory, Red, Green, Silver, and Gold. (Specify Color.)

No.	List
180-5 2 oz. Can	\$1.35
180-7 1 lb. Bag	6.00

G-C TELEVISION GRILLE CLOTH



New television metallic grille cloth specially made for TV cabinets.

Specify "A" or "B" style

No.	Size	List
8656	18" x 24"	\$2.50
8657	24" x 36"	4.75
8658	36" x 36"	7.50
8659	36" wide per yard, bulk	7.25



G-C TV PLASTIC SARAN WOVEN GRILLE CLOTH

Beautiful plastic cloth in a beautiful pattern. Ideal material for custom-built cabinets and commercial sound installations.

No. 8736	List \$1.65
12" x 18" - Bronze & Gold	

No. 8739	List \$9.25
36" x 36" - Bronze & Gold	
No. 8737	List \$1.65
12" x 18" - Ecru & Ivory	
No. 8740	List \$9.25
36" x 36" - Ecru & Ivory	

G-C DELUXE CABINET REPAIR KIT



Comes in handy metal box. Contains ten shades of shellac sticks, bottles of light and dark oil stain, bottles of metal shading varnish, polish, General Skratsh Stik, alcohol lamp (with alcohol), spatula, small brushes, steel wool, sandpaper, and wiping cloth. No special skill required. Directions included.

No.	List
901 Kit	\$7.50

G-C CABINET REPAIR KIT MATERIALS



No.	List
908 Porcelain Patch Stick	\$0.50
937 Shellac Stick Rubbing Fluid 2 oz.55
900-11R Sandpaper, 4/0 Sheet11
900-12R Sandpaper, 7/0 Sheet, very fine17
900-14R Steel Wool Pads, box of 16	2.00
936 Spatula, for Shellac Sticks28
937 Alcohol Lamp with Alcohol50
938 Lamp Fluid, pint	1.00
161-2 Varnish Stain, Walnut, 2 oz.65
162-4 Spirit Stain, Walnut or Mahogany (specify color), 4 oz.95
900-13R Touch-Up Brush60

G-C FELT KOAT KITS



Complete flock kit with flock undercoat, thinner and brushes and shaker type can for applying flock. Colors: Brown, Blue, Taupe, Black, Red, Green and Gold. (Specify Color).

No.	List
180-0 Deluxe Kit	\$3.75
180-1 Reg. Kit (No Brush or Thinner)	2.75

G-C FLOCK SIZING UNDERCOAT



Material is first applied on surface to be flocked. Then flock is applied. Used on metal, wood, paper, etc. Neutral color, can be used with all colors of flock.

No.	List
180-4 4 oz.	\$1.20

G-C FLOCK SIZING THINNER

No.	List
181-4 4 oz.	\$0.50
181-8 8 oz.65

G-C METAL FLOCKED GRILLE SCREEN



Very popular. Both sides flocked with rayon over galvanized metal screen. Used on radios, P.A. speakers, intercoms, auto radios, etc. Waterproof, durable. Colors: Brown, Ivory, Maroon.

No.	Size	Color	List
951-1	8" x 11"	Brown	\$0.95
951-3	8" x 11"	Ivory	.95
951-5	8" x 11"	Maroon	.95
952-1	18" x 24"	Brown	3.20
952-3	18" x 24"	Ivory	3.20
952-5	18" x 24"	Maroon	3.20
953-1	36" x 36"	Brown	9.85
953-3	36" x 36"	Ivory	9.85
953-5	36" x 36"	Maroon	9.85

G-C CABINET SPEAKER GRILLE CLOTH



Beautiful modern patterns of Brown, Gold and light colors to match Walnut, Mahogany and Ivory Cabinets. Specify "Ivory" when ivory is wanted.

No.	Size	List
940	18" x 20"	\$1.50
941	9" x 18"75
942	12" x 12"70
943	14" x 18"	1.00
944	24" x 18"	1.35
945	18" x 18"90
949-2R	50" Wide Cont. lgth., per yd.	6.50

GENERAL CEMENT **RADIO-TV ACCESSORIES**

G-C DIAL DRIVE SPRING KITS

Assorted, for most requirements.

G-C DIAL CORD CLIPS



Handy assortment for fastening dial cords. Squeeze around cord with pliers. 30 Assorted.



No.	8 asst. sizes	List
1054		\$0.45
1054-S	10 small springs	.45
No.	25 asst. sizes	List
1055		1.30

G-C RCA TELEVISION TUNING BELT



New belt for RCA Television Tuner. Used on models series numbers 8TC, 8TK, 8TC, etc. (Belt Part No. 73465.)

No.	Tuner Belt	List
195		\$0.50

G-C DIAL CABLE TOOL



Handy tool to aid in stringing new dial cord and replacing cables slipped off pulleys and drums. It's like an extra hand. Speeds up the job.

No.	List
5096	\$0.85

G-C RECORD TURNTABLE FELT

Re-cover phono turntables with ready cut felts. Dark brown.



No.	Dia.	List
1292	7 7/8"	\$0.50
1293	9 3/8"	.70
1294	11 3/8"	.85
1295	15 3/8"	1.45

G-C LONG NOSE PLIERS



Very handy pliers to reach into places and hold parts. It's very handy for installing radio dial cords. Available in straight nose and curved nose styles.

No.	List
5192	\$1.00
5193	1.00

G-C DIAL POINTERS

Popular Replacement Pointers

No.	List
(a) 6801	\$0.40
3" Rotary Pointer for 1/4" shaft, gold	
(b) 6802	\$0.40
5" 360° Rotary Pointer for 1/4" shaft, gold and red	
(c) 6803	\$0.40
2" Slide Pointer, red translucent	
(d) 6804	\$0.40
2 1/4" Slide Pointer, white enamel	

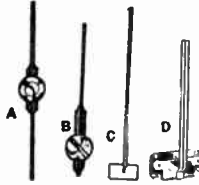

G-C PHONO SPRING KIT



Kit contains assorted springs same as are used on phono turntables. With this kit you can replace the broken or weak spring without waiting or delay in service.

No.	List
6478	\$2.75
6479	4.85

G-C DIAL POINTER KITS

A complete kit of assorted dial pointers. Pointers come in a clear transparent plastic case which keeps the pointers in perfect condition.



No.	List
6810	\$3.25
6805	5.50

G-C HANDY PICK-UP TOOL



Very handy for every one. Picks up pieces in hard-to-get-at places. Will hold and start screws, nuts, etc. Will pay for itself in short time.

No.	List
5089	\$1.65

GENERAL CEMENT

ALIGNMENT KITS

G-C TELEVISION ALIGNMENT TOOL KITS



G-C Television Tools are the best quality tools you can buy. They are made specially for Television work and are all designed to give you long service. The steel tips are all extra thin and are of the best grade hardened steel that will give you service. Kit contains 16 essential Tools.

No.	List
8280	\$12.90

TV Kit in Leatherette Case

No.	List
8281	\$12.90

Kit supplied with Bench Stand



G-C NX ALIGNING KIT

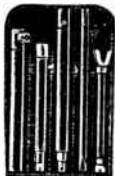

Popular approved Army-Navy Kit for all sets. Fourteen tools. Contains Nos. 5004, 5011, 5017, 5015, 5016, and leatherette case.

No.	List
5020	\$7.15

G-C ALL-PURPOSE TV ALIGNMENT TOOL KIT



Kit contains four basic tools to service most TV sets. Convenient plastic container.

No.	List
8457	\$2.95

G-C PROFESSIONAL ALIGNMENT TOOL KITS



Complete kits. Be prepared to service every set with these DeLux Alignment Kits. In a handy roll-type leatherette case or a steel partitioned box. Kit contains 30 Tools.

No.	List
5024	\$21.95

Kit in Roll-Type Case

G-C ALL-PURPOSE ALIGNMENT TOOL KIT



Seventeen tools designed into nine basic tools some of which telescope into each other. Roll-type leatherette case. Includes Nos. 5001, 5003, 5004, 5011, 5016, 5017, 5053, 5056, 5057.

No.	List
5023	\$6.90

Kit

G-C VEST POCKET ALIGNING KIT



Easy-to-carry all-purpose kit. Four tools with telescoping parts making them equivalent to six. Contains Nos. 5012, 5000, 5003, 5004 and leatherette case.

No.	List
5022	\$3.30

Kit

IT'S G-C FOR ALL TV!

G-C NEW TELEVISION "X 57 PLASTIC LONG SLIM" SCREWDRIVER



Extra long reach, practically unbreakable, insulated screwdrivers. Super-tough tips can be re-ground.

No.	Blade	Overall	List
8987	7"	9 1/4"	\$1.00
8988	12"	14 1/4"	1.50
8989	16"	18 1/4"	2.00



GENERAL CEMENT

RADIO-TV ALIGNMENT TOOLS

G-C "SHORTY" TV ALIGNMENT SCREWDRIVER



Only 2" long, fits No. 4 and 6 studs. Unbreakable plastic, spring steel tips.

No.	Tool	List
8289		\$0.70

G-C TELEVISION 6" DUPLEX ALIGNER



All-purpose, for trimmers. I.F. transformers, coils, etc. Driver and recess tips.

No.	Tool	List
8276		\$0.80

NEW G-C LONG ARM TV TOOL (LONG REACH)

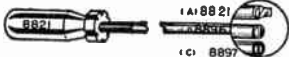

Extra-long reach for those hard-to-get-at places like Zenith sets and others. 18" long.

No.	Tool Type	List
8821	Tool Type A	\$1.50
8896	Tool Type B	1.50
8897	Tool Type C	1.50

G-C TELEVISION CHANNEL TUNING TOOL



Designed for TV receivers, for making channel adjustments, etc. Completely insulated, non-metallic tool, long 1/2" narrow blade. Overall length approx. 7".

No.	TV Tool	List
8195		\$0.90

G-C NEW "SHORTY" TV ALIGNMENT TOOL



For RCA, Zenith and other sets.

No.	List
9051	\$0.75

G-C TELEVISION ALL-PURPOSE ALIGNER



Specially made for TV I.F. adjustments. Plastic handle and hard fibre shaft. Very thin spring steel tip recessed so tool guides itself over screws.

No.	TV Aligner	List
8273		\$1.10

G-C NYLON TELEVISION LONG REACH ALIGNER



Handy new long reach TV aligner with insulated metal shaft and nylon tip that can be replaced. Very sturdy tool for TV work. 12" long overall.

No.	TV Tool	List
8607		\$1.80
8608-E		.30

Nylon Replacement Tip for 8607

G-C TELEVISION 2-IN-1 9" LONG-REACH DUPLEX ALIGNER



For hard-to-get-at No. 4 and 6 studs. Spring steel recessed tips, color coded. Unbreakable.

No.	List
8721	\$1.25

G-C TELEVISION ALIGNMENT TOOL



Special short sturdy tool with a fine metal screwdriver blade to adjust Television and FM sets while they are in the cabinet. Only 2 1/2" long overall.

No.	TV Tool	List
5066		\$0.55

G-C TELEVISION AND FM TUNING TOOL



Special short tool with fine recessed screwdriver tip for TV and FM adjustments. Makes those difficult adjustments when set is installed in console. Only 2 1/2" long. Made of bone fibre.

No.	TV Tool	List
8196		\$0.60

G-C NEW TELEVISION ALIGNMENT TOOL



For RCA, Zenith and other sets.

No.	List
9050	\$0.30

G-C PHONO DRIVE KIT



Kit of 50 assorted phono drives. Drive assortment based on average popularity. Packed in envelopes for easy identification; ideal for the bench or on the job.

No.	List
8846	\$13.50

G-C GENERAL ELECTRIC ALIGNMENT TOOL



Handy alignment tool made of clear plastic. Has metal tip one end and a recessed tip on other end. Tool 6" long, 3/8" diameter. Tip 1/8" wide.

No.	Tool	List
8609		\$1.00

G-C TELEVISION 2-IN-1 7" DUPLEX ALIGNER



For No. 4 and 6 studs, color coded for easy identification. Spring steel recessed tips.

No.	Tool	List
8722		\$1.05

G-C TELEVISION ALIGNING WRENCH



New Television tool with 1/2" square socket wrench, 1/2" shaft with insulated handle. Approximately 6" long.

No.	Television Wrench	List
5080		\$0.85

G-C TELEVISION CORE ALIGNER



For Motorola, Stewart-Warner, Belmont, etc., using Stackpole or other stud type cores that are not slotted. Made of hard fibre 6" long with a milled steel insert on one end and a thin screwdriver blade on other end.

No.	Core Aligner	List
8271		\$0.90

G-C NEW TV LONG REACH ALIGNMENT SCREWDRIVERS



Bone fibre shafts, extra thin 1/8" dia. Sturdy tips on both ends can be re-ground and used over and over.

No.	Length	List
8728A	7"	\$0.45
8728	12"	.70
8729	16"	.90

G-C UNIVERSAL SCREW DRIVER ALIGNER



Unbreakable flexible clear plastic shaft, amber plastic handle. 7" long overall. Very handy and universal all-purpose alignment tool. Spring steel tips.

No.	TV Tool	List
8290		\$1.00

G-C K-TRAN TELEVISION ALIGNER



For K-Tran I.F. Transformer tuner slugs. Bone fibre with plastic handle. 6 1/2" long.

No.	Tool	List
8727		\$0.85

G-C K-TRAN TOOL



Ideal Television Tool

Specially designed for K-Tran and I.F. transformers. Made of bone fibre, screwdriver on both ends.

No.	Tool	List
5097		\$0.85

G-C TELEVISION I.F. OSCILLATOR ALIGNER



For I.F. and oscillator adjustments. Fits all makes of sets, RCA, G-E, Philco, Admiral, etc. Made of plastic handle and steel shaft. Blade is extra thin spring steel for long life.

No.	TV Osc. Tool	List
8272		\$1.20

G-C STANDARD TELEVISION ALIGNMENT TOOL KIT



Here's a popular low-priced alignment kit that has the latest essential tools for Television Sets. Specially engineered for Television Sets. A real value in roll-type case.

No.	List
8455	TV Kit Complete \$7.65



GENERAL CEMENT RADIO-TV ALIGNMENT TOOLS

G-C TELEVISION ZENITH UNIVERSAL ALIGNER



Designed for Zenith and other sets. Made of bone fibre and plastic handle. It has a thin fibre screwdriver on one end and a recessed extra thin spring steel tip on the other end.

No. 8275	TV Universal Aligner	List \$0.80
----------	----------------------	-------------

G-C TELEVISION TUNING WAND



Made of extra thin flexible plastic material to fit small coil openings in TV sets. Brass insert on end reduces inductance and iron core on other end increases the inductance.

No. 8278	TV-Tuning Wand	List \$0.55
----------	----------------	-------------

G-C NEW! TELEVISION 2-IN-1 ALIGNMENT TOOL



Made of molded nylon, has a hex wrench on each end. For Zenith, Admiral, Hoffman, G.E., RCA, and others using the hex type slug tuners.

No. 8606	Tool	List \$0.55
----------	------	-------------

G-C "STRATO" TUNING WAND



Made of Genflex. Brass cylinder on one end, iron core on other end. Used for adjusting and checking coils. Inserting iron core end increases inductance; inserting brass end lowers inductance.

No. 5002	Tool	List \$1.10
----------	------	-------------

G-C INSULATED HEX WRENCH AND DRIVER



Combination hex wrench and insulated screwdriver. The screwdriver may be extended from handle to provide extra long length. No metal parts. This is an all fibre tool.

No. 5005	Extends from 7-13"	List \$0.85
----------	--------------------	-------------

G-C ALLIGATOR WRENCH AND SCREWDRIVER



For RCA, Philco and others. Made of $\frac{3}{8}$ " bone fibre and strong metal wrench on one end and metal screwdriver tip on other end.

No. 5011	Tool	List \$0.55
----------	------	-------------

G-C 4-IN-1 ALIGNMENT TOOL



This is the most popular alignment tool for most receivers. Made of bone fibre, combination tool. Consists of screwdriver with metal nib, $\frac{1}{4}$ " Hex Wrench slotted and $\frac{3}{8}$ " Hex Wrench on other end.

No. 5014	Tool	List \$1.00
----------	------	-------------

G-C DUPLEX INSULATED WRENCH ALIGNMENT TOOL



Made of bone fibre with $\frac{1}{4}$ " Hex Metal Wrench one end and $\frac{3}{8}$ " Hex Metal Wrench on other end.

No. 5017	Tool	List \$1.40
----------	------	-------------

BAKELITE NEUTRALIZING TOOL U. S. Army TL-207



Genuine molded bakelite. Combination screwdriver and $\frac{3}{8}$ " Hex Wrench. Approved by U. S. Army Signal Corps.

No. 5027	Tool	List \$2.85
----------	------	-------------

G-C TELEVISION "SHORTY" DUPLEX ALIGNER



For trimmer and I.F. transformers where space is limited. Bone fibre with extra thin hardened spring steel tips. One end has a projected metal tip, the other end is recessed.

No. 8277	TV Shorty Aligner	List \$0.80
----------	-------------------	-------------

G-C ZENITH TV WRENCH AND ALIGNER



New plastic molded special tool made specially for Zenith TV sets. One end has a plastic hex wrench and the other end a small screwdriver tip.

No. 8282	Zenith TV Tool	List \$0.55
----------	----------------	-------------

G-C DUPLEX ALIGNMENT SCREWDRIVER



Low-inductance Metal Tip on both ends made of Genflex material. One end is $\frac{1}{4}$ " and other end is $\frac{3}{8}$ " for small holes. Strong, completely insulated.

No. 5001	Alignment Screwdriver	List \$0.85
----------	-----------------------	-------------

G-C NO-METAL INSULATING ADJUSTMENT SCREWDRIVER



Made of black bone fibre. Indispensable for aligning all-wave sets. Will give long service. Ends can be re-ground.

No. 5004	7" Long	List \$0.45
No. 5001	Low-Loss Polystyrene Type—Ideal for UHF Sets	List \$0.45

G-C DUPLEX NO-METAL ALIGNMENT SCREWDRIVER



Made of hard bone fibre or Polystyrene— $\frac{1}{4}$ " blade on one end and $\frac{3}{8}$ " blade on other. 6" long. A dual purpose alignment screwdriver. Ends can be re-ground.

No. 5009	Bone Fibre—6"	List \$0.45
No. 5010	Polystyrene—6"	List \$0.45

G-C WRENCH AND SCREWDRIVER ALIGNING TOOL



Made of $\frac{3}{8}$ " bone fibre with $\frac{1}{4}$ " Hex Wrench on one end and screwdriver with metal nib on other end. This is a very handy alignment tool and wrench.

No. 5013	Tool	List \$0.95
----------	------	-------------

G-C 6-IN-1 ALIGNMENT TOOL



Bone fibre, combination tool. Consists of Screwdriver with metal nib, $\frac{3}{8}$ " Hex Wrench, $\frac{1}{4}$ " Hex Side Wrench and $\frac{1}{4}$ " Hex End Wrench slotted.

No. 5016	Tool	List \$1.65
----------	------	-------------

G-C FLEXI-DRIVER



"Around the Corner" screwdriver for radio work. Approved by U. S. Army and Navy.

No. 5019	Tool	List \$2.25
----------	------	-------------

G-C SCREWDRIVERS



Insulated screwdrivers for radio work. No. 5056 for radio knobs. No. 5057 regular type for all-around radio use.

No. 5056	Blade 3" x $\frac{1}{8}$ " (Small)	List \$0.30
No. 5057	Blade 3" x $\frac{3}{8}$ " (Large)	List \$0.80

G-C TELEVISION LONG REACH ALIGNER



Made for Admiral, Zenith, RCA, and other sets to adjust nested iron cores and make front end adjustments. The blades are extra thin, made of bone fibre and are extra long.

No. 8274	Long Reach Aligner	List \$1.20
----------	--------------------	-------------

G-C TELEVISION DUPLEX ALIGNER



All purpose TV aligner for trimmers and I.F. transformers. Made of bone fibre with extra thin spring steel tips. One end has a projected tip, the other end has a recessed tip.

No. 8276	Duplex Aligner	List \$0.80
----------	----------------	-------------

G-C TELEVISION CORE ALIGNER



For hard-to-reach places. Has a recessed steel milled slot to fit over Stackpole and other type stud cores not slotted. Steel insert pinned in a fibre shaft for extra strength.

No. 8279	TV Core Aligner	List \$1.10
----------	-----------------	-------------

G-C ALIGNMENT SCREWDRIVER



Low-inductance Metal Tip Screwdriver made of Genflex—strong, completely insulated. Very popular all-around alignment tool. Two sizes— $\frac{1}{4}$ " and $\frac{3}{8}$ " diameter.

No. 5000	$\frac{1}{4}$ " Diam. x 6" Tool	List \$0.45
No. 5088	$\frac{3}{8}$ " Diam. x 6" Tool	List \$0.45

G-C RCA ALIGNING TOOL



Made of $\frac{1}{4}$ " bone fibre. Narrow screwdriver on one end and screw nib inserted on other end. Used on RCA sets and others for coil and push-button adjustments.

No. 5003	Tool	List \$0.85
----------	------	-------------

G-C NON-EXTENSION TYPE WRENCH AND DRIVER



Same as No. 5005 except screwdriver is permanently attached in wrench. Length not adjustable. Overall length is 6".

No. 5007	Tool	List \$0.45
----------	------	-------------

G-C ALLIGATOR AND WRENCH ALIGNING TOOL



Made of $\frac{3}{8}$ " bone fibre with alligator on one end and $\frac{1}{4}$ " metal Hex Wrench on other end. Very popular tool.

No. 5012	Tool	List \$0.55
----------	------	-------------

G-C 5-IN-1 ALIGNMENT TOOL



Similar to our 5014 except supplied with heavy duty metal screwdriver.

No. 5015	Tool	List \$1.65
----------	------	-------------

G-C TELEVISION AND PUSH-BUTTON TOOL



Required to adjust Push-Button Tuners. Socket Screwdriver made of best steel.

No. 5018	Tool	List \$0.85
----------	------	-------------

HEX INSULATED FIBRE ALIGNING WRENCHES



Hexed full length inside, so end can be cut off when worn.

No.	Length	Hex Size Across Flat	Diam.	List
No. 5051	5"	$\frac{3}{8}$ "	$\frac{1}{2}$ "	\$0.40
No. 5052	5"	$\frac{1}{2}$ "	$\frac{3}{8}$ "	.33
No. 5053	6"	$\frac{3}{8}$ "	$\frac{3}{8}$ "	.36
No. 5054	8"	$\frac{1}{2}$ "	$\frac{3}{8}$ "	.40
No. 5055	12"	$\frac{1}{2}$ "	$\frac{3}{8}$ "	.55

IT'S G-C FOR ALL TV!

G-C INSTALLERS TOOL KIT

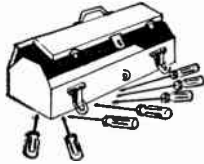

Beautiful steel tool case 18 1/2" long and roomy enough to hold lots of tools. Complete with 7 plastic handled forged blade screwdrivers.

No.	List
9052	\$13.50
9053	5.75
9054	7.95
	Screwdriver kit only

G-C TELEVISION AND TRIMMER TOOL

Handy tool to adjust smallest size trimmer condensers. Screwdriver is 3/16" diameter. Other end has a 3/16" hex nut wrench.

No.	List
5067	\$1.10

G-C ALIGNMENT TOOL FOR PHILCO, RCA, ETC.



For neutralizing air trimmer condensers on all sets. Made of 3/8" Fibre. Metal clip on end.

No.	List
5086	\$0.65

G-C TELEVISION AND TRIMMER TOOL



Specially made for adjusting neutralizing padding condensers and iron core tuners and coils.

No.	List
5091	\$0.85

G-C INSPECTION MIRROR



Inspection Mirror for hard to see places.

No.	List
5090	\$0.55

G-C WIRE STRIPPER



5-in-1 tool. Wire stripper, scraper, cutter, screwdriver, and wire winder all in one. Tempered steel.

No.	List
757	\$0.50

G-C TV PLASTIC PLIERS



Insulated long-nose pliers, shock-proof. High impact bakelite. Handy for picking up nuts and bolts when set is "hot."

No.	List
8387	\$1.65

G-C AMO MINIATURE TUBE PULLER



(Pat. Pending)

Prevents burned fingers and broken tubes. Makes it easy to remove and install tubes such as 6AG5, 50B5, etc. Works on vacuum principle. Operates just by pressing on the tube. Releases tube by pressing button. Tube protected by rubber sleeve. Gets where your fingers can't reach. Sturdily constructed.

No.	List
5093	\$1.80
8106	1.80

G-C TV "HIGH-VOLT" SAFETY PROBE AND TESTER



Check TV high voltage circuits quickly. Tester glows when okay. Handy for H.V. rectifier tubes, transmitters, output and Xmitter tubes.

No.	List
8836	\$2.75



GENERAL CEMENT

ALIGNMENT TOOLS • SERVICE AIDS

G-C TEST Mallet, SCREWDRIVER AND TUBE TAPPER



Handy tool made with insulated screwdriver on one end and rubber mallet on other end. Very handy for tapping tubes to find shorted or intermittent tubes.

No.	Tool	List
5081		\$0.70

G-C BALANCING TOOL



A short neutralizing tool for work in close quarters. Sets can be adjusted without removing from cabinets. A very handy tool.

No.	Tool	List
5084		\$0.65

G-C TELEVISION AND PUSH-BUTTON TOOL



A specially-designed tool for adjusting iron core I.F. and R.F. transformers, coils, alignment condensers, and push-button tuners. Used on Bendix, RCA, and others. Metal tip on one end, other end recessed tip.

No.	Tool	List
5087		\$0.85

ZENITH PUSH-BUTTON WRENCH



Special wrench necessary to use in adjusting Zenith push-button radios.

No.	Zenith Wrench	List
5094		\$0.20

G-C NEUTRALIZING AND ALIGNING TOOL



U. S. Army TL-138-A

Ideal for all-around tuning and aligning. 6" long.

No.	Tool	List
5098		\$1.10

G-C TUBE AND PARTS EXTRACTOR



U. S. Signal Corps Part No. TL-201
Handy prong tool for extracting tubes and picking up parts. Rubber cushions on prongs.

No.	Tube Extractor	List
5092		\$1.65

G-C SOLDERING IRON TIPS



Best grade hard-drawn copper, bright plated to resist corrosion. Heats fast and holds heat.

No.	Tip	List
724	1/4" x 3"	\$0.50
725	3/8" x 4 1/4"	.65
726	1/2" x 4 3/4"	.70
727	3/4" x 4"	.85

G-C AUTO RADIO TUNER



Ideal for adjusting auto radios and to turn controls when radio is removed from car and cables disconnected. Square tip and V-tip ends to fit various type shafts.

No.	Tool	List
8285		\$0.45

G-C MINIATURE TUBE PIN STRAIGHTENER



Saves tubes! Straightens without damage the pins on miniature tubes such as 155, 6AK5, 9002, etc. Insert tube into precision base die and tube prongs are straightened and properly spaced. All metal.

No.	Tool	List
5191	For 7-pin tubes	\$1.25
8105	For 9-pin tubes	1.25

G-C TEST PROBE



Handy new test probe to "dig in" and find the trouble. Fibre point on one end. Metal hook on other end. Excellent for locating loose connections and shorted parts.

No.	Tool	List
5082		\$0.65

G-C ALIGNMENT WRENCH FOR PHILCO, RCA, ETC.



Excellent for neutralizing air trimmers on many models. RCA-Victor, Philco and others. Has a Hex Wrench on one end and metal hook on other end.

No.	Tool	List
5085		\$1.65

G-C ALIGNMENT SCREWDRIVER



Low inductance metal tip screwdriver made of Genflex—strong, durable, completely insulated. 3/16" diameter.

No.	6" Tool	List
5088		\$0.45

G-C CONTACT ADJUSTER



A handy tool to adjust contacts on switches, relays on pin ball machines and radio sets.

No.	Contact Adjuster	List
5095		\$0.25

G-C NEUTRALIZING AND ALIGNING TOOL



Approved by U. S. Army and Navy
Made of fibre. 3/8" diameter by 6" long.

No.	Tool	List
5099		\$1.40

G-C FUSE PULLERS



For cartridge fuses. Heavy duty construction of high dielectric material.

No.	Size	List
5525	Midget size, for fuses 1/4" by 1/2"	\$0.70
5526	Large size, for fuses 3/8" by 1 1/2"	1.40

G-C LONG-REACH TV AND RADIO LUBRICATOR



For hard-to-reach radio and TV controls, bearings, phono motors, etc. Buy two—for both grease and light oil. Clear transparent plastic, long tube.

No.	Tool	List
8690		\$0.80

G-C SPEEDEX SLIM-TYPE SOLDER IRON TIPS



New high-heat turn-down tip made of one-piece copper. Fits 3/8" iron. Tip 4 1/2" long.

No.	Tool	List
8741		\$1.00



G-C DUPLEX TUBE PIN STRAIGHTENER

A tube pin straightener for both miniature and jumbo miniature tubes of the 7 and 9 pin types. Pins on either type can be straightened by inserting in receptacle. Precision constructed steel dies molded in colorful plastic.

No.	Duplex Pin Straightener	List
8655		\$2.50

G-C GENERAL CEMENT

RADIO-TV DIAL CORDS, CABLES and BELTS

DIAL CABLES
Available in special bulk lengths and quantities
WRITE FOR QUOTATIONS

G-C No. 75 STANDARD THIN NYLON CORD

.028" diam. Most popular; used on 95% of sets. Braided nylon over fibre glass core. In plastic container.

No.	Spool	List
75-25	25 ft.	\$1.40
75-50	50 ft.	2.65
75-100	100 ft.	4.95
75-11	Env.	.45

G-C No. 70 BRAIDED BRONZE CABLE

.040" diameter; used on radio dials, instruments and for aircraft reel-in antenna cable. Phosphor bronze braided over fibre glass core for strength. In plastic container.

No.	Spool	List
70-25	25 ft.	\$1.30
70-50	50 ft.	2.65
70-100	100 ft.	3.80
70-11	Env.	.45

G-C No. 73 HEAVY NYLON CORD

.062" diameter; used on Philco, Majestic, Brunswick, etc. Very strong, chemically treated to prevent slipping. In plastic container.

No.	Spool	List
73-25	25 ft.	\$1.90
73-50	50 ft.	3.25
73-100	100 ft.	5.50
73-11	Env.	.45

G-C No. 76 SPECIAL THIN BRONZE CABLE

.025" diameter. Braided bronze as used on GE, RCA, and others. Also for flexible connections on speakers, cones, etc. In plastic container.

No.	Spool	List
76-25	25 ft.	\$1.40
76-50	50 ft.	2.65
76-100	100 ft.	4.95
76-11	Env.	.45

G-C No. 75-A EXTRA THIN NYLON CORD

.025" diam. Used on RCA, GE, Strom-Carl, etc. Braided nylon over fibre glass core. In plastic container.

No.	Spool	List
75A-25	25 ft.	\$1.40
75A-50	50 ft.	2.65
75A-100	100 ft.	4.95
75A-11	Env.	.45

G-C No. 71 42-STRAND BRONZE CABLE

.040" diameter; 42 strands twisted phosphor bronze over fibre glass core. Radio dials, aircraft reel-in-antennas, etc. Durable and flexible. In plastic containers.

No.	Spool	List
71-25	25 ft.	\$1.65
71-50	50 ft.	3.00
71-100	100 ft.	5.50
71-11	Env.	.45

G-C No. 74 MEDIUM NYLON CORD

.040" diameter. Very popular; used by RCA, Philco, GE, etc. Braided nylon over fibre glass core. In plastic container.

No.	Spool	List
74-25	25 ft.	\$1.40
74-50	50 ft.	2.65
74-100	100 ft.	4.95
74-11	Env.	.45



G-C SERVICEMEN'S DIAL BELT KITS

General Cement Belts are approved replacements for all sets. They are made of best quality material and will not stretch. They are specially treated to prevent slipping. They are the best. Sizes available for all sets. They are easy to install as they are made to fit. No adjustments necessary.

BELTS — 50c List Each

G-C SERVICEMEN'S KITS

Servicemen! Have an assortment of belts on hand for prompt replacement. Kits contain only the more popular belts used. **KIT INCLUDES ATTACHMENT STEEL BOX—BELT SCALE AND COMPLETE LISTING OF OVER 1100 MODELS.**

List Price
No. G-25—Kit of 25 popular belts \$13.95

INSTRUCTIONS — FOR MEASURING BELTS

To determine size of belt. If the old belt is available, cut the belt and measure for stretched out length. This will be "cut length" of belt. If old belt is not available or is worn out so that it cannot be properly measured, stretch a thin thread around belt pulleys on set. (Be sure to use thin thread as a thick cord will give an inaccurate reading.) Measure the thread, it will be our "circumference around pulleys." In measuring belts always remember that the circumference around pulleys is not the same as stretched out or cut length. A belt when cut, develops approximately $\frac{1}{8}$ " extra length when stretched out, depending on thickness of belt.

G-C RADIO BELT SPECIFICATIONS

LISTED AS PER BELT SIZE				LISTED AS PER BELT SIZE			
Circumference Around Pulleys	Cut Length	G-C Belt No.		Circumference Around Pulleys	Cut Length	G-C Belt No.	
5-4"x1/4"	5-5/8"x1/2"	195	8-43/64"	8-55/64"	112	11"	11-3/16"
6-23/32"	6-29/32"	101	8-11/16"	8-7/8"	160	11-5/64"	11-17/64"
6-55/64"	7-3/64"	161	8-13/16"	9"	167	11-9/64"	11-21/64"
6-57/64"	7-5/64"	102	9-1/16"	9-1/4"	117	11-5/32"	11-15/32"
6-15/16"	7-1/8"	158	9-13/64"	9-25/64"	115	11-3/16"	11-3/8"
7-1/64"	7-13/64"	157	9-19/64"	9-31/64"	163	11-9/32"	11-15/32"x5/16"
7-1/4"	7-7/16"	106	9-5/16"	9-1/2"	116	11-3/8"	11-9/16"
7-9/32"	7-15/32"	156	9-17/32"	9-23/32"	119	11-25/64"	11-37/64"
7-13/32"	7-19/32"	177	9-7/8"	10-1/16"	123	11-27/64"	11-5/8"
7-15/32"	7-21/32"	103	9-59/64"	10-7/64"	127	11-21/32"	11-27/32"
7-1/2"	7-11/16"	105	10-1/16"	10-1/4"	126	11-3/8"	12"
7-35/64"	7-23/32"	155	10-1/4"	10-7/16"	164	12"	12-3/16"
7-11/16"	7-7/8"	107	10-17/64"	10-29/64"	124	12-1/32"	12-7/32"
7-3/4"	7-15/16"	174	10-19/64"	10-34/64"	128	12-3/32"	12-1/4"
8-15/16"	8-1/8"	111	10-23/64"	10-35/64"	118	12-7/16"	12-13/32"
8-1/64"	8-13/64"	104	10-3/8"	10-9/16"	122	11-21/32"	11-27/32"
8-1/32"	8-7/32"	159	10-25/64"	10-37/64"	125	straight belt	12-7/16"-str. belt
8-3/32"	8-9/32"	113	10-1/2"	10-11/16"	152	12-9/32"	12-15/32"
8-3/16"	8-3/8"	172	10-1/2"	10-37/64"	125	12-13/32"	12-21/32"
8-13/64"	8-25/64"	162	10-41/64"	10-53/64"	129	12-1/2"	12-11/16"
8-15/64"	8-27/64"	114	10-11/16"	10-7/8"	121	12-39/64"	12-51/64"
8-25/64"	8-37/64"	110	10-45/64"	10-57/64"	120	12-3/16"	13"
8-1/2"	8-11/16"	109	10-27/32"	11-1/32"	180	13-3/16"	13-3/8"
8-21/32"	8-27/32"	108	10-61/64"	11-9/64"	133	14-7/32"	14-13/32"
8-39/64"	8-51/64"	153	10-31/32"	11-5/32"	132		

G-C DANDY TEST LITE



New neon test lite for checking radios, television sets, fuses, circuits, etc. Simple, safe and dependable for tracing all kinds of trouble. Use on voltages of 60 volts AC to 550 volts AC or DC.

No.		List
8585	Dandy Lite	\$1.25



GENERAL CEMENT

WIRE STRIPPERS • TEST LEADS

TEST LITES

G-C STANDARD SPEEDEX WIRE STRIPPER



Fast operating precision made hand tool for stripping insulation from all types of wire. Very easy to operate. Strips 750 to 1000 wires per hour. Used by girls or men. All blades are interchangeable and easily replaced.

Standard Models		
No.	Wire	List
733	12 to 20	\$6.60
733-A	14 to 30	6.60
733-B	10 to 18	6.60
733-C	8 to 10	6.60
733-D	16, 18, 20, 22	6.60
733-E	14, 16, 18	6.60
733-F	10, 12, 14	6.60
733-G	For #18 P.O., S.J. or parallel wire	6.60
733-H	For the new 300-Ohm television and FM transmission line	6.60
733-I	For 10, 12, 14, 16, 18, 20, 22 wire	6.60

G-C AUTOMATIC SPEEDEX WIRE STRIPPER



Similar to standard models except has the "stay open feature" with the new Speedex "Trig-O-Matic Action." Automatically holds jaws open until wire is removed, and prevents bending or crushing of fine wires. Has on-off mechanism so tool can be used as standard model if desired.

Automatic Models		
No.	Wire	List
744	12 to 20	\$8.25
744-A	14 to 30	8.25
744-B	10 to 18	8.25
744-C	8 to 10	8.25
744-D	16, 18, 20, 22	8.25
744-E	14, 16, 18	8.25
744-F	10, 12, 14	8.25
744-G	For #18 P.O.S.J. or parallel wire	8.25
744-H	For the new 300-Ohm television and FM transmission line	8.25
744-I	For 10, 12, 14, 16, 18, 20, 22 wire	8.25

G-C HEAVY DUTY SPEED-O-MATIC WIRE STRIPPER



Improved version of the "744" series. Ideal for production line. Delayed return action. Will not crush stranded wires. Sturdy, easy to use. Interchangeable blades.

No.	Wire	List
766	10 to 20	\$8.25
766-A	14 to 30	8.25
766-B	10 to 18	8.25
766-C	8 to 10	8.25
766-D	16, 18, 20, 22	8.25
766-E	14, 16, 18	8.25
766-F	10, 12, 14	8.25
766-G	For #18 P.O.S.J. or parallel wire	8.25
766-H	For 300-Ohm TV & FM twin transmission line	8.25
766-I	For 10, 12, 14, 16, 18, 20, 22 wires	8.25
766-M	10 to 20	8.25
766-N	Straight cutter blades	8.25

G-C SPEEDEX WIRE STRIPPER KIT

Wire stripper complete with seven different size blades put up in a specially designed permanent steel box. For wires No. 8 to No. 30.

No.		List
733-K	Standard Stripper Kit, with blades	\$15.60
744-K	DeLux Automatic Stripper Kit, with blades	17.25
766-K	Speed-O-Matic Kit	17.25



G-C SPEEDEX REPLACEMENT BLADES

Fit standard and automatic models. Blades interchangeable.

No.	Wire	List
3W	12 to 20	\$1.65
3W-A	14 to 30	1.65
3W-B	10 to 18	1.65
3W-C	8 to 10	1.65
3W-D	16, 18, 20, 22	1.65
3W-E	14, 16, 18	1.65
3W-F	10, 12, 14	1.65
3W-G	Blades for parallel #18 P.O.S.J. or similar	1.65
3W-H	Blades for the new 300-Ohm television and FM twin transmission line	1.65
3W-I	10, 12, 14, 16, 18, 20, 22 wire	1.65

When Blades for 766 Series Stripper are wanted — specify 2W — instead of 3W.



G-C SPEEDEX TRIG-O-MATIC PLATE

Converts any standard Speedex Stripper to an Automatic Model.

No. 756	Trig-O-Matic Plate, only	\$2.20
---------	--------------------------	--------



G-C UNIVERSAL TYPE TEST LEADS



Heavy duty 6000-volt leads 50" long, made with unbreakable plastic handles 6" long with solderless type tips. Other and comes with standard banana plugs, phone tips, and alligator clips. Supplied complete.

No. 8463	Universal Test Leads	List \$3.00
No. 8464	Same, but supplied with needle point prods	List 3.00

G-C MASTER TEST LEADS



The best test leads you can buy, 50" long, 6000-volt, heavy duty test prods, solderless type. Flexible leads run through handles and are fastened under the knurled collar on the tips. Available with either the attached angle tips or the straight solderless type tips.

No.		List
5050	With Solderless type Straight Tips	\$1.85
8459	With Angle type Test Tips	2.10

G-C THIN TYPE TEST LEADS



This is a handy pair of test leads for hard-to-reach places. Made with slim, plastic handles with long, slim insulated test rods attached. Made with 50" of 6000-volt test lead wire. Comes equipped with angle type phone tips.

No. 8465	Thin Type Test Leads	List \$2.10
----------	----------------------	-------------

G-C "TUX" TOOL KIT



Made of "Alathlon" polyethylene. Tough, flexible, will not lose shape. Handy for all most needed tools.

No. 8943	"Tux" Tool Kit	List \$3.95
----------	----------------	-------------

G-C NE-O-LITE



A simple, safe, electrical circuit tester for voltages from 60 volts AC to 550 volts AC or DC. Used for radio, electrical and automotive testing. Molded plastic.

No. 5100	Ne-O-Lite	List \$0.60
----------	-----------	-------------

G-C RESISTOR FOR NEON LAMP



Required resistor when using No. 717 neon lamp on voltages of 60 to 550 volts AC or DC. Connect in series.

No. 718	Resistor	List \$0.07
---------	----------	-------------

G-C NEEDLE POINT TEST LEADS



Heavy duty 6000-volt test leads, 50" long, made with unbreakable plastic handles 6" long with needle type chuck and needle to penetrate insulation. Available with either the attached angle tips or the straight solderless type tips.

No.		List
8461	With Solderless Straight Tips	\$1.95
8462	With Angle type Test Tips	2.25

G-C TWEEZERS AND KIT

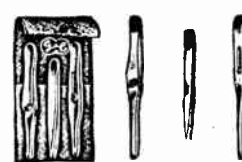

For the shop or laboratory to pick up and examine small parts, start screws and nuts, to get in hard-to-get spots, stringing dial cord, etc.

No.		List
7950	Tweezer Kit, beautiful leatherette case and one each tweezers described below.	\$3.55
7946	6 1/2" Self-closing tweezers. Opens when squeezed, Serrated, blunt points.	1.05
7947	6 1/2" Heavy-duty type with slide lock feature. Holds wires or parts tight. Serrated, blunt points.	1.30
7948	4 1/2" Precision Tweezer. Narrow pointed ends for delicate work.	0.60

G-C NEON GLOW LAMPS



NE-T2 lamp as used in testers, appliances, as pilot light, etc.

No. 717	NEON GLOW LAMP	List \$0.25
---------	----------------	-------------

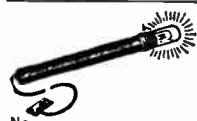

G-C INSPECTION LITE

Operates on 110-120 volts AC or DC. Cord approximately 6 feet long.

No.		List
705	Inspection Light	\$2.25
704	Replacement Bulb for #705	20
704-S	Clear Plastic Shield	.10



GENERAL CEMENT

TEST PRODS • PLUGS • TIPS

G-C TELEVISION HIGH-VOLT BAKELITE TEST PROD HANDLE



Heavy duty type test prod with finger ground ring to protect from the high voltage. Protects against the high voltage in a TV Set. Designed so that the minimum of metal is exposed. Made of black bakelite.

No. 8986 List \$1.50
High-volt Test Prod Handle

G-C LOW-LOSS DELUXE TEST PRODS



New polished low-loss material. Non-breakable. Moisture resistant. Withstands high voltages. Solderless type, brass nickel-plated.

No.	Red	List
5045		\$0.50
5046	Black	.50

G-C TEST LEAD ANGLE TIP



New, attractive, fully insulated, molded plastic angle phone tip plugs. Will take wires up to .140 diameter.

No.	Red, each	List
8149		\$0.45
8150	Black, each	.45

G-C TEST PROD TIPS



Solderless type, brass nickel-plated. Non-insulated. Wire fastens easily.

No.	List
5060	\$0.20

G-C HEAVY DUTY PHONE PLUG



Standard type as used on test prods, leads, etc. Fits snugly in 1/4" hole. Brass nickel-plated.

No.	List
7706	\$0.15

G-C PHONO NEEDLE POINT TEST PROD CHUCK



Push on type fits snugly in 1/4" hole. Brass nickel-plated.

No.	List
7703	\$0.22

G-C INSULATED SPADE LUG



Tapered spade lug fits all screws or terminal strips up to No. 10. Insulated female end fits banana plugs.

No.	Red	List
7712		\$0.18
7713	Black	.18

G-C INSULATED PHONE TIP JACKS



Standard insulated type phosphor bronze spring contacts. 3/8" insulated head. Fits 1/4" hole and panels up to 3/8" thick. Brass parts nickel-plated.

No.	Red	List
7715		\$0.25
7716	Black	.25

G-C SET SCREW TYPE BANANA PLUG



Insulated set screw type. Polished insulated plastic handle. Nickel-plated metal parts.

No.	Red	List
7732		\$0.25
7733	Black	.25

G-C SPLIT BANANA PLUG



Standard size with 6-32 threaded shank. Use on plug-in coils, terminal strips, etc. Complete with lug and nut. Brass nickel-plated.

No.	List
7736	\$0.25

G-C BANANA JACK



Standard size banana pin jack. Fits 1/4" hole up to 3/8" thick panel. Nut and lug supplied. Brass nickel-plated.

No.	List
7740	\$0.17

G-C NEEDLE POINT TEST PRODS



Adjustable chuck tip for needle. 6" polished plastic handles in Red or Black. Brass Nickel-plated chuck removable. Includes needle. (Specify color.)

No.	List
7701	\$0.50

G-C SHIELDED PHONO PICK-UP WIRE



Handy package of single conductor shielded wire as used on phono pick-ups, etc. Enough wire for several jobs in package.

No.	List
1738-E	\$0.45

G-C TEST LEAD WIRE



Ideal long-life replacement wire, extra (flexible, 6000-volt insulation, Red and Black, (Specify color.)

No.	Env.	1 Red, 1 Black 50" long	List
5049			\$0.80
5049-C	100 feet		8.25

G-C INSULATED TEST PROD TIPS



Unbreakable polished plastic insulated handles. Solderless connectors, brass nickel-plated.

No.	Red	List
5061		\$0.25
5061-E	Env. 2	.50
5062	Black	.25
5062-E	Env. 2	.50

G-C PHONO NEEDLE POINT TEST PROD CHUCK



Threaded chuck fits 1/4-20 threaded hole. Needle removable. Brass nickel-plated. Includes needle.

No.	List
7702	\$0.30

G-C STANDARD PHONE TIP



Standard tip made of drawn brass, bright nickel plated.

No.	Env.	List
6320-E	12	\$0.45

G-C SOLID STANDARD PHONE TIP



Solid brass type made to RMA specifications. Bright nickel-plated.

No.	Env.	List
6321-E	8	\$0.45

G-C INSULATED PHONE TIP PLUG



Fits standard phone tip jacks. Polished non-breakable low-loss plastic insulated handles. Brass, nickel-plated tip. Minimum contact exposure.

No.	Red	List
7710		\$0.23
7711	Black	.23

G-C PHONO TIP JACKS



Standard type with phosphor bronze spring contacts. Fits 1/4" hole and panels up to 3/8" thick. Brass parts nickel-plated.

No.	List
7714	\$0.17

G-C SPLIT BANANA PLUG



Insulated solderless type with polished insulated handles. Metal parts nickel-plated.

No.	Red	List
7730		\$0.35
7731	Black	.35

G-C SMALL BANANA PIN PLUG



Approved silver-plated plugs with straight shank. Can be riveted or soldered. For wires, multiple plugs, etc.

No.	Env.	List
6400	10	\$0.45

G-C SPLIT BANANA PLUG



Standard size with 6-32 female thread on end. Supplied with screw and solder lug. Brass nickel-plated.

No.	List
7737	\$0.25

G-C INSULATED BANANA JACK



Standard size with polished plastic insulators. Fits 1/4" hole, up to 3/8" thick panel. Nut, lug, and insulators supplied. Brass, nickel-plated.

No.	Red	List
7741		\$0.22
7742	Black	.22

G-C INSULATED BANANA PLUG OR PHONE TIP JACK



Standard size insulated combination jack. Brass nickel-plated with phosphor bronze spring contacts. Fits 1/4" hole, panels up to 3/8" thick.

No.	Red	List
7744		\$0.35
7745	Black	.35

G-C COMBINATION BINDING POST



Dual purpose insulated head binding post. Banana plug fits in-top, phone tips in side. Supplied with 6-32 x 1/2" stud and 2 hex nuts. Red or black.

No.	Red Binding Post	List
7725		\$0.45
7726	Black Binding Post	.45



**G-C STANDARD
TUBE SOCKETS
BAKELITE SOCKETS**

High quality molded bakelite sockets with plated bronze contacts. Three grounding lugs on base of each socket. 1 1/2" mounting centers.

No.		List
1528	8-prong Octal	\$0.22
1528-L	8-prong Localt	.27

WAFER SOCKETS



No.	Mnt. Center	List
1534	4-prong 1 1/2"	\$0.15
1535	5-prong 1 1/2"	.16
1536	6-prong 1 1/2"	.16
1537	7-pr. Small 1 1/2"	.17
1537-L	7-pr. Large 1 1/2"	.18
1538	8-pr. Octal 1 1/2"	.16
1538-2	8-pr. Octal 1 1/2"	.20
1538-L	8-pr. Localt 1 1/2"	.16

G-C 861 CAP



Spring action, finger grip rubber caps. Approved terminal brass blade.

No.	Cap	List
861	Cap	\$0.22

G-C 860 CAP



Spring action flat brown bakelite cap. Approved brass blades.

No.	Cap	List
460	Cap	\$0.20

G-C CORD CONNECTOR



Brown bakelite with bronze contacts.

No.	Brown	List
863	Brown	\$0.32

G-C ANTENNA CONNECTOR JACK



Shielded jack to fit the 1740 plug for auto antenna and phonograph connection.

No.	List
1741	\$0.25

G-C ANTENNA CONNECTOR



Used for connections on auto antenna and ground lines.

No.	List
1747	\$0.22

G-C REPLACEMENT PARTS FOR ANTENNA AND FUSE CONNECTORS

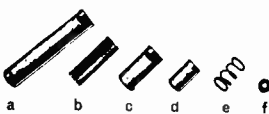

No.		List
(a) 1791	Sleeve of Fuse Connector	\$0.07
(b) 1792	Sleeve of Antenna Connector	.03
(c) 1793	End piece for Antenna and Fuse Connector	.05
(d) 6720	Auto Fuse Insulator Sleeve	.02
(e) 1796	Spring for Antenna and Fuse Connector	.02
(f) 1795	Bakelite Bushing	.04

G-C TERMINAL STRIPS



Laminated bakelite strips, rigidly constructed, terminals will not turn and short.

No.	Contacts	List
1772	2	\$0.12
1773	3	.19
1774	4	.25
1775	5	.28
1776	6	.35
1777	7	.42
1778	8	.50
1779	9	.55
1780	10	.60

SOLDER TYPE

Mounted on laminated bakelite strips. Lugs securely fastened and will not turn.

No.	Contacts	List
1781	1	\$0.05
1782	2	.06
1783	3	.07
1784	4	.09
1785	5	.12
1786	6	.13
1787	7	.20
1788	8	.22

G-C FIBRELOID SPEAKER SHIMS



Shims made of tough and flexible fibreloid. Non-magnetic. 4 each of 5 sizes — twenty in all: Sizes, .005", .0075", .010", .0125", and .015". Color coded. Supplied in gold lettered leatherette snap case with instructions.

No.	Kit	List
702	Kit	\$0.65

**GENERAL CEMENT
RADIO SOCKETS • PLUGS • CONNECTORS
SHIMS**

G-C MINIATURE TUBE SOCKETS

**BAKELITE
MINIATURE
SOCKET**



For Miniature Tubes

High quality molded bakelite socket with metal saddle mounting. Made with phosphor bronze plated contacts for 7-prong tubes. Standard 3/8" mounting centers.

No.	Bakelite Socket	List
1540	Bakelite Socket	\$0.18

WAFER MINIATURE SOCKET



High grade laminated bakelite sockets for new miniature tubes. Phosphor bronze contacts, for 7-prong tubes. Standard 3/8" mtg. centers.

No.	Wafer Socket	List
1541	Wafer Socket	\$0.16
1542	Wafer Socket with grounding strap	.17

**9-PIN MINIATURE
WAFER SOCKET**



Highest quality laminated bakelite wafer socket. Phosphor bronze contacts, for 9-pin tubes. Standard 1 1/2" mounting centers.

No.	Wafer Socket	List
1543	Wafer Socket	\$0.16
1544	Wafer Socket with grounding strap	.18

G-C 867 PLUG



Popular screw plug for standard sockets.

No.	Plug	List
867	Plug	\$0.18

G-C SURFACE BLOCK



3-plug, Bakelite outlet for extension cords. Can fasten to wall or base.

No.	Brown	List
866	Brown	\$0.50

G-C MOTOROLA LEAD ADAPTER



Adapter plug used to adapt bayonet type connector to Motorola type.

No.	List
1745	\$0.50

G-C FUSE CONNECTOR



Regular Type Used on auto radios and other equipment. Completely assembled.

No.	List
1749	\$0.24

G-C CUBE TAP



New type spring action cube tap with 3 outlets always available.

No.	Brown	List
862	Brown	\$0.32

G-C AUTO ANTENNA PLUG



Shielded connector plug as used on Motorola and other auto radios

No.	List
1740	\$0.17

G-C ADAPTER SHELL



Used to change the Motorola fitting to bayonet type connector.

No.	List
1746	\$0.12

G-C ANTENNA CONNECTOR END



To be used with regular antenna connectors. With bushing.

No.	List
1750	\$0.10

G-C PHONO PLUG

For all types of phono connections on RCA, Zenith, Philco and others. Also for auto radio connector.

No.	Single Plug	List
1742	Single Plug	\$0.10
1742-E	Env. 4	.45

G-C PHONO JACK

Companion phono jack for No. 1742 plug.

No.	Single Jack	List
1743	Single Jack	\$0.14
1743-E	Env. 3	.45

**G-C SWEDISH STEEL
SPEAKER SHIMS**



Makes it easier to center speaker voice coil. Permanent flexible Swedish steel. 4 shims each of 4 sizes coded for identification: .004", .006", .008" and .010" thick. Supplied in gold stamped leatherette partitioned snap case. Complete with instructions.

No.	Kit	List
701	Kit	\$0.90

G-C GENERAL CEMENT

SIGNAL LIGHTS • CONNECTOR • CLIPS

G-C 1/4-INCH JEWEL SIGNAL LIGHT
Signal light with facet jewels in colors of Red, Green, Blue, Amber. 1/2" mounting hole. Jewel removed from front. (Specify color.)

No.	Socket	List
7907	Min. Screw	\$0.95
7908	Min. Bayonet	.95
7909	110-V. Candel.	.95

G-C CLIP-ON PILOT LIGHT SOCKETS
Clip up and clip down types for replacements. Cadmium-plated.

No.	Type	List
7920	Min. Screw Clip Up	\$0.17
7921	Min. Screw Clip Down	.17
7922	Min. Bay. Clip Up	.20
7923	Min. Bay. Clip Down	.20
7924	110-V. Cand. Clip Up	.20
7925	110-V. Cand. Clip Down	.20

G-C PILOT LAMP INSTALLER
Makes it easy to install miniature dial bulbs, neon and candelabra lamps in hard-to-get-at places. All rubber.

No.	List
7935	Installer \$0.85

G-C MICROPHONE CHASSIS UNIT CONNECTOR
Single contact male connector for chassis. Used with Type 7942 female connector. Supplied complete. Brass nickel-plated.

No.	List
7941	Connector \$0.40
7943	Closed Circuit Type, prevents open circuit noises when mike is disconnected \$0.50

G-C ALLIGATOR CLIP
Solder type, non-insulated. Strong spring for positive contact. Nickel-plated.

No.	List
5063	Clip \$0.12
5063-E	Envelope of 8 .45

G-C 1/2-INCH JEWEL SIGNAL LIGHT
Signal light, requires 1/2" mounting hole. Facet jewel removed from front. Colors: Red, Green, Blue, Amber, Opal, Clear. (Specify color.)

No.	Socket	List
7910	Min. Screw	\$0.45
7911	Min. Bayonet	.45
7912	110-V. Candel.	.55

G-C BRACKET-TYPE PILOT LIGHT SOCKETS
Sturdy bracket-up or bracket-down type. Cadmium-plated.

No.	Miniature Screw Bracket Up	List
7926	Bracket Up	\$0.17
7927	Bracket Down	.17
7928	Miniature Bayonet Bracket Up	.19
7929	Bracket Down	.19
7930	110-V. Candelabra Bracket Up	.20
7931	Bracket Down	.20

G-C MALE MICROPHONE CONNECTOR
Completely shielded, sturdy, single contact connector. Brass, bright chrome-plated. Steel spring cord protector.

No.	Connector	List
7940	Connector	\$0.50

G-C MICROPHONE CONNECTOR CAP
Chrome-plated cap with anchor chain for all connectors. Seal against dirt and prevent thread damage.

No.	Connector Cap	List
7944	Connector Cap	\$0.60

G-C SCREW TYPE INSULATED ALLIGATOR CLIP
Very popular. Bright polished handles. Set screw for wire.

No.	List
7750	Black Clip \$0.28
7751	Red Clip .28

G-C ONE-INCH JEWEL SIGNAL LIGHT
For signal devices of all types. Bulbs change from the front; for socket bases as listed below. One inch mounting hole. Jewel colors: Red, Green, Amber, and Opal. (Specify Jewel Color.)

No.	List
7901	100-V Cand. Facet \$1.80
7902	110-V. Cand. Smooth List \$1.65
7903	Min. Bayonet Facet List \$1.65
7905	Min. Screw Facet List \$1.55

G-C PANEL JEWELS
Complete assemblies in 1", 3/4", and 3/8" diameters. Fit panels up to 1/4" thick. Brass nickel-plated. Colors: Red, Green, Blue, Amber, Opal, Clear. (Specify color.)

No.	Dia.	Jewel	Mtg. Hole	List
7913	1/2"	Facet	7/16"	\$0.30
7914	3/8"	Smooth	7/16"	.30
7915	3/8"	Facet	11/16"	.65
7916	1"	Facet	1"	1.40

G-C UNMOUNTED PILOT LIGHT SOCKETS
Cadmium-plated. Ideal for replacements or special assemblies.

No.	Type	List
7932	Min. Screw Base	\$0.15
7933	Min. Bayonet Base	.15
7934	110-V. Candelabra	.15

G-C FEMALE MICROPHONE CONNECTOR
Single contact female type used with No. 7940, 7941 and 7943 connectors. Complete, brass chrome-plated.

No.	Connector	List
7942	Connector	\$0.60

G-C INSULATED ALLIGATOR CLIP
Solder type with Red or Black insulated sleeve. Strong spring. Nickel-plated.

No.	List
5064	Red Clip \$0.22
5064-E	Envelope of 2 .45
5065	Black Clip .22
5065-E	Envelope of 2 .45

G-C ALLIGATOR CLIP
Wire fastens under set screw. Handy for all types of connectors. Cadmium-plated.

No.	List
7752	Clip \$0.20

G-C FAHNESTOCK CLIPS AND PLUGS

G-C SMALL CLIP
1/2" long by 3/8" wide. Handles up to No. 16 wire. No. 4 Mtg. Hole.

No.	List
6301	Each \$0.04

G-C DOUBLE CLIP
1 1/2" long by 3/8" wide. No. 6 Mtg. Hole.

No.	List
6304	Each \$0.15

G-C MEDIUM CLIP
3/4" long by 3/8" wide. Handles up to No. 14 wire. No. 6 Mtg. Hole.

No.	List
6302	Each \$0.04

G-C MEDIUM SOLDER LUG CLIP
3/4" long by 3/8" wide. No. 6 Mtg. Hole.

No.	List
6306	Each \$0.07

G-C INSULATED SPRING TYPE BANANA PLUG
Solderless type, no screws or contacts showing. Length 1 1/8", with 1" handle.

No.	List
8994	Red Plug \$0.35
8995	Black Plug .35

G-C TEST LEAD PLUG INTERCHANGE KIT
Handy kit for interchanging alligator clips, banana plugs, spade lugs or phone tips. Includes red and black phone tips, combination jacks and plugs. Fitted plastic case.

No.	List
7743	Kit \$3.25

G-C LARGE CLIP
1 1/2" long by 3/8" wide. No. 8 Mtg. Hole.

No.	List
6303	Each \$0.08

G-C SPRING TYPE BANANA PLUG
Solderless wire connection with set screw on side. Length 1 1/8", with 3/8" handle.

No.	List
8996	Red Plug \$0.30
8997	Black Plug .30

G-C INSULATED BELL STAPLES

No.	List
1751	Fig. 1, 3/8" x 1/2" \$0.30
1752	Box 50, No. 1 .50
1753	Fig. 2, 3/8" x 5/8" .30
1754	Box 100, No. 2 .50
1755	Fig. 3, 3/8" x 3/4" .30
1756	Box 100, No. 3 .50
1757	Fig. 5, 1/2" x 5/8" .30
1758	Box 50, No. 5 .50
1759	Box 100, No. 5 .50
1760	Fig. 6, 1/2" x 3/4" .50
1761	Box 100, No. 6 .50
	Fig. 7, 1/2" x 7/8" .50
	Box 100, No. 7 .50
	Extra Large (table Size) Fig. 10, 3/4" x 3/4" .85
	Box 100, No. 10 .85

G-C BANANA PLUG SPLICE
Couples two standard type banana plugs. Two colors.

No.	List
7746	Red Plug Splice \$0.40
7747	Black Plug Splice .40

G-C SPRING TYPE BANANA PLUG
Hex brass, nickel plated plug. Threads 6-32 x 3/8". Length 1 1/8".

No.	List
8998	Each \$0.25

G-C BANANA PLUG AND TIP JACK COMBINATION
Converts phone tip test leads to fit banana plugs. Length 1 1/8".

No.	List
7748	Red Plug/Jack \$0.50
7749	Black Plug/Jack .50

G-C SPRING TYPE BANANA PLUG
Phosphor bronze contacts. Contact screw 6-32, soldering lug.

No.	List
8999	Each \$0.25

G-C ALLIGATOR CLIP & PHONE TIP JACK
Overall length 2 1/2", with 1" handle. Two colors.

No.	List
7723	Red Clip/Jack \$0.55
7724	Black Clip/Jack .55

G-C COMBINATION ALLIGATOR CLIP PHONE TIP AND BANANA JACK
Length 3", with 1 1/8" handle.

No.	List
7721	Red Clip \$0.65
7722	Black Clip .65



G-C TOGGLE SWITCHES

Ball handle general purpose switch. Made by H & H for G-C. 3 amps., 125 volts. Nickel Plated.

No. 1300 List \$0.80 S.P.S.T.*	No. 1304 List \$1.54 D.P.S.T.**
No. 1301 List \$1.10 S.P.S.T.**	No. 1305 List \$1.75 D.P.S.T.**
No. 1302 List \$1.10 S.P.D.T.*	No. 1306 List \$1.75 D.P.D.T.*
No. 1303 List \$1.30 S.P.D.T.**	No. 1307 List \$2.00 D.P.D.T.**

* 1/2" Shank Length
** 3/4" Shank Length

G-C BAT HANDLE TOGGLE SWITCH



Tear drop handle general purpose switch. Made by H & H for G-C. 3 amps., 125 volts. Nickel Plated.

No. 1330 List \$0.80 S.P.S.T.*	No. 1331 List \$1.10 S.P.D.T.*
No. 1332 List \$1.55 D.P.S.T.*	No. 1333 List \$1.75 D.P.D.T.*

G-C PUSH-ON PUSH-OFF SWITCH



For vacuum cleaners, appliances, test equipment. Made by H & H for G-C. Rated at 3 amps., 125 volts. Nickel Plated.

No. 1338 List \$2.0 S.P.S.T.

G-C NEUTRAL CENTER SWITCH



Handy radio, appliance and tester switch with 3 positions, on-off-on. Rated 15 amps., 110 volts. 3/8" shank. Nickel Plated.

No. 1308 List \$1.80 S.P.D.T.	No. 1309 List \$2.75 D.P.D.T.
----------------------------------	----------------------------------

G-C HEAVY DUTY POWER SWITCH



Push button, D.P.S.T., safety switch for transmitters, refrigerators and high frequency work made by H & H for G-C. 12 amps., 125 volts. Nickel Plated.

No. 1351 List \$3.20 D.P.S.T.



G-C STACKPOLE SLIDE SWITCHES

Made by Stackpole for G-C. Used on radios, phonographs, etc. UL approved at .5A-125V. and higher.

No. 1367 List \$0.22 S.P.S.T.*	No. 1368 List \$0.22 S.P.D.T.*
-----------------------------------	-----------------------------------

* 3/8" w. x 1 1/4" l. ** 3/8" w. x 1-57/64" l.

G-C GENFLEX PLASTIC TUBING



High grade extremely flexible plastic tubing for Radio and Television insulation work. Resistant to acid or heat. High dielectric strength, average 8,000 volts. (Colors: Black, Red, Green, Clear. (Specify).)

No.	Wire	Pkg.	List
603	18	20 ft.	\$1.00
605	16	20 ft.	1.00
607	14	20 ft.	1.00
609	12	20 ft.	1.00
611	10	15 ft.	1.00
613	8	15 ft.	1.05
616	6	10 ft.	1.05
617	4	10 ft.	1.05
620	2	10 ft.	1.25
625	Fits over 300-ohm Twin Line 8 ft.		1.10

G-C PLASTIC TUBING KITS



Handy kits of assorted colors and sizes. Ideal for experimenters and servicemen.

No. 635 List \$1.00 Kit of 25 ft. Asstd.

G-C RADIO FRICTION TAPE



This narrow 3/8" tape was particularly made for radio work. It eliminates waste and tearing of tape. It saves time and is handy to carry with you.

No. 870 List \$0.65 65 ft. 3/8"	No. 871 List \$1.25 65 ft. 3/8"
------------------------------------	------------------------------------



GENERAL CEMENT

SWITCHES • SPAGHETTI • TUBING



G-C ON-OFF PLATE

Will fit the G-C, H & H, Cutler-Hammer and other makes of standard switches.

No. 1329 List \$0.05 On-Off Plate



G-C ROTARY SWITCHES

Best grade enclosed rotary switches. Made by H & H for G-C. 3 amps., 125 volts. Shafts 1 1/2" long.

No. 1320 List \$1.30 S.P.S.T.*	No. 1324 List \$1.90 D.P.S.T.**
No. 1321 List \$1.35 S.P.S.T.**	No. 1325 List \$2.00 D.P.D.T.*
No. 1322 List \$1.50 S.P.D.T.*	No. 1326 List \$2.50 D.P.D.T.**

* 3/4" Shank Length ** 1" Shank Length

G-C EXTRA HEAVY DUTY POWER SWITCH

Three position for motors, projectors, transmitters, movie equipment, etc. Made by H & H for G-C. 10 amps., 125 volts. Neutral off in center. Size 2" x 1" x 1 1/4", shank 3/8" diameter.

No. 1352 List \$6.85 D.P.D.T.	No. 1353 List \$10.50 3-P.D.T.	No. 1354 List \$13.75 4-P.D.T.
----------------------------------	-----------------------------------	-----------------------------------

G-C REAR SPEAKER TONE SWITCH

Designed for rear seat auto radio speakers. Permits use of either speaker separately or together.

No. 8891 List \$0.95 Switch



G-C TOGGLE SWITCH WITH WIRE LEADS

For vacuum cleaners, appliances, radio sets, etc. Made by H & H for G-C. Rated at 3 amps., 125 volts. Nickel Plated.

No. 1335 List \$1.25 "Bat Handle" S.P.S.T.	No. 1336 List \$1.25 "Ball Handle" S.P.S.T.
---	--

G-C PUSH BUTTON SWITCH



Two circuit, "slow make and quick break" momentary contact switch. One circuit normally on, other off; pushing button reverses circuits in use. Made by H & H for G-C. 3 amps., 125 volts. Shank 3/8" long.

No. 1340 List \$1.60 Switch	No. 1340 List \$0.40 PUSH BUTTON
--------------------------------	-------------------------------------

For 1340 Switch, Red or Black (Specify).
No. 1313 List \$0.40
Button

G-C HEAVY DUTY POWER SWITCH



D.P.S.T. toggle power switch for motors, appliances, projectors, etc. Made by H & H for G-C. 12 amps., 125 volts. Nickel Plated.

No. 1350 List \$2.20 D.P.S.T.

G-C MOLDED BAKELITE TOGGLE SWITCHES

Bat handle style, silver plated contacts. Rated 3 amps. at 250 volts, 6 amps., 125 volts. 3/8" shaft. Nickel Plated.

No. 1361 List \$1.20 S.P.S.T.	No. 1362 List \$1.35 S.P.D.T.	No. 1363 List \$1.85 D.P.S.T.	No. 1364 List \$2.20 D.P.D.T.
----------------------------------	----------------------------------	----------------------------------	----------------------------------

Momentary Switches (circuit normally "off")
No. 1365 List \$1.75
S.P.S.T.
No. 1365A List \$2.15
S.D.D.T.
No. 1366 List \$2.75
D.P.D.T.

G-C SPAGHETTI ON SPOOLS "Approved by ASTM"

5000 Volt Dielectric Strength. Best grade varnished tubing put on convenient 20-ft. spools. Will fit wire from No. 12 to No. 18. Colors: Black, Red, Yellow, Green, Blue. Specify color.

No. 499 List \$1.85 Spool - 20-ft.

G-C ASSORTED SPAGHETTI KIT



An assortment of 7 1/2" lengths of spaghetti sleeving. 26 lengths to the kit. Sizes include from No. 17 wire to 3/8" I.D. A very handy bundle to have for repair jobs.

No. 550 List \$0.49 Kit 26 Lengths

G-C SPAGHETTI ASSORTMENT "A Box Full of Spaghetti"



Here's a buy you can't beat on a spaghetti assortment. A variety of sizes and colors are included of high grade varnish tubing. Put up in attractive box.

No. 551 List \$1.40

G-C FIBEROID



"FISH PAPER"

Fish paper has many uses around the shop for repair jobs where electrical insulation is required. 010" — 240 sq. in. roll.

No. 560 List \$0.55 Roll



GENERAL CEMENT TELEVISION SERVICE AIDS

G-C AC-DC INDOOR ANTENNA WIRE



Antenna lead wire for indoor type AC-DC sets. Flexible copper wire with brown plastic insulation.

No.	25-foot coil	List
840		\$0.45

G-C YOKE COIL EXTENSION



Extends leads when removing chassis from cabinet, avoids removing yoke coil and CR tube. For RCA, Philco, etc. 48" long.

No.	List
8847	\$4.50

G-C ANGLE ANODE LEADS



Handy angle type with special "ozone proof" rubber cap that does not deteriorate or break up from high voltage. 18" leads.

No.	List
8637	\$1.00

G-C TV 3-WAY ANTENNA LINE KLIPS



DeLuxe model — used three ways: Straight, side or RCA plug-in. No soldering, easy to attach. Belongs on every set.

No.	List
8744	\$0.50

G-C BEAM-O-CENTER



Used to center picture, fits in back of tube yoke coil. New design, bakelite housing.

No.	List
8956	\$1.75

G-C PIN CUSHION — TYPE III



New "Y" style for reducing pin cushion effect.

No.	List
8955	\$1.25

G-C KINE-CENTER



Centering device for electrostatic tubes. Easy to mount. Picture is centered by rotating two rings, stays centered with no focus distortion.

No.	List
8747	\$1.75

G-C 3-SECOND BEAM ADJUSTER



Fits all tubes, centers TV picture in 3 seconds (not 20-30 minutes). Eliminates fancy tilting controls. Easy to install; snap on yoke coil back; rotate for approx. centering; slide outer plate vertically or horizontally for vernier adjustment.

No.	List
8748	\$1.75

G-C TV INSULATED HIGH-VOLTAGE GRID CAPS



Heavy bakelite cap, wired with high voltage wires 10" long. Two sizes available.

No.	1/2" size Cap	List
8834		\$0.45
No.	3/4" size Cap	List
8835		.45

G-C TV ANODE EXTENSION



Extend high voltage TV anode leads. Pure gum "ozone proof" cap, high voltage plastic plug. 38" long.

No.	List
8693	\$1.50

G-C TV SPRING-TYPE GRID CAPS



For high-voltage TV rectifier tubes. Constant contact and pressure due to unique construction; cannot slip off. For 1/4" and 3/8" caps.

No.	Envelope of 8	List
8838-E		\$0.45

G-C STRAIGHT ANODE LEADS



Special "ozone proof" rubber cap does not deteriorate or break up from high voltage. 18" leads.

No.	List
8636	\$1.00

G-C PIN CUSHION — TYPE I

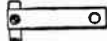

Reduces pin cushion or fuzzy effect around edges of picture tube. Used on all newer sets. Length 3 1/2".

No.	List
8953	\$1.00

G-C PIN CUSHION — TYPE II



Similar to 8953, but for larger picture tubes. Length 4 1/2".

No.	List
8954	\$1.00

G-C ION TRAPS



Used by leading TV set manufacturers. Easy to install, assure brightest pictures. Traps stay put, don't wobble.

No.	Single Ion Trap	List
8745		\$1.00
No.	Double Ion Trap	List
8746		1.75

G-C VARI-LOOPSTICK



Similar to Ferris-Loopstick, but has set screw adjustment to adjust core for precision tuning. Easy to install. For new or old TV sets, gives stronger, clearer reception.

No.	List
8866	\$1.00

G-C TV INTERLOCK SAFETY CORDS



Replacement TV safety interlock or "cheater" cords. UL approved. Best grade wire, with attached molded plugs.

No.	Length	List
8200	8-ft. Reg. TV Cord	\$0.75
8788	9-ft. Reg. TV Cord	1.10
8201	Special Zenith Cord	1.00
8834-E		.45

Receptacle for Reg. TV Cord, 2 Per Env.

G-C BO ELIMINATOR



Barkhausen Oscillation — vertical black bars in TV picture — is caused by horizontal sweep output tube (25BQ6, 6BQ6, 6EU5, 25EU5, 6AU5, 25AU5, etc.). Easy to correct; slip BO Eliminator over tube, move up or down or turn until lines disappear.

No.	List
8749	\$1.25

G-C TV TUBE EXTENSION



Handy CR tube extension for service work; ideal for new electrostatic tubes. Cord 48" long, complete with plugs.

No.	List
8856	\$2.50

G-C TV "SMOOTHER" TUNER DETENTS



Popular short shafted detent. Replaces RCA part No. 71483 used on RCA, Admiral, Air King, Capehart, De-Wald, Garod, Fada, Emerson, Packard-Bell, etc.

No.	List
8600	\$2.80



Long shaft detent. Replaces RCA Part No. 72743 used on RCA models 8TS30, 721TC'S, 730TC'S, 730TV2, etc.

No.	List
8601	\$3.15



Extra long shaft detent for replacing Admiral Part No. 76B14. Used in Admiral Series No. 30-A and No. 8C, etc. Also on sets using RCA tuner type 201E1 — Part No. 71531.

No.	List
8602	\$4.15



All phenolic shaft type detent used to replace RCA Part No. 73440. Used as a replacement on RCA tuners types 73435, 74571, and 74941. Used on RCA models in the 8T, 9T, 6TC, 8TR, 8TV, 9TC, 9TV series.

No.	List
8603	\$4.75

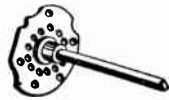

Similar all phenolic shaft type detent to G-C No. 8603. Used to replace RCA Part No. 75162.

No.	List
8604	\$4.00

G-C TV PORTO MIRROR



Adjust rear controls and settings. Mirror has rubber lined spring clamp. Mirror made of heavy chrome plated metal to prevent distortion.

No.	List
8198	TV Mirror, complete with clamp \$4.30
8199	Soft Cloth Carrying Bag 1.70

G-C THIRD-EYE TV MIRROR SET



Deluxe mirror for TV servicing. Adjustable, telescoping stand with glass mirror; no distortion of TV picture. Mirror 12" x 10" in metal frame. Easy carrying.

No.	List
8390	Complete Mirror Set \$7.50
8199	Soft Cloth Carrying Bag 1.70

G-C TV MIRROR & EXTENSION LAMP STAND



Handy metal collapsible stand for No. 8391 mirror or extension lamp. Telescopes to small package.

No.	List
8392	\$4.55

G-C THIRD-EYE GLASS MIRROR



Handy glass mirror in chrome frame, with metal plate and bench bracket. Use on bench or with No. 8392 stand.

No.	List
8391	12" x 10" Glass Mirror \$3.45
8199	Soft Cloth Carrying Bag 1.70

IT'S G-C FOR ALL TV!

G-C TELEVISION ROLL-AROUND

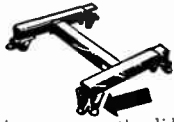

The easy way to put casters on any console TV set! Aids house-keeping, servicing, set mobility. Adjustable metal frame fits most sets. Ball bearing casters are smooth gliding, well concealed.

No. 8957 List \$9.95



GENERAL CEMENT
RADIO-TV SERVICE AIDS

G-C TV LIGHTNING ARRESTOR



All-weather. Underwriters' approved. Easy to connect and install; no wires to strip. For 300-ohm and 450-ohm open line.

No. 8640 List \$1.00



G-C NEW UNIVERSAL UHF-VHF LIGHTNING ARRESTOR

Underwriters' approved, for all types of TV lines — hollow, open, oval, regular 300-ohm, etc. Easy to install, with 2 screws, on walls, masts or pipes.

No. 8642 List \$1.25

G-C SPEEDX SOLDERLESS TERMINALS

Solderless Crimp Type Connectors Will Fit No. 16 to 22 Wires

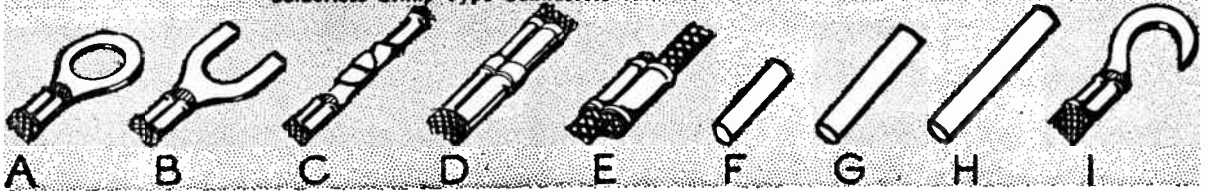

STYLE NO. AND DESCRIPTION	STANDARD BOX		BOX OF 144		BOXES OF 1,000	
	No.	Quan	No.	List	No.	List
Assortment of 50 Terminals	8177	50				
"A" Small Ring Type No. 6 Screw	8178	50	8178-G	\$5.65	8178-M	\$33.75
"A" Large Ring Type No. 6 Screw	8179	50	8179-G	5.39	8179-M	32.00
"A" Large Ring Type No. 8 Screw	8180	50	8180-G	5.65	8180-M	33.75
"A" Large Ring Type No. 10 Screw	8181	50	8181-G	5.65	8181-M	33.75
"A" Large Ring Type for 16-14 Wire, No. 10 Screw	8188	50	8188-G	5.65	8188-M	33.75
"B" Slotted Tongue Type No. 6 Screw	8182	40	8182-G	6.40	8182-M	37.00
"B" Slotted Tongue Type No. 8 Screw	8294	50	8294-G	5.65	8294-M	33.75
"B" Slotted Tongue Type No. 10 Screw	8295	40	8295-G	6.40	8295-M	37.00
"C" Knife Disconnect	8185	25	8185-G	9.35	8185-M	56.00
"D" Butt Connector	8186	35	8186-G	7.80	8186-M	46.75
"E" Parallel Connector 22-16 Wire	8187	50	8187-G	5.35	8187-M	32.00
"E" Parallel Connector 16-14 Wire	8189	50	8189-G	5.35	8189-M	32.00
"F" Disconnect Plastic Tubing	8190	175	8190-G	.90	8190-M	5.00
"G" Connector Plastic Tubing	8191	175	8191-G	.90	8191-M	5.00
"H" Terminal Plastic Tubing	8192	175	8192-G	1.75	8192-M	10.00
"I" Hook Type Connector No. 6 Screw	8193	50	8193-G	5.65	8193-M	33.75

G-C 300-OHM 4-IN-1 TOOL AND KIT



Handy tool is a stripper, cutter, slitter, crimper — all in one. Works well on all 300-ohm wire types. Saves time, does professional job. Supplied separately or with solderless terminal assortment.

No. 8385 4-in-1 Tool, only List \$5.00
8386 Kit, Tool and Terminal Assortment 7.50

G-C TELEVISION SAF-T-RACK



A sturdy rack to use in repairing heavy television chassis. Set it on the rack and tilt it on side. Hooks hold the chassis on its side so you can work on it. Prevents tubes from being damaged.

No. 8045 Saf-T-Rack List \$5.45

G-C CHASS-EZ



A tool to make the Serviceman's job easier. Chassis can be installed in "Chass-Ez" in five seconds. All one unit — no extra bolts or nuts to adjust. Heavy steel, riveted construction, heavily plated.

No. 5207 List \$4.00

G-C PHONO TURNTABLE STAND



New improved model, adjustable to all turntables. Raises the turntable 15 inches above bench. Pivots on swivel joints for easy examination or repairs. Sturdy steel construction. Plated.

No. 5205 List \$8.25

G-C MAGNETIC RECORDING WIRE



For all wire recorders. Includes plastic leads. Finest quality reproduction on stainless steel wire. Fits all standard recorders.

No.	Leaders with Spools	List
5171	1-hr. Spool	\$5.00
5172	1/2-hr. Spool	3.00
5173	3/4-hr. Spool	2.00
5174	Leaders only, for Armour type recorders, per pair	.22
5176	Empty Rewind Spool	.75
5175	Envelope Nylon Webster Cord	.45

G-C MASTER-TONE RECORDING TAPE



The new G-C plastic back master-tone recording tape available in two sizes, for commercial and home use. Comes in a plastic wheel which stops rapidly. Has low surface friction, high frequency response, and is uniform from reel to reel. No magnetic weak spots.

No.	Length	List
5180	1270 foot reel	\$5.50
5181	640 foot reel	3.50
5183	7" Empty reel	.75
5184	5" Empty reel	.65



GENERAL CEMENT KITS and BUSHINGS

It's

G-C

for All TV!

G-C IGNITION SUPPRESSORS



A-B C-D E F G H

Rugged bakelite auto radio ignition suppressors. Resistance, 10,000 ohms (V-8 types, 50,000 ohms). Resistors are moisture-proof and impervious to heat, oil, and mild acids. All metal parts brass. Good for more than 50,000 miles.

No.	Description	List
(a) 1501	Bracket Type	\$0.35
(b) 1502	Ford V8	.35
(c) 1503	Ford V8 Brush Type, 33, 34, 35 Cars	.35
(d) 1504	Ford V8 Brush Type, 36 to 40 Cars	.35
(e) 1505	Screw Type, Universal	.35
(f) 1506	Snap-On Type	.35
(g) 1507	Distributor Type	.35
(h) 1508	Cable type for Splicing Cables	.35

G-C SHAFT COUPLINGS, EXTENSIONS AND REDUCERS



No.	Description	List
6701	1/4" to 1/4" coupling	\$0.20
6702	1/4" to 3/8" coupling	.30
6703	1/4" to 1/2" coupling	.30
6704	3/8" to 3/8" coupling	.30
6705	1/4" hole to 1/4" shaft extension	.30
6710	3/8" hole to 1/4" shaft extension and reducer	.30
6712	1/4" x 6" brass shaft	.25
6713	1/4" x 12" brass shaft	.45
6716	1/4" hole x 1/4" round shaft x 4" long	.35
INSULATED FITTINGS		
6721	1/4" to 1/4" coupling	.25
6722	1/4" to 3/8" coupling	.30
6725	1/4" hole to 1/4" shaft extension	.30
6734	1/4" x 6" fibre shaft	.40
6735	1/4" x 12" fibre shaft	.65

G-C REPLACEMENT AUTO AERIALS

FORD ROOF AERIAL

Ford-Mercury Part No. 51A-18813-A1

Replacement Aerial for all Ford and Mercury Roof Aerials of 1941-42-46-47-48 that operate from behind the dividing post of the windshield. Brass tubing, stainless steel extension rod, triple chrome plated. Free sliding with positive contacts insure noise-free reception. Easy to install, fits without changes, replaces original aerial. Complete with knob and set screw.

No. 7056 Ford-Mercury Roof Aerial List \$2.65

BUICK REPLACEMENT ANTENNA

Buick Part No. 980,688

Standard Buick Roof Aerial Mast. The replacement mast for Buick Roof Aerials on models 1940 through 1949. Easy to replace — merely tightens into position with a set screw. Admiralty brass tubes with a stainless steel top rod. Chrome-plated.

No. 7057 Buick Antenna Mast List \$3.00



G-C TV STAND-OFF "EYE-OPENER" TOOL

Specially developed tool to open stand-off insulators for inserting lead-in and then closing them tight again. Fast. High grade steel.

No. 8450 List \$1.25

G-C ALLEN-BRISTO WRENCH KIT

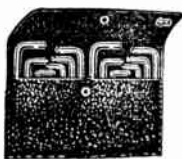

Complete wrench kit for hex and spline type screws. Double snap button case of durable leatherette. Fit No. 2 to 3/8" screws.

No. 5028 List \$1.80

G-C ALLEN-HEX WRENCHES AND KITS



HEX SOCKET

Made of alloy steel properly hardened. Used on knobs, dials, phono needles, motors, pulleys, etc.

No.	Description	List
5029	Kit 6 Asstd. Wrenches in Leatherette Case	\$0.85
5029-A	Env. 3 Hex Key Wrenches for No. 1/4" to 3/8" Set Screws	.55
5031	No. 4	.15
5032	No. 5	.15
5033	No. 8	.15
5034	No. 10	.16
5035	1/4"	.16
5036	3/8"	.25
5037	1/2"	.25

G-C BRISTO-SPLINE WRENCHES AND KITS



SPLINE SOCKET

Very popular "Bristo" or "Spline" type wrenches as used on phono needles, motors, pulleys, knobs, etc. Made of alloy steel, properly hardened.

No.	Description	List
5070	Kit 6 Asstd. Wrenches in Leatherette Case	\$0.85
5071	No. 4	.14
5071-A	No. 5	.14
5072	No. 6	.14
5073	No. 8	.14
5074	No. 10	.15
5075	1/4"	.15

G-C MINI-MAX STRIP



Used for connecting 67 1/2 volt "B" batteries, such as Eveready 455, 466; Burgess XX30, XX45.

No. 8115 List \$0.30

G-C HUB CAP STATIC SPRINGS



Eliminate wheel static noise developed by poor electrical contact between front axle and wheels. Springs have riveted metal points for firm, smooth contact. Plated.

No. 1058 Each List \$0.15
1059 Box, 24 Springs 3.50

G-C STATIC POWDER & INJECTOR GUN



Inject powder in tubes, and eliminate wheel tire static. Easy to apply. Powder also cuts down tire trouble by eliminating those pin-point tube leaks caused by tire static discharge. Powder blown into tube with G-C Injector Gun.

No.	Description	List
5604	Injector Gun, only	\$1.80
5605	Packet Static Powder for 5 tires (1 car)	1.10
5606	Kit, one No. 5604 Injector, and one No. 5605 Powder	2.75

G-C SCREW DRIVER SET



A handy screw driver set in a leatherette case with five interchangeable blades. Unbreakable handle with flanged aluminum screw chuck.

Blade Sizes

1 — cabinet	1/8" x 3 1/4"
1 — cabinet	7/8" x 3 3/4"
1 — mechanic	1/4" x 5 1/2"
1 — recessed head No. 1	7/8" x 4 1/4"
1 — recessed head No. 2	1/2" x 4 1/4"
No. 8615	List \$2.75

G-C 8-PIECE VEST POCKET SET



Hanliest tool! Seven sockets, $\frac{1}{4}$ ", $\frac{5}{16}$ ", $\frac{3}{8}$ ", $\frac{1}{2}$ ", $\frac{5}{8}$ " hex; $\frac{3}{8}$ " round knurled, $\frac{1}{4}$ " square, complete with 4" L handle.
 No. 712 List \$1.75

G-C REDUCING BUSHINGS



No. 6751-E $\frac{1}{4}$ " to $\frac{3}{8}$ " reduction, 8 in Env. \$0.45

G-C SHAFT EXTENSIONS



No. 6755 $\frac{1}{4}$ " x 4 $\frac{1}{2}$ " Long Flat Shaft Ext. \$0.55
 6716 $\frac{1}{4}$ " x 4 $\frac{1}{2}$ " Long Round Shaft Ext. .35

G-C 6-PIECE SLIP-ON WRENCH SET



Handle holds five sockets, sizes $\frac{1}{4}$ ", $\frac{5}{16}$ ", $\frac{3}{8}$ ", $\frac{1}{2}$ ", and $\frac{5}{8}$ ". Easily assembled. Tempered steel, plated.
 No. 715 List \$2.25

G-C PLASTIC HARDWARE ASSORTMENT

Approximately 1000 assorted screws, nuts, washers, springs, clamps, eyelets, grommets, terminals, etc. No cast-offs — only regular hardware. Plastic jar with screw cap.
 No. 6064 1000 Asstd. List \$1.80
 6056-E Env. 100 Asstd. .45

G-C HELL BOX

A grand assortment of useful hardware; screws, nuts, lugs, clips, washers, eyelets, clamps, etc. Thousands of items needed every day. Metal hinged box.
 No. 6500 List \$3.75

GENERAL CEMENT SERVICE AIDS • RADIO KNOBS

G-C BRASS AND INSULATED SPACERS AND BUSHINGS

BRASS		INSULATED		THREADED BRASS BUSHINGS	
No.	O.D.	No.	O.D.	No.	O.D.
6617	Hardware Lab. Jar 12 Asstd. Spacers and Bushings	6775	$\frac{1}{4}$ "	6785	$\frac{1}{4}$ "
6760-E	Env. 12 Asst. Ins. Spacers	6776	$\frac{3}{8}$ "	6786	$\frac{1}{4}$ "
6762	15 Asst. Threaded Brass Bushings 6-32 thread, $\frac{1}{4}$ " to $\frac{3}{4}$ " long	6777	$\frac{1}{2}$ "	6787	$\frac{1}{4}$ "
6763	15 Asst. Threaded Brass Bushings 8-32 thread, $\frac{1}{4}$ " to $\frac{3}{4}$ " long	6778	$\frac{3}{4}$ "	6788	$\frac{1}{4}$ "
6775-E	Env. 12 $\frac{1}{4}$ " x $\frac{1}{4}$ " Ins. Spacers	6779	$\frac{1}{2}$ "	6790	$\frac{1}{4}$ "
6761-E	Env. 12 Asst. Metal Spacers	6780	$\frac{3}{8}$ "	6791	$\frac{1}{4}$ "
		6781	$\frac{1}{2}$ "	6792	$\frac{1}{4}$ "
			$\frac{3}{8}$ "	6793	$\frac{1}{4}$ "

ELECTRONIC HARDWARE LABORATORIES

Complete assortment of hardware. Rack contains several thousand essential electronic hardware items. Packed in clear jars with screw caps. Assortments as below. Free Steel Rack!
 No. 6601 20 jar assortment List \$17.00
 No. 6604 DeLux Hardware Laboratory, 40 jars List \$34.00



G-C RCA RECORD ADAPTERS

Handy plastic adapters for the large hole (45 r.p.m.) RCA-type records for use on standard turntable shafts. Quickly interchangeable.
 No. 8380-E Env. 5 List \$0.45

G-C PLASTIC STOCK BOXES AND TRAYS













Clear Polystyrene boxes for stocking small parts, screws, nuts, bolts, condensers, resistors, etc. Tight fitting covers.
 No. 8022 4" x 4" x 2 $\frac{1}{2}$ " deep List \$0.60
 8023 4" x 8" x 2 $\frac{1}{2}$ " deep 1.20



G-C PHONO NEEDLE AND STYLUS SET SCREWS

Replacements for all popular types of pick-up arms and recording heads. Specially made, round head, hardened machine screws. 10 sizes.
 No. 1052-E Env. 7 List \$0.45
 1052 Kit 15 Screws .75

GENERAL CEMENT RADIO KNOBS - KITS

MAJESTIC BAKELITE KNOBS	ROYAL BAKELITE KNOBS	YANKEE BAKELITE KNOBS	G-C TV-RAD'O KNOB FELTS	INSTRUMENT KNOB	POPULAR LARGE KNOB
 Popular pattern. Set screw type. $\frac{3}{8}$ " dia., $\frac{1}{4}$ " shaft. No. 1100 Walnut List \$0.24 1100-1 Ivory .24	 Beautiful pattern. Set screw type. $\frac{3}{8}$ " dia., $\frac{1}{4}$ " shaft. No. 1105 Walnut List \$0.24 1105-1 Ivory .24	 Set screw type. $\frac{3}{4}$ " and 1" dia., $\frac{1}{4}$ " shaft. No. 1109 $\frac{3}{4}$ " Walnut List \$0.24 1110 1" Walnut List \$0.24 1110-1 1" Ivory List \$0.26	 Brown felt washers. prevent scratching and rubbing on cabinet. No. 1065 E Env. 50 List \$0.45	 Heavy duty knob for communication equipment, instruments. $\frac{3}{4}$ " brass insert, set screw. 1 $\frac{3}{8}$ " O.D. x $\frac{3}{8}$ ". No. 1175 Black List \$0.55	 Knurl shaft or set screw types. 1 $\frac{3}{8}$ " diameter. Knurl Shaft Type No. 1180 Walnut List \$0.17 1180-1 Ivory List \$0.17 Set Screw Type No. 1181 Walnut List \$0.19
MIDGET BAKELITE KNOBS	MIDGET BAKELITE KNOBS Set Screw Type	STREAMLINE POINTERS	MODERN POINTER BAR KNOBS BRASS BUSHING		
 For small sets. $\frac{3}{8}$ " dia., $\frac{1}{4}$ " shaft. Pointer Type No. 1115 Walnut List \$0.14 1116 Ivory .17 1117 Red .17 1118 Black .14	 For small sets. $\frac{3}{8}$ " dia., set screw $\frac{1}{4}$ ". Non-Pointer Type No. 1111 Walnut List \$0.14 1112 Ivory .17 1113 Red .17 1114 Black .14	 The most popular pointer knob. $\frac{1}{4}$ " shaft, set screw type 1 $\frac{1}{4}$ " long. No. 1135 Black List \$0.17 1136-W Walnut .18 1137 Red .20 1137-1 Ivory .22	 A very popular pointer knob. $\frac{1}{4}$ " shaft, set screw type, 2" long. No. 1135 Black List \$0.35 1135-W Walnut .35 1138 Red .35 1138-1 Ivory .35	 For intercoms and instruments. Black finish. Set screw, $\frac{1}{4}$ " shaft, 1 $\frac{1}{2}$ " long. No. 1130 Black List \$0.47 1130-W Walnut .47	 For intercoms and instruments. Black. Set screw, $\frac{1}{4}$ " shaft, 2 $\frac{3}{8}$ " long. No. 1131-W Walnut List \$0.42



GENERAL CEMENT

RADIO • TV KNOBS and KITS

IT'S G-C
FOR ALL
TV!

SPRING AND D-SHAFT KNOBS



Spring type $\frac{3}{8}$ " dia. Fits $\frac{1}{4}$ " flat shafts.

No.	List
1151 Walnut	\$0.16
1152 Ivory	.20

D — or flat shaft type. $\frac{3}{8}$ " diameter.

MIDGET TYPE PLASTIC KNOB



$\frac{3}{8}$ " dia., $\frac{3}{8}$ " shank for $\frac{1}{4}$ " knurled shafts.

No.	List
1157 Walnut	\$0.14
1158 Ivory	.15

MIDGET TYPE PLASTIC KNOB



$\frac{3}{8}$ " diam., $\frac{3}{8}$ " shank for $\frac{1}{4}$ " knurled shafts.

No.	List
1197 Walnut	\$0.14
1198 Ivory	.15

G-C FRONT DUAL CONTROL KNOB



Plated gold finish inlay. 1 1/8" O.D. Used with rear knob No. 8533 and others.

No. 8530	List \$0.45
Fits $\frac{1}{4}$ " Knurl Shaft	
No. 8531	List \$0.50
Fits $\frac{1}{4}$ " Flatted Shaft	
No. 8532	List \$0.50
Fits .202" Flatted Shaft	

G-C FRONT DUAL BAR CHANNEL KNOB



Push-on type for RCA sets and others. Fits standard $\frac{1}{4}$ " shaft flatted to .156". Complete with spring.

No. 8861	List \$0.50
----------	-------------

G-C FRONT KNOB



Push-on type for RCA sets and others; for off-on, volume, etc. Fits $\frac{3}{8}$ " shaft flat to .156". Complete with spring.

No. 8883	List \$0.25
----------	-------------

STREAMLINE POINTERS



BRASS BUSHING
Brass insert, $\frac{1}{4}$ " shaft, set screw, 1 $\frac{1}{4}$ " long.

No.	List
1170 Black	\$0.28
1170-W Walnut	.28
1172 Red	.30
1172-1 Ivory	.30

MIDGET TYPE PLASTIC KNOB



$\frac{3}{8}$ " dia. flush type for $\frac{1}{4}$ " knurled shafts.

No.	List
1159 Walnut	\$0.14
1160 Ivory	.15

MIDGET TYPE PLASTIC KNOB



$\frac{3}{8}$ " dia., flush shank for $\frac{1}{4}$ " knurled shafts.

No.	List
1193 Walnut	\$0.14
1194 Ivory	.15

G-C RADIO KNOB PULLER

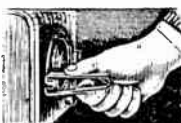

Very handy in removing knobs. Simply slip behind knob and pull off. Saves cabinet and knobs.

No.	List
1063	\$0.50

G-C REAR CHANNEL KNOB



Mate to No. 8861 knob. Fits $\frac{3}{8}$ " shaft flatted to .327". Complete with spring.

No.	List
8862	\$0.45

G-C REAR KNOB



Mate to No. 8863 knob. Fits 17/64" shaft flat to .237". Complete with spring.

No.	List
8864	\$0.45

Brass insert, $\frac{1}{4}$ " shaft, set screw, 2" long.



No.	List
1171 Black	\$0.42
1171-W Walnut	.42
1173 Red	.45
1173-1 Ivory	.45

G-C REAR DUAL CONTROL KNOB



Rear mate to 8530 series knobs, 1 $\frac{1}{8}$ " dia., for standard .265" dia. rear keyway shaft.

No.	List
8533	\$0.28

G-C AUTO RADIO KNOBS



Chrome plated. For $\frac{1}{4}$ " and $\frac{3}{8}$ " shafts. Set screw mounting.

No.	List
1169 $\frac{1}{4}$ "	\$0.35
1174 $\frac{3}{8}$ "	.35

G-C CHANNEL INDICATOR PLATE



For sets using Radio Condenser TV tuner, etc. Spunton, Farnsworth, Sonora, Meek, Walnut, gold letters. Matches 8530 series knobs. Fits $\frac{3}{8}$ " dia. rear flat shaft.

No.	List
8537	\$0.75

G-C FRONT CHANNEL KNOB



Popular front knob used on channel tuners and controls for Motorola, Hallierafter, Stromberg-Carlson, etc., also sets using Chicago Telephone tuner. $\frac{3}{8}$ " dia. Walnut. Fits .202" dia. flat shaft.

No.	List
8538	\$0.22

G-C TV KNOB SPRINGS



Standard and special replacements for TV-radio knobs.

Type A — Fits small .202" dia. flat shaft		
No.	Env.	List
8541-E	100	\$0.45
8541-G	Gross	5.70
Type B — Fits $\frac{3}{8}$ " dia. flat shaft		
No.	Env.	List
8542-E	10	\$0.45
8542-G	Gross	4.65

POPULAR BAR KNOB



For intercoms, instruments, appliances. Bakelite with set screw. $\frac{1}{4}$ " hole, 1 $\frac{1}{8}$ " long.

No.	List
1132 Walnut	\$0.22

PUSH-ON KNURL KNOB



$\frac{3}{8}$ " dia. flush type for $\frac{1}{4}$ " knurled shafts.

No.	List
1184 Walnut	\$0.17
1185 Ivory	.17

G-C KNOB SET SCREW ASST.



Handy set screw assortment for radio knobs, shafts, pulleys, 6-32, 8-32, and 10-32.

No.	List
1060 50 Asst.	\$1.10
1061 100 Asst.	2.00
1062-E 15 Asst.	.45
6605 30 Asst.	.85

G-C COMBINATION DUAL KNOB



Front and rear dual dummy type control knob, 1 $\frac{3}{8}$ " dia. Plated gold finish inlay. Fits $\frac{1}{4}$ " flat shaft.

No.	List
8534	\$0.75

G-C REAR CHANNEL KNOB



Mate to No. 8538 knob. For .265" rear keyway shaft. 1 $\frac{1}{4}$ " dia.

No.	List
8539	\$0.22

POPULAR PLASTIC KNOB



$\frac{3}{8}$ " diameter with $\frac{3}{8}$ " shank extension for $\frac{1}{4}$ " knurled shaft.

No.	List
1153 Walnut	\$0.14
1154 Ivory	.15

PUSH-ON KNURL KNOB



$\frac{3}{8}$ " dia., $\frac{3}{8}$ " shank for $\frac{1}{4}$ " knurled shafts.

No.	List
1186 Walnut	\$0.15
1187 Ivory	.15

G-C KNOB SPRING KITS



Reduce from $\frac{1}{4}$ " to $\frac{3}{8}$ ". For auto radios.

No.	List
No. 1049-E	List \$0.45
Env. 20 Asst.	
No. 1050	List \$1.10
Kit 35	
No. 1051	List \$1.95
Kit 100	
No. 6619	List \$0.85
Kit 35 Asst.	

G-C DUAL TUNER BAR KNOB



Front knob, 2" long bar. Plated gold finish inlay. Used with No. 8536 knob and others. Fits $\frac{1}{4}$ " dia. flat shaft.

No.	List
8535	\$0.95

G-C COMBINATION DUAL DUMMY KNOB



One-knob combination of No. 8538 and 8539 knobs. For matching cabinet design on single control. 1 $\frac{1}{4}$ " dia. at base. Fits $\frac{1}{4}$ " knurled shaft.

No.	List
8540	\$0.45

G-C RADIO KNOB KITS

Popular plastic knobs in assorted kits, all kinds.

No.	Quantity	L
1140	35 Asst. Push-on Buttons	\$4.70
1141	28 Asst. Spring Knobs	4.70
1142	24 Asst. Set Screw Knobs	4.70
1143	30 Asst. All Type Knobs	4.70

ATTRACTIVE PLASTIC KNOB



$\frac{3}{8}$ " dia., flush type for $\frac{1}{4}$ " knurled shafts.

No.	List
1155 Walnut	\$0.14
1156 Ivory	.15

POINTER TYPE PLASTIC KNOB



$\frac{3}{8}$ " dia., $\frac{3}{8}$ " shank for $\frac{1}{4}$ " knurled shafts.

No.	List
1188 Walnut	\$0.15
1189 Ivory	.15

G-C KNOB BUSHINGS



Reduce from $\frac{1}{4}$ " to $\frac{3}{8}$ ". For auto radios.

No.	List
6751 Env. of 8	\$0.45

G-C REAR DUAL TUNER KNOB



Rear knob, used with No. 8535 and others. 1 $\frac{3}{8}$ " dia. Fits standard $\frac{3}{8}$ " dia. rear flat shaft.

No.	List
8536	\$0.28

G-C TV KNOB SET



Set of above 4 TV knobs, boxed. Brown color.

No.	List
No. 8860	List \$1.65
(complete set)	



RADIO HARDWARE IN GLASS JARS

G-C RADIO HARDWARE IN GLASS JARS

G-C Hardware Laboratory



FREE STEEL RACK
(With No. 6601 or No. 6604 Asssts.)

Hardware in glass jars is convenient for the workshop or laboratory. Supplied in modern clear glass jars with a wide mouth opening. All hardware is labelled for easy identification.

Two assortments of hardware — one a 40-jar assortment, the other a 20-jar assortment — are available. Supplied from the jars of hardware listed below.

No. 6601 Hardware Rack Asst. (20 Jars) . \$17.00
List Price
Contains Jars 6605 thru 6624

No. 6604 Hardware Rack Asst. (40 Jars) . 34.00
List Price
Contains Jars 6605 thru 6644

THE HEAVY STEEL RACK IS FREE

A Complete Assortment of Hardware in Glass Jars

No.	Quantity	List Price
ROUND HEAD MACHINE SCREWS		
6610	75 Assorted 4-36 and 6-32 Screws	\$0.85
6611	60 Assorted 8-32 and 10-32 Screws	.85
6005	100 4-36 x 1/4"	.85
6006	100 4-36 x 1/2"	.85
6007	100 4-36 x 3/4"	.85
6005-A	100 4-40 x 1/4"	.85
6005-B	100 4-40 x 1/2"	.85
6005-C	100 4-40 x 3/4"	.85
6008	90 6-32 x 1/4"	.85
6009	85 6-32 x 1/2"	.85
6010	75 6-32 x 3/4"	.85
6011	50 6-32 x 1"	.85
6014	70 8-32 x 3/8"	.85
6015	65 8-32 x 1/2"	.85
6016	60 8-32 x 3/4"	.85
6017	45 8-32 x 1"	.85
6020	40 10-32 x 1/2"	.85
6021	50 10-32 x 3/4"	.85
6022	35 10-32 x 1"	.85

No.	Quantity	List Price
OVAL HEAD RACK and CABINET SCREWS		
6628	45 Assd. Rack Screws and Cup Washers	.85
6541	50 6-32 x 3/4"	.85
6542	45 8-32 x 3/4"	.85
6543	45 10-32 x 3/4"	.85

No.	Quantity	List Price
ORNAMENTAL HEAD SCREWS		
6631	50 Assd. Ornamental Head Screws	.85

No.	Quantity	List Price
WOOD SCREWS		
6633	45 Assd. Wood Screws	.85
6114	45 No. 4 x 1/2"	.85
6115	40 No. 4 x 3/4"	.85
6116	40 No. 6 x 3/4"	.85
6117	35 No. 6 x 1"	.85
6118	35 No. 8 x 3/4"	.85

No.	Quantity	List Price
SHEET METAL SCREWS		
6608	50 Assd. No. 4 & No. 6	.85
6609	45 Assd. No. 8 & No. 10	.85
6090	50 No. 4 x 1/2"	.85
6091	50 No. 6 x 1/2"	.85
6092	50 No. 6 x 3/8"	.85
6093	50 No. 6 x 1/4"	.85
6094	50 No. 6 x 3/4"	.85
6095	50 No. 8 x 3/4"	.85
6096	45 No. 8 x 1/2"	.85
6097	40 No. 8 x 1"	.85
6098	40 No. 10 x 3/8"	.85
6099	40 No. 10 x 1/2"	.85
6100	35 No. 10 x 3/4"	.85

No.	Quantity	List Price
ESCUTCHEON PLATE SCREWS		
6632	50 Assd. Escutcheon Screws	.85

No.	Quantity	List Price
MOUNTING NUTS		
6615	25 Assd. Mounting Nuts	.85

No.	Quantity	List Price
RADIO KNOB SET SCREWS		
6605	30 Assd. Set Screws	.85
6071	30 6-32 x 1/8"	.85
6072	30 6-32 x 1/4"	.85
6073	30 6-32 x 1/2"	.85
6074	30 8-32 x 1/8"	.85
6075	30 8-32 x 1/4"	.85
6076	30 8-32 x 1/2"	.85
6077	30 8-32 x 3/4"	.85
6078	30 10-32 x 1/2"	.85
6079	30 10-32 x 3/4"	.85

No.	Quantity	List Price
HEXAGON NUTS		
6606	60 Assd. 4-36 & 6-32	.85
6607	60 Assd. 8-32 & 10-32	.85
Thread Width Thick.		
6045	80 4-36 x 1/4" x 3/8"	.85
6041-A	80 4-40 x 1/4" x 3/8"	.85
6045-B	75 5-40 x 1/4" x 3/8"	.85
6046	75 6-32 x 1/4" x 3/8"	.85
6047	60 8-32 x 1/4" x 3/8"	.85
6048	50 10-32 x 3/8" x 1/2"	.85

No.	Quantity	List Price
CUP FINISHING WASHERS		
6628	45 Assd. Screws and Washers	.85
6161	65 No. 8 Cup Washer	.85
6162	65 No. 8 Cup Washer	.85
6163	65 No. 10 Cup Washer	.85

No.	Quantity	List Price
C-WASHERS and RETAINING RINGS		
6636	85 Assd. C-Washers	.85

No.	Quantity	List Price
SHAFT		
6182	65 1/8" .171 .125 .062 .031	.85
6183	65 1/4" .234 .156 .046 .031	.85
6184	65 1/2" .260 .187 .062 .031	.85

No.	Quantity	List Price
COTTER PINS		
6642	90 Assd. Cotter Pins	.85

No.	Quantity	List Price
HAIR PIN COTTERS		
6637	75 Assd. Hair Pin Cotters	.85

No.	Quantity	List Price
FLAT FIBRE WASHERS		
6634	85 Assd. Flat Fibre Washers	.85
Screw Size I.D. O.D. Thick-		
6513	100 No. 6 .136" 1/4" 3/8"	.85
6514	100 No. 8 1/4" 3/8" 1/2"	.85
6515	80 No. 10 .196" 3/8" 1/2"	.85
6516	80 1/4" 1/4" 1/2" 3/8"	.85
6517	70 3/8" 3/8" 1/2" 3/8"	.85

No.	Quantity	List Price
EXTRUDED FIBRE WASHERS		
6525	65 A B C D .187 .140 .039	.85
(For No. 6 Screw)		
6526	65 3/8" .250 .169 .031	.85
(For No. 8 Screw)		
6527	65 7/8" .255 .196 .032	.85
(For No. 10 Screw)		
6528	50 1/2" .375 .250 .032	.85
(For 1/4" Shaft)		
6529	50 3/8" .437 .380 .031	.85
(For 3/8" Shaft)		

only 85c per jar



No.	Quantity	List Price
SNAP-IN TRIMOUNTS		
6620	45 Assd. Trimounts	.85
DIAL CORD CLIPS		
6621	75 Assd. Dial Cable Clips	.85
SOLDERING LUGS		
6618	75 Assd. Soldering Lugs	.85
CABLE HOLDER CLAMPS		
6644	40 Assd. Cable Clamps	.85
6251	40 Cable Fit, 1/8" to 3/4"	.85
6252	40 Cable Fit, 1/4" to 1/2"	.85
METAL WASHERS		
6612	135 Assd. No. 4 & No. 6	.85
6613	100 Assd. No. 8 & No. 10 Screw Hole	.85
Size Size O.D. Thick-		
6154	150 No. 4 1/8" 3/8"	.85
6155	125 No. 6 3/8" 1/2"	.85
6156	100 No. 8 1/2" 3/4"	.85
6157	100 No. 10 3/4" 1/2" .049"	.85
LOCK WASHERS		
INTERNAL LOCK WASHERS		
6614	90 Assd. Lock Washers, All Types	.85
6508	50 No. 3/8" 1 1/2" O.D.	.85
SPLIT TYPE LOCK WASHERS		
Screw Size O.D. Thickness		
6503	100 No. 4 1/8" 3/8"	.85
6504	100 No. 6 3/8" 1/2"	.85
6505	90 No. 8 1/2" .025"	.85
6506	90 No. 10 3/4" .050"	.85
6507	80 No. 1/4" 7/8" 1/2"	.85
MISCELLANEOUS		
6616	15 Assd. Dial Springs	.85
6617	12 Assd. Bushings & Spacers	.85
6619	35 Assd. Knob Springs	.85
6622	85 Assd. Rivets & Eyelets	.85
6623	60 1/2" Felt Pads	.85
6624	18 3/8" Rubber Tack Bumpers	.85
6625	25 Assd. Large Rubber Grommets	.85
6626	25 Assd. Soft Rubber Grommets	.85
6627	18 Assd. Acorn Nuts	.85
6629	30 Assd. Phone Tips	.85
6630	60 Assd. Tinerman Speed Nuts	.85
6635	25 Assd. Grid Caps	.85
6638	12 Assd. Dial Pulleys	.85
6639	30 Assd. Fahnestock Clips	.85
6640	50 Assd. Dust Felts	.85
6641	70 Knob Felts	.85
6643	30 Assd. Small Comp Springs	.85



GENERAL CEMENT
MANUFACTURING CO.
ROCKFORD, ILLINOIS, USA

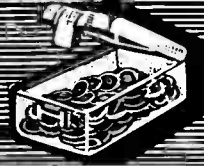

HANDY G-C HARDWARE

In Convenient Packages:

1. Plastic Boxes or Envelopes
2. Boxes of 144 (Gross)
3. Bulk Boxes of 1000.

HINGED COVER PLASTIC BOXES

30-LINE
Distributor's Standard
Display, 10 Boxes
List Price **50c**
Per Box

PLASTIC ENVELOPES

Distributor's Std.
Display, 20 Env.
List Price **45c**
Per Env.

BOXES OF 144

(Gross Packages)
Distributor's
Standard Carton,
7 Boxes of 144

BULK HARDWARE

(Boxes of 1000)
Supplied only in
Multiples of 1000

DESCRIPTION and SPECIFICATIONS

Part No.	Quantity In Box	Part No.	Quantity In Env.	Part No.	List Price Per 144	Part No.	List Price Per 1000 Pcs.
----------	-----------------	----------	------------------	----------	--------------------	----------	--------------------------

G-C ROUND HEAD MACHINE SCREWS
STEEL - NICKEL PLATED

Assorted Machine Screws	H1000-F	35	296-E	35			
Assorted Screws and Nuts	H1001-F	40	6038-E	40			
Assorted No. 2 and No. 4 Screws and Nuts	H1002-F	35	7129-E	40			
Assorted 4-36 Screws	H1010-F	40	6001-E	40			
Assorted 6-32 Screws	H1012-F	40	6002-E	40			
Assorted 8-32 Screws	H1016-F	40	6003-E	40			
Assorted 10-32 Screws	H1018-F	25	6004-E	25			
Machine Screws, 2.56 x 3/4"	H1022-F	40			7130-G	.95	7130-M 5.65
Machine Screws, 2.56 x 1/2"	H1024-F	40			7131-G	.95	7131-M 5.75
Machine Screws, 2.56 x 3/4"	H1026-F	40			7132-G	1.15	7132-M 6.75
Machine Screws, 3-48 x 3/4"	H1028-F	40			7124-G	1.20	7124-M 7.00
Machine Screws, 4-36 x 3/4"	H1032-F	40	6005-E	40	6005-G	1.00	6005-M 5.80
Machine Screws, 4-36 x 3/8"	H1033-F	35			7138-G	1.00	7138-M 6.00
Machine Screws, 4-36 x 1/2"	H1034-F	35	6006-E	35	6006-G	1.05	6006-M 6.20
Machine Screws, 4-36 x 3/4"	H1036-F	35			6007-G	1.20	6007-M 7.20
Machine Screws, 4-40 x 1/4"	H1042-F	40	6005-AE	40	6005-AG	1.00	6005-AM 5.80
Machine Screws, 4-40 x 1/2"	H1044-F	35			6005-BG	1.05	6005-BM 6.25
Machine Screws, 4-40 x 3/4"	H1046-F	35			6005-CG	1.25	6005-CM 7.50
Machine Screws, 6-32 x 1/4"	H1062-F	40	6008-E	40	6008-G	1.05	6008-M 6.25
Machine Screws, 6-32 x 1/2"	H1064-F	30	6009-E	35	6009-G	1.20	6009-M 7.25
Machine Screws, 6-32 x 3/4"	H1066-F	30	6010-E	30	6010-G	1.40	6010-M 8.50
Machine Screws, 6-32 x 1"	H1068-F	30	6011-E	30	6011-G	1.60	6011-M 9.50
Machine Screws, 6-32 x 1 1/4"	H1070-F	30			7141-G	2.00	7141-M 12.00
Machine Screws, 6-32 x 2" (Extra long, handy to mount rectifiers)	H1076-F	20			7148-G	2.95	7148-M 17.50
Machine Screws, 8-32 x 1/4"	H1082-F	30			6013-G	1.35	6013-M 8.00
Machine Screws, 8-32 x 3/8"	H1083-F	25	6014-E	30	6014-G	1.45	6014-M 8.75
Machine Screws, 8-32 x 1/2"	H1084-F	25	6015-E	25	6015-G	1.55	6015-M 9.30
Machine Screws, 8-32 x 3/4"	H1086-F	25			6016-G	1.80	6016-M 10.75
Machine Screws, 8-32 x 1"	H1088-F	20	6017-E	20	6017-G	2.05	6017-M 12.25
Machine Screws, 8-32 x 1 1/4"	H1090-F	20			7142-G	2.60	7142-M 15.50
Machine Screws, 10-32 x 1/2"	H1104-F	20			6020-G	1.80	6020-M 10.85
Machine Screws, 10-32 x 3/4"	H1106-F	20			6021-G	2.15	6021-M 12.85
Machine Screws, 10-32 x 1"	H1108-F	17			6022-G	2.45	6022-M 14.50
Machine Screws, 10-32 x 1 1/2"	H1112-F	15			7143-G	3.25	7143-M 19.50
Machine Screws, 1/4-20 x 1/2"					7144-G	3.10	7144-M 18.50
Machine Screws, 1/4-20 x 3/4"					8061-G	3.75	8061-M 22.50
Machine Screws, 1/4-20 x 1"					8062-G	4.30	8062-M 25.75
Machine Screws, 1/4-20 x 1 1/4"					7145-G	5.15	7145-M 30.75
Machine Screws, 1/4-20 x 1 3/4"					8521-G	5.85	8521-M 35.00
Machine Screws, 1/4-20 x 2 1/2"					7146-G	7.95	7146-M 47.75

G-C ROUND HEAD MACHINE SCREWS
BRASS - NOT PLATED

Assorted Brass Machine Screws	H1210-F	30	8500-E	30			
Machine Screws, Brass, 6-32 x 1/4"					8501-G	2.00	8501-M 12.00
Machine Screws, Brass, 6-32 x 1/2"					8502-G	2.30	8502-M 13.75
Machine Screws, Brass, 6-32 x 3/4"					8503-G	2.90	8503-M 17.25
Machine Screws, Brass, 6-32 x 1"					8504-G	3.75	8504-M 22.50
Machine Screws, Brass, 8-32 x 1/4"					8505-G	2.65	8505-M 16.00
Machine Screws, Brass, 8-32 x 1/2"					8506-G	3.70	8506-M 22.25
Machine Screws, Brass, 8-32 x 3/4"					8507-G	4.25	8507-M 25.50
Machine Screws, Brass, 8-32 x 1"					8508-G	4.75	8508-M 28.50



**GENERAL CEMENT
MANUFACTURING CO.**
ROCKFORD, ILLINOIS, USA

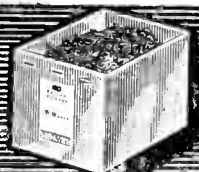

HANDY G-C HARDWARE

In Convenient Packages:

1. Plastic Boxes or Envelopes
2. Boxes of 144 (Cross)
3. Bulk Boxes of 1000.

**HINGED COVER
PLASTIC BOXES**
— SO-LINE
Distributor's Standard
Display, 10 Boxes
List Price
Per Box **50c**

**PLASTIC
ENVELOPES**
Distributor's Std.
Display, 20 Env.
List Price
Per Env. **45c**

**BOXES OF
144**
(Cross Packages)
Distributor's
Standard Carton,
7 Boxes of 144

**BULK
HARDWARE**
(Boxes of 1000)
Supplied only in
Multiples of 1000

DESCRIPTION and SPECIFICATIONS

Part No. In Box
Quantity

Part No. Quantity
In Env.

Part No. List Price
Per 144

List Price Per
Part No. 1000 Pcs.

G-C PHILLIPS TYPE ROUND HEAD MACHINE SCREWS
STEEL - NICKEL PLATED

Assorted Phillips Type Machine Screws	H1180-F	25	8510-E	25		
Machine Screws, Phillips, 6-32 x 1/4"					8511-G	2.35
Machine Screws, Phillips, 6-32 x 1/2"					8512-G	2.40
Machine Screws, Phillips, 6-32 x 3/4"					8513-G	2.40
Machine Screws, Phillips, 6-32 x 1"					8514-G	2.75
Machine Screws, Phillips, 8-32 x 3/8"					8515-G	2.40
Machine Screws, Phillips, 8-32 x 1/2"					8516-G	2.60
Machine Screws, Phillips, 8-32 x 3/4"					8517-G	2.75
Machine Screws, Phillips, 8-32 x 1"					8518-G	3.25
					8511-M	14.00
					8512-M	14.50
					8513-M	14.50
					8514-M	16.50
					8515-M	14.50
					8516-M	15.50
					8517-M	16.50
					8518-M	19.50

G-C BINDING HEAD MACHINE SCREWS
STEEL - NICKEL PLATED

Assorted Binding Head Machine Screws	H1168-F	35	7150-E	35		
Machine Screws, 5-36 x 1/4" (Used on many small toggle switches)	H1170-F	35			7154-G	1.65
Machine Screws, 6-32 x 3/8"					7151-G	1.05
Machine Screws, 6-32 x 1/4"	H1172-F	35	7152-E	35	7152-G	1.30
Machine Screws, 6-32 x 3/8"					7153-G	1.30
Machine Screws, 7-32 x 3/8" (Popular in electrical switches)	H1174-F	30			7155-G	1.75
Machine Screws, 8-32 x 3/8"					7158-G	1.60
					7154-M	8.00
					7151-M	6.25
					7152-M	7.75
					7153-M	7.75
					7155-M	10.50
					7158-M	9.50

G-C OVAL HEAD RACK and CABINET SCREWS
STEEL - NICKEL PLATED

Assorted Rack Screws and Washers	H1005-F	15	6039-E	15		
Machine Screws, 6-32 x 1/2"					6540-G	1.45
Machine Screws, 6-32 x 3/4"	H1266-F	30			6541-G	1.50
Machine Screws, 8-32 x 3/4"	H1270-F	25	6542-E	25	6542-G	1.80
Machine Screws, 10-32 x 1/2"					8848-G	1.95
Machine Screws, 10-32 x 3/4"	H1273-F	20	6543-E	20	6543-G	2.10
					6540-M	8.75
					6541-M	9.00
					6542-M	10.75
					8848-M	11.00
					6543-M	12.50

G-C ORNAMENTAL HEAD SCREWS
STEEL - STATUARY BRONZE PLATED

Assorted Ornamental Head Screws	H1250-F	20	1094-E	15		
Ornamental Head Screws, 6-32 x 3/4"	H1252-F	25	1097-E	20	1097-G	1.50
Ornamental Head Screws, 6-32 x 1"	H1253-F	20	1098-E	20	1098-G	1.70
Ornamental Head Screws, 8-32 x 1 1/4"	H1255-F	12	1099-E	12	1099-G	2.60
					1097-M	9.00
					1098-M	10.25
					1099-M	15.50

G-C WOOD SCREWS

ROUND HEAD - STEEL - NICKEL PLATED

Assorted Wood Screws	H1502-F	25	6110-E	25		
Wood Screws, No. 4 x 1/2"			6114-E	30	6114-G	2.45
Wood Screws, No. 4 x 3/4"					6115-G	2.60
Wood Screws, No. 6 x 3/4"			6116-E	30	6116-G	2.70
Wood Screws, No. 6 x 1"			6117-E	25	6117-G	3.20
Wood Screws, No. 8 x 3/4"					6118-G	3.15
Wood Screws, No. 8 x 1 1/4"			8071-E	15	8071-G	3.90
Wood Screws, No. 10 x 1 1/2"			8073-E	12	8073-G	5.10
Wood Screws, No. 12 x 1 1/2"					8075-G	6.10
Wood Screws, No. 14 x 1 3/4"					8076-G	7.90
					6114-M	14.75
					6115-M	15.50
					6116-M	16.25
					6117-M	19.25
					6118-M	18.75
					8071-M	23.25
					8073-M	30.50
					8075-M	36.50
					8076-M	47.25

G-C SPADE BOLTS or MOUNTING SCREWS
STEEL - NICKEL PLATED

Assorted Spade Bolts	H1570-F	15	6080-E	15		
A	B	C	D	E		
6-32	No. 6	3/32"	11/16"	3/8"		
6-32	No. 6	1/32"	7/8"	11/16"	6081-G	3.10
8-32	No. 8	7/16"	1 1/32"	1 1/8"	6082-G	3.10
					6084-G	5.75
					6081-M	18.50
					6082-M	18.50
					6084-M	34.50



GENERAL CEMENT
MANUFACTURING CO.
ROCKFORD, ILLINOIS, USA



HANDY G-C HARDWARE

In Convenient Packages:

1. Plastic Boxes or Envelopes
2. Boxes of 144 (Gross)
3. Bulk Boxes of 1000.

HINGED COVER PLASTIC BOXES

50-LINE
Distributor's Standard Display, 10 Boxes
List Price **50c**
Per Box

PLASTIC ENVELOPES

Distributor's Std. Display, 20 Env.
List Price **45c**
Per Env.

BOXES OF 144

(Gross Packages)
Distributor's Standard Carton, 7 Boxes of 144

BULK HARDWARE

(Boxes of 1000)
Supplied only in Multiples of 1000

DESCRIPTION and SPECIFICATIONS	Part No.	Quantity In Box	Part No.	Quantity In Env.	Part No.	List Price Per 144	List Price Per Part No. 1000 Pcs.
--------------------------------	----------	-----------------	----------	------------------	----------	--------------------	-----------------------------------



G-C SHEET METAL SCREWS

HEX HEAD - SLOTTED - SELF-TAPPING - NICKEL PLATED POINTED TYPE "A"



Assorted Sheet Metal Screws	H1300-F	25	297-E	25			
Assorted No. 4 and No. 6 Sheet Metal Screws							
Assorted No. 8 and No. 10 Sheet Metal Screws							
Sheet Metal Screws, No. 4 x 1/2"	H1350-F	35	6090-E	35	6090-G	1.65	6090-M 10.00
Sheet Metal Screws, No. 6 x 1/4"	H1362-F	30	6091-E	30	6091-G	1.65	6091-M 9.75
Sheet Metal Screws, No. 6 x 3/8"	H1363-F	25	6092-E	25	6092-G	1.65	6092-M 10.00
Sheet Metal Screws, No. 6 x 1/2"	H1364-F	25	6093-E	25	6093-G	2.25	6093-M 13.50
Sheet Metal Screws, No. 6 x 3/4"	H1366-F	20			6094-G	2.40	6094-M 14.50
Sheet Metal Screws, No. 8 x 1/4" (Auto Radio Size)	H1382-F	20	8102-E	20	8102-G	2.90	8102-M 17.25
Sheet Metal Screws, No. 8 x 3/8"	H1383-F	20	6095-E	20	6095-G	2.10	6095-M 12.50
Sheet Metal Screws, No. 8 x 1/2"	H1384-F	20	6096-E	20	6096-G	2.65	6096-M 15.75
Sheet Metal Screws, No. 8 x 1"	H1388-F	15	6097-E	15	6097-G	3.40	6097-M 20.50
Sheet Metal Screws, No. 10 x 3/8"	H1403-F	15			6098-G	3.00	6098-M 18.00
Sheet Metal Screws, No. 10 x 1/2"	H1404-F	15	6099-E	15	6099-G	3.20	6099-M 19.25
Sheet Metal Screws, No. 10 x 3/4"	H1406-F	12			6100-G	3.55	6100-M 21.25



G-C ESCUTCHEON PLATE SCREWS

ROUND HEAD - SLOTTED - STATUARY BRONZE PLATED



Assorted Escutcheon Screws	H1500-F	25	1090-E	25			
Escutcheon Screws, No. 2 x 1/4"					1091-G	2.05	1091-M 12.25
Escutcheon Screws, No. 2 x 3/8"					1093-G	2.25	1093-M 13.50

CUP POINT Is Standard



G-C RADIO KNOB SET SCREWS
SLOTTED - HEADLESS - HARDENED STEEL



No. 1060 Kit 50 Asst. Set Screws	List Price \$1.10						
No. 1061 Kit 100 Asst. Set Screws	List Price \$2.00						
Assorted Set Screws	H1605-F	15	1062-E	15			
Assorted Set Screws, 6-32			6062-E	15			
Assorted Set Screws, 8-32			6063-E	15			
Set Screws, 6-32 x 1/8"					6071-G	2.90	6071-M 17.25
Set Screws, 6-32 x 3/16"	H1623-F	15	6072-E	15	6072-G	3.15	6072-M 18.75
Set Screws, 6-32 x 1/4"					6073-G	3.15	6073-M 19.00
Set Screws, 8-32 x 1/8"					6074-G	3.75	6074-M 22.50
Set Screws, 8-32 x 3/16"	H1633-F	15	6075-E	15	6075-G	2.75	6075-M 16.50
Set Screws, 8-32 x 1/4"	H1634-F	15			6076-G	2.80	6076-M 16.75
Set Screws, 8-32 x 1/2"					6077-G	3.15	6077-M 18.75
Set Screws, 10-32 x 3/16"					6078-G	3.20	6078-M 19.25
Set Screws, 10-32 x 1/4"	H1644-F	15			6079-G	3.25	6079-M 19.50



G-C BRISTO SET SCREWS
HARDENED STEEL - SPLINE TYPE - HEADLESS



Bristo Set Screws, 6-32 x 3/16"					7182-G	12.50	7182-M 75.00
Bristo Set Screws, 8-32 x 1/4"					7186-G	12.50	7186-M 75.00
Bristo Set Screws, 8-32 x 3/16"					7187-G	12.50	7187-M 75.00



GENERAL CEMENT
MANUFACTURING CO.
ROCKFORD, ILLINOIS, USA



HANDY G-C HARDWARE

In Convenient Packages

1. Plastic Boxes or Envelopes
2. Boxes of 144 (Gross)
3. Bulk Boxes of 1000.

HINGED COVER PLASTIC BOXES

50-LINE —
Distributor's Standard Display, 10 Boxes
List Price Per Box **50c**

PLASTIC ENVELOPES

Distributor's Std. Display, 20 Env.
List Price Per Env. **45c**

BOXES OF 144

(Gross Packages)
Distributor's Standard Carton, 7 Boxes of 144

BULK HARDWARE

(Boxes of 1000)
Supplied only in Multiples of 1000

DESCRIPTION and SPECIFICATIONS

Part No. Quantity In Box Part No. Quantity In Env. Part No. List Price Per 144 Part No. List Price Per 1000 Pcs.



G-C ALLEN HEX SET SCREWS
STEEL - HARDENED - HEADLESS



Assorted Lengths, 4-36	H1674-F	5	7190-E	5		
Assorted Lengths, 6-32	H1676-F	5	7195-E	5		
Assorted Lengths, 8-32	H1678-F	5	7200-E	5		
Hex Set Screws, 4-36 x 1/8"					7191-G 13.90	7191-M 83.50
Hex Set Screws, 6-32 x 1/8"					7196-G 13.90	7196-M 83.50
Hex Set Screws, 6-32 x 3/16"					7197-G 13.90	7197-M 83.50
Hex Set Screws, 8-32 x 1/8"					7201-G 13.90	7201-M 83.50
Hex Set Screws, 8-32 x 3/16"					7202-G 13.90	7202-M 83.50



G-C PHONOGRAPH NEEDLE and STYLUS SET SCREWS

STEEL - BRONZE PLATED



No. 1052 Asst., 15 in Box	List Price \$.75	H1550-F	12	1052-E	7		
Assorted Phono Needle Screws							
No. 1053 Asst., 100 in Box	List Price \$12.25	H1551-F	12				
Phono Needle Screws, 2-56 x 3/16"		H1553-F	12			P1-G 1.15	P1-M 6.90
Phono Needle Screws, 2-64 x 3/4"						P2-G 2.45	P2-M 14.75
Phono Needle Screws, 1-56 x 3/4"						P3-G 6.25	P3-M 37.50
Phono Needle Screws, 1-64 x 1"				P4-E 3		P4-G 3.90	P4-M 23.25
Phono Needle Screws, 1-72 x 3/32"				P5-E 3		P5-G 3.00	P5-M 18.00
Phono Needle Screws, 1-72 x 2/32"		H1555-F	5	P6-E 4		P6-G 4.75	P6-M 28.50
Phono Needle Screws, 0-64 x 2/32"				P7-E 3		P7-G 14.60	P7-M 87.50
Phono Needle Screws, 4-48 x 2/32"				P8-E 3		P8-G 4.60	P8-M 27.50
Phono Needle Screws, 2-64 x 2/32"				P9-E 3		P9-G 7.25	P9-M 43.50
Phono Needle Screws, 1-64 x 3/4"				P10-E 3		P10-G 4.60	P10-M 27.50



PHONO CARTRIDGE MOUNTING SCREWS

STEEL - NICKEL PLATED



Assorted Cartridge Mounting Screws	H1560-F	60	6000-E	60		
Cartridge Screws, 4-36 x 1/4"	H1562-F	40	6005-E	40	6005-G 1.00	6005-M 5.80
Cartridge Screws, 4-40 x 1/4"	H1564-F	40	6005-AE	40	6005-AG 1.00	6005-AM 5.80



G-C HEXAGON NUTS

STEEL - NICKEL PLATED



Assorted Hex Nuts	H1800-F	30	293-E	30			
Thread	Width	Thickness					
2-56	3/16"	1/16"	H1802-F	30	7225-G 1.50	7225-M 9.00	
3-48	3/16"	1/16"	H1803-F	30	7226-E 40	7226-G 1.45	7226-M 8.75
4-36	1/4"	3/32"	H1805-F	30	6041-E 30	6041-G 1.40	6041-M 8.50
4-40	1/4"	3/32"	H1804-F	30	6041-AE 30	6041-AG 1.40	6041-AM 8.50
5-40	3/8"	3/4"			6045-BG 1.40	6045-BM 8.35	
6-32	1/4"	3/32"	H1806-F	30	6042-E 35	6042-G 1.45	6042-M 8.75
6-32	3/8"	3/4"	H1807-F	30	7230-G 1.55	7230-M 9.25	
8-32	1/4"	3/32"	H1808-F	30	6043-E 30	6043-G 1.45	6043-M 8.75
8-32	3/8"	1/8"	H1809-F	30	7233-G 1.60	7233-M 9.50	
10-32	3/8"	3/4"	H1810-F	30	6044-E 25	6044-G 1.55	6044-M 9.30
10-32	3/8"	1/8"			6049-G 1.55	6049-M 9.30	
1/4-20	3/4"	3/16"	H1820-F	25	7235-G 2.20	7235-M 13.25	
1/32-32	3/16"	1/16"			7236-G 3.75	7236-M 22.50	
3/8-32	3/8"	3/32"	H1923-F	15	6050-AG 3.90	6050-AM 23.50	
1/2-27	1/2"	1/4"	H1924-F	10	7238-G 6.10	7238-M 36.50	
15/32-32	3/8"	5/64"			6050-BG 5.40	6050-BM 32.50	



**GENERAL CEMENT
MANUFACTURING CO.**
ROCKFORD, ILLINOIS, USA



HANDY G-C HARDWARE

In Convenient Packages:

1. Plastic Boxes or Envelopes
2. Boxes of 144 (Cross)
3. Bulk Boxes of 1000.

**HINGED COVER
PLASTIC BOXES**

SO-LINE
Distributor's Standard
Display, 10 Boxes
List Price **50c**
Per Box

**PLASTIC
ENVELOPES**

Distributor's Std.
Display, 20 Env.
List Price **45c**
Per Env.

**BOXES OF
144**

(Cross Packages)
Distributor's
Standard Carton,
7 Boxes of 144

**BULK
HARDWARE**

(Boxes of 1000)
Supplied only in
Multiples of 1000

DESCRIPTION and SPECIFICATIONS

Part No.	Quantity In Box	Part No.	Quantity In Env.	Part No.	List Price Per 144	Part No.	List Price Per 1000 Pcs.
----------	-----------------	----------	------------------	----------	--------------------	----------	--------------------------



**G-C BRASS HEXAGON NUTS
NOT PLATED**



Thread	Width	Thickness	Part No.	Quantity In Box	Part No.	Quantity In Env.	Part No.	List Price Per 144	Part No.	List Price Per 1000 Pcs.
2-56	3/16"	1/16"					7241-G	1.60	7241-M	9.50
3-48	3/16"	1/16"					7242-G	1.60	7242-M	9.50
4-36	1/4"	3/32"	H1842-F	35			7243-G	1.65	7243-M	10.00
4-40	1/4"	3/32"	H1844-F	25			7244-G	1.90	7244-M	11.50
6-32	1/4"	3/32"	H1846-F	25	7245-E	25	7245-G	1.95	7245-M	11.75
8-32	3/8"	1/8"	H1848-F	15			7248-G	1.95	7248-M	11.75
10-32	3/8"	1/8"	H1850-F	15			7249-G	2.75	7249-M	16.50



**G-C MOUNTING NUTS
STEEL - NICKEL PLATED**



Assorted Mounting Nuts	Thread	Width	Thickness	Part No.	Quantity	Part No.	Quantity	Part No.	List Price	Part No.	List Price
	1 1/2-32	3/16"	3/32"	H1920-F	12	6050-E	12				
	3/8-32	3/16"	3/32"					7236-G	3.75	7236-M	22.50
	3/8-32	3/16"	3/32"	H1923-F	15	6050-AE	15	6050-AG	3.90	6050-AM	23.50
	3/16-27	3/16"	1/8"					7238-G	6.10	7238-M	36.50
	1 1/2-32	3/16"	5/64"	H1924-F	10			6050-BG	5.40	6050-BM	32.50
	1 1/2-32	Round Ring Nut (Toggle Switch Size)	1/16"	H1926-F	8			6050-CG	4.60	6050-CM	27.50



G-C TINNEMAN SPEED NUTS



Assorted Speed Nuts	Part No.	Quantity	Part No.	Quantity	Part No.	List Price	Part No.	List Price		
Speed Nuts, No. 4	H1960-F	30	6055-E	30			6051-G	1.60	6051-M	9.50
Speed Nuts, No. 6			6052-E	40			6052-G	1.40	6052-M	8.50
Speed Nuts, No. 8							6053-G	1.40	6053-M	8.50



**G-C ACORN NUTS
SOLID BRASS - NICKEL PLATED**



Assorted Acorn Nuts	Part No.	Quantity	Part No.	Quantity	Part No.	List Price	Part No.	List Price		
Acorn Nuts, 6-32	H1950-F	10	6030-E	10			6031-G	5.40	6031-M	32.50
Acorn Nuts, 8-32							6032-G	5.40	6032-M	32.50
Acorn Nuts, 10-32							6033-G	5.75	6033-M	34.50



**G-C KNURLED THUMB NUTS
BRASS - NICKEL PLATED**



Assorted Knurled Thumb Nuts	Part No.	Quantity	Part No.	Quantity	Part No.	List Price	Part No.	List Price		
Knurled Thumb Nuts, 6-32	H1941-F	10	6654-E	10			6655-G	3.40	6655-M	20.50
Knurled Thumb Nuts, 8-32	H1943-F	8					6656-G	3.75	6656-M	22.50
Knurled Thumb Nuts, 10-32	H1944-F	8					6657-G	9.10	6657-M	54.50



**G-C WING NUTS
NICKEL PLATED**



Assorted Wing Nuts	Part No.	Quantity	Part No.	Quantity	Part No.	List Price	Part No.	List Price		
Wing Nuts, 6-32	H1931-F	10	6658-AE	10			6658-G	5.75	6658-M	34.50
Wing Nuts, 8-32	H1933-F	15	6658-E	10			6659-G	5.75	6659-M	34.50
Wing Nuts, 10-32	H1934-F	10	6659-E	8			6660-G	6.25	6660-M	37.50



GENERAL CEMENT
MANUFACTURING CO.
ROCKFORD, ILLINOIS, USA

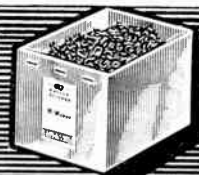

HANDY G-C HARDWARE

- In Convenient Packages:
1. Plastic Boxes or Envelopes
2. Boxes of 144 (Gross)
3. Bulk Boxes of 1000.

HINGED COVER PLASTIC BOXES

50-LINE
Distributor's Standard Display, 10 Boxes
List Price Per Box **50c**

PLASTIC ENVELOPES

Distributor's Std. Display, 20 Env.
List Price Per Env. **45c**

BOXES OF 144

(Gross Packages)
Distributor's Standard Carton, 7 Boxes of 144

BULK HARDWARE

(Boxes of 1000)
Supplied only in Multiples of 1000

DESCRIPTION and SPECIFICATIONS

Part No. In Box Quantity

Part No. Quantity In Env.

Part No. List Price Per 144

List Price Per Part No. 1000 Pcs.

G-C METAL WASHERS
NICKEL PLATED

Assorted Metal Washers				H870-F	80	6150-E	80				
Screw Size	Hole Size	O.D.	Thickness								
No. 4	1/8"	3/32"	1/32"	H874-F	80			6154-G	.60	6154-M	3.50
No. 6	5/32"	3/8"	1/32"	H876-F	80	6155-E	80	6155-G	.65	6155-M	3.75
No. 8	3/16"	1/16"	1/32"	H878-F	80	6156-E	80	6156-G	.70	6156-M	4.25
No. 10	1/4"	3/8"	1/32"	H880-F	70			7306-G	.70	7306-M	4.25
No. 10	13/64"	1/16"	1/32"					7307-G	.70	7307-M	4.25
No. 10	13/64"	1/2"	.049					6157-G	.70	6157-M	4.25
No. 12	.228	7/16"	.021					7308-G	.80	7308-M	4.75
No. 1/4"	9/32"	5/8"	1/16"	H882-F	50			6158-G	.80	6158-M	4.75
No. 1/4"	17/64"	1/2"	1/16"					7311-G	.80	7311-M	4.75
No. 3/16"	3/16"	11/16"	1/16"					7312-G	.90	7312-M	5.25

G-C LOCK WASHERS
INTERNAL LOCK WASHERS
Cadmium Plated

Assorted Lock Washers, All Types				H918-F	45	1717-E	45				
Assorted Internal Lock Washers				H920-F	50	7320-E	50				
Screw Size	O.D.										
Internal Lock Washers, No. 2				H922-F	35			7322-G	1.45	7322-M	8.75
Internal Lock Washers, No. 3								7323-G	1.40	7323-M	8.25
Internal Lock Washers, No. 4				H924-F	50			7324-G	.85	7324-M	5.00
Internal Lock Washers, No. 6		3/32"		H926-F	50	7326-E	50	7326-G	.85	7326-M	5.00
Internal Lock Washers, No. 8		21/64"		H928-F	50	7328-E	50	7328-G	.95	7328-M	5.75
Internal Lock Washers, No. 10		3/8"		H930-F	45			7330-G	1.00	7330-M	6.10
Internal Lock Washers, No. 1/4"		1/16"						7332-G	1.30	7332-M	7.75
Internal Lock Washers, No. 3/16"		19/32"						7333-G	1.65	7333-M	10.00
Internal Lock Washers, No. 3/8"		11/16"						7334-G	2.60	7334-M	15.50
Internal Lock Washers, No. 3/8"		1/16"		H938-F	25			7335-G	2.25	7335-M	13.50
Internal Lock Washers, No. 13/32"		19/32"						7338-G	2.90	7338-M	17.50

EXTERNAL LOCK WASHERS
Cadmium Plated

Assorted External Lock Washers				H950-F	60	7350-E	60				
External Lock Washers, No. 4								7354-G	1.00	7354-M	6.00
External Lock Washers, No. 6						7356-E	60	7356-G	1.00	7356-M	6.00
External Lock Washers, No. 8						7358-E	60	7358-G	1.00	7358-M	6.00
External Lock Washers, No. 10								7360-G	1.05	7360-M	6.25
External Lock Washers, No. 1/4"		1/2"						7361-G	1.35	7361-M	8.00
External Lock Washers, No. 3/8"		11/16"						7363-G	1.35	7363-M	8.00

SPLIT TYPE LOCK WASHERS
Cadmium Plated

Assorted Split Type Lock Washers				H960-F	60	6502-E	60				
Screw Size	O.D.	Thickness									
No. 4	3/16"	1/32"						6503-G	.95	6503-M	5.75
No. 6	15/64"	1/32"						6504-G	.95	6504-M	5.75
No. 8	11/32"	.025						6505-G	.95	6505-M	5.75
No. 10	5/16"	.050						6506-G	.95	6506-M	5.75
No. 1/4"	3/16"	3/64"						6507-G	1.40	6507-M	8.50



GENERAL CEMENT
MANUFACTURING CO.
ROCKFORD, ILLINOIS, USA



HANDY G-C HARDWARE

In Convenient Packages:

1. Plastic Boxes or Envelopes
2. Boxes of 144 (Gross)
3. Bulk Boxes of 1000.

HINGED COVER PLASTIC BOXES

50-LINE
Distributor's Standard Display, 10 Boxes
List Price Per Box **50c**

PLASTIC ENVELOPES

Distributor's Std. Display, 20 Env.
List Price Per Env. **45c**

BOXES OF 144

(Gross Packages)
Distributor's Standard Carton, 7 Boxes of 144

BULK HARDWARE

(Boxes of 1000)
Supplied only in Multiples of 1000

DESCRIPTION and SPECIFICATIONS

Part No. Quantity In Box

Part No. Quantity In Env.

Part No. List Price Per 144

List Price Per Part No. 1000 Pcs.

G-C SPRING FRICTION WASHERS



Assorted Spring Friction Washers				H750-F	12	6190-E	12		
A	B	C	Thickness of Metal						
3/8"	3/16"	1/32"	.012			7385-G	3.75	7385-M	22.50
3/16"	3/16"	1/32"	.008			7386-G	3.35	7386-M	20.00
3/16"	3/16"	1/16"	.008			7387-G	4.40	7387-M	26.50
1/4"	3/16"	1/16"	.012			7389-G	3.75	7389-M	22.50

G-C CUP FINISHING WASHERS NICKEL PLATED



Assorted Screws and Washers				H1005-F	15	6039-E	15				
Assorted Cup Washers:				H805-F	40	6159-E	40				
Cup Washers, No. 6				H806-F	45			6161-G	.75	6161-M	4.50
Cup Washers, No. 8				H808-F	45			6162-G	.85	6162-M	5.00
Cup Washers, No. 10				H810-F	35			6163-G	.90	6163-M	5.50

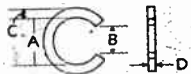

G-C C-WASHERS and RETAINING RINGS STEEL - CADMIUM PLATED



Assorted C-Washers					H770-F	25	6180-E	25				
Shaft. Diam.	A	B	C	D								
3/16"	.171	.125	.062	.031	H772-F	15			6182-G	1.50	6182-M	9.00
1/4"	.234	.156	.046	.031	H774-F	15			6183-G	1.65	6183-M	10.00
1/4"	.260	.187	.062	.031					6184-G	1.90	6184-M	11.25
1/4"	3/32" O.D.	Wire Ring		.029	H778-F	50			6185-G	.75	6185-M	4.50

G-C COTTER PINS STEEL - CADMIUM PLATED



Assorted Cotter Pins				H388-F	60	6440-E	60		
Diameter	Length Under Eye								
Cotter Pins, 1/16"	1/2"					7301-G	.65	7301-M	4.00
Cotter Pins, 1/16"	1"					7303-G	.65	7303-M	4.00
Cotter Pins, 1/16"	1 1/4"					7304-G	.70	7304-M	4.25
Cotter Pins, 3/32"	1/2"					7305-G	.90	7305-M	5.50



G-C HAIR PIN COTTERS



Assorted Hair Pin Cotters				H380-F	50	6475-E	50		
A	B	C							
3/32"	1/16"	.026				7375-G	.75	7375-M	4.25
3/8"	1/16"	.026				7376-G	.75	7376-M	4.25
15/32"	3/32"	.026				7377-G	.75	7377-M	4.25
1/2"	3/32"	.026				7378-G	.75	7378-M	4.25
21/32"	3/16"	.032				7379-G	.80	7379-M	4.50

G-C FLAT FIBRE WASHERS

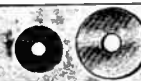

Assorted Flat Fibre Washers				H820-F	35	1718-E	35				
Screw Size	I.D.	O.D.	Thickness								
No. 6	.136	1/4"	1/32"	H824-F	30			6513-G	.55	6513-M	3.25
No. 8	1/64"	3/8"	1/32"	H825-F	30			6514-G	.65	6514-M	4.00
No. 10	.196	3/8"	1/32"	H826-F	30			6515-G	.75	6515-M	4.50
No. 1/4"	1/4"	1/2"	3/64"	H827-F	24			6516-G	.90	6516-M	5.25
No. 3/8"	3/8"	3/8"	3/64"	H828-F	20			6517-G	1.05	6517-M	6.25
No. 15/32"	15/32"	3/4"	1/32"					6518-G	1.15	6518-M	6.75



**GENERAL CEMENT
MANUFACTURING CO.**
ROCKFORD, ILLINOIS, USA



HANDY G-C HARDWARE

In Convenient Packages:

1. Plastic Boxes or Envelopes
2. Boxes of 100 or 144 (Gross)
3. Bulk Boxes of 1000.

**HINGED COVER
PLASTIC BOXES**

30-LINE
Distributor's Standard
Display, 10 Boxes
List Price
Per Box **50c**

**PLASTIC
ENVELOPES**

Distributor's Std.
Display, 20 Env.
List Price
Per Env. **45c**

**BOXES OF
144**

(Gross Packages)
Distributor's
Standard Carton,
7 Boxes of 144

**BULK
HARDWARE**

(Boxes of 1000)
Supplied only in
Multiples of 1000

DESCRIPTION and SPECIFICATIONS

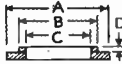

G-C EXTRUDED FIBRE WASHERS



Assorted Extruded and Flat Fibre Washers	H854-F	30	6512-E	30				
Assorted Extruded Fibre Washers	H855-F	30	6520-E	40				
A B C D Screw Size								
3/16"	.187	.140	.039	No. 6				
1/8"	.250	.169	.031	No. 8				
3/16"	.255	.196	.032	No. 10				
1/2"	.375	.250	.032	1/4" Shaft				
5/8"	.437	.380	.031	3/8" Shaft	H864-F	20		
							6525-E	40
							6525-G	1.55
							6526-G	1.55
							6527-G	1.70
							6528-G	1.75
							6529-G	1.90
							6525-M	9.25
							6526-M	9.25
							6527-M	10.25
							6528-M	10.50
							6529-M	11.50



**G-C SNAP BUTTON HOLE PLUGS
NICKEL PLATED**



Assorted Hole Plugs	H300-F	6	1716-E	8				
No. 1710 Asst. 5 1/2 Plugs in Box List Price \$2.75								
For Hole Dia. A B C D								
1/4"	13/32"	1/4"	1/64"	5/64"	H306-F	8		
3/16"	7/16"	1/4"	2/64"	1/16"			1711-AG	5.40
3/8"	17/32"	3/8"	25/64"	5/64"	H308-F	8	1711-E	8
1/2"	21/32"	17/64"	17/32"	3/64"	H310-F	6	1712-E	6
5/8"	51/64"	9/32"	49/64"	5/64"	H312-F	6		
3/4"	15/16"	19/64"	49/64"	3/32"	H314-F	5	1714-E	5
7/8"							1714-AG	12.10
1"	15/32"	19/64"	13/32"	5/64"	H316-F	5	1715-AE	4
1 1/8"	13/16"	13/32"	1 1/64"	3/32"			1715-AG	12.10
1 1/4"	17/16"	5/16"	1 1/64"	3/32"			1715-BG	12.10
							1715-G	15.85
							1711-AM	32.50
							1711-BM	32.50
							1711-M	32.50
							1712-M	37.50
							1713-M	45.00
							1714-M	55.00
							1714-AM	72.50
							1715-AM	72.50
							1715-BM	72.50
							1715-M	95.00

Punched Vent Type



**G-C SNAP-IN VENTILATING PLUGS
NICKEL PLATED**



Screen Vent Type

Ventilating Plugs, 1" Hole Size, Punched Holes	H334-F	4	1709-E	4	1709-G	18.45	1709-M	110.50
Ventilating Plugs, 1" Hole Size, Screen Vent					1708-G	38.35	1708-M	230.00

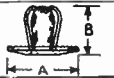

G-C SNAP-IN TRIMOUNTS



No. 1720 Asst. 100 Trimounts List Price \$1.35	H370-F	20	1719-E	20				
Assorted Trimounts								
To Fit Hole A B Fig. No.								
1/8"	3/32"	3/16"	1					
1/8"	9/32"	13/64"	2	H373-F	25	1721-E	25	1721-G
.136	11/32"	17/64"	3			1722-E	25	1722-G
.136	23/64"	9/32"	4	H375-F	20	1723-G	2.25	1723-M
3/32"	3/16" x 11/32"	25/64"	5			1724-G	2.25	1724-M
3/32"	3/16" x 11/32"	21/32"	6	H378-F	17	1726-G	2.60	1726-M
						1727-G	2.75	1727-M
							2.75	1727-M
							3.35	1726-M
							3.75	1727-M



**G-C DIAL CORD CLIPS
NICKEL PLATED**



Assorted Dial Cable Clips	H745-F	30	6220-E	30				
Used on Cord No. A B C								
75 - 75A	1/8"	3/64"	3/32"	H746-F	40	6221-E	40	6221-G
74 - 74L	1/4"	5/32"	5/32"			6222-G	1.55	6222-M
73 - 73X	3/16"	9/64"	3/16"			6223-G	1.55	6223-M
							1.55	6223-M



**G-C FUSE CLIPS
NICKEL PLATED**



For 1/4" Glass Fuses, No. 6 Mounting Hole B	H600-F	12	6311-E	10	6311-G	2.90	6311-M	17.50
Television Fuse Clip (A) No. 8618			(\$0.30 List)					
Television Fuse Clip No. 8618-D			(Display 24 No. 8618 \$7.20)					



**GENERAL CEMENT
MANUFACTURING CO.
ROCKFORD, ILLINOIS, USA**



HANDY G-C HARDWARE

In Convenient Packages:

- 1 Plastic Boxes or Envelopes
- 2 Boxes of 144 (Cross)
- 3 Bulk Boxes of 1000

**HINGED COVER
PLASTIC BOXES**

50-LINE
Distributor's Standard
Display 10 Boxes
List Price **50c**
Per Box

**PLASTIC
ENVELOPES**

Distributor's Std
Display 20 Env
List Price **45c**
Per Env.

**BOXES OF
144**

(Cross Packages)
Distributor's
Standard Carton,
7 Boxes of 144

**BULK
HARDWARE**

(Boxes of 1000)
Supplied only in
Multiples of 1000

DESCRIPTION and SPECIFICATIONS

Part No. In Box Quantity Part No. Quantity In Env. Part No. List Price Per 144 Part No. List Price Per 1000 Pcs.



**G-C SOLDERING LUGS
TINNED**

No. 1020 100 Asst. Solder Lugs List Price \$1.10

Assorted Soldering Lugs			H100-F	30	1019-E	30				
Hole Size	Fig. No	Length								
Solder Lugs, No 6	A	5/8"					8466-G	2.00	8466-M	12.00
Solder Lugs, No 6	A	23/32"					8467-G	4.10	8467-M	24.50
Solder Lugs, No. 8	A	23/32"					8468-G	4.10	8468-M	24.50
Solder Lugs, No 6	B	23/32"	H104-F	25	1021-BE	30	1021-BG	1.95	1021-BM	11.50
Solder Lugs, No 8	B	23/32"	H106-F	25	7445-E	30	7445-G	2.15	7445-M	12.75
Solder Lugs, No 10	B	23/32"					8473-G	2.40	8473-M	14.50
Solder Lugs, No 6	C	13/16"	H108-F	30	1021-CE	30	1021-CG	1.65	1021-CM	9.75
Solder Lugs, No 6	F	9/16"	H112-F	30			1021-FG	1.65	1021-FM	9.75
Solder Lugs, No. 8	F	9/16"	H113-F	30			7451-G	1.80	7451-M	10.25
Solder Lugs, No 6	H	7/8"	H114-F	25	7454-E	30	7454-G	2.15	7454-M	13.00
Solder Lugs, No 8	H	7/8"	H117-F	25	7455-E	30	7455-G	2.25	7455-M	13.50
Solder Lugs, No. 10	H	7/8"	H118-F	25			7456-G	2.30	7456-M	13.75
Solder Lugs, No. 4	K	13/16"					7458-G	2.60	7458-M	15.50
Solder Lugs, No 8	K	13/16"					7460-G	2.60	7460-M	15.50
Solder Lugs, No. 10	K	13/16"					7461-G	2.95	7461-M	17.75
Solder Lugs, No. 6	L	5/8"	H122-F	20	7462-F	30	7462-G	2.60	7462-M	15.50
Solder Lugs, No. 8	L	5/8"					7463-G	2.95	7463-M	17.75
Solder Lugs, No 6	M	13/16"	H124-F	25	7441-E	30	7441-G	2.10	7441-M	12.50
Solder Lugs, No. 8	M	13/16"	H134-F	25	7442-E	30	7442-G	2.15	7442-M	12.75
Solder Lugs, No. 10	M	13/16"	H102-F	25	1021-AE	30	1021-AG	2.40	1021-AM	14.50
Solderless TV Line Lug	O		H225-F	10	8633-E	10	8633-G	5.25	8633-M	32.80



**G-C CABLE HOLDER CLAMPS
NICKEL PLATED**



Assorted Cable Clamps			H500-F	20	6250-E	20				
To Fit Cable	Mounting Hole									
1/8" to 3/16"	No. 6		H502-F	25	6251-E	20	6251-G	1.95	6251-M	11.75
3/16" to 1/4"	No. 6		H503-F	20	6252-E	18	6252-G	2.25	6252-M	13.50
1/4" to 3/8"	No. 6						7503-G	2.40	7503-M	14.50
3/8" to 1/2"	No. 6		H506-F	15	6253-E	15	6253-G	2.55	6253-M	15.25
Baseboard Wire Clips			H509-F	20	8345-E	20	8345-G	3.25	8345-M	18.75



**G-C FAHNESTOCK CLIPS
NICKEL PLATED**



Assorted Fahnestock Clips						H590-F	12	6300-E	12			
Fig.	Length	Width	Mtg. Hole	Max. Wire								
A	1/2"	3/32"	4	16	H592-F	15	6301-E	15	6301-G	3.95	6301-M	23.75
B	3/4"	3/16"	6	14	H594-F	14	6302-E	12	6302-G	4.10	6302-M	24.50
C	1 1/16"	3/16"	8	10					6303-G	4.75	6303-M	28.50
D	1 1/2"	3/16"	6	10					6304-G	23.75	6304-M	142.50
E	3/4"	3/16"	6	14					6306-G	7.75	6306-M	46.50
F	Ammeter Connections								6307-G	20.90	6307-M	125.50



G-C TERMINAL STRIP ASSORTMENT



Assorted Terminal Strips		H250-F	4	6855-E	4
--------------------------	--	--------	---	--------	---

Copyright by U.C. P., Inc.

Radio's Master — 19th Edition

TRADE DISCOUNT APPLIES TO LIST PRICES ONLY

Page U-71



GENERAL CEMENT
MANUFACTURING CO.
ROCKFORD, ILLINOIS, USA



HANDY G-C HARDWARE

- In Convenient Packages:
1. Plastic Boxes or Envelopes
 2. Boxes of 144 (Gross)
 3. Bulk Boxes of 1000.

HINGED COVER PLASTIC BOXES
50-LINE
Distributor's Standard Display, 10 Boxes
List Price Per Box **50c**

PLASTIC ENVELOPES
Distributor's Std Display, 20 Env
List Price Per Env. **45c**

BOXES OF 144
(Gross Packages)
Distributor's Standard Carton,
7 Boxes of 144

BULK HARDWARE
(Boxes of 1000)
Supplied only in Multiples of 1000

DESCRIPTION and SPECIFICATIONS

Part No. In Box Quantity Part No. Quantity In Env. Part No. List Price Per 144 Part No. List Price Per 1000 Pcs.



G-C DIAL PULLEYS
BRASS



Assorted Dial Pulleys				H1966-F	6	6057-E	6				
A	B	C	D (Groove Width)								
3/8"	.120	1/8"	3/32"					6057-AG	7.75	6057-AM	46.50
1/4"	.067	3/64"	1/8"					6057-BG	11.25	6057-BM	67.50
1/2"	1/8"	3/16"	3/32"					6057-0G	8.75	6057-GM	52.50
.620	.128	.165	1/16"					6057-CG	14.10	6057-CM	84.50
.860	.128	5/32"	.050					6057-FG	26.25	6057-FM	157.50

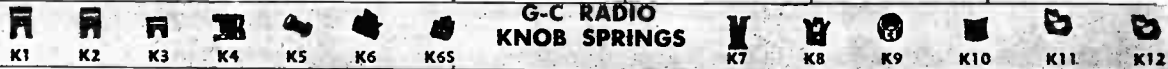

G-C RADIO KNOB SPRINGS

Assorted Knob Springs				H480-F	18	1049-E	18				
TV Knob Spring Assortment				H460-F 12							
No. 1050 Kit of 35 Springs								List Price \$1.10			
No. 1051 Kit of 100 Springs								List Price \$1.95			
Fig. No.	Width	Length	For Knob Shaft Diam.								
K1	3/32" Light	3/16"	1/4"	H482-F	20	6460-E	20	6460-G	2.40	6460-M	14.25
K2	3/32" Heavy	3/16"	1/4"	H484-F	20	6461-E	20	6461-G	2.90	6461-M	17.50
K3	3/32"	5/16"	1/4"	H487-F	20	6462-E	20	6462-G	2.65	6462-M	15.75
K4	3/8"	5/32"	1/4"	H489-F	10	6463-E	10	6463-G	4.25	6463-M	25.50
K5	3/32"	13/32"	1/4"			6464-E	10	6464-G	5.70	6464-M	34.25
K6	3/32"	3/8"	1/4"	H492-F	8	6465-E	10	6465-G	5.25	6465-M	31.50
K6-S	3/32"	1/4"	1/4"			6466-E	10	6466-G	6.40	6466-M	32.50
K7	3/32"	1/2"	1/4"			6467-E	20	6467-G	4.40	6467-M	26.50
K8	3/32"	3/8"	1/4"	H494-F	10	6468-E	10	6468-G	6.25	6468-M	37.50
K9	11/32"	1/4"	1/4"			6469-E	10	6469-G	6.25	6469-M	37.50
K10	3/8"	3/8"	1/4"	H497-F	10	6470-E	10	6470-G	2.65	6470-M	15.75
K11	3/8"	3/8"	1/4"	H498-F	10	6471-E	8	6471-G	4.30	6471-M	25.75
K12	3/8"	3/16"	3/16"	H499-F	10	6472-E	10	6472-G	4.60	6472-M	27.50
TV Knob Spring .202" Shaft				H462-F	10	8541-E	10	8541-G	5.70	8541-M	31.95
TV Knob Spring 3/8" Flat Shaft				H464-F	10	8542-E	10	8542-G	4.65	8542-M	26.10

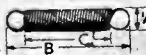

G-C DIAL DRIVE TENSION SPRINGS and PHONO SPRINGS
STEEL - CADMIUM PLATED



Asst. Regular Dial Drive Springs				H401-F	8	1054-E	8						
Asst. Small Dial Drive Springs				H400-F 10		1054-SE 10							
No. 1055 Kit of 25 Asst. Springs								List Price \$1.30					
No. 1056 Kit of 100 Asst. Springs								List Price \$4.85					
Asst. Large Tension Springs				H421-F 10		6421-E 8							
Asst. Small Tension Springs				H420-F 10		6420-E 10							
A	B	C	Wire Size	Old No.	List Price								
1/4"	1/2"	3/4"	.019	T1	\$0.05	H403-F	10	6450-E	10	6450-G	5.40	6450-M	32.50
1/4"	1"	3/4"	.019	T2	.06	H406-F	8	6451-E	8	6451-G	6.15	6451-M	36.75
3/8"	1"	3/8"	.020	T3	.06	H408-F	8	6452-E	8	6452-G	6.10	6452-M	36.50
3/8"	1 1/2"	1"	.020	T4	.06	H410-F	8	6453-E	8	6453-G	7.90	6453-M	47.50
1/4"	1 1/2"	1"	.026	T5	.08	H412-F	6	6454-G	8.75	6454-M	52.50		
1/4"	2"	1 1/2"	.026	T6	.10			6455-G	10.80	6455-M	65.00		

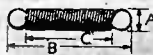

G-C PHONOGRAM SPRINGS
STEEL - CADMIUM PLATED



No. 6478. Kit of 50 Springs				List Price	\$2.75				
No. 6479. Kit of 100 Springs				List Price \$4.85					
Asst. Small Phono Turntable Springs				H450-F 8		6480-E 8			
Asst. Large Phono Turntable Springs				H452-F 8		6481-E 8			
A	B	C	Wire Size						
3/16"	3/16"	1/4"	.008			7535-G	9.10	7535-M	54.50
3/16"	1/4"	1/4"	.016			7537-G	6.65	7537-M	40.00
3/16"	1 1/2"	1 1/2"	.014			7539-G	6.40	7539-M	38.50
3/16"	1 1/4"	3/4"	.014			7543-G	7.75	7543-M	46.50
1/4"	1 1/2"	1 1/2"	.006			7544-G	9.25	7544-M	55.50
3/16"	1 1/4"	3/4"	.010			7545-G	10.40	7545-M	62.50
3/16"	3/16"	1/4"	.033			7547-G	6.40	7547-M	38.50



GENERAL CEMENT
MANUFACTURING CO.
ROCKFORD, ILLINOIS, USA



HANDY G-C HARDWARE

In Convenient Packages:

1. Plastic Boxes or Envelopes
2. Boxes of 144 (Gross)
3. Bulk Boxes of 1000.

HINGED COVER PLASTIC BOXES

50-LINE
Distributor's Standard Display, 10 Boxes
List Price **50c**
Per Box

PLASTIC ENVELOPES

Distributor's Std Display, 20 Env.
List Price **45c**
Per Env.

BOXES OF 144

(Gross Packages)
Distributor's Standard Carton, 7 Boxes of 144

BULK HARDWARE

(Boxes of 1000)
Supplied only in Multiples of 1000

DESCRIPTION and SPECIFICATIONS

Part No.

Quantity In Box

Part No.

Quantity In Env.

Part No.

List Price Per 144

List Price Per Part No. 1000 Pcs.



G-C COMPRESSION SPRINGS

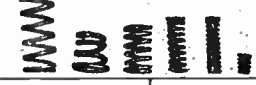

Asst. Small Compression Springs	H440-F	20	6430-E	20		
Asst. Large Compression Springs	H441-F	15	6431-E	15		



G-C PHONO TURNTABLE MOUNTING SPRINGS



O.D.	Length	Wire Size	No. of Coils			
1" x 1 1/16"	1 3/16"	.079	4	Tapered	7497-G	5.40 7497-M 32.50



G-C BRASS EYELETS



Shank Dia	Length Under Head	Head Dia				
.087	1/8"	.145			7251-G	.75 7251-M 4.50
.087	5/32"	.145			7252-G	.80 7252-M 4.75
.087	7/32"	.145			7253-G	.90 7253-M 5.25
.087	1 1/32"	.180			7254-G	1.15 7254-M 7.00
.123	5/32"	.197	H515-F 50		7257-G	.90 7257-M 5.50
.123	7/32"	.195			7259-G	1.00 7259-M 6.00
.123	1/4"	.195			7260-G	1.10 7260-M 6.50
.123	9/32"	.195			7261-G	1.20 7261-M 7.25
.125	5/16"	.289			7264-G	2.50 7264-M 15.00
.127	15/32"	.222			7265-G	2.25 7265-M 13.50
.182	3/16"	.315			7269-G	.75 7269-M 4.50



G-C RIVETS NICKEL PLATED



Shank Diameter	Length Under Head					
.059	5/32"				7276-G	1.70 7276-M 10.25
.059	3/16"				7277-G	1.70 7277-M 10.25
.059	1/4"				7278-G	1.75 7278-M 10.50
.088	3/16"				7280-G	1.70 7280-M 10.25
.098	7/16"				7283-G	1.70 7283-M 10.25
.121	1/8"				7286-G	1.95 7286-M 11.75
.121	3/16"				7288-G	1.95 7288-M 11.75
.121	1/4"				7290-G	1.95 7290-M 11.75
.121	5/16"				7291-G	2.40 7291-M 14.50
.121	1/2"				7293-G	2.40 7293-M 14.50
.146	5/16"				7296-G	2.60 7296-M 15.50



G-C GRID CAPS NICKEL PLATED



Assorted Grid Caps	H609-F	8	6290-E	10		
Glass Tube Grid Caps					6291-G	2.40 6291-M 14.50
Metal Tube Grid Caps					6292-G	2.40 6292-M 14.25
TV Spring Type Grid Caps, Asstd.	H610-F	5	8838-E	8		
1/4" High-Voltage Spring Grid Cap						8838-1RM 42.50
3/8" High-Voltage Spring Grid Cap						8838-2RM 42.50
1/4" Insulated High-Voltage Grid Cap	H612-F	1	8834-E	1		8834-M 284.75
3/8" Insulated High-Voltage Grid Cap	H614-F	1	8835-E	1		8835-M 284.75



GENERAL CEMENT
MANUFACTURING CO.
ROCKFORD, ILLINOIS, USA

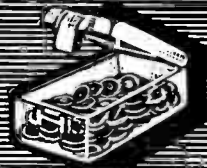

HANDY G-C HARDWARE

In Convenient Packages:

1. Plastic Boxes or Envelopes
2. Boxes of 144 (Cross)
3. Bulk Boxes of 1000.

HINGED COVER PLASTIC BOXES

50-LINE
Distributor's Standard
Display, 10 Boxes
List Price **50c**
Per Box

PLASTIC ENVELOPES

Distributor's Std.
Display, 20 Env.
List Price **45c**
Per Env.

BOXES OF 144

(Cross Packages)
Distributor's
Standard Carton,
7 Boxes of 144

BULK HARDWARE

(Boxes of 1000)
Supplied only in
Multiples of 1000

DESCRIPTION and SPECIFICATIONS

Part No. Quantity In Box

Part No. Quantity In Env.

Part No. List Price Per 144

List Price Per Part No. 1000 Pcs.

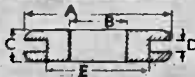

G-C RUBBER GROMMETS



Assorted Soft Grommets

No. 1040 Kit of 50 Asstd. Grommets List Price **\$1.15**

A	B	C	D	E	Part No.	Quantity	Part No.	Quantity	Part No.	List Price	Part No.	List Price
1 1/32"	1/8"	3/16"	1/16"	1/4"	H025-F	15	1039-E	15				
3/16"	3/16"	3/16"	1/16"	3/16"	H030-F	16			1041-2-G	2.75	1041-2-M	16.50
1/8"	1/4"	1/4"	1/16"	3/8"	H032-F	14	1041-E	12	1041-G	2.75	1041-M	16.50
1/2"	1/4"	3/8"	1/8"	3/8"	H034-F	12	1042-E	10	1042-G	3.15	1042-M	18.75
5/8"	3/8"	1/4"	1/16"	1/2"					7566-G	3.35	7566-M	20.00
1 1/16"	1/2"	3/2"	1/16"	5/8"	H036-F	10	1043-E	10	1043-G	3.65	1043-M	21.75
1"	3/8"	1/4"	1/16"	7/8"	H038-F	8			1043-1-G	6.40	1043-1-M	38.50
									7569-G	5.40	7569-M	32.50



G-C PURE GUM GROMMETS

Very soft live rubber grommets for shock and vibration dampening. For mounting tuning condensers, sockets, phono motors, chassis, etc.



Assorted Pure Gum Grommets

No. 7581 Kit of 100 Asst. Grommets List Price **\$2.45**

A	B	C	D	E	Part No.	Quantity	Part No.	Quantity	Part No.	List Price	Part No.	List Price
3/16"	3/16"	3/32"	1/16"	3/16"	H040-F	12	7580-E	12				
3/16"	1/4"	1/4"	1/16"	3/8"	H042-F	12			7582-G	3.45	7582-M	20.75
					H043-F	10	7584-E	10	7584-G	3.80	7584-M	22.75

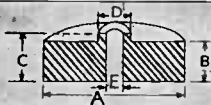

G-C RUBBER CHASSIS MOUNTS



Assorted Chassis Mounts

Rubber Washer and Bumper Asst.

No. 1030 Kit of 25 Mounts List Price **\$2.00**

A	B	C	D	E	Part No.	Quantity	Part No.	Quantity	Part No.	List Price	Part No.	List Price
3/4"	5/32"	3/4"	1/2"	1/4"	H075-F	12	1038-E	10				
3/4"	1/8"	3/8"	1/2"	1/4"	H083-F	12						
3/4"	3/16"	1/2"	3/16"	3/16"					7571-G	8.75	7571-M	52.50
3/4"	11/16"	3/4"	3/16"	3/16"	H076-F	5			1031-G	8.75	1031-M	52.50
3/4"		3/32"	1/4"	1/4"					1032-G	11.65	1032-M	69.75
1"	3/8"	1/2"	1/2"	1/4"					1033-G	13.75	1033-M	82.50
1 1/4"	11/16"	7/8"	1/2"	5/16"					1037-G	8.75	1037-M	52.50
1 1/4"		3/8"	1/2"	1/4"					1034-G	14.40	1034-M	86.50
									1035-G	28.25	1035-M	169.50
									1036-G	12.25	1036-M	73.50

(See Additional Listings on Chassis Mounts on Page 32)



G-C VOICE COIL DUST FELTS

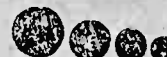

Assorted Dust Felts

Diameter	Part No.	Quantity	Part No.	Quantity	Part No.	List Price	Part No.	List Price
3/4"	H740-F	15	1079-E	15				
1"					1081-G	1.60	1081-M	9.50
1 1/4"					1082-G	1.70	1082-M	10.25
1 1/2"					1083-G	2.15	1083-M	12.75
1 3/4"					1084-G	2.40	1084-M	14.25
2 1/4"					1085-G	2.50	1085-M	15.00
					1085-AG	2.90	1085-AM	17.50



G-C RADIO KNOB FELTS



3/4" O.D. x 1/4" Hole, Brown	Part No.	Quantity	Part No.	Quantity	Part No.	List Price	Part No.	List Price
	H760-F	40	1065-E	40	1065-G	.75	1065-M	4.50

Radio's Master — 19th Edition

Page U-74

TRADE DISCOUNT APPLIES TO LIST PRICES ONLY

Copyright by U. C. P., Inc.



**GENERAL CEMENT
MANUFACTURING CO.**
ROCKFORD, ILLINOIS, USA



HANDY G-C HARDWARE

In Convenient Packages:

1. Plastic Boxes or Envelopes
2. Boxes of 144 (Gross)
3. Bulk Boxes of 1000.

**HINGED COVER
PLASTIC BOXES**

SO-LINE
Distributor's Standard
Display, 10 Boxes
List Price
Per Box **50c**

**PLASTIC
ENVELOPES**

Distributor's Std.
Display, 20 Env.
List Price
Per Env. **45c**

**BOXES OF
144**

(Gross Packages)
Distributor's
Standard Carton,
7 Boxes of 144

**BULK
HARDWARE**

(Boxes of 1000)
Supplied only in
Multiples of 1000

DESCRIPTION and SPECIFICATIONS

Part No.	In Box Quantity	Part No.	Quantity In Env.	Part No.	List Price Per 144	List Price Per Part No. 1000 Pcs.
----------	--------------------	----------	---------------------	----------	-----------------------	--------------------------------------



**G-C CHASSIS FELT FEET
SCREW TYPE**



Asst. Screw Type Chassis Felt Feet				H085-F	4	1086-E	4				
A	B	C	Type of Screw								
1/2"	3/16"	1/2"	No. 6 x 1/2" Sheet Metal Pointed			1086-BE	4	1086-BG	15.40	1086-BM	92.50
1/2"	3/16"	1/2"	6-32 Machine	H087-F	4	1087-E	4	1087-G	14.60	1087-M	87.50
3/4"	1/4"	1/2"	No. 6 x 1/2" Sheet Metal Pointed			1088-G		1088-M	17.45	1088-M	104.50
3/4"	1/4"	1/2"	10-32 Machine			1089-G		1089-M	17.75	1089-M	106.50



G-C RUBBER FEET — Screw Type

45c Env. Supplied with Screws—Gross and Thousands Pkgs. without Screws



Asst. Screw Type Rubber Feet				H050-F	8	1075-AE	8				
O.D.	High										
3/8"	3/16"			H052-F	8	1075-BE	8	1075-BG	1.90	1075-BM	11.50
1/2"	1/4"			H054-F	8	1075-CE	8	1075-CG	2.90	1075-CM	17.50
5/8"	3/16"			H056-F	8	1075-FE	6	1075-FG	4.25	1075-FM	25.50



**G-C RUBBER BUTTON BUMPERS
JUST PUT IN HOLE**



A	B	C	E						
O.D.	Height	Hole	Height						
3/8"	2/3"	3/16"	3/16"			7596-G	2.90	7596-M	17.50
1/2"	2/16"	1/4"	1/4"	H058-F	8	7597-G	4.25	7597-M	25.50
5/8"	9/16"	3/8"	3/16"			7598-G	5.90	7598-M	35.50



G-C RUBBER TACK BUMPERS



3/8" O.D. Rubber Tack Bumpers	H071-F	10	1075-E	10	1075-G	4.40	1075-M	26.50
-------------------------------	--------	----	--------	----	--------	------	--------	-------



G-C FELT PADS



Assorted Felt Pads	H074-F	40	1069-E					
1/2" O.D. x 1/4" Thick Felt Pads					1071-G	.95	1071-M	5.75



G-C CORD STRAIN RELIEFS



Will Fit P.O.S.J. Cord	H048-F	5	6675-E	4	6675-G	9.75	6675-M	58.50
------------------------	--------	---	--------	---	--------	------	--------	-------



G-C ESCUTCHEON PINS

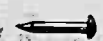

Asst. Escutcheon Pins				H560-F	100	6670-E	100		
Length	Diam.	Finish							
1/4"	No. 18	Stat. Bronze				7526-G	.75	7526-M	4.50
1/4"	No. 19	Stat. Bronze				7527-G	.90	7527-M	5.25
1/4"	No. 20	Stat. Bronze				7528-G	.95	7528-M	5.75
1"	No. 15	Nickel Plated				7529-G	1.10	7529-M	6.50



G-C ANGLES and BRACKETS



Assorted Angles and Brackets				H570-F	12	6260-E	15		
A	B	C	Hole Size						
1/4"	3/16"	3/32"	6			6261-G	2.80	6261-M	16.75
3/8"	1/4"	3/32"	6			6262-G	2.25	6262-M	13.50
1/2"	3/16"	3/8"	6			6263-G	2.90	6263-M	17.50



"It's Sound Planning to Specify SMITH!"

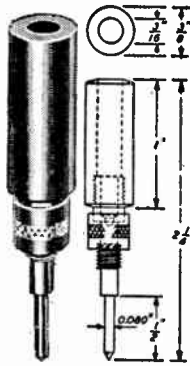

200

INSULATED SOLDERLESS TIP PLUGS

Plug portion brass, nickel plated. Fits all standard phone tip jacks. Wire is wrapped around screw portion and tightened with knurled nut. Molded plastic handle available in Red, Black, Yellow or Green. Specify color.

No. 200 Senior Type \$23.00 Per C
No. 201 Junior Type \$23.00 Per C

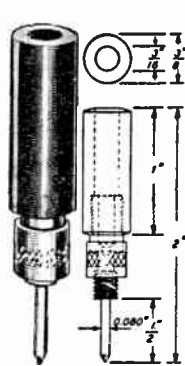

201

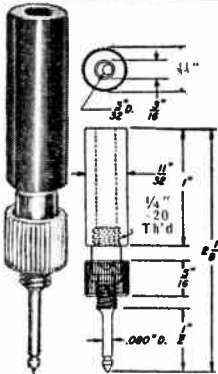

250

SOLDERLESS PHONE TIP PLUG

Signal Corps Approved. Steel. Case hardened phone tip made to Signal Corps drawing and specs. Supplied with Rigid Thermoplastic handle to JAN specs. Available in Red or Black. Specify color.

No. 250 \$90.00 Per C
HEAVY DUTY INSULATED PHONE TIP PLUG
Plug portion brass, nickel plated. Fits all standard phone tip jacks

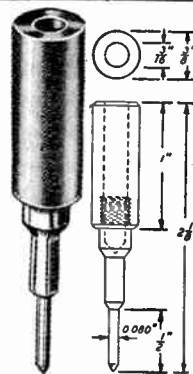

229

Molded plastic handle available in Red, Black, Yellow or Green. Specify color.

INSULATED SHORT PHONE TIP PLUG

Plug portion brass, nickel plated. Fits all standard phone tip jacks. Tip inserts right up to handle. Molded plastic handle available in Red, Black, Yellow or Green. Specify color.

No. 203 \$20.00 Per C

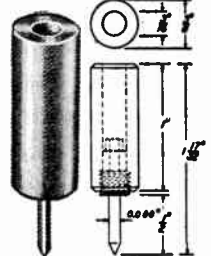

203

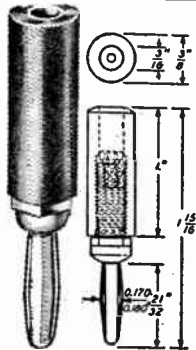

212

INSULATED BANANA PLUGS

Plug portion brass, nickel plated. Fits all standard banana jacks. Beryllium spring retains resiliency after thousands of insertions. Wire can be soldered to brass stud or plug. Molded plastic handle available in Red, Black, Yellow or Green. Specify color.

No. 212 Phosphor Bronze Spring \$30.00 Per C
No. 242 Beryllium Copper Spring \$50.00 Per C
INSULATED BANANA PLUG
Spring Type. Plug portion brass, nickel plated. Fits all standard banana jacks. Four leaved phosphor bronze spring. Wire can be soldered to stud or plug. Molded plastic handle available in Red, Black, Yellow or Green. Specify color.

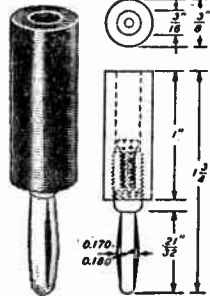

211

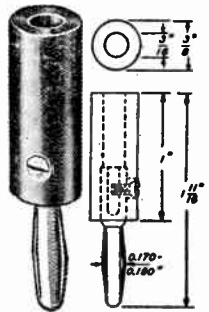

204

INSULATED BANANA PLUG

Spring Type. Plug portion brass, nickel plated. Fits all standard banana jacks. Four leaved phosphor bronze spring. Set screw provided for solderless connection. Molded plastic handle available in Red, Black, Yellow or Green. Specify color.

No. 204 \$25.00 Per C

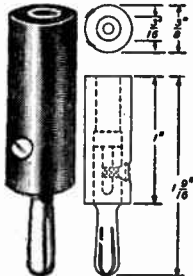

213

INSULATED BANANA PLUG

Split Type. Plug portion brass, nickel plated; cross slotted. Set screw for solderless connection. Molded plastic handle available in Red, Black, Yellow or Green. Specify color.

No. 213 \$20.00 Per C

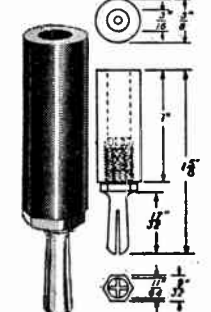

253

INSULATED BANANA PLUG

Plug portion brass, nickel plated. Wire can be soldered to stud or plug. Molded plastic handle. Red, Black, Yellow or Green. Specify color.

No. 253 \$25.00 Per C

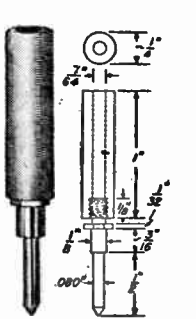

270

SUB-MINIATURE PHONE TIP

Fits standard tip jacks. For checking all types of subminiature equipment. Brass, nickel plated tip Handle Red or Black bone fibre. Specify color.

No. 270 \$20.00 Per C

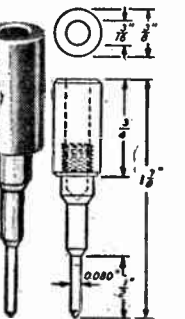

215

HEAVY DUTY INSULATED PHONE TIP PLUG

Banana plug inserts in rear to adapt to phone tip plug. Plug portion brass, nickel plated. Fits all standard phone tip jacks. Molded plastic handle in Red, Black, Yellow or Green. Specify color.

No. 215 \$25.00 Per C

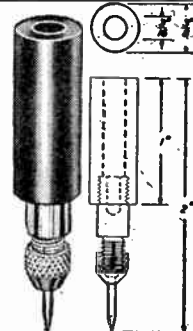

216

INSULATED PHONO NEEDLE TIP PLUG

Brass, nickel plated. Removable chuck. Molded handle. Red, Black, Yellow or Green. Specify color.

No. 216 \$25.00 Per C

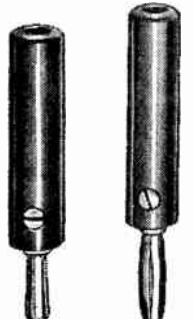

243

INSULATED BANANA PLUGS

Embody our No. 213 Split and 204 Spring Type plugs, except handles are 1 1/2" long. Set screw for solderless connection. Machined plastic handle in Red, Black, Yellow or Green. Specify color.

No. 243 Split Type \$40.00 Per C
No. 244 Spring Type \$40.00 Per C

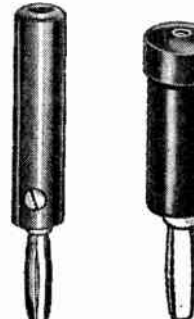

244

TIP PLUG TO BANANA PLUG ADAPTER

Fits all standard banana jacks. Adapts phone tip plug to banana plug. Insulated handle. Red, Black, Yellow or Green. Specify color.

No. 214 \$45.00 Per C

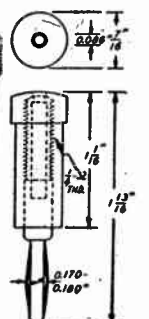

214

For Other Components, Send for Complete HERMAN H. SMITH INC. Catalog No. 55



"It's Sound Planning to Specify SMITH!"

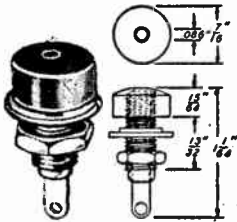

202 - 223

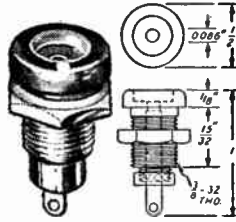

240

INSULATED PHONE TIP JACKS

Accommodates all standard phone tip plugs. Body is brass, nickel plated. Sturdy phosphor bronze spring. Mounts in $\frac{1}{8}$ " hole in panels up to $\frac{3}{8}$ " thick. Molded plastic head available in Red, Black, Yellow or Green. No. 202 available in Blue also. Specify color.

No. 202 $\frac{1}{8}$ " Head Diameter \$20.00 Per C
 No. 223 $\frac{1}{2}$ " Head Diameter \$35.00 Per C

ALL INSULATED TIP JACK

Accommodates all standard phone tips. Sturdy phosphor bronze contact. Mounts in $\frac{3}{8}$ " hole in panels up to $\frac{1}{8}$ " thick. Red, Black, Yellow, Green or Blue. Specify color.

No. 240 \$50.00 Per C

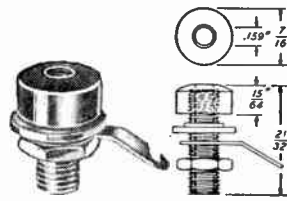

205

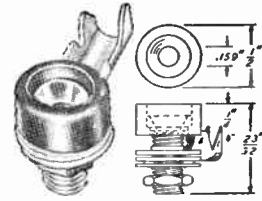

219

INSULATED BANANA JACK

Accommodates all standard banana plugs. Body is brass, nickel plated. Mounts in $\frac{1}{8}$ " hole in panels up to $\frac{3}{8}$ " thick. Molded plastic head, Red, Black, Yellow, Green or Blue. Specify color.

No. 205 \$20.00 Per C

INSULATED BANANA JACK

Accommodates all standard banana plugs. Body is brass, nickel plated. Mounts in $\frac{1}{8}$ " hole in panels up to $\frac{3}{8}$ " thick. Plastic head. Red, Black, Yellow or Green. Specify color.

No. 219 \$22.00 Per C

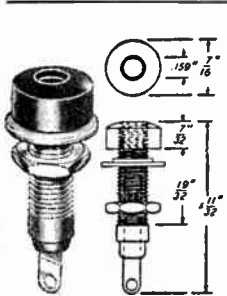

206

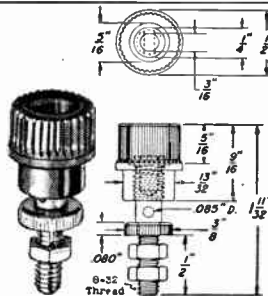

220

INSULATED COMBINATION JACK

Accommodates all standard phone tip or banana plugs. Body is brass, nickel plated; contact is a sturdy phosphor bronze spring. Molded plastic head. Red, Black, Yellow, Green or Blue. Specify color.

No. 206 \$25.00 Per C

COMBINATION BINDING POST

Molded plastic free turning non-removable head. Accepts a phone tip plug, a spade lug, or a banana plug. Normally grounded; can be insulated by use of No. 2155 shoulder and 2163 flat fibre washers. Red or Black. Specify color.

No. 220 \$40.00 Per C

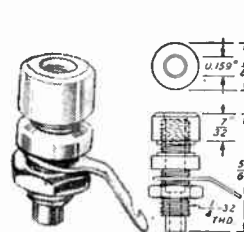

221

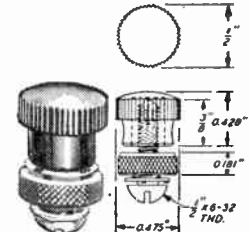

265

INSULATED MIDGET BANANA JACK

Accommodates all standard banana plugs. Brass, nickel plated body. Insulating groove of head mounts in $\frac{1}{8}$ " hole in panels up to $\frac{1}{4}$ " thick. Red, Black, Yellow or Green. Specify color.

No. 221 \$30.00 Per C

BINDING POST

Molded-in brass insert in molded bakelite head supplied only in black. Brass, nickel plated retaining washer. Supplied complete with $\frac{3}{32}$ " x $\frac{1}{2}$ " screw and lockwasher.

No. 265 \$25.00 Per C

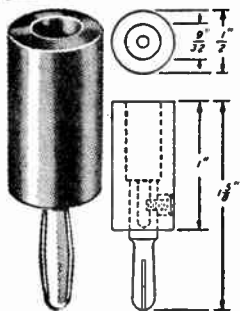

233 - 234

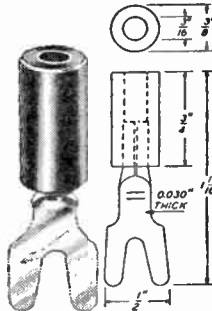

218

HEAVY DUTY INSULATED BANANA PLUG

Embody No. 218 Split Type and No. 204 Spring Type banana plug bodies. Larger plastic handle accommodates heavier wire. Set screw for solderless connection. Red or Black. Specify color.

No. 233 Split Type Plug \$75.00 Per C
 No. 234 Spring Type Plug \$75.00 Per C

INSULATED SPADE LUG

Adapts banana plug to a spade lug. Steel hot tinned lug .030" thick for extra durability. Molded plastic handle in Red or Black. Specify color.

No. 218 Complete \$18.00 Per C No. 129 Lug Only \$20.00 Per M

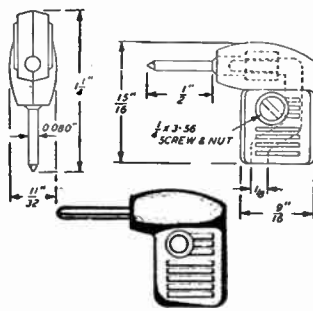

235

MOLDED METER TIP PLUG

Molded in two halves for easy assembling. Brass nickel plated tip fits standard tip jacks. Available in Red and Black. Specify color.

No. 235 Tip Plug \$0.45 Each
 No. 235-D Display of 24 Pairs \$21.60 Each

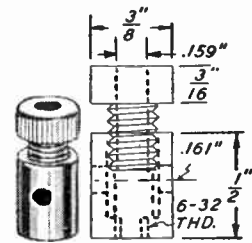

136

METAL COMBINATION BINDING POST

Two-piece brass nickel plated. Accepts all standard phone tip or banana plugs. Mounts to chassis by use of 6-32 screw.

No. 136 \$25.00 Per C

For Other Components, Send for Complete HERMAN H. SMITH INC. Catalog No. 55



"It's Sound Planning to Specify SMITH!"

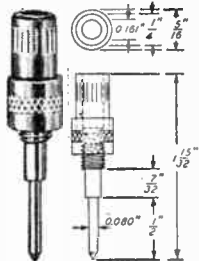

105 SOLDERLESS PHONE TIP PLUGS

Brass, nickel plated. Wire is wrapped around screw portion, and tightened with knurled nut. Fits standard phone tip jacks.

No. 105	Senior Type	\$16.00 Per C
No. 106	Junior Type	\$16.00 Per C

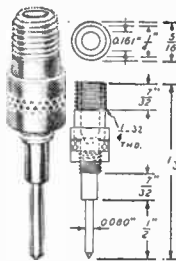
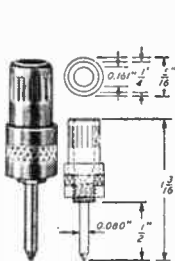

124 127 THREADED SOLDERLESS PHONE TIPS

Brass, nickel plated. Wire is wrapped around screw portion and tightened with knurled nut. Threaded for easy insertion in plastic handles. Fits standard phone tip jacks.

No. 124	Senior Type	\$18.00 Per C
No. 127	Junior Type	\$18.00 Per C

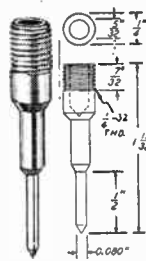
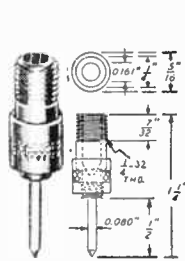

125 135-145 HEAVY DUTY PHONE TIP PLUG

This brass nickel plated phone tip is of extra sturdy construction, and fits all standard phone tip jacks.

No. 125 \$16.00 Per C

BANANA PLUGS — Spring Type

Hexed brass, nickel plated. Beryllium spring retains resiliency after thousands of insertions. Wire can be soldered to stud or plug. Supplied with hex nut.

No. 135	Beryllium Copper Spring	\$45.00 Per C
No. 145	Phosphor Bronze Spring	\$25.00 Per C

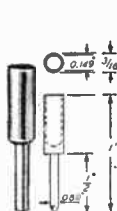
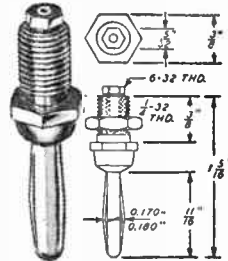

108 123 155 SOLDER TYPE PHONE TIPS

Brass nickel plated.

No. 108	Standard Type	\$ 30.00 Per M
No. 123	Large I.D. Type	\$ 40.00 Per M
No. 155	Heavy Duty Type	\$100.00 Per M

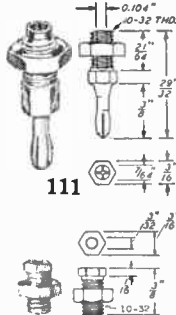
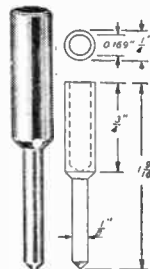
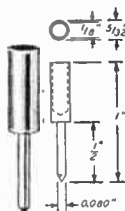

111 112 121 MIDGET BANANA PLUG AND JACK

For use in minimum of space. The plug is cross slotted. Plug and jack are brass, nickel plated.

No. 111	Plug	\$15.00 Per C
No. 112	Jack	\$12.00 Per C

MIDGET BANANA PLUG Rivet Type

Brass, silver plated. Four leaved phosphor bronze spring. Fits all standard banana jacks. Also made to rigid JAN specs.

No. 121		\$25.00 Per C
---------	--	---------------

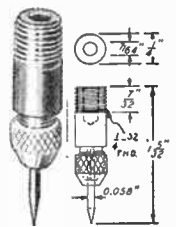
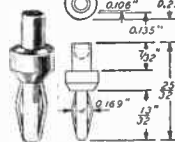

128 104 NEEDLE TIP AND CHUCK

Brass nickel plated body, with steel nickel plated needle. Removable chuck. Threaded for easy insertion in plastic handles.

No. 128		\$20.00 Per C
---------	--	---------------

BANANA PLUG — Split Type

Hexed brass, nickel plated. Cross slotted for positive and lasting contact. Fits all standard banana jacks. One-piece construction. 6-32 hex nut.

No. 104		\$20.00 Per C
---------	--	---------------

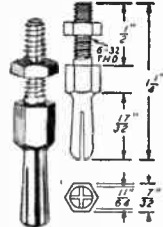

100 BANANA PLUG

Hexed brass, nickel plated. Spring is four-leave phosphor bronze, nickel plated. Plug supplied with screw and phosphor bronze tinned lug. Internal female permits use of this plug on all size panels.

No. 100		\$20.00 Per C
---------	--	---------------

BANANA PLUG

Hexed brass, nickel plated. Four-leaved phosphor bronze spring, nickel plated. 6-32 hex nut.

No. 102		\$20.00 Per C
---------	--	---------------

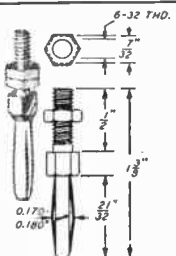
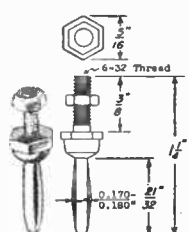

103 BANANA PLUG

Hexed brass, nickel plated. Four-leaved phosphor bronze spring, nickel plated. 6-32 hex nut.

No. 103		\$20.00 Per C
---------	--	---------------

BANANA JACK

Hexed brass, nickel plated jack with recessed head. Recommended for use with No. 100 banana plug but accommodates all standard banana plugs.

No. 101		\$15.00 Per C
---------	--	---------------

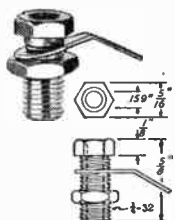
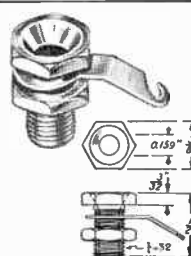

109 107 BANANA JACK

Hexed brass, nickel plated. Mounts in 1/4" hole and fits panels up to 3/8" thick. Accommodates all standard banana plugs.

No. 109		\$15.00 Per C
---------	--	---------------

PHONE TIP JACK

Body is brass, nickel plated, with internal phosphor bronze spring for positive contact. Mounts in 1/4" hole in panels up to 3/8" thick.

No. 107		\$15.00 Per C
---------	--	---------------

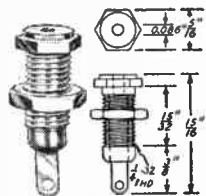

For Other Components, Send for Complete HERMAN H. SMITH INC. Catalog No. 55



"It's Sound Planning to Specify SMITH!"

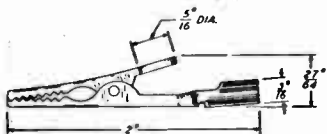

300

ALLIGATOR CLIP

Steel, cadmium plated. Jaws match accurately for firm grip. Banana plug fits in rear of alligator clip.

No. 300 \$10.00 Per C

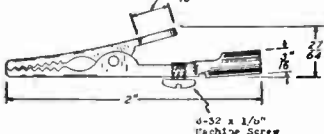

350

**STEEL ALLIGATOR CLIP
Screw Type**

Steel, cadmium plated. Jaws match accurately for firm grip. Supplied with screw for solderless connection.

No. 350 \$11.00 Per C

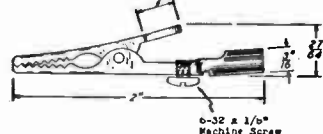

360

**COPPER ALLIGATOR CLIP
Screw Type**

Solid copper. Jaws match accurately for firm grip. Supplied with brass screw for solderless connection.

No. 360 \$15.00 Per C

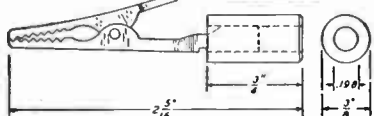

301

INSULATED ALLIGATOR CLIP

Embodies our No. 300 steel cadmium plated alligator clip with molded plastic Red or Black handle. Specify color.

No. 301 3/4" Handle \$18.00 Per C
No. 306 1 1/2" Handle \$35.00 Per C

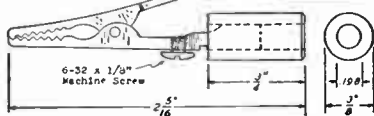

351

INSULATED STEEL ALLIGATOR CLIP

Screw type. Embodies our No. 350 steel, cadmium plated screw type alligator clip with molded plastic Red or Black handle. Specify color.

No. 351 \$19.00 Per C

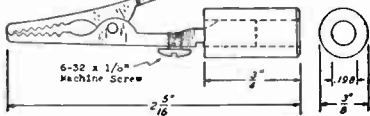

361

INSULATED COPPER ALLIGATOR CLIP

Screw type. Embodies our No. 360 copper screw type alligator clip with molded plastic Red or Black handle. Specify color.

No. 361 \$23.00 Per C

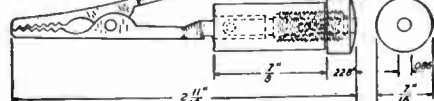

304

PHONE TIP TO ALLIGATOR CLIP ADAPTER

No. 300 Alligator clip with No. 202 tip jack in rear of handle, adapts phone tip plugs to alligator clips. Red or Black. Specify color.

No. 304 \$50.00 Per C

Same, except with No. 360 screw type copper alligator Clip.

No. 334 \$55.00 Per C

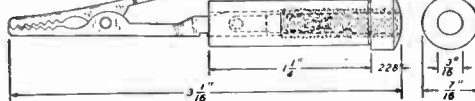

305 335

PHONE TIP OR BANANA PLUG TO ALLIGATOR CLIP ADAPTER

No. 300 alligator clip with No. 206 comb. phone tip and banana plug jack in rear of handle. Adapts phone tips and banana plugs to alligator clips. Red or Black. Specify color.

No. 305 \$60.00 Per C

Same, except with No. 360 screw type copper alligator clip.

No. 335 \$65.00 Per C



365

366

BATTERY TEST CLIP — Midget Size

Steel, cadmium plated, for radio and ignition work, etc. Jaws have meshing teeth. Jaw spread 1/2", 7 lb. spring, 1 1/2" long, 5 amp. capacity.

No. 365 \$9.50 Per C

BATTERY TEST CLIP — Small Size

For general testing and radio use. Steel, Electroplated. Jaws have meshing teeth. Jaw spread 3/8", 10 lb. spring, 2" long, 10 amp. capacity.

No. 366 \$10.00 Per C



680

"CROSS-PATCH" PATCH CORD

Provides a never-ending banana plug receptacle to interconnect an unlimited amount of multiple circuits. The cross hole is designed for positive contact of all standard banana plugs. Fits all standard banana jacks. Four-leaved phosphor bronze nickel plated spring. Red or Black assemblies. Specify color.



No. 680	8" Wire Length	\$1.45 Each
No. 681	12" Wire Length	\$1.55 Each
No. 682	24" Wire Length	\$1.65 Each
No. 683	36" Wire Length	\$1.75 Each



690

PATCH CORD

Embodies No. 211 banana plug and is used to interconnect circuits. Molded plastic handle. Plug portion brass, nickel plated. Fits all standard banana jacks. Four-leaved phosphor bronze nickel plated spring. Red or Black assemblies. Specify color.

No. 690	8" Wire Length	\$.80 Each
No. 691	12" Wire Length	\$.90 Each
No. 692	24" Wire Length	\$1.00 Each
No. 693	36" Wire Length	\$1.10 Each

For Other Components, Send for Complete HERMAN H. SMITH INC. Catalog No. 55



"It's Sound Planning to Specify SMITH!"

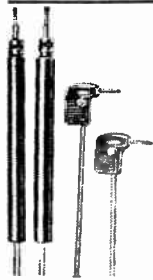

625 - 626

METER TIP TEST LEAD

50" rubber covered kinkless wire. Molded plastic fingertip tips and 4" plastic test prod handles.

No. 625	Solderless prods	\$2.00	Per Pr.
No. 626	Needle Tip Prods	\$2.00	Per Pr.

SOLDERLESS TIP TEST LEADS

Fibre handles 4" long x 3/8" diameter. Flexible kinkless rubber covered wire, 50" long.

No. 600	Phone Tips	\$1.30	Per Pr.
No. 601	Spade Lugs	\$1.30	Per Pr.
No. 602	Alligator Clips	\$1.40	Per Pr.
No. 666	Phone Tips (Plastic Wire)	\$1.15	Per Pr.

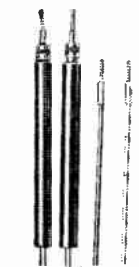

600 - 601 - 602

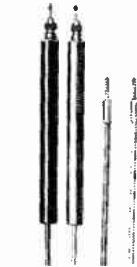

613 - 614 - 615

PHONO NEEDLE TEST LEADS

Fibre handles 4" long x 3/8" diameter. Tips are very sharp phonograph needles. Flexible kinkless rubber covered wires 50".

No. 613	Phone Tips	\$1.30	Per Pr.
No. 614	Spade Lugs	\$1.30	Per Pr.
No. 615	Alligator Clips	\$1.40	Per Pr.

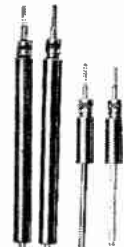

603



604 - 607

ALLIGATOR CLIP TEST LEADS

Very flexible kinkless Red and Black wire with alligator clips at each end.

No. 604	12" Wire Length	\$0.85	Per Pr.
No. 605	24" Wire Length	\$0.95	Per Pr.
No. 606	36" Wire Length	\$1.10	Per Pr.
No. 607	48" Wire Length	\$1.20	Per Pr.

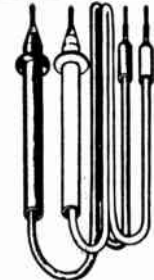

620 - 621 - 622

HIGH TENSION TEST LEADS

Heavy duty probes, 48" high tension kinkless rubber covered wire .248" O.D. 22,000 volt breakdown (50 cycles).

No. 620	Phone Tips	\$3.00	Per Pr.
No. 621	Spade Lugs	\$3.00	Per Pr.
No. 622	Alligator Clips	\$3.60	Per Pr.

ALL SOLDERLESS TEST LEADS

No. 302 handles and No. 200 plugs. Flexible kinkless rubber covered leads 50" long.

No. 603		\$1.90	Per Pr
---------	--	--------	--------

TEST LEADS

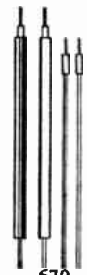

670

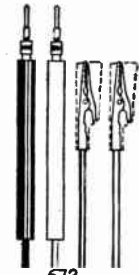

672



678

No. 670—SLIM HANDLE TEST LEADS—Fine, low-cost test leads; slender pencil type tenite handles, 3/8" O.D. 50" of hi-quality kinkless, extra flexible, rubber covered test lead wire. Heavy duty standard phone tips..... \$1.00 Per Pr.

TEST LEADS WITH ALLIGATOR CLIPS

No. 672—Strong, durable test leads with rubber covered alligator clips. 4" handles with 1 1/4" prods. 3/8" O.D. 50" of top-quality, kinkless, rubber covered, low resistance wire..... \$1.90 Per Pr.

SUBMINIATURE TEST LEADS

No. 678—Extra long, extra thin fibre handles, 1/4" O.D. x 4 1/2" long. Insulated phone tips at other end. Flexible kinkless rubber covered wire, 50"..... \$1.90 Per Pr.



627



628



675



671

No. 627—ALLIGATOR CLIP LEAD with solderless tips and 50" flexible rubber covered test lead wire..... \$1.50 Per Pr.
 No. 628—ALLIGATOR CLIP LEAD with meter tips and 50" flexible rubber covered test lead wire..... \$1.85 Per Pr.
 No. 675—CROCODILE CLIP LEAD with meter tips and 50" flexible rubber covered test lead wire..... \$1.75 Per Pr.
 No. 671—CROCODILE CLIP LEAD with insulated lug and 50" flexible rubber covered test lead wire..... \$1.75 Per Pr.

HEX AND SPLINE KEYS

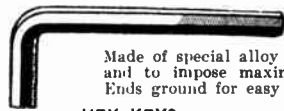

Made of special alloy steel, tempered to avoid brittleness and to impose maximum resistance to torsional strain. Ends ground for easy insertion.

HEX KEYS			SPLINE KEYS		
No.	Screw Size	Per C	No.	Screw Size	Per C
340	No. 2	\$11.00	370	No. 4	\$11.00
341	No. 3, 4	11.00	371	No. 5	11.00
342	No. 5, 6	11.00	372	No. 6	11.00
343	No. 8	11.00	373	No. 8	11.00
344	No. 10	13.20	374	No. 10	13.20
345	3/8"	13.20	375	1/2"	13.20
346	1/2"	13.20	376	5/8"	13.20

HEX AND SPLINE KEY KITS

Attractive tearproof vinyl plastic kit with individual pockets for each of six keys in kit.

Kit of 6 hex keys for screws from No. 3 to 1/8"	\$85.00 per C
No. 355	
Kit of 6 spline keys for screws from No. 5 to 1/8"	\$85.00 per C
No. 385	
Combination Kit of 3 hex and 3 spline keys for No. 8-8-10 screws.	\$85.00 per C
No. 390	
Combination Kit of 7 hex keys for screws from No. 3 to 1/8" and 4 spline keys from No. 4 to No. 10.	\$180.00 per C
No. 395	



DISPLAY CARDS

No.	DESCRIPTION	Each
355D	Display of 24 Hex Kits No. 355	\$20.40
385D	Display of 24 Spline Kits No. 385	20.40
390D	Display of 24 Combination Kits No. 390	20.40
395D	Display of 20 Combination Kits No. 395	36.00



TEST LEAD INTERCHANGE KIT

Permits use of Alligator Clips, Banana Plugs, Spade Lugs or Phone Tips interchangeably. One each red and black solderless phone tips with banana jack rear, spade lugs with banana jack rear, combination alligator clip jack, and banana plugs with phone tip jack rear. Durable vinyl kit. No. 640 \$3.25 Each

ALL PURPOSE TEST LEAD KIT



48" rubber covered kinkless test lead wire. Plastic handles with solderless or needle tips. Other end supplied with standard #204 banana plugs, which are interchangeable with the phone tips, alligator clips, or spade lugs included.

NO.	DESCRIPTION	EACH
610	Kit w/Solderless prods	\$2.75
611	Kit W/Needle point prods	2.75
609	Banana Lead W/Solderless prod	2.00

For Other Components, Send for Complete HERMAN H. SMITH INC. Catalog No. 55



"It's Sound Planning to Specify SMITH!"

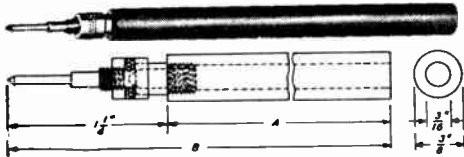

SOLDERLESS TEST PRODS

Wire fits thru handle, and is wrapped around the screw portion and tightened with the knurled nut. Brass nickel plated tip with Red or Black plastic handle. Specify color.

No. 302	4" Handle (A)	5 1/4" Overall (B)	\$0.45 Each
No. 303	5 1/2" Handle (A)	6 3/4" Overall (B)	\$0.50 Each

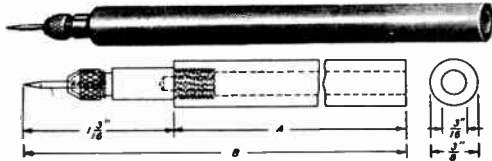

PHONO NEEDLE TEST PRODS

Brass, nickel plated body, with steel nickel plated needle. Removable chuck for replacing needles. Red or Black plastic handle. Specify color.

No. 317	4" Handle (A)	5 3/8" Overall (B)	\$0.45 Each
No. 318	5 1/2" Handle (A)	6 1/8" Overall (B)	\$0.50 Each

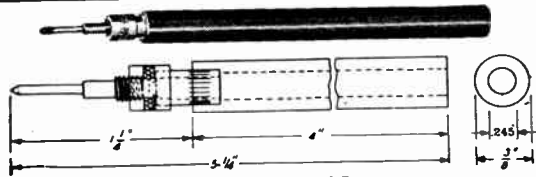

FIBRE TEST PROD

Wire fits through handle and is wrapped around screw portion and tightened with the knurled nut. (Large I.D. of prod permits use of heavy duty wire.) Brass nickel plated tip with Red or Black handle. Specify color.

No. 323			\$0.35 Each
---------	--	--	-------------

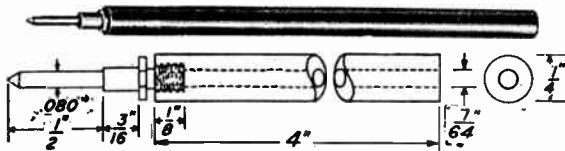

SUBMINIATURE TEST PROD

Brass, nickel plated phone tip. Small 1/4" O.D. handle. Ideally suited for checking sub-miniature equipment. Red or Black bone fibre. Specify color.

No. 322			\$0.40 Each
---------	--	--	-------------

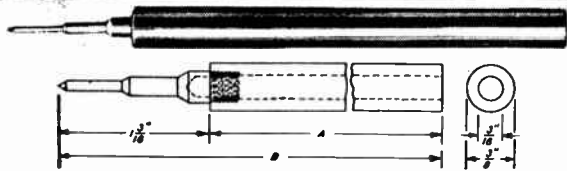

HEAVY DUTY TEST PROD

Extra sturdy brass, nickel plated tip with Red or Black plastic handle. Specify color.

No. 319	4" Handle (A)	5 3/8" Overall (B)	\$0.50 Each
No. 329	5 1/2" Handle (A)	6 1/8" Overall (B)	\$0.55 Each



BAKELITE BARREL DOUBLE PHONE PLUG

Molded bakelite barrel, two-circuit plug, fits all standard phone jacks. Screw terminal contacts. Body brass, nickel plated. Red or Black, specify color.

No. 222			\$0.55 Each
---------	--	--	-------------

MALE CONNECTOR FOR RG-59/U



Mates with 1660 receptacle or cable coupler. Packaged individually with complete instruction sheet.

No. 1650	Each	\$ 0.80
1650-D	Display of 24	19.20

HEAVY DUTY FEMALE RECEPTACLE



Mates with 1660. Threaded stem is 5/8" long. Packaged individually.

No. 1660	Each	\$ 0.80
1660-D	Display of 24	19.20

CABLE JUNCTION FOR RG-59/U



Mates at either end with a 1650 cable connector. Packaged individually.

No. 1680	Each	\$ 1.00
1680-D	Display of 24	24.00

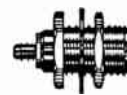

CABLE ADAPTER

This adapter permits coupling of large size RG-11/U and RG-13/U coaxial cables to smaller size RG-59/U cable. One end of adapter takes our No. 1650 connector and the other end takes a PL-259 plug. Packaged individually with complete instruction sheet.

No. 1711	Each	\$ 3.50
1711-D	Display of 20	70.00

CABLE ADAPTER ASSEMBLY



This unit package contains all of the necessary parts for adapting of large size RG-11/U and RG-13/U coaxial cables to smaller size RG-59/U cable. Consist of our No. 1650 connector, 1711 connector, and PL-259 plug. Packaged individually with complete instruction sheet.

No. 1712	Each	\$ 5.25
1712-D	Display of 12	63.00
1713	PL-259 Plug	1.25

HEAVY DUTY CABLE ADAPTER



For RG-11/U or RG-8/U to RG-59/U cable. Packaged individually with complete instruction sheet.

No. 1700	Each	\$ 2.50
1700-D	Display of 20	\$50.00

PLASTIC CABLE CLIPS



These cable clips are fabricated from a tough, durable plastic material, Ethyl Cellulose, and will give maximum service at a minimum cost. Holds open wire, cables, etc., firmly in position.

"T" .060" — "X" 7/32" — "W" 1/8"

T	X	No.	Size	D	E	Per C
		831	1/8"	.115	360	\$3.90
		832	3/16"	.172	423	4.00
		833	1/4"	.234	457	4.30
		834	5/16"	.297	498	4.75
		835	3/8"	.359	529	5.00
		836	7/16"	.422	560	5.50
		837	1/2"	.484	592	6.00

NYLON LACING CORD



The lacing cord meets specification for yardage and tensile strength and is made to meet spec JAN-T-713, Type S, Composition P, Classes 3, 2 and 1. Supplied in 1 lb. tubes.

CLASS 1		CLASS 2		CLASS 3	
No.	Ydgs.	No.	Ydgs.	No.	Ydgs.
734	600	735	800	736	1140
	\$13.50		\$14.00		\$14.30

LINEN LACING CORD

Made from pure flax, waxed and mildew-proofed. Six ply cord meets Spec. JAN-T-713, Type N, Classes 3, 2 and 1.

4 PLY				6 PLY				9 PLY				
Tube	No.	Ydgs.	Each	No.	Ydgs.	Each	No.	Ydgs.	Each	No.	Ydgs.	Each
4 oz.	725	210	\$2.50	728	75	\$2.40	731	100	\$2.40			
8 oz.	726	425	4.30	729	150	4.10	732	200	4.10			
1 lb.	727	850	8.20	730	300	7.30	733	400	7.80			

For Other Components, Send for Complete HERMAN H. SMITH INC. Catalog No. 55



"It's Sound Planning to Specify SMITH!"

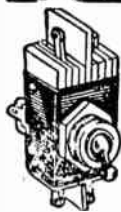

BALL HANDLE TOGGLE SWITCHES

Laminated type. Made by H. & H. Switches nickel plated; supplied with ring nut and mounting nut.

No.	Type	Current Rating		Shaft	Ea.
		125 V.	250 V.		
500	SPST			$\frac{1}{8}$ "	\$0.75
501	SPST	3 Amps		$\frac{1}{8}$ "	1.10
502	SPDT	3 Amps	1 Amp	$\frac{1}{8}$ "	1.00
503	SPDT	3 Amps	1 Amp	$\frac{1}{8}$ "	1.35
504	DPST	3 Amps	1 Amp	$\frac{1}{8}$ "	1.40
505	DPST	3 Amps	1 Amp	$\frac{1}{8}$ "	1.90
506	DPDT	3 Amps	1 Amp	$\frac{1}{8}$ "	1.60
507	DPDT	3 Amps	1 Amp	$\frac{1}{8}$ "	2.05



BAT HANDLE TOGGLE SWITCHES

Laminated type. Made by H. & H. Switches nickel plated; supplied with ring nut and mounting nut.

No.	Type	Current Rating		Shaft	Ea.
		125 V.	250 V.		
510	SPST	3 Amps		$\frac{1}{8}$ "	\$0.75
511	SPDT	3 Amps	1 Amp	$\frac{1}{8}$ "	1.00
512	DPST	3 Amps	1 Amp	$\frac{1}{8}$ "	1.40
513	DPDT	3 Amps	1 Amp	$\frac{1}{8}$ "	1.60



ROTARY SWITCHES

Made by H. & H. Switches nickel plated; supplied with mounting nut. Threaded shank $\frac{1}{4}$ " O.D. x $\frac{3}{8}$ " long. Overall length of shaft $1\frac{1}{2}$ ".

No.	Type	Current Rating		Ea.
		125 V.	250 V.	
570	SPST	3 Amps		\$1.00
571	SPDT	3 Amps	1 Amp	1.20
572	DPST	3 Amps	1 Amp	1.50
573	DPDT	3 Amps	1 Amp	1.85



HEAVY DUTY POWER SWITCHES

Made by H. & H., and specially recommended for use in amplifiers, transmitters, motors and all heavy current circuits. Neutral off in center position. Rated at 10 amps, 125 volts; 5 amps, 250 volts. Mounting sleeve diameter $\frac{3}{4}$ " x $\frac{3}{8}$ " long.

No.	Type	Power Rating	Ea.
574	DPDT	$\frac{3}{4}$ H.P. 250 Volts	\$ 7.25
575	TPDT	$\frac{1}{2}$ H.P. 115-230 V.A.C. 3-ph.	12.00
576	4PDT	$\frac{1}{2}$ H.P. 115-230 V.A.C. 2-ph.	14.75

NAME PLATES

Brass nickel plated name plates to fit all standard $\frac{1}{8}$ " sleeves.

No.	Type	Per C
508	ON-OFF	\$5.50
509	HI-LOW	5.50



MICROPHONE CONNECTOR
Single Contact Female

Used extensively for making connections from microphone to amplifier. Equipped with coupling ring. Brass, heavily chrome plated.

No. 116 \$0.45 each



MOLDED BAKELITE SWITCHES

Made by H. & H. Bat handle. Back connected silver plated contacts, slotted sleeve.

No.	Type	Current Rating		Shaft	Ea.
		125 V.	250 V.		
520	SPST	6 Amps	3 Amps	$\frac{1}{8}$ "	\$1.10
521	SPDT	6 Amps	1 Amp	$\frac{1}{8}$ "	1.25
522	DPST	6 Amps	3 Amps	$\frac{1}{8}$ "	1.70
523	DPDT	6 Amps	3 Amps	$\frac{1}{8}$ "	2.00

MOLDED BAKELITE MOMENTARY SWITCHES

Same as above except switches are momentary type. SPST normally "OFF."

No.	Type	Current Rating		Shaft	Ea.
		125 V.	250 V.		
524	SPST	6 Amps	3 Amps	$\frac{1}{8}$ "	\$1.60
525	DPDT	6 Amps	3 Amps	$\frac{1}{8}$ "	2.50



MOMENTARY PUSH BUTTON SWITCH

Momentary contact A.C. Push Button Switches. Molded type with soldering lug. Rated at 1 amp, 125 volts. Normally "OFF," push to make, release to break. $\frac{1}{8}$ " shank.

No.	Type	Each
540	SPST	\$0.90
541	SPDT	1.00
542	DPST	1.20
543	DPDT	1.50

PUSH BUTTON MOMENTARY SWITCH



Slow make and break switch made by H. & H. Laminated type, solder lug. Circuit normally "OFF," push to make. $\frac{1}{8}$ " slotted sleeve, rated at 1 amp, 125 volts. The two circuit switch has one circuit normally on, one circuit normally off.

No.	Type	Each
579	SPST less button	\$0.90
580	Two Circuit less button	1.40
581	Red or Black button	.35
582	SPST—Normally ON (for Refrigerators)	1.00



SLIDE LEVER SWITCHES

Rated $1\frac{1}{2}$ amps, 110 volts. Size $1\frac{3}{8}$ " x $\frac{1}{2}$ ". Mounting centers $1\frac{1}{2}$ ".

No.	Type	Each
515	SPST	\$0.21
516	SPDT	.22
517	DPST	.29
518	DPDT	.32



SMALL TOGGLE SWITCH

Small molded toggle switch made by H & H rated at 3 amps., 250 volts, $\frac{1}{8}$ " shank. Solder lugs; supplied with hex mounting nut and ring nut.

590	SPST Ball Handle	Each \$0.85
591	SPST Bat Handle	Each \$0.85



MICROPHONE CONNECTOR
Single Contact Male

A completely shielded single contact connector. Made of brass and heavily chrome plated. Mate for No. 116 female connector.

No. 115 \$0.35 each

HEAVY DUTY MOMENTARY SWITCH



Made by H. & H. DPST Momentary contact push button switch, normally off, screw terminal, bakelite case, $\frac{1}{8}$ " slotted sleeve. Rated at 6 amps, 250 volts—12 amps, 125 volts—1 HP at 250 volts.

No. 595 \$3.25 each

HEAVY DUTY SWITCH

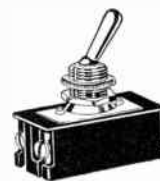

Made by H. & H. DPST Switch Maintained contact bat handle bakelite case, $\frac{1}{8}$ " slotted sleeve, screw terminals. Rated at 6 amps, 250 volts—12 amps, 125 volts—1 HP at 250 volts.

No. 596 \$2.35 each

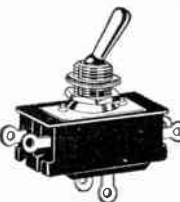

CENTER OFF SWITCHES

Made by H. & H. Three Position bat handle switch. "Center Off." Bakelite case, rated at 3 amps, 250 volts—6 amps, 125 volts—solder terminals.

No.	Type	Each
566	SPDT	\$1.90
567	DPDT	2.35

DPDT CENTER OFF SWITCH



Bat handle toggle switch rated at 1 amp. — 125 volts with center "OFF" position. Lug terminals, $\frac{1}{8}$ " brass nickel plated shaft. Can be used for switching to either high or low frequency antenna on TV receivers.

No. 565 \$1.45 each

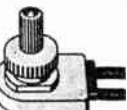

ROTARY TYPE CANOPY SWITCH

Rated at 3 amps, 125 volts, 1 amp, 250 volts. Supplied with 6" leads. C.S.A. approved.

No. 585 \$0.45 each

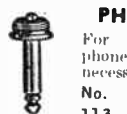

PHONE PLUG ADAPTOR

For mike cables. Fits standard phone jack. No soldering or wiring necessary. Brass, nickel plated.

No. 113 Each \$0.45



CAP AND CHAIN

Made of brass, heavily nickel plated. The cap seals open end units against dust.

No. 118 \$0.60 each



CHASSIS CONNECTOR
Single Contact Male

Brass, heavily nickel plated. Threaded $\frac{3}{16}$ "-27, and mounts in a $\frac{3}{8}$ " hole. Supplied complete with washers, soldering lug and nut.

No. 117 \$0.30 each

For Other Components, Send for Complete HERMAN H. SMITH INC. Catalog No. 55



"It's Sound Planning to Specify SMITH!"

PANEL INDICATOR 1/2 INCH JEWEL

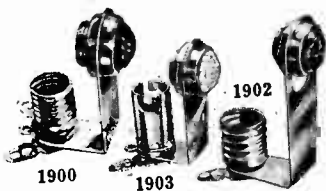

Jewel holder made of brass, nickel plated. Jewel mounts in a single 1/8" dia. hole. Also available with universal adjustable bracket for use where more accurate focus of the jewel to lamp filament is required. Facetted jewel available in Red, Green, Amber, Blue, Opal and Clear colors. Please specify.

No.	Type	Each
1900	Miniature Screw Base	\$0.45
1901	Candelabra Base	.55
1902	Candelabra Base with Univ. Bracket	.58
1903	Bayonet Base	.45
1904	Bayonet Base with Univ. Bracket	.50

PANEL INDICATOR 3/8 INCH JEWEL

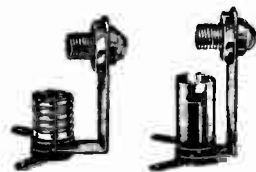

Jewel holder made of brass, nickel plated. Jewel mounts in a single 3/8" dia. hole. Available with facetted jewels in Red, Green, Amber, Blue Opal & Clear colors. Please specify.

No.	Type	Each
1908	Miniature Screw Base	\$0.45
1909	Miniature Bayonet Base	.50

CLIP-ON TYPE PILOT LIGHT SOCKETS

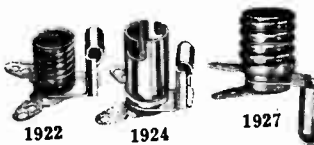

Can be used by clipping on to variable condenser or chassis. All brackets are cadmium plated.

No.	Type	Per C
1922	Min. Screw Up Clip	\$16.00
1923	Min. Screw Down Clip	16.00
1924	Min. Bayonet Up Clip	16.00
1925	Min. Bayonet Down Clip	16.00
1926	Candelabra Up Clip	17.50
1927	Candelabra Down Clip	17.50

PANEL INDICATOR 1/2 INCH OPEN TYPE

Jewel Removable from Front of Panel



Jewel holder made of brass, nickel plated. Mounts in a single 1/2" dia. hole. The embossed rib in center of bracket gives additional strength and assures perfect alignment. Available with facetted jewels in Red, Green, Amber, Blue, Opal and Clear colors.

No.	Type	Each
1920	Miniature Screw Base	\$0.70
1921	Miniature Bayonet Base	.75

GLASS JEWELS

Jewels are available in Red, Green, Amber, Blue, Opal and Clear colors in smooth or facetted types. Jewel holders are brass, nickel plated, and are supplied with mounting nut.



3/8 Inch Jewel Mounts in 3/8" Hole			1/2 Inch Jewel Mounts in 1/2" Hole		
No.	Type	Each	No.	Type	Each
1940	Smooth	\$0.35	1911	Smooth	\$0.35
1941	Facetted	0.35	1912	Facetted	0.35
3/4 Inch Jewel Mounts in 3/4" Hole			1 Inch Jewel Mounts in 1" Hole		
No.	Type	Each	No.	Type	Each
1913	Smooth	\$0.70	1915	Smooth	\$1.25
1914	Facetted	0.70	1916	Facetted	1.25

BRACKET TYPE PILOT LIGHT SOCKETS

Brackets are steel, cadmium plated.

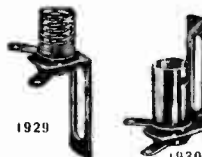

No.	Type	Per C
1928	Min. Screw Up Bracket	\$16.00
1929	Min. Screw Down Bracket	16.00
1930	Min. Bayonet Up Bracket	16.00
1931	Min. Bayonet Down Bracket	16.00
1932	Candelabra Up Bracket	17.50
1933	Candelabra Down Bracket	17.50

RUBBER TACK BUMPERS

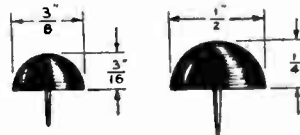

No. 2190 \$2.40 C No. 2191 \$2.65 C

RECESS RUBBER BUMPERS

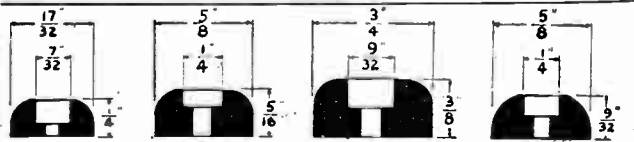

No.	Per C
2192	\$2.20
2193	2.75
2194	4.40
2184	4.50

RUBBER BUMPERS WITH SCREW

Supplied complete with 1/2" screw and hex nut. For panels up to 1/8" thick. Specify larger screw for larger panels.

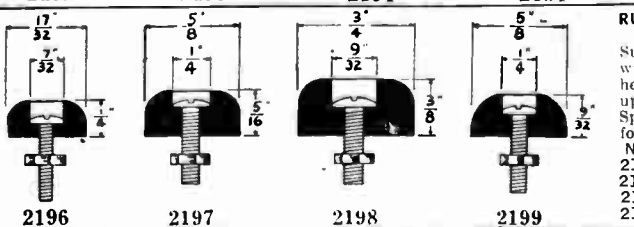

No.	Per C
2196	\$3.90
2197	4.25
2198	5.25
2199	5.50

PANEL INDICATOR 1 INCH OPEN TYPE

Jewel Removable from Front Panel

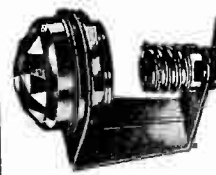

Jewel holder made of brass, chromium plated finish. Jewel mounts in single 1" dia. hole. The embossed rib in center of bracket supplies additional strength, assuring perfect alignment. Available with facetted jewels in the following colors: Red, Green, Amber, Blue, Opal, and Clear colors. Please specify.

No.	Type	Each
1917	Miniature Screw Base	\$1.60
1918	Miniature Bayonet Base	1.60
1919	Candelabra Base	1.70

PANEL INDICATOR 3/4 INCH JEWEL



Jewel holder is made of brass, nickel plated. Jewel mounts in a single 3/4" dia. hole. Available with facetted jewels in Red, Green, Amber, Blue, Opal and Clear colors. Please specify.

No.	Type	Each
1905	Miniature Screw Base	\$0.95
1906	Miniature Bayonet Base	1.00
1907	Candelabra Base	1.00

CLIP-IN SOCKET



This clip-in socket is of the bayonet base type construction, and is assembled with two solder lugs. The special clip-in bracket is steel, cadmium plated, and is designed to clip into the dial directly.

No. 1938 \$15.50 per C

UNMOUNTED TYPE SOCKETS



No.	Type	Per C
1934	Miniature Screw Base	\$14.50
1935	Miniature Bayonet Base	13.50
1936	Candelabra Base	15.50

TEST PROD

"MAKE YOUR OWN R. F. PROBE"



An exceptionally sturdy fibre prod with rear of prod designed to accommodate 1N-34 crystal and condensers, necessary for use as an R.F. Probe. Heavy duty removable screw type tip for easy soldering.

No. 630	\$1.20 each
No. 630-D	— Display of 12	\$14.40 each

RUBBER GROMMETS



A: O.D.
B: I.D.
C: PANEL
D: THICK
E: P. THICK

No.	A	B	C	D	E	Per C
2185	1 1/8"	1 1/8"	1 1/8"	1/8"	1/8"	\$2.20
2172	1 1/8"	1 1/8"	1 1/8"	1/8"	1/8"	3.30
2170	1 1/8"	1 1/8"	1 1/8"	1/8"	1/8"	3.85
2174	1 1/8"	1 1/8"	1 1/8"	1/8"	1/8"	3.60
2175	1 1/8"	1 1/8"	1 1/8"	1/8"	1/8"	3.85
2177	1 1/8"	1 1/8"	1 1/8"	1/8"	1/8"	3.60
2186	1 1/8"	1 1/8"	1 1/8"	1/8"	1/8"	4.95
2187	1 1/8"	1 1/8"	1 1/8"	1/8"	1/8"	5.20
2188	1 1/8"	1 1/8"	1 1/8"	1/8"	1/8"	5.50
2189	1 1/8"	1 1/8"	1 1/8"	1/8"	1/8"	8.00

For Other Components, Send for Complete HERMAN H. SMITH INC. Catalog No. 55



"It's Sound Planning to Specify SMITH!"

SOLDER TYPE LUGS—Hot Tinned

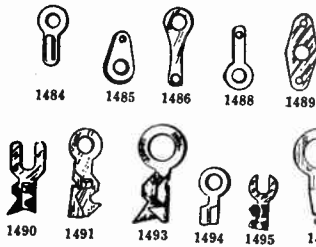

No.	Material	L.	Thick- ness	Hole	Per M
1484	Brass	5/8"	.020"	No. 6	\$7.70
1485-4	Ph. Br.	5/8"	.012"	No. 4	8.00
1485-6	Ph. Br.	5/8"	.012"	No. 6	8.00
1485-8	Ph. Br.	5/8"	.012"	No. 8	8.00
1485-10	Ph. Br.	5/8"	.012"	No. 10	8.00
1486-4	Ph. Br.	5/8"	.012"	No. 4	8.00
1486-6	Ph. Br.	5/8"	.012"	No. 6	8.00
1486-8	Ph. Br.	5/8"	.012"	No. 8	8.00
1486-10	Ph. Br.	5/8"	.012"	No. 10	8.00
1488	Brass	3/4"	.016"	No. 6	6.60
1489	Brass	3/4"	.015"	No. 8	9.00
1490	Brass	3/4"	.020"	No. 10	9.00
1491	Copper	1 1/8"	.020"	No. 10	15.00
1493	Brass	1 1/8"	.027"	1/4"	25.00
1494-6	Brass	3/4"	.020"	No. 6	8.30
1494-8	Brass	3/4"	.020"	No. 8	8.30
1495	Brass	3/4"	.020"	No. 8	7.70
1496	Brass	3/4"	.020"	1/4"	10.00

An attractive display card of each lug containing 24 45c list envelopes, can be obtained by specifying the letter "D" after the above catalog numbers.

TIE DOWN TERMINAL STRIPS

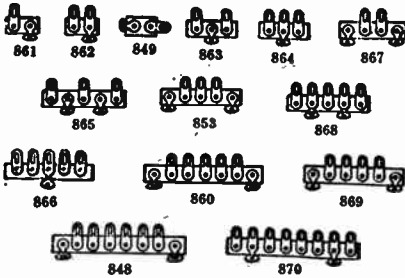

No.	Per C	No.	Per C
848	\$9.75	864	\$3.75
849	2.75	865	6.10
853	5.75	866	5.95
860	8.25	867	5.00
861	2.75	868	6.50
862	2.90	869	7.50
863	3.50	870	9.20

**TERMINAL BOARDS
Screw Type**

Brass hot tinned lugs mounted on 1/8" bakelite. Lugs are spaced 1/8" center to center.

No.	Terminals	Mounting Center	Per C
872	2	1 1/4"	\$12.00
873	3	1 3/4"	18.00
874	4	2 1/8"	22.00
875	5	2 3/8"	28.00
876	6	3 1/8"	33.00
877	7	3 3/4"	40.00



FUSE MOUNTING BASES

Black bakelite, panel mount type. Accommodates 3 A G Auto type cartridge fuse.

No.	Type	Per C
530	Single	\$25.00
531	Double	40.00
532	Clip Only	2.50

**LOCKING
TYPE
TERMINAL
LUGS**

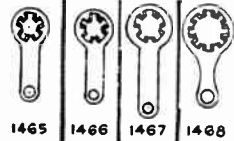

No.	Hole Size	Thick	Per M
1465	No. 4	.020	\$14.00
1466	No. 6	.020	14.00
1467	No. 8	.020	14.00
1468	1/4"	.020	14.00

BRASS ELECTRO PLATED



ANTENNA CONNECTOR

For use as connection of auto radio antenna lead-in to auto radio receiver.

No. 1300	\$12.00 Per C
----------	---------------



FUSE RETAINER

Recommended for use in auto radio power supply cables.

No. 1301	\$20.00 Per C
----------	---------------

PARTS FOR CONNECTOR AND RETAINER

No.	Type	Per C
1305	Male Cap for #1300 & #1301	\$3.00
1306	Female Shell for #1300	3.50
1307	Contact for #1300 & #1301	5.00
1308	Spring for #1300 & #1301	1.00
1309	Washer for #1300 & #1301	.50
1310	Insulating Tube for #1301	.90
1311	Female Shell for #1301	5.00



JUMBO FUSE HOLDERS

These jumbo fuse holders are for use with various types of auto receivers. All parts comprising bushings, springs, contacts, etc., are furnished unassembled, packed in individual envelopes.

No.	Size	Fuse Size	Each
1302	1/2" x 2 1/4"	9 amp.	\$0.32
1303	1/2" x 2 5/8"	14 amp.	.32
1313	1/2" x 2 5/8"	30 amp.	.32



WIRED FUSE RETAINER

Simply cut wire, strip and put in line. Will accommodate either 3 A.G. 20 amp. or SFE 14 amp. fuse.

No.	Each
1304	\$ 0.45
1304-D	10.80

MINI-MAX CONNECTING STRIP



This fastening connecting strip is spaced so that it will snap onto terminal connections of portable batteries.

No.	Type	Per C
1205	67 1/2 Volt	\$30.00
1206	90 Volt	40.00



BATTERY CONNECTOR

For new miniature 45V B Battery used in Emerson Portable.

No. 1234	\$55.00 Per C
----------	---------------

BATTERY CONNECTORS



No.	Type	Per C
1296	Female	\$5.50
1297	Male	5.00



PHONO ADAPTER ATTACHMENT PLUG

R.C.A. type phono plug. For use with record players, recording and reproducing equipment, etc. Extra long pin for new type jacks and large hole in cap for coaxial cable.

No. 1201	\$8.00 per C
----------	--------------

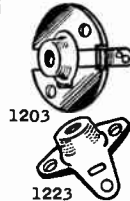

PHONO JACK

Female for No. 1201 plug. Single prong positive grip jack mounted on 1/8" bakelite with 1/8" mounting centers.

No. 1203	\$11.00 Per C
No. 1223	\$12.00 Per C



PHONO JACKS

Used on recording units, phono players, etc.

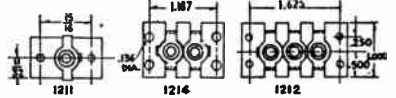

No.	Per C
1211—Single Jack	\$12.00
1214—Double Jack	16.00
1212—Triple Jack	20.00



SHIELDED EXTENSION JACK

Brass shell, cadmium plated. 2 1/8" long, with black bakelite insert. Provides insulation for solder-coated positive grip contact. Uses No. 1201 phono plug.

No. 1237	\$25.00 Per C
----------	---------------



MOTOROLA TYPE PLUG

Attachment plug for all Motorola auto radio receivers and many other types of auto radios.

No. 1200	\$14.00 per C
----------	---------------



LEAD-IN ADAPTER

Lead-in adapter converts Motorola pin plug to Delco type plug.

No. 1204	\$15.00 per C
----------	---------------

ANTENNA CONNECTOR Flange Type



Female connector for No. 1200 Motorola type Plug. Sturdy steel flange, 1/8" mounting centers. Solder coated shell, flange, and contact. Used extensively on auto radios.

No. 1207	\$20.00 Per C
----------	---------------

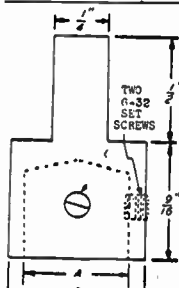

DRILL ADAPTER

Convert your 1/4" drill chuck to drill holes up to 1/2". Steel drill adapter enables the use of drills from 7/8" to 1/2" in portable electric drill with a 1/4" chuck. Drills can be quickly inserted and tightened with two set screws located at 90° angle for firm hold.

No.	Drill Size (A)	O.D. (B)	Each
175	1/8"	1 1/8"	\$0.75
176	3/16"	1 1/4"	.80
177	1/4"	1 1/2"	.85
178	5/16"	1 3/4"	.90
179	3/8"	1 7/8"	3.30

For Other Components, Send for Complete HERMAN H. SMITH INC. Catalog No. 55



"It's Sound Planning to Specify SMITH!"

BRASS SPACERS CADMIUM PLATED

Ideal for use in raising sub panels, chassis, condensers, transformers, etc. Hole in bushing to accommodate a No. 6 or No. 8 screw.

For No. 6 Screw			For No. 8 Screw		
No.	Per C	Length	No.	Per C	Length
2100	\$5.00	1/4"	2105	\$5.00	1/4"
2101	6.50	3/8"	2106	6.50	3/8"
2102	8.00	1/2"	2107	8.00	1/2"
2103	9.50	3/4"	2108	9.50	3/4"
2104	11.00	1"	2109	11.00	1"
3/8" O.D.			3/8" O.D.		
2110	\$8.00	1/4"	2115	\$8.00	1/4"
2111	9.50	3/8"	2116	9.50	3/8"
2112	11.00	1/2"	2117	11.00	1/2"
2113	12.50	3/4"	2118	12.50	3/4"
2114	14.00	1"	2119	14.00	1"

THREADED BRASS SPACERS CADMIUM PLATED

Brass bushings 1/4" O.D. Threaded 6-32 and 8-32

Threaded 6-32			Threaded 8-32		
No.	Per C	Length	No.	Per C	Length
2120	\$6.00	1/4"	2125	\$6.00	1/4"
2121	7.50	3/8"	2126	7.50	3/8"
2122	9.00	1/2"	2127	9.00	1/2"
2123	11.00	3/4"	2128	11.00	3/4"
2124	12.50	1"	2129	12.50	1"

INSULATED SPACERS

For No. 6 Screw			For No. 8 Screw		
No.	Per C	Length	No.	Per C	Length
2130	\$6.00	1/4"	2140	\$6.00	1/4"
2131	6.75	3/8"	2141	6.75	3/8"
2132	7.00	1/2"	2142	7.00	1/2"
2133	9.00	3/4"	2143	9.00	3/4"
2134	10.75	1"	2144	10.75	1"

MINI-SPRING FOR MINI-TUBES

For Table Radios • Electronic Equipment Radio Receivers



The Mini-Tube guard gives support to the Mini-Tube in two ways. It maintains a direct axial pressure downward plus a sideways support that keeps the tube upright and perpendicular to the chassis. The spring action is constant and resilient permanently.

No.	Type	Per C
540	Short	\$13.50
561	Medium	13.50
562	Long	13.50
563	9-Prong	17.50

FIBRE SHOULDER WASHERS

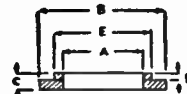

A. Inside Diameter
B. Outside Diameter
C. Thickness Over-all
D. Height of Shoulder
E. Diameter of Shoulder

No.	A	B	C	D	E	Per M
2150	#6-.140	.375	.098	.031	.237	\$11.50
2151	#4-.110	.250	.062	.031	.187	9.50
2152	#6-.136	.260	.093	.031	.187	10.00
2153	#6-.136	.312	.093	.031	.187	11.00
2154	1/4"-.250	.500	.068	.028	.312	12.00
2155	#8-.172	.375	.093	.031	.246	11.00
2156	#10-.196	.375	.093	.031	.308	11.00
2157	3/8"-.375	.750	.093	.031	.500	14.50
2158	3/8"-.385	.625	.093	.031	.500	14.00

FLAT FIBRE WASHERS

No.	For Screw-(I.D.)	O.D.	Thickness	Per M
2160	#6-.136	.250	1/8"	\$9.50
2161	#4-.110	.250	1/8"	9.50
2162	#6-.140	.375	1/8"	8.50
2163	#8-.172	.375	1/8"	8.50
2164	#10-.196	.375	1/8"	9.00
2165	1/4"-.250	.500	3/32"	9.00
2166	3/8"-.375	.500	1/8"	9.50
2167	1/2"-.500	.500	1/8"	9.00
2168	3/8"-.385	.625	1/8"	11.00
2169	3/8"-.375	.750	1/8"	14.00

MINI-SHIELDS FOR MINI-TUBES



These Mini-Shields fit snugly on all Mini-Tubes. Serrations in base clip prevent shielded tube from joggling or working loose. Available in two sizes for 1 1/2" and 2" long tubes.

No.	Type	Over-all Length	Per C
550	For 2" Tube	1 3/4"	\$13.00
551	For 1 1/2" Tube	1 1/4"	11.00
553	3-Prong Base Clip		5.50
554	Single Clips		3.30

BRASS AND INSULATED COUPLINGS



Available in both brass and insulated material. Overall length 3/4". Set screws are provided in coupling for tightening to shaft.

No.	Type	O.D.	Material	Each
120	1/4"-.1"	1/8"	Brass	\$0.25
140	1/4"-.1"	1/8"	Fibre	0.25
131	3/8"-.1"	1/8"	Brass	0.25
141	3/8"-.1"	1/8"	Fibre	0.25
133	3/8"-.3"	1/2"	Brass	0.25
142	3/8"-.3"	1/2"	Fibre	0.25

BRASS AND INSULATED EXTENDERS

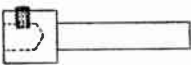

Extra long extenders in either brass or insulated material. Suitable for use on amplifiers, television receivers, radio receivers or wherever a 1/4" or 3/8" shaft extender is required.

No.	Type	Material	Shaft Length	Overall Length	Each
150	1/4"-.1"	Brass	1 3/8"	1 3/4"	\$0.30
130	1/4"-.1"	Fibre	1 3/8"	1 3/4"	0.30
132	3/8"-.1"	Brass	1 3/8"	1 3/4"	0.30
134	3/8"-.1"	Fibre	1 3/8"	1 3/4"	0.30

THREADED BRASS RODS



Rods ordinarily supplied in one foot lengths; if two foot length is required, please specify.

No.	Size	Per Foot
1400	6-32	\$0.35
1401	8-32	.35
1402	10-32	.45
1403	1/4"-20	.50

FAHNESTOCK SPRING BATTERY CLIPS

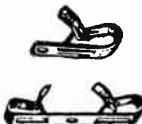

Brass, nickel plated.

No.	Type	Length	Per C
533	Single	3/4"	\$1.80
534	Single	1"	2.20
535	Double	1 1/2"	10.00
536	Double	2 1/8"	11.00

BEARING FOR PANEL ASSEMBLY

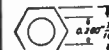

Made of brass, and fits in 3/8" diameter hole in panels up to 3/8" thick. Bearing is made to accommodate 1/4" shafts. Overall length 1/2".
No. 119.....\$0.25 each

PANEL BEARING ASSEMBLY

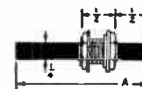

This assembly combines either 3" or 6" brass rod, 1/4" O.D. with our standard No. 119 Panel Bearing. Nickel plated overall.

No.	A	Each
148	3"	\$0.50
149	6"	.60

BRASS AND INSULATED RODS

No.	Type	Length	Dia.	Each
1404	Brass	6"	1/4"	\$0.30
1405	Brass	12"	3/4"	.60
1406	Insulated	6"	3/4"	.25
1407	Insulated	12"	3/4"	.50

Auto Radio IGNITION SUPPRESSORS



Solidly made of molded black bakelite housings with rugged brass metal parts... impervious to heat, oil, moisture and vibration. Resistance of 10,000 ohms, will remain constant over 50,000 miles of operation.

Cat. No.	Type	Per C
805	Snap-On Type Suppressor	\$35.00
806	Universal Type with Double Thread	35.00
807	Angle Type Suppressor	35.00
808	Distributor Type	35.00
809	Distributor Screw Type	35.00
810	Double Screw Type	35.00

PANEL BEARING ASSEMBLY



This panel bearing is accurately machined and is specially recommended for use as dial drives, or for mounting volume controls, switches, etc. Over-all length 1 1/2". Supplied with nut. Drive shaft 1/4" O.D.

No. 126	\$35.00 Per C
---------	---------------

For Other Components, Send for Complete HERMAN H. SMITH INC. Catalog No. 55



HERMAN H. SMITH, INC. • ELECTRONIC COMPONENTS

"It's Sound Planning to Specify SMITH!"

HEAVY DUTY BAKELITE BARRIER TERMINAL STRIPS

Shown below are our popular screw type terminal blocks. Made of molded thermosetting plastics — in high tensile strength bakelite for general commercial use. CFG, MFE, CMG, MME, AND MDG blocks made in strict compliance with latest military specifications MIL-P-14C. Prices available on request. Special flag, spade, hole type lugs, and steel straddle plates available. Manufactured by the KULKA ELECTRIC MANUFACTURING COMPANY, INC. and exclusively distributed by us to the Radio Parts Distributors.

600 Series

Height $\frac{1}{4}$ "., Width $\frac{3}{8}$ "., Thickness $\frac{1}{4}$ "., Terminals $\frac{3}{8}$ " Centers., $\frac{1}{16}$ " Mtg., 5-40x $\frac{1}{4}$ " Screws.



600-2	
No.	Each
600-1	\$0.15
600-2	0.25
600-3	0.33
600-4	0.42
600-5	0.51
600-6	0.59
600-7	0.68
600-8	0.77
600-9	0.86
600-10	0.95
600-11	1.03
600-12	1.12
600-13	1.21
600-14	1.31
600-15	1.40
600-16	1.49
600-17	1.57
600-18	1.66
600-19	1.75
600-20	1.84
600-21	1.93
600-22	2.02



600-ST-2	
No.	Each
600-ST-1	\$0.19
600-ST-2	0.32
600-ST-3	0.44
600-ST-4	0.57
600-ST-5	0.69
600-ST-6	0.83
600-ST-7	0.95
600-ST-8	1.08
600-ST-9	1.21
600-ST-10	1.33
600-ST-11	1.45
600-ST-12	1.58
600-ST-13	1.71
600-ST-14	1.84
600-ST-15	1.96
600-ST-16	2.09
600-ST-17	2.21
600-ST-18	2.34
600-ST-19	2.46
600-ST-20	2.60
600-ST-21	2.72
600-ST-22	2.86



600- $\frac{3}{4}$ -ST-2	
No.	Each
600- $\frac{3}{4}$ -ST-1	\$0.19
600- $\frac{3}{4}$ -ST-2	0.32
600- $\frac{3}{4}$ -ST-3	0.44
600- $\frac{3}{4}$ -ST-4	0.57
600- $\frac{3}{4}$ -ST-5	0.69
600- $\frac{3}{4}$ -ST-6	0.83
600- $\frac{3}{4}$ -ST-7	0.95
600- $\frac{3}{4}$ -ST-8	1.08
600- $\frac{3}{4}$ -ST-9	1.21
600- $\frac{3}{4}$ -ST-10	1.33
600- $\frac{3}{4}$ -ST-11	1.45
600- $\frac{3}{4}$ -ST-12	1.58
600- $\frac{3}{4}$ -ST-13	1.71
600- $\frac{3}{4}$ -ST-14	1.84
600- $\frac{3}{4}$ -ST-15	1.96
600- $\frac{3}{4}$ -ST-16	2.09
600- $\frac{3}{4}$ -ST-17	2.21
600- $\frac{3}{4}$ -ST-18	2.34
600- $\frac{3}{4}$ -ST-19	2.46
600- $\frac{3}{4}$ -ST-20	2.60
600- $\frac{3}{4}$ -ST-21	2.72
600- $\frac{3}{4}$ -ST-22	2.86



600-Y-2	
No.	Each
600-Y-1	\$0.19
600-Y-2	0.32
600-Y-3	0.44
600-Y-4	0.57
600-Y-5	0.69
600-Y-6	0.83
600-Y-7	0.95
600-Y-8	1.08
600-Y-9	1.21
600-Y-10	1.33
600-Y-11	1.45
600-Y-12	1.58
600-Y-13	1.71
600-Y-14	1.84
600-Y-15	1.96
600-Y-16	2.09
600-Y-17	2.21
600-Y-18	2.34
600-Y-19	2.46
600-Y-20	2.60
600-Y-21	2.72
600-Y-22	2.86



600-XY-2	
No.	Each
600-XY-1	\$0.23
600-XY-2	0.40
600-XY-3	0.60
600-XY-4	0.73
600-XY-5	0.93
600-XY-6	1.07
600-XY-7	1.23
600-XY-8	1.40
600-XY-9	1.57
600-XY-10	1.73
600-XY-11	1.89
600-XY-12	2.06
600-XY-13	2.23
600-XY-14	2.40
600-XY-15	2.56
600-XY-16	2.73
600-XY-17	2.89
600-XY-18	3.06
600-XY-19	3.22
600-XY-20	3.40
600-XY-21	3.56
600-XY-22	3.74

600 Series



600-Z-2	
No.	Each
600-Z-1	\$0.23
600-Z-2	0.40
600-Z-3	0.60
600-Z-4	0.73
600-Z-5	0.93
600-Z-6	1.07
600-Z-7	1.23
600-Z-8	1.40
600-Z-9	1.57
600-Z-10	1.73
600-Z-11	1.89
600-Z-12	2.06
600-Z-13	2.23
600-Z-14	2.40
600-Z-15	2.56
600-Z-16	2.73
600-Z-17	2.89
600-Z-18	3.06
600-Z-19	3.22
600-Z-20	3.40
600-Z-21	3.56
600-Z-22	3.74

601 Series

Height $\frac{1}{2}$ "., Width 1 $\frac{1}{8}$ "., Thickness $\frac{3}{16}$ "., Terminals $\frac{1}{16}$ " Centers., 27/64" Mtg., 6-32x $\frac{1}{4}$ " Screws.

No.	Each
601-1	\$0.20
601-2	0.31
601-3	0.42
601-4	0.54
601-5	0.64
601-6	0.75
601-7	0.88
601-8	0.99
601-9	1.10
601-10	1.22
601-11	1.33
601-12	1.44
601-13	1.56
601-14	1.67
601-15	1.78
601-16	1.90
601-17	2.01
601-18	2.12
601-19	2.24
601-20	2.35
601-21	2.47
601-22	2.59
601-23	2.71

No.	Each
601-ST-1	\$0.24
601-ST-2	0.41
601-ST-3	0.57
601-ST-4	0.74
601-ST-5	0.90
601-ST-6	1.07
601-ST-7	1.23
601-ST-8	1.40
601-ST-9	1.56
601-ST-10	1.73
601-ST-11	1.89
601-ST-12	2.06
601-ST-13	2.22
601-ST-14	2.39
601-ST-15	2.55
601-ST-16	2.72
601-ST-17	2.88
601-ST-18	3.05
601-ST-19	3.21
601-ST-20	3.38
601-ST-21	3.55
601-ST-22	3.72
601-ST-23	3.89

No.	Each
601- $\frac{3}{4}$ -ST-1	\$0.24
601- $\frac{3}{4}$ -ST-2	0.41
601- $\frac{3}{4}$ -ST-3	0.57
601- $\frac{3}{4}$ -ST-4	0.74
601- $\frac{3}{4}$ -ST-5	0.90
601- $\frac{3}{4}$ -ST-6	1.07
601- $\frac{3}{4}$ -ST-7	1.23
601- $\frac{3}{4}$ -ST-8	1.40
601- $\frac{3}{4}$ -ST-9	1.56
601- $\frac{3}{4}$ -ST-10	1.73
601- $\frac{3}{4}$ -ST-11	1.89
601- $\frac{3}{4}$ -ST-12	2.06
601- $\frac{3}{4}$ -ST-13	2.22
601- $\frac{3}{4}$ -ST-14	2.39
601- $\frac{3}{4}$ -ST-15	2.55
601- $\frac{3}{4}$ -ST-16	2.72
601- $\frac{3}{4}$ -ST-17	2.88
601- $\frac{3}{4}$ -ST-18	3.05
601- $\frac{3}{4}$ -ST-19	3.21
601- $\frac{3}{4}$ -ST-20	3.38
601- $\frac{3}{4}$ -ST-21	3.55
601- $\frac{3}{4}$ -ST-22	3.72
601- $\frac{3}{4}$ -ST-23	3.89

No.	Each
601-Y-1	\$0.24
601-Y-2	0.41
601-Y-3	0.57
601-Y-4	0.74
601-Y-5	0.90
601-Y-6	1.07
601-Y-7	1.23
601-Y-8	1.40
601-Y-9	1.56
601-Y-10	1.73
601-Y-11	1.89
601-Y-12	2.06
601-Y-13	2.22
601-Y-14	2.39
601-Y-15	2.55
601-Y-16	2.72
601-Y-17	2.88
601-Y-18	3.05
601-Y-19	3.21
601-Y-20	3.38
601-Y-21	3.55
601-Y-22	3.72
601-Y-23	3.89

No.	Each
601-XY-1	\$0.28
601-XY-2	0.49
601-XY-3	0.69
601-XY-4	0.90
601-XY-5	1.10
601-XY-6	1.31
601-XY-7	1.51
601-XY-8	1.72
601-XY-9	1.92
601-XY-10	2.13
601-XY-11	2.33
601-XY-12	2.54
601-XY-13	2.74
601-XY-14	2.95
601-XY-15	3.15
601-XY-16	3.36
601-XY-17	3.56
601-XY-18	3.77
601-XY-19	3.97
601-XY-20	4.18
601-XY-21	4.38
601-XY-22	4.58
601-XY-23	4.78

601 Series

No.	Each
601-Z-1	\$0.28
601-Z-2	0.49
601-Z-3	0.69
601-Z-4	0.90
601-Z-5	1.10
601-Z-6	1.31
601-Z-7	1.51
601-Z-8	1.72
601-Z-9	1.92
601-Z-10	2.13
601-Z-11	2.33
601-Z-12	2.54
601-Z-13	2.74
601-Z-14	2.95
601-Z-15	3.15
601-Z-16	3.36
601-Z-17	3.56
601-Z-18	3.77
601-Z-19	3.97
601-Z-20	4.18
601-Z-21	4.38
601-Z-22	4.58
601-Z-23	4.78

602 Series

Height $\frac{5}{8}$ "., Width 1 $\frac{1}{8}$ "., Thickness $\frac{3}{8}$ "., Terminals $\frac{1}{16}$ " Centers., $\frac{1}{2}$ " Mtg., 8-32x $\frac{3}{8}$ " Screws.

No.	Each
602-1	\$0.23
602-2	0.36
602-3	0.51
602-4	0.65
602-5	0.78
602-6	0.92
602-7	1.07
602-8	1.20
602-9	1.34
602-10	1.49
602-11	1.62
602-12	1.76
602-13	1.90
602-14	2.04
602-15	2.18
602-16	2.32
602-17	2.45
602-18	2.58
602-19	2.76
602-20	2.90
602-21	3.04
602-22	3.19
602-23	3.33
602-24	3.48
602-25	3.62
602-26	3.76

No.	Each
602-ST-1	\$0.30
602-ST-2	0.50
602-ST-3	0.70
602-ST-4	0.90
602-ST-5	1.11
602-ST-6	1.31
602-ST-7	1.52
602-ST-8	1.72
602-ST-9	1.93
602-ST-10	2.12
602-ST-11	2.33
602-ST-12	2.53
602-ST-13	2.74
602-ST-14	2.94
602-ST-15	3.15
602-ST-16	3.34
602-ST-17	3.54
602-ST-18	3.74
602-ST-19	3.99
602-ST-20	4.20
602-ST-21	4.41
602-ST-22	4.62
602-ST-23	4.83
602-ST-24	5.04
602-ST-25	5.25
602-ST-26	5.46

No.	Each
602- $\frac{3}{4}$ -ST-1	\$0.30
602- $\frac{3}{4}$ -ST-2	0.50
602- $\frac{3}{4}$ -ST-3	0.70
602- $\frac{3}{4}$ -ST-4	0.90
602- $\frac{3}{4}$ -ST-5	1.11
602- $\frac{3}{4}$ -ST-6	1.31
602- $\frac{3}{4}$ -ST-7	1.52
602- $\frac{3}{4}$ -ST-8	1.72
602- $\frac{3}{4}$ -ST-9	1.93
602- $\frac{3}{4}$ -ST-10	2.12
602- $\frac{3}{4}$ -ST-11	2.33
602- $\frac{3}{4}$ -ST-12	2.53
602- $\frac{3}{4}$ -ST-13	2.74
602- $\frac{3}{4}$ -ST-14	2.94
602- $\frac{3}{4}$ -ST-15	3.15
602- $\frac{3}{4}$ -ST-16	3.34
602- $\frac{3}{4}$ -ST-17	3.54
602- $\frac{3}{4}$ -ST-18	3.74
602- $\frac{3}{4}$ -ST-19	3.99
602- $\frac{3}{4}$ -ST-20	4.20
602- $\frac{3}{4}$ -ST-21	4.41
602- $\frac{3}{4}$ -ST-22	4.62
602- $\frac{3}{4}$ -ST-23	4.83
602- $\frac{3}{4}$ -ST-24	5.04
602- $\frac{3}{4}$ -ST-25	5.25
602- $\frac{3}{4}$ -ST-26	5.46

No.	Each
602-Y-1	\$0.30
602-Y-2	0.50
602-Y-3	0.70
602-Y-4	0.90
602-Y-5	1.11
602-Y-6	1.31
602-Y-7	1.52



"It's Sound Planning to Specify SMITH!"



603 SERIES
Height $\frac{3}{8}$ ", Width $1\frac{1}{8}$ ", Thickness $\frac{1}{8}$ ", Terminals $\frac{1}{16}$ " Centers, $\frac{5}{16}$ " Mtr., 10-32 x $\frac{3}{8}$ " Screws.

603 Marker Strips					
No.	Each	No.	Each	No.	Per C
603-1	\$0.55	603-ST-1	\$0.66	603- $\frac{3}{4}$ ST-1	\$0.66
603-2	0.94	603-ST-2	1.13	603- $\frac{3}{4}$ ST-2	1.13
603-3	1.32	603-ST-3	1.60	603- $\frac{3}{4}$ ST-3	1.60
603-4	1.71	603-ST-4	2.07	603- $\frac{3}{4}$ ST-4	2.07
603-5	2.09	603-ST-5	2.53	603- $\frac{3}{4}$ ST-5	2.53
603-6	2.48	603-ST-6	3.00	603- $\frac{3}{4}$ ST-6	3.00
603-7	2.86	603-ST-7	3.46	603- $\frac{3}{4}$ ST-7	3.46
603-8	3.25	603-ST-8	3.92	603- $\frac{3}{4}$ ST-8	3.92
603-9	3.63	603-ST-9	4.40	603- $\frac{3}{4}$ ST-9	4.40
603-10	4.02	603-ST-10	4.80	603- $\frac{3}{4}$ ST-10	4.80
				MS603-1	\$6.60
				MS603-2	7.70
				MS603-3	9.60
				MS603-4	11.00
				MS603-5	13.20
				MS603-6	14.30
				MS603-7	15.80
				MS603-8	17.30
				MS603-9	18.70
				MS603-10	20.40



604 SERIES
Height $\frac{1}{2}$ ", Width 2", Thickness $\frac{1}{2}$ ". Terminals $\frac{5}{16}$ " Centers, $\frac{3}{4}$ " Mtr., 12-32 x $\frac{5}{8}$ " Screws.

604 Marker Strips					
No.	Each	No.	Each	No.	Per C
604-1	\$0.90	604-ST-1	\$1.10	604- $\frac{3}{4}$ ST-1	\$1.10
604-2	1.65	604-ST-2	2.00	604- $\frac{3}{4}$ ST-2	2.00
604-3	2.40	604-ST-3	2.90	604- $\frac{3}{4}$ ST-3	2.90
604-4	3.15	604-ST-4	3.80	604- $\frac{3}{4}$ ST-4	3.80
604-5	3.90	604-ST-5	4.70	604- $\frac{3}{4}$ ST-5	4.70
604-6	4.65	604-ST-6	5.60	604- $\frac{3}{4}$ ST-6	5.60
604-7	5.40	604-ST-7	6.50	604- $\frac{3}{4}$ ST-7	6.50
604-8	6.15	604-ST-8	7.40	604- $\frac{3}{4}$ ST-8	7.40
				MS604-1	\$6.60
				MS604-2	10.10
				MS604-3	13.40
				MS604-4	16.75
				MS604-5	20.00
				MS604-6	23.00
				MS604-7	26.00
				MS604-8	29.00



605 SERIES
Height $1\frac{1}{8}$ ", Width $2\frac{1}{2}$ ". Thickness $\frac{5}{8}$ ". Terminals $1\frac{1}{2}$ " Centers, $\frac{7}{8}$ " Mtr., $\frac{1}{4}$ -28 x $\frac{1}{2}$ " Screws.

605 Marker Strips					
No.	Each	No.	Each	No.	Per C
605-1	\$1.25	605-ST-1	\$1.45	605- $\frac{3}{4}$ ST-1	\$1.45
605-2	2.40	605-ST-2	2.80	605- $\frac{3}{4}$ ST-2	2.80
605-3	3.50	605-ST-3	4.20	605- $\frac{3}{4}$ ST-3	4.20
605-4	4.70	605-ST-4	5.60	605- $\frac{3}{4}$ ST-4	5.60
605-5	5.80	605-ST-5	7.00	605- $\frac{3}{4}$ ST-5	7.00
605-6	7.00	605-ST-6	8.30	605- $\frac{3}{4}$ ST-6	8.30
				MS605-1	\$7.15
				MS605-2	12.65
				MS605-3	18.15
				MS605-4	23.50
				MS605-5	29.00
				MS605-6	34.00

MARKER STRIPS

for 600, 600-ST and 600- $\frac{3}{4}$ ST
Black fiber marker strips $\frac{1}{2}$ " thick imprinted to specs. Bakelite marker strips are available. Specify XP. Prices on request.

No.	Per C
MS600-1	\$2.20
MS600-2	3.30
MS600-3	3.30
MS600-4	4.40
MS600-5	5.50
MS600-6	6.60
MS600-7	6.60
MS600-8	7.70
MS600-9	8.80
MS600-10	9.90
MS600-11	11.00
MS600-12	11.00
MS600-13	12.10
MS600-14	13.20
MS600-15	13.20
MS600-16	14.30
MS600-17	15.40
MS600-18	16.50
MS600-19	16.50
MS600-20	17.60
MS600-21	18.70
MS600-22	19.80

MARKER STRIPS

for 600-Y Series
Black fiber marker strips $\frac{1}{2}$ " thick imprinted to specs. Bakelite marker strips are available. Specify XP. Prices on request.

No.	Per C
MS600-Y-1	\$5.50
MS600-Y-2	6.60
MS600-Y-3	7.40
MS600-Y-4	8.25
MS600-Y-5	9.08
MS600-Y-6	9.90
MS600-Y-7	10.73
MS600-Y-8	11.55
MS600-Y-9	12.38
MS600-Y-10	13.20
MS600-Y-11	14.03
MS600-Y-12	14.85
MS600-Y-13	15.68
MS600-Y-14	16.50
MS600-Y-15	17.33
MS600-Y-16	18.15
MS600-Y-17	18.98
MS600-Y-18	19.80
MS600-Y-19	20.63
MS600-Y-20	21.45
MS600-Y-21	22.28
MS600-Y-22	23.10

MARKER STRIPS

for 601, 601-ST and 601- $\frac{3}{4}$ ST

No.	Per C
MS601-1	\$2.75
MS601-2	3.85
MS601-3	4.95
MS601-4	6.05
MS601-5	7.15
MS601-6	8.25
MS601-7	9.35
MS601-8	10.45
MS601-9	11.55
MS601-10	12.65
MS601-11	13.75
MS601-12	14.85
MS601-13	15.95
MS601-14	17.05
MS601-15	18.15
MS601-16	19.25
MS601-17	20.35
MS601-18	21.45
MS601-19	22.25
MS601-20	23.65
MS601-21	24.75
MS601-22	25.85
MS601-23	26.95

MARKER STRIPS

for 601-Y Series

No.	Per C
MS601-Y-1	\$6.00
MS601-Y-2	7.10
MS601-Y-3	8.25
MS601-Y-4	9.25
MS601-Y-5	10.40
MS601-Y-6	11.50
MS601-Y-7	12.60
MS601-Y-8	13.75
MS601-Y-9	14.85
MS601-Y-10	15.95
MS601-Y-11	17.00
MS601-Y-12	18.15
MS601-Y-13	19.25
MS601-Y-14	20.35
MS601-Y-15	21.45
MS601-Y-16	22.55
MS601-Y-17	23.65
MS601-Y-18	24.75
MS601-Y-19	25.85
MS601-Y-20	26.95
MS601-Y-21	28.05
MS601-Y-22	29.15
MS601-Y-23	30.25

MARKER STRIPS

for 602, 602-ST and 602- $\frac{3}{4}$ ST

No.	Per C
MS602-1	\$3.00
MS602-2	4.40
MS602-3	5.50
MS602-4	7.00
MS602-5	8.50
MS602-6	9.90
MS602-7	12.25
MS602-8	12.65
MS602-9	14.00
MS602-10	15.40
MS602-11	16.75
MS602-12	18.15
MS602-13	19.25
MS602-14	20.75
MS602-15	22.25
MS602-16	23.50
MS602-17	25.00
MS602-18	26.50
MS602-19	28.00
MS602-20	29.50
MS602-21	31.00
MS602-22	32.50
MS602-23	34.00
MS602-24	35.50
MS602-25	37.00
MS602-26	38.50

MARKER STRIPS

for 602-Y Series

No.	Per C
MS602-Y-1	\$6.25
MS602-Y-2	7.70
MS602-Y-3	9.00
MS602-Y-4	10.40
MS602-Y-5	11.75
MS602-Y-6	13.20
MS602-Y-7	14.50
MS602-Y-8	15.75
MS602-Y-9	17.25
MS602-Y-10	18.75
MS602-Y-11	20.00
MS602-Y-12	21.25
MS602-Y-13	22.50
MS602-Y-14	24.00
MS602-Y-15	25.50
MS602-Y-16	27.00
MS602-Y-17	28.25
MS602-Y-18	29.75
MS602-Y-19	31.25
MS602-Y-20	32.75
MS602-Y-21	34.25
MS602-Y-22	35.75
MS602-Y-23	37.25
MS602-Y-24	38.75
MS602-Y-25	40.25
MS602-Y-26	41.75



TWO-SIDED LUG

No.	Per C
600-STL	\$3.50
601-STL	5.00
602-STL	6.00
603-STL	8.00
604-STL	15.00
605-STL	20.00



ONE-SIDED LUG

No.	Per C
600-3/4STL	\$3.50
601-3/4STL	5.00
602-3/4STL	6.00
603-3/4STL	8.00
604-3/4STL	15.00
605-3/4STL	20.00



BENT LUG

No.	Per C
600-YL	\$3.50
601-YL	5.00
602-YL	6.00



FLAG LUG

No.	Per M
600-SLF	\$20.00
601-SLF	21.00
602-SLF	23.00
603-SLF	45.00



SPADE LUG

No.	Per M
600-SLS	\$20.00
601-SLS	21.00
602-SLS	23.00
603-SLS	45.00



HOLE LUG

No.	Per M
600-SLH	\$20.00
601-SLH	21.00
602-SLH	23.00
603-SLH	45.00



JUMPER

No.	Per M
600-J	\$35.00
601-J	40.00
602-J	45.00
603-J	55.00
604-J	65.00
605-J	75.00

For Other Components, Send for Complete HERMAN H. SMITH INC. Catalog No. 55

'It's Sound Planning to Specify SMITH!'



STEEL MACHINE SCREWS

Round Head		Cadmium Plated		
No.	Per M	Size	No.	Gross
1000M	\$5.90	6-32 x 1/4"	1C00G	\$1.00
1001M	6.30	6-32 x 3/8"	1001G	1.10
1002M	6.80	6-32 x 1/2"	1002G	1.15
1005M	7.60	8-32 x 1/2"	1005G	1.25
1007M	8.30	8-32 x 3/8"	1007G	1.35
1008M	8.80	8-32 x 1/2"	1008G	1.40

BRASS MACHINE SCREWS
Round Head Nickel Plated

No.	Per M	Size	No.	Gross
1044M	\$6.50	4-36 x 1/4"	1044G	\$1.00
1045M	8.10	4-36 x 3/8"	1045G	1.05
1046M	10.00	4-36 x 1/2"	1046G	1.10
1047M	6.50	4-40 x 1/4"	1047G	1.60
1048M	8.10	4-40 x 3/8"	1048G	1.05
1049M	10.00	4-40 x 1/2"	1049G	1.10
1050M	9.30	6-32 x 1/2"	1350G	1.55
1051M	10.90	6-32 x 3/8"	1051G	1.60
1052M	12.50	6-32 x 1/2"	1052G	2.10
1056M	13.70	8-32 x 1/2"	1056G	2.30
1057M	15.60	8-32 x 3/8"	1057G	2.65
1058M	17.60	8-32 x 1/2"	1058G	2.95

Value Control and Toggle Switch Nuts

Brass Nickel Plated			
No.	Type	Dimensions	Per M
1195	Volume Control	3/8-32 x 3/8 x 3/16	\$21.00
1196	Toggle Switch	15-32 x 1/8 x 3/8	30.00
1197	Toggle Ring Nut	15-32 x 3/8 x 1/8	30.00



HEXAGON NUTS
Brass Nickel Plated

No.	Per M	Size	No.	Gross
1188M	\$9.00	4-36 x 1/4"	1188G	\$1.45
1189M	9.00	4-40 x 1/4"	1189G	1.45
1190M	12.90	6-32 x 1/4"	1190G	2.10
1191M	12.90	6-32 x 3/8"	1191G	2.10
1192M	14.10	8-32 x 1/4"	1192G	2.30
1193M	14.10	8-32 x 3/8"	1193G	2.30
1193M	15.90	10-32 x 1/4"	1193G	2.65

Steel, Cadmium Plated

1179M	\$7.10	6-32 x 1/4"	1179G	\$1.10
1180M	7.90	6-32 x 3/8"	1180G	1.30
1181M	7.90	8-32 x 1/4"	1181G	1.30

PARKER KALON SELF TAPPING SCREWS
Round Head — Cadmium Plated

TYPE A Sharp Point			TYPE Z Blunt Point		
No.	Gross	Size	No.	Gross	
1801	\$1.45	4 x 1/4"	1807	\$1.45	
1802	1.35	6 x 1/4"	1808	1.35	
1803	1.40	6 x 3/8"	1809	1.40	
1804	1.45	6 x 1/2"	1810	1.45	
1805	1.55	8 x 3/8"	1811	1.55	
1806	1.65	8 x 1/2"	1812	1.65	

SLOTTED HEX HEAD — CADMIUM PLATED
Type Z — Blunt Point

No.	Size	Gross
1830	6 x 1/4"	\$1.35
1831	6 x 3/8"	1.40
1832	6 x 1/2"	1.45
1833	8 x 3/8"	1.55
1834	8 x 1/2"	1.65



RACK SCREWS
Oval Head, Steel, Nickel Plated

Specially recommended for mounting panels in racks and cabinets. Available in gross packages or packed 1000 to the box.

No.	Per M	Size	No.	Gross
1111M	\$9.20	10-32 x 1/2"	1111G	\$1.55
1112M	10.40	10-32 x 3/4"	1112G	1.60



COUNTERSUNK WASHERS
Brass, Nickel Plated

Recommended for use with Rack Screws designated above.

No.	Per M	Size	No.	Gross
1115M	\$6.80	6	1115G	\$1.05
1116M	7.20	8	1116G	1.10
1117M	7.20	10	1117G	1.10

"VERI-THIN" ALIGNING TOOL

Fibre aligning tool 7" long x 1/8" O.D. with screw driver on each end.

No.	Each
328	\$ 0.40
328D—Display of 50	20.00
328H—With Amber Handle	0.60
328HD—Display of 25	15.00

EXTRA LONG ALIGNING TOOL

Hard Bone Fibre screw driver 12 inches long by 1/8 inches dia. Extra strong and durable.

No.	Each
333	\$ 0.70
333-D—Display of 50 tools	35.00
333H—With Amber Handle	0.90
333HD—Display of 25	22.50

FLAT WASHERS

Brass Nickel Plated				
No.	Per M	Size	Material	No.
1149M	\$4.80	No. 4 x 3/8" x .037"	Brass	1149G
1150M	4.80	No. 6 x 3/8" x .012"	Ph. Br.	1150G
1151M	4.80	No. 8 x 3/8" x .012"	Ph. Br.	1151G
1152M	4.80	No. 10 x 3/8" x .037"	Brass	1152G

LOCK WASHERS — Steel, Cadmium Plated
Internal Teeth

No.	Per M	Type	No.	Gross
1127M	\$4.50	No. 4	1127G	\$0.65
1128M	4.80	No. 6	1128G	0.75
1129M	4.80	No. 8	1129G	0.75
1130M	5.40	No. 10	1130G	0.60
1132M	7.20	1/4"	1132G	1.10
1131M	9.00	3/8"	1131G	1.45

Narrow Rim Control Shaft Lockwasher — Internal Teeth
1145M \$9.00 1145G \$1.45

External Teeth

No.	Per M	Type	No.	Gross
1139M	\$4.50	No. 4	1139G	\$0.65
1140M	4.80	No. 6	1140G	0.75
1141M	4.80	No. 8	1141G	0.75
1142M	5.40	No. 10	1142G	0.80
1144M	7.20	1/4"	1144G	1.10
1143M	9.00	3/8"	1143G	1.45

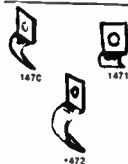

CABLE CLAMPS

Steel Cadmium Plated with No. 8 open Hole.

No.	Length	Width	Cable	Per C
1471	5/8"	3/8"	1/4" to 1/2"	\$2.00
1470	3/4"	3/8"	1/4"	2.00
1472	1"	3/8"	1/2"	2.50

BRASS AND STEEL ANGLES

No.	Material	Size	Per C
1474	Brass N.P.	1/2" x 1/2"	\$2.80
1475	Brass N.P.	5/8" x 5/8"	5.50
1476	Steel H.T.	3/4" x 3/4"	2.20
1477	Steel H.T.	3/4" x 1 1/4"	2.20

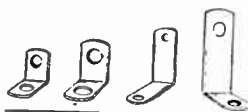

EYELET TYPE SOLDER LUGS



Made of brass. Nos. 1480, 1481 and 1482 are hot tinned and No. 1483 cadmium plated. Specially recommended for mounting on terminal strips.

No.	Length	Hole	Per M
1480	5/8"	3/16" slot	\$ 5.00
1481	5/8"	No. 8	11.00
1482	1 1/8"	No. 8	8.30
1483	1 1/8"	No. 8	8.30

BINDING HEAD SCREWS
Steel Nickel Plated

No.	Per M	Size	No.	Gross
1425M	\$5.90	6-32 x 1/4"	1425G	\$1.00
1426M	6.30	6-32 x 3/8"	1426G	1.10
1427M	6.80	6-32 x 1/2"	1427G	1.15
1428M	7.60	8-32 x 1/4"	1428G	1.25
1429M	8.30	8-32 x 3/8"	1429G	1.35
1430M	8.80	8-32 x 1/2"	1430G	1.40

FANCY HEAD BRONZE FINISH SCREWS

No.	Size	Per M
1160	6-32 x 3/4"	\$10.70
1161	6-32 x 1"	11.40
1162	6-32 x 1 1/4"	12.50

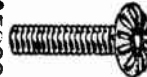

STEEL SPADE BOLTS

Steel, cadmium plated finish, threaded 6-32, thread length 3/8", length overall 3/4".

No. 1500	\$11.00 per M
----------	---------------

FIBRE ALIGNMENT SCREW DRIVERS

Made of bone hard fibre 3/32" O.D. x 7" long.

No.	Each
307	\$ 0.45
307D—Display of 24	\$10.80

"LONG REACH" ALIGNING TOOL

Aligning tool 9" long x .165 O.D. with screw driver on each end. Material of treated clear lucite.

No. 330	\$0.60 each
No. 330D—Display of 36	\$21.60 each

For Other Components, Send for Complete HERMAN H. SMITH INC. Catalog No. 55



STANDARDIZED ELECTRONIC HARDWARE CUSTOM-BILT TERMINAL BOARDS TO JAN SPEC-SPECIAL ASSEMBLIES

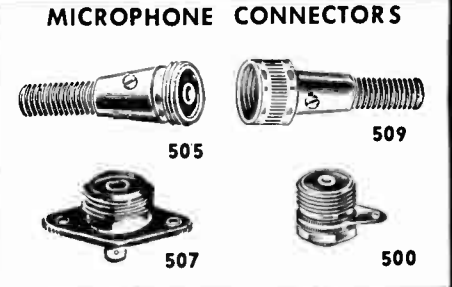
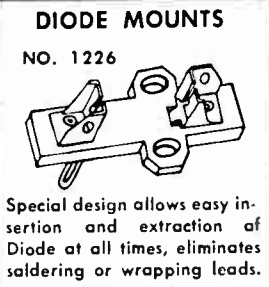
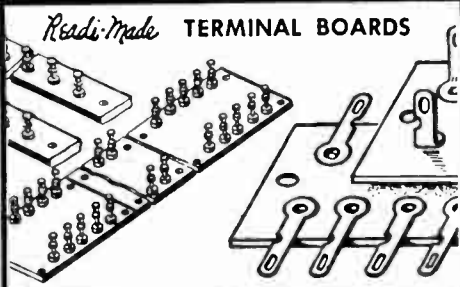

STANDARDIZED TERMINALS TO JAN SPEC ILLUSTRATIONS FULL SIZE. MADE OF BRASS. AVAILABLE IN HOT TIN DIP OR SILVER PLATE.

1503	1507	1509	1506	1538	1557	1504	1554	1501
1552	1529	1534	1555	1502	1526	1522	1576	1520
1209	1277	1248	1535	1268	1276	1266	1241	1202

MINIATURE TERMINALS

EXTRUDED TERMINALS

MINI-PLUGS AND JACKS
NO 452 NO 475

MEDIUM PLUGS AND JACKS
NO 552 NO 575

BRACKETS & BUSHINGS

SHAFT LOCK FOR 1/4" SHAFT

FOR 1/4" DIA SHAFT
2 7/16" HEX BRASS
3/8"-32 THREAD
1/2" HEX. BRASS

No. 1702
BRASS NICKEL PLATED

We are specialists in the design and manufacture of special probes made to JAN specs.

- UHF PROBES
- CO-AX CABLE ASSEMBLIES
- ALIGNMENT TOOLS
- TEST LEAD ASSEMBLIES

SPECIAL ASSEMBLIES

J403

DIAL LOCK

BRASS NICKEL PLATED No. 1703

DIAL LOCK

BRASS NICKEL PLATED No. 1705

Send FOR OUR CATALOG SHOWING OUR COMPLETE LINE OF STOCK ITEMS!

KEYSTONE

ELECTRONICS CORP.
423 BROOME ST., NEW YORK 13, N. Y.
WOrth 2-2789

WALSCO

ELECTRONIC HARDWARE



Now! Both the 50 and the 99 Line are packaged in transparent, re-usable PLASTIC STORAGE BOXES with sliding tops that can be opened with one hand.



PHONO HARDWARE AND RUBBER ITEMS

50 line		99 line	
List Price 50c each		List Price \$1.80 each	
Catalog No.	Approx. Quantity	Catalog No.	Approx. Quantity

WALSCO PHONO-MOTOR DRIVES

Precision-made, Resilient, Synthetic Rubber



	— DIMENSIONS —		
	I.D.	O.D.	Thick
Used on Most 2 & 3 Speed Record Changers			
Gen. Indst. Mod. LX & RX	2	2-3/8	5/32
Alliance, Seeburg, G.E., V.M. 4CO	1-1/2	1-3/4	3/16
Seeburg, RCA, G.E.	7/8	1-1/8	3/16
Philco, RCA, etc.	1/8	3/8	1/4
Detrola	5-3/4	6	3/16
G.I. Recorder/Changer	1-7/32	1-15/32	3/16
Gen. Indust. Mod. LX & RX	2	2-3/8	5/32

Precision-made, resilient, synthetic rubber. Form a non-positive, non-slipping contact with turntable. Ground precisely concentric they obviate wow or turntable rumble caused by irregular drive wheel. Highly abrasion and oil-resistant they are good for many years of trouble-free service.

Replacement Selector.
Lay old motor drive on this chart to quickly find part needed.

7014-F	4
7016-F	2
7017-F	3
7018-F	4
7019-F	4
7020-F	1
7022-F	3

NOT CARRIED IN 99 LINE

WALSCO PHONOGRAPH PICKUP SET SCREWS



Knurled head, steel screws, antique bronze finish. For replacement on pickup and recording heads. Fits all types.

Used on	Size
Various Models	Assorted
Shure and others	2-56 x 5/8"
Most Astatic & Webster	2-64 x 3/4"
Most RCA, etc.	1-72 x 1"

8550-F	12
8552-F	12
8553-F	12
8555-F	5

WALSCO PICKUP CARTRIDGE MOUNTING SCREWS



Machine and self-tapping screws of various lengths. Whatever your problem, the solution can be found in this assortment of small machine and self-tapping screws of various sizes. Spacers are also included.

Assorted
Screws and
Spacers

8560-F	30
--------	----

WALSCO PHONO PANEL MOUNTING SPRINGS



Very resilient, very strong, precision-formed. This is an assortment of conical springs for shock-resistant mounting of record changer units, etc.

Assorted

7450-F	8
--------	---

WALSCO RUBBER GROMMETS

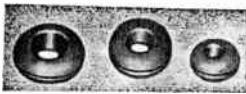

Protect insulation from raw edges of holes in metal chassis. Easily squeezed into place; give a neat, practical finish. Extremely useful for damping vibration when mounting certain parts.

	— DIMENSIONS —				
	A	B	C	D	E
11/32	1/8	3/16	1/16	1/4	
7/16	3/16	7/32	1/16	5/16	
9/16	1/4	1/4	1/16	3/8	
5/8	3/8	1/4	1/16	1/2	
13/16	1/2	9/32	1/16	5/8	
				Assorted	

7030-F	16
7032-F	14
7034-F	12
7036-F	10
7038-F	8
7025-F	15

7030-N	85
7032-N	85
7034-N	65
7036-N	55
*7038-N	35

WALSCO CORD STRAINRELIEFS



For POSJ or POT (plastic) cord. Prevents chafing of ac power cord where it enters chassis. Takes strain off terminals. Protects against breakage of conductors due to sharp kinking over metal edge.

ATTACH TO CORD WITH WALSCO RUBBER CEMENT.

7048-F	5
--------	---

WALSCO CABINET FEET



Supplied in two types—with tacks or screws—WALSCO Cabinet Feet are made of synthetic rubber. Wood screws are supplied with screw type feet. However, machine or sheet metal screws will fit.

SCREW-ON RUBBER FEET	
Dia.	Height
3/8	7/32
1/2	9/32
5/8	3/8
3/4	3/8

TACK-ON RUBBER FEET	
Dia.	Height
3/8	
1/2	

Assorted

7052-F	8
7054-F	8
7056-F	8
7050-F	8
7070-F	10

7052-N	55
7054-N	50
7056-N	30
7058-N	24
7071-N	55
7072-N	50

WALSCO

ELECTRONIC HARDWARE

RUBBER ITEMS (Cont.) & WASHERS & INSULATORS

50 line		99 line	
List Price 50c each		List Price \$1.80 each	
Catalog No.	Approx. Quantity	Catalog No.	Approx. Quantity

WALSCO CHASSIS MOUNTS



These resilient, synthetic rubber mounts are a must wherever vibration may affect performance.

— DIMENSIONS —			
A	B	C	D
3/4	1/2	1/4	3/8
1	1/2	1/4	1/32

7077-F	6
7079-F	4
7075-F	10

WALSCO RUBBER WASHER & BUMPER ASSORTMENT

Eliminate rattles and microphonics with WALSCO Rubber Washers and Bumpers. The assortment consists of round and square pieces of soft rubber.

7083-F	12
--------	----

WALSCO DIAL CORD IN SMALL PACKAGES

WALSCO cords meet the rigid standards set by the Government, Electronic Industries, and Engineering Laboratories. Made with high-abrasion-resistant Nylon over fiberglass core.

Size	Approx. Quantity
Special Thin	10
Standard Thin	10
Medium	10

7395-F	10
7396-F	10
7397-F	10

WALSCO METAL WASHERS



Precision-cut steel washer, cadmium-plated, with concentric center hole. Here are listed the small sizes most frequently used in electronic assemblies.

Screw Size	— DIMENSIONS —		
	I.D.	O.D.	Thick
#4	.125"	5/16"	1/32"
#6	.149"	3/8"	1/32"
#8	.175"	3/8"	1/32"
#10	.203"	7/16"	1/32"
1/4"	.265"	1/2"	1/32"
Assorted			

7874-F	80		
7876-F	80	7876-N	500
7878-F	80	7878-N	500
7880-F	70	7880-N	300
7882-F	50	7882-N	300
7870-F	80		

WALSCO LOCK WASHERS



Made of special steel selected for its elasticity and hardness. WALSCO offers these indispensable washers in the individual sizes most frequently needed in both electronic and electrical appliances, or in a handy assortment that belongs in all labs and shops.

For Screw Size	Approx. Quantity
#2	35
#4	50
#6	50
#8	50
#10	45
1/4"	
3/8"	
Assorted	50

7922-F	35		
7924-F	50		
7926-F	50	7926-N	300
7928-F	50	7928-N	275
7930-F	45	7930-N	275
		7932-N	200
		7935-N	125
7920-F	50		

WALSCO SPRING FRICTION WASHERS



To secure a light drag to a rotating shaft. The WALSCO assortment contains popular sizes of phosphor bronze and spring steel washers.

Assorted

7750-F	12
--------	----

WALSCO RETAINING RINGS AND "C" WASHERS



When servicing rotational components such as volume controls or record changers, it is frequently necessary to replace worn or lost retaining rings and "C" washers. Rings are made of tempered spring steel. Washers are annealed steel, cadmium plated.

"C" Washers for 3/16" shaft	7772-F	15
"C" Washers for 1/4" shaft	7774-F	15
Assorted Rings and Washers	7770-F	25

WALSCO KNOB FELT WASHERS



Space knobs from panel face with these WALSCO Felt washers and get smooth, quiet operation. Made of tough brown felt, they have a 1/4" hole to fit standard control and condenser shafts. O.D. is 3/4", thickness 1/32".

7760-F	40
--------	----

WALSCO INSULATING WASHERS

Insulation of components and controls from chassis or from each other can usually be most easily accomplished with WALSCO Insulating Washers. Precision made from vulcanized phenolic fiber.

Available
FLAT
or
EXTRUDED

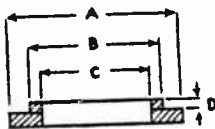

Overall thickness of extruded washers is approximately 3/32" and of the flat washers 1/32".

Fits Screw Size	— DIMENSIONS —				
	A	B	C	D	
#6	5/16	3/16	.136	1/32	Extruded Flat
	5/16136	
#8	3/8	1/4	.165	1/32	Extruded Flat & Ex.
	3/8165	
#10	3/8	.308	.195	1/32	Extruded Flat & Ex.
	3/8195	
1/4"	1/2	11/32	.255	1/32	Extruded Flat & Ex.
	1/2255	
3/8"	5/8	1/2	.380	1/32	Extruded Flat & Ex.
	5/8380	

Assortment of Flat and Extruded

7824-F	30	7856-N	125
		7836-N	250
7825-F	30	7858-N	125
		7838-N	250
7826-F	30	7860-N	100
		7840-N	250
7827-F	24	7862-N	100
		7842-N	225
7828-F	20	7864-N	85
7820-F	35	7844-N	175

WALSCO

ELECTRONIC HARDWARE

INSULATING SPACERS, FUSE CLIPS AND MISCELLANEOUS THREADED FASTENERS

50 line		99 line	
List Price 50c each		List Price \$1.80 each	
Catalog No.	Approx. Quantity	Catalog No.	Approx. Quantity

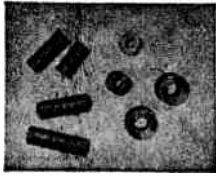

WALSCO METAL AND INSULATING SPACERS

Solve electrical and mechanical spacing and mounting problems when building or remodeling electronic equipment. Very handy for mounting sockets, switches, raising panels, chassis, and condensers. Assortment of various lengths and hole sizes.

Assorted Metal Spacers
Assorted Insulating Spacers

7620-F	12		
7630-F	12		

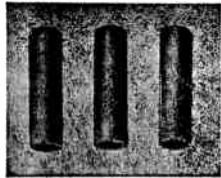

WALSCO FUSE INSULATORS

Standard fiber insulators used on automobile radio installations. Two lengths included in the assortment fit all standard 1/4" diameter fuses.

Assorted

7640-F	20		
--------	----	--	--



WALSCO FUSE CLIPS

Made of spring brass, nickel plated to defy corrosion and guarantee perfect contact. Designed for single hole mounting.

Assorted

7600-F	12		
--------	----	--	--

WALSCO STEEL SET SCREWS



WALSCO furnishes precision, hardened, headless, slotted steel set screws in sizes most frequently used in dial knobs, record changers, home and auto radios, etc.

Size
#6-32 x 3/16"
#8-32 x 3/16"
#8-32 x 1/4"
#10-32 x 1/4"
Assorted

8623-F	15		
8633-F	15		
8634-F	15		
8644-F	15		
8605-F	15	8605-N	55

WALSCO ORNAMENTAL HEAD SCREWS



When you mount a speaker or other component to a wood panel, fasten it with WALSCO Ornamental Screws. Finished in bronze, stamped with rosette design.

Size
#6-32 x 3/4"
#6-32 x 1"
#8-32 x 1-1/4"
Assorted

8252-F	25	8252-N	125
8253-F	20	8253-N	125
8255-F	12	8255-N	80
8250-F	20		

WALSCO STANDARD WOOD SCREW ASSORTMENT



This is the assortment every technician, lab, shop, and handyman should have on hand. Brass and steel round and flathead screws of popular sizes are included.

Assorted

8502-F	25		
--------	----	--	--

WALSCO SMALL ESCUTCHEON & WOOD SCREW ASSORTMENT



Extra small wood screws designed primarily for fastening name plates, escutcheons, trimmings, data plates, etc., to wood or plastic.

Assorted

8500-F	25		
--------	----	--	--

WALSCO

ELECTRONIC HARDWARE

MACHINE SELF-TAPPING, RACK SCREWS

50 line		99 line	
List Price 50c each		List Price \$1.80 each	
Catalog No.	Approx. Quantity	Catalog No.	Approx. Quantity

WALSCO STEEL MACHINE SCREWS

packaged in individual sizes
Size

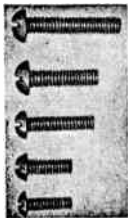

Selected to suit the electronic technician's need for screw fasteners, WALSCO Steel Machine Screws are top-quality round head, cadmium plated. They are packaged in convenient assortments or by individual sizes. Handy, inexpensive assortment for the laboratory or repair shop contains Nos. 6, 8, and 10 plated steel machine screws of various lengths.

- #2-56 x 3/16"
- #2-56 x 3/8"
- #2-56 x 1/2"
- #4-40 x 1/4"
- #4-40 x 3/8"
- #4-40 x 1/2"
- #6-32 x 1/4"
- #6-32 x 3/8"
- #6-32 x 1/2"
- #6-32 x 3/4"
- #6-32 x 1"
- †#6-32 x 2"
- #8-32 x 1/4"
- #8-32 x 3/8"
- #8-32 x 1/2"
- #8-32 x 3/4"
- #8-32 x 1"
- #10-32 x 1/2"
- #10-32 x 3/4"
- #10-32 x 1"

8023-F	40	8021-N	225
8024-F	40	8023-N	200
8042-F	40	8024-N	200
		8042-N	225
8044-F	35	8043-N	200
8062-F	40	8044-N	200
8063-F	35	8062-N	225
8064-F	30	8063-N	200
8066-F	30	8064-N	175
		8066-N	175
		8068-N	150
8078-F	15		
8082-F	30	8082-N	175
8083-F	25	8083-N	160
8084-F	25	8084-N	160
8086-F	20	8086-N	140
		*8088-N	110
8104-F	20	8104-N	125
8106-F	20	8106-N	100
8108-F	17	*8108-N	100

†This size required to fasten selenium rectifiers.

ASSORTED STANDARD MACHINE SCREWS
Various Sizes, Lengths, and Styles.

Assorted

8000-F	35	8000-N	200
--------	----	--------	-----

WALSCO SMALL MACHINE SCREW AND NUT ASSORTMENT

Extra small screws needed in experimental and repair work for fastening small parts, replacing rivets, etc. Special assortment of Nos. 2 and 4 screws with nuts to fit.

Assorted

8002-F	35		
--------	----	--	--

WALSCO SHEET METAL AND SELF-TAPPING SCREWS



Easier than riveting, faster than machine screws—WALSCO Self-tapping Screws cut their own threads in either metal or plastic. Just drill a hole and drive the screw—no nut or tapping necessary. Just the thing for mounting parts to chassis, replacing rivets, eyelets, etc. Listed here are all the popular sizes used by major manufacturers.

Size

- #6 x 1/4"
- #6 x 3/8"
- #6 x 1/2"
- #6 x 3/4"
- #6 x 1"
- #8 x 1/4"
- #8 x 3/8"
- #8 x 1/2"
- #8 x 3/4"
- #8 x 1"
- #10 x 3/8"
- #10 x 1/2"
- #10 x 3/4"
- Assorted

8362-F	30	8362-N	150
8363-F	25	8363-N	150
8364-F	25	8364-N	150
8366-F	20	8366-N	125
8368-F	20	8368-N	125
8382-F	20	8382-N	125
8383-F	20	8383-N	125
8384-F	20	8384-N	125
8386-F	15	8386-N	80
8388-F	15	8388-N	80
8403-F	15	8403-N	80
8404-F	15	8404-N	80
8406-F	12	8406-N	80
8300-F	25	8300-N	125

WALSCO RACK SCREWS AND CUP WASHERS



Nickel-plated WALSCO oval-head screws and cup washers give a workmanlike finish to panels mounted on racks or in cabinets. Recommended for studio and laboratory installations.

- Screws
- #6-32 x 5/8"
 - #8-32 x 3/8"
 - #10-32 x 3/4"
- Washers
- #6 (7/16" O.D.)
 - #8 (1/2" O.D.)
 - #10 (9/16" O.D.)
- Assorted Screws and Washers

8265-F	30	8265-N	175
8269-F	25	8269-N	150
8273-F	20	8273-N	100
7806-F	45	7806-N	400
7808-F	45	7808-N	300
7810-F	35	7810-N	250
8005-F	15		

WALSCO

ELECTRONIC HARDWARE

HEX, LOCK, SPECIAL AND SPEED NUTS AND MISCELLANEOUS FASTENERS

50 line		99 line	
List Price 50c each		List Price \$1.80 each	
Catalog No.	Approx. Quantity	Catalog No.	Approx. Quantity

WALSCO HEX NUTS



Precision tapped for effortless assembly, cadmium plated for corrosion resistance and neat appearance; WALSCO nuts are "Small Pattern" as preferred in the electronics industry.

Steel, Cadmium Plated	Size #2-56	8802-F	30	8802-N	175	
	#4-40	8804-F	30	8804-N	175	
	#6-32	8806-F	30	8806-N	180	
	#8-32	8808-F	30	8808-N	180	
	#10-32	8810-F	30	8810-N	175	
	Assorted	8800-F	30	8800-N	175	
	Brass	#6-32	8846-F	25	8846-N	150
		#8-32	8848-F	15	8848-N	80
		#10-32			8850-N	80

WALSCO SPECIAL MOUNTING NUTS

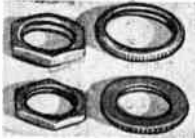

For panel mounting components with threaded bushings such as potentiometers, volume controls, jacks, toggle switches, etc.

Description	3/8" x 32 Vol. Control Hex Nut	8923-F	15	8923-N	85
	15/32" x 32 Toggle Switch Hex Nut	8924-F	10	8924-N	50
	15/32" x 32 Toggle Switch Ring Nut	8926-F	8	8926-N	40
	Assorted	8920-F	12		

WALSCO ACORN NUTS



Give a well-finished look to panel assemblies, test instruments, cabinets, etc., with these cadmium plated, double self-locking WALSCO Acorn Nuts. Assortment contains sizes 6-32, 8-32, and 10-32 nuts.

Assorted	8950-F	10		
----------	--------	----	--	--

WALSCO KNURLED THUMB NUTS



Precision-made, brass knurled thumb nuts preferred for securing conductors to binding posts, batteries, etc.

Size #6-32	8943-F	8		
#8-32	8944-F	8		
#10-32	8945-F	5		

WALSCO WING NUTS



Designed for easy-on, easy-off installation without tools. Frequently used for bolting chassis to supports in wood cabinets, fastening lids to car radios, etc.

Size #6-32	8933-F	15		
#8-32	8934-F	10		
#10-32	8935-F	8		

WALSCO SPEED NUTS

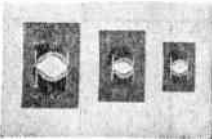

Used in record changer assemblies, tuning units, etc. Replacements will frequently be needed by the busy serviceman and shop.

Assorted	8960-F	30		
----------	--------	----	--	--

WALSCO SNAP-IN TRIMOUNTS

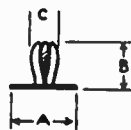

For Hole	— DIMENSIONS —							
	A	B	C					
	1/8"	9/32"	13/64"				1/64"	
	5/32"	23/64"	9/32"				3/16"	
5/32"	3/8"	5/8"	5/32"	Assorted	7373-F	25	7373-N	125
					7375-F	20	7375-N	100
					7377-F	15	7377-N	85
					7370-F	20		

For light duty assembly, WALSCO Snap-in Trimounts provide a neat, handsome fastening. Use on back covers, dial scales, chassis, built-in antennas, etc.

WALSCO RIVET ASSORTMENT



Contains dozens of rivets—hollow, solid, split—and metals—brass, copper, aluminum. From 1/8" to 3/8" diameter and up to 3/4" length.

Assorted	7525-F	50		
----------	--------	----	--	--

WALSCO TV INTERLOCK CORD RIVET ASSORTMENT

Assortment of rivets and washers needed to fasten interlock cords to back of TV set. Contains sizes for fastening interlock receptacles to chassis.

Assorted Rivets and Washers	7527-F			
-----------------------------	--------	--	--	--

WALSCO EYELET ASSORTMENT

Brass eyelets of various diameters and lengths.

Assorted	7510-F	50		
----------	--------	----	--	--

WALSCO SMALL COTTER AND HAIR PINS



Assortment of most popular sizes of cotter and hair pins. Valuable aid in repair of radios and phonograph mechanisms.







	7380-F	50		
--	--------	----	--	--

WALSCO

ELECTRONIC HARDWARE

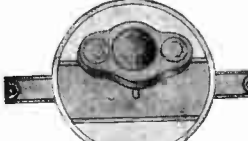
MISC. FASTENERS, BRACKETS, PLUGS, PHONE TIPS

50 line		99 line	
List Price 50c each		List Price \$1.80 each	
Catalog No.	Approx. Quantity	Catalog No.	Approx. Quantity

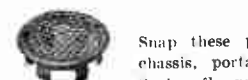
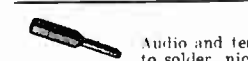
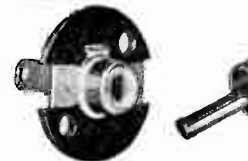
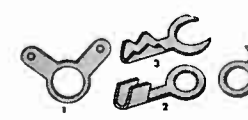
	<p>WALSCO CABLE CLAMPS</p> <p>Made of heavy gauge steel cadmium plated, perfectly punched and stamped. Holes accommodate No. 6 and No. 8 screws. $\frac{3}{8}$" wide. Available in three sizes for cables from $\frac{1}{8}$" to $\frac{5}{16}$" diameter.</p> <p>For Cable Diameter $\frac{1}{8}$" to $\frac{3}{16}$" $\frac{3}{16}$" to $\frac{1}{4}$" $\frac{1}{4}$" to $\frac{5}{16}$" Assorted</p>	<p>7502-F 25 7503-F 20 7505-F 16 7500-F 20</p>	<p>25 20 16 20</p>	<p>7502-N 125 7503-N 100 7505-N 75</p>	<p>125 100 75</p>
	<p>WALSCO ESCUTCHEON PIN ASSORTMENT</p> <p>The quick, neat way to fasten name plates and markers to wood, wals, or plywood. WALSCO Escutcheon Pins are brass finished, packaged in various sizes and lengths from $\frac{1}{4}$" to $\frac{5}{8}$".</p> <p>Assorted</p>	<p>7560-F</p>	<p>100</p>		
	<p>WALSCO TWIN-LEAD WIRING NAILS</p> <p>Improve the appearance of TV installations by fastening 300-ohm twin-lead to walls and mouldings. Line impedance not affected because ornamental head consists almost entirely of insulating material.</p>	<p>7565-F</p>	<p>35</p>	<p>7565-N</p>	<p>200</p>
	<p>WALSCO ANGLE BRACKET ASSORTMENT</p> <p>Instantly solve problems of mounting components at right angles to panel or chassis with the proper WALSCO Angle Bracket. Assortment of plated steel or brass brackets to fill every need of the experimenter, technician, or "ham."</p> <p>Assorted</p>	<p>7570-F</p>	<p>15</p>		
	<p>WALSCO SPADE BOLTS</p> <p>For dozens of jobs no other type fastener can perform quite as well. Indispensable for attaching condensers, coils, cans, and many other items. Stud size 6-32; hole for No. 6 screw or $\frac{1}{8}$" rivet.</p> <p>Length $\frac{3}{4}$" (Straight) $\frac{3}{4}$" (Offset) Assorted</p>	<p>8570-F</p>	<p>15</p>	<p>8572-I 8573-N</p>	<p>75 45</p>
	<p>WALSCO SNAP-HOLE PLUGS</p> <p>The quickest, simplest way ever devised to cover a hole in chassis or panel. Spring flanges hold polished nickel-plated flat-head button firmly in place. Use WALSCO Snap-hole Plugs to seal adjustments, cover unused holes, etc.</p> <p>Fits Hole Diameter $\frac{1}{4}$" $\frac{3}{8}$" $\frac{1}{2}$" $\frac{5}{8}$" $\frac{3}{4}$" 1" Assorted</p>	<p>7306-F 7308-F 7310-F 7312-F 7314-F 7316-F 7300-F</p>	<p>8 8 6 6 5 5 6</p>	<p>7306-N 7308-N 7310-N 7312-N 7314-N 7316-N</p>	<p>50 50 40 40 25 20</p>
	<p>WALSCO VENTILATING HOLE PLUGS</p> <p>Snap these protective screen coverings into ventilating holes on chassis, portable equipment cases, amplifiers, amateur rigs, etc. Spring flange holds plug in place.</p> <p>Assorted</p>	<p>7330-F</p>	<p>3</p>		
	<p>WALSCO PHONE TIPS</p> <p>Audio and test circuits, designed to fit all standard tip jacks. Made of brass, easy to solder, nickel-plated for long wear and good contact.</p>	<p>7645-F</p>	<p>10</p>	<p>7645-N</p>	<p>60</p>
	<p>WALSCO PHONO PLUGS AND JACKS</p> <p>Standard, nickel-plated plugs and jacks for connecting record players, pick-ups, auto radio antennas, etc. Recommended for all single conductor, shielded cable connections.</p> <p>Plugs Jacks</p>	<p>7665-F 7667-F</p>	<p>4 3</p>		
<p>WALSCO TERMINAL LUGS</p> <p>Ready-tinned WALSCO Terminal Lugs are designed to simplify your assembly problems. The types and sizes listed here contain lugs you will need for assembly, experimentation and repair.</p> 	<p>For Screw Size</p> <p>1 Asstd. #6 & #8 #6 #8</p> <p>2 Asstd. #6 & #8 #6 #8</p> <p>3 Asstd. #6 & #8 #6 #8</p> <p>4 Asstd. #6 & #8 #6 #8</p> <p>5 Asstd. #6 & #8 #6 #8</p> <p>6 Asstd. #6 & #8 #6 #8 #10</p> <p>7 #10</p> <p>8 #10</p> <p>9 Assorted Types</p>	<p>7110-F 7120-F 7130-F 7140-F 7150-F 7160-F 7170-F 7180-F 7190-F 7100-F</p>	<p>20 25 25 16 15 35 25 15 8 30</p>	<p>7116-N 7118-N 7126-N 7128-N 7136-N 7138-N 7146-N 7148-N 7156-N 7158-N 7166-N 7168-N 7169-N 7179-N 7189-N 7199-N</p>	<p>125 125 125 125 135 135 90 90 100 100 250 250 200 140 80 35</p>

WALSCO

ELECTRONIC HARDWARE

50 line List Price 50c each		99 line List Price \$1.00 each	
Catalog No.	Approx. Quantity	Catalog No.	Approx. Quantity

STRIPS, CAPS, CLIPS, SPRINGS, SOCKET WRENCHES



WALSCO TERMINAL STRIPS

To organize wire distribution or to mount small parts that must be insulated from chassis. Solder-coated terminals are riveted to high-grade phenolic base. Assortment contains several popular types.

Assortment of Various Size Strips

7250-F

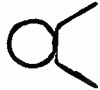

WALSCO GRID CAP ASSORTMENT

Assortment contains 1/4" and 3/8" spring clips for TV high voltage tubes.

Assorted

7609-F

8



WALSCO TV GRID CLIP ASSORTMENT

Precision stamped to fit securely all standard metal and glass tubes. Assortment includes clip for high-voltage TV rectifier tubes.

Assorted

7610-F

5



WALSCO SPRING CONNECTOR CLIPS

Make fast connection with excellent electrical contact. No tools required for connecting or disconnecting. Recommended for "breadboard" work. Made of spring brass or phosphor bronze.

For Wires #16 gauge and smaller #12 to #18 gauge Assorted

7592-F

15

7594-F

14

7590-F

12

WALSCO DIAL DRIVE SPRINGS

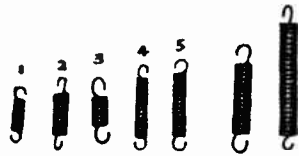

Carefully-looped ends greatly simplify installation. Eliminate fumbling. Rust-proof cadmium plated. Available in all standard sizes. Springs are shown actual size.

— DIMENSIONS —		
Overall Length	Diam.	Wire Thickness
1/2"	1/8"	.016"
5/8"	5/32"	.018"
9/16"	3/16"	.020"
3/4"	1/8"	.016"
3/4"	5/32"	.020"
Assorted Small Springs		
Assorted (Large and Small)		

7404-F

10

7405-F

10

7407-F

10

7409-F

8

7411-F

8

7400-F

10

7401-F

8

7401-N

50

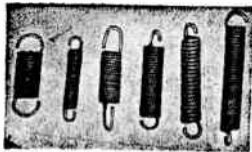

WALSCO EXPANSION SPRINGS

Holds parts or controls under tension. Will fill need of serviceman or technician. Contains many different sizes.

Assorted Small Springs
Assorted Large Springs

7420-F

10

7421-F

10

WALSCO COMPRESSION SPRINGS

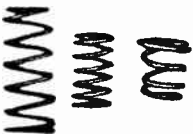

These ordinary hard-to-get compression springs are offered in two wide assortments by WALSCO to solve radio and electronic equipment, motors, appliance problems, etc.

Assorted Small Springs
Assorted Large Springs

7440-F

20

7441-F

15

WALSCO RADIO KNOB SPRINGS



Made of finest grade tempered spring steel; available in all standard sizes and shapes.

1
2
TV 3
4
5
6
7
8
9

7485-F

8

7486-F

10

7488-F

12

7490-F

12

7491-F

20

7493-F

24

7495-F

15

7496-F

25

7497-F

8

7498-F

10

7480-F

18

7481-F

10

Assorted TV Knob Spring Assortment

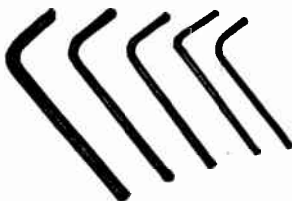

WALSCO KEY WRENCHES

Offered in assortments of sizes to fit practically all standard socket screws used in electronic equipment. In the Hex Assortment are wrenches to fit set screws No. 4 to No. 10 and cap screws No. 2 to No. 6. In the Spline Assortment are wrenches to fit all set screws up to 1/4" and cap screws up to No. 8.

Hex (Allen) Wrench Assortment
Spline (Bristol) Wrench Assortment

8600-F

4

8602-F

4

**HARDWARE ASSORTMENT
MISCELLANEOUS ITEMS
SPECIAL TOOLS AND WIRE STRIPPERS**

WALSCO

walesco quality earned its reputation

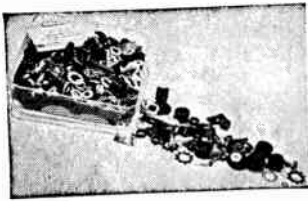

**WALSCO
HARDWARE
ASSORTMENT**

Here are parts to fill the occasional need — the nut, washer, grommet, spring, clamp, eyelet, or terminal of the size and type you don't ordinarily stock. Contains about 600 to 1000 pieces.

List Price Dealer's Net

K3003 Hardware Assortment \$1.80 \$1.08



WALSCO KNOB ASSORTMENT

A real bargain in every way, it contains knobs in different colors — brown, ivory, some red, some clear . . . knobs of many sizes, and various shapes.

Cat. No. Dealer's Net
K-100 Approx. 25 assorted knobs \$0.95



WALSCO STROBOSCOPE DISC

The best way to check and adjust turntable speed. At correct speeds lines on the disc remain stationary when viewed under 60 cycle AC light. Three sets of lines for checking 78, 5, and 33 1/3 rpm speeds.

List Price
Cat. No. 949 Stroboscope Disc \$0.17
Standard Packing: 25



**WALSCO
WALL RACKS**

Keep small hardware and chemical containers in place, within easy reach. And your workbench clear. Made of satin-finish aluminum with polished edges.

List Price
Cat. No. 995 Wall Racks for eight 2-oz. bottles \$1.40
996 Wall Racks holding 7 Walesco 99 Line hardware, Walesco dial cord, or Cat. No. 998 plastic storage boxes 1.40



**WALSCO
GLASS JARS
AND PLASTIC BOXES**

These see-through containers provide the most efficient method yet devised for "filing" small hardware items. Keep small parts clean, rust-free, ready-to-use, easy-to-find.

List Price
Cat. No. 997 Plastic Box with 4 compartments and telescoping lid. 4 1/2" square, 1 3/4" high. (Standard pack: 24) \$0.70
998 Plastic Box with Sliding Lid (99 Line size)28
988A Plastic Box with Sliding Lid (50 Line size)10
999 Glass Jar, 2 oz. size. (Standard pack: 36)13

WALSCO VIEW BINS

Keep small parts sorted, visible, dust-free with WALSCO View-Bins. Most practical method ever devised for storing plugs, knobs, switches, connectors, condensers, resistors, coils, etc.



Each bin can be divided into two compartments with readily insertable metal divider furnished for each. Bins can be removed with one hand, but cannot be pulled out accidentally. Open bin does not block view or access to bin below. Windows made of clear, high-strength glass. Silver-gray hammertone finish. Welded steel construction.

List Price
Cat. No. 1010-6 6 compartments 16" x 8" x 5" \$ 4.95
1010-12 12 compartments 16" x 16" x 6" 9.50
1010-24 24 compartments 30" x 16" x 6" 16.95

WALSCO SERVICE TWEEZERS



List Price
Cat. No. 570 Self-Closing Tweezer with cross-over action, 6 1/2" long, serrated, blunt points \$1.05
(Standard Package: Display card with 10 tweezers. Cat. No. 570D)
571 Heavy-Duty Tweezer with slide-lock feature. Length 6 1/2", serrated, blunt points 1.30
(Standard Package: Display card with 10 tweezers. Cat. No. 571D)
572 Precision Tweezer with narrow, pointed ends especially suitable for delicate work. Over-all length 4 1/2"60
(Standard Package: Display card with 20 tweezers. Cat. No. 572-D)
575 Tweezer Kit, made of durable leatherette, containing one each of the above listed tweezers. Provides servicemen with necessary tweezers for every need. Neat, compact, handy 3.55
(Standard Package: Display of 12 Kits Cat. No. 575-D)

WALSCO PROTECTO TUBE

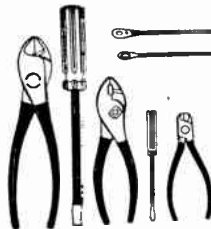

Insulate your own favorite tools: Insulate handles of pliers, wire cutters, screwdriver shanks neatly and effectively. WALSCO Protecto Tube is easy to apply. Soak tubing in "Expanding Solution," then slip over part to be insulated. It dries and shrinks skin tight. Will not crack or shatter even under extremes of temperature. Supplied in variety of colors to aid in identifying tools.

List Price \$1.80
Cat. No. K-18

WALSCO ALL-PURPOSE WIRE STRIPPERS

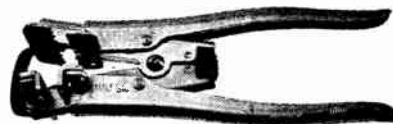

Strip from 700 to 1,000 wires an hour! Cut through insulation without nicking conductor. Built-in locking device prevents crushing of stranded wire. Strips all wires from 16 to 22 gauge. Strips 300-ohm twin lead. Wire cutter is part of the same tool. Made of steel, lasts a lifetime. Blades are precision ground. Equally effective for use with electrical, automotive, aviation, telephone wires, etc.

List Price Dealer's Net
Cat. No. Description Price Net
590 WALSCO All-Purpose Wire Stripper \$8.25 \$4.95
590-1 Replacement Blade Set for No. 590 2.00 1.20
591 WALSCO "Wide-Range" Model for Electrical Trade. Strips all wire gauges from No. 10 to No. 22. Similar construction to No. 590 but does not include cutter. Will not strip 300 ohm twin-lead 8.25 4.95
591-1 Replacement Blade Set for No. 591 2.00 1.20

WALSCO TWISTO WIRE STRIPPER



Patented low-cost, pocket-size, precision stripper: Strip insulation right up next to a soldered connection, plug, or socket. Can be inserted into chassis and assemblies to strip wires without removing them. Quick micrometertype adjustment is set instantaneously for a.w.g. wire sizes 12 to 22. Features a built-in stop for accurately-uniform, repetitive production stripping. To operate, you merely dial wire size, insert wire in hollow end, set sliding collar with thumb, twist and pull. The most compact precision wire stripper on the market!

List Price
Cat. No. 592 WALSCO Twisto Stripper \$4.50
(Standard Pack: 12)
592-3P Replacement blades, per set75
(Standard Pack: 12)

ALIGNMENT TOOLS KITS

WALSCO

walSCO quality earned its reputation

WALSCO ALIGNMENT TOOLS

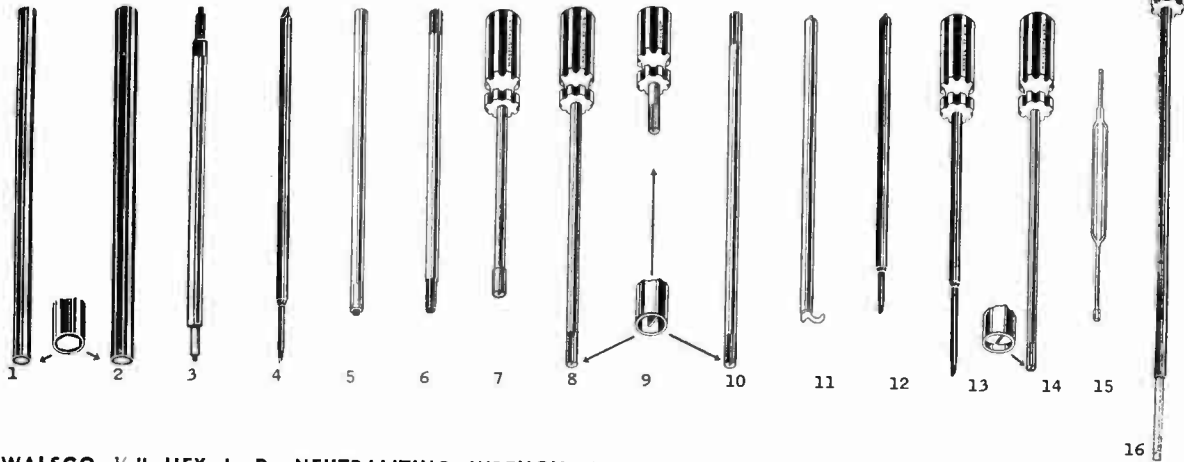

WALSCO 1/4" HEX. I. D. NEUTRALIZING WRENCH.
Very durable. Can be cut if corners become rounded from wear. Over-all length—7 1/2". O.D.—3/8" round.
Cat. No. 2503—Lo-loss Plastic Wrench Picture No. 1 List Price \$0.45

WALSCO 5/16" HEX. I. D. NEUTRALIZING WRENCH.
Same construction as 1/4" wrench listed above. Over-all length—7 1/2". O.D.—1/4".
Cat. No. 2508—Lo-loss Plastic Wrench Picture No. 2 List Price \$0.45

WALSCO DUPLEX ALIGNMENT SCREWDRIVER.
Precision made. Ground or molded to fit large or small screws. Width of blade on large end—3/8"; on small end—5/16". Thickness to conform to standard slot dimensions. Over-all length—7".
Cat. No. 2520—Fibre Screwdriver Picture No. 4 List Price \$0.55

WALSCO METAL TIP ALIGNMENT SCREWDRIVER.
Butyrate handle. This tool combines the low capacity effect of an alignment tool with the mechanical strength of a metal screwdriver. Diameter—3/16"; over-all length—6".
Cat. No. 2525—Alignment Screwdriver Picture No. 5 List Price \$0.50

WALSCO TUNING WAND.
Made from Butyrate rod with inductance-increasing powdered iron core on one end and inductance-reducing brass piece on opposite end. Over-all length—6".
Cat. No. 2540—Tuning Wand Picture No. 6 List Price \$0.55

WALSCO "K-TRAN" ALIGNMENT TOOL.
For adjustment of all miniature (K-Tran) I.F. transformers. Made of tough bone fibre. One end is machined to fit "K-tran" slots; other end is equipped with low-capacity metal screwdriver tip.
Cat. No. 2515—"K-Tran" Alignment Tool Picture No. 12 List Price \$0.80

WALSCO TV OSCILLATOR ALIGNMENT TOOLS.

Cat. No.	Picture No.	List Price
2518—For Philco Receivers	7	\$1.75
2522—For Receivers with "Standard Coil" Front Ends	13	1.10
2523—Extra long (12"); with replaceable super-tough molded nylon tip, for general front-end alignment without removing from cabinet	Picture No. 16	1.80
2523-1—Replacement Tip for tool No. 2523 (Standard Pack: 20 Tips)		0.30
5228—"Slug Saver" tuner tool. "Step" design prevents "loosing" slugs when aligning "standard coil" front ends. 7 1/2" long	Picture No. 3	1.05

WALSCO TV I.F. ALIGNMENT SCREWDRIVERS.
Standard Tools for all TV and FM sets. Made of new flexible low-loss plastic with thin precision screwdriver tips.

Cat. No.	Picture No.	List Price
2516—8 1/2" long, for No. 6 Studs	8	\$1.10
2517—2" long, for No. 6 Studs	9	0.70
2519—7" long—1 end for No. 6 Studs; other end for No. 4 Studs	10	1.05
2524—8 1/2" long, Slotted Type, for No. 6 Studs	14	1.10
2526—5" long, Molded-Nylon Tool, hex stud one end, very small screwdriver other end. For Zenith, Hoffman, Raytheon, and other sets	Picture No. 15	0.55
2527—2 1/2" long molded hi-impact Styrene, for RCA, Zenith and other UHF tuners (photo attached)		0.70

WALSCO WIRE DRESSING AND ALIGNMENT TOOL.
Made with thin (3/32") Butyrate handle, 7" long. Special tool on one end for dressing wires and finding loose connections or shorts. Other end has low capacity metal screwdriver tip.
Cat. No. 2512—Wire Dressing and Alignment Tool Picture No. 11 List Price \$0.60

WALSCO TV-FM ALIGNMENT TOOL KITS

Handy TV-FM alignment tool kit or wall rack. Durable leatherette kit gives servicemen every tool necessary to align TV and FM sets. Handy wall rack for use above bench in shop. Provides proper place for each tool, and always handy.

Cat. No.	List Price
580—12 Tools in leatherette case	\$12.65
581—12 Tools on wall rack	12.65

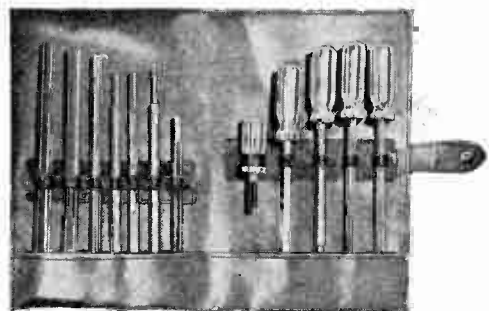

**SPECIAL TOOLS
DIAL CORDS
UNIBELT**

WALSCO

walSCO quality earned its reputation

WALSCO HEX AND SPLINE WRENCH KIT



All of the wrenches listed above are included in this kit. Arranged by size in a durable leatherette case with double snaps, the right wrench is easy to find, the complete set is easy to carry.

Cat. No.	List Price	Dir. Net
560 Wrench Kit	\$1.80	\$1.08
Standard Package	— 25	

WALSCO INSPECTION MIRROR



High-visibility polished glass reflection mirror protected against breakage by a heavy gauge plated metal backing. Has red plastic, insulated grip.

Cat. No.	List Price
554	\$0.55
554D Display Card of 12 No. 554	6.60

WALSCO NYLON DIAL CORD



Made of genuine Nylon braided over a fiberglass core. Stays taut in service. Is chemically treated to increase grip; will not slip. 25 and 100 foot spools packaged in clear plastic, re-usable storage boxes with sliding lids. Proper size for practically any set manufactured since 1934.

Cat. No.	Diam.	Breaking Strength	LIST PRICES		
			25 Feet Per Spool	100	500
"SPECIAL THIN"					
35	.025"	15 lbs.	\$1.40		
35-1C	.025"	15 lbs.		\$4.95	
35-5C	.025"	15 lbs.			\$14.30
STANDARD					
39	.082"	20 lbs.	\$1.40		
39-1C	.082"	20 lbs.		\$4.95	
39-5C	.082"	20 lbs.			\$14.30
MEDIUM					
34	.040"	35 lbs.	\$1.40		
34-1C	.040"	35 lbs.		\$4.95	
34-5C	.040"	35 lbs.			\$17.60
Also available in 50 Line packages. See page 4.					
HEAVY					
(used on many Philco and Majestic sets)					
33	.060"		\$1.90		
33-1C	.060"			\$5.05	
Standard Package: 12					

WALSCO BRONZE DIAL CABLES

strong, flexible, uniform size and quality

When a control-dial linkage requires the strength that only metal can give, WALSCO Bronze Dial Cable is the material to use.

CADMIUM BRONZE CABLE—16-strand, .039" o.d., 50 lb. breaking strength. Good flexibility, excellent abrasion resistance. Specially braided so it will not unravel. Fiberglass core adds to flexibility.

No.	Length	List Price
31	25 ft.	\$ 1.30
31-1C	100 ft.	3.80
31-5C	500 ft.	15.40

PHOSPHOR BRONZE CABLE—42-strand, .032" diam., 40 lb. breaking strength. Numerous strands give cable extraordinary flexibility. Use wherever strong, flexible cable is required.

No.	Length	List Price
30	25 ft.	\$ 1.65
30-1C	100 ft.	5.50
30-5C	500 ft.	22.00

SPECIAL THIN BRONZE CABLE—An extra-thin cable with diameter of only .022". Surprisingly strong and flexible. Non-ravelling.

No.	Length	List Price
32	25 ft.	\$ 1.40
32-1C	100 ft.	4.95
32-5C	500 ft.	14.30

Standard Package: 12

WALSCO STRAIGHT-N'-PULL



3 Tools in 1! Small tube pin straightener for 7 x 9 pin miniature tubes and puller. Includes metal holder to fasten permanently to bench.

Cat. No.	List Price
565	\$1.25
565D—Standard Pack Display of 24	\$30.00

WALSCO SOLDER-EASE TOOL



For quick, easy soldering and unsoldering terminals, sockets, etc. Forked tool end and brush of stainless steel—can't stick to solder.

Cat. No.	List Price
2529—8" long, plastic handle	\$1.65

SERVICEMAN'S TOOL POUCH and BELT

Rawhide leather holds tool supply within easy reach. Attaches to belt. Ideal for all service calls.

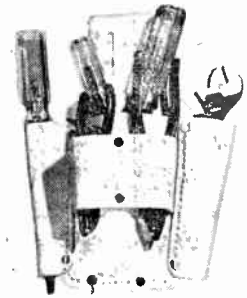

Cat. No.	List Price
510—(Pouch)	(Dir. Net) \$4.25
512—(Belt)	(Dir. Net) \$3.25
(Not shown)	

WALSCO DIAL DRIVE BELTS

precision-made, no stretch, no slip, very strong

Specially treated to maintain maximum friction through years of trouble-free use. WALSCO Dial Drive Belts have earned a reputation for dependability. Best quality materials assure enduring strength. WALSCO guarantees these belts to fit perfectly, 95 different sizes for any set manufactured since 1930.



Cat. No.	Description	List Price
1101-1195	(Complete reference chart free upon request)	\$ 0.50
1195	for RCA TV Tuner	.30
K-250	KIT of 25 most popular belts	12.50
K-260	KIT of 50 most popular belts	26.00
K-270	KIT of 100 belts—all sizes	50.00

WALSCO DIAL CORD CLIPS

easy to use, fit all standard cords

Make an easy task of a fussy chore. With the right clip in the right place at the right time, you can save many precious minutes of fumbling with cord ends. This assortment of WALSCO Dial Cord Clips contains the proper sizes for all standard thicknesses of cords.



Cat. No.	List Price per pkg.
7745-F Approximately 35 Clips	\$0.50

For bulk quantity prices on these items, see WALSCO Industrial and Bulk Price List, available upon request.

WALSCO

walSCO quality earned its reputation

WALSCO PHONO-MOTOR DRIVES

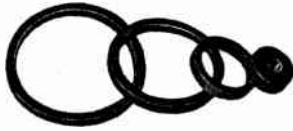

Cut and ground with precision to assure constant, uniform speed, WALSCO Phono-motor Drives are made of abrasion-resistant synthetic rubber for long wear.

Cat. No.	I.D.	O.D.	Thick	No. of Drives per pkg.	Used on	List Price per pkg.
7014-F	5/8"	1 1/8"	3/8"	4	Most 2 & 3 speed record Changers (VM, GI, etc.)	\$0.50
7016-F	2"	2 3/8"	3/8"	2	Gen. Indust. Mod. LX & RX	.50
7017-F	1 1/2"	1 3/4"	1/8"	3	Alliance, Seeburg, G.E. V. M. 400	.50
7018-F	7/8"	1 1/8"	7/8"	4	Seeburg, R.C.A., G.E.	.50
7019-F	1 1/8"	1 3/8"	1/4"	4	Philco, R.C.A., etc.	.50
7020-F	5 3/4"	6"	1/8"	1	Detrola	.50
7022-F	1 3/2"	1 1/2"	1/8"	3	G.I. Recorder/Changer	.50
760-23	1 1/8"	1 1/8"	1/4"	2	R.C.A., RP-176, 177 and most pre-war R.C.A. Changers. Also on G.E. 809-J, etc.	.45
761-23	4 1/2"	5 1/2"	5/8"	1	Same as #760-23	1.10
760-24	2 3/8"	3 3/8"	1/4"	1	R.C.A. 960015, 960280, 960276. Also most Admiral and Crescent post-war changers	.55
†760-25	Spring Drive			1	Detrola-Utah	.55

This is a COMPLETE Phono Drive list and partially duplicates drives shown on Page 3.

WALSCO PHONO TURNTABLE FELTS

brown felt, accurately die-cut

On every overhaul job recommend a new turntable felt to prevent slippage of recordings, and to protect the record. Concentricity is assured because both the center hole and outer circle are cut by the same die.

USE WALSCO FABRIC CEMENT FOR ATTACHING

Cat. No.	Size	List Price
350-8	7 7/8" diameter	\$0.50
350-9	8 3/8" diameter	.50
350-10	9 3/8" diameter	.70
350-12	11 7/8" diameter	.85

WALSCO LOOP ANTENNA

For all small radios, 3 times the Q of regular loop yet occupies fraction of space. Mounts in any position with bracket included. Non-directional. Adjusts for any set, any locality.

Cat. No. 975 List Price \$1.10
Standard Pack: 50

WALSCO SPEAKER ADJUSTMENT SHIMS

non-magnetic, corrosion-resistant, tempered metal



Here is an assortment of plainly marked, easy to carry speaker adjustment shims—indispensable to the serviceman when adjusting voice coils. You get

16 shims in four sizes—.004", .006", .008" and .010". They are made of spring-tempered, corrosion-resistant, non-magnetic metal. Each is clearly marked for immediate identification.

Cat. No.	Description	List Price
2550	16 Assorted Shims—4 of each size	\$0.75

For bulk quantity prices on these items, see WALSCO Industrial and Bulk Price List, available upon request.

WALSCO STANDARD TEST RECORDS

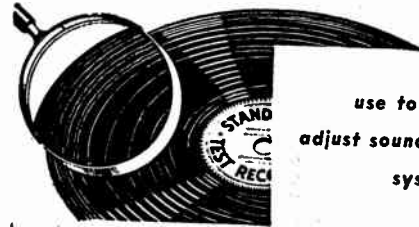

use to test and adjust sound reproduction systems

A set of these WALSCO Test Records quickly furnishes the electronic engineer or technician with complete data for detecting and remedying defects in pickups, amplifiers, speakers, record changers, and turntables. Recordings are made of long-wearing plastic selected for its low surface noise. They are unbreakable in normal use, and one set will last for years.

Cat. No. 720-6—Set of six 10" records consisting of one each of the following: Record No. 720, 721, 725, 726, 727, 728. With this set a complete mechanical and audio check can be run on a phono system quickly and accurately. Needed by every laboratory and service shop. List Price \$10.90

Cat. No. 720—10" record with accelerated pitch. Playing time approximately 45 sec. Lead-in grooves modulated with 3 tones to indicate set-down position of pick-up. Proper tripping action indicated by tone signals at end of record. Both sides of record identical. List Price \$1.80

Cat. No. 721—10" record. One side with accelerated pitch and without starting spiral for checking "feed-in" or pick-up. Other side same as No. 720. List Price \$1.80

Cat. No. 725—10" record. One side: Sweep Frequency Record at N.A.B. standard level. Range 10,000 to 50 c.p.s. Cross-over to constant amplitude at 500 c.p.s. Other side same as No. 720. List Price \$2.10

Cat. No. 726—10" record. One side: Test Frequency Record at N.A.B. standard level. Range 10,000 to 50 c.p.s. in 16 steps. Other side same as No. 720. List Price \$2.10

Cat. No. 727—10" record. One side contains 1000 and 400-cycle tone for 1 min. each. Especially designed for testing irregular turntable speed ("WOW"). Other side same as No. 720. List Price \$2.10

Cat. No. 728—10" record. One side contains silent (unmodulated) groove for checking turntable rumble. Other side same as No. 720. List Price \$1.80

groove for checking turntable rumble. Other side same as No. 720. Designed for use in connection with set No. 720-6 in checking performance of intermix changers. List Price \$10.90

WALSCO PHONO PLUG AND JACK

This WALSCO plug and jack provide a highly efficient means of joining single conductor shielded leads. Widely used in making record player, pick-up, or auto antenna connections.

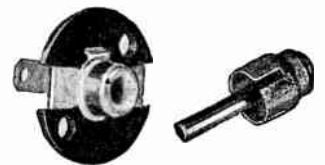

Made of brass, nickel plated to assure corrosion-free contact surface.

Cat. No.	Description	List Price per Pkg.
7665-F	Package of 4 Plugs	\$0.50
7667-F	Package of 3 Jacks	.50

WALSCO PLASTIC DIAL CRYSTALS

The excellent optical qualities of WALSCO Plastic Convex Dial Crystal make it the preferred dial window for custom construction or replacement. Unbreakable, shatterproof, it will not fog with age. You can easily use scissors or knife to cut plastic to correct size. Press or cement in place.

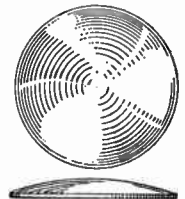

Cat. No.	Size	List Price
990	6" Maximum Diameter	\$1.20
992	9" Maximum Diameter	2.00
994	8" x 10" Flat Sheet	1.80

Use WALSCO Plastic Cement for Installing

**PLASTIC CEMENTS
SOLVENTS
CLEANING & LUBRICATING
COMPOUNDS**

WALSCO

walSCO quality earned its reputation

WALSCO TUNERCLEAN

The royal purple u.h.f. contact cleaner. Thoroughly cleans corrosion and dirt from v.h.f. and u.h.f. switch contacts in TV tuners, etc.; lubricates contact surfaces to give smoother operation, longer life, leaves a corrosion-inhibiting, protective film on contact surfaces after solvents evaporate.

Cat. No.	List Price
105—1 oz. bottle	\$0.85
106—2 oz. bottle	1.60
108—1 pint	12.50

1. WALSCO VINYLITE CEMENT

For porous materials such as paper, leather, cloth and plastics and non-porous materials. Air dries; has amazing thermo-setting properties. As it cools, the cement sets into a tough, flexible, waterproof bond.

Cat. No.	List Price
25—2 oz. bottle	\$0.75

2. WALSCO PLASTIC CEMENT

Cements plastics, metal, wood, glass, and many other materials with a water-proof, heat-resisting, remarkably strong bond. Makes an excellent general household cement, model airplane cement, etc.

Cat. No.	List Price	Cat. No.	List Price
41—1 1/4 oz. tube	\$0.60	44—4 oz. bottle	\$1.20
42—2 oz. bottle	.65	48—8 oz. bottle	1.90

3. WALSCO LUCITE CEMENT

Crystal clear, fast-drying acrylic cement dries fast, forms a bond as strong as the original material, makes an almost invisible joint. Recommended for building components, models, boxes, and cabinets of lucite.

Cat. No.	List Price
165—2 oz. bottle	\$0.65

4. WALSCO RADIO CEMENT

A clear, general-purpose, super-strength adhesive. Fast drying, elastic adhesive, won't become brittle with age. Especially for speaker manufacture and repair; not affected by vibration, high temperature, moisture, or oil. Available in a range of sizes to suit every user.

Cat. No.	List Price	Cat. No.	List Price
51—1 1/4 oz. tube	\$0.60	58—8 oz. bottle	\$1.90
52—2 oz. bottle	.65	59—1 pt. can	3.65
54—4 oz. bottle	1.10	50-GL—1 gal. can	11.35

5. WALSCO WOOD GLUE

Now repair cabinets, affix labels and join wood parts neatly and easily—stronger than ever before. Composition gasket prevents bottle top from sticking, keeps contents fresh.

Cat. No.	List Price	Cat. No.	List Price
222—2 oz. bottle	\$0.65	224—4 oz. bottle	\$1.10

6. WALSCO FABRIC CEMENT

Will not penetrate or shrink fabric. This fast-drying, moisture-proof adhesive will cement cloth to grilles, felt to turntables, fabric to portable radio and equipment cases without the slightest danger of disfiguring the material. Sunlight and high temperature do not affect it; will not become brittle with age.

Cat. No.	List Price
21-A—2 oz. bottle	\$0.65

7. WALSCO RUBBER CEMENT

There is nothing better for cementing rubber mounts to chassis, rubber cushions to lids, rubber gaskets to metal, phono rim drives to drive wheel. Forms a water-tight, air-tight, resilient bond.

Cat. No.	List Price	Cat. No.	List Price
112—2 oz. bottle	\$0.65	114—4 oz. bottle	\$1.20

8. WALSCO "NO-OX"*

Keep volume controls, contacts, and "mixers" absolutely clean and quiet. A liquid, non-gumming chemical that dissolves corrosion with amazing speed. Protects slide wires long after application.

Cat. No.	List Price
101—1 oz. bottle	\$ 0.85
102—2 oz. bottle	1.60
100-16—1 pt. bottle	12.50

*Mfd. under exclusive licensing agreement with NO-OX Laboratories. Trade Mark registered.

9. WALSCO CONTACTENE

Lubricates as it cleans, fast acting, quick drying. Eliminates volume control noise. Powerful solvents remove coatings of oxide, grease, dirt, and corrosion without harm to either metal or insulation. Applicator brush fastened inside bottle cap, or use handy spray can, no spilling or evaporation.

Cat. No.	List Price	Cat. No.	List Price
82—2 oz. bottle	\$0.55	88—8 oz. bottle	\$1.25
84—4 oz. bottle	.95	89—1 pt. can	2.00
88-S—12 oz. spray can			\$2.80

POLYSTYRENE CEMENT AND COIL DOPE

"Welds" polystyrene—ideal u.h.f. coil coating. Makes coils and other parts moisture-proof with just one coating, shrinks on drying to hold windings firmly in place.

Cat. No.	List Price	Cat. No.	List Price
152—2 oz. bottle	\$0.65	154—4 oz. bottle	\$1.10

WALSCO CONTACTENE INJECTOR

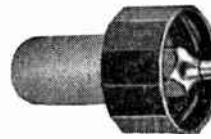

Cat. No.	List Price
989—Contactene Injector	\$0.75
989-D—Display of 12 No. 989	9.00

Put that drop where you want it. Fine surgical-grade steel needle injector can be inserted into places ordinary applicators cannot reach.



WALSCO SOLVENTS AND THINNERS

Solvent	Use With	Cat. No.	Quan.	List Price	Bulk No.
Cement* Solvent	Plastic Cement	62	2 oz.	\$0.55	R-60
	Radio Cement	64	4 oz.	.95	
		68	8 oz.	1.25	
		69	1 pt.	1.80	
Polystyrene Solvent	Polystyrene Cement	162	2 oz.	.55	R-160
		164	4 oz.	.95	
Lacquer Thinner	Vinylite Cement	138-2	2 oz.	.55	R-1
	Plastic Cement*	138-8	8 oz.	1.25	

Radio Cement*		138-GL	1 gal.	7.50	
Crystallizing Lacquer, Fungus Lacquer					
Telephone Black & Gray Light Bulb Coloring, Anti-Corona Lacquer					
CR-Tubecoat					
No. 7 Thinner	Fabric Cement Rubber Cement Wrinkle Varnish Insulating Varnish Flock Undercoat Wood Glue	464	4 oz.	.60	R-7
Water					

**LUBRICATING, CLEANING COMPOUNDS
SPECIAL CHEMICALS AND FINISHES
CABINET POLISHES**

WALSCO

walSCO quality earned its reputation

1. WALSCO "LUBRIPLATE"

Grease-type, protective, super-lubricant. Increases mechanical efficiency by reducing friction loss. Increases service life by reducing wear and preventing rust and corrosion. Spreads itself over entire bearing surface to form a coherent film that stays put. Has just the right weight and viscosity for electronic work. Comes in large tube with handy applicator tip.

Cat. No. 23-A—2 oz. tube List Price \$0.65

2. WALSCOLUB-B

Electrically neutral lubricant that prevents corrosion. WalScolub-B clings to metal surfaces and effectively seals them against oxidation and corrosion. Packaged in generous size, easy-to-use applicator tube. Available also in 1 lb., 5 lb. and 25 lb. containers for industrial users. Prices on request.

Cat. No. 22—1 3/4 oz. tube List Price \$0.65

3. WALSCO "TUNERLUB"

Assures quiet operation of television tuners. Purity—freedom from zinc and other harmful metal oxides—is the secret of the outstanding performance of WalSCO "Tunerlub." Forms a strong film to give lasting protection to high frequency switch contacts.

Cat. No. 26—1 3/4 oz. tube List Price \$0.75



7. WALSCO "NO-SLIP"

Increase friction of pulley belts and cords with WALSCO "No-Slip." A fast-drying liquid, you merely brush it on to stop slipping. Shrinks fibers. Makes cords and belts last longer.

Cat. No. 401—1/2 oz. bottle List Price \$0.50
402—2 oz. bottle80
401-D—Display of 12 #401 6.00

8. WALSCO STRIPVAR

Instantly softens Formvar, Formex, and similar insulation on magnet wires. Dip wire in Stripvar and wipe off—that's all. You're ready to solder.

Cat. No. 130—2 oz. bottle List Price \$ 0.75
131—1 pt. can 4.50
130-GL—1 gal. can 25.00

9. WALSCOFLUX

A non-corrosive, instant-acting soldering flux. Solder flows easily and smoothly with liquid WALSCOFLUX. For all electronic soldering. Won't corrode metal. Made of pure rosin.

Cat. No. 220—2 oz. bottle with applicator List Price \$0.65

WALSCO RH CLEANER

For quick cleaning of tape or wire recording heads. Dissolves scum, loosens lint and dirt. A protective anti-corrosion film remains. Guaranteed not to harm nor adversely affect the performance of wire, tape, or head.

Cat. No. 93—1 oz. bottle List Price \$0.95
Standard Package: 12

4. WALSCOCLEAR (Formula 91)

Neutralizes static electricity in plastics. Wipe plastic lenses crystal clear, free from lint and dust. Counteracts the electrostatic charge caused by the presence of high voltage. Will not fog or dull plastic.

Standard Package: 12

Cat. No. 91—4 oz. bottle List Price \$0.55

5. WALSCO DIAL OIL

A light-bodied jewelers-quality lubricating oil. For quiet, free-running dial mechanisms a drop of WalSCO Dial Oil is essential. Every set that is serviced—whether new or old—needs this light-bodied lubricant at several points.

Cat. No. 72—2 oz. bottle List Price \$0.50

6. WALSCO CARBON TETRACHLORIDE

Top-quality all-purpose cleaning fluid. WALSCO Carbon Tetrachloride is 100% chemically pure; can be used safely to clean grease and dirt from the most delicate instruments. Non-explosive, non-inflammable.

Cat. No. 214—4 oz. bottle List Price \$0.80
219—16 oz. can 1.90
214-GL—1 gal. can 7.60

WALSCO LUBRICATOR

Greatly simplify lubrication problems with this ingenious plastic syringe. It is designed for applying light greases and oils such as WalScolub-B, Lubriplate, Tunerlub, etc., to cramped and otherwise inaccessible points in electronic and mechanical equipment. To use, you simply remove plunger, fill chamber with lubricant, replace plunger, and extrude desired amount of grease with pinpoint accuracy.



Cat. No. 988—Lubricator List Price \$0.80
988D—Display of 12 No. 988 9.60



10. WALSCO SUPER POLISH

Give a "brand new" appearance and a lasting protective finish to fine cabinets.

Cat. No. 412—4 oz. bottle List Price \$0.55
418—8 oz. bottle80

11. WALSCO SCRATCH-REMOVING POLISH

Scratches disappear while you polish! Will not change shade of finish. Use "Dark" for walnut, mahogany, etc., "Light" for maple, bleached oak, pine, etc.

Cat. No. 414 Light List Price \$0.55
434 Dark \$0.55
416 438—8 oz. bottle80

12. WALSCO FLOCK FINISH SPRAY KIT

Now YOU can apply a flock finish that cannot be distinguished from factory work. Kit contains everything needed to obtain a colorful, velvet-like, protective flock finish.

Cat. No. K-50—Complete Flocking Kit List Price \$13.10

WALSCO CARBONEX

This is a brush-applied liquid that forms a conductive coating for patching noisy and worn carbon controls.

Cat. No. 96—1 oz. bottle List Price \$0.80
Standard Package: 12

PAINTS, LACQUERS CABINET REFINISHING AND REPAINT KITS

WALSCO

walSCO quality earned its reputation



1. WALSCO AIR-DRY WRINKLE VARNISH

Just one coat gives a coating that is hard, tough, extremely durable. Can be used on either wood or metal. Will air-dry at room temperature. Can also be baked. Also available in handy, new 12 oz. spray cans. No mess. No brush marks—an even, professional finish every time.

Cat. No.	List Price
145—Gray 2 oz. jar	\$0.65
145—Black 2 oz. jar	.65
147—Gray 16 oz. jar	3.30
147—Black 16 oz. jar	3.30
146-S—Black 12 oz.	3.75
146-S—Grey 12 oz.	3.75

2. WALSCO ANTI-CORONA LACQUER

Prevents corona discharge and arcing in such applications as the high-voltage supply of TV sets. Apply it to wiring, solder lugs, sharp corners, inside high-voltage cages, points on chassis, etc. Also available in handy new 12 oz. spray can.

Cat. No.	List Price
195—2 oz. bottle	\$1.20
196—1 pt. can	7.50
197-S—12 oz. spray can	4.50

WALSCO LIGHT BULB COLORING

Color your own bulbs this simple, inexpensive way. WALSCO Light Bulb Coloring is a transparent, heat- and moisture-resisting, fast-drying lacquer.

Cat. No.	List Price
116—Red 2 oz. jar	\$0.65
117—Blue 2 oz. jar	.65
118—Green 2 oz. jar	.65
119—Assorted Kit of 3	1.75

WALSCO INSULATING VARNISH

This one insulating varnish will take care of 90% of your surface-sealing problems. Because it is highly-resistant to heat, acid, oil and grease, WALSCO Insulating Varnish is recommended for radio coils, transformers, solenoids, motors, and all electrical appliances.

Cat. No.	List Price
192—2 oz. bottle	\$ 0.65
193—1 pt. can	2.75
194—1 gal. can	15.00

WALSCO CABINET PATCHING OUTFIT

Do expert touch-up without previous experience. Contains a wide assortment of needed materials. Included are: two shades of walnut spirit stain, dark brown lacquer, Plastic Wood, two shades of ivory spirit enamel, patching lacquer, WALSCO Super Polish, alcohol, 3 brushes of various sizes, garnet finishing paper, French polishing pad, and steel wool, together with Complete Instruction Booklet.

Cat. No.	List Dealer's Net
K-10—In sturdy box with hinged lid	\$7.15 \$4.29
K-10-W—In California redwood case	8.25 4.95

WALSCO CABINET REPAIR KIT

For occasional limited finish restoration. For the shop or store that is only seldom called on to patch the finish of a cabinet. The kit is very compact, inexpensive and yet contains everything necessary for craftsmanlike work. Included are: ivory spirit enamel, light and dark; dark brown enamel-finish lacquer; spirit stain; WALSCO Super Polish; French varnish; finishing paper; steel wool; polishing cloth; instruction booklet.

Cat. No.	List Dealer's Net
K-9	\$3.30 \$1.98

WALSCO Super-Chief REFINISHING KIT

The most complete kit of its kind on the market. Contains the basic materials needed to establish a cabinet repair and refinishing department. The WALSCO Super-Chief Kit will pay for itself on your first major renovation job. Packed in California redwood portable case.

Cat. No.	List Dealer's Net
K-26	\$20.35 \$12.21

4. WALSCO ANTI-FUNGUS LACQUER

Electronic equipment intended for use in hot and humid climates must be protected from attack by fungi. This WALSCO lacquer meets U. S. government specifications JAN-C-173 for anti-fungus and moisture-repellent treatment. Brush, dip, or spray. Air-dries quickly.

Cat. No.	List Price
135—2 oz. bottle	\$ 0.65
136—1 pt. can	2.75
137—1 gal. can	16.50

5. WALSCO SATIN FINISH LACQUER

Give your panels, racks, meters and cabinets the same finish found on standard telephone and communications equipment. May be brushed, dipped, or sprayed. Air-dries quickly. For both commercial and amateur use.

Cat. No.	List Price
172—Gray 2 oz. jar	\$0.65
179—189 1 pt. can	3.30

WALSCO LACQUER THINNER

Use this thinner with WALSCO Light Bulb Coloring, Fungus Lacquer, Anti-Corona Lacquer, Crystallizing Lacquer, Satin Finish Telephone Lacquer.

Cat. No.	List Price
138-2—2 oz. bottle	\$0.55
138-8—8 oz. can	1.25
138GL—1 gal. can	7.50

WALSCO FURNITURE REFINISHING KIT

For all-around touchup and overhaul of wood finishes. Contains materials for filling nicks and dents; for patching scratches, discolored and scuffed varnish; rebuilding broken edges, etc. Complete Instruction Book. Kit furnished in California Redwood case with hinged lid.

Cat. No.	List Dealer's Net
K-15	\$8.80 \$5.28

WALSCO STICK SHELLAC KIT

The simple method of filling nicks and deep scratches. This is a color to match practically any radio or TV cabinet in this assortment of shellac sticks. Easy to use! Included in the WALSCO Stick Shellac Kit are the following: six colors of stick shellac, alcohol lamp-burn-in spatula, bottle of shellac rubbing fluid, felt, steel wool, alcohol, and complete instructions.

Cat. No.	List Dealer's Net
K-11	\$3.85 \$2.31

REFILLS OF REFINISHING MATERIALS

Cat. No.	Stains	List Price
287	Spirit Stain, 1 oz. (Walnut, Mahogany, Maple, Black)	\$0.33
288	Spirit Stain, 8 oz.	1.55
289	Blending Stain (Lt. Brown, Med. Brown)	.80

PATCHING LACQUER

Cat. No.	(Improved French Varnishing Materials)	List Price
290	4 oz. bottle	1.30
291	16 oz. bottle	3.85

STICK SHELLAC RUBBING FLUID

Cat. No.	List Price	
295	4 oz. bottle	.80
296	16 oz. bottle	1.90

STICK SHELLAC

299	Set of 8 assorted colors	1.95
-----	--------------------------	------

CABINET HARDWARE SPEAKER ACCESSORIES SPAGHETTI, INSULATING SPECIALTIES

WALSCO

walSCO quality earned its reputation

WALSCO KNOBS AND DRAWER PULLS



Cat. No. 330-7



Cat. No. 330-4



Cat. No. 330-1



Cat. No. 330-5



Cat. No. 330-3



Cat. No. 330-6

Distinctive, well-made cabinet hardware. Available in styles to harmonize with period or modern design. Ideal for custom cabinets; the finishing touch to a complete rejuvenation; excellent replacement for bent or broken handles. Specially constructed to avoid rattles. Mounting screws included.

Cat. No.	Size	Finish	Each	List Price	Cat. No.	Size	Finish	Each	List Price
330-1	1 1/2" dia.	Brass	\$0.45		330-5	4 1/4" long	Bronze	\$1.00	
330-2	2 1/2" dia.	Brass	.75		330-6	6 1/2" long	Bronze	1.45	
330-3	3" dia.	Brass	.90		330-7	4" long	Bronze	1.05	
330-4	3 3/4" long	Brass	1.90						

WALSCO DRAWER SLIDES



The most efficient way to suspend drawer-type construction. Made of durable, heavy-gauge, cold-rolled steel with a corrosion-resistant finish. Drawers will slide smoothly and easily without sticking, and with just the right amount of drag. Mounting screws furnished.

Cat. No.	Size	Per Pair	List Price
331-1	14" long		\$2.75
331-3	Ball bearing type (14" long)		5.50

(Standard Pack: 6 pairs)

WALSCO ORNAMENTAL METAL GRILLE

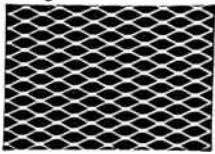

Heavy metal, richly plated in "brushed brass," and lacquered for enduring rich gold effect. Widely used in custom-built radios, high-quality P.A. speakers, in juke boxes, etc.

Cat. No.	Size	List Price
382	12" x 18"	\$ 3.00
384	18" x 24"	5.50
386	24" x 36"	10.45
387	24" x 48"	13.75
388	36" x 48"	19.50

WALSCO CABINET DOOR HINGES

Swing-back hinges for radio, TV, phono cabinets. Allow doors to swing all the way back against the sides of the cabinet. Built-in stop prevents door knob or handle from denting side of cabinet. Antique bronze finish, countersunk screw holes; screws furnished. A pair of hinges is required for each door.

Cat. No.	List Price
332-1—Pair of 1 upper, 1 lower hinges.	\$0.90

WALSCO GRILLE CLOTH



Combines perfect acoustical qualities with top quality appearance. Available in shades to match walnut, light, or mahogany cabinet finishes. Use WALSCO Fabric Cement to attach. Specify color-match when ordering.

Cat. No.	Size	List Price
360—12" x 12"		\$0.70
361—18" x 24"		1.80
362—1 yd. x 50" (pkg.)		6.90

WALSCO "LUMITE" GRILLE CLOTH

Made of genuine Saran plastic fibers, WALSCO Plastic Grille Cloth will not discolor, rot, stain, or mildew; can be whisked clean with damp rag, brush, or vacuum cleaner.

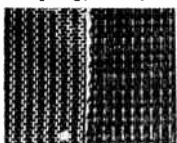

Cat. No.	Size	List Price
366	12" x 18"	\$1.65
367	36" x 36"	9.25

Pattern	Color
A	Maroon
B	Bronze and Gold
C	Ecu (Blond)

Specify color pattern when ordering

WALSCO INSULATING CAMBRIC

This insulating material is put up especially for experimental and repair work. Used in re-building transformers, field coils, solenoids, relays, etc. Yellow color; very flexible and durable.

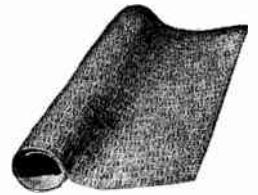

Cat. No.	List Price
645—Roll of approx. 210 sq. in.	\$0.85
645-D—Display of 10 No. 645 rolls	8.50

WALSCO MINIATURE PLUG AND JACK

Fill a long-felt need for compact two-conductor connectors. Excellent for use with lapel microphones, speaker extensions, hearing aids, dictaphones, etc.



Cat. No.	Type	List Price	Cat. No.	Type	List Price
790—Plug (PJ291)		\$0.60	792—Plug (PJ292)		\$0.80
791—Jack (JJ048)		.80	793—Jack (JJ055)		1.20

(Standard Pack: Display Cards of 20)

WALSCO SPAGHETTI BARGAIN ASSORTMENT

Each bundle contains twenty-four 8-inch lengths of durable varnished tubing of assorted sizes and in a variety of bright colors.

Cat. No.	List Price
644	\$ 0.49
644D—Display of 25 #644	12.25

WALSCO FLEXITUBE

High-grade extruded vinyl plastic tubing, recommended for most electronic and electrical applications. Is impervious to water, oil, alcohol, most acids and alkalis. Packed on handy spools.

List Price, per pkg.	Quantity per pkg.*	\$1.00
Cat. No.	Size B & S	Approx. I.D.
	Gauge No.	Inch mm
600	18	.042" 1
601	16	.053" 1.4
602	14	.066" 1.6
603	12	.085" 2
604	10	.106" 2.7
605	8	.133" 3.5
606	6	.166" 4
607	4	.208" 5
608	2	.263" 6.5



Color: Clear will be supplied unless order specifies color. Black, Green or Red available subject to stock on hand.

HANDY ASSORTMENTS OF FLEXITUBE

Cat. No.	List Price	
620	20 ft. of Assorted sizes and colors, from size 18 to 10	\$ 1.00
620-D	36 Assortments of No. 620 in one Display Box	36.00
621	12 ft. of Assorted sizes and colors, from size 10 to 2	1.00
621-D	24 Assortments of No. 621 in one Display Box	24.00



WALSCO RAYOFLEX

Cat. No.	Size B & S	Approx. I.D.	Quantity per pkg.	Price per pkg.
630	18	.042"	10 ft.	\$1.05
631	15	.059"	10 ft.	1.05
632	12	.085"	8 ft.	1.05
633	9	.118"	5 ft.	1.05
634	6	.166"	5 ft.	1.05
635	2	3/8"	30 in.	.60
636	0	1/2"	30 in.	.70
637	00	5/8"	30 in.	.75
638	0000	3/4"	30 in.	1.25



Available in: Black, Blue, Red, Yellow. Please specify color when ordering.

TELEVISION ANTENNAS*

*ALL MODELS INCLUDE U-INSTALL KITS.
SEE LISTING ON FOLLOWING PAGE.

WALSCO

walSCO quality earned its reputation

WALSCO GOLD DIPOLE YAGI (UHF)

24 Kt. Gold Dipole guarantees permanent high gain in any location, under all weather conditions.
GUARANTEED FOR 3 YEARS!

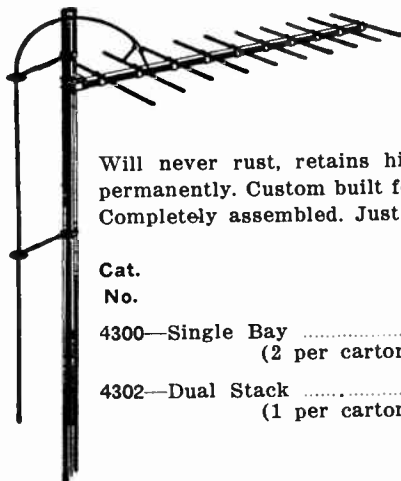

Will never rust, retains high conductivity permanently. Custom built for each location. Completely assembled. Just fasten to mast.

Cat. No.	List Price
4300—Single Bay (2 per carton)	\$ 7.50
4302—Dual Stack (1 per carton)	16.00

WALSCO SIGNAL KING ANTENNA

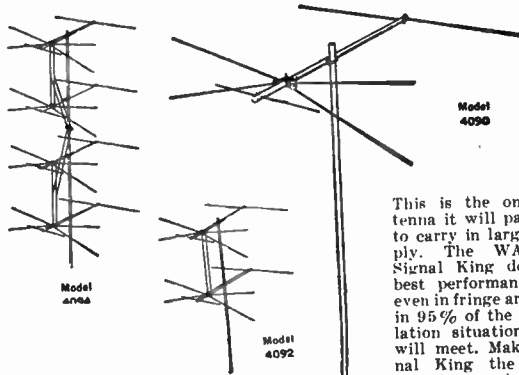

This is the one antenna it will pay you to carry in large supply. The WALSCO Signal King delivers best performance — even in fringe areas — in 95% of the installation situations you will meet. Make Signal King the basic item in your installation

department. Ruggedly built, designed for durability, it will continue to deliver top performance under the most adverse weather conditions. Remarkable new patented design.

Cat. No.	List Price
4090 Single Bay, no mast	\$ 9.25
4092 Dual Stack, no mast	19.85
4094 4-Bay Stack, no mast	44.50

STACKING KITS

4005-7 To convert 2 single bays to one dual stack	1.50
4005-8 To convert 2 dual stacks to one 4-bay stack	5.60

WALSCO IMPERIAL VHF

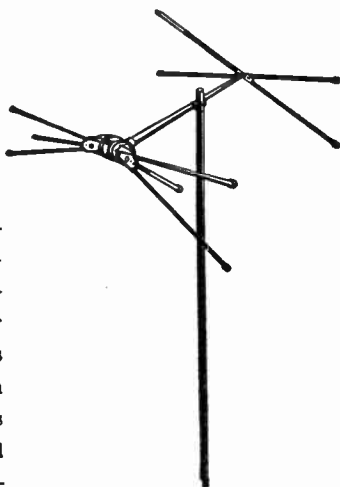

Radically new insulator design incorporates WalSCO's exclusive "barrier discs" and 2 inches of air space between terminals. This gives unusually high and lasting gain. Soot deposits, dirt, moisture, salt, etc., cannot affect the insulator. Stainless steel hardware prevents corrosion. No loose hardware. Pre-assembled.

Cat. No.	List Price
4060-A—Single Bay	\$ 9.25
4062-A—Dual Stack	19.85
4064-A—Four Bay	44.50

WALSCO VHF-UHF "TROMBONE" ANTENNA

The first practical fringe area antenna for high gain reception on all present and future VHF and UHF channels. Precision made with WALSCO's famous "twin tube" construction, the elements remain in perfect alignment for lasting high gain performance. Will give satisfactory results on VHF at distances up to 60 miles and up to 45 miles on UHF, depending on terrain, power of transmitter, etc. For greater distances or difficult locations, the dual or triple stacks are recommended.

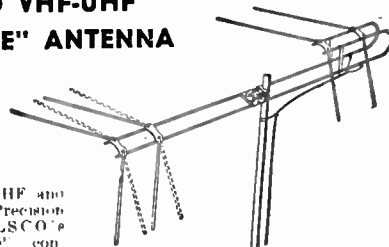

Cat. No.	List Price
4150 Single Bay (less mast)	\$18.50
4152 Dual Bay (less mast)	39.95
4153 Triple bay (less mast)	54.95
4150-2 Stacking Kit to convert two model 4150 to one model 4152	2.95
4150-3 Stacking Kit to convert three model 4150 to one model 4153	7.50

WALSCO DUAL-VEE ANTENNA*

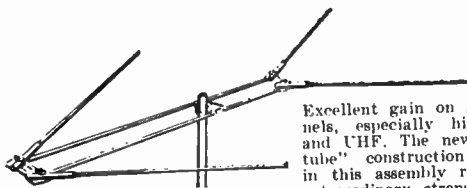

Excellent gain on all channels, especially high VHF and UHF. The new "Twin-tube" construction utilized in this assembly results in extraordinary strength combined with minimum weight.

*Licensed under patents of the Workshop Associates, Inc.

Cat. No.	List Price
4100-A—Single Bay, no mast	\$ 7.50
4102-A—Dual Stack, no mast	17.75

STACKING KITS

4005-9—To convert 2 Single Bays to one Dual Stack	2.90
---	------

TELEVISION ANTENNAS

WALSCO

walSCO quality earned its reputation

WALSCO REFLECTO-FAN ANTENNA

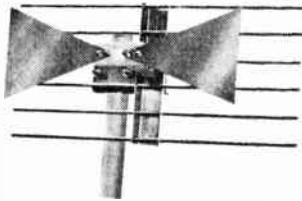

Best-value, broad-band UHF TV antenna reception. For excellent reception on all UHF channels — 14 to 83. Backed by an unconditional one full year guarantee. Offers low wind resistance, provides good directivity in both horizontal and vertical planes. Reflections, ghosts, and noise are eliminated in most locations.

- High gain on all channels. No weak spots. Readily stacked for fringe area reception.
- Easy to assemble. Takes but a few minutes.
- Outstanding mechanical design — highest grade insulation and aluminum alloys used throughout.
- Highly directive, eliminates ghosts as well as noise.
- Unconditionally guaranteed for one full year.

Cat. No.	List Price
4400 Single Bay (less mast)	\$ 5.50
4402 Dual Stack (less mast)	11.70
4404 4-Bay Stack (less mast)	
4405-1 Stacking Kit to convert two model 4400 to one model 4402	.80
4405-2 Stacking Kit to convert two model 4402 to one model 4404	6.75

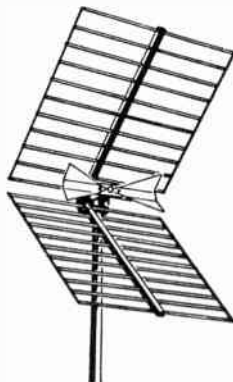

WALSCO CORNER-REFLECTOR ANTENNA

- Frequency Range — 450 to 900 MC.
- Gain 10 to 14 db.
- Front to back ratio — outstanding! 15 to 1
- Ideal where ghosts and reflections are especially troublesome
- Uni-directional on all UHF channels
- Highly directive in both horizontal and vertical planes
- All parts pre-assembled — takes only 5 minutes to set up

The ultimate design for high gain, fringe area reception. Ideal for use in difficult locations, especially where ghosts and reflections are encountered. It is uni-directional on all UHF channels; shows exceptional directivity in both horizontal and vertical planes.

Cat. No.	List Price
4450—(without mast)	\$10.95
4452-A—Dual Stack (no mast)	22.00
4450-2—Complete kit to convert 2 model 4450 to one 4452	5.00

WALSCO SKY KING ANTENNA (VHF)

The **BIG TEN** and the **SUPER EIGHT**

Gives excellent gain, with all channel VHF reception. Light, strong aluminum alloy construction. Hi-impact styrene insulator. Unique locking design ensures complete metal to metal contact.

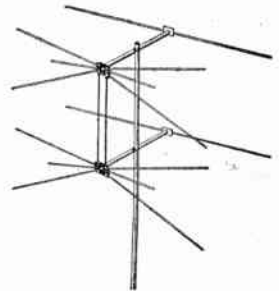

Cat. No.	List Price
4030	\$ 5.85
4032	13.20

WALSCO STACKED-VEE ANTENNA (VHF-UHF)

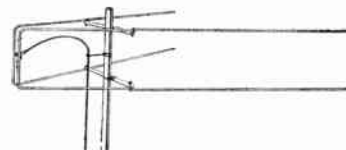

Excellent gain on UHF and hi-band VHF. Sharp, broad directivity. Best where VHF and UHF stations are located in different directions. "Twin Braces" made of famous X-77 polystyrene. Comes completely assembled. Just tighten wing nuts.

Cat. No.	List Price
4060—Single Bay (no mast)	\$7.50

WALSCO U-INSTALL ANTENNA KITS

These kits contain everything needed for most home installations. Quick and easy to install. Popular for today's "Install It Yourself" trend. Each kit contains the following.

- 1 Complete antenna
- 1 Mast
- 1 Guy wire ring
- 40 ft. of guy wire
- 50 ft. of 300 ohm Twin-Lead
- 3 Screw eyes
- 2 Mast stand-off insulators
- 3 Wood screw stand-off insulators

Cat. No.	List Price
4036 Gold Dipole U-Install	\$16.50
4066-A Imperial Conical U-Install	15.75
4096 Signal King U-Install	15.75
4106-A Dual Vee U-Install	14.00
4406 Reflecto-Fan U-Install	14.00
4407 Reflecto-Fan U-Install	20.00
4456 Corner Reflector U-Install	19.95
4046 Sky King U-Install	13.65

PANEL SWITCHES

WALSCO BALL HANDLE TOGGLE SWITCHES

These top-quality WALSCO switches have silver-plated contacts, terminals plated for easy soldering, nickel-plated handles. Durable laminated construction. Rated at 3 amps at 125 volts, or 1 amp at 250 volts. They bear inspection and approval stamp of Underwriters' Laboratories, Inc. Made by H & H for WALSCO.



Cat. No.	Description	Shank Length	List Price
1300	S.P.S.T.	1 1/2"	\$0.80
1301	S.P.S.T.	1 1/2"	1.10
1302	S.P.D.T.	1 1/2"	1.10
1303	S.P.D.T.	1 1/2"	1.30
1304	D.P.S.T.	1 1/2"	1.55
1305	D.P.S.T.	1 1/2"	1.75
1306	D.P.D.T.	1 1/2"	2.00
1307	D.P.D.T.	1 1/2"	2.00

WALSCO BAT HANDLE TOGGLE SWITCHES

Feature easier action with 50% longer bat handle. Electrical and construction characteristics are identical with ball handle switches. Rated at 3 amps at 125 volts. U.L. approved. Made by H & H for WALSCO.



Cat. No.	Description	Shank Length	List Price
1330	S.P.S.T.	1 1/2"	\$0.80
1331	S.P.D.T.	1 1/2"	1.10
1332	D.P.S.T.	1 1/2"	1.55
1333	D.P.D.T.	1 1/2"	1.75

BAT HANDLE TOGGLE SWITCH WITH WIRE LEADS

Has two built-in 6" insulated wire leads which solve many awkward installation problems. Nickel plated. Rated at 6 amps at 125 volts. U.L. approved. Made by H & H for WALSCO.

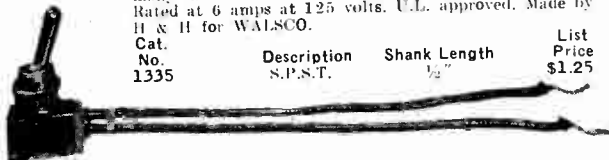

Cat. No.	Description	Shank Length	List Price
1335	S.P.S.T.	1 1/2"	\$1.25

WALSCO ROTARY SWITCHES

Laminated construction. Housing made of stamped steel, plated. Precision-turned shaft with forward edge chamfered makes for easy insertion into knob. Silver-plated contacts. Rated at 3 amps at 125 volts. U.L. inspected and approved. Made by H & H for WALSCO.



Cat. No.	Description	Shank Length	List Price
1320	S.P.S.T.	3/8"	\$1.30
1322	S.P.D.T.	3/8"	1.50
1325	D.P.D.T.	3/8"	2.00

WALSCO PUSH-ON, PUSH-OFF BUTTON SWITCH

Neat appearance and fast action make this switch popular for a great variety of uses. Push to close circuit; push again to break. Nickel plated push button. Rated at 6 amps at 125 volts. Will operate satisfactorily for many thousands of cycles. Inspected and approved by Underwriters' Laboratories. Made by H & H for WALSCO.



Cat. No.	Description	List Price
1338	S.P.S.T.	\$2.00

WALSCO 2-CIRCUIT MOMENTARY CONTACT SWITCH

In this 2-circuit push button switch, one circuit is normally on, the other normally off. When you push and hold button, you cut out one circuit, cut in another. Laminated construction. Shank is 3/8" long. Rated at 1 amp at 125 volts. U.L. approved. Made by H & H for WALSCO.



Cat. No. 1340	List Price \$1.95
---------------	-------------------

WALSCO SLIDE SWITCHES (STACKPOLE)

Neat, handy, easy to install. Mounting hole drilled for No. 6 screw. Rated at .5 amp at 125 volts. U.L. approved.



Cat. No.	Type	Mt. Hole Spacing	Width	Length	List Price
1367	S.P.S.T.	1 1/4"	3/8"	1 3/8"	\$0.22
1368	S.P.D.T.	1 1/4"	3/8"	1 3/8"	.22
1369	D.P.S.T.	1 1/4"	3/8"	1 3/8"	.35
1370	D.P.D.T.	1 1/4"	3/8"	1 3/8"	.35

WALSCO

WALSCO TWIN-LEAD FEED-THRU BUSHING



Neat, inconspicuous method of bringing lead inside. For a first-class permanent and professional installation bring 300-ohm Twin-lead right through wall or window frame. Made of Lo-loss polystyrene. Designed to hold line firmly in place with weather tight seal. Does not affect line impedance. Supplied in 8 3/4" length to fit most walls; easily cut off for thinner walls.

Cat. No.	Description	List Price
1550	Feed-through Bushing	\$ 1.10
1550-D	Display of 12 Bushings	13.20

WALSCO UNIVERSAL FEED-THRU BUSHING

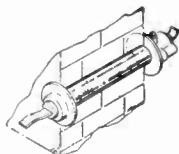

Accommodates all popular standard TV lead wires. Fits all standard types of coaxial or twin-lead wires including shielded and tubular twin leads as well as rotator control cable. Has provision for terminating to open line, enabling you to bring 300-ohm twin lead through wall and into room. The bushing is 1 1/2" over all, fits walls up to 1 1/4" thick. Can be easily cut down to fit with knife or saw. Requires 3/4" hole.

Cat. No.	Description	List Price
1551	Universal Feed-through Bushing	\$1.95

(Standard Pack: 12)

WALSCO TWIN-LEAD FLEXITUBE



For protecting 300-ohm twin-lead. Guard twin-lead against chafing. Made of clear, flexible vinyl plastic, WALSCO Twin-lead Flexitube is remarkably weather-resistant — maintains flexibility and toughness under the most adverse climatic conditions. Protect all Twin-lead with this size WALSCO Flexitube.

Cat. No.	Description	List Price
609-75	75 ft. Hank	\$6.50/hank

WALSCO TWIN-LEAD WIRING NAILS



Fasten antenna lead wires securely to inside walls, moldings, etc. Drive like nails, have no effect on impedance. Head constructed of tough insulating material.

Cat. No.	Approx. Quant.	Per Pkg.	List Price
7565-F	35	(Standard Pack: 12 hanks)	\$0.50
7565-N	200	(Standard Pack: 20 Pkgs.)	1.80
7565	Bulk	(Standard Pack: 6 Pkgs.)	7.70 per M
		(Min. Quant.: 1000)	
1547-C	For Standard Twin Lead (Flatline)	100	1.50
1547-M	For Tubular, Oval, Coat and "Open" Line		12.40 per M

WALSCO 4-BAY TERMINAL BLOCK ASSEMBLY

This insulator assembly simplifies stacking conical antennas such as the WALSCO Imperial and WALSCO Signal King. Positively prevents shorting of elements to mast.

Cat. No.	List Price
4005-5B	\$2.00

(Standard Pack: 25)

REPLACEMENT PARTS FOR CONICAL AND IMPERIAL ANTENNAS

Diameter elements made of butt-seamed high-strength chromium-aluminum alloy. One end reinforced, other end crimped on 44", 48", and 50" lengths.

FOR CONICALS		List Price
Cat. No. 4004-20	20" long, each	\$0.22
4004-26	26" long, each	.30
4004-44A	44" long, each	.60
4004-48A	48" long, each	.65
4004-50A	50" long, each	.70

FOR IMPERIALS

Cat. No.	List Price
4005-11A	\$2.00

Complete replacement insulator with holding straps, clamps, screws, nuts and lugs.

**TV CONNECTORS
GRID CAPS
TV ANTENNA HARDWARE**

WALSCO

walSCO quality earned its reputation

WALSCO MAGNESIUM LADDER



Save energy, install antennas safely. A 20-footer — the lightest ladder made — weighs but 23 pounds. Safer, will not splinter or crack — will outlast wooden ladders three to one.

Cat. No.	Description	List Price
1600	20 ft. Magnesium extension ladder	\$ 53.40
1602	28 ft. Magnesium extension ladder	75.90
1603	40 ft. Magnesium extension ladder	125.70
1605	Pivoted Safety Shoes for above ladder. Specify "small" for 1600 and 1602 — "large" for 1603.	
	Per pair	4.68

WALSCO TV ANTENNA WALL PLATE

Offered in choice of brown or ivory plastic, the WALSCO Wall Plate matches the latest, most modern style plastic electric wall plates. Fits standard junction boxes; may be mounted close to wall or base board.



Cat. No.	Description	List Price
1588	Brown	\$1.50
1589	Ivory	1.50

(Standard Pack: 12)

WALSCO TWIN-LEAD CONNECTOR PLUG

Can be used for attaching lead from set to either wall plate or jack. Has excellent electrical characteristics, is made of tough, transparent lo-loss plastic. Plated prongs. Wires are easily secured to plug with set screws.



Cat. No.	List Price
1582	\$0.45

(Standard Pack: 25)

WALSCO TWIN-LEAD CONNECTOR JACK

Lo-loss plastic jack for 300-ohm twin lead. This jack mates with plug No. 1582. Makes a quick, neat assembly by merely stripping twin-lead, inserting wires, tightening set screws. High impact resistance, excellent electrical properties, does not affect line impedance.



Cat. No.	List Price
1583	\$0.45

(Standard Pack: 25)

WALSCO POLARIZED TWIN-LEAD CONNECTORS

Molded of transparent lo-loss plastic with one male prong and one receptacle on each plug. 300-ohm Twin lead is quickly attached to plug by means of set screws. Matches line impedance.



Cat. No.	List Price
1584	each \$0.45

(Standard Pack: 25)

WALSCO TWIN-LEAD JOINER

Transparent plastic splicer for 30-ohm twin lead. Easy to use, makes a secure connection without affecting line impedance. To splice flat Twin Lead, to strip ends, insert wires into either side of joiner, and secure with set screws. Permanent, neat, inexpensive.



Cat. No.	List Price
1585	\$0.30

(Standard Pack: 25)

WALSCO QUIK-KLIP AND SPEEDY-KLIP



Quickest way to attach lead-in wires to TV set. Provides a simple, speedy method of attaching antenna lead-in wires to TV sets. Ruggedly made of high impact polystyrene. Jaws are heavy steel, brass plates. Two sets of teeth — on end for general use, on side for use in limited space. Can't short out. Works in any position.

Cat. No.	Description	List Price
1525	Quick-Klip, each	\$ 0.35
1526	Speedy-Klip, each	.35

WALSCO INSULATED GRID CAPS WITH LEADS



High-voltage 10-inch-long wire leads are attached to these heavy bakelite high-voltage grid caps. Offered in two sizes — 1/4" and 3/8".

Cat. No.	Size	List Price
1630	1/4" size	\$0.45
1631	3/8" size	.45

(Standard Pack: 25)

WALSCO GUY WIRE



Made of high-grade steel, stranded for flexibility, heavily galvanized for full rust resistance. Put up in 200-foot continuous lengths, tied off into four 50-foot coils.

Cat. No.	Description	List Price
1510	4 Strand No. 20; 3/32" diam.	\$1.45 per C ft.
1512	6 Strand No. 20; 1/8" diam.	1.90 per C ft.

(Standard Pack: 1200 ft.)

WALSCO GUY-WIRE RING



Grips mast firmly without crushing tubing. Generous length gives large friction-contact area; two clamping screws assure maximum purchase. Each clamp accommodates three guy wires. Made of very strong, highly corrosion resistant aluminum alloy.

Cat. No.	Description	List Price
4005-1	For 1" Diam. Masts	\$0.45
4005-26	For 1 1/4" Diam. Masts	.50

(Standard Pack: 25)

WALSCO PERFORATED STEEL STRAP



Made of thin steel, galvanized to prevent rust, it is flexible and strong, 1/4" holes are punched 3/4" apart.

Cat. No.	Description	List Price
1518	10 ft. coil	\$0.70

(Standard Pack: 25 rolls)

WALSCO ALUMINUM GROUND WIRE



Soft and easy to bend to follow house profile. Will not rust, stain walls and window frames, 1/4" diameter (No. 8 B & W Gauge), solid, annealed, pure, high-conductive aluminum.

Cat. No.	Description	List Price
1500	100 ft. coil	\$ 2.20
1505	500 ft. coil	10.00

WALSCO GROUND CLAMP



Assures a solid, dependable contact even on corroded rods and pipes. Adjusts to fit grounding connections from 3/8" to 1 1/4" in diameter.

Cat. No.	List Price
4005-10	\$0.20

(Standard Pack: 25 units)

WALSCO U-BOLT BRACKET ASSEMBLY

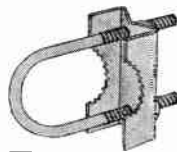

The WALSCO U-bolt Bracket is designed for permanency. Made of weather-resistant, cadmium-plated steel. Sharp teeth on jaws grip mast like pipe vise. Fits mast up to 1 1/2".

Cat. No.	List Price
4005-20	\$0.60

(Standard Pack: 25)

WALSCO MAST SWIVEL BASE



Permits mounting mast at any angle on any pitch roof. Mast can be oriented to signal pattern after it has been installed. Built of aluminum and heavy cadmium-plated steel for endurance.

Cat. No.	Description	List Price
4005-2	For 1" Diam. Masts	\$0.85
4005-27	For 1 1/4" Diam. Masts	0.95

(Standard Pack: 25)

WALSCO TURNBUCKLES



Made of steel with rustproof galvanized finish. A necessity with high mast and tower antenna installations.

Cat. No.	Length Open	Length Closed	List Price
1533	4 1/4"	3"	\$0.30
1535	7 1/2"	5 1/2"	.40
1537	10 1/2"	7 1/2"	.95

(Standard Pack: 1 Dozen)

WALSCO SCREW EYES



Made of heavy steel, cadmium-plated for weather resistance. Just the right weight for securing guy wires to roof structures.

Cat. No.	Description	Each	List Price Per Gross
1540	Over-all length 2"	\$0.05	\$5.40
1542	Over-all length 3"	.08	8.25
1544	Over-all length 5 1/2"	.15	15.00

(Standard Pack: 144)

**“CHEATER” CORDS
ANODE LEADS
DETENTS
TV CHEMICALS**

WALSCO

walSCO quality earned us reputation

**WALSCO ROOF
PATCHING COMPOUND**

Wherever a screw must be driven to install an antenna, apply this waterproofing compound generously. Compound of the very best quality asphalt and fibred asbestos, this material is easily and neatly applied with dispensable applicators furnished with each can.



Cat. No. 1548 16 oz. can List Price \$1.00
(Standard Pack: 24)

WALSCO TV INTERLOCK RECEPTACLE

Interchangeable with receptacles found in RCA, Philco, GE, Admiral and other TV sets. Use to replace broken or damaged receptacles, or in custom cabinets. Sturdily made, stamped steel shell, rugged pins, U.L. approved.



Cat. No. 1650 List Price \$0.25
(Standard Pack: 25)

**WALSCO TV INTERLOCK OR
“CHEATER” CORD**

Molded bakelite plug attached to fit standard electric outlets. Special molded rubber plug fits standard TV Interlock Receptacles. May be used either as a replacement cord, or as a “cheater” cord when servicing.



Cat. No. 1620 List Price \$0.75
(Standard Pack: 12)

WALSCO SERVICEMAN'S “CHEATER” CORD

Equipped with a special male plug (instead of appliance plug) that mates with interlock plug found on TV set back panel. Unnecessary to disconnect TV set from regular wall outlet. Has a special built-in receptacle which taps the line for trouble light, tester, or soldering iron. U.L. approved.

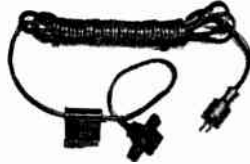

Cat. No. 1621 List Price \$1.30
(Standard Pack: 12)

**WALSCO DELUXE INTERLOCK
“CHEATER” CORD**

Contains a built-in duplex outlet for testers, soldering irons, trouble lights. All connections necessary for TV servicing.

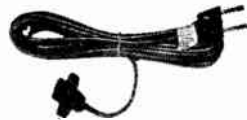

Cat. No. 1622 List Price \$2.50
(Standard Pack: 12)

**WALSCO TV TUBE ANODE LEAD
STRAIGHT TYPE**

WALSCO top-quality materials and construction distinguish this straight-type anode lead. A tinned stranded copper conductor is covered with thick plastic insulation especially developed high-voltage work up to 20 kilovolts. Terminal end has been dipped in solder for quick connection. Lead is 18" long. Tube connection is snap-button type insulated with a special ozone-resistant rubber that will not deteriorate or break down when exposed to high voltage.

Cat. No. 1628 List Price \$1.00
(Standard Pack: 12)

**WALSCO TV TUBE ANODE LEAD
OFFSET TYPE**

Materials used in this lead are identical with those in 1628 above. However, the lead enters the tube connection plug at right angles. Excellent for making conversion from small to large screen. Lead is 18" long. For use up to 20 kilovolts.

Cat. No. 1629 List Price \$1.00
(Standard Pack: 12)

**WALSCO TV TUBE ANODE
LEAD EXTENSION CORD**

With regular anode plug and a high voltage plastic receptacle that mates with the anode plug in most TV sets. Extension cord is 36" long, flexible, with high-dielectric plastic insulation.



Cat. No. 1625 List Price \$1.50
(Standard Pack: 12)

WALSCO TV TUNER DETENTS

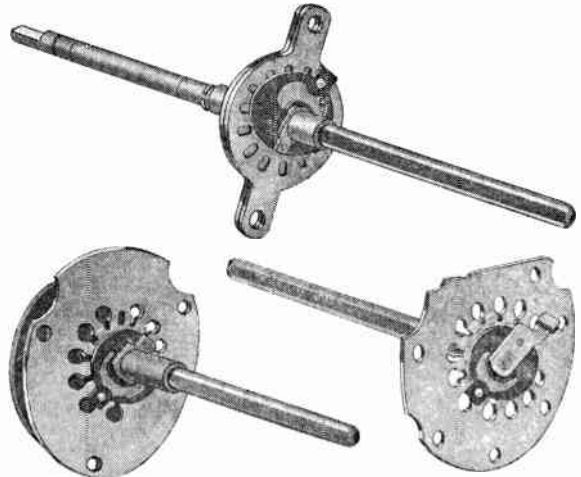

Cat. No. 1213

High-precision top-quality replacements. Three point ball bearing suspension gives smooth, low-torque tuning. Detent spring is made of phosphor bronze for enduring, dependable service. Shafts are made of linen base molded and machines phenolic. They are rigid, precise, non-warping.

SHAFT LENGTH*

Cat. No.	Brass	Phenolic
1210	2 1/8"	3 3/4"
1211	3 3/8"	3 3/4"
1212	4 1/2"	3 3/4"

*Measured from “C” Washer

Cat. No.	List Price
1210 Replaces RCA part 71463	\$2.80
1211 Replaces RCA part 72743	3.15
1212 Replaces RCA part 201E1 for use with Tuner No. 71531	4.15
1213 Replaces RCA part 73440	4.75
1214 Replaces RCA part 75162	4.00

WALSCO C-R TUBECOAT



Quick drying for patching scratched and pitted TV tubes. Brush attached. Or use handy new spray gun for economy and easiest application.

Cat. No.	List Price
199 2 oz. bottle with brush	\$1.20
199-S 12 oz. spray can	4.50

WALSCO TUNERCLEAN

For cleaning and protecting switch contacts. Thoroughly cleans corrosion and dirt from switch contacts in TV tuners. Lubricates contacts and leaves an anti-corrosion protecting film as solvents evaporate. Quiet, like-new operation is prolonged.

Cat. No.	List Price
105 1 oz. bottles	\$ 0.85
108 1 pint	12.50

**WALSCO SILVER CONTACT
CLEANING CLOTH**

Specially-woven fabric, designed to clean and remove the tarnish from turret tuner contact points and springs. Has a microscopic polishing agent; yet, leaves no undesirable chemical deposit. Safe to use on the most delicate equipment.

Cat. No.	List Price
280	\$ 0.50
280-D Display of 20 No. 280	10.00

**DECALS
TV CASTERS
TV ACCESSORIES**

WALSCO
walsco quality earned its reputation

WALSCO SILICONE COMPOUND

Forms a moisture-repellent seal of high dielectric strength. Recommended for treating TV and amateur transmitter antenna lead wires, insulators, and terminals. Prevents high voltage arcing and breakdown under humid conditions.

Cat. No.	List Price
24 1 oz. tube	\$ 2.00
24-D Display of 12 1 oz. tubes	24.00



WALSCO TV RECEIVER DECALS

complete marking set for television controls

Now you can achieve a most professional-finished appearance on custom TV sets or refinished cabinets with easy-to-apply WALSCO decals. Cut out label you need, dip it in water, slide marking off paper backing and onto panel. Cements itself to surface as it dries. Very legible type; letters are gold. Every designation you will ever need — over forty markings on each sheet, 2 complete sheets per set.

STATIONS	VOLUME	ON
TV	RADIO	PHONO
CONTRAST	LINE	TUNING
HORIZONTAL	TRIM	FOCUS
PICTURE	CUSTOM	MADE
HORIZ. LIN.	VERT. LIN.	
HEIGHT	ON	OFF
1	2	3
4	5	6
7	8	9
10	11	12
13		
CHAN. SELECTOR	SOUND	
VERTICAL	BRIGHTNESS	
0	0	0

Cat. No.	List Price
2551 2 complete sets of Decals	\$0.45
2551-D Display of 20 No. 2551	9.00

WALSCO ROLABOUT TV CASTERS

*put wheels under any TV set; easy to install
can be installed in the home*

Give mobility to any TV set this easy way — with WALSCO ball bearing Rolabout TV Casters. Every homemaker has wished for an easy way to move the TV set — in order to get behind it to clean, to move it from room to room, to turn it to face company who have come to watch a favorite program. . . . Further, it simplifies servicing. The WALSCO Rolabout assembly is easily and quickly installed on almost every TV console. Lifetime construction. It consists of a steel, criss-cross, universally adjustable frame; ball bearing casters with good sized wheels for easy moving, wheels that are wide enough to prevent marring floor; and a center wing nut to lock frame members together.

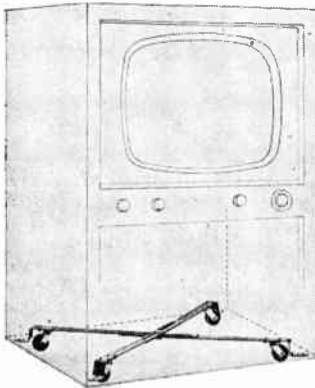

Tips of the frame support of the cabinet at all four corners. Frame is so designed that sides of cabinet hang down to mask caster wheels. To install, you merely adjust frame to fit, drive wood screws at each corner, and lock wing nut in center. Add dollars to your every service call. Every set owner is a ready customer.

Cat. No. 333	List Price \$7.95
(Standard Pack: 12)	

WALSCO GUY-TITE

(The Simple, Easy Way to Tighten Guy Wires)

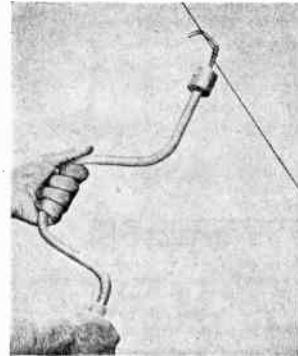

Tighten guy wires faster and better with this new WALSCO tool. Does the job of a turnbuckle at a fraction of its cost.

Cat. No.	List Price
1566—Wrench Kit includes 18 tites	\$8.25
1567	1.65
1568	6.00

WALSCO CLEAN-O-MATIC

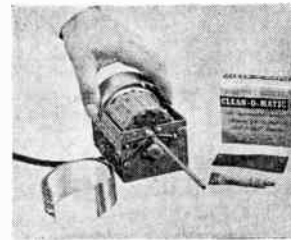

Covers contact on "Standard Coll" tuners and keeps them clean, silent, oxidation-free. Easy to install. Tube of "Tunerlub" and crocus brush included.

Cat. No.	List Price
1200	\$2.50

WALSCO MAST ADAPTER

**To Install UHF
Antenna on
Large Masts**

The complete answer to the problem of installing all UHF antennas on existing large masts. Fits all size masts from 1" to 4".

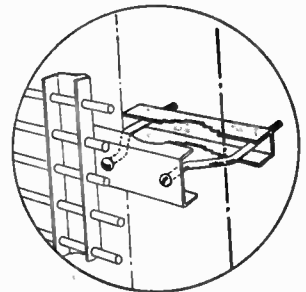

Cat. No.	List Price
4005-18	\$0.80



HARDWARE MANUFACTURING CO., INC.

BROOKLYN 11, N. Y.

CONTROLLED TORQUE KNOBS with the built-in SAFETY FACTOR

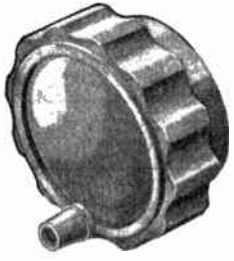

Model K1375

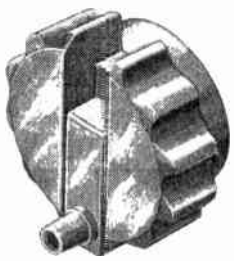

Model K1376

JAN CONTROLLED TORQUE KNOBS are designed to safeguard delicate and costly instruments against careless or inadvertent cranking beyond their normal stops. Designed for multi-turn devices such as variable capacitors, inductors, potentiometers, etc., the knobs work on the principle of the slip clutch, automatically disengaging and slipping when a predetermined torque is exceeded. The knobs which are fluted to aid in sensitive adjustment also have spinners for fast turning. Featuring distinctive styling, the knobs measure $1\frac{7}{8}$ " O.D. & $15/16$ " thick. They fit standard $1/4$ " diameter shafts.

Model K1376 is the same as the model K1375 with the additional feature of a retractable spinner. The retractable feature is useful when equipment must fit into small storage spaces or where there is danger of inadvertent movement of protruding controls. It has a positive toggle type action, being spring loaded either open or closed.

"JOLTA" SHOCK TESTER

Model No. 1001

This new shock tester for meters and small mechanisms provides for rapid and precise testing of the ability of components to withstand shock stresses. Designed for laboratory testing of instruments such as relays, electric meters, clocks and other electrical and electronic devices, it is accurately calibrated for direct readings in accord with specifications now required in most military and commercial contracts. Known as "JOLTA," the tester is a sturdily built bench model machine capable of accommodating all shapes and sizes of specimens up to a weight of 4 pounds and measuring up to 5" x 5" x 5". Mechanisms may be tested while in actual operation and under electrical load. Computation charts are supplied.

Designed to comply with specifications JAN-S-44 and MIL-STD-202; Method 202.

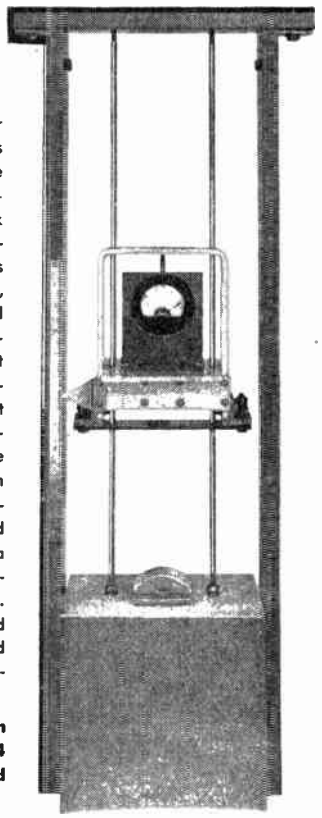

PANEL BEARING & SHAFT ASSY.

The versatile Panel Bearing and Shaft Assembly is used for control of a remote component. Passivated stainless steel shaft is $1/4$ " dia. with one end flattened for attaching to control knob by set screws. Supplied completely assembled with two retaining rings, jam nut with lock washer, and brass panel bearing, nickel plated. Fits all panels up to $1\frac{1}{8}$ " thick; mounts in $1\frac{1}{2}$ " dia. hole.

Cat. No.	"L" Shaft Length
API5350	Panel bearing assy. without shaft.
API5350-1	$1\frac{1}{8}$ "
API5350-2	3"
API5350-3	6"

JACK COVER

These sturdy Jack Covers are used to keep out dust and moisture and to prevent inadvertent disturbance of control settings. They are made of steel and finished in enamel, after bonderizing for rust prevention. Supplied assembled with stainless steel spring, hinge pin and neoprene pad. Fits on jack or panel bushings. For black wrinkle finish, specify (-1), smooth gray (-2) and olive drab (-3).

- Fig. 1..... J1301 ()
- Fig. 2..... J1302 ()
- Fig. 3..... J1303 ()

SHAFT LOCK

This shaft lock securely holds in position the shaft of volume controls, capacitors, switches, etc., which are $1/4$ " in diameter. Body and lock nut of nickel plated brass. Supplied with nickel plated steel lock washer. Body and lock nut are available in stainless steel on special order.

Cat. No. AK5100

BUSHING EXTENDER

This special bushing extender permits staggered mounting of components (having $1/4$ " dia. shafts) behind a panel. Potentiometers or other components can be located in close proximity on a panel without interference. Supplied in nickel plated brass in eight sizes.

Cat. No.	"B" Extension behind panel	"A" Bushing Length
AK5075-1	$5/8$ "	$3/8$ "
AK5075-2	$5/8$ "	$1/4$ "
AK5075-3	$5/8$ "	$3/16$ "
AK5075-4	$3/4$ "	$1/4$ "
AK5075-5	$2/4$ "	$1/4$ "
AK5075-6	$15/16$ "	$1/4$ "
AK5075-7	$1\frac{1}{8}$ "	$3/8$ "
AK5075-8	$1\frac{1}{4}$ "	$1/4$ "

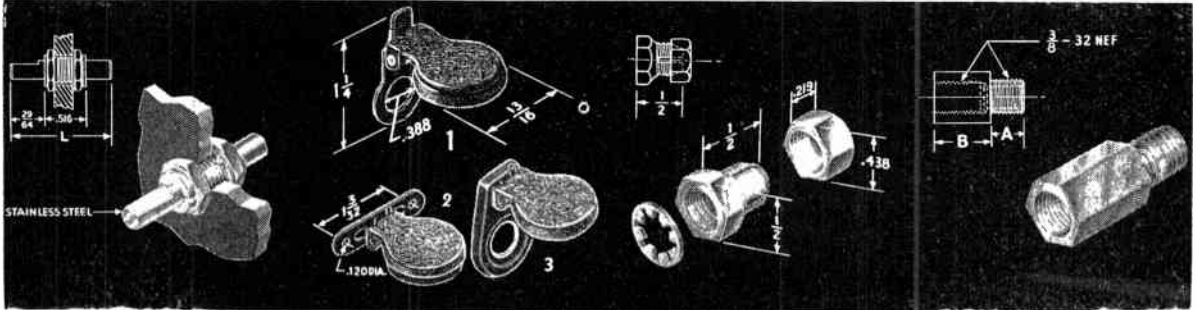

Copyright by U. C. P., Inc.

Radio's Master — 19th Edition



HARDWARE MANUFACTURING CO., INC.

BROOKLYN 11, N. Y.

HIGH VOLTAGE INSULATED COUPLING WITHSTANDS GREATER THAN 15 KV!

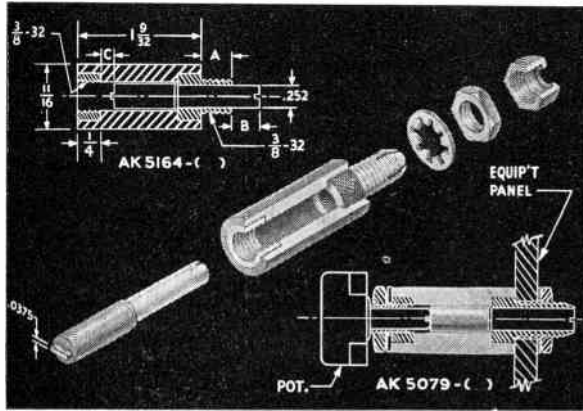

This coupling permits chassis or panel adjustment of high voltage controls without danger of electrical shock to operating personnel. Stainless steel shaft and precision screwdriver tip are mated into a single unit, melamine-to-metal, completely vibration and shock proof. Operates with ease over an ambient temperature range of -75°C to $+175^{\circ}\text{C}$. Supplied complete with nickel plated hardware. Shaft mates slot of all standard potentiometer shafts WITHOUT FURTHER MACHINING. U.S. Pat. No. 2,681,378

Cat. No.	"B" Shaft Length	"A" Mounting Bushing	"C" Pot. Shaft Length
LOCKING TYPE			
AK-5079-X-1	1/8"	9/16"	1/8"
AK-5079-B-1	1/8"	9/16"	1/8"
PLAIN TYPE			
AK-5164-X-2	7/16"	3/8"	1/8"
AK-5164-B-2	7/16"	3/8"	1/8"
AK-5164-X-3	15/16"	3/8"	1/8"
AK-5164-B-3	15/16"	3/8"	1/8"
AK-5164-X-4	1-7/16"	3/8"	1/8"
AK-5164-B-4	1-7/16"	3/8"	1/8"

INSULATED UNIVERSAL COUPLINGS $\pm 30^{\circ}$

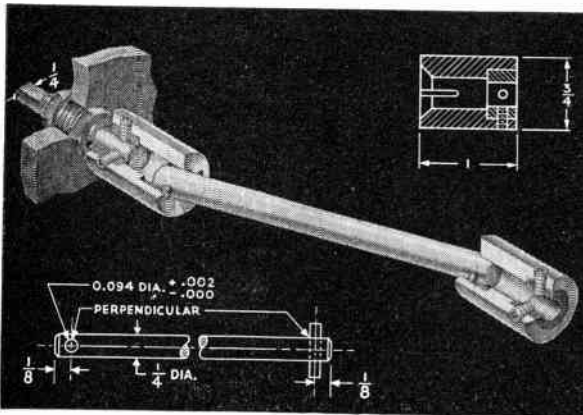

ELIMINATES BACKLASH AND COSTLY FLEXIBLE SHAFTS!

This versatile and extremely durable nylon coupling makes it possible to join two parallel drive shafts offset from each other plus or minus 30 degrees in any direction and separations greater than 3 inches.

- Secures firmly to the drive shaft thru a nickel plated brass insert and 2 set screws.
- Used with 1/4" coupling shaft of any length (not furnished).
- Shaft is keyed to the coupler by zinc plated steel pins supplied by JAN.
- Eliminates backlash and replaces costly flexible shafts.
- Provides for insulation and coupling from front panel to remote control such as potentiometer, selector switch and other devices (rotating).

Cat. No. AP15299

BEZEL ASSEMBLIES

JAN BEZEL ASSEMBLIES consist of cast aluminum alloy bezels finished in smooth dull or wrinkle black enamel paint, Buna-S rubber shock mounts, scale calibrated light filters and mounting hardware. JAN EDGE-LIT BEZELS have engraved calibration scales on the window and accommodate pilot bulbs for edge lighting. All JAN BEZELS are designed for universal application and are specifically adaptable to JAN'S MAGNETIC SHIELDS.

Cat. No.	Fig. No.	C.R.T.	Face	Panel Hole
STANDARD TYPE				
CP-1328-1	1	3"	Curved	3 1/2"
CP-1328-2	1	3"	Flat	3 1/2"
CP-13549-1	2	5"	Curved	6"
CP-13549-2	2	5"	Flat	6"
CAMERA MOUNT TYPE				
CP-13584-1	3	5"	Curved	6"
CP-13584-2	3	5"	Flat	6"
CAMERA MOUNT WITH EDGE WINDOW LIGHTING				
CP-19495-2	4	5"	Flat	5-5/16"

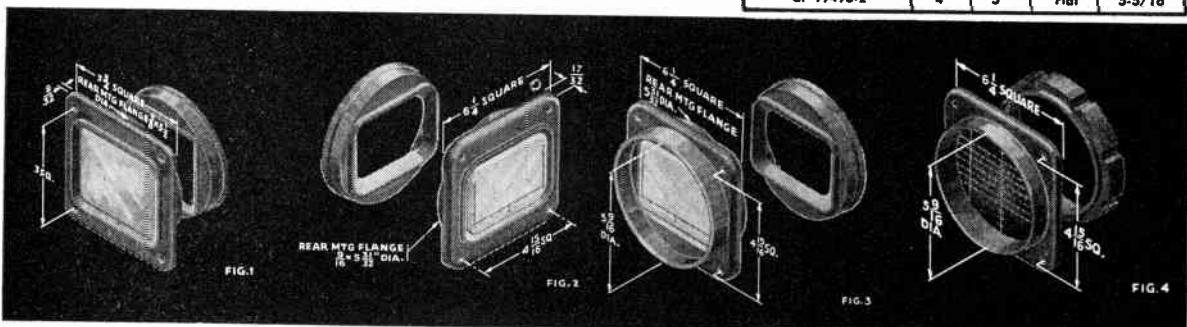



HARDWARE MANUFACTURING CO., INC.

BROOKLYN 11, N. Y.

MAGNETIC SHIELDS FOR CATHODE RAY TUBES

JAN MAGNETIC SHIELDS are made of the highest grade of magnetic metals and are carefully annealed by a special process to assure optimum orientation of the specific grain structure of the alloy. JAN SHIELDS prevent distortion and intensity modulation of the electron beam due to stray magnetic fields and protect personnel against the dangers of accidental tube breakage. Mounting holes are tapped for #6-32 screw.

All cathode ray tubes with curved faces are underlined. Bezels with designations (—1) are used with these tubes only. All others not underlined are flat faced tubes which are used with bezels designated as (—2). See inside page for specifications on JAN BEZEL ASSEMBLIES.
 *Opening for anode provided when required.

SHIELD CAT. NO.	FOR USE WITH C.R.T. NO.	MATCHING JAN BEZEL	DIMENSIONAL OUTLINE
S2001	<u>2AP1</u> <u>2BP1</u> <u>2BP11</u> <u>902</u>	• • • •	<p>Fig. 1</p>
S3001	<u>3RP1</u> <u>3RPA</u>	CP1328-1 CP1328-2	<p>Fig. 2</p> <p>$A = 8 \frac{1}{4}''$ $B = 1 \frac{5}{8}''$</p>
S3002	<u>3MP1</u>	CP1328-1	Same as Fig. 2 except: $A = 7 \frac{1}{4}''$
S3003	<u>3AP1</u> <u>3KP11</u> <u>3KP1</u> <u>908-A</u> <u>3KP4</u>	CP1328-1	Same as Fig. 2 except: $A = 10 \frac{1}{4}''$ $B = 1 \frac{7}{8}''$
S3004 *	<u>3BP1-A</u> <u>3JP7</u> <u>3JP1</u> <u>3ACP</u>	CP1328-1 CP1328-2	Same as Fig. 2 except: $A = 8 \frac{7}{8}''$ $B = 2 \frac{1}{4}''$
S5001	<u>SUP1</u> <u>SUP7</u> <u>SUP11</u>	{ CP13584-1 CP13549-1 9P19495-1	<p>Fig. 3</p>
S5003	<u>SUP1</u> <u>SUP7</u> <u>SUP11</u>	{ CP13584-1 CP13549-1 CP19495-1	<p>Fig. 4</p> <p>$A = 14 \frac{1}{8}''$ $B = 1 \frac{7}{8}''$ $C = 2 \frac{1}{2}''$</p>
S5002 *	<u>SBP1A</u> <u>SCP11A</u> <u>SCP1A</u> <u>SCP12</u> <u>SCP7A</u> <u>5ABP1</u> <u>5ABP7</u> <u>5ABP11</u> <u>5ADP</u>	{ CP13584-1 CP13549-1 CP19495-1 CP13584-2 CP13549-2 CP19495-2	<p>Fig. 5</p>
S5004 *	<u>SBP1A</u> <u>SCP11A</u> <u>SCP1A</u> <u>SCP12</u> <u>SCP7A</u> <u>5ABP7</u> <u>5ADP</u> <u>5ABP11</u> <u>5ABP1</u>	{ CP13584-1 CP13549-1 CP19495-1 CP13584-2 CP13549-2 CP19495-2	Same as Fig. 4 except: $A = 15 \frac{7}{8}''$ $B = 2 \frac{1}{4}''$ $C = 3 \frac{1}{2}''$ Hole for anode provided
S7001	<u>7GP4</u> <u>7JP4</u> <u>7JP1</u> <u>7VP1</u>	• • •	<p>Fig. 6</p>
S7002 *	<u>7OP1</u>		Same as Fig. 6 except anode opening provided.

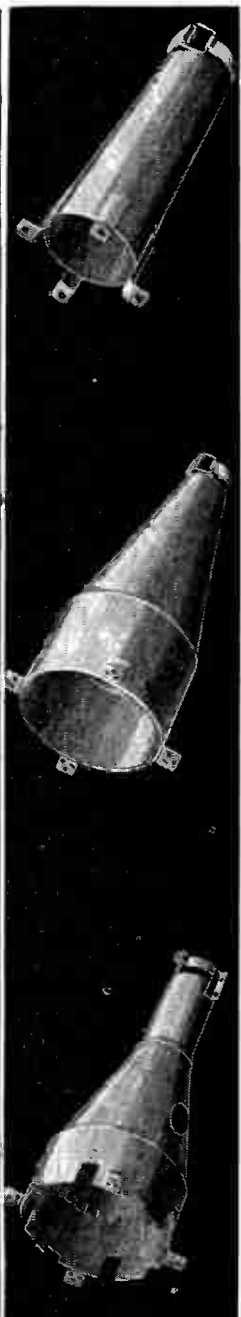

SHIELDS FOR PHOTO-MULTIPLIER AND OTHER C.R. TUBES IN STOCK



PLUGS·JACKS·COUPLINGS·TERMINALS



GIANT BANANA PLUGS and JACKS FOR HEAVY DUTY APPLICATIONS

Giant banana jack, complete with nut and solder lug. For mounting, drill $\frac{3}{8}$ " hole.
Cat. No. **PJ-963**
Dealer Cost \$.17

Giant plug, tapped 10-32. Positive spring action assures firm contact.
Cat. No. **PL-962**
Dealer Cost \$.20

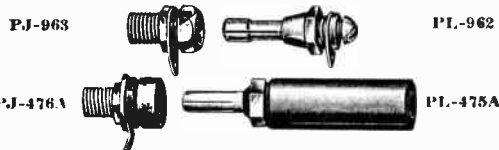

Giant insulated banana plug jack, complete with insulating washers, solder lug and nut. To mount, drill $\frac{1}{2}$ " hole.
Cat. No. **PJ-476A**
Dealer Cost \$.33

High voltage insulated banana plug. Overall length 2 $\frac{1}{2}$ ". Excellent for heavy duty applications.
Cat. No. **PL-475A**
Dealer Cost \$.45

BANANA PLUGS and JACKS (Brass Nickel Plated)

Banana plug jack, threaded $\frac{1}{4}$ " — 28, supplied with nut and solder lug.
Cat. No. **PJ-949**
Dealer Cost \$.10

Banana plug. Overall Length 1 $\frac{1}{4}$ ". Shank threaded 6-32, supplied with 6-32 nut.
Cat. No. **PL-470**
Dealer Cost \$.15

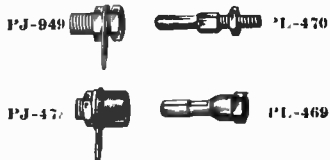

Insulated banana plug jack, complete with insulating washers, solder lug and nut.
Cat. No. **PJ-478**
Dealer Cost \$.17

Banana plug. Shank tapped for 6-32 screws. Nickel plated.
Cat. No. **PL-469**
Dealer Cost \$.10

SOLDERING LUGS and TERMINALS



Catalog No.	Type	Length	Mounting Hole	Width	Wire Opening	Dealer Cost
TL-42	A	27/32"	5/32"	11/32"	3/32"	\$.59C
TL-44	C	15/16"	7/32"	11/32"	3/16"	.86C
TL-45	C	1 $\frac{1}{4}$ "	9/32"	1/2"	3/16"	1.18C
TL-46	D	13/16"	1/4"	3/8"	1/8"	.66C
TL-47	D	3/4"	9/32"	13/32"	3/32"	.76C
TL-48	D	11/16"	5/32"	5/16"	3/32"	.50C
TL-49	D	7/8"	7/16"	9/16"	1/16"	1.55C
TL-50	D	9/16"	1/8"	3/16"	3/32"	.50C
TL-52	D	5/8"	7/32"	3/8"	1/16"	.50C
TL-54	E	13/16"	7/32"	3/8"	3/32"	.92C
TL-55	E	3/4"	3/16"	5/16"	1/16"	.72C
TL-56	E	5/8"	5/32"	15/64"	5/64"	.50C
TL-57	C	11/16"	3/16"	11/32"	3/32"	.86C

DIAL LOCK DL-19-17



This dial lock is a dual purpose item, since it functions as both a dial lock and a position indicator. The problems of dial slippage and accidental movement of dials are absolutely eliminated by this inexpensive and precise lock. Made of brass, nickel plated.

DL-1947 Dealer Cost \$0.18

WALL LEAD-IN I-742

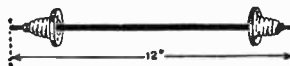

This Lead-In is used to facilitate bringing in antennas or feeders through a wall or window casing with ease and safety. Unit consists of a 12" threaded brass rod insulated with heavy plastic tubing, and two heavy ceramic insulators. Rod and insulator may be readily cut to any length.

I-742 Dealer Cost \$1.08

SHAFT COUPLINGS, REDUCERS and EXTENSIONS



As indicated in the heading, these items are intended for connecting two shafts, changing diameter of shafts, or for increasing shaft lengths. Units made of brass.

Catalog No.	Type	Description	Dealer Cost
SE-1049	Brass	1/4" Coupling	\$0.20
SE-1050	Brass	3/8" Coupling	.25
SE-1051	Brass	1/2" to 3/8" Coupling	.25
SE-1052	Brass	1/4" Male to 1/4" Female	.25
SE-1053	Brass	3/8" Female to 1/4" Male	.28
SE-1054	Brass	1/2" Female to 3/8" Male	.28
SE-1056	Brass	1/4" x 6" Brass Shaft	.17
SE-796	Brass	1/4" x 12" Brass Shaft	.33
SE-1206	Insulated	1/4" Coupling	.20
SE-1207	Insulated	3/8" Coupling	.25
SE-1208	Insulated	1/2" to 3/8" Coupling	.25
SE-1209	Insulated	1/4" Male to 1/4" Female	.22
SE-1210	Insulated	3/8" Female to 1/4" Male	.25
SE-1211	Insulated	1/2" Female to 3/8" Male	.25
SE-1055	Insulated	1/4" x 6" Fiber Shaft	.25
SE-797	Insulated	1/4" x 12" Fiber Shaft	.36
SE-1978	Insulated	1/4" x 6" Bakelite Shaft	.40
SE-1979	Insulated	1/4" x 12" Bakelite Shaft	.66

LUCITE FEEDER SPREADERS



Designed for all average feeder requirements. A 600 ohm line can be made with any size wire from No. 12 to No. 18 by using one of the spreaders listed below. The spreader used for this application depends on the wire size. Further data on this subject is available in any antenna handbook. These spreaders are furnished

with locking screws to clamp the wire in place. All spreaders are $\frac{3}{8}$ " in diameter.

Catalog No.	Wire Splicing	Std. Package	Dealer Cost
I-1900	2"	25	\$0.30
I-1901	4"	25	.36
I-1902	5"	25	.39
I-1903	6"	25	.42

PANEL BEARING ASSEMBLIES

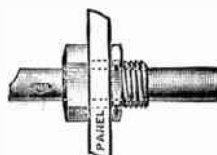

Nos. PB-530 and PB-531 consist of a regular 1/4" shaft bearing with 6" and 3" length of 1/4" brass rod inserted and held in place by washers to prevent shaft from shifting. These two assemblies will facilitate the panel control of condensers, potentiometers, etc., which must be mounted a distance from the panel. Bearing fits in 13/32" hole and on panels up to 5/16" thick. No. PB-532 is bearing only without shaft.

Catalog Number	Overall Length	Distance in front of panels	Dealer Cost
PB-530	6"	4 3/4"	\$0.45
PB-531	3"	1 3/4"	.36
PB-532	Bearing Only15

TUBE CLIPS



These clips may be used for various types of tubes as shown below. Made of heavy gauge spring brass, cadmium plated.

Catalog Number	Type Tube	Std. Package	Dealer Cost
TC-490	Fits Tube Caps up to 3/8" dia.	10	\$0.07
TC-107	Glass Tube Fits 3/8" dia. Cap.	100	1.95C
TC-108	Metal Tube Fits 1/4" dia. Cap.	100	1.10C

Only a few of many BUD Products are shown. For complete catalog, write BUD RADIO, INC., 2118 E. 55th St., Cleveland, Ohio



PRODS • LEADS • JACKS • PLUGS



“WISE-GRIP” TEST PRODS

No longer is it necessary to use a soldering iron or screw-driver to replace a broken or worn lead on a test prod or plug. To install a wire in this unique, patented prod, merely insert end of wire in hole, screw down handle to finger tightness and a positive contact is assured. By far the fastest, most efficient way of doing this job.

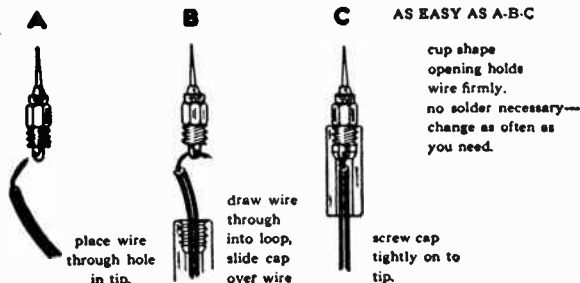

AS EASY AS A-B-C
cup shape opening holds wire firmly. no solder necessary—change as often as you need.

TEST PRODS WITH 1" PLASTIC HANDLE



Prod is made of brass rod, and is nickel plated. Plastic handle is threaded at one end and prod screws into same.

Catalog Number	Dealer Cost
TP-93 Needle Chuck 1" plastic handle—red or black	.21
TP-94 Phone Tip 1" plastic handle—red or black	.18
TP-477A Banana Plug 1" plastic handle—red or black	.18

TEST PRODS WITH 4" PLASTIC HANDLE

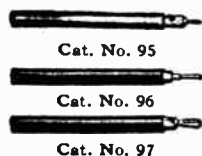

Prods are identical to those described above. Plastic handle is 4" long and made of the best material obtainable.

Needle Chuck—Black or Red, Cat. No. TP-95 Dealer Cost \$0.36

Phone Tip—Black or Red, Cat. No. TP-96 Dealer Cost \$0.27

Banana Plug—Black or Red, Cat. No. TP-97 Dealer Cost \$0.30

SUPER TEST LEADS

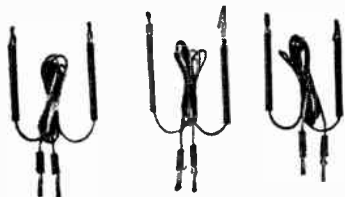

All BUD Super Test Leads use BUD "Vise-Grip" Prods that screw into the highly polished 4" or 1" plastic handles on each end of the leads. The finest, flexible, kinkless, rubber covered wire obtainable is used on all BUD Test Leads.

No. TL-178 is supplied with 4" handles at one end of the wires with removable needle points and on other end 1" handle with phone tips.
Cat. No. TL-178.....Dealer Cost \$1.62

No. TL-179—4" handles, one with removable needle point and the other with phone tip and removable alligator clip. 1" handles with phone tips.
Cat. No. TL-179.....Dealer Cost \$1.62

No. TL-180 have 4" plastic handles with phone tips on one end. Other end, 1" handles with phone tips as illustrated above.
Cat. No. TL-180.....Dealer Cost \$1.41

SMALL JACKS



These panel mounting jacks are desirable for control panels and similar applications where space is at a premium. Parts are accurately machined, with cadmium plated finish and contacts are formed from spring brass. Each jack comes complete with insulating washers and will accommodate standard plugs. Overall length 1 1/2".

Catalog No.	Contacts	Distance Behind Panel	Dealer Cost
J-1038	2	15/16"	\$.33
J-1058	3	15/16"	.55

ALL-PURPOSE JACKS

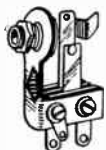

Although small in size, this is one of the finest lines of jacks available. The careful design and high quality materials used in these components assure long, dependable service. Circuit opening contacts are made of pure silver and the laminated bakelite insulation prevents breakdown between springs at all ordinary voltages. Supplied with panel insulating washers. Height 1 1/2", distance behind panel 3/8".

Catalog Number	Circuit Design	Contact Arrangement	Dealer Cost
J-1324		Open Circuit	\$.33
J-1325		Closed circuit	.45
J-1326		3-Contact open circuit	.45
J-1327		Break contact on tip and ring spring	.60
J-1328		Separate make-contact springs	.54
J-1329		Break contact on tip spring—separate make-contact spring	.57
J-1330		Break-make contact on tip spring	.60

MIDGET JACKS



The construction of this jack allows its use in applications having limited space behind the panel. The spring brass contact assures a good connection. These jacks come with insulating washers and accommodate standard phone plugs.

Catalog No.	Type	Distance Behind Panel	Dealer Cost
J-232A	Open Circuit	13/16"	\$.35
J-233A	Closed Circuit	13/16"	.40

PHONE PLUGS



All metal parts on these excellent phone plugs are machined from brass, and are nickel plated. Unshielded plugs have handles of black bakelite; shielded types have attractive brass knurled handles bright nickel plated.

No. PP-1946 is supplied Without a Handle, and is used as an adapter between a female microphone cable connector and a regular plug jack.

Catalog Number	Contacts	Handle	Overall Length	Bushing Diam.	Dealer Cost
FP-230	2	Bakelite	2 3/4"	3/8"	\$.36
FP-282	2	Shielded	2 3/4"	3/8"	.75
FP-1057	3	Bakelite	2 3/4"	3/8"	.84
FP-284	3	Shielded	2 3/4"	3/8"	1.10
FP-1946	2	None	1-7/16"	11/16"	.24

FLEXIBLE SHAFTS and COUPLERS

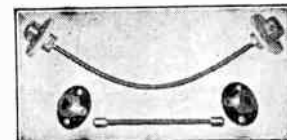

When construction necessitates the mounting of condensers or potentiometers away from the panel and at unusual angles, these Flexible Shafts simplify panel control problems. Both lengths are remarkably free from backlash and will turn at any angle up to 90°.

Nos. FS-859 and FS-860 have 1/4" bushings sweated to each end to fit either plain or insulated couplings. Nos. FS-862 and FS-863 have Steatite insulated couplings attached to each end to fit 1/4" shafts.

Catalog Number	Overall Length	Dealer Cost
FS-859	3 1/4"	\$0.36
FS-860	6 1/4"	.48
FS-862	4 1/4"	1.20
FS-863	7 1/4"	1.38

Only a few of many BUD Products are shown. For complete catalog, write BUD RADIO, INC., 2118 E. 55th St., Cleveland, Ohio

Quantities of
 Larson Wire Goods Used on
 Antenna Installations

Sold Exclusively
 Through Jobbers

EYE BOLTS LAG SCREW THREAD No. 11—Zinc Coated

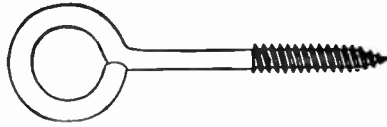

Stock No.	Wire Size and Length Overall	I.D. Eye	Length of Thread	Lbs. Per Gross
EL 1	1/4" x 3 3/4"	1/2"	1 1/4"	8.00
EL 2	5/8" x 4"	5/8"	1 3/4"	27.00
EL 3	3/8" x 4 1/2"	3/4"	1 1/2"	18.00
EL 4	1/4" x 5 1/4"	1"	2 1/4"	43.00
TEL 1	#3 x 5"	3 1/2"	1 1/2"	14.25
TEL 1	#3 x 3"	3 1/2"	1 1/2"	10.20

Packed 1 Dozen in Box. Order by Gross and Stock Number.

SCREW EYES—LARGE EYE—Zinc Coated

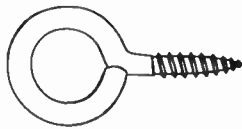

Wire Size	Length Overall	Length of Stem	I.D. Eye	Length of Thread	Lbs. Per Gross
000	3 7/8"	2 1/8"	1 1/8"	1 5/8"	27.00
0	2 7/8"	1 1/8"	1 1/8"	1 1/4"	14.50
2	2 5/8"	1 1/8"	3/8"	1 1/8"	9.25
4	2 3/8"	1 1/8"	3/8"	1 1/8"	6.00
6	1 11/8"	3/8"	3/8"	3/4"	3.75

Size 000 to 4 packed 1/4 Gross in Box. Size 6 packed 1/2 Gross in Box. Order by Gross.

PORCH SWING HOOKS No. 222—Zinc Coated

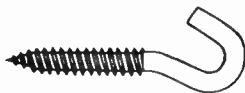

Dia. Wire	Length Overall	I.D. Hook	Length of Thread	Lbs. Per Gross
1/8"	3 5/8"	1/2"	1 3/4"	14.00
3/8"	4 1/4"	3/4"	2 1/8"	23.00

Packed 1 Dozen in Box. Order by Gross and Size.

SCREW HOOKS—CEILING—Zinc Coated



Wire Size	Length Overall	I.D. Hook	Length of Thread	Lbs. Per Gross
0	4 1/8"	1 1/8"	1 5/8"	21.00
2	4 1/8"	1 1/2"	1 1/2"	14.00
3	4 1/8"	3/8"	1 1/2"	11.00
4	3 7/8"	3/8"	1 3/8"	8.50
6	3 3/8"	1 1/8"	1 1/8"	5.50

Size 0 to 5 packed 1/4 Gross in Box. Size 6 packed 1/2 Gross in Box. Order by Gross

LARGE WROUGHT SCREW HOOKS No. 322—Zinc Coated

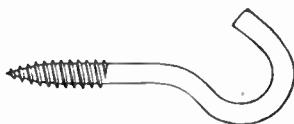

Wire Size	Length Overall Inches	I.D. Hook	Length of Thread	Lbs. Per Gross
1/4"	4 1/4"	1 1/8"	1 1/4"	12.00
5/8"	4 1/2"	7/8"	1 3/4"	21.00
3/8"	4 7/8"	1 1/8"	1 1/2"	31.90
7/8"	5 1/4"	1 1/8"	2 1/4"	46.00

Packed 1 Dozen in Box. Order by Gross and Size.

TOOL HOLDER—No. TH 321—Zinc Coated

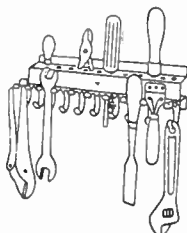

Patent Pending

3 Part Set—each part 12" long—weight per set 1 1/4 lbs. Holds large assortment of hand tools—many in use at radio and television repair shops. Also good item for Home craftsman.

Packed One Set in Colorful Box. 12 Sets in Carton.

CASH IN ON THE BIG TV BUYING!

Stock the Larson Wire Goods for the Ever-Increasing Demand.
 All Larson Wire Goods are Zinc Coated, Weather Proofed Finish.

*Sold Exclusively
 Through Jobbers*

**TV Guy Wire Eye Bolts were especially designed for leakproof application on all roofs.
 Simply fill the cup with roofing compound before using.**

TV GUY WIRE EYE BOLTS—Zinc Coated—With 3" Diameter Shield
 Diameter Wire .268 — Machine Thread $\frac{1}{8}$ x 18

Stock No.	Diameter and O.A. Length	I.D. Eye	Length of Thread	Weight Per Gross
TE5F	$\frac{1}{8}$ x 10"	$\frac{3}{4}$ "	3 $\frac{1}{4}$ "	41.50 Lbs.
TE5H	$\frac{1}{8}$ x 12"	$\frac{3}{4}$ "	3 $\frac{1}{4}$ "	45.00 Lbs.

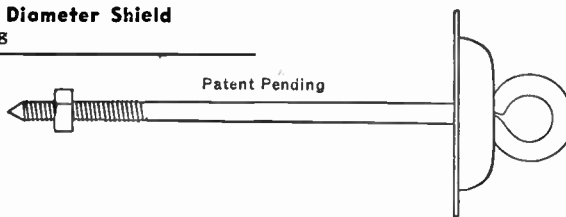

Packed 1 Dozen in Box. Order by Gross and Stock Number.

TV GUY WIRE LAG SCREW EYE BOLT—No. SEL-1111—Zinc Coated
 With 3" Diameter Shield — Diameter Wire .268

Weight and O.A. Length	I.D. Eye	Length of Thread	Weight Per Gross
$\frac{1}{8}$ x 3 $\frac{1}{2}$ "	$\frac{3}{4}$ "	1 $\frac{1}{2}$ "	28.00 Lbs.
$\frac{1}{8}$ x 5"	$\frac{3}{4}$ "	1 $\frac{1}{2}$ "	31.25 Lbs.

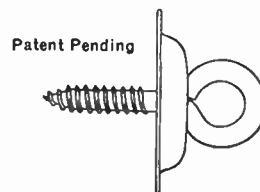

Packed 1 Dozen in Box. Order by Gross and Size.

"U" BOLTS WITH CLAMPS FOR TELEVISION ANTENNA WORK—Zinc Coated

Stock No.	Pipe Size	Wire Dia.	Outside Length	Width Between Legs	Weight Per Hundred
TC3	1"	$\frac{1}{4}$ "	3"	1 $\frac{3}{8}$ "	18.75 Lbs.
TC4	1"	$\frac{1}{4}$ "	4"	1 $\frac{3}{8}$ "	21.25 Lbs.

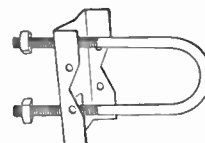

Packed 10 in Box Assembled with Clamp. Order by Hundred and Stock Number.

"U" BOLTS No. 103—Zinc Coated

Stock No.	Pipe Size	Wire Dia.	Outside Length	Width Between Legs	Lbs. Per Doz.
A- $\frac{1}{4}$ "	$\frac{1}{2}$ - $\frac{3}{4}$ "	$\frac{1}{4}$ "	2 $\frac{1}{4}$ "	1 $\frac{1}{8}$ "	1.31
TA- $\frac{1}{4}$ "	1"	$\frac{1}{4}$ "	3"	1 $\frac{3}{8}$ "	1.50
TV- $\frac{1}{4}$ "	1"	$\frac{1}{4}$ "	4"	1 $\frac{3}{8}$ "	1.78
A- $\frac{5}{8}$ "	1"	$\frac{1}{8}$ "	2 $\frac{1}{2}$ "	1 $\frac{1}{8}$ "	2.08
B- $\frac{1}{8}$ "	1 $\frac{1}{4}$ "	$\frac{1}{8}$ "	3"	1 $\frac{3}{8}$ "	2.31
C- $\frac{1}{8}$ "	1 $\frac{1}{2}$ "	$\frac{1}{8}$ "	3"	2"	2.37
D- $\frac{1}{8}$ "	2"	$\frac{1}{8}$ "	3 $\frac{1}{2}$ "	2 $\frac{1}{2}$ "	3.00
A- $\frac{3}{8}$ "	1 $\frac{1}{4}$ "	$\frac{3}{8}$ "	3 $\frac{1}{4}$ "	1 $\frac{3}{4}$ "	3.37

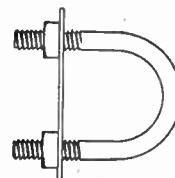

Packed 1 Dozen Bolts in Box with Square Nuts and Flat Straps. Order by Dozen and Stock Number.

TURNBUCKLES—Only Zinc Coated Turnbuckles Stocked

Eye and Eye No.	Wire Size	Hook and Eye No.	Hook and Hook No.	Take Up	Length Closed	Length Open	Lbs. Per Doz.
EE 11	$\frac{5}{16}$ "	HE 21	HH 31	1 $\frac{1}{4}$ "	3 $\frac{1}{2}$ "	4 $\frac{3}{4}$ "	.875
EE 12	$\frac{1}{8}$ "	HE 22	HH 32	1 $\frac{5}{8}$ "	3 $\frac{7}{8}$ "	5 $\frac{1}{2}$ "	1.25
EE 13	$\frac{3}{16}$ "	HE 23	HH 33	1 $\frac{7}{8}$ "	4 $\frac{3}{8}$ "	6 $\frac{1}{4}$ "	1.50
EE 14	$\frac{1}{4}$ "	HE 24	HH 34	2 $\frac{1}{8}$ "	5 $\frac{1}{2}$ "	7 $\frac{3}{4}$ "	2.00
EE 15	$\frac{5}{16}$ "	HE 25	HH 35	2 $\frac{5}{8}$ "	6 $\frac{3}{4}$ "	9 $\frac{3}{8}$ "	4.00
EE 16	$\frac{3}{8}$ "	HE 26	HH 36	3"	7 $\frac{3}{4}$ "	10 $\frac{1}{2}$ "	6.00
EE 17	$\frac{7}{16}$ "	HE 27	—	6"	10 $\frac{3}{4}$ "	16 $\frac{1}{4}$ "	13.00



Hard Brass Buckles — Soon Available in All Sizes. Will Not Permit Electrolytic Action.

Packed 1 Dozen in Box. Order by Dozen.



"QUIETROLE"

Trade Mark Reg. U. S. Pat. Off.

The original most reliable LUBRICANT CLEANER



Size	Cat. No.	Min. Order	Min. Re-order	Distr. Net Resale Price
2 oz.	10-2	24	24	\$1.69
4 oz.	10-3	16	8	2.54
8 oz.	10-4	8	6	5.07

Save on Gross Lot Purchase — Small Size

Size	Cat. No.	Distr. Resale Net Price
2 oz.	10-2	\$1.69

"QUIETROLE" the preferred, standard product of the industry!

Your guarantee for quieting noisy television and radio controls, switches and other moving parts is QUIETROLE. Here is the original, non-inflammable, most reliable lubricant-cleaner on the market today . . . developed through years of factual and authentic research.



Mfd. by **QUIETROLE COMPANY**
SPARTANBURG, S. C.



①

**VINYL
COLOR
TAPE**

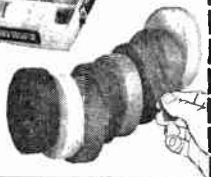

②

④



⑤



**PLASTIC
ELECTRICAL
TAPE**

③



DUTCH BRAND PRODUCTS for Radio and TV use

① VINYL COLOR TAPE

Our newest. Vinyl plastic tapes in eight colors and three widths . . . $\frac{1}{2}$ " , $\frac{3}{4}$ " , $1\frac{1}{2}$ " . . . 108" long. For use wherever color can help in wiring, indexing, coding, etc. Conforms to irregular surfaces. High dielectric resistance . . . up to 1000 V. per mil of thickness. UL listed. Packed in colorful self-service carton.

Also available in large size rolls in four widths, $\frac{3}{8}$ " , $\frac{1}{2}$ " , $\frac{3}{4}$ " , 1" . . . 36 yds. long. Ideal for the industrial user.

② PLASTIC ELECTRICAL TAPE

Plastic Electrical Tape Master Shop Package. This tape is thin and is used in places where space is limited. It has 150% stretch, high dielectric resistance, resists weather, water, oils, acids and corrosive chemicals. It conforms readily to irregular surfaces. Package contains 5 rolls $\frac{3}{4}$ inch by 44 feet each.

③ .010 PLASTIC has the general characteristics of regular Plastic except it is heavier for heavy duty work such as winding heavy cables, heavy electrical harness and for use in tape winding machines.

④ Plastic Electrical Tape Counter Display Carton. DUTCH BRAND Plastic is also available in an attractive point-of-sale display carton containing two dozen consumer size rolls $\frac{1}{2}$ inch by 150 inches. A convenient size for small repair jobs.

⑤ Plastic Tape "Tool Kit" Rolls. Convenient size roll for the home workshop or repair trade. DUTCH BRAND Plastic Tape has many uses around the home and is widely used for professional work. Rolls are $\frac{3}{4}$ inch by 20 feet long. Packaged both in Counter Display Carton of 18 rolls and Junior Shop Package of 5 rolls.

⑥ FRICTION TAPE

DUTCH BRAND Friction Tape—This tape has long life, extra strength for easy use. One layer resists up to 2000 volts. Combined

with DUTCH BRAND Rubber Insulating Tape it produces highest dielectric resistance. Individually boxed and packed in attractive display carton. Each No. 8 roll contains 68 ft. of tape.

⑦ Narrow Width Friction Tape. The handy size for radio and electrical appliance repair shops, electrical contractors, industrial users. The tape comes in a convenient $\frac{3}{8}$ inch width roll, handy for small work.

Special Width Friction Tape—Available in special widths for special uses . . . comes in widths $\frac{1}{2}$, 1, $1\frac{1}{4}$, $1\frac{1}{2}$, 2, 3, 4 inches and wider.

⑧ RUBBER TAPE

For perfect insulation it fuses instantly without heat. Has extra high dielectric strength—resists up to 18000 volts through a single thickness. Strong, durable and non-corrosive to electrical conductors. Assures positive insulation for high tension lines where highest dielectric resistance is needed.

⑨ "DB" WIRE CONNECTORS

Solderless. Vibration Proof. Weather Proof. Long Skirt. "DB" Wire Connectors are now available for the convenience of the many customers who buy and use the well known DUTCH BRAND Electrical Tapes. Those who use wire connectors for many installations will find that "DB's" are a quality product.

Available in four standard sizes to meet all needs. They resist pull-out and vibration . . . are weatherproof and are molded with the necessary length to give full insulation protection. U. L. listed.

⑩ CAULKING & SEALING COMPOUND

Here is a light colored, non-staining plastic material that will not crack or dry out. It comes in $\frac{3}{16}$ " cords, easy to press in place by hand. It is used to caulk antenna lead-ins . . . stops leaks and keeps out dust and cold drafts. It adheres to any dry surface.



⑥



**FRICTION
TAPE**



⑦



⑧

RUBBER TAPE



⑨

**"DB"
WIRE
CONNECTORS**



⑩



**CAULKING &
SEALING
COMPOUND**



**Johns-Manville
DUTCH BRAND
P R O D U C T S**

VAN CLEEF BROS., INC. DIVISION
7800 WOODLAWN AVENUE CHICAGO 19 ILL.

Gee-Lar RADIO AND TELEVISION KNOBS



G-L #1220 FRONT CHANNEL KNOB
Plated gold finish inlay. 2 1/2" dia. 3/8" height. Fits .250" dia. shaft with .156" flat. Calibrated for Standard Tuner.
No. 1220 List \$1.25



G-L #1225 REAR KNOB FOR #1220
2 5/8" Dia. 3/8" Height. Fits 3/8" Dia. Shaft with .328" flat.
No. 1225 List \$0.45



G-L #1230 FRONT KNOB OFF-ON, ETC.
Plated gold finish inlay. 2 1/2" Dia. 3/8" Height. Fits .187" Dia. Shaft with .156" flat.
No. 1230 List \$1.10



G-L #1235 REAR KNOB FOR #1230
2 5/8" Dia. 3/8" Height. Fit .256" Dia. Shaft with .324" flat.
No. 1235 List \$0.45



G-L #1240 TV KNOB SET
Complete set of four TV knobs at left. Boxed. Color, walnut only. For Standard Tuners.
No. 1240 List \$3.00



G-L #3460 FRONT CHANNEL KNOB
Plated gold finish inlay. 2 3/4" Dia. 3/8" Height. Fits .250" Dia. Shaft and .156" flat. Calibrated for Standard Tuner.
No. 3460 List \$1.25



G-L #3465 REAR KNOB FOR #3460
2 9/8" Dia. 3/8" Height. Fits 3/8" Dia. Shaft with .328" flat. Finger Tip Tuning.
No. 3465 List \$0.45



G-L #3470 FRONT KNOB OFF-ON, ETC.
Plated gold finish inlay. 2 3/4" Dia. 3/8" Height. Fits .187" Dia. Shaft with .156" flat.
No. 3470 List \$1.10



G-L #3475 REAR KNOB FOR #3470
2 9/8" Dia. 3/8" Height. Fits .265" Dia. Shaft with .324" flat. Finger Tip Tuning.
No. 3475 List \$0.45



G-L #3480 KNOB SET
Complete set of four TV knobs at left. Boxed. Color, walnut only. For Standard Tuners.
No. 3480 List \$3.00

GEE-LAR NEW GOLD METAL INLAY RADIO KNOBS

Beautiful, Modern Knobs — To Replace Knurl Type Knobs



TENITE PLATED GOLD INLAY
2 1/2" Dia. 1/2" H. Fits 1/4" Shaft.
No. 1540 List \$0.50
Knurl Type
No. 1540S List \$0.55
Spring Type
Walnut Only



TENITE PLATED GOLD INLAY
1 5/8" Dia. 1/2" H. Fits 1/4" Shaft.
No. 1541 List \$0.40
No. 1541S List \$0.45
Spring Type
Walnut Only



TENITE PLATED GOLD INLAY
1 1/2" Dia. 1/4" H. Fits 1/8" Shaft.
No. 1542 List \$0.38
No. 1542S List \$0.40
Knurl Type
Spring Type
Walnut Only



TENITE PLATED GOLD INLAY
1 1/4" Dia. 1/2" H. Fits 1/4" Shaft.
No. 1543 List \$0.35
Knurl Type
No. 1435 List \$0.40
Spring Type
Walnut or Ivory



TENITE PLATED GOLD INLAY
1" Dia. 5/8" Height. Fits 1/4" Shaft.
No. 1544 List \$0.30
Knurl Type
No. 1544S List \$0.35
Spring Type
Walnut or Ivory



TENITE PLATED GOLD INLAY
1" Dia. 1/2" Height. Fits 1/4" Shaft.
No. 1545 List \$0.28
Knurl Type
No. 1545S List \$0.30
Spring Type
Walnut or Ivory



TENITE PLATED GOLD INLAY
1" Dia. 3/8" Height. Fits 1/4" Shaft.
No. 1546 List \$0.28
Knurl Type
No. 1546S List \$0.30
Spring Type
Walnut or Ivory



TENITE PLATED GOLD INLAY
3/4" Dia. 3/8" Height. Fits 3/8" Shaft.
No. 1547 List \$0.26
Knurl Type
No. 1547S List \$0.30
Spring Type
Walnut or Ivory

Gee-Lar AUTOMOBILE RADIO KNOBS

To fit 1/4" Shafts; 3/16" Bushings to Accommodate 3/16" Shafts included.



Tenite
No. List
780SS \$0.40
Dia. 7/8", H. 1 1/8"
Set Screw Type



Tenite
No. List
790SS \$0.40
Dia. 7/8", H. 1 1/8"
Set Screw Type



Tenite
No. List
800SS \$0.40
D. 7/8", H. 7/8"
Set Screw Type



Tenite
No. List
810SS \$0.40
Dia. 1 1/8", H. 1 1/8"
Set Screw Type



Tenite
No. List
820SS \$0.45
D. 1 1/8", H. 1/2"
Set Screw Type



Tenite
No. List
854SS \$0.45
Chrome Inlay
Black Color
D. 7/8", H. 3/8"
Set Screw Type



Tenite
No. List
830SS \$0.40
D. 1 1/8", H. 7/8"
Set Screw Type



Tenite
No. List
840SS \$0.40
D. 1 1/8", H. 5/8"
Set Screw Type



Tenite
No. List
850SS \$0.40
D. 3/4", H. 1/2"
Set Screw Type



Chrome Plated Metal Knob
No. List
851SS \$0.35
D. 1/2", H. 3/4"
Set Screw Type



Tenite
No. List
852SS \$0.35
D. 1 1/8", H. 7/8"
Set Screw Type



G-L Reducing Bushings
To reduce from 1/4" to 1/8" size shafts.
No. List
853-E \$0.44
Enr. 8
853-G \$7.15
Box 144

All Knobs for 1/4" Shafts. Distributor's Standard Package 12 Knobs of a Type to a Box.

INSTRUMENT KNOBS

All Knobs are Set Screw Type with Brass Inserts for 1/4" Shafts. Black only.



No. 580SS List \$0.70
Dia. 1 1/8", H. 5/8", 3/4" Pointer.



No. 620SS List \$0.72
Dia. 1 1/8", H. 1 1/8", 1 1/2" Skirt.



No. 660SS List \$0.38
Dia. 1 1/8", H. 5/8".



No. 700SS List \$0.28
Skirt Dia. 1 1/4", H. 3/4". Set Screw Type.

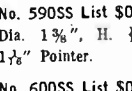

No. 590SS List \$0.77
Dia. 1 3/8", H. 1 1/4", 1 1/8" Pointer.

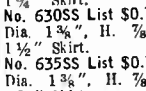

No. 630SS List \$0.72
Dia. 1 3/8", H. 7/8", 1 1/2" Skirt.

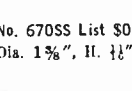

No. 670SS List \$0.44
Dia. 1 3/8", H. 1 1/4".

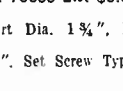

No. 710SS List \$0.28
Skirt Dia. 1 1/2", H. 3/4". Set Screw Type.

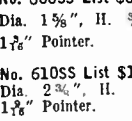

No. 600SS List \$0.88
Dia. 1 3/8", H. 3/4", 1 1/8" Pointer.

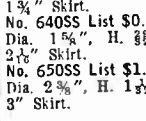

No. 640SS List \$0.94
Dia. 1 5/8", H. 3/8", 2 1/8" Skirt.

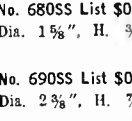

No. 680SS List \$0.55
Dia. 1 3/8", H. 3/4".

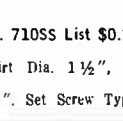

No. 690SS List \$0.83
Dia. 2 3/8", H. 7/8".

Gee-Lar TELEVISION KNOBS

knobs for sets using dual controls and tuners made by Standard Coil, Sarkis-Tarzian, RCA, Leonard and others. Also TV Sets such as RCA, Leonard, Bendix, Westinghouse, Admiral, Hoffman, Packard-Bell, etc. Walnut pattern knobs with plated gold finish inlay on face of knobs.



G-L FRONT DUAL CONTROL KNOB
 1 1/8" O.D. Used with rear knob No. 1205 and others.
 No. 1202 List \$0.45
 Fits 1/4" Knurl Shaft
 No. 1203 List \$0.50
 Fits 1/4" Flatted Shaft
 No. 1204 List \$0.50
 Fits .202" Flatted Shaft



G-L REAR DUAL CONTROL KNOB
 1 5/8" diameter. For standard .265" diameter rear keyway shaft. Used as mate to front dual control knobs.
 No. 1205 Rear Knob List \$0.28



G-L COMBINATION DUAL KNOB
 Dual dummy type knob. Front and rear dual knob combined into one for matching on cabinet. 1 5/8" diameter. Fits 1/4" flatted shaft.
 No. 1206 List \$0.75
 Combination Dummy Knob



G-L DUAL TUNER BAR KNOB
 Front bar knob for use on dual controls and tuners. 2" length. Can be used in combination with knob No. 1208 and others. Fits 1/4" diameter flat shaft.
 No. 1207 Bar Knob List \$0.90



G-L REAR DUAL TUNER KNOB
 For dual tuners and controls. Used with No. 1207 knob and others. 1 5/8" diameter. For standard 3/8" diameter rear flat shaft.
 No. 1208 List \$0.28
 Rear Dual Knob



G-L CHANNEL INDICATOR PLATE
 Used on sets using radio condenser TV tuner, etc. For Sparton, Farnsworth, Sonora, Meck, etc. Matches knobs listed above. Fits standard 3/8" diameter rear flat shaft.
 No. 1209 List \$0.75
 Channel Indicator Plate



G-L FRONT CHANNEL KNOB
 Front dual control knob used on channel tuners and controls for Motorola, Hallcrafters, Stromberg-Carlson, etc., and sets using Chicago Telephone tuner. 1 3/8" diameter. Fits .202" diameter flat shaft.
 No. 1210 List \$0.22
 Front Knob



G-L REAR CHANNEL KNOB
 Rear dual control knob. Walnut. Mate to No. 1210. Center hole for .265" rear keyway shaft. 1 1/4" diameter.
 No. 1211 Rear Knob List \$0.22



G-L COMBINATION DUAL DUMMY KNOB
 A combination of knobs Nos. 1210 and 1211. Used to match cabinet design on single control. 1 1/4" diameter at base. Fits on 1/4" knurled shaft.
 No. 1213 List \$0.45
 Combination Knob



G-L TELEVISION KNOB SPRINGS
 Necessary replacement springs for use on television knobs. Special sizes of springs not regularly used on older type radios.
 No. List
 Type A - Fits small .202" dia. flat shaft.
 1214-G Gross \$5.05
 1214-M 1000 30.25
 Type B - Fits 3/8" diameter flat shaft.
 1215-G Gross \$4.10
 1215-M 1000 24.75

NEW TV KNOBS TO FIT RCA SETS AND OTHERS

Sturdy and Substantial Knobs Combined with Beauty for Lasting Performance



G-L FRONT DUAL BAR POINTER CHANNEL KNOB
 Push-on type to fit standard 1/4" shaft flatted to .156", complete with spring. Flat adjacent to pointer.
 No. 3600 List \$0.50
 Bar Pointer



G-L REAR CHANNEL KNOB FOR #3600
 Push-on type to fit 3/8" shaft flatted to .327". Complete with spring.
 No. 3601 List \$0.45
 Rear Knob



G-L FRONT KNOB OFF-ON-VOLUME, ETC.
 Push-on type to fit 3/8" shaft flatted to .156". Complete with spring.
 No. 3602 List \$0.25
 Front Knob



G-L REAR KNOB FOR #3602
 Push-on type to fit 17/64" shaft flatted to .237". Complete with spring.
 No. 3603 List \$0.45
 Rear Knob



G-L #3604 TV KNOB SET
 Set of 4 TV knobs at left, boxed. Color, brown only.
 No. 3604 List \$1.65
 Complete Set

POINTER KNOBS TO FIT STANDARD 1/4" SHAFTS

Distributors' Standard Package — 12 Knobs of a Type to a Box — Set Screw Type Except Where Noted



No. 860 Tenite List \$0.13
 Knurl Type \$0.17
 Walnut or Ivory



No. 870 Tenite List \$0.13
 Knurl Type \$0.15
 Walnut or Ivory



No. 880 Tenite List \$0.13
 Spring Type \$0.13
 Walnut or Ivory



No. 890SS Bakelite List \$0.20
 Black, Walnut, Red, Ivory



No. 900SS Bakelite List \$0.17
 Walnut or Black



No. 910SS Bakelite List \$0.33
 Walnut, Blk., Red, White



No. 920SS Bakelite List \$0.33
 Walnut or White



No. 930SS Bakelite List \$0.33
 Walnut or White



No. 940SS Bakelite List \$0.22
 Walnut, Black, Red or Ivory



No. 950SS Bakelite List \$0.30
 Walnut, Black, Red or Ivory



No. 960SS Bakelite List \$0.17
 Walnut, Black, Red or Ivory



Brass Insert
 Black or Walnut
 No. 970SS Bakelite List \$0.28
 Plain 1/4" Hole \$0.38
 970ASS



No. 980SS Bakelite List \$0.20
 Plain 1/4" Hole
 Black or Walnut



No. 990SS Bakelite List \$0.21
 Plain 1/4" Hole
 Black, Walnut, Red or Ivory



No. 1000SS Bakelite List \$0.22
 Black, Walnut, Red or Ivory



No. 1010SS Bakelite List \$0.33
 1/4" Hole
 No. 1020SS Bakelite List \$0.46
 1/4" Hole
 Brass Insert
 Black, Walnut, Red, Ivory



No. 1030SS Bakelite List \$0.33
 Brass Insert
 Black or Walnut



No. 1040SS Bakelite List \$0.29
 Metal Insert
 Black or Walnut



No. 1050SS Bakelite List \$0.31
 Brass Insert
 Black, Walnut, Red or Ivory























































Gee-Lar RADIO KNOB KITS

No. 1250 Assmt. "A" Contents: 36 Asstd. Knurled Type \$4.35
 No. 1251 Assmt. "B" Contents: 30 Asstd. Spring Type 4.35
 No. 1252 Assmt. "C" Contents: 26 Asstd. Set Screw Type 4.35
 No. 1253 Assmt. "D" Contents: 12 Asstd. Auto Radio with Brass Bushings and Reducing Bushings for 3/8" Shaft 4.35

No. 1254 Assmt. "E" Contents: 30 Asstd. as follows: 10 Set Screw, 10 Spring Type, 10 Knurled Type \$4.35
 No. 1255 Assmt. "F" Contents: 50 Asstd. Push Buttons 4.35
 No. 1256 Assmt. "H" Contents: 24 Asstd. Pointer and Bar Set Screw Knobs 4.35

All Knobs for 1/4" Shafts — Distributors' Standard Package—12 Knobs of a Type to a Box.

Gee-Lar RADIO AND TELEVISION KNOBS

 No. Tenite List 10 Knurl Type \$0.13 10S Spring Type \$0.15 10SS Set Screw Type Walnut or Ivory	 No. Tenite List 20 Knurl Type \$0.13 Walnut or Ivory	 No. Tenite List 30 Knurl Type \$0.13 30S Spring Type \$0.13 30SS Set Screw Type Walnut or Ivory	 No. Tenite List 40 Knurl Type \$0.13 40SS Walnut or Ivory	 No. Tenite List 50 Knurl Type \$0.13 50S Spring Type \$0.13 Walnut or Ivory	 No. Tenite List 60 Knurl Type \$0.13 Walnut or Ivory 1/2" Shank Extension
 No. Tenite List 70 Knurl Type \$0.13 70SS Set Screw Type Walnut or Ivory	 No. Tenite List 80 Knurl Type \$0.13 Walnut or Ivory	 No. Tenite List 90 Knurl Type \$0.13 90S Spring Type \$0.13 Walnut or Ivory	 No. Tenite List 100 Knurl Type \$0.13 1/4" Shank Only Walnut or Ivory	 No. Tenite List 110 Knurl Type \$0.13 110S Spring Type \$0.15 110SS Set Screw Type Walnut or Ivory	 No. Tenite List 120 Knurl Type \$0.13 Walnut or Ivory 1/4" Shank Extension
 No. Tenite List 130 Knurl Type \$0.13 130S Spring Type \$0.15 Walnut or Ivory	 No. Tenite List 140 Knurl Type \$0.15 140S Spring Type \$0.17 140SS Set Screw Type Walnut or Ivory	 No. Tenite List 150 Knurl Type \$0.15 Walnut or Ivory 1/2" Shank Extension	 No. Tenite List 165 Knurl Type \$0.13 Crystal Clear	 No. Bakelite List 170SS Set Screw Type \$0.17 171SS Set Screw Type w. Arrow Walnut, Blk., Red, Ivory \$0.23	 No. Bakelite List 175SS Set Screw Type Walnut, Black, Red or Ivory \$0.22
 No. Bakelite List 180 Knurl Type \$0.13 Walnut Only	 No. Tenite List 200 Knurl Type \$0.13 200SS Set Screw Type Walnut or Ivory \$0.15	 No. Bakelite List 210SS Set Screw Type Walnut, Black or Ivory \$0.15	 No. Tenite List 220 Knurl Type \$0.13 Walnut or Ivory 1/4" Shank Extension	 No. Tenite List 230 Knurl Type \$0.13 Walnut or Ivory 1/4" Shank Extension	 No. Tenite List 240 Knurl Type \$0.13 240SS Set Screw Type Walnut or Ivory \$0.15
 No. Tenite List 250 Knurl Type \$0.13 Walnut or Ivory 1/2" Shank Extension	 No. Tenite List 270 Knurl Type \$0.13 Walnut or Ivory 1/2" Shank Extension	 No. Tenite List 280 Knurl Type \$0.13 Walnut or Ivory	 No. Tenite List 290 Knurl Type \$0.13 Walnut or Ivory 1/4" Shank Extension	 No. Tenite List 300 Knurl Type \$0.13 300S Spring Type \$0.15 Walnut or Ivory	 No. Tenite List 310 Knurl Type \$0.13 Walnut or Ivory
 No. Tenite List 320 Knurl Type \$0.13 Walnut or Ivory	 No. Tenite List 330 Knurl Type \$0.13 Walnut or Ivory	 No. Tenite List 340 Knurl Type \$0.15 Walnut or Ivory	 No. Tenite List 350 Knurl Type \$0.13 350S Spring Type \$0.15 Walnut or Ivory	 No. Bakelite List 360 Knurl Type \$0.13 360S Spring Type \$0.13 360SS Set Screw Type Walnut, Black or Ivory \$0.15	 No. Bakelite List 370 Knurl Type \$0.15 370S Spring Type \$0.15 370SS Set Screw Type Walnut, Black or Ivory \$0.17
 No. Tenite List 390 Knurl Type \$0.13 Walnut or Ivory	 Tenite Needle Cups List No. \$0.11 400 Per 1000 \$77.00 Walnut	 No. Bakelite List 410SS Set Screw Type Walnut or Ivory \$0.33	 No. Bakelite List 420SS Molded Hole \$0.33 420BSS Brass Insert Set Screw Type Black or Walnut \$0.46	 No. Bakelite List 430SS Molded Hole \$0.33 430BSS Brass Insert Set Screw Type Black or Walnut \$0.38	 No. Bakelite List 440SS Molded Hole \$0.28 440BSS Brass Insert Set Screw Type Black or Walnut \$0.38
 No. Bakelite List 460SS Set Screw Type Walnut or Ivory \$0.20	 No. Bakelite List 470SS Set Screw Type Walnut or Ivory \$0.18	 No. Bakelite List 480SS Set Screw Type Walnut or Ivory \$0.20	 No. Bakelite List 490SS Set Screw Type Walnut or Ivory \$0.20	 No. Tenite List 495 Knurl Type \$0.15 Ivory Only 1/4" Shank Ext.	 No. Tenite List 510 Knurl Type \$0.13 Walnut or Ivory
 No. Tenite List 530 Knurl Type \$0.13 Walnut or Ivory	 No. Bakelite List 531SS Set Screw Type Walnut or Ivory \$0.20	 No. Bakelite List 532SS Set Screw Type Walnut or Ivory \$0.20	 Tenite Dial Knob No. Walnut List 560 \$0.22 1/4" Shank Extension to fit 1/4" Knurl Shaft	 No. Bakelite List 533SS Set Screw Type Black Bakelite with molded white arrow, brass bushing \$0.38	 No. Bakelite List 534SS Set Screw Type Walnut or Ivory \$0.20
 No. Bakelite List 536SS Set Screw Type Walnut or Ivory \$0.20					

All Knobs for 1/4" Shafts — Distributors' Standard Package 12 Knobs of a Type to a Box

Gee-Lar RADIO AND TELEVISION PRODUCTS

GEE-LAR PLASTIC BOXES — MADE OF CLEAR, TRANSPARENT, RIGID PLASTIC



GEE-LAR PLASTIC BOX
Handy box for all types of parts, knobs, condensers, controls, etc. Keep everything handy on the shelf. Supplied with cover. Size: 4" x 4" x 2 1/2" deep.
No. 3650 Plastic Box List \$0.55



GEE-LAR STOCK BOX
Handy box for servicemen's bench, shelves. Also used for jobbers' display shelves. Ideal for displaying knobs, resistors, condensers, etc. Supplied with cover. Size: 4" x 8" x 2 1/2" deep.
No. 3651 Plastic Box List \$1.10



GEE-LAR MIDGET BOX
Ideal plastic box for small screws, nuts, springs, grommets and other small essential parts. Hinged cover with snap on lock. Handy to carry in your tool kit or for the work bench. Size: 2 1/2" x 1 1/4" x 3/4" deep.
No. 3693 Plastic Box List \$0.12



GEE-LAR BENCH BOX
Handy round container for holding small parts on the bench while working on the set. Keeps parts from getting lost. Supplied with cover. Size: 5 1/4" dia. x 5 3/8" deep.
No. 3655 Bench Box List \$1.25



GEE-LAR PARTITION BOX
Handy box with 12 sections and a hinged cover. Keeps all small parts such as screws, nuts, springs, etc. Just where you can find them. Handy to carry with you. Size: 7" x 3 1/2" x 1 1/8".
No. 3654 Partition Box List \$1.65

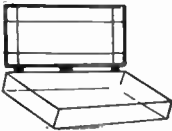

GEE-LAR HINGED BOX
Handy hinged cover box for larger items, such as alignment tools, condensers, resistors, etc. Handy to carry with you. Size: 7" x 3 1/2" x 1 1/8".
No. 3655 Hinged Box List \$1.50

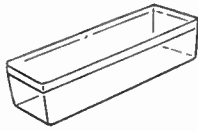

GEE-LAR HANDY BOX
Box for stocking small parts. Can be stacked on top of each other. An ideal box for storing parts. Supplied with cover. Size: 8 1/2" x 2 3/4" x 2 1/2", with cover.
No. 3656 Handy Box List \$1.50

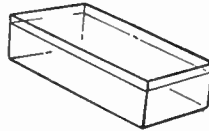

GEE-LAR JR. HANDY BOX
Convenient box for small parts. Boxes can be stacked on top of each other. Supplied with cover. Size: 6 7/8" x 3 3/8" x 1 5/8", with cover.
No. 3657 Jr. Handy Box List \$0.85



GEE-LAR KNOB ASSORTMENT IN PLASTIC JAR
Contains 35 or more popular radio knob type knobs. A good seller.
No. 3482 Plastic Jar Kit List \$2.35



GEE-LAR DECALS
For marking TV sets and custom built jobs. Gold letter-head decals for professional touch. Also handy in replacing old worn out markings.
No. 3452 Envelope of Decals List \$0.50
No. 3452-D Di play of 20 packs List \$10.00



ASSORTED RADIO KNOBS
A plastic bag containing 35 assorted popular knobs, knurl, spring and set screw types.
No. 1200 Kit List \$1.65



GEE-LAR PLASTIC TELEVISION PLIERS
Made of high-impact bakelite will stand high voltage. An insulated long nose plier that is absolutely shock proof. Handy in picking up nuts and bolts or parts when set is "hot."
No. 3689 Plastic Pliers List \$1.65
No. 3689-D Display of 12 List \$19.80

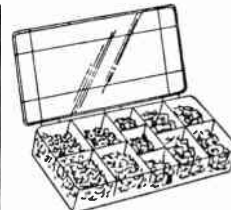

GEE-LAR TELEVISION AND RADIO KNOB SPRING KIT
Spirals for New TV and Radio Knobs
The right assortment of springs for the serviceman. Over 12 different knob springs for all types of knobs. Plastic box 7" x 3 1/2" x 1 1/8", with hinge covers.
No. 3658 100 Springs, Plastic Box List \$3.50

MARKED RADIO KNOBS
Another plastic bag kit containing 50 assorted marked radio knobs. They include volume, off, tune, etc.
No. 1201 Kit List \$1.65

KNOB AND PLATE COMBINATIONS

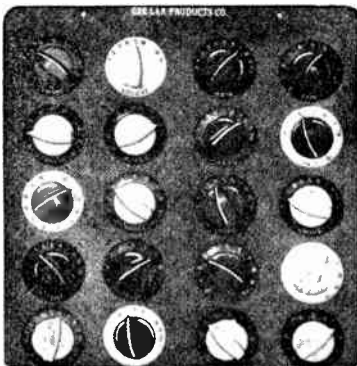

JOBBERS' DISPLAY BOARD #905
Display board is made up of modern knob and plate combinations in various colors.
No. 905 List \$16.00
Knob and Plate Display Board, Complete with Knobs
JOBBERS' KNOB AND PLATE — STOCK DEAL WITH DISPLAY BOARD — DEAL #906
A starting stock deal that gives you a display board and assorted plates and knobs in various colors. All knobs packaged in marked boxes for easy stocking.
Deal Includes: List
125 Assorted Marked Plates — 55¢ ea. \$ 68.75
125 Assorted Color Knobs for Plates — 33¢ ea. 41.25
1 Display Board with 20 Knobs and 20 Plates 16.00
Deal No. 906 126.00



GEE-LAR PLATES ARE AVAILABLE IN THE FOLLOWING MARKINGS:
Permanently Heat-Stamped in Either 180° or 270° — Volume, Treble, Phono, Gain, Mike, Tone, Bass. Special wording available on payment of special stamping die charges.

180° MARKED PLATE ONLY
Bakelite, Dia. 1 7/8", Ht. 3/2". Colors: Red, White, Black, Walnut.
No. 1060 Plain Plate (Specify Color) List \$0.35

270° MARKED PLATE ONLY
Bakelite, Dia. 1 7/8", Ht. 3/2". Colors: Red, White, Black, Walnut.
No. 1070 180° Plate (Specify Color and Marking Wanted) List \$0.55

270° MARKED PLATE ONLY
Bakelite, Dia. 1 7/8", Ht. 3/2". Colors: Red, White, Black, Walnut.
No. 1080 270° Plate (Specify Color and Marking Wanted) List \$0.55



MATCHING POINTER KNOB FOR PLATES
Bakelite, to fit all plates. Colors: Red, White, Black, Walnut.
No. 91055 Set Screw Type (Specify Color) List \$0.33



MATCHING TRI-GRIP POINTER FOR PLATES
Bakelite, to fit all plates. Colors: Black and Walnut.
No. 92055 Set Screw Type (Specify Color) List \$0.33



MATCHING TWO-GRIP POINTER FOR PLATES
Bakelite, to fit all plates. Colors: Black and Walnut.
No. 93055 Set Screw Type (Specify Color) List \$0.33

All Knobs for 1/4" Shafts — Distributors' Standard Package 12 Knobs of a Type to a Box

WALDOM ELECTRONICS, Inc.

CRONAME PRODUCTS

CRONAME CROFLEX TUNERS

Available in five sizes these dials fit any normal chassis. Locate tuning knobs at either end or along lower edge of dial. Place variable condenser at al-

most any point behind the dial. Hub with adapter fits either 3/8" or 1/2" shaft. Pilot socket supplied. Bronze escutcheon and edgelit glass scale, calibrated 55 to 170 AM and 6 to 18 MC.



Cat. No.	Ratio	Pointer Travel	Outside	Escutcheon	Inside	List Each
231	13 to 1	4"	2 1/4" x 4 3/4"	1 3/4" x 4 1/4"		\$ 7.70
232	16 to 1	4 1/2"	2 3/8" x 6 1/8"	1 1/8" x 5 1/8"		8.00
233	18 to 1	5 1/2"	3 3/8" x 6 5/8"	2" x 5 3/4"		8.30
234	23 to 1	6 3/4"	3 3/8" x 8 1/8"	1 7/8" x 7 1/4"		8.70
236	31 to 1	9"	4" x 11 1/8"	2 7/8" x 9 3/8"		13.55

DIRECT DRIVE DIALS

Standard type, deluxe direct drive dials. Knobs are black bakelite with brass inserts. Dial plates are heavy brass, with chromium finish. Indicators for accurate reading. All dials fit 1/4" diameter instrument shafts.

Cat. No.	Calibration	Dial Diam.	List Price
292	0-100 in 180°	4"	\$4.50
293	0-100 in 270°	4"	4.50
294	0-100 in 180°	2 3/4"	3.50
295	0-100 in 270°	2 3/4"	3.50
302	0-100 in 360°	4"	4.50
303	0-100 in 360°	2 3/4"	3.50
27068	0-100 in 180°	1 3/4"	2.00
27069	0-100 in 270°	1 3/4"	2.00

AZIMUTH DIAL Precision Test Dial

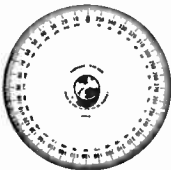

No. 27010. Calibrated in degrees through full 360°. Outer numerals read 0 to 360 in clockwise direction; inner numerals 0 to 360 in counter-clockwise direction. Etched on heavy brass with black graduations and figures on hand-spun chromium background. Hub has two set screws and fits 3/8" shaft. Diameter of dial is 6"; diameter of indicator is 1/2". List Price\$9.95

ACCESSORY DIALS

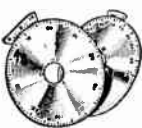

These dials are for attachment to the knobs illustrated. Of heavy etched brass with chromium finish. Calibration lines and numerals are filled with black enamel. are furnished with KD-1 and KD-2 single-line indicators; all the others have spring-mounted vernier indicators. Packed in individual envelope complete with indicator and all necessary screws for attaching dial to knob and indicator to panel.

Cat. No.	Cal.	Dia.	Use Knob	List Price
KD-1	180°	1 3/4"	6537	\$1.65
KD-2	270°	1 3/4"	6537	1.65
KD-3	180°	2 3/4"	6549	2.75
KD-4	270°	2 3/4"	6549	2.75
KD-5	360°	2 3/4"	6549	2.75
KD-6	180°	4"	6550	3.50
KD-7	270°	4"	6550	3.50
KD-8	360°	4"	6550	3.50

PLANETARY DRIVES



The ball-type planetary drive units on this page are useful whenever a compact device is needed for reduced-speed operation. Ratio approximately 5 to 1. May be used as auxiliaries or incorporated in new construction. All units have hubs to fit 1/4" instrument shafts.

No. 599 is a precision device used for both military and civilian production. Can be used as a single-speed drive by omitting knob on the high-speed sleeve. List Price\$8.00

No. 27067 same as No. 599 described above except for threaded sleeve. List Price\$12.65

No. 6665 Knob fits either of the units above. Larger knob is anodized aluminum. Smaller knob is black butyrate with brass insert. List Price\$1.25

TV MASK ASSEMBLIES



Commercial television mask and escutcheon assemblies for the most popular sized TV tubes. Each complete kit consists of a mask, tempered glass and decorative escutcheon. Suitable for use in either conversion work or custom-built installations. Mask is heavy gauge aluminum, green-sprayed finish. Front glass is 1/4" thick, specially tempered. All escutcheons are of durable construction finished in attractive gold finish. For rectangular tubes only.

Cat. No.	Description	List Price
CK-14	14" Kit	\$13.50
CK-16	16" Kit	16.50
CK-17	17" Kit	16.50
CK-20	20" Kit	24.85
CK-21	21" Kit	29.50

FLUTED KNOBS



Black full-fluted knobs of compression-molded Bakelite. With 1/4" brass inserts and slotted head set screws.

PLAIN KNOBS

Cat. No.	Dia.	List Price
6537	1 1/8"	\$.40
6538	1 3/8"	.45
6539	1 5/8"	.50
6540	2 3/8"	.70

KNOB AND POINTER

Cat. No.	Knob Dia.	Ptr. Length	List Price
6566P	1-1/8"	25/32"	\$.75
6571P	1-3/8"	1-1/32"	1.00
6570P	1-5/8"	1-5/16"	.90
6559P	2-3/8"	1-11/16"	1.25

KNOB AND SKIRT

Cat. No.	Knob Dia.	Skirt Dia.	List Price
6545S	1 1/8"	1 1/2"	\$.70
6548S	1 3/8"	1 3/4"	.75
6549S	1 5/8"	2 1/8"	.80
6550S	2 3/8"	3"	1.05

BAR AND LEVER KNOBS



Made of Butyrate with brass insert and slotted head set screws.

Cat. No.	Color	Length	Fig.	List Ea.
BK-1B	Black	11/16"	A	\$.55
BK-1W	Walnut	11/16"	A	.55
BK-2B	Black	1-1/4"	B	.30
BK-2W	Walnut	1-1/4"	B	.30
BK-3B	Black	2-1/4"	B	.40
BK-3W	Walnut	2-1/4"	B	.40
BK-4B	Black	1-31/32"	C	.40
BK-4W	Walnut	1-31/32"	C	.40

List prices shown are subject to usual trade discounts, and are subject to change without notice. For detailed and complete information see our general catalog.

WALDOM ELECTRONICS, INC.

Chicago 10, Illinois

Manufacturers of Field Coils and Replacement Cones

WALDOM ELECTRONICS Inc.

CRONAME PRODUCTS

ETCHED—ANODIZED
DIAL AND TITLE PLATES



Quality anodized aluminum plates designed for amplifier and public address equipment. Black figures are deeply dyed into the aluminum surface to assure long-lasting service.

VERTICAL STYLE

2 5/8" High x 2-3/16" Wide

No.	Description	List Price Ea.
436	Gain 0-10	
437	Gain 5-0-5	
438	Switch 1-2-3	
439	Tone 0-10	
442	Bass 0-10	
443	Treble 0-10	
444	Phono 0-10	
445	Attenuator	
List Price Ea.50

HORIZONTAL STYLE

2-3/16" High x 2 5/8" Wide

Cat. No.	Title and Description	List Price Ea.
410	Without Title 0-10	
411	Tone 0-10	
412	Gain 0-10	
413	Master Gain 0-10	
414	Record 0-10	
415	Microphone 0-10	
416	Microphone 1, 0-10	
417	Microphone 2, 0-10	
422	Gain 5-0-5	
423	Increase with Arrow	
424	Radio-Microphone 5-0-5	
425	Record-Microphone 5-0-5	
426	Volume 0-10	
427	Fader 5-0-5	
428	Bass 5-0-5	
429	Treble 5-0-5	
430	Expansion 0-10	
446	Phono 0-10	
447	Bass 0-10	
448	Treble 0-10	
List Price Ea.50

DOUBLE HORIZONTAL

2-3/16" High x 5" Wide

No.	Description	List Price Ea.
418	Tone 0-10 and Gain 0-10	
419	Record 0-10 and Microphone 0-10	
420	Microphone 1, 0-10 and Microphone 2, 0-10	
List Price Ea.		1.05

QUADRUPLE HORIZONTAL

2-3/16" High x 9 1/2" Wide

No.	Description	List Price Ea.
421	Microphone 0-10—Record 0-10 Master Gain 0-10—Tone 0-10	
List Price Ea.		1.55

SPEAKER SWITCH PLATE

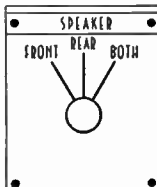

This attractive anodized aluminum plate is suitable for use on "rear seat" automotive speaker installations, or wherever an indicator plate of this description is required. Silvery-white background with black letters indicating "Rear", "Front", "Both". With four mounting holes. Overall size 2 1/4" high x 1 3/4" wide.

No.	Description	List Price Ea.
441	Speaker Plate	
List Price Ea.40

ETCHED DIAL PLATES



Plates in this group are calibrated 0-10 in 300° and titled as listed below. All are etched aluminum with polished figures and horder and black background. Size 2 1/4" x 1-11/16"; 13/32" diameter center hole.

No.	Title	No.	Title
276	Gain	578	Microphone 2
277	Tone	579	Exciter
565	Record	580	Monitor
566	Microphone	585	Bass
570	Master Gain	586	Treble
571	No Title	587	Phono
577	Microphone 1	588	Volume
List Price Ea.32	

ROUND CONTROL PLATES

Control plates at right are 1 3/4" diameter, etched and finished to match those above. Center hole is 13/32" diameter.



No.	Title	List Price Ea.
25	Volume	
26	Off-Tone Control	
569	Calibrated 0-100 in 180°, No Title	
905	Calibrated 0-100 in 270°, No Title	
List Price Ea.30

ANODIZED DIAL PLATES



These four round dials are made of anodized aluminum and have embossed beaded edges for greater stiffness and better appearance. Highly polished black backgrounds and silvery-white figures and borders. Diameter of center hole is 13/32".

No.	Description	List Ea.
550	1 1/2" dia. 0-100 in 180°	.37
551	1 1/2" dia. 0-100 in 270°	.37
552	2 1/2" dia. 0-100 in 180°	.67
553	2 1/2" dia. 0-100 in 270°	.67

CHROME AND BLACK PLATES

The chrome and black dials listed below and illustrated at the right are made of heavy brass with satin chromium figures, graduations and borders. The backgrounds are dull black.



No.	Description	List Ea.
260	3" dia. — 0-100 in 180°	1.10
261	3" dia. — 0-100 in 270°	1.10
No. Description List Ea.		
262	1 1/2" dia. — 0-100 in 180°	.55
263	1 1/2" dia. — 0-100 in 270°	.55
No. Description List Ea.		
264	2 1/4" dia. — 0-10 in 300° and titled "Gain"	.75

BRONZE DIAL PLATES

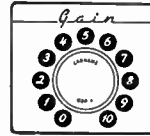

These unusual plates are particularly attractive against wood-color backgrounds in either dark or blonde tones. Good, too, on brown lacquer or wrinkle finishes. Harmonize nicely with traditional as

well as modern cabinet designs. Wording is deeply etched into the solid bronze metal then filled with maroon enamel. All plates are 2 1/4" wide x 2" high. The center hole is 13/32" dia. to clear standard control and switch sleeves.

No.	Title	List Price Ea.
BDP-1	Gain 0-10	
BDP-2	Master Gain 0-10	
BDP-3	Volume 0-10	
BDP-4	Selector 0-100 (180°)	
BDP-5	Selector 100-0 (180°)	
BDP-6	Tone 0-10	
BDP-7	Bass 0-10	
BDP-8	Treble 0-10	
BDP-9	Bass-Treble 5-0-5	
BDP-10	Mixer 5-0-5	
BDP-11	Power-Tone off-on treble-bass	
BDP-12	Power Switch off-on	
BDP-13	Expansion 0-10	
BDP-14	Microphone 0-10	
BDP-15	Mic. 1 0-10	
BDP-16	Mic. 2 0-10	
BDP-17	Phono 0-10	
BDP-18	Phono 1 0-10	
BDP-19	Phono 2 0-10	
BDP-20	Phono 1-Phono 2 5-0-5	
BDP-21	Mic-Phono 5-0-5	
BDP-22	Radio-Mic 5-0-5	
BDP-23	Fader 5-0-5	
BDP-24	Fader 0-10	
BDP-25	No Title 0-10	
BDP-26	No Title 5-0-5	
BDP-27	Brightness	
BDP-28	Contrast	
BDP-29	Vertical Hold	
BDP-30	Fine Tuning	
BDP-31	Channel Selector 1-13	
List Price Ea.50

SWITCH PLATES



"Off - On" Switch Plate. Etched aluminum with black background and polished aluminum letters and border. Size is 1 1/16" x 1 1/16".

No.	Title	List Price
278	"Off-On"	.20

CIRCULAR PLATES

These plates are 1 1/2" in diameter with 15/32" hole. Polished aluminum with black background. Locking lug fits groove in switch.



No.	Description	List Ea.
272	Off-On	.38
589	Off-On (Vertical)	.38
573	Micro-Phono	.38
581	Lo-Hi	.38
582	Monitor	.38



Polished aluminum with black background. All are 1" x 1 1/4".

No.	Description	List Ea.
279	"Broadcast-Shortwave"	
584	"Off-On"	
274	"1-2"	
564	"1-2-3"	

List Each25

The dial and title plates listed on this page are representative of the various type we carry. For complete and detailed information write for our general Catalog No. 503.



MINIATURE SOCKETS 7 PIN TYPE

Standard 7 pin sockets for either bottom or top mounting depending on application. Steel saddle cadmium plated. Contacts are brass cadmium plated. With center shield and ground lugs. Mounting centers are 7/8". Chassis mounting hole required 3/8".

No.	Description	List Ea.
VTS-69	Blk. Bakelite Bottom Mtg.	.18
VTS-70	Mica-filled Bottom Mtg.	.20
VTS-71	Blk. Bakelite Top Mtg.	.18
VTS-72	Mica-filled Top Mtg.	.20

9 PIN TYPE

Same general construction as 7 pin sockets illustrated above, except mounting centers are 1 1/8" and mounting hole required is 3/4".

No.	Description	List Ea.
VTS-73	Blk. Bakelite Bottom Mtg.	.22
VTS-74	Mica-filled Bottom Mtg.	.25
VTS-75	Blk. Bakelite Top Mtg.	.20
VTS-76	Mica-filled Top Mtg.	.33

SHIELD BASE TYPES

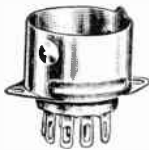

Molded from low loss mica-filled or ceramic material. Saddles brass, nickel plated. Contacts silver tinned, phosphor bronze or beryllium copper. Center shields on all units. 7 pin types mount through top of chassis, requiring 5/8" mounting hole with 3/8" mounting centers. 9 pin types require 3/4" mounting hole with 1 1/8" mounting centers.

No.	Description	List Ea.
VTS-129	7 Pin Mica Phos. Bronze	.65
VTS-130	7 Pin Mica Ber. Copper	.70
VTS-131	7 Pin Ceramic Phos. Bronze	.80
VTS-132	7 Pin Mica Ber. Copper	.85
VTS-133	9 Pin Mica Phos. Bronze	.65
VTS-134	9 Pin Mica Ber. Copper	.75
VTS-135	9 Pin Ceramic Phos. Bronze	.85
VTS-136	9 Pin Ceramic Ber. Copper	.95

TUBE SHIELDS



Matching tube shields for shield-base sockets listed above. Slight downward pressure and twist from top of shield locks shield to socket base firmly and securely. Fabricated from brass with nickel plated finish, complete with plated retainer springs. Available in three sizes for each type.

FOR SEVEN PIN TYPES

No.	Height	List Ea.
TST-93	1 3/8"	.26
TST-94	1 3/4"	.31
TST-95	2 1/4"	.35

FOR NINE PIN TYPES

No.	Height	List Ea.
TST-96	1 1/2"	.37
TST-97	1 3/4"	.35
TST-98	2 3/8"	.40

SADDLE MOUNT OCTALS



Popular Bakelite saddle mount octals. Tinned steel saddle with ground lugs. Contacts are brass, cadmium plated. Available with either 1-5/16" or 1 1/2" mounting centers. Require socket holes as indicated.

1-5/16" Mounting Centers

No.	Description	Mtg. Hole	List Ea.
VTS-65	Blk. Bakelite	15/16"	.15
VTS-66	Mica-filled	15/16"	.20

1 1/2" Mounting Centers

No.	Description	Mtg. Hole	List Ea.
VTS-67	Blk. Bakelite	1-1/16"	.16
VTS-68	Mica-filled	1-1/16"	.22

LAMINATED SOCKETS



General purpose laminated bakelite sockets. Rugged riveted construction. Contacts are brass, cadmium plated. 7 and 9 pin miniature types are supplied with center shields and grounds straps as indicated.

No.	Type	Mtg. Ctrs.	List Ea.
VTS-52	4 prong	1 1/2"	.15
VTS-53	5 prong	1 1/2"	.16
VTS-54	6 prong	1 1/2"	.18
VTS-55	7 prong	1 1/2"	.19
VTS-56	Octal	1 1/2"	.14
VTS-42	7 pin	7/8"	.13
VTS-43	7 pin	7/8"	.15
VTS-44	7 pin	1"	.13
VTS-45	7 pin	1"	.14
VTS-46	7 pin	1-5/16"	.15
VTS-47	7 pin	1-5/16"	.15
VTS-48	9 pin	1 1/4"	.17
VTS-49	9 pin	1 1/2"	.18
VTS-50	9 pin	1-5/16"	.17
VTS-51	9 pin	1-5/16"	.18

*With center shield.
**With ctr. shield and gnd. strap.

PHONO PLUG



Conventional RCA type phono plug. For use on record players, radio, etc. or wherever emergency connections of an experimental nature are required. Pin is 11/16" long, 1/8" in diameter. For use with PS-196 listed below.

No.	List Ea.
PP-105	.09

PHONO SOCKET



Female socket. Companion unit for PP-105 listed above, or for any plug with 1/8" diameter pin. Ceramic insert mounted on 1/16" bakelite disc, with 11/16" mounting centers. Metal parts cadmium plated.

No.	List Ea.
PS-106	.09

BAKELITE METER CASES



Sturdy heavy molded plastic meter cases, with highly polished finish. Will withstand rugged usage, thus providing safety to inner components and meter. BC-140 has outer dimensions of 5-9/32" wide by 6-51/64" high. Inner dimensions are 4-31/32" wide by 6 1/2" high. Designed to accommodate meters with flange sizes up to 4 3/8" by 4-3/16". Complete with four mounting bosses, drilled for 6/32" self-tapping screws. Bosses are recessed 1/8" for flush panel mounting. BC-138 is 3 3/4" wide by 6 1/4" high and 2" deep. Inside dimensions are 3 1/2" wide by 6" high. Matching panels listed at right.

No.	List Ea.
BC-138	1.35
BC-140	2.10

TV INTERLOCK PLUG

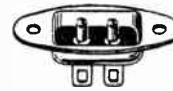

Conventional male interlock TV socket. Standard type used on all television receivers. Heavily plated contact pins. Mounting centers 1 1/2".
VTS-6115

TV ANODE CONNECTORS



Presented in the listing below are a series of anode connectors which will handle the majority of replacement needs for this item. Heavy duty molded rubber cap 1 1/2" in diameter. Contact is one-formed piece with silver plated finish, positive grip. All supplied with heavily insulated leads and choice of cap styles as indicated.

No.	Description	List Ea.
AC-99	18" Lead straight cap	.50
AC-100	18" Lead right angle cap	.50
AC-101	24" Lead straight cap	.55
AC-102	24" Lead right angle cap	.55

SNAP-ON ANODE CONNECTOR

Similar in construction to above units except with button contact for latest type metal-shell picture tubes.

No.	Description	List Ea.
AC-109	24" Lead right angle cap	.55

LAMINATED TV SOCKETS

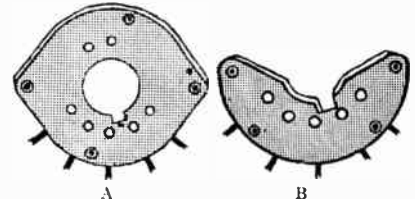

Laminated duo-decal TV sockets with plastic protective backshells. Ideal for replacement use or new installation utilizing picture tubes ranging in size from 7" to 20". Furnished complete with color coded leads for rapid installation. Fig. A is 10 contact wired with 5 leads. Fig. B is popular crescent shaped duo-decal also with 5 leads. All with 20" leads.

No.	Description	List Ea.
VTS-58	Standard (A)	.81
VTS-59	Half-moon (B)	.80
VTS-60	Electrostatic (A)	.90

MOLDED PANELS



Matching molded black phenolic panels 1/8" thick for meter cases listed at left. Both types are precision cut for accurate fit with highly polished finish. No. BP-137 is 3 1/2" x 6" for BC-138. BP-139 is 4 1/8" x 6-15/32" to fit BC-140.

No.	List Ea.
BP-137	.70
BP-139	1.00

The above items are a representative listing of the many items contained in our general catalog. For complete and detailed information, write for our general catalog No. 5C3.

WALDOM ELECTRONICS Inc.

TERMINAL LUGS — STRIPS AND BOARDS

PLATED AND TINNED SOLDER LUGS

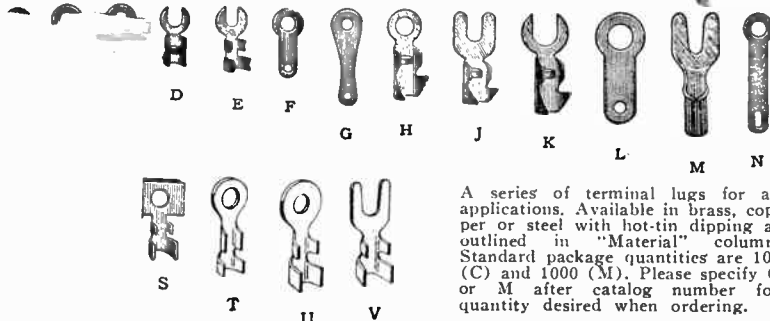

A series of terminal lugs for all applications. Available in brass, copper or steel with hot-tin dipping as outlined in "Material" column. Standard package quantities are 100 (C) and 1000 (M). Please specify C or M after catalog number for quantity desired when ordering.

	Mtl.	Hole Size	Length	List Per "C"	List Per "M"
	.020B	#6	1/2"	.27	6.75
	.020B	#8	13/16"	.25	6.30
	.020B	#10	13/16"	.25	6.30
	.020B	#6	9/16"	.31	7.65
	.032C	3/16"	19/32"	1.25	11.25
	.032C	#6	19/32"	.80	7.20
	.020B	#8	41/64"	.70	6.30
	.020B	#6	21/32"	.75	6.75
	.020B	#8	21/32"	.75	6.75
	.020B	#8	13/16"	.85	7.65
	.020B	#8	3/4"	.80	7.20
	.015B	#8	47/64"	.80	7.20
	.025B	#6	1"	.85	7.65
	.025B	#8	1"	.85	7.65
	.020C	#4	15/16"	1.25	11.25
	.020C	#6	15/16"	1.25	11.25
	.020C	#8	15/16"	1.25	11.25
	.020C	#10	15/16"	1.25	11.25
	.020B	13/32"	15/16"	2.15	19.35
	.020B	3/16"	25/32"	.80	7.20
	.025B	3/16"	31/32"	1.25	11.25
	.025C	9/32"	1-1/16"	1.70	15.30
	.020S	#10	1-5/32"	1.35	12.15
	.020S	7/32"	1-5/16"	1.30	11.70
	.025S	#8	1 1/4"	.65	5.85
	.032B	1/2"	21/32"	1.80	16.20
	.032B	#6	23/32"	2.00	18.00
	.032B	#8	23/32"	2.05	18.45
	.040B	#10	1-1/64"	3.55	31.95
	.032B	1/28	21/32"	1.75	15.75
	.032B	#8	23/32"	1.90	17.10
	.032B	#6	23/32"	1.95	17.55
	.032B	#6	1-1/64"	3.45	31.05
	.032B	#8	23/32"	1.90	17.10
	.032B	#8	23/32"	1.95	17.55
	.040B	#10	1-1/64"	3.50	31.50
	.032B	#8	15/16"	3.15	28.35
	.032B	#10	15/16"	3.15	28.35
	.032B	#6	1-3/32"	4.50	40.50
	.032B	#8	1-3/32"	4.50	40.50
	.032B	#10	1-3/32"	4.50	40.50
	.032B	#8	1-3/32"	4.50	40.50
	.032B	1/4"	1-3/32"	4.50	40.50
	.032B	#8	1"	4.30	38.70

WALDOM TERMINAL STRIPS

Standard type lug mounting terminal strips. Fabricated from X Grade bakelite 1/16" thick 3/8" wide. Square barrelled construction of lugs prevents twisting and slippage. End terminals are spaced 3/16" from end of strip. All strips are furnished with lug holes spaced 3/8" center to center. Type "A" with insulated mounting lugs. Type "B" combined mounting and ground lug.



Cat. No.	Mtg. Type	No. of Term.	List Each	Cat. No.	Mtg. Type	No. of Term.	List Each
TS-1	A	1	.03	TS-17	A	8	.13
TS-2	B	1	.03	TS-113	Illus.	1	.03
TS-3	A	2	.04	TS-114	Illus.	1	.03
TS-4	B	2	.04	TS-115	Illus.	1	.03
TS-5	A	3*	.055	TS-116	Illus.	1	.03
TS-6	B	3*	.06	TS-117	A	2**	.06
TS-7	B	3**	.07	TS-118	B	2**	.07
TS-8	A	4*	.07	TS-119	A	2*	.04
TS-9	B	4*	.06	TS-120	A	2*	.05
TS-10	A	4**	.08	TS-121	B	3**	.065
TS-11	B	4**	.08	TS-122	A	3*	.06
TS-12	A	5**	.09	TS-123	B	4**	.06
TS-13	B	5**	.095	TS-124	A	6**	.11
TS-14	A	6**	.10	TS-125	B	6**	.11
TS-15	B	6**	.08	TS-126	A	7**	.08
TS-16	B	6**	.11	TS-127	A	7**	.10
				TS-128	A	8**	.11

*With 1 mtg. lug

**With 2 mtg. lugs

LOCKING-TYPE LUGS

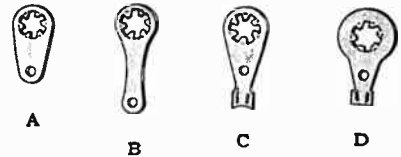

Cat. No.	Fig.	Screw Size	List Per "C"
T-194	A	#6	1.35
T-195	A	#8	1.35
T-196	B	#4	1.35
T-197	B	#6	1.35
T-198	B	#8	1.35
T-199	C	#4	1.50
T-200	C	#6	1.50
T-201	C	#8	1.50
T-202	D	#10	3.50
T-203	D	1/4"	3.50

INTERNAL WASHERS PLATED STEEL



Cat. No.	Screw Size	List Per "C"
T-204	#4	.50
T-205	#6	.50
T-206	#8	.55
T-207	#10	.55
T-208	1/4"	.70
T-209	3/8"	1.25

EXTERNAL WASHERS PLATED STEEL



Cat. No.	Screw Size	List Per "C"
T-210	#4	.50
T-211	#6	.50
T-212	#8	.55
T-213	#10	.55
T-214	1/4"	.70
T-215	3/8"	1.25

TERMINAL BOARDS SCREW-TYPE



Listed below are both standard and heavy duty, bakelite screw type terminal strips. Terminals are hot-tin dipped for easy soldering. All are 5/8" wide, with .136 dia. mounting holes. Standard duty are 1/16" thick, heavy duty 3/32" thick.

Cat. No.	No. of Term	Mtg. Ctrs.	List Each
BTS-18	1	3/8"	.05
BTS-19	2	1-5/16"	.09
BTS-20	3	1 3/4"	.11
BTS-21	4	2-3/16"	.18
BTS-22	5	2 5/8"	.21
BTS-23	6	3-1/16"	.24
BTS-24	7	3 1/2"	.29
BTS-25	8	3-15/16"	.32
BTS-26	9	4 3/8"	.37
BTS-27	10	4-13/16"	.41
BTS-28	11	5 1/4"	.45

HEAVY-DUTY TYPE

Cat. No.	No. of Term	Mtg. Ctrs.	List Each
BTS-30	1	3/8"	.06
BTS-31	2	1-5/16"	.11
BTS-32	3	1 3/4"	.10
BTS-33	4	2-3/16"	.20
BTS-34	5	2 5/8"	.23
BTS-35	6	3-1/16"	.28
BTS-36	7	3 1/2"	.32
BTS-37	8	3-15/16"	.36
BTS-38	9	4 3/8"	.40
BTS-39	10	4-13/16"	.45
BTS-40	11	5 1/4"	.50

KNOBS FROM STOCK MOLDS

For All Types of Instruments and Apparatus . . . Low Cost . . . Immediate Delivery

ROGAN BROTHERS

• *Compression Molders and Branders of Plastics*

• 8023 N. Monticello, Skokie, Ill.

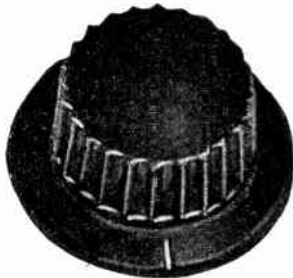

TYPE RB-51

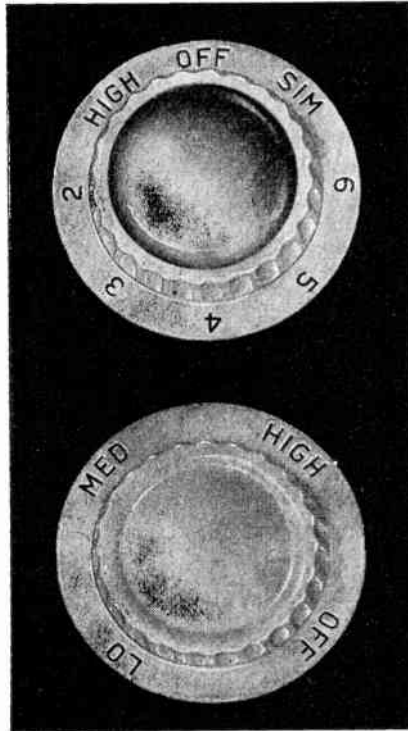

TYPES RB-85 and 80



TYPE RB-211



TYPE RB-141

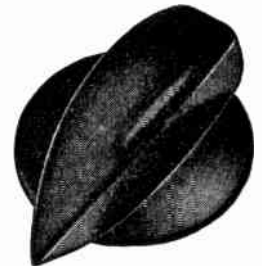

TYPE RB-131

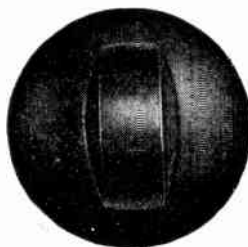

TYPE RB-171



TYPE RB-41



TYPE RB-301



TYPE RB-31

WIDE SELECTION OF SHAPES AND SIZES

Shown above, are but a few of the many Rogan plastic knobs available to you from our regular stock molds. These are supplied without tool charge, resulting in considerable savings in cost, faster delivery. Choice of a wide selection of sizes, shapes and colors. Malted of phenolic or urea thermosetting materials, which will not soften, warp, or scratch easily. Heat resisting materials can be used so knobs can withstand 350-400° F. continuous heat. Most knobs supplied with 1/4" shaft hole and set screws. Special shaft hole sizes and means of fastening can be supplied to specifications at nominal cost.

KNOBS CAN BE BRANDED, AS REQUIRED

Rogan's famous "deep relief" branding process, applied after molding, provides sharp perfect marking at low cost. Any type marking, graduations or numerals can be branded on blank knobs to fit your requirements. Rogan knobs are available in black, brown or walnut, when molded of phenolic materials; and in all light pastel colors when malted of urea materials. Whatever your knob requirements may be, Rogan is equipped to supply you faster, better, more economically. The complete line of Rogan knobs with specifications is shown in the new Rogan catalog. Write for your copy now.

KNOBS FROM STOCK MOLDS

No Tool Charge . . . No Tooling Wait . . . Wide Range of Styles, Sizes and Colors

ROGAN BROTHERS

• Compression Molders and Branders of Plastics •

8023 N. Monticello, Skokie, Ill.

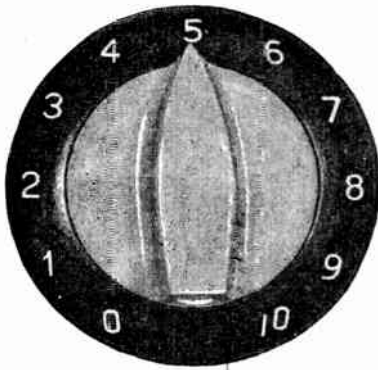

Combination Knobs Save Time, Money

Illustration at left shows RB-1000 escutcheon combined with RB-31 pointer knob, which rotates inside the RB-1000. Available from stock molds, in matching or contrasting colors. Illustrations below, show a few of the stock markings available. These marking dies are already made up, no tool charge, no tooling wait. By using Rogan combination knobs and branding them with these ready-made dies you save time and money. Special markings can also be supplied. Write for complete catalog.

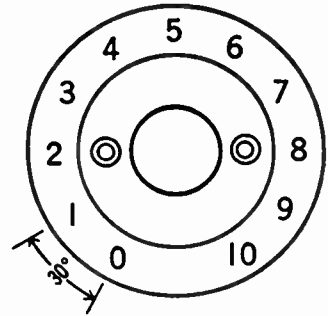

RB-1000-1

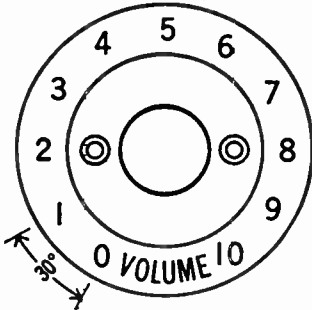

RB-1000-2

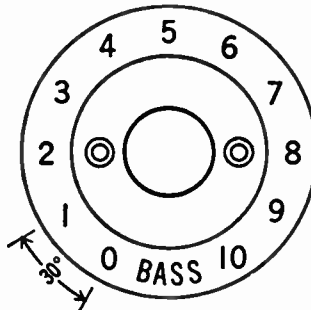

RB-1000-3

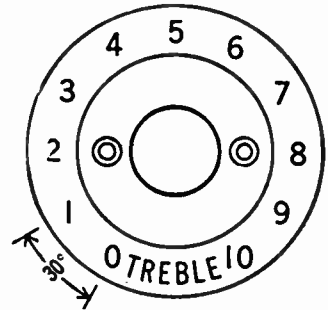

RB-1000-4

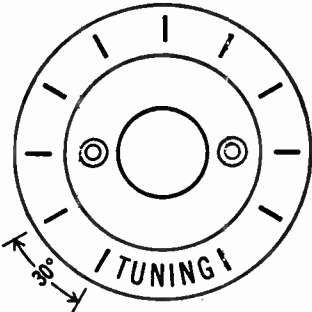

RB-1000-5

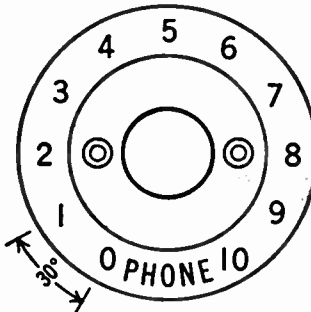

RB-1000-6

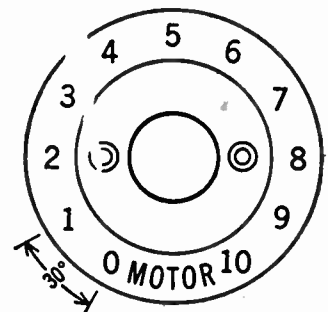

RB-1000-7

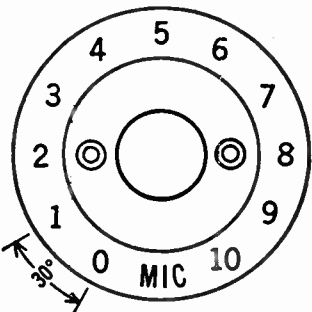

RB-1000-8

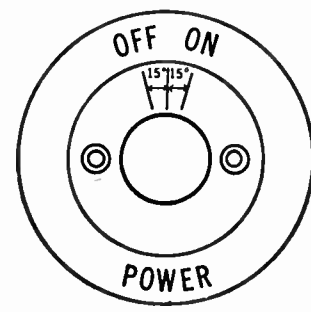

RB-1000-9

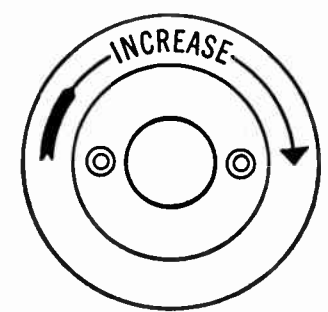

RB-1000-10

Harry Davies Molding Co.

Molders of Plastics

1428 NORTH WELLS STREET • CHICAGO 10, ILL.

ELECTRONIC INSTRUMENT KNOBS



Part No.	Knob Dia.	Skirt Dia.
4104	1 1/8"	1 1/2"
4106	1 3/8"	1 1/2"
4108	1 5/8"	2-1/16"
4109	2 3/8"	3"

Skirts available with or without indicator line filled



Part No.	Knob Dia.	Skirt Dia.
4104	1 1/8"	1 1/2"
4106	1 3/8"	1 1/2"
4108	1 5/8"	2-1/16"
4109	2 3/8"	3"

Branding stamps constructed to your specification

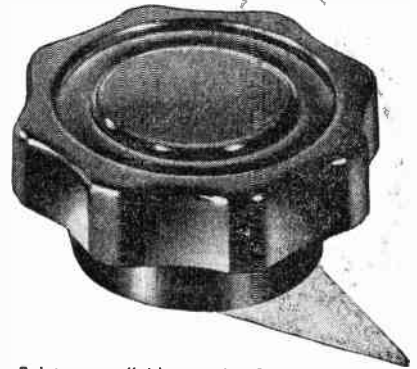

Painter lengths	5/8"	1-3/16"
	3/4"	1 1/4"
	7/8"	1-9/16"
	1-1/16"	

Specify pointer lengths when ordering. Furnished with white vinylite painters only.



Part No.	Knob Dia.
4100	1 1/8"
4101	1 3/8"
4102	1 5/8"
4103	2 3/8"

Entire 4100 Series Available with either 1/4" molded hole or 1/4" brass insert



No. 1475 (no pointer)
Height 1/2". Diameter 1"



No. 1470 with painter-indicator, lined or unlined
Height 1/2". Diameter 1"



No. 1400 (with pointer)
Height 13/32". Diam. 11/16"



No. 1450—Hgt. 13/32".
Diam. 11/16"

No. 5149-A—Oval touch tuning knob. Push on, self-locating. Hgt. 13/16" — 1-1/32".



ACTUAL SIZE



No. 2500—Hgt. 3/4". Diam. 3/4". Set screw, spring, knurl-hole mounting.

No. 2600—Hgt. 7/8". Diam. 7/8". Set screw, spring, knurl-hole mounting.



No. 2710—Height 1/2". Diam. 3/4". Metal - faced or plain insert. Female thread available 8-32, 10-32 and 10-24.



No. 5140
Dia. 1 1/8". Hgt. 7/8"
Set screw, knurl-hole mounting.



No. 1700
Ht. 19/32". Diam. 3/4"
Set screw, spring or knurl hole mounting.



No. 1750
Touch tuning. Push on, self-locating.

Knobs shown are only part of our stock on hand. Our stock molds are interchangeable and meet most requirements with only minor tooling variations. Let us quote on your specifications.

HARRY DAVIES MOLDING CO.

1428 N. WELLS ST., CHICAGO 10, ILL.

Radio's Master — 19th Edition

Page U-130

Copyright by U. C. P., Inc.

Harry Davies Molding Co.

Molders of Plastics

1428 NORTH WELLS STREET • CHICAGO 10, ILL.



No. 1800
Plain or recessed tops.
Dia. 7/16". Heights
from 1" to 1 3/8". Also
studs in various lengths.



No. 2150
Streamlined bar knob.
Length 1 1/4". Height
9/16".



No. 2300
Zephyr bar knob. Lgth.
1 1/4". Height 5/8". Hex
or D-Type set screw,
metal insert, knurl-
hole mounting.

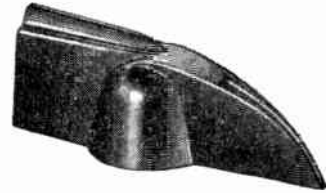

No. 2350
Zephyr bar knob
Length 2". Height 5/8". 1/4" molded
hole, metal insert set screw mounting.

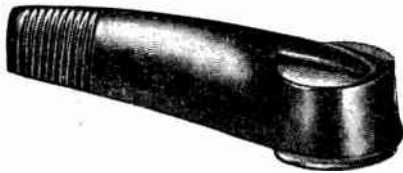

No. 2100
Length overall 2 1/2". Hgt. 5/8".
Dia. 3/4". Molded hole or brass
insert, set screw mounting.

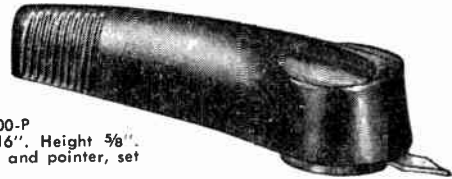

No. 2100-P
Length—overall 2-13/16". Height 5/8".
Dia. 3/4". Metal insert and pointer, set
screw mounting.



No. 2965
Dia. 7/8". Height from 1/2" to 1 1/4".
1/4" molded hole, metal insert,
knurl hole or spring mounting.



No. 1500
1 1/8" Dia. 9/16" High. Set Screw
Mounting Indicator Line Filled or Un-
filled.

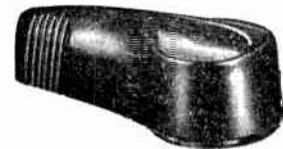

No. 2110
Lgth—overall 1 3/8". Hgt. 19/32".
Dia. 3/4". 1/4" molded hole, metal
insert, knurled hole mounting.

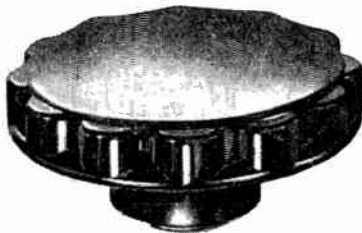

No. 3000
Dia. 1 3/4". Hgt. 3/4", 1", 1 1/4"
and 1 1/2". 1/4" molded hole, metal
insert.

No. 3008
Dia. 1 1/4". Height 3/4". 1/4" molded
hole, metal insert.

No. 3009
Dia. 1 1/2". Height 3/4". 1/4" molded
hole, metal insert.

Stock Instrument Cases

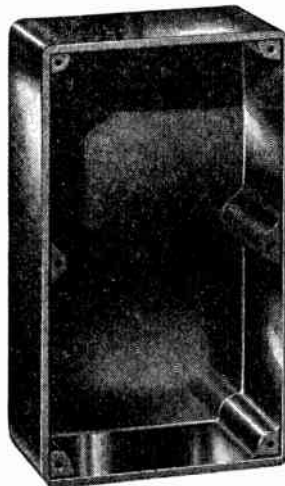

M-260

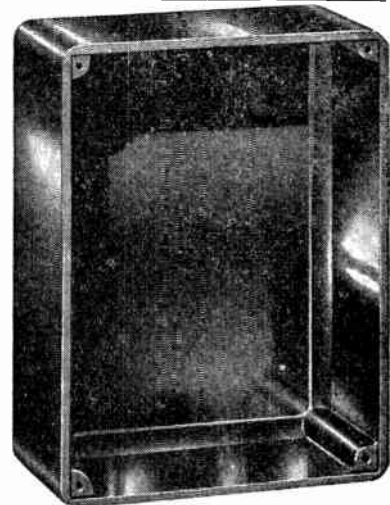

M-240

Overall Dimensions (Outside) M-240 —
2" high x 3 3/4" wide x 6 1/4" long.
M-260 — 2-5/16" high x 5-9/32" wide
x 6-13/16" long.

BRANCH OFFICES: Baltimore, New York, Milwaukee, Boston, Philadelphia,
Fort Wayne, Buffalo, Los Angeles.
FOREIGN OFFICE: Toronto, Canada.

WRITE FOR COMPLETE CATALOG

SINCE
1921



insuline Corporation of America

OVER 3 DECADES OF QUALITY RADIO-TELEVISION PRODUCTS

U. S. ARMY-NAVY SPECIFICATION PLUGS



DESIGNED TO MEET THE LATEST JAN SPECIFICATION P-642. High compression-molded insulation for high dielectric and tensile strengths. Features durability with low moisture absorption characteristics.

No. PJ-055B..... Dealer Cost \$.90

No. PJ-054..... Dealer Cost .90

No. PJ-068—3 Conductor Microphone Plug Dealer Cost \$2 36

ICA 2 — CONDUCTOR PHONE PLUGS

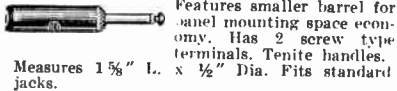

Features smaller barrel for panel mounting space economy. Has 2 screw type terminals. Tenite handles. Measures 1 5/8" L. x 5/8" Dia. Fits standard jacks.

No. 7577—Black..... Dir. Cost \$0.42
No. 7579—Red..... Dir. Cost .42

ICA BAKELITE DOUBLE PHONE PLUG



Molded bakelite ribbed barrel. Takes 2 cord tips. Fits all jacks.

Dealer Cost
No. 24B—Black..... \$.34

Display Card of 24 above

D-70024B..... 8.16
24R—Red..... .34

Display Card of 24 above

D-70024R..... 8.16
34B—Black barrel only..... 13.36C
34R—Red barrel only..... 13.36C
34P—Plug only..... .27

ICA MIDGET PHONE PLUG

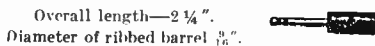

Overall length—2 1/4". Diameter of ribbed barrel 3/8".

No. 29B—Black..... Dealer Cost \$.34

Display Card of 24 above

D-70029B..... 8.16
29R—Red..... .34

Display Card of 24 above

D-70029R..... 8.16

ICA STURBY SHIELDED PHONE PLUG

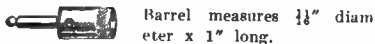

Barrel measures 1 1/2" diameter x 1" long.

No. 27..... Dir. Cost \$.49
No. 37—Barrel only..... Dir. Cost .32

ICA MIDGET SHIELDED PHONE PLUG

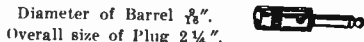

Diameter of Barrel 3/8". Overall size of Plug 2 1/4".

No. 30..... Dealer Cost \$.48

ICA 3-WIRE MICROPHONE PLUG



Has solder connections for cable or microphone use. Ribbed barrel molded of bakelite; brass parts, nickel plated.

No. 1901..... Dealer Cost \$.83

ICA SHIELDED DOUBLE PHONE PLUG

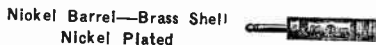

Nickel Barrel—Brass Shell
Nickel Plated

Supplied with fibre insulating tube.
No. 25..... Dealer Cost \$.60

STRAIN RELIEF CLAMP



For firm attachment of cables to PJO and PL type plugs. Approved by government services.

No. 5695..... Dealer Cost \$2.00C

ICA SHIELDED 3-WIRE MICROPHONE PLUG



Shielded Nickel Barrel

No. 1900..... Dealer Cost \$1.10

PHONE TIP WITH INSULATING JACKET



Nickel Plated brass with small O.D. insulating sleeve.

No. 341B—Black..... Dealer Cost \$10.00C
No. 341R—Red..... Dealer Cost 10.00C

SPRING TYPE BANANA PLUG



Has nickel-plated brass body with phosphor bronze spring contacts. Extra sturdy. Overall size 1 3/8" long. Threaded shank length 1/2" long; for 6-32 nuts.

No. 7573..... Dir. Cost \$9.00 C

ICA BANANA PLUG



Nickel-plated brass with snug-fitting one-piece phosphor bronze spring. Includes 6-32 screw and covering lug. Has 6-32 female threaded receptacle. Hex center permits firm tightening. Center shaft extends full length of plug.

No. 7584..... Dir. Cost \$9.00 C

ICA SPLIT BANANA PLUGS



For positive and durable spring action. Allows spring to fit into jack, cannot bend out of shape — Complete with two nuts.

No. 403..... Dealer Cost \$11.66C

WIRE CONNECTOR WITH BANANA PLUG RECEPTACLE

Ideal for quick splicing for testing point.

No. 1933..... Dir. Cost \$.25



BERYLLIUM BANANA PLUGS

Approved by the Signal Corps and other government agencies. These plugs are used in all government equipment. Made of nickel-plated Beryllium copper and guaranteed for its spring and durability.



No. 419 — Overall size 1 1/8" long. Shank length 1/4" long. Shank diam. 1/8". Dealer Cost \$12.00C



No. 421 — Overall size 1 3/8" long. Threaded shank length 1/2" long threaded for 6/32 nuts.

Dealer Cost.....\$21.00C

SILVER-PLATED BANANA PLUGS

No. 424—SILVER-PLATED Beryllium Copper Banana Plug. Overall length 1 1/2". Shank length 3/4", threaded for 8/32 nuts.

Dealer Cost.....\$20.00C

No. 429—Same as No. 424 above with knurled collar for snug panel fit.

Dealer Cost.....\$20.00C

No. 428—Overall length: 1 3/8"; shank 1 1/8"; thread: 8-32.

Dealer Cost.....\$20.00C

INSULATED MIDGET PHONE TIP PLUG

Fits all standard jacks. Tip is threaded. Overall length 1 1/4". Ribbed barrel.



No. 876R—Red..... Dealer Cost \$12.00C
876B—Black..... 12.00C

INSULATED SILVER-PLATED BERYLLIUM COPPER BANANA PLUG



Features a ribbed insulating 1" L. x 3/8" dia. tenite handle... beryllium copper springs. Silver-plated for permanent electrical contact. Fits standard type banana jacks. Cross-drilled holes in barrel for solder connection. Overall length: 1 3/4".

No. 413R—Red..... Dir. Cost \$0.30
No. 413B—Black..... Dir. Cost .30

ICA INSULATED SOLDERLESS BANANA PLUG



Revolutionary new solderless silver plated beryllium copper spring banana plug with insulating ribbed tenite sleeve. Measures 3/8" in dia.; 1" long. Features a novel miniature spring collet which serves as receptacle for phone tip or test lead wire ranging from 1: to 20 gauge.

No. 433B—Black..... Dir. Cost \$0.36
No. 433R—Red..... Dir. Cost .36

ICA INSULATED SOLDERLESS SPLIT BANANA PLUGS



Set screw provided at side of ribbed barrel to fasten screw without soldering.

1 1/2" Long
No. 883B—Black..... Dir. Cost \$15.00C
No. 883R—Red..... Dir. Cost 15.00C
No. 7565—Yellow..... Dir. Cost 15.00C
No. 7566—Green..... Dir. Cost 15.00C
No. 7567—Blue..... Dir. Cost 15.00C

2 1/2" Long
With sleeve covering set screws.
No. 882B—Black..... Dir. Cost \$0.27
No. 882R—Red..... Dir. Cost .27

SINCE
1921



insuline Corporation of America

OVER 3 DECADES OF QUALITY RADIO-TELEVISION PRODUCTS

ICA INSULATED SOLDERLESS SPLIT BANANA PLUGS

With Solderless Wire Nut



No. 434B—Black Dir. Cost \$18.00C
No. 434R—Red Dir. Cost 18.00C

ICA INSULATED SOLDERLESS PLUG



2" long — fits all standard phone tip jacks. Ribbed barrel.

No. 885B—Black Dealer Cost \$13.80C
No. 885R—Red Dealer Cost 13.80C
No. 7555—Yellow Dealer Cost 13.80C
No. 7556—Green Dealer Cost 13.80C
No. 7557—Blue Dealer Cost 13.80C

ICA INSULATED NEEDLE POINT TIP PLUG

Ribbed barrel.

No. 886B—Black Dir. Cost \$14.16C
No. 886R—Red Dir. Cost \$14.16C



ICA GRIP-RITE MOLDED PHONE TIP PLUG

Replacement for ICA and Weston — as well as other make Test Leads.



No. 868—Red Dir. Cost \$27.00C
869—Black 27.00C
Display Card of 12 each above
No. 70868-9 Dealer Cost \$6.4F

ICA SR. SOLDERLESS PLUGS

1 1/2" over-all length
No. 358 Dealer Cost \$9.58C

ICA JR. SOLDERLESS PLUGS—No. 359

1 1/2" over-all length.
Tip 1/2".
Dealer Cost \$9.58C



LOCKING TYPE SOLDERLESS PHONE TIP

Companion piece to ICA No. 432 locking type tip jack. (May also be used with non-locking type jack). Insulated barrel. Overall length: 1 1/2"; tip 3/8".

No. 7530-B—Black Dir. Cost \$18.00C
No. 7530-R—Red Dir. Cost 18.00C



No. 7526—Same as above without insulating barrel. Overall length: 1 3/8"; tip: 3/8".
Dealer Cost \$14.00C

MIDGET SHARP POINT PHONE TIP THREADED—NOT INSULATED

Threaded to fit all test prods.
No. 365 Dir. Cost \$10.00C

ICA PHONO NEEDLE CHUCKS

Push on type can be forced into handles — Threaded type can be screwed into handles. Machined of brass, nickel plated with needle point.

No. 508—Push-on Type, Overall size 1" \$11.00C
509—Threaded Type, Overall size 1" 12.00C



STANDARD PHONE TIPS

Overall Length 1"

No. 360 Dealer Cost \$16.67M



HEAVY DUTY PHONE TIPS

Overall Length 1 1/4".
No. 361 \$60.00M



BATTERY CONNECTOR STRIP

Fitted with easy snap-on clips for the following popular type batteries: Burgess XX30; XX45. Eveready 455; 467. RCA VS016; VS056; Ray-O-Vac P4367.

No. 3397 Dealer Cost \$18.00C

ICA DELUXE PHONE JACKS

Greater Efficiency

New design. Tension fatigue minimized. Spring members made of phosphor bronze. Hooked type soldering lugs — Cannot turn or short. For standard 1/4" plug.



No. 1920—Single Open Circuit \$.50
1921—Single Closed Circuit58
1922—Three-Way Microphone Jack75



ICA PHONE JACKS

Smaller type precision made jacks for limited space. Complete with nut and metal washer.

No. 1870—Single Open Circuit \$.30
1871—Single Closed Circuit34
1872—3-Way Microphone Jack38

ICA PANEL MOUNTING JACKS



Small and compact. Insulated shoulder washers. Phosphor-bronze, nickel-plated springs.

No. 325—Single Open Circuit \$.34
1905—3-Way Microphone Jack75

ICA SHIELDED 3-WAY PORTABLE MICROPHONE JACK



For all types of microphones. Sturdily constructed of brass parts with phosphor bronze springs. Nickel plated and thoroughly insulated.
No. 1904 Dealer Cost \$1.00

ICA SHIELDED PORTABLE JACK

Single Open Circuit Dealer Cost \$.84

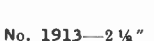

ICA BAKELITE PORTABLE JACKS



Single Open Circuit
Ribbed barrel

No. 1911—Overall Size 1 1/8"; Diam. 3/8" \$.50
Display Card of 16 above

No. D-71911 Dealer Cost \$8.00
No. 1903—Portable Jack, black Bakelite barrel Dealer Cost \$.75

ICA COMBINATION BANANA PLUG OR PHONE TIP JACK



Made to take banana plug or standard phone tips interchangeably. Insulated cap in black and red — With washers and nuts.

No. 528R—Red Dealer Cost \$15.00C
528B—Black \$15.00C

HIGH VOLTAGE NYLON TIP JACK



Nylon insulator can withstand 10,000 v. breakdown. Low leakage resistance; very low moisture absorption. One piece spring contact loop of phosphor bronze. Offers stability in sensitive test equipment. Takes all standard phone tips and test prods. Molded washer affords added protection against "shorts."

No. 1899-N—Natural Finish Dir. Cost \$0.45
1899-B—Black45
1899-R—Red45

MINIATURE NYLON TIP JACKS



Molded from low-loss nylon, resulting in an all-insulated jack. Beryllium copper silver plated contact. Recessed contact for shorting safety; high voltage breakdown. 3/8-32 thread with nut. Overall dimensions: 3/8" dia. x 3/8" L.

No. 7537—White Dir. Cost \$30.00C
No. 7538—Red Dir. Cost 30.00C
No. 7539—Black Dir. Cost 30.00C
No. 7540—Green Dir. Cost 30.00C
No. 7541—Orange Dir. Cost 30.00C
No. 7542—Yellow Dir. Cost 30.00C
No. 7543—Brown Dir. Cost 30.00C
No. 7544—Blue Dir. Cost 30.00C
No. 7545—Ivory Dir. Cost 30.00C

MOLDED TIP JACK

All-molded tip jack with phosphor bronze spring contact includes brass nut for mounting directly on panels up to 3/8" thick. Mounting hole: 3/8". Overall dimensions: 1" L. x 1/2" Dia.

No. 7521—Black Dealer Cost \$21.00C
7522—Red 21.00C
7523—Green 21.00C
7524—Yellow 21.00C
7525—Blue 21.00C



LOCKING TYPE TIP JACKS



Bakelite insulated tip jack with internal thread in metal body to accommodate solderless phone tip. Twist of phone tip locks it in place. May be used with standard phone tips as well as locking type. Phosphor bronze one-piece spring contact loop. Mounting hole: 3/8". Overall length: 1 1/8". Dia. 1/2".

No. 432-R—Red Dealer Cost \$19.00C
432-B—Black 19.00C

BERYLLIUM COPPER INSULATED TIP JACKS



Bakelite. Spring contact of heat treated beryllium copper.

No. 1897—Black Dealer Cost \$.36
1898—Red36

ICA BAKELITE INSULATED TIP JACKS

Molded Bakelite Head

No. 1889—Black Dealer Cost \$15.00C
Display Card of 40 above
D-71889 \$6.00
1890—Red \$15.00C
Display Card of 40 above
D-71890 \$6.00



SINCE
1921



insuline Corporation of America

OVER 3 DECADES OF QUALITY RADIO-TELEVISION PRODUCTS

BAKELITE BANANA TYPE JACKS

No.	Dealer Cost
1891—Black	\$15.00C
Display Card of 40 above	
D-71891	\$6.00
1892—Red	\$15.00C
Display Card of 40 above	
D-71892	\$6.00



ICA INSULATED TIP JACKS

With receptacle for standard phone tips.

No.	Dealer Cost
889B—Black	\$12.00C
889R—Red	12.00C
No. 7360 Yellow Dir. Cost \$12.00 C	
No. 7561—Green	Dir. Cost 12.00 C
No. 7562—Blue	Dir. Cost 12.00 C

INSULATED BANANA JACKS

With receptacle for banana plugs.

No.	Dealer Cost
888B—Black	\$12.00C
888R—Red	12.00C
No. 7570—Yellow Dir. Cost \$12.00 C	
No. 7571—Green	Dir. Cost 12.00 C
No. 7572—Blue	Dir. Cost 12.00 C

ICA BRASS TIP JACKS

Nickel Plated

No. 357	Dealer Cost \$9.00C
---------	---------------------



ICA TRANSMITTING BANANA JACKS

Nickel Plated Brass

No. 402	Dealer Cost \$9.00C
---------	---------------------



SILVER PLATED BRASS BANANA JACK



Has knurled shoulder for firm panel fit. Extended shank suitable for heavy panels. Minimum panel thickness: $\frac{3}{8}$ " maximum: $\frac{1}{2}$ ". Overall length: $\frac{7}{8}$ ". Shank length: $\frac{1}{2}$ ". Hex head dia.: $\frac{7}{8}$ ". Takes Insuline banana plugs No. 410, 421, 424, 428, and 429, 7573 and 7574.

No. 431A	Dealer Cost \$12.00 C
----------	-----------------------



MICROPHONE CONNECTORS

NEW Universal shielded cable single contact microphone connector. Newly designed non-fixed coupling ring permits easy cable connection. Male-female connector in one. Eliminates necessity for mating connectors.

No. 1931	Dealer Cost \$.30
----------	--------------------



MICROPHONE CONNECTORS

Shielded cable type. Single contact male-microphone connector. Chrome-plated brass

No. 1932	Dealer Cost \$24.00C
----------	----------------------



MICROPHONE CONNECTORS

No. 1929—For use on chassis unit or in microphone. Single Contact. Dealer Cost \$18.00C

No. 1930—Closed circuit connector. With spring actuated contact. Dealer Cost .27

PHONE PLUG ADAPTER



Soldering or wiring not necessary.

No. 33	Dealer Cost \$.30
--------	--------------------

CONNECTOR COUPLING RING

Microphone connector coupling ring converts male to female. Offers male-female connector in one unit.



No. 1925	Dir. Cost \$8.00 C
----------	--------------------

ICA CAP AND CHAIN

Provides effective protection to unused male microphone connectors against grit and dirt. Affixed chain prevents loss when making connection. For use with ICA 1929 and No. 1930 or similar connectors.



No. 1918	Dir. Cost \$3.33
----------	------------------

TRANSMITTING PLUGS AND JACKS

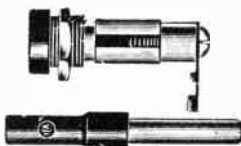

A new line of heavy duty transmitting plugs and jacks. Plug-in type with positive grip contacts. Equipped with heavy insulated threaded heads and handles for safe handling on high R.F. currents. Supplied with large hex nuts for panel mounting.

Handle 1,000 Volts at 10 Amps

No.	Medium Plug—RED	Dealer Cost
450	Medium Plug—BLACK	\$.42
451	Medium Jack—RED	.42
452	Medium Jack—BLACK	.80
453	Medium Jack—BLACK	.80
454	Giant Plug—RED	.63
455	Giant Plug—BLACK	.63
456	Giant Jack—RED	.88
457	Giant Jack—BLACK	.88

ICA PLUGS AND JACKS



Used on RCA recording units, receivers and auto sets.

No.	Dealer Cost
2383—Pin Plug	\$5.00C
2385—Socket and Shield	7.00C

ICA INSULATED BINDING POSTS WITH JACK FOR BANANA TYPE PLUG



Length $1\frac{1}{4}$ " overall when top is up. Extends $\frac{5}{8}$ " above panel when top is screwed down. Fitted with 8/32 screw $\frac{1}{8}$ " long, and two hex nuts.

No.	Dealer Cost
622—Red	\$24.00C
623—Black	24.00C



PORTABLE PHONO JACK

2-section shielded phono jack cadmium plated metal sleeve; bakelite insert for use with ICA 2383 or similar pin plug. No. 2384 Dealer Cost \$15.00 C

ICA ALL METAL BINDING POST

Designed for high amperage use and where low resistance connections are necessary on test equipment, etc. Nickel plated brass. Dimensions same as No. 617 below.



No.	Dealer Cost
620	\$21.00C

ICA BAKELITE BINDING POSTS

$\frac{1}{8}$ " Diameter Head with Brass Threaded Insert. Nickel Plated Screw; Knurled nut.



No.	Dealer Cost
617—Red	\$15.00C
618—Black	15.00C

ICA VISE-GRIP BINDING POST



Engineered on principle of a vise. Can cause no damage to even finest wire strands. Wire hole and designating symbol always in alignment. Two styles.

No. 630 Series—Has 8/32 Male Threaded Shank	Dealer Cost \$4.00
---	--------------------

No. 690 Series—Has 8/32 Female Thread	Dealer Cost \$3.34
---------------------------------------	--------------------

No.	Marking	No.	Marking
630	ANT	690	ANT
631	GND	691	GND
632	A	692	A
633	G	693	G
634	+	694	+
635	—	695	—
636	Rec.	696	Rec.
637 PLAIN (No Marking)		697 PLAIN (No Marking)	



BAKELITE BINDING POST HEADS

Bakelite Heads only with Brass Threaded Insert for 8/32 Screw.



No. 628—Red	Dealer Cost \$10.00C
No. 629—Black	Dealer Cost 10.00C

INSULATED SPADE LUG

Insulated Spade Lug with banana plug receptacle on lead end.



No. 887B—Black	Dealer Cost \$10.00C
No. 887R—Red	Dealer Cost 10.00C

ICA SPADE LUG



Can be used on any size screw or terminal up to size 10. Receptacle fits all I.C.A. and other make Banana Plugs.

No. 879	Dealer Cost \$11.00M
---------	----------------------



HEAVY DUTY INSULATED SPADE LUGS

Heavy gauge nickel-plated brass spade lug which will fit on screws or binding posts up to $\frac{1}{8}$ " in diameter. Supplied with tenite sleeve—red or black—unassembled for forced fit after wiring.

No. 867R—Red	Dealer Cost \$.21
No. 867B—Black	Dealer Cost .21

SINCE
1921



insuline Corporation of America

OVER 3 DECADES OF QUALITY RADIO-TELEVISION PRODUCTS

ALL-INSULATED ALLIGATOR CLIP



Special plastic molding fully encases clip; molded threaded sleeve covers terminal lug and screw. Combines a strong spring-loaded contact with complete insulation. Measures: 2 7/8" overall length.

No. 522-B—Black Dealer Cost \$.48
No. 522-R—Red Dealer Cost .48

ALL INSULATED ALLIGATOR CLIP



Fully insulated alligator clip permits cramped testing without danger of shorting or grounding; shock-proof. Firm gripping jaws; handy push-button release. Takes standard banana plugs. Overall dimensions: 2 1/2" L. x 3/8" dia.

No. 524-B—Black Dir. Cost \$30.00 C
No. 524-R—Red Dir. Cost 30.00 C

ICA ALLIGATOR CLIPS

Good firm grip. Ideal for work in tight places. Overall length 2".



No. 364 Dealer Cost \$6.10C

ICA ALLIGATOR CLIP WITH SCREW CONNECTION



Good firm bite. Convenient screw connection eliminates the necessity for soldering. Overall length 2".

No. 376 Dealer Cost \$6.60C

ICA INSULATED ALLIGATOR CLIPS



No. 884B—Black Dealer Cost \$10.80C
No. 884R—Red Dealer Cost 10.80C

Display Card of 20 each above

No. D-70884B-R Dealer Cost \$4.32

ICA INSULATED ALLIGATOR CLIP WITH PHONE TIP JACK



Has standard phone tip jack in insulated sleeve. Will accommodate phone tip or solderless plug tips.

No. 525R—Red Dealer Cost \$.30
No. 525B—Black Dealer Cost .30

ICA INSULATED COMBINATION JACK ALLIGATOR CLIP



An insulated alligator clip with a dual purpose Jack in catalin sleeve. Equipped with the new combination Jack which takes either solderless phone tip or Banana plug. Overall length—3 1/4".

No. 520R—Red Dealer Cost \$.36
No. 520B—Black Dealer Cost .36

ICA SOLDERING IRONS

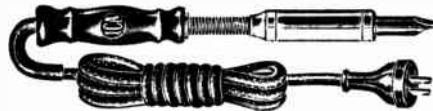

Into each ICA soldering iron are incorporated the most durable materials of each needed type to insure long service. Ability to give continuous usage over an exceptionally long span is a definite feature of these irons.

- Fully insulated, removing slightest possibility of grounding
- Heats to operating temperature in three minutes
- Special air chamber reduces heat losses, assuring cool grip
- Plunger type soldering tip offers proper operating heat at soldering point

60 WATT IRON

No. 1960-A—105-120 Volts Dir. Cost \$3.33
No. 1963—220 Volts Dir. Cost 3.33

85 WATT IRON

No. 1962-A—105-120 Volts Dir. Cost \$4.33
No. 1964—220 Volts Dir. Cost 4.33

115 WATT IRON

No. 1961-A—105-120 Volts Dir. Cost \$5.00
No. 1965—220 Volts Dir. Cost 5.00

REPLACEMENT ELEMENTS FOR ICA SOLDERING IRONS



Because of the practical design of ICA Soldering Irons, burnt out elements may be easily replaced.

105-120 Volts			220 Volts		
No.	Watts	Dir. Cost	No.	Watts	Dir. Cost
1985	60	\$2.00	1990	60	\$2.00
1986	85	2.33	1991	85	2.33
1987	115	2.33	1992	115	2.33

REPLACEMENT TIPS

For ICA Soldering Irons



Available in All Sizes

Made of a special copper alloy. Electrolytically pure. For replacement in ICA Soldering Irons. Can also be used in American Beauty and irons of similar construction.

No.	Watts	Tips	Dia.	Length	Dealer Cost
1970	60	Flat	3/8"	3"	\$.42
1972	85	Point	3/8"	3 1/2"	.58
1971	115	Point	7/8"	3 1/2"	.67

ICA RIVET AND EYELET PUNCH SET



A Universal Tool that can be used for either riveting or eyeletting. It is made of cast iron with hexagonal sides, thus permitting the tool to be placed in a vise without slipping.

No. 785—Complete with ample assortment of eyelets and rivets.

Dealer Cost \$3.33

RIVET AND EYELET ASSORTMENT

Additional eyelets and rivets can be purchased separately.

No. 5265—(Assmt. of 100) Dir. Cost \$.57

RIVET & EYELET SETTING TOOL



No. 786 Dealer Cost \$.64

TUBE EXTRACTOR

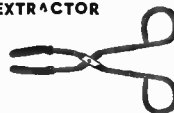

For removing all makes and sizes of tubes. Moulded rubber cushion over claws offers full tube protection. Sturdy zinc-plated steel; "Iridited."

No. 1001 Dealer Cost \$1.05

Display Card of 3 above

No. D-71001 Dealer Cost \$3.15

ICA UNBREAKABLE "TURN-TITE" SOCKET WRENCHES



7" long. Handle is of ribbed shockproof unbreakable material.

No.	Socket	Dir. Cost	No.	Socket	Dir. Cost
940	3/8"	\$.60	944	3/8"	\$.60
941	1/2"	.60	945	7/8"	.60
942	3/4"	.60	946	1 1/2"	.60
943	1 1/4"	.60	949	Set of 7 wrenches as above	4.20

ICA UNBREAKABLE VOLUME CONTROL WRENCH



Socket is 3/8" diameter.

No. 937 Dealer Cost \$1.15

ICA FLEXIBLE SOCKET WRENCH



Especially designed for hard-to-reach spots. Can actually be used around corners or under obstructing objects.

No. 913—1/4" Hex Dealer Cost \$0.90

Display Card of 6 above

No. D-70913 Dealer Cost \$5.40

No. 914—3/8" Hex Dealer Cost \$0.90

Display Card of 6 above

No. D-70914 Dealer Cost \$5.40

SINCE
1921



insuline Corporation of America
OVER 3 DECADES OF QUALITY RADIO-TELEVISION PRODUCTS

The Insuline "Mini-Kit"
A PRECISION SCREW DRIVER KIT

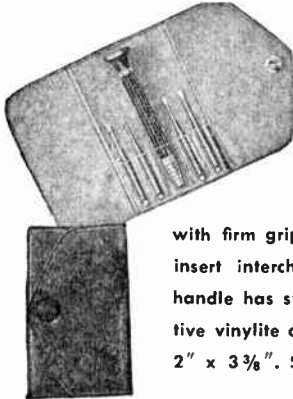

A handy, vest-pocket screwdriver kit designed especially for precision radio, television and electrical requirements. Contains four hardened steel blades measuring .100"; .080"; .070" and .055", which fit into finger grip ribbed plastic handle with firm gripping chuck. To change blades, merely loosen chuck, insert interchangeable blade and tighten chuck. The sure-lock handle has swivel top for finger-tip control. Packed in an attractive vinylite compact case with snapper closure. Measures (closed) 2" x 3 3/8". Sold singly or in colorful display stand of 12.

No. D-70989—Display of 12 Dealer Cost 13.80

ICA LOCK SOCKET WRENCH AND SCREWDRIVER SET

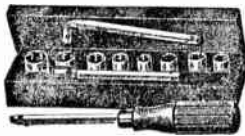

The all-purpose socket wrench, packed in neat, enameled steel case. Includes sturdy 6 1/2" Wood Grip Screw Driver—4" L Handle—3 3/4" Extension Adaptor, 1/4", 5/16", 3/8", 7/8" and 1/2" Hex—3/8" Round Knurled Socket—1/4" and 5/16" Square Sockets.

No. 999 Dealer Cost \$2.15

ICA SHEARING PUNCHES



Sturdy steel punch for smooth accurate holes in chassis. Offers a clean cut; no filing necessary. Simply operated, regular wrench supplies driving power.

No.	Size of Hole	Dealer Cost
723	5/16"	\$2.20
725	3/8"	2.20
724	1"	2.40
727	1 1/8"	2.55
726	1 3/8"	2.55
728	1 7/8"	2.55
729	1 1/2"	2.55
730	1 3/8"	2.90

REPLACEMENT DRILLS AND CUTTERS



Used as replacement on ICA No. 775 and No. 780 circle cutters as well as on other make cutters.

- No. 776—Replacement drill for No. 775 Circle Cutter
Dealer Cost \$.50
- No. 777—Replacement cutter for No. 775 Circle Cutter
Dealer Cost \$.67
- No. 781—Replacement drill for No. 780 Circle Cutter
Dealer Cost \$.50
- No. 782—Replacement cutter for No. 780 Circle Cutter
Dealer Cost \$.67

ICA FLEXIBLE SCREW DRIVER

For the Hard to Reach Spots



Allows access to screws in hard to reach and out of the way places. Can go under objects or around corners.

No. 935 Dealer Cost \$1.35

Display Card of 6 above
No. D-70935 Dealer Cost \$8.10

ICA UNIVERSAL MULTI-PURPOSE CUTTING TOOL



This handy tool can be used for counter-sinking, beading, drilling or cutting holes. Equipped with 7/8" drill for holes from 7/8" diameter up to 3" diameter. Can be used either in drill press or hand brace. Also acts as a boring tool when used in a lathe.

No. 760 Dealer Cost \$3.08

ICA IMPROVED ALL-PURPOSE CIRCLE CUTTER

Will Cut Holes from 1 1/2 to 8 Inches

Cutting bar holder is 7/8" in diameter and also accommodates a centering drill or any size pilot pin. Cutting bar is 3/8" square and is arranged to hold a 7/8" high speed cutting bit.



No. 757 Dealer Cost \$3.00



insuline

... world's largest producer of TEST LEADS and PROBES



Insuline Corporation of America has been the leading maker of test leads and probes (standard and special types) for 32 years.

See following pages for a complete listing of Insuline's extensive line of test leads and probes. Special types made on order.

Announcing . . .

INSULINE'S NEW HOME IN MANCHESTER, N. H.

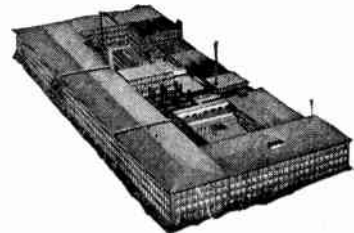

281,000 sq. ft. of air-conditioned manufacturing space with complete trucking, rail siding and air transportation network.

Coincident with its acquisition of tremendously enlarged production footage, Insuline's expanded facilities include:

- ADDED EQUIPMENT
- LATEST STREAMLINED PRODUCTION METHODS
- ENLARGED FACTORY PERSONNEL
- EXPANDED ENGINEERING STAFF

Additional installed equipment quadruples present facilities for the production of electronic products; components; stampings; housings; screw machine products; antennas; and complete communication radar assemblies.

SINCE
1921



insuline Corporation of America
OVER 3 DECADES OF QUALITY RADIO-TELEVISION PRODUCTS

INSULINE ALIGNING . . . SERVICING TOOLS . . . KITS

ICA BONE FIBRE SCREW DRIVER



Double Edged—No Metal—Fully Insulated
Made of 1/4" Bone Fibre Rod
No. 1039 Dealer Cost \$.27
No. D-71039 Display Card of 16 above Dealer Cost \$4.32

INSULATED NEUTRALIZING WRENCHES



Hexed—Full Length
For Philco, Majestic and Other Receivers
3/8" Diameter
No. 985—6" long; Hex 1/4" \$ 0.22C
980—3" long; Hex 3/8" 20.00C
981—5" long—7/8" dia.; Hex 3/8"25

BAKELITE NEUTRALIZING TOOL



Neutralizing tool used by U. S. Army Signal Corps (U. S. Army No. TL-138B).
No. 1010 Dealer Cost \$.37

ICA NEUTRALIZING AND ALIGNING TOOL



U. S. Army No. TL138A — ICA No. 1011
Used for general radio tuning and aligning.
Approved by U. S. Army and Navy.
No. 1011 Dealer Cost \$.66

ICA 4-IN-1 NEUTRALIZING TOOLS, SCREW DRIVER AND WRENCH

Made of Fenoline
Fully Insulated



No. 1019—Complete Dealer Cost \$.60
No. D-71019 Display Card of 12 above Dealer Cost \$7.20

ICA 5-IN-1 NEUTRALIZING AND COMPENSATING TOOL

Same features as the 4-in-1 tool described above with an additional all metal screw driver.



No. 1022 Dealer Cost \$1.00
No. D-71022 Display Card of 12 above Dealer Cost \$12.00

ICA MAGIC TUNING ALIGNMENT TOOL

Consists of a Bakelite rod with a Brass cylinder at one end, and a special finely divided iron core at the other end.
No. 977 Dealer Cost \$.66

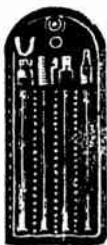

ICA NEUTRALIZING AND ALIGNING TOOL KIT

The Kit consists of twelve separate and distinct parts, some of which can be employed for several operations. These units telescope into each other, forming four separate tools when assembled.

No. 998 Dealer Cost \$3.68
Complete with Carrying Case

"E-Z REACH" TV ALIGNING and SERVICING "PAK-CARD"

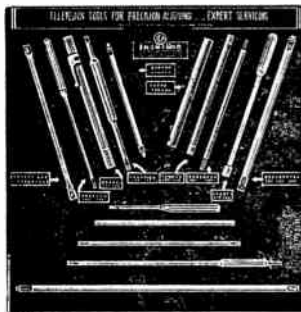

Contains 15 general television servicing and aligning tools neatly mounted on a colorful card for E-Z reach. Excellent for service department, labs, repair benches, etc. Eliminates misplacing or losing needed tools. Each tool identified and marked for type of servicing. E-Z pull elastic grippers. Contains the following popular Insuline tools: No. 978—Aligner for IF, RF, and "K-Tran" Transformers; No. 981—Alignment wrench, hexed full length; No. 1019—"4-in-1" screw driver wrench aligner; No. 6157—Narrow insulated screw driver for deep tuning; No. 6158—Double bladed, narrow shaft fibre TV aligner; No. 6161—Slim aligning tool for cramped spaces; No. 6162—Extra thin long (9") aligner; No. 6163—Thin diameter tuning wand; No. 6164—Extra-thin recessed blade tuning wrench; No. 6171—Hex-square aligner; No. 6192—"Kleer-Aligner", for trimmers, IF transformers, etc.; No. 6193—Extra thin—brass core . . . iron core tuning wand; No. 6194—"Super Stretch" aligner, 12" handle; No. 6247—"Kleer-Aligner", double extended blades; No. 6249—Tuning Wand, brass core; iron core.

No. 6693 Dealer Cost \$7.75

SUPER RADIO-TV SERVICING and ALIGNING TOOL KIT

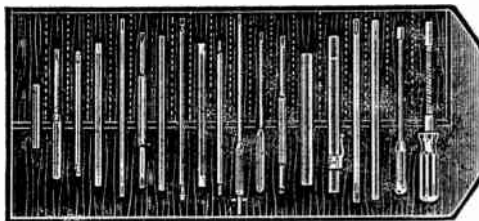

A complete deluxe kit of 19 tools designed especially for the widest possible use in the radio and television servicing field. Contains the following Insuline tools: No. 6193—Extra thin—brass core . . . iron core tuning wand; No. 6157—Narrow insulated screw driver for deep tuning; No. 1019—"4-in-1" screw driver wrench aligner; No. 978—Aligner for IF, RF, and "K-Tran" Transformers; No. 6247—"Kleer-Aligner", double extended blades; No. 981—Alignment wrench, hexed full length; No. 6171—Hex-square aligner; No. 6161—Slim aligning tool for cramped spaces; No. 6192—"Kleer-Aligner", for trimmers, IF transformers, etc.; No. 6158—Double bladed, narrow shaft fibre TV aligner; No. 6163—Thin diameter tuning wand; No. 6164—Extra-thin recessed blade tuning wrench; No. 935—Flexible screw driver; No. 6159—Double edge bone fibre screw driver; No. 6248—All purpose aligner for Motorola, etc. sets; No. 6156—Deep-nib Aligner for IF and RF shielded coils and trimmers; No. 6249—Tuning Wand, brass core; iron core; No. 6170—Core Aligner for Stackpole adjustable cores; No. 6162—Extra thin long (9") aligner.

No. 6696 Dealer Cost \$10.95

TELEVISION JUNIOR "HANDI-KIT"

4 Essential Tools for TV Servicing

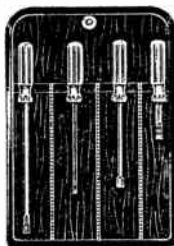

A neat, compact kit containing four of the most popular Insuline tools used for a variety of television servicing requirements. The handy, plastic case is pocket-size for convenient carrying. Includes No. 6846—all insulated aligner for tuning IF and RF shielded coils and trimmers; No. 6848—all insulated recessed blade tuner; No. 6850—aligner for IF, RF, and "K-Tran" midget transformers; No. 6849—extra slim aligner for cramped probing. All tools have amber plastic handles.

No. 6697 Dealer Cost \$2.15

TELEVISION "HANDI-KIT"

For Television servicing. Contains nine (9) latest tools especially designed for television needs. Includes aligner for IF and RF and "K-Tran" Transformers (No. 978); slim alignment tool for cramped spaces (No. 6161); Extra thin long (9") aligner (No. 6162); thin diameter tuning wand (No. 6163); tuning wrench (No. 6164); dual aligner, narrow shaft (No. 6166); Stackpole core aligner (No. 6170); deep nib aligner (No. 6158); narrow insulated screw driver for deep tuning (No. 6157). Packed in attractive leatherette case for easy carrying. A real combination value.

No. 6165 Dealer Cost \$4.50

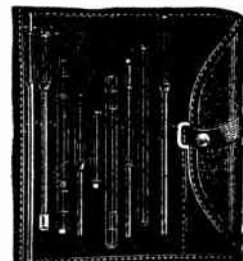

SINCE
1921



insuline Corporation of America
OVER 3 DECADES OF QUALITY RADIO-TELEVISION PRODUCTS

TELEVISION SERVICING . . . ALIGNING TOOLS

DEEP-NIB "KLEER ALIGNER"



All-insulated aligner with clear flexible low-loss rod ($\frac{1}{4}$ " dia.); amber plastic handle. Metal nib for No. 6 studs entirely insulated and set within barrel end. For tuning IF and RF shielded coils and trimmers. Overall length: 4".

No. 6846 Dealer Cost \$0.42

THIN ALIGNER



Has extra thin recessed blade; durable slim metal shaft for cramped probing. Amber plastic handle. Especially suitable for Admiral and similar type TV receivers. Measures 6" overall length.

No. 6849 Dealer Cost \$0.66

"LONG STRETCH" FIBRE TV ALIGNER



Ideal for probing in cramped, inaccessible areas. A double bladed aligning tool, measuring 12" in length. Made of durable fibre for complete insulation and sturdiness. Narrow shaft is $\frac{1}{8}$ " in diam.

No. 6159 Dealer Cost \$.35

Display Card of 12 above

No. D-76159 Dealer Cost \$4.20

No. 6158—7" Long Dealer Cost \$24.00C

Display Card of 12 above

No. D-76158 Dealer Cost \$ 3.84

DOUBLE END "KLEER ALIGNER"



Low-loss CLEAR PLASTIC all-insulated shaft. Has two recessed blades set within rod ends, completely insulated. One blade suitable for No. 6 screw and smaller; other blade for No. 4 screw and smaller. Shaft is 7" long x $\frac{3}{8}$ " diameter.

No. 6193 Dealer Cost \$.60

Display Card of 12 above

No. D-76193 Dealer Cost \$7.20

"KLEER-ALIGNER"



A low-loss CLEAR PLASTIC all-insulated aligning tool. Narrow shaft. Has recessed insulated blade on one end; extended blade on other end. Designed for many aligning uses. For trimmers, IF transformers, etc. Measures 7" in length x $\frac{3}{8}$ " diameter.

No. 6192 Dealer Cost \$.60

Display Card of 12 above

No. D-76192 Dealer Cost \$7.20



"ALIGNER-TRAN"

Aligning tool of tough fibre with insulating amber plastic handle for standard IF, RF and "K-Tran" midget transformers. Measures 6 $\frac{1}{2}$ " overall length.

No. 6850 Dealer Cost \$0.51

"KLEER-TUNER"



Low-loss clear plastic rod measures $\frac{3}{8}$ " in dia. Insulating amber plastic handle. Has recessed blade for No. 6 studs. All-insulated. Measures $\frac{1}{2}$ " overall length.

No. 6848 Dealer Cost \$0.66

"BIG STRETCH" ALIGNER



Extra thin, extra long (9"), bone fibre aligning tool, 6 $\frac{1}{2}$ " blade. Specially designed for adjustment of nested iron cores of "Admiral," "Zenith" and similar make TV sets. Permits use on RCA front ends and normally inaccessible areas.

No. 6162 Dealer Cost \$.73

Display Card of 12 above

No. D-76162 Dealer Cost \$8.76

TUNING WRENCH



Insulated fibre tuning wrench with extra thin recessed blade. Extra thin screw driver blade on other end ($4\frac{1}{4}$ " L.). Tenite handle. Especially designed for "Zenith" TV sets, etc.

No. 6164 Dealer Cost \$0.48

Display Card of 16 above

No. D-76164 Dealer Cost \$7.68

DUAL ALIGNER



Dual purpose narrow shaft, fibre alignment tool for trimmers, IF transformers, coils, condensers, push-button tuners, etc. Recessed screw nib on one end; metal screw driver on other end. Has an extensive application in TV servicing. Used on RCA, Bendix, and other type receivers.

No. 6166 Dealer Cost \$0.52

Display Card of 16 above

No. D-76166 Dealer Cost \$8.32

"SUPER STRETCH KLEER ALIGNER"



All insulated extra long TV aligner for inaccessible areas. The low-loss CLEAR PLASTIC Rod is 12" long x $\frac{3}{8}$ " diam. Carries an extended blade at one end; brass slotted insert at other end. A handy tool for those hard-to-reach spots.

No. 6194 Dealer Cost \$.83

Display Card of 12 above

No. D-76194 Dealer Cost \$9.96

LONG-ROD "KLEER ALIGNER"



All-insulated extra length tool (measures 18" overall) for hard-to-reach trouble points. Clear plastic rod is $\frac{3}{8}$ " in diameter. Has amber plastic handle. Extended blade: $\frac{3}{8}$ " w. No. 6847 Dealer Cost \$0.90

SLIM-ALIGNER



Alignment tool with extra thin recessed blade and slim metal shaft for cramped probing in television receivers. Fiber handle. Especially suitable for "Admiral" and similar make television sets.

No. 6161 Dealer Cost \$0.66

Display Card of 12 above

No. D-76161 Dealer Cost \$7.92

TUNING WAND



Extra thin diameter to fit small coil openings in television sets. Flexible vinylite. Brass insert in one end; molded powdered iron core in other end. Lowers or increases inductance. Suitable for "Zenith," etc. TV sets.

No. 6163 Dealer Cost \$0.35

Display Card of 12 above

No. D-76163 Dealer Cost \$4.20

DEEP-NIB ALIGNER



Tough fibre. Metal nib entirely insulated and set within barrel end. For tuning IF and RF shielded coils and trimmers. Small enough to fit under television tubes without removing. Length: 2 $\frac{1}{2}$ " x $\frac{1}{4}$ " diameter.

No. 6156 Dealer Cost \$.36

Display Card of 16 above

No. D-76156 Dealer Cost \$5.76

CORE ALIGNER



For Stewart-Warner, Beimont and other television receivers employing Stackpole adjustable cores. The 6" insulated fibre shaft has brass insert at one end for milled end cores; recessed screw driver blade at other end for standard slotted cores. Inserts are "pinned-in" and flush with shaft end for durability and ease of use.

No. 6170 Dealer Cost \$.55

Display Card of 16 above

No. D-76170 Dealer Cost \$8.80

SINCE
1921



insuline Corporation of America
OVER 3 DECADES OF QUALITY RADIO-TELEVISION PRODUCTS

TELEVISION SERVICING . . . ALIGNING TOOLS

TELEVISION "CHANNEL TUNER"



A narrow all-insulated screw driver of machined fiber. Ideal for deep, inaccessible tuning. Overall: 7" Length. $\frac{1}{8}$ " blade on $4\frac{1}{2}$ " shaft.

No. 6157 Dealer Cost \$.55
Display Card of 12 above
No. D-76157 Dealer Cost \$6.60

TRAN-ALIGNER



Newly designed all-insulated aligning tool for standard IF and RF and "K-Tran" midget transformers. Trim fiber; milled at one end, screw driver at other end. $2\frac{1}{2}$ " length blade; 6" overall.

No. 978 Dealer Cost \$0.51
Display Card of 16 above
No. D-70978 Dealer Cost \$7.16

HEXY-SQUARE ALIGNER



All bone fibre iron core aligning tool especially designed for Raytheon-Belmont IF transformers and similar type transformers. $\frac{1}{8}$ " shaft has $\frac{1}{8}$ " diam.; $3/32$ " hex one end; $\frac{1}{8}$ " square other end.

No. 6171 Dealer Cost \$.75
Display Card of 12 above
No. D-76171 Dealer Cost \$9.00

HEX-ALIGNER



All bone fibre iron core aligning tool. Has $3/32$ " hex one end; $\frac{1}{8}$ " hex other end. Especially designed for Dumont, Raytheon-Belmont receivers and other sets, using similar type iron cores. Shaft 6" long; $\frac{3}{8}$ " diam.

No. 6199 Dealer Cost \$.83
Display Card of 12 above
No. D-76199 Dealer Cost \$9.96

ALL-PURPOSE ALIGNER



Bone fibre screw driver ends set in red tenite handle. Overall length 6"; blade width $\frac{3}{8}$ "; tip thickness $1/64$ ". Designed for general aligning purposes for Motorola and other popular receivers.

No. 6248 Dealer Cost \$0.50

DUAL BLADED "KLEER" ALIGNER



Low-loss clear plastic; $4\frac{1}{2}$ " handle, $\frac{3}{8}$ " diam. Two corrosion-proof extended blades (Govt. "spec" plated nibs)—one thickness .018", the other .025". Designed specifically for ARC-27 but excellent for television and general aligning purposes.

No. 6247 Dealer Cost \$.73
Display Card of 12 above
No. D-76247 Dealer Cost \$8.76

PRECISION TUNING WAND



High-grade phenolic handle ($4\frac{3}{4}$ " L. x $\frac{1}{4}$ " D.) has precision molded powdered iron core in one end (permeability tolerance $\pm 2\%$; "Q" tolerance $\pm 10\%$); silver-plated brass core in other end — both securely threaded and cemented into shaft. Increases or decreases inductance. Designed specifically for ARC-27, the high-grade properties of this wand make it an excellent tool for general servicing.

No. 6249 Dealer Cost \$.90

RF AND SIGNAL TRACER PROBE



Germanium Crystal Circuit. Assures accurate analysis of circuit defects. May be used with audio amplifier for audible tracing or with V.T.V.M. for RF and AF measurements. Low input capacitance. The ideal probe for the audio section of television circuits. The sturdy bakelite barrel has sealed tenite ends with solderless phone tip and includes 48" RG59/U coaxial cable with phone plug and 18" rubber covered ground lead with alligator clip.

No. 4310 Dealer Cost \$3.75

OHMMETER PROBE

For RCA "Voltohmyst"

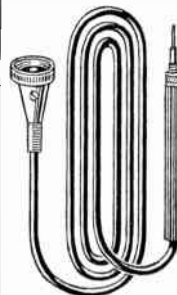

Designed specifically for RCA "Voltohmyst".

Offers precise resistance measurements not ordinarily provided by standard test leads. Includes 48" low-loss coaxial cable; coaxial connector. Tenite handle is 4" long; has heavy duty phone tip.

No. 317 Dealer Cost \$2.50

D. C. PROBE

For RCA "Voltohmyst"

Includes one megohm resistor for voltage measurements in operating circuits demanding minimum disturbance of circuit parameters. Includes 48" low-loss coaxial cable; coaxial connector. 4" long tenite handle has heavy duty phone tip.

No. 316 Dealer Cost \$2.75

"KILOVOLTER" MULTIPLIER PROBE

Equipped with 15 K.V. range multiplier that provides full range PLUS existing meter voltage. For example, use of the ICA probe will increase the range of a 5,000 volt range voltmeter to 20,000 volts full scale.

The three (3) built-in 1% resistors (totaling 6 watts dissipation) are coaxially mounted, providing air-spacing to further assure heat dissipation and a completely insulated probe.

Highest grade components include sturdy thermo-plastic barrel with safety finger guard and sealed ends. Over-all length: $8\frac{1}{2}$ ". Supplied with 5-ft. heavy duty lead with insulated phone tip.

No. 6167—20,000 ohms per volt (50 micro amps. meter movement).....\$5.75
6168—10,000 ohms per volt (100 micro amps. meter movement) . . . 5.75
6169—5,000 ohms per volt (200 micro amps. meter movement) . . . 5.75
NOTE: Probe of special resistance values up to 2000 megohms are available on order to quantity users.



NEW 30-KV PROBE

Similar to the Insuline "Kilovolt" No. 6167 above, for 20,000 ohm per volt, 50 micro amp. meters only. A precision instrument . . . 600 megohms 2% high voltage multiplier
No. 6220 Dealer Cost \$6.50

THE INSULINE "100 X" MULTIPLIER PROBE

A new 30KV to 50KV Multiplier Probe (Internal resistance 1090 meg-ohms). For ALL 10 to 11 megohm input instruments.

This VTVM probe will multiply existing meter ranges by a factor of 100; thus, if the top range of the instrument is 300 volts, meter will read 30,000 volts with probe. If top range is 500 volts, meter with probe will read 50,000 volts.

A few of the most popular VTVM's with which this probe may be used follows:

30-KV TOP RANGE

RCA No. WY65A; WY75A; 145A Electronic Design
Heath No. V1; V2; V2A; V4 Radio City 664; Reiner 661;
Triplet 2541

50-KV TOP RANGE

RCA No. WY95A; 162A; 162B; 162C
No. 6222—With microphone type connector and ground lead Dealer Cost \$6.50

For phone plug instruments, the Insuline No. 33 Adapter is required.
No. 33—Phone Plug Adapter Dealer Cost \$.30



SINCE
1921



insuline Corporation of America
OVER 3 DECADES OF QUALITY RADIO-TELEVISION PRODUCTS

INSULINE TEST LEADS FOR ALL PURPOSES

ICA ALL-PURPOSE TEST LEAD KIT
Complete For Every Testing Need

Equipped with one pair of test leads which have 48" of red and black kinkless live rubber wire. One end has insulated removable banana-type plugs.

- Included in this test kit:
- 1 pr. all-purpose test leads.
 - 1 pr. insulated alligator clips—red and black No. 884.
 - 1 pr. insulated spade lugs—red and black No. 887.
 - 1 pr. insulated needle points—red and black No. 886.



No. 1005—Kit, complete..... Dir. Cost \$1.65

ICA ALL PURPOSE TEST LEADS

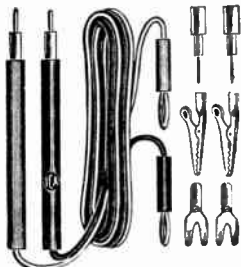

Made of sturdy Tenite Tubing. Slim handles. 6" long. Overall length 7 1/4". Rubber covered wire 48" long.

With Interchangeable Tips
No. 312—Complete Kit..... Dir. Cost \$1.83

ICA DE LUXE EXTRA-FLEXIBLE TEST LEADS
Slim Handles and Solderless Plugs



48" Extra-Flexible Test Leads with 4" Tenite handles. New non-kinking, rubber insulated wire.

No. 355—With Phone Tips \$.73
Display Card of 6 above
D-70355 4.38
356—With Spade Terminals .73

ICA PENCIL TYPE TEST LEADS

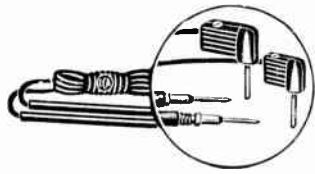

Finger-Grip Molded tips

All connections are properly soldered providing low resistance connections vital in all precision tests. The Molded Finger Grip Tips are provided with rivets for easy removal of wire. Length of test leads is 48". Handles are 5" long.

No. 373..... Dealer Cost \$1.35

Display Card of 6 above

No. D-70373..... Dealer Cost \$8.10

NEW ICA SLIM-LINE TEST LEADS

Long vinyl-insulated shaft permits probing in closely spaced circuits without fear of shorting. Black and red Tenite handles. 48" wire lead. With molded phone tip plug.

No. 438..... Dir. Cost \$1.05 pr.

Display Card of 6 above

D-70438..... \$6.30

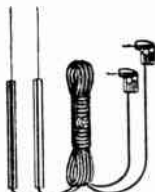

EXTRA LONG HANDLED TEST LEADS

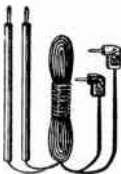

Features special low-loss highly polished hard rubber, high dielectric properties, 8" prod handles — with sharp pointed penetrating tips — for easier testing of less accessible points. The black and red kinkless wire leads measure 48". Includes molded black and red gun-handle phone tip plugs.

No. 329..... Dealer Cost \$2.50

"CLIP-ON" TEST LEADS



A convenient "Clip-on" test lead that includes phone tip plugs on one end; sturdy alligator clips on other end. The red and black kinkless wire leads measure 48". The black and red molded phone plugs are of the gun-handle type.

No. 328..... Dealer Cost \$2.50

HEAVY DUTY "CLIP-ON" TEST LEADS

Heavy duty test leads of the "clip-on" type for use with binding post type instruments. Includes a heavy gauge nickel-plated brass insulated spade terminal which will fit screws or binding posts up to 3/8" in diameter. The sturdy battery-type spring clips are covered with protective sleeve for safe operation. The pair consists of a 48" red and black lead with tenite insulation.



No. 327..... Dealer Cost \$1.20

ICA HEAVY DUTY LABORATORY TEST LEADS

Long Slim Handles and Removable Phone Needle Chuck



Extra long slim red and black handles knurled at end for finger grip ease. Handles 6" long. 48" of heavy duty kinkless, flexible rubber wire.

No. 400—With knurled grip

handle. Insulated solderless plug..... \$1.20

388—With alligator clip..... 1.13

391—With spade lugs..... 1.00

392—With non insulated phone tips..... 1.00

NON-KINK FLEXIBLE TEST LEAD WIRE

Flexible rubber covered wire that will not kink or wear down in service. Consists of very fine tinned stranded copper wire with a heavy wall of live rubber insulation.



No. 307—100 ft. spool, Black..... Dir. Cost \$3.35

No. 309—100 ft. spool, Red..... Dir. Cost 3.35

LUCITE HANDLE TEST LEADS

With Brass Threaded Insert



Features red and black low-loss durable Lucite handles (5" L.) for exacting test requirements. Includes 48" kinkless live red and black rubber wire with molded gun-grip phone tip have threaded type phone

plus. Handles measure 48". Includes molded black and red gun-handle phone tip plugs.

No. 304..... Dealer Cost \$1.65

ICA PHONO-NEEDLE POINT TEST LEADS
With Slim Handles and Flexible Wire

Flexible rubber covered kinkless wire. 48" long. Tenite handle 4" long.



No. 382—With Phone Tips..... \$.73

Display Card of 6 above

D70382..... 4.38
381—With Spade Terminals .73
379—With alligator clips .74

HEAVY DUTY TEST LEADS

Engineered for TV's high voltage measurements. Insulated to withstand 15,000 volts D.C. Thick-walled bakelite handles with finger guards. 48" heavy duty cable.

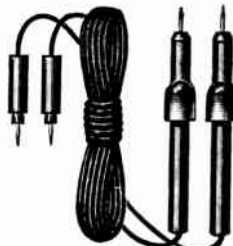

No. 4317..... Dealer Cost \$3 per pair

Display Card of 3 above

No. D-74317..... Dealer Cost \$9.00

ICA SLIM HANDLE TEST LEADS

Made of sturdy Tenite Handles 48" of Kinkless Live Rubber wire. Handles 6" Long — Overall Length 7". Prods have pointed large phone tip plugs.

No. 313—Phone Tips on end \$.92

315—Alligator Clips on end 1.00

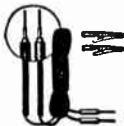

ICA UNBREAKABLE TEST LEADS

Long Metal Prod with Shock-proof Rubber Handles

One end has standard needle point Tips. Other end has Insulated Solderless Plugs. Supplied with 48" Kinkless Rubber Wire.

No. 332—With Phone Tips Non Insulated. Dir. Cost \$.75

No. 331—Insulated Solderless Plug Ends. Dir. Cost \$.64



SINCE
1921



insuline Corporation of America
OVER 3 DECADES OF QUALITY RADIO-TELEVISION PRODUCTS

INSULINE TEST PRODS

ICA LUCITE PROD SET
with BRASS THREADED INSERT



Designed for precision measurements where body is a factor. Red and black handles (measuring $\frac{7}{8}$ " x 5" L.) are made of low-loss high-dielectric strength LUCITE. Has needle chucks on ends. Set includes one black and one red prod. Overall length: 5 $\frac{3}{4}$ ".

No. 302 Dealer Cost \$0.90 Set

ICA SOLDERLESS PLUG TEST PRODS
With Solderless Plug Chuck



Slim tapped Tenite handles in black or red, threaded to take the solderless plug chuck. All brass parts are nickel plated. Available in two sizes.

No. 390R—Red, 5 $\frac{1}{4}$ " L. Dir. Cost \$0.27

No. 390B—Black, 5 $\frac{1}{4}$ " L. Dir. Cost .27

ICA FENO LINE PHONO. NEEDLE
POINT TEST PRODS
With Removable Chuck



Supplied in black or red Tenite tapped handles. Needle point chuck is tapped to screw into handle. Available in two sizes.

No. 389R—Red, 5" L. Dir. Cost \$0.27

No. 389B—Black, 5" L. Dir. Cost .27

ICA HEAVY-DUTY TEST PRODS



Slim tapped Tenite handle fitted with threaded heavy-duty phone tip. Length 5".

No. 387R—Red Dealer Cost \$.37

No. 387B—Black Dealer Cost .37

HIGH VOLTAGE ICA HEAVY-DUTY
BAKELITE TEST PROD HANDLES



High Voltage, 10,000 Volts
Has midret threaded phone tip. Ideal for all high voltage work. Made of black bakelite with finger guard ring. Minimum amount of metal exposed. Prods are 6" long overall. Used for high voltage test purposes.

No. 480 Dealer Cost \$.84

HIGH VOLTAGE HEAVY-DUTY
BAKELITE TEST PRODS



High Voltage, 10,000 Volts
Made of black bakelite. Fully insulated with threaded midret sharp pointed phone tips. Minimum amount of metal exposed. Measures 2" overall. Exposed metal tip is only $\frac{1}{2}$ " long.

No. 485 Dealer Cost \$.42

REPLACEMENT AND INSTRUMENT KNOBS

Insuline provides a varied line of bakelite knobs for radio, television, and instrumentation needs. All knobs fit standard $\frac{1}{4}$ " shaft. Equipped with set screws.



No.	Type	Color	Size	Dir. Cost
248	J	Black	1 $\frac{1}{8}$ "	\$23.00C
249	J	Black	1 $\frac{1}{4}$ "	24.90C
1174	M	Black	$\frac{3}{8}$ "	16.67C

ICA FINGER-GRIP
POINTER KNOBS



Moulded of black bakelite with $\frac{1}{4}$ " hole. Pointer type knobs have white indicators, flange type knobs have white indicating line. With $\frac{1}{4}$ " Brass Inserts



TYPE A—WITH POINTER

No. 1166—1 $\frac{1}{4}$ "	Dealer Cost	\$.40
No. 1168—1 $\frac{1}{2}$ "	Dealer Cost	.55
No. 1170—2 $\frac{1}{4}$ "	Dealer Cost	.70

TYPE A—LESS POINTER

No. 1165—1 $\frac{1}{4}$ "	Dealer Cost	\$.32
No. 1167—1 $\frac{1}{2}$ "	Dealer Cost	.38
No. 1169—2 $\frac{1}{4}$ "	Dealer Cost	.55

TYPE B—WITH FLANGE

No. 1171—2 $\frac{1}{2}$ "	Dealer Cost	\$.55
No. 1172—3"	Dealer Cost	.65

NOTE: Above Knobs also furnished with 2 set screws. Order by adding "S" to each number.

ECONOMY KNOB ASSORTMENT



An assortment containing 50 knobs packed in attractive convenient plastic bag. Includes a variety of all-purpose modern bakelite knobs equipped with set screw. Suitable for many applications.

No. 1064 Dir. Cost \$3.50

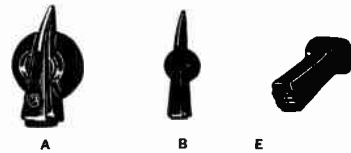

No.	Type	Color	Size	Dir. Cost
1125	A	Black	1 $\frac{1}{4}$ "	\$13.33C
1127	A	Red	1 $\frac{1}{4}$ "	16.67C
1126	B	Black	2"	16.67C
1128	B	Red	2"	18.34C
1153	E	Black	1 $\frac{3}{4}$ "	24.90C
1154	E	Walnut	1 $\frac{3}{4}$ "	24.90C



No.	Type	Color	Size	Dir. Cost
1270	F	Black	1 $\frac{5}{8}$ "	\$18.35C
1271	F	Black	2 $\frac{1}{2}$ "	21.66C
1088	H	Black	1"	16.60C
1274	S	Black	1 $\frac{1}{4}$ " x $\frac{5}{8}$ "	18.35C
1274-S*	S	Black	1 $\frac{1}{4}$ " x $\frac{5}{8}$ "	.25
1275	S	Black	2" x $\frac{5}{8}$ "	20.00C
1275-S	S	Black	2" x $\frac{5}{8}$ "	.25

*With 2 Set Screws.



No.	Type	Color	Size	Dir. Cost
1081	P	Black	$\frac{7}{8}$ "	\$10.00C
1082	P	Red	$\frac{7}{8}$ "	10.00C
1084	P	Brown	$\frac{7}{8}$ "	10.00C
1085	P	White	$\frac{7}{8}$ "	10.00C
1089	N	Walnut	$\frac{3}{8}$ "	23.00C
1090	N	Walnut	1 $\frac{1}{4}$ "	24.90C
1147	U	Black	$\frac{7}{8}$ "	13.33C
1148	U	Walnut	$\frac{7}{8}$ "	13.33C

POPULAR KNOB ASSORTMENT



An assortment of 50 quality knobs of varied types for use in the radio, television, instrument field. Includes the following: Nos. 1165; 1166; 1274; 1081; 249; 1088; 1125; 1273. These knobs are pictured and described above.

No. 1059 Dealer Cost \$10.00

SINCE
1921



insuline Corporation of America

OVER 3 DECADES OF QUALITY RADIO-TELEVISION PRODUCTS

INSULINE BAKELITE SOCKETS... "INSULEX" SOCKETS

ICA CHROME SILVER DIAL PLATES

2 3/4" and 4" diameter. Two types, calibrated 180 degrees 0-100 and 325 degrees, 0-100.



No.	Degrees	Dia.	Calib.	Dir. Cost
2196	325	2 3/4"	0-100	\$.85
2197	180	2 3/4"	0-100	.85
2194	325	4"	0-100	1.03
2195	180	4"	0-100	1.03

ICA BRASS BLACK SATIN FINISH DIAL PLATES

With Etched Silver Numerals



No.	Degrees	Dia.	Calib.	Dir. Cost
2230	325	3 1/2"	0-100	\$.47
2232	180	3 1/2"	0-100	.47
2233	180	2"	100-0	.37
2234	325	2"	0-100	.37
2236	180	2"	0-100	.37

ICA CHROME SILVER DIALS

With Finger Grip Flange Knobs

Beautiful dial plates accurately Etcho-engraved with black numerals and calibrations.



No.	Size	Degrees	Calib.	Dir. Cost
2170	2 3/4"	325	0-100	\$ 1.50
2171	2 3/4"	180	0-100	1.50
2188	4"	325	0-100	2.00
2189	4"	180	0-100	2.00

ICA VERNIER DIAL MARKER

Complete with screws, nuts, and spacers for mounting on metal, wood, bakelite or brass panels.



No. 2189	For 2 3/4"	325° Dials	Dealer Cost	\$.37
No. 2190	For 2 3/4"	180° Dials	Dealer Cost	.37
No. 2191	For 4"	325° Dials	Dealer Cost	.37
No. 2192	For 4"	180° Dials	Dealer Cost	.37

ICA MINIATURE DIALS

Beautiful Chrome Silver dials with black etched numerals. Finger grip black knob. Only 1 1/8" diameter. Fit 1/8" shafts.



No.	Dir. Cost
2164—10-0-180	\$.63
2165—10-0-270	.63

ICA CHROME SILVER DIAL PLATES

Attractive grain satin finish. Black Etcho Engraving on Chrome Silver Background Plates

No.	Degrees	Dia.	Calib.	Dir. Cost
2294	180	2"	0-100	\$.58
2295	325	2"	0-100	.58
2296	180	3 1/2"	0-100	.92
2297	325	3 1/2"	0-100	.92
2298	180	4"	0-100	1.00
2299	325	4"	0-100	1.00

ICA ETCHED DIAL PLATES

RECTANGULAR TYPES

Made of brass—finished in black with etched silver markings. Calibrated for 300 degree rotation. Marked 0 to 10. Will fit on 3/8" bushing. Size: 2 3/4" x 1-11/16"



No.	Marking	Dir. Cost
2244	—Record	\$ 21.66C
2245	—Microphone	21.66C
2246	—Gain	21.66C
2247	—Tone	2.66C
2248	—Plain (Calibrated but not worded)	\$ 21.66C

ICA INDICATING PLATES

Made of heavy brass with black satin background. Silver Etcho Graved numerals and lettering. 1 1/8" center mounting hole. 1 1/8" Diameter.



No.	Degrees	Dir. Cost
2259	—Marked 1 to 6	\$.25
2450	—Marked 1 to 5 (Volume)	.27
2451	—Marked 1 to 5 (Tone)	.27
2453	—Marked Off-On with arrow	.325

ICA NAME PLATES

1-INCH ROUND

No. 2237	For "Microphone"	
No. 2238	For "Phono"	
No. 2239	For "On Off"	
		Dealer Cost \$15.00C



ICA BASE-MOUNTING BAKELITE SOCKETS



No.	Dealer Cost
2480—4 Prong	\$.34
2481—5 Prong	.39
2482—6 Prong	.42
2483—7 Prong comb. large and small	.45
2489—8 Prong OCTAL	.50
2490—Contact for above Sockets	\$2.08C

ICA MOLDED BAKELITE SNAP-ON SOCKETS

Octal — Loktal



Mounted in cadmium plated steel "Saddle." Equipped with 4 grounding lugs on saddle—Positive grip contacts.

No. 2470	—Octal Socket	Dealer Cost \$12.00C
	Mtg Center 1 1/2"	—Chassis Hole 1 1/8"
No. 2471	—Loktal Socket	Dealer Cost 15.00C
	Mtg Center 1 1/8"	—Chassis Hole 1"



ICA BAKELITE WAFER SOCKETS

No.	Dealer Cost
1118—4 Prong	\$ 9.16C
1096—5 Prong	9.16C
1095—6 Prong	9.16C
1120—7 Prong, large	9.16C
1121—8 Prong OCTAL	11.66C
1123—Loktal Wafer	11.66C

ICA "INSULEX" BASE MOUNTING SOCKETS

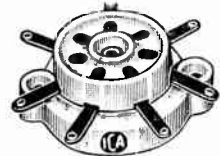

Weatherproof, efficient socket that cuts losses to minimum. Especially adapted for ultra-short-wave and transmitter requirements. Made of Insulex—a ceramic compound.

No.	Dealer Cost
290—4 Prong	\$.50
291—5 Prong	.50
292—6 Prong	.55
294—Comb. 7 Prong, large and small	.55
300—8 Prong OCTAL	.60

ICA "INSULEX" WAFER SOCKETS



Designed for ultra high frequency reception. Made of Insulex—a low loss ceramic compound. Features include: large self-wiping contacts of cadmium plated phosphor bronze; special circular grooves for easy tube inserting; recessed contact rivets to prevent "shorting." For either base board or sub-panel mounting.

No.	Dealer Cost
2600—4 Prong	\$.24
2601—5 Prong	.24
2602—6 Prong	.26
2604—7 Prong, small	.26
2605—8 Prong OCTAL for new metal tubes	.26
2636—Contact for above Sockets	\$2.75C

INSULEX INSULATORS

Made of white glazed Insulex... non-porous; low-loss. All feed-thru types have cork washers.

STAND OFF INSULATORS



No.	Description	Height	Base Size	Dir. Cost
2300	Little Pete	1"	3/4" x 7/8"	\$10.00C
2301	Junior Pete	1 3/8"	3/4" x 1 1/4"	11.66C
2302	Big Pete	1 7/8"	1" x 1 1/2"	16.67C
2304	Jack Type	1 1/2"	1" x 1 1/2"	20.00C



FEED-THRU INSULATORS

No.	Description	Ht.	Base Diam.	Mtg. Hole	Dir. Cost
2305	Sub-Panel	1 3/4"	5/8"	1/8"	\$15.00C
2306	Sub-Panel	2"	3/4"	3/8"	20.00C
2307	Sub-Panel	2 3/4"	7/8"	1/2"	21.66C
2334	Large Sub-Panel	4"	1 1/2"	3/8"	.53
2321	Jack Type	2 7/8"	7/8"	1/8"	.30



2305 2306
2307

GIANT INSULEX INSULATORS

No.	Description	Ht.	Base Diam.	Mtg. Hole	Dir. Cost
*2332	Feed thru	4"	2"	7/8"	.72
**2333	Feed thru	4"	2"	7/8"	.67



2332 2333

SINCE
1921



insuline Corporation of America

OVER 3 DECADES OF QUALITY RADIO-TELEVISION PRODUCTS

TOGGLE SWITCHES . . . KNIFE SWITCHES . . . SLIDER SWITCHES

ICA TOGGLE SWITCHES

Furnished in Nickel or Antique Bronze. Capacity 1 Amp. 250 Volts. 3 Amps. 125 Volts. Mfd. by H & H for ICA.



No.	Shank Length	Description	Finish	Dir. Cost
1230	3/8"	S.P.S.T.	Nickel	.48
1232	3/8"	S.P.S.T.	Bronze	.48
1233	3/8"	S.P.S.T.	Bronze	.66
1235	3/8"	S.P.S.T.	Nickel	.66
1236	3/8"	S.P.D.T.	Nickel	.66
1237	3/8"	S.P.D.T.	Nickel	.78
1238	3/8"	D.P.S.T.	Nickel	.93
1365	3/8"	D.P.D.T.	Nickel	1.05
1366	3/8"	D.P.D.T.	Nickel	1.20

BAT-HANDLE TOGGLE SWITCH

Made by H & H. Identical to toggle switches listed at left, except that handle is longer and shaped like a baseball bat.

Less on and off plate.

Nickel plated only—3/8" shank.



No.	Description	Dealer Cost
1296	S.P.S.T.	\$.48
1297	S.P.D.T.	.66
1298	D.P.S.T.	.93
1299	D.P.D.T.	1.05

BAT HANDLE DOUBLE THROW SWITCH

A sturdy double throw bat handle toggle switch featuring center "OFF" position. Made by H & H. Has many uses: Television Antenna installations; for reversing motor direction; model railroads, etc.

Case Measurements: 1 3/8" L., 1 1/2" W., 1" H., 3/8" Shank.

No.	Dealer Cost
1386—Single Pole Double Throw.....	\$1.08
1387—Double Pole Double Throw.....	1.65



ICA BAKELITE KNIFE SWITCHES

Hardware of brass, heavily nickel-plated. Mounted on highly polished bases of black BAKELITE. Firm contact assured.

No.	Description	Dir. Cost	No.	Description	Dir. Cost
1216	S.P.S.T.	\$.55	1220	3 P.D.T.	\$1.33
1217	S.P.D.T.	.60	1221	4 P.S.T.	1.67
1218	D.P.S.T.	.75	1222	4 P.D.T.	2.00
1219	D.P.D.T.	.90	1364	5 P.D.T.	2.35
1360	3 P.S.T.	1.23			

ICA PORCELAIN KNIFE SWITCHES

Moisture-proof base. Recommended for outdoor use. Hardware of brass, heavily nickel plated.



No.	Description	Base Size	Dir. Cost
235	S.P.S.T.	1 3/4" x 1"	\$.25
236	S.P.D.T.	2 3/8" x 1"	.31
237	D.P.S.T.	1 3/4" x 1 3/8"	.44
238	D.P.D.T.	2 5/8" x 1 1/2"	.54



ICA SLIDER SWITCHES

SMALL . . . COMPACT. Switch dimensions: 1 1/2" x 1/2" x 3/4". S.P.S.T. includes chrome mounting plate.

No.	Description	Dealer Cost
1255	S.P.S.T.	\$15.00C
1259	S.P.D.T.	15.00C
1260	D.P.D.T.	24.00C
1264	D.P.S.T.	24.00C

MINIATURE BAKELITE SWITCHES

Can be mounted on panel or base. Black Bakelite base—highly nickel-plated brass parts with insulated handles.



No.	Description	Base Size	Dir. Cost
2223	S.P.S.T.	1 1/4" x 1/2"	\$.25
2224	S.P.D.T.	1 1/4" x 1/2"	.42
2225	D.P.D.T.	1 1/4" x 1"	.53
2226	D.P.S.T.	1 1/4" x 1"	.50

GT AND GT/G TYPE TUBE SHIELDS

Latest type seamless, drawn shell type. Length 2 1/4".



No.	Description	Dir. Cost
1744	Open top*	\$10.00C
1745	For tube diam. 1.218"	10.00C
1746	Closed top*	10.00C
1746	For tube diam. 1.218"	10.00C
1747	Open Top**	10.00C
1747	For tube diam. 1.165"	10.00C
1747	Closed top*†	10.00C
1747	For tube diam. 1.165"	10.00C

*For GT and GT/G tubes with large metal base.

**For GT tubes with small metal base.

†For Loktal tubes.

ICA COIL SHIELDS

With Detachable Base

A sturdy coil shield made of aluminum with a detachable base.

No.	Dealer Cost
1539—2 1/2" x 3" High.....	\$.24
1540—2 1/2" x 3 1/2" High.....	.47
1549—3" x 3 1/2" High.....	.50



FORM FIT TUBE SHIELDS



A tube shield that assures a snug, positive fit. Vertical grooves provide flexibility. Includes ground clip as illustrated. Protects tubes against excessive vibration.

No. 1727B—For GT; GT/G and Loktal tubes. Length 2 1/2".....Dealer Cost \$10.00C

No. 1729B—For GT and GT/G tubes. Length 2 3/4".....Dealer Cost 10.00C

ICA GRID CAP SHIELDS

(For Metal Tubes)



Fits firmly over grid cap, affording complete shielding. Slotted cap permits passage of grid wire.

No.	Dealer Cost
1552	\$10.83C
1558—With Bakelite Insert	20.00C

ICA 807 TUBE SHIELD



For use with Transmitter Pentodes, and Tetrodes, to prevent oscillation. Can also be used on RK 20, RK 39 and 804 tubes.

No.	Dealer Cost
1545	\$.24

MINIATURE TUBE SHIELD AND CLIP



For miniature tubes with T5 1/2 bulbs. Includes base clip. Length 1 1/8" Mtg. Centers (base clip) 3/8" for standard miniature tubes.

No. 1735.....Dealer Cost \$10.00C

ALUMINUM TUBE SHIELD with Detachable Base



Will fit on all standard Screen Grid Tubes. Supplied with base. Measures 2 1/8" diameter x 3 1/8" high.

No. 1541.....Dealer Cost \$.24

ICA ROTARY SWITCHES

Rated 3 Amps. at 125 Volts. Over-all Length of shafts 1 1/2". Made by H & H for ICA. Underwriters Approved.



No.	Threaded Shank	Description	Dealer Cost
1228*	3/8"	S.P.S.T.	\$.78
1229*	1"	S.P.S.T.	.81
1286.	3/8"	S.P.D.T.	.90
1287	1"	S.P.D.T.	.90
1288	3/8"	D.P.D.T.	1.20
1289	1"	D.P.D.T.	1.50

*Rated 3 Amps. at 250 V.

ICA HI-POWER SWITCH

Push Button Type

Designed to break primary circuit when rack door is open. D.P.S.T. Made by H & H for ICA. Capacity 12 Amp. 125 Volt. Overall size 1 3/8" long, 3/4" wide, 3/4" high, 7/16" shank.

No. 1280.....Dealer Cost \$1.92

ICA PUSH-BUTTON SWITCH

Single pole 2 circuit momentary switch. One circuit is "ON"; other normally "OFF". One Amp., 125 Volt, made by H & H for ICA.

Shank 5/8" long.

No. 1282.....Dealer Cost \$1.05

ICA EXTRA HEAVY DUTY SWITCH

D.P.D.T. With Neutral Center



An extra large heavy duty, Double Pole, Double Throw Switch with neutral position in the center for use in heavy current circuits such as transmitters, power amplifiers, motors, etc. Contacts have fast "break" which reduces the tendency to arc. Rated at 10 Amps., 125 Volts. Size of switch case, 2 1/4" long, 1" high, 1 1/4" wide. Mounting sleeve diameter 3/4".

No. 1283.....Dealer Cost \$4.11

"ON-OFF" PLATE

For Toggle Switch



No.	Dir. Cost
1300	\$3.00C
1300BR	3.00C

ICA POWER SWITCH

(Toggle Type)

Characteristics and dimensions same as No. 1280 described above.

No. 1281
Dealer Cost \$1.12

ICA ROTARY CANOPY SWITCH

Single pole switch 1/4" shank with brown bakelite knob and 6" leads—1 ampere—250 volts.

No. 1257.....Dealer Cost \$.46

SINCE
1921



insuline Corporation of America

OVER 3 DECADES OF QUALITY RADIO-TELEVISION PRODUCTS

INSULINE COILS . . . COIL FORMS

SHORT-WAVE AND BROADCAST PLUG-IN COILS

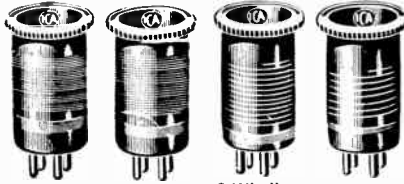

4 Prongs . . . 2 Windings

Wound on Low-Loss Bakelite Forms. Diam. 1 1/4"; height 2 1/4". Rim handle for easy changing. Uniformly spaced winding. Used with either 140 or 150 mmfd. tuning condenser.

No.	Dealer Cost
1471—Set of 4 short wave coils—from 9 1/2 to 217 Meters.....	\$2.50
1473—Set of 2 Broadcast coils—190 to 550 Meters.....	2.00

ICA LARGE LOW-LOSS "RIBBED" COIL FORMS

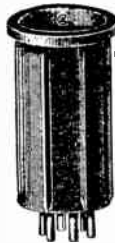

For use in 4, 5, and 6-prong sockets. Designed for easy grooving or threading. Size 3 5/8 x 1 5/8".

No.	Dealer Cost
1051—4-Prong	\$.45
1052—5-Prong45
1053—6-Prong50

ICA SMALL BAKELITE COIL FORMS



Equipped with special rim on top making it easy to insert and pull out of socket. Black Bakelite. Ridge is grooved for color coding.

No.	Dealer Cost
1108B—4-Prong	\$.35
1113B—5-Prong37
1114B—6-Prong38

ICA TRANSMITTING COIL FORMS

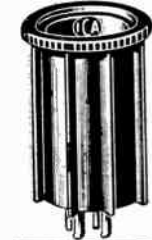

Made of Low-Loss RX-47 Di-electric. Coil forms ribbed for air space winding. Knurled flange for easy handling. Supplied in standard bases, either 4, 5, or 6 prongs to fit standard sockets. Eight 1/4" ribs insure low-loss winding.

No.	Dealer Cost
2670—4-Prong	\$.55
2671—5-Prong55

ICA SMALL RIBBED BAKELITE COIL FORMS



Rugged and durable, these coil forms are designed for long service. Measures 1 3/8" diameter, 2 1/4" high with molded ribs for low-loss winding and special rim on top. There is a recess in the rim to insert the ICA Round Labels to signify wave lengths.

No.	Dealer Cost
2158—4-Prong	\$.35
2159—5-Prong40
2160—6-Prong40

ICA MIDGET PRECISION CONDENSERS

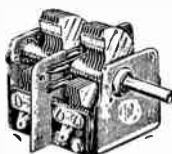

Better mechanical design insures constancy of calibration and uniformity between units. Ball-bearings on both ends of shaft insure long life without wear or side play. Heavy brass springs make direct contact with rotor shaft, insuring a clean wiping contact at all times.

No.	Single Gang Condenser	Dealer Cost
523	185 mmfd.	\$3.25

Two Gang Condenser	
538	185 mmfd. 2.58
534	365 mmfd. 2.58
Three Gang Condenser	
532	185 mmfd. 3.25
531	365 mmfd. 3.25

SUPERHETERODYNE TYPE

Designed for 455KC IF. RF section is 27 plates; 435 Mmfd. Oscillator Section is 19 plates; 173 Mmfd. Measurements similar to two gang condensers shown above.
Overall Width: 1 1/2" Overall Height: 2"
Overall Length: 3 3/8"

No. 545.....	Dealer Cost \$2.58
--------------	--------------------

INSULINE CHOKES

INSULEX R.F. CHOKE COIL

HIGH FREQUENCY. Consists of four narrow sections each universally wound spaced on an Insulex form. Designed especially for high frequency receivers.

Low distributed capacity. Supplied with wire leads for mounting. May be mounted in grid leak clips.



No. 277
Inductance
2.5 M.H.
D.C. Resist.
99 ohms
Current Cap.
150 ma.
Dir. Cost \$3.37

ICA INSULEX R.F. CHOKES

Can be used in any circuit or position. Designed particularly for short wave but equally effective over the broadcast band. Insulex forms are used with a special Radio Frequency Lacquer for impregnation and ample moisture proofing. Solder lugs for firm electrical and mechanical contacts.



No.	Inductance	D.C. Resis.	Current Cap.	Dealer Cost
1777	2.5	30	150	\$.45
1775	5.5	57	150	.57
1774	10	73	150	.60
1772	30	136	125	.67
1773	60	196	125	.87
1771	80	222	125	.92

IRON CORE HIGH "Q" R.F. CHOKES



A high impedance choke coil with low distributed capacity winding on magnetic core, specially impregnated for high frequency purposes. Designed for minimum loss with smallest diameter and space requirements, and minimum D.C. resistance. Ideal for detector plate circuits and R.F. filtering systems in general.

No.	Ind. M.H.	D.C. Res. Ohms	Dealer Cost
6200	2.5	17	\$1.07
6201	3.5	22	1.17
6202	5.5	28	1.17
6203	10	55	1.23
6204	30	83	1.43
6205	60	142	1.60
6206	80	168	1.70
6207	125	214	2.00

ICA TRANSMITTING R.F. CHOKES



Wound on Insulex low-loss core. Has a continuous universal winding in five tapered sections. Designed for maximum impedance in amateur bands from 160 meters downward.

No.	Ind. M.H.	Cur. Ma.	Res. Ohms	Dealer Cost
266	2.8	1000	5	\$2.00
267	5.3	600	12.5	1.83

HEAVY DUTY TRANSMITTING CHOKES

Heavy duty transmitting chokes designed for durable service. Extremely low power loss and distributed capacity. Coils securely fastened.



No.	Ind. M.H.	Cur. Cap. Ma.	D.C. Res. Ohms	Dealer Cost
280	2.5	1000	5	\$1.83
278	5.6	600	12	1.67

ICA CERAMIC PADDING CONDENSERS



Compact, yet rugged Padding Condensers. Designed for aligning tandem condensers, short wave band switch coils, antenna trimmers, etc. Uses high grade Mica and Phosphor Bronze Spring contacts.

No.	Min. Cap.	Max Cap.	Dir. Cost
611	4.0 mmfd.	40 mmfd.	\$.37
612	12.0 mmfd.	100 mmfd.	.37
613	70.0 mmfd.	350 mmfd.	.40
614	160.0 mmfd.	500 mmfd.	.40

SINCE
1921



insuline Corporation of America

OVER 3 DECADES OF QUALITY RADIO-TELEVISION PRODUCTS



ICA BAKELITE FLEXIBLE SHAFT COUPLING

Flexible phosphor bronze spring contact mounted on a round bakelite disc. 1 1/8" diam. Has 1/4" bushing.

No. 2142.....Dealer Cost \$.50

ICA INSULEX FLEXIBLE SHAFT COUPLING

Flexible phosphor bronze spring contact. Mounted on Insaulex disc for efficient low-loss coupling. 1 1/8" diam. 1/4" bushing.

No. 2143.....Dealer Cost \$.58

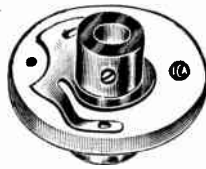

BAKELITE BUSHINGS

Molded bakelite bushings for complete insulation. Strong seamless threads. Heat resisting to 300°F. Complete with stamped lock nuts.

No.	Hole Size	Dealer Cost	No.	Hole Size	Dealer Cost
606	1/4"	\$10.00C	609	1/8"	\$11.68C
607	3/8"	10.00C	610 (Two holes)	3/8"	13.35C
608	1/2"	11.66C			

ICA INSULATED BUSHINGS

Equipped with knurled nut that can be tightened easily. Used as insulated grommet on condenser shafts, panel bearing, etc.



No.	Color	Hole	Diam.	Long.	Dealer Cost
670	Black	1/8"	3/8"	3/8"	\$13.33C
671	Red	1/8"	3/8"	3/8"	13.33C
672	Black	1/4"	1/2"	1/8"	16.68C
673	Red	1/4"	1/2"	1/8"	16.68C

ICA PANEL BEARING ASSEMBLY



Can be used with either rigid or flexible couplings for mounting volume controls, condensers, etc., at a distance away from the panel. Will fit on panels up to 1/8" thickness.

No. 1248	Overall length 3"	Dealer Cost \$.30
No. 1249	Overall length 6"	Dealer Cost .35

UNIVERSAL PANEL BEARING

Designed to accommodate 1/4" shaft wherever a panel bushing is desired. Furnished with nut and insulating washers.

No. 1250.....Dealer Cost \$15.00C



ICA BRASS EXTENSION RODS

No.	Length	O.D.	Dealer Cost
2117	6"	1/4"	\$18.00C
2118	12"	1/4"	.36

FENOLINE EXTENSION RODS

No.	Length	O.D.	Dealer Cost
2120	6"	1/4"	\$15.00C

ALUMINUM IDLER PULLEYS

Precision made. Distortion free. Non-warping. Permits closer tolerances. Supplied in any quantity in any type — with or without shoulders. Listed here are typical sizes without shoulders, hole diam. .128".

No.	O.D.	Cord Diam.	Dir. Cost
601	3/8"	1/4"	\$3.35C
602	1/2"	3/8"	3.67C
603	5/8"	1/2"	4.00C
604	3/4"	5/8"	4.35C
605	7/8"	3/4"	4.66C



ICA BAKELITE BASE FUSE MOUNTINGS FOR 3 AG TYPE FUSES

Flush Type Mounting



For radio or automotive fuses. Countersunk center hole for mounting. Equipped with soldering lugs.



No. 2340	Single Pole	Dealer Cost \$13.33C
No. 7201	Double Pole	Dealer Cost 21.66C



Panel Type Mounting
Equipped with 6-32 mounting screws.

No. 2341—Single Pole
Dealer Cost \$16.67C



No. 7203—Double Pole
Dealer Cost \$27

FOR 8 AG TYPE FUSES

FLUSH MOUNT

PANEL MOUNT

No.	Flush Mount Dealer Cost	No.	Panel Mount Dealer Cost
7202	Single Pole \$11.66C	7205	Single Pole \$15.00C
7204	Double Pole 21.66C	7206	Double Pole 15.00C

STANDARD FUSE HOLDERS

Top quality fuse holder and parts



No. 2348	Standard fuse holder complete	Dealer Cost \$12.00C
No. 2360	Female sleeve only	Dealer Cost 3.00C
No. 2364	Fibre insulator only	Dealer Cost 5.33C

JUMBO FUSE HOLDERS

Fuse holders of various needed values

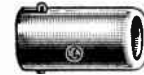

No.	Description	Dealer Cost
No. 2349	SFE 30 Amperes (2 1/2" L. x 1/2" d.)	\$20.00C
No. 2346	SFE 20 Amperes (2 1/2" L. x 1/2" d.)	20.00C
No. 2345	SFE 14 Amperes (2 1/4" L. x 1/2" d.)	20.00C
No. 2344	SFE 9 Amperes (2 1/8" L. x 1/2" d.)	20.00C
No. 2359	Male sleeve only	3.75C
No. 2367	Bakelite bushing only	3.00C
No. 2358	Female sleeve only	5.00C

PRE-WIRED JUMBO FUSE HOLDER



Suitable for 3 A.G. 20 amp. or SFE 14 amp. fuse. Eliminates necessity of soldering when

changing fuse holder. Wire is merely severed, stripped and placed in line.
No. 2368.....Dealer Cost \$.27

ANTENNA CONNECTOR . . . PARTS



No. 2347	Antenna Connector Complete	Dealer Cost \$7.50C
No. 2362	Male part only (also part for 2348)	Dealer Cost 1.80C
No. 2361	Female sleeve only	Dealer Cost 2.10C
No. 2363	Spring only for 2347 and 2348	Dealer Cost 6.00C

MOTOROLA PIN PLUG . . . SHIELDED JACK



No. 2375	Motorola Pin Plug	Dealer Cost \$ 8.33C
No. 2378	Motorola Shielded Jack	Dealer Cost 13.33C

SINCE
1921



insuline Corporation of America.

OVER 3 DECADES OF QUALITY RADIO-TELEVISION PRODUCTS



ICA SHAFT COUPLINGS AND EXTENSION RODS

To increase lengths of shafts of different diameters. In two types—Brass . . . Fenoline.

Brass Couplings and Reducers				
No.	Length	Hole	O.D.	Dir. Cost
2105	3/4"	1/4" coupler	7/8"	\$15.00C
2106	3/4"	3/8" coupler	1"	15.00C
2107	3/4"	3/8" to 1/4" coupler	1"	15.00C
2111	1 1/8"	1/4" to 3/4" shaft	7/8"	18.00C
2112	1 1/8"	1/4" to 3/8" shaft	7/8"	18.00C
2113	1 1/8"	3/8" to 1/4" shaft	7/8"	18.00C

ICA Fenoline Couplings and Reducers				
No.	Length	Hole	O.D.	Dir. Cost
2116	3/4"	1/4" coupler	7/8"	15.00C
2109	3/4"	3/8" to 1/4" coupler	1"	15.00C
2110	1 1/8"	1/4" to 3/4" shaft	7/8"	18.00C

Long Extension Couplings Made of Brass with extra long extension.				
No.	Length	I.D.	O.D.	Dir. Cost
2123	1 3/4"	3/4"	1 1/8"	\$18.00C

BAKELITE AND FENOLINE TUBING

ICA tubing is strong mechanically, has extremely low electrical absorption and is highly resistant to moisture. Absolute perfection in winding of coils is assured by the use of ICA tubing—thus affording relief from complaints or failure in performance.

Finished in Natural and Black Colors
Small sizes up to one inch in Black only.
1/8" Wall Thickness, Full Lengths.
Approximately 30 to 48"

BAKELITE			FENOLINE		
No.	Dir. Cost Per Ft.	Size O.D.	No.	Dir. Cost Per Ft.	
100	\$.65	1/4"	161	\$.58	
101	.78	3/8"	162	.63	
102	.83	1/2"	163	.70	
103	.90	5/8"	164	.73	
104	.97	3/4"	165	.77	
105	1.07	7/8"	166	.78	
106	1.12	1"	167	.87	
147	1.17	1 1/8"	134	.78	
148	1.33	1 1/4"	135	.93	
149	1.42	1 1/2"	136	.95	
150	1.55	1 3/4"	137	1.07	
151	1.75	2"	138	1.17	
152	1.80	2 1/4"	139	1.27	
153	2.17	2 1/2"	140	1.40	
154	2.40	2 3/4"	141	1.67	
155	2.75	3"	142	1.83	
156	2.90	3 1/4"	143	1.97	
157	3.10	3 1/2"	144	2.32	
158	3.10	3 3/4"			
159	3.80	4"			

STOCK SIZES OF BLACK AND BROWN FENOLINE TUBING

Individual lengths tubing in following diam.: 1"; 1 1/4"; 1 1/2"; 1 3/4"; 2"; 2 1/4"; 2 3/4"; 3"; Wall thickness 1/16".

No.	Dealer Cost
2131—3" long—1" O.D. to 3" O.D.	\$.45
2132—4" long—1" O.D. to 3" O.D.	.55
2133—6" long—1" O.D. to 3" O.D.	.78

When ordering, specify exact diameter.

SPECIAL LENGTH BAKELITE TUBING

Cut to Order — Wall Thickness to 1/16"
Outside diameters range from 1" to 4". Prices on request. Other diameters and thicknesses quoted on request.

FENOLINE INSULATED GRID CAPS

Improved type for standard and transmitting tubes. Study cadmium plated brass clip. Furnished with 12" wire.

For 866 Transmitting Tubes
No. 683—Black Dealer Cost \$.42

For Standard Glass Receiving Tubes with small caps
No. 680—Red Dealer Cost \$20.00C
No. 681—Black Dealer Cost 20.00C



RUBBER INSULATED GRID CAPS

For Transmitting Tubes

New improved type. Insulation made of special soft rubber over spring bronze.



For 866 Type Tubes
No. 870—With Leads Dealer Cost \$.25

SPRING ACTION GRID CAPS

For all types of tubes. Positive contact. All grid caps are hot tinned ready for soldering.



No. Dealer Cost
1550—For standard glass receiving tubes with small caps (.360 dia.) \$7.50M
1551—For tubes with miniature caps (.250 dia.) 7.50M
1553—For glass tubes 8.35M
1554—For glass tubes 8.35M

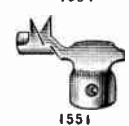

ICA "INSULOID" RODS

Made of phenolic material of high electrical insulating properties and great tensile strength.

No.	Color	Size	Dir. Cost	BAKELITE RODS			FENOLINE RODS		
				No.	Diam.	Dir. Cost Per Ft.	No.	Diam.	Dir. Cost Per Ft.
2175	Black	12" x 1/4"	\$.30	Approximate Lengths: 3 ft.					
2176	Black	24" x 1/4"	.53						
2179	Black	12" x 3/8"	.42						
2180	Black	24" x 3/8"	.85	175	1/4"	\$.87	168	1/4"	\$.57
2183	Black	12" x 1/2"	.57	178	5/8"	1.05	169	3/8"	.77
2184	Black	24" x 1/2"	1.13	176	3/8"	1.25	170	1/2"	.95
				177	1/2"	1.65			

ICA FLEXIBLE SPAGHETTI TUBING

20 Foot Lengths



A flexible tubing in attractive colors. Will accommodate from No. 10 to No. 18 wires.

Furnished in one length—20 feet long on handy spools.

No.	Color	Dealer Cost
210	Red	Per Spool \$.84
211	Yellow	Per Spool .84
212	Brown	Per Spool .84
213	Green	Per Spool .84
214	Black	Per Spool .84

500 Foot Spools, spaghetti tubing, same grade and colors as above. Specify color per spool.

No. 197 Dealer Cost \$19.16

ICA SPAGHETTI TUBING

For No. 10 to No. 18 gauge wire. Guaranteed not to crack. Furnished in 30" lengths.

No.	Color	Dealer Cost per length
182	Red	\$10.00C
183	Yellow	10.00C
184	Brown	10.00C
185	Green	10.00C
186	Black	10.00C

SMALL SIZE SPAGHETTI TUBING

200	Red	\$10.00C
201	Yellow	10.00C
202	Black	10.00C

LARGE SIZE SPAGHETTI TUBING

Supplied in 36" lengths. Diameter 9/84" I.D. x 3/16" O.D.

No. 196—Supplied in black only
Dealer Cost—per length \$3.4

ICA GIANT SLEEVING

Made of high voltage insulation saturated cambric material. Inside diameter 3/8". For Insulating Resistors, Small Condensers, Wire Cables, Leads, etc. 36" lengths.

No. 198 Dealer Cost \$3.4

SINCE
1921



insuline Corporation of America

OVER 3 DECADES OF QUALITY RADIO-TELEVISION PRODUCTS



ICA TERMINAL STRIPS

Specially suited for amplifiers, mixers, receivers, etc. Made of 1/8" heavy black bakelite, engraved in white. Terminals are brass cadmium plated.

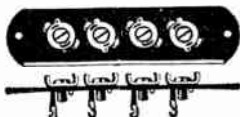

No.	Terminals	Marking	Mtg. Ctrs.	Size	Dealer Cost
2420	2	Plain	1 1/2	3/8 x 2	\$13.35C
2419	2	A & G	1 1/2		13.35C
2418	2	Output	1 1/2		13.35C
2417	2	Input	1 1/2		13.35C
2414	3	Plain	2	3/8 x 2 1/2	18.33C
2415	3	1, 2, 3	2		20.00C
2413	4	Plain	2 1/2	3/8 x 3	23.32C
2408	4	1, 2, 8, 4	2 1/2		.25
2405	5	Plain	3	3/8 x 3 1/2	.28
2406	5	1, 2, 3, 4, 5	3		.32
2404	6	Plain	3 1/2	3/8 x 4	.34
2402	6	1, 2, 3, 4, 5, 6	3 1/2		.40
2412	7	Plain	4	3/8 x 4 1/2	.42
2411	7	1, 2, 3, 4, 5, 6, 7	4		.45
2410	8	Plain	4 1/2	3/8 x 5	.47
2409	8	1, 2, 3, 4, 5, 6, 7, 8	4 1/2		.52
2424	9	Plain	5	3/8 x 5 1/2	.52
2423	9	1, 2, 3, 4, 5, 6, 7, 8, 9	5		.57
2422	10	Plain	5 1/2	3/8 x 6	.57
2421	10	1, 2, 3, 4, 5, 6, 7, 8, 9, 10	5 1/2		.63

BAKELITE TERMINAL STRIPS

Brown bakelite 1/16" thick. Suitable light duty radio work, experimental purposes, etc.



No.	Terminals	Mtg. Ctrs.	Dir. Cost
2520	2	1 1/8	\$ 7.20C
2521	3	1 3/8	10.80C
2522	4	2 1/8	13.20C
2523	5	2 3/8	16.80C
2524	6	3 1/8	19.80C
2528	Terminal Lug & Screw only		3.46C

TWIN JACK STRIP



With two terminals. Takes standard ph-ue tips. Base width 1 1/8" 1 1/4" between mounting holes.

No. 2443 Dealer Cost \$15.00C

Terminal Strip Offset Mounting Bracket



For more rigid mounting of terminal strips. Mounting hole for No. 6 screw.

No. 2430 .. Dir. Cost \$1.50C

Terminal Strip Offset Mounting Bracket and Lug Combination

For sturdy mounting of terminal strips. Affords solder connection for ground. Mounting hole for No. 6 screw.

No. 2431 Dir. Cost \$1.50C



BAKELITE TERMINAL MOUNTING STRIPS



Type A

Mounting tie strips for fastening Resistors, Condensers, etc. Mounting Lug hole diameter .140". Type A shows non-ground mounting lug. Type B shows combination grounding-mounting lug:



Type B

No.	Type	Terminals	Mtg. Centers	Mounting Lugs	Dealer Cost
2434	A	1	} One Hole	1	\$1.65C
2455	B	1		1	1.74C
2435	A	2		1	2.10C
2456	B	2		1	2.10C
2436	A	8	1 1/2	2	3.45C
2457	B	8	1 1/2	2	3.45C
2437	A	4	1 7/8	2	4.50C
2458	B	4	1 7/8	2	4.50C
2438	A	5	2 1/4	2	4.95C
2459	B	5	2 1/4	2	4.95C
2439	A	6	1 3/8	2	6.80C
2460	B	6	1 3/8	2	6.80C
2440	A	7	1 1/2	2	7.40C
2461	B	7	1 1/2	2	7.40C
2441	A	8	1 7/8	2	8.10C
2462	B	8	1 7/8	2	8.10C

TERMINAL LUGS



No.	Description	Dealer Cost
2425	Lugs only (less screws)	\$4.03C
2426	Terminal Screws, 3/8" L.	1.07C

TERMINAL LUGS

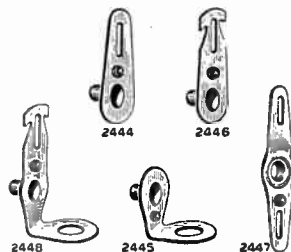

No.	Description	Dealer Cost
2444	Terminal Lug	\$4.00M
2445	Mounting Lug—#6 hole	4.00M
2446	Notched Terminal Lug	4.00M
2448	Combination Term. and Mounting Lug—#6 hole	7.00M
2638	Same as 2448—#8 hole	6.00M
2447	Double lug with center eyelet	7.00M
2463	Combination lug—eyelet type and bracket	4.00M

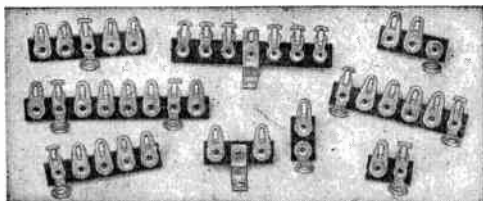

SPECIFICATION TERMINAL STRIPS

Special type terminal strips with terminals in any required position, including offset bracket type. Made to specifications. Send us your print.



ELECTRONIC HARDWARE



A wide range of hardware for varied application. Especially suitable for the requirements of the radio, television, laboratory, engineering and servicing fields.



ROUND HEAD MACHINE SCREWS NICKEL-PLATED

Packed 500 to Package

Bulk Cat. No.	Description	Bulk Dir. Cost
5504	2-56 x 1/4" long	\$4.17M
5500	4-36 x 1/4" long	4.17M
5501	4-36 x 1/2" long	4.17M
5502	4-36 x 3/8" long	4.50M
5507	6-32 x 1/4" long	4.42M
5511	6-32 x 3/8" long	5.00M
5508	6-32 x 1/2" long	5.16M
5509	6-32 x 3/4" long	5.50M
5510	6-32 x 1" long	6.50M
5514	8-32 x 3/8" long	5.42M
5515	8-32 x 1/2" long	6.00M
5517	8-32 x 3/4" long	7.50M
5521	10-32 x 1/2" long	7.50M



BINDING HEAD MACHINE SCREWS

Packed 100 to Package

Bulk Cat. No.	Description	Bulk Dir. Cost
5546	6-32 x 3/8" long	\$9.00M
5547	6-32 x 1/2" long	9.00M
5548	6-32 x 3/4" long	9.00M



OVAL HEAD MACHINE SCREWS NICKEL PLATED

Packed 100 to Package

Bulk Cat. No.	Description	Bulk Dir. Cost
5710†	10-32 x 5/8" long	\$7.50M
5554	8-32 x 3/8" long	7.50M

†For Transmitting Racks.



PARKER-KALON SELF-TAPPING SCREWS

Packed 500 to Package

Bulk Cat. No.	Description	Bulk Dir. Cost
*5562	No. 3 x 7/8" long	\$1.00C-\$9.16M
5555	No. 4 x 1/2" long	1.17C-10.00M
5556	No. 4 x 3/4" long	1.50C-10.00M
5557	No. 6 x 3/8" long	1.50C-13.33M
5558	No. 7 x 1/2" long	1.75C-15.00M
5559	No. 10 x 3/4" long	2.00C-18.33M

*Drive Screws



CUP WASHERS

Packed 100 to Package

Bulk Cat. No.	Description Hole Size	Bulk Dir. Cost
5712	No. 8	\$5.00M
5713	No. 10	\$1.17C-\$5.00M



ESCUTCHEON PLATE SCREWS

Packed 500 to Package

Bulk Cat. No.	Description	Bulk Dir. Cost
5677	No. 1 x 1/4" long	\$11.00M



PLATED STEEL HEXAGON NUTS

Packed 500 to Package

Bulk Cat. No.	Description	Bulk Dir. Cost
5572	4-36 x 1/4"	\$5.00M
5573	4-36 x 3/8"	5.00M
5577	6-32 x 3/8"	5.50M
5576	6-32 x 1/4"	5.50M
5580	8-32 x 3/8"	5.50M
5584	10-32 x 3/8"	\$.85C- 6.66M
5583	1/4-20 x 1/4"	1.00C- 8.33M
5579	1/4-32 x 3/8"	9.50M
5575	3/8-32 x 1/2"	15.00M



PLATED BRASS HEXAGON NUTS

Packed 100 to Package

Bulk Cat. No.	Description	Bulk Dir. Cost
5564	4-36 x 3/8"	\$ 5.83M
5566	6-32 x 1/4"	8.33M
5567	6-32 x 3/8"	9.50M
5570	8-32 x 1/2"	10.00M
5574	3/8-32 x 1/2"	16.50M



BRASS EYELETS

Packed 500 to Package

Bulk Cat. No.	Diam. Shank	Length	Bulk Dir. Cost
5672	.115	1/16"	\$6.00M
5671	.125	1/8"	5.70M
5670	.132	1/8"	5.10M

NICKEL PLATED TUBULAR STEEL RIVETS

Packed 500 to Package

Bulk Cat. No.	Diam. Shank	Length	Bulk Dir. Cost
5730	3/16"	3/8"	\$5.00M
5663	1/8"	7/8"	6.00M
5664	1/8"	1 1/4"	6.00M
5665	1/8"	1 7/8"	6.30M



STEEL CABLE CLAMPS PLATED

Packed 500 to Package

Bulk Cat. No.	Description Length Diam. Bend	Bulk Dir. Cost
5697	3/16"	\$1.33C-\$12.00M
5698	1/8"	1.67C- 15.00M



NICKEL PLATED SPRING CLIP

Packed 100 to Package

Bulk Cat. No.	Description Width Length	Bulk Dir. Cost
5691	3/8"	\$15.00M
5692	1/2"	16.67M
5693	3/4"	19.16M



FLAT STEEL PLATED WASHERS

Packed 500 to Package

Bulk Cat. No.	Description	Bulk Dir. Cost
5595	For No. 6 Screw	\$2.50M
5596	For No. 8 Screw	2.50M
5597	For No. 10 Screw	2.50M
5603	For 1/4" Screw	3.75M
5607	For 3/8" Screw	4.17M



EVERLOCK LOCKWASHERS

Packed 500 to Package

Bulk Cat. No.	Description	Bulk Dir. Cost
5592	For No. 6 Screw	\$3.33M
5593	For No. 8 Screw	3.75M
5594	For No. 10 Screw	4.17M



KANTLINK SPLIT TYPE LOCKWASHERS

Packed 500 to Package

Bulk Cat. No.	Description	Bulk Dir. Cost
5589	For 6-32 Screw-3/8" thick	\$3.33M
5590	For 8-32 Screw-3/8" thick	3.33M
5591	For 10-32 Screw-3/8" thick	3.33M
5602	For 1/4-32 Screw-1/8" thick	4.33M



FLAT FIBRE WASHERS

Packed 500 to Package

Bulk Cat. No.	Diam.	Thick.	Hole	Bulk Dir. Cost
5601	1 1/8"	1/16"	1/8"	\$4.17M
5612	1 1/8"	1/16"	1/4"	4.83M
5609	1 1/2"	1/16"	3/8"	5.00M
5626	1 1/2"	1/16"	3/4"	5.00M
5605	1 7/8"	1/16"	3/4"	5.00M
5610	1 7/8"	1/16"	3/8"	5.00M
5611	1 7/8"	1/16"	3/4"	6.42M



FIBRE SHOULDER WASHERS

Packed 500 to Package

Bulk Cat. No.	Overall Diam.	Shoulder Diam.	Overall Hgt.	Bulk Dir. Cost
5618	1 1/8"	3/8"	3/8"	\$5.83M
5620	1 1/8"	3/8"	3/4"	6.66M
5619	1 1/2"	3/4"	3/8"	5.83M
5616	1 1/2"	3/4"	3/4"	6.66M
5624	1 1/2"	3/4"	3/4"	5.83M
5628	1 7/8"	3/4"	3/8"	6.66M
				8.35M



MIDGET FUSE CLIPS

(For 1/4" Glass Fuses)

Packed 100 to Package

Bulk Cat. No.	Height	Length	Bulk Dir. Cost
5681	1/8"	1/4"	\$15.00M



ICA FLEXIBLE RUBBER GROMMETS

Packed 100 to Package

Bulk Cat. No.	(3) Hole Size	(1) O.D.	(2) Thick-ness	(4) Slot	(5) Mtg. Width	Bulk Dir. Cost
5633	3/8"	1/2"	3/32"	3/8"	3/8"	\$2.92C
5634	3/8"	1/2"	1/16"	3/8"	1/8"	3.08C
5635	3/8"	1/2"	1/8"	3/8"	3/16"	3.33C
5639	3/8"	1/2"	1/16"	3/8"	3/16"	2.42C
5637	3/8"	1/2"	1/8"	3/8"	3/16"	2.75C
5641	1/2"	1"	3/8"	3/8"	3/4"	6.25C
5642	1/2"	1"	1/4"	3/8"	1/2"	3.08C
5687	1/2"	1"	1/8"	3/8"	3/8"	2.75C

AN GROMMET (931-4-7)

Bulk Cat. No.	(3) Hole	(1) O.D.	(2) Thick-ness	(4) Slot	(5) Mtg. Width	Bulk Dir. Cost
5684	1/4"	5/8"	1/16"	1/8"	1/8"	\$5.90C

SINCE
1921



insuline Corporation of America

OVER 3 DECADES OF QUALITY RADIO-TELEVISION PRODUCTS



ANGLE BRACKETS

Packed 100 to Package

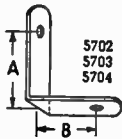

†One Hole Tapped—One Plain.
‡One Slot—One Hole.

Bulk Cat. No.	A	B	Width	Bulk Dir. Cost
5702	3/8"	3/8"	1/8"	\$2.08C
5703	3/8"	3/8"	3/8"	2.25C
5704	3/8"	1 1/8"	3/8"	3.50C
5705	1/2"	1/2"	1/8" †	4.17C-28.85M
5706	3/8"	3/8"	3/8" ‡	2.08C
5707	3/8"	1/8"	3/8" ‡	2.67C

BRASS TINNED TERMINAL LUGS

Packed 500 to Package



Bulk Cat. No.	Length	Hole Size	No.	Dir. Cost
5645	1 1/8"	No. 8		.72C-4.62M
5646	1 1/8"	No. 6		.67C-5.00M
5647	1 1/8"	No. 10		.56C-4.01M
5648	1 1/8"	No. 8		.72C-4.62M
5655	1 1/8"	No. 8		.80C-4.81M
5653	1 1/8"	No. 6		.80C-4.81M
5650	1 1/8"	No. 6		.80C-6.00M
5651	1 1/8"	No. 10		1.04C-7.21M
5652	1 1/8"	No. 1/4"		1.44C-12.66M

EVERLOCK TERMINAL LUGS

Packed 500 to Package



Bulk Cat. No.	Length	Hole Size	No.	Dir. Cost
5480	1 1/8"	No. 8		\$1.25C-11.00M
5481	1 1/8"	No. 1/4"		1.12C-8.08M
5482	3/4"	No. 4		1.12C-8.08M
5483	3/4"	No. 6		1.12C-8.08M
5484	7/8"	No. 8		1.12C-8.08M



ICA ANGLE AND BRACKET ASSORTMENT

A complete assortment of 30 popular angles and brackets, nickel plated finish. This combination of angles and brackets has been carefully selected to fill a wide variety of requirements. Packed for ready availability.
No. 5800..... Dealer Cost \$.60

HANDY RACK SCREW AND WASHER ASSORTMENT

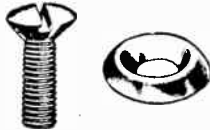

Packed in handy ICA jars. Includes 25 Oval Head Screws (10-32 x 5/8") and 25 Cup Washers (10-32).
No. 5210..... Dealer Cost \$.99

UNIVERSAL RADIO HARDWARE ASSORTMENT



Contains 2 pounds of assorted hardware commonly used by servicemen, amateurs, experimenters, etc. Suitable for many types of radio, television, servicing, etc., jobs. Includes screws, nuts, bolts, rivets, eyelets, lugs, washers, etc.
No. 5250..... Dir. Cost \$1.50



ICA ALL-PURPOSE RADIO HARDWARE AND ESSENTIAL EQUIPMENT
Packed in a handy indestructible metal utility case. This DeLuxe assortment includes such items as knob set screws — escutcheon screws — Parker-Kalon self-tapping screws — rubber grommets — screws — nuts, etc.
No. 5251..... Dealer Cost \$3.92

ICA RUBBER GROMMET ASSORTMENT



Assortment contains popular sizes used in the Radio, Electrical and Television field. Carefully selected group to meet many requirements. Packed for ready use.
No. 5811..... Dealer Cost \$1.20
Contains 60 Rubber Grommets

ICA FIBRE WASHER ASSORTMENT



A representative assortment of fibre washers both plain and shoulder, to fit all popular size screws and bolts. Suitable for wide range of uses. Packed for ready use.
No. 5805..... Dealer Cost \$.60
Contains 100 assorted washers

ICA UTILITY GLASS JARS

For use on service bench to store hardware, etc. 2 1/2" high x 1 1/2" deep.



No. 5400
Dealer Cost \$9.00C



ICA INSULATED AND BRASS SPACERS AND BUSHINGS

Used for raising sub panels, chassis, condensers, etc. For manufacturers, experimenters and laboratory use.

Made of High Quality Brass

No.	Diameter	Length	Dealer Cost per C
5760	1/4"	1/4"	\$4.00
5761	1/4"	3/8"	4.83
5762	1/4"	1/2"	5.66
5763	1/4"	3/4"	6.58
5767	1/4"	1"	7.50
5764	3/8"	1/4"	5.83
5765	3/8"	1/2"	6.66
5766	3/8"	3/4"	7.92
5768	3/8"	1"	10.83

Made of Fenoline Insulation

No.	Diameter	Length	Dealer Cost per C
5775	1/4"	1/4"	3.50
5776	1/4"	3/8"	4.00
5777	1/4"	1/2"	4.50
5778	1/4"	3/4"	5.50
5782	1/4"	1"	6.50
5779	3/8"	1/4"	4.00
5780	3/8"	1/2"	5.00
5781	3/8"	3/4"	6.00
5783	3/8"	1"	7.50

No.	Threaded Brass Bushings—1/4" Diameter	Dealer Cost
5785	for 6/32 screw	4.83
5786	"	5.66
5787	"	6.66
5788	"	7.50
5794	"	8.35
5790	for 8/32 screw	5.50
5791	"	6.50
5792	"	7.50
5795	"	9.16

SPACER AND BUSHING ASSORTMENTS

Brass and Insulated



Assortment of 25 spacers and bushings in 1/4" & 3/8". Diameters from 1/4" to 3/4". Ideal for raising sub panels, chassis, etc.

No.	Dealer Cost
5260—Insulated Assortment	\$1.50
5261—Brass Assortment	1.50

No.	Threaded Brass Bushing Assortments	Dealer Cost
5262	16 Assorted Brass bushings. Threaded for 6/32 from 1/4" to 3/4" lengths	1.50
5263	16 Assorted Brass bushings. Threaded for 8/32 from 1/4" to 3/4" lengths	1.50



Molded Bakelite Eyelet Bushing

No.	Dealer Cost
2365—Suitable for either spacer or bushing. With brass eyelet	\$2.92C
2366—Same as above, without eyelet	1.92C

SINCE
1921



insuline Corporation of America

OVER 3 DECADES OF QUALITY RADIO-TELEVISION PRODUCTS

FILTERVOLT NOISE FILTER



An efficient filter for disturbances caused by electrical appliances. For use with any all-wave or broadcast receiver.

Rated conservatively at 250 watts for 32, 110 and 220 volt AC or DC circuits. Can be installed either at the radio or at the source of disturbance.

Contains heavy duty R.F. chokes, large filter capacitor, and has a "PI" Filter circuit arrangement.

No. 338..... Dealer Cost \$5.00

ICA FILTERVOLT

Improves extremely noisy radio reception due to interruptions in power line caused by electrical appliances, lights, etc.



No. 394

Dealer Cost \$3.00

SIMPLEX FILTERVOLT

Eliminates Radio Noises Caused By—



- Electric Shavers
- Refrigerators
- Fans ● Elevators
- Motors, etc.

No. 90..... Dealer Cost \$1.17

UNIVERSAL VOLTAGE REGULATOR

Voltage fluctuation often occurs not gradually but suddenly, thus bringing a tremendous strain on the tubes. This regulator protects tubes through scientific regulation of current fluctuations. Housing body and end rings are neatly constructed and of perforated japanned metal. For all Radio Sets, AC, DC.



No. 92..... Dealer Cost \$1.17

ICA 3-IN-1 RADIO TUNER



Functions as either an Antenna Tuner, Wave Trap, or Aerial Eliminator. Operates on any make or model radio set.

As an Antenna Tuner, it will improve the reception of a weak station. As a Wave Trap, it will separate interfering stations and improve selectivity. As an Aerial Eliminator, it makes unnecessary the outdoor aerial. Easily installed within a few minutes.

No. 93..... Dealer Cost \$6.00
Complete with Instructions.

IMPROVED ICA DELUXE SIGNA-TONE

AUDIO OSCILLATOR — CODE PRACTICE SET — KEYING MONITOR



The ICA Signature is a perfected Audio Oscillator, having 3 different output frequencies and a continuously variable volume control. The Audio notes are similar to those of high quality commercial CW stations.



1. CODE PRACTICE SET—A number of phones and keys may be connected for intercommunication or for classroom or radio club instruction in code.
 2. KEYING MONITOR—An invaluable aid in improving any ham's "flat." Will follow the "bug" at all speeds. No well-equipped station should be without this keying monitor. (A double pole keying relay is required for this function—one set of contacts for keying transmitter; other set for monitor.)
 3. MODULATION SIGNAL—The steady note of the Signature is ideal for adjusting both the Modulator and modulated stages of your transmitter for 100% modulation.
 4. SIGNAL TRACER—By feeding the output of the Signatone into each stage of your modulator and listening to the output of that stage, defects and "bugs" can easily be located. Complete with 50B5 and 35W4 tubes and self-contained speaker for 110 V AC-DC.
- No. 4300—Dealer Net Cost..... \$15.75
No. 4301—Classroom Model (No Speaker)—Dealer Net Cost..... 13.50

ICA UNBREAKABLE MORSE CODE RECORDS



Learn the International Morse Code Quickly, Easily — Uses EYE - EAR Method. The Complete Linguaphone Code Equipment consists of 5 Double-faced, electrically transcribed records in durable album. Contents: 3 Tables, 10 Lessons.

No. 1800—Complete Dealer Cost \$10.95
No. 1800R—Record only Dealer Cost 2.03
No. 1800B—Booklet only Dealer Cost .98

ICA EAR PHONES

Complete With Head Bands
Made of molded Bakelite and light-weight nickel-plated metal. 2000 ohms.



No. 23—Double Head Phone Dlr. Cost \$2.71

ICA "TRIPLEX"

Radio & Telegraph Code Practice Set
Blinker Light
Radio Signal—Telegraph
No. Dlr. Cost
70—Single Unit (less batteries) \$1.95
71—Double Unit (50 ft. wire) 4.12



EAR CUSHIONS



Made of soft rubber. Ideal for the amateur wireless operator, etc.

No. 195..... Dealer Cost \$.84 pr.

ICA TENNA-SCOPE LOOP

For Midgets or Portables

Eliminates necessity of outdoor or indoor antenna. Replaces the antenna coil in portable or midget sets. Easily assembled.

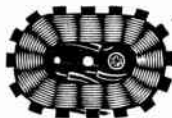

No. 4385..... Dealer Cost \$.83

ICA TENNA-SCOPE

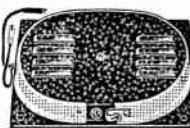

A new style built-in tuned radio antenna. Easily connected. Eliminates use of outside aerial and ground. Features: Better selectivity — Higher signal to noise ratio — Easily connected, no soldering.

No. 4380..... Dealer Cost \$2.00

ICA RECORD-PLAYER SWITCH

Replacement for RCA Switch 9824A



Recommended for quickly connecting Record Players, F.M. attachments, Television attachments, Microphones and similar devices into the audio amplifier of existing radio receivers.

No. 1740..... Dealer Cost \$1.55

UNIVERSAL RESISTOR CORD

From 22 to 330 Ohms on One Cord



Replacement Resistor Cord for all makes of Receivers. Simplifies stock problems. With the Universal Resistor Cord, almost all receivers now in use may be serviced. A complete table of instructions is supplied with each cord.

No. 205..... Dealer Cost \$1.25

NOTES

NOTES

NOTES

NOTES