

Radio's MASTER

OFFICIAL MANUAL
AND BUYING GUIDE
OF ELECTRONIC AND
RADIO EQUIPMENT

UNITED CATALOG PUBLISHERS, INC.
106-110 LAFAYETTE ST
NEW YORK, N. Y.

RADIO'S MASTER

OFFICIAL
PARTS and EQUIPMENT MANUAL
of the
RADIO AND ELECTRONIC INDUSTRY

What to Buy and Where to Buy It

- **ILLUSTRATIONS**
- **DESCRIPTIONS**
- **SPECIFICATIONS**
- **PRICES**

Published by

UNITED CATALOG PUBLISHERS, INC.

106-110 Lafayette Street

New York 13, N. Y.

TENTH EDITION

While every precaution is taken to insure accuracy in the preparation of display pages and indexes, we cannot guarantee against the possibility of error or omission, nor can we be held responsible for price changes or withdrawal of items during or after publication. List prices are furnished only for information; they are not offered as quotations.

Enrolled manufacturers reserve the right, during the war, to make such mechanical changes in specifications as may be required to produce equally suitable substitutes, if necessary.

Copyright 1943

UNITED CATALOG PUBLISHERS, INC.

*No part of this book may be reproduced
without express permission of the publisher.*

Printed in U.S.A.

RADIO'S MASTER

INDEX OF MANUFACTURERS' DISPLAY PAGES

(ALPHABETICAL)

	Section	Page
— A —		
Abbott Instruments, Inc. 8 West 18th St., New York 11, N. Y.	H	24
Acro Electric Company. 1305 Superior Avenue, Cleveland 14, O.	L	27
Advance Electric Company. 1260 West 2nd St., Los Angeles 26, Calif.	H	85 to 88
Aerovox Corporation. New Bedford, Mass.	K	37 to 58
Alliance Manufacturing Co., The. Lake Park Boulevard, Alliance, O.	E	27, 28
Allied Control Co., Inc. 2 East End Ave., New York 21, N. Y.	H	91 to 93
Alpha Wire Corporation. 50 Howard St., New York 13, N. Y.	Q	25 to 30
American Condenser Corporation. 2508 S. Michigan Ave., Chicago 16, Ill.	K	73, 74
American Electrical Heater Co. ("American Beauty") 6110 Cass Ave., Detroit, Mich.	R	41
American Microphone Co., Inc. 1915 S. Western Ave., Los Angeles 7, Calif.	E	31 to 34
American Phenolic Corp. ("Amphenol"). 1830 S. 54th Ave., Chicago 50, Ill.	N	1 to 10
American Radio Hardware Co., Inc. 476 Broadway, New York 13, N. Y.	R	1 to 4
American Radio Relay League ("ARRL"). 38 LaSalle Rd., West Hartford 7, Conn.	G	11, 12
American Television & Radio Corp. ("ATR"). 300 E. 4th St., St. Paul 1, Minn.	T	9 to 12
Ampere Electronic Products Co. 79 Washington St., Brooklyn 1, N. Y.	B	35, 36
Amperite Company. 561 Broadway, New York 12, N. Y.	{ E M	7, 8 13, 14
Arcturus (Standard Arcturus Corp.). 30 Court St. Newark, N. J.	B	23
Astatic Corporation, The. 830 Market St., Youngstown 1, Ohio	E	21 to 24
Atlas Resistor Company. 423 Broome St., New York 13, N. Y.	M	9 to 12
Atlas Sound Corporation. 1443-51 39th St., Brooklyn 18, N. Y.	D	31, 32
Audak Company, Inc. 500 Fifth Ave., New York 3, N. Y.	E	35, 33
Audio Devices, Inc. 444 Madison Ave. New York 22, N. Y.	E	57, 58

— B —		
Barker & Williamson ("B & W"). 235 Fairfield Ave., Upper Darby, Pa.	O	55, 56
Belden Manufacturing Co. 4647 W. Van Buren St., Chicago 44, Ill.	Q	1 to 3
Bell Sound Systems, Inc. 1183 Essex Ave., Columbus 3, Ohio	C	35 to 42
Birnback Radio Company. 145 Hudson St., New York 13, N. Y.	Q	55 to 64

	Section	Page
Bliley Electric Company. P. O. Box 1070, Erie, Pa.	H	131, 132
Blue Wizard Tool Co. (See Roesch & Spears)	R	51
Bogen Company, Inc., David. 663 Broadway, New York 12, N. Y.	C	1 to 17
Brush Development Company. 3311 Perkins Ave., Cleveland 14, Ohio	{ E H	25, 26 136
Bud Radio, Inc. 2118 E. 55th St., Cleveland 3, Ohio	H	101 to 110
Bunnell & Co., Inc., J. H. 215 Fulton St., New York 8, N. Y.	H	67, 68
Burgess Battery Company. Freeport, Ill.	T	1

— C —		
Cannon Company, C. F. Springwater, N. Y.	H	135
Cannon Electric Development Co. 3209 Humboldt St., Los Angeles 31, Calif.	N	24 to 36
Cardwell Mfg. Co., Allen D. 81 Prospect St., Brooklyn 1, N. Y.	H	55 to 60
Centralab (Div. of Glove-Union, Inc.). 900 E. Keeffe Ave., Milwaukee 1, Wis.	L	5 to 12
Chisholm-Ryder Co., Inc. ("Premax"). Niagara Falls, N. Y.	Q	47 to 50
Cincaudagraph Speakers, Inc. 3911-3929 S. Michigan Ave., Chicago 15, Ill.	D	43 to 46
Clarostat Manufacturing Co., Inc. 130 Clinton St., Brooklyn, N. Y.	L	13 to 18
Clarion-Dynamic. (See M. A. Miller Mfg. Co.)	E	73
Continental Carbon Inc. 13900 Lorain Ave., Cleveland 11, Ohio	M	21 to 26
Continental Electric Company ("Cetron"). 903 Merchandise Mart, Chicago 54, Ill.	B	39, 40
Cornell-Dubilier Electric Corp. South Plainfield, N. J.	K	1 to 14d
Corning Glass Works ("Pyrex"). Corning, N. Y.	Q	51, 52
Cornish Wire Co. Inc. ("Corwico"). 15 Park Row, New York 7, N. Y.	Q	35 to 38

— D —		
Drake Electric Works, Inc. 3656 Lincoln Ave., Chicago 13, Ill.	R	13, 14
Drake Manufacturing Co. 1713 W. Hubbard St., Chicago 22, Ill.	L	42 to 46
DuMont Laboratories, Inc., Allen B. 2 Main Ave., Passaic, N. J.	F	59, 60
DuoTone Company, Inc. 799 Broadway, New York 3, N. Y.	E	69, 70

SAY YOU SAW IT IN "Radio's Master"

MANUFACTURERS' DISPLAY PAGES (Continued)

(ALPHABETICAL)

— E —		Section	Page
Eastern Mike-Stand Co.			
56 Christopher Ave., Brooklyn 12, N. Y.	E		9 to 12
Echophone Radio Company.			
201 E. 26th St., Chicago 16, Ill.	H		19, 20
Editors & Engineers, Ltd.			
1422 N. Highland Ave., Los Angeles, Calif.	G		7
Eicor, Inc.			
1501 W. Congress St., Chicago, Ill.	T		18
Eitel-McCullough, Inc. ("Eimac").			
San Bruno, Calif.	B		29, 30
Electric Soldering Iron Co., Inc. ("Esico").			
2444 W. Elm St., Deep River Conn.	R		5, 6
Electronic Laboratories, Inc.			
122 W. New York St., Indianapolis, Ind.	T		19 to 22
Erwood Company, The.			
223 West Erie St., Chicago 10, Ill.	C		45 to 47

— G —		Section	Page
Gammatron (Heints & Kaufman).			
South San Francisco, Calif.	B		27, 28
Gardiner Metal Company.			
4820 S. Campbell Ave., Chicago, Ill.	R		52
General Cement Mfg. Co.			
919 Taylor Ave., Rockford, Ill.	R		15 to 22
General Electric Company ("GE").			
1 River Road, Schenectady 5, N. Y.	B		24
	K		83
General Transformer Corp.			
1250 W. Van Buren St., Chicago 7, Ill.	T		25
Ghirardi (Radio & Technical Publ. Co.).			
45 Astor Place, New York 3, N. Y.	G		1, 2
Globe-Union, Inc. (Centralab Division).			
900 E. Keefe Ave., Milwaukee 1, Wis.	L		5 to 12
Guardian Electric Mfg. Co.			
1400 W. Washington Blvd., Chicago 7, Ill.	H		89, 90
Guthman & Co., Inc., Edwin L.			
15 S. Throop St., Chicago 7, Ill.	O		12

— H —		Section	Page
Haldorson Company, The.			
4500 Ravenswood Ave., Chicago 40, Ill.	J		45, 46
Hallicrafters Company, The.			
2611 S. Indiana Ave., Chicago 16, Ill.	H		1 to 14
Hammarlund Manufacturing Co., Inc.			
424 W. 33rd St., New York 1, N. Y.	H		23
	H		51 to 54
Heints & Kaufman, Ltd. ("Gammatron").			
South San Francisco, Calif.	B		27, 28
Hickok Electrical Instrument Co., The.			
10514 Dupont Ave., Cleveland 8, Ohio	F		35 to 38
Hipower Crystal Company.			
2035 Charleston St., Chicago 47, Ill.	H		133
Howard Radio Company.			
1735 Belmont Ave., Chicago 13, Ill.	E		74
	H		25 to 28

— I —		Section	Page
Industrial Condenser Corp. ("INCCO").			
1725 W. North Ave., Chicago 22, Ill.	K		75 to 79
Insuline Corporation of America ("ICA").			
36-02 35th Ave., Long Island City 1, N. Y.	H		111 to 122
International Resistance Co. ("IRC").			
401 N. Broad St., Philadelphia 8, Pa.	M		27 to 34

— J —		Section	Page
Jackson Electrical Instrument Co., The.			
131 Wayne Ave., Dayton 1, Ohio	F		13 to 16
Jackson Electro Corporation.			
124 Bleecker St., New York 12, N. Y.	R		31, 32
Janette Manufacturing Co., Inc.			
556-58 W. Monroe St., Chicago 6, Ill.	T		13, 14
Jensen Radio Manufacturing Co.			
6601 S. Laramie Ave., Chicago 38, Ill.	D		19 to 26
Johnson Company, E. F.			
Waseca, Minn.	H		61 to 66
Jones, Howard B.			
2460 W. George St., Chicago 18, Ill.	N		11 to 19

— K —		Section	Page
Kainer & Company.			
761-771 W. Lexington St., Chicago 7, Ill.	D		41, 42
Kato Engineering Company.			
530 N. Front St., Mankato, Minn.	T		26
Kenyon Transformer Co., Inc.			
840 Barry St., New York 59, N. Y.	J		51 to 56
Krauter & Co., Inc.			
563 Eighteenth Ave., Newark, N. J.	R		7 to 12

— L —		Section	Page
Lectrohm, Inc.			
5133 W. 25th Place, Cicero, Ill.	M		51, 52
Lenz Electric Manufacturing Co.			
1751 N. Western Ave., Chicago 47, Ill.	Q		19 to 24
Les Logan Co. ("Speed-X").			
530 Gough St., San Francisco 2, Calif.	H		75, 76
Littelfuse, Inc.			
4757 Ravenswood Ave., Chicago 40, Ill.	F		22 to 24

— M —		Section	Page
Mallory & Co., Inc., P. R.			
Indianapolis 6, Ind.	K		91 to 100
	L		49 to 54
	M		41 to 48
	S		5 to 12
	T		31 to 32
Masco (Mark Simpson Mfg. Co.).			
188 W. 4th St., New York 14, N. Y.	C		71 to
McElroy Manufacturing Corp.			
82 Brookline Ave., Boston 15, Mass.	H		69 to
Meissner Manufacturing Co.			
Mt. Carmel, Ill.	O		1 to 1
Millen Manufacturing Co. Inc., James.			
150 Exchange St., Malden 48, Mass.	H		125 to 128
Miller Company, J. W.			
5917 S. Main St., Los Angeles 3, Calif.	O		21 to 28
Miller Mfg. Co., M. A. ("Clarion-Dynamic").			
1169 E. 43rd St., Chicago, Ill.	E		73
Mueller Electric Company.			
1583 E. 31st St., Cleveland 14, Ohio	T		5, 6
Muter Company, The.			
1255 S. Michigan Ave., Chicago 5, Ill.	M		5, 6

MANUFACTURERS' DISPLAY PAGES (Continued)

(ALPHABETICAL)

Section	Page
— N —	
National Company, Inc., 61 Sherman St., Malden 48, Mass	H 31 to 49
National Union Radio Corporation, 15 Washington St., Newark 2, N. J.	B 15 to 17
— O —	
Omite Manufacturing Company, 4835 W. Flournoy St., Chicago 44, Ill.	M 1 to 4
— P —	
Park Metalware Co., Inc. ("Xcelite"), Bank Street, Orchard Park, N. Y.	R 27 to 30
Par-Metal Products Corporation, 32-62 49th St., Long Island City 3, N. Y.	H 97 to 100
Pioneer Genemotor Corporation, 5841 W. Dickens Ave., Chicago 39, Ill.	T 7, 8
Precision Apparatus Company, 92-27 Horace Harding Blvd., Elmhurst, N. Y.	F 75 to 78
Premax Sales Div., Chisholm-Ryder Co., Niagara Falls, N. Y.	Q 47 to 50
Presto Recording Corporation, 242 W. 55th St., New York 19, N. Y.	E 47, 48
Pyrex (Corning Glass Works), Corning, N. Y.	Q 51, 52
— Q —	
Quam-Nichols Company, 526 E. 33rd Place, Chicago 16, Ill.	D 59, 60
— R —	
Racon Electric Co., Inc., 52 E. 19th St., New York 3, N. Y.	D 1 to 7
Radiart Corporation, The, 3571 W. 62nd St., Cleveland 2, Ohio	{ S 19, 20 T 27, 28
Radio City Products Co., Inc., 127 W. 26th St., New York 1, N. Y.	F 31 to 34
Radio Corporation of America, Camden 2, N. J.	{ B 1, 2 E 37, 38
Radio Essentials, Inc., 69 Wooster St., New York 12, N. Y.	R 1 to 4
Radio Mfg. Engineers, Inc. ("RME"), 304 First Ave., Peoria 6, Ill.	H 21, 22
Radio & Technical Publishing Co., 45 Astor Place, New York 3, N. Y.	G 1, 2
Rauland Corporation, The, 4245 N. Knox Ave., Chicago 41, Ill.	C 27, 28
Raytheon Production Corporation, 55 Chapel St., Newton 58, Mass	B 9 to 12
Readrite Meter Works, Bluffton, Ohio	F 7, 8
Regal Electronics Corp. ("Tokfone"), 20 W. 20th St., New York 11, N. Y.	C 23 to 26
Rek-O-Kut Corporation, 173 Lafayette St., New York 13, N. Y.	E 49, 50
Rider Publisher Inc., John F., 404 Fourth Ave., New York 16, N. Y.	G 3 to 6
Roesch & Spears (Blue Wizard Tools), 8913 Olin St., Los Angeles, Calif.	R 51

Section	Page
— S —	
Sangamo Electric Company, Springfield, Ill.	K 84 to 90
Schott Co., Walter L. ("Walsco"), 9306 Santa Monica Blvd., Beverly Hills, Calif.	R 55 to 58
Selectar Mfg. Corp., 21-10 49th Ave., Long Island City, N. Y.	D 63
Shure Brothers, 225 W. Huron St., Chicago 10, Ill.	E 13 to 18
Signal Electric Mfg. Co., Menominee, Mich.	{ H 94 R 42
Simpson Electric Company, 5208-18 W. Kinzie St., Chicago, Ill.	F 25 to 28
Simpson Mfg. Co., Mark ("Masco"), 188 W. 4th St., New York 14, N. Y.	C 71 to 74
Solar Manufacturing Corporation, 285 Madison Ave., New York 17, N. Y.	K 15 to 31
Speed-X (Les Logan Co.), 530 Gough St., San Francisco 2, Calif.	H 75, 76
Sprague Products Company, North Adams, Mass.	K 61 to 70
Standard Arcturus Corporation, 30 Court St., Newark, N. J.	B 23
Standard Transformer Corp. ("Stancor"), 1500 N. Halsted St., Chicago 22, Ill.	{ J 57 to 74 T 17
Sterling Manufacturing Co., The, 9205 Detroit Ave., Cleveland 2, Ohio	F 61, 62
Supreme Instruments Corporation, Greenwood, Miss.	F 19 to 22
Supreme Publications, 328 S. Jefferson St., Chicago 6, Ill.	G 8
Sylvania Electric Products, Inc., Emporium, Pa.	B 5 to 8
— T —	
Talk-A-Phone Manufacturing Co., 1219 W. Van Buren St., Chicago 7, Ill.	C 18 to 22
Taylor Tubes, Inc., 2312-18 Wabansia Ave., Chicago 47, Ill.	B 33, 34
Technical Appliance Corp. ("Taco"), 516 W. 34th St., New York 1, N. Y.	Q 41, 42
Telegraph Apparatus Co. ("Tac"), 325 W. Huron St., Chicago 10, Ill.	H 79, 80
Thordarson Electric Mfg. Co., 500 W. Huron St., Chicago 10, Ill.	J 75 to 82
Tokione (Regal Electronics Corp.), 20 W. 20th St., New York 11, N. Y.	C 23 to 26
Trimm, Inc., 1770 W. Berteau Ave., Chicago 13, Ill.	H 134
Triplett Electrical Instrument Co., 122 Main St., Bluffton, Ohio	F 1 to 6
Tung-Sol Lamp Works, Inc., 95 Eighth Ave., Newark 4, N. J.	B 13, 14
Turner Company, The, Cedar Rapids, Iowa	E 43, 44

MANUFACTURERS' DISPLAY PAGES (Continued)

(ALPHABETICAL)

	Section	Page
— U —		
United Electronics Company, 42 Spring St., Newark 2, N. J.	B	31, 52
United Transformer Company, 150 Varick St., New York 13, N. Y.	J	31 to 42
Universal Microphone Co., Ltd., 424 Warren Lane, Inglewood, Calif.	E	3, 4
University Laboratories, 225 Varick St., New York 14, N. Y.	D	61, 62
Utah Radio Products Company, 812 Orleans St., Chicago 10, Ill.	D	51 to 55
	J	1 to 4
	L	21 to 24
	M	37 to 38
Utica Drop Forge & Tool Corporation, Utica 4, N. Y.	S	35 to 38
	R	53, 54

	Section	Page
— V —		
Vaco Products Company, 317 E. Ontario St., Chicago 11, Ill.	R	47 to 49
Vasco Electrical Manufacturing Co., 4116 Avalon Blvd., Los Angeles 11, Calif.	R	39, 40
Vibroplex Co., Inc., The, 833 Broadway, New York 3, N. Y.	H	77, 78

	Section	Page
— W —		
Walsco (Walter L. Schott Co.), 9306 Santa Monica Blvd., Beverly Hills, Calif.	R	55 to 58
Ward Leonard Electric Co., South St., Mt. Vernon, N. Y.	H	81, 82
	M	19, 20
Westinghouse Electric Mfg. Co., Bloomfield, N. J.	B	37, 38
	U	5
Weston Electrical Instrument Corp., 614 Frelinghuysen Ave., Newark 5, N. J.	F	65 to 70
Wirt Company, 5221 Greene St., Philadelphia 44, Pa.	M	15 to 18
Worner Electronic Devices, 848 N. Noble Street, Chicago 22, Ill.	U	1 to 4

	Section	Page
— X —		
Xcelite (Park Metalware Co., Inc.), Orchard Park, N. Y.	R	27 to 30

FOR DETAILED GENERAL INDEX
REFER TO BACK OF BOOK.

While every precaution is taken to insure accuracy in the preparation of display pages and indexes, we cannot guarantee against the possibility of error or omission, nor can we be held responsible for price changes or withdrawal of items during or after publication.

FOR THE DURATION OF THE WAR, all enrolled manufacturers reserve the right not only to change prices or withdraw items without notice, but also TO MAKE SUCH MECHANICAL CHANGES IN SPECIFICATIONS AS MAY BE REQUIRED TO PRODUCE EQUALLY SUITABLE SUBSTITUTES, IF NECESSARY.

UNITED CATALOG PUBLISHERS, INC.

SAY YOU SAW IT IN "Radio's Master"

RADIO'S MASTER

INDEX OF MANUFACTURERS' DISPLAY PAGES

(NUMERICAL)

Note: The contents of each section are listed below in very sketchy fashion. Many additional items will be found, too numerous to list here; a number of items will also be found in sections to which they may not directly relate. For speedy reference and for the purpose of familiarizing yourself quickly with the general contents, this outline index will do. But for greater accuracy and dependability consult the exhaustive detailed general index in back of book.

SECTION B

Tubes—Receiving—Transmitting—Industrial—Special Purpose

Section & Page	Manufacturer
B-1, 2	Radio Corporation of America
B-5 to 8	Sylvania Electric Products, Inc.
B-9 to 12	Raytheon Production Corp.
B-13, 14	Tung-Sol Lamp Works, Inc.
B-15 to 17	National Union Radio Corp.
B-23	Standard Arcturus Corp.
B-24	General Electric Company
B-27, 28	Heintz & Kaufman, Ltd.
B-29, 30	Eitel-McCullough, Inc.
B-31, 32	United Electronics Co.
B-33, 34	Taylor Tubes, Inc.
B-35, 36	Amperex Electronic Products Co.
B-37, 38	Westinghouse Electric Mfg. Co.
B-39, 40	Continental Electric Company

SECTION C

Public Address—Sound Systems—Amplifying—Intercommunication

C-1 to 17	David Bogen Co., Inc.
C-18 to 22	Talk-A-Phone Manufacturing Co.
C-23 to 26	Regal Electronics Corp.
C-27, 28	The Rauland Corporation
C-35 to 42	Bell Sound Systems, Inc.
C-45 to 47	The Erwood Company
C-71 to 74	Mark Simpson Mfg. Co.

SECTION D

Speakers—Projectors—Reproducers—Horns and Trumpets

D-1 to 7	Racon Electric Co., Inc.
D-19 to 26	Jensen Radio Mfg. Co.
D-31, 32	Atlas Sound Corporation
D-41, 42	Kainer & Company
D-43 to 46	Cinaudagraph Speakers, Inc.
D-51 to 55	Utah Radio Products Co.
D-59, 60	Quam-Nichols Company
D-61, 62	University Laboratories
D-67	Economy Speakers
D-68	Selectar Mfg. Corp.

SECTION E

Microphones—Pickups—Phono and Recording Equipment

E-4	Universal Microphone Co.
E-7, 8	Amperite Company
E-9 to 12	Eastern Mike-Stand Co.
E-13 to 18	Shure Brothers
E-21 to 24	The Astatic Corporation
E-25, 26	Brush Development Co.
E-27, 28	The Alliance Mfg. Co.
E-31 to 34	American Microphone Co.
E-35, 36	Audak Company, Inc.
E-37, 38	Radio Corporation of America

Section & Page

Manufacturer

E-43, 44	The Turner Company
E-47, 48	Presto Recording Corp.
E-49, 50	Rek-O-Kut Corporation
E-57, 58	Audio Devices, Inc.
E-69, 70	DuoTone Company, Inc.
E-73	M. A. Miller Mfg. Co.
E-74	Howard Radio Company

SECTION F

Testers—Analyzers—Testing Equipment—Measuring Instruments

F-1 to 6	Triplett Electrical Inst. Co.
F-7, 8	Readrite Meter Works
F-13 to 16	Jackson Electrical Inst. Co.
F-19 to 21	Supreme Instruments Corp.
F-22 to 24	Littellfuse, Inc.
F-25 to 28	Simpsonelectric Company
F-31 to 34	Radio City Products Co., Inc.
F-35 to 38	Hickok Electrical Inst. Co.
F-59, 60	Allen B. Dumont Laboratories
F-61, 62	Sterling Manufacturing Co.
F-65 to 70	Weston Electrical Inst. Co.
F-75 to 78	Precision Apparatus Company

SECTION G

Books—Manuals

G-1, 2	Radio & Technical Publ. Co.
G-3 to 6	John F. Rider Publisher, Inc.
G-7	Editors & Engineers, Ltd.
G-8	Supreme Publications
G-11, 12	American Radio Relay League

SECTION H

Transmitters—Transmitting Equipment and Accessories—Communication Receivers—Amateur Equipment and Accessories—Variable Condensers—Telegraph Keys—Relays—Crystals—Headphones—Cabinets and Racks

H-1 to 14	The Hallicrafters Company
H-19, 20	Echophone Radio Company
H-21, 22	Radio Mfg. Engineers, Inc.
H-23	Hammarlund Mfg. Co., Inc.
H-24	Abbott Instruments, Inc.
H-25 to 28	Howard Radio Company
H-31 to 49	National Company, Inc.
H-51 to 54	Hammarlund Mfg. Co., Inc.
H-55 to 60	Allen D. Cardwell Mfg. Co.
H-61 to 66	E. F. Johnson Company
H-67, 68	J. H. Bunnell & Co.
H-69 to 72	McElroy Manufacturing Corp.
H-75, 76	Les Logan Company
H-77, 78	The Vibroplex Co., Inc.
H-79, 80	Telegraph Apparatus Co.
H-81, 82	Ward-Leonard Electric Co.
H-85 to 88	Advance Electric Company
H-89, 90	Guardian Electric Mfg. Co.
H-91 to 93	Allied Control Co., Inc.
H-94	Signal Electric Mfg. Co.
H-97 to 100	Par-Metal Products Co., Inc.
H-101 to 110	Bud Radio, Inc.
H-111 to 122	Insuline Corporation of America
H-125 to 128	James Millen Manufacturing Co.
H-131, 132	Bliley Electric Company
H-133	Hipower Crystal Company
H-134	Trimm, Inc.
H-135	C. F. Cannon Company
H-136	Brush Development Co.

INDEX OF MANUFACTURERS' DISPLAY PAGES (Concluded)

(NUMERICAL)

SECTION J Transformers

Section & Page	Manufacturer
J-1 to 4	Utah Radio Products Company
J-31 to 42	United Transformer Corp.
J-45, 46	The Halldorson Company
J-51 to 56	Kenyon Transformer Co., Inc.
J-57 to 74	Standard Transformer Corp.
J-75 to 82	Thordarson Electric Mfg. Co.

SECTION K Capacitors—Resistors

K-1 to 14d	Cornell-Dubilier Electric Corp.
K-15 to 31	Solar Manufacturing Corp.
K-37 to 58	Aerovox Corporation
K-61 to 70	Sprague Products Company
K-73, 74	American Condenser Corp.
K-75 to 79	Industrial Condenser Corp.
K-83	General Electric Company
K-84 to 90	Sangamo Electric Company
K-91 to 100	P. R. Mallory & Co., Inc.

SECTION L Volume Controls—Switches—Resistance Devices—Rheostats Dial Accessories—Plugs and Jacks

L-5 to 12	Centralab - Globe-Union, Inc.
L-13 to 18	Clarostat Mfg. Co., Inc.
L-21 to 24	Utah Radio Products Company
L-27	Acro Electric Company
L-42 to 46	Drake Manufacturing Co.
L-49 to 54	P. R. Mallory & Co., Inc.

SECTION M Resistors—Rheostats—Volume Controls—Attenuators—Switches

M-1 to 4	Ohmite Manufacturing Co.
M-5, 6	The Muter Company
M-9 to 12	Atlas Resistor Company
M-13, 14	Amperite Company
M-15 to 18	Wirt Company
M-19, 20	Ward Leonard Electric Co.
M-21 to 26	Continental Carbon Inc.
M-27 to 34	International Resistance Co.
M-37, 38	Utah Radio Products Company
M-41 to 48	P. R. Mallory & Co., Inc.
M-51, 52	Lectrohm, Inc.

SECTION N Connecting Devices—Plugs—Sockets—Adapters—Terminal Strips

N-1 to 10	American Phenolic Corp.
N-11 to 19	Howard B. Jones
N-24 to 36	Cannon Electric Develop. Co.

SECTION O Coils—Coil Kits—Amateur Accessories

O-1 to 11	Meissner Manufacturing Co.
O-12	Edwin I. Guthman & Co., Inc.
O-21 to 28	J. W. Miller Company
O-55, 56	Barker & Williamson

SECTION Q Wire and Cable—Antenna Accessories

Section & Page	Manufacturer
Q-1 to 3	Belden Manufacturing Co.
Q-19 to 24	Lenz Electric Mfg. Co.
Q-25 to 30	Alpha Wire Corporation
Q-35 to 38	Cornish Wire Company, Inc.
Q-41, 42	Technical Appliance Corp.
Q-47 to 50	Chisholm-Ryder Premax Div.
Q-51, 52	Corning Glass Works
Q-55 to 64	Birnbach Radio Company

SECTION R Tools—Hardware—Service Aids

R-1 to 4	Radio Essentials, Inc.
R-5, 6	Electric Soldering Iron Co., Inc.
R-7 to 12	Kraeuter & Company, Inc.
R-13, 14	Drake Electric Works, Inc.
R-15 to 22	General Cement Mfg. Co.
R-27 to 30	Park Metalware Co., Inc.
R-31, 32	Jackson Electro Corporation
R-39, 40	Vasco Electrical Mfg. Co.
R-41	American Electrical Heater Co.
R-42	Signal Electric Mfg. Co.
R-47 to 49	Vaco Products Company
R-51	Roesch and Spears
R-52	Gardiner Metal Company
R-53, 54	Utica Drop Forge & Tool Corp.
R-55 to 58	Walter L. Schott Company

SECTION S Vibrators

S-5 to 12	P. R. Mallory & Co., Inc.
S-19, 20	The Radiart Corporation
S-35, 36	Utah Radio Products Co.

SECTION T Batteries—Battery Chargers, Eliminators, Accessories—Power Packs—Power Plants—Generators—Converters

T-1	Burgess Battery Company
T-5, 6	Mueller Electric Company
T-7, 8	Pioneer Genemotor Corporation
T-9 to 12	American Televn. & Radio Co.
T-13, 14	Janette Manufacturing Co.
T-17	Standard Transformer Corp.
T-18	Eicor, Inc.
T-19 to 22	Electronic Laboratories, Inc.
T-25	General Transformer Corp.
T-26	Kato Engineering Company
T-27, 28	The Radiart Corporation
T-31, 32	P. R. Mallory & Co., Inc.

SECTION U Photo Electric Equipment

U-1 to 4	Worner Electronic Devices
U-5	Westinghouse Electric Mfg. Co.

While every precaution is taken to insure accuracy in the preparation of display pages and indexes, we cannot guarantee against the possibility of error or omission, nor can we be held responsible for price changes or withdrawal of items during or after publication.

FOR THE DURATION OF THE WAR, all enrolled manufacturers reserve the right not only to change prices or withdraw items without notice, but also TO MAKE SUCH MECHANICAL CHANGES IN SPECIFICATIONS AS MAY BE REQUIRED TO PRODUCE EQUALLY SUITABLE SUBSTITUTES, IF NECESSARY.



RCA RADIO TUBE PRICE LIST

PRICES EFFECTIVE JANUARY 1, 1943 • ALL PRICES SHOWN ARE EXCLUSIVE OF EXCISE TAX

NOTICE: The OPA requires us to call your attention to the following: "The suggested retail price (or Fair Trade price) may be charged only by any one reselling this article (or for any article listed in this catalogue or price list or Fair Trade contract for which a retail price is suggested or minimum price established), if the maximum price for that article, as established by the person so reselling under the appropriate OPA regulation, is at least equal to the suggested retail (or Fair Trade) price".

BROADCAST RECEIVER TYPES

Type	List Price	Type	List Price	Type	List Price	Type	List Price	Type	List Price	Type	List Price
OZ4	\$1.45	3A8GT	\$2.15	6F5GT/G	\$.85	6S07	.70	12K8	\$1.15	36	.80
OZ4G	1.45	3Q4	1.15	6F6	.95	6S07GT/G	.70	12Q7GT/G	.70	37	.70
1A3	1.15	3Q5GT/G	1.15	6F6G	.75	6SR7	.80	12SA7	.85	38	.85
1A4P	1.45	3S4	1.15	6F7	1.45	6S57	.85	12SA7GT/G	.85	39/44	.85
1A5GT/G	.95	5T4	1.75	6F8G	1.15	6S77	1.15	12SC7	1.15	41	.70
1A6	1.15	5U4G	.80	6G6G	1.15	6T7G	.95	12SF5	.85	42	.70
1A7GT/G	1.15	5V4G	1.45	6H6	.95	6U5/6G5	1.15	12SF5GT	.95	43	.95
1B4P	1.15	5W4	.95	6H6GT/G	.95	6U7G	.80	12SF7	1.15	45	.65
1B5/25S	1.15	5W4GT/G	.75	6J5	.75	6V6	1.75	12SG7	.95	45Z3	.85
1B7GT	1.15	5X4G	.95	6J5GT/G	.75	6V6GT/G	.95	12SH7	.95	45Z5GT	.80
1C5GT/G	1.15	5Y3GT/G	.60	6J7	.95	6V7G	1.15	12SJ7	.80	46	.95
1C6	1.15	5Y4G	.60	6J7G	.95	6W7G	1.45	12SK7	.75	47	.95
1C7G	1.15	5Z3	.80	6J7GT	.95	6X5	1.45	12SK7GT/G	.95	48	2.65
1D5GP	1.15	5Z4	1.15	6J8G	1.45	6X5GT/G	.70	12SL7GT	1.15	49	1.15
1D5GT	1.15	6A3	1.75	6K5GT/G	.80	6Y5	2.15	12SN7GT	1.15	50	2.15
1D7G	1.45	6A4/LA	1.45	6K6GT/G	.75	6Y6G	1.45	12SQ7	.70	50L6GT	.80
1D8GT	1.75	6A6	1.45	6K7	.85	6Y7G	1.45	12SQ7GT/G	.70	50Y6GT/G	.95
1E5GP	1.45	6A7	.80	6K7G	.85	6Z5	2.15	12SQ7GT/G	.70	50Z7G	1.15
1E7G	2.15	6A7S	2.15	6K7GT	.85	6Z7G	1.75	12SR7	.85	53	1.45
1F4	1.15	6A8	1.15	6K8	1.15	6ZY5G	1.15	12Z3	.80	55	.95
1F5G	1.15	6A8G	.85	6K8G	1.15	7A4	1.15	14A7/12B7	1.75	56	.65
1F6	1.45	6A8GT	.85	6K8GT	1.15	7A5	1.15	15	1.75	57	.75
1F7G	1.45	6A85/6N5	1.15	6L5G	.85	7A6	1.15	19	1.15	58	.75
1G4GT/G	1.15	6A87/1853	1.15	6L6	1.75	7A7	1.15	24A	.70	59	1.45
1G5G	1.15	6ACS5GT/G	.95	6L6G	1.75	7A8	1.15	25A4	1.75	70L7GT	1.75
1G6GT/G	1.45	6AC7/1852	1.75	6L7	1.45	7B4	1.15	25A4GT/G	.95	71A	.70
1H4G	.80	6AD6G	1.45	6L7G	1.45	7B5	1.15	25A7GT/G	1.45	75	.70
1H5GT/G	.95	6AD7G	1.15	6N6G	2.15	7B6	1.15	25AC5GT/G	1.45	76	.75
1H6G	1.15	6AE5GT/G	1.15	6N7	1.45	7B7	1.15	25B5	2.15	77	.75
1J5G	1.75	6AE6G	1.15	6N7GT/G	1.45	7B8	1.15	25B6G	1.75	78	.75
1J6G	1.15	6AE7GT	1.15	6P5GT/G	.70	7C5	1.15	25B8GT	1.75	79	1.45
1L4	1.15	6AF6G	1.15	6P7G	2.15	7C6	1.15	25C4G	1.75	80	.60
1LA4	2.15	6AG5	2.15	6Q7	1.15	7C7	1.15	25L6	1.45	81	1.75
1LA6	2.15	6AG7	2.15	6Q7G	.70	7E6	1.15	25L6GT/G	.85	82	1.15
1LB4	2.15	6BA4	1.75	6Q7GT	.70	7E7	1.45	25N6G	2.15	83	1.15
1LH4	2.15	6B5	1.75	6R7	1.15	7F7	1.45	25Y5	2.15	83V	1.75
1LN5	2.15	6B6G	.95	6R7GT/G	.75	7G7/1232	1.75	25Z5	.80	84/6Z4	.95
1N5GT/G	1.15	6B7	1.15	6S7	1.45	7H7	1.75	25Z6	1.15	85	.75
1N6G	1.15	6B7S	2.15	6S7G	.95	7J7	1.75	25Z6GT/G	.65	89	.80
1P5GT	1.45	6B8	1.75	6SA7	.85	7Q7	1.15	26	.60	117L7GT/	
1Q5GT/G	1.15	6B8G	1.15	6SA7GT/G	.85	7Y4	1.15	27	.60	117M7GT	2.15
1R5	1.15	6CS	.95	6SC7	1.15	10	2.65	30	.80	117N7GT	2.15
1S4	1.15	6CS5GT/G	.85	6SF5	.85	12A5	2.15	31	.80	117P7GT	2.15
1S5	.95	6C6	.80	6SF5GT	.85	12A7	1.75	32	1.15	117Z6GT/G	1.45
1T4	1.15	6C7	2.15	6SF7	1.15	12A8GT/G	.85	32L7GT	1.75	183/483	1.75
1T5GT	1.45	6C8G	1.45	6SG7	.95	12AH7GT	1.45	33	1.15	485	1.75
1V	.80	6D4	.80	6SH7	.95	12B8GT	1.45	34	1.15	XXD	1.45
2A3	1.75	6D7	2.15	6SJ7	.80	12C8	1.45	35	.80	XXL	1.45
2A5	.80	6D8G	1.15	6SJ7GT	.95	12F5GT	.85	35A5	1.15		
2A6	.80	6E5	.95	6SK7	.75	12H6	.95	35L6GT/G	.80		
2A7	.95	6E6	1.75	6SK7GT/G	.95	12J5GT	.75	35Z3	1.15		
2B7	1.15	6E7	2.15	6SL7GT	1.15	12J7GT/G	.95	35Z4GT	.65		
2E5	1.15	6F5	.95	6SN7GT	1.15	12K7GT/G	.85	35Z5GT/G	.65		

Prices subject to change or withdrawal without notice.

NOTE: Additional charge for service where testing and installation is provided.

ALLIED RECEIVING TYPES

2C21/1642	\$0.95	12A6	\$.70	959	5.00	1613	\$1.55	1629	\$.75	1851	\$2.10
2C22	1.10	864	1.00	1602	2.75	1614	2.80	1631	2.00	9001	2.50
3A4	.75	954	4.50	1603	4.75	1619	2.20	1632	2.00	9002	2.00
3A5	1.30	955	2.75	1608	4.00	1620	2.50	1633	1.50	9003	2.50
5R4GY	1.00	956	4.50	1609	1.60	1621	1.20	1634	1.10	9004	2.00
6AK6	1.10	957	3.00	1610	2.00	1622	1.40	1635	1.15	9005	2.20
6C4	.90	958	3.00	1612	2.00	1626	1.60	1644	1.50	EK-1000	.75
6J6	1.85										



TRANSMITTING & SPECIAL PURPOSE TUBES

NOTICE: The suggested retail price (or Fair Trade price) may be charged only by any one reselling this article (or for any article listed in this catalogue or price list or Fair Trade contract for which a retail price is suggested or minimum price established), if the maximum price for that article, as established by the person so reselling under the appropriate OPA regulation, is at least equal to the suggested retail (or Fair Trade) price.

POWER AND ALLIED TYPES

Type	List Price	Type	List Price	Type	List Price	Type	List Price
203-A	\$10.00	810	\$13.50	835	\$16.00	866A/866	\$1.50
204-A	85.00	811	3.50	836	11.50	872	7.50
211	10.00	812	3.50	837	2.80	872A	7.50
217-A	20.00	813	22.00	838	11.00	872A/872	7.50
217-C	20.00	814	17.50	841*	3.25	1616	5.75
800	10.00	815	4.50	842	3.25	1623	2.50
801-A	2.50	816	1.00	843	1.65	1624	2.40
802	3.50	825	34.50	845	10.00	1625	2.25
803	25.00	826	19.00	849	120.00	1627	13.50
804	15.00	828	17.50	850	37.50	8000	13.50
805	13.50	829-A	19.50	851	195.00	8001	27.50
806	22.00	830-B	16.00	852	16.40	8003	12.00
807	2.25	832-A*	17.00	860	21.50	8005	7.00
808	7.75	833-A	76.50	861	155.00	8008	8.50
809	2.50	834	12.50	865	7.95	8012	19.00
						8025	14.50

SPECIAL TUBE TYPES

Type	List Price	Type	List Price	Type	List Price	Type	List Price
CA4G	\$3.95	885	\$2.00	926	\$3.00	2050	\$1.90
1C21	1.65	917	3.40	927	3.70	2051	1.15
2A4G	1.30	918	2.30	928	2.00	8013-A	12.00
2V3G	1.30	919	3.35	929	3.00	8016	2.75
2X2/879	1.05	920	2.70	930	2.00	VR/75-30	1.05
4B26/2000	6.00	921	2.00	931	12.00	VR/105-30	1.00
858	3.70	922	2.00	934	2.90	VR/150-30	1.00
874	1.50	923	1.25	935	18.00		
878	11.00	924	2.00	991	.90		
884	2.00	925	2.00	1904	20.00		

CATHODE RAY TYPES

Type	List Price	Type	List Price	Type	List Price	Type	List Price
2AP1	\$6.25	5BP1/1802P1	\$24.75	9AP4/1804P4	\$62.50	913	4.00
3AP1/906P1	13.50	5CP1	28.00	9JP1/1809P1	42.00	914	85.00
3AP4/906P4	18.25	5CP4	34.00	12AP4/1803P4	75.00	1847	24.50
3BP1	15.00	5HP1	20.00	902	7.50	1898	24.00
3EP1/1806P1	12.75	5HP4	21.00	904	52.50	1899	95.00
5AP4/1805P4	27.50	7AP4	36.00	905	45.00		
5BP4/1802P4	27.50	7CP1/1811P1	40.00	912	163.40		

* Indicates type subject to Federal Excise Tax.



SYLVANIA RADIO TUBES



Reprinted



May, 1943

Type	List Price	Type	List Price	Type	List Price	Type	List Price
0A4G	\$1.90	6AC5GT/G.....	\$1.05	7B8 (Lock-In).....	\$1.25	35A5 (Lock-In)	\$1.25
0Z4 (Met).....	1.55	6AD7G.....	1.55	7C5 (Lock-In)	1.25	35L6GT/G95
0Z4G.....	1.55	6AF5G.....	1.25	7C6 (Lock-In)	1.25	35S/51S (Maj).....	2.30
01A.....	.85	6B4G.....	1.90	7C7 (Lock-In)	1.25	35V4 (Lock-In).....	1.55
1A4P.....	1.55	6B5.....	1.90	7E6 (Lock-In).....	1.25	35Z3 (Lock-In)	1.25
1A4T	1.55	6B7	1.25	7E7 (Lock-In).....	1.55	35Z5GT/G80
1A5GT/G	1.05	6B7S (Maj).....	2.30	7F7 (Lock-In)	1.55	3695
1A6.....	1.25	6B8G	1.25	7G7/1232 (Lock-In).....	1.90	3780
1A7GT/G	1.25	6C5GT/G95	7H7 (Lock-In)	1.90	38	1.05
1B4P.....	1.25	6C6.....	.95	7J7 (Lock-In).....	1.90	39/4495
1B7G.....	1.25	6C7 (Maj).....	2.30	7L7 (Lock-In).....	1.90	4180
1C5GT/G	1.25	6C8G	1.55	7N7 (Lock-In)	1.90	4280
1C7G.....	1.25	6D6.....	.95	7Q7 (Lock-In).....	1.25	43	1.05
1D5GT.....	1.25	6D7 (Maj).....	2.30	7R7 (Lock-In).....	1.55	4575
1D7G.....	1.55	6E5.....	1.05	7S7 (Lock-In).....	1.90	46	1.05
1E4G.....	1.25	6E6.....	1.90	7V7 (Lock-In)	2.30	47	1.05
1E5GP.....	1.55	6F5GT/G95	7W7 (Lock-In).....	2.30	48	2.80
1E7G.....	2.30	6F6G85	7Y4 (Lock-In)	1.25	49	1.25
1F4.....	1.25	6F7.....	1.55	10.....	2.80	50	2.30
1F5G.....	1.25	6F7S (Maj).....	2.30	12A.....	.95	50A5 (Lock-In).....	1.90
1F7G.....	1.55	6F8G	1.25	12A5.....	2.30	50L6GT	1.05
1G4GT/G.....	1.25	6G6G.....	1.25	12A7.....	1.90	50Y6GT/G	1.05
1G6GT/G.....	1.55	6H4GT.....	1.90	12A8GT95	53.....	1.55
1H4G.....	.95	6H6GT/G	1.05	12F5GT.....	.95	55.....	1.05
1H5G.....	1.25	6J5GT/G85	12J5GT95	55S (Maj).....	2.30
1H5GT/G	1.05	6J7G.....	1.05	12J7GT.....	1.05	5675
1H6G.....	1.25	6J7GT	1.05	12K7GT/G95	56AS (Maj).....	2.30
1J5G.....	1.90	6J8G.....	1.55	12Q7G.....	1.25	56S (Maj).....	2.30
1J6G.....	1.25	6K5G.....	1.05	12Q7GT85	5785
1LA4 (Lock-In)	2.30	6K5GT	1.05	12SA7GT/G	1.25	57AS (Maj).....	2.30
1LA6 (Lock-In).....	2.30	6K6GT/G95	12SJ7GT	1.05	57S (Maj).....	2.30
1LB4 (Lock-In).....	2.30	6K7G.....	1.05	12SK7GT/G	1.05	5885
1LC5 (Lock-In).....	2.30	6K7GT95	12SQ7GT/G	1.05	58AS (Maj).....	2.30
1LC6 (Lock-In).....	2.30	6K8G.....	1.25	12T3.....	.95	58S (Maj).....	2.30
1LD5 (Lock-In).....	2.30	6K8GT	1.25	14A4 (Lock-In).....	1.90	70L7GT	1.90
1LE3 (Lock-In).....	1.90	6L5G.....	1.05	14A7/12B7 (Lock-In)	1.90	71A85
1LH4 (Lock-In).....	2.30	6L6G	1.90	14B6 (Lock-In).....	1.55	7580
1LN5 (Lock-In).....	2.30	6L7G	1.55	14B8 (Lock-In).....	1.90	75S (Maj).....	2.30
1N5GT/G	1.25	6N6G.....	2.30	14C5 (Lock-In).....	1.90	7685
1N6G.....	1.25	6N7G	1.55	14C7 (Lock-In).....	1.90	7785
1P5G.....	1.55	6P5GT/G.....	.75	14F7 (Lock-In).....	1.90	7885
1P5GT	1.55	6P7G.....	2.30	14H7 (Lock-In).....	1.90	8065
1Q5GT/G	1.55	6Q7G.....	.85	14J7 (Lock-In).....	1.90	81	1.90
1T5GT	1.55	6Q7GT85	14N7 (Lock-In).....	1.90	82	1.25
1V.....	.95	6R7GT/G85	14Q7 (Lock-In).....	1.55	83	1.25
2A3	1.90	6S7G.....	1.55	14R7 (Lock-In).....	1.55	83V.....	1.90
2A595	6SA7GT/G	1.05	14S7 (Lock-In).....	1.90	84/6Z4	1.05
2A6.....	.95	6SC7GT	1.25	14W7 (Lock-In).....	2.30	85.....	.85
2A7.....	1.05	6SD7GT	1.25	14Y4 (Lock-In).....	1.90	85AS (Maj).....	2.30
2A7S (Maj).....	2.30	6SJ7GT	1.05	15.....	1.90	99.....	2.80
2B7.....	1.25	6SK7GT/G	1.05	18.....	1.90	117L7/M7GT	2.30
2B7S (Maj).....	2.30	6SQ7GT/G	1.05	19.....	1.25	117Z6GT/G	1.55
2E5.....	1.25	6T7G.....	1.25	20.....	2.80	182B/482B.....	1.90
2Z2/G84 (Maj).....	2.30	6U5/6G5	1.25	22.....	2.30	183/483.....	1.90
3A8GT.....	2.30	6U6GT.....	1.25	24A85	OB3/VR90 ("G").....	2.30
3Q5GT/G	1.55	6V6GT/G	1.05	24S (Maj).....	2.30	VR105-30 ("G").....	2.30
5U4G.....	.95	6V7G.....	1.25	25C6G.....	1.90	OD3/VR150 ("G").....	2.30
5V4G.....	1.55	6W7G.....	1.55	25L6GT/G	1.05	XXD (Lock-In).....	1.55
5X4G.....	1.05	6X5GT/G95	25Z595	XXFM (Lock-In).....	1.90
5Y3GT/G65	6Y5 (Maj).....	2.30	25Z6GT/G95	XXL (Lock-In).....	1.55
5Y4G70	6Y7G.....	1.55	2670		
5Z3	1.05	7A4 (Lock-In)	1.25	2765		
6A3.....	1.90	7A5 (Lock-In).....	1.25	27S (Maj).....	2.30		
6A5G.....	2.80	7A6 (Lock-In)	1.25	3095		
6A6.....	1.55	7A7 (Lock-In).....	1.25	3195		
6A795	7A8 (Lock-In)	1.25	32.....	1.25		
6A7S (Maj).....	2.30	7B4 (Lock-In).....	1.25	32L7GT.....	1.90		
6ABG.....	.95	7B5 (Lock-In)	1.25	33.....	1.25		
6A8GT95	7B6 (Lock-In).....	1.25	34.....	1.25		
6AB5/6N5.....	1.55	7B7 (Lock-In)	1.25	35/5195		

(Maj) Majestic

Types shown in Bold face represent approximately 90% of replacement demand.

SALES AND SERVICE HELPS

COMPLETE RADIO SERVICE

WE RECOMMEND

Sylvania

Sylvania
RADIO TUBES
COMPLETE RADIO SERVICE

YOUR NAME HERE

CORRELATION OF TUBE TYPES FOR SUBSTITUTION

Simplified - Week by Week
BUSINESS RECORD
FOR INCOME TAX PURPOSE

for the Radio Serviceman

SYLVANIA NEWS
Technical Section

RADIO SERVICE

Sylvania
RADIO TUBES

Characteristics

PROMPT RADIO SERVICE
CALL

SYLVANIA RADIO TUBES

Sylvania
TUBE
complement
BOOK

YOU NEED YOUR RADIO NOW -
LET US KEEP IT WORKING!
WE USE AND RECOMMEND
SYLVANIA RADIO TUBES

Window Display and Signs
Direct Mail Advertising
Newspaper Campaigns
Business Forms and Stationery
Technical Literature and Books
Remembrance Advertising
Special Store and Shop Items
Sylvania News

For complete information and details
See your Sylvania Distributor

SYLVANIA

ELECTRIC PRODUCTS INC.
EMPORIUM, PENNA

YOUR NAME HERE

RADIO SERVICE



SYLVANIA RADIO TUBES

RADIO SERVICE



YOU NEED YOUR RADIO NOW -
LET US KEEP IT WORKING!
WE USE AND RECOMMEND
SYLVANIA RADIO TUBES

Sylvania
NEWSPAPER ADVERTISING PLATS

SYLVANIA

Sylvania
RADIO TUBES

Sylvania Panel Lamps



A complete line of Sylvania Panel Lamps is now made available. These Sylvania lamps are especially designed for radio dials, tuning meters, flash-tuning arrangements and the like, but a market will also be found for some of the types in flash-lights, parking lights, auto panel boards, pin ball machines, and wherever a miniature lamp of this style is required.

The early types of panel lamps were used primarily as on-or-off indicators in radio receivers. Present day panel lamps must be constructed to withstand speaker vibrations, have noise free operation, current drain within the required limit (particularly when used in ac-dc receivers and battery receivers), and to provide shadowless illumination. The Sylvania line of radio panel lamps have been constructed for all these requirements.

The replacement of panel lamps **should** be made with lamps having the same type number. This is particularly true in tuning meters, battery, and AC-DC receiver replacements. The filament wires of all standard panel lamps are mounted through a small colored glass bead located above the bulb press. If the markings on the lamp to be replaced are not legible, the bead color may be used as identification, provided voltage supply is known.

Sylvania type S47 is the same as other lamps marked 40A. Lamps marked 49A may be replaced with Sylvania type S49. Type S292 is mainly for use in 2.5 volt receivers where the line voltage is high, and regular 2.5 volt lamps will not stand up.

It is recommended that complete replacement of panel lamps be made on a receiver at one time. Additional profit and a satisfied customer will be the result. The average life of panel lamps is considerable, but unpredictable, because of varying applications and conditions. Therefore, because of the low unit cost, complete replacement is recommended whenever convenient.

Hygrade Sylvania Corporation manufactures a complete line of Sylvania Radio Tubes and Hygrade Lamp Bulbs. Over thirty-five years of Lamp Bulb and Radio Tube manufacturing and merchandising experience has earned Hygrade Sylvania Corporation a prominent and enviable position in these fields. For information regarding Sylvania Radio Tubes, and Sylvania Panel Lamps, we invite you to write to Hygrade Sylvania Corporation, Emporium, Pa.

SYLVANIA
ELECTRIC PRODUCTS INC.

EMPORIUM, PENNA.

Sylvania

REG. U. S. PAT. OFF.

PANEL LAMPS



Fully Licensed as indicated on carton

Type No.	Code Word	Filament		Bulb Style	Type of Base	Bead Color	List Price	
		Volts	Ampere				Each	Carton of 10
S40	Peach	6-8	0.15	T-3¼	Screw	Brown	\$0.09	\$0.90
S41	Pear	2.5	0.50	T-3¼	Screw	White	.09	.90
S42	Plum	3.2	0.35	T-3¼	Screw	Green	.12	1.20
S43	Prune	2.5	0.50	T-3¼	Bayonet	White	.09	.90
S44	Pome	6-8	0.25	T-3¼	Bayonet	Blue	.09	.90
S45	Pine	3.2	0.35	T-3¼	Bayonet	White	.12	1.20
S46	Perch	6-8	0.25	T-3¼	Screw	Blue	.09	.90
*S47	Pick	6-8	0.15	T-3¼	Bayonet	Brown	.09	.90
S48	Page	2.0	0.06	T-3¼	Screw	Pink	.15	1.50
*S49	Port	2.0	0.06	T-3¼	Bayonet	Pink	.15	1.50
S50	Pat	6-8	0.20	G-3½	Screw	White	.10	1.00
S51	Pup	6-8	0.20	G-3½	Bayonet	White	.07	.70
S55	Purr	6-8	0.40	G-4½	Bayonet	White	.07	.70
S292	Past	2.9	0.17	T-3¼	Screw	White	.12	1.20
S292A	Pantry	2.9	0.17	T-3¼	Bayonet	White	.12	1.20
S1455	Parlor	18.0	0.25	G-5	Screw	Brown	.10	1.00
S1455A	Prayer	18.0	0.25	G-5	Bayonet	Brown	.10	1.00

*Sylvania Types S47 and S49 are interchangeable with Types 40A and 49A respectively, in any other brand.

ILLUSTRATIONS AND DIMENSIONS

(Actual Sizes)

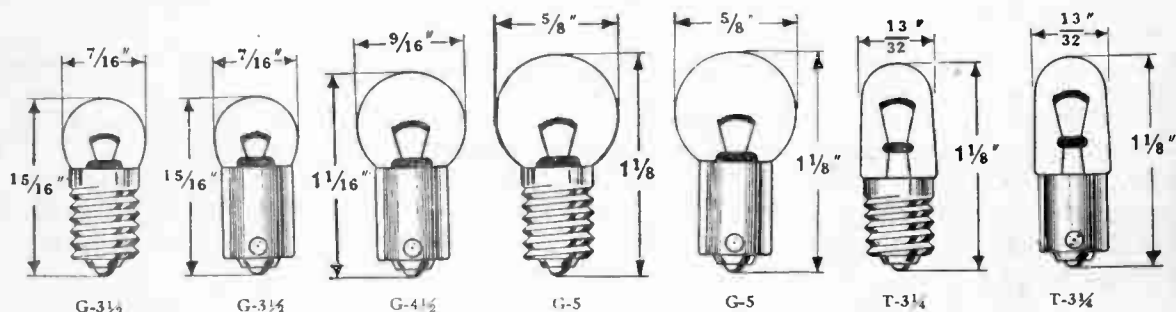

DISCOUNTS TO DEALERS AND SERVICEMEN

Sylvania Panel Lamps are packed in cartons of ten (10) of a type. Cartons (of 10 lamps each) will not be broken.

1 to 9 Cartons (10 to 90 Lamps) 40% from List Prices
 10 to 19 Cartons (100 to 190 Lamps) 40-10% from List Prices
 20 or more Cartons (200 or more Lamps) 50% from List Prices

Cartons May Be Assorted to Obtain Quantity Prices.



WORLD'S LARGEST EXCLUSIVE RADIO TUBE MANUFACTURERS

DEPENDABLE

Type No.	List Price	Type No.	List Price	Type No.	List Price	Type No.	List Price	Type No.	List Price
00A	\$2.30	3Q5GT	\$1.55	6K7GT	\$0.95	7J7	\$1.90	34	\$1.25
01A	.85	3S4	1.55	6K8G	1.25	7L7	1.90	35/51	.95
0A4G	1.90	4A6G	2.15	6K8GT	1.25	7N7	1.90	35A5	1.25
0Z4	1.55	5T4	1.90	6L5G	1.05	7Q7	1.25	35L6GT/G	.95
0Z4G	1.55	5U4G	.95	6L6G	1.90	7R7	1.90	35Z3	1.25
1A4P	1.55	5V4G	1.55	6L7	1.55	7Y4	1.25	35Z4GT	.75
1A4T	1.55	5W4	1.05	6L7G	1.55	10	2.80	35Z5GT	.80
1A5GT	1.05	5W4GT/5W4G	.85	6N6G	2.30	12A	.95	35Z6G	1.25
1A6	1.25	5X4G	1.05	6N7	1.55	12A5	2.30	36	.95
1A7GT	1.25	5Y3GT/G	.75	6N7G	1.55	12A6GT	1.90	37	.80
1B4/951	1.25	5Y4G	.65	6P5G	.80	12A7	1.90	38	1.05
1B5/25S	1.25	5Z3	1.05	6P5GT	.75	12A8GT	.95	39/44	.95
1B7G	1.25	5Z4	1.25	6P7G	2.30	12B7	Use 14A7/12B7	40	1.55
1C5G	1.55	5Z4MG	Use 5Z4	6Q7G	.85	12B8GT	1.55	41	.80
1C5GT	1.25	6A3	1.90	6Q7GT	.85	12C8	1.90	42	.80
1C6	1.25	6A4/LA	1.55	6R7G	1.05	12F5GT	.95	43	1.05
1C7G	1.25	6A5G	2.80	6R7GT	.85	12J5GT	.95	45	.75
1D5GP	1.25	6A6	1.55	6S7	1.55	12J7GT	1.05	45Z5GT	1.05
1D5GT	1.25	6A7	.95	6S7G	1.55	12K7GT	.95	46	1.05
1D7G	1.55	6A8	1.25	6SA7GT	1.05	12K8GT	1.25	47	1.05
1D8GT	1.90	6A8G	.95	6SC7GT	1.25	12Q7GT	.85	48	2.80
1E4G	1.25	6A8GT	.95	6SD7GT	1.25	12SA7GT	1.25	49	1.25
1E5GP	1.55	6AB5/6N5	1.55	6SF5GT	.95	12SC7	1.25	50	2.30
1E7G	2.30	6AC5G	1.25	6SF7	1.25	12SF5GT	1.05	50C6G	1.90
1F4	1.25	6AC5GT	1.05	6SG7	1.25	12SH7GT	1.25	50L6GT	1.05
1F5G	1.25	6AD6G	1.55	6SH7GT	1.25	12SJ7	1.05	50Y6GT	1.05
1F6	1.55	6AD7G	1.55	6SJ7GT	1.05	12SJ7GT	1.05	50Z7G	1.25
1F7GH	1.55	6AE5GT/G	1.25	6SK7GT	1.05	12SK7GT	1.05	52	2.80
1G4G	1.25	6AE6G	1.25	6SL7GT	1.55	12SL7GT	1.55	53	1.55
1G4GT/G	1.05	6AE7GT	1.25	6SN7GT	1.25	12SN7GT	1.25	55	1.05
1G5G	1.25	6AF6G	1.55	6SO7GT	1.05	12SQ7GT	1.05	56	.75
1G6G	1.55	6B4G	1.90	6SR7	1.05	12SR7	1.25	57	.85
1G6GT/G	1.55	6B5	1.90	6T7G	1.25	12SR7GT	1.25	58	.85
1H4G	.95	6B6G	1.05	6U5/6G5	1.25	12Z3	.95	59	1.55
1H5GT	1.05	6B7	1.25	6U6GT	1.25	14A7/12B7	1.90	70A7GT	2.30
1H6G	1.25	6B8	1.90	6U7G	.95	14H7	1.90	70L7GT	1.90
1J5G	1.90	6B8G	1.25	6V6GT	1.05	15	1.90	71A	.85
1J6G	1.25	6C5	1.05	6V7G	1.25	19	1.25	75	.80
1LA4	2.30	6C5G	.95	6W5G	1.90	20	2.80	76	.85
1LA6	2.30	6C5GT	.95	6Y6G	1.55	22	2.30	77	.85
1LB4	2.30	6C6	.95	6W7G	1.55	24A	.85	78	.85
1LC6	2.30	6C8G	1.55	6X5GT	.95	25A6G	1.05	79	1.55
1LH4	2.30	6D6	.95	6Y6G	1.90	25A6GT	1.05	80	.65
1LN5	2.30	6D8G	1.55	6Z7G	1.25	25A7GT/G	1.55	81	1.90
1N5G	1.55	6E5	1.05	6ZY5G	1.25	25AC5G	1.55	82	1.25
1N5GT	1.25	6E6	1.90	7A4	1.25	25AC5GT	1.55	83	1.25
1N6G	1.25	6F5	1.05	7A5	1.25	25B6G	1.90	83V	1.90
1P5GT	1.55	6F5GT	.95	7A6	1.25	25B8GT	1.90	84/6Z4	1.05
1Q5GT	1.55	6F6	1.05	7A7	1.25	25C6G	1.90	85	.85
1R5	1.55	6F6G	.85	7A8	1.25	25L6	1.55	89	.95
1S4	1.55	6F7	1.55	7B4	1.25	25L6GT	1.05	V-99	2.80
1S5	1.55	6F8G	1.25	7B5	1.25	25L6GT	2.30	X-99	2.80
1T4	1.55	6G6G	1.25	7B6	1.25	25Y5	.95	117L7GT/117M7GT	2.30
1T5GT	1.55	6H4GT	1.90	7B7	1.25	25Z5	.95	117N7GT	2.30
1V	.95	6H6	1.05	7B8	1.25	25Z6	1.25	117Z6GT	1.55
2A3	1.90	6H6GT/G	1.05	7C5	1.25	25Z6GT	.95	950	1.90
2A4G	2.30	6J5GT	.85	7C6	1.25	26	.70	1232	Use 7G7/1232
2A5	.95	6J7G	1.05	7C7	1.25	27	.65	1291	2.30
2A6	.95	6J7GT	1.05	7E6	1.25	30	.95	1294	1.90
2A7	1.05	6J8G	1.55	7E7	1.55	31	.95	1299	2.30
2B7	1.25	6K5G	1.05	7F7	1.55	32	1.25	XXD	1.55
2E5	1.25	6K6GT	.95	7G7/1232	1.90	32L7GT	1.90	XXL	1.55
3A8GT	2.30	6K7G	1.05	7H7	1.90	33	1.25		

Prices Subject to Change Without Notice

DEPENDABLE

RAYTHEON

QUALITY

SPECIAL TYPE TUBES

MAJESTIC TYPES

Type No.	List Price	Type No.	List Price
2A7S	\$2.30	24S	\$2.30
2B7S	2.30	27S	2.30
2S/4S	2.30	35S/51S	2.30
2Z2/G84	2.30	55S	2.30
6A7S	2.30	56AS	2.30
6B7S	2.30	56S	2.30
6C7	2.30	57AS	2.30
6D7	2.30	57S	2.30
6E7	2.30	58AS	2.30
6F7S	2.30	58S	2.30
6Y5	2.30	75S	2.30
6Z5	2.30	85AS	2.30

Type No.	SPARTON TYPES	List Price
182B/482B		\$1.90
183/483		1.90

SPECIAL RECTIFIERS

BA	\$6.55
BH	3.70
BR	2.70

TELEVISION TYPES

2X2/879	\$2.30
6AB7/1853	1.90
6AC7/1852	2.30
6AG7	2.30
6AL6G	6.80

VOLTAGE REGULATOR TYPES

VR-90	\$2.30
VR-105	2.30
VR-150	2.30

RESISTOR TUBES

Type No.	List Price	Type No.	List Price
1A1	\$1.25	L49D	\$.85
1B1	1.25	K55B	.85
42A	.85	K55C	.85
K42B	.85	K55D	.85
BK42B	.85	L55C	.85
L42B	.85	L55D	.85
L42C	.85	M73B	.85
49A	.85	165R	.85
K49B	.85	165R4	.85
K49C	.85	185R	.85
K49CB	.85	185R4	.85
BK49C	.85	1e5R8	.85
K49D	.85	NB2	.86
L49B	.85	NB8	.85
L49C	.85		

SOUND SPECIAL TYPES

Type No.	List Price
SS-5U4G	\$1.25
SS-5V4G	1.90
SS-5Y3G	.95
SS-6C5G	1.25
SS-6C8G	1.90
SS-6F6G	1.05
SS-6F8G	1.55
SS-6J7G	1.25
SS-6J7GT	1.25
SS-6K6G	1.25
SS-6L6G	2.30
SS-6L7G	1.90
SS-6N6G	2.80
SS-6N7G	1.90
SS-6V6G	1.55
SS-6X5G	1.25
SS-83	1.55

RAYTHEON DEPENDABLE MINIATURE LAMPS

Lamp No.	Volts	Amps.	Type of Base	Approx. Candle Power	Bead Color	List Price Per Unit Pkg. of 10
----------	-------	-------	--------------	----------------------	------------	--------------------------------

REGULAR PANEL TYPES

R40	6-8	0.15	Miniature Screw	0.5	Brown	\$0.90
R40A	6-8	0.15	" Bayonet	0.5	Brown	0.90
R41	2.5	0.50	" Screw	0.5	White	0.90
R42	3.2	0.50	" Screw	0.75	Green	1.20
R43	2.5	0.50	" Bayonet	0.5	White	0.90
R44	6-8	0.25	" Bayonet	0.8	Blue	1.20
R45	3.2	0.50	" Bayonet	0.75	Green	0.90
R46	6-8	0.25	" Screw	0.8	Blue	1.50
R48	2.0	0.06	" Screw	0.03	Pink	1.50
R49	2.0	0.06	" Bayonet	0.03	Pink	1.80
R49A	2.1	0.12	" Bayonet	0.07	White	1.00
R50	6-8	0.20	" Screw	1.0	White	1.20
R292	2.9	0.17	" Screw	0.3	White	1.20
R292A	2.9	0.17	" Bayonet	0.3	White	1.20

AUTOMOTIVE TYPES

R51	6-8	0.20	Miniature Bayonet	1.0	White	\$0.70
R55	6-8	0.40	" Bayonet	1.5	White	0.70

Raytheon Dependable Panel Lamps are of the highest quality and are designed especially to meet the requirements of the replacement market.

The color of the bead inside the lamp bulb may be used to identify the more common Raytheon types. This information is shown in the column headed "Bead Color."

Raytheon Miniature Lamps are packed in unit boxes of ten (10) of a type.

All orders for these lamps must be for unit quantities, or multiples, of each type.

Ask your Raytheon Jobber for the new Dealer and Service Helps folder picturing all current Raytheon display material and other selling aids.

Prices Subject To Change Without Notice

RAYTHEON RK

Amateur TUBES



Raytheon High Efficiency Beam Power Types

RK-39*
Cathode Type
6.3 Heater
35 Watts output—low drive
Price\$3.50

The RK-39 — one of the most popular Raytheon Transmitting types—is suitable for practically all amateur classes of service. Highest quality parts are used throughout resulting in exceptional performance. This tube is now standard in many commercial transmitters requiring the utmost dependability.

Raytheon Heavy Duty Tantalum Element Types

RK63* **RK65***
Triode Tetrode
525 Watts 510 Watts
output Output
Price \$22.00 Price \$34.50

These two exceptional types are designed for higher power applications requiring long life and dependability. The tantalum elements and rigid exhaust schedules assure gas free operation under all conditions while low capacities, hard glass bulbs and ceramic bases aid in providing efficient results at ultra high frequencies.

Maximum results are obtained from the RK63 with but 17 watts drive but for maximum power gain the RK65 is recommended with only 6 watts drive required. This is particularly advantageous in applications requiring the fewest number of tubes in the rig.

These tubes may also be used as oscillators and as Class B amplifiers.

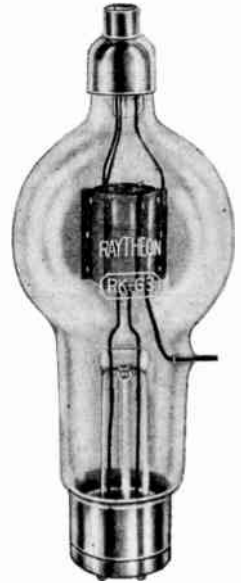

Raytheon Tubes for Radio Control of Models

Transmitter **Receiver**
RK34* **RK62***
Price \$3.50 Price \$3.50

The combination of these two types is ideal for remote control of model airplanes, boats, etc. Even with battery operation at less than full ratings the RK34 will provide sufficient output to operate the RK62 receiver over an appreciable distance.

One type RK62 in our recommended super-regenerative circuit will provide sufficient power gain to operate a relay without addi-

Raytheon High Vacuum Full Wave Rectifier

RK60*
600 volts 250 ma.
Price \$2.75

Specially designed to furnish power for 2 type RK39 or similar types. Applicable to all types of service particularly where operation is required under temperature conditions unsuitable for



A LOW-COST RECTIFIER OF CHARACTERISTIC RAYTHEON QUALITY*

THE 866 AS
RAYTHEON
BUILDS IT!



One dollar and fifty cents never bought so much in a radio tube. Regardless of the price, our engineers had to build real performance into this tube—because it carries the name RAYTHEON. Save with safety. Ask your dealer for RAYTHEONS. They cost no more, but they're worth a lot more to you. Note the new higher ratings.

RAYTHEON FLAT HEARING AID TYPES

Number	Net Price	Type	DIMENSIONS			FILAMENT (OXIDE)		RATED VOLTAGES		
			Length	Width	Thickness	Volts	Amps.	Plate	Grid	Ser. Grid
CK-502AX	\$3.50	Pentode	1½"	.385"	.285"	1.25	0.030	30	0	30
CK-503AX	\$3.50	Pentode	1½"	.385"	.285"	1.25	0.030	45	-1.25	45
CK-505AX	\$3.50	Pentode	1½"	.385"	.285"	0.625	0.030	30	0	30
CK-507AX	\$3.50	Pentode	1½"	.385"	.285"	1.25	0.047	45	-1.25	45
CK-509AX	\$3.10	Triode	1½"	.385"	.285"	0.625	0.030	45	0	—

*SEE OTHER SIDE OF THIS PAGE FOR DETAILED DATA

DEPENDABLE RAYTHEON QUALITY

HIGH GAIN, LOW GRID-PLATE CAPACITY MULTI-GRID TRANSMITTING TUBES were first developed and manufactured by Raytheon. The RK-25, RK-39 and RK-65 are all tubes of advanced design in this class. The RK-34, RK-38, RK-63 and RK-65 are now widely used in amateur, commercial

and diathermy U.H.F. equipment. The RK-62 is a U.H.F. gas triode used in radio controlled model planes and boats. The RK-60 and the 10,000 volt 866A/866 represent real value in low price rectifier tubes. Raytheon has manufactured many million more gaseous rectifier tubes than any other com-

IMPORTANT CHARACTERISTICS...RAYTHEON AMATEUR TUBES

TYPE	CONSTRUCTION	FILAMENT		PURPOSE	RATED VOLTAGES				POWER		Net Price	
		Volts	Amps.		Plate	Grid	Screen Grid	Supp. Grid	Pl. Diss. Max.	Output		
RK-20A	R-F Pentode	7.5	3.25	Thor.	Osc. R-F Amp. 1250	-100	300	0	40W	64W	\$15.00	
3B23	Full-W. Rect.	2.5	8	K	Osc. R-F Amp. 1250	-100	300	+ 45	40W	84W		
RK-22					Supp. Mod. Phone 1250	-100	300	- 45	40W	21W		
HIGH VACUUM—LOW VOLTAGE DROP—MAX. INVERSE PEAK 3500 V.—0.2 AMP. OUTPUT CURRENT												
RK-23	R-F Pentode	2.5	2.0	K	Osc. R-F Amp. 500	- 90	200	0	10W	18W	4.50	
RK-24	Triode	2.0	0.12	Oxide K	Osc. R-F Amp. 500	- 90	200	+ 45	10W	22W		
RK-25	R-F Pentode	6.3	0.9		5 Meter Osc. 180	- 45	150	1	5W	2.0W	2.25	
CHARACTERISTICS SAME AS RK-23 SHOWN ABOVE												
RK-28A	R-F Pentode	10.0	5.0	Thor.	Osc. R-F Amp. 2000	-100	400	0	125W	200W	28.50	
2C21	Twin Triode	6.3	0.6	K	Osc. R-F Amp. 2000	-100	400	+ 45	125W	250W		
RK-33					Supp. Mod. Phone 2000	-100	400	- 45	125W	60W		
RK-34	Dual Triode	6.3	0.8	K	Osc. R-F Amp. 250	- 60	2.5W	3.5W	5.15	
RK-38	Triode	5.0	8.0	Thor.	Osc. R-F Amp. 300	- 36	10W*	16W*		
RK-39	Beam Type R-F Tetrode	6.3	0.9	K	Class B. Mod. 300	- 15	10W*	13W*	3.50	
RK-48A	Beam Type R-F Tetrode	10.0	5.0	Thor.	Osc. R-F Amp. 2000	-200	100W	225W		
RK-49	Beam Type R-F Tetrode	6.3	0.9	K	Class B. Mod. 2000	- 52	100W	330W*	13.50	
RK-59	Dual Triode	6.3	1.0	Oxide	Osc. R-F Amp. 600	- 90	300	25W	36W		
RK-60	Full W. Rect.	5.0	3.0	Oxide	Osc. R-F Amp. 2000	-100	400	100W	250W	27.50	
RK-62	Gas Triode	1.4	0.05	Oxide	Class B. R-F Amp. 2000	- 35	400	100W	60W		
HIGH VACUUM—61 VOLT DROP—750 V. R.M.S. PER ANODE—250 MA. OUTPUT CURRENT												
RK-63	Triode	5.0	10.0	Thor.	Det. Thyatron 45	3.50	
RK-64	R-F Pentode	6.3	0.5	Oxide	Osc. R-F Amp. 3000	-200	200W	525W		
RK-65	Tetrode	5.0	14.0	Thor.	Class B. Mod. 3000	- 60	200W	800W*	22.00	
RK-75	Pentode	5.5	1.0	Thor.	Osc. R-F Amp. 400	- 30	100	+ 30	6W	10W*		
RX-120	Half-W. Rect.	2.5	30.0	K	Osc. R-F Amp. 3000	-100	400	215W	510W	34.50	
RX-212	Half-W. Rect.	2.5	31.0	K	Supp.-Mod. Amp. 500	- 35	200	- 50	15W	6W		
RX-215	Full-W. Rect.	2.5	30.0	K	MERCURY VAPOR AND ARGON GAS—MAX. AVERAGE CURRENT 20 AMPS.					24.00
RX-233A	Gas Triode	2.5	2.5	Oxide	MERCURY VAPOR—MAX. INVERSE PEAK 1000 V.—AVERAGE CURRENT 20 AMPS.					
RK-807	Beam Type Twin Tetrode	6.3	0.9	K	MERCURY VAPOR—MAX. INVERSE PEAK 500 V.—AVERAGE CURRENT 15 AMPS.					21.00
RK-829	(Beam Type) Half-W. Rect.	12.6*	1.125	K	THYRATRON—MAX. INVERSE PEAK 2000 V.—AVERAGE CURRENT 25 MA.					
RK-836	Half-W. Rect.	2.5	5	K	Osc. R-F Amp. 600	- 45	250	25W	40W	2.50	
RK-837	R-F Pentode	12.6	0.7	K	HIGH VACUUM—MAX. INVERSE PEAK 5000 V.—AVERAGE CURRENT 25 AMP.				
866A	Half W. Rect.	2.5	5.0	Oxide	Osc. R-F Amp. 500	- 75	200	40	12W	22W	7.50	
866	Half W. Rect.	2.5	5.0	Oxide	MERCURY VAPOR—MAX. INVERSE PEAK 10,000 V.—AVERAGE CURRENT 25 AMP.				
872A	Half W. Rect.	5.0	6.75	Oxide	MERCURY VAPOR—MAX. INVERSE PEAK 10,000 V.—AVERAGE CURRENT 1.25 AMP.					11.00
954	Pentode	6.3	0.15	K	Detector 250	- 6	100		
955	Triode	6.3	0.15	K	H.F. Amp. 250	- 3	100	5.00	
956	Pentode	6.3	0.3	K	Detector 180	- 7		
957	Triode	1.25	0.05	K	Osc. R-F Amp. 180	- 35	0.5W	3.00	
CK-1003	Full W. Rect.	Ionic Heated	Thor.	Mixer 250	- 10	100		
OZ4A	Full-W. Rect.	**6.3	0.1	H.F. Amp. 250	- 3	100	1.90	
1005					GAS FILLED—24 VOLT DROP—MAX. INVERSE PEAK 800 V.—AVERAGE CURRENT 110 MA.
CK-1005	Full W. Rect.	**1.75	2.25	GAS FILLED—20 VOLT DROP—MAX. INVERSE PEAK 450 V.—AVERAGE CURRENT 70 MA.					3.80
CK-1006					GAS FILLED—20 VOLT DROP—MAX. INVERSE PEAK 1600 V.—AVERAGE CURRENT 200 MA.	
CK-1007	Full-W. Rect.	**1.0	1.2	GAS FILLED—24 VOLT DROP—MAX. INVERSE PEAK 800 V.—AVERAGE CURRENT 115 MA.					1.90
RK-1625					Beam Type	12.6	.45	K	Osc. R-F Amp. 600	- 45	250	
2050	Gas Tetrode	6.3	0.6	K	THYRATRON—MAX. INVERSE PEAK 1300 V.—AVERAGE CURRENT 100 MA.					3.50
2051	Gas Tetrode	6.3	0.6	K	THYRATRON—MAX. INVERSE PEAK 700 V.—AVERAGE CURRENT 75 MA.					

*Indicates Value for Two Tubes or Two Sections of Dual Types.
**May be Used as Cold (Ionic Heated) Cathode Rectifier.

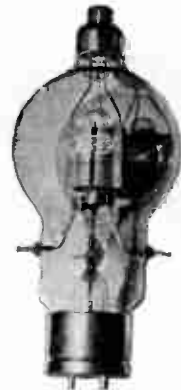

RAYTHEON
RK

Copyright by U. C. P., Inc.

USE RK TUBES FOR THE MOST OUTPUT PER DOLLAR OVER THE LONGEST PERIOD OF TIME

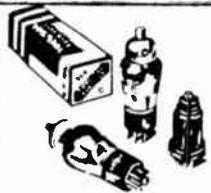

TUNG-SOL

RADIO TUBES

PRICE LIST—FEBRUARY, 1941—REPRINTED JUNE 1, 1943

Type No.	Description	List Price	Type No.	Description	List Price
00A	Triode Detector	\$2.30	6AC5G	Power Triode	\$1.25
01A	Triode Amplifier	.85	6AC5GT/G	Power Triode	1.05
0Z4 Met	Cold Cathode Full-Wave Rectifier	1.55	6AC7/1852	Television Amplifier Pentode	2.30
0Z4G	Cold Cathode Full-Wave Rectifier	1.55	6AD6G	Electron Ray Tube	1.55
1A3	H-F Diode Midget	1.55	6AD7G	Triode-Pentode Power Amplifier	1.55
1A4P	Remote Cut-Off Pentode Amplifier	1.55	6AE5GT/G	Single Grid Twin Plate Control Tube	1.25
1A5G	Power Pentode	1.55	6AE6G	Triode Amplifier	1.25
1A5GT/G	Power Pentode	1.05	6AE7GT	Combination Driver Triode	1.25
1A6	Pentagrid Converter	1.25	6AF5G	Triode Amplifier	1.25
1A7G	Pentagrid Converter	1.55	6AF6G	Electron Ray Tube	1.55
1A7GT	Pentagrid Converter	1.25	6AL6G	Tetrode Power Amp.	1.05
1B4P	RF Pentode Amplifier	1.25	6B4G	Power Triode	1.90
1B5/25S	Duo-Diode Triode Amplifier	1.25	6B5	Dynamic Coupled Triodes	1.90
1B7G	Pentagrid Converter	1.25	6B7	Duo-Diode Pentode Amplifier	1.25
1C5G	Power Pentode	1.55	6B8 Met	Duo-Diode Pentode Amplifier	1.90
1C5GT/G	Power Pentode	1.25	6B8G	Duo-Diode Pentode Amplifier	1.25
1C6	Pentagrid Converter	1.25	6B8GT	Duo-Diode Pentode Amplifier	1.25
1C7G	Pentagrid Converter	1.25	6C5 Met	Triode Amplifier	1.05
1D5GP	Remote Cut-Off Pentode Amplifier	1.25	6C5G	Triode Amplifier	.95
1D7G	Pentagrid Converter	1.55	6C5GT/G	Triode Amplifier	.95
1D8GT	Diode-Triode Power Pentode	1.90	6C6	RF Triple Grid Amplifier	.95
1E4G	Triode Amplifier	1.25	6C7	Duo-Diode Triode Amplifier	2.30
1E5GP	RF Pentode Amplifier	1.55	6C8G	Twin Triodes Amplifier	1.55
1E7G	Twin Power Pentodes	2.30	6D6	Remote Cut-Off Triple Grid Amplifier	.95
1F4	Power Pentode	1.25	6D8G	Pentagrid Converter	1.55
1F5G	Power Pentode	1.25	6E5	Electron Ray Tube	1.05
1F6	Duo-Diode Pentode Amplifier	1.55	6E6	Twin Power Triodes	1.90
1F7GH	Duo-Diode Pentode Amplifier	1.55	6E7	Remote Cut-Off Triple Grid Amplifier	2.30
1G4G	Triode Amplifier	1.25	6F5 Met	High-Mu Triode Amplifier	1.05
1G4GT/G	Triode Amplifier	1.05	6F5G	High-Mu Triode Amplifier	1.05
1G5G	Power Pentode	1.25	6F5GT	High-Mu Triode Amplifier	.95
1G6G	Twin Power Triodes	1.55	6F6 Met	Power Pentode	1.05
1G6GT/G	Twin Power Triodes	1.55	6F6G	Power Pentode	.85
1H4G	Triode Amplifier	.95	6F6GT/G	Power Amp. Pentode	.85
1H5G	Diode Triode Amplifier	1.25	6F7	Triode Pentode Amplifier	1.55
1H5GT	Diode Triode Amplifier	1.05	6F8G	Twin Triode Amplifiers	1.25
1H6G	Duo-Diode Triode Amplifier	1.25	6G6G	Power Pentode	1.25
1J5G	Power Pentode	1.90	6H4GT/G	Single Diode Rectifier	1.90
1J6G	Twin Power Triodes	1.25	6H6 Met	Twin Diode Rectifier	1.05
1L4	R-F Amplifier Pentode Min.	1.55	6H6GT/G	Twin Diode Rectifier	1.05
1LA4 Loo	Power Pentode	2.30	6H6GT	Twin Diode Rectifier	1.05
1LA6 Loo	Pentagrid Converter	2.30	6J5 Met	Triode Amplifier	.85
1LB4 Loo	Power Pentode	2.30	6J5G	Triode Amplifier	.95
1LC5 Loo	RF Pentode	2.30	6J5GT/G	Triode Amplifier	.85
1LC6 Loo	Diode-Triode Amplifier	2.30	6J7 Met	RF Triple Grid Amplifier	1.25
1LD5 Loo	Diode-Pentode Amplifier	2.30	6J7G	RF Triple Grid Amplifier	1.05
1LE3 Loo	General Purpose Triode	1.90	6J7GT	RF Triple Grid Amplifier	1.05
1LH4 Loo	Diode-Triode Amplifier	2.30	6J8G	Triode Heptode Converter	1.55
1LN5 Loo	RF Triple Grid Amplifier	2.30	6K5G	High-Mu Triode Amplifier	1.05
1N5G	RF Pentode Amplifier	1.55	6K6G	Power Pentode	1.05
1N5GT	RF Pentode Amplifier	1.25	6K6GT/G	Power Pentode	.95
1N6G	Diode-Power Triode	1.25	6K7 Met	Remote Cut-Off Triple Grid Amplifier	1.05
1P5G	Remote Cut-Off Triple-Grid Amplifier	1.55	6K7G	Remote Cut-Off Triple Grid Amplifier	1.05
1P5GT	Remote Cut-Off Triple-Grid Amplifier	1.55	6K7GT	Remote Cut-Off Triple Grid Amplifier	.95
1Q5G	Beam Power Tube	1.55	6K8 Met	Triode Hexode Converter	1.25
1Q5GT/G	Beam Power Tube	1.55	6K8G	Triode Hexode Converter	1.25
1R5	Pentagrid Converter (miniature type)	1.55	6K8GT	Triode Hexode Converter	1.25
1S4	Pentode Power Amplifier (miniature type)	1.55	6L5G	Triode Amplifier	1.05
1S5	Diode Pentode Amplifier (miniature type)	1.55	6L6 Met	Beam Power Tube	1.90
1SA6GT	R.F. Pentode	1.55	6L6G	Beam Power Tube	1.90
1SB6GT	Diode Pentode Amplifier	1.55	6L7 Met	Pentagrid Mixer	1.55
1T4	Diode Pentode Amplifier (miniature type)	1.55	6L7G	Pentagrid Mixer	1.55
1T5GT	Beam Power Tube	1.55	6N6G	Dynamic Coupled Triodes	2.30
1V	Half-Wave Rectifier	.95	6N7 Met	Twin Power Triodes	1.55
2A3	Power Triode	1.90	6N7GT/G	Twin Power Triodes	1.55
2A4G	Argon Filled Thyatron	2.30	6P5GT/G	Triode Amplifier	.75
2A5	Power Pentode	.95	6P7G	Triode Pentode Amplifier	2.30
2A6	Duo-Diode High-Mu Triode Amplifier	.95	6Q7 Met	Duo-Diode High-Mu Triode Amplifier	1.25
2A7	Pentagrid Converter	1.05	6Q7G	Duo-Diode High-Mu Amplifier	.85
2B7	Duo-Diode Pentode Amplifier	1.25	6Q7GT	Duo-Diode High-Mu Triode Amplifier	.85
2E5	Electron Ray Tube	1.25	6R7 Met	Duo-Diode Triode Amplifier	1.55
2G5	Electron Ray Tube	1.55	6R7G	Duo-Diode Triode Amplifier	1.05
3A4	Power Amp. Pentode Min.	1.55	6R7GT	Duo-Diode Triode Amplifier	.85
3A5	H.F. Twin Triode Min.	2.80	6S7 Met	Remote Cut-Off Triple Grid Amplifier	1.55
3A8GT	Diode Triode Pentode Amplifier	2.30	6S7G	Remote Cut-Off Triple Grid Amplifier	1.55
3R5GT	Beam Power Amplifier	1.55	6S7GT	Pentagrid Converter	.95
3Q4	Power Amp. Pentode Min.	1.55	6SA7G/G	Pentagrid Converter	1.05
3Q5GT/G	Beam Power Tube	1.55	6SC7 Met	Twin Triodes Amplifier	1.25
3S4	Pentode Power Amplifier (miniature type)	1.55	6SD7GT	Twin Triode Amp.	1.25
5T4 Met	Full-Wave Rectifier	1.90	6SD7GT	Semi-Remote Cut-Off Triple Grid Amplifier	1.25
5U4G	Full-Wave Rectifier	.95	6SF5 Met	High-Mu Triode Amplifier	.95
5V4G	Full-Wave Rectifier	1.55	6SF5GT	High-Mu Triode Amplifier	.95
5W4 Met	Full-Wave Rectifier	1.05	6SG7	Semi-Remote Cut-Off Triple Grid	1.25
5W4G	Full-Wave Rectifier	1.05	6SH7GT	RF Amplifier Pentode	1.90
5W4GT/G	Full-Wave Rectifier	.85	6SJ7 Met	RF Triple Grid Amplifier	1.05
5X4G	Full-Wave Rectifier	1.05	6SJ7GT	RF Triple Grid Amplifier	1.05
5Y3GT/G	Full-Wave Rectifier	.65	6SK7 Met	Remote Cut-Off Triple Grid Amplifier	.95
5Y4G	Full-Wave Rectifier	.70	6SK7GT/G	Remote Cut-Off Triple Grid Amplifier	1.05
5Z3	Full-Wave Rectifier	1.05	6SL7GT	Twin Triode Amplifier	1.55
5Z4 Met	Full-Wave Rectifier	1.25	6SN7GT	Twin Triode Amplifier	1.25
6A3	Power Triode	1.90	6SQ7 Met	Duo-Diode High-Mu Triode Amplifier	.95
6A4/LA	Power Pentode	1.55	6SQ7GT/G	Duo-Diode High-Mu Triode Amplifier	1.05
6A5G	Power Triode	2.80	6SP7 Met	Duo-Diode Triode Amplifier	1.05
6A6	Twin Power Triodes	1.55	6SR7GT	Duo-Diode Triode Amp.	1.25
6A7	Pentagrid Converter	.95	6SS7	Remote Cut-Off Triple Grid	.95
6A8 Met	Pentagrid Converter	1.25	6T7G/6Q6G	Duo-Diode High-Mu Triode Amplifier	1.25
6A8G	Pentagrid Converter	.95	6U5/6G5	Electron Ray Tube	1.25
6A8GT	Pentagrid Converter	.95	6U6GT	Beam Power Tube	1.25
6AB5/6N5	Electron Ray Tube	1.55	6U7G	Remote Cut-Off Triple Grid Amplifier	.95

TUNG-SOL RADIO TUBES

Type No.	Description	List Price	Type No.	Description	List Price
6V6 Met	Beam Power Tube	\$1.90	25A7GT/G	Power Pentode Half-Wave Rectifier	\$1.55
6V6G	Beam Power Tube	1.25	25AC5GT/G	Power Triode	1.55
6V6GT/G	Beam Power Tube	1.05	25B6G	Dynamic Coupled Triodes	2.30
6V7G	Duo-Diode Triode Amplifier	1.25	25B8GT	Power Pentode	1.90
6W5G	Full-Wave Rectifier	1.90	25C6G	Triode-Remote Cut-Off Pentode Amplifier	1.90
6W7G	RF Triple Grid Amplifier	1.55	25D8GT	Beam Power Tube	1.90
6X5 Met	Full-Wave Rectifier	1.55	25L6 Met	Diode Triode Pentode Amplifier	1.90
6X5G	Full-Wave Rectifier	1.05	25L6G	Beam Power Tube	1.55
6X5GT/G	Full-Wave Rectifier	.95	25L6GT/G	Beam Power Tube	1.25
6Y5S	Full-Wave Rectifier	2.30	25N6G	Beam Power Tube	1.05
6Y6G	Beam Power Tube	1.55	25Z5	Dynamic Coupled Triodes	2.30
6Y7G	Twin Power Triodes	1.55	25Z6 Met	Full-Wave Rectifier Voltage Doubler	.95
6Z5	Full-Wave Rectifier	2.30	25Z6G	Full-Wave Rectifier Voltage Doubler	1.25
6Z7G	Twin Power Triodes	1.90	25Z6GT/G	Full-Wave Rectifier Voltage Doubler	.95
6ZY5G	Full-Wave Rectifier	1.25	26	Triode Amplifier	.70
7A4 Loc	Triode Amplifier	1.25	27	Triode Amplifier	.65
7A5 Loc	Beam Power Tube	1.25	30	Triode Amplifier	.95
7A6 Loc	Twin Diode Rectifier	1.25	31	Power Triode	.95
7A7 Loc	Remote Cut-Off Triple Grid Amplifier	1.25	32	RF Tetrode Amplifier	1.25
7A8 Loc	Octode Converter	1.25	32L7GT	Beam Power Tube Half-Wave Rectifier	1.90
7B4 Loc	High-Mu Triode	1.25	33	Power Pentode	1.25
7B5 Loc	Power Pentode	1.25	34	Remote Cut-Off Pentode Amplifier	1.25
7B6 Loc	Duo-Diode High-Mu Triode Amplifier	1.25	35/51	Remote Cut-Off Tetrode Amplifier	.95
7B7 Loc	Remote Cut-Off RF Triple Grid Amplifier	1.25	35A5 Loc	Beam Power Tube	1.25
7B8 Loc	Pentagrid Converter	1.25	35L6GT/G	Beam Power Tube	.95
7C5 Loc	Beam Power Tube	1.25	35Z3 Loc	Half-Wave Rectifier	1.25
7C6 Loc	Power Triode	1.25	35Z4GT	Half-Wave Rectifier	.75
7C7 Loc	RF Triple Grid Amplifier	1.25	35Z5GT/G	Half-Wave Tapped Heater Rectifier	.80
7E6 Loc	Duo-Diode Triode Amplifier	1.25	35Z6G	Twin-Diode High Vacuum Rectifier Voltage Doubler	1.25
7E7 Loc	Duo-Diode Pentode Amplifier	1.55	36	RF Tetrode Amplifier	.95
7F7 Loc	Twin Triodes Amplifier	1.55	37	Triode Amplifier	.80
7G7/1232 Loc	Triode Grid Amplifier	1.90	38	Power Pentode	1.05
7H7 Loc	Semi-Remote Cut-Off Triple Grid Amplifier	1.90	39/44	Remote Cut-Off Pentode Amplifier	.95
7J7 Loc	Triode Heptode Converter	1.90	40	High-Mu Triode Amplifier	1.55
7N7 Loc	Twin Triode Amplifier	1.90	41	Power Pentode	.80
7L7 Loc	RF Triple Grid Amplifier	1.90	42	Power Pentode	.80
7Q7 Loc	Pentagrid Converter	1.25	43	Power Pentode	1.05
7V7 Loc	RF Pentode	2.30	45	Power Triode	.75
7Y4 Loc	Duo-Diode High-Mu Triode Amplifier	1.25	45Z3	Miniature Type Half-Wave Rectifier	1.05
10	Full-Wave Rectifier	2.80	45Z5GT	Half-Wave Tapped Heater Rectifier	1.05
12A	Triode Amplifier	.95	46	Dual Grid Power Tube	1.05
12A5	Power Pentode	2.30	47	Power Pentode	1.05
12A6GT	Beam Power Amp. Pentode	2.30	48	Power Tetrode	2.80
12A7	Power Pentode Half-Wave Rectifier	1.90	49	Dual Grid Power Tube	1.25
12A8GT	Pentagrid Converter	.95	50	Power Triode	2.30
12A7GT	Twin Triode Amplifier	1.90	50C6G	Beam Power Amplifier	1.90
12B8GT	Triode-Remote Cut-Off Pentode Amplifier	1.55	50L6GT	Beam Power Tube	1.05
12C8 Met	Duplex-Diode Pentode Amplifier	1.90	50Y6GT/G	Full-Wave Rectifier Voltage Doubler	1.05
12E5GT	Triode Amplifier	1.55	50Z7G	Full-Wave Tapped Heater Rectifier	1.25
12F5GT	High-Mu Triode Amplifier	.95	53	Twin Power Triodes	1.55
12J5GT	Triode Amplifier	.95	55	Duo-Diode Triode Amplifier	1.05
12J7GT	RF Triple Grid Amplifier	1.05	56	Triode Amplifier	.75
12K7GT	Remote Cut-Off Triple Amplifier	.95	57	RF Triple Grid Amplifier	.85
12K8GT	Triode Hexode Converter	1.25	58	Remote Cut-Off Triple Grid Amplifier	.85
12Q7GT	Duo-Diode High-Mu Triode Amplifier	.85	59	Triple Grid Power Tube	1.55
12SA7 Met	Pentagrid Converter	.95	70A7GT	Beam Power Tube Half-Wave Tapped Rectifier	2.30
12SA7GT/G	Pentagrid Converter	1.25	70L7GT	Beam Power Tube Half-Wave Rectifier	1.90
12SC7 Met	Twin Triode Amplifier	1.25	71A	Power Triode	.85
12SC7GT	Twin Triode Amplifier	1.25	75	Duo-Diode High-Mu Triode Amplifier	.80
12SF5 Met	High-Mu Triode Amplifier	1.05	76	Triode Amplifier	.85
12SF5GT	High-Mu Triode Amplifier	1.05	77	RF Triple Grid Amplifier	.85
12SG7	Semi-Remote Cut-Off Triple Grid	1.25	78	Remote Cut-Off Triple Grid Amplifier	.85
12SH7GT	H-F Amplifier Pentode	1.90	79	Twin Power Triodes	1.55
12SJ7 Met	RF Triple Grid Amplifier	1.05	80	Full-Wave Rectifier	.65
12SJ7GT	RF Triple Grid Amplifier	1.05	81	Half-Wave Rectifier	1.90
12SK7 Met	Remote Cut-Off Triple Grid Amplifier	.95	82	Mercury Vapor Full-Wave Rectifier	1.25
12SK7GT/G	Remote Cut-Off Triple Grid Amplifier	1.05	83	Mercury Vapor Full-Wave Rectifier	1.25
12SL7GT	Twin Triode Amplifier	1.55	83V	Full-Wave Rectifier	1.90
12SN7GT	Twin Triode Amplifier	1.25	84/6Z4	Full-Wave Rectifier	1.05
12SQ7 Met	Duo-Diode High-Mu Triode Amplifier	.95	85	Duo-Diode Triode Amplifier	.85
12SQ7GT/G	Duo-Diode High-Mu Triode Amplifier	1.05	89	Triode Grid Power Tube	.95
12SR7GT	Duo-Diode Triode	1.25	99V	Triode Amplifier	2.80
12Z3	Half-Wave Rectifier	.95	99X	Triode Amplifier	2.80
14A7/12B7 Loc	Remote Cut-Off Triple Grid Amplifier	1.90	117L7/M7GT	Beam Power Amplifier, Half-Wave Rectifier	2.30
14C7 Loc	RF Triple Grid	1.90	117P7GT	Beam Power Amplifier, Half-Wave Rectifier	2.30
14H7 Loc	Semi-Remote Cut-Off Triple Grid	1.90	117Z4GT	Half-Wave Rectifier	1.55
14J7 Loc	Triode Hexode Converter	1.90	117Z6GT/G	Full-Wave Rectifier Voltage Doubler	1.55
14Q7 Loc	Pentagrid Converter	1.55	183	Power Triode	1.90
14R7 Loc	Duo-Diode Pentode	1.90	257	Power Pentode	2.80
15	RF Pentode Amplifier	1.90	485	Triode Amplifier	1.90
19	Twin Power Triodes	1.25	950	Power Pentode	1.90
20	Power Triode	2.80	XXD Loc	Twin Triodes	1.55
22	RF Tetrode Amplifier	2.30	XXFM Loc	Duo-Diode Triode	1.90
24	RF Tetrode Rectifier	.85	XXL Loc	Triode	1.55
25A6 Met	Power Pentode	1.90			
25A6G	Power Pentode	1.05			
25A6GT/G	Power Pentode	1.05			
25A7G	Power Pentode Half-Wave Rectifier	1.55			

TUNG-SOL RADIO DIAL LAMPS

Lamp No.	Volts	Amperes	Approx. Candle-Power	Bead Color	Base	Bulb Type	List Price
40	6-8	0.15	0.5	Brown	Miniature Screw	T-3 1/4	.09
41	2.5	0.5	0.5	White	Miniature Screw	T-3 3/4	.09
42	3.2	0.85	0.75	Green	Miniature Screw	T-3 3/4	.12
43	2.5	0.5	0.5	White	Miniature Bayonet	T-3 3/4	.09
44	6-8	0.25	0.8	Blue	Miniature Bayonet	T-3 3/4	.09
45	3.2	0.5	0.75	Green	Miniature Bayonet	T-3 3/4	.12
46	6-8	0.25	0.8	Blue	Miniature Screw	T-3 3/4	.09
47	6.3	0.15	0.5	Brown	Miniature Bayonet	T-3 3/4	.09
48	2.0	0.06	Pink	Miniature Screw	T-8 1/4	.15
49	2.0	0.06	Pink	Miniature Bayonet	T-8 1/4	.15
50	6-8	0.2	1.0	White	Miniature Screw	G-3 1/2	.10
51	6-8	0.2	1.0	White	Miniature Bayonet	G-3 1/2	.07
55	6-8	0.4	1.5	White	Miniature Bayonet	G-4 1/2	.07

NATIONAL UNION RADIO PRODUCTS

RADIO RECEIVING TUBES

Government Order Limits Us To These Types for Sale to Civilians. For information on the types not shown but required for special priority applications, write.

TYPES

OZ4G	5U4G	6K7GT	7B5	14A7/1237	43
1A5GT/G	5V4G	6K8GT	7B7	24A	45
1A7GT/G	5X4G	6L6G	7C5	25L6GT/G	47
1C5GT/G	5Y3GT/G	6L7G	7C6	25Z5	50L6GT
1H5GT	5Y4G	6N7GT/G	7C7	25Z6GT/G	50Y6GT
1LA4	5Z3	6Q7GT	7F7	26	56
1LB4	6A7	6R7GT	7H7	27	57
1LC6	6A8GT	6SA7GT/G	7J7	30	58
1LD5	6B7	6SC7GT	7N7	35/51	70L7GT
1LE3	6B8G	6SD7GT	7V7	35A5	71A
1LH4	6C5GT/G	6SJ7GT	7Y4	35L6GT/G	75
1LN5	6C8G	6SK7GT/G	12A8GT	35Z3	76
1N5GT	6F5GT	6SQ7GT/G	12J5GT	35Z5GT/G	77
1P5GT	6F6GT/G	6U5/6G5	12K7GT	36	78
1Q5GT/G	6F8G	6V6GT/G	12Q7GT	37	80
1T5GT	6H6GT/G	6X5GT	12SA7GT/G	38	83
1V	6J5GT/G	7A4	12SJ7GT	39/44	84/6Z4
2A3	6J7GT	7A6	12SK7GT/G	41	117L7/M7GT
2A5	6K5GT	7A8	12SQ7GT/G	42	117Z6GT/G
3Q5GT/G	6K6GT/G				

CONDENSERS

These are "Victory" types. For interchangeable data send for our War-Time condenser Substitution Chart.

V-Numites	V-Electrolytics
VT-6405	VCT-10025
VT-600025	VCT-1050
VT-6001	VCT-2015
VT-6002	VCT-2215
VT-6005	VCT-50-15
VT-601	VCT-2025
VT-602	VCT-1045
VT-605	VCT-1145
VT-610	VCT-4045
VT-625	

"SAV-A-SHAFT" VOLUME CONTROLS

10 Types Handle 95 Per Cent of Your Service Work

TYPES OF NATIONAL UNION MIDGET "SAV-A-SHAFT" CONTROLS

Type No.	Curve	5,000	Complete with
NU 5M-A	A	5,000	Switch
NU 10M-B	B	10,000	"
NU 25M-A	A	25,000	"
NU 50M-B	B	50,000	"
NU 100M-B	B	100,000	"
NU 250M-TX	X	250,000	Switch & Tap
NU 500M-TX	X	500,000	" " "
NU 1 MEG TX -	X	1 MEG	" " "
UU 2 MEG TX	X	2 MEG	" " "
NU 500 M-CB	B	500,000	Tone Control with Switch

Switch may be placed in operation by pulling out stop lug.

PACKING and HANDLING:

Each control is individually packaged in colorful N.U. carton, with full mounting instructions.

RADIO PANEL LAMPS

Lamp No.	Base	Volts	Amp.
N48}	Screw	2.0*	.06
N49}	Bayonet		
N49A	Bayonet	2.1*	.12
N41}	Screw	2.5	.50
N43}	Bayonet		
N292 }	Screw	2.9	.17
N292A }	Bayonet		
N42}	Screw	3.2	.50
N45}	Bayonet		
N40}	Screw	6-8†	.15
N40A-47 }	Bayonet		
N46}	Screw	6-8†	.25
N44}	Bayonet		
N50}	Screw	6-8	.20
N51}	Bayonet		
55	Bayonet	6-8	.40

* For "Air Cell" Receivers
† Design Voltage—6.3

FLASHLIGHT LAMPS

N14	Screw	3.8	.30
N13	Screw	2.5	.30

RADIO BATTERIES

During normal times National Union provides a complete line of popular types of replacement batteries for radios and flashlight batteries. At present the line is limited to one type, N801—Pack.

SOUND SYSTEMS

National Union in peace time makes available a wide choice of amplifiers including Portable Systems, Mobile Systems and School Systems. These units while not now available due to war time restrictions will be again offered to the trade after the war.

NATIONAL UNION

Research & Development

National Union has extensive research and development laboratories staffed by leading scientific personnel. Problems having to do with production of advanced electronic devices employing vacuum tubes may be submitted to this division for study.

The local National Union Distributor carries stocks of many kinds of materials and parts used in the electronic field. Use him as a quick source of supply, rely on him as an expeditor.

**Other National Union Products: Transmitting Tubes - Cathode Ray Tubes
NATIONAL UNION RADIO CORP. - - NEWARK, N. J. — LANSDALE, PA.**

NATIONAL UNION

TRANSMITTING and SPECIAL PURPOSE

RADIO-ELECTRONIC TUBES

Engineered and produced to meet the most exacting requirements of such users as the Army and Navy these National Union tubes offer an assurance to the purchaser that they are scientifically correct. War time restrictions do not permit the disclosure of many improvements in performance made possible by National Union research and engineering technique. Inquiries are invited for availability information on types not listed but which may be required for special applications.

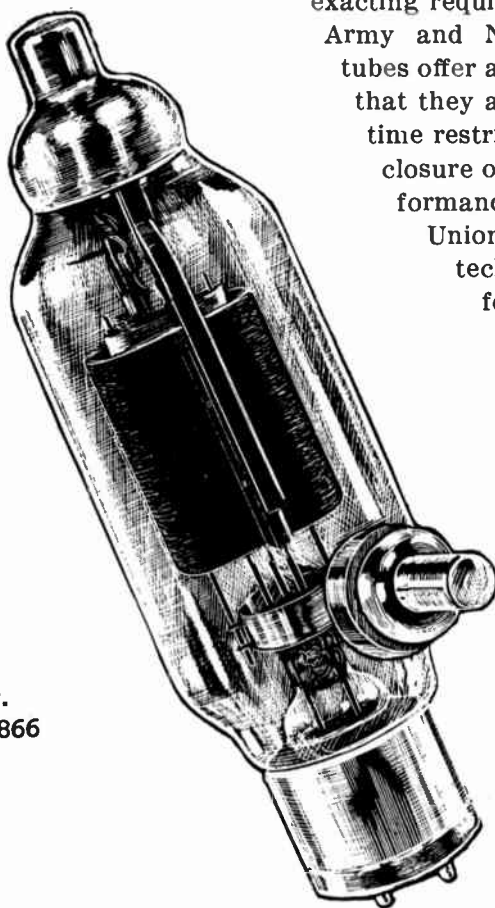

TYPES

NU30Z	NU805
NU31Z	NU807
NU34	NU813
NU40T	NU829
NU40TZ	NU832
NU51A	NU836
NU51Z	NU-838
NU60	NU-845
NU69	NU866 Jr.
NU75H	NU866A/866
NU114B	NU872
NU200	NU873
NU211	NU872A
NU300	NU1201
NU615	NU1203A
NU801A/801	NU1625
	NU1626

OTHER NATIONAL UNION PRODUCTS

Cathode Ray Tubes, Receiving Tubes, Condensers, Volume Controls, Photo Electric Cells, Exciter Lamps, Panel Lamps, Flashlight Bulbs.

Extensive research and development facilities are available at National Union for industrial concerns having problems which involve creation of special radio-electron tubes. Consult a local National Union Distributor for information regarding standard types. These local sources of supply are equipped to give on the spot expediting service.

NATIONAL UNION RADIO CORP. - - - NEWARK, NEW JERSEY

NATIONAL UNION

VIDEOTRONS*

CATHODE RAY TUBES

*TRADE MARK

Having pioneered in the development of Cathode Ray Tubes, National Union was well prepared to undertake extensive manufacturing operations to meet war time requirements. A complete new National Union Factory division is now devoted to the production of many types of Cathode Ray Tubes. War time restrictions do not permit listing of all types we are able to supply. If information is required for special applications, write and outline your problem.

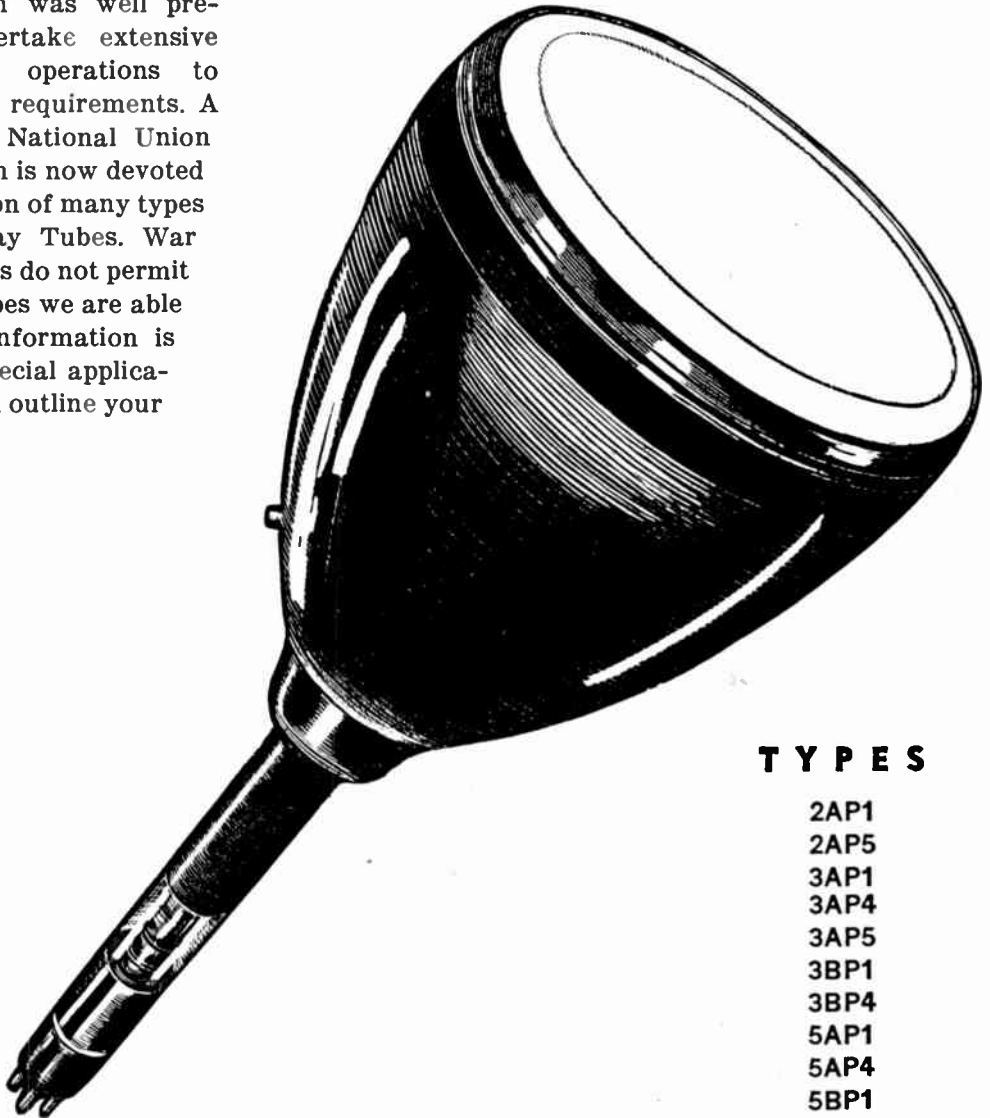

TYPES

2AP1
2AP5
3AP1
3AP4
3AP5
3BP1
3BP4
5AP1
5AP4
5BP1
5BP4
5CP1
902P1

OTHER NATIONAL UNION PRODUCTS

*Transmitting Tubes, Receiving Tubes, Special Purpose Tubes, Condensers, Volume Controls, Photo Electric Cells, Exciter Lamps, Panel Lamps, Flashlight Bulbs.

NATIONAL UNION RADIO CORP. - - NEWARK, NEW JERSEY

Thank You!

When writing for additional
information or when ordering
from sources of supply listed
in this book, please mention

RADIO'S MASTER



ELECTRONIC TUBES

for Transmitting Service

Priced Low

Unsurpassed in Value



● General Electric has designed and built tubes to meet the most exacting requirements on land and sea and in the air for three decades. G.E. on a transmitting tube assures you of long, dependable service at low cost. Bulletin GEA-3315 lists the complete G-E transmitting-tube line, together with technical data and prices. Ask for a copy.

NET PRICES

GL-203A	\$12.00
GL-211	12.00
GL-800	10.00
GL-801	3.45
GL-802	3.50
GL-803	28.50
GL-805	15.00
GL-806	22.00
GL-807	3.50
GL-809	2.50
GL-810	13.50
GL-811	3.50
GL-812	3.50
GL-813	22.00
GL-814	17.50
GL-815	4.50
GL-829	19.50
GL-833	85.00
GL-837	7.50
GL-838	13.25
GL-845	12.00
GL-860	32.50
GL-866A/866	1.50
GL-872	9.00
GL-872A	11.00
GL-1623	2.50

FOR ECONOMICAL MEDIUM POWER

GL-811 High Mu Triode

ICAS* Class B Modulator Rating (2 tubes)
 Max. Plate Volts.....1500
 Max. Plate Current.....200 mils
 Driving Power.....10.5 watts
 Output Power.....225 watts

Net \$3.50

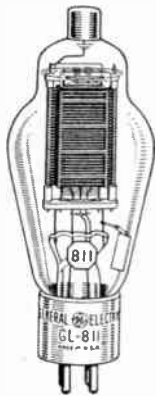

GL-812 Low Mu Triode

ICAS* Class C. Telegraph Rating
 Max. Plate Volts.....1500
 Max. Plate Current.....150 mils
 Driving Power.....6.5 watts
 Power Output.....170 watts
 Max. Frequency.....100 mc

Net \$3.50

*Intermittent Commercial and Amateur Service.

TOPS IN "50-WATTERS"

GL-838

Class B Audio
 260 watts output
 (2 tubes)

Class C Telephony

100 watts output

Class C Telegraph

130 watts output

Max. Frequency

30 mc at full

input

120 mc at reduced ratings

Net \$13.25



G-E BEAM POWER TUBES

for More Power with Less Equipment

Low Driving Power—Quick Band Change

GL-807 Net \$3.50

● The G-E beam tube for your low-power requirements. Oscillator, amplifier, frequency multiplier or modulator—you can't buy a more versatile performer for \$3.50! Less than half a watt drives two 807's; ICAS cw output: 100 watts!

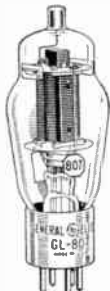

GL-814 Net \$17.50

● The G-E beam power tube for any medium-power r-f application up to 30 mc. 160 watt cw 130 watts plate-modulated phone (ICAS) with 1.5 or 3.2 watts driving power respectively. A fb frequency multiplier, too. \$17.50 puts one in your rig.

GL-813 Net \$22.00

● The G-E beam tube for high power. It will produce 150 watts cw as a crystal oscillator, 500 watts cw with only 1 watt driving power. An excellent frequency multiplier. Makes quick band change at high power easy.

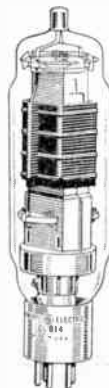

G-E MERCURY-VAPOR RECTIFIERS

GL866A/866

Net \$1.50

All the sock of the 866A for the price of the 866.

Better performance, longer life, lower cost.

Max. Peak Inverse Volts...10,000

Peak Plate Current.....1 amp.

Average Plate Current

0.25 amp.

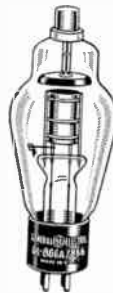

FOR HEAVY DUTY

GL-872 . . Net \$9.00

Max Peak Inverse Volts.....7500

Peak Plate Current.....5 amp.

Average Plate Current

1.25 amp.

GL-872A Net \$11.00

Max Peak Inverse Volts...10,000

Peak Plate Current.....5 amp.

Average Plate Current

1.25 amp.



GAMMATRON *Tantalum Tubes*

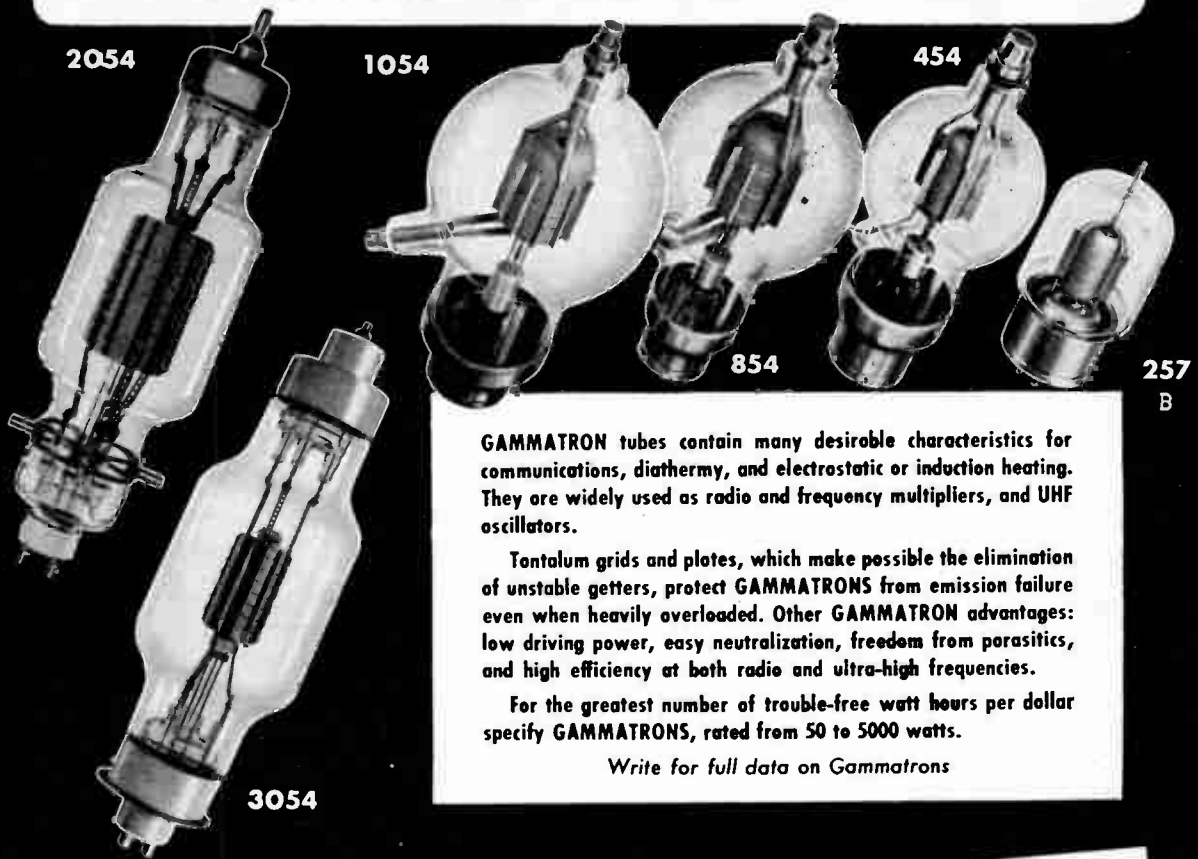

GAMMATRON tubes contain many desirable characteristics for communications, diathermy, and electrostatic or induction heating. They are widely used as radio and frequency multipliers, and UHF oscillators.

Tantalum grids and plates, which make possible the elimination of unstable getters, protect GAMMATRONS from emission failure even when heavily overloaded. Other GAMMATRON advantages: low driving power, easy neutralization, freedom from parasitics, and high efficiency at both radio and ultra-high frequencies.

For the greatest number of trouble-free watt hours per dollar specify GAMMATRONS, rated from 50 to 5000 watts.

Write for full data on Gammatrons

TYPE NO.	14	24	54	152L	158	254	257*	304L	354C	354E	454L	454H	654	854L	854H	1054L	1554	2054A	3054	
MAX. POWER OUTPUT: Class C R.F.	60	90	250	610	200	500	230	1220	615	615	900	900	1400	1800	1820	3000	3600	2000	5300	
PLATE DISSIPATION: Watt	20	25	50	150	50	100	75	300	150	150	250	250	300	450	450	750	1000	1200	1500	
AVERAGE AMPLIFICATION FACTOR	20	25	27	10	25	25		10	14	35	14	30	22	14	30	13.5	14.5	10	20	
MAX. RATINGS: Plate Volts Plate M.A. Grid M.A.	1500 80 15	2000 75 25	3000 150 30	3000 500 75	2000 200 40	4000 225 40	4000 150 25	3000 1000 150	4000 300 60	4000 300 70	5000 375 60	5000 375 65	4000 600 100	6000 800 80	6000 800 110	6000 1000 125	5000 800 250	3000 800 200	5000 2000 500	
MAX. FREQUENCY, Mc.: Power Amplifier	600	200	200	175	100	175	150	175	50	50	150	150	50	125	125	100	30	20	30	
INTERELECTRODE CAP: C _g - p.u.f. C _g - f.u.f. C _p - f.u.f.	1.9 2.7 0.5	1.7 2.5 0.4	1.8 2.1 0.5	5 7 0.4	4.6 4.7 1.0	3.8 3.3 1.0	0.04 13.8 In. 6.7 Out.	9 12 0.8	3.8 4.5 1.1	3.8 4.5 1.1	3.4 4.6 1.4	3.4 4.6 1.4	5.5 6.2 1.5	5 8 0.5	4 8 0.5	5 8 0.8	11 15.5 1.2	18 15 7	15 25 2.5	
FILAMENT: Volts Amperes	3.1 5	6.3 3	5.0 5	5-10 13-6.5	12.6 2.5	6.0 7.5	6.0 7.5	5-10 13-26	5 10	5 10	5 11	5 11	5 11	7.5 15	7.5 12	7.5 12	7.5 21	11 17.5	10 22	14 45
PHYSICAL: Length, Inches Diameter, Inches Weight, Oz. Base	3 3/4 1 2 Small UX	4 1/4 1 1/2 Small UX	5 1/4 2 Std. UX	7 3/4 2 1/2 John-son #213	4 3/4 2 Std. UX	7 2 1/2 6 1/2 Std. 50 Watt	6 3/4 2 1/2 6 Giant 7 Pin	7 3/4 3 1/2 John-son #213	9 3 3/4 6 1/2 Std. 50 Watt	9 3 3/4 6 1/2 Std. 50 Watt	10 3 3/4 7 Std. 50 Watt	10 3 3/4 7 Std. 50 Watt	10 1/2 3 3/4 7 Std. 50 Watt	10 3/4 3 3/4 7 Std. 50 Watt	12 1/2 5 14 Std. 50 Watt	12 1/2 5 14 Std. 50 Watt	16 1/2 7 42 John-son #214	18 6 56 HK 295	21 1/4 6 66 W.E. Co.	30 3/4 9 200 HK 255
*Beam Pentode.																				
NET PRICE	21.50	4.75	8.00	30.00	18.50	13.50	27.50	65.00	24.50	24.50	27.50	27.50	27.50	75.00	75.00	75.00	175.00	225.00	300.00	395.00

HEINTZ AND KAUFMAN LTD.



SOUTH SAN FRANCISCO
CALIFORNIA U.S.A.

WHY *Gammatrone* LEAD IN

THE V. H. F. FIELD

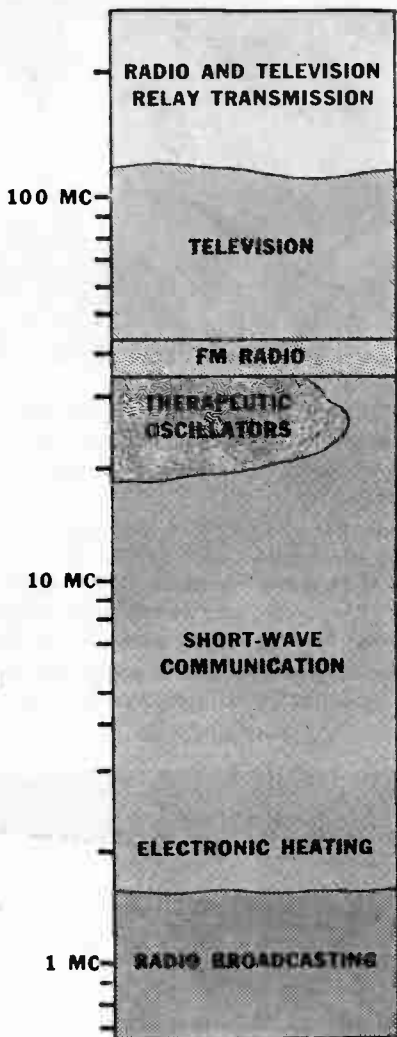
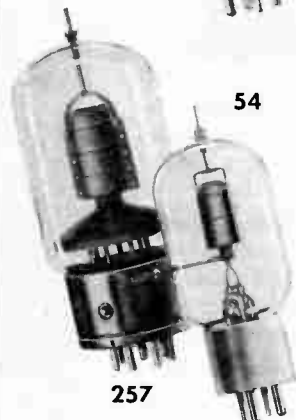
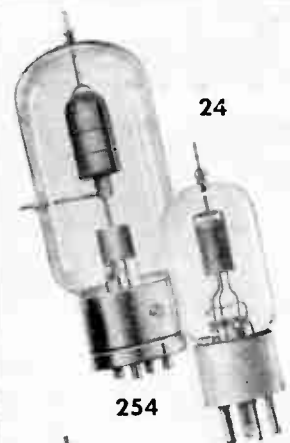

- Gammatrone provide high efficiency at the very high frequencies because the long, capped plate confines the entire electron stream for useful output.
- Grid is closely spaced to the filament for short electron time-flight.
- Inter-electrode capacities are very low, and grid and plate leads are short.
- Gammatrone are easy to neutralize, and parasitic oscillation is avoided.
- They have great stamina. Due to tantalum plates and grids they can handle heavy overloads without the release of gas internally.
- Unique Gammatron design eliminates all internal insulators, reducing ultra high frequency power losses to minimum.
- Extra long life in any type of service — up to 12,000 hours has been reported.

HEINTZ AND KAUFMAN, LTD.

SOUTH SAN FRANCISCO, CALIFORNIA, U. S. A.

Gammatron Tubes

HIGH VACUUM RECTIFIERS

Type	253	953-B	953-D	953-E
Peak Inverse Volts	15,000	30,000	75,000	150,000
Max. Peak Current, ma	1,500	80	120	400
Max. Average Current, ma	350	40	60	200
Filament	Thor Tungsten	Tungsten	Tungsten	Tungsten
Filament Volts	5.0	7.5	7.5	15
Filament Amps.	11	6.5	11	15
Length, Inches	8½	7%	12½	22½
Diameter, Inches	2½	2	3%	5
Base	50 Watt	M. 4 Pin	50 Watt	50 Watt
Net Price	\$18.50	\$12.00	\$30.00	\$75.00



GAMMATRONS of course

In Most All the Important NEW Developments in Radio
You'll Find Eimac Tubes Every Time

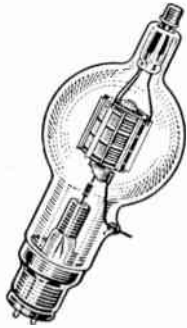

A NEW CONCEPTION OF VACUUM TUBE CONSTRUCTION

Long filament life, uniformity of characteristics, outstanding performance and complete freedom from failure caused by gas. These, and other features of Eimac tubes, have been the result of patient research, study and extensive experimentation. Old theories have been discarded and an entirely new conception of vacuum tube construction discovered. Fundamentally, Eimac tubes are far in advance of the industry. New design principles and construction methods give them a marked degree of superiority over conventional tube types.

Cause of Emission Failure

Eimac engineers disproved the popular fallacy that high anode temperatures destroy emission. These high temperatures, or overloads, merely release gas from certain types of tube elements. This gas, not heat, is the cause for emission failure. Conventional anode materials and ceramics, as used for internal insulators, are the main sources of this poison gas. Eimac's recognition of this fact blasted many old theories and led the way for an advanced technique of vacuum tube construction. Processes and materials are used which enable Eimac to develop a real vacuum without the use of a chemical agent or "getter." THE RADICAL DESIGN OF EIMAC TUBES PRACTICALLY ELIMINATES INTERELECTRODE CAPACITIES.

Tantalum Plates & Grids

Both plates and grids are fabricated from completely de-gassed tantalum and mounted into clear glass envelopes without the use of internal insulators. Tantalum is the best suited material to vacuum tube construction because it has the smallest original gas content of any known metal. (1/10 that of Molybdenum and only 1/1000 that of carbon such as commonly used for anodes). This relatively small gas content is entirely removed by an exclusive Eimac process (pat. applied for). Anodes are suspended from the top of the bulb

and grids are permanently secured without the use of extra supporting bars. This greatly increases the effective area of the plate and reduces the amount of grid current necessary for top performance.

A New Thoriated Filament

Certain negative conditions which existed in the old type filament, such as: low ratio of usable to peak plate current, "cranky" filament voltage, tubes going flat for no apparent reason; are practically eliminated with the new Eimac thoriated filament. Specifically this new filament operates at a lower temperature and all forms of "cheating" such as under processing are not attempted. This results in the highest possible thermionic efficiencies plus longer filament life and uniformity. A special support makes displacement impossible, hence characteristics are never altered.

Eimac Guarantee

Eimac tubes are conservatively rated as to plate dissipation and are unconditionally guaranteed against failure caused by gas released internally. Momentary overloads of as much as 400% to 600% which is sufficient to cause the anode to become incandescent will positively not release gas. Spotlessly clean glass bulbs and metal parts, perfect alignment of the elements and uniformity of electrical characteristics attest the skill of the artisans who fabricate Eimac tubes.

Eimac
TUBES

**Eimac Tubes are now being used by practically every Commercial
Airline in the United States.**

SEE REVERSE SIDE FOR COMPLETE DATA ON ALL EIMAC TUBES

UNCONDITIONALLY GUARANTEED AGAINST TUBE FAILURES CAUSED BY GAS RELEASED INTERNALLY

This chart gives the essential data and characteristics of the most popular Eimac tubes

<i>Eimac</i> TUBES		35T	35 TG	Twin 30	UH 50	75T	100 TL	100 TH	152 TL	250 TL	250 TH	304 TL	450 TL	450 TH	750 TL	1000 UHF	1500 T	2000 T
CHARACTERISTICS	Filament Voltage (volts)	5	5 to 5.1	6	7.5	5	5	5	5 or 10	5	5	5 or 10	7.5	7.5	7.5	7.5	7.5	10
	Filament Current (amperes)	4	4	4	3.25	6.5	6.5	6.5	13 or 6.5	10.5	10.5	26-13	12	12	21	16	26	26
	Amplification Factor	30	30	32	10.6	10	12	30	10	13	32	10	16	30	13.5	30	18.5	18.5
	Grid-Plate Capacity (mmfds)	1.9	1.7	2*	2.6	2.3	2.3	2	5	3.5	3.3	5	4	4	4.5	4	7	9
	Grid-Filament Cap. (mmfds)	4.0	1.9	1.9*	2.2	2.2	2	2.2	5	3	3.5	10	4	4	6.0	6	10	13
	Plate-Filament Cap. (mmfds)	.2	.2	.2	.3	.3	.4	.3	.75	.5	.3	1.5	.6	.6	.8	.6	.9	1
	Bulb	T14 Noneox	T14	T14 Noneox	S21 Noneox	G22 Noneox	GT25 Noneox	GT25 Noneox	G20	GT30 Noneox	GT30 Noneox	G28	GT40 Noneox	GT40 Noneox	GT56 Noneox	GT40 Noneox	GT56 Noneox	GT64 Pyrex
	Base	Isobulbite UX14 Prong	Isobulbite UX14 Prong	Isobulbite UX14 Prong	Isobulbite UX14 Prong	Isobulbite UX14 Prong	Isobulbite UX14 Prong	Isobulbite UX14 Prong	Isobulbite UX14 Prong	Isobulbite UX14 Prong	Isobulbite UX14 Prong	Isobulbite UX14 Prong	Isobulbite UX14 Prong	Isobulbite UX14 Prong	Isobulbite UX14 Prong	Isobulbite UX14 Prong	Isobulbite UX14 Prong	Isobulbite UX14 Prong
	Overall Height (inches)	5½	5½	4¾	6¾	7	7½	7½	7½	9¾	9¾	7½	12½	12½	16½	12½	16½	17½
	Maximum Diameter (inches)	1¾	1¾	3	2¾	2¾	3¼	3¼	2¾	3¾	3¾	3¾	5	5	7	5	7	8
FCC Maximum Ratings	Max. Plate Voltage (volts)	2000	2000	1500	1250	3000	3000	3000	3000	3000	3000	3000	6000	6000	6000	6000	6000	6000
	Max. Plate Current (millamps)	150	150	85*	125	175	225	225	500	350	350	1000	500	500	1000	750	1250	1750
	Max. Grid Current (millamps)	35	30	30*	25	30	35	60	75	50	100	150	75	125	125	125	175	225
	Plate Dissipation (watts)	70	70	30*	50	75	100	100	150	250	250	300	450	450	750	1000	1500	2000
	Power Output (watts)	240	240	175	125	300	400	400	600	800	800	1200	1800	1800	3000	3500	5000	7500
FCC	Power Output (watts) High Level Modulated	50	50	100	100	100	350	350	500	500	1000	1000	2500	2500
	Power Output (watts) Linear Amplifier	25	50	50	125	125	125	125	350	350	500	1000
	LIST PRICE (NET)	\$6.00	\$6.75	\$13.50	\$12.50	\$9.00	\$13.50	\$13.50	\$20.00	\$24.50	\$24.50	\$65.00	\$75.00	\$75.00	\$175	\$175	\$225	\$300

VACUUM TANK CONDENSERS



Only 6½ inches long with a diameter of 2¼ inches, yet it carries a peak rf voltage rating of 32,000. May be used in a push pull 100% modulated transmitter operating at 4000 volts on the plate . . . higher voltages may be used with single ended transmitters where no modulation is required. Proper combinations of the standard units will produce any desired capacity for optimum circuit efficiencies on any frequency at any voltage. Rf current rating 20 to 50 amperes per unit depending upon frequency.

Type	Capacity	Rating	Price
VC 6-20	6 mmfd	20,000 Volts RF Peak	\$10.00
VC 12-20	12 mmfd	20,000 " " "	11.30
VC 25-20	25 mmfd	20,000 " " "	14.00
VC 50-20	50 mmfd	20,000 " " "	16.70
VC 6-32	6 mmfd	32,000 " " "	12.00
VC 12-32	12 mmfd	32,000 " " "	13.30
VC 25-32	25 mmfd	32,000 " " "	16.00
VC 50-32	50 mmfd	32,000 " " "	18.70

MERCURY VAPOR RECTIFIERS



	RX21	Grid Control KY21
Filament Voltage	2.5 volts	2.5 volts
Filament Current	10 amperes	10 amperes
Peak Inverse Voltage	11,000 volts	11,000 volts
Peak Plate Current	3 amperes	3 amperes
Aver. Plate Current	.75 amps.	.75 amps.
NET PRICE	\$7.50	\$10.00

Complete data sheets are available for every Eimac tube. Write for these data now.

Eimac
TUBES

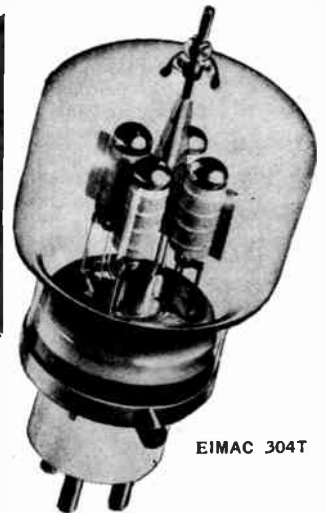

EIMAC 304T

4 Triodes in one . . . the Eimac 304T tube was designed in the Eimac laboratories for the precise purpose of providing a high power, low voltage (1000 to 2500 volts) tube having an extremely low internal resistance which would operate efficiently up to 200 megacycles. In actual operation Eimac 304T tubes are seeing service with as much as 20,000 volts on the plates . . . 10 times the rated voltage.

Price \$65.00

PRICES SUBJECT TO CHANGE WITHOUT NOTICE



UNITED

TRANSMITTING TUBES

AMATEUR, BROADCAST, COMMERCIAL, DIATHERMY, ELECTRONICS, FILM—SOUND

AND SO ON THROUGH THE ALPHABET OF POWER TUBE APPLICATIONS—

THIS TUBE IS THE ANSWER

UNITED VERSATILE 70-D

Increase your power with minimum cost and effort if you have been using the lower power types T-40, T-55 or 812.

This heavy duty V70-D has same base style, and 7½ volt filament. It drives easily, and its similar inter-electrode capacities make neutralizing simple when used in place of these smaller tubes.

★NONEX means non-expansion and high melting point. To be sure a tube is made of NONEX glass, look for tungsten seal wires, rather than copper clad which is used with soft glass. The expansion coefficient of soft glass is 3 times as high as NONEX. This fixes a correspondingly lower limit of safe plate dissipation and input in all soft glass tubes.



\$8.00

VALUE COMPARISONS, V70-D

70 watts plate dissipation
 ★Hard glass (nonex) envelope and stem
 Heavy gauge tungsten seal wires
 SPEER graphite anode
 300 watts plate input

MAXIMUM RATINGS PER TUBE

	R. F. Amplifier Class O		R. F. Amplifier Class C	
	Telephony	Telegraphy	Telephony	Telegraphy
	*CCS	†ICAS	*CCS	†ICAS
Eb	1000	1500 volts	1250	1500 volts
Ec	—260	—260 volts	—260	—260 volts
Ib	165	170 mils	200	200 mils
Ic	40	40 mils	40	40 mils
Input	165	255 watts	250	300 watts

*CCS—Continuous commercial service.
 †ICAS—Intermittent commercial and amateur service.
 Filament: 7.5 volts—3.2 amperes.
 Amplification factor 20; Rp—7500 ohms; GM—2500 umhos.
 Interelectrode capacitance (MMF) G-P 4.5; G-K 4.5; P-K 1.75.

HIGH FREQUENCY AND REGULAR COMMERCIAL TRIODES



Triode Type	Net Price	Watts Plate Diss.	Filament Volts	Filament Amps.	Purpose	Dimensions in Inches
303A (203A)	\$10.00	100	10.	3.25	R. F. Amp. Osc. Cl. B Mod.	2 3/8 x 7 7/8
304A (204A)	Inquire	250	11.	3.85	RF Amp. Osc. Mod.	4 1/8 x 14 3/8
305D (205D)	5.00	14	4.5	1.60	Theatre Audio Amp.	2 3/8 x 4 1/2
310 (801)	3.45	20	7.5	1.25	R. F. Amp. Osc. Cl. B Mod.	2 3/8 x 5 3/8
311 (211)	10.00	100	10.	3.25	General Purpose	2 3/8 x 7 7/8
312E (212E)	Inquire	350	14.	6.	Osc., Mod., A. F. Amp.	3 3/8 x 13 3/8
342B (242B)	15.00	85	10.	3.25	Theatre Audio Amp.	2 3/8 x 7 7/8
361A (261A)	16.00	100	10.	3.25	General Purpose	2 3/8 x 7 7/8
376A (276A)	16.00	100	10.	3.0	General Purpose	2 3/8 x 7 7/8
384D (284D)	15.00	85	10.	3.25	Theatre Audio Amp.	2 3/8 x 7 7/8
905 (805)	13.50	125	10.	3.25	R. F. Amp. Osc. Cl. B Mod.	2 3/8 x 8 1/2
930 (830)	8.75	40	10.	2.0	Osc. Mod. R. F. Amplifier	2 3/8 x 5 7/8
930B (830B)	10.00	60	10.	2.0	Osc. Cl. B Mod., R. F. Amp.	2 3/8 x 6 3/8
938 (838)	11.00	100	10.	3.25	Cl. B Mod., Osc., R. F. Amp.	2 3/8 x 7 7/8
941 (841)	4.50	20	7.5	1.25	R. F. Amp. Osc. A. F. Volt. Amp.	2 3/8 x 5 3/8
942 (842)	4.50	15	7.5	1.25	A. F. Amp., Mod.	2 3/8 x 5 3/8
945 (845)	10.00	75	10.	3.25	A. F. Amp., Mod.	2 3/8 x 5 7/8
949 (849)	Inquire	400	11.	5.	Osc., Mod., R. F. Amp.	4 1/8 x 14 3/8
949A (849A)	Inquire	500	11.	7.7	H. F. Osc., R. F. Amp., Mod.	4 1/8 x 14 3/8
949H (849H)	Inquire	500	11.	7.7	H. F. Osc., R. F. Amp., Mod.	4 1/8 x 14 3/8
HV12 (814)	18.00	200	10.	4.0	Osc., R. F. Amp.	2 3/8 x 9 1/2
HV18 (11F200)	22.50	200	10.	4.0	H. F. Osc. and R. F. Amp.	4 1/8 x 9 1/2
HV27 (822)	18.00	200	10.	4.0	Osc., R. F. Amp. Cl. B Audio.	2 3/8 x 9 1/2
BW11 (304B)	12.00	50	7.5	3.25	H. F. Osc. and R. F. Amp.	2 3/8 x 6 3/8



WORLD FAMOUS UNITED MERCURY RECTIFIERS



972
 This member of the illustrious UNITED rectifier family interchanges with type 872.
 Filament volts 5
 Filament current 10
 Filament mounting exposed
 Plate volts (max. inv. peak) 7500
 Plate current (max. peak) 5 amps.
NET PRICE \$9.00

966
 The much praised rectifier you hear so much about. Only 5 seconds preheating. Measured minimum mercury avoids amalgams and flash-overs. Replaces 866.
 Fil. Volts 2.5
 Fil. Amps. 5
 Exposed Filament
 Max. Inv. Volts. ... 7500
 Max. Peak Amps. ... 1
NET PRICE \$1.20



967
 The grid control rectifier so popular for power supply keying and countless industrial applications. Replaces FG-17.
NET PRICE \$3.50



UNITED ELECTRONICS CO.
 42 Spring Street
 Newark N. J.

972-A
 Used widely by U. S. Government and important commercial transmitters — Replaces type 872-A.
 Filament volts 5
 Filament current 6.75 amps.
 Filament mounting shielded
 Plate volts (max. inv. peak) 10,000
 Plate current (max. peak) 5 amps.
NET PRICE \$11.00

966-A
 Meeting U. S. Government requirements for anode shielding and break-down test, this mercury rectifier is a world wide professional favorite. Replaces 866-A.
 Fil. Volts 2.5
 Fil. Amps. 5
 Shielded Filament
 Max. Inv. Volts. ... 10,000
 Max. Peak Amps. ... 1
NET PRICE \$1.50



UNITED tubes are used as initial equipment in HARVEY, TEMCO and many other well known transmitters.



UNITED

DIATHERMY OSCILLATOR TUBES

AMATEUR, BROADCAST, COMMERCIAL, DIATHERMY, ELECTRONICS, FILM—SOUND

AND SO ON THROUGH THE ALPHABET OF POWER TUBE APPLICATIONS—

Ever since the electronic tube appeared to displace old spark-gap diathermy, UNITED has worked hand in hand with the leading therapy instrument designers. In consequence of this great co-operative research, UNITED radio-therapy oscillators and rectifiers are used by the majority of short wave generator manufacturers.

These tubes are specifically designed for heavy duty use in these self excited oscillator circuits, in which general purpose tubes cannot properly be applied.

Accurate replacement of tubes can most readily be made by selecting the proper UNITED types from the tables below.

RENEWAL TUBE INDEX FOR STANDARD MACHINES

(If machine is not listed, replace tubes in accordance with guide at bottom of this page)

Manufacturer	Model	United Tubes	Manufacturer	Model	United Tubes
Adlanca	Portable	2 type 311T	Fischer of Glendale	Clinic	{2 type 311CT, 2 type 966
Barr	SW15	2 type 311CT	"	Cansale	{2 type 311CT, 2 type 966
Beck Lee	1205 & 1206	2 type 311T	"	F-99	2 type 311CT
Bristaw	FP-35 & FP-12	2 type 311CT	"	102A	2 type 311CT
Brapar	NP	{2 type 311CT, 2 type 966	High Tension International	RF1 and RF5	2 type 311T
Birtcher	Challenger, models 900, 960, 970, 980, and 990	{2 type 311CT, 2 type 966	MacIntosh	Brevatherm	2 type 311CT
"	Crusader #500 (Serial numbers over 63401)	2 type CV11	Mooradian	Model C	2 type 311T
"	Viking #550	2 type CV11	Nassau	All models	2 type 303U
"	Surgical #3000	2 type CV11	Rose	CW1, CW2, CW3	2 type 311T,
Burdick	Triplex	2 type HV18	"	CW4, CW5	2 type HV18
"	Magnetherm	2 type FV20	"	CW6	2 type 311T
"	SWD 50	2 type 311T	"	CX1	2 type HV18
"	SWD 5	2 type 952	"	CX2	{2 type HV18, 2 type 966
Cameron	Cauteradio	1 type 930	"	C-U	2 type 311T
De Forest	Models K, A, B, C, E, L, R250, R300, D300, LR300	{2 type 311CT, 2 type 966	"	Tube-Gap Surgical	2 type 311T
"	Models NE, D400, R400, LL, M, Cansale and 81-Wave	{2 type HV18, 2 type 966	Sanitex	S1	1 type HV27
"	Thermodyne	{1 type FV20, 2 type 966	"	S2	2 type 311CT
Denmark	SWF	2 type 311CT	"	S3	{2 type FV20, 2 type 966
"	ENT	2 type 303-U	"	S4	{2 type FV20, 2 type 966
"	HFP	2 type HV12	"	S10	2 type 311CT
Falconer	Portable 6	2 type 311CT	Scherco	Portable 100	2 type 311T
Fischer of Glendale	#106C	2 type 311CH	"	Portable 200	2 type 311T
"	#114A	2 type HV18	"	2000	{2 type 311T, 2 type 966
"	Portable	{2 type 311CT, 2 type 966	Termo	T-2 B	2 type 311CT
			"	R-4	{2 type 311CT, 2 type 966
			"	R-6	{2 type FV20, 2 type 966
			"	R-7	{2 type HV18, 2 type 966
			"	P-14	1 type HV27



Replace Worn Out Tubes With UNITED Types In Accordance With Following Guide



203 H	replaced by	UNITED 303U
211	replaced by	UNITED 311T
211 C	replaced by	UNITED 311CT
241 D	replaced by	UNITED 311T
211 H	replaced by	UNITED 311CH
303 C	replaced by	UNITED 303U
814	replaced by	UNITED HV 12
822	replaced by	UNITED HV 27
830	replaced by	UNITED 930
852	replaced by	UNITED 952
866	replaced by	UNITED 966

C 455	replaced by	UNITED 930
FP 195	replaced by	UNITED 952
FP 197	replaced by	UNITED 311T
FP 252A	replaced by	UNITED FV 20
FP 285	replaced by	UNITED 311CT
HD 211	replaced by	UNITED 311CH
HF 200	replaced by	UNITED HV 18
T 200	replaced by	UNITED HV 18
WL 195	replaced by	UNITED 952
WL 211	replaced by	UNITED 311T
WL 460	replaced by	UNITED HV 18



COMPLETE TECHNICAL BULLETIN DESCRIBING ALL ABOVE TUBES WILL BE SENT UPON REQUEST

NET PRICES

Type	Net Price	Type	Net Price	Type	Net Price	Type	Net Price
311T	\$16.00	FV-20	\$17.50	HV-12	\$18.00	930	\$ 8.75
311CT	16.00	HV-18	22.50	HV-27	18.00	303U	18.00
311CH	18.00	952	16.40	CV-11	10.00	966	1.20

See other pages in this catalog for replacement condensers, resistors, insulators, switches, etc., needed for servicing short wave diathermy machines.

Taylor

HEAVY

CUSTOM
BUILT

DUTY

Tubes

THE WONDER TUBES Set A New Standard In Value and Performance

T-40

Thousands in use throughout the world. Widely copied but quality never equalled. 40 watts plate dissipation. Fil. 7.5 V.—2.5 A. Plate 1000 V.—115 MA. Amp. Factor 25. G to P cap. 4.8 mmf. Efficient on all frequencies up to 120 MC. Easy to drive.

\$3.50

TZ-40 Zero Bias

Same general characteristics as the T-40 except the amp. factor is 62. A pair will deliver up to 225 watt Class B audio output. An extremely efficient doubler and preferred by thousands for all-around superior Class C performance.

\$3.50

Tops In Value T-20

Considered by thousands of Amateurs as the real all-purpose tube. Easy to drive and is truly efficient on all frequencies up to 60 mc. Plate dissipation 20 watts. Fil. 7.5 V.—1.75A. Plate 750 V.—75 M.A. Amp. factor 20. G to P cap. 5.0 mmf. The greatly improved T-20 is making real records for long life.

\$2.25

TZ-20 Zero Bias

Same general characteristics as the T-20 except the amp. factor is 62. A pair will deliver up to 80 watts Class B audio output. Also recommended for efficient doubler service.

\$2.25

866 Jr.

Half-wave, Mercury Vapor Rectifier. Has plate lead through UX 4 prong Alsimag-base. Fil. 2.5 V.—2.5 A. Max. RMS A.C. volts 1250. Max. D.C. current per pair (choke input) 250 MA. Intended for use as rectifiers in power supplies of from 600 to 1000 volts D.C. where the receiving type full-wave rectifiers will not stand up and where the power capabilities of the regular 866's are not necessary. The smaller size of Taylor's 866 Jrs. is another advantage in compact transmitters. Multi-strand filament and Svea metal anode.

\$1.00

Write us for
TAYLOR TUBES
new **MANUAL.**
FREE



T-282

T-282

Tantalum Anode

A Taylor designed screen grid, RF Power amplifier used in multi-channel transmitters.

The improved vertical filament eliminates sagging that prevailed with the old helical wound type of filament.

Filament Volts	10
Filament Current Amps	3
Max. Plt. Volts	1000
Max. Plt. Current Amps100
Max. RF Grid Current Amps	5
Screen Grid Volts	150
Grid Bias Volts	—90
Max. Plt. Dissipation Watts	70
Amplification Factor	100

UX 4-prong Statite Base

\$22.50

Amateurs Favorite!

T-55

Continues to be one of the most popular transmitting tubes. Now greatly improved with semi-thin carbon anode and abuse-proof grid. Plate dissipation 55 watts. Fil. 7.5V.—3.0A. Plate 1500 V.—150 MA. Amp. factor 20. G to P 3.85 mmf. Very easy to drive—easy to neutralize. An ultra efficient tube for 5 and 10 meter service. Greatly outsells other tubes of the same class. Nonex glass.

\$6.00

T-21

A Taylor Beam Amplifier Tube 6 prong Alsimag base

Especially efficient as an oscillator, amplifier or frequency multiplier and desirable for mobile and portable radio transmitters. 21 watts plate dissipation. Heater 6.3 V.—0.9A. Plate 400 V.—95 MA. Amp. factor 138. Many Amateurs hailed the advent of the T-21 as it enabled them to have "100% Taylorized" rigs.

\$1.95

The New Shielded 866

Half-wave, Mercury Vapor Rectifier. Delivers all the characteristics of an 866-A at this new low price. Has complete cathode shield which insures lower heat and longer life. Fil. 2.5 V.—5A. Peak inverse 10,000 volts. Peak current 1.0 amp. max. Has multi-strand filament and Svea Metal Anode and shield. The Alsimag insulator below the plate cap increases safety and minimizes glass failures. Universally recognized as the best 866, this Taylor Tube leads in sales by a very wide margin.

\$1.50

We carry a complete stock of Taylor Tubes and always have the New Tubes as soon as they are announced.



T-40



T-55



T-20



T-21



866 Jr.



866

Taylor

HEAVY

CUSTOM
BUILT

DUTY

Tubes

"More Watts per Dollar!"

203-Z

Zero Bias

300 Watts Audio in Class B

Will work with all standard 203-A type Transformers. Filament 10 volt—3.25 amp. Plate 1250 volt 175 MA. per tube. Amp. factor 85. Plate to plate load at 1250 V. for 300 W. output 7900 Ohms. Nonex Glass—Metal plate—50 watt type base. A very popular Class B Audio Tube.

\$8.00

805

Zero Bias

450 Watts Audio in Class B

Standard type Carbon Anode Zero Bias 805. Filament 10 Volt—3.25 Amp. In RF—plate 2000 Volt—200 MA. In Class B—195 MA. per tube. Amp. factor 40 to 60. G to P cap. 6.5 mmf. A fine tube for all Class C services and extremely popular as an Audio Amplifier. Nonex Glass—50 watt type base.

\$13.50

872-A

This new and greatly improved Taylor design uses a processed Carbon Anode and Shield plus a Multi-strand filament. A pair will deliver up to 2.5 Amps. at 3500 Volts D.C. Filament 5.0 Volt—6.75 Amp. Peak inverse 10,000 Volts. Peak current 5.0 Amp. Nonex Glass. Scores of Commercial Stations are creating New life records with Taylor 872-A's. A performance test will prove their superiority.

\$10.50

T-200

Amateur's "Power House" Tube

200 Watts plate dissipation. Heavy duty filament 10 volt—5.75 Amp. Plate 2500 Volt—350 MA. G to P cap. 7.8 mmf. Amp. factor 16.6. An easy to drive tube widely favored by Commercial Short Wave Stations and Amateurs. Extra heavy leads and safety type construction throughout handles serious overloads without damage. A popular type for Diathermy service. Nonex Glass.

\$21.50

OTHER TAYLOR TUBES

Diathermy Types

841SW	50 watts	\$7.00
211C	100 watts	12.50
303C	150 watts	14.50
HD211C	150 watts	14.50

Amateur Types

756	40 watts	3.95
HD203A	150 watts	14.50
204A	250 watts	60.00

The Taylor Manual giving full characteristics of all Taylor Tubes will be sent to you upon request.

WE RECOMMEND TAYLOR TUBES



203Z

805

872A



T200

822

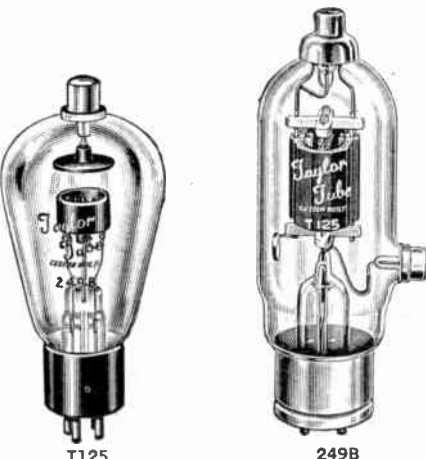

T125

249B

822

700 Watts Audio in Class B

200 Watts plate dissipation. An extra heavy duty tube of the 03A type featuring a Super Carbon Anode. Filament 10 Volt—4.0 Amp. Plate 2500 Volt—300 MA. G to P cap. 13.5 mmf. Amp. factor 27. Popular for Class B Audio and used by many low powered Broadcast Stations. Also used in Diathermy service. Nonex Glass.

\$18.50

814

Same general characteristics as the 822 except Amp. factor is 12. Is favored for use in Grid Modulated Transmitters.

\$18.50

203-A

Standard Characteristic

Carbon Anode 203-A. 100 Watts Plate dissipation. Filament 10 Volt—3.25 Amp. Plate 1500 Volt—175 MA. Amp. factor 25. G to P cap. 14 mmf. Taylor 203-A's are giving satisfactory long-life service in many Commercial Stations. Have FCC approval. Nonex Glass.

\$10.00

211

Same characteristics as 203-A except Amp. factor is 12.5.

\$10.00

845

Class "A" Audio Tube. 70 watts Plate Dissipation. Filament 10 Volt—3.25 Amp. Plate 1250 Volt—75 MA. Carbon Anode—Nonex Glass.

\$10.00

T-125

With Accelerating Fins

A type that gives all the advantages of a Low C tube together with the advantages of a Higher C tube—without the disadvantages of either. Plate dissipation 125 Watts. Filament 10 Volt—4.5 Amp. Plate 2000 Volt—200 MA. G to P cap. 6 mmf. Amp. factor 25. Very easy to drive. Can be operated at full rated input up to 30 Mc. Taylor's T-125's have an enviable reputation among Amateurs thruout the World. Nonex glass—50 watt type base.

\$13.50

249-B

A Heavy Duty Rectifier

Of the Half-Wave Mercury Vapor type. Has processed Carbon Anode and Shield and Multi-strand filament. In a single phase full-wave power supply, two 249-B's will deliver up to 1.25 Amp. at 3300 D.C. Volts. Filament 2.5 Volt—7.5 Amp. Peak inverse 10,000 Volts. Peak current 2.5 Amp. Approx. Volt. drop 15 per tube. Nonex Glass—UX 4 prong base. An ideal tube for 1 KW stations.

\$5.00

AMPEREX

GRAPHITE ANODE TRANSMITTING TUBES

FOR BROADCASTING, DIATHERMY, PHYSIOTHERAPY, AMATEUR AND INDUSTRIAL APPLICATIONS

Even cursory inspection will show how AMPEREX tubes differ from the mere adaptations of conventional tube types . . . Exclusive engineering developments and radical design refinements are incorporated in the structure of these tubes and reflected in their superior performance.

So universal has been the recognition of the merits and efficiency of these tubes that now more than 70% of all diathermy ultra short wave generators are equipped with AMPEREX tubes and thousands more are in operation in almost every country in the world . . . in broadcast, communication, amateur and industrial apparatus where they have replaced more costly or less efficient tubes.

HF-100



An ultra-high, normal R. F. power amplifier and oscillator and class B audio amplifier or modulator.

The HF-100 is one of a distinctive group of low voltage high current tubes, an original development of the AMPEREX ENGINEERING LABORATORIES. It is in addition characterized by an extraordinary high ratio of transconductance to interelectrode capacitance, a characteristic which is responsible for its outstanding efficiency in ultra-high frequency circuits.

GENERAL CHARACTERISTICS

Filament: Voltage	10-10.5
Current	2 amperes
Amplification Factor	23
Grid to Plate Transconductance @ 100 ma.	4200
Direct Interelectrode Capacitances:	
Grid to Plate	4.5 uuf
Grid to Filament	3.5 uuf
Plate to Filament	1.4 uuf

Net Price \$12.50

HF-200

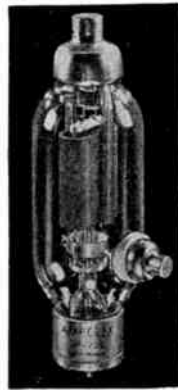

High and normal R. F. power amplifier, oscillator, class B modulator.

The HF-200 is another of the highly proficient ultra-high frequency generators of original AMPEREX design and development. The outstanding features of low voltage high current and a high ratio of transconductance to interelectrode capacitance are also properties of this tube.

GENERAL CHARACTERISTICS

Filament: Voltage	10-11 volts
Current	3.4 amperes
Amplification Factor	18
Grid to Plate Transconductance @ Plate Current of 150 ma.	5000 micromhos
Direct Interelectrode Capacitances:	
Grid to Plate	5.8 uuf
Grid to Filament	5.2 uuf
Plate to Filament	1.2 uuf

Net Price \$24.50

R. F. power amplifier, oscillator, class B modulator.

The HF-300 has found favor with many broadcasters and transmitter designers as a substitute for the 204A. A study of the operational data will disclose its superiority, in many classes of service, to the latter tube. It also, like the HF-100 and HF-200, is an efficient ultra-high frequency generator and possesses the characteristic common to AMPEREX designed tubes, of a high ratio of transconductance to interelectrode capacitance.

GENERAL CHARACTERISTICS

Filament: Voltage	11-12 volts
Current	4 amperes
Amplification Factor	23
Grid to Plate Transconductance @ 150 ma.	5600 micromhos
Direct Interelectrode Capacitances (App.):	
Grid to Plate	6.5 uuf
Grid to Filament	6.0 uuf
Plate to Filament	1.4 uuf

Net Price \$35.00

HF-300

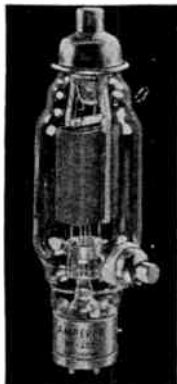

Low Distortion zero-bias class B amplifier and modulator, high efficiency R. F. frequency multiplying power amplifier, conventional R. F. power amplifier.

The ZB-120 is an exclusive AMPEREX development. In common with other tubes of original AMPEREX design it is a low voltage high current type and possesses a high ratio of transconductance to interelectrode capacitance. Although it approaches nearer the ideal in a zero-bias class B tube it is also a highly efficient performer in many other classes of service.

GENERAL CHARACTERISTICS

Filament: Voltage	10-10.5 volts
Current	A.C. or D.C. 2 amperes
Amplification Factor	90
Grid to Plate Transconductance @ 120 ma.	5000 micromhos
Direct Interelectrode Capacitances:	
Grid to Plate	5.2 uuf
Grid to Filament	5.3 uuf
Plate to Filament	3.2 uuf

Net Price \$10.00

ZB-120

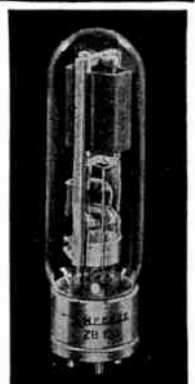

SEE REVERSE SIDE FOR COMPLETE LISTING AND NET PRICES



AMPEREX TRANSMITTING AND RECTIFYING TUBES



Amperex 891-R
AIR RADIATION TYPE
Water Cooled Tube
\$410*

Amperex HF-3000
ALL GLASS AIR RADIATION
High Frequency, High Power Tube
\$300

RADIATION COOLED TYPES

TYPE NO.	PRICE	FILAMENT		Capacitance Grid to Plate	*Max. Plate Dissipation Watts	*Nominal Output Watts
		Volts	Amps.			
AB-150	15.00	10.0	3.25	9.5	100	AB150
HF- 6D	5.75	10.0	2.50	5.2	60	C100
HF- 75	8.00	10.0	3.25	2.0	75	C150
HF-100	12.50	10.0	2.00	4.5	75	C150
HF-120	15.00	10.0	3.25	10.5	100	C150
HF-125	17.50	10.0	3.25	11.5	100	C200
HF-130	17.50	10.0	3.25	9.0	125	C170
HF-140	15.00	10.0	3.25	12.5	100	C150
HF-150	17.50	10.0	3.25	7.2	125	C200
HF-175	19.00	10.0	4.00	6.3	125	C300
HF-200	24.50	10.5	4.00	5.8	150	C350
HF-250	27.50	10.5	4.00	5.8	150	C375
HF-300	35.00	11.0	4.00	6.5	200	C600
ZB-120	10.00	10.0	2.00	5.2	75	B300
111H	12.50	10.0	2.25	4.6	75	C175
203A	10.00	10.0	3.25	13.5	100	C150
203H	17.50	10.0	3.25	11.5	100	C200
204A	85.00	11.0	3.85	15.0	250	C500
211	10.00	10.0	3.25	12.5	100	C150
211C	17.50	10.0	3.25	9.0	125	C175
211H	17.50	10.0	3.25	7.2	125	C200
212E	75.00	14.0	6.00	19.0	275	BR75
241B	85.00	14.0	6.00	18.8	275	C400
242A	12.50	10.0	3.25	13.0	85	A20
242B	12.50	10.0	3.25	13.0	100	A20
242C	15.00	10.0	3.25	13.0	100	A20
251A	300.00	10.0	16.00	8.0	1000	C1200
261A	17.50	10.0	3.25	9.0	125	C175
270A	168.00	10.0	9.75	21.0	350	C700
276A	15.00	10.0	3.00	9.0	125	C175
279A	300.00	10.0	21.00	18.0	1200	BR500
304B	12.50	7.5	3.25	2.5	50	C85
308B	75.00	14.0	6.00	17.4	250	A50
800	10.00	7.5	3.25	2.5	35	C65
801	3.25	7.5	1.25	6.0	42	C25
805	13.50	10.0	3.25	6.0	125	B400
810	13.50	10.0	4.50	4.8	125	C375
830	8.75	10.0	2.00	9.9	40	C60
830B	10.00	10.0	2.00	11.0	60	B175
833	85.00	10.0	10.00	6.3	300	C1000
834	12.50	7.5	3.25	2.5	50	C75
838	11.00	10.00	3.25	8.0	100	B275
841	3.25	7.5	1.25	7.0	15	B25
842	3.25	7.5	1.50	7.0	12	A3
845	10.00	10.0	3.25	11.5	75	A25
849	120.00	11.0	5.00	33.0	300	B1225
849A	135.00	11.0	7.70	11.5	500	B1900
849H	135.00	11.0	7.70	11.5	500	C1180
851	195.00	11.0	15.50	47.0	750	C1700
852	16.40	10.0	3.25	2.6	100	C165

*Ratings given are typical of the class of service in which the tube is most commonly used.

The letter preceding each rating identifies the particular class of service as follows:

A —power output per tube as Class A power amplifier and modulator
AB —power output per pair of tubes as Class AB power amplifier and modulator

B —power output per tube as Class B power amplifier and modulator
BR —power output per pair of tubes as Class B Radio Frequency power amplifier

C —power output per tube as Class C power amplifier or oscillator
CP —power output per tube as Class C plate modulated power amplifier

FORCED-AIR COOLED TYPES

TYPE NO.	PRICE	FILAMENT		Capacitance Grid to Plate	*Max. Plate Dissipation Watts	*Nominal Output Watts
		Volts	Amps.			
220R	\$410.00†	21.5	41.0	22.0	6000	BR2500
232R	605.00†	20.0	72.0	22.0	7500	CP10000
345R	410.00†	21.5	57.5	23.5	5000	CP5000
889R	400.00	11.0	125.0	19.0	3000	CP4000
891R	410.00†	11.0†	60.0	28.0	4500	B10000
892R	410.00†	11.0†	60.0	32.0	2000	CP5000
HF3000(°)	300.00	21.5	40.5	10.0	3000	C7500
ZB3200(°)	300.00	21.5	40.5	10.0	2000	B8000

†\$100.00 credit for return of radiator and crate in good condition.

°Single or two-phase filament (two units); voltage is per unit.

*All glass radiation and air-cooled transmitting tubes.

WATER-COOLED TYPES

TYPE NO.	PRICE	FILAMENT		Capacitance Grid to Plate	*Max. Plate Dissipation Watts	*Nominal Output Watts
		Volts	Amps.			
207	\$275.00	22.0	52.0	27.0	10000	C20000
220C	290.00	21.5	41.0	22.0	10000	BR2500
228A	249.00	21.5	41.0	23.4	3000	BR1000
232C	480.00	20.0	72.0	22.0	20000	BR8500
342A	480.00	20.0	67.0	27.0	25000	BR8500
343A	290.00	21.5	57.5	23.5	10000	BR3500
520B	210.00	22.0	34.0	27.0	5000	C5000
846	300.00	11.0	51.0	9.0	1600	C2500
848	325.00	22.0	52.0	27.0	7500	A2000
858	450.00	22.0	52.0	18.0	20000	C20000
859	525.00	11.0†	71.0	15.0	20000	C35000
863	325.00	22.0	52.0	27.0	7500	B22000
889	275.00	11.0	125.0	17.5	5000	C10000
891	285.00	11.0†	60.0	27.0	5000	B22000
892	285.00	11.0†	60.0	32.0	6000	CP6000
1652	325.00	14.5	52.0	27.0	5000	C6000
HF50K	750.00	{27.0**	{100.0}	{20.0}	{30000}	{C25000}
		{13.5**	{200.0}			

†Single or two-phase filament (two units), voltage is per unit.

*Single or two-phase filament excitation.

°At upper frequency limit of 50 megacycles.

MERCURY VAPOR RECTIFIERS

TYPE NO.	PRICE	FILAMENT		Peak Inverse Volts	*Approximate Average Plate Amps.	Peak Plate Amps.
		Volts	Amps.			
249B	10.00	2.5	7.50	7500	0.50	1.5
258B	9.85	2.5	7.50	7500	0.50	1.5
266B	297.00	5.0	42.0	22000	7.00	20.0
267B	23.00	5.0	6.75	10000	1.25	5.0
315A	42.50	5.0	10.00	15000	1.50	6.0
575A	35.00	5.0	10.00	15000	1.50	6.0
857B	240.00	5.0	40.00	22000	10.00	49.0
866	1.50	2.5	5.00	7500	0.25	1.0
866A	1.50	2.5	5.00	10000	0.25	1.0
869B	125.00	5.0	20.00	20000	2.50	11.0
872	9.00	5.0	10.00	7500	1.25	5.0
872A	11.00	5.0	6.75	10000	1.25	5.0

*Actual value will depend on wave-form resulting from load and filter circuit.



Westinghouse RADIO TRANSMITTING TUBES



Westinghouse manufactures a complete line of transmitting tubes for broadcasting and other uses. These tubes reflect in quality and performance the accumulated experience of the

oldest name in commercial radio broadcasting. Be sure to specify Westinghouse when ordering Radio Transmitting Tubes. They are dependable, efficient, and economical to operate.

AIR-COOLED TYPES

Type Number	Net Price	Class	CATHODE		PLATE			Max. Me. For Max. Plate Volts & Input	Cap. Grid. Plate uuf.	Mu or Gm
			Volts	Amps.	Max. Volts	Max. Amps.	Max. Dissipation Watts			
WL-203A	\$10.00	Triode	10	3.25	1250	0.175	100	15	14.5	25
WL-204A	85.00	Triode	11	3.85	2500	0.275	250	3	15	23
WL-211	10.00	Triode	10	3.25	1250	0.175	100	15	14.5	12
WL-809	10.00	Triode	7.5	3.25	1250	0.080	35	60	2.5	15
WL-802	3.50	Pentode	6.3	0.90	500	0.060	10	30	.15	2250
WL-803	28.50	Pentode	10	5.00	2000	0.175	125	20	.15	4000
WL-805	13.50	Triode	10	3.25	1500	0.210	125	30	6.5	50
WL-806	22.00	Triode	5	10.0	3000	0.200	150	30	4.2	12.6
WL-807	3.50	Beam	6.3	0.90	3300*	0.300*	225*	60	0.2	6000
WL-809	2.50	Triode	6.3	2.50	600	0.100	25	60	6.7	50
WL-810	13.50	Triode	6.3	4.50	750	0.100	25	60	6.7	50
WL-811	3.50	Triode	6.3	4.00	1000*	0.100*	30*	60	6.7	50
WL-812	3.50	Triode	6.3	4.00	1000*	0.100*	30*	60	6.7	50
WL-813	22.00	Beam	10.0	5.00	2000	0.180	100	30	0.2	3750
WL-814	17.50	Beam	10.0	3.25	1250	0.150	50	30	0.1	3300
WL-815	4.50	2-Beam	6.3	1.6	500*	0.150*	25*	150	0.2	4000
WL-828	17.50	Beam	10.0	3.25	1250	0.160	70	30	0.05	2800
WL-833A	85.00	Pentode	10.0	10.00	1500*	0.180*	80*	30	6.3	35
WL-837	7.50	Pentode	12.6	0.70	3000	0.500	400	20	0.2	3400
WL-838	11.00	Triode	10.0	3.25	500	0.080	12	20	8.0	24
WL-845	10.00	Triode	10.0	3.25	1250	0.175	100	3	33.5	53
WL-849	120.00	Triode	11.0	5.00	2500	0.350	400	3	33.5	19
WL-851	195.00†	Triode	11.0	15.50	2500	1.00	750	3	47	20.5
WL-863	32.50	Tetrode	10.0	3.25	3000	0.180	100	30	0.08	1100
WL-861	195.00†	Tetrode	11.0	10.0	3500	0.350	400	20	0.10	2100
WL-865	12.75	Tetrode	7.5	2.0	750	0.060	15	15	0.10	750



WL-806



WL-807



WL-866A/866



WL-809



WL-803



WL-211



WL-891



WL-892



WL-872A



WL-204A

† Ratings given are typical for continuous commercial service (CCS). For design purposes complete ratings should be requested.
* These ratings are for intermittent commercial and amateur service (ICAS).
† F.O.B. Bloomfield. ‡ Ratings with forced air cooling. ¶ Heater type cathode.

FORCED-AIR COOLED TRIODES

Type Number	Net Price†	CATHODE		PLATE			MAX. FREQ. MC.		Mu
		Volts	Amps.	Max. Volts	Max. Amps.	Max. Dissipation Watts	At Max. Plate Input	At 50% Max. Plate Input	
WL-889R	\$375.00	11	125	8500	2	5000	25.0	100	21
WL-891R	410.00*	11z	60z	10000	2	4000	1.6	20	8
WL-892R	410.00*	11z	60z	12500	2	4000	1.6	20	50
WL-893R	1050.00‡	10y	61y	20000	4	20000	5.0	40	36

z Single or two-phase filament (Two units); voltage is per unit, current is per unit. † F.O.B. Bloomfield.
y Single, three or six-phase filament (Six units); voltage is per unit; current is per unit.
* \$100 credit for return of radiator and crate in good condition.
‡ On a replacement tube, a saving may be made by returning radiator and crate to factory in good usable condition. The returned radiator will be applied to a new WL-893 at regular price plus an additional service charge of \$100.00.

WATER-COOLED TRIODES

Type Number	Net Price†	CATHODE		PLATE			MAX. FREQ. MC.		Mu
		Volts	Amps.	Max. Volts	Max. Amps.	Max. Dissipation Watts	At Max. Plate Input	At 50% Max. Plate Input	
WL-207	\$300.00	22	52	15000	2	10000	1.6	20	20
WL-862	1650.00‡	33	207	20000	5	100000	1.6	40	48
WL-880	750.00	12.6	320	10500	6	20000	25.0	100	21
WL-889	275.00	11	125	8500	2	5000	50.0	150	21
WL-891	285.00	11z	60z	12000	2	6000	1.6	20	8
WL-892	285.00	11z	60z	15000	2	10000	1.6	20	50
WL-893	750.00	10y	61y	20000	4	20000	5.0	40	36
WL-898	1650.00‡	16.5y	70y	20000	10	100000	1.6	40	44
WL-899A	750.00	14.5	180	18000	5	30000	5.0	60	27

z Single or two-phase filament (Two units); voltage is per unit, current is per unit. † F.O.B. Bloomfield.
y Single, three or six-phase filament (Six units); voltage is per unit; current is per unit.
‡ \$18 credit for return of crate in good condition; also \$10 credit for return of tube.

DIODE RECTIFIER TYPES

Type Number	Net Price	Class	Cooling	CATHODE		Peak Inverse Volts	Avg. Plate Amps.	Peak Plate Amps.
				Volts	Amps.			
WL-531	125.00†	Vacuum	Forced Air	11.5	20	50000	0.29	0.75
WL-857B	240.00†	Mercury	Air	5	30	22000	10.0	40
WL-866A/866	1.50	Mercury	Air	2.5	5	10000	0.25	1
WL-869B	125.00†	Mercury	Air	5	18	20000	2.50	10
WL-872	9.00	Mercury	Air	5	10	15000‡	5.00‡	15‡
WL-872A	11.00	Mercury	Air	5	6.75	7500	1.25	5

† Quadrature Filament Excitation. ‡ F.O.B. Bloomfield.



Westinghouse INDUSTRIAL TUBES



Westinghouse was a pioneer in the manufacture and application of industrial tubes. Through the years, untiring research and engineering skill have been combined to produce dependable

electronic devices and tubes for every industrial requirement. Ask for Westinghouse tubes and be sure of getting a quality product.

PLIOTRONS—THERAPY OSCILLATOR TRIODES

Tube Type Number	Net Price†	FILAMENT		PLATE			Max. Me. For Full Volts & Input	Cap. G-P uuf	Amp. Factor	Max. Length Inches	Max. Dia. or Radius Inches
		Volts	Amps.	Volts	Milli.	Watts					
WL-469	\$18.00	10	3.25	1500	200	100	20	13.5	12	7½	2½
WL-471	20.00	10	3.25	1500	200	100	20	13.5	12	8½	2½
WL-195	26.00	10	3.25	3000	125	125	30	2.8	12	8½	4¼*
WL-196	26.00	10	3.25	3000	125	125	30	3.0	30	8½	4¼*
WL-468	24.75	10	4.1	2000	200	150	30	7.25	18	11	3½
WL-460	26.00	10	4.1	2500	200	150	50	7.5	18	11	2½*
WL-463	37.00	11	5.0	2500	275	200	50	7.5	22	11½	2½*

* Indicates Radius.

PLIOTRON—ELECTROMETER TRIODE

RH-507	\$24.50	2.0	0.06	4	0.2	0.8	5	1½
--------	---------	-----	------	---	-----	------	------	------	-----	---	----

THYRATRONS

Tube Type Number	Net Price†	Peak Inverse Volts	Average Amps.	Peak Anode Amps.	Gas	Control	FILAMENT		Max. Length Inches	Max. Dia. or Radius Inches
							Volts	Amps.		
WL-629	\$ 4.50	350	0.04	0.2	Inert	Neg.	2.5	2.6	4½	1½
KU-636	15.00	350	0.1	0.4	Inert	Neg.	2.5	7.0	7	2½
KU-610	17.50	500	0.1	0.4	Inert	Pos.	2.5	6.5	6½	2½
WL-631	15.00	1000	2.5	15.0	Merc.	Neg.	5.0	4.5	7½	3½
WL-632	19.00	1000	2.5	15.0	Merc.	Neg.	5.0	4.5	7½	2½*
KU-676	40.00	1000	6.4	40.0	Merc.	Neg.	5.0	9.5	11½	3½
KU-627	11.00	2500	.64	2.5	Merc.	Neg.	2.5	6.0	7	2½
KU-628	22.00	2500	2.0	8.0	Merc.	Neg.	5.0	11.5	9	3½
KU-634	37.50	7500	1.25	5.0	Merc.	Neg.	5.0	11.5	9	3½
KU-677	40.00	7500	4.0	16.0	Merc.	Neg.	5.0	9.5	11½	3½

* Indicates radius.

GRID GLOW TUBE

KU-618	\$ 9.50	800	0.015	0.10	Inert	Pos.	Cold Cathode	5¾	2¾
--------	---------	-----	-------	------	-------	------	--------------	----	----

KENOTRONS—VACUUM RECTIFIER TUBES

Tube Type Number	Net Price†	Peak Inverse Volts	Average Anode Amps.	Peak Anode Amps.	Full or Half Wave	FILAMENT		Max. Length Inches	Max. Dia. Inches
						Volts	Amps.		
RO-585	\$12.00	1500	.003	.005	Half	5.0	1.1	4¾	1¾
WL-579B	9.50	20000	.025	.27	Half	2.5	6.0	7½	2½
WL-608	120.00	60000	.06	.20	Half	10	10	14¾	5½
WL-613	150.00	140000	.06	.20	Half	11	10	19	5¾
WL-456	125.00	140000	.06	.20	Half	11	20	18½	5½
WL-612	195.00	150000	.24	.75	Half	10	50	25¾	6¾
WL-660	200.00	230000	.03	.10	Half	10	10	33	6¾

PHANOTRONS—GAS RECTIFIER TUBES

Tube Type Number	Net Price†	Peak Inverse Volts	Average Anode Amps.	Peak Anode Amps.	Gas	Full or Half Wave	FILAMENT		Max. Length Inches	Max. Diam. Inches
							Volts	Amps.		
WL-786	\$67.00	1500	30.0	150.0	Mercury	Half	2.5	100.0	19½	4¼
WL-669	8.00	1000	1.0*	3.1	Mercury	Full	2.5	12.0	6	2¾
WL-670	15.00	1000	3.0*	9.5	Mercury	Full	2.5	24.0	7¾	3¾

* The plate current values are per anode, and double these figures can be obtained when using both anodes in a proper circuit.

PHOTOTUBES

Tube Type Number	Net Price†	Spectral Range	Typical Micro. Amps. Per Lumen	Description	Cathode Surface Material	Maximum Anode Volts	Aperture Inches
SR-53	7.50	Deep Red—Violet	25	Vacuum	Cs-O	500	¾ x 1¾
SK-60	5.00	Deep Red—Violet	60	Gas	Cs-O	90	¾ x 1¾
SK-63	7.50	Deep Red—Violet	125	Gas	Cs-O	90	¾ x 1¾
WL-734	2.60	Deep Red—Violet	15	Vacuum	Cs-O	500	¾ x 1¾
WL-735	2.60	Deep Red—Violet	60	Gas	Cs-O	90	¾ x 1¾
WL-770	25.00	Visible	0.75	Vacuum	Cs-Mg	500	1¾ diam.
WL-767	50.00	2000—3200 Angs.	Vacuum	Titanium	500	1¾ x 1¾
WL-773	50.00	2000—3700 Angs.	Vacuum	Thorium	500	1¾ x 1¼
WL-775	50.00	2000—3000 Angs.	Vacuum	Tantalum	500	1¾ x 1¼
WL-789	75.00	Below 2000 Angs.	Vacuum	Platinum	500	1¾ diam.

MISCELLANEOUS INDUSTRIAL ELECTRONIC TUBES BALLAST TUBES

Tube Type Number	Net Price†	Base	Description	No. of Electrodes	Range Volts	Nominal Amps.	Maximum Length Inches	Maximum Diameter Inches
WL-896	\$4.50	Med. Screw	Hallast	1	5-8	.25	2½	1¾
WL-788	3.50	Med. Screw	Ballast	1	9-18	.25	2½	1¾
WL-710	4.00	Med. Screw	Ballast	1	20-28	.25	2½	1¾

† All Industrial Type Tubes F.O.B. Point of Shipment.

CONTINENTAL ELECTRONIC TUBES

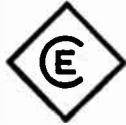

Continental Electronic Tubes have achieved a world-wide recognition for their high quality, ruggedness, dependable operation and long life. They are used as standard equipment by many of the country's outstanding electrical and sound equipment manufacturers. You can depend on Continental Electronic Tubes.

CETRON PHOTOTUBES

Continental produces the widest range of photo tubes and, probably, more of them than any manufacturer in the world. This is because Cetron phototubes have an outstanding reputation for high sensitivity, dependability, and long life built over the last twelve years. You can't buy better phototubes than these.

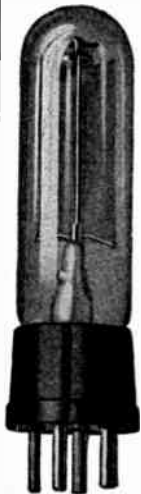

CE-1

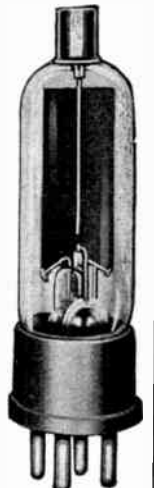

CE-11

Type	Dimensions Top to bottom of base x Diameter	Base	Net Price
CE-1	3 1/4" x 1 1/2"	Tapered small 4-pin	\$3.00
CE-2	3" x 1 1/2"	Standard UX 4-pin	3.30
CE-3	4 1/2" x 2 1/4"	Special	3.30
CE-4	2 3/4" x 1 1/2"	Tapered small 4-pin	3.30
CE-5	2 3/4" x 1 1/2"	Min. 3-prong	3.50
CE-7	4" x 1 1/2"	Standard UX 4-pin	3.30
CE-11	3 1/4" x 1 1/2"	Tapered small 4-pin. Anode cap	3.75
CE-21	3 3/8" x 1 3/8"	Two cathodes—anodes	
CE-22	2 1/4" x 1 1/2"	Tapered small 4-pin	5.75
CE-23	2 1/4" x 1 1/2"	Cathode faces end. Min. 3-prong	1.50
CE-25	1 1/4" x 3/8"	Small 4-pin	2.50
CE-31-V	3 1/4" x 1 1/2"	Min. 3-prong	3.50
CE-930	2 1/2" x 1 1/8"	Tapered small 4-pin Int. Shell 5-prong Octal	3.75 2.00

NOTE: All phototubes available gas filled or vacuum. If latter type is desired add letter "V" after type number. The gas type have a sensitivity of 50 to 100 microamperes per lumen; vacuum types 10-15 microamperes. Gas types are recommended for general use, but where a high degree of stability is desired vacuum tubes are recommended. The phototubes listed above have their peak sensitivity in the visible and infra-red part of the spectrum. Ask for Bulletin PC 7 giving complete data and curves.

COMPARATIVE TYPES

Cetron	RCA	G.E.	Westinghouse
CE-1-E	868	PJ23	WL735
CE-1-D	918
CE-1-V	PJ22	WL734
CE-2	WL737
CE-3	WL738
CE-11-V	917
CE-21	920
CE-22	924
CE-23	923
CE-25	927
CE-31-V	919
CE-930	930



CE-21



CE-25



CE-23



CE-18

CONTINENTAL ELECTRONIC TUBES

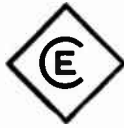

Continental produces a wide range of industrial and electronic tubes. Each has been carefully designed and produced for its special purpose. They will give you extra service at lower cost.

CETRON RECTIFIERS

Cetron Rectifiers are designed and built by special methods. They will stand hard service and have a long dependable life. These rectifiers will be found in some of the best known equipment in the country—chosen after exhaustive and rigid tests.

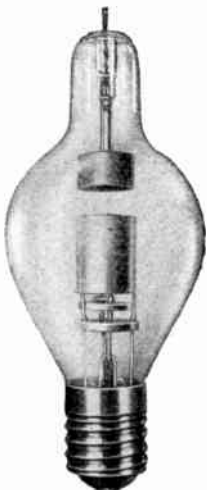

CE-203



CE-202

Type	Description	Filament	D.C. Voltage	Net
CE-200	2A. Full Wave Mercury Vapor	2 V.—7 A.	250 V.	\$7.75
CE-201	2A. Full Wave Mercury Vapor	2 V.—7 A.	250 V.	8.00
CE-202	15A. Half Wave Mercury Vapor	2.5 V.—20 A.	250 V.	30.00
CE-203	15A. Half Wave Mercury Vapor	2.5 V.—20 A.	150 V.	14.00
CE-205	5A. Half Wave Mercury Vapor	2 V.—12 A.	250 V.	16.00
CE-206	6A. Half Wave Mercury Vapor	2 V.—12 A.	90 V.	6.00
CE-213	2.5A. Half Wave Mercury Vapor	2.5 V.—7 A.	600 V.	8.00
CE-215	15A. Half Wave Mercury Vapor	2.5 V.—20 A.	75 V.	12.00
CE-220	20MA. Half Wave High Vacuum	2.5 V.—3 A.	7500 V.	12.10
CE-226	6A. Half Wave Argon (Tungar type)	2.2 V.—17 A.	90 V.	5.00
CE-235	15A. Half Wave Argon (Tungar type)	2.5 V.—21 A.	60 V.	10.00

Engineering bulletins giving detailed specifications on all tubes listed here are available and may be had upon request.

The extensive engineering and manufacturing facilities which we have, make possible the development and production of many types of special tubes. If you have a problem involving the use of any CETRON tubes you are invited to consult with us. We are also prepared to make special tubes to your specifications.

WARRANTY

We guarantee all products manufactured by us to be free from all material and manufacturing defects and to give satisfactory service when operated in accordance with instructions indicated for their use.

Continental Electric Co.

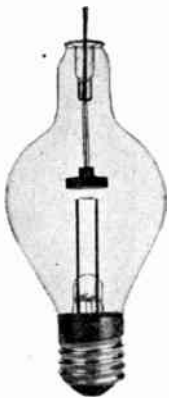

CE-226

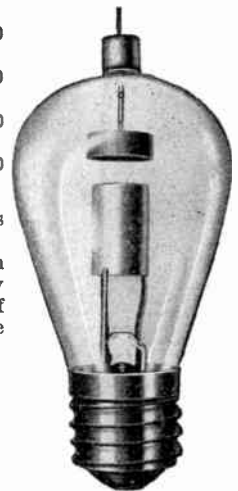

CE-206

Special Price List of Bogen Sound Equipment

Subject to Change Without Notice

IMPORTANT—PLEASE READ AND SAVE TIME

NOTE: Shortages of P. M. Speakers may necessitate the substitution of equivalent Electro-Dynamic speakers on systems listed herein.

LICENSED BY AGREEMENT WITH ELECTRICAL RESEARCH PRODUCTS, INC. UNDER PATENTS OWNED OR CONTROLLED BY WESTERN ELECTRIC CO. AND AMERICAN TELEPHONE AND TELEGRAPH COMPANY.

SPECIAL FEATURES

LOW IMPEDANCE INPUTS: Models EL70, EL35, EL25 and HH-HLO Preamplifiers can be obtained with additional Low Impedance Inputs built-in at an extra cost of \$23.75 per input — Specify when ordering.

Additional Low Impedance Inputs are obtainable on Models EL75 — EL30 — EL20 — EL14 at an extra cost of \$17.50 — Specify when ordering.

RACK AND PANEL MOUNTING: All Bogen Amplifiers, Boosters and Preamplifiers are available for rack and panel mounting if specified when ordering. Models PV20 — PV10 — E75 — E8 — E10 — E100 add \$8.00. Models with Sloping Panels — EX70 — EX35 — EX25 — E30 — E20 — E14 — HH — HLO — LLO — add \$10.00.

PHOTO ELECTRIC CELL INPUT: All Bogen Amplifiers can be obtained with photo electric cell Input for theatre installation if specified when ordering, at an extra cost of \$5.00 for one input and \$6.50 for two inputs.

REMOTE CONTROL CIRCUITS: Models E14 — EL14 — E20 — EL20 — E30 — EL30 — E75 — EL75 can be obtained with remote control circuits for all inputs, built-in, at an extra cost of \$5.00, if specified when ordering.

REMOTE CONTROL UNIT: Model SRC50 — SR Remote Control complete with 50 ft. Cable and Plugs for use with all Bogen Amplifiers equipped for Remote Control — Price — \$11.00

CHOICE OF MICROPHONES: All Bogen Systems can be obtained with a choice of microphones other than those listed with each system by referring to Page 19 of the Catalog and adjusting the difference in price. (Specify Microphone Selected when ordering.)

ADDITIONAL OUTDOOR SPEAKERS: As listed for Model EX25 and E20 Systems — Model SAPH Trumpet and Unit Complete — Price \$57.25. Model SALH Trumpet and Unit Complete — Price \$72.25.

SPECIAL AMPLIFIERS

(WRITE FOR COMPLETE DESCRIPTION.)

MODEL PA15 — Laboratory Standard 15 Watt Amplifier & Tubes — Custom Built — Price \$137.50.

MODEL PA15V — Similar to PA15 but with built-in Expander Price \$165.00.

MODEL PO15 — Special 15 Watt Booster Amplifier for use

with PA15 or PA15V — Complete with Tubes — Price \$75.00

MODEL POSO — Special 50 Watt Booster Amplifier for use with PA15 or PA15V — Complete with Tubes — Price \$130.00.

MODEL	PRICE
PV20 Amplifier & Tubes	
PV20L " " "	
PV20C " " "	
Extra Kit of Tubes	
PV10 Amplifier & Tubes	
PV10C " " "	
Extra Kit of Tubes	
EX70 Amplifier & Tubes	
EL70 Amplifier & Tubes	
EX70F Basic System	
EX70B Indoor System	
EX70T Outdoor System	
Extra Kit of Tubes	
EX35 Amplifier & Tubes	\$127.50
EL135 " " "	151.25
EX35F Basic System	222.00
EX35B Indoor System	244.00
EX35P Portable System	255.25
EX35T Outdoor System	299.50
Extra Kit of Tubes	15.05
EX632 Amplifier with Meter	203.00
EX32-6 Same as EX632 but less Hydrometer	198.00
EX632F Mobile System	263.50
EX632T Outdoor	345.00
A H G Special Microphone Handle	5.00
Extra Kit of Tubes	11.70
EX25 Amplifier & Tubes	\$107.50
EL25 Amplifier " " "	131.25
EX25F Basic System	202.00
EX25B Indoor " " "	224.00
EX25P Portable " " "	235.25
EX25T Outdoor System	207.25
Extra Kit of Tubes	44.50
E75 Amplifier & Tubes	148.75
EL75 " " "	166.25
E75F Basic System	298.25
E75B Indoor " " "	342.25

MODEL	PRICE
E75T Outdoor System	\$453.25
Extra Kit of Tubes	19.50
E30 Amplifier & Tubes	\$ 89.50
EL30 " " "	107.00
E30F Basic System	139.00
E30B Indoor " " "	155.00
E30P Portable " " "	159.00
E30T Outdoor " " "	219.50
Extra Kit of Tubes	10.80
E20 Amplifier & Tubes	80.00
EL20 " " "	97.50
E20F Basic System	129.50
E20B Indoor " " "	145.50
E20 Portable " " "	149.50
E20T Outdoor " " "	152.75
Extra Kit of Tubes	10.80
E14 Amplifier & Tubes	\$ 67.50
EL14 " " "	85.00
E14F Basic System	117.00
E14B Indoor " " "	133.00
E14P Portable " " "	137.00
Extra Kit of Tubes	10.45
E620 Amplifier & Phono & Tubes	121.00
E620F Basic System	170.00
E620T Outdoor " " "	193.75
Extra Kit of Tubes	7.85
E8 Amplifier & Tubes	33.25
E8P System less Microphone	51.00
E8PX " with " " "	58.50
E8PJ " " " " "	63.50
Model 25 Speaker Extension Cable	2.50
Extra Kit of Tubes	4.65
E10 Amplifier & Tubes	\$ 51.25
E10F Basic System Complete	89.00
E10B Indoor " " "	101.50
E10P Portable " " "	104.50
Extra Kit of Tubes	6.30

MODEL	PRICE
E66 Amplifier & Tubes	\$ 47.50
E66F Mobile System Complete with "MB" Speaker Bracket	85.00
Extra Kit of Tubes for E66	5.20
MB Mobile Speaker Bracket only	3.75
HH Preamplifier & Tubes	52.50
HLO Preamplifier & Tubes	87.50
LLO Preamplifier & Tubes	177.50
AM2 Ad-A-Mixer Control	8.50
VE2 Volume Expander & Tubes	43.50
E100 Booster Amplifier & Tubes	134.50
Extra Kit of Tubes for E100	10.75

8004A Portable Phonograph	
8005 " "	
8006 " "	
8007 " "	
8008 " "	
8016 " "	
8016L " "	
PT Phono Assembly	
PT5 Portable Amplified Phonograph	
PT16 Portable Transcription Player	
PT16AD " "	
PC201 Automatic Record Changer	
BA12 Speaker Baffle	
BA10 " "	
BA8 " "	
BA6 " "	
W12 DeLuxe Baffle	
No. 553 Inner Baffle—10"	
No. 554 " " —12"	
W8 DeLuxe Baffle	
W6 " "	

R300 Bogen High Fidelity Tuner	67.50
R301 " "	79.50
KP30 " Speaker-Amplifier Case	21.50
10A " " " "	15.50
K20 " " " "	20.00
K30 " " " "	20.00
B10 " Microphone Stand	8.00
B35 " Banquet Stand	6.50
BRR " Studio Stand	17.50
H10 " " "	10.50
DS1 " Desk " "	4.50
DS2 " " " "	2.00

134X Bogen Portable Speaker Baffle	17.00
131 " " " "	9.50
128 " " " "	9.50
129 " " " "	12.50
716 " " " "	20.75
140 " " " "	25.00
133X " " " "	16.25
SR " Remote Control—only	7.50
RC50 " 50 ft. Cable & Plugs	3.50
RC100 " 100 ft. " "	6.25
1103 Special Remote Control Cable—100 ft.	5.25

Bogen Special Wire and Cables

1048 Bogen Microphone Cable per 100 ft.	8.00
1049 " " " "	5.75
1008 " 2 Cond. " "	9.50
1021 Bogen Rubber Speaker Cable 2 Cond. per 100 ft.	5.00
1010 " " " " 4 Cond. " "	8.75
1004 " Cotton " " 4 Cond. " "	7.00
1017 " Speaker Zip " 2 Cond. " "	2.65
1102S Bogen School System Cable 2 Cond. per 100 ft.	5.25
1302S Bogen School Insulated Cable 2 Cond. per 100 ft.	6.25
1302W Bogen School Weatherproof Cable 2 Cond. per 100 ft.	7.00

INTERCOMMUNICATION EQUIPMENT

(Including Models Listed in Complete Bogen Catalog No. C7-41P.)

ALL PRICES INCLUDE TUBES MASTER TO REMOTE SYSTEMS

4A 4 Station Master only	\$ 37.00
4AE 4 Station Master with Earphone	42.75
12A 12 Station Master only	42.50
12AE 12 Station Master with Earphone	48.25
219A 19 Station Master only	46.25
219AE 19 Station Master with Earphone	52.00
AR Remote Station for any of above Masters	7.00
RS Remote with Call Switch for any of above Masters	9.00
CS Remote Control Call Switch can be added to any Remote	3.25

MULTIPLE MASTER SYSTEMS

6C 6 Station Multiple Master only	\$ 42.50
6CE 6 Station Multiple Master with Earphone	48.25
12C 12 Station Multiple Master only	43.75
12CE 12 Station Multiple Master with Earphone	49.50
219C 19 Station Multiple Master only	50.00
219CE 19 Station Multiple Master with Earphone	55.75
25C 25 Station Multiple Master only	57.50
25CE 25 Station Multiple Master with Earphone	63.25

COMBINATION MULTIPLE MASTER AND MASTER TO REMOTE SYSTEMS

12S Combination 12 Station Master only	\$ 52.50
12SE Combination 12 Station Master with Earphone	58.25
25S Combination 25 Station Master only	65.00
25SE Combination 25 Station Master with Earphone	70.75
SAR Remote Station for any "S" System	8.50
SRS Remote Station with Call Switch for any "S" System	10.50
RS3 Selective Remote with Call Switch to call 3 "S" Masters	12.50
RS12 Selective Remote with Call Switch to Call 12 "S" Masters	21.00
AB10 10 Station Annunciator for use with 12S System	25.00
AB20 20 Station Annunciator for use with 25S System	41.25

UNIVERSAL INDUSTRIAL PAGING SYSTEMS

These are all Combination Multiple Master and Master to Remote Systems.

S115 15 Watt 10 Station Master only	\$ 83.75
S215 15 Watt 20 Station Master only	97.50
S315 15 Watt 30 Station Master only	110.00
S415 15 Watt 40 Station Master only	122.50
Note: Any "S" Paging Master is available with Earphone for privacy, if specified when ordering at an additional	6.25
BS6 Wall Mounting Walnut Remote Station for offices	11.00
BS8 De Luxe Wall Mounting Walnut Remote Station for offices	15.00
MS8 Industrial Metal Cased Remote Station for factories	16.25
CR Industrial "Booster" Remote Station for noisy areas	42.00
SAPH Industrial "Hi-Power" Trumpet for noisy or outdoor areas	57.25
TW Special Weatherproof transformer for use with SAPH	6.00
CS-1 Remote Control Call Switch to call one "S" Master	3.75
CS-3 Selective Remote Control Call Switch to call 3 "S" Masters	7.50
CS-12 Selective Remote Control Call Switch to call 12 "S" Masters	15.00
IA10 10 Station Annunciator for use with S115 Master	28.75
IA20 20 Station Annunciator for use with S215 Master	47.50
IA30 30 Station Annunciator for use with S315 Master	66.25
IA40 Station Annunciator for use with S415 Master	82.50
PB35 35 Watt Booster Amplifier for use with "S" Systems where more power is required	90.00

BOGEN WIRELESS INTERCOMMUNICATION SYSTEMS

5W Two station wireless System - Price for two stations	\$ 96.25
5WE Similar to 5W but with each Master equipped with Earphone	107.75
7W 7 Station Selective Multiple Master Wireless - Per Master	81.25
7WP Similar to 7W but Master equipped with Earphone	87.50

INTERCOMMUNICATION JUNCTION BOXES

Recommended to facilitate installation and connections on all Bogen Systems.

2AJ Junction Box for 12A System	\$ 4.25
2CJ " " " 12C " "	2.75
2SJ " " " 12S and S115 Systems	3.75
5SJ " " " 25S and S215	5.50
For Model S315 Systems use 1-2SJ and 1-5SJ Box.	
For Model S415 System use 2-5SJ Boxes.	
9AJ Junction Box for 219A System	5.25
9CJ " " " 219C " "	3.75
BJ " " " AB10 Annunciator Pedestal	3.75
2BJ " " " AB20 " "	5.50
IJ " " " IA10 " "	3.75
2IJ " " " IA20 " "	5.50

For Model IA30 Annunciators use 1-IJ and 1-2IJ Box.
For Model IA40 Annunciators use 2-2IJ Boxes.

INTERCOMMUNICATION CABLES

Special Multi-Conductor Cable — Cotton braid overall No. 20 Stranded — for use with all Bogen Systems except "S" types.

1203S 3 Conductor	per 100 ft.	\$ 5.25
1204S 4 " "	" "	6.25
1205S 5 " "	" "	7.50
1206S 6 " "	" "	8.75
1207S 7 " "	" "	10.25
1208S 8 " "	" "	11.50
1209S 9 " "	" "	13.00
1210S 10 " "	" "	14.50
1211S 11 " "	" "	16.25
1213S 13 " "	" "	18.75
1220S 20 " "	" "	25.00
1226S 26 " "	" "	33.75

Special 2 Conductor No. 20 shielded with insulating braid overall for use with "S" type systems.

1302S 2 Conductor Stranded	per 100 ft.	6.25
1302W Similar to 1302S with weatherproof braid overall (not waterproof)	per 100 ft.	7.00

BOGEN EX35 De Luxe "Streamliner" Systems

MODELS WITH LOW AND HIGH IMPEDANCE INPUTS

35

Watts

- ★ Exclusive New Triple Range Electronic Tone Corrector
- ★ Controls Bass, Treble and Intermediate Tone Ranges
- ★ Four Input Channels
- ★ Three Microphones and Phono
- ★ Remote Control Circuits built in for all inputs
- ★ Illuminated Sloping Control Panels
- ★ Push pull 6L6 Output
- ★ Inverse Feedback and fixed bias
- ★ Weatherproof Outdoor Trumpet Systems

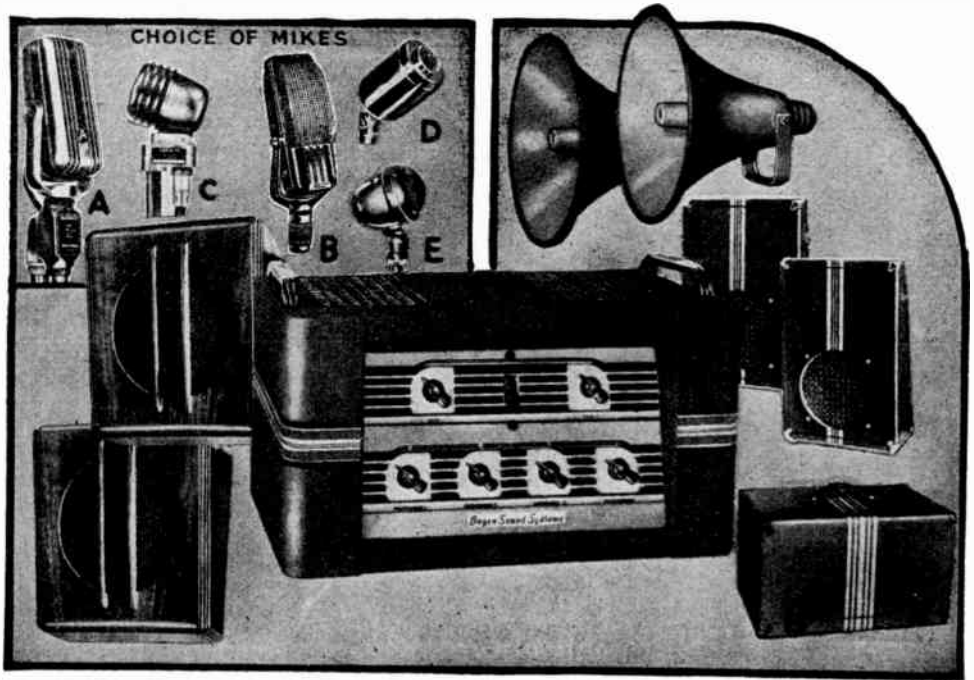

COMBINING every desirable feature of advanced sound engineering with new and exclusive Bogen developments, the EX35 "Streamliners" invite comparison with any equipment in their power range. Chief among the exclusive features of the new "Streamliners" is the **BOGEN TRIPLE RANGE ELECTRONIC TONE CORRECTOR**. Exceeding all previous standards of performance this new circuit offers complete control of three tone ranges—Bass, Treble, and the middle register. Three separate tubes, each one acting as an electronic audio channel, control and amplify the overall tone range. A unique dual control system permits the operator to create any tone range desired regardless of the acoustics of the installation. The Electronic Tone Corrector differs completely from ordinary Bass or Treble controls or equalizers, and it has none of the objectionable features of compensators or tone controls such as power loss or distortion. Other de luxe features of the new EX35 "Streamliners" are four input channels for three microphones and phono—Electronic Mixing between all input channels—full range individual gain controls for all inputs and a low impedance model for installations where long microphone cables are required. The model EL35 low impedance amplifier provides one low impedance input channel. The other two microphone inputs and phono remain high impedance as in the model EX35 but if desired, additional low impedance inputs can be obtained built-in at an additional cost. A remote control circuit is built-in on all "Streamliner" models permitting mixing and fading with Bogen wired or wireless remote controls, of two microphones or one microphone and phono. Sloping control panels, illuminated, insure greater visibility and ease of operation. For further convenience variable tapped outputs are available at a terminal strip and two speaker sockets—the variable taps permitting correct matching at both points. These and many other quality features contribute greatly toward making the new Bogen EX35 "Streamliner" amplifiers second to none.

BOGEN DE LUXE MODEL EX35 "STREAMLINER"—Amplifier, complete with tubes. Price

LOW IMPEDANCE AMPLIFIER

DE LUXE MODEL EL35 "STREAMLINER"—Amplifier, with first microphone input channel equipped for low impedance operation—tapped at 50, 200, and 500 ohms. Specify tap setting desired when ordering. Model EL35 "Streamliner" amplifier, complete with tubes. Price

BOGEN EX35 "STREAMLINER" SOUND SYSTEMS

MODEL EX35F—Complete basic system includes: 1—EX35 amplifier, 1—Kit of matched tubes, 2—Jensen PM12B heavy duty 12" dynamic speakers each with 25' heavy rubber covered speaker cable and plugs and, choice of 1—(a) Amperite BH velocity microphone, (b) BOGEN de luxe velocity model VR-HF, (c) Amperite BAH dynamic, (d) American D8T dynamic, (e) Astatic T3 crystal. Each with 25' cable and plugs. Price

FOR INDOOR INSTALLATIONS

MODEL EX35B—"STREAMLINER"—Complete system as above but with 2—W12 de luxe walnut baffles with reinforcing inner baffles. Price

FOR PORTABLE USE

MODEL EX35P—"STREAMLINER"—Complete system as above but with 1—Heavy duty No. 134X reinforced dual speaker case and one No. 133X de luxe amplifier cage. Price

FOR OUTDOOR INSTALLATIONS

MODEL EX35T—"STREAMLINER"—Complete system includes: 1—Model EX35 amplifier, 1—Kit of matched tubes, 2—Bogen-University 4½' reflexed non-resonant weatherproof trumpets and two Bogen-University 25-watt PM dynamic trumpet units (not dynamic cone speakers), choice of 1—(a) Amperite BH velocity microphone, (b) BOGEN de luxe velocity model VR-HF, (c) Amperite BAH dynamic, (d) American D8T dynamic, (e) Astatic T3 crystal. Each with 25' cable and plugs. Price ...

MODEL SRC50—SR Remote Control, for use with any of above systems or amplifier. Complete with Models RC50 50' cable and plugs. Price

MODEL EX35 "STREAMLINER" SPECIFICATIONS

POWER OUTPUT: 35 watts undistorted (less than 5%)—peak power—50 watts.

INPUT CIRCUITS: Four input channels—three Microphone inputs, 1—Phono input. All circuits may be mixed simultaneously.

INPUT IMPEDANCES: Microphone channels—High impedance 500,000 ohms. (Low impedance channels available in Model EL35 provides taps of 50, 200, 500 ohms). Phono input—high impedance—500,000 ohms.

OUTPUT CIRCUITS: Tapped terminal strip and two plug-in speaker sockets.

OUTPUT IMPEDANCES: 2, 4, 8, 250 and 500 ohms available at both terminal strip and sockets.

GAIN: Microphone inputs, 130 db. Phono inputs, 90 db.

FREQUENCY RESPONSE: 30 to 14,000 cycles + or - 1 db. Tone corrector range—bass control—15 db. to + 13 db. at 30 cycles. Treble control—15 db. to + 12 db. at 10,000 cycles.

tone control: Triple Range Electronic Tone Corrector; Intermediate Range, fixed, 1—Bass control, 1—Treble control.

CONTROL PANEL: Illuminated, mounting three microphone controls, one phono control, 2 electronic tone corrector controls and master AC power switch.

REMOTE CONTROL PROVISION: Built-in—provides complete mixing and fading of any two of the 4 available inputs from remote point.

TUBES: 3—6SF5, 1—6C8G, 2—6F8G, 1—6F6G, 2—6L6G, 1—5X4G, 1—5Y4G.

POWER CONSUMPTION: 250 watts, 117 volts, 50-60 cycles A.C.

DIMENSIONS: 16½" x 8½" x 10¼".

BOGEN EX632 De-Luxe MOBILE SYSTEMS

UNIVERSAL FOR 6 VOLTS DC AND 115 VOLTS AC OPERATION

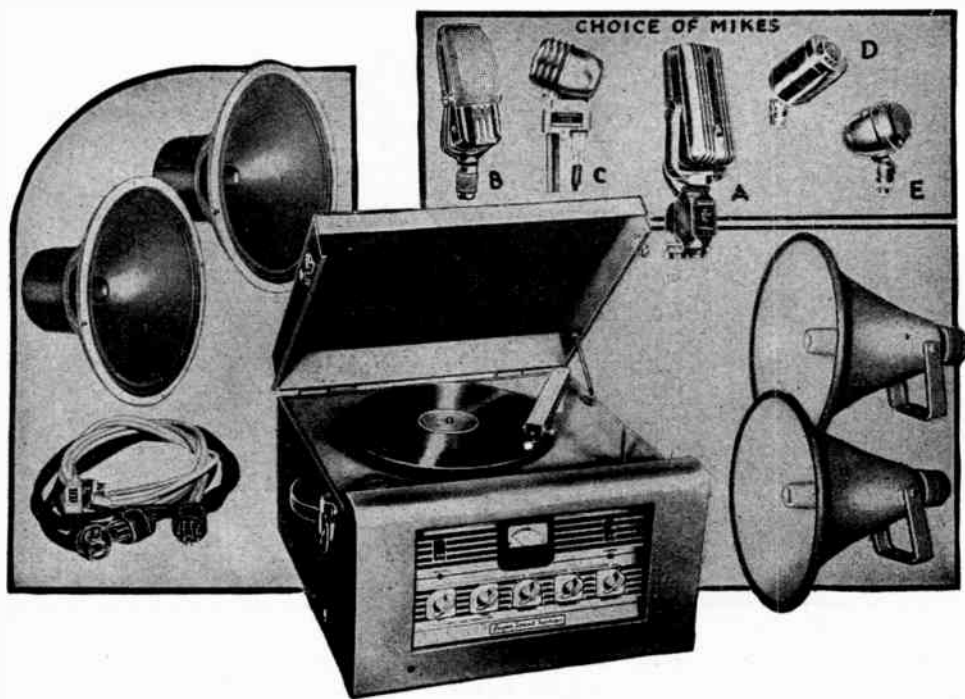

FEATURES

- ★ 32 Watts
- ★ No Outside Power Packs
- ★ Electronic Hydrometer
- ★ Electronic Tone Corrector
- ★ 3 Channel Input
- ★ Automatic Change-over from AC or DC
- ★ Standby Switch - for Battery Economy
- ★ Provision for Remote Mixing

MODEL EX632 UNIVERSAL MOBILE SYSTEM is recommended wherever the finest in sound is required.

- * Makes passenger car easily convertible for sound work.
- * Makes ideal portable unit for truck use.
- * Will amply cover all average requirements for indoor and outdoor use.

NO OUTSIDE POWER PACKS REQUIRED

The EX632 is completely self contained in one compact unit including amplifier, and phono assembly with its own hinged cover. A six volt D. C. and 115 volt A. C. power supply is built in. Changeover is automatic.

THREE INPUT CHANNELS

The EX632 allows mixing of two microphones and phono at the same time.

TRIPLE RANGE ELECTRONIC TONE CORRECTOR

An extremely important feature of the EX632 is the Bogen Triple Range Electronic Tone Corrector. Exceeding all previous standards of performance this new circuit offers complete control of three tone ranges, Bass, Treble and the Middle register. A unique dual control system permits the operator to create any tone range desired regardless of the acoustic condition of the installation. The Electronic Tone Corrector differs completely from ordinary Bass or Treble controls or equalizer, and it has none of the objectionable features of compensators or tone controls such as power loss or distortion.

ELECTRONIC HYDROMETER CONSTANT CHECK ON BATTERY

An exclusive Bogen feature is the new Electronic Hydrometer which is a special meter mounted on the control panel. This meter gives an accurate check of the condition of the battery at all times under load.

STANDBY SWITCH

A switch located on the control panel cuts the B power but allows the tubes to remain heated, ready for instant return to operation. REMOTE STANDBY SWITCH is incorporated in special microphone handle—performs same function except at any distance away from the amplifier. This standby switch on your Bogen amplifier means reducing battery consumption.

DASHBOARD OR EXTERNAL REMOTE CONTROL

A very desirable feature on the EX632 is the provision for connecting the Bogen remote control unit which may be mounted on the dash for finger tip operation or used at distances up to 2000 feet or more for controlling volume of any two channels. Remote control may be transferred to any two of the three available input channels quickly and easily.

PHONO MOTOR

A constant speed motor insures smooth running operation, eliminating wows or waver on either 6 volt D. C. or 115 volt A. C.

An Astatic crystal pickup with a new type shock-proof arm is mounted on the phono assembly.

MODEL EX632—De luxe Mobile Ampl. complete with phono assem. and tubes. Price

DE LUXE UNIVERSAL SOUND SYSTEMS

MODEL EX632F MOBILE DE LUXE SYSTEM—Complete with Model EX632 Universal mobile amplifier and tubes. Two heavy duty 12" Jensen PM dynamic speakers, each with 15' of cable and plugs and, choice of 1—(a) Amperite BH velocity, (b) BOGEN de luxe velocity Model VR-HF, (c) Amperite BAH dynamic, (d) American D8T dynamic, (e) Astatic T3 crystal microphone. Each with 25' microphones cable and plugs.

MODEL EX632F—Complete. Price

OUTDOOR INSTALLATIONS

MODEL EX632T DE LUXE MOBILE SYSTEM — Complete with EX632 amplifier and tubes. Two high power University 3 1/2" trumpets, each with 25 watt unit, choice of 1—(a) Amperite BH velocity, (b) BOGEN de luxe velocity Model VR-HF, (c) Amperite BAH dynamic, (d) American D8T dynamic, (e) Astatic T3 crystal microphone. Each with 25' microphone cable and plugs.

MODEL EX632T complete. Price

MODEL SRC50—SR Remote Control, for use with any system or amplifier described above. Complete with Model RC50. 50' cable and plugs. Price

MODEL AHG SPECIAL MICROPHONE HANDLE — with built-in remote control standby switch and complete with 25' remote control cable and plugs. List Price

EX632 AMPLIFIER SPECIFICATIONS

OUTPUT: 32 watts.
 OUTPUT IMPEDANCE: 2.4-8-250-500 ohms.
 GAIN: 120 db. on microphone, 81 db. on phono.
 INPUT: 3—2 microphone at 500,000 ohms, 1—phono 500,000 ohms.
 FREQUENCY RESPONSE: ± 30—12000 cycles.
 PROVISION FOR REMOTE CONTROL: Built in.
 TUBES: 2-6F5S, 1-6SC7, 1-6C8G, 1-6SJ7, 2-6L6G, 1-5X4G.
 CURRENT DRAIN: 6 volt D. C. 23.5 amps., 117 volt A. C. 120 watts.
 DIMENSIONS: 16" long x 16" wide x 10 1/4" high.

BOGEN E30 "Trail Blazer" Sound Systems

MODELS WITH LOW AND HIGH IMPEDANCE INPUTS

30

Watts

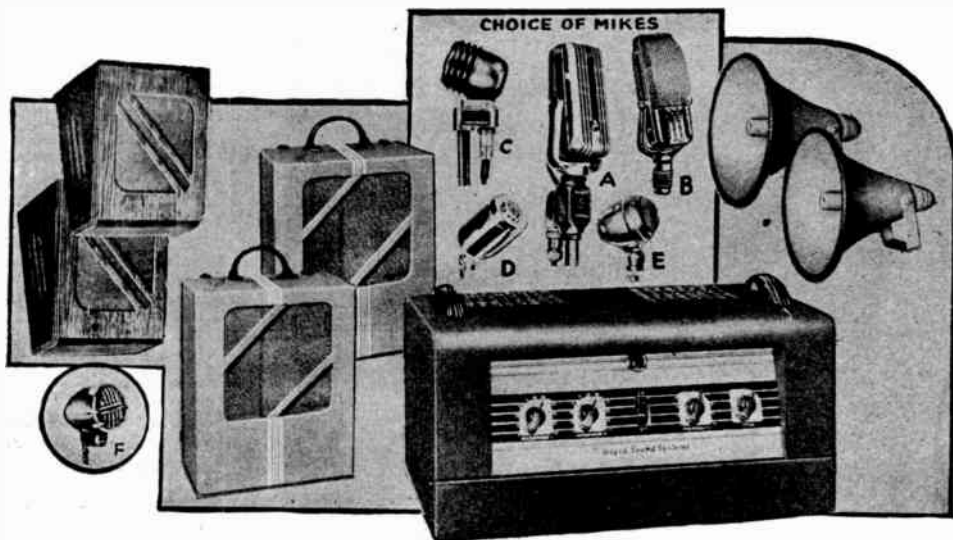

- ★ Three Input Channels
- ★ Two Microphones and Phono
- ★ Electron Mixing on all channels
- ★ Full Range Controls
- ★ Treble and Bass Tone Compensator
- ★ Built-in Remote Control for all Inputs (Optional)
- ★ Beam Power 6L6 Push Pull Outputs
- ★ Illuminated Sloping Control Panel
- ★ Outdoor Weather-proof Trumpet Systems

ESTABLISHING a new standard of quality, performance and features, the new Bogen E30 "Trail Blazer" amplifier and systems, leads the way in offering finer sound equipment at lower and more popular prices.

Available in both High and Low Impedance Models, the E30 "Trail Blazer" units are seven-tube high gain amplifiers using the popular 6L6 Beam Power Tubes in the output stage to insure maximum power output and excellent tone quality. Equipped with three input channels for two microphones and one phono the E30 amplifier permits wide flexibility of operation. Each input channel is individually controlled and all channels can be mixed and used simultaneously. All inputs are high impedance on the Model E30. The Model EL30 Low Impedance amplifier is provided with a low impedance microphone input channel which is extremely valuable for installations where long microphone cables are used. In addition, the EL30 amplifier includes a second high impedance microphone input and a separate phono input thereby permitting the use of both high and low impedance microphones. An optional feature is the Remote Control provision which can be obtained built-in to any "Trail Blazer" amplifier. This feature permits complete wired or wireless remote control and mixing of any two of the available three input channels from distant points as far as 2,000' from the amplifier. For complete variation of tone, a bass and treble compensator is built-in insuring better variation of tone ranges than the ordinary tone controls commonly used. An illuminated sloping panel, handsomely etched in bright modern colors matches the smart streamline chassis design. A variable impedance output strip and two built-in speaker sockets add greater convenience for speaker connection and matching. All component parts are selected materials of the finest quality and "Trail Blazer" amplifiers are engineered to give lasting and consistent service.

MODEL E30 "TRAILBLAZER"— Amplifier and tubes. Price.....

LOW IMPEDANCE AMPLIFIER

MODEL EL30—30-watt amplifier, same as above Model E30 "Trail Blazer" but with first microphone input channel equipped for low impedance. When ordering specify one of the following impedances: 50, 200, 500 ohms. Model EL30, complete with tubes. Price.....

BOGEN E30 "TRAIL BLAZER" SYSTEMS

MODEL E30F—Complete, basic system, includes 1 Model E30 amplifier and tubes, 2—12" Jensen PM12C speakers each with 25' cable and plugs. 1—Astatic JT30 Crystal microphone, with 25' cable and plugs. Price.....

FOR INDOOR INSTALLATIONS

MODEL E30B—Same as above, with 2—BA12 Walnut speaker baffles. Price.....

FOR PORTABLE USE

MODEL E30P—Same as E30F but with Model K30 portable carrying case for 2 speakers and amplifier. Price.....

FOR OUTDOOR INSTALLATIONS

MODEL E30T— Complete system includes: 1—E30 amplifier and tubes, 2—Bogen-University 3½' reflexed non-resonant weatherproof trumpets each with swivel mounting brackets, 2—25-watt Bogen-University PM trumpet units (not dynamic cone speakers), 1—Astatic Crystal JT30 microphone, and 25' of cable and plugs. Price.....

CHOICE OF MICROPHONES, other than those listed above: (a) Amperite BH velocity, (b) BOGEN de luxe velocity model VR-HF, (c) Amperite BAH dynamic, (d) American D8T dynamic, (e) Astatic T3 crystal. Each with 25' cable and plugs. Add to any of above system prices.....

OPTIONAL FEATURE—Remote control circuit built-in for operation of all input channels, can be obtained at an additional if specified when ordering.

MODEL SRC50—SR remote control comes complete with RC50, 50' cable and plugs. Model SRC50. Price.....

MODEL E30 "TRAILBLAZER" SPECIFICATIONS

POWER OUTPUT: 30 watts undistorted (less than 5 per cent.), peak power, 40 watts.

INPUT CIRCUITS: Three input channels, two Microphone inputs, one Phono input.

INPUT IMPEDANCES: Microphone channels: High impedance 500,000 ohms. (Low impedance channels available in Model EL30 provides taps of 50, 200, 500 ohms.) Phono input, High impedance, 500,000 ohms.

OUTPUT CIRCUITS: Tapped terminal strip and two plug-in speaker sockets.

OUTPUT IMPEDANCES: 2, 4, 9, 250 and 500 ohms available at both terminal strip and sockets.

GAIN: Microphone inputs—129 db.
Phono input—89 db.

FREQUENCY RESPONSE: 40 to 12,000 cycles + or - 1.5 db.

tone control: 1—Bass, Treble compensator.

CONTROL PANEL: Illuminated. Mounting two microphone controls, one phono control, one tone compensator control and master A.C. power switch.

REMOTE CONTROL PROVISION (OPTIONAL): Built-in, provides complete mixing and fading of any two of the three available inputs from remote point.

TUBES: 2—6SF5, 1—6C9G, 1—6F8G, 2—8L6G, 1—5X4G.

POWER CONSUMPTION: 130 watts, 117 volts, 50-60 cycles A.C.

DIMENSIONS: 15" x 7¾" x 8¼".

BOGEN E75 High Power Systems

MODELS WITH LOW AND HIGH IMPEDANCE INPUTS

70

WATTS

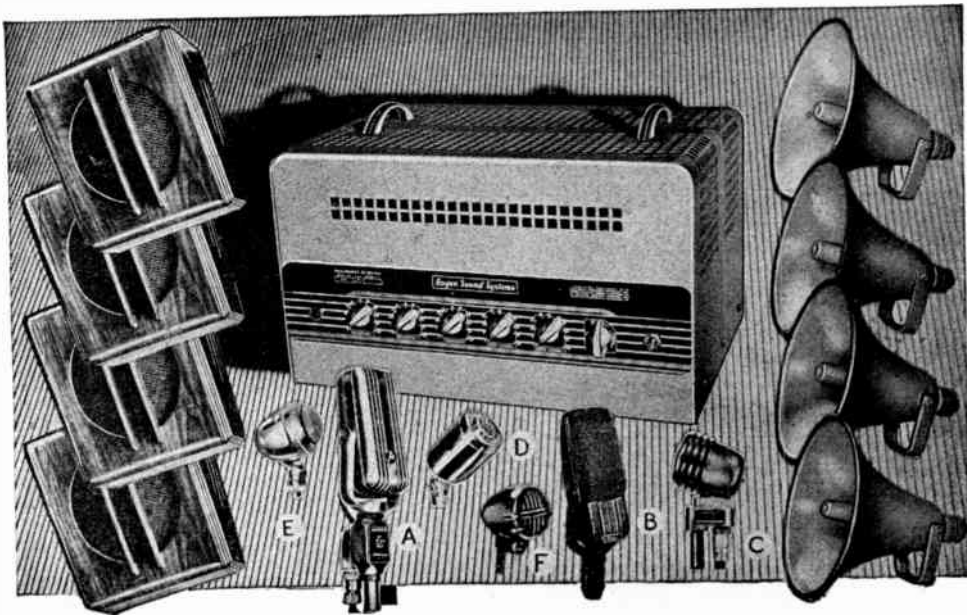

- ★ Less than 4% distortion
- ★ Exclusive BOGEN dual construction
- ★ Two complete 35 watt power amplifiers
- ★ Separate power supply for each amplifier
- ★ Three input channel mixing
- ★ Two microphone and Phono input
- ★ Remote Control circuits built-in for all channels
- ★ Bass and treble tone compensator.

THE NEW BOGEN E75 is a high powered amplifier retaining most of the outstanding features of the famous Bogen De Luxe EX70 Amplifier. It is designed for installations where high power and exceptional tone quality are desired—at an economical cost. Containing the exclusive Bogen Dual Amplifier circuit the E75 offers the greatest value in sound equipment at a price range previously considered low for SINGLE OUTPUT Amplifiers.

GENERAL DESCRIPTION

The E75 is a dual unit consisting of two separate 35 watt power amplifiers, each with its own Driver Stage, Power Supply, Separate Fixed Bias Rectifiers, Inverse Feedback, and Separate Master Gain Controls.

DUAL POWER AMPLIFIERS

The E75 may be used as two separate 35 watt Power amplifiers—driven by preamplifier common to both—or the outputs of both amplifiers may be paralleled to deliver 70 watts. The tapped output transformer of each amplifier is connected to marked terminal strips. An external switch may be attached to obtain instant changeover from either output, in cases of emergency.

UNIVERSAL APPLICATION

This new low cost 70 watt amplifier is highly recommended for all high power installations such as Skating rinks, Athletic fields, Stadia, Dance halls, Airports, etc.

As an emergency feature the dual amplifier design of the E75 safeguards against complete breakdown. In the event of tube burn out, condenser or transformer failure, etc., half the power (35 watts) of the E75 is still available in the amplifier section not affected.

MULTIPLE MICROPHONE AND PHONO INPUTS

Two Microphones and Phono may be mixed simultaneously thru the three High Impedance inputs. Each input has its full range volume control. A LOW IMPEDANCE MODEL EL75 is available, at a slight additional cost, for installations where it is necessary to run very long microphone lines. This provides one Low Impedance Input for Mike—one high Impedance Input for mike and one Phono Input.

MULTIPLE REMOTE CONTROL

The E75 has provision for plugging-in a Bogen multiple remote volume control. Any two input channels may be mixed and their volume regulated at any distance, from the amplifier. The Bogen Remote Control circuit is exclusive and is not subject to the Loss, Hum or Frequency discriminations that is inherent with most other remote controls.

DUAL PROTECTIVE FUSES

Two fuses are located on the rear of the chassis, one for each power amplifier. A switch is also provided to obtain voltage for the preamplifier from either power supply.

BASS AND TREBLE TONE COMPENSATOR

A complete variation of the overall tone is made possible by the Bass and treble compensator, insuring better flexibility of

the tone ranges than is possible to obtain thru the use of ordinary tone controls.

Auxiliary equipment to use with the E75 for indoor and outdoor installations has been carefully selected to insure the finest results for the purchaser of these splendid amplifiers.

BOGEN MODEL E75 AMPLIFIER—Complete with tubes.

LOW IMPEDANCE AMPLIFIER

MODEL EL75 AMPLIFIER — Same as above Model E75 but with first micro-input channel equipped for low impedance. Uses special high fidelity input transformer mounted right on chassis, humless, tapped at 50-200-500 ohms. Complete with tubes.

NOTE: If additional low impedance inputs are desired, refer to price sheet.

NOTE: If any systems are ordered less microphone refer to price sheet.

BOGEN E75 SYSTEMS

MODEL E75F BASIC SYSTEM — Complete E75 amplifier with tubes—Four Jensen 12" heavy duty PM12B speakers, 1—(f) Astatic JT30 Crystal Microphone. With 25' microphone cable and plugs.

FOR INDOOR INSTALLATIONS

E75B SYSTEM — Complete system same as above, but with 4 12 inch speakers mounted in De Luxe walnut baffles Model W12.

FOR OUTDOOR INSTALLATIONS

E75T SYSTEM — Complete E75 amplifier and tubes — four 4½' University trumpets and 25 watt units. 1—(f) Astatic JT30 Crystal Microphone. Each with 25' microphone cable and plugs.

CHOICE OF DE LUXE MICROPHONES other than listed above: (a) Amperite BH Velocity Microphones, (c) Amperite BAH Dynamic, (d) American D8T Dynamic, (e) Astatic T3 Crystal. Each with 25' microphone cable and plugs. For extra cost refer to price sheet.

E75 AMPLIFIER SPECIFICATIONS

OUTPUT: 70 watts. (2-35 watt power amplifiers) less than 4% distortion.

OUTPUT IMPEDANCES: Each power amplifier tapped—4-8-15-250-500 ohms may be paralleled to deliver 70 watts.

GAIN: Microphone 124 db, Phono 95 db.

INPUTS: 3-2 Microphones, 1 Phono—each 500,000 ohms. (In Model EL75, low impedance channel is tapped at 50-200-500 ohms.)

FREQUENCY RESPONSE: 30—14000 cycles—1 db.

REMOTE CONTROL PROVISION: Built-in.

TUBES: 15 - 2-7B4, 2-7F7, 2-6F6G, 4-6L6G, 2-5X4G, 2-5W4GT.

CONTROLS: (6) 2 Mike, 1 Phono, 2 Master Controls, 1—Bass and

Treble Compensator.

CURRENT DRAIN: 290 watts at 117 volts—50-60 cycle. AC.

DIMENSIONS: 17½" long x 10" high x 12½" deep.

BOGEN E14 "Pacemaker" Sound Systems

MODELS WITH LOW AND HIGH IMPEDANCE INPUTS

14
Watts

- ★ Multi-channel Inputs
- ★ Two Microphones and Phono
- ★ Full Range Electron Mixing on All Inputs
- ★ 6L6 Beam Power Push Pull Outputs
- ★ Bass and Treble Tone Compensator
- ★ Remote Control for All Inputs—Optional
- ★ Variable Impedance Speaker Matching and Tapped Outputs
- ★ Illuminated Sloping Controls Panel

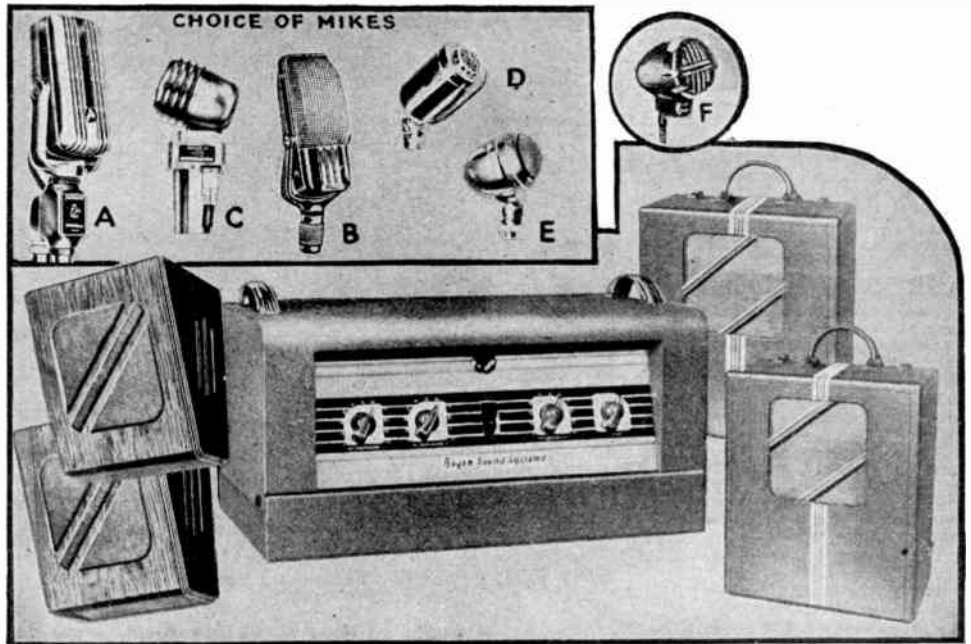

THE new Model E14 "Pacemaker" Sound Systems set the pace for medium powered Public Address equipment in the popular price range.

No other amplifier or system incorporates all of the features, listed above, at these low prices. Most of these features have only been available in larger so-called De Luxe units selling at much higher prices. The Bogen E14 "Pacemaker" is a 7-tube high gain amplifier providing three input channels for two microphones and phono. Each microphone input has its own separate input tube and full range individual gain control. Phono input is also provided with separate gain control and electronic mixing is effected between all three channels simultaneously. All input channels are high impedance and microphone inputs are universal for use with all current high impedance microphones, dynamic, crystal, velocity, or velotron. Low impedance inputs, an exclusive Bogen feature, are available on any or all inputs in the Model E14 amplifier, (described below). A new and exclusive two channel remote control input for wired or wireless remote controls is an optional feature of the Model E14. Bogen remote controls permit the operator to mix and fade any two of the three input channels available from a remote point and are not to be confused with remote controls that do not provide mixing or multi-channel operation. With the exclusive Bogen Remote Control the operator can control either two microphones or one microphone and phono at will. A bass and treble tone compensator is another De Luxe feature built in the Model E14 "Pacemaker." This is not an ordinary tone control but permits accentuation of the bass or treble ranges at will. A pair of 6L6 beam power output tubes in push-pull assure ample power with excellent quality. A beautifully etched, sloping control panel illuminated for greater visibility enhances the appearance of the new Bogen E14 "Pacemaker." For ease of connection lock type shielded connectors are provided for the microphone inputs, terminal strips for phono inputs and a new variable output terminal strip tapped at 2, 4, 9, 250, and 500 ohms insures quick and easy speaker matching. For further convenience two speaker sockets are built-in. The new E14 "Pacemaker" establishes a new standard in the medium priced field.

MODEL E 14—Amplifier and Tubes. Price.....

LOW IMPEDANCE AMPLIFIER

MODEL EL14—14 watt amplifier same as Model E14 "Pacemaker" above with first microphone input channel equipped for low impedance operation—tapped at 50, 200 and 500 ohms. Specify tap setting desired when ordering. MODEL EL14, complete with tubes. Price.....

BOGEN MODEL E14 SYSTEMS

MODEL E14F—Complete basic system consists of: 1—Bogen Model E14 "Pacemaker" amplifier, 1—Kit of matched tubes, 2—10" Jensen PM10C Dynamic speakers each with 25' of speaker cable

and plug. Astatic JT30 Crystal microphone and 25' of microphone cable fitted with lock type connectors. MODEL E14F "Pacemaker" System as described above. Price..

FOR INDOOR INSTALLATIONS

MODEL E14B—Complete system. Same as E14F but with 2—BA10 Walnut speaker baffles. Price.....

FOR PORTABLE USE

MODEL E14P—Complete system. Same as E14F but with Model K14 Portable Carrying Cases for two speakers and amplifier. Price.....

CHOICE OF DE LUXE MICROPHONES than listed above (a) Amperite BH velocity, (b) BOGEN de luxe velocity Model VR-HF, (c) Amperite BAH dynamic, (d) American D8T dynamic, (e) Astatic T3 crystal microphone. Each with 25' cable and plugs. Add to any above system prices

OPTIONAL FEATURE

Remote control circuit built-in for operation of all input channels can be obtained at an additional list if specified when ordering.

MODEL SRC50 —SR remote control complete with RC50, 50' cable and plugs. Price.....

MODEL E14 AMPLIFIER SPECIFICATIONS

POWER OUTPUT: 14 watts undistorted (less than 5 per cent.), peak power, 25 watts.

INPUT CIRCUITS: Three input channels, two Microphone inputs, one Phono input.

INPUT IMPEDANCES: Microphone channels—High impedance 500,000 ohms. (Low impedance channels available in Model EL14 provides taps of 50, 200, 500 ohms.) Phono input, High impedance, 500,000 ohms.

OUTPUT CIRCUITS: Tapped terminal strip and two plug-in speaker sockets.

OUTPUT IMPEDANCES: 2, 4, 9, 250 and 500 ohms available at both terminal strip and sockets.

GAIN: Microphone Inputs—125 db.
Phono Inputs—85 db.

FREQUENCY RESPONSE: 40 to 12,000 cycles + or - 1.5 db.

TONE CONTROL: 1—Bass, Treble compensator.

CONTROL PANEL: Illuminated. Mounting two microphone controls, one phono control, one tone compensator control and master A.C. power switch.

REMOTE CONTROL PROVISION (OPTIONAL): Built-in, provides complete mixing and fading of any two of the three available inputs from remote point.

TUBES: 2—6SF5, 1—6C8G, 1—6F8G, 2—6L6G, 1—5Y4G.
POWER CONSUMPTION: 90 watts, 117 volts, 50-60 cycles A.C.
DIMENSIONS: 14" x 7 7/8" x 8".

BOGEN E620 "UNIVERSAL" MOBILE SYSTEM

← 20 WATTS →

THE Improved new Bogen E620 mobile system answers a long felt need for an economical amplifier that may be easily converted to operation from six volt storage battery or 115 volt A. C. Change-over from 6 volt battery to 110 volt A. C. is automatic.

The E620 amplifier comprises a single self-contained amplifier unit with its own power supply and phono assembly. Microphone and phono inputs may be mixed or faded thru two independent volume or gain controls. A Bass and Treble compensator control is built-in. The E620 features a sloping recessed four color panel.

The E620 is furnished with a phono assembly comprising a constant speed motor, powered by a built in supply to eliminate any speed variation or waver on 6 V. D. C. and 110 V. A. C. The phono assembly is complete with Astatic crystal pickup.

Tapped output transformer — Speaker plug-in connections — Smart styling and fine performance makes this an amplifier that lends itself to a wide variety of uses.

MODEL E620 AMPLIFIER complete with phono assembly and tubes.



MODEL E620F SYSTEM—Complete with E620 amplifier and tubes. Two PM12C Jensen 12 inch dynamic speakers, Astatic JT30 crystal microphone with 25' microphone cable and 15' speaker cable and plugs on each speaker.

MODEL E620T SYSTEM—Complete with Model E620 amplifier and tubes. One University 3½" high power trumpet and 25 watt unit. Astatic JT30 Crystal microphone with 25' microphone cable and plugs.

NOTE: Model E620 Systems are available with choice of De Luxe Microphone at an extra cost. Refer to price sheet; (a) Amperite BH Velocity, (c) Amperite BAH Dynamic, (d) American D8T Dynamic, (e) Astatic T3 Crystal microphone. Each with 25' cable and plugs.

E620 AMPLIFIER SPECIFICATIONS

OUTPUT: 20 watts undistorted (less than 5%) peak—25 watts.
OUTPUT IMPEDANCES: 4-8-15-250-500 ohms.
GAIN: Microphone 116 db. Phono 69 db.
INPUT: Two—1 microphone—500,000 ohms. 1 phono—500,000 ohms.
FREQUENCY RESPONSE: 30—12000 cycles + or - 2 db.
TUBES: 1-7B4, 1-7F7, 2-6L6G, 1-7ZA.
CURRENT DRAIN: 6 volt D. C.—13.75 amps. 117 V. A. C.—95 watts.
DIMENSIONS: 15" long x 9¼" deep x 8½" high.

BOGEN E8P "Ultra Compact" System



SPECIFICATIONS:

4 TUBES: 1-7F7; 1-6AD7; 1-6F6G; 1-5W4GT.
GAIN: Microphone 104 db. Phonograph 71 db.
INPUT IMPEDANCE: High, 500,000 ohms. **OUTPUT IMPEDANCES:** 4, 8, 15 ohms available at speaker socket with field supply for 1000-ohm speaker. **AMPLIFIER DIMENSIONS:** 4½" deep x 7" wide x 7½" high.

- ★ 8 Watts Output—Pushpull
- ★ Separate Inputs for Mike and Phono
- ★ Electronic Mixing of Both Inputs
- ★ Individual Mike, Phono and Tone Controls

The Bogen Model E8 is one of the most remarkable low power amplifiers available. Complete portable model is compact, lightweight and durable. 8" PM dynamic speaker is mounted in portable leatherette speaker baffle, designed so that system can operate when it is closed. Electro dynamic speaker field supply is also provided, built in. Amplifier can be removed from case and operated at a distance. Particularly suitable for small orchestras, traveling demonstrators, lecturers and political meetings.

BOGEN MODEL E8 AMPLIFIER: Complete with tubes.

MODEL E8P SYSTEM: 1-E8 Amplifier and tubes. 1 — 8" PM dynamic speaker. 1 — portable leatherette speaker baffle to carry amplifier and speaker.

MODEL E8PX SYSTEM: Same as above plus Astatic Y30 Microphone, desk stand, 7½ ft. cable and connector.

MODEL E8PJ SYSTEM: Same as E8P plus Astatic JT30 Microphone and 25' cable and connector.

MODEL 25: 25' Speaker Extension Cable.

BOGEN E10 De Luxe Economy System

← 10 Watts →

THE improved Bogen EP10 system meets the demand for medium powered, two speaker sound systems at an economical price. Many features of the more expensive de luxe systems are incorporated in the EP10.

The amplifier is equipped with separate input channels for one microphone and one phono. These two channels each have their own full range gain control. Electronic mixing permits fading and mixing between both channels and also their use simultaneously. A high frequency tone control is provided. All controls and A. C. switch are mounted on an especially styled and colorful control panel.

The output circuit comprises a pair of 7CS beam power tubes in push-pull amplification assuring excellent tone quality and volume. The output transformer is tapped at 4-8-15-250-500 ohms and connected to a speaker terminal strip. In addition two speaker sockets are built in and provide quick and easy means of connecting speakers.

The E10 amplifier may be used in many types of installations for hard of hearing aids, small paging systems, etc. The unit is ideal for speech modulation and may be used as a driver for medium powered transmitters.

The components used in making up the EP10 sound systems assure fidelity of reproduction, and dependable long life for continuous operation.

MODEL E10F "Economy" system comprises 1—E10 amplifier with tubes; 2—10" PM dynamic speakers. Each with 25' cable and plugs, and one Astatic Crystal microphone Model JT30 and 25' cable.

FOR INDOOR INSTALLATIONS

MODEL E10B—Complete system same as above but with two BA10 Walnut Baffles.

FOR PORTABLE USE

MODEL E10P—Complete system same as E10F but with port-

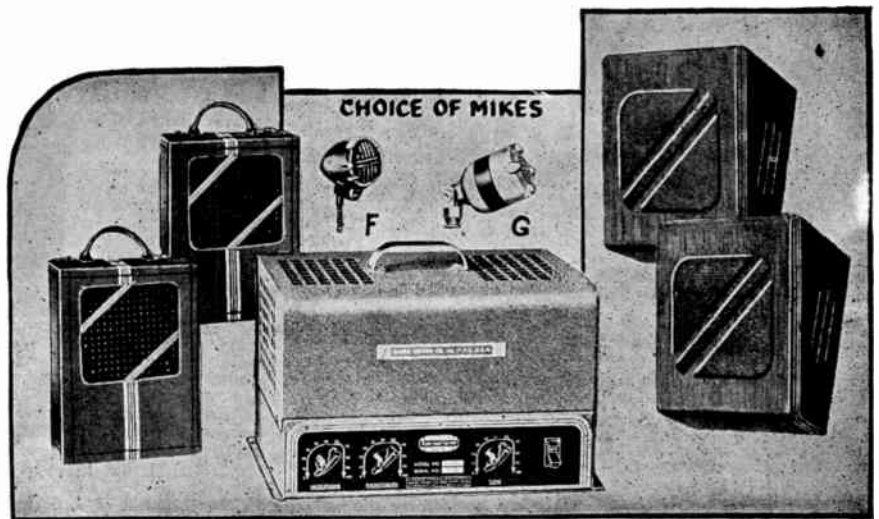

able two section leatherette covered speaker baffle Model 10A for carrying amplifier and mounting the 2 speakers.

MODEL E10—Amplifier only, complete with tubes.

NOTE: If system is ordered less microphone refer to price sheet. If system is ordered with (G) American D4T Dynamic, for extra cost refer to price sheet.

E10 AMPLIFIER SPECIFICATIONS

OUTPUT: 10 watts—less than 5% distortion.
 OUTPUT IMPEDANCES: 4-8-15-250-500 ohms.
 FREQUENCY RESPONSE: 65—9000 ± 2 db.
 CONTROLS: Three—one microphone, one phono, one tone.
 GAIN: Microphone 114 db., phono 75 db.
 INPUTS: 1—microphone 500,000 ohm, 1—phono 500,000 ohm.
 TUBES: Total 5; 2-7F7, 2-7CS, 1-5W4GT.
 CURRENT DRAIN: 88 watts at 117 v. A. C.
 DIMENSIONS: 7" deep x 11" wide x 7-5/16" high.

BOGEN E66 Universal MOBILE AMPLIFIER



MODEL E66F—System, complete, includes: 1-E66 Amplifier; 1-complete set of matched tubes; 1 Special Bogen University trumpet; 1-Astatic Y30 Crystal microphone with removable handle, removable base for desk stand operation and 7½' of cable.

MODEL MB—Special mobile speaker bracket.

MODEL E66—Amplifier only with Tubes.

MODEL E66 SPECIFICATIONS

POWER OUTPUT: 8 watts (or + 31 db).
 HUM: AC: — 45 db; DC: — 62 db.
 INPUT CIRCUITS: 1 microphone input—Lock Type Screw on Connector; 1 jack for Phonograph Input.
 INPUT IMPEDANCE: High Impedance, (500,000 ohms) for Microphone and Phonograph.
 OUTPUT IMPEDANCE: 4, 8, 15 ohms available at 5-prong speaker socket.
 POWER CONSUMPTION: 6.3 volt storage battery: 7 amperes; 117 volts AC: 50 watts.
 GAIN: Overall gain: microphone input: 110 db; phonograph input: 75 db.
 TUBE COMPLEMENT: (4) 1-7F7, 1-6F6G, 1-6AD7G, 1-7Z4.
 DIMENSIONS: 5¾" wide x 7¾" deep x 6¾" high.

★ Extremely Compact

★ Built to Police Specifications

★ Mounts Under Car Dashboard

★ 6 Volt DC and 110 Volt AC Operation

★ Output Equals Ordinary 15-18 Watt Amplifiers

The Bogen Model E66 is a radical departure in mobile amplifier construction, and has been designed in accordance with the specifications of Police Departments in some of the country's largest cities. Compact, inexpensive—yet highly efficient, it is intended for use in Police, safety, fire and emergency cars, and also as a public address system for outdoor gatherings. The Bogen Model E66 can be used on either a 6 volt storage battery or a 117 volts AC and the current drain is exceptionally low. It is modern in design, extremely simple to install and mounts directly under the dash-board. It takes as little space in a car and is as simple to operate as a radio or small heater.

The speaker, developed as a companion unit for the Model E66 is a special Bogen University reflex trumpet of the folded exponential type. It may be mounted easily in the motor compartment under the engine hood—or on a fender alongside the headlight. This speaker is so amazingly efficient that with it, the Bogen Model E66 delivers the equivalent results of a 15 watt system. 100% waterproof and of all metal construction, this specially designed speaker will stand considerable abuse and is a revelation in high efficiency reproduction. A special bracket is available for speaker mounting.

The microphone, a streamlined Astatic crystal with a handle and 7½ feet of cable, can be used by the driver without interfering with his normal driving operations.

The Amplifier utilizes push pull output and incorporates a stand-by switch which reduces the current drain and keeps the Amplifier ready at all times for immediate use. A phonograph connection is provided and the unit is constructed so that tubes or vibrator may be removed without disturbing the amplifier mounting.

The usefulness of Police Cars is immeasurably increased when the compact, mobile E66 is added to the usual two way radio communication, making each police car an extremely effective traffic safety car.

BOGEN Booster and Pre-Amplifiers • Phono-Players

100 WATT BOOSTER AMPLIFIER

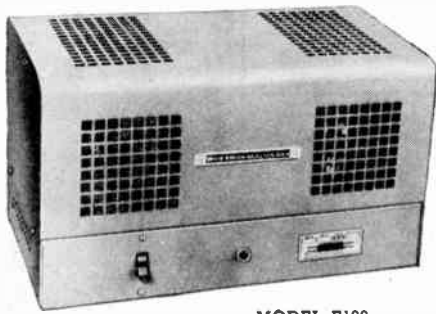

MODEL E100

The Bogen 100 Watt Booster Model E100 lends itself ideally to large installations such as stadiums, memorial parks, auditoriums, ball parks, etc. Embodies the latest circuit developments. Four 6L6 tubes arranged in a special push-pull parallel circuit deliver 100 watts of undistorted power output. All transformers are generously designed to give the excellent regulation so necessary in this type of circuit. Despite the enormous power output, surprisingly little driving power is necessary—only 2 watts. Thus any existing small system may easily be converted into a high powered installation of the largest type.

Input 15, 50, 250 and 500 ohms; output 500, 250, 166, 125, 100, 84 and 72 ohms. Separate secondary for voice coil with taps at 15, 9, 4 and 2 ohms to enable the matching of any combination of speakers or lines. Connections on terminal strips. MODEL S-100—complete, with tubes.

MODEL E100 SPECIFICATIONS—(Complete with tubes).

GAIN: Overall 17 db. **FREQUENCY RESPONSE:** 30 to 12,000 cycles. **CURRENT DRAIN:** 300 watts, 110 volts, 50-60 cycles. **DIMENSIONS:** 9" deep, 16½" wide, 9½" high. **OUTPUT:** 100 watts—less than 5 per cent Harmonic Content. **TUBE COMPLEMENT:** 4-6L6G, 3-5X4G. **CONTROLS:** 1 Master Power Switch.

4 CHANNEL MIXER-PREAMPLIFIERS

BUILT IN REMOTE CONTROL PROVISION
FOR ALL CHANNELS ON EACH MODEL

MODEL HH

FOR ALL NORMAL P. A. APPLICATIONS

This four position mixer and pre-amplifier will mix four high-impedance microphones into any high impedance amplifier. Each input channel has its own tube and gain control. A master volume control is provided for overall gain. The unit includes its own built in A. C. power supply. Will answer to a wide variety of uses such as mixing and fading microphones to recording equipment, also to increase the input channels of existing amplifiers. Compact and smartly styled.



MODEL HH

SPECIFICATIONS: Input impedance 500,000 ohms on all inputs. Output impedance 500,000 ohms. For 110 volts A. C. operation. **TUBES:** 5-7B4, 1-7Z4. **SIZE:** 14-1/16" x 8" x 7½" high. **MODEL HH** complete with tubes without meter. Gain 60 D. B.

MODEL HLO FOR REMOTE LINE APPLICATIONS

Similar to Model HH, with four high impedance inputs, but equipped with a zero level output amplifier built-in with output transformer terminating in 50-125-200-500 ohms taps. A DB meter is provided on control panel to indicate output level and master gain control is built in. Ideal for use as a remote Pre-Amp on telephone lines or as a remote pre-amp operated for P. A. work at a distance from the main amplifiers. All input impedances—500,000 ohms. For 110 volts A. C. operation. **SIZE:** 14-1/16" long x 8" deep x 7½" high. **TUBE KIT:** 5-7B4, 1-7A4, 1-7Z4. **MODEL HLO** with tubes and D. B. meter. Overall gain 76 D. B.

MODEL LLO FOR PROFESSIONAL BROADCAST USE

Built to conform to strictest requirements of broadcast equipment. Embodies four low impedance input channels, each with separate gain control. Each input is tapped at 50-125-200-500 ohms. A master gain control is included along with a built in DB level meter. Low impedance output of 50-125-200-500 ohms is available at zero level. Built in A. C. power supply is absolutely humless. Precision equipment combined with smart styling. **SIZE:** 14-1/16" long x 8" deep x 7½" high. **TUBES USED:** 5-7B4, 1-7A4, 1-7Z4. **MODEL LLO** with tubes and meter. Overall gain 76 D. B.

PHONOGRAPHS

PORTABLE MODEL 8007

Complete with Green Flyer governor controlled motor, model AB8 crystal pickup, and 10" turntable. Self-contained in well constructed carrying case reinforced and covered with durable gray leatherette. Dimensions 15¾" x 13" x 7¼". For 110 volts, 60 cycles.



MODEL 8007

De-Luxe PORTABLE MODEL 8016

FOR 16" RECORDINGS

The DeLuxe Model 8016 supplies demand for a unit capable of playing 16" professional transcription recordings as well as the Standard 10" and 12" records. Contains a heavy duty Green Flyer motor, dual speed for 78 and 33-1/3 R.P.M. Recordings. Equipped with a crystal pickup and special 12" arm. Complete with 12" turntable. Entire unit mounted in a fine leatherette carrying case strongly reinforced and finished with leather corners and gunmetal hardware. For 110 volts, 60 cycles. Dimensions: 21¾" x 17" x 7".



MODEL 8016

MODEL 8016L

Similar to Model 8016 but equipped with the new Model HP-16 low pressure pickup with permanent sapphire stylus. Especially recommended for professional use.

MODEL PT16 TRANSCRIPTION PLAYER

This general purpose phono player with amplifier is designed to handle 16" transcription records along with the standard variety. The 12" turntable is driven by a special heavy duty General Industries dual speed motor for 33-1/3 and 78 RPM. Astatic Crystal pickup feeds the built in 6 watt high quality amplifier that is equipped with master gain and tone controls. 10" PM dynamic speaker mounted in cover of carrying case. Cover is removable and may be used at a distance from the main unit. Ideal as a portable record player to handle any size recordings. Operation is from 110 volt A. C. only.

DIMENSIONS: 23½" x 17¼" x 10¾". Complete with tubes.

TUBE COMPLEMENT: 1-7F7, 2-7C5, 1-5W4GT.



MODEL PT16

MODEL PT16AD PORTABLE PHONO AMPLIFIER

Same as Model PT16 except this model operates from either 110 volt A. C. or D. C. current and the output of the amplifier is 4 watts. Complete with tubes. **TUBES USED:** 1-7F7, 2-25L6G, 1-25Z6G.

NOTE: Either of above models are available with a microphone input at slight extra cost. They can also be obtained equipped with new Low Pressure Astatic HP-16 Professional Pickup with Sapphire Stylus at slight extra cost. Specify when ordering extras.

P. A. System Cases—Mike Stands

**SPECIAL MODEL KP30
BAFFLES - HOUSES AMPLIFIER
WITH PHONO TOP AND 2-12" SPKRS.**

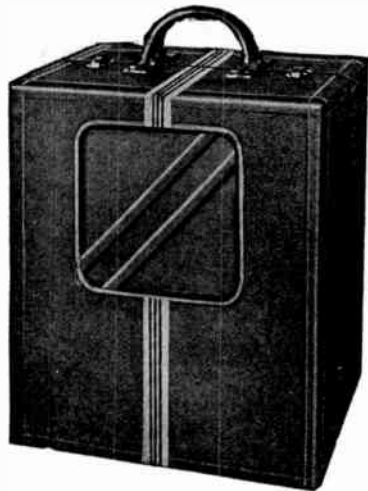

The Model KP30 Portable Case was especially designed to accommodate complete phono equipped amplifiers and 2-12" speakers in one compact single carrying unit. This case is heavily reinforced throughout and covered with a fine grey leatherette. Bogen amplifiers such as the E14, E20 or E30 equipped with Model PT Phono assemblies mounted on top, or amplifiers with built-in Phono assemblies such as the Bogen E620 mobile unit, will fit in the bottom section of the KP 30 case and the upper sections will still house 2-12" speakers thereby permitting a complete phono-amplifier - 2 speaker system to be easily carried in these baffles.

Amplifiers with overall dimensions up to 15" x 10" x 9 1/4" will fit the KP30 with ample room left to mount 2 standard 12" speakers - Model KP30—Overall Dimensions 18" wide x 14 1/2" deep x 22 1/2" high.

**MODEL 10A
PORTABLE SPEAKER - AMPLIFIER BAFFLES**



Used with the Bogen EP10 Portable Sound Systems. An extremely compact portable baffle for two 10" speakers and an amplifier. Heavily constructed of 3/8" plywood covered with a smart gray leatherette. Divides into two sections when open, each section serving as a baffle for a 10" speaker. The lower part of the two sections is fitted with blocks to permit a small amplifier to be carried without sliding around when case is closed. Amplifier space accommodates a Bogen E10 amplifier or any amplifier of similar dimensions: 7" deep x 11" wide x 7 1/2" high. Cable brackets are also provided in each section for winding speaker cables. Overall Dimensions: 8 3/4" x 12 1/2" x 17 3/4".

MODEL 10A—Speaker-amplifier baffle.

**MODEL K20 AND K30
PORTABLE SPEAKER - AMPLIFIER BAFFLES**

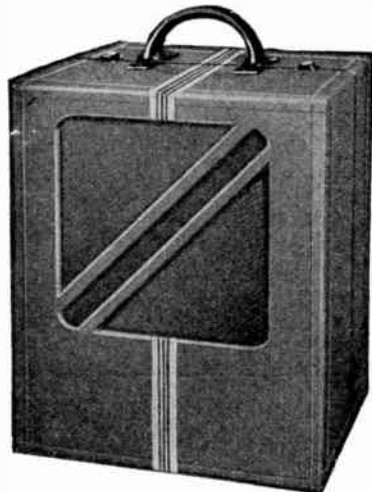

Designed for Bogen E14, E20 and E30 Sound Systems. Accommodates a large amplifier and two 12" speakers. Covered with a durable gray leatherette. Amplifier section in lower part of the case is fitted with blocks to prevent amplifier sliding about when carried. Amplifier fits in as shown in Model 10A illustration. A Bogen E14 or E20 Amplifier or a unit of the same dimensions will fit in the K20 case. The K30 case accommodates the E30 Bogen amplifier or one of similar dimensions. Overall dimensions of K20 and K30 cases: 16" wide x 14 1/2" deep x 20" high.

MODEL K20—Amplifier space: 14" long x 8" high x 8" deep.

MODEL K30—Amplifier space: 15" long x 8" high x 9 1/4" deep.

MODEL B10 FLOOR STAND

This deluxe floor stand is equipped with an exclusive silent friction locking clutch which will never wear out. Heavy 10" Base is cast in smart modern design with tripod legs to prevent rocking on uneven floors. Seamless tubing heavily chrome plated. Base finished in durable gray wrinkle baked enamel. Weight 10 lbs. Fits all standard microphones with 5/8-27 thread. Extends from 34" to 62".



BS

MODEL BS BANQUET STAND

A medium-weight Banquet stand equipped with silent friction clutch with 7" heavy gray wrinkle base. Tubing heavily chrome plated. Fits all standard microphones with 5/8-27 thread. Extends from 15" to 26".



B10

DELUXE MODERNISTIC STUDIO STANDS

The New Model BRR adjustable Microphone Stand is a combination of beauty and convenience. Finished in durable lacquered gunmetal, the graceful modernistic lines blend with modern studio surroundings. An ingenious arrangement makes it possible to lower or raise the movable part of the stand by a half turn of the automatic clutch collar. The positive internal lock will outlast the life of the stand. The round base with special tripod feet finds its own level, no matter how uneven the floor may be. Extends from 36" to 64". Weight 18 lbs. Standard 5/8-27 thread.



BRR

MODEL H10 STUDIO MICROPHONE STAND

The Model H10 stand is similar to the Model BRR in design and overall construction but equipped with a 10" diameter base weighing 14 lbs. Base features projecting tripod feet and is finished in smart gray wrinkle baked enamel. Extends from 35" to 63". Fits all standard microphones with 5/8-27 thread.



H10

MODEL DS1 ADJUSTABLE STAND

Model DS1 is an adjustable Desk Stand with heavy cast 7" Base finished in smart grey baked enamel shrivel. Ample weight to prevent tipping over—2 section chrome plated seamless tubing with 5/8-27 thread to fit all microphones. Extends from 10" to 14".



MODEL DS2 DESK STAND

A heavy duty desk stand with cast 6" Base finished in durable gray shrivel. Not easily tipped over. 4" Seamless Chrome plated tubing with 5/8-27 thread to fit all standard microphones. Overall height 6 1/2".

PORTABLE CARRYING CASES AND REMOTE CONTROL

PORTABLE SPEAKER BAFFLE FOR TWO 12" SPEAKERS

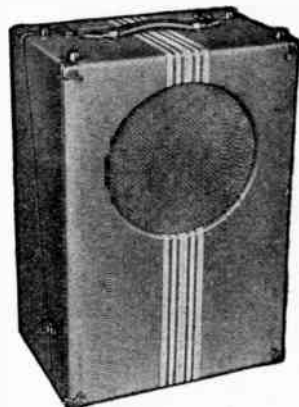

The Model 134X dual speaker baffle is divided diagonally into two sections. Each section serves as a speaker baffle sufficient to assure good tone quality. Speaker openings are protected by a strong screen which will not rattle. Has strong leather handle and rattleproof snap locks. Made of heavy $\frac{3}{8}$ " plywood covered with fine gray leatherette. Metal corners and bumper feet protect against abuse and prevent wear. A deluxe case for heavy duty purposes. Dimensions: 24" x 16" x 10".

MODEL 134X

PORTABLE SINGLE SPEAKER BAFFLES



MODEL 131

These cases are constructed of heavy plywood, with rounded corners and covered with gray leatherette. The backs are detachable and openings are provided to avoid cone pressure. Metal screen over speaker opening. For Speakers 8"-10". Size: 13" x 13" x 8 $\frac{1}{4}$ ".

MODEL 128

For Speakers 11"-14". Size 15" x 15" x 10 $\frac{1}{4}$ ".

PORTABLE PHONO CASES



MODEL 129

A handsome phono carrying case designed to accommodate any Green Flyer, General Industries or similar phonograph motor. Supplied complete with leatherette covered motor board. Heavy plywood construction thruout with glue block reinforcements at all joints. Covered in a smart grey leatherette with modern hand striping. Will take motors with 12" turntables and can be operated closed. Dimensions 15" x 13" x 7 $\frac{1}{4}$ ".

SPECIAL TRANSCRIPTION PHONO CASE

MODEL 715—De-Luxe Phono Case. This case is designed to accommodate Phono Motors and Turntables for 16" records. It is finished with the finest leatherette and strongly reinforced with leather corners. Dimensions closed: 21 $\frac{1}{4}$ " x 17" x 7 $\frac{1}{4}$ ".

DELUXE DUAL 12" SPEAKER BAFFLE

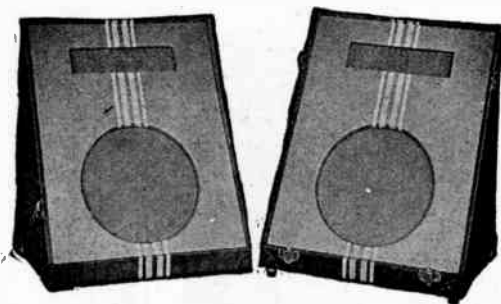

MODEL 140

These De-Luxe dual speaker baffles are completely enclosed and act as infinite baffles. They contribute considerably to the quality of reproduction on any sound system. They are scientifically designed with a special grill vent to eliminate boominess or cavity resonance.

The Baffle panels are covered with a Tan leatherette creating an extremely attractive two-tone appearance which is enhanced by a modern streamline striping.

Cases are solidly constructed of $\frac{3}{8}$ " heavy plywood covered with durable black leatherette.

The No. 140 case divides into two sections. Each section will accommodate a heavy duty 12" dynamic speaker. Dimensions: 22 $\frac{1}{2}$ " high x 18" wide x 12 $\frac{1}{2}$ " deep.—Closed.

PORTABLE AMPLIFIER CASES

These De-Luxe Amplifier cases are constructed of heavy plywood, reinforced throughout, covered with handsome gray leatherette. The covers are provided with demountable clasps and are removable during operation to permit free access to amplifier controls. Inside dimensions are given below.



MODEL 133X—18 $\frac{1}{2}$ " long, 12 $\frac{1}{4}$ " deep and 10 $\frac{3}{4}$ " high. For EX25 and EX35 Amplifiers.

MODEL SR REMOTE CONTROL

The Model SR Remote Control is ideal for remote control operation of any Bogen amplifier.

The Remote Control unit is extremely compact and equipped with two gain controls. These controls permit the operator to control volume and mix any two channels of a Bogen amplifier, such as two microphone channels or one microphone and one phono.

The Model SR Remote Control is not subject to inductive hum pickup in the cable or unit as are other types of wired Remote Controls. In addition, the SR Remote Control can be used with 1000 or 2000 feet of cable with negligible loss and long lengths of cable do not affect the tone quality of the amplifier.

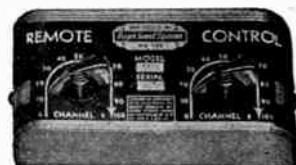

MODEL SR REMOTE CONTROL—Complete—less cable.

MODEL RC50—50 ft. cable and plugs for Model SR Remote Control.

No. 1103—Three Conductor Remote Control cable only for SR Remote Control.

BOGEN *Communo-Phones*

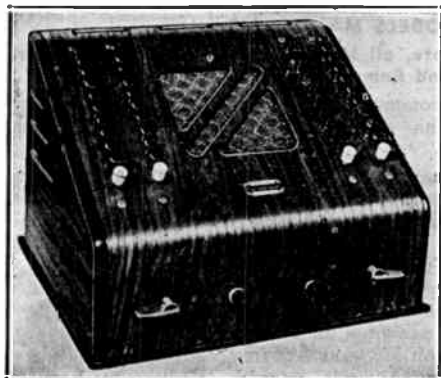

- Model S115 — Master for 10 stations
- Model S215 — Master for 20 stations
- Model S315 — Master for 30 stations
- Model S415 — Master for 40 stations
- Tubes Used: 2—7F7, 2—7C5, 1—7Z4

Any of above models may be obtained with earphone for private listening. Specify when ordering.

(Prices on Page C-2)

Wiring Note: On all connections between Masters use 2 conductor shielded. Between Master and Remotes not equipped to initiate calls, use 2 conductor shielded. Between Master and Remotes equipped to initiate call to one Master use 2 cables each 2 conductor shielded. For selective remotes the number of shielded cables required is one plus the number of Masters to be called.

Example: RS3 Remote would take 4 pairs of 2 conductor shielded.

ANNUNCIATOR PEDESTALS

An exclusive optional feature is the annunciator pedestal base which can be installed on any Bogen paging master as an alternate means of permitting remote stations to initiate calls to the master. When the annunciator pedestal is used instead of the remote station calling directly to the master by voice, remote stations are able to signal the master stations by means of a buzzer built in the annunciator unit.

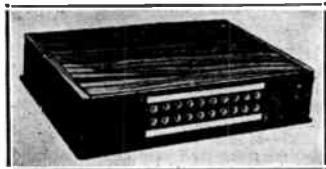

- Model 1A10—With 10 annunciators for use with S115.
 - Model 1A20—With 20 annunciators for use with S215.
 - Model 1A30—With 30 annunciators with S315.
 - Model 1A40—With 40 annunciators for use with S415.
- See complete catalog for Junction Boxes that should be used with these pedestals.

(Prices on Page C-2)

In addition the unit is equipped with small annunciator plungers, each one representing a particular remote station. When a remote station calls a master equipped with the annunciator unit, the annunciator buzzes and a plunger is released, which denotes at the master station, which remote station is calling. This offers the additional advantage of registering calls. In the event that the operator at the master station is not at his desk when he is called, the plunger will remain out, registering the call, so that upon the return of the operator to the master unit he can see which remote station called him and can then initiate a call to that particular remote station.

Annunciator pedestal units are mounted in beautiful walnut cabinets which are designed to serve as pedestal bases for the master unit.

UNIVERSAL INDUSTRIAL PAGING SYSTEMS

THESE new systems incorporate the greatest flexibility of application necessary to cover every combination of paging system installation that is required. Model S115 provides multiple master as well as master to remote station operation for paging purposes. All units are equipped with push-button selection of stations throughout. Models are available for 10, 20, 30 or 40 station installations. Masters are Universal for either single master operation or multiple master operation. Masters can call remote stations individually, in groups, or by means of one master emergency switch, all stations can be called at one time. Several masters can be used in a system in conjunction with several remote stations. Masters can intercommunicate with other masters in the system at will, maintaining two-way conversation. Masters can also call any remote in the system and remotes can initiate a call at will. Model S115 masters permit several different installation arrangements covering practically every combination of intercommunicating paging systems in one installation. Remote stations are available in different types for varying power level of operation or indoor or outdoor work and also equipped to permit selective initiation of calls to several different masters in the system or non-selective call for single master operation. Any number of masters and remote stations can be used in a single system and several different types of remotes can be used in the same system.

Masters are equipped with pushbutton selective switches in banks of ten, each bank being provided with a separate release button. In addition, a press-to-talk switch, master on and off switch, indicating pilot light and volume control as well as a master emergency switch for paging all stations at one time are mounted on the same panel. Master stations are housed in beautiful walnut cabinets especially designed to permit adequate ventilation. Masters deliver 15 watts of power, more than sufficient to cover the average paging system requirements. However, boosters can be used in addition to the master stations for installations where greater power levels are necessary. Remote stations are available in several types, mounted in walnut cabinet speaker housings, for wall mounting to be installed in offices or other similar installations, stream-lined metal speaker housings for wall mounting to be installed in factories or other industrial places where metal housings are required, and reflex waterproof remote stations, of all metal construction, designed for high power reproduction, in particularly noisy locations or for outdoor operation.

Since remote stations for paging systems are customarily mounted on walls or posts high up to permit covering large areas, special switch boxes for initiating calls are available designed to be mounted on a desk, or wall within convenient arm's length of operator. These switch boxes permit initiating a call from remote stations by actual remote control since the switch boxes can be placed a considerable distance away from the remote speaker itself.

Remote station switch boxes are available in three types; a non-selective type which consists of the initiating call switch mounted in a compact metal switch

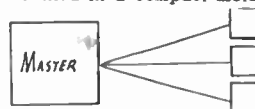

Fig. 1—For a one-way paging system from one Bogen "Universal" Master unit, use any Bogen paging remote station. The 15 watt output of Bogen "Universal" Masters are sufficient to handle a high-power paging installation. If desired, each remote can be equipped with CS switch box to permit remotes to initiate calls for two-way operation.

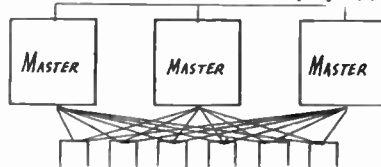

Fig. 2—Use any Bogen paging remote stations for one way paging system. If calls are to be initiated from the remotes to any 3 Masters, use CS3 selective call switches at each remote. When there are more than 3 Masters to be called by remotes use CS12 selective call switch.

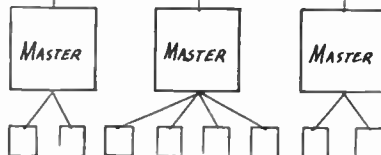

Fig. 3—This arrangement illustrates an installation where several remotes are common to its own Master unit. Any Bogen paging remotes can be used for one-way paging. For initiating calls from remote to Master, use CS-1 switch box at each remote station. All Masters can converse with each other.

FOR OTHER SYSTEMS ASK FOR BOGEN COMMUNOPHONE CATALOG

BOGEN *Communa-Phones*



BOGEN Deluxe SYSTEMS

MODELS MA, MC, MS

Deluxe Master to Remote, all Master and Combination Master, and Remote Systems

BOGEN Deluxe Intercommunication Systems represent a new step forward in the design of interoffice communication equipment.

The master station is functionally designed for maximum efficiency and appearance. The speaker-microphone is completely concealed in the top of the streamlined walnut cabinet, and the master volume control, indicating pilot light, separate on-off switch, Talk-listen switch and push-button station selectors are all mounted on a sloping control panel. The push-buttons are the latest self-locking type. The master stations are designed for 50 ohm balanced lines, operate on 110 volts AC, and provide an output of three watts, enough power to permit their use as a medium power selective paging amplifier.

Remote stations are housed in walnut finished plastic cabinets, and are equipped with volume controls. Remote stations are available with selector and break-in switches to initiate calls to master stations.



BOGEN "MS" SERIES—for operation of a number of master stations with a number of remote stations in one system.

Model MS307—Capacity of 7 master and remote stations, combined

Model MS313—Capacity of 13 master and remote stations, combined

Model MS319—Capacity of 19 master and remote stations, combined

Model MS325—Capacity of 25 master and remote stations, combined

Tubes Used: 1—7F7; 1—7C5; 1—7ZA.

BOGEN "MA" SERIES—for one master station and a number of remote stations.

Model MA307 Master—Capacity for 6 remote stations

Model MA313 Master—Capacity for 12 remote stations

Model MA319 Master—Capacity for 18 remote stations

Model MA325 Master—Capacity for 24 remote stations

BOGEN "MC" SERIES—for all master operation.

Model MC307—Capacity for system of 7 master stations

Model MC313—Capacity for system of 13 master stations

Model MC319—Capacity for system of 19 master stations

Model MC325—Capacity for system of 25 master stations

BOGEN DELUXE REMOTE STATIONS:

Model DAR—Remote station with volume control—without break-in switch. For MA and MS systems.

Model DRS—Remote station with volume control and break-in switch to a single master for MA and MS systems.

Model DR3—Selective remote for calling three masters. With volume control. For MS systems.

Model DR12—Selective remote for calling up to 11 masters—with volume control. For MS systems.

WIRING NOTES ON DELUXE SYSTEMS:

SINGLE MASTER TO REMOTE SYSTEMS (MA TYPE)—Use one 2 conductor twisted cable, unshielded, to each DAR Remote. Use two 2 conductor twisted unshielded cables to each DRS Remote to permit initiating call. Bogen Cable No. 1401S.

MASTER TO MASTER SYSTEMS (MC TYPE)—Use a 2 conductor twisted cable unshielded for each Master in the system. Example: 8 master stations require eight 2 conductor cables.

COMBINATION MASTER TO MASTER AND MASTER TO REMOTE SYSTEMS (MS TYPE)—Use same method for wiring as described for the above systems, wiring all Masters with 2 conductor twisted cable for each Master. Between a Master and Remote not equipped to initiate a call to one Master (DRS) use 2 cables, each 2 conductor twisted from each remote to the Master. For selective remotes (DR3-DR12) use one more 2 conductor cable than the number of Masters to be called. Example: DR3 would take 4 pairs of 2 conductor twisted cable, unshielded.

BOGEN TYPE "S" SYSTEMS

MODELS 112S, 125S

Multiple Master and Remote Combination Systems

BOGEN Type "S" Intercommunication Systems are among the most flexible systems on the market. Capacity up to 12 or 25 stations in any combination of master and remote units. Masters can communicate with other masters in the system at will, maintaining two way conversation. Masters can also call any remote in the system, and remotes can initiate calls to masters at will.

The master station operates on 110 volt AC-DC, and is equipped with an output transformer for 50 ohm balanced line operation. The master station is equipped with a rotary selector switch for selection of stations to be called, a press-to-talk switch, master on and off switch, indicating pilot light and volume control. Masters are finished in highly polished walnut bakelite to harmonize with any office surroundings.

Remote stations are available in four types: Model 1SAR, a non-selective type which can reply when called, but cannot initiate a call. Model 1RSR, a non-selective type, but equipped with a call switch to initiate calls.

Model 1RS3 is a remote equipped with a selector switch which permits it to select any one of three masters in a system and initiate a call to it. Model 1RS12 is equipped with an eleven station selective switch for use in systems where more than three masters are involved. This remote station can initiate calls to any number of masters up to eleven.

CABLE NOTE: To interconnect masters, use as many pairs of UNSHIELDED two conductor twisted cables as there are masters. Five masters require five two conductor UNSHIELDED cables. Between master and remote not equipped to initiate calls, use one two-conductor UNSHIELDED cable. Between master and remote equipped to initiate calls to one master, use two UNSHIELDED pairs. For selective remotes, the number of UNSHIELDED pairs is one plus the number of masters to be called. The RS3 employs four pairs.



MODEL SRS

Model 112S—Master with capacity of 12 stations, masters and remotes combined. Model 112SE—Same as Model 112S, but equipped with earphone for private listening.

Model 125S—Master with capacity of 25 stations, masters and remotes combined. Model 125SE—Same as Model 125S, but equipped with earphone for private listening.

Model 1SAR—Non-selective remote equipped with line matching transformer.

Model 1RSR—Non-selective, but with call switch to initiate call to a single master. Equipped with line transformer.

Model 1RS3—Selective remote for use in system with up to three masters.

Model 1RS12—Selective remote for system with up to 12 masters.

Model AB10—10 station annunciator register pedestal to visually indicate station which is calling.

Model AB20—20 station annunciator register pedestal.

Tubes Used: 1—14F7; 1—50L6; 1—35Z5.

BOGEN *Communo-Phones*

BOGEN TYPE "A" SYSTEMS

MODELS 4A, 12A, 219A

Master to Remote Station Communication

BOGEN Type "A" Communo-Phones provide instant communication between distant points. Systems consist of one Master and additional remote stations. Up to four remote stations may be added on the Model 4A, up to eleven remote stations on the Model 12A, and up to eighteen stations on the Model 219A. A Master can select any one remote station to speak with, or with a 4A Master—all remote stations at once, thereby instantly locating any person in your organization. Persons called reply through the remote station nearest to them—they need not be close to the station—replies made from 20 to 30 feet away can be received by the Master station clearly and distinctly.

The Master station can be set to permit any remote station to call it, or remote stations can be obtained with call-in switches, either built-in or external, to permit remote stations to initiate a call to the Master at any time.

Masters are equipped with an "on-off" switch, "press-to-talk" switch, and station selector. On the Model 4A a special arrangement permits closing out background noise levels from remote stations by a "silent" position on the Master station selector. A volume control on the Master permits adjustment of volume to any desired listening level.

Masters are finished in highly polished walnut bakelite to harmonize with any office surroundings.

TUBES USED: 1—14F7; 1—50L6GT; 1—35Z5GT.

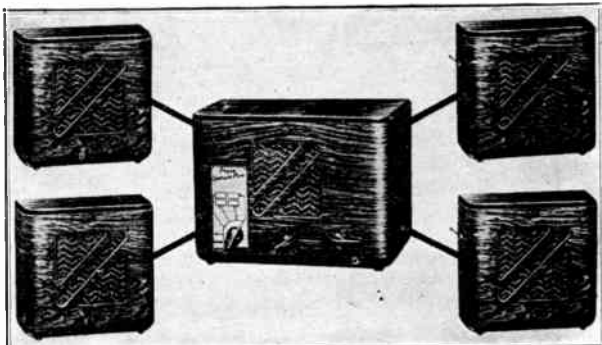

Model 4A—One Master only, for up to 4 stations, complete with tubes.

Model 4AE—Same as 4A, but equipped with earphone for privacy of conversation.

Model AR—Remote station only, for all type "A" Masters.

Model RS—Same as AR, but with built-in call switch.

MODELS 12A and 219A

These models are for larger installations than the Model 4A. They are similar in all features except that they do not include the ALL STATION call position or the SILENT position.

Model 12A—One Master only, for up to 11 stations.

Model 12AE—Same as 12A, but with earphone for privacy of conversation.

Model 219A—One Master only, for up to 18 stations.

Model 219AE—Same as 219A, but with earphone.

NOTE:—Type "A" Systems require a 2-conductor cable between Master and each Remote station.

Systems using Remote stations with call switch require a 3-conductor cable between Master and each Remote station.

BOGEN TYPE "C" SYSTEMS

MULTIPLE MASTER SYSTEMS

(Model 6C Equipped with Paging Switch)

BOGEN Type "C" Intercommunication Systems have been designed to meet the requirements of Multiple Station installations where a number of executive stations are desired. Systems for up to six, twelve, or nineteen stations are available. Each station is a Master and can call any other Master independently. Two Masters can converse with each other at will and several pairs of Masters can converse at once without interference.

An extremely desirable feature of the Model 6C is the All-Station switch which permits any station to call or page all other stations in the system at one time. This feature is not available on Models 12C or 219C.

If private conversations are desired, earphone Masters are available for one or all the Masters. This type of arrangement works like an inter-office telephone system. An extremely important feature is that it is not necessary to use the "Press-to-Talk" switch on any Master equipped with earphone, when earphone is in use.

Each station is housed in a beautiful walnut finished bakelite cabinet and equipped with station selector, master volume control, talk-listen switch, on-off switch and pilot light that shows when system is on or off.

TUBES USED: 1—14F7, 1—50L6GT, 1—35Z5GT

CABLE NOTE:—Installation of Type "C" Systems requires a cable with one more conductor than the number of stations to be installed (i.e.) five stations require a six conductor cable, etc.

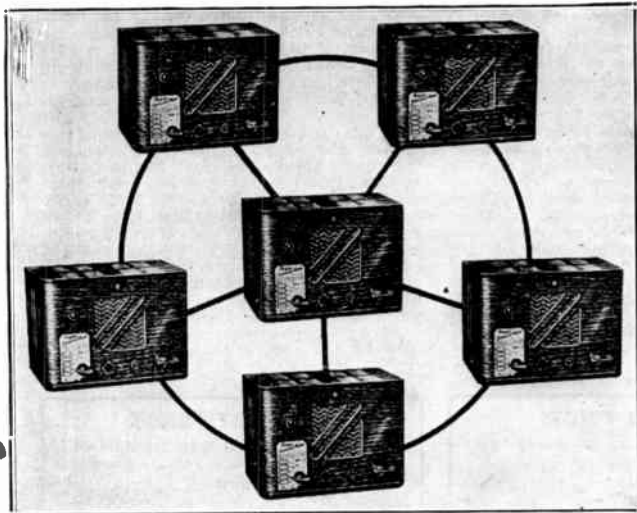

Model 6C—One Master only, for up to 6 stations, complete with tubes.

Model 6CE—Same as 6C, except with earphone for privacy of conversation.

Model 12C—One Master only, for up to 12 stations.

Model 12CE—Same as 12C, but with earphone.

Model 219C—One Master only, for up to 19 stations.

Model 219CE—Same as 219C, but with earphone.

FOR FURTHER INFORMATION AND LARGER SYSTEMS

ASK FOR COMPLETE INTERCOMMUNICATION AND PAGING SYSTEM CATALOG

INTERCOMMUNICATION **Talk-A-Phone** DE LUXE SYSTEMS

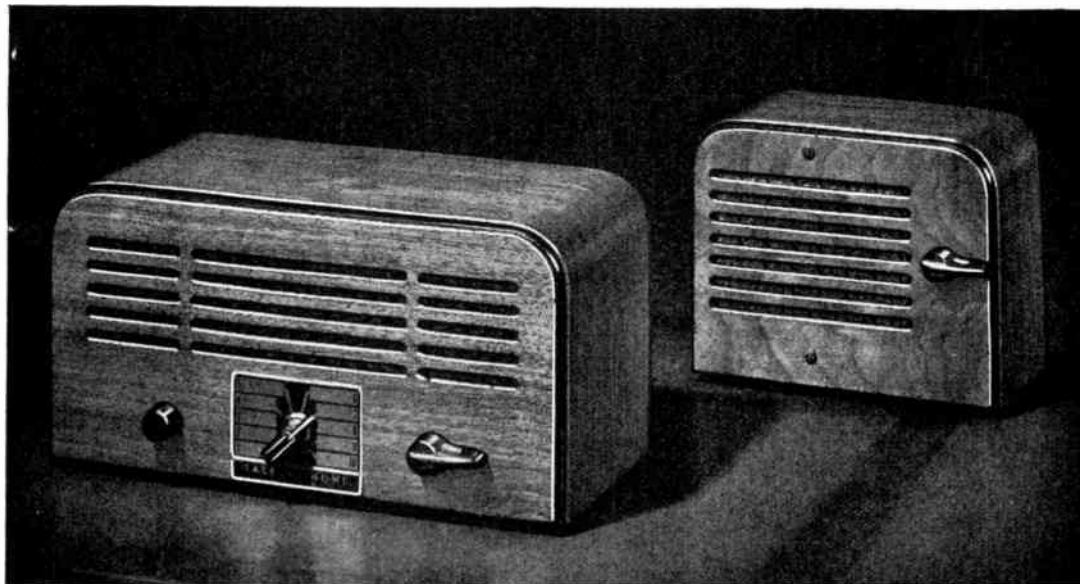

**AMERICA'S FINEST INSTANT SPEAKING COMMUNICATION!
SAVES TIME, STEPS, MONEY—SPEEDS UP PLANT & OFFICE ROUTINE**

KR-40 MASTER SELECTIVE

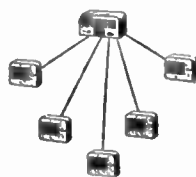

Consists of 1 Master Station working with up to a total of 10 Sub-stations. Affords private 2-way communication between Master and any of the Sub-stations as well as simultaneous address from Master to all Sub-station units. Sub-stations can answer and call the Master, but cannot call one another (Privacy earphone optional). Up to a total of 10 Sub-stations may be used with the Master. You can begin with a single Sub-station and a Master, and then add any number of Sub-stations up to a total of 10. System will operate with units as far as 2000 feet apart from each other. Voices carry to a distance of from 25 to 50 feet from the Sub-station location. Individuals at Sub-stations may answer when called without leaving their work and without touching the unit, from as far away as 25 to 50 feet. "Silent Feature" shuts out noises originating at Sub-stations—yet permits Sub-stations to originate call to Master Station. Volume level is controlled by Master. The Master is housed in a streamlined compact walnut cabinet, only 12" long x 6 1/2" high x 5 1/2" deep. Weight packed, 10 lbs. Sub-station (small cabinet) is only 7 1/2" long x 3 3/4" deep x 6 1/2" high. Weight packed, 4 lbs. The KR-40 System operates on 110-115 volts, AC or DC. Complete System operates for an entire month for less than 15c.

or not. Up to a total of 10 Master Stations may be employed. You can begin with 2 Masters and then add units up to a total of 10, as required. Complete privacy of communication is assured by the KS-60 System. (Privacy earphone optional—when used, system works like a telephone without use of "talk-listen" switch.) "Silent Feature" assures 100% silence at every Master Station between conversations. The KS-60 operates with undiminished power with units as far as 3000 feet away from one another. The volume may be adjusted at each Master from a whisper to a loudness that can be heard at 25 to 50 feet from the unit. The KS-60 is amazingly economical—each unit costs less than 15c per month to run! KS-60 units (large cabinet above) are luxuriously fashioned of choice walnut woods. Compact in size (only 12" long x 6 1/2" high x 5 1/2" deep). Weight packed, 10 lbs. The KC-60 System will operate universally on 110-115 volts AC or DC.

KS-60 SUPER SELECTIVE

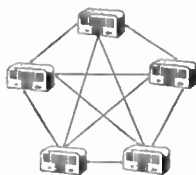

Consists of Master Stations only, up to 10 in number. Permits five 2-way private conversations to be held simultaneously without interference or cross-talk. Masters can call one another regardless of whether station being called has power "on"

cannot listen in on the Masters except when they are called by the Masters themselves. Masters may talk to each other or to Sub-stations at will, but Sub-stations do not originate calls. (Privacy earphone optional). Up to a total of 10 mixed units (Master or Sub-station types) may be used. You can begin with 2 Stations (at least one must be a Master) and then add units as required, up to a total of 10. Operates with units as far as 2000 feet away from one another. Volume is adjustable at each Master from a whisper to a loudness that can be heard at 25 to 50 feet away from his station unit. The KC-80 Master cabinet units are built of choice walnut woods; measure only 12" x 6 1/2" x 5 1/2"; weight packed, 10 lbs.; the Sub-stations 7 1/2" x 3 3/4" x 6 1/2"; weight packed, 4 lbs. The KC-80 Master Station can be operated for an entire month for less than 15c! Sub-stations consume no electricity. System operates on 110-115 volts, AC, or DC.

KC-80 COMBINATION MASTER

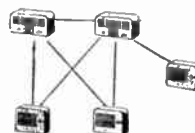

Any Master in this System can talk at will to up to 10 other Stations, either Masters or Sub-station types, or both. Masters may listen in at will to any of the other units in the System. The Sub-stations

cannot listen in on the Masters except when they are called by the Masters themselves. Masters may talk to each other or to Sub-stations at will, but Sub-stations do not originate calls. (Privacy earphone optional). Up to a total of 10 mixed units (Master or Sub-station types) may be used. You can begin with 2 Stations (at least one must be a Master) and then add units as required, up to a total of 10. Operates with units as far as 2000 feet away from one another. Volume is adjustable at each Master from a whisper to a loudness that can be heard at 25 to 50 feet away from his station unit. The KC-80 Master cabinet units are built of choice walnut woods; measure only 12" x 6 1/2" x 5 1/2"; weight packed, 10 lbs.; the Sub-stations 7 1/2" x 3 3/4" x 6 1/2"; weight packed, 4 lbs. The KC-80 Master Station can be operated for an entire month for less than 15c! Sub-stations consume no electricity. System operates on 110-115 volts, AC, or DC.

KR-40 LIST PRICES

Model KR-40. De Luxe Master Station Selective Unit as illustrated (but less earphone) complete with tubes, junction box and instructions. List Price \$59.00

Model KR-40C. Same as above, but with privacy earphone attachment. List Price \$74.00

Model RU-43. Sub-station unit, for connecting to Master Station. List Price \$18.95

No. 4433 Connecting Cable. For inter-connecting KR-40 Master to Sub-stations. List Price per 10 feet \$0.75

KS-60 LIST PRICES

Model KS-60. De Luxe Super-Selective Intercom Master Unit as illustrated (but less earphone), complete with tubes, junction box, and instructions. List Price \$59.00

Model KS-60C. Same as above but with privacy earphone attachment. List Price \$74.00

No. 6655 Connecting Cable. The proper cable for inter-connecting KS-60 Master Units. List Price per 10 feet \$2.20

KC-80 LIST PRICES

Model KC-80. Master Selective Unit for 10-Station use, with tubes, junction box, and instructions. List Price \$64.75

Model KC-80C. Same as above, but with privacy earphone attachment. List Price \$79.75

Model UC-82. Sub-station for connecting to Master Stations. List Price \$18.95

No. 2100 Connecting Cable. For inter-connecting KC-80 Masters. List Price per 10 feet \$2.50

No. 2222 Connecting Cable. For inter-connecting KC-80 Masters with UC-82 Sub-station Units. List Price per 10 feet \$0.30

Each of the above models may be had in systems consisting of 20, 40, 60, 80, etc. stations, on special order. Write for details.

CHICAGO

Talk-A-Phone Mfg. Co.

ILLINOIS

INTERCOMMUNICATION **Talk-A-Phone** STANDARD SYSTEMS

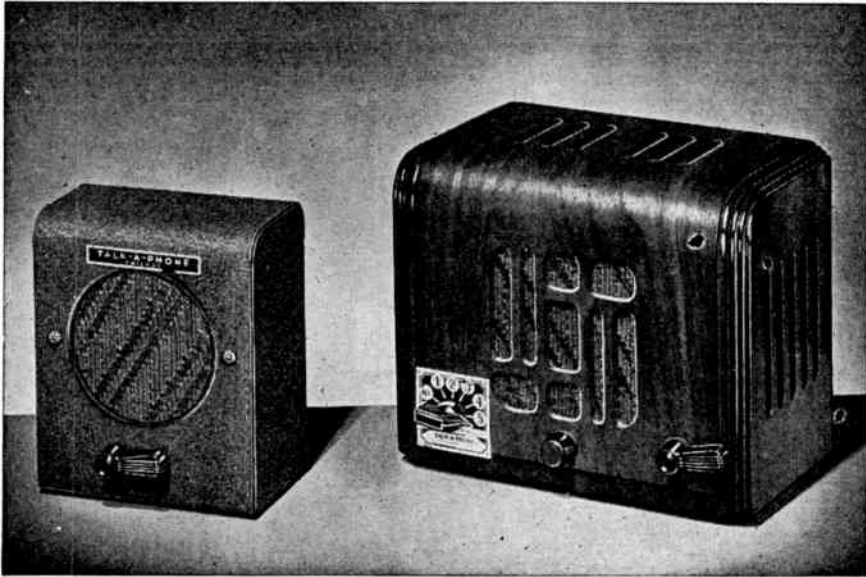

SPLIT-SECOND SPEAKING COMMUNICATION — SPEEDS UP OFFICE AND PLANT ROUTINE — SAVES TIME, STEPS, MONEY

LP-5 MASTER SELECTIVE

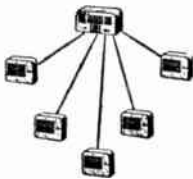

Consists of 1 Master Station working with up to a total of 5 Sub-stations. Master Station can talk privately to any of the Sub-stations or to all at one time. Each Sub-station can answer and call the Master, but Sub-stations cannot call each

other. Up to a total of 5 Sub-stations can be used with the Master. You can begin with a single Sub-station and Master, and then add any number of Sub-stations up to 5, as they are required. The Master enjoys complete privacy; Sub-stations cannot listen in on the Master; they can hear only when they are called. "Silent" feature shuts out all noises originating at Sub-stations. Operates with units as far as 2000 feet apart from each other. Voices carry clearly to a distance of from 25 to 50 feet from Sub-stations. Individuals at Sub-stations may answer when called without leaving work or touching units, at distances from 25 to 50 feet from Sub-stations. Volume level is controlled by Master. The LP-5 Master is housed in a handsome walnut cabinet, only 9 3/4" long x 5 3/4" deep x 8" high. Weight packed, 8 lbs. Sub-station is contained in an attractive metal cabinet of modern design, only 5 3/4" long x 3 3/4" deep x 7" high. Weight packed, 4 lbs. The LP-5 System operates universally on 110-115 volts, AC or DC.
(Also available for use with up to 10 Sub-stations.)

LP-5 LIST PRICES

- Model LP-5—Master Station Selective Unit, for 5 Sub-stations, complete with tubes and instructions. List \$34.00
- Model LP-10—Master Station Selective Unit, for 10 Sub-stations, complete with tubes and instructions. List Price\$42.50
- Model RS-3—Sub-station Unit, for connecting to the Master Units above. List Price\$12.50
- No. 2330 Connecting Cable—The proper cable (3 conductor) for connecting RS-3 Sub-stations to the LP-5 or LP-10 Master Selective Units. List Price per 100 feet.....\$4.50

LP-100 SUPER-SELECTIVE

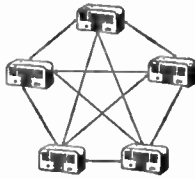

System is made up exclusively of Master Stations up to 5 in number. Permits two complete 2-way conversations to be maintained simultaneously, without cross-talk, or interference. Any one Master can talk to any other Master at will with absolute privacy. Masters may call one another regardless of whether station being called has power "on" or not. Up to a total of 5 Master Stations may be used. You can begin with 2 Masters and then add other units up to a total of 5, as required. Complete privacy of operations is assured by the LP-100. An exclusive advantage is the "Silent" feature which assures 100% silence at every Master Station between conversations. The LP-100 operates with units as far as 2000 feet apart. Voice volume can be adjusted at each Master from a whisper to a loudness that can be heard at 25 to 50 feet from the unit. Master Stations are fashioned of choice walnut woods, finished beautifully both front and back, and compact in design; only 9 3/4" long x 5 3/4" deep x 8" high. Weight packed, 8 lbs. The LP-100 System will operate universally on 110-115 volts, AC or DC. Each Master unit costs only 15c per month to operate at average rates. (Also available for use with up to 10 Masters.)

LP-100 LIST PRICES

- Model LP-100—Master Station Super-Selective Unit, for 5-Station use, complete with tubes and instructions. List Price\$39.75
- Model LP-110—Master Station Super-Selective Unit, for 10-Station use, complete with tubes and instructions. List Price\$44.75
- No. 3333 Connecting Cable—The proper cable (6 conductor) for inter-connecting LP-100 Master Units. List Price per 100 feet.....\$1.45
- No. 6655 Connecting Cable—The proper cable (11 conductor) for inter-connecting LP-110 Master Units. List Price per 10 feet.....\$2.20

LP-65 COMBINATION MASTER

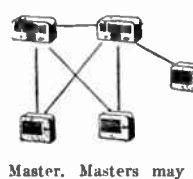

Any Master in the System can talk at will to any of up to 4 other Stations, either Master or Sub-station type, or both intermixed. Sub-stations cannot listen in on the Masters except when called by a Master. Masters may talk to each other or to Sub-stations at will, but Sub-stations do not originate calls. Up to a total of 5 mixed units (Master or Sub-station types) may be used. You can begin with 2 Stations (at least one must be a Master) and then add units as required, up to a total of 5. The LP-65 will operate effectively even when units are as far as 2000 feet apart. Incoming voice volume is adjustable at each Master unit from a whisper to a loudness that can be heard at 25 to 50 feet away from the unit. Individual being called may reply without leaving work even if he is 25 to 50 feet away from the unit. Master Stations are beautifully built of choice walnut woods. Masters measure only 9 3/4" long x 3 3/4" deep x 7" high. Weight packed, 4 lbs. The LP-65 System will operate universally on 110-115 volts, AC or DC. System can be operated for an entire month for less than 15c. Sub-stations consume no electricity at all.
(Also available for use with up to 10 stations mixed as desired.)

LP-65 LIST PRICES

- Model LP-65—Master Selective Station Unit for 5-Station use, complete with tubes and instructions. List, \$42.50
- Model RS-2—Sub-Station Unit. List Price\$11.25
- Model LP-70—Master Selective Station Unit for 10-Station use, complete with tubes and instructions. List, \$49.95
- No. 2050 Connecting Cable—The proper cable (5 pair) for inter-connecting LP-65 Master Stations Units to each other. List Price per 10 feet.....\$1.75
- No. 2100 Connecting Cable—The proper cable (10 pair) for inter-connecting LP-70 Masters to each other. List Price per 10 feet.....\$2.50
- No. 2222 Connecting Cable—The proper cable (2 conductor) for inter-connecting LP-65 and LP-70 Masters with RS-2 Sub-station Units. List Price per 10 feet.....\$0.30

Each of the above models may be had in systems consisting of 20, 40, 60, 80, etc. stations, on special order. Write for details.

CHICAGO **Talk-A-Phone Mfg. Co.** ILLINOIS

Talk-A-Phone CHIEF



FINGER-TIP! SPLIT SECOND CO-ORDINATION — OF ALL DEPARTMENTS! RELIEVE YOUR SWITCHBOARD!

MODEL C-410 MASTER SELECTIVE SYSTEMS

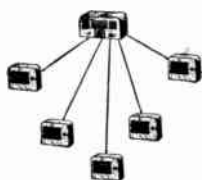

The "Chief" Master Selective System (illustrated above) made up of a master station working with up to a total of ten stations affords instant private two-way communication between master and any of the sub-stations as well as simultaneous address from master to all sub-station units by the use of one button. Sub-stations can answer and call the master but can not call one another. Privacy earphone which automatically shuts off speaker is optional. You can begin with a single sub-station and master and then add any number of sub-stations up to a total of ten. Volume is adjusted at each master station from a whisper to full room volume. Built-in automatic "Silent Feature" shuts out noises originating at sub-stations yet permits sub-station to originate call to master station. As an added feature the unit is provided with paging facilities if needed. The "Power" button is depressed when the auxiliary amplifier HP-16 is used to overcome extremely high noise levels. Thus the call can be heard above the noise of machinery, etc. The C-410 System operates on 110-115 volts AC-DC.

The "Chief" Master Selective System (illustrated above) made up of a master station working with up to a total of ten stations affords instant private two-way communication between master and any of the sub-stations as well as simultaneous address from master to all sub-station units by the use of one button. Sub-stations can answer and call the master but can not call one another. Privacy earphone which automatically shuts off speaker is optional. You can begin with a single sub-station and master and then add any number of sub-stations up to a total of ten. Volume is adjusted at each master station from a whisper to full room volume. Built-in automatic "Silent Feature" shuts out noises originating at sub-stations yet permits sub-station to originate call to master station. As an added feature the unit is provided with paging facilities if needed. The "Power" button is depressed when the auxiliary amplifier HP-16 is used to overcome extremely high noise levels. Thus the call can be heard above the noise of machinery, etc. The C-410 System operates on 110-115 volts AC-DC.

MODEL C-410 LIST PRICES

Model C-410—"Chief" Master Station as illustrated, complete with tubes, junction box, and instructions. List Price\$69.95
 Model C-410-C—"Chief" Master Station, same as above but with privacy earphone attachment. List Price\$84.95
 Model RU-43—Sub-station unit. List Price\$18.95
 No. 4433—Interconnecting Cable—the proper cable for interconnecting Model C-410 to sub-stations. List Price per 10 feet.....\$0.75

MODEL C-610 SUPER SELECTIVE SYSTEMS

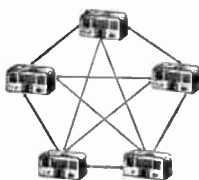

The "Chief" Model C-610 utilizes only master stations up to ten in number. With the use of the patented "Hold-A-Matic" push button action, not only may five private two-way conversations be held simultaneously but in addition a conference between any number of stations may be held without any danger of eavesdropping. All stations can call each other, and masters can call one another regardless if station being called has power on or not. You can begin with two masters and then add units up to a total of ten as required. Other features include "Power" and "Uni-Trans," the latter being especially effective for one way transmission of speech. When privacy earphone is used, system works like a telephone without the use of the "talk-listen switch." Built in "Silent Feature" assures 100 per cent silence at every master between conversations. Model C-610 operates with undiminished power with units as far as 3000 feet away from each other. The volume may be adjusted at each master from a whisper to a loudness which can be heard at 25 to 50 feet from the unit. C-610 Units (large cabinet above) are luxuriously finished of choice walnut woods; size 15" L. x 6 1/4" H. x 7" D. C-610 System will operate universally on 110-115 volts AC-DC.

MODEL C-610 LIST PRICES

Model C-610—"Chief" Super Selective Master unit as illustrated, complete with tubes, junction box, and instructions. List Price.....\$69.95
 Model C-610-C—"Chief" Super Selective Master unit, same as above but with privacy earphone attachment. List Price\$84.95
 No. 9911—Interconnecting Cable—The proper cable for interconnecting C-610 Master Stations. List Price per 10 feet\$2.90

MODEL C-810 COMBINATION SYSTEMS

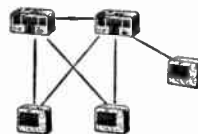

The Talk - A - Phone "Chief" Model C-810 combines the use of either master stations and selective type sub-stations or both. Master stations may carry on a number of two-way conversations or have a conference in complete privacy. Sub-stations can not eavesdrop or interrupt master stations. Selective type sub-stations may select the master to whom they wish to speak and originate a call. Sub-stations also have perfect privacy. Master stations can not eavesdrop. Privacy earphone is also optional on this model. You can begin with two stations (at least one must be a master) and then add units as required up to a total of ten. Outstanding features include optional "Power" and "Uni-trans" control described previously. Volume is adjusted at each master station by a continuously variable control easily accessible on the front of the unit. The system operates on 110-115 volts AC-DC.

MODEL C-810 LIST PRICES

Model C-810—"Chief" Master Station unit for ten station use, complete with tubes, six foot extension cable, junction box, and instructions. List Price\$79.95
 Model C-810-C—"Chief" Master Station unit, same as above but with privacy earphone attachment. List Price\$94.95
 Model UC-900—Non-originating Sub-station unit. List Price\$18.95
 Model UC-905—Sub-station unit for originating calls to any of five master stations. List Price.....\$24.95
 Model UC-910—Sub-station unit for originating calls to any of ten master stations. List Price.....\$27.50
 No. 3606—Interconnecting Cable — The proper cable for interconnecting up to six masters. List Price per 10 ft.\$2.90
 No. 1212—Interconnecting Cable— The proper cable (two-conductor) for interconnecting masters with UC-200 Sub-stations. List per 10 feet.\$0.50
 No. 3636—Interconnecting Cable— The proper cable for interconnecting UC-201, UC-205, UC-210 Sub-stations to masters. List Price per 10 feet\$1.45

Each of the above models may be had in systems consisting of 20, 40, 60, 80, etc. stations, on special order. Write for details.

CHICAGO

Talk-A-Phone Mfg. Co.

ILLINOIS

Talk-A-Phone *Super* CHIEF

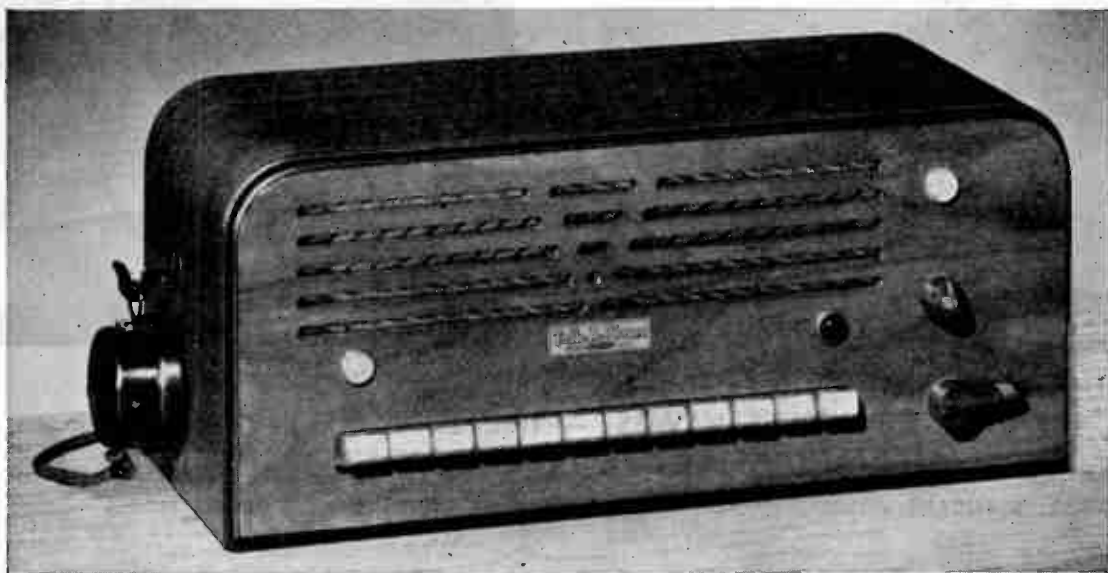

**THE FINEST IN INTERCOMMUNICATION — FEATURES INCLUDE
CONFERENCE TRAFFIC CONTROL—BUSY SIGNAL LIGHT—UNI-TRANS**

MODEL CS-1410 MASTER SELECTIVE SYSTEMS

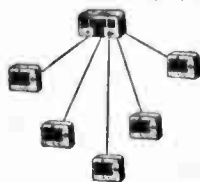

The "Super Chief" Model CS-1410 has incorporated in its design innovations never before used in the master selective type inter-communication system. This system using one master and up to a total of ten sub-stations affords private two-way communication between the master and any of the sub-stations. Built into this unit are the now famous Talk-A-Phone "Call Waiting" and "Busy Signal" lights. When the master is talking to a sub-station and another station wishes to call the master, as soon as the sub-station attempts to originate the call a red light goes on his station indicating that the master is busy. At the same time an amber light appears at the master station indicating that another sub-station is trying to reach him. As soon as the conversation is completed, the lights go off and the new conversation may proceed. Other features include the "Power" button used with the auxiliary amplifier HP-16 to overcome extremely high noise levels and automatic "Silent Feature." Units have extremely high power, undistorted five watts—more than enough for any normal operation. System operates on 110 volts AC, 60 cycles.

communication between the master and any of the sub-stations. Built into this unit are the now famous Talk-A-Phone "Call Waiting" and "Busy Signal" lights. When the master is talking to a sub-station and another station wishes to call the master, as soon as the sub-station attempts to originate the call a red light goes on his station indicating that the master is busy. At the same time an amber light appears at the master station indicating that another sub-station is trying to reach him. As soon as the conversation is completed, the lights go off and the new conversation may proceed. Other features include the "Power" button used with the auxiliary amplifier HP-16 to overcome extremely high noise levels and automatic "Silent Feature." Units have extremely high power, undistorted five watts—more than enough for any normal operation. System operates on 110 volts AC, 60 cycles.

MODEL CS-1410 LIST PRICES

Model CS-1410—"Super Chief" Master Station for ten station use, complete with tubes, junction box and instructions. List Price \$120.00
Model CS-1410-C—"Super Chief" Master Station, same as above but with privacy earphone attachment. List Price \$135.00
Model US-703—Sub-station unit for connecting to CS-1410 Master Station, complete with "Busy Signal Light." List Price \$35.00
No. 8866—Interconnecting Cable—The proper cable for interconnecting Model CS-1410 Master stations and sub-stations. List Price per 10 feet..... \$1.45

MODEL CS-1010 SUPER SELECTIVE SYSTEMS

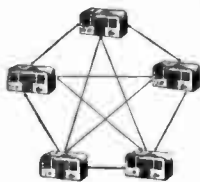

The Model CS-1010 "Super Chief" is made up exclusively of master stations. Any number up to ten may be had in the system. This system permits five two-way conversations to be held simultaneously without interference or

cross-talk. You can begin with two masters and then add up to ten as required. In addition by the use of "Traffic Conference Control" any number of stations may hold private conferences without interruption or eavesdropping from stations outside of the conference group. If one of the conference group is called by an outside station, he is signalled by a light so that he knows a call is waiting. At the same time the "Busy Signal Light" on the caller's unit is illuminated so that he knows that the line he is trying to reach is busy. An outstanding feature is "Uni-Trans" control which enables you to talk to one or as many as you want without interruption, a splendid feature when dictating to one or to a group. When earphone is used, system works like a telephone without use of "Talk-Listen Switch." Styled by industrial designers, cabinets are beautiful ultra-modern and of harmonious matched wood design size 15" L x 6 1/2" H. x 7" D. System operates on 110 volts, AC, 60 cycles.

MODEL CS-1010 LIST PRICES

Model CS-1010—"Super Chief" Master Station for ten stations, complete with tubes, junction box and instructions. List Price \$120.00
Model CS-1010-C—"Super Chief Master Station, same as above but with privacy earphone attachment. List Price \$135.00
No. 2142—Interconnecting Cable—The proper cable for interconnecting Model CS-1010 "Super Chief" Master Stations. List Price per 10 feet..... \$5.00

MODEL CS-1810 COMBINATION SYSTEMS

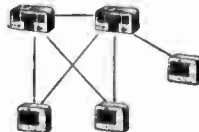

The "Super Chief" Model CS-1810 offers supreme versatility of a type never before achieved in inter-communication equipment. Either masters or sub-stations or both up to a total of

ten may be used. Master stations may carry on private two-way conversations or conferences without interruption or eavesdropping by use of the "Private Conference Traffic Control." In addition master stations may call and communicate with sub-stations, and sub-stations may select the master which they wish to call and providing the master's line is not busy originate the call. If the master is busy, a red light will go on at the sub-station and an amber light will go on at the master station indicating that someone is trying to reach him. After the conversation is over the lights will go out, and the new conversation may proceed. "Uni-Trans" is also built into this system. The volume of incoming voice may be adjusted at each master station. Voice reproduction is lifelike and natural. Privacy earphone is optional in this system. Operation of these units is on 110 volts, AC, 60 cycles.

MODEL CS-1810 LIST PRICES

Model CS-1810—"Super Chief" Master Station for ten station use, complete with tubes, junction box and instructions. List Price \$135.00
Model US-901—Sub-station for originating calls to one master, complete with "Busy Signal Light." List Price \$35.00
Model US-910—Sub-station for originating calls to any of ten masters, including lights. List Price \$45.00
No. 2142—Interconnecting Cable—The proper cable for connecting up to six CS-1810 Master Stations to each other. List Price per 10 feet..... \$5.00
No. 6363—Interconnecting Cable—The proper cable for interconnecting US-901, US-905 and US-910 Sub-stations to Masters. List Price per 10 feet..... \$1.45

Each of the above models may be had in systems consisting of 20, 40, 60, 80, etc. stations, on special order. Write for details.

CHICAGO

Talk-A-Phone Mfg. Co.

ILLINOIS

COMBINATION **Talk-A-Phone** SYSTEMS

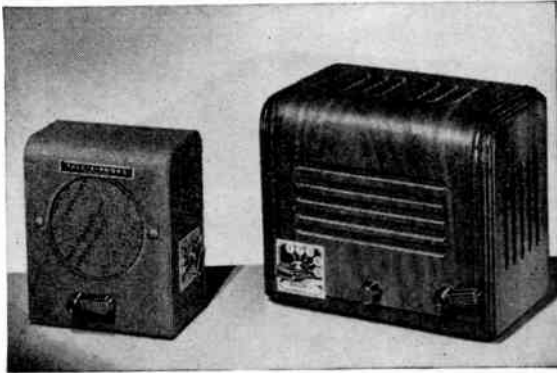

Standard Model

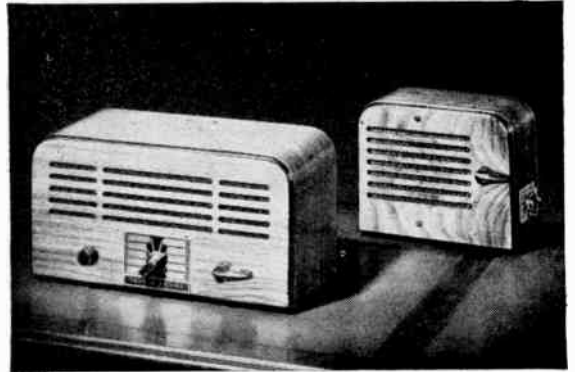

DeLuxe Model

TALK-A-PHONE'S NEWEST — THE SUPREMELY VERSATILE MASTER AND SELECTIVE TYPE STAFF-STATION MODEL

STANDARD MODEL

With this versatile system any master can talk at will to any of up to four other stations either master or sub-station type or both intermixed. The staff type sub-stations, illustrated above, can select any master and originate calls but can not eavesdrop at any time on masters nor can they interrupt when masters are speaking to each other. Regular RS-2 non-originating type sub-station may also be used with this system.

You can begin with two stations (at least one must be a master) and add units as required, up to a total of five. The Model LP-67 will operate effectively even with the units as far as 2000 feet apart. Incoming voice volume is adjustable on each master unit. Masters measure 9 3/4" L. x 3 3/4" D. x 7" H.; weight packed 7 lbs. The Model LP-67 System will operate universally on 110-115 volts AC-DC. The system can be operated for an entire month for less than 15c. Sub-stations consume no electricity at all.

(Also available for use for up to ten stations mixed as desired.)

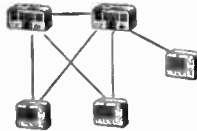

DELUXE MODEL

This Deluxe System permits the use of up to ten stations either master or staff type sub-stations or both. Master stations may communicate with each other in perfect privacy. Sub-stations can not eavesdrop or interrupt the master stations. Selective type sub-stations may select the master to whom they wish to speak and originate the call. Non-selective type sub-stations may also be used in this system. Privacy

earphone is also optional on this model. You can begin with two stations (at least one must be a master) and then add units as required up to a total of ten. It operates with units as far as 3000 feet away from one another. Volume is adjustable at each master from a whisper to a loudness that can be heard from 25 to 50 feet away from the unit. The Model KC-87 Master Stations as well as the Sub-stations are beautifully designed and built of choice walnut woods. The Master Station weight packed is 10 lbs.; the Sub-station 4 lbs. The KC-87 Units are furnished complete with tubes, instructions, six foot cable, and junction box. The system operates on 110-115 volts AC-DC.

MODEL LP-67 LIST PRICES

Model LP-67—Master Station unit for five station use, complete with tubes and instructions. List Price.....	\$45.00
Model LP-77—Master Station unit for ten station use, complete with tubes and instructions. List Price.....	\$49.95
Model RS-2—Non-originating Sub-station unit. List Price.....	\$11.25
Model RS-31—Sub-station unit for originating calls to one master station. List Price.....	\$14.95
Model RS-35—Sub-station unit for originating calls to any of five master stations. List Price.....	\$17.95
No. 3603—Interconnecting Cable—The proper cable for interconnecting up to three masters. List Price per 10 feet.....	\$1.45
No. 3606—Interconnecting Cable—The proper cable for interconnecting up to six masters. List Price per 10 feet.....	\$2.90
No. 1212—Interconnecting Cable—The proper cable for interconnection masters with RS-2 Sub-stations. List Price per 10 feet.....	\$0.50
No. 3636—Interconnecting Cable—The proper cable for interconnecting RS-31 and RS-35 Sub-stations to masters. List Price per 10 feet.....	\$1.45

MODEL KC-87 LIST PRICES

Model KC-87—DeLuxe Master Station unit for ten station use, complete with tubes, six foot extension cable, junction box, and instructions. List Price.....	\$64.75
Model KC-87-C—DeLuxe Master Station unit. Same as above but with privacy earphone attachment. List Price.....	\$79.75
Model UC-82—Non-originating Sub-station unit. List Price.....	\$18.95
Model UC-201—Sub-station unit for originating calls to one master station. List price.....	\$22.00
Model UC-205—Sub-station unit for originating calls to any of five master stations. List Price.....	\$24.95
Model UC-210—Sub-station unit for originating calls to any of ten master stations. List Price.....	\$27.50
No. 3606—Interconnecting Cable—The proper cable for interconnecting up to six masters. List Price per 10 feet.....	\$2.90
No. 3636—Interconnecting Cable. The proper cable for interconnecting Models UC-201, UC-205 and UC-210 Sub-stations to Masters. List Price per 10 feet.....	\$1.45

Talk-A-Phone MULTIPLE STATION SYSTEMS

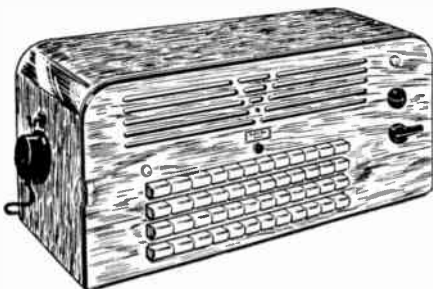

Super Chief Model

Talk-A-Phone Systems are available in unlimited number of stations from five to 100. Illustrated at the left is the "Super Chief" or "Chief" model for 46 stations complete with earphone. At the right is shown our 40 station Standard Model. These multiple station units are available in either the Master Selective, Super Selective, or Combination type units. Write for quotations.



Standard Model

CHICAGO

Talk-A-Phone Mfg. Co.

ILLINOIS



510 Series Master to Master

"Tokfone"

**Model 510—MASTER to MASTER
SELECTIVE SYSTEM**

Use of Talk and Listen Switch Unnecessary

The Master System Model 510 has many new features to recommend it. Two-way private conversation between any two stations with a total selection of 10 stations is now possible. Every Master Station Model 510 is a veritable complete and private self-contained telephone switchboard! Just turn the selector switch to the station to which you wish to speak and you can carry on a private conversation. **FIVE SEPARATE AND DISTINCT PRIVATE CONVERSATIONS CAN BE CARRIED ON SIMULTANEOUSLY.**

The 510 System does not require the use of a "talk and listen" switch. Simply lift the phone to your ear and you can carry on a **RUNNING CONVERSATION.**

Master Station 510 comes complete with ear phone, selector switch, "on" and "off" switch, "talk and listen" switch, volume control. Cabinet of beautiful hand rubbed walnut, 50 feet of wire. Complete **\$48.00**



SW 3 Wire Remote



141 Remote



141 Master

**"Tokfone" Model 141
BEAM POWER SYSTEM**

With 2 Watt Output. From 2 to 11 Stations with Selector Switch

Where efficient, economical and fast, direct two-way **AMPLIFIED** communication is desired between two or more persons of departments, this System is just the thing.

Model 141 TOKFONE Master station comes with selector switch, "on and off" switch, "talk and listen" switch, volume control, complete with one sub station and 50 feet of wire for **\$49.50**

The Model 141A illustrated may be used for extra stations, wherever needed. Each comes with 50 feet of wire. Each **\$10.00**

The Model 141-S and 141-SW is exactly the same as the Model 141 and 141-A except that it comes equipped with a special switch on the right hand side of the Master and a special switch on the sub station. The Master Station and one sub station and 50 feet of wire complete is only **\$53.00**

TOKFONE Remote SW Station is used where additional Remote stations are needed for any 3 wire SW systems. **\$11.50**



Model 140

**"Tokfone"
WIRELESS
SYSTEM**

Works on A.C. or D.C.—
No Wiring Necessary

The Tokfone Wireless Model 140 provides two-way communication between any two points without the necessity of laying wires between the units to be used. This arrangement makes the "140" desirable where it is impractical to do wiring. For example it is ideal for use in the home between the sick room and the kitchen, from the nursery and the living room, etc. Extreme portability is its chief claim to fame. Just plug each station into the nearest electric baseboard outlet and it's ready for use. Comes in beautiful walnut cabinet equipped with "on and off" switch, volume control, "talk and listen" switch, jewel pilot light. Per pair..... **\$69.50**

**"Tokfone"
REMOTE
SWITCH
CONTROL**



Remote Switch Control

A highly practical, and efficient means of speaker control where the speakers are located on wall brackets, or mounted in some other position which is not easily accessible . . . up to distances of 15, 20 or 30 feet. Comes equipped with 6 feet of wire **\$7.50**

**"Tokfone" STORM-PROOF
"MARINE MIDGET" P.M. SPEAKER**

This new horn of inverted reflex design offers an air column length of 15" thus giving a maximum ratio of power input to sound pressure output. Features wide range frequency response and fine reproduction of voice. Because of complete weather and mechanical protection, dependable operation can be expected with a driving rain beating directly into the bell opening.

Constructed of heavy gauge aluminum. Battleship grey enamel finish.

Adjustable steel mtg. bracket at no extra charge. The P.M. Speaker unit has a conservative power rating of 5 watts. Overall size of horn: Bell 10", overall depth 8". Price..... **\$24.50**

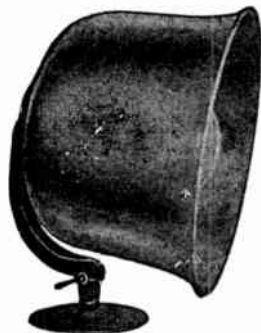

"Tokfone" TRUMPET

The exclusive design of Tokfone Trumpets increases their strength and eliminates rain leakage at the seam where the 2 sections of the baffle are joined. The cone speaker is securely held in place with the same bolts that hold the baffle together. Extra mtg. bolts not needed.

Comes equipped with cadmium plated hardware and two mtg. loops for hanging. **6" SPEAKER, 15" bell opening, 10" length; overall length 15". All aluminum.**

Price
\$29.50



Add \$2.00 for 220 Volts for all Models.



MASTER JR.

*"TokFone"
Jr.*

HERE'S A LOW PRICED TWO-WAY SYSTEM FOR EXECUTIVES, PROFESSIONALS & HOME USE

MASTER WITH 1 REMOTE AND 50 FEET OF WIRE
TOKFONE, Jr. is an inexpensive but highly efficient two way communication system which can be used between any two remote points in an office, factory, or home.

TOKFONE, Jr. gives you instant personal contact between managers and their employees, between one department and another or from one room in the home to another.

TOKFONE, Jr. is attractive in appearance, simple to install and costs a trifle to operate. It is a thoroughly practical and proven product which will pay for itself over and over again in saving time, steps and anxiety.

TOKFONE, Jr. will be found indispensable for simplifying and speeding up office routine, interdepartmental contacts and will save the housewife many steps in keeping in touch with the kitchen, nursery, garage or other parts of the home. Complete **\$27.50**

"TokFone" Jr. S-W

TOKFONE, Jr. SW is optional equipment. Its use permits calling the master station from the outlying station. The arrangement is such, however, that the switch on the remote station must be operated to permit person called to answer the call from the master station. It also keeps the remote station in quiet position, and the master station at all times can call the remote station.

This system complete with switch on remote station only, and 50 ft. of triple twisted wire **\$30.50**

TokFone

REG. U.S. PAT. OFF.



JR. REMOTE



142 SERIES REMOTE



MASTER 142 SERIES

*"TokFone"-2-11
Station System*

MODEL 142-EA

THE IDEAL SYSTEM FOR HOTEL PAGING, HOSPITALS, DEPARTMENT STORES, FACTORIES, OFFICE SUITES, FOR DIRECT 2-WAY AMPLIFIED COMMUNICATION

COMPLETE WITH SELECTOR SWITCH

The most efficient, economical, and fastest means of holding direct, two way, amplified communication between two or more persons or departments. Complete 2-way system comprising one Model 142-EA, one Model 142-E and 50 feet of wire. Complete..... **\$49.50**

MODEL 142-EA and MODEL 142-E comprise a complete two way system. Additional sub-stations up to ten units can be added to the TokFone system. This is the only communication system having this many stations; also on each sub-station 4 speakers may be connected in series parallel, giving you a total of forty direct stations which no other communication system affords. Master comes equipped with Earphone. Works on AC-DC current. Communication between master station and any remote station in which any remote station can call the master, and the master is the only one that can call all remote stations separately or altogether. EXTRA STATIONS with 50 ft. of wire **\$10.00**

"TokFone" Model 143 & 143-A

Is exactly the same as Model 142-EA—except that it does not come equipped with earphone. Model 143 and 143-A come complete with master sub station and 50 feet of wire..... **\$47.50**

"TokFone" Model 143-S — 143-SW

Is exactly the same as Model 143-143A except that it comes equipped with special switch on the right hand side of the Master and a special switch on the sub station, complete with master, sub station and 50 feet of wire **\$50.75**

"TokFone" Model 142-EA SW

Switches on both master and sub station. Is optional equipment and its use permits calling the master station from the outlying station. The arrangement is such, however, that the remote switch need not be operated to permit the person called to answer questions to the master station. It also keeps the remote station in a quiet position but the master station at all times can call the sub station. This system complete with switch on master and remote station and triple twisted wire **\$53.00**

Every Home Needs the Protection of the Amazing *"Talking Door"*



SP-3 REMOTE



TALKING DOOR
"MASTER"



BX-3 REMOTE



A modern convenience for every home which permits a two-way conversation to either the front or rear door from the kitchen or other convenient location. Keeps out undesirables such as promotion salesmen, solicitors, time wasters—even kidnappers. No need to "go to the door" and stand in the draft of an open door. Small initial cost, easy installation and low operating cost make

this a necessity in every home. Consumes no current except when in use. Comes complete with 1 station and 50 ft. of wire ready to install. May be had with either Model BX3 in black crackle finish for mounting outside of door or Model SP3 for mounting inside of door.

Talking Door with one Remote complete **\$24.95**

Additional units of BX3 or SP3 for another door **\$10.00**

LICENSED, by agreement with Electrical Research Products, Inc., UNDER PATENTS OWNED OR CONTROLLED BY WESTERN ELECTRIC CO., and AMERICAN TELEPHONE AND TELEGRAPH COMPANY.

Tok Fone
REG. U. S. PAT. OFF.
De Luxe

INTERCOMMUNICATION SYSTEM

Model 743S Master and 743W Remote Unit

List Price \$69.50

The TOKFONE DeLuxe represents the culmination of many years' experience in the manufacture and sale of Intercommunication Systems. It is by far the most efficient, most economical and the fastest means of carrying on direct, two-way, amplified intercommunication between two or more persons, offices or departments.

The basic system comprises one DeLuxe Master Unit (top) and one DeLuxe Remote Station (bottom), although Additional Remotes may be added (to the total of 10) to meet the specific requirements of any business.

The DeLuxe System utilizes PUSH BUTTON CONTROL. By simply pressing one button on either side you automatically connect the circuit between the Master and any one Remote. Two-way conversation is made possible by means of the talk-listen key.

The flexibility of this unit may be judged by the fact that when set up for its maximum communication possibilities, 10 Remote stations may be connected to the Master. These are arranged in two groups of 5 each. The Master may call one single station in either group or one station in each group at the same time or may call and converse with all 5 Remotes in either group or all 10 Remotes in both groups at one time. If desired, any Remote can call the Master at any time.

One of the exclusive features of the TOKFONE DeLuxe System is that it is designed so that it may be used with either a two-wire or three-wire cable.

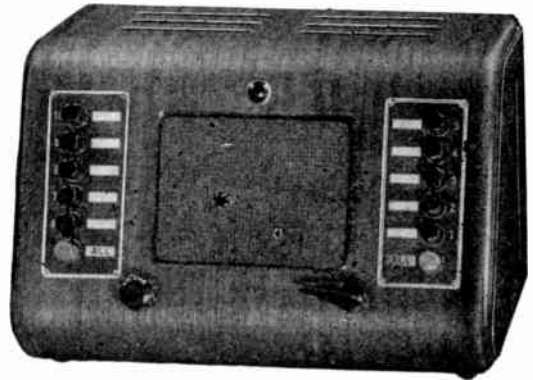

Flexibility

When used as a 3-wire system a switch at the side of the cabinet enables a Remote station to carry on a running conversation with the Master, once the circuit is completed. It also permits the Remote to remain silent when the circuit is not in use and prevents the Master from listening to trivial or non-pertinent conversations at the Remote.

When a two-wire cable is used, both the Master and Remote stations always remain open so that a running conversation is possible at all times when the "all" button is depressed or in a closed position.

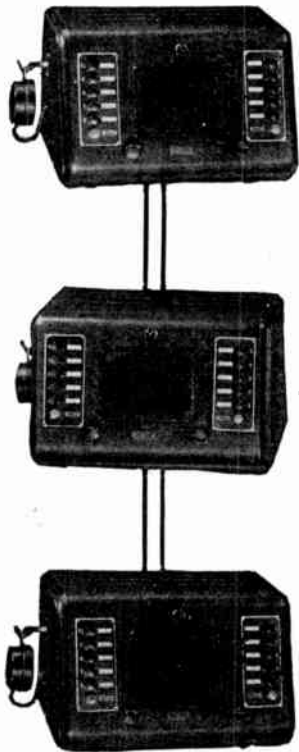

Tok Fone
REG. U. S. PAT. OFF.
De Luxe

INTERCOMMUNICATION Reaches New High With MASTER TO MASTER SYSTEM

A Selective System Which Makes Use of Talk-and-Listen-Switch Unnecessary

The Master System Model 710 has many features to recommend it. Two-way private conversation between any two stations is now possible. Every Master Station in this system is a veritable and complete and private self-contained telephone switchboard! Just press in the button indicating which station you wish to speak to and you can carry on a private conversation. SIX SEPARATE AND DISTINCT PRIVATE CONVERSATIONS CAN BE CARRIED ON SIMULTANEOUSLY.

The 710 System does not require the use of a "talk and listen" key. Simply lift the phone to your EAR and you can carry on a RUNNING CONVERSATION. The only time "Talk Listen Key" is used by Master is when loud-speaker operation is desired.

Master Station 710 comes complete, with earphone, "on" and "off" switch, "talk and listen" switch, volume control and 12 push button selector. Cabinet of beautiful hand rubbed walnut, sloping front.

List Price for Each Model No. 710 — \$54.00

PRICES SUBJECT TO CHANGE WITHOUT NOTICE. APPLY FOR TRADE DISCOUNTS.

Licensed by Electrical Research Products, Inc., under U. S. Patents of American Telephone and Telegraph Company and Western Electric Company, Inc.

TOKFONE AMPLIFIERS



**8 WATT
AMPLIFIER
COMPLETE**
•
Model 8WA
List \$32.50
with tubes

Here is a low priced 8 watt amplifier that meets all TokFone requirements of Quality at a price that fits the most restricted budget. Comes COMPLETE, ready to use WITH Sylvania tubes, screen, and carrying handle.

- Full 8 Watt Amplifier
- 4 Tube Chassis
- 2 Channels—1 Microphone and 1 Phono Input
- Separate Control for Each
- Separate Tone Control with Switch
- Has 8 Ohm Output Impedance
- Tube Lineup: 6SJ7-6SF5-6L6-83V
- Extra Heavy Chassis
- Completely Shielded
- Extra Heavy Duty Transformer
- Oversize Components
- High Gain, Wide Frequency Response
- Operates on 110-120 Volts, 50-60 Cycle

**15 WATT
AMPLIFIER
COMPLETE**
•
Model 15WA
List \$24.50
less tubes

PERFORMANCE PLUS
AT LOW COST



- Extra Heavy Chassis
- Completely Shielded
- All Oversized Components
- Six Tube Class A Push-Pull
- Fifteen Watt Output
- Three Input Positions—2 Microphone, 1 Phono Unit
- 2-4-8-500 Ohm Outputs
- High Gain, Wide Frequency Response
- Continuous, Variable Tone Control
- Four Stages of Amplification
- Tube Lineup: 1-6SJ7, 2-6SC7, 2-6N6, 1-83V
- Operation on 110-120 Volts, 5-60 Cycle

**15 WATT
PHONO
AMPLIFIER**

•
Model P15WA
List \$44.95
with tubes



This new TokFone Model P15WA fills a long felt need. The amplifier is the same as Model 15A but has the added feature of a built-in electric phonograph. Entire unit comes complete WITH tubes, screen, motor and pick up and is easily portable.

- Extra Heavy Chassis
- Completely Shielded
- All Oversized Components
- Six Tube Class A Push-Pull
- Fifteen Watt Output
- Three Input Positions
- 2 Microphone, 1 Phono Input
- 2-4-8-500 Ohm Outputs
- High Gain, Wide Frequency Response
- Astatic Crystal Pickup
- High Gain Output
- Alliance Rim Driven Constant Speed Motor, 78 RPM
- On and Off Switch for Motor on Phono Control
- Continuous, Variable Tone Control
- Four Stages of Amplification
- Tube Lineup: 1-6SJ7, 2-6SC7, 2-6N6, 1-83V

**15 WATT
AMPLIFIER
COMPLETE**
•
Model 15WA
List \$24.50
less tubes

**30 WATT
PHONO
AMPLIFIER**
•
Model PW30A
List \$87.95
tubes included



- Seven Tube Chassis
- Three Channels
- Two Microphone and one Phono Input
- Separate Control for Each
- Separate Tone Control
- Jewel Pilot Light
- Has 4-8-15-500 Ohm Output Impedances
- Rubber Floated Tube Trays
- Tube Lineup: 1-6SJ7, 1-6SF5, 2-6SC7, 2-6L6, 1-83V
- Extra Heavy Chassis, Completely Shielded
- Full 30 Watt Amplifier
- On and Off Toggle Switch
- Oversize Components
- High Gain Wide Frequency Response
- Operates on 110-120 Volt, 50-60 Cycle
- Astatic Crystal Pickup
- High Gain Output
- Alliance Rim Driven Constant Speed Motor, 78 RPM Response
- On and Off Switch for Motor on Phono Control

For a splendid all-purpose amplifier this model P30WA has no equal. Comes complete with tubes, screen, motor and pickup as illustrated.

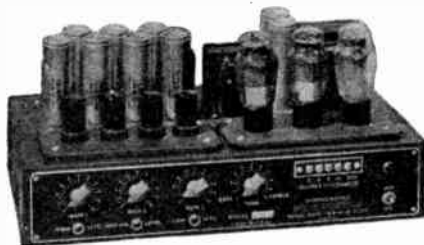

30 WATT AMPLIFIER — Model 30WA
List \$67.50 — less tubes

- Full 30 Watt Amplifier
- Seven Tube Chassis
- Three Channels
- Two Microphone and One Phono Input
- Separate Control for Each
- Separate Tone Control
- Jewel Pilot Light
- Has 4-8-15-500 Ohm Output Impedances
- Rubber Floated Tube Trays
- Tube Lineup: 1-6SJ7, 1-6SF5, 2-6SC7, 2-6L6, 1-83V
- Extra Heavy Chassis, Completely Shielded
- On and Off Toggle Switch
- Oversize Components
- High Gain, Wide Frequency Response
- Operates on 110-120 Volt, 50-60 Cycle

If screen is desired add \$7.50 to list price. If set of matched tubes are desired, add \$12.50 to list price. Price as quoted above is for chassis only, less screen and tubes. Chassis is equipped with carrying handles.

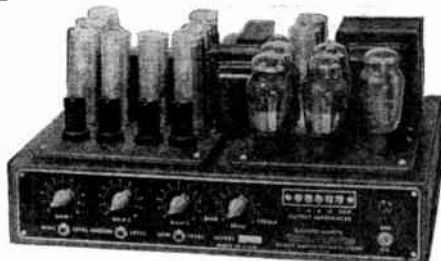

60 WATT AMPLIFIER — Model 60WA
List \$82.50 — less tubes

- Nine Tube Chassis
- Uses 4-6L6 in Push-Pull Parallel
- Rubber Floated Tube Trays
- Tube Lineup: 1-6SJ7, 1-6SF5, 2-6SC7, 4-6L6, 1-5Z3
- Extra Heavy Chassis, Completely Shielded
- All Oversize Components
- Continued Variable Tone Control
- Full 60 Watt Amplifier
- Two Microphone Inputs and One Phono Input
- Separate Control for Each
- Separate Tone Control
- Jewel Pilot Light
- On and Off Toggle Switch
- High Gain Wide Frequency Response
- Operates on 110-120 Volt, 50-60 Cycle

If screen is desired add \$8.50 to list price. For set of matched tubes add \$14.00 to list price. Price as quoted above is for chassis only, less screen and tubes. Chassis is equipped with carrying handles.

AMPLICALL HELPS SPEED UP AMERICA'S WAR EFFORT EVERYWHERE



W-106Q



Remote Unit

**W-100 Series
Combination Masters and Remotes**

The W-100 Series Systems are extremely versatile and are among the most popular Intercom equipment because of their ability to fill the greatest number of installation needs. These Systems provide instant 2-way communication between central or Master locations and a number of Remote locations—beginning with a 6-Station System to handle the popular demand for six or less stations—and also available in 12 and 18-station Systems designed to handle the expanded needs of larger installations. Masters may call any one or all other stations simultaneously. On single master installations remotes may call the one master but cannot talk to each other. On multiple master installations, remotes cannot originate a call. Compact Master station is beautifully housed in a streamlined cabinet of choice woods; Remote station is equally attractive. (To provide for complete privacy of conversation, models are also available with earphone attachment.)



M-318

W-300 Series—Combined Intercom & Paging

Here is a System of great versatility and considerable power in which the central Master station can not only carry on a two-way conversation with each Remote station in the system, but can also page independently over any one remote station or over all Remote stations simultaneously. Remote stations can originate calls to Master. Maximum facilities of the W-300 System are for 18 Remote stations. Maximum power is 25 watts. Accurate station selection is accomplished by new type push-button selector switches. Master station is of beautiful, compact design; paging stations are metal-cased; Remote stations are of wood. The flexibility of the W-300 System makes it ideal for army barracks, rifle ranges, and similar military application as well as for wartime industrial use. Offers instant location of personnel through the "all call" paging feature.

**PRICES AND
DISCOUNTS QUOTED
ON REQUEST**

There is a Rauland-Webster AMPLICALL Intercom System for every type of installation. AMPLICALL speeds up office and plant routine—saves time, steps, and money—plays a vital role in the war effort. Write for complete catalog giving full details. (See other side of page for information covering the complete line of Webster-Rauland Amplifiers, Sound Systems, Factory Paging units, Power Stages, etc.)

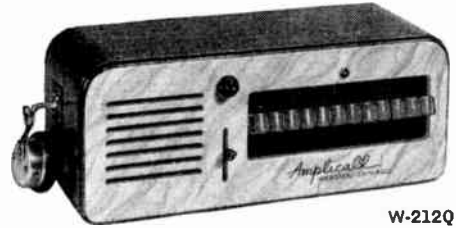

W-212Q

W-200 Series—All-Master Systems

The W-200 Series, recognized as one of the most universal and advantageous of all Intercom Systems, consists entirely of Master stations. This Series permits every station of the system to call and converse at will with every other station. All conversations are absolutely private—there is no cross-talk or eavesdropping possible. Each Master has a 3-position "talk-listen" switch: depress to talk; returns automatically to center position for listening; raise to "up" position when carrying on long conversation or dictation, or when using earphone. When earphone is used, it is not necessary to operate "talk-listen" switch; conversation is carried on same as on a telephone instrument. The W-200 Series is available in two models—Systems for 12 or for 24 stations. Units are fashioned of beautiful two-toned walnut and birch in modern design.

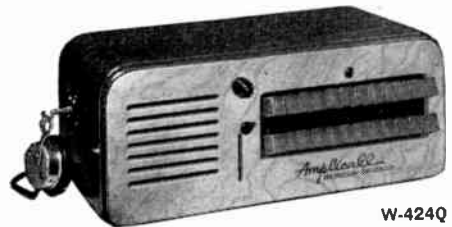

W-424Q

**W-400 Series
All Combination Hi-Power Systems**

Here is the very latest in deluxe Intercom equipment. Master stations can be combined with Remote stations in practically any combination; all conversations between Masters are absolutely private; Masters can listen in on Remote stations; Remote stations are able to originate a call to as many as six Master stations. New features include: two volume controls for both incoming and outgoing volume; individual locking type, finger-tip push-buttons selectors; 3-position "talk-listen" switch, etc. There can be no eavesdropping or cross-talk on Masters; multiple Master conversations are absolutely private. Models are also available with earphone attachment for extra privacy. Compact station units are streamlined modern, in two-tone birch and walnut. W-400 Series Systems are available in two models—for 12 or for 24 stations.

SOUND
EQUIPMENT FOR

Rauland

MILITARY AND
INDUSTRIAL USES

RAULAND - WEBSTER "TAILORED - TO - FIT" SOUND HELPS SPEED AMERICA'S WAR EFFORT



840 Watt
Installation

Typical of Rauland-Webster Sound installations designed for war industry, is the 840 watt rack and panel Sound Unit (illustrated at left) built for a new government ordnance plant. This giant RAULAND System covers 30 square miles, and is used primarily for instant paging, for direction, and for emergency announcements.

Rauland-Webster Sound helps boost the output of wartime industries by providing instant communication; by preventing production tie-ups; by speeding the movement of materials; by protecting plants, providing instant warning against air-raids, fire, and sabotage; by improving morale with the provision of music during lunch and fatigue periods, etc.

Rauland-Webster will build "tailored-to-fit" Sound Equipment (on priority ratings available to industry) to meet any special requirement. Write for full details.

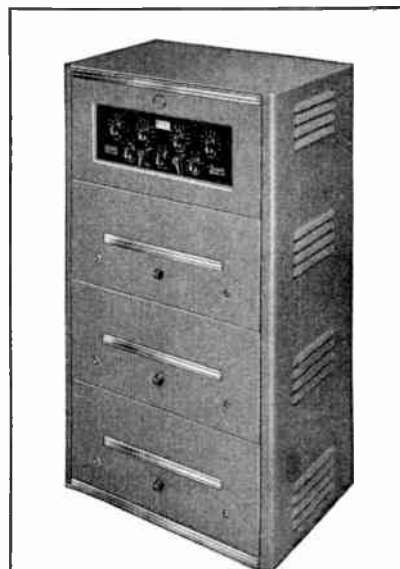

New Deluxe Power Stages and Mixer Pre-Amplifier

Also available for industrial and similar applications is a new line of super-fidelity rack type equipment. Illustrated above are several of these Power Stages combined in a short rack cabinet. Illustrated at top is the W-4205 "Super-Fidelity" Mixer—Pre-Amplifier for 4 microphones (high or low impedance) and 2 phonos. The new W-4260 Bi-Power 60 watt Power Stages are mounted directly below the Mixer. An unlimited number of these stages may be used with the W-4205 unit. Write for complete details describing Rauland-Webster Power Stages and Mixer-Pre-Amplifiers.



Mobile Amplifiers That Can "Take It"!

Rauland-Webster offers a selection of superb Mobile Amplifiers designed for operation from 117 volts AC or from 6 volts DC. The W-841 Amplifier (illustrated) has a 30 watt output; has 3 microphone inputs; one phono input; mixer-fader control on all 4 inputs (remote mixing on mikes); separate bass and treble controls; phono motor, crystal pickup, etc. The W-821 Amplifier has 20 watts output; includes 2 microphone inputs; one phono input; mixer-fader

control on all three inputs; dual tone control; phono motor and crystal pickup.

There's a Rauland-Webster Amplifier for Every Need

Write for our Catalog No. 141 for full details covering a most complete selection of quality Sound equipment. There is a Rauland-Webster Amplifier available for every industrial requirement (paging, recreation, emergency alarms, etc.), for use by our Armed Forces, for experimental or laboratory use, etc. Rauland-Webster Deluxe Amplifiers are available in power outputs ranging from 14 to 60 watts, and can be had in a wide range of complete Systems from low-power portable Systems to the famous new BI-POWER High-Power Systems. The finest of 1942 features are embodied in each Rauland-Webster Amplifier to meet the most exacting requirements of wartime industry and business. No matter what your Amplifier needs may be, write for complete details. Ask for Catalog No. 141.

Rauland-Webster also offers a fine selection of Dynamic, Velocity, and Crystal Microphones, as well as a wide variety of high-quality Sound accessories, designed and built to render the dependable service demanded by today's rigid requirements. Write for complete descriptive literature.

**PRICES AND DESCRIPTIVE
LITERATURE FURNISHED
ON REQUEST**

The **Rauland** Corp.

RAULAND - Webster Sound Division

AMPLIFIERS IN ALL POPULAR WATTAGES

By
BELL SOUND SYSTEMS, Inc.

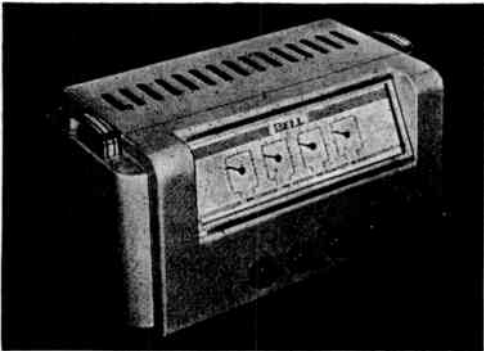

This amplifier is as fine in performance as its beautiful, modern design suggests. A new peak in appearance and tone! Its illuminated, full-vision pointer dials are set on an incline, at the proper eye level, in a beautiful, two-tone gray cabinet trimmed in deep red. With push-pull beam power output tubes utilizing inverse feedback and an expertly engineered circuit, it is literally a packaged miracle in performance and ease of operation.

The 15-watt output has less than 5% distortion. Peak output is 18 watts. Two individually controlled microphone channels and one phono channel can be mixed in any combination of volume. Circuit and tubes are easily accessible through the one-piece removable top-and-back panel.

15-Watt Amplifier Model 615

- Three Input Channels
- Illuminated Control Panel
- Streamlined Two-Tone Case
- Beam Power Output Tubes
- Exceptional Tone Quality

MODEL 615 SPECIFICATIONS

POWER OUTPUT: 15 watts at less than 5% distortion. 18 watts peak.

GAIN: Microphone channels 124 db. Phono 85 db.

FREQUENCY RESPONSE: 35 to 10,000 cycles—within plus or minus 1.5 db.

INPUT IMPEDANCE: Two microphone channels 10 megohms each (low impedance available at extra cost). Phono 500,000 ohms.

TUBES: 2—6SJ7; 1—6SF5; 1—6N7; 2—6V6G; 1—5Y3G.

OUTPUT IMPEDANCES: 1.25; 2.5; 4; 8; 15; 250 and 500 ohms.

CONTROLS: Two microphone volume controls; one phono control; one tone control.

POWER REQUIRED: 100 watts, 110-120 volts AC 50-60 cycles.

DIMENSIONS: 8½" deep; 8" high; 16½" long.

NET WEIGHT: 25 lbs.

List price, including matched tubes...\$67.10

30-Watt Amplifier Model 630

- Four Separately Controlled Inputs
- Electronic Bass and Treble Boost
- Inverse Feedback Stabilizer
- Convenient Inclined Illuminated Panel
- Streamlined Two-Tone Housing

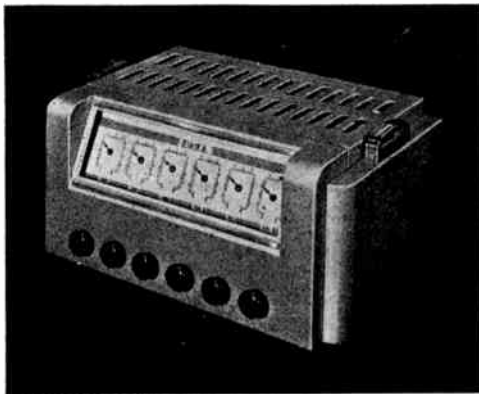

A new high in amplifier value! Undistorted 30-watt output, a peak power of 38 watts, and a perfected circuit utilizing push-pull beam power output tubes and inverse feedback. Separately regulated tonal control—and when properly used, helps reduce feedback. Three microphone inputs and one phono input, with separate volume controls, permit any combination.

This versatile, feature-packed unit is encased in an ultra-modern housing finished in two-tone gray and featuring easy-to-read, illuminated pointer dials. One of the most attractive units you've ever seen! The interior circuit is accessible through an easily removable one-piece top and back. No detail in amplifier perfection has been overlooked!

MODEL 630 SPECIFICATIONS

POWER OUTPUT: 30 watts at less than 5% distortion. 38 watts peak.

GAIN: Microphone channels 132 db. Phono 85 db.

FREQUENCY RESPONSE: 35 to 12,000 cycles—within plus or minus 1 db.

INPUT IMPEDANCE: Three microphone channels 10 megohms each (low impedance available at extra cost). Phono 500,000 ohms.

TUBES: 3—6SJ7; 2—6SC7; 1—6C5; 1—6N7; 2—6L6G; 1—5U4G.

OUTPUT IMPEDANCES: 1.25; 2.5; 4; 8; 15; 250 and 500 ohms.

CONTROLS: Three microphone volume controls; one phono control; one bass boost tone control; one treble boost tone control.

POWER REQUIRED: 130 watts, 110-120 volts AC 50-60 cycles.

DIMENSIONS: 11" deep; 8½" high; 16½" long.

NET WEIGHT: 33 lbs.

List price, including matched tubes...\$107.80

10-Watt Amplifier Model 610

- Undistorted Output
- Three Input Channels
- Modern Two-Tone Design
- Illuminated Sloping Panel
- Easily Removable Top

MODEL 610 SPECIFICATIONS

POWER OUTPUT: 10 watts with less than 5% distortion. 14 watts peak.

GAIN: Microphone 115 db. Phono 75 db.

FREQUENCY RESPONSE: 50 to 10,000 cycles within 2 db.

INPUT IMPEDANCE: 2 Microphones 10 megohms. 1 Phono 500,000 ohms.

TUBES: 2—6SJ7; 1—6N7; 2—6V6G; 1—5Y3G.

OUTPUT IMPEDANCE: 1.25; 2.5; 4; 8; 15; 250 and 500 ohms.

CONTROLS: Two volume controls for microphones, one for phono and one tone control.

POWER REQUIRED: 85 watts, 110-120 volts AC 50-60 cycles.

DIMENSIONS: 8½" deep; 8" high; 16½" long.

NET WEIGHT: 23 lbs.

List price, including matched tubes...\$53.80

25-Watt Amplifier Model 625

- Electronic Bass and Treble Boost
- Three Separately Controlled Inputs
- Inverse Feedback Stabilizer
- Modern Housing—Illuminated Panel
- Built to Last—Easy to Service

MODEL 625 SPECIFICATIONS

POWER OUTPUT: 25 watts at less than 5% distortion. 30 watts peak.

GAIN: Microphone channels 130 db. Phono 85 db.

FREQUENCY RESPONSE: Within plus or minus 1 db. 35 to 12,000 cycles.

INPUT CIRCUITS: Two microphone channels 10 megohms each (low impedance available at extra cost). Phono 500,000 ohms.

TUBES: 2—6SJ7; 1—6SF5; 1—6N7; 2—6L6G; 1—5U4G.

OUTPUT IMPEDANCE: 1.25; 2.5; 4; 8; 15; 250 and 500 ohms.

CONTROLS: Two microphone volume controls; one phono control; one bass boost control; one treble control.

POWER REQUIRED: 120 watts; 110-120 volts AC 50-60 cycles.

DIMENSIONS: 8½" deep; 8" high; 16½" long.

NET WEIGHT: 27 lbs.

List price, including matched tubes...\$84.55



HIGH WATTAGE AMPLIFIERS AND SPECIALS

By
BELL SOUND SYSTEMS, Inc.



- 50 or 100-Watt Undistorted Output
- Twin 50-Watt Power Units—Operable Separately or Together
- Electronic Treble Boost
- Automatic Expressor Level Control
- Automatic Expressor Switch
- Inclined Dial Panel with Remote Control Knobs
- Five Input Channels
- Tap Impedance Switch
- Compact, Modern Design
- Handles for Portability

100-Watt Amplifier Model 700

The finest amplifying unit money can buy. Powered by twin, independently operated 50 watt amplifiers, combined with many extra quality features, it affords versatility, power and clarity of tone for practically any P.A. requirement. Attractive, economical and exceptionally carefree in maintenance.

MODEL 700 SPECIFICATIONS

POWER OUTPUT OF EACH OUTPUT STAGE: 50 watts with not more than 2% distortion, 58 watt peak with not more than 7% distortion.

GAIN: Microphone channels, 135 db. low level. Phono channel, 90 db. high level.

FREQUENCY RESPONSE: 30 to 12,000 cycles within plus or minus 1/2 db., with tone controls in normal position.

INPUT IMPEDANCE: Four microphone channels 10 megohms. One high impedance phono circuit, 500,000 ohms.

OUTPUT IMPEDANCE: Each amplifier, 1.25; 2.5; 4; 8; 15; 250; 500 ohms.

TUBES: 2—5U4G; 2—5Y3G; 4—6L6G; 2—6N7; 1—6SF5; 1—6L7 or 1612; 1—7F7; 2—6SC7; 4—6SJ7.

CONTROLS: Four microphone volume controls; one phono volume control; two master gain controls, one bass boost tone control; one treble boost tone control; one auto expressor level control; one auto expressor switch; two power switches—one for each amplifier unit; one power switch for preamplifier B supply.

POWER REQUIRED: 350 watts, 120 volt 50-60 cycle A.C.

DIMENSIONS: 17 1/2" high; 12 1/2" deep; 16 1/2" long.

NET WEIGHT: 88 lbs.

List price, including matched tubes...\$237.15

50-Watt Amplifier Model 650

- Quality—Power—Tone Excellence
- Four Separately Controlled Inputs
- Separate Bass and Treble Boosters
- Ultra-Modern—Illuminated Panel
- Beam Power Tubes and Inverse Feedback

MODEL 650 SPECIFICATIONS

POWER OUTPUT: 50 watts at less than 5% distortion. 58 watts peak.

GAIN: Microphone channels 132 db. Phono 85 db.

FREQUENCY RESPONSE: 35 to 12,000 cycles—within plus or minus 1 db.

INPUT IMPEDANCE: Three microphone channels, 10 megohms each (low impedance available at extra cost). Phono 500,000 ohms.

TUBES: 3—6SJ7; 2—6SC7; 1—6SF5; 1—6N7; 2—6L6G; 1—5Y3G; 1—5U4G.

OUTPUT IMPEDANCE: 1.25; 2.5; 4; 8; 15; 250 and 500 ohms.

CONTROLS: Three microphone volume controls; one phono control; one bass boost tone control; one treble boost tone control.

POWER REQUIRED: 215 watts, 110-120 volts AC 50-60 cycles.

DIMENSIONS: 12" deep; 8 1/2" high; 16 1/2" long.

NET WEIGHT: 44 lbs.

List price, including matched tubes...\$149.90



Illustrates Two-Channel-Model 604

A.C. MULTI-CHANNEL PRE-AMPLIFIERS Model 602—Two Channels

This finely engineered, beautifully housed, two channel, Pre-Amplifier is just the unit for installation where microphone equipment is to be used at a distance from the main amplifier, or where modern microphone equipment is to be adapted to a low gain amplifier. It provides for mixing two high impedance microphone circuits, with master gain control, and incorporates a built-in AC power supply.

Model 604

Similar to Model 602 but provides for mixing four high impedance "mikes," each having separate volume controls.

List price, with tubes\$91.85

MODEL 602 SPECIFICATIONS

OVER-ALL GAIN: 58 db.

TUBES: 3—6SJ7; 1—6X5G.

INPUT CHANNELS: Two 10 megohm inputs are provided for high impedance microphones.

OUTPUT IMPEDANCE: 500; 250 and 100,000 ohms.

CONTROLS: Two microphone mixer volume controls. One master gain control.

POWER REQUIRED: 50 watts, 110-120 volts AC 50-60 cycles.

DIMENSIONS: 8 1/2" deep; 8" high; 16 1/2" long.

NET WEIGHT: 20 lbs.

List price, including matched tubes \$58.00

Model V-15 Microphone and Phono Amplifier

The renewed popularity of recorded music has brought heavy demands for this equipment. The model V-15 phono amplifier delivers unsurpassed fidelity of tone and faithfulness from every type of recording. It features 15 watt undistorted output and a new form of automatic volume expansion. This expander recaptures with amazing fidelity the full richness of expression, power, range, and volume of the original music. It requires no intricate adjustment; and it will reproduce symphonic, dance or vocal music equally well.

Model V-15 is designed especially for record reproduction. Its compactness makes it an ideal unit with which to modernize older phonographs, or to incorporate in new or old record-playing systems for home, school or entertainment use. It has a high impedance (10 megohm) microphone input channel for regular public address use, or for home novelty stunts. It is also equipped with a volume control for the microphone and one for the phonograph; a control for the degree of expansion, and a fourth control which permits a range of tone adjustment for widely varying requirements. Tubes utilized: 1—6SJ7; 1—7F7; 1—8L7; 1—6N7; 2—6V6G; 1—5Y3G.

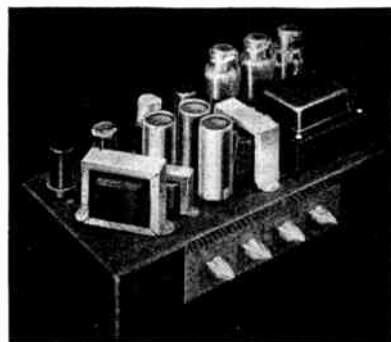

MODEL V-15

List price, including matched tubes \$59.00

POPULAR PUBLIC ADDRESS SYSTEMS

By
BELL SOUND SYSTEMS, Inc.



10-14 Watts—Model P.A. 610

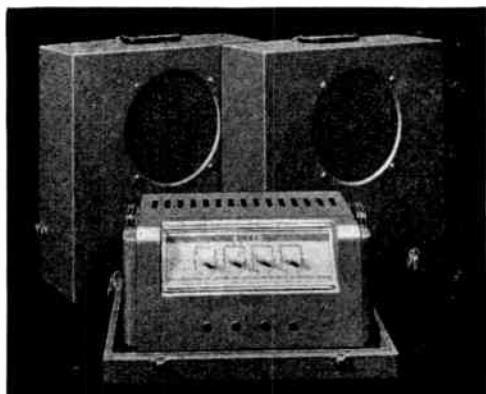

- Undistorted 10-Watt Output
- Three Input Channels
- Illuminated Control Panel
- Dual Speakers—One Case
- Easy to Operate—Easy to Service

This moderately priced, medium powered portable system is "just right" for many needs. It utilizes a Model 610 amplifier (for specifications see page C-35) which incorporates push-pull beam power output tubes and inverse feedback, and develops undistorted output of 10 watts, with

a peak power of 14 watts. Three input channels—two microphone and one phono—have separate volume controls and can be simultaneously mixed.

The amplifier is housed in a streamlined cabinet finished in two-tone gray and trimmed in deep red. Two 10-inch high quality dynamic speakers are mounted in a gray, Keratol-covered carrying case which also accommodates the amplifier, cables and microphone. A similar system for permanent installation is available in Model P.X. 610D, listed below.

MODEL P.A. 610 SPECIFICATIONS

For Amplifier Specifications see Model 610—page C-35

P.A. 610E—ECONOMY DUAL SPEAKER SYSTEM, LESS TUBES

- 1—Model 610 Amplifier (less tubes).
- 2—Model 33—10" Dynamic Speakers.
- 2—25-ft. Speaker Cables and Plugs.
- 1—Model 30 Crystal Microphone.
- 1—15-ft. "Mike" Cable and Plug.
- 1—Model 20 Desk Stand.
- 1—Model 15—Three Piece Carrying Case.

Shipping Weight—48 lbs.
List price\$115.25

P.A. 610—STANDARD DUAL SPEAKER SYSTEM, LESS TUBES

Same as Model P.A. 610E except choice of 59, 60, 62 or 63 "Mike" (Model 59 unless otherwise specified). Less tubes. Shipping Weight—48 lbs.

List price\$123.75

P.A. 610D—DELUXE DUAL SPEAKER SYSTEM, LESS TUBES

Same as Model P.A. 610 except with Model 57 Uniplex Crystal Microphone for greater distance pickup. Less tubes. Shipping Weight—50 lbs.

List price\$134.50

P.X. 610D—DELUXE PERMANENT SYSTEM, LESS TUBES

- 1—Model 610 Amplifier (less tubes).
 - 2—Model 33—10" Dynamic Speakers.
 - 2—Model 90 Speaker Housings.
 - 1—Model 57 Uniplex Crystal Microphone.
 - 1—Model 22 Pedestal "Mike" Stand.
- Shipping Weight—48 lbs.

List price\$137.00

KIT OF MATCHED TUBES—LIST PRICE.....\$7.05

Note: For other Microphones, Speakers, Trumpets and accessories available for this system, write to factory.



Note: Bell Portable P.A. Systems can be supplied with choice of microphones illustrated: No. 59—Crystal diaphragm; No. 63—high impedance dynamic; No. 57—"Uniplex," sensitive in front, dead in rear; No. 62—Dynamic protected against humidity and temperature change; or No. 60—"Rocket" Crystal diaphragm.



The complete P. A. 610 System closes into this compact case: overall size: 18" wide, 20" high and 13 1/2" deep. Portable system weighs 48 pounds. Each speaker has 25 feet of cable.

6-8 Watts Model 606

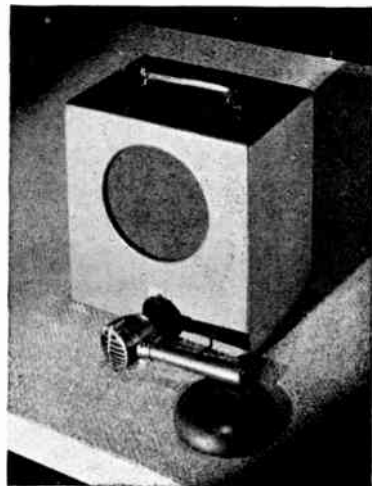

Ballyhoo Unit

- 6-8 Watts
- Beam Power Output
- Quality Crystal Microphone
- Completely Self-contained
- Two-way Mike Stand

A compact, quality-tone amplifier at rock-bottom cost. Window and store demonstrators, auctioneers, lecturers, ballyhoo artists, entertainers of every description hail this as the ideal unit for smaller crowds.

Has one input for a high impedance microphone and one for a high impedance phono pickup.

The carrying case is of durable construction, covered in brown Keratol. The 8-inch loudspeaker is an electro-dynamic type. Over-all size of complete portable unit is 11 1/4" x 12" x 8". Weight is 14 pounds.

MODEL 606 SPECIFICATIONS

Ballyhoo System, with tubes.

- 1—6-8 Watt Amplifier with tubes.
 - 4—Tubes: 1—6SJ7; 1—6LG6; 1—6C5; 1—5Y3G.
 - 1—Model W30 Crystal Microphone with 15 ft. mike cable and plug.
 - 1—8" Electro-dynamic speaker with 25 ft. cable and plug.
 - 1—Carrying Case.
 - 1—Two-Way (Desk or Hand) "Mike" Stand.
- Cased Size: 11 1/4" x 12" x 8".
Shipping weight, 16 lbs.

List price, with tubes.....\$52.50



VERSATILE PUBLIC ADDRESS SYSTEMS

By

BELL SOUND SYSTEMS, Inc.

25 Watts—Model P.A. 625

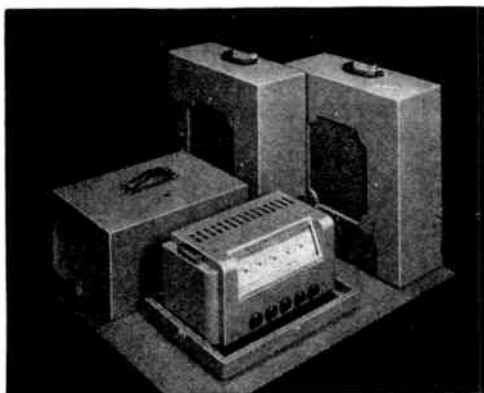

- Undistorted 25-Watt Output
- Electronic Bass Boost
- Electronic Treble Boost
- Inverse Feedback
- Inclined Illuminated Dials
- Three Inputs—Separate Control
- Smart, Modern Design and Finish
- Compact, Easy to Carry

Popular wattage, inexpensive, compact, and light in weight.

Amplifier Model 625, described on page C-35, has peak power of 30 watts. Inverse feedback stabilizer, bass boost and treble compensators, two electronic tone controls, and separate controls for all three channels.

Complete system is contained in two compact cases. The speaker case is 20" high, 18" long, and 13 1/2" deep. The amplifier case is 10" x 18" x 12 1/2". Also supplied for permanent installation system.

MODEL P.A. 625 SPECIFICATIONS

for specifications of amplifier see Model 625—page C-35

P.A. 625E—ECONOMY SYSTEM (DUAL SPEAKER)

- 1—Model 625 Amplifier (less tubes).
 - 2—Model 34 Heavy Duty Dynamic 12" Speakers.
 - 2—50 Ft. Speaker Cables and Plugs.
 - 1—Model 30 Crystal Microphone.
 - 1—15 Ft. Mike Cable and Plug.
 - 1—Model 20 Desk Type "Mike" Stand.
 - 1—Model 95 Two Piece Carrying Case for Speakers.
 - 1—Model 14 Amplifier Carrying Case.
- Shipping Weight—65 lbs.
List price, less tubes.....\$169.75

P.A. 625—STANDARD SYSTEM (DUAL SPEAKERS)

- Same as Model P. A. 625E except choice of Model 59, 60, 62 or 63 "Mike." (Model 59 unless otherwise specified).
- Shipping Weight—65 lbs.
List price, less tubes.....\$178.25

P.X. 625D—DELUXE PERMANENT SYSTEM

- 1—Model 625 Amplifier (less tubes).
 - 2—Model 95 Heavy Duty Speakers.
 - 2—Model 90A Speaker Housings—Walnut Finish.
 - 1—Model 57 Uniplex Crystal Microphone.
 - 1—Model 22 Pedestal Microphone Stand.
- Shipping Weight—58 lbs.
List price, less tubes.....\$185.70

KIT OF MATCHED TUBES—List price.....\$10.30

NOTE: For other Microphones, Speakers, Speaker Housings and accessories that may be used with this System, write factory.

30 Watts—Model P.A. 630

- Four Individually Controlled Inputs
- Separate Bass and Treble Boost
- Inverse Feedback Stabilizer
- 30-Watt Undistorted Output
- Inclined, Illuminated Panel
- Handsome Streamlined Design
- Easily Accessible for Service
- Strong, Compact Construction

- 1—Model 95 Two Pce. Carrying Case for Speakers.
 - 1—Model 14 Amplifier Carrying Case.
- Shipping Weight—70 lbs.
List price, less tubes.....\$214.70

P.A. 630D—DELUXE SYSTEM (DUAL SPEAKER)

- Same as Model P.A. 630 except supplied with Model 57 Uniplex Crystal Microphone for greater distance pickup.
- List price, less tubes.....\$225.45

P.X. 630D—DELUXE—(PERMANENT SYSTEM)

- 1—Model 630 Amplifier (less tubes).
 - 2—Model 35 Heavy-Duty Dynamic 12" Speakers.
 - 2—Model 90A Spkr. Housings—Walnut Finish.
 - 1—Model 57 Uniplex Crystal Microphone.
 - 1—Model 22 Pedestal Microphone Stand.
- Shipping Weight—68 lbs.
List price, less tubes.....\$221.90

KIT OF MATCHED TUBES—List price \$14.30

NOTE: For other Microphones, Speakers, Speaker Housings and accessories, write factory.

MODEL P.A. 630 SPECIFICATIONS

For Amplifier Specifications See Model 630—page C-35.

P.A. 630—STANDARD SYSTEM (DUAL SPEAKER)

- 1—Model 630 Amplifier (less tubes).
- 2—Model 35 Heavy-Duty Dynamic 12" Speakers.
- 2—50-ft. Speaker Cables and Plugs.
- 1—Microphone; choice of 59, 60, 62 or 63. (Model 59 Crystal Microphone furnished unless otherwise specified.)
- 1—25-ft. Mike Cable and Plug.
- 1—Model 20 Desk Type "Mike" Stand.

15 Watts—Model P.A. 615

- Three Input Channels
- Illuminated Control Panel
- Convenient Angle-Set Dials
- Twin Heavy-Duty Speakers
- Inverse Feedback Stabilizer
- Easily Portable in One Case



MODEL P.A. 615

Medium wattage with many fine points of design. Peak of 18 watts. High gain amplifier (see page C-35 for specifications). The two 10-inch high quality dynamic loudspeakers, in neat gray Keratol housings fit together to form a compact carrying case which also houses the amplifier, microphone and necessary cable.

Furnished for permanent installation as Model P.X. 615D.

MODEL P.A. 615 SPECIFICATIONS

For Amplifier Specifications See Model 615—page C-35.

P.A. 615E—ECONOMY PORTABLE SYSTEM (DUAL SPEAKER)

- 1—Model 615 Amplifier (less tubes).
 - 2—Model 33 Heavy-Duty 10" Speakers.
 - 2—25-ft. Speaker Cables and Plug.
 - 1—Model 30 Crystal Microphone with 15 ft. Shielded Cable and Plug.
 - 1—Model 20 Desk-type Microphone Stand.
 - 1—Model 15 Portable Carrying Case.
- Shipping Weight—50 lbs.

List price, less tubes.....\$127.50

P.A. 615—STANDARD PORTABLE SYSTEM (DUAL SPEAKER)

- Same as Model P.A. 615E except with choice of Model 59, 60, 62 or 63 "mike." (Model 59 unless otherwise specified.) Less tubes.
- Shipping Weight—50 lbs.

List price, less tubes.....\$136.00

P.A. 615D—DELUXE PORTABLE SYSTEM (DUAL SPEAKER)

- Same as Model P.A. 615 except with Model 57 Uniplex Crystal Microphone for greater distance pickup.
- Shipping Weight—50 lbs.

List price, less tubes.....\$146.75

KIT OF MATCHED TUBES—List price \$8.10

NOTE: For other Microphones, Speakers, Speaker Housings and accessories, write factory.

HIGH WATTAGE AND MOBILE P.A. SYSTEMS

By
BELL SOUND SYSTEMS, Inc.

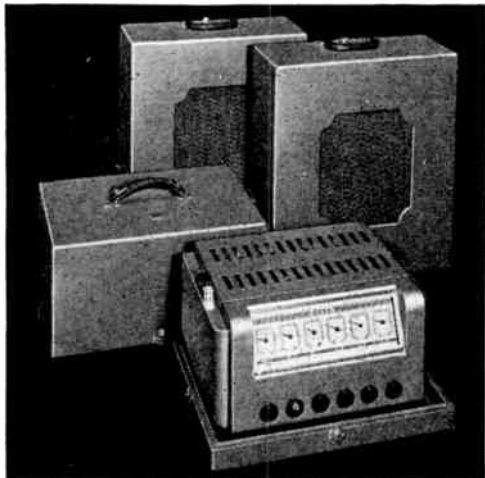

"Deluxe" equipment featuring ample wattage to cover a majority of needs, both large and small.

The high-gain 50-watt amplifier (see Model 650—page C-36) has almost unlimited tone selection. Inverse feedback eliminates acoustic feedback and also stabilizes the amplifier.

Three microphone channels and the phono pickup channel have separate volume controls. Connections are provided for using and matching as many as six speakers.

Matchless appearance is achieved in this

streamlined amplifier housing. The steel cabinet is of welded construction, finished in rich two-tone gray. Trim is in deep red plastic. Pointer dials are mounted on an inclined panel, and are indirectly illuminated. Dials have remote knob control. The carrying case for the amplifier matches the twin Keratol-covered speaker housings, which fit together to form a convenient, easily-portable carrying case. The speaker case also holds the microphone and cables.

SIZES: Amplifier Case—10" high, 18" wide, 12½" deep; Speaker Case—20" high, 18" wide, 13½" deep.

50 Watts—Model P.A. 650

MODEL P.A. 650 SPECIFICATIONS
For Amplifier Specifications See Model 650—page C-36.

P.A. 650—STANDARD SYSTEM (DUAL SPEAKER)

- 1—Model 650 Amplifier (less tubes).
- 2—Model 35 Heavy-Duty 12" Dynamic Speakers.
- 2—50-ft. Speaker Cables and Plugs.
- 1—Microphone; choice of 59, 60, 62 or 63. (Model 59 Crystal Microphone furnished unless otherwise specified.)
- 1—25-ft. Mike Cable and Plug.
- 1—Model 20 Desk Type Mike Stand.
- 1—Model 95 Two-pce. carrying case for Speakers.
- 1—Model 14 Amplifier Carrying Case.

Shipping Weight—80 lbs.
List price, less tubes.....\$256.00

P.A. 650D—DELUXE SYSTEM (DUAL SPEAKER)

Same as Model P.A. 650 except supplied with Model 57 Uniplex Crystal Microphone for greater distance pickup.
List price, less tubes.....\$266.75

P.X. 650D—DELUXE PERMANENT INSTALLATION SYSTEM

- 1—Model 650 Amplifier (less tubes).
- 1—Model 35 Heavy-Duty 12" Dynamic Speakers.
- 2—Model 90A Speaker Housings—Walnut Finish.
- 1—Model 57 Uniplex Crystal Microphone.
- 1—Model 22 Pedestal Microphone Stand.

Shipping Weight—76 lbs.
List price, less tubes.....\$263.40

KIT OF MATCHED TUBES—List price \$14.90

NOTE: For other Microphones, Speakers, Speaker Housings and accessories, write factory.



Sufficient wattage to cover gatherings of as many as 10,000 people, this all-purpose mobile system operates on either a 6-volt DC storage battery or 110-volt 60 cycle AC line current. Conversion from one type of current to the other is simple.

MODEL M-30 SPECIFICATIONS

POWER OUTPUT: 30 watts at less than 5% distortion. Peak, 35 watts.

POWER CONSUMPTION: Approximately 25 amperes for DC operation; 160 watts for 110-volt AC operation.

TUBES: 2—6SJ7; 1—6CS; 1—6N7; 2—6L6G; 2—6X5G.

INPUT CIRCUITS: Three channels—two for high impedance microphones—one for phonograph.

OUTPUT IMPEDANCE: 500; 250; 15; 8; 4; 2.5; 1.25 ohms.

CONTROLS: Three volume controls—bass boost and treble boost controls, filament switch, economizer power supply switch and phono switch.

POWER REQUIRED: 6 volts DC—110-120 volts, 60 cycles AC.

DIMENSIONS: 14½" deep; 9" high; 16½" long.

NET WEIGHT: 43 lbs.

MODEL M-30—COMPLETE MOBILE SYSTEM, LESS TUBES

- 1—30 Watt Amplifier-Phono Assembly (less tubes).
- 2—Model 35 Heavy-Duty 12" Dynamic Speakers each with 25-ft. Cable and Plug.
- 1—Model 59HS Crystal Microphone (Model 61A Dynamic if preferred).

Shipping Weight—65 lbs.
List price, less tubes.....\$249.50

KIT OF MATCHED TUBES—List price.....\$11.50

NOTE: For trumpets and other accessories write factory.

30 Watt Mobile Model M-30

- Universal (110-Volt AC or 6-Volt DC) Operation
- Three Separately Controlled Inputs
- Dual Shielded Chassis
- Inverse Feedback
- Beam Power Output Tubes
- Power Economizer Switch
- Bass Boost and Treble Compensators
- New Inclined, Illuminated Panel

Current consumption is reduced by a power economizer switch and high-efficiency dynamic speakers. Separate power switches. The amplifier housing is finished in two-tone gray.

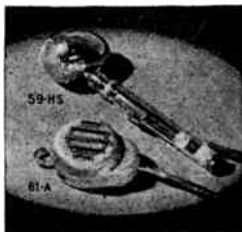

While Model 59HS Crystal Microphone is supplied, the Model 61A dynamic type microphone will be furnished if preferred.

15 Watt Mobile Model MN-15

SPECIFICATIONS

POWER REQUIRED: 6 volt DC or 110-120 volt 60 cycles AC.

POWER CONSUMPTION: Approximately 20 amperes for DC operation; 120 watts for AC operation.

TUBES: 1—6SJ7; 1—6CS; 1—6N7; 2—6V6G; 2—6X5G.

INPUT CIRCUIT: Two channels, one for high impedance microphone, one for phono.

OUTPUT IMPEDANCE: 500; 250; 15; 8; 4; 2.5; and 1.25 ohms.

CONTROLS: Two volume controls—one for microphone, one for phonograph; one tone compensator; filament power and phono switches.

SIZE: 12" deep; 9" high; 16½" long.

WEIGHT: 35 lbs. (Amplifier phono unit only.)

MODEL MN-15—COMPLETE MOBILE SYSTEM, LESS TUBES

- 1—15-watt Amplifier-Phono Assembly (less tubes).
- 2—Model 34 Heavy-Duty 12" Speakers with 15-ft. Cables.

1—Model 59HS Crystal Microphone (Model 61A dynamic type if preferred).

Shipping Weight—55 lbs.

List price, less tubes.....\$177.80

KIT OF MATCHED TUBES—List price.....\$8.35

NOTE: For trumpets and other accessories write factory.



PHONO-P.A. AND SCHOOL SYSTEMS

By
BELL SOUND SYSTEMS, Inc.

15 Watt Phono—P.A. System

- Self-Contained Phono Unit
- 15-Watt Undistorted Output
- Beam Power Output Tubes
- Inverse Feedback Stabilizer
- Improved Treble Compensator
- Portable—Easy to Operate
- Plays All 12" and Smaller Records



Model 676—Specifications

POWER OUTPUT: Rated 15-watt. Peak, 18 watts.
OVER-ALL GAIN: 124 db.
TUBES: 2—6SJ7; 1—6SF5; 1—6N7; 2—6V6G; 1—5Y3G.

CONTROLS: AC off-on switch; three volume controls; treble compensator.

OVER-ALL SIZE OF AMPLIFIER UNIT: 12" wide; 8 1/2" high; 16 1/2" long.

WEIGHT: 35 lbs. (Amplifier unit only.)

MODEL 676—PHONO—P.A. SYSTEM (DUAL SPEAKER SYSTEM)

- 1—15-watt Amplifier with Phono Turntable and Crystal Pickup (less tubes).
 - 2—Model 33 10" Heavy-Duty Speakers.
 - 2—25-ft. Speaker Cables and Plugs.
 - 1—Model 59 Crystal Microphone.
 - 1—25-ft. "Mike" Cable and Plug.
 - 1—Model 20 Desk Type Stand.
 - 1—Model 15 Three-piece Carrying Case.
- Shipping Weight—55 lbs.
List price, with tubes **\$165.95**

Model 676

One of the most completely satisfactory phono systems ever offered for general use where 110 volt AC current is available. It combines a 15-watt amplifying system of quality and tone with a phono-pickup that plays all 12-inch and smaller records. Capacity is ample for the majority of needs.

The high gain amplifier has a peak power of 18 watts. Specifications for the amplifier are very similar to those for Model 615, shown on page C-35. Inverse feedback; improved tone compensator; beam power output tubes; and two microphone inputs and one phono input, each with separate volume controls are features.

Amplifier housing is of modern design, with two-tone-gray finish. Trim is in deep red plastic. A high quality phono turntable and crystal pickup are mounted on top of the amplifier. The phono unit operates at a speed of 78 r.p.m.

The two 10-inch heavy-duty dynamic speakers are conveniently assembled in two-section case covered in gray Keratol. This case also provides space for the amplifier-phono unit. Over-all size of the case is only 18" wide, 20" high, and 15 1/2" deep.



10 Watt Phono—P.A. Model 677

A smaller capacity 10 watt system similar to Model 676. Fine tone amplifier like Model 610, described on page C-35. Fine quality motor and crystal pickup. Takes 12-inch records—speed, 78 r.p.m. One 10" dynamic speaker. Amplifier-phono unit and speaker housed in one gray Keratol carrying case, size 13" x 16 1/4" x 17".

Model 677—Specifications

POWER OUTPUT: Rated 10 watts. Peak 14 watts.

OVER-ALL GAIN: 122 db.

TUBES: 1—6SJ7; 1—6N7; 2—6V6G; 1—5Y3G.

CONTROLS: AC on-off switch, one volume control for microphone and one for phonograph, tone control.

OVER-ALL SIZE: Amplifier-Phono unit 13" wide, 16 1/4" high and 17" long.

WEIGHT: 36 lbs.

MODEL 677—COMPLETE PHONO-AMPLIFIER (SINGLE SPEAKER SYSTEM)

- 1—10-watt Amplifier with Phono Turntable and Crystal Pickup (less tubes).
 - 1—Model 33 Heavy-Duty Dynamic 10" Speaker.
 - 1—25-ft. Speaker Cable and Plug.
 - 1—Model 30 Crystal Microphone.
 - 1—15-ft. "Mike" Cable and Plug.
 - 1—Model 20 Desk Stand.
- Shipping Weight—42 lbs.
List price, with tubes **\$126.10**

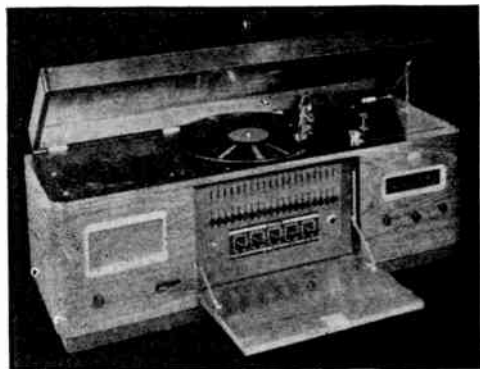

MODEL 601—ZEPHYR—(Unit shown above)

- 1—Model 615 Amplifier Unit, 15-watt (less tubes).
 - 1—3 1/2 watt Call-Reply Amplifier (less tubes).
 - 1—6 Tube Superheterodyne Radio (less tubes).
 - 1—Electric Phono Turntable and Pickup.
 - 1—Headphone Monitor Input.
 - 1—Set of 10 Room Switches.
 - 1—Walnut Cabinet.
- List price, less tubes **\$365.00**
KIT OF TUBES—List price 23.40
NOTE: For further details on variations and combinations of this equipment, write factory.

COMPLETE SYSTEM FOR SCHOOLS

Zephyr Model 601

Everything needed to give the modern school, hotel, club or hospital an all-purpose sound system is available in the new Bell Zephyr Unit.

RADIO—A high-quality, superheterodyne receiver of standard manufacture, features: Frequency coverage, 537 to 1660 KC, 5.85 to 18.8 MC—6 tubes, including cathode-ray tuning indicator (magic eye)—R.F. mixer, and oscillator stages on all bands—3-Gang precision-tuning condenser—Full-vision, calibrated dial—7 1/4" Linear scale; vernier tuning—Sensitivity control—Single-stage, high-gain ferrocort I.F. channel—Automatic volume control—Audio volume control.

AMPLIFIER—A 15-watt amplifier, with a total harmonic distortion of not more than 5% under average output conditions. Circuit is four-stage class-A resistance coupled. Filter components are built into the amplifier chassis. The room-selector keys are of the lever-operated three-position type, each switch having positions for talk-back, radio or phono, and off. For larger requirements an amplifier having additional power output can be furnished.

PHONO PICKUP—The electrical turntable and phonograph pickup are capable of playing 10" or 12" laterally-cut records. One-speed motor provides for 78 r.p.m. records. Special phono units can be supplied if desired.

LICENSED BY ARRANGEMENT WITH E.R.P.I.

BELfone Intercommunicating Systems

By
BELL SOUND SYSTEMS, Inc.



350 Series

BELfone Systems save thousands of unnecessary steps, eliminate lost time and irritating, costly delays in all kinds of inter-departmental communications. Instant contact with other departments or offices is obtained by merely pressing a key . . . conversation is as easy as though the parties involved were facing each other across a desk! Waiting for central switchboard connections is eliminated. Employees are never called away from their work needlessly.

LEFT: Model 350 Master Unit in choice of dark brown Keratol or walnut finish.
List price (10 station capacity) with tubes.....\$43.95

BELOW: Model 356 Desk Type Speaker Substation finished like master units and equipped with switch to initiate call to master station. Used with Model 350 or 352.
List price\$16.00

Also shows **Model 357 Loudspeaker** used and equipped in similar manner. List price\$14.00

This BELfone Master and Substation series permits almost any multiple-station arrangement that may be desired. In convenience, compactness, efficiency, clarity of tone and dependability, this series simply cannot be duplicated in its price range. Power consumption is remarkably low. No noticeable heat is generated. Top-quality intercommunication equipment at a truly moderate price!

- Key-type Selector Switches
- Two-Watt Power Output
- Convenient Key-type Send-Receive Switch
- 20-Watt Power Consumption
- Two Volume Controls—One for Speaker Stations and One for Master Unit
- Master Unit Uses either AC or DC
- Plug-In Cable Connector
- Beautiful Walnut or Keratol Cabinets. (Specify type desired.)
- Octal Tubes (Low Power Consumption and Minimized Heat Development)
- Dependable, Proved Performance

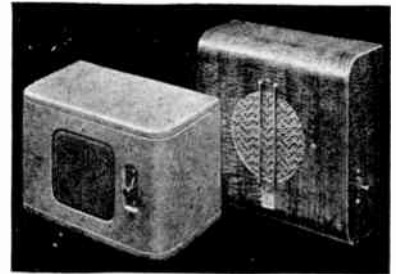

MULTIPLE MASTER TO MASTER

For Complete, Deluxe Intercommunication

MODEL 351 Master Unit: For use in master-to-master circuit arrangements where any number of master units up to 10, inclusive, are desired for complete two-way intercommunication. Used in master unit systems only. Operates on 110-volt AC or DC. Other features identical to Model 350, at right.

List price, with tubes.....\$43.95

MODEL 351C: Same as Model 351, above, except that it is equipped with earphone.
List price, with tubes.....\$53.95

MASTER TO SUBSTATIONS

For Average Requirements

MODEL 350 Master Unit: For use in Master-to-substation circuits in which one master unit is connected to 10 (or fewer) speaker stations. Power output of two watts. Operates on either 110-volt DC or AC. Weight, 8 lbs. Cabinets available in dark brown Keratol, or walnut finish. (Specify type desired.)

List price, with tubes.....\$43.95

MODEL 350C: Same as Model 350, above, but equipped with earphone, for use where confidential conversation is desired.

List price, with tubes.....\$53.95

MASTER TO SUBSTATIONS

For Larger Requirements

MODEL 352 Master Unit: This unit has a power output of 3.5 watts. For master-to-substation circuits where extra power is required, and where one master station and up to 10 inclusive speaker stations are utilized. Will not operate in multiple master-unit arrangements. It operates on 110-volt AC 50-60 cycles only. Weight, 10 lbs.

List price, with tubes.....\$54.95

MODEL 352C: Same as Model 352, above, except that it is equipped with an earphone.

List price, with tubes\$64.95

360 SERIES—INTERCOMMUNICATION AT LOW COST

Multiple Master to Master

The Master BELfone units listed below for all applications calling for complete, two-way communication; that is, where any station in the system wishes to have two-way communication with any of the other stations in the system.

MODEL 362M: For master-to-master unit operation, with two-station selection. Designed for systems utilizing two or three master stations.

List price, with tubes.....\$32.45

MODEL 366M: For six-station master-to-master operation. Any one of six (or fewer) stations can communicate with any other station in the system.

List price, with tubes.....\$36.85

Master to Substation

The BELfone Master units listed at right are for two-way communication between a central or master station and each of several outlying stations or substations. The outlying stations can communicate with the master station, but not with each other.



MODEL 362: A Master unit similar in appearance to the Model 362M (listed at left) but with selector switches for two stations only.

List price, with tubes\$32.45

MODEL 366: This Master unit has selector switches for six stations and is recommended for three or four-station systems where additional stations are apt to be required soon.

List price, with tubes\$36.85

- Key-type Selector Switches
- Two-Watt Power Output
- Convenient Key-type Send-Receive Switch
- 20-Watt Power Consumption
- Two Volume Controls—One for Speaker Stations and One for Master Unit
- Master Unit Operates on Either 110 volts AC or DC
- Plug-In Cable Connector
- Beautiful Walnut or Dark Tan Leatherette Cabinets*
- Octal Tubes (Low Power Consumption and Minimized Heat Development)

* To order leatherette cabinets, add "DT" to model number of each unit.

MODEL 367: Desk-type speaker substation for use with Master unit Models 362 and 366. This unit is equipped with a push-button call switch, permitting substation to call master station — but not used after conversation is started.

List price\$10.45

MODEL 367S: Same as Model 367, above, without call switch.

List price\$8.80





Intercommunication and Paging Systems

By

BELL SOUND SYSTEMS, Inc.

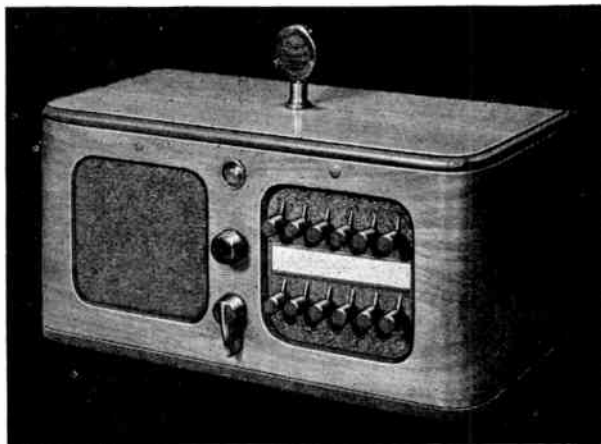

MODEL 374-SS Belfone shown above provides for up to 12 stations (also furnished for 24 or upward). Attractively designed and has walnut finish. Operates on 110 volt AC, 50-60 cycle only. Price on request.

Deluxe Secretive System

No finer inter-office communication equipment can be found than this beautifully designed, full-featured Belfone Model 374SS. It provides for completely secretive conversations between any two parties, with connections in the standard unit for a system of as many as 12 additional stations. With this secretive feature no third party can listen-in on the conversation between any two stations, although it is possible to call in on a busy circuit in case immediate contact is needed. Also a "busy signal" indicates when the party being called is already communicating with another station. Where more confidential conversation is desired unit may be equipped with earphone.

Another advantage of this model is that no talk-listen switch is required. A special, high fidelity microphone is mounted on top of the cabinet. To converse with an individual at any other station, you merely flip the station selector key and talk back and forth without further use of keys—exactly as though the individual were at your desk. When the conversation is completed, the station selector key is flipped back into its original position. A control switch on each unit permits volume adjustment.

While it is impossible, as stated above, for any individual to listen-in on a conversation between any two other stations, several stations may join in a conference merely by switching the station selector keys of all parties to be included on any one of the units.

SPEAKER SUB-STATIONS

One or more speaker substations may be used in a system of 374SS master units, at stations where a paging or call service only is required, and where two-way conversation or reply is not essential.

INDUSTRIAL VOICE PAGING SYSTEM for Plant Broadcasting of Music, Announcements and Paging

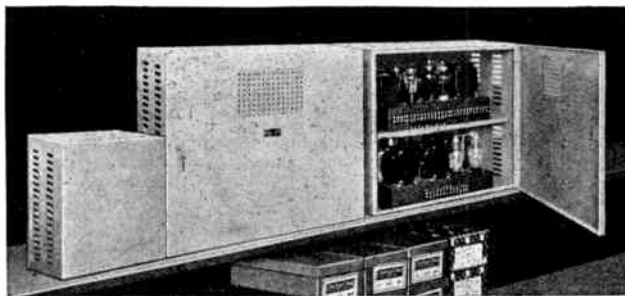

With today's emphasis on efficiency, plant broadcasting or amplifying equipment is becoming increasingly important—increasing efficiency through the broadcasting of music to workers on the job or during rest periods . . . saving time through explicit verbal paging . . . permitting management to make plant-wide talks . . . or by serving as a signaling system. But until now equipment for this industrial service had to be either custom built or made up of light duty standard commercial units. The Bell Voice Paging System offers for the first time a truly standard industrial system readily adaptable to practically any plant requirement. Heavy-duty, top-quality standard units specially designed and built for high power amplification, fool-proof and tamper-proof operation, and long maintenance-free service. The standard units are designed not only for initial installations of any size but also to permit future expansion of the system by merely adding units to the original setup.

An "on-off" switch, a microphone with either a hand or foot "Talk-switch," and a phonograph unit (if recordings are to be used) are all located at receptionist's desk or control station. A Driver or Control Amplifier and one or more Speaker Amplifiers (AC operated) are remotely located at convenient points. Loud speakers are then strategically located in all departments or buildings to be covered by the system. Though the on-off switch is turned on, the units, being relay operated, merely idle except during actual broadcasting.

Control circuits are of low voltage-type. Through the use of a control amplifier the speaker power amplifiers may be located in the departments covered by their respective speakers. The unit is protected against tampering by a neat, wall-mounted, steel housing and is capable of controlling up to six 100-watt speaker amplifiers.

The speaker power amplifier is of 100-watt capacity. Every part is of the highest, heavy-duty quality. Under average conditions, one amplifier will adequately handle up to 15 speakers.

Dynamic microphone on 9" desk stand; illustrated, equipped with hand "talk" switch. If preferred foot treadle can be furnished in place of hand switch.



MODEL J-26 radial reflex trumpet, generally preferred for this system, provides uniform 360 degree sound distribution. (Other type speakers also available.) Height 19" and acoustic length 60". Price on request.

SPECIFICATIONS

CONTROL AMPLIFIER—Model 2A

TUBES UTILIZED: 2—6SJ7; 1—6SC7; 1—6C5-G; 1—5Y3G.

INPUT CONNECTIONS: For two high impedance (10 megohms) microphones of dynamic or crystal type. (Low impedance inputs available at additional cost.)

OUTPUT CONNECTIONS: 500; 333; 200; 125 and 50 ohms.

RELAY CONTROLS: 3 heavy duty relays: One a momentary type for applying plate voltage; one time delay relay to prevent applying plate voltage to main amplifier power tubes before filaments are at correct temperature; one latch-up type relay for turning ON or OFF the 110 volt AC supply—controlled at central station.

POWER SOURCE: 110-120 volts 60 cycles AC. (Special voltages and frequencies at additional cost.)

CABINET: Wall mounting type—heavy gauge steel—finished gray wrinkle. Provided with

wall mounting holes. Size: 19" wide, 12" high, and 13" deep.

SPEAKER AMPLIFIER—Model 100A

POWER OUTPUT: 100 watts at less than 5% distortion (Rated) 145 watts (Peak).

TUBES UTILIZED: 2—6AS6; 2—839; 2—866.

RELAY CONTROLS: 1 heavy duty momentary relay for plate supply when operator talks. 1 heavy duty latch-up type relay for turning 110 volt AC supply ON or OFF controlled at central station.

INPUT IMPEDANCE: 500 ohms.

OUTPUT IMPEDANCE: 500; 250; 166; 125 ohms.

POWER SOURCE: 110-120 60 cycles AC. (Special Voltages and frequencies at additional cost.)

CABINET: Wall mounting type—heavy gauge steel—finished gray wrinkle. Provided with wall mounting holes. Size: 24" wide; 20" high and 13" deep.

(Specifications Subject to Change Without Notice)

Note: For prices of equipment on this page write factory.

Erwood SOUND EQUIPMENT

Erwood

MODEL No. 1312 — 12 WATT PORTABLE PUBLIC ADDRESS SYSTEMS

Styled like airplane type hand luggage this low priced system is distinguished for its superb reproduction. Ample reserve capacity provides "big-system" volume without over-load, distortion or blasting.

APPLICATION: Adapted to smaller installations of not over 1000 persons in such places as assembly halls, churches, night clubs, bingo games, funeral parlors, etc. Exceptionally fine record reproduction is possible when used with our No. 101 record player.

FEATURES: Model No. 1312 is a portable system contained in a compact and durable carrying case with a heavy tweed covering. Ample space is provided for substantially mounting the speakers, amplifier, microphone, all cables, and a full length floor stand. The same precision and care has been exercised in the manufacture of this equipment that is so evident in our larger and more expensive equipment.

AMPLIFIER SPECIFICATIONS

Power Output: 12 Watts. **Gain:** Microphone 119 D.B. Phonograph 75 D.B. **Controls:** One microphone, one phono, one tone control and ON and OFF switch. Provision is also made for remote control of microphone volume. **Input Impedance:** Two megohms for microphone and one-half megohm for crystal pickup. **Tubes:** Five required, consisting of: 1—6J7G; 1—6Y7G; 2—6V8G; 1—5V4G. **Output Impedance:** 3-4 and 6-8 ohms. **Power Consumption:** 86 Watts. **Dimensions:** 7" x 8" x 11". **Amplifier is equipped with 6 ft. A.C. cord and plug.**

MICROPHONE: Model 150-A is a streamlined high impedance crystal having an output of —52 D.B. The response is free from objectionable peaks or dips. The crystal cartridge is cushion mounted to prevent floor and stand noises in reproduction. Finish is a beautiful gray and chrome combination. The microphone is furnished complete with floor stand and 25 feet of SRC cable and plug.

SPEAKERS: Two 8-inch permanent magnet type speakers complete the system. They have a speaker voice coil diameter of 1 inch. The magnetic structure contains 14 ozs. of magnetic material per speaker. Both speakers are equipped with 25 feet of rubber covered cable and plug.

Model 1312-PC comprises complete portable system, consisting one Model 1312 Amplifier, one Model 150-A Crystal Microphone with floor stand and 25 feet of cable, two Model 108 Permanent Magnet Speakers with 25 feet of cable and

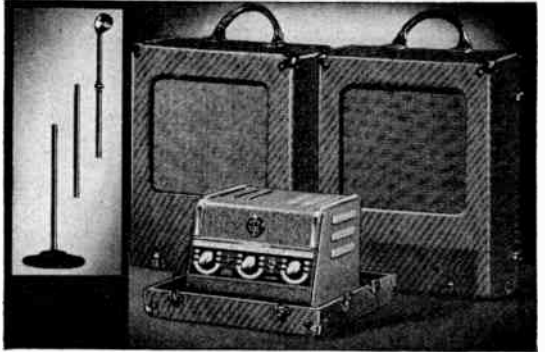

plug, and one Model C-3 Portable Carrying Case. **List Price:** \$112.80. **Shipping Weight:** 55 lbs. **Code:** PACKS. **Model 1312 Amplifier only, less tubes.** **List Price:** \$41.50. **Shipping Weight:** 22 lbs. **Code:** AHASE. **Kit of Matching Tubes:** \$6.00. **Shipping Weight:** 2 lbs. **Code:** TABOO.

Erwood

MODEL No. 2418

18 WATT PORTABLE PUBLIC ADDRESS SYSTEM

- Dual Speakers ● One or Two Floor Stands and Microphones
- Remote Control (Optional) ● Edge Illuminated Non-Breakable Dial ● Single Case Construction.

APPLICATION: For all temporary or semi-permanent installations, most particularly adapted to traveling orchestras, road shows, religious activity and other applications for crowds up to 3000 persons.

AMPLIFIER: Is a model 2418—18 watt power amplifier of exceptional range and power handling capacity. Two microphones can be used simultaneously with perfect control over each microphone. The gain of the amplifier is sufficient to (129 DB) effect pickup by the microphone over a wide area. A tone control permits modification of the reproduction to meet local conditions. Controls are located on a beautiful edge illuminated non-breakable dial which is easy to see in a dark room. The amplifier is of substantial construction housed in an attractive steel case finished in deep maroon, and chrome trimmed.

MICROPHONES: Model 151A uni-directional microphones are furnished with this system. Their excellent frequency characteristic extends from 30 to 10,000 cycles, and while very sensitive to the front, are relatively insensitive to sounds from the rear, a characteristic which is highly desirable for public address installations. Each microphone is furnished with 25 feet of special shielded cable and polarized plug. The head is tilting and is finished in satin chrome. Microphones are furnished with a three piece sectionalized floor stand.

LOUD SPEAKERS: This system is furnished with two model 120 permanent magnet speakers having a diameter of 12 inches and a power handling capacity of 12 watts. The voice coil and cone structure is particularly adapted to the baffles to which they are mounted. Each speaker is provided with 25 feet of rubber covered cable and polarized plug.

PORTABLE CARRYING CASE: The Model C4 portable carrying case is of three piece construction, the lower section functioning as a compartment for carrying the amplifier. The upper sections are of trapezoidal construction and contain the speakers, microphones and microphone stands. In which use, they function as the loud speaker baffles and provision is made for securing them to the wall.

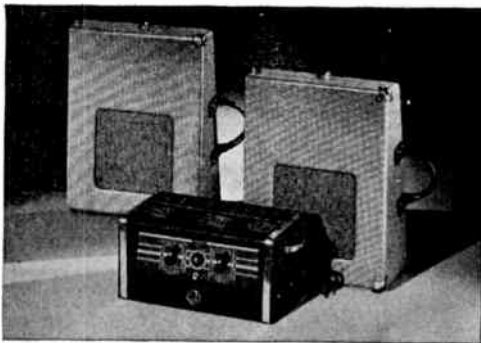

Model 2418-P2C is a complete system comprising a 2418 amplifier less tubes, two No. 151A microphones with cords, plugs and floor stands, two No. 120 permanent speakers with cords and one No. C4 portable carrying case. **List Price:** \$208.00. **Shipping Wt.:** 78 lbs. **Code:** PORTS.

Model 2418-P1C. Same as above except with one microphone and one stand. **List Price:** \$183.50. **Shipping Wt.:** 67 lbs. **Code:** POOLS. **Kit of extra sound tubes, for Model 2418 amplifier.** **List Price:** \$8.20. **Shipping Wt.:** 2 lbs. **Code:** TALCS.

Model 2418, Amplifier only, less tubes. **List Price:** \$56.00. **Shipping Wt.:** 31 lbs. **Code:** ABYSS.



Erwood

MODEL No. 3428 28 WATT AMPLIFIERS

Housed in a metal cabinet of unusual beauty, this new design exceeds its rating by a substantial margin. This increased margin guarantees high quality performance without distortion at levels considerably in excess of the rating. The three inputs accommodate two microphones and a phonograph. In our opinion, this amplifying system will be most talked about because of its unusual dynamic range and tone quality.

APPLICATION: A well-balanced engineered system capable of exceptional performance. Well adapted to use in auditoriums, theatres, schools, churches and other public gathering places. Provides perfect reproduction for audiences of 4000 or for auditoriums of 1,000,000 cubic feet.

FEATURES: Model 3428 amplifier permits the use of two microphones and a phonograph input in a multiple mixing circuit. Extra refinement in circuit design reduces noise and hum to new low levels only attained in expensive recording amplifiers. Provision is incorporated for the use of a two-position remote control unit. Two tone controls permit perfect balancing of reproduction to auditorium requirements.

AMPLIFIER SPECIFICATIONS

Power Output: 28 Watts. **Gain:** Microphone 130 DB. Phonograph 75 DB. **Controls:** Two microphone volume controls, one phonograph volume control, one high frequency control, one low frequency control, and an ON and OFF switch. Remote control attachment optional. **Input:** Two, two-megohm for microphones and one-half megohm for phonograph. **Tubes:** Eight required, consisting of: 2—6J7; 2—6C5; 2—6L6; 1—5V4; 1—6X7. **Output Impedance:** Four, eight, two hundred and fifty and five hundred ohms. (Current consumption 125 Watts. **Dimensions:** 8" x 9 1/2" x 14 1/2".

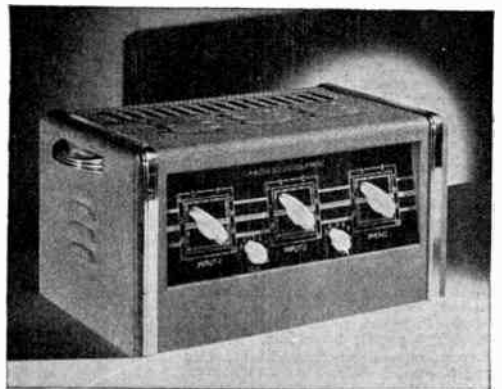

Model 3428 amplifier only, less tubes. **List Price:** \$75.00. **Shipping Wt.:** 38 lbs. **Code:** ABBEY. **Kit of matched tubes for Model 3428 amplifier.** **List Price:** \$8.55. **Shipping Wt.:** 2 lbs. **Code:** TABBY.

Erwood SOUND EQUIPMENT

Erwood MODEL No. 1420 — 20 WATT MOBILE PUBLIC ADDRESS SYSTEM



Designed and engineered by the originators of Mobile Public Address Systems, Model No. 1420 provides in simple compact equipment a dependable combination of 6-volt and 120-volt services. Primarily designed for mobile services, the case with which this model may be transported makes it desirable for general public address applications.

APPLICATION: Suitable for outdoor crowds of 2,000 or more people, with corresponding greater indoor capacity. Suitable for civic celebrations, sports announcements, orchestral broadcasting, etc.

FEATURES: Will operate on either standard 120-volt A.C. power line or 6-volt storage battery. Facilities for one microphone. Self-contained record playing mechanism for phonograph record reproduction. Hum and other noises generally associated with mobile equipment have been eliminated by special Erwood extra shielding and filtration. High quality crystal pickup and noiseless rim drive turntable motor. Amplifier is equipped with 7 tubes operated well within manufacturers' ratings to eliminate tube trouble. Reproduction is excellent with ample capacity for extra power and stepped-up quality performance when required. Well designed ventilation. Accessibility has been stressed in this model.

AMPLIFIER SPECIFICATIONS

Power Output: 20 Watts. Gain: Microphone, 129 DB. Phonograph, 73 DB. Controls: One microphone, phonograph, tone control, ON and OFF switch, and a standby switch. Input: For one microphone. Tubes: Seven required, consisting of: 1—6J7, 2—6N7, 2—6L6, 2—6X5. Output Impedance: Four, Eight, Two Hundred Fifty and Five Hundred Ohms. Power Consumption: 130 Watts AC, 20 Amperes, DC. Dimensions: 18" x 16" x 12". Shipping Weight: 42 lbs.

MICROPHONE: Because of particularly durable construction, Model 156C crystal microphone is included with these systems. Microphone has a wide frequency range, is sensitive over a wide angle of pickup. Particularly adapted to the rough usage of outdoor work and frequent handling. Frequency ranges flat output level, —62 DB. Microphone is furnished complete with 25 feet of RCS cable, plug and handle.

SPEAKERS: Two No. 120—12" permanent magnet speakers are included with this system. The magnetic structure of these speakers uses 21 ounces of magnetic material. They have a power handling capacity of 10 watts per speaker. Speakers are furnished with 25 feet of cable and plug.

System 1420M comprises one 1420 high fidelity amplifier, one 156C crystal microphone with 25 foot cable and plug and two 120—12" permanent magnet speakers, with 25 foot cables and plugs. List: \$154.00. Shipping Weight: 55 lbs. Code: SAGES. Kit of matched tubes. List \$7.80. Shipping Weight: 2 lbs. Code: TABLE.

Erwood MODEL No. 3545 45 WATT AMPLIFIER



For the elaborate and exacting requirements of the "big installation," this system has been designed to embrace every modern improvement known to sound. In every respect it can be depended upon to meet every expectation.

APPLICATION: Adopted to larger installations requiring multiple microphone, where the stage presentation covers considerable area—automatic volume control greatly improves the pickup of the system and helps to eliminate feedback. Will handle crowds up to 10,000 persons under the most adverse conditions.

FEATURES: Model 3545 amplifier combines automatic volume control for microphones, volume expansion for record reproduction, remote control for the three microphone positions permits monitoring the program from a remote position. High and low tone compensation permits adapting the equipment to troublesome acoustical conditions. Uses a new circuit with two power transformers, variable output impedance switch, locking type input plugs.

AMPLIFIER SPECIFICATIONS

Power Output: 45 Watts.

Gain: Microphone 130 DB. Phonograph 75 DB.

Controls: Three microphone volume controls, one master gain control, one combination volume control, one low frequency control, one ON and OFF switch.

Input Impedance: For microphones, two megohms; for phonograph, one-half megohm.

Tubes: Fourteen required, consisting of: 4—6J7G, 2—6N7G, 1—6L7G, 1—6F6G, 1—6H6G, 2—6L6G, 1—5U4G, 1—83.

Output Impedance: Four, Eight, Two Hundred Fifty and Five Hundred Ohms.

Current Consumption: 320 Watts.

Dimensions: 8 3/4" x 11" x 18".

No. 3545—Amplifier Only.....List \$132.50

Shipping Weight: 55 lbs. Code: APPLE.

Kit of matched tubes for Model 3545 Amplifier.

List: \$12.85. Shipping Weight: 4 lbs. Code: TUBES.

Erwood MODEL No. 101 PHONOGRAPH UNIT



Model No. 101 phonograph unit is a record playing device for either ten or twelve inch phonograph records and it comprises a 78 R.P.M., rim drive phonograph motor with a ten inch flock covered turntable. The phonograph pickup is of the off-set arm type with a crystal cartridge. Output for 500,000 ohm load.

The equipment also includes a six foot power cord, a six foot shielded input cord and a gain control with an attached ON and OFF switch. The entire assembly is enclosed in an attractive portable case with a tweed covering. Dimensions 7" x 13" x 13". Shipping Weight 13 lbs. List Price: \$29.50. Code: PHONO.

Erwood SOUND EQUIPMENT

8 WATT PORTABLE



COMPLETE LOW PRICE PORTABLE PUBLIC ADDRESS SYSTEM . . . UNUSUAL PERFORMANCE

APPLICATION: An 8-watt portable public address system that is adapted to the smaller assemblies encountered in churches, schools, clubs, lodges and other organizations where groups up to several hundred should be given adequate hearing facilities.

FLEXIBILITY: The simplicity of this system, together with facilities for the use of additional equipment adapts it to many applications not ordinarily expected of such low priced equipment. Speaker cables can be extended and an additional speaker used if desired. A tone control is incorporated to adapt the unit to various acoustical or reproducing conditions. It is very simple to operate—as easy as a midget radio.

PHONOGRAPH ATTACHMENT: The Erwood No. 101 Phonograph Attachment is ideal for the reproduction of phonograph records when used in conjunction with this system.

AMPLIFIER: The Amplifier utilizes five tubes and has an output of 8 watts. It is built into a section of the portable case. Input connection is provided for the microphone furnished with the system, and for a record playing attachment. Controls include a microphone volume control, a phonograph volume control and a tone control. A power switch and pilot light complete the control panel. Two speaker sockets are provided with 3-4 and 6-8 ohm taps. The amplifier is attractively finished in burgundy maroon, the control panel is two-tone screened.

MICROPHONE: The Model 149-A Crystal Microphone is of the compensated diaphragm type having reproduction characteristics that are highly desirable for speech work. It is furnished complete with 25 feet of low capacity shielded fabric covered cable and a polarized plug of simple design to attach it to the amplifier.

SPEAKER: The 10" Model 110 Permanent Magnet speaker utilizes 12 ounces of magnetic material and has a cone assembly capable of reproducing the necessary high frequencies for intelligible speech reproduction. The speaker is furnished complete with a polarized plug and 25 feet of rubber covered cable.

LUGGAGE: Model 1308 System is contained in a portable carrying case of substantial construction having dimensions of 11" x 12½" x 13½". The covering is a serviceable brownish tweed that is durable and does not scuff.

ADDITIONAL SPEAKERS: Two speaker plugs are provided on the amplifier so that an additional speaker can be used where it is desirable to obtain greater sound distribution.

1308PIC System, as described, less tubes. Shipping weight 28 lbs.....**LIST PRICE \$49.50**

Kit of tubes include 1-5Y3G, 2-6V6GT, 1-6Y7G, 1-6Q7GT. Shipping weight 2 lbs.....**LIST PRICE \$4.90**

SINGLE UNIT PUBLIC ADDRESS SYSTEM COMBINED WITH A READING LAMP AND DESK

APPLICATION: Churches, Hotels, Schools, Lodges and Clubs and other social gatherings will find wide use for the Rostrum System. Particularly adapted to after-dinner and impromptu gatherings . . . easy to install . . . simply place rostrum unit in front of the speaker, plug into a convenient A.C. connection and system is ready to operate. Make it easy for your speaker to be heard and your audience to hear.

EASE OF OPERATION: Although the Rostrum system combines all of the elements of a public address system, they are all permanently mounted in one easy-to-carry case . . . it's no more of a job to install this system than an electric iron and as easy to use as an automatic toaster. Simply plug into the light socket, remove the snap-on cover and the system is ready to operate. And in addition, you have an illuminated desk to facilitate the reading of papers, etc. You control the volume with one simple control . . . fewer controls than a midget radio set.

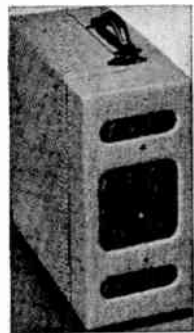

EQUIPMENT: The complete assembly comprises . . . a 6½" dynamic reproducer having an excellent frequency range . . . a powerful four tube amplifier with plenty of reserve power to give you extra power without distortion . . . a compensated diaphragm crystal microphone mounted on a flexible goose neck type of stand . . . all mounted in an attractive case.



Complete Model R-6 Unit System, as described. Shipping Weight: 24 lbs.
LIST PRICE \$48.75

Kit of Tested Tubes, comprising 1—6X5GT, 1—6K6GT, 2—6Q7GT. Shipping Weight: 2 lbs.....**LIST PRICE \$3.40**

Thank You!

When writing for additional
information or when ordering
from sources of supply listed
in this book, please mention

RADIO'S MASTER

SOUND SYSTEMS



MASCO 17 WATT PORTABLE OR PERMANENT SOUND SYSTEM

FEATURES

- Tapped Output, 2-4-8-15-500 Ohms
- Beam Power Output (2—6L6G)
- Electronic Mixing Overall
- Aero-dynamic Design
- Full Range Controls
- Individual Controls
- Inverse Feedback
- 24 Hour Operation
- Custom Made
- Built-in Field Supply

Ease of setup and operation, plus maximum output and excellent tonal quality are the salient features of these systems. The amplifier chassis is finished in a hard baked smooth crystal of tan and brown. Chrome and red trim are added to enhance the rich appearance. The carrying case is styled after the finest aeroplanc hand luggage with tweed facings and calf skin tan overall striping. The interior of the case is designed to hold the complete system and accessories. Amplifier is mounted on sliding panel for ease in removing from case when in use.

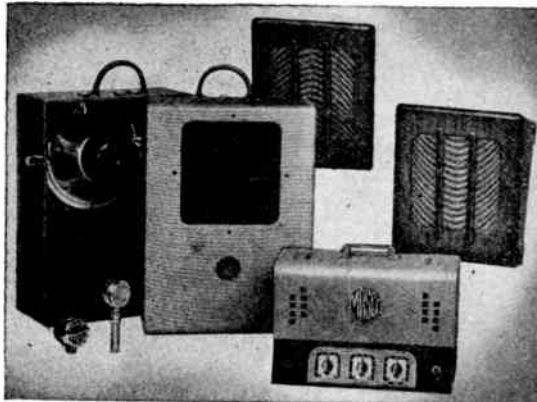

APPLICATION

These systems are highly efficient and afford outstanding results to meet requirements for medium power installations. For coverage up to 175,000 cubic feet. Microphone and Phono may be used simultaneously through the use of separate controls. Hum and noise have been reduced to a negligible level through correct design and filter.

PORTABLE SYSTEM

The MAS-17 complete portable system consists of: Model MA-17 amplifier less tubes, mounted in carrying case. An Astatic JT-30 Microphone with 25' cable with connectors, two 10" electro dynamic speakers each with 25 ft. cable plus plugs.

MAS-17—Complete portable system as described	List Price	\$88.00
MAS-17—Complete portable system, same as above but with Astatic T-3 Microphone		96.75
MA-17—Amplifier less tubes, with streamline cover		38.50
Kit of MATCHED tubes		7.00
Model 304—Portable amplifier case only, Case dimensions: 14 1/2" wide, 13" deep, 18" high		16.25
No. 102—10" Walnut speaker cabinet		6.25
MA-17P—Amplifier with Phono Top Cover, less tubes		53.50
If Astatic JT-30 Microphone is not desired, deduct		12.50

SPECIFICATIONS FOR MODEL MA-17 AMPLIFIER: Power Output: 17 Watts • Gain: Microphone 118 DB, Phono 74 DB • Controls—Three: Microphone, Phono, Tone • Separate on-off AC Switch • Input—Two: Microphone and Phono • Tubes: 1—6SJ7, 1—6SC7, 2—6L6G, 1—5Y3G • Output: Tapped—2-4-8-15-500 Ohms • Power Consumption: 90 Watts • Hum Level: Below Zero Level—22DB • Frequency Response: 50 to 10,000 cycles • Dimensions: 12" x 6 3/4" x 7 3/4".



De Luxe Phono-Top P.A. Equipment (A.C.)

Note: If Model MA-17P Phono Top Amplifier is desired as a Portable System, Deduct List Price of the MA-17 Amplifier from System and Add List Price of MA-17P Phono Top Amplifier.

Note: Chassis size for Model MA-17P: 12" x 10" x 8". All other specifications same as Model MA-17.

MASCO 25 WATT PERMANENT OR PORTABLE SOUND SYSTEM

FEATURES

- Output Tapped, 2-4-8-15-500 Ohms
- Two Microphones and Phono
- Electronic Mixing Overall
- Beam Power 6L6 Output
- Undistorted 25 Watt Output
- Triple Channel Inputs
- Inverse Feedback
- 24 Hour Operation
- Custom Made
- Built-in Field Supply

Here MASCO offers industrial streamlining extra refinement in circuit design, imperative in modern

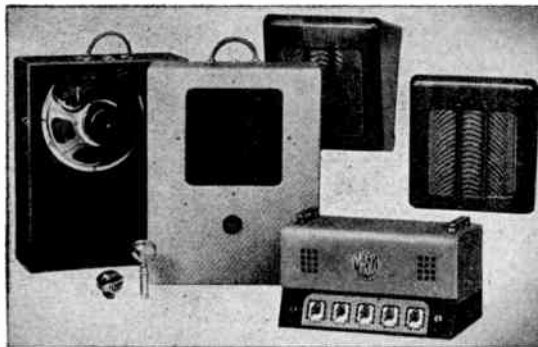

sound equipment. The Model MA-25 permits the use of two microphones and phono in a multiple mixing circuit. Output is tapped to match any speaker or speaker groups. Humless operation plus fine tonal quality at high level output are only a few of the outstanding features of this amplifier. The richly appointed carrying case covered with two-tone tan calf and tweed has been styled after aeroplanc hand luggage. The Model MA-25 amplifier is finished in sturdy tan and brown baked crystal with red and chrome handles, dial plate and trimmings. Accessories are housed within the carrying case. Amplifier is mounted on sliding panel for ease in removing from case when in use.

AMPLIFIER SPECIFICATIONS FOR MODEL MA-25: Power Output: 25 Watts • Gain: Microphone 125 DB, Phono 78 DB • Controls—Four: Two Microphones, Phono, Tone • Separate On-Off Switch • Input—Three: Two Microphones, Phono • Tubes: 2—6SF5, 1—6SC7, 1—6N7, 2—6L6G, 1—6U4G • Output: Tapped—2-4-8-15-500 Ohms • Power Consumption: 120 Watts • Hum Level: —55 DB below 25 Watts • Frequency Response: 50 to 10,000 Cycles • Dimensions: 15" x 8" x 8".

PORTABLE SYSTEM: The MAS-25 complete system consists of: Model MA-25 amplifier less tubes, mounted in carrying case as described. Astatic JT-30 Microphone with 25' cable with connector, two heavy duty 12" Electro-Dynamic Speakers, each with 35' cable plus plugs.

MAS-25—Complete portable system as described	List Price	\$104.00
MAS-25—Complete portable system same as above but with Astatic T-3 Microphone		112.75
MA-25—Amplifier less tubes, with streamline cover		52.50
Kit of MATCHED tubes		10.00
Model 305—Portable amplifier case, Case dimensions: 23" high, 15" deep, 18 1/2" wide		19.00
No. 101—12" Walnut Speaker Cabinet		7.50
MA-25P—Amplifier with Phono Top Cover, less tubes		67.50
If Astatic JT-30 Microphone is not desired, deduct		12.50

Due to Government demands we are forced to supply the above systems with Electro-Dynamic Speakers, but if PM's are available they will be substituted. Note: All amplifiers made for interchangeable use of either type of speaker.

Model MA-25P Top Amplifier

Note: If Model MA-25P Phono Top Amplifier is desired as a Portable System, deduct List Price of MA-25 Amplifier from System and Add List Price of MA-25P Phono Top Amplifier.



Note: Chassis size for Model MA-25P: 12" x 10" x 8". All other specifications same as Model MA-25.

Please Note: When desiring combination of equipment other than listed herein, write for further details. All specifications, prices, etc., mentioned herein are subject to change without notice. West of the Rockies add 5% to above prices.



SOUND SYSTEMS

17 WATT AND 25 WATT UNIVERSAL PHONO-TOP MOBILE SYSTEMS FOR BATTERY AND 115 VOLT AC OPERATION



17 WATT Model MAC-17P

APPLICATION: The Models MAC-25P and MAC-17P are 25 watt and 17 watt complete systems for 6 volt DC and 115 volt AC operation.

FEATURES: The Model MAC-17P has a working output of 17 watts of power, and is so ruggedly constructed that a 75% overload safety factor is maintained. Low Battery Drain is an exclusive MASCO feature. To assure long-hour usage from the battery, we have incorporated a "stand-by" battery saver switch, which keeps the filaments lit and cuts off the power supply, thus the amplifier is ready for instant use. Battery cable is included. Chassis is beautiful two-tone tan and brown with red and chrome trim, with handles.

AMPLIFIER SPECIFICATIONS, MC-17P: Power Output: 17 Watts • Gain: Microphone 118 DB, Phono 74 DB • Controls—Three: Microphone, Phono, Tone • Switches: On-off, AC; On-off Phono Motor; Stand-by Battery Saver Switch • Input—Two: Microphone and Phono • Tubes: 1—6SJ7, 1—6SC7, 2—6L6G, 1—5Y3G • Output: Tapped—2-4-8-15-500 Ohms • Power Consumption: AC 90 Watts, 6 Volts DC 10 Amps. • Hum Level: —22 DB below zero level, Ripple Free on Battery • Frequency Response: 50 to 10,000 cycles • Dimensions: 12" x 10" x 8".

PORTABLE SYSTEM: Model MAC-17P complete portable system consists of: Model MC-17P Phono-top 6 volt DC and 115 volt AC amplifier less tubes, mounted in the "slip-in" carrying case of two-tone tan and brown, and Astatic JT-30 Microphone with 25 feet cable with connector, two heavy duty 10" Speakers, each with 25 feet cable plus plug.

List Price

MAC-17P—Complete portable system as described.....\$121.50
 MAC-17P—Complete portable system as above but with Astatic T-3 Microphone 130.00
 MC-17P —6 volt DC and 115 volt AC phono top amplifier less tubes 72.00

List Price

MC-17 —6 volt DC and 115 volt AC amplifier with plain cover, less tubes 57.00
 Kit of MATCHED tubes 7.00
 Model 304—Portable amplifier case 16.25
 Case dimensions: 14½" wide, 18" deep, 18" high
 Model 401—All steel non-resonant baffle 11.50
 If Astatic JT-30 Microphone is not desired, deduct..... 12.50
 NOTE: If amplifier with plain cover is desired with above system, deduct 15.00

25 WATT MODEL MAC-25P MOBILE SYSTEM

AMPLIFIER FEATURES: Model MC-25P 6 volt DC and 115 volt AC amplifier is a high-powered De Luxe Unit that is applicable to all uses for outdoor sound. Provisions for two microphones and phono-input with independent controls along with universal speaking matching of 2-4-8-15 and 500 Ohms, add to its value. The MASCO battery saver "stand-by" switch is also incorporated. The extra-heavy duty vibrator assures a 75% overload safety factor, and through its use steady voltage and frequency is maintained. A primary feature is the Ripple-Free operation; chassis finish is two-tone tan and brown with red and chrome trim, with handles.

AMPLIFIER SPECIFICATIONS FOR MODEL MC-25P: Power Output: 25 Watts • Gain: Microphone, 125 DB; Phono, 78 DB. • Controls—Four: Two Microphones, Phono, Tone • Switches: On-off AC, On-off Phono Motor, Stand-by Battery Saver Switch • Input—Two: Microphone and Phono • Tubes: 2—6SF5, 1—6SC7, 1—6N7, 2—6L6G, 1—5U4G • Output: Tapped—2-4-8-15-500 Ohms • Power Consumption: AC 120 Watts, 6 Volts DC 16 Amps • Hum Level: Ripple-Free on Battery —55DB below 25 Watts • Frequency Response: 50 to 10,000 cycles • Dimensions: 12" x 10" x 8".

PORTABLE SYSTEM: The Model MAC-25P complete portable system consists of: Model MC-25P Phono-top amplifier less tubes, mounted in carrying case of attractive two-tone tan and brown. One Astatic JT-30 Microphone with 25 Ft. cable with connector, two heavy-duty 12" Speakers with 35 ft. cable and plugs.

List Price

MAC-25P—Complete portable system as described.....\$149.00
 MAC-25P—Complete portable system as above but with Astatic T-3 Microphone 157.75
 MC-25P —6 volt DC and 115 volt AC phono-top amplifier less tubes 97.50
 MC-25 —6 volt DC and 115 volt AC amplifier less tubes, with plain cover 82.50
 Kit of MATCHED tubes 10.00
 Model 305—Portable amplifier case 19.00
 Case dimensions: 23" high, 15" deep, 18½" wide
 Model 402—12" all steel non-resonant baffle 11.50
 If Astatic JT-30 Microphone is not desired, deduct..... 12.50
 NOTE: If amplifier with plain cover is desired with above system deduct 15.00
 NOTE: If the above amplifier systems are desired as Outdoor Systems, deduct the List Prices of the Amplifier Cases and Add the List Price of two No. 401 baffles or two No. 402 baffles.

MASCO 8 WATT SOUND SYSTEM

Features: Four Tubes 8 Watt Output • Microphone and Phono Inputs • Standard Voice Coil Output • Variable Tone Control • Individual Controls • Beam Power Output • 24 Hour Operation • Custom Made • Built-in Field Supply.

Original streamline design has been incorporated in the entire system. Amplifier finished in beautiful two-tone tan and brown, chrome and red trim, with handles. Microphone and Phono may be used simultaneously through the use of separate controls. Carrying case designed as latest style aeroplane luggage, covered in contrasting tan and tweed.

AMPLIFIER SPECIFICATIONS FOR MODEL MA-8: Power Output: 8 Watts • Gain: Microphone 117 DB, Phono 73 DB • Controls: Microphone, Phono, Tone. (With on-off switch) • Input—Two: Microphone, Phono • Tubes: 1—6SJ7, 1—6SF5, 1—6L6G, 1—5Y3G • Output: 6 to 8 Ohms • Power Consumption: 44 Watts • Hum Level:—55 DB below 8 Watts • Frequency Response: 50 to 9000 cycles • Dimensions: 9½" x 6" x 7½".

PORTABLE SYSTEM: As illustrated, MAS-8 complete portable system consists of: Model MA-8 amplifier less tubes, mounted in carrying case; Astatic JT-30 Microphone, 25 ft. cable with connector; one heavy-duty 10" Electro Dynamic Speaker, 25 ft. cable plus plug.

List Price

MAS-8—Complete portable system as described.....\$58.00
 MA-8 —Amplifier only 24.50
 Streamline cover for MA-8 amplifier 3.00
 Kit of MATCHED tubes 5.00
 Model 303—Portable amplifier case 11.50
 Case dimensions: 12½" wide, 9½" deep, 15" high
 No. 102—10" Walnut speaker cabinet 6.25
 If Astatic JT-30 Microphone is not desired, deduct..... 12.50



Due to Government demands we are forced to supply the above systems with Electro Dynamic Speakers, but if PM's are available they will be substituted. NOTE: All amplifiers made for interchangeable use of either type of speaker.

PLEASE NOTE: When desiring combination of equipment other than listed herein, write for further details.

All specifications, prices, etc., mentioned herein are subject to change without notice.

WEST OF THE ROCKIES ADD 5% TO ABOVE PRICES

SOUND ACCESSORIES



DE LUXE WALNUT SPEAKER CABINETS



No. 115

No. 101

No. 102

No. 103

No. 104

No. 105

Uniformity throughout has been the keynote of our design in bringing you the new "MASCO" DE LUXE line of walnut speaker cabinets. Ranging in size from 5" to 15". All "MASCO" cabinets are designed primarily from the standpoint of acoustical efficiency, however, one look at the STURDY CONSTRUCTION, will convince you that in endeavoring to attain the highest acoustical standard we did not SACRIFICE BEAUTY. We call your attention to the GROOVED back on all cabinets which releases air pressure or back lash. These cabinets will not resonate or rattle at high volume due to their STURDY CONSTRUCTION.

15" Model No. 115—MASCO Super Quality Walnut Speaker Cabinet

Made to accommodate a 15" speaker. Made of choice Walnut Veneer. Heavily constructed and reinforced throughout. Slope front and attractive grille bars add to the beauty of this cabinet. Size: 18" high, 18" wide, 10 3/4" deep. Supplied with hardware for mounting speaker. List Price\$12.50

12" Model No. 101—MASCO De Luxe Walnut Speaker Cabinet

Made to accommodate a 12" speaker. Beautiful WALNUT finish. Constructed to permit correct release of speaker pressure. Slope front and attractive raised grille bars. Size: 14" wide, 15 1/2" high, 9 1/2" deep. Supplied with hardware for mounting speaker. List, \$7.50

10" Model No. 102—MASCO Superior Quality Walnut Speaker Cabinet

For installation where the finest type of equipment is required. Has slope front with raised grille bars. Made to accommodate a 10" speaker. Size: 12" wide, 13 1/2" high, 7 1/2" deep. Supplied with hardware for mounting speaker. List Price\$6.25

8" Model No. 103 MASCO Standard Wall Cabinet

To house 8" or 9" speakers. Handsome WALNUT finish. Raised grille bars. Slope front. Size: 10" wide, 11 1/2" high, 7 1/4" deep. Supplied with hardware for mounting speaker. List Price\$5.00

6" Model No. 104 All Purpose Wall Cabinet

To house 5" and 6" speakers. WALNUT finish. Slope front with raised grille bars. Size: 7 1/2" wide, 9" high, 5 1/2" deep. Supplied with hardware for mounting speaker. List, \$4.00

5" Model No. 105—MASCO General Purpose Walnut Cabinet

Front and back grilles, finished in two tone walnut and black trim. Made to fit any standard 5" speaker. Used in PA or Inter-Office communication. Rubber humpers are supplied at base of cabinet to prevent marring. Size: 6 1/4" wide, 6 1/2" high, 4" deep. Supplied with hardware for mounting speaker and back cover. List Price\$3.75

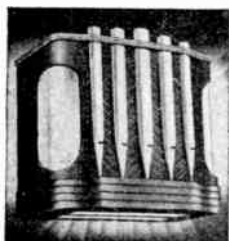

Model MO-12—MASCO "Organtone" Speaker Cabinet

This beautiful walnut cabinet, is designed to simulate an organ. Organ "pipes" cover the front, and are finished in gold lacquer. Illumination of front and sides is accomplished by light shining through the colored translucent panels which are part of the cabinet. Wired-in bulb socket is included. Speaker opening is for 12" speaker. This unit is ideally suited for use as an extension with coin operated phonographs.

Size: 17 1/2" wide, 15" high, 9" deep. Supplied with hardware for mounting speaker. List Price\$17.50

Model MM-12—MASCO "Music-Box" Speaker Cabinet

Similar in appearance to our de luxe walnut cabinets, the Model MM-12 is finished in handsome Spanish antique leatherette. As shown, side and front vents are provided with translucent colored material which permits light from bulb inside cabinet to penetrate through the plastic. Bulb socket is wired-in. Unit is recommended for use as extension with coin operated phonographs, etc.

Size: 14" wide, 15 1/2" high, 9 1/2" deep. Supplied with hardware for mounting speaker. List Price\$11.50

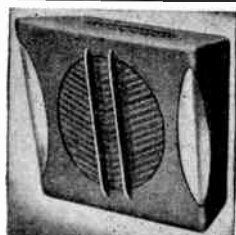

MUSICAL CONTACT MICROPHONES

- Ease of Installation
- Operates With All Instruments
- Operates With Most Modern Radios
- Will Not Mar Surfaces
- Operates With All Makes of Amplifiers
- Mellow Rounded Tone

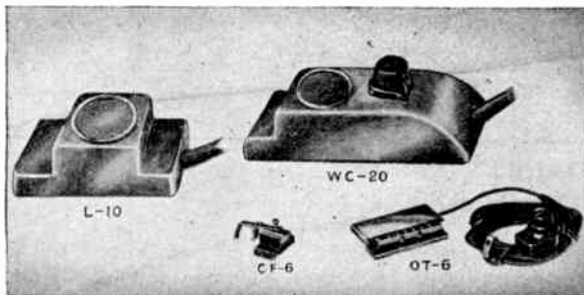

"MASCO Musical Microphones" are designed for use with ANY musical instrument. They operate by being placed in contact with the body of the instrument and receiving vibrations from the instrument when it is played. The resulting brilliance of tone far exceeds the power of the instrument alone. MASCO MUSICAL MICROPHONES may be slipped on in a moment, and require no special strings or instrument changes.

THE MODELS No. WC-20 AND L-10

Features: Twelve model L-10 less volume control, with 15' of cable each, may be connected in parallel and plugged into one input, while five model No. WC-20 with volume control and 15' of cable each, may be paralleled and connected to one input. Both models are ideal for use as a pickup for disc and film recording. Use of them in this manner eliminates background noises usually encountered with regulation microphones. They are also well adapted for use as vibration testers for machinery, mechanical devices, etc.

Model No. OT-6

Features: The model No. OT-6 instrument pickup, with volume control and 15' of cable has been designed for use with the steel stringed instruments, such as guitars, mandolins, etc. This unit operates on a different principle than the models No. L-10 and No. WC-20 in that it receives its impulses from the vibrations of the steel strings. Finished in a highly polished chrome, it enhances the appearance of the instrument. The Model OT-6 consists of a specially ADJUSTABLE

BRIDGE to which is attached the pickup unit with volume control. The bridge replaces the one on the instrument, and by simple set screw adjustment it is set to the EXACT position as the original. Installation is simple and is made instantly without marring or defacing the instrument. Reproduction of tone is astounding and beautiful. Effects not to be had with the instrument alone are obtained with this unit. The model No. OT-6 may be used with any standard P.A. or guitar amplifier.

WC-20—With volume control and 15' cable\$12.00
 L-10—Less volume control, with 15' cable 9.00
 OT-6—With bridge, volume control and 15' cable 18.00
 CF-6—Bridge clamp only 1.00
 If any of the above units are desired with chromium metal plugs, add List 1.25
 NOTE: The MAP-10 and MAP-15 Musical Instrument Amplifiers are highly recommended for use with the Models L-10, WC-20 and OT-6 pickup units.

WEST OF ROCKIES ADD 5% TO ABOVE PRICES : : : PRICES SUBJECT TO CHANGE WITHOUT NOTICE



SOUND ACCESSORIES

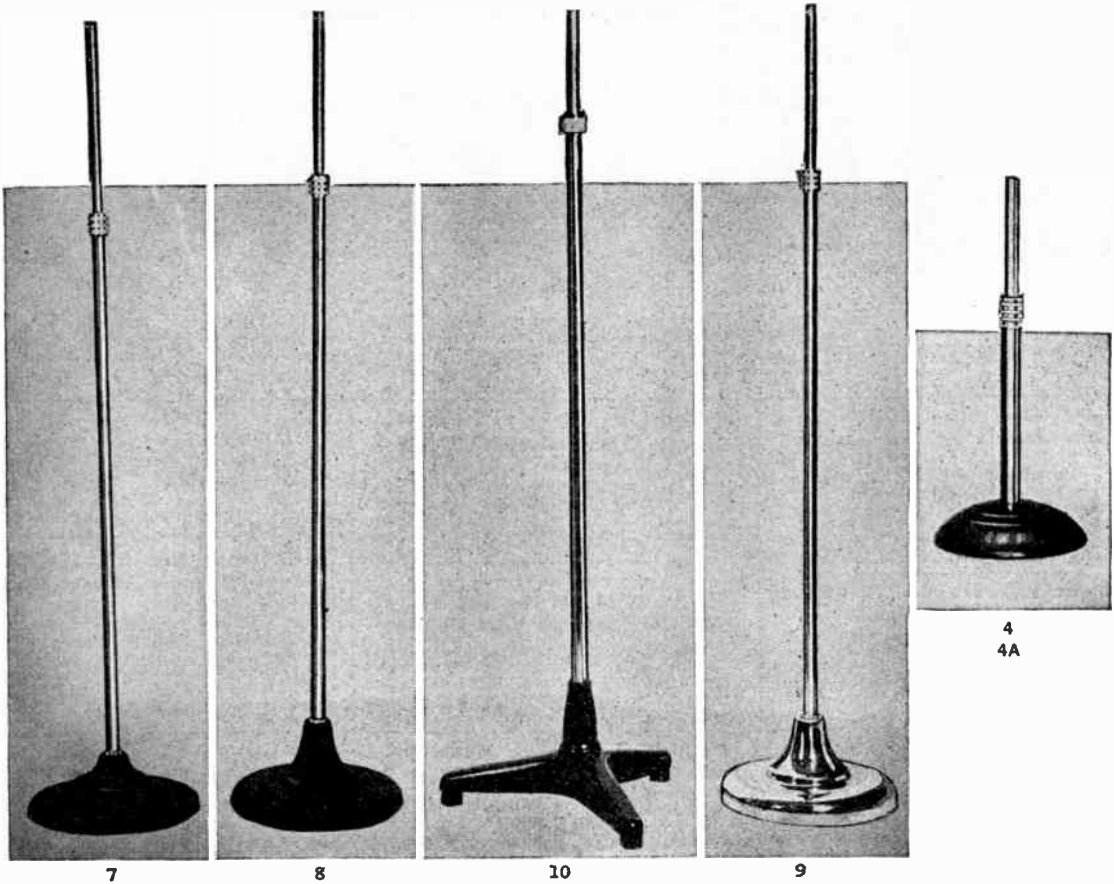

MASCO DE LUXE MICROPHONE STANDS

All "MASCO" microphone stands are made of seamless extra heavy gauge brass tubing throughout. Assuring dependability and service, also eliminating rust and corrosion. These stands are heavily chrome plated to insure long and lasting wear.

The "EVER SILENT" friction clutch will never wear out due to the exclusive MASCO hardened fibre bushing, which is incorporated

into both the clutch and telescope sections of the $\frac{3}{8}$ " tube. Easily adjusted with one hand and stays "PUT". MASCO'S NEW GRIP TIGHT, STAY-FAST LOCKING CLUTCH prevents disturbing adjustment noises when amplifier is working. MASCO DE LUXE stands have standard $\frac{3}{8}$ x 27 thread, for all types and makes of microphones. Standard height: 35" to 68".

Model No.	Base Finish	Tube Finish	Base Diameter	Height	Weight Lbs.	List Price
7	Black Crackle	Chromium	10"	35" to 68"	10 $\frac{1}{2}$	\$ 6.75
8	Black Crackle	Chromium	10"	35" to 68"	11 $\frac{1}{2}$	8.00
9	Chromium	Chromium	10"	35" to 68"	11 $\frac{1}{2}$	9.50
9A	Chromium	Chromium	10"	35" to 68"	18	12.50
10	Black Crackle	Chromium	(Base spread 15")	35" to 68"	18	12.50

NOTE: Models Nos. 8, 9 and 9A, have felt screwed in bumpers to prevent marring of floors.
Model No. 10 has large rubber bumpers which completely eliminates all floor vibration pickup.

BANQUET STANDS

For your convenience in PA applications, MASCO offers the following types of banquet stands:

All tubing made of extra heavy gauge brass, heavily chrome plated. All models have felt screwed in bumpers to prevent marring of desk or table.

All models are available in chromium or black crackle finish, on both the adjustable or or fixed type stands.

The adjustable models, Nos. 6 and 6A, use the "EVER-SILENT clutch.

The models Nos. 4 and 4A, use the same type of tubing and "EVER-SILENT" friction clutch as used on the floor stands. Bases may be had in gray crackle with contrasting red circle, or in all chrome.

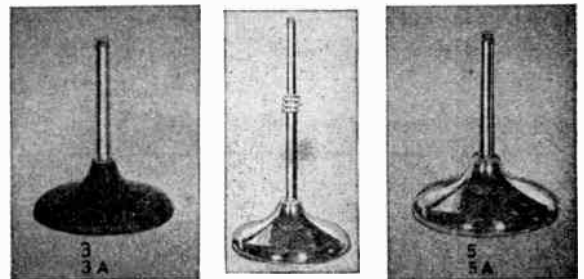

Model No.	Type	Base Finish	Base Diameter	Height	Weight Lbs.	List Price
4	Adjustable	Chromium	7"	18" to 32"	6	\$7.00
4A	Adjustable	Gray	7"	18" to 32"	6	6.00
6	Adjustable	Chromium	6"	10" to 15"	3	4.25
6A	Adjustable	Black Crackle	6"	10" to 15"	3	3.25
3	Fixed	Black Crackle	6"	9"	2 $\frac{1}{2}$	2.00
3A	Fixed	Black Crackle	6"	12"	2 $\frac{1}{2}$	2.25
5	Fixed	Chromium	6"	9"	2 $\frac{1}{2}$	3.00
5A	Fixed	Chromium	6"	12"	2 $\frac{1}{2}$	3.25

WEST OF ROCKIES ADD 5% TO ABOVE PRICES : : : PRICES SUBJECT TO CHANGE WITHOUT NOTICE



PERMANENT MAGNET HORN UNITS

All Permanent Magnet units use the finest grade of Alnico steel magnets and Armco iron throughout. All steel parts cadmium-plated to prevent corrosion. Inside of magnet structure contains an additional means for maintaining air gap and a preventative against filings and dust from entering same. Units are magnetized, using an electromag-

netic cutout which gives the maximum flux density obtainable in the gap. All magnets are measured for flux density and each unit is tested with special machines for power handling capacity as well as 300 volt ground-test, making for uniform ability to stand all types of service. Voice coil impedance 15 ohms.



BULL PERMANENT MAGNET UNIT

One of the largest Permanent Magnet Units ever developed, using a patented special compensating phase cancellation device and patented heavy duty diaphragm.

Operating capacity at 250 cycles.....50 watts
Peak capacity100 watts
400 oz. magnet.

Flux density.....16,000 gaussses per sq. cm.
Total weight 65 pounds

Code: REVUL..... List Price \$250.00

ELECTRODYNAMIC HORN UNITS



ALL RACON Electrodynamic units are made of best grade Armco iron. Standard field 6-8 volts. Special fields to order. Voice coil impedance 15 ohms. Operating capacities and sizes similar to Permanent Magnet Units shown above.

	Code	List
SUPER GIANT	RHEUM	\$66.00
GIANT	RANGE	55.00
MASTER	RINSE	44.00



SUPER GIANT Permanent Magnet Horn Unit

Operating capacity at 250 cycles....25 watts
Operating capacity at 110 cycles 10-12 watts

130 oz. Alnico Magnet.
Flux density.....15,000 gaussses per sq. cm.
Total weight.....17 pounds
Code: REVUM..... List Price \$70.00

GIANT Permanent Magnet Horn Unit

Operating capacity at 250 cycles....25 watts
Operating capacity at 100 cycles 10-12 watts

104 oz. Alnico Magnet.
Flux density.....14,000 gaussses per sq. cm.
Total weight.....13 pounds
Code: REVUX.....List Price \$57.50

MASTER Permanent Magnet Horn Unit

Operating capacity:
At 250 cycles 25 watts
At 100 cycles 10 watts

60 oz. Alnico Magnet.
Flux density.....12,000 gaussses per sq. cm.
Total weight.....9 pounds

Code: REVUE..... List Price \$47.50

JUNIOR Permanent Magnet Horn Unit

Operating capacity at 250 cycles....20 watts
Operating capacity at 100 cycles.....8 watts
46 oz. Alnico Magnet.

Flux density.....10,000 gaussses per sq. cm.
Total weight.....7 3/4 pounds

Code: REVAT..... List Price \$37.50

BABY Permanent Magnet Horn Unit

Operating capacity at 300 cycles....10 watts
17 oz. Alnico Magnet.
Flux density.....8,000 gaussses per sq. cm.
Total weight.....3 pounds

Code: REVEL..... List Price \$22.00
(Coupling included for attachment to standard horns, if desired.)

MULTIPLE HORN COMBINATIONS

Connectors made of heavy cast bronze with loose couplings for unit connection.

Combinations of two or three trumpet horns driven by one unit through properly designed connectors, will be found very efficient and flexible for public address service. Wider coverage can be obtained from the same power level, and frequency response is improved since the low-frequency cut-off is a product of the total bell area of all the horns.

Double Connector — Dispersion angle 75°
Code: RADIX.....List Price \$15.50

Triple Connector — Dispersion angle 105°
Code: RACER.....List Price \$21.00



DIAPHRAGM REPLACEMENTS

Code	Description	Net Price
Code: RUTEX	Type A Diaphragms only.....	\$2.60*
Code: RUVEX	Type B Diaphragms only.....	3.60*
Code: RUZEN	Type A Head Assembly (including diaphragm) Theatre Type.....	4.25*
Code: RUZUR	Type B Head Assembly (including diaphragm) General PA Type.....	5.25*
Code: RUCHE	Type C Head Assembly (including heavy duty diaphragm) Aeroplane Type.....	6.00*
Code: RUBUF	Type A High Fidelity Head Assembly (including diaphragm).....	6.00*
Code: RULES	Bull Unit Diaphragms only.....	15.00*
Code: RUSEY	Super Power Diaphragm only.....	7.50*

UNITS **RACON** TRUMPETS

ARMORED CONE SPEAKER PROJECTORS



Bell 22" x 22" overall



Bell 24" x 29" overall



Bell 30" x 40" overall

Newly designed heavy gauge aluminum projectors to give highest efficiencies obtainable with cone speakers. Steel back enclosures have properly designed release holes to prevent resonance effects, and a cast aluminum mounting plate. An all-purpose projector for indoor or outdoor use! Provided with mounting hook and mounting holes.

Simple to install and efficient. Supplied without steel back, with steel back or with damped steel back having silk gauze and wire screen for cone protection.

For 6"-8" Cone
Without steel back.
Code: REDAY...List \$21.00
With steel back.
Code: REDAZ...List \$23.50
With damped back and cone opening protected by silk gauze and wire screen.
Code: REDAD...List \$26.50

For 8"-10" Cone
Without steel back.
Code: REFER...List \$25.75
With steel back.
Code: REFID...List \$30.00
With damped back and cone opening protected by silk gauze and wire screen.
Code: REFAD...List \$34.50

For 10"-12" Cone
Without steel back.
Code: REGAN...List \$52.50
With steel back.
Code: REGIM...List \$57.00
With damped back and cone opening protected by silk gauze and wire screen.
Code: REGAL...List \$61.50

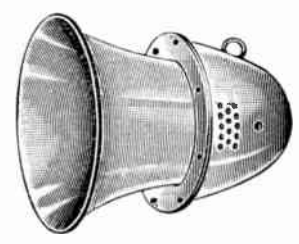

ARMORED CONE PROJECTOR

An efficient heavy gauge steel and aluminum projector for dynamic cone speakers. Rugged and suitable for indoor or outdoor use. Steel back enclosure and heavy gauge aluminum bell with waterproof overlap. Provided with mounting hook and mounting holes. Overall length 20". Bell diameter 17". For use with 12" cone speakers.

Code: RUMID.....List Price \$10.00
All steel projector (steel back and steel bell).

Code RUMIS.....List Price \$11.00

Projector with aluminum bell and steel back, acoustically damped and cone opening protected by wire screening and silk gauze.
Code: ROBOT.....List Price \$12.50

BALL TYPE CONE SPEAKER

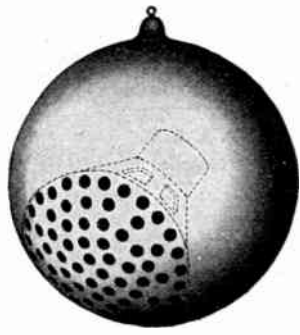

A new type ball speaker to be used where directional sound is required and where the standard type of cone projections clash with the surrounding furnishings or architecture.

Will project a beam at an angle of 45°.

Will operate with 6", 8" and 10" cone speakers, and can be used for paging systems (voice reproduction) as well as for musical reproduction.

Made of steel, with hanging lamp fixture. Finished in silver.

	Bell Diameter	Weight	Code	List Price
For 6" Cone.....	9 1/2"	3 1/2 lbs.	REBAL	\$9.00
For 8" Cone.....	12"	6 lbs.	REMAL	10.50
For 10" Cone.....	14"	9 lbs.	RESAL	14.00



ARMORED CONE PROJECTOR

For use with 8" cone speakers. Overall length 15". Bell diameter 15".

Code: RUMIX.....List Price \$8.00
Above with steel back, acoustically damped with heavy sound absorbing material, and cone opening protected by wire screening and silk gauze.

Code: RIFLE.....List Price \$10.00

All steel projector; steel back and bell.
Code RUMIL.....List Price \$9.00

STEEL SWIVEL BRACKETS FOR CONE PROJECTORS

For wall or truck mounting, with tooth ratchet swivel to give 180° angular movement; with or without stand, to attach to standard pipe.



For Cone Projectors
Without Base
Code: RAMIS
List Price \$3.00
With Base
Code: RAMIT
List Price \$4.50

For 12" or 8" Cone Marine
Without Base
Code: RAMUN
List Price \$3.00
With 1 1/2" Base
Code: RAMUB
List Price \$5.00



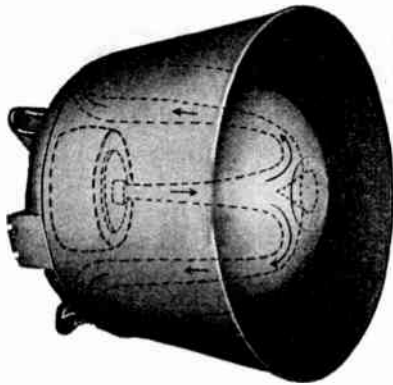

BULL MARINE SPEAKER

A large re-entrant type of horn, 28" diameter, 21" deep, made of heavy aluminum casting and Racon unbreakable bell and centre section. Will withstand extremely high wattages without vibration.

Designed to operate with Racon Bull unit for 50 watts, with 4 Racon Marine units for 40 watt operation, or 2 Racon Marine units for 20 watt continuous operation. Cut-off 125 cycles.

Code: REDUL REVUL—Bull Horn with Bull Unit complete, 50 watt operation; wt. 120 lbs.	\$525.00
Code: RADOF REVUE—Bull Horn with 4 Marine Units complete, 40 watt operation; wt. 118 lbs.	490.00
Code: RADOT REVUE—Bull Horn with 2 Marine Units complete, 20 watt operation; wt. 91 lbs.	400.00

List Price

MARINE SPEAKER

Approved by the Bureau of Marine Inspection and Navigation, Department of Commerce, for all Emergency Loudspeaker Systems on ships, under the 53rd Supplement of the Bureau, after tests made by the Bureau of Standards, Washington, D.C.

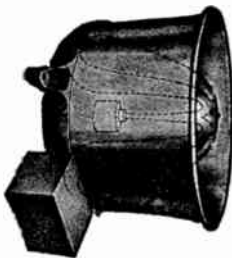

The latest speaker in Marine Practice! A double re-entrant type of horn, 14" in diameter, 10" deep—having a base of heavy aluminum casting and heavy aluminum spinning. Uses a Racon Master Unit. The driving Unit and connections are all enclosed, making a completely waterproof speaker not affected by temperature or weather, including use on sea even during storms!

This Marine Speaker is used both as a Loudspeaker and as a Microphone. It will pick up sound outdoors from distances up to 100 feet with very small amplifying gain, and will deliver 100 DB of sound

10 feet from the horn with an input of approximately one watt! Cut-off 250 cycles.

Makes an ideal speaker not only for Marine work but also for general P.A. use, where a highly concentrated sound for great distance is required.

Code REDIM—Complete with upnit; weight 25 lbs. Standard Aluminum castings; single coat finish. List Price \$100.00

Code: REDIX—Complete with unit; weight 25 lbs. Special non-corrosive Aluminum castings; Baked Chromatic Undercoat Finish plus outside lacquer finish. List Price \$125.00

MIDGET MARINE SPEAKER

Approved by the Bureau of Marine Inspection & Navigation, Dept. of Commerce, for ship use. A double re-entrant type horn, 9 1/4" diameter, 6 3/4" deep. Uses a Racon Junior P.M. unit. Built as sturdily as the regular Marine speaker but smaller in size. A highly efficient and directional P.A. speaker. Cut-off 350 cycles.

Code: RASOM—Marine Speaker, complete with Junior unit; weight 10 1/2 lbs. List Price \$55.00

Code: RASOB—Marine Speaker, complete with baby unit; weight 7 1/2 lbs. List Price \$40.00

MINIATURE MARINE SPEAKER

Approved by the Bureau of Marine Inspection & Navigation, Dept. of Commerce, for ship use. A miniature re-entrant type of horn, similar in design to the above Marine speakers. Bell diameter 6 1/4", depth 4 3/4". Uses a Racon Baby Unit. Ideal where a highly efficient and directional speaker is required to occupy a small space and where voice reproduction must overcome high noise levels. Cut-off 500 cycles.

Code: REDUP—Miniature Marine Speaker, complete with unit; Weight 5 1/4 lbs. List Price \$29.00

CONE MARINE SPEAKER

IN ALL RACON CONE MARINE SPEAKERS bell is made of heavy gauge aluminum; cone mounting is made of aluminum casting; and center bullet is made of RACON ACOUSTIC material to prevent resonant effects. Material is stormproofed for all weather conditions.

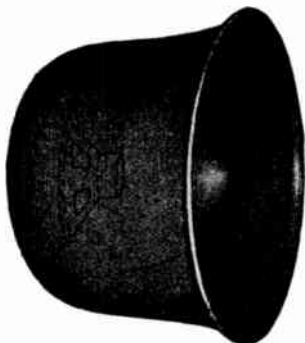

A re-entrant speaker of the marine type, for cone operation. . . . Owing to its unusual construction, this speaker can be used outdoors as well as indoors, in all weather and temperatures, without impairment. . . . The cone diaphragm is protected not only from direct contact with rain but also from physical damage. Can be used for voice as well as musical reproduction.

FOR 12" CONE

Bell Diameter	24"
Depth	15"
Weight	10 lbs.
Code: RELIM	
List Price, without speaker	\$32.50

FOR 5" CONE*

Bell Diameter	10 1/2"
Depth	8 1/2"
Weight, without speaker	2 1/4 lbs.
Code: REKIM	
List Price, without speaker	\$9.50

FOR 8" CONE

Bell Diameter	17 1/2"
Depth	11 1/2"
Weight	4 1/2 lbs.
Code: REFIM	
List Price, without speaker	\$17.50

FOR 4" and 3" CONE

Bell Diameter	7 1/4"
Depth	5 1/4"
Weight	2 1/4 lbs.
Code: REPIM	
List Price, with speaker	\$10.50

*NOTE: 5" and 4" Cone Marine supplied with bracket without charge.



TRUMPETS for HORN UNITS



ACOUSTIC TRUMPETS

Trumpets are made of Racon patented acoustic non-vibratory material. Stormproof models are guaranteed for life as waterproof in outdoor use in all climates and weathers, including immersion in water. Brass loose couplings for easy unit attachment. For voice or band music.

3 1/2-Foot Reguler Model

Equipped with rolled-metal beaded edge, metal ferrule and suspension ring. Adapted for 7/8-18" or 1 1/8-18" threaded unit. Weight 6 1/2 lbs. 22" diameter.

Code: RELAY.....List Price \$27.50

De Luxe Type—Equipped with rolled-metal beaded edge, reinforced cast-aluminum tone-arm, and suspension ring. For indoor use. Weight 10 lbs.

Code: REMIT.....List Price \$35.00

Stormproof Type—Equipped same as De Luxe. Waterproof. Weight 12 lbs.

Code: RENEW.....List Price \$50.00

4 1/2-Foot Trumpet

Equipped with rolled-metal beaded edge and 25" cast-aluminum throat. Demountable into two sections, which can be quickly assembled or disassembled.

De Luxe Type—Weight 16 lbs.

Code: RANCH.....List Price \$52.50

Stormproof Type—Weight 18 lbs.

Code: RACEY.....List Price \$71.00

6-Foot Trumpet

Equipped with rolled-metal beaded edge, 34" cast-aluminum throat, and suspension eyelets. Bell 30" diameter.

De Luxe Type—Weight 18 lbs.

Code: RHYME.....List Price \$72.50

Stormproof Type—Weight 23 lbs.

Code: RIDER.....List Price \$90.00



ALL ALUMINUM TRUMPETS

All trumpets made of 12-gauge aluminum with cast-aluminum throat sections and cast-aluminum clamping edges, with reinforced bell. Brass loose coupling for easy unit attachment. For voice as well as musical reproduction.

6-Foot Trumpet

Bell 30" diameter. Demountable into three sections. Weight: 19 lbs.

New Single-Unit Type—34" cast throat.
Code: RHINO.....List Price \$75.00

New Two Single-Unit Type.
Code: RHOMB.....List Price \$82.50

4 1/2-Foot Trumpet

Demountable into 2 sections. 25" cast throat. Bell: 25". Weight: 11 lbs.

Single-Unit Type
Code: DIANT.....List Price \$55.00

Two-Unit Type
Code: RIBES.....List Price \$62.50

3 1/2-Foot Trumpet

Demountable into 2 sections. 10" cast throat. Bell: 22". Weight: 7 lbs.

Code: REPEX.....List Price \$30.00

UNBREAKABLE REINFORCED TRUMPETS

Made of Racon acoustic stormproof material, reinforced throughout. Guaranteed unbreakable. The last word in trumpet design and particularly adaptable where high quality and high efficiency is required, with the ability to withstand the roughest handling without breakage. Loose coupling for unit attachment.

4 1/2-Foot Trumpet

Demountable into 2 sections. 25" cast throat. Bell: 25". Weight: 15 lbs.

Code: REFIX.....List Price \$85.00

6-Foot Trumpet

Demountable into three sections. Equipped with 34 inches of aluminum throat casting.

Single Unit Type
Code: REGON.....List Price \$110.00

Two-Unit Type
Code: REGAY.....List Price \$117.50



PAGING HORN

A small, extremely efficient 2-foot trumpet speaker, for use where highly concentrated sound is required to override high noise levels, such as in factories, outdoors, etc. Uses a small, very efficient Permanent Magnet unit. Particularly adaptable for paging systems, hotel lobbies, trucks, etc.

Horn is made of RACON ACOUSTIC stormproof material with a beaded edge around the bell. Cast aluminum tone arm.

Bell diameter 12".

Overall length 29".

Code: RAGON—Complete with Unit

List Price\$40.00



PERMANENT MAGNET HIGH FREQUENCY UNIT

An efficient and precision built unit, to meet the latest requirements for wide-range reproduction. Designed to cover the frequency band from 3,000 to 12,000 cycles. Special models are available for response up to 18,000 cycles. Supplied with horn, (as shown) and mounting bracket, (not shown). Designed to operate in conjunction with a suitable low frequency speaker (cone or horn type) in order to give high fidelity reproduction in the wide-range audio frequency band. Not made to operate below 3,000 cycles. Voice Coil impedance 15 ohms.

Code: RABAT—Complete with Unit

List Price\$27.50



RE-ENTRANT TRUMPETS



A compact trumpet of the double re-entrant type, made to occupy a small space, yet has a long air column, delivering highly concentrated sound with the greatest efficiency over long distances.

Standard P.M. Units can be used, from the Junior size at \$35.00 list to the Super Giant at \$66.00 list.

ALL RACON RE-ENTRANT SPEAKERS have base and inside tone arm made of aluminum castings, outside bell of heavy gauge aluminum spinning, and center reflecting section of RACON ACOUSTIC material to prevent resonant effects prevalent in all metal reflecting surfaces. Sturdy construction makes them practically abuse-proof.

Swivel ratchet mounting bracket supplied without charge. Can be attached to 1/2" or 1 1/4" pipe.

Equipped with loose couplings for easy unit attachment.

Made in three sizes:

6 FT. RE-ENTRANT

Bell Diameter 25 1/2"
 Overall Length 28"
 Weight 20 lbs.

Code: REMOL
 List Price \$60.00

4 1/2 FT. RE-ENTRANT

Bell Diameter 24 1/2"
 Overall Length 23 1/2"
 Weight 11 lbs.

Code: REMOM
 List Price \$45.00

3 1/2 FT. RE-ENTRANT

Bell Diameter 18"
 Overall Length 16"
 Weight 7 lbs.

Code: REMOX
 List Price \$30.00

RADIAL CONE SPEAKER

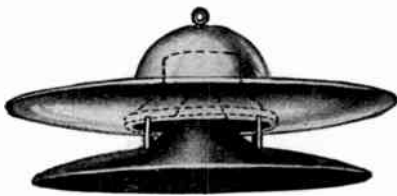

A radial speaker for cone operation.

This speaker is designed to project sound over a complete circumference of 360°, distributing the sound with even intensity and bringing out the high response lacking in direct cone horns.

Particularly adapted for use on trucks and in auditoriums where complete coverage is desired.

Can be camouflaged to blend with ceiling architecture.

IN ALL RACON RADIAL CONE SPEAKERS, the upper deflector is made of heavy gauge steel, cone covering of steel, and lower deflector of RACON ACOUSTIC material to prevent resonant effects prevalent in all metal reflecting surfaces, and storm-proofed for all weather conditions.

FOR 12" OR 10" CONE

Reflector diameter 31"
 Depth 14"
 Weight 10 lbs.

Code: RADAG
 List Price, without speaker \$27.50

FOR 6" OR 5" CONE

Reflector diameter 17"
 Depth 7"
 Weight 3 1/2 lbs.

Code: RADAC
 List Price, without speaker \$9.50
 Code: RASAY
 List Price, with 5" speaker \$13.50



CELLULAR HORN

A new type of cellular horn for operation between 350 and 12,000 cycles, with an angular distribution of 60 degrees.

Uses a highly efficient P.M. Unit with a patented phase cancellation compensating device, reproducing all frequencies without cancellation effects.

Made only in blocs of 4 cells—of Racon unbreakable material, having heavy aluminum throat castings and unbreakable bell sections. Overall length 32½". Total bell opening 12" x 12". Weight 18½ pounds.

Code: RAGAM—Cellular Horn with Master Size Unit.....**\$135.00**
 Code: RAGOT—Cellular Horn with Giant Size Unit..... **145.00**



6-FT. FLAT BELL TRUMPET

This trumpet has been developed to meet special conditions where the height or width available are insufficient for the standard round bell horns. It is acoustically equal to the standard circular bell 6 Foot Trumpet. The bell section, however, is 12" in height by 51" wide. This horn is particularly suited for truck mounting and for interior work such as above or on the sides of stages.

All types equipped with double cross braces, cast aluminum throat sections semi-demountable, and loose couplings for unit attachment.

DELUXE INDOOR TYPE—Weight 24 lbs.
 Code: ROGUE..... List Price **\$72.50**
 STORMPROOF TYPE—Weight 28 lbs.
 Code: ROBIN..... List Price **\$95.00**

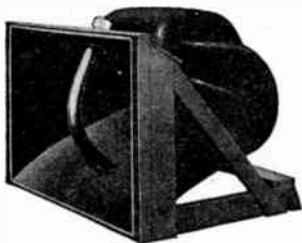

AUDITORIUM HORN

A 7 foot length horn folded to occupy a space 21½" x 26½" x 23½".

An excellent horn for auditoriums, small theatres, portable talkie equipment, etc., and for mounting in the proscenium arch of a large theatre. Small in size and light in weight.

A departure in standard horn design, giving excellent musical as well as speech reproduction out of all proportion to the small size of the horn.

DeLuxe Type for indoor use. Weight 25 lbs.
 Code: ROOST (horn only). List Price**\$66.00**
 Storm-proof Type, guaranteed for all climates and weather.
 Weight 29 lbs.
 Code: RETRO (horn only). List Price**\$88.00**



RADIAL HORN

Width 43"

Height 50"

Equipped with cast aluminum throat, cold rolled steel suspension brackets, reinforced edge. Demountable. Loose couplings for easy unit attachment.

This horn is accurately designed to project sound over a complete circumference of 360 degrees, distributing same with even intensity. It is particularly adapted for use on trucks, tower equipment, churches, amusement parks and general public address use where a complete circumferential coverage is desired.

2 Unit Radial Horn

RADIAL Horn only, STORMPROOF

Weight 60 lbs. without units and brackets.

Code: ROUND..... List Price **\$275.00**

RADIAL Horn only, REGULAR—For indoor use

Weight 55 lbs. without units and brackets.

Code: RUSAN..... List Price **\$225.00**

4 Unit Radial Horn

RADIAL Horn only, STORMPROOF

Weight 68 lbs. without units and brackets.

Code: RADAH..... List Price **\$340.00**

RADIAL Horn only, REGULAR—For indoor use

Weight 63 lbs. without units and brackets.

Code: RUSHY..... List Price **\$275.00**



RADIAL HORN SPEAKER

A 3½ foot re-entrant type horn designed to project sound over a complete circumference of 360°, distributing the sound with an even intensity. For all sound installations where complete coverage is desired.

Base and tone arm made of heavy aluminum castings, center deflector and deflecting bells made of RACON ACOUSTIC material to prevent all resonant effects. Material storm-proofed and guaranteed against all weather conditions. Brass loose couplings for easy unit connection.

Uses standard RACON Units.
 Width 17" Height 15" Weight 7 lbs.
 Code: RADAK. List Price.....**\$37.50**



MULTIPLE UNIT HORNS



4 1/2 FOOT AEROPLANE HORN

Bell 24" diameter. Length 42".

Requires an overall width of 39" to clear Super-Giant Units when mounted.

Equipped with cast aluminum throat section, rolled metal beaded edge, loose couplings for units, and suspension ring. Demountable. Specially developed for installations where space is limited and weight factor small.

2 Unit Type

DELUXE—Indoor type. Weight 18 pounds.

Code: REPAY.....List Price \$60.00

STORMPROOF. Weight 20 pounds

Code: RECUE.....List Price \$82.50

4 Unit Type (Illustrated)

DELUXE—Indoor type. Weight 23 pounds.

Code: REGUS.....List Price \$90.00

STORMPROOF. Weight 25 pounds

Code: RELAX.....List Price \$115.00



4 UNIT AEROPLANE HORN

Bell 30" diameter.

Length overall 54".

STORMPROOF. Rolled metal beaded edge. Heavy cast aluminum throat section. Loose couplings for unit. Suspension ring. Demountable.

Equipped to operate 4 Units.

An extremely powerful and efficient Public Address Aeroplane Horn for long range projection.

Two mile ground projection capacity.

Weight 30 pounds.

Code: RECUR.....List Price \$200.00



9 UNIT AEROPLANE HORN

Bell 30" diameter.

Length overall 54".

STORMPROOF. Rolled metal beaded edge. Heavy aluminum throat section. Loose couplings for units. Suspension ring. Demountable.

Equipped to operate with 9 Units.

A super-powerful and efficient Public Address Horn for extreme long range projection.

Three mile ground projection capacity.

Weight 48 pounds.

Code: RABIB.....List Price \$335.00

STORMPROOF TYPE GUARANTEED WEATHERPROOF INCLUDING IMMERSION IN WATER

Thank You!

When writing for additional
information or when ordering
from sources of supply listed
in this book, please mention

RADIO'S MASTER

Jensen

FULL RANGE SOUND EQUIPMENT

Known all over the world for predominating high quality

NEW Hypex PROJECTORS

with Annular Diaphragm Unit

These new Jensen "Hypex" Projectors consist of a Type H "Hypex" Horn and Type U "Annular" Driver Unit. The "Hypex" Horn (Patents Pending) is a totally new Jensen development—not "exponential," but with an entirely new flare formula that gives increased efficiency in the region above acoustic cut-off. Two horn sizes give nominal cut-off values of 165 cps. and 140 cps., either of which can be used with any Type U "Annular" Driver Unit below.

Type U "Annular" Driver Units (U. S. Pat. 1,845,768), offered in equivalent Field Coil and PM designs, employ the exclusive Jensen "Annular" principle in which the dural diaphragm is clamped at periphery and center. This gives extra stability, greater freedom from harsh "breakup" sometimes encountered with "dome" diaphragms.

"Hypex" Projectors are especially suitable for speech reproduction, since response extends from the vicinity of acoustic cut-off to the 5,000 cycle region with greatest emphasis on middle highs that add "punch" and "carrying power." Commercially acceptable music reproduction, within the limitations of all small reflex horns, is also provided. Sturdy steel encased unit, plus reflex horn construction insures dependable operation indoors and out, under all weather conditions. Finish is durable baked two-tone gray lacquer.



STANDS AND SUPPORTS

EA-6. Adjustable Stand. Sturdy cast fitting with three-leg base, for mounting projector on wall or other surface. Horizontal and vertical adjustment.

List Price\$5.00

EA-7. Adjustable Support. Provides adjustment when projector is mounted on pipe mast. 3/4 inch pipe thread both ends.

List Price\$3.75

TYPE U "Annular" DRIVER UNITS

U-20. "Annular" Driver Unit. Permanent Magnet type. Rated at 15 watts average, 25 watts maximum, with normal voice or music input. 16-ohm voice coil. Internal screw terminals. Dustproof, screened sound chamber. Diameter, 6 1/4". Depth, 3 3/4". Shipping weight, 11 lbs. Specify ST-630.

List Price\$36.00

UF-20. "Annular" Driver Unit. Field Coil type, 1250 ohms. Normal excitation, 10 watts from FS-10 or other Field Supply. Shipping weight, 12 lbs. Specify ST-631.

List Price\$36.00

UF-20. "Annular" Driver Unit. Field Coil type for 6-volt (1.6 amp.) battery. Specify ST-632. List Price.....\$36.00



Type H "Hypex" PROJECTOR HORNS

H-20. "Hypex" Horn only. Bell diameter, 20 3/4". Depth, 16 3/4". Acoustical length, 4 feet. Nominal acoustic cut-off, 165 cps. Stand coupling flange tapped for 3/4" pipe thread. Net weight, 11 1/4" lbs. Shipping wt., 18 1/4 lbs.

List Price\$28.50

H-24. "Hypex" Horn only. Bell diameter, 24 3/4". Depth, 20 1/2". Acoustical length, 5 feet. Nominal acoustic cut-off, 140 cps. Net weight, 14 3/4 lbs. Shipping wt., 21 3/4 lbs.

List Price\$35.00

JENSEN Type "S" Peri-Dynamic Projector ...

15-25 WATTS CAPACITY



These Projectors are complete assemblies of specially designed Driver Speaker and acoustic system utilizing the Peridyamic principle and correctly designed projector horn. Unusually good response is obtained in the 100-cycle region and high frequency response at good efficiency is maintained to 5500 cycles, thus especially qualifying these projectors for applications emphasizing music reproduction and naturalness in speech quality. Except for opening into horn, projector is completely weatherproofed, suitable for use indoors and out. Power rating is 15 watts average, 25 watts maximum, with normal voice or music input. Voice coil impedance, 8 ohms. Bell diameter, 24 1/2". Overall length, 30". Shipping weight, 30 lbs. Complete with plugs for voice coil and field connections. Field coil designs require 10-watt normal excitation from battery or Field Supply Unit.

SPH-81. Projector, complete. PM Type. ST-633. List.....\$62.50

SFB-81. Projector, complete. 1250 ohm field. ST-634. List.....\$62.50

SFB-81. Projector, complete. 6 volt field. ST-635. List.....\$62.50

All above Projectors are furnished complete with Driver Speaker, but LESS stand.

EA-5. Adjustable Stand. List\$5.00

ST-570. Weatherproof Cover. For projector bell. List.....\$2.00

Jensen

FULL RANGE SOUND EQUIPMENT

Known all over the world for predominating high quality

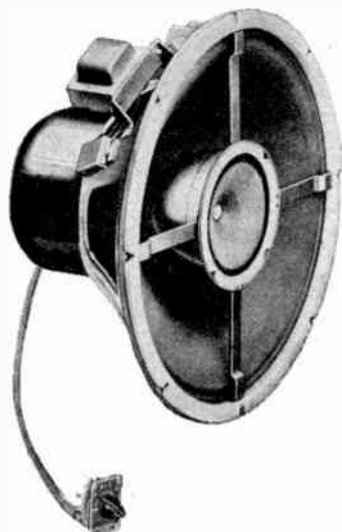

A control of this type permits the full extended-range performance of the coaxial speaker to be utilized on distortion-free program material, while limited-range performance is immediately available when needed for low and medium quality input such as worn lateral records, overmodulated AM radio, and the like. Control knob is installed on right side of cabinet on complete reproducers.

These New Coaxial Speakers bring you the high type of performance only obtainable in a properly designed and co-ordinated two-way reproducing system in which separate speakers handle most effectively their particular portion of the total frequency range. Low frequency performance depends also on the acoustic enclosure provided and Jensen Bass Reflex cabinets are recommended for best results.

The High Frequency Control Systems now furnished or available as accessories, enable you to take full advantage of the extended high frequency range on high quality program material, yet instantly adjust for most acceptable results when some distortion is present. Thus Jensen Coaxial Speakers become more nearly universal for quality, moderate-level reproduction . . . adaptable to a wider range of circumstances and preferences.

HIGH FREQUENCY RANGE CONTROL FURNISHED WITH JAP-60 AND JHP-52

Previously, frequency range controls have been limited to the most expensive types of two-way reproducing systems. Now Jensen engineers have developed a new method of adjusting the high-frequency cut-off which is incorporated in the high channel of a two-channel frequency dividing network. This system is offered for the first time on JAP-60 and JHP-52 Coaxial Speakers, A40-1 Network, and on reproducers incorporating these speakers. A 4-position switch on an extension cable provides choice of four cut-off frequencies, corresponding to typical high-quality single speaker performance as the lower limit, the full range of the coaxial speaker as the upper limit, and two intermediate values.

JAP-60 (15-Inch) This coaxial speaker is a high efficiency model ideally suited for such professional applications as FM-AM broadcast monitoring, transcription playback and the like. Efficiency is approximately 3 db higher than that of other 15-inch models listed. Response, when installed in suitable enclosure such as a Bass Reflex cabinet, extends smoothly from 50 to 12,000 cps, with a substantial contribution in the 15,000-cycle region. High Frequency Range Control switch lowers cut-off in four steps to suit program quality. Two channel network effects frequency division at 4,000 cps, with a cut-off slope of 10-12 db per octave. While intended for moderate level operation, maximum power input rating is 14-15 watts. Input impedance, 500 ohms. H.F. Control Switch is furnished complete with knob and escutcheon. Shipping weight, 23 1/2 lbs. Specify ST-600.

List Price\$70.00

JHP-52 (15-Inch) Unqualifiedly recommended for all general applications requiring extended range high fidelity reproduction. Fully equivalent to the JAP-60 in every essential respect, differing only in efficiency which has been lowered slightly to a value suitable for average use at lower cost. Excellent for high quality FM-AM radio receivers, phonograph reproducers, monitoring and similar applications. Complete with H.F. Range Control Switch on extension cable, escutcheon and knob. Input impedance, 500 ohms. Power rating 12 to 14 watts. Specify ST-601.

List Price\$49.50

HIGH QUALITY OUTPUT TRANSFORMERS

These transformers are designed to match push-pull output tubes to 500 ohms (JAP-60 and JHP-52). No voice coil taps provided. Output is ± 1 db from 30 to 15,000 c.p.s. Encased in metal can; will not mount directly on speakers.

Z 3155—(8,000 C.T. to 500) Z 3156—(5,000 C.T. to 500)
Z 3157—(10,000 C.T. to 500)

List Price\$9.25†



Q8P HIGH-FREQUENCY SPEAKER

As used in 15" coaxials. Designed to reproduce the high frequencies from 4,000 to 15,000 cps., when used with dividing network (such as A40-1) and suitable low frequency speaker. Impedance, 16 ohms. Overall diameter, 5 1/2". Depth, 3 3/4". P.M. design.

Q8P. H.F. Speaker. ST-589.
List Price\$13.00

ST-605. Mounting Arms. Set of 4 as used on 15" coaxials.
List Price\$1.00

A40-1 NETWORK



This uniquely designed two-channel network is offered to those who wish to assemble their own two-way speaker systems, or add a high-frequency speaker to an existing single speaker. Frequency division is at 4,000 cps., with an attenuation outside pass band of 10-12 db per octave. Low frequency channel will accommodate any suitable 8 ohm 12" or 15" speaker. High channel takes one to four Q8P High Frequency Speakers (16, 8 and 4 ohm taps). Input, 500 ohms. High Frequency Range Control Switch feature included. Specify ST-604.

List Price\$26.00

JCP-40 (12-Inch) COAXIAL SPEAKER

The JCP-40 is a new member of the Jensen coaxial family. It makes available at a new low cost the extended range performance inherent in a correctly designed combination of low and high frequency speakers. Physically interchangeable with any full-size 12" conventional speaker, it is an ideal replacement and modernizing unit. In a suitable enclosure (such as Jensen "Bass Reflex") the JCP-40 gives effective reproduction of the frequency range from 50 to 10,000 cycles with some contribution even in the 12,000-cycle region. Simplified low-cost bridging network is incorporated. Terminals are provided so that accessory ST-606 High Frequency Level Control may be added by purchaser if desired. Voice coil impedance, 8 ohms. Power rating, 8 to 10 watts. PM design. Specify ST-603.

JCP-40. Coaxial Speaker. List Price.....\$29.50



Accessory H. F. Level Control for JCP-40

A simplified system of fidelity control which can be added by the purchaser to the JCP-40 Coaxial Speaker has been developed. This consists of a properly designed continuously variable resistance network which is easily connected to terminals provided for this purpose on the speakers. The control permits the user to adjust the level contributed by the high frequency speaker, thus permitting instant accommodation to program quality and listener preference. Control can also be used as general purpose 16-ohm 15-watt level control. 3/4" bushing 1" long for mounting on heavy cabinets. Complete with antique bronze escutcheon and brown bakelite knob.

ST-606. High Frequency Level Control. List Price.....\$3.50



Jensen

FULL RANGE SOUND EQUIPMENT

Known all over the world for predominating high quality

HIGH FIDELITY REPRODUCERS

with Bass Reflex

FURNITURE AND UTILITY MODELS - - COAXIAL AND SINGLE RADIATOR TYPES

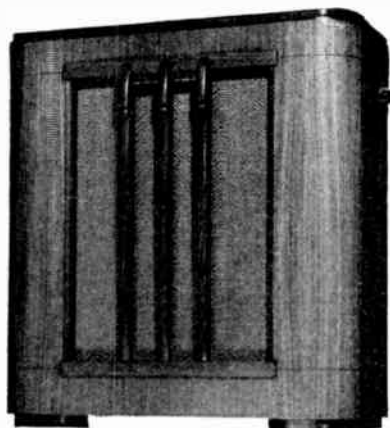

TYPE "CR" REPRODUCERS

Type "CR" Reproducers combine arresting beauty and distinction with outstanding performance at moderate cost. They are ideal for broadcast and recording monitoring and audition on FM or AM, for FM-AM receivers, high quality record reproduction, and many other professional and home applications. Cabinets are handsomely styled, suitable for practically any environment, and are well constructed of beautiful striped walnut.

Choice of coaxial or single radiator types is available, with performance in accordance with descriptive data on speakers, each having provided the ideal acoustic environment in a beautiful properly designed Bass Reflex Cabinet. Coaxial reproducers are equipped with high frequency control knob on right side of cabinet. CA-15 cabinet is 27 3/4" wide, 31 1/2" high, 14" deep. CA-12 is 27 3/4" wide, 31 1/2" high, 12" deep.

Reproducer	Stock No.	Cabinet	Speaker	Input Impedance	List Price
CRJ-60†	ST-610	CA-15	JAP-60	500 ohms	\$118.75
CRT-12	ST-577	CA-12	PM12-CT	6 ohms	58.50
CRT-12G*	ST-637	CA-12	G12-RT	6 ohms	60.25
CRJ-40‡	ST-407	CA-12	JCP-40	6 ohms	75.25
CRJ-52‡	ST-600	CA-15	JHP-52	500 ohms	98.25

* 105-120 V. 60 cy. model, complete with Field Supply, A.C. cord and switch.
 † Coaxial Reproducer, complete with High Frequency Control.

TYPE "MT" REPRODUCERS

Type "MT" Reproducers give performance in every way equivalent to that of more expensive corresponding types. Cabinets are durably constructed of plywood and finished in two-tone brown lacquer. Reproducers incorporate speakers from 8-inch single radiator to 15-inch coaxial sizes, answering every demand for the finest performance in attractive but unpretentious cabinetry.

All "MT" Reproducers of course incorporate Bass Reflex for maximum extension of low frequency response. For data on performance of particular reproducers, refer to description of speakers incorporated in reproducer. Coaxial models are equipped with high frequency control knob on right side of cabinet. MT-81 cabinet: 17 1/4" by 23 3/4" by 11". MT-121: 23 3/4" by 30 3/4" by 12 3/4". MT-151: 25" by 33 3/4" by 13 3/4".

Reproducer	Stock No.	Cabinet	Speaker	Input Impedance	List Price
MT-8C	ST-559	MT-81	PM8-CT	6 ohms	\$34.60
MT-8C*	ST-638	MT-81	G8-RT	6 ohms	39.85
MT-12C	ST-571	MT-121	PM12-CT	6 ohms	48.50
MT-12G*	ST-639	MT-121	G12-RT	6 ohms	50.25
MTJ-40‡	ST-611	MT-121	JCP-40	6 ohms	64.25
MTJ-52‡	ST-613	MT-151	JHP-52	500 ohms	84.75

* 105-120 V. 60 cy. model, complete with Field Supply, A.C. cord and switch.
 † Coaxial Reproducer, complete with High Frequency Control.

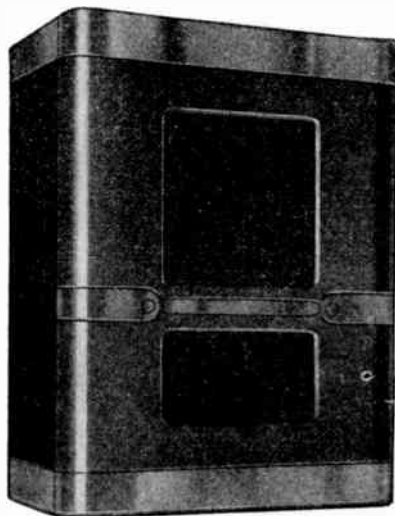

New "Sector-Speaker" .. a Modern, Multi-Purpose High Fidelity Reproducer

FUNCTIONALLY DESIGNED TO SOLVE SPACE AND POSITION PROBLEMS

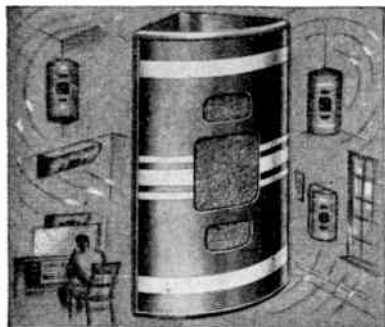

Because it is functionally designed to fit into corners . . . occupy minimum space . . . blend into surfaces . . . the new, modern "Sector Speaker" provides wider latitude, new convenience in installation. The "Sector Speaker" has the form of a quarter cylinder requiring less than 1 square foot of floor space. The unit fits into most any 90-degree corner formed by sidewalls, ceiling or floor. Mounted horizontally, sound is projected downward at 45 degrees. Two units combined form semi-cylinder, blend attractively into wall and provide wide angle sound distribution. Reproducers listed incorporated the famous PM8-CT (and field coil equivalent G8-RT) extended-range high-fidelity speakers which, in the "Sector" Bass Reflex enclosure, effectively reproduce the full 50 to 10,000-cycle range. Suitable for broadcast monitoring and other applications requiring moderate level extended-range reproduction. Plywood construction, finished in two-tone brown lacquer. Height, 28". Radius, 13". Power input rating, 6 watts. 6-ohm voice coil.

AB-20. "Sector Speaker." PM type. ST-615. List Price..... \$39.75
 AB-20. "Sector Speaker." For 105-120 v. 60-cy. operation. Complete with Field Supply, AC cord and switch. ST-640. List Price..... \$45.00

Jensen

FULL RANGE SOUND EQUIPMENT

Known all over the world for predominating high quality

"Standard" SPEAKERS . . . For General Applications

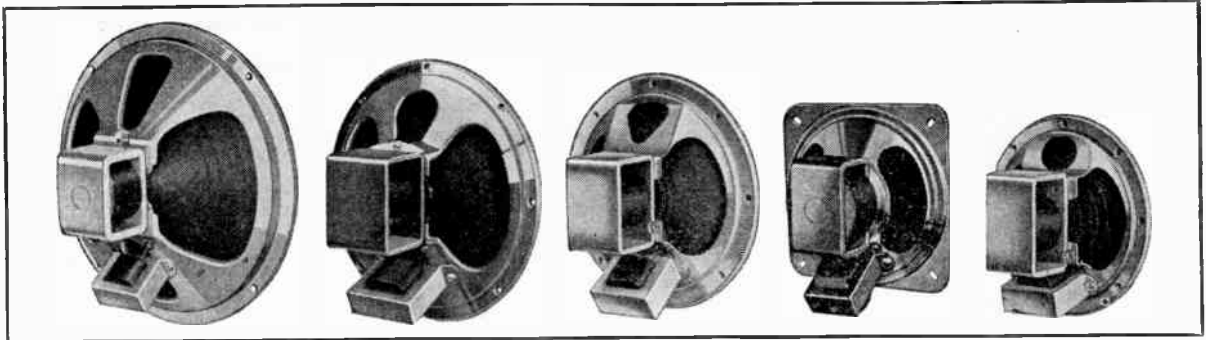

Exceptionally good speakers for use in radio receivers, low power public address and the like. Not to be confused with many cheaply made inefficient speakers. All speakers are completely dust-proofed and all are supplied less transformer but with facilities permitting

easy attachment of the transformers listed on page D-25. Mounting dimensions are standard R.M.A. All field coil models (except 6 volt types) have bucking coil.

WITH FIELD COIL

	Model	Stock No.	Input Impedance	FIELD COIL		Watts	*List Price
				Watts	Resistance		
4"	H4-S	ST-537	4	1 1/2	450	3	\$3.20
	H4-S	ST-538	4	1 1/2	1000	3	3.20
	H4-S	ST-539	4	1 1/2	3000	3	3.20
5"	H5-S	ST-426	4500	2	3000	3	4.25
	H5-S	ST-427	4	2	2750	3	3.30
	H5-S	ST-558	4	2	1800**	3	3.30
	H5-S	ST-449	4	2	1000	3	3.30
	H5-S	ST-450	4	2	450	3	3.30
	H5-S	ST-428	4	2	6 volt	3	3.30
6"	H6-S	ST-429	4	3	2750	3	3.60
	H6-S	ST-430	4	3	1800**	3	3.60
	H6-S	ST-431	4	3	1000	3	3.60
	H6-S	ST-451	4	3	450	3	3.60
	H6-S	ST-432	4	3	6 volt	3	3.60
	E6-RS	ST-565	4	4	2500***	5	5.00
8"	F8-RS	ST-433	4	4	2500	4	4.70
	F8-RS	ST-434	4	4	1800**	4	4.70
	F8-RS	ST-435	4	4	1000	4	4.70
	F8-RS	ST-436	4	4	6 volt	4	4.70
	D8-RS	ST-437	4	5	2500***	6	5.50
	D8-RS	ST-438	4	5	1800**	6	5.50
10"	G10-RS	ST-440	6	8	2500	8	8.25
	G10-RS	ST-441	6	8	1250***	8	8.25
12"	G12-RS	ST-469	6	9	2500	8	10.20
	G12-RS	ST-470	6	9	1250***	8	10.20

WITH PERMANENT MAGNET

	Model	Stock No.	Impedance	VOICE COIL		†Gap Energy	*List Price
				Watts	Resistance		
4"	PM4-FS	ST-540	4	2	.212	\$3.45	
5"	PM5-FS	ST-443	4	2 1/2	.212	3.50	
	PM5-DS	ST-522	4	3	.337	5.50	
6"	PM6-ES	ST-445	4	3 1/2	.860	4.40	
	PM6-DS	ST-455	4	4	.497	5.80	
	PM6-GS	ST-646	6	5	.985	7.20	
8"	PM8-ES	ST-569	4	4	.261	5.15	
	PM8-DS	ST-461	4	5	.663	6.30	
	PM8-GS	ST-523	6	7	.985	7.70	
10"	PM10-GS	ST-466	6	8	.985	8.80	
	PM12-GS	ST-475	6	9	.985	11.00	

* List Prices are less Transformer, except H5-S ST-426 which includes transformer for Single 43 tube.
 ** Tapped at 300 ohms. *** Correct field resistance for Jensen FS-10, Field Supply.
 † Gap energy expressed here in millions of ergs; indicates relative efficiency of speaker.

TRANSFORMERS AND DESIGN DATA

TRANSFORMERS . . . SPECIAL DESIGNS

Transformers are listed on page D-25 in both fixed and adjustable impedance types, and are shipped separately. There is a minimum charge of 50c list for special speaker designs, including attachment of transformer.

VOLUME CONTROLS

These "L Pad" type volume controls are highly satisfactory for use in voice coil circuits. Complete with pointer knob and escutcheon.
 ST-276 For 6 ohm v.c. 5-watt rating.....List \$1.75
 ST-411. For 8 ohm v.c. 15-watt rating.....List \$4.00
 ST-606. For 16 ohm v.c. 15-watt rating.....List \$4.00

Jensen

FULL RANGE SOUND EQUIPMENT

Known all over the world for predominating high quality

Concert SPEAKERS

These are heavy-duty highly efficient speakers and are widely used for Public Address and high quality Radio and Phonograph applications. All Speakers are designed so that they may be used in the Jensen BASS REFLEX Enclosures and Cabinets. All field coil models have bucking coils.

Facilities are provided for easily attaching any of the transformers listed on page D-25. Speakers are supplied without transformers attached unless specifically ordered, in which case increase list price by \$1.00, plus list price of transformer. For special field coils, increase speaker list price \$1.00.

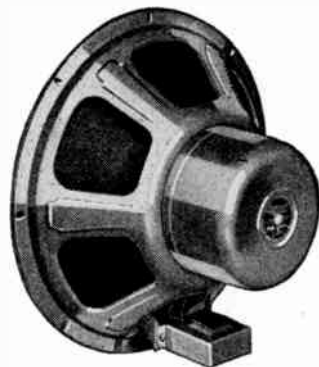
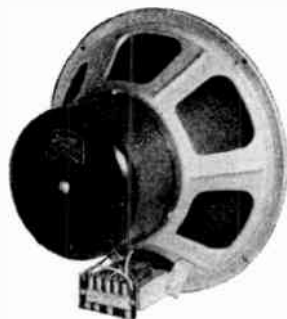

WITH PERMANENT MAGNET

Model	Stock No.	—Voice Coil—		List Price
		Imped. Watts	†Gap Energy	
8" PM8-C	ST-230	6	8	1.36 \$11.00
10" PM10-C	ST-246	6	9	1.36 13.50
12" PM12-C	ST-250	6	10	1.36 15.50
	PM12-H	8	12	2.54 23.50
	A12-PM	8	15	7.57 41.00

WITH FIELD COIL

Model	Stock No.	Voice Coil		—Field Coil—		List Price
		Imp. Watts	Resist.	Watts	Watts	
8" C8-RS	ST-457	8	8	2500	8	\$11.25
8" C8-RS	ST-594	8	8	1250***	8	11.25
C10-RS	ST-463	8	9	2500	8	11.75
10" C10-RS	ST-464	8	9	1250***	8	11.75
C12-R	ST-172	8	10	2500	8	12.75
12" C12-R	ST-176	8	10	1250***	8	12.75

Model	Std. Fl.	*Hi. Fl.	Voice Coil		—Field Coil—		List Price
			Imp. Watts	Resist.	Watts	Watts	
12" B12-X	ST-343	ST-480	8	12.5	2500	10	20.50
	ST-345	ST-479	8	12.5	1250***	10	20.50
	ST-331	ST-337	8	15	860	14	25.00
	ST-333	ST-339	8	15	2500	14	25.00
	ST-335	ST-341	8	15	5400**	14	25.00
B15-X	ST-315	ST-314	8	15	2500	10	23.00
B15-X	ST-319	ST-318	8	15	1250***	10	23.00
15" A-15	ST-311	ST-310	8	17	860	14	29.50
	ST-307	ST-306	8	17	2500	14	29.50
	ST-487	ST-488	8	17	5400**	14	29.50

*** Correct field resistance for Jensen FS-10. Field Supply. See page D-24 for data on Field Supply Units.

† Gap Energy, expressed in millions of ergs, indicates relative efficiency of speakers.

** Correct field resistance for Jensen FS-1, FS-4 and FS-5 field supplies (300 volts).

* High Frequency Response extended to 7500 cps. NOT recommended for General P.A. applications.

SPECIAL EXTENDED RANGE — HIGH FIDELITY SPEAKERS

For those applications where high fidelity performance extending to 10,000 cps. is required, these Special Extended Range High Fidelity Speakers are recommended. Power handling capacity is limited by permissible distortion. They are designed for home and

studio use and will accommodate indoor audiences on the order of 100 people. They are highly qualified for monitoring in broadcast stations and for high fidelity reproduction of voice at relatively low levels.



Model	Stock No.	—Voice Coil—		—Field—		List Price
		Imped. Watts	Resistance	Watts	Watts	
8" G8-RT	ST-562	6	5	2500	8	\$11.00
	ST-595	6	5	1250***	8	11.00
	PM8-CT	ST-560	6	5	Permanent Magnet	8
10" G10-RT	ST-596	6	6	2500	8	11.50
	ST-597	6	6	1250***	8	11.50
12" G12-RT	ST-573	6	7	2500	8	12.50
	ST-598	6	7	1250***	8	12.50
	PM12-CT	ST-572	6	7	Permanent Magnet	8

*** Correct field resistance for FS-10 Field Supply Unit.



JENSEN AUDITORIUM SPEAKERS

These Auditorium Speakers are undeniably the best known and respected high quality loud speakers available. Series M are recommended as general purpose units. Series V was designed with greatest emphasis on reproduction of voice, but in accomplishing this, bass response has not been sacrificed.

WITH PERMANENT MAGNET

Model	Stock No.	—Voice Coil—		List Price†
		Impedance	Watts	
18" PMJ-18	ST-541	8	25	\$175.00
	PVJ-18	ST-542	8	25

WITH FIELD COIL

Model	Stock No.	—Voice Coil—		Field Coil	List Price†
		Imped. Watts	Watts		
14" M-20	3063	8	20	*300 volt	\$66.00
	V-20	3162	8	*300 volt	66.00
	M-10	3005	8	110 V. 60 Cy. AC	89.00
	V-10	3105	8	110 V. 60 Cy. AC	89.00
18" M18-DC	5812	8	25	*300 volt	\$77.00
	V18-DC	5912	8	*300 volt	77.00
	M18-AC	5801	8	110 V. 60 Cy. AC	99.00
	V18-AC	5901	8	110 V. 60 Cy. AC	99.00

*These fields, (3000 ohms) may be excited from Jensen Model FS-1, FS-4 and FS-5 Field Supplies; other resistance values available on special order at \$3.00 increase in List Price.

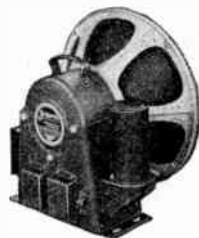
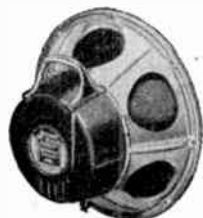

Jensen

FULL RANGE SOUND EQUIPMENT

Known all over the world for predominating high quality



MT CABINETS
BR ENCLOSURES



CA CABINETS

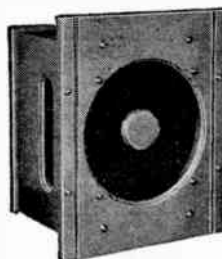

VO ENCLOSURES



No. 3000 and 4000
CABINETS

JENSEN Enclosures . . . BASS REFLEX . . . PERI-DYNAMIC

The BASS REFLEX principle introduced four years ago by JENSEN is now a byword in the industry. For those who desire the maximum performance from a loudspeaker we recommend these cabinets employing BASS REFLEX. Through the use of this principle extra octaves of low frequency performance are available to an extent not possible even with an infinite baffle. A "BR" enclosure will improve the performance of any loudspeaker. For maximum value, however, we always recommend that the speaker be designed for Bass Reflex use. All Jensen Concert, Special and Auditorium Speakers (see page D23) are designed so that they may be used in Bass Reflex enclosures.

TYPE CA CABINETS

Type CA Cabinets are arresting in distinctive beauty of form and finish. Beautifully-grained genuine striped walnut paneling, and attractive styling, make these cabinets suitable for practically any environment in studio, home, or institution. The Jensen Bass Reflex principle is of course employed. Two sizes are offered to accommodate twelve inch and fifteen-inch speakers. CA cabinets are an ideal choice for housing high-performance speakers such as the new extended-range high-fidelity coaxial units. They can of course be used for single radiator speakers with outstanding results.

Model	For Speaker Size	Dimensions	List Price
CA-12	12"	27 3/4" x 31 1/4" x 12"	\$39.50†
CA-15	15"	27 3/4" x 31 1/4" x 14"	46.50†

TYPE MT CABINETS

For those who desire an inexpensive but durably constructed plywood cabinet employing Bass Reflex we now offer the type MT cabinet. These are identical in performance and construction to the well known type BR enclosures but are shipped completely assembled.

Model	For Speaker Size	Dimensions	List Price
MT-81	8"	17 1/4" x 23 3/4" x 11"	\$20.55†
MT-121	12"	23 1/4" x 30 1/4" x 12 1/2"	28.50†
MT-151	15"	25" x 33 3/4" x 13 3/8"	33.00†

TYPE BR ENCLOSURES (Unassembled)

We think an unusually effective compromise has been made between appearance, performance and low cost in these model BR Bass Reflex enclosures. Durably constructed of plywood, finished in rich brown lacquer with contrasting trim. Shipped knocked-down for economy, but easy to assemble.

Model	For Speaker Size	Dimensions	List Price
BR-81	8"	17 1/4" x 23 3/4" x 11"	\$18.90
BR-101	10"	21 1/4" x 28" x 12 1/2"	23.50
BR-121	12"	23 1/4" x 30 1/4" x 12 1/2"	26.50
BR-151	15"	25" x 33 3/4" x 13 3/8"	31.00
BR-181	18"	27 3/4" x 36" x 15 3/8"	39.25

TYPE VO ENCLOSURES (Unassembled)

In these enclosures the low frequency response has been purposely attenuated since they are intended primarily for the reproduction of speech. They are accordingly recommended for paging, announcing, and any application involving principally voice reproduction. Constructed of plywood and finished in neutral gray lacquer. Shipped knocked down in the interests of economy.

Model	For Speaker Size	Dimensions	List Price
VO-8	8"	9 3/4" x 11 3/4" x 6 1/4"	\$ 8.70
VO-10	10"	11 3/4" x 14 1/4" x 7 1/4"	10.00
VO-12	12"	13 3/4" x 16 3/4" x 9 3/4"	12.50

WALL MOUNTING CABINETS

Model 3000 Cabinets are heavily built of hardwood panels finished in ebony black lacquer with natural walnut trim. They are designed for surface mounting on a wall and are recommended for school room, hotel room and extension speaker use. Will accommodate an 8" speaker. The front panel is equipped with three knock-out buttons so that volume controls and selector switches as required may be installed if desired. Model 4000 is larger but otherwise similar. It accommodates a 12" speaker and employs the Bass Reflex principle.

Model	For Speaker Size	Dimensions	List Price
3000	8"	12 1/2" x 16 1/2" x 8"	\$11.25
4000	12"	20" x 30" x 14 3/4"	35.00†

FIELD SUPPLIES

Ratings from 10 to 120 Watts

FS-10. Field Supply. Small and inexpensive, yet conservatively designed. May be mounted on amplifier chassis or in speaker cabinet. Easily wired to A.C. line and field from under-chassis lugs. Will supply 10 watts of field power to a 1250-ohm field. For example, it will supply 1-B12X ST-345, 1-1F-20 ST-631 or 2-E6RS ST-565, etc. Complete with 117-Z6GT tube.

List Price\$4.25

FS-11. Field Supply will fully excite two 1,250-ohm fields in series, such as 1F-20 ST-631, SFB-81 ST-634, AP-20 ST-642, B12-X ST-345, etc. Will also acceptably excite one Jensen Auditorium speaker (3000-ohm field) or two A-12 speakers with 5400-ohm fields in parallel. Has Hi-Lo tap. Complete with type '80 rectifier tube.

List Price\$10.50



FS-10 FS-11

FS-1. Field Supply. Ruggedly constructed and conservatively rated. Will deliver 45 watts continuously. D.C. voltage output, 300 volts at full load. Equipped with fuse, terminal strips and Hi-Lo switch to control output. Has unusually low hum level at rated load. Complete with 5Z3 rectifier tube. List Price\$34.00†

FS-5. Field Supply. Similar in construction to model FS-4. Power output, 60 watts. Delivers 200 ma. at 300 volts. Equipped with twist lock plugs and receptacles for both A.C. input and D.C. output. 1.5% ripple voltage at rated output. Complete with 5Z3 tube. List Price\$45.00†



FS-4

FS-4. Field Supply. A heavy duty unit with exceptionally good power regulation. 1% ripple voltage at full 120 watts output. D.C. voltage output, 300 volts at 400 ma. at full load. Supplied with twist lock plugs and receptacles for both A.C. input and D.C. output. Has Hi-Lo switch. Complete with 2 5Z3 rectifier tubes. List Price\$62.50†

All Jensen Field Supplies are designed for 105-120 volt 60 cycle operation only.

Jensen

FULL RANGE SOUND EQUIPMENT

Known all over the world for predominating high quality

TRANSFORMERS FOR JENSEN SPEAKERS

ADJUSTABLE IMPEDANCE TRANSFORMERS

All Jensen Speakers are offered, (1) Less input transformer, (2) With input transformer. Those speakers carried in our stock for immediate shipment are less transformer, but any speaker may be shipped complete with transformer attached when the proper transformer is specified. In such cases add the price of the transformer to the price of the speaker plus

the extra charge for attachment of transformer, (\$0.50 for Standard Series; \$1.00 for all others.) The best way to order speakers is to order them less input transformer and then select the proper transformer from the list on this page. All speakers and transformers are arranged so that you can easily complete the assembly.

MODEL "X"

These transformers are for matching conventional "plate" impedance values. See illustration at right and observe how easily the adjustments are made with flexible lead and pin

Stock No.	Size	Voice Coil	For Use on Model	List Price
ZX1002	3/4 x 3/4	8	C8RS, C10RS, C12R	\$3.10
ZX1004	3/4 x 3/4	6	PM8C, PM12C, G12RS, PM12GS	3.10
ZX1005	3/4 x 3/4	8	PM12H, A12PM, B12X, A12, B15X	4.15
ZX1007	1 x 1	8	A15	6.50
ZX1012	3/4 x 3/4	6	G8RT, G10RT, G12RT, PM8CT, PM12CT, MT8	
			CRT-12, Section Speaker, JCP-40, MT12	4.15
ZX3000	1 x 1 1/4	8	All Auditorium Speakers	12.00†

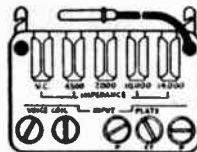

MODEL "X"

MODEL "Y"

Model Y is the same as Model "X" except it is for matching "line" impedance values; 500, 1000, 1500, 2000, and voice coil. See illustration at right.

Stock No.	Size	Voice Coil	For Use on Model	List Price
ZY2001	3/4 x 3/4	6	PM8C, PM12C, G12RS, PM12GS	\$3.10
ZY2002	3/4 x 3/4	8	C8RS, C10RS, C12R, PA18, SFR81, SFR81, FAR8	3.10
ZY2003	3/4 x 3/4	8	PM12H, A12PM, B12X, A12, B15X	4.15
ZY2005	1 x 1	8	A15	6.50
ZY2007	3/4 x 3/4	4	E8RS, D8RS, PM8DS, PM6DS, PM5DS	2.25
ZY2008	3/4 x 3/4	6	G10RS, PM10GS, PM8GS, PM6GS	2.25
ZY2009	3/4 x 3/4	6	G8RT, G10RT, G12RT, PM8CT, PM12CT, MT8	
			CRT-12, Sector Speakers, JCP-40, MT12	4.15
ZY4000	1 x 1 1/4	8	All Auditorium Speakers	12.00†

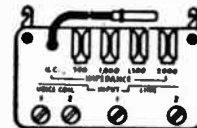

MODEL "Y"

MODEL "P" AND "L"

These Transformers have somewhat less convenient method for making adjustments in the terminal board since a soldering iron is required. But they are lower priced than Models "X" and "Y" and when used in proper application are perfectly

Stock No.	Size	Voice Coil	For Use on Model	List Price
ZP-1020	1/2 x 1/2	4	H4S, H5S, H6S, F8RS, PM4FS, PM5FS, PM6ES, PM8ES	\$1.45
ZP-1021	3/4 x 3/4	4	E6RS, D8RS, PM8DS, PM6DS, PM5DS	2.00
ZP-1022	3/4 x 3/4	6	G10RS, PM10GS, PM8GS, PM6GS	2.00
ZL-2020	1/2 x 1/2	4	H4S, H5S, H6S, F8RS, PM4FS, PM5FS, PM6ES, PM8ES	1.45

FIXED IMPEDANCE TRANSFORMERS

It is easy to select the proper fixed impedance transformer for any Jensen speaker from the list below. If a design is required not included in the list give complete information regarding primary and voice coil impedance plus the size

transformer wanted. Increase list price of transformer 25% for special design. Example, list price of 3/4 x 3/4 transformer in special design is \$1.70 plus 25%

Stock No.	Ohms Impedance	For Speaker Models	List Price	Stock No.	Ohms Impedance	For Speaker Models	List Price
Z2350	Size 1/2x1/2			Z1520	500 to 6		
Z2360	500 to 4			Z2208	*3000 to 6		
Z2235	1500 to 4			Z2382	4500 to 6	PM8C, G12RS	
Z2254	2500 to 4	H4S, PM4FS		Z1843	*4500 to 6	PM12GS, PM12C	\$1.70
Z2361	*4500 to 4	H5S, PM5FS		Z1842	7000 to 6		
Z2255	*4500 to 4	H6S, PM6FS	\$0.95	Z1880	*10000 to 6		
Z2256	10000 to 4	F8RS, PM8ES		Z1582	*14000 to 6		
Z2362	*10000 to 4	AP-10, AP-11					
Z2383	25000 to 4						
Z3051	4 to Grid	AP-10, AP-11	\$1.15				
Z2364	Size 3/4x3/4			Z2666	500 to 6	G8RT, PM8CT	
Z2365	500 to 4			Z2711	*3000 to 6	G10RT, G12RT	
Z2366	1500 to 4			Z2727	*4500 to 6	PM12CT, MT12	\$2.50
Z2342	*3000 to 4	PM6DS		Z2692	7000 to 6	CRT12, JCP40	
Z2367	4500 to 4	E8RS, D8RS		Z2813	*10000 to 6	Sector Speaker	
Z2368	*4500 to 4	PM8DS, PM5DS	1.45	Z2726	*14000 to 6	MT-8	
Z2369	7000 to 4						
Z2370	10000 to 4			Z1882	500 to 8		
Z2371	*10000 to 4			Z1971	*3000 to 8		
Z2372	25000 to 4			Z2385	*5000 to 8	B12X, A12	
				Z1984	*6000 to 8	PM12H, A12PM	2.50
				Z1885	7000 to 8	B15X	
				Z1886	*10000 to 8		
				Z1887	*14000 to 8		
Z2373	Size 3/4x3/4			†23097	500 to 16	Hypex	\$5.00
Z2374	500 to 6						
Z2375	1500 to 6			Z1888	500 to 8		
Z2376	2500 to 6			Z2386	*3000 to 8		
Z2377	4500 to 6	PM8GS, PM6GS		Z2387	*5000 to 8		
Z2378	*4500 to 6	G10RS, PM10GS	\$1.45	Z1890	*6000 to 8	A15	\$4.25
Z2379	7000 to 6			Z2388	7000 to 8		
Z2380	10000 to 6			Z1891	*10000 to 8		
Z2381	*10000 to 6			Z2241	*14000 to 8		
Z1830	Size 3/4x3/4			Z1892	500 to 8	Auditorium	\$5.75†
Z2382	500 to 8			†2777	500 to 4	Speakers	9.25†
Z1878	*3000 to 8	C8RS, C10RS		†2780	500 to 8		9.25†
Z1880	*4500 to 8	C12R	\$1.70				
Z2384	7000 to 8						
Z1881	*10000 to 8			†22731	500 to 8 or 16	Hypex and Auditorium	\$13.00†
Z2800	Size 3/4x3/4	PAH8, FAR8	\$1.70				
	500 to 8	SFR81, SFR81					

* Center Tapped.

† Encased in Metal can; will not mount directly on speaker.

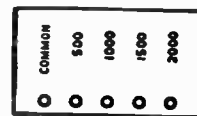

MODEL "L"

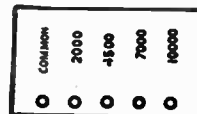

MODEL "P"

Jensen

FULL RANGE SOUND EQUIPMENT

Known all over the world for predominating high quality

JENSEN *Speech Master* REPRODUCERS

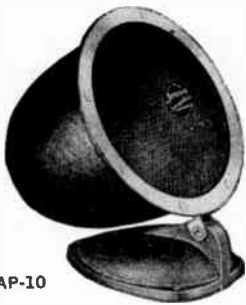

AP-10

Phone Communication: For amateur, commercial, police, aviation, as separate unit or integral equipment.

C W Telegraph: Aids selectivity, helps signals over-ride QRM and QRN. Husky voice-coil to withstand keying transients.

Intercom and PA: For modern Intercom, Paging and PA at moderate levels. Good "talk-back" performance.

Short-Wave Listening: Better than your regular speaker. Can be used on any receiver.

5-Watt "AP-10, 11" for DESK AND PANEL

The truly remarkable performance of these new "Speech Masters" is due to the Peri-Dynamic principle and special radiating system. Normal room level requires less than 0.5 watt input; maximum rating of 5 watts on speech insures dependability. Speech reproduction is especially clear, crisp, intelligible . . . yet if required, music can be reproduced with better quality than that of the average "midget" radio.

Extra-sturdy construction, overall mechanical protection, double dust-proofing, beautiful streamlined design, exceptional acoustic performance . . . all these combine to set AP-10 and AP-11 "Speech Masters" entirely apart from conventional speakers.

AP-10 Desk Type "Speech-Master." Permanent Magnet design. For desk or wall mounting. Complete with "tilt" adjustment and base. Double dust-proofed, fully enclosed and protected. Internal mounting bracket for $\frac{1}{2}$ " x $\frac{1}{2}$ " transformer. R.C. cord 36" long. Height 6 $\frac{3}{4}$ "; depth 5 $\frac{1}{8}$ "; diameter 5". Shipping weight, 5 $\frac{1}{4}$ lbs. Attractive Hammered Gray finish.

AP-10 ST-590. (4 ohm v.c.). List..... \$10.95
 AP-10 ST-591. (45 ohm v.c.). List..... 10.95

AP-11 Panel Type "Speech-Master." Similar to AP-10 less base and swivel bracket. Has clearance eyelets for mounting screws. Mounts in 4 27/64" cut-out, extends 4 $\frac{1}{2}$ " inside panel (from front surface). Screws and drilling template included. Shipping weight, 3 $\frac{3}{4}$ lbs.

AP-11. ST-592. (4 ohm v.c.). List..... \$8.90
 AP-11. ST-593. (45 ohm v.c.). List..... 8.90



AP-11

6-Watt "AR-10" REFLEX SPEECH MASTER FOR GENERAL APPLICATIONS

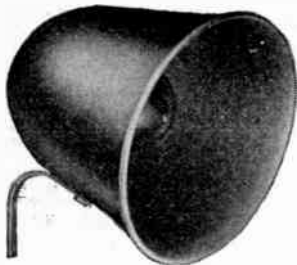

This new Jensen reflex type "Speech Master" has many applications for paging, intercom and call systems operating at medium levels under moderate noise conditions. Specially designed reflex horn increases efficiency in mid-frequency range, giving added effectiveness and "punch" to speech quality. Though not classified as a strictly weatherproof device, reflex construction prevents direct access of rain and snow to speaker diaphragm. Voice coil impedance, 4 ohms or 45 ohms. Power rating, 6 watts. Internal space for $\frac{1}{2}$ " by $\frac{1}{2}$ " transformer (designs stocked for 4-ohm v.c. only). Overall diameter 10". Depth, 8". Complete with mounting bracket. P.M. design.

AR-10. "Speech Master." 4 ohm v.c. ST-643. List Price..... \$16.50
 AR-10. "Speech Master." 45 ohm v.c. ST-644. List Price..... 16.50

25-Watt "AP-20" SPEECH MASTER FOR HIGH-LEVEL PAGING AND CALL SYSTEMS

The AP-20 "Speech Master" is heavy-duty unit for high level paging and call systems in noisy industrial installations. Rated maximum input, 25 watts. Voice coil impedance, 8 ohms. Furnished with eyebolt for overhead suspension but less EA-5 stand required for wall mounting. Separable plug for voice coil connections. Overall diameter 13 $\frac{1}{2}$ ". Depth 9".

AP-20. "Speech Master." PM design. ST-641. List Price..... \$45.00
 EA-5. Adjustable Stand. List Price..... 5.00

PAH-5. Driver Speaker only. PM design. ST-563. List Price..... \$20.00
 FAB-5. Driver Speaker only. Field resistance, 1250 ohms. Requires 10 watts excitation. ST-582. List Price 20.00



Copyright by U. C. P., Inc.

ATLAS SOUND CORPORATION



"DYNAMIC REFLEX" SOUND PROJECTORS



The utmost in sound projection can be expected of the "Dynamic Reflex" Projectors which are highly efficient . . . storm-proof . . . rugged and compact. Constructed of heavy gauge steel spinnings and sturdy iron castings, the "DR" Projectors are finished in a combination battleship gray enamel and gun-metal shrivel.

MODEL DR-42-3½ FT. PROJECTOR—has a bell diameter of 20", overall length of 18", air column length of 3½ ft., acoustic cut-off at 135 cycles, projection angle 80°. Universal strap-iron mounting bracket supplied. Less Driver Unit. \$24.50 LIST

MODEL DR-54-4½ FT. PROJECTOR—has a bell diameter of 25", overall length of 24", air column length of 4½ ft., acoustic cut-off at 110 cycles, projection angle 90°. Universal strap-iron mounting bracket supplied. Less Driver Unit. \$36.75 LIST

MODEL DR-72-6 FT. PROJECTOR—has a bell diameter of 29", overall length of 28", air column length of 6 ft., acoustic cut-off at 85 cycles, projection angle 100°. Universal cast malleable iron mounting bracket supplied. Less Driver Unit. \$55.00 LIST



"DYNA-FLUX" P.M. DRIVER UNITS

Designed for "DR" Projectors

Highest conversion efficiency combined with improved frequency response makes these P.M. compression units the best obtainable. Exclusive Atlas Sound features include non-corrosive diaphragms, best grade ALNICO magnets, and "sealed-tite" waterproofing. Special heat-treating, anodizing, parkerizing, and electro-chemical processes insure trouble-free operation. Twelve months guarantee.

MODEL PM-25 STANDARD 18-25 WATT UNIT—has a voice coil impedance of 15 ohms. Frequency response: 60-5500 cycles. Recommended for critical public address applications. Thread size: 1¼"-18 to fit "DR" Projectors. Baked gray and green two-tone enamel finish. \$50.00 LIST

MODEL PM-26 "HI-FI" 18-25 WATT UNIT—incorporates a special high-fidelity sound chamber. Voice coil impedance of 15 ohms. Frequency response: 55-6000 cycles. Recommended for ultra-high fidelity applications. Thread size: 1¼"-18 to fit "DR" Projectors. Baked gray and green two-tone enamel finish. \$55.00 LIST

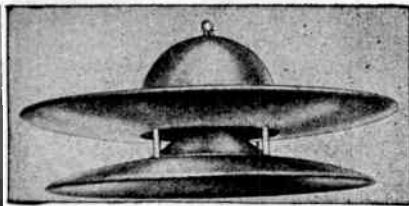

360° "CHANDELIER" SPEAKER BAFFLES

Radial sound dispersion is uniform over a complete 360° area with minimum of feedback. Baffles are constructed of heavy gauge steel finished in pearl gray enamel. Large mounting loop permits quick, simple suspension.

MODEL L-360-12" SPEAKER BAFFLE—for all 12" speakers. Overall diameter 31", height 14". \$29.50 LIST

MODEL L-360SL-BAFFLE COMPLETE WITH 12" SPEAKER—The 12" speaker used is a P.M. type with a normal power of 12 watts, peak 16 watts. V. C. imp. 6-8 ohms. \$43.50 LIST

MODEL M-360-8" SPEAKER BAFFLE—for all 8" speakers. Overall diameter 24", height 15". \$19.50 LIST

MODEL M-360HL-BAFFLE COMPLETE WITH 8" SPEAKER (12 Watts)—Speaker used is a P.M. type with a normal power of 12 watts, peak 16 watts. V. C. imp. 6-8 ohms. \$35.00 LIST

MODEL M-360LL-BAFFLE COMPLETE WITH 8" SPEAKER (7 Watts)—Speaker used is a P. M. type with a normal power of 7 watts, peak 10 watts. \$26.50 LIST

"CHANDELIER, JR." P.M. SPEAKER

Ideal for call systems . . . will also reproduce music with good fidelity. Heavy gauge metal spinnings finished in pearl gray enamel. Overall diameter 17", height 7", weight 6 lbs. The S-360SP comes complete with 5" P.M. cone unit. Rating 5 watts, v. c. imp. 3.5 ohms.

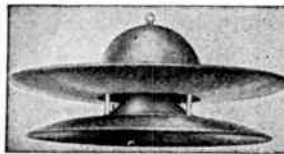

MODEL S-360SP \$14.50 LIST



ALL-STEEL PARABOLIC BAFFLES FOR 6", 8", 12" SPEAKERS

ALL-STEEL "armor plate" baffles will stand up under the severest service. Exclusive inter-lock seal eliminates rain leakage at the seam. No drilling required as all speaker mounting holes are punched at the factory. Cadmium-plated hardware, and two suspension loops with each baffle. Finish is a durable blue-gray weather resistant enamel.

MODEL SM-6 BAFFLE FOR 6" SPEAKERS—Bell opening 11½", bell length 6", total length 10½", shipping weight 4 lbs. \$9.00 LIST

MODEL SM-8 BAFFLE FOR 8" SPEAKERS—Bell opening 17½", bell length 8", total length 14", shipping weight 5 lbs. \$10.50 LIST

MODEL SM-12 BAFFLE FOR 12" SPEAKERS—Bell opening 20", bell length 8", total length 18", shipping weight 9 lbs. \$12.00 LIST

BAFFLE FIXTURES

MODEL SA-10 SADDLE FIXTURE—includes saddle bracket, ratchet, and wing nut arrangement. Lower casting has ½" female pipe thread for attachment to standard pipe fittings. \$3.00 LIST

MODEL ST-8 COMPLETE FIXTURE AND BASE—(illustrated) with heavy iron pipe stem and sturdy base casting. Height 12", base 8". \$4.75 LIST



WX "MARINE HORNS" WITH P.M. SPEAKERS

"WX" Marine Horns will withstand a direct driving rain without damage to the cone speaker. Spinnings are heavy gauge metal, finished in weatherproof battleship gray enamel. Speaker hardware supplied.

MODEL WX-8 HORN FOR 8" SPEAKERS—has a bell opening of 18" and a depth of 12", shipping weight 15 lbs. \$21.00 LIST

MODEL WX-8HL HORN COMPLETE WITH 8" SPEAKER (12 WATTS)—P.M. Speaker has a normal operating power of 12 watts, peak 16 watts. V. C. imp. 6-8 ohms. Shipping weight 22 lbs. 36.50

MODEL WX-8LL HORN COMPLETE WITH 8" SPEAKER (7 WATTS)—P.M. Speaker has a normal operating power of 7 watts, peak 10 watts. V. C. imp. 6-8 ohms. Shipping weight 20 lbs. 28.50

MODEL WX-8 MOUNTING FIXTURE AND BASE—has a heavy cast back plate, goose-neck, and base finished in a durable black crackle. 7.00

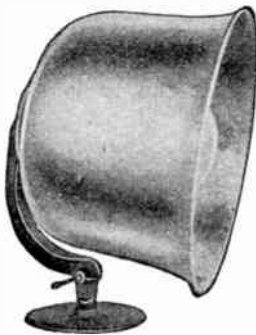

"MARINE MIDGET" P.M. SPEAKER

Inverted reflex design offers air column of 15" . . . which allows cone to operate with maximum efficiency. WX-5SP is ideal as a "talk-back" unit in call systems. Entirely storm-proof with speaker protected against mechanical damage. Constructed of heavy gauge metal finished in durable battleship gray enamel. Steel mounting bracket supplied. P.M. Speaker unit supplied has a power rating of 5 watts, v. c. imp. 3.5 ohms. Size of horn: Bell 10", Depth 8", weight 5 lbs.

MODEL WX-5SP HORN AND SPEAKER \$13.50 List

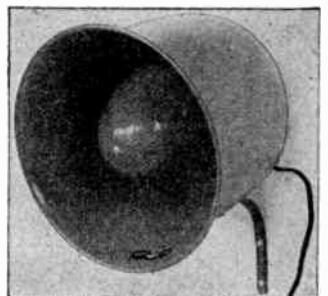

We reserve the right—during the present emergency—to change prices and mechanical specifications without notice.



ATLAS SOUND CORPORATION

"MUSIC BOX" Walnut Cabinets

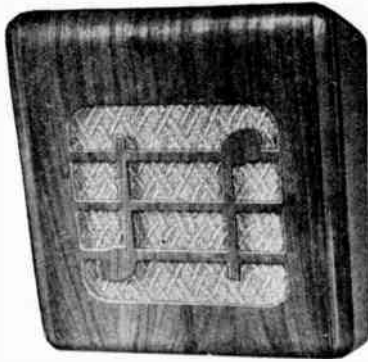

Attractive natural grain walnut cabinets with musical motif, and distinctive gold grille cloth. Sturdy glue-block construction.

- MODEL AE-8 FOR 8" SPEAKERS**—Dimensions: 12½" high, 11" wide, 7½" deep at top end. Weight 4 lbs. **\$6.25 LIST**
- MODEL AE-12 FOR 12" SPEAKERS**—Dimensions: 15½" high, 14" wide, 10" deep at top end. Weight 7½ lbs. **\$8.25 LIST**
- MODEL AE-15 FOR 15" SPEAKERS**—Dimensions: 20" high, 18" wide, 12" deep at top end. Weight 15 lbs. **\$11.75 LIST**

"PERI-CONIC" Triangular Cabinet

★For 12" Speaker

Triangular cabinet permits corner, side-wall mounting, and cluster arrangements. Bass reflex aids response of any 12" speaker. Sturdy cabinet of natural walnut, with gold grille cloth. Dimensions: overall height 19½", width 19", maximum depth 9", inside depth 7".



MODEL TR-12 ENCLOSURE..... \$13.00 LIST

"TWO-WAY" ENCLOSURE

★For 8" Speaker

Offers two-directional sound projection with the use of a single 8" speaker. Case is of pressed steel finished in gray enamel. Metal-cloth grille for both sides of the enclosure. Convenient adjustable mounting brackets. Speaker hardware supplied. Case diameter 10", depth 5". Wt. 4 lbs.

MODEL TW-8 ENCLOSURE..... \$7.00 LIST



SPEAKER POWER VOLUME CONTROL

MODEL RC-1 VOLUME CONTROL—Constant impedance control for use across voice coil of any speaker, providing uniform tapered, gradual control from full ON to OFF position. Includes special tapered wire wound potentiometer, fixed vitreous resistor for power absorption at minimum volume settings, etched indicator plate, and red molded bar knob

mounted on gun-metal finished steel case (Atlas CB Box). Diameter 3". **\$3.50 LIST**

MODEL CB "UTILITY" CONNECTOR AND CONTROL BOX—Identical to the one used for RC-1 Control. For switch mountings, connector plug-ins, microphone connection terminals, and other applications. Snap-buttons cover holes not in use; rubber grommet supplied. **\$1.00 LIST**

ATLAS "Velvet Action" Microphone Floor Stands

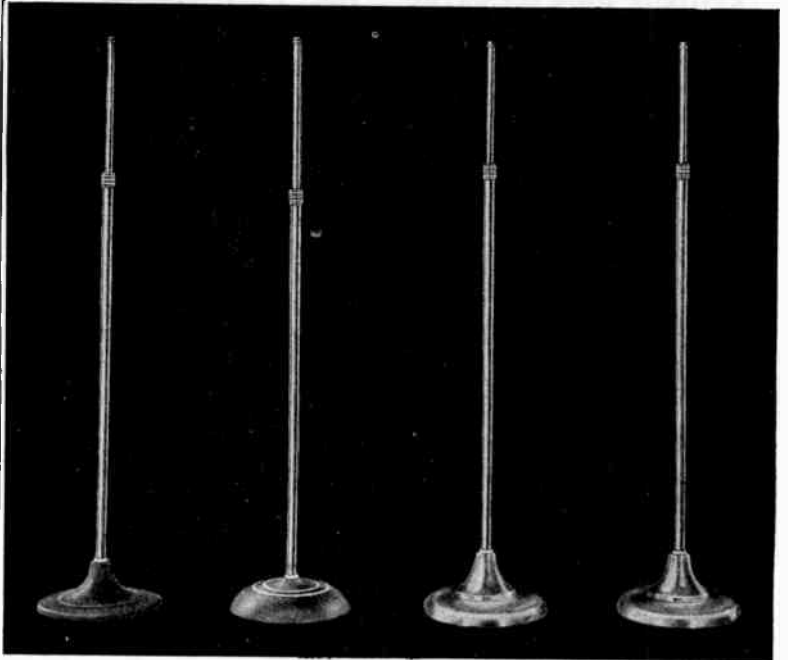

MS-8C

MS-9C

MS-11C and MS-12C

MS-18C

Velvet Action means no slipping . . . no scratching . . . no noise. Positive assurance against sudden dropping of the telescoping tube, and subsequent damage to the microphone. Telescoping sections are of heavy tubing with triple "super-chrome" plating. All models have a ¾" diameter outer tube, and a ½" inner tube. Microphone thread size is ⅝"-27 male. All bases furnished with rubber bumper pads to protect floor surfaces.

MODEL	BASE FINISH	BASE DIAMETER	ADJUSTMENT	WEIGHT	LIST PRICE
MS-8C	Black Crackle	10"	36 to 67"	8 lbs.	\$7.25
MS-9C	Gun-Metal, Red Rings	10½"	37 to 68"	9 lbs.	9.00
MS-11C	"Super-Chrome"	10½"	38 to 69"	11 lbs.	10.00
MS-12C	Gun-Metal Crackle	10½"	38 to 69"	11 lbs.	8.50
MS-18C	"Super-Chrome"	10½"	38 to 69"	18 lbs.	12.50
MS-10C*	Gun-Metal Crackle	16½"	38 to 69"	10 lbs.	9.50
MS-31C†	Gun-Metal, Red Rings	10½"	19 to 67"	9 lbs.	10.50

* MS-10C has a three-legged cast base † MS-31C has a "take-down" tube arrangement of three sections. Base is same as the MS-9C shown above.

"VELVET ACTION" DESK STANDS

Tubes on all stands finished in triple-plate "super-chrome." Bases available in chromium or black crackle finish. Adjustable models DS-3 and DS-4 use the exclusive "Velvet Action" friction clutch. All desk stands have a 6" base mounted on scratch-proof felt bumpers. The TS-5 is a special Banquet Stand using the ¾" and ½" telescoping tubes as used on the Atlas Floor Stands, and a base of 8". Standard ⅝"-27 male microphone thread on all models.



Model DS-3

MODEL	TYPE	HEIGHT	BASE	LIST PRICE
DS-1	Fixed	8"	Black Crackle	\$2.25
DS-2	Fixed	8"	Chromium	3.25
DS-3	Adjustable	10 to 15"	Chromium	4.50
DS-4	Adjustable	10 to 15"	Black Crackle	3.50
TS-5	Adjustable	18 to 32"	Gun Metal Crackle	6.50

"HOLD-TITE" SHIELDED CONNECTORS



F-1 Female Connector

Accommodates mike cable sizes up to 5/16" o. d. Constructed of solid brass machined parts, chrome-plated. Ingenious internal clamp for shield contact, spring extension for cable protection.

MODEL F-1 FEMALE CONNECTOR—Thread size: Female ⅝"-27, permitting use with Atlas and other standard connectors. **\$.55 LIST**

MODEL M-1 MALE CONNECTOR—Thread size: Male ⅝"-27, to fit F-1 and other female connectors. **\$.45 LIST**

MODEL P-1 PHONE PLUG—Thread size: Male ⅝"-27. Use with F-1 to make a handy combination connector. **\$.50 LIST**

MODEL C-1 CHASSIS CONNECTOR—Thread size: Male ⅝"-27. Practical terminal for input circuits. **\$.35 LIST**

We reserve the right—during the present emergency—to change prices and mechanical specifications without notice.

See and Hear
KAINER SOUND PROJECTORS

NEW KAINER "High Intensity" REFLEX TRUMPETS

Another Forward Step in Sound Projection! The same practical and unique construction that has been used so successfully in all KAINER Weatherproof and Reflex Horns is the basis of the new design of these Reflex Trumpets. Like all other KAINER Projectors, a special spun steel alloy is employed, assuring excellent acoustic properties, ruggedness and durability.

The mounting fixture supplied with both the R-T21 and R-T25 models is easily adjustable to all practical angles and is constructed of cast malleable iron with rust protective finish. The driver unit is directly attached to a cast section which is integral with the primary reflex tube and mounting fixture, insuring a rigid, permanently aligned assembly. The use of a casting which holds the secondary air column in place assures a perfect alignment of the air column and rigidity of the entire assembly.

These NEW Reflex Trumpets are beautifully finished with gray high lustre weatherproof baked-on art enamel which adds to the acoustic value and durability of the finish.

A moulded rubber rim attached to the beading on the edge of the bell is supplied as standard equipment, as illustrated. Both models are equipped with a threaded attachment 1 1/2 inches diameter by 18 thread to use KAINER P. M. Driver Units or any other standard driver units.

Permanent Magnet Driver Units—Manufactured to the highest of electrical and mechanical standards and of the finest available materials. Three models designed to take care of all public address work, rated at the same handling capacity in watts. The chief difference is in the increased efficiency in power output and in total range evident in the larger models. Diaphragms are breakdown proof at the rated capacity of 25 watts continuous operation and the unit is waterproof from all angles.

All units are equipped with 1 1/2" by 18 thread connection to fit either the R-T21 or the R-T25 Trumpet models.



Model No. DU-3
 Continuous Power Cap. .25 watts
 Freq. Response . . .55-6000 cycles
 Recommended Trumpet . . . R-T25
 Net Weight12 lbs.
 List Price \$66.00



Model No. DU-2
 Continuous Power Cap. .25 watts
 Freq. Response . . .60-5500 cycles
 Rec. Trumpets . . . R-T21 & R-T25
 Net Weight7 lbs.
 List Price \$53.00



Model No. DU-1
 Continuous Power Cap. .25 watts
 Freq. Response . . .70-5000 cycles
 Rec. Trumpets . . . R-T21 & R-T25
 Net Weight4 lbs.
 List Price \$33.00



Model R-T25
 Overall Length21"
 Bell Diameter25"
 Acoustic Length4' 10"
 Projection Angle90 degrees
 Ship. Wt. Approx. 20 lbs.
 List Price **\$37.00**

Model R-T21
 Overall Length18"
 Bell Diameter21"
 Acoustic Length4'
 Projection Angle80 degrees
 Ship. Wt. Approx. 16 lbs.
 List Price **\$23.00**



All Steel Exponential Sound Projector for 12" Speakers

Model J-12 all steel sound projector is the result of severe laboratory and field tests. It will accommodate all types of 12" speakers with or without matching transformers, including those with extra heavy permanent magnets.

Sturdily constructed of heavy spun steel alloy, it is light in weight yet strong enough to stand the abuse of heavy vibration under load as well as rough handling.

Breather opening is screened. Entire projector is beautifully finished with high lustre, baked-on, weatherproof art enamel. The malleable iron fixture to which the lower bracket can be attached is welded to the base and extends up the sides to include two of the speaker bolts which assures the minimum of vibration in the entire instrument.

The malleable iron base and bracket carries a tilting dog-toothed adjustment with a swivel and lock nut.

Model J-12
 Overall Length20"
 Circular Mouth Opening17"
 Flare Extension11"
 Shipping Weight16 lbs.
 J-12—Base only, includes fixture with 1/2" I. P. S. tapping **\$15.00**
 J-12-B—Adjustable bracket with base as illustrated **\$2.50**
 J-8-B—Mounting fixture, includes flange elbow and pipe connection **\$1.00**

All Steel Exponential Sound Projector for 8" Speakers

Model J-8 is specially designed to accommodate all types of 8" speakers and is very similar in construction to Model J-12 above.

The sturdy spun steel alloy construction is light in weight yet very strong. The baffle is spun in only two pieces, with the exclusive KAINER wedge fit feature which overcomes vibrations under extreme load.

Built with perforated breather opening. Both baffle and bracket are attractively finished with a new high lustre, weatherproof, baked-on art enamel.

The malleable iron fixture to which the lower bracket extension can be attached is firmly welded to the baffle, and is tapped so that any distance from the floor, wall or ceiling may easily be obtained by using 1/2" pipe, nipples, couplings, etc.

Bracket attachment furnished separately consists of flange base with length of pipe and elbow for either wall or upright mounting.

Model J-8
 Overall Length17"
 Circular Mouth Diameter14"
 Flare Extension9"
 Shipping Weight8 lbs.
 J-8—Baffle **\$12.25**
 List Price
 J-8—Mounting Fixture Only—List Price **\$1.00**



All Steel Exponential Sound Projector for 6" Speakers

Model J-6 is used extensively in parking lots, garages, small playgrounds, hallways, stock rooms, hotels, hospitals, warehouses and other places where call systems are needed. A perfect accessory to installations where 6" speakers must withstand all weather conditions and heavy service. Severe tests have proved that the Model J-6 Ba e produces clearer and more perfectly projected speech than when unprotected speakers or flat type speaker housings are used.

Has perforated breather opening. The shell is built to accommodate any 6" P.M. speaker with matching transformer.

Constructed of heavy spun steel alloy all parts attractively finished in the new high lustre, weatherproof, baked-on art enamel. The malleable iron fixture is welded to the baffle and tapped so that any distance off the wall or ceiling may be obtained by attaching required length of 1/2" pipe, nipples, couplings, etc., thus insuring a permanent and rigid installation.

Model J-6
 Overall Length9 1/2"
 Circular Mouth Opening10"
 Flare Extension5"
 Shipping Weight4 1/2 lbs.
 J-6—Baffle **\$7.50**
 List Price
 J-6-B—Mounting Fixture Only—List Price **\$1.00**

See and Hear

KAINER SOUND PROJECTORS

CHANDELIER BAFFLE

A late Kainer development in speaker baffles for uniform coverage. Eliminates areas of concentrated sound, tends to reduce feed back. This one baffle replaces multiple speaker installations when desirable and numerous wall baffles. Ideal for restaurants, clubs, cabarets and dance halls where the necessity of projecting sound close to the performers is important—recommended only for ceiling heights above 12 feet. Suspended from ceiling with link chain or sash cord—easy to install. Accommodates any heavy duty 12" P.M. Speaker.

CONSTRUCTION: Spun steel alloy finished in attractive grey baked enamel. SIZE: Diameter, 32"; height 17".

PRICE: Complete without speaker, List\$30.00



AIR COLUMN HORN Model A-C-8

Specially effective for all outdoor work: Baseball Parks, Circuses, Athletic Fields, and all installations where power and direction of sound are particularly required. ☐The A-C-8 Air Column Horn is well suited for applications where sound must be projected great distances and with the minimum of feedback. When using a microphone under conditions where ordinary baffles would be unsatisfactory, this horn with its uni-directional qualities will allow in most cases double or more power to be used before the feed back point is reached. ☐The back of this horn is completely closed, eliminating to the best possible extent, interference to person or persons using a microphone, and allowing the best possible placement of speakers either directly above and slightly forward of the microphone, or to the left or right of the microphone and slightly forward. Both of these positions eliminate bothersome "double talk" and "lag" which is objectionable to audiences. This method of placement gives the best illusion that the sound is coming directly from the person using the microphone. ☐The bracket attachment is welded to the horn, properly balanced, and mounting fixtures with base can be furnished as a complete unit, permitting exceptionally convenient means for installation. ☐THE KAINER AIR COLUMN HORN is constructed of heavy spun steel alloy, light in weight, yet very strong. All parts finished with durable baked art metal enamel. Designed* for 8" HEAVY DUTY Speaker—Bell Opening 24"—Overall Length 36".

Horn Complete with Mounting Fixture, but without Base and Adjustable AttachmentList \$34.80
Base and Fixture.....List \$3.00

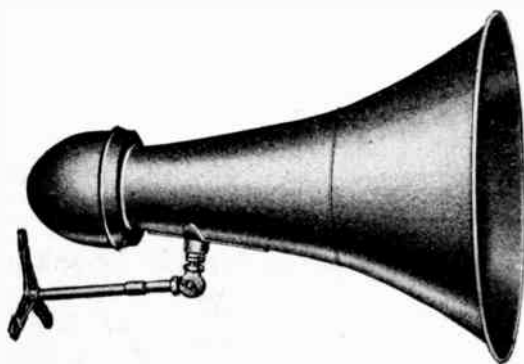

KAINER WEATHERPROOF HORNS

Model WH-5

FOR 5" SPEAKERS—COMPACT AND EFFICIENT

The inverted reflex design is similar to that used in the WH-6 and WH-8 models, which aids materially to the performance of any good cone speaker. ☐For all purpose use, including use as a microphone in Talk-Back installations—wide frequency range, good for both music and voice. ☐The very substantially constructed bell and reflex cone are of spun steel alloy, finished with grey baked art metal enamel. The bell and cone are mounted on an aluminum alloy casting to which the base fixture is also attached. This insures a rigid assembly and makes it convenient to install 5" cone speaker direct to the aluminum casting.

SPECIFICATIONS

Over All Length—8". Bell Opening—11". Ship. Wt. 5 1/2 lbs.
Horn complete with baseList \$10.



Model W-H-8

Constructed for all unsheltered outdoor and indoor use: Factories, Airports, Sound Trucks, Police and Fire Cars, Stadiums, etc., etc. ☐Exceptionally sturdy construction—Possible physical damage to the cone speaker is overcome due to its inverted position. The speaker faces the inside of the horn. ☐This construction will withstand exposure to rain, snow and wind. ☐The bell and housing are spun of heavy gauge steel alloy, light in weight, yet very strong; and all parts are heavily finished with a durable baked art metal enamel. ☐Bracket attachment is welded to the horn, properly balanced, and mounting fixture with base can be furnished as a complete unit, permitting exceptionally convenient means for installation on Sound Trucks, Wall, or Portable Use. ☐Designed for 8" HEAVY DUTY Speaker, Bell Opening 22 1/2". Overall Length 17 1/2"—Height from Base 27".

Horn Complete Without Base and Fixture.

List \$25.85

Base and FixtureList \$2.50



Model WH-6

Construction similar to Model WH-8 except size is for 6" speaker. ☐Used for all unsheltered outdoor and indoor installations, factories, airports, sound trucks, police and fire cars, stadiums, etc., etc. ☐The bell and speaker housing are of spun heavy gauge steel alloy, all parts finished with a durable art baked enamel. ☐Heavy aluminum casting firmly holds speaker. Mounting is attached to casting on which the speaker is mounted. ☐Very sturdy construction throughout. Designed for 6" Heavy Duty P.M. Speaker.

SPECIFICATIONS

Bell Opening—15". Over All Length 12".
Shipping Weight—11 lbs.

Horn complete with base and mounting fixtureList \$15.00

Cinaudagraph Speakers, inc.

REPLACEMENT SPEAKERS 2" TO 12"

Cinaudagraph Speakers offer the most complete range of speakers available, for replacement, small P. A. installation and inter-office communicators. Each speaker has the inherent Cinaudagraph quality.

PERMANENT MAGNET

Cat. No.	Model No.	Size	Norm. Watts	Peak Watts	U.C. Imp. Ohms	Ship. Wt.	List Price
22MP	RM2	2"	1	1 1/2	3-4	7 oz.	\$2.20
32MP	RM3	3"	1 1/2	2	3-4	8 oz.	2.35
30MP	RM3-1	3"	2	2 1/2	5	1 1/4 lbs.	3.30
42MP	RM4	4"	2	2 1/2	3-4	10 oz.	2.45
52MP	RM5	5"	2	2 1/2	3-4	12 oz.	2.55
50MP	RM5-12	5"	2 1/2	3	5	1 1/2 lbs.	3.30
60MP	RM6-4	6"	3 1/2	4	5	1 3/4 lbs.	3.80
8RMP	RM8-5	8"	4	5 1/2	6-8	2 lbs.	6.00
8EMP	RM8-6	8"	5	6	6-8	3 1/4 lbs.	6.00
12AMP	RM12-11	12"	8	10	6-8	5 1/2 lbs.	11.00

ELECTRO-DYNAMIC

Cat. No.	Model No.	Size	Trans.	Field Ohms	Output Cap.	V. Coil Imp.	Ship. Wt.	List Price
3W1	RE3-A	3"	None	450	2	4-5	10 oz.	\$ 2.20
3W2	RE3-B	3"	None	2750	2	4-5	10 oz.	2.35
4W1	RE4-A	4"	None	450	2	4-5	10 oz.	2.35
4W2	RE5-B	4"	None	2750	2	4-5	10 oz.	3.40
V51L	RE5-C	5"	S-43	1800T300	3	4-5	1 1/2 lbs.	3.40
V53L	RE5-A	5"	S-42	1000	3	4-5	1 1/2 lbs.	3.40
V54L	RE5-D	5"	S-251,6	450	3	4-5	1 1/2 lbs.	3.40
V55L	RE5-F	5"	S-41	6 Volt	3	4-5	4 1/2 lbs.	---

(5" series available less transformer—indicate by letter "L" after Cat. No.—deduct \$0.85 list)

J61	RE6-B	6"	Univ.	2750	5	5	3 lbs.	4.50
J62	RE6-C	6"	Univ.	1800T300	5	5	3 lbs.	4.50
J63	RE6-A	6"	Univ.	1000	5	5	3 lbs.	4.50
J64	RE6-F	6"	Univ.	6 Volt	5	5	3 lbs.	4.50

(6" series available less transformer—indicate by letter "L" after Cat. No.—deduct \$1.25 list)

J81	RE8-B	8"	Univ.	2500	6	6-8	4 lbs.	6.00
J82	RE8-C	8"	Univ.	1800T300	6	6-8	4 lbs.	6.00
J83	RE8-A	8"	Univ.	1000	6	6-8	4 lbs.	6.00
J84	RE8-D	8"	Univ.	6 Volt	6	6-8	4 lbs.	6.00

(8" series available less transformer—indicate by letter "L" after Cat. No.—deduct \$1.65 list)

10J1	RE10-B	10"	Univ.	2500	8	6-8	7 lbs.	9.25
10J2	RE10-C	10"	Univ.	1800T300	8	6-8	7 lbs.	9.25
10J3	RE10-A	10"	Univ.	1000	8	6-8	7 lbs.	9.25

(10" series available less transformer—indicate by letter "L" after Cat. No.—deduct \$1.65 list)

12U1	RE12-B	12"	Univ.	2500	10	6-8	8 lbs.	10.50
12U2	RE12-C	12"	Univ.	1800T300	10	6-8	8 lbs.	10.50
12U3	RE12-A	12"	Univ.	1000	10	6-8	8 lbs.	10.50

(12" series available less transformer—indicate by letter "L" after Cat. No.—deduct \$2.25 list)

TRANSFORMERS

Universal or Single Output and Line

Transformers are for general applications, and are arranged so that they can be mounted on the speaker. The Universal Transformers are tapped on the primary winding to provide matching impedances to the output tube or line as indicated. The Universal Output Transformers are center tapped and provide primary impedance terminations for the popular output tubes. The Universal Line Transformers are tapped to provide matching impedances of 500, 1000, 1500 ohms.

The transformers listed below have been especially designed for use with these speakers. They are highly efficient and provide the correct matching for maximum output efficiency. Model 1290 voice coil to grid transformer is enclosed in a metal shell.

Trans. No.	Type	Output Tube	Core Size	For Speakers	Load Imp. Ohms	List Price
21H25	Single	25L6	1 1/2" x 1 1/2"	{ 2"—3"—4"—5" }	2000	\$0.85
21F55	Single	25A7	1 1/2" x 1 1/2"	" " " "	4500	.85
12J75	Single	42	1 1/2" x 1 1/2"	" " " "	7000	.85
1290	V. C. to grid	*	1 1/2" x 1 1/2"	" " " "	Universal	1.25
U21	Universal	Line	1 1/2" x 1 1/2"	" " " "	500	.85
L21	500 ohm	Line	1 1/2" x 1 1/2"	" " " "	500-1000-1500-2000	1.25
UL21	Universal	Line	5/8" x 5/8"	(6"—8")	Universal	1.65
U85	Universal	Line	5/8" x 5/8"	(6"—8")	500	1.25
L85	500 ohm	Line	5/8" x 5/8"	(6"—8")	500-1000-1500-2000	1.65
UL85	Universal	Line	3/4" x 3/4"	(10"—12")	Universal	2.25
U43	Universal	Line	3/4" x 3/4"	(10"—12")	500	1.65
L43	500 ohm	Line	3/4" x 3/4"	(10"—12")	500-1000-1500-2000	2.25
UL43	Universal	Line	7/8" x 7/8"	(12")	Universal	3.00
U7	Universal	Line	7/8" x 7/8"	(12")	500	2.75
L87	500 ohm	Line	7/8" x 7/8"	(12")	500-1000-1500-2000	3.00
UL87	Universal	Line	1" x 1 1/4"	(13"—18")	Universal	4.00
U110	Universal	Line	1" x 1 1/4"	(13"—18")	500-1000-1500	4.00

*Universal output transformers for most output tubes—single, PP parallel or Class B.

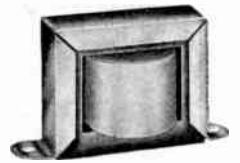

NOTE: THIS UNIT DISCONTINUED FOR THE DURATION.

Cinaudagraph Speakers, inc.

PUBLIC ADDRESS SPEAKERS AND AIR COLUMN UNITS

The ultimate in precision built, high quality reproducers for the largest or smallest installation.

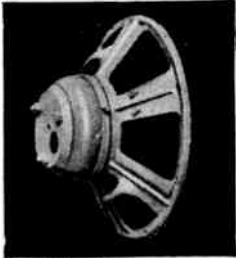

There is a Cinaudagraph speaker for every P.A. requirement from inter-communicating systems to stadium sound projection. All Electro-dynamics have bucking coils.

The speakers listed, with the exception of the 15" and 18", are provided with transformer mounting brackets so that transformers can be easily attached. The speakers, however, are supplied without transformers attached.



Cinaudagraph Air Column Sound Projectors differ from the conventional exponential horn unit. The high efficiency and broad frequency response of these cone type speakers overcome the various deficiencies and failures of the conventional dynamic units.

The air column speakers are made to withstand rigorous conditions imposed by weather and rough handling out-of-doors. The composition of the tough and pliant weather proof cone eliminates failures due to the crystallization of the flexing portions of the conventional brittle metal diaphragms.

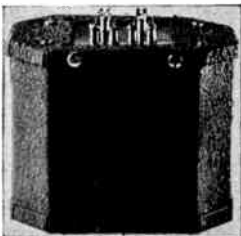

The wide range transformers are for use where the highest efficiency is required. These transformers are sealed in metal cases fully protected against moisture, but due to their design can not be mounted on the speaker.

PERMANENT MAGNET

Cat. No.	Model No.	Size	Norm. Watts	Peak Watts	Factor of Merit	Voice Coil Dia.	Ship. Wt. Lbs.	List Price
PM 8-9	EZ 8-7	8"	6	13	173	1"	5	\$ 8.25
PM 8-11	EZ 8-10	8"	8	15	216	1"	5 1/2	10.50
PM 10-12	NZ 10-10	10"	9	16	216	1"	7	12.50
PM 12-13	FZ 12-10	12"	10	18	216	1"	7 1/2	14.00
PM 12-16	FB 12-11	12"	13	21	334	1 1/4"	10	22.50
*PM 12-18	FY 12-12	12"	15	23	430	1 1/2"	12
*PM 13-21	DX 13-12	13"	21	29	556	2"	25
*PM 15-18	FY 15-12	15"	15	23	430	1 1/2"	20
*PM 15-28	FW 15-13	15"	25	33	754	2 1/2"	45
*PM 18-33	DU 18-12	18"	28	43	920	3 1/2"	64
MZ 6-10	Mallard	6" Marine Speaker					3 1/4"	14.50
*MZ 8-10	Mallard	8" Marine Speaker					3 3/4"

ELECTRO-DYNAMIC

Cat. No.	Model No.	Size	Norm. Watts	Peak Watts	Field Ohms	Field Volts	Voice Coil Dia.	Ship. Wt. Lbs.	List Price
PE 8-10A	EZE	8"	8	14	1000	90V. DC	1"	6	\$ 7.75
PE 8-10B	EZE	8"	8	14	2500	140V. DC	1"	6	7.75
PE 10-12A	NZE	10"	10	16	1000	100V. DC	1"	7	10.00
PE 10-12B	NZE	10"	10	16	2500	150V. DC	1"	7	10.00
PE 12-16A	FBE	12"	13	21	1000	110V. DC	1 1/4"	12	15.00
PE 12-16B	FBE	12"	13	21	2500	175V. DC	1 1/4"	12	15.00
PE 12-20A	FYE	12"	15	25	1000	110V. DC	1 1/2"	16	22.50
PE 12-20B	FYE	12"	15	25	2500	175V. DC	1 1/2"	16	22.50
*PE 15-35	FWE	15"	30	40	350	110V. DC	2 1/2"	50
*PE 18-40	DUE	8"	35	45	300	110V. DC	3 1/2"	75

Air Column Units and Accessories

For high power installations where maximum coverage is desired, Cinaudagraph Air Column Units are highly recommended.

COMPLETE ASSEMBLY—INCLUDES DRIVER UNIT, EXPONENTIAL HORN, HANDLE OR SUPPORTING BRACKET—(No Stand)

Cat. No.	Model No.	Peak Watts	Unit No.	Horn No.	Handle or Bracket No.	Ship. Wt. Lbs.	List Price
*CM 25K	FBAK	30	CM 25A	KA	U	33
*CM 30K	FYAK	35	CM 30	KA	U	35
*CM 40WH	HWAH	45	CM 40	SW	HA	52
*CM 60WS	SUAH	65	CM 60	SW	SA	63

Driver Units

Cat. No.	Model No.	Factor of Merit	Voice Coil Dia.	Norm. Watts	Peak Watts	Ship. Wt. Lbs.	List Price
*CM 25A	FBA	334	1 1/4"	20	30	8
*CM 30	FYA	430	1 1/2"	25	35	10
*CM 40	HWA	754	2 1/2"	35	45	30
*CM 60	SUA	920	3 1/2"	55	65	40

All of the above are supplied with 6-8 ohm voice coils.

Exponential Horns

Cat. No.	Bell Dia.	Over-all Length	Cut-off	Ship. Wt. Lbs.	List Price
*KA	24"	39" (including back cover)	150 cps.	25
*SW	32"	30" (from driver to bell opening)	150 cps.	23

Accessories

B-FS	Telescopic floor stand with heavy cast base—maximum height 8 ft., black crackle finish.....	33	\$17.50
T1	Line transformer fully encased; 1500 ohms tapped 1000-500 ohms. 40 watts, max.....	6	12.00
T2	Line transformer fully encased; 1500 ohms tapped 1000-500 ohms. 60 watts, max.....	10	15.00
U	Supporting stand for KA horn.....	4	4.50
SA	Handle and supporting bracket for CM 60WS.....	3	5.75
HA	Handle and supporting bracket for CM 40WH.....	3	4.50

WIDE RANGE TRANSFORMERS

Wide range transformers designed for use with these speakers assure maximum efficiency.

UNIVERSAL OUTPUT				UNIVERSAL LINE			
Cat. No.	Undistorted Peak Watts	List Price	For Speaker	Cat. No.	Undistorted Peak Watts	List Price	
WR 1	Up to 8	\$4.00	10" - 12"	WR 5	Up to 8	\$4.00	
WR 2	Up to 12	5.25	12" - 13"	WR 6	Up to 12	5.25	
WR 3	Up to 18	6.50	13" - 15"	WR 7	Up to 18	6.50	
WR 4	Up to 40	8.50	15" - 18"	WR 8	Up to 40	8.50	

*DISCONTINUED FOR DURATION

Cinaudagraph Speakers, inc.

DISCONTINUED FOR DURATION

LINEAR STANDARD SPEAKERS

CINAUDAGRAPH linear standard speakers represent the closest approach to the ideal from the viewpoint of uniform response, low wave form distortion, high efficiency and dependability. These speakers are used extensively for high fidelity service in broadcast monitoring, custom built radio sets, high quality PA, frequency modulation receivers, motion picture sound work, and wherever exacting requirements must be met.

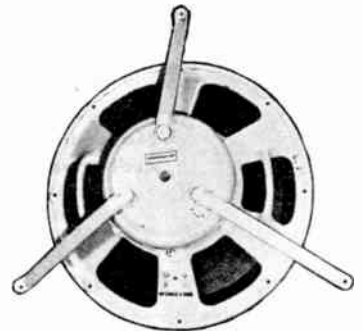

- **HIGH FIDELITY** — The unequalled high fidelity characteristics of the linear standard speakers are achieved through the use of special polyfibrous cones plus efficient magnetic structures.

- **LOW DISTORTION** — Both the electrical and mechanical elements of these speakers have been carefully related to effect a minimum of harmonic distortion combined with a high rate of decay, which overcomes the detrimental effects of "tails" and "hangovers."

PERMANENT MAGNET VOICE COIL IMPEDANCE 6-8 OHMS

Model	Size	Norm. Watts	Peak Watts	Factor of Merit	Voice Coil Dia.	Ship. Wt.	List Price
LM8-8	8"	6	10	216	1"	5½ lbs.
LM10-10	10"	8	13	216	1"	7 lbs.
LM12-13	12"	10	18	334	1½"	10 lbs.
LM12-15	12"	12	20	430	1½"	12 lbs.
LM13-23	13"	20	28	754	2½"	38 lbs.
LM15-25	15"	22	30	754	2½"	45 lbs.
LM18-30	18"	25	40	920	3½"	64 lbs.

ELECTRO-DYNAMIC VOICE COIL IMPEDANCE 6-8 OHMS

Model	Size	Norm. Watts	Peak Watts	Field Ohms	Field Volts	Voice Coil Size	Ship. Wt.	List Price
LE8-8	8"	6	10	1000	110V-DC	1"	7 lbs.
LE10-10	10"	8	13	1000	110V-DC	1"	8 lbs.
LE12-16	12"	13	21	600	110V-DC	1½"	17 lbs.
LE15-30	15"	25	35	350	110V-DC	2½"	50 lbs.
LA15-30	15"	25	35		110V-AC	2½"	60 lbs.

The speakers listed, with the exception of the 15" and 18", are provided with transformer mounting brackets so that transformers can be easily attached. The speakers, however, are supplied without transformers attached.

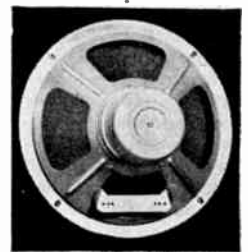

NOTE:—Due to the extreme high-fidelity response on the linear standard speakers it is important that the input or the output of the amplifying system should be free from all forms of distortion. If such a combination is not available then it is recommended that the public address series of speakers be used.

ALL PRICES SUBJECT TO CHANGE WITHOUT NOTICE

WRITE FOR COMPLETE CATALOG

Copyright by U. C. P., Inc.

D-45

Cinaudagraph Speakers, inc.

DISCONTINUED FOR DURATION

FM-12 CINAXIAL SPEAKER AND WOOFER - TWEETER SERIES

*The Ideal Speaker for FM, Broadcast Monitor,
Auditorium, or Other High Fidelity Service*

MODEL FM-12

● Frequency Response

The lows are propagated by a heavy 12-inch speaker capable of efficient response from 45 cps. to 2500 cps. with proper baffle. The higher frequencies are reproduced by the smaller unit which is designed to function efficiently from 2000 cps. to 15,000 cps.

● Power

There is a limit to which power can be applied without distortion. Much depends upon the perfection of the audio system. Under ideal conditions the Cinaxial unit will handle up to 15 watts easily. However, the very nature of FM requirements does not call for "Power"; rather, fidelity of tone at room level.



FM-12



CINAUDAGRAPH Permanent Magnet Woofer Speakers are specifically designed for low frequency service in woofer-tweeter combinations. In addition to excellent low frequency response, the design effects negligible cone break-up and minimum "hangover."

Model	Size	Undist. Norm. Watts	Peak Watts	Factor of Merit	Voice Coil Dia.	Ship. Wt.	List Price
FM-12	*12" † 5"	10	15 *Woofer	430	1½" †Tweeter	18 lbs.
WM12-15	12"	10	15	430	1½"	12 lbs.
WM13-23	13"	15	23	754	2½"	38 lbs.
WM15-25	15"	15	25	754	2½"	45 lbs.
WM18-30	18"	18	30	920	3½"	64 lbs.
LM5-15T	5"	10	15			
PM6-T	6"	5	7			
CN1500V — 1500-cycle cross over network to 6 to 8 ohm output.						
CN1500L — 1500-cycle cross over network to 500 ohm line.						



LM-5-15T—new high frequency permanent magnet tweeter fully enclosed, response—5dB, 1,500 to 17,000 cycles, for 15 watt combinations. For 20 to 30-watt woofer-tweeter combinations, two of these tweeters should be used.

● Network

It is essential that a correctly designed network be employed when using a two speaker system to allocate properly the frequencies to their respective speakers. The FM-12 Cinaxial system utilizes a cross over frequency of 1500 cps. which has been ascertained to be the most efficient point of change on this system. Networks may be purchased separately—see listing above.

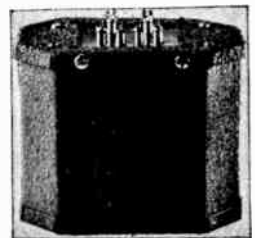

ALL PRICES SUBJECT TO CHANGE WITHOUT NOTICE

WRITE FOR COMPLETE CATALOG

Copyright by U. C. P., Inc.

REPRODUCERS

THE NEW BAFLEX REPRODUCER

Utah engineering and precision manufacturing score another triumph! Straight from the Utah laboratories, the latest refinements

in sound equipment construction and design have been combined to augment the broad and diversified Utah speaker line.



In the new Utah Baflex Reproducer, Utah engineering has incorporated all the latest developments and improvements of reproducers for public address systems, schools, colleges,

greatly improved bass response. They are especially adaptable for use with television and Frequency Modulation (FM) receivers, which require a wide audio frequency range. The frequency response has a range, up to approximately 9500 cycles per second.

taverns, dance halls, auditoriums, clubs, etc. They are available in four models.

The cabinets are of sturdy, extra-heavy construction, scientifically designed to eliminate cabinet vibration and resonance. The cabinet design is strikingly modern, with an attractive, durable satin bronze finish.

These new Utah Public Address Reproducers are marked by a total absence of "back radiation." There is no distortion in the

Stock Number	Cone Housing Diameter	Magnet Weight	Voice Coil Impedance	Voice Coil Diameter	Normal Wattage	Peak Wattage	Dimensions (Inches)	Shipping Weight	List Price	Net Price
M-820	8 Inch	20 oz.	8	1 Inch	10	15	11¼ x 17¾ x 24	38 lb.	\$32.00	\$19.20
Line Transformer No. 8749 for above reproducer.....								1 lb.	2.00	1.20
Universal Plate Transformer No. 8760 for above reproducer.....								1 lb.	2.00	1.20
M-831	8 Inch	31 oz.	8	1¼ Inch	12	18	11¼ x 17¾ x 24	40 lb.	36.50	21.90
Line Transformer No. 8752 for above reproducer.....								1½ lb.	2.60	1.56
Universal Plate Transformer No. 8762 for above reproducer.....								1½ lb.	2.60	1.56
M-123	12 Inch	46 oz.	8	1¼ Inch	17	26	12¾ x 22⅝ x 31	52 lb.	49.50	29.70
Line Transformer No. 8750 for above reproducer.....								1½ lb.	2.60	1.56
Universal Plate Transformer No. 8761 for above reproducer.....								1½ lb.	2.60	1.56
M-127	12 Inch	7 lb.	8	1½ Inch	22	33	12¾ x 22⅝ x 31	57 lb.	67.50	40.50
Line Transformer No. 8753 for above reproducer.....								2¼ lb.	3.15	1.89
Universal Plate Transformer No. 8764 for above reproducer.....								2¼ lb.	3.15	1.89

NOTE: 12-Inch Cabinet in Natural Walnut — \$10.00 additional list.

UTAH BAFLEX REPRODUCERS

Especially Designed for Frequency Modulation Reception

Stock Number	Cone Housing Diameter	Magnet Weight	Voice Coil Impedance	Voice Coil Diameter	Normal Wattage	Peak Wattage	Dimensions (Inches)	Shipping Weight	List Price	Net Price
FM- 820	8 Inch	20 oz.	8	1 Inch	10	15	11¼ x 17¾ x 24	38 lb.	\$33.00	\$19.80
FM-1220	12 Inch	20 oz.	8	1 Inch	13	20	12¾ x 22⅝ x 31	49 lb.	43.00	25.80
Line Transformer No. 8749 for above reproducer.....								1 lb.	2.00	1.20
Universal Plate Transformer No. 8760 for above reproducer.....								1 lb.	2.00	1.20

HIGH FIDELITY SPEAKERS

PERMO-DYNAMIC MODELS

Completely Dustproofed



E6P



F8P



F12P



H15P

Stock Number	Cone Housing Diameter	Magnet Weight	Voice Coil Impedance	Voice Coil Diameter	Normal Wattage	Peak Wattage	Shipping Weight	List Price	Net Price
E6P	6 Inch	7 Oz.	6-8	3/4 Inch	4.5	7	2 Lb.	\$ 5.25	\$ 3.15
Line Transformer No. 8746 for Above Speaker							3/4 Lb.	1.50	.90
Universal Plate Transformer No. 8759 for Above Speaker							3/4 Lb.	1.50	.90
F8P	8 Inch	12 Oz.	6-8	3/4 Inch	8	12	3 Lb.	8.50	5.10
Line Transformer No. 8747 for Above Speaker							3/4 Lb.	1.50	.90
Univ. Plate Transformer No. 8759 for Above Speaker							3/4 Lb.	1.50	.90
G8P	8 Inch	20 Oz.	6-8	1 Inch	10	15	4 1/2 Lb.	11.75	7.05
Line Transformer No. 8749 for Above Speaker							1 Lb.	2.00	1.20
Universal Plate Transformer No. 8760 for Above Speaker							1 Lb.	2.00	1.20
E10P	10 Inch	20 Oz.	6-8	1 Inch	11	17	5 1/4 Lb.	13.75	8.25
Line Transformer No. 8749 for Above Speaker							1 Lb.	2.00	1.20
Universal Plate Transformer No. 8760 for Above Speaker							1 Lb.	2.00	1.20
F10P	10 Inch	31 Oz.	6-8	1 1/4 Inch	14	21	7 Lb.	17.25	10.35
Line Transformer No. 8752 for Above Speaker							1 1/2 Lb.	2.60	1.56
Universal Plate Transformer No. 8762 for Above Speaker							1 1/2 Lb.	2.60	1.56
E12P	12 Inch	20 Oz.	6-8	1 Inch	13	20	6 1/2 Lb.	16.00	9.60
Line Transformer No. 8749 for Above Speaker							1 Lb.	2.00	1.20
Universal Plate Transformer No. 8760 for Above Speaker							1 Lb.	2.00	1.20
F12P	12 Inch	31 Oz.	8	1 1/4 Inch	16	24	8 1/2 Lb.	17.25	10.35
G12P	12 Inch	46 Oz.	8	1 1/4 Inch	17	26	9 3/4 Lb.	24.25	14.55
Line Transformer No. 8750 for Above Speakers							1 1/2 Lb.	2.60	1.56
Universal Plate Transformer No. 8761 for Above Speaker							1 1/2 Lb.	2.60	1.56
GS12P	12 Inch	4 Lb.	8	1 1/2 Inch	20	30	12 3/4 Lb.	34.75	20.85
H12P	12 Inch	7 Lb.	8	1 1/2 Inch	22	33	15 1/2 Lb.	43.00	25.80
Line Transformer No. 8753 for Above Speakers							2 1/4 Lb.	3.15	1.89
Universal Plate Transformer No. 8764 for Above Speakers							2 1/4 Lb.	3.15	1.89
GS15P	15 Inch	4 Lb.	8	1 1/2 Inch	22	33	15 1/2 Lb.	38.00	22.80
H15P	15 Inch	7 Lb.	8	1 1/2 Inch	24	36	18 3/4 Lb.	49.75	29.85
Line Transformer No. 8754 for Above Speakers							2 1/4 Lb.	3.15	1.89
Universal Plate Transformer No. 8765 for Above Speakers							2 1/4 Lb.	3.15	1.89

NOTE—All Line Transformers Tapped for 500—1000—1500—2000 Ohms.

UTAH FREQUENCY MODULATION SPEAKERS

Stock Number	Cone Housing Diameter	Magnet Weight	Voice Coil Impedance	Voice Coil Diameter	Normal Wattage	Peak Wattage	Shipping Weight	List Price	Net Price
FP-820	8 Inch	20 Oz.	8	1 Inch	10	15	4 1/4 Lb.	\$11.75	\$7.05
FP-1020	10 Inch	20 Oz.	8	1 Inch	11	17	5 1/4 Lb.	13.75	8.25
FP-1220	12 Inch	20 Oz.	8	1 Inch	13	20	6 1/4 Lb.	16.00	9.60
Line Transformer No. 8749 for above speakers							1 Lb.	2.00	1.20
Universal Plate Transformer No. 8760 for above speakers							1 Lb.	2.00	1.20

IMPORTANT INSTRUCTIONS For Ordering Replacement Cone and Voice Coil Assemblies

In ordering cone replacements, it is absolutely necessary to supply us with all the numbers stamped on the speaker. All speakers are stamped with three sets of numbers, and on many speakers, with the voice coil impedance. One number designates the date on which the speaker was made; one is our catalog stock number; and the third is our production number which gives us the complete specifications of the speaker.

When all the numbers are given on your order, we shall be able to supply the correct cone and voice coil assembly for the designated speaker. It is also helpful if you can inform us of the voice coil impedance and whether the spider is of the bakelite or corrugated paper construction. . . . REMEMBER, THE STOCK NUMBER OF THE SPEAKER DOES NOT GIVE US COMPLETE INFORMATION.

Utah

STANDARD FIDELITY SPEAKERS

PERMO-DYNAMIC MODELS

Completely Dustproofed



Stock Number	Cone Housing Diameter	Magnet Weight	Voice Coil Impedance	Voice Coil Diameter	Normal Wattage	Peak Wattage	Shipping Weight	List Price	Net Price
3P	3 1/2 Inch	5 Oz.	3-5	1/2 Inch	2.5	3.75	1 Lb.	\$3.75	\$2.25
3PY	3 1/2 Inch	1 1/2 Oz.	2.5	1/2 Inch	2.0	3.0	12 Oz.	2.50	1.50
3PZ	3 1/2 Inch	2 1/2 Oz.	2.5	1/2 Inch	2.0	3.0	13 Oz.	2.65	1.59
4PY	4 Inch	1 1/2 Oz.	2.5	1/2 Inch	2.5	3.75	13 Oz.	2.50	1.50
4PZ	4 Inch	2 1/2 Oz.	2.5	1/2 Inch	2.5	3.75	1 Lb.	3.00	1.80
5PY	5 Inch	1 1/2 Oz.	2.5	1/2 Inch	3.0	4.5	13 Oz.	2.65	1.59
5PZ	5 Inch	2 1/2 Oz.	2.5	1/2 Inch	3.0	4.5	1 Lb.	3.00	1.80
5P	5 Inch	5 Oz.	6	3/4 Inch	3	4.5	1 1/4 Lb.	3.85	2.31
Single Output Transformer No. 8770 (25L6-25L6G-25L6GT-25B6G-35L6GT-48, 2000 Ohm. Impedance) for Above Speakers							1/2 Lb.	1.05	.63
Single Output Transformer No. 8771 (6V6-6V6G-25A6-25A6G-25A7G-43-71A, 4000 Ohm. Impedance) for Above Speakers							1/2 Lb.	1.05	.63
Single Output Transformer No. 8772 (1C5G-1G5G-6A4-6F6-6G6-6K6GT-20-30-1H4G-31-33-38-89-112A-41-42, 10,000 Ohm. Impedance) for Above Speakers							1/2 Lb.	1.05	.63
Single Output Transformer No. 8773 (1A5G-1F4-1F5G-25,000 Ohm Impedance) for Above Speakers							1/2 Lb.	1.05	.63
6P	6 Inch	5 Oz.	6-8	3/4 Inch	4	6	1 1/4 Lb.	4.75	2.85
Line Transformer No. 8746 for Above Speaker							3/4 Lb.	1.50	.90
Universal Plate Transformer No. 8759 for Above Speaker							3/4 Lb.	1.50	.90
8P	8 Inch	5 Oz.	6-8	3/4 Inch	7	11	2 1/4 Lb.	5.75	3.45
8P	8 Inch	7 Oz.	6-8	3/4 Inch	7	11	2 1/4 Lb.	6.50	3.90
Line Transformer No. 8747 for Above Speakers							3/4 Lb.	1.50	.90
Universal Plate Transformer No. 8759 for Above Speakers							3/4 Lb.	1.50	.90
10P	10 Inch	12 Oz.	6-8	1 Inch	9	14	4 1/4 Lb.	9.25	5.55
12P	12 Inch	12 Oz.	6-8	1 Inch	10	15	5 1/4 Lb.	11.25	6.75
Line Transformer No. 8749 for Above Speakers							1 Lb.	2.00	1.20
Universal Plate Transformer No. 8760 for Above Speakers							1 Lb.	2.00	1.20

NOTE—All Line Transformers Tapped for 500—1000—1500—2000 Ohms.



THE NEW UTAH BI-DIRECTIONAL SPEAKERS

The Utah Bi-Directional Speaker embodying the latest speaker design and construction features, has been especially developed and engineered for factory call and paging systems.

Their sturdy construction and improved design

combined with their popular price make them ideal for factories, hotels, clubs, etc. The baffles are molded, non-metallic. There is no excessive low frequency response to distort intelligibility. A swivel joint bracket assures correct mounting.

Stock Number	Cone Housing Diameter	Magnet Weight	Voice Coil Impedance	Voice Coil Diameter	Normal Wattage	Peak Wattage	Dimensions (Inches)	Shipping Weight	List Price	Net Price
W-800	8 Inch	12 Oz.	6-8	3/4 Inch	8	12	9 1/2 x 5	6 1/4 Lb.	\$15.50	\$9.30
List Price Includes Line Transformer. 1 to 8 speakers can be connected across 250 or 500 Ohm line. Transformer tapped for 500—1000—1500—2000 Ohms.										
W-801	8 Inch	12 Oz.	6-8	3/4 Inch	8	12	9 1/2 x 5	6 1/4 Lb.	\$15.50	\$9.30
List Price Includes Line Transformer. 9 to 20 speakers can be connected across 250 or 500 Ohm line. Transformer tapped for 2500—3750—4000—4750 Ohms.										

UTAH WALL REPRODUCER

The new Utah Wall Reproducer is the effective solution for sound systems that require a reproducer for music as well as voice. Its low price makes it an economical one as well. The finish blends with any decorative scheme.

The tone quality has been immeasurably improved by the molded, non-metallic housing. Ideal coverage of a given area is assured because of the scientifically engineered angle of the new Utah Wall Reproducer.



Stock Number	Cone Housing Diameter	Magnet Weight	Voice Coil Impedance	Voice Coil Diameter	Normal Wattage	Peak Wattage	Dimensions (Inches)	Shipping Weight	List Price	Net Price
W-810	8 Inch	12 Oz.	6-8	3/4 Inch	8	12	13 x 11	4 Lb.	\$13.75	\$8.25
Line Transformer No. 8747 for above wall reproducer								3/4 Lb.	1.50	.90
Universal Plate Transformer No. 8759 for above wall reproducer								3/4 Lb.	1.50	.90

REPLACEMENT SPEAKERS

UTAH "Q" SERIES REPLACEMENT SPEAKERS

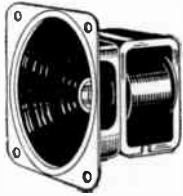

Stock Number	Cone Housing Diameter	Field Resistance (Ohms)	Voice Coil Diameter	Shipping Weight	List Price	Net Price
Q330	3 1/2 Inch	3000	1/2 Inch	1 Lb.	\$3.05	\$1.83
Q345	3 1/2 Inch	450	3/8 Inch	1 Lb.	3.05	1.83
Single 25L6 Output Transformer (2000 Ohm Impedance) No. 8757 for Above Speaker				1/2 Lb.	1.05	.63
Q-427	4 Inch	2750	1/2 Inch	1 1/2 Lb.	3.05	1.83
Q-445	4 Inch	450	1/2 Inch	1 1/2 Lb.	3.05	1.83
Q506	5 Inch	6	3/8 Inch	1 1/2 Lb.	3.05	1.83
Q510	5 Inch	1000	3/8 Inch	1 1/2 Lb.	3.05	1.83
Q518	5 Inch	1800 Tapped at 300	3/8 Inch	1 1/2 Lb.	3.05	1.83
Q530	5 Inch	3000 Tapped at 2500	3/8 Inch	1 1/2 Lb.	3.05	1.83
Q545	5 Inch	450	3/8 Inch	1 1/2 Lb.	3.05	1.83
Single Output Transformer No. 8770 (25L6-25L6G-25L6GT-25B6G-35L6GT-48, 2000 Ohm Impedance) for Above Speakers				1/2 Lb.	1.05	.63
Single Output Transformer No. 8771 (6V6-6V6G-25A6-25A6G-25A7G-43-71A, 4000 Ohm Impedance) for Above Speakers				1/2 Lb.	1.05	.63
Single Output Transformer No. 8772 (1C5G-1G5G-6A4-6F6-6G6G-6K6GT-20-30-1H4G-31-33-38-39-112A-41-42, 10,000 Ohm Impedance) for Above Speakers				1/2 Lb.	1.05	.63
Single Output Transformer No. 8773 (1A5G-1F4-1F5G, 25,000 Ohm Impedance) for Above Speakers				1/2 Lb.	1.05	.63
Shipping Weight of Above Transformers				1/2 Lb.		
NOTE —Special Triangular Mounting Bracket for Crosley Sets— Stock Number P7705 —List Price .25						
NOTE —Above Transformers available with Type D, Chassis style mounting at same prices.						

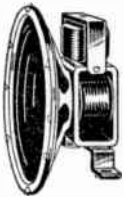

Stock Number	Cone Housing Diameter	Field Resistance (Ohms)	Voice Coil Diameter	Shipping Weight	List Price	Net Price
Q606	6 Inch	6	5/8 Inch	2 1/2 Lb.	\$4.70	\$2.82
Q610	6 Inch	1000	5/8 Inch	2 1/2 Lb.	4.70	2.82
Q618	6 Inch	1800 Tapped at 300	5/8 Inch	2 1/2 Lb.	4.70	2.82
Q620	6 Inch	2000	5/8 Inch	2 1/2 Lb.	4.70	2.82
Q625	6 Inch	2500	5/8 Inch	2 1/2 Lb.	4.70	2.82
Q810	8 Inch	1000	3/4 Inch	3 1/2 Lb.	6.05	3.63
Q818	8 Inch	1800 Tapped at 300	3/4 Inch	3 1/2 Lb.	6.05	3.63
Q820	8 Inch	2000	3/4 Inch	3 1/2 Lb.	6.05	3.63
Q825	8 Inch	2500	3/4 Inch	3 1/2 Lb.	6.05	3.63
Q1010	10 Inch	1000	1 Inch	5 1/2 Lb.	8.25	4.95
Q1015	10 Inch	1500	1 Inch	5 1/2 Lb.	8.25	4.95
Q1020	10 Inch	2000	1 Inch	5 1/2 Lb.	8.25	4.95
Q1025	10 Inch	2500	1 Inch	5 1/2 Lb.	8.25	4.95
Q1210	12 Inch	1000	1 Inch	6 1/2 Lb.	9.65	5.79
Q1215	12 Inch	1500	1 Inch	6 1/2 Lb.	9.65	5.79
Q1220	12 Inch	2000	1 Inch	6 1/2 Lb.	9.65	5.79
Q1225	12 Inch	2500	1 Inch	6 1/2 Lb.	9.65	5.79

NOTE—Universal Transformer—Standard Equipment on Above Speakers.

THE FAMOUS UTAH "R" SERIES REPLACEMENT DYNAMIC SPEAKERS

The "R" Series combines maximum performance at lowest possible cost. One size heavier wire used in the field gives higher flux density resulting in better efficiency and damping and purer tone quality. Bucking coil for "humless" performance used throughout the entire "R" series. Undoubtedly the best speaker value in the industry.



Stock Number	Cone Housing Diameter	Field Resistance (Ohms)	Voice Coil Diameter	Shipping Weight	List Price	Net Price
R345	3 1/2 Inch	450	5/8 Inch	1 Lb.	\$3.60	\$2.16
R506	5 Inch	6	3/8 Inch	1 1/2 Lb.	3.60	2.16
R510	5 Inch	1000	3/8 Inch	1 1/2 Lb.	3.60	2.16
R518	5 Inch	1800 Tapped at 300	3/8 Inch	1 1/2 Lb.	3.60	2.16
R530	5 Inch	3000 Tapped at 2500	3/8 Inch	1 1/2 Lb.	3.60	2.16
R545	5 Inch	450	3/8 Inch	1 1/2 Lb.	3.60	2.16
R606	6 Inch	6	5/8 Inch	2 1/2 Lb.	5.75	3.45
R610	6 Inch	1000	5/8 Inch	2 1/2 Lb.	5.75	3.45
R618	6 Inch	1800 Tapped at 300	5/8 Inch	2 1/2 Lb.	5.75	3.45
R620	6 Inch	2000	5/8 Inch	2 1/2 Lb.	5.75	3.45
R625	6 Inch	2500	5/8 Inch	2 1/2 Lb.	5.75	3.45
R810	8 Inch	1000	3/4 Inch	5 Lb.	6.85	4.11
R815	8 Inch	1500	3/4 Inch	5 Lb.	6.85	4.11
R818	8 Inch	1800 Tapped at 300	3/4 Inch	5 Lb.	6.85	4.11
R820	8 Inch	2000	3/4 Inch	5 Lb.	6.85	4.11
R825	8 Inch	2500	3/4 Inch	5 Lb.	6.85	4.11
R1010	10 Inch	1000	1 Inch	7 1/2 Lb.	10.25	6.15
R1015	10 Inch	1500	1 Inch	7 1/2 Lb.	10.25	6.15
R1020	10 Inch	2000	1 Inch	7 1/2 Lb.	10.25	6.15
R1025	10 Inch	2500	1 Inch	7 1/2 Lb.	10.25	6.15
R1210	12 Inch	1000	1 Inch	8 Lb.	11.85	7.11
R1215	12 Inch	1500	1 Inch	8 Lb.	11.85	7.11
R1220	12 Inch	2000	1 Inch	8 Lb.	11.85	7.11
R1225	12 Inch	2500	1 Inch	8 Lb.	11.85	7.11

NOTE—Universal Transformers Standard Equipment on Above Speakers except No. R345 (Voice Coil Impedance 3 1/2 Ohm.) **Single 25L6 Output Transformer (2000 Ohm Impedance) No. 8757 for No. R345**—List Price \$1.05, Net Price 63c. (Shipping Weight 1/2 Lb.)

Utah

SPEAKERS & TRUMPETS

NEW UTAH AC FIELD EXCITED SPEAKERS

Again Utah engineering brings you a solution for the current shortage of certain essential raw materials. A complete line of AC Field Excited Speakers humless in operation, and equivalent in performance to the famous Utah high fidelity Permo Dynamic line. A speaker for every public address and sound requirement. Require only the addition of the AC field supply shown below to substitute for any Permo Dynamic application. Standard Utah weather-resistant construction. Use Standard Utah output transformers.

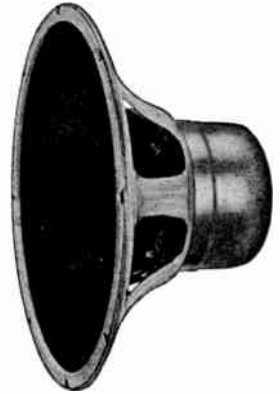

12 AC 20

Stock Number	Cone Diameter	Voice Coil Impedance	Voice Coil Diameter	Normal Wattage	Peak Wattage	List Price	NET PRICE
8 AC 30	8 Inch	6-8 Ohm	1 1/4"	12	18	\$ 8.75	\$ 5.25
10 AC 12	10 Inch	"	1"	9	14	6.00	3.60
12 AC 12	12 Inch	"	1"	10	15	7.00	4.20
12 AC 20	12 Inch	"	1"	13	20	9.00	5.40
12 AC 40	12 Inch	"	1 1/4"	16	24	11.25	6.75
12 AC 75	12 Inch	"	1 1/2"	21	32	17.50	10.50

NEW AC FIELD EXCITATION SUPPLY

AC field supply properly designed for humless operation of any of the above Speakers. At 117 volts, 60 cycle input, the maximum output is 12 watts at 105 mills. May be mounted directly in the speaker baffle. Use a separate supply for each speaker. Price less Rectifier tube but includes ballast and plug. No cord furnished. Requires 1—50 Y6 GT rectifier tube. Stock No. ACSFI—List Price \$4.75.....NET PRICE \$2.85

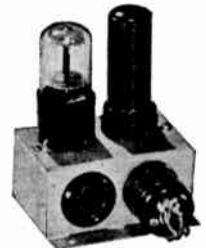

ACSFI

DRIVER REFLEX TRUMPETS

Three years of Utah research now gives you a new projector trumpet that will amaze you with its higher efficiency, its broader frequency response, its sturdier construction, its new beautiful finish. Available in 2 models, reflexed for compactness, fully weather proofed, and equipped with a sturdy ratchet lock mounting fixture that locks positively at any practical angle. In combination with the driver unit listed below, we invite you to compare Utah's projectors with any on the market. We know your reaction will be favorable.



24D

21D SPECIFICATIONS

Overall Length17 Inches
 Bell Diameter21 Inches
 Projection Angle90 Degrees
 Shipping Weight16 Lbs
 Driver unit attachment tapped for 1 3/8 x 18 "standard".
 Mounting Fixture tapped for 1/2 inch I.P.S.
 High Lustre Baked-on Art Enamel.
 Exponential length4 Feet
 List Price, Less Unit\$24.50
NET PRICE\$14.70

25D SPECIFICATIONS

Overall Length20 Inches
 Bell Diameter25 Inches
 Projection Angle90 Degrees
 Shipping Weight20 Lbs
 Driver unit attachment tapped for 1 3/8 x 18 "standard".
 Mounting Fixture tapped for 1/2 inch I.P.S.
 High Lustre Baked-on Art Enamel.
 Exponential length4 Feet 10 Inches
 List Price, Less Unit\$34.50
NET PRICE\$20.70

TRUMPET DRIVER UNIT ONLY

Utah's new driver unit in combination with the Utah projectors shown above offers power, efficiency and a frequency band coverage you never expected to be able to secure in a trumpet before. See it now—at your Utah Jobber. 25 Watt rating, dust proof, weather proof and fool proof. 16 ohm voice coil.

List Price \$42.50.....NET PRICE \$25.50



Driver

Thank You!

When writing for additional
information or when ordering
from sources of supply listed
in this book, please mention

RADIO'S MASTER

QUAM

SPEAKERS

with Interchangeable Transformers

QUAM Senior ELECTRO-DYNAMICS

The problems of service engineers became the problems of our engineers when planning the QUAM line of replacement speakers. Every possible situation that might confront the engineer in the field was taken into consideration. We sincerely believe that our success in solving these problems is indicated by a study of the various features that make the line distinctive. The field coils of QUAM Senior Electro Dy-

amic speakers are enclosed in Fire Underwriter's Approved metal shields. This provides weather proofing and protection from mechanical injury. Universal mounting brackets are supplied with the 4", 5", 5½" and 6½" speakers. The field coil pots are drilled and tapped for mounting direct to the chassis, or on a bracket. Each speaker may be installed with minimum effort.

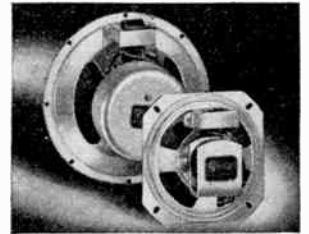

MODEL 40S 4" Standard List \$2.85
Rating 3.5 watts. Dustproofed. 10" leads. Dimensions: Dia., 4½"
Square basket; Mtg. Dia., 4¼"; Depth, 2¼". Ship. Wgt., ¾ lbs.
MODEL 40SM—Same as 40S EXCEPT depth 2½".

MODEL 50S 5" Standard List \$2.95
Rating 3.5 watts. Dustproofed. 10" leads. Dimensions: Dia., 5"
Round basket; Mtg. Dia., 4¼"; Depth, 2½". Ship. Wgt., 2 lbs.

MODEL 55S 5½" Standard List \$3.30
Rating 4.5 watts. Dustproofed. 10" leads. Dimensions: Dia., 5½"
Square basket; Mtg. Dia., 6½"; Depth, 2¾". Ship. Wgt., 2½ lbs.

MODEL 65M 6½" Modified List \$3.45
Rating 4.5 watts. Dustproofed. 12" leads. Dimensions: Dia., 6½"
Round basket; Mtg. Dia., 6½"; Depth, 2¼". Ship. Wgt., 2½ lbs.

Field resistances are indicated by part numbers. Be sure to specify part numbers and model numbers when ordering.

Field	Models 40S	40SM	50S	55S	65M	65S	80M	80S	120S
3000 Ohms	43038	43038M	53038	553038	6M3038	63037	8M2536	82535	122535
2500 Ohms	42537	42537M	52537	552537	6M2537	62536	8M1836	81834	121533
1800 Ohms	41836	41836M	51836	551836	6M1836	61835	8M1034	81033	121032
1500 Ohms							8M4532*		
1000 Ohms	41035	41035M	51035	551035	6M1035	61034	8M622	8621	
450 Ohms*	44533*	44533M*	54533*	554533*	6M4533*	64532*			
6 Volt	4624	4624M	5623	55623	6M623	6622			

*Bucking Coil included.

Voice coil impedances on above speakers 4 ohms at 400 cycles. Transformer mounting brackets included on all speakers. List prices do not include transformers. See reverse side for matching transformers.

QUAM Senior P. M. DYNAMICS

Service and sound engineers have adopted QUAM Senior P. M. Dynamics as their standard. These units are designed to fill the demand for speakers with unusual power handling capacity. They have excellent frequency response characteristics. The arc welded construction used insures permanent alignment of integral parts. QUAM

Senior P. M. Dynamics are suited for a wide range of installations such as AC and AC-DC sets, automobile sets and battery portables, home sets, public address systems, inter-office communication systems, and as auxiliary speakers. They do not require current for field excitation.

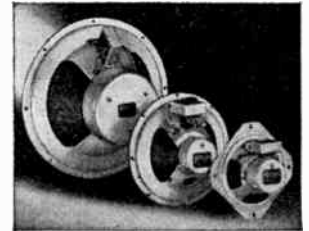

MODEL 40PM 4" 5 oz. Magnet List \$3.80
Rating 3.5 watts. Completely dustproofed. Dimensions: Dia., 4½"
Square basket; Mtg. Dia., 4¼"; Depth, 2¼". Ship. Wgt., 2½ lbs.

MODEL 50PM 5" 5 oz. Magnet List \$3.90
Rating 3.5 watts. Completely dustproofed. Dimensions: Dia., 5"
Round basket; Mtg. Dia., 4¼"; Depth, 2½". Ship. Wgt., 2½ lbs.

MODEL 55PM 5½" 8 oz. Magnet List \$4.90
Rating 4.5 watts. Completely dustproofed. Dimensions: Dia., 5½"
Square basket; Mounting Dia., 6½"; Depth, 2¾". Ship. Wgt. 2½ lbs.

MODEL 65PM 6½" 8 oz. Magnet List \$5.00
Rating 5.5 watts. Completely dustproofed. Dimensions: Dia., 6½"
Round basket; Mounting Dia., 6½"; Depth, 2¾". Ship. Wgt. 2½ lbs.

MODEL 80PM 8" 8 oz. Magnet List \$5.80
Rating 7 watts. Completely dustproofed. Dimensions: Dia., 8"
Round basket; Mtg. Dia., 7¼"; Depth, 3¼". Ship. Wgt., 3 lbs.

Voice coil impedances on 120 PM, M120PM, D80PM and S80PM, 6 ohms at 400 cycles. All other speakers shown above have 4 ohm voice coil impedance at 400 cycles. Transformer mounting brackets included on all speakers. List prices do not include transformers. See reverse side for matching transformers.

MODEL S80PM 8" 28 oz. Magnet List \$12.50
Rating 10 watts. Pot cover. Completely dustproofed. Dimensions: Dia., 8" Round basket; Mounting Dia., 7¼"; Depth 3¼". Ship. Wgt. 5¾ lbs.

MODEL D80PM 8" 48 oz. Magnet List \$18.20
Rating 15 watts. Pot cover. Completely dustproofed. Dia., 8" Round basket; Mtg. Dia., 7¼"; Depth, 4½". Ship. Wgt., 7½ lbs.

MODEL M120PM 12" 28 oz. Magnet List \$14.05
Rating 15 watts. Pot cover. Completely dustproofed. Dia., 12" Round basket; Mtg. Dia., 11¾"; Depth, 5¾". Ship. Wgt. 7 lbs.

MODEL 120PM 12" 48 oz. Magnet List \$19.75
Rating 25 watts. Pot cover. Completely dustproofed. Dia., 12" Round basket; Mtg. Dia., 11¾"; Depth, 5¼". Ship. Wgt. 8½ lbs.

QUAM Permanic SPEAKERS

MODEL 40 4" Permanic List \$2.70

10" leads. Dimensions: Dia., 4½"
Square basket; Mounting Dia., 4¼"; Depth, 2½". Ship. Wgt. ¾ lb.

MODEL	TUBE IMPEDANCE
40L	Low
40M	Medium
40H	High
40C	500 ohm line

MODEL 50 5" Permanic List \$2.75

10" leads. Dimensions: Dia., 5"
Round basket; Mounting Dia., 4¼"; Depth, 2¾". Ship. Wgt. 1 lb.

MODEL	TUBE IMPEDANCE
50L	Low
50M	Medium
50H	High
50C	500 ohm line

MODEL 65 6½" Permanic List \$3.10

10" leads. Dimensions: Dia., 6½"
Round basket; Mounting Dia., 6½"; Depth, 2¼". Ship. Wgt. 1½ lbs.

MODEL	TUBE IMPEDANCE
65L	Low
65M	Medium
65H	High
65C	500 ohm line

Check this listing of tube impedances for correct selections

LOW IMPEDANCE TUBES (Order 40L, 50L or 65L)

Types 48 and 43 in push-pull, single types 43, 45, 59, 71A, 12A5, 25L6, 32L7, 50L6, 25B5 and for any type of output tube in single or push-pull having a total primary load impedance of 2000 to 6000 ohms.

MEDIUM IMPEDANCE TUBES (Order 40M, 50M or 65M)

Types 43, 45, 71A in push-pull and single types 10, 12A, 18, 19, 20, 31, 33, 38, 41, 42, 43, 46, 47, 49, 59, 89, 2A5, 6A4, 6A6, 12A5, LA, GA, PZ, 1C5, 1Q5, 6K6, 6F6, 6C6 and for any type of output tube in single or push-pull having a total primary load imp. of 6000 to 12,000 ohms.

HIGH IMPEDANCE TUBES (Order 40H, 50H or 65H)

Types 10, 12A, 18, 19, 20, 31, 33, 38, 41, 42, 46, 47, 79, 59, 89, 2A5, 6A4, LA, 6A6. in push-pull and single types 38, 49, 12A7, 1A5, and for any type of output tube in single or push-pull having a total primary load impedance of 12,000 to 25,000 ohms.

QUAM

SPEAKERS

with *Interchangeable* Transformers

QUAM Junior Electro-Dynamics

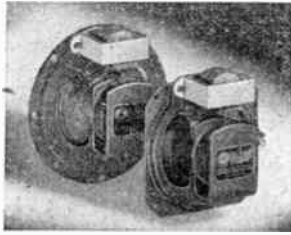

The demand for lower priced replacement speakers carrying the full guarantee of the manufacturer resulted in the QUAM JUNIOR Replacement Line. These speakers are constructed of quality materials and give excellent performance characteristics. The finish is baked brown enamel.

MODEL 40J 4" Junior List \$2.35
Rating 2.5 watts. 10" leads. Dimensions: Dia., 4 $\frac{1}{2}$ " Square basket; Mounting Dia., 4 $\frac{1}{4}$ "; Depth, 1 $\frac{3}{8}$ ". Ship. Wgt. 1 $\frac{1}{2}$ lbs.

MODEL 50J 5" Junior List \$2.45
Rating 2.5 watts. 10" leads. Dimensions: Dia., 5" Round basket; Mounting Dia., 4 $\frac{1}{4}$ "; Depth, 2 $\frac{1}{2}$ ". Ship. Wgt. 2 lbs.

MODEL 65J 6 $\frac{1}{2}$ " Junior List \$3.00
Rating 3.5 watts. 12" leads. Dimensions: Dia., 6 $\frac{1}{2}$ " Round basket; Mounting Dia., 6 $\frac{1}{4}$ "; Depth, 2 $\frac{3}{8}$ ". Ship. Wgt. 2 $\frac{1}{2}$ lbs.

MODEL 80J 8" Junior List \$4.00
Rating 4 watts. 15" leads. Dimensions: Dia., 8" Round basket; Mounting Dia., 7 $\frac{1}{4}$ "; Depth, 3 $\frac{1}{2}$ ". Ship. Wgt. 2 $\frac{1}{2}$ lbs.

Field resistances are indicated by part numbers. Be sure to specify part numbers and model numbers when ordering.

Field	40J	Model Number	50J	65J	80J
3000 Ohms	4JD30	5JD30	6JD30	8JD30	
2500 Ohms	4JD25	5JD25	6JD25	8JD25	
1800 Ohms	4JD18	5JD18	6JD18	8JD18	
1000 Ohms	4JD10	5JD10	6JD10	8JD10	
450 Ohms*	4JD45*	5JD45*	6JD45*	8JD45*	
6 Volt†	4JD4†	5JD4†	6JD4†	8JD4†	

*Bucking Coil included. †Dustproofed. Voice coil impedances on above speakers 4 ohms at 400 cycles. Transformer mounting brackets included on all speakers. List prices do not include transformers. See column at right for matching transformers.

QUAM Cabinet SPEAKERS



Suitable for table or wall mounting. Scientifically designed and constructed of seasoned hardwood throughout to provide clear, wide range reproduction. Cabinets are not sold separately.

To arrive at complete unit price, add list price of cabinet to list price of speaker. Any 12" QUAM speaker can be ordered installed in the 120 cabinet and any 8" QUAM speaker in the 80 cabinet.

SPEAKER CABINET 120 List \$10.95
Cabinet Only. For 12" speaker. Not sold separately. Dimensions: Height 15", Width 14", Depth at Base 9 $\frac{1}{2}$ ", at Top, 5". Ship. Wgt. 9 lbs.

SPEAKER CABINET 80 List \$5.50
Cabinet Only. For 8" speaker. Not sold separately. Dimensions: Height, 11 $\frac{1}{2}$ "; Width, 11 $\frac{1}{2}$ "; Depth at Base, 5"; at Top, 3". Ship. Wgt. 4 lbs.

QUAM Junior P. M. Dynamics

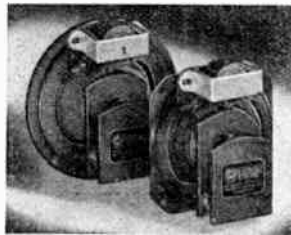

Well designed and built. Performance characteristics are excellent. Made in various sizes and specifications for table models, consoles, automobile sets, battery portables and inter-communication systems. The finish is baked brown enamel.

MODEL 4JP2 4" List \$2.45
Rating 1.5 watts. L.F.S. dustproofing. Dimensions: Dia. 4 $\frac{3}{8}$ " Square basket; Mounting Dia., 4 $\frac{1}{4}$ "; Depth, 1 $\frac{3}{8}$ ". Ship. Wgt. 1 $\frac{1}{4}$ lbs. 2 oz. Magnet.

MODEL 4JP4 4" List \$3.05
Rating 2.5 watts. L.F.S. dustproofing. Dimensions: Dia., 4 $\frac{3}{8}$ " Square basket; Mounting Dia., 4 $\frac{1}{4}$ "; Depth, 1 $\frac{3}{8}$ ". Ship. Wgt. 1 $\frac{1}{2}$ lbs. 4 oz. Magnet.

MODEL 5JP2 5" List \$2.55
Rating 1.5 watts. L.F.S. dustproofing. Dimensions: Dia., 5" Round basket; Mounting Dia., 4 $\frac{1}{4}$ "; Depth, 2 $\frac{1}{4}$ ". Ship. Wgt. 1 $\frac{1}{2}$ lbs. 2 oz. Magnet.

MODEL 5JP4 5" List \$3.15
Rating 2.5 watts. L.F.S. dustproofing. Dimensions: Dia., 5" Round basket; Mounting Dia., 4 $\frac{1}{4}$ "; Depth, 2 $\frac{1}{4}$ ". Ship. Wgt. 1 $\frac{1}{2}$ lbs. 4 oz. Magnet.

MODEL 6JP4 6 $\frac{1}{2}$ " List \$3.35
Rating 2.5 watts. L.F.S. dustproofing. Dimensions: Dia., 6 $\frac{1}{2}$ " Round basket; Mounting Dia., 6 $\frac{1}{4}$ "; Depth, 2 $\frac{3}{8}$ ". Ship. Wgt. 2 $\frac{1}{4}$ lbs. 4 oz. Magnet.

MODEL 8JP5 8" List \$4.50
Rating 3.5 watts. L.F.S. dustproofing. Dimensions: Dia., 8" Round basket; Mounting Dia., 7 $\frac{1}{4}$ "; Depth, 3 $\frac{1}{2}$ ". Ship. Wgt. 2 $\frac{1}{2}$ lbs. 5 oz. Magnet.

MODEL 8JP7 8" List \$5.25
Rating 6 watts. L.F.S. dustproofing. Dimensions: Dia., 8" Round basket; Mounting Dia., 7 $\frac{1}{4}$ "; Depth, 3 $\frac{1}{2}$ ". Ship. Wgt. 2 $\frac{3}{4}$ lbs. 7 oz. Magnet.

Voice coil impedances on above speakers 4 ohms at 400 cycles. Transformer mounting brackets included on all speakers. List prices do not include transformers. See column at right for matching transformers.

QUAM Permanic Microphones

A truly sensational microphone that requires no batteries or transformer. Compares favorably with a crystal microphone and yet it costs only about one-third as much! Frequency range of 60 to 8000 cycles with an output level of — 50 DB. Connects directly to the grid of the amplifier tube in any radio set. Finds many uses for home broadcasting, sales meetings, call systems, truck ballyhoos, amateur radio use, and wherever a low priced, sturdy microphone is needed. Also used in conjunction with wireless record players. Available in brown or black crackle finish. (Brown furnished unless black is specified.)

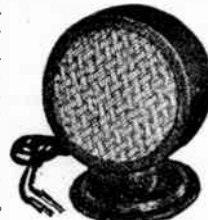

5' cord and pin tip connectors..... List \$3.80
5' shielded cable and pin tip connectors..... List \$4.10
With 20' cord, not shielded..... List \$4.40
Dimensions: Height, 5 $\frac{1}{2}$ "; Width, 4 $\frac{1}{4}$ "; Base Diameter 3 $\frac{1}{2}$ ". Ship. Wgt. 1 $\frac{1}{2}$ lbs.

Select Matching Transformers from this list

One of the greatest contributions to servicing is the interchangeable transformer. This feature, pioneered by QUAM, continues to meet with universal enthusiasm. Prior to the inception of this feature, engineers in the field had to be content with transformers having various matches which were not only inefficient, but costly, or wait for factory delivery of proper transformers. The transformer with correct matching impedance renders greater value in truer tone at less cost. All QUAM replacement transformers are manufactured from quality materials and are made impervious to climatic conditions by vacuum wax impregnation.

Models 40S, 40SM, 50S, 55S, 65M, 40PM, 50PM, 55PM, 40J, 50J, 65J, 4JP2, 4JP4, 5JP2, 5JP4, 6JP4

No.	Impedance	Size — $\frac{1}{2}$ x $\frac{1}{2}$ Tube
T-773	2000 ohm	25B5, 25L6, etc.
T-704	4000 ohm	25A7, 43, etc.
T-706	7000 ohm	2A5, 42, 6F6, 47
T-717	10000 ohm	41, 89, etc.

LIST PRICE — EACH.....\$0.85
Model 65S, 80M, 65PM, 80PM, 80J, 8JP5, 8JP7

No.	Impedance	Size — $\frac{1}{2}$ x $\frac{3}{8}$ Tube
T-766	16000 ohm	1T5
T-774	2000 ohm	25B5, 25L6, etc.
T-543	4000 ohm	25A7, 43, etc.
T-548	7000 ohm	2A5, 42, 6F6, 47
T-557	10000 ohm	89, 41, etc.
T-733	10000 ohm	P.P., 6F6, 19, etc.

(plate to plate)
T-747 500 and 1000 ohm line
T-992 25000 ohm 1A5G
LIST PRICE — EACH.....\$0.95
Transformers listed above can be furnished with metal shells. Add 10c to list price.
Size — $\frac{1}{2}$ x $\frac{3}{8}$
T-752 Universal (all tubes) List \$1.35

Models 80S, 80PM

No.	Impedance	Size — $\frac{5}{8}$ x $\frac{3}{8}$ Tube
T-813	16000 ohm	1T52
T-771	2000 ohm	25B5, 25L6, etc.
T-767	4000 ohm	43, etc.
T-718	7000 ohm	42, 6F6, etc.
T-797	10000 ohm	41, etc.
T-1009	25000 ohm	1A5G

LIST PRICE — EACH.....\$1.20
T-743 14000 ohm P.P., 42, 6F6, etc.
(plate to plate)
T-798 8000 ohm P.P., 43
(plate to plate)
T-744 500 and 1000 ohm line
T-745 10000 ohm 19, P.P., 41, 6F6, etc.
(plate to plate)

LIST PRICE — EACH.....\$1.35
T-751 Universal.....All Tubes List \$1.75

Models 120S, 80PM, D80PM, M120PM, 120PM

No.	Impedance	Size — $\frac{3}{4}$ x $\frac{3}{4}$ Tube
T-799	2500 ohm	2A3-45, etc.
T-559	4000 ohm	6L6, 6V6, etc.
T-740	7000 ohm	42, 2A5, etc.
T-546	10000 ohm	41, 49, etc.

LIST PRICE — EACH.....\$1.50
T-741 14000 ohm P.P., 42, etc.
(plate to plate)
T-749 10000 ohm P.P., 41, etc.
(plate to plate)
T-748 5000 ohm P.P., 2A3, 45, 6L6, etc.
(plate to plate)
T-742 500 and 1000 ohm line
LIST PRICE — EACH.....\$1.75
T-750 Universal.....All tubes List \$2.10

**HIGH EFFICIENCY
REFLEX SPEAKERS**



**HIGH POWER
DRIVER UNITS**

HIGH EFFICIENCY REFLEXED LOUSPEAKERS

The invention and development of University Reflexed Loudspeakers constitute one of the few really important additions to the art of acoustic reproducers in recent years.

It represents a fusing together of the basic scientific instrument for the high efficiency reproduction of sound, with the modern streamline concepts in engineering design.

A few of the important features of University Reflexed loudspeakers are listed below:

- Absolutely Non-Resonant under all conditions.
- Efficient enough to cut amplifier cost in half.
- 25 watts power rating cuts down number of speakers
- High acoustic output overcomes worst background noise
- Totally waterproof under all climatic conditions.
- Uniform frequency response eliminates "microphonics".
- Unbreakable diaphragm increases life of installation.
- Razor sharp clarity on voice reproduction.

All University Reflexed loudspeakers include the following as standard equipment:

- Non-Resonant acoustic rubber rims to eliminate resonance.
- Universal U bracket for a quick permanent mounting.
- Dust covers for driver units (only with PAH or PLH units).

Although outwardly of the appearance of cone speaker projectors, the University Reflexed Projectors are of the high efficiency exponential air-column type.

It is a well known fact that the driver unit-exponential horn loudspeaker possesses the highest possible acoustic efficiency, a correctly designed combination having up to 50% electro-acoustic conversion efficiency at speech frequencies. Compare this with the usual 10-15% for cone speakers with projectors.

University Reflexed loudspeakers therefore have the following advantages due to high efficiency:

- Less amplifier power for given coverage.
- Double the acoustic power with the same amplifier.

Great annoyance in sound installations is caused by acoustic feedback, otherwise known as "microphone howl" or "singing".

Resonance peaks in the speaker feed back acoustically to the microphone, forcing the system into a state of continuous oscillation or "singing" even at low reinforcement sound levels.

University speakers eliminate this in three ways.

- Absolutely Non-Resonant.
- Uniform frequency response at high power levels.
- No "Rear" sound projection to feed back to microphone.

Reinforcement sound levels that reproduce speech clearly through the worst type of background noise are therefore obtained without any "microphonics".

HIGH POWER PERMANENT MAGNET DRIVER UNITS

Model	MD8	SAH	PAH	PLH
List	\$22.00	\$33.00	\$53.00	\$66.00
Power	12 Watts	25 Watts	25 Watts	25 Watts
Recommended Reflexed Horns	PH LH	SMH PH LH	PH LH GH	LH GH
Impedance	8	15 Ohms	15 Ohms	15 Ohms

The PM Driver Units listed on this sheet should preferably be used with any of the reflexed horns recommended.

Standard coupling threads used for all horns and driver units make any combination possible. The high power capacity of these driver units is due to the following:

- Unbreakable diaphragm suspension gives indefinite vibrating life.
- Duraluminium (heat proof) voice coil suspension for excess heat dissipation.
- Continuous check (for strength) at all stages of diaphragm construction.

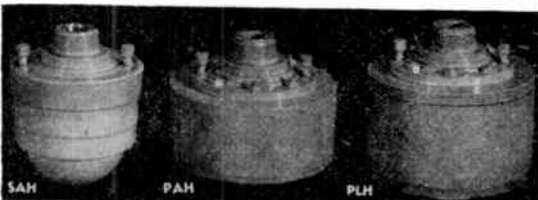

Model	GH
Price	\$76.50
Overall Length	25"
Bell	30"
Recommended Use	
For best results for symphonic music and similar high quality installations.	

Model	LH
Price	\$39.25
Overall Length	21"
Bell	25"
Recommended Use	
Most popular speaker for general high power voice and music projection. Good clear distance projection for army camps, etc.	

Model	PH
Price	\$24.25
Overall Length	16"
Bell	21"
Recommended Use	
Intermediate speaker for general P.A. where average conditions are encountered.	

Model	SMH
Price	\$18.00
Overall Length	12"
Bell	14"
Recommended Use	
Voice only — Excellent for mobile use — Police cars, etc.	



Every part in the construction of the driver units is manufactured in our factory under the supervision of trained acoustic engineers. The high electro-acoustic conversion efficiency of University driver units is due to the following:

- Accurately machined magnetic quality "Armco" (99.7% pure iron) pole piece assembly.
- Tested "Alnico" permanent magnets for highest flux density.
- Micrometer centering of voice coil to insure close magnetic gap tolerance.
- Acoustic coupling chamber machined to close tolerances.

RADIAL
SPEAKERS
—
DUAL DRIVE
SPEAKERS



"BOOSTER"
SPEAKERS
—
"BULL"
SPEAKERS

WIDE RANGE DUAL DRIVER SPEAKER



Model WLC

Complete, including: Universal mounting, bracket, high and low frequency driver units, and wired-in filter net work.	
Length	25"
Bell	31"
Price	\$156.00

Model WLC consists of two complete speakers in one housing with filter net work to divide high and low frequency signal components.

The output of both speakers is so blended as to give a faithful response over the widest possible frequency range.

Wide angle distribution is secured by the use of the cellular type construction in the high frequency horn.

An "Infinite Baffle" sealed acoustic chamber for the base cone driver results in extra low frequency response. Reflex driver projector gives very high efficiency in upper frequency range.

The result is uniform high efficiency over a wide frequency range. Speaker is waterproof for outdoor use.

RADIAL REFLEX PROJECTORS

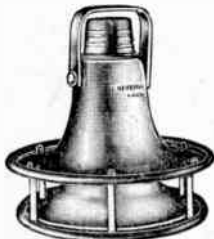

Model RLH

Model	RLH	RSH
Price	\$59.00	\$26.00
Bell	26"	15"
Height	19"	12"
Recommended Driver	PAH	SAH

UNIVERSITY Radial Reflex Projectors are designed to give absolutely uniform 360° radial sound projection in all directions. A single radial reflex projector will cover large areas due to the speaker's high efficiency and non-directional projection. Radial Reflex Speakers are absolutely Non-Resonant and are waterproof for outdoor use. Both models of the single driver unit type listed come complete with suspension attachments but less driver units.

Models RSH and RLH have been widely used in airplane plants and other large National Defense factories with very successful results.

SUPER POWER BULL PROJECTORS



Model 2YH

Model	Price	Watts
2YH	\$64.75	50
2RYH	\$76.50	50
4XH	\$88.25	100
4RXH	\$120.00	100

For very highest power installations (National Defense, etc.), UNIVERSITY Bull Reflex high efficiency speakers should be used.

The 2YH "Baby Bull" uses two PAH or PLH driver units. It is similar in size to the Model LH. May be wired for 8 or 30 ohms.

Shipped complete (less drivers) with universal bracket and special "mushroom" dust cover.

Model 4XH is for use with four PAH or PLH driver units. May be wired for 4, 15 or 60 ohms. Similar in size to the model GH. Shipped complete (less drivers) with heavy duty universal bracket.

The models 2RYH and 4RXH listed are the radial 360° types of the speakers described above. They are especially good for chime installations, etc.

HIGH EFFICIENCY BOOSTER SPEAKERS



Model CR

Model	1B-8	CR
Price	\$26.40	\$42.00
Watts	12	20
Bell	8"	11"
Length	9"	8"

UNIVERSITY "Booster" Speakers are of the reflex high efficiency type and therefore will deliver many times the acoustic output of cone speakers. They have very uniform response in the voice frequency range and will overcome worst factory background noises.

They are being specified as standard in almost all airplane factories and National Defense plants. 1B-8 and CR Booster speakers are also available in radial 360° type on special order.

All "Booster" Speakers are shipped complete with universal mounting bracket and built-in driver unit.

Waterproof construction for outdoor use. For automobile use, order with special heavy duty mounting.

RADIAL CONE SPEAKER PROJECTORS

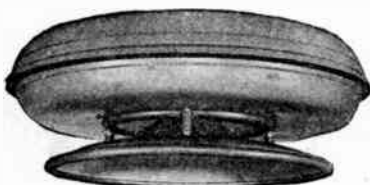

Model RBP-12

Model	RBP-12	RBP-8
Price	\$29.40	\$19.60
Diam.	26"	17"
Height	9"	7"

UNIVERSITY'S exclusive new design in 360° radial cone speaker projectors. Uses the "Infinite Baffle" principle to secure added, pure tone, low frequency response. Absolutely no trace of resonance. May be mounted flat against ceiling or by single point suspension. Floating rubber speaker mounting. All metal and rubber water-shedding construction makes projector satisfactory for outdoor use. Good tone quality makes speakers good for music installations in large National Defense factories.

ALL PRICES SUBJECT TO CHANGE WITHOUT NOTICE

Economy LOUD SPEAKERS PLUS-VALUE

● This complete line of sturdy, dependable loud speakers was designed by a world-famous manufacturer of high-quality sound reproducers to give you most performance at lowest cost for radio replacement and general-purpose speaker applications. Every unit has been engineered for best possible performance consistent with low cost—every unit manufactured to high standards, carefully inspected and tested before shipment. Here is a complete range of sizes in P M and Field Coil designs — the answer to 99 percent of your low cost speaker requirements at a price that makes it unnecessary to consider cone replacements or job-lot "bargains."

PM SPEAKERS

Size Class	Stock Number	Voice Coil Ohms	Diam.	Overall Depth	Dealer Net Price
2"	P-200	4	2½"	1½"	\$1.29
3"	P-300	4	3½"	1⅞"	1.31
4"	P-400	4	4½"	2¼"	1.38
5"	P-500	4	5"	2⅝"	1.39
6"	P-600	4	6½"	3⅞"	2.05
8"	P-800	4	8½"	3⅝"	2.66
10"	P-1000	6	10"	4¾"	4.00
12"	P-1200	6	12½"	5½"	4.75

FIELD COIL SPEAKERS

Size Class	Stock No.	Voice Coil Ohms	Field Ohms	Diam.	Overall Depth	Dealer Net Price
4"	F-400	4	2750	4½"	2⅞"	\$1.29
	F-401	4	1000	4½"	2⅞"	1.29
	F-402	4	450	4½"	2⅞"	1.29
5"	F-500	4	2750	5"	2⅞"	1.36
	F-501	4	1800(T)	5"	2⅞"	1.36
	F-502	4	1000	5"	2⅞"	1.36
	F-503	4	450	5"	2⅞"	1.36
	F-504	4	6 volt	5"	2⅞"	1.36
	F-600	4	2750	6½"	2¾"	1.56
6"	F-601	4	1800(T)	6½"	2¾"	1.56
	F-602	4	1000	6½"	2¾"	1.56
	F-603	4	6 volt	6½"	2¾"	1.56
8"	F-800	4	2500	8½"	3¼"	2.29
	F-801	4	1800(T)	8½"	3¼"	2.29
	F-802	4	1000	8½"	3¼"	2.29
	F-803	4	6 volt	8½"	3¼"	2.29
10"	F-1000	6	2500	10"	4¾"	3.09
	F-1001	6	1250	10"	4¾"	3.09
12"	F-1200	6	2500	12½"	5⅞"	3.93
	F-1201	6	1250	12½"	5⅞"	3.93

(T) Tapped at 300 Ohms.



TRANSFORMERS

FOR Economy LOUD SPEAKERS

All ECONOMY Loud Speakers are sold without attached transformers because (1) this avoids the expense of replacing original transformer if in good condition; (2) compromise performance can be avoided—you can select an efficient unit of appropriate impedance in plate or line types; (3) you save money, can service sets with a smaller speaker stock.

Note: Transformers mount directly on speakers except 2" and 3" models.

FIXED IMPEDANCE TYPE

Primary ohms	For 8" and smaller speakers (4 ohm v.c.)	For 10" and 12" speakers (6 ohm v.c.)
500	No. J-10	No. J-30
2,500 Center Tap	No. J-11	No. J-31
7,000	No. J-12	No. J-32
10,000 Center Tap	No. J-13	No. J-33
25,000	No. J-14	No. J-34
Dealer Net Price	\$0.46	\$0.75

No. J-20 Talkback Grid Transformer. Matches 4 to 6 ohm voice coil to high-impedance grid when speaker is used as microphone.
Dealer Net Price\$0.79

ADJUSTABLE IMPEDANCE TYPE

Adjustable impedance transformers provide a variety of primary impedances in one unit. Plate Types reflect 4,500, 7,000, 10,000 and 14,000 ohms, all center-tapped. Line Types provide primary values of 500, 1,000, 1,500 and 2,000 ohms.

PLATE TO SPEAKER

Dealer Net

No. JP-50—For 8" and smaller speakers (4 ohm v.c.).....\$0.69
No. JP-60—For 10" and 12" speakers (6 ohm v.c.)..... .97

LINE TO SPEAKER

No. JL-70—For 8" and smaller speakers (4 ohm v.c.).....\$0.69
No. JL-80—For 10" and 12" speakers (6 ohm v.c.)..... .97

For Every Low Cost Application

Selectar connectors

by **BRUNO** FOR GREATER flexibility.

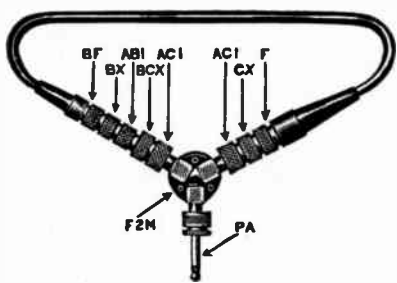

The height of convenience! THE "CONNECTAR" KIT for Service Men

Amazingly handy! A universal connector kit that makes possible any sort of wiring combination . . . changing from Standard to Baby, from Male to Female, splices, extensions, phone plugs, etc. Kit consists of two AC1, one AB1 Adaptor Ring, one F2M 3-Way Connector, one each CX, BX Cable Extension, one BCX Cable Extension Reducer (from 5/8" to 1/2"-27 Thread). One PA Plug and a cable extension 1 1/2 ft. long terminated with one F and one BF Connector. Cat. No. K10.....List \$5.50



3-Way Baby Connectors

With this ingenious smaller unit you can connect three cables in parallel (1/2"-27 thread). Sturdily made, finished black and brush chrome.

- Cat. No. B3F —3 femalesList \$1.75
- Cat. No. B2FM—2 females and 1 male 1.75
- Cat. No. B2MF—2 males and 1 female 1.75
- Cat. No. B3M —3 malesList 1.75

3-Way Standard Connectors

To connect three cables in parallel. 5/8"-27 thread. Greatly increases P.A. flexibility.

- Cat. No. 3F —3 femalesList \$1.75
- Cat. No. 2FM—2 females and 1 male 1.75
- Cat. No. 2MF—2 males and 1 female 1.75
- Cat. No. 3M —3 malesList 1.75

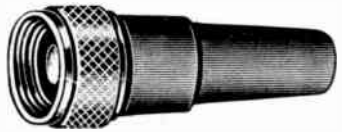

Cat. No. F—Female cable connector, complete with protecting rubber sleeve . . . 5/8"-27 thread, accommodates cable up to 1/4" in diameter. Finished brush chrome.....List 50c

Cat. No. BF—A smaller female cable connector with protective rubber sleeve to prevent breakage of cable. 1/2"-27 thread, takes cable up to 1/8" . . . Finished brush chrome. List 45c

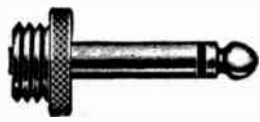

Cat. No. BPA—Screws into Baby BF connector, allowing cable to be plugged into any phone-jack. No soldering necessary. 1/2"-27 threadList 45c

Cat. No. PA—Screws into Standard F connector, allowing cable to be plugged into any phone-jack. No soldering necessary. 5/8"-27 threadList 45c



Locking Type Shielded Telephone Plug

Cannot be accidentally loosened from jack. Fountain pen thread requires single turn to hold it firmly locked. Strain relief positively eliminates ripping of cord from plug terminals. Twisting or tugging at cord will not mar the connection. Plug floats loosely in shell when removed from panel. Supplied with knurled panel receptacle which replaces hex. nut. Nickel plated polish finish.

Cat. No. LP2—(including receptacle) 2 circuitsList \$2.50

Cat. No. LP3—(including receptacle) 3 circuitsList \$2.75

Cable Connectors



Cat. No. BCX—Cable terminated with Standard female and cable terminated with Baby female, speedily connected with this convenient unit. 5/8"-27 thread.....List \$1.00



Cat. No. BX*—Extends two cables having two female connectors, replacing male connector and cable. 1/2"-27 thread. Finished brush chromeList 55c



Cat. No. CX—To extend two cables equipped with two female connectors, taking place of male connector and cable. 5/8"-27 thread . . . finished brush chrome.....List 65c

Connectors



Cat. No. AB1—1/2"-27 thread . . . changes male into female connection in a jiffy. Finished brush chromeList 20c



Cat. No. AC1—A great convenience for changing male into female. 5/8"-27 thread. Finished brush chrome. List 20c

Single F Connector
Cable Assemblies

Convenient extension cables completely assembled with rubber-sleeved female connector and skinned at other end.

- STANDARD (98% shielded)
- FC25 —25-ft. cable. List \$2.50
- FC50 —50-ft. cable. List \$4.50
- FC100—100-ft. cable. List \$8.50

- BABY (2 wire non-shielded)
- BFC25 —25-ft. cable. List \$2.00
- BFC50 —50-ft. cable. List \$3.75
- BFC100—100-ft. cable. List \$7.00

Double F Connector
Cable Assemblies

Convenient extension cables completely assembled with rubber-sleeved female connector at each end.

- STANDARD (98% shielded)
- 2FC25 —25-ft. cable. List \$3.00
- 2FC50 —50-ft. cable. List \$5.00
- 2FC100—100-ft. cable. List \$9.00

- BABY (2 wire non-shielded)
- B2FC25 —25-ft. cable. List \$2.40
- B2FC50 —50-ft. cable. List \$4.15
- B2FC100—100-ft. cable. List \$7.40

Chassis Connectors

Cat. No. CC—Standard chassis type, closes circuit automatically when F connector is removed. Prevents howling. 5/8" hole, 5/8" threadList 40c

Cat. No. C—This is standard chassis connector, taking 3/8" chassis hole. 5/8"-27 thread. New, improved contacts. Finished brush chrome. List 30c

Cat. No. BC—Ochassis type, same high quality as our Standard type C, but small, for 5-16" hole. 1/4"-27 thread, Finished brush chrome. List 25c



UNIVERSAL Microphones

"5mm" SERIES

Velocity Type

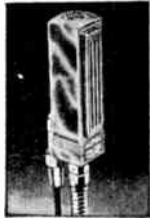

Outstanding for all around use; P. A. systems, orchestras, stage and drama pick up. So small and compact does not hide face of performer. Will greatly reduce feedback in any installation. Sensitive 5 mm ribbon element. Frequency response; 40-10,000 CPS. Output level; 58 db. below one volt per bar. Highly

polished Chrome finish. De Luxe equipment included in handsome package; 25 ft. rubber covered cable, with lock ring connector at housing; suspension loop; Duvello cover and "Flex-tube" (allows tilting of microphone and "stays-put"). 5/8 inch-27 thread stand coupling. Microphone size; 1 1/4 inches square x 4 1/2 inches high. Weight 16 oz., packed 3 lbs.

Model	Impedance	Price
805	High	\$24.50
807	500 ohms	24.50
806	200 ohms	24.50
805	33 ohms	24.50

"CINEMA" SERIES



Distinctive in all professional applications. Beautifully chrome plated case with swivel yoke. Its rich appearance fills need for movie type microphone. Furnished with popular 15mm elements. (See 15mm models). Diameter: 2 1/4 inches, depth, 3 1/2 inches. 25 foot cable furnished. 5/8 inch - 27 thread stand coupling. Lock ring connector at housing. Weight, 14 ozs., packed, 2 1/2 lbs.

DYNAMIC TYPE:—

Model	Impedance	Price
723	High	\$24.50
722	500 ohms	24.50
721	200 ohms	24.50
720	33 ohms	22.50

CRYSTAL TYPE:—

Model	Impedance	Price
716	High	\$22.50
719	500 ohms	24.50
718	200 ohms	24.50
717	33 ohms	24.50

New AIRCRAFT MODEL FOR PRIVATE CRAFT

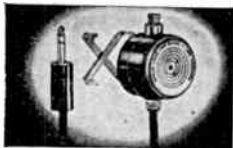

For aircraft and marine installations; mobile transmitters, etc. Natural voice reproduction. Single button carbon. Sturdy black Bakelite case. Moisture proof cord 3 1/2 ft. Reinforced six inches from each end. Motor noises damped out by Anti-noise construction. Button impedance 200 ohms, output approximately 30 volts RMS across microphone transformer secondary. Double pole, single throw, press-to-talk switch connects microphone and relay circuit simultaneously. Complete with heavy duty "push-in" mounting bracket. Dia. 2 1/4", thickness, 1 1/2". Net wt. 6 1/2 oz., packed 3/4 lb.

Model CU-1 with 3 way plug...Price, \$16.25
Model CU-2 with 109-A plug...Price, 18.25

Copyright by U. C. P., Inc.

"15mm" SERIES



Ideal for all general P. A. Applications; recording, broadcasting and any place where a reliable instrument is required. Sensitive 15 millimeter actuated elements. Modernistic, chrome plated body. De Luxe equipment included in handsome package. 25 ft. rubber covered cable with lock ring connector at housing. Suspension loop, Duvello cover, and "Flex-tube" (allows tilting of microphone and "stays put"). 5/8 inch 27 thread stand coupling. Diameter 2 1/4 inches. Depth 2 3/4 inches. Weight 2 1/2 lbs.

DYNAMIC TYPE:—

A rugged, reliable unit. Not affected by temperature or humidity. Frequency response; 50-8000 CPS. Output level; 58 db. below one volt per bar.

Model	Impedance	Price
308	High	\$24.50
307	500 ohms	24.50
306	200 ohms	24.50
305	33 ohms	24.50

CRYSTAL TYPE:—

Clear, brilliant reproduction. Curvi-linear diaphragm. Element protected against moisture and mechanical shock. Barometrically compensated. Frequency response: 50-8000 CPS. Output level: 48 db. below one volt per bar.

Model	Impedance	Price
312	High	\$24.50
311	500 ohms	27.50
310	200 ohms	27.50
309	33 ohms	27.50

"M4" SERIES

VELOCITY TYPE



Scientifically developed, four-magnet Velocity type. For general public address and semi-professional use Non-resonant. A best seller. Will greatly reduce feed-back in any installation. Frequency range, 40-10,000 CPS. Output level; 58 db below one volt per bar. Hum-bucking transformers. Available in four impedances. Equipped with tilting cradle. 25 foot cable and lock ring connector at housing. Black "crackle" finish with high polish chrome trim. Size: 2 inches x 3 3/4 inches x 5 1/2 inches. 5/8 inch 27 thread stand coupling. Packed weight, 3 1/2 lbs.

Model	Impedance	Price
105	High	\$22.50
106	500 ohms	22.50
105	200 ohms	22.50
	33 ohms	22.50

"AV" SERIES

Constant air-velocity. Super microphone. Ultra-refined unit. Wide range pick-up. Fidelity of tone unsurpassed. High flux magnets. Non-resonant. Will greatly reduce feed back in any installation. For all professional applications; recording, broadcasting studios, etc. Output level; 58 db below one volt per bar. Equipped with tilting cradle; 25 ft. rubber covered cable; 5/8 inch-27 thread stand coupling. Beautifully finished in High Lighted Satin Chrome plate. Frequency response; 30-12000 CPS. Size: 2 1/2 inches x 3 3/4 inches x 5 1/2 inches high. Packed weight 3 1/2 pounds.

Model	Impedance	Price
958	High	\$44.50
957	500 ohms	44.50
956	200 ohms	44.50
955	33 ohms	44.50

Model "W"



Single button Carbon, high sensitivity, light weight, compact design. Ideal dictaphone, used on small transmitters, communicating systems; experimenters' favorite. Clear-cut response to all voice frequencies. (Output level, -38 db). Screw terminals. Impedance, 200 ohms. Black Bakelite Case. Diameter 1 1/2 inches; thickness 1/2 inch. Weight 1 1/2 ozs. packed 2 1/2 ounces. Price, \$3.00

inch. Weight 1 1/2 ozs. packed 2 1/2 ounces. Price, \$3.00

New Model "KO" CRYSTAL and "KD" DYNAMIC



- RECORDING
- AMATEURS
- PUBLIC ADDRESS
- ORCHESTRAS
- CARNIVALS
- CALL SYSTEMS
- New high output crystal and dynamic units with slightly rising frequency characteristics.

- Brilliant tone quality with well rounded bass response.
- Luxurious satin stately bronze finished case contrasted with polished chrome face and grille.
- 10 foot low capacity, rubber covered cable included.

Furnished in color to match microphone. Output level; 48 db below one volt per bar. Frequency range; 50-8000 CPS. 5/8 inch-27 thread stand coupling. Diameter 2 1/4 inches, depth 2 3/4 inches. Weight packed; 1 1/4 pounds. Model "KD" Crystal or "KD" Dynamic Microphone including 10 foot cable as shown (less stand) \$16.25

New Aircraft Type Hand Set



For aircraft, amateurs, mobile, pack transmitters and two way phone systems. May be used anywhere. Rugged, light weight construction. A low priced dependable instrument. Furnished in black Bakelite with six foot cord. Microphone and receiver terminated separately. Receivers available in two resistances; 75 ohms for matching line impedances, 2000 ohms for matching plate circuit of output tube. Switch not available. (See Heavy Duty Type.) Replaces older "FIMEX" and "FIMEX" types. Weight only 7 ozs., packed, 1 lb.

Model	Microphone	Receiver	Price
875	S. B. Carbon 200 ohms -38db	Magnetic 75 ohms	\$10.00
820	S. B. Carbon 200 ohms -38db	Magnetic 2000 ohms	10.00

AR-1 SERIES

Aircraft Microphones
Approved by U. S. Government Civil Aeronautics Authority



Approval Nos. 185 & 186 Single button carbon, anti-noise construction for private and commercial aircraft. Operates in any position, any climate and any place a lightweight rugged unit is required. Rising "communications" characteristic. Button impedance 200 ohms. Output approx. 30 volts RMS across microphone transformer secondary. Heavy duty, press to talk, double pole, single throw switch; connects microphone and relay circuit simultaneously. Moisture proof, four foot cord; reinforced six inches from each end. Body diameter, 1 1/2 inches. Thickness 1 1/2 inches. With positive grip roller bracket. All metal Dural body finished in Ivory Black Dielectric. Complete with 109-A plug. Microphone weighs 4 oz., packed 1 lb.

See last page for Transformer
Model AR-1S. For closed cabin craft. Maximum sensitivity. Anti-Noise. C.A.A. Approval No. 185. Price, \$35.00
Model AR-1M. For moderately quiet cabin craft. Medium sensitivity. Anti-Noise. C.A.A. Approval No. 186. Price, \$35.00
Model AR-1D. For open cockpit and combat aircraft. Extra damped. Anti-Noise, Non-Commercial application. Price, \$35.00

"1941 AMATEUR'S CHEST MIKE

For amateurs, mobile transmitters, sound trucks. May be used any place where operator must have both hands free. Excellent voice characteristics. "Communications" type crystal microphone. Moisture and shock proof element. Ten foot rubber covered cable. Chrome plated. Light weight, rugged construction. Frequency response: 50-5000 CPS. Output: 48 db below one volt per bar. Weight only 7 oz., packed 1 1/4 pounds.



MODEL N-3 PRICE \$19.50

UNIVERSAL Microphones

HANDI-MIKES



An unbeatable value in the field of portable sound equipment. For use in sports events, call systems, small transmitters, sound trucks and all spots where a close-talking clear reproduction unit is required. Balanced-grip. Polished chrome plate. Overall length 8 in. Diameter of head 2 3/4 in. Snap switch and "A" circuit standard, as illustrated, with 6 ft. flexible cord. Packed weight 1 1/4 lbs.

Model	Unit	Impedance	Output	Price*
200-A	S. B. Car.	200 ohms	-38 db	\$10.00
201-A	D. B. Car.	200/B ohms	-55 db	15.00
202-A	Crystal	High	53 db*	18.50
203-A	Crystal	High	48 db*	22.50
216-A	Crystal	500 ohms	-59 db	24.50
215-A	Crystal	200 ohms	-59 db	24.50
214-A	Crystal	33 ohms	-59 db	24.50
212-A	Dynamic	High	58 db*	24.50
211-A	Dynamic	500 ohms	-64 db	24.50
210-A	Dynamic	200 ohms	-64 db	24.50
204-A	Dynamic	33 ohms	-64 db	22.50

POLICE TYPE HANDI-MIKE

MODEL PCT

Special single button carbon unit. Designed particularly for police transmitter work. Motor frequencies damped out. Ventilated rubber mouthpiece for close talking "Press-to-talk" switch for relay operation. 6 foot weather-proof cable. Shield used as common ground. Price \$18.50*

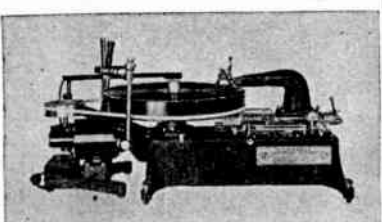

Universal Professional Recorder

A Reliable "Rock Solid" Recording Machine Built for Long and Continued Service

Adjustable mounting feet. Chassis of cast iron. 16-inch turntable weighing 110 lbs. ● Endless, non-elastic, gum-dipped linen belt insures smooth running without "wavers" or "wows." ● Self-starting motor, guaranteed 100 per cent synchronous. ● Lead Screw has clutch mechanism which enables operator to "start" lead screw riding shoe, or release it instantly for moving slide to any new position. Safety grooves at each end prevent "jamming" or damage to mechanism. ● Slide bar rolls on frictionless, hardened ball-bearing grooves, in renewable rails. Dimensions over all: 36" x 19" x 14". Net wt. 225 lbs. Boxed for shipping (two boxes) 3/8 and 5/4 cu. ft., gross wt. 300 lbs. Complete with 15 ohm full frequency cutting head and standard high quality crystal pickup, ready to connect to amplifier and associate equipment. Price.....\$585.00 (Packing and Boxing \$.50 Net additional)

UNI-CORD

Non-Inflammable

Aetate Coated Cardboard Blanks Flexible, easy cutting, long wearing, economical. Made especially for home and school recording.



6 1/2"	Double-faced.	Carton of 6.....	Price \$1.00
8"	Double-faced.	Carton of 3.....	Price 1.00
10"	Double-faced.	Carton of 2.....	Price 1.00
12"	Double-faced.	Carton of 2.....	Price 1.25

*Below one volt per bar.

GRASP-TO-TALK DESK MODELS

For all communication systems, police departments, Ship-to-shore, and portable sound equipment. Several types of microphone units available. Grasp-to-talk switch turns microphone "on and off." Other circuits on order. Polished chrome plating. Height overall 11 inches. Rubber non-skid base. Six foot cable. Weight 2 1/4 lbs., packed 4 1/2 lbs.

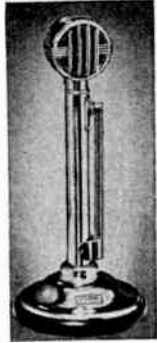

Model	Unit	Impedance	Output	Price*
509-A	S. B. Carbon	200 Ohms	-38 DB	\$18.50
510-A	D. B. Carbon	200/B Ohms	-55 DB	23.00
511-A	Crystal	High	48 DB*	27.50
514-A	Crystal	500 Ohms	-59 DB	27.50
513-A	Crystal	200 Ohms	-59 DB	27.50
512-A	Crystal	33 Ohms	-59 DB	27.50
518-A	Dynamic	High	58 DB*	27.50
517-A	Dynamic	500 Ohms	-64 DB	27.50
516-A	Dynamic	200 Ohms	-64 DB	27.50
515-A	Dynamic	33 Ohms	-64 DB	25.50

PRESS-TO-TALK DESK MODELS

Same as Grasp-to-talk model except non-locking, press-to-talk switch turns microphone on. Other circuits available. Write for bulletin.

Model	Unit	Impedance	Output	Price*
600-A	S. B. Carbon	200 Ohms	-38 DB	\$17.50
601-A	D. B. Carbon	200/B Ohms	-55 DB	22.50
602-A	Crystal	High	48 DB*	26.50
605-A	Crystal	500 Ohms	-59 DB	26.50
604-A	Crystal	200 Ohms	-59 DB	26.50
603-A	Crystal	33 Ohms	-59 DB	26.50
609-A	Dynamic	High	58 DB	26.50
608-A	Dynamic	500 Ohms	-64 DB	26.50
607-A	Dynamic	200 Ohms	-64 DB	26.50
606-A	Dynamic	33 Ohms	-64 DB	24.50

Press-to-Talk Heavy Duty Hand Set



Double pole press-to-talk switch

Use on yachts, pack transceivers, two-way talk back systems; any commercial application. Thick walled Bakelite construction. Polished metal rings make for modernistic appearance and sturdy construction. "Communications" type microphone characteristic. "Super-fine" magnetic type earphone unit, using new magnetic principle. Available in two resistances; 75 ohms for matching line impedances, 2000 ohms for matching plate circuit of output tube. "Tropic" sealed. Separate

Rugged construction, wires to switch. Six foot flexible cord. Weight packed, 1 1/2 lbs.

Model	Microphone	Receiver	Price*
175-E	S. B. Carbon 200 ohms -38db	Magnetic 75 ohm	\$14.50
120-E	S. B. Carbon 200 ohms -38db	Magnetic 2000 ohm	14.50
275-E	Hi-Imp. 48 db*	Magnetic 75 ohm	28.50
220-E	Crystal Hi-Imp. 48 db*	Magnetic 2000 ohm	28.50
375-E	Dynamic 33 ohms -64 db	Magnetic 75 ohm	28.50
320-E	Dynamic 33 ohms -64 db	Magnetic 2000 ohm	28.50

Carbon Microphones

Model "XX" DOUBLE BUTTON



Small heavy duty, double button carbon microphone. World's favorite carbon microphone. For use in sports events, concessions, amateur stations. Low hiss granules. Stretched Duralumin diaphragm. Frequency range: 40-6000 C/P.S. Impedance: 200 ohms per button. Output level: -50db. Polished chrome finish. Diameter: 2 1/2 inches, overall thickness 1 1/4 inches. Weight 2 ozs., packed 1 lb. PRICE \$10.00*

Model X-1 SINGLE BUTTON

Same characteristics and size as XX except single button construction. PRICE \$7.50*

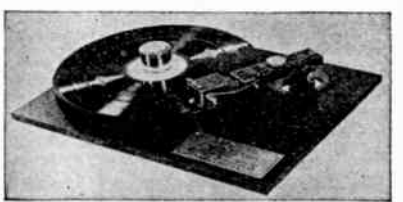

PRECISION CUTTING HEAD

Scientific design. Capable of cutting any type of record material. Maximum field generated by Hi-Flux NITRO permanent magnet. Designed for long and dependable service with maximum sensitivity within audio frequency range. Frequency response 70 to 8200 cycles per second. Furnished in 15 ohm imp. only. Will operate where average loudspeaker voice coil has been attached. Finish black "crackled" baked enamel. Size 1 1/2" high, 1" wide, 5/8" thick. Net wt. 4 oz. Complete with set of instructions. Price.....\$22.50



New Universal Full Frequency Cutting Head

Perfect electrical balance! Magnetic balance! Mechanical balance! Gives crisp, clean, clear recordings with brilliant HIGHS and full rounded BASS! Records frequencies from 30 to 10,000 cycles and over. Electrical circuit designed to be fed direct from 15-ohm power source. Operates in any climate unaffected by heat, cold or humidity - tropic sealed! All precision metal construction. All adjustments locked and sealed. Gives uniform performance every day for years! Price, \$90.00 Reference zero, six milliwatts with 10 bar signal, unless otherwise indicated.

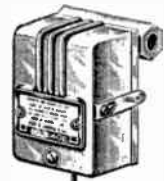

RECORDING TURNABLES

Ideal assemblies for the radio amateur, recording experimenter, public address man, schools and classes who wish to build or assemble their own system. Small and compact, but ultra-efficient Recording chassis for easy mounting and simple hook-up to any amplifier or radio permitting at minimum investment clear and clean full volume recordings. Cutting head extra sensitive, wide range Magnetic Unit of 15 ohms. Requires 2 watts to handle. Impedance for cutting heads match speaker voice coil circuits, eliminating necessity of purchasing special transformers, etc. Lead screw cuts out to in-118 lines cuts up to 10" blanks. Constant Speed Induction Type Motor (not synchronous) of more than ample power to drive the weighted turntable to standard speed of 78 R.P.M.—Self-starting, quiet, powerful. Weight at center collects threads at same time holding blank in position and operates as Stop and lifter for cutting head at end of cut. This feature alone worth many dollars to any owner. Mounted on leatherette-covered veneered top-board, 11" x 14" wide. Net wt. 12 1/2 lbs. Packed wt. 18 lbs. Model PB-60—For 60 cy., 110 volt....Price \$39.50 Model PB-50—For 50 cy., 110 volt....Price 39.50 Model PB-25—For 25 cy., 110 volt....Price 39.50

SYNCHRONOUS PLAYBACK AND TURNABLE ASSEMBLY

100% synchronous condenser start and run motor operates turntable at both 78 and 33 1/3 R.P.M. The ball planetary change speed device is shifted by lever for transcription speed and for phonograph speed. Reproduces music in true pitch and fidelity, absolutely without "wows" or "waver". Turntable 12" diameter with brown flock finish. Aluminum mounting plate 5 1/2" x 10". Total weight 12 1/2 lbs. Packed, 17 lbs. Model No. 81—For 60 cy., 110 volt....Price \$81.00 Model No. 91—For 50 cy., 110 volt....Price 91.00 Model No. 95—For 25 cy., 110 volt....Price 95.00

PREFERRED BY LEADING P. A. MEN THE WORLD OVER



•UNI-DIRECTIONAL

NEW SUPERIOR ELIPSOID PICKUP PATTERN

•ELIMINATES FEEDBACK

TROUBLE BECAUSE IT HAS LOWEST FEED BACK POINT OF ALL DIAPHRAGM TYPE MICROPHONES

•FLAT RESPONSE. FREE FROM ANNOYING PEAKS, GIVING STUDIO QUALITY REPRODUCTION

The P.G. diaphragm follows air particle velocity where amplitude is a GRADIENT of the PRESSURE. In ordinary dynamics amplitude is restricted from following air particle velocity. The P.G. DYNAMIC is a radical improvement in this type of microphone. You can actually hear the difference. Case is designed according to modern acoustic principles. Rugged, not affected by temperature, altitude or humidity. Has unusually high output.

Model PGH —hi-imp.	} \$32.00
Model PGL —50 ohms	
Output	—55 db
Freq. Resp.	40-10000 CPS
Cable Length	25 ft.
Finish	Chrome
Switch	Yes
Cable Connector	Yes
Stand Thread	5/8-27
Ship. Wt.	2 1/2 lbs.



PLASTIC BAFFLE FOR P.G. DYNAMIC
Increases output of the microphone 4 db. Especially useful when performer is at distance of 12" or more. Excellent for picking up entire stage, bands, etc. Snaps into place.
Model PG.....List \$1.50

Model PGAH —hi-imp.	} \$25.00
Model PGAL —50 ohms	
Output	—60 db
Freq. Resp.	70-8000 CPS
Cable Length	12 ft.
Finish	Chrome
Switch	Yes
Cable Connector	Yes
Stand Thread	5/8-27
Ship. Wt.	2 1/2 lbs.

AMPERITE MICROPHONE STANDS

Scientifically designed, Amperite stands feature:

1. Positive, non-sliding clutch. Will never wear out, never require adjustment. Will not "creep".
2. Shock-absorbing rubber bottom.

The microphone can be rotated without loosening clutch.

The action up and down is smooth, pneumatic-like.

AMPERITE MICROPHONE STANDS—SPECIFICATIONS

Model	Description	Base Wt.	Base Spread	Height Range	Thread	List Gunmetal or Chrome	Ship. Wt.
FS-8M	Floor Stand	14 lb.	12"	37"-55"	1/2-27"	\$14.00	15 lb.
FS-25M	Studio 3-legged Floor Stand	16 lb.	17"	42"-69"	1/2" pipe	26.00	25 lb.
DS-M	Comb. desk & Banquet Desk only	6 lb.	7 1/2"	16"-24"	5/8-27"	10.00	11 lb.
DS	Desk Stand	6 lb.	7 1/2"	3"	5/8-27" & 1/2" P.	5.00	11 lb.
5D	Desk Stand	1 1/2 lb.	5"	6"	5/8-27"	3.50	3 lb.
FSB	Boom	21 lb.	17"	36"-96"	1/2" pipe	50.00	43 lb.

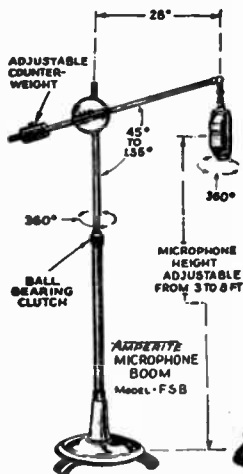

Floor Stand Model FS-8

PREFERRED BY LEADING P. A. MEN THE WORLD OVER



New Studio Model SR80n, Output 56 db.

On the basis of all-around tests, Model SR80n has achieved an outstanding record. Now accepted as the best for studio, P.A., and recording. Frequency range 40 to 15,000 cps. Output, —56 db Triple shielded, fitted with switch (optional) cable connector, and 25' of cable.

Model List
 SR-80Hn hi-imp. . . \$80.00
 SR-80n 200 ohms* 80.00
 Chrome or gunmetal finish.
 Call Letter Plate. . \$7.00
 *Other impedances obtainable at no extra cost.

A Very Popular, Very Excellent VELOCITY-RAH



Answering the demand for a high quality velocity microphone at a competitive price, Amperite presents models RAH-RAL. Excellent for both speech and music. Eliminates feedback. Has a frequency range of 60 to 7500 cps. Output, —68 db. Unaffected by temperature or humidity. Unusually rugged. Triple shielded, and fitted with heavy shock absorber. Shipping weight 5 lbs.

Model List
 RAH hi-imp. 12' cable
 RAL 200 ohms 8' cable
 Either Model, Chrome or Gunmetal. List \$22.00

New Amperite-ACH Compact Velocity

The smallest complete velocity ever made. Complete with output transformer, cable connector and switch. Has the output of a large velocity —70 db open line. Frequency response 60 to 7500 cps. ± 2 db. Can be used for speech or music. Fits standard 3/8"-27 stand. Can also be used as a hand microphone—has comfortable pistol grip.

Size of Head: 1 1/2" x 2 3/8" x 1 3/8".
 Net weight 1 lb.

Model List
 ACH—25' cable. \$25.00



Kontak Mike

For Musical Instruments Can Be Attached To Most Radio Sets Gives natural reinforcement without peaks. Easily attached without tools. Will operate with either low or high-gain amplifiers. Frequency response 40 to 9000 cps. Output, —40 db. Shipping Weight 2 lbs.

Model List
 SKH Hi-imp. \$12.00
 KTH DeLuxe Hi-imp. 22.00
 KKH With Hand Volume Control 18.00
 KF Foot Pedal Only 12.00
 BT Boosting Transformer for radio sets 3.00
 Low impedance available in models SKH and KTH at same price.

THE AMPERITE VELOCITY

Distinguished in Design and Quality

offers an exclusive feature in

THE ACOUSTIC COMPENSATOR

Models RBHk-RBMk

Considered the finest types of microphone available for P. A. work, these models are excellent for close talking and distant pickup, speech, music, or wherever else a high-quality microphone is required. Frequency range 40 to 11,000 cps. Output, —65 db. Excellent also for studio or recording. Complete with switch, cable connector and 25' of cable.

The Acoustic Compensator permits the increase of the high frequencies by the mere flip of the finger. Simple construction. As shown in diagram, simply push the knob up to increase high frequencies, or down to increase lows. Makes microphone adjustable for close talking or distant pickup.

Models RBHk-RBMk, with acoustic compensator. Frequency range 40 to 11,000 cps. Output, —65 db. Complete with switch, cable connector and 25' of cable. Chrome or Gunmetal. List \$42.00
 Same as above, except without acoustic compensator Chrome or Gunmetal List \$42.00

Model RBHn High impedance List \$42.00
Model RBMn 200 ohms List 42.00



PUSH UP TO INCREASE HIGHS;
 PUSH DOWN TO INCREASE LOWS



Models RBBHn-RBBn

For unusual feedback conditions such as footlight installations. Not to be used for close talking. Frequency range 40 to 11,000 cps. Complete with switch, cable connector and 25' of cable.

Model RBBHn High impedance Chrome or Gunmetal List \$42.00
Model RBBn 200 ohms List 42.00

AMPERITE MICROPHONES ARE TRIPLE SHIELDED against all RF or magnetic fields, entirely eliminating hum pickup. They are acoustically designed to eliminate any possibility of cavity resonance.

FINISHES: All microphones have the new standard gunmetal finish. Also available at no extra charge in long-lasting chrome finish.

NOTE: Special custom microphones, such as microphones with increased low or high frequencies, or special impedances, obtainable at no extra charge.

Additional CABLE LENGTHS obtainable at 8c list per foot.

New RSHk-RBSk

With Acoustic Compensator



Similar in appearance to RB11K. Has slightly less output and frequency range. For speech or music. ACOUSTIC COMPENSATOR permits adjustment for close or distant pickup or for various conditions encountered. Complete with switch and cable connector. Output —68 db. Frequency range 60 to 8000 cps. 12 ft. of cable.

Chrome or gunmetal
Model RSHK high-imp. List \$32.00
Model RBSK 200 ohms List 32.00

Obtainable without Acoustic Compensator at same price.

Amperite-7JH Velocity Mike

"Lapel"



The most successful "lapel" made. Size of match box. Ideal for lectures and specialty acts. Can be hidden under coat. Output constant with any position of the head. Transformer included in microphone case. Flat response 60 to 7500 cps. Output, —70db. Shipping weight 3 lbs.

Model 7J-H Hi-imp. List \$22.00
Model 7J 200 ohms. 22.00

Input Transformer (Cable Type) LGP

Enables the use of low impedance microphones and cable lengths up to 5000 ft. with amplifiers having high impedance input. Hum trouble entirely eliminated. Can be used with 25, 50, or 200-ohm microphones. Output connects directly to high imp. input of amplifier. Standard grade recommended for speech; laboratory grade for music. 2' cable. Shipping Wt. 3 lbs.



Model List
 LGP (Standard) 60-8000 cps. \$ 6.00
 LGP (Lab.) 40-14,000 cps. 10.00

NEW! IMPROVED! "The Mike-Stand of Tomorrow"

A one-piece hollow base of die-cast metal, zinc, aluminum and copper, which is the equal of cast iron in durability, now replaces the cast iron metal shell combination . . . thereby offering the following advantages:

- Elimination of dented and disfigured shells which detract from the appearance of the stand.
- Elimination of metallic vibration caused by misfit shells over iron castings.
- Base weight can be increased, depending on materials used.

The heavy gauge brass tubing section also has original features developed by Eastern:

- Variable pressure chuck-lock.
- Noiseless pump action adjustment.
- Non-dropping mike rod.

Base diameter is 10 inches. Adjustment 36" to 67". $\frac{5}{8}$ " — 27 thread.

Now supplied with a rubber ring around the edge of the base acting both as a base guard as well as a shock absorber. Available in the following weights and finishes:

HOLLOW BASES

Two Section

EF153—Has hollow base described above combined with "EASTERN" pump action tubing. Appearance is that of our popular EF17 but has a net weight of 6 lbs. Ideal for use with the new streamline microphones but can be weighted for heavier microphones. Interior of base will hold four pounds of sand. Height 36" to 67". $\frac{5}{8}$ "-27 thread. All chromium finish.
List Price\$9.50

Three Section

EF155—Combines hollow base with new "BRAKE-LOCK" 3 section telescopic tubing which replaces thumbscrews used heretofore. Has threads for $\frac{1}{2}$ "-pipe and $\frac{5}{8}$ "-27. Height 25" to 60". Net weight 6 lbs.
List Price\$10.50

Either of above stands can be supplied filled with sand to make a full weight 10 lb. floor stand at \$1.00 additional list price. Specify EF157 for two section stand at \$10.50 list and EF158 for three section stand at List Price.....\$11.50

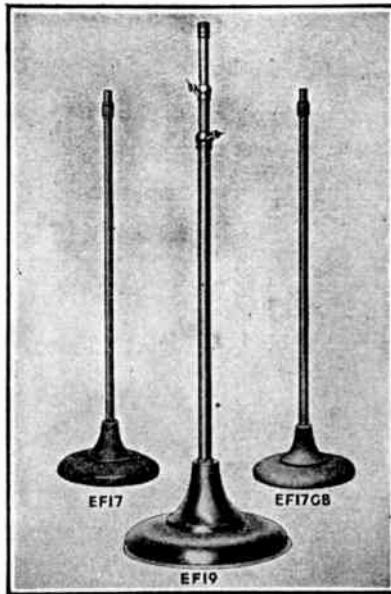

CAST IRON BASES

For those who want the stand equipped with cast iron bases, same are available as follows:

Two Section

EF17 — All chromium two section floor stand with no rust copper shell over base casting. With "EASTERN" pump action section, height is 36" to 67". Three rubber feet. Net weight 10 lbs. $\frac{5}{8}$ "-27 thread.
List Price\$8.50
EF33—Same characteristics as EF17 but has a net weight of 17 lbs. for heavy microphones. Six rubber feet. All chromium finish.
List Price\$11.00

Three Section

EF19—All chromium 3 section stand with copper shell over iron casting. Has new "BRAKE-LOCK" telescopic tubing which replaces thumbscrews formerly used. Has threads for $\frac{1}{2}$ "-pipe and $\frac{5}{8}$ "-27. Height 25" to 60". 3 rubber feet. Net weight 10 lbs.
List Price\$9.50
EF34—Same characteristics as EF19 but with heavier base giving net weight of 16 lbs. All chromium finish.
List Price\$12.00

THREE-LEGGED STANDS

SOLID TRIPOD

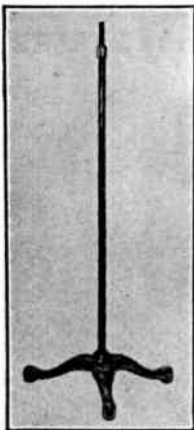

EF-55
EF-111

EF55—Has three legged cast iron base with 15" spread. Overall height of stand, 37" to 66". The base is smoothly ground to make an all chromium stand. Fitted with rubber feet. Net weight 12 lbs. Pump action tubing section has $\frac{5}{8}$ "-27 thread. List.....\$13.75

EF111—Three legged stand similar to above but base is finished in grey wrinkle and pump action tubing in chromium. Height 37" to 66". $\frac{5}{8}$ "-27 thread. Net weight 12 lbs. List.....\$9.50

FOLDING TRIPOD

EF73—A three section music type folding stand made of heavy material especially for microphone use. 26" to 60" height. 20" base spread. Folds to 21". $\frac{5}{8}$ "-27 thread. Rubber feet. Net weight 3 $\frac{3}{4}$ lbs. All chromium finish only. New "BRAKE-LOCK" tubing.
List \$11.00

EF74—A four section music type folding stand similar to above but with fourth section added, giving adjustable height from 27" to 78". Folds to 22". Supplied with fitting for $\frac{5}{8}$ "-27 thread. Rubber feet. Net weight 4 lbs. All chromium finish. Thumbscrew tubing. List\$12.50

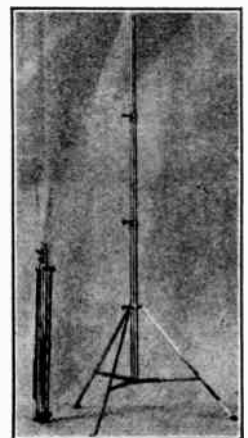

EF-73
EF-74

EASTERN

MICROPHONE STANDS

MODERNISTIC FLOOR STANDS

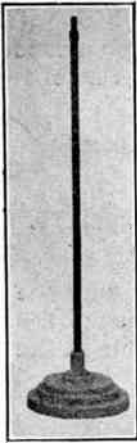

EF-139
EF-140

EF139—Beautifully proportioned 12" cast iron base in grey wrinkle finish combined with "Eastern" pump-action tubing in chromium. Has six rubber feet. Height 37" to 65". $\frac{5}{8}$ "-27 thread. Net weight 16 lbs. List.....\$10.00

EF140—A heavy type of floor stand for use with large velocity microphones. Has a chrome plated tubing section of larger diameter than that used on stand above. Base in grey wrinkle finish. Height 37" to 65". Fittings for $\frac{5}{8}$ "-27 and $\frac{1}{2}$ " pipe thread. Net weight 24 lbs. List\$15.00

LIGHT-WEIGHT STANDS

FOR PACKAGE SOUND AND RECORDING SYSTEMS

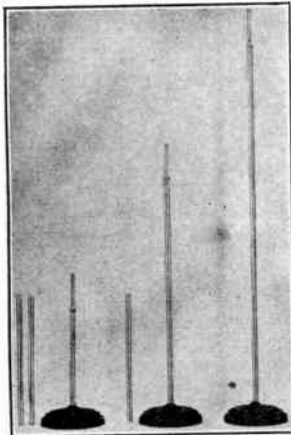

EF144—Consists of two 14" sections and one adjustable section which screw into each other for desired height. Adjustable section only forms a banquet stand of 17" to 28". With one 14" section added adjustment is 32" to 42", correct for a seated person. Adding the second 14" section forms a full size floor stand adjustable from 47" to 58". The 9" base, of neat modernistic design, is 3" tall, making the stand ideal for case systems. Base is in grey wrinkle with chromium tubing. Net weight 6 lbs. List.....\$10.00

EF94—Has same base as EF144 but with new "BRAKE-LOCK" telescopic 3 section tubing. Sections are non-removable and has a height of 25" to 60". Black wrinkle base with chromium tubing. Has $\frac{1}{2}$ "-pipe and $\frac{5}{8}$ "-27 threads. Net weight 7 lbs. List Price.....\$6.75

EF92—Our lightest and lowest price two section floor stand with 9" modernistic base in black wrinkle and Chromium upright. Height 35" to 64". $\frac{5}{8}$ "-27 thread. Net weight 8 lbs. List Price\$6.00

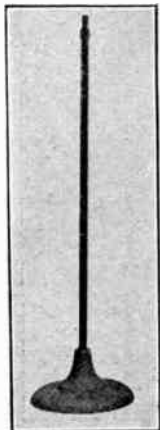

ROUND BASE FLOOR STAND

EF141—A two section floor stand with 10" cast iron base in grey wrinkle combined with "Eastern" pump-action chromium tubing. Height 36" to 67". Three rubber feet in base. $\frac{5}{8}$ "-27 thread. Net weight 10 lbs. Good value at this price! List\$7.25

EF148—Above base with "BRAKE-LOCK" 3 section telescopic tubing. Base is in grey wrinkle with tubing in chromium. Height 25" to 60". Has $\frac{1}{2}$ "-pipe and $\frac{5}{8}$ "-27 threads. Net weight 9 lbs. List Price \$8.75

NEW! Locking Type, Shielded TELEPHONE PLUG

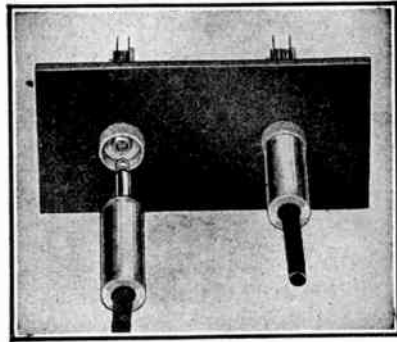

Another original "Eastern" development. A phone plug which cannot be accidentally removed from its jack. Fountain pen thread requires single turn to hold plug firmly locked. Strain relief positively eliminates ripping of cord from plug terminals. Twisting or tugging at cord will positively not harm plug connections. Plug floats loosely in shell when removed from panel. Supplied with panel receptacle which replaces hex nut of present jack. Nickel plated finish. Prices include panel receptacle.

PP84—2 Terminal Plug. List.....\$2.50
PP85—3 Terminal Plug for 3 contact microphones. List..... 2.75

MICROPHONE SWITCHES

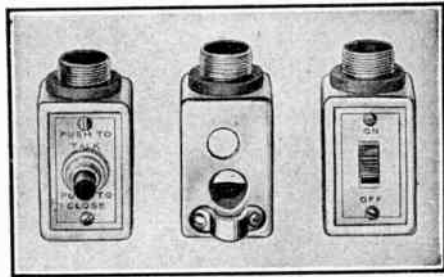

Type PS

Type SS

New die-cast case with slide contact or push to talk switch. Equipped with cable strap for strain relief. Has knocked out hole for mike wire. Terminals insulated from case. Chromium finish.

Slide Type	Push Type	Mike Thread	List
No. 304SS	No. 304PS	$\frac{5}{8}$ "-27	\$1.75
No. 305SS	No. 305PS	$\frac{1}{2}$ " pipe	2.50
No. 306SS	No. 306PS	$\frac{3}{8}$ " pipe	2.25

MICROPHONE SHOCK ABSORBERS



401



405

Improve performance of microphone by absorbing noises which may be picked up by over sensitive microphones, thereby permitting increase of gain.

Cat. No.	Mike Thread	Stand Thread	List
405	$\frac{5}{8}$ "-27	$\frac{5}{8}$ "-27	\$2.50
401	$\frac{1}{2}$ " pipe	$\frac{1}{2}$ " pipe	3.50
402	$\frac{1}{2}$ " pipe	$\frac{5}{8}$ "-27	3.00

EASTERN

MICROPHONE STANDS

TABLE STANDS — 5 1/2" BASES

Deluxe Type — All Chromium — 3 Felt Feet in Base



ED140



ED130



ED53



ED51L
ED149



ED5D

ED140—Adjustable height 9"-18". Swivel has threads for 1/8" pipe and 3/8"-27 thread.....	List Price
ED130—Height 4". 3/8"-27 thread.....	\$4.75
ED53—Desk stand kit for carbon microphone. Combination of four stands in one unit. Tall desk stand. Short desk stand. Suspension ring and carrying handle.	2.75
	6.50

ED51L—Height 6 3/4". 3/8"-27 thread.....	List Price
ED149—Height 8 1/2"; otherwise same as ED51L; 3/8"-27 thread.....	\$3.00
ED5D—Height 10 3/4". Swivel has threads for 1/8" pipe and 3/8"-27.....	3.00
	4.00

Economy Type — Grey Wrinkle Bases with Chromium Tubing 3 Felt Feet in Base



ED127



ED101



ED129



ED126

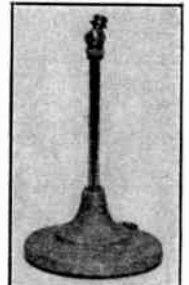

ED125

ED127—Height 8 1/2". 3/8"-27 thread.....	List Price
ED101—Height 6 3/4". 3/8"-27 thread.....	\$2.00
ED129—Height 8 3/4". 3/8"-27 thread.....	1.75

ED126—Adjustable height 8"-12". Fitting for 3/8"-27 thread.....	List Price
ED125—10 3/4" height. Swivel has threads for 1/8" pipe and 3/8"-27.....	\$2.75
	3.00

HEAVY TABLE STANDS — 7 1/2" BASES

Chromium or Gun Metal Finish
3 Rubber Feet in Base



EB4-EB41



ED23R



ED131



ED21

EB4—Banquet stand. Height 16"-25". Fitting for 3/8"-27 thread. Net weight 6 lbs.....	List Price
EB41—Same as EB4 but with grey base.....	\$6.50
ED23R—Height 8". Fitting for 3/8"-27 thread. Net weight 6 3/4 lbs.....	5.50
ED23P—For 1/2" pipe thread.....	5.00
	5.00

ED131—Height 4 1/2". 3/8"-27 thread. Net weight 5 1/2 lbs.....	List Price
ED131P—For 1/2" pipe thread.....	\$4.75
ED21—Short banquet stand. Height 8 1/4"-12". 3/8"-27 thread. Net weight 5 3/4 lbs.....	5.75
ED21P—With fitting for 1/2" pipe thread.....	6.00

EASTERN

MICROPHONE STANDS



F



P



R

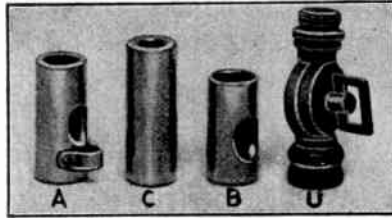

A

C

B

U



D



S

REDUCERS

Cat. No.	Mike Thread	Stand Thread	Figure	List
101	1/8" Pipe	5/8"-27	F	\$0.75
102	1/8" Pipe	1/2"-27	F	.75
107	1/2" Pipe	5/8"-27	P	1.00
108	1/2" Pipe	1/2"-27	P	1.00
161	1/2" Pipe	1/8" Pipe	P	1.00
145	1/2" Pipe	3/4"-27	P	1.00

Cat. No.	Mike Thread	Stand Thread	Figure	List
109	5/8"-27	1/2"-27	R	\$0.75
112	5/8"-27	1/2" Pipe	R	1.00
132	5/8"-27	3/4"-27	R	1.00
*113	1/4"-20	5/8"-27	T	.75
115	See No. 118		B	
118	WE630A, 633A, 639A	5/8"-27	A	1.50

* NOTE: No. 113 can also be used with CAMERAS.

SWIVELS

Cat. No.	Mike Thread	Stand Thread	Figure	List
103	1/8" Pipe	5/8"-27	D	\$1.00
104	1/8" Pipe	1/2"-27	D	1.00
162	1/8" Pipe & 5/8"-27	1/4" Pipe	D	1.00

Cat. No.	Mike Thread	Stand Thread	Figure	List
110	5/8"-27	5/8"-27	S	1.00
111	5/8"-27	1/2"-27	S	1.00
117	5/8"-27	5/8"-27	U	3.75



EG

CABLE GUIDES

No.	List
EG24—For 7/8" Tube	\$1.50
EG25—For 3/4" Tube	1.50
EG27—For 5/8" Tube (Cable Grip)	1.25



420

ACCESSORIES

No.	List
414 — 6 1/2" Chrome Mike Ring, 5/8"-27 threads	\$2.00
ER6—Suspension Ring	2.50
420 — Side Hole Bracket, 5/8"-27 threads	.75



ER6

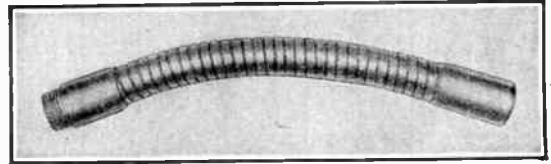

FLEXIBLE GOOSE NECKS

Flexible goose necks 5/8"-27 threads on each end.
 No. FL83—12" length for floor stands..... \$2.00
 FL84—7" length for desk stands..... 1.50

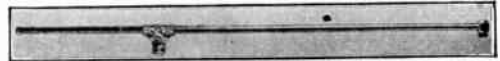

BA78

BOOM ARMS FOR LIGHT MIKES

No. BA78—Non-adjustable. Extends 30" horizontally. 5/8"-27 threads. Chrome plated..... \$8.50
 BA79—Similar to above but can be adjusted to any angle within 90 degrees of horizontal position..... 12.00
 For other threads see list of fittings above.

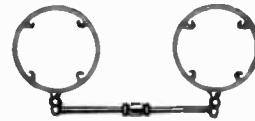

DAC

DOUBLE ARMS

No. DAC—Double Arm 6 1/2" Rings..... \$12.50
 DA5—Above with 5/8"-27 Threads..... 9.00
 DA1/2—Above with 1/2" Pipe Threads..... 12.50

EASTERN "NECK SUSPENSION"

NEW!



Here is the "THIRD HAND" you have been asking for. Made from die-cast metal and supplied with a 7" flexible goose-neck. An integral part of the casting is a call letter plate which is suitable for station or chain affiliation (letter in your own call letters). Has a neck strap which is held by snap fasteners and a body strap which prevents shifting of

microphone when leaning forward. Straps are extra large. Finished in beautiful black wrinkle.

Catalog No. ES160..... List Price \$3.50

NOTE: Mountings available for Western Electric Type 618 microphones. For W.E. 630A, 633A and 639A microphones to Eastern stands, see fitting No. 118 listed above.

SHURE

CARDIOID MICROPHONES

Stop Feedback * Permit More Volume * Increase Pickup Range * Reduce Reverberation Effects
Improve Reproduction * Simplify Installations

"UNIPLEX" CARDIOID CRYSTAL

True Uni-Directional Performance — at Low Cost!

It's "Goodbye Feedback" when you install this famous Shure "Uniplex"—the lowest priced true cardioid microphone. High quality reproduction from 30 to 10,000 cycles over a wide angle at the front, yet practically unaffected by sound approaching from the rear. (Rear response down approximately 15 db.) Permits more volume without feedback—simplifies microphone placement—greatly improves systems using ordinary microphones—makes possible a good P.A. installation where poor acoustic conditions did not permit it before. Uses exclusive Shure "Uniphase" principle. Output level: 63 db below 1 volt per bar. Specially moisture-proofed Grafoil Bimorph Crystal. Swivel-head. Distinctively modern streamlined case design, finished in Satin Chrome. Built-in cable connector. Standard $\frac{5}{8}$ "-27 thread. Diam. $3\frac{1}{8}$ ", depth $3\frac{3}{8}$ " Shpg. wt. $1\frac{1}{2}$ lbs. (Shure Pat. 2,198,424, 2,237,298).

Model 730B. "UNIPLEX" Cardioid Crystal Microphone. Complete with 25 ft. shielded cable. Code: **Rupex**.
List Price.....\$34

"UNIDYNE" CARDIOID DYNAMIC

Today's Most Popular True Uni-Directional Microphone

Solves feedback, reverberation, background noise. Specially suspended double wind-screened moving-coil system. Employs exclusive Shure "Uniphase" principle. Smooth response from 40 to 10,000 cycles. Wide angle pick-up at front, dead at rear (down 12-15 db). Rugged, shock-proof construction. Practically unaffected by heat and humidity. Ideal for severe outdoor and indoor service. Head tilts through 90 degree angle. Built-in cable connector. Satin Chrome finish. Permissible cable length practically unlimited on low impedance models. Standard $\frac{5}{8}$ "-27 thread. Case dimensions: $4\frac{1}{4}$ " high; $3\frac{1}{4}$ " wide; $3\frac{1}{2}$ " deep. Shipping weight $4\frac{1}{2}$ lbs. (Shure Pat. 2,237,298).

Model 55A. Low impedance. For 35-50 ohm circuits. 25 ft. two-conductor shielded cable. Output level into 50 ohms: 62.8 db below 6 milliwatts for 10 bar signal.
Code: **Rudar**.
List Price.....\$47

Model 55B. Low impedance. For 200-250 ohm circuits. Includes internal transformer. 25 ft. two-conductor shielded cable. Output level into 250 ohms: 63.8 db below 6 milliwatts for 10 bar signal. Code: **Rudat**.
List Price.....\$49.50

Model 55C. High impedance. May be used with any crystal microphone amplifier or other amplifier with input impedance of 100,000 ohms or more. Includes internal transformer. 25 foot single conductor shielded cable. Output level: 55.5 db below 1 volt per bar.
Code: **Rudas**.
List Price.....\$49.50

Model 55AV. Same as Model 55A but specially designed for voice reproduction in Communications, Public Address and Recording. Code: **Rudog**.
List Price.....\$47.00

Model 55BV. Same as Model 55B but specially designed for voice reproduction in Communications, Public Address and Recording. Code: **Rudoj**.
List Price.....\$49.50

Model 55CV. Same as Model 55C but specially designed for voice reproduction in Communications, Public Address and Recording. Code: **Rudol**.
List Price.....\$49.50

Model A86A. High Quality Cable-Type Transformer to match 35-50 and 200-250 ohm microphones to high impedance amplifier input. Code: **Rudeb**.
List Price.....\$12.00

"556" BROADCAST CARDIOID DYNAMIC

Solves Tough Pick-up Problems in Broadcasting and Recording

Broadcast Stations and Recording Studios are rapidly replacing present equipment with this new Shure 556 Broadcast Unidyne. Solves troublesome sound pick-up problems in studio and remote applications. Exclusive Shure "Uniphase" principle provides true cardioid uni-directional performance at surprisingly low cost. Smooth response from 40 to 10,000 cycles at front; dead at rear (down 12-15 db). Cuts down reflection and reverberation effects, reduces background noise pick-up. Extremely rugged construction. Specially-suspended double-wind screened moving coil system. Built-in transverse vibration isolation unit. Swivel head. Satin Chrome finish. Standard $\frac{5}{8}$ "-27 thread. Easily adapted to fit stands with other threads. Equipped with 18" stub of rubber-covered two-conductor shielded cable, trimmed on free end for attachment of connector plug. Stub may easily be replaced by longer length of cable if desired. Case dimensions: $4\frac{1}{2}$ " high, $3\frac{1}{4}$ " wide, $3\frac{1}{2}$ " deep. Shipping weight $4\frac{1}{2}$ lbs. (Call Letter Plate not included). (Shure Pat. 2,237,298).

Model 556A. Broadcast "Unidyne" Dynamic, for 35-50 ohm circuits. Output level into 50 ohms: 62.8 db below 6 milliwatts for 10 bar signal. Code: **Rudom**.
List Price.....\$75

Model 556B. Broadcast "Unidyne" Dynamic, for 200-250 ohm circuits. Includes internal transformer. Output level into 250 ohms: 63.8 db below 6 milliwatts for 10 bar signal. Code: **Rudop**.
List Price.....\$75

Model 556C. Broadcast "Unidyne" Dynamic. High impedance. Includes internal transformer. Output level: 55.5 db below 1 volt per bar. Code: **Rudor**.
List Price.....\$75

(Broadcast Call Letter Plate, as illustrated, Suspension Adapter, Vibration Isolation Unit, also available for Model 555. Write for Bulletin 165C).

Patented by Shure Brothers

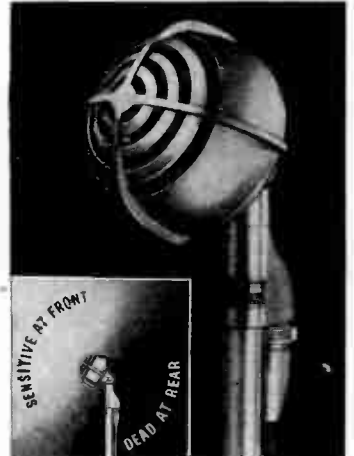

SHURE

DYNAMIC and CRYSTAL WIDE-RANGE MICROPHONES

MODERN "STRATOLINER" DYNAMIC

Smoother Response for Voice and Music



A dynamic leader in beauty and performance for general-purpose P.A., remote broadcasting, recording, call systems, and other applications indoors and outdoors. Moving-conductor type. Smooth wide-range frequency response. No annoying peaks or distortions. Very rugged. Practically immune to heat and humidity. Built-in high quality transformer. Permissible cable length practically unlimited with low impedance models. Die cast case finished in rich Satin Chrome. Swivel head easily aimed at source of sound. Semi-directional or non-directional operation. Built-in cable connector. Standard $\frac{5}{8}$ "-27 thread. Diam. $2\frac{1}{2}$ ", length $4\frac{1}{8}$ ". Shpg. wt. $2\frac{3}{4}$ lbs.

Model 508C. High Impedance Dynamic. May be used with crystal microphone amplifier and others with input impedance of 100,000 ohms or more. Output: 60 db below 1 volt per bar. Complete with 18 ft. single-conductor shielded cable. Code: **Ruvas.** **\$2880**
List Price.....

Model 508A. Low Impedance Dynamic. For 35-50 ohm lines. Output: 68 db below 6 milliwatts for 10 bar signal. Complete with 18 ft. two-conductor shielded cable. Code: **Ruvam.** **\$28.80**
List Price.....

Model 508B. Low Impedance Dynamic. For 200-250 ohm lines. Output: 68 db below 6 milliwatts for 10 bar signal. Complete with 18 ft. two-conductor shielded cable. Code: **Ruvap.** **\$28.80**
List Price.....

Model A86A. High Quality Cable-Type Transformer to match 35-50 and 200-250 ohm microphones to high impedance amplifier input. Code: **Rudeb.** **\$12.00**
List Price.....



SHURE "500C" DYNAMIC

Streamlined for Low-Cost Public Address

High impedance. Excellent frequency response assures faithful reproduction of voice and music. Moving-conductor type. Internal matching transformer. Sturdy die cast case finished in Iridescent Gray with highly polished plating on grille. Standard $\frac{5}{8}$ "-27 thread. Spring cable protector. Output: 63 db below 1 volt per bar. May be used with any amplifier with input of 100,000 ohms or more. Diameter $2\frac{3}{8}$ ". Shpg. wt. $2\frac{1}{4}$ lbs.

Model 500C-7Ft. High Impedance Dynamic. 7 ft. single-conductor shielded cable. Code: **Rudix.** **\$1750**
List Price.....

Model 500C. High Impedance Dynamic. 25 ft. single-conductor shielded cable. Code: **Rudig.** **\$19.00**
List Price.....

"ULTRA" 700D CRYSTAL

Highest Quality General Purpose Performance

Famous for its fidelity of reproduction and dependable performance. Shure "Ultra" wide-range response from 30 to 10,000 cycles. Output level: 58 db below 1 volt per bar. Triple-moisture-sealed Grafoil Bimorph Crystal. Complete barometric compensation. Internal screen-protected cartridge. Small, compact swivel head for semi-directional or non-directional operation—easily aimed at source of sound for best response. Satin Chrome finish. Built-in cable connector. Standard $\frac{5}{8}$ "-27 thread. Diameter $2\frac{3}{8}$ ". Shpg. wt. $2\frac{1}{4}$ lbs.



Model 700D. "Ultra" Crystal Microphone. Complete with 25 ft. single-conductor shielded cable. Code: **Rupaj.** **\$2750**
List Price.....

"ROCKET" 705A CRYSTAL

Shure "Ultra" Performance and Beauty



An outstanding choice for general-purpose P.A. Provides both modern beauty and faithful reproduction. Smooth "Ultra" wide-range response from 30 to 10,000 cycles. Output level 58 db below 1 volt per bar. Special moisture-sealed Grafoil Bimorph Crystal and other exclusive Shure "Ultra" features. Swivel head easily aimed at source of sound for best response. Semi-directional or non-directional operation. Built-in cable connector. Satin Chrome finish. Standard $\frac{5}{8}$ "-27 thread. Dia. $2\frac{3}{8}$ ". Lgth. $3\frac{1}{8}$ ". Shpg. wt. $2\frac{1}{4}$ lbs.

Model 705A. "Rocket" Crystal Microphone. Complete with 25 ft. shielded single-conductor cable. Code: **Rupeq.** **\$2750**
List Price.....

SHURE

CRYSTAL MICROPHONES

Remarkable Quality at Low Cost

NEW "STRATOLINER" CRYSTAL

Modern as Tomorrow—Low in Cost!

Improves appearance of sound set-ups—gives quality reproduction of voice and music for low-cost Public Address, paging, call systems and other general-purpose uses. Excellent, smooth frequency response. High output level 49.7 db below one volt per bar at end of 7 ft. cable. Genuine Bimorph Crystal. Rich Satin Chrome die cast case. Swivel head easily aimed at source of sound. Built-in cable connector. Standard $\frac{3}{8}$ "-27 thread. Diameter $2\frac{1}{8}$ ". Length $4\frac{1}{16}$ ". Complete with 7 foot single-conductor shielded cable. Shpg. wt. $2\frac{1}{2}$ lbs.

Model 708A. "Stratoliner" Crystal Microphone. Code: **Rudum.**
List Price..... **\$19.50**

Model 708A-18 Ft. Same, with 18 ft. cable. Code: **Ruvat.**
List Price..... **\$20.30**

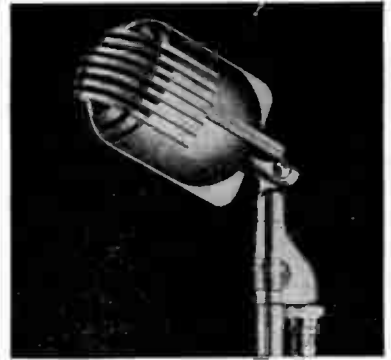

70H "SUPER-LEVEL" CRYSTAL

Famous for Performance the World Over

For years, the "standby" among sound men for dependable high quality performance! Excellent wide-range response. Highest output level available today in crystal microphones: 47.5 db below 1 volt per bar (27.5 db below 1 volt for 10 bar signal). Requires less amplifier gain; provides a useful margin of extra sensitivity when needed. Moisture-sealed Grafoil Bimorph Crystal. Sturdy cast case; Satin Chrome finish. Built-in cable connector. Standard $\frac{3}{8}$ "-27 thread. 7 ft. shielded cable. Diameter $3\frac{3}{16}$ ". Depth $1\frac{3}{8}$ ". Shpg. wt. 2 lbs.

Model 70H. "Super-Level" Crystal Microphone. Code: **Rupep.**
List Price..... **\$22.50**

Model 70H-25 Ft. Same, with 25 ft. cable. Code: **Rupec.**
List Price..... **\$24.00**



New 707A Crystal

Nothing like it at this low cost! Attractive modern die cast case in Iridescent Gray finish with highly polished plating on front grille. Excellent smooth response. Output level 49.7 db below one volt per bar at end of 7 ft. cable. Bimorph Crystal, mechanically isolated. 7 ft. single-conductor shielded cable, with spring protector. Standard $\frac{3}{8}$ "-27 thread. Diam. $2\frac{3}{4}$ ". Shpg. wt. $1\frac{1}{4}$ lb.

Model 707A. Crystal Microphone. Code: **Rudof.**
List Price..... **\$12.50**

Model 707A-25 Ft. Same, with 25 ft. cable. Shpg. wt. $2\frac{3}{4}$ lbs. Code: **Rudug.**
List Price..... **\$14.00**



New Hand Microphone

A new lightweight hand microphone developed by Shure Engineers. Beautiful **Tenite** resilient plastic case and handle. Rugged, handy to use. Output level 49.7 db below one volt per bar at end of 7 ft. cable. Genuine Bimorph Crystal, mechanically isolated. Excellent, smooth response. 7 ft. single-conductor, shielded cable. Diam. $2\frac{1}{2}$ ", height overall 6", depth $1\frac{1}{2}$ ". Shpg. wt. $\frac{3}{4}$ lb.

Model 717A. Crystal Hand Microphone with clip-on metal base. Code: **Ruduk.** List Price..... **\$9.95**



Shure 76B Lapel Microphone

Small, light, crystal microphone with high output level. Gives high quality reproduction of speaker's voice. Inconspicuous. Only $1\frac{1}{8}$ " diameter; weight only $1\frac{1}{2}$ oz. Iridescent Gray finish. Handy lapel clip. Complete with 25 ft. shielded single-conductor cable. Shpg. wt. 1 lb. **Model 76B.** Lapel Microphone. Code: **Rulop.**

List Price..... **\$25**



Special Microphone Cable

Available in standard trimmed 7 ft. and 25 ft. lengths. Other lengths in bulk untrimmed.

Model C10C. Cable. For Crystal and high-impedance dynamic microphones. Low capacity and high insulation resistance. Single-conductor type with close shield. Overall rubber jacket. Code: **Rusob.** List Price, per ft..... **12c**

Model C24A. Cable. Specially designed for low-impedance dynamic microphones. Has two twisted rubber-insulated conductors, close shield and overall rubber jacket. Code: **Rubel.** List Price, per ft..... **12c**

Model C14A. "Super-Shielded" Cable. Hum-free even in intense magnetic and static fields. Single-conductor with double shield. Recommended for Shure "Uniplex" microphone. Code: **Rubem.** List Price, per ft..... **20c**

For Shure Microphone Locking-Plug attached to cable, add \$1.50 list.

Cordsets complete with Shure microphone plug and amplifier input plug, completely wired, are available to fit most amplifiers. State amplifier make and model number.

Shure Crystal Devices are Licensed under Patents of the Brush Development Company. Shure Patents Pending.

SHURE

COMMUNICATIONS MICROPHONES

Best for Amateur, Police and Commercial Use



CARDIOID CRYSTAL COMMUNICATIONS

Cleans Up Voice Transmission! Makes Break-in 'Phone Easy!

Famous "Uniplex" model with special Shure speech characteristic! Dead at rear. (Rear response down 12-15 db). Gives studio performance. Cuts down room-noise pick-up, eliminates echoes, assures clearer, more intelligible speech. Cleans up voice transmission. Makes break-in 'phone easy. Ideal for police, commercial and high quality amateur communications. Specially moisture-proofed Grafoil Bimorph Crystal. Output level: 33 db below 1 volt for 10 bar speech signal. Swivel head. Built-in R.F. filter protects against burnouts. Built-in cable connector. Rich Satin Chrome finish. Diameter 3 1/8". Depth 3 3/4". Standard 3/8"-27 thread. Shpg. wt. 1 1/2 lbs. Complete with 7 ft. super-shielded cable.

Model 730SII. Cardioid Crystal Microphone without desk mount. Code: **Rupod**. **\$35.50**
List Price.....

Model 730S. Same, complete with Model S36A Iridescent Gray Desk Mount. Shpg. wt. 3 lbs.
Code: **Rupof**.
List Price..... **\$39.00**

New Shure 708SH Crystal



The beautiful new "STRATOLINER" with special Shure speech characteristic for commercial and amateur 'phone. Assures clear, crisp signals. High output level: 29.7 db below 1 volt for 10 bar speech signal. Built-in R.F. filter protects against burnouts. Bimorph Crystal. Die cast case; Satin Chrome finish. Swivel head. Cable connector. Standard 3/8"-27 thread. 7 ft. shielded cable. Diam. 2 1/4". length 4 1/8". Shpg. wt. 2 1/2 lbs.

Model 708SH. Crystal Microphone, without desk mount.
Code: **Rupob**. **\$19.50**
List Price.....

Model 708S. Same, complete with Model S36A Iridescent Gray Desk Mount. Shpg. wt. 4 lbs. Code: **Rupoc**.
List Price..... **\$23.00**

"Super-Level" 70STH Crystal



Here's the world-famous Shure "Super-Level" Communications Microphone. Has the highest output available in a crystal microphone. (26 db below 1 volt for 10 bar speech signal). Shure high-efficiency speech characteristic assures clear, crisp signals, cuts through noise and static. R. F. filter protects against burnouts. Satin Chrome die cast case. Built-in cable connector, with 7 foot shielded cable. Diam. 3 3/8". Depth 1 3/4". Shpg. wt. 2 lbs.

Model 70STH. Crystal Microphone without desk mount.
Code: **Rupic**. **\$22.50**
List Price.....

Model 70ST. Same, complete with Model S36A Iridescent Gray Desk Mount. Shpg. Wt. 3 1/2 lbs. Code: **Rupib**.
List Price..... **\$26.00**

Rings and Springs—Fit All Shure Stands

Model R20C. 6" standard ring for carbon microphones. "Quickway" mounting hooks. Satin Chrome, 8 rust-proof springs. Shpg. wt. 1 lb. Code **Ruket**.
List Price..... **\$2.50**

Model R10B. Light 5" ring for small carbon microphones. Satin Chrome finish. 8 rust-proof springs. Shpg. wt. 3/4 lb. Code: **Rujes**.
List Price..... **\$2.25**



"Military-Type" Crystal Microphone



Fits comfortably in palm of hand. Light, compact. Takes minimum space in portable equipment. Die cast case in Iridescent Gray with satin finish grille. Excellent response. Output level; 32.5 db below 1 volt for 10 bar speech signal. Specially designed "ON-OFF" switch. Complete with removable suspension hook. 7 ft. shielded cable and spring cable protector. 3 3/4" high, 2 3/4" wide, 1 3/4" thick. Shpg. wt. 1 lb.

Model 750B. "Military-Type" Hand Microphone complete with switch. Code: **Rusel**. **\$25**
List Price.....

(Carbon Type "Military" Hand Microphones are available in quantity only, on special order).

Model 3B Two-Button Carbon



Full-size two-button microphone with quality performance for amateur transmitters, intercommunications systems and P.A. installations. Can be used as a single-button microphone. Rigid cast frames. Protective grille. Shure "Quickway" hooks. Satin Chrome finish. Frame diam. 3". Thickness 1 1/8". Shpg. wt. 3/4 lb.

Model 3B. Code: **Ruciv**. **\$5.50**
List Price.....

Model 5B Two-Button Carbon



High quality, full-size two-button microphone. Regular full-size precision adjustable buttons and special screen-protected diaphragm insure exceptionally fine reproduction. Rugged construction. Satin Chrome finish. Shure "Quickway" Hooks. Diam. overall 3 3/4". Thickness 1 1/8". Shpg. wt. 1 1/2 lbs.

Model 5B. Code: **Rucit**. **\$10**
List Price.....

Two-Button Hand Microphone

Convertible Hand Microphone. Convenient for general-purpose Public Address use! Easily changed from hand to 3B type for stand mounting by removing handle. Iridescent Gray handle. Overall length, 8 7/8". Shpg. wt. 1 1/2 lbs. Complete with 6 ft. three-conductor cable and 4 "Quickway" Hooks.

Model 10B. Two-Button Hand Microphone.
Code: **Rucor**. **\$10**
List Price.....



Microphone Repair Service

All microphones require occasional repairs. Carbon microphones need reconditioning at least once a year to maintain sensitivity and quality. "Microphone Headquarters" maintains a special department for repairing and reconditioning many types and makes of microphones. Write for quotations.

SHURE

STANDS and ACCESSORIES

Improve Microphone Operation and Performance

"Stabilized" Friction-Lock Floor Stands

Beautiful, sturdy Shure Floor Stands improve appearance and operation of any sound set-up. Height adjustments made easily, quietly, with super-positive Friction Lock. 3-point "Stabilized" base cushioning gives 10-18 db reduction of shock and vibration. Molded soft rubber cable guide. $\frac{5}{8}$ "-27 thread.

Model S50B. Floor Stand. Satin Chrome finish. Round Base (9 $\frac{1}{4}$ " diam.; wt. 8 lbs.). Height adjustment 44 $\frac{3}{8}$ " to 70 $\frac{1}{2}$ ". Shpg. wt. 11 $\frac{1}{2}$ lbs. Code: **Rusaf.** **\$11**

Model S55A. "Studio-Type" Floor Stand. Heavy 3-leg base. (Wt. 10 $\frac{1}{2}$ lbs.). Leg spread 15 $\frac{1}{2}$ ". Height adjustment 48" to 70". Shpg. wt. 14 lbs. Iridescent Gray finish. Code: **Rusat.** **List Price \$17.00**

3-Section Utility Stand

Model S74C. 3-section Floor Stand. Especially suitable for portable use. Shure Friction-Lock. Modern round base. (Diam. 9 $\frac{1}{2}$ ", wt. 8 lbs.). Iridescent gray finish. Ht. range 30" to 64". Shpg. wt. 11 $\frac{1}{2}$ lbs. Code: **Rusap.** **\$11**

List Price

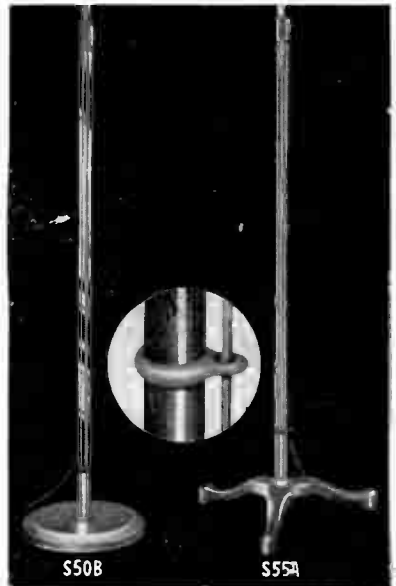

S50B

S55A

Cable-Type Transformer

Model A86A. High quality Cable-Type Transformer. Matches 35-50 and 200-250 ohm microphones to high impedance amplifier input. Compact, sturdy. Case diam. 1 $\frac{3}{8}$ ", length 2 $\frac{7}{8}$ ". 7 ft. cable. Shpg. wt. 1 $\frac{1}{2}$ lbs. Code: **Rudeb.** **\$12**

List Price



Take-Apart Stand

Model S34A. New, handy low-cost stand for desk or hand use. One twist of handle locks it securely in base or use as a desk or table stand, or releases handle for use in hand. Metal base, wood handle. Metal top threaded $\frac{5}{8}$ "-27. Height over all 6 $\frac{11}{16}$ ". Base diam. 4 $\frac{1}{2}$ ". Length of handle 5 $\frac{3}{8}$ ". Shpg. wt. 1 lb. Code: **Rukab.** **List Price \$2.00**



Model A41A. Microphone handle. Solid wood with brass ferrule on top threaded $\frac{5}{8}$ "-27. Code: **Rujad.** **List Price 75c**

New "Broadcast" Stand

Model S510A. Designed for both beauty and utility. Heavyweight, stabilized 3-leg base hugs floor, provides firm footing. Quick, positive friction lock. Mounts all types of microphones. Standard $\frac{5}{8}$ "-27 thread. Inner tubing has $\frac{3}{8}$ " pipe thread outside and $\frac{5}{8}$ "-24 thread inside. Height adjustable from 45" to 79". Leg spread 16 $\frac{1}{2}$ ". Net wt. of tubing assembly 6 $\frac{1}{2}$ lbs. Net wt. of base 22 $\frac{1}{2}$ lbs. Shpg. wt. 32 lbs. (Isolation Unit not included). Code: **Rusop.** **List Price \$35**

Microphone "On-Off" Switches

Rotary and push-button types. $\frac{5}{8}$ "-27 thread

Model A83A. Quickly attached to any cable-connector type Shure microphone. No wiring; internal plug establishes connections. Bakelite arrow knob. Code: **Runim.** **List Price \$4.00**



Model A80B. Threaded $\frac{5}{8}$ "-27 to fit non-connector type microphones. Bakelite arrow knob. Code: **Runib.** **List Price \$2.50**

Model A84A. Momentary On-Off Switch. Press-to-talk Bakelite disc. Code: **Runid.** **List Price \$4.50**

Model A85A. Momentary Relay-Type Switch. Normally open switch closes circuit comprising one conductor and shield of outgoing cable for operation of relay or other device. Remaining conductor and shield of cable carry microphone output. Bakelite disc. Code: **Runif.** **List Price \$4.50**



S510A

Modern Desk Stands

Model S36A. Beautiful, streamlined Desk Mount, with stable support at correct height. Fits Shure connector-type microphones, concealing plug in base. Adapter plate and tubing provided for other type microphones. Ornamental button at front may be removed for installation of $\frac{3}{8}$ " standard bushing switch or volume control. Iridescent Gray finish. Base: 2 $\frac{1}{2}$ " high, 5" wide, 7" long. Shpg. wt. 1 $\frac{1}{2}$ lbs. Code: **Rused.** **List Price \$4**

Model S32D. Highly attractive modern desk stand, finished in Iridescent Gray and Satin Chrome. Shure "Friction-Lock" provides easy, positive height adjustment from 7" to 11". $\frac{5}{8}$ "-27 thread. Base diam. 6". Shpg. wt. 3 $\frac{1}{2}$ lbs. Code: **Rused.** **List Price \$7.50**

Stand Adapter

Model A20A. Mounts microphones with $\frac{1}{2}$ " Pipe Thread on $\frac{5}{8}$ "-27 thread stand. Code: **Ruap.** **List Price \$1.00**



SHURE

CRYSTAL PICKUPS and MAGNETIC RECORDING HEAD



New "Hi-Lo" Lightweight Crystal Pickup Permanent Sapphire Point Needle

Only 1 ounce needle pressure with 1.4 volts output at 1000 cps (Audiotone record)—over twice the output of any other light weight pickup—at low cost! Makes possible easy replacement of conventional pickups. Modernizes record players. Gives life-like reproduction of full frequency range—practically eliminates record wear—increases record life. Permanent sapphire point eliminates inconvenience of changing needles. Exclusive Shure design permits accurate production control of uniformity. Plays 10" and 12" records. Streamlined plastic arm in mahogany finish blends harmoniously with modern cabinets. Offset head. Set screw permits changing of needle without replacing entire cartridge. Genuine Bimorph Crystal. Response from 60-7000 cycles. Playing radius 7/8". Overall length 8 3/4". Can be mounted in 1/4" or 1/2" hole. Furnished with 14" cable and arm rest. Shpg. wt. 9 ozs.

Model 97AN. "Hi-Lo" Crystal Pickup. Complete with permanent sapphire point needle. Code: **Ruzer.**
List Price..... **\$6.50**

Model 97A. Same as Model 97AN, but less needle. Furnished with set screw and thumb screw. Code: **Ruzep.**
List Price..... **\$5.50**

Model 95A. Semi-Lo-Pressure Crystal Pickup. Same as Model 97A, but with 2 ounce needle pressure and 3 volts output at 1000 cps (Audiotone record). For use with any conventional removable needle. Assures improved performance and less record wear than conventional 2 3/4 ounce pickups. Shpg. wt. 10 ozs. Code: **Ruzes.**
List Price..... **\$5.50**

Shure 44A Magnetic Recording Head

High-quality wide-range record cutter. Ideal for use with home recording equipment. Designed to operate directly from the voice-coil winding of the output transformer. Stiff moving element permits recording on practically all recording materials. Exceptionally rugged and stable under all climatic conditions. High Sensitivity. May be operated from the output stage of almost any radio set. Impedance: 4 ohms DC (10 ohms at 400 cycles), suitable for output circuits having impedance of 4 to 8 ohms. Other impedance values are available on special order. Thousands of these Cutters are in service today on home recorders. In making replacement, be sure to give the numbers that appear on the cutter to obtain correct type bracket and impedance. Steel, alloy-tipped, or sapphire recording stylus may be used. 36" flexible leads. Length overall 3 3/4"; less screw 3 1/4". Shpg. wt. 8 oz.



Model 44A. 4-ohm Magnetic Recording Head. Without cutting stylus. Code: **Ruzad.**
List Price..... **\$11.50**

New "Hi-Lo" Crystal Pickup Cartridges Greatly Improve Pickup Performance



These advanced type Crystal Cartridges developed by Shure Engineers will directly replace other flat-type cartridges and give improved pickup performance. Sturdy metal case, size, 2 5/8" long, 3/4" wide, 7/16" deep. Genuine Bimorph Crystal.

Model W42AN. Crystal Cartridge with permanent sapphire point needle. Design for Shure Model

97AN Hi-Lo Pickup and other pickups with a pressure of 1 ounce or more. Low needle point impedance. 1.4 volts output at 1000 cps (Audiotone record). Complete with permanent sapphire point needle and set screw. Code: **Ruzod.**
List Price..... **\$5**

Model W42A. Same as Model W42AN, but less needle. Furnished with set-screw and thumb screw. Code: **Ruzog.**
List Price..... **\$4.00**

Model W40A. Crystal Cartridge designed for Shure Model 95A Semi-Lo-Pressure Pickup and other pickups with 2 ounce pressure or more. Output 3 volts at 1000 cps (Audiotone record). Minimum recommended pressure 1 3/4 ounces, but will work with heavier pressures and retain advantage of low needle point impedance for reduced surface noise and better response. Furnished with thumb-screw for use with any removable needle. Code: **Ruzop.**
List Price..... **\$4.00**

Model A60A. Specially designed Permanent Sapphire Point Needle. For use with Models 97AN and 97A Pickups, and Models W42AN and W42A Cartridges. Code: **Ruzot.**
List Price..... **\$1.00**

Other Crystal Pickup Cartridges



W20C

Model W20C. Metal type cartridge that fits Shure 99, 94 and 910 pickups. Has built-in "Needle-Tilt" Balanced-Tracking. Code: **Ruzim.** List Price..... **\$4.00**



W27C

Model W27C. Bakelite type cartridge for universal replacement. Three-in-one all-purpose unit. Has lug terminals, but is also supplied with screws and pins for quick, easy conversion to screw or "plug-in" pin terminal type as used in many record players and "coin machines." Straight needle tracking. Code: **Ruzor.**
List Price..... **\$5.00**

Transcription-Type Crystal Pickup

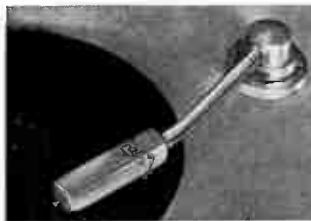

Meets the latest requirements for high quality reproduction of lateral records in broadcasting, recording and public address work. Smooth high frequency response. Full bass response adjustable with simple networks in the input circuit. Output approximately 2 1/2 volts. Grafoil Bimorph Crystal, triple-moisture-sealed. Easy needle-changing. Head locks in place when tilted back. Arm

locks in place when swung away from turntable. Needle-pressure 2 1/2 ounces. Statuary Bronze finish overall. Complete with 3 1/2 ft. shielded cord, mounting screws and motorboard drilling template.

Model 914A. For 16", 12" and 10" records. Bent arm tracking correction. Overall length, 12 1/2". Shpg. wt. 2 lbs. Code: **Ruzig.**
List Price..... **\$16.50**



ASTATIC



CRYSTAL MICROPHONES

TRADE MARK REGISTERED

LICENSED UNDER BRUSH DEVELOPMENT CO. PATENTS.

JT-SERIES MICROPHONES

This Astatic Microphone, popular because of its wide range of usefulness, excellent performance and low price, is used extensively for amateur, public address and home recording. JT-Series Microphones are available in both wide and voice range models and, in addition to standard equipment, are furnished complete with concentric cable connector, convenient wood handle, interlocking metal base and 25-ft. shielded cable. Wood handle may be removed and microphone used on floor stand. Pleasing bass response with uniform highs free from objectionable peaks or dips. Output level —52 db provides ample reserve for use with high gain amplifiers. Choice of all chrome or chrome and gray finish. Stand and handle gray.

JT-30-TT Wide Range, Code ASVLG,
List Price\$15.50

JT-40-TT Voice Range, Code ASVID,
List Price 15.50

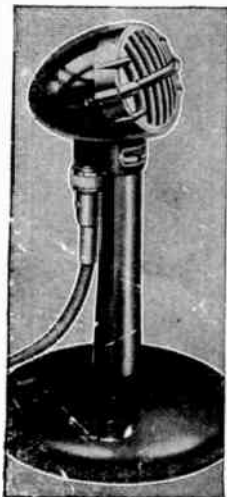

WR-SERIES MICROPHONES

The WR-Series, Multi-Unit Microphones, made in two models for varied cable lengths, are highly recommended for studio, public address and high quality recording purposes. These microphones are built with dual-diaphragm crystal cartridges in multi-unit arrangements, assuring high fidelity reproduction. Overall frequency response is exceptionally smooth up to 10,000 cycles. Due to their special interior assembly design, the WR-Series Microphones cannot be acoustically overloaded. Model WR-20 may be used on cable up to 100 ft. with negligible loss of output and Model WR-40 is more than able to handle cable twice this length. Output level —56 db. Finish, all chrome.

WR-20, Code ASVGZ.....\$29.50

WR-40, Code ASVAL..... 39.50



N-SERIES MICROPHONES

Because of their exceptionally smooth frequency response and many other improved characteristics, Astatic Model N-Series Crystal Microphones are especially desirable for modern public address installations. Swivel joint, tilting head permits adjustment to either semi-directional or directional position, providing a practical and effective method of acoustic feedback control. Concentric cable connector facilitates quick interchange of cables. Two models are available. Model N-30, with output level —52 db, is a high fidelity, wide range microphone, 30 to 10,000 cycles. Model N-80, voice range microphone, output level —49 db, with rising response to 3,500 cycles. All chrome finish. Complete with 25-ft. cable and spring protector.

N-30 Wide Range, Code ASVJR,
List Price\$17.50

N-80 Voice Range, Code ASVJP,
List Price 17.50

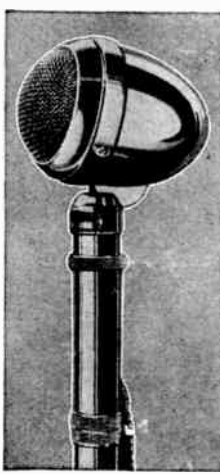
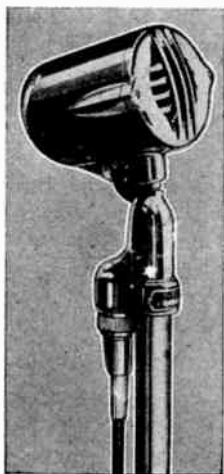

MODEL T-3 MICROPHONE

In Model T-3, Astatic offers a Crystal Microphone for practical use in almost every field of usage. Here is a microphone with an ideal frequency response, definitely established by long and continued popularity, that appeals to professionals and amateurs alike. Its use is suggested for studio set-ups, with amateur rigs, intercom communicating systems, public address installations and for high class recording purposes. Microphone head may be tilted with ease on unique swivel mounting and pickup pattern made semi or non-directional, as desired. Output level —52 db. Frequency response substantially uniform from 30 to 10,000 cycles. Equipped with interchangeable plug and socket connector and 25-ft. cable. All chrome finish.

T-3, Code ASVCX.....List Price \$25.00

TYPE S SWITCH ADAPTOR

When so ordered, at little extra cost, a convenient on-off switch, as shown with N-Series Microphone, in accompanying illustration, may be had with Astatic Model Microphones N-30, N-80, T-3, WR-20, WR-40, D-104 and K-2. This Model "S" Switch is NOT SOLD SEPARATELY but must be ordered with microphone. Model "S" Switch shorts the microphone circuit in "off" position, and is a convenient method of cutting in and out on two-way conversations. In practical fields, using intercommunicating systems, the "S" Switch plays an important role in convenience and usefulness. With amateurs, too, this switch is becoming increasingly popular. In ordering this switch, add \$2.50 to the List Price of any Astatic Microphone listed above and add the letter "S" to the model number.



MODEL D-104 MICROPHONE

This is Astatic's time-tested and proven microphone . . . the first practical crystal microphone ever developed . . . and still preferred by a great host of veteran amateurs. Model D-104, it is safe to assert, is used by more amateurs than any microphone ever made. With high output level —48 db, possesses definitely reduced feedback tendencies and does not gum up or overload when used for close-talking applications. New type yoke-driven, bridge-mounted Graphoil crystal element, improved shock-proof mounting and barometric compensation. Speech range frequency response from 500 to 4,000 cycles. Bright chrome finish. Standard equipment includes interchangeable plug and connector, spring cable protector and 7-ft. cable.

D-104, Code ASUPA...List Price \$22.50





ASTATIC



MICROPHONES AND STANDS

TRADE MARK REGISTERED

LICENSED UNDER BRUSH DEVELOPMENT CO. PATENTS.

MODEL K-2 MICROPHONE

Because of its smooth, undistorted reproduction and the fact that it cannot be acoustically overloaded, Astatic Model K-2 Crystal Microphone is highly recommended. In this model, Astatic provides a small size, dual-diaphragm type crystal microphone for studio use, recording, dance bands, public address installations and general applications where quality performance is required. With dual crystal unit design, Model K-2 has twice the capacitance of the usual crystal microphone and correspondingly longer cable lengths may be used. Output level —60 db, below one volt per bar. Frequency response 30 to 10,000 cycles with rising characteristic beyond 6,000 cycles with non-directional pick-up. Standard equipment includes plug and socket connector and 25-ft. cable. All chrome finish.

K-2, Code ASURX.....List Price \$27.50



DYNAMIC MICROPHONE

Model "DN" is a semi-directional, all-purpose dynamic microphone incorporating a new unitary moving coil system, and carefully proportioned acoustic circuit to highly damp the natural resonance of the moving system and provide a response characteristic substantially flat from 50 to 7,000 cycles. The "DN" design employs all features necessary for wide applicability, including Astatic's tilting-head swivel mount, permitting semi- or non-directional positions. Standard equipment includes plug and connector, spring cable protector and 25-ft. cable. Two-tone gray and chrome finish.

- DN-50 (50 ohms), Code ASVNJList Price \$20.00
- DN-200 (200 ohms), Code ASVNIList Price 22.50
- DN-500 (500 ohms), Code ASVNIList Price 22.50
- DN-HZ (50,000 ohms to grid), Code ASVNGList Price 22.50



ASTATIC MICROPHONE STANDS CONNECTORS AND ADAPTORS

SC-25—\$5.00
Code ASUWQ

F-11—\$3.20
With 8-ft. Cable
Code ASUWU

HA-25—\$4.00
Code ASUWF

HS-25—\$5.00
Code ASUWH



Floor Stand A-1—\$8.50
Code ASUZZ

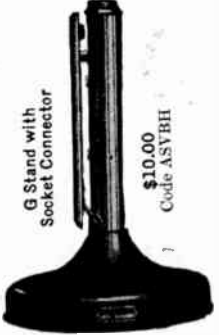

G Stand with Socket Connector
Code ASVBH
\$10.00



5/8" x 27 Thread
E-1 \$3.00
Code ASVCZ



F Stand with Socket Connector
Code ASUZO
\$6.00



5/8" x 27 Thread
E-6G Code ASUZA
E-6G Code ASUZK
\$2.50



LAPEL TYPE MODEL L-1

This very small dual-diaphragm crystal microphone was developed to meet especially difficult pickup conditions. Equipment includes lapel-type spring clip and over-shoulder cord to permit wide latitude of movement. Output level —62 db. Frequency response uniform from 30 to 10,000 cycles with rising characteristic beyond 6,000 cycles. Finish, statuary bronze. Furnished with 25-ft., small diameter, single conductor cloth covered cable.

Model L-1, Code ASUSX.....List Price \$25.00

SPECIAL MODEL 218

Astatic's concealed placement crystal microphone, Model 218, is used extensively for dictographic and detective work. The unit is small, only 3/8-inches thick, finished in black and therefore easily made inconspicuous. Cable connects through collet type ferrule. Spring clip on back of case for easy attachment purposes. Output level —46 db. Frequency response designed with rising characteristic above 500 cycles for speech frequencies.

Model 218, Code ASUVV.....List Price \$22.50



MODEL VP VIBRATION TYPE

Astatic's inertia type pickup of simple design and inherent ruggedness, for production testing of moving and reciprocation machinery, motor cars, aircraft, water leak detection and similar applications. All contact points are of hardened steel. Wave form may be observed with the oscillograph. Model VP case is made from heavy machined brass finished in bright chrome.

Model VP, Code ASZGK
List Price.....\$25.00

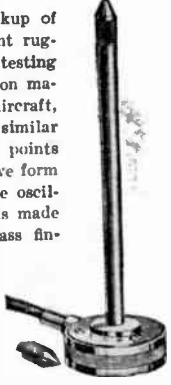

KNOWN
THE WORLD
OVER

ASTATIC

KNOWN
THE WORLD
OVER

CRYSTAL PICKUPS

TRADE MARK REGISTERED

LICENSED UNDER BRUSH DEVELOPMENT CO. PATENTS.

Low Pressure CRYSTAL PICKUPS

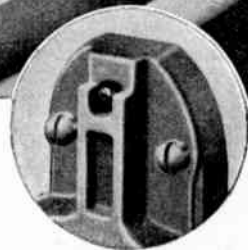
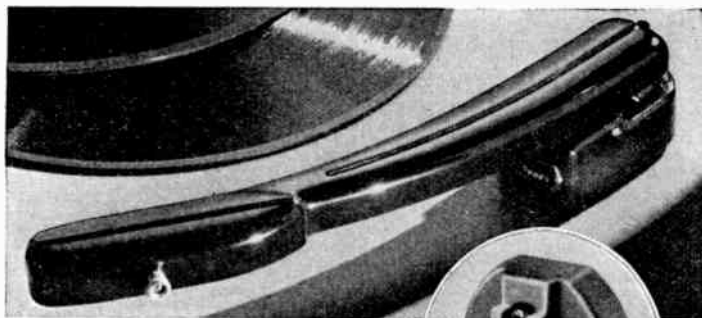

Designed for a higher standard of phonograph performance, Astatic Low Pressure Crystal Pickups, with permanent, built-in Sapphire jewel points, have contributed immeasurably to the convenience, economy and enjoyment of electrical phonographs and radio-phonograph combinations. This rounded Sapphire stylus, gliding smoothly over the record with feather-weight one-ounce pressure, makes this pickup basically different from any crystal pickup previously available. No needles to change. No wear on records. No gadgets to get out of order. With stylus pressure of only one ounce, scarcely more than one-third the pressure necessary in conventional pickups, records, literally speaking, don't wear out but, instead, retain their newness for hundreds of plays. Surface noise and distortion due to wear are, as a result, practically eliminated. The offset angle in arm design is such that a low tracking error is combined with balanced sidewall pressure in the record groove. Stylus pressure is controlled by spring action, permitting a low value of up and down inertia not obtainable with a counterweighted arm.

PERMANENT SAPPHIRE STYLUS

Only highest quality precisely ground, highly polished, natural Sapphires are used in Astatic Low Pressure Pickups. This jewel point is protected with a "U" shaped guard surface and internal protector spring. With a radius slightly larger than the record groove, the stylus point rides slightly up on the groove sidewalls for finer reproduction.

Model FP- 8, Cartridge LP- 6, Code ASXIF	List Price \$16.50
Model FP-18, Cartridge LP-21, Code ASXIE	List Price 16.50
Model FP-38, Cartridge LP-23, Code ASXID	List Price 16.50

PROFESSIONAL MODEL LOW PRESSURE PICKUP

Incorporating all the advantages of Low Pressure design and performance, Models HP-16 and HP-36 are particularly suited for Broadcast and Recording Studio use. Ball-bearing swivel base, accurately counterbalanced arm for one-ounce needle pressure on transcriptions up to and including the 16" size. Maroon finish.

HP-16, 30 to 7,000 cycles, Code ASKIB
List Price \$25.00
HP-36, 30 to 10,000 cycles, Code ASXIA
List Price \$25.00



Model HP-16 and HP-36



- ← **MODEL B-16**—This is Astatic's finest offset arm Crystal Pickup designed for professional use on lateral transcriptions of all sizes. Tru-Tan offset head reduces tracking error to 2.4 degrees on a 16" record. Free from mechanical resonance throughout the audio range. Response characteristic may be altered to suit conditions by modification of input circuit. Overall length, 14". Needle pressure 2 1/4 oz. Complete with 4-ft. single conductor shielded cable and individual arm rest. Black and Chrome finish.
Model B-16, Code ASWKG.....List Price \$22.50
- ← **MODEL B-10**—Here is another deluxe Crystal Pickup, intended for those who desire the ultimate in fidelity of record reproduction. Tru-Tan offset head design. Plays both 10" and 12" records. Ball bearing swivel base. Selected Type B Cartridge. Beautifully finished in black and chrome. Overall length 12 1/4". Needle pressure, 2 1/4 oz. Complete with 4-ft. single conductor shielded cable and individual arm rest.
Model B-10, Code ASWKII.....List Price \$17.50
- ← **MODEL AB-8**—In this Crystal Pickup, Astatic offers a new high type performance combined with ultra modern styling. Special features include Spring-Axial Cushioning, Astatic's famous Type B (Bakelite encased) Cartridge with internal damping to assure permanence, Bender Crystal element with "Ebonite" water proof coating, and last but not least, a sturdy, new die-cast arm. For use with 10" and 12" records. Overall length 10 1/2". Needle pressure, 2 1/4 oz. Staturary Brown finish. Complete with 4-ft. single conductor shielded cable and arm rest.
Model AB-8, Code ASXFZ.....List Price \$10.00
- ← **MODEL O-7**—This Astatic Pickup was designed primarily for radio-phonograph combinations and public address applications requiring quality output combined with short mounting center of only 7". Axial cushioned, die-cast, Tru-Tan arm. Now furnished with the improved M-22 Type Cartridge. Graphoil Bimorph Crystal element, Ebonite treated. Output response may be altered to suit conditions. Telephone black with bright chrome trim. Overall length, 9 1/2". Needle Pressure, 2 1/4 oz. Complete with 4-ft. single conductor shielded cable and arm rest.
Model O-7, Code ASWOK.....List Price \$6.50



ASTATIC



CRYSTAL PRODUCTS

TRADE MARK REGISTERED

LICENSED UNDER BRUSH DEVELOPMENT CO. PATENTS.

MODEL D-9—Combining low cost with high performance standards. Ideal for manual record players. Used extensively for modern replacements. Mounting center adjustable to 6 1/2" or 7". Tru-Tan offset head. Employs L-Type Cartridge. Staturary Brown finish. Complete with 12" plain leads. Model D-9, Code ASXFU...List Price \$4.95

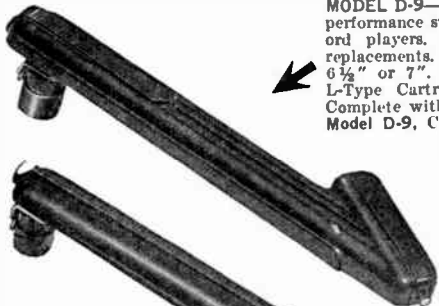
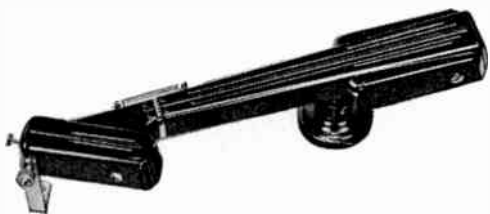

MODEL SL-8—Straight-arm pickup ideal for certain specific applications, particularly for lightly cut home recordings. Not apt to jump grooves or sweep to inside of record. Employs L-Type Cartridge. Adjustable to 7" or 8" mounting center. Staturary Brown finish. Complete with 12" plain leads. Model SL-8, Code ASXFT...List Price \$4.95



MODELS S-8 and S-12—This is the ORIGINAL CRYSTAL PHONOGRAPH PICKUP engineered by Astatic and still a favorite with sound men desiring a straight arm. Rigid steel channel arm with axial cushioning and ball-bearing swivel base. Use Type B Cartridge. Black wrinkle finish. Complete with 4-ft. cable and arm rest.

Model S-8, 8" Mtg. Center, Code ASWCA...\$10.00
S-12, 12" Mtg. Center, Code ASWEZ 12.50

MOBILE MODEL AB-8M PICKUP

The pickup illustrated above is designed by Astatic especially for use on sound trucks, airplanes, automobiles, trains, and other mobile units. Model AB-8M is mechanically counterbalanced so as to track on recordings even in a vertical position without jumping the groove. Hinged head may be tilted upward for quick and easy changing of needles. Characteristics almost identical to Model AB-8. Standard equipment includes locking arm rest, 2-ft. shielded cable, 7" mounting center. Standard telephone black finish.

Model AB-8M, Code ASXEA.....\$12.50

For more detailed description of Astatic Products, see your Astatic Jobber or write for Catalog.

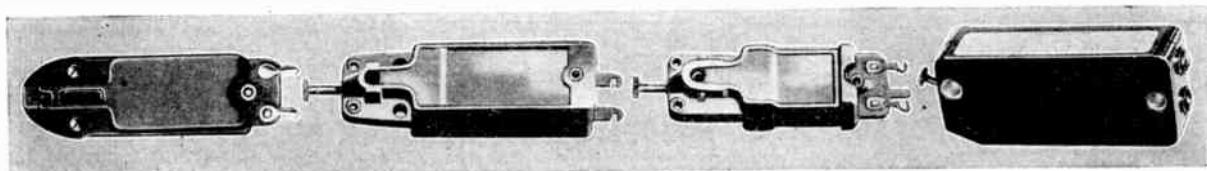

Type "LP"

Type "L"

Type "M"

Type "B"

ASTATIC CRYSTAL PICKUP REPLACEMENT CARTRIDGES

Model	Terminals	Replacement for	Recommended Needle Pressure	*Output Voltage	Code	List Price
LP-6	Lug	FP-8 and Record Changers	1 oz.	0.85	ASWUM	\$8.00
LP-21	Lug	FP-18 and HP-16	1 oz.	0.85	ASWUL	8.00
LP-23	Lug	FP-38 and HP-36	1 oz.	0.65	ASWUJ	8.00
L-40	Lug	FL-48	1 1/4 oz.	0.80	ASWUA	4.00
L-22	Lug	AI-8	2 3/4 oz.	1.75	ASWUP	5.00
L-24	Lug	Record Players	2 3/4 oz.	2.95	ASWVY	5.00
L-25	Lug	—	2 oz.	1.25	ASWUK	5.00
L-26	Lug	D-9 — SI-8	2 3/4 oz.	1.4	ASWVZ	4.00
L-27	Lug	Record Players	2 3/4 oz.	1.40	ASWVX	5.00
M-22	Lug	O-7	2 3/4 oz.	2.9	ASWJM	5.00
B-2	Universal Terminals	B-10, B-16, AB-8, AB8M, S-8, S-12 and Auto. Phonos	2 3/4 oz.	2.5	ASWHJ	5.00
B-4	Wires 3" Long	Record Changers	2 3/4 oz.	2.5	ASWHH	5.00

*Average at 1,000 c.p.s. Audiotone 78-1 Record

NOTE—B types, Bakelite; LP, L and M types, Metal



E4P TONE EQUALIZER

This tone equalizer is an adjustable tone compensation network to be connected between crystal pickup and amplifier, recommended for use with all crystal pickups. Rotary switch control.

Model E4P
Code ASVHD
List Price, \$3.00

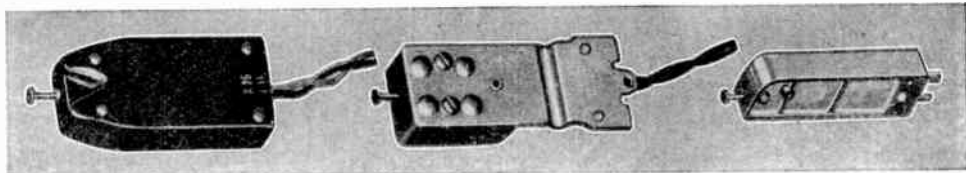

Models X-26 and X-29A

Model M-41

Model C-42

ASTATIC RECORDING HEADS

Model	Item	Driving Voltage	Useful Upper Limit	Finish	Dimensions	Net Weight	Code	List Price
X-26	Crystal	75 V.RMS	5,000 cps	Tel.-Blk.	1 3/8" x 5/8" x 3 1/4"	5 1/2 oz.	ASXMI	\$11.50
X-29A	Crystal	120 V.RMS	6,500 cps	Tel.-Blk.	1 3/8" x 5/8" x 3 1/4"	5 1/2 oz.	ASXMH	11.50
C-42	Crystal	75 V.RMS	5,000 cps	Tel.-Blk.	1 1/2" x 1 1/8" x 3"	1 1/2 oz.	ASXMG	11.50
M-41-8	Magnetic	3.0 V.RMS	7,000 cps	Tel.-Blk.	1 3/8" x 1 1/8" x 3 3/4"	3 1/2 oz.	ASXMF	11.50
M-41-500	Magnetic	22 V.RMS	7,000 cps	Tel.-Blk.	1 3/8" x 1 1/8" x 3 3/4"	3 1/2 oz.	ASXME	11.50

BRUSH

CRYSTAL Microphones



BR2S

BRUSH MODEL BR2S "Sound Cell" Type

The first commercially available spherical microphone, introduced by Brush and accepted the world over. Floating, shockproof sound-cell assembly in satin chrome grille type case. Output level —66 db.* Used as standard equipment for sound measurement and in practically all applications where fidelity of response is important. Especially suitable for close speaking.

Microphone complete with plug and socket..... **List Price \$29.50**
 Net Wt., 7 oz. Shipping Wt., 2 lbs. Code, Maple

BRUSH MODEL QO "Quality with Output" Microphone

The compensated diaphragm driven crystal cartridge on shock-proof mountings is enclosed within a spherical, satin chrome case designed to appeal to the most critical Fidelity of response 30 to 9000c.p.s. High output level (—54 db.*). Fullness of tone combined with brilliancy for speech and music. Same swivel design as on the AP.

Microphone complete with 3 prong plug and socket and 25 ft. of cable... **List Price \$27.50**
 Net Wt., 1 lb. 6 oz. Shipping Wt., 4 lbs. Code, Moque



QO

BRUSH MODEL AP "All-Purpose" Microphone

The diaphragm driven crystal unit is housed in a satin chrome die cast case of modern design. Exceptional sensitivity (—48 db.*). Variable tone control of bass or treble. High or low impedance operation by means of transformer and terminal strips conveniently located in back. Crystal capacity unusually high (.007 mfd.) permitting use of much more cable than with ordinary microphones. Easily adjustable with unique swivel design.

Microphone complete with 3 prong plug and socket and 25 ft. of cable... **List Price \$29.50**
 Net Wt., 2 lbs. 4 oz. Shipping Wt., 5 lbs. Code, Maple

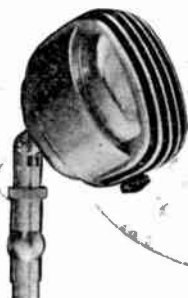

AP

BRUSH MODEL VM-1 "Vibromike", Contact Microphone

Extreme sensitivity with minimum amplification, responding only to direct contact vibration. Unusually small size, only 7/8" x 3/4" x 5/8". Broad field of applications, musical instruments, industrial uses—detecting mechanical vibrations, etc. Enclosed in soft, molded rubber case adding to its inherent ruggedness. Easily installed.

Microphone complete with mounting clamp and 25 ft. of cable..... **List Price \$17.50**
 Net Wt., 6 oz. Shipping Wt., 2 lbs. Code, Music



VM-1

BRUSH MODEL BL-1 Sound Cell Microphone

An efficient lapel microphone. Unusually small and light weight. Removal of lapel clip makes it useful as a compact hand microphone. Sound cell construction with typical sound cell response. Soft rubber covering adding to its inherent ruggedness.

Microphone complete with 25 ft. of cable..... **List Price \$25.00**
 Net Wt., 8 oz. Shipping Wt., 2 lbs. Code, Maize



BL-1

PRICES SUBJECT TO CHANGE WITHOUT NOTICE

Complete technical data available on request.

*Zero reference 1 volt per dyne per sq. cm.

BRUSH

Crystal Pickups AND RECORD CUTTERS

Brush Crystal Pickups, the PL-20 and PL-25, through their fine performance have won a prominent place in the art of disc recording. These two pickups, employing the same crystal cartridges, have practically identical performance ratings. Their low stylus pressures, (about 30 grams or approximately one oz.) minimize background noise and virtually eliminate record wear.

The polished permanent sapphire stylus shows no measurable wear over a period of 250 hours continuous playing on commercial shellac pressings.

The low inertia vibratory system of both the PL-20 and PL-25 pickups assures wide range frequency response—flat within ± 2.5 db. from 50 to 6000 c.p.s. with only a slight rise to 10,000 c.p.s.

BRUSH PL-20 CRYSTAL PICKUP



PL-20

Precision built for quality reproduction. Enough output for a conventional 2-stage amplifier. Reproduces "Constant Amplitude" recordings without equalization. For commercial "Constant Velocity" recordings Brush equalizer No. 3761-B is used. 14" Pickup arm is designed for records and turntables up to 17-1/4" in diameter. Readily adaptable to most phonographs. Two color combinations, taupe arm with colonial bronze metal parts, or black arm with satin chrome metal parts.

PL-20 Pickup complete with No. 3761-B equalizer (and base mounting spacers if required). List Price \$45.00
Net Wt., 2 lbs. 4 oz. Shipping Wt., 8 lbs. Code, Payle

No. 3761-A low impedance equalizer. (50, 200 and 500 ohms)
List Price \$15.00
Net Wt., 5 oz. Shipping Wt., 1 lb. Code, Loped

BRUSH PL-25 CRYSTAL PICKUP

Practically identical to the PL-20 Pickup in response and electrical characteristics. This pickup is designed to operate in a limited space—with turntables and records not over 12" in diameter. Mottled red mahogany arm with all metal parts finished in colonial bronze.

PL-25 Pickup (no equalization included)
List Price \$33.00
Net Wt., 1 lb. 4 oz. Shipping Wt., 7 lbs. Code, Playi

No. 3761-B High Impedance Equalizer..List Price \$2.50
Net Wt., 3 oz. Shipping Wt., 1 lb. Code, Hiped

No. 3761-A Low Impedance Equalizer..List Price \$15.00
Net Wt., 5 oz. Shipping Wt., 1 lb. Code, Loped



PL-25

BRUSH RC-20 CRYSTAL CUTTER



The Brush RC-20 Crystal Cutter has been designed to satisfy the demand for high quality, low cost recordings in the home, school and studio.

Due to its inherent stiffness, the RC-20 will cut lateral type records in virtually all hard or soft disc materials. Being of simple and compact design, it is readily adaptable to all types of transcription equipment. A three watt amplifier is sufficient to satisfactorily drive the RC-20 Cutter. Frequency response—flat within ± 3 db. from 50 to 9000 c.p.s. Cuts constant amplitude without equalization, and constant velocity or other desired characteristics with suitable equalization. Technical bulletin supplied giving full information as to circuits.

RC-20 Cutter (less stylus).....List Price \$25.00
Stylus 3629List Price 7.50
Net Wt., 4 oz. Shipping Wt., 2 lbs. Code, Reco



PRICES SUBJECT TO CHANGE WITHOUT NOTICE

Complete technical data available on request

ALLIANCE *"Even Speed"* PHONO-MOTORS

3 MOTORS THAT MEET 95% OF ALL REPLACEMENT REQUIREMENTS

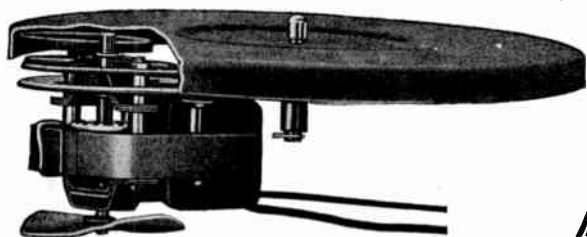

Better Built - Better Engineered

"Even-Speed" MODEL 80

Available for operation on 110 or 220 volt, 40, 50 or 60 cycle source at 16 watts input, 78 R.P.M. only. Simple and quiet in operation—no gears—smooth positive friction rim drive. Good regulation characteristics for uniformity of table speed. Amply proportioned bearings—large oil reserves. Motor and idler plate shock mounted to mounting plate for low vibration transfer to turntable and motor board. Forced ventilation for cool operation. Slip type fan precludes possibility of injury. Mounting plate maintains correct turntable height regardless of mounting board thickness. Available with 8, 9 or 10 inch turntable top. Maximum depth below base mounting plate, $2\frac{1}{8}$ inches.

PRICES

110 V. 60 C.—78 R.P.M. with
 8" Table—List \$5.00—Net \$3.00
 9" Table—List 5.28—Net 3.17
 10" Table—List 5.55—Net 3.33

EXTRAS ON BASE PRICES

220 V. 60 C.—List \$1.00—Net \$0.60

110 V. 50 C.—List 1.00—Net .60
 220 V. 50 C.—List 1.00—Net .60
 110 V. 40 C.—List 1.00—Net .60
 CESA Approved Type—
 List .75—Net .45
 Retractable Turntable Pin—
 List .28—Net .17



ALL EVEN-SPEED MOTORS INDIVIDUALLY PACKAGED

"Even-Speed" MODEL 60

Alliance's Latest and Finest Phonograph Motor. Available for operation on 110 or 220 volt, 50 or 60 cycle source at 14 watts input. Self-starting—maintains constant record speed. Designed for superior speed regulation under wide variations of voltage, load and temperature. Large bearings, ample oil reserves. Laminated bakelite helical cut gears for quiet operation, completely enclosed and protected. Forced ventilation for cool operation. Universal mounting plate maintaining correct turntable height with any thickness of mounting board. Available with 8, 9 or 10 inch turntable top. Motor dimensions: Length, $4\frac{3}{8}$ "; width, $3\frac{1}{8}$ "; depth to mounting plate, $3\frac{1}{4}$ ". Precision assembly for uniform production.

PRICES

110 V. 60 C.—78 R.P.M. with
 8"-9" Table—List \$8.50—Net \$5.10
 10" Table—List 9.00—Net 5.40
 110 V. 60 C. only—33½ R.P.M. with
 10" Table—List \$12.50—Net 7.50

EXTRAS ON BASE PRICES

110 V. 50 C.—List \$2.00—Net \$1.20
 220 V. 60 C.—List 2.00—Net 1.20
 220 V. 50 C.—List 3.00—Net 1.80
 CESA Approved Type—
 List .25—Net .15



Replacement Parts for MODELS 80 and 60

FINISHED TURNTABLE TOP ONLY
 STANDARD BROWN FLOCK

Model 80 Type
 X278R—8" Size—List \$0.97—Net \$0.58
 X278S—9" Size—List 1.03—Net .62
 X278T—10" Size—List 1.14—Net .68
 Model 60 Type
 X377R—8" Size—List \$1.25—Net \$0.75
 X377S—9" Size—List 1.25—Net .75
 X377T—10" Size—List \$1.39—Net .83

MODEL 80 TYPE IDLER WHEEL ASSEMBLY ONLY

X643R—List \$0.75—Net \$0.45
 T.T. HOLDING CLIP
 Y959—List \$0.05—Net \$0.03
 MODEL 60 TYPE RUBBER T.T. CORK
 X495R—List \$0.25—Net \$0.15
 MODEL 80 TYPE 60 TO 50 CYCLE
 CONVERSION SPRINGS (Specify Table Size)
 X805—List \$0.10—Net \$0.06

ALLIANCE Phonograph and Fractional Horse Power MOTORS

"Even-Speed" MODEL K

The 25-cycle Companion to the Model 80 Friction Drive Phonomotor. Available for operation on 110 V. 25 cycle source at 12 watts input. This phonomotor is designed specifically for 25 cycle operation, having a motor of entirely new design, but employing the same efficient, positive, friction rim drive as the popular Model 80. Interchange-ability in mounting is therefore obtained without sacrifice in performance. Amply proportioned bearings and large oil reserves assure long, trouble-free service. Motor and idler plate are shock mounted to cabinet mounting plate for low vibration transfer to turntable and motor board. Available in 8 or 9 inch turntable sizes only. Maximum depth below base mounting plate, 2 1/4".

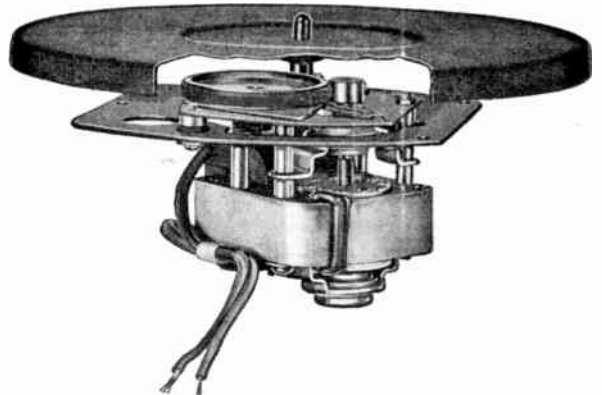

PRICES

110 Volt—25 C.—78 R.P.M. with			
8" Table—List \$6.50.....	Net \$3.90	Retractable Turntable Pin.....	\$0.17 Extra Net
9" Table—List 6.75.....	Net 4.05	CESA Approved Type—List \$0.75.....	Net \$0.45

FRACTIONAL H. P. MOTORS FOR AMATEUR NEEDS



MODEL "K"

Scores of uses such as driving fans, movie projectors and other light home appliances, powering toys, motion displays, switches and control systems—these and many other applications are proving the lasting dependability of Alliance's Model K Motor.

This recently designed motor is of the shaded pole induction type and is the last word in efficient small motor design. Finest materials and precision manufacturing assure long life and freedom from breakdowns.

SPECIFICATIONS: 117 V.—60 Cycle—Cont. Open Rating—50° C. Rise—No Fan			
Stack Thickness, Inches	.800	1.000	1.200
Locked Amps.—Cold	.68	.75	.82
Locked Watts.—Cold	36.0	41.0	46.0
Starting Torque—			
Oz. In. Cold	1.5	1.9	2.5
Idle Amps.—Hot	.52	.54	.56
Idle Watts.—Hot	22.0	23.0	25.5
Idle R.P.M.—Hot	3450	3450	3450
Full Load Amps.	.57	.60	.65
Full Load Watts	28	32	36
Full Load Horsepower	.0068	.0085	.0100
Stack Thickness, Inches	.800	1.000	1.200
Full Load Torque (Oz. In.)	2.4	2.9	3.5
Full Load—R.P.M.	2900	2900	2900
Overall Dimensions, Exclusive of Take Off—Shaft Extension:			
3 3/8" x 2 3/8" x 2 1/8"	2 5/8"	2 3/4"	
Weight	1# 12-oz.	2# 2-oz.	2# 8-oz.
Rotor Shaft—Centerless Ground	.171" Diameter		
Bearings—Graphite Bronze Oilless Type, Self-Aligning, Amply Proportioned.			

PRICES

Spec. K828—.8" Stack—List \$4.00—Net \$2.40
Spec. K1002—1.0" Stack—List 4.75—Net 2.85
Spec. K1201—1.2" Stack—List 5.50—Net 3.30



MODEL "MS"

For 110 volt (A.C.) 60 cycle operation. Only the very best quality of materials used. Extreme accuracy in sizes of parts and careful assembling in precision jigs make for long life and freedom from breakdowns. This motor is not a laboratory curiosity but a power unit designed to meet numerous small motor requirements.

SPECIFICATIONS: Consumes about 25 watts at 3000 R.P.M. without load. Speed 2500 to 3000 R.P.M., depending on frequency and load. Develops about .006 H.P. 3/2" Dia. Centerless ground steel shaft. Latest type graphite bronze oilless bearings, self-aligning and amply proportioned. Motor measures 1 3/4" x 2" x 3 3/8".

Spec. 144—110 V. 60 C. Standard Version—List \$3.00—Net \$1.80
--

NOTE: ALL PRICES ON THIS PAGE HAVE BEEN INCREASED APPROXIMATELY 10%

American MICROPHONES

Licensed under Pat. of The Brush Develop. Co. and Licensed by Electrical Research Prods, Inc., under U. S. Pat. of A. T. & T. Co., and Western Elec. Co., Inc.

VR2 DYNAMIC MICROPHONE

A Microphone with a NEW IDEA and a NEW USEFULNESS

For the first time, the many desirable characteristics found only in several different types of microphones have been combined in a single unit. The VR2 has an easily accessible external adjustment of the most important acoustical reactors in the dynamic microphone. A smooth change from a communication-type response, with a cutoff below 500 c. p. s., through a flat response to an augmented bass, attained by a simple, positive adjustment.

The response adjustment on the VR2 has a very broad effect and does not introduce narrow peaks. It is different from anything previously introduced.

Complete with 12½' cable and plug at microphone providing balanced line. Dull chrome finish. Net wt. less cable, 15 ozs. Hgt. 4". Greatest diameter 3".

VR2T Dynamic (38,000 ohms), Code: VARIT. List \$35.00

Available on order in 200 or 500 ohms.....List \$35.00
(Complete with 12½' cable)

VR2 Dynamic (30-50 ohms), Code: VARIA.....List \$32.50
(Complete with 12½' cable)



The above graph illustrates the average response characteristics for the various settings as indicated on the scale.

D8T DYNAMIC MICROPHONE



THE D8T DYNAMIC MICROPHONE has been carefully designed to have a consistent, well-balanced response. It is exceptionally rugged and assures the user of trouble-free service over a long period of time.

The D8T is particularly useful for all types of public address installations, orchestra pick-up, as well as solo work and straight announcing.

The D8T is 3¼" long, 2" in diameter, weighs only 13 ozs. A swivel mounting permits either nondirectional or semidirectional pick-up. Comes complete with 12½' cable and plug at microphone and ⅝" x 27 thread for suspension or stand mounting. Platinum Chrome Finish.

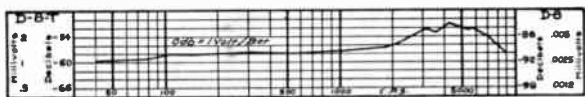

D8T Dynamic (38,000 ohms), Code DATAH.....List \$25.00

Available on order in 200 or 500 ohms.....List \$25.00

D8 Dynamic (30-50 ohms), Code: DATAL.....List \$22.50

D5T DYNAMIC MICROPHONE

IN FOURTH YEAR PRODUCTION

THE D5T DYNAMIC MICROPHONE is well known. An excellent, diversified-purpose microphone. The dynamic is the most rugged type microphone and its life of trouble-free operation is indefinite. Being a pressure-operated instrument, the response is unaffected by either a close or distant sound source. The D5T approaches the ideal microphone for general use due to its versatility and dependability. Sensitivity: 52 db below 1 V/bar.



D5T Dynamic, 38,000 ohms, Code: DYHIM.....LIST PRICE \$32.50

Available on order in 200 or 500 ohms.....LIST PRICE \$32.50

D5 Dynamic, 30-50 ohms, Code: DYLOM.....LIST PRICE \$27.50

Moving-Coil, Permanent Magnet Dynamic ● Semidirectional ● Close or Distant Pick-up ● Excellent Frequency Response ● Freedom from Wind Noises ● High Output, Low or High Impedance ● Immune to Temperature Changes ● Minimum Feed-Back (Flat Response) ● Low-Level Mixing ● Exceptionally Rugged.

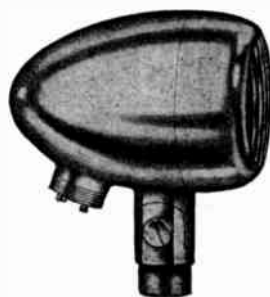

IMPORTANT NOTE: ALL PRICES ON THIS PAGE HAVE BEEN INCREASED BY 10%

American MICROPHONES

Licensed under Pats. of The Brush Develop. Co. and Licensed by Electrical Research Prods, Inc., under U. S. Pat. of A. T. & T. Co., and Western Elec. Co., Inc.

AT2 Specialized COMMUNICATION-TYPE MICROPHONE

THE AT2 CARBON HAND MICROPHONE has been designed for a specific purpose. The response characteristics are such that the greatest efficiency covers the important voice frequencies. Frequencies below 200 c.p.s. and above 3500 c.p.s. do not contribute to intelligibility. The AT2 has a sharp cut off above and below the intelligibility band; therefore equipment used with the Model AT2 will operate at greatly increased efficiency. The graph illustrates the high output of the AT2. For a 10-bar signal the output is -12 db.

As a hand microphone it will pick up efficiently in any position with minimum variance in level. A positive switch, for the operation of a relay and the microphone unit, is built into the case. The beryllium-copper switch blades, with rare metal contacts, wiping action, assure long life. Recommended current 15 ma. and load impedance 100-150 ohms. Four-foot length three-conductor, cloth-covered cable supplied with each microphone. Finish: Natural black plastic. Weight with cable 7 1/2 oz.

The case fits the hand comfortably and the convenient thumb switch requires but four ounces of pressure to operate. Prolonged use of the switch does not tire the thumb. The case and insulating parts are molded from an indestructible plastic. All circuits are thoroughly insulated from the hand. A convenient hanger eye is provided.

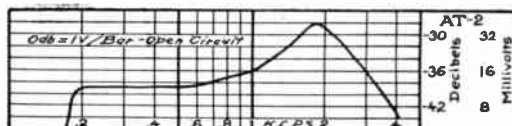

AT2 Microphone. Code: ATMIKList Price **\$16.50**

C6 CRYSTAL MICROPHONE

EXTREME SENSITIVITY. New crystal driving lever, twice as efficient as previously used, produces twice the voltage output with equal sound pressure.

BROADER RESPONSE. Results of new construction include extension of both low and high end.

BASS END IMPROVED. Naturalness insured by improvement in low frequency response.

LONGER LINES. By increasing the voltage output, the cable length may be increased proportionately. In laboratory tests, regular cables 250 feet in length have been used with a net voltage sufficient to operate any standard high gain amplifier.

MECHANICAL NOISE REDUCED. Mechanical and stand noise is no longer a factor. The C6 method of crystal mounting reduces mechanical noises by 12 db.

LESS AMPLIFIER AND INDUCED NOISE. The high output of this microphone assures a very desirable signal-to-noise ratio.

SWIVEL HEAD. All angles for semidirectional and nondirectional pick-up are provided by the 3/8" x 27 (standard) mounting connector.

Complete with 7' cable and plug at microphone. Polished chrome finish. Net weight 8 oz. Over-all height 3". Diameter 2 3/8". 5/8"x27 thread provided for suspension or stand mounting. C6 Crystal, Code CESIXLIST PRICE **\$16.50**

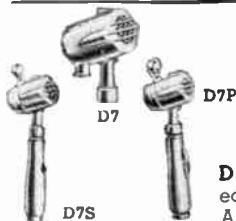
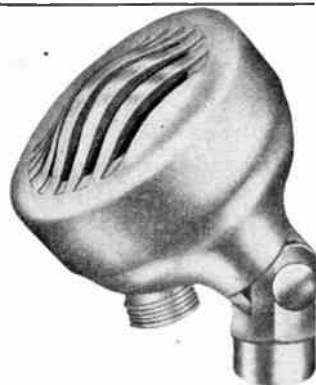

THE "Clipper" DYNAMIC

D7 and D7T MICROPHONES equipped with 12 1/2' R/J cable and Amphenol plug. Chrome finish. 5/8-27 connector. Over-all height, 2 1/2". Diameter, 1 1/2". Net weight, 8 1/2 ozs.

APPLICATIONS: Excellent for communication purposes, airplane use, Marine safety-at-sea installations, police broadcasting, amateur communication, public address, indoor and outdoor installations.

- D7T**—High Imp., 38,000 or 500 or 200 Ohms;
Code: DISETList Price **\$22.50**
- D7TP** (Press-contact Switch),
Code: DIMATList Price **\$26.00**
- D7TS** (Slide Switch), Code: DIAHT.....List Price **\$25.00**
- D7**—Low Impedance, 50 Ohms,
Code: DISEVList Price **\$20.00**
- D7P** (Press-contact Switch),
Code: DIMARList Price **\$23.50**
- D7S** (Slide Switch), Code: DIAHL.....List Price **\$22.50**

RC CRYSTAL MICROPHONE

Complete with **NON-BREAKABLE PLASTIC STAND** and **7 foot Cable**



RC Crystal Microphone may also be mounted on any stand equipped with standard 5/8" x 27 thread. . . . An excellent microphone for Communication, Public Address or Amateur Radio.

HOME RECORDING OR BROADCASTING HIGH OUTPUT, GOOD QUALITY

Base easily removed by quarter turn, releasing bayonet lock. Cable replacements accomplished by releasing set screw in back of microphone and pulling gently on spring cable protectorList Price **\$9.95**

IMPORTANT NOTE: ALL PRICES ON THIS PAGE HAVE BEEN INCREASED BY 10%

American MICROPHONES

Licensed under Pats. of The Brush Develop. Co. and Licensed by Electrical Research Prods. Inc., under U. S. Pat. of A. T. & T. Co., and Western Elec. Co., Inc.

D9A Unidirectional MICROPHONE

GUARANTEED to produce 30% MORE VOLUME (power) than any microphone at twice the list price. UNIDIRECTIONAL, True CARDIOID pattern pickup, frequency response good to 10,000 c. p. s.

Actual Tests are Convincing Arrange for Test with your Jobber

THE D9A DYNAMIC, a pressure-velocity combination microphone, with pick-up from front only, broad frequency response and high output, plus the usual dynamic microphone qualities of ruggedness, immunity to weather conditions, and circuit adaptability, should fill the majority of requirements.

The D9A Microphone is recommended for public address and general sound installations because its energy response field (cardioid of revolution) excludes extraneous pick-up and reduces feed-back by two-thirds. May be used for close talking due to the modified velocity section which also reduces wind noises to a minimum.

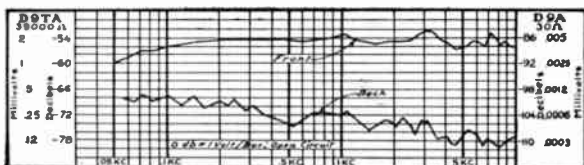
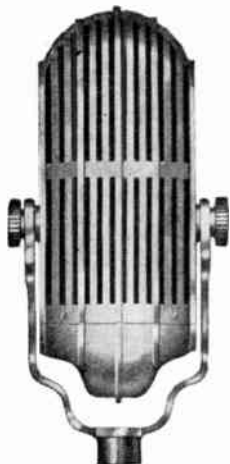

The above graph illustrates the average response characteristics for the D9A and D9AT. Voltage output levels, for 1 bar sound pressure (1 bar=1 dyne per sq. cm.) of the high and low impedance models. For 10 bar signal the output will be 20 db. higher.

Net weight, 2 1/2 lbs. Packed weight, 4 lbs. Height, 7"; depth, 2 1/4"; breadth, 2 1/2". Standard 5/8-27 thread provided for suspension or stand mounting. Finish: Satin Chrome.

25' Shielded Rubber-jacketed Cable Supplied with each Microphone.

D9A, Low Imp. (50 ohms). Code: LOWELList \$35.00

D9AT, High Imp. (38,000 ohms). Code: HIWELList \$37.50
Available on Order in 200 or 500 ohmsList \$37.50

D4T DYNAMIC MICROPHONE

A QUALITY, LOW-PRICED, MOVING-COIL MICROPHONE. For general use where clear speech and natural music reproduction is required. This new AMERICAN microphone is a very efficient instrument, having a broad range, from 60 to 7500 c.p.s., and high output of -56 db (0 db=1 v/bar). The utility value lies not only in the quality and type of response but also in mechanical features, such as light weight (approximately 10 1/2 oz.), a full 180° vertical angular setting, and positive friction lock at the swivel.

The D4T, high impedance, is equipped with a single-contact, shielded plug. The 50, 200 and 500 ohm models are equipped with a two-conductor plug and have a balanced line out.

The D4 model is of voice-coil impedance, approximately 30 ohms. Lines up to several hundred feet may be used on all models except the high impedance, where line should be restricted.

The complete assembly includes 12 1/2 feet of shielded, rubber-covered cable and shielded plug. Finished in platinum chrome. Standard mounting, 5/8" x 27 thread.

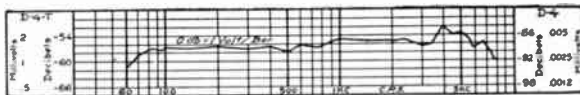
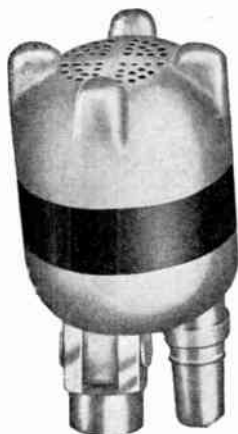

D4T Dynamic (38,000 ohms) Code: DFORT.....LIST PRICE \$20.00
Available on order in 200 or 500 ohms.....LIST PRICE \$20.00
D4 Dynamic (30-50 ohms) Code: DEFOR.....LIST PRICE \$18.00

D6T DYNAMIC MICROPHONE

Ideal for general public address including stage sound-reinforcement, both permanent and portable installations. It is entirely suitable for playground and athletic field direction, police and amateur broadcasting, and recording.

Net weight, 1 3/4 lbs. Packed weight, 2 lbs. Height, 3 3/4", diameter 2 1/2". Standard 5/8-27 thread provided for suspension or stand mounting. Finish: Polished Chrome. 12 1/2' Shielded Rubber-Jacketed Cable supplied with each microphone.

characteristics may be had by varying the angle of the microphone to the source of sound. For nondirectional horizontal pick-up, the response is substantially flat.

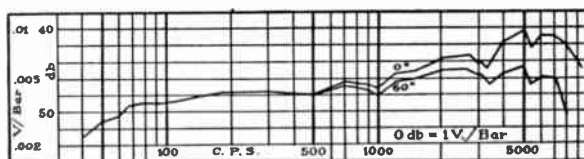

D6T Dynamic (38,000 ohms) Code: DIXIT.....List \$27.50
Available on order in 200 or 500 ohms.....List \$27.50
D6 Dynamic (30-50 ohms) Code: DIXIE.....List \$25.00



Typical field calibration for the D6T. A choice of frequency

American MICROPHONES

1. **C6 CRYSTAL MICROPHONE.** The best buy in a crystal microphone. New crystal driving lever, twice as efficient as previously used, produces twice the voltage output with equal sound pressure. Long cables, 250 feet or longer, may be used with this microphone. The increased output voltage assures only slight proportional losses in cable lengths. Provided with plug at microphone and mounting swivel with standard $\frac{3}{8}$ "x 27 thread. Chrome finish. Net weight 8 ozs. Complete with 7' cable and microphone plug. Accessories 7, 8, 9, 10, 11, 12, 13, 14, and 16 available for use with this model.
C6 Crystal Microphone. Code: CESIX.....List Price \$16.50
2. **AG CRYSTAL MICROPHONE.** Preferred by crystal buyers for four years. Communication-type response. Equipped with mounting yoke, providing rear or through cable outlet. Standard $\frac{3}{8}$ "x 27 thread. Accessories 7, 8, 9, 10, 11, 12, 13, 14, and 16 available for use with this microphone.
AG Crystal Microphone. Code: AGTAL.....List Price \$22.50
3. **B9 CRYSTAL MICROPHONE.** Semi-directional. Recommended for public address. Chrome finish. $\frac{3}{8}$ "x 27 thread. Complete with 8' cable and plug at microphone. Accessories 7, 8, 9, 10, 11, 12, 13, 14, and 16 available for use with this microphone. Code: BENIN.....List Price \$22.50
4. **CL2 CRYSTAL LAPEL MICROPHONE.** Built especially for lapel use. Maximum sensitivity in voice range. $2\frac{1}{2}$ " diameter. Weight $1\frac{1}{2}$ ozs. Complete with 25' cloth-covered, shielded cable and clip for attaching to clothing.
CL2 Crystal Lapel Microphone. Code: LATAL.....List Price \$25.00
5. The B9 as a hand microphone. Chrome finish. Available with two types of switches. 8' cord. B9P with press-contact switch in handle, and B9S with slide switch in handle.
B9P Crystal Hand Microphone. Code: BECON.....List Price \$26.00
B9S Crystal Hand Microphone. Code: BEHAN.....List Price \$25.00
6. The AG as a hand microphone. Chrome finish. Available with two types of switches. 8' cord. AH using slide switch, and AGP using press-contact switch.
AH Crystal Hand Microphone. Code: AHTAL.....List Price \$25.00
AGP Crystal Hand Microphone. Code: AGPAH.....List Price \$26.00
7. **AG DESK STAND.** Consists of upright (handle) and base. Chrome finish. No adapter necessary when used with B9, AG, or EL-4. AG Adapter necessary for connection to other microphones. Code: AGESK.....List Price \$2.50
8. **AG HANDLE.** Upright of AG Stand. Easily attached to AG Base by half turn, bayonet lock. Chrome finish. Code: AGHAN.....List Price \$1.50
9. **AH HANDLE.** Upright of AG Stand with slide switch. Chrome finish.
Code: SHAND.....List Price \$2.50
10. **DH HANDLE.** Upright of AG Stand with press-contact switch. Chrome finish.
Code: DEPAH.....List Price \$3.50
11. **AG ADAPTER.** Chrome finish. For uses, see Copy No. 7.
Code: AGFIT.....List Price \$.50
12. **SUSPENSION EYE.** For suspending any microphone with standard $\frac{3}{8}$ "x 27 thread. Chrome finish. Sturdy. Code: DYEYE.....List Price \$1.00
13. **BS BANQUET STAND.** Round base 8" in diameter. Rods 12". Extended height 24". Satin Black finish. Code: FUDAS.....List Price \$8.00
14. **FH3 and FL3 FLOOR STANDS.** Approved by the best sound studios. Positive, leather, friction-lock clutch. Noiseless operation. Rods 38". Extended height 6'. Three-contact, "floor grip," rubber-mounted base. FH3, studio model, net weight 15 lbs. FL3, public address model, net weight 10 lbs.
FH3 Floor Stand. Code: FUHET.....List Price \$15.50
FL3 Floor Stand. Code: FLEXR.....List Price \$10.50
15. **EL4 CARBON MICROPHONE.** Double button. Semi-stretched diaphragm. Good quality. Mounting yoke included. No ring or springs necessary.
Code: LITEG.....List Price \$7.50
16. **DD DESK STAND.** Round base, 4" upright. Net weight $1\frac{1}{4}$ lbs. $5\frac{1}{4}$ " base. Chrome finish. Code: DYNES.....List Price \$2.50
DS Desk Stand. Same as DD Stand except with $4\frac{1}{4}$ " base. Chrome finish.
Code: DINAC.....List Price \$2.50
17. **SJ CARBON MICROPHONE.** Single button. Sensitive. Chrome finish.
Code: JOHNE.....List Price \$5.00
18. **FP CARBON MICROPHONE.** New single-button, sensitive, carbon microphone. Operates in any position. For use in French phones and other types of telephone and listening devices. Code: FRONE.....List Price \$3.00
19. **CARBON HAND MICROPHONES WITH SLIDE SWITCH.** Chrome finish.
DB2, Double-button, Hand Mike. Code: DBTWO.....List Price \$15.00
SB2, Single-button, Hand Mike. Code: SUTRO.....List Price \$10.00
Either above models with press-contact switch list \$1.00 extra.
20. **SB HAND MICROPHONE.** Sensitive. Operates in any position. Black crackle finish. Code: TILEX.....List Price \$5.00

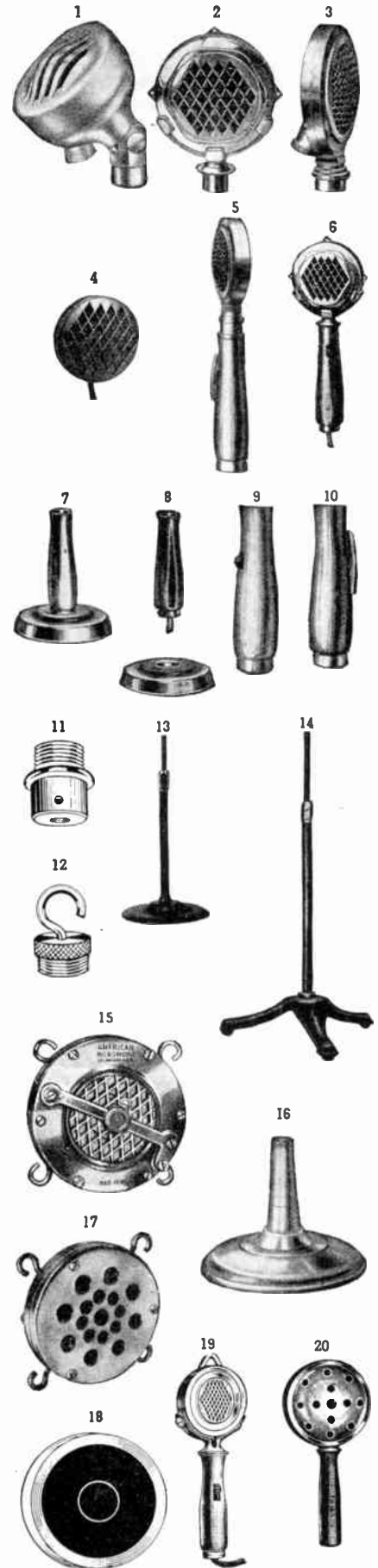

Licensed under Patents of The Brush Development Co., and Licensed by Electrical Research Products, Inc., under United States Patents of A. T. & T. Co. and Western Electric Co., Inc., for use only in Public Address Systems.

AMERICAN MICROPHONE CO., INC.

PICK-UP UNITS

AUDAX

RECORDERS

The Standard by which Others are Judged and Valued

FOR more than a decade the design of the phonograph pickup has progressed but little, experiencing no fundamental improvement. It is a pleasure, therefore, to record here for readers of "Electronics" the results of much research on the part of Maximilian Weil of the Audax Company, leading finally to a new unit—the MICRODYNE, in which the bugaboo of moving-mass has been eliminated etc." (reprint "Electronics") . . . The magazine, "American Music Lover," says . . . "the pickups on the majority of commercial machines represent a sort of minimum acceptability in both cost and quality, etc." . . . True indeed . . . and that is where thousands of MICRODYNES go as replacements . . . improving those machines beyond comparison . . . This bears out the contention long made by leading scientists . . . that the MOVING-INDUCTOR principle is the only one that makes possible HIGH FIDELITY—and that means MICRODYNE.

RELAYED-FLUX MICRODYNE*

THESE remarkable instruments operate on the famous "RELAYED-FLUX" principle. They are recommended to those who desire the finest of which science is capable. Because of abrasive in the material, present-day records operate best with steel-needles. This is a serious factor to be reckoned with when JEWEL-POINT operation is considered. For this reason, the "RELAYED-FLUX" MICRODYNE PRO-2 is the answer . . . While low point-pressure is desirable (provided it is not carried to extreme); VIBRATORY-MOMENTUM is the No. 1 factor in record wear. By ingenious design the VIBRATORY-MOMENTUM in the "RELAYED-FLUX" MICRODYNE has been brought down almost to the vanishing point.

COMPENSATED MICRODYNE

FOR RECORDS UP TO 12"

MICRODYNE D-36-E . . . FLAT within \pm about 2 db to 7500 cycles. Rising bass curve reaching about 8 db at 50 cycles. Exceptionally low Vibratory-Momentum. Point pressure about 39 grams. If desired, may be used with JEWEL-POINT. Tip-jack connectors. Black and Chrome finish. Overall length 12 $\frac{1}{8}$ ". Impedance 200 or 500 ohms. **\$39.75**

MICRODYNE D-31-E . . . FLAT within \pm 2 $\frac{1}{2}$ db to approx. 7000 cycles. Rising bass curve reaching about 9 db at 50 cycles. Greatly reduced Vibratory-Momentum. Point pressure about 1 $\frac{3}{4}$ ozs. Tip-jack connectors. Brown and Gold finish. Overall length 12 $\frac{1}{8}$ ". High impedance or 200 or 500 ohms. **\$27.50**

MICRODYNE D-27-E . . . FLAT within \pm about 3 db to approx. 6600 cycles. Rising bass curve reaching about 9 db at 50 cycles. Low Vibratory-Momentum. Point pressure about 1 $\frac{3}{4}$ ozs. Tip-jack connectors. Brown and Gold finish. Overall length 12 $\frac{1}{8}$ ". High impedance or 200 or 500 ohms. **\$19.75**

FOR RECORDS UP TO 18"

MICRODYNE D-37-E . . . FLAT within \pm about 2 db to over 7500 cycles. Rising bass curve reaching about 8 db at 50 cycles. Exceptionally low Vibratory-Momentum. Point-pressure about 39 grams. If desired, may be used with JEWEL-POINT. Tip-jack connectors. Black and Chrome finish. Overall length 14 $\frac{1}{2}$ ". Impedance 200 or 500 ohms. **\$52.75**

MICRODYNE D-32-E . . . FLAT within \pm about 2 $\frac{1}{2}$ db to 7000 cycles. Rising bass curve reaching about 9 db at 50 cycles. Greatly reduced Vibratory-Momentum. Point pressure about 1 $\frac{3}{4}$ ozs. Tip-jack connectors. Brown and Gold finish. Overall length 14 $\frac{1}{2}$ ". High impedance or 200 or 500 ohms. **\$40.50**

MICRODYNE D-28-E . . . FLAT within \pm 3 db to approximately 6600 cycles. Rising bass curve reaching about 9 db at 50 cycles. Low Vibratory-Momentum. Point pressure about 1 $\frac{3}{4}$ ozs. Tip-jack connectors. Brown and Gold finish. Overall length 14 $\frac{1}{2}$ ". High impedance or 200 or 500 ohms. **\$32.75**



FOR RECORDS UP TO 18"

"RELAYED - FLUX" MICRODYNE PRO-5 . . . Used in Radio Stations, Recording Studios and wherever super-quality performance is desired. Designed for and equipped with special Sapphire Jewel-Point. Extremely small moving mass cuts VIBRATORY-MOMENTUM down almost to the vanishing point. Flat within \pm 1 $\frac{1}{2}$ db to over 10,000 cycles. Output about -35 db. Will track with less than 19 grams. However, to overcome the great variation in turntables, warped records, etc., the point-pressure is made 26 grams, for 100% safety margin. Tip-jack connectors. Black and Chrome finish. Overall length 15 $\frac{3}{8}$ ". Impedance 200 or 500 ohms. **\$108.00**

MULTIPLE EQUALIZER: Five positions, complete with special rotary switches which properly compensate different makes of records, such as Orthacoustic, Standard Lateral, etc. **\$58.00**

FOR RECORDS UP TO 12"

"RELAYED - FLUX" MICRODYNE PRO-2 . . . Designed for use with either steel needle or Jewel-Point—depending on type of records used. Extremely small moving mass cuts VIBRATORY-MOMENTUM down almost to the vanishing point. Flat within \pm about 1 $\frac{1}{2}$ db to over 8500 cycles. Output about -35 db. Point-pressure about 29 grams. Black and Chrome finish. Overall length 12 $\frac{1}{8}$ ". Impedance 200 or 500 ohms. **\$68.50**

"RELAYED - FLUX" MICRODYNE PRO-1 . . . Similar to Pro-2 above—response not quite as smooth. **\$49.75**
* For working principle of "RELAYED-FLUX" see "PICKUP-FACTS."

CUT-OFF FILTER: Four positions. **\$32.00**

ALL PRICES SUBJECT TO CHANGE WITHOUT NOTICE

PICK-UP UNITS

AUDAX

RECORDERS

The Standard by which Others are Judged and Valued

AUDAX AT-12 . . . Beautifully streamlined head, scientifically offset; point-pressure about 1 7/8 ozs. Response flat within ± about 3 db to 6000 cycles; bass gradually rising to about 8 db at 50 cycles; new needle guide; new non-resonant arm; precision ball-bearing; brown and gold finish; available in high impedance or 200 or 500 ohms. For records up to 12"; overall length 9 3/4". **\$14.50**

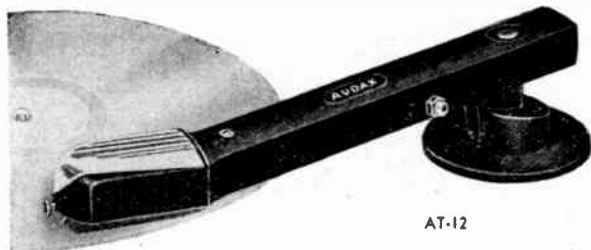

AT-12

AUDAX AT-10 . . . Similar in appearance to AT-12. Has excellent frequency response; beautifully streamlined scientifically offset head; new needle guide; new non-resonant arm; point-pressure about 2 1/4 ozs.; precision ball-bearings; Black and Silver finish; high impedance; for records up to 12"; overall length 9 3/4". **\$11.50**

NEW AUDAX HIGH FIDELITY CUTTERS



AUDAX CUTTERS are magnetically powered—their characteristics are not affected by temperature or atmospheric changes. They are readily interchangeable on any recording machine.

DISTORTION has been the greatest retarding factor in producing high quality instantaneous recordings. These NEW AUDAX CUTTERS make possible recordings that are comparable to the best commercial records. Yet, with all their superlative qualities, cost no more than ordinary cutters. They fill an important gap in quality Recording technique.

AUDAX CUTTER H-2 . . . Substantially FLAT to about 6000 cycles. Distortion about 1.8% at 1000 cycles. Fully modulates groove with input of 16 db with 96 lines. Impedances up to 4000 ohms..... **\$48.50**

AUDAX CUTTER H-3 . . . Substantially FLAT to about 7500 cycles. Distortion about 1.2% at 1000 cycles. Fully modulates groove with input of 16 db with 96 lines. Impedances up to 500 ohms..... **\$78.00**

AUDAX CUTTER H-4 . . . Substantially FLAT to over 9000 cycles. Distortion about .7% at 1000 cycles. Fully modulates groove with input of 16 db with 96 lines. Impedances up to 500 ohms..... **\$125.00**

AUDAX CUTTER 9-X . . . Substantially FLAT to over 5600 cycles. Distortion about 2.8% at 1000 cycles. Fully modulates groove with input of 18 db with 96 lines. Impedances up to 5000 ohms..... **\$32.50**

AUDAX JEWEL POINTS

Jewel-Point operation is a highly critical matter. Its use should not be undertaken without advice from the AUDAX COMPANY. All AUDAX jewels are made with the greatest

precision, by the highest skilled craftsmen of the lapidary art. Every AUDAX Jewel is finished and highly polished to the extreme accuracy of ± .0001"

- AUDAX SAPPHIRE PLAYING POINT..... **\$ 5.00**
- AUDAX DIAMOND PLAYING POINT..... **\$25.00**
- AUDAX SAPPHIRE CUTTING POINT..... **\$ 7.00**

ALL PRICES SUBJECT TO CHANGE WITHOUT NOTICE



RECORD-PLAYING PARTS

LOW-COST AUTOMATIC RECORD CHANGER

One of the most exceptional automatic record players ever offered at a popular price. Exactly the same as used in the latest RCA Victrolas. Quickly converts any modern a-c radio into a fine radio-phonograph combination. Excellent for use with sound installations. Plays ten 12" records or twelve 10" records. Repeats last record. Low-pressure crystal pick-up with sapphire point lowers surface noise to a minimum, prolongs record life. No. 9922 Record changer is completely automatic. Tone arm need never be touched. All operations are controlled by "Start-Reject" button. Instrument includes a new type "safety-clutch" that warns user in case "jamming" caused by defective records.



... Specifications ...

- Automatic Operation . . . Plays ten 12" or twelve 10" records.
 - Needle Pressure . . . 2 oz., approx.
 - Output . . . 5.0 volts at 400 cycles.
 - Impedance . . . 150,000 ohms at 1000 cycles.
 - Power Supply . . . 115 volts, 60-cycles, a.c.
 - Motorboard Clearance . . . 4" above; 3 1/4" below.
 - Shipping Wt. . . . 15 lbs., approx.
- No. 9932—Low-cost Automatic Record Changer Net Price \$17.97

SYNCHRONOUS REACTION MOTOR AND TURNTABLE

This exceptionally fine motor is used on hundreds of RCA Victor Combinations and Record Players. It has shock-proof mountings and is free from wows. It is simple in design and practically wear- and trouble-free in operation. Turntable is finished in an attractive brown flock which blends with any cabinet finish. A soft rubber spindle cap



prevents pick-up vibration by records. Turntable diameter is 7 inches. Plays any size record up to twelve inches in diameter. Consumes only 10 watts.

No. 33343 Net Price \$3.57

SENIOR PICK-UP ARM WITH AUTOMATIC SWITCH

Enjoy the advantages of both unusually fine record reproduction with automatic off-on operation. This attractive and well-built modern combination consists of the famous RCA Senior Crystal Pick-Up arm with its top needle loading and automatic ejection features, plus an automatically operated switch. Fool-proof switch starts the motor when the pick-up arm is placed on the record . . . stops the motor when the record is finished. All switch parts are concealed beneath the mo-



torboard assembly. Characteristics of the pick-up arm are identical to No. 9869. Needle box and pick-up rest included with assembly.

No. 9911—Complete and with installation instructions . . . Net Price \$4.77

JUNIOR CRYSTAL PICKUP

RCA's most popular-priced crystal pickup. Plays 10" or 12" records; completely sealed crystal; needle position is offset to assure true tracking; swiveled pick-up arm; new feature is use of viscaloid dampening; shock-proof mounting parts included. Finished in attractive brown wrinkle lacquer.

Specifications: IMPEDANCE—100,000 ohms at 1,000 cycles (1,300 mmfd orer range 70-7000 cycles). FREQUENCY RANGE—70-7000 cycles. OUTPUT VOLTAGE—1.5 volts at 1000 cycles with 500,000 ohm load. NEEDLE PRESSURE—2.7 oz.



No. 9891 Net Price \$2.97
No. 33217—Crystal Cartridge for above 2.25

IMPROVED JUNIOR PICK-UP ARM



This new pick-up arm incorporates all the features of the older types but has an unusually attractive molded housing. Excellent fidelity of reproduction is obtained through the use of a sealed crystal pick-up and the arm may be used for either 10-or 12-inch records. Needle insertion is easy and shock-proof mounting parts are included. The polished brown finish blends with any type of cabinet.

Specifications: IMPEDANCE—100,000 ohms at 1,000 cycles (1,300 mmfd. orer range 70-7,000 cycles). FREQUENCY RANGE—70-7,000 cycles. OUTPUT VOLTAGE—1.5 volts at 1000 cycles with 500,000 ohm load. NEEDLE PRESSURE—2.7 ounces. FINISH—Polished moulded Bakelite.

Net Price
No. 9886 \$3.27
No. 33122—Crystal Cartridge for above 2.25

SENIOR CRYSTAL PICK-UP



Outstanding design features plus top needle loading make the Senior Crystal Pick-Up an exceptional accessory for fine reproduction. With the Stock No. 33909 needle box, worn needles are ejected by mere loosening of the needle screw and by pressing needle box lever. New needles are inserted by placing them in the hole at the top. The ejector functions as a needle-positioning bracket. This is a sturdy, well-built arm and pick-up of unusual balance for true reproduction. It is recommended for the most discriminating of music lovers.

... Specifications ...

- IMPEDANCE . . . 100,000 ohms at 1000 cycles. (1,300 uuf over 70 to 7000-cycle range).
- FREQUENCY RANGE . . . 70 to 7000 cycles.
- OUTPUT VOLTAGE . . . 1.5 volts at 1,000 cycles with 500,000-ohm load.
- NEEDLE PRESSURE . . . 3 oz.
- FINISH . . . Brown wrinkle lacquer.

Net Price
No. 9869—(Less needle bracket) \$3.87
No. 33909—Needle Box and Pick-Up Rest60
No. 35171—Crystal Cartridge for Above 2.55

Prices apply only in U.S.A. and are subject to change or withdrawal without notice.



TRANSFORMERS AND ACCESSORIES

Universal Interstage A-F Transformer



Permits all audio replacements with a single unit. Center tapped primary and center tapped secondary for connecting either from or to any single or push-pull stage. Easily mounted on any type of chassis. Also recommended to step up pickup output for use with low gain amplifiers.

Specifications:
 SIZE—2 x 2 3/4 x 2 1/2 in. Shielded black finish case—

vacuum wax impregnated. **TURN RATIO**—Primary to secondary 1:3 overall. **PRIMARY CURRENT**—10 milliamperes d.c. (max.) **FREQUENCY RESPONSE**—30-10,000 cycles. **PRIMARY CONNECTIONS**—Primary connects to any single or push-pull triode. Secondary, to single or push-pull stage.

No. 9632, Net Price \$1.20

UNIVERSAL OUTPUT TRANSFORMER

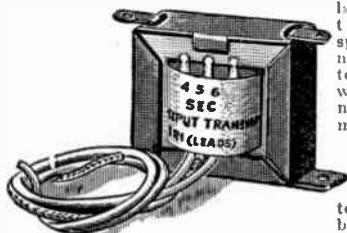

Fits any combination of tubes and speakers ordinarily encountered in service work. Quickly mounted by means of slot angle brackets; silicon steel core; windings protected with a baked varnish impregnation.

Tinned terminals and long primary leads.

Specifications: SIZE—Standard Model—2 1/4 x 2 in. **VOICE COIL IMPEDANCES**—1 to 15 ohms. **PRIMARY LOAD IMPEDANCES**—1,000 to 20,000 ohms. **MAXIMUM WORKING POTENTIAL**—500 volts. **MAXIMUM PLATE CURRENT** (each tube)—55 milliamperes. **FREQUENCY RANGE**—30 to 10,000 cycles.

No. 7852, Net Price \$1.20

RECORD-PLAYER SWITCH AND CONNECTOR

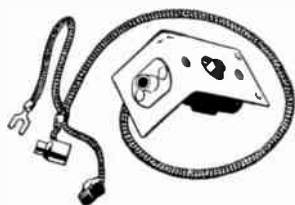

This handy, easily-installed switch is used for connecting RCA Victor and Radiola Record Players, or practically any other type of phonograph turntable, to a radio receiver so that the listener may quickly change from radio to record reproduction. Anyone can install it. The majority of installations can be made without removing the receiver chassis from its cabinet or without need for soldering. The switch suppresses radio when turned to "record" position. Design of this accessory provides improved performance because it maintains and isolates original bias and other d-c voltages in the receiver circuit. Includes a sufficient length of shielded cable, knob and mounting screws.

No. 9824A New Record-Player Switch and Connector, complete with installation instructions.
 Net Price \$1.15

MULTI-RANGE WAVE TRAP

For receiver locations troubled by unwanted interference, this unit has important application. It is tuned by means of a magnetite core. Attenuation at tuning frequency 40:1 from 450 to 2,100 kc. Small size and simple mounting make it easy to install in any receiver.

No. 33033—Net Price \$1.11

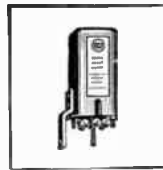

RCA VICTOR SERVICE NOTES

Complete service information on RCA Radiola, RCA Victor and service test equipment. Contain not only wiring diagrams but also complete alignment instructions and other details available from no other source.

No. 108 1938
 No. 109 1939
 No. 110 1940
 Net Price, No. 109, 110 \$1.50
 Net Price, No. 108 1.25



EXTERNAL ANTENNA COUPLER FOR LOOP RECEIVERS

Extremely useful for receiver installations where it is desirable to connect an external antenna to a receiver loop to improve receiver sensitivity and signal-noise ratio. Range, 550 to 1750 kc. and 1750 to 5000kc., with adjustments for each band. Easy to install, easy to adjust. Also useful as a fixed-tuned substitute for any standard loop antenna to aid aligning loop receivers.

No. 9912—Net Price \$1.35

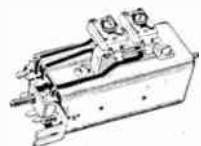

AERO-CRYSTAL MICROPHONES

The RCA Aero-Crystal Microphone MI-6205 is scientifically designed, beautifully styled, and engineered for performance and dependability. It is ideal for public-address systems, experimental, commercial, and amateur applications in the low-priced field. Housed in beautiful satin-chromium finished streamlined case, the MI-6205 is unusually well-suited to microphone applications requiring a crystal-type unit. The Aero-Crystal microphone has high output level and wide frequency response. It is thoroughly shielded and is unaffected by r-f or a-c fields. It is fitted for adapting 1/4" pipe fitting to 3/8"—27 fixture thread. It includes a 12-foot shielded cable (less plug).

- TYPE Crystal
- FREQUENCY RESPONSE 30 to 10,000 cycles
- OUTPUT LEVEL
 35 db* (10-bar signal across an open circuit)
- LOAD IMPEDANCE 0.25 to 3 megohms
- DIMENSIONS 2 3/8" W. x 3 3/8" D. x 3" H.



AEROCRYSTAL SPEECH MICROPHONE FI-6202

This microphone is suitable for speech applications. It is for use either with large or small sound systems using amplifiers with high-impedance inputs. High output together with frequency-response compensation over the useful range of speech makes the MI-6202 particularly useful for applications requiring clear, crisp, intelligible speech that will readily penetrate through high noise levels. Specifications for MI-6202 same as MI-6205 except for compensated frequency response. Finished in brush chromium and umber gray.

MI6205—General-Purpose Microphone, Net Price \$8.70
 MI6202—Speech-Type Microphone, Net Price 8.10

Prices apply only in U.S.A. and are subject to change or withdrawal without notice.

Net

Copyright by U. C. P., Inc.

TURNER Microphones

CARDIOID



No. 101 Licks Feedback

Where the going is tough, and acoustic conditions practically impossible, the new Turner Cardioid Microphone will do the job. The two-element generator produces true cardioid characteristics, offering the best features of both the dynamic and velocity

No. 101 is extremely sensitive in front, and completely dead in rear. Through the use of these 2 elements, NO SACRIFICE of frequency response is necessary. For studio, public address and recording. All have tilting heads balanced line output connection and 25 feet of heavy duty cable. Brushed chrome finish

Standard Model 101A

Level —59DB below 1 volt per bar for hi-impedance models. Range —30-9000 cycles. Front to back ratio: 24 DB at 1,000 cycles.

500 ohm model-output 1.6 millivolt for 10 bar signal, 200-250 ohm model-output 1 millivolt per 10 bar signal, 30-50 ohm model-output .16 millivolt for 10 bar signal. 101A
List Price, 30, 50, 200, 500 ohms
or hi-impedance. **\$55.00**

De Luxe Model 101B

Same as 101A but with 3-position switch to allow different pickup patterns. List \$65.00.

Broadcast Model 101C

Same as 101B with range extended to 10,000 cycles, and not furnished in hi-impedance. All other impedances available. List \$70.00.

Tilting Heads

Models 22X, 22D, 211, 101A, B, and C, and 33X and 33D all equipped with 90 degree tilting heads permitting semi or non-directional operation.

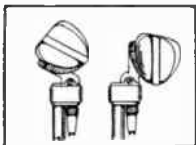

22X and 22D

Tops in Performance

22X Crystal gives clear reproduction. Smartly engineered design cuts feedback to minimum. Full satin chrome finish, 90 degree tilting head and removable 7 foot cable set. Built-in wind-gag permits outdoor operation. Crystal impregnated against moisture. Automatic barometric compensator. Range 30-7,000 cycles. High level —52DB. Complete with schematics, 7 ft. cable set and chamoisette mike pouch. **\$18.50**
List



Turner 22D Dynamic

Same appearance as 22X, but has high level dynamic cartridge. Dependable indoors and out. Reproduces smoothly at all frequencies. Range 40-8,000 cycles. Output —54DB. Complete with tilting head, 7 ft. removable cable

set, schematics, and mike bag, 200 or 500 ohms or hi-impedance. **\$23.50**
List

30,50 ohm. List

ADD \$2.00 LIST for 25 ft. cable set with either 22X or 22D.

GUARANTEE

Turner microphones are guaranteed against defective workmanship and materials for **ONE YEAR**, when all instructions are fully complied with, and units are not opened or tampered with in any way.

Switch Equipment

Models 22X, 22D, 33X and 33D are all available with SWITCH illustrated. Permits finger-tip control of microphone, regardless of distance from amplifier. Shorts the line quietly, and allows mike to be used as push-to-talk unit. For S (switch models of 22 or 33). ADD \$2.00 List.

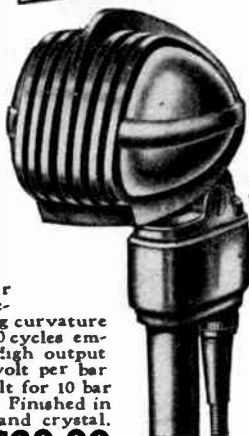

Model VT-73

Doubles your effective power at the intelligible voice frequencies at **LOW COST**. Rising curvature of response between 500-4,000 cycles emphasizes speech frequencies. High output —48DB with reference of 1 volt per bar (-28DB with reference of 1 volt for 10 bar signal) Range 50-7,000 cycles. Finished in telephone black, aluminum and crystal. Complete with stand and 7ft. anti-resonant cable. List **\$20.00**

33X and 33D

Rugged Turner Mikes

33X Crystal satin chrome finished, with high capacity crystal, to permit extra long lines. Response 30-10,000 cycles free

from peaks. Output —52DB. Tilting head. Ideal for amateur, recording or P. A. work. With 25 ft. cable set, diagrams and mike bag. List **\$22.50**

33D Dynamic, same appearance as X, with balanced line cable on low impedance units eliminates noise pickup. 200, 500 or hi-impedance, complete with 25 ft. cable set, diagrams **\$25.00** and protective bag, List

50 ohm model, List

NEW TURNER CHALLENGER MODELS

Where the utmost in performance, quality and appearance must be had at lowest cost, use these Turner Challenger Models, for exceptionally fine results.

Crystal models are complete with shock-proof cartridges, barometric valves, moisture-sealed crystals and wind-gags-to prevent blasting.

Dynamic models give equally clear-cut results for both voice and music. Unusually rugged and dependable. You can rely on these models — they're fully Turner Guaranteed!

BX Crystal

... for recording, P. A. and ham use. Bronze enamel finish. Level 55DB. Range 50-6,000 cycles. Complete with 7 ft. cable. List **\$9.95**

BD Dynamic

Same finish as BX. Works indoors or out. Level —52DB. Range 50-6,000 cycles. 200-250 ohms, 500 ohms or hi-impedance, with 7 ft. cable. List **\$14.50**

CX Crystal

In rich brushed chrome finish. With 7 ft. removable cable set, using Amphenol connectors. Level —55DB. Range 50-7,000 cycles. List **\$15.00**

CD Dynamic

Same style and finish as CX. In 200-250 ohms, 500 ohms or hi-impedance. Level —52DB. Range 50-7,000 cycles. With 7 ft. removable cable set. List **\$16.50**

TURNER Microphones



211

New Turner Dynamic

Because of its new type magnet structure and acoustic network, Turner 211 Dynamic offers outstanding performance characteristics. The salt-shaker type is dictated by these two features, and to this Turner has added style and streamlining.

Modern engineering has extended the high frequency range, and the extreme lows have been raised 2 to 4 decibels, to compensate for over-all deficiencies in loud speaker systems. Model 211 meets requirements of extended range, set up by the new frequency modulation method of broadcasting. Unique diaphragm structure results in extremely low harmonic and phase distortion, without sacrificing high output level. Equipped with tilting head, balanced line output connection and 25 ft. heavy

duty cable. Finished in rich satin chrome.

Level —56DB below 1 volt per bar for hi-impedance models. Range 30-10,000 cycles. 500 ohm model has output of 2.5 millivolt for 10 bar signal. 200 ohm model has output of 1.6 millivolt for 10 bar signal. 30-50 ohm model has output of .25 millivolt for 10 bar signal. 200,500 ohm or hi-impedance. List **\$45.00**
30,50 ohm model, List \$42.50

99 and 999

Sure-Fire Performer

Model 99 Dynamic is the most rugged mike in the entire Turner line. Withstands climate and temperature changes. Adjustable saddle Fits any standard stand. Semi- or non-directional operation. Model 99 won't blast from close speaking. Broadcast studios, large city police departments and internationally famous manufacturers specify Turner 99 for crisp, clear results. Finished in fine gunmetal. Range 40-9,000 cycles. Level —52 DB. Complete with 25 ft. cable set, diagrams and chamoisette mike bag. 200 or 500 ohms or hi-impedance, **\$32.50**
List \$29.50
30 or 50 ohm, List \$29.50
Brushed Chrome Finish, ADD \$2.00 List.



999 Balanced Line Dynamic

Same appearance as 99. Voice coil and transformer leads insulated from ground and microphone case. Gives smooth, dependable, professional performance. Complete with dignified gunmetal finish, 3-pin polarized locking connector and 25 ft. balanced line low-capacity cable. Range 40-9,000 cycles. Level —52 DB. 200, 500 ohms or hi-impedance. **\$35.00**
List \$32.50
30 or 50 ohms. List \$32.50



U9S

Fills 50 Ohm, 200,500 Ohm and Hi-Impedance Needs

Same professional design and finish as 99 and 999. Whatever impedance you need, 50 ohm, 200 or 500 ohm or hi-impedance, a twist of the switch illustrated on U9S, fills your requirements. Adjustable to semi- or non-directional operation. Removable 25 ft. cable set. Level —52 DB. at high impedance. Response is free from peaks and holes from 40 to 9,000 cycles. Handle the toughest job with U9S. Packed with 25 ft cable **\$37.50**
set, diagrams and chamoisette mike bag. List \$37.50

TESTED

Each and every Turner Microphone is given an individual sound pressure test over the entire audio band, before leaving the factory — your assurance of complete satisfaction.

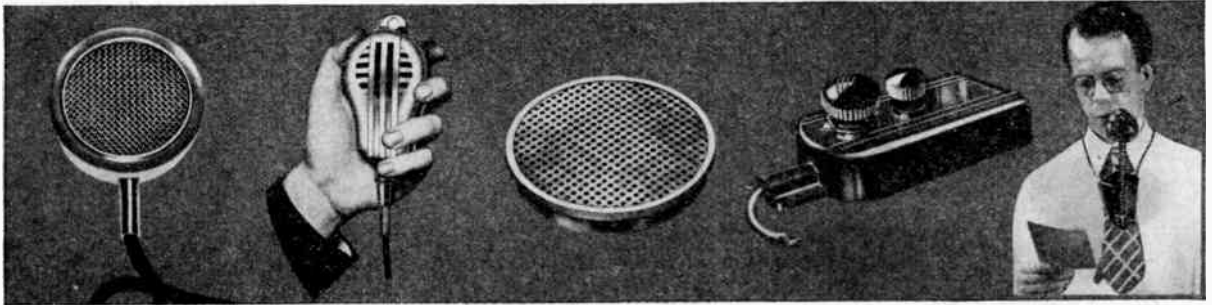

Lapel Mike L40

Extra high signal level. Alligator clip secures it to clothing, prevents twisting in lapel. Flexible cable fits shoulder snugly. Minimizes feedback. Level —50 DB. Brushed chrome finish. 25 ft. black cloth covered cable. **\$25.00**
List \$25.00

Hand D Mike 9X or 9D

For voice, music or portable application. Hang it, hold it, or fit it on standard stands. Low feedback. Positive contact slide switch. Brushed chrome. Packed with 7 ft. cable set. Range 60-7,000 cycles. 9X Crystal, List . . . **\$22.50**
9D Dynamic, List \$25.00

Hearing Aid Mike 7

Small crystal microphones for compact hearing aids. Light weight, high level, with unusual response for voice pick-up. Protective diaphragm guard. Mounts flush to panel eliminating cavity resonance. Available in 2 types of response. Send for details. **\$8.00**
List \$8.00

Magnetic Pick Up MM

Gives immense volume from any stringed instrument without feedback. Novel clamp for fastening to instrument, without tools, or adhesives. Continuous volume control. Hi-impedance, works directly to grid. Rich brown enamel. With 25 ft. **\$16.50**
cable, List \$16.50
Without volume control, List \$14.50

Third Hand 3H

Holds microphone for you. Goose neck adjusts to any position. Excellent volume. Leaves both hands free. Can be used as traveling mike. **\$5.00**
List \$5.00
For Mike Switch, when ordered with Turner Mike, Add \$1.00 List.

CRYSTAL MICROPHONES LICENSED UNDER PATENTS OF THE BRUSH DEVELOPMENT CO.

PORTABLE

PRESTO

STATIONARY

SOUND RECORDING EQUIPMENT

PRESTO MODEL "Y" RECORDER

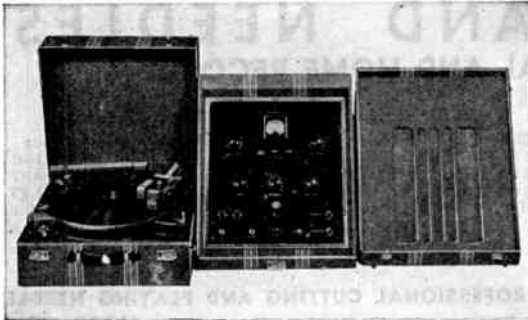

The PRESTO model Y recorder fills the need for a 16" transcription recording and playback equipment which is extremely portable and yet capable of producing high grade recordings. It makes continuous 15 minute, 33 1/2 RPM electrical transcriptions of sufficiently good quality to be used by broadcasting stations. It also makes 78 RPM recordings on 6", 8", 10" or 12" discs and may be used to cut 11 1/2", 13 1/2" and 17 1/2" master recordings from which commercial pressings are produced. In addition to recording, the model Y gives excellent reproduction of both electrical transcriptions and phonograph records and is widely used for adding recorded radio programs to prospective sponsors. As a public address system it will provide sound for audiences up to 1000 persons.

Among the important features of the model Y recorder are:

1. The exclusive Presto rubber-rimmed-turntable driven directly by a steel pulley on the motor shaft, a simple, foolproof drive system that eliminates vibration and holds the turntable speed absolutely constant. Maintenance is negligible. There are only two moving parts which need replacement about once a year.
2. A lever changes the turntable speed instantly without stopping the table or removing the record.
3. A lever adjusts the cutting mechanism to cut either from the outside of the disc toward the center or from the center out.
4. A cam lever lowers the cutting head gently on the record preventing accidental damage to sapphire needles.
5. A vibration damper attached to the cutting head suppresses vertical modulation in the record groove and eliminates variation in groove depth due to surface irregularities in

PRESTO MODEL "L" TRANSCRIPTION PLAYBACK



This equipment is designed for radio stations, advertising agencies and program producers, who demonstrate recorded programs at the offices of prospective clients.

Salesmen who use the Model L Playback will particularly appreciate its attractive, workman-like appearance, its small size and light weight which make it extremely easy to carry, its simplicity which makes it possible to set up for operation within a few seconds and the remark-

ably clear, wide range reproduction . . . far superior to that ordinarily expected from portable equipment.

The Model L Playback was developed to meet an insistent demand among the larger broadcasting stations and agencies for "something better" in portable reproducing equipment. Those who use the Model L Playback in connection with important sales of station time and programs will consider its exceptional performance well worth its cost.

L-2—Portable transcription playbackList, \$275.00

the disc. The damper also eliminates flutter when the records are played with pickups having a resonant peak in the low frequency range.

6. The cutting arm may be unlocked from the feed mechanism to cut spiral starting and runout grooves.
7. A time scale on the cutting arm shows the starting point for each size record and elapsed recording time at both 78 and 33 1/2 RPM.
8. The cutting head feed mechanism is located beneath the turntable where it is protected from dust or accidental damage. The parts of this mechanism are hand finished and fitted and its performance is equal in every way to the overhead lathe type mechanism commonly used.
9. The recording amplifier includes a two microphone mixer, high and low frequency equalizers and a change-over switch for continuous recording or re-recording. The amplifier and loudspeaker fit together to carry in a single case.

Y-2 Recorder\$737.00
Y-4 Recorder (low impedance inputs)..... 776.00

PRESTO MODEL "K" RECORDER



The Presto model K is a portable sound recorder, record player and public address system complete in a single carrying case. Exceptionally light and compact, it is ideally suited to the needs of sales training and industrial schools, teachers of speech, music and dramatics, as well as professional actors and musicians who require an instrument that can be carried easily and set up for operation in a few minutes time.

The model K records 15 minutes continuously at 33 1/2 RPM on one side of a 13 1/4" disc. It may be connected to any home radio set to record complete radio programs. It also makes 6, 8, 10 and 12 inch records, and plays all makes of phonograph records. As a voice amplifying system it will serve audiences of about 500 persons.

Although it is the lowest priced complete Presto recorder, it contains many valuable features of the more expensive instruments such as:

1. A magnetic cutting head and pickup, the design used in the highest grade equipment.
2. A full sized, 6 tube amplifier having push-pull triodes in the power stage.
3. A high frequency equalizer for 33 1/2 RPM recording and a tone control for suppressing needle scratch when commercial records are played.
4. A safety cam lever for lowering the cutting head to prevent accidental damage to sapphire needles.
5. A detachable, dynamic loudspeaker which may be operated at any desired distance from the recorder.
6. A cutter feed mechanism located beneath the turntable where it is protected from dust or accidental damage.
7. Provision for quick change from cutting outside-in to inside-out.
8. The exclusive Presto rubber-tired turntable driven directly by a pulley on the motor shaft, a drive system that eliminates rubber pulleys and belts which are subject to rapid wear. Turntable speed may be changed in 5 seconds from 78 to 33 1/2 RPM by removing a brass pulley on the motor shaft.

These features, not found in any other low-priced recorder enable the user to make high quality recordings, consistently. They simplify the operation of the instrument for non-technical owners and reduce operating costs by preventing spoilage of discs and needles. As a result of its excellent performance, more Presto model K recorders are now used by schools, industrial concerns and in the home than any other recorder in a similar price range. K-8—Complete Recorder less microphone and stand, List, \$303.00

WORLD'S LARGEST MANUFACTURERS OF RECORDING EQUIPMENT AND DISCS

PORTABLE

PRESTO

STATIONARY

SOUND RECORDING EQUIPMENT

PRESTO DISCS AND NEEDLES FOR COMMERCIAL, EDUCATIONAL AND HOME RECORDING



All Presto discs may be cut on both sides. Each disc is labeled and enclosed in an individual envelope. Playing time per side for various sizes is as follows:

6" — 1 minute 10" — 3.5 minutes
8" — 2 minutes 12" — 4.5 minutes
16" — 15 minutes (33 1/2 RPM)

GREEN LABEL GLASS BASE DISCS

Highest quality for delayed broadcasts. Overall thickness "B" type: .075"; "C" type: .080". Overall thickness 917-B Oversize Master, .135".

Type	Size	Price Each	Code
910-B and C	10"	\$1.00	GLLOSS
912-B and C	12"	1.25	GLOVE
913-B and C	13 1/2"	1.50	GLIDE
916-B and C	16"	2.50	GLEEN
917-B	17 1/4"	4.00	GLAMM

RED LABEL GLASS BASE DISCS

For audition, reference and educational recording. Overall thickness .060" to .075".

Type	Size	Price Each	Code
510-B and C	10"	\$0.80	GLACE
512-B and C	12"	1.00	GLAFF
516-B and C	16"	1.80	GIANT

NOTE: All Glass 10", 12" and 16" discs are packed 20 to a box.

MONOGRAM DISCS

Economical composition base, but same coating as Green Label glass discs. Overall thickness .050".

Type	Size	Price Each	Code
706-A	6"	\$0.20	MOBEL
708-A	8"	.35	MONOR
710-A	10"	.50	MOSEY
712-A	12"	.70	MOTAX
713-A	13 1/2"	1.00	MOXIE
716-A	16"	1.50	MOTUD

NOTE: 16" Monogram discs are packed 25 to the box. All other sizes, 10 to the box.

ALUMINUM DISC RECOATING SERVICE

Size	Perfect One Side	Both Sides	Code
12"	\$1.10	\$1.25	CLIVE
13 1/2"	1.40	2.00	CLAFF
16"	1.50	2.25	CLEXP

NOTE: We reserve the right to reject any discs which are damaged to such an extent that they cannot be recoated. About 20% of the recoated discs are perfect on one side only.

PROFESSIONAL CUTTING AND PLAYING NEEDLES

Cat. No.	Description	List Price	Code
603-A	Short Dural shank sapphire cutting needle.	\$ 8.00	PABST
604-A	Long Dural shank sapphire cutting needle.	8.00	PACEL
806-A	Resharpener sapphire cutting needle.	3.00	PADIM
601-A	Diamond playing needle.	30.00	PAGUR
631-A	Disclube, pint (Record Preserver).	2.50	PAMUS

COMMERCIAL, CUTTING AND PLAYING NEEDLES

Cat. No.	Description	List Price	Code
320-A	Short Sapphire cutting needle.	\$ 6.00	DABAC
321-A	Long Sapphire cutting needle.	6.00	DABIT
806-B	Resharpener Sapphire Point.	2.50	DACEL
330-A	Short Stellite cutting needle.	2.00	DADUS
331-A	Long Stellite cutting needle.	2.00	DADAR
807-A	Resharpener Stellite Point.	.75	DAFEF
350-A	Steel cutting needle (pkg. of 3).	1.00	DASTE
350-B	Steel cutting needle (carton, 12 pkg. of 3)	12.00	DATOR
420-A	Sapphire playing needle.	1.25	DAUVE
430-A	Transcriptone playing needle.	1.00	DAVEY
440-A	Red Shank Steel playing needle (pkg. of 25).	.25	DAVID
440-B	Red Shank Steel playing needle (carton, 40 pkg. of 25).	10.00	DAWES

Type 10-A Turntable

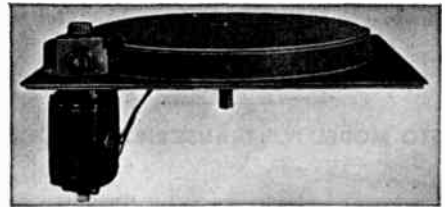

The 10-A table forms a part of the Presto 62-A and 63-A transcription turntables. The chassis only is offered as a replacement unit for stations having satisfactory reproducing pickups mounted on worn or inadequate turntables. The 10-A chassis can be mounted in most cabinets without disturbing the pickups or controls.

The mechanical design of the 10-A table is extremely simple. There are but 2 moving parts. The table consists of a metal platter to which a live rubber tire is fitted. This assembly is machined to perfect roundness and dynamic balance. A steel step pulley on the motor shaft drives against the rubber rim of the table. Speed is changed instantly by moving the motor carriage to engage either section of the drive pulley. Maintenance consists of oiling at 90 day intervals, occasional adjustment of the drive pressure and replacement of the tire once yearly.

The 10-A table is used and recommended by leading radio stations and transcription makers for playing both vertical and lateral recordings. List Price.....\$228.00

Type 75-A Recording Turntable



The lightest 16" dual speed recording turntable made. Recommended for all services requiring a high grade portable recorder. Widely used by broadcasting stations that record local news events for delayed broadcasts; a rugged, compact recording installation for mobile pickup units.

Used by industrial concerns, hospitals, scientific laboratories and in the visual education departments of schools and colleges in conjunction with 16 mm sound-film projectors for recording and reproducing narrative comment, sound effects and background music with locally produced silent films.

75-A—Turntable in Carrying Case.....List \$424.00

Type 11-A Turntable

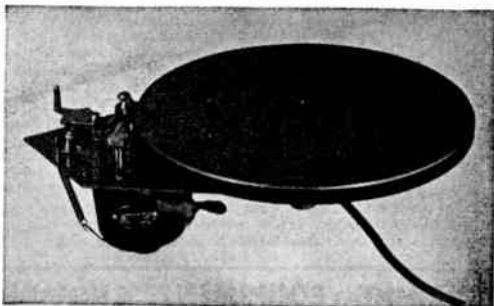

The Presto 11-A turntable chassis is recommended for use in radio phonograph combinations, centralized sound systems, portable transcription playback equipment, wherever high quality reproduction of records and transcriptions is required. It is particularly convenient for use in sound effects reproducing equipment where a number of turntables must be combined in a single compact unit. Designed for recording it has ample power for playing 16" transcriptions without "wow" and without change of pitch due to the drag of the pickup. It operates at either 78 or 33 1/2 RPM. Speed can be changed in less than 5 seconds. The mounting base is cut to a convenient size to facilitate mounting.

11-A Turntable chassis only.....List \$75.00
127-B Tire for replacement.....List 3.00

NOTE: Add \$10.00 for table adapted to operate on 220 volts, 60 cycles; 110 volts or 220/240 volts 50 cycles. Add \$25.00 for table to operate on 25 cycle supply.

Type 11-A

PORTABLE

PRESTO

STATIONARY

SOUND RECORDING EQUIPMENT

PRESTO MODEL "Y" RECORDER

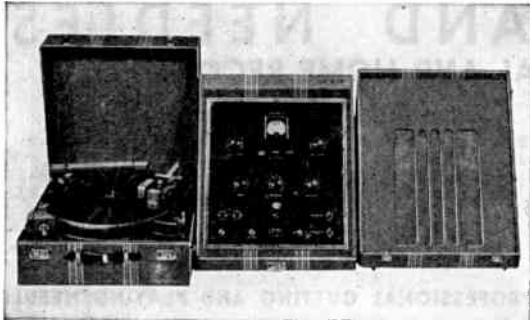

The PRESTO model Y recorder fills the need for a 16" transcription recording and playback equipment which is extremely portable and yet capable of producing high grade recordings. It makes continuous 15 minute, 33½ RPM electrical transcriptions of sufficiently good quality to be used by broadcasting stations. It also makes 78 RPM recordings on 6", 8", 10" or 12" discs and may be used to cut 11½", 13½" and 17½" master recordings from which commercial pressings are produced. In addition to recording, the model Y gives excellent reproduction of both electrical transcriptions and phonograph records and is widely used for auditioning recorded radio programs to prospective sponsors. As a public address system it will provide sound for audiences up to 1000 persons.

Among the important features of the model Y recorder are:

1. The exclusive Presto rubber-rimmed-turntable driven directly by a steel pulley on the motor shaft, a simple, foolproof drive system that eliminates vibration and holds the turntable speed absolutely constant. Maintenance is negligible. There are only two moving parts which need replacement about once a year.
2. A lever changes the turntable speed instantly without stopping the table or removing the record.
3. A lever adjusts the cutting mechanism to cut either from the outside of the disc toward the center or from the center out.
4. A cam lever lowers the cutting head gently on the record preventing accidental damage to sapphire needles.
5. A vibration damper attached to the cutting head suppresses vertical modulation in the record groove and eliminates variation in groove depth due to surface irregularities in

PRESTO MODEL "L" TRANSCRIPTION PLAYBACK



This equipment is designed for radio stations, advertising agencies and program producers, who demonstrate recorded programs at the offices of prospective clients.

Salesmen who use the Model L Playback will particularly appreciate its attractive, workman-like appearance, its small size and light weight which make it extremely easy to carry, its simplicity which makes it possible to set up for operation within a few seconds and the remark-

ably clear, wide range reproduction . . . far superior to that ordinarily expected from portable equipment.

The Model L Playback was developed to meet an insistent demand among the larger broadcasting stations and agencies for "something better" in portable reproducing equipment. Those who use the Model L Playback in connection with important sales of station time and programs will consider its exceptional performance well worth its cost.

L-2—Portable transcription playbackList, \$275.00

the disc. The damper also eliminates flutter when the records are played with pickups having a resonant peak in the low frequency range.

6. The cutting arm may be unlocked from the feed mechanism to cut spiral starting and runout grooves.
7. A time scale on the cutting arm shows the starting point for each size record and elapsed recording time at both 78 and 33½ RPM.
8. The cutting head feed mechanism is located beneath the turntable where it is protected from dust or accidental damage. The parts of this mechanism are hand finished and fitted and its performance is equal in every way to the overhead lathe type mechanism commonly used.
9. The recording amplifier includes a two microphone mixer, high and low frequency equalizers and a change-over switch for continuous recording or re-recording. The amplifier and loudspeaker fit together to carry in a single case.

Y-2 Recorder\$737.00
Y-4 Recorder (low impedance inputs).....776.00

PRESTO MODEL "K" RECORDER



The Presto model K is a portable sound recorder, record player and public address system complete in a single carrying case. Exceptionally light and compact, it is ideally suited to the needs of sales training and industrial schools, teachers of speech, music and dramatics, as well as professional actors and musicians who require an instrument that can be carried easily and set up for operation in a few minutes time.

The model K records 15 minutes continuously at 33½ RPM on one side of a 13¼" disc. It may be connected to any home radio set to record complete radio programs. It also makes 6, 8, 10 and 12 inch records, and plays all makes of phonograph records. As a voice amplifying system it will serve audiences of about 500 persons.

Although it is the lowest priced complete Presto recorder, it contains many valuable features of the more expensive instruments such as:

1. A magnetic cutting head and pickup, the design used in the highest grade equipment.
2. A full sized, 6 tube amplifier having push-pull triodes in the power stage.
3. A high frequency equalizer for 33½ RPM recording and a tone control for suppressing needle scratch when commercial records are played.
4. A safety cam lever for lowering the cutting head to prevent accidental damage to sapphire needles.
5. A detachable, dynamic loudspeaker which may be operated at any desired distance from the recorder.
6. A cutter feed mechanism located beneath the turntable where it is protected from dust or accidental damage.
7. Provision for quick change from cutting outside-in to inside-out.
8. The exclusive Presto rubber-tired turntable driven directly by a pulley on the motor shaft, a drive system that eliminates rubber pulleys and belts which are subject to rapid wear. Turntable speed may be changed in 5 seconds from 78 to 33½ RPM by removing a brass pulley on the motor shaft.

These features, not found in any other low-priced recorder enable the user to make high quality recordings, consistently. They simplify the operation of the instrument for non-technical owners and reduce operating costs by preventing spoilage of discs and needles. As a result of its excellent performance, more Presto model K recorders are now used by schools, industrial concerns and in the home than any other recorder in a similar price range.

K-8—Complete Recorder less microphone and stand, List, \$303.00

WORLD'S LARGEST MANUFACTURERS OF RECORDING EQUIPMENT AND DISCS

PORTABLE

PRESTO

STATIONARY

SOUND RECORDING EQUIPMENT

PRESTO DISCS AND NEEDLES FOR COMMERCIAL, EDUCATIONAL AND HOME RECORDING



All Presto discs may be cut on both sides. Each disc is labeled and enclosed in an individual envelope. Playing time per side for various sizes is as follows:

6"—1 minute 10"—3.5 minutes
8"—2 minutes 12"—4.5 minutes
16"—15 minutes (33 1/2 RPM)

GREEN LABEL GLASS BASE DISCS

Highest quality for delayed broadcasts. Overall thickness "B" type: .075"; "C" type: .060". Overall thickness 917-B Oversize Master, .135".

Type	Size	Price Each	Code
910-B and C	10"	\$1.00	GLOSS
912-B and C	12"	1.25	GLOVE
913-B and C	13 1/2"	1.50	GLIDE
916-B and C	16"	2.50	GLEEN
917-B	17 1/4"	4.00	GLAMM

RED LABEL GLASS BASE DISCS

For audition, reference and educational recording. Overall thickness .060" to .075".

Type	Size	Price Each	Code
510-B and C	10"	\$0.80	GLACE
512-B and C	12"	1.00	GLAFF
516-B and C	16"	1.80	GIANT

NOTE: All Glass 10", 12" and 16" discs are packed 20 to a box.

MONOGRAM DISCS

Economical composition base, but same coating as Green Label glass discs. Overall thickness .050".

Type	Size	Price Each	Code
706-A	6"	\$0.20	MOBEL
708-A	8"	.35	MONOR
710-A	10"	.50	MOSEY
712-A	12"	.70	MOTAX
713-A	13 1/2"	1.00	MOXIE
716-A	16"	1.50	MOTUD

NOTE: 16" Monogram discs are packed 25 to the box. All other sizes, 10 to the box.

ALUMINUM DISC RECOATING SERVICE

Size	Perfect One Side	Both Sides	Code
12"	\$1.10	\$1.25	CLIVE
13 1/2"	1.40	2.00	CLAFF
16"	1.50	2.25	CLEXE

NOTE: We reserve the right to reject any discs which are damaged to such an extent that they cannot be recoated. About 20% of the recoated discs are perfect on one side only.

PROFESSIONAL CUTTING AND PLAYING NEEDLES

Cat. No.	List Price	Code
603-A Short Dural shank sapphire cutting needle.....	\$ 8.00	PABST
604-A Long Dural shank sapphire cutting needle..	8.00	PACEL
806-A Resharping sapphire cutting needle.....	3.00	PADIM
601-A Diamond playing needle.....	30.00	PAGUR
631-A Disclube, pint (Record Preserver).....	2.50	PAMUS

COMMERCIAL, CUTTING AND PLAYING NEEDLES

Cat. No.	List Price	Code
320-A Short Sapphire cutting needle.....	\$ 6.00	DABAC
321-A Long Sapphire cutting needle.....	6.00	DABIT
806-B Resharping Sapphire Point.....	2.50	DACEL
330-A Short Stellite cutting needle.....	2.00	DADUS
331-A Long Stellite cutting needle.....	2.00	DADAR
807-A Resharping Stellite Point.....	.75	DAFE
350-A Steel cutting needle (pkg. of 3).....	1.00	DASTE
350-B Steel cutting needle (carton, 12 pkg. of 3)	12.00	DATOR
420-A Sapphire playing needle.....	1.25	DAUVE
430-A Transcriptone playing needle.....	1.00	DAVEY
440-A Red Shank Steel playing needle (pkg. of 25).....	.25	DAVID
440-B Red Shank Steel playing needle (carton, 40 pkg. of 25).....	10.00	DAWES

Type 10-A Turntable

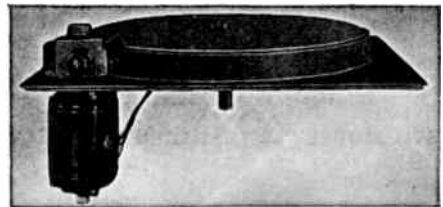

The 10-A table forms a part of the Presto 62-A and 63-A transcription turntables. The chassis only is offered as a replacement unit for stations having satisfactory reproducing pickups mounted on worn or inadequate turntables. The 10-A chassis can be mounted in most cabinets without disturbing the pickups or controls.

The mechanical design of the 10-A table is extremely simple. There are but 2 moving parts. The table consists of a metal platter to which a live rubber tire is fitted. This assembly is machined to perfect roundness and dynamic balance. A steel step pulley on the motor shaft drives against the rubber rim of the table. Speed is changed instantly by moving the motor carriage to engage either section of the drive pulley. Maintenance consists of oiling at 90 day intervals, occasional adjustment of the drive pressure and replacement of the tire once yearly.

The 10-A table is used and recommended by leading radio stations and transcription makers for playing both vertical and lateral recordings. List Price.....\$228.00

Type 75-A Recording Turntable

The lightest 16" dual speed recording turntable made. Recommended for all services requiring a high grade portable recorder. Widely used by broadcasting stations that record local news events for delayed broadcasts; a rugged, compact recording installation for mobile pickup units.

Used by industrial concerns, hospitals, scientific laboratories and in the visual education departments of schools and colleges in conjunction with 16 mm sound-film projectors for recording and reproducing narrative comment, sound effects and background music with locally produced silent films.



75-A—Turntable in Carrying Case.....List \$424.00

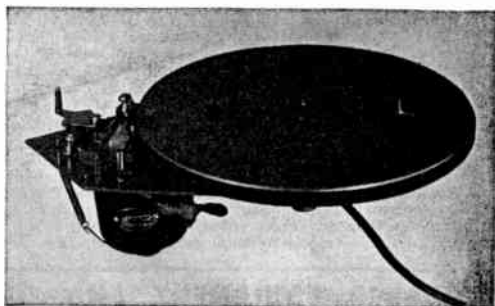

Type 11-A

Type 11-A Turntable

The Presto 11-A turntable chassis is recommended for use in radio phonograph combinations, centralized sound systems, portable transcription playback equipment, wherever high quality reproduction of records and transcriptions is required. It is particularly convenient for use in sound effects reproducing equipment where a number of turntables must be combined in a single compact unit. Designed for recording it has ample power for playing 16" transcriptions without "wow" and without change of pitch due to the drag of the pickup. It operates at either 78 or 33 1/2 RPM. Speed can be changed in less than 5 seconds. The mounting base is cut to a convenient size to facilitate mounting.

11-A Turntable chassis only.....List \$75.00

127-B Tire for replacement.....List 3.00

NOTE: Add \$10.00 for table adapted to operate on 220 volts, 60 cycles; 110 volts or 220/240 volts 50 cycles. Add \$25.00 for table to operate on 25 cycle supply.

REK-O-KUT

Professional RECORDING EQUIPMENT

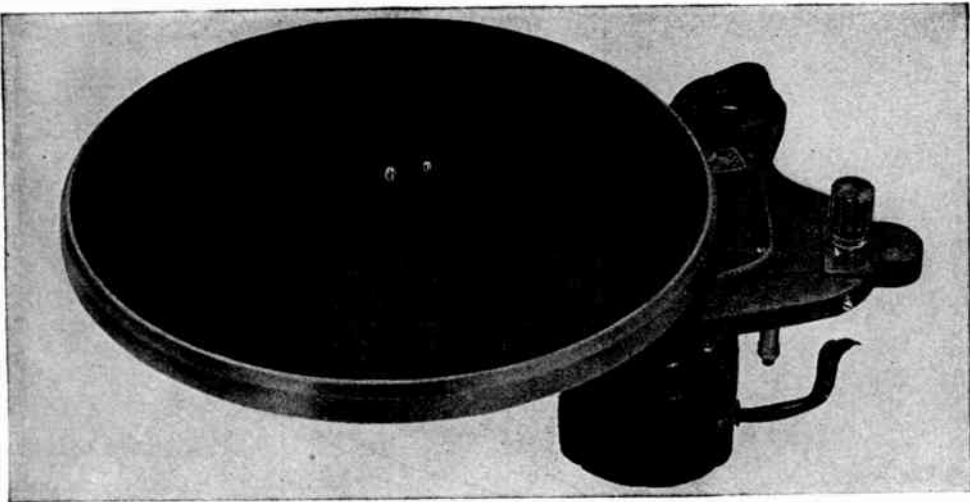

RK-D16 DUAL SPEED 16" RECORDING MOTOR ASSEMBLY

This precision-constructed instrument, unsurpassed in quality and performance is operating in many of the leading broadcasting stations and educational institutions. Ruggedly constructed and painstakingly assembled for efficient and prolonged service.

EQUIPMENT

- 1) Lathe turned, 25 lb. cast iron turntable, dynamically balanced, with disappearing drive pin and rubber turntable pad.
- 2) Turntable fitted with one inch diameter polished steel shaft, with special oil grooves for force feed lubrication when operating. Rotates on a single ball bearing at the bottom of the turntable well.
- 3) 1/20 H.P. General Electric constant speed motor.
- 4) One dual and one single speed idler.
- 5) Adjustable stops to regulate idler pressure against turntable.
- 6) 10 lb. machined mounting base of Cast Iron, with integral lathe bored and lapped turntable bearing.
- 7) This single unit type construction insures positive and easy alignment of the REK-O-KUT overhead mechanism with the turntable.
- 8) Entire assembly can be permanently installed in 15 minutes.

RK-D16—Dual Speed 16" Recording table, mounting base and motor..... Net Price, \$125.50



RK-D12 DUAL SPEED 12" RECORDING MOTOR ASSEMBLY

The answer to the demands of small studios, program and advertising agencies, educational institutions, etc. . . . for professional dual speed 12" recording units at substantially lower cost. Design and construction similar to model RK-D16, 16" assembly. Turntable can accommodate 16-inch blanks for playback.

CONSTRUCTION—Similar to RK-D16 (16" assembly) in material, workmanship and design. RK-D12 differs only in that the cast iron turntable weighs 12 lbs., and smaller constant speed recording motor and special rotor speed shift arm are employed.

Net Price

RK-D12—Dual Speed 12" Recording table, base and motor \$59.50
 RK-12—Single Speed 12" 37.50

RK Monitor Meter

A sturdy meter of the rectifier type, especially designed for monitoring purposes. The meter has four scales, one reading from -10 db. to +7 db., and a second from +7 db. to +25 db. The other two scales for recording level indication are calibrated in terms of "undercut," "normal cut," and "overcut." They are clearly indicated. The meter is tapped for 8 ohm and 500 ohm input.



RK—Monitor Meter Dual scale 8 and 500 ohm..... Net Price, \$9.75

ACCESSORIES

	Net Price
F-12—120 line deluxe lathe cut feedscrew with gear and feednut for 12" units	\$13.50
F-16—120 line deluxe lathe cut feedscrew with gear and feednut for 16" units	15.75
RC-20—Brush crystal cutter	15.00
R-84—Webster magnetic cutter for 8 ohms.....	12.00
R-84G—Webster magnetic cutter for 500 ohms.....	12.00
M-41—Astatic magnetic cutter for 8 or 500 ohms.....	7.00
X-29—Astatic crystal cutter	7.00
44-A—Shure magnetic cutter	7.00
Rubber turntable pad for 12" table.....	.90
Rubber turntable pad for 16" table.....	1.50

ALL PRICES SUBJECT TO CHANGE WITHOUT NOTICE

REK-O-KUT

**Professional
RECORDING
EQUIPMENT**

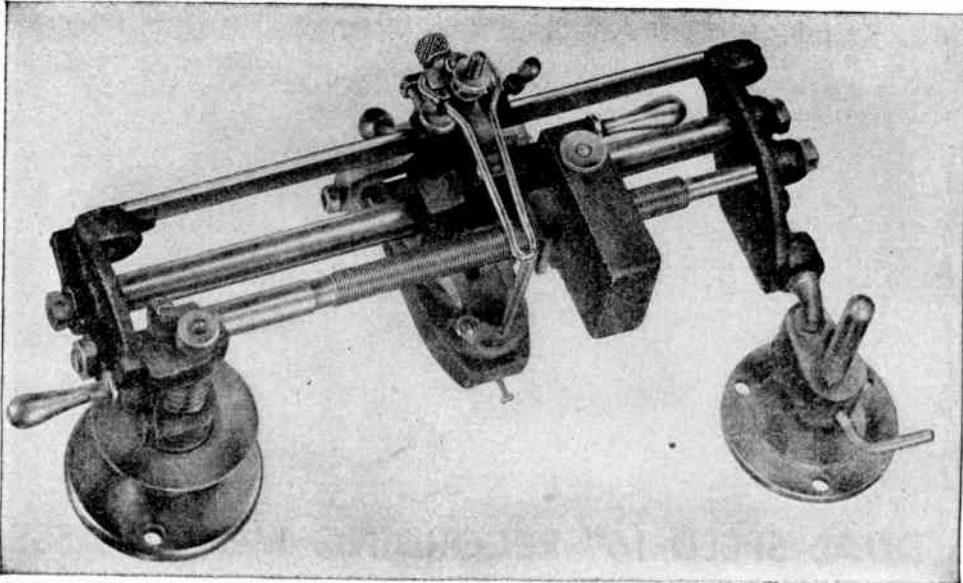

REK-O-KUT OVERHEAD FEED MECHANISMS

(Illustrated above with horizontal type crystal cutter)

The REK-O-KUT 1942 Model overhead feed mechanism is the first professional unit to offer a Universal Cutter Mount with micrometer adjustment. This exclusive feature, not found on any other machine, permits the user to interchange the vertical magnetic cutter with the horizontal crystal or magnetic type, or the Brush Crystal oblong Cutter, without changing the position or the height of the mechanism after it has been mounted. The micrometer adjustment enables the operator to raise or lower the cutter in easy stages to compensate for the height of the cutter, and to get the proper stylus angle. Mechanisms are made for both 12" and 16" turntables.

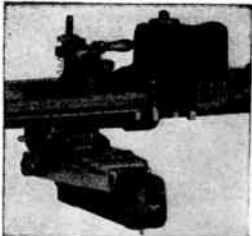

Universal cutter mount with Brush crystal oblong type cutter.

OUTSTANDING FEATURES

- 1) Universal cutter mount for interchanging popular type cutters.
- 2) Micrometer adjustment for selecting preferred stylus angle and to compensate for record thickness, without raising or removing the entire mechanism.
- 3) Double action swivel for easy alignment of mechanisms with REK-O-KUT turntable.
- 4) Simplified carriage lift for accurate spot recording or spiral.
- 5) Standard units record 100 lines per inch, outside in. Also available inside out at no extra charge.
- 6) Deluxe units are now offered with 120 line precision, lathe cut feedscrews.
- 7) Either 100 or 120 line feedscrews available as standard replacements.
- 8) Patented chip collector eliminates stylus "pull" and doublecutting.

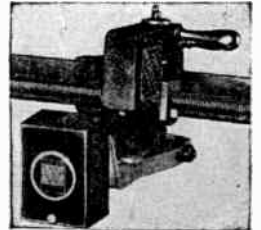

Universal cutter mount with vertical magnetic type cutter.

Overhead Feed Recording Mechanisms (For 12" Records)

	Net Prices	
	Standard 100 Lines	Deluxe 120 Lines
RX-12—With Astatic Crystal X-29 Cutter.....	\$42.50	\$55.00
RM-12—With Astatic Magnetic M-41 Cutter.....	42.50	55.00
RW-12—With Webster R84, 30-6000 cycles.....	47.50	60.00
RB-12—With Brush RC 20 Crystal Cutter.....	53.00	65.50

(For 16" Records)

RX-16—With Astatic Crystal X-29 Cutter.....	\$51.50	\$66.25
RM-16—With Astatic Magnetic M-41 Cutter.....	51.50	66.25
RW-16—With Webster R84, 30-6000 cycles.....	55.75	70.50
RB-16—With Brush RC20 Crystal 50-9000 cycles	61.50	76.25

ALL MAGNETIC CUTTERS AVAILABLE 8 OR 500 OHMS
NO OVERHEAD MECHANISMS SOLD WITHOUT CUTTERS

RK MATCHING TRANSFORMER

Specially designed to operate with Brush High Fidelity cutter. The frequency response of the RK Matching Transformer is flat from 50 to 9000 cycles. Input taps of 6-8 and 500 ohms gives user a choice of tapping his cutter into either an 8 ohm or 500 ohm line. This matching transformer is required where the user of a crystal cutter is unable to have a direct hook up to a high impedance line.

RK—Matching Transformer for Brush and Astatic Cutters 50-9000 cycles, Net Price, \$5.50

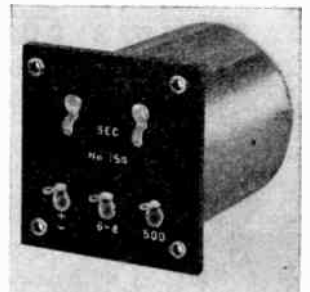

ALL PRICES SUBJECT TO CHANGE WITHOUT NOTICE

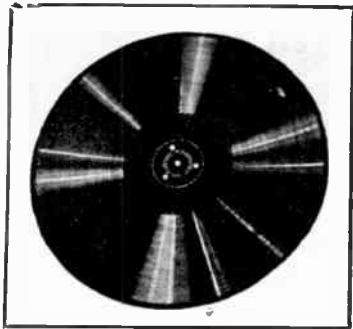

audiograms

—they speak for themselves



**RED LABEL • YELLOW LABEL • MASTER
REFERENCE RECORDING AUDIODISCS**

GLASS BASE, INSTANTANEOUS RECORDING BLANKS

Highest quality, precision made. "Acetate" coated on thin, flexible glass base. These blanks are establishing new standards of perfection in all types of recording in radio stations, recording studios, edu-

ational institutions, for sales talks and demonstrations. AUDIODISCS meet every recording need with a type for each particular operation.

PHYSICAL PROPERTIES

UNIFORM COATING

AUDIODISCS' exclusive machine-coating process, unlike the usual dipping, spraying, or flowing processes, produces a smooth, flat surface free from swirls, waves, and "orange peel," uniform to within one-half a thousandth of an inch.

LONG STYLUS LIFE

Due to elaborate filtering and air-conditioned drying, the AUDIO-DISC coating is free from embedded abrasive material which may damage cutting styli and cause "clicks" and unpleasant surface noises in playing back.

CHEMICAL PROPERTIES

HOMOGENEOUS COATING

While other discs are coated to irregular thicknesses by successively applying layers of liquid material, AUDIODISCS are uniformly coated in one operation with a material of exclusive formula and by means of precision machines.

WILL NOT DRY OUT

Unlike other discs which dry out and harden, a special curing process removes from AUDIODISCS the last trace of volatile constituents. After the disc leaves the factory nothing that can dry out remains in the material. Blanks made by this same process over four years ago, today still cut easily and play back perfectly.

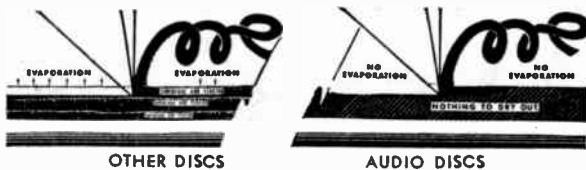

UNIFORMITY OF PRODUCT

AUDIODISCS are manufactured by a unique, automatic, precision-machine process which guarantees consistent quality and makes possible adherence to the highest standards. AUDIODISCS are manufactured in U.S.A. under exclusive license from LA SOCIETE DES VERNIS PYROIAC, FRANCE.

SOUND PROPERTIES

SILENT BACKGROUND

Under correct cutting conditions there is not a whisper of background scratch to be heard from an AUDIODISC at normal playback volume. This silence is best obtained by using a perfect stylus and setting the cutting angle vertical as explained in leaflet entitled "Helpful Suggestions for Cutting" furnished with each package of AUDIODISCS.

BRILLIANT FREQUENCY RESPONSE

While the easy cutting qualities of the AUDIODISC coating permit the recording of the full range of the best cutters, its tough nature keeps the pickup from mushing down minute modulations and results in brilliant "highs."

LONG PLAYBACK LIFE

Under good playing conditions (a shadowgraphed needle, such as AUDIOPoint No. 151, and a pickup with two ounces pressure) an AUDIODISC can be played back at least one hundred times with no noticeable increase in surface noise.



	Type	Description	Size (In.)	Base Material	List Price per Disc	Standard Quantities	Code Word	Type	Description	Size (In.)	Base Material	List Price per Disc	Standard Quantities	Code Word
								REGULAR LINE	YELLOW LABEL					
PROFESSIONAL LINE	RED LABEL	Highest quality PROFESSIONAL recording blanks, "acetate" coated on thin, flexible glass. For lateral or vertical recording in broadcasting stations, sound and movie studios and all applications requiring the ultimate in disc perfection. Double-sided with 3 DRIVE PIN HOLES.	8	Glass	\$.70	Box of 25	ArivD	"Wide-latitude", high quality recording blanks, "acetate" coated on thin, flexible glass. Popular priced for use in radio recordings, voice and speech classes, demonstrations, sales talks, amateur, home, school and college recording. Double sided. Labelled.	8	Glass	\$.60	1 box of 24	DropA	
			10	Glass	1.00	Box of 25	AwarD							
			12	Glass	1.25	Box of 25	AplaD							
			16	Glass	2.50	Box of 25	AgreD							
	MASTERS	Oversize PROFESSIONAL master blanks, coated on extra thick glass. For making copies (pressings) by conventional electroplating process.	12	Glass	1.55	Box of 25	AreoD	16	Glass	2.00	1 box of 24	DelmA		
			13 1/4	Glass	2.25	Box 12or25	AstnD							
			17 1/4	Glass	3.75	Box 12or25	AtunD							
	SINGLE FACE	Appearance and properties same as RED LABEL. Both sides coated. Recordable side identified. For economy in applications requiring one side only.	12	Glass	.95	Box of 25	SurnF							
			16	Glass	1.75	Box of 25	SaknF							
			13 1/4	Glass	1.60	Box 12or25	SlipF							
17 1/4			Glass	2.25	Box 12or25	SenbF								
REFERENCE RECORDING DISC	"Acetate" coated on glass. For extreme economy in making test cuts, filing and reference recordings.	12	Glass	.70	Box of 25	RameR								
		16	Glass	1.40	Box of 25	RenoR								

NOTE: Due to National Defense requirements for aluminum this material is no longer available for recording discs. AUDIO, therefore, developed a special glass base which makes possible production of discs with the finest sound and physical properties ever seen by the industry.

audiopoints

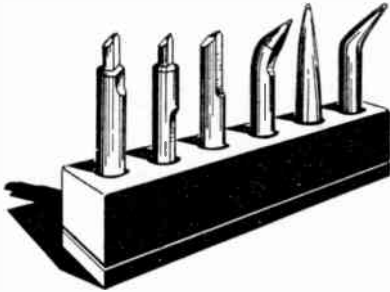

MICROSCOPICALLY MATCHED CUTTING AND PLAYBACK POINTS

Especially Designed for Use with Audi discs and Other Instantaneous Recording Blanks

The quality of sound obtainable from a recording blank can be no better than the points used in its cutting and playing. Our research has established a much-needed set of cutting and playing needle standards which, if adhered to, bring out the best qualities not only of AUDIODISCS but of ALL blanks. The following data explains why AUDIPOINTS will solve your needle problems.

AUDIO CUTTING POINTS

Audio Cutting Points are available in several types and materials to give full range to the recorder's needs.

SAPPHIRE

Sapphire, though brittle and requiring careful handling, makes the finest cutting point. It takes a fine polish, has a low coefficient of friction and is extremely long wearing. Though more expensive, it is, in view of its long life and the fact that it can be repeatedly sharpened, the most economical of stylus materials. It is especially recommended for professional and master-recording work.

STELLITE

Stellite, an extremely hard metal alloy, cuts a groove comparable to a sapphire. Stellite styli are low in first cost, have good wear life and can be repeatedly sharpened.

STEEL

Where first cost is a major consideration, good steel points can be used. The groove is not as silent and shiny as that obtained with a sapphire but is, for many purposes, entirely satisfactory. Steels must be changed often and cannot be economically resharpened.

AUDIO PLAYBACK POINTS

Manufactured and checked to specifications which bear a practically ideal relationship to Audio Cutting Points. Audio Playback Points are made in several types and give best playback results and longest life to all records.

SAPPHIRE

The finest playback needle from every standpoint is the sapphire. One sapphire AUDIO-PLAYBACK POINT will play thousands of recordings and, when finally worn, can be resharpened. Care, however, must be used in handling to prevent breakage of the brittle point, as the jagged edge of a break will seriously score the record grooves.

STEEL

The most practical playback is the shadowgraphed steel needle. Steel AUDIO-PLAYBACK-POINTS will each play dozens of instantaneous recordings without damage to the grooves because they are shaped to match AUDIO-CUTTING-POINTS. They are shadowgraphed, highly polished, and wear-resistant.

Type	Description	Point Material	Shank Material	Type No.	List Price	Code Word
Cutting	Every sapphire and stellite is disc-tested for perfect cutting...	Sapphire	Dural*	14	ea. \$8.25	AzorD
	Diamond-Lapped.....	Stellite	Brass*	34	ea. 1.50	AkviD
	Standard.....	Steel	Steel**	50	ea. .35 dz. 3.50	AveniD
Playback	Microscopically MATCHED to characteristics of AUDIO cutting points, checked by shadowgraph.....	Steel	Steel**	51	ea. .25 dz. 2.50	AfrmD
	Shadowgraphed for light pickups.....	Sapphire	Steel Alloy	113	ea. \$6.50	AmorD
	For heavy pickups.....	Steel	Straight Bent	151 154	100 .75 100 .60	AbonD AnieD
Resharpening Service	No delay. All resharpened styli are disc-tested.....	Sapphire	Cutting	14	\$2.20	AforD
		Stellite	Cutting	34	.70	AvisD
		Sapphire	Playing	113	4.00	AxiD

*Supplied in standard short shank (17/32 inch) with "flat" (unless long) and/or round shank are specified.

** Best type for home recorders with crystal cutting heads.

AUDIPOINT PACKAGING—AUDIPOINTS reach you in specially developed, convenient packages. Avoid sending styli in envelopes. Where this must be done be sure to mark package "Hand-Stamp Only."

SAFETY CARTON

For Shipping Glass Base Audi discs or Shellac Pressings

COMPLETE PROTECTION

The SAFETY CARTON consists of an inner carton to contain the discs, an outer carton to contain the inner carton, and shredded lint-proof, paper cushioning material. Each carton holds from 1 to 3 AUDIODISCS. Approved by leading transportation companies, the ability of this carton to protect discs in spite of rough handling is self evident. In view of the irreplaceability of many recorded discs, shipping in a SAFETY CARTON is essential.

NET PRICES

12" CARTONS PER DOZEN	\$2.50
Weight per Carton 1 lb.-14 oz.	
16" CARTONS PER DOZEN	3.00
Weight per Carton 2 lbs.-10 oz.	
17 1/4" CARTONS PER DOZEN	5.00
Weight per Carton 3 lbs.-4 oz.	

A SOUND-RECORDING "MUST"



"HOW TO MAKE GOOD RECORDINGS"

List Price \$1.25

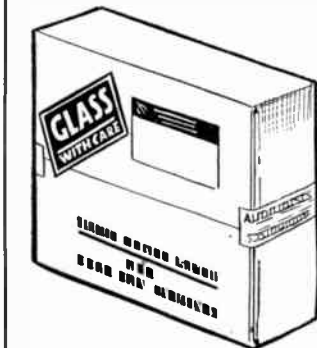

DUOTONE Needles

FILTER POINT No. 610



The Filter Point needle is a newly developed needle which actually filters surface noise, yet retains the brilliance of your recordings. The highly polished and rounded point assures smooth movement in the record groove, reducing record wear to a minimum. The needles are hand picked and will play from 12 to 15 records without frequency loss or distortion. The specially designed point is guaranteed not to break when used with any type of record changer.

- List Price**
- Cat. No. 610-P—Package of 12 needles.....\$ 0.10
 - Cat. No. 610-B—Carton of 100 pkgs..... 10.00
 - Cat. No. 610-C—Display card of 50 pkgs... 5.00
 - Cat. No. 625-P—Package of 35 needles.....\$ 0.25
 - Cat. No. 625-B—Carton of 50 pkgs..... 12.50
 - Cat. No. 625-C—Display card of 50 pkgs... 12.50
 - Cat. No. 665-P—Package of 100 needles....\$ 0.65
 - Cat. No. 665-B—Carton of 25 pkgs..... 16.25



No. 21

The Miro Point Needle is the "low surface" specialist of the Duotone Line. Despite this fact it still brings out the highs in a manner never before attained by a needle of this type. Designed to play at least 1000 records the Miro Point is the outstanding needle in the field today.

- List Price**
- Cat. No. 21-P—Needle, list price, each.....\$0.50
 - Cat. No. 21-C—Display card of 18 needles... 9.00

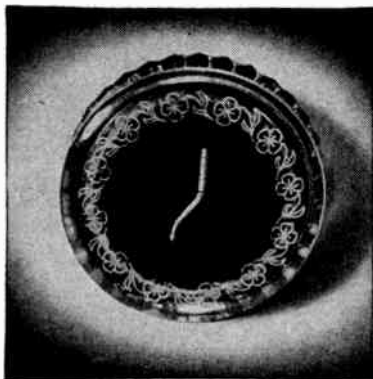

No. 19 "STAR" SAPHIRE

Reproduces any type of record without surface noise yet maintains brilliant high frequencies. Finest quality gem, brightly polished for smooth riding in groove. Special design filters out all noise and needle talk. Has flat on shank for easy insertion in pickup. May be removed if desired. Individually packed in beautiful lucite box. Ideal for dubbing.

- List Price**
- Cat. No. 19-P—Needle, list price, each....\$ 5.00
 - Cat. No. 19-B—Carton of 12 needles..... 60.00



guaranteed to play at least 50 records, assuring a full evening of music without requiring a change of needle.

- List Price**
- Cat. No. 17-P—Package of 5 needles\$ 0.25
 - Cat. No. 17-B—Carton of 50 pkgs... 12.50
 - Cat. No. 17-C—Display card of 25 pkgs.... 6.25

TRANSCRIPTION No. 710

Transcription needles are individually shadowgraphed to insure each needle being perfect. They are especially designed to reduce record wear on home recordings and will give life-like reproductions when used on commercial or home records. This needle, because of its perfect point and fine frequency response, is extensively used by broadcasting stations, and recording studios. Economically packed for use in homes and studios.

- List Price**
- Cat. No. 710-P—Package of 12 needles.....\$ 0.10
 - Cat. No. 710-B—Carton of 100 packages..... 10.00
 - Cat. No. 710-C—Display card of 50 packages..... 5.00
 - Cat. No. 725-P—Package of 35 needles.....\$ 0.25
 - Cat. No. 725-B—Carton of 50 packages..... 12.50
 - Cat. No. 725-C—Display card of 50 packages..... 12.50
 - Cat. No. 750-P—Package of 100 needles.....\$ 0.50
 - Cat. No. 750-B—Carton of 20 packages..... 10.00

DURPOINT No. 15

Permanent needle for home use. Will play over 3000 records without changing. Takes additional polish from the groove of the record thus minimizing record wear, and reducing surface noise. Because of this feature the Durpoint should not be removed from pick up until replacement is necessary. Packed individual cards.

- List Price**
- Cat. No. 15-P—Needle, each\$ 1.00
 - Cat. No. 15-C—Display card of 12 needles..... 12.00

CACTUS NEEDLES No. 18

Made from specially selected cactus thorns chemically treated to prolong life of point and assure quiet reproduction. Each needle may be re-sharpened many times. Can be used on record changers as well as ordinary phonographs. Especially recommended for use on records with high surface noise.

- List Price**
- Cat. No. 18-P—Package of 12 needles.....\$ 0.35
 - Cat. No. 18-B—Carton of 50 packages..... 17.50
 - Cat. No. 18-C—Display card of 25 pkgs..... 8.75

DUO-MATIC No. 22



Duomatic Needles are a real dealer item. This economical package of fifteen needles offers the best value obtainable. 200 needles for \$1.50.

Also an excellent item for the regular record buyer. The handy tin provides a permanent receptacle for keeping the needles available at all times. Because of their non-breaking quality they are perfect for use on record changers.

- List Price**
- Cat. No. 22-P—Tin of 200 needles.....\$1.50
 - Cat. No. 22-B—Carton of 5 tins..... 7.50

DUOTONE

No. 20
"LIFETONE"
NEEDLE
4000
PERFECT
PLAYINGS



The Duotone Lifetone Needle was especially designed for use with record changers. Its brilliant performance coupled with low surface noise makes it ideal for this purpose. When properly used, it will give at least 4000 perfect playings, maintaining throughout its life the same bright reproductive qualities. Packed in beautiful plastic container.

- List Price**
- Cat. No. 20-P—Needle, each\$ 1.50
 - Cat. No. 20-B—Carton of 12 needles..... 18.00
 - Cat. No. 20-C—Display card of 12 needles.. 18.00

STRAIGHT SAPHIRE PLAYBACK No. 13



A permanent needle with a flat on the shank allowing removal from, and insertion into pickup as required. The exceedingly high polish on the jewel eliminates the necessity for bending the shank. Will play approximately 5000 home recordings, or 2000 commercial recordings. Finest quality jewel assures natural tone reproduction and very low record wear. Especially recommended for use in light weight pickups. Packed in beautiful velvet lined box.

- List Price**
- Cat. No. 13-P—Needle, each\$ 2.00
 - Cat. No. 13-B—Carton of 12 needles..... 24.00

BENT SAPHIRE PLAYBACK No. 14



The Duotone Bent Sapphire needle will play over 2000 records with a minimum of record wear and surface noise. The highly polished jewel point will reproduce your finest records with a tone value of unusual fidelity. Should not be removed from pickup. Packed in beautiful velvet lined box.

- List Price**
- Cat. No. 14-P—Needle, each\$ 1.50
 - Cat. No. 14-B—Carton of 12 needles..... 18.00



DUOTONE Needles

STEEL CUTTING STYLUS No. 8



The ideal needle for use in homes by amateur record makers. With ordinary care will make a quiet, record of good quality, which can be played back many times. Will make approximately 15 to 25 10" records. Packed 4 to handy point-protecting felt-lined package.

- List
 Cat. No. 8-P—Package of 4 needles.....\$ 1.00
 Cat. No. 8-B—Carton of 25 pkgs..... 25.00
 Cat. No. 8-C—Display card of 25 pkgs.... 25.00

STELLITE CUTTING STYLUS No. 9



The Stellite cutting stylus with proper care, will make a record that compares favorably with a professional cutting. Its hand-lapped edge cuts a groove which assures a noiseless recording. Stellite styli are recommended after some cutting experience has been acquired. The reduction in surface noise and the improved quality of the recording will be instantly noticeable, and will be well worth the difference in cost. Will cut approximately 500 6" records. Individually packed on cards.

- List
 Cat. No. 9-P—Needle, each\$ 2.00
 Cat. No. 9-B—Carton of 12 needles..... 24.00
 Cat. No. 9-C—Display card of 12 needles... 24.00

LAPPED STEEL CUTTING STYLUS No. 10



The hand-made lap on the cutting edge of the needle, makes a much smoother cut, thereby reducing surface noise and adding to the life of the needle. Especially recommended for making vocal recordings.

- List
 Cat. No. 10-P—Card of 5 needles.....\$ 1.50
 Cat. No. 10-C—Display card of 50 needles.. 15.00

SAPPHIRE STYLUS No. 12



The sapphire Professional cutting stylus is the finest available. The cutting jewel is very highly polished and has a patented hand-lapped edge, which cuts and polishes the groove, making a record with the lowest surface noise. With proper handling will give 10-15 hours of cutting and can be re-sharpened many times.

DO NOT DROP

Packed in plastic container.

- Cat. No. 12—Needle, list price, each\$5.50
 (Resharping—Each \$3.00)

DURAL SHANK No. 11

This needle is similar to No. 12, and in addition is held to more exacting specifications, as established by leading engineers. Mounted in Dural shank. Packed in plastic container. Each \$7.25

DUOTONE DISPLAY CARDS

Are Available for the Following Needles:

Number	List	Number	List
FILTER POINT			
610C—10c per pkg.—50 pkg.	\$5.00	LIFETONE	
to card		20C—\$1.50 per needle—12 cards to display ..\$18.00	
625C—25c per pkg.—50 pkg.	\$12.50	MIRO POINT NEEDLE	
to card		21C—50 cents per needle—18 needles to display	9.00
TRANSCRIPTION			
710C—10c per pkg.—50 pkg.	\$4.00	STEEL CUTTING STYLUS	
to card		8C—\$1.00 per pkg. of 4 needles—25 pkg. to display card ..	25.00
725C—25c per pkg.—50 pkg.	\$12.50	STELLITE STYLUS	
to card		9C—\$2.00 per needle individually packed—12 needles to display card	24.00
DURPOINT			
15C—\$1.00 each—12 needles to card	\$12.00	LAPPED STEEL STYLUS	
CHROMIUM			
17C—5 needles to pkg.—25c, 25 pkg. to card ..	6.25	10C—\$1.50 per pkg. of 5 needles—10 pkg. to display card ...	15.00
CACTUS			
18C—35c per pkg.—25 pkg. to card	8.75		

COMPLETE LINE OF RECORDING BLANKS



- 12" Glass.....\$1.25 List
 10" Glass..... 1.00 List
 Packed 12 to carton
 10" Compo.....\$0.40 List
 8" Compo30 List
 6 1/2" Compo20 List
 Packed 5 to package
 10 packages to carton

DUOTONE RECORDING FLUIDS



DUOTONE RECORD PRESERVER

A newly developed fluid that helps make phonograph records (Victor, Columbia, Decca, etc.) last much longer. Duotone Record Preserver not only cleans the record, but actually puts a thin protective coating on it. This coating protects the record against excessive wear and in addition enables the needle to glide smoothly, thus reducing surface noise.

- List
 Cat. No. 105-P—One 2-oz. bottle, each.....\$0.50
 Cat. No. 105-B—Attractive display card of twelve 2-oz. bottles... 6.00



BEARING LUBRICANT

For Recording Mechanism, Turntable Spindles and Phonograph Motors. Will not dry out—will not thin or run—Non-Acid. Will improve performance of any machine.

- Cat. No. 103-P List
 Each\$0.50
 Cat. No. 103-B
 (Carton of 12 bottles)..... 6.00



PRE-RECORDING FLUID

For use on the disc before cutting. When applied to the surface with a piece of soft cotton, it allows the needle to cut smoothly, thus reducing surface noise and needle wear. Will not harm ANY kind of coating.

- Cat. No. 101-P List
 Each\$0.50
 Cat. No. 101-B
 Carton of 12 bottles..... 6.00



HARDENING FLUID

For use on home recorded records after cutting. Apply to surface with piece of soft cotton, covering entire surface of record. Preserves groove structure and record life. Materially reduces surface tension. Restores original tone quality on older records.

- Cat. No. 102-P List
 Each\$0.50
 Cat. No. 102-B
 Carton of 12 bottles..... 6.00



CACTUS NEEDLE SHARPENER No. 104

A "fool proof" sharpener guaranteed to make a point the equal of a new one. Utilizes the turntable of your phonograph. Each disc has pointing and polishing sides, assuring a sharp smooth finish to the point. Emery disc will last for many months. Extra discs available 30c each at any dealer.

- List
 Cat. No. 104—Each.....\$1.25
 Extra discs, each 0.30

CLARION-DYNAMIC NEEDLES

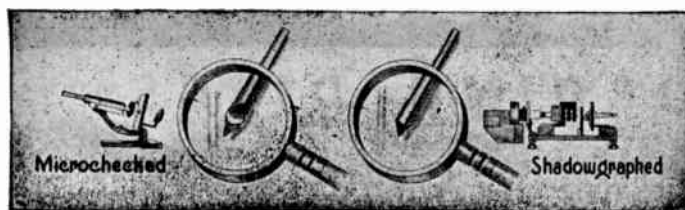

RECORDING

Precious Metal Alloy



A high grade recording stylus, for the advanced amateur and professional use. Electrically welded precious metal alloy tip, microscopically ground, and polished with diamond dust. Hand finished tip cuts round bottom groove for best possible results. Will cut approximately five hundred six inch records.

List \$1.00

Stellite



This patented Stellite recording stylus, when used by the advanced amateur or professional, will give results closely approximating the finest Sapphire. Hand finished tip, cuts quiet round bottom groove. Will cut approximately five hundred six inch records.

List \$1.25

Alloy Tool Steel



Made of the finest alloy tool steel, microscopically ground and polished with diamond dust. Recommended for amateur home use. Will cut approximately twenty-five six inch records.

List \$.25

Precious Metal Alloy



Precious metal alloy tip recording stylus, for the advanced amateur. A sturdy, long wearing, highly polished needle. Cuts a V bottom groove. Will make approximately three hundred six inch recordings.

List \$.50

PLAY-BACKS

Rigid Type

Semi-permanent, precious metal alloy tip, play back needle for home or commercial use. Rigid type, high fidelity. Will play more than four thousand records. Ideal for coin operated phonographs.

List \$.50



Flexible Type

Semi-permanent, flexible type play back needle, for home use on new light weight pick-ups. Reduces record scratch to minimum. Precious metal alloy tip, will play more than four thousand records.

List \$1.00



Soft-Tone

Semi-permanent, low scratch level play back needle, for home use on light weight pick-ups. Gives excellent results for thousands of records.

List \$.50



Increase your sales with our New Counter Sales Builder. Twelve needle cards mounted on each display.

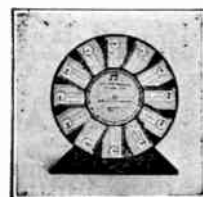

Needles mounted on individual cards and enclosed in cellophane envelopes.



HOWARD

RECORDING DISCS

- Metal Base
- Long Life
- Low Cost
- Flame Proof
- Quiet Operation
- Listed by Underwriters' Laboratories

For highest quality semi-professional and home recordings, the reproduction from HOWARD discs will be a revelation, actually rivalling the tone and frequency response of commercially made records. Here are a few of the many features that make HOWARD outstanding:

- 1—**Metal Base**—The soft, permanently flat metal core absolutely eliminates warping. Provides a more sturdy recording that cannot be damaged as easily as paper or fibre core discs.
- 2—**Type "C" Coating**—An exclusive HOWARD development and the real reason for HOWARD superiority. Cutting needle makes clean, even grooves, a factor vital to quiet long-life recordings.
- 3—**Reinforced Edges**—A heavier coating on edges prevents cutting needle from digging into the metal core which dulls the needle and spoils the entire record.
- 1—**Single Layer Coating**—The fine grain Type "C" coating is of even liberal thickness (not in layers) and will not deteriorate with age.
- 5—**Hardness Processed**—All HOWARD discs are hardness processed for better reproduction of high frequencies and longer play-back life.

Howard Metal-Base Recording Discs are supplied five discs in an attractive album, constructed of heavy paper, with individual pockets for the discs, and "Title Lines" on front cover for quickly locating desired recording. Order discs in lots of five and obtain this handy album free.



QUALITY METAL-BASE DISCS

- No. 6C—6½" Discs. Time, 2 minutes each side.....20c List
Album with five discs—\$1.00 List
- No. 8C—8" Discs. Time, 3 minutes each side.....30c List
Album with five discs—\$1.50 List
- No. 10C—10" Discs. Time, 4¼ minutes each side...40c List
Album with five discs—\$2.00 List

ECONOMY DURO-BOARD DISCS

- A new inexpensive disc having the same superior type "C" coating as used on Howard Metal-Base Discs. A punched special paper base known as Duro-Board is used, which retains a remarkable degree of flatness for discs of this type.
- No. 6F—6½" Duro-Board Discs10c List
Five in a sturdy envelope—50c List
 - No. 8F—8" Duro-Board Discs18c List
Five in a sturdy envelope—90c List

HOWARD RECORDING NEEDLES

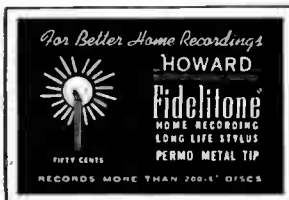

Highest quality cutting needles. Produce noise-free recordings having natural tone. **Type R-25, Standard Needle**, cuts 20 or more 6½" discs. **Type R-50, Long-Life Needle**, has Permo Metal Tip and cuts 200 6½" discs.

- Type R-25—Standard Recording Needle, each.....25c List
 - Type R-50—Long-Life Recording Needle, each.....50c List
- Individually Packaged*

HOWARD PHONO NEEDLES



For brilliant, natural tone, and minimum wear on records, use HOWARD phono (play-back) needles. **Type 14 Standard Needles** are for either commercial or home recordings. **Type 17** is a special needle, designed for extra long life (1000 play-backs) and noise-free reproduction.

- Type 14—Standard Phono Needle for Commercial and Home Recordings, pkg. of 25.....25c List
- Type 17—Long-Life Phono Needle for Commercial and Home Recordings, each.....80c List

COUNTER DISPLAY

Howard recording discs and needles are sold from this handy counter display by all progressive dealers. Three sizes of discs, phono needles and recording needles are conveniently stocked for easy sales. An actual sample of the 6½" disc is mounted on the front of the display so that the quality of Howard Discs can actually be seen. Each display contains the following saleable merchandise:

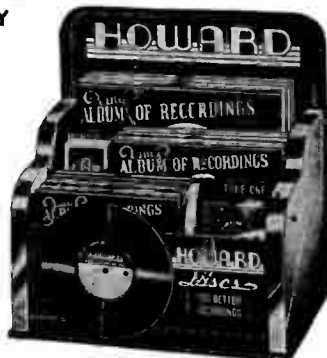

- | | | |
|---------------|----------------------------------|--------------|
| Quantity | | Retail Value |
| 20 (4 pkgs.) | — 6½" Metal-Base Recording Discs |\$4.00 |
| 15 (3 pkgs.) | — 8" Metal-Base Recording Discs | 4.50 |
| 15 (3 pkgs.) | — 10" Metal-Base Recording Discs | 6.00 |
| 6 pkgs. of 25 | — Standard Phono Needles | 1.50 |
| 6 Only | — Standard Recording Needles | 1.50 |

TOTAL RETAIL VALUE...\$17.50

Found on counters and in the windows of all Howard Dealers

AMERICA'S OLDEST RADIO MANUFACTURER

NOTE: ALL PRICES ON THIS PAGE HAVE BEEN CHANGED. WRITE FOR NEW LISTING.

Radio **TRIPLET** Testers

COUNTER OR PORTABLE TUBE TESTER—7" INSTRUMENT

This sensational new Tube Tester has a large six-inch scale RED DOT Lifetime Guaranteed Measuring Instrument. Filament voltages are provided in 20 steps from 1 to 110 and transformer connections are made for future tubes with voltages between these ranges. This continues Triplet's policy of providing every sensible anti-obsolescence feature, and accounts for the thousands of Triplet tube testers in use today although built four or five years ago.

Model 1612 has a fully balanced RMA circuit and leakage test for Cathode and Heater and inner elements, with shorts test between any two elements, check for open filaments, and any two elements, hot leakage check, separate section test of multi-section tubes, separate plate tests of diodes and rectifiers. Other features are the noise test jack, and a separate line voltage meter, essential for settings while tube readings are taken. Tests for all types receiving tubes including Miniatures, Loctals, Bantam Single Ends, Bantam Jr., new high voltage 117Z6, etc., gaseous rectifiers and ballast tubes. The customer reads the same tests on the GOOD-BAD illuminated scale of the oversize instrument. The illuminated speed roll chart is an outstanding feature. Thirty-six tubes are visible at one time. Entire chart can be rotated in less than 4 seconds. Easy to keep up to date. Auxiliary wall chart with frequent mailings as new tubes appear also provided. Has streamlined, beautifully finished seamless heavy steel case and panel with silver grey suede baked enamel finish and maroon and chrome fittings. Size is 15 1/2" x 11 1/2" x 6".



Model 1612

Model 1612—Code—TAIOA—List Price.....\$44.75 Net Price.....\$29.84

Model 1613—Portable Style

Model 1613 is a portable tester, same as the Model 1612, but has a detachable cover with attached handle. Cover is removable permitting use as a counter tester. Case size with cover, 15 3/4" x 11 1/2" x 6 1/2".

Model 1613—Portable Tester. Code—TASSE. List Price.....\$52.25 Net Price.....\$34.84



Model 1604

NEW 25,000 OHMS PER VOLT SET TESTER

A New Sensational Set Tester—Triplet quality-made—with features that give the serviceman everything he will want.

D.C. VOLTS—0-10-50-250-500-1000-2500 at 25,000 ohms per volt. A.C. VOLTS—0-10-50-250-500-1000-2500 at 1000 ohms per volt. DIRECT CURRENT—0-50 Microamperes; 0-1-10-50-250-500 Milliampers; 0-1-2-20 Amperes. RESISTANCE—0-500 Low ohms, shunt type circuit; 0-20,000 and 0-200,000 ohms, 2 and 20 Megohms, series type circuit. CONDENSER TESTER—Ranges for capacity checking, .001 to 30 mfd. Electrolytic leakage test. FREE POINT TESTER—Makes all series and parallel meter connections. DECIBEL METER—Special chart provides Decibel readings against volts from minus 20 to plus 55. LARGE MODERNISTIC INDICATING INSTRUMENT with RED DOT Lifetime Guarantee against defects in materials or workmanship. The patented ohmmeter zero adjustment is unique in this tester. There is but one adjustment for all resistance ranges. PLUG-IN-RECTIFIER — Simplifies replacement in case of accidental damage. Case is heavy steel with black suede baked enamel finish, 14 1/2" x 7 7/8" x 4 1/2". Leather strap handle. Black, silver and red etched panel.

Model 1604—Complete with all accessories. Code—TATEX. List \$74.75.....Net \$49.84

WIDE-RANGE SIGNAL GENERATOR — MODEL 1632

Model 1632 wide-range Signal Generator provides continuous coverage of standard broadcast ranges; as well as the new high frequencies for frequency modulated and television receivers. CONTINUOUS FREQUENCY COVERAGE from 100 Kc. to 120 Mc. on 10 bands... All frequencies fundamentals. METERED OUTPUT to multiplier and attenuator. HETERODYNE DETECTOR is incorporated. Permits checking the oscillator, or beating with another oscillator, without a receiver. OUTPUT AVAILABLE AT END OF CO-AXIAL CABLE. Minimizes losses and disturbance to circuit under test. PROVISION FOR EXTERNAL MODULATION at audio or radio frequencies. VOLTAGE REGULATOR TUBE... regulates voltage for the oscillator. Improves stability. PERMEABILITY ADJUSTMENT AND TUBULAR AIR-TRIMMER CAPACITORS are used throughout for increased accuracy and stability of calibration. LOW RESISTANCE COPPER SHIELDING and low-loss construction. Coil and trimmer assemblies and condensers shielded to minimize radiation of the unmodulated radio frequencies. POSITIVE VERNIER DIAL TUNING control... no backlash. ACCURACY AND STABILITY beyond anything before demanded in the test field. STREAMLINED METAL CASE with attractive-rolled-edge design. Size is 15" x 9" x 6 3/4". Silver-gray suede electro-enamel finish. Snap-away handle. Beautiful three-tone panel, maroon background gray and white trim. Model 1632. Complete with accessories. A.C. operated.

List Price \$119.75.....U. S. A. Dealers Net Price \$79.84



Model 1632

MODEL 1631 SIGNAL GENERATOR

Model 1631 is an outstanding ELECTRONIC FREQUENCY MODULATED Signal Generator for extreme accuracy. TRIPLE SHIELDING eliminates the most negligible leaks. COVERS 100 KC. TO 30 MC. IN SIX RANGES. Each coil is individually calibrated and tracked for linearity over the entire range. A continuously variable attenuator of the pad type offers steps from zero output to full output. FREQUENCY MODULATION is continuously variable from 5 Kc. to 40 Kc. Either CW, 400 cycle internal or external modulation. Can be used with Cathode Ray Oscilloscopes without separate frequency modulator. Metal case is 14 1/2" x 7 7/8" x 4 1/2", black suede electro enamel finish. Sapon metal cover. For 60 cycle A. C. operation. Model 1631, Complete with Accessories. Shipping weight 30 lbs. A.C. operated.

Code—TRABB

List Price \$82.50.....U. S. A. Net Price \$55.00

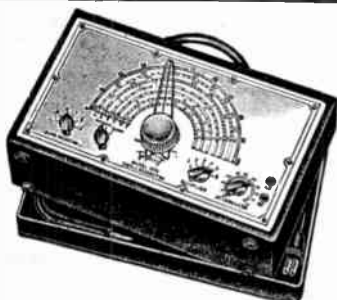

Model 1631

NOTE: ALL PRICES ON THIS PAGE HAVE BEEN CHANGED. WRITE FOR NEW LISTING.

Radio TRIPLET Testers

A.C.-D.C. POCKET VOLT-OHM-MILLIAMMETER



Model 666-H

Just the instrument for A.C.-D.C. voltage, direct current and resistance analyses. This handy Pocket Volt-Ohm-Milliammeter reads to 5000 volts without external multipliers. Has selector switch for all instrument readings. Molded case and panel, completely insulated. A.C.-D.C. Voltage at 1000 ohms per volt 0-10-50-250-1000-5000; D.C. Milliamperes 0-10-100-500; Resistance—0-300 ohms (shunt type circuit) 10 ohms reading at center scale; 0-250,000 ohms (series type) 3700 ohms at center scale. Higher resistance measurements are available by using external batteries. Black molded panel and case, completely insulated. Handy pocket-size $3\frac{1}{2} \times 5\frac{1}{2} \times 2\frac{1}{2}$ " deep. Complete with self-contained battery and special test leads with pee wee clips.

Model 666-1—Code—TRAIB. List \$21.75..... Net \$14.50

MODEL 666

Model 666 Pocket Volt-Ohm-Milliammeter is the same as Model 666-H but has the following ranges: A.C.-D.C. Volts 0-10-50-250-500-1000; 1000 ohms per volt; 0-1-10-50-250 D.C. M.A.: Low Ohms $\frac{1}{2}$ to 100; High Ohms to 250,000.

Model 666—Code—TRYMA *4. List \$21.00..... Net \$14.00

Attractive leather carrying case, Model 669, available. Net \$3.67
 Plug-in type external 0-25 D.C. Amp, shunt for Model 666 or 666-H. List \$3.00..... Net \$2.00

MODEL 696 BATTERY TESTER



Model 696

With the Model 696, all dry batteries may be checked under their proper loads, quickly and easily.

Eleven selector switch settings enable actual INDIVIDUAL LOAD TESTS for $1\frac{1}{2}$, 3, $4\frac{1}{2}$, 6, $7\frac{1}{2}$, 9, 22 $\frac{1}{2}$, 45, 67 $\frac{1}{2}$, 90 and 135 Volt batteries. In addition to battery testing, the Model 696 can be used as a sensitive voltmeter to check on NINE D. C. VOLTAGE ranges at 1000 ohms per volt. Ranges of 2-4-8-10-25-50-75-100-150 volts. Simply changing the position of the toggle switch control permits use of the unit as a battery tester or as a sensitive voltmeter.

Pocket-size black molded case. $3\frac{1}{2} \times 5\frac{1}{2} \times 2\frac{1}{2}$ ". The metal panel is gray with black markings. Has a RED • DOT LIFETIME GUARANTEED 3-inch indicating instrument. Model 696. Complete with leads.

List Price \$11.75..... U. S. A. Dealer Net Price \$7.84

CASES FOR 600 SERIES LITTLE TRIPLETTS

Attractive leather carrying case for any 600 Series Little Triplet test. Has leather handle. Holds tester and accessories. List Price \$5.50..... Net Price \$3.67

Leatherette covered carrying case with individual compartments for any three Little Triplets also available. Has a separate compartment for accessories. Size $10\frac{1}{2} \times 8\frac{1}{2} \times 3\frac{1}{2}$ ". List Price \$3.75..... Net Price \$2.50

MODULATION MONITOR

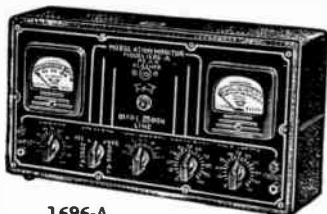

1696-A

Model 1696-A is easy to use. Plug it into your A. C. line—make simple coupling to the transmitter output and the monitor shows: FIRST—CARRIER REFERENCE LEVEL (only one adjustment for operating calibration.) SECOND—PER CENT OF MODULATION on specially designed high speed meter (Fast Upwaving of meter pointer; Slow Downstroke.) THIRD — INSTANTANEOUS NEON FLASHER (no inertia) indicates when per cent of modulation has exceeded your predetermined setting. Setting can be from 40 to 120 per cent. Peaks of very short duration are instantly detected. Balance control permits interchangeability of tubes. Maximum efficiency from 100 to 130 volts, 50 to 60 cycle A. C. line. Use of the Monitor assists in complying with FCC regulations. Convenient switch permits reading of positive or negative peaks. Two RED • DOT Lifetime Guaranteed Triplet instruments. Modernistic metal case, $14\frac{1}{2} \times 7\frac{1}{2} \times 4\frac{1}{2}$ ", with black suede electro enamel finish. Black and white panel. Blends with standard amateur equipment in appearance.

Model 1696-A—List Price \$52.25. U.S.A. Amateur's Net Price \$34.84

FOR RACK PANEL MOUNTING

Also available as a rack panel mounting unit. The monitor is mounted in a heavy steel panel, $19 \times 10\frac{1}{2}$ ", with black wrinkle finish. List Price \$54.25..... U.S.A. Amateur's Net Price \$36.18

LITTLE TRIPLETTS—A MATCHED LINE

THE "LITTLE TRIPLETTS" comprise a series of matched instruments available in single units or in combination to answer every servicing or electrical analyzing problem. Completely self-contained. All incorporate large three-inch Triplet instruments with long scales having the RED • DOT Lifetime Guarantee against defects in materials or workmanship. Red molded cases, $3\frac{1}{8} \times 5\frac{1}{8} \times 2\frac{1}{8}$ ". Panels are ivory with red markings and trim.

MODEL 670 A. C. AMMETER

This handy little tester has wide uses in countless fields. A self-contained current transformer permits measurements in these ranges: 0-1; 0-2.5; 0-5; 0-10; 0-25 A. C. Amperes. (For use on 60 cycles).

List Price \$13.50..... Net Price \$9.00

MODEL 671 A. C. MILLIAMMETER

Permits complete A. C. Milliamperes measurements on five ranges. Invaluable for radio servicing, laboratory and experimental work. Ranges: 0-5; 0-10; 0-25; 0-50; 0-100; 0-250; 0-500; 0-1000 A. C. Milliamperes. List Price \$13.50..... Net Price \$9.00

MODEL 672 A. C. VOLTMETER

A three-range A. C. Voltmeter particularly adapted to testing of electric appliances, motors, etc. The three ranges are those in which there is the most need for measurements: 0-150; 0-300; 0-750 A. C. Volts. List Price \$13.50..... Net Price \$9.00

MODEL 673 A. C. VOLTMETER (Rectifier Type)

This rectifier type A. C. Voltmeter is used most in circuits where a limited amount of power is available. Also fine for output measurements in conjunction with a condenser. Ranges: 0-5; 0-10; 0-25; 0-50; 0-100; 0-250; 0-500; 0-1000 A. C. Volts. List Price \$13.50..... Net Price \$9.00

MODEL 674 D. C. AMMETER

For Direct Current measurements in five ranges from a fraction of an ampere to 25 amperes. No external shunts required. Everything self-contained. Ranges: 0-1; 0-2.5; 0-5; 0-10; 0-25 D. C. Amperes. List Price \$13.50..... Net Price \$9.00

MODEL 675 D. C. MILLIAMMETER

Eight D. C. Milliamperes ranges that cover all the needs in radio servicing, experimental work and checking in many other fields. Ranges: 0-1; 0-5; 0-10; 0-25; 0-100; 0-250; 0-500; 0-1000 D.C. Milliamperes. List Price \$13.50..... Net Price \$9.00

MODEL 676 D. C. MICROAMMETER

Self-contained shunts for five D. C. Microampere ranges. External resistors can be used for highly sensitive voltmeter readings at 20,000 Ohms per Volt. Ranges: 0-50; 0-100; 0-250; 0-500; 0-1000 D. C. Microamperes. List Price \$13.50..... Net Price \$9.00

MODEL 677 D. C. VOLTMETER

A 10-range D. C. Voltmeter with sensitivity of 1000 Ohms per Volt. All resistors self-contained. Ranges: 0-1; 0-2.5; 0-5; 0-10; 0-25; 0-50; 0-100; 0-250; 0-500; 0-1000 D.C. Volts at 1000 Ohms per Volt. List Price \$13.50..... Net Price \$9.00

MODEL 678 OHMMETER

An ohmmeter with self-contained batteries for readings from .2 Ohms to 10 Megohms. Ranges: 0-1000 Ohms (10 Ohms Center Scale); 0-10,000 Ohms (100 Ohms Center Scale); 0-100,000 Ohms; 0-1 Megohm; 0-10 Megohms. List Price \$13.50..... Net Price \$9.00

FLEXIBLE VIBRATOR TESTERS

COMPLETE TESTING facilities for all standard 6-volt vibrators, as used in automotive and home battery radio receivers. THREE-SCALE DIAL

... 0-10 Volts scale shows input voltage to vibrator for start or running tests ... Two-zone, two-color merit scale shows vibrator condition as GOOD or BAD ... 0-100 scale permits inter-comparison of vibrator output under standardized input conditions. ADVANCED CIRCUIT developed with cooperation of leading vibrator engineers. Uses standardized 5000 Ohms-R-Mfd. load. SPEED ROLL CHART with listing of key settings. Assures quicker operation. FUSED AGAINST SHORTED VIBRATORS. ANTI-OBSOLESCENCE DESIGN Included in accessories is an adapter with leads with which it is possible to check new vibrators without waiting for instructions from the factory. Individual switches for each element afford another safeguard against obsolescence. STREAMLINED METAL CASE with blue-gray suede electro-enamel finish; $14\frac{1}{2} \times 7\frac{1}{2} \times 4\frac{1}{2}$ ". Complete with accessories. List Price \$44.75..... U. S. A. Dealer Net Price \$29.84

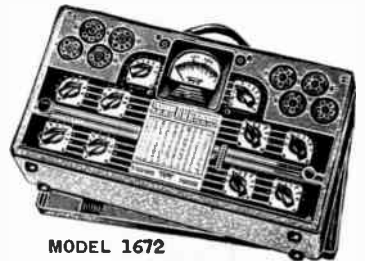

MODEL 1672

PUSH-BUTTON MODEL 1671

Model 1671 has the same circuit and features of Model 1672, but it is push-button operated. List Price \$59.75..... U. S. A. Dealer Net Price \$39.84

NOTE: ALL PRICES ON THIS PAGE HAVE BEEN CHANGED. WRITE FOR NEW LISTING.

Radio TRIPLET Testers

VOLT-OHM-MILLIAMMETERS



Model 1200-E

25,000 OHMS PER VOLT D.C. measurements and resistance readings to 40 megohms with this new super sensitive Volt-Ohm-Milliammeter. Instrument reads D.C.: 10-50-250-500-1000 volts at 25,000 ohms per volt; 0-50 microamperes; 1-10-50-250 milliamperes; low ohms, backup circuit, 1/4 to 1000; 40,000 ohms, 4 and 40 megohms; A.C. 10-50-250-500-1000 volts. Has two RED DOT Lifetime guaranteed instruments, A.C. and D.C., in tilting type twin case. Switch contact error less than 1/2% on milliamperes. No error on voltages. Resistance measurements have individual zero adjustments. Selector switch for all readings. Contains 22 1/2 and 1 1/2 volt batteries. Shpg. wt. 10 lbs.

1200-E Unit—Code—TWARB
List \$38.75.....Net \$25.84

Model 1200-A—Same as 1200-E but reads as follows: D.C. 10-50-250-500-1000 volts at 2000 ohms per volt; 1-10-50-250 M.A. low ohms, backup circuit, 1/2 to 500; 1500 ohms, 1 1/2 and 2 megohms. A.C. 10-50-250-500-1000 volts. Shpg. wt. 10 lbs.

1200-A Unit—Code—TRITE
List \$32.75.....Net \$21.84

Model 1200-C—Same as 1200-A but with 5000 ohms per volt D.C. suitable for AVC checking; 250 microamperes, and 7 1/2 megohms scales. Shpg. wt. 10 lbs.

1200-C Unit—Code—TRFFA
List \$34.25.....Net \$22.84

SIGNAL GENERATORS



Model 1232-A

New improvements in these Signal Generators answer the demands for reasonably priced service instruments with performance approaching that of precision laboratory equipment. Model 1232-A is for 110 volts, 60 cycles operation. Its features include: Triple Shielding—A new assurance of satisfaction. Top panel is insulated from R.F. Main wiring is beneath double shielded panel. Coils and the band switch are individually shielded. Improved Attenuation Zero for all practical purposes. Large Dial Opening 180°—Improves readability. Scale is 345°. Dial is direct geared, permitting quick and accurate settings. Six Bands cover frequencies from 115 KC to 30.5 MC. All frequencies are fundamental. Line Filter—Filters RF between oscillator and the line. Six Trimmer Calibrated Coils—For accuracy well within servicing requirements on all bands. 400 Cycle Audio Note—obtained from panel jacks. Improved Band Selector Switch—for added convenience. Low loss switching. All parts low capacity. Model 1232-A (A.C. Operated). Complete with accessories.

Code—TAPET *18
List \$44.75.....Net \$29.84

Model 1231-A—Same as 1232-A but battery operated. Uses standard Eveready 22 1/2 V (X-163) Burgess (A-15-ST) and three flashlight cells (Eveready 935). Replacements may be readily obtained. Complete with batteries and accessories.

Code—TARDI *15
List \$41.25.....Net \$27.50

TUBE TESTER



Model 1213

Checks all receiving tubes quickly and conclusively including Loctal, Miniature, Bantam Jr., high voltage 117Z6, etc., gaseous rectifier types and ballast tubes. Provision for future tubes, with filament voltages ranging from 1 to 110. Has fully balanced RMA approved circuit. Separate plate tests on diodes and rectifiers. Neon shorts test shows slightest inter-element shorts and leakages. Results show directly on the three-color GOOD-BAD scale of the RED DOT guaranteed instrument. Separate line voltage control meter, essential for making adjustments while testing. Hinged card index type tube chart is a unique development. Attached under spring clips in cover, or can be removed and fastened on wall. Sections replaceable. See case description below.

Model 1213 Code—TAMOT *14
List \$33.00.....Net \$22.00

VACUUM TUBE VOLTMETERS



Model 1252

Self-calibrating developments plus the advantages of the tube on the end of the cable make Model 1252 the ideal instrument for high frequency measurements. Any A.C. or D.C. impulse of low magnitude can be checked easily and quickly without current drain. Ranges are 3-15-75-300 volts. The input capacity is less than six micromicrofarads. Input resistance is 10 megohms on A.C. Model 1252 is self-calibrating, an exclusive development in Triplett Vacuum Tube Voltmeters. This self-calibrating feature is automatic and controlled by the tube bridge circuit developed by Triplett engineers. Adjusting the bridge at the zero level insures exact calibration independent of tube emission values, or when replacing tubes.

RED DOT Lifetime guaranteed twin instrument, tilting type, has separate D.C. movements. The galvanometer indicates when the bridge is in balance. The other is a four-range voltmeter with scales reading in peak A.C. and D.C. volts.

Model 1252—60 cycle, A.C. 115 V. Code—TAPON *20
List \$72.50.....Net \$48.33

Model 1251—Self-Calibrating Vacuum Tube Voltmeter is the same as Model 1252, but the tube is mounted inside the case, rather than on the cable.

1251 Unit—Code—THEKA
List \$71.50.....Net \$47.67

1200 SERIES CASES

1200 Series Cases are metal with brown suede baked enamel finish, 7 1/2" x 6 1/2" x 5 1/2". Attached leather strap handle. Modernistic durable panels are in new three-tone design.

TELEVISION AND HIGH VOLTAGE TESTER



Model 1280

Model 1280—Code—TANIA. List \$47.25.....Net \$31.50

MODEL 1220-C FREE POINT TESTER

For those who use the free point method of testing, Triplett has available an up-to-the-minute Free Point Tester, Model 1220-C. Sockets to accommodate all current type receiving tubes are incorporated on the etched panel—including local and miniature. All series and parallel meter connections are made through the six sockets which have standard RMA markings.

Model 1220-C—Code—TRICH *10. List \$20.00.....Net \$13.34
Loctal, Miniature, Bantam Jr. and Midget Adapters, \$2.50 List extra, each. (\$1.67 Net).

Copyright by U. C. P., Inc.

AUTOMATIC VOLT - OHM - MILLIAMMETER



Model 1200-F

Push-button switching by a new, simpler way makes the Model 1200-F an entirely automatic Volt-Ohm-Milliammeter with maximum speed and minimum switching. Only one button need be pressed for any range and test setting.

D. C. VOLTS 0-10-50-250-500-1000 at 25,000 Ohms per Volt. A. C. VOLTS 0-10-50-250-500-1000 at 1000 Ohms per Volt. D. C. MILLIAMPERES 0-1-10-50-250. O. C. MICROAMPERES 0-50 (through separate jacks). RESISTANCE 0-1000 Low Ohms, shunt type circuit; 0-300,000 Ohms; 0-3 and 0-30 Megohms, series type circuit. Self-contained batteries for all ranges. OUTPUT READINGS available on A. C. Voltage ranges, through a built-in 1/2 Mfd. condenser.

This is the first tester on which only one button need be depressed to make any test. Buttons of different color for A. C. and D. C. Voltage, Current and Resistance ranges.

RED DOT LIFETIME GUARANTEED INSTRUMENT, rectifier type. Guaranteed for all time against defects in materials or workmanship. Instrument is modernistic four-inch rectangular type with extra-long readable scales.

PLUG-IN RECTIFIER—Simplifies replacement in case of accidental damage. Rectifiers are pre-calibrated and thoroughly impregnated after incorporation in a small molded case.

ATTRACTIVE METAL CASE with rich brown suede enamel finish, 7 1/2" x 6 1/2" x 5 1/2". Attached strap handle for convenience in portability. Snap cover has elastic strap inside for carrying accessories and instructions. Striking three-tone panel in brown, tan and red. Approximate shipping weight 13 lbs.

Model 1200-F. Complete with all accessories.

List Price \$41.75.....U. S. A. Dealer Net Price \$27.64

NOTE: ALL PRICES ON THIS PAGE HAVE BEEN CHANGED. WRITE FOR NEW LISTING.

Radio TRIPLET Testers

FLEXIBLE TUBE TESTER



Model 1620

This sensational new Triplet counter model has every facility that could be desired including anti-obsolescence design; a new highly flexible switching system; unsurpassed beauty and customer appeal.

Every precaution is taken to provide facilities for testing tubes in the event of future changes . . . individual connections for each tube element as well as a spare socket . . . Even in case of unanticipated radical changes in tubes, this tester need not be discarded, nor will expensive remodeling be required . . . This is made possible by the four separate panel sections, (socket, meter, roll chart, switching and power supply) which can be entirely replaced by anyone at nominal cost with a trade-in allowance for the old section.

FLEXIBLE SWITCHING, new lever-type, gives individual control for each tube prong. This also takes care of roaming elements, dual cathode structures, multi-purpose tubes, etc. Simply set the switch according to instructions appearing above each lever on the roll chart. Only three lever switch settings required for most tubes.

CONCLUSIVE TESTS of all present receiving tubes. Tests Gaseous Rectifier tubes and has improved Ballast Tube continuity test. Noise test jack incorporated. Fully balanced RMA approved circuit. **FILAMENT VOLTAGE SWITCHING** from 1.1 to 110 to take care of present and future tubes with filament voltage up to 117-volt types.

NEON SHORTS TEST. Separate plate tests on diodes and rectifiers.

SEPARATE LINE VOLTAGE METER permits constant observation and adjustment for line fluctuation.

SPEED ROLL CHART simplifies testing. It can be spun from one end to the other in less than four seconds.

RED • DOT LIFETIME GUARANTEED 7" indicating instrument has long 8" Direct Reading GOOD-BAD scale in colors. The wood case is of graceful proportions; with natural finish. Socket and switching panels are sloping with brown-tan background and ivory sockets, knobs and markings. L'olished metal chrome trim with in-laid color. Case size is 18½" x 10½" x 6¾".

Model 1620. For 60 cycles, 110 volts.

List Price \$56.75..U. S. A. Dealer Net Price \$37.84

PORTABLE TUBE TESTER



Model 1621

Model 1621 is a counter or portable Tube Tester similar to Model 1820 described in first column. It comes in a smaller more readily portable case. Has 4" square RED • DOT Lifetime Guaranteed Indicating Instrument with GOOD-BAD scale. Otherwise features are the same as Model 1620.

Model 1621, for counter use only, less carrying case. Size 12½" x 7" x 10".

List Price \$52.25..U. S. A. Dealer Net Price \$34.84

CARRYING CASE

Snappy two-tone tan tweed airplane type case. Purple plush lining. Heavy rubber feet on bottom of tester fit in holes in case to hold it in place. List Price \$7.50..U. S. A. Dealer Net Price \$5.00

ULTRA-SENSITIVE V-O-MA.

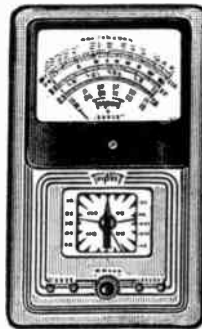

Model 1600-E

Instrument. STREAMLINED CASE is maroon and the panel is ivory with maroon trim. Size is 15" x 9" x 4".

Model 1600-E, complete with batteries for all but 20 megohm range, and all accessories, in case. List Price \$38.25..U. S. A. Dealer Net Price \$25.50

Model 1600-E for panel mounting, less case. Otherwise same as above. Panel size is 15" x 9". With leads. List Price \$31.50..U. S. A. Dealer Net Price \$21.00

COMBINATION TESTER



Model 1183

Three Testers in One—Volt-Ohm-Milliammeter, Tube Tester and Free Point Tester. A. C.—D. C. VOLTS 0-10-50-250-500-1000 D. C. at 10,000 Ohms per Volt; A. C. at 2,000 Ohms per Volt. D. C. MILLIAMPERES 0-1-10-50-250. RESISTANCE 0-500 low Ohms, shunt type circuit; 0-15,000 Ohms; 0-1.5 and 15 Megohms, series type circuit.

CONCLUSIVE TUBE TESTING. Approved RMA circuit. Employs the same operating controls as Models 1820 and 1821.

RED • DOT LIFETIME GUARANTEED 4" indicating instrument has an all-time warranty against defects in materials or workmanship.

COMPLETE FREE POINT TESTER makes all series and parallel meter connections. Has sockets for all tubes; (plus adapters must be purchased separately for locals, Bantam Jr., Miniatures and Midgets if desired.)

HEAVY METAL CASE with brown suede baked enamel finish. Size 14½" x 7-7/18" x 4¾". Leather strap handle. Beautiful three-tone panel, brown and gray. Snapon metal cover with room for accessories. Model 1183 Combination Tester. List Price \$74.75..U. S. A. Dealer Net Price \$49.84

Model 1182—Tube Tester only, as above. List Price \$52.25..U.S.A. Dealer Net Price \$34.84

Model 1184—Tube Tester-Volt-Ohm-Milliammeter List Price \$67.25..U.S.A. Dealer Net Price \$44.84

APPLIANCE TESTER (For Watts, Volts, Amperes)



Model 1270

Measures the wattage consumption, amperes and line voltage of all household appliances and small motors under actual operating conditions Testing facilities are:

FIVE WATTMETER SCALES 0-20-500-1000-2000-4000. (4000 scale is most essential for modern range testing). **FOUR ALTERNATING CURRENT SCALES** 0-260 Milliamperes; 0-6.5-13-26 Amperes. **TWO A. C. VOLTAGE SCALES** 0-130-260. All

switches and leads are ample to carry full load current continuously. See Page F-3 for Case description.

Model 1270, Complete with Leads for Two-Wire Circuits. List Price \$44.75..U. S. A. Dealer Net Price \$29.83
3-wire male connector cable..... List \$6.00 Net..\$4.00
3-wire female connector cable..... List..\$6.00 Net..\$4.00

DUAL-INSTRUMENT APPLIANCE TESTERS

Model 2000 provides quick and accurate means of testing power consumption of radios, refrigerators, fractional horsepower motors and household appliances under actual running conditions. Wattmeter readings 1500 watts at 220 volts; 750 watts at 110 volts. Current rating 7.5 amperes. Dual voltmeter scale reads 130-260. Leather case 8½" x 4¼" x 3¼".

Model 2000— List Price \$29.00..U. S. A. Dealer Net Price \$19.34
Model 2001, Same as Model 2000 but has additional switch to permit use with any current transformer having a 5 amp. secondary, for higher single phase wattmeter readings. List Price \$44.75..U. S. A. Dealer Net Price \$29.83

Model 2001— List Price \$31.00.....Net Price \$20.67
Model 2002, Same as the 2000 but has current rating of 10 amperes. Wattmeter ranges are 1500 and 3000. Voltage ranges are 130 and 260. List Price \$29.50.....Net Price \$19.67

PORTABLE LABORATORY



Model 1181-C

Model 1181-C Portable Laboratory combines: Volt-Ohm-Milliammeter (A.C. and D.C. Volts 0-15-75-150-750 at 1000 ohms per volt; D.C. Ma. 1.5-15-150; A.C. Ma. 15-150; 0-1500 ohms; 1.5 and 3 megohms); Battery operated Signal Generator with direct reading dial from 115 to 18,000 KC; Free Point Auxiliary Set Tester. (Measures Voltages, currents, resistance and continuity.) Durable etched panels. Quartered oak case with removable cover, 18½" x 7½" x 4¾". Batteries and accessories included. Shipping weight 17 lbs.

Model 1181-C— Code—TRAMA
List \$67.25.....Net \$44.84

Model 1166-C (less case) Shipping weight 8 lbs. Code—TRASH.

List \$17.75.....Net \$11.84

NOTE: ALL PRICES ON THIS PAGE HAVE BEEN CHANGED. WRITE FOR NEW LISTING.

Measuring **TRIPOLET** Instruments



223, 323-D.C.
233, 333-A.C.



221, 321, 521-D.C.
231, 331, 531-A.C.



324, 328, 524-D.C.
334, 338, 534-A.C.



227-A, 327-A D.C.
237-A, 337-A A.C.



326, 421-D.C.
336, 421-A.C.

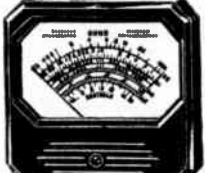

426 and 436

TRIPOLETT D.C. INSTRUMENTS are the D'Arsonval type with extra light-weight moving coil, magnets of chrome, cobalt or alnico with uniform pole pieces and scales with maximum linearity. A.C. INSTRUMENTS are the double iron repulsion type, air damped, with extra light weight moving parts. Dynamometer type also available is a most efficient standard design.

All with two of the best sapphire jewel bearings, metal bar bridge, finest workmanship and processed in a most modern equipped factory. White enameled metal dials, molded zero adjusters. Easiest serviced instruments of any in case of accidental damage. Front and rear illumination also available. Write for information.

DIMENSIONS OF A. C. AND D. C. MODELS

Model No.	D. C.	A. C.	D. C.	A. C.	Body	Flange	Body Depth	Type Case	D. C.	A. C.	Case
221	231	THROW	THRAM	2 1/8" diam.	2 5/8" diam.	1 1/2"	Flush	1 23/32"	1 35/64"	Molded	
223	233	THROW	THRAM	2 1/8" diam.	2 5/8" diam.	1 1/2"	Clamp-on	1 23/32"	1 35/64"	Metal	
227-A	237-A	TAZZ	TENZ	2 3/16" diam.	2 3/8" diam.	1 1/2"	Flush	1 23/32"	1 35/64"	Molded—Inserts in Rear	
323	333	TACIT	TOBIT	2 3/8" diam.	3 3/16" diam.	1 1/2"	Clamp-on	2 2/9"	2 9/64"	Metal	
321	331	TRIBE	TROUT	2 3/8" diam.	3 3/8" diam.	1 1/2"	Flush	2 2/9"	2 9/64"	Molded or Metal	
324	334	TIGER	TROWL	2 3/8" diam.	3 1/16" diam.	1 1/2"	Projection	2 2/9"	2 9/64"	Metal Case—Molded Base	
326	336	TRZAZ	TRUUI	2 3/8" diam.	3 3/8" diam.	1 1/32"	Flush	2 2/9"	2 9/64"	Molded	
326-A	336-A	TRJFM	TROME	2 3/16" diam.	2 21/32" diam.	1 1/32"	Flush	2 2/9"	2 9/64"	Molded—Square Type (not shown)	
327-A	337-A	TEPAT	TEPIK	2 3/8" diam.	3"x3"	1 1/2"	Flush	2 2/9"	2 9/64"	Molded—Inserts in Rear	
328	338	TRQOE	TRTH	3" diam.	3 1/4" diam.	1 21/32"	Projection	2 2/9"	2 9/64"	Metal	
421	431	TOOTH	TRINE	2 3/8" diam.	4 1/4"x4"	1 16" 18"	Flush	3 2/9"	3 2/9"	Molded	
521	531	TREES	TRIMS	4 3/8" diam.	5 3/8" diam.	1 1/2"	Flush	3 2/9"	3 2/9"	Molded	
524	534	TALOS	TUTOR	4 3/8" diam.	4 3/8" diam.	1 1/2"	Projection	3 2/9"	3 2/9"	Molded	
529	539	TUJIM	TUMKA	2 23/32" diam.	4 3/4"x4"	1 5/16"	Flush	3 2/9"	3 2/9"	Molded—Fan Type	
726	736	TABAM	THACK	3 1/2" diam.	6 3/4"x7 3/4"	1 5/16"	Semi-Flush	6 3/4"	5 3/4"	Molded—Inserts in Rear (not shown)	
TWIN TWIN. (See page F-6).				4 1/4"x2 3/4"	5 1/4"x3 3/4"	1 1/2"	Flush			Molded	

3" portable same style as output meter illustrated page F-6.

D. C. VOLTMETERS—125 OHMS PER VOLT

Range	Code	Med. 221-223-227-A	Med. 321-324-327-A	Med. 326-326-A	Med. 421-426-529	Med. 521-524	Med. 726
0-5	TRCXC	\$4.50	\$5.75		\$7.50	\$8.25	\$15.25
0-10	TRDWD	4.50	5.75	5.75	7.50	8.25	15.25
0-15	TRVE	4.50	5.75				
0-25	TRFUF	4.50	5.75				
0-50	TRGTG	4.50	5.75		7.50	8.25	15.25
0-100	TRHSH	4.50	5.75		7.50	8.25	15.25
0-150	TRIRI	4.50	5.75	5.75	7.50	8.25	15.25
0-300	TRLLO	6.50	8.25	8.25	9.75	32.00	19.00
0-500	TRMNM	7.75			11.00		
0-2,000	TRPKP	26.50	28.00		29.75		

D. C. VOLTMETERS—1000 OHMS PER VOLT

Range	Code	Med. 221-223-227-A	Med. 321-324-327-A	Med. 326-326-A	Med. 421-426-529	Med. 521-524	Med. 726
0-10	TAIGA	\$6.50	\$8.25	\$8.25	\$8.75	\$11.75	\$18.75
0-150	TAINE	7.75	9.75			12.75	19.75
0-300	TRULL	10.00	11.00	10.00	11.50	14.25	23.25
0-500	TRUAL	10.00	11.00		12.75		
0-1,000	TURIN	23.50	25.25		27.75		

* Price includes recommended external resistance boxes.

D. C. MILLIAMMETERS

Range	Approx. Res.	Code	Med. 221-223-227-A	Med. 321-324-327-A	Med. 326-326-A	Med. 421-426-529	Med. 521-524	Med. 726
0-1	.33	TRAAN	\$5.75	\$7.00	\$7.00	\$9.00	\$10.00	\$17.00
0-15		TRFFS	4.50	5.75		7.50	8.25	15.25
0-25	1.2	TRGGT	4.50	5.75	5.75	7.50	8.25	15.25
0-50	.6	TRHHU	4.50	5.75	5.75	7.50	8.25	15.25
0-100	.3	TRJJW	4.50	5.75	5.75	7.50	8.25	15.25
0-150	.23	TRKKX	4.50	5.75	5.75	7.50	8.25	15.25
0-200	.15	TRLLY	4.50	5.75	5.75	7.50	8.25	15.25
0-250	.12	TRMMA	4.50	5.75	5.75	7.50	8.25	15.25
0-300	.1	TRNNA	4.50	5.75	5.75	7.50	8.25	15.25
0-500	.06	TROOB	4.50	5.75	5.75	7.50	8.25	15.25

D. C. MICROAMMETERS

Range	Approx. Res.	Code	Med. 221-223-227-A	Med. 321-324-327-A	Med. 326-326-A	Med. 421-426-529	Med. 521-524	Med. 726
0-50	.2150	TALBE	\$15.00	\$15.00	\$15.00	\$16.75	\$17.50	\$22.50
0-100	.90	TRABA	13.00	13.00	13.00	14.75	15.50	21.00
0-200	.360	TARDY	12.00	12.00	12.00	14.00	17.25	21.00
0-500	.156	TWIRL	\$7.75	9.25	9.25	10.75	11.75	18.75

D. C. AMMETERS

Range	Approx. Res.	Code	Med. 221-223-227-A	Med. 321-324-327-A	Med. 326-326-A	Med. 421-426-529	Med. 521-524	Med. 726
0-1	.05	TALUS	\$4.50	\$5.75		\$7.50	\$8.25	\$18.25
0-10	.005	TROCK	4.50	5.75	5.75	7.50	8.25	15.25
0-25	.002	TANGS	4.50	5.75	5.75	7.50	8.25	15.25
30-0-30	.0016	TAPIR	4.50	5.75				

A. C. VOLTMETERS

Range	Approx. Ohms per V.	Code	Med. 221-223-227-A	Med. 321-324-327-A	Med. 326-326-A	Med. 421-426-529	Med. 521-524	Med. 726
0-5	10.7	TERSE	\$4.50	\$8.75	\$8.75	\$7.50	\$8.25	\$15.25
0-10	.16	TRUMP	4.50	5.75	5.75	7.50	8.25	15.25
0-15	.16	TURCO	4.50	5.75	5.75	7.50	8.25	15.25
0-150	.10	TOYTE	5.75	7.00	7.00	9.00	10.00	17.00
0-300	.165	TWEAK	7.25	8.25	8.25	9.75	15.75	22.75

A. C. AMMETERS

Range	Approx. Res.	Code	Med. 221-223-227-A	Med. 321-324-327-A	Med. 326-326-A	Med. 421-426-529	Med. 521-524	Med. 726
0-3	.02	TULIP	\$4.50	\$5.75		\$7.50	\$8.25	\$15.25
0-6	.01	TRCNA	4.50	5.75	5.75	7.50	8.25	15.25
0-10	.005	TERHE	4.50	5.75	5.75	7.50	8.25	15.25
0-25	.001	TELEO	5.75	7.00	7.00	9.00	10.00	17.00

A. C. MILLIAMMETERS

Range	Approx. Res.	Code	Med. 221-223-227-A	Med. 321-324-327-A	Med. 326-326-A	Med. 421-426-529	Med. 521-524	Med. 726
0-10	.1950	TEETH	\$5.50	\$6.75		\$10.00	\$11.00	\$
0-15	.1125	TOUSY	4.50	5.75			8.25	\$15.25
0-50	.85	TEPMT	4.50	5.75		7.50	8.25	\$15.25
0-100	.23	TEARM	4.50	5.75	5.75	7.50	8.25	\$15.25
0-250	.4	THEEK	4.50	5.75	5.75	7.50	8.25	\$15.25
0-500	.8	THEOS	4.50	5.75	5.75	7.50	8.25	\$15.25

NOTE: ALL PRICES ON THIS PAGE HAVE BEEN CHANGED. WRITE FOR NEW LISTING.

Measuring **TRIPLET** Instruments

25,000 OHMS PER VOLT KITS



Model 726

Foundation instruments with 25,000 ohms per volt sensitivity D.C. available in four styles. Have dials for reading: D.C.—0-10-50-250-1000 volts at 25,000 ohms per volt; 0-50-250 microamperes; 1-10-50-250 milliamperes; ½ to 500 ohms, back-up circuit; 20,000, 200,000 ohms and 2 megohms. A.C.—0-10-50-250-1000 volts at 1000 ohms per volt.

INSTRUMENTS ONLY

- Model 321—Code—TEJFM. 3" Round. White dial. Shipping weight 3 lbs. List Price \$15.00
- Model 426—Code—TIGKA. 4" Square. White dial. Shipping weight 4 lbs. List Price \$16.75
- Model 521—Code—TITMA. 5" Round. White dial. Shipping weight 5 lbs. List Price \$17.50
- Model 726—Code—TOWKA. 7" Square. Black dial, scale markings in color. Unique edgewise illumination feature is regular in 7" only. Shpg. wt. 8 lbs. List Price \$27.50

KITS (Less Instruments)

- A.C.-D.C. Control Box. All necessary parts for above readings. Completely assembled in metal box. Code—THUFY. List Price \$23.50
- A.C.-D.C. Kit with Box—Unassembled. Code—TRUPE. List Price \$16.75
- A.C.-D.C. Kit less Box—Assembled for mounting to panel. Code—TOOFA. List Price \$21.75

TWIN INSTRUMENTS

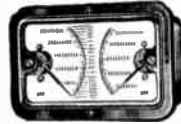

THE TWIN is furnished in any combination of A.C. or D.C. instruments. Both are included in the special rectangular molded case that requires a minimum of space. Permits simultaneous readings on both instruments when connected in the same or separate circuits. Instrument scales are side by side making possible two distinct readings at a glance. Used to balance loads in three-wire circuits; detect line fluctuations when load readings are taken; measure antenna and modulation current; determine filament and plate voltages and similar applications.

To determine List Price of Twin Instruments take the sum total list price of both instruments as supplied in Models 321 or 331.

MODEL 1200-A KIT

Enables the engineer to build his own Volt-Ohm-Milliammeter. Has No. 120 Triplet Twin Instrument with scale reading: D.C. 10-50-250-500-1000 volts at 2000 ohms per volt; 1-10-50-250 milliamperes; ½ to 500 low ohms by back up circuit; 1500 ohms; 1.5 and 3 megohms. A.C. 10-50-250-500-1000 volts. Also included in the kit are mounted resistors and shunts for the above readings; No. 121 Special Triplet Selector Switch; No. 124 .5 MFD Condenser for output measurements; No. 125 Rheostat Assembly; Complete set of diagrams and instructions; Hook-up wire; Complete set of hardware; Marked panel plate; Test leads.

- Model 1200-A Kit—Complete. Code—TRIPS. List Price \$27.50
- No. 120 Twin Instrument only—(for above kit) List Price \$15.50

WATTMETERS—DYNAMOMETER TYPE

Outstanding new developments assure extreme ruggedness and accuracy within 2 per cent. The instruments can be used on single phase A.C. or D.C. as wattmeters. On special order they can be made up as voltmeters or ammeters. Instruments are self-contained to 300 Volts—10 Amperes. Over that external connection can be made. For use on frequencies up to 133 cycles per second. Dynamometers are available in cases to match current Triplet three-inch models; Models 361 (331) and 387-A (377-A). (Case dimensions are the same except for depth, the dynamometer case being 2" back of the flange. (2-15/16" over the studs.) Wattmeters can be combined in the Triplet twin case with a voltmeter or ammeter. Available later in larger models.



Standard ranges as follows:

Code	Watts	Limit	Amp.	Se.	List Price	Code	Watts	Limit	Amp.	Se.	List Price
TABEW	75	150	¼	75	\$15.75	THOAC	150	300	¼	75	\$16.75
TAMMA	150	150	1	75	15.75	THRON	300	300	1	60	16.75
TAWAB	300	150	2	60	15.75	TIABA	600	300	2	60	16.75
TEPEG	750	150	5	75	15.75	TIMAB	1500	300	5	75	18.25
THEAN	1500	150	10	75	17.50	(TOBU)	3000	300	10	60	19.75

DOUBLE RANGE WATTMETERS (Double Voltage Limits Only)

Code	Watts	Limit	Amp.	Se.	List Price
TAABO	75-150	150-300	75	75	\$20.50
TACAB	150-300	150-300	1.5	60	20.50
TAFBO	300-600	150-300	3	60	20.50
TAHBO	750-1500	150-300	7.5	75	20.50
TALDO	1500-3000	150-300	15	60	22.25

VOLT-OHM-MILLIAMMETERS

- Model 321—(Scale reads 30-300-600 volts; 30-300 milliamperes; 100,000 ohms.) Code—THIES. Shipping weight 3 lbs. List Price \$7.50
 - Model 321—(Scale reads 10-50-250-500-1000 volts; 1-10-50-250 milliamperes; low ohms .2 to 500; high ohms 100 to 100,000.) Code—TABOR. Shipping weight 3 lbs. List Price \$7.50
 - Model 326—(Scale reads 10-50-250-500-1000 volts; 1-10-50-250 milliamperes; low ohms .2 to 500; high ohms 100 to 100,000.) Code—THENN. Shipping weight 3 lbs. List Price \$7.50
 - Model 421—(Scale reads 10-50-250-500-1000 volts; 1-10-50-250 milliamperes; low ohms .2 to 500; high ohms 100 to 100,000.) Code—THERE. Shipping weight 4 lbs. List Price \$9.50
 - Model 521—(Scale reads 10-50-250-500-1000 volts; 1-10-50-250 milliamperes; low ohms .2 to 500; high ohms 100 to 100,000.) Code—THILL. Shipping weight 5 lbs. List Price \$10.50
- (Wiring diagrams furnished with each instrument)

SHUNTS AND RESISTORS FOR ABOVE INSTRUMENTS

- Resistors mounted on bakelite for 30-300-600 volts. Code—TRICK. List Price \$7.25
- Shunts mounted on bakelite for 30-300 milliamperes. Code—TRULY. List Price \$2.00
- Current Limiting Resistor for 100,000 ohms. Code—TRGGU. List Price \$1.00
- Resistors mounted on bakelite for 10-50-250-500-1000 volts. Code—TAMWA. List Price \$11.00
- Shunts for 1-10-50-250 milliamperes; current limiting resistors for low and high ohms (.2 to 500; 100 to 100,000); and shunt for low ohms; all mounted on bakelite. Code—TATER. List Price \$3.50
- Zero adjusting rheostat for ohms ranges. Code—TAUJM. List Price \$1.00
- Multi-Deck Selector Switch. (2 decks.) With knob. Code—TEYON. List Price \$2.50

THERMO AMMETERS † High Frequency. Accuracy 2%

Triplet Thermo Ammeters are supplied in Models 241, 341, 346, 441 and 541. These models correspond in size, etc. to corresponding D.C. models. All have molded cases. Have external couples which withstand 50% overload connected to meter with 2 ft. leads. Couples are easily replaced when necessary. Internal couples to order.



External Couples only, for any Model..... List Price \$4.00

Range	Approx. Res.	Code	Model 241 List	Code	Model 341 List	Code	Model 346 List	Code	Model 441 List	Code	Model 541 List
0-1 Amps.35	TORIS	\$8.75	TONGA	\$10.00	TRUST	\$10.00	TUBER	\$11.75	TACHE	\$12.50
0-1.5 Amps.21	TITHE	8.75	TIZZA	10.00	THRED	10.00	TONIC	11.75	TOTAL	12.50
0-2.5 Amps.13	TODDY	8.75	TESTA	10.00	TWILL	10.00	TONUS	11.75	THANK	12.50
0-5 Amps.08	TOLYL	8.75	TOUGH	10.00	TWIST	10.00	THEOR	11.75	TOUCH	12.50

Three-Inch Models (341-346-347-A) with internal couples in any standard range..... List Price, each \$6.75

OUTPUT METER



The Triplet Output Meter has 3 ranges—2.5-5-50 volts. Copper-oxide rectifier type. Contains condenser for blocking the D.C. component. Four marked bind-posts or pin jacks and meter are mounted on substantial molded base. Test leads with clips and break-in adapter furnished. Shipping weight 3 lbs.

With Tip Jacks— Code—TRALI. List Price \$16.75

With Binding Posts— Code—THREX. List Price \$16.75

Output Meter—In Master Case Code—TWYNN. List Price \$19.25

SENSITIVE RELAYS

Highly sensitive Triplet relays are of the D'Arsonval Moving Coil type, carefully designed to give dependable, satisfactory performance. Fixed contacts of instruments are set in adjustable screws, allowing a wide adjustment of upper and lower limits of contact. Contacts furnished are Handy metal; also platinum, silver, and platinum-iridium are supplied according to applied current and voltages. These relays are generally used in connection with polarized relays when current draw exceeds 50 M.A. Magnetic clutch type with manual release can also be had. Since relays cover such a wide field and most of them are made to special order, no standard models are listed. Each application should be accompanied with information specifying maximum and minimum currents and voltages which will pass through relay coil and contact points.

POWER LEVEL INDICATORS

Used to measure sound or noise levels in amplifiers for Public Address, Theatres, Broadcasting Studios, Broadcasting Station Equipment, etc. The Decibel Meter permits the operator to make instant adjustments to prevent sound blasting or distortion. Furnished in two ways—either standard or highly damped. Standard range furnished reads up 6 and down 10 decibels. Zero decibel at 1.73 volts, 500 ohm lines, 6 milliwatts. Standard damping furnished, unless highly damped is specified. Other ranges to order only.



- Model 421—Up 6 down 10 Decibel Meter. Code—TROOP. List Price \$19.75
- Model 321—Up 6 down 10 Decibel Meter. Code—TAINT. List Price \$11.75

DECIBEL METERS AND KITS

Kits are now available to increase range of Power Level Indicators. Readings advance in steps of 4 decibels up to 22 decibels. Easily assembled Triplet Decibel Meter Kits are supplied for non-constant impedance. 500 ohm input line.

Model 150 Decibel Meter Kit—(Non-constant Impedance)—Includes; Triplet Model 321 Decibel Meter, Selector Switch, 9 Wire-wound Multipliers on Bakelite Mounting Board, Hook-up Wire, Diagrams and Instructions. Code—TILTH. List Price \$23.75

We also distribute a complete line of TRIPLET Multipliers, Shunts, Ring Shunt Assemblies, Multi-Deck Selector Switches and Bar Knobs.

NOTE: ALL PRICES ON THIS PAGE HAVE BEEN CHANGED. WRITE FOR NEW LISTING.

RADIO INSTRUMENTS



TEST EQUIPMENT

TUBE TESTER



Model 432-A

"The Outstanding Tube Tester Buy" of them all. Readrite's generation-old reputation for building high grade test equipment without extravagance is more pronounced than ever in the Model 432-A. A safeguard against further tube filament changes is provided by the flexible filament switching arrangement in 19 steps from 1 to 110 volts. Tester has sockets for Miniatures, Loctals, Single Ends, Bantam Jr., Gaseous Rectifiers, Ballast, all regular types and the new high voltage series 117Z6, etc. Separate plate tests on diodes and rectifiers. Neon shorts test immediately indicates the slightest shorts and leakages.

Triplet precision instrument with GOOD-BAD 3-color scale has two best quality sapphire jewel bearings. The separate line voltage meter permits constant line indication and control without switching and readjusting load controls. Professional appearing black leatherette case has handle and removable cover—suitable for counter or portable use. Size 9" x 8 1/2" x 7". Modernistic etched panel is silver and black. Up-to-date charts are furnished to registered owners as new tubes appear. A.C. operated—110 volts, 60 cycles.

(Leatherette case) Shipping weight 18 lbs.

Model 432-A— Code—RABBI
List \$29.75... U.S.A. Dealer's Net Price \$17.85
Model 432-A in case with compartment for accessories. Code—RANDY
List \$31.40..... Net \$18.85

New D.C. Pocket Volt-Ohmmeters



Models 510-511

These handy pocket-size instruments are just what you have always wanted for D.C. voltage and ohmmeter testing. Model 511 has a square Readrite meter with full open dial for reading 0-3-30-300 D.C. Volts and 0-10,000 ohms. Case is black wood, nicely finished, 2 1/2" x 2 1/2" x 2". Attached leads for making connections and switching. Furnished complete with self-contained three-volt battery.

Model 511— Code—REMEY
List \$4.75... U.S.A. Dealer's Net Price \$2.85

Model 510— Code—RALLY
A Volt-Ohmmeter, same as the above, but with the following ranges: 0-300 D.C. Volts; 0-10,000 ohms. Complete with battery.
List \$3.75... U.S.A. Dealer's Net Price \$2.25

Pocket Volt-Ohm-Milliammeter



Model 739

Model 739 Pocket Volt-Ohm-Milliammeter has A.C. and D.C. ranges. Molded case with rounded corners. Knob operated zero adjustment for resistance measurements. Precision Triplet three-inch meter with two highest quality sapphire jewel bearings. Furnished complete with accessories.

Ranges are A.C.-D.C. Volts 0-15-150-750-1500 (D.C. at 1000 ohms per volt); D.C. Milliampers 0-1 1/2-15-150; Resistance, Low Ohms, 0-500, shunt type circuit, with 25 ohms at center scale; 0-500,000 ohms, series type circuit. External batteries may be used for higher resistance measurements. The sturdy molded case has rounded corners, 3 1/4" x 5 7/8" x 2 1/8". Modernistic silver and black panel. All accessories including test leads, alligator clips, battery and instructions are included. Shipping weight, 5 lbs.

Model 739— Code—REACH
List \$16.50... U.S.A. Dealer's Net Price \$9.90

Model 738 is the same as Model 739 but for D.C. readings only.

List \$12.50..... Net \$7.50

UNIVERSAL POCKET TESTER



Model 612

Universal wide-range A.C.-D.C. pocket-size instrument nominally priced. Ranges are A.C.-D.C. Volts 0-15-150-450 (60 ohms per volt); A.C.-D.C. Milliampers 0-15; Resistance 0-20,000 and 0-100,000 ohms; Capacitance range .01 to 20 mfd.

Tester has Triplet repulsion type three-inch instrument with two highest quality sapphire jewel bearings. The case is black molded, 3 1/4" x 5 7/8" x 2 1/8", pocket size. Has selector switch for all ranges. Ohmmeter has separate zero adjustment. Current supply is from either A.C. or D.C. source by means of cord and plug. Silver and black panel. No batteries needed. Complete with leads.

Model 612— Code—RALLY
List \$13.25..... U.S.A. Net Price \$7.95

MULTI-PURPOSE TESTER



Model 432-A-742

This Tube Tester Volt-Ohm-Milliammeter combination gives the serviceman everything he could get from separate units. An outstanding quality model at a price within the reach of everyone.

Has Model 432-A Tube Tester (see opposite column). The Volt-Ohm-Milliammeter section is a separate panel with range selector switch, ohmmeter zero adjuster, and jacks. The precision three-inch indicating instrument has a sensitivity of one mill as described in Model 432-A. Volt-Ohm-Milliammeter ranges are: A.C.-D.C. Volts 0-10-50-250-2500 (D.O. at 1000 ohms per volt); D.C. Milliampers 0-1-10-100; Resistance .5 to 500 with 25 ohms at center scale; 0-100,000 ohms and 1 1/2 meg-ohms. Ohmmeter is battery operated. The circuit is favored by servicemen who demand more accuracy than obtained from ordinary ohmmeter power supply circuits. The case is black leatherette, with handle, 13" x 10 1/2" x 7". Has compartment for accessories. Panels are silver and black.

Model 432-A-742 (less batteries) Code REFIT
List \$46.40... U.S.A. Dealer's Net Price \$27.85

POINT-TO-POINT TESTERS



Model 720-A

Designed for speedy and efficient servicing. Equipped to handle sets using glass or glass-metal tubes. Measures resistance, capacity and continuity; checks voltage of any tube circuit. Has two meters—D.C. scale reading 15-150-300-600 volts, 15-150 milliamperes; A.C. scale reading 10-25-150 and 750 volts. Black leatherette covered case which measures 11" x 8" x 4 3/8". Shipping weight 10 pounds.

Model 720-A— Code—READY
List \$25.00... U.S.A. Dealer's Net Price \$15.00
Same as 720-A, but has Triplet 223 D.C. voltmeter with scale reading 15-150-300-600 volts at 1000 ohms per volt. Shpg. wt. 11 lbs.

Model 730-A— Code—REIGN
List \$31.00... U.S.A. Dealer's Net Price \$18.60
Similar to 720-A, but has three meters. Shipping weight 10 pounds.

Model 710-A— Code—ROBOT
List \$27.50..... Dealer's Net Price \$16.50
Same as 710-A, but has Triplet 1000 ohm per volt D.C. voltmeter; scale 15-60-300-600. Shipping weight 11 pounds.

Model 712-A— Code—REMIT
List \$37.00..... Dealer's Net Price \$22.20
Loctal free point adapters available for the above 700 Series testers at slight additional cost.

NOTE: ALL PRICES ON THIS PAGE HAVE BEEN CHANGED. WRITE FOR NEW LISTING.

RADIO INSTRUMENTS



TEST EQUIPMENT



MODEL 860 BIG BOY

Here is a new A.C.-D.C. Volt-Ohm-Milliammeter with all the ranges you want . . . All easily readable on the large instrument with 6-inch scale . . . The price is the kind you always have wanted on top-quality test equipment . . . This sensational new tester is engineered in keeping with the latest approved engineering practices and is styled to today's demands for professional equipment in modern color combinations.

D. C. VOLTS 0-10-50-250-500-1000 at 5000 Ohms per Volt. For the measurement of D. C. power from any source, including that of batteries, power packs, or voltage drops across resistances, or across high resistance units.

A. C. VOLTS 0-10-50-250-1000 at 1000 Ohms per Volt. An added advantage is the special chart which permits Decibel readings against volts from Minus 20 to Plus 55.

D. C. Milliamperes 0-1-10-100. For the measurement of milliamperes from any source to determine circuit over-loading, under-loading, or high resistance connections.

RESISTANCE 0-1500 Ohms, shunt type circuit, accurate readings of 1/2 Ohm; 0-750,000 Ohms and 0-7.5 and 0-15 Megohms, series type circuit. Measures the D. C. resistance of all component parts such as chokes, coils, condensers, connections, transformers, wiring, etc. Knob-operated zero adjustment.

SIX-INCH SCALE INSTRUMENT D'Arsonval type with two genuine sapphire jewel bearings . . . made of the finest parts, assuring accurate readings and lasting service.

THREE-TONE METAL CASE—the last word in design. Has maroon body, rich cream-yellow panel and red trim markings. Size 11 1/2" x 7 3/4" x 4 1/4". Attached handle for easy portability.

Furnished complete with instructions and accessories, including test leads. Battery provided for 0-1500 Ohms range. (22 1/2 Volt C battery is required for 750,000 Ohms and 7.5 Megohms. A second 22 1/2 Volt battery will permit checking 15 Megohms. Mounting brackets, current limiting resistors and battery connectors for the higher resistance ranges are built into the tester.)

Model 860 Readrite Big Boy Volt-Ohm-Milliammeter.
List Price . . . \$29.75

U.S.A. Dealer Net Price . . . \$17.85

MODEL 641 FREE POINT TESTER

Has sockets for handling any type receiving tubes, including the Loctal and Bantam Jr. Standard RMA markings. Eight automatic switch type and ten single action jacks. Makes all series and parallel instrument connections through the set sockets to all parts of the circuit. Complete with accessories. Approximate shipping weight 8 pounds.

Model 641—Code—RATAN
List Price \$18.25 . . . Dealer's Net Price \$10.95



Model 540

MODEL 540 SIGNAL GENERATOR

This All-Wave Direct Reading D.C. oscillator has new plug-in coils, peaked with trimmer condensers and individually calibrated to exceptionally low tolerances. Five frequency bands from 110 to 20,000 Kc.—all fundamentals. Greater accuracy is assured also by the absence of switch contacts, and short grid wire connections. Guaranteed accuracy is within all servicing requirements. Completely shielded for static and magnetic fields. Attenuation and stability are outstanding features. Strong signals, both modulated and unmodulated, are provided. Three 1 1/2 volt unicells, 45 volts of B batteries and two type 30 tubes are included with necessary accessories. Handy compartment, with snap-on cover, for accessories. Approx. shpg. wt. 11 lbs. Metal case with black electro-enamel finish. Size is 5 7/8" x 7 7/8" x 4 1/4". Silver and black panel. Leather strap carrying handle.

Model 540—Code—RAMUS
List \$32.50 . . . U.S.A. Dealers' Net Price \$19.50

Model 557 (in leatherette case.)
List \$31.50 . . . Net \$18.90

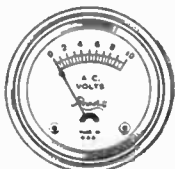

Model 55



Model 65



Model 75



Model 85

READRITE instruments are economical, ruggedly constructed, and dependably accurate. D.C. are the polarized vane, solenoid type. A.C. are double vane repulsion type. Easy reading black lithographed on white, metal plates. Model 55, flush mounted clamp-on type, requires a 2 1/4" hole; has narrow rim and is furnished in full nickel; this model will be furnished unless other types are specified. No. 65-A flange ring

is used to convert Model 55 into Model 65 wide flange type. Dealer's Net Price . . . \$0.09

"Model 95 Square Meter"—A new addition to the Readrite line. (Shown above.) Modern in design. Square case, black lacquer finish, 2 1/4" x 2 1/4". Requires 2 1/4" mounting opening. Prices \$0.35 list more in corresponding ranges.

(Prices apply to Models 55, 65, 75—Model 85, \$1.75 list extra—Model 95, \$0.35 list extra)

Range	Code	List Price	Net	Range	Code	List Price	Net	Range	Code	List Price	Net
D.C. VOLTMETERS				D.C. MILLIAMMETERS				A.C. VOLTMETERS			
0-1	Royal	\$1.00	\$0.60	0-5	Ratio	\$2.25	\$1.35	0-6	Rale	\$2.75	\$1.65
0-3	Ridge	1.00	.60	0-10	Rue	2.00	1.20	0-10	Ram	2.75	1.65
0-5	Rive	1.00	.60	0-15	Ruff	1.00	.60	0-15	Ramp	2.75	1.65
0-6	Rite	1.00	.60	0-25	Rug	1.00	.60	0-300	Rath	4.50	2.70
0-8	Road	1.00	.60	0-50	Razor	1.00	.60	0-750	Rase	5.50	3.30
0-10	Roam	1.00	.60	0-100	Rump	1.00	.60	0-10-140	Reck	7.75	4.65
0-15	Roar	1.00	.60	0-150	Run	1.00	.60		Rural	4.50	2.70
0-50	Rod	1.00	.60	0-200	Rung	1.00	.60	A.C. AMMETERS			
0-100	Roil	1.50	.90	0-300	Runt	1.00	.60	0-1	Rant	\$2.75	\$1.65
0-150	Roll	1.75	1.05	0-400	Ruse	1.00	.60	0-3	Ritz	2.75	1.65
0-150	Romp	3.25	1.95	0-20-100	Raven	2.00	1.20	0-5	Route	2.75	1.65
0-300	Rood	3.25	1.95	0-15-150	Rebel	2.00	1.20	0-10	Rast	2.75	1.65
0-500	Roof	4.50	2.70	A.C. MILLIAMMETERS				0-50	Rouge	3.75	2.25
0-60-800	Rook	4.50	2.70	0-25	Raff	\$2.75	\$1.65	SELECTOR SWITCHES			
D.C. AMMETERS				0-50	Rum	2.75	1.65	Single Pole, 18 Positions. Code—RALLS			
0-1	Repel	\$1.00	\$0.60	0-100	Rome	2.75	1.65	List Price \$1.25 . . . Net Price \$0.75			
0-3	Rot	1.00	.60	0-250	Rong	2.75	1.65	Double Pole, 12 Positions. Code—RADDS			
0-10	Rote	1.00	.60	0-500	Roost	2.75	1.65	List Price \$1.75 . . . Net Price \$1.05			
0-25	Ridd	1.50	.90	D.C. POCKET TYPE							
0-50	Rokk	2.50	1.50	40 Amp.	Rise	\$1.00	\$0.60				
20-0-20	Rud	1.00	.60	50 Volts	Risk	1.00	.60				
30-0-80	Ryky	2.00	1.20	40 A.—50 V.	Rustle	1.50	.90				

We also distribute the complete line of READRITE Selector Switches, Bar Knobs, Precision Resistors and Multipliers, Ohmmeters, Resistance Meters, Induction Ammeters, Air-Cell Testers and TUNING METERS. Special meters for battery charging, electric fences, etc.

JACKSON*Radio Testing Equipment*

THE JACKSON ELECTRICAL INSTRUMENT CO., DAYTON, OHIO

MODEL 636 DYNAMIC TUBE TESTER

With Built in Rotary Tube Chart

Has every feature of finest design and construction including Dynamic test method, roll chart, noise test, neon shorts test, line control, power switch, etc.

- NEW in design and performance including the latest Jackson patented switching circuits.
- MODERN in every feature of construction, appearance and operation.
- COMPLETE with every valuable feature. Up to date for all newest tube types.

SPECIFICATIONS

"DYNAMIC" METHOD OF TEST—Makes a better test on every tube. The "Dynamic" method is more accurate, frequently finding "poor" tubes which might pass for "good" in ordinary testers.

NEW-HIGH VOLTAGE POWER SUPPLY is a feature of this tester. By testing tubes at higher plate voltages (over 200 V. for some types), more accurate results are obtained.

TESTS ALL TUBES—ALL of the popular receiving types and television amplifiers, including HAMTAMS—LOCTALS—SINGLE ENDED—HIGH VOLTAGE FILAMENT TYPES and MINIATURES. Provision for many more. The tester is protected against obsolescence in every possible feature.



Bench Style

ROLL CHART tube index—simplifies correct settings.

FULL RANGE FILAMENT SELECTION—From $\frac{1}{4}$ V. to 115 V. Selector marked directly in volts. This feature eliminates guess work and helps the operator to avoid mistakes.

MOST IMPROVED TYPE OF SWITCHING SYSTEM—Spare circuits and switch positions provided for future use. Two "spare" socket positions.

NOISE TEST jacks are provided for audible test of possible tube noise.

Illustrated above is the Model 636 Portable. The tester is installed in a beautiful French grey leatherette case. The hinged lid is removable. The Portable Model is recommended because of the extra convenience and added protection for instrument panel.

Dimensions: 14" long x 12" x 5 $\frac{1}{2}$ ". Wt. 11 lbs.

MODEL 636 (PORTABLE) NET CASH PRICE \$41.50

BENCH STYLE

Installed in welded steel cabinet, with sturdy handle and rubber bumpers on both base and back. Two tone grey finish. Dimensions: 13" long x 9 $\frac{1}{2}$ " x 5 $\frac{1}{2}$ ". Wt. 10 lbs.

MODEL 636-B (BENCH STYLE) NET CASH PRICE \$36.95

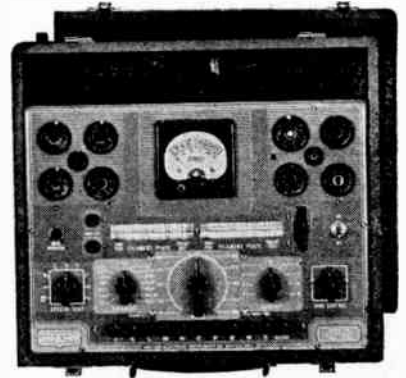

Portable Style

MODEL 637 DYNAMIC OUTPUT TUBE TESTER

With Complete Universal Meter Ranges

IN THE SHOP or OUT ON THE JOB, here's the ideal tester for modern servicing. Combines 27 ranges and 10 functions including—

- 1—Dynamic Output Tube Tester—accurate, thorough.
- 2—Ballast tube tester—finds shorts or burn-outs.
- 3—High sensitivity neon continuity tester.
- 4—Condenser test for finding shorted or leaky condensers.
- 5—Multi-range A.C. Voltmeter 0-10/100/250/500/1000/2500.
- 6—Multi-range D.C. Voltmeter 0-10/100/250/500/1000/2500.
- 7—Decibel Meter—Ranges from minus 10 to plus 14/10 to 34/30 to 54.
- 8—Multi-range D.C. Milliammeter 0-1/10/100/250.
- 9—Ammeter range—0 to 10 amperes D.C.
- 10—Triple range Ohmmeter 0-3000/300,000/0-30 megohms.

AUTOMATIC PUSH BUTTON SELECTOR provides for instant use of any meter range. This new selector is remarkably fast to use and also reduces the possibility of mistakes in selecting meter ranges.

FULL RANGE FILAMENT SELECTION—From $\frac{1}{4}$ V. up to and including 115 V. Filament selector marked directly in volts at each position. This feature eliminates guess work and helps the operator to avoid mistakes.

TESTS ALL TUBES—All of the popular receiving types and television amplifiers, including BAMTAMS - MINIATURES - LOCTALS - SINGLE ENDED - AND HIGH VOLTAGE FILAMENT TYPES. Provision for many more. Tester is protected against obsolescence in every possible feature of design and manufacture.

"DYNAMIC" METHOD OF TEST—Makes a better test on every tube. The "Dynamic" method is more accurate and frequently finds "poor" tubes which might pass for "good" in ordinary testers.

NEW - HIGH VOLTAGE POWER SUPPLY is a feature of this tester. By testing tubes at higher plate voltages (over 200 V. for some types), more accurate results are obtained.

MOST IMPROVED TYPE OF SWITCHING SYSTEM—Spare circuits and switch positions are provided for future use if new or different tubes are announced. Two "spare" socket positions are provided on the tester panel.

REMARKABLY EASY TO USE—Notice the simplicity of panel and controls. The engineering is all **BENEATH THE PANEL**—you don't lose valuable time figuring out "the next move."

ILLUMINATED METER DIAL—Easy to read in any room. Panel lettering is large and distinct.

NOISE TEST jacks are provided for audible test of possible tube noise.

ALL READINGS DIRECT on "Good-Bad" Scale. No special marks for diodes, etc.

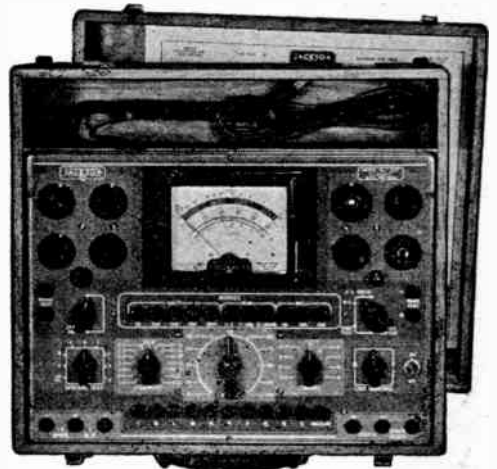

The **FULL VISION** Jackson Meter is an exclusive feature of this tester. Meter measures 6 inches over flanges. **DIAL IS ILLUMINATED.**

OAK CASE is of finest construction and has removable hinged lid. Dimensions 14 $\frac{3}{4}$ " x 13 $\frac{3}{4}$ " x 6". Weight 14 pounds.

ACCESSORIES—Furnished complete with self contained battery (for ohmmeter), and test prods.

MODEL 637 NET CASH PRICE \$61.50

JACKSON*Radio Testing Equipment*

THE JACKSON ELECTRICAL INSTRUMENT CO., DAYTON, OHIO

UNIFORM SIZE PORTABLE INSTRUMENTS

PANEL SIZES ARE IDENTICAL



TUBE TESTER

FULL RANGE FILAMENT SELECTION—From $\frac{1}{4}$ V. up to and including 115 V. Filament selector marked directly in volts at each position. This feature eliminates guess work and helps the operator to avoid mistakes.

TEST ALL TUBES—All of the popular receiving types and television amplifiers, including BANTAMS - LOCTALS - SINGLE ENDED - HIGH VOLTAGE FILAMENT TYPES AND MINIATURE SERIES.

"DYNAMIC" METHOD OF TEST—Makes a better test on every tube. The "Dynamic" method is more accurate and frequently finds "poor" tubes which might pass for "good" in ordinary testers.

NEW - HIGH VOLTAGE POWER SUPPLY is a feature of this tester. By testing tubes at higher plate voltages (over 200 V. for some types), more accurate results are obtained.

MOST IMPROVED TYPE OF SWITCHING SYSTEM—Spare circuits and switch positions are provided for future use if new or different tubes are announced. A "spare" socket position is provided on the tester panel.

MODEL 634

NET CASH PRICE

\$33.95

CONDENSER TESTER

MODEL 650-A**RANGE—.00001 to 1,000 mfd.**

AUTOMATIC PUSH BUTTON CONTROLLED—Amazing in speed and simplicity of use. Capacity readings almost instantaneous! Leakage test by just pressing a button.

The Model 650 is a modern, accurate and complete instrument for detecting faulty condensers—ELECTROLYTIC, PAPER or MICA. Uses a new method for Leakage Test which will reveal otherwise unnoticed condenser defects.

SCALE IS GLASS ENCLOSED and is equipped with the new Jackson **SCALE EXPANDER** indicating pointer—doubles effective scale length.

MEASURES ALL VALUES direct reading in Microfarads.

RANGES

.00001 to .001 mfd.

.1 to 100 mfd.

.001 to .1 mfd.

50 to 1000 mfd.

MEASURES POWER FACTOR on direct reading dial. Power Factor range calibrated from 0 to 60%.

COMPLETE SELECTION OF TEST VOLTAGE. 20 volts to 500 volts.

ELECTION RAY TUBE indicates exact balance or shows if leakage is present.

INSTANTANEOUS LEAKAGE INDICATION—counting of flashes eliminated. No other guess-work with this modern tester. Has special built-in amplifier stage which actually responds to slightest leakage, if present. Thus all leakage defects may be located.

MODEL 650-A

NET CASH PRICE

\$36.95

MODEL 640 TEST OSCILLATOR

A complete "standard type" oscillator for all general purpose work. Has full range direct reading dial from 100 KC up to 30 Megacycles. No skips or harmonics calibrated. All ranges are fundamental frequencies. **PUSH BUTTON** selection of all ranges makes speedy and accurate operation possible.

GLASS ENCLOSED DIAL—prevents dust and avoids possibility of damage to pointer.

TWO CIRCUIT ATTENUATOR provides variable ratio and also vernier control.

HAS POWERFUL SIGNAL output which may be used either as pure R.F. or Modulated R.F. Carrier is modulated at approximately 30%. The A.F. voltage is available for external use.

ACCURACY GUARANTEED to $\frac{1}{2}$ of 1% on all ranges.

Operates from 110 volt 60 cycles. Uses three tubes (rectifier, oscillator and modulator).

MODEL 640

NET CASH PRICE

\$36.95

JACKSON

Radio Testing Equipment

THE JACKSON ELECTRICAL INSTRUMENT CO., DAYTON, OHIO

MODEL 645 AC-DC ELECTRONIC MULTIMETER

(Vacuum Tube Voltmeter)



BOTH A.C. AND D.C. VOLT RANGES ARE ELECTRONIC. This provides the maximum of sensitivity and overload protection for all A.C. ranges as well as D.C. and ohms ranges.
MEASURES RESISTANCE UP TO 1 BILLION OHMS (1 thousand megohms)—and as low as 2/10 ohm.
3 MILLION OHMS PER VOLT SENSITIVITY on 0.4 volt D.C. range. Constant input resistance 12 megohms on all D.C. volts ranges.
Over 4 million ohms per volt sensitivity on 0.1 volt A.C. range. Input resistance of 4.4 megohms on all A.C. ranges. Flat frequency response between 50 cycles and 10,000 cycles.
METER CANNOT BE DAMAGED BY ACCIDENTAL OVERLOAD on any electronic range. Electronic overload protection on all A.C. and D.C. volts, and ohms ranges.
Variations in line voltage do not affect accuracy within the range of 100 to 125 volts. The instrument is equipped with ballast control tube and self-compensating circuits.
Contains 3 tubes (6X5GT/6K6GT/7N7), neon regulator, 1-1/2 volt battery and ballast; all self-contained and furnished with the instrument.
METER RANGES—

- A.C. Volts: 0-1/4/10/40/100/400/1000
- D. C. Volts: 0-4/10/40/100/400/1000
- Ohms: 0-1000/10,000/100,000/1meg/10meg/100meg/1000meg
- M.A.: 0-1/4/10/40/100/400/1000
- Decibels: Minus 30 to minus 5/minus 10 to plus 15/10 to 35/30 to 55

Either positive or negative D.C. voltmeter indications instantly by means of reversal switch. Signal Tracing type test lead with isolation resistor in probe.
Model 645 is an ultra-modern high sensitivity instrument, with all of the famous Jackson features, including exceptional accuracy and simplicity of use.

MODEL 645 NET PRICE **\$56.50**

GENERAL SPECIFICATIONS

The instruments listed on these pages are perfectly matched units—identical in panel size, style, color, and case construction. (Models 634, 640, 642, 643, 645, and 650-A.)

DIMENSIONS—8 1/2" x 8 1/2" x 6"—Unit welded steel, finished in grey morocco. Each instrument (except Model 640 Oscillator) is equipped with removable hinged metal lid.

ACCESSORIES—Each instrument is completely equipped with all necessary tubes, test leads or batteries and ready to operate.

Shipping weight for any unit—approximately 10 lbs.

MODEL 642 UNIVERSAL MULTIMETER 20,000 OHMS PER VOLT

A valuable and necessary instrument for all measurements of sensitive circuits such as A.V.C. voltages, etc. Many measurements may be made with current drain as low as 10 microamperes!

AUTOMATIC RANGE SELECTION—PUSH BUTTON CONTROLLED. Instant selection of any meter range is made simple with the eleven key push button selector.

TWENTY-THREE RANGES—SEVEN FUNCTIONS AC/DC volts—ohms—decibels—milliamperes—microamperes and amperes. Has special built-in shunt and 10 ampere range.

OHMS RANGES from 1/2 ohm up to thirty megohms. No external batteries or line power required. Current readings may be made as low as 2/1000ths of one milliampere. All D.C. volts ranges are 20,000 ohms per volt.

METER RANGES—

- A.C. Volts: 0-10/100/250/500/1000/5000
- D.C. Volts: 0-10/100/250/500/1000/5000
- Decibels: Minus 10 to plus 14/10 to 34/30 to 54
- D.C. M.A.: 0-10/100/250
- Microamps: 0-100
- Amperes: 0-10
- Ohms: 0-3000/300,000/30,000,000

Construction is of the finest in materials and workmanship. Case is welded steel finished in grey morocco. Fitted with removable hinged steel cover. Protects meter and controls.

Case dimensions: 8 1/2" x 8 1/2" x 6". Weight 6 lbs. Complete with self-contained battery. Furnished with test leads.

MODEL 642 NET CASH PRICE **\$48.50**

1,000 OHMS PER VOLT MODEL—Same ranges as above except micro-amps is 0-1000 and ohms ranges are 0-3000/300,000/3,000,000.

MODEL 643 NET CASH PRICE **\$33.95**



NEW COMPACT MULTIMETERS

Models 610 and 615 are excellent general purpose instruments, compact in size but very complete in ranges. The two instruments are identical in size and style. Panels are finished in attractive two tone grey with white lettering.

RANGE SELECTION—Rotary switch method saves time and reduces errors. **HIGH QUALITY METER**—Three inch square type meter with two jewelled bearings.

RANGES MODEL 610

- TWO OHMS RANGES—0-1000/0-500,000
- FIVE D.C. VOLTS RANGES—0-5/50/100/250/1000
- FOUR D.C.M.A. RANGES—0-1/5/50/250

RANGES MODEL 615—Same as Model 610 except has additional ranges of—

- FIVE A.C. VOLTS RANGES—0-10/100/200/500/2000
- ADDITIONAL HIGH VOLTAGE D.C. RANGE—0-2500 v.

Each instrument supplied complete with self-contained battery for ohms ranges. Test leads not included. Dimensions—7" x 4 1/4" x 3"

MODEL 610
DEALER NET PRICE **\$13.50**

MODEL 615
DEALER NET PRICE **\$18.95**



JACKSON

Radio Testing Equipment

THE JACKSON ELECTRICAL INSTRUMENT CO., DAYTON, OHIO

INDUSTRIAL CIRCUIT TESTER

Volt Ohm Milliammeter
MODEL 665-J



This multiple range instrument is designed to meet exacting requirements in various uses where thorough electrical testing is a necessity.

Production testing on motors, controls, etc.
Industrial and educational laboratories.
Military use—Signal Corps, Air Corps, etc.
Manufacturing—Plant Maintenance.
Tests on Signal Systems, Alarm Devices, etc.

The instrument is completely self-contained, is lightweight, compact, and portable. The unusually complete selection of meter ranges are suited to a wide range of measurements. A total of 33 ranges are provided. Any range may be rapidly selected by means of the switching and pin jack arrangement. All meter shunts and multiplier resistors are wire wound. The resistors are non-inductive and have a negligible temperature coefficient. All resistor spools are protected against moisture absorption.

The indicating meter is of finest quality, designed for sustained accuracy under severe service conditions. It is designed to withstand various temperature and humidity changes as well as vibration, overloads, etc.

A.C. ranges are accomplished by means of a full wave type copper oxide rectifier. This full wave rectifier circuit provides more stability at various frequencies and wave forms than the half wave type.

The panel is molded bakelite with all characters white filled for maximum legibility. Pin tip jacks for test leads are molded into the panel. The case is made of steel and finished in black morocco enamel.

RANGES

VOLTS AC & DC (1000 ohms per volt)
0-1000/500/250/100/50/25/10/5/2.5/1.0

MILLIAMPERES
0-500/250/100/50/25/10/5/2.5/1.0

OHMS
0-1,000 —(25 ohms center scale)
0-10,000 —(250 ohms center scale)
0-100,000 —(2,500 ohms center scale)
0-1,000,000 —(25,000 ohms center scale)

OUTPUT RANGES

The A.C. Ranges of 1 to 1000 volts may be used by means of the built-in series condenser. This provides for adjustment of output levels of receivers, speakers, amplifiers, etc.

ACCURACY: 2% on DC Ranges—5% on AC Ranges.
DIMENSIONS: 5 1/2" x 8 1/4" x 3-27/32". WEIGHT: 5 lbs.
Test Leads Furnished.

NET PRICE (Less carrying case) \$65.00
Case for 665-J (Leatherette) 5.00

AUDIO OSCILLATOR

MODEL 652



The Model 652 provides an audio frequency voltage DEVELOPED AT ITS FUNDAMENTAL FREQUENCY. The basic design of the instrument is entirely different from the "beat frequency" type of Audio Oscillator.

FEATURES

RESISTANCE CAPACITY TUNED CIRCUIT DESIGN, engineered for modern needs of audio measurements.

NO ZERO ADJUSTMENT—Tuned Fundamental Frequency method provides permanently locked calibration.

OUTPUT CHARACTERISTICS—Model 652 meets the most exacting requirements as to WAVE FORM—UNIFORM FREQUENCY CHARACTERISTIC—AND OUTPUT LOAD IMPEDANCE SELECTION. A special feature of the output system is the ten ohm tap for low impedance circuits such as speaker voice coils, etc.

COMPLETE STABILITY—The stability of frequency calibration is constant throughout the entire range. The stabilized circuit permits large changes in line voltage to occur without affecting frequency or waveform and having negligible effect on output voltage.

SIMPLIFIED OPERATION—It is only necessary to select desired FREQUENCY and OUTPUT. THERE ARE NO OTHER CONTROLS. Therefore the possibility of errors in operation is eliminated.

HIGH OUTPUT POWER—More than THREE TIMES the output power usually available from "ordinary" audio oscillators.

CONSTRUCTION—Frequency dial is glass enclosed. All controls are legibly marked. Rugged mechanical construction assures trouble-free operation under severe service conditions.

SPECIFICATIONS

Frequency Range—20 cycles to 20,000 cycles in 3 ranges. 20-200 cycles/200-2000 cycles/2000-20,000 cycles.

Accuracy—Frequency calibration accurate to within 3% or 1 cycle.

Output Impedance—Five values of output impedance 10 ohms/250 ohms/500 ohms/5000 ohms/HIGH. Controlled by selector switch.

Output Power—500 milliwatts. Continuously variable from zero to maximum.

Waveform—Less than 5% Harmonic Distortion between 30 and 15,000 cycles.

Frequency Characteristic—Plus or Minus 1 DB between 30 and 15,000 cycles.

Line Voltage—105-120 Volts—50-60 Cycle A.C.

Tubes—1-80, 1-6SJ7, 2-6F6 furnished installed in instrument.

Dimensions—13" wide, 9 1/2" high, 9 3/4" deep. Wt. 26 lbs.

MODEL 652 NET CASH PRICE \$88.50

CATHODE RAY OSCILLOGRAPH — MODEL 523

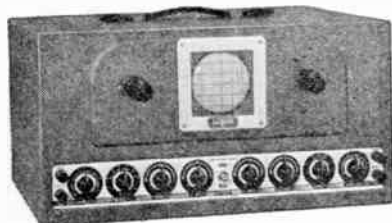

SENSITIVITY—The input sensitivity to vertical plates is 4/10 of one volt R.M.S. per inch of deflection. This sensitivity is secured by means of high gain amplifiers having a frequency range to 100 kilocycles.

HORIZONTAL SWEEP—A horizontal time axis "sawtooth" oscillator provides a frequency from 20 to 20,000 cycles. Frequencies up to 100,000 cycles may readily be inspected, resulting in a five pattern image. Timing frequency range switch is marked directly in frequency. This feature greatly simplifies the selection of a desired frequency range.

CONSTRUCTION—Design and construction are practical in every respect. The entire cabinet is heavy gauge steel construction. The instrument is attractively finished in grey morocco, oven-baked enamel. The control plates are etched with white back-ground and black characters. The very finest of materials and construction are employed throughout.

POWER SUPPLY & TUBES—Operates from 110-volt, 50-60 cycle power supply. The Model 523 is supplied complete with 3-inch Cathode Ray Tube, two type 57, one type 885 and two type 80.

DIMENSIONS—17" x 8 3/4" x 12 3/4" overall. Weight 30 lbs.

MODEL 523 NET CASH PRICE \$76.50

- Vertical Amplifier and Horizontal Amplifier
- Calibrated Linear Timing Circuit
- Frequency Control and Vernier
- Automatic "Lock-in" Control
- Spot and Focus Controls on Main Panel
- Calibrated Screen

SUPREME INSTRUMENTS

Newest Engineering Developments

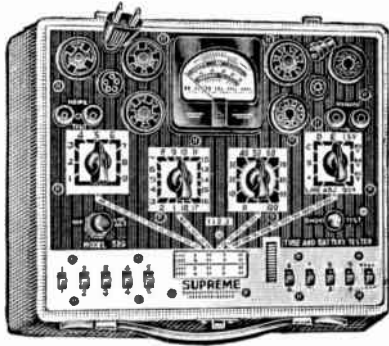

MODEL 589
TUBE AND BATTERY TESTER

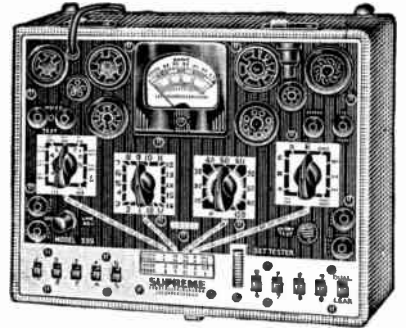

MODEL 599
TUBE AND SET TESTER

MODEL 589 TUBE AND BATTERY TESTER has a completely modernized circuit. The tube test sockets are not wired directly to the circuit, but, instead, pass through the patented Supreme Double Floating Filament Return Selector system which automatically re-connects all tube elements to any possible tube base arrangement. Due to the fact that any or all elements of each socket can be rotated to any desired position, only one socket of each type is necessary. Tests every type of tube from 3/4 volt to full line voltage at its correct anode potential under proper load. Tests separate sections in multi-purpose tubes. Checks all leakages, shorts, open elements and filament continuity with a neon lamp. A circuit insert is provided for checking noise, leakage, loose and bad connections.

The battery testing circuit of the Model 589 provides the proper load at which each battery is to operate, plainly marked on the panel, for all 1.5, 4.5, 6.0, 45 and 90 volt portable radio types. The condition of the battery is indicated on an English reading scale.

This is the fastest and easiest tester to operate. Just "follow the arrows"—you can't go wrong. Roller type tube chart with brass geared mechanism lists tubes in logical numerical order. Each tester carries a one year free tube setting service. SUPREME engineering and construction PLUS the best materials the market affords, make the 589 your biggest dollar value. You will be proud to own this instrument.

Dealer Net Cash Price..... **\$38.50**

MODEL 599 TUBE AND SET TESTER is very similar in appearance to the Model 589, and includes all the features and advantages of this instrument. In addition, it provides the following ranges:

0.2 TO 1500 D.C. VOLTS—5 carefully selected ranges—0/6 15/150/600/1500 volts. 1000 ohms per volt STANDARD sensitivity.

0.2 TO 600 A.C. VOLTS—4 A.C. ranges—0/6/15/150/600 volts. Rectifier guaranteed with instrument and fully protected from overload damages.

0.2 M.A. TO 600 M.A.—3 direct current ranges 0/6/60/600 allow measurement of screen, plate, "B" supply and D.C. filament loads.

0.2 TO 600 OUTPUT VOLTS—0/6/15/150/600—ideal for alignment. No button to hold down—no external condenser necessary.

0.1 OHM TO 20 MEGOHMS—4 ranges 0/200/20,000 ohms, 0/2 20 megohms. A low range at high current with 3.5 ohms center scale.

ELECTROSTATIC—ELECTROLYTIC LEAKAGE TEST—provides an excellent test of paper condensers by means of the highly sensitive 20 megohm range. Much better than neon lamp methods as the ohmmeter is calibrated. Equally useful in checking leakage in electrolytic condensers. Just as the 589 is your best value in a tube and battery tester, the 599 is your best value in a combination tube tester, battery tester and set tester. All the features of the 589 PLUS a complete AC, DC, volt, ohm, megohm, milliammeter, at a cost of only 47c per range.

Dealer Net Cash Price..... **\$49.95**

MODEL 563 AUDIO OSCILLATOR

The SUPREME Beat Frequency Audio Oscillator has many important service applications. It provides three output impedances of 250, 500, and 5,000 ohms; output frequency of 30 to 15,000 cycles \pm 1 db. from 30 to 10,000 cycles. Down 2 db. at 15,000 cycles; power output is 125 milliwatts; distortion less than 5% RMS over entire range; hum level —60 db. below maximum output; large ratio dial, calibrated scale 11" in length; tube complement of 2 type 6SK7, 2 type 6C5, and 1 6X5; power consumption 35 watts—fuse protection. Shipping weight 20 lbs.

Dealer Net Cash Price **\$56.15**



MODEL 504-A COMBINATION TESTER



Model 504-A is radio's finest quality combination tube tester, battery tester, condenser leakage tester, and a 31 range push-button operated multimeter. Correctly tests all types receiving tubes with filaments from 3/4 volt to full line voltage. Uses patented Double Floating Filament Return Selector System which automatically re-connects each tube socket for any possible tube base arrangement. Due to this special circuit only one socket is required for each tube base. Tests all standard type tubes, including octals, locals, miniatures, Bantam, Jr., pilot lamps, etc. Speedy operation. Set controls from left to right—just "follow the arrows". Neon lamp checks for leakage, shorted elements, open elements and filament continuity. Pressing a button increases the sensitivity of the neon lamp to 2 megs. Circuit insert for noise test. Fast roll chart—free tube setting service for one year. Checks portable radio batteries under proper load. Checks leakage of electrolytic and electrostatic by-pass condensers. Quality of tubes, batteries, and electrolytic condensers all indicated on English reading "good-bad" scale. Multimeter section completely automatic with instantaneous push-button finger-tip control—7 ranges 0.1-5/25/100/250/500/1000/2500 D.C. volts; 5 ranges 0.1-5/10/50/250/1000 A.C. volts and output; 7 ranges 10-500 microamperes/2.5/10/50/250 mils., 1/10 amperes; 5 ranges 0.1-200/2000/20,000/2 meg./20 megs.—3.5 ohms center scale. Rectifier guaranteed—temperature compensated circuit. No external condenser required on output volts. Accuracy of calibration 2% on D.C. and 3% on A.C. Complete with batteries and detailed instructions.

Dealers Net Cash Price **\$83.50**

SUPREME INSTRUMENTS

Supreme by Comparison

MODEL 571 SIGNAL GENERATOR



A test oscillator which offers high accuracy and stability at an amazingly low price! By using air core trimmer capacitors and iron core inductors Model 571 can be calibrated at both ends of the dial, making over-all accuracy to less than 1/2 of 1%. High "Q" coils and ideal L/C combination, together with rugged construction provide high frequency stability. Double shielding makes unit capable of withstanding large temperature and humidity changes as well as minimizing unwanted leakage. Wide frequency range from 65 KC to 20.5 megacycles in five bands on fundamentals and to over 60 megacycles on harmonics. All five bands read on but two basic scales calibrated on a large 6-inch illuminated dial. Dual ratio tuning mechanism provides easy, accurate adjustment. Has built-in 400 cycle audio oscillator with sine wave out-put. Provisions for internal modulation at two levels (high and low) for checking second detector distortion. Audio output also available from panel for checking A.F. systems. R.F., I.F. and high frequency fully controllable with double shielded non-shorting ladder type attenuator. Beautiful black metal panel with silver and red trim. Complete with all accessories and operating instructions.

Dealer Net Price..... **\$49.40**

MODEL 546 OSCILLOSCOPE

Model 546 has merited the endorsement of servicemen, radio set manufacturers in research and production, industrial laboratories, factories and colleges for more than four years. A complete oscilloscope incorporating a cathode ray scope, vertical and horizontal amplifiers and linear sweep generator. Uses a high vacuum 3" cathode ray tube of the medium persistence type. All controls are on the front panel including special terminals for direct connection to deflecting plates. Can be used with or without the specially designed sensitive linear amplifiers. Both vertical and horizontal amplifiers have high impedance input and wide frequency response. Has built-in linear sweep generator for providing timing axis from 15 to 30,000 cycles. Positive, stable synchronization, internal or external. Observations may be made using external or internal sweep. Ideal for checking alignment of radio receivers, percentage of modulation on transmitters, waveforms. Extremely flexible design makes applications unlimited. Complete with detailed instructions.



Dealer Net Price..... **\$82.50**



MODEL 561 COMBINATION A.F. & R.F. METERED SIGNAL GENERATOR

The Model 561 is a combination of four indispensable instruments—each of the highest quality and a leader in its classification. Engineered and built into one beautiful unit it includes a RADIO FREQUENCY GENERATOR, an AUDIO FREQUENCY GENERATOR, a FREQUENCY MODULATOR and a CARRIER AND MODULATION MONITOR. The RADIO FREQUENCY GENERATOR is of special design to insure high stability and good wave-form from 65 kilocycles to 20.5 megacycles in five bands on ONLY TWO SCALES. Last band will provide signal to over 60 megacycles using harmonics. All R. F. coils are provided with adjustable iron cores and air trimmer capacitors, making the calibration accuracy to less than 1/2 of 1%. A separate tube is used as a buffer amplifier to provide smooth carrier control and linear modulation. Output is equipped with a completely shielded attenuator for signal control from 1/2 microvolt to 100,000 microvolts. The AUDIO FREQUENCY GENERATOR covers the complete audio spectrum from 15 to 15,000 cycles. Audio output has excellent wave-form with less than 5% harmonic content. Frequency response is virtually flat from 30 to 10,000 cycles and down 2 db. at 15,000 cycles. Power output is approximately 150 milliwatts with an open circuit voltage of 35 volts. Push button selection of four output impedances (50/500/5000 and 50,000) with provisions for push-pull inputs. The FREQUENCY MODULATOR is of the electronic type with internal frequency to produce a double image pattern with automatic synchronization. Two vacuum tube voltmeters are built into the unit to monitor the R. F. voltage and percentage of modulation. Each generator may be used separately or in conjunction with each other to provide the radio technician with any type of signal required for the testing and alignment of radio receivers and other electronic equipment. Each unit is shipped complete with all cables, tubes, and detailed instructions.

Dealer Net Cash Price **\$107.50**

MODEL 562 AUDOLYZER



This is a quick, easy, inexpensive test instrument for DYNAMIC TESTING of every radio receiver using the Signal Tracing method. Easy to operate. You always HEAR the demodulated signal instead of watching a meter or magic eye. You can find the dead portion of any receiver by connecting your modulated signal generator to the receiver and touching the SUPREME AUDOLYZER'S probe first to the antenna post, then the grid of the R.F. tube, the R.F. tube plate, etc., right back through the complete receiver. You will hear a signal in the AUDOLYZER'S speaker (which has a volume control) until you hit the dead stage. You can use the AUDOLYZER'S vacuum tube volt meter to measure all D.C. voltages without disturbing receiver's normal operations. 7 D.C. voltage ranges of 0/1/3/10/30/100/300/1000 at 15 megs input. Meter is center-reading type with "plus" and "minus" readings to each side of center eliminating reversing test leads for polarity changes. You can measure resistance from 0.1 ohm to 20 megohms. 5 ranges give you perfect overlap as the 0/200 is the low range with 3.5 ohms center scale. Total ranges are 0/200/2000/20,000 ohms and 2/20 megohms. Next, you can check receiver's oscillator. If oscillator cuts out or is weak when receiver dial is rotated, AUDOLYZER meter immediately indicates it. To determine unknown frequency of oscillator, I.F., or R.F. signal, use tuning portion of SUPREME AUDOLYZER and AUDOLYZER'S V.T.V.M. as frequency meter.

For receiver's oscillator place probe on oscillator output and tune AUDOLYZER for greatest meter swing. Read actual frequency on AUDOLYZER'S direct-reading dial. For R.F. determination, connect your signal generator to receiver's input and place AUDOLYZER probe on output of R.F. stage under test. Adjust signal generator and AUDOLYZER to same frequency. Adjust receiver trimmer until receiver dial reads correctly. To determine actual signal fed to I.F. stages connect AUDOLYZER probe to first Det. output, feed a

signal into receiver and adjust AUDOLYZER dial until you get maximum swing of its meter needle. Read actual I.F. signal's frequency on AUDOLYZER. Relative gain or loss of signal strength in any stage, tube or transformer can be determined. You can check A.V.C. circuits for correct applied voltage under actual operating conditions. You can adjust A.V.C. circuits. Distortion is easily noted by ear.

Dealer Net Cash Price..... **\$99.95**

SUPREME INSTRUMENTS

Supreme by Comparison

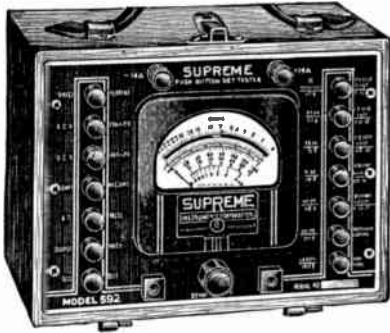

MODEL 592 SET TESTER

Service men who know the principle of Model 592 operation will never go back to rotary switch or pin jack operation. 44 ranges at your finger tips.

1 Microampere to 14 amps; 8 ranges (1—70/700 microamps; 7/35/140/350 M A; 1.4/14 amps.)

0.1 to 1400 D.C. volts; 7 ranges at 1000 ohms per volt and 7 ranges at 25,000 ohms per volt sensitivity of: (0.1-3.5/7/35/140/350/700/1400). Double Meter Sensitivity.

1/4 ohm to 50 megs; 6 ranges (1/4—500/5,000/50,000/500,000 ohms and 5/50 megs). All from self contained battery power.

0.1 to 1400 A.C. volts: 6 ranges 0.1—7/35/140/350/700/1400). Temperature compensated—rectifier guaranteed.

Complete output ranges: 6 ranges (0/7/35/140/350/700/1400). No external condenser necessary.

—0 to +46 D.B.; 4 ranges 0.006 to almost 200 watts—(0/+16; +10/+26; +20/+36; +30/+46).

50 meg. resistance range allows very accurate leakage check of all electrostatic paper and mica condensers. New specially designed A.C. rectifier circuit minimizes burnouts from momentary overloads. NO SAFETY SWITCH TO HOLD DOWN. Copper-oxide rectifier GUARANTEED the same as every other part. D.B. (decibel) conversion chart furnished so D.B. readings can also be taken on any line of known impedance. D.B. readings direct from 500 ohm line. SUPREME 592 easiest multimeter to operate—just depress one button on left side of panel for desired function and one button

on right side for desired range. One set of pin jacks serve 43 ranges. 14 amps range on separate binding posts. 40 microampere meter movement. Wire wound shunt resistors. Special push-button for quick ohmmeter zero adjustment. Four years actual field use by thousands of Service Men prove the 592 to be TOPS in instrument value.

Dealers Net Cash Price **\$55.95**



MODEL 543



MODEL 542

MULTIMETERS

A POPULAR COMPACT POCKET LABORATORY

MODEL 543 POCKET MULTIMETER

The Model 543 Pocket Multimeter uses the same bakelite case as Model 542. Attractive two-color panel—full size 3" one-mil meter. A single rotary selector switch provides functions and ranges of: Resistance—0/2000/200,000 ohms; Direct Current—0/6/60/600 M.A.; AC—0/15/150/600/3000 volts; D.C. 0/15/150/600/3000 volts. Batteries furnished and contained within case. Ranges at 1,000 ohms per volt standard sensitivity. With this instrument you can make A.C. and D.C. voltage measurements in radio and television receivers and if you are a "Ham" you can use the high voltage ranges on your transmitter and scope. This is a beautifully designed and rugged little instrument at an astonishingly low price.

Dealer Net Cash Price..... **\$16.25**

MODEL 542 POCKET MULTIMETER

A regular little pocket laboratory with a case only 3 x 5 1/2 x 2" in size, weighing but 23 ounces—24 ranges—just as accurate and even more convenient than you would expect to find in an instrument twice its price. 4 DC mil ranges (with first scale division 5 microamperes) of 0/0.3/6/30/150; 4 DC volt ranges (with first scale division 0.1 volt) of 0/6/150/300/1500; 4 ohms ranges (with 1 ohm first scale division and 25 ohms center scale) of 0/2,000/20,000/200,000/2 meg; 4 AC volt ranges (with first scale division 0.1 volt) of 0/6/30/150/600; 4 output ranges of 0/6/30/150/600; 4 decibel ranges of —6/+10, +8/+24, +22/+38, +34/+50. The Model 542 is not a toy—it uses a full size 3" square meter with a rugged, accurate 200 microampere movement and a knife edged pointer. This movement has a sensitivity of 5000 ohms per volt. All ohmmeter ranges, including the megohm ranges, are operated by batteries furnished with the instrument and contained within its durable black moulded bakelite case.

Dealer Net Cash Price..... **\$20.75**

BUILT FOR PUNISHMENT

Popular Supreme Model 542 and Model 543 in a Blitzkrieg dress—used by the army—and telephone companies—where hard knocks are the rule rather than the exception. Built for Punishment. Heavy steel cover protects meter—snaps into place. Full protection without the inconvenience of the old style lid. Large, sturdy leather handle, but still small enough to slip in your pocket. Size 3 1/2" x 6 1/4" x 2 3/4". Wt. 2 lbs. 2 oz.

Model 542 with Metal Case

Dealer Net Cash Price..... **\$22.95**

Model 543 with Metal Case

Dealer Net Cash Price..... **\$17.95**



LITTELFUSE

"Quicker than a Short Circuit"

AIRCRAFT LITTELFUSES — ANTI-VIBRATION TYPE

Especially designed for Aircraft Service. Characteristics: High Mechanical Strength—Resistance to Fatigue—Long Vibration Life.



4 A G Aircraft Fuse showing reinforced twisted element. (Note clear label.)



Bakelite-enclosed 4 A B Fuse.

CONSTRUCTION: Glass-enclosed, Littelfuse Locked Cap Assembly (no cements) prevents loosening of caps. High visibility transparent label for amperage. Elements mechanically depolarized by twisting at 90° (see illustrations) are braced against extreme vibration. "Gooseneck" non-crystallizing fuse element takes up expansion and contraction. Ratings 5 amps. or less use Spring and Link. Service life six times simple wire. The 4 AG and 5 AG sizes are supplied for Aircraft Services for their strength and greater carrying capacity than 3 AG fuses.

CURRENT RATING: Rated to NEC specifications to carry 10% overload indefinitely, to blow on 35% overload within 1 hr., and 100% overload within 2 min.

VOLTAGE RATING: Voltage at which fuses will break without arcing over, or bursting under short circuit conditions.

VIBRATION FACTOR: Minimum hours these fuses endure our Magnetic Vibrator operating 120 cycles a second, while carrying the rated current. Acceleration is 10 times the worst field conditions.

BAKELITE-ENCLOSED 4 AB fuses recommended where severe overloads might shatter glass.

4 AG, 4 AB, 5 AG, 5 AB Fuses + Intermediate amperages furnished for 20% additional price.			4 AG Fuses 1 1/4" x 5/8" Dia. Unit wt.—3.5 Gms.		4 AB Fuses 1 1/4" x 5/8" Dia. Unit wt.—3.75 Gms.		5 AG Fuses 1 1/2" x 13/16" Dia. Unit wt.—8.5 Gms.		5 AB Fuses 1 1/2" x 13/16" Dia. Unit wt.—8.0 Gms.	
Vibration Factor	Ampere Rating	Volts	Cat. No.	List Price	Cat. No.	List Price	Cat. No.	List Price	Cat. No.	List Price
100+	1	250	1091	\$0.15	1091B	\$0.25	1160	\$0.15	1160B	\$0.30
100+	2	250	1092	.15	1092B	.25	1161	.15	1161B	.30
100+	3	250	1093	.15	1093B	.25	1162	.15	1162B	.30
500+	5	*25	1094	.15	1094B	.25	1163	.20	1163B	.30
500+	10	*25	1095	.15	1095B	.25	1164	.20	1164B	.30
500+	15	*25	1096	.15	1096B	.25	1165	.20	1165B	.30
500+	20	*25	1097	.15	1097B	.25	1166	.20	1166B	.30
500+	25	*25	1098	.15	1098B	.25	1442	.24	1442B	.36
500+	30	*25	1099	.15	1099B	.25	1167	.20	1167B	.30
500+	35	*25	1438	.18	1438B	.30	1443	.24	1443B	.36
500+	40	*25	1100	.20	1100B	.30	1168	.30	1168B	.35
500+	50	*25					1169	.30	1169B	.35
500+	60	*25					1222	.30	1222B	.35

All 4 sizes standard package 100. Standard package weights: 4 AG, 2 lbs., 4 AB, 2 lbs., 5 AG, 4 lbs., 5 AB, 4 lbs.

HEAVY DUTY AIRCRAFT FUSES—HI-AMP TYPE

Small, light, renewable, easily inspected fuse for aircraft main line service. Holder has two split aluminum end-bodies connected by a bakelite strip held by two screws and lock washers. Transparent tenite-resin tube for inspection. Elements braced on dielectric core soldered to nickel-plated copper caps. Renewals made by releasing screws through split end caps. Conservatively rated at 25 volts for battery circuits. May be used for service up to 125 volts on power supplies below 50 KVA. Uses No. 1235 Links. Type B is 1 3/4" long. Also furnished in 1 1/2" length. For this size specify Type C up to 100 amp.

ASSEMBLY—Including Holder and Fuse
Av. Unit Wgt. 45 Gms. Std. Pkg. 100. Wgt. 8 lbs.

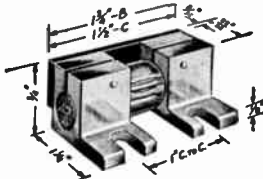

Hi-Amp. Aircraft Littelfuse.

Cat. No.	Rating Amps.	List Price Ea.
1117	40	\$1.25
1118	50	1.25
1119	60	1.25
1120	70	1.25
1121	75	1.25
1122	80	1.25
1123	100	1.25
1324	125	1.50
1325	150	1.50

LITTELFUSE AIRCRAFT FUSE MOUNTINGS

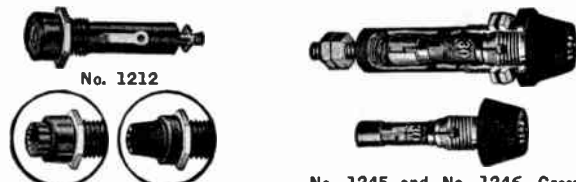

No. 1212



No. 1212-C
No. 1212-B

No. 1245 and No. 1246. Cross section above. Knob removed below.

Cat. No.	Mtg. Hole Dis. Clearance	Length Under Panel	How Operated	Wt. Gms.	List Price, Each
1212	5/8"	2 1/4"	Screw driver (fuse knob) Finger	23.5	\$0.65
1212B	5/8"	2 1/4"	Finger	24	.75
1212C	Similar to No. 1212 but front mounted.		Screw Driver (fuse knob) Finger	25	.75
1245†	7/8"	3 1/2"	Finger	111	2.00
1246†	1 1/8"	3 3/4"	Finger	230	2.50

*As required by Underwriters' Laboratories.
†No. 1245 used with Hi-Amp. Element No. 1235.
*No. 1246 for Removable Link No. 1236, Standard Package 20.

RENEWABLE HI-AMP FUSE LINKS—TWO SIZES

No. 1235 (1 3/4" x 3/8") has two nickel-plated copper caps mounted on dielectric core, with 1, 2, 3 or 4 elements soldered to caps. (Number of elements determined by amperage.) Used in standard Hi-Amp. Fuses as illustrated, or with No. 1245 Mounting.

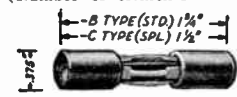

Cat. No. 1235—40 to 150 amps.

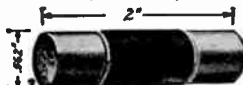

Cat. No. 1236—used in No. 1246 Mtg. 150 to 300 amps.

No. 1236 FUSE LINK (2" x 9/16") similar, except has bakelite enclosure, and is used in No. 1246 Fuse Holder. Voltage Rating 25 volts or less. Vibration Factor 500+. Standard Pkg. (50). Wgts. No. 1235, 3 lbs. No. 1236, 7 lbs.

Cat. No.	Rating Amps	Unit Wgt Gms	List Price, Ea.
1235	40 to 80	16.5	\$0.50
	100 to 150		.60
1236	150 to 300	50.5	.90

Littlefuse Beryllium Copper Fuse Clips



New Alloy of Beryllium and Copper, has spring qualities of steel. Heat resistance to 200° C. Extremely high tensile strength, and resistance to corrosion and vibration. Triple the grip of phosphor bronze. Silver plated.

Cat. No.	Use For	Wt Gms	Ht	Wth	Fuse Dia.	Hole Dia. ±.005	List Per 100
1216B	1/4" dia. Fuses.....	1	3 1/2"	5/8"	3/8"	.171	\$5.00
1217B	4 AG & 4 AB Fuses, 5/8" dia.	1.5	3 1/2"	5/8"	3/8"		12.00
1218B	H.V. Aircraft, 5 AG & 5 AB Fuses, 1 1/8" dia.....	3	3 1/2"	7/8"	1 1/8"		16.00
1219	N.E.C. Fuses & No. 1243 non-renewable bakelite enclosed 5/8" dia.....	4.5	1 1/2"	1 1/8"	5/8"	.203	21.00
1221	H.V. Fuses 2000, 3000, 4000 Number Series, 1 1/4" dia..	13	1 1/2"	3 1/8"	1 1/4"	.265	26.00
1417	Like No. 1216, except no fuse stops.....	1	3 1/2"	5/8"	3/8"	.130	6.00

PHOSPHOR BRONZE FUSE CLIPS: Also manufactured by Littelfuse in same sizes as shown above.

HIGH VOLTAGE AIRCRAFT FUSES

Full information on Littelfuse Aircraft Fuses, 1000 to 3000 Volts and Mountings furnished on request.

LITTELFUSE

"Quicker than a Short Circuit"

INSTRUMENT high speed LITTELFUSES

Locked Cap Assembly and other exclusive Littelfuse features for protection of delicate test equipment, galvanometers, microammeters, milliammeters, voltmeters, etc. Glass-enclosed; 1 1/4" dia., accurately rated, high speed action, short time lag. Voltage ratings up to 250 V., AC or DC. For higher voltages use fuses in series.



(\$100 protection guaranty against meter burnouts.)

Cat. No.	Rating Amps.	Max. Load M. A.	Aver. Resis. 5 M. A. Load	APPLICATIONS			List Price Each
				Voltmeters Ohms P. V.	All Magnetic Movements	Thermo-couples	
1000	1/200	5	500	Over 1000	Galvanometers	Up to 0-5	\$0.30
1001	1/100	10	110	1000	Up to 0-1	0-5 to 0-10	.20
1002	1/32	25	20	500-1000	0-1 to 0-10	0-10 to 0-25	.20
1003	1/16	60	5.0	100-500	0-10 to 0-25	0-25 to 0-60	.20
1004	1/8	100	3.0	20-100	0-25 to 0-75	0-75 to 0-150	.15
1004-L	1/8		1.5	Same as No. 1004, but lower resistance.			.20
1005	1/4	200	6.2	10-20	0-75 to 0-150	0-115 to 0-200	.15
1006	3/8	300	3.0	5-10	0-150 to 0-250	0-200 to 0-300	.15
1007	1/2	400	2.5	3-5	0-250 to 0-350	0-300 to 0-400	.15
1007-A	3/4	600	.40		0-350 to 0-500	0-400 to 0-600	.15
1008	1	1000	.24		0-500 to 0-750	0-600 to 0-1000	.10
1008-A	1 1/2	1500	.18		0-750 to 0-1000	0-1000 to 0-1500	.10
1009	2	2000	.14		0-1000 to 0-1500	0-1500 to 0-2000	.10
Special	3 to 15	Instrument Littelfuses for ranges up to 15 amps. will be furnished on request.					.15

MOUNTINGS FOR LITTELFUSES

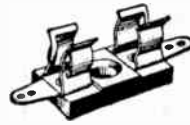

Single Pole

CAT. NO. 1010—Black bakelite base, 1 1/2" x 1 1/2". Overall length 1 1/2". Height 1/2". Tinned shakeproof terminals. Phosphor bronze nickel-plated fuse clips. Mounting hole takes No. 8FMS. Std. Pkg. 20. Wgt. 1/2 lb. List PRICE EA. \$0.16.

Meter Back Mounting



CAT. NO. 1059—Mounts directly on meter binding post. Will not touch other posts on smallest standard meter. Linen bakelite base, 1" x 1 1/4". Length over screw terminal, 1 1/2". Std. Pkg. 20. Wgt. 1/2 lb. List PRICE EA. \$0.20.

Panel Type Mounting

CAT. NO. 1050—For concealed wiring. Black bakelite base, 1-3/16" x 1/2" x 3/16"; height 1/2". Studs 1" long, threaded 6-32 full length, with nuts and washers. Std. Pkg. 20. Wgt. 1/4 lb. List PRICE EA., \$0.20



HINGED TYPE 3 AG FUSE MOUNTING

Meets Underwriters' Requirements



Cover fibre-lined. Metal shielded cover hinged to bakelite base. Terminal mounting extends through insulated base. Nut lightly staked to cover to prevent loss. Requires 1 1/2" x 1 1/2" knockout hole in panel. Two 6/82" x 5/16" mounting studs at 2 1/2" centers. Base 2 1/2" x 1 1/4". 3/4" high above panel. Std. Pkg. 20. CAT. NO. 1237—Double Pole. List PRICE EA., \$0.60. CAT. NO. 1379—Single Pole. List PRICE EA., \$0.30.

3 AG ECONOMICAL MOUNTING

CAT. NO. 1128—1 1/2" x 9/16" x 9/16". Bakelite mounting strip with 1/32" thick fibre insulator at bottom covering all metal parts. Permits mounting on metal panels. Mounting hole for No. 6 screw. Std. Pkg. 100. Wgt. 1 1/2 lb. List PRICE EA., \$0.10.



Extractor Fuse Post

CAT. NO. 1075—Black bakelite panel mounting. Meets Underwriters' Specifications. For 3 AG fuses, 8 amp. max., 125 V., AC or DC. Shock proof. Takes panels up to 5/16" thick, 1/2" mounting hole. Length 2 1/2" from front of panel, 2 1/2" overall. Std. Pkg. 20. Wgt. 1 lb. List PRICE EA., \$0.40.



Finger-Operated Extractor Post

CAT. No. 1075-A—Same as No. 1075 above, but finger operated. Std. Pkg. 20. Wgt. 1 lb. List PRICE EA., \$0.45.



3 AG Single Pole Open Type Mounting

CAT. NO. 1060—Bakelite base 1 1/2" x 3/16". Overall 2 1/2". Live parts space insulated. Shakeproof tinned terminals. Mounting hole for No. 6 RIMS. Std. Pkg. 20. Wgt. 1/2 lb. List PRICE EA., \$0.15.



FUSE RETAINER

CAT. NO. 1070—Holds 3 AG fuses. Excellent for test leads or battery cable for auto sets. Cadmium plated. Bayonet lock end takes cable to 3/16" dia. Size 2 1/2" x 3/8" dia. (Other sizes available.) Std. Pkg. 20. Wgt. 2 lbs. List PRICE EA., \$0.10.



UNDERWRITERS' APPROVED LITTELFUSES

3 AG GLASS FUSES—250 Volts

Littelfuse is the first manufacturer to receive Underwriters' approval of 3 AG fuses (1 1/4" x 1/4" dia) in current ratings over 3 amps. at 250 volts. Following list gives standard approved ratings carried in stock. However, the Underwriters' approval to Littelfuse is a blanket approval from 0 to 8 amps. Intermediate ratings can be furnished without separate approval, at a small extra charge. Littelfuse name, the amperage and voltage rating must appear on the fuse caps of approved fuses. Many new fields are opened up by the extension of approval from 3 to 8 amps, where formerly bulky cartridges or plug fuses and their mountings were used. This applies specially to electrical appliances, heavy duty power supplies, amplifiers, radios, communication equipment, electronic devices, motors, etc.



Rating up to 1/2 Ampere—250 Volts

Cat. No.	Rating Amps	Ohms	List Price Each
1259	1/100	3000	\$0.30
1261	1/32	450	.30
1262	1/16	100	.25
1263	1/8	28	.25
1263-A	3/16	20	.25
1264	1/4	8	.25
1265	3/8	4	.25

CONSTRUCTION

Made in Littelfuse Slo-Blo construction. A carbon pellet provides the heat inertia. (A) melts on short circuits. (A) separates from (B) on sustained overloads.



Ratings 1/2 Ampere to 3 Inclusive—250 Volts

Cat. No.	Rating Amps	Ohms	List Price Each
1041	1/2	1.0	\$0.15
1047	3/4	.05	.15
1040	1	.22	.07
1041	1-1/2	.14	.07
1042	2	.10	.07
1043	3	.07	.07

Littelfuses of this group are of the standard straight link type. Elements are rosin coated to prevent oxidation in service, and to promote a clean break or fusion.

Ratings 4 to 8 Amperes Inclusive—250 Volts

Cat. No.	Rating Amps	Ohms	List Price Each
1357	4	.036	\$0.10
1358	5	.016	.10
1359	6	.012	.10
1360	8	.010	.15

This is the new Littelfuse "Sleeve Type" 3 AG fuse that made possible the higher approved ratings on this relatively small fuse. (Pat. Pend.) A separate glass sleeve over the entire fuse element takes the pressure shocks under short circuits. (On the 8 ampere rating the sleeve is powder packed.)

4 AG VACUUM LITTELFUSES

Cat. No.	Rating Amps	Blow Point M A	Resistance Ohms (Approx)	List Price Each
1331	1/1000	1.5	250	\$0.50
1332	1/500	3.0	100	.50
1333	1/200	7.5	30	.50
1334	1/100	51	20	.50
1335	1/32	54	16	.50
1336	1/16	09	13	.50
1337	1/8	160	5	.50

For lower voltage types of television, X-ray equipment, delicate instrument protection. Suitable for 3000 volts AC and 1000 volts DC. Especially well designed to protect delicate thermo-couples of approximately their own rating, because of the low lag characteristics. Glass enclosed. 1 1/4" long x 9/32" dia.

Std. Package 50.—Wt., 1 lb.

LITTELFUSE

"Quicker than a Short Circuit"

LITTELFUSE SIGNALLETTE

Interchangeable with Lamp Assembly AC42B3593

CAT. NO. 1534—An entirely new signal indicator for aircraft and other purposes. Operates by reflected light—in daylight—at night time—by "black light"—and no light, by fluorescent radio-active luminescence. Activated by solenoid. When activated, "butterfly" opens instantly showing signal. Non-shatterable protection. No burnouts as with lamps. No delicate parts to break from shock or explosion. No spare lamps required. Uses about 1/2 current of filament lamps. Reflecting member available in Red, Amber, Green or White. Length overall 2-5/32", for mounting in panels up to 3/8" thickness. Unit Wgt. 45 Gms. Std. Pkg. 20. Weight 2 lbs. Prices on request.

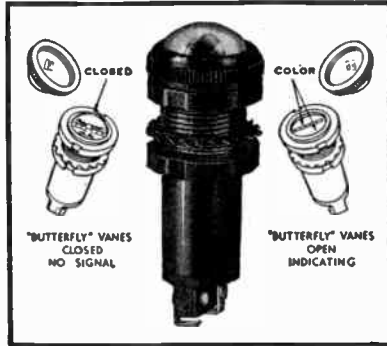

LITTELFUSE PANEL MOUNTING WITH LAMP Instantly Reports Break In Circuit

CAT. NO. 1414 — Applicable to many circuits, circuit breakers, line switches, etc. Designed for use with Littelfuse No. 5122 Lamp. Can be had for 24 or 48-volt filament bulb with which no resistor is used; otherwise uses built-in 200,000 ohm protective resistor in series with neon lamp. Lamp glows on currents as low as 100 micro-amperes. Black bakelite body, transparent molded cap. Made for panels up to 5/16" thick, and 1/2" dia. mounting hole. Overall length 2" below panel, 3/8" above. Rating 90 to 250 volts. Regularly furnished with No. 5122 Neon Lamp. Std. Pkg. 25. List PRICE EA., \$1.00.

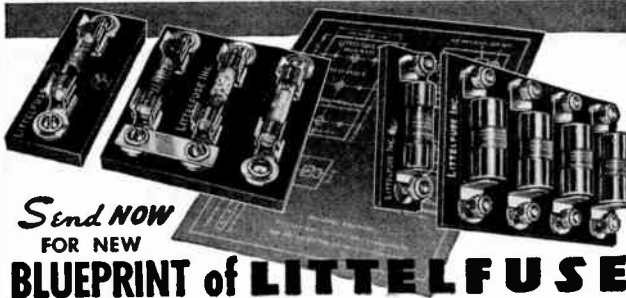

Send NOW FOR NEW BLUEPRINT of LITTELFUSE Universal FUSE PANEL No. 1505

CAT. NO. 1505—Blueprint of standard panel sent free enables you to designate panel or panels exactly to your specifications. A short cut to designing and ordering. Panels made up from print are ready for mounting, equipped with terminals, beryllium copper fuse clips, studs, bus bars. Meet all Army Air Corps requirements. Built to specifications. Prices on application. Littelfuse makes all types of special panels.

LITTELFUSE SPARE FUSE PULLER & HOLDER COMBINED

For 4 AG and 5 AG Fuses

Convenience for changing fuses in close quarters, replacing blown fuses instantly, giving notice on inspection that another fuse is required! Fuse in circuit goes through one end of the rectangular soft rubber fuse-holder, between the clips. Above and at right angle is an opening for the spare. Caps of fuse extend beyond holder for easy finger grip. When fuse in circuit blows operator pulls and reverses holder. This puts the spare in the circuit and brings blown fuse at top. One end of holder is painted red. When reverse is made, red end comes on top, indicating another spare needed. Windows in holder keep elements always in view.

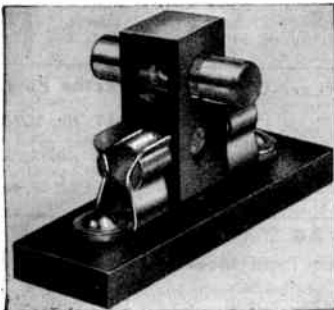

Cat. No.	For Fuse Size	Holder Size	List Price Each
1422	4 AG	1/2" x 1/2" x 1 3/8" long	\$0.11
1378	5 AG	3/8" x 3/8" x 1 3/8" long	.12



LITTELFUSE NEON LAMP

CAT. NO. 5122 — May be used on any voltage above minimum of 90 DC or 65 AC, provided sufficient series resistance limits current to 1 MA on steady loads. Recommended resistance 100,000 ohms for 110 volts, 200,000 ohms for 220 volts, etc. Requires external resistor. Standard octagon switchboard lamp base. Size 1 1/8" long x 9/32". Used in standard lamp jacks or in No. 1414 Mounting above. Std. Pkg. 25. List PRICE EA., \$0.35.



TATTELITE TESTERS

Three Models—Std. Pkg. 10

Compact, dependable vest-pocket Testers for trouble-shooting. Widest variety of uses for engineers, electricians, radio men, electronic and instrument service engineers, etc. Gives visual indication of continuity, character and current of circuit, estimate of voltage, etc. Tests filament circuits, auto and aviation circuits, blown fuses, etc. A professional tool in every respect.



Cat. No.	For Voltages	List Price Each
5370	3 to 25 AC or DC	\$1.75
5420	6 to 50 AC or DC	1.75
5076	90 V DC 60 V AC to 500 V AC or DC	1.00

Pocket Type Neon Tester

Has built-in 200,000 ohm resistor. Will not blow up as ordinary test lamps. Uses 122-1 lamp. Tests for live lines, polarity, and whether AC or DC, RF, blown fuses, defective spark plugs, cables, etc. Indicates approximate voltage (110, 220, 440, etc.) grounded lines, open circuits or shorts. Full directions. Packed 10 to a display card and in individual boxes. Cat. No. 5076. List Price ea., \$0.60.



SIMPSON

Instruments that
STAY accurate

MODEL 260

VOLT—OHM—MILLIAMMETER

The New "High Sensitivity" Tester

AT 20,000 ohms per volt this instrument is far more sensitive than any other instrument even approaching its price or quality, and covers a wide range of unusual conditions that cannot be checked by ordinary servicing instruments. The practically negligible current consumption assures remarkably accurate full-scale voltage readings, ranging from 2.5 to 5000 volts. Current readings as low as 1 microampere, and as high as 500 milliamperes, are available. Resistance readings are equally dependable, ranging from 1/2 ohm to 10 megohms. The finely built 4 1/2 inch meter is mounted in a handsome molded bakelite case, which is provided with a leather handle.

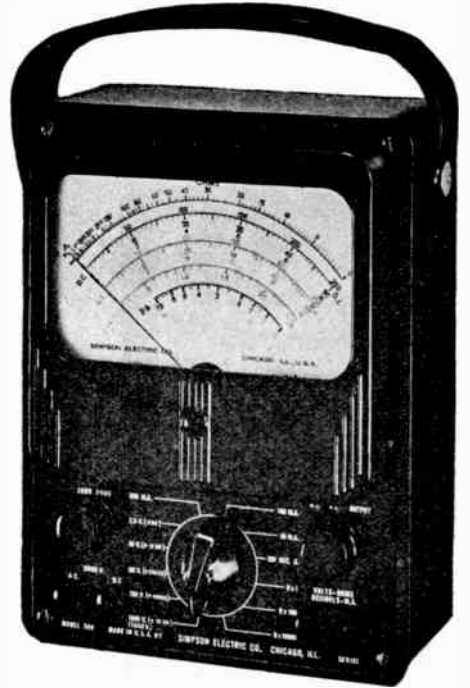

Size: 5 1/2" wide, 7" long, 3" deep. Weight 2 1/2 lbs.

RANGES

(20,000 ohms per volt, D.C.)
(1,000 ohms per volt, A.C.)
Volts, A.C. and D.C.: 0-2.5, 10, 50, 250, 1000, 5000
Output, A. C. Volts: 2.5, 10, 50, 250, 1000, 5000
Milliamperes, D.C.: 0-10, 100, 500
Microamperes, D.C.: 0-50, 100
Decibels: (5 ranges) —10 to +52 DB
Ohms: 0-1000 (12 ohms center)
0-100,000 (1200 ohms center)
0-10 megohms (120,000 ohms center)

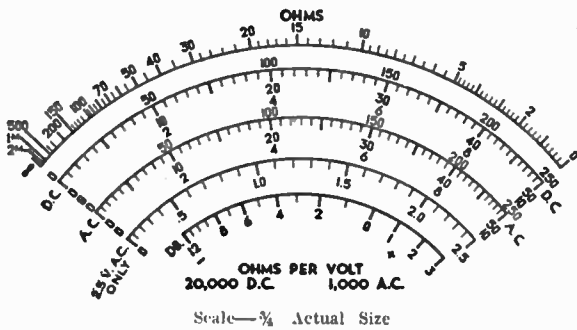

Dealer's Net Price **\$33.25**
Genuine Leather Carrying Case (Cat. No. 8067).....**\$4.75**

MODEL 215

VOLT—OHM—MILLIAMMETER

The Model 215 Tester incorporates all of the essential ranges for modern servicing, both AC and DC. It is the first small, low priced instrument to incorporate a large 4 1/2 inch meter, with a long, easy-to-read scale—before now available only in Simpson higher priced Testers. Handsome molded bakelite case has leather handle for easy carrying. Pair of test leads furnished with each instrument.

RANGES

(5000 ohms per volt D.C.; 1000 ohms A.C.)
Volts, A.C. and D.C.: 0-2.5, 10, 50, 1000, 5000
Output, A.C. Volts: 2.5, 10, 50, 250, 1000, 5000
Milliamperes, D.C.: 0-10, 100, 500
Microamperes, D.C.: 0-250
Decibels: (5 ranges) —12 to —52 DB
Ohms: 0 to 4000 (30 ohms center); 0 to 400,000 (3000 ohms center); 0 to 4 megohms (30,000 ohms center)

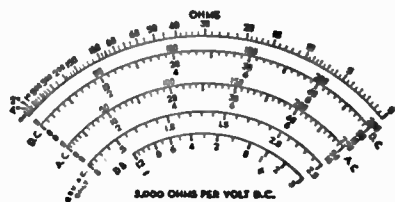

Size: 5 1/2" wide, 7" long, 3" deep.
Weight: 2 1/2 lbs.

Dealer's Net Price..... **\$27.75**
Genuine Leather Carrying Case (Cat. No. 8067).....**\$4.75**

SIMPSON

*Instruments that
STAY accurate*

"Micro-Testers"

MEET EVERY TESTING REQUIREMENT



MODEL 280

A.C. Ammeter. Half actual size.
Ranges: 0-1, 0-2.5, 0-5, 0-10, 0-25 amps.
Dealer's net price\$11.75

THE Simpson Micro-Testers represent a new idea in the form and use of testing instruments. Each of these compact, finely built instruments covers a complete zone of electrical measurements. Model 280, at left, for example, is the first low cost A.C. ammeter ever offered that combines an indicating instrument with a current transformer—that provides readings in five different ranges. Models 280 to 288 inclusive blanket 55 ranges of current, voltage and resistance. Any three can be combined in a handy carrying kit to provide a low cost combination unit that will meet practically any testing requirement.

Micro-Testers can perform a vital service in industrial plants—in some cases replacing high priced laboratory instruments, in most cases becoming a handy portable supplement to them.

Micro-Tester Models 230, 235, 240 (see p. F-28) are small combination instruments for use where narrower ranges will meet the requirements. Model 245, which tests batteries the right way, under load, completes the line.

All Micro-Testers are housed in sturdy red moulded bakelite cases with matching red bakelite meter cases. Models 280 to 288, inclusive, have metal panels with a beautiful silver-satin finish and are furnished with binding posts. Models 230, 235, 240 (see p. F-28) and 245 have bakelite panels because of the high voltage ranges and incorporate jacks as illustrated. All Micro-Testers are the same small handy size—2 $\frac{7}{8}$ " x 5 $\frac{1}{4}$ " x 1 $\frac{3}{4}$ "—and each weighs about 20 ozs.

The low prices of these Micro-Testers do not mean a sacrifice of quality or accuracy but, rather, serve as proof that Simpson offers today's greatest value in testing instruments.

- | | |
|---|--------|
| Sturdy leatherette carrying case to hold 3 Micro-Testers
(Cat. No. 8089) | \$3.25 |
| Individual leather cases (Cat. No. 8032)..... | 2.75 |
| Test leads with prods..... | 1.25 |
| Test leads with alligator clips and insulated sleeves..... | 1.25 |



MODEL 281

A.C. Voltmeter.
Ranges: 0-150, 0-300, 0-600 volts.
Dealer's net price.....\$11.25



MODEL 282

Ranges: 1000 Ohms, 10 Ohms center; 10,000 Ohms, 100 Ohms center; 100,000 Ohms, 1000 Ohms center.
1 Megohm, 10,000 Ohms center; 10 Megohms, 100,000 Ohms center.
Dealer's net price.....\$11.75



MODEL 283

D.C. Milliammeter.
Ranges: 0-1, 5, 10, 25, 50, 100, 250, 500, 1000 MA.
Dealer's net price.....\$11.25



MODEL 284

D.C. Microammeter.
Ranges: 0-50, 100, 250, 500, 1000 Microamps.
Dealer's net price.....\$11.75

SIMPSON

*Instruments that
STAY accurate*

"Micro-Testers"

MEET EVERY TESTING REQUIREMENT



MODEL 230

A.C. & D.C. Volt
Ohm Milliammeter.

Ranges: 0-10, 250, 1000 A.C. Volts; 0-10, 50, 250, 1000, D.C. Volts; 0-10, 50, 250 D.C. Milliamperes; 0-1000 ohms; 0-100000 ohms.

Dealer's net price.....\$17.25

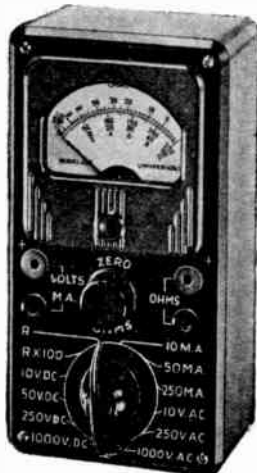

MODEL 235

D.C. Volt Ohm Milliammeter.

Ranges: 0-10, 50, 250, 500, 1000 Volts; 0-10, 100, 500 milliamperes; 0-250 microamperes; 0-2000 ohms; 0-200000 ohms; 0-2 megohms.

Dealer's net price.....\$12.00

NOTE

MODEL 240
"HAMMETER"
IS
DESCRIBED
ON
NEXT PAGE

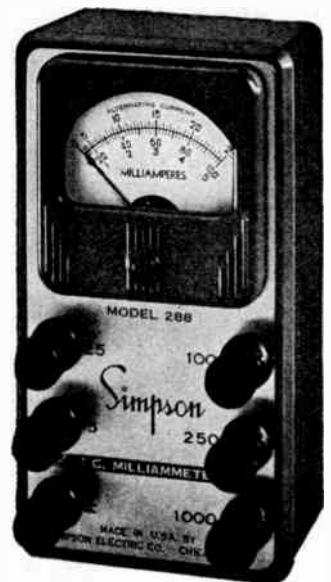

MODEL 288

A.C. Milliammeter.

Ranges: 0-5, 0-25, 0-100, 0-250, 0-1000 M.A.

Dealer's net price.....\$11.75

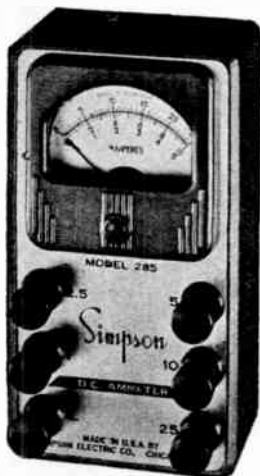

MODEL 285

D.C. Ammeter.

Ranges: 0-1, 0-2.5, 0-5, 0-10, 0-25 Amperes.

Dealer's net price.....\$11.25



MODEL 286

A.C. Voltmeter (Rectifier type).

Ranges: 0-5, 10, 25, 50, 100, 250, 500, 1000 Volts.

Dealer's net price.....\$11.75



MODEL 287

D.C. Voltmeter.

Ranges: 0-1, 2.5, 5, 10, 25, 50, 100, 250, 500, 1000 Volts.

Dealer's net price.....\$11.25

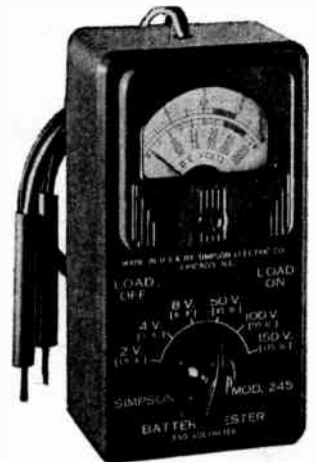

MODEL 245

Load type Battery
Tester and Voltmeter.

Ranges: 0-2, 4, 8, 50, 100, 150 Volts. Tests all dry batteries correctly—under load.

Dealer's net price.....\$9.75

SIMPSON *Instruments that* STAY accurate

"Micro-Testers"

MEET EVERY TESTING REQUIREMENT

MODEL 240 "HAMMETER"

THE Simpson "Hammeter" answers the amateur's vital need for a compact, all-purpose tester.

The range and utility of this instrument are far greater than its small size or modest price would indicate—it is a 3000 volt, self contained unit (no external multipliers necessary). A copper oxide rectifier is built into the meter for A.C. voltage ranges and a battery is provided for both ohmmeter ranges. By adding an external condenser in series with A.C. voltage ranges it may be used as an output meter for checking receivers.

Completely encased in bakelite, the Hammeter is shockproof in every detail. The test cables for instance are insulated for 5000 Volts—a 2,000 volt margin of safety. Well insulated tips for plugging into jacks are provided, and the Alligator clips with ample rubber sleeves as illustrated provide a safe means for making high voltage connections.

The typical Simpson beauty of design is apparent in the illustration. The panel is black Formica with distinct gold characters. A knife-edge pointer gives sharp readings on a handsome silver-etched scale with clear black and red characters.

WIDE UTILITY

The "Hammeter" is the answer to every need for testing all component parts and circuits when constructing transmitters. It is indispensable for trouble shooting—quickly locating the flaws in transmitters and receivers—checking A.C. or D.C. filament voltage, line voltage and transformer voltage on high A.C. ranges. Extremely high voltage may be checked by measuring to the center tap from each side.

Other tests that can be made with the Hammeter include: Checking grid bias, screen and plate voltage on the lower D.C. voltage ranges—checking power supply D.C. voltages in accordance with latest requirements—checking grid, screen, and plate current of any tube—checking current of carbon microphones. With its self-contained battery, the Hammeter is an excellent continuity meter and will save many hours in construction by locating faulty connections.

RANGES

Volts: A.C.—0-15, 150, 750, 3000; D.C.—0-15, 75, 300, 750, 3000.

Milliamperes, D.C.: 0-15, 0-150, 0-750.

Ohms: 0-3000 (center 30); 0-300000 (center 3000).

Resistance 1000 Ohms per volt both A.C. and D.C.

Dealer's net price\$18.00



Model 240

SIMPSON Round and Rectangular INSTRUMENTS AVAILABLE IN DC, AC, RF, AND RECTIFIER TYPES

Available in All Standard Ranges

Voltmeters, Ammeters, Milliammeters, Microammeters



3 1/2" Round Case

Flange diameter, 3 1/2"; depth overall, 1 1/4"; body diameter, 2 3/8"; scale length 2 1/8". Bakelite case.
Model 25—Direct Current.
Model 35—Radio Frequency.
Model 45—Rectifier Type.
Model 55—Alternating Current.



3" Rectangular Case

Width, 3"; height 3 1/8". Mounts in round hole. Body diameter 2 3/8". Bakelite case.
Model 27—Direct Current.
Model 37—Radio Frequency.
Model 47—Rectifier Type.
Model 57—Alternating Current.



2 1/2" Round Case

Flange diameter, 2 3/8"; depth overall, 1 1/4"; body diameter, 2 1/8"; scale length 1 3/8". Metal case—rim type. Bakelite case—wide flange.
Model 125—Direct Current.
Model 135—Radio Frequency.
Model 145—Rectifier Type.
Model 155—Alternating Current.



2" Rectangular Case

2 1/2" square. Mounts in round hole—body diameter, 2 1/8". Bakelite case.
Model 127—Direct Current.
Model 137—Radio Frequency.
Model 147—Rectifier Type.
Model 157—Alternating Current.



RADIO CITY PRODUCTS CO.

Dependable

TESTING EQUIPMENT



Model 471—OUTPUT METER



This instrument has non-inductive constant input impedance of 4,000 ohms for all five ranges. All resistors are precision wire wound, non-inductive and accurate within 1%.

A high quality instrument, finely built, extremely rugged construction of heavy bakelite panel and sub panels. Metal case. D.C. component of any measurement is isolated by means of a blocking condenser built into the unit. Selector switch provides for range selection on the following A.C. voltage scales.

0-1.5; 0-6; 0-15;
0-60; 0-150

Size—5½" x 3¾" x 2½". Weight—1¼ lbs. **\$26.50**
DEALER NET PRICE

Model 423—VOLT OHM MILLIAMMETER



A sensitive multitester using a 3-inch 2% accurate meter having movement of 395 microamperes or a sensitivity of 2,500 ohms per volt; uniform AC-DC voltmeter sensitivity of 1,000 ohms per volt. High ohmmeter range 10 meg. Center to full scale ratio 125. Low ohm scale reads 5 ohms at center and each of first ten divisions reads 0.1 ohms. Each shunt and multiplier is individually calibrated to a tolerance of ±2%. All multipliers individually matched in pairs so that overall accuracy is within 1%. Suppressor type copper oxide rectifier is used for AC

measurements. Cabled or harness type construction throughout.

Ranges: DC Voltmeter—0-2.5-10-50-250-1,000 volts;
AC Voltmeter—0-10-50-250-1,000 volts;
DC Milliammeter—0-1-10-100-1,000 milliamps;
Ohmmeter—0-500-100,000-1 meg.-10 megohms;
DB Meter—10 to 15/ 4 to 29/ 18 to 43/ 30 to 55 db.

Note: The db range is calibrated for a 500 ohm impedance line. For lines of other impedances, correction charts are supplied.

Model 423—completely self-contained with necessary batteries in a hardwood walnut finish case, size 7½ x 5¾ x 3¾", wt. 2 lbs.

DEALER NET PRICE **\$23.50**

Model 423P—in portable solid walnut hand-rubbed case with hinged cover and carrying handle, equipped with complete set of test leads, size 8 x 6¾ x 4¾", wt. 3¾ lbs.

DEALER NET PRICE **\$25.95**

Model 481—VOLT OHMMETER

A practical high quality, high accuracy tester that is precision built throughout. Meter movement is 50 microamperes but voltage measurements are made at sensitivity of 1,000 ohms per volt.

All resistors are wire wound accurate to within 1%. Ohmmeter is equipped with self contained batteries that can readily be replaced in the specially designed holding clamps and contact springs. Test leads are supplied.

Ohmmeter scale spread is designed for good readings at the high end. Ratio of full scale calibration on all ohmmeter ranges is 40 to 1.

Ranges

Volts — D.C. — 2.5/-10/100/250/500/1000

Milliamps — D.C. — 1/5/25/100

Ohms full scale — 0-200 / 1000 / 10,000 / -100,000 / 1,000,000

Ohms center scale—0-5/25/250/2000/25,000/250,000

Model 481—complete with batteries, test leads, instructions, etc., size 8¼ x 5½ x 3¾". Wt. 3½ lbs.

DEALER NET PRICE, including carrying case. **\$64.50**



Model 703—SIGNAL GENERATOR

A well designed service test oscillator with good performance characteristics. Highly desirable for receiver calibration. Supply is thoroughly filtered and electrostatically shielded. Range: 95 kc to 100 mc. Fundamental frequencies in 5 bands continuously variable from 95 kc to 25 mc. Accurately calibrated, direct reading, planetary drive condenser. Output can be modulated or unmodulated.



Self-contained modulation source is 400 cycles sine wave which modulates carrier at 30%. This frequency is available for external use. Provision also made for applying external modulation to signal. All coils not in use automatically shorted. Individual shielding of R.F. circuits, coil assembly and attenuator, in addition to overall test case, chassis and panel. Attenuation in approximate microvolts by five step ladder attenuator, calibrated to 500,000.

Model 703—size 8 x 11¾ x 5", wt. 11½ lbs. **\$33.50**
DEALER NET PRICE

“POCKET” MULTITESTERS

This group of multitesters have the features of good commercial accuracy combined with compactness and ruggedness. Meter movements are guaranteed accurate within 2%. Voltage multipliers are metallized matched pair resistors having tolerance of 1%. Open face Models 416 and 418 are in the "pocket" size class: 6¾ x 3½ x 3" —wt. 25 oz. Portable Models 416P and 418P include test leads and have compartment for same; cases are solid walnut, hand-rubbed, with latched cover; size 6¾ x 4½ x 4¼". Wt. 3¾ lbs.

Model 416—for D-C measurements only—meter is 3" square type range 0-1 ma.
Ranges: DC Volts—0-2.5-10-50-250-1,000;
DC Milliampers—0-1-10-100-1,000;
Ohmmeter—0-500-100,000-1,000,000 ohms. Model 416P—portable **16.85**

Model 418—for both A-C and D-C measurements. Basic meter is 0-400 microamperes.
Ranges: AC Volts—0-2.5-50-250-1,000;
DC Volts—0-2.5-10-50-250-10,000;
DC Milliampers—0-1-10-100-1,000;
Ohmmeter—0-500-100,000-1,000,000 ohms. Model 418P—portable **20.50**



Model 418



Model 416P Portable



RADIO CITY PRODUCTS CO.

Dependable

TESTING EQUIPMENT



Model 461—ULTRA SENSITIVE MULTITESTER

20,000 OHMS PER VOLT



An ultra sensitive multitester providing a wide range of measurements and features required for general laboratory purposes. Also ideally suited for field and shop measurements on military, naval and Radar equipment.

Sensitivity of 20,000 ohms per volt on all D.C. measurements results in negligible loading of delicate circuits. Wide scale, 4 1/2" rectangular meter with a movement of 50 microamperes. Readings as low as 1 microampere can be made on the 100 microampere scale. A.C. voltmeter sensitivity is 1,000 ohms per volt. Meter movement is 2% accurate. Matched pair metallized voltage multipliers accurate to within 1%. A suppressor-type copper oxide rectifier is used. Overall dimensions 7" x 5 1/2" x 3".

- Ranges: D.C. Voltmeter—0-2.5-10-250-1,000-5,000.
- A.C. Voltmeter—0-2.5-10-50-250-1,000-5,000.
- Output Voltmeter—0-2.5-10-50-250-1,000-5,000.
- D.C. Microammeter—0-100 microamps.
- D.C. Milliammeter—0-10-100-500 milliams.
- Ohmmeter—0-2,000-200,000-20 megohms.
- db Meter—minus 10 to plus 55.

Model 461—Bench type, open face, complete with self-contained battery supply and convenient leather handle. Wt. 2 1/2 lbs.

DEALER NET PRICE

\$34.50

Model 461—portable model (illustrated) Wt. 3 3/4 lbs. **\$38.50**

Model 553—3" CATHODE RAY OSCILLOSCOPE

The new R.C.P. Model 553 Cathode Ray Oscilloscope fills the need for an extended frequency 3" oscilloscope. Compactness, comparative light weight, sturdy construction, low power consumption—an ideal instrument for field work. More brilliant images than can be obtained on similar scopes.

All controls and terminals are positioned on the front panel. Switching arrangements will connect input either directly to deflection plate or to amplifier. Position and stable locking of image can be obtained with either internal or any external signal. Built-in sweep has the widest range consistent with good linearity.

Input impedance through either amplifier is 0.5 megohms and 20 mmfd. Input impedance without amplifier is 2.2 megohms and 40 mmfd. Maximum deflection sensitivity through amplifiers is 0.6 volt, r.m.s. per inch. Without amplifiers deflection sensitivity is 35 volts, r.m.s. per inch. Frequency response is flat within 3 db from 20 to 100,000 cycles. Sweep frequency range is 15 to 22,000 cycles. Internal 60 cycle synchronizing source is provided in addition to terminals for connecting an external source.

Black crackle, non-corrosive steel case; size 12 1/8" x 8 1/8" x 13 1/4". Operates on standard 110 volt, 60 cycle A.C. power supply, power consumption 50 watts. Convenient carrying handle.

Wt. 22 lbs.

Model 553—DEALER NET PRICE

\$76.00



Model 446A—AC-DC MULTITESTER

A unique general test instrument where appearance, performance, quality of materials and construction put it in a class with other makes of testers selling for double the price.

- Bakelite case, 3 inch square D'Arsonval Meter, accurate within 2 per cent.
- D.C. Voltmeter—0/5/50/250/500/2500.
- D.C. Milliammeter—0/1/10/100/1000.
- D.C. Ammeter—0/10.
- A.C. Voltmeter—0/10/100/500/1,000.
- Ohmmeter—0/500/100,000/1 Meg.

• Low range is low drain type reading at 0.1 ohm. Center of scale only 10 ohms. Ideal for measuring voice coils, locating shorted turns, poor contacts.

- Decibel ranges — 8 to +15/15 to 35/26 to 49/32 to 55.

- Four output ranges—same as A.C. volts.

- Shunts are wired wound within tolerances of 2 1/2% and multipliers are held well within 5% tolerance. Overall tolerance is kept within 5% on A.C. readings and is of course better on D.C.

- Here is the equivalent of 25 different instruments in a single case complete with batteries.

- Convenient selector switch operation, attractive panel case and multi-colored dial.

- Meter sensitivity 1 Milliampere or 1,000 ohms per volt.

Model 446A—Size: 3" x 8 1/2" x 5". Wt.: 2 lbs. **\$13.45**
DEALER NET PRICE

Model 446AP—Walnut finish, portable hinged cover case with handle and compartment for test prods, plier, screw driver, etc. High quality set of test leads with prods are included.

DEALER NET PRICE **\$15.45**



Model 488—Ultra-Sensitive Multitester

Dual D.C. Sensitivity 20,000 and 1,000 ohms per volt. With Measurements for A.C. Amperes

Here's a multitester built to satisfy the exacting demands of the Signal Corps. Durable, sturdily constructed and supplied with a convenient carrying case, Radio City Products' MODEL 488 is the ideal instrument for field and shop testing of military and naval electronic equipment.

CHECK THESE FEATURES:

Dual D.C. sensitivity of 20,000 ohms per volt and 1,000 ohms per volt. A.C. sensitivity of 1,000 ohms per volt. Wide scale 4 1/2" meter with movement of 50 microamperes. Readings as low as 1 microampere. All multipliers matched and 1% accurate. Three ohmmeter ranges. Center of ohmmeter scale 40 ohms. Readings as low as 0.25 ohms. Batteries are readily accessible . . . can be replaced merely by releasing spring clamp. No soldered terminal connection to batteries.

RANGES:

- D.C. Voltmeter 0-3-12-60-300-600-1,200-6,000 volts
- A.C. Voltmeter 0-3-12-60-300-600-1,200-6,000 volts
- Output Voltmeter 0-3-12-60-300-600-1,200-6,000 volts
- D.C. Microammeter 0-60-300 microamperes
- D.C. Milliammeter 0-3-20-120-600 milliamperes
- D.C. Ammeter 0-12 amperes
- A.C. Ammeter 0-3-12 amperes
- Ohmmeter 0-3,000-300,000-30,000,000 ohms

Model 488, complete with self-contained battery, test probes and a convenient carrying case with removable cover. Overall dimensions of case: 12 1/2" x 10 1/8" x 6 1/2".

Wt. 10 lbs. DEALER NET PRICE **\$71.50**





RADIO CITY PRODUCTS CO.

Dependable TESTING EQUIPMENT



TUBE TESTERS—Model 310

Model 310 testers are ultra modern in circuit design, operation and efficiency. Finest quality rotary selector switches for speediest operation. Heavily silver plated contacts for low loss. Far superior to the cheap slide switch with its imperfect contact.

Famous dynoptimum test circuit gives finest correlative test—made under plate voltages and plate loads as specified by R. M. A.

Tests all tubes including miniature and bantam Jr.

Tests tubes of all filament voltages from 1 volt to full line voltage.

Separate test for noise, hum, intermittents and bad connections.

Spare socket provides for future new tubes having new base arrangement.

Tests separate sections of multi-purpose tubes, full wave rectifiers, etc.

Hot interelement short and leakage test between all individual elements. Hot cathode leakage test. Neon indicators show leakages at high sensitivity.

Continuous variable adjustment for operation at any line voltage from 105 to 135 volts. This method is far better than the cheaper and jumpy method of using only a few transformer taps without a power rheostat.

Line voltage is directly indicated (by independent rectifier circuit) on D'Arsonval meter. This is far more accurate and reliable than the wobbly indication on an A.C. vane meter.

Tests all Ballast tubes, pilot lights, Xmas tree lights, etc. Accurate calibration checked against laboratory standards.

Newest and finest "Rolindex" brass geared mechanically operated roll type tube test charts. Insures smoothest, positive, speedy operation.

De luxe line cord and plug — double fused line protection. Jewelled pilot light indicates: "ON" or "OFF".

Model 310C for counter use has sloping front, size 11 1/2 x 13 1/2 x 7 1/2 inches. Wt. 10 lbs.

Model 310P for combination portable-counter use. Slip hinge cover — rich looking sturdy luggage type case—two tone black-grey. Bakelite handle. Has compartment for tubes, tools, etc. Series 4 testers have 4 1/4 inch rectangular meters. Wt. 11 1/4 lbs. Series 4 testers have 4 1/4 inch rectangular meters.



Model 310C-4



Model 310P-3

Model 310C series 3—(115 volt) DEALER NET PRICE \$25.95

Model 310C series 4—(115 volt) DEALER NET PRICE \$28.95

Model 310P series 3—(115 volt) DEALER NET PRICE \$28.95

Model 310P series 4—(115 volt) DEALER NET PRICE \$30.95

PLUG IN SET ANALYZER—Model 4196

Combines Model 419P and 506 instruments to provide a very comprehensive, accurate and sensitive instrument for plug in socket analysis in compact form. The case size is exactly the same as for Model 419P. (See p. F-34 for description of Model 419P.) Weight 9 1/2 lbs.

Finely rubbed natural finish maple, slip hinge cover case.

Model 4196—(115 volts) DEALER NET PRICE \$51.50



Model 4196

Model 442 MULTIMETER

A compact pocket meter with a 200 micro-ampere movement and a sensitivity of 5,000 ohms per volt. Size is only 5 3/8" x 3 1/8" x 2 1/8"—3 inch square meter.

4 DC milliammeter ranges: 0/0.3/6/30/150.

4 DC voltmeter ranges: 0/6/150/300/1500.

4 AC voltmeter ranges: 0/6/30/150/600.

4 Ohmmeter ranges (with 1 ohm first scale division and 25 ohms center scale): 0/2000/20,000/200,000/2 meg.

4 Output voltmeter ranges: 0/6/30/150/600.

4 Decibel ranges: -6/+10, +8/+24, +22/+38, +34/+50.

Model 442—Wt. 1 1/4 lbs.

DEALER NET PRICE \$21.00

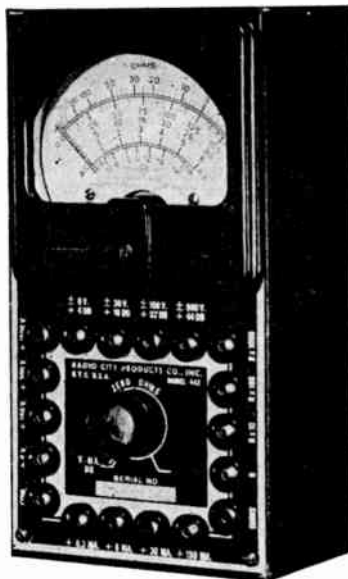

MASTER ANALYST—Model 504

An analyzer unit, more useful, efficient, foolproof, speedier and convenient than any other. Completely push button operated, it combines every advantage of rotary switches and button switches yet eliminates the chief disadvantages that are present in other makes that are either push button or selector switch operated.

Model 504 is a super flexible circuit selector, free point, free reference unit for plug in socket analysis for measurements of voltage, current resistance capacity.

- 1. Two or more buttons may be pushed simultaneously without danger of "shorting".
2. Buttons may be left locked in depressed position.
3. Eliminates necessity for "release" button.
4. Speedier servicing because — no time lost nor danger in turning through unwanted intermediate positions — no necessity for "meter read" and "reverse" buttons.
5. Measures current and voltage simultaneously.
6. Voltage buttons can automatically reverse meter polarity.
7. Contains new "midget" socket and midget analyzer plug adapter.
8. 10 wire analyzer cable including spare lead.
9. Complete with toggle latch plug, 8 adapters. Terminal numbers etched at sockets and buttons.

Model 504C—Size 9 1/4" x 7" x 3 1/4". Weight 3 lbs. with natural finish wood case. DEALER NET PRICE \$20.75

Model 504—Same as above less case, requires 3" mounting depth. DEALER NET PRICE \$18.95



Model 504C

PUSH BUTTON ANALYZER—Model 4194

Here is an ultra modern combination of instruments, Models 419P and 504 to give the last word in convenience, flexibility, safety and speed for accurate socket analysis. (See p. F-34 for description of Model 419P.)

Natural finish maple case. Size—9 1/4" x 12 1/2" x 8 1/4". Weight 9 1/2 lbs.

Model 4194—(115 volts) DEALER NET PRICE \$57.50



Model 4194



RADIO CITY PRODUCTS CO.

Dependable

TESTING EQUIPMENT



MASTER MULTITESTER—Model 419

Original advanced design gives the series of Model 419 Multitesters, advantages, that far outclass other multi-range, multi-purpose meters. METER IS FUSED and supply line is double fused.

The R.C.P. system of A.C. measurements eliminates troublesome inaccurate copper oxide rectifier. Rectifier is more rugged, yet more sensitive, simpler to replace and more economical. It is not subject to the frequency, wave form and temperature errors that are large with the copper oxide rectifier.

A.C. scales are practically linear and coincide with D.C. scales, eliminating the additional A.C. scale with its crowded scale and confusion.

Sensitivity—2000 ohms per volt—Accurate within 2%.

Direct reading CAPACITY measurements in 5 individual ranges from 0.0001 to 300.00 microfarads. Easy reading wide spread scales. Ohmmeter has self contained power supply—ranges below 1 megohm have self contained battery; Megohm ranges are operated from A.C. line.

Ultra sensitive low ohm range with center of scale only 2 ohms. Each of first ten full size divisions read 0.05 ohm—excellent for detecting shorted turns, contact resistance, voice coils, etc.

Inductance measurements available from curve chart.

High voltage and High current Measurements—5000 volts A.C. and D.C. and 25 amperes D.C.



Model 419P

- D.C. volts 0/5/50/250/2500/5000
- A.C. volts 0/10/100/500/1000/5000
- D.C. mils 0/10/50/250/1000
- D.C. amp 0/1/5/25
- Capacity Mfd. 0/.03/.3/3/30/300
- Low Ohms 0-100
- Ohms 0-15,000/150,000
- Megohms 0-1.5/15
- Inductance .25-1000 millihenries — .25-100/1000/10,000 henries.

Model 419—Open face bench type with 4½" meter, hard wood case.
9¼" x 9¼" x 5¼". Wt. 6 lbs. (115 volts)
DEALER NET PRICE \$33.50

Model 419P—combination portable bench type — handsome maple case hand rubbed natural finish — Cover is deep enough to mount Model 506 into it.

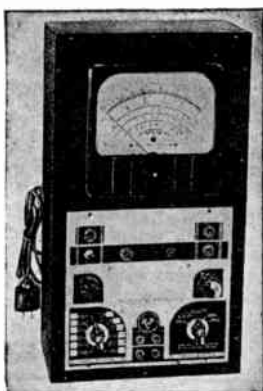

Model 419—Series V7

9¾" x 12½" x 6". Wt. 7 lbs. (115 volts)
DEALER NET PRICE \$36.50

Model 419 Series V7—Large 7¼" bakelite square meter—jewel indicating light—front panel screw cap holder for immediate replacement of METER fuse. Black crackle finish steel case. 10½" x 19" x 5¼". Wt. 14 lbs. (115 volts)
DEALER NET PRICE \$46.00

Model 663 ELECTRONIC MULTITESTER

Voltmeter—Ohmmeter—Capacitymeter

● A genuine vacuum tube voltmeter on A.C. also—not a copper oxide rectifier type. ● An accurate comprehensive capacity meter that reads directly in microfarads. ● Meter cannot be damaged checking live resistor or by using a low range on high readings. ● Co-axial cable supplied for high frequency measurements; cable capacity 10 mmfd. ● Matched pair multiplier resistors ± 1% accurate. ● VR105-30 regulator tube and associated circuits eliminates error due to line voltage fluctuation.

DC VACUUM TUBE VOLTMETER—DIRECT READING
Sensitivity 160 megohms (high ranges), 16 megohms (low ranges). Ranges: 0/6/30/150/600/1500/6000.

Measures all voltages without affecting circuit constants.
AC VACUUM TUBE VOLTMETER—DIRECT READING
Input capacity only .00005 mfd., input resistance 160 megohm high and 16 megohms low. Ranges: 0/3/6/30/150/600/1500/6000.

Measures signal and output voltages, etc.
VACUUM TUBE OHMMETER—DIRECT READING
From the lowest scale division .1 ohm to 1,000 megohms. Ranges: 0/1000/10,000/100,000/1 meg./10 meg./100 meg./1000 meg. No test leads to short. No resetting when changing ranges. No danger of shock on high measurements.

VACUUM TUBE CAPACITY METER—DIRECT READING
Accurate measurements from .00005 to 2000 mfd. Ranges: 0/.001/.01/1/10/100/1000. No danger of shock on low capacity measurements. No test leads to short. No resetting when changing ranges. Wt. 15½ lbs.

Model 662—DEALER NET PRICE **\$52.50**



VACUUM TUBE VOLTMETER Model 666

Designed for accurate measurements throughout entire audio frequency range—essentially a peak voltmeter with r.m.s. calibration. Ranges: 0/3/6/30/150 volts. Tubes: 6K6GT, 6X5GT, 6H6, and VR105-30 (voltage regulator tube). Input resistance 16 meg. for all ranges. Designed for 105-130 volt, 60 cycle operation, but provision is made for external battery operation. 4½" meter, 2% accurate microammeter with movement of 0-200 microamperes. Grey finish steel case with leather strap handle. Size 9¾ x 9¾ x 4¾". Wt. 8½ lbs.

DEALER NET PRICE \$35.50



ANALYZER UNIT—Model 506



Model 506

An improved multiple selector circuit system which when used with any suitable multi-meter makes a comprehensive free point, free reference system, set tester. Provides for metering at all socket terminals for current, voltage, resistance and capacity. Permits tube testing from radio receiver chassis. Socket terminal numbers are clearly etched into the panel, standard R.M.A. numbering. Future requirements are provided for by 10 wire cable including a spare and also a spare terminal at the panel. Can easily be mounted in the cover of any instrument — total depth required including below and above panel 1½". Panel dimensions 5¾ x 7¼ inches. Complete with latest design toggle latch, bakelite plug and 7 latch lock adapters. New miniature socket in panel and new miniature adapter for cable plug are provided.

Model 506—(No Case) Wt. 2 lbs.
DEALER NET PRICE \$14.95

Model 506C—Same as above in 3 inch deep case.
DEALER NET PRICE \$16.50

NOTE: ALL PRICES ON THIS PAGE HAVE BEEN INCREASED APPROXIMATELY 10%



TEST EQUIPMENT



Model 510X
Size: 14" x 13 3/4" x 6"

MODEL 510X RADIO TUBE AND SET TESTER

Measuring Dynamic Mutual Conductance in Micromhos*

THREE RANGES: 0-3000, 0-6000, 0-15,000 MICROMHOS

With Five Inch Rectangular Meter—Scale Length Over 4 1/2 Inches

Both 510X and 530 units test tubes identically. Includes A.C., D.C. Volts, Ohms, Milliampere, Capacity, Leakage, Inductance, Output and Decibel Measurements. Tests all tubes, octal, loktal and tubes up to and including 117 volt filament. Contains sensitive test for noisy tubes. Indications, Set Tester Section: Reliable electronic rectifiers for A.C. Volts. No Copper oxide rectifiers used on any ranges. No burnt out rectifiers, no trouble. Linear scale. A.C. Volts: 0-20, 0-200, 0-500, 0-1000—Readable as low as .1 volt. A.C. voltmeter used to read output. D.C. Volts: 0-20, 0-200, 0-500, 0-1000. 1000 ohms per volt, all ranges. D.C. Milliampere: -20, 0-200. Ohms 1 to 25 Megohms in 3 overlapping ranges. No Batteries Used. Capacity, .0001 to 24 Microfarads in 3 overlapping ranges. Checks leakage in electrolytic condensers with polarizing voltage.

Indications Tube Tester Section: Delivers filament voltages up to 117 in consecutive steps. No obsolescence! Micromhos: 0-3000, 0-6000, 0-15000. Also expressed in English reading scale "Good", "Replace" and "Doubtful", three colors. Diodes tested separately for emission. Highly accurate line test on meter—Extremely stable.

FEATURES: ● Uniform Scale for both A.C. and D.C. Volts. ● True Dynamic Mutual Conductance. ● Sufficient plate current to accurately check both Power and Mutual Conductance. ● Each tube element receives proper voltage. ● Checks gas content accurately. ● Detects both short and open elements. ● Elements tested separately in multi-element tubes. ● Short tests made hot or cold. ● Selector switches take care of all future tubes. ● Sells more tubes—culls them closer. ● No complications. No Customer confusion. ● Rectified current is used on both Plate and Grid. No Copper Oxide Rectifiers Used. ● A.C. Voltmeter accurate on Audio Frequencies. ● Instructions supplied for reading Decibels. ● Checks inductance of chokes with or without D.C. Component of Current. ● Checks leakage in electrolytic or paper condensers. ● Measures hum in filter systems. ● Method of measuring Dynamic Mutual Conductance patented.

NET \$69.00

MODEL 530 TUBE TESTER

Measuring Dynamic Mutual Conductance in Micromhos*

(Illuminated Dial)

THREE RANGES: 0-3000, 0-6000, 0-15000 MICROMHOS (Patented)

*Note: The Unit of Mutual Conductance is the Micromho. If a Tube Tester does not read in Micromhos it is not a Dynamic Mutual Conductance Tester. The only dual reading units made indicating Dynamic Mutual Conductance in Micromhos—also Good, Replace, Doubtful. New roll chart, greatly enlarged and simplified. See arrows pointing to chart on tester panel. Most simple of all to operate. Tests all tubes, including Octal, Loktal, and up to and including 117 volt filament types. Contains sensitive test for noisy tubes.

Technical Description of 530C and 530P Tube Testers: Rectified current is used to energize both plate and grid. Superimposed on the rectified voltage in the grid circuit is an alternating signal voltage. The large square meter responds only to the change in plate current caused by the signal on the grid. The meter is not affected by the steady value of plate current, except in diodes and rectifiers in which plate current is indicated. The 530 type testers are truly Dynamic Mutual Conductance Testers. In twin and multi-element tubes, the components are tested separately, determining the dynamic mutual conductance of each component. In twin grid tubes each grid is energized separately, determining the relative function of each. Diode plates are tested separately.

FEATURES: ● Reads Dynamic Mutual Conductance Directly in Micromhos which is standard engineering practice. No Graphs. ● Sufficient Plate Current to accurately check both emission and Mutual Conductance simultaneously. ● Each tube element receives proper voltage. Rectified current is used on both Plate and Grids. ● Checks gas content on meter. Gassy tubes ruin the operation of even the best radio receivers. ● Detects both short and open elements. ● Elements tested separately ● Mutual Conductance readings not affected by amount of plate current. ● Ninety-four unused in multi-element tubes. ● Short tests made hot or cold. ● Selector switches take care of all tubes. switch positions for future tubes, only 50 used. All positions wired. ● Only one setting to make. No complications. No customer confusion. ● Tests Diode plates separately. ● Tests all ballast tubes, Magic Eye Tubes, New Battery tubes, Gas tubes: OZ4, OA4, 874, Octal, Loktal and to 117 Volt. Made in either Portable or Counter Type as shown—Specify When Ordering.

Size: 530C, Counter Type, 14" x 16" x 6".

Size: 530P, Portable Type, 14 1/4" x 13" x 6".

For Portable or Counter Model.....NET \$56.40



MODEL 133 — LABORATORY QUALITY SET TESTER

BUILT WITH PRECISION — MEASURES WITH PERMANENT ACCURACY

Here is a completely new and modern Radio Set Tester and should not be confused with ordinary Volt-Ohm-Meters or a multiplicity of small units that provide at best, only partial service.

This instrument is accurate within 2% of full scale deflection on all ranges, and employs a special new design meter with full range 40 microampere. Sensitivity—25,000 ohms per volt, sufficient to service the new frequency modulation receivers. Uniform scale 5" square meter — four-color dial.

METER RANGES

D.C. Microampere — 0-40-500.
D.C. Milliampere — 0-5-50-500.
A.C. and D.C. Volts — 0-2.5-10-50-250-500-2500.
D.C. Volts — 25,000 ohms per volt.
A.C. Volts — 1000 ohms per volt.
Ohms — 0-80-10,000-1 meg.-10 meg.
Decibels — -20 to +3, +15, +29, +43.
Contains battery tester, for testing batteries, in all popular sizes up to 135 volts.

A new type of rectifier is used that gives a uniform scale for the A.C. voltage ranges. A.C. and D.C. volts are shown on the same uniform scale. The improved rectifier gives the A.C. voltmeter a flat frequency response for audio frequency measurements up to 10,000 cycles. Change in battery voltage does not affect the accuracy of the ohms range.

Size: 11" x 13" x 7".

MODEL 133

NET \$45.00



NOTE: ALL PRICES ON THIS PAGE HAVE BEEN INCREASED APPROXIMATELY 10%



TEST EQUIPMENT

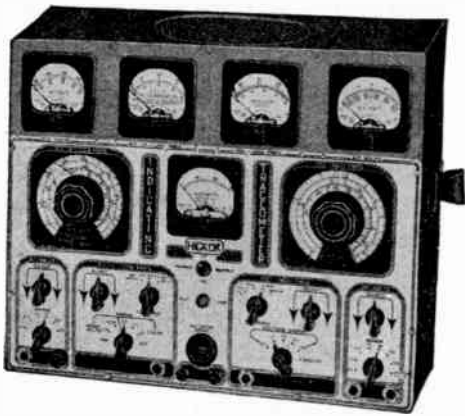

NOW with the Model 155 Indicating Traceometer and its five precision meters you can measure and trace the signal (without interfering with the performance of the set), in any five circuits at one time. Vacuum Tube Voltmeter circuits so arranged that accidental overload can not damage meters.

D.C. VOLTMETER SECTION
Voltage Ranges
0-2.5-5.0-25.0-50.0-250.0-500.0 volts.
Zero Center. Accuracy $\pm 1\frac{1}{2}\%$.
Input Impedance 18 megohms.

MODEL 155 TRACEOMETER

FOR RAPID SERVICING OF FREQUENCY MODULATED AND AMPLITUDE MODULATED RECEIVERS. SELF CONTAINED SPEAKER INTERNALLY CONNECTED FOR MONITORING EITHER R.F.-I.F. OR A.F. CHANNELS.

● Actually measure the signal in microvolts at any point in the entire R.F.-I.F. section.
● Measure the actual oscillator voltage throughout its entire range. ● Measure all of the D.C. voltages. A. V. C., A. F. C., Power Supply, etc. ● Measure any A.P. or A.C. voltage in any circuit. ● Measure the actual wattage consumption of any A.C. system to 300 watts. ● Trace the signal by means of self contained speaker through the entire R.F.-I.F. and Audio Channels.

RF-I.F. (LOW FREQUENCY) SECTION
Frequency Ranges
100-250 K.C., 250-650 K.C., 650-1800 K.C.
Accuracy $\pm 1\%$. Scale length — 23".

Voltage Ranges
0-5000-25,000-100,000 microvolts.
0-0.5-2.5-15.0-25.0 volts.
Basic sensitivity without cable — 0 — 25 microvolts for full scale deflection.
Input capacity — 0.85 micro microfarads.
Monitor Jack on front panel for connection to phones or oscillograph.

OSCILLATOR (HIGH FREQ.) SECTION
Frequency Ranges
600-1700 K.C., 1.7-5.0 M.C., 5.0-15.0 M.C.
Accuracy $\pm 1\%$. Scale length — 23".

Voltage Ranges
0-0.5-1.5-7.5-30.0-150.0 volts.
Basic sensitivity without cable—200 microvolts.
Input capacity—1.2 micro microfarads.
Monitor Jack on front panel for checking with phones or oscillograph for modulation hum.

AF VOLTMETER SECTION
Voltage Ranges
0-0.1-1.0-5.0-10.0-50.0-100.0-500.0.
Input Impedance 20 to 200,000 cycles, ± 1 D.B. Accuracy $\pm 2\%$.
Monitor Jack on front panel for oscillograph or phone use.

Wattage Range
0-300 watts. Accuracy $\pm 1\frac{1}{2}\%$.
Wattmeter connection on front panel.
Meter protection — Fuse.

FUSE PROTECTION
5 ampere fuse on front panel. fuses entire equipment including wattmeter.

VOLTAGE REGULATION
Complete Voltage Stabilization against Line Fluctuation. Self-contained voltage regulation of the vacuum tube voltmeter circuits operating the indicating meters. Pilot lamps on front panel, continuous indication when instrument is in operation. Two ground connections are provided on the front panel—one for the receiver under test and the other connection for the oscillograph or other equipment being used as a monitor. Complete operating instructions outlining in detail the use of the Traceometer.

ACCESSORIES
Complete with four universal (test probe or clip type) low capacity shielded cables and chassis connector lead. **\$123.00**
Size: 13" x 16" x 10". NET
Other than 110 volts, 60 cycles—\$3.00 Net Ex.

MODELS 177X & 188X UNIVERSAL CRYSTAL CONTROLLED SIGNAL GENERATORS

SPECIFICALLY DESIGNED FOR FREQUENCY AND AMPLITUDE MODULATION SERVICING

OUTPUT SELECTIONS

- Wide Band Frequency Modulated R.F. Output, 750 K.C. Sweep, 100 K.C. to 133 Megacycles. (Modulated internally at 60 cycles for visual alignment of wide band frequency modulated and television) R.F. and I.F. stages.
- Frequency Modulated R.F. Output (Frequency modulated standard sweep—150 K.C.) 1000 K.C. to 133 Megacycles. Modulated internally at 400 cycles or can be modulated from external source from 10 to 15,000 cycles.
- Frequency Modulated R.F. Output (30 K.C. sweep standard for visual alignment of amplitude modulated receivers) from 100 K.C. to 110 megacycles.
- Amplitude Modulated R.F. Output 400 cycles 100 K.C. to 110 megacycles (or can be externally modulated from 50 cycles to 15,000 cycles).
- Unmodulated R.F. Output 100 K.C. to 110 megacycles.

Four Crystal Controlled Outputs.

- 100 K.C. Modulated (400 Cycle)—100 K.C. to 15,000 K.C.
- 100 K.C. Unmodulated—100 K.C. to 15,000 K.C.
- 1000 K.C. Modulated (400 cycle) 1000 K.C. to 100 Megacycles.
- 1000 K.C. Unmodulated—1000 K.C. to 100 Megacycles.
- 100 to 10,000 Cycle Variable Audio Frequency Output.
- 400 Cycle Fixed Audio Output.
- All Ranges Controlled by Output Attenuator.
- Synchronized Sweep Voltage for Oscillograph use.

METER

Self-contained Power Level Meter. Three Ranges. —10 to +6, +6 to +22, +22 to +38 db. Model 188 and 188X only.

R.F. RANGES 100 K.C. TO 110 M.C.
Seven Fundamental (Continuously Variable R.F. Ranges with accuracy better than $\frac{1}{2}\%$.
100 K.C. to 300 K.C., 300 K.C. to 850 K.C., 850 K.C. to 2.6 M.C., 2.6 M.C. to 8.0 M.C., 8.0 M.C. to 24.0 M.C., 24.0 M.C. to 60 M.C., 60 M.C. to 110 M.C.

AUDIO FREQUENCY

Two Negative Resistance Audio Frequency Oscillators. 400 cycles, fixed and 100 to 10,000 cycle variable. Accuracy approximately 5%. Output voltage continuously variable from 0 to 1.0 Volt.
All coils but 60 to 110 M.C. are High "Q" iron core type permeability and capacity tuned.

VOLTAGE REGULATION

If so desired can be instantly added by inserting V.R. 150-30 Tube in socket provided.

TUBES:

- 1-6J5 Variable R.F. Oscillator.
- 1-6J5 Crystal Oscillator.
- 1-6K8 Frequency Modulated Oscillator and Mixer.
- 1-6AG7 Quadrature Control Tube.
- 1-6XJ7 Negative Resistance Oscillator. 400 cycles and 0-10 K.C.
- 1-6X5G Full Wave Rectifier.
- 1-VR150-30 Voltage Regulator Tube (not supplied).

POWER: The Oscillator includes a complete built-in power supply (consisting of a transformer, rectifier and filter. It may be operated from any 110 volt A.C. line, 40 to 65 cycles, other voltage and frequencies available at slight additional cost.

CABLES: Each oscillator comes completely equipped and supplied with all necessary connecting cables. Complete and 27-page manual furnished with each signal generator.



Size: 13" x 13" x 7"

Models 177 and 188 are identical electrically to Models 177X and 188X and are wired for crystal control but the crystal or 6J5 crystal tube is not included in shipment. Crystal and tube can be installed at any later date without returning the signal generator to the factory.

- Model 177X **NET \$57.60**
- Model 188X **NET \$67.20**
- Model 177, less crystal..... **NET \$48.60**
- Model 188, less crystal..... **NET \$58.20**

MODEL 145 A. C. - D. C. APPLIANCE TESTING VOLT - WATTMETER

Checks line voltage while measuring power consumption in watts of refrigeration, washing machines, motors, flat irons, etc. Voltage drop through house wires checked by noting drop in voltmeter reading when appliance is plugged in. Checks starting coils in fractional horse-power single phase motors. Amperes calculated from Volt and Watt indications.



WATTS: 0-750-1500. Note uniform scale. Exclusive Hickok feature. Wattmeter current coil designed for 7.5 amperes maximum. Electrodynamometer movement in wattmeter.
VOLTS: 0-300. Red Line at 110 and 220 Volts. Meter has magnetic vane movement giving easy to read practically uniform scale.

A.C. ACCURACY $1\frac{1}{2}\%$ from 25 to 133 c.p.s. On D.C. the voltmeter is accurate within $2\frac{1}{2}\%$. Wattmeter accurate within $1\frac{1}{2}\%$.

SCALE LENGTH OF METER 2-1/32". Legible dials. Case size 7" x 4 1/4" x 3 1/2". Meter 3" x 3 1/4". Two sets of leads supplied, five feet long male and five foot female appliance connecting cables. One pair three foot leads with test prods to connect to voltmeter jacks for point to point circuit continuity testing. Circuit provides pair of jacks connecting directly to voltmeter. Press to read switch to protect wattmeter current coil from high starting currents. Fuse protects all volt circuits. Toggle switch connects voltmeter direct to separate test jacks. Steel case eliminates possibility of error caused by using tester too near heavy current carrying mains. Engraved black bakelite panel. Tester is constructed for roughest usage. Hickok quality throughout. Meters may be continuously connected to circuit under test. Case designed so that appliance connecting cables may be placed inside and out of the way.

- Model 145 **NET \$22.50**
- Carrying Case with lead and parts compartment **NET \$4.20**
- With Watts range 1500-3000, Model 145A **NET \$27.60**
- Wattmeter current coil in this model designed for 15 amperes maximum.

NOTE: ALL PRICES ON THIS PAGE HAVE BEEN INCREASED APPROXIMATELY 10%



TEST EQUIPMENT

MODEL RFO-5 OSCILLOGRAPH

THE ONE OSCILLOGRAPH SPECIFICALLY DESIGNED FOR FREQUENCY MODULATED — AMPLITUDE MODULATED AND TELEVISION SERVICING. FOR COMPLETE VISUAL ANALYSIS —
Self-Contained Wide Band F.M. Oscillator, Narrow Band F.M. Oscillator, Demodulator, Video Amplifiers, Signal Tracer, Visual A.C. Vacuum Tube Voltmeter 0.2 to 1000 Volts.

USE — This Oscillograph in both R.F. and I.F. stages.

TROUBLE SHOOTING — Single or consecutive stage by stage trouble shooting from antenna post to speaker in frequency modulated, amplitude modulated and television receivers.

SELF CONTAINED: WIDE BAND — (100 to 900 K.C. Sweep) Frequency Modulated Oscillator (basic frequency 23-M.C.) for frequency modulated and television servicing.

NARROW BAND — (10-30 K.C. Sweep) Frequency Modulated Oscillator (basic frequency 1000 K.C.) for visual alignment on amplitude modulated receivers, demodulators, etc.

WIDE BAND FREQUENCY MODULATED OSCILLATOR — Can be modulated from external audio frequency source such as phonograph pickup, microphone or audio frequency oscillator to provide a frequency modulated transmitter for your own laboratory checks. No external oscillator needed since first harmonic of 23 megacycles is 46 megacycles in the center of the 43-50 megacycle frequency modulated band.

SELF CONTAINED MIXER CIRCUIT provided so that when used in connection with any good external oscillator wide band or narrow band frequency modulated outputs may be produced within the frequency limits of the external oscillator.

VISUAL ALIGNMENT of any R.F.-I.F. stage in any frequency modulated or amplitude modulated receiver.

ONLY IN THE MODEL RFO-5 WILL YOU FIND ALL THESE IMPORTANT FEATURES

1. Self-contained wide band frequency modulated signal generator.
2. Self-contained narrow band frequency modulated signal generator.
3. Return trace eliminator (simplifies alignment of A.F.

- and R. F. Circuits).
4. Horizontal amplifier for sweep expansion.
5. High sensitivity amplifiers (0.2 volts per inch).
6. Trapezoidal patterns for percent modulation measurements.
7. Calibrated screen.
8. Cathode ray tube rotation adjustable by means of flexible mounting.
9. Easy operation due to simplicity of control locations.
10. Video Amplifiers.
11. Signal tracer.
12. Variable width frequency modulated sweep.
13. Fuse protection.
14. Pilot light.
15. Phasing control.

UNIVERSAL DESIGN—Every facility for research and laboratory measurements. Model RFO-5 is made up of seven different units: Horizontal panel, Tube Panel, Vertical Panel, Demodulator, Synchronization and Return Eliminator Panel, Sweep Circuit Oscillator Panel and Radio Frequency Modulator Panel. Each section contains the control needed for all oscillographic measurements.

For complete visual analysis and trouble shooting, some method is necessary for viewing the high frequency signal before it reaches the second detector and is demodulated to an audio frequency. Only in the Model RFO-5 is the usefulness of the oscillograph extended to make these measurements and tests. This is made possible by the incorporation of a video (wide band) amplifier which permits frequencies up to 3.5 megacycles to be amplified and amplifier. The R.F. signal can be picked off any place from the antenna to the second detector, demodulated and viewed directly on the screen.

SIGNAL TRACER — It is often desirable to be able to follow the signal from the antenna post on to the speaker by means of a pair of ear phones or auxiliary loud speaker. The signal tracer in the Model RFO-5 enables this to be done by merely connecting the phones position. The signal can then be heard as well as seen simultaneously as it is traced through the receiver. Size 11" x 13" x 15 1/4". **NET \$97.20**



MODEL 19X CRYSTAL CONTROLLED MICROVOLTER

CALIBRATED OUTPUT IN MICROVOLTS FROM 100 KC TO 30 MEGACYCLES

Self-contained vacuum tube voltmeter, power level meter and crystal give more measurements than any other signal generator. Over 250 Crystal Controlled, modulated or unmodulated outputs; from 100 KC to 15,000 KC every 100 KC and from 1000 KC to 100 megacycles every 1000 KC. Accuracy better than .01%. Gain per Stage—Selectivity—Sensitivity: All standardized by self-contained vacuum tube voltmeter. Calibrated Output Ranges: R.F.—1/2 microvolt to 100,000 on all ranges; A.F.—0 to 1.0 volt. Decibels, Triple Ranges: —10 to +6, +6 to +22, +22 to +38 db. 100 inches of direct reading frequency scales. Accuracy better than 1/2%. Radio Frequency Ranges Calibrated Directly 100 KC to 60 Megacycles.

Crystal Control: Model 19 includes a built-in crystal oscillator providing a modulated or unmodulated output accurate to better than 100 parts in one million. Selection of either 100 KC or 1000 KC by merely turning Band Selector switch to desired frequency. Crystal can be used for checking or calibrating the main variable oscillator throughout its entire range. Modulator: The 400 cycle modulator supplies the 400 cycle modulating voltage for the radio frequency section and modulates this to approximately 35% throughout the entire range of the radio frequency oscillator. The output from this modulator may also be switched to the attenuator network so that a 400 cycle calibrated audio output of 1.0 volt is available. Attenuator: The input to the attenuator serves the dual purpose of attenuating either the radio frequency or audio frequency output to a predetermined level across the attenuator output. This gives direct calibration of the radio frequency section from 1/2 microvolt to 100,000 microvolts on all ranges and from 0-1.0 volts of audio frequency. The built-in vacuum tube voltmeter is used to standard the voltage across the attenuator network so that the calibration of this unit holds true. Decibel Meter and Vacuum Tube Voltmeter: The built-in decibel meter is so arranged that it can be either connected into the vacuum tube voltmeter circuit or switched to an external circuit which provides three ranges of decibels. The switching of this meter from the vacuum tube voltmeter circuit to the external circuit does not in any way upset the calibration of frequency of the signal generator and thereby provides a means of setting exact input in microvolts to a receiver. Radio Frequency Coils: All radio frequency coils are wound on ceramic forms and impregnated with special lacquer, making them moisture proof and not subject to inductance change with humidity or temperature. Each coil is individually calibrated for inductance and air-trimmed for capacity, thereby giving an accuracy better than 1/2% on all radio frequency ranges. Shielding: Each high frequency unit in the signal generator is completely shielded, giving triple shielding on the radio frequency output. Triple filtering is also used in the power supply input. Accessories: Supplied complete with self-contained dummy antenna, necessary cables, and concise, practical operating instructions. Size 13" x 6" x 7". **NET \$87.00**



Size: 11" x 13" x 7"

MODEL 110 UNIVERSAL VACUUM TUBE VOLTMETER

DUAL PURPOSE — UNIVERSAL DESIGN

Seven D.C. Ranges: 1.5-3.0-15-75-150-750-7500 Volts.

High Frequency A.C. Voltmeter Four Ranges: 1.5-3-50-150 Volts.

High Frequency Voltmeter: The high frequency A.C. voltmeter utilizes a type 955 acorn low capacity tube at the end of the test probe so that the loading of the circuit under test is held to the low value of approximately 5 micro-micro-farad capacity.

Frequency Error: With the test probe in place, the resonance frequency of the input circuit is approximately 150 megacycles and negligible frequency error may be expected up to this value. If it is necessary to measure frequencies above this the test probe may be removed increasing the resonance frequency to over 200 megacycles.

Zero Adjust: A single zero adjustment is necessary for all of the high frequency and D.C. ranges and once this has been set it is possible to change to any range without resetting to zero.

Overload: Another desirable feature of the A.C. and D.C. ranges is that excessive overload cannot in any way damage the meter or equipment. In fact two or three hundred volts can be accidentally applied to the 1 1/2 volt A.C. range with little possibility of a damage to the equipment. When measuring A.C. voltages it is not necessary to provide a D.C. return path between the input circuit and ground since the input circuit is taken through a capacity to the diode rectifier and then on to a D.C. amplifier.

D.C. Voltmeter: Seven ranges of D.C. are provided with zero center so that the chassis or ground of the voltmeter may be connected direct to the chassis of the receiver or television set under test, and if the voltage under test is positive with respect to ground the meter will read up scale and if negative with respect to ground the meter will read down scale. The input impedance of the D.C. section is 24 megohms up to 150 volts and 700 megohms up to 7500 volts.

Power Supply: 100 to 130 volts A.C. 40 to 60 cycles. Other voltages and frequencies available at slight extra cost. Power consumption 20 watts.

Tube Complement: 6X5 Rectifier, 955 vacuum tube voltmeter tube, and 6K5G vacuum tube voltmeter amplifier. **NET \$54.00**

NOTE: ALL PRICES ON THIS PAGE HAVE BEEN INCREASED APPROXIMATELY 10%



TEST EQUIPMENT



210S—Size: 13" x 16" x 7"

Ranges:

- D.C. Volts—0-2.5-10-50-250-500 infinite ohms per volt.
- D.C. Volts—0-2.5-10-50-250-500-2500 at 1000 ohms per volt.
- A.C. Volts—0-2.5-10-50-250-500-2500 at 1000 ohms per volt.
- D.C. Microamperes—0-500.
- D.C. Milliamperes—0-2.5-10-50-250-500.
- D.C. Amperes—0-2.5-25.
- A.C. Amperes—0-5.

- Capacity—Three ranges covering from .0001 mfd. to 200 mfd.
- Resistance—Four ranges covering from .05 ohms to 50 megohms.
- Decibels—Three ranges from -20 to +43.

Model 4800S Portable Zero Current Voltmeter Tester

With built-in Multi Selector Unit, and socket analysis cable.

The portable Model 4800S includes many of the features listed for the Model 210X above, but is not intended to be mounted in the Paneline. It may be mounted in the Model 60 Show-Lab, BUILT-IN MULTI SELECTOR UNIT.

Cables and Accessories for All Tubes—New improved long life jacks for series or parallel connections. Connections may be made to any or all tube elements. Gives quick and convenient method for complete socket analysis without disturbing any of the connections in the set under test.

Ranges:

- D.C. Volts—0-10-50-250 at infinite ohms per volt (Zero Current Voltmeter).
- D.C. Volts—0-2.5-10-50-250-500-2500 at 1000 ohms per volt.
- A.C. Volts—0-2.5-10-50-250-500-2500 at 1000 ohms per volt.
- D.C. Microamperes—0-500.
- D.C. Milliamperes—0-1-5-50-500.
- Decibels—Three ranges from -20 to +43.

MODELS 210S & 4800S ZERO CURRENT VOLTMETER TESTERS

INFINITE OHMS PER VOLT

The giant Model 210S with its 9 1/4" meter is the most recent addition to the complete coverage testers featuring the famous Hickok Zero Current Voltmeter circuit. You can now get zero current testers in compact portable type with suitable carrying case or a larger display panel type for mounting in your Paneline. Special ranges have been included for television service and additional low ranges give more accurate measurements of the smaller values.

The Zero Current Voltmeter Offers Many Advantages—Infinite ohms per volt. It is no longer necessary to worry along with 5000, 20,000 or 25,000 ohms per volt when you can have infinite ohms per volt with absolutely no current drain from the circuit under test.

AVC, AFC and other high resistance circuit voltages are accurately measured without disturbing the operation of the set. Connection can be made directly to the grid cap of any RF or IF tube to measure the operating bias voltage directly.

Model 210S Jumbo Radio and Television Zero Current Tester—DISPLAY PANEL TYPE

Meter—Large open face Hickok built meter 9 3/4" wide x 8 3/4" high with a scale length of 8 3/4". Illuminated Scale—4 colors.

General—Case 13" high x 16" wide x 7" deep. Finish in blue wrinkle with etched aluminum panel.

Special Features:

The 5 ampere A.C. range is wired directly through to a convenience outlet on the front of the panel where any receiver or other appliance may be plugged in and the power consumed by it measured directly on the 5 ampere A.C. scale of the meter. The circuit is so constructed that this receptacle is completely isolated from all other meter circuits so the test prods are used for any other ranges without danger of coming in contact with this 110 volt circuit.

All ranges and functions have been grouped around rotary switches for the greatest convenience of operation. All voltage and current ranges are selected by the one five position rotary switch to the left of the meter and all other ranges, with the exception of some that are included for special purposes, are grouped around the selector switch to the right of the meter.

All balancing rheostats and potentiometers are controlled by the one knob below the meter.

Resistance—Five ranges covering from .1 ohm to 10 megohms.

Capacity—Five ranges covering from .0001 mfd. to 200 mfd.

Decibels, Impedance, Inductance and A.C. ripple (hum) measurements.

Special External Shunts—The Model 4800-S is calibrated in millivolts so external shunts can be used for higher D.C. current ranges. A specially designed two range shunt, 5-50 amperes (250MV), is available at slight extra cost. Other shunts on special order.

Special Guaranteed Rectifier

The rectifiers used in the A.C. voltmeter circuits of the Model 4800-S and Model 210X are of special heavy duty construction and are guaranteed to maintain their calibration against normal use and accidental overload. Any rectifier in the above instrument found to be defective will be replaced free of charge in our factory or at any of our authorized repair stations within a period of one year.

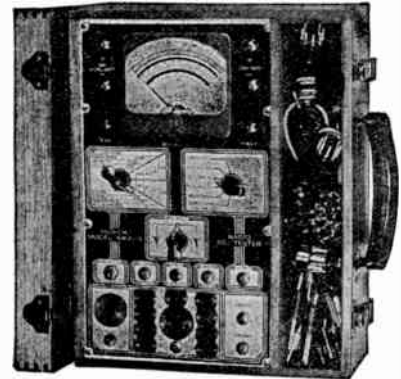

4800S—Size: 10" x 12 3/4" x 5"

MODEL 210S

MODEL 4800-S

NET \$63.00
NET \$67.20

VOLT OHM MILLIAMMETERS

RUGGED, HIGH TORQUE METERS — GUARANTEED RECTIFIER CIRCUITS HIGH ACCURACY

The models 4922S and 4955S, Volt-Ohm Milliammeters have been standard equipment for service bench and portable use with leading service men for years. Both have the following ranges:

- A.C. -D.C. Volts—0-10-50-250-500-2500, 1000 ohms per volt.
- Output—0-10-50-250-500-2500. Blocking condenser in circuit.
- D.C. Microamperes—0-500.
- D.C. Milliamperes—0-1-5-50-500.
- A.C. Milliamperes—0-1.
- Ohms—0-30-10,000-1 meg.-10 meg.

GUARANTEED ACCURACY — The accuracy of each tester is stated as percentage of full scale deflection within the temperature range of 50 degrees to 90 degrees Fahrenheit. The instruments incorporate a new type rectifier and circuit which will withstand more overload than other types. The rectifier is guaranteed against accidental overload for one year.

The instrument used in these Volt-Ohm-Milliammeters are especially built by Hickok for this service. The movement is large and rugged, and a very high torque-weight ratio gives lively, instantaneous pointer action. Large open face dial. The movement is curve corrected by an exclusive Hickok process which gives a higher accuracy at all points on the scale. Permanently correct calibration. These complete self-contained units are suited for industrial applications owing to rugged construction. All parts are of the highest standard of quality and all resistors are moisture proof and accurately adjusted. These are the finest Volt-Ohm-Milliammeters obtainable today. Regular leads supplied are 4' long with special insulated pin prods of proper diameter for insertion in the latest type tube socket.



Model 4955S Regular 4 inch meter—Four-color Scale. Accuracy within 2%. Size: 7" x 4 1/2" x 3 1/2"

Model 4955S

Model 4955S, with Carrying Case

Model 1001-4, Shunt for increasing range to 5 and 50 amperes.....\$5.70

NET \$27.60
NET \$29.40

Model 4922S

Model 1001-4, Shunt for increasing range of either model to 5 and 50 amperes

NET \$38.40



Model 4922S Jumbo 9 inch meter—Decibel Scale. Size: 10" x 13" x 7 1/2"



Cathode-Ray TUBES ★ OSCILLOGRAPHS ★ EQUIPMENT



DU MONT TYPE 164E 3" CATHODE-RAY OSCILLOGRAPH

Because of its compactness, limited weight and modest price, the Type 164E Cathode-Ray Oscilloscope is a favorite with radio servicemen and with engineers who require a small portable field instrument. The limited power consumption of this instrument is also a valuable factor in field work.

A three-inch cathode-ray tube is employed operating at an accelerating potential of 1100 volts, to provide good brilliance with a fine, sharp trace. The single-stage vertical amplifier has a voltage-gain of 43, over the frequency range from 5 to 100,000 sinusoidal cycles per second. The horizontal amplifier may be switched to amplify either the sweep circuit or any externally-provided signal, so that Lissajous patterns for frequency determinations may be employed.

Deflection-plate terminals are available at the rear of the instrument without removing the case. Either a Type 3AP1 cathode-ray tube with medium-persistence green screen or a Type 3AP5 cathode-ray tube with short persistence blue screen for photographic applications may be employed. A removable calibrated scale, which is supplied with the instrument, fits over the screen of the cathode-ray tubes.

SPECIFICATIONS

Standard 3-in. Type 3AP1 supplied. Standard tube has green, medium-persistence screen. Short-persistence blue screen for moving-film recording supplied on order at slight additional cost. Removable calibrated scale fits over tube screen.

Input-Impedance: Vertical: 1,000,000 ohms. Horizontal: 500,000 ohms. Maximum potential 400 d.c. volts.

Frequency-Range: Vertical and Horizontal amp. both uniform within 7.5% from 5 to 100,000 cycles.

Deflection Sensitivity: Maximum vertical: 0.70 r.m.s. volt/in. Maximum horizontal: 0.55 r.m.s. volt/in. Deflection sensitivity of cathode-ray tube is 30 r.m.s. volt/in.

Sweep Circuit: Amplified sweep circuit over continuous range from 15 to 30,000 cycles. Return-trace elimination included. Synchronization from either vertical deflection or external signal.

Power Supply: 115/230 volts, 40-60 cycles a.c. Power consumption 50 watts.

Tubes: All tubes, including the cathode-ray tube are supplied with the instrument.

Physical Specifications: Black wrinkle-finish steel cabinet. Convenient carrying handle. Black characters on etched bright metal background. Height, 11 1/2 in.; width, 7 3/4 in.; depth, 14 in. Shipping weight 25 lbs.

Cat. No.	Type No.	Description	Net Price
1064A	164E	115v. 40-60 cycles with 3AP1 Teletron	\$64.50
1065A	164E	230v. 40-60 cycles with 3AP1 Teletron	64.50
1066A	164E	115v. 40-60 cycles with 3AP5 Teletron	67.25
1067A	164E	230v. 40-60 cycles with 3AP5 Teletron	67.25



DU MONT TYPE 224A — 3" EXPANDED-RANGE OSCILLOGRAPH

The greatly expanded frequency range of this instrument permits study of signals of frequencies far beyond the range of usual standard oscillographs. It has a comparably faithful square and sinusoidal wave response. Also, it is a more versatile instrument because it provides for extreme variety in the application of the signal to the cathode-ray tube through front panel jacks or binding posts. Also, terminal on panel couples into grid of cathode-ray tube for intensity modulation. Y-amplifier has an input connection for the test probe and shielded cable supplied, reducing input capacitance and eliminating usual stray pickup.

This instrument is housed for severe service out in the field as well as in the laboratory or plant. Protective, removable front cover safeguards panel and controls when not in use or when in transit, and also holds the test probe and shielded cable.

SPECIFICATIONS

Standard 3-in. Type 3GP1/2537A3 supplied. Standard tube is green medium-persistence screen. Removable calibrated scale fits over tube screen.

Input-Impedance: Vertical and horizontal: To terminals, 2 meg., 25 uuf. To probe, 1 meg., 15 uuf. Direct (Balanced) 10 meg., 20 uuf. Direct (Unbalanced) 5 meg., 25 uuf.

Frequency Range: Y-axis sine wave response uniform from 20 c. to 2 mc. Comparably faithful square and sinusoidal wave response. X-axis uniform within 3 db. from 10 c. to 100 kc. Distortionless input attenuator and gain control.

Deflection Sensitivity: With amplifier, to Y-axis terminals, 0.1 volt r.m.s./in. deflection; to Y-axis with probe, 0.4 r.m.s./in. deflection; to X-axis terminals, 0.7 volt r.m.s./in. deflection. Direct to deflection plates, to Y-axis, 25 volts r.m.s./in. deflection; to X-axis, 28 volts r.m.s./in. deflection.

Linear Time-Base: Frequency range of 15 to 30,000 c.p.s. Direction of sweep, left to right. Synchronizing signal sources, internal or Y signal, 60 cycle, or external. Synchronizes with either polarity of synchronizing signal.

Power Supply: 115 volts, 40-60 cycles a.c. Power consumption 150 watts. Fuse protection 2 amps.

Tubes: All tubes, including cathode-ray tube, are supplied with the instrument.

Physical Specifications: Black wrinkle-finish steel cabinet. Convenient carrying handle. Black characters on etched bright metal panel. Removable front cover. Height, 14 1/2 in.; width, 8 3/4 in.; depth, 15 1/2 in. Shipping weight, 49 lbs.

Cat. No.	Type No.	Description	Net Price
1191	224A	115v. 40-60 cycles with 3GP1/2537A3 Teletron	\$250.00

DATA

Only the more popular oscillographs and cathode-ray tubes are presented in this highly-condensed cataloging. More detailed literature on the entire DuMont line, together with a free subscription to the "DuMont Oscillographer", may be had by addressing Allen B. DuMont Laboratories, Inc., 2 Main Ave., Passaic, New Jersey.

ALL PRICES SUBJECT TO CHANGE WITHOUT NOTICE



Cathode-Ray TUBES ★ OSCILLOGRAPHS ★ EQUIPMENT



DU MONT TYPE 208 5" CATHODE-RAY OSCILLOGRAPH



Popular five-inch instrument incorporating every possible desirable feature in a standard instrument along with many new improvements which have been incorporated for the first time in any cathode-ray equipment. High accelerating-potential on the new intensifier-type tube insures good brilliance. New, wide-frequency-range amplifiers with symmetric deflection and high sensitivity provide good focus over the entire screen area of the Teletron. The direct-current-coupled deflection amplifier provides for d.c. amplification with a sensitivity of approximately 0.5 d.c. volt per inch deflection.

The cathode-loaded input stage of this instrument gives undistorted frequency-response over the entire frequency-range regardless of input attenuator setting.

Unusual mechanical design of this cathode-ray oscillograph has been incorporated which gives more efficient electrical operation and balances the weight distribution of the instrument so that it is very convenient to carry. Amplifier, sweep, and position-control circuits offer extended frequency-range and ease of operation, permitting the beam to follow immediately all changes in control adjustment. Regulated power supplies make the oscillograph practically independent of line-voltage surges in spite of its high gain.

SPECIFICATIONS

Cathode-Ray Tube: Type 5LP1 intensifier type, high-vacuum, with four free deflection plates. Standard tube, Type 5LP1, has green medium-persistence screen. Type 5LP5 with blue, short-persistence screen supplied at slight additional cost. Beam switch provided on front panel. Removable calibrated scale supplied.

Input-Impedance: X-axis, 5 megohms. 25 uuf Y-axis, 2 megohms, constant 30 uuf input loading. Continuously-variable attenuator free from both frequency and amplitude distortion attenuates signal with no pattern-shift.

Frequency Range: Y-axis, plus or minus 10% from 2 to 100,000 sinusoidal cycles; X-axis, plus or minus 15% from 2 to 100,000 sinusoidal cycles.

Voltage Gain: Y-axis—2000; X-axis—43 times.

Deflection Sensitivity: Max. Y-axis 0.010 r.m.s. volt/in. Max. X-axis 0.500 r.m.s. volt/in. Direct to deflection plates—21 and 22 r.m.s. volts/in. Y-axis and X-axis respectively.

Horizontal Switching: Frequency-range control for horizontal sweep-circuit is arranged so that its OFF position connects X-axis amplifier input to input terminal provided on front panel.

Sweep Circuit: Recurrent sweep available over continuously-variable range from 2 to 50,000 cycles. Direction of sweep is from left to right.

Power Supply: High-voltage power unit supplies 1120 v. d.c. in series with amplifier power unit to furnish total accelerating potential of 1400 volts. Deflection-plate potentials vary in balanced pairs about ground. Voltage regulation is provided for low-level amplifiers and positioning circuits. Instrument operates directly from 115/230 v. 40-60 cycle a.c. Consumption 90 watts.

Tubes: All tubes including the cathode-ray tube are supplied with the instrument. A total of 15 tubes is employed.

Physical Specifications: Black, wrinkle-finished steel cabinet. Convenient carrying handle. Plated steel front panel with chrome-on-black lettering. Height, 14 1/4 in.; width 8 3/4 in.; depth 19 1/2 in. Shipping weight 67 lbs.

Cat. No.	Type No.	Description	Net Price
1146	208	115 v. 40-60 cycles with 5LP1 Teletron	\$167.75
1147	208	230 v. 40-60 cycles with 5LP1 Teletron	167.75
1148	208	115 v. 40-60 cycles with 5LP5 Teletron	170.50
1149	208	230 v. 40-60 cycles with 5LP5 Teletron	170.50

DU MONT TYPE 185A ELECTRONIC SWITCH



The Type 185 Electronic Switch is an extremely valuable supplementary instrument for use with Du Mont or other make of cathode-ray oscillograph.

The instrument has been designed for simultaneous studies of such signals as input and output signals of amplifiers, of both phases of push-pull amplifiers, and for simultaneous voltage- and current-studies of a.c. circuits. Two units may be operated in cascade to provide three channels for investigations of three- and other polyphase a.c. circuits.

The Type 185 Electronic Switch consists of two amplifiers, operating in parallel, which are alternately biased to cut off by a multivibrator type square-wave generator whose frequency may be varied over a wide range to suit operating conditions. The outputs of the two amplifiers are fed to a mixing stage. In application one unknown signal is connected to the input of each amplifier and their mixed and switched output is fed from the mixing stage to the input of a standard cathode-ray oscillograph to give the appearance of observing both signals at once. The balance control of the Electronic Switch makes it possible to superimpose both signals for direct comparison or to separate them on the screen of the cathode-ray tube for individual study.

SPECIFICATIONS

Frequency Range: Continuously variable, 10 to 2000 times per second. Essentially uniform response of amplifier from D.C. to 5,000 sinusoidal cycles per second. No phase distortion experienced from low-frequency limit to 25,000 sinusoidal cycles per second.

Voltage Gain: 10 times for identical amplifiers on each axis.

Power Supply: Instrument entirely A.C. operated from 115/230 v. 40-60 cycle supply. Power consumption, 30 watts. Fuse protection, 1 amp.

Tubes and Functions: All tubes supplied with instrument, as follows: 2—Type 6V6 Blocking Tubes; 2—Type 6SJ7 Switching Amplifiers; 2—Type 6J5 Oscillators; 1—Type 80 Rectifier.

Physical Specifications: Black wrinkle-finish steel cabinet. Convenient carrying handle. Plated panel with black-filled etched lettering. Dimensions: Height, 11 1/2 in.; width, 7 3/4 in.; depth 13 in. Net weight 17 lbs.

Cat. No.	Type No.	Description	Net Price
1072A	185A	115 v. 40-60 cycles	\$71.50
1073A	185A	230 v. 40-60 cycles	71.50

Du Mont Cathode-ray Tubes

Type	Screen Dia.	Max. Over-all Length	Color	Persistence	Use	Net Price
3AP1	3"	11 1/2"	Green	Medium	Osc.	\$14.85
3AP5	3"	11 1/2"	Blue	Short	Osc.	16.50
5MP1	5"	16"	Green	Medium	Osc.	38.50
5MP5	5"	16"	Blue	Short	Osc.	41.25
5LP1	5"	17"	Green	Medium	Osc.	33.00
5LP2	5"	17"	Green	Long	Osc.	38.50
5LP5	5"	17"	Blue	Short	Osc.	35.75
5BP1	5"	17"	Green	Medium	Osc.	24.75
5BP4	5"	17"	White	Medium	Osc.	24.75
5BP5	5"	17"	Blue	Short	Osc.	27.50

STERLING PANEL METERS

AMMETERS, VOLTMETERS, MILLIAMMETERS

FOR USE ON DIRECT AND ALTERNATING CURRENT

A COMPLETE MODERN LINE

These improved STERLING Panel Meters while retaining the accuracy, beauty and ruggedness which have always characterized STERLING instruments, show a modern trend in the gracefully unique arrangement of the broader and more clearly defined scales. The meters for alternating current and direct current are perfectly matched and therefore suitable for mounting on the same panel. Both the A.C. and D.C. meters are of the permanent magnet, iron vane type. This affords positiveness of action and breadth of movement suggestive of those of the D'Arsonval type. The large needle-tipped pointers and wide clearly marked scale divisions of these panel meters make them easily read.

STERLING Panel Meters may be had in any of the types illustrated and also in the Type 90 Projecting Case, 2" in diameter, base 2 1/4" in diameter. Long terminal screws mount through panel. The ZERO ADJUSTER can be supplied for any of the instruments listed, A.C. or D.C. but it can be applied only to those put up in the type 68, 78 or 88 case.

SPECIAL COMBINATION A.C.-D.C. METERS WITH HAIR-SPRING REPULSION TYPE MOVEMENT FITTING SAME CASES, ARE ALSO AVAILABLE.

Standard pkg., 100 meters, Ship. wt. 30 lbs.

ALL STERLING Panel Meters are guaranteed accurate within 5%.



TYPE 68

Flush case, square flange, standard finish black enamel. Screw holes in flange for mounting. Width flange 2 1/2". Dia. case 2 1/4". Depth case 3/4".



TYPE 80

Flush case, narrow flange, standard finish black enamel or nickel. Circular adjustable back clamp for mounting. Diameter flange 2 1/4". Diam. case 2". Depth case 1 1/4". Requires hole 2 1/8" in Diameter Length terminals 1/4"

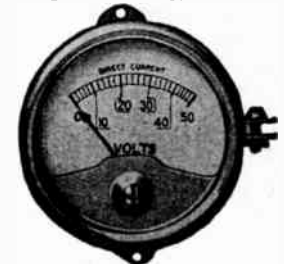

TYPE 88

Flush case, narrow apron flange, for ZERO ADJUSTER equipment. Standard finish black enamel or nickel. Circular adjustable back clamp for mounting. Same dimensions as Type 80.

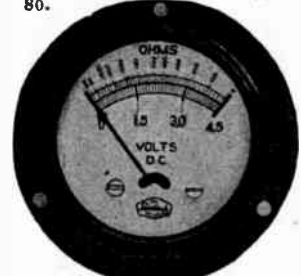

TYPE 70

Flush case, wide flange, standard finish black enamel or nickel. Screw holes in flange for mounting. Diameter flange 2 5/8". Diam. case 2". Depth case 7/8". Requires hole 2 1/2" in Diameter

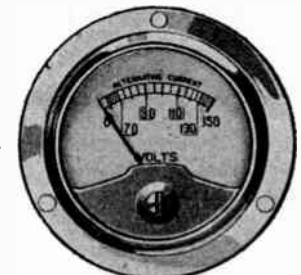

TYPE 78

Flush case, wide flange with apron designed to carry ZERO ADJUSTER equipment. Standard finish black or nickel, screw holes in flange for mounting. Same dimensions as Type 70.

Alternating Current Meters

A. C. VOLTMETERS		
Number	Range	List Price
870	0-4 Volts	\$2.75
871	0-6 Volts	2.75
872	0-10 Volts	2.75
873	0-15 Volts	2.75
874	0-150 Volts High Res.	4.75
875	0-300 Volts	5.75
876	0-600 Volts	6.60
877	0-750 Volts	8.50
878	0-10-140 Volts	4.75
879	0-50 Volts	3.30

A. C. MILLIAMMETERS		
Number	Range	List Price
880	0-25 Milliampers	\$2.75
881	0-50 Milliampers	2.75
882	0-100 Milliampers	2.75
883	0-250 Milliampers	2.75
884	0-500 Milliampers	2.75

A. C. AMMETERS		
Number	Range	List Price
886	0-1 Amperes	\$2.75
887	0-3 Amperes	2.75
888	0-5 Amperes	2.75
889	0-10 Amperes	2.75
890	0-20 Amperes	3.00
891	0-50 Amperes	3.30
892	0-30 Amperes	3.00
898	0-150 A. C. Voltmeter.	3.60

RESISTANCE METERS		
Direct Reading		
Number	Range	List Price
901	4.5 Volts, 10,000 Ohms.	\$3.00
3 Flashlight cells required.		
902	2 M. A., 9 Volts, 100,000 Ohms	4.40
6 Flashlight cells required.		
903	Resistor for 901 Meter.	2.00
904	Resistor for 901 Meter.	2.50

Direct Current Meters

D. C. VOLTMETERS		
Number	Range	List Price
801	0-1 Volts	\$1.25
802	0-3 Volts	1.25
803	3-0-3 Volts	1.25
804	0-5 Volts	1.25
805	0-6 Volts	1.25
806	0-8 Volts	1.25
807	0-10 Volts	1.25
808	0-15 Volts	1.25
809	0-25 Volts	1.25
810	0-25 Volts High Res.	3.00
811	0-50 Volts	1.25
812	0-50 Volts High Res.	3.60
823	0-75 Volts	1.50
813	0-100 Volts	1.65
814	0-100 Volts High Res.	3.60
815	0-150 Volts	2.00
816	0-150 Volts High Res.	3.50
817	0-300 Volts	3.50
818	0-500 Volts	5.00
819	0-750 Volts	6.00
820	0-8-160 Volts	2.50

D. C. MILLIAMMETERS		
Number	Range	List Price
835	0-2 Milliampers	\$4.00
836	0-5 Milliampers	2.50
837	0-10 Milliampers	2.20
838	0-15 Milliampers	1.25
839	0-25 Milliampers	1.25
840	0-50 Milliampers	1.25
841	0-100 Milliampers	1.25
842	0-150 Milliampers	1.25
843	0-200 Milliampers	1.25
844	0-300 Milliampers	1.25
845	0-400 Milliampers	1.25
846	0-20-100 Milliampers	2.20
847	0-15-150 Milliampers	2.20
848	0-500 Milliampers	1.25

D. C. AMMETERS		
Number	Range	List Price
855	0-1 Amperes	\$1.25
856	0-3 Amperes	1.25
857	0-5 Amperes	1.25
858	0-10 Amperes	1.25
859	1-0-1 Amperes	1.25
860	3-0-3 Amperes	1.25
861	6-0-6 Amperes	1.25
862	10-0-10 Amperes	1.25
863	20-0-20 Amperes	1.25
864	0-15 Amperes	1.50
865	0-30 Amperes	2.00
866	0-50 Amperes	2.20
867	30-0-30 Amperes	2.20
868	0-20 Amperes	1.65
869	0-40 Amperes	2.20

Type 68 square flange case furnished for any range of meter at an additional list price of 40 cents each. Both A. C. and D. C. meters supplied with ZERO ADJUSTER at an additional list price of 35 cents each.

STERLING POCKET METERS

STANDARD LINE

Direct Current Pocket Ammeters, Voltmeters and Voltammeters for all Purposes



No. 24A Ammeter

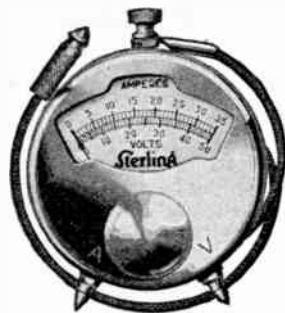

No. 45 Voltammeter

STERLING Pocket Meters are useful in all kinds of battery testing, in railroad signal work, and in telephone and low-voltage electrical work generally. They are polarity indicators.

- No. 24 Ammeter, for testing No. 6 dry cells. 0-35 ampere scale, 1 ampere divisions. List Price \$1.25
- No. 24A Ammeter for testing dry cells including the heavy-duty Ignition type of cell. 0-50 ampere scale, 1 ampere divisions. List Price, \$1.25
- No. 23 Ammeter, for photo-flash dry batteries. 0-20 amp. scale, 1/2 amp. div. List Price, \$2.00
- No. 33 Voltmeter for ordinary single cells and "Flashlight" cells, 0-3 v. scale, 1/10 v. div. List Price, \$1.50
- No. 34 Voltmeter for "Hot Shot" and Radio batteries. 0-10 volt scale, 1/5 volt div. List Price, \$1.50
- No. 34A Voltmeter for 12 volt batteries. 0-16 volt scale, 1/2 volt divisions. List Price, \$1.75
- No. 34B Voltmeter for ordinary 22½ v. radio "B" batteries. 0-30 v. scale, 1 v. divisions. List Price, \$1.75
- No. 34C Voltmeter for testing ordinary 45 v. radio "B" batteries. 0-50 v. scale, 1 v. div. List Price, \$2.00
- No. 44 Voltammeter for "Hot Shot" and Radio batteries and No. 6 dry cells, 0-35 ampere scale, 1 ampere divisions; 0-10 volt scale, 1/5 volt divisions. List Price, \$1.75
- No. 44A Voltammeter for 12 volt batteries and No. 6 dry cells. 0-35 ampere scale, 1 ampere divisions; 0-16 volt scale, 1/2 volt divisions. List Price, \$2.00
- No. 45 Voltammeter for testing No. 6 dry cells and ordinary 45 volt radio "B" batteries. 0-35 ampere scale, 1 ampere divisions; 0-50 volt scale, 1 volt divisions. List Price, \$3.00
- No. 45A Voltammeter for testing dry cells including the heavy-duty Ignition type and ordinary 45 v. radio "B" batteries. 0-50 amp. scale, 1 amp. div.; 0-50 v. scale, 1 v. div. List Price, \$3.25

Meters 2¼" in diameter and ⅝" thick. Nickel finish. Standard package, ten instruments, ship. wt. 4 lbs.

STERLING SPECIAL-PURPOSE POCKET METERS—NEW SERIES

Testers for Portable Radio Batteries

The special "A" and "B" dry batteries built for the operation of Portable Radio sets cannot be satisfactorily tested with ordinary battery testers. The new STERLING double voltmeters are designed for testing with correct loads the special "A" and "B" dry batteries used on Portable Radio sets. The new STERLING flexible plugs of these meters fit easily into the small closely spaced socket holes.

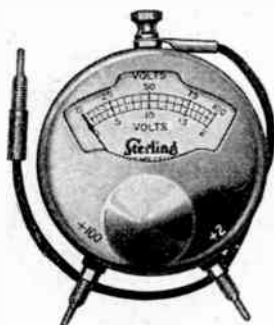

No. 38A Voltmeter



No. 42A General Tester

- No. 37A Voltmeter for 45 v. "B" batteries and 1.5 v. "A" batteries. Scale 0-50 v., 1 v. div. Scale 0-2 v., 1/10 v. div. Tests 45 v. "B" and 1½ v. "A" batteries. List Price \$2.50
- No. 38A Voltmeter for 90 v. "B" batteries and 1.5 v. "A" batteries. Scale 0-100 v., 5 v. div. Scale 0-2 v., 1/10 v. div. Tests 45 v. and 90 v. "B" batteries and 1½ v. "A" batteries. List Price \$2.75
- No. 39A Voltmeter for 90 v. and 135 v. "B" batteries and 1.5 v. "A" batteries. Scale 0-150 v., 5 v. div. Scale 0-2 v., 1/10 v. div. Tests 90 v. and 135 v. "B" batteries and 1½ v. "A" batteries. List Price \$2.75
- No. 40A Voltmeter for 90 v. and 135 v. "B" batteries and 4.5 v., 6 v. and 7.5 v. "A" batteries. Scale 0-150 v., 5 v. div. Scale 0-10 v., 1/5 v. div. Tests 90 v. and 135 v. "B" batteries and 4½ v., 6 v. and 7½ v. "A" batteries. List Price, \$3.00
- No. 42A Graphic General Tester. Red and Green color chart for all standard batteries including 45 v. and 90 v. "B" batteries and 1.5 v., 4.5 v., 6 v. and 7.5 v. "A" batteries. 0-100 v. scale for special sizes of "B" batteries, 5 v. div. Tests all Portable Radio batteries. List Price, \$6.00

Testers for Hearing Aid Batteries

- No. 31 Double voltmeter for special 30 or 45 v. "B" batteries and 1½ v. "A" batteries, scale 0-50 v., 1 v. div., scale 0-2 v., 1/10 v. divisions. Carefully engineered to impose the correct loads on the small delicate batteries used to operate vacuum tube hearing aids. Equipped with new STERLING flexible plugs. List Price, \$3.50
- No. 35A Voltmeter for batteries used on carbon type hearing aids, also "C" batteries, scale 0-5 v., 1/10 v. divisions. List Price, \$1.75

Tester for "Eveready Air Cell" Batteries

- No. 30 Tester designed for 2 cell "Air Cell" battery. Condition of the "Air Cell" battery is graphically shown on the colored scale as soon as the connection is made. It indicates reliable minimum strength for new batteries as well as for batteries in operation. List Price, \$1.75

Meters 2¼" in diameter and ⅝" thick. Nickel finish. Standard package, ten instruments, ship. wt. 4 lbs.

Weston RADIO INSTRUMENTS

MODEL 776—OSCILLATOR

Complete Frequency Ranges—50-160 kc; 150-600 kc; 550-2100 kc; 1.6-6 mc; 5-19 mc; 9.5-33 mc by fundamentals; 60 mc by harmonics. **Output**—1 microvolt to .1 volt in 4 controllable steps an I.F. and B.C. bands. Strong signal eliminates need for breaking into I.F. circuit. **Audio Signal**—400 cycle note available for audio test—signal controlled through attenuator. **30% modulation** means greater audibility. Good sine wave characteristics. No 60 cycle distortion. **Operation**—110-130 volts, 50-60 cycles. **Hand Calibrated Scales.** Accuracy — $\frac{1}{2}$ of 1% on I.F. and B.C. Bands; 1% on short wave bands. **NO PADDERS OR TRIMMERS.** **Two Speed Dial**—1 revolution of the knob covers entire dial. Gives very fine Vernier adjustments. Big, direct-reading dial—6 feet of visible scale. **Automatic Amplitude Control**—New electronic method of Automatic Amplitude Control (AAC) holds signal more constant than hitherto possible, over entire frequency range. Prevents frequency drift commonly experienced by line voltage fluctuations and tube variations. **Band Switch**—All wiring has been eliminated between switch contacts and coils, and properly isolates coils not in use. **Carefully Filtered**—elaborate filters—shielded line cord—double shielding—separate attenuator tube—line feedback at a minimum. **Wobbler Jack** is provided for use with frequency modulator for oscillograph tests. **Tubes**—1 No. 6L7; 1 No. 84; 2 No. 76. Stock tubes may be used without special selection. Size: 10" x 16" x 5". Weight 13 $\frac{1}{4}$ lbs.

Net Price, Model 776 complete.....\$60.00



MODEL 791—BATTERY TESTER

To assist dealers, servicemen and manufacturers in testing and selling dry cell batteries, Weston offers this portable, easy to use tester. This instrument provides a quick, non-technical and convincing means of determining the operating condition of all standard commercial dry batteries. It is direct reading and tests batteries under **ACTUAL OPERATING CONDITIONS** by virtue of proper resistors mounted in the case. The scale is divided into colored sections so that the pointer deflection instantly shows the condition of the battery. Pin jacks on the panel are marked with standard voltage ranges of 1.5, 4.5, 6, 7.5, 45 and 90 volts. Approximate dimensions; 5 $\frac{1}{2}$ " x 3-11/16" x 2 $\frac{1}{4}$ ". Approximate weight 2 lbs.

Net Price Model 791 Battery Tester.....\$15.00



MODEL 669—VACUUM TUBE VOLTMETER

This vacuum tube voltmeter gives measurement of a-c and d-c potentials over an extremely broad band of frequencies. Rapid audible as well as visual meter checks available through the use of ear-phones plugged into special phone jack on the panel. Tests on antenna coils, gain per stage, detector and audio circuits, signal strength and distortion can easily be made.

Practically infinite resistance in ohms per volt. All ranges have input impedance equal to the tube itself, no resistance network being used in the input circuit. AVC circuits not upset when making measurements. **NEON BULB VOLTAGE REGULATOR MAINTAINS CONSTANT OPERATING VOLTAGE.** Operates on 105-130 volts, 42-60 cycles. Size: 8 $\frac{1}{4}$ " x 5 $\frac{1}{2}$ " x 5 $\frac{3}{4}$ ". Weight: 6 $\frac{1}{2}$ lbs.

RANGES: 0/1.2/3/6/8/12/16/30/60/80/120/160 Volts.

Net Price, Model 660, less carrying case.....\$49.50

Net Price, carrying case.....\$4.13

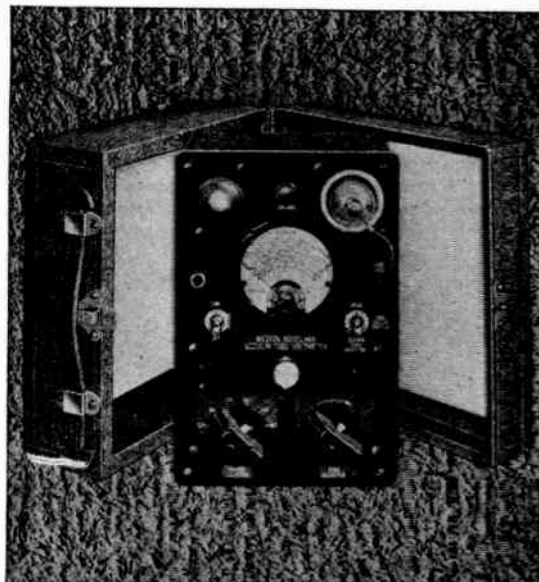

Weston RADIO INSTRUMENTS

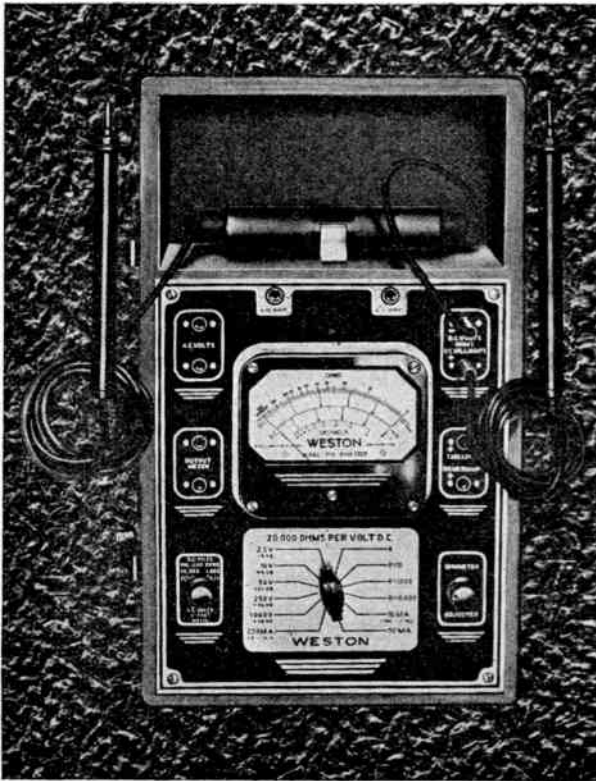

MODEL 772—TYPE 6 SUPER-SENSITIVE ANALYZER

1,000 Volts—20,000 Ohms per Volt

The most complete super-sensitive analyzer on the market today, Model 772 type 6 provides d-c voltage ranges at a sensitivity of either 1000 or 20,000 ohms per volt. Addition of new Weston Model 766 Televerter gives top d-c voltage range of 5000 volts. Services television and radio transmitters and receivers, P.A. systems, vacuum tube and cathode ray equipment, sensitive telephone and telegraph relay circuits and can readily be used for industrial and household appliance testing.

Model 766 Televerter is a carefully designed high resistance (100 megohms) multiplier which fits conveniently into the tool compartment of the analyzer. Specially insulated test prongs for protection of operator. Breakdown voltage of 17,000 volts in accordance with A.I.E.E. safety standards. Present owners of Model 772's can adapt the Televerter to the instrument at small extra cost.

Measurements of plate voltage and current on amateur transmitters, as required by the F.C.C., can easily be made. Diode currents in AVC circuits and AFC current can be quickly and accurately measured. Ideal for condenser leakage tests—maximum voltage on any range being 15 volts. Overall accuracy on a-c ranges is within 3% on normal frequencies due to improved rectifier circuit. Practically no frequency error from 50 to 7000 cycles. Temperature error is guaranteed to be within 2% from 40° F to 110° F.

Equipped for mounting Model 665 Socket Selector unit. Black panel trimmed in red and chromium. Size: 15 1/8" x 5 1/8" x 8 3/4". Weight: 8 1/2 lbs.

(Continued top of next column)

MODEL 772 —(continued)

VOLTS		CURRENT			RANGES	
D-C	A-C	D-C Only	DECIBELS	OHMS		
2.5	2.5	.1 Ma.	-14 to +2	0-3000		
10	10	1 Ma.	-2 to +14	0-30,000		
50	50	10 Ma.	+12 to +28	0-3 Meg.		
250	250	50 Ma.	+26 to +42	0-30 Meg.		
1000	1000	250 Ma.	+38 to +54			
5000 (with Televerter)		1 Amp.				
		10 Amp.				
Net Price, Model 772, Type 6.....				\$49.50		
Net Price, Model 766 Televerter.....				\$18.75		

MODEL 778—SERVISET

This deluxe test set is a complete portable workshop! It contains Model 772 Super-Sensitive Analyzer and Model 777 Type 1 Tube and Battery Checker. Ideal for both field and shop use—units are mounted in handy combination case . . . with ample room for Weston socket selector units or tools. Can be quickly mounted on any panel or shop bench—both instruments are identical in size, shape and color—a matched set of accurate radio servicing equipment. If you now own one of these individual instruments, you can complete the set by ordering the remaining unit in the combination case. Size: 5 3/8" x 14 1/4" x 17 1/4". Weight: 17 lbs.

Net Price, 778 less socket selectors.....\$97.50



Weston RADIO INSTRUMENTS



MODEL 777—TYPE 2

COUNTER TYPE TUBE AND BATTERY TESTER

Step up your tube and battery sales with this eye-appealing Tube and Battery checker, equipped with the TIME SAVING ROTATOR TYPE TUBE INDEXER and the new type SELF-WIPING, LONG SERVICE TOGGLE SWITCHES. . . . RICH . . . colorful . . . dignified . . . With a big, sensitive Weston meter stepped up from an attractive red and black panel. This counter model Tube and Battery checker is ideal for promoting effective merchandising campaigns.

All features . . . TOTAL EMISSION . . . INDIVIDUAL ELECTRODE test . . . neon short check . . . CATHODE LEAKAGE . . . NOISE TEST . . . LINE VOLTAGE CONTROL . . . load tests. WILL CHECK LOCTAL, MINIATURE, AND HIGH FILAMENT VOLTAGE TUBES. 1.5, 6, 45 AND 90 VOLT RANGES FOR BATTERY TESTING. Size 14½" x 10½" x 7". Weight 11½ pounds.

Net Price, Model 777, Type 2, complete.....\$54.75

MODEL 785

INDUSTRIAL CIRCUIT TESTER

27 Practical Ranges

For . . . Industry—Laboratories—Schools

The Model 785 Industrial Circuit Tester brings new simplicity and ease to production and maintenance testing. This compact, self-contained unit with its ultra sensitive instrument provides all the ranges necessary for voltage, current and resistance measurements wherever high sensitivity is a factor . . . including all types of signal systems, telephone circuits, photo-cell circuits, oscilloscope circuits, and for servicing network protectors, etc. . . . checking the electrical values in sensitive relays, cathode ray tubes, public address systems and amplifiers, thyratron tubes, electrical equipment, etc. . . . as well as for many other plant production and electrical maintenance requirements.

RANGE OF MEASUREMENTS

DC VOLTAGE—10 Millivolts to 1000 Volts (20,000 ohms per volt).

AC VOLTAGE—0.1 to 750 Volts (1000 ohms per volt).

DC CURRENT—0.5 Microampere to 10 Amperes—Self-contained.

AC CURRENT—10 Milliampere to 10 Amperes—Self-contained.

RESISTANCE—0.5 Ohm to 30 Megohms.

Further information on Model 785, foot of Page F68.

MODEL 777—TYPE 1

The same instrument described above is available in a light weight portable carrying case. Has generous compartment for tubes or tools—ideal for checking and selling tubes on the job. Complete rapid-reference chart in cover. Size: 15½" x 8¾" x 5½". Weight: 10 lbs.

Net Price, Model 777, Type 1, complete.....\$49.50



Weston RADIO INSTRUMENTS



Model 665

MODEL 665, TYPE 1—SELECTIVE ANALYZER

With this analyzer, a-c and d-c voltage, direct current and resistance can be measured over a total of 33 ranges—all self-contained within this one instrument. A simplified switching and pin jack arrangement facilitates rapid operation.

All d-c and a-c ranges have a sensitivity of 1000 ohms per volt. The accuracy of a-c readings at various frequencies and wave forms is better maintained by using the more efficient full wave rectifier. Output measurements are made through a self-contained fixed condenser.

All resistance spoils are adjusted within 1/2 of 1%, and are non-inductive. Sustained accuracy is assured under all operating conditions.

Ranges: VOLTS, a-c and d-c, (1000 ohms per volt) 1000/500/250/100/50/25/5/2.5/1

OHMS (full scale) 1000/10,000/100,000/1,000,000
 OHMS (center scale) 25/250/2500/25,000
 MILLIAMPERES, d-c only—500/250/100/50/25/10/5/2.5/1
 A-c output ranges—1 to 1000 volts

Size: 5 1/2" x 8 1/4" x 3 7/8" Weight: 5 lbs.
 Net Price, Model 665, Type 1 without carrying case.....\$58.50
 Net Price, Carrying Case\$4.13



Model 663

MODEL 663—VOLT-OHMMETER

Model 663 is exceptionally suited for radio servicing where a wide range, battery-operated ohmmeter is desired along with d-c voltage and current ranges. All ranges are rapidly selected by the rotary switch and pin jacks. The instrument requires only 50 microamperes for full scale deflection. This low current drain permits resistance measurements in critical circuits without seriously disturbing the circuit characteristics.

Standard self-contained batteries supply energy for resistance readings. A special ohmmeter adjustment compensates for changes in battery potential without any effect on meter accuracy.

Ranges: OHMS, (full scale) 0-200/1,000/10,000/100,000/1,000,000/10,000,000
 OHMS, (center scale) 0-5/25/250/2,500/25,000/250,000
 MILLIAMPERES, d-c—1/5/25/100
 VOLTS, d-c—2.5/10/100/250/500/1,000

Size: 8 1/4" x 5 1/2" x 3 7/8" Weight: 4 1/2 lbs.
 Net Price, Model 663 without carrying case.....\$49.13
 Net Price, Carrying Case\$4.13

Further Information on Model 785 Continued from Page F-67 INSTRUMENT

Standard Weston 4 1/4" instrument. D-c sensitivity 50 microamperes. New temperature compensated rectifier circuit gives greater a-c accuracy.

FULL SCALE RANGES

D-c Voltage—1/10/50/200/500/1000 volts (20,000 ohms per volt). Accurate within 2% up to 500 volts, 3% at 1000 volts.
 A-c Voltage—5/15/30/150/300/750 volts (1000 ohms per volt). Accurate within 3%.
 D-c Current—1/10/100 milliamperes, 1/10 amperes. Instrument is calibrated so that 100 mv. and 50 mv. shunts can be used for ranges above 10 amperes.
 A-c Current—5/1/5/10 amperes. Higher ranges with external current transformers. Accurate within 3% on 60 cycles.
 Resistance—3,000/30,000/300,000/3 meg./30 meg. Center scale values are: 25/250/2,500/25,000/250,000 ohms. Self-contained batteries. Accurate within 2% of the linear arc length on any ohmmeter range.

SIZE AND WEIGHT

13" x 12 1/2" x 5 1/2" (34 x 32 x 14 cm.). Weight with batteries, oak case, etc.: 13 1/2 pounds (6.12 kgs.).

NET PRICES

Model 785 in Oak Carrying Case.....\$93.75
 Model 785 without Carrying Case..... 78.75

Weston RADIO INSTRUMENTS

MODEL 697—VOLT-OHM-MILLIAMMETER

Very popular pocket-size device with a-c and d-c voltages, d-c milliampere and ohm ranges. Precision resistors used throughout. Accuracy has not been sacrificed for size. All ranges brought out to pin jacks. Toggle switches protect and connect the meter in the circuit as a voltmeter or ohmmeter. Self-contained $4\frac{1}{2}$ volt battery supplies necessary potential for ohm ranges. Ohmmeter adjustment compensates for changes up to 25% in battery potential without affecting meter accuracy. Accuracy guaranteed to be within 2% on d-c and within 5% on rectified a-c.

Ranges: VOLTS a-c and d-c—0-7.5/15/150/750

MILLIAMPERES, d-c only—0-7.5/75

OHMS (full scale)—5,000/500,000

OHMS (center scale)—35/3500

Size: $5\frac{9}{16}$ " x $3\frac{3}{4}$ " x $3\frac{9}{16}$ "

Weight: $1\frac{3}{4}$ lbs.

Net Price, Model 697, complete with pair of test leads.....\$24.00



Model 697

MODEL 695—TYPE 11

POWER LEVEL METER, VOLTMETER, OUTPUT METER

Gives readings in decibels as well as volts making it ideal for power level measurements in all types of speech equipment and radio receivers. Medium speed, moderately damped movement. Constant impedance of 20,000 ohms. 11 Db ranges from -4 to +36 Db at zero on the Db scale. 7 voltage ranges from 2 to 200 volts. Calibrated for 500 ohm lines with zero level of 6 milliwatts (.006 watts) or 1.73 volts. Complete with pair of test leads. Accuracy guaranteed to be within 5% on rectified a-c. Size: $5\frac{1}{2}$ " x $3\frac{3}{4}$ " x $3\frac{1}{8}$ ". Weight: $1\frac{1}{2}$ lbs.

Net Price, Model 695, Type 11.....\$28.50



Model 695

MODEL 564—VOLT-OHMMETER, TYPE 3-C

A fine, Weston quality instrument with a very useful selection of voltage and resistance ranges. A self-contained $4\frac{1}{2}$ volt battery provides the necessary potential for the ohmmeter ranges. Ohmmeter adjustment compensates for changes in battery potential without any affect on meter accuracy. Ranges are available from pin jacks. A toggle switch connects meter in circuit as a voltmeter. Complete with a pair of 4 ft. test leads. Accuracy guaranteed to be within 2%.

Ranges: VOLTS, d-c, at 1,000 ohms per volt—0-3/30/300/600

OHMS (full scale)—0-1,000/10,000/100,000/1,000,000

Size: $5\frac{1}{2}$ " x $3\frac{3}{4}$ " x $2\frac{9}{16}$ "

Weight: $1\frac{3}{4}$ lbs.

Net Price, Model 564, Type 3-C.....\$28.80



Model 564

MODEL 666, TYPE 1C SOCKET SELECTORS

With this selector unit you can make all current, voltage and resistance measurements AT THE TUBE SOCKET without breaking soldered connections in the receiver, etc. In addition to all standard tubes, this unit is now equipped to handle the octal, loctal and miniature tubes.

The selector block of the Model 666, Type 1B is quickly mounted on Models 666, 772 and 778 or any analyzers.

Net Price, Model 666, Type 1C.....\$15.83



Model 666, Type 1B

Weston RADIO INSTRUMENTS

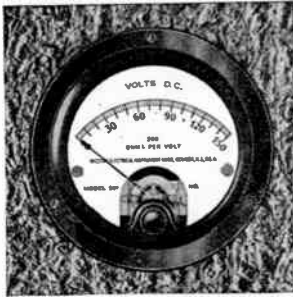

Round Style

PANEL INSTRUMENTS

Distinguished for their fine workmanship and permanently dependable performance with exceptional accuracy for their size, Model 301, 425 and 476 round instruments are regularly supplied in flush type 3 3/8" bakelite, 3 1/2" bakelite or 3 1/4" metal cases with black finish. Model 476 can be obtained in surface metal; Model 301 or 425 in surface metal or bakelite cases. Rectangular bakelite cases, flush type only, are also available.

Model 506, 507 and 517 instruments are regularly supplied in flush type, narrow flange, black finished metal cases with a clamp for panel mounting. Wide flange metal or bakelite cases are available at no extra cost. When ordering specify style, and whether metal or bakelite case is desired.

Instruments for use on circuits above 300 volts should be specified with bakelite cases when not possible to connect in grounded side of line. Normally calibrated for use on non-magnetic panels. If they are to be used on steel panels, specify panel thickness when ordering. List prices shown below, are subject to 25% discount. For other instrument prices write to Weston Electrical Instrument Corp., Newark 5, N. J.



Rectangular Style

3 1/2" PANEL INSTRUMENTS

MODEL 301 D-C VOLTMETERS

Approximate resistance of Model 301 in ohms per volt—1 to 40 volts, 62; 50 to 150 volts, 200; 200 volts, 250.

Range	Price	Range	Price	Range	Price
3	\$ 9.00	15	\$ 9.00	150	\$11.25
5	9.00	30	9.00	200	13.00
8	9.00	50	9.00		
10	9.00	100	10.00		

With Resistance of 1,000 ohms per Volt

Range	Price	Range	Price	Range	Price
50	\$12.00	300	\$15.00	1500	\$36.50*
100	12.50	500	17.25	2000	40.00*
200	14.00	1000	24.50*	3000	50.00*

* Supplied with external resistor. Scale reading in kilovolts.

MODEL 301 D-C MILLIAMMETERS*

Range	Approx. Res. Ohms	Price	Range	Approx. Res. Ohms	Price
1	105	\$10.00	30	1.2	\$9.00
1.5	27	10.00	50	2.0	9.00
2	27	10.00	100	1.0	9.00
5	5.7	9.00	150	0.66	9.00
10	2.0	9.00	300	0.33	9.00
15	2.0	9.00	500	0.2	9.00

* Milliammeters with ranges above 30 MA. are shunted, and have a drop of approximately 100 MV.

MODEL 301 D-C AMMETERS*

Single Ranges: 1/1.5/5/10/15/30/50 at \$9.00

* Ammeters are supplied in self-contained ranges up to 50 amperes inclusive, and have a drop of 50 MV ± 5%. Ranges above 50 amperes supplied with external shunts.

MODEL 301 D-C MICROAMMETERS

Range	Price	Range	Price
200	\$14.25	500	\$14.25

MODEL 301 RECTIFIER TYPE A-C VOLTMETERS

1000 ohms		2000 ohms		1000 ohms		2000 ohms	
Range	per volt	per volt	per volt	Range	per volt	per volt	per volt
1	\$19.25	50	\$17.00	\$19.75
1.5	19.25	100	17.50	21.50
3	\$17.00	19.25	150	19.00	23.00
5	17.00	19.25	300	20.00
15	17.00	19.25				

MODEL 301 RECTIFIER TYPE A-C MILLIAMMETERS

Range	Price	Range	Price
0.5	\$19.25	2	\$15.00
1	15.00	5	14.00

MODEL 301 RECTIFIER TYPE A-C MICROAMMETERS

Range	Price
500	\$19.25

MODEL 476 A-C AMMETERS

Single Ranges: 1/1.5/2/3/5/10/15/20/30/50 at \$9.00.

MODEL 476 A-C VOLTMETERS

Range	Price	Range	Price	Range	Price
5	\$ 9.00	100	\$10.00	500	\$19.50
10	9.00	150	11.25	750	23.50*
30	9.00	250	14.50	1000	28.50*

* Supplied with external resistance box.

MODEL 425 THERMOCOUPLE TYPE AMMETERS

Single Ranges: 1/1.5/2/3/5/10/15/20 at \$16.00.

2 1/2" PANEL INSTRUMENTS

MODEL 506 D-C VOLTMETERS

Approximate resistance of Model 506 in ohms per volt: 3 to 150 volts, 125; 200 volts, 200.

Range	Price	Range	Price	Range	Price
3	\$ 7.50	10	\$ 7.50	100	\$ 8.50
5	7.50	15	7.50	150	9.75
8	7.50	50	7.50	200	11.50

MODEL 506 D-C AMMETERS

Single Ranges: 1/1.5/5/10/15/30/50 at \$7.50.

Ammeters, self-contained up to 50 amps., inclusive—drop 50 MV ± 5%.

MODEL 506 D-C MILLIAMMETERS

Range	Approx. Resis.	Price	Range	Approx. Resis.	Price
1	27	\$ 8.50	50	1	\$ 7.50
1.5	18	8.50	100	.5	7.50
2	18	8.50	150	.33	7.50
5	8.5	7.50	300	.16	7.50
10	3.2	7.50	500	.1	7.50
15	1.5	7.50			

Milliammeters above 30 MA are shunted—drop approximately 50 MV.

MODEL 507 THERMO AMMETERS

For use on a-c of any frequency, including radio frequency. Single Ranges: 1/1.5/2/3/5/10/15/20 at \$14.50.

MODEL 517 A-C AMMETERS

Range	Approx. Res. in ohms	Price	Range	Approx. Res. in ohms	Price
1	.203	\$ 7.50	20	.0016	7.50
3	.024	7.50	30	.0007	7.50
5	.01	7.50	50	.00057	7.50
10	.0058	7.50			

MODEL 517 A-C VOLTMETERS

Range	Approx. Ohms per Volt	Price	Range	Approx. Ohms per Volt	Price
5	10	\$ 7.50	50	52	\$ 7.50
10	14	7.50	130	110	9.00
15	14	7.50	150	110	9.75
25	26	7.50	250	166	13.00
			300	166	15.00

IMPORTANT NOTE: ALL PRICES ON THIS PAGE HAVE BEEN INCREASED BY 10%

PRECISION

TEST EQUIPMENT

STANDARD OF ACCURACY

ALL PRICES ARE SUBJECT TO CHANGE WITHOUT NOTICE

SERIES 920 Combination Dynamic Mutual Conductance Type Tube Tester, Battery Tester and 33 Range A.C. - D.C. Multi-Range Set Tester

AVAILABLE IN FOLLOWING MODELS

- * 920-P—(illustrated) In hardwood, walnut finished portable case with tool compartment and hinged removable cover. Size 12 x 13 x 6". Complete with battery, test leads and operating instructions. Code: Drive. **NET PRICE \$59.95**
- * 920-MCP—Open type Metal Case Portable, black ripple finish as illustrated for Series 912-MCP. Size 10½ x 12 x 6". Complete as above. Code: Dicer. **NET PRICE \$55.95**
- * 920-PM—Consists of Series 920-MCP inserted into matching steel panel and dust cover. Panel size 12¼ x 19" for standard rack mount. Appearance same as illustrated for Series 912-PM. Unit removable from front for portable use. Code: Dream **NET PRICE \$59.95**
- * 920-C—In modern, chrome trimmed, round cornered, counter type cabinet; black ripple finish on heavy gauge steel as illustrated for Series 912-C. Size 16 x 13½ x 7". Slopes to 3 inches at front. Complete, ready to operate. Code: Drake **NET PRICE \$59.95**



SET ANALYZING FEATURES

* SIX A.C. and SIX D.C. VOLTAGE RANGES at 1000 ohms per volt: 0-12-50-300-600-1200-3000 volts. * FIVE D.C. CURRENT RANGES: 0-1-2-12-120-600 MA., and 0-12 AMPS. * FOUR SELF-CONTAINED RESISTANCE RANGES: 0 to 400 ohms, 0-100,000 ohms, 0-1-10 megs. * SIX DECIBEL RANGES from -12 to +64 D.B. * SIX OUTPUT RANGES: Same as A.C. volts. * SIMPLIFIED MASTER ROTARY RANGE SELECTOR SYSTEM. * LARGE 4½" EASY READING "PRECISION" 400 micro-ohm-meter. * CONDENSER LEAKAGE TESTS. * 1% WIRE-WOUND SHUNTS and MATCHED MULTIPLIERS employed throughout. * ALL RANGES INDIVIDUALLY CALIBRATED within 2% D.C. and 3% A.C. overall accuracy.

TUBE AND BATTERY ANALYZING FEATURES

* A DYNAMIC MUTUAL CONDUCTANCE TYPE TUBE TESTER employing an exclusive "PRECISION" engineered circuit, which in one operation, effectively tests all radio receiving tubes for both MUTUAL CONDUCTANCE and CATHODE STRUCTURE. * TESTS ALL TUBE TYPES: FILAMENT VOLTAGES from 1.4 to 120 volts. LOKTALS, BANTAM JUNIOR and BUTTON-7-PIN PORTABLE RADIO AND HEARING-AID BATTERY TYPES, SINGLE-ENDED, TELEVISION AND F. M. AMPLIFIERS, REGULAR OCTALS (MG, G, GT and METALS), SPRAY-SHIELD AND GLASS TYPES. * AUTOMATIC PUSH-BUTTON SYSTEM: Flexibility for non-obsolete free point tube analysis. * DUAL FREE-POINT FILAMENT TERMINAL SELECTION. * VISIBLE FILAMENT CONTINUITY TESTS. * SPECIFIC INDIVIDUAL LOADS AND VOLTAGES: APPLIED TO ELEMENTS OF TUBE UNDER TEST. * VARYING A. C. SIGNAL applied to control grids. * METER READS IN PLATE CIRCUIT: Indications entirely dependent upon control action (transconductance) of the intervening elements. Shows up tubes having open elements. * Individual tests for each section of multi-section tubes. Visible tests of fluorescent screen and winking of cathode ray indicator tubes. * HOT CATHODE LEAKAGE and INTER-ELEMENT SHORT TESTS. * NOISE TEST pin jacks for earphone or amplifier connection. * BALLAST TESTS: The regular tube test sockets accommodate all ballast units. * PILOT LIGHT TESTS. * DOUBLE WINDOW ROLLER TUBE CHART. * MICRO-LINE ADJUSTMENT read directly on meter. No arbitrarily tapped transformer employed. * TESTS ALL POPULAR RADIO A. B. AND C BATTERIES 1.5 to 135 volts, UNDER ACTUAL LOAD. Condition read on simple 3 colored REPLACE-WEAK-GOOD scale. A single selector switch automatically applies appropriate load for the particular battery under test. * TELEPHONE CABLED WIRING EMPLOYED THROUGHOUT. * ACCURACY of tube test circuit closely maintained by use of individual calibrating controls.

SERIES 910 and 912 Dynamic Mutual Conductance Type Tube Testers

The PRECISION Series 910 and 912 are Dynamic Mutual Conductance Type Tube Analyzers incorporating the same time-proven tube test circuit features described for Series 920, above. Series 910 makes use of an attractive 3" bakelite cased meter. Series 912 utilizes an extra large 4½" meter, and in addition also provides the full battery testing facilities described for Series 920. The physical appearance and overall dimensions of Series 910, 912 and 920 are the same. (See illustrations.)

* 910-P—(as illustrated for Series 920-P) In hardwood, walnut finished portable case. Size 12 x 13 x 6". Complete with operating instructions. Code: Front. **NET PRICE \$37.95**

* 910-MCP—Open type Metal Case Portable, as illustrated for 912-MCP, at right. Size 10½ x 12 x 6". Complete, ready to operate. Code: Frail **NET PRICE \$33.95**

* 910-C—In modern, chrome trimmed, round cornered counter type cabinet. Size 16 x 13½ x 7". Slopes to 3" at front, as illustrated at right, for Series 912-C. Code: Frisk. **NET PRICE \$37.95**

* 910-PM—Consists of Series 910-MCP, removably inserted into matching steel panel and dust cover. Panel size 12¼ x 19" for standard rack mount, as illustrated for 912-PM at right. Code: Fried. **NET PRICE \$37.95**

* 912-P—(as illustrated for Series 920-P) In hardwood, walnut finished portable case with tool compartment and hinged removable cover. Size 12 x 13 x 6". Complete with operating instructions. Code: Fence. **NET PRICE \$41.95**

* 912-MCP—Open type Metal Case Portable, black ripple finish, as illustrated at right. Size 10½ x 12 x 6". Complete, ready to operate. Code: Felon **NET PRICE \$37.95**

* 912-C—In modern, chrome trimmed, round cornered counter type cabinet. Black ripple finish on heavy gauge steel. Size 16 x 13½ x 7". Slopes to 3" at front. Complete, as illustrated at right. Code: Frame. **NET PRICE \$41.95**

* 912-PM—Consists of Series 912-MCP, removably inserted into matching steel panel and dust cover. Panel size 12¼ x 19", for standard rack mount. See illustration at right. Code: Fetid **NET PRICE \$41.95**



* 912-MCP



* 912-C



* 912-PM

IMPORTANT NOTE: ALL PRICES ON THIS PAGE HAVE BEEN INCREASED BY 10%

PRECISION

TEST EQUIPMENT

STANDARD OF ACCURACY

ALL PRICES ARE SUBJECT TO CHANGE WITHOUT NOTICE

SERIES 914

Modern Counter Type Tube & Battery Merchandiser employing a large 7" chrome trimmed SWIVEL MOUNTED METER.



An economically priced, but nevertheless elaborate, attractively designed instrument, occupying a minimum of counter space. The 7" swivel mounted meter provides both customer and operator with a FULL VIEW of test results, regardless of cabinet position.

- * A modern, streamlined, customer appealing tube merchandiser.
- * Large, easy reading, 7" chrome trimmed bakelite cased meter.
- * 3 colored—REPLACE—WEAK—GOOD SCALE with 0-100 division tube matching reference arc.
- * Full vision double-window roller tube chart.
- * Dynamic Mutual Conductance Tube testing and Battery test features, same as described for Series 920.
- * 914 TUBE MERCHANDISER—Attractive, modern streamlined design with chrome trimming on fine dull black wrinkle-finished, heavy gauge cabinet. Separately encased meter, swivel mounted. Cabinet size 16" x 13 1/2" x 7", slopes to 3" at front. Code: Handy. NET PRICE \$45.95

SERIES 954

Combination Dynamic Mutual Conductance Type Tube Tester, Battery Tester and 37 Range Super-Sensitive A.C.-D.C. Multi-Range Set Tester 20,000 OHMS PER VOLT DC



A complete service laboratory; one compact unit, provides every facility for accurate, reliable solutions of all tube test and measurement problems of Radio (A.M. and F.M.); and Television.

TUBE AND BATTERY ANALYZING FEATURES

* Same as Dynamic Mutual Conductance tube test circuit described for the Series 920.

SET ANALYZING FEATURES

- * SEVEN AC and SEVEN DC VOLTAGE RANGES; 0-3 to 0-6000 volts. 20,000 ohms/volt DC—1000 ohms/volt AC. * SEVEN DC CURRENT RANGES. 0-60 microamps to 0-12 AMPS. * SELF-POWERED RESISTANCE RANGES to 60 MEGOHMS. * SIX DECIBEL RANGES: -12 to +70 DB. * SEVEN OUTPUT RANGES to 6000 volts. * 4 5/8"—50 microampere bakelite cased meter.
- * 954P—(illustrated) In hardwood portable walnut finish case; removable cover and tool compartment. Size 12" x 13" x 6". Complete with batteries and extra-high voltage test leads. Code: Happy. NET PRICE \$73.95
- The Series 954 is also available in the same additional types of housings described for the Series 920.
- * 954MCP—Open type portable—complete with batteries and high voltage test leads. Code: Horse. NET PRICE \$69.95
- * 954C—Counter type—complete with batteries and high voltage test leads. Code: Human. NET PRICE \$73.95
- * 954PM—Standard Panel Mount—complete with batteries and high voltage test leads. Code: Hermit. NET PRICE \$73.95

SERIES 832-A

31 Range A.C.-D.C. Multi-Range Tester

Though small in size, Series 832-A incorporates the same full-bodied electrical components provided in all larger "Precision" multi-range instruments. Meter scale-plate design is in Black, Red and White with large sized numerals, for maximum ease of reading.

SPECIFICATIONS

- * 6 D.C. voltage ranges—1000 ohms / volt 0-6-30-150-300-600-1200 volts.
- * 6 A.C. voltage ranges—500 ohms/volt 0-12-60-300-600-1200-2400 volts.
- * 4 D.C. current ranges—0-1.2 to 0-600 Milliamps.
- * 3 Resistance ranges to 5 MEGS. Up to 500,000 ohms on internal battery.
- * 6 Decibel ranges (-10 to +62DB).
- * 6 Output ranges to 2400 volts.
- * Wire-wound shunts, metallized multipliers—1% tolerance.
- * A PRECISION instrument designed to withstand the abuse and punishment of rough service.



* 832-A—In hardwood walnut finished case (7" x 4 1/2" x 3") with leather handle, complete with batteries (less test leads). Code: Anvil. NET PRICE \$16.95

SERIES 834

31 Range A.C.-D.C. Circuit Tester

1000 OHMS PER VOLT A.C. AND D.C.

The Series 834 is an advanced and highly practical improvement in compact, A.C.-D.C. multi-range circuit testers. Simplified rotary selection allows all measurements from ONLY TWO tip jacks (except 1200 and 6000 volts). An extra large 3 1/4" 400 Microampere meter provides Scale Length and Ease of Reading not usually associated with compact instruments.

SPECIFICATIONS

- * 6 D.C. and 6 A.C. voltage ranges—1000 ohms/volt: 0-12-60-300-600-1200-6000 volts.
- * 4 D.C. Current Ranges: 0-1.2-12-60-600 milliamps.
- * 3 Resistance Ranges: Batteries fit inside of case. 0-5000-500,000-5,000,000 ohms.
- * 6 Decibel Ranges: from -10 to +70 DB.
- * 6 Output Ranges: at 1000 ohms per volt. 0-12-60-300-600-1200-6000 volts.
- * 1% wire wound shunts and matched metallized multipliers.
- * Each instrument individually calibrated: 2% D.C. and 3% A.C. overall accuracy.



* Series 834—In hardwood, walnut finished case with leather handle. Size 7 x 4 1/2 x 3". Complete with 3 volt battery (less test leads). Code: Labor. NET PRICE \$19.95

IMPORTANT NOTE: ALL PRICES ON THIS PAGE HAVE BEEN INCREASED BY 10%

PRECISION TEST EQUIPMENT

STANDARD OF ACCURACY

ALL PRICES ARE SUBJECT TO CHANGE WITHOUT NOTICE

SERIES 844

34 RANGE A.C.-D.C. Volt-Ohm-Decibel-Milliammeter
6000 volts A.C. and D.C., 10 megohms, and 12 amps.
1000 OHMS PER VOLT A.C. & D.C.



The Series 844 is an excellent general purpose A.C.-D.C. multi-range tester, invaluable to laboratory, industrial, serviceman and engineer. Ruggedly constructed, it will maintain its initially high degree of accuracy under constant usage and handling.

* 844L—(illustrated) Housed in walnut finished hardwood open type case with carrying handle. Compact in size 7" x 8" x 4". Code: Manse. NET PRICE (Less batteries and test leads)

\$24.95

SPECIFICATIONS

- * SIX A.C. and SIX D.C. VOLTAGE RANGES at 1000 ohms per volt: 0-12; 0-60; 0-300; 0-600; 0-1200; 0-6000 volts.
- * SIX D.C. CURRENT RANGES: 0-1.2 MA to 0-12 AMPERES.
- * FOUR RESISTANCE RANGES: Batteries mount inside of case. 0-400; 0-100,000 ohms; 0-1 meg.; and 0-10 DB.
- * SIX DECIBEL RANGES from -12 to +70DB.
- * SIX OUTPUT RANGES: 0-12 to 0-6000 volts.
- * Large 4 1/2" 400 microampere bakelite cased meter.
- * All instruments individually calibrated and sealed against laboratory standards assuring 2% D.C. and 3% A.C. overall accuracy. Complete telephone cabling employed.

* 844P—In closed type portable case. Code: Malad. NET PRICE (Less batteries and test leads)

\$26.95

* 844PM—In standard panel mount. 19" x 12 1/4". Code: Maize. NET PRICE (Less batteries and test leads)

\$27.95

SERIES 845

41 RANGE HIGH SENSITIVITY A.C.-D.C. TESTER
RANGES TO 6000 VOLTS, 20 MEGS., AND 12 AMPS.
5000 OHMS PER VOLT D.C.
1000 OHMS/VOLT D.C. 1000 OHMS/VOLT A.C.



Series 845 is a reliable, highly accurate, multi-range tester of moderate sensitivity for more accurate measurements in sensitive communications and electronic apparatus. Its dual-sensitivity feature, suits Series 845 to the requirements of laboratory, maintenance and production testing.

* 845L—(illustrated) Housed in walnut finished hardwood open type case with carrying handle. Compact in size 7" x 8" x 4". Code: Isben. NET PRICE (Less batteries and test leads)

\$28.95

SPECIFICATIONS

- * 6 D.C. voltage ranges at 5000 ohms per volt: 0-12; 0-60; 0-300; 0-600; 0-1200; 0-6000 volts.
- * 6 A.C. and 6 D.C. voltage ranges at 1000 ohms per volt: 0-12-60-300-600-1200-6000 volts.
- * 7 D.C. current ranges: 0-300 Microamps. 0-1.2-12-60-300-1200 MA and 0-12 Amps.
- * 4 Resistance Ranges: Batteries mount inside of case. 0-2000-200,000 ohms. 0-2-20 megohms.
- * 6 Decibel Ranges from -12 to +70 DB.
- * 6 Output Ranges: same as A.C. voltage ranges.
- * Large 4 1/2" 200 microampere, easy reading bakelite cased meter.
- * 1% wire-wound shunts and matched multipliers, plus individual instrument calibration assures 2% D.C. and 3% A.C. overall accuracy.

* 845P—In closed type portable case. Code: Icing. NET PRICE (Less batteries and test leads)

\$30.95

* 845PM—In standard panel mount. 19" x 12 1/4". Code: Ideal. NET PRICE (Less batteries and test leads)

\$31.95

SERIES 856

44 RANGE SUPER-SENSITIVE A.C.-D.C. TESTER,
6000 VOLTS, 60 μAMPS., 12 AMPS., 60 MEGS.
20,000 OHMS PER VOLT D.C.
1000 OHMS/VOLT D.C. 1000 OHMS/VOLT A.C.

The Series 856 is specifically designed for obtaining reliable measurements in modern communication and electronic circuits where only minute current drain of the measuring instrument can be tolerated.

The DUAL SENSITIVITY FEATURE doubles its utility, providing the equivalent of ANOTHER COMPLETE INSTRUMENT for measurements at standard 1000 OHMS PER VOLT sensitivity.



SPECIFICATIONS

- * SEVEN D.C. VOLTAGE RANGES: 20,000 ohms/volt: 0-3; 0-12; 0-60; 0-300; 0-600; 0-1200; 0-6000 volts.
- * SEVEN A.C. and SEVEN D.C. VOLTAGE RANGES: 1,000 ohms/volt: 0-3-12-60-300-600-1200-6000 volts.
- * SEVEN D.C. CURRENT RANGES: 0-60, 0-300 microamps: 0-3, 30, 120, 600 MA; 0-12 AMPS.
- * SEVEN D.C. CURRENT RANGES: 2% accuracy: 0-60, 0-300 microamps: 0-3, 30, 120, 600 MA; 0-12 AMPS.
- * THREE RESISTANCE RANGES: Self-contained batteries: 0-6000, 0-600,000 ohms, 0-60 megohms.
- * SIX DECIBEL RANGES FROM -12 to +70DB.
- * SEVEN OUTPUT RANGES: 0-3-12-60-300-600-1200-6000 volts.
- * Large 50 microampere 4 1/2" bakelite-cased meter.
- * WIRE-WOUND SHUNTS, METALLIZED MULTIPLIERS—1% ACCURACY.
- * All ranges individually calibrated to within 2% D.C. and 3% A.C. overall accuracy.
- * Wax-impregnated telephone cabling and XXX bakelite mounting strips employed throughout.

* 856P—(illustrated) In attractive walnut finished hardwood portable case with removable cover and tool compartment. Size 9" x 10" x 6". Code: Jalop. NET PRICE (Complete with batteries and high voltage test leads)

\$39.95

The Series 856 is also available in the same type of mountings and combinations described for Series 844.

* 856L—Open portable: complete with batteries and high voltage test leads. Code: Jabot. NET PRICE

\$37.95

* 856PM—Panel mounted: complete with batteries and high voltage test leads. Code: Janet. NET PRICE

\$40.95

SERIES 864

A.C.-D.C. VOLT - OHM - DECIBEL - MILLIAMMETER
A Laboratory Multi-Range Tester Incorporating a
Large 9" Meter and Remote Control Selector Unit

* 864—In standard panel mount finished in black ripple. Size 19" x 12 1/4" with dust cover 6 inches deep. Code: Kapok. NET PRICE (Complete with batteries and high voltage test leads) —

\$45.95

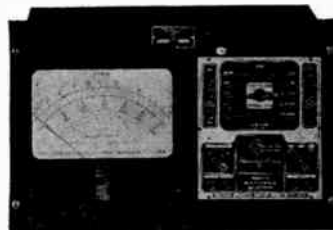

ELECTRICAL SPECIFICATIONS SAME AS SERIES 845

Conforming electrically to all specifications of Series 845 (adjacent), Series 864 Deluxe Multi-Range Tester is housed in standard 12 1/4 x 19" panel with completely enclosed rear dust cover, and is designed to mount into any standard relay rack. The separately encased Selector Unit is easily slid out from its panel compartment for remote bench operation. A seven foot flexible cord, permanently connecting meter to Remote Selector Unit, allows complete freedom of manipulation.

The 9" Precision Rectangular 200 Microampere Meter with large easy reading scales and numerals, allows highly accurate readings with greatest ease and minimum eye strain.

This instrument is an indispensable adjunct to the modern laboratory for radio service, industrial and television application and wherever operator efficiency is at a premium.

IMPORTANT NOTE: ALL PRICES ON THIS PAGE HAVE BEEN INCREASED BY 10%

PRECISION TEST EQUIPMENT

STANDARD OF ACCURACY

ALL PRICES ARE SUBJECT TO CHANGE WITHOUT NOTICE

SERIES EV-10

A NEW TYPE OF VACUUM TUBE MULTI-RANGE METER with Ranges to 6000 Volts A.C. and D.C. 2000 Megs. — 12 Amps. — 70 DB.



PERFORMANCE, ACCURACY, EASE OF MANIPULATION—Series EV-10 provides eight distinct instruments for most all measurements in the present and future electronics and communications fields. Combining both VTVM as well as standard 1000 ohms per volt test circuits. Series EV-10 permits rapid check of all voltage, current, and resistances encountered in television, photo-electric, F.M. networks, etc., without disturbing operation of circuit under analysis.

IMPORTANT FEATURES

- * VOLTAGE REGULATED—BRIDGE TYPE CIRCUIT: provides unusually high VTVM accuracy. Uses one type 6C5, 6X5 and VR-150.
- * ZERO-CENTER VTVM—READS voltage at any test point WITHOUT reversal of test prods.
- * SINGLE MASTER RANGE SELECTOR—Provides rapid, positive selection of all ranges.
- * SHIELDED COAXIAL TEST PROBES—permit direct voltage measurements without disrupting apparatus under test.
- * DUO-BALANCED ELECTRONIC-BRIDGE OHMMETER—BOTH ends of ohmmeter scales are independently zero adjusted, providing high accuracy throughout scale length. A single OHMS scale serves for ALL ranges.
- * 1% wire-wound shunts and matched multipliers plus telephone-cabled, wax-impregnated, wiring employed throughout.
- * EACH INSTRUMENT INDIVIDUALLY CALIBRATED.
- * FULL VISION 8 1/2" RECTANGULAR 400 microampere METER. RANGES
- * Eight Zero-Center Vacuum Tube Voltmeter Ranges—from ± 3 to ± 6000 volts D.C.—Input Resistance— $13\frac{1}{3}$ — $26\frac{2}{3}$ and $133\frac{1}{3}$ Megohms.
- * Six Circuit Probing, Zero-Center, VTVM Ranges—from ± 3 to ± 600 volts D.C.
- * Six Wide-Range Ohmmeter-Megohmmeter Ranges: 0-2000-200M ohms. 0-2-20-200-2000 Megohms.
- * Eight A.C. and Eight D.C. Voltage Ranges at 1000 ohms per volt. 0-3-6-12-60-300-600-1200-6000 volts.
- * Seven D.C. Current Ranges—0-600 Microamps: 0-3-12-60-300-1200 MA; 0-12 AMPS.
- * Eight Output Ranges—0-3-6-12-60-300-600-1200-6000 volts.
- * Eight Decibel Ranges—from -26 to +70 DB.
- * EV-10-MCP—(illustrated) In black ripple finish, heavy gauge steel case. Size $10\frac{1}{2}$ x 12 x 6 ". Complete with tubes, battery and testing probes. Code: Place. NET PRICE **\$49.95**
- * EV-10-P—Complete as described above but in hardwood walnut finished portable case. Code: Phone. NET PRICE **\$53.95**
- * EV-10-PM—In standard panel mount. Code: Panel. NET PRICE **\$53.95**

SERIES "J" Multi-Range A.C. Ammeter



THE PRECISION SERIES "J" is a rugged, portable, MULTI-RANGE A.C. AMMETER; with wide selection of ranges to meet the requirements of many fields of application from 25 cycles up.

SPECIFICATIONS

Eight alternating current ranges: 0-300-600-1200 Milliamps. 0-3-6-12-30-60 AMPS. Internal heavy duty current transformer designed for 25 cycle operation and up. Heavy duty, brass, bakelite insulated, binding posts. Full vision, easy reading $4\frac{3}{8}$ " bakelite cased meter, Accuracy 2%.

* Series J-P—(illustrated) In hardwood walnut finished carrying case, size 9 x 10 x 6 ". Code: Apple. NET PRICE **\$21.95**

* Series J-L—In open face hardwood carrying case, size $7\frac{1}{2}$ x $8\frac{1}{2}$ x 4 ". Code: Atone. NET PRICE **\$19.95**

SERIES E-200 SIGNAL GENERATOR

For All A.M., F.M. and Television Receivers, featuring "Servicing by Signal Substitution"



- * Six Bands: 90 KC to 88 MC.
- * Accuracy—Constancy of calibration: MAXIMUM of 1% DEVIATION on all bands, insured by use of the "PRECISION" developed "UNIT OSCILLATOR" construction. ENTIRE "UNIT OSCILLATOR" is SINGLE-POINT-MOUNTED, providing positive freedom from effects of mechanical shock, eliminating the need of costly, useless, single frequency reference crystals.
- * LARGE FULL VISION 8 1/2" INCH NO-GLARE DIAL: approx. 6 feet of direct reading deeply etched scales. Ball bearing planetary drive.
- * 0-100 Point Vernier Scale and Twin Hair-Line Indicators: provide direct reading to one part in 1000 for critical laboratory usage.
- * The Circuit—uses the new 6SJ7 in a highly stable E.C.O. circuit—Modulated in the buffer amplifier by a 6C5 400 cycle sine-wave audio oscillator. An 80 full-wave rectifier forms the basis of a hum-free D.C. supply.
- * 400 Cycle Sine-Wave Audio Oscillator—Independently Controlled—provides both modulation and external audio signal of over 60 volts.
- * DUAL CALIBRATED R.F. Attenuators—Separately shielded—provides direct R.F. gain measurement facilities and smooth stepless control.
- * LOW LEAKAGE: complete shielding of all vital components, in addition to a heavy gauge etched panel and steel cabinet—Power transformer electro-statically shielded—A.C. line, choke-condenser filtered.
- * SELF-SHIELDING COAXIAL OUTPUT CABLE and dual (LOW-HIGH) coaxial connectors with separate screw cap for elimination of leakage from unused terminal.
- * Four Types of Signals—"Unmodulated R.F." "400 cycle Modulated R.F." "EXTERNALLY Modulated R.F." "FREQUENCY or amplitude" "400 cycle Audio Output."
- * VARIABLE MODULATION CONTROL—0-100% modulation AT WILL—more than triples signal utility as against obsolete fixed modulation of only 30 or 40%.
- * A.V.C. SUBSTITUTION SYSTEM—The Series E-200 fully overcomes serious alignment troubles arising from receiver A.V.C., by supplying ITS OWN A.V.C. VOLTAGE, controllable at the front of the panel from 0-50 volts.
- * HAND CALIBRATION—Each instrument INDIVIDUALLY hand calibrated on all six bands.
- * Fully licensed under patents of American Telephone & Telegraph Co.
- * Not only an unsurpassed, efficient Signal Generator for purposes of alignment but SPECIFICALLY DESIGNED for "Servicing by Signal Substitution", the new modern Dynamic speed approach to receiver alignment and adjustment problems, described in a new 120 page illustrated text book.
- * E-200—In black ripple heavy gauge steel case. Size $12\frac{1}{2}$ x $10\frac{1}{2}$ x 6 ". Complete with FREE copy of "SERVICING BY SIGNAL SUBSTITUTION." Code: Trade. NET PRICE **\$39.95**
- * E-200PM—In standard panel mount. Code: Trace. NET PRICE **\$43.95**

A.C.-D.C. INDUSTRIAL CIRCUIT TESTERS

- Series 844-J—1000 OHMS per VOLT—42 RANGES Code: Miser. NET PRICE **\$48.95**
- Series 845-J—5000 OHMS per VOLT—49 RANGES Code: Ignite. NET PRICE **\$52.95**
- Series 856-J—20000 OHMS per VOLT—52 RANGES Code: Jason. NET PRICE **\$59.95**

(Series 856-J illustrated below in hardwood finished portable case with tool compartment and removable cover.) Size 11 x 15 x 6 ".

Ranges to 6000 Volts A.C.-D.C. • 60 Amps A.C. • 12 Amps D.C. Precision INDUSTRIAL CIRCUIT TESTERS provide a practical solution to A.C.-D.C. circuit test and maintenance problems. Through matching design of Series "J" A.C. Ammeter, these wide-range Circuit Testers will meet your individual sensitivity requirements. Merely combine Series "J" with either Series 844, 845 or 856 and a universal A.C.-D.C. circuit tester is produced to YOUR SPECIFICATIONS, providing every desirable range of Series 844, 845 or 856, PLUS the full facilities of Series "J".



LEARN SERVICE WORK

from **This Book!**

MODERN Radio SERVICING

(1st Edition)

by **A. A. GHIRARDI**



Ghirardi gives you a complete course in modern radio service work in this remarkable 1300-page textbook containing over 700 illustrations and 723 self-review questions. Everything explained for you clearly—from the very fundamentals of servicing instruments to the servicing of the most complicated all-wave high-fidelity receivers. There's even a chapter on sales promotion and radio service business management. 1300 pages of invaluable servicing information—written by this leading servicing authority—is yours for only five dollars! Here are the chapter headings:

- | | |
|------------------------------------|---|
| 1. Measuring Instruments. | 19. Voltage-Current Set Analyzers. |
| 2. Resistance Measurement. | 20. Resistance Analyzers. |
| 3. Constructing Ohmmeters. | 21. Tests for Individual Components. |
| 4. Commercial Ohmmeters. | 22. Difficult, Obscure Troubles. |
| 5. Capacity and Condenser Testers. | 23. Aligning and Neutralizing T-R-F Receivers. |
| 6. Output and V-T Voltmeters. | 24. Aligning Superhets (Cathode-Ray). |
| 7. Tube Checkers. | 25. Repairing Individual Parts. |
| 8. Constructing Tube Checkers. | 26. Auto-Radio Installation and Servicing. |
| 9. Commercial Tube Checkers. | 27. All-Wave Receiver Servicing. |
| 10. Voltage-Current Set Analyzers. | 28. Marine Receiver Installation and Servicing. |
| 11. Point-to-Point Testing. | 29. Noise Elimination. |
| 12. Constructing Set Analyzers. | 30. High-Fidelity Receiver Problems. |
| 13. Commercial Set Analyzers. | 31. How to Sell Your Service (Advertising and Merchandising). |
| 14. Service Test Oscillators. | |
| 15. Constructing Test Oscillators. | |
| 16. Commercial Test Oscillators. | |
| 17. Preliminary Trouble Tests. | |
| 18. AVC and QMC Circuits. | |

This is the most complete book on every phase of practical service work ever written—and YOU CAN'T AFFORD TO MISS IT!

OVER 1,300 PAGES . . . \$5.00



It's New!

Third Edition

RADIO Troubleshooter's HANDBOOK
by **A. A. GHIRARDI**

Brand new completely revised and greatly enlarged 3rd edition of a time-saving data Handbook that has become "standard equipment" in the shops of thousands of smart service men. It now contains 744 manual-size (8 1/2 x 11) pages check full of tabulated servicing data of all kinds arranged for immediate reference. All data is "factory checked." **HANDY . . . COMPACT . . . EASY TO USE.** Entirely different from anything you now have in your regular servicing manuals. Here are a few of the sections:

★ **OVER 4,800**

"CASE HISTORIES"

Symptoms and remedies for the Common Troubles in over 4,800 different home and auto-radio receivers, and record changers. Compiled from actual service records of large servicing organizations. A real time-saver!

★ **OVER 20,800 I-F. PEAKS**

Up-to-date listings for all makes and models of superhets, old and new, including latest sets, and also instructions for aligning "orphan" sets.

★ **AUTO-RADIO DATA**

Ignition-System Interference Data for over 80 car models. Electrical Wiring Diagrams. Table of battery polarities, breaker-point gaps, spark-plug gaps, antenna data, etc. Gear Ratios and Dial Directions of Control Heads, etc.

★ **OTHER FEATURES**

Comprehensive Tube Charts for all tube types—from oldest to the newest! Over 50 Charts and Data Tables on Resistors, Condensers, Transformers, portable receiver Replacement Batteries, RMA Color Codes, Trade Directories, etc., etc.—every one of vital importance to every service man.

744 PAGES (8 1/2 x 11") . . . \$5.00

SPECIAL MONEY-SAVING COMBINATION OFFER! Modern Radio Servicing **\$9.50**
WITH
Trouble-Shooter's Handbook

SHORT-WAVE HANDBOOK

By **CLIFFORD E. DENTON**



Everything you could ask for in a book on short-wave radio is here. It is so comprehensive in scope that it is entirely unnecessary to resort to external references for details. Coil-winding data for all standard forms and for all types of tuning condensers are graphically depicted. There are invaluable wire tables for both solid and

is that everyone can use. The section on audio amplifiers for s.w. receivers is complete. There is a large section devoted to complete construction details on s.w. oscillators, t.r.f. receivers, and a superheterodyne. A good part of the material in this book is based on the actual questions asked by thousands of short-wave experimenters in letters addressed to the author during the last few years—the very questions you yourself need information on.

128 Pages—Over 150 diagrams and illustrations—Bound in heavy, black durable cover. Net Price \$1.00



Radio and Technical Publishing Company of New York City are the publishers of the famous "Ghirardi books," known all over the world as the finest works available on radio subjects. Send for complete circulars describing the books announced on this page and on the page following.



YOUR INVENTION

How to Protect and Merchandise It

By **ELMORE B. LYFORD**

A book of practical patent information for the inventor, purchaser, or user of patents, explaining in detail every single step which must be taken to secure adequate patent protection, make the most advantageous arrangements for the licensing, sale, or purchase of the patent rights, and raising capital for the manufacture of the patented article.



"YOUR INVENTION" will save its co-hundreds of times over if it merely succeeds in preventing only one of those expensive mistakes that inventors so often make.

210 pages, 5 1/2 x 8—illustrated. Cloth binding

Net Price \$1.50



RADIO & TECHNICAL PUBLISHING COMPANY

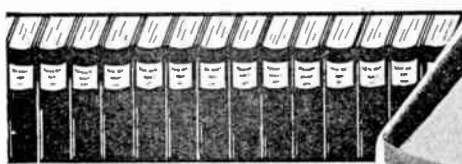

The equivalent of
36 Radio books

Ghirardi's
Famous

RADIO PHYSICS COURSE

The world's greatest collection of radio knowledge gathered together in one huge 972-page inexpensive volume. A complete radio course so head-and-shoulders above anything in the field that it is used as the basic text by thousands of students and schools in 82 different countries.

Ghirardi gives you everything you want to know—the most simple, complete and comprehensive book published on the fundamentals of radio, electricity and sound. Everything is explained clearly, and is easy to understand for quick study and reference.

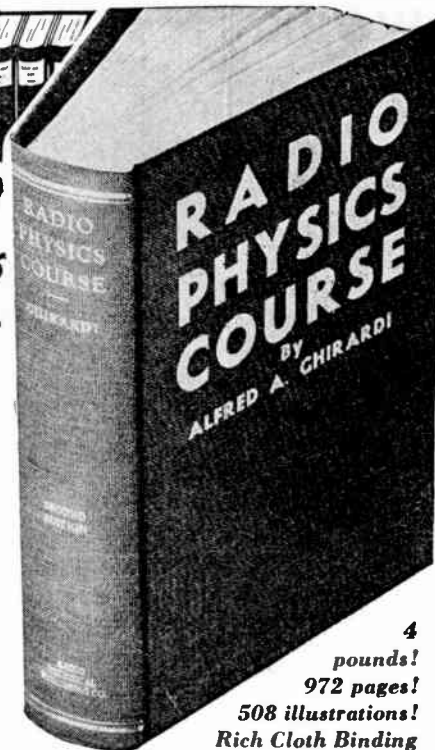

4
pounds!
972 pages!
508 illustrations!
Rich Cloth Binding

LEARN
RADIO FUNDAMENTALS
from
This Book!



All in one
big \$5 volume

EVERYTHING about RADIO, SOUND and ELECTRICITY

1. Radio Broadcasting System.—2. Sound, Speech and Music.—3. Electron Theory; Electric Current.—4. Electrical Units; Ohm's Law; Resistance.—5. Electrical Circuits; Batteries.—7. Electromagnetism. 8. Electro-magnetic Induction. — 9. Inductance and Inductors.—10. Capacitance and Condensers.—11. Alternating Current Circuits.—12. Electric Filters.—13. Electrical Measuring Instruments.—14. Electromagnetic Radiations.—15. Radio Transmission; The Broadcasting Station.—16. The Receiving Station.—17. Elementary Study of the Vacuum Tube.—18. Vacuum Tube Characteristics. — 19. Construction Features of Vacuum Tubes.—20. Vacuum Tube Detector and Amplifier Action. 21. Radio Frequency Amplification.—22. Superheterodyne Receivers.—23. R.F. Amplifier and Tuning Coils. — 24. Audio Amplification. 25. Loud Speakers.—26. Battery-operated Receivers.—27. Power Supply Units.—28. Electric Receivers.—29. Auto-radio and Aircraft Receivers.—30. Phonograph Pickups and Public Address Systems.—31. Short-wave Receivers.—32. Vacuum Tube Applications and Photoelectric Cells. — 33. Television. — 34. The Antenna and Ground.—35. Testing and Servicing. — 36. Sound Motion Pictures. — Appendixes. — 856 Review Questions for Self-Study.



Your Service Work
with GHIRARDI'S GADGETS

You'll marvel at these ingenious "TWIN GADGETS." Handiest little time-savers you ever saw! They'll "trouble-shoot" radio sets with lightning speed—just a flip of a card and there before you are the "remedies" and "tests" to make for whatever "trouble" symptoms you find. They'll cut your trouble-shooting time in half and earn back their small cost on a couple of calls.

ORDER THEM TO-DAY!
Ghirardi's Amazing

POCKET TROUBLE SHOOTERS

Only 50c Each—\$1 for the Pair

HOME-RADIO GADGET

Spots 400 different "troubles" in Power Unit, Receiver Circuits Proper, Tubes, Loudspeaker, Antenna, Ground, "A" Battery, "B" Battery, etc. for such symptoms as "Hum," "Weak," "Noisy," "Inoperative," "Intermittent Reception," "Fading," "Oscillation," and "Distortion." It not only tells you exactly what test to make to definitely locate each trouble, but actually suggests the "Remedy" for it.

AUTO-RADIO GADGET

Spots 444 special auto-radio "troubles" in all possible trouble-sources for 11 common symptoms: 1. "Hum;" 2. "Weak;" 3. "Noisy" when both car and engine are at rest; 4. "Noisy" when car is at rest with engine idling; 5. "Noisy" when car is driven normally; 6. "Noisy" when car is coasting with ignition off; 7. "No Reception;" 8. "Intermittent Reception;" 9. "Fading;" 10. "Distortion;" and 11. "Oscillation."



The handiest, simplest, most practical AUTO-MATIC WORLD-TIME INDICATOR that has ever been thought up! Absolutely unique and novel. Just turn the rotating clock dial in the center—and there's the information you want—at a glance. No fussing! No fumbling! No guessing! No calculating! This little wonder-worker figures it all out for you accurately, instantly. Every ham and short-wave fan will find this compact, pocket-size Indicator Gadget indispensable. ORDER YOURS AT ONCE! Only 50c postpaid

In a Flash SHOWS YOU:

- ★ Exact Greenwich Mean Time. Standard or Daylight Saving Time in any city and country in the world.
- ★ Difference between local time and G.M.T.
- ★ Time difference between any 2 cities.
- ★ Complete S.-W. station list.
- ★ Plus many other exclusive features.

MAKE SERVICING EASY

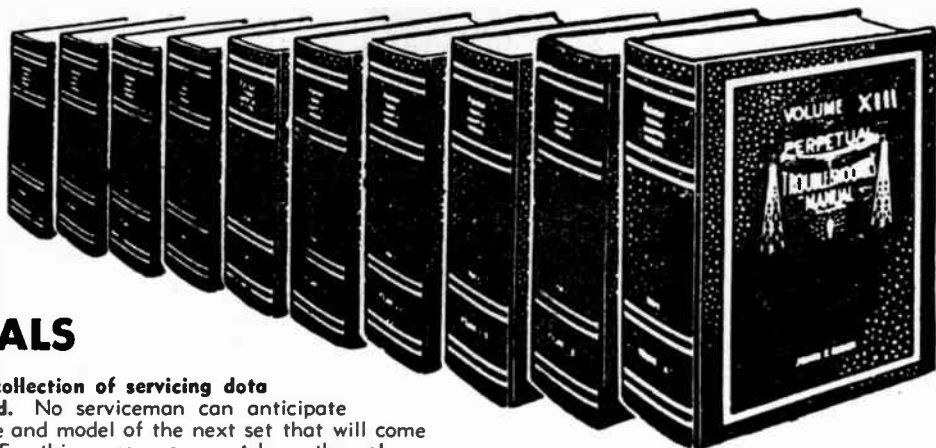

RIDER MANUALS

The greatest collection of servicing data ever assembled. No serviceman can anticipate the year, make and model of the next set that will come to his bench. For this reason you **must** have the volume of Rider Manuals that contains the servicing information on that particular set. Benefit from the **complete** servicing information that only Rider Manuals can give you: Data on alignment, I-F peaks, operating voltages, parts lists and parts values, voltage ratings of condensers,

wattage ratings of resistors, coil resistance data, and all the other information that is vital if you are to know exactly what the manufacturer put in that receiver. No more new receivers after April 22nd! The old sets will now come into the service shop. **So be prepared!**

ABRIDGED MANUAL

Volumes I-V

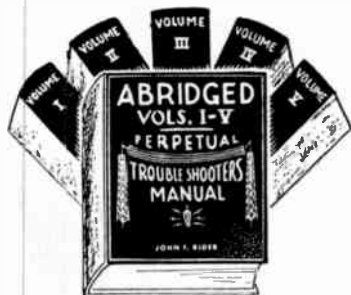

The servicing information you need to service the old receivers will be found in the Abridged Manual, Volumes I-V. It is a compilation of the most widely distributed receivers released after 1929 that formerly appeared in Volumes I-V.

As can be readily appreciated, it is by no means as complete as the original first five individual volumes; these contained a total of approximately 5000 pages, whereas the Abridged Volume contains 2000 pages.

In order to select the proper receivers for inclusion in the Abridged Manual, all the manufacturers who were responsible for the sale of the greatest number of sets between 1930 and 1935 were contacted, and information was obtained as to the most widely distributed receivers. The Abridged Manual was then compiled.

2,000 Pages Net Price \$12.50

- VOL. XIII. This newest Rider Manual covers the servicing data on receivers manufactured as late as March, 1942. Because of the curtailment of receiver manufacturing, every effort was made to include information on those receivers produced during the latter months of 1941 and the early months of 1942. This addition of Rider's Volume XIII makes available to the radio industry more than 18,000 pages of authentic servicing information.1672 pages, Net Price \$11.00
- VOL. XII. Covers receivers manufactured up to April 1941. . . . New arrangement provides for maximum number of sets. Clarified schematics give breakdowns of complicated r-f and a-f switching circuits. Also double spread pages for complicated diagrams and cumulative index for Volumes XI and XII.1,648 pages, Net Price \$11.00
- VOL. XI. Covers receivers manufactured up to June 1940. Includes vest pocket manual containing push-button frequency ranges of all automatically tuned receivers and other handy servicing data. Also double spread pages and new How It Works section devoted to explanations of the electrical and mechanical operations of the more complicated 1940 receivers including television, facsimile, and frequency modulation.1,652 pages, Net Price \$11.00
- VOL. X. Complete information on receivers manufactured up to August, 1939. Also a special 64-page How It Works Section and double-spread pages for the complicated diagrams. Includes a separate 188-page index with lists of exactly what appears on every page in Volume X and all preceding volumes. 1,664 pages, Net Price \$11.00
- VOL. IX. Contains installation and servicing instructions on 1889 models manufactured up to October, 1938. Also a special 36-page "How It Works" section and double-spread pages for the complicated diagrams. 1,672 pages, Net Price \$11.00
- VOL. VIII. Receivers manufactured up to October, 1937 will be found in this volume. Contains installation and servicing instructions on many types of intercommunication systems. Also a special 64-page "How It Works" section and double-spread pages for the complicated diagrams. 1,650 pages, Net Price \$11.00
- VOL. VII. In this volume will be found sets manufactured up to October, 1936, together with data on older receivers hitherto unavailable. Data on more than 1,700 models—complete information.1,600 pages, Net Price \$11.00
- VOL. VI. In this volume will be found sets manufactured up to November, 1935, together with data on older receivers hitherto unavailable. Data on more than 950 models—complete information. 1,240 pages, Net Price \$8.25
- VOL. V. In this volume will be found sets manufactured up to October, 1934, together with data on older models, hitherto unavailable. Data on more than 940 models are presented—not only electrical data, but information on the mechanical intricacies of the sets. 1,200 pages, Net Price \$8.25
- VOL. IV. Receivers manufactured up to March, 1934, will be found in this volume. Herein will be found the more complicated superhets with QAVC, noise gates, duo-diode pentodes, automatic tone controls, and all the other new designs. A special 24-page section explains some of the more complicated sets 1,060 pages, Net Price \$8.25
- VOL. III. The receivers produced between the middle of 1932 up to June, 1933, are included in Volume III. Herein will be found the early Superheterodyne receivers, which were introduced in this period.1,070 pages, Net Price \$8.25

Vol. I and Vol. II out of print—no longer available

RIDER'S MANUALS HAVE more schematics . . . more I.F. peaks . . . more alignment data . . . more circuit descriptions. . . . MORE EVERYTHING THAN ANY OTHER MANUALS.

FORTHCOMING PUBLICATION

INSIDE THE VACUUM TUBE

A complete elementary explanation of vacuum tube fundamentals written especially for the man who wants to know how all types of vacuum tubes function. The electron viewpoint is used consistently throughout the book. The illustrations are of a new kind, greatly simplifying the understanding of tube behavior.

Copyright by U. C. P., Inc.

Net

G-3

FREQUENCY MODULATION

The latest development in radio—FREQUENCY MODULATION—is on the air. More and more stations all over the country are making provision for “staticless” broadcasting and the number of F-M receivers on the market is increasing. . . . Here is your chance to get in at the start—Rider’s newest book explains the transmission and reception of frequency-modulated signals with especial attention given to the different types of f-m receivers now available—their adjustments and maintenance. . . . This is a “must” for every serviceman who has an eye on the future. . . . It is an investment that will pay real dividends!

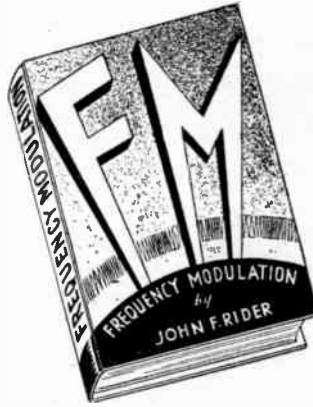

CONTENTS

Chapter I. Frequency Modulation.—An introduction to the subject with comparisons drawn between the frequency-modulation and amplitude-modulation forms of transmission and reception. Chapter II. What Happens at the Transmitter.—A non-mathematical explanation of how frequency-modulated signals are broadcast, including a discussion of phase modulation. Chapter III. What Happens in the Receiver.—How the f-m signal progresses through the receiver and how it is affected by the limiter discriminate tubes. Chapter IV. Wave Propagation and Service Areas.—How the ultra-high frequency waves are used for f-m transmission and the area covered. Chapter V. F-M Receiving Antennas.—Explanations and data concerning the best types of antennas for the reception of f-m signals. Chapter VI. Servicing F-M Receivers.—Valuable instructions for the adjusting and maintenance of the receiver including numerous oscillograms that will guide you in your servicing problems.

136 PAGES TYPE SET FLEXIBLE CLOTH PROFUSELY ILLUSTRATED NET PRICE \$1.50

THE METER AT WORK



Here is a practical book for all who employ electric meters in radio and the allied electronic arts.

It is only through knowledge of the principles underlying the functioning of any piece of apparatus that a man can get the utmost use from it. To that end, it will be found that the subject matter of this book is treated from an entirely new angle, the theory upon which each meter is based is separate and distinct from any other type and complete in itself.

Inasmuch as some types of meters can do several jobs, the practical aspects of the meter are confined to the latter portion of the book. Thus, you can cover whichever phase of the subject you are interested in, and with the new construction of the book—the separation of text and illustrations—you will be able to obtain the information quickly and with the minimum of effort.

CONTENTS

I—General Considerations. II—Moving-Iron Meters. III—Moving-Coil Meters. IV—Electrodynamometer Meters. V—The Electrostatic Meter. VI—Thermal Meters. VII—Components of Meters. VIII—Characteristics of Meters. IX—Rectifiers and Thermocouples. X—Practical Applications of Meters.

152 Pages . . . 138 Illustrations . . . \$1.50

THE OSCILLATOR AT WORK

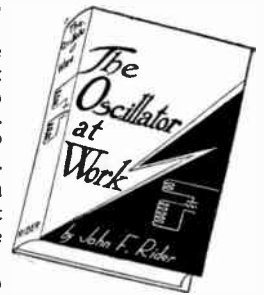

Do you get your money’s worth out of your present-day oscillator? Do you derive maximum utility from that unit? Do you know how to test your oscillator and establish if it is working properly? Would you know how to repair it if it went bad? Do you know how many different types of oscillators can be used in the servicing field?

Here is your opportunity to get the true facts about oscillators! Rider’s “The Oscillator at Work” is worth many times the price asked because it helps protect the investment you have made in oscillator equipment.

CONTENTS

I—How an oscillator works. II—Alternating Currents. III—Triode Oscillators. IV—Electron-Coupled Oscillators. V—Ultra-High Frequency Oscillators. VI—Negative-Resistance Oscillators. VII—Electro-Mechanical Oscillators. VIII—Relaxation Oscillators. IX—Superheterodyne Oscillators. X—R-F Signal Generators. XI—Audio-Frequency Oscillators. XII—Modulation of Oscillators. XIII—Wobblers. XIV—Adjustment of Transmitters. Bibliography.

256 Pages . . . 167 Illustrations . . . \$2.00

A.C. CALCULATION CHARTS

146 charts 7" x 11" printed in two colors, covering all alternating current calculations from 10 cycles to 1000 megacycles. A tremendous time saver for all engineers and others who work on power, audio, supersonic, high frequency and ultra high frequency problems. Eliminates the slide rule.

160 PAGES 9 1/2 x 12 INCHES CLOTH BINDING \$7.50

RIDER

Publications



Just what the Servicing Industry ordered!—

RIDER'S "Automatic Record Changers and Recorders"

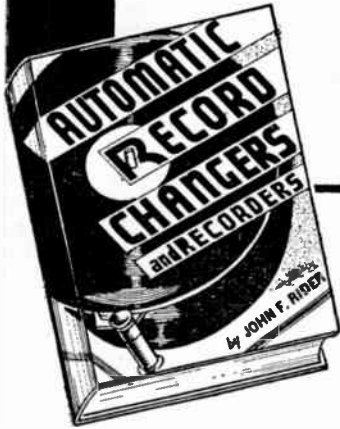

come necessary. Hence the birth of Automatic Record Changers and Recorders. Printed on 8 1/4 x 11 paper, the same size as Rider Manuals, the book covers, by means of explanatory text, mechanical and electrical diagrams, all the information you must have to service these high cost instruments quickly and profitably.

CONTENTS

Chapter I—MOTORS AND DRIVES. D-C Motors. A-C Motors. Universal Motors. Maintenance of Motors. Commonplace Troubles. SPEED REGULATORS and REDUCTION DRIVES. Chapter II—RECORDERS AND PHONOGRAPHS. The Cutting Head. The Groove. Recording Needles. Pick-ups. Phonograph Needles. Chapter III—AUTOMATIC RECORD CHANGERS. Mechanisms. Troubles. Chapter IV—ANALYSIS OF RCA MODEL RP-152-C RECORD CHANGER. MANUFACTURERS' SERVICE DATA.

744 PAGES BOUND IN BUCKRAM \$6.00

800,000 record changers are providing an important source of profit for the wide-awake service shops of the country and creating a need for adequate and ready reference data to speed up trouble shooting and repair. Rider anticipated this need and has prepared—just when you need it—a sturdily bound volume containing everything you need know on any automatic record changer or recorder coming to your shop.

Heretofore, the serviceman's prime interest has revolved around the invisible defects which accompany the operation of electrical devices. Mechanics in radio receivers was limited to a lesser degree. However, with the introduction of the automatic record changer, some knowledge of the development of motion by means of gears, levers and cams has become

SERVICING BY SIGNAL TRACING



Signal Tracing is destined to become the universally adopted method of locating defects in communication systems, no matter what the nature of the system—if it is a home broadcast receiver, auto-radio receiver, police receiver, commercial, marine, navy or army receiver. Every public address system, every centralized radio system comes within the capabilities of signal tracing. . . . Television receivers, facsimile receivers and other systems intended for special application can be serviced with equal ease. . . . Signal Tracing, founded upon the signal itself, is the most basic, most fundamental method of trouble shooting ever devised. . . . It is free of every limitation which in the past has hindered speedy service operations. . . .

You can't afford to be without this book. . . . We mean every word of this statement. . . . It is vital to your immediate welfare—to your future. . . . Get your copy today—NOW!

CONTENTS

Chapter I—Introduction to Signal Tracing. Chapter II—Amplifier Operation and The Signal. Chapter III—Diode Detector Tube Systems. Chapter IV—Multi-Element Detector Systems. Chapter V—Oscillator Tube Systems. Chapter VI—Mixer Tube Systems. Chapter VII—Control Circuits and Voltages. Chapter VIII—Coupling Devices. Chapter IX—The T-R-F Receiver. Chapter X—The Superheterodyne Receiver. Chapter XI—Television and Facsimile Receivers. Chapter XII—Public Address Systems. Chapter XIII—Localizing Defects by Signal Tracing. Chapter XIV—Signal Tracing in Receiver Design.

360 PAGES . . 188 ILLUSTRATIONS . . \$3.00
SPANISH EDITION . . . \$3.50

Copyright by U. O. P., Inc.

VACUUM TUBE VOLTMETERS



The vacuum-tube voltmeter has been rapidly forging to the front as a favorite tool of engineers, research workers and servicemen. By its proper use, dynamic measurements can be made under any and all conditions with a minimum of effort and time. Here is a book that is a perfect mine of information for everybody who wants to know all about these important instruments. Not only is the theory explained upon which the functioning of the different types of v-t voltmeters is based, but the practical applications of these instruments are completely described. Like nearly all types of voltmeters, multipliers and shunts are employed with vacuum-tube voltmeters to extend their ranges. These and their uses are explained, as is the calibration of the different types.

For those men who are interested in the construction of v-t voltmeters, adequate information will be found for v-t voltmeters were built in the author's laboratory, and constants are given for the components of many types, as well as a wealth of other useful data.

CONTENTS

Chapter I. Fundamentals of Vacuum-Tube Voltmeter. Chapter II. Diode Vacuum-Tube Voltmeters. Chapter III. Triode Vacuum-Tube Voltmeters. Chapter IV. Slide-Back Vacuum-Tube Voltmeters. Chapter V. Rectifier-Amplifier Vacuum-Tube Voltmeters. Chapter VI. Tuned Vacuum-Tube Voltmeters. Chapter VII. Audio-Frequency and Logarithmic Vacuum-Tube Voltmeters. Chapter VIII. Vacuum-Tube Voltmeters for D-C Voltage, Current, and Resistance Measurements. Chapter IX. Design and Construction of Vacuum-Tube Voltmeters. Chapter X. Calibration and Testing of V-T Voltmeters. Chapter XI. Applications of V-T Voltmeters. Bibliography.

180 PAGES . . 111 ILLUSTRATIONS . . \$2.00

Net

G-5

RIDER

Publications



THE CATHODE-RAY TUBE AT WORK



A new era in the servicing of radio receivers, public-address systems, transmitters, etc., is in the offing. It is the use of the cathode-ray tube and the progressive serviceman will prepare himself now for the change that is coming. The theory underlying the functioning of the cathode-ray tube and the circuits that accompany it receives full consideration in this book. The second half of the volume is devoted to specific and practical applications of commercial oscilloscopes to servicing and adjustment problems. Order your copy today!

CONTENTS

I—The Theory of the Tube. A complete explanation of the different types of cathode-ray tubes. How the spot is focussed and how the beam of electrons is deflected. II—Sweep Circuits. How and why the spot moves across the screen and forms the image. III—A.C. Voltages on Both Sets of Plates. An explanation of the patterns formed on the cathode-ray tube screen when a.c. voltages are applied. IV—Commercial Cathode-Ray Oscillographs. A detailed description of the various cathode-ray oscillographs that are on the market. V—Practical Application of the Cathode-Ray Oscillograph. General directions for adjusting the cathode-ray oscillograph for all tests. VI—Alignment of Tuned Circuits. Understandable explanation of the theory of the frequency modulated oscillator and how it is used in testing with the cathode-ray oscillograph. VII—The A-F. Frequency Modulator. How overall a-f. response curves of audio units are developed and what they mean. VIII—Auto Radio Vibrator Testing. The connections for testing vibrators with the cathode-ray tube oscillograph. IX—Transmitter Adjustment. How the modulation of a wave is measured and the trapezoidal pattern is developed on the screen. X—Other Applications of the Cathode-Ray Oscillograph. Beat patterns, c-w. reception and detection.

338 Pages . . Profusely Illustrated . . Net Price \$3.00



SERVICING SUPERHETERODYNES

No other circuit in the radio field has undergone all the changes that have been incorporated in the superheterodyne. In order to service these receivers with profitable speed, you must be able to analyze the different portions of the circuit quickly and this is just what Rider tells you how to do in this book. Not only is the theory of all types of Superhets thoroughly covered, but actual servicing details are most complete. Many thousands of Servicemen are using "Servicing Superheterodynes" daily and are finding the investment one that paid dividends in increased profits.

CONTENTS

I—The Principles Underlying the Operation of the Superheterodyne Receiver. II—The Generation of and the Relation Between Harmonics. III—Explanation of the Different Types of Superheterodyne Circuits. IV—Function and Characteristics of Individual Parts of the Superheterodyne Receiver. V—Special Circuits and Tube Applications. VI—Troubles and Symptoms Encountered in Superheterodynes. VII—Application of Test Oscillators. VIII—Vibrator Units. Appendix—Intermediate Peak Frequencies of Commercial Receivers with Model Numbers.

288 Pages . . Profusely Illustrated . . Net Price \$1.00

Alternating Currents in Radio Receivers

Are you familiar with the different forms of alternating currents which are present in a radio receiver? When once you understand the basic facts relating to the cycle—frequency—sine wave—harmonics—complex waves—modulated waves—phase relations—you will have no trouble in understanding the servicing problems which involve these factors.

D.C. Voltage Distribution

Only a casual glance at the schematics of some of the 1939 multi-tube sets will convince you that the distribution of the D.C. voltage to the tube elements is complicated. The many different forms these systems take should be recognized at a glance and understood. You should know thoroughly how the value of resistance and wattage rating of each resistor is calculated and why.

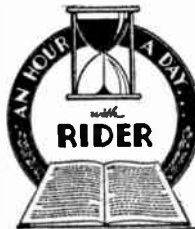

96 Pages Each
Net Price 90c Each

Resonance and Alignment

Do you know what happens when you tune a circuit to resonance? In order to align a receiver, oscillator, or transformer properly, so that maximum efficiency is attained, you must be familiar with more than just the mechanical operation. Are you familiar with I.F. oscillator, R.F. and detector alignment for all types of circuits—single, double and triple tuned systems?

Automatic Volume Control

Automatic volume control has now become a standard feature of every well made receiver. Are you familiar with every type in use and can you recognize one system from another by examining the schematic? Do you know how various types of tubes are used in each circuit? Noise suppression systems, time delay circuits—audio-frequency volume expander systems and other such networks have greatly increased servicing problems.

HARD COVERS TYPE SET PROFUSELY ILLUSTRATED HANDY POCKET SIZE

SERVICING RECEIVERS BY MEANS OF RESISTANCE MEASUREMENT

Take the guesswork out of servicing by using an ohmmeter in your trouble shooting. This book tells you how to make and correctly interpret point to point resistance measurements. It will simplify your servicing problems and enable you to use the resistance data furnished in RIDER MANUALS to the best advantage. Now that more and more manufacturers are supplying resistance data, you need this book to speed up your servicing with greater accuracy. Let Rider show you how to use a modern servicing procedure on the complicated receivers—you will find in this book the usual Rider clarity of explanation of how theory is applied to practice.

203 Pages Net Price \$1.50

G-6



ALIGNING PHILCO RECEIVERS Two Volumes

Everything you need for aligning Philco receivers . . . I.F. peaks—adjustment frequencies—trimmer and padder locations—complete and detailed information for aligning every Philco model from 1929 to 1941. These two volumes, prepared with the cooperation of the engineering staff of the Philco Radio & Television Corp., are the authentic source of alignment information and the data are presented in a brand new way that makes alignment easier and quicker. You will find all the necessary data arranged so that every step in the alignment procedure is carried out in a definite and forth is eliminated completely in this radically new style of presenting alignment data.

Vol. I—1929 to 1936—176 pages—\$1.50
Vol. II—1937 to 1941—200 pages—\$1.75

Net

AUTOMATIC FREQUENCY CONTROL SYSTEMS

From the simplest type of A.F.C. circuit to the most complicated push pull control circuit . . . you will find them all clearly explained in Rider's book. The first part of the book is devoted to a review of the combination of D.C. voltages, the phase relations in inductive, capacitive, and transformer circuits, with particular reference to the manner in which these principles appear in A.F.C. circuits. The remaining chapters cover the operation of all types of discriminator circuits, the operation of the various types of control tube circuits, including the push-pull type, the reflected reactance type, and the mutual inductance type. Let Rider tell you all about A.F.C. in this up-to-the-minute book that combines theory and practice.

144 Pages Net Price \$1.25

Copyright by U. C. P., Inc.

Radio's leading practical text

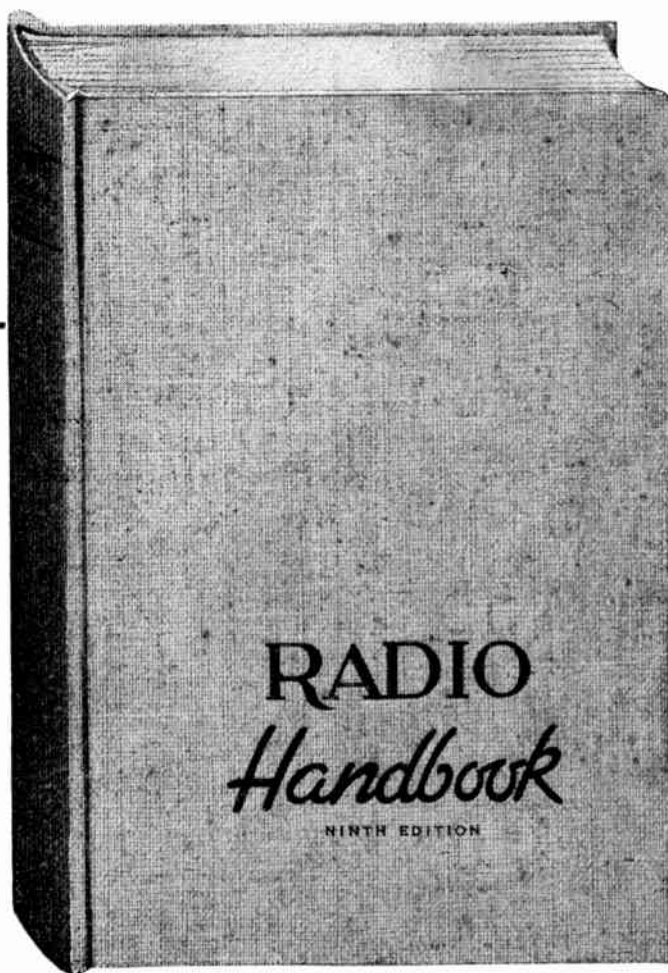

COMPLETE — CONCISE — ACCURATE

Written in clear, easy-to-understand language for the man without extensive mathematical or technical training.

Basic electrical and radio theory in the simplest possible language, accompanied by detailed constructional data on transmitting, receiving and test equipment of all types.

An expanded basic but simple theory section, added data on test instruments which can be built on the home or field, and a new section on radio mathematics make this the

ideal text for war radio training purposes

Over 600 pages, durably clothbound, goldstamped

\$2.00 in continental U. S. A.

Elsewhere, \$2.25

THE "RADIO" HANDBOOK
ninth edition

SUPREME PUBLICATIONS

RADIO BOOKS • SERVICE MANUALS

RADIO DIAGRAMS and Servicing Information

1942 New volume of recent most popular sets. Data you need for quick repairs. 204 pages, 8½ x 11 inches. **\$2.00**

1941 These easy-to-use, inexpensive manuals will give you 4 out of 5 circuits you will ever need. This volume covers 1941 models, with alignment data, service hints, I. F. peaks and replacement parts lists. Compiled by M. N. Beitman, radio serviceman for many years, author, and teacher, **\$2.00**



1940 Let this important manual give you over 80% of 1940 circuits you will ever need, acquaint you with new developments, train you to service quickly and efficiently millions of sets. Data on F.M., portables, recording, etc. 417 models of 43 manufacturers. **\$2.00**

1939 Another condensed manual of most-popular diagrams you need. Circuit data, hints, and information are time-savers and money-makers for you. Let these diagram manuals guide you to easier service. 192 pages, 8½ x 11 inches. Diagram of 39 manufacturers. **\$2.00**

1926-1938 The most popular manual of the series. Will pay for itself with time saved the first day of use. 427 diagrams of most-serviced radios, with parts list and alignment information. 244 pages, 8½ x 11 inches. **\$2.50**

RECORD PLAYERS AND RECORDERS

Just what you need to repair quickly and correctly thousands of automatic record changers, manual units, pickups, wireless oscillators, recorders, and combinations. Hundreds of mechanical and electrical diagrams. Instructions for adjustments and repairs. The most popular units of all makes included. 132 large pages, 8½ x 11 inches. **\$1.50**

STEWART-WARNER MANUAL

This handy diagram manual contains diagrams, service notes, alignment data, for popular Stewart-Warner radios of all periods. Get this inexpensive book and be ready to service your next set of this important make. Size: 5½ x 11 inches **50c**

ARVIN DIAGRAM MANUAL

The most-often-needed diagrams of Noblitt-Sparks (Arvin) radios are included in this manual. Service these popular sets with confidence and skill, using this low priced radio publication. Size: 5½ x 11 inches. **50c**

GENERAL ELECTRIC MANUAL

This 64-page complete manual of the most-popular GE sets is something you must have. The entire manual of these "often-needed" important circuits is yours for less than the cost of a single diagram. Size: 5½ x 8½ inches. **50c**

Simplified Radio Servicing by COMPARISON Method

Repair radios in minutes instead of hours. Revolutionary different COMPARISON technique permits you to do expert work on all radio sets. Most repairs can be made without test equipment or with only a voltohmmeter. Many simple, point-to-point cross-reference, circuit suggestions locate the faults instantly. Plan copyrighted. Covers every radio set—new and old models. This new servicing technique presented in handy manual form, size 8 x 11 inches, 112 pages. Over 1,000 practical service hints. 16 large, trouble-shooting blueprints. Charts for circuit analysis. 114 tests using a 5c resistor. Developed by M. N. Beitman. **\$1.50**



How to MODERNIZE RADIOS for Profit

You can learn quickly to modernize all sets. Lack of new sets will make a tremendous market for this service. Cash-in by improving audio circuits, modernizing cabinets, adding features usually found on late model sets. Practical job-sheets with schematics and photographs make the work easy. You are told how to obtain modernization work, what to charge, and how to complete the job quickly and efficiently. Large size, 8½ x 11 inches manual is priced at only **\$1.00**



CYCLOPEDIA OF TELEVISION FACTS

This new television book defines and explains every term and part used in television transmitting and receiving equipment. The more important terms are described in greater detail. You will find the TELEVISION CYCLOPEDIA an excellent introduction to television and a great aid in understanding more technical articles and books. Included are many photographs and charts to assist you. Every radio serviceman, amateur, and technician must have this book to understand television. 64 fact-packed pages; 5½ x 8½ inches. **40c**

RADIO SERVICING COURSE BOOK

Learn new speed-tricks of radio fault finding, case histories of common troubles, servicing short-cuts, extra profit ideas. Many large lessons on the use of regular test equipment, explanation of signal tracing, television to the minute, recording dope. With this information you will save enough time on a single radio job to pay the special \$2.50 price for the complete course of 22 money-making lessons. Many active servicemen used this reduced price radio training for brush-up and study of new servicing methods.

Reprinted in 1941 with information on signal-tracing, television, visual alignment, P.A., photo-cells, etc. All about AVC, how to use an oscilloscope, what is feed-back, resonance action, and every other fact you must know to be most expert in your work. **\$2.50**

PRACTICAL RADIO MATHEMATICS



Introduces and explains the use of arithmetic and elementary algebra in connection with units, color code, meter scales, Ohm's Law, alternating currents, ohmmeter testing, wattage rating, series and parallel connections, capacity, inductance, mixed circuits, vacuum tubes, curves, the decibel, etc., etc., and has numerous examples. Plainly written and easy to understand. Only useful data included. 32 pages. Size: 5½ x 8½ inches **25c**

2nd Edition

MOTOROLA SERVICE MANUAL

This up-to-the-minute manual will tell you how to repair every MOTOROLA auto radio. Includes detail schematics, service notes, alignment data, and parts lists for all of the 72 models made to 1941. Prepared with the help of Galvin Mfg. Co. engineers. This large 8½ x 11 inch, 96 page manual is priced at only **\$1.50**



The Radio Amateur's Handbook

"THE ALL-PURPOSE VOLUME ON RADIO"

Text, data book, operating manual — it is all these and more. As a text it is probably more used in radio schools and colleges than any other single volume. As a practical constructional handbook, it stands in a class alone. As an operating manual, it provides information available from no comparable source.

Standard Edition

The latest Edition of THE RADIO AMATEUR'S HANDBOOK is the largest ever published. It includes a comprehensive chapter dealing with War Emergency Radio Service plus other new material — all added without sacrificing the essential information in previous editions which made the HANDBOOK the world's most valuable and widely-used radio book. The theory and design sections cover every subject encountered in practical radio communication, sectionalized by topics with abundant cross-referencing and fully indexed.

\$1.00 In Continental U. S. A.

\$1.50 Elsewhere

\$2.00 Buckram Edition

Special Defense Edition

This edition of the HANDBOOK is designed especially for use in radio training courses. It eliminates those portions of the regular edition which are not useful for instruction purposes and has added chapters on mathematics, measuring equipment and code instruction. The first chapter covers the elementary mathematics necessary for the solution of all formulas and interpretation of graphs appearing throughout the text. A four-place log table is included in the Appendix.

\$1.00 Postpaid Anywhere

A Course in Radio Fundamentals

BY GEORGE GRAMMER

The objective in preparing this course was to accent those principles most frequently applied in actual radio communication. "A Course In Radio Fundamentals" is a study guide, examination book and laboratory manual. Its text is based on the "Radio Amateur's Handbook". Either the special edition for war training purposes or the Standard Edition may be used. References contained in the "Course" are identical in both editions. As a text, this book greatly smooths the way for the student of the technicalities of radio. It contains interesting study assignments, experiments and examination questions for either class or individual instruction. It describes in detail 40 experiments with simple apparatus giving a complete practical knowledge of radio theory and design.

Price 50c

Learning the Radiotelegraph Code

BY JOHN HUNTOON

This booklet is designed to train students to handle code skillfully and with precision. Employing a novel system of code-learning based on the accepted method of *sound* conception, it is particularly excellent for the student who does not have the continuous help of an experienced operator or access to a code machine. It is similarly helpful home-study material for members of code classes. Adequate practice material is included for classwork as well as for home-study. There are also helpful data on high-speed operation, typewriter copy, general operating information — and an entire chapter on tone sources for code practice, including the description of a complete code instruction table with practice oscillator.

Price 25c

The A. R. R. L. Antenna Book

BY GEORGE GRAMMER and BYRON GOODMAN

A comprehensive manual of antenna design and construction. Sixteen chapters, profusely illustrated. Both the theory and the practice of all types of antennas used by the amateur, from simple doublets to multi-element rotaries, including long wires, rhomboids, vees, phased systems, u.h.f. systems, etc. Feed systems and their adjustment. Construction of masts, lines and rotating mechanisms. The most comprehensive and reliable information ever published on the subject. Over 100 pages.

Price 50c

AMERICAN RADIO RELAY LEAGUE, INC., West Hartford, Conn., U.S.A.



How To Become A Radio Amateur

Universally recognized as the standard elementary guide for the prospective amateur. Features equipment which is simple in construction. The apparatus is of a thoroughly practical type capable of giving long and satisfactory service — while at the same time it can be built at a minimum of expense. The design is such that a high degree of flexibility is secured, making the various units fit into the more elaborate station layouts which inevitably result as the amateur progresses. Complete operating instructions and references to sources of detailed information on licensing procedure are given.

Price 25c

The Radio Amateur's License Manual

To obtain an amateur operator's license you must pass a government examination. The License Manual tells how to do that — tells what you must do and how to do it. It makes a simple and comparatively easy task of what otherwise might seem difficult. In addition to a large amount of general information, it contains questions and answers such as are asked in the government examinations. If you know the answers to the questions in this book, you can pass the examination without trouble.

Price 25c

Hints & Kinks

Amateurs are noted for their ingenuity in overcoming by clever means the minor and major obstacles they meet in their pursuit of their chosen hobby. An amateur must be resourceful and a good tinkerer. He must be able to make a small amount of money do a great deal for him. He must frequently be able to utilize the contents of the junk box rather than buy new equipment. Hints and Kinks is a compilation of hundreds of good ideas which amateurs have found helpful. It will return its cost many times in money savings — and it will save hours of time.

Price 50c

Lightning Calculators

Radio Type A

Price \$1.00

This calculator is useful for the problems involving frequency, wavelength, inductance, capacity, etc. It has two scales for physical dimensions of coils from one-half inch to five and one-half inches in diameter and from one-quarter to ten inches in length; a frequency scale from 400 kilocycles through 150 megacycles; a wavelength scale from two to 600 meters; a capacity scale from 3 to 1,000 micro-microfarads; two inductance scales with a range of from one microhenry through 1,500; a turns-per-inch scale to cover enameled or singler silk covered wire from 12 to 35 gauge, double silk or cotton covered from 0 to 36 and double cotton covered from 2 to 36. Using these scales in the simple manner outlined in the instructions on the back of the calculator, it is possible to solve problems involving frequency in kilocycles, wavelength in meters, inductance in microhenrys and capacity in microfarads. Gives the direct reading answers for these problems with accuracy well within the tolerances of practical construction.

Ohm's Law Type B

Price \$1.00

With this concentrated collection of scales, calculations may be made involving voltage, current, and resistance, and can be made with a single setting of a dial. The power or voltage or current or resistance in any circuit can be found easily if any two are known. This is a newly-designed Type B Calculator which is more accurate and simpler to use than the justly-famous original model. It will be found useful for many calculations which must be made frequently but which are often confusing if done by ordinary methods. All answers will be accurate within the tolerances of commercial equipment.

AMERICAN RADIO RELAY LEAGUE, INC., West Hartford, Conn., U.S.A.

THE 1942 SKYRIDER "32"



THE "SKYRIDER 32" has two stages of preselection—high fidelity audio—calibrated band spread—micrometer dial on main dial control—heavy gauge steel cadmium plated chassis—standard size relay rack panel $\frac{1}{8}$ " thick—machine tool gray wrinkle finish cabinet well ventilated and attractively designed.

GENERAL SPECIFICATIONS

FREQUENCY RANGE:

- Band 1—500 to 1455 KC
- Band 2—1400 to 2800 KC
- Band 3—2670 to 5800 KC
- Band 4—5.3 to 11.3 MC
- Band 5—10.8 to 23.1 MC
- Band 6—20.8 to 40 MC

TUBE LINEUP:

- 1—6AB7 1st RF Amplifier
- 1—6SK7 2nd RF Amplifier
- 1—6SA7 Mixer
- 1—6SA7 H.F. Oscillator
- 1—6SK7 1st IF Amplifier
- 1—6SK7 2nd IF Amplifier
- 1—6B8 AVC Amplifier
- 1—6H6 ANL & 2nd Det.
- 1—6J5 B.F.O.
- 1—6SC7 1st Audio Amplifier
- 2—6V6GT Push-Pull Output Amplifier
- 1—5Z3 Rectifier

CONTROLS:

- Main tuning with micrometer scale
- Calibrated band spread inertia controlled
- Tone and AC ON-OFF
- Beat Frequency Oscillator
- A.F. Gain
- R.F. Gain
- 6 Position band switch
- Antenna Trimmer
- 6 Position selectivity control
- Crystal phasing
- Send-Receive Switch
- A.V.C.—B.F.O. Switch
- Phone jack

PHYSICAL CONSTRUCTION:

Chassis substantially constructed of 14 gauge steel with flanged edges and flame welded corners. Condenser cover and coil shield compartments assembled to chassis in box girder type of construction. Brushed cadmium plating protects the chassis and metal components. A $\frac{1}{8}$ inch thick steel panel is used with etched control markings and Morocco finish.

The $8\frac{3}{4}$ " x 19" dimensions of the panel are for standard relay rack mounting.

The Cabinet is made of 16 gauge steel attractively finished in machine tool gray wrinkle. Special consideration in the design of the cabinet was given to provide adequate ventilation.

ELECTRICAL FEATURES:

- 1—13 tubes
- 2—6 bands for most satisfactory L/C ratio
- 3—2 R.F. Stages on bands 3, 4, 5, 6
- 4—Push-pull high fidelity, audio output
- 5—6 step wide range variable selectivity
- 6—Wide angle "S" meter
- 7—Phono jack
- 8—Adequate headphone output
- 9—Improved signal to image and noise ratio
- 10—80/40/20/10 meter amateur bands calibrated
- 11—Temperature compensated high frequency Oscillator

CABINET DIMENSIONS:

20 $\frac{1}{2}$ " long—14 $\frac{1}{2}$ " deep—9 $\frac{1}{2}$ " high.

The SKYRIDER "32" with crystal and tubes, less speakerNET

\$149 50

Hallicrafters Jensen bass-reflex enclosure including 12" speaker 30" high—16" deep—22 $\frac{1}{2}$ " wide—Model R12

\$34 50

Hallicrafters Jensen bass-reflex enclosure including 8" speaker 23 $\frac{1}{2}$ " high—10 $\frac{1}{4}$ " deep—17 $\frac{1}{2}$ " wide—Model R8

\$29 95

PRICES SUBJECT TO CHANGE WITHOUT NOTICE

HALLICRAFTERS COMMUNICATIONS EQUIPMENT

WORLD'S LARGEST BUILDERS OF AMATEUR COMMUNICATIONS EQUIPMENT

The New 1942 SUPER SKYRIDER!

The Communications receiver that sets new standards for receiver performance! Frequency range 550 KC to 42 MC in 6 bands.

Two stages of preselection—high fidelity, push pull audio—band pass audio filter—Calibrated band spread—micrometer scale on main dial knob. Heavy gauge steel cadmium plated chassis—standard size relay rack panel 1/8 inch thick—machine tool gray wrinkle finished cabinet well ventilated and attractively designed.

See the 1942 SUPER SKYRIDER and you will know why the HALLICRAFTERS lead in communications equipment value.

The Model SX-28 1942 SUPER SKYRIDER PRICES **\$17950** start at.....NET



The SKYRIDER 28

GENERAL SPECIFICATIONS

FREQUENCY RANGE:

- Band 1— 550 to 1650 KC
- Band 2— 1.5 to 3.2 MC
- Band 3— 3.0 to 6.2 MC
- Band 4— 5.5 to 12.0 MC
- Band 5—11.0 to 23.0 MC
- Band 6—21.0 to 42 MC

TUBE LINEUP:

- 1—6AB7 1st RF Amplifier
- 1—6SK7 2nd RF Amplifier
- 1—6SA7 Mixer
- 1—6SA7 H.F. Oscillator
- 1—6L7 1st IF Amplifier—
noise limiter
- 1—6SK7 2nd IF Amplifier
- 1—6B8 2nd Detector and meter
- 1—6B8 AVC Amplifier
- 1—6AB7 Noise Amplifier
- 1—6H6 Noise Rectifier
- 1—6J5 B.F.O.
- 1—6SC7 1st Audio Amplifier
- 2—6V6GT Push-Pull output
Amplifier
- 1—5Z3 Rectifier

CONTROLS:

- Micrometer scale main tuning inertia controlled
- Calibrated band spread inertia controlled
- Tone and AC ON-OFF
- Beat Frequency Oscillator
- A.F. Gain
- R.F. Gain
- 6 Position band switch
- Antenna Trimmer
- 6 Position selectivity control
- Crystal phasing
- Adjustable noise limiter
- Send-Receive Switch
- A.V.C.-B.F.O. Switch
- Bass boost switch
- Phone jack

PHYSICAL CONSTRUCTION:

Chassis substantially constructed of 14 gauge steel with flanged edges and flame welded corners. Condenser cover and coil shield compartments assembled to chassis in box girder type of construction. Brushed cadmium plating protects the chassis and metal components.

A 1/8 inch thick steel panel is used with etched control markings and Morocco finish.

The 8 3/4" x 19" dimensions of the panel are for standard relay rack mounting.

The Cabinet is made of 16 gauge steel attractively finished in machine tool gray wrinkle. Special consideration in the design of the cabinet was given to provide adequate ventilation.

MECHANICAL FEATURES:

New type inertia-controlled back-lash free dial mechanism on both main tuning and bandspread dials. This mechanism is preloaded and the main shafts are supported at both ends with ball bearings.

The chassis is removed from the front panel and firmly positioned with two brackets which support it without danger of strain or torque.

Both main tuning and band spread condensers are semi-floating and mounted to the chassis at three points.

Components arranged for best electrical efficiency with full consideration for convenience of control mountings.

ELECTRICAL FEATURES:

- 1—15 tubes
- 2—6 bands for most satisfactory L/C ratio
- 3—2 R.F. Stages
- 4—Push-pull high fidelity, audio output
- 5—6 step wide range variable selectivity
- 6—Band pass audio filter
- 7—Wide angle "S" meter
- 8—Phono jack
- 9—Adequate headphone output
- 10—Improved signal to image and noise ratio
- 11—80/40/20/10 meter amateur bands calibrated
- 12—Temperature compensated high frequency oscillator

CABINET DIMENSIONS:

20 1/2" long—14 1/2" deep—9 1/2" high.

The MODEL SX-28 Receiver with crystal and tubes, **\$17950** less speaker(SKYER) NET

Hallcrafters Jensen bass-reflex enclosure including 12" speaker 30" high—16" deep—22 1/2" wide—Model R12.....(SPTWE) **\$3450**

Hallcrafters Jensen bass-reflex enclosure including 8" speaker 23 1/2" high—10 1/4" deep—17 1/2" wide—Model R8.....(SPEIG) **\$2995**

The New **SUPER DEFIANT SX-25**

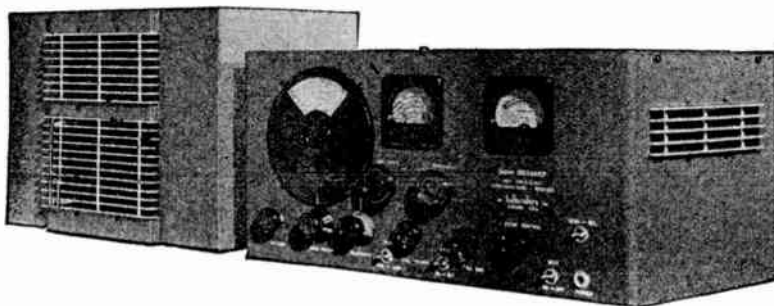

FEATURES

2 Stages of Preselection.
 Twelve tubes:

6SK7 —1st RF Amplifier.	6SQ7 —Phase Inverter.
6SK7 —2nd RF Amplifier.	FP-6F6 —2nd audio output stage.
6K8 —1st Detector-Mixer HF Oscillator.	6H6 —Automatic Noise Limiter.
6SK7 —1st IF Amplifier.	6J5GT —Beat Frequency Oscillator.
6SK7 —2nd IF Amplifier.	80 —Rectifier.
6SK7 —2nd Detector, AVC, 1st stage of audio.	

Overall Range 550 kc. to 42 mc. in four bands:

1—550 kc.-1700 kc.	3—5.0 mc.-15.5 mc.
2—1.7 mc.-5.1 mc.	4—15.1 mc.-42 mc.

Separate calibrated bandspread dial for the 10, 20, 40 and 80 meter bands provides frequency meter tuning. Oscillator compensation for frequency stability. Automatic noise limiter.

Six-step variable selectivity covering wide range from high fidelity to extreme CW crystal.

S meter calibrated in "S" and "DB" units.

Push-pull output stage furnishes 8 watts of audio.

Front panel controls: RF Gain, Selectivity Switch, Crystal Phasing, Audio Gain, Pitch Control, Main Tuning Control, Bandspread Tuning Control, ANL Switch, Hi-Lo Tone, Send-Receive Switch and BFO Switch.

External provision for: Send-Receive Terminals, Headphones, 5000 or 500 ohm output, Single Wire or Doublet Antenna.

Laboratory checked, piezo quartz crystal filter included as standard equipment.

Ten-inch heavy duty PM dynamic speaker in matching metal cabinet included as standard equipment.

Dimensions of receiver cabinet only: 19½" long, 9½" high, 11½" deep.

110 volt 50-60 cycle AC operation. DC operation socket provided for battery or vibrapack.

A MATEURS from coast to coast acclaim this new, de luxe model, amateur receiver as the finest ever developed at anywhere near this price. It offers even better performance than that of the famed SX-17. Its general circuit is based on the proved efficiency of America's best selling receiver, the Skyrider DEFIANT.

Among its outstanding advantages are *extreme selectivity* and *more and better audio*. The design of the crystal filter makes possible critical CW operation under trying conditions of interference, and, in addition, the sensitivity of the receiver is raised from 2.8 to 4 times in the "CW Xtal" position when the receiver is tuned to the exact resonant frequency of the crystal itself; this means more *usable* sensitivity.

Both IF stages are expanded in the "Broad IF" position for high fidelity performance. An effective AVC or automatic volume control circuit keeps most signals at uniform audibility. The automatic noise limiter reduces interference by as much as 70%. The extremely low noise level of the SUPER DEFIANT makes it sensitive to very weak signals.

Every part is placed for best performance without regard for symmetry or beauty. Being self-contained there are no external units except the speaker. Tuning is effortless. Controls are conveniently located.

The SUPER DEFIANT (Model SX-25)—Complete with Crystal and Tubes. Ship- **\$94.50**
 ping weight 52 lbs..... (SKYTF)

Extra for Univ. 110-250 volts, 25-60 cycles.....\$5.00



FEATURES of the SKYRIDER DEFIANT

One stage of preselection. • Accurately calibrated band-spread dial throughout the amateur bands. • Frequency stability throughout a wide range of line-voltage, humidity and temperature variations. • DC operation socket—battery or vibrapack. • A brand new, highly efficient, noise limiter circuit. • Six point variable selectivity from sharp CW crystal to high-fidelity. • Terminals provided for break-in relay operation. Single-signal crystal filter standard equipment. • Meter calibrated in both S and DB units.

The SKYRIDER DEFIANT WITH FREQUENCY METER TUNING

The Sky Rider Defiant offers performance that can be favorably compared with most receivers at twice the price. Every advanced feature of the entire Hallcrafters line is incorporated in this unit. Truly, it has all of the desirable features and qualities that are needed for outstanding amateur reception. Four bands cover the range from 550 kc. to 42 mc.; frequency meter tuning on 10, 20, 40 and 80 meter amateur bands. Tubes—3-6SK7, 1-6K8, 1-6SQ7, 1-6F6G, 1-6H6, 1-76, 1-80. Controls include RF gain, selectivity switch, crystal phasing, audio gain, pitch control, main tuning control, bandspread tuning control, A.N.L. switch, Hi-Lo tone, send-receive switch

and BFO switch. Cabinet size—19½" long, 9½" high, 10⅞" deep. For operation from 110 volt 50-60 cycle AC. For 110 volt AC operation from 6 volt DC use No. 301 Electronic Converter.

The SKYRIDER DEFIANT (Model SX-24)—Complete with tubes and crystal. Shipping weight \$7450 40 lbs. (SKYFY)

The SKYRIDER DEFIANT (Model SX-24)—With tubes, crystal and 10" PM23 Dynamic Speaker. \$8950 Shipping weight 56 lbs.....

Extra for Univ. 110-250 volts, 25-60 cycles... \$500

S-29 SKY TRAVELLER



Take it with you—Use it at Home—The Model S-29 SKY TRAVELLER is truly a universal receiver. Operates on either 110 volt AC or DC from its self-contained batteries. Here is a portable designed to communications receiver tolerances. Mounted in an attractive black crackle finished cabinet with rounded corners, the Receiver covers from 550 kc. to 30.6 mc. (550 to 9.9 meters). Self-contained antenna with high gain coupling circuit provides truly remarkable reception throughout its tuning range. Band spreading is electrical—both RF and IF circuits permeability tuned—average sensitivity below two microvolts on all bands—one stage of preselection on all bands—improved automatic noise limiter for most satisfactory portable operation. \$69.50 The Model S-29 SKY TRAVELLER.....NET

GENERAL SPECIFICATIONS

CONTROLS:

- Main Tuning
- Bandspread
- R.F. Gain
- A.F. Gain
- Band Switch
- Power Switch
- AVC OFF-ON Switch
- BFO OFF-ON Switch
- ANL OFF-ON Switch
- Send-Receive—Standby Switch

CONNECTORS:

- Doublet Antenna Socket
- Long Antenna Socket
- Phone Jack
- Battery Cable with Plugs
- AC/DC Outlet Cord

FEATURES:

- 1—Operates on either 110/125 volts AC or DC and in addition from its self-contained batteries.
- 2—Electrical bandspread
- 3—1.4 volt tubes used throughout
- 4—Battery life prolonged through a self-contained charging circuit
- 5—Automatic Noise limiter
- 6—Self-contained collapsible antenna which can be extended to nearly 3 feet
- 7—An RF stage used on all bands
- 8—Sensitivity below two microvolts on all bands
- 9—High gain antenna coupling circuit for maximum antenna energy transfer
- 10—Approximate battery life 100 hours
- 11—Neon lamp to indicate tubes are lighted
- 12—Permeability tuned RF and IF circuits

PHYSICAL CONSTRUCTION:

Attractive black crackle finished aluminum cabinet substantially constructed to withstand hard usage. All corners of the cabinet are rounded for convenience in carrying. The one piece aluminum chassis is so designed for the greatest rigidity consistent with the least weight.

DIMENSIONS:

7" high—8½" wide—13¼" deep
Weight including all batteries:—18 lbs.

FREQUENCY RANGE:

- Band 1— 550 to 1490 kc
- Band 2— 1.43 to 4.35 mc.
- Band 3— 4.12 to 11.9 mc.
- Band 4—11.26 to 30.6 mc.

TUBE LINEUP:

- 1—1T4 RF Amplifier
- 1—1R5 Mixer
- 1—1P5-GT 1st IF Amplifier
- 1—1P5-GT 2nd IF Amplifier
- 1—1I15-GT 2nd Detector, AVC, 1st audio
- 1—3Q5-GT Output Amplifier
- 1—1G4-GT Beat Oscillator
- 1—1G4-GT Noise Limiter
- 1—25Z5G Rectifier

HALLICRAFTERS COMMUNICATIONS EQUIPMENT
WORLD'S LARGEST BUILDERS OF AMATEUR COMMUNICATIONS EQUIPMENT



**The SKY
 BUDDY**

The new SKY BUDDY is an amateur receiver in every respect, covering everything on the air from 44 mc. to 550 kc., including the 10, 20, 40, 80 and 160 meter amateur bands. It now employs the same electrical bandspread system used in higher priced Hallicrafter models. The more important features are: Electrical bandspread, broadcast Band, BFO, AVC switch, phone jack, pitch control, built-in speaker. For operation on 110 volts 50-60 cycles AC. For operation in 110 volt AC from 6 volt DC use No. 302 Electronic Converter. Dimensions 17½" x 8½" x 8½" high.



FEATURES

Six tubes. Tunes 10 meter band. Electrical bandspread. Coverage and bandspread from 550 kc. to 44 mc. DC operation socket—battery or vibrapack.

The SKY BUDDY (Model S19R)—Including tubes and speaker. Shipping weight 21 lbs.....(SKYBU) **\$3250**

Extra for Univ. 110-250 volts, 25-60 cycles **\$500**



**The
 SKY CHAMPION**

A 9-tube Communications receiver with preselection and built-in speaker, offering a quality of performance never before available at this price.

Has all of the essential controls for good amateur reception as follows: RF gain, tone control, phone jack, AVC switch, BFO switch, send-receive switch, audio gain, pitch control and 4-position band switch. Easily adapted to 6 volt operation with a Model No. 302 Electronic Converter.

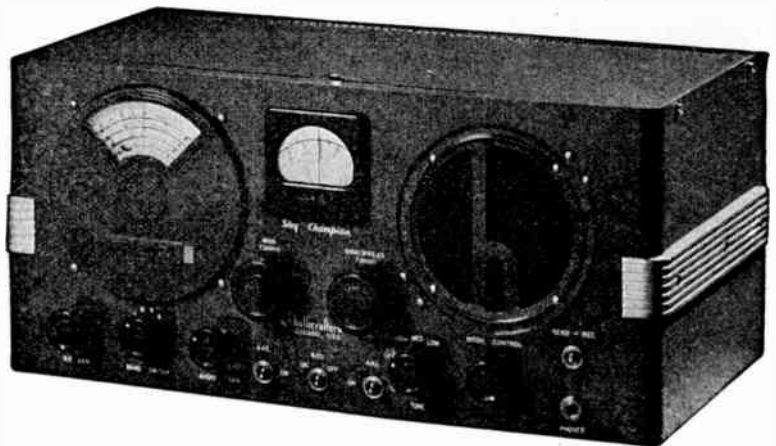

FEATURES: 9 tubes. Complete coverage (545 kc. to 44 mc.). Inertia tuning. Separate electrical bandspread. Beat frequency oscillator. Battery-vibrapack DC operation socket. Cabinet size—18½" long, 8½" high, 9¾" deep.

The SKY CHAMPION (Model S-20R)—Shipping weight 32 lbs.....(SKYON) **\$5450**

Extra for Univ. 110-250 volts, 25-60 cycles.... **\$500**

SM-20R carrier level meter..... **\$1175**

ALLCRAFTERS COMMUNICATIONS EQUIPMENT

WORLD'S LARGEST BUILDERS OF AMATEUR COMMUNICATIONS EQUIPMENT

MODEL S-27

**FREQUENCY MODULATION
AMPLITUDE MODULATION
145 MC—27 MC
COMMUNICATIONS RECEIVER**



THIS Frequency Modulation communications receiver covers 3 bands: 27 to 46mc; 45 to 84mc; 81 to 145mc. Switch changing from FM to AM reception. Acorn tubes in R.F. and converter system. High gain 1852 tubes in Iron Core I.F. stages. Beam power tubes in A.F. amplifier. Controls are: R.F. gain control. Band switch. Antenna trimmer. I.F. selectivity control and power switch.

Volume control. Pitch control. Tone control. S-meter adjustment. AVC on-off switch. Send-receive switch. Phone jack. Amplitude or Frequency Modulation switch. 15 tubes. 110 volt 50-60 cycle AC. Dimensions: 19" long, 9" high, 14" deep. Model S-27. Complete with tubes. Shipping weight 75 lbs. (FREMO) **\$195⁰⁰**



HT-4 450 WATT

The HT-4 is intended for those who want the BEST in an efficient, high-powered rig. The carrier output is 325 watts on phone and 450 watts on CW. The HT-5 preamplifier, supplied with the transmitter, may be mounted at the operating position, controlling volume, keying and standby. Thus, once adjusted to any band the rig may be operated remotely. The transmitter may be set to any three of the 10, 20, 40, 80 and 160 meter bands. Subsequent selection of any of the three frequencies is by a switch on the front panel. Tubes used are: 1-6F6 crystal oscillator, 1-6L6 doubler, parallel RK39's-buffer-driver, 1-RK63 final amplifier, PP-2A3 drivers, PP-RK38 modulators, 2-5Z3, 2-866 rectifiers. The HT-5 preamplifier uses 1-6J7, 3-6J5, 1-80. For operation from 110 volts 50-60 cycles AC. Available for special frequencies. Write for prices. MODEL HT-4—Complete with tubes and HT-5 pre-amplifier. Dimensions: 29" x 19" x 37" high.

Shipping weight 550 lbs. (TRACO) **\$795⁰⁰**

Additional set of coils for any one amateur band (10 to 160) .. **\$275⁰⁰**

MODEL S33 SKY TRAINER

The SKY TRAINER transceiver operates in the 2½ meter amateur band and with this one completely self contained unit, enables you to receive and transmit both voice and code signals. The frequency range of the model S33 is 112mc to 118mc—the transceiver is 10" high by 6½" wide by 4¼" deep. Its weight—complete with batteries is 16 pounds.

The four foot metal antenna rod is held in position on the side of the case by two insulated binding posts. The unit can be conveniently carried about by the leather handle mounted on the top of the case.

Three tubes, a 3Q5 oscillator, 1 H5 AF amplifier and 2Q5 power amplifier are used. CW signals can be transmitted by plugging a key into terminals which are provided.

No external microphone is required. To transmit merely place switch in transmit position and talk.

MODEL S33 SKY TRAINER—Complete. (WALKI)

\$295⁰⁰



Copyright by U. C. P., Inc.



The HT-9

A NEW 100-WATT TRANSMITTER

... at Less Than You Could Build It Yourself

IT IS probably true that only the largest builders of amateur communications equipment, with unlimited engineering and production facilities, could produce such a transmitter at so low a price. Were you to attempt to build it yourself, the cost for parts alone would be far in excess of this price.

The HT-9 is a 5-frequency phone and CW unit, rated at 100 watts on CW and 75 watts on phone (carrier output). Coils are available for all bands from 1.7 to 30 megacycles. Exciter coils for five bands can be plugged in, pretuned, and left in the transmitter. Bandswitch, controls and meters, governing every function of the transmitter, are all on the front panel. 100% modulation with very low distortion is assured. Carrier hum is at least 40 db below 100% modulation. Any medium-level high impedance type of microphone can be used.

14 Tubes — 1-6F6 Oscillator, 1-6L6 Doubler, 1-814 Power Amplifier, 1-6J7 Audio Input Amplifier, 1-6J5 Audio Amplifier, 4-6L6G PP Parallel Modulators, 2-866 High Voltage Rectifier, 1-5Z3 Exciter Rectifier, 1-5Z3 Audio Rectifier, 1-80 Audio Rectifier. For operation from 110 volts, 50-60 cycles AC. Dimensions. 28" wide, 18½" deep, 11½" high. Shipping weight 165 lbs.

Copyright by U. C. P., Inc.

FEATURES

Any 5 frequencies in range 1.7 to 30 megacycles.

Crystals and tuning units for all circuits up to the grid of the final amplifier are plugged and tuned in for each frequency channel desired.

Antenna coil will match any resistive load from 10 to 600 ohms.

Frequency response is flat within 3 db from 100 to 7000 cycles.

MODEL HT-9—Complete with tubes, but less crystals and coils.....	\$22500
160-80-40 meter coils (for operation on crystal frequency), each set.....	\$950
20-10 meter coils (for operation on twice crystal frequency), each set.....	\$1050
160-80-40 meter crystals, each.....	\$480
20 meter crystals (for 10 meter operation), each.....	\$575

NET

H-7

HALLICRAFTERS COMMUNICATIONS EQUIPMENT

WORLD'S LARGEST BUILDERS OF AMATEUR COMMUNICATIONS EQUIPMENT

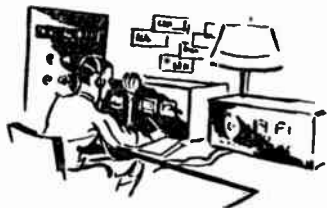

HT-6 25 WATT Phone and CW Transmitter



YOU have a real thrill when you operate the HalliCrafter HT-6 transmitter. Using an 807 in the final stage the power output is 25 watts on most bands. Frequency range is 1.7 mc. to 60 mc.

Coils for any three bands may be plugged in, pretuned, and then switched at will by a control on the front panel, which properly connects all circuits from crystal to antenna. It is only necessary to retune the final amplifier plate. Coils are available for any amateur band, 5 to 160 meters with crystal control; or with ECO on the 160, 80, 40, 20 meter amateur bands.

A special form of oscillator keying gives a clean chirpless signal, providing for break-in operation on CW.

Any high level high impedance mike may be used, such as an Astatic type D-104 or Shure 706-SA. Excellent voice quality with 100% modulation is assured. Output circuit is adjustable to match any resistive load of from 10 to 600 ohms.

Tube complement: 1-6L6 Osc.-dblr., 1-807 final R.F. amplifier, 1-6F5 microphone amplifier, 1-6J5 Audio amplifier, 2-6L6G modulators and 2-5Z3 rectifiers. Power drain about 120 watts CW and 225 watts phone. Size—20" long, 9" high, 15" deep. For operation on 110 volts 50-60 cycle AC.

- MODEL HT-6—Transmitter with tubes, less \$11000
coils and crystals. Ship. wt. 67 lbs. (TRANO)
- Coils for 160, 80, 40 or 20 meter operation, each set \$600
 - E.C.O. unit for 160, 80, 40 or 20 meter operation for corresponding coils listed above, each \$450
 - Set of coils for 5 or 10 meter operation on twice crystal frequency, each set \$850
 - Random Frequency Crystal for 160, 80, 40 meters, each \$480
 - Random Frequency Crystal for 20, 10 and 5 meters, each \$575
 - Extra for 220 volt 50-60 cycle operation..... \$950

HT-7 FREQUENCY STANDARD

The HT-7 Frequency Standard consists of a stable crystal oscillator providing either 1000 kc. or 100 kc. output, together with a 10 kc. multi-vibrator and a harmonic amplifier. A switch on the front panel selects harmonics of 1000 kc., 100 kc. or 10 kc. With output fed into any good communications receiver accurate marker frequencies at 1000 kc., 100 kc. or 10 kc. appear across the dial. The frequency of the 100 kc. crystal is adjustable over a narrow range, so that it is possible to set its frequency to zero beat with either WWV or domestic broadcast stations, and once set will maintain its frequency accurately over long periods of time. Unequaled for checking transmitter frequency, and receiver calibrations. Also for calibrating and bandsetting receivers, locating signals for skeds, and setting ECO frequency. For operation on 110 volt 50-60 cycle. Shipping weight 10 lbs. Dimensions 5½" x 8" x 7½" high.

- MODEL HT-7—Complete with tubes and crystal... (TRAFR) \$3250
Extra for Univ. 110-250 volts, 25-60 cycles..... \$500



S-30 RADIO COMPASS

Know your location! The Model S-30 Radio compass and direction finder enables you to check your position against beacon, broadcast or shore radiophone stations. Coverage from 200 to 3000 kc. (1500 to 100 meters).

Sensitive headphones and tuning eye serve as indicators when taking a bearing. Normally used with a 6 volt battery—"A" and "B" battery box available when no 6 volt vibrapack power source available. Has provisions for external speaker should such an accessory be used. Substantially constructed, attractively finished aluminum cabinet houses the receiver and supports the rotatable loop antenna. Power supply is in separate cabinet.

Place a Model S-30 Radio Compass on board and have the assurance of knowing your position anytime.

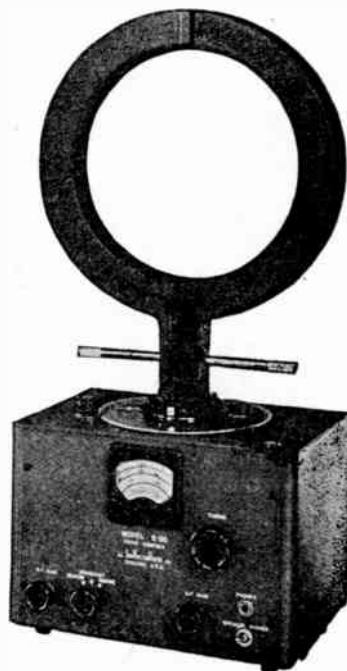

GENERAL SPECIFICATIONS

FREQUENCY RANGE:

Beacon Band — 220 to 540 KC
Broadcast Band — 535 to 1340 KC
Marine Band — 1200 to 3000 KC

TUBE LINEUP:

1—6SK7 RF Amplifier
1—6K8 Mixer
1—6SK7 I.F. Amplifier
1—6SQ7 2nd Detector—A.V.C.
1—6U5G Tuning Indicator
1—6G6G Output Amplifier

CONTROLS:

Main Tuning
R.F. Gain
A.F. Gain
Band Switch
Phone Jack
Speaker headphone switch
Compass card adjustment

POWER:

Standard power unit consists of thoroughly filtered vibrapack for 6 volt battery operation.

A battery box with "A" and "B" batteries is available for emergency use or where no 6 volt battery is available.

NULL INDICATION:

A sensitive pair of headphones is supplied with the radio. A tuning eye is built in as an auxiliary indicator.

SPEAKER:

A 5" Permanent Magnet Dynamic Speaker is available as an accessory.

PHYSICAL CONSTRUCTION:

The Model S-30 Radiocompass is built in a welded aluminum cabinet with a durable wrinkle finish. A 12" loop is mounted in an aluminum casting. No Magnetic materials are used wherever possible. All magnetic parts such as speaker and vibrapack are separate units for mounting at a distance from the compass itself.

DIMENSIONS:

11" wide—10⁵/₈" deep
7¹/₂" high—overall height
including loop—23¹/₂"

MODEL S-30 RADIO COMPASS:

Complete with tubes, headphones and 6 volt vibrapack power supply.

NET PRICE . . . (RADCO) **\$134⁵⁰**

Separate Emergency Battery Box complete—NET PRICE . . (EBB30) **\$20.00**

HALLICRAFTERS COMMUNICATIONS EQUIPMENT
WORLD'S LARGEST BUILDERS OF AMATEUR COMMUNICATIONS EQUIPMENT

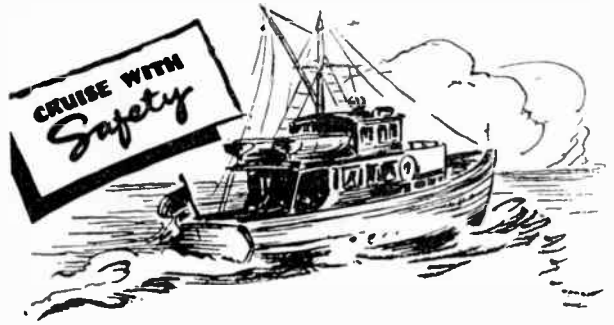
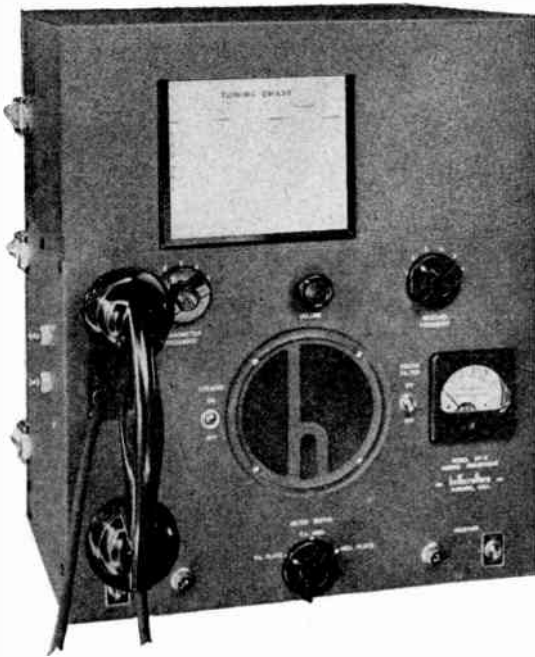

The HT-8
25 WATT
RADIOPHONE

THE HT-8 radiotelephone transmitter-receiver is the ideal unit for any type of craft, commercial or pleasure. It is designed to operate equally well on sailboat, power cruiser, large yacht, fishing boat, tug, barge or freighter.

The transmitter covers five frequencies and the receiver six frequencies (all crystal controlled). All are in the 2000-3000 range; or, if desired, two may be in the 3000-6700 range. When the telephone handset is lifted off the hook, the receiver output automatically transfers from the built-in loud speaker to the handset. To transmit, simply press the button on the handset and speak into the microphone.

FEATURES: 25 watts phone carrier. Five marine frequencies. Separate power supply. Quartz crystal controlled transmitter and receiver. Simple to operate. Precision built. 7-tube receiver. Effective squelch circuit. Handset or speaker output. No tuning required after installation. Modern design. Economical to operate. Low in purchase cost.

The very effective squelch circuit prevents static and noise from appearing in the loud speaker output when no carrier is present. Hence, the receiver may be left tuned to any station frequency without annoying bursts of static drumming on the ears.

MODEL HT-8—Bulkhead type. Dimensions 15" x 10" x 18" high. Shipping weight 105 lbs. Complete with tubes, separate power supply for 110 volt 60 cycle AC. Less crystals and installation. **\$32500**



The SKYRIDER MARINE-S22R

Specifically designed for marine service, in the range from 16.7 to 2730 meters (18 mc. to 110 kc.). Improved image rejection at the higher frequencies is achieved through the use of 1600 kc. IF transformers. The directly calibrated main tuning dial eliminates the use of complicated charts and tables. An efficient mechanical bandspread with separate dial provides easy logging. Built for 110 volt AC-DC operation. Also may be operated from 6 volt battery supply with the addition of a Model No. 302 Electronic Converter. Dimensions 18½" x 9¼" x 8½" high. The SKYRIDER MARINE (Model S-22R)—Complete with tubes and speaker. Shipping weight 31 lbs..... **\$7450** (SKYCU)



HALLICRAFTERS COMMUNICATIONS EQUIPMENT

WORLD'S LARGEST BUILDERS OF AMATEUR COMMUNICATIONS EQUIPMENT

The Model HT-11 Marine Radiophone is a complete moderately priced ship to shore radio transmitter and receiver. The transmitter can be operated on three frequencies in the marine band of 2000 to 3000 kc. The receiver is manually tuned and covers the standard broadcast band on range #1. Range #2 covers the marine channels. The separate power supply is supplied for 6 to 12 volt DC operation. Other voltages can be used with suitable converter. Ruggedly constructed—attractively finished—compact in shape—small in size—light in weight—the HT-11—12 watt Radiophone is the ideal unit for the smaller pleasure craft, wanting to cruise in safety.

PRICES START AT **\$179 50**
NET



HT-11 MARINE RADIOPHONE UNIT

12 WATT

GENERAL SPECIFICATIONS

FREQUENCY RANGE:

Transmitter—3 crystal controlled Frequencies in the range of 2000 to 3000 kc.

Receiver: Manually tuned with directly calibrated dial

Band 1 550 to 1700 kc.

Band 2 2000 to 3000 kc.

TUBE LINEUP:

Transmitter 1—6V6 Oscillator
1—807 Power Amplifier
2—6V6G Modulators

Receiver: 1—6SK7 R.F. Amplifier
1—6K8 Mixer
1—6SK7 I.F. Amplifier
1—6SQ7 2nd Detector—AVC
—1st audio
1—6K6G Audio Amplifier
2—6X5G Rectifiers

CONTROLS:

Transmitter channel switch
Receiver Band Switch
Receiver Volume control and ON-OFF switch
Receiver tuning
Transmitter Fil. OFF-ON switch
Speaker-headphone switch
Handset with Send-Receive push button

POWER SUPPLY:

The HT-11 power supply is a separate unit connected to the transmitter-receiver with a cable. The standard power pack is for 6 or 12 volt DC operation as specified. Also available is a 110 volt-60 cycle AC power supply which may be used with a rotary converter for 32 or 110 volt DC operation.

PHYSICAL CONSTRUCTION:

The small sturdy metal cabinet can be easily mounted on a table or shelf. Rust proofing and corrosion protective used throughout.

DIMENSIONS:

14 $\frac{1}{8}$ " wide—8 $\frac{5}{8}$ " high—9 $\frac{1}{4}$ " deep.

MODEL HT-11 RADIOPHONE

Complete with tubes and power supply for 110 volt **\$179 50**
AC operation—Less crystals and installation..NET

HALLICRAFTERS COMMUNICATIONS EQUIPMENT

WORLD'S LARGEST BUILDERS OF AMATEUR COMMUNICATIONS EQUIPMENT



The Model HT-12—50 watt Radiophone answers every marine radio need!

Ten crystal controlled transmitting and receiving channels provide communications with shore stations wherever you cruise.

Power supplies available for operation on 12-32-110 DC and 110 volt-60 cycles AC.

No switches to throw to place the transmitter on the air—all operation by voice controlled relays!

Attractively finished in machine tool gray wrinkle lacquer, the durable rust proofed cabinet is suitable for either table or bulkhead mounting—the HT-12 will provide the maximum in safety and convenience.

PRICES START AT.....NET **\$47500**

HT-12 MARINE RADIOPHONE UNIT

50 WATT

GENERAL SPECIFICATIONS

FREQUENCY RANGE:

10 crystal controlled transmitting and receiving channels in range of 2000-3000 kc. When specified, two of these channels can be used for operation in the range of 3000 to 6700 kc.

TUBE LINEUP:

1—6L6 Oscillator
2—807 Power Amplifier
1—6J5 Input audio amplifier
4—6L6G Modulators

RECEIVER:

1—6SK7 R. F. Amplifier
1—6SA7 Mixer
1—6SJ7 H. F. Oscillator
1—6SK7 I. F. Amplifier
1—6SQ7 2nd Detector—Q.A.V.C.
1—6SF5 Audio Amplifier
1—6K6G Output Amplifier
1—6X5G Rectifier
2—5Z3 Rectifiers

CONTROLS:

Only controls which are used by the Operator are accessible on the front panel.

Receiver—ON-OFF Switch
Transmitter filaments Switch
Receiver channel Switch
Transmitter channel Switch
Receiver volume control
Speaker ON-OFF Switch
Hand set on Hanger (transmitter is voice-controlled—no push button is needed)

POWER SUPPLY:

The power supply is a separate unit. A 110 volt-60 cycle AC power supply is standard and is furnished with a rotary converter for 32 or 110 volt DC operation. Where 12 volt DC is used, the power supply consists of a heavy duty vibrapack for the receiver and a dynamotor for the transmitter both mounted in a single unit.

PHYSICAL CONSTRUCTION:

Heavy metal cabinet suitable for table or bulkhead mounting. Corrosion protected treatment throughout. Exterior of unit finished in attractive, durable machine-tool gray wrinkle, after complete rust proofing treatment.

TUNING ADJUSTMENT:

Readily accessible controls for resonating transmitter are covered by easily removed protective face plates. Tuning adjustments are made only at time of installation.

DIMENSIONS OF RADIOPHONE:

20 1/2" high—19 1/4" wide—12" deep.
Complete with tubes, less crystals and installation but with power supply for 110 volt 50/60 cycles. **\$47500**

MODEL HT-12

Same as above but for 32 or 110 volts DC Operation—**\$58000**

MODEL HT-12

Same as above but for operation from 12 volts DC **\$60500**

New High Fidelity **FM-AM TUNER**



*FM/AM Reception by a
turn of the Bandswitch
with
Hallicrafters Model S-31*

PRECISION Engineered High Fidelity Tuner for Frequency Modulation and Amplitude Modulated Broadcast Reception.

The No. 1 band covers all frequencies used by amplitude modulated broadcast stations. The dial reads kilocycles by the addition of a zero to the numbers shown. Thus, 100 would be 1000 kilocycles.

The No. 2 band covers frequencies used by high fidelity frequency modulated broadcast stations. The dial is calibrated in megacycles.

Fundamentally, amplitude modulation (AM) consists of adding and subtracting power from a carrier in accordance with the modulating voice or music. With Frequency Modulation (FM), however, the carrier is kept constant in amplitude and is shifted back and forth in frequency in accordance with modulation. The circuits involved in the reception of the two types are much different—usually requiring two separate receivers. The Model S-31 tuner combines both circuits in one chassis and changes from FM

to AM with the bandswitch.

To appreciate the full capabilities of this tuner, a high fidelity audio system should be incorporated. A high fidelity audio system consists of not only a high fidelity amplifier, but also a high fidelity speaker system.

SPECIFICATIONS

- 8 tubes.
- Frequency range: Band one, 540 to 1650 kc.; Band two, 40 to 50 mc.
- Power output 130 milliwatts undistorted.
- Power consumption 50 watts.
- Controls: Band switch, phone switch, main tuning, audio gain, tone control, "S" meter adjustment.
- Operates on 115-125 volts, 60 cycles AC.

MODEL S-31—Tuner, complete with
19" x 8 $\frac{3}{4}$ " rack panel, metal cabinet
and tubes(TUNER)

\$74⁵⁰

MODEL S-31A

HIGH FIDELITY AMPLIFIER

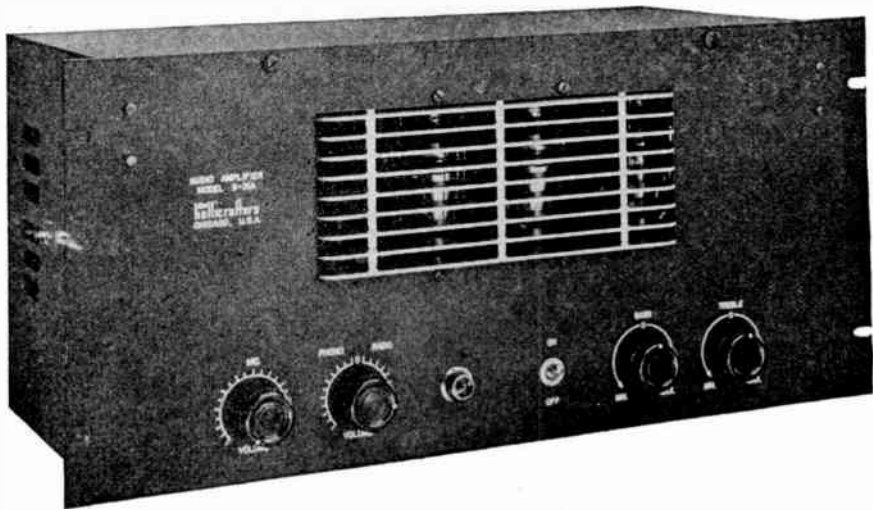

hallicrafters **MODEL S-31A**

THE Model S-31A, a Hallicrafters amplifier, deliver 25 watts of high fidelity audio power to either speaker or 500 ohm load. Designed for rack mounting and for use as a companion unit to the FM/AM Model S-31 Tuner, it will provide reproduction of sparkling depth and brilliance.

MODEL S-31A — High fidelity,
25 watt amplifier, complete with
Cabinet and tubes. . . . (TRAAM)

\$54⁰⁰

SPECIFICATIONS

- 6 tubes.
- Fidelity 2 DB from 50 to 15,000 cycles.
- Gain—Channel No. 1, microphone (high impedance) 96 DB.
- Channel No. 2, phone (low impedance) 60 DB.
- Power output 25 watts.
- Power consumption 100 watts.
- Output impedance No. 1, 500 ohms; No. 2, 8 ohms; No. 3, 4 ohms.
- Dimensions: Panel, 19" x 8³/₄"; Dust cover, 18" x 8³/₄" x 10".

ECHOPHONE — FINE RADIO RECEIVERS FOR SEVENTEEN YEARS



\$24⁵⁰

Complete with Tubes

... FEATURES ...

- AC/DC operation—115/125 volts.
- Electrical bandspread on all bands.
- Beat frequency oscillator for locating weak stations.
- Dial calibrated in megacycles with all important service bands indicated.
- Bandspread logging scale.
- Complete isolation for headphones through phone circuit transformer.
- Self-Contained Speaker.
- Controls: Main Tuning, Bandspread, Bandswitch, AF Gain, Standby Switch, Speaker-Headphone Switch, Combined BFO-AVC ON-OFF Switch.
- Rear Chassis Edge: Phone tip jacks—Doublet Antenna Terminals.
- Physical Construction: The receiver is housed in a metal cabinet attractively finished in machine tool gray crinkle lacquer. The cadmium plated steel chassis is substantially constructed with riveted corners. The speaker is mounted in the cabinet with the speaker opening in the top.
- Dimensions: 7 1/2" high, 10 3/4" wide, 7 3/8" deep. Weight—(unpacked) 10 pounds.

COMMERCIAL MODEL

A real Communications Receiver at this sensationally low price, including all these important features: Three bands covering from 550 kc. to 30.5 mc. (550 to 9.85 meters); Electrical bandspread on all bands; Beat Frequency Oscillator; Self-contained PM Dynamic Speaker; 6 tubes; AC/DC operation, 115/125 volts; Good selectivity and exceptional sensitivity; Bandspread logging scale; Complete isolation for headphones through phone circuit transformer; Dial calibrated in megacycles with all important service bands indicated.

Every necessary feature is incorporated in the EC-1 to give the short wave listener and the amateur an up-to-the-minute communications receiver.

Echophone Portable Model EC-4

A truly portable all-wave receiver operates from its self contained batteries or from either 110 volts AC or DC. Two loop aerials are used to cover the 550 KC to 30 MC frequency range of the receiver. Both loops are hinged to the cabinet and turn independently of each other. Provision is also made for the use of an external antenna if desired.

The outside dimensions of the cabinet are 9 3/4" high by 6 1/2" wide by 5" deep and it weighs only 9 1/2 pounds complete with self contained batteries. Nine tubes are used in the model EC4 Portable to give truly remarkable performance.

Separate electrical band spread, beat frequency oscillator and noise limiter, standby switch and phone jack make the model EC4 the ideal receiver for both fixed station and portable use.

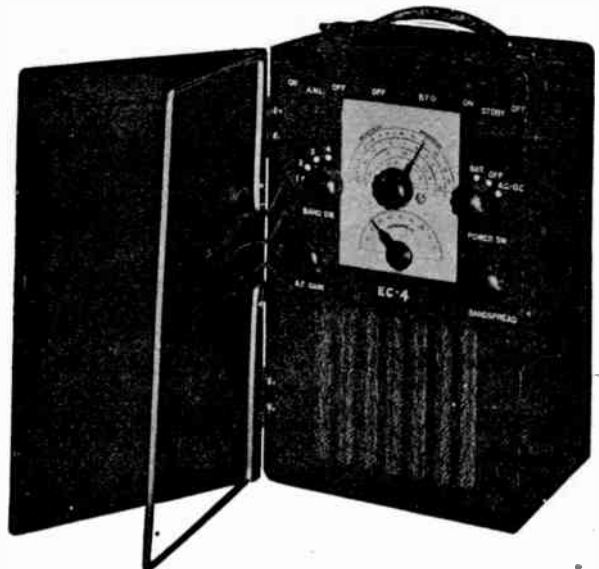

MODEL EC4 (Code ECOFO) \$49⁵⁰

ECHOPHONE—FINE RADIO RECEIVERS FOR SEVENTEEN YEARS



An astounding value at \$42.50
Never before has a communications receiver been offered, including all these features, at anywhere near this price.

\$42⁵⁰

Complete with Tubes

... FEATURES ...

Preselection on all bands; Calibrated Bandspread; Automatic Noise Limiter; Eight tubes, including ballast; Three bands with frequency coverage of 550 kc. to 30.5 mc.; Electrical bandspread available at all frequencies in the tuning range; One stage tuned RF in all bands; Automatic noise limiter operated by a

switch; Separated BFO oscillator for CW reception; 5" PM dynamic speaker mounted in top of cabinet; Frequency coverage includes broadcast band and extends through 10 meter band; Calibrated bandspread scale on 80, 40, 20 and 10 meter amateur bands; Operates on 115 volts AC or DC. Available for operation on higher voltages with resistance cord.



All the features incorporated in the EC-3 are usually found only in communications receivers selling at double this price. Check these features carefully: Crystal filter (four position variable selectivity) calibrated bandspread scale on 80, 40, 20 and 10 meter amateur bands; Automatic noise limiter; Preselection all bands; Two stages IF amplifier; Fly wheel tuning; Electrical bandspread available at all frequencies in the tuning range; One stage tuned RF in all bands; Separate BFO oscillator for CW reception with variable pitch control; 6" PM speaker in separate cabinet complete with cord and plug; Operates on 115 volts AC or DC. Available also for operation on higher voltages with resistance cord.

\$59⁵⁰

Complete with Tubes

RME ACCESSORY UNITS FOR RECEIVING EQUIPMENT

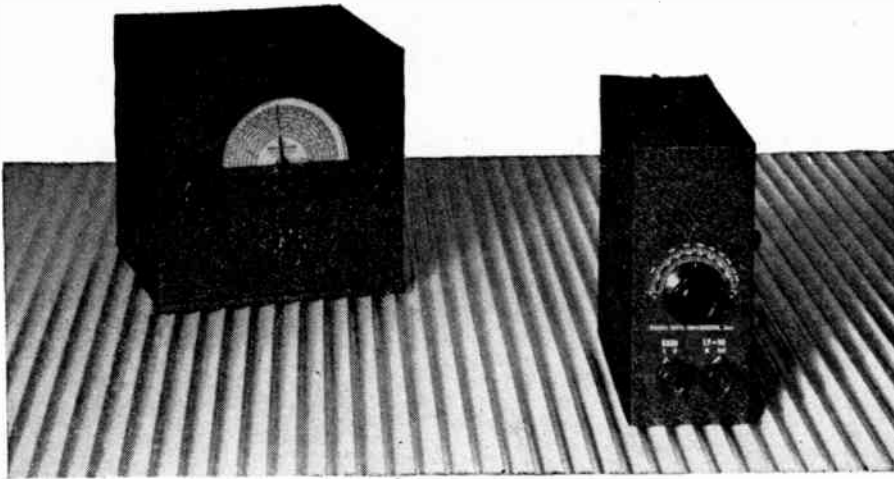

DB-20

LF-90

PRESELECTOR

DB-20

The addition of the DB-20 PRESELECTOR will improve the operating characteristics of any standard communications receiver enormously. Its addition adds 2 stages and 3 tuned circuits of radio frequency amplification ahead of the instrument.

Using 2-6K7 tubes in a high gain and completely stable circuit, this unit provides a signal step up of over 25 db operating on all frequencies from 550 to 32,000 kilocycles; at the same time it increases the ratio between signal and image until, at a 14 megacycle operating frequency this proportion becomes 50,000 to 1.

Contained in one cabinet, 9¼" high, 9½" wide, and 10½" deep, finish—black or gray crinkle—power supply incorporated, antenna changeover switch, velvet smooth planetary tuning control, and 6 position band change switch.

DB-20 complete with tubes and interconnecting plug and cable, ready for operation from 110-120 volt, 50-60 cycle source.

Code: MONEL.

List \$93.24 Net \$55.94

DB-20-70 (to match the 70 type receiver).

Code: MOSAR.

List \$93.24 Net \$55.94

INVERTER

LF-90

The LF-90 is a conversion unit designed for the purpose of expanding the tuning range of a standard radio receiving set to include reception of signals in the 90 to 608 kilocycles band. The only prerequisite for using the LF-90 for this purpose is that the receiver to be converted, must be capable of tuning to a conversion frequency of 1550 KC.

The LF-90 is ideal for simple and economical reception of low frequency signals such as beacon stations, weather reports, aircraft, and ship-to-shore radio telephones. Its gain is about 15 db over that of a standard receiving set. Its selectivity is quite adequate for the requirements of this type of reception.

This unit is of small size neatly housed in a black or gray metal cabinet measuring 4" wide, 9¼" high, and 10½" deep. It has its own power supply, uses two tubes, a 6K8 and a 6ZY5G, and is provided with a convenient antenna changeover switch.

LF-90 complete with tubes and interconnecting plug and cable, ready for operation from a 110-120 volt, 50-60 cycle source.

Code: LIFER.

List \$42.84 Net \$25.70

41 & 43

Communications Receivers

The RME 41 & 43 receiver models are identical with the exception of crystal filter and meter assemblies. The Model No. 41 is equipped with provision for installing a plug-in crystal filter and meter at the convenience of the individual listener. The 43 comes fully equipped with these units.

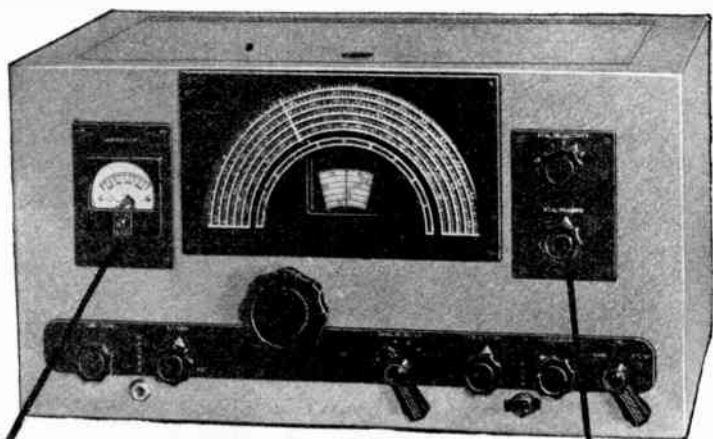

The RME 41-43 series receivers have been built for practical, all-around reception of all frequency channels from 550 to 33,000 kilocycles. Primarily designed as accurately calibrated, vernier tuned, sensitive communications receivers, these models are at the same time unusually convenient for purely private reception purposes.

Nine tubes are incorporated in the RME-41-43 using the superheterodyne circuit. Local tubes, proven for their ideal high frequency tuning characteristics, have been chosen for every radio-frequency, intermediate-frequency, and audio function in these instruments. Coupled with such innovations as a centrally located tuning condenser with triple spaced oscillator plates and with temperature compensated padder condensers, these local tubes produce incomparable results . . . especially on the higher frequency tuning channels.

Easily installed plug-in crystal filter and signal level

meter are provided for the purpose of converting the RME-41 model into a complete RME-43. Other than this one exception the two models are identical in workmanship, components, and circuit construction.

The RME 41-43 series of receivers introduces for the first time in any RME receiver, a radically new type tuning system in which both the general coverage dial and bandspread dial are operated directly from one control. Termed the CAL-O-MATIC system, this innovation provides accurate direct calibration of the 5 amateur bands from 160 to 10 meters. . . and in addition, this system permits arbitrary calibration of ALL frequencies within the overall tuning range. All calibration points, whether bandspread or general tuning, are located automatically as these receivers are tuned. There are no dials to be pre-set and no padders to be pre-adjusted . . . all that is necessary for accurate tuning is the adjustment of a single tuning control.

TUBES USED: 7B7 r.f.; 7J7 det. & osc.; 7B7 i.f., 7B7 i.f.; 7A6 limiter; 7B6 detector & B.O., 7C7 a.f.; 7C5 beam power output; 80 rectifier.

- ★ 550-33,000 KC. in 6 bands
- ★ Calibrated bandspread
- ★ 455 KC. i.f.
- ★ 6 position variable crystal selectivity
- ★ Excellent signal-to-noise ratio
- ★ Uniform sensitivity

- ★ Temperature compensated oscillator components
- ★ Double antenna input
- ★ 4 watts audio output
- ★ R.F. gain control, audio level control, standby switch, band change switch, B.O. pitch control, crystal phasing control, tone control, and head-phone jack
- ★ Gray crinkle finish with black trim

RME-41 Communications Receiver, two-tone only, in a gray crackle finished cabinet measuring 10"x10½"x19" with black trim, 9 tubes, less crystal filter and signal level meter. This model is equipped for easy installation of filter and meter. (See Codes: POMMY & PANER below.) 115 volt 50 to 60 cycle operation. With speaker in baffle.

Code: POMMY List \$187.37—Net \$112.42
Plug-in signal level meter, fully calibrated in R-db units, for installation in the RME-41 receiver. (Includes a new panel plate.)

Code: PANER List \$18.90—Net \$11.34

Plug-in crystal filter complete with crystal, built as a unit, designed to plug into the RME-41. (Includes a new panel plate.)

Code: POMMY List \$17.00—Net \$10.21

RME-43, mounted in a two-tone gray and black crackle finished cabinet with black trim, measuring 10"x10½"x19", complete with tubes, crystal filter, and signal level meter. For 115 volt 50 to 60 cycle operation. With speaker in baffle.

Code: PILAR List \$215.20—Net \$129.12



HAMMARLUND



"HQ-120-X" AMATEUR RECEIVER

THE HAMMARLUND "HQ-120-X" meets the most critical demands of amateur and professional operators. Hammarlund engineers have gone beyond ordinary practice in designing this new and outstanding receiver. This ultra-modern 12-tube superheterodyne covers a continuous range of from 31 to .54 mc. (9.7 to 555 meters) in six bands, taking in all important amateur, communication, and broadcast channels. The "HQ-120-X" is not to be confused with modified broadcast sets. Two years were required to develop it. This is a special receiver with special parts throughout. Every wave range is individual—that is, each range has its own individual coil and a tuning condenser of proper value for maximum efficiency; thus, including the broadcast band does not decrease efficiency at high frequencies. Besides having all the necessary features for perfect short wave reception, such as A.V.C., beat oscillator, send-receive switch, phone jack and relay terminals, the "HQ-120-X" also includes a new and outstanding crystal filter circuit which is variable in 6 steps from full



band-width to razor edge selectivity. This permits the use of the crystal filter for the reception of both voice and music. It is no longer necessary to contend with serious heterodyne interference. These annoying disturbances can be phased out with the phasing control on the panel. Other features include a new and accurate "S" meter circuit for measuring incoming signal strength; antenna compensator to compensate for various antennas, and 310 degrees band-spread for each amateur band from 80 to 10 meters. The band spread dial is calibrated in megacycles for each of these amateur bands. The main tuning dial is calibrated in megacycles throughout the entire range of the receiver. Rack Adapter \$6.00 extra. Standard models finished in gray.

Prices Include Speaker and Tubes

Code	Type	Tuning Range	Speaker	Net Price
HQ-120-X	Crystal	31 — .54 mc.	10" P.M. Dyn.	\$148.00
Speaker cabinet (metal) 12 1/2" x 12 1/2" x 7 inches				3.90

Special model finished in black.....\$168.00 Net
Speaker Cabinet to match.....3.90 Net

Send for Descriptive Booklet!

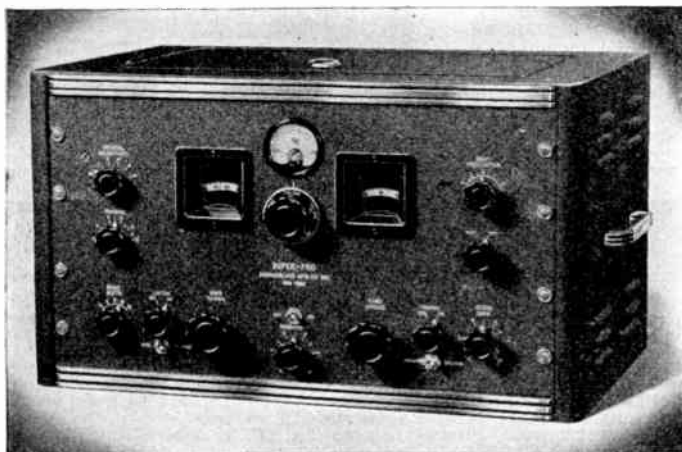

THE "SUPER-PRO"

THIS new 18-tube "SUPER-PRO" includes all the outstanding features which have made the "Super-Pro" famous, and in addition many recent developments have been added. The new "Super-Pro" has a variable selectivity crystal filter. This crystal filter has five positions of selectivity—3 for phone and 2 for CW. The variable crystal filter, in addition to the variable band width I.F., provides a selectivity range of from less than 100 cycles to approximately 16 kc. The new "Super-Pro" also has an improved noise limiter designed to minimize interference caused by automobile ignition systems and disturbances of similar nature. Maximum image suppression is obtained with two stages of high selectivity tuned R.F. ahead of the first detector. Three stages of I.F. are employed and there are three stages of high fidelity audio amplification resulting in an output of approximately 16 watts. A new and improved "S" meter has been installed in the "Super-Pro" for accurately reporting relative signal strength. Other features include full band-spread on all bands; beat oscillator; send-receive switch; relay connections; phone connections; connections for phono-pickup; beautifully finished modernistic cabinet. The sensitivity of the "Super-Pro" is better than 1 microvolt. Available in rack mounting type at \$10.50 extra.

Write for Circular!

Code	Type	Spkr.	Tuning Range	Net Price
SP-210-X	Crystal	10"	15 — 560 meters	\$318.00
SP-210-SX	Crystal	10"	7 1/2 — 240 meters	318.00
SP-220-X	Crystal	12"	15 — 560 meters	330.00
SP-220-SX	Crystal	12"	7 1/2 — 240 meters	330.00
PSC	10" Speaker Cabinet to Match Receiver			5.10

Special Models Covering Other Wave Ranges Available On Order

ABBOTT

INSTRUMENTS for defense . . . emergency . . . or amusement

TR-4 Ultra High Frequency 2½ Meter TRANSMITTER-RECEIVER



Designed for either fixed station operation or as a mobile unit in automobile, truck, boat or airplane . . . the TR-4 requires a 6 volt battery or 110 volt, 60 cycle A.C. power supply. Its separate receiver employs a Hytron HY-615 as a super-generative detector, while the transmitter utilizes a Hytron HY-75 as an ultra-high frequency oscillator. Operating at approximately 15 to 20 volts, the detector becomes extremely sensitive, and reduces receiver radiation to an absolute minimum. The receiver portion of this Abbott TR-4 incorporates a specially designed circuit in addition to numerous mechanical refinements, including front of panel control variable inductive coupling, variable sensitivity control, audio volume control, etc. . . . Absolute separation of transmitter and receiver sections eliminates the inconvenience of retuning when switching from SEND to RECEIVE during a contact. A ganged antenna send-receive switch is automatically operated when the single, master SEND-RECEIVE switch is operated, enabling the use of a common antenna for both the transmitter and the receiver. The 5 inch PM speaker is self-contained.

● **FREQUENCY:** 112 to 116 MC ● **RANGE:** Varying from 5 to 75 miles, depending upon terrain. Contacts up to 150 miles have been completed in field tests ● **TUBES USED:** One each of Hytron HY-615, Hytron HY-75, 7F7, 6V6 or 6L6 ● **MICROPHONE:** Any good single button microphone.
TR-4—Overall size 9" x 8" x 4½", less tubes and power supply, Net Price to Amateur **\$3900**

HIGH POWER — 2½ METER MOBILE OR FIXED STATION MRT-3 TRANSCEIVER

New, redesigned MRT-3—20 WATTS INPUT; rugged and compact; low priced; ideal for use in automobile, truck, boat or airplane; simple to install and operate; satisfactory operating range from 5 to 50 miles, depending upon terrain and antenna.

● **FOR MOBILE OPERATION:** Any standard 300 volt, 100 MA Vibrator power supply with filter added ● **FOR FIXED STATION:** Any good AC power supply having an output of 300 volts at 100 MA and 6.3 volts at 3.5 amperes ● Antenna coupling is mounted on Polystyrene rod and can be varied by pushing in or out ● **TUBES REQUIRED,** HY-75, 6C5, and 6L6 (or 6V6). MRT-3—9" x 8" x 4" in size, with self-contained P.M. Dynamic speaker, less tubes and power supply.

Net Price to Amateur **\$2940**



200 ohm carbon mike and any standard headphones. Handsets should incorporate 200 ohm microphone and high impedance phone ● **OPERATION:** One volume control, with on-off switch, for both receive and transmit positions; microphone and headphone jacks; variable antenna coupling knob; ceramic antenna insulators; transmit and receive switch; large easy-tuning knob.
DK-3 Transceiver for 2½ meter operation. Completely self-contained, battery operated, ultra high frequency radio-telephone transmitter or receiver. Compact, grey wrinkle finish metal case with sturdy leather handle. Removable back panel for easy access to batteries and tubes. Size, 11" x 11" x 4½". Shipping weight, 11 pounds. Net Price to Amateur **\$1920**

2½ METER PORTABLE—MOBILE—FIXED STATION DK-3 TRANSCEIVER

The DK-3 features **INDUCTIVE ANTENNA COUPLING**, continuously variable and controlled from a special coupling knob on the front panel. This enables use of maximum power while the transmitter is in operation and permits a wide degree of receiver control. Weak signals, lost under ordinary conditions, can be worked. Effective range varies from 2 to 30 miles, depending upon terrain.

SPECIFICATIONS

● **FREQUENCY:** Covers the amateur 2½ meter band (112 to 116 mc.) ● **FOR PORTABLE OR MOBILE BATTERY OPERATION:** Three 45 volt B batteries (Eveready No. 482 or Burgess M30) and four 1½ volt batteries (Eveready No. 742 or Burgess 4FH) ● **FOR FIXED STATION, 110 VOLT AC OPERATION:** Use an AC power supply giving 135 to 180 volts DC output ● **INDUCTIVE ANTENNA COUPLING:** Variable antenna coupling knob on front panel permits maximum power in transmit position and enables flexible receiver control for both weak and powerful signals ● **ANTENNA:** For portable operation; two pieces of copper or aluminum tubing approximately 17 inches long or an adjustable vertical antenna. For fixed station operation; most standard antennas will work with the DK-3 variable inductive coupling ● **ONLY TWO INEXPENSIVE TUBES:** 6G6G as Audio Amplifier (to receive) or as modulator (to transmit); 6J5GT as Super Regenerative Detector (to receive) or as Oscillator (to transmit) ● **MICROPHONES AND HEADPHONES:** Use any good single button

ALL PRICES SUBJECT TO CHANGE WITHOUT NOTICE

HOWARD

COMMUNICATION RECEIVERS

Progressive Series

ALL MODELS—TUNED R.F. STAGE ON ALL BANDS

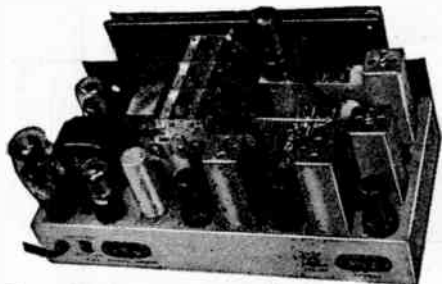

The gleaming copper-plated heavy steel chassis, coated with clear lacquer, is formed and punched in Howard's own factory. Internal A.F. shielding is silver plated, preventing any intercoupling of circuits.

For the first time! Popular priced communication receivers with a stage of **TUNED RADIO FREQUENCY ON ALL BANDS**, using 3-gang tuning condensers. The equal in performance of receivers costing double the price. Every "Ham" and experienced Short-Wave-Listener will appreciate what the addition of a T.R.F. stage means: Improved selectivity, better signal to noise and image ratio, and greatly increased sensitivity.

Designed by the Howard Laboratory, these fine receivers represent an outstanding development in the art of communications. No expense or effort was spared in the design or construction of these fine instruments. All High Frequency R.F. circuits are insulated by ultra-low-loss ceramics (steatite), including coil forms and trimmer bases. Iron core I.F. transformers, specially designed oscillator padding condensers, molded bakelite sockets and many other of the finest developments in radio are used. Silver-plated switch contacts reduce losses to a minimum. Switch action shorts out unused coils for peak efficiency.

Howard Communication Receivers Are Unconditionally Guaranteed to Outperform Any Other Receiver at a Comparable Price.

PROGRESSIVE MODEL "435-A"—7 TUBES

Tuning Range: 540 KC to 43 MC (556 to 7 Meters) →

Designed for Amateur communication work and for Short-Wave Fans who desire reception from all parts of the world. Incorporates all the latest engineering improvements and every desirable basic feature. (See above for special features.) Has built-in 6½" Howard-Jensen electro-dynamic speaker, with connection for an extra external speaker if desired. Headphone jack is provided on front panel. Has Send-Receive switch, AVC Off-On switch, BFO Off-On switch, BFO variable pitch control, AF Gain volume control and Electric Band Spread. Has connections for Doublet or "L" antenna, socket for preamplifier and socket for battery operated power pack.

EXCEPTIONALLY EASY TO TUNE. The experienced radio operator will appreciate the accuracy of tuning and logging signals, the novice and Short-Wave Fan will welcome the ease with which stations are located. The giant 8½" slide rule dial is calibrated directly in megacycles, and has a "band-in-use" indicator at the left side and a 340° band spread dial with 8" coverage at the right for accurate logging. The entire dial assembly is illuminated. Both main tuning and band spread condensers are anti-backlash controlled.

SPECIFICATIONS: Operates from 105-125 volt, 60 cycle AC Current. Power consumption, 50 watts. To operate from 6-volt storage battery, use Power Pack 610. Output 2½ watts maximum. Uses the following tubes: 6SD7GT, T.R.F.; 6SA7, Mixer Osc.; 6SK7, I.F. Amp.; 6SQ7, AVC Det. and 1st A.F.; 6K6G, Beam Power Output; 6J5, BFO; 5Y3G, Rectifier. Entire unit, including 6½" speaker, housed in attractive, sturdy one piece copper-plated, welded steel cabinet, finished in gray wrinkle enamel. Size, 15¼" wide, 9¼" high, 9" deep. Shpg. wt., 26 lbs.



MODEL "435-A"—Complete with tubes and built-in 6½" Howard-Jensen electro-dynamic speaker. **\$36⁷⁵**
Net Price to Amateurs.....

Pacific Coast and Export prices slightly higher.

Model "435-A" can be changed at the factory at any time into a Model "436-A" for only \$12.75 net, or it can be converted to a Model "437-A" for only \$12.00 (\$35.05 complete with crystal). Conversion charges include complete realignment of receiver at the factory.



PROGRESSIVE MODEL "436-A"—8 TUBES

All the features of the Model 435-A listed above are included in this new 8-tube communication receiver, **PLUS AN AUTOMATIC NOISE LIMITER and INERTIA TUNING KNOBS.** Provides greater noise-free enjoyment. Excessive QRN caused by auto ignition, diathermy machines and other sources of high frequency interference is effectively minimized. Howard Inertia Knobs provide fast "fly-wheel" tuning. Knobs are spun when "looking over the band," or provide slow smooth adjustment when hunting DX. Physical and electrical characteristics are identical to the Model 435-A: Tunes 4 bands, from 540 KC to 43 MC (556 to 7 Meters) continuously without skip bands; has a stage of **TUNED RADIO FREQUENCY ON ALL BANDS.** Has the same controls as "435-A," plus the noise limiter Off-On switch.

SPECIFICATIONS: Operates from 105-125 volt, 60 cycle AC current. Power consumption, 50 watts. For operation from 6-volt storage battery use Power Pack 610. Tube complement, same as Model 435-A, plus 6H6 for noise limiter. Cabinet, identical in size and construction to Model 435-A. Shipping weight, 27 lbs.

Model "436-A" can be converted into Model "437-A" for only \$21.00 (\$28.50 complete with crystal). Price includes a complete realignment of receiver.

MODEL "436-A"—Complete with tubes and built-in 6½" Howard-Jensen electro-dynamic speaker. **\$41⁷⁵**
Net Price to Amateurs.....

Pacific Coast and Export prices slightly higher.

AMERICA'S OLDEST RADIO MANUFACTURER

HOWARD

COMMUNICATION RECEIVERS

PROGRESSIVE MODEL "437-A," 9 TUBES

Equipped with Crystal Filter and 2 I.F. Stages

The finest of all moderately priced communication receivers. Has all the features of Models "435-A" and "436-A." Plus Crystal Phasing Control and Two Iron Core Transformer I.F. Stages. Weak signals from far off places are whipped in with surprising strength and clarity through the most troublesome QRN. The Short-Wave Fan and Communication Operator will get a real thrill out of the ease with which stations are located and then logged.

Maximum Sensitivity, Selectivity and Stability for nine tube receivers are achieved through the use of the finest parts obtainable and the incorporation of latest engineering improvements. Superhet circuit has a stage of Tuned Radio Frequency on all bands and two Intermediate Frequency stages. Has built-in Noise Limiter that practically eliminates disturbances from auto ignition and other electrical apparatus, and squelches static by cutting off signals having modulation above 85%.

Crystal Phasing Control permits eliminating all unwanted signals, either phone signals 2000 cycles away or CW that is only a few cycles off resonance. (Note: It is recommended that crystal be purchased with receiver to insure proper alignment.)

Easy to Tune and Log Stations. The giant 8½" slide rule main tuning dial is calibrated directly in megacycles, making it simple for even the novice to quickly locate the desired station. A "band-in-use" indicator is located at the left of the tuning scale, and at the right is a 340° band spread dial with 8" coverage. The entire tuning assembly is well illuminated. Both the main tuning and the band spread condensers are equipped with Howard Inertia Knobs for fast "fly-wheel" tuning.

Has Every Control Necessary for perfect operation. In addition to the controls used on Models "435-A" and "436-A" (see previous page), the "437-A" has the Crystal Phasing Control, Crystal In-Out Switch and R.F. Gain Control.

Specifications: Operates from 105-125 volt, 60 cycle AC current. Power consumption, 60 watts. Tube complement, same as Model "436-A," plus one additional 6SK7 I.F. Amplifier. Cabinet, identical in size and construction to Models "435-A" and "436-A." Shipping weight, 28 pounds.



MODEL "437-A"—Complete with tubes and built-in 6½" Howard-Jensen electro-dynamic speaker. Less Crystal. **\$61⁹⁵**
Net Price to Amateurs.....

MODEL "437-A"—As above but complete with crystal. Net Price to Amateurs..... \$69.75
Pacific Coast and Export prices slightly higher.

Model "437-A" is the final receiver in the Howard Progressive series. But those interested in the most complete communication reception equipment can continue to add to their station by adding the Preamplifier listed below and the Frequency Monitor and Carrier Level Meter on the next page. The completed station will represent the finest that money can buy.

HOWARD RECEIVERS FOR SPECIAL APPLICATIONS

Special Operating Voltages and Frequencies

All Howard Radio Receivers and self-powered accessories listed on these pages are available for operation on voltages other than the standard 105-125, and frequencies other than 60 cycle. Prices are \$5.00 higher per unit than the standard price.

With 750 to 2000 Meter Band

All Howard Progressive Communication Receivers are available with the 750 to 2000 meter (150 KC to 400 KC) band at \$7.50 extra. The receiver tunes four bands: 750 to 2000 meters, 545 to 176 meters, 176 to 54 meters and 54 to 16.6 meters.

PROGRESSIVE MODEL "650" PREAMPLIFIER

Adds 2 High Gain Tuned R.F. Stages to Any Radio

Easily connected to almost any radio by means of the low-loss cable which is supplied. Adds six distinct outstanding advantages:

(1) **Greatly Increased Signal Strength.** Operators will be amazed at the additional wallop. Signals that could not be heard before will roll in with clarity and strength.

(2) **Higher Image Ratio.** The two high gain R.F. stages make it possible to practically eliminate any image.

(3) **Better Signal to Noise Ratio.** Proper setting of the R.F. gain control will in many cases of "heavy noise bombardment" provide a readable signal that might otherwise be lost.

(4) **Increased Selectivity** is of course provided. A complete new set of controls is added to the receiver for eliminating unwanted signals or noise, this in addition to the great increase in selectivity by the two R.F. stages.

(5) **Directional Loop Tuning.** Manipulating the loop so that it points directly at the station to be received will often eliminate troublesome interference. Also makes locating signals easier when direction of station is known.

(6) **Use Doublet or "L" Antenna Also.** A switch on the front panel of the Preamplifier permits rapid changing from the loop to an outside aerial. Another switch cuts out Preamplifier entirely and outside antenna is fed directly into receiver. No loop is necessary if directional tuning is not desired.

The "650" Preamplifier tunes four bands, from 540 KC to 43 MC (556 to 7 Meters). Uses two high gain 1853 tubes in two stages of tuned radio frequency, using a three gang tuning condenser. Has built-in power supply that uses a type 80 rectifier. Giant slide rule dial is calibrated directly in megacycles with "band-in-use" indicator at left side. Entire tuning assembly is well illuminated. Howard inertia tuning knob permits smooth "fly-wheel" tuning. Unit is housed in an attractive welded steel cabinet, finished in baked-on black wrinkle enamel. Cabinet size, 13" x 9¼" x 9". For operation on 105-125 volt, 60 cycle AC current. Shipping weight, 20 lbs.

MODEL "650" PREAMPLIFIER—Complete with three necessary tubes. (No loop antennas are included.) Net Price to Amateurs..... **\$36⁷⁵**

DIRECTIONAL LOOP ANTENNAS
Efficient loop antennas for use with the above Preamplifier. (L11 and L12 are formed from hard-drawn brass rod, chromium plated.)

MODEL	BAND COVERED	NET
L14	540 KC to 1700 KC.....	\$2.75
L13	1700 KC to 5500 KC.....	2.75
L12	5.5 MC to 22 MC.....	2.75
L11	27 MC to 34 MC.....	2.75
KIT 655	Contains one each of the above four loops covering all bands.	
Net Price to Amateurs.....		\$8.25

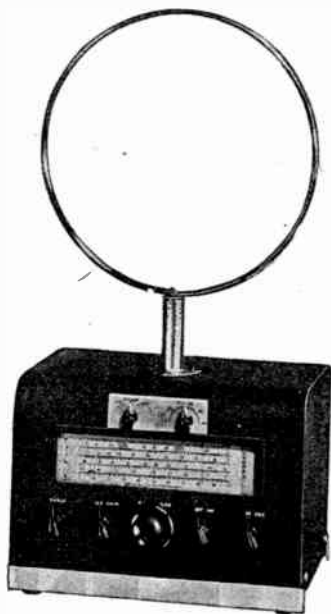

AMERICA'S OLDEST RADIO MANUFACTURER

HOWARD Progressive Series Plan

Provides This Entire IDEAL RECEIVING LAYOUT

for Only

\$164⁷⁰



If you want the best receiving layout your money can buy . . . this is the sure way to get it. The various accessories shown above can be bought at any time or as you progress from one receiver model to another. The complete 15 tube **Ideal Receiving Layout** gives you three R.F. Stages, four tuned R.F. Circuits, two Iron Core I.F. Stages and directional

Loop Operation! Complete HOWARD layout: 437-A Receiver —with crystal and Carrier Level Meter; 650 Pre-amplifier with set of loop antennas; 660 Frequency Monitor and 3-820 External Speaker. . . . \$146.35. (Export and Pacific Coast prices slightly higher.)

ACCESSORIES ADAPTED TO PROGRESSIVE SERIES MODELS

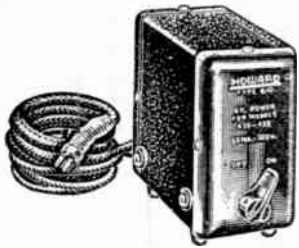

POWER-PACK
For conversion of 6 volts DC to 300 volts DC for operation of HOWARD Progressive Series, the Type 610 Power-Pack is convenient, practical and efficient. The output of 60 m.a. at 300 volts provides ample "B" power. A four prong plug fits the socket on back of receivers, carrying both "A" and "B" power to the set. Only two connections to the storage battery are required.

Ample length of cable is provided. Total power consumption equivalent to an auto radio of similar size. On and off switch on power unit. Dimensions of case 6" x 5 1/2" x 3" deep. Net wt. 5 1/2 lbs. Shipping wt. 7 lbs.

Type 610—Power-Pack with instructions. \$13.50

CARRIER LEVEL METER

This relatively new instrument to the amateur communication field provides an accurate means of measuring the actual carrier input signal strength delivered to the receiver in terms of the laboratory standard—the microvolt. The actual measurement of a signal is easy to obtain. Uses 7E7 tube. The meter scale is illuminated through the meter when turned on. Due to the accuracy of this instrument it must be built into the receiver at the factory. This may be done either at the time of receiver purchase or later.



INSTALLED IN HOWARD RECEIVERS

Type 605 in models 435, 436, 437 **\$15.75**
Type 605-A in models 435-A, 436-A, 437-A **\$15.75**

UNIVERSAL COMMUNICATION RECEIVER

OPERATES ON 105 to 240 VOLTS AC OR DC

A new type of universal receiver, designed primarily for communications work, but also ideal for receiving entertainment on short-wave or the standard broadcast band. **Tunes from 540 KC to 43 MC (556 to 7 meter)** in four overlapping bands. Operates on AC or DC —105-117, 120-150 or 210-240 volts. Is especially recommended for use by the radio amateur in DC districts of large cities, by radio operators and seamen aboard ship for both communications and entertainment, and by the world traveler.

Has Tuned R.F. on All Bands

A stage of tuned radio frequency on all bands insures excellent sensitivity, selectivity and signal-to-noise ratio. Six latest type tubes provide nine tube performance: 12SG7, RF; 12SA7, Converter; 12SF7, IF and Diode; 12SC7, 1st AF BFO; 35L6, Beam Power Output; 35Z5, Rectifier. The giant 6 1/2" slide rule dial is calibrated directly in megacycles, and has a "band-in-use" indicator at the left side and a **340° band spread dial with 8" coverage at the right for accurate logging.** The entire dial assembly is illuminated. Both main tuning and band spread condensers are anti-backlash controlled. Entire unit, including Howard-Jensen 6 1/2" speaker, housed in attractive, sturdy one-piece copper-plated, welded steel cabinet, in gray wrinkle enamel. Size, 15 1/4" wide, 9 1/4" high, 9" deep. Model 445 is available with the 750 to 2000 meter (150 KC to 400KC) band at \$5.50 extr. Tunes four bands: 750 to 2000 meters, 545 to 176 meters, 176 to 54 meters and 54 to 16.6 meters.

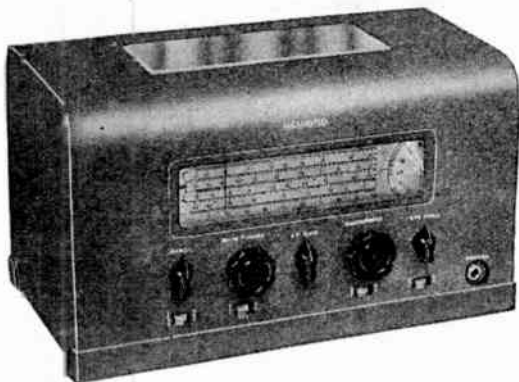

MODEL "445"—Complete with tubes and built-in 6 1/2" Howard-Jensen electro-dynamic Speaker. Shpg. wt., 26 lbs. **\$36⁷⁵**
Net Price to Amateur.
Pacific Coast and Export prices slightly higher.

AMERICA'S OLDEST RADIO MANUFACTURER

HOWARD Model "490"

14 TUBE COMMUNICATION RECEIVER

- 540 KC—43.5 MC
- 2 Stages R.F. Preselection
- Calibrated Band Spread
- Air-Tuned I.F. Transformers
- Variable I.F. Selectivity
- Temperature Compensated Oscillator
- Split Stator Ceramic Insulated Tuning Condensers
- Variable Fidelity Audio
- Push Pull Output—8 Watts
- Automatic Noise Limiter



The HOWARD 490 is the result of years of engineering and development. New standards of performance were set and are now available in the 490 for the first time outside of laboratory equipment.

MODEL "490"—Complete with crystal filter and tubes, less speaker..... \$164.50
 10" P. M. Howard-Jensen Speaker with cabinet..... 12.50

These Specifications Tell Their Own Performance Story

Two Stages R.F. Preselection: The special high frequency R.F. coils, designed for both stages of preselection, take full advantage of the 6AB7 (1853) tubes to secure a good signal to noise ratio. The maximum in sensitivity, selectivity and image ratio is assured on all 5 bands.

Temperature Compensated Oscillator: The temperature compensated oscillator circuit reduces receiver drift and increases its overall stability. Oscillator coil forms are of ceramic insulation. Special ventilation screens on sides, top and back of receiver provide adequate heat dissipation.

Fully Shielded Coil and Condenser Assembly: The entire coil and variable condenser system including trimmers, resistors, switches, tubes, etc., is ruggedly mounted and shielded as one unit on its own chassis. Split stator on main condenser gang provides favorable L/C ratios on all bands.

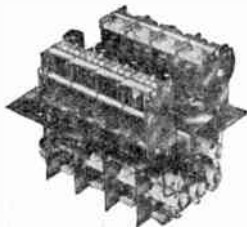

New Efficient Noise Limiter: The noise limiter is very effective in cutting through frequent and irregular automobile ignition interference and reducing electrical and atmospheric disturbances.

Carrier Level Meter: Provides an accurate indication of the strength of the signal carrier in microvolts and "S" readings as delivered to the receiver. An individual correction factor chart for exact microvolt readings on all bands accompanies each receiver.

Variable Selectivity Air-Tuned I.F. System: The two stage iron core I.F. system is provided with five fixed selectivity positions which enable the operator to obtain nine selectivity degrees. A polystyrene insulated crystal holder assures maximum crystal selectivity.

Variable Fidelity Audio System: In the normal position the audio system is substantially flat from 30 to 10,000 cycles. The exclusive HOWARD Audio Control System allows cutting off of frequencies at either the high or low ends of the audio spectrum or peaking at 1600 cycles. Signals which are covered by heterodynes and noise can easily be copied through the use of this unique audio arrangement.

Dials, Tuning and Band Spread: The 80, 40, 20 and 10 meter bands are accurately calibrated on the band spread dial. The easy to read calibrations on the metal drum type dials are indirectly illuminated. Fast, smooth and accurate tuning control is achieved by the exclusive HOWARD Inertia Tuning System and indirect cable drive mechanism.

Chassis, Cabinet, Panel, etc.: The chassis, cabinet and all component parts are constructed of heavy drawn, welded and copper plated steel. Heavy girder type bracing assures absolute rigidity. Cabinet and panel is finished in beautiful blue-grey wrinkle trimmed in satin silver. Panel is 19" wide for rack mounting. Standard models designed for 105 to 125 volts, 60 cycle, AC operation. Universal supply voltage AC models for 25-60 cycles, 105-230 volts, \$9.00 extra. Model 490 for rack and panel installation with dust cover, \$6.00 extra.

Write for FREE Technical Manual. Has complete circuit details and data for Model "490," including Selectivity, Sensitivity, Image Ratio and Fidelity Charts. Explains in detail the art of receiver measurements.

Tube Complement: 6AB7 (1853)—1st R.F.; 6AB7 (1853)—2nd R.F.; 6SA7—1st Detector-Mixer; 6SA7—H.F. Oscillator; 6SK7—1st I.F.; 6SK7—2nd I.F.; 6H6—2nd Detector—A.V.C.—Noise Limiter; 6SF5—1st Audio-Driver; 6J5—Phase Inverter; 2-6K6's—Push Pull Output; 6J5—B.F.O.; 7E7—Carrier Level Meter Amplifier; 5Y3G—Rectifier.

Dimensions: 11" high x 21½" long x 13½" deep.

Weight: 50 lbs. net. Domestic shipping weight 57 lbs.

AMERICA'S OLDEST RADIO MANUFACTURER

NATIONAL



NEW PRICE LIST

AUDIO AMPLIFIERS		
Symbol	List	Net
NSA	\$125.00	\$75.00
NSA-RA	140.00	84.00
NSA-RS	135.00	81.00
BUSHINGS		
SB	.30	.18
TPB	Doz. .85	.51
XP-6	Ten .85	.51
XS-6	.20	.12
BUSHINGS (Antenna)		
XS-1	Pr. 1.20	.72
XS-2	Pr. 1.35	.81
XS-3	Pr. 6.00	3.60
XS-4	Pr. 7.25	4.35
XS-5	En. 8.25	4.95
XS-5F	Pr. 17.00	10.20
XS-7	.55	.33
XS-8	.75	.45
CABINETS		
C-SW3	6.00	3.60
C-NC100	9.50	5.70
C-HRO	9.50	5.70
C-110	5.00	3.00
C-SRR	4.00	2.40
CABINETS (Speaker)		
NDC-2	8.50	5.10
NDC-8	5.50	3.30
NDC-10	6.60	3.96
CHART FRAMES		
CFA	.55	.33
CHOKES		
R-100	.50	.30
R-100U	.60	.36
R-300	.50	.30
R-300U	.60	.36
R-175	3.00	1.80
R-152	2.50	1.50
R-154	2.50	1.50
R-154U	2.00	1.20
COILS (Exciter)		
AR16-5	1.65	.99
AR16-10	1.65	.99
AR16-20	1.65	.99
AR16-40	1.65	.99
AR16-80	1.65	.99
AR16-160	1.65	.99
COILS (Receiver)		
"HRO"		
HRO-A	22.00	13.20
HRO-B	22.00	13.20
HRO-C	22.00	13.20
HRO-D	22.00	13.20
HRO-E	22.00	13.20
HRO-F	22.00	13.20
HRO-G	30.00	18.00
HRO-H	33.00	19.80
HRO-J	40.00	24.00
"HRO Junior"		
JA	18.25	10.95
JB	18.25	10.95
JC	18.25	10.95
JD	18.25	10.95
SW-3		
General Coverage		
No. 30	3.85	2.31
No. 31	3.85	2.31
No. 32	3.85	2.31
No. 33	3.85	2.31
No. 34	3.85	2.31
No. 35	3.85	2.31
No. 36	4.40	2.64
No. 37	4.40	2.64
No. 38	5.50	3.30
No. 39	7.25	4.35
No. 40	7.25	4.35
No. 41	7.25	4.35
No. 42	9.50	5.70
SW-3		
Band Spread		
30A	3.85	2.31
31A	3.85	2.31
33A	3.85	2.31
34A	3.85	2.31
35A	3.85	2.31
COIL ASSEMBLIES		
UR-10A	5.00	3.00
UR-13	2.75	1.65
UR-13A	2.25	1.35
UR-14A	7.00	4.20

COIL BASES (Plug-In)		
Symbol	List	Net
PB-5	\$.85	\$.51
PB-10-5, PB-10-6	.85	.51
PB-10A-5, PB-10A-6	.45	.27
PB-15	1.50	.90
PB-16	.45	.27
COIL CONTAINERS (Rack)		
HCRP	30.00	18.00
COIL DOPE		
CD-1	1.65	.99
COIL FORMS		
High Frequency		
PRC-1	.20	.12
PRC-2	.20	.12
PRC-3	.20	.12
PRD-1	.20	.12
PRD-2	.20	.12
PRE-1	.25	.15
PRE-2	.25	.15
PRE-3	.35	.21
PRF-1	.35	.21
PRF-2	.45	.27
Receiver		
XR-4, XR-5, XR-6	.85	.51
XR-1	.55	.33
XR-2	.40	.24
XR-3	.35	.21
Transmitter		
XR-10A	1.65	.99
XR-13	1.25	.75
XR-13A	.70	.42
XR-14A	4.00	2.40
XR-16	.70	.42
COMBINATION UNITS		
SPC	99.00	59.40
CONDENSERS (Neutralizing)		
NC-75	4.50	2.70
NC-150	7.25	4.35
NC-500	13.75	8.25
NC-600	.50	.30
NC-600U	.60	.36
NC-800	3.00	1.80
STN	2.00	1.20
TCN	4.00	2.40
CONDENSERS (Padding)		
M-30	.35	.21
MSR 25	1.45	.87
MSR 50	1.65	.99
MSE 75	1.90	1.14
MSL 100	2.10	1.26
MSL 25	1.45	.87
USR 50	1.65	.99
USE 75	1.90	1.14
USL 100	2.10	1.26
W-75	2.50	1.50
W-100	2.75	1.65
CONDENSERS (Precision)		
NPW-3	26.50	15.90
NPW-X	22.50	13.50
PW-1R	16.50	9.90
PW-1L	16.50	9.90
PW-2R	22.00	13.20
PW-2L	22.00	13.20
PW-2S	22.00	13.20
PW-3R	26.50	15.90
PW-3L	26.50	15.90
PW-4	30.00	18.00
CONDENSERS (Receiving)		
EMC-150	3.75	2.25
EMC-250	4.25	2.55
EMC-350	4.75	2.85
EMC-500	5.25	3.15
EMC-1000	8.00	4.80
EMCD-350	8.25	4.95
EX-15	.95	.57
EX-25	.95	.57
EX-35	1.10	.66
EX-50	1.00	.60
EX-100	1.10	.66
EX-140	1.40	.84
SEU-15	2.75	1.65
SEU-20	3.00	1.80
SEU-25	3.00	1.80
SE-50	2.50	1.50
SE-75	2.75	1.65
SE-100	3.00	1.80
SE-150	3.25	1.95
SEH-200	3.25	1.95
SEH-250	3.50	2.10
SEH-300	3.50	2.10
SEH-335	3.85	2.31

CONDENSERS (Receiving) — Continued		
Symbol	List	Net
STHS-15	\$ 1.50	\$.90
STHS-25	1.65	.99
STHS-50	1.75	1.05
ST-35	1.65	.99
ST-50	2.00	1.20
ST-75	2.25	1.35
ST-100	2.50	1.50
ST-140	2.75	1.65
ST-150	2.75	1.65
STH-200	3.00	1.80
STH-250	3.30	1.98
STH-300	3.50	2.10
STH-335	4.00	2.40
STD-50	4.00	2.40
STHD-100	5.00	3.00
UM-15	1.40	.84
UM-35	1.65	.99
UM-50	1.75	1.05
UM-75	1.90	1.14
UM-100	2.10	1.26
UMA-25	2.00	1.20
UMB-25	2.00	1.20
CONDENSERS (Transmitting)		
TMA-300	12.00	7.20
TMA-50A	4.50	2.70
TMA-100A	10.00	6.00
TMA-150A	12.00	7.20
TMA-230A	16.00	9.60
TMA-100B	13.50	8.10
TMA-150B	17.00	10.20
TMA-50C	8.00	4.80
TMA-100C	14.50	8.70
TMA-200D	15.00	9.00
TMA-50DA	11.00	6.60
TMA-100DA	17.50	10.50
TMA-60DB	18.50	11.10
TMA-40DC	13.50	8.10
TMC-50	4.40	2.64
TMC-100	5.00	3.00
TMC-150	5.75	3.45
TMC-250	6.60	3.96
TMC-300	7.25	4.35
TMC-50D	7.25	4.35
TMC-100D	8.25	4.95
TMC-200D	11.00	6.60
TMH-50	3.85	2.31
TMH-75	4.40	2.64
TMH-100	5.25	3.15
TMH-150	6.60	3.96
TMH-35A	5.75	3.45
TMH-35D	6.00	3.60
TMH-50D	6.60	3.96
TMH-75D	8.00	4.80
TMK-35	3.60	2.16
TMK-50	3.85	2.31
TMK-75	4.15	2.49
TMK-100	4.40	2.64
TMK-150	5.00	3.00
TMK-200	5.50	3.30
TMK-250	6.00	3.60
TMK-35D	5.75	3.45
TMK-50D	6.50	3.90
TMK-100D	8.00	4.80
TML-75E	28.75	17.25
TML-150D	29.00	17.40
TML-100D	26.00	15.60
TML-50D	18.00	10.80
TML-245B+	31.50	18.90
TML-150B+	28.75	17.25
TML-100B+	27.50	16.50
TML-75B+	20.00	12.00
TML-50A+	38.50	23.10
TML-30A+	30.75	18.45
TML-250A+	28.75	17.25
TML-30DE	29.00	17.40
TML-60DD	31.50	18.90
TML-100DB+	35.00	21.00
TML-60DB+	30.00	18.00
TML-200DA+	38.50	23.10
TML-100DA+	31.50	18.90
TMS-100	2.75	1.65
TMS-150	3.00	1.80
TMS-250	3.30	1.98
TMS-300	4.00	2.40
TMSA-35	3.30	1.98
TMSA-50	3.60	2.16
TMS-50D	4.25	2.55
TMS-100D	5.00	3.00
TMSA-50D	4.40	2.64
COUPLINGS		
TX-1	1.10	.66
TX-2	1.25	.75
TX-8	.85	.51
TX-9	1.25	.75
TX-10	.60	.36
TX-11	.70	.42
TX-12	1.40	.84
TX-13	1.65	.99

NATIONAL PRICE LIST - Continued

DIALS			MODULATORS			SHIELDS (Tube)		
Symbol	List	Net	Symbol	List	Net	Symbol	List	Net
A-2, A-4, A-5	\$ 3.30	\$ 1.98	NSM	\$143.00	\$ 85.80	TS	\$.45	\$.27
A-2, 3 3/8"	3.30	1.98	NSM-RA	159.50	95.70	T14	.45	.27
ACN	5.00	3.00	NSM-RS	154.00	92.40	T5	.45	.27
AL	5.00	3.00	OSCILLOSCOPES			T8	.45	.27
AO	4.00	2.40	CRM	21.00	12.60	T78	.45	.27
B-1, B-5	3.00	1.80	CRR	35.00	21.00	T07	.45	.27
BM-1, BM-5	2.75	1.65	OSCILLATOR COILS			SOCKETS (Coil)		
K	1.65	.99	OSR	1.65	.99	XB-5	.85	.51
L	2.75	1.65	POWER SUPPLIES (Receivers)			XB-15	2.00	1.20
M	2.75	1.65	5856	32.50	19.50	XB-16	.55	.33
N-2, N-3, N-4, N-5	7.50	4.50	5886	32.50	19.50	XC-6C	.85	.51
O	1.65	.99	697	29.50	17.70	SOCKETS (Tube)		
R	.85	.51	SPU-697	55.00	33.00	CIR-4 to 8	.45	.27
DIAL ILLUMINATORS			SPU-56	55.00	33.00	JX-50	1.35	.81
B-Type	.55	.33	DPU-697	87.50	52.50	JX-50S	1.65	.99
DIAL KNOBS			POWER SUPPLIES (Vibrapak)			JX-100	3.30	1.98
HRK	.95	.57	686	49.50	29.70	JX-100S	4.00	2.40
HRP	.30	.18	RECEIVERS			XC-4	.65	.39
HRP-P	.40	.24	HRO-Table	329.50	197.70	XC-5	.65	.39
DIAL LOCKS			HRO-Rack	352.00	211.20	XC-6	.70	.42
ODL	.55	.33	HRO-C	475.00	285.00	XC-7S	.75	.45
DRIVES			HRO-Jr. Table	198.00	118.80	XC-7L	.75	.45
NPW-O	12.00	7.20	HRO-Jr. Rack	220.00	132.00	XC-8	.65	.39
PW-O	15.00	9.00	* NC-45			XCA	1.65	.99
ODD	.70	.42	* NC-45A	84.17	50.50	XMA	2.20	1.32
EXCITER TANKS			* NC-45B	84.17	50.50	XM-10	1.50	.90
FXT	5.00	3.00	NC-100A	220.00	132.00	XM-50	2.00	1.20
FXTB-5, FXTB-6	5.50	3.30	NC-100AB	200.00	120.00	SPEAKERS		
GRID AND PLATE GRIPS			NC-100SA	244.75	146.85	MCS	18.25	10.95
No. 8	.05	.03	NC-100XSA	226.00	171.60	NC-2RS	25.00	15.00
No. 12	.10	.06	NC-100XA	261.25	156.75	NC-2TS	25.00	15.00
No. 24	.05	.03	NC-100XAB	244.00	146.40	NC-45TS	11.66	7.00
GRID AND PLATE GRIPS (Insulated)			NC-101X	236.50	141.90	RFSH	33.00	19.80
SPG	.40	.24	NC-101XB	220.00	132.00	SWITCHES		
SPP-9	.40	.24	NC-101XA	236.50	141.90	ACS-1	1.40	.84
SPP-3	.35	.21	NC-101XAB	220.00	132.00	ACS-4	5.50	3.30
HARDWARE			* NC-200TG	265.83	159.50	TANKS (Transmitting)		
SMH	.15	.09	* NC-200RG	289.33	173.60	5-B-100	40.00	24.00
INSULATORS (Antenna)			NHU	302.50	181.50	TERMINALS		
AA-3	.60	.36	NHU-20	319.00	191.40	FWA-post	.30	.18
AA-5	.50	.30	NHU-R	324.50	194.70	FWF-plug	1.10	.66
AA-6	.90	.54	NHU-20-R	341.00	204.60	FWG	.70	.42
INSULATORS (Panel)			SCR-2	275.00	165.00	FWH	.95	.57
FWC	.40	.24	"1-10"	93.50	56.10	FWJ	.75	.45
FWB	.10	.06	SW-3U	38.50	23.10	TRANSFORMERS (Audio)		
INSULATORS (Stand-Off)			RELAY RACKS			S-101	6.60	3.96
GS-1	.40	.24	MRR	24.75	14.85	TRANSFORMERS (I.F.)		
GS-2	.50	.30	RELAY RACK ADAPTERS			IFC	5.50	3.30
GS-3	1.00	.60	RRA	2.75	1.65	IFCO	5.50	3.30
GS-4	1.25	.75	SHAFT LOCKS			IFD	3.85	2.31
GS-4A	1.75	1.05	RSL	.95	.57	IFE	5.50	3.30
GS-5	.40	.24	SHIELDS (Coil)			TRANSMITTERS		
GS-6	.70	.42	B30	.40	.24	NTX-30	215.00	129.00
GS-7	1.25	.75	B30-B	.55	.33	NTX-30, RS	226.00	135.60
GS-8	.90	.54	J30	.40	.24	NTX-30, RA	231.50	138.90
GS-9	1.25	.75	RO	.40	.24	NTX-30, NSM Comb.	380.00	228.00
GS-10	Ten 1.20	.72	SHIELDS (Jack)			TUNER UNITS (Broadcast)		
JACKS			JS-1	.40	.24	DLCA-Chassis	5.00	3.00
FWE	.20	.12	* Price does not include Loud Speaker.					
JACK TOPS			NATIONAL COMPANY, INC.					
GSJ	.10	.06						

Prices Subject To Change Without Notice

NATIONAL NTE EXCITER — SPEECH AMPLIFIER

The new National Combination Exciter and Speech Amplifier is the ideal answer to transmitter control at the operating position. It includes a versatile multi-band exciter unit with a choice of frequencies in each band, and a high-gain speech amplifier. The exciter can be used with either a conventional single crystal, a National "Vari-gap" variable frequency holder, or a National four-crystal multiple holder, although the multiple holder is usually supplied. The crystal oscillator is followed by three frequency-multiplier stages using 6L6's. The crystals can be controlled from the front panel, and the same is true of the frequency-multiplier stages which are selected by a convenient interlocking push switch of special low-loss design. The four stage amplifier delivers 10 watts output from PP 2A3's with an input of .005 volts. Although the power supply is entirely self-contained, the hum level is exceedingly low. A meter and multi switch are provided for circuit adjustments.

RACK MODELS

Relay Rack Models can be supplied at an increased price of \$10.00 list for black wrinkle-finished steel panels $\frac{1}{8}$ " thick, or at an increase of \$15.00 list for black leatherette or gray enamel panels of aluminum $\frac{3}{16}$ " thick. When ordering Rack Model units add letters RS for steel or RA for aluminum to table model symbols and specify finish desired.

NTX-30 TRANSMITTER

The NTX-30 is an exceedingly compact and convenient transmitter for CW or Phone, having an output of 30 watts on 10, 20, 40 and 80 meters. It employs the same exciter system used so successfully in the NTE, and like the NTE features a special interlocking push switch in the exciter circuits. AR16-S swinging link type coils described on Page 9 are used in the output stage. Four 6L6's are used as crystal oscillator and doublers, and two 6L6G's are used in the final.

The unit is a self-contained transmitter for CW operation. For phone an external modulator must be used. The NSM described on page 15 is ideal for this purpose. Terminals are provided at the rear of the NTX-30 for connecting the modulator.

Structurally, the NTX-30 consists of an NTE Exciter with a final stage substituted for the speech amplifier, and it is very similar in appearance to the NTE illustrated above. All the features of the NTE are retained, including panel control of crystal frequency, interlocking push switch, meter for circuit adjustments, etc. The NTX-30 thus has the advantage of a proven design in its circuits, and is ideally suited for use as an exciter-buffer combination whenever higher power is desired.

Special combination NTX-30 Transmitter and NSM Speech Amplifier mounted in steel cabinet, black wrinkle finish.

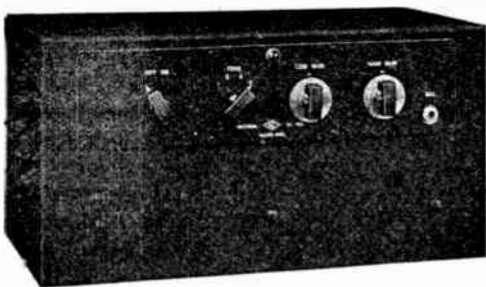

NSA Speech Amplifier, table model, in wrinkle-finish steel cabinet, including tubes.

NSA-RS Relay rack mounting, with black wrinkle-finish steel panel $\frac{1}{8}$ inch thick.

NSA-RA Relay rack mounting, with black leatherette or gray enamel aluminum panel $\frac{3}{16}$ inch thick.

Approx. Shipping Weight 50 Lbs.

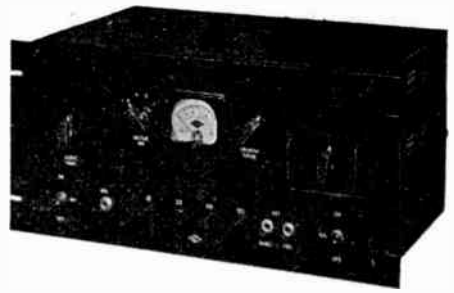

TABLE MODELS

NTE Exciters are available in three models as follows: Black wrinkle-finish

NTE-A,
Exciter-Speech Amplifier, for 5, 10, 20 and 80 meters, table model

NTE-B,
Same as NTE-A, but for 10, 20, 40 and 80 meters

NTE-C,
Same as NTE-B, but without speech amplifier
Shipping Weight Approx. 70 Lbs.

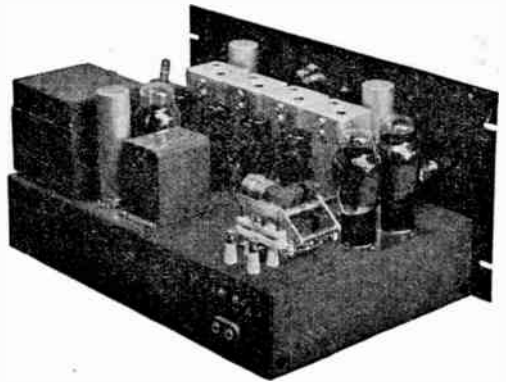

NTX-30, Table Model Transmitter, complete with all coils, tubes, and crystal holder, but less crystal for operation on 10, 20, 40, and 80 meter bands.

NTX-30, RS, Rack Model, same as above but mounted on $\frac{1}{8}$ " steel. Panel, black wrinkle finish.

NTX-30, RA, Rack Model, same as above but mounted on $\frac{3}{16}$ " aluminum. Panel, black leatherette or gray finish.

Shipping Weight Approx. 70 Lbs.

NSA SPEECH AMPLIFIER

The National Speech Amplifier has two input channels with an electronic mixer. One input circuit provides an over all gain of 125 db, and is suitable for crystal microphones, etc. The other input circuit has one less amplifier stage and is intended for high level sources such as phonograph pickups, etc. The frequency characteristic is flat within less than 1 db from 25 to 10,000 cycles. A separate rectifier supplies bias voltage for the PP 2A3's, which deliver 15 watts output. A tone control is provided.



NATIONAL NSM MODULATOR

The new Type NSM Modulator Unit is intended particularly for use with the NTX-30 Transmitter, but its many advanced features make it desirable for any modulating job within its 30 watt rating. Typical among its features are Automatic Volume Compression, permitting high modulation levels without danger of overmodulation, its DB meter indicating the amount of compression, its four-position tone control which cuts either highs or lows, or both, or leaves intact the normal range of 50 to 10,000 cycles, and its two separate input circuits.

Four stages of resistance-coupled amplification with 6C6 input, 6D6 second stage, 6F8G phase inverter, and push pull 6L6G output — Power gain approximately 135 db, output 30 watts — 6X5 high voltage rectifier used in Automatic Volume Compression circuit — VR-150 Voltage Regulator. Two separate input circuits, one of which omits the first 6C6 amplifier tube — Frequency response flat from 50 to 10,000 cycles.

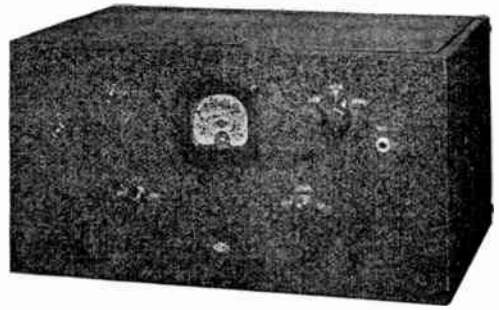

NSM, Complete with tubes and mounted in the table model steel cabinet. Finished in black wrinkle. As illustrated above.

NSM-RS, Same as above but mounted on 1/8" relay rack panel finished in black wrinkle.

NSM-RA, Ditto but with 3/16" aluminum panel. Finished in black leatherette on gray enamel.

NATIONAL CRYSTAL HOLDERS

National Crystal Holders are available in three types. All use R-39 insulation for low losses and all are carefully designed for maximum crystal activity. The newest holder (Figure 1) is the Type 4-in-1 and is very con-

venient where a choice of frequencies is desired. It is designed to hold four separate crystals up to 1" square which may be selected by a built-in low capacity switch. The CHV Crystal Holder (Figure 3) is of the variable gap type and, when used with a suitable crystal, permits tuning the crystal over a range of 1 part in 600. The small holder shown in Figure 2 is available in two forms. Type CHR for receivers, resonator type. Type CHT for transmitters, pressure type.

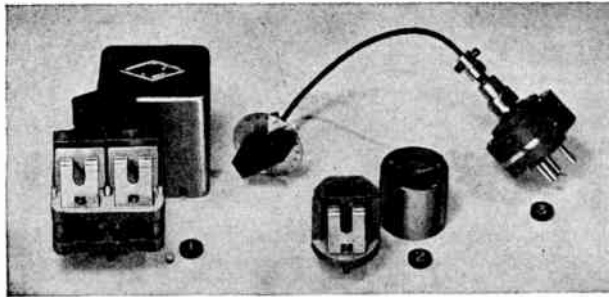

4-in-1 Fig. 1

CHR Fig. 2

CHT Fig. 2

CHV, less crystal Fig. 3

CHV, with 80-meter crystal that will double into the 20-meter phone band

NATIONAL CATHODE-RAY OSCILLOSCOPES



The Type CRM oscilloscope is mounted in a small steel cabinet (4 1/8" x 6 1/8" x 8") and uses a one-inch screen RCA-913 with 6X5 rectifier. Power supply and input controls are built in. A panel switch permits use of the built-in 60 cycle sweep or external audio sweep for securing the familiar trapezoid pattern for modulation measurements. CRM, less tubes,

The Type CRR oscilloscope is mounted on a standard 3 1/2" relay rack panel, and employs a two-inch screen RCA-902 and 6X5 rectifier. The power supply is mounted back of the panel, and input controls are provided. A panel switch permits use of the built-in 60 cycle sweep or external audio sweep for securing the familiar trapezoid pattern for modulation measurements. CRR, less tubes,



METAL SPEAKER CABINETS

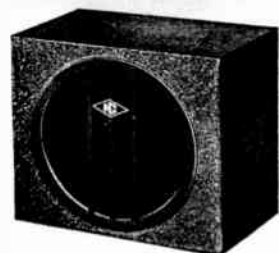

These cabinets are corrected acoustically to prevent undesired resonance peaks. Acoustic felt lined. Finish: black wrinkle.

NDC-8 for 8" speaker

NDC-10 for 10" speaker

INTERLOCKING PUSH SWITCH

The National Interlocking Push Switch has low losses, complete reliability and positive contacts. Insulation is R-39. The silver-plated contacts are double pole, double throw.

ACS-4, Four gang, with trigger bar

ACS-1, Single section, less trigger bar

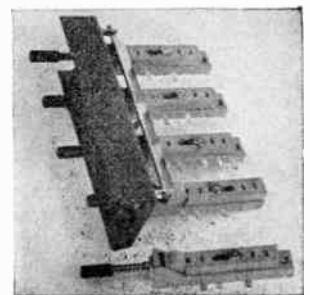

NATIONAL HRO

The HRO Receiver is a high-gain superheterodyne designed for communication service. Two preselector stages give remarkable image suppression, weak signal response and high signal-to-noise ratio. Air-dielectric tuning capacitors account, in part, for the high degree of operating stability. A crystal filter with both variable selectivity and phasing controls makes possible adjustment of selectivity over a wide range. Heterodynes and interfering c.w. signals may be "phased out" (attenuated) by correct setting of the phasing control. A signal strength meter, connected in a vacuum tube bridge circuit, is calibrated in S units from 1 to 9 and in db above S9 from 0 to 40. Also included are automatic and manual volume control features, a beat oscillator, a headphone jack and a B+ stand-by switch. Power supply is a separate unit. The standard model of HRO is supplied with four sets of coils covering the frequencies from 1.7 to 30 megacycles. Each coil set covers two amateur bands and the spectrum between. The higher frequency amateur band of each range, by a simple change-over operation, may be expanded to occupy 400 divisions of the 500 division PW instrument type dial.

For those who require the high performance of the HRO but do not need its extreme versatility, the HRO Jr. is offered. The fundamental circuit and mechanical details of both receivers are identical, but the HRO Jr. is simplified by omitting the crystal filter, signal strength meter and by supplying coils less the band-spread feature.

The frequency range of both the HRO and HRO Jr. may be extended to 50 kilocycles by using additional coil sets.

A technical bulletin covering completely all details will be supplied upon request.

HRO-C DELUXE COMBINATION

HRO-C, a deluxe receiver installation, see illustration, combines an HRO with an SPC unit (power unit, coil container and loud speaker) in an MRR table rack.



Chromium-plated appearance strips and side trim strips included.

SPC, combination of 697 power unit, coil container (5 coil capacity) and 8" PM dynamic speaker. Rack panel, 3/16" x 15 3/4" x 19". Chrome strips included.

MRR, table rack, standard width, panel capacity 2 1/8", finish black or gray. Side trim strips included.

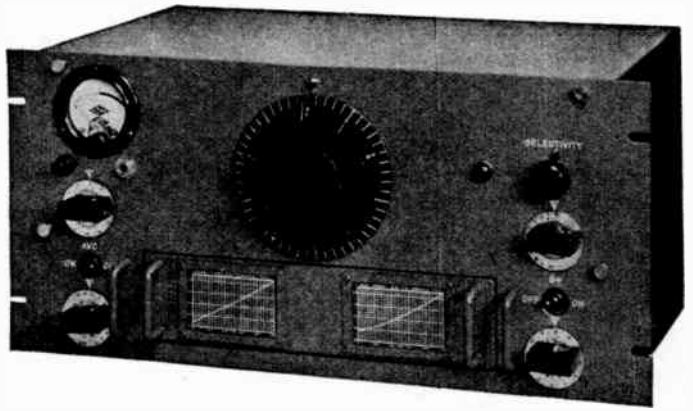

RECEIVERS

All models of the HRO are supplied with 6.3 volt heater type tubes. Table models and accessories are finished in black wrinkle enamel; rack panel types in either black leatherette or smooth gray enamel.

HRO table model, receiver only, complete with four sets of coils (1.7-4.0, 3.5-7.3, 7.0-14.0, 14.0-30.0 MCS)

HRO, same as above, but mounted on 3/16" x 8 3/4" x 19" aluminum panel.

HRO Jr., table model, receiver only, with one set of 14 to 30 mc. coils.

HRO Jr., same as above, but mounted on an aluminum panel.

COILS

HRO Type E, Range 900-2050 kc

HRO Type F, Range 480-960 kc

HRO Type G, Range 180-430 kc

HRO Type H, Range 100-200 kc

HRO Type I, Range 50-100 kc

HRO Jr. Type JA, Range 14.0-30.0 mc

HRO Jr. Type JB, Range 7.0-14.4 mc

HRO Jr. Type JC, Range 3.5-7.3 mc

HRO Jr. Type JD, Range 1.7-4.0 mc

COIL CONTAINER

HCRP coil container, rack panel 3/16" x 8 3/4" x 19", capacity 5 coils.

LOUD SPEAKERS

MCS table model cabinet, 8" PM dynamic speaker and matching transformer.

RFSH, speaker as above, but mounted on 3/16" x 8 3/4" x 19" aluminum panel.

POWER SUPPLIES

697 Table power unit, 115 volt, 60 cycle input; 6.3 volt heater and 230 volt, 75 m.a. output, with tube.

686 Table power unit, 6 volt battery operated vibrator pack, 165 volts, 50 m.a. output.

SPU-697 Single power unit, rack mounted panel, 3/16" x 5 1/4" x 19".

DPU-697 Double power unit, rack mounted, as above but having two separate 697 power units.

Shipping weights: HRO — 62 lbs. HRO Jr. — 42 lbs. 697 — 15 lbs. SPU-697 — 36 lbs. DPU-697 — 48 lbs. SPC — 48 lbs. MRR — 21 lbs.

NATIONAL NEW SW-3

General Coverage Coils

Catalog Number	Range — Meters	List Price Per Pair
30	9. to 15.....	
31	13.5 to 25.....	
32	23. to 41.....	
33	40. to 70.....	
34	65. to 115.....	
35	115. to 200.....	
36	200. to 360.....	
37	350. to 550.....	
38	500. to 850.....	
39	850. to 1200.....	
40	1200. to 1500.....	
41	1500. to 2000.....	
42	2000. to 3000.....	

Band Spread Coils

30A	— 10 meter.....
31A	— 20 meter.....
33A	— 40 meter.....
34A	— 80 meter.....
35A	— 160 meter.....

The SW-3 Receivers employ a circuit consisting of one R.F. stage transformer coupled to a regenerative detector and one stage of impedance coupled audio. This circuit provides maximum sensitivity and flexibility with the smallest number of tubes and the least auxiliary equipment. The single tuning dial operates a precisely adjusted two gang condenser; the regeneration control is smooth and noiseless, with no backlash or fringe howl; the volume control is calibrated from one to nine in steps corresponding to the R scale.

ONE UNIVERSAL MODEL — The circuit of the SW-3 is arranged for either battery or AC operation without coil substitution or circuit change. Battery operation utilizes two 1N5-G and one 1A5-G tubes. AC operation utilizes type 5886 AB power supply with two 6J7-G and one 6C5-G tubes.

Shipping Weights: Receiver, 17 lbs. — No. 5886 AB pack, 18 lbs.
SW-3, universal model, without coils, phones, tubes or power supply.
5886-AB, Power Supply, 115 V, 60 cycle, with 80 Rectifier.

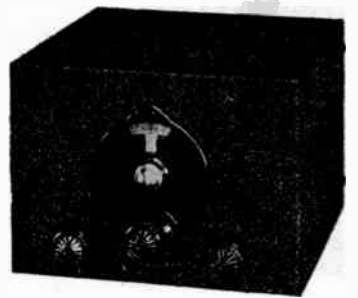



NATIONAL NHU

This specialized communication receiver is a superheterodyne covering the range from 27 to 62 MC in three ranges, each being calibrated on a direct reading full-vision dial.

The circuit uses three acorn tubes (956 RF, 954 First Detector, and 955 Oscillator) followed by three IF stages using 6K7's. A 6C8G Twin Triode is used as an infinite-impedance diode detector, and as a noise limiter. An additional 6C8G acts as first audio and as a carrier-off noise suppressor. Two 6SJ7's are used for the

CW oscillator and for the AVC, which is amplified and delayed. The output employs a 6V6G.

The mechanical details of the NHU are unique. One large knob on the panel slides in or out to engage either the tuning condenser or the range-changing system. Inertia-type tuning is used, with a ratio of approximately 70 to 1. The pointer is positively driven by rack and pinion, and moves vertically when the coil range is changed so that it always points to the proper frequency. The coils are mounted radially in a cast aluminum turret which is easily turned into position by the knob on the panel. Directly above the coil turret is the three-gang straight-line-frequency tuning condenser. The RF circuit and tubes are built completely inside the frame of the condenser, thus making a compact assembly with the shortest possible leads from coils to condensers to tubes.

All features and controls commonly found in high-quality communication receivers are incorporated in the NHU, including a wide range crystal filter.

Battery models operate on 135 to 180 V. B-battery and 6.3 V. A-Battery

NHU Receiver, table model, complete with tubes, 8" speaker with cabinet and coils covering from 27 to 62 MC, but without power supply, black finish.

NHU-B Receiver, same as above, but for battery operation.

NHU-20 Receiver, same as NHU but with 20 Meter Coil.

NHU20B Receiver, same as above but for battery operation.

Relay rack models of above receivers. Additional.

5856 Power Supply, table model with rectifier, for NHU or NHU-20.

SPU-56 Relay rack power supply with rectifier.

NHU Shipping Weight, 82 lbs., **5856**, 18 lbs.

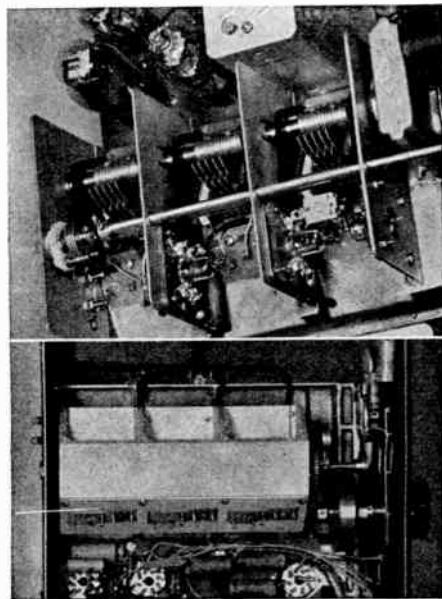

110 Receiver and 6 sets of coils, without tubes, speaker or power supply.

5886 Power Supply for above receiver, with tube.

Shipping Weights: Receiver, 16 lbs.—No. 5886 AB pack, 17 lbs.

NATIONAL ONE-TEN

Designed chiefly for the experimenter, the One-Ten Receiver fulfills the need of the experimenter for an adequate receiver to cover the field between one and ten meters.

A four tube circuit is used, composed of one tuned R.F. stage, a self-quenching super-regenerative detector, transformer coupled to a first stage of audio which is resistance coupled to the power output stage. Tubes required: 954-R.F.; 955-Detector; 6C5-1st Audio, 6F6-2nd Audio.

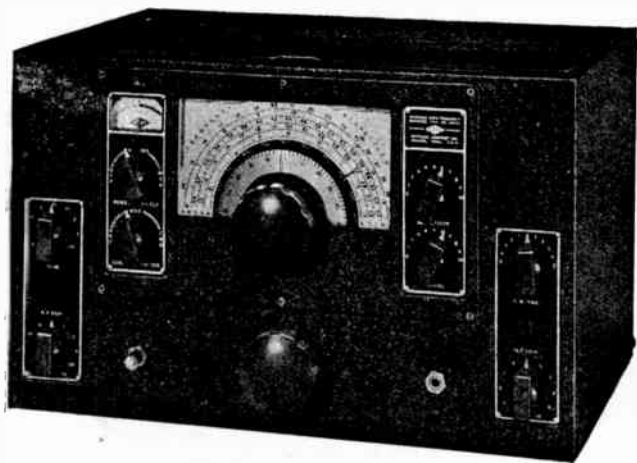

NATIONAL NC-100A NC-100XA

NC-101X NC-101XA

These 11 tube superheterodyne receivers are self-contained (except for the speaker) in a table model cabinet that is readily adapted to relay rack mounting. One stage of R.F. and two stages of I.F. are used. Low loss insulation and high-Q coils give ample sensitivity and selectivity. Separate R.F. and Audio Gain Controls and a signal strength meter are mounted on the panel. Other controls are tone, CW Oscillator, AVC with amplified and delayed action, a B+ switch, and a phone jack. A self-contained power supply provides all necessary voltages including speaker field excitation. The range changing system is unique in that it combines the mechanical convenience of a coil switch with the electrical efficiency of plug-in coils.

All NC-100 series receivers are fitted with a noise limiter of truly remarkable effectiveness.

The NC-100A illustrated above, covers the range from 540 KC to 30 MC. The large full vision dial is calibrated directly in megacycles and a separate high speed vernier scale provides high precision in logging. The NC-100XA is similar but equipped with a crystal filter.

The NC-101X, illustrated below, is built strictly for the amateur bands and covers only the following ranges: 1.7-2.05 MC, 3.5-4.0 MC, 7.0-7.3 MC, 14.0-14.4 MC, and 28.0-30.0 MC. The NC-101X is equipped with a crystal filter, S-meter, and the PW type instrument dial.

The NC-101XA has the same features as the NC-101X, except for the direct reading dial and the cabinet, which are similar to the NC-100XA. Prices are the same as for the NC-101X. The battery models use 9 tubes, and operate on 180 V. B-batteries and 6.3 V. A-batteries. Power output of AC model 10 watts, battery model 2 watts.

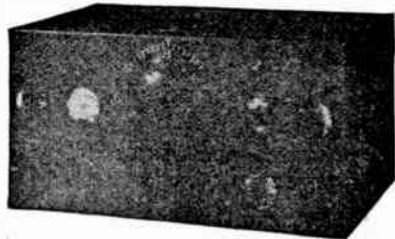

NC-100A — complete with tubes. AC model — 10" speaker in cabinet.

Battery model — 8" speaker in cabinet.

NC-100XA — complete with tubes and crystal filter. AC model — 10" speaker.

Battery model — 8" speaker in cabinet.

NC-100SA — complete with tubes. AC model — 12" Rola G-12 Speaker.

NC-100XSA — complete with tubes and crystal filter. AC model — 12" Rola G-12 Speaker.

NC-101X — complete with tubes. AC model — 10" speaker in cabinet.

Battery model — 8" speaker in cabinet.

NDC-10 — Metal Cabinet for 10" speaker, same finish as receiver.

NDC-8 — Metal Cabinet for 8" speaker, same finish as receiver.

Note: Cabinets for 12" speaker chassis cannot be supplied.

RRA, Relay Rack Adapters, designed for mounting any of the above receivers in a standard relay rack.

Note: 230 volt 50 cycle and 115 volt 25 cycle models of above receivers available at slightly higher price.

Shipping weights: NC100A, 70 lbs. — NC100XA, 71 lbs. — NC101X, 71 lbs.

NOTE: Special models of the NC-100 receiver with bands covering the 200-400 KC range are available. Data and prices furnished upon request

NATIONAL NC-44

The new NC-44 Communication Receiver combines capable performance with low price. It employs seven tubes in a superheterodyne circuit. There are separate controls for RF and AF gain, and on and off switches for the AVC and CWO circuits. The self-contained power supply operates on 105-130 volts AC or DC. A battery model is available for operation with 90-135 V. B-battery and 6.3 V. A-battery. A model for operation from a self-contained AC power supply is listed for the first time.

A straight-line-frequency condenser is used in conjunction with a separate band spread condenser. This combination plus the full vision dial calibrated in frequency for each range covered and a separate linear scale for the band spread condenser, makes accurate tuning easy. Both condensers have an inertia-type drive. A coil switch with silver plated contacts selects the four ranges from 550 KC to 30 MC. Provision is made for either head phone or speaker operation.

Like all receivers which have no preselector stage, the NC-44 is not free from images. However, where price is an important consideration, the NC-44 will be found a satisfactory receiver.

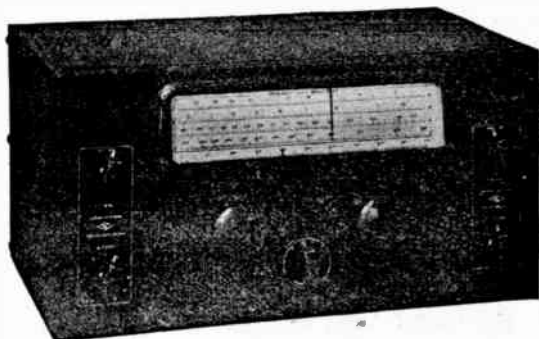

NC-44 — Receiver, complete with tubes, coils covering from 550 KC to 30 MC, and speaker in cabinet, for 105-130 volts AC or DC operation — black finish.

NC-44B — Receiver, same as above but for battery operation, less batteries.

NC-44A — Receiver, same as above but for 105-130 volts AC only.

RRA — Relay Rack Adapters designed for mounting these receivers in a standard relay rack.

Shipping Weights: NC-44, 45 pounds — NC-44B, 45 pounds.



NATIONAL

NC-200



The National NC-200 is a new communications receiver having a number of features not previously available. Twelve tubes are used in a highly perfected circuit that includes an extremely effective noise limiter. The crystal filter has an exceptionally wide selectivity range for use on both CW and phone, as well as a phasing circuit that makes rejection ratios as high as 10,000 to 1 available even when the interfering signal is only a few hundred cycles from the desired signal. The AVC holds the audio constant within 2 db for signals from 10 microvolts to 100,000 microvolts. The sensitivity of the NC-200 is particularly high, requiring only 1 microvolt input for 1 watt of audio output on the highest frequencies covered by the receiver. Signal-to-image ratio is better than 30 db at ten meters.

There are ten calibrated coil ranges, each with its own scale on the direct-reading dial. Six of these ranges provide continuous coverage from 490 KC to 30 MC. The remaining four ranges cover the 10, 20, 40 and 80 meter bands, each of which is spread over the major portion of the dial scale. Ranges are selected by a panel control knob. A movable-coil system similar to the NC-100 is used. The inertia-type dial drive has a ratio of 30 to 1.

All models of the NC-200 are suitable for either AC or battery operation, having both a built-in AC power supply and a special de-

tachable cable and plug for battery connection. Removal of the speaker plug disconnects both plate and screen circuits of the audio power stage thus providing maximum battery economy. The B supply filter and the standby switch are wired to the battery terminals, so that the filter is available for vibrator or dynamotor B supplies.

The ten-inch speaker is housed in a separate cabinet specially designed to harmonize with the trim lines of the receiver. The undistorted output is 8 watts.

All features expected in a fine communication receiver are provided. These include CW oscillator, Signal Strength Meter, B-supply switch, etc.

NC-200 TG Table Model, two tone Gray wrinkle

Price includes a 10" P.M. dynamic speaker in cabinet.

NC-200 RG Rack Model, Gray or Black wrinkle, mounted on 3/16" aluminum panel

Price includes a 10" P.M. dynamic speaker mounted on 10½" rack panel.

Shipping weight approx. 95 lbs.



NATIONAL 600 WATT TRANSMITTER

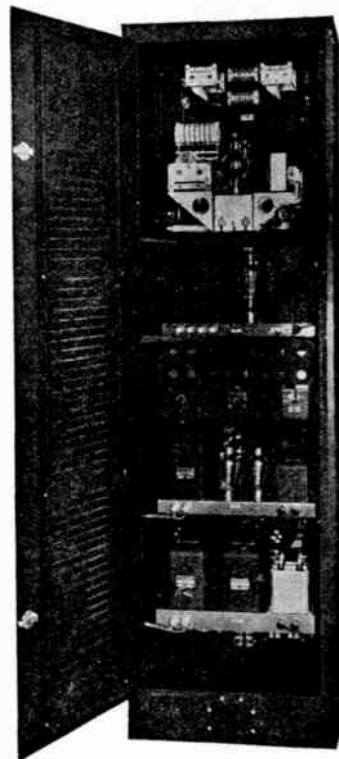

The National 600 Watt Transmitter is a compact and efficient unit of flexible design. The standard design provides a plate input of 600 watts on 10, 20, 40 or 80 meters.

An NTE Exciter-Speech Amplifier (described on page 15) is used as speech amplifier and as exciter for the buffer and final amplifier unit immediately above it. A Pi Network antenna coupler at the top of the cabinet completes the RF units.

The buffer and final amplifier unit features a compact, open construction that results in short leads, symmetry of the push-pull circuit and complete accessibility. The final employs a pair of 100 TH's driven by a single 35T as buffer.

The modulator chassis is immediately above the Exciter-Speech Amplifier, which serves as driver for the Class B amplifier. A pair of zero-bias 203-Z tubes provide 300 watts of modulating power.

Power for the modulator stage is supplied by the power unit immediately below the NTE. This 1250 volt supply also provides power for the buffer.

The power supply at the bottom of the cabinet delivers 300 MA at 2000 Volts for the final.

All transformers and chokes are Thordarson CHT units, except those in the NTE, which are special units of National manufacture. The National 600 Watt Transmitter, as described, complete except for the microphone.

TRANSMITTER FOUNDATION UNITS

The individual units of the 600 Watt Transmitter described above are available as separate chassis. In the table below, the first column lists completely wired and tested units. The chassis listed

in the second column are drilled, punched and formed, and ready for assembly. Panels, brackets, screws and small hardware are included.

UNIT	WIRED AND TESTED	FINISHED ASSEMBLY
High Voltage Supply	NT 2000 PCW	NT 2000 PC
Medium Voltage Supply	NT 1200 PCW	NT 1200 PC
Class B Modulator	NT 300 PCW	NT 300 PC
Final Amplifier	NT 100 PCW	NT 100 PC
Pi Network Coupler	NT-APW	NT-AP
Relay Control Panel	NT-RPW	

NATIONAL POWER SUPPLIES

National Power Supplies are specially designed for high frequency receivers, and include efficient filters for RF disturbances as well as for hum frequencies. The various types are listed under the receivers with which they are used.

FOR AC OPERATION, 115 volt, 50-60 cycle.

Type 697, Table model, (230 V., 75 MA., 6.3 V. Filaments) with tube

5886, Table model, (170 V., 50 MA., 6.3 V. Filaments, with tube

GRSPU, Rack mounted, same electrical characteristics as either 697 or 5886, with tube

GRDPU, Rack mounted, with two separate and complete power supplies same as GRSPU, with tubes

FOR AC OPERATION, 230 volt or 25 cycle.

Supplies for 230 volts or 25 cycles can be supplied at slightly higher prices than the standard models.

FOR BATTERY OPERATION

High voltage power supplies can be supplied for National Receivers for operation from batteries. These units are of the vibrator type. Complete information will be given on request.

686, Table model, (165 V., 50 MA.,) for operation from 6.3 volts DC, with vibrator

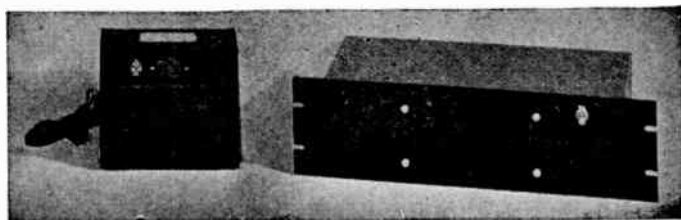

NATIONAL DIALS

PRECISION NW DIAL

The six-inch NW Dial has an engine divided scale and vernier of solid nickel silver. The vernier is flush with the scale. The variable ratio drive is unusually powerful at all settings. 2, 3, 4 or 5 scale. Standard Dial fits $\frac{3}{8}$ " shaft. $\frac{1}{4}$ " shaft on request.

NW Dial

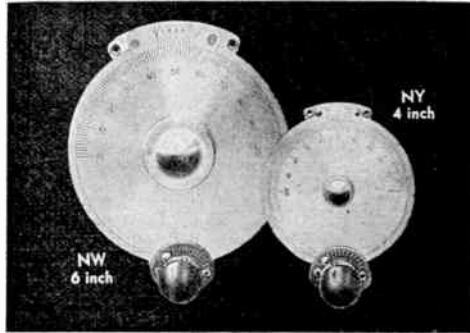

PRECISION NY DIAL

The four-inch NY Dial is similar to the NW Dial except for size. Scales are engine divided on solid nickel silver. A flush vernier and a variable ratio drive are provided. 2, 3, 4 or 5 scale. Fits $\frac{1}{4}$ " shaft.

NY Dial

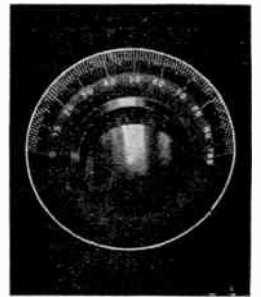

The four-inch N Dial has an engine divided scale and vernier of solid nickel silver. The vernier is flush with the scale. The planetary drive has a ratio of 5 to 1, and is contained within the body of the dial. 2, 3, 4 or 5 scale. Fits $\frac{1}{4}$ " shaft.

N Dial

The original black bakelite "Velvet Vernier" Dial, Type A, is still an unchallenged favorite for general purpose use. The planetary drive has a ratio of 5 to 1. In 4 inch diameter with 2, 4 or 5 scale, and in $3\frac{3}{8}$ inch diameter with 2 scale. Fits $\frac{1}{4}$ " shaft.

A Dial

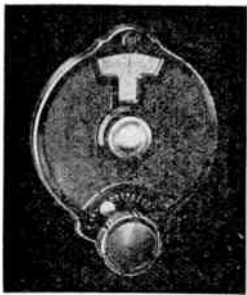

"Velvet Vernier" Dial, Type B, has a compact variable ratio 6 to 1 minimum, 20 to 1 maximum drive that is smooth and trouble free. An illuminator is available. The case is black bakelite. 1 or 5 scale. 4" diam. Fits $\frac{1}{4}$ " shaft.

B Dial

Illuminator, extra

The BM Dial is a smaller version of the B Dial (described in the opposite column) for use where space is limited. The drive ratio is fixed. Although small in size, the BM Dial has the same smooth action as the larger units. 1 or 5 scale. 3" diam. Fits $\frac{1}{4}$ " shaft.

BM Dial

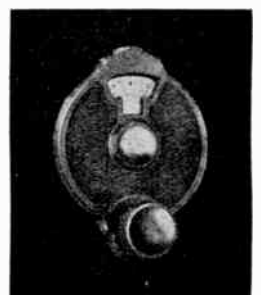

INEXPENSIVE DIALS



TYPE R

Etched nickel-silver dial, 1 $\frac{3}{8}$ " Dia. Not insulated from shaft.



TYPE O

Etched nickel-silver dial, 3 $\frac{1}{2}$ " Dia. Insulated from shaft.

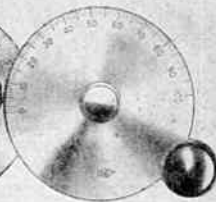

TYPE K

Etched nickel-silver dial, 3 $\frac{1}{2}$ " Dia. Vernier drive.

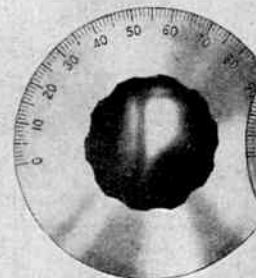

TYPE L

Etched nickel-silver dial, 5" Dia. Insulated from shaft.

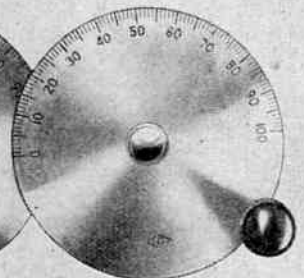

TYPE M

Etched nickel-silver dial, 5" Dia. Vernier drive.

All above Dials for $\frac{1}{4}$ " shafts

KNOBBS



HRK,

Black bakelite knob $2\frac{3}{8}$ " diam. Fits $\frac{1}{4}$ " shaft.

HRP-P,

Black bakelite knob 1 $\frac{1}{4}$ inch long and $\frac{1}{2}$ inch wide and fits $\frac{1}{4}$ inch shaft. Equipped with pointer.

HRP,

The Type HRP knob has no pointer, but is otherwise the same as the knob above.

DIAL SCALES

Scale	Divisions	Rotation	Direction of Condenser Rotation for Increase of dial reading
1	0-100.0	180°	Either
2	0-100	180°	Counter Clockwise
3	100-0	180°	Clockwise
4	150-0	270°	Clockwise
5	200-0	360°	Clockwise
6	0-150	270°	Counter Clockwise

ROTOR SHAFT LOCK

RSL, Designed to fit TMA, TMC or similar condensers, this clamp provides a convenient and secure rotor lock. Fits $\frac{1}{4}$ " shaft.

ACCESSORIES

ODL,

A locking device which clamps the rim of O, K, L and M Dials. Brass, nickel plated.

ODD,

This vernier drive unit may be used with O, K, L, M or other plain dials.

SB,

A nickel plated brass bushing $\frac{3}{8}$ " dia., hole fits $\frac{1}{4}$ " shaft.

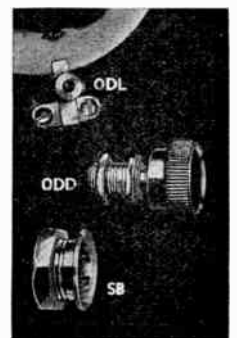

NATIONAL PRECISION CONDENSERS

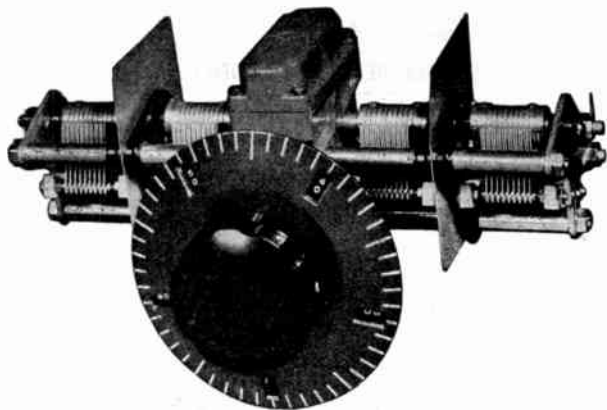

The Micrometer dial reads direct to one part in 500. Division lines are approximately $\frac{1}{4}$ " apart. The dial revolves ten times in covering the tuning range, and the numbers visible through the small windows change every revolution to give consecutive numbering by tens from 0 to 500. The condenser is of extremely rigid construction, with four bearings on the rotor shaft. The drive, at the mid-point of the rotor, is through an enclosed pre-loaded worm gear with 20 to 1 ratio. Each rotor is individually insulated from the frame, and each has its own individual rotor contact, of the multi-fingered brush type. Stator insulation is Steatite.

PW Ganged Condensers are available in 2, 3 or 4 sections, in either 160 or 225 mmf per section. Larger capacities cannot be supplied.

A single-section PW condenser with grounded rotor is supplied in capacities of 150, 200, 350 and 500 mmf, single spaced, and capacities up to 125 mmf, double spaced. Plate shape is straight-line-frequency when the frequency range is 2:1.

PW condensers and drives are all with rotor shaft parallel to the panel.

- PW-1, Single Section
- PW-2, Two Section
- PW-3, Three Section
- PW-4, Four Section

NOTE: When ordering specify capacity per section and desired position — right or left of dial.

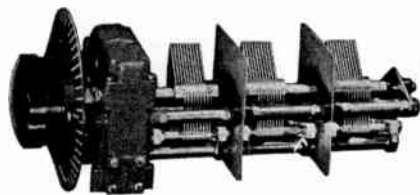

NPW MODELS

NPW condensers are similar to PW models, except that the rotor shaft is perpendicular to the panel. They were originally designed for use in the NC-100. Prices include micrometer dial.

NPW-3, Three sections, each 225 mmf.

NPW-X, Three sections, each 25 mmf.



NPW-0



PW-0

DRIVE UNITS

Two drive units are available, each with micrometer dial and gear drive. The Type PW-0 uses parts from the PW condenser, and the drive shaft is parallel to the panel. Two Type TX-9 couplings are supplied. The NPW-0 uses parts from the NPW condenser, with the drive shaft perpendicular to the panel. One Type TX-9 coupling is furnished.

PW-0

NPW-0

NATIONAL RECEIVING CONDENSERS

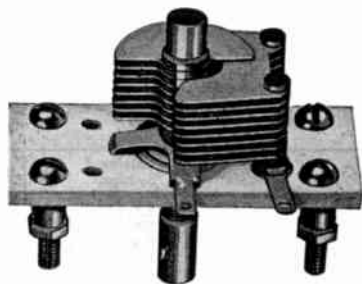

TYPE UM
STRAIGHT-LINE CAPACITY
180° Rotation

Dimensions: Base 1" x 2 $\frac{1}{4}$ "
Mounting Holes: $\frac{5}{8}$ " x 1 $\frac{23}{32}$ "
Overall Length: 2 $\frac{1}{8}$ "

Capacity	Minimum Capacity	No. of Plates	Air Gap	Catalog Symbol	List Price
15 Mmf.	1.5	6	.017"	UM- 15	
35	2.5	12	.017"	UM- 35	
50	3	16	.017"	UM- 50	
75	3.5	22	.017"	UM- 75	
100	4.5	28	.017"	UM-100	
25	3.4	14	.050"	UMA- 25	
BALANCED STATOR MODEL					
25	2	4-4-4	.017	UMB- 25	

The **UM CONDENSER** is designed for ultra high frequency use and is small enough for convenient mounting in our square shield cans. They are particularly useful for tuning receivers, transmitters, and exciters. Shaft extensions at each end of the rotor permit easy ganging when used with one of our flexible couplings. The UMB-25 Condenser is a balanced stator model, two stators act on a single rotor. The UM can be mounted by the angle foot supplied or by bolts and spacers.



NATIONAL RECEIVING CONDENSERS

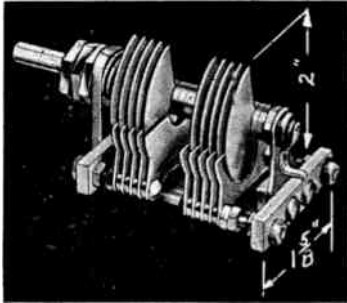

TYPE ST

(Type STD Illustrated)

STRAIGHT-LINE WAVELENGTH

180° Rotation

NOTE — Type SS Condensers, having straight-line-capacity plates but otherwise similar to the Type ST, are available on application. Capacities and Prices same as Type ST.

Capacity	Minimum Capacity	No. of Plates	Air Gap	Length	Catalog Symbol	List
SINGLE BEARING MODELS						
15 Mmf.	3 Mmf.	3	.018"	1 3/4"	STHS-15	
25	3.25	4	.018"	1 3/8"	STHS-25	
50	3.5	7	.018"	1 3/8"	STHS-50	
DOUBLE BEARING MODELS						
35 Mmf.	6 Mmf.	9	.026"	2 1/4"	ST-35	
50	7	11	.026"	2 1/4"	ST-50	
75	8	15	.026"	2 1/4"	ST-75	
100	9	20	.026"	2 1/4"	ST-100	
140	10	28	.026"	2 3/4"	ST-140	
150	10.5	29	.026"	2 3/4"	ST-150	
200	12.0	27	.018"	2 1/4"	STH-200	
250	13.5	32	.018"	2 3/4"	STH-250	
300	15.0	39	.018"	2 3/4"	STH-300	
335	17.0	43	.018"	2 3/4"	STH-335	
SPLIT STATOR DOUBLE BEARING MODELS						
50-50	5-5	11-11	.026"	2 3/4"	STD-50	
100-100	5.5-5.5	14-14	.018"	2 3/4"	STHD-100	

The ST Type condenser has Straight-Line Wavelength plates. All double-bearing models have the front bearing insulated to prevent noise. On special order a shaft extension at each end is available, for ganging. On double-bearing single shaft models, the rotor contact is through a constant impedance pigtail. Isolantite insulation.

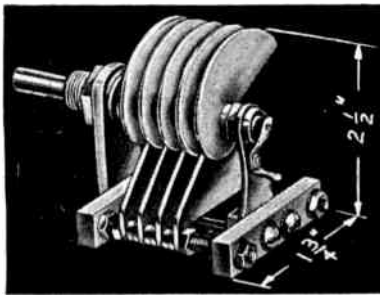

TYPE SE

(Type SEU Illustrated)

STRAIGHT-LINE FREQUENCY

270° Rotation

Capacity	Minimum Capacity	No. of Plates	Air Gap	Length	Catalog Symbol	List
15 Mmf.	7 Mmf.	6	.055"	2 1/4"	SEU-15	
20	7.5	8	.055"	2 1/4"	SEU-20	
25	8	9	.055"	2 1/4"	SEU-25	
50	9	11	.026"	2 1/4"	SE-50	
75	10	15	.026"	2 1/4"	SE-75	
100	11.5	20	.026"	2 1/4"	SE-100	
150	13	29	.026"	2 3/4"	SE-150	
200	12	27	.018"	2 1/4"	SEH-200	
250	14	32	.018"	2 3/4"	SEH-250	
300	16	39	.018"	2 3/4"	SEH-300	
335	17	43	.018"	2 3/4"	SEH-335	

TYPE SE — All models have two rotor bearings, the front bearing being insulated to prevent noise. A shaft extension at each end, for ganging, is available on special order. On models with single shaft extension, the rotor contact is through a constant impedance pigtail. The SEU models (illustrated) are suitable for high voltages as their plates are thick polished aluminum with rounded edges. The other SE condensers do not have polished edges on the plates. Isolantite insulation.

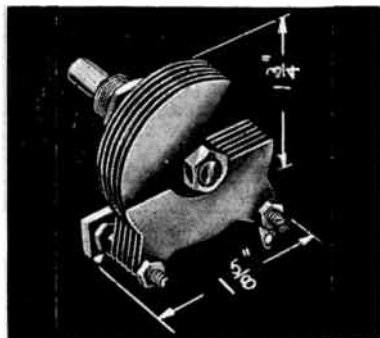

EXPERIMENTER

STRAIGHT-LINE CAPACITY

180° Rotation

Capacity	Minimum Capacity	Length	Air Gap	No. of Plates	Catalog Symbol	List
15 Mmf.	3.5	1 3/4"	.045"	5	EX-15	
25	3.75	1 3/4"	.045"	7	EX-25	
35	3.75	1 3/4"	.045"	10	EX-35	
50	4	1 3/4"	.017"	6	EX-50	
100	4.75	1 3/4"	.017"	12	EX-100	
140	5.5	1 3/4"	.017"	15	EX-140	

The National "Experimenter" Type Condensers are low-priced models suitable for general experimental work. They are of all-brass construction. The rotor has only one bearing. Plates can be removed without difficulty if desired. Bakelite insulation.



NATIONAL GENERAL PURPOSE CONDENSERS

Capacity	Minimum Capacity	No. of Plates	Length	Catalog Symbol	List
150 Mmf.	9	9	4"	EMC-150	
250	11	14	2 1/2"	EMC-250	
350	12	20	2 3/8"	EMC-350	
500	16	27	4 3/8"	EMC-500	
1000	22	55	6 3/4"	EMC-1000	
SPLIT-STATOR MODEL					
350-350	12-12	20-20	6"	EMCD-350	

National EMC Condensers are made in large sizes for general purpose uses. They are similar in construction to the TMC Transmitting condenser, and have high efficiency and rugged frames. Insulation is Isolantite, and Peak Voltage Rating is 1000 Volts. Plate shape is Straight Line Wavelength.

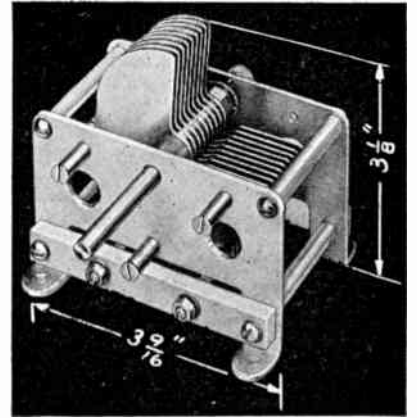

STRAIGHT-LINE WAVELENGTH
180° Rotation

NATIONAL PADDING CONDENSERS

US — See table — Type US condensers are small, compact, low-loss units. Their soldered construction makes them particularly suitable for applications where vibration is present. Adjustment is made with a screw driver. Steatite base.

USE — See table — Type USE condensers are similar to Type US, but are provided with a 1/4" diameter shaft extension at each end.

USL — See table — Type USL condensers are similar to Type US, but are provided with a rotor shaft lock, so that the rotor can be clamped at any setting.

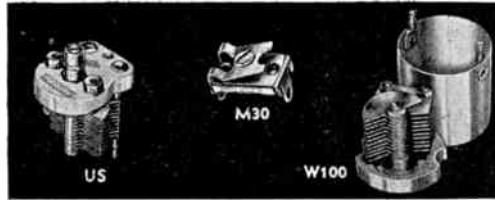

Capacity	Catalog Symbol			List
25 mmf.	US-25	USE-25	USL-25	
50	US-50	USE-50	USL-50	
75	US-75	USE-75	USL-75	
100	US-100	USE-100	USL-100	
140	US-140	USE-140	USL-140	

M-30

Type M-30 is a small adjustable mica condenser with a maximum capacity of 30 mmf. Dimensions 1 1/16" x 3/16" x 1/2". Isolantite base.

W-75, 75 mmf.

W-100, 100 mmf.

Small padding condensers having very low temperature coefficient mounted in an aluminum shield 1 1/4" in diameter.

NATIONAL NEUTRALIZING CONDENSERS



NC-600U
With standoff insulator

NC-600
Without insulator

The NC-600 and NC-600U are for neutralizing low power beam tubes requiring from .5 to 4 mmf, and 1500 max. total volts such as the 6L6. The NC-600U is supplied with a GS-10 standoff insulator screwed on one end, which may be removed for pigtail mounting.

STN

The Type STN neutralizing condenser has a maximum capacity of 18 mmf (3000 V), making it suitable for such tubes as the 10 and 45. It is supplied with two standoff insulators.

TCN

The Type TCN neutralizing condenser is similar to the TMC. It has a maximum capacity of 25 mmf (6000 V), making it suitable for the 203A, 211 and similar tubes.

NC-800

The NC-800 disk-type neutralizing condenser is suitable for the RCA-800, 35T, HK-54 and similar tubes. It is equipped with a micrometer thimble and clamp. The chart below gives capacity and air gap for different settings.

NC-75

For 75T, 808, 811, 812 & similar tubes.

NC-150

For HK354, RK36, 300T, 852, etc.

NC-500

For WE-251, 450TH, 450TL, 750TL, etc.

These larger desk type neutralizing condensers are for the higher powered tubes. Disks are aluminum, insulation steatite.

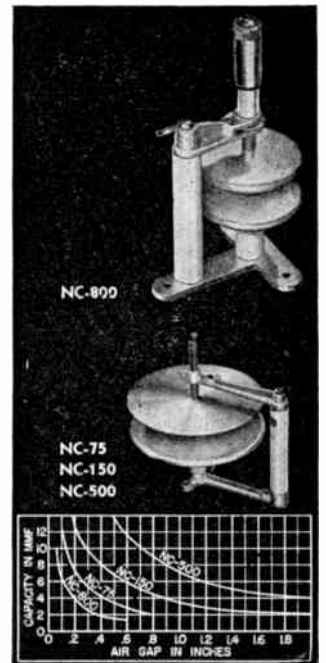

NATIONAL TRANSMITTING CONDENSERS

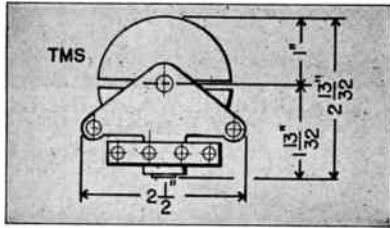
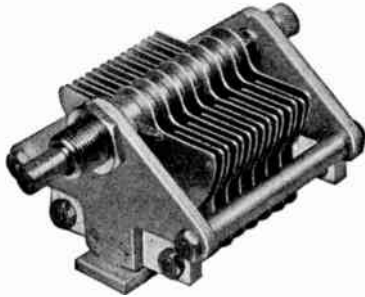

Capacity	Minimum Capacity	Length	Air Gap	Peak Voltage	No. of Plates	Catalog Symbol	List
SINGLE STATOR MODELS							
100 Mmf.	9.5	3"	.026"	1000v.	10	TMS-100	
150	11	3"	.026"	1000v.	14	TMS-150	
250	13.5	3"	.026"	1000v.	23	TMS-250	
300	15	3"	.026"	1000v.	27	TMS-300	
35	8	3"	.065"	2000v.	8	TMSA-35	
50	11	3"	.065"	2000v.	11	TMSA-50	
DOUBLE STATOR MODELS							
50-50 Mmf.	6-6	3"	.026"	1000v.	5-5	TMS-50D	
100-100	7-7	3"	.026"	1000v.	9-9	TMS-100D	
50-50	10.5-10.5	3"	.065"	2000v.	11-11	TMSA-50D	

Type TMS is a condenser designed for transmitter use in low power stages. It is compact, rigid, and dependable. Provision has been made for mounting either on the panel, on the chassis, or on two stand-off insulators. Insulation is Isolantite. Voltage ratings listed are conservative.

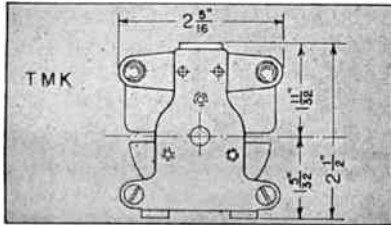
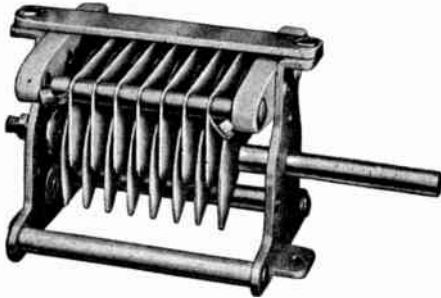

Capacity	Minimum Capacity	Length	Air Gap	Peak Voltage	No. of Plates	Catalog Symbol	List
SINGLE STATOR MODELS							
35 Mmf.	7.5	2 1/8"	.047"	1500	7	TMK-35	
50	8	2 3/8"	"	"	9	TMK-50	
75	9	2 5/8"	"	"	13	TMK-75	
100	10	3"	"	"	17	TMK-100	
150	10.5	3 5/8"	"	"	25	TMK-150	
200	11	4 1/4"	"	"	33	TMK-200	
250	11.5	4 7/8"	"	"	41	TMK-250	
DOUBLE STATOR MODELS							
35-35 Mmf.	7.5-7.5	3"	.047"	1500	7-7	TMK-35D	
50-50	8-8	3 5/8"	"	"	9-9	TMK-50D	
100-100	10-10	4 1/4"	"	"	17-17	TMK-100D	
Extra for Swivel Mounting Hardware for AR 16 Coils							

Type TMK is a new condenser for exciters and low power transmitters. Special provision has been made for mounting AR-16 coils in a swivel plug-in mount on either the top or rear of the condenser, (see page H-88). For panel or stand-off mounting. Isolantite insulation.

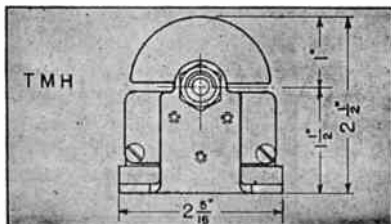
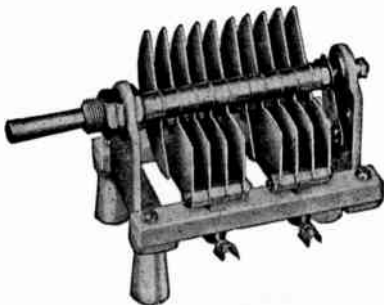

Minimum Capacity	Length	Air Gap	Peak Voltage	No. of Plates	Catalog Symbol	List
SINGLE STATOR MODELS						
f.	9	3 3/4"	.085"	3500	15	TMH-50
	11	3 3/4"	.085"	3500	19	TMH-75
	12.5	5 1/8"	.085"	3500	25	TMH-100
	18	6 1/2"	.085"	3500	37	TMH-150
	11	5 1/8"	.180"	6500	17	TMH-35A
DOUBLE STATOR MODELS						
35-35 Mmf.	6-6	3 3/4"	.085"	3500	9-9	TMH-35D
50-50	8-8	5 1/8"	.085"	"	13-13	TMH-50D
75-75	11-11	6 1/2"	.085"	"	19-19	TMH-75D

Type TMH features very compact construction, excellent power factor, and aluminum plates .040" thick with polished edges. It mounts on the panel or on removable standoff insulators. Isolantite insulators have long leakage path. Standoffs included in listed price.

NATIONAL TRANSMITTING CONDENSERS

Capacity	Minimum Capacity	Length	Air Gap	Peak Voltage	No. of Plates	Catalog Symbol	List
SINGLE STATOR MODELS							
50 Mmf.	10	3"	.077"	3000v.	7	TMC-50	
100	13	3 1/2"	.077"	3000v.	13	TMC-100	
150	17	4 5/8"	.077"	3000v.	21	TMC-150	
250	23	6 1/8"	.077"	3000v.	32	TMC-250	
300	25	6 3/4"	.077"	3000v.	39	TMC-300	
DOUBLE STATOR MODELS							
50-50 Mmf.	9-9	4 5/8"	.077"	3000v.	7-7	TMC-50D	
100-100	11-11	6 3/4"	.077"	3000v.	13-13	TMC-100D	
200-200	18.5-18.5	9 1/4"	.077"	3000v.	25-25	TMC-200D	

TMC is designed for use in the power stages of transmitters where peak voltages do not exceed 3000. The frame is extremely rigid and arranged for mounting on panel, chassis or stand-off insulators. The plates are aluminum with buffed edges. Insulation is Isolantite. The stator in the split stator models is supported at both ends.

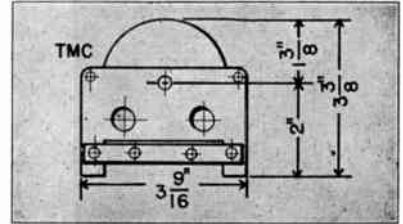

Capacity	Minimum Capacity	Length	Air Gap	Peak Voltage	No. of Plates	Catalog Symbol	List
SINGLE STATOR MODELS							
300 Mmf.	19.5	4 3/8"	.077"	3000v.	23	TMA-300	
50	15	4 1/2"	.171"	6000v.	8	TMA-50A	
100	19.5	6 1/8"	.171"	6000v.	17	TMA-100A	
150	22.5	6 3/8"	.171"	6000v.	23	TMA-150A	
230	33	9 1/8"	.171"	6000v.	35	TMA-230A	
100	30	9 1/2"	.265"	9000v.	23	TMA-100B	
150	40.5	12 1/2"	.265"	9000v.	35	TMA-150B	
50	21	7 1/8"	.359"	12000v.	13	TMA-50C	
100	37.5	12 1/8"	.359"	12000v.	27	TMA-100C	
DOUBLE STATOR MODELS							
200-200 Mmf.	15-15	6 7/8"	.077"	3000v.	16-16	TMA-200D	
50-50	12.5-12.5	6 1/8"	.171"	6000v.	9-9	TMA-50DA	
100-100	17-17	9 1/8"	.171"	6000v.	15-15	TMA-100DA	
60-60	19.5-19.5	12 1/8"	.265"	9000v.	15-15	TMA-60DB	
40-40	18-18	12 1/8"	.359"	12000v.	11-11	TMA-40DC	

TMA is a larger model of the popular TMC. The frame is extremely rigid and arranged for mounting on panel, chassis or stand-off insulators. The plates are of heavy aluminum with rounded and buffed edges. Insulation is Isolantite, located outside of the concentrated field.

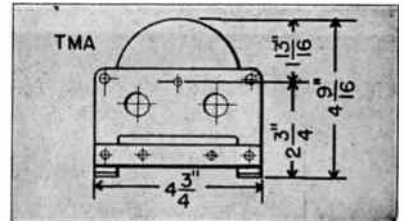
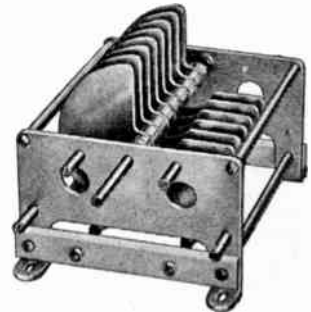

Capacity	Minimum Capacity	Length	Air Gap	Peak Voltage	No. of Plates	Catalog Symbol	List
SINGLE STATOR MODELS							
75 Mmf.	25	18 1/2"	.719"	20,000v.	17	TML-75E	
150	60	18 1/2"	.469"	15,000v.	27	TML-150D	
100	45	13 1/2"	.469"	15,000v.	19	TML-100D	
50	22	8 1/2"	.469"	15,000v.	9	TML-50D	
245	54	18 1/2"	.344"	10,000v.	35	TML-245B+	
150	45	13 1/2"	.344"	10,000v.	21	TML-150B+	
100	32	10 1/2"	.344"	10,000v.	15	TML-100B+	
75	23.5	8 1/2"	.344"	10,000v.	11	TML-75B+	
500	55	18 1/2"	.219"	7,500v.	49	TML-500A+	
350	45	13 1/2"	.219"	7,500v.	33	TML-350A+	
250	35	10 1/2"	.219"	7,500v.	25	TML-250A+	
DOUBLE STATOR MODELS							
30-30 Mmf.	12-12	18 1/2"	.719"	20,000v.	7-7	TML-30DE	
60-60	26-26	18 1/2"	.469"	15,000v.	11-11	TML-60DD	
100-100	27-27	18 1/2"	.344"	10,000v.	15-15	TML-100DB+	
60-60	20-20	13 1/2"	.344"	10,000v.	9-9	TML-60DB+	
200-200	30-30	18 1/2"	.219"	7,500v.	21-21	TML-200DA+	
100-100	17-17	10 1/2"	.219"	7,500v.	11-11	TML-100DA+	

TML condenser is a 1 KW job throughout. Isolantite insulators, specially treated against moisture absorption, prevent flashovers. A large self-cleaning rotor contact provides high current capacity. Thick capacitor plates, with accurately rounded and polished edges, provide high voltage ratings. Sturdy cast aluminum end frames and dural tie bars permit an unusually rigid structure. Precision end bearings insure smooth turning and permanent alignment of the rotor. End frames are arranged for panel, chassis or stand-off mountings.

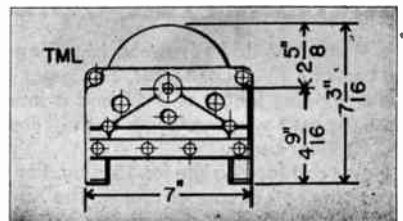
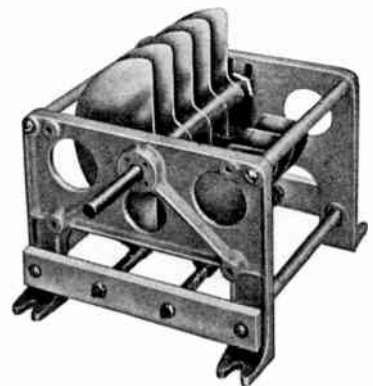

NATIONAL SHAFT COUPLINGS

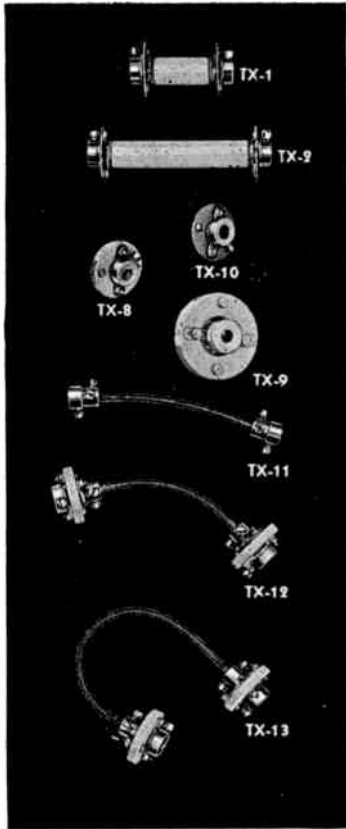

TX-1, Leakage path 1"

TX-2, Leakage path 2½"

Flexible couplings with glazed Isolantite insulation which fit ¼" shafts.

TX-8

A non-flexible rigid coupling with Isolantite insulation. 1" diam. Fits ¼" shaft.

TX-9

This small insulated flexible coupling provides high electrical efficiency when used to isolate circuits. Insulation is Steatite. 1⅝" diam. Fits ¼" shaft.

TX-10

A very compact insulated coupling free from backlash. Insulation is canvas Bakelite. 1⅛" diam. Fits ¼" shaft.

TX-11

The flexible shaft of this coupling connects shafts at angles up to 90 degrees, and eliminates misalignment problems. Fits ¼" shafts. Length 4¼".

TX-12, Length 4⅝"

TX-13, Length 7⅛"

These couplings use flexible shafting like the TX-11 above, but are also provided with Isolantite insulators at each end.

COIL DOPE — Liquid Polystyrene Cement CD-1, ¼ pint can

H.F. COIL FORMS



For ultra high frequency work, where very low losses are essential, these small Victron coil forms will be found extremely useful. They can be readily drilled and grooved with ordinary tools, and firmly cemented with National Coil Dope without impairing electrical characteristics.

Symbol	Outside Diameter	Length	List Price
PRC-1	3/8"	3/8"	
PRC-2	3/8"	1/2"	
PRC-3	3/8"	3/4"	
PRD-1	1/2"	1/2"	
PRD-2	1/2"	1"	
PRE-1	3/16"	3/4"	
PRE-2	3/16"	1"	
PRE-3	3/16"	2"	
PRF-1	3/4"	3/4"	
PRF-2	3/4"	1 1/4"	

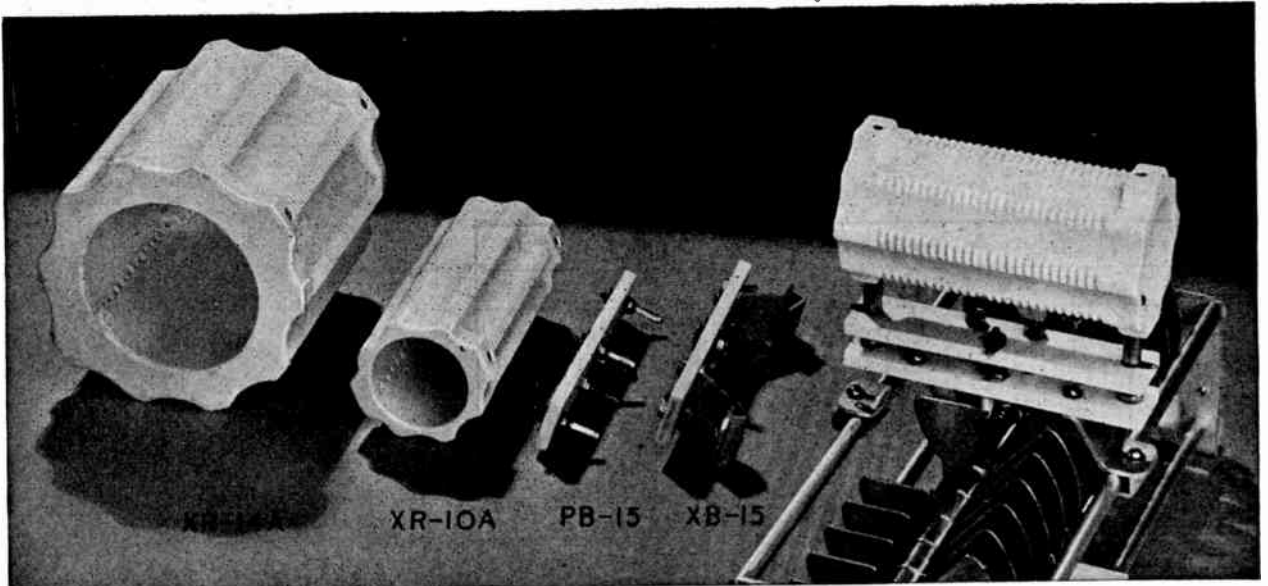

TRANSMITTER COIL FORMS

The Transmitter Coil Forms and Mounting are designed as a group, and mount conveniently on the bars of a TMA condenser. The larger coil form, Type XR-14A, has a winding diameter of 5" and a winding length of 3¾" and is intended for the 80 meter band. The smaller form, Type XR-10A, has a winding length of 3¾" and a winding diameter of 2½". It is intended for the 20 and 40 meter bands.

Either coil form fits the PB-15 plug. For higher frequencies, the plug may be used with a self-supporting coil of copper tubing. The XB-15 Socket may be mounted on breadboards or chassis, as well as on the TMA Condenser.

SINGLE UNITS

XR-10A, Coil Form only

XR-14A, Coil Form only

PB-15, Plug only

XB-15, Socket only

ASSEMBLIES

UR-10A, Assembly (including small Coil Form, Plug and Socket)

UR-14A, Assembly (including large Coil Form, Plug and Socket)



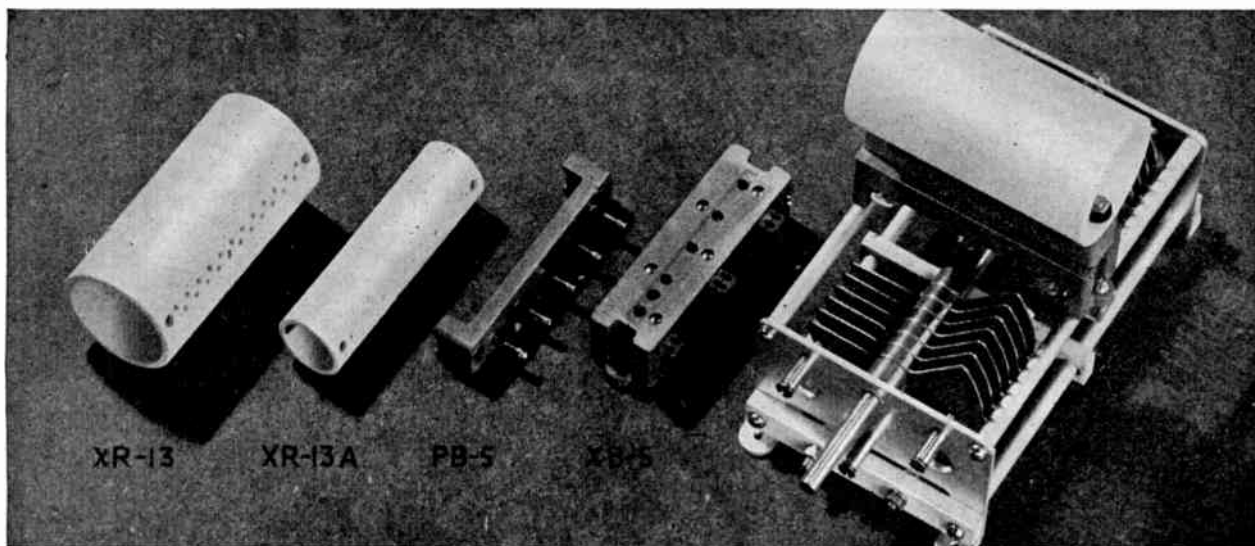

BUFFER COIL FORMS

National Buffer Coil Forms are designed to mount directly on the tie bars of a TMC condenser using the PB-5 Plug and XB-5 Socket. Plug and Socket are of molded R-39.

The two coil forms are of Isolantite, left unglazed to provide a tooth for coil dope. The larger form, Type XR-13, is 1 3/4" in diameter and has a winding length of 2 3/4". The smaller form, Type XR-13A, is 1" in diameter and provides a winding length of 2 3/4". Both forms have holes for mounting and for leads.

SINGLE UNITS

XR-13, Coil Form only
 XR-13A, Coil Form only
 PB-5, Plug only
 XB-5, Socket only

ASSEMBLIES

UR-13A, Assembly (including small Coil Form, Plug and Socket)
 UR-13, Assembly (including large Coil Form, Plug and Socket)

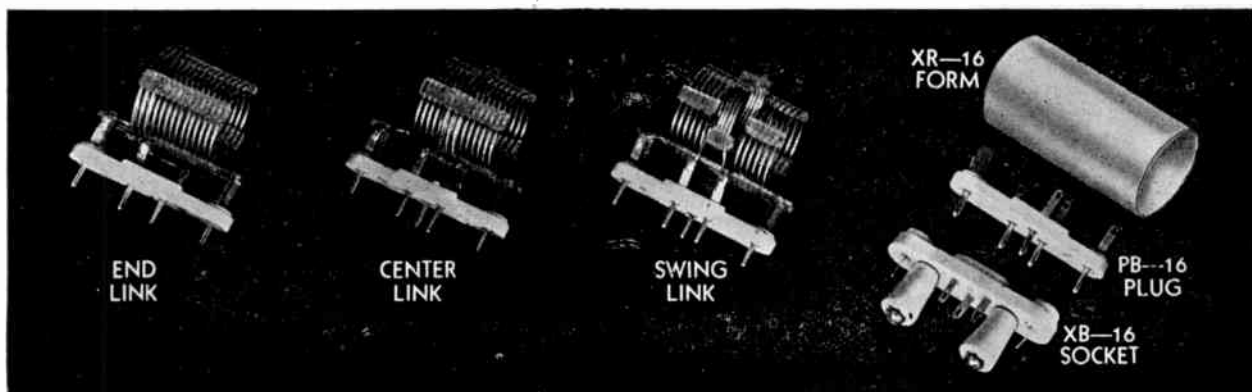

EXCITER COILS AND FORMS — TYPE AR-16 (Air Spaced)

These air-spaced coils are suitable for use in stages where the plate input does not exceed 50 watts and are available in the sizes tabulated below. Capacities listed will resonate the coils at the low frequency end of the band and include all stray circuit capacities. All have separate link coupling coils and all fit the PB-16 Plug and XB-16 Socket.

The XR-16 Coil Form also fits the PB-16 Plug and XB-16 Socket. It has a winding diameter of 1 1/4" and a winding length of 1 3/4".

XR-16, Coil Form only
 PB-16, Plug-in Base only
 XB-16, Plug-in Socket only
 AR-16 Coils—Any type (see table)

Price includes P.B.-16 plug as illustrated.

Order by Catalog Symbol Shown in This Table

BAND	END LINK	CAP MMF	CENTER LINK	CAP MMF	SWINGING LINK	CAP MMF
5 meter	AR16-5E	20	AR16-5C	20	—	—
10 meter	AR16-10E	20	AR16-10C	20	AR16-10S	25
20 meter	AR16-20E	26	AR16-20C	26	AR16-20S	40
40 meter	AR16-40E	33	AR16-40C	33	AR16-40S	55
80 meter	AR16-80E	37	AR16-80C	37	AR16-80S	60
160 meter	AR16-160E	65	AR16-160C	65	—	—



NATIONAL LOW-LOSS SOCKETS AND INSULATORS

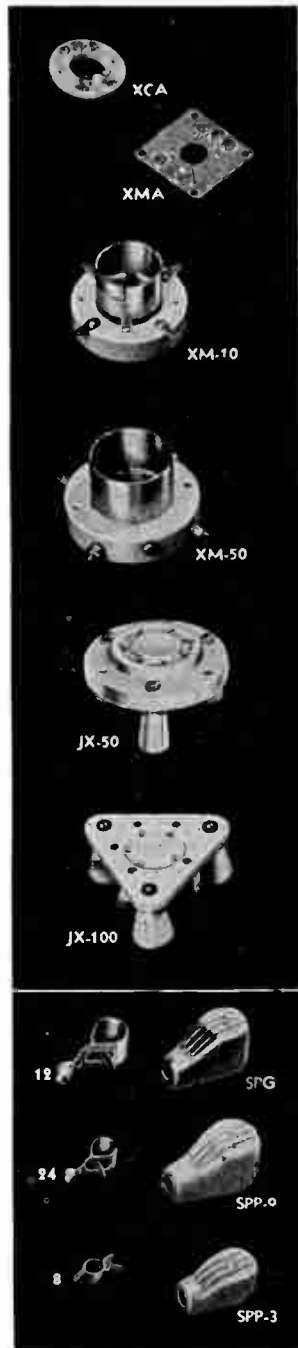
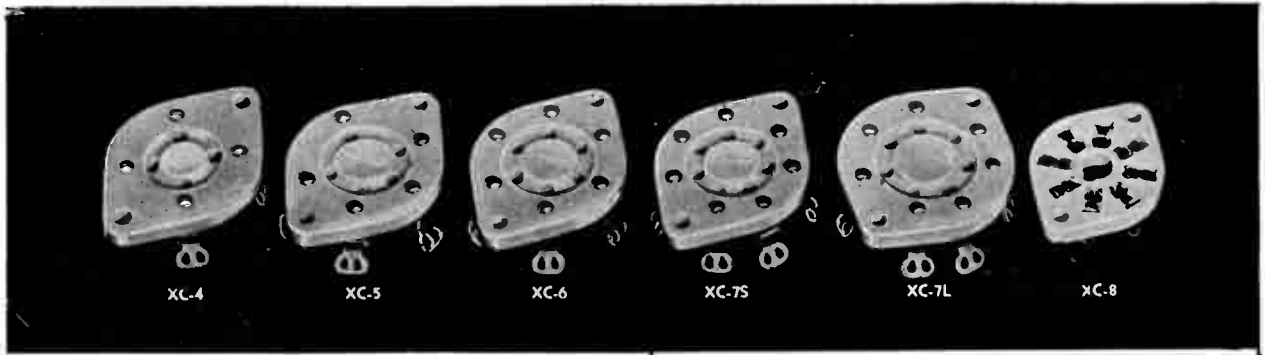

XCA

A low-loss socket for acorn triodes.

XMA

For pentode acorn tubes, this socket has built-in by-pass condensers. The base is a copper plate.

XM-10

A heavy duty metal shell socket for tubes having the UX base.

XM-50

A heavy duty metal shell socket for tubes having the Jumbo 4-pin base ("fifty watt-ers").

JX-50

Without Standoff Insulators

JX-50S

With Standoff Insulators

A low-loss wafer socket for the 813 and other tubes having the Giant 7-pin Base.

JX-100

Without Standoff Insulators

JX-100S

With Standoff Insulators

A low-loss wafer socket for the 803, RK-28 and other tubes using the Giant 5-pin Base.

SAFETY GRID & PLATE CAPS

SPG

$\frac{9}{16}$ " Cap, L. L. R-39 insulation

SPP-9

$\frac{9}{16}$ " Cap L. L. ceramic insulation. These offer protection against accidental contact with High Voltage lobe Caps

SPP-3

$\frac{3}{8}$ " Cap L. L. ceramic insulation

GRID & PLATE GRIPS

12, for $\frac{9}{16}$ " Caps

24, for $\frac{3}{8}$ " Caps

8, for $\frac{1}{4}$ " Cap

12 & 24 suitable for glass tubes
8 is for metal tubes

XC Series Sockets

National wafer sockets have exceptionally good contacts with high current capacity together with low loss Isolantite insulation. All types have a locating groove to make tube insertion easy, with the exception of the Octal socket which has a central locating hole.

GS-1, $\frac{1}{2}$ " x $1\frac{3}{8}$ "

GS-2, $\frac{1}{2}$ " x $2\frac{7}{8}$ "

GS-3, $\frac{3}{4}$ " x $2\frac{7}{8}$ "

GS-4, $\frac{3}{4}$ " x $4\frac{7}{8}$ "

GS-4A, $\frac{3}{4}$ " x 6"

Cylindrical low-loss Steatite stand-off insulators with nickel plated caps and bases.

GSJ, (not illustrated)

A special nickel plated jack top threaded to fit the $\frac{3}{4}$ " diam. Insulators GS-3, GS-4 & GS-4A.

GS-5, $1\frac{1}{4}$ "

GS-6, 2"

GS-7, 3"

GS-10, $\frac{3}{4}$ ", package of 10

These cone type standoff insulators are of low-loss ceramic. They have a tapped hole at each end for mounting.

GS-8, Plain

GS-9, with Jack

These low-loss ceramic stand-off insulators are also useful as lead-through bushings.

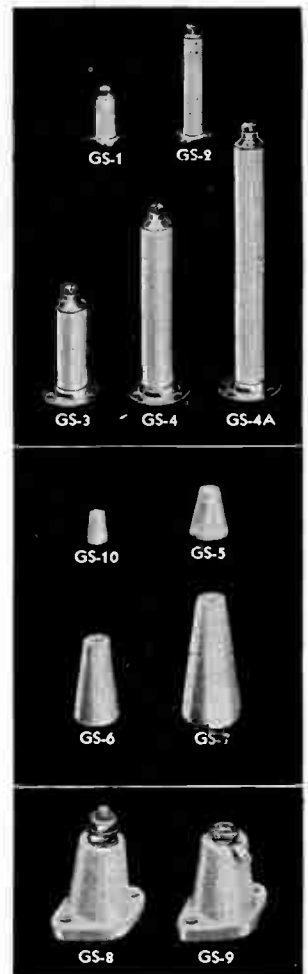

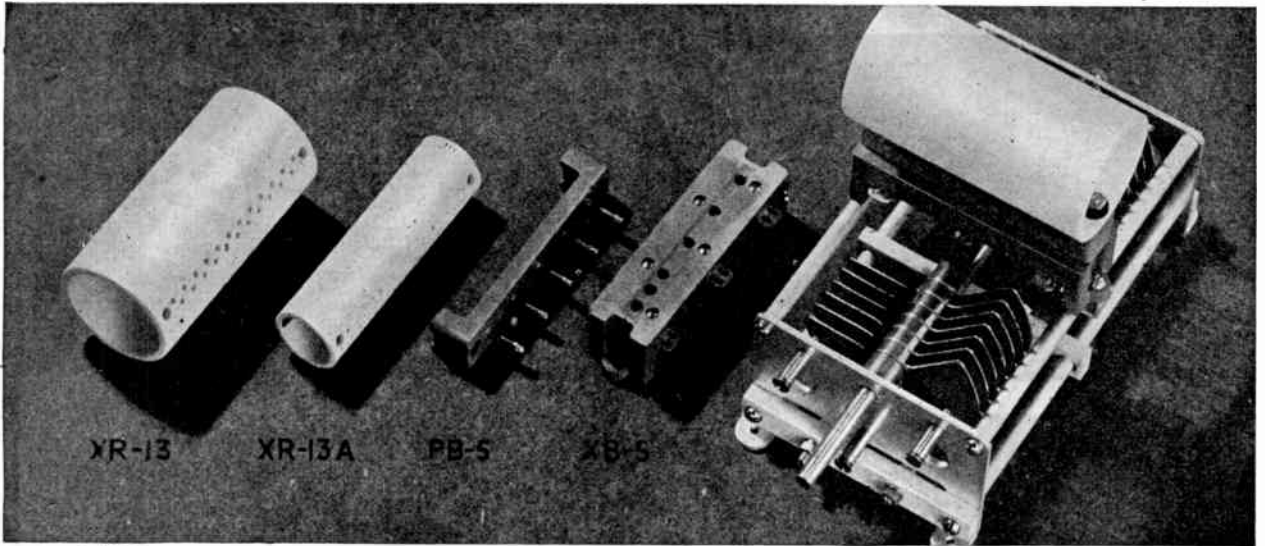

BUFFER COIL FORMS

National Buffer Coil Forms are designed to mount directly on the tie bars of a TMC condenser using the PB-5 Plug and XB-5 Socket. Plug and Socket are of molded R-39.

The two coil forms are of Isolantite, left unglazed to provide a tooth for coil dope. The larger form, Type XR-13, is 1 3/4" in diameter and has a winding length of 2 3/4". The smaller form, Type XR-13A, is 1" in diameter and provides a winding length of 2 3/4". Both forms have holes for mounting and for leads.

SINGLE UNITS

XR-13, Coil Form only
 XR-13A, Coil Form only
 PB-5, Plug only
 XB-5, Socket only

ASSEMBLIES

XR-13A, Assembly (including small Coil Form, Plug and Socket)
 XR-13, Assembly (including large Coil Form, Plug and Socket)

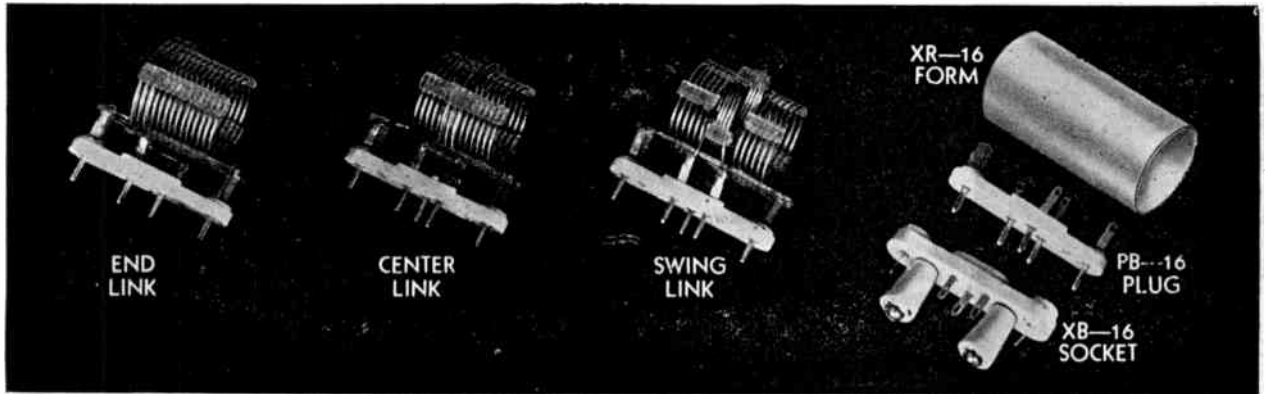

EXCITER COILS AND FORMS — TYPE AR-16 (Air Spaced)

These air-spaced coils are suitable for use in stages where the plate input does not exceed 50 watts and are available in the sizes tabulated below. Capacities listed will resonate the coils at the low frequency end of the band and include all stray circuit capacities. All have separate link coupling coils and all fit the PB-16 Plug and XB-16 Socket.

The XR-16 Coil Form also fits the PB-16 Plug and XB-16 Socket. It has a winding diameter of 1 1/4" and a winding length of 1 3/4".

XR-16, Coil Form only
 PB-16, Plug-in Base only
 XB-16, Plug-in Socket only
 AR-16 Coils — Any type (see table)

Price includes P.B.-16 plug as illustrated.

Order by Catalog Symbol Shown in This Table

BAND	END LINK	CAP MMF	CENTER LINK	CAP MMF	SWINGING LINK	CAP MMF
5 meter	AR16-5E	20	AR16-5C	20	—	—
10 meter	AR16-10E	20	AR16-10C	20	AR16-10S	25
20 meter	AR16-20E	26	AR16-20C	26	AR16-20S	40
40 meter	AR16-40E	33	AR16-40C	33	AR16-40S	55
80 meter	AR16-80E	37	AR16-80C	37	AR16-80S	60
160 meter	AR16-160E	65	AR16-160C	65	—	—

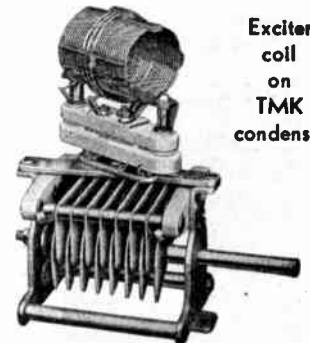

Exciter coil on TMC condenser

NATIONAL LOW-LOSS SOCKETS AND INSULATORS

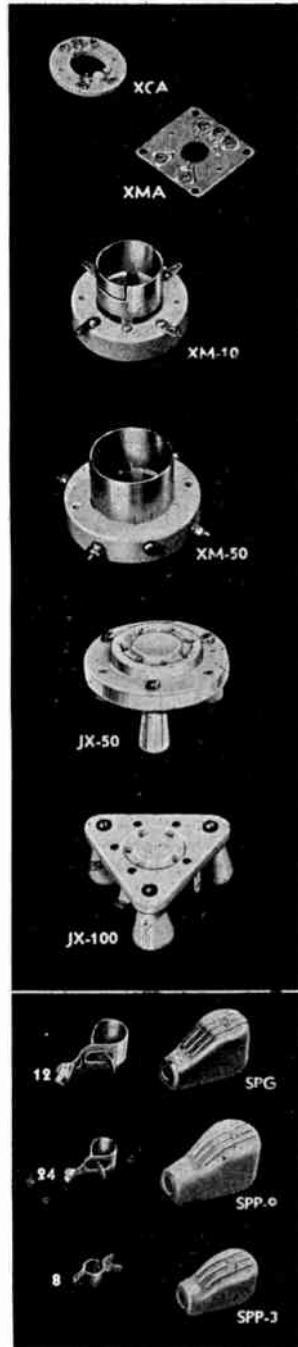
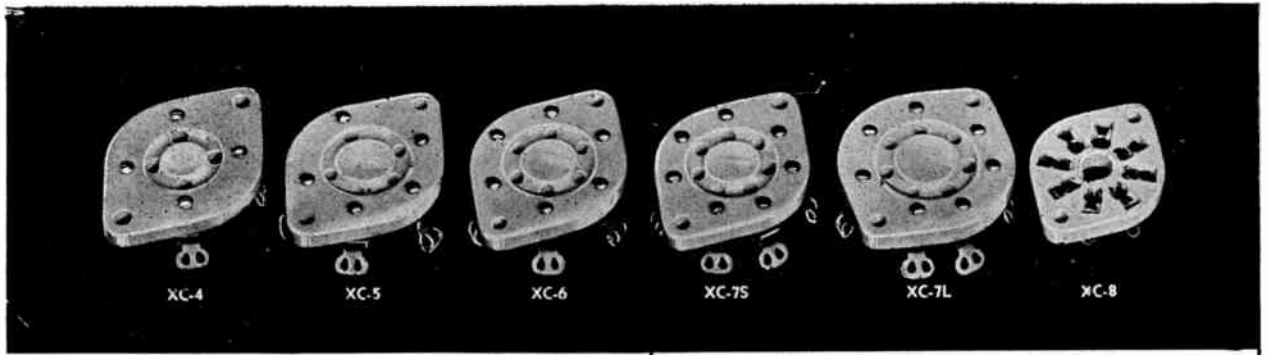

XCA

A low-loss socket for acorn triodes.

XMA

For pentode acorn tubes, this socket has built-in by-pass condensers. The base is a copper plate.

XM-10

A heavy duty metal shell socket for tubes having the UX base.

XM-50

A heavy duty metal shell socket for tubes having the Jumbo 4-pin base ("fifty watt-ers").

JX-50

Without Standoff Insulators

JX-50S

With Standoff Insulators

A low-loss wafer socket for the 813 and other tubes having the Giant 7-pin Base.

JX-100

Without Standoff Insulators

JX-100S

With Standoff Insulators

A low-loss wafer socket for the 803, RK-2B and other tubes using the Giant 5-pin Base.

SAFETY GRID & PLATE CAPS

SPG

9/16" Cap, L. L. R-39 insulation

SPP-9

9/16" Cap L. L. ceramic insulation. These offer protection against accidental contact with High Voltage lobe Caps

SPP-3

3/8" Cap L. L. ceramic insulation

GRID & PLATE GRIPS

12, for 9/16" Caps

24, for 3/8" Caps

8, for 1/4" Cap

12 & 24 suitable for glass tubes

8 is for metal tubes

XC Series Sockets

National wafer sockets have exceptionally good contacts with high current capacity together with low loss Isolantite insulation. All types have a locating groove to make tube insertion easy, with the exception of the Octal socket which has a central locating hole.

GS-1, 1/2" x 1 3/8"

GS-2, 1/2" x 2 7/8"

GS-3, 3/4" x 2 7/8"

GS-4, 3/4" x 4 7/8"

GS-4A, 3/4" x 6"

Cylindrical low-loss Steatite stand-off insulators with nickel plated caps and bases.

GSJ, (not illustrated)

A special nickel plated jack top threaded to fit the 3/4" diam. Insulators GS-3, GS-4 & GS-4A.

GS-5, 1 1/4"

GS-6, 2"

GS-7, 3"

GS-10, 3/4", package of 10

These cone type standoff insulators are of low-loss ceramic. They have a tapped hole at each end for mounting.

GS-8, Plain

GS-9, with Jack

These low-loss ceramic stand-off insulators are also useful as lead-through bushings.

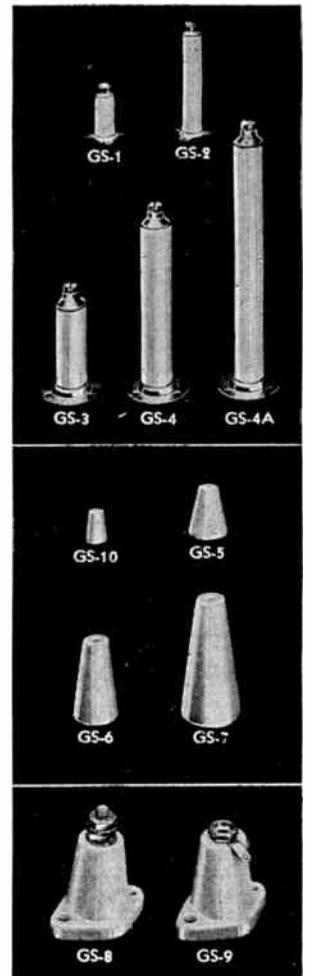

NATIONAL LOW-LOSS SOCKETS AND INSULATORS



CIR Series Sockets

Type CIR Sockets feature low-loss isolantite or steatite insulation, a contact that grips the tube prong for its entire length, and a metal ring for six position mounting. The sockets are supplied with two metal standoffs.

AA-3

A low-loss steatite spreader for 6 inch line spacing. (600 ohms impedance with No. 12 wire)

AA-5

A low-loss steatite aircraft-type strain insulator.

AA-6

A general purpose strain insulator of low-loss steatite.

XS-6

A low-loss isolantite bushing for $\frac{1}{2}$ " holes.

TPB

A threaded Polystyrene bushing with removable .093 conductor moulded in, $\frac{3}{8}$ " diam., 32 thread.

XS-7, ($\frac{3}{8}$ " Hole)

XS-8, ($\frac{1}{2}$ " Hole)

Steatite bushings. Prices include male and female bushings with metal fittings.

XS-1, (1" Hole)

XS-2, ($1\frac{1}{2}$ " Hole)

Prices listed are per pair, including metal fittings. Insulation — steatite.

XS-3, ($2\frac{3}{4}$ " Hole)

XS-4, ($3\frac{3}{4}$ " Hole)

Prices are per pair, including metal fittings. These low-loss steatite bowls are ideal for lead-in purposes at high voltages.

XS-5, Without Fittings

XS-5, With Fittings

These big low-loss bowls have an extremely long leakage path and a $5\frac{1}{4}$ " flange for bolting in place. Insulation — steatite.

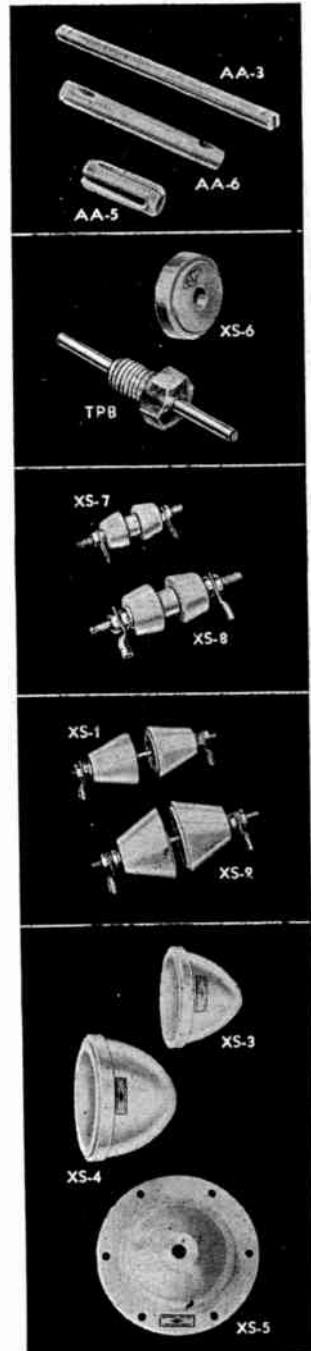

FWG

A Victron terminal strip for high frequency use. The binding posts take banana plugs at the top, and grip wires through hole at the bottom, simultaneously, if desired.

FWH

The insulators of this terminal assembly are molded R-39 and have serrated bosses that allow the thinnest panel to be gripped firmly, and yet have ample shoulders. Binding posts same as FWG above.

FWJ

This assembly uses the same insulators as the FWH above, but has jacks. When used with the FWF plug (below), there is no exposed metal when the plug is in place.

FWF

This molded R-39 plug has two banana plugs on $\frac{3}{4}$ " centers and fits FWH or FWJ above. Leads may be brought out through the top or side.

FWA, Post
Brass Nickel Plated

FWE, Jack
Brass Nickel Plated

FWC, Insulator

R-39 Insulation

FWB, Insulator
Polystyrene insulation

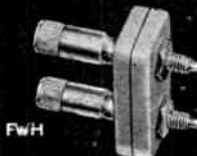
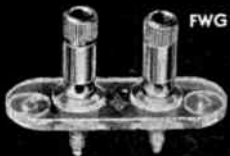

NATIONAL I.F. TRANSFORMERS

This new I.F. Transformer has air dielectric condensers (isolated from each other by an aluminum shield) and Litz wound coils mounted on a ceramic base which is treated against moisture absorption. The aluminum shield can, housing the assembly, measures $4\frac{1}{8}'' \times 2\frac{3}{8}'' \times 2''$. These transformers are available with or without Iron Cores in the 450-550 KC model; the 175 KC model is air core only. For iron core add to List \$5.50.

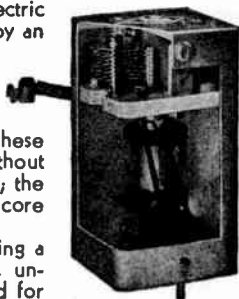

An additional model, Type IFD, having a tuned primary and a closely-coupled, un-tuned, push-pull secondary is intended for operation with diode rectifiers. It is particularly suitable for use in noise silencing circuits. It is available only with an air core, and for 450-550 KC use.

IFC, Transformer (air core)
IFCO, Oscillator (air core only)
IFD, Diode Transformer (air core only)

NATIONAL FIXED TUNED EXCITER TANK

Similar in general construction to the I.F. transformer described above, this unit has two 25 mmf, 2000 volt air condensers and an unwound XR-2 coil form.

FXT, without plug-in base

FXTB, with base (either 5- or 6-prong)

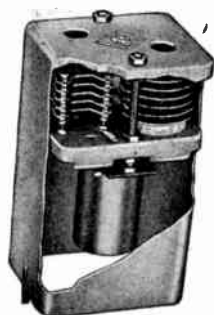

PLUG-IN BASE AND SHIELD

The low-loss R-39 base is ideal for mounting condensers and coils when it is desirable to have them shielded and easily removable. Shield can is $2'' \times 2\frac{3}{8}'' \times 4\frac{1}{8}''$. Two models are available; 5- or 6-prong.

PB-10, (Base and Shield)

PB-10A, (Base only)



SAFETY METER PANEL

This new panel makes it safe to connect meters into high-voltage leads. The meters are mounted behind a glass window on a sub-panel. It is available either blank, or punched with 2, 3, or 4 holes for $2''$ diameter meters. Holes for bolting the meters in place are not provided, as their location varies with different makes of meters. Finish is black wrinkle.

MPF

Meter Panel with glass window

MPS

Sub-panel for meters (specify whether 2, 3, or 4 holes, or blank panel is desired)

NATIONAL JACK SHIELD

The new National Jack Shield accommodates small standard jacks. It is primarily designed for mounting behind the panel, where it is held in place by the bushing of the jack, but may also be used on the ends of extension cords, etc.

JS-1



NATIONAL RECEIVER COIL FORMS

These well known R-39 forms are machineable, permitting them to be grooved and drilled to suit individual requirements. They are available with four, five, or six prongs. A special socket is required for the six-prong forms. Coil form diameter is $1\frac{1}{2}''$, length $2\frac{1}{4}''$



XR-4, XR-5, or XR-6

XC6C, Special 6-prong socket



Also R-39, these small coil forms are designed with excellent form factor, contributing to high efficiency in H.F. circuits. Diameter, $1''$; Length, $1\frac{1}{2}''$; Wall thickness, $1/16''$. Type XR-1 has four prongs, others are plain.

XR-1, four prongs

XR-2, without prongs

XR-3, $9/16''$ dia. x $3/4''$ long

SCREEN GRID DETECTOR COUPLER

This impedance coupling unit, when employed to couple the output of a screen grid detector to an audio amplifier tube, will give from two to three times as much amplification as resistance coupling. Plate choke, 700 henries. Coupling condenser, .01 mfd. Grid leak, 250,000 ohms.

S-101



NATIONAL L. F. OSCILLATOR COIL

Two separate inductances, closely coupled, in an aluminum shield. It is used in the SRR and other super-regenerative receivers for the interruption-frequency oscillator. Sec. Inductance 6.25 m.h. Tunes to 100 KC with .00041 Mfd.



OSR

CODE PRACTICE OSCILLATOR

This small audio oscillator is suitable for either code practice, or as an audio signal source for ICW on the Ultra High Frequency Bands.

A type 30 tube is used, and four flashlight cells in the case provide filament and plate current.

CPO, without batteries or tube



NATIONAL HIGH FIDELITY TRF UNITS

The new National Tuners are based on a high performance TRF circuit reduced to its simplest terms. Similar in construction to an IF Amplifier, each chassis provides a three-stage RF Amplifier tuned to one station only. A group of four or more separate chassis are usually used in each

installation to receive a like number of stations.

Each RF Transformer has an individual coupling adjustment and is tuned both primary and secondary (8 tuned circuits). The coupling is adjustable to include 10 KC with less than 1 db variation in the audio range. Sensitivity is adjustable from 5 microvolts to one volt. For best efficiency, three models have been made available covering ranges of 540-875, 740-1230, and 1100-1700 KC. The chassis fits a standard $3\frac{1}{2}''$ relay rack panel.

DLCA, Chassis as illustrated with sockets and terminals riveted in place

DLPS, Steel $1/8''$ panel

DLPA, Aluminum $3/16''$ panel

DLT, RF Transformer, set of four required

(Specify approximate operating frequency)

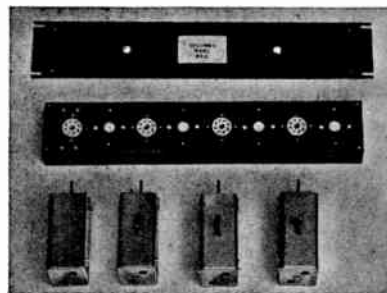

NATIONAL CABINETS

National Receiver Cabinets are for use in constructing special equipment. List Prices include sub-bases and bottom covers. They are available in the sizes shown below.



Type	Width	Height	Depth
C-HWR	13½"	7"	7¼"
C-FB7	11½"	8"	12"
C-SW3	9¾"	7"	9"
C-NC100	17¼"	8¾"	11¼"
C-HRO	16¾"	8¾"	10"
C-One-Ten	11"	7"	7¼"
C-PSK	6"	8"	12"
C-SRR	7½"	7"	7½"

CAST ALUMINUM SHIELDS

These rugged cast aluminum shields are useful for a variety of purposes. They may be used as cases for small wavemeters, monitors and the like and as stage shields in high-gain equipment. The two smaller sizes mount conveniently on a 5¼" relay rack panel or on a chassis. The largest size clears a 7" relay rack panel.

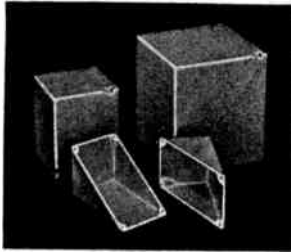

- CS-1, 5" x 3" x 3" (outside)
- CS-2, 5" x 4" x 4" (outside)
- CS-3, 6¾" x 6" x 6" (outside)

RF CHOKES



R-100

Isolantite mounting, continuous universal winding in four sections. For pigtail connections or standard resistor mountings. Inductance 2½ m.h.; distributed capacity, 1 mmf.; D.C. resistance 50 ohms; current rating, 125 m.a. For low powered transmitters and high frequency receivers.

R-100U

The new R-100U Choke is similar to the R-100 electrically but is designed to mount directly on the chassis by means of a stand-off insulator screwed on one end. Inductance 2½ m.h.; distributed capacity, 1 mmf.; D.C. resistance 50 ohms; current rating 125 m.a.



R-300

The R-300 Choke is similar in size to the well known R-100, but has higher current capacity. Inductance 1 m.h.; distributed capacity, 1 mmf.; D.C. resistance 10 ohms; current rating 300 m.a.

R-300U

The new R-300U Choke is similar to the R-300 electrically but is designed to mount directly on the chassis by means of a stand-off insulator screwed on one end. Inductance 1 m.h.; distributed capacity, 1 mmf.; D.C. resistance 10 ohms; current rating 300 m.a.



NATIONAL TUBE AND COIL SHIELDS

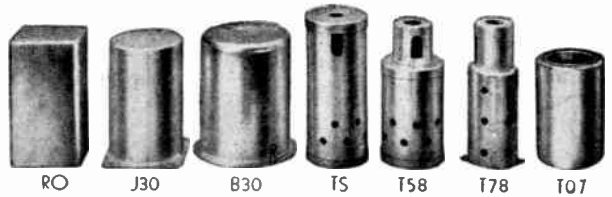

Type

RO, coil shield, 2" x 2¾" x 4⅛" high

J30, coil shield, 2½" dia. x 3¾" high

B30, coil shield, 3" dia. x 3¾" high

B30, coil shield, with mounting base

TS, tube shield, with cap and base

T58, tube shield, with cap and base, (for 77, 78 tubes, etc.)

T78, tube shield, with cap and base, (for 77, 78 tubes, etc.)

T14, tube shield 2½" high (for 814, RK-20, etc.)

T07, tube shield, 3" high, (for 807, RK-23, etc.)

NATIONAL CHART FRAMES

National Chart Frames are blanked from one piece of solid nickel silver. Sides of all charts are ¼" wide. Prices include a celluloid sheet to protect the chart. Dimensions given below.

Size A, 2¼" x 3¼"

Size B, 3" x 4"

Size C, 3¾" x 4"



R-175

The R-175 transmitting r.f. choke is suitable for parallel-feed as well as series-feed circuits in transmitters of up to 3000 volts modulated plate supply. Without plate modulation of the transmitter, they are suitable for 4000-volt circuits. In contrast to conventional r.f. chokes, the inductive reactance of the R-175 is high throughout the 28- and 14-mc. bands as well as the 1.7-, 3.5-, and 7-mc. bands. Inductance 225 uh., distributed capacity 0.6 mmf., DC resistance 6 ohms, DC current rating 800 ma., voltage breakdown to metal base 12,500 volts.

R-152

The R-152 Choke has honeycomb coils wound on Isolantite cores, and is intended for the 80 and 160 meter bands. Inductance 4 m.h.; D.C. resistance 10 ohms; current capacity 600 m.a.



R-154

The Type R-154 Choke is similar to the Type R-152, but is designed for the 20, 40 and 80 meter bands. Inductance 1 m.h.; D.C. resistance 6 ohms; current capacity 600 m.a.

R-154U

The R-154U Choke has the same coil and ratings as the R-154, immediately above, but does not have the small insulating pillar and the third mounting foot.



Thank You!

When writing for additional
information or when ordering
from sources of supply listed
in this book, please mention

RADIO'S MASTER



HAMMARLUND



"MC" MIDGET CONDENSERS



Ideal variable for ultra-short wave and short wave tuning, laboratories, etc. Isolantite insulation. All contacts riveted or soldered. Vibration proof. New improved Hammarlund split type rear bearing, and noiseless wiping contact. Cadmium plated soldered brass plates. Shaft— $\frac{1}{4}$ ".

Code	Capacity	List
MC-20-S	20 mmf.....	\$2.20
MC-35-S	35 mmf.....	2.30
MC-50-S	50 mmf.....	2.40
MC-50-M	50 mmf.....	2.40
MC-75-S	80 mmf.....	2.60
MC-75-M	80 mmf.....	2.60
MC-100-S	100 mmf.....	2.80
MC-100-M	100 mmf.....	2.80
MC-140-S	140 mmf.....	3.00
MC-140-M	140 mmf.....	3.00
MC-200-M	200 mmf.....	3.30
MC-250-M	260 mmf.....	3.60
MC-325-M	320 mmf.....	4.00

"M"—Midline Plates

"S"—Straight Line Cap. Plates

"MCD" SPLIT-STATOR CONDENSERS

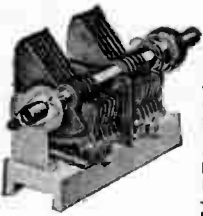

Like single midgets, these incorporate every requirement imperative to highest quality. Specifications identical to single types except that shield plate is located between stator sections. Also equipped with new Hammarlund noiseless wiping contact and split type rear bearing. Overall length behind panel— $3\frac{1}{2}$ ". Strong Isolantite base. Single hole panel mount.

Code	Capacity	List
MCD-50-M	50 mmf. per sect.....	\$4.60
MCD-50-S	50 .mmf. per sect.....	4.60
MCD-100-S	100 mmf. per sect.....	5.00
MCD-100-M	100 mmf. per sect.....	5.00
MCD-140-M	140 mmf. per sect.....	5.40
MCD-140-S	140 mmf. per sect.....	5.40

"M"—Midline Plates

"S"—Straight Line Cap. Plates

IMPORTANT NOTICE

Due to the necessity of our taking a major part in the United Nations' war program, we find ourselves unable to guarantee prices or deliveries. The extreme difficulty of obtaining certain raw materials may require that we use substitute materials at times. It is, therefore, necessary that we reserve the right to change prices or specifications without notice. Correspondence is invited regarding the above in cases where prices, materials, or deliveries may affect your plans.

THE HAMMARLUND MFG. CO., INC.

"SM" STAR MIDGET CONDENSERS



For receiving and transmitting, for short wave tuning, regeneration, antenna coupling, vernier, etc. Low loss, natural bakelite insulation. Non-corrosive aluminum plates. Phosphor bronze spring plate affords proper tension and smooth control and also provides perfect contact. Single hole mounting. $\frac{1}{4}$ " shaft. $\frac{5}{16}$ " mounting bushing. $1\text{-}\frac{9}{16}$ " wide x $1\frac{1}{4}$ " high. Depth behind panel from $1\frac{1}{16}$ " to $1\frac{1}{4}$ " depending on capacity. Exceptionally light in weight

and strong and compact in construction. Tinned soldered lugs on the front end are supplied to simplify wiring. Plates of straight line capacity types.

Code	Capacity	List
SM-15	15 mmf.....	\$0.90
SM-25	25 mmf.....	.90
SM-50	50 mmf.....	1.00
SM-100	100 mmf.....	1.20
SM-140	140 mmf.....	1.40
*SM-35-X	35 mmf.....	1.20
*SM-50-X	50 mmf.....	1.40

* Double Spaced Transmitting Types

"MCDX" DOUBLE SPACED CONDENSERS

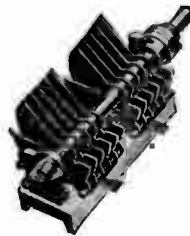

Identical to split stator condensers except that plates are widely spaced—actual air gap between rotor and stator plates—.0715". No shield between stators. Equipped with new Hammarlund noiseless wiping contact, and split type rear bearing. Condenser ideal for ultra-high frequency transmitters using up to 1000 volts.

Code	Capacity	List
MCD-35-MX	31 mmf. per sect.....	\$4.80
MCD-35-SX	31 mmf. per sect.....	4.80

"MX"—Midline Plates

"SX"—Straight Line Cap. Plates

"MCX" DOUBLE SPACED CONDENSERS



Exceptional unit for ultra-s.w. receivers and transmitters particularly compact transmitters. Plate spacing—.0715". Great for tuning crystal controlled transmitter amplifier stages or for neutralizers up to 1000 volts. In midline (MX) and straight line cap. types (SX).

Code	Capacity	List
MC-20-SX	20 mmf.....	\$2.40
MC-20-MX	20 mmf.....	2.40
MC-35-MX	32 mmf.....	2.60
MC-35-SX	32 mmf.....	2.60
MC-50-MX	50 mmf.....	2.80
MC-50-SX	50 mmf.....	2.80
MC-100-SX	100 mmf.....	3.50

"APC" MICRO CONDENSERS



For S.W. and ultra-S.W. For I.F. tuning, trimming R.F. coils or gang condensers, general padding, etc. Constant capacity under any conditions of temperature or vibration. Size 100 mmf. $1\text{-}\frac{7}{32}$ " x $1\frac{1}{16}$ " x $1\text{-}\frac{7}{32}$ ". Isolantite base. Cadmium plated soldered brass plates.

Code	Capacity	List
APC-25	25 mmf.....	\$1.30
APC-50	50 mmf.....	1.50
APC-75	75 mmf.....	1.70
APC-100	100 mmf.....	1.90
APC-140	140 mmf.....	2.25



HAMMARLUND



"TC" TRANSMITTING CONDENSER

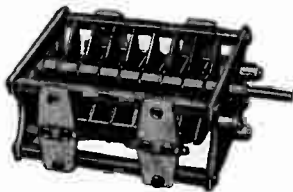

An entirely new moderately priced, heavy duty transmitting condenser, featuring heavy aluminum end plate, Isolantite insulation, non-inductive, self-cleaning silver plate J beryllium contacts, full floating rotor bearing, non-magnetic rotor assembly, polished heavy aluminum plates accurately

spaced. All, except type "L," have round edge plates of .040" thickness. Type "L" has .025" plates with plain edges. Type "E" has .230" 7500 V. air gap. Type "G" .200" 6750 V. Type "H," .171" 6000 V. Type "J," .100" 4250 V. Type "K," .084" 3750 V. Type "L," .070" 2000 V. air gap. Available in a wide variety of capacities and working voltages, these condensers are ideal for modern up-to-date transmitters with power outputs ranging from 200 watts to 1 kw.

Type	Capacity	Overall Length	List
TC-220-L	220 mmf.	4 $\frac{1}{8}$ "	\$ 6.30
TC-440-L	465 mmf.	5 $\frac{1}{8}$ "	9.10
TC-90-K	95 mmf.	2 $\frac{3}{8}$ "	5.70
TC-165-K	170 mmf.	4 $\frac{1}{8}$ "	6.50
TC-220-K	225 mmf.	4 $\frac{5}{8}$ "	8.00
TC-330-K	340 mmf.	6 $\frac{1}{2}$ "	10.00
TC-240-J	250 mmf.	6 $\frac{1}{2}$ "	10.20
TC-25-H	25 mmf.	2 $\frac{3}{8}$ "	5.10
TC-50-H	53 mmf.	4 $\frac{1}{8}$ "	6.00
TC-110-H	115 mmf.	6 $\frac{1}{8}$ "	9.00
TC-40-G	45 mmf.	4 $\frac{1}{8}$ "	7.00
TC-65-G	72 mmf.	5 $\frac{1}{8}$ "	8.80
TC-100-G	110 mmf.	7 $\frac{1}{2}$ "	11.20
TC-150-G	165 mmf.	10 $\frac{1}{8}$ "	14.80
TC-55-F	60 mmf.	5 $\frac{1}{8}$ "	8.00

"TCD" SPLIT STATOR TYPES

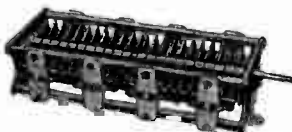

These split-stator transmitting condensers are identical to the singles shown above, except that the stator sections are individual. Ideal for push-pull power amplifiers ranging in power up to

1 kw. They are of convenient size and lend themselves to construction of compact apparatus. Overall dimensions in back of panel are given in the accompanying table. The capacity values listed are for each section. The last letter in the code represents plate spacing and working voltage. These are identical to those given above. Type "M"—plain plates, .030" air gap.

Type	Capacity	Overall Length	List
TCD-500M	505 mmf.	4 $\frac{1}{8}$ "	\$10.30
TCD-80-L	88 mmf.	4 $\frac{1}{8}$ "	8.30
TCD-210-L	215 mmf.	5 $\frac{1}{8}$ "	10.40
TCD-90-K	95 mmf.	4 $\frac{5}{8}$ "	9.40
TCD-165-K	170 mmf.	6 $\frac{1}{2}$ "	11.50
TCD-325-K	335 mmf.	11 $\frac{1}{8}$ "	20.50
TCD-240-J	250 mmf.	11 $\frac{1}{8}$ "	19.00
TCD-50-H	53 mmf.	6 $\frac{1}{2}$ "	9.80
TCD-110-H	115 mmf.	11 $\frac{1}{8}$ "	16.00
TCD-40-G	48 mmf.	7 $\frac{1}{2}$ "	10.50
TCD-75-G	82 mmf.	11 $\frac{1}{8}$ "	14.50
TCD-55-F	60 mmf.	11 $\frac{1}{8}$ "	13.50

"HF" MICRO CONDENSERS



For tuning or trimming on high frequencies. Cadmium plated soldered brass plates. Isolantite. Base mounting, single hole panel mount, or panel mounting with bushings. 140 mmf. size 1 $\frac{1}{2}$ " high x $\frac{1}{2}$ " behind panel.

Code	Capacity	List
HF-15	17.5 mmf.	\$1.40
HF-35	35 mmf.	1.60
HF-50	50 mmf.	1.70
HF-100	100 mmf.	2.10
HF-140	140 mmf.	2.40
*HF-15-X	15 mmf.	1.70
*HF-30-X	30 mmf.	1.90

* Double spaced

"MTC" TRANSMITTING CONDENSERS

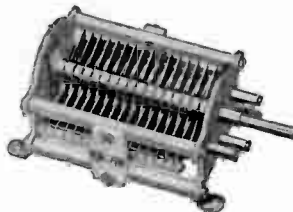

Compact types, Isolantite insulation. Base or panel mounting. Polished aluminum plates. Stainless steel shaft. Size of 150 mmf. with .070" plate spacing only 4 $\frac{5}{8}$ " behind panel. "A" model has .040" plate thickness, all others .025". "A" and "B" models—rounded plates. "C" types—plain plate edges. Self-cleaning wiping contact.

Code	Capacity	List
MTC-20-B	20 mmf.	\$4.10
MTC-35-B	35 mmf.	4.30
MTC-50-B	50 mmf.	4.60
MTC-100-B	100 mmf.	5.30
MTC-150-B	150 mmf.	6.10
MTC-50-C	50 mmf.	4.10
MTC-100-C	100 mmf.	4.40
MTC-150-C	150 mmf.	4.80
MTC-250-C	260 mmf.	5.30
MTC-350-C	365 mmf.	5.80

"MTCD" SPLIT-STATOR TYPES

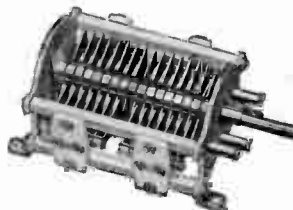

Same outstanding features as MTC singles except that stator sections are separate. Model 110-B with .070" plate spacing, only 5 $\frac{3}{4}$ " behind panel. "B" models—rounded plates "C" models—plain plate edges.

Code	Capacity	List
MTCD-20-B	20 mmf. per sect.	\$6.50
MTCD-35-B	35 mmf. per sect.	6.00
MTCD-50-B	50 mmf. per sect.	6.50
MTCD-100-B	100 mmf. per sect.	8.75
MTCD-50-C	50 mmf. per sect.	5.50
MTCD-100-C	100 mmf. per sect.	6.00
MTCD-150-C	150 mmf. per sect.	6.50
MTCD-250-C	265 mmf. per sect.	7.50

"HFD" MICRO DUAL CONDENSERS



A compact dual—ideal as a high frequency tuning condenser, for tuning and neutralizing low-powered short wave and ultra-short wave transmitters, etc. Heavy Isolantite base. Equipped with new outstanding Hammarlund split rear bearing and individual noiseless wiping contact for each section. Rotor contacts variable to several positions for shortest leads. Shield between sections for grounding. The 140 mmf. size is only 1 $\frac{1}{2}$ " high x 3 $\frac{3}{4}$ " long behind panel. 1/4" shaft. Cadmium plated soldered brass plates.

Code	Capacity	List
HFD-50	50 mmf. per sect.	\$3.60
HFD-100	100 mmf. per sect.	4.10
HFD-140	140 mmf. per sect.	4.50
*HFD-15-X	15 mmf. per sect.	3.40
*HFD-30-X	28.5 mmf. per sect.	3.80

*Double-Spaced



HAMMARLUND



"MEX" EQUALIZERS

The midget equalizer shown at right is an extremely small condenser designed expressly for trimming R.F. coils, but useful, of course, for many other purposes. Self-supporting in wiring. Isolantite base— $\frac{3}{8}$ x $\frac{7}{8}$. Mica dielectric, phosphor bronze spring plates.



Code	Capacity	List
MEX	4-30 mmf.	\$0.30

"N" NEUTRALIZING CONDENSERS



Rounded edges. Isolantite. Fine adjusting screw. Positive lock. Horizontal adjustment. Type "N-10", $2\frac{1}{8}$ " high x $1\frac{3}{16}$ " deep. "N-15" $4\frac{15}{16}$ " high x $3\frac{1}{2}$ " deep. "N-20", $5\frac{11}{16}$ " high x $4\frac{1}{8}$ " deep.

Code	List
N-10—(2.1—10 mmf.)	\$4.60
N-15—(3.2—14 mmf.)	8.70
N-20—(3.8—14 mmf.)	9.30

"ETU" EXCITER TUNING UNIT



Compact tuning unit for exciters. Ready-wound for 80, 40, 20 and 10 meters. Link output. Has two 25 mmf. double spaced condensers. "ETU-80" for 80 meters, "ETU-40" for 40 meters, etc. Supplied completely wired and ready for installation. Also available unwound. Size $2\frac{1}{2}$ " x $4\frac{1}{4}$ " x $1\frac{1}{8}$ ".

Code	List
ETU-10-20-40-80—(Wound)	\$5.50 ea.
ETU—(Unwound)	4.80 ea.

"FC" FLEXIBLE COUPLINGS



The sides of coupling are insulated from each other, allowing instruments in gang to be operated as independent electrical units. Bakelized canvas with brass bushings for $\frac{1}{4}$ " shaft. Four rust proofed and hardened steel set screws provide against shaft slipping. Overall diameter $1\frac{1}{2}$ ".

Code	List
FC	\$0.75

"CK-125" STAR CHOKE



This low-priced midget choke has four universal wound pies on an Isolantite rod. The pies are impregnated to reduce moisture absorption. Current carrying cap. 125 ma. DC Res.—50 ohms. Ind.—2.5 mh. Dist. Cap.—1 mmf. Has flat flexible leads for easy soldering and mounting. Individually packed.

Code	List
CK-125	\$0.35

"CH-500" TRANSMITTING CHOKES

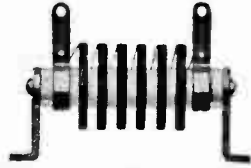

For parallel feed in high powered transmitters—20- 40- 80- and 160-meter amateur bands. High equivalent impedance more than 500,000 ohms. Effective from 1,500 to 15,000 kc. with exception of frequencies between 5,300 and 6,400 and between 8,000 and 9,000. Six thin universal pies. Isolantite core. Insulated mounting brackets secured to Isolantite core with short machine screws. Brackets removable and choke mounted with a single machine screw. Ind.—2.5 mh. Dist. cap. less than 1.5 mmf. D.C. res.—8 ohms. Max. recommended D.C. (continuous) 500 ma. Overall size, less brackets— $1\frac{1}{8}$ " x $2\frac{1}{2}$ ".

Code	List
CH-500	\$1.75

"CHX" AND "CH-250" CHOKES



Invaluable item where space is at a premium. Small in size, light in weight, can be supported by leads. "CHX" has five impregnated pies. Ind.—2.1 mh. DC. res.—35 ohms. Dist. Cap.—1 mmf. 125 ma. DC. Length, $1\frac{1}{2}$ ". Dia., $\frac{1}{2}$ ". "CH-250" similar to "CHX". Has 250 ma. current rating. Ind.—1 mh. DC. Res. 10 ohms. Dist. cap. 1 mmf. Length, $1\frac{1}{2}$ ". Dia., $\frac{5}{8}$ ".

Code	List
CHX	\$.50
CH-250	.50

"XS-2" CRYSTAL SOCKET



The "XS-2" is a special crystal socket designed to conserve space and provide a low loss mounting for standard crystal holders. Made with heavy-duty spring contacts and mounted on glazed Isolantite. Can also be mounted inside "SWF" coil forms for changing coil and crystal in one operation. Overall diameter $1\frac{1}{8}$ ".

Code	List
XS-2	\$0.60



SHORT WAVE MANUAL SIXTH EDITION

Receivers, transmitters, antennas, modulators—everything for the short wave amateur and experimenter will be found in this valuable little book. Its 32 pages are crammed with information on constructing and operating shortwave transmitting and receiving apparatus. Written in simple language, the new Short Wave Manual will appeal to the beginner and oldtimer alike.

Code SWM	Price \$0.10
----------	--------------



HAMMARLUND



"CF" ISOLANTITE COIL FORMS



Popular coil forms so many fans are using today. Black enameled wooden knob. Removable paper indicating disc protected by celluloid. Surface "non-skid". Plenty of holes—eliminates drilling. Slotted bottom for primary or tickler. Four, five, and six prong types. 1 1/2" diameter. 2 1/2" long exclusive of knobs and prongs.

Code	List
CF-4 (four prongs)	\$1.60
CF-5 (five prongs)	1.60
CF-6 (six prongs)	1.60

"XP-53" COIL FORMS AND KITS



Outstanding forms using new low loss insulation material—XP-53. Natural coloring eliminating losses. Groove-ribbed for air spaced windings. Flange grips, meter indexes. Moulded threaded shelf in form. 1 1/2" diameter and 2 1/4" long exclusive of prongs. Kits with wound coils for MC-140-M condenser also available.

Code	List
SWF-4 (four prongs, coil form only)	\$0.50
SWF-5 (five prongs, coil form only)	.50
SWF-6 (six prongs, coil form only)	.60
No. 40 coil (wound coil, 4 prongs, 10-20 meters)	1.25
No. 41 coil (wound coil, 4 prongs, 17-41 meters)	1.25
No. 42 coil (wound coil, 4 prongs, 33-75 meters)	1.25
No. 43 coil (wound coil, 4 prongs, 66-150 meters)	1.00
No. 44 coil (wound coil, 4 prongs, 135-270 meters)	1.00
BCC-4 (wound coil, 4 prongs, 250-560 meters)	1.25
No. 60 coil (wound coil, 6 prongs, 10-20 meters)	1.50
No. 61 coil (wound coil, 6 prongs, 17-41 meters)	1.50
No. 62 coil (wound coil, 6 prongs, 33-75 meters)	1.50
No. 63 coil (wound coil, 6 prongs, 66-150 meters)	1.25
No. 64 coil (wound coil, 6 prongs, 135-270 meters)	1.25
BCC-6 (wound coil, 6 prongs, 250-560 meters)	1.50
SWK-4 (kit—4, four-prong coils, 17-270 meters)	4.25
SWK-6 (kit—4, six-prong coils, 17-270 meters)	5.00

"TCF" COIL FORM

A transmitting coil form of XP-53 dielectric is also available. This may be permanently mounted on special brackets supplied, or in plug-in coil fashion. 2 1/4" diameter. 3 3/8" long exclusive of prongs.

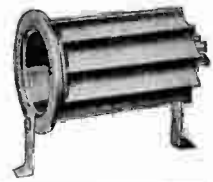

Code	List
TCF-4 (4 prongs)	\$0.80
TCF-5 (5 prongs)	.80

"CF-M" ULTRA S. W. FORMS



Unusual coil form for maximum efficiency at ultra-high frequencies or within the 28-56 megacycle band. Isolantite with correct form factor and resultant minimum high frequency resistance guaranteeing absolute stability. Plenty of holes to facilitate any inductance desired and any type of wiring. Form is 1 1/8" in diameter and 2" long exclusive of prongs.

Code	List
CF-5-M	\$1.30

"S" ISOLANTITE SOCKETS

Standard socket of right. Lowest losses. Constant resistivity. Gripped prongs—cannot shift. Guide groove. Rust-proof side gripping contacts. Glazed top and sides. Sub-panel or base mounting. 2 1/4" x 1 3/8".



Code	List
S-4 (4 prongs)	\$0.60
S-5 (5 prongs)	.65
S-6 (6 prongs)	.70
S-7 (large base, 7 prong)	.75
S-7 B (small base, 7 prongs)	.75
S-8 (8 prongs)	.80



Code	List
UHS-900	\$1.10
UHS-900-X	1.50

New "locking" acorn tube socket for high frequency acorn tubes—954 or 955. 1 1/8" diameter. Five double grip silver plated Beryllium prongs. Top and sides glazed. Shielded plate to reduce feedback. UHS-900-X has 1 3/8" mounting centers.

"HFBD" TRANSMITTING CONDENSERS

High efficiency, high frequency dual condensers with isolated rotor. Both mounting brackets and control shafts are insulated. DC can be applied to rotor as well as stator. Isolantite end plates, soldered brass construction, cadmium plated. End plate size 1 1/8". Types "E", "F" and "G" have rounded edge plates.

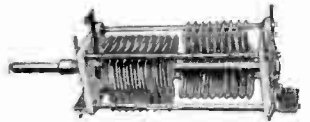

Code	Capacity	Length	Air Gap	List
HFBD-35-C	35 mmf.	2 1/8"	.050"	\$6.80
HFBD-50-C	50 mmf.	2 7/8"	.050"	7.00
HFBD-100-C	100 mmf.	4 5/8"	.050"	8.30
HFBD-200-C	200 mmf.	7 1/8"	.050"	11.00
HFBD-35-E	35 mmf.	3 3/8"	.070"	6.20
HFBD-65-E	65 mmf.	4 1/8"	.070"	7.10
HFBD-100-E	100 mmf.	6 1/8"	.070"	9.00
HFBD-35-F	35 mmf.	4 5/8"	.100"	6.50
HFBD-65-F	65 mmf.	7 3/8"	.100"	8.25
HFBD-35-G	35 mmf.	6 5/8"	.125"	7.25

"HFB" CONDENSERS

Some as above but single stator types. Stator is mounted at top to reduce capacity to chassis. The "HFB" has insulated mounting brackets and control shaft. Types "E" and "F" have rounded edge plates.



Code	Capacity	Length	Air Gap	List
HFB-50-C	50 mmf.	1 1/2"	.050"	\$4.60
HFB-100-C	100 mmf.	2 7/8"	.050"	5.10
HFB-150-C	150 mmf.	3 3/8"	.050"	5.60
HFB-50-E	50 mmf.	2 3/8"	.070"	4.90
HFB-100-E	100 mmf.	3 1/8"	.070"	5.80
HFB-50-F	50 mmf.	3 3/8"	.100"	5.00
HFB-100-F	100 mmf.	5 7/8"	.100"	6.90

"HFA" & "HFAD" CONDENSERS

"HFAD" has the same general construction as "HFBD" except that it is smaller in size and does not have the insulated control shaft. Ideal for ultra-high frequency operation. End panels 1 1/2" square. "HFA" same construction, except end panel 1 1/4" x 1 1/4". Both can be single hole panel mounted or can be mounted to the panel with stand-off bushings. Plain edge plates.

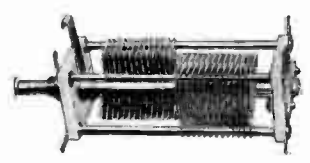

Code	Capacity	Type	Length	Air Gap	List
HFAD-75-A	75 mmf.	Dual	2 3/8"	.020"	\$5.00
HFAD-100-A	100 mmf.	Dual	2 3/8"	.020"	5.30
HFAD-140-A	140 mmf.	Dual	3 3/8"	.020"	5.90
HFAD-25-B	25 mmf.	Dual	1 1/8"	.030"	3.90
HFAD-35-B	35 mmf.	Dual	2 1/8"	.030"	4.10
HFAD-50-B	50 mmf.	Dual	2 7/8"	.030"	4.40
HFAD-100-B	100 mmf.	Dual	3 3/8"	.030"	5.40
HFAD-150-B	150 mmf.	Dual	5 3/8"	.030"	6.40
HFAD-15-E	15 mmf.	Dual	2 3/8"	.070"	4.00
HFAD-30-E	30 mmf.	Dual	4 1/8"	.070"	4.60
HFA-75-A	75 mmf.	Single	1 1/4"	.020"	2.40
HFA-100-A	100 mmf.	Single	1 3/8"	.020"	2.60
HFA-140-A	140 mmf.	Single	1 3/4"	.020"	3.00
HFA-10-B	10 mmf.	Single	3/8"	.030"	2.00
HFA-15-B	15 mmf.	Single	7/8"	.030"	2.10
HFA-25-B	25 mmf.	Single	1 1/8"	.030"	2.20
HFA-35-B	35 mmf.	Single	1 3/8"	.030"	2.30
HFA-50-B	50 mmf.	Single	1 3/4"	.030"	2.40
HFA-100-B	100 mmf.	Single	2 1/4"	.030"	3.20
HFA-150-B	150 mmf.	Single	2 3/4"	.030"	3.70
HFA-15-E	15 mmf.	Single	1 3/8"	.070"	2.20
HFA-30-E	30 mmf.	Single	2 1/2"	.070"	2.50



TYPES C AND D CONDENSERS

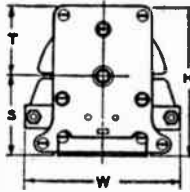
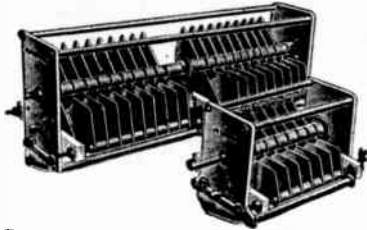

Type	T	S	W	H
C	2 1/8	3 3/8	5 1/2	5 1/8
D	1 3/8	2 5/8	4 1/4	4

Johnson C and D condensers are sturdily constructed to give trouble-free operation under the most severe service. Only the finest materials are employed, yet these units are lower in price than any other quality condensers. Although value is evident throughout the line the models designed for high power applications are particularly outstanding.

All dual models have center rotor connections to insure balanced operation at ultra-high frequencies.

Important features include: Heaviest plates of any similar condenser, .051" thick . . . Ultra-steatite insulation . . . Large laminated rotor brushes . . . Center rotor contacts on all dual condensers . . . Heavy 1/4" diameter tie rods, for frame strength and rigidity, insulated to prevent "Short circuit loops" . . . 1/4" steel shafts, cadmium plated, extending 1 1/2" in front, 3/4" in rear permitting ganging or rear drive. Panel space Type D, 4 1/4" wide x 4" high Type C, 5 1/2" wide x 5 3/8" high.

TYPE C CONDENSERS SINGLE SECTION

Cat No.	Capacity*		Spacing	Number Plates	Length**	List Price
	Max.	Min.				
250C70	240	31	.175"	23	6 1/8"	\$18.00
500C70	496	56	.175"	47	12 3/8"	21.00
250C90	245	45	.250"	31	12 3/8"	17.00
350C90	343	63	.250"	43	14 1/8"	20.60
50C110	51	19	.350"	8	4 1/8"	9.00
100C110	102	30	.350"	17	8 1/8"	11.80
250C110	251	65	.350"	41	18 1/8"	20.80
50C130	50	23	.500"	10	7 1/8"	9.90
100C130	101	41	.500"	21	13 1/8"	14.10

TYPE C DUAL SECTION

200CD45	206	21	.125"	15	7 1/8"	17.50
300CD45	295	26	.125"	21	10 1/8"	21.50
200CD70	198	27	.175"	19	12 1/8"	21.00
300CD70	305	37	.175"	29	16 1/8"	27.00
150CD90	150	29	.250"	19	14 1/8"	22.00
200CD90	196	38	.250"	25	18 1/8"	26.50
50CD110	50	18	.350"	8	10 1/8"	14.50
65CD110	65	20	.350"	11	12 1/8"	16.50
100CD110	103	32	.350"	17	16 1/8"	21.50
50CD130	50	23	.500"	10	14 1/8"	16.75

.060 spacing supplied in either C or D types, also special capacities and spacings.

TYPE D SINGLE SECTION

50D35	49	11	.080"	5	2 1/8"	5.00
100D35	100	14	.080"	8	2 1/8"	5.75
150D35	152	18	.080"	12	2 1/8"	6.50
250D35	257	24	.080"	20	4 1/8"	8.00
350D35	347	27	.080"	17	5 1/8"	9.50
500D35	501	36	.080"	39	6 1/8"	11.75
100D45	107	19	.125"	12	4 1/8"	6.75
150D45	152	27	.125"	17	4 1/8"	7.90
50D70	51	16	.175"	7	2 1/8"	6.50
70D70	72	18	.175"	11	4 1/8"	7.40
100D70	100	23	.175"	15	4 1/8"	8.25
150D70	151	31	.175"	23	6 1/8"	10.00
250D70	244	45	.175"	37	10 1/8"	13.50
350D70	351	62	.175"	53	13 1/8"	17.00
50D90	54	19	.250"	10	4 1/8"	7.00
70D90	73	24	.250"	14	5 1/8"	8.00
100D90	99	30	.250"	19	7 1/8"	9.00
150D90	149	43	.250"	29	10 1/8"	11.50
250D90	249	70	.250"	49	15 1/8"	16.00

TYPE D DUAL SECTION

100DD35	99	12	.080"	8	4 1/8"	8.25
150DD35	151	15	.080"	12	5 1/8"	9.75
200DD35	202	19	.080"	16	7 1/8"	11.50
300DD35	291	23	.080"	23	9 1/8"	16.00
500DD35	504	37	.080"	39	13 1/8"	22.50
150DD45	155	22	.125"	18	9 1/8"	13.00
200DD45	200	29	.125"	23	12 1/8"	15.35
50DD70	50	13	.175"	8	5 1/8"	9.00
70DD70	72	16	.175"	11	7 1/8"	10.50
100DD70	99	21	.175"	15	9 1/8"	12.50
150DD70	151	31	.175"	23	13 1/8"	16.00
200DD70	200	40	.175"	30	16 1/8"	19.50
50DD90	52	18	.250"	10	9 1/8"	11.50
100DD90	97	29	.250"	19	14 1/8"	16.50

*Capacity per Section **Length Over End Plates

TYPES E AND F CONDENSERS

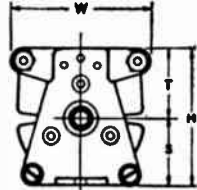
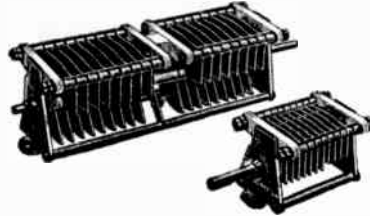

Type	T	S	W	H
E	1 1/8	1 3/8	2 5/8	2 1/8
F	1 3/8	1 5/8	2 3/4	2

Designed as rugged, compact units for medium and low power transmitters, type E and F condensers are in a class by themselves. Heavy (.032") plates, rounded and buffed . . . Heavy (1/4") frame rods . . . Ultra-steatite insulation . . . Heavy, cadmium plated, phosphor bronze contact springs . . . and stators mounted above to reduce capacity to ground are outstanding features of these condensers. Front (1 1/2") and rear (3/4") shaft extensions permit ganging. In addition to the spacing shown .030" can also be supplied on special order.

TYPE E CONDENSERS SINGLE SECTION

Cat. No.	Capacity*		Spacing	Number Plates	Length**	List Price
	Max.	Min.				
250E20	244	12	.045"	23	2 1/8"	\$5.35
350E20	356	14	.045"	33	3 1/8"	6.35
500E20	495	18	.045"	45	4 1/8"	7.50
35E30	38	6	.075"	6	1 1/8"	3.80
50E30	51	7	.075"	8	1 1/8"	4.00
70E30	73	10	.075"	11	2 1/8"	4.30
100E30	100	10	.075"	15	2 1/8"	4.65
150E30	154	13	.075"	23	3 1/8"	5.40
250E30	250	19	.075"	37	4 1/8"	6.75
350E30	350	22	.075"	51	6 1/8"	8.10
35E45	38	8	.125"	9	2 1/8"	4.10
50E45	47	10	.125"	12	2 1/8"	4.35
70E45	75	13	.125"	17	3 1/8"	5.00
100E45	101	16	.125"	23	4 1/8"	5.60
150E45	145	20	.125"	33	6 1/8"	6.70
250E45	245	30	.125"	55	9 1/8"	9.10

TYPE E DUAL SECTION

200ED20	206	10	.045"	19	5 1/8"	8.25
300ED20	304	15	.045"	29	6 1/8"	9.95
50ED30	52	7	.075"	8	4 1/8"	5.95
70ED30	71	8	.075"	11	4 1/8"	6.50
100ED30	99	10	.075"	15	5 1/8"	7.25
150ED30	152	11	.075"	23	7 1/8"	8.70
200ED30	195	15	.075"	29	8 1/8"	9.95
50ED45	51	9	.125"	12	6 1/8"	6.80
70ED45	73	11	.125"	17	7 1/8"	7.90
100ED45	100	15	.125"	23	9 1/8"	9.15

TYPE F SINGLE SECTION

35F20	35	6	.045"	6	1 1/8"	3.50
50F20	48	7	.045"	9	1 1/8"	3.70
70F20	67	8	.045"	11	1 1/8"	4.00
100F20	106	9	.045"	17	2 1/8"	4.50
150F20	156	12	.045"	25	2 1/8"	5.25
250F20	255	18	.045"	41	4 1/8"	6.65
35F30	34	7	.075"	9	1 1/8"	3.90
50F30	51	8	.075"	13	2 1/8"	4.15
70F30	68	10	.075"	17	2 1/8"	4.60
100F30	102	13	.075"	25	3 1/8"	5.30
150F30	150	18	.075"	37	4 1/8"	6.40

TYPE F DUAL SECTION

50FD20	47	6	.045"	9	3 1/8"	5.75
70FD20	67	7	.045"	11	3 1/8"	6.25
100FD20	105	9	.045"	17	4 3/8"	7.30
150FD20	155	10	.045"	25	6 1/8"	8.50
200FD20	207	13	.045"	33	7 1/8"	10.00
50FD30	51	7	.075"	13	4 1/8"	6.70
70FD30	67	10	.075"	17	5 1/8"	7.45
100FD30	101	11	.075"	25	7 1/8"	8.95

*Capacity per section **Length Over End Plates

GENERAL CONDENSER INFORMATION

The first part of the catalog number indicates the capacity in mmfd. The following letter indicates the frame size or type, and if a dual condenser the second letter D indicates this. The final number multiplied by 100 is the approximate breakdown voltage. Since many conditions, such as altitude, humidity, and frequency, also influence this factor, this figure is only approximate. The maximum and minimum capacity for the dual condenser applies only to one section. In series maximum will be slightly more than one-half and minimum approximately two-thirds.



E. F. JOHNSON Company

WASECA, MINNESOTA

TYPE H, G, AND J CONDENSERS

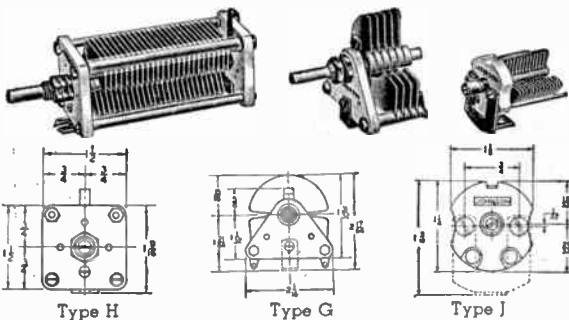

Type H Condensers

The Type H Condenser was designed for aircraft transmitters and combines a minimum of weight and size with simple but rugged construction. Extremely small panel space, .020" plates, and universal mounting brackets make this one of the most popular condensers in the line.

TYPE H CONDENSERS SINGLE SECTION

Cat. No.	Capacity*		Spacing	Number Plates	Length**	List Price
	Max.	Min.				
25H15	24	4	.030"	5	1 1/4"	\$2.20
35H15	35	5	.030"	7	1 3/4"	2.25
50H15	52	6	.030"	11	2 1/8"	2.35
70H15	71	7	.030"	15	1 3/4"	2.45
100H15	101	8	.030"	21	1 7/8"	2.60
150H15	150	9	.030"	31	2 1/4"	3.45
250H15	250	11	.030"	51	3 1/4"	3.95
25H30	26	8	.080"	13	2 3/4"	2.85
35H30	35	9	.080"	17	2 7/8"	2.95
50H30	50	10	.080"	25	3 1/4"	3.30
70H30	70	12	.080"	35	4 1/4"	3.75

TYPE H DUAL SECTION						
Cat. No.	Capacity*		Spacing	Number Plates	Length**	List Price
	Max.	Min.				
35HD15	35	5	.030"	7	1 1/4"	4.60
50HD15	52	6	.030"	11	2 1/8"	4.85
70HD15	71	7	.030"	15	2 1/4"	5.05
100HD15	101	8	.030"	21	3 1/8"	5.40
35HD30	35	9	.080"	17	3 1/4"	5.30
50HD30	50	12	.080"	25	4 1/4"	5.80

*Capacity per Section **Length Over End Plates
NOTE: 25H15 to 100H15 inclusive have single end plates.

Type J Condensers

The type J condenser is a midget with big condenser characteristics. Wider spacing than most small types makes it ideal for oscillator and low power amplifier stages. It can be used in conjunction with Johnson tube socket type inductors to provide an extremely compact tank unit. Universal brackets make possible a variety of mountings.

Cat. No.	Capacity		Spacing	Number Plates	Length	List Price
	Max.	Min.				
7J12	7	2	.025"	3	3/4"	\$1.65
15J12	15	2.5	.025"	6	7/8"	1.70
25J12	28	3.5	.025"	10	1 1/8"	1.90
50J12	55	4.3	.025"	19	1 3/8"	2.05
75J12	74	5	.025"	26	1 7/8"	2.30
100J12	102	7	.025"	36	2 1/8"	2.55

Type G Condensers

The type G condenser is extremely popular as a neutralizing condenser for medium and low power stages. Universal mounting brackets, simplicity in construction, together with a wide range of capacities and spacings, make it adaptable to many applications. Features include a single end plate of ultra-steatite, low minimum capacity, .032" plates, locking nut, and front and rear shaft extension.

Cat. No.	Capacity		Spacing	Number Plates	Length	List Price
	Max.	Min.				
25G20	27	3.5	.045"	5	1 1/4"	\$2.75
50G20	52	5	.045"	9	1 3/4"	3.10
8G45	7.5	3	.125"	3	1 1/2"	2.55
13G45	13	4.3	.125"	5	1 3/4"	2.75
23G45	23	6.3	.125"	9	1 7/8"	3.10
6G70	5.5	3	.225"	3	1 1/4"	3.30
12G70	12	5.3	.225"	7	2 1/8"	4.15

TYPE N CONDENSERS

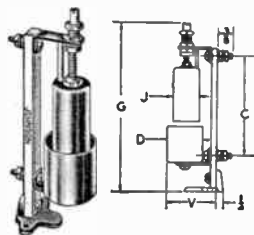

Small mounting space requirements, extremely high voltage rating in proportion to size, fine adjustment with uniform voltage breakdown throughout the full capacity range, and low cost make these neutralizing condensers ideal for the modern transmitter. "Plates" are aluminum cups supported on an ultra-steatite frame with cast aluminum mounting bracket.

Because of the design these condensers will stand much higher voltage than conventional flat plate condensers of the same spacing. Type N125 for plate voltages up to 1500 volts, plate modulated; type N250 for plate voltages up to 2500 volts, plate modulated; type N375 for plate voltages up to 3500 volts, plate modulated. This is not to be confused with peak voltage ratings which are several times those shown.

Cat. No.	Capacity		J	D	DIMENSIONS			V Spacing	List Price
	Max.	Min.			C	G	V		
N125	12	2.5	1	1.375	3 1/8	6 1/4	1 1/4	.125"	\$4.50
N250	12	2.9	1.125	1.73	3 3/4	7 1/4	2 1/4	.250"	4.90
N375	13	3.4	1.375	2.25	4 3/8	8 1/4	2 3/4	.375"	6.00

ROTATING COIL "HI-Q" INDUCTORS

Johnson Hi-Q inductors were designed for optimum LC ratios. The highly glazed porcelain coil form includes ribs which insure a minimum of contact between the wire and the insulating form. Losses involved in this type of construction are a minimum and yet provide a rigid unit which cannot be damaged by careless handling. Floating Jacks in the mounting bar insure perfect contact. Two sizes are provided and both are available either with or without the rotating coupling coil. On the higher frequency bands the coupling coils are adequate for working directly into a 600 ohm open wire line, while on the lower frequency bands couplings may easily be made into a 70 ohm line or an antenna tuner.

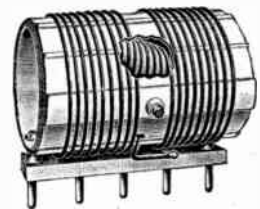

Cat. No.	Band (Meters)	Cap.* (mmf.)	Coupling	Dimensions LxD	Watts Input	List Price
661	20	33	Rotary	4 1/4" x 2 1/2"	350	3.95
662	40	40	Rotary	4 1/4" x 2 1/2"	350	4.10
663	80	75	Rotary	4 1/4" x 2 1/2"	350	4.25
664	160	150	Rotary	4 1/4" x 2 1/2"	350	4.40
670	10	26	None	4 1/4" x 2"	350	1.95
671	20	33	None	4 1/4" x 2 1/2"	350	2.10
672	40	40	None	4 1/4" x 2 1/2"	350	2.20
673	80	75	None	4 1/4" x 2 1/2"	350	2.30
674	160	150	None	4 1/4" x 2 1/2"	350	2.40
686	Form only			4 1/4" x 2 1/2"		.80
667	Form only			4 1/4" x 2 1/2"		.85
668	Ultra-steatite	Plug Strip for		666 and 667		1.00
669	Ultra-steatite	Jack Base for		Mounting above		
		Inductors				1.00
680	10	26	Rotary	6 3/4" x 2 3/4"	1000	5.20
681	20	26	Rotary	6 3/4" x 3 1/2"	1000	5.55
682	40	42	Rotary	6 3/4" x 3 1/2"	1000	5.75
683	80	70	Rotary	6 3/4" x 3 1/2"	1000	5.90
684	160	140	Rotary	6 3/4" x 3 1/2"	1000	6.00
690	10	26	None	6 3/4" x 2 3/4"	1000	3.00
691	20	26	None	6 3/4" x 3 1/2"	1000	3.25
692	40	42	None	6 3/4" x 3 1/2"	1000	3.40
693	80	70	None	6 3/4" x 3 1/2"	1000	3.50
694	160	140	None	6 3/4" x 3 1/2"	1000	3.65
686	Form only			6 3/4" x 2 3/4"		1.65
687	Form only			6 3/4" x 3 1/2"		1.55
688	Ultra-steatite	Plug Strip for		686 and 687		1.50
689	Ultra-steatite	Jack Base for		Mounting above		
		Inductors				1.50

* Total Circuit Capacity required to effect resonance at low frequency end of band. Actual condenser capacity will be smaller by the sum of the tube out-put and wiring capacities, generally between 5 and 20 mmf.
For Edgewise Wound Inductors see next page.

TUBE-SOCKET "HI-Q" INDUCTORS



These inductors were designed to plug into a four or five prong tube socket such as Johnson Nos. 224 or 225. They are available for all bands with either center or end links. Those with center links are center tapped for split stator circuits. The forms are composed of glazed high grade porcelain and provided with ribs so that a negligible portion of the winding is in contact with the insulating form. Used with the type J condenser mounted inside, they make excellent tank units for oscillator and low power stages. Rugged in construction, there is no danger of damaging a delicate winding by careless handling. Wound of heavy wire they will safely handle powers of 100 watts or less. Convenient additional terminal at top for plate connection to tubes with plate cap. All sizes use coil forms 1 3/4" in diameter and 3 3/4" high.

Cat. No.	Band (Meters)	Cap. (mmf.)	Coupling	Watts Input	List Price
641	20	33	Link at Center	100	1.65
642	40	37	Link at Center	100	1.65
643	80	71	Link at Center	100	1.65
644	160	130	Link at Center	100	1.65
650	10	36	Link at Bottom	100	1.55
651	20	58	Link at Bottom	100	1.55
652	40	70	Link at Bottom	100	1.55
653	80	75	Link at Bottom	100	1.55
654	160	110	Link at Bottom	100	1.55
646	Form Only, Four Prong				.80
647	Form Only, Five Prong				.80



TUBE SOCKETS

"The World's Most Famous Tube Sockets," a title earned over years of top quality in material, workmanship and design, cover nearly every transmitting tube requirement. Johnson sockets are specified by exacting users wherever conditions are most severe, as in Government services.

No. 209 is similar to No. 210 but provides greater spacing between contacts and shell, for higher voltages. No. 211, the standard "50 watt" socket, has double filament contacts for carrying heavy currents. No. 216 is for "jumbo 5 prong" tubes such as 204A, 849, etc., and features a plate terminal "safety cup." 210F and 211F are for front of panel mounting and are enclosed in lustrous black finished aluminum housings.

EIMAC 152TL and 304TL tubes take the new 213 socket, and EIMAC 1500TH etc., take the new 214 (with air jet for cooling filament seal).



209-210-211-216



213-214

All contacts are heavy, side wiping type, phosphor bronze, with choice of beryllium copper in most cases; shells, where used, are heavy brass, nickel plated; bases of excellent white porcelain, with steatite (Gov't grade G) optional.

Explanation of catalog number. No letter suffix indicates porcelain base and phosphor bronze contacts. Letter B indicates beryllium copper contacts. Letter S indicates steatite base (Government Grade G).

Cat. No.	Base	List Price	Cat. No.	Base	List Price
209	"UX"	\$0.95	211SB	"50 watt"	\$3.00
209B	"UX"	1.10	211F	"50 watt"	3.50
209S	"UX"	1.85	213	"Eimac"	1.50
209SB	"UX"	2.00	214	"Eimac"	2.50
210	"UX"	.85	215	"250 watt"	3.50
210B	"UX"	1.00	216	"5 prong"	2.50
210F	"UX"	2.50	216B	"5 prong"	3.00
211	"50 watt"	1.25	216S	"5 prong"	4.25
211B	"50 watt"	1.60	216SB	"5 prong"	4.75
211S	"50 watt"	2.70			

WAFER SOCKETS



237-247



217-224-225-226-227-228



235

Johnson ceramic wafer sockets are insulated with steatite (Gov't grade G, wax impregnated) making them excellent for use at high and ultra-high frequencies. Contacts are cadmium plated, reinforced with cadmium plated steel springs, recessed in the form to prevent movement. All metal parts are counter-sunk and mounting holes bossed to permit mounting on metal panel without shorting.

No. 235 acorn socket has silver plated beryllium copper contacts mounted on bosses, providing long leakage paths. No. 237 is a socket for the HK 257 and RCA 813 tubes and No. 247 for the RCA 829 and 832 tubes is similar, with an aluminum tube shield.

Cat. No.	Base	List Price	Cat. No.	Base	List Price
224	4 prong	\$.55	228	Octal	\$.70
225	5 prong	.60	235	Acorn	1.25
226	6 prong	.60	237	7 prong	1.25
227	7 pr. large	.85	247	7 prong	1.75
217	7 pr. small	.85			

EDGEWISE WOUND "HI-Q" INDUCTORS



Wound with plated edgewise copper strip and supported by low-loss hard rubber insulation, these inductors present a very commercial appearance and safely handle up to 1000 watts. Sizes for all bands and for impedance matching networks. Also available on special order with Mycalex or Bakelite insulation. Other edgewise wound inductors are listed in the Commercial Catalog.

Cat. No.	Band (Meters)	Cap. mm.	Coupling	Dimensions LxD	Watts Input	List Price
810	33 mh	impedance matching		7 3/4" x 2 1/2"	1000	\$5.45
811	14 mh	impedance matching		4" x 2 1/2"	1000	3.80
820	160	100	None	9" x 4"	1000	6.75
822	80	50	None	6 1/2" x 3 1/4"	1000	5.15
824	40	25	None	6" x 3 1/4"	1000	4.20
826	40	50	None	5" x 2 1/2"	1000	3.50
828	20	30	None	4 3/4" x 2 1/2"	1000	3.00
819	20 mh	coupling inductor		3 1/4" x 4"	1000	3.35
823	8.1 mh	coupling inductor		2 1/4" x 3 1/4"	1000	2.75
827	2.2 mh	coupling inductor		1 1/2" x 2 1/4"	1000	2.40
LC4 Connector Clips for above inductors						.20

*Total circuit capacity required to effect resonance at low frequency end of band. Actual condenser capacity will be smaller by the sum of the tube out-put and wiring capacities, generally between 5 and 20 mm.

PLUGS AND JACKS

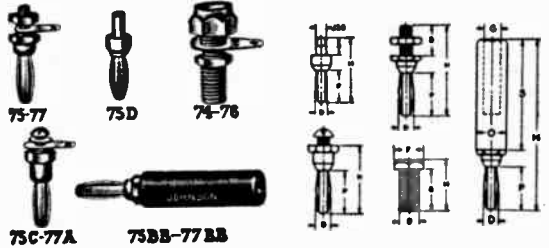

"Banana Spring" TYPE

Nickel-silver springs, and high-grade nicked brass screw machine parts with accurate threads and milled nuts. Studs extend full length of springs.

75C is a tapped plug with 1/8" 6-32 machine screw in head. 75D is designed for riveting or soldering. Spring is of beryllium copper.

75BB has 1 3/8" black insulated handle; 75 BR same but red. 77BB has 1 3/4" black insulated handle; 77BR same but red.

Dimensions

Cat. No. Plugs	S	P	D	H	G	O	Thread	List Price
75	3/8"	.53	.170	1.115			6-32	\$0.07
75A	3/8"	.53	.170	1.490			6-32	.07
75BB	1 3/8"	.53	.170	2.115	.215	1/4"		.15
75BR	1 3/8"	.53	.170	2.115	.215	1/4"		.15
75C		.53	.170	.94			6-32 Screw	.08
75D	3/8"	.40	.155	.81				.08
77	5/8"	.74	.300	1.77			1/4-28	.20
77A	5/8"	.74	.300	1.15			10-32 Screw	.25
77BB	1 3/4"	.74	.300	2.90	3/8"	5/8"		.35
77BR	1 3/4"	.74	.300	2.90	3/8"	5/8"		.35
Jacks	F	D	S	H	H	H		
74		3/8"	1/4"	1 1/4"	5/8"	1 1/2"	1/4-28	.06
76		1 1/8"	3/8"	1 1/4"	1 1/8"	1 1/2"	3/8-24	.25
76A		1 3/8"	Body				1/4-20 Screw	.25

"Spring-Sleeve" TYPE

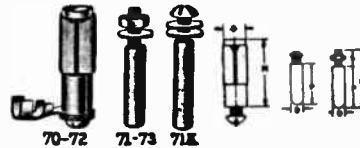

These jacks have maximum current carrying capacity, minimum resistance, great mechanical strength, and snug fit. Tension is maintained by phosphor bronze "spring sleeves."

Dimensions

Cat. No. Plugs	D	S	P	H	Thread	List Price
71	.375	1/2"	1 1/4"	1 3/8"	1/4-28	\$0.14
73	.250	3/8"	1 1/4"	1 1/4"	10-32	.07
73A	.250		1 1/4"	1 1/4"	10-32 Screw	.07
Jacks						
70		1 1/2"		1 1/2"	1/4-20 Screw	.35
72	1/2"			1 1/2"	10-32 Screw	.25

TUBE CAPS



Tube caps of phosphor bronze, cadmium plated, for transmitting use. Provide positive grip and low resistance contact. Formed on one piece there are no mechanical joints to corrode and cause resistance.

Cat. No.	List Price
852—Medium, for 802, etc.	\$0.05
854—Large, for 866, etc.	.10

TINNED COPPER SOLDERING TERMINALS



Available in six sizes, Johnson soldering terminals meet the requirements of most applications. Composed of copper for low resistance, they are tinned to permit easy soldering. Composed of heavy material and accurately formed these terminals are far superior to most products.

Cat. No.	List Price per 100
880—1/4" long, 6-32 hole	\$0.40
881—1/2" long, 1/4" hole	.53
882—1/2" long, 3/8" hole	1.25
883—1/2" long, No. 10 hole	1.85
884—1/2" long, No. 10 spade	2.05
885—1 1/4" long, 1/4" hole	3.25



E. F. JOHNSON Company WASECA, MINNESOTA

THE JOHNSON "Q" AND JOHNSON "Q" BEAM

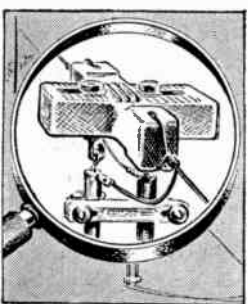

The phenomenal results obtained by the thousands of users of the Johnson Q antenna system are due to the extremely high efficiency of this famous antenna. Applications include half-wave doublet, either horizontal or vertical, harmonic or "long wire" radiator, radiator-reflector, radiator-director, "V" Beam, Johnson Q Beam and others. All of these systems, including complete technical details, are described in the JOHNSON-BASSETT ANTENNA HANDBOOK listed on page seven.

The Johnson Q Beam is a special application of the Q system. It consists of two half-wave Q antennas spaced 1-5 wave and Q sections connected in parallel at the bottom. In ordering specify two QS antennas for the lower frequency of the two bands desired. For example if you want a Q Beam to operate on 10 and 20 meters, order two Johnson Qs for 20 meters.

COMPLETE "Q" SYSTEMS

Cat. No.	Band (Meters)	List Price
SOS	5	\$7.00
SOM	5	10.80
10QS	10	8.65
20QS	20	14.50
40QS	40	26.00

"S" indicates straight tubing.

ALUMINUM "Q" TUBING

Cat. No.	Lengths	Band	List Price	Cat. No.	Lengths	Band	List Price
ST5	2-4' 3"	5	\$ 2.45	ST20	4-8' 6"	20	\$ 9.20
ST10	2-8' 6"	10	4.20	ST40	8-8' 6"	40	18.40

"Q" SPACING BARS

Made of dense, highly vitrified white glazed porcelain, with aluminum tubing clamps. Used for spacing tubing in matching transformer applications. Clamps are arranged so spacing is continuously variable from zero to four inches.

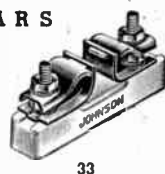

No. 33—Spacing Bar.....List \$0.30

"Q" SUSPENSION ASSEMBLY

Includes new type insulator and all necessary hardware for connecting "Q" matching section to antenna and transmission line. Insulator may also be used to bring off "Zepp" feeders from the flat top.

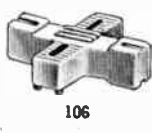

Cat. No. List Price
39—Suspension Assembly\$1.90
106—Antenna-Feeder Insulator only..... .60

ENAMELLED COPPERWELD ANTENNA WIRE



Johnson Enamelled Copperweld Antenna Wire is the ideal material for any system where the wire must not stretch nor sag. The steel core provide almost three times the strength of ordinary copper wire, the copper coating provides low RF resistance, and the enamel prevents corrosion. Prices are per 100 feet. Carried by most suppliers in bulk, it is available from the factory in any specified length.

Cat. No.	B&S Gauge	Feet per lb.	Breaking Strength	List Price
346	8	22	1700 lbs.	\$4.25
348	10	34 1/2	1130 lbs.	2.75
350	12	54	720 lbs.	1.90
352	14	85	400 lbs.	1.25

ANTENNA INSULATORS

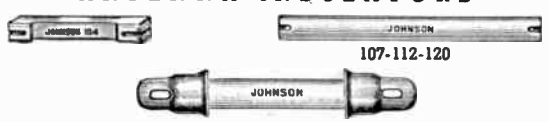

These insulators are of genuine WET PROCESS porcelain, with smooth white glazing. The all-porcelain types are 1" in diameter. Their long leakage path, low capacity, and freedom from moisture absorption result in exceptional efficiency. The Commercial Type is 1 1/2" in diameter, for uses where much greater strength is necessary. End fittings are of non-corrosive aluminum alloy. No. 104 is a dry process 4" antenna insulator, 3/8" square for service where the strength of the 1" types is not required.

Cat. No.	Break Strength	Length	List Price
104	400 lbs.	4"	\$0.20
107	800 lbs.	7"	.70
112	800 lbs.	12"	.90
120	800 lbs.	20"	1.50

Cat. No.	Break Strength	Net	Overall	List Price
151	5000 lbs.	8"	15 1/2"	\$9.00
152	5000 lbs.	12"	19 1/2"	10.75
153	5000 lbs.	20"	25 1/2"	15.00

STRAIN INSULATORS



Numbers 30 and 32 are ideal for ordinary application requiring a sturdy insulator at a low price. Number 38 provides an extremely long leakage path and was intended for high voltage application. All are of white glazed low absorption porcelain. Particularly useful in breaking up guy wires where good insulation and light weight is essential. Keep several on hand for emergencies.

Cat. No.	Length	List Price
30	2"	\$0.11
32	1 1/2"	.08
38	1 1/2"	.15

FEEDER INSULATORS



Numbers 132, 134 and 136 are conventional feeder spreaders having a cross-section of 3/8" x 1/2" and No. 132 is also provided with notches for 1 1/2" line spacing. Number 31 Transposition insulator makes possible crossing over the transmission line at frequent intervals to prevent radiation and provide 2" line spacing. All insulators are of high grade low absorption glazed porcelain.

Cat. No.	Length	List Price
132	2"	\$0.15
134	4"	.20
136	6"	.25
31		.16

RADIO FREQUENCY CHOKES



Uniformly flat in response, Johnson R.F. chokes are equally effective over the entire range for which they are designed. Coils are of enamelled silk-covered wire impregnated with high grade R.F. lacquer, and are wound on steatite cores. Current ratings are for continuous service and may be increased for intermittent use.

Cat. No.	Frequency	Current Rating	Lgh.	List Price
750	1.7 to 30 mc	150 ma	1 1/2"	\$0.70
752	1.7 to 30 mc	500 ma	2 7/8"	1.25
754	1.7 to 30 mc	750 ma	4 3/8"	2.15
760	Ultra-high	250 ma	1 1/2"	.55
762	Ultra-high	1500 ma	2 7/8"	.80

INDUCTOR CLIPS



Phosphor bronze, cadmium plated with clamping screw and integral solder loop. The only clip taking wire from No. 20 to No. 10, without danger of tilting and shorting adjacent turns.

No. 860—Clip.....List \$0.10



E. F. JOHNSON Company WASECA, MINNESOTA

STAND-OFF AND CONE INSULATORS



Available in a variety of shapes and sizes all are composed of superior white glazed porcelain except the 500 series which is Alsimag 196. Numbers 65, 66, 67 and 68 are equipped with metal bases which are available either in cadmium plated steel or lacquered brass. Porcelain cones in 600 series have threaded brass inserts, far superior to poorly fitting porcelain threads.

STAND-OFF INSULATORS

Cat. No.	A	B	C	H	Hardware	List Price
Dimensions						
All Porcelain Types						
20	3/4	1 1/4	1 1/8	1 1/8	10-32	\$0.14
20J	3/4	1 1/4	1 1/8	1 1/8	74 Jack	.18
22	3/4	1 1/4	3/8	1	8-32	.10
22J	3/4	1 1/4	3/8	1	74 Jack	.14
24	3/4	1	3/8	5/8	6-32	.08
60	1 1/8	2 1/2	1 1/8	4 1/2	1/4-20	.65
62	1 1/8	1 1/8	1 1/8	2 1/4	1/4-20	.40
Metal Base Types						
65	3/8	1 1/8	7/8	1 1/8	10-32	.25
65B*	3/8	1 1/8	7/8	1 1/8	10-32	.30
65J	3/8	1 1/8	7/8	1 1/8	74 Jack	.30
66	3/8	1 1/4	1 1/4	2 1/4	1/4-20	.40
66B*	3/8	1 1/4	1 1/4	2 1/4	1/4-20	.50
66J	3/8	1 1/4	1 1/4	2 1/4	76 Jack	.55
67	1 1/4	2 1/4	1 1/4	4 1/2	1/4-20	.60
67B*	1 1/4	2 1/4	1 1/4	4 1/2	1/4-20	.70
67J	1 1/4	2 1/4	1 1/4	4 1/2	76 Jack	.80
68	1 1/4	1 1/4	1 1/4	2	10-32	.30
68B*	1 1/4	1 1/4	1 1/4	2	10-32	.40
68J	1 1/4	1 1/4	1 1/4	2	74 Jack	.35

* "B" suffix indicates Brass Base.

CONE INSULATORS

Cat. No.	A	B	C	H	Hardware	List Price
Porcelain						
600	1 1/2	5/8	5/8	5/8	6-32	.14
601	1 1/2	3/4	1	1	8-32	.16
601J	1 1/2	3/4	1	1	74 Jack	.22
602	1 1/2	1	1 1/2	1 1/2	8-32	.20
602J	1 1/2	1	1 1/2	1 1/2	74 Jack	.25
603	5/8	1 1/8	2	2	10-32	.25
603J	5/8	1 1/8	2	2	74 Jack	.30
604	3/4	1 1/2	3	3	10-32	.35
604J	3/4	1 1/2	3	3	76 Jack	.50
Ultra-Steatite						
500	1 1/2	5/8	5/8	5/8	6-32	.20
501	1 1/2	3/4	1	1	8-32	.30
502	1 1/2	1	1 1/2	1 1/2	8-32	.55
503	5/8	1 1/8	2	2	10-32	.80
504	3/4	1 1/2	3	3	10-32	1.30

BRASS BASES



For outside use, particularly under corrosive conditions, lacquered brass bases are recommended, if necessary for replacement, on Numbers 65, 66, 67 and 68 insulators.

Cat. No.	For Use With	List Price
866-867	65	\$0.07
865	66-68	.10
866	67	.12
867		

SHAFT COUPLINGS



Flexible coupling units insulated with Ultra-Steatite are available in two sizes, No. 250, 1 3/8" diameter and No. 251, 2 1/4" diameter. Flexibility is obtained by cadmium plated phosphor bronze spring with no backlash.



No. 252 is an improved solid insulated coupling of Ultra-Steatite for 1/4" shaft. Long leakage path and accurate alignment of hubs are outstanding features.



No. 258 cadmium plated brass compression shaft coupling will not burr shaft and is much stronger than set screw type. Ideal for coupling together 1/4" shafts where they need not be insulated.

Cat. No.	Shaft	Diameter	List Price
250	1/4"	1 3/8"	\$0.80
251	3/8"	2 1/4"	1.40
251A	1/2"	2 1/4"	1.40
251B	1/4" & 3/8"	2 1/4"	1.40
252	1/4"	1 1/4"	.75
258	1/4"	1/2"	.15

Copyright by U. C. P., Inc.

THRU-PANEL AND LEAD-IN INSULATORS



All types are composed of high quality white glazed porcelain except No. 55 which is Alsimag 196. Numbers 53 and 54 are single porcelain bushings without hardware. See below for mounting flanges and threaded brass rod to meet your individual requirements. All other types are complete with hardware.

THRU-PANEL INSULATORS

Cat. No.	A	B	C	D	E	H	Hardware	List Price
Dimensions								
40	1 1/2	1 1/4	1 1/4	1 1/4	1/2	1 1/4	10-32	\$0.30
40J	1 1/2	1 1/4	1 1/4	1 1/4	1/2	1 1/4	74 Jack	.35
42	1 1/2	3/4	3/4	.400	3/8	7/8	10-32	.23
42J	1 1/2	3/4	3/4	.400	3/8	7/8	74 Jack	.28
44	1 1/2	5/8	5/8	.305	3/8	3/8	6-32	.18
45	1 1/2	1 1/4	7/8	1 1/4	1 1/4	1 1/8	10-32	.40
45J	1 1/2	1 1/4	7/8	1 1/4	1 1/4	1 1/8	74 Jack	.45
46	1 1/2	1 1/4	1 1/4	1 1/4	1	2 3/8	1/4-20	.65
46J	1 1/2	1 1/4	1 1/4	1 1/4	1	2 3/8	76 Jack	.80
47	1 1/2	2 1/8	1 3/4	1 3/4	1 1/2	4 1/2	1/4-20	1.05
47J	1 1/2	2 1/8	1 3/4	1 3/4	1 1/2	4 1/2	76 Jack	1.25
48	1 1/2	1 3/8	1 1/4	1 1/4	2	2	10-32	.45
48J	1 1/2	1 3/8	1 1/4	1 1/4	2	2	74 Jack	.50

LEAD-IN BUSHINGS

Cat. No.	A	B	C	D	E	H	List Price
50	3/8	3/4	3/4	3/4	1/2	1 1/2	.20
51	5/8	1 1/4	1 1/4	1 1/4	3/8	3 1/2	.35
52	5/8	1 3/4	1 1/2	1 1/2	1 1/2	1 1/2	.50
53	1 1/4	2 1/2	2	2	1 1/2	1 3/4	.30
54	1 1/4	3 1/2	2 7/8	2 7/8	2	4	.70
55	1/2	3/4	1/2	1/2	1/4	1 1/4	.25

MOUNTING FLANGES

Mounting Flanges of cast aluminum for Lead-in Bushings 53 and 54.

Cat. No.	For Bushing No.	List Price
90	53	\$0.30
91	54	.60



THREADED BRASS ROD



Used with stand-off and thru-panel insulators for making lead-in bushings, and for other purposes. 1/4" diameter, threaded 1/4-20. Nickel plated. Complete with 4 nuts and washers.

Cat. No.	Length	List Price
240-241-242	8"	\$0.35
240	10"	.45
241	15"	.55
242		

PANEL BEARINGS

Cadmium plated brass, for 1/4" shaft and up to 3/8" panels. Also with 3" and 6" cadmium plated brass shafts.



Cat. No.	List Price
255—Panel Bearing	\$0.15
256—Bearing and 3" shaft	.30
257—Bearing and 6" shaft	.40

FLEXIBLE SHAFTS



Phosphor bronze, non-rusting, with 1/4" hubs. Permit out-of-line or up to 90 degree angular control.

Cat. No.	Length	List Price
253	3"	\$0.35
254	6"	.50

HANDLE INDICATORS



Highly attractive although low in price these solid molded Bakelite controls will enhance the appearance of any equipment. No. 204 fits 1/4" shafts and has 4" scale. No. 206 fits 1/4" shaft, has removable bushing for 3/8" shaft, and 6" scale.

Cat. No.	List Price
204—Handle Indicator	\$1.00
206—Handle Indicator	1.25



LADDER-TYPE CENTER STRUCTURE

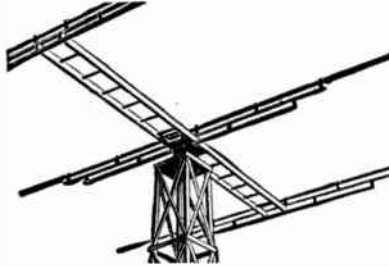

The ladder-type center supporting structure has been proven the most practical and economical type of support yet devised. Strong yet light and inexpensive it comes in five sizes to meet all rotary beam requirements. It can be used equally well with any type beam.

2101 3 1/2' 2 El 10M...\$ 4.90	2102 7' 2 El 20M...\$ 9.35
2102 7' 3 El 10M... 9.35	2106 14' 3 El 20M... 18.20
2103 10 1/4' 4 El 10M... 13.50	2107 21' 4 El 20M... 27.50

CENTER STRUCTURE HINGE BRACKET

Designed to be used in conjunction with the above ladder-type center structure for mounting the beam assembly on the rotating device. Permits hinging the array down for adjustment, and simplifies mounting. Complete with all necessary hardware. 2151 Bracket for 2101, 2102, 2103 center structure...\$ 9.50
2152 Bracket for 2106, 2107 center structure..... 10.50

ELEMENT SUPPORTING CROSS ARMS

A special truss-type support designed for 1 inch or smaller tubing elements. Construction and length has been worked out to hold the elements rigidly in place under most severe conditions. 2161 5 3/4' 10M\$4.25 2162 11' 20M\$7.00

ADJUSTABLE TUBING ELEMENTS

Composed of 1 inch and 3/8 inch rust-proof manganese aluminum alloy, these elements are much stronger than ordinary aluminum, and far superior to other types due to low surface resistance. They are supplied cut to length and a close fitting adjustable section is provided for tuning, locked securely in place by clamps. Elements complete for mounting except for insulators and supplied in matched sets for the rotary antennas indicated.

2201 2 El 10M.....\$15.85	2205 2 El 20M.....\$35.00
2202 3 El 10M..... 21.30	2206 3 El 20M..... 50.25
2203 4 El 10M..... 26.75	2207 4 El 20M..... 65.25

ELEMENT SUPPORTING INSULATORS

A special insulator having low RF losses and designed to carry any type tubing elements without breaking. 2171 Insulator complete with hardware, each.....35c

IMPEDANCE MATCHING RECEIVER COUPLER



Most modern communications receivers such as RME, Hallicrafters, Hammarlund, etc., have an input impedance of 300 to 600 ohms resulting in considerable signal attenuation when used with low impedance lines. This coupler was designed to match such receivers to lines having an impedance of 70 ohms or less. The usual result is a 20 db. increase in signal strength. Highly recommended for all antennas using concentric cable. 2251 Receiver Coupler\$2.50

VERTICAL COAXIAL ANTENNAS

One of the newest developments in UHF antennas, the Coaxial is rapidly becoming very popular because of low cost, ease of installation, and outstanding results. Elements are of 3/8 inch manganese aluminum alloy tubing mounted on wooden base by means of high frequency insulators. Easily mounted in a few minutes on any type of support or mast. All types adjustable over entire frequency band and priced less cable. Amount and power of 64 ohm cable should be selected above, and factory installation will be made at no extra charge. Length is measured from center of radiator. Police types are adjustable over a range of 5 MC. In ordering specify frequency desired. Receiving type uses 64-200 cable. Television type of 3/8 inch manganese aluminum tubing supplied less cable, and uses 64-200 cable. All types complete with wooden base, insulators, hardware, and full instructions.

Amateur Type		Police Type	
2301 5 Meter.....\$15.00		2310 Transmitting	\$32.50
2302 10 Meter..... 19.75		2311 Receiving ...	25.00
2303 20 Meter..... 36.25		Television Type	
2320 Television			\$9.75



JOHNSON-BASSETT CONCENTRIC CABLE

A patented concentric cable which has been manufactured for several years by the Bassett Radio Mfg. Corp. having many advantages not found in other types. Flexible, waterproof, will not stretch and change the impedance, light, low loss, can be supplied in any length at no extra cost, and can be provided with molded waterproof end seals at small extra charge. Available in a variety of power ratings and impedances. Also available with lead sheath for use underground or in water. Widely used by marine and government services. The first number indicates the impedance in ohms and the second number the power in watts.



64-1000.....35c per ft.	34-1000.....18c per ft.
64-500.....20c per ft.	28-1000.....15c per ft.
64-200.....8c per ft.	13-1000.....11c per ft.

Factory molded end seal, each.....\$2.50

FLEXIBLE LEAD COVERED MARINE CABLE

64-1000 Marine ..62c per ft.	64-200 Marine ...17c per ft.
64-500 Marine ...42c per ft.	34-1000 Marine ..35c per ft.

CONCENTRIC MATCHING TRANSFORMERS

JOHNSON-Bassett transformers are made in a variety of impedances and power ratings. The first number indicates the impedance, the second the power rating in watts, and the third the amateur band for which it is designed. Many applications will be found for matching various impedance feed lines to different types of antennas. The necessary matching transformer can be calculated by multiplying together the impedance of the feed line and the impedance of the antenna and extracting the square root of this product. Prices shown are for end seals at both ends. Transformers with only one end seal may be obtained on special order and \$2.50 (list) deducted from the price.



64-1000-10\$7.35	50-1000-20\$7.95
64-1000-20 9.25	34-1000-10 6.35
64-500-10 6.35	34-1000-20 7.40
64-500-20 7.45	28-1000-10 6.10
64-200-10 5.50	28-1000-20 7.00
64-200-20 5.90	13-1000-20 5.75
50-1000-10 6.60	13-1000-20 6.35

The transformers for 10 meters are approximately 6 feet long while those for 20 meters are about 12 feet long.

CONCENTRIC MATCHING FEEDER

JOHNSON-Bassett Matching feeder can be supplied as a combination of Matching Transformer and a section of Concentric Feeder, joined with a special rubber seal at the factory, for a variety of applications. The first number indicates impedance of antenna, second power rating of cable, third amateur band for which designed. Prices are with one end seal. Additional end seal \$2.50.

	Application	50 ft. length	Each Addl. ft.
3-1000-10	6 Element Beam.....	\$21.40	35c
3-1000-20	6 Element Beam.....	20.10	35c
3-500-10	6 Element Beam.....	14.70	20c
3-500-20	6 Element Beam.....	14.25	20c
3-200-10	6 Element Beam.....	9.45	8c
3-200-20	6 Element Beam.....	9.45	8c
5-1000-10	4 Element Beam.....	13.80	18c
5-1000-20	4 Element Beam.....	13.40	18c
8-1000-10	3 Element Beam.....	12.45	15c
8-1000-20	3 Element Beam.....	12.20	15c

Note: 2 Element Beam uses 28 ohm cable.

JOHNSON-BASSETT ANTENNA HANDBOOK

Written as a result of years of research and experimentation by both the Johnson and the Bassett organizations, it is a practical handbook of "how to do it". A combination of the famous Bassett Rotary Beam Handbook with the Johnson Q system, methods of impedance matching and many new ideas never before published. Truly an outstanding contribution to the antenna field, and the only authentic manual on rotary beam construction and operation.



2351 Handbook25c net

NEW IMPROVED JOHNSON-BASSETT ROTOMATIC DRIVE

The new JOHNSON-Bassett Rotomatic Drive is the result of more than four years of development and experimentation by the Bassett organization followed by further electrical and mechanical improvement by JOHNSON. Completely automatic in operation. Simply set the control pointer at one of twelve positions under the world map and beam rotates to this position and stops. Will operate either direction. Center shaft is hollow through which any type cable or matching transformer may be led providing simple and easy method of feeding beam. A small but powerful drive capable of giving many years of service for 2, 3, or 4 element 10 meter beams. (A new heavier unit is being developed for 20 meter beams and will be announced soon.)

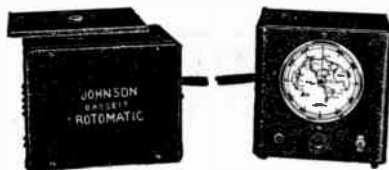

2051 Rotomatic Drive and Indicator control complete with 50 ft. control cable.\$132.50
More or less No. 2401 16 wire control cable for above, per foot.....25c

NOTE: ALL PRICES ARE LIST SUBJECT TO USUAL DISCOUNTS

J. H. BUNNELL

Telegraph Keys • Learner's Sets • Sounders • High Frequency Buzzers



**TRIUMPH
KEY
No. 9050
Type 5-4**

A commercial Telegraph Key on cast brass base with nickel plated steel lever. Has tungsten contacts and "Bug" lip of polished silver. All brass parts are polished and lacquered.

Used extensively by Western Union, Postal, and other communication companies. Can also be supplied with $\frac{1}{8}$ " or $\frac{1}{4}$ " diameter silver points—polished and lacquered bronze lever and "Navy" knob or bronze nickel plated lever at additional charge. Shipping weight 1 lb.

No. 9050 Triumph Key with polished brass body.

**BUNNEL
Open Circuit
Key No. 9037
Type 5-23**



Front and Back Contact—Legless Key

When it is preferable to use dry cells instead of closed circuit cells this type of key is highly recommended. Even though a closed circuit is maintained for communication in either direction no current is being used except when key is depressed. Each individual station supplies its own current from local batteries.

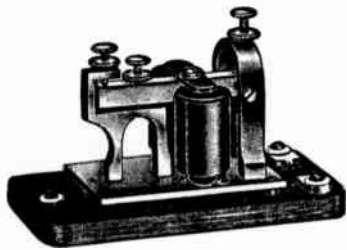

**GIANT
SOUNDER
with
Aluminum
Lever
No. 500
Type 7-3**

A commercial Telegraph Sounder with aluminum lever. Used extensively by Western Union, Postal and other communication companies. Sounder is supplied with brass base mounted on wood sub-base. Three brass pillars between the wood and brass base create a "sounding board" effect, giving loud, clear signals. Coils of sounder are furnished wound to any required resistance. State resistance required when ordering. Shipping weight—2 lbs. packed.

**QUAD
REPEATING
SOUNDER
with Rigid
Points
No. 9109
Type 7-6**

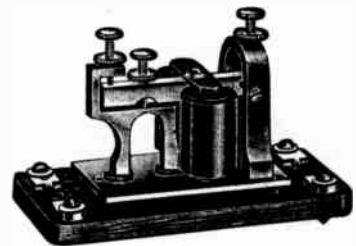

Similar in all respects to No. 500 aluminum lever sounder, but has in addition, a pair of auxiliary contacts in the anvil and sounder bar which are connected to two additional binding posts used to repeat the signal to another circuit or a local one. Coils furnished wound to any required resistance. Shipping weight—2 lbs. packed.

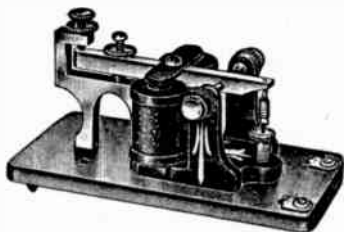

**DANDY
LEARNER'S
SOUNDER
No. 776
Type 7-9**

Same sounder as used on Dandy Morse Learner's Outfit, is mounted on wood base and has adjustable trunion screws as well as adjustable spring tension. Shipping weight—2 lbs. packed.

**BUZZOPLEX
No. 8656
Type 17-1**

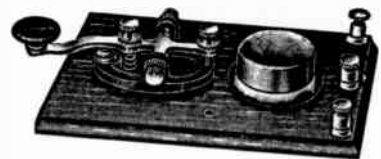

This instrument consists of a No. 775 key and high grade buzzer mounted on a common base of birch, finished mahogany. Equipped with 3 binding posts to connect batteries and phones. Shipping weight — 3 lbs. packed.



**CENTURY
HIGH FREQUENCY
BUZZER
No. 9740
Type 17-3**

A high frequency Buzzer with adjustable tone control. Operates from 1 or 2 dry cells. May be supplied on either Buzzoplex or Blinko Buzzoplex at an additional charge.

**BLINKO
BUZZOPLEX
No. 9028
Type 17-2**



Same equipment as used on Buzzoplex, but with addition of lamp and switch. Used to give audible or visual signals. Shipping weight—3 lbs.

J. H. BUNNELL

Telegraph Keys • Learner's Sets • Sounders • High Frequency Buzzers



Bunnell Professional Flash Key #1 No. 800 — Type 5-48

A handsome and efficient transmitting machine, with unlimited sending possibilities. Suitable for all classes of transmitting work where speed and perfect sending are prime essentials. THE OLD RELIABLE SINGLE LEVER KEY.

Two pairs of large, coin silver contact points . . . one for dots, the other for dashes. Designed to meet

the most exacting demands of professionals. Equipped with cord as illustrated. Base, $6\frac{1}{2} \times 3\frac{1}{2} \times \frac{1}{2}$ inches. 800—Black crackle finish.

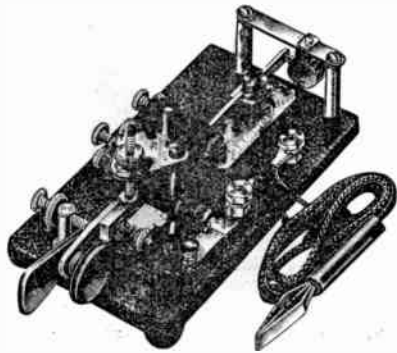

Bunnell Professional Flash Key #6 No. 801 — Type 5-45

Experienced professional operators have acclaimed this model as the smoothest, fastest "bug" on the market, surpassing anything ever before achieved in any sending machine. Single lever with improved flat pendulum and instantly adjustable dot contact spring. Two pairs of large coin silver contact points . . . one for dots, the other for dashes. Equipped with cord as

illustrated. Weight $3\frac{1}{2}$ pounds. Base $6\frac{1}{2} \times 3\frac{1}{2} \times \frac{1}{2}$ inches. 801—Black crackle finish.

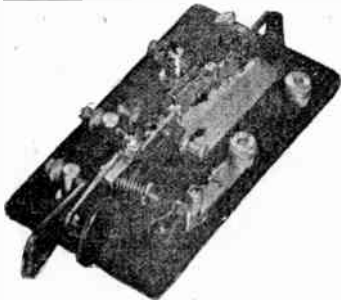

BUNNELL AMATEUR FLASH KEY No. 803 — Type 5-46

The greatest value ever made available to amateurs. Sturdy construction. Single lever. Two pairs of coin silver contact points . . . one for dots, the other for dashes. Designed especially to meet the demands of amateur operators. Weight 2 pounds. Base, $6 \times 3 \times \frac{3}{8}$ inches. 803—Black crackle finish.

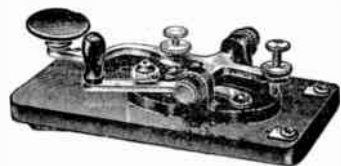

DANDY LEARNER'S KEY No. 775 — Type 5-19

A substantial well designed key mounted on a black japanned cast iron base and wooden sub-base. Has steel nickel plated lever, adjustable brass trunion screws polished and lacquered. Spring tension screw and back screw can be removed when key is used for radio operation. Shipping weight 1 lb. packed.

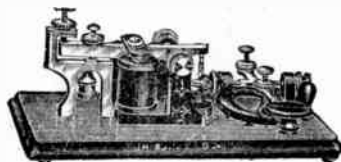

Dandy Morse Learner's Outfit No. 607 — Type 7-17

The same key and sounder as our No. 775 and 776 except mounted on common base and furnished with 2 Western Union type flat binding posts connected to key and sounder. Can be used singly as a learner's outfit or in pairs. Weight—2 lbs. packed.



DOUBLE SPEED KEY No. 5876 — Type 5-12

A non-automatic side action key on brass base. Lever is nickel plated and all brass parts are polished and lacquered. Supplied for telegraph work with circuit closer, which may be removed when key is required for radio use. Dots or dashes made on either side by pressing the lever right or left. In ordering, state whether for telegraph or radio use. Shipping weight—1 lb. packed.



Carrying Case - No. 5-165 for No. 800 or 801 Flash Key

Carrying case for No. 800 or No. 801 FLASH KEY — a sturdy lightweight case covered with imitation leather over wood frame, with hinged front. Shipping weight, 3 lbs. packed.

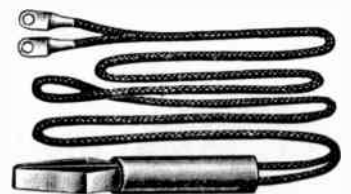

CORD AND WEDGE Set No. 5-183

A $2\frac{1}{2}$ foot cord with spring wedge on one end and round eyelet terminals on the other end. The springs of the plug are nickel silver securely held in place in a fibre tube with fibre insulation between springs. Shipping weight—6 ozs. packed.

If it hadn't been for Brass Pounders

But for that valiant group of radio telegraph operators who finger their keys with the deftness and affection of virtuosos . . . if it hadn't been for men like Ted McElroy, who established the world's record of 77 words per minute for reception of radio code signals . . . wireless transmission, as we know it today, might have taken a different—not so fortunate—turn.

Restless men, not content with forging an art out of brass pounding, they have utilized their skill and imagination to pioneer the advancement and perfection of mechanical transmission and reception. It is to these men . . . of the Army, Navy, Merchant Marine, Commercial and Amateur fields . . . that we pay tribute.

Ted McElroy, who operates both manual and automatic apparatus, proudly acknowledges the cooperation of Brass Pounders everywhere in helping him develop his commercial high speed equipment. While signal recorders in use to date have been capable of attaining reasonably high speeds, the new McElroy Commercial Recorder can "go" as high as 1000 words every sixty seconds. All of us can well appreciate the value of such speeds in these critical times, especially when in cases of emergency a split-second can mean the difference between victory and defeat, between life and death.

Throughout each chapter of wireless history, throughout the structure of every new development, mechanical and otherwise, you can bet your bottom dollar that somewhere you will find the hand of the men who pound the keys. May their tribe increase.

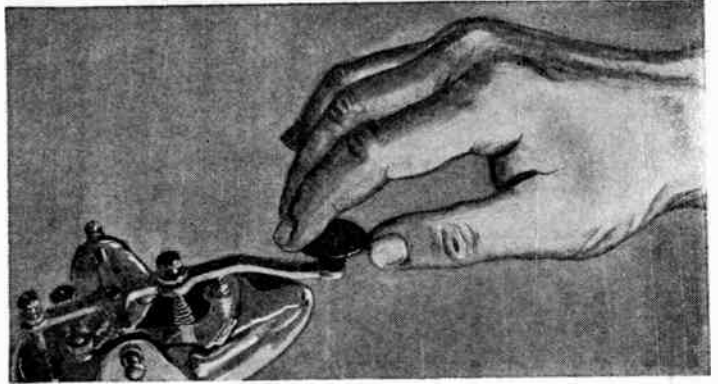

High-Speed Automatic Radiotelegraph Assemblies

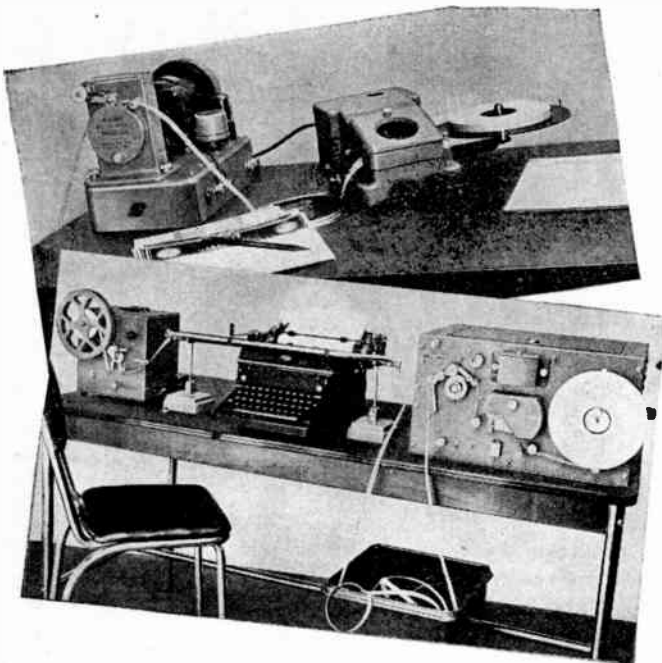

These two photographs illustrate a complete automatic transmitting assembly (upper photograph) and an automatic receiving assembly (lower photograph). Installations of this type are typical of the high-speed radio telegraph equipment employed by such international commercial companies as R.C.A. Communications, Mackay Radio, Globe Wireless, Press Wireless . . . and Military and Naval services everywhere.

Each piece of equipment is illustrated individually and described more fully in the pages following. Technical manuals and operating instructions may be secured by writing direct to the manufacturer.

McElroy

MANUFACTURING CORPORATION
82 BROOKLINE AVENUE BOSTON, MASSACHUSETTS

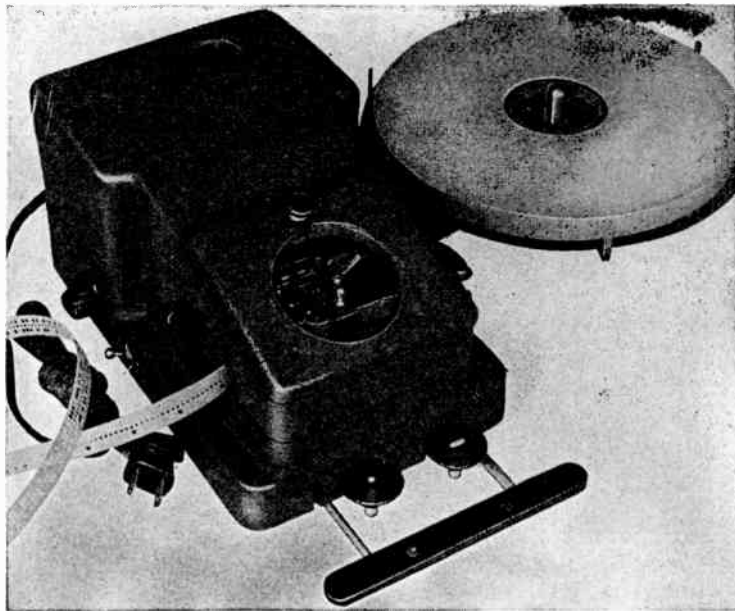

McElroy PFR-443 Wheatstone Code Tape Perforator

Ted McElroy is justifiably proud of this remarkable unit. It assures perfect transmission of radio telegraph signals, thereby replacing inadequate hand-sending that often results in errors and repetition requests. Manual deficiencies contribute largely to unnecessary use of radio transmitters, with consequent congestion of the radio spectrum.

The Wheatstone Code Tape Perforator is unquestionably one of the outstanding contributions to the art of radio telegraph.

graphy. Actuated by 110 volt AC or DC current, this model PFR-443 prepares tape cleanly and accurately at speeds up to 50 words per minute, for feeding through automatic transmitters.

It does not necessarily require experienced radiomen to operate it effectively. Anyone with a basic knowledge of the dots and dashes comprising signal codes can prepare perfect tape for transmission, not only in International Morse, but in other codes used throughout the world, such as Japanese, Russian, Turkish, Arabic, Greek, etc.

The method of operation is simplicity itself. The unit is placed in a position similar to a hand telegraph key and may be operated with a feather-light touch of the index finger, middle finger and thumb of the right hand. Depressing the dot, dash or space closes electrical contacts actuating a powerful die mechanism.

This perforator may be used fully automatic, providing a continuous series of characters, and with a variable speed control—or may be operated semi-automatically to form only one character at a time.

This method of machine sending will prove of great value in improving the efficiency of radio communications on ships and at all other radio stations.

McElroy Automatic Transmitter Models XTR-442 and XTR-442A

The McELROY AUTOMATIC TRANSMITTER, MODEL XTR-442, in response to Wheatstone perforated tape, will open and close a keying circuit to execute mechanically precise signal elements, dots and dashes. It will key either the intermediate relay of a radiotelegraph station for communications purposes, or an audio oscillator for training radiotelegraph operators.

In any service, the XTR-442 will execute radio-telegraph signals with exactly fixed relative lengths. It consists of the McElroy MAH-142 Auto Head, which accepts the perforated tape, the motor which drives the Auto Head including its associated speed control, an electronic polarizing circuit, and a relay.

The motor which energizes the MAH-142 is capable of driving the Transmitter at a speed range of from 4 to 300 words per minute. A rheostat enables gradual and positive control of speed through the entire range.

Model XTR-442A, like XTR-442, offers constant control at all available transmitting speeds. The rate of transmission is indicated directly upon the dial, calibrated in words per minute.

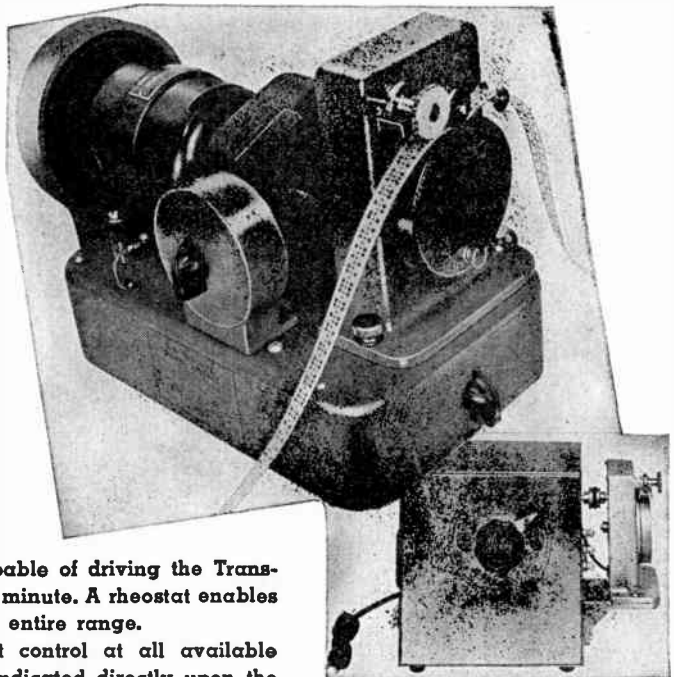

McElroy

MANUFACTURING CORPORATION
82 BROOKLINE AVENUE BOSTON, MASSACHUSETTS

McElroy School Recorder Model G-913-A with Tape Puller Model TP-845

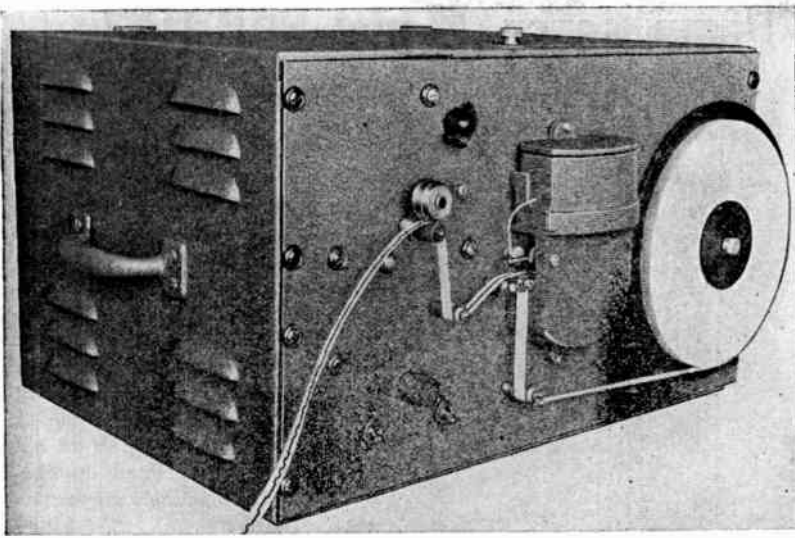

Sturdily housed in one complete unit for table operation, the school recorder may also be incorporated in a panel rack. Because most satisfactory performances can be secured when using the recorder with this particular tape puller, both units have been combined into this one compact instrument at no increase in cost over the price of the recorder when purchased singly.

Both units which comprise the G-913-A School Recorder are ruggedly built but should be accorded the care and attention normally given to laboratory equipment. Properly operated, this instrument will be trouble-free. Forty-eight of these recorders are in daily operation, 24 hours each day, in the production of G-15-AA sets of practice tapes at our factory.

The School Recorder is indispensable for teaching, since operators are enabled to examine actual printed examples of their own techniques. It demonstrates visually to the student any defects in his hand sending and can also re-transmit to him accurate reproductions of the signals he has sent. With the faithfulness of a sound recording mechanism it offers an operator the opportunity to study and improve the rhythm and spacing of his keying.

The model G-913-A School Recorder will operate at speeds up to 100 words per minute, recording clearly signals of readable strength from any radio communication receiver.

McElroy High-Speed Recorder Model SR-900-A

This entirely new and different recorder has many unique advantages which permit it to record signals at a maximum speed approximating 1,000 words per minute.

Recorders of earlier design have been limited because signals to be recorded were required to overcome the inertia of mechanical spring action. In the McElroy SR-900-A, the return of the exciter coil and ink stylus to the signal base line is not dependent upon a spring. With the exciter coil constantly energized, a change in polarity occurs when a signal impulse is transmitted to it. The coil and ink stylus is moved without resistance. At the end of the signal impulse, the polarity of the coil is changed again and it is returned to its no-signal position with equal force. Lightly balanced and delicately but sturdily pivoted, the coil and inking stylus float freely without restriction.

The Model SR-900-A operates directly from the tone signal of any radio receiver, rejecting all but the signal of the highest level, reducing the effects of interference to a minimum. Background noises, weaker interfering signals and static are rejected by the amplifier and selector incorporated in this recorder.

The inking mechanism feeds directly down with the pen recording in a vertical position, presenting a distinct advantage over other types which record with the pen touching the tape in a horizontal position. While the tape puller, with adjustments for three speeds is built-in, the tape reel is mounted on the panel.

Designed to accommodate mounting in a standard radio panel, if desired for monitoring purposes, the recorder is nevertheless completely enclosed for table operation at high speeds. In addition, a separate pull-motor can be utilized for normal speeds when operator desires to transcribe direct signals.

With the McElroy High-Speed Recorder, clean and readable signals are assured where other recorders might respond with hopelessly jumbled and undecipherable copy.

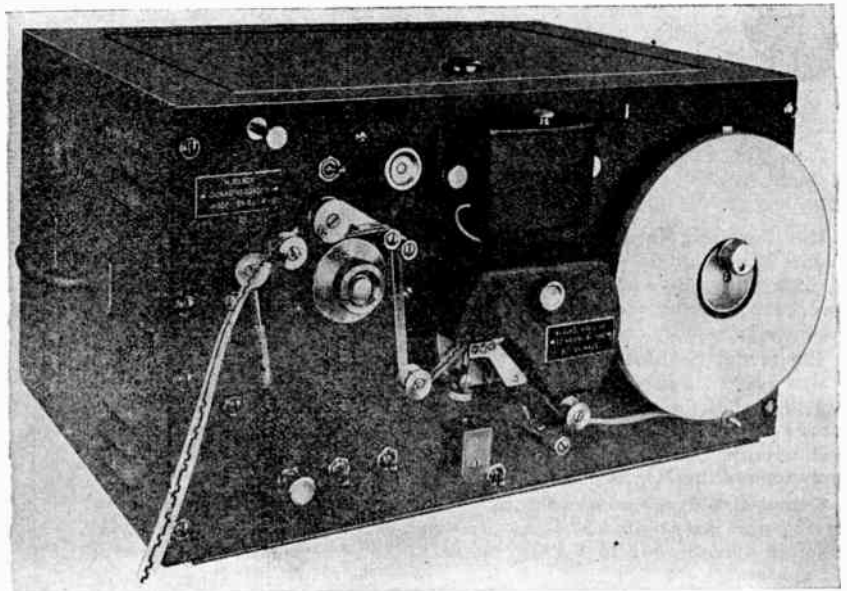

McElroy MANUFACTURING CORPORATION
82 BROOKLINE AVENUE BOSTON, MASSACHUSETTS

McElroy Radio Beam Keyer, Model RBK-1142

The Radio Beam Keyer was developed to fill a need for a reliable instrument which would operate as a constant source of specific information; repeating that information in code characters at any speed within a range of from 5 to 75 words per minute.

The Keyer can be adjusted quickly for continuous and timed transmissions, without tape or other media of limited durability, of signals in any order required. In addition, it can open or close the circuit it keys for a determined length of time to provide either a period of uninterrupted silence or a dash of specified length.

The most obvious commercial applications for an instrument of this type are keying high-frequency beam transmitters for blind landings . . . keying station and frequency calls, etc. . . . However, its adaptability to almost any requirements makes it a most flexible instrument for a multitude of other needs.

The Model RBK-1142 is designed to fit standard rack assemblies and may be mounted with the same fixtures that secure it in its sturdy, enclosed housing.



To the Future...

Ted McElroy is operating the largest laboratory and plant devoted exclusively to the design and production of equipment for the transmission and reception of dots and dashes. There, within the limitations of a full-scale war production, we are compiling a practical knowledge of not only all the complex phases of the radio-telegraph art but also the associated applications of electronic apparatus for industry.

Today we are limiting productive capacity to our field where, as creative telegraphic engineers, we are leaders. We create. We design. We build. We do not imitate and we do not copy. And we can deliver. In the future, when it will be possible for us to manufacture new products, we will be ready with a wealth of experience in electronic techniques.

High-frequency heating will speed production of innumerable commodities. Medical science can see new wonders ahead. Electric controls will check the foods we eat, the air we breathe, the colors we see . . . The opportunities for development are limitless.

McElroy Electronic Keyer Model G-813-A

The Electronic Keyer, an original McElroy development, converts into sound, code signals which have been transcribed in ink on standard $\frac{3}{8}$ inch paper tape at any speed chosen by the operator. The clarity and even spacing with which the signals are reproduced will assist students in rapidly mastering correctly sent code.

The Model G-813-A continues to be the only instrument of its kind which has the outstanding practical advantage of keying only the signal line of the tape. Speed control is constant to a maximum of 40 words per minute. Tapes which undergo the effects of excessive wear will operate this unit with an efficiency impossible to achieve with imitations of the McElroy Electronic Keyer.

Cumulative developments through years of experience with the photo keying unit, an original McElroy achievement, have resulted in many inherent advantages that continue to build widespread acceptance for this unit.

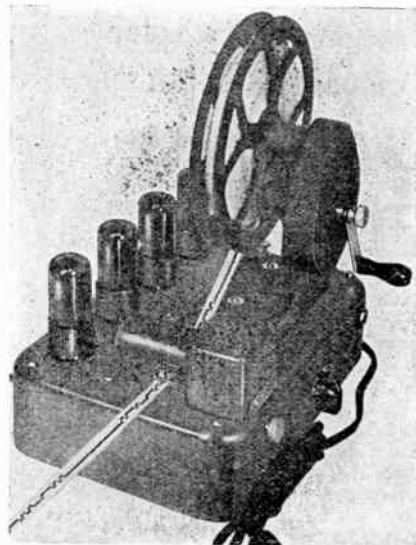

McElroy Tape Pulleys, Model TP-845-A and Model TP-890-A with constant control over wide speed ranges

By far the most important consideration in the planning of these units is the incorporation of newly designed motors, oversized and capable of sustaining constant speeds. Model TP-890-A (illustrated at the right) is recommended for high-speed applications, while the Model TP-845-A (at left) is principally used in conjunction with training equipment. Both will operate at maximum efficiency with a minimum of required maintenance.

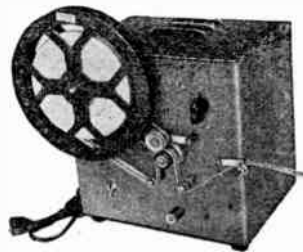
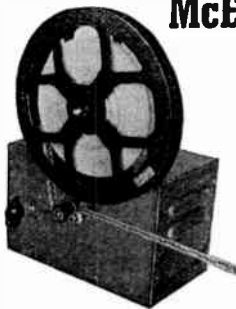

McElroy MANUFACTURING CORPORATION
82 BROOKLINE AVENUE BOSTON, MASSACHUSETTS

Practice Sets
Buzzers



Transmitting and
High Speed Keys

TELEGRAPH KEYS FOR EVERY PURSE AND PURPOSE

HIGH SPEED SEMI-AUTOMATIC KEYS

SPEED-X Semi-Automatic Keys are designed and constructed to rigid specifications and are approved by the experienced professional and amateur C. W. operators. They are fully adjustable from lowest to highest speeds. Manufactured in four distinctive and attractive models. Fully guaranteed against any defect in material or workmanship. Bases of all models drilled for stationary mounting.

STANDARD MODEL No. 500. New-Improved Standard Model Semi-Automatic Key mounted on extra heavy steel base $3\frac{1}{2} \times 6\frac{1}{4} \times \frac{1}{2}$ " finished in attractive black wrinkle baked enamel. Mounted on four rubber feet to insure stationary position at all times. The finish will not scratch or chip and will last indefinitely. The frame is chromium finished and has five adjustments with lock nuts, assuring dependable operations at all speeds. Vibrator arm, posts, switch and all machine parts heavily plated in beautiful chromium. Complete with two adjustable weights, two sets $\frac{1}{8}$ " pure silver contacts, circuit-closing switch and two paddles adjustable to any desired height. Net weight $4\frac{1}{2}$ lbs.

No. 500—List Price \$13.50..... Net \$8.10

No. 500-L (Left-handed model) List \$15.50..... Net \$9.30

No. 380—Cord and Plug Extra List \$1.00..... Net \$.60

PROFESSIONAL MODEL No. 501. New-Improved Beautiful Polished Chromium Plated Heavy Steel Base $6\frac{1}{4} \times 3\frac{1}{2} \times \frac{1}{2}$ " with four non-slip rubber feet. Heavy brass connector strips mounted under base. Frame is a Polished Chromium Brass Casting with five screws for sensitive adjustments. Vibrator is designed to obtain slowest and fastest speeds required by high speed operators. Two sets of $\frac{1}{4}$ " pure silver contacts. Pigtail connections to vibrating arm. Perfectly aligned free acting vibrator bearings. Lock nuts on all adjustments. Paddles adjustable to any required height. All machine parts heavily chrome plated, which makes this the most outstanding semi-automatic key on the market. Furnished with circuit closing switch. Net Weight $4\frac{1}{2}$ lbs.

No. 501—List Price \$17.50..... Net \$10.50

No. 501-L (Left-handed model) List Price \$19.50..... Net \$11.70

No. 380—Cord and Plug Extra List \$1.00..... Net \$.60



Nos. 500, 501



No. 515

AMATEUR MODEL No. 515. Baked Black Crinkle Enamel Finished Steel Base $6\frac{1}{4} \times 3 \times \frac{3}{8}$ " with four rubber feet to prevent slipping or tilting. Heavy Brass connector strips. Die Cast Frame finished same as base with adjustable trunion screws. Chromium brass Vibrator has main spring and U-spring made of clock spring for smooth snappy action. Two adjustable weights. Two adjustable black fibre paddles. Two sets $\frac{1}{8}$ " pure silver contacts. Lock nuts for every adjustment. Deadener wheel, posts, screws, springs and terminals polished chrome plated. Packed in attractive carton. Net Weight $3\frac{1}{4}$ lbs.

No. 515—List Price \$9.25..... Net \$5.55

No. 515-L (Left-handed model)—List \$11.25..... Net \$6.75

No. 380—Cord and Plug Extra List \$1.00..... Net \$.60

JUNIOR MODEL No. 510. Die Cast Base $2\frac{3}{4} \times 6 \times \frac{3}{4}$ " finished in black wrinkle baked enamel concealing heavy brass connector strips. Frame is same finish as base and all other parts are chromium plated. Vibrator Arm same as Standard model with lots of pep. Adjustable from eight words per minute to as high a rate as desired. Two sets of $\frac{1}{8}$ " pure silver contacts, two adjustable weights and two adjustable paddles. Circuit closing switch mounted on base. Being small, compact and streamlined, this semi-automatic key is an outstanding value. A light-weight but sturdy built machine for clean-cut sending. Net Weight $2\frac{1}{2}$ lbs.

No. 510—List Price \$10.75..... Net \$6.45

No. 380—Cord and Plug Extra List \$1.00..... Net \$.60

REPLACEMENT PARTS

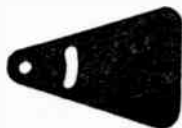

No. 370



No. 330

No. 335



	List	Net		List	Net
No. 330 Adjustable Weight.....	\$0.25	\$0.15	No. 363 1" Chrome Screw.....	.15	.09
No. 335 Key Springs.....	.10	.06	No. 364 $\frac{1}{2}$ " Knurled Nut.....	.10	.06
No. 336 Dash Spring.....	.10	.06	No. 375 Vibrator Arm Comp.....	3.00	1.80
No. 340 Set $\frac{1}{8}$ " Contacts.....	1.00	.60	No. 376 Vibrator Arm Only.....	1.75	1.05
No. 341 Set $\frac{1}{4}$ " Contacts.....	2.00	1.20	No. 370 Adjustable Paddle.....	.25	.15
No. 345 (2) $\frac{1}{8}$ " Contacts.....	.20	.12	No. 380 Cord and Plug.....	1.00	.60
No. 346 (2) $\frac{1}{4}$ " Contacts.....	.50	.30	No. 390 U-Spring $\frac{1}{8}$ " Contact.....	.60	.36
No. 350 Knob.....	.20	.12	No. 391 U-Spring $\frac{1}{4}$ " Contact.....	.75	.45
No. 360 Navy Knob.....	.30	.18			
No. 362 $\frac{3}{4}$ " Chrome Screw.....	.13	.08			

No. 444 KIT

An assortment of the best selling parts for all makes of keys, selected from the above list, and packed in a beautiful display box. List price of complete kit \$20.00
NET PRICE . . . \$12.00



No. 360



No. 350



No. 390

Practice Sets Buzzers



Transmitting and High Speed Keys

TELEGRAPH KEYS FOR EVERY PURSE AND PURPOSE

MOULDED BAKELITE KEYS, BUZZERS, PRACTICE SETS

SPEED-X Moulded Bakelite and Metal Hand Keys, Practice Sets and Buzzers are used throughout the world as standard equipment in amateur and commercial work. Each unit is built according to rigid specifications and is fully guaranteed. All models have holes for stationary mounting. Code card supplied with each individually packed unit.



No. 301

AMATEUR KEY No. 301—A general purpose key with moulded black bakelite base. Perfect insulation—adjustable smooth acting bearings—improved spring—nickel key arm—pigtail connections—no current on bearings— $\frac{1}{8}$ " pure silver contacts. Net Wt. 6 oz.

No. 301—List Price \$2.15.....Net **\$1.29**

No. 301-S with switch—List \$2.50.....Net **1.50**

Add "L" for $\frac{1}{4}$ " Contacts—Extra List \$.25.....Net **.15**

PRACTICE KEY No. 300—A well-built and inexpensive practice key for the beginner. Moulded Brown Bakelite base and knob. Spring bearings, perfect action, simple adjustments, $\frac{1}{8}$ " pure silver contacts. All machine parts nickel plated. Standard Code card furnished. Net Wt. 5 oz.

No. 300—List Price \$1.50.....Net **\$.90**

PRACTICE KEY No. 312—A standard spring adjustable hand key with $\frac{1}{8}$ " pure silver contacts mounted on a moulded brown bakelite base $2\frac{3}{4}$ " x 5", with circuit closing switch and terminal connections on base. Heavy base connector strips concealed under base. Key arm, switch, and all machine parts nickel plated. Net Wt. 8 oz.

No. 312—List Price \$2.50.....Net **\$1.50**

PRACTICE SET No. 450—Consists of one constant frequency adjustable buzzer and a standard hand key with $\frac{1}{8}$ " pure silver contacts mounted on a moulded brown bakelite light-weight base 6" x 4". Adjusting screws, key arm and all machine parts nickel plated. Light Spring for perfect keying. A complete sending and receiving set. Three hook-up diagrams on carton show how this Practice Set may be used singly for code practice and in pairs for point to point communications. Standard Code Card included. Net Wt. 12 oz.

No. 450—List Price \$2.75.....Net **\$1.65**



No. 450

CONSTANT FREQUENCY BUZZER No. 400—Moulded Black Bakelite Base and Cap eliminates insulation problems. Large pure silver contacts—precision parts hold adjustments. Additional adjustment on vibrator. Resistance 2 ohms. Operates on two dry cells or one "C" battery. A high quality buzzer for all purposes. Net Wt. 3 oz.

No. 400—List Price \$1.25.....Net **\$.75**



No. 400

HEAVY DUTY METAL HAND KEYS

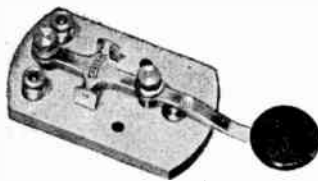

Nos. 300. 305. 306

METAL HAND KEY No. 305—An inexpensive metal base key with black wrinkled enamel finish. Smooth acting spring bearings and adjustable key arm spring. Key arm and all machine parts bright nickel finish. $\frac{1}{8}$ " pure silver contacts. Net Wt. 10 oz.

No. 305—List Price \$1.75.....Net **\$1.05**

No. 306—Lacquered BRASS finish Base—List Price \$1.75.....Net **1.05**

STANDARD Key No. 310—Heavy die cast base finished in black wrinkled enamel. Smooth adjustable bearings. $\frac{1}{8}$ " pure silver contacts. Has provisions for plugging in our semi-automatic keys when desired. Net Wt. 9 oz.

No. 310—List Price \$2.50.....Net **\$1.50**

No. 311—Chromium Base—List \$3.00.....Net **1.80**

No. 316—Lacquered BRASS Finish—List \$2.50.....Net **1.50**

Add "L" for $\frac{1}{4}$ " Contacts—Extra List \$.25.....Net **.15**



Nos. 310. 311. 316

STANDARD KEY No. 310-S—Same specifications as Standard model key No. 310 with circuit closing switch mounted on base. $\frac{1}{8}$ " pure silver contacts. An attractive high-quality key. Net Wt. 10 oz.

No. 310-S—List Price \$3.00.....Net **\$1.80**

No. 311-S—Chromium Base with switch—List \$3.50.....Net **2.10**

No. 316-S—Lacquered BRASS Finish with switch—List \$3.00.....Net **1.80**

Add "L" for $\frac{1}{4}$ " Contacts—Extra List \$.25.....Net **.15**

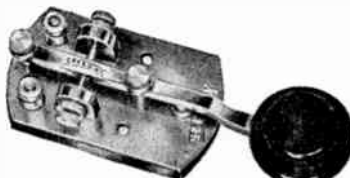

Nos. 320. 321. 326

HEAVY DUTY KEY No. 320—Black wrinkle enameled extra heavy Die Cast Base. Large sturdy chromium plated key arm with adjustable steel bearings. Heavy brass connector strip concealed under base. Well insulated for heavy duty work. Improved Navy Type Knob and $\frac{1}{4}$ " pure silver contacts. Net Weight 12 oz.

No. 320—List Price \$3.50.....Net **\$2.10**

No. 321—Chromium Base—List Price \$4.00.....Net **2.40**

HEAVY DUTY KEY No. 326—Same specifications as Heavy Duty Model No. 320 but base finished in a beautiful Lacquered BRASS finish. Arm and machine parts chromium plated. Well designed spring gives this model a light keying touch. Navy Type Knob and $\frac{1}{4}$ " pure silver contacts. Net Wt. 12 oz.

No. 326—List Price \$3.50.....Net **\$2.10**

The Vibroplex

A SEMI-AUTOMATIC TELEGRAPH AND WIRELESS TRANSMITTING MACHINE

Embodying the latest exclusive features

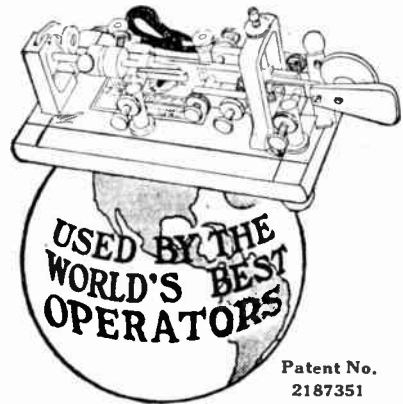

PROMINENT features which have contributed to the success of the Vibroplex are:

- Simplicity - Durability
- Perfect control - Easy adjustment
- Strong carrier - Ease of manipulation
- Adaptability to changing wire conditions
- Ability to transmit perfect Morse and Continental signals at high speed

These features, which are found only in the genuine Vibroplex models illustrated on these pages, make for clear, rapid, easy transmission; relieve the arm of strain caused by sending on the ordinary key; rest and

strengthen the overworked muscles, and prevent telegrapher's paralysis.

CLEAR, RAPID SENDING MADE EASY

The Vibroplex transmits the same grade of Morse and Continental code as the strongest clearest hand sender, faster than is possible on the ordinary key, and with less than half the labor.

There is no tensing of the muscles, no nerve strain, no pounding on the key in order to make clear, rapid signals. You simply press the lever—the machine does the rest.

THE "CHAMPION" VIBROPLEX

For Radio Use Only

The new "Champion" is an inexpensive transmitter having exceptional sending qualities . . . clarity . . . speed . . . sending ease, which will appeal alike to amateur and professional radio operators. Designed to meet the demand for a low priced Vibroplex in the radio field.

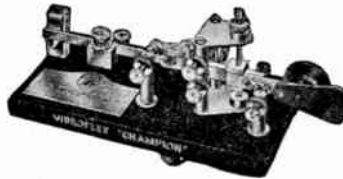

Designed to fulfill the demand for a low priced radio transmitter.

SPECIFICATIONS

Single lever with two pairs of contact points. Mounted on large standard size base. Weight 3 lbs. 8 oz. Without circuit closer, cord and wedge. Standard finish only. Chromium finished top parts, with black crystal base.

Amateur Net Price **\$9.95**

THE "ORIGINAL" VIBROPLEX



Suitable for all classes of transmitting work where speed and perfect Morse are prime essentials.

SPECIFICATIONS

Old Style, Single Lever. Two pairs of contact points: one for dots, the other for dashes. Weight, 3 lbs. 8 oz. A handsome and efficient transmitting machine, with unlimited sending possibilities. Complete with cord and wedge. Finishes—Standard—Polished Chromium parts with black base.

Amateur Net Price **\$15.95**
DeLuxe—Polished Chromium, Gray base and jeweled movement **19.50**

THE "BLUE RACER" VIBROPLEX

Very similar to the Original Vibroplex except that it is only half the size. Suitable for all classes of telegraph work and in high favor with wireless men.

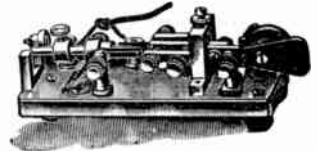

UNLIMITED SENDING POSSIBILITIES

Small and compact, the Blue Racer Vibroplex can be carried around and never be in the way. Embodies the same sending possibilities, the same carrying qualities, the same strength and durability as the larger models. Built especially to meet the demand of telegraphers requiring a small, lightweight and efficient sending machine.

SPECIFICATIONS

Single Lever. Two pairs of contact points—one for dots, the other for dashes. Weight, 2 lbs. 8 oz. Complete with cord and Wedge. Finishes—Standard—Polished Chromium top parts with black base.

Amateur Net Price **19.50**
DeLuxe—Polished Chromium, Gray base. With jeweled movement **19.50**

ALL THE VIBROPLEXES ILLUSTRATED ARE NOW EQUIPPED WITH LARGE 3/16 DIAMETER CONTACT POINTS, WHICH ARE THE SAME DIAMETER AS FURNISHED ON SPECIAL RADIO MODELS SELLING HERETOFORE UP TO \$25.00.

The

Vibroplex

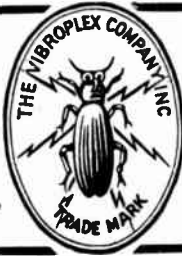

Telegraph & Wireless
Transmitting Machines

THE "LIGHTNING BUG" VIBROPLEX

One of the Latest Model Vibroplexes

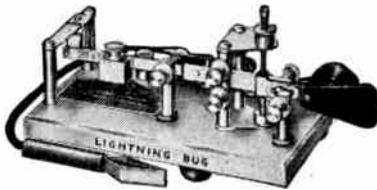

Sending ease surpassing anything ever achieved in any sending machine.

HIGH QUALITY SIGNALS AT ALL SPEEDS

This Great New Vibroplex is the smoothest and easiest working BUG ever made. It has won fame on land and sea for its clarity, precision and ease of manipulation. Can be slowed down to 10 words per minute or less or geared to as high rate of speed as desired. Maintains the same high quality signal at whatever speed, insuring easy reception under all conditions.

SPECIFICATIONS

Single lever, with improved flat pendulum, instantly adjustable dot contact spring, circuit breaker parallel with pendulum. Two pairs of contact points, one for dots, the other for dashes. Complete with cord and wedge. Weight 3 lbs. 8 oz. Finishes—Standard—Polished Chromium top parts with black base.

Amateur Net Price **\$13.95**
DeLuxe — Polished Chromium, gray base, and jeweled movement **17.50**



VIBROPLEX CARRYING CASE

Keeps the machine free from dust, dirt and moisture. Insures safe-keeping when not in use.

A plush-lined case, finished in handsome black morocco. Corners are reinforced, adding to its durability and attractiveness. A flexible leather handle makes it more convenient to carry. Has lock and key.

Amateur Net Price **\$3.50**

ALL THE VIBROPLEXES ILLUSTRATED ARE NOW EQUIPPED WITH LARGE 3/16 DIAMETER CONTACT POINTS, WHICH ARE THE SAME DIAMETER AS FURNISHED ON SPECIAL RADIO MODELS SELLING HERETOFORE UP TO \$25.00.

THE "ZEPHYR" VIBROPLEX

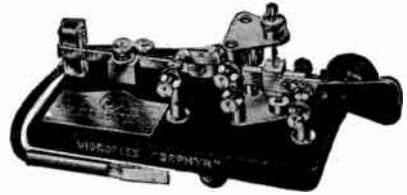

A Genuine Vibroplex. Slightly lighter in weight. Having plenty of "Pep" and "Power"

Smaller and more compact but designed in most details the same as the "Lightning Bug" model. Planned to meet the demand for a low priced, efficient and high speed transmitter for telegraph use.

SPECIFICATIONS

Single lever with standard size contact points. Mounted on slightly smaller base. Weight 3 lbs. 2 oz. Equipped with circuit closer, cord and wedge. Standard finish only. Chromium finished top parts, with black crystal base.

Amateur Net Price **\$12.50**

● For a limited time only all of the DeLuxe Model Vibroplexes are furnished with patented JEWEL MOVEMENT, without additional charge.

This special introductory price is subject to change without notice.

The JEWELS used in this Model Vibroplex are the same as placed in the World's finest precision made watches and instruments.

A JEWEL bearing main lever insures a "LIFETIME" of service and an ease of operation that can only be referred to as "FEATHER-TOUCH" sending.

TELEGRAPH Apparatus Co. NOT INC.



MASTER OSCILLATOR MS-700

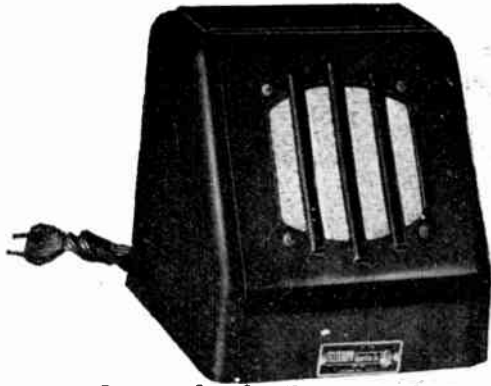

A very fine code Oscillator, encased in a beautiful bakelite cabinet.

Especially designed for individual or class code learning. Features incorporated are: Continuously variable volume control, tone adjustable from 500 to 1500 cycles; provisions for disconnecting or connecting the speaker when phones are used. Terminals are provided for head phones and any number up to 300 may be used by connecting the phones in parallel, with no other matching devices.

The head phone circuit is completely isolated from any direct current, permitting phones with exposed terminals to be used without danger of shock. Operates on 110 volts AC or DC current. Either a 117N7GT or 117P7GT is used.

AMATEUR NET PRICE\$11.85

WITH TUBE

CODE PRACTICE SET MS-700P



An ideal practice set that is being used extensively by all branches of the armed forces for learning code and maintaining speed at inactive intervals. External connections are provided for additional keys and headphones. All of the features in the MS700 are incorporated in this unit, including variable volume control, provisions for disconnecting or connecting the speaker when phones are used, bakelite cabinet, etc.

Operates on 110 volts AC or DC current. Either a 117N7GT or 117P7GT is used.

AMATEUR NET PRICE\$15.90

WITH TUBE

MODEL 200 HAND KEY

(Designed by the World's Champion Telegrapher)

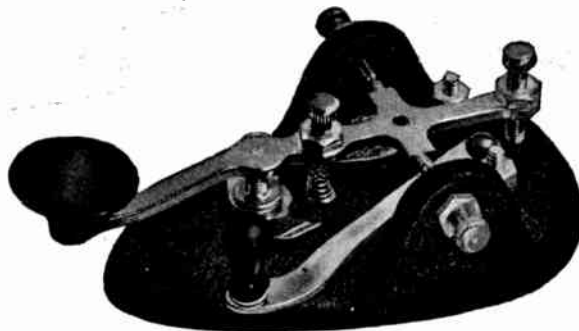

A professional telegraph key in performance and appearance, using $\frac{3}{16}$ " coin silver contacts. The scientifically designed key lever is balanced between two accurately machined bearing screws and the entire key is mounted on a black crackle finished metal base, equipped with a circuit closing switch.

AMATEUR NET PRICE\$2.25

TELEGRAPH Apparatus Co. NOT INC.



DeLuxe SPEED KEY MODEL CP-500

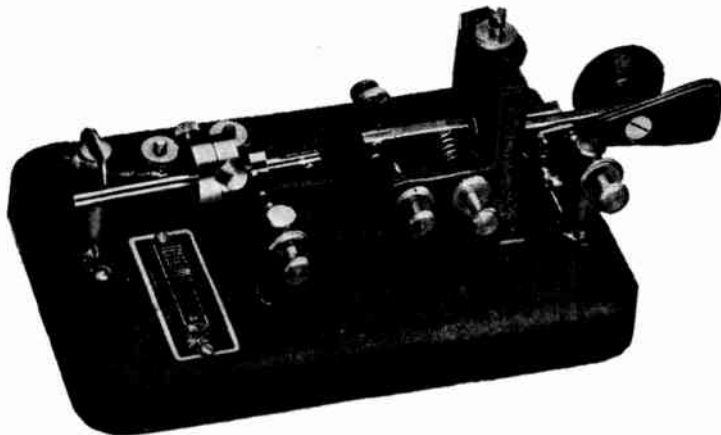

A professional Speed Key, designed by the world's champion telegrapher. This Bug was designed to conform with the United States Navy specifications. Finished in a battleship gray wrinkle enamel. It is a masterpiece of mechanical craftsmanship and precision workmanship.

Rhythmical Morse sending is a real pleasure with this key. The contact points are $\frac{3}{16}$ " silver, right and left arm tension springs, contact spacings and vibrating arm are all fully adjustable. Size $3\frac{3}{4}$ " x $6\frac{1}{4}$ " x $3\frac{1}{4}$ ".

AMATEUR NET PRICE \$11.85

Super SPEED KEY MODEL CP-800

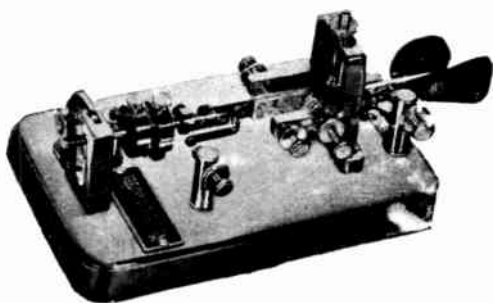

The finest commercial or amateur bug available. A masterpiece of mechanical craftsmanship and precision workmanship. The massive base is finished in a highly polished chrome, as well as all the metal parts of the super-structure and lever. The main and U-spring are of carefully selected blue spring steel, resulting in uniform performance in all keys. Contacts are $\frac{3}{16}$ " in diameter. This bug is fully adjustable to suit the particular feel of any operator. Equipped with connecting cord.

AMATEUR NET PRICE \$15.90

DeLuxe HAND KEY MODEL 300



The ultimate in fine telegraph keys. Finished in polished chrome and nickel. Its sturdy, balanced construction gives a feeling of smooth effortless keying. Contacts are $\frac{3}{16}$ " in diameter, adjustable for tension, spacing and bearing position. Equipped with a circuit closing switch.

AMATEUR NET PRICE \$3.45

RING TYPE RHEOSTATS

WARD
LEONARD 



CONSTRUCTION—The core and base of these rheostats are of refractory material. The resistance wire is wound toroidally around the core and coated with vitreous enamel.

The contact arm construction separates the functions of current handling and contact pressure. The contact is a special alloy and of large area to avoid sticking, pitting, local heating, or oxidation when setting remains fixed for any length of time.

STEPS—There are as many steps of resistance as there are turns of wire in the winding. Three terminals provide rheostat or potentiometer connection.

WATT RATINGS—are based on continuous operation in free air with a temperature rise not exceeding 300° C which is within the limits specified by the Underwriters' Laboratories and NEMA.

DEPTH BACK OF PANEL—1105 1 1/8", 1106 1 1/8", 1107 1 3/4", and 1108 2".



300 and 500 Watt Rheostats for Heavy Duty

Watt Rating	Available Ohms	Steps	Diam.	List Price
300	1 to 2500	20	6"	\$18.00
500	1 to 5000	33	8"	27.00

Pressed steel plate type. The watt rating, based on the minimum current being one-half the maximum current, is the product of the maximum current, minimum current and the total rheostat resistance.

1105 25 WATTS 1 1/2" Dia.				
Total Resis. Ohms	Max. Current m. a.	Approx. No. Steps	Catalog No.	List Price
1.0	5,000	45	1105-2	\$4.50
1.6	3,950	45	1105-3	4.00
2.5	3,160	54	1105-4	4.00
4.0	2,500	72	1105-5	4.00
6.4	1,980	90	1105-6	4.00
10.	1,580	90	1105-7	4.00
16.	1,250	108	1105-8	4.00
25.	1,000	103	1105-9	4.00
40.	791	137	1105-10	4.00
64.	625	137	1105-11	4.00
100.	500	171	1105-12	4.00
160.	395	205	1105-13	4.00
250.	316	240	1105-14	4.00
400.	250	274	1105-15	4.00
640.	198	308	1105-16	4.00
1,000.	158	390	1105-17	4.50
1,600.	125	411	1105-18	4.50
2,500.	100	520	1105-19	4.50
4,000.	79	520	1105-20	4.75

1106 50 WATTS 2 1/4" Dia.				
Total Resis. Ohms	Max. Current m. a.	Approx. No. Steps	Catalog No.	List Price
0.64	8,850	30	1106-1	\$5.00
1.0	7,070	49	1106-2	5.00
1.6	5,590	59	1106-3	5.00
2.5	4,470	69	1106-4	4.50
4.0	3,535	69	1106-5	4.50
6.4	2,795	119	1106-6	4.50
10.	2,235	150	1106-7	4.50
16.	1,760	140	1106-8	4.50
25.	1,415	188	1106-9	4.50
40.	1,120	150	1106-10	4.50
64.	884	188	1106-11	4.50
100.	707	225	1106-12	4.50
160.	559	263	1106-13	4.50
250.	447	300	1106-14	4.50
400.	353	375	1106-15	4.50
640.	279	413	1106-16	4.75
1,000.	223	450	1106-17	4.75
1,600.	176	570	1106-18	4.75
2,500.	141	570	1106-19	4.75
4,000.	112	713	1106-20	5.00
6,400.	88	855	1106-21	5.00
10,000.	70	998	1106-22	5.00

1107 100 WATTS 3" Dia.				
Total Resis. Ohms	Max. Current m. a.	Approx. No. Steps	Catalog No.	List Price
0.64	12,500	31	1107-1	\$7.50
1.0	10,000	41	1107-2	7.50
1.6	7,900	41	1107-3	7.50
2.5	6,320	52	1107-4	7.50
4.0	5,000	62	1107-5	7.00
6.4	3,950	72	1107-6	7.00
10.	3,160	72	1107-7	7.00
16.	2,500	156	1107-8	7.00
25.	2,000	196	1107-9	7.00
40.	1,580	235	1107-10	7.00
64.	1,250	274	1107-11	7.00
100.	1,000	274	1107-12	7.00
160.	790	313	1107-13	7.00
250.	632	313	1107-14	7.00
400.	500	392	1107-15	7.00
640.	395	392	1107-16	7.00
1,000.	316	470	1107-17	7.50
1,600.	250	595	1107-18	7.50
2,500.	200	744	1107-19	7.50
4,000.	158	744	1107-20	8.00
6,400.	125	1041	1107-21	8.50
10,000.	100	1041	1107-22	9.00

1108 150 WATTS 4" Dia.				
Total Resis. Ohms	Max. Current m. a.	Approx. No. Steps	Catalog No.	List Price
0.64	15,000	43	1108-1	\$9.50
1.0	12,250	43	1108-2	9.50
1.6	9,680	54	1108-3	9.50
2.5	7,750	54	1108-4	9.50
4.0	6,120	54	1108-5	9.50
6.4	4,840	54	1108-6	9.00
10.	3,870	118	1108-7	9.00
16.	3,060	118	1108-8	9.00
25.	2,450	204	1108-9	9.00
40.	1,935	245	1108-10	9.00
64.	1,530	286	1108-11	9.00
100.	1,225	367	1108-12	9.00
160.	968	326	1108-13	9.00
250.	775	408	1108-14	9.00
400.	612	408	1108-15	9.00
640.	484	489	1108-16	9.50
1,000.	387	620	1108-17	9.50
1,600.	306	620	1108-18	10.00
2,500.	245	775	1108-19	10.00
4,000.	193	930	1108-20	10.50
6,400.	153	1085	1108-21	11.00
10,000.	122	1240	1108-22	12.00

Non-Inductive

PLAQUE RESISTORS

Non-Capacitive

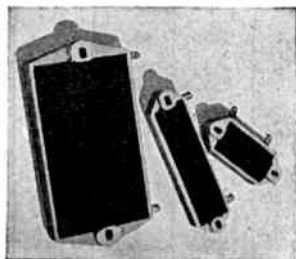

Vitrohm Plaque Resistors are rated 20, 40, and 125 watts with full ventilation. In practice it is difficult to achieve this ideal ventilation. However, a single resistor mounted on a panel should operate safely at approximately 80% of the full rating in watts.

These Vitrohm Plaque Resistors are flat in form. The resistance wire is so arranged as to give the lowest obtainable values of inductance and distributed capacitance for a power resistor. Both the inductance at frequencies up to 1000 kilocycles and the distributed capacity up to 5 megacycles are negligible.

Prices and Specifications

Shipping weight List Price Each	3 1/4" 20 Watt	4 3/4" 40 Watt	5 3/4" 125 Watt
	2 oz. \$1.50	4 oz. \$2.00	6 oz. \$3.00

Resis. Ohms	20 Watt		40 Watt		125 Watt	
	Cat. No.	Cur. m. a.	Cat. No.	Cur. m. a.	Cat. No.	Cur. m. a.
0.64	507-600	5,590	507-624	7,910	507-655	14,000
1.00	507-601	4,470	507-625	6,320	507-656	11,200
1.6	507-602	3,540	507-626	5,000	507-657	8,800
2.5	507-603	2,830	507-627	4,000	507-658	7,050
4.0	507-604	2,240	507-628	3,160	507-659	5,600
6.4	507-605	1,770	507-629	2,500	507-660	4,400
10	507-606	1,415	507-630	2,000	507-661	3,500
16	507-607	1,120	507-631	1,580	507-662	2,800
25	507-608	895	507-632	1,260	507-663	2,200
40	507-609	705	507-633	1,000	507-664	1,770
50	507-610	630	507-286	895	507-665	1,580
64	507-611	560	507-635	790	507-666	1,400
100	507-612	445	507-115	630	507-667	1,120
160	507-613	355	507-637	500	507-668	880
250	507-614	285	507-638	400	507-669	705
400	507-615	225	507-639	315	507-670	560
640	507-616	175	507-640	250	507-671	440
1,000	507-617	140	507-641	200	507-672	350
1,600	507-618	110	507-642	160	507-673	280
2,500	507-619	90	507-643	125	507-674	220
4,000	507-620	70	507-644	100	507-675	177
5,000	507-621	65	507-111	90	507-676	158
6,400	507-646	80	507-677	140
10,000	507-647	65	507-678	112



WARD LEONARD

RELAYS

FOR AUTOMATIC CONTROL

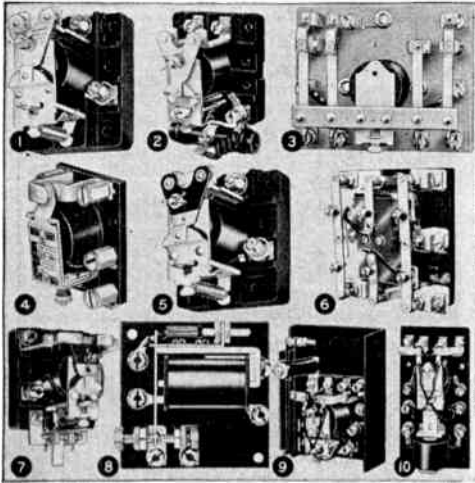

1. REMOTE CONTROL—Single or Double pole, light or heavy duty.
2. UNDERLOAD—Protects class "B" modulator tubes and transformers.
3. BREAK-IN-(Push-to-Talk)-MIDGET TYPE—Handy on phone work. See (6) for Heavy Duty Type of construction.
4. REMOTE CONTROL—Heavy Duty Midget, single pole only, see 507-547.
5. KEYING—For center tap or grid bias keying. Will handle up to 40 words per minute.
6. R. F. ANTENNA CHANGE-OVER—Heavy duty type of construction. See (3) for light duty type of construction.
7. OVERLOAD—Protects tube while tuning and also if excitation fails.
8. SENSITIVE—Operates on 0.014 watts D.C. Can be furnished for use on A.C.
9. THERMAL TIME DELAY—Protects tube by delaying plate voltage until filament has reached operating temperature.
10. LATCH-IN-ARMATURE is held "in" by mechanical latch, tripped electrically.

Description	Cat. No.	CONTACTS					List Price	COIL DATA					
		Poles	Throw	Break	Normal Position	Amps		Voltage		Resist. Ohms	Current m. a.	Watts	
								A.C.▲	D.C.				
Thermal Time Delay.....	507-501	Single	Double	Single	4.	\$15.00	110	2.6	660.	3.0
Remote Control.....	507-503	Double	Single	Single	Open	4.	8.00	6	...	6	16.9	350.	2.1
Remote Control.....	507-504	Double	Single	Single	Open	4.	8.00	...	6	...	2.6	660.	3.0
Remote Control.....	507-505	Double	Double	Single	4.	9.00	6	16.9	350.	2.1
Remote Control.....	507-506	Double	Double	Single	4.	9.00	...	6	...	2.6	660.	3.0
Low Voltage Keying.....	507-507	Single	Single	Double	Open	6.	7.00	6	...	6	16.9	350.	2.1
Low Voltage Keying.....	507-508	Single	Single	Double	Open	6.	7.00	...	6	...	2.6	660.	3.0
Remote Control.....	507-510	Single	Single	Double	Open	6.	7.00	110	1050.	33.	2.5
Remote Control.....	507-511	Double	Double	Single	4.	9.00	110	1050.	33.	2.5
Overload.....	507-512	Single	Single	Double	Closed	6.	8.50	...	4.2	...	16.9	250.	...
Overload.....	507-513	Single	Single	Double	Closed	6.	8.50	...	2.1	...	4.2	500.	...
Underload.....	507-514A	Single	Single	Double	Open	4.	10.00	...	9	...	45.	200.	...
Underload.....	507-515A	Single	Single	Double	Open	4.	10.00	...	6	...	20.	300.	...
Midget Latch-In.....	507-517	Single	Double	Double	6.	14.50	110	715.	40.	4.0
Heavy Duty Remote Control...	507-518	Single	Single	Double	Open	10.	8.80	110	1050.	33.	2.5
Steel Knock-out Box.....	507-519	3.00
Bakelite Cover.....	507-52070
Heavy Duty — R. F. Antenna Change Over.....	507-521A	Double	Double	Single	15.	25.00	110	108.	119.	5.2
Heavy Duty — R. F. Antenna Change Over.....	507-522A	Double	Double	Single	15.	25.00	220	425.	76.	5.8
Heavy Duty — R. F. Antenna Change Over.....	507-523A	Double	Double	Single	15.	25.00	...	6	...	16.	375.	2.3
Heavy Duty—R. F. Break-In...	507-526A	Four	Single	15.	27.50	110	108.	119.	5.2
Heavy Duty—R. F. Break-In...	507-527A	Four	Single	15.	27.50	220	425.	76.	5.8
Heavy Duty—R. F. Break-In...	507-528A	Four	Single	15.	27.50	...	6	...	16.	375.	2.3
Midget—R. F. Antenna Change Over.....	507-531	Double	Double	Single	4.	8.00	110	715.	40.	4.0
Midget—R. F. Antenna Change Over.....	507-532	Double	Double	Single	4.	8.00	...	6	...	10.	600.	3.6
Band Switching.....	507-533	Single	Single	Double	Open	10.	8.50	110	715.	40.	4.0
Midget—R. F. Break-In.....	507-534	Four	Single	4.	11.00	110	715.	40.	4.0
Midget—R. F. Break-In.....	507-535	Four	Single	4.	11.00	...	6	...	10.	600.	3.6
D. C. Sensitive.....	507-539	Single	Double	Single	2.	12.50	...	0.51	...	19.2	25.7	0.014
D. C. Sensitive.....	507-540	Single	Double	Single	2.	12.50	...	1.28	...	120.	10.7	0.014
D. C. Sensitive.....	507-541	Single	Double	Single	2.	13.00	...	3.24	...	765.	4.23	0.014
D. C. Sensitive.....	507-542	Single	Double	Single	2.	13.00	...	5.17	...	1950.	2.65	0.014
D. C. Sensitive.....	507-543	Single	Double	Single	2.	13.50	...	8.07	...	4750.	1.70	0.014
D. C. Sensitive.....	507-544	Single	Double	Single	2.	14.00	...	12.40	...	11300.	1.10	0.014
D. C. Sensitive.....	507-545	Single	Double	Single	2.	18.00	...	20.20	...	31000.	0.65	0.014
Safety Relay.....	507-546	Single	Single	Double	Closed	4.	9.00	110	...	6	715.	40.	4.0
Remote Control Heavy Duty..	507-547	Single	Double	Single	15.	4.70	...	6
Remote Control Heavy Duty..	507-548	Single	Double	Single	15.	4.70	6
Remote Control Heavy Duty..	507-549	Single	Double	Single	15.	5.00	115

▲ 60 Cycles A. C.
 ● With D. P., D. T., S. R. contacts insulated for R. F. and two contacts with standard insulation, one N. O., one N. C.
 ■ Can also be furnished with additional N. O. or N. C. contact not insulated for R. F. Price on application.
 ♦ With one N. O., one N. C., and two D. T. contacts, all S. B. and insulated for R. F.

Advance RELAYS

GENERAL CIRCUIT CONTROL RELAYS Alternating and Direct Current

These sturdy, compact General Circuit Controls are available for operation on both alternating and direct current—Series 100 and 200 respectively—and incorporate many superior construction features not usually found in economically priced lines. "Full Floating" armature suspension, "wiping" contacts, and more than adequate insulation are but a few of their highly desirable qualities.

The switch stacks, composed of

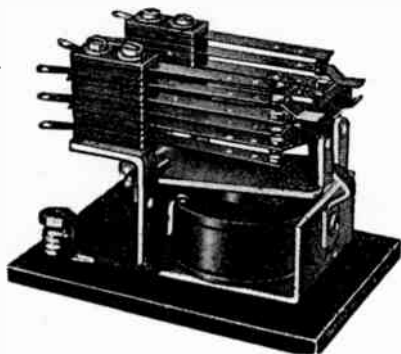

Dimensions—3¼" x 2¼"

die-cut, spring phosphor-bronze blades, Bakelite spacers, and hard rubber sleeving, have a break-down test of 2500 volts, and will give a lifetime of service.

Each unit, mounted on a Bakelite base and equipped with binding posts for the coil connections, is entirely "above ground" and all current carrying screws and terminals are fully counter-sunk to prevent any possibility of "short-circuiting."

PRICE CHART—For Series 100 (A.C.) and Series 200 (D.C.) Relays

CONTACT RATINGS:	1/8"	4.5 AMPS. AT 6 VOLTS TO 1.5 AMPS. AT 115 VOLTS
	3/16"	15 AMPS. AT 6 VOLTS TO 5 AMPS. AT 115 VOLTS
	1/4"	30 AMPS. AT 6 VOLTS TO 10 AMPS. AT 115 VOLTS

Contact Combinations	Type Numbers, Contact Sizes and List Prices					
		1/8" List		3/16" List		1/4" List
SINGLE POLE-SINGLE THROW Normally Open	101	\$4.00	101A	\$4.25	101B	\$4.50
SINGLE POLE-SINGLE THROW Normally Closed	102	4.00	102A	4.25	102B	4.50
SINGLE POLE-DOUBLE THROW	103	4.25	103A	4.50	103B	5.00
DOUBLE POLE-DOUBLE THROW	104	4.50	104A	4.75	104B	5.25
DOUBLE POLE-SINGLE THROW Normally Open	105	4.25	105A	4.50	105B	5.00
DOUBLE POLE-SINGLE THROW Normally Closed	106	4.25	106A	4.50	106B	5.00
THREE POLE-SINGLE THROW Normally Open	107	4.75	107A	5.25	107B	5.75
THREE POLE-SINGLE THROW Normally Closed	108	4.75	108A	5.25	108B	5.75
THREE POLE-DOUBLE THROW	109	5.50	109A	6.00	109B	6.75
FOUR POLE—Two Make—Two Break	110	5.75	110A	6.25	110B	7.25
FOUR POLE-SINGLE THROW Normally Open	111	5.75	111A	6.25	111B	7.25
FOUR POLE-SINGLE THROW Normally Closed	112	5.75	112A	6.25	112B	7.25
FOUR POLE-DOUBLE THROW	113	6.50	113A	7.25	113B	8.75
FIVE POLE-SINGLE THROW Normally Open	114	6.75	114A	7.50	114B	8.75
FIVE POLE-SINGLE THROW Normally Closed	115	6.75	115A	7.50	115B	8.75
FIVE POLE-DOUBLE THROW	116	7.50	116A	8.50	116B	10.00
SIX POLE-SINGLE THROW Normally Open	117	7.75	117A	8.75
SIX POLE-SINGLE THROW Normally Closed	118	7.75	118A	8.75
SIX POLE-DOUBLE THROW	119	8.50	119A	10.50

The above chart, listing A.C. Relays, may also be used when ordering D.C. Relays by Changing the Series Number from 100 to 200. To avoid possible errors, always specify the correct A.C. or D.C. input voltage. The Series 100 Coils are obtainable for any voltage from 1 to 115 A.C.—Series 200 Coils for any Voltage from 2 to 60 D.C. Prices for other voltages will be furnished on request.

Advance RELAYS

Isolantite model Antenna Change-Over. Designed for use in Amateur Transmitters.

The contact system is Double Pole-Double Throw, using $\frac{1}{4}$ " Pure Silver contacts, with exceptional wiping action. Three and four pole arrangements are available on special order.

For high radio frequency control. Entirely hum-

TRANSMITTER RELAYS

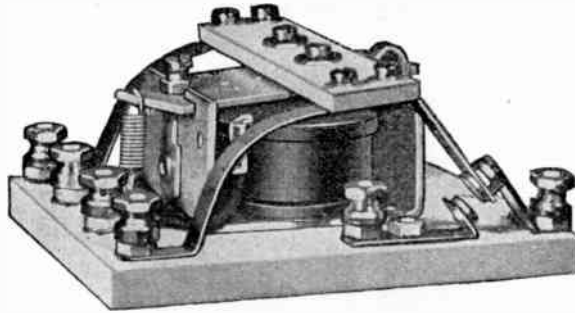

Type 400

free where intended for A.C. operation, and highly efficient on D.C. supplies. All metallic parts are cadmium and chromium plated.

Standard coils are for 110V A.C. and may also be used for 24V D.C. However, they will also be supplied for lower A.C. or D.C. voltages at no increase in price.

List Price\$9.00

KEYING RELAYS

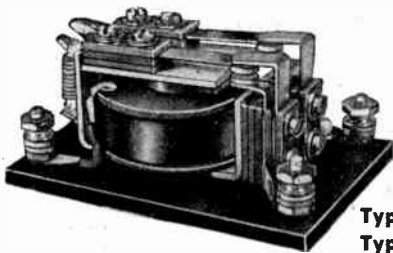

Type 101K—A.C.
Type 210K—D.C.

Designed expressly for use in Keying Circuits where it is desired to use low voltage across the key to control high voltage transmission through the Relay contacts. The heavy duty coil and strong return spring makes possible an exceptional keying speed. Two sets of $\frac{1}{4}$ " Pure Silver contacts in series allow a carrying capacity of 2500 volts. The complete unit, mounted on a $\frac{3}{16}$ " Bakelite base with binding posts for coil connections, has over-all dimensions of 3" x 2" x $1\frac{3}{8}$ " and is obtainable for A.C. operation to 115 volts or D.C. operation to 60 volts.

List Price \$5.00

TIME DELAY RELAYS

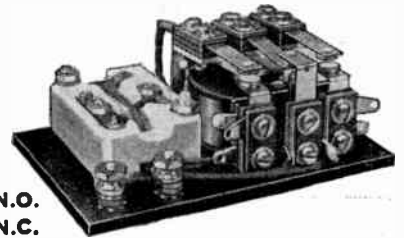

Type 300—N.O.
Type 350—N.C.

Particularly suited for use where short time delays (10 sec. to 1 min.) are required, these Relays are available with both normally open and normally closed thermostats. Types 300 and 350 respectively, the former being widely used for pre-heating tube filaments, etc. The contact combination on both models is Double Pole Single Throw with $\frac{1}{4}$ " Pure Silver contacts. Mounted on $\frac{3}{16}$ " Bakelite bases measuring $3\frac{3}{4}$ " x $2\frac{3}{8}$ " x $1\frac{1}{2}$ " with binding posts for coil connections. Standard operating voltage is 110 A.C. List Price \$7.75

Low voltage units are available on special order.

LATCHING RELAYS

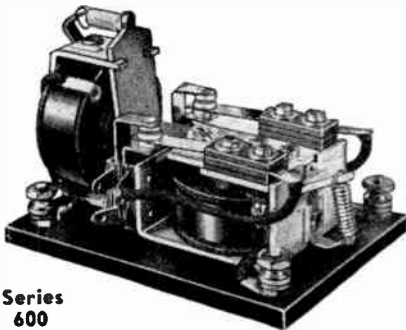

Series 600

These Relays are highly desirable for applications where it is impractical to have the holding coil in constant service. When the coil actuating the contact arrangement is momentarily energized, the armature is locked in the closed position, and may be released electrically (Type 600) or manually (Type 650).

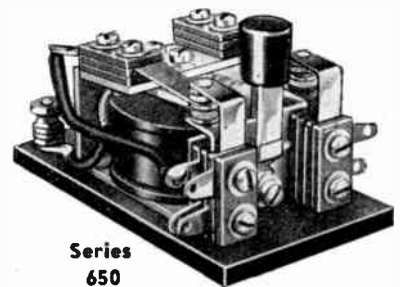

Series 650

	List		List
Type 640B	\$8.75 Double Pole-Double Throw	Type 654B \$6.50
Type 605B	8.50 Double Pole-Single Throw (N. O.)	Type 655B 6.25
Type 606B	8.50 Double Pole-Single Throw (N. C.)	Type 656B 6.25

The above list prices are for $\frac{1}{4}$ " contacts. For $\frac{3}{16}$ " points deduct 25c—for $\frac{1}{8}$ " points deduct 50c. When ordering these types SPECIFY THE VOLTAGE.

Advance RELAYS

OVERLOAD RELAYS

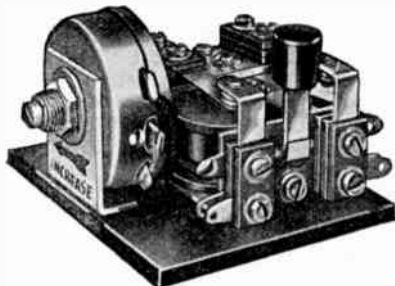

Type 700

These Relays are designed to provide accurate and positive protection against current surges and continuous overloads, and both the Manual Reset (Type 700) and Electrical Reset (Type 750) are divided into two classifications: Type "A" allows the Relay to attract on any current value between 250 and 500 mills, and Type "B" for any setting between 500 mills and 1 ampere. When the current flow passes

the safety setting, the Double Pole-Single Throw $\frac{1}{4}$ " Pure Silver contacts are opened, breaking the power supply circuit until reset.

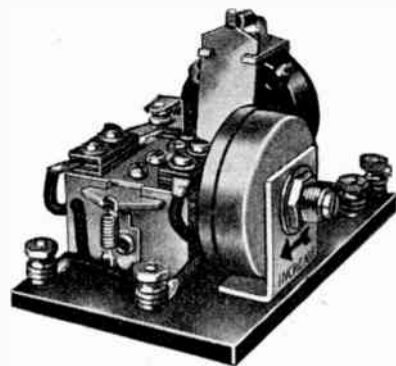

Type 750

Type 700—Base dimensions 3" x 2 $\frac{1}{2}$ "	List Price
Type 750—Base dimensions 4" x 2 $\frac{1}{2}$ "	\$ 9.25
	12.00

MIDGET RELAY

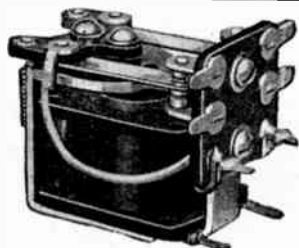

Series 1500 and 1600

Of particular interest where size and cost are factors, this new series of Midget Relays incorporates all of the fine construction features typical of the ADVANCE line. This unit measures only 1 $\frac{1}{2}$ " x $\frac{3}{4}$ " x 1 $\frac{1}{8}$ " high. Pure Silver contacts are used, $\frac{1}{8}$ " in diameter. Standard coils are obtainable from 2 to 32 V D.C. and 1 to 115 V A.C. The following switch combinations can be supplied:

TYPE		CONTACT COMBINATION	LIST PRICES
A.C.	D.C.		
1505	1605	DP-ST NOR. OPEN	\$3.75
1506	1606	DP-ST NOR. CLOSED	3.75
1504	1604	DP-DT	4.00

ELECTRONIC RELAY

An ultra-sensitive unit for use in electronic tube circuits, providing positive, dependable control on as little as 12 milliwatts. Adjustment screws to change the air-gap between the armature and the pole face, allow operation on a voltage differential of 30%, a condition ideal for electronic applications. The contact combination is Single Pole-Double Throw, employing $\frac{1}{8}$ " Pure Silver points to safely handle 100 watt non-inductive loads. Obtainable in resistances of 2500, 3000, 5000 and 10,000 ohms at no increase in price.....List Price...\$6.50

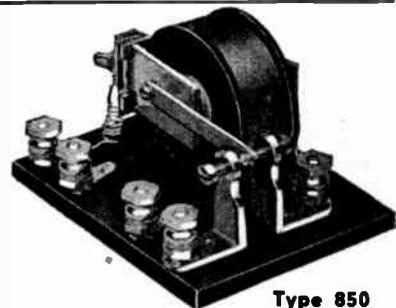

Type 850

GENERAL PURPOSE RELAYS

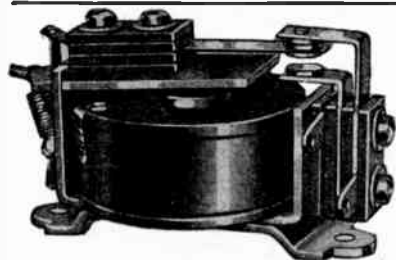

These Relays afford maximum power and efficiency at very low cost. $\frac{1}{4}$ " Pure Silver contacts are standard on the Single Pole-Single Throw (N. O.) Type 951B—Single Pole-Single Throw (N. C.)—952B—and Single Pole- Double Throw—953B—switch combinations. Adequately insulated and entirely above "ground," these Relays may be mounted on any type of panel, quickly and easily, by means of the metal mounting bracket. Coils are obtainable to 115V A. C. or 60V D. C.

List Price\$3.50

GEN-E-MOTOR STARTING RELAY

An exceptionally sturdy power transfer Relay, easily capable of handling the heavy current surge encountered on "cold" starts in motor-generator systems. The contacts are $\frac{3}{8}$ " Pure Silver and have ample carrying capacity for the usual 200-500V converters. Heavy-duty in every phase of construction, this unit is not to be compared with the common five and ten ampere circuit controls. Base dimensions are 3" x 2" and each unit is complete with a braided generator-cable pig-tail and binding posts for all connections. Coils for 5 $\frac{1}{2}$ to 32V D. C. or 1 to 115 A. C.List Price...\$6.00



Type 951C

Advance RELAYS

MIDGET TYPE CIRCUIT CONTROLS

These Relays are designed for general circuit control applications where the space for mounting is limited, and measure only 2½" in length, 1½" in width, and 1¼" in height. A.C. operated Relays in this series require but 4 watts on 50/60 cycle current, and the D. C. models from 1.5 to 2 watts, affording maximum effi-

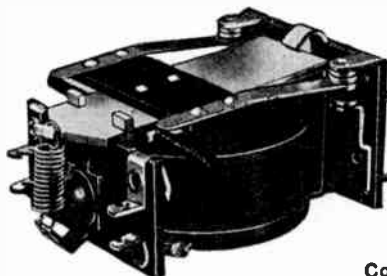

ciency without sacrifice of power and dependability. Metal brackets (not shown in the illustration) are supplied with all Relays of this type, and except on special order, these models are limited to the following contact arrangements and the usual standard operating voltages:

Type Numbers Contact Sizes and List Prices

Contact Combinations	3/16" List	1/4" List	1/4" List
Double Pole-Double Throw	104AM \$5.00	104BM \$5.50	
Double Pole-Single Throw (N. O.)	105AM 4.75	105BM 5.25	
Double Pole-Single Throw (N. C.)	106AM 4.75	106BM 5.25	

The above chart lists type numbers for A.C. operated Relays. D. C. coils may be obtained by changing the series number from 100 to 200. Prices apply to both.

INDUSTRIAL CONTROL RELAYS

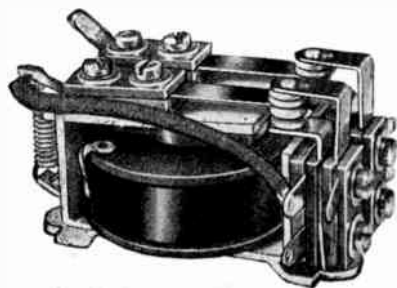

Series 960

Designed mainly for industrial applications — air conditioning, lighting, and power transfer systems, the Series 960 Relays embody all of the rugged construction features demanded in units of this type without sacrificing the desirable qualities of the midget style. Available in the following contact combinations, and to operate on standard A. C. and D. C. voltages.

Type 964B—Double Pole Throw	List \$5.00
Type 965B—Double Pole-Single Throw (N. O.)	4.75
Type 966B—Double Pole-Single Throw (N. C.)	4.75

For smaller contacts, deduct 25c for 3/16" or 50c for ¼" points, from the above list prices.

Having the same characteristics as the Series 960 Relays, these Three Pole units, Series 970, may be used for fractional h/p 3-phase motor controls, etc. The area required for mounting, 2½" x 1½" for Type 970 Relays, as against 2½" x 1¼" for the Type 960's, is due to the slightly larger frame. The metal brackets are the same in both instances—2.5/16" long, and 2" between centers of the 6/32 mounting holes. Available in the voltages indicated in the preceding series, and in the following contact combinations:

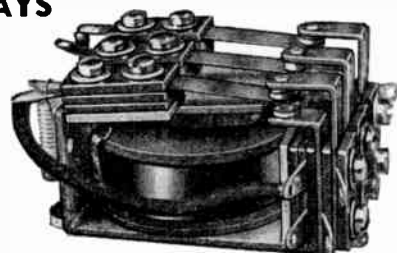

Series 970

Type 977B—Three Pole-Single Throw (N. O.)	List \$5.25
Type 978B—Three Pole-Single Throw (N. C.)	5.25
Type 979B—Three Pole-Double Throw	6.00

For smaller contacts, deduct 50c for 3/16" or 75c for ¼" points from the above list prices.

IMPULSE RELAYS

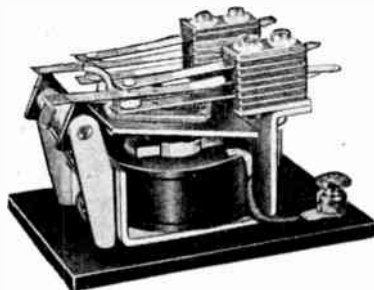

Series 900

This is another type of Relay for use where it is not feasible to have the holding coil in constant service, but differs from the latching types in that it may be controlled with a single push-button. Coils to operate this type of unit are extremely heavy-duty, and are for intermittent (impulse) use only. Available for standard A. C. and D. C. voltages in the following combinations:

	D.P.S.T. List	D.P.D.T. List
With ¼" Pure Silver contacts	\$8.50	\$9.00
With 3/16" Pure Silver contacts	9.00	9.50
With ¼" Pure Silver contacts	9.50	

When ordering these types, be sure to specify the input voltage, contact combination, and size of points.

MIDGET TYPE R.F. RELAYS

These models are sturdy, compact Pole-Double Throw Transmitter Relays, designed expressly for use in all types of mobile-portable communications equipment

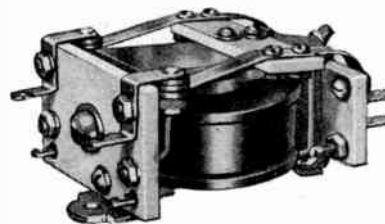

Series 1000—A.C. Series 2000—D.C. where space is at a premium. The insulation on this, as on the Type 400's, is Isolantite for both the cross-arm and end pieces, with all holes adequately well spaced to prevent structural weakness and possible "creepage." Coils are obtainable for all A. C. and D. C. voltages, and will operate in any position, the former consuming approximately four watts—the latter, two watts of power. Dimensions are 2¾" x 1½" x 1¼".

List Price \$7.50

RELAYS BY GUARDIAN

THE MOST COMPLETE LINE OF AMATEUR AND INDUSTRIAL RELAYS

A-100 ANTENNA RELAYS

A-100 Antenna Relays have been designed for the amateur who wants compact, convenient, low cost antenna changeover control.

OPERATING DATA

- Contacts**
 A. Points—Large, fine silver, which give long life even when under heavy overloads.
 B. Insulation — Low loss AISiMag 196.
 C. Switches—Low capacity due to special form.
 D. Control Capacity—Up to 1 KW. either AF or RF circuits, on frequencies up to and including 28 MC. Tested for these ratings under actual operating conditions.

Terminals

- A. Solder lug type, tinned for easy soldering.

Coil

- A. Standard coils operate on 110 volts 50-60 cycles A. C. Coils for other voltages and currents on specification at 10% addition to list price.
 B. Power consumption at above voltage approximately 7 VA.

Mounting

- A. Two holes, single screw. Screw furnished.
 B. May be mounted on any type panel. All terminals are insulated from ground.

Applications

A. Radio:—

- A-100—Antenna changeover, break-in, heavy duty keying in the primary with contacts in parallel, grid controlled rectifier keying, and many other double pole double throw uses.
 A-100-C—For single wire fed antenna installations. Two A-100-C Relays in place of an A-100 in open wire line systems avoid possible mismatch caused by distorting the feed system to provide for relay installation.

B. Industrial:—

- HF and UHF equipment, remote motor control, heating equipment, etc.

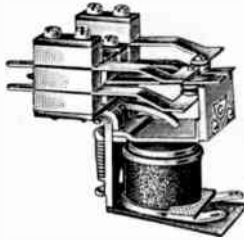

	Length	Width	Height	Shp. Wt.	List Price	Net Price
*A-100	2 3/4"	2"	2 3/8"	7 oz.	\$6.85	\$4.11
*A-100-C	2 3/4"	1"	2 3/8"	6 oz.	3.80	2.28

*Double pole, double throw. †Single pole, double throw.

RC-100 REMOTE LOCKING CONTROL RELAY



RC-100 Remote Locking Control Relays are a Guardian development of the momentary impulse locking control relay. The circuit to the coil needs be energized only long enough to close armature; contacts lock automatically. Each impulse reverses position of contacts.

OPERATING DATA

- Contacts**
 A. Contacts—1/4" fine silver. Can handle up to 1500 watts at 110 volt, 60 cycle, non-inductive AC. Can also be used in AC primary circuit of any inductive power supply delivering up to and including 1 KW.
 B. Insulation—High test Bakelite.
 C. Furnished in two standard combinations:
 1. Four pole single throw. (RC-100-AR)
 2. Three pole. One pole double throw, two poles single throw. (RC-100-BR).
 For combinations other than above, add 10% to list prices.

Terminals

- A. Solder lug type, tinned for easy soldering.

Coil

- A. Standard coils operate on 110 volt, 50 to 60 cycle AC. Coils for other voltages and currents on specification at 10% addition to list prices.

- B. Power consumption—Standard coil requires approximately 23 VA, is for intermittent duty only. Coil is energized only long enough to allow relay to step to the next switch position. Power is consumed for the duration of the energizing impulses only, and remains off until the next switching operation is required.

Mounting

- Mounts on metal base with all terminals insulated.

Applications

- Break in control; phone to CW switching. Any circuit control where locking circuits are used.

	Shp. Wt.	List Price	Net Price
RC-100-AR	8	\$5.75	\$3.45
RC-100-BR	8	6.30	3.78

T-100 TIME DELAY RELAYS

A laminated relay in assembly with a resistance wound thermostatic unit. The laminated construction of the field piece and armature give an efficient, powerful, trouble free time delay relay. Unit is mounted in a tightly closed metal box for protection against dust and dirt.

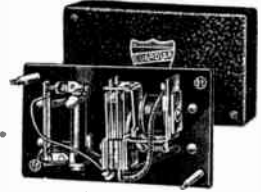

OPERATING DATA

- Contacts** A. Oversize silver contacts give long life, can take severe overloads without damage.
 B. Contact capacity—1500 watts on 110 volt 60 cycle, non-inductive AC. Can also be used in the AC primary of any inductive power supply delivering up to, and including, 1 KW.
 C. Insulation—high test bakelite—tested at 1500 volts for breakdown to ground.
 D. Maximum switch capacity—single pole, single throw.
 E. Time delay—adjustable for any period between 10 and 60 seconds.
 F. After contacts close, thermostat blade is cut out of circuit.
Coil A. Standard unit designed for operation on 110 volt 60 cycle non-inductive AC. For coils operating on other than standard voltage, add 10% to list price.
 B. Power consumption of coil and time delay during closing of thermostatic blade is approximately 10 VA, after closing, 5.5 VA.

Applications

- A. Radio—In transmitter circuits to prevent damage of rectifiers and tube filaments by application of plate current before filaments are sufficiently heated.
 B. Industrial—Any control problem requiring the changing of circuits after a predetermined interval.

T-100—5 1/4" long, 3" wide, 2 1/4" high. Shipping weight 1 1/4 lbs.
 List Price \$13.80 each Net Price \$8.28 each

T-110 TIME DELAY RELAYS

The T-110 is a compact, sturdy, economical time delay relay for use in applications not requiring the capacities of the T-100. Contact capacity—1250 watts on 110 volt, 60 cycle, non-inductive AC. Can also be used in the AC primary circuit of any inductive power supply delivering up to, and including, 1 KW.
 T-110—5 1/8" long, 3 1/4" wide, 2 1/4" high. Shp. Wgt. 8 oz.
 List Price \$8.60 each Net Price \$5.16 each

R-100 HIGH FREQUENCY RELAYS

R-100 Relays are small, efficient, economical, rugged controls designed to give maximum contact capacity in minimum space at low cost.

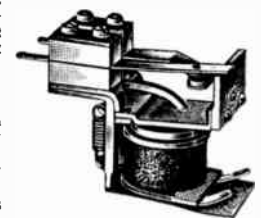

OPERATING DATA

- Contacts**
 A. Points—Large fine silver which give long life even when severely overloaded.
 B. Insulation — Low loss AISiMag 196.
 C. Switches—Special form of leaves gives low capacity.
 D. Contact Capacity—Up to 1 KW at any frequency up to and including 28 MC, on AF and RF circuits.

Terminals

- A. Solder lug type, tinned for easy soldering.
Coil A. Standard coils operate on 110 volt 60 cycles A.C., draw approximately 7 VA.
 B. For coils operating on other voltages or specifications, add 10% to list price.

Mounting

- A. Two holes, single screw. Screw furnished.
 B. May be mounted on any type of panel, as all terminals are insulated from ground.

Applications

- A. Radio—Band switching, high voltage keying, grid controlled rectifier keying, crystal switching, remote control of receiver and transmitter, etc.
 B. Industrial—Oven control, remote motor control, short wave therapy and diathermy, and innumerable RF and UHF uses.

	Wdth.	Hgt.	Shp. Wt. (oz.)	List Price	Net Price
R-100—S.P.S.T., normally open	1"	2"	6	\$3.15	\$1.89
R-100-B—S.P.S.T., normally closed	1"	2 3/8"	6	3.15	1.89
R-100-C—S.P.D.T.	1"	2 3/8"	6	3.80	2.28
*R-100-G—D.P.D.T.	2"	2 1/4"	5 1/2	5.75	3.45

Length for above items: 2 3/4".
 *The R-100-G is TripleX insulated, is rated at 400 watts at 14 megacycles. For applications requiring higher ratings use the A-100.

CIRCUIT DIAGRAMS FURNISHED ON REQUEST

RELAYS BY GUARDIAN

THE MOST COMPLETE LINE OF AMATEUR AND INDUSTRIAL RELAYS

U-100 AND U-200 ADJUSTABLE UNDERLOAD RELAYS

Sensitive, precise, finely constructed instruments designed for long, trouble free service. Relays are encased in attractive black metal container protecting them against dust, dirt, and accidental misadjustment.

OPERATING DATA

Contacts

- A. Points—Oversize, fine silver for long life, can take severe overloads.
- B. Insulation—Bakelite.
- C. Switches—Single pole, single throw, normally open.
- D. Control Capacity—A. C. primary of any power supply delivering up to and including 500 watts. Tested for this rating under actual operating conditions.

Coil

- A. Standard coil operates over an adjustable range of 100 to 200 mils D. C. on the U-100 model; 200 to 400 mils on the U-200 model. Release current value is 75% of the attract current value. Desired attract current is obtained by screw adjustment of the spring tension.
- B. Normal current through coil of U-100 is 300 mils; of the U-200, 600 mils.
- C. At above ratings, the voltage drop through the U-100 coil is 10.5 volts; through U-200 coil, 9 volts.
- D. To prevent possible "talking back" of relay during modulation, it is recommended that a 200 volt condenser of sufficient capacity, usually a 10 mfd., be connected across the relay coil.

Mounting

- A. Preferred mounting position has armature hinge on bottom with armature vertical.
- B. Two insulated mounting studs and protective fibre disc permit mounting on any type of panel.
- C. Two holes, two screws. Screws furnished.
- D. Dust proof metal cover, thumb screw fasteners.

Terminals

Heavy solder lugs, tinned for easy soldering.

Applications

- A. Radio—Protection of class "B" audio equipment in case of class "C" load failure.
 - B. Industrial—Any D. C. circuit where it is desirable to maintain currents above a set value.
- U-100 and U-200 are 3 1/4" in diameter, 2 1/4" high. Shipping weight 14 oz. List Price \$9.75 ea. Net Price \$5.85 ea.



X-100 ADJUSTABLE OVERLOAD RELAYS

Positive precise protection against current surges and continuous overloads. X-100 replaces expensive, unsatisfactory, time wasting fuses, provides flexible control of the current flow.

OPERATING DATA

Contacts

- A. Points—Large, fine silver, for long life. Can take severe overloads without damage, rated for 1500 watts on 110 volt, 60 cycle, non-inductive A. C. and in A. C. primary circuit of any inductive power supply delivering up to and including 1 KW.



- B. Insulation—High test bakelite.
- C. Switches—Single pole, single throw with special constant tension form. Contacts lock open, cannot be reset, or points held in contact, until overload stops.

Terminals

- A. Solder lug type, tinned for easy soldering.

Coil

- A. Adjustable to operate on any current flow from 150 to 650 mils.
- B. Voltage drop across coil is 6.5 volts at 650 mils, 9 volts at 150 mils.
- C. Insulation between coil and ground rated at 200 volts.

Mounting

- A. Single hole. Mounts on rear of panel with reset button extending through panel. Bushing, and lock nut, supplied with relay, hold unit firmly in place. Bushing requires a 1/8" hole.
- B. May be mounted on any type of panel. All terminals are insulated from ground.

Applications

Overload protection in circuits with varying current demands. Adjustability makes this an ideal relay for experimental work with new circuits.

X-100 4" long, 2 1/2" wide, 3 1/2" high. Shipping weight 12 oz.

List Price \$11.50 ea. Net Price \$6.90 ea.

Available in non-adjustable type to operate on 150-250-500-750 mils List Price \$8.60 ea. Net Price \$5.16 ea.

B-100 BREAK IN RELAYS

Specially designed for break-in operation on amateur transmitters. Low current draw and compact assembly, plus use of laminated field piece and armature, make the B-100 an ideal relay for this purpose.

OPERATING DATA

Contacts

- A. Points—1/4" fine silver, capacity to 1500 watts. 60 cycle non-inductive A. C. and in A. C. primary circuit of any inductive power supply delivering up to and including 1 KW.
- B. Insulation—High test bakelite.
- C. Switches—Double pole, double throw, ample capacity.

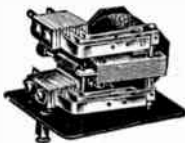

- D. Control Capacity—Break-in circuit on any transmitter up to 1 KW.

Coil

- A. Standard coils operate on 50-60 cycle A. C. 110 volts. Coils for other voltages and currents, on specifications at 10% addition to list price.
- B. Power Consumption—Standard coil requires approximately 8 1/2 VA.

Applications

- A. Break-in circuits in amateur transmitters.
- B-100—2 3/4" long, 2 1/8" high, 2 1/4" wide. Shipping weight 11 oz. List Price \$8.60 ea. Net Price \$5.16 ea.

K-100 KEYING RELAYS

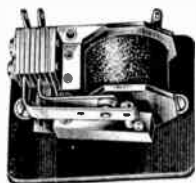

Low voltage relays controlling high voltage transmission. Relay will follow key or bug at highest WPM rate attainable. High speed of response, plus strong magnet and return spring, gives a clean make and break, producing the best CW note.

OPERATING DATA

Contacts

- A. Points—Oversize silver. Handle 1500 watts on 60 cycle non-inductive 110 volt A. C. and in A. C. primary circuit of any inductive power supply delivering up to and including 1 KW.

- B. Insulation—High test bakelite. Unit will withstand 5000 volts to ground.
- C. Switches—Compact, single pole, single throw. Design of

- leaves give exceptionally fast response.
- D. Control Capacity—Up to 2000 volts with clean make and break.

Coil

- A. Standard coils operate on 1 1/2 to 4 volts D. C., 5 to 16 volts A. C. Power consumption on A. C., approximately 1 1/2 V. A., D. C. approximately 1 watt. Coils for other voltages on specification at 10% addition to list price.

Applications

Control of battery receivers, transmitters using filament center tap keying of any stage having up to 2000 volts on plate, primary keying or control of power supplies up to and including 500 watts and grid-controlled rectifier keying of 3000 volt power supplies.

K-100—2 3/4" long, 2 1/4" wide, 1 7/8" high. Shipping weight 10 oz. List Price \$6.30 ea. Net Price \$3.78 ea.

CIRCUIT DIAGRAMS FURNISHED ON REQUEST

ALLIED RELAYS

FOR CURRENT AND VOLTAGE CONTROL EQUIPMENT

DESIGNED, ENGINEERED AND PRECISION BUILT TO CONTROL CIRCUITS AND VOLTAGE IN WAR AND INDUSTRIAL EQUIPMENT.

"AK" A HIGH SPEED KEYING RELAY

AK keys at 20 cycles per second, is magnetically held in either position and does not rely on back spring pressure.

Its contact rating (RF) is 2 amperes at 1,000 volts 20 megacycles . . . (DC) ½ ampere at 500 volts . . . tested at 30,000 ft. altitude.

Coil operation—Standard 12 and 24 volts DC.

AK is a compact, high voltage, high speed, anti-vibration type Keying Relay for break-in operation for radio equipment. It has an alternating magnetic arrangement which provides magnetic holding pressure on both transmit and receive contacts. One pole is equipped with two windings, one of which is a holding winding connected directly across the battery supply. The other winding is connected in series with the single winding on the other pole so that when the circuit is completed thru the key, the flux is neutralized on the holding or receive position pole and the armature pulls up to the transmit position. Opening the key cuts off the bucking flux and the holding flux pulls the armature back to receive position. Its weight is 17 ounces.

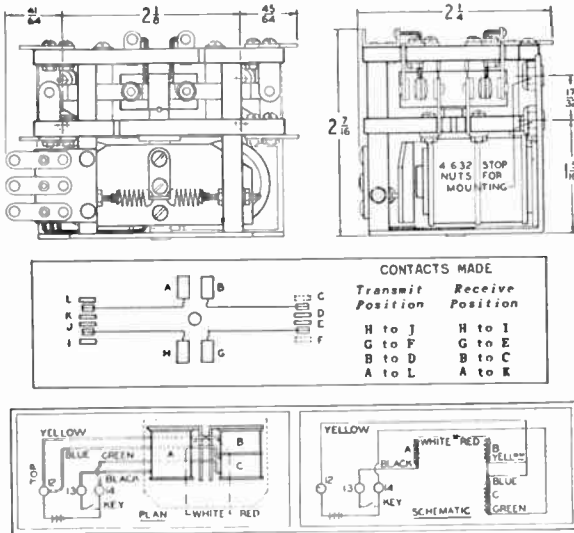

A3 AND A5 HC SEALED SWITCHES

Sealed to give the switch contacts positive protection against the hazards of dirt, dust, oil and sand.

The operating characteristics of these switches are: Contact Arrangements: single pole, single throw, A3 normally closed double break; A5 normally open double break. Contact Rating: non-inductive, 50 amperes at 12 and 24 volts DC and 110 volts AC. Operating Pressure: 1½ to 3½ pounds. Plunger Travel: travel differential 0.006 to 0.012 of an inch. Over Travel: 0.050 to 0.070 of an inch at maximum pressure. Vibration Resistance: 10 G for either horizontal or vertical position. Weight 5 ounces.

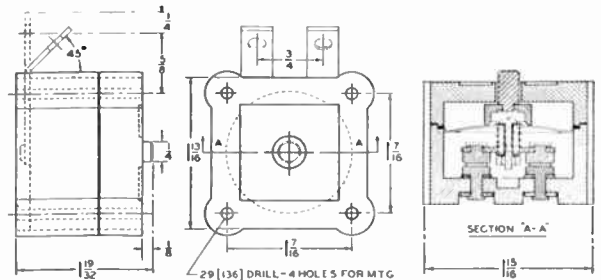

AR AND AS FEATHERWEIGHT RELAYS

AR is a single pole double throw relay with transfer contact grounded to frame. AS is a single pole double throw relay with transfer contact insulated from frame. Their contact ratings are 5 amperes for 12 and 24 volts DC and 110 volts AC, non-inductive. Weights are 50 grams.

ALL ALLIED CONTROL RELAYS ARE DESIGNED TO MEET ARMY, NAVY and CAA SPECIFICATIONS. THEY CAN BE ADAPTED TO MEET SPECIFIC CUSTOMER NEEDS.

Write for Catalog

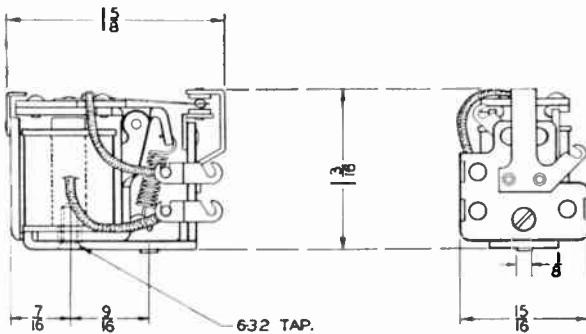

ALLIED CONTROL COMPANY, INC.

2 EAST END AVENUE • (AT 79th STREET) • NEW YORK, N. Y.

FACTORIES: NEW YORK CITY • PLANTSVILLE, CONN. • CHICAGO, ILL.

ALLIED RELAYS

FOR CURRENT AND VOLTAGE CONTROL EQUIPMENT

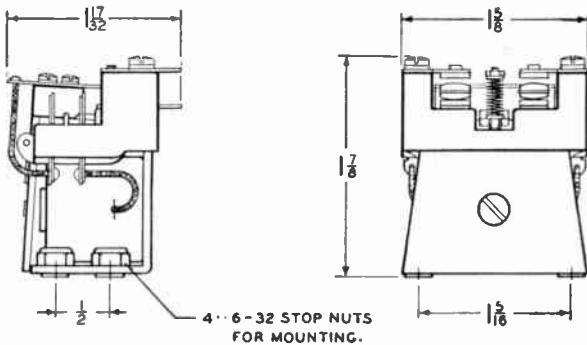

BO 6

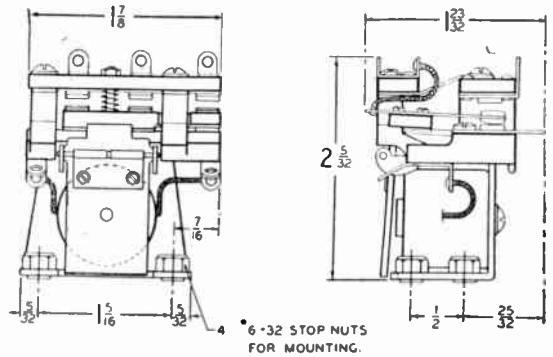

BO 9

"BO" A SMALL POWER RELAY

A compactly designed $2\frac{1}{2}$ watt operating power relay with contacts rated at 15 amperes for 24 volts DC and 110 volts AC. Standard is double pole, double throw. Also made in 3 and 4 pole double throw. BO may be had in either of 6 mounting bases; bakelite, steatite, metal base, stud base or tube base. BO withstands vibration to 12 G., operates at plus 120° C. or minus 50° C. and weighs from 4 to 6 ounces depending upon the base and the contact arrangement.

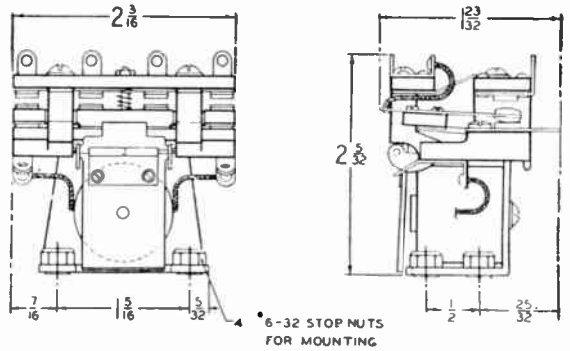

BO 12

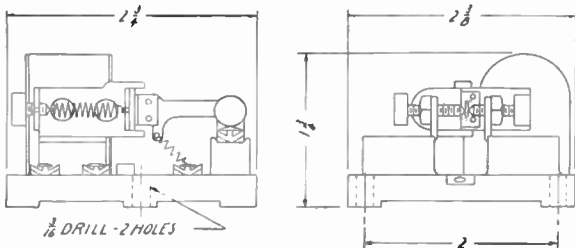

"B" A SENSITIVE RELAY

Operates at 0.12 watts, is single pole double throw and weighs 7 ounces. Maximum contact rating, non-inductive, 48 volts DC at 1 ampere, 110 volts AC at 5 amperes.

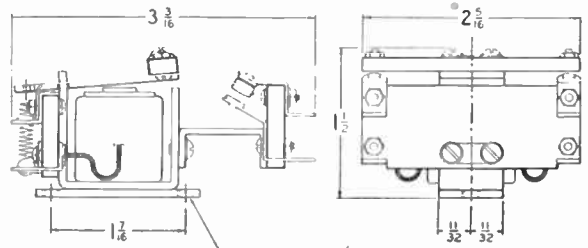

HF RELAY

A double pole double throw relay with Ceramic Contact Plate and Cross Arm of low-loss Steatite. Contact rating is 15 amperes for 12 and 24 volts DC and 110 volts AC non-inductive.

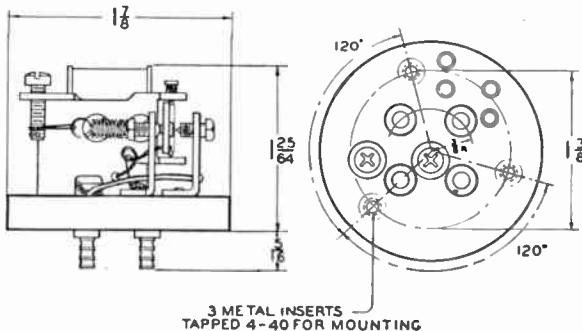

"G" A SENSITIVE RELAY

Single pole, single throw, normally open or closed. Operates at 0.05 and is rated at 1 ampere for 48 volts DC and 5 amperes for 110 volts AC, non-inductive. Weight $3\frac{1}{2}$ ounces.

ALL ALLIED CONTROL RELAYS ARE DESIGNED TO MEET ARMY, NAVY and CAA SPECIFICATIONS. THEY CAN BE ADAPTED TO MEET SPECIFIC CUSTOMER NEEDS.

Write for Catalog



ALLIED CONTROL COMPANY, INC.
2 EAST END AVENUE • (AT 79th STREET) • NEW YORK, N. Y.

FACTORIES: NEW YORK CITY • PLANTSVILLE, CONN. • CHICAGO, ILL.

ALLIED RELAYS

FOR CURRENT AND VOLTAGE CONTROL EQUIPMENT

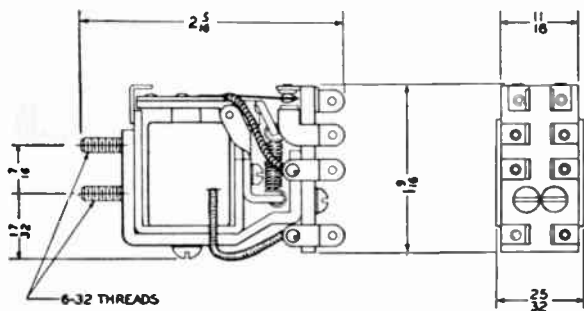

BJ A SMALL POWER RELAY

A small compactly designed 2 watt operating power relay with contacts rated at 5 amperes for 24 volts DC or 110 volts AC. Standard is double pole double throw. Weight is 2 1/4 ounces.

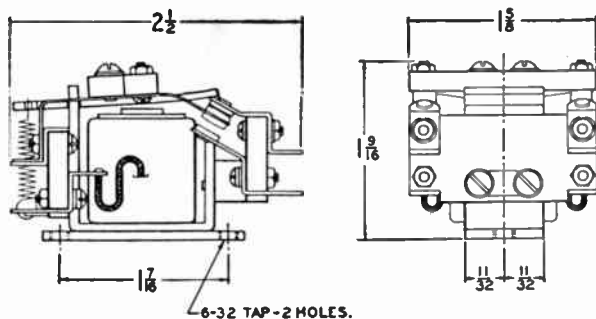

HR RELAY

A double pole double throw relay with Contact Plate of Ceramic and Cross Arm of low-loss Steatite. Operates at 15 amperes for 12 and 24 volts DC and 110 volts AC non-inductive. Weighs 6 ounces.

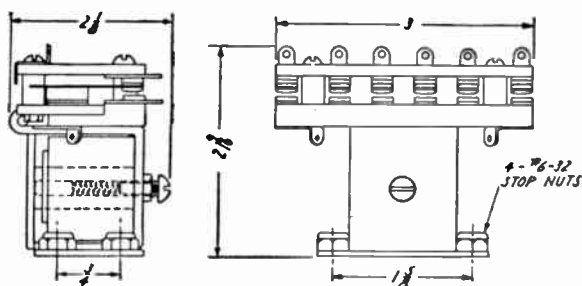

"BN" A MULTIPLE CONTACT RELAY

Contact arrangement is 6 pole double throw. Contact rating (with Silver Contacts) 15 amperes for 12 and 24 volts DC and 110 volts AC. Weight is 9 1/2 ounces.

GJU A TOGGLE LATCHING RELAY

BJU locks mechanically in either position so that momentary current needs to be applied to the coils. Four pole double throw, maximum rating 5 amperes per contact, non-inductive, for 12 and 24 volts DC and 110 volts AC. Weight is 6 1/2 ounces.

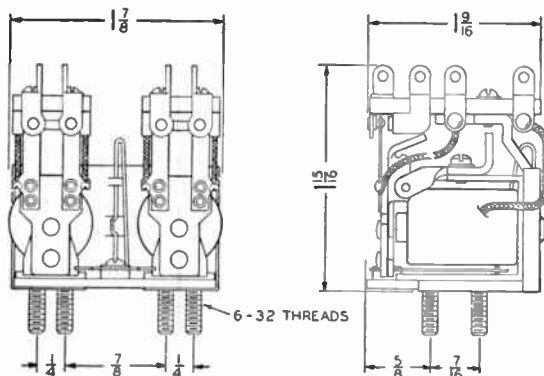

"AN" A POWER RELAY

Contact arrangement is single pole single throw, normally open or closed, double break. Contact rating is (with Silver Contacts) 50 amperes for 12 and 24 volts DC or (Model ANS with Alloy Contacts) 75 amperes for 12 and 24 volts DC. Weight is 9 ounces.

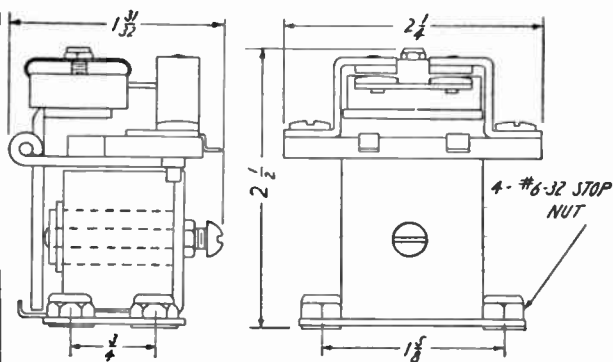

ALL ALLIED CONTROL RELAYS ARE DESIGNED TO MEET ARMY, NAVY and CAA SPECIFICATIONS. THEY CAN BE ADAPTED TO MEET SPECIFIC CUSTOMER NEEDS.

Write for Catalog



ALLIED CONTROL COMPANY, INC.
2 EAST END AVENUE • (AT 79th STREET) • NEW YORK, N. Y.

FACTORIES: NEW YORK CITY • PLANTSVILLE, CONN. • CHICAGO, ILL.



**112-K
KEY**

This key is designed for learners who want something that is scientifically correct but moderate in price. Has black enamel metal base and is mounted on a mahogany finished wood base. Key lever is nickel plated. Contact points are platinum.

List \$2.50

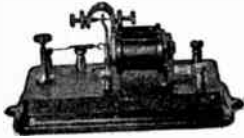

PONY RELAY

All the metal parts on this pony relay are brass with lacquer finish, excepting armature which is polished and plated steel. Magnets are non-adjustable. Mounted on a mahogany finished wood sub base and cast iron black enamel base.

	List
M-104—4 Ohm	\$6.50
M-105—20 Ohm	6.75
M-106—50 Ohm	7.00
M-107—75 Ohm	7.25



**R-48
KEY**

The beginner in the field of wireless approves this 1/4 K. W. Key for its desirability and inexpensiveness. It is well made with polished key lever and lacquered parts. Contact points are platinum.

List \$2.80

R-68 PRACTICE SET

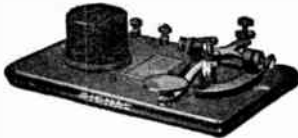

Designed for those who want a well made instrument to learn the code. Set consists of a key and high frequency buzzer mounted on a mahogany finished wood base equipped with binding posts. The code is printed on a plate and fastened to the base between the key and buzzer. Buzzer is adjustable.

List \$4.00

R-60 BUZZER



The R-60 high frequency buzzer is the same type used on the R-68 Wireless Practice Set. It is adjustable and has a standard resistance of 2 Ohms.

Finish is black crystallized lacquer.

List \$1.25

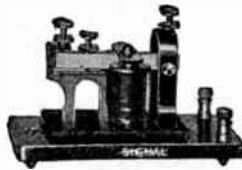

SOUNDER

The tone quality and instant action of this correctly designed sounder are well and widely known. All adjustments are simple and accurate. Bar frame is black enamel and has an aluminum sounding bar, brass bridge and black lacquered steel sounder plate. It is mounted on a mahogany finished wood base equipped with binding posts.

	List
112-S—4 Ohm	\$3.90
113-S—20 Ohm	4.15

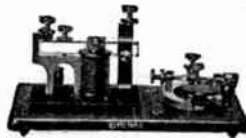

LEARNER SET

On city, private and short lines learners will find this instrument easy to handle and having a clear, distinct tone. Bar frame and key base are black enamel, the bridge is brass, sounding bar is aluminum with black lacquered steel sounder plate. Key lever is nickel plated. Sounder and key are mounted on a mahogany finished wood base.

	List
M-110—4 Ohm	\$5.75
M-111—20 Ohm	6.00



STANDARD KEY

This standard wireless key is designed to carry heavy currents. All brass construction with lacquer finish. Furnished with 3/16, 1/4 or 3/8-inch coin silver contacts. Navy type key knob.

	List
R-62—3/16" contacts	3.50
R-63—1/4" contacts	3.60
R-64—3/8" contacts	3.85

R-70 TWIN PRACTICE SET



In this practice set is represented value that appeals to the beginner. Set includes two R-69 instruments, 75 feet of wire and instruction manual packed in an attractive, illustrative box.

List \$3.75

**M-100
KEY**



For rapid transmitting this key is preferred by skilled operators and beginners. The base, equipped with binding posts, is brass with a lacquer finish. Key lever is nickel plated. Furnished with platinum contact points.

List \$3.40

COMMERCIAL RELAY



The commercial relay is well designed and constructed for long, continuous service on commercial lines. Heel iron and armature are made of Norway iron. Has rubber covered adjustable coils. Mounted on mahogany finished wood sub base and cast iron black enamel base.

	List
916—150 Ohm	\$15.00
917—250 Ohm	15.50

**KEY
R-50**



For the amateur who wants an inexpensive, high grade wireless key, here is the proper instrument. It is equipped with a heavy, cast, well insulated base in a black finish, coin silver contacts, composition knob and nickel parts.

List \$1.75

R-69 PRACTICE SET



The R-69 Practice Set is for those who want an inexpensive instrument. Consists of a key lever, non-adjustable buzzer and code plate mounted on a metal base equipped with binding posts and rubber feet. Has maroon finished base and gold lacquered key lever and buzzer cover.

List \$1.75

To cooperate with the War Effort we reserve the privilege of altering specifications or materials, without notice.

PAR-METAL RACKS · CHASSIS · CABINETS for ELECTRONIC APPARATUS

TYPE "A" ENCLOSED RELAY RACKS

Black Ripple Finish
(Slate Grey Ripple Finish Optional)

This completely enclosed rack will give your job the "professional appearance" so desirable on transmitters, P.A. systems, etc. Substantially constructed from $\frac{1}{4}$ " cold rolled steel; panel mounting angles are of $\frac{1}{8}$ " steel, accurately drilled on universal centers for either type "A" or type "C" panels, tapped for 10/32 machine screws. Panels fit into a recess, so that edges are not exposed. Louvres in sides and screen sections in rear door provide ample ventilation. Rear door is hung on sturdy loose-joint hinges, and closed by two flush snap catches. Shipped "knocked-down" with all necessary bolts for easy assembly. Ample supply of panel mounting screws and washers supplied.



Cat. No.	Overall Size	Panel Space	Wt. lbs.	Net Price
ER203	42 x 21 x 16 1/2"	36 3/4"	75	\$19.80
ER205	66 1/2 x 21 x 16 1/2"	61 1/4"	135	26.40
ER207	82 1/4 x 21 x 16 1/2"	77"	165	32.40

Slate Grey Ripple Finish
(Black Ripple Finish Optional)

The ideal streamlined rack for your next transmitter or P.A. system. The vertical corners at front are rounded. Uniform slate grey ripple finish gives assembly an attractive exterior appearance. Substantially fabricated from $\frac{1}{4}$ " cold rolled steel; the panel mounting angles are of $\frac{1}{8}$ " steel, accurately drilled on universal centers for either type "A" or type "C" panels, tapped for 10/32 machine screws. Panels fit into a recess, so that the edges are not exposed. Louvres in the sides and screen sections in the rear door provide ample ventilation. Rear door is hung on sturdy loose-joint hinges, and closed by two flush snap catches. Shipped "knocked-down" with all necessary bolts for easy assembly.

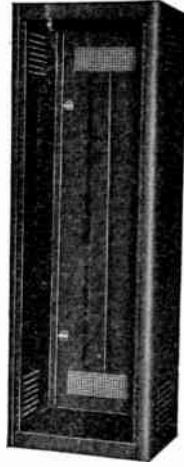

Cat. No.	Overall Size	Panel Space	Wt. lbs.	Net Price
R-213	42 x 22 x 16 1/2"	36 3/4"	100	\$23.10
R-215	66 1/2 x 22 x 16 1/2"	61 1/4"	150	30.60
R-217	82 1/4 x 22 x 16 1/2"	77"	175	36.60

TYPE "A" TRANSMITTER RACKS

Slate Grey Ripple Finish
(Black Ripple Finish Optional)

Produced in the new streamlined style, in keeping with modern design. The removable vertical corner moldings are rounded and cover the panel mounting screws, same as on our type "C" commercial racks (see page H-99). The top, which has also been "streamlined," is perforated at the back to provide additional ventilation. Rack is substantially fabricated from $\frac{1}{4}$ " cold rolled steel; panel mounting angles are of $\frac{1}{8}$ " steel, accurately drilled on universal centers for either type "A" or type "C" panels, tapped for 10/32 machine screws. Louvres in side and screen sections in rear door provide ample ventilation. Rear door is hung on sturdy loose-joint hinges, and closed by two flush snap catches. Shipped "knocked-down" with all necessary bolts for easy assembly.



Cat. No.	Overall Size	Panel Space	Wt. lbs.	Net Price
R-223	43 1/4 x 22 x 18"	36 3/4"	105	\$28.50
R-225	67 1/2 x 22 x 18"	61 1/4"	160	36.60
R-227	83 1/2 x 22 x 18"	77"	185	44.10

TYPE "A" CHANNEL RELAY RACKS

Black Ripple Finish

Ideal for use on all types of transmitters and public address systems. Substantially constructed of $\frac{1}{4}$ " pressed steel. Vertical members and top cross-brace securely welded together. Base is 22" deep and extends both front and rear on the RR-195 rack; it is 19" deep on the RR-193 rack. Panel mounting holes accurately drilled on universal centers for either type "A" or type "C" panels, tapped for 10/32 machine screws. Ample supply of panel mounting screws and finishing washers supplied.



Cat. No.	Overall Size	Panel Space	Wt. lbs.	Net Price
RR-195	73 1/4 x 20 x 22"	71 3/4"	85	\$12.90
RR-193	38 1/4 x 20 x 19"	36 3/4"	57	10.50

Note: Panels to fit these racks are listed on page H-100.

TABLE TYPE

For table mounting. Useful where a regular floor type heavy duty rack is not required. Base constructed of one piece, similar to a chassis. Mounting holes accurately drilled on universal centers, tapped for 10/32 screws. Finished in black ripple enamel and shipped "knocked-down" with all necessary screws. Shipping weight of rack is 20 pounds.



Cat. No.	Overall Size	Panel Space	Net Price
TR-2520	25 x 21 x 12"	21 x 19"	\$4.05
TR-3220	32 x 21 x 12"	28 x 19"	5.25

ROLLER TRUCKS FOR RACKS



STANDARD TYPE

These roller trucks are substantially made from steel with welded corners. The overall size is about 3" wider than the racks, to provide a better distribution of weight. Castors have ball-bearing swivels, with steel wheels. Finish is black ripple enamel.

Cat. No.	Inside Clearance	Wheels	Net Price
RT-400	10 1/2 x 15"	2" Steel	\$4.05
RT-401	21 1/4 x 17"	2" Steel	5.10

DELUXE TYPE

These trucks are especially designed for use on our deluxe streamlined racks, and have rounded corners at the front. Overall size is about 3" wider than the racks for better distribution of weight. Castors are ball-bearing swivel type with steel or rubber composition wheels. Finished in slate grey ripple enamel.

Cat. No.	Inside Clearance	Wheels	Net Price
T-410	21 1/4 x 15 1/2"	2" Steel	\$3.60
T-411	22 3/8 x 17 1/4"	2" Steel	5.40
T-412	22 3/8 x 18 3/4"	2" Steel	6.60
T-415	22 3/8 x 16"	2" Steel	6.60

HINGED STEEL CABINETS

Excellent for housing monitors, oscillators, etc. Full piano hinged doors, front panels removable. Modern grille type ventilation at sides and back; top corner at front is rounded to give attractive appearance. Finished in black ripple enamel. Prices do not include chassis bases.



Cat. No.	H. L. D.	For Chassis	Net Price
CA-100	7 1/4 x 10 1/4 x 8"	5 1/2 x 9 1/2 x 1 1/2"	\$1.65
CA-101	7 1/4 x 8 x 8"	7 x 7 x 2"	1.68
CA-102	7 1/4 x 10 x 8"	7 x 9 x 2"	1.95
CA-103	7 1/4 x 14 x 8"	7 x 13 x 2"	2.16
CA-104	9 x 15 x 10 3/4"	10 x 14 x 3"	3.30
CA-105	12 x 18 x 12"	10 x 17 x 3"	3.90

DELUXE TYPE

Front vertical corners are streamlined, and a panel type door is provided, hung on a full length piano hinge. Ventilating louvres at sides. Opening at rear allows for necessary leads, cables, etc. Finished in slate grey ripple enamel. Prices do not include chassis.

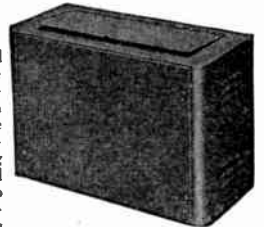

Cat. No.	H. L. D.	Panel Size	For Chassis	Net Price
CA-200	8 x 10 x 8"	8 x 8"	7 x 7 x 2"	\$2.10
CA-201	8 x 12 x 8"	8 x 10"	7 x 8 x 2"	2.25
CA-202	8 x 16 x 8"	8 x 11"	7 x 13 x 2"	2.85
CA-203	9 x 17 x 11"	9 x 15"	10 x 14 x 3"	4.50
CA-204	12 x 20 x 12"	12 x 18"	10 x 17 x 3"	5.40

PAR-METAL RACKS · CHASSIS · CABINETS

for ELECTRONIC APPARATUS

DELUXE TYPE "A" DESK PANEL CABINET RACKS

For Standard 19" Rack Panels
Black Ripple Finish
(Slate Grey Ripple Finish Optional)



Streamlined styling. In keeping with our other Deluxe racks, the vertical front corners are rounded. Panels fit into a recess, so that the edges are not exposed. Panel mounting holes accurately drilled on universal centers, for either type "A" or type "C" panels; holes are tapped for 10/32 machine screws. May be used with any chassis up to 13" x 17" in size. All cabinets rigidly constructed of 1/8" thick cold rolled sheet steel, with all joints electrically welded. Louvres provide ample ventilation through sides and back. Piano type hinges are used on the top doors, which are provided with flush snap catches. Panel mounting screws and washers are furnished.

Cat. No.	Overall Size	Panel Space	Net Price
With door in top only			
D-128	10 1/2 x 21 1/2 x 15"	deep 8 3/4"	\$6.54
D-1225	14 x 21 1/2 x 15"	deep 12 1/4"	8.04
D-1413	15 3/4 x 21 1/2 x 15"	deep 14"	9.24
With door in top and door on rear panel			
D-1713	19 1/4 x 21 1/2 x 15"	deep 17 1/2"	10.98
D-2613	28 x 21 1/2 x 15"	deep 26 1/4"	12.33
D-3513	36 3/4 x 21 1/2 x 15"	deep 35"	13.98

STANDARD TYPE

Black Ripple Finish



Same as above, but with square corners. Ideal for small transmitters, P.A. amplifiers, oscillators, test equipment, and similar apparatus.

Cat. No.	Overall Size	Panel Space	Net Price
With door in top only			
SC-128	8 3/4 x 19 x 14 3/4"	deep 8 3/4"	\$4.80
SC-1225	12 1/4 x 19 x 14 3/4"	deep 12 1/4"	6.00
With door in top and door on rear panel			
SC-1713	17 1/2 x 19 x 14 3/4"	deep 17 1/2"	9.00
SC-2613	26 1/4 x 19 x 14 3/4"	deep 26 1/4"	9.60
SC-3513	35 x 19 x 14 3/4"	deep 35"	11.40

Note: Panels to fit all of above racks are listed on page H-100.

BLANK STEEL CHASSIS BASES



Black Ripple Finish

HEAVY DUTY TYPE

All of the chassis listed on this page may be used with the various Par-Metal racks and cabinets. Substantially constructed for "heavy duty" uses, being formed from one piece of 1/8" sheet steel, with all corners and bottoms reinforced. Bottom covers and mounting screws supplied. Ends drilled to fit standard brackets listed below. Finished in either uniform black ripple enamel or plated.

Black Ripple Cat. No.	*Cadmium Plated Cat. No.	Dimensions W.L.D.	Net Price
15280	15208	8x17x2"	\$1.74
15281	15209	8x17x3"	1.95
15282	15218	11x17x2"	1.95
15210	15219	11x17x3"	2.10
15212	15214	13x17x2"	2.28
15213	15215	13x17x3"	2.49
15216	15217	13x17x4"	2.76

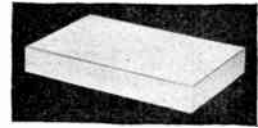

*CADMIUM PLATED

STANDARD TYPE

Construction is the same as our heavy-duty chassis. Stamped from one piece of cold rolled steel, and have four solid sides with welded corners. Bottom edges are flanged in on four sides to provide additional reinforcement, and they are drilled for bottom plates. The chassis are made from #20 gauge steel, except those marked (*) which are stamped from 1/8" steel exactly like our heavy-duty type. Bottom plates have holes to match the chassis, and have pressed "bumpers" at the corners. Both chassis and bottom plates may be obtained in either a uniform black ripple finish, or plated.

Black Ripple Cat. No.	*Cadmium Plated Cat. No.	Size	Net Price
B-4500	C-4500	5 1/2 x 9 1/2 x 1 1/2"	\$0.48
B-4508	C-4508	5x10x3"	.66
B-4509	C-4509	6x14x3"	.78
B-4510	C-4510	7x 7x2"	.57
B-4511	C-4511	7x 9x2"	.66
B-4512	C-4512	7x11x2"	.72
B-4513	C-4513	7x13x2"	.78
B-4514	C-4514	7x15x3"	.99
B-4518	C-4518	4x17x3"	.81
B-4515	C-4515	7x17x2"	.96
B-4531	C-4531	8x17x2"	1.05
B-4532	C-4532	8x17x3"	1.11
B-4525	C-4525	10x12x3"	1.05
B-4524	C-4524	10x14x3"	1.11
B-4528	C-4528	10x17x2"	1.11
B-4526	C-4526	10x17x3"	.99
B-4527	C-4527	10x23x3"	1.32
B-4533*	C-4533*	11x17x3"	1.35
B-4534*	C-4534*	11x17x3"	1.47
B-4516	C-4516	12x17x2"	1.23
B-4517	C-4517	12x17x3"	1.32
B-4530	C-4530	12x17x4"	1.44
B-4535*	C-4535*	13x17x2"	1.62
B-4536*	C-4536*	13x17x3"	1.83
B-4537*	C-4537*	13x17x4"	2.07

* Made from 1/8" thick steel.

BOTTOM PLATES

Black Ripple Cat. No.	*Cadmium Plated Cat. No.	Size	Net Price
BP-4500	CP-4500	5 1/2 x 9 1/2"	\$0.30
BP-4508	CP-4508	5x10"	.30
BP-4509	CP-4509	6x14"	.39
BP-4510	CP-4510	7x 7"	.33
BP-4511	CP-4511	7x 9"	.36
BP-4512	CP-4512	7x11"	.42
BP-4513	CP-4513	7x13"	.45
BP-4514	CP-4514	7x15"	.48
BP-4518	CP-4518	4x17"	.39
BP-4515	CP-4515	7x17"	.51
BP-4531	CP-4531	8x17"	.51
BP-4525	CP-4525	10x12"	.51
BP-4524	CP-4524	10x14"	.54
BP-4528	CP-4528	10x17"	.66
BP-4527	CP-4527	10x23"	.87
BP-4533	CP-4533	11x17"	.69
BP-4516	CP-4516	12x17"	.72
BP-4535	CP-4535	13x17"	.75

* IMPORTANT NOTE: Due to present conditions, we reserve the right to use zinc plating instead of cadmium plating on chassis listed above. If zinc plating is not acceptable, please specify accordingly on your order. We also reserve the right to make substitutions for hardware as specified or illustrated.

SHELVES FOR CABINET RACKS



These shelves are designed to fit into the various enclosed racks listed in this catalog. They are constructed to be mounted inside the rack, with side bolt mounting. All shelves are 1" high and finished in black ripple enamel. Shipping wt. 15 lbs.

Cat. No.	Will Fit Rack No.	Net Price
ER-2012	ER-203, 205, 207; D-128, 1225, 1413, 1713, 2613, 3513	\$1.80
ER-2112	R-213, 215, 217	2.25
ER-2212	R-223, 225, 227	2.25
R-2015	R & P-3675, 6625, 8325	3.15
R-2018	R & P-3618, 6618, 8318	3.15

CHASSIS MOUNTING BRACKETS



These brackets will fit any of the chassis listed above, as the mounting holes are drilled to match. Panels must be at least 7" high. Finished in black ripple enamel.

Cat. No.	Dimensions	Shpg. Wt.	Net Price
SB-78	For 8" Base	2 lbs.	\$0.54
SB-710	For 10" Base	2 lbs.	.75
SB-711	For 11" Base	3 lbs.	.81
SB-713	For 13" Base	3 lbs.	.99

PAR-METAL RACKS · CHASSIS · CABINETS for ELECTRONIC APPARATUS

SLOPING FRONT CABINETS



May be readily adapted as instrument cases for use in studios, laboratories, etc. Top corner is rounded, which when combined with the slate grey ripple finish makes a very attractive case. A chassis may be mounted to front panel and removed as a unit. Rear of case is adequately ventilated, with an opening for necessary connections. Prices do not include chassis.

Cat. No.	H.W.D.	Size of Chassis	Net Price
F-500	8x8x8"	7x7x2"	\$2.04
F-501	8x10x8"	7x9x2"	2.19
F-502	8x14x8"	7x13x2"	2.49
F-503	9x18x8"	7x17x3"	3.51
F-504	12x18x12"	10x17x3"	4.41

DELUXE SLOPING FRONT Amplifier Foundation Chassis

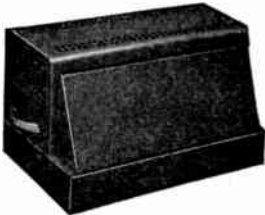

Latest trend in amplifier design. Combination of sloping front panel and streamlined cover enables you to build up a job similar to that used on commercial deluxe type amplifiers. All parts finished in slate grey ripple enamel. Front panel removable and protrudes 3" from face of screen cover. Chassis supplied complete WITH bottom plates.

Cat. No.	Chassis Size	Screen Cover	Net Price
10120	10x12x3"	6 1/2" high	\$4.11
10170	10x17x3"	6 1/2" high	4.86
13170	13x17x3"	6 1/2" high	5.46

STANDARD Amplifier Foundation Chassis



Rounded corners effectively streamline the covers on these units. Grille type ventilation gives them a modern appearance. Chassis stamped from one piece of cold rolled steel, with corners securely spot welded. Covers finished in slate grey, chassis in black ripple enamel. Chassis are drilled for bottom plates. Handles can be mounted at both ends of the cover at an addition of 42c net.

Cat. No.	Size	Depth of Cover	Shpg. Wt.	Net Price
F-510	5x10x3"	6"	9 lbs.	\$1.65
F-615	6x14x3"	6"	10 lbs.	1.92
F-717	7x17x3"	6"	11 lbs.	2.40
F-1012	10x12x3"	6"	11 lbs.	2.40
F-1017	10x17x3"	6"	13 lbs.	2.91
F-1317	13x17x3"	6"	15 lbs.	3.26

TYPE "C" TRANSMITTER RACKS

Similar to standard type "C" racks listed at right except that they have been reinforced at rear corners for use with heavier apparatus. At the rear, knockouts are provided for conduit and 4" square duct, as well as a double convenience outlet with receptacle. Knockouts are also supplied at sides for conduit, suitable for entry of cables when units are ganged. The rear door, which is removable, has ample louvres for ventilation, and is covered on the inside with copper mesh screening. Front trim rounded on vertical corners. Racks are regularly supplied with corner trim for use as a sin-unit, but will be furnished with suitable front connecting strips for ganging in rows of two or more without additional charge.

FINISH: Black ripple enamel with dull black corner trim as standard. Slate grey ripple enamel furnished without additional charge, if so specified. For grey lacquer finish, add 8% to prices. PANELS: Type "C" panels to fit the G-2218 and G-2219 racks are listed on page H-100. For coat of 30" panels to fit the G-3024 rack, add 100% to prices of 19" panels on page H-100.



Cat. No.	Overall Size	Shpg. Space	Wt. lbs.	Net Price
G-2218	76 1/4 x 22 x 18"	19" Panels	270	\$69.45
G-2219	83 1/2 x 22 x 18"	19" Panels	290	78.45
G-3024	76 1/4 x 33 x 24"	30" Panels	450	121.95

Standard Speaker Cabinets

These cabinets are given a streamline appearance by rounded front corners. They are substantially made from sheet steel, with a louvred back cover. Keyhole slots are provided in back cover for wall hanging. Finished in black ripple enamel.

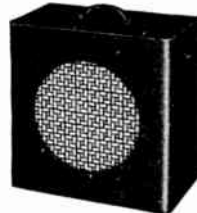

Cat. No.	Hole Size	Spkr. Size	Cabinet Size	Shpg. Wt.	Net Price
C-996	4 3/4"	6"	10x10x6	8 lbs.	\$2.25
C-1170	6 1/2"	8"	12x12x7	9 lbs.	2.76
C-1380	9"	10"	14x14x8	15 lbs.	3.60
C-1580	11"	12"	16x16x8	20 lbs.	4.80

STEEL METER CASES



These meter cases may be obtained for 2" and 3" meters. Substantially made from steel, with welded joints, and finished in black ripple enamel. Top front corner is rounded to harmonize with streamlined equipment. Size is 4 1/4" x 4" x 4".

Cat. No.	Meters	Meter Hole	Net Price
SM-12	Single 2"	2 1/4"	\$0.75
SM-13	Single 3"	2 1/8"	0.75

TYPE "C" CABINET RACKS With Louvres

Professional type racks used on many commercial installations. All-steel construction, welded into an integral unit, to give a lifetime of service. Panel mounting screws concealed by means of full length corner trim on each side at front, rounded on vertical corners. Rear corners finished with regular angle trim. Door has grille at top and bottom, and is hung on sturdy loose-joint hinges; it is held closed by two flush snap-action catches. Additional ventilation provided by louvres at sides. Panel mounting angle irons are 3/8" thick, with mounting holes accurately drilled and tapped 1/24 thread on multiple 1/4" — 1/2" spacings. Rack is made from 1/4" thick cold rolled steel, rigidly braced and reinforced throughout; bottom is 3/8" thick steel. Rectangular opening in bottom for conduits, leads, etc. Opening in back under door for installation of duplex outlet if required.

FINISH: BLACK RIPPLE; if slate grey ripple is desired, substitute letters "RC" instead of "R", when ordering.

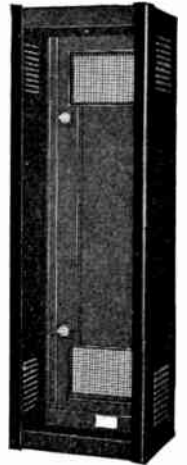

15 1/4" Deep Racks

Cat. No.	Overall Size	Panel Space	Wt. lbs.	Net Price
R-3675	42 1/4 x 22 x 15 1/4"	36 3/4"	150	\$37.50
R-6625	67 3/4 x 22 x 15 1/4"	61 1/4"	210	49.50
R-8325	83 3/4 x 22 x 15 1/4"	77"	240	67.50

18" Deep Racks

Cat. No.	Overall Size	Panel Space	Wt. lbs.	Net Price
R-3618	42 1/4 x 22 x 18"	36 3/4"	160	40.50
R-6618	67 3/4 x 22 x 18"	61 1/4"	230	54.00
R-8318	83 3/4 x 22 x 18"	77"	280	72.00

Without Louvres

Same design and construction as above. To permit racks to be set up in gangs or rows of two or more, the louvres at sides are omitted. Racks may be joined by a flat trim fastened to front of adjacent support angles, overlapping both racks. Knockout holes 1 1/4" are provided at sides to permit connections. Shipped with corner trim as illustrated; where specified, front joining without additional charge in place of corner trim.

FINISH: BLACK RIPPLE; if slate grey ripple is desired, substitute letters "PG" instead of "P", when ordering.

15 1/4" Deep Racks

Cat. No.	Overall Size	Panel Space	Wt. lbs.	Net Price
P-3675	42 1/4 x 22 x 15 1/4"	36 3/4"	150	\$37.50
P-6625	67 3/4 x 22 x 15 1/4"	61 1/4"	210	49.50
P-8325	83 3/4 x 22 x 15 1/4"	77"	240	67.50

18" Deep Racks

Cat. No.	Overall Size	Panel Space	Wt. lbs.	Net Price
P-3618	42 1/4 x 22 x 18"	36 3/4"	160	40.50
P-6618	67 3/4 x 22 x 18"	61 1/4"	230	54.00
P-8318	83 3/4 x 22 x 18"	77"	270	72.00

PANELS AND RACK SHELVES to fit Type "C" Cabinets are listed on page H-100.

PAR-METAL RACKS · CHASSIS · CABINETS for ELECTRONIC APPARATUS

TYPE "C" STEEL RACK PANELS — 19" WIDE

For Racks with Multiple 1¼" - ½" Spacings

BLANK PANELS



These panels are made from 1/8" thick steel and are uniformly slotted to fit type "C" cabinet racks shown on page H-99 and all type "A" racks. They will also fit any other rack equipment having multiple 1¼x½" spacings or what is commonly termed as "W.E. spacing." There are twelve standard sizes available to fill almost every requirement. They may be obtained in either black ripple enamel, slate grey ripple enamel, or grey lacquer as specified below.

Black Ripple Finish

Cat. No.	Width	Shpg. Wt.	Net Price
6600	1¾"	2 lbs.	\$0.48
6601	3½"	5 lbs.	0.54
6602	5¼"	7 lbs.	0.63
6603	7"	8 lbs.	0.75
6604	8¾"	9 lbs.	0.90
6605	10½"	10 lbs.	1.11
6606	12¼"	12 lbs.	1.32
6607	14"	13 lbs.	1.50
6608	15¾"	14 lbs.	1.68
6609	17½"	15 lbs.	1.89
6610	19¼"	16 lbs.	2.01
6611	21"	17 lbs.	2.28

Slate Grey Ripple Finish

Cat. No.	Width	Shpg. Wt.	Net Price
G-6600	1¾"	2 lbs.	\$0.48
G-6601	3½"	5 lbs.	0.54
G-6602	5¼"	7 lbs.	0.69
G-6603	7"	8 lbs.	0.75
G-6604	8¾"	9 lbs.	0.90
G-6605	10½"	10 lbs.	1.11
G-6606	12¼"	12 lbs.	1.32
G-6607	14"	13 lbs.	1.50
G-6608	15¾"	14 lbs.	1.68
G-6609	17½"	15 lbs.	1.89
G-6610	19¼"	16 lbs.	2.01
G-6611	21"	17 lbs.	2.28

Grey Lacquer Finish

Cat. No.	Width	Shpg. Wt.	Net Price
6630	1¾"	2 lbs.	\$0.72
6631	3½"	5 lbs.	0.78
6632	5¼"	7 lbs.	0.87
6633	7"	8 lbs.	0.99
6634	8¾"	9 lbs.	1.26
6635	10½"	10 lbs.	1.47
6636	12¼"	12 lbs.	1.77
6637	14"	13 lbs.	1.98
6638	15¾"	14 lbs.	2.16
6639	17½"	15 lbs.	2.40
6640	19¼"	16 lbs.	2.70
6641	21"	17 lbs.	3.00

These panels are made from 1/8" thick steel and are uniformly slotted to fit type "C" cabinet racks shown on page H-99 and all type "A" racks. They will also fit any other rack equipment having multiple 1¼x½" spacings or what is commonly termed as "W.E. spacing." They may be obtained in either black ripple enamel or slate grey ripple enamel.

GRILLE PANELS

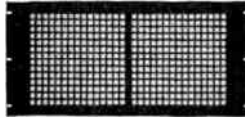

This modern type ventilating grille panel is stamped into the panel itself; it is not a pieced assembly.

Catalog Number	Panel Size	Grille Size	Net Price
P-661	G-661 5¼"	3¾x14¾"	\$1.80
P-662	G-662 7"	4¾x14¾"	1.95
P-663	G-663 8¾"	6¾x14¾"	2.40
P-664	G-664 8¾"	*3¾x14¾"	2.10
P-665	G-665 10½"	8¾x14¾"	2.55
P-666	G-666 10½"	*5¾x14¾"	2.25
P-667	G-667 12¼"	*7¾x14¾"	2.70

*Allows 3½" space at bottom for chassis mounting.

GRILLE DOOR PANELS

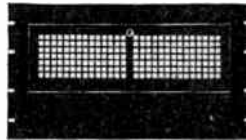

These panels have flush hinged doors with modern type ventilating grille. Doors are equipped with piano hinges, chrome knob and concealed snap catch. All doors start 1" from top to allow space for chassis at bottom. Regular chassis brackets may be used if desired.

Catalog Number	Panel Size	Door Size	Net Price
P-680	G-680 8¾"	4½x15¾"	\$3.15
P-681	G-681 10½"	6 x15¾"	3.45
P-682	G-682 12¼"	7½x15¾"	3.90

SOLID DOOR PANELS



These panels have flush hinged doors with full length piano hinges; they are equipped with a chrome knob and concealed snap catch. All doors are located 1" from top to allow space for chassis at bottom. Regular chassis brackets may be used if desired.

Catalog Number	Panel Size	Door Size	Net Price
P-670	G-670 8¾"	4½x15¾"	\$2.34
P-671	G-671 10½"	6 x15¾"	2.58
P-672	G-672 12¼"	7½x15¾"	3.00

METER PANELS

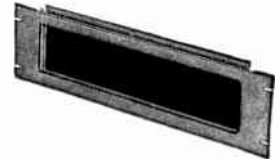

These panels are made so that the meters may be recessed from the front of the panel. Meters are protected by a plate glass insert, allowing 3/4" clearance in back of panel. A blank bakelite sub-panel is provided. The clear sub-panel space is 4 1/8"x15" on the 19" wide panel which is sufficient for 4-3" meters. On the 24" and 30" wide panel the clear sub-panel space is 5 1/4"x20" and 5 1/4"x26" respectively.

Cat. No.	Cat. No.	Size	Net Price
P-690	G-690	5¼x19"	\$3.90
P-691	G-691	7 x24"	6.60
P-692	G-692	7 x30"	9.00

STANDARD DESK PANELS



These standard tables are rigidly made of 1/8" thick furniture steel. The rounded front corners are of seamless construction and the flanges of the shelf are folded in to provide smooth edges underneath. They are securely mounted to regular 1/4" steel panels, size 10½"x19". They may be obtained in two sizes and finishes as listed below. The tables are 22" wide to give full working space across the front of the racks when mounted in place. Shipping weight is 35 lbs.

Cat. No.	Width	Depth	Finish	Net Price
BT-2220	22"	20"	Black enamel	\$9.30
BT-2216	22"	16"	Black enamel	8.70
AT-2220	22"	20"	Grey lacquer	9.90
AT-2216	22"	16"	Grey lacquer	9.30

TYPEWRITER DESK PANELS



These tables are similar in construction to standard desk type except that a recess 4 1/2" deep is provided for using a standard typewriter. They are securely mounted on regular 1/4" steel panels, 10 1/2"x19", and are 22" wide to give full working space across the front of the rack. Shipping weight is 40 lbs.

Cat. No.	Width	Depth	Finish	Net Price
BY-2220	22"	20"	Black enamel	\$12.00
AY-2220	22"	20"	Grey lacquer	12.60

NOTE: ALL PRICES ON THIS PAGE HAVE BEEN CHANGED. WRITE FOR NEW LISTING.

BUD RADIO PRODUCTS

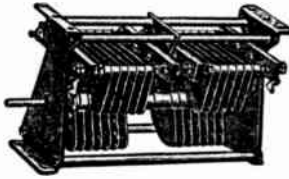

MASTER TRANSMITTING CONDENSERS

For greater efficiency. Heavy aluminum rounded plates. Aluminum end plates, rigid frame, close fitting cone type bearings. Phosphor bronze rotor contact. Mycalex insulation. Made in SINGLE, DUAL and ULTRA HIGH FREQUENCY types. Panel space required $3\frac{1}{8}'' \times 3\frac{3}{4}''$.

Cat. No.	Max. Cap.	Min. Cap.	No. Plates	Air Gap	Length Behind Panel	Net Price
BC-1600	40	7	5	.100"	$3\frac{3}{8}''$	\$ 4.05
BC-1601	55	8	7	.100"	$4''$	4.44
BC-1602	70	9	9	.100"	$4\frac{1}{8}''$	4.80
BC-1603	100	13	13	.100"	$4\frac{1}{4}''$	5.01
BC-1604	150	17	17	.100"	$5\frac{1}{8}''$	5.25
BC-1605	250	22	29	.100"	$7\frac{1}{2}''$	6.00
BC-1606	340	27	39	.100"	$9\frac{1}{2}''$	7.20
BC-1607	25	10	5	.200"	$4\frac{1}{8}''$	4.50
BC-1608	35	11	7	.200"	$4\frac{1}{4}''$	4.80
BC-1609	50	13	11	.200"	$5\frac{1}{8}''$	5.10
BC-1610	75	16	15	.200"	$6\frac{1}{8}''$	5.40
BC-1611	100	20	21	.200"	$8\frac{1}{4}''$	5.70
BC-1612	145	35	29	.200"	$10\frac{1}{8}''$	6.90
BC-1613	85	14	9	.300"	$5\frac{1}{4}''$	5.10
BC-1614	55	18	15	.300"	$8''$	6.00
BC-1615	75	21	21	.300"	$10\frac{1}{8}''$	6.90
BC-1616	100	28	29	.300"	$12\frac{3}{8}''$	7.50
BC-1617	30	15	9	.375"	$6\frac{1}{4}''$	5.40
BC-1618	50	22	15	.375"	$9\frac{1}{4}''$	6.30
BC-1619	75	28	25	.375"	$13\frac{1}{4}''$	7.50

MASTER DUAL CONDENSERS

Cat. No.	Max. Cap.	Min. Cap.	No. Plates	Air Gap	Length Behind Panel	Net Price
BC-1620	80	9	7	.070"	$6\frac{3}{8}''$	\$6.00
BC-1621	100	10	9	.070"	$6\frac{1}{2}''$	6.60
BC-1622	150	12	13	.070"	$7\frac{1}{2}''$	7.20
BC-1623	250	15	21	.070"	$9\frac{1}{2}''$	9.00
BC-1624	40	10	5	.100"	$6\frac{1}{4}''$	6.00
BC-1625	55	8	7	.100"	$6\frac{3}{8}''$	6.30
BC-1626	70	9	9	.100"	$7\frac{1}{8}''$	6.90
BC-1627	100	13	13	.100"	$8\frac{1}{8}''$	7.50
BC-1628	150	17	17	.100"	$9\frac{3}{8}''$	8.40
BC-1629	200	20	23	.100"	$11\frac{1}{8}''$	9.00
BC-1630	35	12	7	.200"	$8\frac{3}{8}''$	6.90
BC-1631	50	13	11	.200"	$10\frac{3}{8}''$	8.10
BC-1632	75	16	15	.200"	$12\frac{1}{4}''$	9.00
BC-1633	100	20	21	.200"	$15\frac{1}{8}''$	9.60
BC-1634	50	15	13	.300"	$13\frac{3}{8}''$	9.30

MASTER U.H.F. CONDENSERS

Cat. No.	Max. Cap.	Min. Cap.	No. Plates	Air Gap	Length Behind Panel	Net Price
1635	25	7	5	.200"	$7\frac{3}{8}''$	\$ 9.30
1636	35	11	7	.200"	$8\frac{3}{8}''$	10.20
1637	50	13	11	.200"	$10\frac{1}{4}''$	11.10
1638	75	16	15	.200"	$12\frac{1}{8}''$	12.00

STAT-AIR CONDENSERS

Keeping a proper L/C ratio in all-band operation is now simplified by using a variable air condenser as a vernier and plug Fixed Stat-air sections in parallel with the tank tuning condenser for lower frequency operation. Brass plates with rounded edges are solder welded to their shafts for sturdy, uniform, low loss construction. Alsimag 196 insulation. Fitted with standard banana plugs. Cadmium plated finish.



Junior Type

Cat. No.	Cap.	Air Gap	Mtg. Area	Net Price
777	25 mmfd.	.144"	$1\frac{1}{4}'' \times 1\frac{1}{2}''$	\$1.98
780	50 mmfd.	.144"	$1\frac{1}{4}'' \times 1\frac{1}{2}''$	2.31
781	100 mmfd.	.144"	$1\frac{1}{4}'' \times 1\frac{1}{2}''$	2.97
782	100 mmfd.	.078"	$1\frac{1}{4}'' \times 1\frac{1}{2}''$	2.49
783	150 mmfd.	.078"	$1\frac{1}{4}'' \times 1\frac{1}{2}''$	2.97

Senior Type

Cat. No.	Cap.	Air Gap	Mtg. Area	Net Price
778	25 mmfd.	.238"	$2'' \times 2\frac{1}{4}''$	\$2.31
784	50 mmfd.	.238"	$2'' \times 2\frac{1}{4}''$	2.64
785	100 mmfd.	.100"	$2'' \times 2\frac{1}{4}''$	2.64
786	100 mmfd.	.238"	$2'' \times 2\frac{1}{4}''$	3.30
787	150 mmfd.	.100"	$2'' \times 2\frac{1}{4}''$	3.15

JUNIOR TRANSMITTING CONDENSERS

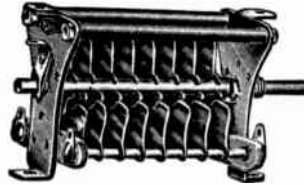

A new conception in design and construction make these condensers ideal for use in low and medium power transmitters. Recommended for portable and air-craft equipment where efficient, light weight, small size and rigid construction are a factor. Satin Finished Aluminum end plates have two formed brackets for universal mounting and coil supports. Plates are Cadmium plated hard temper brass with edges rounded and solder welded to their respective shafts for uniform spacing and low loss construction. Dural tie rods add rigidity to frame. Brass bearings. Phosphor bronze contacts. Alsimag 196 insulation. Panel space required $2\frac{3}{4}'' \times 3''$.

Cat. No.	Max. Cap.	Min. Cap.	No. Plates	Air Gap	Length Behind Panel	Price Net
1525	50	4	7	.051"	$2\frac{1}{4}''$	\$1.65
1526	100	6	13	.051"	$2\frac{3}{8}''$	1.80
1527	145	7	19	.051"	$3\frac{1}{8}''$	2.13
1528	250	11	33	.051"	$4\frac{1}{8}''$	2.64
1529	340	15	43	.051"	$5\frac{1}{8}''$	3.30
1530	25	4	5	.078"	$2\frac{3}{8}''$	1.62
1531	35	4	7	.078"	$2\frac{3}{8}''$	1.71
1532	55	6	11	.078"	$3\frac{1}{8}''$	1.89
1533	80	7	15	.078"	$3\frac{3}{8}''$	1.98
1534	110	9	21	.078"	$4\frac{1}{8}''$	2.31
1535	150	12	29	.078"	$4\frac{3}{8}''$	2.79
1536	190	15	37	.078"	$5\frac{1}{8}''$	3.45
1537	245	17	47	.078"	$6\frac{1}{8}''$	4.11
1538	20	5	7	.144"	$3''$	1.80
1539	40	7	13	.144"	$3\frac{1}{4}''$	1.98
1540	55	9	17	.144"	$4\frac{1}{8}''$	2.31
1541	80	12	25	.144"	$5\frac{1}{8}''$	2.64
1542	105	15	33	.144"	$7\frac{1}{8}''$	3.06
1543	18	5	7	.175"	$3\frac{3}{8}''$	1.98
1544	40	9	15	.175"	$4\frac{1}{8}''$	2.64
1545	55	10	19	.175"	$4\frac{3}{8}''$	2.97
1546	85	16	31	.175"	$6\frac{1}{8}''$	3.30
1547	100	17	37	.175"	$8\frac{1}{4}''$	3.96

JUNIOR DUAL CONDENSERS

Cat. No.	Max. Cap. Per Sec.	Min. Cap. Per Sec.	No. Plates Per Sec.	Air Gap	Length Behind Panel	Net Price
1550	20	8	3	.051"	$8\frac{1}{4}''$	\$2.31
1551	50	5	7	.051"	$4\frac{1}{4}''$	2.79
1552	70	5	9	.051"	$4\frac{3}{8}''$	3.30
1553	100	6	13	.051"	$5\frac{1}{8}''$	3.60
1554	145	7	19	.051"	$6\frac{1}{8}''$	4.29
1555	200	9	25	.051"	$6\frac{3}{8}''$	4.80
1556	250	11	33	.051"	$7\frac{1}{8}''$	5.61
1557	25	4	5	.078"	$4\frac{1}{8}''$	2.79
1558	35	4	7	.078"	$4\frac{1}{8}''$	2.97
1559	55	6	11	.078"	$5\frac{1}{8}''$	3.30
1560	80	7	15	.078"	$6\frac{1}{8}''$	3.81
1561	110	9	21	.078"	$7\frac{1}{8}''$	4.11
1562	150	11	29	.078"	$8\frac{1}{8}''$	4.95
1563	20	5	7	.144"	$5\frac{1}{8}''$	3.30
1564	40	7	13	.144"	$7\frac{1}{8}''$	3.60
1565	55	9	17	.144"	$8\frac{1}{8}''$	3.87
1566	18	5	7	.175"	$5\frac{1}{8}''$	3.60
1567	40	9	15	.175"	$8\frac{3}{8}''$	4.11

JUNIOR U.H.F. CONDENSERS Dual Types Only Plates .040 Thick

No. Cat.	Cap. Max. Per Sec.	Cap. Min. Per Sec.	Plates No. Per Sec.	Gap Air	Length Panel Behind	Net Price
1569	200	9	25	.051"	$6\frac{3}{8}''$	\$5.40
1570	25	4	5	.070"	$4\frac{1}{8}''$	3.00
1571	35	4	7	.070"	$4\frac{1}{8}''$	3.60
1572	55	6	11	.070"	$5\frac{1}{4}''$	4.20
1573	80	7	15	.070"	$6\frac{1}{8}''$	4.80
1574	20	5	7	.186"	$5\frac{1}{8}''$	4.05
1575	40	7	13	.186"	$7\frac{1}{8}''$	4.50
1576	55	9	17	.186"	$8\frac{1}{8}''$	5.10

**SEE BUD CATALOG FOR OTHER CONDENSERS
AND ITEMS NOT LISTED ON THESE PAGES**

NOTE: ALL PRICES ON THIS PAGE HAVE BEEN CHANGED. WRITE FOR NEW LISTING.

RADIO PRODUCTS

TINY MITE CONDENSERS

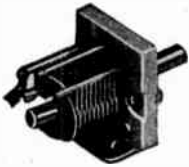

For efficient tuning of ultra-high frequency circuits. Alsimag 196 insulation. Soldered brass plate assemblies, cadmium plated. Rear shaft extension for ganging. Three way mounting. Mounting space $1\frac{1}{2} \times 1\frac{1}{4}$ ".

Cat. No.	Max. Cap. mmfd.	Min. Cap. mmfd.	Air Gap	Net Price
LC-1640	8	2.5	.017"	\$0.57
LC-1641	13	3	.017"	.63
LC-1642	25	4	.017"	.72
LC-1643	35	5	.017"	.84
LC-1644	50	6	.017"	.90
LC-1645	75	7	.017"	.99
LC-1646	100	9	.017"	1.08
LC-1647*	140	12	.017"	1.38
LC-1648	10	4	.037"	.66
LC-1649	15	5	.037"	.84
LC-1650	25	5.5	.037"	.99
LC-1651	35	6	.037"	1.11
LC-1652*	50	8	.037"	1.32
LC-1653	6	3.5	.073"	.75
LC-1654	15	5.5	.073"	.93
LC-1655*	25	9	.073"	1.23

* Indicates DOUBLE BEARING type.

TINY MITE DUAL CONDENSERS

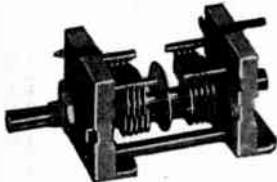

The two end pieces are held together firmly with insulated tie rods, and a separate round plate on the rotor rod is provided to shield the two stator sections.

Cat. No.	Cap. per sec.		Air Gap	Net Price
	Max.	Min.		
LC-1660	15	3	.017"	\$1.32
LC-1661	25	4	.017"	1.44
LC-1662	50	6	.017"	1.65
LC-1663	100	9	.017"	1.80
LC-1664	10	4	.037"	1.50
LC-1665	15	5	.037"	1.65
LC-1666	25	5.5	.037"	1.80
LC-1667	35	6	.037"	1.98

TINY MITE AIR PADDERS



Holds constant capacity under varying atmospheric conditions or vibration. Fits into $1\frac{1}{2}$ " dia. coil form. Ideal for trimming, tuning or padding components used in high frequency circuits.

Cat. No.	Max. Cap. mmfd.	Min. Cap. mmfd.	Air Gap	Net Price
LC-1681	25	4	.017"	.72
LC-1682	50	6	.017"	.84
LC-1683	75	7	.017"	.93
LC-1684	100	9	.017"	1.05

UNIVERSAL NEUTRALIZING CONDENSERS

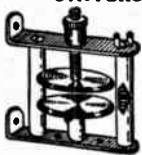

Can be mounted with plates in either horizontal or vertical position for most efficient layout. Solid frame construction. Two heavy duty Alsimag 196 pillars insulate rotor from stator. All metal parts are aluminum. Plates are rounded and buffed.

Cat. No.	Plate Dia.	Recommended for	Net Price
1000	1 1/2"	T40, 35T, HF100	\$1.65
1001	2 1/4"	T200, 250T, etc.	2.40
1002	4 3/4"	750T, etc.	3.30

MIDGET CONDENSERS

A superior built condenser for mid line tuning. Positive wiping contact with screw adjustment eliminates mechanical noises on high frequencies. Isolantite insulation. Soldered brass plate assemblies. Heavy aluminum end plates with closely fitted bearings for smooth operation. Carefully designed and constructed for maximum efficiency. Extended shaft from rear for ganging several units.

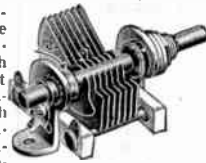

Cat. No.	Max. Cap. mmfd.	Min. Cap. mmfd.	Plates	Net Price
926	15	3	3	\$0.75
900	20	3	3	.78
902	35	4	5	.84
903	50	5	7	.90
904	80	6	11	1.05
905	100	6	14	1.23
906	140	7	19	1.32
907	150	7	21	1.44
908	200	9	27	1.59
909	250	10	33	1.65
910	325	12	43	1.98

MULTI-SPACED MIDGET CONDENSERS

Cat. No.	Max. Cap. mmfd.	Min. Cap. mmfd.	Air Gap	Net Price
565	15	4	.060"	\$0.99
897	35	6	.060"	1.11
898	50	7	.060"	1.32
899	75	8	.060"	1.71
941	100	10	.060"	1.98
965	35	9	.095"	1.32
966	50	11	.095"	1.65
967	75	14	.095"	1.98

DUAL MIDGET CONDENSERS

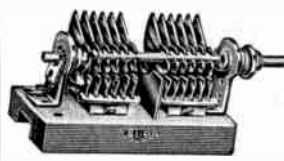

For short wave receivers and low power transmitters. Mounted on ceramic base. Construction similar to single midget condensers.

Cat. No.	Cap. per Sect.		Air Gap	Net Price
	Max.	Min.		
911	100	6	.024"	\$1.98
912	140	7	.024"	2.31
913	35	5	.060"	1.98
942	20	4	.060"	1.98
329	35	9	.095"	2.31
330	50	7	.060"	2.31
331	75	8	.060"	2.61

COMPACT NEUTRALIZING CONDENSERS



Tubular construction makes them extremely compact. No. NC-1928 uses ceramic insulation and is intended for use with 1000 volts or less. Nos. NC-1929 and NC-1930 use Lucite insulation and are for use with 2000 and 3000 volts respectively.

Cat. No.	Cap. Mmfd.	Recommended for	Net Price
NC-1928	.25 to 4	807, 6L6, etc.	\$0.33
NC-1929	.25 to 4.75	HK-54, TZ-40, etc.	.75
NC-1930	1 to 9.5	100T, T-125, etc.	.96

BUD MIDGET CONDENSERS

These condensers are of the straight line frequency type. Panel or base mounting. Isolantite insulation. Closely fitted single end bearing for constant and definite capacity. Soldered brass plate assemblies.



Cat. No.	Max. Cap. mmfd.	Min. Cap. mmfd.	Plates	Net Price
324	10	2	2	\$0.54
328	15	3	3	.54
323	20	3	3	.54
322	35	4	5	.60
148	50	5	7	.66
901	80	6	11	.75
321	100	6	14	.78
396	140	7	19	.87
320	150	7	21	.96

SINGLE BEARING DUAL-SPACED CONDENSERS

Spacing between plates .060".

Cat. No.	Max. Cap. mmfd.	Min. Cap. mmfd.	Net Price
327	6	2	\$0.54
311	15	4	.66
319	35	6	.81
312	50	7	.90

MIDGET CONDENSERS



SEMI-CIRCULAR PLATE TYPE

Identical in construction to Bud Midline condensers except that plate design is semi-circular or straight-line capacity. Rotor plate diameter is $1\frac{1}{2}$ ".

DOUBLE BEARING—SINGLE SPACING

Cat. No.	Max. Cap. mmfd.	Min. Cap. mmfd.	Air Gap	Net Price
MC-1850	15	4	.024"	\$0.78
MC-1852	35	5	.024"	.84
MC-1853	50	6	.024"	.90
MC-1855	100	7	.024"	1.23
MC-1857	150	9	.024"	1.47
MC-1858	200	9	.024"	1.59
MC-1859	250	10	.024"	1.65
MC-1860	320	13	.024"	1.98

MULTI-SPACING

MC-1861	15	5	.060"	\$0.99
MC-1862	35	7	.060"	1.11
MC-1863	50	8	.060"	1.32
MC-1864	75	10	.060"	1.71
MC-1865	100	13	.060"	1.98
MC-1866	35	9	.095"	1.32
MC-1867	50	10	.095"	1.65
MC-1868	75	14	.095"	1.98

SINGLE BEARING—SINGLE SPACING

MC-1870	15	4	.024"	\$0.51
MC-1872	35	5	.024"	.57
MC-1873	50	6	.024"	.63
MC-1875	100	7	.024"	.75
MC-1876	140	7	.024"	.81

DOUBLE SPACING

MC-1879	15	5	.060"	\$0.60
MC-1880	35	7	.060"	.75
MC-1881	50	8	.060"	.84

6L6 NEUTRALIZING CONDENSER



For 6L6, 6V6, 807, RK41, RK39, etc. Small, compact and well built. Heavy 1" dia. aluminum plates with edge rounded and polished. Thumb nut locking device.

Cat. No.	Capacity mmfd.	Net Price
890	.5 to 9	\$0.60

NOTE: ALL PRICES ON THIS PAGE HAVE BEEN CHANGED. WRITE FOR NEW LISTING.

BUD RADIO PRODUCTS

SECTIONAL CABINET RELAY RACK



Build a cabinet rack to your required height without having waste space. A complete rack from 3 1/2", progressing in multiples of 1 1/2" to any desired height. Side wall sections are 14 1/2" deep. Front and back flanges drilled and tapped for 10-32 screw. Fit both W.E. and Amateur type rack panels. Dust covers can be supplied as listed. Made from heavy gauge steel, finished in durable black crackle. Supplied with necessary hardware.

No.		Net Price
1300	—Base Assembly—	
	Size 20 1/4" x 15 3/4" x 2 1/2".....	\$3.00
1301	—Top Cover. 19 1/4" x 14 1/4" x 1 1/2" ..	1.65

Side Wall Sections

Consist of two side wall sections complete with mounting brackets, bolts, nuts, etc.

Cat. No.	Size	Net Price
1302	3 1/2" x 14 1/2"	\$1.35
1303	5 1/2" x 14 1/2"	1.50
1304	7" x 14 1/2"	1.65
1305	8 3/4" x 14 1/2"	1.98
1306	10 1/2" x 14 1/2"	2.19
1307	12 1/2" x 14 1/2"	2.64
1308	14" x 14 1/2"	2.79
1309	15 1/2" x 14 1/2"	3.00
1310	17 1/2" x 14 1/2"	3.30
1311	19 1/4" x 14 1/2"	3.45
1312	21" x 14 1/2"	3.60

Dust Cover Back Sections

Slotted to fit standard rack drilling.

Cat. No.	Size	Net Price
1313	3 1/2" x 19"	\$0.51
1314	5 1/2" x 19"	.60
1315	7" x 19"	.66
1316	8 3/4" x 19"	.84
1317	10 1/2" x 19"	.99
1318	12 1/2" x 19"	1.14
1319	14" x 19"	1.35
1320	15 1/2" x 19"	1.50
1321	17 1/2" x 19"	1.65
1322	19 1/4" x 19"	1.80
1323	21" x 19"	1.98

MIDGET RELAY RACKS



An ideal unit for that low power transmitter, amplifier or test panel. Made of heavy gauge sheet steel. Black crackle enamel finish. Drilled to fit 19" rack panels. Light in weight, sturdily built. Shipped knocked down with necessary hardware. Easy to assemble.

No. 1248—Over-all height 24", width 20". Depth of base 12". Panel space 21".
Net Price \$3.75

No. 1249—Over-all height 31", width 20". Depth of base 12". Panel space 28".
Net Price \$4.95

PROFESSIONAL CABINET RACKS



A sturdy, stylish rack for Commercial, Amateur and Industrial use. Made from 16 gauge steel throughout. Black crackle finish. Drilled and tapped for 10-32 screw to fit either W.E. or Amateur notched rack panels. Sides louvred for ample ventilation. Hinged rear door has two snap catches. Shipped knocked down with all screws, nuts and washers.

No. 874 — Height 47", width 21", depth 17". Panel space 42".

Net Price \$21.60

No. 875 — Height 66 1/2", width 21", depth 17". Panel space 61 1/4".

Net Price \$26.70

No. 884—Height 82", width 21", depth 17". Panel space 77".

Net Price \$32.40

GENERAL CABINET RACKS

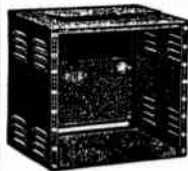

Ideal for transmitters, Public Address and Laboratory equipment. Made from 1/2" thick, cold rolled steel. Beautifully finished in black crackle. All joints welded. Louvred for ventilation. Drilled and tapped 10-32 for either W.E. or Amateur notched 19" rack panels. Hinged doors have nickel plated snap catch. No. 697 and 698 have solid top construction.

Trim can be supplied for above racks. See Bud Catalogue.

No.	H.	W.	D.	Panel Space	Net
694	9"	x19 1/2"	x13 3/4"	8 3/4"	\$4.80
695	10 3/4"	x19 1/2"	x13 3/4"	10 1/2"	6.00
696	17 1/2"	x19 1/2"	x14 1/2"	17 1/2"	9.00
697	26 1/2"	x19 1/2"	x14 1/2"	26 1/4"	9.75
698	35 1/4"	x19 1/2"	x14 1/2"	35"	11.40

STANDARD RELAY RACKS



Made to standard specifications. 1/2" x 3" steel channels braced with 1/2" steel brackets. Holes drilled and tapped 10-32. Will fit W.E. or Amateur notched 19" rack panels. Black crackle finish. Shipped knocked down with necessary hardware.

No. 1263—Over-all height 35 1/2", width 20", Base Depth 22", Panel space 31 1/2". Shpg. Wght. 32 lbs.

Net Price \$9.60

No. 1264—Over-all height 70 1/2", width 20", Base depth 22", panel space 66 1/2". Shpg. Wght. 45 lbs.

Net Price \$11.40

No. 1265 — Heavy Duty commercial type. Height 72 1/2", width 20", Base depth 15", Panel space 66 1/2". Shpg. Wght. 90 lbs.

Net Price \$21.60

STREAMLINE CABINET RACKS



Rounded corners at the front of these cabinets add an ultra-modern touch to an already pleasing appearance. Constructed from heavy 16 gauge steel. Trimmed at top and bottom with chrome strip moulding. Drilled and tapped 10-32 to fit either W.E. and/or Amateur notched rack panels. Sides are louvred for ventilation. Full length rear door has two snap catches. Overall width is 22". Inside depth clearance 16". Supplied with interlock switch bracket for safety. Shipped knocked down with all necessary hardware for easy assembly. Finished in Crackle enamel, GREY or BLACK optional as requested. Sides without louvres for bays can be supplied when so ordered.

in Crackle enamel, GREY or BLACK optional as requested. Sides without louvres for bays can be supplied when so ordered.

Cat. No.	Overall Height	Panel Space	Shipping Weight	Net Price
CR-1771	47"	42"	100 lbs.	\$26.40
CR-1772	66 1/2"	61 1/4"	140 lbs.	31.50
CR-1773	82"	77"	166 lbs.	37.50

STREAMLINE GENERAL CABINET RACKS

A beautiful streamline effect has been added to these cabinets by putting a radius on the front vertical edges. These are ideal housings for transmitters, Amplifiers, etc. Panels are recessed to fit flush with front of cabinet. Drilled and tapped 10-32 to fit either W.E. or Amateur notched rack panels. All sizes have recessed hinged cover in top with snap catch. The three larger sizes also have hinged rear door with snap catch. Chrome trim moulding is attached to top and bottom of cabinet. Overall width 22", depth 14 1/2" GREY or BLACK crackle finish optional. Shipped completely assembled with all necessary hardware.



Cat. No.	Panel Space	Overall Height	Net Price
CR-1741	8 3/4"	10 3/4"	\$ 7.50
CR-1742	12 3/4"	14 3/4"	9.00
CR-1743	17 3/4"	19 3/4"	12.00
CR-1744	26 3/4"	28 3/4"	13.50
CR-1745	35"	37"	15.00

SMALL CABINET RACK

This small, inexpensive cabinet is ideal for emergency transmitters and has many other uses. Made of sheet steel, welded corners, hinged rear door has key lock. Overall size 18" wide, 21 1/4" high, 10" deep. Will take chassis 8 1/2" deep x 15" wide. Black crackle finished. Supplied complete with one



Cat. No.	Shipping Weight	Net Price
RC-1749	25 lbs.	\$7.50

ASK FOR A COMPLETE BUD CATALOGUE

NET

H-103

NOTE: ALL PRICES ON THIS PAGE HAVE BEEN CHANGED. WRITE FOR NEW LISTING.

RADIO PRODUCTS

OSCILLOSCOPE CABINETS



A size for 1", 2" and 3" cathode-ray tubes. Ideal for housing experimental television equipment. Rounded front corners. Louvres on sides for ventilation. Black crackle finish. Supplied complete with chassis and bakelite terminal strip.

Cat. No.	Height	Width	Depth	Chassis Size	Net Price
C-1754	7"	8"	7 1/2"	7 1/2 x 5 1/4 x 1 1/2"	\$3.60
C-1755	8"	8 1/2"	11"	10 1/2 x 5 1/4 x 2"	4.20
C-1756	9 1/4"	9 1/4"	15"	14 1/2 x 5 1/4 x 3"	4.80

SLOPING PANEL CABINETS

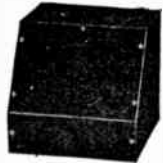

Excellent as housings for field strength meters, frequency meters, laboratory equipment, etc. The entire front panel is removable so chassis can be attached. Vertical portion of panel is 2 1/4" high for mounting dial plates. Made of sheet steel, solidly welded and black crackle finished.

Cat. No.	Width	Depth	Height	Net Price
C-1584	7"	7 1/4"	6 1/2"	\$1.95
C-1585	9"	7 1/4"	6 1/2"	2.25
C-1586	11"	7 1/4"	6 1/2"	2.55

METAL CARRYING CASES



Ideal for housing portable transceivers, amplifiers, etc. Removable front and rear panels. Ruggedly constructed yet light in overall weight. Black crackle finished. All seams and corners reinforced and spot welded. Substantial leather carrying handle.

Cat. No.	Size	Net Price
1096	6" x 7" x 12"	\$1.59
1097	7" x 7 1/4" x 15"	1.95
1100	7" x 10" x 10"	1.80

SPEAKER CABINETS



For housing loud speakers in portable and permanent installations. Solidly constructed from cold rolled sheet steel. Fully enclosed. Back cover louvred for ventilation. Metal grill over speaker opening protects speaker. Black crackle finish. Has carrying handle.

Cat. No.	Speaker Size	Cabinet Size	Net Price
471	6"	9x 9x6	\$2.25
472	8"	11x11x7	2.76
473	10"	13x13x8	3.60
474	12"	15x15x8	4.80

STREAMLINE AMPLIFIER FOUNDATIONS

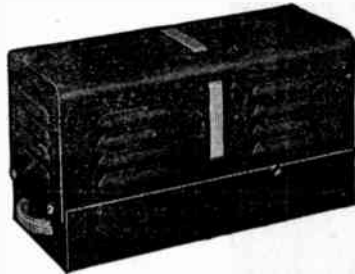

Rounded edges on cover. Grill work in top and louvres in sides of cover for ventilation. Chrome trim and handles. Cover attached by chrome thumb screws. Overall height 9", chassis height 3". BLACK or GREY crackle finish optional.

Cat. No.	Chassis Width	Chassis Depth	Net Price
CA-1750	10"	5"	\$2.40
CA-1751	12"	7"	2.85
CA-1752	17"	7"	3.45
CA-1753	17"	10"	3.90

AMPLIFIER FOUNDATION KIT

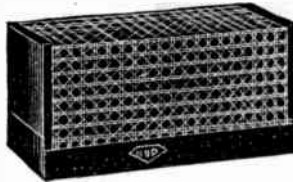

An amplifier built on these foundation kits will have real professional appearance. Chassis is formed from heavy-gauge cold-rolled steel. Corners are folded over and welded. Shield cover is sheet metal perforated in cane design. Finished in black crackle. Chassis furnished undrilled.

No.	Overall Size	Chassis Height	Net Price
699	5" x 9 1/2" x 8 1/4"	2 1/2"	\$1.50
1125	5" x 13 1/2" x 8 1/4"	2 1/2"	1.77
1126	7" x 17" x 8 1/4"	2 1/2"	2.19
1127	10" x 17" x 8 1/4"	3"	2.70
1128	10" x 12" x 8 1/4"	3"	2.25

METER CASES



A convenient and safe means for making portable instruments out of any 2" and 3" round or square panel mounting meters. Several sizes for 1, 2 and 3 meters. Made of sheet steel, Black Crackle finish. Size 4" deep, 4 1/2" high. Insulators supplied only on one meter cases.

Cat. No.	Meters	Hole Dia.	Net Price
CM-1241	1	2 1/2"	\$0.90
CM-1687	2	2 1/2"	1.35
CM-1688	3	2 1/2"	1.80
CM-1242	1	2 1/2"	.90
CM-1689	2	2 1/2"	1.35
CM-1690	3	2 1/2"	1.80

BUD BOX TYPE SHIELDS

These shields are recommended to shield transformers, audio chokes, variable gang condensers, etc., and isolate them from other circuits in the instrument, thereby eliminating magnetic and electrostatic interference. Made from cold rolled sheet steel. All seams and corners spot welded for rigidity. Formed flanges on bottom to attach to chassis. Finished in black crackle enamel. Size 4 1/4" x 7 1/2" x 6" high.



No. 1244—Net Price \$0.66

STREAMLINE CABINETS



Distinctive styling for receivers, instruments etc. Rounded front vertical edges. Hinged top. All corners spot-welded. Black crackle finish. Height 8", depth 8 1/4".

Cat. No.	Panel Size	Overall Width	Net Price
C-1746	8" x 10"	12 1/4"	\$2.25
C-1747	8" x 12"	14 1/4"	2.55
C-1748	8" x 14"	16 1/4"	2.85

METAL CABINETS

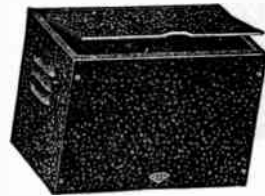

Made from heavy gauge sheet steel, all corners reinforced and spot welded. Hinged lid, louvres on side. Removable front panel. Black crackle finish.

Cat. No.	Size—Inches	Net Price
973	7 x 8 x 7 1/2"	\$1.65
993	7 x 10 x 6"	1.65
994	7 x 12 x 7 1/2"	1.95
995	7 x 14 x 7 1/2"	2.10
999	7 x 10 x 8"	1.95
1190A	8 x 16 x 8"	3.54
975A	9 x 15 x 11"	3.87

METAL BOX CABINETS



Excellent for housing Monitors, oscillators, receivers, etc. Front and back panels removable. Black crackle finish.

Cat. No.	Size—Inches	Net Price
883	2" x 4" x 4"	\$0.54
728	3" x 5" x 4"	.60
1098	6" x 6" x 6"	.69
1099	5" x 6" x 9"	1.05
879	7" x 8" x 10"	1.35
1124	6" x 7" x 12"	1.41
880	8" x 10" x 10"	1.65
881	6" x 11" x 12"	1.80
882	7" x 9" x 15"	1.95

CHASSIS DECKS

These mounting bases will fit Bud metal box cabinets. Made of rust proof zinc coated steel and sturdily constructed. Can be mounted to panel any height from bottom.

Cat. No.	Fits No.	Net Price
522	1098 Cabinet	\$0.27
523	1099 Cabinet	.24
524	879 Cabinet	.36
525	1124 & 1096 Cabinet	.30
526	880 Cabinet	.42
527	881 Cabinet	.45
528	882 Cabinet	.39
536	1097 Cabinet	.36
537	1100 Cabinet	.42

NOTE: ALL PRICES ON THIS PAGE HAVE BEEN CHANGED. WRITE FOR NEW LISTING.

RADIO PRODUCTS

STEEL CHASSIS BASES

Made of heavy gauge bright finish cold rolled sheet steel. Ends are folded down and spot welded. Folded over on bottom to attach bottom plate. Supplied undrilled in the following sizes.



(Zinc Plated)		Chassis Size (Black Crackle)		Cat. No. Net Price	
Cat. No.	Net Price	Inches 20 Gauge		Cat. No.	Net Price
645	\$0.54	5 x 9 1/2 x 2 1/2		644	\$0.54
776	.45	5 x 9 1/2 x 1 1/2		788	.45
1191	.54	7 x 7 x 2		789	.54
1192	.60	7 x 9 x 2		790	.60
1193	.66	7x11 x 2		791	.66
1194	.72	7x13 x 2		646	.72
1198	.66	5x13 1/2 x 2 1/2		647	.66
1189	.90	7x15 x 3		649	.90
666	.96	8 1/2 x 15 x 3		665	.96
1066	.75	4x17 x 3	1068	.75	
1199	.87	7x17 x 2 1/2	648	.87	
1195	.96	10x12 x 3	652	.96	
779	1.02	10x14 x 3	653	1.02	
774	.96	8x17 x 2	650	.96	
775	1.02	8x17 x 3	651	1.02	
769	1.02	10x17 x 2	654	1.02	
637	.90	10x17 x 3	636	.90	
18 Gauge					
1196	1.08	10x17 x 3	655	1.08	
1197	1.38	10x23 x 3	656	1.38	
770	1.23	11x17 x 2	657	1.23	
771	1.35	11x17 x 3	658	1.35	
661	1.26	12x17 x 2	663	1.26	
662	1.38	12x17 x 3	664	1.38	
772	1.50	13x17 x 2	659	1.50	
773	1.65	13x17 x 3	660	1.65	
641	1.44	10x17 x 4	640	1.44	
643	1.80	13x17 x 4	642	1.80	
624	2.10	10x17 x 5	623	2.10	
626	2.40	13x17 x 5	625	2.40	

HEAVY DUTY CHASSIS

Made of 16 Ga. steel. Supplied complete with bottom plate.

Black Crackle		Electro-Zinc Plated		Shp. D. W. H. Lbs. Wt.		Net Price
Cat. No.	Cat. No.	Size—Inches				
CB-1757	CB-1764	8 17 2 14				\$1.62
CB-1758	CB-1765	8 17 8 15				1.80
CB-1759	CB-1766	11 17 8 20				1.80
CB-1760	CB-1767	11 17 8 20				1.95
CB-1761	CB-1768	13 17 8 21				2.10
CB-1762	CB-1769	13 17 8 22				2.31
CB-1763	CB-1770	18 17 4 24				2.55

CHASSIS BOTTOM PLATES

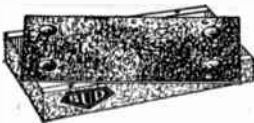

These plates make excellent dust covers and conceal the wiring and component parts in the chassis. Four formed bosses act as feet and eliminate marring or scratching table.

Zinc Coated Crackle	Black Crackle	Bottom Plates Listed Fit the Following Size Chassis Bases	Net Price
667	680	5" x 9 1/2"	\$0.27
668	681	7" x 7"	.30
669	682	7" x 9"	.33
670	683	7" x 11"	.39
671	684	7" x 13"	.42
672	685	5" x 13 1/2"	.33
513	516	7" x 15"	.45
1067	1069	4" x 17"	.36
673	686	7" x 17"	.48
674	687	8" x 17"	.48
675	688	10" x 12"	.48
514	517	10" x 14"	.51
676	689	10" x 17"	.60
677	690	11" x 17"	.66
678	691	12" x 17"	.72
679	692	13" x 17"	.75
515	518	10" x 23"	.81

RELAY RACK PANELS



These panels are 19" long. Widths are 1/2" undersize for easy fit. Black crackle finish.

STEEL panels are 1/8" thick and notched either W.E. or Amateur standard. Specify "A" for Amateur or "W" for Western Electric notching after catalog number. MASONITE panels are 3/8" thick, tempered, tough, non-magnetic and can be worked same as wood. Supplied in "A" notching only.

STEEL		MASONITE	
No.	Net	Panel Size	No. Net
1250	\$0.45	1 1/2" x 19"	1588 \$0.33
1251	.51	3 1/2" x 19"	1588 .42
1252	.63	5 1/2" x 19"	1590 .57
1253	.66	7" x 19"	1591 .63
1254	.84	8 1/2" x 19"	1592 .75
1255	1.02	10 1/2" x 19"	1593 .87
1256	1.20	12 1/2" x 19"	1594 .99
1257	1.38	14" x 19"	1595 1.11
1258	1.56	15 1/2" x 19"	1596 1.26
1259	1.74	17 1/2" x 19"	1597 1.41
1260	1.86	19 1/4" x 19"	1598 1.56
1261	2.10	21" x 19"	1599 1.71

METER PANELS



Made in STEEL and MASONITE. Same specifications as Rack Panels. 5 1/4" high, 19" long. Black crackle finish. Hole diameter 2 1/4" to fit 3" meters and 2 1/2" to fit 2" meters.

STEEL		MASONITE	
No. Holes	Net	Size	No. Holes Net
440	3 \$0.99	2 1/2"	509 3 \$0.87
441	5 1.47	2 1/2"	510 4 .99
442	3 .99	2 1/2"	511 3 .87
443	5 1.47	2 1/2"	512 4 .99

RELAY RACK PANELS (Door Type)

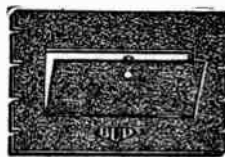

Ideal for use in speech amplifiers, Exciter units, etc. Made from steel 1/2" thick. Hinged door is 5 1/2" W. x 12" L. has snap catch. Sufficient margin on panel for meters, dials, etc. Panels listed (cut-out) have

hole for glass window. Glass not supplied. Finished in Black Crackle. NOTCHED AMATEUR STANDARD ONLY.

Cat. No.	Length	Width	Type	Net Price
615	19"	10 1/2"	Door	\$2.34
616	19"	12 1/2"	Door	2.70
617	19"	10 1/2"	Cut-out	1.95
618	19"	12 1/2"	Cut-out	2.25

CHASSIS MOUNTING BRACKETS



These brackets are made of heavy gauge sheet steel. Black crackle finish. Fit 7" high or larger panels. Have a 1" panel mounting flange which is cut away at bottom so chassis can be mounted flush against panel.

No.	Height	Length	Net Price
458	6 1/2"	x 8" for 3" H. chassis	\$0.54 pr.
448	6 1/2"	x 10" for 3" H. chassis	.75 pr.
459	6 1/2"	x 11" for 3" H. chassis	.84 pr.
449	6 1/2"	x 12" for 3" H. chassis	.93 pr.
460	6 1/2"	x 13" for 3" H. chassis	.99 pr.
450	8 1/2"	x 10" for 4" H. chassis	1.05 pr.
451	8 1/2"	x 13" for 4" H. chassis	1.20 pr.



CABINET RACK DOLLIES

Solid steel frames have black crackled finish. Ball bearing swivel casters have composition wheels which do not scratch polished floors. Nos. 505 and 506 fit cabinets having up to 17" x 21" base. Nos. 507 and 508 fit cabinets having up to 18" x 22 1/2" base.

Cat. No.	Type	Wheel Diam.	Net Price
RD-505	Light Duty	1 1/2"	\$3.45
RD-506	Heavy Duty	2"	5.25
RD-507	Light Duty	1 1/2"	4.05
RD-508	Heavy Duty	2"	5.85



REMOVABLE TOP CHASSIS

A new design and easy to punch chassis. Top is removable for easy layout of parts and to work with. Can be discarded and new top put on for change in layout. Made of heavy gauge steel. Welded corners.

COMPLETE CHASSIS

Black Crackle	Electro-Zinc Plated	Size—Inches	Net
Cat. No.	Cat. No.	D. W. H.	Price
CB-196	CB-193	10 17 3	\$1.20
CB-197	CB-194	10 17 4	1.62
CB-251	CB-210	13 17 3	1.80
CB-252	CB-211	18 17 4	2.25

REPLACEMENT CHASSIS TOPS ONLY

RT-198	RT-195	10 17	\$0.60
RT-253	RT-212	13 17	.75

RACK MOUNTING BRACKETS



For mounting shelves and chassis to rack panels. Are triangular in shape, so that they may be used in numerous ways. Made from heavy gauge cold rolled steel. Finished in black crackle enamel.

No.	Size	Net Price
No. 1266	—5" Brackets	\$0.42 per pr.
No. 1267	—7" Brackets	.54 per pr.
No. 1268	—9" Brackets	.66 per pr.

INTER-STAGE SHIELDS



These shields are ideal for use on receiver and transmitter chassis for eliminating interstage coupling and isolating component parts. Made of 20 gauge electro zinc coated steel. Folded on front and bottom for fastening to panel or chassis.

No.	Size	Net Price
No. 1246	—5 1/2" high, 7" long	\$0.21
No. 1247	—5 1/2" high, 10" long	.27
No. 1245	—6 1/2" high, 10" long	.30

Rack, Meter and Door Panels, also other metal items listed GREY Crackle finish optional can be so supplied at no additional cost. Other metal items in Grey are special so add 10% to net price.

NOTE: ALL PRICES ON THIS PAGE HAVE BEEN CHANGED. WRITE FOR NEW LISTING.

BUD RADIO PRODUCTS

CODE PRACTICE OSCILLATOR



For individual or group practice. Uses 117L7GT tube and works on A.C. or D.C. Has provision for two keys and an additional speaker. Two tones selected by switch on front panel. Comes complete with built in dynamic speaker and tube.

Cat. No. Net Price
CPO-120—Oscillator\$7.95
CPS-121—Add. Spkr. 1.90

WAVEMETER

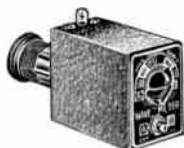

A highly useful device for the proper adjustment and operation of an amateur transmitter. Necessary for detecting harmonics, standing waves, neutralization, etc. Comes with dial plate calibrated from 10 to 160 meters and bandswitch on front panel. Indicator bulb supplied.

Cat. No. Net Price
WM-77\$4.35

OPEN END CHASSIS



These light weight steel chassis fit BUD metal cabinets and have many other uses. Ends are folded over $\frac{3}{8}$ " for additional strength. Zinc plated finish.

Cat. No.	Size—Inches D. W. H.	Fits Cab. No.	Net Price
CB-38	7 6 2	C-1584	\$0.36
CB-30	5 7 1 1/230
CB-41	7 7 1 1/2	C-973	.39
CB-39	7 8 2	C-1585	.42
CB-996	5 1/2 9 1 1/2	C-993	.36
CB-976	7 1/2 9 1 1/2	C-999, C-1746	.45
CB-40	7 10 2	C-1586	.45
CB-997	7 11 1 1/2	C-994, C-1747	.48
CB-998	7 13 1 1/2	C-995, C-1748	.57
CB-34	10 1/2 14 2	C-975A	.87
CB-35	7 15 2	C-1190A	.75

PANELS

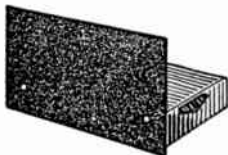

Metal panels are 16 Ga. cold rolled steel. Masonite panels are $\frac{1}{8}$ " thick, easy to drill and work. Both types are black crackle finished.

STEEL		MASONITE	
Cat. No.	Net	Size	Cat. No. Net
1200	\$0.27	7x8 \$
1201	.33	7x10	607 .39
1202	.39	7x12	608 .45
1203	.45	7x14	609 .51
239	.39	8x10	606 .45
240	.45	8x12	610 .51
1204	.48	8x14	611 .57
1205	.54	8x16	612 .66
1187	.60	8x18
1188	.69	8x19
700	.57	9x15	613 .69

500 WATT R.F. AMPLIFIER KITS

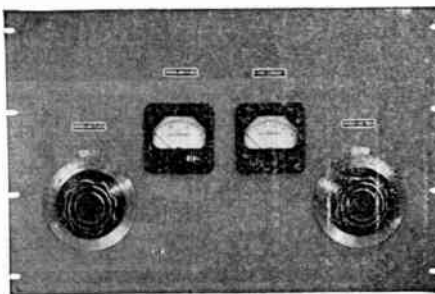

Unusual features not previously found in the average push-pull radio-frequency Amplifier are incorporated in these kits giving the amateur a really different "Final" of high efficiency, new type layout and design. Semi-skeleton style of construction. No closed metallic loops to cause losses due to circulating currents, etc. Layout symmetrical for both parts and wiring. Uses standard, medium power triode tubes. Kits come with drilled panel and formed and drilled metal parts. All kits come complete, less Meters, Tubes and Coils. Use BUD OCL and VCL coils with these amplifiers.

BPA 500	For 5, 10, 20 and 40 meters.	Net Price \$24.00
BPA 500-LF	For 20, 40, 80 and 160 meters.	Net Price 25.50
BPA 500-S	Foundation kit. (Drilled panel, semi-chassis and brackets)	Net Price 3.60

BUD PANEL BEARING ASSEMBLY

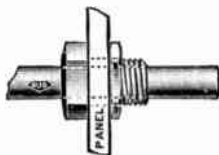

Is ideal for use with rigid or flexible couplings when mounting volume controls, condensers, etc. back from the panel. Shaft is slotted and held securely to bearing with horse-shoe washers to keep shaft from shifting. Brass bearing fits up to $\frac{1}{4}$ " thick panel.

No.	Net Price
530—Overall length 6"	\$.24
531—Overall length 3"	.18
532—Bearing only	.09

ETCHED DIAL PLATES (Plain)

These dial plates are made of high grade tempered aluminum. Raised polished dial divisions and numerals on black satin finish background. Center hole will fit over $\frac{3}{8}$ " bushing.



Cat. No.	Size	Arc	Calibrated	Net Price
1175	3"	180°	0 to 100	\$0.18
1176	3"	180°	100 to 0	.18
1177	2"	180°	0 to 100	.12
1178	2"	180°	100 to 0	.12

WITH MARKING

2" Dia. calibrated 0-100 in 300° rotation.

Cat. No.	Marking	Net Price
1224	Record	\$.12
1225	Microphone	.12
1226	Gain	.12
1227	Tone	.12
117912
1228	Tone Control (arrow calib.)	.12
1229	Volume (arrow calib.)	.12
1273	Marked 1 to 5 for sw.	.12

BUD TUNING DIALS

For Use on Transmitters and Other Equipment



Made of heavy gauge brass, spun and chrome plated. Black die stamped numerals. Large bakelite knob, brass insert. Insulated from shaft. Supplied with No. 1736 Indicator.

FLUTED KNOBS—180 DEG.

Cat. No.	Dial Div.	Diam.	Net Price
D-1732	0-100	2 1/2"	\$0.87
D-1733	100-0	2 1/2"	.87
D-1734	0-100	4"	1.35
D-1735	100-0	4"	1.35

TAPERED KNOBS—180 DEG.

D-713	0-100	2 1/2"	.75
D-714	100-0	2 1/2"	.75
D-715	0-100	4"	1.11
D-716	100-0	4"	1.11

INDICATORS ONLY

Cat. No.	Type	Net Price
IN-723	Vernier Indic. for 2 1/2" Dials.	\$0.18
IN-725	Vernier Indic. for 4" Dials.	.18
IN-1736	Single Line Indicator.	.06

RECTANGULAR TYPE

Size 1 1/4"x2 1/4". Calibrated 0-10 in 300° rotation.

Cat. No.	Marking	Net Price
978	Record	\$.12
979	Microphone	.12
980	Gain	.12
981	Tone	.12
98212



JACK NAME PLATES

For identifying input and output circuits. Polished letters on black satin background. Fit on $\frac{3}{8}$ " dia. bushings. 1 1/2" diameter.

No.	Marking	Net Price
1180	Microphone	\$.09
1181	Phono Pick Up	.09
1182	Phones	.09

NOTE: ALL PRICES ON THIS PAGE HAVE BEEN CHANGED. WRITE FOR NEW LISTING.

BUD RADIO PRODUCTS

LATTICE-WOUND R.F. CHOKES

Low D.C. resistance, high impedance. Moisture proof; low distributed capacity. Wound on Isotex.



No.	M.H.	Net	No.	M.H.	Net
1212	2.5	\$.21	1217	16	\$.33
1213	3.4	.24	1218	30	.36
1214	5.5	.27	1219	60	.45
1215	8.	.27	1220	80	.48
1216	10.	.30			

MAGICORE "HY-Q" R.F. CHOKES

IRON CORE
These new metallic alloy core chokes have nearly double Q factor of air core coils. High permeability with minimum hysteresis. Wound with silk covered enamel wire.

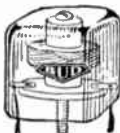

Cat. No.	Inductance	Net Price
1277	1.5 M.H.	\$0.51
1278	2.5 M.H.	.51
1279	3.4 M.H.	.54
1280	5.5 M.H.	.54
1281	8 M.H.	.60
1282	10 M.H.	.60
1283	16 M.H.	.69
1284	30 M.H.	.69
1285	60 M.H.	.78
1286	80 M.H.	.87
1287	125 M.H.	1.08

HY-FREQUENCY R.F. CHOKES

For H.F. receivers and low powered transmitters. Wound with SSE wire on Isolantite core. Extremely low distributed capacity.

Cat. No.	Inductance	Net Price
920	2.5 M.H.	\$0.27
922	5.5 M.H.	.36
923	8. M.H.	.45
924	10. M.H.	.51

BUD H.F. TRANSMITTING CHOKE

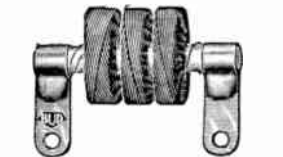

This newly designed choke is for use with the new medium power transmitting tubes in high and ultra-high frequency circuits. Three lateral wound pieces on 1/4" diameter Isolantite core. Heavy strap leads. Size 3/8" diameter by 1 1/2" long. Inductance, 2.5 M.H.; D.C. Res. 16 ohms; Current Cap. 250 MA. continuous; Dist. Cap. 2 mmfd.

No. 876Net Price \$0.51

ISOTEX SOCKETS

Moisture-proof, high surface resistance. Low loss effect. Sub-panel, base-mounting. Size 2 1/4" x 1 1/2".

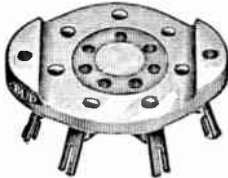

No.	Net	No.	Net
954 4 pr.	\$.24	957 7 Sm.	\$.30
955 5 pr.	.24	958 7 Lge.	.30
956 6 pr.	.27	959 8 Pr.	.33

BUD TUBE SOCKETS

Made of BOKELITE
Are constructed of the finest materials throughout, using genuine phosphor bronze contacts. Top is grooved for tube guide. Excellent for regular as well as experimental work. Used as standard equipment by manufacturers of test equipment.



No.	Net Price
268 4 Prong	\$.15
269 5 Prong	.15
270 6 Prong	.18
271 7 Prong Lge.	.18
983 7 Prong Sm.	.18
1060 5, 6, Sin. 7 Pr. Comb.	.21
1061 7 Prong Combination	.18
1062 4, 5, 6 Prong Comb.	.21
1063 8 Prong, Octal	.21

BUD COMBINATION BASE OR PANEL MOUNT SOCKETS

No.	Net Price
264 4 Prong	\$.18
265 5 Prong	.18
266 6 Prong	.21
267 7 Prong (Reg.)	.24
885 7 Prong (Small)	.24

TRANSMITTER R.F. CHOKES

Pie Wound
Exceptionally low power loss, no transmission bands. Continuous windings of 5 lateral wound tapered sections. Low D.C. resistance.
Ind. 2.8 M.H.; 5 ohms D. C. Res.; rating 1000 M.A.
No. 568...Net \$1.05
Ind. 5.3 M.H.; 12 1/2 ohms D.C. Res.; rating 500 M.A.
No. 569Net \$0.90

U. H. F. linear wound, Ind. 15 micro-henries, .2 ohms D.C. Res.; rating 4 amps.
No. 570Net \$0.60

BUD ULTRA HY-FREQ. R.F. CHOKE

A compact, well designed R.F. choke for use in ultra high frequency transmitters and receivers. Wound on Isolantite core. Size — 1 1/2" long, 3/8" diameter, inductance 5.7 microhenries, resistance 1.4 ohms. Current rating—750 m.a.
No. 925Net \$0.15



BUD TOGGLE SWITCHES

For controlling radio sets, small motors, lamps, etc. Underwriter approved. Rated 3 amps. at 125 volts or 1 amp. at 250 volts. Supplied in nickel plated or stately bronze finish. Made by H&H for BUD. Packed 5 to Carton.



Cat. No.	Description	Shank Length	Net Price
1003	S.P.S.T.	1"	\$0.24
1004	S.P.S.T.	3/4"	.27
1005	S.P.D.T.	1"	.33
1006	S.P.D.T.	3/4"	.36
1007	D.P.S.T.	1"	.45
1008	D.P.S.T.	3/4"	.51
1009	L.P.D.T.	1"	.57
1010	L.P.D.T.	3/4"	.60
1077	Closes 3 circuits for R.C.A., etc.		.42

BUD ROTARY SWITCHES

Positive contact rotary power switch, underwriter approved. Rated 3 amps. at 125 volts and 1 amp. at 250 volts. Copper plated steel encased, Bakelite insulation. Shafts are 1 1/2" long. Made by H&H for BUD.



Cat. No.	Description	Shank Length	Net Price
499	S.P.S.T.	3/4"	\$0.27
1070	S.P.S.T.	1"	.33
1071	S.P.D.T.	3/4"	.33
1072	S.P.D.T.	1"	.42
1073	D.P.S.T.	3/4"	.51
1074	D.P.S.T.	1"	.60
1075	D.P.D.T.	3/4"	.69
1076	D.P.D.T.	1"	.69

PUSH BUTTON SWITCHES

Two circuit non-indicating slow make and quick break momentary contact switch. One circuit is "ON" and the other is normally "OFF".
No. 743Price \$0.42

POWER SWITCHES

These heavy duty switches are ideal for primary circuits in transmitters. They are D.P.S.T. but can be paralleled for larger capacity. Rated 12 amps. 125 volts. Size 1 3/4" x 3/4" x 3/4". Shank 3/8" long. Push button and Toggle types.

No.	Description	Net Price
1270	Push button	\$1.20
1269	Toggle	.69

FLEXIBLE COUPLINGS

For ganging units or shaft extensions. Fit 1/4" diameter shafts.
No. Dia. Insulation Net
855 1 1/2" Bakelite \$0.21
845 1" Fibre .15
795 1 1/4" Isotex .27



High Voltage Type
Glazed Isolantite Rod Insulation
No. 741—3 1/4" long...Net \$0.48
No. 740—1 3/4" long...Net .39

HEAVY DUTY COUPLER

New type spring construction. Very flexible. Alsimag 196 disc is 1 1/2" dia x 3/16" thick. Fits 3/8" shafts.



Cat. No.	Insulation	Net
614	Alsimag 196	\$0.45
619	Bakelite	.30

FLEX-O-SHAFTS

Will turn at angles up to 90 degrees. Free from back lash. 1/4" hubs sweated on each end to fit any type coupling.
No. 859—Length 3".....Net \$0.21
No. 860—Length 6".....Net .30

GIANT SOCKETS

For Transmitting Tubes
Base made of Isotex, glazed top and sides to resist moisture. Snug fitting machined jack type contacts.
226—50 watt size.....Net \$0.60
227—For RK28, 803, etc.Net .90



BAT HANDLE SWITCHES

Same construction as regular toggle switch except handle is shaped like ball bat and is trifle longer. Nickel plated. Shank 3/8".



Cat. No.	Description	Net Price
SW-1115	S. P. S. T.	\$0.24
SW-1118	S. P. D. T.	.33
SW-1119	D. P. S. T.	.45
SW-1120	D. P. D. T.	.57

ETCHED NAME PLATES

High quality aluminum used. Raised polished letters on black satin finish. For transmitters, amplifiers, etc. Furnished with following inscriptions:

- Oscillator
- Amplifier
- Plate Volts
- Send-Receive
- Microphone
- Power Amp.
- Input
- Neutralizer
- Monitor
- Fader
- Send
- Antenna
- Selector
- Key
- Crystal Osc.
- A.C. Input
- CW-Phone
- Transceiver
- 200-Ohm
- Speech Amp.
- 500-Ohm
- Gain Control
- Tone Control
- Grid
- Output
- Modulator
- Freq. Meter
- Doubler
- Beat Osc.
- Transmitter

ASK FOR A COMPLETE BUD CATALOG

Which Describes Numerous Other Money Saving Items Not Listed Here

NOTE: ALL PRICES ON THIS PAGE HAVE BEEN CHANGED. WRITE FOR NEW LISTING.

RADIO BUD PRODUCTS

BAND SWITCH ASSEMBLIES



Made in 50 and 100 watt sizes. No. OCS-1 is for oscillator and buffer use with capacity coupling. Nos. OCS-2 and XCS-2 are for single ended operation with link coupling. Nos. OCS-3 and XCS-1 are center tapped and center-linked. All types except Nos. OCS-16 and XCS-16 are for all band operation from 10 to 160 meters. Nos. OCS-16 and XCS-16 are for 10 and 160 meters only. All units tune with

single 100 mmfd. condenser or dual 200 mmfd. condenser in split-tap. Supplied with nameplate, mounting hardware and instructions.

Cat. No.	Rating	Net Price
OCS-1	50 watts	\$3.30
OCS-2	50 watts	4.50
OCS-3	50 watts	5.40
OCS-16	50 watts	2.10
XCS-1	100 watts	6.00
XCS-2	100 watts	5.40
XCS-16	100 watts	3.75

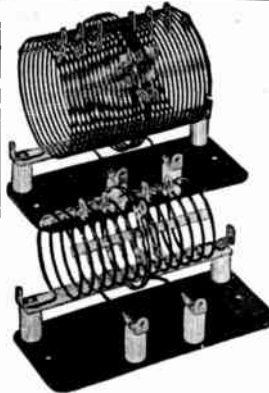

ANTENNA MATCHING NETWORK COILS

Designed to meet all of the various requirements encountered in antenna matching networks. Made in 500 and 1000 watt sizes and in two values of inductance. The low frequency coil in each size is for 40 to 160 meter operation and the high frequency coil is for 10 and 20 meter operation. Coil and links have a large number of

taps allowing the inductance and coupling to be varied over a wide range.

Cat. No.	Rating	Range in Meters	Net Price
ACV-1	500 watts	40 to 160	\$3.42
ACV-2	500 watts	10 to 20	2.64
ACM-1	1000 watts	40 to 160	6.60
ACM-2	1000 watts	10 to 20	5.10



EVER-READY TEST LEADS

Made of the finest quality insulated flexible wire. Black lead is negative, red positive.

No. 280—42" long. Supplied with spade terminals or phone tips. Net Price \$0.36

No. 184—42" long. Removable needle point inserted into the chuck; penetrates the insulation without injury; spade or phone tip terminals. Net Price \$0.39

No. 1841—42" long. Long fixed needle point; spade or phone tip terminals. Net Price \$0.39

No. 621—De-Luxe Test Leads—60" long. Heavy duty with removable tips; phone tip terminals; handles are polished hard rolled fibre; extremely flexible. Continuity test tips are the chuck type. Net Price \$0.75

BAR KNOBS



Genuine bakelite. White pointer stripe. Has numerous uses.

No.	Type	Size	Color	Net Price
K-579	A	1 1/4"	Black	\$0.06
K-580	A	1 1/4"	Walnut	.06
K-174	A	1 1/4"	Red	.09
K-204	A	1 1/4"	Green	.09
K-581	A	2 1/4"	Black	.08
K-582	A	2 1/4"	Walnut	.08
K-175	A	2 1/4"	Red	.11
K-205	A	2 1/4"	Green	.11
K-575	B	1 1/4"	Black	.06
K-576	B	1 1/4"	Walnut	.06
K-559	B	1 1/4"	Red	.09
K-577	B	2 1/4"	Black	.08
K-578	B	2 1/4"	Walnut	.08
K-560	B	2 1/4"	Red	.11

SEE BUD CATALOGUE FOR OTHER TYPES AND STYLES OF KNOBS.

NEUTRALIZING WRENCH



Inside of tube is broached. If end breaks part can be cut off.

No. 254—5 1/2" long.	Net Price	\$0.15
No. 255—8" long.	Net Price	.18
No. 256—12" long.	Net Price	.24

DE LUXE ADJUSTABLE NEUTRALIZING TOOL

No metal parts. Made of high di-electric, hard rolled fibre. Screw driver slides into one end of handle.

No. 236—Adjustable. 7" to 10"	Net Price	\$0.39
No. 237—Adjustable. 11" to 17"	Net Price	.51

BUD NEUTRO-WRENCH



Alligator jaw type for knurled and hex head trimmers. Metal blade screw driver at other end.

NEUTRALIZING SCREW DRIVER

Hard rolled fibre handle.

No.	Net Price
235—No metal ends	\$0.21
287—With metal blade	.21

4-IN-1 NEUTRALIZING AND ALIGNING TOOL



No.	Net Price
118	\$0.39
119M—Majestic Attachment	.12
119C—Crosley Attachment	.15

ASK FOR A COMPLETE BUD CATALOGUE WHICH DESCRIBES NUMEROUS OTHER MONEY SAVING ITEMS NOT LISTED HERE

JEWEL LIGHT ASSEMBLIES



For Radio and Electric Panel Switchboards, Signal Devices, etc. Single hole mounting. Jewel holder, polished chrome plated brass. Specify color wanted. Red, Green, Amber, Blue, Opal, Crystal

1/2" Dia. Jewel, Mtg. Bracket Depth 1 1/8" Mtg. hole dia. 1/4"

No.	Type Socket	Jewel	Net
JL 1692 F	Miniature	Facetted	\$0.15
JL 1692 S	Miniature	Smooth	.15
JL 1693 F	Cand. 110 volt	Facetted	.18
JL 1693 S	Cand. 110 volt	Smooth	.18
JL 1694 F	Min. Bayonet	Facetted	.18
JL 1694 S	Min. Bayonet	Smooth	.18

3/4" Dia. Jewel, Mtg. Bracket Depth 1 1/8" Mtg. hole dia. 3/8"

JL 1695 F	110 volt	Facetted	.36
-----------	----------	----------	-----

1" Dia. Jewel, Mtg. Bracket Depth 2" Mtg. hole dia. 1"

JL 1698 F	Cand. 110 volt	Facetted	.60
JL 1698 S	Cand. 110 volt	Smooth	.60
JL 1699 F	Min. Screw	Facetted	.60
JL 1699 S	Min. Screw	Smooth	.60
JL 1699 F	Min. Bayonet	Facetted	.60
JL 1699 S	Min. Bayonet	Smooth	.60

JEWEL HOLDERS



Fit panels up to 3/4" thick. Specify color wanted.

Red, Green, Amber, Blue, Opal, Crystal

No.	Jewel	Size	Net
JL 1696 F	Facetted	3/4"	\$0.09
JL 1696 S	Smooth	3/4"	.09
JL 1697 F	Facetted	3/4"	.24
JL 1691 F	Facetted	1"	.51

NOTE: ALL PRICES ON THIS PAGE HAVE BEEN CHANGED. WRITE FOR NEW LISTING.

RADIO BUD PRODUCTS



OSCILLATOR AND BUFFER COILS

Low loss, highly efficient, air wound. Windings are properly spaced and securely locked to acetate strips. Proper L/C ratio. Glazed ceramic base fits standard 5 prong tube socket. Conservative rating 60 watts.

OCL coils have link at center with main winding center tapped.

OEL coils have links at one end and are NOT tapped.

CENTER LINKED AND TAPPED

Cat. No.	Band	Capacity*	Net Price
OCL-160	160 Meters	90 mmfd.	\$0.99
OCL-80	80 Meters	75 mmfd.	.90
OCL-40	40 Meters	50 mmfd.	.90
OCL-10	10 Meters	28 mmfd.	.90
OCL-20	20 Meters	33 mmfd.	.90
OCL-5	5 Meters	18 mmfd.	.75

END LINKED NO TAP

OEL-160	160 Meters	90 mmfd.	.99
OEL-80	80 Meters	75 mmfd.	.90
OEL-40	40 Meters	50 mmfd.	.90
OEL-20	20 Meters	33 mmfd.	.90
OEL-10	10 Meters	28 mmfd.	.90
OEL-5	5 Meters	18 mmfd.	.75

CENTER ADJUSTABLE LINK

OLS-160	160 Meters	95 mmfd.	.99
OLS-80	80 Meters	75 mmfd.	.90
OLS-40	40 Meters	50 mmfd.	.90
OLS-20	20 Meters	33 mmfd.	.90
OLS-10	10 Meters	21 mmfd.	.90

* Denotes total capacity required to tune to resonance at the low frequency end of the band.

AIR-WOUND TANK COILS



A highly efficient air-wound inductance having the proper L/C ratio for phone operation. Large size enameled copper wire in the coil insures against heating losses. All coils have fixed center link. Windings are cemented to acetate strips. Alsimag 196 insulation.

Nickel plated brass hardware.

150 WATT

Cat. No.	Band	Capacity*	Net Price
RCL-160	160 Meters	87 mmfd.	\$2.25
RCL-80	80 Meters	68 mmfd.	2.10
RCL-40	40 Meters	36 mmfd.	1.92
RCL-20	20 Meters	27 mmfd.	1.62
RCL-10	10 Meters	25 mmfd.	1.50
AM-1932	Mtg. base for above coils.		.48

500 WATT

VCL-160	160 Meters	90 mmfd.	2.70
VCL-80	80 Meters	69 mmfd.	2.40
VCL-40	40 Meters	26 mmfd.	2.10
VCL-20	20 Meters	23 mmfd.	1.95
VCL-10	10 Meters	21 mmfd.	1.80
VCL-5	5 Meters	14 mmfd.	1.65
AM-1356	Mounting Base for Above Coils		.66

KILOWATT

MCL-160	160 Meters	86 mmfd.	5.70
MCL-80	80 Meters	73 mmfd.	4.95
MCL-40	40 Meters	37 mmfd.	4.50
MCL-20	20 Meters	33 mmfd.	4.20
MCL-10	10 Meters	24 mmfd.	3.90
MCL-5	5 Meters	18 mmfd.	3.60
AM-1354	Mounting for Above Coils		1.05

* Denotes total capacity required to tune to resonance at the low frequency end of the band.

ADJUSTABLE LINK TRANSMITTER COILS



All coils in this series incorporate adjustable link coupling. In each series the link winding is attached to the jack bar into which the coils are plugged. One link coil is used for all tank coils in the series and is controllable from the panel by means of a 3/4" shaft. The link coil on the 150 watt size is a single layer helical-wound coil. On the 500 watt and 1000 watt sizes, a new type eccentric helical wound link is used. This type of winding allows maximum coupling to be obtained with various diameters of tank coils.

150 WATT

Cat. No.	Band	Capacity*	Net Price
RLS-160	160 Meters	95 mmfd.	\$1.95
RLS-80	80 Meters	78 mmfd.	1.80
RLS-40	40 Meters	38 mmfd.	1.56
RLS-20	20 Meters	30 mmfd.	1.35
RLS-10	10 Meters	28 mmfd.	1.29
AM-1339	Base and link assembly for above		1.95

500 WATT

VLS-160	160 Meters	95 mmfd.	2.19
VLS-80	80 Meters	70 mmfd.	2.01
VLS-40	40 Meters	38 mmfd.	1.71
VLS-20	20 Meters	28 mmfd.	1.56
VLS-10	10 Meters	21 mmfd.	1.41
AM-1352	Base and link assembly for above		2.70

1000 WATT

MLS-160	160 Meters	95 mmfd.	4.80
MLS-80	80 Meters	65 mmfd.	4.35
MLS-40	40 Meters	37 mmfd.	3.90
MLS-20	20 Meters	33 mmfd.	3.60
MLS-10	10 Meters	25 mmfd.	3.15
AM-1340	Base and link assembly for above		4.20

* Denotes total capacity required to tune to resonance at the low frequency end of the band.

TRANSMITTER TANK FORMS

Made in three sizes to cover the inductance requirements of the amateur frequency spectrum. These forms are grooved for No. 10 wire or smaller and drilled with sufficient holes for wires and supports. Isotex is a special moulded low loss ceramic having exceptional low loss properties. All forms are glazed.

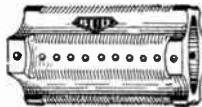

No. 383—20 or 40 meter form is grooved twenty-four turns in 4" of winding space. Size 2 1/2" O. D. x 5" long.

Net Price \$0.75

No. 384—20 or 40 meter form with supports. Net Price \$1.35

No. 376—80 meter form is grooved thirty-two turns in 5" of winding space. Size 3" O. D. x 6" long. Net Price \$1.05

No. 377—80 meter form with supports. Net Price \$1.65

No. 393—160 meter form is grooved forty-eight turns in 6" of winding space. Space 4" O. D. x 7 1/4" long. Net Price \$1.35

No. 394—160 meter form with supports. Net Price \$1.95

SHORT WAVE PLUG-IN COIL FORMS MADE OF LOW LOSS BAKELITE



Supplied with disc in top which permits writing in wave-length range, and makes identification positive. These forms are supplied in 4, 5, and 6 prong units to fit standard tube sockets. All sizes have eight ribs moulded on wall of coil forms which give low loss air core windings.

GIANT COIL FORMS

2 1/2" in diameter. 3 1/4" winding space.

No.	List	Net
734	4 prong	\$0.39
735	5 prong	.42
736	6 prong	.45

Same as above, but threaded 12 turns per inch for space winding coils.

No.	List	Net
1221	4 Prong	\$0.54
1222	5 Prong	.57
1223	6 Prong	.60

SENIOR COIL FORMS

1 1/2" in diameter. 2 1/2" winding space.

No.	List	Net
125	4 Prong	\$0.21
126	5 Prong	.21
310	6 Prong	.24

JUNIOR COIL FORMS

1 1/4" in diameter. 2 1/8" winding space.

No.	List	Net
594	4 prong	\$0.15
595	5 Prong	.18
596	6 Prong	.18

LO-COIL KITS



SENIOR

Wound on 1 1/2" diameter coil forms. Covers wave-length of 16 to 200 meters when tuned with .00014 mfd. condenser. Each kit has 4 coils.

No.	List	Net
222	4 Prong 2 Windings	\$1.65
918	6 Prong 3 Windings	2.10
916	5 Prong 2 Windings	
Secondary tapped for electron coupled circuits.		1.98

JUNIOR

Wound on 1 1/4" diameter forms. Wave-length range, 11 to 210 meters with .00014 mfd. condenser. 4 coils to kit.

No.	List	Net
384	4 Prong 2 Windings	\$1.20
356	6 Prong 3 Windings	1.74

SUPERHETERODYNE

Consists of 8 coils. 4 detector coils and 4 oscillator coils to track with I.F. transformers tuned 465 KC. Wave-length range 13 to 200 meters with .00014 mfd. condenser.

No. 397 Net \$3.30

NOTE: ALL PRICES ON THIS PAGE HAVE BEEN CHANGED. WRITE FOR NEW LISTING.

BUD RADIO PRODUCTS

BUD FLOOR STANDS FOR CRYSTAL, VELOCITY & DYNAMIC MICROPHONES



Insulated against rattling or dropping of adjustable stems. Positive and smooth acting chuck type lock. Telescoping stems finished in polished chromium plate. Two section stands adjustable 35" to 66". Three section 24" to 66". Heavy cast bases are finished in durable black crackle enamel. Adjustable stem has 1/8-27 thread. On stands supplied with ring, the ring is 6" dia. with E-Z hooks finished in black crackle enamel.

- No. 585—Net Price.....\$7.20
Two section; modernistic base, base dia. 12". Weight 12 lbs.
- No. 587—Net Price.....\$8.10
Three section; modernistic, 12" dia. base. Weight 12 lbs.
- No. 583—Net Price.....\$7.50
Three sections; tripod base, leg spread 17". Weight 9 1/2 lbs.
- No. 586—Net Price.....\$6.00
Two section; tripod base, leg spread 17". Weight 9 1/2 lbs.
- No. 584—Net Price.....\$5.10
Two section; modernistic 10" diameter base. Weight 8 1/2 lbs.
- No. 6753—6" Dia. Ring with 8 springs to fit stands listed above. Net Price.....\$0.90

DESK & BANQUET STANDS

Ruggedly built for use on tables, desks, pulpits, etc. Heavy cast base of modernistic design is finished in black crackle enamel and will not tip easily. Stems are chromium plated finish. Adjustable types have thumb nut locking device. Stem is threaded 1/8-27. Where rings are supplied, they are also finished in black crackle.



- No. 588—Net Price.....\$1.05
Height 6". Base Dia. 6". Weight 2 lbs.
- No. 589—Net Price.....\$1.35
Height 8". Base Dia. 6". Weight 3 1/4 lbs.
- No. 590—Net Price.....\$3.00
Height adjustable 10" to 16". Base Dia. 6". Weight 3 1/2 lbs.
- No. 803—Net Price.....\$3.90
Same as No. 590, complete with 6" microphone ring and 8 springs.
- No. 591—Net Price.....\$3.45
Height adjustable 13" to 22". Base Dia. 6". Weight 3 1/2 lbs.
- No. 802—Net Price.....\$4.35
Same as No. 591, complete with 6" microphone ring with 8 springs.

BUD DESK STANDS



These beautiful stands are preferred by most amateurs and are ideal for portable P.A. installations. Ruggedly constructed. Modernistic designed base casting. Black crackle finish.

- No. 817—Net Price \$1.35
Height 9". Base Dia. 5". 5" octagonal microphone ring.
- No. 818—Net Price.....\$1.65
Height 10". Base Dia. 6". 6" round microphone ring.
- No. 819—Net Price.....\$2.01
Height 13". Base Dia. 6". 6" diameter round microphone ring.

CARBON GRANULES



Carefully selected and highly polished. Acid treated to remove all trace of ash. Will stand 20% more current without burning. Highly sensitive. Vial contains enough carbon to repack four two button microphones.

- No. 410—Net Price.....\$0.45

MICROPHONE CABLE CLIP

Holds microphone cable parallel to stem. Made of spring steel and nickel plated. Fits around 1" dia. stem. Easily attached and adjusted.

- Cat. No. 599—Net Price.....\$0.06 ea.

CONE STAND-OFF INSULATORS



These glazed ceramic insulators fill all requirements for insulated mountings and supports. A type and size for any purpose. Jack types accommodate standard banana plugs.

REGULAR

Cat. No.	Height	Top Dia.	Base Dia.	Thread	Net Price
1-300	5/8"	1 1/8"	5/8"	6-32	\$0.06
1-301	1"	1 1/2"	3/4"	8-32	.09
1-302	1 1/2"	2"	1"	10-32	.12
1-303	2 3/4"	3 1/4"	1 1/4"	10-32	.15

JACK TYPE

1-304	1"	1 1/4"	3/4"	8-32	.12
1-305	1 1/2"	2"	1"	10-32	.15
1-306	2 3/4"	3 1/4"	1 1/4"	10-32	.21

CONE FEED-THRU INSULATORS



Excellent insulation when bringing high voltage and R.F. leads through panels, chassis, etc. Glazed Ceramic.

Cat. No.	Top Height	Bottom Height	Mounting Hole Dia.	Net Price
1-435	5/8"	1 1/8"	1 1/8"	\$0.07
1-436	1"	1 1/2"	1 1/2"	.12
1-437	1 1/2"	2"	2"	.15
1-438	2 3/4"	3 1/4"	2 1/4"	.30

JACK TYPE

1-453	1"	1 1/4"	1 1/4"	.15
1-454	1 1/2"	2"	2"	.18
1-455	2 3/4"	3 1/4"	2 1/4"	.33

NET

PHONE & MICROPHONE PLUGS



- No. 230—Net Price.....\$0.24
Duplex; takes 2 cords with tips; bakelite handle.
- No. 282—Net Price.....\$0.39
Same as above with shielded metal handle.
- No. 1057—Net Price.....\$0.45
Three way mike plug; bakelite handle.
- No. 284—Net Price.....\$0.66
Same as No. 1057 with shielded metal handle.

PORTABLE PHONE & MICROPHONE CONNECTORS

- No. 1039—Net Price.....\$0.30
Two way; fits No. 230 plug; bakelite handle.
- No. 279—Net Price.....\$0.54
Same as No. 1039 with shielded metal handle.
- No. 1059—Net Price.....\$0.45
Three way; fits No. 1057 mike plug; bakelite handle.

- No. 283—Net Price.....\$0.66
Same as No. 1059 with shielded metal handle.



- No. 1058—Net Price.....\$0.30
Three way microphone jack for panel mounting.
- No. 1038—Net Price.....\$0.18
Two way microphone jack for panel mounting.

ALL PURPOSE JACKS



Small in size, highly efficient. Nickel silver springs for equal, positive tension at all times. Contacts are pure silver. Large bakelite separators overlap springs for long leakage path. Supplied with insulating washers.

Cat. No.	Type	Net
1324	Open Circuit	\$0.21
1325	Single Closed	.27
1326	3 Circuit Mic.	.30
1327	Double Closed	.36

JACK



Small, compact spring brass contacts, nickel plated. Supplied with insulating washers.

- No. 232—Open Circuit. Net Price.....\$0.18

BUD GRID CLIPS



For transmitter, rectifier, metal and glass type tubes. Made from heavy gauge spring brass, cadmium plated.

No.	Type Tube	Net Price
490	Transmitting. 10 in pkg. Each	\$0.05
107	Glass. 100 in pkg. Per C	.09
108	Metal. 100 in pkg. Per C	.09

ICA INSULINE ICA

RADIO PRODUCTS

ICA DE LUXE HINGED STEEL CABINETS



The cabinets have rounded corners with specially designed Chrome plated "Air-Gate" ventilators on sides; and vertical Chrome Plated Trim moulding on front. Modern grille type ventilators are provided on the back panels which also have an opening on the bottom to allow for leads, cable connections, etc.

Bottoms have 4 embossed feet. Finished in a beautiful Marine Gray Ripple Enamel.

No.	H.	L.	D.	Panel Size	Net
3860	8" x 10" x 8"	8" x 8"	\$4.35		
3861	8" x 12" x 8"	8" x 10"	4.50		
3862	8" x 14" x 8"	8" x 12"	5.40		
3863	12" x 20" x 12"	12" x 18"	8.40		

ICA DE LUXE SLOPING PANEL CABINETS

The top corners are rounded and trimmed with a beautiful red striped chrome trim. The sides of the cabinets have the beautiful "Air-Gate" Chrome ventilators.

The front panel is removable so that the chassis can be attached to it and used as one unit.

Beautifully finished in Marine Gray Ripple Enamel.

No.	H.	W.	D.	Net
3990	8" x 8" x 8"	8"	\$3.96	
3991	8" x 10" x 8"	8"	4.35	
3992	8" x 14" x 8"	8"	5.25	
3993	12" x 18" x 8"	8"	7.65	

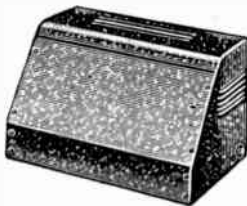

ICA MULTI-USE METAL CABINETS

An ideal unit for public address systems, transmitters, receivers, test equipment, etc. Has rounded corners on front of Cabinet. Trimmed with handsome red striped chrome trim moulding. Equipped with hinge doors, and nickel brass snap locks. Completely assembled, ready for use. Finished in Black or Marine Gray Ripple Enamel. Black will be supplied unless Gray is specified.



SINGLE UNITS

No.	Size	Net
3880	10 1/2" x 21" x 13 1/2" Deep.	\$9.90
	Door on top only. Panel size 8 3/4" x 19".	

No. 3881	Size 14" x 21" x 13 1/2" Deep.	12.00
	Door on top only. Panel size 12 1/4" x 19".	

DOUBLE UNIT

No. 3882	Size 19 1/4" x 21" x 13 1/2" Deep.	16.65
	Doors on top and rear. Panel size 17 1/2" x 19".	

TRIPLE UNIT

No. 3883	Size 28" x 21" x 13 1/2" Deep.	18.60
	Door on rear panel only. Panel size 26 1/4" x 19".	

QUADRUPLE UNIT

No. 3884	Size 36 3/4" x 21" x 13 1/2" Deep.	20.70
	Door on rear panel only. Panel size 35" x 19".	

ICA DE LUXE SPEAKER CABINETS



Trimmed with red striped chrome trim. Has beautiful red striped chrome handle on top. Marine Gray Ripple finish.

No.	Size	Hole Size	Speaker Size	Net
3935	10 x 10 x 6"	4 3/4"	6"	\$4.20
3936	12 x 12 x 7"	6 1/2"	8"	5.28
3937	14 x 14 x 8"	9"	10"	6.60
3938	16 x 16 x 8"	11"	12"	8.70

ICA STANDARD SPEAKER CABINETS

Finished in Black Ripple Enamel with plain back steel handles to match.

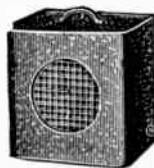

No.	Size	Hole Size	Speaker Size	Net
3942	10 x 10 x 6"	4 3/4"	6"	\$3.06
3943	12 x 12 x 7"	6 1/2"	8"	3.66
3944	14 x 14 x 8"	9"	10"	4.80
3945	16 x 16 x 8"	11"	12"	6.45

ICA DE LUXE SLOPING CHASSIS AMPLIFIER UNITS

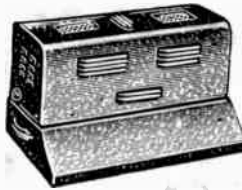

Chassis are sloped and are equipped with beautiful chrome trimmed handles. Slope provides ample space for mounting instruments.

The top covers have beautiful Chrome Plated "Air-Gate" Ventilators with red striped chrome trim. Supplied with ventilating louvres on sides and back. Have raised rectangular screen opening on the tops, embellished with red striped chrome moulding. Marine Gray Ripple finish.

No.	Overall Size	Chassis Bottom	Chassis Height	Slope Size	Net
3962	7 x 17 x 9 1/2"	10 x 17	3 1/2"	4"	\$5.46
3963	10 x 14 x 9 1/2"	13 x 14	3 1/2"	4"	6.15
3964	10 x 17 x 9 1/2"	13 x 17	3 1/2"	4"	6.60

ICA DE LUXE AMPLIFIER FOUNDATION CHASSIS

Top covers have rounded corners and fronts are embellished with the newly created Chrome plated "Air-Gate" Ventilators. Additional ventilation is obtained through the raised screen openings on the top as well as louvres on both sides and back.

Have beautiful red striped Chrome mouldings and Chrome handles. Finished in Marine Gray Ripple Enamel.

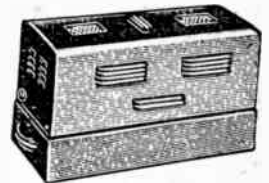

No.	Size	Height of Chassis	Net
3971	5 1/2" x 10" x 9"	3"	\$3.69
3972	8" x 12" x 9"	3"	4.80
3973	7" x 17" x 9"	3"	4.95
3974	10" x 14" x 9"	3"	5.40
3975	10" x 17" x 9"	3"	5.70

ICA STANDARD AMPLIFIER FOUNDATION UNITS



Top covers have rounded corners. The front, sides and back are equipped with louvre ventilators. The tops have raised screen openings for additional ventilation.

Finished in beautiful Marine Gray Ripple Enamel.

No.	Size	Height of Chassis	Net
3980	5 1/2" x 10" x 9"	3"	\$2.16
3981	8" x 12" x 9"	3"	3.15
3982	7" x 17" x 9"	3"	3.24
3983	10" x 14" x 9"	3"	3.51
3984	10" x 17" x 9"	3"	3.69

ICA SLOPING FRONT CHASSIS

Has a sloping front for mounting instruments and which enhances the appearance of any unit on which it is used. Has the effect of a beautiful open cabinet receiver, or amplifier unit, when used without top covers. Made of Heavy Duty Steel, finished in Black Ripple Enamel.



No.	Top of Base	Bottom of Base	Height	Size of Slope	Net
3320	7 x 17"	10 x 17"	3 1/2"	4"	\$1.98
3321	10 x 14"	13 x 14"	3 1/2"	4"	2.19
3322	10 x 17"	13 x 17"	3 1/2"	4"	2.49

ICA DE LUXE SPEAKER CABINETS

Trimmed with red striped chrome trim. Has beautiful red striped chrome handle on top. Marine Gray Ripple finish.

No.	Size	Hole Size	Speaker Size	Net
3935	10 x 10 x 6"	4 3/4"	6"	\$4.20
3936	12 x 12 x 7"	6 1/2"	8"	5.28
3937	14 x 14 x 8"	9"	10"	6.60
3938	16 x 16 x 8"	11"	12"	8.70

ICA STANDARD SPEAKER CABINETS

Finished in Black Ripple Enamel with plain back steel handles to match.

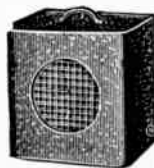

No.	Size	Hole Size	Speaker Size	Net
3942	10 x 10 x 6"	4 3/4"	6"	\$3.06
3943	12 x 12 x 7"	6 1/2"	8"	3.66
3944	14 x 14 x 8"	9"	10"	4.80
3945	16 x 16 x 8"	11"	12"	6.45

ICA DE LUXE METER CASES

Finished in Marine Gray Ripple Enamel with rounded tops and trimmed with beautiful red striped Chrome band. Available for 2" or 3" meters.



No.	D.	W.	H.	Meter Hole	Net
3995	4 1/4"	4 1/4"	4 1/2"	2 1/8"	\$1.35
3996	4 1/4"	4 1/4"	4 1/2"	2 1/8"	1.35

ICA INSULINE ICA

RADIO PRODUCTS

ICA STEEL CHASSIS BASES

HEAVY DUTY



One-piece steel chassis bases. Solidly constructed! Suitable for receivers, transmitters, amplifiers, etc. Chassis bases are folded over on bottom for additional strength. They are also drilled to allow for the attaching of bottom plates.

ICA CHASSIS BOTTOM PLATES



Designed to fit all ICA Chassis Bases and amplifier units listed above. Equipped with four raised bosses which prevent marring or scratching.

Cadmium Plated Finish					Black Ripple Finish				
No.	Size	Gauge	Net		No.	Size	Gauge	Net	
1560	4 3/4 x 8 1/2 x 1 1/2	#20	\$.63		4000	4 3/4 x 8 1/2 x 1 1/2	#20	.60	
1530	5 x 9 1/2 x 1 1/2	#20	.66		4001	5 x 9 1/2 x 1 1/2	#20	.63	
1565	5 x 9 1/2 x 3	#20	.87		4002	5 x 9 1/2 x 3	#20	.84	
1582	5 1/2 x 10 x 3	#20	.93		4032	5 1/2 x 10 x 3	#20	.84	
1566	5 1/2 x 13 x 3	#20	1.05		4003	5 x 13 x 3	#20	.99	
1526	7 x 7 x 2	#20	.84		4024	7 x 7 x 2	#20	.78	
1569	7 x 9 x 2	#20	.90		4004	7 x 9 x 2	#20	.84	
1570	7 x 11 x 2	#20	.99		4005	7 x 11 x 2	#20	.90	
1527	7 x 12 x 3	#20	1.17		4006	7 x 12 x 3	#20	1.05	
1571	7 x 13 x 2	#20	1.08		4007	7 x 13 x 2	#20	.99	
1572	7 x 15 x 3	#20	1.29		4008	7 x 15 x 3	#20	1.23	
1528	7 x 17 x 3	#20	1.29		4009	7 x 17 x 3	#20	1.23	
1567	8 x 12 x 3	#20	1.29		4013	8 x 12 x 3	#20	1.23	
1573	8 x 17 x 2	#20	1.38		4014	8 x 17 x 2	#20	1.32	
1575	8 x 17 x 3	#20	1.47		4035	8 x 17 x 3	#20	1.41	
1562	10 x 11 x 2 1/2	#20	1.38		4015	10 x 11 x 2 1/2	#20	1.32	
1520	10 x 12 x 3	#20	1.41		4016	10 x 12 x 3	#20	1.32	
1568	10 x 14 x 3	#20	1.47		4017	10 x 14 x 3	#20	1.38	
1583	10 x 17 x 3	#20	1.32		4033	10 x 17 x 3	#18	1.23	
1521	10 x 17 x 3	#18	1.59		4018	10 x 17 x 3	#18	1.50	
1522	10 x 23 x 3	#18	1.98		4019	10 x 23 x 3	#18	1.86	
1577	11 x 17 x 2	#18	1.80		4027	11 x 17 x 2	#18	1.65	
1519	11 x 17 x 3	#18	1.98		4023	11 x 17 x 3	#18	1.86	
1574	12 x 17 x 2	#18	1.80		4020	12 x 17 x 2	#18	1.86	
1578	12 x 17 x 3	#18	1.98		4028	12 x 17 x 3	#18	2.07	
1579	13 x 17 x 2	#18	2.16		4029	13 x 17 x 2	#18	2.31	
1524	13 x 17 x 3	#18	2.49		4021	13 x 17 x 3	#18	2.31	
1580	10 x 17 x 4	#18	2.10		4030	10 x 17 x 4	#18	1.98	
1581	13 x 17 x 4	#18	2.82		4031	13 x 17 x 4	#18	2.64	

Cadmium Plated No.	Black Ripple No.	Size	Net
1601	4051	5 x 9 1/2	\$.39
1602	4052	5 x 13	.48
1623	4073	7 x 7	.48
1603	4053	7 x 9	.48
1604	4054	7 x 11	.54
1605	4055	7 x 12	.57
1606	4056	7 x 13	.57
1607	4057	7 x 15	.63
1608	4058	7 x 17	.66
1612	4062	8 x 12	.66
1613	4063	8 x 17	.69
1614	4064	10 x 11	.69
1615	4065	10 x 12	.69
1616	4066	10 x 14	.75
1617	4067	10 x 17	.84
1618	4068	10 x 23	1.08
1622	4072	11 x 17	.84
1619	4069	12 x 17	.90
1620	4070	13 x 17	1.08
1624	4074	13 x 14	.90

ICA SLOPING FRONT CHASSIS

Has a sloping front for mounting instruments. Has the effect of a beautiful open cabinet receiver, or amplifier unit, when used without top covers. Made of Heavy Duty Steel, finished in Black Ripple Enamel.

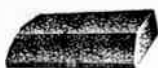

No.	Top of Base	Bottom of Base	Hgt. Slope	Size of Slope	List
3320	7x17"	10x17"	3 1/2"	4"	\$1.65
3321	10x14"	12x14"	3 1/2"	4"	1.80
3322	10x17"	13x17"	3 1/2"	4"	1.98

ICA Masonite Relay Rack Panels

Made of Tempered Masonite—a non-magnetic material, sturdy and tough yet easily drilled and worked with ordinary wood-working tools and punches. Fin-

ished in Black or Gray. Supplied in Black Ripple finish unless Gray is specified.

No.	Base	Size	List
3662	1 1/2 x 19"		\$.48
3663	3 1/2 x 19"		.60
3664	5 x 19"		.75
3665	7 x 19"		.87
3666	8 3/4 x 19"		1.05
3667	10 1/2 x 19"		1.20
3668	12 1/4 x 19"		1.20
3669	14 x 19"		1.50
3670	15 3/4 x 19"		1.65
3671	17 1/2 x 19"		1.92
3672	19 3/4 x 19"		2.07
3673	21 x 19"		2.31

Special Sizes Rack Panels To Order

We can supply Rack Panels in any thickness from 1/8" to 3/4" in Steel, Aluminum or Masonite; in any finish to specifications.

ICA RELAY RACK BRACKETS

Black Ripple Finish. Used to reinforce racks and for mounting of panels, shelves, chassis, etc.



No.	Base	Size	Net
3950	5" Base Brackets	Per Pair	\$.63
3951	8" Base Brackets	Per Pair	.90
3952	11" Base Brackets	Per Pair	1.20

ICA Standard Relay Rack Panels

ICA relay rack panels are supplied in 1/8" thickness, completely slotted and finished in a beautiful Baked Black or Marine Gray Ripple Finish. Supplied in Amateur Rack notching, first notch 3/8" from edge of Panel and 1 1/4" between centers. 19" long.



Steel			Gray		
No.	Size	Net	No.	Size	Net
3600	1 1/2"	\$.66	3612	1 1/2"	\$.66
3601	3 1/2"	.75	3613	3 1/2"	.75
3602	5 1/2"	.87	3614	5 1/2"	.87
3603	7"	.93	3615	7"	.93
3604	8 3/4"	1.17	3616	8 3/4"	1.17
3605	10 1/4"	1.32	3617	10 1/4"	1.32
3606	12 1/4"	1.62	3618	12 1/4"	1.62
3607	14"	1.86	3619	14"	1.86
3608	15 3/4"	2.16	3620	15 3/4"	2.16
3609	17 1/2"	2.31	3621	17 1/2"	2.31
3610	19 1/4"	2.49	3622	19 1/4"	2.49
3611	21"	2.82	3623	21"	2.82

ICA METER PANELS

Slotted to fit all standard racks. Finished in Baked Black or Gray Ripple. Size 5 1/4" x 19". Black will be shipped unless Gray is specified.



No.	No. Holes	Meter Size	Net
3651	5	2"	\$2.16
3652	3	2"	1.50
3653	5	3"	2.16
3654	3	3"	1.50

ICA Chassis Mounting Brackets



Made to fit on 17" relay rack chassis. Panels must be at least 7" high. Black ripple finish.

No.	For	Size	Net
3955	For 8" base	Per Pair	\$.75
3956	For 11" base	Per Pair	1.14
3957	For 13" base	Per Pair	1.32

ICA BAKELITE RADIO PANELS

Black, Polished Mirror Finish



1/8" Thickness		3/8" Thickness	
No.	Net	No.	Net
832	7 x 10 \$.93	842	7 x 10 \$1.35
833	7 x 12 1.11	843	7 x 12 1.65
834	7 x 14 1.20	844	7 x 14 1.95
835	7 x 18 1.80	845	7 x 18 2.46
836	7 x 21 2.16	846	7 x 21 2.79
837	7 x 24 2.52	847	7 x 24 3.30
840	7 x 30 2.70	850	7 x 30 4.05
860	10 x 12 1.65	863	10 x 12 2.49
861	10 x 18 2.19	864	10 x 18 3.39

ICA METAL

PANELS

Black Ripple Finish
Thickness of Panels 3/4"



No.	Size	Net
3175	7 x 10"	\$.48
3176	7 x 12"	.54
3177	7 x 14"	.63
3178	7 x 18"	.84
3183	8 x 12"	.66
3184	8 x 14"	.72
3186	8 x 18"	.84
3191	10 x 14"	1.17
3192	10 x 18"	1.32
3194	10 x 24"	1.65

ICA MASONITE PANELS

Black Ripple Finish
Thickness of Panels 3/4"



No.	Size	Net
810	7 x 10"	\$.60
811	7 x 12"	.66
812	7 x 14"	.75
813	7 x 18"	.90
814	7 x 21"	.99
815	8 x 12"	.81
816	8 x 14"	.87
817	8 x 16"	.99
818	8 x 18"	1.08

ICA INSULINE RADIO PRODUCTS ICA

ICA HINGED COVER CABINETS



Supplied in knocked-down form for easy handling. Easily assembled. Finished in Black Ripple Enamel.

No.	W.	L.	H.	Net
3825	9" x 5"	5" x 6"		\$2.40
3826	10" x 8"	8" x 7"		3.00
3828	12" x 8"	8" x 7"		3.45
3829	12" x 11"	8" x 8"		4.11
3830	14" x 8"	8" x 7"		3.66
3831	18" x 12"	8" x 9"		5.16

ICA METAL CABINETS

Black Ripple Finish

Have various uses such as input stages, mixers, transceivers, amplifiers, monitors, etc. Front and back covers are removable and can be fastened to cabinet with self tapping machine screws. Finished in Black Ripple Enamel.



No.	L.	W.	H.	Net
3810	4" x 2"	4" x 4"		\$.78
3811	4" x 3"	5" x 6"		.84
3800	6" x 6"	6" x 6"		.93
3801	8" x 5"	6" x 6"		1.50
3802	10" x 8"	7" x 7"		1.89
3803	10" x 8"	10" x 10"		2.31
3804	12" x 11"	8" x 8"		2.49

ICA SLOPING PANEL CABINETS

Small—Compact



New streamlined cabinets, rugged, small and compact, have various uses such as speaker cabinets, oscillator cases, input stages, small receivers, tele-talk systems, monitors, etc.

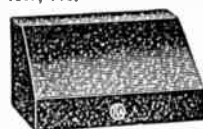

Beautifully designed, with rounded corners and finished in marine gray ripple.

No.	W.	H.	D.	Net
3905	4 1/4" x 4 1/2"	4 1/4" x 4 1/4"		\$1.29
3906	7 1/2" x 4 1/2"	4 1/4" x 4 1/4"		2.31

ICA PORTABLE STEEL CABINETS



Ideal for housing oscillators, transceivers, test equipment, etc. Both front and back panels are removable and are held with self-tapping screws which are supplied. Equipped with leather handle. Finished in black ripple.

No. 3850—Size 12 x 7 3/4 x 7"	Net	\$2.31
No. 3851—Size 15 x 7 3/4 x 7"	Net	2.70
Chassis for above		
No. 4025—7 1/2" x 6 3/4" x 2 1/2"	Net	.45

ICA SPAGHETTI TUBING

For No. 10 to No. 18 gauge wire. Guaranteed not to crack. Furnished in 30" lengths.

No.	Color	Net per length
182	Red	\$.11
183	Yellow	.11
184	Brown	.11
185	Green	.11
186	Black	.11

SMALL SIZE SPAGHETTI TUBING

200—Red	\$.11
201—Yellow	.11
202—Black	.11

LARGE SIZE SPAGHETTI TUBING

Supplied in 36" lengths. Diameter 9/64" I.D. x 15/64" O.D.
No. 196—Supplied in black only
Net — per length \$.30

ICA CHROMO-GRAYVE METAL TRIM PLATES

A new and excellent material used to lend Beauty and Color to any Chassis, Cabinets, Amplifier Chassis, Receivers, Test Equipment Cases, etc.

No.	Size	Net
3550	3" x 10"	\$.60
3551	3" x 12"	.75
3552	3" x 14"	.84
3553	3" x 17"	1.02
3554	3" x 23"	1.44
3555	4" x 14"	1.20
3556	4" x 17"	1.44

ICA CHROME TRIM MOULDING

Beautiful chrome trim mouldings to dress up any cabinet, chassis, receiver, speaker cabinet, transmitter, etc. All mouldings furnished with mounting tracks or clips.



No.	Net
3510—Chrome Moulding with single Red Stripe—size 1/4" w. by 4" l.	\$.36
3513—Chrome Moulding with double Red Stripe—size 3/8" w. by 8" l.	.60
3514—Chrome Moulding with double Red Stripe—size 3/8" w. by 12" l.	.69
3515—Chrome Moulding with double Red Stripe—size 3/8" w. by 18 7/8" l.	.84
3505—Bullet Shape all Chrome Moulding—size 1/8" w. by 6" l.	.36

ICA CHROME HANDLES



A beautiful adornment for any cabinet, amplifier chassis transmitter, etc. Furnished with mounting screws.

No. 3500—Chrome Handle with two Red Stripes across the full length. Dimensions 4" long, 1 1/4" wide. Mounting centers 2 3/4" apart.

No. 3501—All Chrome Handle. Dimensions 5 1/2" long by 1 1/2" wide. Mounting centers 4 1/2" apart.

ICA CHROME VENTILATING LOUVRES

A set of 5 chrome plated trim plates fastened together to form an "air-gate" Ventilating louvre. Used on all I.C.A. De Luxe chassis and cabinets—Adds the finishing touch to any receiver, amplifier, transmitter, etc.



Overall size 4 3/4" Wide—2 1/2" High. Air Space between Trim Louvre Plates 1/4" Wide.
No. 3525 Net \$.84

ICE FLEXIBLE VARNISHED TUBING SPAGHETTI

20 Foot Lengths



A flexible tubing, heavily varnished, in attractive colors. Average dielectric strength, 5000 volts. Will accommodate from No. 10 to No. 18 wires. Furnished in one length—20 feet long on handy spools.

No.	Color	Per Spool	Net
210	Red		\$.75
211	Yellow		.75
212	Brown		.75
213	Green		.75
214	Black		.75
500 Foot Spools, spaghetti tubing, same grade and colors as above. Specify color per spool.			
No. 197			Net \$17.10

ICA GLOVE-TITE TUBE SHIELDS



No. 1720 TYPE A—For Dome type (ST-12 short).
No. 1720 Type C—With Ring. (ST-12 short).
No. 1722 TYPE B—For Dome type (ST-12 long).
No. 1722 Type C—With Ring (ST-12 long).
No. 1718 TYPE C—For Dome type (ST-12 med.).
No. 1721 TYPE D—For Dome type (ST-14).

All Types, each Net \$.15

ICA G. T. and BANTAM TUBE SHIELDS

Designed for the new 1 1/2 Volt Bantam glass tubes or T9 Bulbs. Available with or without grid cap.

No.	Net
1729—G. T.—Shield	\$.12
1726—Shielded cap—one piece—grounds automatically	.12
1727—Shield complete with grid lead cap and ground clip	.15

ICA ALUMINUM TUBE SHIELD

For 55, 67, 68, etc. type tubes.

No.	Net
1708—1 1/8" mounting centers	\$.27
1709—1 1/2" mounting centers	.27

ICA COIL SHIELDS

with Detachable Base

No.	Net
1539—2 1/8" x 3" High	\$.36
1540—2 1/2" x 3 1/2" High	.42
1549—3" x 3 1/2" High	.45

ICA GRID CAP SHIELDS

(For Metal Tubes)

No.	Net
1552	\$.12

BAKELITE AND FENOLINE TUBING

ICA tubing is strong mechanically, has extremely low electrical absorption and is highly resistant to moisture. Absolute perfection in winding of coils is assured by the use of ICA tubing—thus affording relief from complaints or failure in performance.

Finished in Natural and Black Colors

Small sizes up to one inch in Black only.

1/8" Wall Thickness, Full Lengths.

Approximately 36 to 48"

BAKELITE		FENOLINE	
No.	O.D. Per Ft.	No.	O.D. Per Ft.
100	1/4" \$.57	161	1/4" \$.51
101	3/8" .69	162	3/8" .54
102	1/2" .72	163	1/2" .60
103	5/8" .78	164	5/8" .63
104	3/4" .84	165	3/4" .66
105	7/8" .93	166	7/8" .69
106	1" .99	167	1" .75
147	1" 1.05	134	1" .69
148	1 1/4" 1.17	135	1 1/4" .81
149	1 1/2" 1.23	136	1 1/2" .84
150	1 3/4" 1.35	137	1 3/4" .93
151	2" 1.50	138	2" 1.02
152	2 1/4" 1.62	139	2 1/4" 1.11
153	2 1/2" 1.89	140	2 1/2" 1.23
154	2 3/4" 2.10	141	2 3/4" 1.47
155	3" 2.40	142	3" 1.59
156	3 1/4" 2.52	143	3 1/4" 1.71
157	3 1/2" 2.70	144	3 1/2" 2.01
158	3 3/4" 2.70		
159	4" 3.30		

ICA "INSULOID" RODS

No.	Color	Size	Net
2175	Black	12" x 1/4"	\$.27
2176	Black	24" x 1/4"	.48
2179	Black	12" x 3/8"	.36
2180	Black	24" x 3/8"	.72

ICA INSULINE RADIO PRODUCTS

RADIO REPLACEMENT AND INSTRUMENT KNOBS

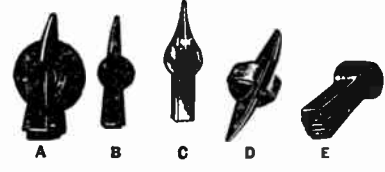

No.	Type	Color	Size	Each	Net Price	Lots of 10
1125	A	Black	1 1/4"	\$.12	\$1.20	
1127	A	Red	1 1/4"	.13	1.30	
1126	B	Black	2 1/4"	.13	1.30	
1128	B	Red	2 1/4"	.15	1.50	
1135	C	Black	1 1/4"	.13	1.30	
1156	C	Black	2 1/4"	.15	1.50	
1161	C	Red	1 1/4"	.15	1.50	
1162	C	Red	2 1/4"	.17	1.70	
1143	D	Black	2 1/4"	.15	1.50	
1144	D	Walnut	2 1/4"	.17	1.70	
1153	E	Black	2 1/4"	.21	2.10	
1154	E	Walnut	2 1/4"	.21	2.10	

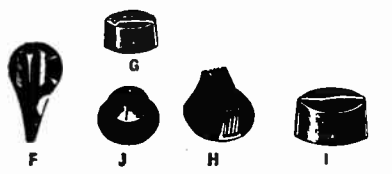

No.	Type	Color	Size	Each	Net Price	Lots of 10
1270	F	Black	1 1/2"	\$.18	\$1.80	
1271	F	Black	2 1/2"	.21	2.10	
1138	G	Walnut	3/4" x 1 1/2"	.11	1.10	
1139	G	Walnut	1" x 1 1/2"	.13	1.30	
1087	H	Walnut	1"	.12	1.20	
1088	H	Black	1"	.12	1.20	
1133	I	Walnut	3/4" x 1 1/2"	.11	1.10	
1134	I	Walnut	1" x 1 1/2"	.13	1.30	



No.	Type	Color	Size	Each	Net Price	Lots of 10
248	J	Black	1"	\$.12	\$1.20	
249	J	Black	1 1/2"	.13	1.30	
1076	K	Walnut	1 1/2"	.13	1.30	
1080	K	Walnut	1"	.15	1.50	
1049	L	Walnut	13/16"	.12	1.20	
1050	L	Walnut	1 1/2"	.13	1.30	
1174	M	Black	15/16"	.13	1.30	
1089	N	Walnut	13/16"	.13	1.30	
1090	N	Walnut	1"	.15	1.50	



No.	Type	Color	Size	Each	Net Price	Lots of 10
1072	O	Walnut	13/16"	\$.13	\$1.30	
1073	O	Walnut	3/4"	.13	1.30	
1081	P	Black	3/4"	.12	1.20	
1082	P	Red	3/4"	.12	1.20	
1083	P	Green	3/4"	.12	1.20	
1084	P	Brown	3/4"	.12	1.20	
1085	P	White	3/4"	.12	1.20	
1116	Q	Walnut	3/4"	.13	1.30	
1117	Q	Walnut	1"	.15	1.50	
1135	R	Walnut	3/4"	.10	1.00	
1136	R	Walnut	3/4"	.13	1.30	

ICA FINGER-GRIP POINTER KNOBS

Moulded of black bakelite with 1/4" hole. Pointer type knobs have white indicators, flange type knobs have white indicating line. With 1/4" Brass Inserts

TYPE A—With Pointer

No. 1166—1 1/4" Net \$.39 No. 1168—1 1/2" Net \$.51
No. 1170—2 3/4" Net \$.60

TYPE B

No. 1165—1 1/4" Net \$.30 No. 1167—1 1/2" Net \$.42
No. 1169—2 3/4" Net \$.48

No. 1171—2-1/16" Net \$.48 No. 1172—3" Net \$.54

ICA CHROME SILVER DIALS WITH FINGER GRIP FLANGE KNOBS

Beautiful dial plates accurately Etcho-engraved with black numerals and calibrations.

No.	Size	Degrees	Calibr.	Net
2170	2 3/4"	325	0-100	\$1.26
2171	3 1/4"	180	0-100	1.26
2168	4 1/4"	325	0-100	1.55
2169	4"	180	0-100	1.65

ICA NEW VERNIER DIAL

Satin silver finish. Marker calibrated at 0-100 in 180 degrees. Complete with tuning knob for receivers or transmitters.

No. 2205—2 3/4" Diam. Net \$1.35
No. 2206—4" Diam. Net 1.65

ICA MINIATURE DIALS

1 1/2" Diameter
Beautiful Chrome Silver dials with black etched numerals. Finger grip black knob. Only 1 1/2" Diameter. Fit 1/4" Shafts.

No.	Net
2164—0-10	180 \$1.51
2165—0-10	27051

ICA CHROME SILVER DIAL PLATES

Attractive grain satin finish. Black Etcho Engraving on Chrome Silver Background Plates.

No.	Degrees	Dia.	Calibr.	Net
2294	180	2"	0-100	\$.48
2295	325	2"	0-100	.48
2296	180	3 1/4"	100-0	.75
2297	180	3 1/4"	0-100	.75
2298	180	4"	0-100	.84
2299	325	4"	0-100	.84

ICA BRASS BLACK SATIN FINISH DIAL PLATES

With Etched Silver Numerals

No.	Degrees	Dia.	Calibr.	Net
2230	325	3 3/4"	0-100	\$.36
2231	180	3 3/4"	100-0	.36
2232	180	3 3/4"	0-100	.36
2233	180	2"	100-0	.27
2234	325	2"	0-100	.27
2235	325	2"	100-0	.27
2236	180	2"	0-100	.27

ICA INDICATING PLATES

Made of heavy brass with black satin background. Silvered "Etcho Graued" numerals and lettering. 13/32" center mounting hole. 1 1/2" Diameter.

No.	Degrees	Net
2259—Marked 1 to 6	180 \$2.1
2450—Marked 1 to 5 (Volume)	325 .21
2451—Marked 1 to 5 (Tone)	325 .21
2452—Marked 1 to 10	325 .21
2453—Marked Off-On—with arrow	325 .21

ICA ETCHED DIAL PLATES

RECTANGULAR TYPES
Made of brass—finished in black with etched silver markings. Calibrated for 300 degree rotation. Marked 1 to 10. Will fit on 3/8" bushing. Size 2 1/4" x 1-11/16".

No.	Marking	Net
2244—Record	\$.24
2245—Microphone24
2246—Gain24
2247—Tone24
2248—Plain (Calibrated but not worded)24

ICA TOGGLE SWITCHES

Furnished in Nickel or Antique Bronze. Capacity 1 Amp. 250 Volts. 3 Amps. 125 Volts. Mfd. by II & II for ICA.

No.	Shank Length	Description	Finish	Net
1230	3 1/2"	S.P.S.T.	Nickel	\$.33
1232	3 1/2"	S.P.S.T.	Bronze	.33
1233	3 1/2"	S.P.S.T.	Bronze	.36
1235	3 1/2"	S.P.S.T.	Nickel	.36
1236	3 1/2"	S.P.D.T.	Nickel	.45
1237	3 1/2"	S.P.D.T.	Nickel	.45
1238	3 1/2"	D.P.D.T.	Nickel	.48
1365	3 1/2"	D.P.D.T.	Nickel	.60
1366	3 1/2"	D.P.D.T.	Nickel	.78

ICA ROTARY SWITCHES

Rated 3 Amps. at 125 Volts. Overall Length of shafts 1 1/2". Made by II & II for ICA. Underwriters Approved.

No.	Shank	Description	Net
1228	3/8"	S.P.S.T.	\$.36
1229	3/8"	S.P.S.T.	.42
1286	3/8"	S.P.D.T.	.48
1287	3/8"	S.P.D.T.	.60
1288	3/8"	D.P.D.T.	.75
1289	1"	D.P.D.T.	.93

BAT-HANDLE TOGGLE SWITCH

Made by II & H. Identical to toggle switches listed above, except that handle is longer and shaped like a baseball bat. Less on and off plate. Nickel plated only—7/16" shank. Packed 5 in a standard carton.

No.	Description	Net
1296—S.P.S.T.	\$.33
1297—S.P.D.T.45
1298—D.P.S.T.60
1299—D.P.D.T.75

'ON-OFF' PLATE

No. 1300
For Toggle Switch Net \$0.4

ICA EXTRA HEAVY DUTY SWITCH

D.P.D.T. With Neutral Center
An extra large heavy duty. Double Pole. Double Throw switch with neutral position in the center for use in heavy current circuits such as transmitters, power amplifiers, motors, etc. Contacts have fast "break" which reduces the tendency to arc. Rated at 10 amperes, 125 Volts. Size of Switch sleeve diameter 5/8".

No. 1283 Net \$3.30

ICA HI-POWER SWITCH

PUSH BUTTON TYPE
When used in racks it is designed to break primary circuit when rack door is open. D.P.S.T. Made by II & H for ICA. Capacity 12 Amp. 125 Volt. Overall size 1 3/4" long. 3/4" wide. 3/4" high; 7/16" shank

No. 1280 Net \$1.65

ICA POWER SWITCH

(Toggle Type)
Characteristics and dimensions same as No. 1280 described above.

No. 1281 Net \$1.02

ICA PUSH BUTTON SWITCHES

Single pole 2 circuit momentary switch. One circuit is "ON" and the other normally "OFF". 1 Ampere, 125 Volt, made by II & II for I.C.A. Shank 3/8" long.

No. 1282 Net \$0.66

ICA VERNIER DIAL MARKER

Complete with self-tapping screws for mounting on metal, wood, bakelite or brass panels.

No.	For	Net
2189	For 2 3/4" —325° Dials \$1.30
2190	For 2 3/4" —180° Dials30
2191	For 3" —325° Dials30
2192	For 4" —180° Dials30

ICA INSULINE ICA

RADIO PRODUCTS

ICA Bakelite Double Phone Plug



No. 24B—Black Net \$.36
No. 24R—Red Net .36

ICA Midget Phone Plug

Overall length—
2 5/8". Diameter
of barrel 1/4".



No. 29B—Black Net \$.36
No. 29R—Red Net .36

ICA Stubby Shielded Phone Plug

Barrel Measures
1 1/4" diameter x
1" long.
No. 27.....Net \$.48

ICA Midget Shielded Phone Plug

Diameter of Barrel
3/8". Overall
size of Plug 2 1/4"
No. 30.....Net \$.42

ICA 3-Wire Microphone Plug



The ICA 3-Wire Microphone Plug has solder connections for cable or microphone use. Barrel molded of bakelite with brass parts, nickel plated.

No. 1901..... Net \$.66

ICA Shielded Double Phone Plug

Nickel Barrel
Brass Shell
Nickel Plated



Supplied with pure gum rubber insulating bushing.

No. 25..... Net \$.60

ICA Shielded 3-Wire Microphone Plug

Shielded
Nickel Barrel



No. 1900..... Net \$.93

ICA Shielded 3-Way Portable Microphone Jack

For all types of microphones. Sturdily constructed of brass parts with phosphor bronze springs. Nickel plated and thoroughly insulated.

No. 1904..... Net \$.90

ICA Bakelite Portable Jacks

Single Open
Circuit



No. 1911—Overall Size 1 1/4"
Diameter 3/4" Net \$.42

ICA Shielded Portable Jack

Single Open
Circuit



No. 1913—2 1/4" Long, 1 1/4"
Diameter Net \$.75

ICA 3-Way Microphone Jack

Small compact size where minimum space is important. Excellent insulation and positive contact.



No. 1902..... Net \$.60

ICA Panel Mounting Jacks



Small
and
Compact

No. 325—Single Open Circuit.....\$.30
1905—3-Way Microphone Jack .45

ICA Single Open Circuit Jack

No. 362.....Net \$.30
Single Closed Circuit
No. 363.....Net \$.36



ICA Insulated Tip Jacks

With receptacle for standard phone tips.

No. 888B—Black Net \$.11
889B—Black \$1.11
889R—Red11

Insulated Banana Jacks

With receptacle for banana plugs.

No. 888B—Black Net \$.11
888R—Red11

ICA Bakelite Insulated Tip Jacks

Moulded of Low-Loss
Bakelite

No. 1889—Black Net \$.13
1890—Red13

Bakelite Banana Type Jacks

No. 1891—Black Net \$.13
1892—Red13

ICA Combination Banana Plug or Phone Tip Jack

Made to take Banana plug or standard phone tips interchangeably. Insulated cap in black and red—Complete with Washers and nuts.

No. 528R—Red Net \$.18
No. 528B—Black Net .18

ICA Insulated Binding Posts with Jack for Banana Type Plug

Length 1 1/2" overall when top is up. Extends 3/4" above panel when top is screwed down. Fitted with 8/32 screw 3/8" long, and two hex nuts.

No. 622—Red Net \$.18
623—Black18

ICA Bakelite Binding Posts

3/8" Diameter Head with Brass Threaded insert, Nickel Plated Screw and Knurled nut.

No. 617—Red Net \$.11
618—Black11

ICA Insulated Midget Phone Tip Plug

Fits all standard jacks. Tip is threaded. Overall length 1 1/4".

No. 876R—Red Net \$.12
876B—Black12

ICA Midget Sharp Point Threaded Phone Tip Non-Insulated
No. 365.....Net \$.09

ICA Insulated Solderless Plug

2 1/4" long—fits all standard phone tip jacks.

No. 885B—Black Net \$.13
No. 885R—Red Net .13

ICA Sr. Solderless Plugs

1 1/4" overall length.
No. 358
Net \$9.00 per 100

ICA Brass Tip Jacks

Nickel Plated
Net \$9.00 per 100

ICA Insulated Needle Point Tip Plug

886B — Black
Net \$.13
886R — Red
Net \$.13

ICA Alligator Clips

Good firm grip. Ideal for work in tight places. Overall length 2".
No. 364.....Net \$.07

ICA Insulated Alligator Clips

No. 884B—Black Net \$.15
No. 884R—Red Net .15

ICA Insulated Double Handle Alligator Clips

No. 925—Red \$1.18
926—Black18

ICA Insulated Solderless Split Banana Plugs

Set screw provided at side of barrel to fasten screw without soldering.

1 1/2" Long
No. 883B—Black Net \$.15
No. 883R—Red Net .15

2 1/2" Long
With sleeve covering set screws.
No. 882B—Black Net \$.27
No. 882R—Red Net .27

4" Long
With sleeve covering set screws.
No. 881B—Black Net \$.36
No. 881R—Red Net .36

Insulated Spade Lug

Insulated Spade Lug with banana plug receptacle on lead end.
No. 887B—Black Net \$.12
No. 887R—Red Net .12
10 in Standard Carton.

ICA Spade Lug

Can be used on any size screw or terminal up to size 10. Receptacle fits all I.C.A. and other make Banana Plugs.
No. 879..... Net \$4.20 C
100 in Standard Package

Giant Insulated Transmitting Plugs and Jacks

Plug-in type with positive grip contacts. Equipped with heavy insulated threaded heads and handles for safe handling on high R.F. currents.

Handle 1,000 Volts at 10 Amps. Net

No. 450—Medium Plug-RED \$.33
451—Medium Plug-BLACK33
452—Medium Jack-RED57
453—Medium Jack-BLACK57
454—Giant Plug-RED45
455—Giant Plug-BLACK45
456—Giant Jack-RED69
457—Giant Jack-BLACK69

ICA Split Banana Plugs

For positive and durable spring action. Allows spring to fit into jack, cannot bend out of shape—Complete with two nuts.
No. 403.....Net \$.09

ICA Transmitting Banana Jacks

No. 402—Nickel Plated Brass \$.09
1891—Insulated Black Bakelite13
1892—Insulated Red Bakelite13

Beryllium Banana Plugs

Approved by the Signal Corps and other government agencies. These plugs are used in all government equipment. Made of Beryllium copper and guaranteed for its spring and durability. Threaded plug accommodates 6/32 nuts.

No. 419—Overall size 1 1/4" Long. Shank Length 1/4" Long. Diameter of Shank 3/8".

No. 420—Overall size 1 1/2" Long. Threaded Shank Length 3/8" Long. Threaded for 6/32 nuts.

No. 419.....Net \$.12
No. 420.....Net .21

ICA Insulated Combination

Jack
Alligator
Clip

An insulated alligator clip with a dual purpose Jack in catalin sleeve—Equipped with the new combination Jack which takes either solderless phone tip or Banana plug. Overall length—2 3/4".

No. 520R—Red Net \$.36
No. 520B—Black Net .36

ICA INSULINE ICA

RADIO PRODUCTS

ICA BAKELITE KNIFE SWITCHES

Hardware of brass, heavily nickel-plated. Mounted on highly polished bases of Black BAKELITE. Firm contact assured.



No.	Description	Net
1216	S.P.S.T.	\$.51
1217	S.P.D.T.	.60
1218	D.P.S.T.	.69
1219	D.P.D.T.	.81
1360	3.P.S.T.	1.11
1220	3.P.S.T.	1.20
1221	4.P.S.T.	1.50
1222	4.P.D.T.	1.80
1364	5.P.D.T.	2.10

MINIATURE BAKELITE SWITCHES

Can be mounted on panel or base. Black Bakelite base—highly nickel-plated brass parts with insulated handles.



No.	Base Size	Net
2223	S.P.S.T. 1 1/4" x 1/2"	\$.30
2224	S.P.D.T. 1 1/4" x 1/2"	.36
2225	D.P.D.T. 1 1/4" x 1"	.45
2226	D.P.S.T. 1 1/4" x 1"	.42

ICA SLIDER SWITCHES

Small — Compact

S.P.S.T. Switch furnished with chrome mounting plate. Switch dimensions 1 1/2" x 1/2" x 1/4".



No.	Net
1255—S.P.S.T.	\$.30
1259—S.P.D.T.	.33
1260—D.P.D.T.	.39

ICA SLIDING LEVER SWITCHES

The Modern slider switch for all electrical appliances, panels, analyzers, etc. Replacement for analyzers, tube checkers. Complete with plate. Rated 3 amps. at 125 volts.



No.	Net
1265—S.P.S.T.	\$.90
1266—D.P.D.T.	1.17

ICA ROTARY CANOPY SWITCH

Single pole switch 1/4" shank with brown bakelite knob and 6" leads—1 ampere—250 volts.



No.	Net
1257	\$.30

10 in Standard Package

ICA TERMINAL STRIPS

Made of 3/32" heavy black Bakelite engraved in white. Terminals are nickel-plated phosphor bronze with non-removable collars.

No.	Terminals	Marking	Size	Net
2420	2	Plain	3/8 x 2 1/2	\$.15
2419	3	A & G		.18
2418	3	Output		.18
2417	3	Input	7/8 x 3 3/4	.21
2414	3	Plain		.24
2415	3	1, 2, 3	7/8 x 3 3/4	.30
2413	4	Plain		.33
2408	4	1, 2, 3, 4	7/8 x 4	.33
2405	5	Plain		.33
2406	5	1, 2, 3, 4, 5	7/8 x 4 1/2	.36
2404	6	Plain		.39
2402	6	1, 2, 3, 4, 5, 6	7/8 x 5 1/4	.42
2412	7	Plain		.51
2411	8	1, 2, 3, 4, 5, 6, 7	7/8 x 5 3/4	.54
2410	8	Plain		.60
2409	8	1, 2, 3, 4, 5, 6, 7, 8	7/8 x 6 1/2	.60
2424	9	Plain		.69
2423	9	1, 2, 3, 4, 5, 6, 7, 8, 9	7/8 x 7	.69
2422	10	Plain		.75
2421	10	1, 2, 3, 4, 5, 6, 7, 8, 9, 10		

ICA BAKELITE TERMINAL MOUNTING STRIPS

For fastening Resistors, Condensers, etc.



No.	Terminal	Net—In Lots of 10	No.	Terminal	Net—In Lots of 10
2434	1	\$.012	2437	4	\$.054
2435	2	.27	2438	5	.63
2436	3	.42	2439	6	.78

ICA BAKELITE TERMINAL STRIPS

Brown Bakelite, 1/16" Thick.



No.	Terminal	Net. Each	No.	Terminal	Net. Each
2520	2	\$.012	2523	5	\$.021
2521	3	.15	2524	6	.21
2522	4	.18			

ICA Rubber Insulated Grid Caps

For Receiving Tubes

For 866 Type Tubes

No.	Net
870—With leads	\$.18
871—Without leads	.15

For Receiving Tubes

No.	Net
872—With 12" lead	.12
873—Without lead	.04

For New Metal Tubes

No.	Net
874—With 12" lead	.12
875—Without lead	.04



ICA Fenoline Insulated Grid Caps

Supplied with 12" wire.

For Standard Glass Receiving Tubes

No.	Net
680—Red	\$.15
681—Black	.15

For 866 Transmitting Tubes

No.	Net
682—Red	\$.30
683—Black	.30



ICA Insulated Dual Grid Caps

For Metal and Glass Tubes

Equipped with 12" lead

No.	Net
877—Black	\$.24

No.	Net
878—Red	.24



ICA GRID CAPS

No. 1550 Standard Glass Tubes

Net \$1.50 per C

No. 1551 Metal Tubes

Net \$1.50 per C



ICA GRID CAPS

No. 1553 Glass Tubes

Net \$1.50 per C



ICA GRID CAPS

No. 1554 Glass Tubes

Net \$1.50 per C



ICA TRANSMITTING TUBE PLATE CAPS



A new style heavy duty plate cap connector for transmitting tubes such as 809, 866, T-20, TZ-40, T-55, 803, 250-T, 838, 813. Has cooling fins for radiating heat, preventing the plate cap loosening. Heavy spring contacts insure perfect connection at all times. Can easily handle over a kilowatt output. Diameter of cap—1 1/4". Connectors are 5/8" wide flexible plated copper strips. Length of connectors—2 3/4". Overall length—3 3/4".

No.	Net
950	\$.75

ICA Fenoline Phono. Needle Point Test Prods With Removable Chuck



No.	Test Prod	Net
389R	5 Inch Test Prod—Red	\$.30
389B	5 Inch Test Prod—Black	.30
334R	7 Inch Test Prod—Red	.36
334B	7 Inch Test Prod—Black	.36

ICA Solderless Plug Test Prods With Solderless Plug Chuck



No.	Test Prod	Net
390R	5 1/2 Inch Long Prods—Red	\$.30
390B	5 1/2 Inch Long Prods—Black	.30
335R	7 1/4 Inch Long Prods—Red	.36
335B	7 1/4 Inch Long Prods—Black	.36

High Voltage ICA Heavy Duty Bakelite Test Prod Handles



No.	Net	
480	Black Bakelite	\$.69

High Voltage Heavy Duty Bakelite Test Prods

No.	Net	
485	Black Bakelite	\$.33

ICA Grip-Rite Molded Phone Tip Plug



Replacement for ICA and Weston—as well as other make Test Leads.

No.	Net	
868	Red	\$.30
869	Black	\$.30

ICA PHONO NEEDLE CHUCKS



Push on type can be forced into handles—Threaded type can be screwed into handles—Machined of brass, nickel plated with needle point.

No.	Net	
508	Push on Type, Overall size 1"	\$.09
509	Threaded type, Overall size 1 1/8"	\$.11

HEAVY DUTY PHONE TIP



Made of high quality heavy brass with nickel plated finish. Used on test leads—prods, etc. (Overall length is 1 1/2")

No.	Net
361	\$.78 per C

25 in Standard Package

ICA Insulated Bushings



No. 670	Black 1/8" Hole 3/8" Diam. 3/8" Long	\$.12
No. 671	Red 1/8" Hole 3/8" Diam. 3/8" Long	\$.12
No. 672	Black 1/4" Hole 1/2" Diam. 1/2" Long	\$.15
No. 673	Red 1/4" Hole 1/2" Diam. 1/2" Long	\$.15

ICA INSULINE RADIO PRODUCTS ICA



ICA BASE-MOUNTING BAKELITE SOCKETS

No.	Prong	Net
2480	4 Prong	\$.27
2481	5 Prong	.30
2482	6 Prong	.33
2483	7 Prong comb. large and small	.36
2489	8 Prong OCTAL	.39

ICA "INSULEX" WAFER SOCKETS

An ideal low loss socket designed for ultra high frequency reception.

No.	Prong	Net
2600	4 Prong	\$.39
2601	5 Prong	.39
2602	6 Prong	.42
2603	7 Prong, large	.42
2604	7 Prong, small	.42
2605	8 Prong OCTAL for new metal tubes	.51



ICA BAKELITE WAFER SOCKETS

No.	Prong	Net
1118	4 Prong	\$.10
1096	5 Prong	.10
1095	6 Prong	.10
1119	7 Prong, small	.10
1120	7 Prong, small	.10
1121	8 Prong OCTAL	.12
1123	Loktal Wafer	.12

ICA MOLDED BAKELITE SNAP-ON SOCKETS

Octal—Loktal
Mounted in cadmium plated steel "Saddle" Standard 1 1/2" Mounting centers—Requires 1 1/2" hole in chassis—Equipped with 4 grounding lugs on saddle—Positive grip contacts.
No. 2470—Octal Socket Net \$1.11
No. 2471—Loktal Socket Net .12



"INSULEX" BASE MOUNTING SOCKETS

Especially adapted for ultra short-wave work and transmitters.
No. 290—4 Prong\$.54
291—5 Prong54
292—6 Prong60
294—Comb. 7 Prong, large and small60
300—8 Prong OCTAL60

ICA "INSULEX" ACORN TUBE SOCKET

For 954, 955 and 956 acorn tubes. The perfect socket for U.H.F. and micro wave transmitters and receivers. 1 1/8" in diameter, 5/8" high.
No. 959 Net \$.90



HEAT DISSIPATING TUBE CAPS

Heavy Duty plate cap connectors for dissipating heat connections at Grid and plate connections of transmitting tubes. Supplied for wire and cap type leads.
No. Net
965—HK 54, 35T\$.30
966—HK 24, etc.30
967—866, T-125, etc.51
968—100, T-807, etc.51

ICA BAKELITE FLEXIBLE SHAFT COUPLING

Flexible phosphor bronze spring contact mounted on a round bakelite disc. 1" diameter. Has 1/4" bushing.
No. 2142 Net \$.39



ICA INSULEX FLEXIBLE SHAFT COUPLING

Flexible phosphor bronze spring contact mounted on Insulex disc for efficient low-loss coupling. 1" diameter. Has 1/4" bushing.
No. 2143 Net \$.48

ICA INSULEX FLEXIBLE COUPLERS

Utilizes a circular disc of Insulex 3/4" diameter and two 1/4" bushings mounted on flexible phosphor bronze springs.
No. 2100 Net \$.36



ICA BAKELITE FLEXIBLE COUPLER

Made of Flexible bakelite. diameter 3/4" and 1/4" bushings mounted on flexible phosphor bronze spring.
No. 2101 Net \$.27



ICA PANEL BEARING ASSEMBLY

Will fit on panels up to 1/8" thickness.
No. Net
1248—Over-all length 3"\$.30
1249—Over-all length 6"36
1250—Bearings only15



ICA SHAFT COUPLINGS AND EXTENSION RODS

Brass Couplings and Reducers	No.	Length	Hole	Coupler	O.D.	Net
2105	3/8"	1/2"	3/8"	3/8"	3/8"	\$.15
2106	3/8"	3/8"	3/8"	3/8"	9/16"	.15
2107	3/8"	3/8"	3/8"	3/8"	3/8"	.15
2111	1 1/8"	1/4"	1/4"	1/4"	9/16"	.15
2112	1 1/8"	3/8"	3/8"	3/8"	3/8"	.15
2113	1 1/8"	1/4"	1/4"	1/4"	9/16"	.15
2118	3/8"	1/4"	1/4"	1/4"	9/16"	.15
2125	Brass Split Bushing	3/8" long x 3/8"	O.D. x 1/4"	I.D.		.09
ICA Fenolic Couplings and Reducers	No.	Length	Hole	Coupler	O.D.	Net
2116	3/8"	1/4"	3/8"	3/8"	3/8"	\$.15
2108	3/8"	3/8"	3/8"	3/8"	9/16"	.15
2109	3/8"	3/8"	3/8"	3/8"	3/8"	.15
2110	1 1/8"	1/4"	1/4"	1/4"	9/16"	.15
2114	3/8"	1/4"	1/4"	1/4"	3/8"	.15
Long Extension Couplings	No.	Material	Length	I.D.	O.D.	Net
2123	Brass	3/8"	3/4"	3/8"	3/4"	\$.21

ICA SPACER AND BUSHING ASSORTMENTS

Brass and Insulated Assortment of 25 spacers and bushings in 1/4" & 3/8" diameters from 1/4" to 3/4" long. Ideal for raising sub panels, chassis, etc.
No. Net
5260—Insulated Assortment\$.84
5261—Brass Assortment84
5262—Threaded Brass Bushing Assortments
5262—16 Assorted Brass bushings Threaded for 8/32 from 1/4" to 3/4"84
5263—16 Assorted Brass bushings Threaded for 8/32 from 1/4" to 3/4"84

ICA SHORT-WAVE AND BROADCAST COILS



Wound on Small Bakelite Rim Type Forms
Tuned with 140 MMF. (.00014) or 150 MMF. (.00015) condensers.
4 PRONG—2 WINDINGS
With Primary and Secondary Windings
No. Net
1421B—Set of 4 Short Wave Coils
—Covering 9 1/2 to 217 Meters. \$1.20
1430B—Set of 2 Broadcast Coils
—Covering 190 to 550 Meters. 1.05
6 PRONG—3 WINDINGS
With Primary, Secondary and Tlektor
1423B—Set of 1 Short Wave Coils
—Covering 9 1/2 to 200 Meters. \$1.80
1424B—Set of 2 Broadcast Coils
—Covering 190 to 550 Meters. 1.41

ICA SHORT WAVE AND BROADCAST PLUG-IN COILS

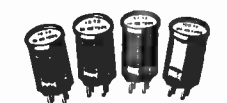

Wound on Low-Loss Bakelite Ribbed Forms
No. 4 PRONG—2 WINDINGS Net
1471—Set of 4 short wave coils—
—covering 9 1/2 to 217 Meters. \$1.50
1473—Set of 2 Broadcast coils—
—covering 190 to 550 Meters. 1.20
1474—Set of 4 short wave coils—
—covering 9 1/2 to 200 Meters. 2.10
1476—Set of 2 Broadcast coils—
—covering 190 to 550 Meters. 1.80

ICA TRANSMITTING COIL FORMS

2 1/2" Diameter
3/4" High
Made of Low-Loss RX-47 Dielectric. Rugged and durable. Amber color. Size of body affords 3/4" of winding space.
No. 2670—1 Prong Net \$.54
No. 2671—5 Prong Net .57
No. 2672—6 Prong Net .66

ICA GROOVED TRANSMITTING COIL FORMS

2 1/2" diam., 3/4" high
Ribs grooved for Precision Space Winding with a right hand thread—20 grooves per inch, cut at 98° per inch—.025 deep.
No. 2675—4 Prong Net \$.81
No. 2676—5 Prong Net .84
No. 2677—6 Prong Net .90

ICA LARGE LOW-LOSS RIBBED COIL FORMS

AMBER BAKELITE
1 1/2" Diameter
3/4" High
No. Net
1051—4 Prong\$.30
1052—5 Prong30
1053—6 Prong33

ICA SMALL RIBBED COIL FORMS

Made of Amber Color Bakelite
1 1/8" diam., 2 1/4" high
No. Net
2158—1 Prong\$.24
2159—3 Prong24
2160—6 Prong24

ICA SMALL BAKELITE COIL FORMS

1 1/4" diam., 2 1/4" high
No. Net
1108B—4 Prong\$.21
1113B—5 Prong21
1114B—6 Prong21

ICA LOW-LOSS "INSULEX" RIBBED COIL FORMS

1 1/2" diam., 3" high
No. Net
952—4 Prong\$.48
953—5 Prong54
954—6 Prong60



No. 277
Inductance 2.5 M.H.
D.C. Resist. 16 ohms
Current Cap 150 ma.
Net \$.30

"Insulex"
R.F. CHOKE COIL
Silk Wire Wound
Supplied with wire leads for mounting.

ICA "INSULEX" R.F. CHOKES

Cat. No.	Inductance	D.C. Resist.	Current Cap	Net
1777	2.5	30	150	\$.36
1775	5.5	57	150	.45
1774	10	73	150	.48
1772	30	136	125	.54
1773	60	196	125	.69
1771	80	222	125	.75

IRON CORE HIGH "Q" R.F. CHOKES

No.	Incl. M.H.	D.C. Res. ohms	Cap	Net
6200	2.5	17	150	\$.51
6201	3.5	22	150	.54
6202	5.5	28	150	.60
6203	10	55	150	.69
6204	30	83	125	.75
6205	60	142	125	.84
6206	80	168	125	.96
6207	125	214	125	1.20

ICA INSULEX R.F. CHOKES

No.	Incl. M.H.	D.C. Res. Ohms	Cap. Ma.	Net
2277	2 1/2	24	150	\$.39
2279	5	62	150	.51
2280	10	78	150	.69
2282	60	195	125	.75
2283	80	250	125	.84

ICA TRANSMITTING R.F. CHOKES

Tapered Sections Wound on Insulex low-loss core. Has a continuous universal winding in five tapered sections. Designed for maximum impedance in amateur bands from 160 meters downward.

No.	Incl. M.H.	Cur. Ma.	Res. Ohms	Net
266	2.8	1000	5	\$.165
267	5.3	500	12.5	1.50

HEAVY DUTY TRANSMITTING CHOKES

No.	Incl. M.H.	Cur. Ma.	D.C. Res. Ohms	Net
280	2.5	1000	5	\$.150
278	2.5	500	12	1.35

ICA 2 1/2 and 5 METER R.F. CHOKES

A compact, efficient R.F. choke for use in transmitters and receivers at ultra-high frequencies. Single layer spaced winding on pig-tailed Insulex low-loss form. Small enough to be wired directly into the smallest transceivers. Inductance 5.4 Mic.-Henries; Resistance 0.45 ohms; maximum current 1000 M.A. Diameter x 1 1/4" long.
No. 1645 Net \$.30

ICA INSULINE ICA

RADIO PRODUCTS

INDIVIDUAL RADIO HARDWARE ITEMS



The following sizes and types of hardware can be purchased in individual jars, either for refilling the assortment racks or as a refill for your own hardware stock. Each jar contains the amount mentioned.

Individual types and sizes. Packed in handsome glass display jars.

NET 39c PER JAR



ICA INSULATED AND BRASS SPACERS AND BUSHINGS

Used for raising sub panels, chassis, condensers, etc. For manufacturers, experimenters and laboratory use.

Made of High Quality Brass Net

No.	Diameter	Length	per C
5760	1/4"	1 1/2"	\$2.40
5761	1/4"	3/4"	3.00
5762	1/4"	1/2"	3.30
5763	1/4"	3/8"	3.60
5764	3/8"	1/2"	3.30
5765	3/8"	1 1/2"	3.90
5766	3/8"	3/4"	4.20

25 in Standard Package

Made of Fenoline Insulation Net

No.	Diameter	Length	per C
5775	1/4"	1 1/2"	\$2.40
5776	1/4"	3/4"	3.00
5777	1/4"	1/2"	3.30
5778	1/4"	3/8"	3.60
5779	3/8"	1/2"	3.30
5780	3/8"	1 1/2"	3.90
5781	3/8"	3/4"	4.20

25 in Standard Package

Threaded Brass Bushings—1/4" Diameter

No.	Size	Length	per C
5785	for 6/32 screw	1/4"	\$3.30
5786	"	3/8"	4.20
5787	"	1/2"	4.80
5788	"	3/4"	5.40
5790	for 8/32 screw	1/4"	3.30
5791	"	3/8"	4.20
5792	"	1/2"	4.80

25 in Standard Package

ICA FUSE MOUNTINGS



No. 2340—Flush Mounting	Net \$1.15
No. 2341—Panel Type	Net .15

No.	Quantity	Size
5000	100	4-36 x 1/4" long
5001	100	4-36 x 1/8" long
5002	75	4-36 x 3/8" long
5007	90	6-32 x 1/2" long
5008	80	6-32 x 3/8" long
5009	70	6-32 x 3/4" long
5010	50	6-32 x 1" long
5014	75	8-32 x 3/8" long
5015	70	8-32 x 1/2" long
5016	65	8-32 x 3/4" long
5017	10	8-32 x 1" long
5022	60	10-32 x 1/2" long
5023	50	10-32 x 3/4" long
5024	35	10-32 x 1" long

Parker-Kalon Self-Tapping Screws

No Tapping Necessary—No Nut Required

No.	Quantity	No.	Type
5051	50	No. 4	x 1/2"
5052	50	No. 6	x 1/4"
5053	45	No. 6	x 3/8"
5054	40	No. 7	x 1/2"
5055	35	No. 10	x 3/8"
5056	45	No. 10	x 3/8"

Nickel Plated Hexagon Nuts

No.	Quantity	Size	Diam.
770	109	4-36	x 1/4"
371	93	6-32	x 1/4"
7072	80	8-32	x 5/16"
5073	70	10-32	x 3/8"
5074	80	6-32	x 5/16"

Cont-Lin: Lock Washers

No.	Quantity	For
5080	125	For 6-32 Screws
5081	125	For 8-32 Screws
5082	100	For 10-32 Screws

Shakeproof Lock Washers

No.	Quantity	For
5085	100	For 6-32 Screws
5086	90	For 8-32 Screws
5087	80	For 10-32 Screws

Plain Steel Plated Washers

No.	Quantity	For
5090	100	For 6-32 Screws
5091	100	For 8-32 Screws
5092	100	For 10-32 Screws

Escutcheon Plate Screws

No.	Quantity	Size
5122	100	No. 1—1/4" length

Fahnestock Clips—Spring Brass N.P.

No.	Quantity	Size
5190	40	3/4" long
5191	40	1" long

No.	Quantity	Size
5120	20 each	(10 32 x 3/8) Oval Bend Screw Cup Washer

Flexible Rubber Grommets

No.	Quantity	Diam.	Thick.	Hole
5120	15	1/2"	9/32"	7/64"
5121	12	21/32"	1/4"	3/8"
5122	15	1/2"	1/4"	1/4"
5124	10	13/16"	3/8"	3/8"
5125	10	3/8"	3/8"	3/8"

Plain Fibre Washers

No.	Quantity	Diam.	Hole	Thick.
5100	125	5/16"	1/8"	1/32"
5101	100	3/8"	3/16"	1/16"
5102	90	1/2"	1/8"	3/64"

Shoulder Fibre Washers

No.	Quantity	Over-all Diam.	Shoulder Diam.	Height
5100	100	3/8"	1/4"	5/64"
5111	90	7/16"	13/64"	7/64"
5112	75	1/2"	3/8"	3/64"
5113	50	1/2"	3/8"	3/32"

Brass Tinned Terminal Lugs

No.	Quantity	Type	Length	Size of Hole
5135	125	Flat	1/4"	No. 6
5136	100	Flat	3/8"	No. 10
5141	75	Flat	1"	No. 8 or 5/16"
5137	75	Link	1"	No. 8
5138	100	Spade	3/8"	9/64 Slot
5139	75	Cord	3/8"	1/4"
5140	50	H.D. Battery Cable	1 1/4"	3/4"

Nickel Plated Rivets

No.	Quantity	Length	Diameter
5160	100	3/16"	1/8"
5161	80	1/4"	1/8"
5162	70	5/16"	1/8"

Nickel Plated Eyelets

No.	Quantity	Length	Diameter
5170	100	1/4"	3/16"
5171	90	5/16"	3/8"
5172	80	5/16"	7/64"
5173	75	5/16"	11/64"

Cable Clamps

No.	Quantity	Size
5200	35	3/8" long x 5/16" Bend
5201	30	1" long x 1/2" Bend

Angles and Brackets

No.	Quantity	Size
5207	25	7/16" x 7/16" x 5/16"
5205	16	5/8" x 1" x 3/8" wide
5206	15	1/2" x 1 3/8" x 3/8" wide



ICA ANGLES AND BRACKETS

An assortment of Angles and Brackets commonly used in the radio and electrical fields.

No.	Size	Width	Description	per C
5702	7/16 x 7/16"	3/8"	Angle Bracket	\$1.50
5703	5/8 x 1"	3/8"	Angle Bracket	1.80
5704	1/2 x 1 1/4"	3/8"	Angle Bracket	3.60
5705	1/2 x 3/8"	1/2"	One hole tapped for 8/32—other plain	3.60

100 in Standard Package



ICA MASTER SCREW AND NUT ASSORTMENT

Contains a substantial quantity of all the popular sizes machine screws, wood screws, Parker-Kalon self-tapping screws and nuts to match.

No. 5252	Net \$3.30
----------	------------

ICA ALL-PURPOSE RADIO HARDWARE AND ESSENTIAL EQUIPMENT

Packed in a handy indestructible metal utility case.



This De Luxe assortment includes such items as knob set screws — escutcheon screws — Parker-Kalon self-tapping screws — rubber grommets — screws — nuts, etc.

No. 5251	Net \$2.85
----------	------------



ICA FIBRE WASHER ASSORTMENT

A representative assortment of fibre washers both plain and shoulder, to fit all popular size screws and bolts.

No. 5805	Net \$5.1
----------	-----------

Contains 100 assorted washers



ICA RUBBER GROMMET ASSORTMENT

Assortment contains popular sizes used in Radio and Electrical Work.

No. 5810	Net \$5.1
Contains 28 Rubber Grommets	
No. 5811	Net \$9.0
Contains 60 Rubber Grommets	



ICA ANGLE AND BRACKET ASSORTMENT

A complete assortment of 30 popular angles and brackets, nickel plated finish.

No. 5800	Net \$5.1
----------	-----------

ICA INSULINE RADIO PRODUCTS ICA

ICA 4-in-1 NEUTRALIZING TOOLS, SCREW DRIVER and WRENCH

Made of Fenoline Fully Insulated



No. 1019—Complete as shown Net \$.60
 1020—Majestic Attachment for #101921
 1021—Crosley Attachment for #1019..... .21

ICA 5-in-1 NEUTRALIZING AND COMPENSATING TOOL

Same features as the 4-in-1 tool described above with an additional all metal screw driver.



No. 1022 Net \$.90

ICA 3-in-1 NEUTRALIZING TOOL



With Metal Nibs Made of Sturdy Fenoline Material, with Brass Nickel Plated Metal Nibs. Unbreakable.
 No. 988 Net \$.75

ICA Neutralizing Tools with Metal Nibs

Patent No. U.S. 83,321 Sturdy, unbreakable, will outlast all other type neutralizing tools.
 No. 996 Net \$1.05

LO-LOSS ALIGNING TOOL



Have extremely low capacity and high Q. Will not affect the most delicate electrical balance.
 No. 1035 Net \$.30

ICA BONE FIBRE SCREW DRIVER



Made entirely of 1/8" bone fibre rod with a sturdy blade.
 No. 1029 Net \$.48

ICA BONE FIBRE SCREW DRIVER



Double Edged—No Metal—Fully Insulated Made of 1/4" Bone Fibre Rod
 No. 1039 Net \$.33

ICA NEUTRALIZING TOOL For Push Button Tuners



The Socket is 3/8" in diameter, and contains a screw driver blade.
 No. 1003 Net \$.45

ICA SET TRIMMER NEUTRALIZING TOOLS FOR PHILCO, ZENITH, RCA, Etc.



Fits the smallest size trimmer condensers. Trimmer end is 1/2" diam. to fit 1/4" hole.
 No. 992—6" long Net \$.75
 No. 933—10" long Net \$.90

ICA ALIGNMENT WRENCH For RCA, PHILCO, etc.



Used on all makes Air Trimmer. Made of 3/8" Fenoline Rod—8 1/2" long—one end has hollow shaft hexagon wrench—other end has an especially shaped hook.
 No. 1008 Net \$1.05

ICA BALANCING TOOL



Fits into No. 1019 Neutralizing Tool.
 No. 1026 Net \$.36

INSULATED NEUTRALIZING WRENCHES



Hexed—Full Length For Philco, Majestic and Other Receivers 3/8" Diameter
 No. 985—6" long Net \$.21
 No. 986—8" long Net \$.24

ICA Alignment Tool for Philco Receivers For Air Trimmer Sets



Has specially designed metal clip for air trimmers. Made of narrow fine rod, 3/8" diam. by 6" long.
 No. 1033 Net \$.39

ICA Insulated Adjustable Neutralizing Tools



Absolutely no metal parts. Screw driver slides into inside of neutralizing wrench.
 No. 990—Extending from 6" to 11" Net \$.60
 No. 991—Extending from 10" to 18" Net \$.75

ICA ALL PURPOSE ALIGNING TOOL



Handle is of 3/8" Fenoline. End has Socket Screw Driver for neutralizing all iron core tuning systems.
 No. 1002 Net \$.45

ICA ALIGNMENT TOOLS For R.C.A. Receivers



Narrow shaft Neutralizing Tools made of Bone Fibre—3/8" Wide. Has screw nib inserted in Brass Collar on end.
 No. 1015 Net \$.57

ICA NARROW SHAFT ALIGNMENT TOOL



RCA—Zenith—etc. 3/8" Bone Fibre Rod.
 No. 987 Net \$.51

ICA MAGIC TUNING ALIGNMENT TOOL



Consists of a Bakelite rod with a Brass cylinder at one end, and a special finely divided iron core at the other end.
 No. 977 Net \$.81

ICA FORK TYPE NEUTRALIZING WRENCH and SCREW DRIVER For RCA and Other Sets



No. 1024 Net \$.36

ICA Fenoline Neutralizing Screw Drivers



Made of Fenoline. Strong and sturdy, completely insulated for neutralizing and aligning coils, condensers, receivers, etc.
 No. 1028 Net \$.30

ICA ALL-PURPOSE TEST LEAD KIT COMPLETE FOR EVERY TESTING NEED

Equipped with one pair of test leads which have 60" of red and black kinkless live rubber wire. One end has insulated removable banana-type plugs. Included in this test kit:
 1 pr. test leads.
 1 pr. insulated alligator clips—red and black.
 1 pr. insulated spade plugs—red and black.
 1 pr. insulated needle points—red and black.
 No. 1005—Kit, complete \$2.10



ICA PHONO, NEEDLE POINT TEST LEADS

With Slim Bone-Fibre Handles and Flexible Wire

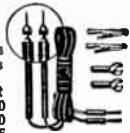

Flexible, rubber-covered, kinkless wire, 50" long. Fenoline handles 4" long.
 No. 355—With Phone Tips Net \$.60
 382—With Spade Terminals60
 379—With Alligator Clips66

ICA DE LUXE EXTRA-FLEXIBLE TEST LEADS

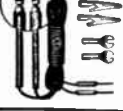

Slim Handles & Solderless Plugs 50" Extra-Flexible Test Leads with 4" Bone Fibre Handles. New non-kinking, rubber insulated wire.
 No. 355—With Phone Tips Net \$.60
 356—With Spade Terminals60

ICA PENCIL TYPE TEST LEADS

Finger-Grip Molded Tips



All connections are properly soldered providing low resistance connections vital in all precision tests. The Molded Finger Grip Tips are provided with rivets for easy renewal of wire. Length of test leads is 65". Handles are 5" long.
 No. 373 Net \$1.05

ICA HEAVY DUTY LABORATORY TEST LEADS



Long Slim Handles and Removable Phone Needle Chuck Extra long slim red and black handles knurled at end for finger grip ease. Handles 6" long, 50" of heavy duty kinkless, flexible rubber wire.
 No. 400—With knurled grip Net \$.99
 388—With alligator clip90
 391—With spade lugs84
 392—With non insulated phone tips84

ICA Slim Handle Test Leads

Made of sturdy Bone-Fibre Handles. 50" of Kinkless Live Rubber wire. Handles 6" long—Overall Length 7". Prods have pointed large phone tip plugs.
 No. 313—Phone Tips on end \$.75
 314—Spade Lugs on end75
 315—Alligator Clips on end84



ICA HIGH VOLTAGE HEAVY DUTY TEST LEADS



10,000 VOLTS Made of large diameter Bakelite handles with guards to prevent fingers from slipping. Cable 18 gauge, 67/36 tinned copper, with heavy walled rubber covering. Prods 6" long with 50" red and black cable and 2" Bakelite Prods on either end.
 No. 475 Net \$2.40 per pair

ICA Unbreakable Test Prods Long Metal Prod with Shock-proof Rubber Handles

One end has standard needle point Tips. Other end has Insulated Solderless Plugs. Supplied with 50" Kinkless Rubber Wire.
 No. 332—With Phone Tips Non Insulated .. Net \$.60
 No. 331—Insulated Solderless Plug Ends Net \$.69



ICA ALL PURPOSE TEST LEADS

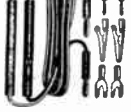

Made of sturdy Bone Fibre Tubing. Slim handles, 6" long. Over length 7 1/4". Rubber covered wire 50" long. With interchangeable Tips
 No. 312—Complete Kit Net \$1.50

ICA SMALL HANDLE INSULOID TEST LEADS

Equipped with phone tip inserted in black and red insuloid handle on one end.
 No. 368—Phone Tips \$.42
 367—Spade Lugs42



ICA FLEXIBLE SCREW DRIVER



Allows access to screws in hard to reach and out of the way places. Can go under objects or around corners.
 No. 935 Net \$1.35

ICA INSULINE ICA

RADIO PRODUCTS

ICA SHEARING PUNCHES

Now! No Hammering Necessary to Punch Chassis Holes.

Shearing is accomplished with a wrench which forces shear punch into die. Made of High Grade Steel.



No.	Size of Hole	Net
725	3/16"	\$2.55
726	1/8"	3.00
727	1/4"	3.00
728	3/8"	3.00
729	1/2"	3.00
730	5/8"	3.30

ICA Improved All-Purpose Circle Cutter

Will Cut Holes from 3/4 to 8 Inches

Cutting bar holder is 1" in diameter and also accommodates a centering drill or any size pilot pin. Cutting bar is 3/8" square and is arranged to hold a 3/8" high speed cutting bit.



No. 775 Net \$3.60

ICA Universal Multi-Purpose Cutting Tool



This handy tool can be used for counter-sinking, beading, drilling or cutting holes. Equipped with 3/8" holes from 1/16" diameter up to 3" diameter. Can be used either in drill press or hand brace. Also acts as a boring tool when used in a lathe.

No. 780 Net \$2.40

ICA SQUARE HOLE SHEARING PUNCH

This new punch permits the cutting of any size odd-shape hole (square rectangular, hexagon, oblong, etc.) on any size panel or chassis. Good for Enlarging or punching TRANSFORMER Holes.

No. 790 Net \$9.00



ICA RIVET AND EYELET PUNCH SET

A Universal Tool that can be used for either riveting or eyeletting. Holder is made of cast iron with hexagonal sides, thus permitting the tool to be placed in a vise without slipping.

No. 785—Complete with ample assortment of eyelets and rivets. Net \$2.40



RIVET & EYELET ASSORTMENT

Additional eyelets and rivets can be purchased separately. No. 5265—(Assortment of 100) Net \$4.8

ICA SOLDERING IRONS



ICA Highest Quality Soldering Irons are "Best By Test". Each model is submitted to the most severe tests and results prove conclusively that ICA irons are equal, if not superior, to any soldering iron on the market today.

60 WATT IRON

No. 1960-A—110-115 Volts Net \$3.00

85 WATT IRON

No. 1962-A—110-115 Volts Net \$3.90

115 WATT IRON

No. 1961-A—110-115 Volts Net \$4.50

ICA SOLDERING IRON TIPS

For American Beauty Irons

Made of special copper alloy. Ends are hot tinned. For replacement in American Beauty Irons and other makes that have the same specification for size.

No.	Length	Diam.	Net
1937	4 5/8"	3/8"	\$.66
1974	1 3/8"	1/8"	.39



ICA Unbreakable Volume Control Wrench



Socket is 1 1/8" diameter. Net \$1.05
No. 937

ICA UNBREAKABLE "TURN-TITE" SOCKET WRENCHES



7 1/2" long. Handle is of ribbed shockproof unbreakable material.

No.	Socket	Net
940	1/8"	.57
941	1/4"	.57
942	3/8"	.57
943	1/2"	.57
944	5/8"	.57
945	3/4"	.57
946	7/8"	.57
949	(Set of 7 Wrenches as above)	3.99

ICA "TURN-TITE" SOCKET WRENCHES



HOLLOW SHAFTS

Made of hardened steel, cadmium plated, with sturdy Black Japanned wooden handles.

6 Inches Long		9 Inches Long	
No.	Net	No.	Net
898—1/8"	.30	900—1/8"	.36
890—1/4"	.30	894—1/4"	.36
891—3/8"	.30	895—3/8"	.36
892—1/2"	.30	896—1/2"	.36
893—3/4"	.30	897—3/4"	.36
899—1/2"	.30	901—1/2"	.36
910—Set of 6	Wrenches 1.80	911—Set of 6	Wrenches 2.16

RIVET & EYELET SETTING TOOL

No. 786 Net \$5.4



ICA DE LUXE NEUTRALIZING and ALIGNING TOOL KIT

Complete for Every Service Need



Consists of fourteen tools, most of which telescope into one another, forming six units when assembled into the attractive black leatherette case.

The complete kit in carrying case can be kept in the pocket. Tools complete with carrying case.

No. 994 Net \$4.50

ICA NEUTRALIZING AND ALIGNING TOOL KIT

The Kit consists of twelve separate and distinct parts, some of which can be employed for several operations. These units telescope into each other, forming four separate tools when assembled.

No. 998 Net \$3.90
Complete With Carrying Case



ICA Complete Neutralizing Tool Kit

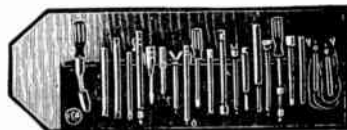

The kit consists of one of each of the following ICA tools, described herein:—No's 382, 1008, 987, 1015, 976, 996, 992, 985, 990, 1024, 1019, 1026, 1022, 1004, 1013, 1028, 1039, 1029, 1033, 935, 937. Total list of tools if purchased individually \$18.50.

No. 995—Kit, Complete with Carrying Case \$12.00

ICA LOCK SOCKET WRENCH and SCREW DRIVER SET

Actually a set that will take care of all socket wrench requirements, either radio or electrical, ignition or mechanical needs.

All parts are steel cadmium plated and are packed in an attractive box. The set includes the following:

- 1—Screw Drives and Handle
- 1—1/4" Hex Handle and Extension Ell Shaped —5" long
- 1—1/4" Hex Staright Extension—3" long
- 1—Socket which holds the extensions to screw drives
- 1—1/8" Socket
- 1—1/4" Socket
- 1—3/8" Socket
- 1—1/2" Socket
- 1—Internal Knurled Socket to fit any 12 point Double Hex nut between size 1/8" and 3/8"
- 1—1/4" Socket

No. 999 Net \$1.50



ICA AMBER COLORED UNBREAKABLE MIDGET SCREW DRIVER



Particularly shaped to fit into set screws of knobs. Complete with pocket clip. Length 4 5/8".

No. 1013 Net \$1.15
No. 1017—Length 6" Net \$1.18

ICA INSULINE RADIO PRODUCTS

ICA MIDGET CONDENSERS LO-LOSS CERAMIC INSULATION

Highly efficient, compact and rugged condensers for short wave receivers and transmitters. Employ non-corrosive plates, wiping phosphor bronze rotor contacts. Single Hole Mounting—Shaft is of Brass and 1/8" in Diameter; plated to resist corrosion—Complete with mounting nuts.

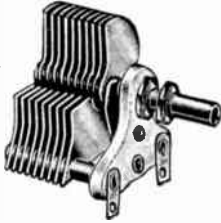

No.	Plates	Max. Cap.	Min. Cap.	Net
6302	3	15 mmfd.	8 mmfd.	\$.72
6304	4	25 mmfd.	35 mmfd.	.78
6305	7	50 mmfd.	4 mmfd.	.81
6306	11	80 mmfd.	6 mmfd.	.90
6303	14	100 mmfd.	6 mmfd.	.96
6301	19	140 mmfd.	7 mmfd.	1.05
Double-Spaced Condenser				
6300	10	35 mmfd.	6.5	1.05

ICA CERAMIC PADDING CONDENSERS



Compact, yet rugged Padding Condensers. Designed for aligning tandem condensers, short wave band switch coils, antenna trimmers, etc. Uses high grade Mica and Phosphor Bronze Springs contacts.

No.	Min. Cap.	Max. Cap.	Net
611	4.0 mmfd.	50 mmfd.	\$.30
612	12.0 mmfd.	120 mmfd.	.30
613	130.0 mmfd.	450 mmfd.	.33
614	160.0 mmfd.	500 mmfd.	.33

INSULEX INSULATORS



Made of WHITE Glazed Insulex. This new line of insulators meets the demand for a perfect, non-porous low loss product. Used by broadcasters, amateurs, experimenters and set-builders. Available in various sizes and types. All feed-thru have cork washers.



various sizes and types. All feed-thru have cork washers.

STAND OFF INSULATORS

No.	Description	Height	Base Size	Net
2300	Little Pete	1"	1/2" x 7/8"	\$.07
2301	Junior Pete	1 1/8"	3/8" x 1 1/8"	.09
2302	Big Pete	1 1/2"	1" x 1 1/2"	.11
2303	Beehive	2 1/2"	2" Diam.	.15
2304	Jack Type	1 3/4"	1" x 1 1/2"	.15

FEED-THRU INSULATORS

No.	Description	Ht.	Base Diam.	Mtg. Hole Size	Net
2305	Sub-Panel	3/4"	3/8"	1/8"	\$.12
2306	Sub-Panel	1"	3/8"	1/8"	.15
2307	Sub-Panel	1 1/4"	7/8"	1/8"	.17
2334	Large Sub-Panel	2 1/2"	1 1/2"	1 1/8"	.42
2320	Jack Type	1"	3/4"	1/8"	.21
2321	Jack Type	1 1/4"	7/8"	1/8"	.24

CERAMIC RODS

Made of Alsimag. Suitable for mounting insulators, condensers, coils, etc.

Available in two lengths. No. Lgth. Dia. Tap. Net
2310 1 1/4" 1/2" 6-32 \$.17
2311 3 1/4" 1/2" 6-32 .24



ICA DELUXE SIGNA-TONE — CODE PRACTICE SET — KEYING MONITOR



No. 4300

The ICA Signatone is a perfected Audio Oscillator, having 3 different output frequencies and a continuously variable volume control. The Audio notes are similar to those of high quality commercial CW stations.



No. 4301

- CODE PRACTICE SET**—A number of phones and keys may be connected for intercommunication or for classroom or radio club instruction in code.
 - KEYING MONITOR**—An invaluable aid in improving any ham's "fist". Will follow the "hug" at all speeds. No well-equipped station should be without this keying monitor.
 - MODULATION SIGNAL**—The steady note of the Signatone is ideal for adjusting both the Modulator and modulated stages of your transmitter for a maximum modulation percentage of not over 100.
 - SIGNAL TRACER**—By feeding the output of the Signatone into each stage of your modulator and listening to the output of that stage, defects and "bugs" can easily be located.
- No. 4300—Dealer Net Cost \$12.00
No. 4301—Classroom Model (No Speaker)—Dealer Net Cost 9.00

LINGUAPHONE MORSE CODE RECORDS



Learn the International Morse Code Quickly, Easily—Uses EYE-EAR Method. The Complete Linguaphone Code Equipment consists of 5 Double-faced, electrically transcribed records in durable album. Contents: 8 Tables, 10 Lessons, 14 Exercises, 4 Appendices.

No. 1800—Complete Net \$9.00

ICA "TRIPLEX"

Radio & Telegraph Code Practice Set
Blinker Light
Radio Signal—Telegraph



No. 70—Single Unit (less batteries) \$1.65
No. 71—Double Unit (50 ft. wire) 3.39

CERAMIC BEAD INSULATORS

3/8" Diam. Used for construction of short concentric link lines.



No. 2315—(100 beads) Net \$6.00

HOME ANTENNAS

12 FEET—4 SECTIONS
Made of Admiralty Brass—Guaranteed Rust Proof

- The Latest Type Home Antenna suggested by leading Radio Set Manufacturers for best results.
 - Eliminates unsightly and dangerous wires.
 - Clear, noise-free reception with no power line interference.
 - Very sturdy construction—made of Admiralty Brass with Beautiful Nickel-Plated Finish.
 - Guaranteed Rust-proof for the Life of Antenna.
 - Universal Bracket allows permanent and convenient installation on soil pipe, window pipe, chimney, roof, gables, cornices, wall copings, etc. Individually boxed.
- Vertical Mast Only—With Attaching Clamps—Less Lead-in Wire.



No. 4515 Net \$2.70
10 to a Standard Carton—Weight 25 lbs.

COMPLETE VERTICAL MAST ANTENNA

Vertical Mast with all accessories for Universal Mounting—including lead-in Wire, Ground Wire, Brackets, Lightning Arrestor, Screws, Insulators, etc.
No. 4516 Net \$2.97
10 to a Standard Carton—Weight 33 lbs.

DE LUXE WINDOW ANTENNAS

8 FEET—12 FEET
Made of Admiralty Brass—

with Beautiful Nickel-Plated Finish

- For Homes, Apartments, Hotels, Office Buildings, and places where it is inconvenient to install outdoor aerials or to improve reception on indoor installations.
- Quickly and easily installed.
- Adjustable Bracket at base, permits the antenna to be focused in any position for best reception.
- Furnished completely assembled with mounting flange, insulator and lead-in strip. Individually boxed.



3 Section Telescopic Antenna Opens to 96" Total Length
No. 4527B Net \$2.70
10 to a Standard Carton—Weight 14 lbs.

4 Section Extra Long Window Antenna
12 Feet Long
Ideal for DX Reception and Rural sections where extra length is needed for best results.

No. 4513 Net \$2.97
10 to a Standard Carton—Weight 33 lbs.

ICA INSULINE ICA

RADIO PRODUCTS

I. C. A. "DE LUXE" AUTO RADIO ANTENNAS

SIDE COWL AERIALS

NOISELESS! **RATTLE PROOF!**

Lifetime Guarantee Against Rusting
Admiralty Brass and Stainless Steel Antennae
● Static Discharge Ball supplied on all aerials
● All Antennae supplied with 36" Fool-proof Spring Tensioned Lo-Loss Cables protected by Heavy Shielded Loom to prevent noise pick-up

The "GOVERNOR"

Two Section Telescopic
49" Total Length
Extends from 23" to 49"
No. 4551 Net \$2.07

The "CHANCELLOR"

Three Section Telescopic
65" Total Length
Extends from 20" to 65"
No. 4566 Net \$2.37

The "COMMODORE"

Three Section Telescopic
72" Total Length
Extends from 23 1/2" to 72"
No. 4555 Net \$2.67

The "PRESIDENT"

Three Section Telescopic
96" Total Length
Extends from 31 1/2" to 96"
No. 4553 Net \$3.00

The "COUNSELLOR"
FOR LONG DISTANCE
RECEPTION AND
POLICE WORK

Four Section Telescopic—105" Total Length
Made of Extra Large Diameter Brass Tubing.
No. 4558A Net \$3.57

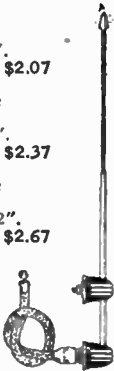

ICA "ROCKER" AERIAL

A Variable Angle Antenna to Fit the Contours of All Car Bodies

- The adjustable mounting mechanism is concealed so as to make it both tamper-proof and weather-proof.
- Beautifully fashioned — Rugged construction.
- Easy to install requiring the drilling of only 2 small holes adjusting the antenna to the desired angle and tightening.

Completely assembled, ready for installation with 36" shielded Lo-Loss Cable and Universal plug-in attachment.

"ROCKER" ANTENNA"

2 Section Telescopic—49"
Extends from 23" to 49"
No. 4540 Net \$2.40
10 to a Standard Carton—Weight 12 lbs.

3 Section Telescopic—72"
Extends from 23 1/2" to 72"
No. 4541 Net \$2.70
10 to a Standard Carton—Weight 16 lbs.

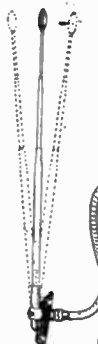

UNI-MOUNT UNDERHOOD ANTENNA

Only One Aerial for All Type Mountings Fits All Model Cars Including Latest 1940 Styles
● Dual Brackets designed so that they can be interchanged in a minute for both Underhood and Alligator types
● Eliminates drilling of holes on body of car
● Made of Admiralty Brass, Triple-Chrome Plated. Guaranteed Rust-proof
● Both Underhood and Alligator Mounting Brackets are included as standard equipment with every aerial.
● All Antennae are supplied with Shielded Lo-Loss Lead-in Cable

The "WASP"

2 Section Telescopic—49"
No. 4800 Net \$1.95

The "TRAVELLER"

3 Section Telescopic—60"
Extends from 20" to 60".
No. 4801 Net \$2.37

The "CLIPPER"

3 Section Telescopic—72"
Extends from 23 1/2" to 72".
No. 4802 Net \$2.67

The "NEW YORKER"

3 Section Telescopic—96"
Extends from 31 1/2" to 96".
No. 4803 Net \$3.00



ICA SUPER-TEST AUTO RADIO IGNITION SUPPRESSORS

Made of Moulded Bakelite—All Metal Parts Made of Rugged Machined Brass



No.	Net
Type E—349B—Spark Plug Slip-on Suppressor Fit 1939-40 cars	\$1.18
Type E—349F—Slip-on Spark Plug Suppressors for New Model Ford Cars	.18
Type D—350B—Spark Plug Suppressors with Dual Threaded Inserts	.18
Type D—351B—Spark Plug Suppressors for Ford cars up to 1939	.18
Type A—377—Bracket type Suppressor	.18
Type B—352B—Distributor Suppressor for all cars	.21
Type C—446F—Ford Early Models	.21
Type C—446B—Ford Late Models	.21

ICA FRONT WHEEL NOISE SUPPRESSORS

Simple — effective. Equipped with plate and screw for easy attachment to wheel caps.



No. 4475—Per pair Net \$2.24

ICA WHEEL HUB STATIC ELIMINATOR

Used under hub of front wheel. An essential on all cars to eliminate front wheel static. Less Back Plate and screw.

No. 4476—Per pair Net \$1.18

ICA FORD V8 CONDENSERS

FOR 1939-1940 MODELS

Equipped with Special Bracket. Capacity 1/2 mfd.
No. 1246 Net \$1.45



ICA PLUG AND JACK

Used on RCA recording units, receivers and auto sets.

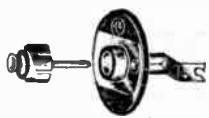

No.	Net
2383—Pin Plug	\$0.09
2385—Socket & Shield	.15

ICA WIRE WOUND SUPPRESSORS LOW RESISTANCE 30 OHMS. D. C.



These suppressors have an extremely low D.C. resistance and thus definitely do not affect the intensity of the ignition spark or cut down the speed of the car.

No.	Net
2351B—Spark Plug Suppressor	\$0.39
2353B—Distributor Suppressor	.39
2354B—1938-1939 Slip-On Suppressor; Will Also Fit Older Type Cars	.39

ICA AUTO ANTENNA CONNECTORS AND ADAPTERS

No. 2347—Antenna Connector
Net\$0.06 ea.

No. 2348—Standard Fuse Holder
Net\$0.09 ea.

No. 2349—Jumbo Fuse Holder (2 1/2" long x 1/2" wide) Net \$1.18 ea.

No. 2395—Lead-in Adapters — converts Motorola lead to Delco Fittings.
Net\$1.18 ea.

No. 2372—Lead-in Adapter — converts standard leads to Motorola Fittings.
Net\$1.18 ea.

No. 2375—Motorola Pin Plug
Net\$1.18 ea.

ICA SHIELDED LO-LOSS AUTO ANTENNA LEAD-IN CABLES



Replacement for any make Auto Antenna. Made of flexible cable—protected by a durable shielded loom, covered with black processed braid.

No.	Net
4590—24" Long—Male Connector and Ground Lead	\$.48
4591—24" Long—Male and Female Connectors	.48
4592—24" Long—Both Male Connectors	.48
4593—36" Long—Male Bayonet Terminal Lug End	.54
4594—48" Long—Male and Female Connectors	.60
4595—72" Long—Male Connectors with Ground Lead	.84
4597—Shielded Cowl Lead with Pin Plug 36" long	.54
4598—Shielded Lead for ICA Universal Bracket Cowl Antenna with Pin Plug 36" long	.54

ICA AUTO BY-PASS CONDENSER

For by-passing ammeter, dome light or generator. Capacity 1/2 mfd.
No. 1244 Net \$0.30

ICA GENERATOR SILENCER

Heavy duty generator condenser eliminates generator, ammeter, distributor noises. Capacity 1 mfd.
No. 1243 Net \$0.45

ICA FORD V8 NOISE SILENCER

No. 1245
Net \$0.48

JAMES

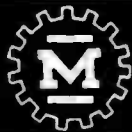

MILLEN

Amateur Band

TRANSMITTER ACCESSORIES

50-Watt Transmitter—Exciter

USES 6L6 AND 807

Compact relay rack mounting

A Tri-tet circuit, which is used to obtain harmonic output, is reduced to the simple tetrode circuit for oscillator output at the crystal fundamental by short-circuiting the cathode tank circuit. Sufficient oscillator output at the fourth harmonic of the crystal frequency is obtainable to drive the 807, which may be operated as either a straight amplifier or frequency doubler, making it possible to obtain an output of 25 to 50 watts or more in four bands from a single crystal of properly-chosen frequency.

The entire unit is designed to operate from a single 250-ma. supply delivering up to 750 volts, the maximum voltage at which the 807 is designed to operate. A fixed bias of 45 volts is required for the 807 and the two heaters together consume 1.8 amperes at 6.3 volts. A single milliammeter with a scale of 200 ma. may be switched to read the plate current of either stage.

Because it is possible to double or quadruple frequency in the plate circuit of the oscillator and to double frequency in the plate circuit of the 807 as well, there are several possible combinations of coils and crystals which will produce the same output frequency.

90800, less tubes, but including one set of coils. **Net Price** \$37.50

Additional coils, per set of three. **Net Price** \$3.00

(In ordering state band in which crystal operates and band in which output is desired)

Variarm—ECO

A GOOD ECO AT A LOW PRICE

LOW DRIFT—Less than 0.06% from cold start. Most drift in first 10 minutes.

VIBRATION IMMUNE—Shock mounted oscillator section; sturdy construction.

NO HAND CAPACITY

CHIRPLESS KEYING—Constant load on power supply.

GOOD BAND SPREAD—100 dial divisions from 3500 to 3650 kc. on model 90700. "Variarm" vernier tuning on both models.

COMPLETE—Vibrationless power supply, three tubes, output coupling unit.

The Rice-Variarm was described in detail in a comprehensive article by Henry E. Rice, Jr., in the January issue of QST. The Millen commercial models are:

No. 90700 has fundamental oscillator frequency range of from 3500 to 3650 kc. "Convenient-to-change" taps on amplifier and link coils provide for output on 80 or 40. Complete with G.E. tubes, ready to use. **Net Price** \$32.50

No. 90701 is the same as No. 90700 except fundamental oscillator frequency range of from 1750 to 2000 kc., providing for output on 160 or 80. Complete with G.E. tubes, ready to use. **Net Price**... \$32.50

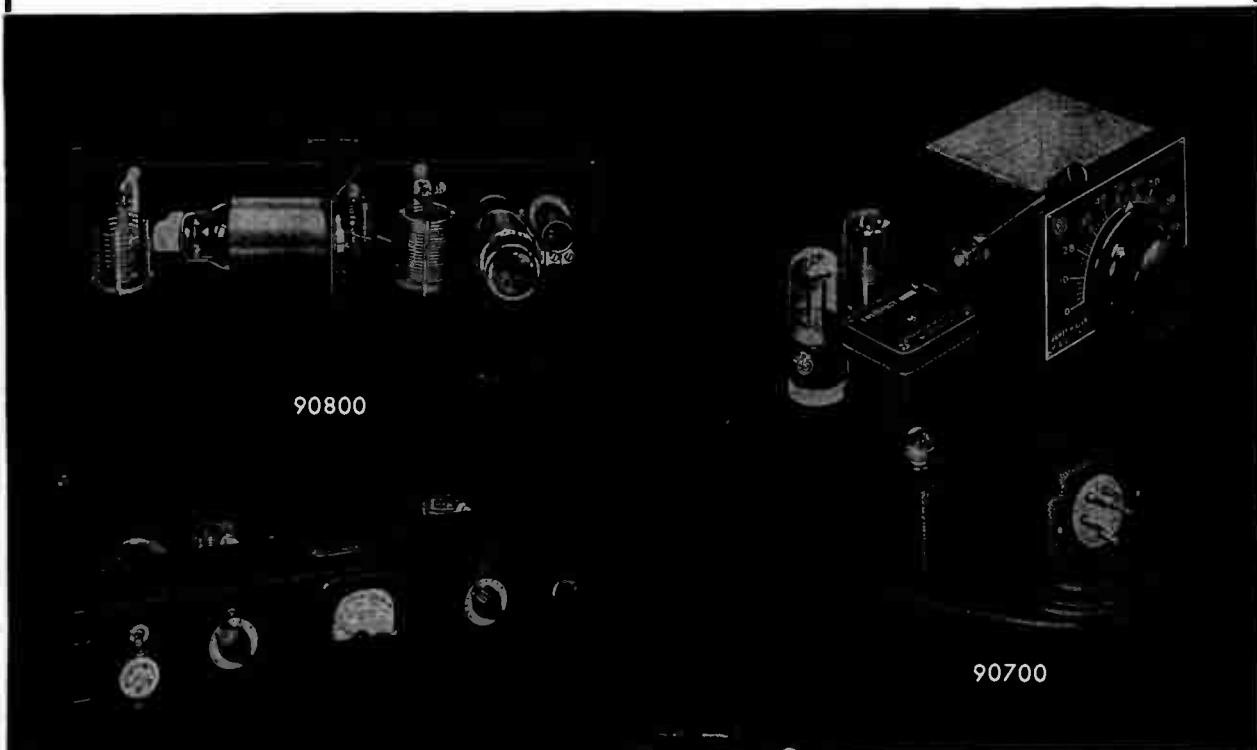

90800

90700

JAMES



MILLEN

Modern Parts Designed for Application



MILLEN RADIO PRODUCTS are well designed MODERN PARTS for MODERN CIRCUITS, attractively packaged, moderately priced, and fully guaranteed. They have been designed with a view toward easy and practical application as well as efficient performance. For instance, the terminals are located so as to provide shortest possible leads, mounting feet are designed for easy insertion of screws and socket contacts, so that the solder won't run down inside them and make impossible the insertion of the tube etc. Thus our slogan, "Designed for Application." Our general catalog is available for the asking either from your favorite parts supply house or direct from the factory.

11000, 12000, 13000, 14000 SERIES CONDENSERS 11000 Series has worm drive.

MILLEN TYPE

Code	Capacity per side		Air Gap	Voltage Rating	Net Price
	Max.	Min.			
11035	36	4.6	.077"	3000	\$6.90
11050	51	6.5	.077	3000	7.14
11070	74	9.5	.077	3000	7.89
13035	35	4.9	.077	3000	4.56
13050	49.5	6.3	.077	3000	5.20
13070	71	7.3	.077	3000	5.88
14200	204	10.7	.077	3000	7.80
14100	90.5	12.9	.171	6000	12.00
14050	59		.171	6000	7.20
14060	60		.265	9000	12.00

CONVENTIONAL SINGLE SECTION TYPE

Code	Capacity per section		Air Gap	Finish on Plates	Net Price
	Min.	Max.			
12035	9	37	.176"	Polished	\$4.32
12036	9	37	.176	Plain	3.90
12336	6	43	.077	Plain	2.40
12511	7	55	.077	Plain	2.70
12576	9	76	.077	Plain	3.00
12510	12	101	.077	Plain	3.60
12515	18	151	.077	Plain	4.50

CONVENTIONAL DOUBLE SECTION TYPE

Code	Capacity per section		Air Gap	Finish on Plates	Net Price
	Min.	Max.			
12035	6	43	.077"	Polished	\$4.32
12036	6	43	.077	Plain	3.90
12050	7	55	.077	Polished	5.10
12051	7	55	.077	Plain	4.32
12075	9	76	.077	Polished	5.61
12076	9	76	.077	Plain	5.40

Code	Description	Net Price
10000	Worm Drive Unit	\$1.50
10001	Drum Meter Dial 0-100	1.85
10007	1 1/2" Nickel Silver Inst. Dial 0-100	.50
10008	3/8" Nickel Silver Inst. Dial 0-100	1.00
10050	Dial Lock	.45
10060	Shaft Locks for 1/2" Shafts	.36
10061	Shaft Lock	.36
10065	Vernier Drive Unit	.36
10067	Shaft Bearing	.21
13001	Neutralizing Condenser 0.7-1.3 "Poly"	.90
13002	Neutralizing Condenser 0.5-1.5 "Poly"	1.05
13003	Neutralizing Condenser 1.5-8.5 "Poly"	.90
13005	Neutralizing Condenser 3.4-11.6 "Air"	2.00
13006	Neutralizing Condenser 2.8-9.1 "Air"	3.00
20015	Stearite Ultra Midget 15 mmfd SS	.75
20035	Stearite Ultra Midget 35 mmfd SS	1.00
20050	Stearite Ultra Midget 50 mmfd SS	1.20
20100	Stearite Ultra Midget 100 mmfd SS	1.50
20140	Stearite Ultra Midget 140 mmfd SS	1.70
20920	Stearite Ultra Midget 20 mmfd LS	1.20
20935	Stearite Ultra Midget 35 mmfd LS	1.40
21050	Stearite Ultra Midget 50 mmfd SS	1.75
21100	Stearite Ultra Midget 100 mmfd SS	1.90
21140	Stearite Ultra Midget 140 mmfd SS	2.10
21935	Stearite Ultra Midget 35 mmfd LS	1.90
22075	Stearite Midget 75 mmfd SS	1.32
22100	Stearite Midget 100 mmfd SS	1.38
22140	Stearite Midget 140 mmfd SS	1.62
22915	Stearite Midget 15 mmfd LS	1.20
22935	Stearite Midget 35 mmfd DS	1.30
22950	Stearite Midget 50 mmfd DS	1.50
23075	Stearite Dual Midget 75 mmfd per section SS	2.60
23100	Stearite Dual Midget 100 mmfd per section SS	2.50
23925	Stearite Dual Midget 25 mmfd per section DS	2.25
23950	Stearite Dual Midget 50 mmfd per section DS	2.50
24100	100 mmfd per section. Single spaced	2.75
24935	35 mmfd per section. Double spaced	2.75
25130	93-130 Air Padder	1.50
26025	3-2-25 Air Padder	.96
26050	4-50 Air Padder	1.08
26075	4-3-76 Air Padder	1.20
26100	5-97 Air Padder	1.32
26920	4-5-20 Air Padder	1.40
26935	5-5-36 Air Padder	1.50
27010	10 mmfd Silver on Mica	.36
27025	25 mmfd Silver on Mica	.36
27050	50 mmfd Silver on Mica	.36
27100	100 mmfd Silver on Mica	.36



JAMES



MILLEN

Modern Parts Designed for Application

Code	Description	Net Price	Code	Description	Net Price
27150	150 mmf Silver on Mica	\$.42	43081	Plug No. 1 at end of code means center link.	\$.90
28030	30 mmf Mica Trimmer	.15	43161	No. 2, end link	.90
30001	Standoff, 1/2 x 1 3/4, Quartz(Q)	.15	44000	Quartz(Q) Coil Form 1 3/4" dia. x 3 3/4"	.75
30002	Standoff, 1/2 x 2 3/4, Quartz(Q)	.21	44001	Quartz(Q) Blank Coil Form and Plug	1.20
30003	Standoff, 3/4 x 2 3/4, Quartz(Q)	.55	44005		1.50
30004	Standoff, 3/4 x 4 3/4, Quartz(Q)	.65	44010		1.50
31001	Standoff, 1/2 x 1, Isolantite	.20	44020		1.50
31002	Standoff, 1/2 x 2 1/2, Isolantite	.27	44040	"100 watt" coils for each band.	1.50
31003	Standoff, 3/4 x 2, Isolantite	.30	44080	Mounted on No. 40305 plug	1.90
31004	Standoff, 3/4 x 3 1/2, Isolantite	.42	44160		2.10
31011	Cone, 1/4 x 1/2, Steatite	.10	44500	Swinging Link and Socket	1.75
31012	Cone, 1 x 1, Steatite	.21	45000	Coil Form, 1" dia. no p. low loss mica base	
31013	Cone, 1 1/2 x 1, Steatite	.27		Phenolic	.21
31014	Cone, 2 x 1, Steatite	.75	45004	Coil Form, 1" dia. 4 p., low loss mica base	
31015	Cone, 3 x 1 1/2, Steatite	.45		Phenolic	.30
32100	Steatite Bushing for 3/8" hole	.30	45005	Coil Form, 1" dia. 5 p., low loss mica base	
32101	Steatite Bushing for 1/2" hole	.35		Phenolic	.30
32102	Steatite Bushing for 3/4" hole	.20	45500	Coil Form, 3/8" dia., Steatite	.45
32103	Steatite Bushing for 1" hole	.45	46100	Coil Form, 1 1/2" dia. no p., Quartz(Q)	.45
32150	Isolantite Thru-bushing, for 1/2" hole	.05	47001	Coil Form, 1 1/2" dia., Quartz(Q)	.15
32201	Steatite Bushing and Hardware	.75	47002	Coil Form, 1 1/2" dia., Quartz(Q)	.35
32203	Steatite Bushing and Hardware	3.60	47003	Coil Form, 3/4" dia., Quartz(Q)	.45
32300	Isolantite Bushing	1.80	47004	Coil Form, 3/4" dia., Quartz(Q)	.45
33002	Crystal Socket	.25	55001	Sheet, 3 x 8 1/2 x .1, Quartz(Q)	.45
33004	4 Prong Socket	.24	58000	Coil Dope, 2-oz., Quartz(Q)	1.00
33005	5 Prong Socket	.24	77083	"83" Hash Filter 250MA	1.40 pr.
33006	6 Prong Socket	.24	77866	"866" Hash Filter 500MA	1.25 pr.
33008	8 Prong, Octal Socket	.24	77872	"872" Hash Filter	1.40 pr.
33087	Base Clamp for 807, etc.	.30	79020	14mc Band Wave Trap	.90
33105	Acorn Socket, Quartz(Q)	.90	79040	7mc Band Wave Trap	.90
33888	Aluminum Shield for 33003	.18	79080	3.5mc Band Wave Trap	.90
33991	Socket for 991, etc.	.45	79160	1.7mc Band Wave Trap	.90
34010	Shielded 10 MH receiving	.75			
34100	Universal 2.5 MH	.36			
34104	Universal 2.5 MH, less Standoff	.30			
34102	Commercial type 2.5 MH	.36			
34140	Universal Air Core Transmuting	1.00			
34154	Amateur Band Transmitting Choke	1.50	60454	456 Diode Air Trimmed	4.50
34210	General Purpose RFC 10 MH	.60	60455	456 Interstage (1) Air Core	4.50
34225	General Purpose RFC 25 MH	1.75	60456	456 Interstage (2) Air Core	4.50
34240	General Purpose RFC 40 MH	.75	60501	5000 Interstage (2) Air Core	4.50
34285	General Purpose RFC 85 MH	1.25	60502	5000 Diode Air Core	4.50
34800	Interruption Frequency Oscillator Coil	1.20	60503	5000 FM Interstage Air Core	4.50
36001	Ceramic Plate Cap, 3/16" for 866, etc.	.21	60504	5000 FM Disc Air Core	4.50
37001	Ceramic Plate Cap, 3/8" for 807, etc.	.21	62161	1600 Interstage Iron Core	4.50
37104	Black Bakelite Safety Terminal	.40	62162	1600 Diode Iron Core	4.50
37105	Four Terminal Black Bakelite	.60	62454	456 Diode Iron Core	4.50
37202	Five Terminal, Steatite	.75	62456	456 Interstage Iron Core	4.50
37211	Steatite Plates, Pr.	.30	63163	1600 BFO Air Core	4.50
37222	Bracket	.15	63156	456 BFO Air Core	4.50
37501	Terminal Posts, Pr.	.30	63503	5000 BFO Air Core	4.50
38001	Low Loss Mica Bakelite Safety Terminal	.55			
38500	Isolantite 3/16" O.D. Beads (Pk. of 50)	.30	67454	456 Diode Mica Trimmed	1.25
39001	100 Beads, 3/16" dia., Quartz(Q)	.60	67456	456 Interstage Iron Core	1.25
39002	Truly Flexible Isolantite	.36	67503	5000 FM Interstage Air Core	1.50
39003	Conventional	.36	67504	5000 FM Disc Air Core	1.50
39005	Solid Brass N.P.	.21			
39006	Universal Joint, Non-Insulated	.36			
40205	Slide Action	.36	64454	456 Diode (2) Permeability Tuned	1.50
40305	Midget Coil Plug	.24	64456	456 Interstage (2)	1.50
41205	Intermediate Size Coil Plug	.45	65456	456 BFO	1.50
43001	Midget Coil Socket	.30	64161	1600 kc Interstage	2.50
43011	Intermediate Size Coil Socket	.45	65163	1600 kc BFO	2.25
43021	Quartz(Q) Blank Coil Form and Plug	.90			
43041	Midget Coils for Each Band. Mounted on No. 40205	.90	66454	456 Diode Triple Tuned	1.75
			66456	456 Interstage	1.75
			90721	Hetrofil	4.00

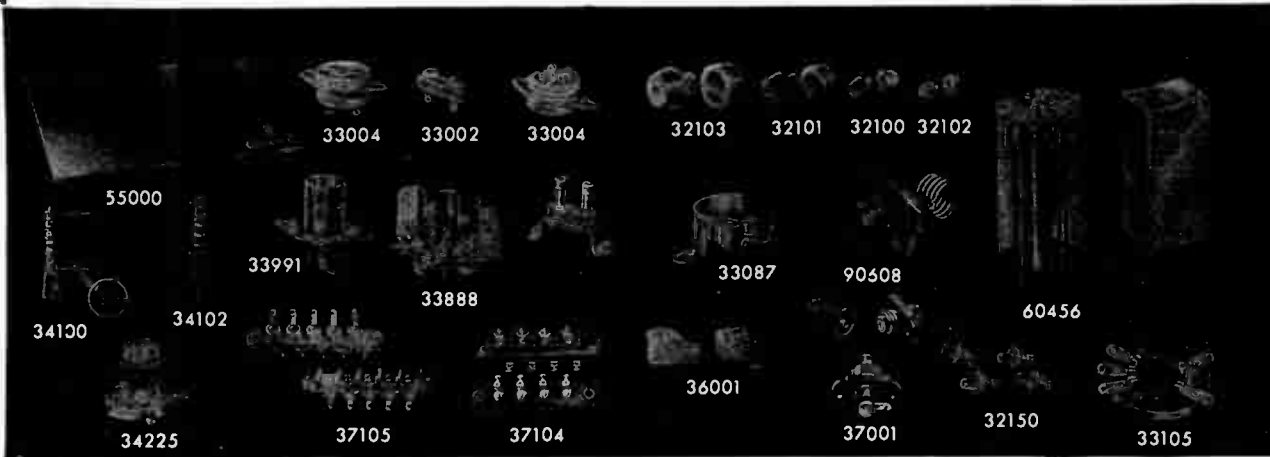

JAMES



MILLEN

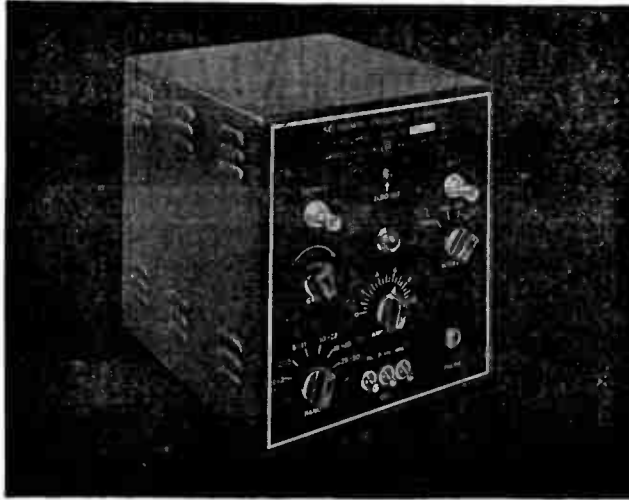

A Precision Crystal Secondary FREQUENCY STANDARD

A precision frequency standard capable of being adjusted to WWV or some other primary standard and putting out uniformly accurate calibrating signals with 10, 25, 100, 1000 KC intervals. Uses the new GENERAL ELECTRIC 1000 KC crystal having a frequency temperature coefficient of less than one cycle/Mc/C°. The crystal is sealed in Helium in a standard metal tube envelope.

The self-contained AC power supply has VR150-30 voltage regulator tube. . . . In addition to oscillator, multivibrators, and amplifier, a built-in detector with phone jack and gain control on panel is incorporated.

The August 1940 issue of the magazine *QST* contains a detailed technical description by the designer, Mr. George M. Brown.

Tubes required: VR150-30; 6K8; 2-6SC7; 6V6; 6SJ7; 5W4. Cabinet size: 9" x 9 1/2" x 10 1/2". Weight of the 110 volt 60 cycle model, less packing, is 16 lbs.

- 90505 Frequency Std., with G.E. tubes and crystal 110V60 net pr. . . \$135.00
- 90507 Frequency Std., with G.E. tubes and crystal 220V50-60 net pr. 145.00

MIDGET FREQUENCY METERS

Many amateurs and experimenters do not realize that one of the most useful "tools" of the commercial transmitter designer is a series of very small absorption type frequency meters. These handy instruments can be poked into small shield compartments, coil cans, corners of chassis, etc., to check harmonics; parasitics; oscillator-doubler, etc., tank tuning; and a host of other such applications. Quickly enables the design engineer to find out what is really "going on" in a circuit. Sold in sets of 4 in handy protective case or individually.



- 90605 Range 3.0 to 10 mc. \$3.00
- 90606 Range 9.0 to 23 mc. 3.00
- 90607 Range 23 to 60 mc. 3.00
- 90608 Range 50 to 140. 3.00
- 90600 Complete set of four, in case. 12.00

BLILEY CRYSTAL UNITS

TYPE HF2 MOUNTED CRYSTAL FOR THE AMATEUR 20-METER BAND



Frequency multiplication in 2½, 5, 10, or 20-meter transmitters is minimized with the HF2 unit for 20 meters. This fully dependable mounted crystal has high activity comparable to lower frequency crystals and is, therefore, easily excited. Physical ruggedness is accomplished by employing the harmonic vibrating principle. The crystal can be used in any conventional triode, pentode

or Tri-tet oscillator and the only necessary precautions are the usual low-loss design considerations required for all high-frequency circuits. Regenerative or Pierce circuits generally are to be avoided.

- Type HF2—Amateur 20-meter band, drift +20 cycles/mc./°C., within 15 KC. of specified frequency*.....Net **\$5.75**
 Within 5 KC. of specified frequency.....Net **\$10.00**
 14.4 to 15.0 MC., drift +20 cycles/mc./°C., within 30 KC. of specified frequency* (for multiplying to the 5 and 10-meter bands).....Net **\$5.75**
 Within 5 KC. of specified frequency.....Net **\$15.00**

*Or choice from dealer's stock.

TYPE BC3 MOUNTED CRYSTAL FOR THE 40, 80 AND 160-METER BANDS

Thoroughly reliable in every respect, this economically priced crystal unit has found wide favor with amateurs throughout the world. The accurately cut crystal is an active oscillator and has a drift of only 23 cycles/mc./°C. Heat, developed by the crystal during oscillation, is dissipated by the stainless-steel holder cover-plate. This design assures greatest stability by limiting the temperature rise of the crystal.

Type BC3—within ±5 KC. of specified frequency in the 40 or 80-meter bands*. Negative drift.

NET **\$3.35**

Within ±10 KC. of specified frequency in the 160-meter band. (+) drift.

NET **\$3.35**

At exact Integral specified KC's. in the 40 or 80-meter bands.

NET **\$4.95**

*Or choice from dealer's stock.



TYPE B5 MOUNTED CRYSTAL FOR THE AMATEUR 40-METER BAND

Plus performance is achieved in the B5 40-meter crystal unit by combining the results of intensive research with painstaking manufacturing procedure. The crystal is a ready oscillator because it is designed and finished for uniformly high activity. Frequency drift under operating conditions is small inasmuch as the temperature coefficient is limited to a maximum of (±) 4 cycles/mc./°C.

The oscillating frequency is accurately calibrated and is guaranteed correct within ±.03% in your transmitter at normal room temperature.

The holder is unusually compact and is equipped with pins for plugging into a standard 5-prong tube socket. Because the crystal is held under firm pressure applied by a coil spring, the unit can be operated in any desired position. Both electrodes are heat treated and carefully lapped to insure permanently reliable crystal performance.

Type B5—Within 5 KC. of specified frequency* in the amateur 40-meter band.....Net **\$4.80**

Frequency to exact Integral specified KC's.....Net **\$5.90**

*Or choice from dealer's stock.



TYPE LD2 MOUNTED CRYSTAL FOR THE 80 and 160-METER BANDS

The type LD2 Unit is a mounted, precision low-drift crystal for the 80 and 160-meter amateur bands. The crystal is carefully cut from selected Brazilian Quartz, lapped to exacting limits, accurately calibrated and rigidly tested. It possesses high activity and has a frequency drift of less than ±4 cycles/mc./°C. The mounting is low-loss molded Bakelite with the crystal held under constant spring pressure between two stainless-steel electrodes. The unit plugs into any standard 5-prong tube socket and may be mounted in any position.

Type LD2—Within 5 KC. of specified frequency or choice from dealer's stock.

NET **\$4.80**

Supplied to exact Integral specified KC's.

NET **\$5.90**

NET **\$5.90**



Engineering Bulletin E-6, FREQUENCY CONTROL WITH QUARTZ CRYSTALS, should be read by every engineer, amateur or experimenter interested in frequency control or the measurement of radio frequencies. Price, 10c per copy (Canada and foreign, 15c).

BLILEY CRYSTAL UNITS

VARIABLE FREQUENCY CRYSTAL UNIT TYPE VF1

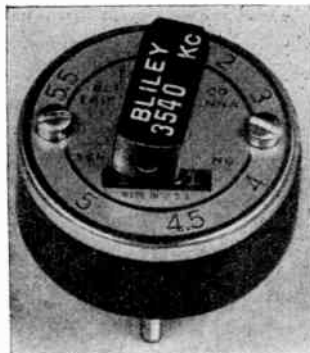

Pat. No. 2,079,540

Enjoy clear channels with a variable frequency crystal unit. By a mere twist of the control knob, your station frequency is continuously variable up to 6 KC. with the 80-meter unit or 12 KC. with the 40-meter unit. When frequency multiplying, the variation is proportionately increased.

The specially ground crystal has a drift of less than ± 4 cycles/mc./ $^{\circ}$ C. and an activ-

ity only slightly less than that of corresponding fixed-frequency crystals. With the average transmitter, no changes in tuning will be required over the entire adjustable range of the VF1 Unit.

Type VF1—Within 5 KC. of specified minimum frequency in the 80-meter band.....	Net	\$6.60
Minimum frequency at exact integral specified KC's., in the 80-meter band.....	Net	\$8.50
Type VF1—Within 15 KC. of specified minimum frequency in the 40-meter band.....	Net	\$6.60
Within 5 KC. of specified minimum frequency in the 40-meter band.....	Net	\$8.50

CALIBRATOR CRYSTAL UNIT TYPE SMC100

The type SMC100 Crystal Unit offers a simple means for constructing a flexible, inexpensive frequency standard. Its dual-frequency feature is advantageous for rapidly checking the calibration of radio receivers, test oscillators, signal generators or amateur monitors. Radio servicemen will find a frequency standard using a type SMC100 Unit to be an invaluable servicing instrument.

By shunting a small variable condenser across the crystal, the 100kc. frequency can be adjusted to exact value at normal room temperatures. The 1000kc. frequency is correct within $\pm .05\%$.

Type SMC100—100 KC.—
1,000 KC. mounted crystal.
NET

\$7.75

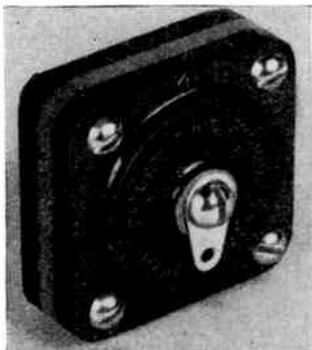

STANDARD FREQUENCY CRYSTAL UNIT TYPE SOC100

A 100 KC. mounted crystal of high precision designed for use in frequency standards. This unit, in a simple circuit, provides reliable accuracy for calibration of frequency meters, test oscillators, radio receivers, or for frequency measurements in general.

The rigidly mounted crystal has a frequency-temperature coefficient of less than ± 3 cycles/mc./ $^{\circ}$ C., which value is sufficiently low that temperature control is not necessary for general practice. Included in the aluminum shielded mounting is a tank coil of the proper characteristics for use with this crystal. The complete unit plugs into any standard 5-prong tube socket and may be mounted in any position. Circuit instructions furnished.



Type SOC100.....	Net	\$15.50
Type SOC100, calibrated at specified oven temperature.....	Net	\$21.00
Type SOC100X—Mounted 100 KC. X-cut bar, (no tank coil included).....	Net	\$9.50

BLILEY CRYSTAL FILTER TYPE CFI

A high-frequency receiver is not complete unless it incorporates a quartz crystal filter. Only through the use of an effective intermediate-frequency filter is it possible to obtain the high degree of selectivity necessary for modern communications.

The Bliley CFI Crystal Filter Unit, with its high Q and freedom from spurious responses, assures maximum selectivity and minimum signal loss. Each crystal is carefully ground to frequency and rigidly tested in equipment simulating actual receiver conditions. The low-loss Steatite holder plugs into any standard 5-prong tube socket.

Type CFI — for 456 KC.,
465 KC. or 500 KC. I.F.

NET
\$5.50

For 1600 KC. I.F.
NET
\$9.50



Bliley General Communication Frequency Crystals and Mountings are manufactured for all frequencies from 20 KC. to 30 MC. Quotations or recommendations will gladly be extended upon receipt of detailed information concerning your requirements.

HIPOWER

CRYSTALS

RUBIES & EMERALDS

HIPOWER "RUBY"



Type LTC 1
160—80 and 40 meter crystal units.
The ARISTOCRAT of amateur crystal control units. Designed to give peak performance in the amateur bands. Constantly improving a GOOD product, has resulted in these compact units, incorporating the finest workmanship and materials.

Each unit consists of a precision ground LOW-DRIFT crystal of high activity, mounted in a correctly designed molded Bakelite holder. "ALUMILITE" electrodes are used to insure an extremely hard and polished surface. The holder is plug-in type and fits into a five prong tube socket.

The temperature coefficient of this unit is 4 cycles or less per MC. per ° C.

BUILT RIGHT — PRICED RIGHT — WILL MAKE YOUR TRANSMITTER LOOK BETTER AND WORK BETTER.

Type LTC 1 supplied within 5 Kc. of specified frequency or choice of dealers stock	Net Price \$4.50
Supplied within 1 Kc. of specified frequency	5.50

HIPOWER "EMERALD"



Type LTC 2
160—80 and 40 meter crystal units.
This crystal unit has every modern feature. An efficient unit, designed to meet the requirements of the amateur who desires LOW-DRIFT, LOW COST, STABLE crystal control.

Consisting of an extremely active crystal with a temperature coefficient of 10 cycles or less per MC. per ° C. Mounted between NICKEL SILVER electrodes, in a molded Bakelite holder, for plug-in mounting in a five prong tube socket.

TRULY A QUALITY PRODUCT. Sold at a price far below the value of a unit, giving complete satisfaction under all conditions.

Type LTC 2 supplied within 5 Kc. of specified frequency or choice of dealers stock	Net Price \$3.35
Supplied within 1 Kc. of specified frequency	4.35

Type "AH" CRYSTAL HOLDER

This popular all purpose crystal holder needs no introduction, as thousands are in use daily, in amateur transmitters all over the world.

It is a molded Bakelite plug-in type holder for use with 160 and 80 meter crystals, accommodating crystals up to 1" square.

Constant pressure, from a spiral spring, holds the crystal securely between NICKEL SILVER electrodes.

Unit plugs into any standard five prong tube socket. Net Price **\$1.00**
Supplied with Banana pins 50c extra



Type "AH 10" UNMOUNTED CRYSTALS

A precision ground crystal for use in the 160 and 80 meter amateur bands. Made from high grade selected Brazilian Quartz. These crystals are LOW-DRIFT, active oscillators with a temperature coefficient of 10 cycles per MC. per ° C.

These are the crystals which made HIPOWER CRYSTALS the standard of comparison.

Type AH 10 sold unmounted only,
1715 to 2000 Kc., or 3500 to 4000 Kc. supplied within 10 Kc. of specified frequency or choice of dealers stock Net Price **\$2.35**
Supplied within 1 Kc. of specified frequency 3.35

HIPOWER "RUBY"



Type TH 3
An outstanding gem among 20 meter crystal units. A unit which foreshadows tomorrow's requirements for ultra-high frequency control.

Designed to give the super-stability necessary in modern transmitters operating in the crowded amateur bands. This dependable unit also incorporates a crystal of high activity,

with a temperature coefficient of 4 cycles or less per MC. per ° C. Mounted between "ALUMILITE" electrodes, in a plug-in type holder, especially engineered for high frequency operation.

The low price of this unit is made possible only through our high production facilities. Our advance is your gain.

Type TH 3—14000 to 14400 Kc. within 15 Kc. of specified frequency or choice of dealers stock	Net Price \$7.25
Type TH 3—14400 to 15000 Kc. within 30 Kc. of specified frequency or choice of dealers stock	7.25
Supplied within 5 Kc. of specified frequency	11.25

HIPOWER "EMERALD"



Type TH 10
This Unit Is Without Competition

A 20 meter crystal unit unsurpassed in QUALITY and PRICE. It IS a LOW-DRIFT crystal, with a temperature coefficient of 10 cycles or less per MC. per ° C. Extremely accurate methods of manufacture, has enabled us to produce a unit with much less drift, than most units sold at anywhere near our price.

This active crystal is also mounted between "ALUMILITE" electrodes, in a plug-in type, molded Bakelite holder, for five prong tube socket mounting.

Type TH 10—14000 to 14400 Kc. within 15 Kc. of specified frequency or choice of dealers stock	Net Price \$5.50
Type TH 10—14400 to 15000 Kc. within 30 Kc. of specified frequency or choice of dealers stock	5.50
Supplied within 5 Kc. of specified frequency	9.50

The Biggest Dollar For Dollar Value Offered to the Radio Amateur Today

TRIMM

HEADSETS

KNOWN AROUND THE WORLD



MADE IN U.S.A. SINCE 1922

ACME DELUXE



A superior headset in the lightweight low price fold. Cap and shell of molded bakelite, chrome steel magnets, and weighs six ounces complete with two units, 4 1/2 foot cord and metal headband.

Double Headset—2000 ohms d.c. resistance \$2.50
 Single Headset—1000 ohms d.c. resistance \$1.50

IN ADDITION TO THE PRODUCTS SHOWN ON THIS CATALOG PAGE, TRIMM WILL FURNISH PRICES AND FULL INFORMATION ON VARIOUS TYPES OF GOVERNMENT-SPECIFIED HEADSETS TO FIRMS REQUIRING HEADSETS FOR COMMUNICATION EQUIPMENT. OUR PRODUCTION TODAY IS 100% WAR WORK. TRIMM IS DOING ITS

UTMOST TO HELP WIN THIS WAR AND PROVIDE THE

BEST COMMUNICATION EQUIPMENT FOR THE

ARMED FORCES OF THE ALLIES AND THE GOOD OLD

USA

PROFESSIONAL



The choice of countless users... the original TRIMM headset. Double unit watch case type. Bakelite cap and shell, forged magnet of chrome steel, impregnated coils, 5 foot moisture-proof wear resisting cord, entirely concealed terminals. Fabric-covered wire headband. Standard resistances.

No. 70—Double Unit Headset, \$4.65
 No. 72—Single Unit Headset, wire band and 6 foot cord \$2.60

FEATHERWEIGHTS



The world famous TRIMM Featherweight. Recognized as a leading quality headset. Weighs 4 1/2 oz. complete with two units, 5 foot moisture-proof wear resisting cord, and adjustable nickel-plated steel headband. Bakelite shell and cap. Magnet of highest quality 38% cobalt steel alloy.

Pole pieces of finest magnetic iron. Coils especially impregnated. A custom built phone throughout. Standard resistances.
 No. 100—Adjustable nickel-plated steel headband \$10.00
 No. 104—Fabric-covered wire headband 10.00

COMMERCIALS



The most sensitive, yet ruggedly constructed unit available. Practically nonbreakable. A 5 foot special moisture-proof cord, with No. 500 telephone type plug attached, and brown leather-covered wire headband with exclusive spring lock and adjusting clamp are all part of this lightweight headset. Dia. 2 1/8", depth 3/4", forged magnet of the best grade 38% cobalt steel. Color... a rich, warm walnut brown.

This headset is recommended for monitoring service, because of its high quality performance.

No. 156—600 ohms Imp. per pair \$16.00
 No. 157—17,000 ohms Imp. per pair 16.00
 No. 158—Like 156, no plug 14.50
 No. 159—Like 157, no plug 14.50

THE DEPENDABLE



When a high-grade headset is desired, but price must be considered, choose the Dependable. Bakelite caps and shells. Extra heavy bar chrome steel magnets forged to insure strength. 5 foot tinsel cord, fabric-covered wire headband.
 No. 65—2000 ohms d.c. only \$3.80
 No. 67—Single Dependable, 1000 ohms d.c. only 2.00

24,000 Ohms Imp. Featherweights

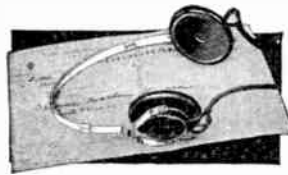

Featherweight headset built especially for the Amateur. Precision built throughout, this phone embodies the results of years of experience. Again ultra-sensitivity combined with rugged construction makes a fine headset, which is very lightweight.

No. 106—Adjustable nickel-plated steel headband \$10.00
 No. 107—Fabric-covered wire headband 10.00

ARMY-NAVY HEADSETS



Very sensitive. Meet both army and navy specifications. 5 foot moisture-proof cord, phone tip terminals. Inside terminals. Leather headband. Bipolar magnets, 2 lbs. Available in two impedances. High impedance type (2200 ohms d.c.) indicated by code letter K, and low impedance (112 ohms d.c.) indicated by code letter W.
 No. K29D—2200 ohms d.c. \$16.00
 No. W28D—112 ohms d.c. 16.00

PHONE PLUGS

Most compact plug. Bakelite with nickel-plated stem. Cord tips held tightly by screws. Easily attached to cord.
 No. 512—Flat plug \$0.60



EAR CUSHIONS

Rubber ear cushions enable phones to be worn with utmost comfort. They also reduce sound leakage.
 No. 654—Fits Trimm Featherweight, Trimm Commercial, Kellogg, and Telephonic \$0.90

SUBJECT TO CHANGE WITHOUT NOTICE

Quality Phones for all Purposes in times of Peace
 Quality Phones for our Armed Forces now at War

HEADPHONES By C. F. CANNON



THE "CHIEF"—Cannon-Ball Bakelite Headset

The "Chief" is a new addition to the Cannon-Ball family of headsets. There is a demand for a high grade bakelite phone, reasonably priced, and The "Chief" meets this requirement in every respect. It is an inside terminal type. The diameter of the diaphragm is $2\frac{1}{4}$ ". Bakelite cases and caps. Double coils, two in each receiver. Laminated Chrome Magnets. Braid covered headbands with permanent adjustment and having no removable parts. Cotton covered cord four and one-half feet long.

No.	List Price
CC-2—2000 ohms D.C. 10000 ohms impedance at 1000 cycles.....	\$3.75
CC-3—3000 ohms D.C. 15000 ohms impedance at 1000 cycles.....	4.25
CC-5—5000 ohms D.C. 25000 ohms impedance at 1000 cycles.....	5.25
Leather covered headband in place of the braid band.....	List 45c extra



THE CHIEF

THE BRANDES "SUPERIOR" MATCHED TONE HEADSET

The Brandes "Superior" headset has been on the market since 1908. It was one of the first headsets available to amateurs. It is the outside terminal type. The diameter of the diaphragm is $2\frac{1}{4}$ ". Aluminum cases. Black bakelite or aluminum unbreakable caps. Double coils, two in each receiver. Magnets made of chrome magnet steel $\frac{1}{4}$ " square. It has a stainless steel headband with permanent adjustment and having no removable parts. Cotton covered cord four and a half feet long.

No. BS-2—2000 ohms D.C. 10000 ohms impedance at 1000 cycles. List Price.....	\$3.10
--	--------

THE BRANDES "ADMIRAL" MATCHED TONE HEADSET

The Brandes "Admiral" phone is of the same general construction as the Brandes Superior but has the terminals on the inside.

No. BA-2—2000 ohms D.C. 10000 ohms impedance at 1000 cycles. List Price.....	\$3.35
No. BA-3—3000 ohms D.C. 15000 ohms impedance at 1000 cycles. List Price.....	3.75
No. BA-5—5000 ohms D.C. 25000 ohms impedance at 1000 cycles. List Price.....	5.25

THE "MASTER" CANNON-BALL That Old Reliable Headset

The "Master" Cannon-Ball headset is of exceptional high quality and rugged construction. It is used extensively in institutions, hospitals and prisons, and by radio servicemen and amateurs everywhere. It is of the concealed terminal type. The diameter of the diaphragm is $2\frac{1}{4}$ ". Aluminum cases. Bakelite or aluminum unbreakable caps. Double coils, two in each receiver. Magnets made of chrome magnet steel $\frac{1}{4}$ " square. It has a stainless steel headband with permanent adjustment and having no removable parts. Cord is cotton, four and a half feet long.

No. MC-2—2000 ohms D.C. 10000 ohms impedance at 1000 cycles. List Price.....	\$3.10
No. MC-3—3000 ohms D.C. 15000 ohms impedance at 1000 cycles. List Price.....	3.50
No. MC-5—5000 ohms D.C. 25000 ohms impedance at 1000 cycles. List Price.....	5.00



THE EMPIRE

THE "EMPIRE" CANNON-BALL New Lightweight Headset

The "Empire" Cannon-Ball is a lightweight, low priced headset, high in efficiency and attractive in appearance. Although it weighs less than six ounces, including headband and cord, it has a large magnet and double coils. It reproduces with clarity and volume equal to most of the larger, heavier and more expensive sets now on the market. It is of the concealed terminal type. The diameter of the diaphragm is $1\frac{1}{4}$ ". Aluminum cases. Black bakelite or aluminum unbreakable caps. Double coils, two in each receiver.

A round chrome magnet of substantial size insures powerful magnetism. Cotton cords four and a half feet long. Headband is spring steel with adjustable yokes.

No. EC-2—2000 ohms D.C. 10000 ohms impedance at 1000 cycles. List Price.....	\$2.10
No. EC-3—3000 ohms D.C. 15000 ohms impedance at 1000 cycles. List Price.....	2.35
Stainless steel or braid covered band in place of the plain steel. List Price.....	25c extra



THE SUPERIOR

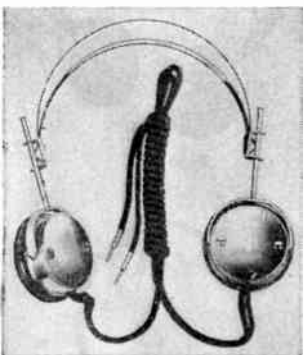

THE MASTER

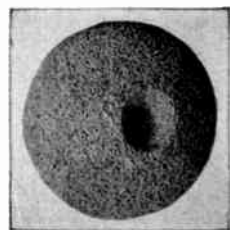

Cannon-Ball Sponge Rubber Headset Ear Cushion

A comfortable, sanitary cushion which will fit over the cap of any headset. No. HC-1—

List Price, per pair \$0.50



CANNON-BALL HEADPHONE ADAPTOR

This Adaptor can be attached to any radio set. It has a three-way switch. You can listen with phones or speaker alone or with the phones and speaker together.

No.	List Price
K-3 —Mounted Adaptor Switch with cord.....	\$2.40
K-E 3—Kit complete with Empire phones and switch	4.75
K-M 3—Kit complete with Master phones and switch	5.75

BRAND COVERED HEADBAND WILL BE FURNISHED WITH THE BRANDES SUPERIOR, BRANDES ADMIRAL, MASTER CANNON-BALL, IF DESIRED WITHOUT EXTRA CHARGE. IF THE BRAID BAND IS DESIRED SPECIFY BRAID BAND WHEN ORDERING.

BRUSH

CRYSTAL Headphones

Each of the many and varied applications of headphones requires some special qualification for satisfactory performance. Brush has a most complete line of headphones, and each model is designed for a specific group of applications.

As is well known, Brush phones are crystal operated and for this and other reasons possess the following exclusive features:

1. Exceptionally high impedance, thus causing a minimum of disturbance in critical electrical circuits.
2. Wider range response with more uniform output.
3. Non-magnetic, permitting their use in close proximity to delicate electrical instruments normally affected by external magnetic fields.
4. Designed to give better ear seal, improving low frequency response.
5. Light weight and durable construction.

HIGH FIDELITY, Type "A-1" ... Exceptionally uniform response, 100 to 12,000 c.p.s. Impedance of such high magnitude, over the operating frequency range, that line or circuit characteristics are not affected when monitored by these phones. Specially treated fibre diaphragm, eliminating possibility of diaphragm resonance and chatter. Headphone case of taupe-gray molded plastic, comfortable with good ear seal. Headband conveniently adjustable. Headset complete with band and 5' cord. **List Price.....\$28.70**
Net Wt., 6 oz. Shipping Wt., 2 lbs. Code, Mihit



Type "A"

BRUSH TYPE "A" General Purpose

Accepted as standard by radio amateurs, experimenters and radio listeners. Widely used for monitoring and laboratory work and in the hard-of-hearing field. Headset complete with 5' cord and headband.

List Price\$11.00
Net Wt., 6 oz. Code, Millo
Shipping Wt., 2 lbs.



"A" Single

BRUSH TYPE "A" SINGLE PHONE with Headband

Particularly adapted to individual or group hearing aids and radio phones. Light weight, good ear seal and comfortable to wear. Spring steel headband with soft rubber end to eliminate slipping. Single phone complete with 5' cord and headband.

List Price\$5.90
Net Wt., 3 oz. Code, Milod
Shipping Wt., 1 lb.



Type "A" Lorgnette

BRUSH TYPE "A" LORGNETTE

5-inch telescope extension—12" to 17". Attractively finished in telephone black. Light weight, easy to handle and comfortable at the ear. Single "A" phone complete with 5' cord and lorgnette handle. **List Price\$7.50**

Net Wt. 5 oz. Code, Milme
Shipping Wt., 1 lb.

COMMUNICATIONS (Type "BJ")

Ruggedness, comfort, good ear seal, and safety against shock assured by molded soft rubber jacket encasing the cartridge. Specially protected against adverse climatic conditions by hermetically sealed aluminum cartridge construction. All rubber yokeless cord design for greater freedom and comfort. High impedance and sensitivity. Bakelite diaphragm, direct crystal drive. Standard adjustable headband. Headset complete with 5' cord and headband.

List Price\$14.50
Net Wt., 6 oz. Code, Micom
Shipping Wt., 2 lbs.



Type "BJ"

TYPE "B" SINGLE PHONE with Headband

Excellent for hearing aid because of extremely light weight. Soft rubber ring assures comfort and good ear seal with improved bass response. Snap fastener terminals facilitate cord replacement. Furnished with or without soft rubber sealing ring.

Single "B" phone complete with headband, 5' cord and sealing ring. **List Price \$6.70**
Net Wt., 3 oz. Code, Milbor
Shipping Wt., 1 lb.



"B" Single

BRUSH SS-1J "HUSHATONE" Pillow Speaker

Private entertainment in the home, hospital or sanatorium. Simply place it under a pillow and enjoy your favorite radio programs without disturbing others. Enclosed within a moulded sponge rubber case. Good response for either talking or music. Easily installed on any type of radio.

"Hushatone, with 7' cord.
List Price\$8.25
Net Wt., 7 oz. Code, Sepil
Shipping Wt., 2 lbs.



SS-1J "Hushatone"

PRICES SUBJECT TO CHANGE WITHOUT NOTICE
Complete technical data on request

TRANSFORMERS

A complete line of replacement transformers designed to service the requirements of practically any radio set on the market. Utah Transformers are standard equipment in millions of receivers throughout the world—definite proof of their reliability and performance under all operating conditions—your assurance of permanently satisfied customers. Fully impreg-

nated and climate-proof.

First letter in Part No. designates mounting style; next number principal filament voltage; next two numbers, total mills output. A letter at end designates additional filaments — E is 3 filaments, G is 5 filaments. No letter means 2 filaments.

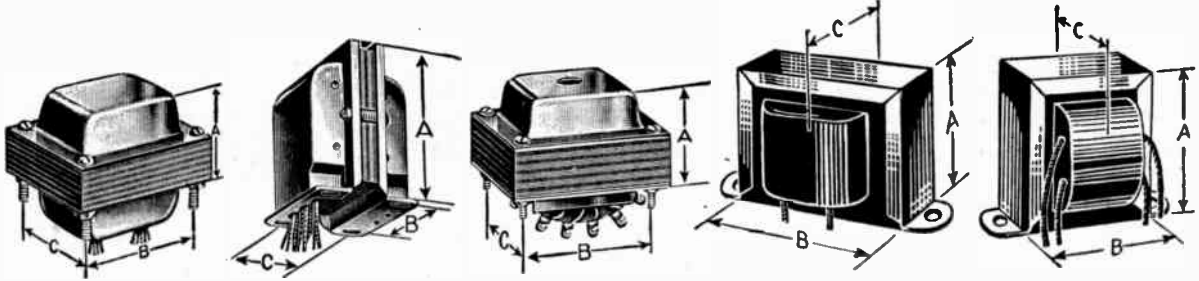

2 1/2 VOLT TUBE POWER TRANSFORMERS — 2 FILAMENTS

Style	Stock Number	A.C. Plate Volts	Filament No. 1	Filament No. 2	Dimensions (In.) A B C	Mounting Centers (In.)	Shipping Weight	List Price	Net Price	
X	X 240	650 Volts C.T.	40 Mills.	5 Volts 2 Amps.	2.5 V.C.T. 4 Amps.	1 3/4 x 3 x 2 1/2	2 1/2 x 2	2 Lbs.	\$2.40	\$1.44
Y	Y 240	650 Volts C.T.	40 Mills.	5 Volts 2 Amps.	2.5 V.C.T. 4 Amps.	3 1/2 x 2 1/2 x 2 1/2	2 x 1 1/2	2 Lbs.	2.65	1.59
Z	Z 240	650 Volts C.T.	40 Mills.	5 Volts 2 Amps.	2.5 V.C.T. 4 Amps.	1 3/4 x 3 x 2 1/2	2 1/2 x 2	2 Lbs.	2.25	1.35
X	X 245	650 Volts C.T.	40 Mills.	5 Volts 2 Amps.	2.5 V.C.T. 7 Amps.	1 3/4 x 3 x 3 1/2	2 1/2 x 2	2 1/2 Lbs.	3.30	1.98
Y	Y 245	650 Volts C.T.	40 Mills.	5 Volts 2 Amps.	2.5 V.C.T. 7 Amps.	3 1/2 x 2 1/2 x 2 1/2	2 x 1 1/2	2 1/2 Lbs.	3.40	2.04
Z	Z 245	650 Volts C.T.	40 Mills.	5 Volts 2 Amps.	2.5 V.C.T. 7 Amps.	1 3/4 x 3 x 2 1/2	2 1/2 x 2	2 1/2 Lbs.	3.15	1.89
X	X 250	700 Volts C.T.	50 Mills.	5 Volts 2 Amps.	2.5 V.C.T. 5 Amps.	1 3/4 x 3 x 2 1/2	2 1/2 x 2	2 1/2 Lbs.	2.80	1.68
Y	Y 250	700 Volts C.T.	50 Mills.	5 Volts 2 Amps.	2.5 V.C.T. 5 Amps.	3 1/2 x 2 1/2 x 2 1/2	2 x 1 1/2	2 1/2 Lbs.	3.10	1.86
Z	Z 250	700 Volts C.T.	50 Mills.	5 Volts 2 Amps.	2.5 V.C.T. 5 Amps.	1 3/4 x 3 x 2 1/2	2 1/2 x 2	2 1/2 Lbs.	2.65	1.59

2 1/2 VOLT TUBE POWER TRANSFORMERS — 3 FILAMENTS

Style	Stock Number	A.C. Plate Volts	Filament No. 1	Filament No. 2	Filament No. 3	Dimensions (In.) A B C	Mounting Centers (In.)	Shipping Weight	List Price	Net Price
X	X 250E	650 Volt C.T. 50 Mills.	5 Volts 3 Amps.	2.5 V.C.T. 1 1/4 Amps.	2.5 V.C.T. 5 3/4 Amps.	2 x 3 x 2 1/2	2 1/2 x 2	3 Lbs.	\$3.30	\$1.98
Y	Y 250E	650 Volt C.T. 50 Mills.	5 Volts 3 Amps.	2.5 V.C.T. 1 1/4 Amps.	2.5 V.C.T. 5 3/4 Amps.	3 1/2 x 2 1/2 x 2 1/2	2 x 2	3 1/2 Lbs.	3.55	2.13
Z	Z 250E	650 Volt C.T. 50 Mills.	5 Volts 3 Amps.	2.5 V.C.T. 1 1/4 Amps.	2.5 V.C.T. 5 3/4 Amps.	2 x 3 x 2 1/2	2 1/2 x 2	2 3/4 Lbs.	3.15	1.89
X	X 260E	700 Volt C.T. 60 Mills.	5 Volts 2 Amps.	2.5 V.C.T. 1 1/4 Amps.	2.5 V.C.T. 7 Amps.	2 x 3 x 2 1/2	2 1/2 x 2	3 Lbs.	3.65	2.19
Y	Y 260E	700 Volt C.T. 60 Mills.	5 Volts 2 Amps.	2.5 V.C.T. 1 1/4 Amps.	2.5 V.C.T. 7 Amps.	3 1/2 x 2 1/2 x 2 1/2	2 x 2	3 1/2 Lbs.	3.90	2.34
X	X 270E	700 Volt C.T. 70 Mills.	5 Volts 3 Amps.	2.5 V.C.T. 3 Amps.	2.5 V.C.T. 7 Amps.	3 x 3 3/4 x 2 1/2	2 3/4 x 2 1/2	3 3/4 Lbs.	3.75	2.25
Y	Y 270E	700 Volt C.T. 70 Mills.	5 Volts 3 Amps.	2.5 V.C.T. 3 Amps.	2.5 V.C.T. 7 Amps.	3 1/2 x 2 1/2 x 3 1/2	2 1/2 x 2	4 Lbs.	4.15	2.49
Z	Z 270E	700 Volt C.T. 70 Mills.	5 Volts 3 Amps.	2.5 V.C.T. 3 Amps.	2.5 V.C.T. 7 Amps.	2 x 3 3/4 x 2 1/2	2 3/4 x 2 1/2	3 1/2 Lbs.	3.60	2.16
X	X 290E	700 Volt C.T. 90 Mills.	5 Volts 3 Amps.	2.5 V.C.T. 3 Amps.	2.5 V.C.T. 10 1/2 Amps.	1 3/4 x 3 3/4 x 3 1/2	3 1/2 x 2 1/2	4 Lbs.	4.15	2.49
Y	Y 290E	700 Volt C.T. 90 Mills.	5 Volts 3 Amps.	2.5 V.C.T. 3 Amps.	2.5 V.C.T. 10 1/2 Amps.	3 1/2 x 3 3/4 x 3 1/2	2 1/2 x 1 1/2	4 1/2 Lbs.	4.40	2.64
Z	Z 290E	700 Volt C.T. 90 Mills.	5 Volts 3 Amps.	2.5 V.C.T. 3 Amps.	2.5 V.C.T. 10 1/2 Amps.	1 3/4 x 3 3/4 x 3 1/2	3 1/2 x 2 1/2	3 3/4 Lbs.	4.00	2.40
X	X 211E	700 Volt C.T. 110 Mills.	5 Volts 3 Amps.	2.5 V.C.T. 3 Amps.	2.5 V.C.T. 15 1/2 Amps.	2 1/2 x 3 3/4 x 3 1/2	3 1/2 x 2 1/2	4 1/2 Lbs.	5.30	3.18
Y	Y 211E	700 Volt C.T. 110 Mills.	5 Volts 3 Amps.	2.5 V.C.T. 3 Amps.	2.5 V.C.T. 15 1/2 Amps.	3 1/2 x 3 3/4 x 3 1/2	2 1/2 x 2 1/2	5 Lbs.	5.65	3.39
Z	Z 211E	700 Volt C.T. 110 Mills.	5 Volts 3 Amps.	2.5 V.C.T. 3 Amps.	2.5 V.C.T. 15 1/2 Amps.	2 1/2 x 3 3/4 x 3 1/2	3 1/2 x 2 1/2	4 1/2 Lbs.	5.15	3.09
X	X 212E	800 Volt C.T. 125 Mills.	5 Volt C.T. 3 Amps.	2 1/2 Volt C.T. 3 1/2 Amps.	2 1/2 Volt C.T. 15 Amps.	2 3/4 x 4 1/2 x 3 1/2	3 3/4 x 3 1/2	5 3/4 Lbs.	5.90	3.54
Y	Y 212E	800 Volt C.T. 125 Mills.	5 Volt C.T. 3 Amps.	2 1/2 Volt C.T. 3 1/2 Amps.	2 1/2 Volt C.T. 15 Amps.	4 1/4 x 3 1/2 x 3 3/4	2 3/4 x 2 1/2	6 Lbs.	6.15	3.69
Y	Y 216E	850 Volt C.T. 160 Mills.	5 Volts 3 Amps.	2.5 V.C.T. 8 Amps.	2.5 V.C.T. 14 Amps.	4 5/8 x 3 3/4 x 3 3/4	3 x 2 1/2	7 1/2 Lbs.	6.35	3.81
Z	Z 216E	850 Volt C.T. 160 Mills.	5 Volts 3 Amps.	2.5 V.C.T. 8 Amps.	2.5 V.C.T. 14 Amps.	2 1/2 x 4 1/2 x 3 3/4	3 3/4 x 3	6 1/2 Lbs.	5.90	3.54
Y	Y 220E	850 Volt C.T. 200 Mills.	5 Volts 3 Amps.	2.5 V.C.T. 8 Amps.	2.5 V.C.T. 14 Amps.	4 5/8 x 3 3/4 x 4 1/2	3 x 3 1/2	8 1/2 Lbs.	8.15	4.89



TRANSFORMERS

6.3 VOLT TUBE POWER TRANSFORMERS — 2 FILAMENTS

Style	Stock Number	A.C. Plate Volts	Filament No. 1	Filament No. 2	Dimensions (In.) A B C	Mounting Centers (In.)	Shipping Weight	List Price	Net Price
X	X 640	650 Volts C.T. 40 Mills.	5 Volts 2 Amps.	6.3 V.C.T. 1.6 Amps.	1½x3x2½	2½x2	2 Lbs.	\$2.40	\$1.44
Y	Y 640	650 Volts C.T. 40 Mills.	5 Volts 2 Amps.	6.3 V.C.T. 1.6 Amps.	3½x2½x2½	2x1½	2½ lbs.	2.65	1.59
Z	Z 640	650 Volts C.T. 40 Mills.	5 Volts 2 Amps.	6.3 V.C.T. 1.6 Amps.	1½x3x2½	2½x2	2 lbs.	2.20	1.32
X	X 650	700 Volts C.T. 50 Mills.	5 Volts 2 Amps.	6.3 V.C.T. 2 Amps.	1½x3x2½	2½x2	2½ lbs.	3.10	1.86
Y	Y 650	700 Volts C.T. 50 Mills.	5 Volts 2 Amps.	6.3 V.C.T. 2 Amps.	3½x2½x2½	2x1½	2½ lbs.	3.35	2.01
Z	Z 650	700 Volts C.T. 50 Mills.	5 Volts 2 Amps.	6.3 V.C.T. 2 Amps.	1½x3x2½	2½x2	2½ lbs.	3.05	1.83
X	X 660	700 Volts C.T. 60 Mills.	5 Volts 2 Amps.	6.3 V.C.T. 2.5 Amps.	2x3x2½	2½x2	3 lbs.	3.40	2.04
Y	Y 660	700 Volts C.T. 60 Mills.	5 Volts 2 Amps.	6.3 V.C.T. 2.5 Amps.	3½x2½x2½	2x2	3½ lbs.	3.85	2.31
Z	Z 660	700 Volts C.T. 60 Mills.	5 Volts 2 Amps.	6.3 V.C.T. 2.5 Amps.	2x3x2½	2½x2	2½ lbs.	3.25	1.95
X	X 675	700 Volts C.T. 75 Mills.	5 Volts 3 Amps.	6.3 V.C.T. 3.2 Amps.	2x3½x2¾	2¾x2½	3½ lbs.	3.70	2.22
Y	Y 675	700 Volts C.T. 75 Mills.	5 Volts 3 Amps.	6.3 V.C.T. 3.2 Amps.	3½x2½x3½	2½x2	3½ lbs.	4.05	2.43
Z	Z 675	700 Volts C.T. 75 Mills.	5 Volts 3 Amps.	6.3 V.C.T. 3.2 Amps.	2x3½x2¾	2¾x2½	3½ lbs.	3.55	2.13
X	X 690	700 Volts C.T. 90 Mills.	5 V.C.T. 3 Amps.	6.3 V.C.T. 3.5 Amps.	2½x3¾x3½	3½x2½	4½ lbs.	4.15	2.49
Y	Y 690	700 Volts C.T. 90 Mills.	5 V.C.T. 3 Amps.	6.3 V.C.T. 3.5 Amps.	3¾x3½x3½	2½x2½	5 lbs.	4.50	2.70
Z	Z 690	700 Volts C.T. 90 Mills.	5 V.C.T. 3 Amps.	6.3 V.C.T. 3.5 Amps.	2½x3¾x3½	3½x2½	4½ lbs.	4.00	2.40
X	X 612	750 Volts C.T. 125 Mills.	5 Volts 3 Amps.	6.3 V.C.T. 5 Amps.	2½x3¾x3½	3½x2½	5 lbs.	4.30	2.58
Y	Y 612	750 Volts C.T. 125 Mills.	5 Volts 3 Amps.	6.3 V.C.T. 5 Amps.	3¾x3½x3½	2½x2½	5½ lbs.	4.75	2.85
Z	Z 612	750 Volts C.T. 125 Mills.	5 Volts 3 Amps.	6.3 V.C.T. 5 Amps.	2½x3¾x3½	3½x2½	4½ lbs.	4.15	2.49
Y	Y 616	800 Volts C.T. 160 Mills.	5 Volts 3 Amps.	6.3 V.C.T. 6 Amps.	4¼x3½x3¾	2¾x2½	6 lbs.	5.75	3.45

6.3 VOLT FILAMENT POWER TRANSFORMERS — 3 FILAMENTS

Style	Stock Number	A.C. Plate Volts	Filament No. 1	Filament No. 2	Filament No. 3	Dimensions (In.) A B C	Mounting Centers (In.)	Shipping Weight	List Price	Net Price
X	X 620E	800 Volts C.T. 200 Mills.	5 Volts 3 Amps.	6.3 V.C.T. 3 Amps.	6.3 V.C.T. 6 Amps.	2½x4½x3¾	3¾x3	6½ lbs.	\$6.65	\$3.99
Y	Y 620E	800 Volts C.T. 200 Mills.	5 Volts 3 Amps.	6.3 V.C.T. 3 Amps.	6.3 V.C.T. 6 Amps.	4¾x3¾x3½	3x2½	6¾ lbs.	7.00	4.20
Z	Z 620E	800 Volts C.T. 200 Mills.	5 Volts 3 Amps.	6.3 V.C.T. 3 Amps.	6.3 V.C.T. 6 Amps.	2½x4½x3¾	3¾x3	6 lbs.	6.50	3.90

COMBINATION 6.3 and 2.5 VOLT FILAMENT POWER TRANSFORMERS

Style	Stock Number	A.C. Plate Volts	Filament No. 1	Filament No. 2	Filament No. 3	Filament No. 4	Dimensions (In.) A B C	Mounting Centers (In.)	Shipping Weight	List Price	Net Price
X	X 62-70E	700 Volts C.T. 70 Mills.	5 Volts 2 Amps.	2.5 V.C.T. 4 Amps.	6.3 V.C.T. 3 Amps.	—	2x3½x2½	2¾x2½	3½ lbs.	\$3.50	\$2.10
Y	Y 62-70E	700 Volts C.T. 70 Mills.	5 Volts 2 Amps.	2.5 V.C.T. 4 Amps.	6.3 V.C.T. 3 Amps.	—	3½x2½x3½	2½x2	3½ lbs.	3.75	2.25
Z	Z 62-70E	700 Volts C.T. 70 Mills.	5 Volts 2 Amps.	2.5 V.C.T. 4 Amps.	6.3 V.C.T. 3 Amps.	—	2x3½x2½	2¾x2½	3½ lbs.	3.35	2.01
Y	Y 62-25F	870 Volts C.T. 250 Mills. Bias Tap 80 V	5 Volts 3 Amps.	2.5 V. 3 Amps.	2.5 V.C.T. 10.5 Amps.	6.3 V.C.T. 1.6 Amps.	4¾x3¾x3¾	3x2½	6¾ lbs.	10.00	6.00

6.3 VOLT POWER TRANSFORMERS WITH MOTOR TUNING WINDING

Style	Stock Number	A.C. Plate Volts	Filament No. 1	Filament No. 2	Motor Winding	Dimensions (In.) A B C	Mounting Centers (In.)	Shipping Weight	List Price	Net Price
X	X 2511	700 Volts C.T. 120 Mills.	5 Volts C.T. 5 Amps.	6.3 Volts C.T. 5 Amps.	50 Volts Tapped 18 V. and 24 V.—35 Watts	2½x4½x3¾	3x3¾	7 lbs.	\$5.50	\$3.30
Y	Y 2515	700 Volts C.T. 120 Mills.	5 Volts C.T. 5 Amps.	6.3 Volts C.T. 5 Amps.	50 Volts Tapped 7 V. and 24 V.—35 Watts	4¾x3¾x3¾	3x2½	7½ lbs.	5.75	3.45
X	X 2510	750 Volts C.T. 150 Mills.	5 Volts C.T. 5 Amps.	6.3 Volts C.T. 5.2 Amps.	50 Volts Tapped 18 V. and 24 V.—35 Watts	2½x4½x3¾	3x3¾	7 lbs.	6.25	3.75
Y	Y 2514	750 Volts C.T. 150 Mills.	5 Volts C.T. 5 Amps.	6.3 Volts C.T. 5.2 Amps.	50 Volts Tapped 18 V. and 24 V.—35 Watts	4¾x3¾x3¾	3x2½	7½ lbs.	6.50	3.90
X	X 2509	800 Volts C.T. 200 Mills.	5 Volts C.T. 3 Amps.	6.3 Volts C.T. 5.3 Amps.	50 Volts Tapped 18 V. and 24 V.—35 Watts	2½x4½x3¾	3x3¾	7½ lbs.	8.00	4.80
Y	Y 2516	800 Volts C.T. 200 Mills.	5 Volts C.T. 3 Amps.	6.3 Volts C.T. 5.3 Amps.	50 Volts Tapped 18 V. and 24 V.—35 Watts	4¾x3¾x3¾	3x2½	8 lbs.	8.25	4.95



TRANSFORMERS

FILTER CHOKES

Style	Stock Number	Mills.	Henries	D.C. Res.	Core Size (In.)	Dimensions (In.) A B C	Mounting Centers (In.)	Shipping Weight	List Price	Net Price
D	4831	40	5	150	1/2 x 1/2	1 1/2 x 1 1/2 x 1 1/2	2	7 Oz.	\$.60	\$.36
D	4660	30-40	7	200	1/2 x 3/4	1 3/4 x 1 3/4 x 1 1/2	2	7 Oz.	.60	.36
D	4818	30-40	8	300	1/2 x 3/4	1 3/4 x 1 3/4 x 1 1/2	2	7 Oz.	.70	.42
D	4661	30-40	10	400	1/2 x 3/4	1 3/4 x 1 3/4 x 1 1/2	2	7 Oz.	.60	.36
D	4815	30-40	12	500	1/2 x 3/4	1 3/4 x 1 3/4 x 1 1/2	2	7 Oz.	.70	.42
D	4662	30-40	10	200	3/4 x 3/4	1 3/4 x 1 3/4 x 1 3/4	2 3/4	10 Oz.	.85	.51
D	4663	30-40	15	400	3/4 x 3/4	1 3/4 x 1 3/4 x 1 3/4	2 3/4	10 Oz.	.85	.51
D	4664	30-40	18	500	3/4 x 3/4	1 3/4 x 1 3/4 x 1 3/4	2 3/4	10 Oz.	.85	.51
D	4665	75	15	200	3/4 x 3/4	1 3/4 x 2 3/4 x 1 3/4	2 3/4	1 Lb.	1.40	.84
D	4001	50	23	400	3/4 x 3/4	1 3/4 x 2 3/4 x 1 3/4	2 3/4	1 Lb.	1.40	.84
D	4027	50	30	550	3/4 x 3/4	1 3/4 x 2 3/4 x 1 3/4	2 3/4	1 Lb.	1.40	.84
D	4816	40	40	800	3/4 x 3/4	1 3/4 x 2 3/4 x 1 3/4	2 3/4	1 Lb.	1.40	.84
D	4666	100	15	160	1/2 x 3/4	2 1/4 x 2 3/4 x 1 3/4	3 1/4	1 1/2 Lbs.	1.65	.99
D*	4002	75	30	340	1/2 x 3/4	2 1/4 x 2 3/4 x 1 3/4	3 1/4	1 1/2 Lbs.	1.65	.99
D	4667	175	10	100	1x1	2 3/4 x 3 1/2 x 2 1/2	3 3/4	2 1/2 Lbs.	2.10	1.26
D*	4003	110	30	235	1x1	2 3/4 x 3 1/2 x 2 1/2	3 3/4	2 1/2 Lbs.	2.10	1.26
E †	4668	200	10	120	1 1/2 x 1 1/2	3 3/4 x 2 3/4 x 2 1/2	2 1/2 x 2 1/2	3 1/2 Lbs.	3.25	1.95
E †	4008	250	12	125	1 1/2 x 1 1/2	3 3/4 x 3 1/2 x 2 3/4	2 1/2 x 2 1/2	4 1/2 Lbs.	4.00	2.40
E †	4669	300	10	80	1 1/2 x 1 1/2	4 1/2 x 3 1/2 x 3 1/2	3 x 2 1/2	7 1/2 Lbs.	5.25	3.15

* Lug Terminals. † Vertical Angle Bracket Mounting and Lug Terminals.

AUDIO REACTORS

Style	Stock No.	Mills.	Henries	D. C. Resistance	Core Size (Inches)	Dimensions (In.) A B C	Mounting Centers (In.)	Shipping Weight	List Price	Net Price
D*	4830	10	150	3,500	3/4 x 3/4	1 1/2 x 2 3/4 x 1 1/2	2 3/4	1 Lb.	\$2.00	\$1.20
D	4824	10	300	6,000	3/4 x 3/4	1 1/2 x 2 3/4 x 1 1/2	2 3/4	1 Lb.	1.85	1.11
Y	4825	10	1000	10,000	1x1	3 3/4 x 2 1/2 x 2 1/2	2x1 3/4	2 1/4 Lbs.	4.50	2.70

*Center Tapped

INPUT AUDIO TRANSFORMERS — SINGLE PLATE TO PUSH PULL GRIDS

Style	Stock Number	Ratio	Core Size (In.)	Dimensions (In.) A B C	Mounting Centers (In.)	Shipping Weight	List Price	Net Price
D	8301	3 - 1	1/2 x 3/4	1 1/2 x 1 3/4 x 1 1/2	2	7 Oz.	\$1.35	\$0.81
D	8305	3 - 1	3/4 x 3/4	1 3/4 x 1 3/4 x 1 1/2	2 3/4	10 Oz.	1.60	.96
D	8311	3 - 1	3/4 x 3/4	1 3/4 x 2 3/4 x 1 1/2	2 3/4	1 Lb.	1.95	1.17
D	8319	3 - 1	1x1	2 1/2 x 3 1/2 x 2 1/2	3 3/4	2 1/4 Lbs.	2.90	1.74

INPUT AUDIO TRANSFORMERS — SINGLE PLATE TO SINGLE GRID

Style	Stock Number	Ratio	Core Size (In.)	Dimensions (In.) A B C	Mounting Centers (In.)	Shipping Weight	List Price	Net Price
D	8300	3 - 1	1/2 x 3/4	1 1/2 x 1 3/4 x 1 1/2	2	7 Oz.	\$1.30	\$0.78
D	8304	3 - 1	3/4 x 3/4	1 3/4 x 1 3/4 x 1 1/2	2 3/4	10 Oz.	1.35	.81
D	8310	3 - 1	3/4 x 3/4	1 3/4 x 2 3/4 x 1 1/2	2 3/4	1 Lb.	1.95	1.17
D	8316	4 - 1	3/4 x 3/4	2 1/4 x 2 3/4 x 1 1/2	3 1/4	1 1/2 Lbs.	2.60	1.56

FILAMENT TRANSFORMERS

Style	Stock Number	Filament	Dimensions (In.) A B C	Mounting Centers (In.)	Shipping Weight	List Price	Net Price
D	2467	2.5 Volts C.T. 5 Amps.	2 1/2 x 2 3/4 x 1 1/2	3 1/4	1 1/2 Lbs.	\$1.25	\$0.75
D*	2468	5 Volts C.T. 4 Amps.	2 3/4 x 3 1/2 x 1 1/2	2 3/4 x 1 1/2	2 Lbs.	1.65	.99
D*	2466	6.3 Volts C.T. 5 Amps.	2 3/4 x 3 x 2	2 3/4 x 1 1/2	2 1/2 Lbs.	1.75	1.05
D	2471	6.3 Volts Tapped 2.5 V. and 5 V. All at 2.5 Amps.	2 1/4 x 2 1/2 x 1 1/2	3 1/4	1 1/2 Lbs.	1.95	1.17

*Similar to Style D—Horizontal Mounting Angle Frame

6 VOLT VIBRATOR TRANSFORMERS

Style	Stock Number	D.C. Volts To Filter	M.A.	Dimensions (In.) A B C	Mounting Centers (In.)	Shipping Weight	List Price	Net Price
D*	2482	150	35	2 1/4 x 2 3/4 x 1 1/2	3 1/4	1 1/2 Lbs.	\$2.15	\$1.29
D*	2459	225	40	2 1/4 x 2 3/4 x 1 1/2	3 1/4	1 1/2 Lbs.	2.25	1.35
Y	2460	250	50	3 1/4 x 2 3/4 x 2 3/4	2x1 3/4	2 3/4 Lbs.	2.75	1.65
Y	2461	275	75	3 3/4 x 2 3/4 x 2 3/4	2x1 3/4	2 3/4 Lbs.	3.25	1.95

*Same as style D except fully encased



TRANSFORMERS

SPECIAL AUDIO AND DRIVER INPUT TRANSFORMERS — SINGLE AND PUSH PULL

Style	Stock Number	Description		Core Size In.	Dimensions (In.)			Mounting Centers (In.)	Shipping Weight	List Price	Net Price
		Driver Tube	Output Tube		A	B	C				
D	8748	1-30	1-19, 1-1J6G, 2-30	$\frac{1}{8} \times \frac{1}{8}$	$1\frac{1}{8} \times 1\frac{1}{8} \times 1\frac{1}{8}$		2	7 Oz.	\$1.50	\$0.90	
D	8329	1-30	1-19, 1-1J6G, 2-30	$\frac{3}{4} \times \frac{3}{4}$	$1\frac{1}{8} \times 2\frac{1}{8} \times 1\frac{1}{8}$		$2\frac{3}{8}$	1 Lb.	1.90	1.14	
D	8323	1-56, 76, 6C5	2-2A3, 2-6A3	$\frac{3}{4} \times \frac{3}{4}$	$1\frac{1}{8} \times 2\frac{1}{8} \times 1\frac{1}{8}$		$2\frac{3}{8}$	1 Lb.	2.90	1.74	
D	8328	1-56, 76, 6C5	2-45	$\frac{3}{4} \times \frac{3}{4}$	$2\frac{1}{8} \times 2\frac{1}{8} \times 1\frac{1}{8}$		$3\frac{1}{8}$	$1\frac{1}{2}$ Lbs.	3.50	2.10	
D	8324	2-56, 76, 6C5	2-2A3, 2-6A3	$\frac{3}{8} \times \frac{3}{8}$	$2\frac{1}{8} \times 2\frac{1}{8} \times 1\frac{1}{8}$		$3\frac{1}{8}$	$1\frac{1}{2}$ Lbs.	3.50	2.10	
D	8326	1-2A5, 42, 6F6 Triode	2-2A5, 2-42 Fixed Bias	$\frac{3}{8} \times \frac{3}{8}$	$2\frac{1}{8} \times 2\frac{1}{8} \times 1\frac{1}{8}$		$3\frac{1}{8}$	$1\frac{1}{2}$ Lbs.	3.50	2.10	
D	8327	1-2A5, 42, 6F6 Triode	2-2A5, 2-42 Self Bias	$\frac{3}{8} \times \frac{3}{8}$	$2\frac{1}{8} \times 2\frac{1}{8} \times 1\frac{1}{8}$		$3\frac{1}{8}$	$1\frac{1}{2}$ Lbs.	3.50	2.10	
D	8325	1-45, 2A5, 42	PAR or PP 2A3	1x1	$2\frac{1}{8} \times 3\frac{1}{8} \times 2\frac{1}{8}$		$3\frac{1}{8}$	$2\frac{1}{4}$ Lbs.	4.10	2.46	
D	8321	Single Plate 35 Mills.	Push Pull Class "A"	$\frac{3}{4} \times \frac{3}{4}$	$1\frac{1}{8} \times 2\frac{1}{8} \times 1\frac{1}{8}$		$2\frac{3}{8}$	1 Lb.	2.90	1.74	
D	8322	Push Pull Plates 35 Mills.	Push Pull Class "A"	$\frac{3}{8} \times \frac{3}{8}$	$2\frac{1}{8} \times 2\frac{1}{8} \times 1\frac{1}{8}$		$3\frac{1}{8}$	$1\frac{1}{2}$ Lbs.	3.50	2.10	

UNIVERSAL OUTPUT TRANSFORMERS

Style	Stock Number	Description		Nominal Wattage	Core Size (In.)	Dimensions (In.)			Mounting Centers (In.)	Shipping Weight	List Price	Net Price
		Primary	Secondary			A	B	C				
D	8775	Universal—any tube combination	Any voice coil	4	$\frac{1}{2} \times \frac{3}{8}$	$1\frac{3}{8} \times 1\frac{1}{8} \times 1\frac{1}{8}$		2	7 Oz.	\$1.50	\$0.90	
D	7364	"	Any voice coil	8	$\frac{3}{8} \times \frac{3}{8}$	$1\frac{3}{8} \times 1\frac{1}{8} \times 1\frac{1}{8}$		$2\frac{3}{8}$	$\frac{3}{4}$ Lb.	1.90	1.14	
E	5999*	"	Any voice coil	12	$\frac{3}{4} \times \frac{3}{4}$	$2\frac{1}{8} \times 1\frac{1}{8} \times 1\frac{1}{8}$		$2\frac{3}{8}$	$1\frac{1}{4}$ Lbs.	2.00	1.20	
D	7390	"	Any voice coil	18	$\frac{3}{8} \times \frac{3}{8}$	$2\frac{1}{8} \times 2\frac{1}{8} \times 1\frac{1}{8}$		$3\frac{1}{8}$	$1\frac{3}{4}$ Lbs.	2.60	1.56	
E	8777	Universal—any tube combination or 500 Ohm line	Any voice coil	12	$\frac{3}{4} \times \frac{3}{4}$	$2\frac{1}{8} \times 1\frac{1}{8} \times 1\frac{1}{8}$		$2\frac{3}{8}$	$1\frac{1}{4}$ Lbs.	3.00	1.80	
D	8776	"	Any voice coil	18	$\frac{3}{8} \times \frac{3}{8}$	$2\frac{1}{8} \times 2\frac{1}{8} \times 1\frac{1}{8}$		$3\frac{1}{8}$	$1\frac{3}{4}$ Lbs.	3.00	1.80	
E	8332	Heavy Duty Push-Pull 4-6-8-10-16 Ohms		26	1x1	$3\frac{1}{8} \times 2\frac{1}{8} \times 2$		$3\frac{1}{8}$	$2\frac{1}{4}$ Lbs.	4.00	2.40	
E	8331	Heavy Duty Push-Pull 250-500 Ohms		26	1x1	$3\frac{1}{8} \times 2\frac{1}{8} \times 2$		$3\frac{1}{8}$	$2\frac{1}{4}$ Lbs.	4.00	2.40	
D	8779	Heavy Duty Push-Pull 500-1000-1500-2000 Ohms		26	1x1	$2\frac{1}{2} \times 3\frac{1}{8} \times 2\frac{1}{8}$		$3\frac{1}{8}$	$2\frac{1}{4}$ Lbs.	4.00	2.40	
E	8335	Heavy Duty Push-Pull Class "B"	250-500 Ohms	26	1x1	$3\frac{1}{8} \times 2\frac{1}{8} \times 2$		$3\frac{1}{8}$	$2\frac{1}{4}$ Lbs.	4.00	2.40	
D	8755	Universal Line 500-1000-1500-2000 Ohms	5 Ohms	4	$\frac{1}{2} \times \frac{1}{8}$	$1\frac{3}{8} \times 1\frac{1}{8} \times 1\frac{1}{8}$		2	7 Oz.	1.50	.90	
D	8747	"	6 Ohms	8	$\frac{3}{8} \times \frac{3}{8}$	$1\frac{3}{8} \times 1\frac{1}{8} \times 1\frac{1}{8}$		$2\frac{3}{8}$	$\frac{3}{4}$ Lb.	1.50	.90	
D	8746	"	8 Ohms	8	$\frac{3}{8} \times \frac{3}{8}$	$1\frac{3}{8} \times 1\frac{1}{8} \times 1\frac{1}{8}$		$2\frac{3}{8}$	$\frac{3}{4}$ Lb.	1.50	.90	
E	8749	"	6-8 Ohms	12	$\frac{3}{4} \times \frac{3}{4}$	$2\frac{1}{8} \times 1\frac{1}{8} \times 1\frac{1}{8}$		$2\frac{3}{8}$	$1\frac{1}{4}$ Lbs.	2.00	1.70	
D	8750	"	8 Ohms	18	$\frac{3}{8} \times \frac{3}{8}$	$2\frac{1}{8} \times 2\frac{1}{8} \times 1\frac{1}{8}$		$3\frac{1}{8}$	$1\frac{3}{4}$ Lbs.	2.60	1.56	
E	8752	"	8 Ohms	18	$\frac{3}{8} \times \frac{3}{8}$	$2\frac{1}{8} \times 2\frac{1}{8} \times 1\frac{1}{8}$		$2\frac{3}{8}$	$1\frac{3}{4}$ Lbs.	2.60	1.56	
E	8753	"	8 Ohms	26	1x1	$3\frac{1}{8} \times 2\frac{1}{8} \times 2$		$3\frac{1}{8}$	$2\frac{1}{4}$ Lbs.	3.15	1.89	
D	8871	Universal Line	Any voice coil	8	$\frac{3}{8} \times \frac{3}{8}$	$1\frac{3}{8} \times 1\frac{1}{8} \times 1\frac{1}{8}$		$2\frac{3}{8}$	$\frac{3}{4}$ Lbs.	2.25	1.35	
E	8513	Universal Line	Any voice coil	12	$\frac{3}{4} \times \frac{3}{4}$	$2\frac{1}{8} \times 1\frac{1}{8} \times 1\frac{1}{8}$		$2\frac{3}{8}$	$1\frac{1}{4}$ Lbs.	2.60	1.56	
E	8514	Universal Line	Any voice coil	18	$\frac{1}{2} \times \frac{1}{2}$	$2\frac{1}{8} \times 2\frac{1}{8} \times 1\frac{1}{8}$		$2\frac{3}{8}$	$1\frac{3}{4}$ Lbs.	3.15	1.89	

*Number 5999 Available also for Horizontal Mounting—List Price \$2.00—Net Price \$1.20

MICROPHONE, LINE TO GRID AND PICKUP TRANSFORMERS

Style	Stock Number	Description	Core Size (Inches)	Dimensions (In.)			Mounting Centers (In.)	Shipping Weight	List Price	Net Price
				A	B	C				
D	8865	S. B. Microphone to Single Grid—200 or 70 Ohms at 25 Ma.	$\frac{1}{2} \times \frac{1}{2}$	$1\frac{3}{8} \times 1\frac{1}{8} \times 1\frac{1}{8}$		2	6 Oz.	\$1.00	\$0.60	
D	8864	S. B. Microphone to Single Grid—100 Ohms to 60,000 Ohms	$\frac{1}{2} \times \frac{3}{8}$	$1\frac{3}{8} \times 1\frac{1}{8} \times 1\frac{1}{8}$		2	7 Oz.	1.20	.72	
E	8863	D. B. Microphone to Single Grid—200 Ohms to 57,000 Ohms	$\frac{3}{8} \times \frac{3}{8}$	$1\frac{3}{8} \times 1\frac{1}{8} \times 1\frac{1}{8}$		2	$\frac{3}{4}$ Lb.	1.75	1.05	
Y	8862	D. B. Microphone to Single Grid—200 Ohms to 100,000 Ohms	$\frac{3}{4} \times \frac{3}{4}$	$2\frac{3}{8} \times 2$	2	$1\frac{1}{8} \times 1\frac{3}{8}$	$1\frac{1}{4}$ Lbs.	2.75	1.65	
Y	8861	D. B. Microphone or Low Imped. Pickup to Single Grid—200 & 500 Ohms C.T. to 150,000 Ohms	1x1	$3\frac{1}{8} \times 2\frac{1}{8} \times 2\frac{3}{8}$		$2 \times 1\frac{3}{4}$	$2\frac{3}{4}$ Lbs.	4.00	2.40	
Y	8860	Low Imped. Pickup or Dynamic Microphone to Sgle. Grid—4, 8, 15 & 30 Ohms to 200,000 Ohms	$\frac{3}{4} \times 1$	$2\frac{3}{8} \times 2 \times 2\frac{1}{4}$		$1\frac{1}{8} \times 1\frac{3}{8}$	$1\frac{1}{2}$ Lbs.	2.75	1.65	
Y	8859	D. B. Microphone and 200 Ohm Line to P. P. Grids 200 Ohm C.T. to 100,000 Ohms	$\frac{3}{4} \times \frac{3}{4}$	$2\frac{3}{8} \times 2 \times 2$		$1\frac{1}{8} \times 1\frac{3}{8}$	$1\frac{1}{4}$ Lbs.	2.00	1.20	



LINEAR STANDARD TRANSFORMERS

UTC LINEAR STANDARD Components represent the closest approach to the ideal transformer from the standpoint of uniform response, low wave form distortion, high efficiency, thorough shielding and dependability.

The multiple tap windings used make possible a wide combination of impedance connections without impairing the audio range or efficiency.

UTC engineers have spent considerable time studying the many annoying hum pickup difficulties which are prevalent in high gain A.C. operated amplifying equipment. As a result, a special cast alloy has been developed to house all UTC Linear Standard units. In addition, low level input transformers use the new UTC dual and quadruple alloy shields thus making possible a transformer with the lowest hum pickup of any available commercially.

LINEAR STANDARD UNITS FEATURE:

- **True Hum Balancing Coil Structure . . .** maximum neutralization of stray fields.
- **Balanced Variable Impedance Line . . .** permits highest fidelity on every tap of a universal unit . . . no line reflections or transverse coupling.
- **Reversible Mounting . . .** permits above chassis or subchassis wiring.
- **Full Electrostatic Shielding . . .** brought out to separate terminal.
- **Alloy Shields . . .** maximum shielding from inductive pickup.
- **Multiple Coil, Semi-Toroidal Coil Structure . . .** minimum distributed capacity and leakage reactance.
- **Precision Winding . . .** accuracy of winding .1%, perfect balance of inductance and capacity; exact impedance reflection.
- **Hiperm-Alloy . . .** a Stable high permeability nickel-iron core material.
- **High Fidelity . . .** UTC Linear Standard transformers are the only audio units with a guaranteed uniform response, from 30 to 20,000 cycles ± 1 db.

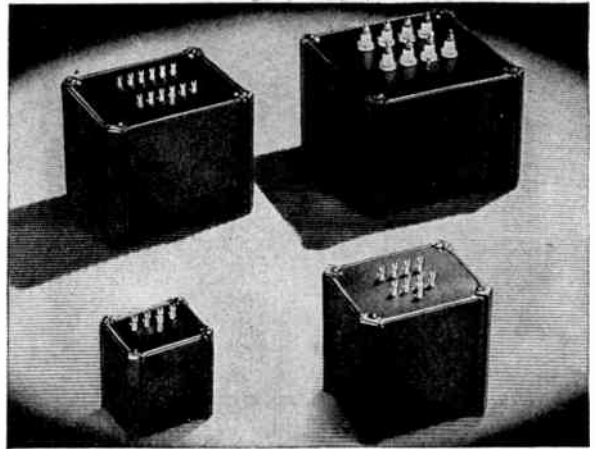

PLATE, CRYSTAL, PHOTOCCELL AND BRIDGING TO LINE TRANSFORMERS

OVERALL DIMENSIONS				Mtg.	Dim.	Weight Lbs.
Case	L	W	H			
LS-1	2 $\frac{3}{8}$	3 $\frac{1}{8}$	3 $\frac{1}{8}$	1 $\frac{1}{8}$	2 $\frac{1}{4}$	4
LS-2	3 $\frac{1}{2}$	4 $\frac{1}{2}$	4 $\frac{1}{2}$	2 $\frac{1}{8}$	3 $\frac{1}{8}$	8
LS-3	5	5 $\frac{1}{2}$	5 $\frac{1}{2}$	4 $\frac{1}{8}$	5 $\frac{1}{2}$	15
LS-4	6 $\frac{1}{8}$	6 $\frac{1}{2}$	5 $\frac{1}{2}$	5 $\frac{1}{8}$	5 $\frac{1}{2}$	23
CC-1	7 $\frac{1}{2}$	10 $\frac{1}{2}$	5 $\frac{1}{2}$	6 $\frac{1}{4}$	4 $\frac{1}{2}$	33
CC-2	11	11	9 $\frac{1}{4}$	9 $\frac{1}{8}$	4 $\frac{1}{2}$	83
LS-6	16	14	18	8	14 $\frac{1}{2}$	200
LS-7	21	18	21	11 $\frac{1}{2}$	19 $\frac{1}{2}$	500

LOW IMPEDANCE TO GRID TRANSFORMERS

Type No.	Application	Primary Impedance	Secondary Impedance	Shielding and hum reduction	Case No. List Price
LS-10	Low impedance mike, pick-up, or multiple line to grid	50, 125, 200, 250, 333, 500 ohms	60,000 ohms in two sections	Dual Alloy shield -74DB	LS-1 \$18.00
LS-10X	As above	As above	50,000 ohms	Quadruple alloy shield -92DB	LS-1 22.50
LS-12	Low impedance mike, pick-up or multiple line to push pull grids	50, 125, 200, 250, 333, 500 ohms	120,000 ohms overall in two sections	Dual alloy shield -74DB	LS-1 20.00
LS-12X	As above	As above	80,000 ohms overall in two sections	Quadruple alloy shield -92DB	LS-1 25.00
LS-14	Low impedance mike, pick-up, or parallel mixer to grid	2.5, 5.5, 10, 15, 22, 30, 38, 60 ohms	60,000 ohms in two sections	Dual alloy shield -74DB	LS-1 20.00
LS-14X	As above	As above	50,000 ohms	Quadruple alloy shield -92DB	LS-1 25.00
LS-15	Three isolated lines or pads to one or two grids	30, 50, 200, 250 ohms each primary	60,000 ohms overall, in two sections	Dual Alloy shield -74DB	LS-1 20.00
LS-15X	As above	As above	As above	Quadruple alloy shield -92DB	LS-1 25.00
LS-18	High level multiple line to push pull grids	50, 125, 200, 250, 333, 500 ohms	50,000 ohms overall, in two sections	Alloy casting -60DB	LS-2 22.00

Type No.	Application	Primary Impedance	Secondary Impedance	Shielding and hum reduction	Case No. List Price
LS-27	Single plate to multiple line	8,000 to 15,000 ohms 8 MA, D. C.	50, 125, 200, 250, 333, 500 ohms	Dual alloy shield -74DB	LS-1 \$17.00
LS-50	Single plate to multiple line	8,000 to 15,000 ohms	50, 125, 200, 250, 333, 500 ohms	Dual alloy shield -74DB	LS-1 17.00
LS-51	Push pull low level plates to multiple line	8,000 to 15,000 ohms each side	50, 125, 200, 250, 333, 500 ohms	Dual alloy shield -74DB	LS-1 17.00
LS-37	Crystal microphone or pick-up to multiple line	100,000 ohms	50, 125, 200, 250, 333, 500 ohms	Dual alloy shield -74DB	LS-1 18.00
LS-38	Crystal microphone or pick-up to multiple line, with internal equalizer	100,000 ohms	50, 125, 200, 250, 333, 500 ohms	Dual alloy shield -74DB	LS-1 22.50
LS-39	Photocell, high-mu triode diode or over-biased detector to multiple line	100,000 ohms	50, 125, 200, 250, 333, 500 ohms	Dual alloy shield -74DB	LS-1 18.00
LS-150	Bridging transformer from 50 to 500 ohm line to multiple line	4,000 ohms, bridging	50, 125, 200, 250, 333, 500 ohms	Dual alloy shield -74DB	LS-1 18.00
LS-151	Bridging transformer from 50 to 500 ohm line to multiple line	16,000 ohms, bridging	50, 125, 200, 250, 333, 500 ohms	Dual alloy shield -74DB	LS-1 18.00

MIXING TRANSFORMERS

Type No.	Application	Primary Impedance	Secondary Impedance	Shielding and hum reduction	Case No. List Price
LS-30	Mixing, low impedance mike, pickup or multiple line to multiple line	50, 125, 200, 250, 333, 500 ohms	50, 125, 200, 250, 333, 500 ohms	Dual alloy shield -74DB	LS-1 \$18.00
LS-30X	As above	As above	As above	Quadruple alloy shield -92DB	LS-1 22.50
LS-31	Three isolated lines or pads to multiple line	30, 50, 200, 250 ohms each primary	50, 125, 200, 250, 333, 500 ohms	Dual alloy shield -74DB	LS-1 20.00
LS-31X	As above	As above	As above	Quadruple alloy shield -92DB	LS-1 25.00
LS-32	Mixing, low impedance mike, pickup, or parallel mixer to multiple line	2.5, 5.5, 10, 15, 22, 30, 38, 60 ohms	50, 125, 200, 250, 333, 500 ohms	Dual alloy shield -74DB	LS-1 20.00

INTERSTAGE AUDIO TRANSFORMERS

Type No.	Application	Primary Impedance	Secondary Impedance	Shielding and hum reduction	Case No. List Price
LS-19	Single plate to PP grids like 2A3, 59, 46, 6L6	8,000 to 15,000 ohms; split primary	95,000 ohms; turn ratio 1.25:1 each side; split secondary	Alloy casting -50 DB	LS-1 \$17.00
LS-20	Single plate to single grid	8,000 to 15,000 ohms.	60,000 ohms; 2:1 turn ratio	Dual alloy shield -74DB	LS-1 16.00
LS-21	Single plate to push pull grids	8,000 to 15,000 ohms.	135,000 ohms; turn ratio 1.5:1 each side. Primary and secondary each in two sections	Dual alloy shield -74DB	LS-1 17.00
LS-40	Single plate to push-pull grids	As above, will carry 8 MA DC	135,000 ohms 1.5:1 turn ratio each side	Dual alloy shield -74 DB	LS-1 17.00
LS-22	Push pull plates to push pull grids	8,000 to 15,000 ohms	38,000 ohms each secondary. turn ratio 1.6:1 each side of center. Primary and secondary each in two sections	Alloy casting -50DB	LS-2 22.00
LS-25	P. P. plates to P. P. grids. Medium level	8,000 to 15,000 ohms; split primary	100,000 ohms overall; 25,000 ohms each side. Turn ratio 1.3:1. Split secondary	Alloy casting -50DB	LS-1 20.00
LS-26	Bridging line to 1 or 2 grids	5000	60,000 ohms in two sections	Dual alloy shield -74 DB	LS-1 16.00



OUTPUT TRANSFORMERS TO LINE AND VOICE COIL

Type No.	Primary will match following tubes	Primary Impedance	Secondary Impedance	Case No. List Price
LS-52	Push pull 245, 250, 6V6, 42 or 2A5 A prime	8,000 ohms	500, 333, 250, 200, 125, 50, 30, 20, 15, 10, 7.5, 5, 2.5, 1.2	LS-2 \$20.00
LS-54	Same as above	8,000 ohms	30, 20, 15, 10, 7.5, 5, 2.5, 1.2	LS-2 14.00
LS-55	Push pull 2A3's, 6A5G's, 300A's, 275A's, 6A3's	5,000 ohms plate to plate and 3,000 ohms plate to plate	500, 333, 250, 200, 125, 50, 30, 20, 15, 10, 7.5, 5, 2.5, 1.2	LS-2 20.00
LS-57	Same as above	5,000 ohms plate to plate and 3,000 ohms plate to plate	30, 20, 15, 10, 7.5, 5, 2.5, 1.2	LS-2 14.00
LS-58	Push pull parallel 2A3's, 6A5G's, 300A's, 6A3's	2,500 ohms plate to plate and 1,500 ohms plate to plate	500, 333, 250, 200, 125, 50, 30, 20, 15, 10, 7.5, 5, 2.5, 1.2	LS-4 30.00
LS-61	Push pull 6B5, 6A6, 53, 6F6, 71A, 59, 79, 89, Class B46, 59's	10,000 ohms plate to plate and 6,000 ohms plate to plate	500, 333, 250, 200, 125, 50, 30, 20, 15, 10, 7.5, 5, 2.5, 1.2	LS-2 20.00
LS-63	Same as above	10,000 ohms plate to plate and 6,000 ohms plate to plate	30, 20, 15, 10, 7.5, 5, 2.5, 1.2	LS-2 14.00
LS-6L1	Push pull 6L6's self bias	6,600 ohms plate to plate	500, 333, 250, 200, 125, 50, 30, 20, 15, 10, 7.5, 5, 2.5, 1.2	LS-3 30.00
LS-6L3	Same as above	6,600 ohms plate to plate	30, 20, 15, 10, 7.5, 5, 2.5, 1.2	LS-3 20.00
LS-6L4	Push pull 6L6's fixed bias or push pull parallel 6L6's self bias	3,800 ohms plate to plate and 3,300 ohms plate to plate	500, 333, 250, 200, 125, 50, 30, 20, 15, 10, 7.5, 5, 2.5, 1.2	LS-4 35.00
LS-845	845 tubes class AB	8,800 ohms plate to plate	500, 333, 250, 200, 125, 50, 30, 20, 15, 10, 7.5, 5, 2.5, 1.2	CC-1 60.00

OUTPUT TRANSFORMERS TO HIGH IMPEDANCE (RF) LOAD

Type No.	Primary will match the following tubes	Primary Impedance	Secondary Impedance	Case No. List Price
LS-56	Push pull 2A3's, 6A5G's, 300A's, 275A's, 6A3's. +36DB	5,000 ohms plate to plate and 3,000 ohms plate to plate	6,000, 5,000, 4,000, 1,800, 1,500, 1,000, 30, 20, 15, 10, 7.5, 5, 2.5, 1.2	LS-2 \$20.00
LS-66	Class B 203A, 838, ZB120, 805 +46DB	9,000 ohms plate to plate	5,000, 3,500, 2,100, 1,250, 600	CC-1 70.00
LS-67	Class B 203A, 838, ZB120, 805 +46DB	9,000 ohms plate to plate	10,000, 2,500	CC-1 70.00
LS-691	Class B 849, 833, 250th	10, 400 ohms plate to plate	4,500, 4,000, 3,500, 2,750, 2,000	LS-6* 250.00
LS-692	Class B push-pull parallel 833's	3,650 ohms plate to plate	2,500, 2,000, 1,750, 1,500, 1,250	LS-7* 500.00

*Special oil filled construction

DRIVER TRANSFORMERS

Type No.	Application	Primary Impedance	Reflected Secondary Impedance	Case No. List Price
LS-5	Driver, multiple line to class B 838's, 805's, ZB-120's, 203A's and similar tubes	50, 125, 200, 250, 333, 500 ohms	2,000 ohms; 1:2 overall turns ratio	LS-2 \$30.00
LS-6	Driver, push pull 45's, 59's, 2A3's, 6A5's, etc. to push pull 845 or 211D grids	800 to 2,000 ohms	.6 primary impedance turns ratio 1.3:1 overall	LS-2 22.00
LS-7	Push pull 56, 6C5 or similar plates to A prime 45's, 42's, 6F6's, 2A3's	8,000 to 15,000 ohms	.45 primary impedance turns ratio 1.5:1 overall	LS-2 22.00
LS-47X	Driver from push pull 2A3's, 6A5G's, or 300A's to Class B 838's, 203A's 805's, or ZB120's	800 to 1,000 ohms	.1 pri. impedance turns ratio. Pri. 1/4 Sec. 3:2:1	LS-2 26.00
LS-48	Driver transformer push pull 845's, to 204 or 849 grids in class B	1,000 to 2,000 ohms	.038 pri. impedance turns ratio. Pri. 1/4 Sec. 5:1:1	LS-4 36.00
LS-49	Push pull parallel 2A3, 6A5G, or 300A tubes to four 838, 203A, 805, or ZB120 tubes	800 to 2,000 ohms	.028 pri. impedance turns ratio. Pri. 1/4 Sec. 6:0:1	LS-4 30.00

HIGH LEVEL MATCHING TRANSFORMERS

Type No.	Application	Primary Impedance	Secondary	Case No. List Price
LS-33	High level line matching. 15 watts	50, 125, 200, 250, 333, 500 ohms	1.2, 2.5, 5, 7.5, 10, 15, 20, 30, 50, 125, 200, 250, 333, 500 ohms	LS-2 \$20.00
LS-34	High level line matching. 30 watts	50, 125, 200, 250, 333, 500 ohms	1.2, 2.5, 5, 7.5, 10, 15, 20, 30, 50, 125, 200, 250, 333, 500 ohms	LS-3 25.00



LINEAR STANDARD POWER COMPONENTS

(SEE PAGE 2 FOR DIMENSIONS)

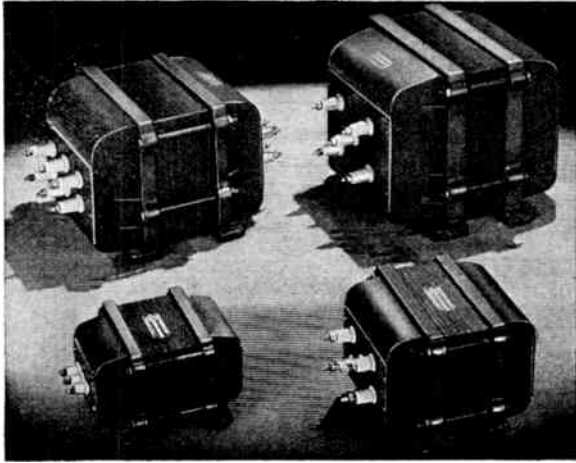

PLATE TRANSFORMERS

Type No.	Primary Voltage 50/60 Cycles	High Voltage	DC Current	List Price
LS-181	100, 110, 120, 220, 230, 240	1500-1250-0-1250-1500	200 MA	\$50.00
LS-182	100, 110, 120, 220, 230, 240	1500-1250-0-1250-1500	350 MA	65.00
LS-183	100, 110, 120, 220, 230, 240	1750-1500-0-1500-1750	400 MA	85.00
LS-184	100, 110, 120, 220, 230, 240	3500-3000-2500-0-2500-3000-3500	500 MA	125.00
LS-185	100, 110, 120, 220, 230, 240	3500-3000-2500-0-2500-3000-3500	1.2 amp.	300.00

FILAMENT TRANSFORMERS

Type No.	Application	Primary Voltage 50/60 Cycles	Secondary Voltage	Insulation Voltage	Case No. List Price
LS-80	866A rectifiers	100, 110, 120, 220, 230, 240	2.5 V.C.T.-10A	12,000	LS-3 \$17.00
LS-82	872 rectifiers	100, 110, 120, 220, 230, 240	5 V.C.T.-20A	12,000	LS-3 22.00
LS-84	203A, 845, etc., 11F200, 11F300	100, 110, 120, 220, 230, 240	10 V.C.T.-8A	10,000	LS-3 17.00
LS-85	Combined filament transformer for 866 rectifiers and 845 or 203A audio tubes	100, 110, 120, 220, 230, 240	2.5 V.C.T.-10A 10 V.C.T.-8A	10,000	LS-3 25.00
LS-88	0.3 volt tubes	105, 115, 125	0.3 V.C.T.-2A	2,500	LS-1 8.00
LS-118	849, 204A, 11F300	100, 110, 120, 220, 230, 240	11 V.C.T.-10A	2,500	LS-3 20.00
LS-120	866 bridge rectifier	100, 110, 120, 220, 230, 240	2.5 V.C.T.-10A 2.5 V.C.T.-5A 2.5 V.C.T.-5A	12,000	LS-3 30.00
LS-121	872 bridge rectifier	100, 110, 120, 220, 230, 240	5 V.C.T.-20A 5 V.C.T.-10A 5 V.C.T.-10A	12,000	CC-0 40.00
LS-83	872A, 875 or 869 rectifiers	100, 110, 120, 220, 230, 240	5 V.C.T.-20A	35,000	CC-0 45.00
LS-89A	Three 869 rectifiers	100, 110, 120, 220, 230, 240	5 V.C.T.-60A	35,000	CC-1 65.00

COMBINED PLATE AND FILAMENT TRANSFORMERS

Type No.	Primary Voltage 50/60 cycles	High Voltage	Filament Windings	Case No. List Price
LS-180	115	225-0-225 15 MA	6.3 V.C.T.-2A 6.3 V.C.T.-.5A	LS-1 \$12.00
LS-180H	Same as above but in hum-balanced construction (dual coils)			LS-1 15.00
LS-190	100, 105, 110, 115, 120, 125	350-300-0-300-350 125 MA	5 V.C.T.-3A 2.5 V.C.T.-.6A 6.3 V.C.T.-3A	LS-3 20.00
LS-190H	Same as above but in hum-balanced construction (dual coils)			LS-3 25.00
LS-191	100, 105, 110, 115, 120, 125	325-250-0-250-325 35 MA	5 V.C.T.-3A 2.5 V.C.T.-2A 6.3 V.C.T.-2A	LS-2 15.00
LS-70	100, 105, 110, 115, 120, 125	425-375-0-375-425 200 MA 70-0-70 50 MA	5 V.C.T.-3A 5 V.C.T.-2A 2.5 V.C.T.-10A 6.3 V.C.T.-1A 6.3 V.C.T.-3A	LS-4 25.00
LS-72	100, 105, 110, 115, 120, 125	525-450-0-450-525 250 MA 70-0-70 50 MA	5 V.C.T.-3A 2.5 V.C.T.-3A 2.5 V.C.T.-3A 6.3 V.C.T.-1A 6.3 V.C.T.-3A tapped at 5 V.C.T.-6A	LS-4 30.00
LS-73	100, 105, 110, 115, 120, 125	500-400-0-400-500 500 MA 70-0-70 50 MA	5 V.C.T.-10A 2.5 V.C.T.-3A 6.3 V.C.T.-4A 6.3 V.C.T.-6A tapped at 5 V.C.T.-6A	CC-1 40.00

FILTER, SWINGING, AND AUDIO CHOKES

Type No.	Application	Inductance	DC Current	DC Resistance	Case No. List Price
LS-90	Filter choke with hum bucking tap	Series-50 hy Parallel-12.5 hy	50 MA 100 MA	510 ohms 128 ohms	LS-2 \$10.00
LS-91	Filter choke with hum bucking tap	Series-14 hy Parallel-3.5 hy	125 MA 250 MA	200 ohms 50 ohms	LS-2 10.00
LS-92	Filter choke with hum bucking tap	Series-16 hy Parallel-4 hy	175 MA 350 MA	96 ohms 24 ohms	LS-3 17.00
LS-93	Filter choke with hum bucking tap	Series-26 hy Parallel-6.25 hy	200 MA 400 MA	112 ohms 28 ohms	LS-4 30.00
LS-94	Parallel feed and filter choke	Series-320 hy Parallel-80 hy	3 MA 6 MA	6400 ohms 1600 ohms	LS-1 10.00
LS-950	Filter choke with hum bucking tap	Series-100 hy Parallel-25 hy	35 MA 75 MA	1000 ohms 250 ohms	LS-2 40.00
LS-98	Filter choke with hum bucking tap	Series-20 hy Parallel-5 hy	500 MA 1 amp.	90 ohms 22.5 ohms	CC-1 50.00
LS-980	Filter choke with hum bucking tap	Series-14 hy Parallel-3.5 hy	400 MA 800 MA	90 ohms 22.5 ohms	LS-4 30.00
LS-98	Swinging choke	8-40 hy	400 MA	90 ohms	LS-4 30.00
LS-99	Filter choke with hum bucking tap	Series-20 hy Parallel-5 hy	1 amp. 2 amp.	50 ohms 12.5 ohms	CC-2 75.00
LS-105	Swinging choke	8-40 hy	1 amp.	50 ohms	CC-2 75.00
LS-102	Modulation reactor	50 hy	350 MA	250 ohms	CC-1 50.00
LS-103	Modulation reactor	50 hy	500 MA	175 ohms	CC-2 70.00
LS-104A	Modulation reactor	50 hy	1.3 amp.	75 ohms	Spec. 350.00

UTC HIPERM ALLOY TRANSFORMERS

The UTC Hiperm Alloy audio and power transformers are specifically designed for portable and compact high fidelity service. The frequency characteristic of the Hiperm Alloy audio units is uniform from 30 to 20,000 cycles. The outer case is of high conductivity alloy finished in high polish black anodic. Through the use of tapped metallic inserts, these transformers can be mounted with the terminals either up or down, and with no waste space. A hum balanced coil structure is used on all audio units to insure minimum pickup. The electrostatic shields are brought out to separate terminals on the terminal strip.

The H-1 case units weigh 1 3/4 lbs. and are 2" x 2 3/4" x 3" high with 1 3/8" mtg. centers. The H-2 case units weigh 2 1/4 lbs. and are 2 1/2" x 3 3/8" x 3 3/8" high with 2" x 2 1/4" mtg. centers.

PLATE, CRYSTAL AND PHOTOCELL TO LINE TRANSFORMERS

Type No.	Application	Primary Impedance	Secondary Impedance	Case No. List Price
HA-111	Crystal microphone or pickup, to multiple line	100,000 ohms	50, 125, 200, 250, 333, 500 ohms	H-1 \$14.00
HA-112	Photocell, high-mu triode, diode or over-biased detector to multiple line	100,000 ohms	50, 125, 200, 250, 333, 500 ohms	H-1 14.00
HA-113	Single plate to multiple line	8,000 to 15,000 ohms	50, 125, 200, 250, 333, 500 ohms	H-1 13.50
HA-114	Push pull low level plates to multiple line	8,000 to 15,000 ohms	50, 125, 200, 250, 333, 500 ohms	H-1 14.00
HA-133	Single plate to multiple line	8,000 to 15,000 ohms	50, 125, 200, 250, 333, 500 ohms	H-1 13.50
HA-134	Push-pull 89's or 2A3's to line	5,000 to 10,000 ohms	50, 125, 200, 250, 333, 500 ohms	H-2 15.00
HA-135	Push-pull 2A3's to voice coil	3,000 to 5,000 ohms	30, 20, 15, 10, 7.5, 5, 2.5, 1 2	H-2 14.00
HA-136	Portable transmitter output, push-pull 53's or single 6F6	7,000 to 10,000 ohms	5,000, 10,000 ohms	H-1 15.00

POWER TRANSFORMERS

Type No.	Primary Voltage 50/60 Cycles	High Voltage	Filament Windings	Case No. List Price
HP-122	115	220-0-220 15 MA	6.3 V.C.T.-.5A 6.3 V.C.T.-1.2A	H-1 \$10.00
HP-123	115	275-0-275 35 MA	6.3 V.C.T.-.5A 6.3 V.C.T.-2A	H-2 15.00

FILTER AND AUDIO CHOKES

Type	Inductance	DC Current	DC Resistance	Case No. List Price
HC-115	Series-400 hy Parallel-100 hy	2.5 MA 5 MA	7,000 ohms 1,750 ohms	H-1 \$9.50
HC-116	Series-600 hy Parallel-150 hy	8 MA 16 MA	4,000 ohms 1,000 ohms	H-2 15.00
HC-117	60 hy	15 MA	3,000 ohms	H-1 9.50
HC-127	60 hy	40 MA	1,000 ohms	H-2 15.00
HC-128	Series 50 Hy. Parallel 12.5 Hy.	50 MA 100 MA	500 125	H-2 15.00

UTC ULTRA COMPACT AUDIO UNITS

The UTC Ultra Compact audio units are small, light-weight units ideal for remote pickup and similar equipment. High fidelity is obtainable in all individual units, the frequency response being ± 2 DB from 30 to 20,000 cycles, except A-11, A-21, A-25 (50-10,000 cycles). All units employ true hum balancing coil structures, which combined with a high conductivity outer case, afford a maximum of inductive shielding.

Ultra Compact audio units weigh 5 1/2 ounces and have overall dimensions 1 1/8" x 1 1/8" x 1 1/8". Mounting dimensions are 1 1/8" between centers, top and bottom.



Type No.	Application	Primary Impedance	Secondary Impedance	List Price
A-10	Low impedance mike, pickup, or multiple line to grid	50, 125, 200, 250, 333, 500 ohms	50,000 ohms	\$11.00
A-11	Line to grid, tri-alloy shielding for low pickup	50, 200, 500	50,000 ohms for 1 or 2 grids	12.00
A-12	Low impedance mike, pickup, or multiple line to push pull grids	50, 125, 250, 250, 333, 500 ohms	80,000 ohms overall, in two sections	11.00
A-14	Dynamic microphone to one or two grids	30 ohms	50,000 ohms overall, in two sections	10.00
A-16	Single plate to single grid	8,000 to 15,000 ohms	60,000 ohms, 2:1 turn ratio	9.00

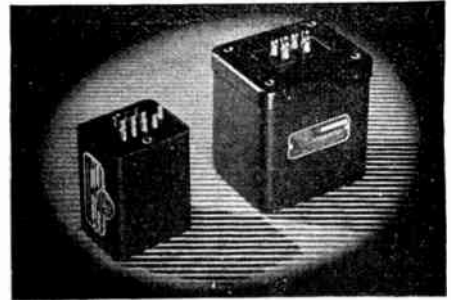

LOW IMPEDANCE TO GRID AND MIXING TRANSFORMERS

Type No.	Application	Primary Impedance	Secondary Impedance	Case No. List Price
HA-100	Low impedance mike, pickup, or multiple line to grid	50, 125, 200, 250, 333, 500 ohms	60,000 ohms in two sections	H-1 \$14.00
HA-100X	Same as above but with tri-alloy internal shield to effect very low hum pickup			H-1 18.00
HA-101	Low impedance mike, pickup, or multiple line to push pull grids	50, 125, 200, 250, 333, 500 ohms	120,000 ohms overall, in two sections	H-1 16.00
HA-101X	Same as above but with tri-alloy internal shield to effect very low hum pickup			H-1 20.00
HA-103A	Low impedance mike pickup, or parallel mixer to grid	2.5, 5.5, 10, 15, 22, 30, 38, 60 ohms	60,000 ohms in two sections	H-1 16.00
HA-108	Mixing, low impedance mike, pickup, or multiple line	50, 125, 200, 250, 333, 500 ohms	50, 125, 200, 250, 333, 500 ohms	H-1 14.00
HA-108X	Same as above but with tri-alloy internal shield to effect very low hum pickup			H-1 18.00
HA-130X	Three isolated lines or pads to one or two grids with tri-alloy internal shield	30, 50, 200, 250 ohms each primary	60,000 ohms overall, in two sections	H-1 20.00

INTERSTAGE AUDIO TRANSFORMERS

Type No.	Application	Primary Impedance	Secondary Impedance	Case No. List Price
HA-104	Single plate to P.P. grids like 2A3, 59, 46, 6L6	8,000 to 15,000 ohms	95,000 ohms; turn ratio 1.25:1	H-1 \$14.50
HA-105	Single plate to single grid	8,000 to 15,000 ohms	60,000 ohms 2:1 turn ratio	H-1 10.00
HA-106	Single plate to push pull grids	8,000 to 15,000 ohms	135,000 ohms 1.5:1 ratio, each side	H-1 12.00
HA-107	Push pull plates to push pull grids	8,000 to 15,000 ohms	35,000 ohms each secondary 1.5:1 turn ratio overall	H-2 18.00
HA-137	Same as above, but medium level (+15DB)			H-1 16.00

Type No.	Application	Primary Impedance	Secondary Impedance	List Price
A-17	Single plate to single grid	As above, will carry 8 MA DC	60,000 ohms 2:1 turn ratio	\$11.00
A-18	Single plate to two grids	8,000 to 15,000 ohms	80,000 ohms overall, 2.3:1 turn ratio overall	10.00
A-19	Single plate to two grids	As above, will carry 8 MA DC	80,000 ohms 2.3:1 turn ratio	13.00
A-20	Mixing, low impedance mike, pickup, or multiple line to multiple line	50, 125, 200, 250, 333, 500 ohms	50, 125, 200, 250, 333, 500 ohms	11.00
A-21	Mixing, tri-alloy shielding for low pickup	50, 200, 500	50, 200, 500	12.00
A-24	Single plate to multiple line	8,000 to 15,000 ohms	50, 125, 200, 250, 333, 500 ohms	11.00
A-25	Single plate to multiple line	As above, will carry 8 MA DC	50, 125, 200, 250, 333, 500 ohms	10.00
A-26	Push pull low level plates to multiple line	8,000 to 15,000 ohms each side	50, 125, 200, 250, 333, 500 ohms	11.00
A-27	Crystal microphone to multiple line	100,000 ohms	50, 125, 200, 250, 333, 500 ohms	11.00
A-30	Audio choke, 300 henrys @ 2 MA 6000 ohms D.C., 75 henrys @ 4 MA 1500 ohms D.C., inductance with no D.C. 450 henrys			7.50

OUNCER HIGH FIDELITY AUDIO UNITS

The new UTC OUNCER series represents the acme in compact quality transformer practice. These units are ideal for hearing aid, aircraft, glider, portable, concealed service, and similar applications. The overall dimensions are $\frac{7}{8}$ " diameter by $1\frac{3}{16}$ " height, including lugs. Mounting is effected by two screws, opposite the terminal board side, spaced $\frac{1}{16}$ ". Weight approximately one ounce. Units not carrying D.C. have high fidelity characteristics being uniform from 40 to 15,000 cycles. Items with D.C. in pri. and O-14 and O-15 are for voice frequencies from 150 to 4,000 cycles.

OUNCER HIGH FIDELITY AUDIO UNITS (MAX. LEVEL 0 DB)

200 ohm balanced winding may be used for 250 ohms.

Type No.	Application	Pri. Imp.	Sec. Imp.	List Price
O-1	Mike pickup or line to 1 grid	50, 200, 500	50,000	\$10.00
O-2	Mike pickup or line to 2 grids	50, 200, 500	50,000	10.00
O-3	Dynamic mike to 1 grid	7.5/30	50,000	9.00
O-4	Single plate to 1 grid	8,000 to 15,000	60,000	8.00
O-5	Single plate to 1 grid, D.C. in Pri.	8,000 to 15,000	60,000	8.00
O-6	Single plate to 2 grids	8,000 to 15,000	95,000	9.00
O-7	Single plate to 2 grids, D.C. in Pri.	8,000 to 15,000	95,000	9.00
O-8	Single plate to line	8,000 to 15,000	50, 200, 500	10.00
O-9	Single plate to line, D.C. in Pri.	8,000 to 15,000	50, 200, 500	10.00
O-10	Push pull plates to line	8,000 to 15,000 each side	50, 200, 500	10.00
O-11	Crystal mike or pickup to line	50,000	50, 200, 500	10.00
O-12	Mixing and matching	50,200	50, 200, 500	9.00
O-13	Reactor, 200 Hys.—no D.C.; 50 Hys.—2 M.A. D.C.; 6,000 ohms			
O-14	50:1 mike or line to 1 grid	200	$\frac{1}{4}$ megohm	7.50
O-15	10:1 single plate to 1 grid	8,000 to 15,000	1 megohm	10.00



UTC VARITRAN CONTROLS

FOR CONTROLLING: Line Voltage, Rectifier Output, Motors, Lights, Heaters, etc.

- Variable voltage transformers for smooth voltage control. Varitran units employ a special non-fusing roller contact to contact the exposed turns of an auto-transformer winding. Rugged construction is employed, with glass insulation to assure dependability. Output of 115 Volt unit variable from 0-130 volts (230 Volt unit; 0-260 V.) smoothly without interrupting circuit. Output voltage independent of load.
- Maximum Amp. rating applies from 0 to 20 and 95 to 130 volts. Between 20 and 95 volts current rating tapers off to 50% of rated current at 65 V. point.
- Top and bottom mounting for laboratory bench or panel mounting. All units supplied mounted, with terminal strips as in Fig. A except V-1 (Fig. B) and V-1M (Fig. C).

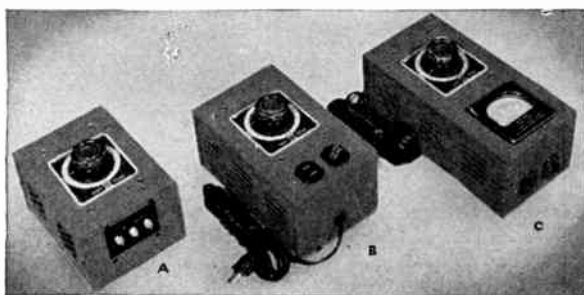

UNIVERSAL VARITRANS

These varitrans have a 115/230 V. primary winding and a smoothly variable secondary from 0-28 volts. Line voltage control can be effected for 102/140 V. or 197/243 volts to 115 V. or 220 volts respectively. The 28 volt secondary can also be used for low voltage lights, cauteries, trains, rectifiers, etc. The primary and secondary windings can be arranged to effect variable 220/115 or 115/220 volt arrangements. Appearance as in Fig. A above.

Type	Max. Amps. Output	Approx. Dimensions	Approx. Weight, Lbs.	Net Price
VL-0	1.5	$3\frac{3}{8} \times 4\frac{1}{4} \times 3\frac{3}{8}$	5	\$7.00
VL-1	3.5	$4\frac{3}{8} \times 6 \times 4\frac{3}{8}$	7	8.00
VL-2	6	$4\frac{3}{8} \times 6 \times 5\frac{1}{4}$	10	10.00
VL-3	11	$4\frac{3}{8} \times 6 \times 6\frac{1}{8}$	15	16.00

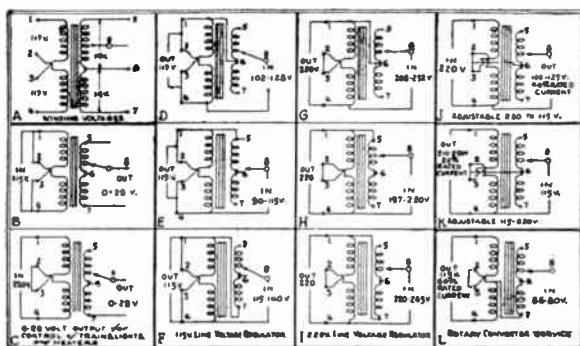

Type	Input Voltage	Output Voltage	Watts	Maximum Amps.	Approx. Wt. Lbs.	Net Price
V-0	115 volts	0-130	230	2	8	\$8.50
V-0-B	230 volts	0-260	230	1	10	10.50
V-1	115 volts	0-130	570	5	11	12.00
V-1-M	115 volts	0-130	570	5	12	20.00
V-2	115 volts	0-130	570	5	11	10.00
V-2-B	230 volts	0-260	570	2.5	14	12.50
V-3	115 volts	0-130	850	7.5	14	15.00
V-3-B	230 volts	0-260	850	3.75	18	20.00
V-4	115 volts	0-130	1250	11	32	22.00
V-4-B	230 volts	0-260	1250	5.5	38	28.00
V-5	115 volts	0-130	1950	17	45	35.00
V-5-B	230 volts	0-260	1950	8.5	56	40.00
V-6	115 volts	0-130	3500	30	90	65.00
V-6-B	230 volts	0-260	3500	15	100	80.00



VARIMATCH TRANSFORMERS

(For dimensions of cases see following page)

UTC VARIMATCH transformers are available in various types for every PA and transmitter requirement. Thru unique construction high efficiency and good response are obtainable on all terminations.

Pri. Ohms P to P	SECONDARY RF LOAD IMPEDANCES AVAILABLE											AUDIO LOAD IMPEDANCE	
	1070	1650	2150	3620	3920	4300	6350	6550	7900	8600	11400	200	350
2000	1070	1650	2150	3620	3920	4300	6350	6550	7900	8600	11400	200	350
3000	1620	2050	3240	5500	5900	6500	9400	10000	11800	13000	17000	300	520
4000	1380	1850	2160	2850	3450	4300	5500	7300	8650	12500	17400	250	400
5000	1730	2300	2700	3500	4300	5400	7000	9150	10800	15700	21600	300	500
6000	1070	2140	2180	2750	3620	4250	4300	5150	6350	8300	8600	200	370
7000	1250	2400	2500	3200	4280	5000	5050	6000	7300	9700	10000	230	430
8000	1440	2760	2900	3700	4900	5650	5800	6900	8400	18000	12000	270	500
9000	1620	2050	3100	3240	3900	4150	6200	6500	7750	9400	12500	300	550
10000	1800	2300	3500	4300	4600	6100	6900	7100	8600	10500	14000	330	600
12000	2070	2150	2750	4250	4320	5150	7250	8300	8700	12500	17400	370	400
14000	2440	3200	4900	6000	9700							430	
16000	2780	3700	5600	6900	11000							500	
18000	3140	4150	6300	7750	12500							550	

500* 1070 1950 2150 3020 3920 4300 6350 6550 7900 8600 11400

* In some cases it is desired to match an RF load to the 500 Ohm output of a PA amplifier. The terminal arrangement noted will take care of this application.

† These impedances are suitable for PA applications. If a monitor speaker is desired, proper distribution of power is obtained by operating this low impedance into the high impedance primary of the speaker transformer.

Intermediate P.P. primary impedance values available in addition to those shown.

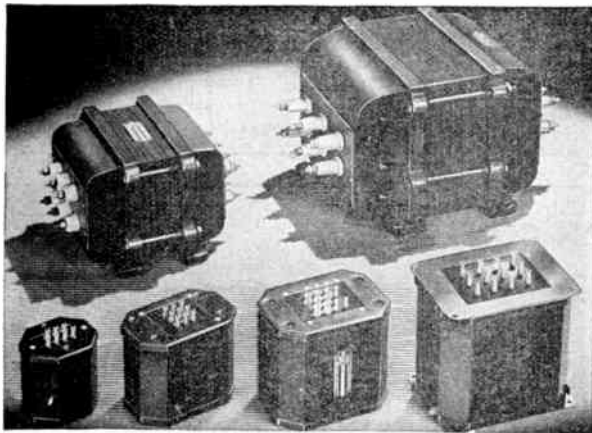

VARIMATCH DRIVER TRANSFORMERS

Type No.	Primary	Typical Output Tubes	Case No. List Price
PA-51AX	All single tubes like: 6C5, 30, 49, 53, 79, 89, 6A6, 45, 46, 2A3	19, 30, 49, 79, 89, 2A3, 45, 46, 6L6, 42, 59	PA-1 \$6.50
PA-63AX	P. P. tube like: 45, 59, 2A3, 6B5, 6L6	46, 4-46, 841, 210, 801, RK-18, 800, 208A, 838, 805, 50T, 830B	PA-2 8.00
PA-69AX	50, 200, 500 ohm line	805, 838, 203A, ZB-120, 100T11, 800, 55T, RK-18	PA-2 8.00
PA-238AX	4-2A3, 4-45, 4-50, 2-211A, 2-845	4-805's, 4-838's, 4-203A's, 2-204's, 2-849's, 2-HF300's, 2-HF200's, 2-250T11's, 2-450T11's	PA-3 20.00
PA-612	50, 200, 500 ohm line	2-250T11, 2-450T11, 2-HF200, 2-HF300, 2-204A, 2-849	PA-3 20.00

VARIMATCH MODULATION TRANSFORMERS

Will match any modulator tube to any RF load. Here's the answer to your modulation problem. A line of transformers providing a universal range of load impedances for any modulator combination. The VARIMATCH transformer can never become obsolete. All units carry class C current and are supplied with charts giving impedance combinations.

Type No.	Max. Audio Watts	Max. Class C Input	Typical Modulator Tubes	Case	List Price
VM-0	12	25	30, 40, 79, 6A6, 53, 2A3, 6B5	PA-1	\$6.00
VM-1	30	60	6V6, 6B5, 2A3, 42, 46, 6L6, 210	PA-2	9.50
VM-2	60	125	801, 6L6, 809, 4-46, T-20, 1608	PA-3	14.00
VM-3	125	250	800, 807, 845, TZ-20, RK-30, 35-T	PA-4	20.00
VM-4	300	600	50-T, 203A, 805, 838, T-55, ZB-120	CA-1	35.00
VM-6	600	1200	805, HF-300, 204A, 11K-354, 250T11	CA-2	80.00

PA VARIMATCH OUTPUTS

Universal units designed to match any tubes within the rated output power, to line or voice coil. Output impedance 500, 200, 50, 15, 8, 5, 3, 1.5 ohms.

Type No.	Audio Watts	Typical Tubes	Case No.	List Price
PVM-1	12	42, 43, 45, 47, 2A3, 6A6, 6F6, 25L6	PA-1	\$6.00
PVM-2	30	42, 45, 2A3, 6L6, 6V6, 6B5	PA-2	9.50
PVM-3	60	46's, 50's, 300A's, 6L6's, 801, 807	PA-3	14.00
PVM-4	125	600's, 801's, 807's, 4-6L6's, 845's	PA-4	20.00
PVM-6	300	211, 242A's, 203A's, 838's, 4-845's, ZB-120's	CA-1	35.00

VARIMATCH LINE TO VOICE COIL TRANSFORMERS

The UTC VARIMATCH line to voice coil transformers will match any voice coil or group of voice coils to a 500 ohm line. More than 50 voice coil combinations can be obtained from the LVM-1, LVM-2, LVM-3, and the actual impedances are as follows:

.2, .4, .5, .62, 1, 1.25, 1.5, 2, 2.5, 3, 3.3, 3.8, 4, 4.5, 5, 5.5, 6, 6.25, 6.6, 7, 7.5, 8, 9, 10, 11, 12, 14, 15, 16, 18, 20, 25, 28, 30, 31, 40, 47, 50, 63, 69, 75.

Type No.	Audio Watts	Primary Impedance	Secondary Impedance	Case No.	List Price
LVM-1	15	500 ohms	.2 to 75 ohms	PA-1	\$5.50
LVM-2	40	500 ohms	.2 to 75 ohms	PA-2	8.00
LVM-3	75	500 ohms	.2 to 75 ohms	PA-3	12.00

VARIMATCH LINE AUTOFORMERS

UTC Varimatch Line Autoformers will match one to ten 500 ohm lines or LVM-500 ohm windings to the 500 ohm output of an audio amplifier. The LVM-10 to LVM-14 autoformers have impedances of 500, 250, 167, 125, 100, 83, 71, 62, 50.

Type No.	Audio Watts	Case No.	List Price
LVM-10	15	PA-1	\$5.50
LVM-11	30	PA-2	8.00
LVM-12	60	PA-3	12.00

UTC PUBLIC ADDRESS AUDIO COMPONENTS

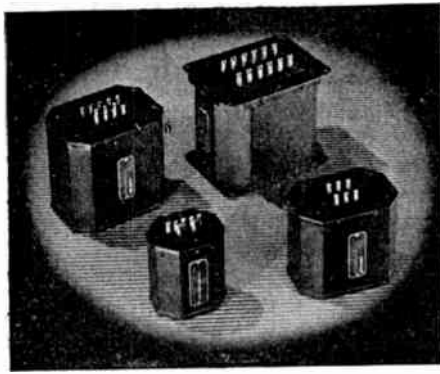

A quality line of popular-priced transformers incorporating conservative design and construction to assure dependability under the most adverse operative and climatic conditions. Uniform drawn cases finished in telephone black enamel with threaded inserts for top or bottom mounting. These units are professional in appearance and suited for continuous commercial service in amplifiers and transmitters. All items are poured with special moisture-proof sealing compound in addition to vacuum impregnation of coil structures. Items in same case size have approximately the same weights, as noted below.

low hum pick-up. All audio components are linear, $\pm 1\frac{1}{2}$ DB from 60 to 8,500 cycles. 200 ohm windings on input transformers are balanced and may be used for 250 ohm circuits.

PA-134, 135 and 136 are of the hum-bucking type to assure

VARITONE UNITS

The UTC VARITONE is a revolutionary audio device incorporating a transformer and frequency response corrective network. Using the VARITONE, tone correction can be effected for defects in acoustic conditions or overall audio response from microphones, pickups, loud speakers, etc. It is also possible to produce new tonal effects from phonograph recordings or radio reception, bringing back notes which would be practically lost otherwise. Due to the high equalization obtainable, an additional stage of amplification is sometimes necessary if the equalizer is to be used at maximum setting. The VT-1 and VT-2 require an external 50,000 ohm potentiometer as the control device.

OVERALL DIM., IN.				Mtg. Dim.		Weight Lbs.
Case	L	W	H	L	W	
PA-1	2 $\frac{1}{4}$	3	3	1 $\frac{13}{16}$...	2
PA-2	3 $\frac{1}{8}$	4 $\frac{1}{8}$	4 $\frac{1}{8}$	1 $\frac{1}{2}$	3 $\frac{1}{8}$	5
PA-3	3 $\frac{1}{8}$	4 $\frac{1}{8}$	4 $\frac{1}{8}$	1 $\frac{13}{16}$	3 $\frac{1}{8}$	10
PA-4	6	4 $\frac{1}{8}$	6	3 $\frac{1}{8}$	5 $\frac{1}{8}$	18
CA-1	7 $\frac{3}{8}$	9	5 $\frac{1}{8}$	23
CA-2	11	11	9	83

INPUT TO GRID TRANSFORMERS

PA-1 CASE

Type No.	Application	Primary Impedance Ohms	Secondary Impedance Ohms	List Price
PA-131	1 plate to 1 grid	8,000/15,000	90,000 3:1 ratio	\$6.00
PA-132	1 plate to 2 grids	8,000/15,000	160,000 center-tapped 2:1 ratio each side	6.50
PA-133	2 plates to 2 grids	8,000/15,000	30,000 each side 1.75:1 ratio each side	8.00
PA-134	1 line to 1 grid hum-bucking	50, 200, 500	100,000	8.00
PA-135	1 line to 2 grids hum-bucking	50, 200, 500	150,000 overall	8.50
PA-235	1 line to 1 or 2 grids hum-bucking; multiple alloy shielded for low hum pick-up	50, 200, 500 ohms	80,000 overall	11.00
PA-136	Single plate and low impedance mike or line to 1 or 2 grids. Hum-bucking	8,000/15,000 50, 200, 500	120,000 overall	8.50
PA-233	PP 6C5, 56, similar triodes to A13 45's, 2A3's, 6L6's, etc.	8,000/15,000	8,000 .9:1 ratio	7.00
PA-333	PP 6C5, 56, similar triodes to fixed bias 6L6's	8,000/15,000	2,500 .5:1 ratio	7.00
PA-433	PP 45, 2A3, similar tubes to fixed bias 2 or 4 6L6's	5,000	1,250 .5:1 ratio PA-2 case	7.50

MIXING AND LOW LEVEL OUTPUT TRANSFORMERS

PA-1 CASE

Type No.	Application	Pri. Imp. Ohms	Sec. Imp. Ohms	List Price
PA-137	Mixing	50, 200, 500	50, 200, 500	\$6.50
PA-140	Triode plate to line	8,000/15,000	50, 200, 500	7.50
PA-141	PP triode plates to line	8,000/15,000	50, 200, 500	8.50

Type No.	Matching	Equalization	List Price
VT-1	Triode plate, low impedance mike or line--to 1 or 2 grids	High end, low end, or both	\$10.00
VT-2	Connects across triode plate or low impedance mike or line	High end, low end, or both	8.00
VT-10	Band pass filter for amateur service removes unnecessary low and high frequencies, reducing QRM, increasing efficiency and intelligibility. Connects in plate circuit of triode		12.00

OUTPUT TRANSFORMERS

Secondary impedances 500, 200, 50, 16, 8, 5, 3, 1.5 ohms

Type No.	Imped. P.P. Ohms	Typical Tubes	Case	List Price
PA-15	8,000	45's, 50's, 6F6 triodes	PA-2	\$7.00
PA-16	3,000/5,000	2A3's, 6A5G's	PA-2	7.00
PA-19	6,000/10,000	6B5, 6A6, 6F6, 89, 46	PA-2	7.00
PA-710	14,000/20,000	10's, 47's, 2A5 pentodes	PA-2	7.00
PA-2L6	6,000	6L6's self bias	PA-3	12.00
PA-4L6	3,300/3,800	2-6L6's, AB2 or 4-6L6's AB	PA-4	18.00

COMBINED PLATE AND FILAMENT TRANSFORMERS

Primary 115 volts 50/60 cycles. *Tappe 1 for either voltage. † Replaces former transformer types PA-22, PA-425 and PA-426.

Type No.	High Voltage	DC. MA.	Fil. 1	Fil. 2	Fil. 3	Fil. 4	Case No. List Price
†PA-422	435-365-0 365-435 125-0-125	125 25	5V-3A	5V-2A	6.3 VCT-3A	2.5 VCT-5A	PA-3 \$12.50
PA-428	500-0-500 80-0-80	250 100	5V-3A	5V-2A	6.3 VCT-4A	*6.3 VCT-3A 2.5 VCT-3A	PA-4 17.00
PA-429	600-525-0-525-600	250	5V-3A	6.3 VCT-3-A	*7.5 VCT-3A 6.3 VCT-3A		PA-4 18.00
PA-431	500-400-0-400-500 80-0-80	500 100	5V-3A	5V-2A	6.3 VCT-5A	6.3 VCT-3A	CA-1 27.00

NEW COMMERCIAL TYPE POWER SUPPLY COMPONENTS

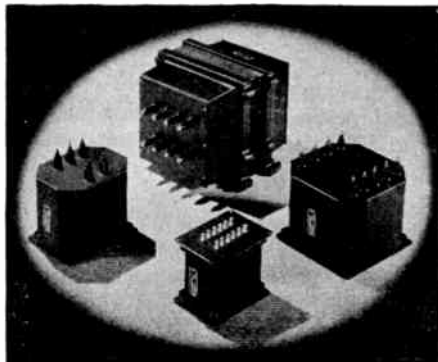

HIGH POWER PLATE TRANSFORMERS

Primaries for 105, 115, 220, 230 volts, 50/60 cycles. For reduced power secondary voltages can be reduced to half by using 220V. Pri. on 110 volts. These transformers may be used on 25 to 43 cycles if 220V. Pri. is used on 110 volts.

Type No.	High Voltage	D.C. Voltage	D.C. MA	Case No.	List Price
PA-300	625-615-0-615-625	500/400	200	PA-3	\$12.00
PA-301	580-530-300-0-300-530-580	475/425/250	500	PA-4	17.00
PA-302	950-760-0-750-950	760/610	325	PA-4	20.00

Type No.	High Voltage	D.C. Voltage	D.C. MA.	L	W	H	Wt. lbs.	List Price
PA-303	1500-1235-400-0-400-1235-1500	1250/1000/300	300/175	8	7 1/2	5 1/2	32	\$30.00
PA-304	1500-1235-0-1235-1500	1250/1000	800	14	11	9 1/4	118	80.00
PA-305	2400-1750-0-1750-2400	2000/1500	300	10	7 1/2	5 1/2	50	45.00
PA-306	2400-1750-0-1750-2400	2000/1500	500	14	11	9 1/4	120	80.00
PA-307	3500-3000-2400-0-2400-3000-3500	3000/2500/2000	300	13	11	9 1/4	110	75.00
PA-308	3500-3000-2400-0-2400-3000-3500	3000/2500/2000	500	15	11	9 1/4	140	95.00
PA-309	3500-3000-2400-0-2400-3000-3500	3000/2500/2000	1000	17	14	11 1/4	210	165.00
PA-310	4600-4050-3500-0-3500-4050-4600	4000/3500/3000	600	15	14	11 1/4	168	125.00
PA-311	1500-1235-0-1235-1500	1250/1000	500	10	7 1/2	5 1/2	50	45.00

UNIVERSAL BIAS TRANSFORMERS

Primary 115 V. 50/60 cycles. No filament windings.

Type No.	D.C. Voltage	D.C. Ma.	Case No.	List Price
PA-315	Tapped for any voltage from 15 to 100 V. within 6 %	250	PA-2	\$10.00
PA-318	Tapped for any voltage from 75 to 400 V. within 6 %	250	PA-4	17.00

VARIPOWER AUTO-FORMERS

Designed for line voltage control, filament voltage control and reduced power operation. Output voltage from 0 to 130 volts, 50/60 cycles. Varipower units permit control of filament voltage at the tube socket to within 2 1/2% of desired value simultaneously with line voltage control and plate voltage control. Can be used to reduce or increase voltages on filament transformers. Taps at 25, 55, 75, 95, 100, 105, 110, 115, 120, 125 and 130 volts permit output voltages from 0 to 130 volts in 5 volt steps.

Type No.	Watts Output	Dimensions	Weight Lbs.	List Price
VA-1	150	4 1/4 x 3 1/4 x 3 1/4	6	\$7.00
VA-2	250	4 1/4 x 4 1/4 x 3 1/4	9	9.00
VA-3	500	5 1/2 x 4 1/2 x 4	11	12.00
VA-4	1000	5 1/2 x 6 x 4	19	18.00
VA-5	2000	7 x 6 x 5 1/4	25	25.00

The new UTC PA power transformers and chokes have been designed to commercial standards. Temperature rise and insulation requirements are in accordance with the conservative specifications of the A.I.E.E. and Fire Underwriters. Ratings are conservative, for continuous duty, and suitable for all commercial and amateur applications. All items are vacuum impregnated in addition to sealing with special insulating compound. Rugged ceramic bushings are used for high voltage terminals.

These transformers and reactors are designed for temperature rise less than 55 degrees C., and are tested for breakdown on all windings at twice working voltage plus 1,000 volts. In addition, plate transformers are given a surge test at 2 1/2 times normal applied voltage using a 500 cycle supply. In view of the conservative ratings and manufacturing procedure, these units are suitable for use on most types of government and standard commercial communication equipment. However, these same quality features make these units ideal for amateur transmitter equipment and also for quality PA units.

LOW POWER FILTER CHOKES

Type No.	Inductance Henrys	D.C. MA	D.C. res. Ohms	Case No.	List Price
PA-40	10	200	110	PA-2	\$5.50
PA-41	5-25	200	100	PA-2	5.50
PA-44	30	100 max.	375	PA-2	5.50
PA-45	250	15 max.	4500	PA-1	5.50
PA-48C	100	50 ma.	2500	PA-1	5.50

SMOOTHING CHOKES

Tapped for humbucking circuit. Commercial safety factors. Inductance rating at max. DC.

Type No.	Inductance Henrys	D.C. M.A.	D.C. res. Ohms	Case No.	List Price
PA-100	12	150	115	PA-2	\$6.00
PA-102	12	200	105	PA-3	9.00
PA-104	12	300	90	PA-4	14.00
PA-108	10	500	60	CA-1	25.00
PA-115	10	1000	50	CA-1	40.00

SWINGING INPUT CHOKES

Type No.	Inductance Henrys	D.C. M.A.	D.C. res. Ohms	Case No.	List Price
PA-101	5-25	150	115	PA-2	\$6.00
PA-103	5-25	200	105	PA-3	9.00
PA-105	5-25	300	90	PA-4	14.00
PA-109	5-25	500	60	CA-1	25.00
PA-11C	5-25	1000	50	CA-1	40.00

FILAMENT TRANSFORMERS

Primary for 105, 115, 220, 230 volts, 50/60 cycles. These transformers may be used on 25 to 43 cycles if 220 volt primary is used on 110 volts. Secondary voltage is simultaneously reduced to half.

*Two Windings.

Type No.	Sec. Volts C. T.	Sec. Amps.	Working Voltage	Test Voltage	Case No.	List Price
PA-34	2 1/2	10	2500	6000	PA-2	\$7.50
PA-120	2 1/2	10	5000	11000	PA-3	10.00
PA-121	5	22	5000	11000	PA-3	14.00
PA-122	7.5/6.3	8	1500	4000	PA-3	12.00
PA-124	10	10	1500	4000	PA-3	12.00
PA-125	14/12/11	10	1500	4000	PA-3	14.00
PA-128	*14/11/10/14/11/10	10/10	1500	4000	PA-4	22.00



RADIO SET REPLACEMENT TRANSFORMERS



The new UTC replacement type transformers represent the culmination of years of development in this field. All units are vacuum sealed against humidity with special impregnating materials to prevent corrosion and electrolysis. Shells and brackets are finished in attractive high lustre black enamel.

The new UTC shells and universal brackets employed make possible a latitude in mounting dimensions never approached heretofore. Using Varitap coil construction a minimum number of transformers have been developed to cover any requirement in the replacement field.

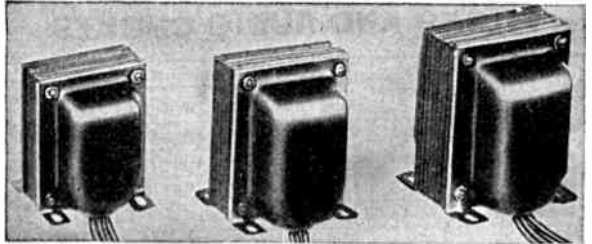
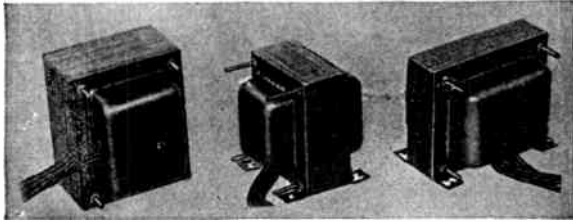

Through unique construction the five UTC Varitap Duplicate replacement transformers will service as many types of radio receivers as the 15 or 20 units more customarily employed for such service. The universal feet may be used for upright or horizontal mounting, or eliminated for flush mounting.



UTC vertical power transformers are unusually attractive in appearance, having smooth drawn cases finished in high lustre black enamel. The Varitap coil structure assures flexibility of application and permits the three units described to take the place of 5 to 8 units customarily employed for equivalent service.

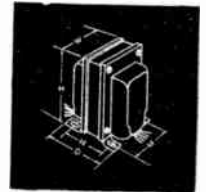

VARITAP DUPLICATE REPLACEMENT POWER TRANSFORMERS

Type No.	High Voltage	Rect. Fil.	FIL. 1	FIL. 2	Dimensions, In.						Wt. Lb.	List Price
					W	D	H	M	N			
R-1	325-0-325 40MA	5V-2A	6.3 VCT-2A or 2.5-VCT-4A		3	2 3/4	2 3/4	2 3/4	2	2 3/4	\$3.75	
R-2	350-0-350 70MA	5V-3A	6.3 VCT-2.5A or 2.5-VCT-5A		3 3/4	2 3/4	3	2 3/4	2 3/4	3 3/4	4.60	
R-3	350-0-350 95MA	5V-3A	6.3 VCT-4.5A or 2.5-VCT-4.5A	2.5 VCT-9A	3 3/4	3 3/4	3 3/4	3 3/4	2 3/4	6 3/4	6.50	
R-4	375-0-375 120-MA	5V-4A	6.3 VCT-5A or 2.5-VCT-5A	2.5 VCT-15A	4 1/4	3 3/4	3 3/4	3 3/4	3	6 3/4	6.50	
R-5	385-0-385 180-MA	5V-4A	6.3 VCT-4A or 2.5-VCT-8A	0.3 VCT-5A	4 1/4	3 3/4	4 1/4	3 3/4	3	8 3/4	8.00	

VERTICAL SHIELDED POWER TRANSFORMERS FOR RECEIVERS AND AMPLIFIERS

Type No.	High Voltage	Rect. Fil.	FIL. 1	FIL. 2	Dimensions, In.						Wt. Lb.	List Price
					W	D	H	M	N			
R-5A	300-0-300 60MA	5V-2A	6.3 VCT-2A or 2.5 VCT-5A		2 3/4	2 3/4	3 3/4	2	1 3/4	2 3/4	\$4.00	
R-11	350-0-350 75MA	5V-3A	6.3 VCT-3A or 2.5-VCT-3A	2.5 VCT-8A	3	3 3/4	3 3/4	2 3/4	2 3/4	4	6.75	
R-12	375-0-375 100-MA	5V-3A	6.3 VCT-4A or 2.5-VCT-4A	6.3 VCT-2A or 2.5 VCT-8A	3 3/4	3 3/4	4	2 3/4	2 3/4	6 3/4	6.50	
R-13	425-0-425 200-MA	5V-3A	6.3 VCT-5A or 2.5-VCT-5A	6.3 VCT-3A or 2.5 VCT-12A	3 3/4	4 1/4	4 1/4	3	3 3/4	8 3/4	9.50	

VARITAP FLUSH TYPE POWER TRANSFORMERS

The UTC flush type transformers are husky units designed for low temperature rise and good regulation. By employing a Varitap universal coil structure, (brought out to sturdy lugs) the five units described take the place of 12 to 15 units normally found in a flush type series.

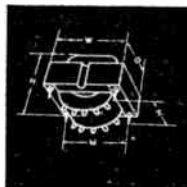
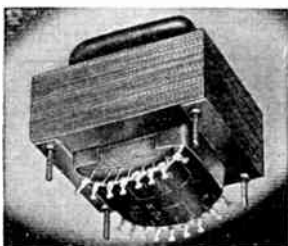

Type No.	High Voltage	Rect. Fil.	FIL. 1	FIL. 2	Dimensions, In.						Wt. Lb.	List Price
					W	D	H	M	N			
R-6	300-0-300 50MA	5V-2A	6.3 VCT-2A or 2.5-VCT-5A		3	2 3/4	3	2 3/4	2	2 3/4	\$3.75	
R-7	350-0-350 75MA	5V-3A	6.3 VCT-3A or 2.5-VCT-3A	2.5 VCT-8A	3 3/4	2 3/4	3 3/4	2 3/4	2 3/4	3	4.75	
R-8	375-0-375 100-MA	5V-3A	6.3 VCT-4A or 2.5 VCT-4A	2.5 VCT-10A	3 3/4	3 3/4	3 3/4	3 3/4	2 3/4	5 3/4	6.75	
R-9	400-0-400 125-MA	5V-3A	6.3 VCT-4A or 2.5-VCT-4A	6.3 VCT-2A or 2.5 VCT-10A	4 1/4	3 3/4	4	3 3/4	3	6 3/4	8.75	
R-10	425-0-425 200-MA	5V-3A	6.3 VCT-5A or 2.5-VCT-5A	6.3 VCT-3A or 2.5 VCT-12A	4 1/4	3 3/4	4 1/4	3 3/4	3	8 3/4	8.50	

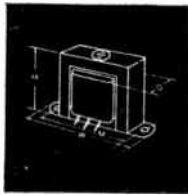
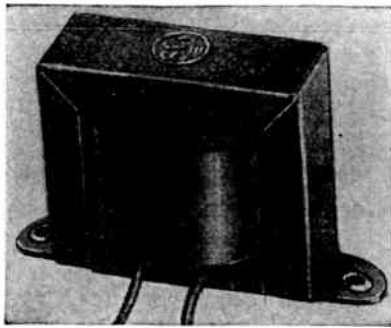

UTC filter chokes are conservatively designed and rated. Standard black enamel mounting channels are employed. Coils are completely sealed against adverse humidity conditions.

FILTER AND AUDIO CHOKES

Type No.	Induct. Hys.	Current	Resistance Ohms	Dimensions, Ins.				Wgt. Lbs.	List Price
				W	D	H	M		
R-55	10	35MA	300	2 1/2	1 3/8	1 3/8	2 1/2	1/2	\$1.10
R-14	12	40MA	250	2 1/2	1 3/8	1 1/2	2 3/8	3/4	1.35
R-15	15	30MA	450	2 1/2	1 3/8	1 1/2	2 3/8	3/4	1.35
R-16	20	30MA	600	2 1/2	1 3/8	1 1/2	2 3/8	3/4	1.35
R-17	25	30MA	850	3 3/8	1 3/8	2	2 3/8	1	1.80
R-18	10	75MA	250	3 3/8	1 3/8	2	2 3/8	1	1.80
R-19	15	100MA	450	3 3/8	1 3/8	2 3/8	3 3/8	1 1/2	2.50
R-20	8	160MA	100	4 1/2	2	2 3/8	3 3/8	2 1/2	2.75
R-21	5/25	160MA	100	4 1/2	2	2 3/8	3 3/8	2 1/2	2.75
R-22	500	5MA	4000	3 3/8	1 3/8	2	2 3/8	1	2.50

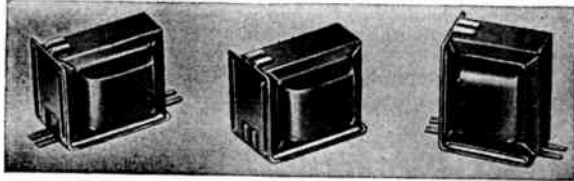

The Varitap Duplicate audio units represent the acme in replacement transformer development. The units are extremely attractive, the double shells and universal mounting brackets being finished in high lustrous black enamel. The figure A units use the new UTC universal bracket. This bracket makes possible four hole horizontal or vertical mounting and two hole, channel type, horizontal or vertical mounting. The coils of these units, in addition to efficient design and mechanical shielding, are vacuum impregnated and completely sealed with a special compound to assure complete protection against adverse climatic conditions.

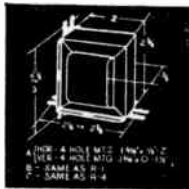

VARITAP DUPLICATE AUDIO TRANSFORMERS AND FILTER CHOKES

(Completely Shielded Units, Universal Mtg.)

Type No.	Application	Description	Fig.	Wgt. Lbs.	List Price
R-23	1 plate* to 1 grid	3 1/2:1 ratio	A	1	\$2.50
R-24	1 plate* to 2 grids	2:1 ratio	A	1	2.60
R-25	2 plates* to 2 grids	1.5:1 stepup for class A triodes 1.5:1 stepdown for 6L6's, 2A3's, 2A5's, etc.	A	1 1/2	2.75
R-28	Driver, 1 plate to 2 grids	Single 42, 2A5, 6F6, 45, 46 to A3 6L6's, 42's, 2A5's, 6F6's, 46's	A	1 1/2	2.75
R-27	15 watt Universal Output	All tubes up to 15 watts to any voice coil from .1 to 30 ohms	A	1 1/2	2.50
R-28	35 watt Universal Output	All tubes up to 35 watts to any voice coil from .1 to 30 ohms	B	2 1/2	2.50
R-29	Mike to grid	Single or double button mike or line to 1 grid	A	1 1/2	2.50
R-30	Filter choke	13 Hys—250 MA—100 ohms	C	7	7.00
R-31	Filter choke	10 Hys—80 MA—250 ohms	A	2 1/2	2.25
R-32	Filter choke	10 Hys—150 MA—100 ohms	B	2 1/2	3.25

*Will match tubes like 27, 37, 56, 6C5 triode, 6C5. Can be used with high mu triodes with loss in low frequencies.

UTC channel frame TROPICAL WETPROOF audios are excellently designed. In addition to good frequency range, coils are vacuum-pressure treated followed by the UTC MOULD SEAL process of WET PROOFING to prevent moisture absorption.

CHANNEL FRAME AUDIO TRANSFORMERS

Type No.	Application	Description	Dimen., Ins.				Wgt. Lbs.	1st Price
			W	D	H	M		
R-33	1 plate* to 1 grid	4:1 ratio	2 1/2	1 3/8	1 3/8	2 3/8	3/4	\$1.80
R-34	1 plate* to 2 grids	2:1 ratio	2 1/2	1 3/8	1 3/8	2 3/8	3/4	1.85
R-35	Mike to 1 grid	17:1 ratio	2 1/2	1 3/8	1 3/8	2 3/8	3/4	2.25
R-53	Plate and mike to grid	3:1 and 17:1 ratio	2 1/2	1 3/8	1 3/8	2 3/8	3/4	2.25
R-56	1 plate to 2 grids	2:1 ratio	3 3/8	1 3/8	2	2 3/8	1	2.25
R-57	1 plate to 2 grids	2 1/2:1 ratio	4 1/2	2	2 3/8	3 3/8	2 1/2	3.50
R-36	Driver	30, 49, etc. to class B 19, 49, 79, 89 grids	2 1/2	1 3/8	1 3/8	2 3/8	3/4	2.25
R-37	R.F. Output	Class B 19, 49, 79, 89 plates to 3500 and 5,000 ohms	2 1/2	1 3/8	1 3/8	2 3/8	3/4	2.35
R-58	5 watt Universal output	Any single tube to any voice coil .1 to 30 ohms	2 1/2	1 3/8	1 3/8	2 3/8	3/4	1.85
R-38A	6 watt Universal	Any tubes up to 6 watts to any voice coil .1 to 30 ohms	2 1/2	1 3/8	1 3/8	2 3/8	3/4	1.85
R-59	10 watt Universal	Any tubes up to 10 watts to any voice coil .1 to 30 ohms	2 1/2	1 3/8	1 3/8	2 3/8	3/4	2.10
R-60	15 watt Universal	Any tubes up to 15 watts to any voice coil .1 to 30 ohms	3 3/8	1 3/8	2	2 3/8	1 1/2	2.25
R-39	10 watt line Matching Transformer	250, 500, 1,500 ohms to 2, 8, 15 ohms	2 1/2	1 3/8	1 3/8	2 3/8	3/4	2.35
R-40	25 watt line Matching Transformer	250, 500, 1,500 ohms to 2, 8, 15 ohms	4 1/2	2 1/2	2 3/8	3 3/8	2 1/2	3.65

*Will match tubes like 27, 37, 56, 6C5 triodes, 6C5. Can be used with high mu triodes with loss in low frequencies.

CHANNEL FRAME FILAMENT TRANSFORMERS

Pr. 115 V.—50/60 Cycles

Type No.	Secondary	Dimensions, Inches				List Price
		W	D	H	M	
FT-1	2.5 V. C. T.-3A	2 1/2	1 3/8	1 1/2	2 3/8	\$1.75
FT-2	6.3 V. C. T.-1.2A	2 1/2	1 3/8	1 1/2	2 3/8	1.75
FT-3	2.5 V. C. T.-8A	3 3/8	1 3/8	2	2 3/8	2.90
FT-4	6.3 V. C. T.-2.5A	3 3/8	1 3/8	2	2 3/8	2.25
FT-5	2.5 V. C. T.-10A	3 3/8	1 3/8	2 3/8	3 3/8	2.25
FT-6	5 V. C. T.-3A	3 3/8	1 3/8	2 3/8	3 3/8	2.25
FT-7	7.5 V. C. T.-3A	3 3/8	1 3/8	2 3/8	3 3/8	2.25

STEP DOWN AUTO-TRANSFORMERS

220-240 to 110-120 Volts—50/60 Cycles

Type No.	Application	Wgt. Lbs.	List Price
R-41	85 watt capacity	4	\$6.50
R-42	125 watt capacity	5	7.00
R-43	175 watt capacity	5 1/2	8.50
R-44	250 watt capacity	6 1/2	10.00
R-45	500 watt capacity	13	20.00
R-46	1000 watts, no cord	26	35.00



EXPORT VOLTAGE ADAPTERS

Complete with cord and plug and special locking switch providing for line voltages of 105, 115, 125, 135, 150, 210, 230, 250 volts; 42 to 60 cycles. Output voltage 115.

Type No.	Rating	Weight, Lbs.	List Price
R-48	150 watts	5 1/2	\$10.00

LINE VOLTAGE CORRECTORS

Auto-transformers complete with cord, plug and tap switch. Switch will effect 115 volts plus or minus 2 1/2 volts output for any input voltage from 90 to 135 volts, 50/60 cycles.

Type No.	Rating	Weight, Lbs.	List Price
R-50	100 watts	4	\$8.00
R-51	250 watts	5 1/2	10.00
R-52	1000 watts	18	35.00



SPECIAL SERIES AUDIO TRANSFORMERS



UTC Special Series transformers represent unprecedented value. These items are specifically designed for amateur and popular-priced PA service. For commercial equipment the PA or LS series of units are recommended. The Special Series units are finished in a rich, commercial type gray crinkle enamel. A recessed terminal strip is provided permitting above chassis or breadboard wiring in addition to standard chassis type wiring. The universal windings provided on driver, matching and output transformers assure a maximum of flexibility. Modulator output units will carry the DC current in the class C stage and will match practically any audio tubes to any RF load within the power rating of the transformer. Large components are housed in formed cases with top or bottom mounting and louvers for good ventilation.

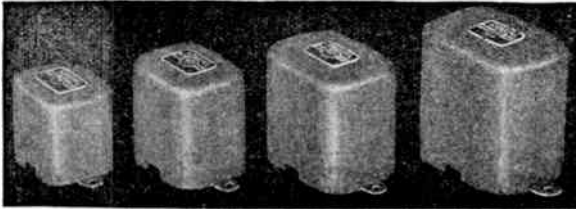

CASE SIZES

Type No.	H	W	D	M	Weight Lbs.
G-1	1 1/4	2	1 1/4	2 1/4	1
G-2	2 1/4	2 1/4	1 1/4	2 1/4	1 1/4
G-3	2 1/4	2 1/4	2 1/4	3 1/4	2
G-4	2 1/4	3 1/4	2 1/4	3 1/4	3

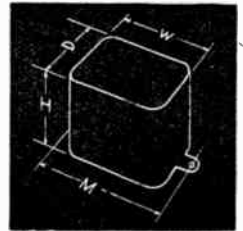

CLASS A INPUT TRANSFORMERS

Type No.	Application	Ratio	Case No.	Net Price
S-1	1 plate* to 1 grid	3 1/2:1	G-2	\$2.10
S-2	1 plate* to 2 grids	2:1	G-2	2.40
S-3	1 plate* to 1 or 2 grids compact type	4:1 2:1 P.P.	G-1	1.95
S-4	1 plate* to 2 grids wide range response	1:1	G-3	3.30
S-5	Single or double button mike or line to 1 grid hum-bucking type	16:1	G-2	2.70
S-6	Single or double button mike or line to 1 grid, compact type	16:1	G-1	1.95
S-7	Single plate* and carbon mike to one or two grids	3:1 16:1	G-2	3.15

*Will match tubes like 56, 6C5, 6C6 triode, 77 triode, 37, etc. Can be used with high mu triodes with loss in low frequencies.

UNIVERSAL OUTPUT TRANSFORMERS TO LINE AND VOICE COIL

Type No.	Tubes and Pri. Ohms	Sec. Ohms	Power	Case No. Net Price
S-14	Single tubes: 2500 ohms for 2A3, 6A3, 6A5 G, 6B4 G, 6L6, 6Y6, 25L6 4,000 ohms for 2A5, 6F6 triode, 12A5, 25A6, 43, 45, 50, 71A 7,000 ohms for 2A5, 6F6, 6K6, 20, 31, 33, 47 10,000 ohms for 6G6, 38, 41	2, 8, 15, 500	10 W	G-2 \$2.85
S-15	P. P. tubes: 4,000 ohms for 25L6, 6Y6G 5,000 ohms for 2A3, 6A3, 6A5G, 6B4G, 45 10,000 ohms for 19, 7J6G, 30, 49, 89, 6Z7G, 6AC5G, 53, 6A6, 6N6, 6N7, 6B5	2, 8, 15, 500	12 W	G-2 3.00
S-16	3,000 ohms for 2A3, 6A3, 6A5G, 6B4G, AB 6,000-8,600 ohms for 2A5-6F6-42 triodes AB, 46, 59, 6L6 10,000 ohms for 6B5, 6V6, 2A5-6F6-42 pentodes AB	2, 8, 15, 500	30 W	G-4 3.90
S-17	3,300 ohms for 4 6L6's, 4-46's 3,800 ohms for 2 6L6's, AB2 6,000 ohms for 1608, 809	2, 8, 15, 500	55 W	G-5 4.80

UNIVERSAL DRIVER TRANSFORMERS

Type No.	Primary	Typical Output Tubes	Case No. Net Price
S-8	All single tubes like: 6C5, 30, 49, 53, 79, 89, 6A6, 45, 40, 2A3	19, 30, 49, 79, 89, 2A3, 45, 46, 6L6, 42, 59	G-3 \$2.55
S-9	P. P. tubes like: 45, 59, 2A3, 6B5, 6L6	46, 4-46, 841, 210, 801, RK-18, 800, 203A, 838, 805, 50T, 830B	G-4 3.30
S-10	P. P. 56, 6C5, etc.	AB 45, 42, 2A3, 6L6	G-3 3.00
S-73	500 or 200 ohm line to all watts	Class B grids up to 400	G-4 3.30

MATCHING TRANSFORMERS

Type No.	Application	Pri. Ohms	Sec. Ohms	Case No. Net Price
S-11	Single 56, 6C6 triode, 6C5 or similar tube to line.	10,000	200/500	G-2 \$2.70
S-12	Line to speaker 15 watts	500, 2000, 4000	2, 4, 8, 15	G-2 3.00
S-13	Line to speaker 30 watts	500, 2000, 4000	2, 4, 8, 15	G-4 3.90

COMBINED PLATE AND FILAMENT TRANSFORMERS

Primary 115 V.—60/60 Cycles

Type No.	High Voltage	D.C. Voltages	Rectifier Fil.	Fil. No. 1	Fil. No. 2	Case No. Net Price
S-39	490-400-0-400-490 175 Ma.	400/310	5V.-3A.	2.5 V. C. T. 6A	6.3 V. C. T. 4A	G-7 \$6.00
S-40	525-425-0-425-525 250 Ma.	400/310	5V.-3A.	6.3 V. C. T.-3A	6.3 V. C. T.-3A	G-7 6.00
S-41	600-0-600 200 Ma.	475	5V.-3A.	7.5V. tapped 6.3V-3A	6.3 V. C. T.-2A	G-7 5.40
S-42	600-525-0-525-600 300 Ma.	480/400	5V.3A-	7.5V. tapped 6.3V.-3A	6.3 V. C. T.-3A	G-8 7.20
S-43	525-0-525 450 Ma. 40-0-40 200 Ma.	400	5V.-3A 5V.-6A	6.3 V. C. T.-2A	6.3 V. C. T.-5A	G-9 9.90

*Based on two section filter, choke input.

SPECIAL SERIES POWER EQUIPMENT

UTC Special Series power supply components are designed specifically for amateur and popular-priced PA service. The ratings are based on such applications and recommended for intermittent service. For commercial applications, PA or LS grade components should be employed. Tapped coil structures on power and bias supply transformers afford maximum flexibility, permitting a given transformer to be used with many circuits and types of tubes.

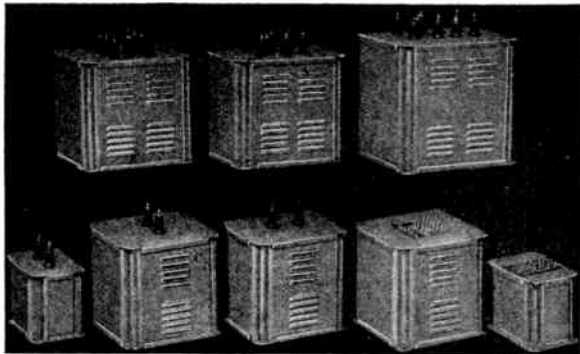

CASE SIZES

Type	H	W	D	M	N	Wt. Lbs.
G-6	3 3/8	3 1/2	4 9/16	3 7/8	2 1/8	4 1/2
G-7	5 3/8	4 9/16	5 9/16	4 7/8	3 5/8	9
G-8	5 3/8	5 1/2	5 1/2	4 3/8	4 3/8	13
G-9	6 1/4	5 3/8	6 13/16	5 3/8	4 11/16	18
G-10	6 1/4	6 3/8	6 11/16	5 11/16	5 13/16	24
G-11	7 1/4	6 3/8	7 3/8	6 13/16	5 3/8	31

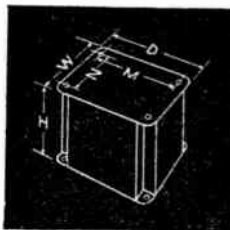

FILTER, SWINGING, AND AUDIO CHOKES

Type No.	Service	Inductance	Current	Resistance	Case No.	Net Price
S-23	Audio	500 Hy.	5 Ma.	4,500 ohms	G-2	\$2.10
S-24	P.P. Choke	500 Hy. C.T.	3 Ma.	4,000 ohms	G-2	2.25
S-25	Filter	30 Hy.	30 Ma.	800 ohms	G-2	1.95
S-26	Filter	15 Hy.	60 Ma.	230 ohms	G-2	1.95
S-27	Filter	30 Hy.	75 Ma.	350 ohms	G-4	2.40
S-28	Filter	20 Hy.	100 Ma.	350 ohms	G-4	2.40
S-29	Filter	6 Hy.	175 Ma.	95 ohms	G-4	2.40
S-30	Swinging	5/25 Hy.	175 Ma.	95 ohms	G-4	2.40
S-31	Filter	15 Hy.	225 Ma.	120 ohms	G-5	3.15
S-32	Swinging	5/25 Hy.	225 Ma.	120 ohms	G-5	3.15
S-33	Filter	15 Hy.	300 Ma.	90 ohms	G-7	4.60
S-34	Swinging	5/25 Hy.	300 Ma.	90 ohms	G-7	4.50
S-35	Filter	15 Hy.	400 Ma.	85 ohms	G-8	5.60
S-36	Swinging	5/25 Hy.	400 Ma.	85 ohms	G-8	9.00
S-37	Filter	15 Hy.	550 Ma.	60 ohms	G-8	9.00
S-38	Swinging	5/25 Hy.	550 Ma.	60 ohms	G-8	9.00

UNIVERSAL BIAS TRANSFORMERS

Primary 115 V.—50/60 Cycles No Filament Windings

Type No.	Application	D.C. Current	Case No.	Net Price
S-51	Will supply any bias voltage from 15 to 100 volts D.C. within approximately 6% of desired value.	200 Ma.	G-5	\$6.40
S-52	Will supply any bias voltage from 75 to 400 volts D.C. within approximately 6% of desired value.	200 Ma.	G-7	7.20

UNIVERSAL OUTPUT TRANSFORMERS

Any modulator tubes to any RF load.

Type No.	Audio Power	Case No.	Net Price
S-18	12 watts	G-3	\$3.15
S-19	30 watts	G-4	4.80
S-20	55 watts	G-5	5.90
S-21	110 watts	G-7	9.60
S-22	250 watts	G-9	15.00

PLATE TRANSFORMERS

Primary 115 V.—50/60 Cycles

Type No.	High Voltage	D.C. Voltages*	D.C. Current	Case No.	Net Price
S-44	575-525-0-525-575	470/430	500 Ma.	G-9	\$9.30
S-45	900-750-0-750-900	750/620	200 Ma.	G-8	7.20
S-46	1000-750-0-750-1000	825/600	300 Ma.	G-9	9.00
S-74	1175-500-0-500-1175 Duplex rectifier	1000/400	1150 MA/1150 MA	G-10	9.90
S-47	1500-1250-1000-0-1000-1250-1500	1275/1050/825	300 Ma.	G-10	11.70
S-48	1500-1250-1000-0-1000-1250-1500	1300/1075/850	500 Ma.	G-11	15.80
S-49	2100-1800-1500-0-1500-1800-2100	1815/1540/1275	300 Ma.	G-11	16.20
S-50	3000-2500-0-2500-3000	2625/2175	300 Ma.	G-11	22.50

*Based on two section filter for 200 Ma. and 300 Ma. units, single section filter for 500 Ma. units, both choke input.

Note: Using a bridge rectifier circuit D.C. Voltages shown are doubled but available D.C. current reduced to half. S-49 and S-50 are not suitable for bridge rectifiers.

1200 MA if used alone.

‡ 250 MA if used alone.

SINGLE SECONDARY FILAMENT TRANSFORMERS

Primary Tapped 105, 115 Volts—50/60 Cycles

Type No.	Secondary Volts	Secondary Current	Insulation	Case No.	Net Price
S-53	2.5 VCT	10 A.	1500 V.	G-3	\$2.10
S-54	5 VCT	4 A.	2500 V.	G-3	2.10
S-55	6.3 VCT	3 A.	1,500 V.	G-3	2.10
S-56	7.5 VCT	3 A.	1,500 V.	G-3	2.10
S-57	2.5 VCT	10 A.	10,000 V.	G-5	3.00
S-58	2.5 VCT	20 A.	10,000 V.	G-5	3.50
S-59	5 to 5.25 VCT	13 A.	5,000 V.	G-5	3.00
S-60	5 to 5.25 VCT	22 A.	10,000 V.	G-7	6.50
S-61	7.5 VCT tapped 6.3 VCT	8 A.	3,000 V.	G-5	3.00
S-62	10 VCT	10 A.	3,000 V.	G-5	3.50
S-63	14 VCT tapped 12 VCT and 11 VCT	10 A.	5,000 V.	G-7	5.60

MULTIPLE SECONDARY FILAMENT WINDINGS

Primary Tapped 105, 115 Volts—50/60 Cycles

Type No.	Fl. 1	Fl. 2	Fl. 3	Insulation V.	Case No.	Net Price
S-64	2.5 VCT-5A	2.5 VCT-5A	5 VCT-6A	3,000	G-5	\$3.50
S-65	2.5 VCT-5A	5 VCT-4A	6.3 VCT-3A	3,000	G-5	3.50
S-66	2.5 VCT-10A	7.5 VCT-6.5A		3,000	G-5	3.50
S-67	5 VCT-6A	6.3 VCT-5A		3,000	G-5	3.50
S-68	5 VCT-3A	6.3 VCT-4A	7.5 VCT-5A	3,000	G-5	3.90
S-69	6.3 VCT-3A	7.5 VCT-6.5A		3,000	G-5	3.90
S-70	6.3 VCT-5A	6.3 VCT-5A		3,000	G-5	3.90
S-71	2.5 VCT-6A	2.5 VCT-6A	2.5 VCT-12A	10,000	G-7	6.50
S-72	5 VCT-3A	5 VCT-3A	5 VCT-6A	5,000	G-5	4.20

HALLDORSON Replacement Transformers

POWER TRANSFORMERS

Cat. No.	Plate Voltage C.T.	5 V. Fil.	2.5 V. Fil.	6.3 V. Fil.	Tube Combinations	Mtg Type	Dimensions		Mounting Centers	Wgt. Lbs.
							H. W.	D.		
51	700 V.—70 M.A.	3 A.	10 A., C.T.		1-4b, 47, 2A5; 6-2a, 27, or 9-56, 57	S T	4" x3 1/4" x3 1/4"	2 1/4" x2 1/4"	5 4 1/2	
52	700 V.—110 M.A.	3 A.	(1) 3.5 A., C.T. (2) 3.5 A., C.T. (3) 9 A., C.T.		2-45, 47, 2A5 2-45, 47, 2A5 5-24, 27, or 9-56, 57	S T U	4 1/4" x4" x4" 3 1/4" x4 1/4" x3 1/4" 4" x4 1/4" x3 1/4"	3" x2 1/4" Universal 3 1/4" x2 1/4"	8 1/4 7 3/4 7 3/4	
53	700 V.—110 M.A.	3 A.	(1) 3.5 A., C.T. (2) 12.25 A., C.T.		2-45, 47, 2A5 7-24, 27 or 12-56, 57	S T	4 1/4" x4" x3 1/4" 3 1/4" x4 1/4" x3 1/4"	3" x2 1/4" Universal	9 8 1/4	
56	700 V.—90 M.A.	3 A.	(1) 3.5 A., C.T. (2) 8.75 A., C.T.		2-45, 47, 2A5 5-24, 27, or 9-56, 57	S T	4 1/4" x4" x3 1/4" 3 1/4" x4 1/4" x3 1/4"	3" x2 1/4" Universal	7 1/4 6 1/4	
57	600 V.—80 M.A.	(1) 3 A., (2) 1/2 A.	10.5 A., C.T.		6-24, 27, or 10-56, 57	S T	4" x3 1/4" x3 1/4" 3 1/4" x3 1/4" x3 1/4"	2 1/4" x2 1/4" Universal	5 4 1/2	
47	650 V.—40 M.A.	2 A.	3.75 A., C.T.		1-2A5; 2-57, 58	M L	1 1/2" x3" x2 1/4" 2 1/4" x3" x2 1/4"	2 1/4" x2" Universal	2 1/4 2 1/2	
48	650 V.—40 M.A.	3 A.	(1) 1.75 A., C.T. (2) 3.5 A.		1-47, 2A5 2-24, 27, or 3-56, 57	M L	2 1/4" x3 1/4" x2 1/4" 2 1/4" x3 1/4" x2 1/4"	2 1/4" x2 1/4" Universal	3 1/4 3 1/2	
448	650 V.—40 M.A.	3 A.	(1) 1.75 A., C.T., or 1.6 A., C.T. (2) 3.5 A., C.T.		1-47, 2A5 or 3-77, 6K7; 1-42, 6F6 2-24, 27, or 3-56, 57	M L	2 1/4" x3 1/4" x2 1/4" 2 1/4" x3 1/4" x2 1/4"	2 1/4" x2 1/4" Universal	3 1/4 3 1/4	
476	650 V.—40 M.A.	2 A.		1.6 A., C.T.		M L	1 1/2" x3" x2 1/4" 2 1/4" x3" x2 1/4"	2 1/4" x2" Universal	2 1/4 2 1/2	
49	650 V.—40 M.A.	3 A.	5.25 A., C.T.		2-24, 27, or 3-56, 57; 1-47, 2A5	M S	1 1/2" x3" x2 1/4" 3 1/4" x2 1/4" x2 1/4"	2 1/4" x2" 2" x1 1/4"	2 1/4 2 1/2	
60	650 V.—50 M.A.	3 A.	(1) 1.75 A., C.T. (2) 5.25 A.		1-47, 2A5 3-24, 27, or 5-56, 57	M L	2 1/4" x3 1/4" x2 1/4" 2 1/4" x3 1/4" x2 1/4"	2 1/4" x2 1/4" Universal	3 1/4 3 3/4	
660	650 V.—50 M.A.	3 A.	(1) 1.5 A., C.T., or 1.9 A., C.T. (2) 5.25 A., C.T.		1-47, 2A5, or 4-77, 6K7; 1-42, 6F6 3-24, 27, or 5-56, 57	M L	2 1/4" x3 1/4" x2 1/4" 2 1/4" x3 1/4" x2 1/4"	2 1/4" x2 1/4" Universal	3 1/4 3 3/4	
61	700 V.—60 M.A.	3 A.	7 A., C.T.		3-2a, 27 or 6-56, 58; 1-47, 2A5	M S	2 1/4" x3 1/4" x3 1/4" 4" x3 1/4" x3 1/4"	3 1/4" x2 1/4" 2 1/4" x2 1/4"	4 1/4 5	
661	700 V.—60 M.A.	3 A.	(1) 1.75 A., C.T., or 1.9 A., C.T. (2) 7 A., C.T.		1-47, 2A5, or 4-77, 6K7; 1-42, 6F6 4-24, 27 or 7-56, 58	M I.	2 1/4" x3 1/4" x3 1/4" 3 1/4" x3 1/4" x3 1/4"	3 1/4" x2 1/4" Universal	4 1/4 5 1/4	
62	700 V.—70 M.A.	3 A.	(1) 3.5 A., C.T. (2) 9 A.		2-47, 2A5 5-24, 27, or 9-56, 58	M S	2 1/4" x3 1/4" x3 1/4" 4" x3 1/4" x3 1/4"	3 1/4" x2 1/4" 2 1/4" x2 1/4"	5 5 1/2	
662	700 V.—70 M.A.	3 A.	(1) 3.5 A., C.T., or 2.5 A., C.T. (2) 9 A., C.T.		2-47, 2A5, or 6-77, 6K7; 1-42, 6F6 5-24, 27, or 9-56, 58	M L	2 1/4" x3 1/4" x3 1/4" 3 1/4" x3 1/4" x3 1/4"	3 1/4" x2 1/4" Universal	5 5	
63	700 V.—110 M.A.	3 A.	(1) 3.5 A., C.T. (2) 10.5 A.		2-47, 2A5 6-24, 27, or 10-56, 57	M L	2 1/4" x4 1/4" x3 1/4" 3 1/4" x4 1/4" x3 1/4"	3 1/4" x2 1/4" Universal	6 6 1/2	
663	700 V.—110 M.A.	3 A.	(1) 3.5 A., C.T., or 3.5 A., C.T. (2) 10.5 A., C.T.		2-47, 2A5, or 7-77, 6K7; 2-42, 6F6 6-24, 27, or 10-56, 57	M L	2 1/4" x4 1/4" x3 1/4" 3 1/4" x4 1/4" x3 1/4"	3 1/4" x2 1/4" Universal	6 1/4 6 1/4	
64	700 V.—100 M.A.	3 A.	(1) 3.5 A., C.T. (2) 15 A.		2-47, 2A5 8-24, 27, or 15-56, 57	M L	2 1/4" x4 1/4" x3 1/4" 3 1/4" x4 1/4" x3 1/4"	3 1/4" x2 1/4" Universal	7 7 1/2	
65	650 V.—40 M.A.	3 A.		1.6 A., C.T.	3-77, 78, 6K7; 1-42, 6F6	M S L	2" x3" x2 1/4" 3 1/4" x2 1/4" x2 1/4" 2 1/4" x3" x2 1/4"	2 1/4" x2" 2" x1 1/4" Universal	2 1/4 2 1/4 2 1/4	
66	650 V.—50 M.A.	3 A.		2 A., C.T.	4-77, 78, 6K7; 1-42, 6F6	M S	2 1/4" x3 1/4" x2 1/4" 3 1/4" x2 1/4" x3 1/4"	2 1/4" x2 1/4" 2 1/4" x2 1/4"	3 1/4 3 1/4	
67	700 V.—70 M.A.	3 A.		3 A., C.T.	5-77, 78, 6K7; 2-42, 6F6	M S	2 1/4" x3 1/4" x3 1/4" 4" x3 1/4" x3 1/4"	3 1/4" x2 1/4" 2 1/4" x2 1/4"	4 1/4 5	
68	700 V.—120 M.A.	3 A.		4.5 A., C.T.	10-76, 6C6, 6K7; 2-42, 6F6	M L	2 1/4" x4 1/4" x3 1/4" 3 1/4" x4 1/4" x3 1/4"	3 1/4" x2 1/4" Universal	6 6 1/2	
58	700 V.—100 M.A.	3 A.		5 A., C.T.	12-76, 6C6, 6K7; 2-42, 6F6	S	4 1/4" x4" x3 1/2"	3" x2 1/4"	7 1/2	
59	800 V.—120 M.A.	3 A.	(1) 3.5 A., C.T. (2) 14.5 A., C.T.		2-47, 2A5 8-24, 27 or 14-56, 57	S	4 1/4" x4" x3 1/4"	3" x2 1/4"	9	
70	700 V.—100 M.A.	3 A.	6 A., C.T.	3.3 A., C.T.	including 77, 78, 6K7; 42, 6F6, 47 2A5, 24, 27, 56, 58	S L	4 1/4" x4" x3 1/4" 3 1/4" x4 1/4" x3 1/4"	3" x2 1/4" Universal	8 8	
80	800 V.—150 M.A.	3 A.		2.5 A., C.T.	6J7, 6Y7, 2-6L6	S	4 1/4" x3 1/4" x3 1/4"	3 1/4" x2 1/4"	7 3/4	
75	750 V.—180 M.A.	3 A.	6 A., C.T.	3.5 A., C.T.		M S L	2 1/4" x4 1/4" x3 1/4" 4 1/4" x3 1/4" x3 1/4" 4 1/4" x4 1/4" x3 1/4"	3 3/4" x3" 3 1/4" x2 1/4" Universal	8 8 8	
77	800 V.—200 M.A.	3 A.		5.5 A., C.T.		S	4 1/4" x3 1/4" x3 1/4"	3 1/4" x3"	9	
74	745 V.—145 M.A.	3 A.		5 A., C.T.	6L6, 42, 6F6	S M L	4 1/4" x4" x3 1/4" 3 1/4" x4 1/4" x3 1/4" 3 1/4" x4 1/4" x3 1/4"	3" x2 1/4" 3 1/4" x3" Universal	8 1/4 8 1/4 8 1/4	
85	500 V.—50 M.A.		(1) 1.5 A. (2) .6 A.			L	3" x3" x2 1/4"	Universal	3	
					7.5 V. Fil.	1.5 V. Fil.				
50	600 V.—70 M.A.	(1) 3 A. (2) 1/2 A.	3.5 A., C.T.		(1) 4.2 A. (2) 1.05 A.	S T	4 1/4" x3 1/4" x3 1/4" 3 1/4" x3 1/4" x3 1/4"	2 1/4" x2 1/4" Universal	5 4 1/2	
54	800 V.—110 M.A.	3 A.	(1) 3.5 A. (2) 3 A., C.T.		(1) 1.05 A. (2) 5.25 A.	S T	4 1/4" x4" x4" 3 1/4" x4 1/4" x3 1/4"	3" x3" Universal	8 1/4 8 1/4	
73	900 V.—110 M.A.		10.5 A.		(1) 2.5 A. (2) 2.5 A., C.T.	S	4 1/4" x4" x4 1/4"	3" x3 1/4"	10 1/4	
76	700 V.—100 M.A.	3 A.	(1) 2 A., C.T. (2) 3 A., C.T.		(1) 5A. (2) 1A.	S	4" x3 1/4" x3 1/4"	2 1/4" x2 1/4"	5 1/4	

The above are 50-60 cycle; for 25 cycle, add 60% to price, and for 220 volt, 50-60 cycle, add 10%.

FILAMENT TRANSFORMERS

Capacity at 50-60 Cycles	Number	Mounting	Mounting Centers	Core	H. Size L. W.	Wt.
115 V. to 2 1/2 Volts, 12 A. C.T.	E4-1051	E4	3 3/8"	1" x1"	2 1/2" x4" x2 1/4"	2 1/4
115 V. to 6.3 Volts, 3 A. C.T.	B5-860	B5	2 1/2"	3/4" x 3/4"	2 1/4" x2 1/4" x1 1/4"	1
115 V. to 2 1/2 Volts, 8 A. C.T.	B5-861	B5	2 1/2"	3/4" x 3/4"	2 1/4" x2 1/4" x1 1/4"	1
115 V. to 6.3 V., 4 A. C.T., 5 V., 3 A.	S-25	S	2 1/4" x2 1/4"	1 1/2" x1 1/2"	4 1/4" x3 1/4" x3 1/4"	3
115 V. to 5 V., 3 A.	B5-859	B5	2 1/4"	3/4" x 3/4"	2 1/4" x2 1/4" x1 1/4"	1

DRIVER TRANSFORMERS

Drivers	Class	Driving	Number	Mounting	Ratio Pri. to 1/2 Sec.	Mounting Centers	H. Size L. W.	Wt.
6CS, 6R7 or 6F6 Triode	AB	6L6 P.P.	E-1045	E	5-1	5-1	3 1/4" x2 1/4" x2 1/4"	2 1/2
6CS, 6R7 or 6F6 Triode	AB	6L6 P.P.	B7-830	B7	5-1	2 1/2"	2 1/4" x2 1/4" x1 1/4"	1
6A6 or 53 Paralleled	B	6N7 P.P.	B7-831	B7	5-1	2 1/2"	2 1/4" x2 1/4" x1 1/4"	1
30.	B	1-19 or 2-30	B4-819	B4	2.5-1	2 1/2"	2" x3 1/4" x3 1/4"	1
89 Triode	B	1-70	B7-832	B7	2.5-1	2 1/2"	2 1/4" x2 1/4" x1 1/4"	1
or 46 or 59.	B	2-46 or 2-59						

HALLORSON

REPLACEMENT TRANSFORMERS

OUTPUT TRANSFORMERS



L Mtd.

To Feed From	Voice Coil Impedance	Number	Mounting	Mounting Centers	Core	H. L. W.	Size	Wt.
Universal	Given in Chart	D4-604	D4	2"	1 1/2" x 1 1/2"	1 3/8" x 2 3/8" x 1 1/2"		1/2
		A4-777	A4	2 1/2"	3/4" x 3/4"	1 3/8" x 2 3/8" x 1 1/2"		10 oz.
		B6-816	B6	Universal	3/4" x 3/4"	2" x 2 1/2" x 1 1/2"		1
		B5-816	B5	2 1/2"	3/4" x 3/4"	2 3/8" x 2 3/8" x 1 1/2"		1
		B4-816	B4	2 3/8"	3/4" x 3/4"	2" x 3 3/8" x 1 1/2"		1
P. P. 6L6—(60 Watt)	4, 8, 15, 500	S-72	S	2 1/2" x 2 1/2"	1 1/4" x 1 1/4"	4 1/4" x 3 3/4" x 3 3/8"		5 1/2
P. P. 6L6, 2A3, 6B5 (30 Watt)	4, 8, 15, 500	E-1042	E	2" x 1 3/4"	1" x 1"	3" x 2 3/4" x 2 3/8"	4"	2 1/2
P. P. 6L6, Reverse Feedback (35W.)	4, 8, 15, 500							
2A3, 43, 45, 50, 59, 71A	4, 8, 15	B5-850	B5	2 3/8"	3/4" x 3/4"	2 3/8" x 2 3/8" x 1 1/2"		1
31, 33, 42, 47, 79, 2A5		B5-851	B5	2 3/8"	3/4" x 3/4"	2 3/8" x 2 3/8" x 1 1/2"		1
6A4, 10, 38, 41, 53		B5-852	B5	2 3/8"	3/4" x 3/4"	2 3/8" x 2 3/8" x 1 1/2"		1
P. P. 2A3, 43, 45, 50, 59, 71A, 6B5		B5-853	B5	2 3/8"	3/4" x 3/4"	2 3/8" x 2 3/8" x 1 1/2"		1
P. P. 6A4, 10, 38, 41, 53		B5-855	B5	2 3/8"	3/4" x 3/4"	2 3/8" x 2 3/8" x 1 1/2"		1
P. P. 2A3, 43, 45, 50, 59, 71A, 6B5	2, 4, 8	A5-700	A5	2"	3/8" x 3/8"	2" x 2 1/2" x 1 1/2"		10 oz.
2A5, 42, 47, 79	3 to 6 Ohm Voice Coll	D4-600	D4	2"	1 1/2" x 1 1/2"	1 3/8" x 2 3/8" x 1 1/4"		3/4
— For Midget		D4-601	D4	2"	1 1/2" x 1 1/2"	1 3/8" x 2 3/8" x 1 1/4"		3/4
— and A.C.-D.C. Sets		D4-602	D4	2"	1 1/2" x 1 1/2"	1 3/8" x 2 3/8" x 1 1/4"		3/4
41, 19, 38	3 to 6 Ohm Voice Coll	A4-770	A4	2 1/2"	3/4" x 3/4"	1 3/8" x 2 3/8" x 1 1/4"		10 oz.
2A5, 19, 38, 41, 42, 43, 47, 79		A4-771	A5	2"	3/4" x 3/4"	2" x 2 1/2" x 1 1/2"		10 oz.
2A5, 19, 38, 41, 42, 43, 47, 79	3 to 6 Ohm Voice Coll	A5-772	A5	2"	3/4" x 3/4"	2" x 2 1/2" x 1 1/2"		10 oz.
Single and P. P. 2A5, 19, 38, 41, 42, 43, 47, 79								
Single 154	3 to 6 Ohm Voice Coll	K4-800	K4	1 3/4"	3/8" x 3/8"	1 3/8" x 2 3/8" x 1 1/2"		6 oz.
Single 1A5G, 1E7G, 1N6G, 6V7G		A4-775	A4	2 1/2"	3/4" x 3/4"	1 3/8" x 2 3/8" x 1 1/2"		10 oz.

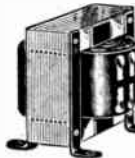

U Mtd.



T Mtd.

AUDIO TRANSFORMERS

Application	Number	Mounting	Over All Ratio	Mounting Centers	Core	H. L. W.	Size	Wt.
Single Plate to Single Grid Class A From general purpose tubes such as 27, 56, etc. To 27, 45, 2A5, etc.	B-805	B	2 1/2—1	1 1/2" x 2 1/2"	3/4" x 3/4"	2 1/4" x 2 1/4" x 2 3/8"		1 1/2
	B4-805	B4	2 1/2—1	2 3/8"	3/4" x 3/4"	2" x 3 3/4" x 1 1/4"		1
	B4-807	B4	3 1/2—1	2 3/8"	3/4" x 3/4"	2" x 3 3/4" x 1 1/4"		1
	B4-808	B4	2 1/2—1	2 3/8"	3/4" x 3/4"	2" x 3 3/4" x 1 1/4"		15 oz.
	A4-751	A4	3—1	2 3/8"	3/4" x 3/4"	1 3/8" x 2 3/8" x 1 1/2"		10 oz.
A4-752	A4	2 1/2—1	2 3/8"	3/4" x 3/4"	3/4" x 3/4"	1 3/8" x 2 3/8" x 1 1/2"		9 oz.
Single Plate to Pushpull Grids Class A From general purpose tubes such as 27, 56, etc. To 27's, 45's, 2A5's, etc. in Push Pull.	E-1027	E	4—1	2" x 2"	1" x 1"	3" x 2 3/4" x 2 3/8"		2 1/2
	E4-1027	E4	4—1	3 1/2"	1" x 1"	2 3/4" x 4" x 2 1/4"		2 1/4
	B5-810	B5	4—1	2 3/8"	3/4" x 3/4"	2 3/8" x 2 3/8" x 1 1/2"		1 1/2
	B7-893	B7	3—1	2 3/8"	3/4" x 3/4"	2 1/2" x 2 1/2" x 1 1/2"		1 1/4
	B4-815	B4	3 1/2—1	2 3/8"	3/4" x 3/4"	1 3/8" x 2 3/8" x 1 1/2"		15 oz.
	A4-761	A4	3 1/2—1	2 3/8"	3/4" x 3/4"	1 3/8" x 2 3/8" x 1 1/2"		9 oz.
A4-760	A4	3—1	2 3/8"	3/4" x 3/4"	1 3/8" x 2 3/8" x 1 1/2"		10 oz.	
B5-809	B5	4—1	2 3/8"	3/4" x 3/4"	3/4" x 3/4"	2 3/8" x 2 3/8" x 2"		1 1/4
Universal Pushpull Input To replace any input transformer used in Class A Circuit.	B6-818	B6	3—1	Universal	3/4" x 3/4"	2" x 3 3/4" x 1 1/4"		1
	B4-818	B4	3—1	2 3/8"	3/4" x 3/4"	2 3/8" x 2 3/8" x 1 1/2"		1
	B5-818	B5	3—1	2 3/8"	3/4" x 3/4"	2 3/8" x 2 3/8" x 1 1/2"		1
Two Plates to Two Grids—Class A	B-811	B	1 1/2—1	1 1/2" x 2 1/2"	3/4" x 3/4"	2 1/4" x 2 3/8" x 2 3/8"		1 1/2
	B4-811	B4	1 1/2—1	2 3/8"	3/4" x 3/4"	2" x 3 3/4" x 1 1/4"		1



S Mtd.



M Mtd.



A4, B4, E4 D4 Mtd.



B5 A5 Mtd.



B Mtd.



E Mtd.

MICROPHONE AND LINE TRANSFORMERS

Application	Pri. Impedance	Sec. Impedance	Number	Mtg.	Mounting Centers	H. L. W.	Size	Wt.
Microphone, Line or Mixer to Single Grid	*500 C.T., 250, } *200 C.T., 50 }	Grid of Tube C.T	E-1040	E	2"x2"	3"x2 3/4" x 2 3/8"		2 1/2
Line to Line or Line to Voice Coll.	*500 C.T., 250, } *200 C.T., 50 }	4, 8, 15, 500	E-1041	E	2"x2"	3"x2 3/4" x 2 3/8"		2 1/2
Microphone to Single Grid	200 C.T.	Grid of Tube	F-822	F	2 1/2"	3"x2 3/4" diam.		1 1/4
Line to Multiple Speakers—60 Watt	250 or 500	Adjustable to Match 1 to 6 Speakers	P-300	Special	"	3"x5" x 4 1/2"		6 1/2

FILTER CHOKES

Number	Ohms	Henries	At M.A.	Mounting	Mounting Centers	Core	H. L. W.	Size	Wt.
E-1030	250	23	110	E	2"x2"	1"x1"	3"	2 1/4" x 2 1/4" x 2 1/4"	2 1/2
E4-1030	250	23	110	E4	3"	1"x1"	2 1/2"	2 1/4" x 4" x 3"	2 1/4
C4-967	350	31	80	C4	3 1/2"	3/4" x 3/4"	2 1/4"	2 1/4" x 3 3/4" x 2 1/4"	1 1/2
C4-968	1400	50	60	C4	3 1/2"	3/4" x 3/4"	2 1/4"	2 1/4" x 3 3/4" x 2 1/4"	1 1/2
B4-836	700	30	35	B4	2 3/8"	3/4" x 3/4"	2"	2 3/8" x 3 3/8" x 1 1/4"	1
B4-837	400	15	40	B4	2 3/8"	3/4" x 3/4"	2"	2 3/8" x 3 3/8" x 1 1/4"	1
T-1002	300	11	50	A4	2 3/8"	3/4" x 3/4"	1 3/8"	2 3/8" x 3 3/8" x 1 1/4"	10 oz.
T-1001	400	12	40	A4	2 3/8"	3/4" x 3/4"	1 3/8"	2 3/8" x 3 3/8" x 1 1/4"	10 oz.
T-391	350	14.5	35	A4	2 3/8"	3/4" x 3/4"	1 3/8"	2 3/8" x 3 3/8" x 1 1/4"	10 oz.
T-333	200	6.5	60	A4	2 3/8"	3/4" x 3/4"	1 3/8"	2 3/8" x 3 3/8" x 1 1/4"	10 oz.
T-341	400	12.5	30	D4	2"	1 1/2" x 1 1/2"	1 3/8"	2 3/8" x 3 3/8" x 1 1/4"	6 oz.
T-343	200	6.5	30	D4	2"	1 1/2" x 1 1/2"	1 3/8"	2 3/8" x 3 3/8" x 1 1/4"	6 oz.
E-1031	2200	80	28	E	2"x1 1/2"	1"x1 1/4"	3 1/2"	2 3/8" x 2 3/8" x 2 3/8"	2 1/2
E-1032	180	7.5	150	E	2"x2"	1"x1 1/4"	3 1/2"	2 3/8" x 2 3/8" x 3"	2 1/2



KENYON TRANSFORMERS



DIMENSIONS OF "T"-LINE TRANSFORMERS

MOUNTING DIMENSIONS			OVERALL DIMENSIONS		
Case No.	ML	MW	Length (L)	Width (W)	Height (H)
1A	2 $\frac{1}{2}$ "	1 $\frac{1}{8}$ "	2 $\frac{1}{8}$ "	2	2 $\frac{7}{8}$ "
2A	2 $\frac{1}{8}$ "	1 $\frac{1}{8}$ "	2 $\frac{3}{4}$ "	2 $\frac{3}{8}$ "	3 $\frac{1}{8}$ "
3A	2 $\frac{1}{8}$ "	1 $\frac{1}{8}$ "	3 $\frac{1}{8}$ "	2 $\frac{1}{8}$ "	3 $\frac{3}{8}$ "
4A	3 $\frac{1}{8}$ "	2 $\frac{1}{8}$ "	4 $\frac{1}{2}$ "	3	3 $\frac{7}{8}$ "
5A	4 $\frac{1}{8}$ "	3 $\frac{1}{8}$ "	5	3 $\frac{7}{8}$ "	5
5 $\frac{1}{2}$ A	4 $\frac{1}{8}$ "	3 $\frac{3}{8}$ "	5	4 $\frac{1}{2}$ "	5
6A	4 $\frac{1}{8}$ "	4 $\frac{1}{2}$ "	5	5 $\frac{1}{8}$ "	5
7A	5 $\frac{1}{2}$ "	4 $\frac{1}{8}$ "	6 $\frac{1}{8}$ "	5 $\frac{1}{8}$ "	6 $\frac{3}{8}$ "
8A	5 $\frac{3}{4}$ "	4 $\frac{1}{8}$ "	6 $\frac{1}{8}$ "	5 $\frac{1}{8}$ "	7 $\frac{1}{8}$ "
9A	6 $\frac{1}{8}$ "	5 $\frac{3}{4}$ "	7 $\frac{3}{4}$ "	6 $\frac{3}{8}$ "	7 $\frac{1}{8}$ "
10A	8 $\frac{5}{8}$ "	7 $\frac{1}{8}$ "	9 $\frac{1}{2}$ "	8 $\frac{1}{4}$ "	10 $\frac{3}{8}$ "

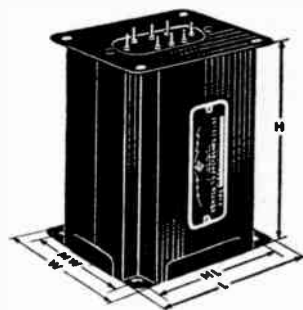

LOW IMPEDANCE SOURCE TO GRID TRANSFORMERS

Type No.	From	Primary Ohms	Secondary Ohms	Case No.	List Price
T-1 (Hum Bucking Type)	S.B. or D.B. Mic.	400-300-200-100-50	80,000 Single Grid	1A	\$5.50
T-2 (Hum Bucking Type)	Any Line	500-333-250-200-125-50	80,000 Single Grid	1A	5.50
T-3 (Hum Bucking Type)	Any Line	500-333-250-200-125-50	80,000 P.P. Grids	1A	5.50
T-4	Plate or D.B. Mic.	400-20,000	160,000 Single Grid	2A	5.50
T-5	S.B. or D.B. Mic.	400 C.T.	140,000 Single Grid	1A	4.50
T-6 (See Bottom Page 9)	Any Line	500-333-250-200-125-50	20,000 Single Grid	1A	9.75
T-7 Ratio 1:100	S.B. Mike	100	P.P. cl.A Grids	1A	4.75

LINE TRANSFORMERS—LINE to LINE and LINE to VOICE COIL

Type No.	Primary Ohms	Secondary Ohms	Maximum Level	Case No.	List Price
T-25	500-200-50	500-200-50	+24 D.B.	2A	\$5.50
T-26 (Hum Bucking Type)	500-333-250-200-125-50	500-333-250-200-125-50	+24 D.B.	1A	5.50
T-27	500-200	15-8-4	15 watts	3A	6.25
T-28	500-200	15-8-4	30 watts	4A	7.00
T-29	500-200	15-8-4	60 watts	5A	9.75

KEN-O-LINE AUTO TRANSFORMERS

(TO COUPLE ONE TO SIX SPEAKERS TO LINE)

Type No.	Primary Ohms	Secondary Ohms	Maximum Level	Case No.	List Price
T-30	500-1000-1500-2000-2500-3000	.16-.36-.64-1-1.4-2-3.2-4-5-8-10-16	10 watts	2A	\$5.50
T-31	500-1000-1500-2000-2500-3000	.16-.36-.64-1-1.4-2-3.2-4-5-8-10-16	30 watts	4A	8.00
T-32	500-1000-1500-2000-2500-3000	.16-.36-.64-1-1.4-2-3.2-4-5-8-10-16	60 watts	5A	10.75

INTERSTAGE AUDIO TRANSFORMERS

Type No.	From	To	Ratio	Case No.	List Price
T-51	Single 10,000 Ohm Plate	Single Grid	1:4	1A	\$4.25
T-52	Single 10,000 Ohm Plate	P.P. Grids	1:4	1A	4.25
T-53	Detector or S.B. Mic.	Single Grid		1A	5.00
T-54	P.P. 10,000 Ohm Plates	P.P. Grids	1:1.8	2A	5.50
T-55	Single 10,000 Ohm Plate	Single Grid	1:3	2A	5.00
T-56	Single 10,000 Ohm Plate	P.P. Grids	1:2	2A	5.00
T-57 (Hum Bucking Type)	Single 10,000 Ohm Plate	Single Grid	1:2	2A	5.50
T-58 (Hum Bucking Type)	Single 10,000 Ohm Plate	P.P. Grids	1:2	2A	5.50

KEN-O-DRIVE UNIVERSAL DRIVER TRANSFORMERS

T-261	500-ohm line to P. P. grids. Level 7 watts Primary and Secondary tapped to drive any Class "B" grids	3A	\$7.50
T-262	500-ohm line to P. P. grids. Level 18 watts Primary and Secondary tapped to drive any Class "B" grids	4A	8.75
T-264	To match a 500-ohm line or any driver plates to any Class "B" grids, maximum driving power, 7 watts	3A	7.50
T-263	To match a 500-ohm line or any driver plates to any Class "B" grids, maximum driving power, 18 watts	4A	10.25

DRIVER TRANSFORMERS

Type No.	Primary To Match	Class AB or Class B Tubes	Ratio (Pri. to 1/2 Sec.)	Case No.	List Price
T-251	Single 53, 6A6, 6N7, 56, 6CS	53, 6A6, 6N7	2.3:1	2A	\$4.25
T-252	Single 30, 49, 89	19, 30's, 49's	1.7:1	1A	3.75
T-253	Single 46, 59	46's, 59's, 6F6's	2.3:1	2A	4.50
T-254	Single 45, 2A5, 6F6, 42	45's, 2A5's, 6F6's, 42's	3.0:1	2A	4.50
T-255	P.P. 56, 6CS, 53, 6N7	6L6's	3.2:1	2A	4.25
T-256	P.P. 56, 6CS	45's, 2A3's, 6F6's	3.0:1	2A	4.50
T-257	P.P. 45's	4-46's	3.0:1	2A	4.50
T-258	P.P. 45's	800's	2.2:1	3A	6.00
T-259	P.P. 2A3's	203A's, 838's, 805's	3.1:1	4A	7.25
T-260	4-2A3's	HD203A's, 4-838's	3.1:1	4A	8.75
T-265	4-2A3's	T-814's, 806's, 150T's, HF-200's	1.35:1	4A	8.75
T-266	P.P. 2A3's	50T's, 100TL's, HK-154	1.5:1	4A	8.75
T-267	4-2A3's	354E's, 354F's	2.1:1	4A	8.75
T-271	P.P. 45's, 2A3's, 6F6's	6L6's, 809's, TZ40's	3.7:1	3A	6.00



KENYON TRANSFORMERS



PLATE AND FILAMENT TRANSFORMERS

Type No.	High Voltage—Volts	Filament No. 1 M.A. Volts Amps	Filament No. 2 Volts Amps	Filament No. 3 Volts Amps	Filament No. 4 Volts Amps	Case No.	List Price
T-211**	0-1000	10 2.5 1.75				4A	\$9.50
T-249*	235-0-235	20 6.3C.T. 0.6	6.3C.T. 0.9			2A	5.50
T-245*	320-0-320	40 5 2	6.3C.T. 2			3A	6.25
T-201*	0-75	70 5 2				2A	5.00
T-205*	350-0-350	75 5 2	6.3C.T. 3			4A	8.00
T-222*	250-0-250	50 5 2	6.3C.T. 2			3A	6.75
T-206*	325-0-325	100 5 3	6.3C.T. 3	6.3C.T. 2		5A	10.25
T-212	420-0-420	125 5 3	6.3C.T. 3	2.5C.T. 4		5A	11.50
T-214	420-360-125-0-360-420	150 5 3	2.5C.T. 3	2.5C.T. 5	6.3C.T. 3	5A	12.00
T-244*	425-0-425	165 5 3	6.3C.T. 3	6.3C.T. 3		6A	13.50
T-248*	425-0-425	165 5 3	2.5C.T. 6	2.5C.T. 6		6A	15.00
T-213	520-110-0-520	180 5 3	2.5 3	6.3C.T. 3	6.3C.T. 3	5A	13.50
T-215	360-125-0-360	200 5 3	2.5C.T. 3	2.5C.T. 10	6.3C.T. 2.1	5A	13.50
T-247	590-0-590	200 5 3	6.3C.T. 3	6.3C.T. 3		5A	13.50
T-216	520-85-0-520	250 5 3	2.5C.T. 3	6.3C.T. 3	6.3C.T. 3	6A	15.50
T-202*	0-150	20 6.3 0.6				1A	5.00
T-220*	125-0-125	200 5 3				4A	7.50
T-246	625-0-625	250 5 3	6.3C.T. 3	6.3C.T. 3		6A	16.25
T-223	600-0-600	300 5 6	6.3C.T. 3	6.3C.T. 2		6A	14.25
T-221	High Voltage Secondary	520-390-105-390-520 to deliver 400 V.D.C. at 400 M. A. and 300 V.D.C. at 160 M.A.				7A	31.00

Filament No. 1
5V-6A

Filament No. 2
5V-3A

Filament No. 3
2.5V-3A

Filament No. 4
6.3V C.T.-4A

Filament No. 5
6.3V C.T.-4A

* Indicates unit designed for condenser input. (All other units should be used choke input.)

** Primary Tapped 0/105/115/125 Secondary 0/100/200/300/400/500/600/700/800/900/1000 V. A.C.

POWER LINE AUTO TRANSFORMERS

Type No.	Input	Output	Capacity Volt-Amperes	Case No.	List Price
T-217	88 to 130 volts	115 volts	150	3A	\$8.00
T-218	88 to 130 volts	115 volts	300	4A	10.50
T-219	88 to 130 volts	115 volts	500	5A	13.50

FILAMENT TRANSFORMERS — SINGLE WINDING

Type No.	Input	Output	Case No.	List Price
T-388	2.5, 5, 6.3 V-2A	1000 V. Test	1A	\$3.75
T-379	2.5 V.-5 A. CT.	2000 V. Test	1A	4.00
T-352	2.5 V.-10 A. CT.	2000 V. Test	2A	4.50
T-360	2.5 V.-10 A. CT.	5000 V. Test	3A	6.25
T-354	5 V.-3 A. CT.	2000 V. Test	2A	4.50
T-357	5.25 V.-12 A. CT.	2000 V. Test	4A	7.50
T-358	5.25 V.-20 A. CT.	2000 V. Test	5A	8.75
T-380	5, 5.1, 5.25 V.-8 A. CT.	2000 V. Test	4A	7.50
T-391	5, 5.1, 5.25 V.-10.5 A. CT.	2000 V. Test	4A	8.00
T-382	5, 5.1, 5.25 V.-16 A. CT.	2000 V. Test	4A	9.00
T-383	5, 5.1, 5.25 V.-21 A. CT.	2000 V. Test	5A	10.00
T-393	5, 5.1, 5.25 V. 26 A. CT.	2000 V. Test	5A	10.00
T-351	6.3 V.-3 A. CT.	2000 V. Test	2A	4.25
T-378	6.3, 7.5 V.-7 A. CT.	2000 V. Test	3A	5.50
T-392	7.5, 7.7, 7.9 V. 6 A. CT.	2000 V. Test	3A	5.25
T-353	7.5 V. 4½ A. CT.	2000 V. Test	2A	4.50
T-358	7.5 V.-9 A. CT.	2000 V. Test	4A	7.00
T-365	10 V.-4 A. CT.	5000 V. Test	3A	6.25
T-361	10 V.-8 A. CT.	5000 V. Test	4A	8.00
T-384	10, 10.5, 11 V.-5 A. CT.	2000 V. Test	4A	8.00
T-385	10, 10.5, 11 V.-10 A. CT.	2000 V. Test	5A	10.00
T-387	6.3, 6.45, 6.6 V.-8A	2000 V. Test	3A	5.00
T-389	2.5 V.-10 A. CT.	9000 V. Test	4A	9.25
T-390	5 V.-20 A. CT.	10000 V. Test	5½A	17.25
T-391	5 V.-20 A. CT.	5000 V. Test	5A	10.00

FILAMENT TRANSFORMERS — TWO WINDINGS

Type No.	Input	Output	Case No.	List Price
T-386	6.3 V.-3 A. CT.	2000 V. Test 5 V.-4 A. CT.	3A	5.50
T-369	2.5 V.-8 A. CT.	1000 V. Test 6.3 V.-4 A. CT.	4A	7.00
T-368	6.3 V.-4 A. CT.	2000 V. Test 6.3 V.-4 A. CT.	4A	7.00
T-386	2.5 V.-10 A. CT.	5000 V. Test 2.5 V.-10 A. CT.	4A	8.75
T-363	10 V.-6.5 A. CT.	5000 V. Test 10 V.-3.25 A.	5A	10.25
T-362	11-12 V.-8 A. CT.)	5000 V. Test 10-11 V.-3.5 A. CT.	5A	12.00

FILAMENT TRANSFORMERS — THREE WINDINGS

Type No.	Input	Output	Case No.	List Price
T-376	6.3 V.-4 A. CT.	2000 V. Test 6.3 V.-4 A. CT.	2000 V. Test 4A	8.00
T-364	2.5 V.-8 A. CT.	750 V. Test 2.5 V.-10 A. CT.	750 V. Test 4A	8.75
T-356	6.3 V.-3 A. CT.	750 V. Test 5 V.-4 A. CT.	3000 V. Test 4A	9.75
T-355	5 V.-3 A. CT.	4000 V. Test 5 V.-3 A. CT.	4000 V. Test 4A	8.75
T-375	2.5 V.-5 A. CT.	6000 V. Test 2.5 V.-5 A. CT.	6000 V. Test 4A	10.25



KENYON TRANSFORMERS



PREAMPLIFIER OUTPUT TRANSFORMERS

Type No.	From	Secondary Ohms	Case No.	List Price
T-101	Single 56, 76, 6C5	200-500	1A	\$4.25
T-102	P.P. 56, 76, 6C5	200-500	1A	4.25

OUTPUT TRANSFORMERS TO 500-200 or 15-8-4 OHMS

Type No.	From	Primary Ohms	Case No.	List Price
T-103	Class "A", P.P. 45's, 43's	10,000	2A	\$5.50
T-104	Single 2A5, 6F6, 42, 47, 89	7,000	2A	5.00
T-105	Class "A", P.P. 2A5's, 6F6's, 42's, 47's, 89's	14,000	2A	5.50
T-106	Class "A", P.P. 6B5's, 2B6's	10,000	3A	6.25
T-107	Class "A", P.P. 25L6's	2,000	2A	5.00
T-301	Class "A", P.P. 6L6's, Class AB 45's, 2A3's	5,000 or 3,000	4A	7.50
T-302	Class "AB", 6V6's, Class "B" 19, 49's, 53, 6N7, RK-34	10,000	3A	7.00
T-303	Class "AB", 42's, 6F6's, 2A5's, Class "B" 46's, 59's	10,000 or 6,000	4A	7.25
T-304	Class "AB", 4-45's, 4-2A3's	2,500 or 1,500	4A	8.75
T-305	Class "AB" 4-2A5's, 42's, 6F6's, Class "B" 4-46's, 59's	5,000 or 3,000	4A	8.75
T-306	Class "B", P.P. 25L6's	2,000	2A	6.00
T-307	Class "AB2", P.P. RK-39's, 807's, 4-6L6's	6,400 or 1,900	6A	16.25
T-317	Class "AB", P.P. 6L6's	6,600 or 3,800	4A	8.75
T-319	Class "AB2", P.P. 6L6's	6,000 or 3,800	5A	10.25

KEN-O-DYNE UNIVERSAL OUTPUT TRANSFORMERS

Type No.	Case No.	List Price	Will match any set of Push-Pull or Push-Pull Parallel—a single plate to 500-200 or speaker voice-coils. Low impedance connection for speaker voice-coils range from .5 to 25 ohms.
T-108	15 watts	3A \$7.00	
T-109	30 watts	4A 9.75	
T-110	60 watts	5A 12.00	

GRID MODULATION TRANSFORMERS

Type No.	Application	Case No.	List Price
T-490	Single 2A5, 42, 6F6 to Grids of 203A's, 211's	2A	\$5.00
T-491	Single 45 to Grids of 203A's, 211's	2A	5.00
T-492	P.P. 45's to Grids of 203A's, 211's	3A	5.50

MODULATION TRANSFORMERS

Type No.	Primary Ohms	Max. Audio Level	Ohms	Secondary M.A.	Ohms	M.A.	Ohms	M.A.	Case No.	List Price
T-451	10,000	10 watts	5,000	100	3,000	100			2A	\$5.00
T-452	15,000	5 watts	5,000	50	3,000	50			1A	4.25
T-453	5,000	20 watts	5,000	130	3,000	130			4A	8.75
T-454	10,000 or 6,000	30 watts	8,000	75	6,000	100	4,000	140	4A	8.75
T-455	10,000	60 watts	9,000	130	7,000	150	5,000	180	5A	13.50
T-456	2,000	40 watts	9,000	100	7,000	125	5,000	150	5A	13.50
T-457	5,000 or 3,000	60 watts	7,000	120	5,000	160	3,000	220	5A	13.50
T-458	10,000	80 watts	9,000	130	7,000	150	5,000	180	6A	13.50
T-459	3,800	60 watts	7,000	200	5,000	250	2,500	300	5A	13.00
T-460	12,000	100 watts	10,000	150	8,000	175	6,000	200	6A	15.25
T-461	16,000	140 watts	10,000	175	7,000	200	5,000	240	6A	16.25
T-462	7,000	140 watts	8,000	200	6,000	250	4,000	300	6A	16.25
T-463	11,000	500 watts	6,000	400	4,000	500	3,000	570	8A	46.75
T-464	12,000	300 watts	8,000	250	6,000	300	4,000	370	7A	29.50
T-465	(Replaced by T-479)									
T-466	8,400	110 watts	8,000	160	5,000	200	3,000	270	6A	16.25
T-467	7,200	200 watts	6,500	240	4,500	280	3,000	350	7A	26.50
T-468	16,000	400 watts	8,000	300	5,000	375	3,000	500	8A	46.75
T-469	12,000	70 watts	10,000	120	7,000	140	4,500	180	5A	13.50
T-470	(Replaced by T-480)									
T-477	6,700 or 4,700	80 watts	10,000	130	7,000	160	4,500	200	5 1/2 A	13.50
T-478	16,000	225 watts	7,000	270	5,000	320	3,500	400	7A	29.25
T-479	9,000 or 6,700	300 watts	8,000	250	6,000	300	4,000	370	7A	29.75
T-480	9,000 or 6,700	500 watts	8,000	350	6,000	400	4,000	500	8A	46.75

PLATE TRANSFORMERS FOR STANDARD AMATEUR DUTY

Type No.	Secondary Voltage	D.C. Volts	D.C. M.A.	Case No.	List Price
T-668	1000/750-0-750/1000	500/750	300	5 1/2 A	\$12.00
T-669	1460/1180-0-1180/1460	1000/1250	300	7A	19.25
T-670	2360/2080/1760-0-1760/2080/2360	1500/1750/2000	300	8A	26.50
T-671	1460/1180-0-1180/1460	1000/1250	500	9A	26.50
T-672	1760/1460/1250-0-1250/1460/1760	1000/1250/1500	300	8A	24.00



KENYON TRANSFORMERS



KEN-O-TAP MODULATION TRANSFORMERS

KEN-O-TAP Transformers never grow obsolete! Ideal for amateurs who wish to keep up to date with new tube combinations. Will match any Class B tube or tubes to any Class C load.

Type No.	Audio Output Primary	Class "C" Secondary	Primary Range	Secondary Range	Case No.	List Price
T-489	15 watts	30 watts	2000 - 20000	200 - 20000	3A	\$5.50
T-493	40 watts	80 watts	2000 - 20000	200 - 20000	4A	8.00
T-494	75 watts	150 watts	2000 - 20000	200 - 20000	5A	12.00
T-495	125 watts	250 watts	500 - 18000	200 - 19000	7A	26.50
T-496	300 watts	600 watts	500 - 18000	200 - 19000	8A	40.25

PLATE TRANSFORMERS FOR HEAVY AMATEUR DUTY

Type No.	Primary Conn.	SECONDARY No. 1			SECONDARY No. 2			SECONDARY No. 3			Standard Amateur M.A. D.C.	Case No.	List Price
		D.C.	A.C.	M.A. D.C.	D.C.	A.C.	M.A. D.C.	D.C.	A.C.	D.C.			
T-864		600	740-0-740	150						200	5A	\$10.25	
T-855	High	450	575-0-575	250						325	5A	10.75	
	Low	350	460-0-460	250									
T-856	High	750	925-0-925	300						400	6A	14.75	
	Low	600	740-0-740	300									
T-857	High	1000	1170-0-1170	200	1000	1170-0-1170	200			250	7A	31.00	
	Low	750	900-0-900	200	750	900-0-900	200						
T-858	High	500	650-0-650	175	560	710-0-710	175	560	710-0-710	175	All windings	7A	28.25
	Medium	450	585-0-585	175	510	640-0-640	175	510	640-0-640	175			
	Low	400	520-0-520	175	450	570-0-570	175	450	570-0-570	175			
T-854	High	470	610-0-610	250	625	785-0-785	250	625	785-0-785	250	20%	8A	37.00
	Medium	420	550-0-550	250	560	710-0-710	250	560	710-0-710	250			
	Low	375	490-0-490	250	500	630-0-630	250	500	630-0-630	250			
T-859	High	500	650-0-650	350	560	710-0-710	350	560	710-0-710	350	higher current	9A	40.25
	Medium	450	585-0-585	350	510	640-0-640	350	510	640-0-640	350			
	Low	400	520-0-520	350	450	570-0-570	350	450	570-0-570	350			
T-865	High	1250	1470-0-1470	250						300	7A	26.50	
	Low	1000	1180-0-1180	250									
T-866		1250	1460-0-1460	350						400	8A	32.25	
T-867		1250	1460-0-1460	500						600	9A	39.75	
T-860		1250	1460-0-1460	500	500	630-0-630	200			600-400	9A	46.75	
T-861		1750	2080-0-2080	200						250	7A	26.75	
T-852	High	1750	2080-0-2080	450						550	9A	50.75	
	Low	1500	1760-0-1760	450									
T-651	High	1750	2080-0-2080	300						350	9A	40.25	
	Low	1500	1760-0-1760	300									
T-653		2000	2360-0-2360	300						350	9A	43.00	
T-663		2000	2360-0-2360	600						700	10A	80.25	
T-673		3000/2500	3400/2840-0-2840/3400	350						450	10A	84.75	

All power transformers are designed for 115 volt, 50 to 60 cycle operation. For 230 volt 60 cycle operation add 25% to list prices. For 115 volt 25 cycle operation add 60% to list prices. For 230 volt 25 cycle operation add 100% to list prices. Case sizes for 25 cycle application are different than those specified for standard 115 volt 50 to 60 cycle operation.

FILTER REACTORS

Type No.	Inductance Henries	Max. M.A.	D.C. Resistance	Insulation Test	Case No.	List Price
T-155	290	10	4700	1000 V.	2A	\$4.25
T-156	350—CT	10	10000	1000 V.	3A	4.25
T-156	30	25	800	1000 V.	1A	3.25
T-157	20	50	200	1000 V.	1A	2.75
T-153	30	90	350	1000 V.	3A	4.25
T-154	15	165	210	1000 V.	3A	4.50
T-151	10	250	100	1000 V.	4A	7.00
T-152	10	200	100	1000 V.	3A	5.00
T-164	14	250	135	1500 V.	5A	9.75
T-166	11	300	125	1500 V.	5A	9.75
T-159	12	500	77	1500 V.	6A	12.00
T-165	10	150	275	3000 V.	3A	5.00
T-169	13	250	125	3000 V.	5A	9.75
T-160	11	300	120	3000 V.	5A	10.75
T-167	11	400	80	3000 V.	6A	12.75
T-175	10	200	140	5000 V.	4A	7.00
T-176	10	300	110	5000 V.	5A	9.75
T-178	10	400	90	5000 V.	6A	13.50
T-177	12	500	95	5000 V.	7A	20.75
T-161	10	600	50	5000 V.	7A	20.75
T-179	20	400	110	7000 V.	8A	30.25

SWINGING REACTORS

Type No.	Inductance Henries	Max. M.A.	D.C. Resistance	Insulation Test	Case No.	List Price
T-517	15-45	90-20	350	1000 V.	3A	\$4.25
T-515	10-25	165-30	210	1000 V.	3A	4.50
T-506	5-20	200-30	100	1000 V.	3A	5.00
T-501	5-15	250-30	100	1000 V.	4A	7.00
T-507	7-25	250-50	135	1500 V.	5A	9.75
T-510	6-19	300-30	125	1500 V.	5A	9.75
T-502	6-18	500-50	77	1500 V.	6A	12.00
T-511	5-20	170-20	275	3000 V.	3A	5.00
T-508	7-26	250-50	125	3000 V.	5A	9.75
T-514	5-20	300-50	120	3000 V.	5A	10.75
T-516	5-20	400-50	80	3000 V.	6A	12.75
T-509	6-19	200-30	140	5000 V.	4A	7.50
T-512	5-15	300-30	110	5000 V.	5A	9.75
T-513	5-18	400-50	90	5000 V.	6A	13.50
T-521	6-21	500-50	95	5000 V.	7A	20.25
T-505	5-17	600-60	50	5000 V.	7A	19.75
T-522	5-20	400-50	110	7000 V.	8A	30.25



KENYON TRANSFORMERS



FILAMENT TRANSFORMERS — FOUR WINDINGS

T-373	2.5 V.-5 A. CT. 750 V. Test	5 V.-3 A. 750 V. Test	7.5 V.-3.25 A. CT. 3000 V. Test	7.5 V.-8 A. CT. 3000 V. Test	5A	\$10.75
T-374	2.5 V.-5 A. CT. 750 V. Test	5 V.-3 A. 750 V. Test	6.3 V.-3 A. CT. 3000 V. Test	7.5 V.-8 A. CT. 3000 V. Test	5A	10.75
T-370	6.3 V.-3 A. CT. 750 V. Test	6.3 V.-3 A. CT. 750 V. Test	2.5 V.-4 A. CT. 750 V. Test	5 V.-3 A. 750 V. Test	4A	8.75
T-371	5 V.-3 A. 750 V. Test	6.3 V.-3 A. CT. 750 V. Test	6.3 V.-3 A. CT. 750 V. Test	7.5 V.-8 A. CT. 2500 V. Test	5A	10.75
T-372	5 V.-3 A. 750 V. Test	5 V.-3 A. CT. 750 V. Test	6.3 V.-3 A. CT. 750 V. Test	7.5 V.-4 A. CT. 2000 V. Test	5A	10.75
T-367	6.3 V.-5 A. CT. 2000 V. Test	6.3 V.-5 A. CT. 2000 V. Test	5 V.-6 A. CT. 2000 V. Test	5 V.-3 A. CT. 2000 V. Test	5A	10.75

FILAMENT TRANSFORMERS — FIVE WINDINGS

T-377	5 V.-3 A. 2000 V. Test	5 V.-6 A. 2000 V. Test	6.3 V.-1 A. CT. 2000 V. Test	6.3 V.-5 A. CT. 2000 V. Test	6.3 V.-5 A. CT. 2000 V. Test	5A	12.00
-------	---------------------------	---------------------------	---------------------------------	---------------------------------	---------------------------------	----	-------

LABORATORY STANDARD AUDIO TRANSFORMERS

We invite you to investigate our laboratory standard units to convince yourself that our claims are modest indeed. These units can be found in the finest broadcast stations of the world. Ask the man who uses Kenyon and you will then understand the phenomenal success of these thoroughly dependable high-fidelity transformers.

PORTABLE BROADCAST TRANSFORMERS

Designated by letter "P"—case size of all units—1A—see "T" line case size chart.

LINE TO LINE TRANSFORMERS

Type	Application	Response	Impedance Ratio	Level	List Price
P-100	Line to line	±1 db, 40-12,000	Multiple line to multiple line	+20	\$13.25
P-101	Dynamic microphone or low impedance pickup to line	40-12,000	10/20/30 ohm line to multiple line	+20	13.25

LINE TO GRID TRANSFORMERS

P-200	Line to grid	40-12,000	Multiple line to 80,000 ohms (α)	+20	13.25
P-201	Dynamic microphone or low impedance pickup to grid	40-12,000	10/20/30 ohm line to 80,000 ohms (α)	+20	13.25
P-202	Line to grid	±2 db 30-15,000	Multiple line to 50,000 ohms (α)	+20	15.50
P-203	Line to PP grids	±2 db 30-15,000	Multiple line to 100,000 ohms (α)	+20	18.75
P-204	Line to grid	30-20,000	Multiple line to 50,000 ohms (α)	+20	22.00
P-205	Line to PP grids	30-20,000	Multiple line to 100,000 ohms (α)	+20	25.75

INTERSTAGE TRANSFORMERS

P-300	Single plate to single grid	40-12,000	1:2 overall	6 MA	11.00
P-301	Single plate to push pull grids	40-12,000	1:2 overall	6 MA	13.25

OUTPUT TRANSFORMERS

P-400	Single plate to line	40-12,000	Plate (c) to multiple line	+20	13.25
P-401	Push pull plates to line	40-12,000	Plates (c) to multiple line	+20	13.25

AUDIO CHOKES

	Rated D.C.	Inductance	D.C. Resistance	List Price
P-500	3 MA	300 Hys.	6000 Ohms	11.00
P-501	10 MA	40 Hys.	800 Ohms	11.00

(α) Solit winding—impedance refers to entire secondary.

(c) "Plate" refers to such tubes as 6C5, 56, 30, 846, etc., having an A.C. plate resistance of the order of 10,000 ohms.



BAND PASS FILTER T-800*

Designed to help put signals through tough QRM by eliminating those frequencies unnecessary for amateur communication purposes.

Primary impedance VC/500/10,000 ohms. Secondary impedance VC/500/10,000 ohms. Max. level, 6 watts. **List Price \$17.25**

*Can be used as an interstage, input or output transformer. Also from VC to VC for receiving purposes.



KENYON TRANSFORMERS

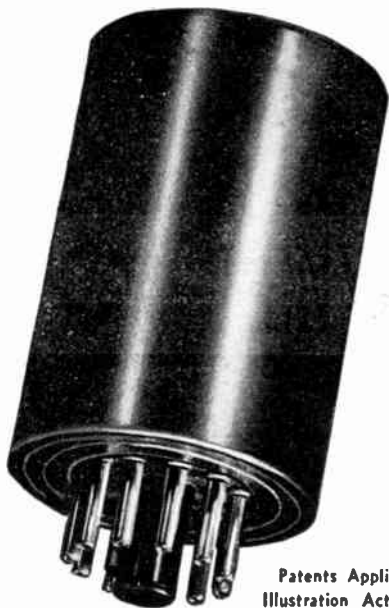

Patents Applied For
Illustration Actual Size

Tube Base... AUDIO UNITS Standard and Submersion Proof Types

Here is really the latest in transformer design. Smart in appearance, quickly installed, compact in space, wide in application, these new Kenyon "A" Line Units will solve many a manufacturing and P. A. problem. Designed for use where space is at a premium and where weight must be kept at a minimum without making any sacrifice in performance characteristics.

"A" Line transformers are excellent for aircraft, marine, portable broadcast, geophysical and undersea operation. They cut space and assembly time in half. Merely punch a 1 1/8" round hole, fasten the 11-prong socket in place and plug any of the "A" Line Units in position. They fit so snugly that it requires considerable effort to remove them. ALL "A" Line transformers have the minimum hum pick-up axis parallel to the locating pin on the octal base in order that they may be oriented for minimum hum pick-up. All units are supplied with Kenyon Mounting Sockets.

CASE DIMENSIONS

All "A" Line units are housed in a round case 2-3/16" high and 1 1/2" in diameter. Illustration shown on this page is ACTUAL SIZE.

Type No.	Primary Impedance	Secondary Impedance	Stand. Type List Price	Sub. Proof Type List Price
LINE TRANSFORMER				
A-10	500-333-250 200-125-50 ohms	500/125 ohms •	12.25	15.25
CRYSTAL MIKE TO LINE				
A-15	100,000	500-333-250 200-125-50 ohms	13.25	16.25
LOW IMPEDANCE SOURCE TO GRID				
A-20	500-333-250 200-125-50 ohms	50,000 ohms • single grid	12.75	15.75
A-21	30/120 ohms	50,000 ohms • single grid	12.75	15.75
A-22	500-333-250 200-125-50 ohms	100,000 ohms • P. P. grids	13.25	16.25
A-23	200/50	Single grid † 50:1 ratio 500,000 ohms	13.25	16.25
A-24	200/50	P. P. grids † 50:1 ratio 500,000 ohms	13.25	16.25
INTERSTAGE TRANSFORMERS				
A-30	8,000-15,000 ohm plate	1 grid • 1:2 ratio overall	12.25	15.25
A-31	8,000-15,000 ohm plate	2 grids • 1:2.3 ratio overall	12.25	15.25
A-32	8,000-15,000 ohm plate	1:12.5 ratio † overall	13.25	16.25
A-33	8,000-15,000 ohm plate	2 grids † 1:12.5 overall	13.25	16.25
A-34	Hi-mu triode or pentode plate	1 grid † 1:2 ratio overall	12.25	15.25
A-35	Hi-mu triode or pentode plate	2 grids † 1:2.3 ratio overall	12.25	15.25
A-36	1G4G, 1H4G, 19 30 plate	P. P. class B † 1G6G, 1J6G 19, 30 grids	12.25	15.25

Type No.	Primary Impedance	Secondary Impedance	Stand. Type List Price	Sub. Proof Type List Price
OUTPUT TRANSFORMERS				
A-40	8,000-15,000 ohm plate 8 MA. MAX. D. C.	500-333-250- • 200-125-50	12.25	15.25
A-41	P. P. 8,000-15,000 ohm plate 8 MA. MAX. D. C.	500-333-250- • 200-125-50	12.25	15.25
A-42	1-1A5G, 1-1E7G 1F5G, 2-1F5G's (AB)	5000-3330- † 2500-2000-		
A-43	1-1C5G, 1-1Q5GT, 1-1S4, 1-1G5G, (12,000 ohms C.T.) 15 MA. MAX. D. C.	1250-500	11.00	14.00
A-44	1-1D8GT (Pent sec) 1-1G6G (cl B) 1-1T5 1-1J6G (cl B) 8,500 ohms C.T. 20 M.A. MAX. D. C.	5000-3330- † 2500-2000- 1250-500	11.00	14.00
CHOKES				
A-50	300 hys. 2 MA - 6000 ohms 75 hys. 4 MA - 1500 ohms 6/12 M.A. Max. D. C.		11.00	14.00
A-51	60 hys. 7.5 MA - 2500 ohms 15 hys. 15 MA - 825 ohms 15/30 MA. MAX D. C.		11.00	14.00
* ±2 db 30 to 20,000 cycles (No. D. C. in windings) † Voice frequencies All others ±2 db 30 to 15,000 cycles ALL HUM-BUCKING CONSTRUCTION				

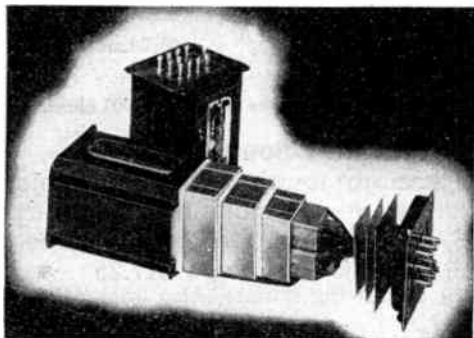

TELESCOPIC SHIELDED HUMBUCKING TRANSFORMERS

TYPE P-202
Multiple line to single class A grid. (50,000 Ohms). Plus or minus 2 DB. 30 to 15,000 cycles. Shielding: 90 DB. Case Size: 1A. List Price **\$15.50**

TYPE P-203
Primary and Frequency Response, same as P-202. Secondary: 100,000 ohms to PP Grids. Case Size: 1A. List Price **\$18.75**

TYPE P-204
Primary, Secondary and Shielding same as P-202. Frequency Response: plus or minus 1 DB. 30 to 20,000 cycles. Case Size: 2A. List Price . **\$22.00**

TYPE P-205
Primary, Secondary and Shielding same as P-203 except frequency response 1 DB 30 to 20,000 cycles. Case Size: 2A. List Price **\$25.75**

TYPE T-6
Primary: Multiple line to single Class A grid. Plus or minus 3 DB. 60 to 10,000 cycles. Case Size: 1A. List Price... **\$9.75**

STANCOR REPLACEMENT TRANSFORMERS

THE ONLY 100% COMPLETE TRANSFORMER SERVICE

POWER TRANSFORMERS — NEW UNIVERSAL TYPE

These units will service the majority of radios in use today. Four black-enamelled brackets furnished with each transformer to permit choice of five mounting positions—horizontal, vertical four hole half-shell, two hole half shell or Underwriter's type. Electro-statically shielded—R.M.A. color coded flexible leads.

Stancor Number	No. of Tubes	Plate V.C.T. Ma.	Fil. No. 1 V Ma.	Fil. No. 2 V Ma.	Fil. No. 3 V Ma.	Mtg. Type	Mtg. Area	Mtg. Ctrs.	Lbs. Wgt.	List Price
----------------	--------------	------------------	------------------	------------------	------------------	-----------	-----------	------------	-----------	------------

Universal Type — 2.5 Volt

P-6001	4-5	650	40	50-C.T.	2.0	25-C.T.	4.0	M	2 1/2" x 3"	2" x 2 1/2"	3.3	\$3.70	
P-6002	5-6	700	50	50-C.T.	2.0	25-C.T.	7.25	M	2 1/2" x 3"	2" x 2 1/2"	3.3	4.75	
P-6009	6-7	550	70	50-C.T.	3.0	50-C.T.	05	2.5-C.T.	10 5	M	2 1/2" x 3 1/2"	2 1/4" x 2 1/2"	4.2	5.45
P-6005	6-7	700	70	50-C.T.	3.0	25-C.T.	9.0	2.5-C.T.	3 5	M	2 1/2" x 3 1/2"	2 1/4" x 2 1/2"	5.4	5.45
P-6003	6-7	700	70	50-C.T.	3.0	25-C.T.	9.0	M	2 1/2" x 3 1/2"	2 1/4" x 2 1/2"	3.8	4.95	
P-6004	8-9	700	90	50-C.T.	3.0	25-C.T.	12.5	M	3 1/2" x 3 3/4"	2 1/2" x 3 1/2"	5.4	5.80	
P-6007	10-12	800	110	50-C.T.	3.0	25-C.T.	15.0	2.5-C.T.	3 5	M	3 1/2" x 3 3/4"	2 1/2" x 3 1/2"	6.3	7.45
P-6006	11-13	700	120	50-C.T.	3.0	25-C.T.	12.5	2.5-C.T.	3 5	M	3 1/2" x 3 3/4"	2 1/2" x 3 1/2"	5.9	7.15

Universal Type — 6.3 Volt

P-6289	5-6	420	40	50-C.T.	2.0	6.3-C.T.	2.0	M	2 1/2" x 3"	2" x 2 1/2"	3.1	\$3.70
P-6297	4-5	480	40	50-C.T.	2.0	6.3-C.T.	2.0	M	2 1/2" x 3"	2" x 2 1/2"	3.2	3.70
P-6010	4-5	650	40	50-C.T.	3.0	6.3-C.T.	2.0	M	2 1/2" x 3"	2" x 2 1/2"	3.3	3.70
P-6119	6-7	600	55	50-C.T.	2.0	6.3-C.T.	2.7	M	2 1/2" x 3"	2" x 2 1/2"	3.5	3.75
P-6129	7-9	630	70	50-C.T.	3.0	6.3-C.T.	3.5	M	2 1/2" x 3 1/2"	2 1/4" x 2 1/2"	5.2	5.00
P-6011	6-7	700	70	50-C.T.	3.0	6.3-C.T.	2.5	M	2 1/2" x 3"	2" x 2 1/2"	3.3	4.75
P-6312	7-8	580	90	50-C.T.	3.0	6.3-C.T.	2.8	M	3 3/4" x 2 1/2"	2 1/2" x 2 1/2"	5.4	5.70
P-6012	8-9	700	90	50-C.T.	3.0	6.3-C.T.	3.8	M	2 1/2" x 3 1/2"	2 1/4" x 2 1/2"	5.2	5.35
P-6013	11-13	700	120	50-C.T.	3.0	6.3-C.T.	4.7	M	3 1/2" x 3 3/4"	2 1/2" x 3 1/2"	5.3	5.90
P-6313	11-13	580	125	50-C.T.	3.0	6.3-C.T.	4.5	M	4 1/2" x 3 3/4"	3 1/2" x 2 1/2"	6.4	6.30
P-6014	13-15	750	150	50-C.T.	3.0	6.3-C.T.	5.0	M	3 3/4" x 3 3/4"	2 1/2" x 3 1/2"	5.8	7.75
P-6165	14-16	800	200	50-C.T.	4.0	6.3-C.T.	5.5	M	3 3/4" x 4 1/2"	3" x 3 3/4"	6.5	8.95
P-6314	14-16	700	207	50-C.T.	3.0	6.3-C.T.	5.8	M	4 1/2" x 3 3/4"	3 1/2" x 3"	7.7	8.80
P-6315	16-18	740	278	50-C.T.	3.0	6.3-C.T.	7.0	M	4 1/2" x 3 3/4"	3 3/4" x 3"	8.5	12.00

Universal Type — 6.3 and 2.5 Volt Combination

P-6293	6-7	600	60	50-C.T.	3.0	6.3-C.T.	2.5	2.5-C.T.	7.5	M	2 1/2" x 3 1/2"	2 1/4" x 2 1/2"	4.0	55.35
P-6294	8-9	750	85	50-C.T.	3.0	2.5-C.T.	9.0	6.3-5.0, 2.5-C.T.	3.5	M	2 1/2" x 3 1/2"	2 1/4" x 2 1/2"	4.0	6.25
P-6295	8-9	700	90	50-C.T.	3.0	6.3, 2.5 C.T.	3.5	2.5-C.T.	9.0	M	3 1/2" x 3 3/4"	2 1/2" x 3 1/2"	5.7	6.25
P-6234	11-13	660	90	50-C.T.	3.0	2.5-C.T.	12.0	6.3, 5.0, 2.5-C.T.	4.0	M	3 1/2" x 3 3/4"	2 1/2" x 3 1/2"	5.9	8.15
Has an additional 2.5 V. at 1.75 A.C.T. winding.														
P-6008	14-16	750	180	50-C.T.	3.0	6.3-C.T.	3.3	2.5-C.T.	6.0	M	3 1/2" x 4 1/2"	2 1/4" x 3 1/2"	6.5	8.35

UNIVERSAL POWER TRANSFORMERS With Motor Tuning Windings

P-6290	11-13	700	120	50-C.T.	3.0	6.3	4.7	50-24-18		M	3 3/4" x 3 1/2"	3 1/4" x 2 1/2"	5.4	\$7.20
P-6291	13-15	750	150	50-C.T.	3.0	6.3	5	50-24-18		M	3 3/4" x 3 1/2"	3 1/2" x 2 1/2"	5.9	8.15
P-6292		800	200	50-C.T.	3.0	6.3	5.2	50-24-18		M	4 1/2" x 3 1/2"	3 3/4" x 3"	7.8	10.50

Underwriters' type mounting studs, tapped to fit the bolts on these transformers. Catalog No. 2053. List price \$0.25 per set.

HALF SHELL TRANSFORMERS

Stancor No.	No. of Tubes	Plate		Filament 1		Filament 2		Filament 3		Mount- ing Type	Mtg. Area	Wgt. in Carton	List Price
		V.C.T. Ma.	V. Ma.	V.	A.	V.	A.	V.	A.				

Half Shell With Lugs—2.5 Volts

P-2750	4	650	40	5.0	2.0	2.5-C.T.	3.75	G	2 1/2" x 3"	2" x 2 1/2"	2.2	\$3.00
P-2770	4-5	650	40	5.0	2.0	2.5-C.T.	4.8	G	2 1/2" x 3"	2" x 2 1/2"	2.8	3.70
P-2868	4-5	650	40	5.0	2.0	2.5-C.T.	1.75	2.5	3.5	G	2 1/2" x 3"	2" x 2 1/2"	2.5	3.95
P-2869	5-6	700	50	5.0	2.0	2.5-C.T.	1.75	2.5	5.25	G	2 1/2" x 3 1/2"	2 1/4" x 2 1/2"	3.0	4.30
P-2859	6-7	700	70	5.0	3.0	2.5-C.T.	3.5	2.5	7.5	G	3 1/2" x 3 1/2"	2 1/4" x 2 1/2"	3.6	5.15
P-2860	8-9	700	90	5.0	3.0	2.5-C.T.	3.5	2.5	9.0	G	3 1/2" x 4 1/2"	2 1/4" x 3 1/2"	5.2	5.45

Half Shell With Lugs—6.3 Volts

P-2751	4	650	40	5.0	2.0	6.3-C.T.	1.6	G	2 1/2" x 3"	2" x 2 1/2"	2.2	\$3.25
P-2771	4-5	650	40	5.0	2.0	6.3-C.T.	2.0	G	2 1/2" x 3"	2" x 2 1/2"	2.8	3.50
P-947	4-5	700	50	5.0	2.0	6.3-C.T.	2.0	G	2 1/2" x 3 1/2"	2 1/4" x 2 1/2"	3.3	4.15
P-948	5-6	675	70	5.0	3.0	6.3-C.T.	2.5	G	3 1/2" x 3 1/2"	2 1/2" x 3 1/2"	4.7	5.45
P-949	7-10	700	120	5.0	3.0	6.3-C.T.	3.0	G	3 1/2" x 4 1/2"	2 3/4" x 3 1/2"	5.5	6.25
P-6335	6-8	700	120	5.0	3.0	6.3-C.T.	3.0	G	2 3/4" x 3 1/2"	2 1/4" x 2 1/2"	4.2	6.20
P-6336	6-8	600	150	5.0	3.0	6.3-C.T.	3.0	G	2 3/4" x 3 1/2"	2 1/4" x 2 1/2"	4.2	5.90
P-955	11-14	800	160	5.0	3.0	6.3-C.T.	4.5	G	3 3/4" x 4 1/2"	3" x 3 3/4"	6.5	8.15

All of the above transformers are for operation on 115 volts, 50-60 cycles. Other voltage and frequency combinations available on special order. Write for quotations.



TYPE "M"
Mounted
Vertically



TYPE "M"
Mounted
Half Shell



TYPE "M"
Mounted
Horizontally



TYPE "M"
May Also Be
Mounted
Underwriters'



TYPE "M"
Two Hole
Mounting



TYPE "G"



Write for Your
Free Stancor
Service Guide



STANCOR REPLACEMENT TRANSFORMERS

THE ONLY 100% COMPLETE TRANSFORMER SERVICE

POWER TRANSFORMERS (Fully Cased)

Stancor Number	No. of Tubes	Plate V.C.T.	Ma.	Fil. No. 1 V.C.T.	Ma.	Fil. No. 2 V.C.T.	Ma.	Fil. No. 3 V.C.T.	Ma.	Mtg. Type	Mtg. Area	Mtg. Ctrs.	Lbs. Wgt.	List Price
----------------	--------------	--------------	-----	-------------------	-----	-------------------	-----	-------------------	-----	-----------	-----------	------------	-----------	------------

Fully Shielded With Leads — 2.5 Volts

P-4042	6-7	700	70	5.0	3.0	2.5-C.T.	3.5	2.5	7.5	C	3 1/4" x 3"	2 1/2" x 1 3/8"	3.7	\$6.25
P-4043	8-9	700	90	5.0	3.0	2.5-C.T.	3.5	2.5	9.0	C	3 3/8" x 3 3/8"	2 1/4" x 2 1/2"	4.5	7.20
P-4044	10-12	700	110	5.0	3.0	2.5-C.T.	3.5	2.5	14.0	C	3 1/2" x 3 5/8"	2 1/4" x 2 1/2"	4.7	8.40

Fully Shielded With Leads — 6.3 Volts

P-4076	4-5	650	40	5.0	2.0	6.3-C.T.	2.0	C	2 1/2" x 2 1/2"	2 1/2" x 1 3/4"	2.7	\$4.80
P-4077	5-6	700	50	5.0	2.0	6.3-C.T.	2.6	C	3" x 2 3/4"	2 1/4" x 1 3/8"	3.2	5.20
P-4078	6-7	700	70	5.0	3.0	6.3-C.T.	3.0	C	3 1/2" x 3"	2 3/4" x 1 7/8"	4.0	6.20
P-4079	8-9	700	90	5.0	3.0	6.3-C.T.	3.5	C	3 3/8" x 3 3/8"	2 3/4" x 2 1/4"	4.9	6.85
P-4080	10-12	700	110	5.0	3.0	6.3-C.T.	4.5	C	3 3/8" x 3 3/8"	3" x 2 1/4"	5.4	7.50
P-6143	8-9	880	130	5.0	3.0	6.3-C.T.	3.5	C	3 3/8" x 4"	3" x 3"	5.0	8.75
P-4081	11-14	800	160	5.0	3.0	6.3-C.T.	4.5	C	3 3/8" x 3 1/2"	3" x 2 1/2"	5.0	8.95
P-4084*	11-14	800	175	5.0	3.0	6.3-C.T.	2.5	6.3-C.T.	2.5	C	3 3/8" x 4 1/8"	3" x 2 3/4"	11.0	10.70
P-5059	11-14	675	200	5.0	3.0	6.3-C.T.	5.0	C	3 3/8" x 4 3/8"	3" x 3 1/8"	10.0	10.25
P-6170	1200	200	5.0	3.0	6.3-C.T.	3.0	6.3-C.T.	4.0	C	3 3/8" x 4 3/8"	3" x 3 1/8"	13.3	10.00

Fully Shielded With Leads — 2.5 and 6.3 or 7.5 Volt Combination

P-4045	4-5	600	40	5.0	2.0	2.5-C.T.	5.25	6.3	2.0	C	2 5/8" x 2 5/8"	2 1/4" x 1 3/4"	2.7	\$4.70
P-4046	5-6	700	50	5.0	2.0	2.5-C.T.	7.25	6.3	2.6	C	3" x 3"	2 1/4" x 2"	3.2	5.45
P-4047	6-7	700	70	5.0	3.0	2.5-C.T.	9.0	6.3	3.0	C	3 1/2" x 3"	2 1/2" x 1 7/8"	3.7	6.40
P-4048	8-9	700	90	5.0	3.0	2.5-C.T.	10.0	6.3	3.5	C	3 3/8" x 3 1/2"	2 3/4" x 2 3/8"	5.0	6.95
P-4049	10-12	700	110	5.0	3.0	2.5-C.T.	14.0	6.3	4.5	C	3 3/8" x 3 3/8"	3" x 2 3/4"	5.3	7.85
P-3005†	10-12	720	125	5.0	3.0	2.5-C.T.	10.0	6.3-C.T.	4.0	C	3 3/8" x 3 3/8"	3" x 2 3/4"	5.5	7.50
P-4050*	11-14	800	160	5.0	3.0	2.5-C.T.	14.0	6.3	4.5	C	3 3/8" x 3 3/8"	3" x 2 3/4"	6.2	9.00
P-6169	1200	200	5.0	3.0	2.5-C.T.	10.0	7.5-C.T.	3.0	C	3 3/8" x 4 1/8"	3" x 3 1/8"	12.0	10.00

Universal 1.5; 2.5; 5 and 7.5 Volt Combination Transformers

Stancor Number	Plate		Rectifier		Filament No. 1		Filament No. 2		Mounting Type	Mounting Area	Mtg. Centers	Wght. in Carton	List Price
	V.C.T.	Ma.	V.	A.	V.	A.	V.	A.					
P-1501	600	60	5.0	3.0	1.5-C.T.	1.0	1.5	4	C	3 1/2" x 3 3/8"	2 1/2" x 2 1/2"	5.0	\$7.50
P-1503	700	120	5.0	3.0	1.5-C.T.	1.0	1.5	5	C	4" x 3 3/4"	3 1/2" x 3 1/8"	7.5	7.75
P-1505	700	120	5.0	3.0	2.5-C.T.	4.0	2.5-C.T.	3.5	C	4" x 3 3/4"	3" x 3"	7.5	7.85

SIX VOLT UNIVERSAL VIBRATOR TRANSFORMERS

These units equipped with mounting brackets for universal replacement work.

Stancor Number	Secondary		Type Mounting	Dimensions			Weight in Carton	List Price
	D.C. Volts to Filter	Ma.		H	W	D		
P-6301	150	40	S	2 1/4"	1 3/8"	2"	1.3	\$3.30
P-4060	225	40	N	3 1/2"	2 1/2"	3"	2.2	3.50
P-4061	250	50	N	3 1/2"	2 1/2"	3"	2.3	3.80
P-4062	260	65	N	3 1/2"	2 1/2"	3"	2.6	4.40
P-4063	285	75	N	3 1/2"	2 1/2"	3 1/4"	3.0	5.00
P-6131	330	100	N	3 1/2"	2 13/16"	3 1/4"	3.5	5.45

SIX VOLT D.C. OR 115 VOLT A.C. VIBRATOR TRANSFORMER

P-6166	350 Fil. 6.3 V.C.T.	135 2.25 A.	C	4 3/8"	3 3/8"	4"	9.0	\$8.50
--------	------------------------	----------------	---	--------	--------	----	-----	--------

SPEAKER FIELD SUPPLY TRANSFORMERS

Stancor Number	Primary Voltage	Secondary D.C. Volts	Secondary Ma. Output	Filament Winding	Type Mounting	Mounting Dimensions			Weight in Carton	List Price
						H	W	D		
P-6149	115	100	150	5 V @ 3 A	C	3 1/2"	2 13/16"	3 1/4"	3.2	\$5.00
P-6146	115	115	Up to 250	5 V @ 3 A	C	4"	3 1/4"	3 1/4"	5.0	5.90
P-6147	115	300	Up to 200	5 V @ 3 A	C	4 3/8"	3 1/8"	3 3/4"	7.5	8.00

*Has 80 V. bias tap and extra 2.5 V. 1.75A filament. †Has 80 V. bias tap and extra 5 V. 2A filament.
All of the above power transformers are for operation on 115 volts, 50-60 cycles.
Other voltage and frequency combinations available on special order. Write for quotations.



TYPE "C"



TYPE "H"



TYPE "S"



TYPE "N"



TYPE "KA"



TYPE "D"



OUTPUT TRANSFORMERS



UNIVERSAL OUTPUT TRANSFORMERS

Stancor Number	Output Tubes	Impedance		D.C. Pri. M.A.	Max. Audio Watts	Type Mounting	Dimensions			Weight in Carton	List Price
		Primary	Sec.				H	W	D		
A-3856	Single or P.P. Plates	4,000, 7,000, 8,000, 10,000, 14,000 C.T.	1 to 30	35	4	Q	1 1/8"	2 3/4"	1 1/4"	0.6	\$1.85
A-3843	Universal Single Plate	1,500, 2,000, 4,000, 5,000, 7,000, 10,000	1 to 30	55	10	Q	1 3/8"	2 11/16"	1 3/8"	0.7	1.85
A-3823	Single or P.P. Plates	4,000, 7,000, 8,000, 10,000, 14,000 C.T.	1 to 30	40	8	Q	1 3/4"	2 11/16"	1 3/8"	0.7	1.85
A-3850	Single or P.P. Plates	4,000, 7,000, 8,000, 10,000, 14,000 C.T.	1 to 30	40	8	J	2"	2 3/8"	1 3/8"	0.7	1.85
A-3852	Single or P.P. Plates	4,000, 7,000, 8,000, 10,000, 14,000 C.T.	1 to 30	40	18	J	2 1/4"	2 3/4"	2 1/4"	1.6	2.40
A-3870	Single or P.P. Plates	4,000, 7,000, 8,000, 10,000, 14,000 C.T.	1 to 30	50	18	Q	2"	3 1/8"	2 1/4"	1.6	2.40
A-3880	Single or P.P. Plates	4,000, 7,000, 8,000, 10,000, 14,000 C.T.	1 to 30	40	15	Q	2 1/4"	3 3/8"	2 1/4"	1.7	3.50
A-3830	Single or P.P. Plates	3,000, 5,000, 6,600, 7,000, 8,000, 10,000 C.T.	1 to 30	60	20	Q	2 3/8"	4 1/8"	2 1/4"	3.0	3.50
A-3890	Single or P.P. Plates	4,000, 7,000, 8,000, 10,000, 14,000 C.T.	1 to 30	50	15	E	2 1/4"	2 3/4"	2 1/8"	1.3	3.90
A-2855	Single or P.P. Plates	4,000, 7,000, 8,000, 10,000, 14,000 C.T.	1 to 30	50	15	L	2"	2 1/8"	2 1/8"	1.3	2.25
A-3841	Universal Single Plate	2,500, 4,000, 5,000, 6,000, 7,000	500	60	10	J	2 11/16"	2 11/16"	2 3/8"	1.8	4.70
A-3842	Universal P.P. Plates	8000, 10,000, 12,000, 14,000 C.T.	500	55	10	J	2 11/16"	2 11/16"	2 3/8"	1.8	4.70

CRYSTAL RECORDER OUTPUT TRANSFORMERS

The first four units were designed especially for use in radio receivers either for conversion or replacement purposes. Separate transformers are available for either single or push-pull output stages and for simultaneous monitoring while cutting record.

The last three units have high fidelity type construction and are for use with amplifiers designed expressly for recording work. All transformers are conservatively designed to have the best electrical characteristics consistent with their size.

Stancor Number	Output Tubes	Impedance in Ohms		Core Size	Max. Watts Level	Type Mtg.	Dimensions			Mtg. Ctrs.	Wgt. Ctn.	List Price
		Primary	Secondary				H	W	D			
A-3853	SGL. 2A5, 6AC5, 6B5, 7B5, 6F6, 6K6, 6N6, 42	7,000	70,000 or 4-6	1/2"x3/4"	5	A	1 3/8"	3 3/8"	1 3/8"	2 11/16"	1.0	\$2.40
A-3854	SGL. 2A5, 6AC5, 6B5, 7B5, 6F6, 6K6, 6N6, 42	7,000	70,000 and 4-6	1/2"x3/4"	10	A	2 1/4"	3 3/8"	2 1/4"	3 1/4"	1.5	3.30
A-3859	P.P. 6AC5, 6B5, 7B5, 6F6, 6K6, 6N6, 42	10,000	70,000 or 4-6	1/2"x3/4"	5	A	1 3/8"	3 3/8"	1 3/8"	2 11/16"	1.0	2.40
A-3860	P.P. 6AC5, 6B5, 7B5, 6F6, 6K6, 6N6, 42	10,000	70,000 and 4-6	1/2"x3/4"	10	A	2 1/4"	3 3/8"	2 1/4"	3 1/4"	1.5	3.30
A-3869	P.P. 2A3, 6A3, 6L6 (C1. A1)	3,000-5,000	70,000	1/2"x3/4"	10	W2	3 1/2"	2 3/4"	3 1/8"	...	3.0	12.00
A-3886	P.P. 6AC5, 6B5, 7B5, 6F6, 6K6, 6N6, 42	10,000	70,000	1/2"x3/4"	10	W2	3 1/2"	2 3/4"	3 1/8"	...	3.0	12.00
A-3897	500 Ohm Line	500	70,000	1/2"x3/4"	10	W2	3 1/2"	2 3/4"	3 1/8"	...	3.0	12.00

TUBE TO LINE TRANSFORMERS (UNIVERSAL)

Stancor Number	From	To	Impedance		D.C. Pri.	Type Mounting	Dimensions			Weight in Carton	List Price
			Pri.	Sec.			H	W	D		
A-3250	Sgl. or P.P. 27, 30, 12A, 37, 55, 56, 76, 6C5, 6C6.	Line	10,000 or 20,000	50, 125, 200, 333, 500	10	Q	2"	3 3/8"	1 3/8"	1.2	\$2.80
A-3315	Sgl. or P.P. 27, 30, 37, 55, 56, 76, 12A, 6C5, 6C6.	Line	10,000 or 20,000	50, 125, 200, 333, 500	35	D	3 1/8"	2 3/8"	3 1/8"	2.6	5.65
A-4770	Univ. Single Tube	Line	2,500, 4,500, 5,000, 6,000, 7,000	500	60	J	3 1/8"	2 3/8"	2 1/4"	2.3	4.40
A-4771	Univ. P.P. Tubes	Line	8,000, 10,000, 12,000, 14,000, C.T.	500	55	J	3 1/8"	2 3/8"	2 1/4"	2.3	4.75

MICROPHONE OR LINE TO LINE TRANSFORMER

A-4350	Sgl. or D.B. microphone	Line	50, 125, 200, 333, 500	50, 125, 200, 333, 500	150	Q	2"	3 3/8"	1 3/8"	1.0	\$3.50
A-4407	Sgl. or D.B. Microphone	Line	50, 125, 200, 333, 500	50, 125, 200, 333, 500	150	E	2 3/4"	2 3/4"	2 1/4"	2.6	5.80



TYPE "Q"



TYPE "J"



TYPE "E"



TYPE "L"



TYPE "A"



TYPE "W2"





OUTPUT TRANSFORMERS

OUTPUT TRANSFORMERS TO LINE AND VOICE COIL

Stancor Number	Output Tubes	Class	Impedance in Ohms		D.C. Pri. Ma.	Max. Audio Watts	Type Mounting	Dimensions			Wt. in Carton	List Price
			Primary	Secondary				H	W	D		
A-3865	SGL, 48, 25B6, 25L6, 50L6	A	1,500	2, 4, 6	55	5	A	1 3/4"	2 3/8"	1 1/2"	0.5	\$1.55
A-3876	SGL, 2A3, 6A3, 6B4, 6V6, 6Y6, 25AC5, 25B5, 25B6, 5L6, 35A5, 35L6, 50L6	A	2,000	4	60	5	A	1 5/16"	2 3/4"	1 1/16"	0.5	1.15
A-3825	SGL, 2A3, 6A3, 6B4, 6L6, 6Y6, 25AC5, 25B5, 25L6, 25N6, 35N6, 35L6, 50L6, 6V6	A	2,500	1, 2, 4	75	8	Q	1 3/8"	3 1/4"	1 3/4"	1.0	2.00
A-3306	P.P. PAR. 48, 25L6 P.P. PAR. 2A3, 45	A AB	2,500	4, 8, 15, 500	100	25	C	3 1/2"	2 13/16"	3 1/8"	3.6	7.50
A-3301	P.P. 2A3, 6A3, 6B4 P.P. 48, 25L6	AB A	3,000	4, 8, 15, 500	55	30	C	3 1/2"	2 13/16"	3 1/8"	3.7	5.00
A-3802	P.P. PAR. 6L6 P.P. 45, 6L6	AB1 AB2	3,300 3,800	4, 8, 250, 500	250	75	C	4 3/8"	3 3/8"	3 3/8"	8.3	8.50
A-2203	SGL, 12A5, 25A6, 31, 43, 45, 71, 48	A	4,000	8	40	5	A	1 3/8"	2 1/4"	1 3/8"	0.7	1.55
A-5528	P.P. 6Y6, 25L6	A	4,000	4, 8, 15, 500	65	8	C	3 1/8"	2 3/8"	2 3/8"	2.4	4.20
A-3851	P.P. 6L6*	AB1	4,400	4, 8, 15, 250, 500	70	30	C	3 1/2"	2 13/16"	3 1/8"	3.6	6.00
A-3877	SGL, 2B6, 6V6, 7C5, 12A, 25A6, 31, 43, 59	A	5,000	4	40	5	A	1 3/16"	2 3/8"	1 1/16"	0.5	1.15
A-3872	P.P. 6L6 P.P. 2A3, 6A3, 45	A AB	5,000	4, 8	150	18	E	2 3/8"	2 3/4"	2 1/8"	1.8	3.50
A-3310	SGL, 45, 2B6, 6L6, 6V6, 25A6, 25A7	A	5,000	4, 8, 15, 500	55	20	C	3 1/8"	2 3/8"	2 3/8"	2.5	5.00
A-3800	P.P. 6L6 P.P. 2A3, 6A3, 45	A AB	5,000	4, 8, 15, 250, 500	80	30	C	3 1/2"	2 13/16"	3 1/4"	3.7	5.65
A-3307	P.P. 2A5, 6F6, 42 P.P. 46, 59 P.P. PAR. 6A6, 6N7, 53	AB2 B	6,000	4, 8, 15, 500	100	30	C	3 1/2"	2 13/16"	3 1/8"	3.6	6.00
A-3801	P.P. 6L6	AB1	6,600	4, 8, 15, 250, 500	150	35	C	3 3/8"	3 1/4"	3 3/8"	5.0	6.60
A-3822	SGL, 2A5, 6AC5, 6B5, 6F6, 6K6, 6N6, 7B5, 38, 41, 42, 47, 59, 89	A	7,000 10,000	4, 8, 15, 1.4 2, 2.8, 4	45	5	Q	1 3/8"	2 3/8"	1 1/2"	0.5	1.45
A-3878	SGL, 2A5, 6AC5, 6B5, 7B5, 6F6, 6K6, 6N6, 20, 31, 33, 42	A	7,000	4	30	5	A	1 3/16"	2 3/8"	1 1/16"	0.5	1.15
A-2313	SGL, 2A5, 6AC5, 6F6, 6K6, 6N6, 7B5, 33, 41, 42, 47, 59, 89	A	7,000	8	40	10	A	1 3/8"	3 1/4"	1 3/8"	1.1	1.75
A-3855	SGL, 2A5, 6AC5, 6F6, 6K6, 6N6, 7B5, 33, 41, 42, 47, 59, 89 P.P. 12A5, 45	A	7,000	10, 2,000	40	5	E	2 1/4"	2 3/4"	2 1/8"	1.7	3.40
A-2201	SGL, 6A6, 53 P.P. 25A6, 43, 45, 48, 71 P.P. 46	A	8,000	6	40	10	A	1 3/8"	3 3/4"	1 3/8"	1.0	2.25
A-3824	SGL, 6A6, 6N7, 53 P.P. 46	B	8,000	1, 2, 4	75	8	Q	1 3/8"	3 1/4"	2"	1.4	2.40
A-3885	P.P. 6L6	AB1	9,000	4, 8, 15, 250, 500	150	35	C	3 3/8"	3 3/8"	3 3/8"	5.0	6.60
A-3304	SGL, 6A4, 6B5, 6N6 P.P. 6V6, 45 SGL, 6A6, 6N7, 53 P.P. 6AC5	A B	7,000 7,000 10,000 10,000	4, 8, 15, 500	60	25	C	3 1/8"	2 3/8"	2 3/8"	2.6	4.80
A-3879	SGL, 1I6, 3C5, 6A4, 6G6, 6N7, 6R7, 12A, 38	A	10,000	4	30	5	A	1 3/16"	2 3/8"	1 1/16"	0.5	1.20
A-3831	SGL, 1G6, 1I6, 19, 6E6 P.P. 30, 49	B	10,000	2, 4, 8	40	5	A	1 13/32"	2 3/8"	1 3/16"	2.6	1.75
A-3839	SGL, 1G6, 1I6, 19 P.P. 1H4, 30, 49 SGL, 1G5, 3C5, 6G6, 6N7, 12A	B A	10,000	4, 8, 15, 2000	30	10	E	2 3/4"	2 3/4"	2 1/8"	1.7	3.95
A-3311	SGL, 6A6, 6N7, 53 P.P. 6B5, 6N6 P.P. 6F6, 6N6	B AB	10,000	4, 8, 15, 500	70	25	C	3 1/2"	2 13/16"	3 1/8"	3.8	5.65
A-3496	P.P. 2A5, 6F6, 6K6, 7B5, 33, 41, 42, 47, 49	A	14,000	4	45	5	A	1 1/4"	2 1/16"	1 3/16"	0.7	1.70
A-2312	P.P. 2A5, 6F6, 6K6, 7B5, 33, 41, 42, 47, 49	A	14,000	4	40	10	A	1 3/8"	3 3/4"	1 3/8"	1.1	1.85
A-3303	SGL, 6Y7, 6Z7, 79 P.P. 2A5, 6F6, 6K6, 7B5, 41, 42, 47, 59, 89	B A	14,000	4, 8, 15, 500	55	20	C	3 1/8"	2 3/8"	2 3/8"	2.6	4.40
A-3881	SGL, 1D8, 1E7, 1F4, 1F5, 1I5, 1T5, 6V7, 6Y7, 12A7	A	15,000	4	10	5	A	1 3/16"	2 3/8"	1 1/16"	0.5	1.20
A-3848	SGL, 1D8, 1F4, 1F5, 1I5, 1T5, 6R7, 950	A	16,000	1, 2, 4	10	5	Q	1 3/8"	2 3/8"	1 3/8"	0.5	1.55
A-3857	SGL, 1A5, 1E7, 1N6, 6V7 P.P. 1F4, 1F5, 1I5, 1T5, 6G6, 12A7, 950	A	25,000 C.T.	4	10	5	A	1 3/8"	2 1/16"	1 3/16"	0.7	1.60

*10% Inverse Feedback Winding Used. NOTE: All transformers shown for P. P. operation have C. T.



TYPE "Q"



TYPE "A"



TYPE "E"



TYPE "C"



TYPE "B"



TYPE "D"



AUDIO TRANSFORMERS



PLATE TO GRID INTERSTAGE TRANSFORMERS

Stancor Number	From	To	Primary Impedance	Secondary Impedance	Turns Ratio Sec. to Pri.	D.C. Pri. Ma.	Type Mounting	Mounting Dimensions			Weight in Carton	List Price
								H	W	D		
A-4205	20,000 ohm plate	Grid	20,000	115,000	2.4:1	15	C	3 1/4"	2 1/2"	2 1/2"	2.5	\$5.35
A-53 C	10,000 ohm plate	Grid	10,000	90,000	3:1	10	A	1 3/8"	2 3/8"	1 1/2"	0.5	1.55
A-63 C	10,000 ohm plate	Grid	10,000	90,000	3:1	10	A	1 3/8"	2 13/16"	1 1/2"	0.75	1.80
A-73 C	10,000 ohm plate	Grid	10,000	90,000	3:1	10	A	2"	3 1/8"	1 3/8"	1.0	2.25
A-6198	10,000 ohm plate	Grid	10,000	125,000	3.5:1	30	W-1	2 1/2"	1 13/16"	2"	1.8	5.80



TYPE "A"

PUSH-PULL INPUT TRANSFORMERS

A-2132	Screen Grid Tube P.P. Grids	10,000	10,000	1:1	10	S	3"	4"	2 1/16"	2.4	\$4.70
For coupling screen grid or power detector.											
A-52 C	10,000 ohm plate P.P. Grids	10,000	40,000	2:1	10	A	1 3/8"	2 3/8"	1 1/2"	0.5	1.55
A-62 C	10,000 ohm plate P.P. Grids	10,000	40,000	2:1	10	A	1 3/8"	2 13/16"	1 1/2"	0.75	1.80
A-4741	10,000 ohm plate P.P. Grids	10,000	40,000	2:1	10	S	2"	1 3/4"	1 1/2"	0.8	1.85
A-4745	10,000 ohm plate P.P. Grids	10,000	40,000	2:1	10	E	2 3/8"	2 3/8"	2 3/8"	1.5	3.60
For super-regenerative detector static shield between windings.											
A-53 C	10,000 ohm plate P.P. Grids	10,000	90,000	3:1	10	A	1 3/8"	2 3/8"	1 1/2"	0.5	1.55
A-63 C	10,000 ohm plate P.P. Grids	10,000	90,000	3:1	10	A	1 3/8"	2 13/16"	1 1/2"	0.75	1.80
A-73 C	10,000 ohm plate P.P. Grids	10,000	90,000	3:1	10	A	2"	3 1/8"	1 3/8"	1.0	2.25
A-103C	10,000 ohm plate P.P. Grids	10,000	90,000	3:1	10	A	2 3/8"	4 1/8"	2"	2.2	4.40
A-4155	10,000 ohm plate P.P. Grids	10,000	90,000	3:1	10	L	2 1/4"	2 3/8"	2 3/8"	1.2	2.50
A-4719	10,000 ohm plate P.P. Grids	10,000	90,000	3:1	10	E	2 3/8"	2 3/8"	2 3/8"	1.5	3.95
A-4750	10,000 ohm plate P.P. Grids	10,000	90,000	3:1	10	S	2 1/4"	2 3/8"	1 3/8"	1.0	2.25
A-4740	10,000 ohm plate P.P. Grids	10,000	90,000	3:1	10	S	2"	2 3/8"	1 1/2"	0.75	2.00
A-83 C	10,000 ohm plate P.P. Grids	10,000	90,000	3:1	10	A	2 1/4"	3 13/16"	1 3/8"	1.5	3.50
A-4206*	20,000 ohm plate P.P. Grids	20,000	180,000	3:1	15	C	3 1/8"	2 3/8"	2 3/8"	2.5	5.25
A-64 C	10,000 ohm plate P.P. Grids	10,000	160,000	4:1	10	S	1 3/8"	2 13/16"	1 1/2"	0.75	2.00

*Split Secondary.



TYPE "E"



TYPE "L"

PUSH-PULL INTERSTAGE TRANSFORMERS

A-4208*	P.P. Plates	P.P. Grids	25,000	13,000	1:1.39	15	C	3 1/8"	2 3/8"	2 3/8"	2.5	\$4.30
A-4711	P.P. Plates	P.P. Grids	20,000	20,000	1:1	10	A	1 3/8"	2 13/16"	1 1/2"	0.8	2.25
A-4772*	P.P. Plates	P.P. Grids	20,000	45,000	1.5:1	10	S	3 1/8"	2 3/8"	2 3/8"	2.2	4.20
A-4777*	P.P. Plates	P.P. Grids	20,000	45,000	1.5:1	10	C	3 1/8"	2 3/8"	2 3/8"	2.5	4.75
A-4155	P.P. Plates	P.P. Grids	10,000	90,000	3:1	10	L	2 1/4"	2 3/8"	2 3/8"	1.2	2.50

*Split Secondary.

UNIVERSAL INTERSTAGE TRANSFORMERS

(Split Secondaries)

May be used as plate to grid; push-pull input or push-pull interstage replacement transformers. Have 3:1 over all ratio, however primary is center-tapped and secondary has split winding thus permitting ratios of 1:1, 3:1 and 6:1. Transformers may be used in either step-up or step-down applications.

Stancor Number	Application	Turns Ratio	D.C. Pri. Ma.	Type Mtg.	Dimensions			Mounting Centers	Weight in Carton	List Price
					H	W	D			
A-4773	Universal	3:1	10	E	2 3/8"	2"	2 1/8"	2 3/8"	1.5	\$3.10
A-4774	Universal	3:1	10	S	2 1/4"	2 3/8"	2 1/4"	2 3/8"	1.5	2.60
A-4775	Universal	3:1	10	S	2 3/8"	3 1/4"	2 3/8"	2 3/8"	1.8	3.50



TYPE "S"

DRIVER TRANSFORMERS

Stancor Number	From	To	Primary Class	Primary Impedance	1/2 Sec. Impedance	Turns Ratio Pri. to 1/2 Sec.	D.C. Pri. Ma.	Type Mounting	Mounting Dimensions			Wgt. in Ctn.	List Price
									H	W	D		
A-4722	1-42, 47, 2A5, 6K6	P.P. 42, 2A5, 6F6, 6K6	AB	10,000	10,000	1:1	30	E	2 1/4"	2 3/8"	2 3/8"	1.5	\$3.00
A-4752	1-6G6G, 6F6, 42, 2A5 as Triodes	P.P. Grids 6V6, 6Y6, 6F6, 6L6, 6Z7	AB	10,000	2,500, 4,400, 10,000	2:1, 1.5:1, 1:1	35	S	2 1/4"	2 3/8"	1 3/8"	1.5	2.50
May be used from P.P. primary with ratio of 2:1.													
A-4713	1-46, 4S, 2A5, 6F6,	P.P. Grids 79, 2A5, 6A6, 6F6	AB	10,000	2,500	2:1	30	A	1 3/8"	2 13/16"	1 1/2"	0.7	1.00
A-4292	1-6CS, 30, 49	1-1J6, 19, 2-30, 2-49	B	10,000	1,600	2.5:1	10	A	1 3/8"	2 13/16"	1 1/2"	0.7	1.85
A-4734	1-30, 2A5, 6A6, 1G5, 6F6, 6K6	P.P. Grids 19, 2A5, 6A6, 1J6	B	10,000	1,600	2.5:1	15	A	2 1/4"	2 3/8"	1 3/8"	1.4	2.20
A-4401	1-27, 30, 37, 56, 76, 6CS, 1H4, 6J5	1-19, 79, 1J6	B	10,000	1,400	2.66:1	15	J	2 3/8"	2 3/4"	2 1/4"	1.3	2.70
A-4723	1-30, 2A5, 6A6, 1G5, 6K6 etc.	P.P. Grids 19, 79, 2A5, 6A6, 6F6, 1J6, 6K6	B	10,000	1,100	3:1	30	A	1 3/8"	2 13/16"	1 1/2"	0.7	1.85
A-4712	P.P. 27, 30, 37, 56, 76, 6CS, 1H4, 6J5	P.P. 19, 53, 6A6, 1J6, 6N7	B	20,000	2,200	3:1	10	A	1 3/8"	2 13/16"	1 1/2"	0.7	1.85



TYPE "J"



TYPE "C"





AUDIO TRANSFORMERS

UNIVERSAL LINE TO VOICE COIL TRANSFORMERS

Stancor Number	or Coupling	Primary Impedance	Secondary Impedance	Max. Audio Watts	Type Mounting	Dimensions			Weight in Carton	List Price
						H	W	D		
A-3922	Line to voice coil	250, 333, 500	4, 8, 15	25	D	3 1/8"	2 5/8"	3 1/4"	2.6	54.20
A-3883	Line to voice coil	500	4, 6, 8, 15	25	J	2 1/4"	1 7/8"	1 1/2"	1.5	2.20
A-3919	Line to voice coil	500, 1000, 1500	4, 8, 15	25	B	3 1/4"	2 3/4"	2 5/8"	2.6	3.60
A-3820	Line to voice coil	500, 1000, 1500, 2000	4, 8, 15	40	D	4 1/4"	3 1/2"	3 5/8"	5.8	7.30
A-3838 (autoformer)	Line to speakers	500	250, 166, 125, 100, 84	30	B	3 1/8"	2 3/8"	2 3/4"	2.6	4.35
A-3837	Line to voice coil. 1 to 6 can be paralleled across 500 ohm line	500, 1000, 1500, 2000, 2500, 3000	.06 to 8 ohm from primary of 500 ohms. .12 to 16 from 1000, etc.	15	J	2 1/4"	2 1/2"	2 1/2"	2.0	3.20

MICROPHONE, PICKUP OR LINE TO GRID TRANSFORMERS

Stancor Number	From	To	Impedance		Ratio Overall	Type Mounting	Dimensions			Weight in Carton	List Price
			Pri.	Sec.			H	W	D		
A-6199	S.B. Microphone	Single Grid	200	160,000	1:28.4	W-1	2 1/2"	1 1/2"	2"	2.5	55.40
A-4742	S.B. Microphone	Sgl. or P.P. Grids	100	400,000 C.T.	1:64	S	2 1/4"	2 7/8"	2 3/4"	1.0	2.50
A-4743	S.B. Microphone	Sgl. or P.P. Grids	100	400,000 C.T.	1:64	S	2 1/4"	2 7/8"	2 1/2"	1.1	2.80
Has shield cover which encloses entire coil.											
A-4707	S.B. Microphone	Single Grid	100	58,500	1:24.2	J	2"	2 1/2"	1 1/2"	0.8	1.85
A-4706	S.B. Microphone	Single Grid	100	60,000	1:24.6	A	1 1/2"	2 1/4"	1 1/2"	0.6	1.50
A-4708	D.B. Microphone	Single Grid	200 C.T.	57,000	1:17	J	2"	2 1/2"	1 1/2"	0.8	2.20
A-4727	D.B. Microphone	Single Grid	200 C.T.	100,000	1:22.2	E	2 1/2"	2 3/4"	2 1/4"	1.8	3.50
A-4709	Dynamic or Pickup	Single Grid	4, 8, 15, 30	106,000	1:60	F	2 3/8"	2 1/4"	2 1/4"	1.8	3.55
A-4351	S.B. or D.B. Microphone or Line	Single Grid	50, 125, 200, 333, 500	89,000	1:13.3	E	2"	3 1/8"	1 5/8"	1.0	3.10
A-4408	S.B. or D.B. Microphone or Line	Single Grid	50, 125, 200, 333, 500	80,000	1:12.5	D	3 1/8"	2 5/8"	3 1/4"	2.6	6.10
A-4411	D.B. Microphone Low Imp. Pickup	Single Grid	200 C.T. or 500	144,000	1:17.5	C	3 1/4"	2 3/8"	2 5/8"	2.6	4.75
A-4726	D.B. Microphone & 200 ohm line	P.P. Grids	200 C.T.	100,000	1:22.3	E	2 3/8"	2 1/4"	2 1/4"	1.8	3.50
A-4352	S.B. or D.B. Microphone or Line	P.P. Grids	50, 125, 200, 333, 500	89,000	1:13.3	Q	2"	3 1/8"	1 5/8"	1.0	3.50
A-4409	S.B. or D.B. Microphone or Line	P.P. Grids	50, 125, 200, 333, 500	157,000	1:17.7	D	3 1/8"	2 5/8"	2 5/8"	2.6	6.30
A-4705	S.B. Microphone	Single Grid	200 or 70	80,000	1:20	A	1 3/4"	2 1/4"	1 1/4"	0.5	1.50
A-4728	1, 2, 3, or 4 Circuit Mixer	Single Grid	50, 100, 150, 200	1000,00	1:22.2	E	2 3/8"	2 1/4"	2 1/4"	1.8	5.00
A-4729	1, 2, 3, or 4 Circuit Mixer	Single Grid	200, 400, 600, 800	100,000	1:11.2	E	2 1/4"	2 1/4"	2 1/4"	2.0	5.00

INTERCOMM. INPUT TRANSFORMERS

Stancor Number	From	To	Impedance in Ohms		Core Size	Type Mtg.	Dimensions			Wgt. in Ctn.	List Price	
			Pri.	Sec.			H	W	D			
A-4744	Voice Coil	Sgl. grid	4	25,000	1 1/2" x 5/8"	A	1 5/8"	2 3/8"	1 1/2"	2 3/8"	0.5	51.50

Has shield cover enclosing entire coil.

HEARING AID CHOKES (MANUFACTURERS' TYPES)

These small uncased chokes are made available because of mounting interest created by the recent release of very small midget tubes. Two typical circuits are shown in the current issue of Stancor's Service Guide. Measurements shown are made with .5 M.A.-D.C. in windings; impedances

given are from actual measurements; all inductances are calculated values.

Because of their extremely small size these chokes are not as rugged as their bigger Stancor brothers, and care should be exercised when using them to see that current carrying capabilities are not exceeded.

Stancor No.	D.C. ohms Resistance		400 Cycles				60 Cycles		Dimensions H W D	List Price
			2VAC	10VAC	2VAC	10VAC	2VAC	10VAC		
C-65	1,875	Impedance (ohms), 54,000 Inductance (Hys.) 21.5	70,000 27.9	27,000 21.5	39,000 31	11,500 30.5	13,000 47.5	3/4" x 3/8" x 1/2"	53.60	
C-66	3,675	Impedance (ohms), 77,000 Inductance (hys.) 31	88,000 35.1	37,000 30	48,000 38.3	14,500 38	21,000 55.6	3/4" x 1/2" x 1/2"	5.90	
C-67	2,520	Impedance (ohms), 96,000 Inductance (hys.) 39.4	113,000 45	45,000 36	62,000 49.5	18,000 47.6	25,500 67.5	7/8" x 3/4" x 1/2"	4.50	

TONE CONTROL UNIT

The necessary components for a dual tone control circuit to provide both bass and treble attenuation when used in conjunction with two dual 250,000 ohm potentiometers. Contained in Hi-Fitype W-1 cast case for shielding against hum pickup and provided with 12" Flexible Coded Leads for direct connection in the circuit. Dimensions H.3 1/2" x W.2 3/4" x L.3 1/16"

STANCOR No. C-2332-1..... List \$6.30



TYPE "A"



TYPE "B"



TYPE "Q"



TYPE "E"



TYPE "C"



TYPE "D"



MISCELLANEOUS TRANSFORMERS

FENCE CONTROLLER TRANSFORMERS

Stancor Number	Primary		Filament		Secondary Open Circuit	Type Mounting	Dimensions			Weight in Carton	List Price
	Voltage	Cycles	Volts	Amps.			H	W	D		
P-6122	6V.D.C.	None	3000 Inst. Peak	A*	2½"	2½"	2"	1.5	52.50
P-6126†	200V. A.C.	None	3000 Inst.	N*	2½"	3½"	2½"	4.0	4.40
P-6127	115V. A.C.	5.0	2.0	2.0	900 V. (25 Ma. Peak)	N*	4½"	3½"	2½"	2.0	7.50
			2.0	8.0							

*Has special moisture resisting compound overall.

†P-6126 special output transformer used in conjunction with P-6127 power transformer. Insulated for 5000V. A.C.

VARIABLE LINE AUTOFORMERS

These transformers designed so that associated equipment may be kept at a specific input voltage regardless of line voltage. Line regulating transformers continuously variable in 5 volt steps from 85-125 volts.

Stancor Number	Primary		Secondary		Output Watts	Type Mounting	Dimensions			Weight in Carton	List Price
	Volts	Cycles	Volts	Cycles			H	W	D		
P-5066	85-125	50-60	85-125	50-60	35	B	3½"	2½"	2½"	2.0	\$4.60
P-5067	85-125	50-60	85-125	50-60	75	B	3½"	3"	2½"	3.4	5.90
P-5068	85-125	50-60	85-125	50-60	125	B	3½"	3"	3½"	4.0	6.90
P-6145	85-125	50-60	85-125	50-60	500	B	4½"	3½"	4½"	10.0	11.35

SPECIAL AUTOFORMER

This Autoformer will deliver full output wattage at any secondary voltage specified above or can be used to supply any voltage in 5 volt steps from zero to 130 volts for special experimental applications.

P-6148	Primary		Secondary		Output Watts	Type Mtg.	Dimensions			Wgt. in Carton	List Price
	Volts	Cycles	Volts	Cycles			H	W	D		
	25-55-75	50-60	25-55-75	50-60	250	B	4½"	3½"	3½"	8.0	\$10.00
	95-105-110		95-105-110								
	115-120		115-120								
	125-130		125-130								

TESTING AUTOFORMER

Incorporates a convenient tap switch to permit variable voltages from 90 to 150 volts. Primary equipped with 5 ft.

approved cord and plug. Secondary connected to female receptacle. Locking screw mounted on switch.

Stancor No.	Secondary Voltage	Primary Voltage	Output Watts	Type Mtg.	Dimensions			Wgt. in Carton	List Price
					H	W	D		
P-6299	90, 100, 110, 120, 130, 140, 150, @ 50-60 cy.	115V.	150	KA	3½"	3½"	4½"	8.0	\$9.75

UNIVERSAL SPEAKER FIELD SUBSTITUTE CHOKE

Designed for the service department, to take the place of the speaker field on the test bench. It is so designed that, when used with tap switch or plug-in jacks, all popular speaker

field impedances and resistance are readily obtained. May also be used as substitute filter choke in radio to determine correct unit to use. Packed complete with full instructions.

Stancor No.	D.C. Resistance in Ohms	Resistance and Current Rating	Type Mtg.	Dimensions			Wt. in Carton	List Price
				H	W	D		
C-2302	3000 tapped at 2500, 1000 and 750	250, 750, 1000, 1750 ohms — 60 Ma. cont. or 75 Ma. Int. Duty 500, 1500, 2000, 2250, 2500, 3000 ohms — 40 Ma. cont. or 55 Ma. Int. Duty	B	3½"	2½"	3"	2.6	\$5.35

STEP-DOWN AUTOFORMER

These transformers are excellent units to be used with standard apparatus on 220-250 volt lines. May also be wired to step up 110-125 volts to 220-250 volts for test.

Stancor Number	Primary		Secondary		Output Watts	Type Mounting	Mounting Dimensions			Weight in Carton	List Price
	Volts	Cycles	Volts	Cycles			H	W	D		
P-6247	220-250	50-60	110-125	50-60	40	*	4½"	3"	3"	2.5	\$4.75
P-5062	220-250	50-60	110-125	50-60	80	K	3½"	2½"	3½"	4.5	6.00
P-5063	220-250	50-60	110-125	50-60	100	K	3½"	3½"	3½"	5.2	6.90
P-5064	220-250	50-60	110-125	50-60	150	K	4½"	3½"	3½"	6.6	7.85
P-5065	220-250	50-60	110-125	50-60	250-300	K	4½"	3½"	4½"	9.8	10.00
P-6141	220-250	50-60	110-125	50-60	500	K	4½"	3½"	5½"	14.5	15.00
P-6124	220-250	50-60	110-125	50-60	1000	F	7½"	6"	6½"	30.0	25.25

*Mounted in special can and equipped with cord, plug and receptacle.

ISOLATION TRANSFORMERS

These transformers are designed with an electro-static shield to isolate line noises and interference from the apparatus being used. They are suitable for screen test booths, electrical therapeutic machines, medical instruments, beauty parlor equipment, electric furnaces, amateur transmitters,

etc. Each unit complete with a 6 ft. cord and plug and a female receptacle. Primary tapped for 105, 115, and 125 volt, 50-60 cycles. Secondary rated at 115 volts. Tapped switch controls primary voltage, except on Nos. P-6123 and P-6125.

Stancor Number	Watts	Type Mounting	Mounting Dimensions			Weight in Carton	List Price
			H	W	D		
P-6160	100	KA	4½"	3½"	3½"	5.5 lbs.	\$12.60
P-6161	250	KA	4½"	3½"	5½"	14.0 lbs.	24.50
P-6298	500	FK	7½"	6"	6½"	37.0 lbs.	37.75
P-6125	1000	FK	7½"	7½"	6½"	50.0 lbs.	50.00
P-6123	1500	FK	7½"	7½"	7½"	60.0 lbs.	63.00

NOTE: Type FK is Type F with female receptacle mounted in side.

TUBE CHECKER TRANSFORMER

Especially designed for use in modernizing older types of tube checkers. Ideal for other testing equipment and laboratory. Packed with wiring instructions giving color coding of leads.

Stancor Number	Primary		Secondary Volts	Type Mounting	Dimensions			Wgt. in Carton	List Price
	Volts	Cycles			H	W	D		
P-1834-3	105, 115, 125	50-60	1.1, 1.4, 1.5, 2.0, 2.5, 3.0, 3.3, 5.0, 6.3, 7.5, 12, 25, 30, 35, 50, 70, 85, 110, 117	A	2½"	4½"	2"	2.6	\$8.65



TYPE "C"



TYPE "B"



TYPE "K"



TYPE "N"



TYPE "KA"



TYPE "F"





CHOKES -- MISC. TRANSFORMERS

FILTER CHOKES (REPLACEMENT TYPES)

Stancor Number	Rated Inductance in Henries	Maximum Current in Ma.	D.C. Resistance in Ohms	Volts Insulation	Type Mounting	Mounting Dimensions			Weight in Carton	List Price
						H	W	D		
C-1515	50	15	900	1650	A	1 3/8"	2 15/16"	1 1/2"	0.7	\$1.20
C-1706	5	50	300	1650	A	1 3/8"	2 3/8"	1 1/8"	0.8	1.15
C-1707	7	50	500	1650	A	1 3/8"	2 3/8"	1 1/8"	0.5	1.15
C-1003	30	50	550	1650	A	1 3/8"	3 3/8"	1 3/8"	1.4	1.55
C-1708	10	65	460	1650	A	1 7/8"	3 1/4"	2 15/16"	1.1	1.50
C-1355	20	75	275	1650	L	2 1/4"	2 1/8"	1 3/8"	1.2	1.50
C-1002	30	75	400	1650	A	2 1/4"	3 11/16"	1 7/8"	1.7	2.10
C-1709	9	85	250	1650	A	1 7/8"	3 1/4"	2 15/16"	1.5	2.00
C-1710	8	150	200	1650	A	2 1/2"	4"	2 1/8"	2.3	2.50
C-2305	20	100	275	2000	E	2 3/8"	2 3/4"	2 1/8"	1.7	2.50
C-2303	10	130	100	2000	A	2"	3 3/8"	1 9/8"	1.4	1.85
C-2304	8	150	65	2000	A	2"	3 3/8"	1 9/8"	1.4	1.85
C-2309	8	150	90	2000	A	2 1/4"	3 11/16"	1 7/8"	1.5	2.20
C-1001	30	110	200	3000	A	2 1/2"	4"	2"	2.4	2.65



TYPE "A"



TYPE "L"



TYPE "O"



TYPE "B"



TYPE "D"



TYPE "KB"



A.C.-D.C. CHOKES

C-1723	4.4	50	330	1600	A	1 5/16"	2 3/8"	1 1/8"	0.5	\$1.15
C-1711	4.5	50	325	1600	Q	1 5/16"	2 3/8"	1 1/8"	0.5	1.15
C-1080	15	50	200	1600	A	1 5/8"	2 13/16"	1 3/8"	0.6	1.20
C-1325	15	50	250	1600	A	1 5/8"	2 13/16"	1 3/8"	0.6	1.20
C-1277	15	50	300	1600	A	1 5/8"	2 13/16"	1 3/8"	0.6	1.20
C-1277	15	50	350	1600	A	1 5/8"	2 13/16"	1 3/8"	0.6	1.20
C-1279	15	50	400	1600	A	1 5/8"	2 13/16"	1 3/8"	0.6	1.20
C-1333	15	50	450	1600	A	1 5/8"	2 13/16"	1 3/8"	0.6	1.20
C-1215	15	50	500	1600	A	1 5/8"	2 13/16"	1 3/8"	0.6	1.20
C-1362	15	50	550	1600	A	1 5/8"	2 13/16"	1 3/8"	0.6	1.20

OUTPUT CHOKES

C-1003	30	50	550	1600	A	2"	3 3/8"	1 9/8"	1.4	\$1.55
C-1034*	30	30	1150	1600	A	1 3/8"	2 1/4"	1 3/8"	1.3	1.90

*Center tapped.

AUDIO REACTORS

Stancor Number	Rated Inductance in Henries	Inductance Measured at Ma.	Max. Current Ma.	D.C. Res. Ohms	Volts Insulation	Type Mounting	Mounting Dimensions			Weight in Carton	List Price
							H	W	D		
C-2300	1000	0.5	10	5500	1600	E	2 3/8"	2 3/8"	2 3/8"	1.5	\$2.70
C-2301	300	5	10	6000	1600	E	2 3/8"	2 3/8"	2 1/2"	1.8	3.00
C-1701*	300	10	10	11400	1600	D	3 1/8"	2 3/8"	2 3/8"	2.5	5.30

*Center tapped.

TRANSCEIVER — TRANSFORMERS

Small compact, efficient, light weight transformers for transceiver and aeronautical applications.

Stancor Number	Type	Impedance		D.C. Pri. Ma. Watts	Max. Audio Watts	Type Mounting	Mounting Dimensions			Weight in Carton	List Price	
		Pri. Sec.	Sec.				H	W	D			
A-3833	Sgl. Button Micro. and Plate to Single Grid.	5,000	200	60,000	10	5	A	1 3/8"	2 13/16"	1 1/4"	0.7	\$2.10
A-3836	Pentode Plate to Low or High Impedance Phone or Oscillator	10,000	2,000	50	30	5	A	1 3/8"	2 13/16"	1 1/2"	0.7	2.35
A-4413	Sgl. Button Micro. and Plate to Single Grid.	10,000	200	90,000	45	10	J	2 3/8"	2 3/8"	2 3/8"	1.5	3.10

VOLT ADJUSTERS

STANCOR'S volt-adjuster is the answer to the fluctuating voltage problem. It is a compact unit containing a ruggedly constructed step-up; step-down autoformer.

The primary winding accommodates various voltages in 10 volt steps. A 10 position tap switch with an off position permits changing of the primary winding when a voltage

shift occurs, and through this switch the output may be changed and kept at 115 or 230 volts. A meter with 0-150 or 0-250 volt range indicates the output at all times. The nominal output is indicated on the meter face by a red line. The entire unit is housed in a beautifully designed modern black wrinkle finished case and is equipped with a six foot approved rubber cord and plug.

Stancor Number	Voltages		Freq. in Cycles	Output Watts	Type Mtg.	Dimensions			Wgt. in Ctn.	List Price
	Primary	Secondary				H	W	D		
P-6171	65, 75, 85, 95, 105, 115, 125, 135, 145	115	50-60	150	KB	7"	4"	5"	7.0	\$16.20
P-6245	170, 180, 190, 200, 210, 220, 230, 240, 250	230	50-60	150	KB	7"	4"	5"	7.0	16.75
P-6247	65, 75, 85, 95, 105, 115, 125, 135, 145	115	50-60	300	KB	7"	4"	5"	9.0	20.40
P-6246	170, 180, 190, 200, 210, 220, 230, 240, 250	230	50-60	300	KB	7"	4"	5"	9.0	21.00
P-6248	65, 75, 85, 95, 105, 115, 125, 135, 145	115	50-60	500	KB	7"	4"	5"	12.5	26.50
P-6231	170, 180, 190, 200, 210, 220, 230, 240, 250	230	50-60	500	KB	7"	4"	5"	12.5	28.75
P-6230	65, 75, 85, 95, 105, 115, 125, 135, 145	115	50-60	1000	KB	10"	7"	7"	27.	82.75
P-6230C	170, 180, 190, 200, 210, 220, 230, 240, 250	220	50-60	1000	KB	10"	7"	7"	27.	85.00

"HI-FI" TRANSFORMERS

(HIGH FIDELITY)



HIGH FIDELITY COMPONENTS

Noted for their generous design, fine quality of workmanship and many excellent features, this group of transformers is recommended to those engineers who demand and use only the best. Three mounting types are listed, each with individual characteristics. Units mounted in the W-1 and W-2 cast cases feature reversible mounting, high permeability laminations and special coil construction. They have an extended frequency response uniform from 60 to 12,000 C. P. S. All W-2 type units have hum-bucking construction in addition to all of these features.

Units mounted in T-1 cases are "Tiny-Trans," especially designed to fill the need for midget lightweight components. The types rated to carry D.C. in any of their windings are for frequencies from 150 to 5,500 C. P. S. Those not carrying D.C. have the same frequency response as the W-1 and W-2 units. All T-1 units need only one $\frac{1}{8}$ " diameter hole to mount above or below chassis with two small screws.

Every high fidelity component receives the famous STANCOR vacuum impregnation and is then hermetically sealed with a high melting point compound to make it impervious to extreme moisture and humid conditions.

Specific data or curves will be furnished on any of these units upon request.

DIMENSIONS	H	W	L	Mtg. Centers	Weight Lbs.
W-1 Case	2 $\frac{1}{2}$ "	1 $\frac{1}{2}$ "	2"	1 $\frac{1}{2}$ " x 1 $\frac{3}{4}$ "	1.2
W-2 Case	3 $\frac{1}{2}$ "	2 $\frac{3}{4}$ "	3 $\frac{3}{4}$ "	2 $\frac{1}{2}$ " x 2"	4.3
T-1 Case	$\frac{1}{8}$ " Dia. x $\frac{1}{4}$ " High overall				4 oz.

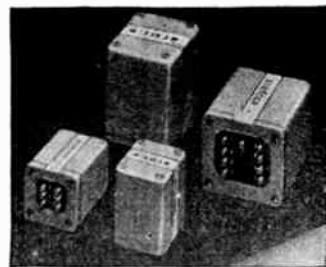

HIGH FIDELITY TRANSFORMERS

TINY-TRANS

INTERSTAGE TRANSFORMERS

Stancor Number	Application		Ohms Impedance		Primary Max.		Overall Turns Ratio	Max. D.B. Level	Case Type	List Price
	From	To	Primary	Sec.	Max. D.C. Per Side	Un-bal.				
A-8520	Single Plate	Single Grid	10,000, 15,000	60,000	0	0.0	1:2	0	T-1	510.00
A-8523	Single Plate	Single Grid	10,000, 15,000	60,000	2	2.0	1:2	0	T-1	10.00
A-8528	Single Plate	Single Grid	10,000, 15,000	1,000,000	0	0.0	1:26	0	T-1	12.60
A-8521	Single Plate	Single Grid	10,000 or 15,000	60,000	0	0.0	1:2	+10	W-1	10.00
A-8522	Single Plate	Single Grid	10,000 or 15,000	60,000	0	0.0	1:2	+15	W-2	22.75
A-8524	Single Plate	Push-Pull Grids	10,000, 15,000	95,000	0	0.0	1:2.52	0	T-1	11.35
A-8527	Single Plate	Push-Pull Grids	10,000, 15,000	95,000	2	2.0	1:2.52	0	T-1	11.75
A-8525	Single Plate	Push-Pull Grids	10,000 or 15,000	80,000 Overall	0	0.0	1:2.3	+10	W-1	11.75
A-8526	Single Plate	Push-Pull Grids	10,000	100,000 Overall	0	0.0	1:3.15	+15	W-2	22.75

MICROPHONE PICKUP AND LINE TRANSFORMERS

Stancor Number	Application		Ohms Impedance		Max. D.B. Level	Pri. D.C. Ma.		Case Type	List Price
	From	To	Primary	Secondary		Max. Per Side	Un-bal.		
A-8510	Micro., Pickup or Line	Single Grid	50, 200, 500	60,000	0	25	0.5	T-1	512.60
A-8511	Mixer, Pickup or Line	Single Grid	50, 125, 200, 250, 333, 500	50,000	+10	75	0.5	W-1	12.60
A-8513	Mixer, Pickup or Line	Single Grid	2.5, 5, 10, 15, 22, 30, 40, 60	50,000	+10	75	0.5	W-1	12.60
A-8514	Micro., Pickup or Line	Push-Pull Grids	50, 200, 500	80,000	0	25	0.5	T-1	12.60
A-8515	Micro. Pickup, or Line	Push-Pull Grids	50, 125, 200, 250, 333, 500	80,000 Overall in Two Sections	+10	75	0.5	W-1	12.60
A-8512	Balanced Line	Single Grid	50, 200*, 125, 500*	18,750, 75,000*	+15	100	0.5	W-2	22.75
A-8516	Balanced Line	Push-Pull Grids	50, 200*, 125, 500*	25,000, 100,000*	+15	100	0.5	W-2	23.95
A-8518	Dynamic Micro.	1 or 2 Grids	30	50,000 Overall (2 Sec)	+10	0	0.0	W-1	12.60
A-8519	D.B. Microphone or Line	Single Grid	200	500,000	0	10	10.0	T-1	12.60
A-8014	Single Plate	Line	10,000, 15,000	50, 200, 500	2	2.0	0.0	T-1	12.60
A-8017	Single Plate	Line	10,000, 15,000	50, 200, 500	0	0	0.0	T-1	12.60
A-8010	Velocity Microphone	Line	0.2	200, 500	0	0	0.0	T-1	11.35
A-8011	Dynamic Microphone	Line	7.5, 30	200, 500	0	0	0.0	T-1	11.35

*Balanced Center-Tap.

OUTPUT TO LINE OR VOICE COIL TRANSFORMERS

A-8012	Crystal Microphone	Multiple Line	100,000	50, 125, 200, 250, 333, 500	+10	0	0.0	W-1	512.60
A-8015	Single Plate (6CS, etc.)	Multiple Line—No D.C. in Pri.	10,000 or 15,000	50, 125, 200, 250, 333, 500	+10	0	0.0	W-1	12.60
A-8016	Single Plate (6CS, etc.)	Multiple Line D.C. in Primary	10,000 or 15,000	50, 125, 200, 250, 333, 500	+10	8	0.8	W-1	12.60
A-8018	Single Triode	Multiple Line	10,000 or 15,000	50, 200*, 125, 500*	+15	8	0.8	W-2	22.75
A-8020	Single or Push-Pull Triodes	Multiple Line	7,500, 30,000	50, 200*, 125, 500*	+20	10	0.5	W-2	22.75
A-8021	Push-Pull Low Level Plates	Multiple Line	10,000 Ea. Half 15,000	50, 125, 200, 250, 333, 500	+10	8	0.0	W-1	12.60
A-8022	Single Plate (6G6-G, etc.)	Voice Coil	10,000 or 15,000	1.5, 2, 4, 6, 8, 16	+15	10	10.0	W-1	12.60

LINE TO LINE (MIXING) TRANSFORMERS

A-8533	Microphone or Line	Line	50, 125, 200, 500	50, 125, 200, 500	0	20	0.5	T-1	511.35
A-8534	Mixing, Microphone, Pickup, or Line	Multiple Line	50, 125, 200, 250, 333, 500	50, 125, 200, 250, 333, 500	+10	75	0.5	W-1	12.60
A-8535	Multiple Line	Multiple Line	50, 200*, 125, 500*	50, 200*, 125, 500*	+15	100	0.5	W-2	22.75



FILAMENT TRANSFORMERS

SINGLE SECONDARY

All secondary windings are center tapped except those marked with asterisk (*).

Stancor Number	Primary Voltage	Secondary C. T.		Type Mounting	Mounting Dimensions			Insulation in Volts	Weight in Carton	List Price
		Volts	Amperes		H	W	D			
P-4026	115	2.5	1.5	A	1 ¹ / ₁₆ "	1 ⁵ / ₁₆ "	2 ³ / ₁₆ "	2,500	0.5	\$1.70
P-4082	105-115	2.5	2.5	E	2 ³ / ₈ "	2 ⁵ / ₈ "	2 ¹ / ₈ "	2,500	1.4	2.90
P-6133	115	2.5	5	S	2 ¹¹ / ₁₆ "	2 ¹ / ₂ "	2 ³ / ₄ "	7,500	2.7	2.40
P-614J	115	2.5	5.25	N	2 ¹¹ / ₁₆ "	2 ¹ / ₂ "	2 ³ / ₄ "	2,500	1.6	2.50
P-4083	105-115	2.5	6	C	3 ¹ / ₂ "	2 ⁵ / ₈ "	2 ³ / ₈ "	2,500	2.2	3.80
P-3024	105-115	2.5	10	C	3 ¹ / ₂ "	2 ⁵ / ₈ "	2 ⁵ / ₈ "	2,500	2.7	4.75
P-3060	115	2.5	10	B	3 ¹ / ₂ "	2 ¹³ / ₁₆ "	2 ³ / ₈ "	10,000	3.0	4.10
P-3025	105-115	2.5	10	FA	5"	4 ¹ / ₄ "	8 ¹ / ₄ "	10,000	5.3	9.10
P-3026	105-115	5	3	C	3 ¹ / ₂ "	2 ⁵ / ₈ "	2 ⁵ / ₈ "	2,500	2.5	3.80
P-4088	115	5	3	B	3 ¹ / ₂ "	2 ¹ / ₂ "	2 ¹ / ₂ "	2,500	2.0	2.80
P-3062	115	5	6	B	3 ¹ / ₂ "	2 ¹ / ₂ "	2 ³ / ₄ "	2,500	2.5	3.50
P-5000	105-115	5	6	C	3 ¹ / ₂ "	2 ⁵ / ₈ "	2 ⁷ / ₈ "	2,500	3.2	4.4)
P-6135	115	5	10	N	3 ¹ / ₂ "	2 ⁵ / ₈ "	3 ¹ / ₄ "	2,500	3.1	4.4)
P-4086	105-115	5	14	FA	5"	4 ¹ / ₄ "	8 ¹ / ₄ "	10,000	9.4	10.75
P-6302	105-115	5	22	FA	5"	4 ¹ / ₄ "	8 ¹ / ₄ "	10,000	12.0	12.5)
P-6136	115	5.25	4	N	2 ¹¹ / ₁₆ "	2 ¹ / ₂ "	2 ³ / ₄ "	2,500	2.3	2.90
P-6137	115	5.25	13	N	3 ³ / ₈ "	3 ¹ / ₄ "	3 ⁵ / ₈ "	2,500	4.2	5.45
P-5011	105-115	5.25	13	C	3 ³ / ₈ "	3 ³ / ₄ "	3 ⁵ / ₈ "	2,500	5.8	6.60
P-6134	115	6.3	1.2	A	1 ¹ / ₂ "	1 ¹ / ₂ "	1 ¹ / ₂ "	2,500	0.6	1.70
P-5014	115	6.3	3	B	3 ¹ / ₂ "	2 ¹ / ₂ "	2 ¹ / ₄ "	2,500	2.0	2.95
P-4019	105-115	6.3	4	C	3 ¹ / ₂ "	2 ⁵ / ₈ "	2 ⁵ / ₈ "	2,500	2.8	4.40
P-3064	115	6.3	6	B	3 ¹ / ₂ "	2 ¹ / ₂ "	2 ³ / ₄ "	2,500	2.4	3.50
P-4089	105-115	6.3	6	C	3 ³ / ₈ "	2 ¹³ / ₁₆ "	3 ¹ / ₈ "	2,500	3.7	4.75
P-6303	115	6.3	10	N	3 ¹ / ₂ "	2 ¹³ / ₁₆ "	3 ¹ / ₈ "	2,500	4.0	4.60
P-6309	115	6.3	20	N	4 ³ / ₈ "	3 ⁷ / ₈ "	3 ⁷ / ₈ "	2,500	7.5	9.40
P-5015	115	7.5	4	B	3 ¹ / ₂ "	2 ¹ / ₂ "	2 ¹ / ₂ "	2,500	2.5	3.00
P-4091	105-115	7.5	5	C	3 ³ / ₈ "	2 ¹³ / ₁₆ "	2 ⁷ / ₈ "	2,500	4.0	5.00
P-6138	115	7.5	8	N	3 ³ / ₈ "	3 ¹ / ₂ "	3 ¹ / ₂ "	2,500	4.1	4.75
P-4092	105-115	7.5	8	C	3 ¹ / ₂ "	3 ¹ / ₄ "	3 ³ / ₈ "	2,500	5.6	6.00
P-4094	105-115	7.5	15	FA	5"	4 ¹ / ₄ "	8 ¹ / ₄ "	5,000	7.8	11.40
P-4093	105-115	7.5	24	FA	5"	4 ¹ / ₄ "	8 ¹ / ₄ "	5,000	15.8	16.75
P-5016	115	10	4	B	3 ¹ / ₂ "	3"	2 ¹ / ₂ "	2,500	3.0	3.80
P-4096	105-115	10	5	C	3 ¹ / ₂ "	3 ¹ / ₄ "	3 ³ / ₄ "	2,500	4.6	5.65
P-6139	115	10	8	N	3 ¹ / ₂ "	3 ¹ / ₄ "	3 ¹ / ₂ "	2,500	4.1	5.00
P-4097	105-115	10	8	C	3 ¹ / ₂ "	3 ¹ / ₄ "	3 ³ / ₈ "	2,500	5.8	6.30
P-5002	105-115	10	12	FA	5"	4 ¹ / ₄ "	8 ¹ / ₄ "	7,500	11.6	11.35
P-3020	105-115	11	10	C	4 ³ / ₈ "	3 ³ / ₈ "	3 ³ / ₈ "	2,500	7.8	9.10
P-6164	115	*6.3, 5.2, 2.5	2.5	B	2 ⁵ / ₈ "	2 ¹ / ₄ "	2 ⁵ / ₈ "	2,500	1.8	2.80

MULTIPLE SECONDARY

P-5012	105-115	2.5 C.T.	10.0	FA	5"	4 ¹ / ₄ "	8 ¹ / ₄ "	10,000	7.9	\$11.95
		5.0 C.T.	3.0							
P-3061	115	2.5 C.T.	5.0	B	3 ¹ / ₂ "	2 ⁷ / ₈ "	3"	2,000	3.5	4.20
		7.5 C.T.	4.0							
P-6324	105-115	5.0 C.T.	3.0	C	3 ³ / ₈ "	3 ¹ / ₄ "	3 ³ / ₈ "	2,500	5.0	6.00
		2.5 C.T.	6.0							
P-5009	105-115	5.0 C.T.	3.0	C	3 ¹ / ₂ "	3 ¹ / ₄ "	3 ³ / ₈ "	2,500	4.7	6.00
		6.3 C.T.	6.0							
P-5008	105-115	5.0 C.T.	4.0	C	3 ¹ / ₂ "	2 ¹³ / ₁₆ "	3 ¹ / ₄ "	2,500	4.0	5.65
		6.3 C.T.	3.6							
P-4022	105-115	5.0 C.T.	6.0	C	3 ³ / ₈ "	3 ¹ / ₄ "	3 ³ / ₈ "	2,500	5.0	6.30
		6.3 C.T.	6.0							
P-4090	115	6.3 C.T.	3.0	B	3 ¹ / ₂ "	2 ⁷ / ₈ "	3"	2,500	3.7	4.20
		7.5 C.T.	4.0							
P-6144	115	2.5 C.T.	3.5	C	3 ¹ / ₂ "	3 ¹ / ₄ "	3"	2,500	4.0	6.30
		5.0 C.T.	3.0							
		6.3 C.T.	3.0							
P-4084	105-115	5.0 C.T.	3.0	C	3 ¹ / ₂ "	3 ¹ / ₄ "	3 ³ / ₈ "	2,500	5.6	7.20
		6.3 C.T.	3.6							
		7.5 C.T.	3.25							
P-6310	105-115	2.5	4.0	C	3 ¹ / ₂ "	2 ¹³ / ₁₆ "	3 ¹ / ₈ "	2,500	3.7	7.50
		2.5	4.0							
		*2.5	4.0							
		*2.5	4.0							
P-6333	115	7.5, 6.3 C.T.	3.0	B	2 ⁷ / ₈ "	3 ³ / ₈ "	2 ¹ / ₄ "	2,500	4.6	5.45
		*5.0	3.0							
		*5.0	3.0							
		*6.3	4.0							
P-6338	115	*6.3	3.0	C	3 ¹ / ₂ "	2 ⁷ / ₈ "	3 ¹ / ₈ "	2,500	4.0	5.35
		*2.5	3.0							
		*5.0	3.0							
		5.0	2.0							

*Windings not center tapped.
Other voltage and frequency combinations available on special order. Write for quotations.



TYPE "C"



TYPE "L"

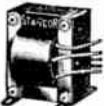

TYPE "N"



TYPE "FA"



TYPE "B"



TYPE "D"



PLATE TRANSFORMERS -- CHOKES

PLATE TRANSFORMERS

This group of transformers is designed primarily to deliver the rated D.C. voltage and current outputs when used with full-wave mercury vapor rectifier tubes in conjunction with a two section filter employing choke input and two 2 mfd. condensers working into a resistive load. Generous

coil and core design result in a transformer with above average regulation and efficiency. Phenolic terminal boards and heavy duty ceramic insulators assure protection from voltage breakdown.

Stancor Number	Primary Voltage	D. C. Voltage		Taps	Current in Ma.	Type Mounting	Mounting Dimensions			Weight in Carton	List Price
		After Filter					H	W	D		
P-8040	115	400		40	300	C	4 $\frac{3}{8}$ "	3 $\frac{3}{8}$ "	4 $\frac{1}{8}$ "	12.3	\$11.25
P-8041	115	500		400-40	250	C	4 $\frac{3}{8}$ "	3 $\frac{3}{8}$ "	5 $\frac{1}{2}$ "	9.0	13.75
P-8042	115	600		400-40	300	C	4 $\frac{3}{8}$ "	3 $\frac{3}{8}$ "	6 $\frac{1}{2}$ "	16.5	18.00
P-8043	115	750		600-40	300	FS	7 $\frac{1}{2}$ "	6 $\frac{1}{8}$ "	8"	27.2	27.00
P-8044*	115	1000		400	150-150	FS	7 $\frac{1}{2}$ "	6 $\frac{1}{8}$ "	8 $\frac{1}{4}$ "	28.0	29.00
P-8045	115	1000		750	250	FS	7 $\frac{1}{2}$ "	6 $\frac{1}{8}$ "	8"	27.2	27.00
P-8025	115	1000		750	400	FS	7 $\frac{1}{2}$ "	6 $\frac{1}{8}$ "	8 $\frac{3}{4}$ "	35.5	32.00
P-8026	115	1250		1000	300	FS	7 $\frac{3}{8}$ "	7 $\frac{3}{8}$ "	8 $\frac{3}{4}$ "	36.0	34.00
P-8027	115	1250		1000	500	FS	7 $\frac{3}{8}$ "	7 $\frac{3}{8}$ "	9 $\frac{1}{2}$ "	40.0	42.00
P-8028	115	1500		1250	300	FS	7 $\frac{3}{8}$ "	7 $\frac{3}{8}$ "	9"	38.0	37.50
P-8029	115-230	1500		1250	500	FS	7 $\frac{3}{8}$ "	7 $\frac{3}{8}$ "	9 $\frac{1}{4}$ "	52.0	52.50
P-8030	115	1750		1500	300	FS	7 $\frac{3}{8}$ "	7 $\frac{3}{8}$ "	9 $\frac{1}{2}$ "	40.0	41.00
P-8031	115-230	1750		1500	500	FS	11"	7 $\frac{3}{8}$ "	9 $\frac{1}{4}$ "	52.0	55.00
P-8032	115	2000		1750	300	FS	7 $\frac{3}{8}$ "	7 $\frac{3}{8}$ "	9 $\frac{3}{4}$ "	45.0	43.00
P-8033	115-230	2000		1750	500	FS	11"	7 $\frac{3}{8}$ "	10"	57.0	67.50
P-8034	115-230	2500		2000	300	FS	7 $\frac{3}{8}$ "	7 $\frac{3}{8}$ "	9 $\frac{1}{4}$ "	52.0	51.00
P-8035	115-230	2500		2000	500	FS	11"	7 $\frac{3}{8}$ "	10 $\frac{1}{4}$ "	60.0	80.00

*Secondary with taps suitable for dual rectifier supply. Each output available at rated current.

Note: Transformers with more than one high voltage output have secondary with taps suitable for dual rectifier supply. Total current should not exceed rating.

BIAS TRANSFORMERS

Stancor No.	D.C. Output		Filament		Primary Volts	Mounting Type	Dimensions			Weight in Carton	List Price	
	Volts		Ma.	Amps.			H	W	D			
P-6317	90-130-170-200		200	5	3	115	CD	3 $\frac{3}{8}$ "	3 $\frac{1}{4}$ "	3 $\frac{3}{4}$ "	4.9	59.60
P-6318	250-350-400-450		200	5	3	115	CD	4 $\frac{1}{4}$ "	3 $\frac{3}{8}$ "	4 $\frac{1}{4}$ "	7.0	10.80

Above plate and bias transformers are for listed voltage 50-60 cycle operation.

Other voltage and frequency combinations available on special order. Write for quotations.

CHOKES — SWINGING

Stancor Number	Inductance in Henries	Maximum Current in Ma.	D.C. Resistance		Volts Insulation	Type Mounting	Mounting Dimensions			Weight in Carton	List Price
			in Ohms				H	W	D		
C-1718	8-30	150	130	2000	C	3 $\frac{1}{8}$ "	2 $\frac{1}{2}$ "	2 $\frac{1}{2}$ "	2.5	\$4.10	
C-1400	8-40	175	100	3000	C	3 $\frac{1}{8}$ "	2 $\frac{1}{2}$ "	2 $\frac{1}{2}$ "	2.7	3.80	
C-1719	5-25	200	120	3000	N	3 $\frac{3}{8}$ "	3 $\frac{3}{8}$ "	3 $\frac{1}{4}$ "	5.0	5.00	
C-1401	8-30	200	80	3000	C	3 $\frac{1}{8}$ "	2 $\frac{1}{16}$ "	3 $\frac{1}{8}$ "	3.5	4.70	
C-1645	8-35	200	85	5000	C	3 $\frac{3}{8}$ "	3 $\frac{1}{4}$ "	3 $\frac{3}{8}$ "	4.7	5.25	
C-1702	8-30	250	60	3000	B	3 $\frac{1}{2}$ "	2 $\frac{1}{16}$ "	3"	3.9	5.00	
C-1402	8-30	250	60	3000	C	3 $\frac{3}{8}$ "	2 $\frac{1}{16}$ "	3 $\frac{1}{8}$ "	4.6	5.50	
C-1720	5-25	300	80	3000	N	4 $\frac{1}{2}$ "	3 $\frac{3}{8}$ "	3 $\frac{1}{2}$ "	8.5	6.30	
C-2307	5-25	300	80	3000	C	4 $\frac{3}{8}$ "	3 $\frac{3}{8}$ "	3 $\frac{3}{8}$ "	9.0	8.15	
C-1403	8-25	300	80	5000	D	4 $\frac{3}{8}$ "	3 $\frac{3}{8}$ "	3 $\frac{3}{8}$ "	8.4	8.65	
C-1404	5-25	400	60	5000	D	4 $\frac{3}{8}$ "	3 $\frac{3}{8}$ "	4 $\frac{1}{8}$ "	12.3	11.35	
C-1405	5-20	500	65	5000	F	8 $\frac{1}{16}$ "	6"	5 $\frac{3}{4}$ "	17.0	18.90	

CHOKES — FILTER

C-1420	30	80	350	2000	C	3 $\frac{1}{8}$ "	2 $\frac{1}{2}$ "	2 $\frac{1}{2}$ "	2.6	\$3.19
C-1421	25	140	160	3000	C	3 $\frac{1}{8}$ "	2 $\frac{1}{2}$ "	2 $\frac{1}{2}$ "	2.7	3.80
C-1410	20	175	100	3000	C	3 $\frac{3}{8}$ "	2 $\frac{1}{2}$ "	2 $\frac{1}{2}$ "	2.7	3.60
C-1721	15	200	120	3000	N	3 $\frac{3}{8}$ "	3 $\frac{3}{8}$ "	3 $\frac{1}{4}$ "	4.5	4.80
C-1411	15	200	80	3000	C	3 $\frac{3}{8}$ "	2 $\frac{1}{16}$ "	3 $\frac{1}{4}$ "	4.0	4.70
C-1646	20	200	70	5000	C	3 $\frac{3}{8}$ "	3 $\frac{1}{4}$ "	3 $\frac{3}{8}$ "	4.7	5.25
C-1703	15	250	60	3000	B	3 $\frac{1}{2}$ "	2 $\frac{1}{16}$ "	3 $\frac{1}{2}$ "	3.9	5.00
C-1412	15	250	60	3000	C	3 $\frac{3}{8}$ "	2 $\frac{1}{16}$ "	3 $\frac{1}{4}$ "	4.8	5.50
C-1722	13	300	80	3000	N	4 $\frac{1}{2}$ "	3 $\frac{3}{8}$ "	3 $\frac{1}{2}$ "	8.5	6.30
C-2308	13	300	80	3000	C	4 $\frac{3}{8}$ "	3 $\frac{3}{8}$ "	3 $\frac{3}{8}$ "	9.0	8.15
C-1413	12	300	80	5000	D	4 $\frac{3}{8}$ "	3 $\frac{3}{8}$ "	3 $\frac{3}{8}$ "	8.5	8.65
C-1414	10	400	60	5000	D	4 $\frac{3}{8}$ "	3 $\frac{3}{8}$ "	4 $\frac{1}{8}$ "	13.5	11.35
C-1415	8	500	65	5000	F	8 $\frac{1}{16}$ "	6"	5 $\frac{3}{4}$ "	17.0	18.90



TYPE "H"



TYPE "C"

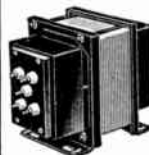

TYPE "FS"



TYPE "D"



TYPE "N"



TYPE "B"





DRIVER TRANSFORMERS

POLY-PEDANCE DRIVER TRANSFORMERS

These most versatile Poly-Pedance transformers are tapped to give many usable ratios as Class B drivers. Ratio chart and instructions furnished with each unit.

Stancor No.	Capacity in Watts	Primary Ma. Per Side	Ratio Primary to 1/2 Secondary	Type Mounting	Dimensions			Weight in Carton	List Price
					H	W	D		
A-4761	15	60	1.25:1, 1.4:1, 1.6:1, 1.8:1, 2:1, 2.2:1, 2.4:1	CD	3 1/4"	2 3/8"	3 3/4"	3.0	\$8.15
A-4762	15	60	2.6:1, 3:1, 3.2:1, 3.4:1, 4:1, 4.5:1, 5:1	CD	3 1/2"	2 3/8"	3 1/4"	2.8	8.15
A-4763	30	120	1.25:1, 1.5:1, 1.75:1, 2:1, 2.25:1, 3.2:1	CD	3 1/2"	3"	4"	4.3	10.00
A-4764*	30	120	1.5:1, 2:1, 2.5:1, 3:1, 3.5:1	CD	3 1/2"	3"	4"	4.3	10.00

*P.P. 6L6's with 16% inverse feed back.

POLY-PEDANCE LINE DRIVER TRANSFORMERS

Stancor No.	Capacity in Watts	Ratio Primary to 1/2 Secondary	Dimensions			Type Mounting	Weight in Carton	List Price
			H	W	D			
A-4765	15	1:0.75, 1:0.85, 1:1, 1:1.25, 1:1.45, 1:1.75, 1:2, 1:2.25, 1:2.5, 1:2.75, 1:3.15	3 1/2"	2 3/8"	3 1/2"	CD	3.0	\$7.50
A-4766	30	1:0.75, 1:0.85, 1:1, 1:1.25, 1:1.45, 1:1.75, 1:2, 1:2.25, 1:2.5, 1:2.75, 1:3.15	3 1/2"	3"	3 3/4"	CD	4.0	8.80

DRIVER TRANSFORMERS

Stancor Number	From	To	Class	Impedance		Ratio Pri. to Sec.	D.C. Type Pri. Mounting	Mounting Dimensions			Weight in Carton	List Price	
				Pri.	1/2 Sec.			H	W	D			
A-4752†	P.P. or 1-45, 6F6, 2A5, 42, 6K6, 6N7, 6CS	P.P. 6K6, 2A5, 42, 6F6, 6L6, 6V6, 6Y6, 6Z7	AB	10,000	10,000	1:1 1.5:1 2:1	35	S	2 1/4"	2 3/8"	1 7/8"	1.5	\$2.50
A-4405	1-45, 6F6, 42, 2A5, 6K6, 41	P.P. 42, 89, 2A5, 6F6, 6V6, 6Z7	B	10,000	6,400	1.24:1	40	C	3 1/4"	2 3/8"	2 3/8"	2.7	4.75
A-4406	P.P. 2A3, 6A3, 45	P.P. 50T, 154, 203A, HF100, HF200, 825	B	18,500	6,250	1.71:1	95	C	3 1/8"	2 3/8"	2 3/4"	2.6	5.25
A-4721	1-2A3, 6A3, 45, 46, 59, 42, 6F6, 2A5, 89, 53, 6A6, 6N7, 6CS, 37, 30, 1H4	1-1J6, 19, 79, 6Z7, 53, 6N7, P.P. 42, 45, 6F6, 46, 49, 2A5, 59, 89, 6K6, TZ20	B	10,000 22,500	2,500	2:1 3:1	30	E	2 3/8"	2 3/4"	2 1/2"	1.5	3.60
A-4404	P.P. 2A3, 6A3, 45, 6L6, 6V6, 6F6, 50, 42, 59 P.P. Par. 2A3, 6A3, 6L6	P.P. 849, P.P. 800, 830B, 203, 10, RK18, RK58, HF100, T20, TZ40, 811, P.P. 154, 812, 203A, 838, 211, 203Z, RK38, HF100, 100TL, HF200, 822, HD203A, 354, 150T	A B	14,000	3,500	2:1	90	C	3 1/2"	2 15/16"	3 1/8"	3.7	5.25
A-4292	1-6CS, 6J5, 30, 1H4, 49	1-1J6, 19, 79, 6Z7, P.P. 30, 1H4, 49	B	10,000	1,600	2.5:1	10	A	1 3/8"	2 15/16"	1 1/2"	0.7	1.85
A-4208†	P.P. 6CS, 6J5, 6N7, 6L5, 56, 27, 76, 55, 85, 6R7	P.P. 2A3, 2A5, 6A3, 6F6, 6L6, 6V6, 42, 45, 50, 59, 89	AB	25,000	3,200	2.79:1	15	C	3 1/4"	2 3/8"	2 3/8"	2.5	4.30
A-4210	1-2A3, 6A3, 45, 46, 59, 2A5, 6F6, 42, 89, 6CS, 6N7, 76	P.P. 2A3, 6A3, 46, 59, P.P. 2A5, 42, 45, 6F6, 6L6, 807	B AB	22,500	2,500	3:1	40	C	3 1/8"	2 3/8"	2 3/8"	2.6	4.10
A-4701†	P.P. 46, 89, 6CS, 6J5, 56, 37, 27, 76	P.P. 6L6, 6V6, 6Y6, 42, 6F6, 45, 2A3, 6A3	AB1	20,000	2,200	3.1:1	25	C	3 1/4"	2 3/8"	2 3/8"	2.7	4.40
A-4212	P.P. 2A3, 6A3, 45, 6L6	P.P. 801, 830B, 35T, 808, 838, RK52, Z120, RK57, HY40Z, 805, 828, 756, 100TL, 100TH, TZ20, TZ40, P.P. Par. 46, 59, P.P. 807	B AB	25,600	2,500	3.2:1	50	C	3 1/3"	2 3/8"	2 3/8"	2.6	4.40
A-4216	1-53, 6A6, 6N7, 79, 6L6, 2-53, 6A6, 6N7	1-53, 6A6, 6N7, 6E6, 6N6, 89, 2-53, 6A6, 6N7	B	25,000	1,000	5:1	15	E	2 4/3"	2 3/8"	2 1/8"	1.5	3.50
A-4416†	P.P. 2A3, 45, 46, 59, 6F6, 2-53, 6A6, 6N7	P.P. 6L6, 6V6, P.P. Par. 46, 59, 2-53, 6A6, 6N7	AB2 B	30,000	1,200	5:1	40	C	3 1/8"	2 3/8"	2 3/8"	2.7	4.75
A-4702†	1-2A3, 45, 46, 89, 2A5, 6F6, 42	P.P. 6L6, 6V6, 6F6, 45, P.P. Par. 6L6	AB2 AB1	50,000	2,000	5:1	80	C	3 1/8"	2 3/8"	2 3/8"	2.7	4.15
A-4703†	P.P. 2A3, 45, 46, 6L6, 89, 6F6, 2A5, 42	P.P. 807, HY61, P.P. Par. 6L6	AB2	10,000	325	5.6:1	95	C	3 1/2"	2 15/16"	3 1/4"	3.8	5.35

†P.P. primary ratio is 2:1. †Split Secondary.



TYPE "A"



TYPE "E"



TYPE "C"



TYPE "CD"



TYPE "J"



TYPE "S"



MODULATION TRANSFORMERS

POLY-PEDANCE MODULATION TRANSFORMERS

These most versatile Poly-Pedance transformers are tapped to give wide range of impedances for correctly matching every type of load. Impedance chart and instructions furnished with each unit.

Stancor No.	Max. Aud. Watts	Pri. Ma. Per Side	Secondary Ma.		Type Mtg.	Dimensions			Wt. in Carton	List Price
			Series	Parallel		H	W	D		
A-3891	15	45	45	90	D	3 1/8"	2 3/8"	3 1/8"	2.5	\$6.95
A-3892	30	80	80	160	D	3 7/8"	3 1/4"	4 3/8"	6.0	8.50
A-3893	60	125	125	250	D	3 7/8"	3 1/4"	4 7/8"	7.3	10.00
A-3894	125	150	150	300	D	4 5/8"	3 7/8"	5 1/2"	12.0	13.20
A-3898	300	260	260	520	FS	7 5/8"	7 1/8"	8 3/4"	40.0	47.50
A-3899	600	350	350	700	FS	11"	7 1/2"	10"	75.0	98.00

PLATE MODULATION TRANSFORMERS

Conservatively rated for continuous duty at maximum current and audio wattage. Well insulated against voltage breakdown. Excellent construction and impregnation assure quiet operation and long life.

Stancor No.	Output Tubes	Class	Impedance		D.C. Pri. Ma.	D.C. Sec. Ma.	Max. Audio Watts	Type Mounting	Dimensions			Weight in Carton	List Price
			Pri.	Sec.					H	W	D		
A-3812	1-1G6, 1J6, 19, 6E6, 6G6, 6Z7, P.P. 1H4, 30, 49, 1-1G5, 6K6, 37, 38, 41	B A	10,000	4,000	32	50	5	A	1 1/2"	2 1/8"	1 1/2"	0.7	\$1.70
A-3871	1-6B5*, 6F6*, 6L6, 6N6*, HY69	A1	4,500	8,500	60	50	10	E	2 3/8"	2 3/4"	2 1/2"	1.8	3.50
A-3873	P.P. 6L6, RK56, HY60	AB1	8,500	8,000	100	100	25	C	3 1/4"	2 3/8"	3 1/4"	6.1	6.30
A-3845	1-6A6, 6N7, 53, 79, 6Y7, P.P. 6F6, 6V6, 2A5, 42	B AB2	10,000	3,000, 5,000, 6,500, 8,000	100	100	25	C	3 1/4"	2 3/8"	2 3/4"	3.5	4.10
A-3835	P.P. 2A3, 6A3, 45, 6A5, 6B4, 50, P.P. 6L6	AB A1	3,000, 5,000	5,350, 8,350, 10,000	80	100	25	C	3 3/8"	3 1/4"	3 3/8"	5.2	6.30
A-6200	1-HY69; 807	A	4,000	5,000	80	80	12	W-2	3 1/2"	2 3/4"	3 1/4"	4.3	6.90
A-3868	P.P. 6L6	AB1	6,600	12,000	100	70	35	C	3 1/4"	2 3/8"	3 3/4"	6.1	6.00
A-2906	P.P. 10, HK24, 46, 89, 801, 1602, P.P. 6L6, 50, HY69	B AB	6,000	3,300, 4,000, 5,000, 6,250	200	125	40	D	4 1/8"	3 3/8"	4"	7.0	8.15
A-3843	P.P. 6L6, RK56, HY60	AB1	6,600	5,000, 7,500, 14,500	150	150	40	D	4 1/8"	3 3/8"	3 3/4"	7.0	8.50
A-3874	P.P. 6L6	AB1	6,000	500, 2,800	100	200	50	C	4 1/4"	3 1/2"	3 1/2"	6.5	8.50
A-3808	P.P. 6L6, 807, HY61, RK41, P.P. PAR. 6L6	AB2 AB1	3,800, 3,300	4,000, 5,000, 7,500, 10,000	260	170	60	D	4 5/8"	3 3/8"	3 3/8"	7.7	9.20
A-2907	P.P. 10, T20, TZ20, HY28, 46, 801, 825, 841	B	8,000	3,300, 5,000, 6,800, 9,000, 12,500	200	150	90	D	4 1/2"	3 3/8"	4 1/4"	10.2	11.95
A-2908	P.P. RK18, T20, TZ20, HY25, RK31, 35T, 50T, 800, 801, 830B, 1623	B	7,200, 12,000	3,000, 4,500, 5,350, 6,250	260	220	120	D	4 3/4"	3 3/4"	4 3/4"	10.4	12.60
A-3829	P.P. RK12, HY25, 35T, HY40Z, T40, TZ40, 100TL, HK354, 756, 809, 830B	B	6,900, 9,000	3,300, 4,000, 5,000, 6,250	250	300	175	D	4 3/8"	3 3/8"	5"	11.8	13.60

*Secondary winding used as primary.

CATHODE MODULATION TRANSFORMERS

Stancor No.	Impedance		D.C. Pri. Ma.	D.C. Sec. Ma.	Max. Audio Watts	Type Mounting	Dimensions			Weight in Carton	List Price
	Pri	Sec.					H	W	D		
A-3888	4000, 6000, C.T.	150, 250, 500, 750, 1000, 1500, 2000, 2500	50	250	25	D	3 3/8"	2 3/8"	3 3/4"	3.0	\$6.10
A-3889	4000, 6000, C.T.	150, 250, 500, 750, 1000, 1500, 2000, 2500	125	450	60	D	3 3/8"	3 1/4"	4 1/4"	4.8	8.50

MODULATION TRANSFORMERS—LINE TO R. F. LOAD

Stancor No.	Ohms Impedance		D.C. Sec. Ma.	Max. Audio Watts	Type Mtg.	Dimensions			Weight in Carton	List Price
	Primary	Secondary Load				H	W	D		
A-3834	500, 200	4,000, 6,000, 9,500	150	30	C	4 1/8"	3 3/8"	3 3/4"	6.5	\$8.15
A-3866	500, 200	5,000, 6,000, 7,000, 8,000, 9,000, 10,000	150	30	D	4 1/8"	3 3/8"	3 3/4"	6.5	10.00



TYPE "D"



TYPE "FS"



TYPE "A"



TYPE "C"



TYPE "E"

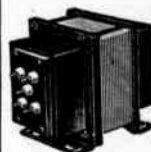

TYPE "FS"



Audio Transformers



STANCOR Professional Series Audio Transformers are carefully designed to give uniform frequency response throughout the audio range. STANCOR engineering, skilled labor and high grade materials combined, result in a unit of greater efficiency, better electrical characteristics and negligible wave form distortion and phase shift.

All units are housed in heavy steel cases which provide efficient shielding against hum pickup due to stray electric or magnetic fields.

Absolute protection against moisture in all climates is provided by the special moisture-proof compound which covers the core and coil and fills the case.

Low Impedance to Grid Audio Transformers Hum-Bucking Type Construction

Stancor Number	Application		Impedance in Ohms		Max. DB. Level	Over-all Turns Ratio	Pri. Ma. Un-bal.		Type in Mtg. Carton	Wgt. in Carton	List Price
	From	To	Pri.	Sec.			D.C.	per side			
A-9510	Low Imp. Mixer Pick-up or Line	Single or P. P. Grids	50/125/200 250/333/500	80,000	+15	1:12.7	100	0.5	R B	2.5	\$6.00
A-9511	Dbl. Button Mike	Sgl. or P. P. Grids	400 C. T.	140,000	+15	1:18.7	75	0.5	R B	2.5	6.00

Plate to Grid Interstage Transformers Hum-Bucking Type Construction

Stancor Number	Application		Impedance in Ohms		Turns Ratio	D.C. Ma.	Type Mtg.	Wgt. in Carton	List Price
	From	To	Pri.	Sec.					
A-9500	Single Plate	Single or P. P. Grids	10,000	40,000	1:2	10	R B	2.5	\$5.50
A-9501	Single Plate	Single or P. P. Grids	10,000	90,000	1:3	10	R B	2.5	5.50
A-9502	P. P. Plates	P. P. Grids	20,000	80,000	1:2	10	R B	2.5	5.50
A-9503	P. P. Plates	P. P. Grids	20,000	180,000	1:3	10	R B	2.5	5.50

Line to Line and Voice Coil Transformers

Stancor Number	Application		Impedance in Ohms		Max. Audio Watts	Type Mtg.	Wgt. in Carton	List Price
	From	To	Pri.	Sec.				
A-9540*	Line	Line	50/125/200 250/333/500	50/125/200 250/333/500	+24 D.B.	R A	2.3	\$5.50
A-9541	Line	Voice coil	250/500	4/8/15	15	R C	3.0	6.25
A-9542	Line	Voice coil	250/500	4/8/15	30	R D	6.0	6.75
A-9543	Line	Voice coil	250/500	4/8/15	60	R E	9.5	9.50
A-9544	Line	Voice coil	500/1000, 1500/2000	4/8/15	30	R D	3.0	6.25

*Hum-Bucking type construction.

Driver Transformers

Stancor Number	Application		Primary Range in Ohms	Ratio Pri. to 1/2 Sec.	D.C. Pri. Ma.	Max. Audio Watts	Type Mtg.	Wgt. in Carton	List Price
	From	To							
A-9520	Sgl. plate	P.P. Grids	2,000 to 5,000	2:1 2.5:1	40	10	R B	2.6	\$5.00
A-9521	Sgl. plate	P.P. Grids	5,000 to 10,000	2:1 2.5:1	50	15	R C	3.6	6.50
A-9522	Sgl. plate	P.P. Grids	5,000 to 10,000	3:1 3.25:1	50	15	R C	3.6	6.50
A-9523	P.P. plates	P.P. Grids	2,500 to 5,000	2.5:1 3:1	50	15	R C	3.7	7.00
A-9524	P.P. plates	P.P. Grids	5,000 to 10,000	2.5:1 3:1	50	15	R D	4.5	7.35
A-9525	P.P. plates	P.P. Grids	2,500 to 5,000	2:1 2.25:1	50	15	R C	3.7	7.00
A-9526	P.P. plates	P.P. Grids	1,500 to 5,000	1.5:1 2:1	100	30	R D	5.0	7.40
A-9531	Sgl. plate	P.P. Grids	5,000 to 10,000	4:1 5:1	40	10	R C	2.6	5.00
A-9532	P.P. plates	P.P. Grids	5,000 to 10,000	4:1 5:1	50	15	R D	3.6	6.50

These Transformers have fixed ratios as shown, however the primary is so designed that it may be used with tubes having the impedance ranges as shown. For example, P. P. 2A3's require 5000 ohms plate to plate load; similarly P. P. 6L6's can be operated at a plate load of 6600 ohms, therefore the same primary may be used in each instance, and likewise the same driver transformer, since ratio is the important consideration in choosing the driver transformer. Tubes having higher load requirements may be used on any transformer. Example: A tube having 6000 ohms load requirement may be used on a 5000 ohm primary. However, the performance will decrease approximately as the following empirical equation:

% DECREASE IN PERFORMANCE

$$= \left[\sqrt{2} \log \left(\frac{Z_2}{Z_1} \right) \right] \times 100$$

Z₂ = NEW LOAD
Z₁ = RATED LOAD

Example: Z₂ = New Plate—Plate Load of Tubes = 6000 ohms.
Z₁ = Rated Plate—Plate Load of Trans = 5000 ohms.

% DECREASE IN PERFORMANCE

$$= \left[\sqrt{2} \log \frac{6000}{5000} \right] \times 100 = \left[\sqrt{2} \log .145 \right] \times 100 = 20.2\%$$

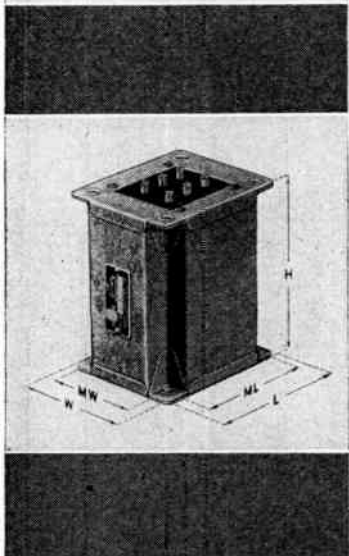

DIMENSIONS

Professional Series Transformers

Case Type	H	W	L	MW	ML
RA	2 7/8"	2"	2 1/8"	1 9/16"	2 1/8"
RB	3 1/16"	2 3/8"	2 3/8"	1 13/16"	2 3/8"
RC	3 5/8"	2 3/8"	3 1/8"	1 13/16"	2 3/8"
RD	3 7/8"	3"	4 1/2"	2 1/8"	3 3/8"
RE	5"	3 3/8"	5"	3 3/8"	4 5/8"
RF	5"	4 1/2"	5"	3 7/8"	4 5/8"
RG	5"	5 1/8"	5"	4 1/2"	4 5/8"
RH	9"	7 1/2"	7"	6 1/2"	6"
RJ	9"	8 3/4"	7 1/2"	7 3/4"	6 1/2"
RK	9"	8 3/4"	9"	7 3/4"	8"
RL	13"	8 3/4"	10"	7 3/4"	9"

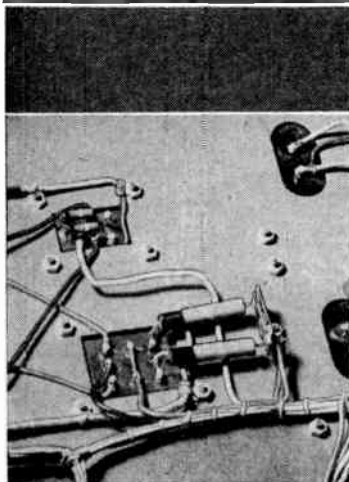

Poly-Pedance Transformers

Circuit changes have in the past, often required new transformers, and many times it was found that a correct match of impedances was not always possible. Therefore STANCOR engineered the Poly-Pedance line of tapped driver and modulation transformers.

Poly-Pedance Driver Transformers

Poly-Pedance Driver Transformers are so constructed that a wide range of reflected impedances, for a given load impedance, is possible. Thus a closer approach to optimum operation for a given combination of driver and output tubes or line-driver combinations can be obtained.

Stancor Number	Watts Capacity	Pri. Ma. per side	Ratio		Type Mtg.	Wgt. in Carton	List Price
			Primary to 1/2 Sec.	1/2 Sec.			
A-9527	15	60	1.25:1, 3:1, 3.5:1, 4:1	2:1, 2.5:1, 4:1	R D	4.0	\$ 9.50
A-9528	30	120	1.25:1, 3:1, 3.5:1, 4:1	2:1, 2.5:1, 4:1	R D	4.9	10.50
A-9529	15	..	1: .75, 1:1.45, 1:2.5, 1:2.75, 1:3.15	.85, 1:1, 1:1.25, 1:2, 1:2.25, 1:3.15	R D	3.5	8.50
A-9530	30	...	1: .75, 1:1.45, 1:2.5, 1:2.75, 1:3.15	.85, 1:1, 1:1.25, 1:2, 1:2.25, 1:3.15	R D	4.5	11.00

Poly-Pedance Modulation Transformers

In the past it has been frequently found that a proper match of modulator tubes to Class "C" stage could not be had with standard units. While 20% mismatch does not seriously reduce the power it generally results in higher distortion values because the proper plate load is not reflected to the tubes. Through the use of Poly-Pedance units one need no longer tolerate this condition.

PRIMARY RANGE ALL UNITS: 2,000 to 20,000 ohms. Secondary range Class "C" load impedance 175 to 20,000 ohms. Complete chart furnished with each transformer to facilitate and assure proper impedance match.

Stancor Number	Max Audio Watts	Pri. Ma. Per side	Secondary Ma.		Type Mtg.	Wgt. in Carton	List Price
			Series	Par.			
A-9000	15	45	45	90	R C	3.0	\$ 8.00
A-9001	30	80	80	160	R D	6.5	8.90
A-9002	60	125	125	250	R E	7.8	12.00
A-9003	125	150	150	300	R F	13.0	16.75
A-9004	300	260	260	520	R H	38.0	42.50
A-9005	600	350	350	700	Y	90.0	115.00

Dimensions: H-8 1/2" W-11 3/4" L-13 1/2" MW-10 1/4" ML-5"---Slotted for 3/8" bolt.

Plate Modulation Transformers

Stancor Number	Output Tubes	Class	Impedance in Ohms		D.C. Pri. Ma.	D.C. Sec. Ma.	Max. Audio Watts	Type Mtg.	Wgt. in Ctn.	List Price
			Pri.	Sec.						
A-9011	Sgl. 6B5*, 6F6*, 6N7* Sgl. 6L6, HY69	A	4,500	8,500	60	50	10	R B	2.5	\$ 4.75
A-9012	Sgl. 6L6, HY69, 807	A	4,000	5,000	80	80	12	R B	3.5	6.00
A-9013	P. P. 6A6, 6N7, 53 P. P. 2A5, 6F6, 6V6, 42	B AB2	10,000	3,000 5,000 6,500 8,000	100	100	25	R D	4.5	8.50
A-9014	P P 6L6, RK56, HY60	AB1	6,600	5,000 7,500 14,500	150	150	40	R E	8.8	9.25
A-9015	P. P. 6L6, 807 HY61, RK41 P P Par. 6L6	AB2 AB1	3,800 3,300	4,000 5,000 7,500 10,000	260	170	60	R E	10.0	13.50
A-9016	P. P. 10, T20, 35T, TZ20, HY25, 46, 801, 809, 825, 841	B	8,000	3,300, 5,000 6,800, 9,000 12,500	200	150	90	R F	12.5	15.00
A-9017	P. P. RK18, T20, TZ20, HY25, RK31, 35T, 800, 801, 830B, 1623	B	7,200	3,000 4,500 5,350 6,250	260	220	120	R F	11.4	16.00
A-9018	P. P. RK12, HY25, 35T, HY40Z, T40, TZ40, 100TL, HK354, 756, 809, 830B	B	6,900	3,300 4,000 5,000 6,250	250	300	175	R F	14.0	22.00
A-9019	P. P. HY51, RK52, 100TH, ZB120, T155, 203A, H, Z, 211, C, D, H, 242A, 261A, 276A, 805, 808, 838	B	6,900	4,000 6,000 8,000 10,000	300	400	300	Y See Note	56.0	50.00
A-9020	P. P. RK57, T155, HF200, HD203A, HK354E, 805, T814, 822	B	8,000	4,000 6,250 9,000	500	500	500	Y See Note	110.0	95.00

*Secondary winding used as primary.

A-9019 dimensions: H-7" W-8 1/4" L-11" MW-7 3/4" ML-3"---Slotted for 1/4" bolt.

A-9020 dimensions: H-8 1/2" W-11 3/4" L-14" MW-10 1/4" ML-5 1/2"---Slotted for 3/8" bolt.

Cathode Modulation Transformers

Stancor Number	Impedance in Ohms		D.C. Pri. Ma.	D.C. Sec. Ma.	Max. Audio Watts	Type Mtg.	Wgt. in Carton	List Price
	Pri.	Sec.						
A-9009	4000, 6000 C.T.	150, 250 500, 750 1000, 1500 2000, 2500	50	250	25	R D	3.5	\$ 7.00
A-9010	4000, 6000 C.T.	150, 250 500, 750 1000, 1500 2000, 2500	125	450	60	R E	5.3	10.50

These prices are quoted subject to any changes required by O. P. A. regulations.

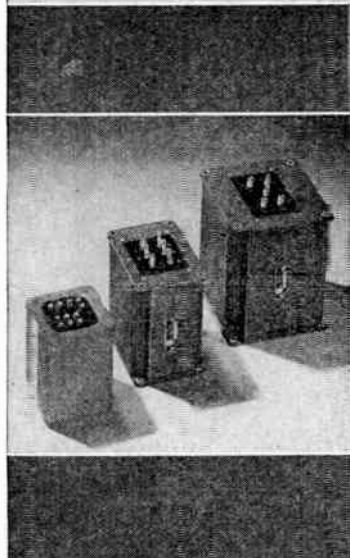

Output—Power—Bias Transformers



Output Transformers

STANCOR Professional Series Output Transformers are carefully designed and constructed of high grade materials and are engineered to provide uniform frequency response, greater wave form fidelity and high efficiency. The case offers good shielding from extraneous fields. These units are provided with several taps so that a close match can be effected. Their design results in good frequency response even with a slight mismatch, thus extending their range of usefulness.

Stancor Number	Output Tubes	Class	Impedance in Ohms		D.C. Pri. Ma.	Max. Audio Watts	Type Mtg.	Wgt. in Carton	List Price
			Pri.	Sec.					
A-9040	P.P. Par. 2A3, 6A3, 45	AB	1,500	4, 8, 15, 2,500 C.T.	150	30	R D	5.0	\$ 8.75
A-9041	P.P. Par. 6L6 P.P. RK-39, 807	AB2 AB2	1,900	4, 8, 15, 6,400 C.T.	220	100	R F	15.0	16.50
A-9042	P.P. 25L6	A	2,000 C.T.	4, 8, 15, 250, 500	50	10	R C	3.5	5.00
A-9043	P.P. 2A3, 6A3, 45 P.P. 6L6	AB A	3,000	4, 8, 15, 5,000 C.T.	80	20	R D	4.0	7.50
A-9044	P.P. Par. 46, 59 P.P. Par. 2A5, 6F6, 42	B AB	3,000	4, 8, 15, 5,000 C.T.	150	40	R D	5.4	9.50
A-9045	P.P. 6L6	AB2	3,800	4, 8, 15, 6,000 C.T.	250	60	R E	9.1	10.00
A-9046	P.P. 6L6	AB1	3,800	4, 8, 15, 6,600 C.T.	150	30	R D	5.0	8.75
A-9047	P.P. 46, 59 P.P. 2A5, 6F6, 42	B AB	6,000	4, 8, 15, 10,000 C.T.	100	30	R D	4.5	7.25
A-9048	Srl. 2A5, 6F6, 42	A	7,000	4, 8, 15, 250, 500	40	8	R B	2.5	5.50
A-9049	P.P. 43, 45	A	10,000 C.T.	4, 8, 15, 250, 500	40	8	R B	2.5	5.50
A-9050	P.P. 26B, 6B5, 6N6	A	10,000 C.T.	4, 8, 15, 250, 500	50	10	R C	3.0	6.80
A-9051	P.P. 6V6 P.P. 19,49,53,6A6,6N7	AB B	10,000 C.T.	4, 8, 15, 250, 500	60	20	R C	3.6	6.80
A-9052	P.P. 2A5, 6F6, 42	A	14,000 C.T.	4, 8, 15, 250, 500	35	10	R B	3.1	6.20

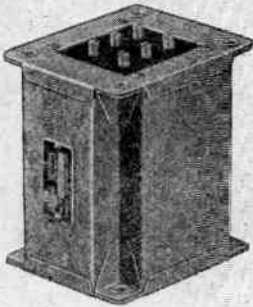

Universal Output Transformers

Stancor Number	Output Tubes	Impedance Range in Ohms		D.C. Pri. Ma.	Max. Audio Watts	Type Mtg.	Wgt. in Carton	List Price
		Pri.	Sec.					
A-9070	Single or P. P. Plates	1,500 to 20,000	.02 to 50	80	15	R C	3.7	\$ 7.00
A-9071	Single or P. P. Plates	1,500 to 20,000	.02 to 50	150	30	R D	4.9	10.50

Power Transformers

Power Transformers of the STANCOR Professional Series represent the acme in reliability. Their durable construction is the outcome of careful engineering and years of experience in the fabricating of equipment for leading radio manufacturers. All are conservatively designed for maximum life. By the use of large wire sizes and ample high grade core material in these units temperature rise is kept low and the efficiency and durability are increased.

Stancor Number	Sec. Load Volts	A.C. Sec. Ma.	D.C. Rectifier	Filaments		Type Mtg.	Wgt.	List Price
				No. 1	No. 2			
P-8587	350-0-350	75	5V @ 2A	6.3V @ 3A C.T.	R E	10.5	\$ 7.25
P-8588	350-0-350	100	5V @ 3A	6.3V @ 5A C.T.	R E	10.7	9.20
P-8589	300-0-300	125	5V @ 3A	6.3V @ 4.5A C.T.	R E	11.0	9.75
P-8580	500-0-500	150 †	5V @ 3A	6.3/7.5V @ 5A C.T.	R F	11.7	15.00
P-8581	500-0-500	400 †	5V @ 6A	6.3V @ 6A C.T.	R H	19.0	21.00
P-8582	800-0-800	200 †	2.5V @ 10A	6.3/7.5V @ 3A C.T.	R H	16.2	16.00
P-8583	400-0-400	200 †	5V @ 3A 5V @ 3A	6.3V @ 3A C.T.	2.5V @ 4A C.T.	R F	13.1	16.50
P-8584	340-0-340 Has 75 Volt Bias Tap.	135 †	5V @ 2A	6.3V @ 4A C.T.	2.5/6.3V @ 5A C.T.	R F	10.7	16.00
P-8585	370-0-370	175 †	5V @ 3A	6.3V @ 5A C.T.	R E	10.7	14.75
P-8586	450-0-450	325 †	5V @ 6A	6.3V @ 8A C.T.	R H	19.0	19.25

†Measured with input inductance sufficient to maintain the output current substantially constant.

Bias Transformers

Stancor Number	D.C. Output Volts	D.C. Output Ma.	Filament		Pri. Volts	Type Mtg.	Wgt. in Carton	List Price
			Volts	Amps.				
P-8534	90/130/170/200	200	5.0	3.0	115	RD	5.4	\$11.50
P-8535	250/350/400/450	200	5.0	3.0	115	RE	7.5	13.00

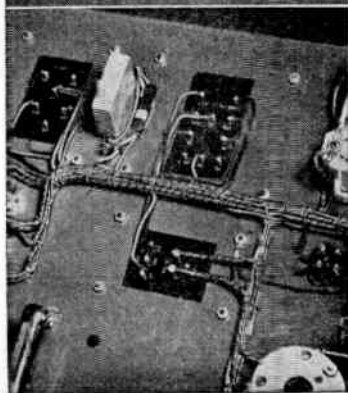
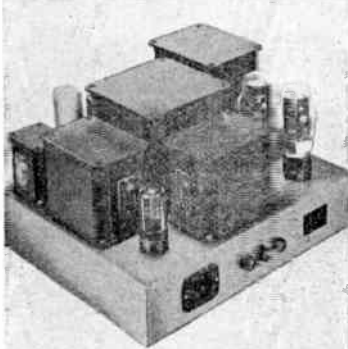

PROFESSIONAL SERIES Plate Transformers

By using an entirely new design of cast semi-steel end bells both mechanical strength and eye appeal have been added together with other features such as more effective shielding, etc. Durable Ceramic terminals are mounted on phenolic panels to assure adequate insulation. End bells are compound filled.

The primaries of the new Professional Series Plate Transformers are wound for use on either 115 or 230 volt line. Secondary voltages are balanced to center tap. Symmetrical coil design (resistive, capacitive and inductive balance) results in a more uniform D.C. output from the rectifier tubes.

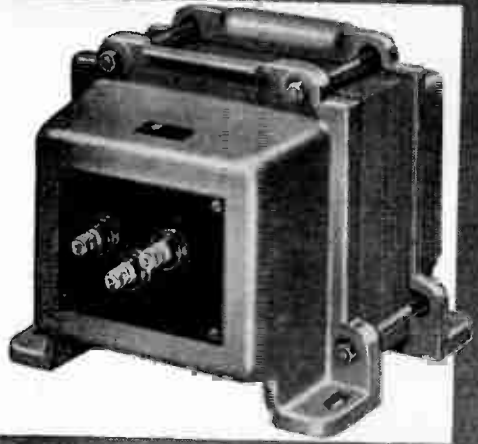

These rugged units are built to take it. All are insulated to RMA standards. Primaries designed for 50-60 cycle operation.

Plate Transformers

Stancor Number	Primary Volts	V.A.	Sec. A.C. Load Volts	D.C. Volts After Filter†	Current in Ma.	Type Mfg.	Wgt. in Carton	List Price
P-8500	115-230	180	510-0-510	400	250	RF	11.6	\$13.50
P-8501	115-230	220	625-0-625 500-0-500 40 V bias tap.	500 400	250	RF	12.2	17.50
P-8502	115-230	410	950-0-950 750-0-750	750 600	300	Y	17.3	32.00
P-8503	115-230	350	1250-0-1250 535-0-535	1000 400	130 150	Y	16.8	35.00
P-8516	115-230	450	1250-0-1250 950-0-950	1000 750	250	Y	21.5	32.50
P-8504	115-230	670	1550-0-1550 1250-0-1250	1250 1000	300	Y	30.0	42.00
P-8505	115-230	1100	1550-0-1550 1250-0-1250	1250 1000	500	Y	40.8	62.00
P-8517	115-230	400	1900-0-1900	1500	175	Y	22.1	37.50
P-8506	115-230	820	1900-0-1900 1550-0-1550	1500 1250	300	Y	34.0	45.00
P-8507	115-230	1350	1900-0-1900 1550-0-1550	1500 1250	500	Y	48.5	65.00
P-8508	115-230	950	2200-0-2200 1900-0-1900	1750 1500	300	Y	36.0	48.50
P-8509	115-230	900	2500-0-2500	2000	250	Y	34.5	47.50
P-8510	115-230	1080	2500-0-2500 2200-0-2200	2000 1750	300	Y	38.4	50.00
P-8511	115-230	1280	2950-0-2950 2500-0-2500	2500 2000	300	Y	50.1	55.00
P-8512	115-230	1590	2200-0-2200 1900-0-1900	1750 1500	500	Y	59.6	62.50
P-8513	115-230	1800	2500-0-2500 2200-0-2200	2000 1750	500	Y	67.7	80.00
P-8514	115-230	2150	3000-0-3000 2500-0-2500	2500 2000	500	Y	70.0	95.00
P-8515	115-230	1950	3600-0-3600	3000	375	Y	65.0	105.00

†All D.C. voltages measured after choke input filter.

These prices are quoted subject to any changes required by O. P. A. regulations.

Plate Transformer Dimensions ("Y" Case)

No.	Mounting Space			Mounting Centers		No.	Mounting Space			Mounting Centers	
	H	x W	x L	MW	x ML		H	x W	x L	MW	x ML
P-8502	6 3/4"	7 3/4"	10 3/4"	6 1/2"	4"	P-8510	8 1/2"	11 3/4"	14"	10 1/2"	5 1/2"
P-8503	6 3/4"	7 3/4"	10 3/4"	6 1/2"	4 1/4"	P-8511	8 1/2"	11 3/4"	14"	10 1/2"	5 1/4"
P-8504	7"	8 1/4"	10 3/4"	7 1/2"	4 1/4"	P-8512	8 1/2"	11 3/4"	14 1/2"	10 1/2"	5 3/4"
P-8505	7"	8 1/4"	12"	7 1/2"	5 1/4"	P-8513	8 1/2"	11 3/4"	15"	10 1/2"	6 1/4"
P-8506	7"	8 1/4"	11 1/2"	7 1/2"	4 3/4"	P-8514	10 1/2"	13 1/4"	13 1/2"	11 1/2"	5 3/2"
P-8507	8 1/4"	11 3/4"	14 1/2"	10 1/2"	5 3/4"	P-8515	10 1/2"	13 1/4"	13 1/2"	11 1/2"	6 1/2"
P-8508	7"	8 1/4"	11 1/2"	7 1/2"	5"	P-8516	6 3/4"	7 3/4"	10 3/4"	6 3/4"	4 1/4"
P-8509	8 1/4"	11 3/4"	14"	10 1/2"	5 1/4"	P-8517	6 3/4"	7 3/4"	11 1/4"	6 3/4"	5"

These prices are quoted subject to any changes required by O. P. A. regulations.

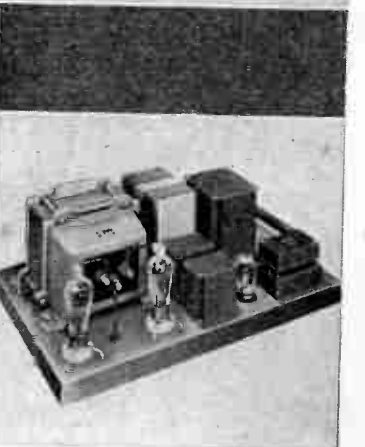
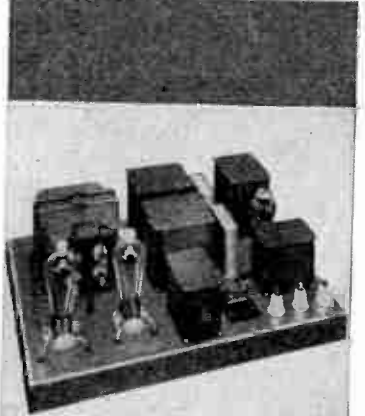
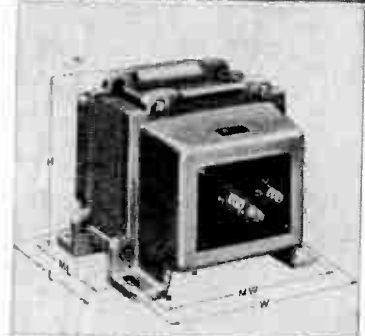

Filament Transformers—Chokes



Filament Transformers (Single Secondary)

Stancor Number	Secondary V.C.T.	Amperes	Primary Volts	V. A.	Volt Ins.	Type Mtg.	Wgt. in Carton	List Price
P-8536	2.5	5.0	115	17.6	2,500	R B	2.5	\$ 3.85
P-8537	2.5	10.0	115	35.8	2,500	R C	3.6	4.45
P-8538	2.5*	10.0	105-115	35.8	10,000	R D	3.7	9.00
P-8539	5.0	6.0	115	42.9	2,500	R C	3.6	4.25
P-8540	5.0*	8.0	105-115	57.2	2,500	R D	4.5	7.50
P-8541	5.0*	13.0	105-115	93.0	2,500	R D	5.0	8.00
P-8542	5.0*	20.0	105-115	143.2	10,000	R F	10.0	16.00
P-8543	5.0*	21.0	105-115	150.0	2,500	R E	9.0	10.00
P-8544	6.3*	3.0	105-115	27.4	2,500	R C	2.5	4.75
P-8549	6.3*	6.0	105-115	54.5	2,500	R D	5.0	5.35
P-8550	6.3*	10.0	105-115	90.0	2,500	R D	5.4	7.00
P-8545	7.5*	4.0	105-115	42.8	2,500	R D	3.8	4.65
P-8546	7.5*	8.0	105-115	85.6	2,500	R D	5.6	7.50
P-8547	10.0*	4.0	105-115	57.1	5,000	R D	4.7	6.00
P-8548	10.0*	8.0	105-115	114.2	5,000	R E	6.0	8.00

*10% higher voltage may be obtained by applying 115 volts to 105 volt tap.

Filament Transformers (Multiple Secondaries)

Stancor Number	Secondaries		Primary		Volt Ins.	Type Mtg.	Wgt. in Carton	List Price
	Volts	Amperes	Volts	V.A.†				
P-8565	5.0	4.0	115	61.0	2,500	R D	4.5	\$ 7.00
	6.3	3.6						
P-8566	6.3	3.0	115	70.0	2,500	R D	4.2	7.00
	7.5	4.0						
P-8567	2.5*	4.0	115	57.2	2,500	R D	4.2	9.25
	2.5*	4.0						
	2.5	4.0						
	2.5	4.0						
P-8568	2.5*	8.0	115	114.4	2,500	R E	7.0	14.75
	2.5*	8.0						
	2.5	8.0						
	2.5	8.0						
P-8569	6.3-7.5*	3.0	115	110.5	2,500	R E	5.2	8.00
	5.0	3.0						
	5.0	3.0						
	6.3	4.0						
P-8570	6.3	3.0	115	73.7	2,500	R D	4.5	7.50
	2.5	3.0						
	5.0	3.0						
	5.0*	2.0						

*Center-tapped Winding.

Filter Chokes

Stancor Number	Inductance in Henries	Max. Current in Ma.	D.C. Resistance in Ohms	Volt Insulation	Type Mtg.	Wgt. in Carton	List Price
C-2714	10	75	400	3,000	RB	2.5	\$ 3.00
C-2715	10	110	220	3,000	RC	3.4	3.60
C-2716	10	175	100	3,000	RD	6.5	4.50
C-2710	8	200	80	5,000	RD	4.5	5.75
C-2711	6	350	80	5,000	RE	9.5	9.75
C-2712	5	400	60	5,000	RF	15.0	13.50
C-2713	4	500	65	5,000	RH	19.0	21.00

Swinging Chokes

C-2700	3-15	200	80	5,000	RD	4.5	\$ 5.75
C-2701	3-12	350	80	5,000	RE	9.5	9.75
C-2702	3-12	400	60	5,000	RF	15.0	13.50
C-2703	3-10	600	65	5,000	RH	19.0	21.00

These prices are quoted subject to any changes required by O. P. A. regulations.

Thank You!

When writing for additional
information or when ordering
from sources of supply listed
in this book, please mention

RADIO'S MASTER



Catalog prices are list, subject to trade discount and change without notice. Add 100% for 25 cycle 115 v. primary; 60% for 230 v. 60 cycle primary; 100% for 230 v. 25 cycle primary.

The letter separating the first two digits of the type number from the last two indicates the classification of the unit. The following legend will further explain:
A = Audio, D = Driver, K = Foundation Unit, P = Plate, S = Output or Speaker, W = Wired Amplifier.
C = Choke, F = Filament, M = Modulation, R = Power, V = Voltage Changer.

Type No.	List Price	Type No.	List Price	Type No.	List Price	Type No.	List Price	Type No.	List Price	Type No.	List Price
T-1A50	\$17.40	T-13R15 *	\$6.90	T-15C37	\$15.00	T-18V03	\$8.70	T-19F92	\$4.20	T-67M74	\$5.40
T-1A51	17.40	T-13R16 *	7.80	T-15C38	18.00	T-18V04	10.80	T-19F93 *	3.00	T-67D78 *	3.60
T-1A52	18.60	T-13R17	5.70	T-15C39	27.00	T-18V05	16.20	T-19F94 *	3.60	T-67A91	4.20
T-1A53	18.60	T-13R18	6.00	T-15C41	33.00	T-18V06 *	7.50	T-19F95 *	3.30	T-67S92	4.80
T-1A54	16.80	T-13R19 *	3.60	T-15C45	10.80	T-18V07	16.20	T-19F96 *	4.20	T-67R97 *	5.10
T-1A55	17.40	T-13R20	4.50	T-15C46	15.00	T-18V10	3.60	T-19F97 *	2.10	T-68S06	3.00
T-1A56	18.00	T-13C26 *	1.10	T-15C47	18.00	T-18V20	7.20	T-19F98 *	3.30	T-68C07 *	2.40
T-1A57	16.80	T-13C27 *	1.30	T-15C48	27.00	T-18V21	8.40	T-19F99 *	4.20	T-68C08	2.10
T-1A59	16.80	T-13C28 *	1.45	T-15C50	33.00	T-18V22	10.80	T-26V04 *	5.70	T-68R26	8.70
T-1A69	16.80	T-13C29 *	1.90	T-15C52 *	6.60	T-18V23	15.00	T-29C27 *	2.10	T-69R35	8.10
T-1C62	12.00	T-13C30 *	2.40	T-15C53	7.50	T-18V24	2.70	T-29A99 *	2.40	T-70R20 *	3.90
T-1C63	12.00	T-13A34 *	1.60	T-15C54 *	6.90	T-18V25	4.80	T-33A91 *	2.40	T-70R21	5.40
T-2A36	21.00	T-13A35 *	1.80	T-15C55	9.00	T-18V26	6.90	T-33S99	1.80	T-70R61 *	5.70
T-2A66	21.60	T-13A36	2.40	T-15C56	12.00	T-18C92 *	1.80	T-37C36	2.40	T-70R62 *	7.50
T-2A68	22.60	T-13S37 *	1.50	T-15R60	23.40	T-19D01	7.50	T-37R70-C	9.00	T-70R78 *	5.10
T-3S16	45.00	T-13S38 *	1.80	T-15R61	21.00	T-19D02	7.50	T-43C92 *	2.00	T-70A82	4.20
T-3S17	54.00	T-13S39	1.50	T-15R62	23.40	T-19D03	7.50	T-44C02 *	1.80	T-70A83	4.20
T-3S21	21.60	T-13S40	1.80	T-15A66	9.60	T-19D04 *	7.50	T-47V01 *	9.00	T-72S58	2.00
T-3S22 *	22.80	T-13S41	3.30	T-15A67	9.60	T-19D05 *	7.50	T-47V02 *	13.20	T-72A59 *	2.00
T-3S23	45.00	T-13S42 *	1.80	T-15A68	9.60	T-19D06 *	3.30	T-47V03	26.10	T-73M52	27.00
T-3A32	21.00	T-13S43	1.60	T-15A69	9.60	T-19M13 *	5.70	T-47V04	42.00	T-73F60	4.80
T-5A1	12.60	T-14A29	3.00	T-15A70	9.60	T-19M14 *	9.90	T-47C07 *	2.00	T-74F23	6.00
T-5A2	13.20	T-14R32	9.00	T-15A71	9.60	T-19M15	14.40	T-47A25	2.70	T-74F24 *	10.20
T-5A3	11.40	T-14R33 *	3.60	T-15A72	9.60	T-19M16	20.40	T-49C91	2.10	T-74R28	8.10
T-5A4	10.50	T-14R34 *	4.26	T-15A73	9.00	T-19M17	33.00	T-50R03	3.90	T-74C29 *	4.80
T-5A5	9.60	T-14R35 *	4.50	T-15A74 *	8.40	T-19M21	8.40	T-50V11 *	9.00	T-74C30 *	1.80
T-5A7	12.00	T-14R36	5.70	T-15A75	8.70	T-19M22	12.00	T-50F61	2.10	T-74A31	4.20
T-5A8	12.60	T-14R37	6.00	T-15D76	10.80	T-19R30	9.60	T-52C98	2.40	T-74D32 *	3.90
T-5A9	12.60	T-14R38	6.90	T-15D77	10.80	T-19R31	11.40	T-53C19	1.80	T-75R47 *	5.70
T-6A0	12.60	T-14R39 *	3.30	T-15D78	10.80	T-19R32	15.00	T-53S81 *	5.70	T-75C49 *	1.80
T-6A1	12.60	T-14R40	9.00	T-15D79	10.80	T-19C35 *	4.80	T-54D63	2.70	T-75R50 *	9.30
T-6A3	11.40	T-14M49	21.60	T-15D82	10.80	T-19C36 *	8.40	T-55A16 *	3.30	T-75C51 *	6.00
T-6A4	12.00	T-14C61	1.20	T-15D83	18.00	T-19C37	15.00	T-56R01	6.90	T-75A74	3.30
T-9V30 *	51.00	T-14C62 *	1.20	T-15D85	9.60	T-19C38 *	18.00	T-56R02	5.10	T-75F75 *	4.80
T-9V31 *	78.00	T-14C63	1.20	T-15D86	10.80	T-19C39 *	3.90	T-56R03	8.10	T-76S74	4.50
T-9V32 *	120.00	T-14C64 *	1.20	T-15S90	12.00	T-19C42 *	4.80	T-56R05	8.10	T-78D46 *	1.80
T-9V33 *	210.00	T-14C70 *	3.00	T-15S91	15.00	T-19C43 *	8.40	T-57S01 *	2.40	T-79F84	5.70
R-1068 *	3.00	T-14A75	17.40	T-15S92	18.00	T-19C44	15.00	T-57S02	2.40	T-81S01 *	1.80
T-11F50	10.80	T-14A76	17.40	T-15S93	21.00	T-19C45 *	18.00	T-57A36	2.70	T-81C15	2.40
T-11F51	13.20	T-14S80 *	2.40	T-15S94	24.00	T-19C46 *	3.90	T-57A38	3.60	T-81D42 *	3.90
T-11F52	15.90	T-14S81	1.50	T-15S96	15.00	T-19P54	7.20	T-57A39	3.00	T-81D52	3.90
T-11F53	10.20	T-14S82	1.50	T-15S97	19.20	T-19P55 *	7.80	T-57A40	3.90	T-82V11	18.00
T-11F54	24.00	T-14S83 *	1.50	T-15S98	12.00	T-19P56 *	8.40	T-57A41 *	4.20	T-82V12	24.00
T-11F55	15.00	T-14S84 *	1.50	T-15S99	12.00	T-19P57 *	10.20	T-57A42	4.20	T-82V13	36.00
T-11F57	16.50	T-14S85	1.80	T-16C07 *	2.70	T-10P58 *	18.00	T-57C51 *	1.80	T-82M25	51.00
T-11F58	18.10	T-14A90 *	3.00	T-17C00-B *	3.30	T-19P59 *	21.00	T-57C52	2.10	T-83D21	4.20
T-11F59	9.00	T-14A91 *	3.00	T-17D01 *	2.40	T-19P60 *	25.20	T-57C53 *	2.40	T-83M22	13.60
T-11F60	9.60	T-14A92	1.60	T-17A02 *	3.00	T-19P61	27.00	T-57C54 *	2.70	T-83A78 *	2.70
T-11F61	27.00	T-14D93	2.10	T-17D03 *	5.40	T-19P62 *	32.10	T-58A37	2.70	T-83R82	12.00
T-11F62	10.20	T-14A94	3.00	T-17D04 *	5.40	T-19P63 *	30.90	T-58A70 *	4.50	T-83R85	15.00
T-11F63	11.40	T-15R00	15.00	T-17S10 *	3.60	T-19P64 *	35.70	T-58S72	4.50	T-83S87	10.80
T-11F64	12.00	T-15R01	21.00	T-17S11 *	5.40	T-19P65	37.20	T-60S48 *	3.60	T-84S58	7.20
T-11M69	10.80	T-15R02	15.90	T-17S12 *	5.40	T-19P66	49.80	T-60R49	3.60	T-84D59 *	3.90
T-11M70	15.00	T-15R03	16.50	T-17S13 *	7.20	T-19P67	60.00	T-61S25 *	3.90	T-84P60	9.00
T-11M71	18.00	T-15R04	9.00	T-17S14	7.20	T-19P68	70.20	T-61S26 *	4.20	T-84M70	12.00
T-11M74	13.20	T-15R05	15.90	T-17S15	7.80	T-19P69	18.00	T-61F85	2.70	T-86A02	2.70
T-11M75 *	15.30	T-15R06	14.70	T-17S16	18.00	T-19P70	13.80	T-61A94 *	3.90	T-86A03	2.70
T-11M76 *	27.00	T-15R07	15.90	T-17S17	7.80	T-19P71	16.80	T-63R63	3.90	T-87R85 *	9.00
T-11M77 *	36.00	T-15R08	19.20	T-17S18	4.50	T-19F75	2.70	T-63F99	3.90	T-89R28 *	13.80
T-11M78 *	72.00	T-15P11	16.80	T-17R30 *	10.20	T-19F76	5.70	T-64F14	6.00	T-89S68	7.80
T-11K99	18.00	T-15P12	19.20	T-17R31	15.00	T-19F77	9.90	T-64M26	7.20	T-89S74	4.50
T-13R00	5.40	T-15P13	28.80	T-17R32	12.30	T-19F78	6.90	T-64F33	7.20	T-89S75	4.80
T-13R01 *	4.20	T-15P14	36.00	T-17R33	20.40	T-19F79	8.10	T-64F38	7.20	T-90A02	20.40
T-13R02 *	4.50	T-15P15	42.00	T-17R34	6.30	T-19F80 *	1.60	T-65A73	3.60	T-90A03	20.40
T-13R03 *	5.10	T-15P16	63.00	T-17R35	4.20	T-19F81 *	1.80	T-65S94	4.80	T-90A05	20.40
T-13R04	6.00	T-15P17	45.00	T-17R36	4.80	T-19F82	6.00	T-67C46 *	2.10	T-90A06	20.40
T-13R05 *	6.00	T-15P18	84.00	T-17R37	5.70	T-19F83 *	2.70	T-67D47	3.00	T-90S07	21.60
T-13R06 *	6.90	T-15P19 *	81.00	T-17R38	6.30	T-19F84	3.30	T-67S48	4.20	T-90C09	15.00
T-13R07	7.20	T-15P20	120.00	T-17C40	6.60	T-19F85 *	4.80	T-67C49 *	3.30	T-90A10	20.40
T-13R08	6.00	T-15P21 *	114.00	T-17A42	12.00	T-19F86	6.60	T-67F150	3.30	T-90S12	20.40
T-13R09	7.50	T-15C30	6.00	T-17A43	12.00	T-19F87	7.50	T-67S51 *	4.20	T-92F20	6.30
T-13R11 *	3.90	T-15C31	7.20	T-17S57	2.70	T-19F88 *	2.40	T-67S52 *	4.80	T-92R21 *	9.00
T-13R12 *	4.50	T-15C32	9.60	T-17M59 *	3.30	T-19F89	2.70	T-67S54 *	4.80	T-92R33	5.40
T-13R13 *	5.40	T-15C34	10.80	T-18V00 *	12.60	T-19F90 *	3.60	T-67M69 *	3.30	T-92R53	6.90
T-13R14 *	6.00	T-15C36	10.80	T-18V01 *	23.40	T-19F91	3.00	T-67M73	4.20	T-93C20	3.30



AUDIO (A) INTERSTAGE TRANSFORMERS

For coupling the plate or plates of an amplifier stage to the grid or grids of the next stage where grid current is not drawn. C. H. T. interstage audio transformers have hum-bucking coil construction and balanced windings. Frequency response of

C.H.T. types using parallel feed in the primary winding, is flat within $\pm 1\frac{1}{2}$ db from 60 to 8,000 c.p.s. Compound filled cases fully protect the coils from adverse climatic conditions.

Type No.	Classification	Ohms Impedance		Pri. M.A.	Turns Ratio	Mtg. Fig.	Mtg. Centers		Dimensions			Wt. Lbs.
		Pri.	Sec.				Width	Depth	W.	D.	H.	
Single Plate To Single Grid												
T-13A34	Receiver (midget)	10,000	90,000	8	3:1	3B	2 $\frac{3}{8}$	2 $\frac{3}{8}$	1 $\frac{3}{8}$	1 $\frac{3}{8}$	3 $\frac{1}{8}$	
T-29A99	Receiver	10,000	90,000	8	3:1	2B	2 $\frac{3}{8}$	2 $\frac{3}{8}$	2 $\frac{3}{8}$	2 $\frac{3}{8}$	1 $\frac{1}{8}$	
T-57A36						2F	2 $\frac{3}{8}$	2 $\frac{3}{8}$	2 $\frac{3}{8}$	2 $\frac{3}{8}$	1 $\frac{1}{2}$	
T-57A38	Amplifier	10,000	90,000	8	3:1	2F	2 $\frac{3}{8}$	2 $\frac{3}{8}$	3 $\frac{3}{8}$	2 $\frac{1}{8}$	3	2 $\frac{1}{4}$
T-15A73-	C.H.T.	10000/2500	40000/10000	10 $\frac{1}{2}$	2:1	3U	2 $\frac{3}{8}$	2 $\frac{1}{2}$	3	3	3 $\frac{3}{8}$	2 $\frac{3}{8}$
Maximum Signal Level + 15 db §Parallel feed recommended.												



3B

Single Plate To Push-Pull Grids												
T-14A92	Receiver (midget)	10,000	90,000	8	3:1	3B	2	2 $\frac{3}{8}$	1 $\frac{3}{8}$	1 $\frac{3}{8}$	1 $\frac{3}{8}$	1 $\frac{1}{2}$
T-13A35	Receiver (midget)	10,000	90,000	8	3:1	3B	2 $\frac{3}{8}$	2 $\frac{3}{8}$	1 $\frac{3}{8}$	1 $\frac{3}{8}$	1 $\frac{3}{8}$	3 $\frac{1}{8}$
T-33A91	Receiver	10,000	90,000	8	3:1	2B	2 $\frac{3}{8}$	2 $\frac{3}{8}$	2	2 $\frac{3}{8}$	1 $\frac{1}{8}$	
T-57A39						2F	2 $\frac{3}{8}$	2 $\frac{3}{8}$	2 $\frac{3}{8}$	2 $\frac{3}{8}$	1 $\frac{1}{2}$	
T-57A40	Amplifier	10,000	90,000	8	3:1	2B	2 $\frac{3}{8}$	3 $\frac{3}{8}$	2 $\frac{1}{8}$	3	2	
T-57A41						2F	2 $\frac{3}{8}$	3 $\frac{3}{8}$	2 $\frac{1}{2}$	3	2 $\frac{1}{2}$	
T-74A31	Amplifier	10,000	10,000	8	1:1	2F	2 $\frac{3}{8}$	3 $\frac{3}{8}$	2 $\frac{1}{2}$	3	2 $\frac{1}{2}$	
T-57A42	Receiver (large)	10,000	90,000	8	3:1	2B	2 $\frac{3}{8}$	3 $\frac{3}{8}$	2 $\frac{1}{8}$	3	2	
T-15A74	C.H.T.	10,000/2,500	40,000/10,000	10 $\frac{1}{2}$	2:1	3U	2 $\frac{3}{8}$	2 $\frac{1}{2}$	3	3	3 $\frac{3}{8}$	2 $\frac{3}{8}$
Max. signal level + 15 db §Parallel feed recommended.												



6B

Push-Pull Plates To Push-Pull Grids												
T-13A36	Receiver (midget)	20,000	20,000	8 $\frac{1}{2}$	1:1	3B	2 $\frac{1}{16}$	3	1 $\frac{1}{8}$	2	1	
T-58A70	Amplifier—Split Secondary	20,000	45,000	10 $\frac{1}{2}$	1.5:1	2F	2 $\frac{3}{8}$	3 $\frac{3}{8}$	2 $\frac{1}{2}$	3	2 $\frac{1}{2}$	2 $\frac{1}{4}$
T-15A75	C.H.T.	20,000/5,000	45,000/11,250	10 $\frac{1}{2}$	1.5:1	3U	2 $\frac{3}{8}$	2 $\frac{1}{2}$	3	3	3 $\frac{3}{8}$	2 $\frac{3}{8}$
Maximum signal level + 15 db												

Universal Interstage Replacement Transformer

Will couple single plate to single grid, single plate to push-pull grids or push-pull plates to push-pull grids. Has split secondary.

T-17A02	Receiver	Universal	10	3:1	2F	2 $\frac{3}{8}$	2 $\frac{3}{8}$	2 $\frac{1}{8}$	2 $\frac{3}{8}$	1 $\frac{1}{2}$		
Low Impedance Source (Microphone, Line or Mixer) to Grid												
T-65A73	DB mike to grid	200/50	100,000	1:22.2	2F	2 $\frac{3}{8}$	3 $\frac{3}{8}$	2 $\frac{1}{8}$	3	2		
T-58A37	DB mike to grid	200/50	100,000	1:22.2	2F	2 $\frac{3}{8}$	2 $\frac{3}{8}$	2 $\frac{1}{8}$	2 $\frac{3}{8}$	1 $\frac{1}{2}$		
T-83A78	Single button mike to single or P-P grids	100	400,000 Ct.	1:64	2F	2 $\frac{3}{8}$	2 $\frac{3}{8}$	1 $\frac{7}{8}$	2 $\frac{3}{8}$	1 $\frac{1}{8}$		
T-86A02					2B	2 $\frac{3}{8}$	2 $\frac{3}{8}$	1 $\frac{3}{4}$	2 $\frac{3}{8}$	1		
T-55A16	Dyn. mike, line or mixer to single or P-P grids	200/50	100,000 Ct.	1:22.3	2F	2 $\frac{3}{8}$	2 $\frac{3}{8}$	2 $\frac{1}{8}$	2 $\frac{1}{8}$	2 $\frac{3}{8}$	1 $\frac{1}{2}$	
T-61A94	Line to single or P-P C.L.A. grids	500/125	100,000 Ct.	1:14.1	2F	2 $\frac{3}{8}$	3 $\frac{3}{8}$	2 $\frac{1}{8}$	3	2 $\frac{1}{4}$		
T-72A59	Plate and Single Button microphone to grid	5,000 200	100,000	1:3.25 1:35	2B	2 $\frac{1}{8}$	2 $\frac{3}{8}$	1 $\frac{3}{8}$	2	3 $\frac{1}{8}$		
T-14A94	Voice Coil to grid	4-8	100,000	1:112	2B	2 $\frac{3}{8}$	2 $\frac{3}{8}$	2 $\frac{1}{8}$	2 $\frac{3}{8}$	1		
T-15A66	C.H.T. Low Impedance to grid	500†/333/250/ 200†/125/50	60,000/15,000 Single Grid	1:10.95	3U	2 $\frac{3}{8}$	2 $\frac{1}{2}$	3	3	3 $\frac{3}{8}$	2 $\frac{3}{8}$	
T-15A67	C.H.T. Low Impedance to P-P grids	500†/333/250/ 200†/125/50	120,000/30,000 P-P Grids	1:15.5	3U	2 $\frac{3}{8}$	2 $\frac{1}{2}$	3	3	3 $\frac{3}{8}$	2 $\frac{3}{8}$	
T-15A68	C.H.T. Low Impedance to single grid	60†/38/30/22†/ 15†/10/5.5/2.5	60,000/15,000 Single Grid	1:31.6	3U	2 $\frac{3}{8}$	2 $\frac{1}{2}$	3	3	3 $\frac{3}{8}$	2 $\frac{3}{8}$	
T-17A42	C. H. T. MAGNETICALLY SHIELDED	500†/333/250/ 200†/125/50	50,000 Single Grid	1:10	3U	2 $\frac{3}{8}$	1 $\frac{3}{8}$	3	2 $\frac{3}{8}$	3 $\frac{1}{8}$	1 $\frac{1}{4}$	
Min. level—20 db.												



2F

Microphone or Line to Mixer or Line												
T-70A83	Crystal mike to line or mixer	100,000	200/50	1:22.4	2F	2 $\frac{3}{8}$	3 $\frac{3}{8}$	2 $\frac{1}{8}$	3	2 $\frac{1}{4}$		
T-15A69	C.H.T. Low Impedance to mixer or line	500†/333/250/ 200†/125/50	500†/333/250/ 200†/125/50	1:1	3U	2 $\frac{3}{8}$	2 $\frac{1}{2}$	3	3	3 $\frac{3}{8}$	2	
T-15A70	C.H.T. Dyn. mike to mixer or line	60†/38/30/22/ 15†/10/5.5/2.5	500†/333/250/ 200†/125/50	1:2.88	3U	2 $\frac{3}{8}$	2 $\frac{1}{2}$	3	3	3 $\frac{3}{8}$	2	



3L

Tube to Line or Mixer (Low Level)												
T-14A90	Sgl. or P-P Plates to line or mixer	20,000 Ct.	500/125	8*	2F	2 $\frac{3}{8}$	2 $\frac{3}{8}$	2 $\frac{1}{8}$	2 $\frac{3}{8}$	1 $\frac{1}{2}$		
T-14A91			(200/50 — for T-14A91 only.)									
T-72A59	Plate and sgl. button mike to grid	5,000 and 200	100,000	10*	2B	2 $\frac{1}{8}$	2 $\frac{3}{8}$	1 $\frac{3}{8}$	2	3 $\frac{1}{8}$		
T-15A71	C.H.T. single plate to line or mixer.	20,000/5,000 Single Plate	500†/333/250/ 200†/125/50	8*	3U	2 $\frac{3}{8}$	2 $\frac{1}{2}$	3	3	3 $\frac{3}{8}$	1 $\frac{1}{8}$	
T-15A72	C.H.T. P-P plates to line or mixer.	20,000/5,000 P-P Plates	500†/333/250/ 200†/125/50	0*	3U	2 $\frac{3}{8}$	2 $\frac{1}{2}$	3	3	3 $\frac{3}{8}$	1 $\frac{1}{8}$	
T-17A43	C.H.T. MAGNETICALLY SHIELDED	10,000 to 15,000	500†/333/250/ 200†/125/50	0*	3U	2 $\frac{3}{8}$	1 $\frac{3}{8}$	3	2 $\frac{3}{8}$	3 $\frac{1}{8}$	1 $\frac{1}{4}$	



3U

* Indicates Primary M.A. † Balanced center tap. ‡ Each side of C. T.

We can supply all Thordarson products. Ask for complete Thordarson catalog.



CHOKES AND REACTORS (C)

Parallel Feed Audio Reactors

For supplying plate current to a vacuum tube where it is desirable to isolate plate current from the transformer primary or where the voltage drop caused by a resistor load is objectionable.



2F

Type No.	Application	Typical Tubes	Induct. Hen.	Cur. M.A.	D.C. Res. Ohms	R.M.S. Test Volts	Mtg. Fig.	Mtg. Centers		Dimensions			Wt. Lbs.
								Width	Depth	W.	D.	H.	
T-37C36 T-67C46	Plate Impedance	56-30-76-6C5-55-85, etc.	300	5	6470	1600	2F	2 3/8	2 3/8	2 3/8	2 3/8	1 1/2	
2B							2 3/8	2 3/8	2 3/8	1 1/2			
T-52C98	Plate Impedance for screen Grid detector or as grid impedance	24-57-56-76-6C5-6F5-6J7	700	.5	6150	1600	2F	2 3/8	2 3/8	1 1/2	2 3/8	1 1/2	
T-29C27							2B	2 3/8	2 3/8	1 1/2	2 3/8	1	
T-68C08 T-18C92	Plate Impedance or Filter	45-46-10, etc.	22	35	405	1600	2F	2 3/8	2 3/8	2 3/8	2 3/8	1 1/2	
						1100	3B	2 3/8	3 3/8	2 3/8	2	1 1/2	



2B

Tuned Audio Circuit Reactors

Type No.	Application	Induct. Hen.	Cur. M.A.	D.C. Res. Ohms	R.M.S. Test Volts	Mtg. Fig.	Width	Depth	W.	D.	H.	Wt. Lbs.
T-81C15	Tuned Audio Circuits	.75	.5	30	30	2B	2 3/8	2 3/8	1 1/2	2	3/4	
T-93C20	Tuned Audio Circuits	250	.5	6400	6400	2B	2 3/8	2 3/8	2 3/8	2 3/8	1 1/2	
T-74C30	Tuned Audio Circuits or Filter	42	15	2100	2100	3B	2 3/8	2 3/8	3 3/8	1 1/2	2	1



Type No.	Application	Induct. Hen.	Cur. M.A.	D.C. Res. Ohms	R.M.S. Test Volts	Mtg. Fig.	Width	Depth	W.	D.	H.	Wt. Lbs.
T-14C70	Tone Control, hum-bucking type	22	0	220	220	3Y	1 1/2	1 1/2	1 1/2	2 1/4	1 1/2	
R-1068	Dual tone control potentiometer											

DUAL TONE CONTROL COMPONENTS

FILTER CHOKES

Thordarson filter reactors are rated in henries under actual working conditions. It is well known that as the D.C. current in a choke increases, there is a corresponding decrease in inductance. In selecting a filter choke from this listing, full assurance may be had that inductance rating has been measured under full operating load conditions.

Replacement Filter Chokes



3B

Type No.	Inductance		Current Rating M.A.	D.C. Res. Ohms	R.M.S. Test Volts	Mtg. Fig.	Mtg. Centers		Dimensions			Wt. Lbs.
	At Zero D.C.	At Rated D.C.					Width	Depth	W.	D.	H.	
T-13C26	21	8	40	530	1600	3B	2	2 3/8	1 3/8	1 3/8	1 3/8	3/4
T-13C27	22	10	40	475	1600	3B	2 1/8	2 1/8	1 3/8	1 3/8	1 3/8	3/4
T-13C28	20	10	65	460	1600	3B	2 1/8	3	1 1/2	2	1	
T-43C92	24	10	75	260	1600	2C	1 3/8	1 1/2	2 1/8	1 1/2	2 3/8	1 1/4
T-47C07	20	12	75	410	1600	3B	3 1/8	3 3/8	2	2 1/4	1 1/4	
T-44C02	31	12	80	405	1600	3B	2 3/8	2 3/8	2	2	1 3/8	
T-57C51	15	6	80	138	1600	2B	2 3/8	2 3/8	2 3/8	2 3/8	1 1/4	
T-13C29	20	9	85	250	1600	3B	2 3/8	3 3/8	2 3/8	2	1 3/8	
T-68C07	32	15	85	375	1600	2B	2 3/8	3 3/8	2 3/8	3	2	
T-57C53	27	10	110	200	1600	2B	2 3/8	3 3/8	2 3/8	3	2 3/8	
T-75C49	22	8	120	290	1600	3B	2 3/8	3 3/8	2 3/8	2	1 3/8	
T-53C19						2B	2 3/8	2 3/8	2 3/8	2 3/8	1 3/8	
T-13C30	25	8	150	200	1600	2B	2 3/8	3 3/8	2 3/8	3	2 3/8	



2C

Filter Chokes for Replacement in AC-DC Receivers

T-14C61	14	7	55	200	1600	3B	2 3/8	2 3/8	1 3/8	1 3/8	3/4
T-14C62	16	8	55	250	1600	3B	2 3/8	2 3/8	1 3/8	1 3/8	3/4
T-14C63	19	8	55	300	1600	3B	2 3/8	2 3/8	1 3/8	1 3/8	3/4
T-14C64	21	10	55	350	1600	3B	2 3/8	2 3/8	1 3/8	1 3/8	3/4

Filter Chokes for Amplifiers and Small Transmitters

T-57C52	15	5	80	138	1600	2F	2 3/8	2 3/8	2 3/8	2 3/8	1 1/2	
T-16C07	32	15	85	375	1600	2F	2 3/8	3 3/8	2 3/8	3	2 3/8	
T-57C54	27	10	110	200	1600	2F	2 3/8	3 3/8	2 3/8	3	2 3/8	
T-49C91	12	4	120	160	1600	2F	2 3/8	2 3/8	1 1/2	2 3/8	1 1/2	
T-17C00-B	28	12	150	231	1600	2F	3 3/8	3 3/8	3	3 1/2	3 3/8	
T-74C29	29	15	150	200	2000	2G	2 3/8	2 3/8	3 3/8	3 3/8	4 3/8	5 3/8
T-67C49	12	5	200	80	1600	2F	3 3/8	3 3/8	3 3/8	3 3/8	3 3/8	
T-75C51	24	13	250	121	1600	2G	3	2 3/8	3 3/8	3 3/8	4 3/8	8
T-15C52		30 Parallel	35	675	1600	3U	2 3/8	2 3/8	3	3	3 3/8	3
		120 Series	17	2700								
T-15C53		12 Parallel	100	272	1600	3U	2 3/8	2 3/8	3	3	3 3/8	3 3/8
		50 Series	50	1090								
T-15C54		8 Parallel	150	184	1600	3U	2 3/8	2 3/8	3	3 3/8	4 3/8	3 3/8
		32 Series	75	735								
T-15C55		2 Parallel	500	32	1600	3U	3 3/8	3 3/8	4 3/8	3 3/8	4 3/8	7 3/8
		8 Series	250	180								

Also available, free to the serviceman -- #352 Replacement Encyclopedia. Ask for your copy now.

We can supply all Thordarson products. Ask for complete Thordarson catalog.



No. 352 Replacement Guide—Free



Chokes (C) — Driver (D) Transformers



TRANSMITTER INPUT AND FILTER CHOKES

Matched input and smoothing chokes for amateur, amplifier or experimental applications. Inductance values are measured under full load conditions and adequate insulation is provided for recommended service.

"19" SERIES TRANSMITTER CHOKES

Type No.	Current D.C. M.A.	Inductance Henries	D.C. Res. Ohms	R.M.S. Test Volts	Mtg. Fig.	Mtg. Centers		Dimensions			Wt. Lbs.
						Width	Depth	W.	D.	H.	
Input Chokes											
T-19C39	150	5-20	215	3000	2F	3 3/8	3 3/8	3 3/8	3 1/2	3 3/4	3 3/4
T-19C35	200	5-20	130	3000	2D	3 1/4	2 1/8	3 3/8	3 3/8	4	5 1/2
T-19C36	300	5-20	105	5000	2D	2 3/4	3 1/8	3 3/8	4 1/8	4 3/8	10 3/4
T-19C37	400	5-20	90	5000	2J	3 1/4	3 3/8	4 1/4	5 3/8	6	19 1/2
T-19C38	500	5-20	75	5000	2J	3 1/4	3 3/8	5	5 1/2	6 3/8	25 1/4
Smoothing Chokes											
T-19C46	150	12	215	3000	2F	3 3/8	3 3/8	3 3/8	3 1/2	3 3/4	3 3/4
T-19C42	200	12	130	3000	2D	3 1/4	2 1/8	3 3/8	3 3/8	4	5 1/2
T-19C43	300	12	105	5000	2D	2 3/4	3 1/8	3 3/8	4 1/8	4 3/8	10 3/4
T-19C44	400	12	90	5000	2J	3 1/4	3 3/8	4 1/4	5 3/8	6	19 1/2
T-19C45	500	12	75	5000	2J	3 1/4	3 3/8	5	5 1/2	6 3/8	25 1/4



3L



2D



2J

C.H.T. TRANSMITTER CHOKES

Conservatively designed for continuous and quiet operation. Cases are compound filled for complete coil protection.

Input Chokes											
Type No.	Current D.C. M.A.	Inductance Henries	D.C. Res. Ohms	R.M.S. Test Volts	Mtg. Fig.	Mtg. Centers	Dimensions			Wt. Lbs.	
						Width	Depth	W.	D.	H.	
T-15C36	200-20	5-25	105	4,000	3U	3 3/8	3 3/8	4 3/8	4 1/8	5 7/8	10
T-15C37	300-30	5-25	78	4,000	3U	4 3/8	4 3/8	5 3/8	4 3/8	6 3/8	22
T-15C38	400-30	5-25	95	4,000	3U	4 3/8	4 3/8	5 3/8	5 3/8	6 3/8	24
T-15C39	500-30	5-25	86	10,000	3U	6 3/8	5 3/8	7 3/8	6 3/8	8	38 1/2
T-15C41	650-50	5-25	46	10,000	3U	6 3/8	5 3/8	7 3/8	6 3/8	8	51
Smoothing Chokes											
T-15C45	200	12	105	4,000	3U	3 3/8	3 3/8	4 3/8	4 1/8	5 7/8	10
T-15C46	300	12	78	4,000	3U	4 3/8	4 3/8	5 3/8	4 3/8	6 3/8	22
T-15C47	400	12	95	4,000	3U	4 3/8	4 3/8	5 3/8	5 3/8	6 3/8	24
T-15C48	500	12	86	10,000	3U	6 3/8	5 3/8	7 3/8	6 3/8	8	38 1/2
T-15C50	650	12	46	10,000	3U	6 3/8	5 3/8	7 3/8	6 3/8	8	51

DRIVER (D) TRANSFORMERS

For coupling the plate or plates of an amplifier stage to the grids of an amplifier stage in which grid current is drawn during a part of the audio cycle.

Type No.	List Price	Driver Tubes	Output Tubes	Class	Ratio Pri. to 1/2 Sec.	Pri. Mtg. M.A.	Mtg. Centers	Dimensions			Wt. Lbs.	
							Width	Depth	W.	D.	H.	

DRIVER TRANSFORMERS FOR SPECIFIC APPLICATIONS

These driver transformers have the correct primary to secondary ratio for the tubes specified, which assures good regulation and minimum driver distortion on the positive grid peaks. The first three types are specifically designed for replacement requirements.

T-78D46	1-30	1-1J6G, 19	B	2.4:1	7 2B	2 1/2	2 3/8	1 3/8	2	3/4	
T-17D01	1-6F6 Triode 1-42 Triode, 1-2A5 Triode	2-6F6, 6L6, etc.	AB	1.7:1 1.5:1, 1.3:1	31 3B	2 3/8	3 3/8	2 1/2	2	1 1/2	
T-14D93	1-76 Triode	1-6A6, 6N7	B	4:1	8 3B	2 3/8	2 3/8	1 3/8	1 3/8	3/4	
T-19D06	1-6A6, 1-6N7, 1-6C5	1-6A6, 6N7	B	5:1, 4:1, 3:1, 2.5:1	10 2F	2 3/8	2 3/8	2 3/8	2 3/8	1 3/2	
T-54D63	1-30, 1-49, 1-6C5	1-1J6G, 19, 2-49, 2-6V6 B,	AB2	2.4:1	7 2F	2 3/8	2 3/8	1 3/8	2 3/8	1 1/4	
T-67D47	1-6N7, 6A6, 53	1-6N7, 6A6, 53	B	5.25:1	10 2F	2 3/8	2 3/8	2 3/8	2 3/8	1 1/2	
T-81D52	1-6C5, 76 1-56	2-6F6 Triode 2-42, 2A5 Triode	AB AB	1.82:1 1.67:1	8 2F	2 3/8	3 3/8	2 1/2	3	2 1/4	
T-84D59*	2-6C5, 6N7 2-6A6, 53	2-6L6, 6V6 2-6N7, 6A6, 53	AB2 B	5:1	10 2F	2 3/8	3 3/8	2 1/2	3	2 1/4	
T-74D32	2-6C5, 76, 56	2-6F6, 42, 2A5 4-2A3, 6B4G	AB2 AB	3:1	10 2F	2 3/8	3 3/8	2 1/2	3	2 1/4	
T-81D42	1-6F6 Triode 1-42 Triode 1-2A5 Triode	2-6F6 Triode 2-42 or 2-2A5 Pentode	AB2 AB2 AB2	1.7:1 1.5:1 1.3:1	31 2F	2 3/8	3 3/8	2 1/2	3	2 1/4	
T-17D03*	1-6F6 Triode	2-6L6	AB2	1.4:1	40 2F	3 3/8	3 3/8	3 3/8	3 3/8	3 3/2	
T-17D04*	2-6F6	4-6L6	AB2	2.6:1	32 2F	3 3/8	3 3/8	3 3/8	3 3/8	3 3/2	
T-67D78	1-46, 59, 6F6, 42, 2A5 Triode	2-46, 59 2-6L6	B AB2	2.2:1	32 2F	2 3/8	3 3/8	2 1/2	3	2 1/4	

*Split secondary as required for inverse feedback and separate power tube bias.

Line-to-Grid Driver Transformer (High Level)

T-83D21	Line 500 ohms	2-6L6, 50 12,500/5,100 Ohms	AB	1.3:2, 1:5	2F	2 3/8	3 3/8	2 1/2	3	2 1/4	
---------	------------------	--------------------------------	----	------------	----	-------	-------	-------	---	-------	--

We can supply all Thordarson products. Ask for complete Thordarson catalog.



2B



3B



UNIVERSAL AND MULTI-MATCH DRIVER (D) TRANSFORMERS

Versatility of application reduces to a minimum transformer obsolescence which is a costly problem to the amateur in these days of rapid tube development. Through the use of five ratios

on each transformer, these transformers will handle all driver requirements usually encountered in amateur transmitter circuits.

Universal Driver Transformers "19" Series

Type No.	Cap. Watts	Max. Pri. M.A. Per Side	Ratio Pri. to 1/2 Sec.	Mtg. Fig.	Mtg. Centers		Dimensions			Wt. Lbs.
					Width	Depth	W.	D.	H.	
T-19D01	15	60	1:1, 1.2:1, 1.4:1, 1.6:1, 1.8:1	4D	3 3/8	3 3/8	3 3/8	3 3/8	3 1/2	3 1/2
T-19D02	15	60	2:1, 2.2:1, 2.4:1, 2.6:1, 2.8:1	4D	3 3/8	3 3/8	3 3/8	3 3/8	3 1/2	3 1/2
T-19D03	15	60	3:1, 3.2:1, 3.4:1, 3.6:1, 3.8:1	4D	3 3/8	3 3/8	3 3/8	3 3/8	3 1/2	3 1/2
T-19D04	15	60	4:1, 4.5:1, 5:1, 5.5:1, 6:1	4D	3 3/8	3 3/8	3 3/8	3 3/8	3 1/2	3 1/2
T-19D05	15	Primary for 500 ohm line	1:3.15, 1:2.75, 1:2.5, 1:2.25, 1:2, 1:1.75, 1:1.4, 1:1.25, 1:1.85, 1:1.75	4D	3 3/8	3 3/8	3 3/8	3 3/8	3 1/2	3 1/2

C.H.T. Multi-Match Driver Transformers

Feature Convenient Switchboard Plug-In Terminal Board and Compound Filled Cases

Type No.	Cap. Watts	Max. Pri. M.A. Per Side	Ratio Pri. to 1/2 Sec.	Mtg. Fig.	Mtg. Centers Width	Mtg. Centers Depth	Dimensions W.	Dimensions D.	Dimensions H.	Wt. Lbs.
T-15D78*	15	60	3:1, 3.2:1, 3.4:1, 3.6:1, 3.8:1	4U	3 3/8	3 3/8	4 3/8	4 3/8	4 3/8	6
T-15D79*	15	60	4:1, 4.5:1, 5:1, 5.5:1, 6:1	4U	3 3/8	3 3/8	4 3/8	4 3/8	4 3/8	6
T-15D82	15	Primary for 500 ohm line	1:3.15, 1:2.75, 1:2.5, 1:2.25, 1:2, 1:1.75, 1:1.4, 1:1.25, 1:1.85, 1:1.75	4U	3 3/8	3 3/8	4 3/8	4 3/8	4 3/8	5 3/4
T-15D83	30	Primary for 500 ohm line	1:3.15, 1:2.75, 1:2.5, 1:2.25, 1:2, 1:1.75, 1:1.4, 1:1.25, 1:1.85, 1:1.75	4U	3 3/8	3 3/8	4 3/8	4 3/8	4 3/8	8 3/4

*P.P. 45 or 2A3, 6B4G.

FILAMENT (F) TRANSFORMERS

The essentials of improved voltage regulation and minimum heat rise have been given prime consideration in the design of these units. Ratings given are for continuous operation at full load.

Type No.	Primary Volts	Secondary Volts	Sec. Amps.	Pri. V.A.	R.M.S. Test Volts	Mtg. Fig.	Mtg. Centers Width	Mtg. Centers Depth	Dimensions W.	Dimensions D.	Dimensions H.	Wt. Lbs.
Single Secondary												
T-50F61	115	2.5 Ct.	3.5	10	1600	2B	2 3/8	2 3/8	1 3/8	2 3/8	1	
T-19F88	115	2.5 Ct.	5.25	15	1600	2B	2 3/8	2 3/8	2 3/8	2 3/8	1 1/2	
T-19F75	115	2.5 Ct.	5	12.5	7500	2B	2 3/8	2 3/8	3 3/8	2 3/8	3	2
T-19F89	115	2.5 Ct.	10	25	1600	2B	2 3/8	2 3/8	3 3/8	2 3/8	3	2
T-19F90	115	2.5 Ct.	10	25	7500	3C	2	1 3/4	2 3/8	2 3/8	3 1/2	2 3/4
T-64F33	105/110/115	2.5 Ct.	10	25	7500	2N	3 3/8	2 3/8	3 3/8	3 3/8	4	4 3/4
T-19F82	115	2.5 Ct.	15	45	10000	3C	3 3/8	1 3/8	3 3/8	2 3/8	4	4
T-63F99	115	5 Ct.	4	20	1600	2D	2 3/8	1 3/8	2 3/8	3	3 1/2	2 3/4
T-19F83	115	5 Ct.	5	30	1600	2B	2 3/8	2 3/8	2 3/8	2 3/8	3	2
T-19F84	115	5 Ct.	8	45	1600	3C	2	1 3/4	2 3/8	2 3/8	3 3/8	2 3/4
T-19F85	115	5 Ct.	13	75	1600	3C	3 3/8	1 3/8	3 3/8	2 3/8	4	4
T-19F86	115	5 Ct.	21	120	1600	3C	3 3/8	2 3/8	3 3/8	2 3/8	4	4 3/4
T-74F23	105/110/115	5 Ct.	13	75	1600	2D	3 3/8	1 3/8	3 3/8	3 3/8	4	4 1/2
T-74F24	105/110/115	5 Ct.	21	125	1600	2D	2 3/8	1 3/8	3 3/8	3 3/8	4 3/8	5 3/4
T-19F91	115	5.25 Ct.	4	25	1600	3C	2	1 3/4	2 3/8	2 3/8	3 1/2	2 3/4
T-19F92	115	5.25 Ct.	13	75	1600	3C	3 3/8	1 3/8	3 3/8	2 3/8	4	4
T-19F80	115	6.3 Ct.	1	7	1600	2B	2	2	2 3/8	1 3/8	2	5/8
T-19F81	115	6.3 Ct.	2	14	1600	2B	2 3/8	2 3/8	2 3/8	1 3/8	2 3/8	3/4
T-19F97	115	6.3 Ct.	3	21	1600	2B	2 3/8	2 3/8	2 3/8	2 3/8	2 3/8	1 3/8
T-61F85	115	6.3, 5, 2.5	2.5	18	1600	3E	3 3/8	3 3/8	3 3/8	2 3/8	2 3/8	1 1/2
T-73F60	105/110/115	6.3 Ct.	5	36	1600	2D	2 3/8	1 3/8	2 3/8	2 3/8	3 3/8	3 3/8
T-19F98	115	6.3 Ct.	6	47	1600	3C	2	1 3/4	2 3/8	2 3/8	3 1/2	2 3/4
T-19F99	115	6.3 Ct.	10	73	1600	3C	3 3/8	1 3/8	3 3/8	2 3/8	4	4
T-19F93	115	7.5 Ct.	4	34	1600	3C	2	1 3/4	2 3/8	2 3/8	3 1/2	2 3/4
T-19F94	115	7.5 Ct.	8	67	1600	3C	2 3/8	2 3/8	3	2 3/8	3 3/8	4
T-19F95	115	10 Ct.	4	48	1600	3C	2	1 3/4	2 3/8	2 3/8	3 3/8	2 3/4
T-19F96	115	10 Ct.	8	92	1600	3C	2 3/8	2 3/8	2 3/8	2 3/8	3 3/8	4
T-64F14	105/110/115	10 Ct.	8	90	1600	2D	3 1/2	2	3 3/8	3 3/8	4	5
T-19F87	115	10 Ct.	12	140	1600	3C	3 3/8	2 3/8	3 3/8	3 3/8	4	6 3/4
Multiple Secondaries												
T-19F76	115	Sec. 1-5 V. Sec. 2-7.5/6.3/5	3 6	67 1600	1600	2G	2 3/8	2 3/8	3 3/8	3 3/8	4 3/8	4 3/8
T-19F77	115	Sec. 1-5 V. Sec. 2-2.5 V. Ct. Sec. 3-10/7.5/6.3/5	3 10 8	183 7500 1600	1600	2G	3	2 3/8	3 3/8	3 3/8	4 3/8	7
T-19F78	115	Sec. 1-2.5 V. Ct. Sec. 2-5 V.	10 3	45 1600	7500	2G	2 3/8	2 3/8	3 3/8	3 3/8	4 3/8	5
T-19F79	115	Sec. 1-6.3 V. Ct. Sec. 2-10/7.5/6.3/5	3 10	183 1600	1600	2G	2 3/8	2 3/8	3 3/8	3 3/8	4 3/8	6
T-79F84	115	Sec. 1-2.5 V. Ct. Sec. 2-5 V. Ct. Sec. 3-6.3 V. Ct.	3.5 3 3	48 1600 1600	1600	2G	2 3/8	2 3/8	3 3/8	3 3/8	4 3/8	4 3/8

We can supply all Thordarson products. Ask for complete Thordarson catalog.



Modulation (M) — Plate (P) Transformers



MODULATION TRANSFORMERS FOR SPECIFIC APPLICATIONS

To couple the plate or plates of an audio output stage to a Class C R.F. load.

Type No.	Tube Type	Class	Ohms Impedance		Max. D.C. Sec. M.A.	Max. Audio Pwr. Watts	Mtg. Fig.	Mtg. Centers		Dimensions			Wt. lbs.
			Pri.	Sec.				Width	Depth	W.	D.	H.	
T-17M59	1-6A6, 6N7 or 53	B	10,000	3,000 3,750/4,500	100	10	2F	2%	3 3/8	2 1/2	3	2	
T-64M26	2-46 or 59 2-250	E AB	5,800	5,000 10,000	100	40	2D	3 1/4	2 1/4	3 3/4	3 3/4	4	5
T-84M70	2-6L6 2-35T 4-210	AB B B	3,800	2,500 5,000 7,500	250 200 150	75	2D	2 1/4	2 1/4	3 3/4	4 1/4	4 3/4	10
T-14M49	2-TZ-40	B	6,900	2,850 4,500 6,500	350 300 235	175	2Q	6 1/4	3 3/4	7 1/2	5 1/4	6 1/2	20



2D



2F



2Q

"19" SERIES UNIVERSAL MODULATION TRANSFORMERS

Type No.	Capacity Watts	Pri. M.A. Each Side	Secondary M.A.		Mtg. Fig.	Mtg. Centers		Dimensions			Wt. lbs.
			Series	Parallel		Width	Depth	W.	D.	H.	
T-19M13	15	50	50	100	4D	2%	3 3/8	2 1/2	3	2	
T-19M14	30	75	75	150	2N	3 1/4	1 1/4	3 3/4	3 3/4	4	4 1/2
T-19M15	60	125	125	250	2N	3 1/4	2 1/4	3 3/4	3 3/4	4	6 1/2
T-19M16	100	175	175	350	2N	3 1/4	2 1/4	4 1/4	4 1/4	6 1/4	12 1/2
T-19M17	250	225	225	450	2Q	7 1/4	3 3/4	8 1/2	5 1/4	6 3/4	30 3/4



2Q

C. H. T. MULTI-MATCH MODULATION TRANSFORMERS

A premium feature of this group is the exclusive Thordarson Switchboard Plug-in terminal board, enabling quick and accurate matching of tube loads without soldering.

Type No.	Capacity Watts	Pri. M.A. Each Side	Series	Parallel	Mtg. Fig.	Width	Depth	W.	D.	H.	Wt. lbs.
T-11M74	40	100	80	160	4U	3 3/8	3 1/2	4 1/4	4 1/4	4 1/4	7 1/2
T-11M75	75	145	145	290	4U	3 3/8	3 1/2	4 1/4	4 1/4	4 1/4	9
T-11M76	125	210	160	320	4U	4 1/4	4 1/4	5 3/8	5 1/4	6 1/2	18
T-11M77	300	250	250	500	4U	5 3/8	6 1/4	6 1/4	7 1/4	7 1/4	30
T-11M78	500	320	320	640	3P	3 1/4	10 3/4	5 3/8	13 1/4	6 1/4	54



2N

PLATE SUPPLY (P) TRANSFORMERS

While ordinarily used to supply the plate voltage for amateur transmitters, there are additional applications requiring relatively high voltages in which Thordarson plate transformers may be used to good advantage. Thordarson plate transformers are rated in D.C. voltages from a two section filter which includes the voltage drop through the rectifier tubes. Designed especially for Amateur transmitting or experimental equipment. Electrostatic shielding is provided between primary and secondary windings.

Type No.	Primary Volts	Sec. A.C. Load Volts	D.C. Volts	Bias Tap	D.C. M.A.	Pri. V.A.	Mtg. Fig.	Mtg. Centers		Dimensions			Wt. lbs.
								Width	Depth	W.	D.	H.	
T-19P54	115	560-0-560	400		150	115	2G	3	2 1/4	3 3/4	3 3/4	4 1/4	7
T-19P55	115	660-0-660 550-0-550	500 400	30 V.	250	200	2G	3	3 3/8	3 3/4	4 1/4	4 1/4	8
T-84P60	115	515-0-515	400	30 V.	250	190	2G	3	4	3 3/4	4 1/4	4 1/4	11 1/4
T-19P70	115	900-0-900 605-0-605	750* 400		100 225	260	2G	3	3 1/4	3 3/4	4 1/4	4 1/4	11 1/4
T-19P56	115	900-0-900 800-0-800	750 600		225	260	2G	3	3 1/4	3 3/4	4 1/4	4 1/4	10
T-19P57	115	1075-0-1075 500-0-500	1000* 400		125 150	245	2G	3	3 3/4	3 3/4	4 1/4	4 1/4	10 1/2
T-19P58	115	1200-0-1200 900-0-900	1000* 750		200 150	500	2G	3 1/4	3 3/4	4 3/8	5 1/4	6 1/4	19
T-15P69	115	1180-0-1180 900-0-900	1000 750		300	430	2G	3 3/4	3 3/4	5 1/4	6 1/4	6 1/4	20
T-19P71	115	1325-0-1325 595-0-595	1250* 400		125 200	320	2G	3	4 1/4	3 3/4	5 1/4	4 1/4	13
T-19P59	115	1560-0-1560 1250-0-1250	1250 1000		300	550	2K	4 1/4	3 3/4	5 3/8	7 1/4	6 1/4	26 1/2
T-19P60	115	1875-0-1875 1560-0-1560	1500 1250		300	620	2K	5 1/4	4 3/8	6 1/4	7 1/4	6 3/4	29 1/4
T-19P61	115	2125-0-2125 1875-0-1875	1750 1500		300	745	2K	5 1/4	4 3/8	6 1/4	7 1/4	6 3/4	31 1/4
T-19P62	115	2420-0-2420 2125-0-2125	2000 1750		300	860	2K	5 1/4	5	6 1/4	7 1/4	6 3/4	34 1/4
T-19P65	115	3000-0-3000 2420-0-2420	2500 2000		300	1195	2K	5 1/4	6	6 1/4	9 1/4	6 3/4	44
T-19P63	115	1560-0-1560 1265-0-1265	1250 1000		500	925	2K	5 1/4	5 1/4	6 1/4	8 3/4	6 3/4	38
T-19P64	115	1875-0-1875 1560-0-1560	1500 1250		500	1130	2K	5 1/4	6	6 1/4	9 1/4	6 3/4	43 1/4
T-19P66	115	2125-0-2125 1875-0-1875	1750 1500		500	1185	2K	5 1/4	4 3/8	6 1/4	7 1/4	9 1/4	45 1/2
T-19P67	115	2450-0-2450 2125-0-2125	2000 1750		500	1380	2K	5 1/4	4 3/8	6 1/4	7 1/4	9 1/4	51
T-19P68	115	3000-0-3000 2450-0-2450	2500 2000		500	1760	2K	5 1/4	5 1/4	6 1/4	8 1/4	9 1/4	61



3G



3U



4U

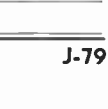

2K

*These transformers designed for double rectifiers and will deliver both secondary ratings simultaneously. If only the lower voltage taps are used the current rating is equal to the current rating of both windings.

We can supply all Thordarson products. Ask for complete Thordarson catalog.

UNIVERSAL REPLACEMENT POWER TRANSFORMERS — "13R" SERIES

The choice of servicemen in all parts of the world because of the universal adaptability to receiver replacement, from both electrical and mechanical considerations. Adjustable mounting brackets permit flush, vertical or horizontal mounting. Replacement recommendations are given in Thordarson Replacement Transformer Encyclopedia No. 352.



3A
Flush



3A
Horizontal



3A
Vertical



2G



3L



4G



3C

Type No.	Secondary		Filament Windings			Mtg. Centers		Dimensions			Wt. Lbs.			
	Pri. V.A.	A.C. Load Volts	D.C. M.A.	Rect. Fil.	Fil. No. 1	Fil. No. 2	Fil. No. 3	Mtg. Fig.	Width	Depth		W.	D.	H.
T-13R19	45	240-0-240	40	5V-2A	6.3V-2A Ct.			3A	2 1/2	2 1/2	3	2 1/2	2 1/2	2 1/2
T-13R11	60	290-0-290	50	5V-3A	6.3V-2A Ct.			3A	2 1/2	2 1/2	3	2 1/2	2 1/2	3 1/2
T-13R20	60	305-0-305	70	5V-2A	6.3V-3.5A Ct.			3A	2 1/2	2 1/2	3	2 1/2	3 1/2	3 1/2
T-13R12	65	350-0-350	70	5V-3A	6.3V-2.5A Ct.			3A	2 1/2	2 1/2	3	2 1/2	3 1/2	3 1/2
T-13R13	90	350-0-350	90	5V-3A	6.3V-3.5A Ct.			3A	3 1/2	2 1/2	3 1/2	3 1/2	3 1/2	5 1/2
T-13R14	115	350-0-350	120	5V-4A	6.3V-4.7A Ct.			3A	3 1/2	2 1/2	3 1/2	3 1/2	3 1/2	5 1/2
T-13R15	140	375-0-375	150	5V-4A	6.3V-5A Ct.			3A	3 1/2	3	4 1/2	3 1/2	3 1/2	6 1/2
T-13R16	180	400-0-400	200	5V-4A	6.3V-5.14A Ct.			3A	3 1/2	3	4 1/2	3 1/2	3 1/2	7 1/2
T-13R17	85	300-0-300	60	5V-3A	6.3V-2.5A Ct.	2.5V-7.5A Ct.		3A	2 1/2	2 1/2	3 1/2	2 1/2	3 1/2	4 1/2
T-13R18	115	350-0-350	90	5V-3A	6.3/2.5-3.5A Ct.	2.5V-9A Ct.		3A	3 1/2	3	4 1/2	3 1/2	3 1/2	5 1/2
T-13R08	105	350-0-350	90	5V-3A	6.3V-3.3A Ct.	2.5V-6A Ct.		3A	3 1/2	2 1/2	3 1/2	3 1/2	3 1/2	5 1/2
T-13R09	160	375-0-375	180	5V-3A	6.3V-3.3A Ct.	2.5V-6A Ct.		3A	3 1/2	3	4 1/2	3 1/2	3 1/2	7 1/2
T-13R00	70	275-0-275	70	5V-3A	5V-5A Ct.	2.5V-10.5A Ct.		3A	2 1/2	2 1/2	3 1/2	2 1/2	3 1/2	4
T-13R01	60	325-0-325	40	5V-3A	2.5V-4A Ct.			3A	2 1/2	2 1/2	3	2 1/2	2 1/2	3 1/2
T-13R02	60	350-0-350	50	5V-3A	2.5V-7.25A Ct.			3A	2 1/2	2 1/2	3	2 1/2	2 1/2	3 1/2
T-13R03	75	350-0-350	70	5V-3A	2.5V-9A Ct.			3A	2 1/2	2 1/2	3 1/2	2 1/2	3 1/2	4
T-13R04	115	350-0-350	100	5V-3A	2.5V-12.5A Ct.			3A	3 1/2	2 1/2	3 1/2	3 1/2	3 1/2	5 1/2
T-13R05	110	350-0-350	70	5V-3A	2.5V-9A Ct.	2.5V-8.5A Ct.		3A	3 1/2	2 1/2	3 1/2	3 1/2	3 1/2	5 1/2
T-13R06	130	350-0-350	120	5V-3A	2.5V-12.5A Ct.	2.5V-8.5A Ct.		3A	3 1/2	3	4 1/2	3 1/2	3 1/2	6 1/2
T-13R07	140	400-0-400	110	5V-3A	2.5V-15A Ct.	2.5V-3.5A Ct.		3A	3 1/2	3	4 1/2	3 1/2	3 1/2	6 1/2

Amplifier, Transmitter and Replacement Power Transformers

FULLY SHIELDED — UPRIGHT MOUNTING

Leads are brought out through opening in base.

T-56R01	60	325-0-325	70	5V-2A	2.5V-3A Ct.	1.5V-1A 1.5V-4A	5V-5A Ct.	2G	2 1/2	2 1/2	3 1/2	3 1/2	4 1/2	5 1/2
T-56R03	85	350-0-350	105	5V-3A	2.5V-3A Ct.	2.5V-1.75A Ct.	1.5V-5A 1.5V-1A	2G	3	2 1/2	3 1/2	3 1/2	4 1/2	7 1/2
T-56R05	115	350-0-350	110	5V-3A	2.5V-9A Ct.	2.5V-3A Ct.	2.5V-3A Ct.	2G	3	2 1/2	3 1/2	3 1/2	4 1/2	7 1/2
T-70R78	60	340-0-340	55	5V-2A	6.3V-1.5A Ct.			2G	2 1/2	2 1/2	3 1/2	2 1/2	4 1/2	4
T-17R34	90	300-0-300	125	5V-2A	6.3V-4.8A Ct.			2G	2 1/2	2 1/2	3 1/2	3 1/2	4 1/2	4 1/2
T-17R35	60	290-0-290	50	5V-3A	6.3V-2A Ct.			4G	2	1 1/2	2 1/2	3	3 1/2	3 1/2
T-17R36	65	350-0-350	70	5V-3A	6.3V-2.5A Ct.			4G	2	2 1/2	2 1/2	3 1/2	3 1/2	3 1/2
T-17R37	90	350-0-350	90	5V-3A	6.3V-3.5A Ct.			2G	2 1/2	2 1/2	3 1/2	3 1/2	4 1/2	5 1/2
T-17R38	115	350-0-350	120	5V-4A	6.3V-4.7A Ct.			2G	2 1/2	2 1/2	3 1/2	3 1/2	4 1/2	5 1/2
T-70R61	60	385-0-385	70	5V-2A	6.3V-2.5A Ct.			2G	2 1/2	2 1/2	3 1/2	3 1/2	4 1/2	4 1/2
T-70R62	110	350-0-350	145	5V-3A	6.3V-4.5A Ct.			2G	3	3 1/2	3 1/2	3 1/2	4 1/2	8 1/2
T-92R21	150	389-0-389	200	5V-3A	6.3V-5A Ct.			2G	3	3 1/2	3 1/2	3 1/2	4 1/2	9
T-17R30	200	370-0-370	280	5V-3A	6.3V-7A Ct.			2G	3	3 1/2	3 1/2	4 1/2	4 1/2	9 1/2
T-17R31	300	430-0-430	325	5V-6A	6.3V-8A Ct.			2G	3	3 1/2	3 1/2	4 1/2	4 1/2	13 1/2
T-74R28	105	440-0-440	125	38V 5V-3A 2.5V-3A	6.3V-3.3A Ct.			2G	3	2 1/2	3 1/2	3 1/2	4 1/2	8
T-87R85	145	330-0-330	160	77V 5V-3A 5V-2A	6.3V-2A Ct.	2.5V-5A Ct.		2G	3	3 1/2	3 1/2	3 1/2	4 1/2	8 1/2
T-68R26	160	550-0-550	150	5V-3A	7.5V-2.5A Ct.	2.5V-5A Ct.		2G	3	3 1/2	3 1/2	4 1/2	4 1/2	10 1/2
T-69R35	135	385-0-385	200	5V-3A	6.3V-3A Ct.			2G	3	3 1/2	3 1/2	4 1/2	4 1/2	9 1/2
T-75R50	160	435-0-435	250	80V 5V-3A 2.5V-3A	6.3V-1.5A Ct.	2.5V-10A Ct.		2G	3	3 1/2	3 1/2	4 1/2	4 1/2	10 1/2
T-83R65	290	740-0-740 325-0-325	200	150V 5V-3A 2.5V-3A	7.5V-5A Ct.			2G	3	4 1/2	3 1/2	5 1/2	4 1/2	13 1/2
T-89R28	250	550-0-550	275 75	5V-3A 5V-2A Ct.	6.3V-6A Ct.			2G	3	4 1/2	3 1/2	5 1/2	4 1/2	15
T-19R30	170	560-0-560	150	5V-3A	6.3V-3A Ct.	7.5V-2.5A Ct.		2G	3	3 1/2	3 1/2	4	4 1/2	8 1/2

C. H. T. POWER TRANSFORMERS

For amplifiers, transmitters, or deluxe receivers. Designed to operate continuously at full rated load. Cases compound filled for complete coil protection.

T-15R04	30	255-0-255	25		6.3V-2.1A Ct.			3U	2 1/2	2 1/2	3	8	3 1/2	3
T-15R05	150	340-0-340	135	77V	5V-3A 5V-2A	6.3V-4A Ct.	*6.3V-2A Ct. *2.5V-5A Ct.	3U	3 1/2	3 1/2	4 1/2	4 1/2	5 1/2	10
T-15R06	165	360-0-360	175		5V-3A	6.3V-5A Ct.		3U	3 1/2	3 1/2	4 1/2	4 1/2	5 1/2	11
T-15R07	238	380-0-380	280		5V-3A	6.3V-7A Ct.		3U	3 1/2	4 1/2	4 1/2	4 1/2	5 1/2	12
T-15R08	253	450-0-450	325		5V-6A	6.3V-8A Ct.		3U	4 1/2	4 1/2	5 1/2	4 1/2	5 1/2	22

SPEAKER FIELD SUPPLY TRANSFORMERS

T-67R97	55	115 V.D.C. @ 50 to 250	5V-3A					4G	3 1/2	1 1/2	3 1/2	3 1/2	3 1/2	4 1/2
T-92R53	120	300 V.D.C. @ 200	5V-3A					4G	3 1/2	2 1/2	3 1/2	3 1/2	3 1/2	6 1/2

*Not simultaneous — for 2A3's or 6A3's Fil.

UNIVERSAL 115 VOLT A. C. OR 6 VOLT D. C. VIBRATOR POWER TRANSFORMER

T-14R40		350V. DC @		135 Ma.	Fil.-6.3V Ct.	4.75 Amp.		2G	8	3 1/2	3 1/2	4	4 1/2	8 1/2
---------	--	------------	--	---------	---------------	-----------	--	----	---	-------	-------	---	-------	-------

We can supply all Thordarson products. Ask for complete Thordarson catalog.



Output (S) Transformers



OUTPUT (S) TRANSFORMERS

For coupling audio power amplifier tubes to a loud speaker voice coil or line. Correctly matching the output tubes to a speaker load is important. Efficiency, frequency response and distortion are affected by this matching. Small, unshielded types are listed for use with receivers where the transformer is usually mounted on the loud speaker frame. Larger shielded types have multiple secondary impedances as required in sound amplifiers. C.H.T. output transformers have a greater selection of output impedances, meeting practically all speaker requirements. These units are compound filled and are provided with jacks and plugs to facilitate speaker matching. Tertiary winding included on some types for inverter feed-back voltage.

Type No.	Tube Type	Class	Ohms Impedance		Pri. M.A. Per Max. Mtg.		Mtg. Centers		Dimensions			Wt. Lba.
			Pri.	Sec.	Side	Watts	Fig.	Width	Depth	W.	D.	
REPLACEMENT OUTPUT TRANSFORMERS												
T-14S81	1-42, 2A5, 6F6 or P-P45, 71	A	7,000 Ct.	3 to 6	40	5	3B	2	2 3/8	1 3/8	1 3/8	1/2
T-14S82	1-25L6	A	1,500	3 to 6	55	5	3B	2	2 3/8	1 3/8	1 3/8	1/2
T-14S83	1A5-G, 1E7-G	A	25,000 Ct.	3 to 6	8	5	3B	2	2 3/8	1 3/8	1 3/8	1/2
T-14S84	1-1C5G, 1Q5G	A	8,000	3 to 6	10	5	3B	2	2 3/8	1 3/8	1 3/8	1/2
T-13S37	1-6F6, 42, 2A5, 47	A	7,000	1/2/4	36	5	3E	2	2 3/8	2	1 3/8	1/2
T-13S39	1-45, 12A5, 43, 71A	A	4,000	1/2/4	36	5	3E	2	2 3/8	2	1 3/8	1/2
T-13S43	1-1F4, 1D4, 1F5G	A	16,000	1/2/4	10	5	3E	2	2 3/8	1 3/8	1 3/8	1/2
T-33S99	2-45, 71, 43, 25A6 P-P	A	8,000 Ct.	6 to 12	36	10	2B	2 3/8	2 1/8	2 1/8	2 3/8	1 1/2
T-13S40	2-6F6, 42 P-P, 2-2A5, 47 P-P	A	14,000 Ct.	1/2/4	40	10	3E	2 3/8	2 3/8	2	1 3/8	3/4
T-81S01	1-19, 1J6G, 1G6G P-P 2-30, 49 P-P	B B	10,000 Ct.	2/4/8	15	8	2B	2 1/8	2 3/8	1 3/8	2	3/4



3B



3E

HEAVY DUTY OUTPUT TRANSFORMERS TO LINE OR SPEAKER (High Level)

T-72S58	Pentode Plate to phones or oscillator	A	10,000	2,000 50	30	5	2B	2 1/8	2 3/8	1 3/8	2	3/4
T-17S10	1-6L6	A	2,500	2/4/8/500	80	8	2F	2 3/8	3 3/8	2 1/2	3	2 1/4
T-17S11	2-6V6 P-P	AB1	8,000*	4/8/15/250/500	52	15	2F	3 1/8	3 3/8	3 3/8	3 3/8	3 3/8
T-17S12	2-6L6 P-P	AB1	4,300*	4/8/15/250/500 (with 300 V. on plate and screen)	95	25	2F	3 1/8	3 3/8	3 3/8	3 3/8	3 3/8
T-17S13	2-6L6 P-P	AB1	6,600*	4/8/15/250/500	80	34	2G	2 3/8	2 3/8	3 3/8	4 3/8	5 1/4
T-17S14	2-6L6 P-P	AB2	5,500*	4/8/15/250/500	90	40	2G	2 3/8	2 3/8	3 3/8	4 3/8	5 1/4
T-17S15	4-6L6 P-P Par.	AB1	3,300*	4/8/15/250/500	155	60	2G	2 3/8	2 3/8	3 3/8	4 3/8	5 1/4
T-68S06	1-6F6, 42, 2A5, 1-47	A	7,000	10 or 2,000	36	5	2F	2 3/8	2 3/8	1 3/8	2 3/8	1
T-67S51	2-6F6, 42, 2A5, 47 P-P	A	14,000	4/8/15/500	40	20	2F	2 3/8	3 3/8	2 1/2	3	2 1/4
T-67S48	2-45, 71, 43, 25A6 P-P 1-6N7, 6A6, 53 P-P	A B	8,000	4/8/15/500	36	25	2F	2 3/8	3 3/8	2 1/2	3	2 1/4
T-67S52	2-46, 59 P-P 2-6F6, 42, 2A5 P-P 2-6N7, 6A6, 53 P-P Par.	B AB2 B	5,800	4/8/15/500	60	30	2F	3 1/8	3 3/8	3 3/8	3 3/8	3 3/8
T-58S72	2-2A3, 6B4G P-P 2-48, 25L6 P-P	AB A	3,000	4/8/15/500	60	30	2F	3 1/8	3 3/8	3 3/8	3 3/8	3 3/8
T-67S54	2-6L6 P-P 2-2A3, 6B4G, 45 P-P	A AB	5,000	4/8/15/500	60	30	2F	3 1/8	3 3/8	3 3/8	3 3/8	3 3/8
T-67S92	4-2A3, 6B4G, 45 P-P Par. 4-48, 25L6, P-P Par.	AB A	1,500	4/8/15/500	80	40	2F	3 1/8	3 3/8	3 3/8	3 3/8	3 3/8
T-65S94	2-50 P-P 2-6F6, 42, 2A5 P-P	A AB2	8,000	4/8/15/500	55	40	2F	3 1/8	3 3/8	3 3/8	3 3/8	3 3/8
T-75S75	2-6F6, 42 or 2A5 1-6N7, 6A6, 53 P-P 2-6N6G, 6B5, 2B6, 6AC5 P-P	AB2 B A	10,000	4/8/15/500	45	40	2F	3 1/8	3 3/8	3 3/8	3 3/8	3 3/8
T-84S58	2-6L6 P-P	AB2	3,800	4/8/15/500	115	60	2G	2 3/8	2 3/8	3 3/8	4 3/8	6
T-89S75	2-6L6 P-P	AB1	6,600	4/8/15/500	80	40	2F	3 1/8	3 3/8	3 3/8	3 3/8	3 3/8

*10% feed-back winding.

UNIVERSAL REPLACEMENT TUBE TO VOICE COIL

Preferred by many because of their wide plate impedance and voice coil coverage. Proper matching of load impedances to speaker voice coils is accomplished by using taps as specified in the instruction sheets.

T-13S38	Universal	A	4,000/7,000	Adjustable	36	8	3E	2 3/8	2 3/8	2	1 3/8	3/4
T-14S85	Single or P-P Tubes		8,000/10,000	.1 to 29			3B	2 3/8	2 3/8	1 3/8	1 3/8	3/4
T-57S01*			14,000 Ct.				2E	2 3/8	2 3/8	2 1/8	2 3/8	1 1/2
T-57S02†							2B	2 3/8	2 3/8	2 1/8	2 3/8	1 1/2
T-13S42	Universal	A	1,500/2,000	Adjustable	55	10	3E	2 3/8	2 3/8	2	1 3/8	3/4
	Single Tube		4,000/5,000	.1 to 29								
	Tube		7,000									
T-13S41	Universal	A	3,000/5,000	Adjustable	60	20	2E	2 3/8	3 3/8	2 1/2	3	2 1/4
	P-P Tubes		6,600/7,000	.1 to 29								
	Tube		8,000/10,000									

*Solder terminals for voice coil connections. †Color coded leads for voice coil connections.

UNIVERSAL TUBE TO LINE

T-61S25	Univ. Single Tube	A	2,500/4,000	500	60	10	2E	2 3/8	3 3/8	2 1/2	3	2 1/4
			5,000/6,000/7,000									
T-61S26	Univ. P-P Tubes	A	8,000/10,000	500	55	10	2E	2 3/8	3 3/8	2 1/2	3	2 1/4
			12,000/14,000 Ct.									

UNIVERSAL LINE TO VOICE COIL

T-53S81	Line to Voice Coil		500/250	4-8-15	35	2D	2 1/8	1 3/4	2 1/8	2 3/8	3 3/8	3 3/8
T-60S48	Line to Voice Coil		500/1,000	Pri. as 500	10	2E	2 3/8		3 3/8	2 1/2	3	2
T-17S18	1 to 6 may be con. in par. to 500 ohm line		1,500/2,000	ohm-.06 to 8.; pri. as								
			2,500/3,000	1,000 ohm-.12 to 16, etc.								
T-14S80	Line to Voice Coil		500	2/4/6/8	12	2E	2 3/8		2 1/8	2 1/8	2 3/8	1 1/2

We can supply all Thordarson products. Ask for complete Thordarson catalog.



2D



C. H. T. MULTIPLE TAP OUTPUT TRANSFORMERS

Include these C. H. T. premium quality features: Switchboard plug-in terminal board for quick and accurate selection of secondary impedances, conservative design for exceptional performance, and complete coil protection against humidity. Tertiary winding to give a feedback voltage 10% of full primary. Split Primaries.

Type No.	Application	Class	Ohms Impedance		Pri. M. A. Max. Mtg. Per Side Watts Fig.		Mtg. Centers		Dimensions			Wt. Lbs.	
			Pri.	Sec.			Width	Depth	W.	D.	H.		
T-15S90	2-6V6 P-P	AB1	8,000	2/3/4/6/-	70	15	4U	3 3/8	3 1/4	4 1/2	4 3/8	4 3/8	7 1/2
	2-6L6 P-P	AB1	5,000	8/16/125/-									
	2-2A3 P-P (self bias)	AB	5,000	250/500									
T-15S91	2-6L6 P-P (300 V. P. & Sc.)	AB	4,300	Same	95	25	4U	3 3/8	3 1/4	4 1/2	4 3/8	4 3/8	8
	2-2A3 P-P (fixed bias)	AB	3,000	as above									



3U

C. H. T. CRYSTAL RECORDER TRANSFORMERS

The wave of interest in recording radio programs, speech and other audio happenings has created the desire to build recording equipment. These two transformers are offered to meet the requirements for coupling to a crystal recording head. Secondary designed for constant velocity recording (series connection) and constant amplitude recording (parallel connection).

Type No.	Application	Capacity	Series	Mtg.	Mtg. Centers	Dimensions	Wt.				
		Watts	Par.	Fig.	Width	Depth	Lbs.				
T-15S98	Line to crystal cutting head	500	Series 20,000 Par. 5,000	10	3U	2 3/8	2 1/2	3	2 3/4	4	5
T-15S99	Push-pull 2A3, 6B4G etc. to crystal head	3,000	Series 20,000 Par. 5,000	10	3U	2 3/8	2 1/2	3	2 3/4	4	5



3H

VOLTAGE CHANGER (V) TRANSFORMERS

FILAMENT CORRECTOR AUTOTRANSFORMERS

To compensate for variations in line voltage or for drop in filament leads. Correct filament voltage at the tube is made possible.

Type No.	Capacity Filament Power Watts	Primary Taps	Mtg. Fig.	Mtg. Centers		Dimensions			Wt. Lbs.
				Width	Depth	W.	D.	H.	
T-18V24	60	105/110/115/120/125V.	2E	2 3/8	2 1/2	2 3/8	2 3/8	2 3/8	1
T-18V25	150	105/110/115/120/125V.	2E	2 3/8	2 1/2	3 3/8	2 3/8	2 3/8	1 1/2



2E

AUTOTRANSFORMERS

Autotransformers consist of a single winding on an iron core. Voltage variation is accomplished by means of taps.

Step Down — Convenience Outlet Type

Input side equipped with cord and plug. Output side has standard receptacle.

Type No.	Input Volts	Output Volts	Output Load		Mtg. Fig.	Mtg. Centers		Dimensions			Wt. Lbs.
			V.A.	Amps.		Width	Depth	W.	D.	H.	
T-26V04	220-250	110-125	.80	0.725	2V	2 3/8	2 1/2	3 3/8	2 3/8	4 3/8	4 1/2
T-18V06	220-250	110-125	150	1.35	2V	2 3/8	2 3/8	3 3/8	3 3/8	4 3/8	6 1/2
T-50V11	220-250	110-125	250	2.25	2V	3	3 1/2	3 3/8	4 1/4	4 3/8	10 1/2
T-18V07	220-250	110-125	500	4.5	2V	3	4 1/8	3 3/8	4 3/8	4 3/8	13



2V

Line Voltage Adjusting — Convenience Outlet Type

For boosting or lowering line voltage. Input taps may be selected by means of a convenient plug arrangement as illustrated (Fig. 4E)

Type No.	Input	Output	V.A.	Amps.	Mtg. Fig.	Mtg. Centers	Dimensions	Wt.			
	Volts	Volts				Width	Depth	Lbs.			
T-18V20	95/105/125	115	100	0.9	2V	2 3/8	2 1/2	3 3/8	2 3/8	4 3/8	4 1/2
T-18V21	95/105/125	115	150	1.3	2V	2 3/8	2 3/8	3 3/8	3 3/8	4 3/8	5
T-18V22	95/105/125	115	250	2.2	2V	3	2 3/8	3 3/8	3 3/8	4 3/8	6 1/2
T-18V23	95/105/125	115	500	4.5	2V	3	3 1/8	3 3/8	3 3/8	4 3/8	9



4E

LINE REGULATING AUTOTRANSFORMER

Provides for an increase or decrease of 7.5 volts. May be used on any A.C. line of 50-60 cycle frequency from 90V to 125V as a step-up or step-down transformer. Especially suitable for boosting line voltage for fluorescent lighting units. Fully enclosed (similar to 2H) and mounted on a 4" outlet box cover, allowing for complete enclosure of all wiring in a conduit or BX system.

Type No.	Input	Output	V.A.	Amps.	Mtg. Fig.	Mtg. Centers	Dimensions	Wt.		
	Volts	Volts				Width	Depth	Lbs.		
T-18V26	90-125	7.5 Variation	1150	10	4L	3 3/8	4 1/8	3 3/8	4 1/8	5

THORDARSON OSCILLOSCOPE KIT

An accurately designed circuit using a 913 tube. Magnifying lens gives clear 2" image and small overall size of unit makes it ideal for relay rack of servicemen and for amateur and experimental uses.

Type No.	Description
T-11K99	Foundation Unit (Consists of punched chassis, panel, light shield, etched panel, ventilated cabinet and 2" magnifying lens with retainer ring, and complete circuit with constructional and operating data.) In addition to the foundation unit, one T-92R33 power transformer (see below) and one T-74C30 filter choke are required.



Circuit diagram, description and complete parts list given in catalog sheet SD266



No. 340 Manual

POWER TRANSFORMERS FOR CATHODE RAY TUBES

Type No.	Volts D.C.	M.A.	Rect. Fil.	Fil. No. 1	Fil. No. 2	Mtg. Fig.	Mtg. Centers		Dimensions			Wt. Lbs.
							Width	Depth	W.	D.	H.	
T-14R32	400	15	5V-2A	6.3V-.6A	2.5V-2A	2G	2 3/8	2 3/8	2 3/8	3 3/8	3 3/8	4
For Dumont 24XH; RCA902, tap-430			5V-2A. Ct		(No. 3, 6.3V-.6A)							
T-92R33	**500	3	6.3V-.9A	6.3V-.6A	6.3V-.6A	2F	3 1/4	3 1/4	3 3/8	3 3/8	3 3/8	3 3/8
For 913 tube tap-400 15					(No. 3, 2.5V-1.4A)							

**With half wave rectification.

#340 Complete Transformer Manual — 35c postpaid — contains Sound Amplifier Guide, Transmitter Guide, and Replacement Encyclopedia with catalogs. A popular book in every technical library.

#333 Amateur Radio — a beginner's guide — 75c postpaid — one of the most comprehensive and clearly written books available for learning Amateur Radio. Cloth bound book, 160 pages, over 100 illustrations. A handy reference book for the experienced amateur.



No. 333 Amateur Radio

We can supply all Thordarson products. Ask for complete Thordarson catalog.



DRY ELECTROLYTIC CAPACITORS

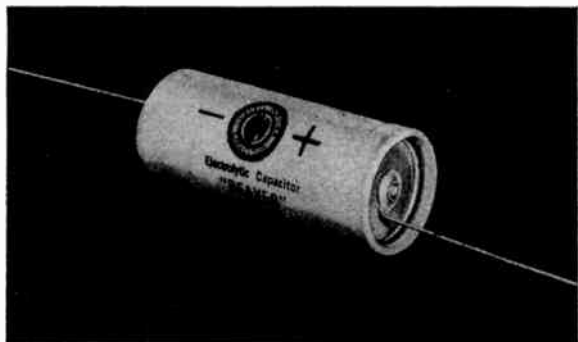

TYPE BR "BLUE BEAVERS"

Type BR "Blue Beavers" are the most universal capacitors available for use where single section units are required. They are extremely small, handy, and completely eliminate the use of exact duplicate replacement capacitors. Polarity is clearly indicated on a protective varnished cardboard sleeve fitted over a pure aluminum cartridge. Hermetically sealed, vented, and especially designed for use in all radio circuits.

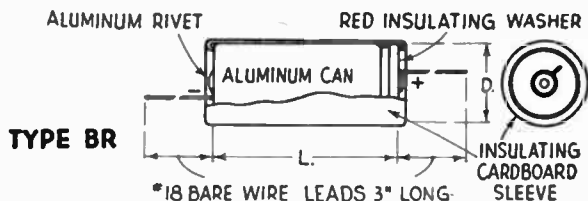

Cat. No.	Cap. Mid.	Size—Inches Diam. x Length	List Price	Net Price
25 V. D.C.				
BR 102A	10	$\frac{3}{8}$ x $1\frac{1}{2}$	\$0.50	\$0.30
BR 202A	20	$\frac{3}{8}$ x $1\frac{1}{2}$.55	.33
BR 252A	25	$\frac{3}{8}$ x $1\frac{1}{2}$.60	.36
BR 502	50	$\frac{3}{8}$ x $1\frac{1}{2}$.75	.45
50 V. D.C.				
BR 550	5	$\frac{3}{8}$ x $1\frac{1}{2}$.50	.30
BR 105	10	$\frac{3}{8}$ x $1\frac{1}{2}$.55	.33
BR 205	20	$\frac{3}{8}$ x $1\frac{1}{2}$.60	.36
BR 255	25	$\frac{3}{8}$ x $1\frac{1}{2}$.70	.42
BR 505	50	$\frac{3}{8}$ x $1\frac{1}{2}$.85	.51
150 V. D.C.				
BR 415	4	$\frac{3}{8}$ x $1\frac{1}{2}$.50	.30
BR 815	8	$\frac{3}{8}$ x $1\frac{1}{2}$.55	.33
BR 1215	12	$\frac{3}{8}$ x $1\frac{1}{2}$.60	.36
BR 1615	16	$\frac{3}{8}$ x $1\frac{1}{2}$.70	.42
BR 2015	20	$\frac{3}{8}$ x $1\frac{1}{2}$.75	.45
BR 3015	30	$\frac{3}{8}$ x 2	.80	.48
BR 4015	40	$\frac{3}{8}$ x 2	.85	.51
250 V. D.C.				
BR 425	4	$\frac{3}{8}$ x $1\frac{1}{2}$.55	.33
BR 825	8	$\frac{3}{8}$ x $1\frac{1}{2}$.60	.36
BR 1225	12	$\frac{3}{8}$ x 2	.80	.48
BR 1625	16	$\frac{3}{8}$ x $1\frac{1}{2}$.90	.54
BR 2025	20	$\frac{3}{8}$ x $1\frac{1}{2}$	1.00	.60
BR 4025	40	$\frac{3}{8}$ x 2	1.15	.69
350 V. D.C.				
BR 435	4	$\frac{3}{8}$ x $1\frac{1}{2}$.60	.36
BR 835	8	$\frac{3}{8}$ x $1\frac{1}{2}$.70	.42
BR 1235	12	$\frac{3}{8}$ x 2	.85	.51
BR 1635	16	$\frac{3}{8}$ x 2	1.00	.60
450 V. D.C.				
BR 145	1	$\frac{3}{8}$ x $1\frac{1}{2}$.55	.33
BR 245	2	$\frac{3}{8}$ x $1\frac{1}{2}$.60	.36
BR 445	4	$\frac{3}{8}$ x $1\frac{1}{2}$.70	.42
BR 845	8	$\frac{3}{8}$ x 2	.75	.45
BR 1045	10	$\frac{3}{8}$ x $1\frac{1}{2}$.85	.51
BR 1245	12	$\frac{3}{8}$ x $1\frac{1}{2}$.90	.54
BR 1645	16	$\frac{3}{8}$ x 2	1.10	.66
BR 2045	20	1 x 2 $\frac{1}{2}$	1.20	.72
BR 3045	30	1 x 3	1.45	.87
500 V. D.C.				
BR 850	8	$\frac{3}{8}$ x $1\frac{1}{2}$	1.05	.63
BR 1650	16	1 x 2 $\frac{1}{2}$	1.60	.96

* Reg. U. S. Pat. Off.

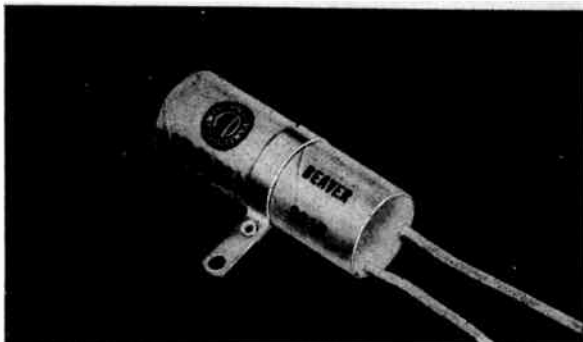

TYPES BRL AND BRS "BEAVERS"

Type BRL "Beavers" are dual and triple common negative capacitors, while Type BRS are dual common positive units. Capacities, voltages and polarity of the leads are clearly defined by color coding stamped on the cardboard tube casing. Units are provided with a mounting strap around the center of the cardboard tube casing which enables mounting with one screw under the chassis assembly.

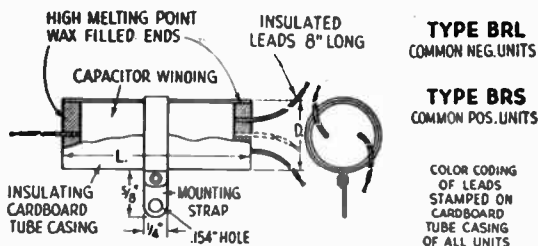

TYPE BRL
COMMON NEG. UNITS

TYPE BRS
COMMON POS. UNITS

COLOR CODING
OF LEADS
STAMPED ON
CARDBOARD
TUBE CASING
OF ALL UNITS

Dual Common Negative Units

Cat. No.	Cap. Mid.	D.C. W. Volts	Size—Ins. Dia. x Lgth.	List Price	Net Price
BRL 2055	5-5	25	$\frac{3}{8}$ x $1\frac{1}{4}$	\$0.75	\$0.45
BRL 2101	10-10	25	$\frac{3}{8}$ x $1\frac{1}{4}$.85	.51
BRL 3055	5-5	50	$\frac{3}{8}$ x $1\frac{1}{4}$.90	.54
BRL 115	10-10	50	$\frac{3}{8}$ x $2\frac{1}{4}$	1.00	.60
BRL 4415	4-4	150	$\frac{11}{16}$ x $2\frac{1}{4}$.85	.51
BRL 8815	8-8	150	$\frac{3}{8}$ x $2\frac{1}{4}$	1.00	.60
BRL 8115	8-16	150	$\frac{15}{16}$ x $2\frac{1}{4}$	1.05	.63
BRL 1115	16-16	150	$\frac{1}{2}$ x $2\frac{1}{4}$	1.15	.69
BRL 2115	20-10	150	$\frac{3}{8}$ x $2\frac{1}{4}$	1.15	.69
BRL 2215	20-20	150	$\frac{3}{8}$ x $2\frac{1}{4}$	1.30	.78
BRL 4215	40-20	150	$\frac{15}{16}$ x $2\frac{1}{4}$	1.40	.84
BRL 8125	8-16	250	$\frac{1}{2}$ x $2\frac{1}{4}$	1.30	.78
BRL 1125	16-16	250	1 x 2 $\frac{1}{4}$	1.50	.90
BRL 8845	8-8	450	1 x 2 $\frac{1}{4}$	1.30	.78
BRL 8145	8-16	450	$\frac{1}{2}$ x 3 $\frac{1}{4}$	1.65	.99

Triple Common Negative Units

Cat. No.	Cap. Mid.	D.C. W. Volts	Size—Ins. Dia. x Lgth.	List Price	Net Price
BRL 201	4-8, 10	150, 25	$\frac{3}{8}$ x 2 $\frac{1}{4}$	\$1.35	\$0.81
BRL 202	10-16, 10	150, 25	$\frac{3}{8}$ x 2 $\frac{1}{4}$	1.50	.90
BRL 203	16-16, 20	150, 25	$\frac{15}{16}$ x 2 $\frac{1}{4}$	1.65	.99
BRL 205	8-8-8	150	$\frac{15}{16}$ x 2 $\frac{1}{4}$	1.40	.84
BRL 206	4-8-16	150	$\frac{3}{8}$ x 2 $\frac{1}{4}$	1.45	.87
BRL 207	10-10-20	150	1 x 2 $\frac{1}{4}$	1.70	1.02

Dual Common Positive Units

Cat. No.	Cap. Mid.	D.C. W. Volts	Size—Ins. Dia. x Lgth.	List Price	Net Price
BRS 4815	4-8	150	$\frac{3}{8}$ x 2 $\frac{1}{4}$	\$1.15	\$0.69
BRS 8815	8-8	150	$\frac{15}{16}$ x 2 $\frac{1}{4}$	1.20	.72
BRS 1415	4-12	150	$\frac{15}{16}$ x 2 $\frac{1}{4}$	1.20	.72
BRS 8115	8-16	150	$\frac{15}{16}$ x 2 $\frac{1}{4}$	1.35	.81
BRS 1115	16-16	150	1 x 2 $\frac{1}{4}$	1.50	.90
BRS 2215	20-20	150	$\frac{15}{16}$ x 2 $\frac{1}{4}$	1.65	.99
BRS 3115	30-10	150	$\frac{15}{16}$ x 2 $\frac{1}{4}$	1.65	.99
BRS 3215	30-20	150	1 x 2 $\frac{1}{4}$	1.70	1.02



DRY ELECTROLYTIC CAPACITORS

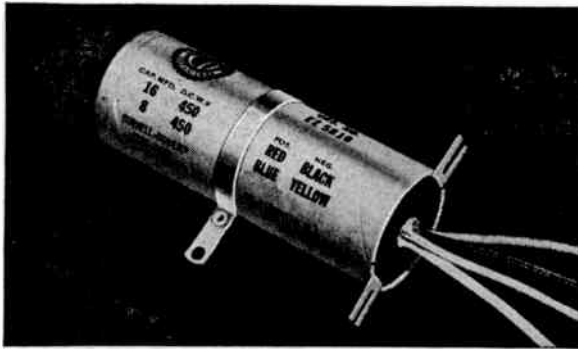

TYPE EZ UNIVERSAL MOUNTING UNITS

Type EZ capacitors are especially popular for radio servicing where low cost replacements are required. They are designed with mounting feet for upright mounting to replace inverted can-type units, spade-lug units, or may be mounted beneath the chassis by means of the mounting strap provided around the center of the cardboard tube casing. In any instance, the unused mountings may easily be cut off.

These units are without doubt the most practical all-around replacement capacitors available and incorporate C-D etched foil features in design and construction. They are completely sealed in moisture-proof cardboard tube casing, filled with special wax compound, and provided with insulated wire leads eight inches long.

All units are clearly stamped with capacities, voltages and color code designation of leads.

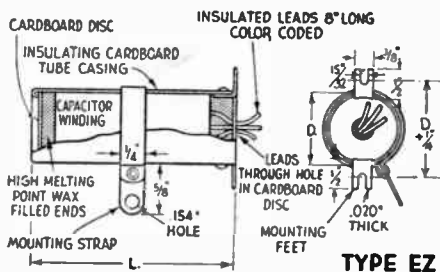

TYPE EZ



TYPE BRH HIGH-CAPACITY LOW-VOLTAGE UNITS

These compact C-D etched foil electrolytic capacitors have been especially designed for all applications requiring high capacity units operating in low voltage D.C. circuits. They are widely employed in portable radio power rectifying circuits, electric fence devices, telephone and D.C. timing circuits. Units are available in standard capacities and voltage ratings for all uses.

Hermetically sealed in pure aluminum cans with an external cardboard insulating sleeve, these units are provided with metal mounting strap and bare wire leads for convenient wiring into any circuit assembly. They are constructed identically the same as Type BR "Blue Beavers" except all units are provided with a mounting strap.

Cat. No.	Cap. Mfd.	D.C. W. Volts	Size—Inches Dia. x Lgth.	List Price	Net Price
BRH 601	100	6	3/8 x 1 1/8	\$0.90	\$0.54
BRH 6025	250	6	3/8 x 1 1/8	1.15	.69
BRH 605	500	6	3/8 x 2 1/8	1.50	.90
BRH 610	1000	6	3/8 x 2 1/8	2.10	1.26
BRH 615	1500	6	3/8 x 2 1/8	2.70	1.62
BRH 620	2000	6	1 x 2 1/8	3.30	1.98
BRH 121	100	12	3/8 x 1 1/8	1.00	.60
BRH 1225	250	12	3/8 x 2 1/8	1.30	.78
BRH 125	500	12	3/8 x 2 1/8	1.80	1.08
BRH 151	100	15	3/8 x 1 1/8	1.05	.63
BRH 1525	250	15	3/8 x 2 1/8	1.50	.90
BRH 155	500	15	3/8 x 2 1/8	2.10	1.26
BRH 251	100	25	3/8 x 2 1/8	1.10	.66
BRH 2525	250	25	3/8 x 2 1/8	1.60	1.08
BRH 255	500	25	1 x 2 1/8	2.70	1.62
BRH 501	100	50	3/4 x 2	1.20	.72

Cat. No.	Cap. Mfd.	D.C. W. Volts	Size—Ins. Dia. x Lth.	List Price	Net Price
EZ 825	8	250	3/8 x 2 1/8	\$0.65	\$0.39
EZ 1625	16	250	1 x 2 3/8	.90	.54
EZ 2425	24	250	1 1/8 x 2 3/8	1.05	.63
EZ 835	8	350	1 1/8 x 2 3/8	.70	.42
EZ 1235	12	350	1 1/8 x 2 3/8	.85	.51
EZ 1635	16	350	1 x 2 3/8	1.00	.60
EZ 2435	24	350	1 x 3 1/8	1.20	.72
EZ 845	8	450	3/8 x 2 3/8	.75	.45
EZ 1245	12	450	1 x 2 3/8	.90	.54
EZ 1645	16	450	1 1/8 x 2 3/8	1.10	.66

Dual Common Negative Units

Cat. No.	Cap. Mfd.	D.C. W. Volts	Size—Ins. Dia. x Lth.	List Price	Net Price
EZ 3315	30-30	150	1 x 2 3/8	\$1.75	\$1.05
EZ 5515	50-50	150	1 x 3 1/8	2.00	1.20
EZ 8525	8-8	250	1 x 2 3/8	1.03	.63
EZ 8535	8-8	350	1 1/8 x 3 1/8	1.15	.69
EZ 8545	8-8	450	1 x 3 1/8	1.30	.78

Dual Separate Section Units

Cat. No.	Cap. Mfd.	D.C. W. Volts	Size—Ins. Dia. x Lth.	List Price	Net Price
EZ 288	8-8	250	1 3/8 x 2 3/8	\$1.30	\$0.78
EZ 2116	16-16	250	1 3/8 x 3 3/8	2.00	1.20
EZ 388	8-8	350	1 3/8 x 3	1.50	.90
EZ 3112	12-12	350	1 3/8 x 3 3/8	1.90	1.14
EZ 3116	16-16	350	1 3/8 x 4 3/8	2.20	1.32
EZ 588	8-8	450	1 3/8 x 3	1.65	.99
EZ 5816	8-16	450	1 3/8 x 3 3/8	2.00	1.20
EZ 5112	12-12	450	1 3/8 x 3 3/8	2.00	1.20
EZ 5116	16-16	450	1 3/8 x 4 3/8	2.40	1.44

Type EZ capacitors continued in next column.

Triple Common Negative Units

Cat. No.	Cap. Mfd.	D.C. W. Volts	Size—Ins. Dia. x Lth.	List Price	Net Price
EZ 601	24-16, 20	150, 25	1 x 3	\$1.75	\$1.05
EZ 602	30-10, 20	150, 25	1 x 3	1.75	1.05
EZ 603	40-20, 20	150, 25	1 1/8 x 3	1.80	1.08
EZ 604	30-20, 10	150	1 1/8 x 2 3/8	1.80	1.08
EZ 605	40-20-20	150	1 1/8 x 3	2.00	1.20
EZ 606	15-10, 20	350, 25	1 1/8 x 3 1/8	2.00	1.20
EZ 607	20-10, 25	400-350, 25	1 1/8 x 3 1/8	2.25	1.35

Triple Separate Section Units*

Cat. No.	Cap. Mfd.	D.C. W. Volts	Size—Ins. Dia. x Lth.	List Price	Net Price
EZ 608	8-8, 20	250, 25	1 1/8 x 3	\$1.85	\$1.11
EZ 609	16-16, 20	250, 25	1 1/8 x 3 3/8	2.40	1.44
EZ 610	8-8, 20	350, 25	1 1/8 x 3 3/8	1.80	1.08
EZ 621	12-12, 20	350, 25	1 1/8 x 3 3/8	2.30	1.38
EZ 611	16-16, 20	350, 25	1 1/8 x 4 3/8	2.55	1.53
EZ 612	8-8, 20	450, 25	1 1/8 x 3 3/8	2.00	1.20
EZ 613	12-12, 20	450, 25	1 1/8 x 4 3/8	2.40	1.44
EZ 614	8-8-8	250	1 1/8 x 3	2.00	1.20
EZ 615	8-8-8	350	1 1/8 x 3 3/8	2.00	1.20
EZ 616	8-8-8	450	1 1/8 x 3 3/8	2.25	1.35

Quadruple Common Negative Units

Cat. No.	Cap. Mfd.	D.C. W. Volts	Size—Ins. Dia. x Lth.	List Price	Net Price
EZ 617	8-8, 10-10	150, 25	1 x 2 3/8	\$1.75	\$1.05
EZ 618	30-20, 10-10	150, 25	1 1/8 x 2 3/8	2.20	1.32

Quadruple Separate Section Units*

Cat. No.	Cap. Mfd.	D.C. W. Volts	Size—Ins. Dia. x Lth.	List Price	Net Price
EZ 619	16-16, 10-10	150, 25	1 1/8 x 3	\$2.30	\$1.38
EZ 620	8-8, 10-10	450, 25	1 1/8 x 3 3/8	2.40	1.44

*First section separate, others common negative.



DRY ELECTROLYTIC CAPACITORS



TYPE FA HIGH-CAPACITY LOW-VOLTAGE UNITS

Type FA capacitors in round aluminum cans are designed for high capacity, low voltage applications, and are especially popular as replacements in motion picture sound equipment, "A" battery power supplies and other low voltage circuits where hum-free operation is essential. Their physical size for a given capacity and voltage rating makes them particularly desirable for compact assemblies. All units are provided with lug terminals on a moulded bakelite cover and furnished with an external cardboard insulating sleeve for protection against short circuits with associated parts of equipment assemblies.

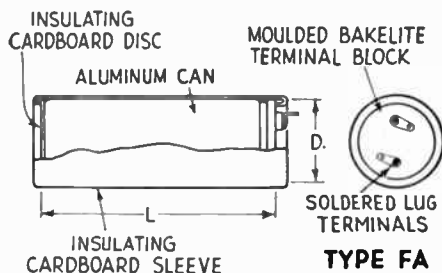

TYPE FA

Cat. No.	Cap. Mfd.	D.C. W. Volts	Size—Inches Dia. x Lgth.	List Price	Net Price
FA 1205	500	12	1 3/4 x 2 1/2	\$ 1.80	\$1.08
FA 1210	1000	12	1 3/4 x 3 1/4	3.00	1.80
FA 1215	1500	12	1 3/4 x 4 1/4	3.60	2.16
FA 1220	2000	12	1 3/4 x 4 3/4	3.90	2.34
FA 1225	2500	12	1 3/4 x 4 3/4	4.50	2.70
FA 1230	3000	12	1 3/4 x 4 3/4	4.80	2.88
FA 1240	4000	12	1 3/4 x 4 3/4	6.60	3.96
FA 1505	500	15	1 3/4 x 2 1/2	2.10	1.26
FA 1510	1000	15	1 3/4 x 3 1/4	3.60	2.16
FA 1520	2000	15	1 3/4 x 4 1/4	4.50	2.70
FA 1530	3000	15	1 3/4 x 4 1/4	6.30	3.78
FA 1540	4000	15	1 3/4 x 4 1/4	9.60	5.76
FA 1805	500	18	1 3/4 x 2 1/2	2.40	1.44
FA 1810	1000	18	1 3/4 x 3 1/4	3.60	2.16
FA 1820	2000	18	1 3/4 x 4 1/4	4.80	2.88
FA 1840	4000	18	1 3/4 x 4 1/4	10.80	6.48
FA 2005	500	20	1 3/4 x 3 1/4	2.70	1.62
FA 2010	1000	20	1 3/4 x 4 1/4	3.90	2.34
FA 2020	2000	20	1 3/4 x 4 1/4	5.40	3.24
FA 2040	4000	20	2 x 4 1/4	12.00	7.20
FA 2505	500	25	1 3/4 x 3 1/4	2.70	1.62
FA 2510	1000	25	1 3/4 x 4 1/4	4.20	2.52
FA 2520	2000	25	1 3/4 x 4 1/4	7.20	4.32
FA 2540	4000	25	2 x 4 1/4	15.00	9.00
FA 3010	1000	30	1 3/4 x 4 1/4	4.50	2.70
FA 3020	2000	30	2 1/4 x 4 1/4	9.60	5.76
FA 3040	4000	30	3 x 4 1/4	17.40	10.44
FA 3505	500	35	1 3/4 x 4 1/4	3.60	2.16
FA 3510	1000	35	1 3/4 x 4 1/4	4.80	2.88
FA 3520	2000	35	2 1/4 x 4 1/4	10.80	6.48
FA 3530	3000	35	3 x 4 1/4	15.90	9.54
FA 4010	1000	40	1 3/4 x 4 1/4	5.40	3.24
FA 4020	2000	40	2 1/4 x 4 1/4	12.00	7.20
FA 5005	500	50	1 3/4 x 4 1/4	3.90	2.34
FA 5010	1000	50	1 3/4 x 4 1/4	7.20	4.32
FA 5020	2000	50	2 1/4 x 4 1/4	15.00	9.00

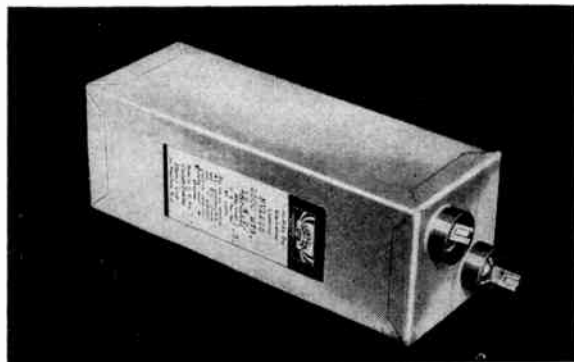

TYPE FV HIGH-CAPACITY LOW-VOLTAGE UNITS

Type FV high capacity, low-voltage capacitors in rectangular metal cans are widely employed in standard types of low-voltage rectifiers for sound picture equipment, public address and sound systems, low-voltage power supplies, etc. They are particularly popular as replacements for servicing requirements where exact duplicate units are desired.

All units are hermetically sealed in an internal aluminum can insulated from the external metal casing, and provided with bakelite, barrier-insulated terminals and fork soldering lugs.

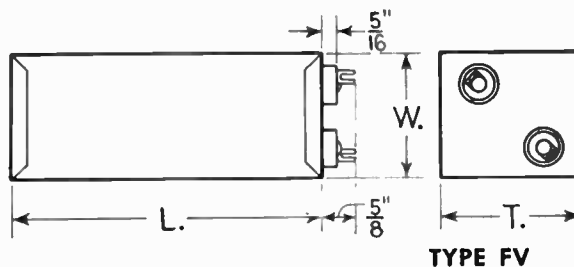

TYPE FV

Cat. No.	Cap. Mfd.	D.C. W. Volts	Size—Inches Hgt. x Wth. x Dpt.	List Price	Net Price
FV 1205	500	12	4 1/4 x 2 1/2 x 1 1/4	\$2.85	\$1.47
FV 1210	1000	12	4 1/4 x 2 x 2	4.30	2.58
FV 1215	1500	12	4 1/4 x 2 1/2 x 2 1/4	5.95	3.57
FV 1220	2000	12	6 1/4 x 2 1/2 x 2 1/4	7.60	4.56
FV 1225	2500	12	6 1/4 x 2 1/2 x 2 1/4	9.30	5.68
FV 1230	3000	12	6 1/4 x 3 x 3	11.10	6.60
FV 1240	4000	12	6 1/4 x 3 x 3	14.35	8.61
FV 1505	500	15	4 1/4 x 2 1/2 x 1 1/4	3.00	1.80
FV 1510	1000	15	4 1/4 x 2 x 2	5.10	3.06
FV 1520	2000	15	6 1/4 x 2 1/2 x 2 1/4	9.30	5.68
FV 1530	3000	15	6 1/4 x 3 x 3	13.60	8.16
FV 1540	4000	15	6 1/4 x 3 x 3	17.80	10.68
FV 1805	500	18	4 1/4 x 2 x 2	3.45	2.07
FV 1810	1000	18	4 1/4 x 2 1/2 x 2 1/4	5.90	3.54
FV 1820	2000	18	6 1/4 x 3 x 3	11.00	6.60
FV 1840	4000	18	6 1/4 x 4 x 4	21.00	12.60
FV 2005	500	20	4 1/4 x 2 x 2	6.75	2.25
FV 2010	1000	20	6 1/4 x 2 1/2 x 2 1/4	6.50	6.17
FV 2020	2000	20	6 1/4 x 3 x 3	11.95	6.17
FV 2040	4000	20	6 1/4 x 4 x 4	23.25	13.95
FV 2505	500	25	4 1/4 x 2 x 2	4.50	2.70
FV 2510	1000	25	6 1/4 x 2 1/2 x 2 1/4	7.90	4.74
FV 2520	2000	25	6 1/4 x 3 x 3	14.95	8.97
FV 2540	4000	25	6 1/4 x 4 x 4	28.80	17.28
FV 3010	1000	30	6 1/4 x 2 1/2 x 2 1/4	9.30	5.58
FV 3020	2000	30	6 1/4 x 3 x 3	17.70	10.62
FV 3040	4000	30	6 1/4 x 4 x 4	34.50	20.70
FV 3505	500	35	6 1/4 x 2 1/2 x 2 1/4	5.95	3.57
FV 3510	1000	35	6 1/4 x 2 1/2 x 2 1/4	10.70	6.42
FV 3520	2000	35	6 1/4 x 3 x 3	21.00	12.60
FV 3530	3000	35	6 1/4 x 4 x 4	30.30	18.18
FV 4010	1000	40	6 1/4 x 3 x 3	11.95	7.17
FV 4020	2000	40	6 1/4 x 4 x 4	23.25	13.95
FV 5005	500	50	6 1/4 x 2 1/2 x 2 1/4	7.80	4.68
FV 5010	1000	50	6 1/4 x 3 x 3	14.95	8.97
FV 5020	2000	50	6 1/4 x 4 x 4	28.80	17.28



DRY ELECTROLYTIC CAPACITORS



TYPE UP CYLINDRICAL CAN UNITS

Type UP capacitors are the smallest can-type electrolytic units available. They are hermetically sealed in aluminum cans with positive terminal lugs on a bakelite insulating cover, the can being the common negative terminal.

Projecting tongues provide facilities for mounting in a vertical position on metal chassis bodies or on metal or bakelite mounting washer. Bakelite and metal washers are furnished with each unit. The projecting tongues have small wire holes and are tinned for convenient soldering to common negative connections. All solder lugs are mechanically strong, being made of cold rolled steel, although nothing other than pure aluminum comes in contact with the electrolyte within the container to cause galvanic corrosion. Electrically, these Type UP units possess excellent characteristics, having exceptionally low leakage and power factor, and are especially dependable in operation over wide temperature variations with minimum capacity change.

DIMENSIONS OF
METAL AND BAKELITE
MOUNTING WASHERS
FOR TYPE UP CAPACITORS
METAL WASHER - .025" THICK
BAKELITE WASHER - 1/16" THICK

TYPE UP

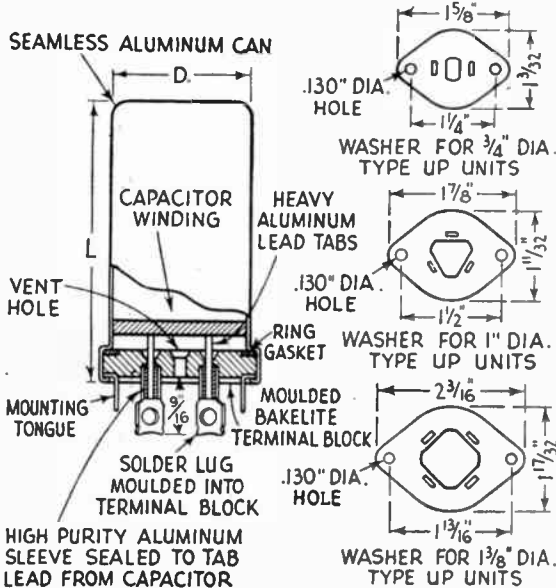

Cat. No.	Cap. Mfd.	D.C. W. Volts	Size—In. D. x L.	List Price	Net Price
UP 1A J22	40	25	3/4 x 2	\$0.80	\$0.48
UP 4A J23	100	25	1 x 2	1.30	.78
UP 1A J24	30	150	3/4 x 2	.85	.51
UP 4A J25	50	150	1 x 2	1.15	.69
UP 1A J26	20	250	3/4 x 2	.85	.51
UP 4A J10	30	250	1 x 2	1.10	.66
UP 4A J27	40	250	1 x 2	1.20	.72
UP 1A J28	15	300	3/4 x 2	.80	.48
UP 4A J29	30	300	1 x 2	1.20	.72
UP 6A J30	50	350	1 x 3	1.75	1.05
UP 9A J31	125	350	1 1/2 x 3	3.15	1.89
UP 4A J37	10	450	1 x 2	.90	.54
UP 1045	10	450	1 x 2	.90	.54
UP 4A J18	15	450	1 x 2	1.20	.72
UP 2045	20	450	1 x 2	1.35	.81
UP 4045	40	450	1 x 3	1.95	1.17
UP 9A J32	80	400	1 3/4 x 3	2.95	1.77

Dual Section Units

UP 4B J33	40-40	.25	1 x 2	\$1.20	\$0.72
UP 2215	20-20	150	1 x 2	1.20	.72
UP 4B J6	15-30	150	1 x 2	1.20	.72
UP 3315	30-30	150	1 x 2	1.35	.81
UP 6B J34	50-50	150	1 x 3	1.60	.96
UP 2225	20-20	250	1 x 2	1.35	.81
UP 6B J35	40-40	250	1 x 3	1.75	1.05
UP 4B J36	15-15	300	1 x 2	1.20	.72
UP 6B J37	30-30	350-300	1 x 3	1.80	1.08
UP 1145	10-10	450	1 x 2	1.45	.87
UP 6B J38	20-20	450	1 x 3	2.00	1.20
UP 9B J39	40-40	450	1 1/2 x 3	3.20	1.92
UP 9B J40	80-10	400	1 3/4 x 3	3.30	1.98

Triple Section Units

Cat. No.	Cap. Mfd.	D.C. W. Volts	Size—In. D. x L.	List Price	Net Price
UP 4C J2	30-20/20	150/25	1 x 2	\$1.40	\$0.84
UP 6C J41	50-50/20	150/25	1 x 3	1.75	1.05
UP 4C J3	15-15/20	250/25	1 x 2	1.35	.81
UP 6C J21	30-30/20	250/25	1 x 3	1.65	.99
UP 6C J42	40-15/20	300/25	1 x 3	1.75	1.05
UP 4C J5	10-10/20	350/25	1 x 2	1.35	.81
UP 4C J4	10-10/20	450/350/25	1 x 2	1.45	.87
UP 6C J12	10-10/20	450/25	1 x 3	1.60	.96
UP 6C J13	10-20/20	450/25	1 x 3	1.95	1.17
UP 4C J3	20-20-20	25	1 x 2	1.10	.66
UP 4C J1	20-20-20	150	1 x 2	1.45	.90
UP 6C J7	10-30-30	150	1 x 3	1.50	.90
UP 6C J44	40-40-15	150	1 x 3	1.90	1.14
UP 4C J14	10-15-15	250	1 x 2	1.40	.84
UP 6C J45	10-15-30	250	1 x 3	1.60	.96
UP 6C J11	10-20/30	250/350	1 x 3	1.80	1.08
UP 4C J46	10-10-10	300	1 x 2	1.30	.78
UP 6C J20	20/15-10	450/300-300	1 x 3	1.80	1.08
UP 6C J17	15-20-20	450-350-250	1 x 3	2.00	1.20
UP 6C J18	10-10-10	450	1 x 3	1.90	1.14
UP 6C J47	15-15-10	450	1 x 3	2.10	1.26
UP 10C 156	15-15/10	450/300	1 x 3 1/2	1.90	1.14

Quadruple Section Units

UP 7D J19	40-40-30/20	150/25	1 1/2 x 2	\$2.00	\$1.20
UP 9D J48	50-50-50/20	150/25	1 3/4 x 3	2.30	1.38
UP 9D J49	40/40-20/20	350/300/25	1 3/4 x 3	2.80	1.68
UP 9D J50	20/15-15/20	450/350/25	1 3/4 x 3	2.25	1.35
UP 7D J51	10-10-10/20	450/25	1 3/4 x 2	2.05	1.23
UP 7D J52	20-15-20/20	450/25	1 3/4 x 2	2.20	1.32
UP 9D J53	40-30-10/20	450/25	1 3/4 x 3	3.40	2.04
UP 7D J54	10-10-10-10	450	1 3/4 x 2	2.30	1.38
UP 9D J55	20-20-30-30	450/300	1 3/4 x 3	3.10	1.86
UP 9D J56	20-20-20-20	450	1 3/4 x 3	3.30	1.98

Hardware For Type UP Capacitors

Cat. No.	Item	Description	List Price	Net Price
22272	Wrench for	Mounting Type UP Units	\$0.90	\$0.54
19891	Bakelite Washer	For 3/16" UP	.06	.04
19884	Bakelite Washer	For 1/4" UP	.06	.04
19888	Bakelite Washer	For 1 3/8" UP	.06	.04
19890	Metal Washer	For 3/16" UP	.06	.04
19883	Metal Washer	For 1/4" UP	.06	.04
19887	Metal Washer	For 1 3/8" UP	.06	.04
21368-1	Mounting Clip	For 3/16" UP	.12	.07
21368-2	Mounting Clip	For 1/4" UP	.12	.07
21368-3	Mounting Clip	For 1 3/8" UP	.12	.07
22153-1	Insulating Tube	For 3/4 x 2" UP	.06	.04
22153-4	Insulating Tube	For 1 x 2" UP	.06	.04
22153-6	Insulating Tube	For 1 x 3" UP	.06	.04
22153-7	Insulating Tube	For 1 3/4 x 2" UP	.06	.04
22153-9	Insulating Tube	For 1 3/4 x 3" UP	.06	.04



DRY ELECTROLYTIC CAPACITORS

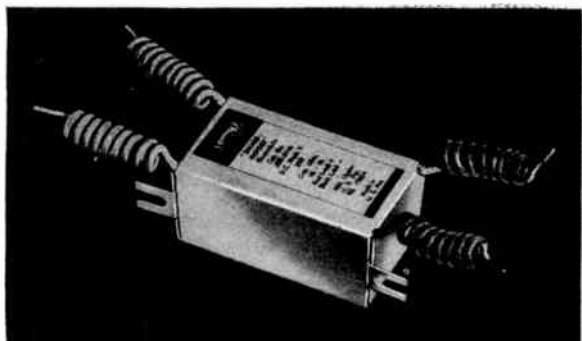

TYPES JR, JRC & JRX CARDBOARD BOX UNITS

C-D etched foil "Handy-Mikes" in silvered cardboard boxes have won outstanding recognition as universal replacement units for servicing all types of sets. Equipped with convenient mounting feet and color-coded wire leads.

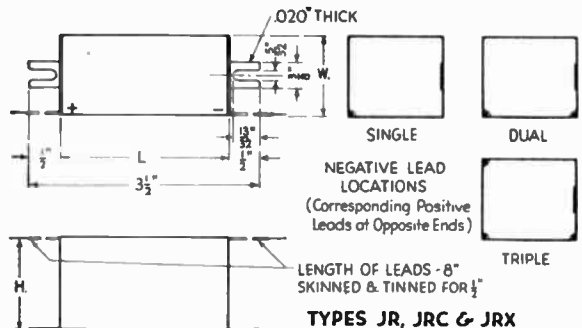

Cat. No.	Cap. Mfd.	Size—Inches W. x H. x L.	List Price	Net Price
250 V. D.C.				
JRX 204	4	$\frac{1}{2}$ x $\frac{1}{4}$ x $2\frac{1}{4}$	\$0.80	\$0.48
JRX 208	8	$\frac{1}{2}$ x $1\frac{1}{4}$ x $2\frac{1}{4}$	1.00	.60
JRX 210	10	$\frac{1}{2}$ x $1\frac{1}{2}$ x $2\frac{1}{4}$	1.15	.59
JRX 212	12	$\frac{1}{2}$ x $1\frac{1}{2}$ x $2\frac{1}{4}$	1.20	.72
JRX 216	16	$\frac{1}{2}$ x $1\frac{1}{2}$ x $2\frac{1}{4}$	1.35	.81
450 V. D.C.				
JR 502	2	$\frac{1}{2}$ x $1\frac{1}{4}$ x $2\frac{1}{4}$.80	.48
JR 504	4	$\frac{1}{2}$ x $1\frac{1}{4}$ x $2\frac{1}{4}$.90	.54
JR 506	6	$\frac{1}{2}$ x $1\frac{1}{4}$ x $2\frac{1}{4}$	1.10	.66
JR 508	8	$\frac{1}{2}$ x $1\frac{1}{4}$ x $2\frac{1}{4}$	1.15	.69
JR 510	10	$\frac{1}{2}$ x $1\frac{1}{4}$ x $2\frac{1}{4}$	1.40	.84
JR 512	12	$\frac{1}{2}$ x $1\frac{1}{4}$ x $2\frac{1}{4}$	1.60	.96
JR 516	16	$1\frac{1}{2}$ x $1\frac{1}{4}$ x $2\frac{1}{4}$	1.75	1.05

Common Negative Units

Cat. No.	Cap. Mfd.	Size—Inches W. x H. x L.	List Price	Net Price
250 V. D.C.				
JRC 244	4-4	$\frac{1}{2}$ x $1\frac{1}{4}$ x $2\frac{1}{4}$	\$1.10	\$0.66
JRC 248	4-8	$\frac{1}{2}$ x $1\frac{1}{4}$ x $2\frac{1}{4}$	1.40	.84
JRC 288	8-8	$\frac{1}{2}$ x $1\frac{1}{4}$ x $2\frac{1}{4}$	1.60	.96
JRC 2888	8-8-8	$\frac{1}{2}$ x $1\frac{1}{4}$ x $2\frac{1}{4}$	2.35	1.41
450 V. D.C.				
JRC 544	4-4	$\frac{1}{2}$ x $1\frac{1}{4}$ x $2\frac{1}{4}$	1.45	.87
JRC 548	4-8	$\frac{1}{2}$ x $1\frac{1}{4}$ x $2\frac{1}{4}$	1.65	.99
JRC 588	8-8	$\frac{1}{2}$ x $1\frac{1}{4}$ x $2\frac{1}{4}$	1.80	1.08
JRC 5888	8-8-8	$\frac{1}{2}$ x $1\frac{1}{4}$ x $2\frac{1}{4}$	2.65	1.59

Separate Section Units

Cat. No.	Cap. Mfd.	Size—Inches W. x H. x L.	List Price	Net Price
250 V. D.C.				
JRX 244	4-4	$\frac{1}{2}$ x $1\frac{1}{4}$ x $2\frac{1}{4}$	\$1.10	\$0.66
JRX 248	4-8	$\frac{1}{2}$ x $1\frac{1}{4}$ x $2\frac{1}{4}$	1.40	.84
JRX 288	8-8	$\frac{1}{2}$ x $1\frac{1}{4}$ x $2\frac{1}{4}$	1.60	.96
JRX 2888	8-8-8	$\frac{1}{2}$ x $1\frac{1}{4}$ x $2\frac{1}{4}$	2.35	1.41
JRX 2116	16-16	$\frac{1}{2}$ x $1\frac{1}{4}$ x $2\frac{1}{4}$	2.20	1.32
450 V. D.C.				
JR 544	4-4	$\frac{1}{2}$ x $1\frac{1}{4}$ x $2\frac{1}{4}$	1.45	.87
JR 5444	4-4-4	$\frac{1}{2}$ x $1\frac{1}{4}$ x $2\frac{1}{4}$	2.20	1.32
JR 548	4-8	$\frac{1}{2}$ x $1\frac{1}{4}$ x $2\frac{1}{4}$	1.65	.99
JR 588	8-8	$\frac{1}{2}$ x $1\frac{1}{4}$ x $2\frac{1}{4}$	1.80	1.08
JR 5816	8-16	$\frac{1}{2}$ x $1\frac{1}{4}$ x $2\frac{1}{4}$	2.30	1.38
JR 5888	8-8-8	$\frac{1}{2}$ x $1\frac{1}{4}$ x $2\frac{1}{4}$	2.65	1.59



TYPE KR CYLINDRICAL CAN UNITS

Types KR and KRC are compact etched foil type dry electrolytic capacitors furnished in cylindrical (inverted mounting) aluminum cans. Available in single, dual and triple sections with color-coded leads. Made in all popular voltage ratings for use in A.C.-D.C. or voltage-doubler midsets and A.C. operated sets.

The substantial reduction in size of these capacitors allows their use in compact and portable amplifiers and receivers.

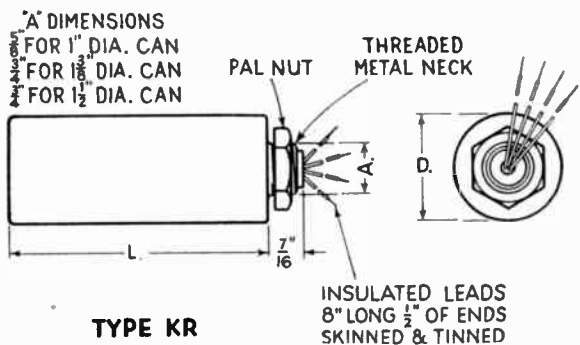

Cat. No.	Cap. Mfd.	D.C. W. Volts	Size—Ins. Dia. x Lth.	List Price	Net Price
TYPE KR					
KR 105	50	25	$1\frac{1}{2}$ x $2\frac{3}{8}$	\$1.30	\$0.78
KR 204	4	250	$1\frac{1}{2}$ x $2\frac{3}{8}$.90	.54
KR 208	8	250	$1\frac{1}{2}$ x $2\frac{3}{8}$	1.15	.69
KR 212	12	250	$1\frac{1}{2}$ x $2\frac{3}{8}$	1.35	.81
KR 225	25	250	$1\frac{1}{2}$ x $3\frac{1}{8}$	1.80	1.08
KR 350	50	300	$1\frac{3}{4}$ x $3\frac{3}{8}$	3.30	1.98
KR 504	4	450	$1\frac{1}{2}$ x $2\frac{3}{8}$	1.05	.63
KR 508	8	450	$1\frac{1}{2}$ x $2\frac{3}{8}$	1.30	.78
KR 512A	12	450	$1\frac{1}{2}$ x $2\frac{3}{8}$	1.70	1.02
KR 516A	16	450	$1\frac{1}{2}$ x $3\frac{1}{8}$	1.90	1.14
KR 604	4	600	$1\frac{3}{8}$ x $3\frac{3}{8}$	2.25	1.35
KR 608	8	600	$1\frac{3}{8}$ x $4\frac{1}{8}$	3.15	1.89
KR 616	16	600	$1\frac{3}{8}$ x $4\frac{1}{8}$	4.20	2.52

Common Negative Units

Cat. No.	Cap. Mfd.	D.C. W. Volts	Size—Ins. Dia. x Lth.	List Price	Net Price
Common Negative Units					
KRC 248	4-8	250	$1\frac{1}{2}$ x 3	\$1.60	\$0.96
KRC 288	8-8	250	$1\frac{1}{2}$ x 3	1.75	1.05
KRC 2888	8-8-8	250	$1\frac{1}{2}$ x 3	2.55	1.53
KRC 548	4-8	450	$1\frac{1}{2}$ x 3	1.75	1.05
KRC 588	8-8	450	$1\frac{1}{2}$ x $2\frac{1}{2}$	1.95	1.17
KRC 5888	8-8-8	450	$1\frac{1}{2}$ x $3\frac{1}{2}$	2.80	1.68

Separate Section Units

Cat. No.	Cap. Mfd.	D.C. W. Volts	Size—Ins. Dia. x Lth.	List Price	Net Price
Separate Section Units					
KR 248	4-8	250	$1\frac{1}{2}$ x $2\frac{1}{2}$	\$1.60	\$0.96
KR 288	8-8	250	$1\frac{1}{2}$ x $2\frac{1}{2}$	1.75	1.05
KR 2888	8-8-8	250	$1\frac{1}{2}$ x $2\frac{1}{2}$	2.55	1.53
KR 2881	8-8-16	250	$1\frac{1}{2}$ x $3\frac{1}{2}$	2.85	1.71
KR 2811	8-16-16	250	$1\frac{1}{2}$ x $3\frac{1}{2}$	3.15	1.89
KR 548A	4-8	450	$1\frac{1}{2}$ x 3	1.75	1.05
KR 588A	8-8	450	$1\frac{1}{2}$ x 3	1.95	1.17
KR 5816A	8-16	450	$1\frac{1}{2}$ x $4\frac{1}{2}$	2.30	1.38
KR 5888A	8-8-8	450	$1\frac{1}{2}$ x $4\frac{1}{2}$	2.80	1.68



DRY ELECTROLYTIC CAPACITORS

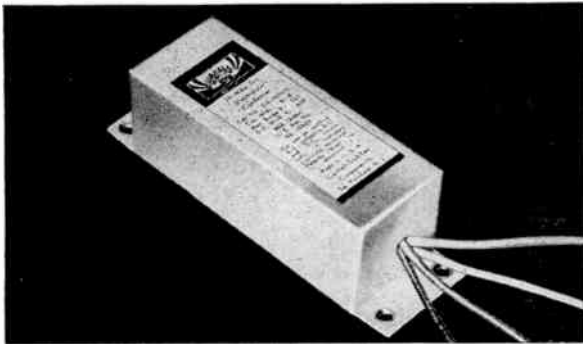

TYPE EH CARDBOARD BOX UNITS

Type EH capacitors are standbys for "heavy-duty" units in filter circuits of console model receivers or equipment where larger size units can be used. They have mounting flanges (which may be easily cut off if necessary). Dual units are available in separate section construction, having four color-coded wire leads; also in common negative three lug-terminal assembly, with two positive and one negative terminals. Triple section units have four leads, three of which are positive and the fourth, common negative. No deviation is made from this practice because most circuit combinations can be successfully met by the use of one or more of capacitors listed. (L denotes wire leads; SL separate leads.) Color code of leads with polarity, capacity and voltage rating of each section is clearly stamped on all units.

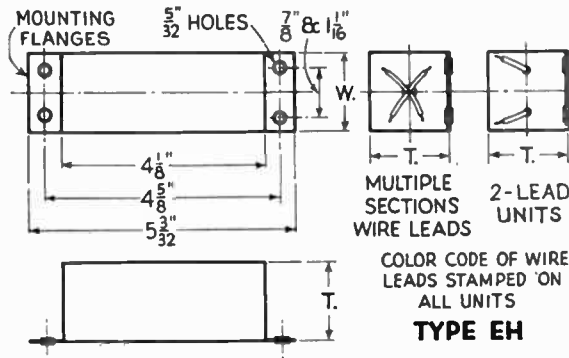

Cat. No.	Cap. Mfd.	Size—Inches L. W. T.	List Price	Net Price
450 V. D.C.				
EH 9400	4	4 1/8 x 1 3/8 x 3/8	\$0.90	\$0.54
EH 9400L	4	4 1/8 x 1 3/8 x 3/8	.90	.54
EH 9800	8	4 1/8 x 1 3/8 x 1	1.15	.69
EH 9800L	8	4 1/8 x 1 3/8 x 1	1.15	.69
EH 9160	16	4 1/8 x 1 3/8 x 1 3/16	1.75	1.05
EH 9404	4-4	4 1/8 x 1 3/8 x 1 3/16	1.45	.87
EH 9404SL	4-4	4 1/8 x 1 3/8 x 1 3/16	1.45	.87
EH 9408	4-8	4 1/8 x 1 3/8 x 1 3/16	1.62	.97
EH 9408SL	4-8	4 1/8 x 1 3/8 x 1 3/16	1.62	.97
EH 9808	8-8	4 1/8 x 1 3/8 x 1 3/16	1.80	1.08
EH 9808SL	8-8	4 1/8 x 1 3/8 x 1 3/16	1.80	1.08
EH 9444L	4-4-4	4 1/8 x 1 3/8 x 1 3/16	2.20	1.32
EH 9888L	8-8-8	4 1/8 x 2 x 2	2.65	1.59

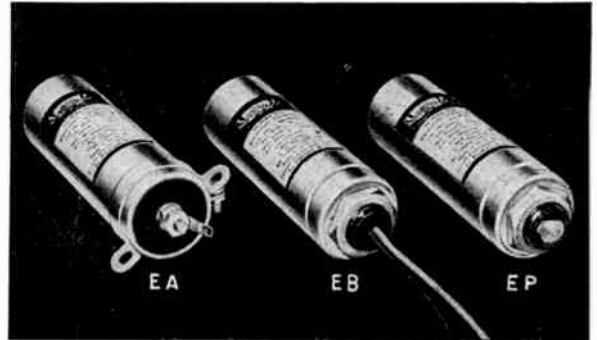

TYPES EA, EB & EP ALUMINUM CAN UNITS

These Types, EA, EB and EP, are the most popular of the larger round can electrolytic capacitors. Type EB has insulated, color-coded wire leads; in single section units, red lead is positive, black negative. In dual units, this combination holds for the one section, while a blue lead and its complementary yellow lead makes up the other section. In the EP and EA units, the central insulated terminal is the positive, while the metal container is the negative. In multiple section units, EP and EA, positive terminals are insulated and the container is common negative, most generally grounded to the chassis. EB and EP have lock washers and hexagon nuts, EA a mounting ring, (see page 9). Color code of leads with polarity, capacity and voltage rating of each section is clearly stamped on all units.

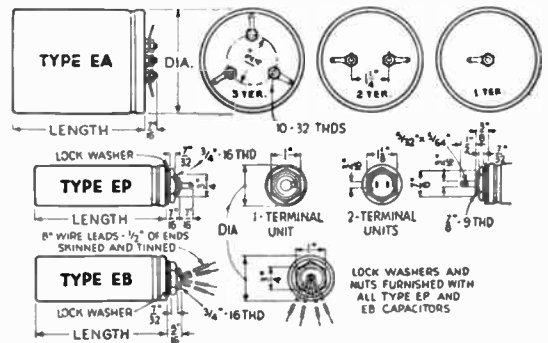

Cat. No.	Cap. Mfd.	Size—Inches Diam. x Length	List Price	Net Price
450 V. D.C.				
EB 9040	4	1 1/8 x 2 1/8	\$1.05	\$0.63
EB 9080	8	1 1/8 x 4 1/8	1.30	.78
EB 9100	10	1 1/8 x 4 1/8	1.50	.90
EB 9120	12	1 1/8 x 4 1/8	1.70	1.02
EB 9160	16	1 1/8 x 4 1/8	1.90	1.14
EB 9180	18	1 1/8 x 4 1/8	2.00	1.20
EB 4400	4-4	1 1/8 x 4 1/8	1.60	.96
EB 4800	4-8	1 1/8 x 4 1/8	1.75	1.05
EB 8800	8-8	1 1/8 x 4 1/8	1.95	1.17
500 V. D.C.				
EB 11080	8	1 1/8 x 4 1/8	2.05	1.23
450 V. D.C.				
EP 9080	8	1 1/8 x 4 1/8	1.30	.78
EP 9081	8	1 x 4 1/8	1.30	.78
EP 9250	25	1 1/8 x 4 1/8	2.40	1.44
EP 9808	8-8	1 1/8 x 4 1/8	1.95	1.17
450 V. D.C.				
EA 9080	8	1 1/8 x 4 1/8	1.30	.78
EA 5150	5-15	2 1/8 x 4 1/8	2.80	1.68
EA 8800*	8-8	2 1/8 x 4 1/8	2.25	1.35
EA 8801	8-8	2 1/8 x 4 1/8	2.25	1.35
EA 8160	8-16	2 1/8 x 4 1/8	2.80	1.68
EA 8880	8-8-8	3 x 4 1/8	3.25	1.95
EA 9918	9-9-18	3 x 4 1/8	4.50	2.70
EA 9911	9-9-18-18	3 1/2 x 4 1/8	6.30	3.78

* EA 8800 is a Dual, Separate-Section 4-Terminal Unit.



DRY ELECTROLYTIC CAPACITORS

Cardboard Tube Units

Cat. No.	Cap. Mfd.	D.C. W. Volts	Size—Inches Dia. x Length	List Price	Net Price
UM 101	8-16	250	1 1/4 x 3 1/4	\$2.80	\$1.68
UM 105	12-20-10-10	150-150-25-25	1 x 3	2.30	1.38
UM 112	8-8-8, 5-5	200, 25	1 x 3 1/4	3.00	1.80
UM 118	16-12	200	1 x 3 1/4	1.90	1.14
UM 121	8-30	300-30	1 1/4 x 4 1/4	1.65	.99
UM 126	65	30	1 x 2 1/2	1.35	.81
UM 139	8-16, 5-5	200, 50	1 1/4 x 2 1/2	2.60	1.56
UM 141	16-2-2, 25	450, 25	1 1/4 x 4 1/4	3.15	1.89
UM 150	6-4-16	350-350-25	1 x 3 1/4	1.95	1.17
UM 151	6-6	250	1 1/4 x 3 1/4	1.40	.84
UM 152	8-12	400	1 1/4 x 4	2.10	1.26
UM 155	8-8-20	350-350-25	1 1/4 x 2 1/2	2.25	1.35
UM 158	8-16-10-10	450-450-25-25	1 1/4 x 4	3.50	2.10
UM 159	12-8-8-10	450-450-350-25	1 1/4 x 5	3.10	1.86

Cardboard Box Units

Cat. No.	Cap. Mfd.	D.C. W. Volts	Size—Inches L. x W. x D.	List Price	Net Price
UM 100	8-16	200	1/2 x 1 1/2 x 2 1/2	\$2.60	\$1.56
UM 104	4-4-4	150	1/2 x 1 1/2 x 2 1/2	1.65	.99
UM 106	8-8-8-8	250	1 1/4 x 1 1/2 x 3	3.15	1.89
UM 107	5-25-10	150	1 1/4 x 1 1/2 x 2 1/2	2.35	1.41
UM 108	8-8	250-300	1 1/4 x 1 1/2 x 2 1/2	1.60	.96
UM 113	8-8-8, 5-5	200, 25	1 1/4 x 1 1/2 x 3	3.00	1.80
UM 115	8-8-8-8	450	1 1/4 x 1 1/2 x 3	3.55	2.13
UM 116	20-20	150	1 1/4 x 1 1/2 x 2 1/2	2.00	1.20
UM 117	5-8-16	150	1 x 1 1/2 x 2 1/2	2.20	1.32
UM 119	8-12	300	1 1/4 x 1 1/2 x 2 1/2	1.90	1.14
UM 122	3-5-6	300-300-12	1 1/4 x 1 1/2 x 2	1.80	1.08
UM 124	6-6	350	1 1/4 x 1 1/2 x 2 1/2	1.65	.99
UM 125	6-4-6	300-300-12	1 1/4 x 1 1/2 x 2 1/2	1.90	1.14
UM 128	8-8-25	400-400-25	1 1/4 x 1 1/2 x 2 1/2	2.30	1.38
UM 129	8-8-25	350-300-25	2 x 2 x 2 1/2	2.25	1.35
UM 131	16-30-16	200	1 1/4 x 1 1/2 x 4	3.25	1.98
UM 132	8, 8-8, 12-12	450, 250, 25	1 1/4 x 1 1/2 x 2 1/2	3.50	2.10
UM 136	5-20-10, 5	150, 25	1 1/4 x 1 1/2 x 2 1/2	2.70	1.62
UM 137	5-5	35	1/2 x 1 1/2 x 1 1/2	.90	.54
UM 138	30-10	150	1 1/4 x 1 1/2 x 3	1.90	1.14
UM 140	8-8, 12	350-25	1 1/4 x 1 1/2 x 2 1/2	2.10	1.26
UM 142	4-4-10-4	300-300-150-25	1 1/4 x 1 1/2 x 3 1/2	2.50	1.50
UM 143	8-8, 5-5	450, 50	1 1/4 x 1 1/2 x 4 1/2	2.65	1.59
UM 144	8-4-4-12	450-350-150-25	1 1/4 x 1 1/2 x 3 1/2	2.50	1.50
UM 145	4-4	450-150	1 x 1 1/2 x 3 1/2	1.30	.78
UM 147	6-4-10	350-300-25	1 1/4 x 1 1/2 x 4 1/2	2.00	1.20
UM 148	16-8-10	150-150-25	1 1/4 x 1 1/2 x 4	2.10	1.26
UM 149	4-12-16	150	1 1/4 x 1 1/2 x 2 1/2	2.25	1.35

All Type UM capacitors are clearly stamped with capacity and voltages of sections, including color coding of leads in order to preclude against error in wiring.

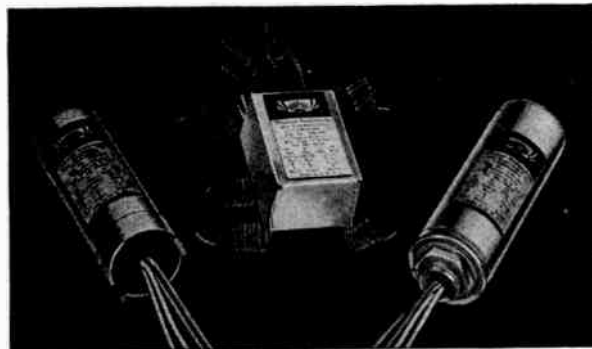

TYPE UM UNIVERSAL REPLACEMENTS

C-D universal replacement capacitors Type UM cover a wide variety of requirements where units of special capacity and voltage combinations are needed. They are furnished in standard cylindrical aluminum cans, cardboard tube and box-type casings as noted in the listing below.

Cylindrical Aluminum Can Units

Cat. No.	Cap. Mfd.	D.C. W. Volts	Size—Inches Dia. x Length	List Price	Net Price
UM 102	8-16	250	1 1/4 x 3 1/4	\$2.90	\$1.74
UM 111	3-2-1-1	450	1 1/4 x 2 1/2	2.55	1.53
UM 120	6-4-6	300-300-25	1 1/4 x 2 1/2	2.05	1.23
UM 123	8-8	350	1 1/4 x 3	1.90	1.14
UM 127	8-8-25	400-400-25	1 1/4 x 2 1/2	2.55	1.53
UM 130	8-8, 16-16	350, 100	1 1/4 x 4	3.50	2.10
UM 133	8-8-8	450-450-350	1 1/4 x 2 1/2	2.70	1.62
UM 134	8-8-8	450-450-350	1 1/4 x 4	2.70	1.62
UM 135	16-16-10	150-150-25	1 1/4 x 2 1/2	2.35	1.41
UM 146	8-8-10	300-300-25	1 1/4 x 2 1/2	2.25	1.35
UM 153	12	150	1 x 2 1/2	1.15	.69
UM 154	12-4	150	1 x 2 1/2	1.35	.81
UM 156	8-8	450	1 1/4 x 3 1/4	1.95	1.17
UM 157	8-8	450	1 1/4 x 3 1/4	1.95	1.17
UM 160	8-8	450	1 1/4 x 2 1/2	1.95	1.17
UM 161	10	450	1 1/4 x 2 1/2	1.90	.90
UM 162	12	450	1 1/4 x 3	1.70	1.02
UM 163	8-8	450	1 1/4 x 3 1/4	1.95	1.17

CAPACITOR MOUNTING HARDWARE

Additional hardware for mounting all types of electrolytic capacitors as well as tubular paper units is available as shown in the accompanying diagrams and listed below.

Part No.	Description	List Price	Net Price
14582	Mounting Ring for 1" dia. Cans		
12125	Mounting Ring for 1 1/4" dia. Cans	\$0.08	\$0.05
15591	Mounting Ring for 1 1/2" dia. Cans	.08	.05
16693	Mounting Ring for 1 3/4" dia. Cans	.12	.07
14464	Mounting Ring for 2" dia. Cans	.14	.09
13590	Mounting Ring for 2 1/4" dia. Cans	.18	.11
13591	Mounting Ring for 2 3/4" dia. Cans	.18	.11
15266	Mounting Ring for 3 1/4" dia. Cans	.18	.11
17842	Mounting Ring for 1" dia. Cans	.08	.05
19213	Mounting Ring for 1 1/4" dia. Cans	.08	.05
18573	Mounting Ring for 1 1/2" dia. Cans	.08	.05
17843	Mounting Ring for 1 3/4" dia. Cans	.08	.05
18444	Mounting Ring for 1 1/2" dia. Cans	.12	.07
21368-1	Mounting Clip for 1 1/4" dia. Cans	.12	.07
21368-2	Mounting Clip for 1" dia. Cans	.12	.07
21368-3	Mounting Clip for 1 1/2" dia. Cans	.12	.07
17920	"C" Clamp for 3/4"-3/8" Cans or Tubulars	.12	.07
17921	"C" Clamp for 1/2"-1" Cans or Tubulars	.12	.07
17922	"C" Clamp for 1 1/4"-1 1/2" Cans or Tubulars	.12	.07
17923	"C" Clamp for 1 3/4"-1 1/2" Cans or Tubulars	.12	.07
16279 to 16287	Tubular Straps for Mounting All Types of Tubular Units	.06	.04

MOUNTING RINGS

MADE OF 03% CADMIUM PLATED STEEL

FOR CAN SIZES 1" TO 1 1/2" DIA

PART No.	A	B	C
17842	1 1/4"	1 1/2"	1 1/2"
19213	1 1/4"	1 1/2"	1 1/2"
18573	1 1/2"	1 1/2"	1 1/2"
17843	1 1/2"	1 1/2"	1 1/2"
17844	1 1/2"	1 1/2"	1 1/2"

*INSIDE DIAMETER (CAN DIAMETER SIZE)

MOUNTING RINGS

FOR CAN SIZES - 1" TO 3 1/2" DIAMETER

MADE OF 1/2% CADMIUM PLATED STEEL

PART No.	A	B	C	FOR CAN SIZE"
14582	1 1/4"	1 1/2"	1 1/2"	1"
12125	1 1/4"	1 1/2"	1 1/2"	1 1/4"
15591	1 1/2"	1 1/2"	1 1/2"	1 1/2"
16693	1 3/4"	1 1/2"	1 1/2"	1 3/4"
14464	2"	1 1/2"	1 1/2"	2"
13590	2 1/4"	1 1/2"	1 1/2"	2 1/4"
13591	2 3/4"	1 1/2"	1 1/2"	2 3/4"
15266	3 1/4"	1 1/2"	1 1/2"	3 1/4"

MOUNTING CLIPS

EMBOSSMENT 1/8" DEEP

MADE OF CADMIUM PLATED STEEL

PART No.	A	B	C	D	FOR CAN SIZE"
21368-1	1 1/4"	1 1/2"	1 1/2"	1 1/2"	1 1/4"
21368-2	1 1/4"	1 1/2"	1 1/2"	1 1/2"	1 1/4"
21368-3	1 1/2"	1 1/2"	1 1/2"	1 1/2"	1 1/2"

TUBULAR STRAPS

MADE OF 020% TINNED STEEL

PART No.	I, D	PART No.	I, D
16279	3/8"	30240	3/8"
16280	1/2"	16280	1/2"
17203	3/8"	21187	3/8"
16289	3/8"	21068-1	3/8"
16285	3/8"	19033-1	3/8"
17517	3/8"	17673-1	3/8"
16287	3/8"	17605	3/8"

"C" CLAMPS

MADE OF CADMIUM PLATED STEEL

PART No.	A	FOR TUBULAR SIZE	B
17920	3/4"	3/8"	1/2"
17921	1"	1"	1"
17922	1 1/4"	1 1/4"	1 1/4"
17923	1 3/4"	1 3/4"	1 3/4"



WET ELECTROLYTIC CAPACITORS



TYPES EX AND EY WET ELECTROLYTICS

NOTICE: Due to the material requirements of our National Defense program we are unable to supply wet electrolytic capacitors until further notice. However, we have made available three universal dry type electrolytic units suitable for replacement purposes as follows:

Cat. No.	Replacement for	Size—Ins. Dia. x Length	List Price	Net Price
KR 10	4 to 12 mfd. use	1 3/8 x 3 1/2	\$1.15	\$0.69
KR 20	16 to 20 mfd. use	1 3/8 x 4	1.65	.99
KR 40	24 to 40 mfd. use	1 3/8 x 4	2.00	1.20

For 1" diameter wet electrolytics we recommend Type KR capacitors as listed on a preceding page.

When ordering, please specify above dry type electrolytics desired according to the above catalog numbers.

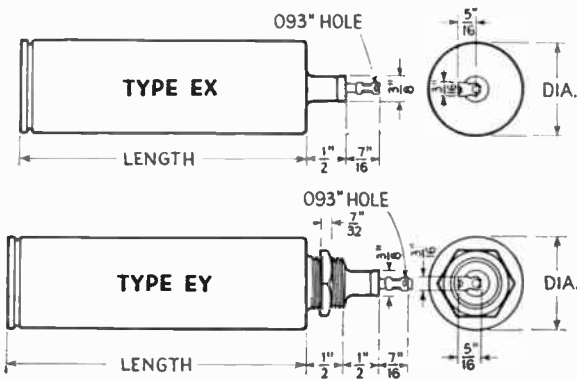

Cat. No.	Cap. Mfd.	Size—Inches Dia. x Length	List Price	Net Price
500 Volts D. C. Working—600 Peak Volts				
EY 11040	4	1 3/8 x 4 1/2	\$1.60	\$0.96
EY 11080	8	1 3/8 x 4 1/2	1.80	1.08
EY 11081	8	1 3/8 x 4 1/2	1.80	1.08
EY 11100	10	1 3/8 x 4 1/2	1.95	1.17
EY 11600	16	1 3/8 x 4 1/2	2.40	1.44

Cat. No.	Cap. Mfd.	Size—Inches Dia. x Length	List Price	Net Price
450 Volts D.C. Working—500 Peak Volts				
EY 9040	4	1 3/8 x 4 1/2	\$1.00	\$0.60
EY 9043	4	1 x 3 3/8	1.00	.60
EY 9080	8	1 3/8 x 4 1/2	1.15	.69
EY 9081	8	1 3/8 x 4 1/2	1.15	.69
EY 9082	8	1 x 4 1/2	1.15	.69
EY 9083	8	1 x 3 3/8	1.15	.69
EY 9084	8	1 3/8 x 3 3/8	1.15	.69
EY 9100	10	1 3/8 x 4 1/2	1.30	.78
EY 9104	10	1 3/8 x 3 3/8	1.30	.78
EY 9120	12	1 3/8 x 4 1/2	1.40	.84
EY 9124	12	1 3/8 x 3 3/8	1.40	.84
EY 9160	16	1 3/8 x 4 1/2	1.65	.99
EY 9162	16	1 x 4 1/2	1.65	.99
EY 9164	16	1 3/8 x 3 3/8	1.65	.99
EY 9180	18	1 3/8 x 4 1/2	1.80	1.08
EY 9184	18	1 3/8 x 3 3/8	1.80	1.08
EY 9200	20	1 3/8 x 4 1/2	1.80	1.08
EY 9201	20	1 3/8 x 4 1/2	1.80	1.08
EY 9240	24	1 3/8 x 4 1/2	2.00	1.20
EY 9250	25	1 3/8 x 4 1/2	2.00	1.20
EY 9301	30	1 3/8 x 4 1/2	2.05	1.23
EY 9350	35	1 3/8 x 4 1/2	2.10	1.26
EY 9400	40	1 3/8 x 4 1/2	2.30	1.38

Cat. No.	Cap. Mfd.	Size—Inches Dia. x Length	List Price	Net Price
300 Volts D.C. Working—350 Peak Volts				
EY 7082	8	1 x 4 1/2	\$1.10	\$0.66
EY 7180	18	1 3/8 x 4 1/2	1.50	.90
EY 7240	24	1 3/8 x 4 1/2	1.80	1.08
EY 7301	30	1 3/8 x 4 1/2	1.95	1.17
EY 7350	35	1 3/8 x 4 1/2	2.10	1.26

Cat. No.	Cap. Mfd.	Size—Inches Dia. x Length	List Price	Net Price
250 Volts D.C. Working—300 Peak Volts				
EY 6080	8	1 x 3 3/8	\$1.05	\$0.63
EY 6160	16	1 x 3 3/8	1.30	.78
EY 6243	24	1 x 3 3/8	1.40	.84

Cat. No.	Cap. Mfd.	Size—Inches Dia. x Length	List Price	Net Price
150 Volts D.C. Working—200 Peak Volts				
EY 5202	20	1 x 4 1/2	\$1.30	\$0.78
EY 5400	40	1 3/8 x 4 1/2	1.50	.90
EY 5402	40	1 x 4 1/2	1.50	.90

Cat. No.	Cap. Mfd.	Size—Inches Dia. x Length	List Price	Net Price
500 Volts D.C. Working—600 Peak Volts				
EX 11080	8	1 3/8 x 4 1/2	\$1.80	\$1.08

Cat. No.	Cap. Mfd.	Size—Inches Dia. x Length	List Price	Net Price
450 Volts D.C. Working—500 Peak Volts				
EX 9080	8	1 3/8 x 4 1/2	\$1.15	\$0.69

REGULATING TYPE WETS				
250 W. V.—300 Reg. Volts				
Cat. No.	Cap. Mfd.	Size—Inches Dia. x Length	List Price	Net Price
EY 6180R	18	1 3/8 x 3	\$1.40	\$0.84
EY 6401R	40	1 3/8 x 4 1/2	1.65	.99

300 W. V.—350 Reg. Volts				
Cat. No.	Cap. Mfd.	Size—Inches Dia. x Length	List Price	Net Price
EY 7180R	18	1 3/8 x 3 3/8	\$1.50	\$0.90
EY 7301R	30	1 3/8 x 4 1/2	1.95	1.17

"ELECTROLYTIC CAPACITORS"

By PAUL McK. DEELEY

Chief Engineer of the Electrolytic Division

CORNELL-DUBILIER ELECTRIC CORPORATION

Here in one masterly volume, "Electrolytic Capacitors," you will find a wealth of the most practical information ever published on the subject of electrolytic capacitors.

Never before has the technician been offered a manual so complete and so comprehensive at this price—\$1.00 net, formerly \$3.00. "Electrolytic Capacitors" should be in every radio man's professional library and technical file.

This instructive book supplies the reader with specific information concerning the many factors involved in the theory, design and construction of electrolytics. It is profusely illustrated and describes all applications of electrolytic capacitors. 300 pages, size 5 1/2" x 7 7/8", cloth bound hard cover. Every page is a gold mine of facts and data.

This 300-page book is yours postpaid—for only **\$1.00 net**

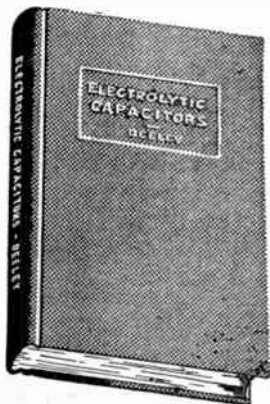



TUBULAR PAPER CAPACITORS

C-D Type DT, "Dwarf Tiger" paper tubulars are non-inductively wound, specially sealed and impregnated. They are small, have a high safety factor, are uniform in electrical properties and have well-soldered rigidly anchored wire leads. A specially-treated cardboard tube keeps out moisture. High melting point wax ends add strength and give extra protection to the unit.

C-D Type MD "Blue Tiger" tubular paper capacitors are designed to meet the more rigid requirements of improved modern radio receivers. They provide greater permanency of electrical characteristics such as higher resistivity, lower power-factor and more stable capacity over a long period of time. They are non-inductively wound, specially sealed with a wax outer coating, impregnated with Dykanol "D", and are provided with bare, tinned wire leads.

FEATURES OF TYPES DT & MD

1. **Type DT-Halowax Impregnated** Reduced physical size.
2. **Type MD-Dykanol "D" Impregnated** Improved power-factor; higher and more stable insulation resistance; more constant capacity characteristics; longer life under most severe conditions of humidity and temperature.
3. **Hi-Purity Aluminum Foil**-Lower R.F. resistance, light weight.
4. **Hi-Purity Multi-Laminated Tissue**-Higher working voltage.
5. **Vacuum Dried and Impregnated**-Lower losses, longer life.
6. **Oil-Cooled**-Higher voltage breakdown.
7. **Rigidly Tested**-Uniform product.
8. **Self-Supporting Leads**-No contact resistance; added strength.
9. **Wax Impregnated Tube** Protected against moisture.
10. **Small Size, Non-Inductive**-"Short-path" R.F. bypass.
11. **Special Wax-Potted Ends**-Better humidity and temperature seal.
12. **Conservative D.C. Rating** Triple-tested for dependable service.

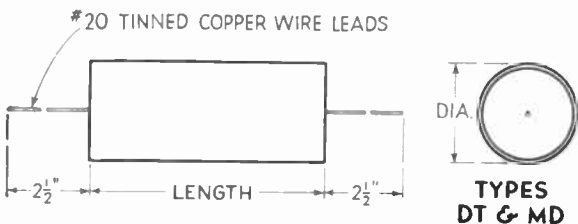

TYPE DT—Wax Impregnated Units

Cat. No.	Cap. Mfd.	Size—Inches Dia. x Length	List Price	Net Price
400 V. D.C.				
DT 4S1	.01	1 1/2 x 1 1/4	\$0.20	\$0.12
DT 4S15	.015	1 1/2 x 1 1/4	.20	.12
DT 4S2	.02	1 1/2 x 1 1/4	.20	.12
DT 4S25	.025	1 1/2 x 1 1/4	.20	.12
DT 4S3	.03	1 1/2 x 1 1/4	.20	.12
DT 4S4	.04	1 1/2 x 1 1/4	.20	.12
DT 4S5	.05	1 1/2 x 1 1/4	.20	.12
DT 4S6	.06	1 1/2 x 1 1/4	.25	.15
DT 4P1	.1	1 1/2 x 1 1/4	.25	.15
DT 4P2	.2	1 1/2 x 2	.30	.18
DT 4P25	.25	1 1/2 x 2	.30	.18
DT 4P5	.5	1 1/2 x 2 1/4	.45	.27
DT 4W1	1.	1 x 2 3/8	.60	.36
600 V. D.C.				
DT 6T1	.0001	1 1/2 x 1 1/4	.20	.12
DT 6T25	.00025	1 1/2 x 1 1/4	.20	.12
DT 6T5	.0005	1 1/2 x 1 1/4	.20	.12
DT 6D1	.001	1 1/2 x 1 1/4	.20	.12
DT 6D2	.002	1 1/2 x 1 1/4	.20	.12
DT 6D3	.003	1 1/2 x 1 1/4	.20	.12
DT 6D4	.004	1 1/2 x 1 1/4	.20	.12
DT 6D5	.005	1 1/2 x 1 1/4	.20	.12
DT 6D6	.006	1 1/2 x 1 1/4	.20	.12
DT 6S1	.01	1 1/2 x 1 1/4	.20	.12
DT 6S15	.015	1 1/2 x 1 1/4	.20	.12
DT 6S2	.02	1 1/2 x 1 1/4	.20	.12
DT 6S25	.025	1 1/2 x 1 1/4	.25	.15
DT 6S3	.03	1 1/2 x 1 1/4	.25	.15
DT 6S4	.04	1 1/2 x 1 1/4	.25	.15
DT 6S5	.05	1 1/2 x 1 1/4	.25	.15
DT 6S6	.06	1 1/2 x 1 1/4	.30	.18
DT 6P1	.1	1 1/2 x 1 1/4	.30	.18
DT 6P2	.2	1 1/2 x 2	.45	.27
DP 6P25	.25	1 1/2 x 2	.45	.27
DT 6P3	.3	1 x 2 1/4	.55	.33
DT 6P5	.5	1 x 2 3/8	.60	.36

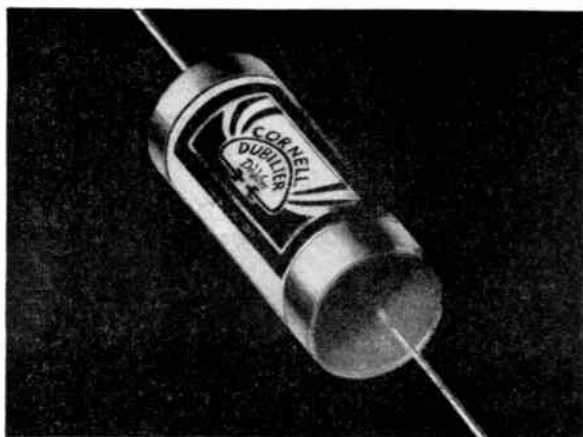

TYPE DT & MD PAPER TUBULARS

TYPE MD—Dykanol Impregnated Units

Cat. No.	Cap. Mfd.	Size—Inches Dia. x Length	List Price	Net Price
800 V. D.C.				
MD 8T1	.0001	3/8 x 1 1/8	\$0.25	\$0.15
MD 8T25	.00025	3/8 x 1 1/8	.25	.15
MD 8T5	.0005	3/8 x 1 1/8	.25	.15
MD 8D1	.001	3/8 x 1 1/4	.25	.15
MD 8D2	.002	3/8 x 1 1/4	.25	.15
MD 8D25	.0025	3/8 x 1 1/4	.25	.15
MD 8D3	.003	3/8 x 1 1/4	.25	.15
MD 8D4	.004	3/8 x 1 1/4	.25	.15
MD 8D5	.005	3/8 x 1 1/4	.25	.15
MD 8D6	.006	15/32 x 1 1/4	.25	.15
MD 8D7	.007	15/32 x 1 1/4	.25	.15
MD 8D8	.008	15/32 x 1 1/4	.25	.15
MD 8S1	.01	15/32 x 1 1/2	.25	.15
MD 8S15	.015	15/32 x 1 1/2	.25	.15
MD 8S2	.02	1 1/8 x 1 1/2	.25	.15
MD 8S25	.025	1 1/8 x 1 1/2	.25	.15
MD 8S3	.03	5/8 x 1 1/2	.30	.18
MD 8S4	.04	5/8 x 1 1/2	.30	.18
MD 8S5	.05	5/8 x 2	.30	.18
MD 8S6	.06	21/32 x 2	.30	.18
MD 8S8	.08	15/16 x 2	.40	.24
MD 8P1	.1	15/16 x 2	.40	.24
MD 8P15	.15	15/16 x 2 1/2	.45	.27
1200 V. D.C.				
MD 12D1	.001	3/8 x 1 1/4	.30	.18
MD 12D2	.002	3/8 x 1 1/4	.30	.18
MD 12D3	.003	15/32 x 1 1/4	.30	.18
MD 12D4	.004	15/32 x 1 1/4	.30	.18
MD 12D5	.005	15/32 x 1 1/4	.30	.18
MD 12D6	.006	15/32 x 1 1/2	.30	.18
MD 12D7	.007	15/32 x 1 1/2	.30	.18
MD 12D8	.008	15/32 x 1 1/2	.30	.18
MD 12S1	.01	1/2 x 1 1/2	.30	.18
MD 12S15	.015	1/2 x 1 1/2	.30	.18
MD 12S2	.02	1/2 x 1 1/2	.30	.18
MD 12S3	.03	11/16 x 2	.40	.24
MD 12S4	.04	11/16 x 2	.40	.24
MD 12S5	.05	25/32 x 2	.45	.27
MD 12S6	.06	7/8 x 2	.50	.30
MD 12S8	.08	7/8 x 2 3/8	.55	.33
MD 12P1	.1	15/16 x 2 3/8	.60	.36
1600 V. D.C.				
MD 16D1	.001	3/8 x 1 1/4	.45	.27
MD 16D2	.002	3/8 x 1 1/4	.45	.27
MD 16D25	.0025	15/32 x 1 1/4	.45	.27
MD 16D3	.003	15/32 x 1 1/2	.45	.27
MD 16D4	.004	1/2 x 1 1/2	.45	.27
MD 16D5	.005	1/2 x 1 1/2	.45	.27
MD 16D6	.006	9/16 x 1 1/2	.45	.27
MD 16D7	.007	5/8 x 1 1/2	.45	.27
MD 16D8	.008	5/8 x 1 1/2	.45	.27
MD 16S1	.01	9/16 x 2	.45	.27
MD 16S15	.015	9/16 x 2	.45	.27
MD 16S2	.02	11/16 x 2	.45	.27
MD 16S25	.025	3/4 x 2	.45	.27
MD 16S3	.03	25/32 x 2	.45	.27
MD 16S4	.04	15/16 x 2	.50	.30
MD 16S5	.05	1 x 2	.55	.33



METAL SHELL CASED PAPER CAPACITORS

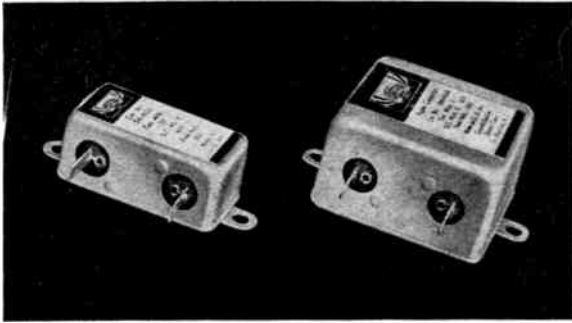

TYPES DA, DB, DC & DD WAX FILLED UNITS

C-D Metal Shell Type DA to DD capacitors are non-inductively wound, well protected against climatic conditions and available in a large variety of ratings for radio frequency bypass, audio frequency coupling and bypass functions. Lug terminals are amply insulated. Integral with casing, the mounting feet allow ease of assembly.

In the single and dual section capacitor units, the terminals are insulated from the container. The duals have three terminals, the common lug being on the left. In the triple and quadruple section capacitors, the common terminal connection is grounded to the metal case.

All units are wound with the highest grade pure aluminum foil and multi-laminated Kraft tissue, thoroughly dried under vacuum pressure, impregnated in the finest grade wax compound, oil-cooled, and potted in a special wax compound. Conservative D. C. ratings of these capacitors by triple testing assures dependable service in operation.

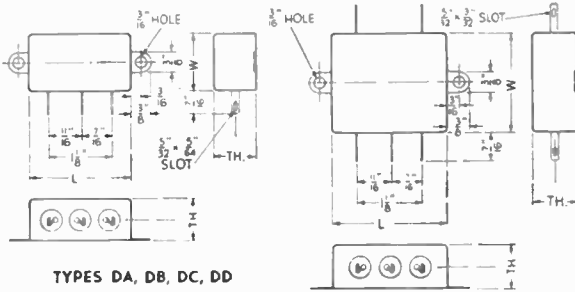

TYPES DA, DB, DC, DD

Cat. Co.	Capacity Mfd.	Size—Inches Lth. x Wid. x Thick.	List Price	Net Price
400 D.C.V. Work.				
DA 4011	.1	1 13/16 x 1 x 3/4	\$0.80	\$0.48
DA 4025	.25	1 13/16 x 1 x 3/4	.90	.54
DA 4050	.5	1 13/16 x 1 x 7/8	1.15	.69
DA 4100	1	2 x 1 3/4 x 1 1/16	1.50	.90
DA 4200	2	2 x 2 x 1 1/8	1.90	1.14
DB 4010	.1-1	1 13/16 x 1 x 3/4	1.00	.60
DB 4025	.25-.25	2 x 1 1/4 x 3/4	1.20	.72
DB 4050	.5-.5	2 x 1 3/4 x 1	1.50	.90
DC 4010	.1-.1-1	1 13/16 x 1 x 3/4	1.30	.78
DD 4010	.1-.1-1-1	2 x 1 3/4 x 1 1/16	1.70	1.02
600 D.C.V. Work.				
DA 6011	.1	1 13/16 x 1 x 3/4	.90	.54
DA 6025	.25	1 13/16 x 1 1/4 x 3/4	1.10	.66
DA 6050	.5	2 x 1 3/4 x 1 1/16	1.45	.87
DA 6100	1	2 x 2 x 1 1/8	1.80	1.08

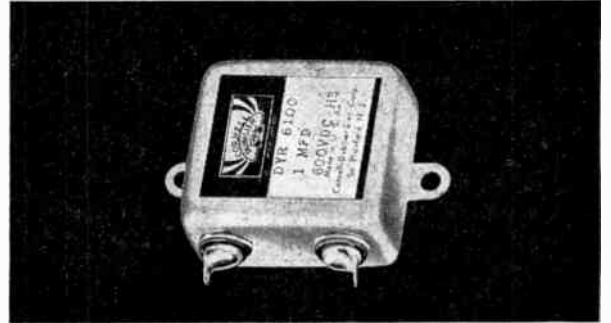

TYPE DYR DYKANOL FILLED UNITS

Type DYR Dykanol Bypass Capacitors are non-inductively wound and fill the need for dependable capacitors of fractional capacities that will operate efficiently in R.F. and A.F. bypass, audio frequency coupling and A.C. circuits under all humidity conditions and at temperatures up to approximately 80° C. (180° F.). They are built to stand an immersion test in hot water and have been specially designed to fill the severe requirements of aircraft, submarine, marine and tropical applications for maximum capacity and voltage in minimum space, where quality and reliability are of paramount importance. They are impregnated and filled with Dykanol "A" and sealed in non-corrosive cases with leakproof riveted terminals.

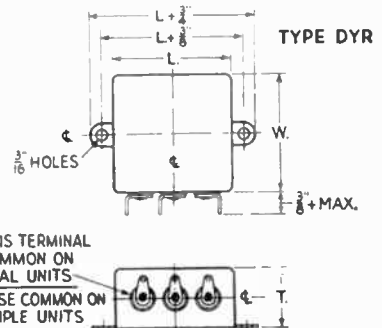

Cat. No.	Capacity Mfd.	Size—Inches Lth. x Wid. x Thick.	List Price	Net Price
600 V.D.C. Work.				
DYR 6005	.05	1 13/16 x 1 x 3/4	\$2.05	\$1.23
DYR 6010	.1	1 13/16 x 1 x 3/4	2.10	1.26
DYR 6025	.25	1 13/16 x 1 x 3/4	2.20	1.32
DYR 6050	.5	1 13/16 x 1 x 7/8	2.35	1.41
DYR 6100	1	2 x 1 3/4 x 1 1/16	2.70	1.62
DYR 6200	2	2 x 2 x 1 1/8	3.60	2.16
DYR 60055	.05-.05	1 13/16 x 1 x 3/4	2.60	1.56
DYR 6011	.1-1	1 13/16 x 1 x 3/4	2.65	1.59
DYR 6022	.25-.25	1 13/16 x 1 1/4 x 3/4	2.70	1.62
DYR 6055	.5-.5	2 x 1 3/4 x 7/8	3.10	1.86
DYR 6110	1-1	2 x 2 x 1 1/8	3.80	2.28
DYR 6111	1-1-1	1 13/16 x 1 x 3/4	3.00	1.80
DYR 6222	.25-.25-.25	2 x 1 3/4 x 1 1/16	3.40	2.04
DYR 6555	.5-.5-.5	2 x 2 x 1 1/8	4.10	2.46
1000 V.D.C. Work.				
DYR 10005	.05	1 13/16 x 1 x 3/4	2.10	1.26
DYR 10010	.1	1 13/16 x 1 x 3/4	2.25	1.35
DYR 10025	.25	1 13/16 x 1 x 3/4	2.30	1.38
DYR 10050	.5	2 x 1 3/4 x 1 1/16	2.50	1.50
DYR 10100	1	2 x 2 x 1 1/8	3.30	1.98
DYR 100055	.05-.05	1 13/16 x 1 x 3/4	2.60	1.56
DYR 10011	.1-1	1 13/16 x 1 x 3/4	2.80	1.68
DYR 10022	.25-.25	2 x 1 3/4 x 1 1/16	3.00	1.80
DYR 10055	.5-.5	2 x 2 x 1 1/8	3.90	2.34
DYR 10111	1-1-1	1 13/16 x 1 1/4 x 3/4	3.30	1.98
DYR 10222	.25-.25-25	2 x 2 x 1 1/8	4.20	2.52



REPLACEMENT PAPER CAPACITORS



EXACT DUPLICATES FOR STANDARD SETS

Manufacturer and Part No.	C-D Cat. No.	Total Capacities	List Price	Net Price
ATWATER-KENT				
37-9497	AK 201	3 x .25	\$2.05	\$1.23
37-9575	AK 202	.25	.85	.51
COLONIAL				
1728SA	CN 400	3 x .1-.25	1.50	.90
1748SA	CN 401	.1-.25	1.10	.66
CROSLY				
W4919	C 57	.5	.90	.54
GREBE				
SK-4	SG 217	2 x .1	1.00	.60
MAJESTIC				
7BP6	MC 101	10	5.40	3.24
7P6	MC 102	9	5.40	3.24
8P6	MC 103	9	10.80	6.48
9P6	MC 104	7	5.40	3.24
SPARTAN				
A5032 1334	SW 311	1	1.10	.66
A5933 1335	SW 312	.25	.90	.54
A5031	SW 320	.5	.95	.57

UNCASED PAPER CAPACITORS



Type RM uncased capacitors are made available to repair paper dielectric filter blocks which were used in the early models of A.C. operated radio sets. Also useful in the elimination of electrical interference caused by pushbuttons, bells, buzzers, and similar applications in radio, electronic and electrical devices.

Special capacitor units can be made up and potted into suitable containers by servicemen to fulfill many requirements.

Cat. No.	Cap. Mfd.	Size Inches Lth. x Wid. x Thick.	List Price	Net Price
RM 4050	.5	400 V. D.C.		
RM 4100	1	2 x 1 3/4 x 3/4	\$0.60	\$0.36
RM 4200	2	2 x 1 3/4 x 1 1/8	.90	.54
RM 4400	4	2 x 1 7/8 x 1 1/8	1.40	.84
		3 3/4 x 1 7/8 x 1 1/8	2.40	1.44
		600 V. D.C.		
RM 6010	.1	2 x 1 x 3/16	.50	.30
RM 6025	.25	2 x 1 x 3/16	.60	.36
RM 6050	.5	2 x 1 3/8 x 3/4	.75	.45
RM 6100	1	2 x 1 7/8 x 3/4	1.10	.66
RM 6200	2	3 3/8 x 1 3/8 x 3/4	1.65	.99
RM 6400	4	4 1/8 x 1 3/8 x 3/4	3.25	1.95
		1000 V. D.C.		
RM 10100	1	4 1/4 x 1 3/8 x 3/4	1.80	1.08
RM 10200	2	4 1/4 x 1 3/8 x 1 3/4	3.00	1.80

TYPES PE-CH, PE-A AND PE-B PAPER UNITS

Paper Replacement Capacitors that simulate electrolytics in appearance; these types fulfill a real service need. Their actual capacity is from 1/3 to 1/2 of the usual value employed when using electrolytics. They afford a high voltage breakdown which an electrolytic does not offer. There is no polarity to observe when using these capacitors. In Types PE-B and PE-CH, the dual section units have separate leads, a set of two leads of one color identify the terminals for each capacity. In Type PE-A triple section units, the common terminal stud is insulated, with provision made to ground same by means of a small wire lead soldered to the grounding lug on the metal container.

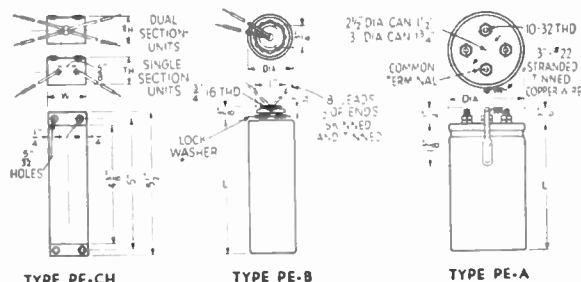

Cat. No.	"Replacement" for Electrolytic Cap. Mid.	Actual Capacity	Size - Inches Length x Width x Thickness	List Price	Net Price
----------	--	-----------------	--	------------	-----------

TYPE PE-CH, 1000 V. D.C. Test, 600 V. D.C. Peak, 450 V. D.C. Working

PE-CH 4004	8	2	4 3/4 x 1 3/4 x 1 1/16	\$1.10	\$0.66
PE-CH 4008	8	3 1/2	4 3/4 x 1 3/4 x 1 1/16	1.40	.84
PE-CH 4808	8-8	2 3/4 x 2 1/2	4 3/4 x 1 3/4 x 1 1/2	2.30	1.38

TYPE PE-CH, 1200 V. D.C. Test, 800 V. D.C. Peak, 600 V. D.C. Working

PE-CH 6004	4	2	4 3/4 x 1 3/4 x 1 1/16	\$1.45	\$0.87
PE-CH 6008	8	3	4 3/4 x 1 3/4 x 1 1/4	1.95	1.17
PE-CH 6808	8-8	2 3/4 x 2 3/4	4 3/4 x 2 x 1 1/2	3.20	1.92

TYPE PE-B, 1200 V. D.C. Test, 800 V. D.C. Peak, 600 V. D.C. Working

PE-B 6004	4	1 3/4	4 3/4 x 1 3/4	\$1.65	\$0.99
PE-B 6008	8	2 3/4	4 3/4 x 1 3/4	2.10	1.26
PE-B 6808	8-8	1 3/4 x 1 3/4	4 3/4 x 1 1/2	3.40	2.04

TYPE PE-A, 1000 V. D.C. Test, 800 V. D.C. Peak, 600 V. D.C. Working

PE-A 6444	4-4-4	1 1/2 x 1 1/2 x 1 1/2	4 3/4 x 2 1/2	\$4.20	\$2.52
PE-A 6888	8-8-8	2 3/4 x 2 3/4 x 2 3/4	4 3/4 x 3	5.90	3.54
PE-A 6918	9-9-18	3-3-6	4 3/4 x 3	7.80	4.68



AUTO RADIO CAPACITORS

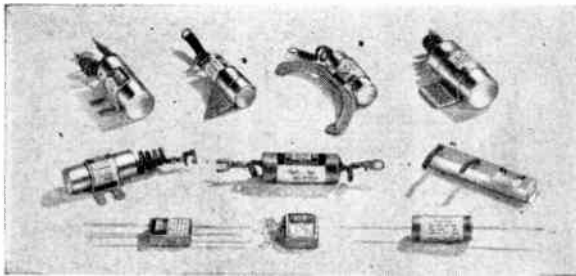

Top Row—TYPES IC-2P55, FC-2PV, FC-2P5A & ICH-2W1A.
Center Row—TYPES IC-2P5C, HC-870E & VL-S1
Lower Row—TYPES VC 1160, VUL S2 & DT16D5.

The mechanical design of C-D Auto Radio Capacitors insures against damage by the high temperatures and excessive vibration existing under the hood of an auto. Special units such as these are designed for certain particular installations. Thus, for instance, Ford generator capacitor, FC-2P5V, has a special mounting bracket while others are also provided with special mountings and terminals. Vibrator capacitors are oil-treated to withstand high peak and surge voltages.

Cat. No.	Cap. Mfd.	Size—Inches Lth. x Wth. x Thick.	List Price	Net Price
----------	-----------	-------------------------------------	------------	-----------

GENERATOR UNITS

ICS 2SSA	.05	1.16 x 1.14	\$0.60	\$0.36
IC 2P5C	.5	1.78 x 1.14	.60	.36
FC 2P5A	.5	1.78 x 1.14	.60	.36
FC 2P5V	.5	1.78 x 1.14	.60	.36
IC 2P55	.5	1.78 x 2	.90	.54
ICH 2W1A	1.0	1 x 2.16	.85	.51
ICV 2P25A	.25	1.16 x 1.14	.60	.36
ICV 2P5A	.5	1.16 x 1.14	.60	.36
ICV 2W1A	1.0	1 x 2.16	.85	.51

AMMETER UNIT

HC 870E	.5	3/4 x 2	\$0.55	\$0.33
---------	----	---------	--------	--------

VIBRATOR BUFFER UNITS

Cat. No.	Cap. Mfd.	Size—Inches Lth. x Wth. x Thick.	List Price	Net Price
Metal "postage stamp" capacitors, oil filled, 2000 V. Peak				
VUL D7	.007	7/8 x 1 1/16 x 5/16	\$0.55	\$0.33
VUL D8	.008	7/8 x 1 1/16 x 5/16	.55	.33
VUL S1	.01	7/8 x 1 1/16 x 5/16	.55	.33
VUL S2	.02	7/8 x 1 1/16 x 5/16	.55	.33
VU S3*	.03	7/8 x 1 1/16 x 5/16	.55	.33

* This unit has one insulated lead.

Oil-impregnated and processed paper tubular capacitors 2000 V. Peak				
DT 16T5	.0005	3/8 x 1 1/8	\$0.45	\$0.27
DT 16T8	.0008	3/8 x 1 1/8	.45	.27
DT 16D1	.001	3/8 x 1 1/8	.45	.27
DT 16D2	.002	3/8 x 1 1/8	.45	.27
DT 16D25	.0025	3/8 x 1 1/8	.45	.27
DT 16D3	.003	3/8 x 1 1/8	.45	.27
DT 16D4	.004	3/8 x 1 1/8	.45	.27
DT 16D5	.005	3/8 x 1 1/8	.45	.27
DT 16D6	.006	3/8 x 1 1/8	.45	.27
DT 16D7	.007	3/8 x 1 1/8	.45	.27
DT 16D8	.008	3/8 x 1 1/8	.45	.27
DT 16D75	.0075	3/8 x 1 5/8	.45	.27
DT 16S1	.01	3/8 x 2	.45	.27
DT 16S2	.02	3/8 x 2	.45	.27
DT 16S3	.03	3/8 x 2	.45	.27
DT 16S4	.04	3/8 x 2	.50	.30
DT 16S5	.05	1 x 2	.55	.33

Metal shell units for old style vibrator "B" supplies

VL S1	.01—1500V.	3 3/16 x 1 5/16 x 3/8	\$0.75	\$0.45
VL P5	.5—200V.	3 3/16 x 1 5/16 x 3/8	.80	.48

Special dual .0008 rectangular unit with four leads

VC 1160	2x.0008	1 1/16 x 3/4 x 3/8	\$0.60	\$0.36
---------	---------	--------------------	--------	--------

Vibrator Buffer (oval shaped) capacitor provided with flexible braid leads. 120 V.D.C. Working.

HC 1306	.5	2 x 3/4 x 3/16	\$0.55	\$0.33
---------	----	----------------	--------	--------

Metal cased oil-impregnated and processed tubular paper capacitors with cardboard insulating sleeve and mounting strap. 2000 V.D.C. Peak.

TVC 16D5-6	.005	5/8 x 1 5/8	\$0.55	\$0.33
TVC 16D7-6	.007	5/8 x 1 5/8	.60	.36
TVC 16S1-6	.01	5/8 x 1 5/8	.70	.42
TVC 16S2-6	.02	5/8 x 1 5/8	.75	.45

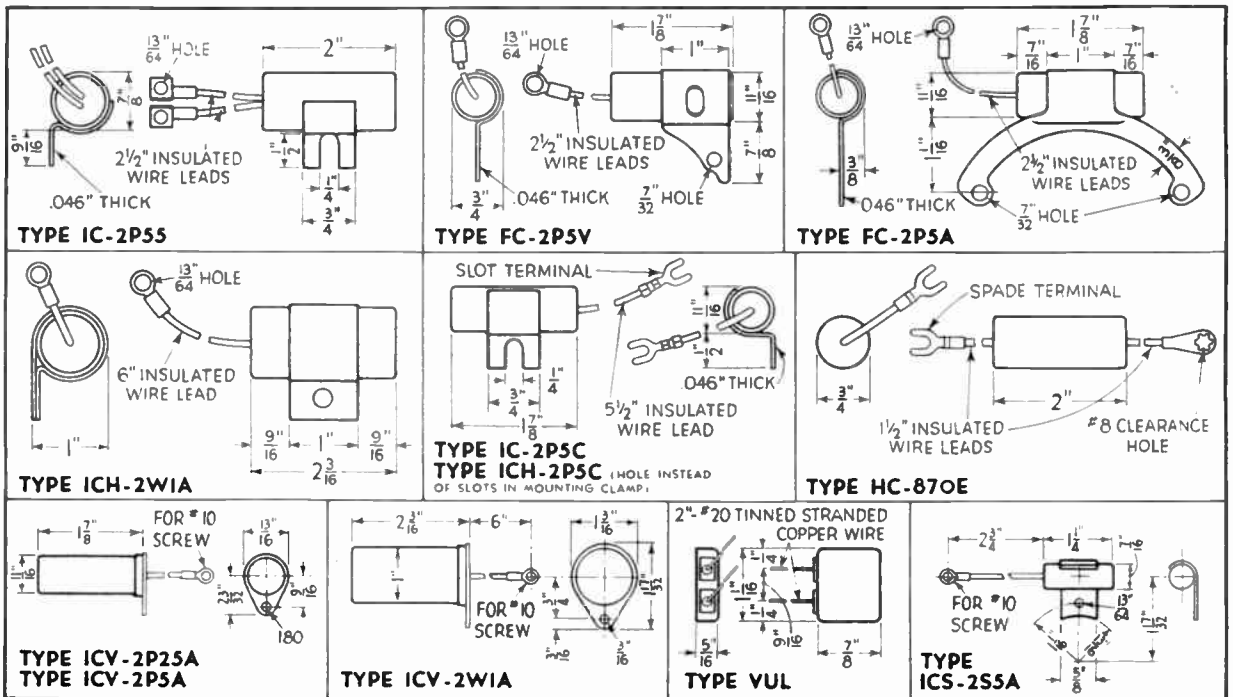



DYKANOL TRANSMITTING CAPACITORS

Cat. No.	Cap Mfd.	Dimensions—Inches						List Price	Net Price
		A	B	C	D	E	F		
600 V.D.C. Working									
TJU 6005	.5	2 1/4	1 13/16	1 1/4	7/8	1 13/16	2 1/4	\$3.30	\$1.98
TJU 6010	1	2 1/4	1 13/16	1 1/4	7/8	1 13/16	2 1/4	4.20	2.52
TJU 6020	2	2 1/4	1 13/16	1 1/4	7/8	1 13/16	2 1/4	5.10	3.06
TJU 6030	3	3 1/4	1 13/16	1 1/4	7/8	1 13/16	2 1/4	6.00	3.60
TJU 6040	4	3 3/8	2 1/2	1 1/4	7/8	1 13/16	3	6.60	3.96
TJU 6050	5	4 3/4	1 13/16	1 1/4	7/8	1 13/16	2 1/4	7.50	4.50
TJU 6060	6	4 3/4	2 1/2	1 1/4	7/8	1 13/16	3	8.10	4.86
TJU 6080	8	3 13/16	3 3/4	1 1/4	7/8	2	4 3/8	9.60	5.76
TJU 6100	10	4 3/8	3 3/4	1 1/4	7/8	2	4 3/8	10.80	6.48
1,000 V.D.C. Working									
TJU 10001	.1	2	1 13/16	1 1/4	7/8	1 13/16	2 1/4	3.00	1.80
TJU 100025	.25	2 1/4	1 13/16	1 1/4	7/8	1 13/16	2 1/4	3.30	1.98
TJU 10005	.5	2 1/4	1 13/16	1 1/4	7/8	1 13/16	2 1/4	3.60	2.16
TJU 10010	1	2 1/4	1 13/16	1 1/4	7/8	1 13/16	2 1/4	4.50	2.70
TJU 10020	2	4	1 13/16	1 1/4	7/8	1 13/16	2 1/4	6.00	3.60
TJU 10030	3	3 1/2	2 1/2	1 1/4	7/8	1 13/16	3	6.90	4.14
TJU 10040	4	4 3/4	2 1/2	1 1/4	7/8	1 13/16	3	7.50	4.50
TJU 10050	5	3 13/16	3 3/4	1 1/4	7/8	2	4 3/8	9.00	5.40
TJU 10060	6	4 3/4	3 3/4	1 1/4	7/8	2	4 3/8	10.00	6.00
TJU 10080	8	4 3/4	3 3/4	1 1/4	7/8	2	4 3/8	10.80	6.48
TJU 10100	10	4 3/4	3 3/4	1 1/4	7/8	2	4 3/8	12.00	7.20
TJU 10120	12*	3 13/16	3 3/4	2 1/2	1 1/4	2	4 3/8	13.00	7.80
TJU 10150	15	4 3/4	3 3/4	2 1/2	1 1/4	2	4 3/8	14.50	8.70
1,500 V.D.C. Working									
TJU 15005	.5	2 7/8	1 13/16	1 1/4	7/8	1 13/16	2 1/4	4.50	2.70
TJU 15010	1	4	1 13/16	1 1/4	7/8	1 13/16	2 1/4	5.40	3.24
TJU 15020	2	4 1/4	2 1/2	1 1/4	7/8	1 13/16	3	7.50	4.50
TJU 15030	3	4 3/4	2 1/2	1 1/4	7/8	1 13/16	3	9.00	5.40
TJU 15040	4	4 5/4	3 3/4	1 1/4	7/8	2	4 3/8	10.00	6.00
TJU 15050	5	4 3/4	3 3/4	1 1/4	7/8	2	4 3/8	10.80	6.48
TJU 15060	6	4 3/4	3 3/4	1 1/4	7/8	2	4 3/8	12.25	7.35
TJU 15080	8	4 3/4	3 3/4	1 1/4	7/8	2	4 3/8	15.00	9.00
TJ 15100	10*	4 3/4	3 3/4	3 1/4	1 1/4	2	4 3/8	18.00	10.80
TJ 15120	12*	4 3/4	3 3/4	3 1/4	1 1/4	2	4 3/8	19.50	11.70
TJ 15150	15*	4 3/4	3 3/4	4 1/4	1 1/4	2	4 3/8	21.50	12.90
2,000 V.D.C. Working									
TJU 20001	.1	2 1/4	1 13/16	1 1/4	7/8	1 13/16	2 1/4	4.80	2.88
TJU 200025	.25	2 1/4	1 13/16	1 1/4	7/8	1 13/16	2 1/4	5.10	3.06
TJU 20005	.5	2 7/8	1 13/16	1 1/4	7/8	1 13/16	2 1/4	5.40	3.24
TJU 20010	1	3 3/8	2 1/2	1 1/4	7/8	1 13/16	3	6.60	3.96
TJU 20020	2	4	3 3/4	1 1/4	7/8	1 13/16	3	7.80	4.68
TJU 20030	3	4 3/4	3 3/4	1 1/4	7/8	2	4 3/8	9.60	5.76
TJU 20040	4	4 3/16	3 3/4	2 1/4	1 1/4	2	4 3/8	10.80	6.48
TJU 20050	5	4 3/4	3 3/4	2 1/4	1 1/4	2	4 3/8	12.00	7.20
TJ 20060	6*	4 3/4	3 3/4	3 1/4	1 1/4	2	4 3/8	14.50	8.70
TJ 20080	8*	4 3/4	3 3/4	3 1/4	1 1/4	2	4 3/8	18.00	10.80
TJ 20100	10*	4 3/4	3 3/4	4 1/4	1 1/4	2	4 3/8	22.00	13.20
TJ 20120	12*	5 3/8	3 3/4	4 1/4	1 1/4	2	4 3/8	24.00	14.40
2,500 V.D.C. Working									
TJU 25005	.5	3 1/2	3 3/4	1 1/4	1 1/4	2	4 3/8	8.40	5.04
TJU 25010	1	3 1/2	3 3/4	1 1/4	1 1/4	2	4 3/8	9.60	5.76
TJU 25020	2	4 1/4	3 3/4	1 1/4	1 1/4	2	4 3/8	15.50	9.30
TJ 25040	4*	4	3 3/4	4 1/4	1 1/4	2	4 3/8	21.50	12.90
TJ 25100A	10*	6 3/8	3 3/4	4 1/4	1 1/4	2	4 3/8	54.00	32.40
3,000 V.D.C. Working									
TJU 30001	.1	2	2 1/2	1 1/4	1 1/4	1	1	10.00	6.00
TJU 30025	.25	2 1/2	2 1/2	1 1/4	1 1/4	1 1/2	3	10.80	6.48
TJU 30005	.5	3 7/8	2 1/2	1 1/4	1 1/4	1 1/2	3	12.00	7.20
TJU 30010	1	3 13/16	3 3/4	2 1/4	1 1/4	2	4 3/8	14.50	8.70
TJ 30020	2*	4 1/4	3 3/4	3 1/4	1 1/4	2	4 3/8	18.00	10.80
TJ 30040	4*	4 3/4	3 3/4	4 1/4	1 1/4	2	4 3/8	26.50	15.90
4,000 V.D.C. Working									
TJU 40001	.1	2 3/4	3 3/4	2 1/4	2	2	4 3/8	18.00	10.80
TJU 400025	.25	2 3/4	3 3/4	2 1/4	2	2	4 3/8	19.00	11.40
TJU 40005	.5	4	3 3/4	2 1/4	2	2	4 3/8	21.50	12.90
TJU 40010	1	5	3 3/4	2 1/4	2	2	4 3/8	26.50	15.90
TJ 40020	2*	5	3 3/4	4 1/4	2	2	4 3/8	33.50	20.10
TJ 40040A	4*	8	3 3/4	4 1/4	2	2	4 3/8	48.00	28.80
5,000 V.D.C. Working									
TJU 50005	.5	4 1/4	3 3/4	2 1/4	2	2	4 3/8	24.00	14.40
TJ 50010	1*	4 1/4	3 3/4	4 1/4	2	2	4 3/8	30.00	18.00
TJ 50020	2*	6	3 3/4	4 1/4	2	2	4 3/8	38.50	23.10
6,000 V.D.C. Working									
TJ 60010A	1*	8	3 3/4	4 1/4	2	2	4 3/8	60.00	36.00

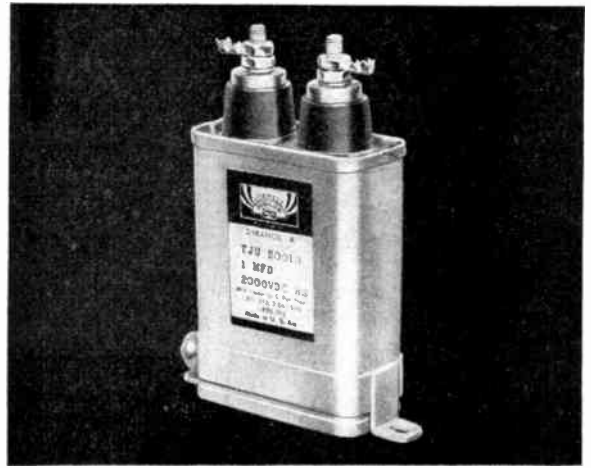

TYPE TJU DYKANOL CAPACITORS

C-D Dykanol Transmitting Capacitors Type TJU are without doubt the most dependable units offered to the radio trade—amateur, broadcast and commercial. Beautifully designed, compact, light-weight, safely-rated, furnished with universal mounting clamp, well-insulated terminals. These are the capacitors which practically every broadcast and government station in the world uses with such marked success. Standard equipment with tens of thousands of amateurs. Also employed in all types of television receivers and transmitters.

These units are thoroughly impregnated and filled with Dykanol "A" (chlorinated diphenyl), a non-inflammable, fire-proof non-oxidizable liquid compound which is unaffected by wide latitude of temperature changes or voltage stresses.

All units are conservatively rated and may be operated continuously at 10% above their rated voltage. Clamp-type mounting brackets as shown below, for mounting units in either upright or inverted position are furnished with all units.

(For higher voltage units 6000 to 25,000 V. D.C. see Cat. No. 160-T which is available to accredited engineering, educational, broadcasting and manufacturing organizations on request.)

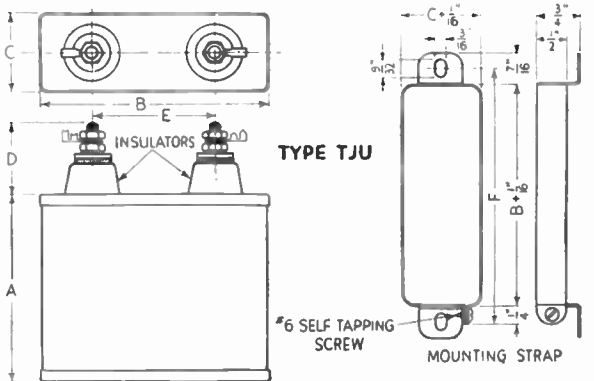

*Type TJU units are not furnished in these larger sizes. But type TJ units can be supplied with mounting feet soldered to bottom of can.



DYKANOL TRANSMITTING CAPACITORS

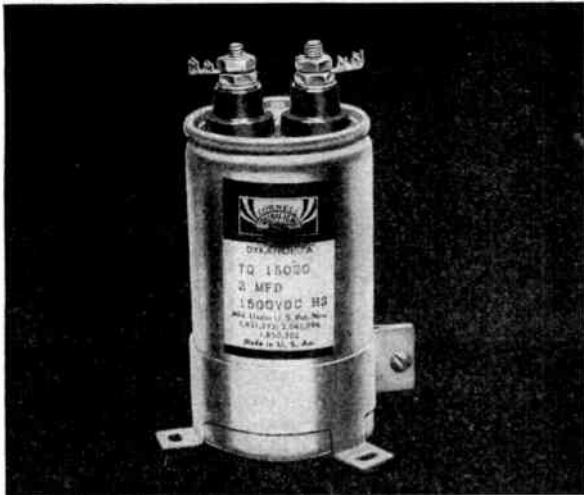

TYPE TQ DYKANOL CAPACITORS

Cornell-Dubilier, Type TQ Dykanol Capacitors, in cylindrical aluminum containers are provided with two insulated terminals and universal mounting rings for mounting the unit in any position with terminals either above or below a subpanel assembly. These units are designed primarily for filter circuits in amateur, low-power broadcast and commercial transmitters. They are also adapted for high-power, high-fidelity public address systems and portable power amplifiers.

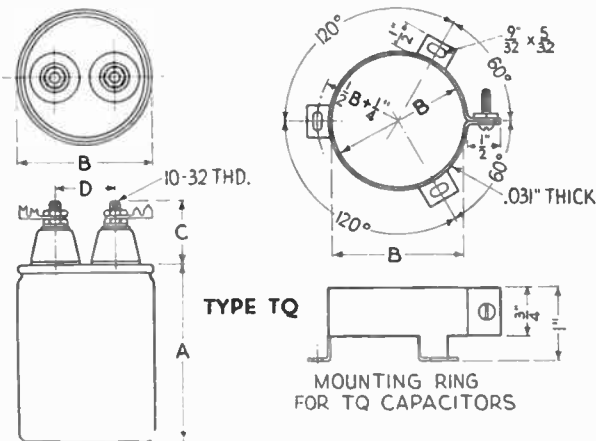

Cat. No.	Cap. Mfd.	Dimensions—Inches				List Price	Net Price
		A	B	C	D		
600 Volts D.C. Working							
TQ 6020	2	2 1/8	2	1	1 13/16	\$4.00	\$2.40
TQ 6040	4	2 3/8	2	1	1 13/16	5.40	3.24
1000 Volts D.C. Working							
TQ 10010	1	1 7/8	2	1	1 13/16	3.30	1.98
TQ 10020	2	2 1/2	2	1	1 13/16	4.50	2.70
TQ 10040	4	3 1/8	2	1	1 13/16	5.70	3.42
1500 Volts D.C. Working							
TQ 15010	1	2 3/8	2	1	1 13/16	4.20	2.52
TQ 15020	2	3 5/8	2	1	1 13/16	5.70	3.42
2000 Volts D.C. Working							
TQ 20010	1	3 1/8	2	1	1 13/16	5.40	3.24
TQ 20020	2	4 7/8	2	1	1 13/16	6.00	3.60
TQ 20040	4	4 3/8	3	1 1/4	1 13/16	8.40	5.04
3000 Volts D.C. Working							
TQ 30010	1	3 1/4	3	1 1/4	1 13/16	10.80	6.48
TQ 30020	2	5 1/4	3	1 1/4	1 13/16	13.00	7.80



TYPE TLA DYKANOL CAPACITORS

For compact high-voltage filter applications in high-fidelity P.A. amplifiers, power supplies for short-wave portable transmitters and transceivers, type TLA Dykanol filter units in cylindrical aluminum containers are ideal in every respect. One terminal is well insulated, the other being the metal can itself. They will withstand transient voltages as well as high-peak voltage surges, as they are designed to operate for continuous, full-load duty.

Insulating washers, as well as a large spade lug, are provided so that the metal container may be insulated from the chassis. They are thoroughly impregnated and filled with Dykanol as the Dykanol has a di-electric constant of 4.8, a power factor of .3%, and enables the fabrication of capacitors having a direct current resistance of 10,000 megohms per microfarad, of small size and high insulation resistance. An appreciably lower space factor accounts for the substantial reduction in physical size for a given capacity and voltage rating.

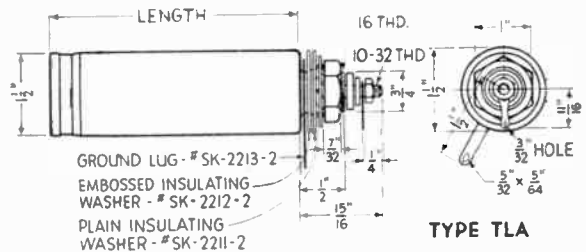

Cat. No.	Cap. Mfd.	D.C. W. Volts	Size—Inches Lth. x Diam.	List Price	Net Price
TLA 6020	2	600	2 7/8 x 1 1/2	\$3.30	\$1.98
TLA 6030	3	600	4 1/2 x 1 1/2	4.00	2.40
TLA 6040	4	600	4 3/8 x 1 1/2	4.50	2.70
TLA 10010	1	1000	2 7/8 x 1 1/2	3.00	1.80
TLA 10020	2	1000	4 1/2 x 1 1/2	4.00	2.40
TLA 15005	5	1500	2 7/8 x 1 1/2	3.60	2.16
TLA 15010	1	1500	4 1/2 x 1 1/2	4.00	2.40

HIGH SPEED PHOTO-FLASH DYKANOL CAPACITOR

Type KGT 6250-1 capacitor is rated for operation at 2000 volts D.C. and each unit offers a capacity value of 25 microfarads. Two or more units may be used to provide any desired multiple of this value in the construction of speed flash lamps for making stroboscopic pictures. Unit comes in sealed metal case, 6 3/8 x 4 3/16 x 3 3/4".

Type KGT 6250-1 25 Mfd. 660 V. A. C. - 2000 V. D. C. Peak

List Price \$32.40

Net Price \$19.45

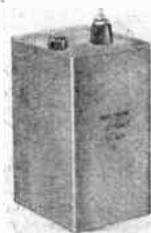

CORNELL DUBILIER



MICA TRANSMITTING CAPACITORS

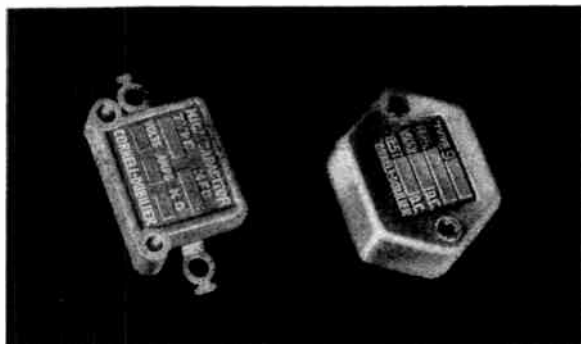

TYPES 4 & 9 MICA CAPACITORS

C-D Mica Capacitors Types 4 and 9 are designed to meet the requirements of power amplifiers and low-power transmitters. They are principally employed for grid and plate blocking purposes and for r. f. by-pass functions. These popular units are available in a wide range of capacities and three standard voltage ratings.

TYPE 4

Cat. No.	Cap. Mfd.	List Price	Net Price
1000 V. D. C. Test— 600 V. D. C. Working			
4-14050	.00005	\$0.60	\$0.36
4-13010	.0001	.60	.36
4-13020	.0002	.60	.36
4-13025	.00025	.60	.36
4-13030	.0003	.60	.36
4-13040	.0004	.60	.36
4-13050	.0005	.60	.36
4-12010	.001	.65	.39
4-12015	.0015	.65	.39
4-12020	.002	.70	.42
4-12025	.0025	.80	.48
4-12030	.003	.85	.51
4-12040	.004	.85	.51
4-12050	.005	.85	.51
4-12060	.006	1.05	.63
4-12070	.007	1.15	.69
4-12080	.008	1.20	.72
4-11010	.01	1.40	.84
4-11015	.015	1.65	.99
4-11020	.02	1.90	1.14
4-11025	.025	2.30	1.38
4-11030	.03	2.55	1.28

TYPE 9

Cat. No.	Cap. Mfd.	List Price	Net Price
1000 V. D. C. Test— 600 V. D. C. Working			
9-14050	.00005	\$0.75	\$0.45
9-13010	.0001	.75	.45
9-13025	.00025	.75	.45
9-13050	.0005	.75	.45
9-12010	.001	.75	.45
9-12020	.002	.80	.48
9-12025	.0025	.90	.54
9-12030	.003	1.05	.63
9-12040	.004	1.05	.63
9-12050	.005	1.05	.63
9-12060	.006	1.20	.72
9-12080	.008	1.45	.87
9-11010	.01	1.70	1.02
9-11015	.015	1.95	1.17
9-11020	.02	2.25	1.35
9-11025	.025	2.80	1.68
9-11030	.03	3.00	1.80
9-11040	.04	3.90	2.34
9-11050	.05	4.65	2.79
9-11060	.06	5.40	3.24
2500 V. D. C. Test— 1200 V. D. C. Working			
9-24050	.00005	\$0.85	\$0.51
9-23010	.0001	.85	.51
9-23025	.00025	.85	.51
9-23050	.0005	.85	.51
9-22010	.001	1.10	.66
9-22020	.002	1.65	.99
9-22025	.0025	1.75	1.05
9-22030	.003	1.90	1.14
9-22040	.004	1.90	1.14
9-22050	.005	2.10	1.26
9-22060	.006	2.10	1.26
9-22080	.008	2.70	1.62
9-21010	.01	3.40	2.04
9-21015	.015	4.05	2.43
9-21020	.02	4.75	2.85
9-21025	.025	5.30	3.18
9-21030	.03	5.55	3.33

Cat. No.	Cap. Mfd.	List Price	Net Price
2500 V. D. C. Test— 1200 V. D. C. Working			
4-24050	.00005	\$0.85	\$0.51
4-23010	.0001	.85	.51
4-23020	.0002	.85	.51
4-23025	.00025	.85	.51
4-23030	.0003	.85	.51
4-23050	.0005	.85	.51
4-22010	.001	1.10	.66
4-22015	.0015	1.40	.84
4-22020	.002	1.65	.99
4-22025	.0025	1.75	1.05
4-22030	.003	1.90	1.14
4-22040	.004	1.90	1.14
4-22050	.005	2.10	1.26
4-22060	.006	2.10	1.26
4-22080	.008	2.70	1.62
4-21010	.01	3.40	2.04

Cat. No.	Cap. Mfd.	List Price	Net Price
5000 V. D. C. Test— 2500 V. D. C. Working			
9-54050	.00005	\$1.10	\$0.66
9-53010	.0001	1.10	.66
9-53025	.00025	1.30	.78
9-53050	.0005	1.50	.90
9-52010	.001	1.80	1.08
9-52020	.002	2.70	1.62
9-52025	.0025	3.00	1.80
9-52030	.003	3.30	1.98
9-52040	.004	3.80	2.28
9-52050	.005	4.10	2.46
9-52060	.006	4.20	2.52
9-52080	.008	4.60	2.76
9-51010	.01	4.95	2.97
9-51015	.015	5.40	3.24

Cat. No.	Cap. Mfd.	List Price	Net Price
5000 V. D. C. Test— 2500 V. D. C. Working			
4-54050	.00005	\$1.10	\$0.66
4-53010	.0001	1.10	.66
4-53020	.0002	1.30	.78
4-53025	.00025	1.30	.78
4-53030	.0003	1.35	.78
4-53050	.0005	1.55	.93
4-52010	.001	1.80	1.08
4-52015	.0015	2.35	1.41
4-52020	.002	2.70	1.62
4-52025	.0025	3.00	1.80
4-52030	.003	3.30	1.98
4-52040	.004	3.80	2.28
4-52050	.005	4.10	2.46

Standard tolerance $\pm 10\%$. Also available in closer capacity tolerances at slightly higher prices, and low-loss bakelite. . . For low-loss bakelite add 25c to list price.



TYPE 86 MICA CAPACITORS

C-D new and improved Type 86 Mica Capacitors in dehydrated porcelain cases have been designed for amateur radio communication, 'fone, CW and ICW, for plate blocking, grid, buffer, tank, and antenna coupling purposes.

By selecting a special high grade ruby mica, Type 86 capacitors have very low radio frequency resistance and power factor, but extremely high direct current resistance.

While entirely satisfactory for intermittent duty in amateur transmitters, these units are not recommended for use in broadcast station equipment, aircraft transmitters or commercial applications where more rigid tolerances* and other heavier current carrying characteristics are essential.

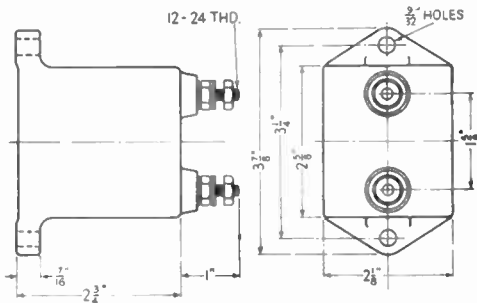

Cat. No.	Cap. Mfd.	Max. D.C. Volt.	Maximum Current in Amps.					List Price	Net Price
			30 10M	15000 20M	7500 40M	3750 80M	1875 160M		
45A 86	.00005	12,500	3.5	3	2.5	1.5	1	\$6.60	\$3.96
31A 86	.0001	12,500	5	5	4	3	2	6.00	3.60
325A 86	.00025	12,500	5	7	8	6	4	6.60	3.96
35A 86	.0005	12,500	5	8	9	8	7	6.60	3.96
35C 86	.0005	7,000	5	7	8	6	4	5.40	3.24
21A 86	.001	12,500	5	9	10	11	12	6.60	3.96
21C 86	.001	7,000	5	8	9	10	8	6.00	3.60
21D 86	.001	3,500	5	8	9	8	5	5.40	3.24
215A 86	.0015	12,500	6	9	10	11	12	7.80	4.68
21A 86	.002	12,500	6	9	12	13	15	9.00	5.40
22C 86	.002	7,000	6	8	9	10	10	7.80	4.68
22D 86	.002	3,500	6	8	8	9	7	6.60	3.96
25B 86	.005	10,000	7	10	13	14	15	12.00	6.56
11C 86	.01	7,000	7	10	13	15	15	12.60	7.20
11D 86	.01	3,500	7	10	13	14	14	12.00	6.56
12D 86	.02	3,500	7	10	14	16	17	12.00	6.56
IE 86	.1	2,000	7	10	14	17	18	13.20	7.92

* Standard tolerance $\pm 20\%$. For closer tolerance units, see Types 6, 15L and 30B as listed in C-D Transmitter Capacitor Catalog No. 160-T.



MICA RECEIVING CAPACITORS

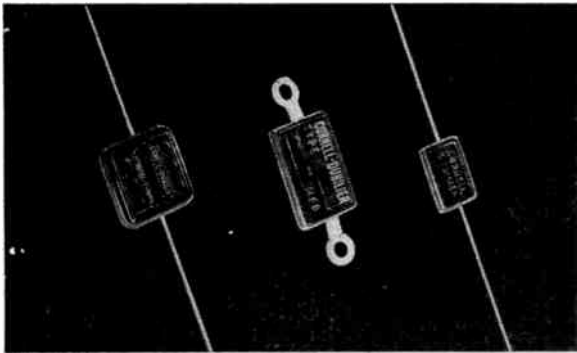

TYPES 1W, 3L & 5W MICA CAPACITORS

Moulded Bakelite Capacitors, Types 1W, 3L and 5W are suitable for numerous electronic uses and are specially adapted to serve many important functions in low-voltage radio circuits. All units are rated at 500 volts D.C. working and tested at 1000 volts D.C. except on capacities higher than .003 mfd. of Types 1W and 3L which are rated at 300 volts D.C. working—600 volts test. They are individually tested for accuracy of capacity and voltage breakdown and designed to give dependable service where small size units are required.

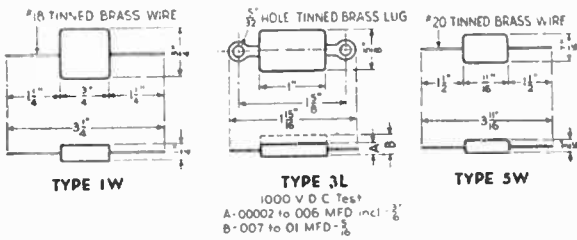

Cap. Mfd.	1000 V.D.C. Test—500 V.D.C. Work.			List Price	Net Price
	Type 1W Cat. No.	Type 3L Cat. No.	Type 5W Cat. No.		
.000005			5W 5V5	\$0.25	\$0.15
.00001			5W 5Q1	.25	.15
.00002			5W 5Q2	.25	.15
.000025			5W 5Q25	.25	.15
.00003			5W 5Q3	.25	.15
.00004			5W 5Q4	.20	.12
.00005			5W 5Q5	.20	.12
.00007			5W 5Q7	.20	.12
.0001		3L 5T1	5W 5T1	.20	.12
.00015		3L 5T15	5W 5T15	.20	.12
.0002		3L 5T2	5W 5T2	.20	.12
.00025		3L 5T25	5W 5T25	.25	.15
.0003		3L 5T3	5W 5T3	.25	.15
.0004		3L 5T4	5W 5T4	.25	.15
.0005		3L 5T5	5W 5T5	.25	.15
.0006	1W 5T6	3L 5T6		.25	.15
.0007	1W 5T7	3L 5T7		.25	.15
.0008	1W 5T8	3L 5T8		.25	.15
.0009	1W 5T9	3L 5T9		.25	.15
.001	1W 5D1	3L 5D1		.30	.18
.0015	1W 5D15	3L 5D15		.30	.18
.002	1W 5D2	3L 5D2		.40	.24
.0025	1W 5D25	3L 5D25		.45	.27
.003	1W 5D3	3L 5D3		.50	.30
600 V D.C. Test 300 V D.C. Working					
.004	1W 3D4	3L 3D4		.55	.33
.005	1W 3D5	3L 3D5		.60	.36
.006	1W 3D6	3L 3D6		.75	.45
.007	1W 3D7	3L 3D7		.80	.48
.008	1W 3D8	3L 3D8		.80	.48
.009	1W 3D9	3L 3D9		.85	.51
.01	1W 3S1	3L 3S1		.90	.54

Standard capacity tolerance is $\pm 20\%$. Also available in closer capacity tolerances and low-loss bakelite at slightly higher prices.

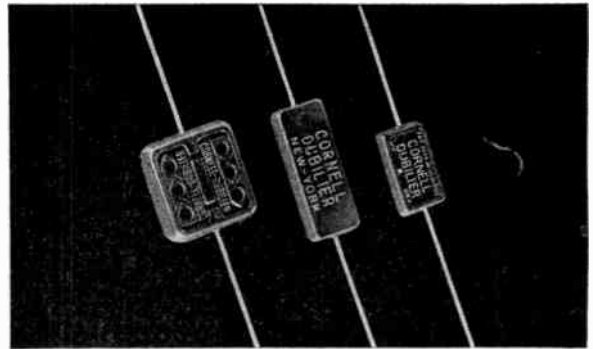

TYPES 1R, 2R & 5R MICA CAPACITORS

Types 1R, 2R and 5R "Silver-Mike" Silvered Mica Capacitors are designed for use in electronic circuits where frequency stability must be maintained. They are ideally suited for use in circuits where the LC product must be maintained constant, and particularly adapted for use in tuning IF transformers, push-button tuning circuits and other similar applications. Standard units are moulded in low-loss red bakelite and furnished with tinned brass wire leads.

All units are rated at 500 volts D.C. working and tested at 1000 volts D.C. except on capacities higher than .0025 mfd. of Type 1R which are rated at 300 volts D.C. working—600 volts test.

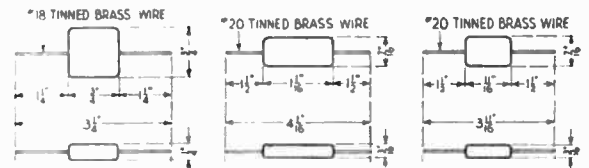

Cap. Mfd.	1000 V.D.C. Test—500 V.D.C. Work.			List Price	Net Price
	Type 1R Cat. No.	Type 2R Cat. No.	Type 5R Cat. No.		
.000001			5R 5V1*	\$0.60	\$0.36
.000005			5R 5V5*	.60	.36
.00001			5R 5Q1*	.50	.30
.00002			5R 5Q2*	.50	.30
.000025			5R 5Q25	.50	.30
.00003			5R 5Q3	.50	.30
.00004			5R 5Q4	.50	.30
.00005			5R 5Q5	.50	.30
.00007			5R 5Q7	.50	.30
.0001		2R 5T1	5R 5T1	.50	.30
.00015		2R 5T15	5R 5T15	.60	.36
.0002		2R 5T2	5R 5T2	.60	.36
.00025		2R 5T25	5R 5T25	.60	.36
.0003		2R 5T3	5R 5T3	.90	.54
.0004		2R 5T4	5R 5T4	.90	.54
.0005		2R 5T5	5R 5T5	.90	.54
.0007		2R 5T7		1.20	.72
.0008		2R 5T8		1.35	.81
.0009		2R 5T9		1.35	.81
.001	1R 5D1			1.50	.90
.0015	1R 5D15			1.80	1.08
.002	1R 5D2			1.80	1.08
.0025	1R 5D25			2.40	1.44
600V.D.C. Test 300VDCWkg					
.003	1R 3D3			2.70	1.62
.004	1R 3D4			2.85	1.71
.005	1R 3D5			3.00	1.80

Standard capacity tolerance is $\pm 5\%$; can also be furnished in $\pm 3\%$, $\pm 2\%$ or $\pm 1\%$ at slightly higher prices.
*Closest tolerance of these units ± 1 mmfd.



CAPACITOR TEST INSTRUMENTS



C-D CAPACITOR ANALYZER

The Model BF-50 Capacitor Analyzer quickly and accurately measures all important characteristics of all types of capacitors. It offers the most accurate and thorough capacitor test of any instrument of its type, and may be operated on any 110-volt, 50-60 cycle power line. The analyzer will determine the true condition of all paper, mica and electrolytic capacitors, including A.C. motor starting types. It is the only instrument of its type which provides a complete test for all capacitors, with amplifier for adequate sensitivity, easy reading linear scales, push-button switches for simplicity of adjustments, D.C. voltage supply and visual eye leakage indicator.

Features of C-D Analyzer

1. Measures Capacity—Accurately measures capacity of paper, mica, air, electrolytic and motor-starting capacitors from .00001 to 240. mfd.
2. Measures Power Factor—Measurements of power factor from zero to 50 percent on all types of electrolytic capacitors including motor-starting types.
3. Employs Wien Bridge—Assures permanent accuracy of capacity and power factor measurements. Readings not affected by line voltage variations.
4. Indicates Insulation Resistance—Insulation resistance measurements of paper and mica capacitors up to 1500 megohms. Also measures many types of insulation.
5. Indicates Leakage—Measurements of leakage of electrolytic capacitors by means of built-in direct current power supply.
6. Visual Eye Leakage Indicator—Provides simplified and reliable leakage tests on all types of capacitors. Enables measurements to be made rapidly.
7. Detects Defective Capacitors—Character measurements, such as leaky, shorted, open, high and low capacity, and high power factor on all capacitors.
8. High Sensitivity on All Measurements—Amplifier for capacity, power factor and leakage tests provides sharp and accurate readings. Amplifier built in Analyzer.
9. Balance Sensitivity Control—Provides sharp or broad balances for quick and accurate readings. All readings are made simply and directly.
10. Direct Reading Linear Scale Calibration—Provides simplified measurements. All scales on panel uniformly spaced, easy to read, thus avoiding possible errors in using multipliers or charts.
11. Push-Button Switching—For convenient and simplified adjustments, all tests and circuit changes are made by means of modern push-button switches.
12. Visual Eye Bridge Balance—Visual detector gives positive indication of bridge balance for convenient, simplified and accurate capacity and power factor measurements.
13. Six Color-Coded Scales—Accurately calibrated, six color-coded scales. Uniformly spaced over total spacing of sixty inches. Easy to read. No "blind" spots.
14. General Purpose Instrument—May be used to check continuity capacity between circuits, insulation of transformer windings and other types of coils, etc.
15. Self-Contained—Portable—An instrument complete in itself, requiring no external standard, headphones, meters or accessories. A portable unit, for 110 volt, 50-60 cycle operation, supplied in walnut cabinet, removable cover, with carrying handle. Size, 6 1/2 x 12 x 9 3/4 inches. Weight, 9 pounds.

MODEL BF-50 CAPACITOR ANALYZER

List Price, less tubes, \$49.80

Net Price.....

\$29-88

For Operation on 110 volts, 50-60 cycles.

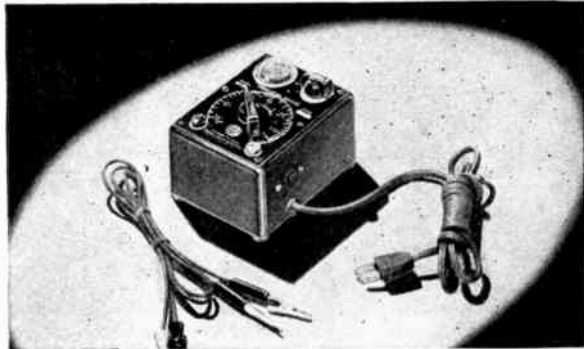

C-D CAPACITOR BRIDGE

The Model BN Midget Capacitor Bridge quickly and accurately measures all types of capacitors between limits of .00001 mfd. and 50. mfd.

Features of C-D Capacitor Bridge

1. Measures Capacity—Accurately measures capacity of paper, mica electrolytic and air capacitors between limits of .00001 mfd. to 50. mfd.
2. Indicates Power Factor—Power factor of electrolytic capacitor indicated by means of visual eye detector tube.
3. Detects Defective Capacitors—Detects many types of defective capacitors, open and short circuited, high and low capacity, and high power factor.
4. Checks Circuit Continuity—May be used on continuity meter. A handy instrument for checking circuits, coils, transformers and many other uses.
5. Employs Wien Bridge—Employs Wien Bridge circuit for all measurements. Accuracy independent of line voltage variations.
6. Visual Eye Bridge Balance—Dual type visual bridge balance for accurate measurements facilitates quick tests on service jobs.
7. Direct Reading Scale—Direct reading ranges with all scale markings directly in microfarads. Clear reading dial scale. All capacity calibrations marked on panel. No charts or multipliers required.
8. Self-Contained—The Capacitor Bridge is complete in itself and requires no headphones, standards, external meters or similar accessories.
9. Extremely Compact—The unusually small size of this bridge makes it particularly handy for portable use—3 1/4" x 5" x 3" weight 2 pounds.
10. Attractive—Supplied in attractive walnut Bakelite case complete with detachable test leads and useful instruction booklet.

MODEL BN CAPACITOR BRIDGE

List Price, less tubes, \$19.80

For operation on 110 volts, 60 cycles.

Net Price..... **\$11.88**

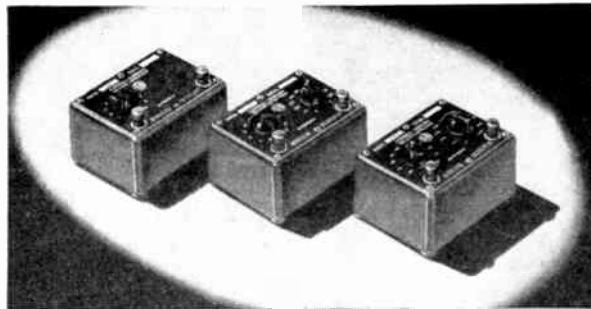

C-D CAPACITOR DECADES

C-D Capacitor Decades provide accurate standards over a wide range of capacity. May be used in groups of the three decades, shown above, or used individually for maximum flexibility. Each decade is furnished with calibration chart giving exact capacity values for all scale markings, extending use to more precise measurements.

Rated Voltage—600 D. C.—220 A. C.

Model	Capacity	T or Tol.	Dielectric	List Price	Net Price
CDA-5	.011 mfd. in .0001 mfd. steps	5%	Mica	\$10.80	\$6.48
CDB-5	1.1 mfd. in .01 mfd. steps	5%	Oil-Paper	10.80	6.48
CDB-3	1.1 mfd. in .01 mfd. steps	3%	Oil-Paper	13.80	8.28
CDC-5	10.0 mfd. in 1.0 mfd. steps	5%	Oil-Paper	19.20	11.52
CDC-3	10.0 mfd. in 1.0 mfd. steps	3%	Oil-Paper	22.20	13.32



QUIETONE INTERFERENCE FILTERS

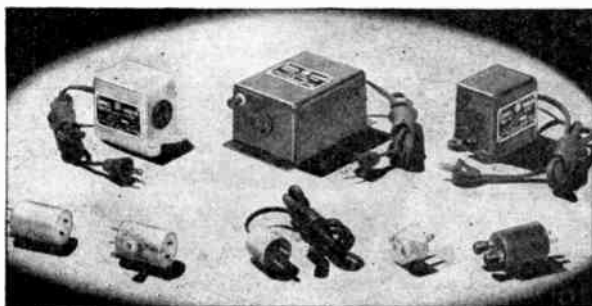

Top Row—IF-19, IF-18 and IF-21
Lower Row—IF-4 & 5, IF-6, IF-22, IF-20, AF-10

RADIO AND APPLIANCE QUIETONES

Most satisfactory results are obtained when Quietones are installed at the source of the interference. A Quietone installed in connection with an offending appliance corrects the noise conditions caused by that appliance, improving your neighbor's radio reception as well as your own.

Where source of interference cannot be located a Quietone connected in the electric supply line of the radio receiver will alleviate, if not fully correct, the condition. When a Quietone is installed, interference will be greatly reduced. Remaining interference usually enters receiver through the antenna system.

Quietones for Use at the Radio Receiver

TYPE IF-4—For use on small radio receivers, such as A.C.-D.C. midget sets, etc., where noise level is not too severe. Connects in power line between the radio receiver plug and wall receptacle. Rating: 110 V.A.C.-D.C. 5 amps. Colors—Furnished in ivory, walnut, or green finish. List Price \$0.90 Net Price \$0.54

TYPE IF-18—For use in connection with all radio receivers where noise level is severe. Furnished in Bakelite case (see colors). Employs highly effective all-wave capacitive-inductive type filter. Ratings: 110 V.A.C.-D.C. 5 amps. Colors—Furnished in ivory or walnut Bakelite. List Price \$6.00 Net Price \$3.60

Quietones for Use at Appliances

TYPE IF-5—For small electrical appliances such as food mixers, hair dryers, etc., where radio interference is of low intensity. Plug type filter. Convenient to install. Rating: 110 V.A.C.-D.C. 5 amps. Colors—Furnished in ivory, walnut or green finish. List Price \$0.90 Net Price \$0.54

TYPE IF-6—For all types of home electrical appliances where interference is of moderately low intensity. Installed between appliance and power supply line with short return lead which reduces radiation. Rating: 110 V.A.C.-D.C. 5 amps. Colors—Furnished in ivory, walnut or green finish. List Price \$1.50 Net Price \$0.90

TYPE IF-18—An efficient all-wave capacitive-inductive sectional band type filter for use in connection with all types of electrical appliances where interference conditions are severe. Provided with frame connection for reduction of radiation. Furnished in Bakelite case (see colors). Rating: 110 V.A.C.-D.C. 5 amps. Colors—Bakelite case, walnut finished. List Price \$6.00 Net Price \$3.60

TYPE IF-19—Capacitive-inducted type filter for use where interference is severe. Frame connection provided. Furnished in Bakelite case. Rating: 110 V.A.C.-D.C. 5 amps. Colors—Bakelite case. Ivory or walnut finish. List Price \$4.80 Net Price \$2.88

TYPE IF-20—For use on small electrical appliances where interference is very low. Simply connected to cord plug of appliance and plugged into wall receptacle. Rating: 110 V.A.C.-D.C. 5 amps. Colors—Bakelite case. Ivory or walnut finish. List Price \$0.60 Net Price \$0.36

TYPE IF-21—All-wave capacitive-inductive type filter for use on appliances where return lead to the frame of appliance cannot be made, such as shaver, barber clippers, etc. Furnished in Bakelite case. Rating: 110 V.A.C.-D.C. 1.6 amps. Colors—Bakelite case. Ivory or walnut finish. List Price \$3.00 Net Price \$1.80

TYPE IF-22—For use in connection with electric shavers of all standard types. Line cord and plug provided with Schick and Packard type adapters which fit practically all type shavers. (Specify type desired when ordering.) Type IF-22A for Schick, Knapp Monarch, and similar type shavers. Type IF-22B for Packard, Zephyr, Remington-Rand and Ronson type shavers. Rating: 110 V.A.C. 5 amps. Colors—Bakelite case. Ivory or black finish. List Price \$2.15 Net Price \$1.29

TYPE AF-10—Antenna Eliminator for all types of receivers. Furnished in Bakelite case with two binding posts. Plugs into wall receptacle and provides an efficient aerial connection. Colors—Furnished in ivory, walnut or green finish. List Price \$1.20 Net Price \$0.72

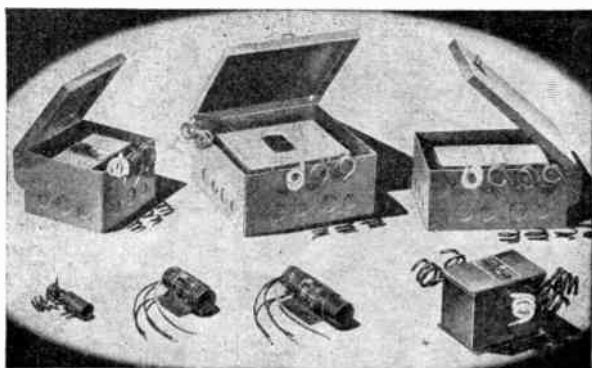

Top Row—IF-11 & 12, IF-7A, 15, 16 and IF-14
Lower Row—IF-24, IF-25, IF-26 and IF-27, 28, 29

INDUSTRIAL QUIETONES

The development of radio receiving and broadcasting equipment has been perfected to a degree where complete enjoyment of programs is within the reach of all. However, only too frequently is radio reception marred by disturbing noises commonly referred to as "man-made static." This condition does not have to be endured. It is unnecessary to tolerate the majority of these offending noises. Quietone Filters enable you to enjoy quiet, noise-free reception.

Although atmospheric disturbances in many instances cause radio noises, this condition is not chronically annoying. With the average radio receiver, noise is generally caused by the operation of electrical appliances or apparatus which create high frequency oscillations. Many types of equipment cause minute sparks as a result of a change in electrical conditions within the device, which are essential to its operation. In effect these appliances act as miniature radio transmitters, setting up a disturbance which may affect radio receivers at a considerable distance.

It is highly desirable to correct noise conditions at the source as one filter properly installed at this point may eliminate the noise in a number of radio receivers. Where it is impossible to locate the equipment which is causing the interference a Quietone installed at the receiver will correct the noise in that receiver.

The Quietones listed below will correct radio noise conditions caused by motors, generators, elevators, stokers and many other types of industrial electrical apparatus. They are designed for convenient mounting, and contain highest quality capacitors, with lowest possible impedance internal connections. There are no current limitations for (CP) Capacitive Quietones.

Capacitive (CP) Quietones

Type	Volts A.C.— D.C.	Connections	Housing	List Price	Net Price
IF-24*	110	Flex-Leads	Metal	\$0.90	\$0.54
IF-25	110-220	Flex-Leads	Metal	3.60	2.16
IF-26	110-220	Flex-Leads	Metal	6.00	3.60
IF-11	110	BX	Cutout Box	8.40	5.04
IF-12	220	BX	Cutout Box	12.00	7.20
IF-14**	110-220	BX	Cutout Box	16.80	10.08

** All Quietones listed above with exception of IF-14 are for single phase circuits. IF-14 is for 2 or 3 phase or 3-wire circuits.

* Dual unit for use on fluorescent lighting fixtures.

The Quietones listed below are for the more severe radio noise conditions caused by motors, generators, elevators, dithermy, oil burners, etc. They are designed for convenient mounting and quick connection to these machines. They consist of low-loss coils and highest quality capacitors with correct noise conditions in both broadcast and short wave receivers. They are the most efficient filters available for heavy duty application. All capacitive-inductive (CI) Quietones are for single phase circuits.

Capacitive-Inductive (CI) Quietones

Type	Volts A.C.— D.C.	Max Amps	Connections	Housing	List Price	Net Price
IF-7A*	110-220	5	BX	Cutout Box	\$9.00	\$5.40
IF-15	110-220	10	BX	Cutout Box	18.00	10.80
IF-16	110-220	20	BX	Cutout Box	26.40	15.84
IF-27	110	5	Flex-Leads	Steel Box	5.40	3.24
IF-28	110	10	Flex-Leads	Steel Box	9.60	5.76
IF-29	110	20	Flex-Leads	Steel Box	16.80	10.08

*For use on oil burners.



★ ★ ★ ★ ★ ★ ★ ★ ★ ★ DRY ELECTROLYTICS

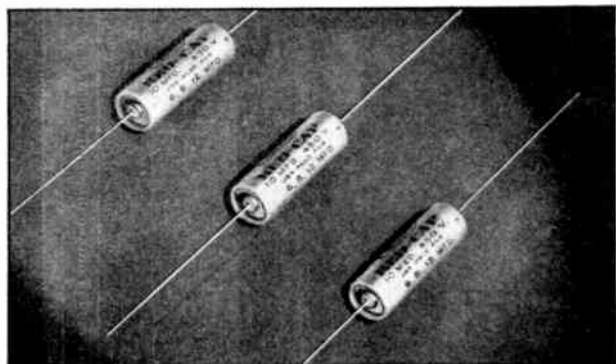

"RED-CAPS" for SERVICE

DRY ELECTROLYTICS IN PLASTIC TUBES

New! The most modern development in service-type dry electrolytic capacitors—tiny, handy, attractive in waterproof, color-coded plastic tubes! Thirteen single values can be used for forty-one capacity applications. Small inventory. Simplicity!

Lengths are uniform; diameters are minimums, so that Red-Caps group together neatly and literally fit anywhere. Bare leads. Packaged with straps.

No need for exact duplicates in an endless number of different sizes! Standardize on "Red-Caps for Service!"—for Speed!—for Value!

"RED-CAPS"—In Plastic Tubes

Catalog Number	Nominal Cap. Mfd.	Use also for Mfd.	D.C. Voltage		Dimensions, Inches*	
			Wkg.	Surge	Diam.	Lnth.
SINGLE CAPACITIES—TWO LEADS						
R-020	20	5, 10, 25	50	75	1 1/16	2 3/16
R-210	10	6, 8	150	225	1 1/16	2 3/16
R-215	15	12, 16	150	225	1 1/16	2 3/16
R-220	20	24, 25	150	225	1 1/16	2 3/16
R-230	30	35	150	225	1 1/16	2 3/16
R-240	40	45, 50	150	225	1 1/16	2 3/16
R-310	10	6, 8, 12	350	375	1 1/16	2 3/16
R-320	20	15, 16, 24	350	375	1 1/16	2 3/16
R-505	5	4, 6	450	525	1 1/16	2 3/16
R-510	10	8, 12	450	525	1 1/16	2 3/16
R-515	15	16	450	525	1 1/16	2 3/16
R-520	20	24, 25	450	525	1 1/16	2 3/16
R-610	10	6, 8, 12	525	600	1 1/16	2 3/16

DUAL CAPACITIES—NEGATIVE COMMON—3 LEADS

R-2205	20 + 20	5 + 5, 10 + 10, 25 + 25	25	40	1 1/16	2 3/16
R-1010	10 + 10	8 + 8, 12 + 12	150	225	1 1/16	2 3/16
R-2020	20 + 20	15 + 15, 16 + 16	150	225	1 1/16	2 3/16
R-3030	30 + 30	25 + 25	150	225	1 1/16	2 3/16
R-1115	10 + 10	8 + 8, 12 + 12	450	525	1 1/16	2 3/16

*± .001".



"MINICAP"

METAL ENCASED TUBULAR DRY

- Compact.
- Hermetically sealed in metal—encased in insulating tubes.
- Dual units negative common; three bare leads, with neutral strap.
- Individually packaged.

"MINICAP" TYPE M

Catalog Number	Capacity Mfd.	D.C. Voltage		Size, Inches	
		Working	Surge	Diam.	Length
M-010	10	25	40	1 1/16	1 1/16
M-025	25	25	40	1 1/16	1 1/16
M-5010	10	50	75	1 1/16	1 1/16
M-5025	25	50	75	1 1/16	1 1/16
M-50100	100	50	75	1 1/16	1 1/16
M-204	4	150	225	1 1/16	1 1/16
M-208	8	150	225	1 1/16	1 1/16
M-212	12	150	225	1 1/16	1 1/16
M-216	16	150	225	1 1/16	1 1/16
M-220	20	150	225	1 1/16	1 1/16
M-224	24	150	225	1 1/16	1 1/16
M-230	30	150	225	1 1/16	1 1/16
M-240	40	150	225	1 1/16	1 1/16
M-258	8	250	300	1 1/16	1 1/16
M-2516	16	250	300	1 1/16	1 1/16
M-308	8	350	375	1 1/16	1 1/16
M-316	16	350	375	1 1/16	1 1/16
M-404	4	450	525	1 1/16	1 1/16
M-408	8	450	525	1 1/16	1 1/16
M-412	12	450	525	1 1/16	1 1/16
M-416	16	450	525	1 1/16	2 3/16
M-420	20	450	525	1 1/16	2 3/16
M-508	8	525	600	1 1/16	2 3/16
M-011	10 + 10	25	40	1 1/16	1 1/16
M-288	8 + 8	150	225	1 1/16	1 1/16
M-816	8 + 16	150	225	1 1/16	2 3/16
M-1616	16 + 16	150	225	1 1/16	2 3/16
M-2020	20 + 20	150	225	1 1/16	2 3/16
M-488	8 + 8	450	525	1 1/16	2 3/16

SPECIAL SERVICE CARTONS

Catalog Number	Carton Contains
M-3	Five M-408 Minicaps
M-4	Five M-208 Minicaps
M-5	Five M-216 Minicaps

NOTE: For special high capacity, low voltage units, see page K-18.

SOLAR

★ ★ ★ ★ ★ ★ ★ ★ ★ ★

DRY ELECTROLYTICS

HANDY UNIVERSAL REPLACEMENTS

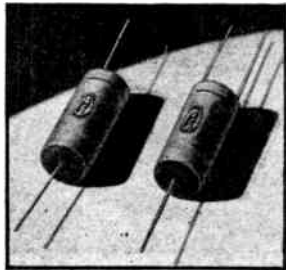

TYPE DT

Type DT units are encased in attractive, varnish-finish, non-absorbent cardboard tubes with 2" bare wire leads one out each end. Dual units have two positive leads at one end, and a common negative at the other.

For mounting straps, refer to "Mounting Hardware" listing at bottom of page K-19.

TYPE DT—Single Capacity Cartridge Type

Catalog Number	Capacity Mfd.	D.C. Wkg. Voltage	Size, Inches Diam. Length
DT-856	1	450	$\frac{9}{16}$ 2
DT-857	2	450	$\frac{9}{16}$ 2
DT-858	4	450	$\frac{5}{8}$ 2
DT-859A	8	450	$\frac{7}{8}$ 2
DT-859B	12	450	1 2
DT-859C	16	450	$\frac{7}{8}$ $2\frac{3}{4}$
DT-859D	20	450	$\frac{7}{8}$ $2\frac{3}{4}$
DT-860A	8	350	$\frac{3}{4}$ 2
DT-860B	16	350	$\frac{7}{8}$ 2
DT-866	4	150	$\frac{9}{16}$ 2
DT-868	8	150	$\frac{9}{16}$ 2
DT-868B	12	150	$\frac{9}{8}$ 2
DT-868A	16	150	$\frac{5}{8}$ 2
DT-868C	20	150	$\frac{3}{4}$ 2
DT-869D	30	150	$\frac{3}{4}$ 2
DT-869E	40	150	$\frac{7}{8}$ 2
DT-869F	50	150	1 2
DT-873	5	50	$\frac{9}{16}$ 2
DT-874	10	50	2 2
DT-875	25	50	$\frac{9}{16}$ 2
DT-876	50	50	$\frac{5}{8}$ 2
DT-877	100	50	$\frac{3}{4}$ 2
DT-878	5	25	$\frac{9}{16}$ 2
DT-879	10	25	$\frac{9}{16}$ 2
DT-882	25	25	$\frac{9}{16}$ 2
DT-885	10-10	25	$\frac{5}{8}$ 2

TYPE DH

Popular service-type cardboard tubular units, in single and multiple values, arranged in a really practical manner so that a few types cover virtually every service requirement.

Insulated leads are all brought out one end. Special mounting ears permit upright mounting. For horizontal mounting, a metal

strap is packaged separately with each capacitor. Individually packaged.

(See listing at right)

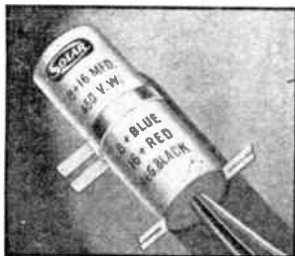

TYPE DH—continued.

SERVICE-TYPE DH TUBULAR DRYS

Catalog Number	Nominal Rating Mfd. & W.V.	Use also for Mfd.	Size, Inches Diam. Lgth.
SINGLE CAPACITY UNITS—2 LEADS			
DH-201	20-150	15, 16	$\frac{7}{8}$ $2\frac{1}{2}$
DH-82	8-250	6, 10	$\frac{7}{8}$ $2\frac{1}{2}$
DH-162	16-250	12, 15, 20	$\frac{7}{8}$ $2\frac{1}{2}$
DH-83	8-350	6, 10	$\frac{7}{8}$ $2\frac{1}{2}$
DH-163	16-350	12, 15, 20	$\frac{7}{8}$ $2\frac{1}{2}$
DH-84	8-450	6, 10	$\frac{7}{8}$ $2\frac{1}{2}$
DH-164	16-450	12, 15	$\frac{7}{8}$ $2\frac{7}{8}$
DH-85	8-525	6, 10	$\frac{7}{8}$ $2\frac{7}{8}$

DUAL CAPACITIES—COMMON NEGATIVE—3 LEADS

DH-2020	20+20-25	5+5, 10+10, 25+25	$\frac{7}{8}$ $2\frac{1}{2}$
DH-20201	20+20-150	10+10, 15+15	$\frac{7}{8}$ $2\frac{1}{2}$
DH-30301	30+30-150	24+24, 25+25	1 $2\frac{7}{8}$
DH-50501	50+50-150	40+40	1 $2\frac{7}{8}$
DH-882	8+8-250	6+6, 10+10	$\frac{7}{8}$ $2\frac{1}{2}$
DH-883	8+8-350	6+6, 10+10	$\frac{7}{8}$ $2\frac{7}{8}$
DH-884	8+8-450	6+6, 10+10	1 $2\frac{7}{8}$

DUAL CAPACITIES—SEPARATE SECTIONS—4 LEADS

DHS-20201	20+20-150	10+10, 12+20, 15+15	1 3
DHS-882	8+8-250	6+6, 10+10	1 3
DHS-883	8+8-350	6+6, 10+10	$1\frac{1}{4}$ 3
DHS-16163	16+16-350	12+12, 15+15	$1\frac{3}{8}$ 3
DHS-884	8+8-450	4+4, 4+8, 6+6, 10+10	$1\frac{1}{4}$ 3
DHS-8164	8+16-450	6+12, 10+15	$1\frac{3}{8}$ 3
DHS-16164	16+16-450	12+12, 15+15	$1\frac{3}{8}$ $3\frac{7}{8}$

TRIPLE CAPACITIES—COMMON NEGATIVE—4 LEADS

DHTN-222	20+20-150 + 20-25	10+16-150 + 10-25, 16+16-150 + 20-25, 24+16-150 + 20-25	1 $2\frac{7}{8}$
DHTN-422	40+20-150 + 20-25	30+10-150 + 20-25, 30+20-150 + 20-25	1 $2\frac{7}{8}$
DHTN-3211	30+20+ 10-150	20+10-10-150, 20+20+10-150	1 $2\frac{7}{8}$
DHTN-112	15+10-350 + 20-25	10+10-150 + 20-25	$1\frac{1}{8}$ $2\frac{7}{8}$
DHTN-212	20-400 + 10-350 + 25-25	10+10-350 + 20-25	$1\frac{1}{8}$ $3\frac{1}{4}$

TRIPLE CAPACITIES—SEPARATE SECTIONS—6 LEADS

DHTS-882	8+8-350 + 20-25	8+8-250 + 20-25	$1\frac{3}{8}$ $3\frac{1}{4}$
DHTS-16162	16+16-350 + 20-25	16+16-250 + 20-25, 12+12-350 + 20-25, 8+16-350 + 20-25	$1\frac{3}{8}$ $3\frac{1}{4}$
DHTS-88422	8+8-450 + 20-25	4+8-450 + 20-25, 6+6-450 + 20-25, 10+10-450 + 20-25	$1\frac{3}{8}$ $3\frac{1}{4}$
DHTS-816422	8+16-450 + 20-25	12+12-450 + 20-25	$1\frac{3}{8}$ 4
DHTS-8883	8+8+8-350	8+8+8-250	$1\frac{3}{8}$ $3\frac{1}{4}$
DHTS-8884	8+8+8-450		$1\frac{3}{8}$ 4

SOLAR

DRY ELECTROLYTICS



little giants

- Handy midget units—in attractive silvered-cardboard boxes, with leads.
- Single values feature "Flex-mount" adjustable flanges. Multiple values have fixed flanges, easily removable. Separate sections and separate leads.

TYPE LG5—525 VOLTS SURGE PEAK

Catalog Number	Capacity Mfd.	D.C. Working Voltage	Dimensions, Inches
LG5-2	2	450	2 1/8 x 3/4 x 1/2
LG5-4	4	450	2 1/8 x 3/4 x 1/2
LG5-8	8	450	2 1/8 x 1 1/8 x 1 1/8
LG5-10	10	450	2 1/8 x 1 1/8 x 1 1/8
LG5-12	12	450	2 1/8 x 1 1/8 x 1 1/8
LG5-16	16	450	2 1/8 x 1 1/8 x 1 1/8
LG5-44	4+4	450	2 1/8 x 1 1/8 x 1 1/8
LG5-48	4+8	450	2 1/8 x 1 1/8 x 1 1/8
LG5-88	8+8	450	2 1/8 x 1 1/8 x 1 1/8
LG5-816	8+16	450	2 1/2 x 1 3/8 x 1 1/8
LG5-888A	8+8+8	450	2 1/2 x 1 3/8 x 1 1/8

TYPE LG2—250 VOLTS SURGE PEAK

Catalog Number	Capacity Mfd.	D.C. Working Voltage	Dimensions, Inches
LG2-8	8	200	2 1/8 x 3/4 x 1/2
LG2-16	16	200	2 1/8 x 1 1/8 x 1 1/8
LG2-20	20	200	2 1/8 x 1 1/8 x 1 1/8
LG2-30	30	200	2 1/8 x 1 1/8 x 1 1/8
LG2-88	8+8	200	2 1/8 x 1 1/8 x 1 1/8
LG2-816	8+16	200	2 1/8 x 1 1/8 x 1 1/8
LG2-1616	16+16	200	2 1/8 x 1 1/8 x 1 1/8

LARGE SIZE CARDBOARD BOXES

These are the familiar large dry electrolytics formerly standard for years. Supplied with mounting flanges and leads.

TYPES DAA & DJ—525 VOLTS SURGE

Catalog Number	Capacity Mfd.	D.C. Wkg. Voltage	Dimensions, Inches
DAA-0602	2	450	2 1/4 x 1 1/8 x 5/8
DAA-0604	4	450	4 1/4 x 1 1/8 x 5/8
DAA-0608	8	450	4 1/4 x 1 1/8 x 5/8
DAA-0616	16	450	4 3/8 x 1 1/2 x 1 1/8
DJ-0362	8+8	450	4 3/8 x 1 3/8 x 1 1/4

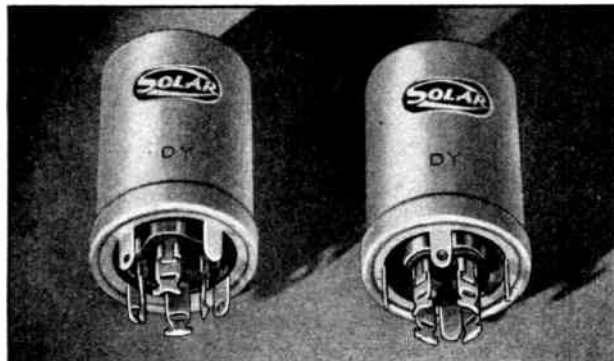

TYPE DY METAL CANS

FOR TWIST-PRONG MOUNTING

Hermetically sealed, with distinctive Solar base assuring long life, proper venting and rigidity. It is always permissible (if necessary) to use higher capacities than in the original. Terminal codes are stamped on cans.

TYPE DY

Catalog Number	Capacity in Mfd. & D.C. Working Voltage	Can Size, Inches
DY-10	10-450	1x2
DY-20	20-450	1x2 1/2
DY-30	30-450	1x3
DY-40	40-450	1x3 3/8
DY-41	10-525	1x3
DY-61	20+20-150	1x2
DY-63	30+30-150	1x2
DY-65	50+50-150	1x2
DY-66	40+20-150	1x2
DY-70	15+15-300	1x2
DY-71	30+30-350-300	1x2
DY-94	10+10-450	1x2 1/2
DY-92	20+20-450	1x3 3/8
DY-90	20+20+20-150	1x2
DY-97	40+20+20-150	1x2 1/2
DY-98	40+40+40-150	1x3
DY-99A	40+20+20-250	1x3
DY-105	10+10+10-450	1x3
DY-106	15+15+10-450	1x3
DY-150	20-450 + 15+10-300	1x3 3/8
DY-144	15-450 + 20-350 + 20-250	1x3
DY-103	30+30-150 + 20-25	1x2 1/2
DY-103A	30+20-150 + 100-6	1x2
DY-104	50+50-150 + 20-25	1x3
DY-110	50+30-150 + 100-25	1x3
DY-111	15+15-250 + 20-25	1x2
DY-133	15+15-350 + 20-25	1x3
DY-134	30+20-350 + 20-25	1x3 3/8
DY-141	10+10-450 + 20-25	1x3
DY-142	15+15-450 + 20-25	1x3
DY-145	30+30-450 + 20-25	1 3/8 x 3
DY-1010	50+50+50-150 + 20-25	1 3/8 x 3
DY-1030	40-350 + 40+20-300 + 20-25	1 3/8 x 3 3/8
DY-1020	10+10+10-450 + 20-25	1 3/8 x 2 1/2
DYP-3	Metal Plate for 1" Cans—Grounding	
DYP-4	Bakelite Plate for 1" Cans—Insulating	
DYP-7	Metal Plate for 1 3/8" Cans—Grounding	
DYP-8	Bakelite Plate for 1 3/8" Cans—Insulating	

SOLAR

DRY ELECTROLYTICS

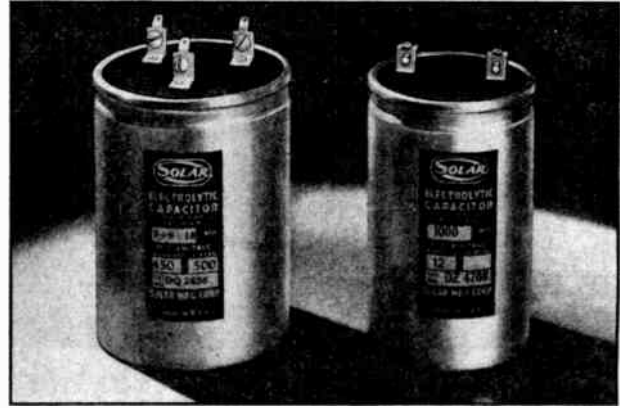
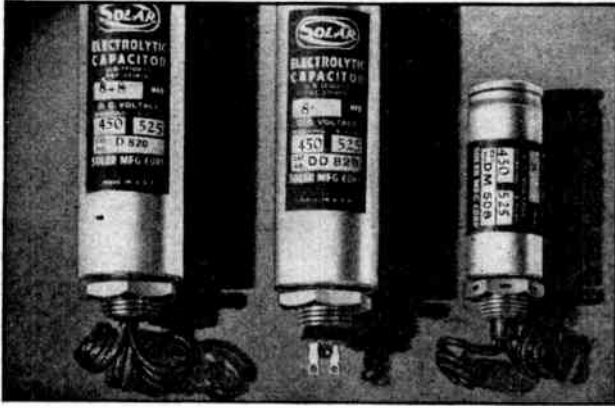

ROUND SCREW BASE CANS

- Dependable capacity and voltage ratings.
- Supplied with mounting nuts.

TYPE D—1 3/8" x 4 3/8"; Leads; Insulated Can; 3/4" Base

Catalog Number	Capacity Mfd.	D.C. Voltage	
		Working	Surge
D-800	8	475	600
D-808	8	450	525
D-813	16	450	525
D-8131	20	450	525
D-8132	30	450	525
D-8133	40	450	525
D-8134	50	450	525
*D-820	8+8	450	525
*D-838	8+8+8	450	525

TYPE DD—1 3/8" x 4 3/8"; Positive Lug, Can Negative; 3/4" Base

DD-828	8	450	525
--------	---	-----	-----

TYPE DM—1" x 2 1/2"; Leads; Insulated Can; 5/8" Base

DM-508	8	450	525
**DM-516	16	450	525

TYPE DI—1 3/8" x 3 1/4"; Lugs in Molded Screw Base 7/8" Diam.

DI-854	8	450	525
DI-859	16	450	525
†DI-869	8+8	450	525
†DI-877	8+8+8	450	525

*Separate Sections. **DM-516 can height 3 1/2".
†Common Negative.

TYPE DO—OCTAL TUBE BASE TYPE

PRONGS FIT STANDARD OCTAL SOCKETS

Catalog Number	Capacity Mfd.	D.C. Voltage		Can Size, Inches	
		Working	Surge	Diam.	Length
DO-140	40	150	225	1 1/4	2 1/2
DO-410	10	450	525	1 1/4	2 1/2
DO-420	20	450	525	1 1/4	3 1/4
DO-430	30	450	525	1 1/4	4
DO-1230	30+30	150	225	1 1/4	2 1/2
DO-4210	10+10	450	525	1 1/4	3 1/4
DO-4310	10+10+10	450	525	1 1/4	4

LARGE ROUND CANS

- Metal can negative; positive connections on top.
- Mounting rings included.

TYPE DP—2 1/2" DIAMETER CANS

Catalog Number	Capacity Mfd.	D.C. Voltage	
		Working	Peak
DP-2508	8+8	450	525
DP-2515	5+15	450	525
DP-2524	8+16	450	525
DP-2538	8+8+8	450	525

TYPE DQ—3" DIAMETER CANS

DQ-2608	8+8	450	525
DQ-2624	8+8+8	450	525
DQ-2636	9+9+18	450	525
DQ-2720	9+9+18+18	450	525

HIGH CAPACITY—LOW VOLTAGE DRY

TYPE DZ—2" DIAMETER x 4" HIGH

Catalog Number	Capacity Mfd.	D.C. Voltage
*DZ-4750	2000	25
*DZ-4752	1500	25
DZ-4753	1000	25
DZ-4765	2000	12
DZ-4766	1500	12
DZ-4768	1000	12

*Diameter 2 1/2".

TYPE DGM—MINICAP CONSTRUCTION†

Catalog Number	Capacity Mfd.	D.C. Wkg. Voltage	Size, Inches	
			Diam.	Length
DGM-05	500	6	1 1/16	2 7/8
DGM-1	1000	6	1 1/16	2 7/8
DGM-2	2000	6	1 1/16	3 1/8
DGM-9	500	12	1 1/16	2 7/8
DGM-10	1000	12	1 1/16	3 1/8
DGM-12	2000	12	1 1/16	3 1/8
DGM-20	500	25	1 1/16	2 7/8

†For use in electric fence control, low power rectifier circuits, communications control equipment, etc.

NOTE: For A.C. Motor Starting Dry Electrolytic Capacitors, see special Solar Bulletin Number AC.



WET ELECTROLYTICS PAPER CAPACITORS

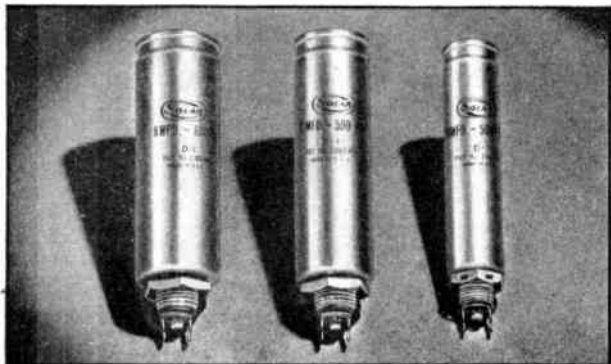

"Z" TYPE WETS

- Can negative
- Palnut included

TYPE ZD—1 3/8" x 4 3/8" Can Size; Base 3/4" Diam.

Catalog Number	Capacity Mfd.	D.C. Peak Voltage
ZD-8	8	500
ZD-12	12	500
ZD-16	16	500
ZD-20	20	500
ZD-24	24	500

TYPES Z AND ZV—1 1/2" x 4 3/8" Can Size; Base 3/4" Diam.

Z-230	30	500
Z-235	35	500
Z-240	40	500
ZV-278	8	600
ZV-285	16	600

TYPES ZK & ZM—1" Diam.; ZK Can 4 3/8", ZM 3 1/8" High; Base 5/8" Diam.

ZK-8	8	500
ZK-16	16	500
ZM-8	8	500

MOUNTING HARDWARE FOR WET OR DRY ELECTROLYTICS

Cat. No.	Description
H-35	2 fibre washers, 1 ground lug, 5/8" base
H-20	2 fibre washers, 1 ground lug, 3/4" base
PN-5-8	Palnut for 5/8" x 18 thread
PN-3-4	Palnut for 3/4" x 16 thread
RG-01	Mounting ring for round can 1" diameter
RG-02	Mounting ring for round can 1 1/8" diameter
RG-03	Mounting ring for round can 1 1/4" diameter
RG-1	Mounting ring for round can 1 3/8" diameter
RG-2	Mounting ring for round can 1 1/2" diameter
RG-5	Mounting ring for round can 2" diameter
RG-6	Mounting ring for round can 2 1/2" diameter
RG-7	Mounting ring for round can 3" diameter

MOUNTING STRAPS FOR TUBULAR CAPACITORS

Catalog Number	Tube Diam.	List Price	Catalog Number	Tube Diam.
CL-2	3/8"	\$.07	CL-10	7/8"
CL-3	1/4"	.07	CL-11	1 1/8"
CL-4	1/2"	.07	CL-12	1"
CL-5	5/8"	.07	CL-13	1 1/4"
CL-6	3/4"	.07	CL-14	1 5/8"
CL-7	1 1/8"	.10	CL-15	1 3/4"
CL-8	1 1/4"	.10	CL-16	1 7/8"
CL-9	1 1/2"	.10	CL-17	1 1/2"



"TOM THUMB" UNCASED

- Compact, flat sections
- Ideal for "potting"
- Varnished wrappers
- 6" insulated leads

For small, hearing-aid types, see page K-21.

1000 V. D.C. WORKING; 2000 V. D.C. TEST—RED LEADS

Catalog Number	Capacity Mfd.	Length	Width	Thickness
TT-11	.1	2 1/8	1 1/2	1/4
TT-12	.25	3	1 3/8	3/8
TT-13	.5	4 1/4	1 3/4	3/8
TT-14	1.0	4 1/4	2 1/8	1/2
TT-15	2.0	4 1/4	2 1/8	1/2

600 V. D.C. WORKING; 1200 V. D.C. TEST—BLUE LEADS

TT-01	.1	2 1/8	1 1/2	1/4
TT-025	.25	2 1/8	1 1/8	3/8
TT-05	.5	2 1/8	1 3/8	3/8
TT-1	1.0	2 1/8	1 3/8	3/8
TT-2	2.0	2 1/8	1 3/8	1 1/8
TT-4	4.0	2 1/8	2 1/8	1 5/8

400 V. D.C. WORKING; 800 V. D.C. TEST—YELLOW LEADS

TT-22	.25	2 1/8	1 1/2	1/4
TT-23	.5	2 1/8	1 1/2	3/8
TT-24	1.0	2 1/8	1 1/2	3/8
TT-25	2.0	2 1/8	1 3/4	1 1/8
TT-26	4.0	2 1/8	2 1/8	1 1/8

200 V. D.C. WORKING; 400 V. D.C. TEST—BLACK LEADS

TT-34	1.0	2 1/8	1 5/8	3/8
TT-35	2.0	2 1/8	1 5/8	1 1/8
TT-36	4.0	2 1/8	1 3/4	1 3/8

DRAWN CAN TYPES

TYPE XV—1 1/8" x 1" x 3/4"

Catalog Number	Capacity Mfd.	D.C. Working Voltage
P1503	.5	200
P1509	.1	400
P1511	.1 + .1	400
P1513	.1	600

TYPE XVIII—2" x 1 3/4" x 7/8"

P1821	.5	400
P1801	1.	200

TYPE XIX—2" x 2 1/4" x 1"

P1901	2.	200
P1921	1.	400
P1925	.5 + .5	400
P1930	.5	600



P1511 Dual Type
Center Lug Common

For Oil-filled Units,
see Page K-22.



PAPER CAPACITORS

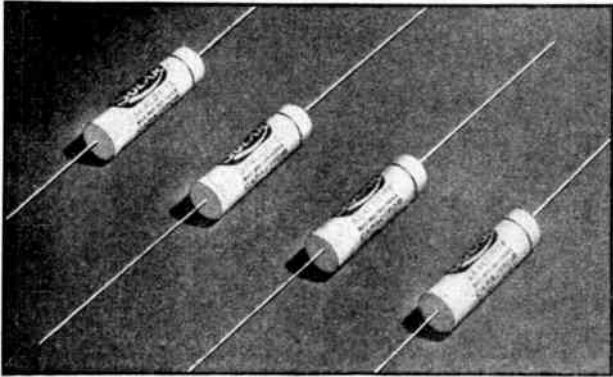

"SEALDTITE" TUBULARS Moisture-proof Wax-Molded

Exclusively Solar! No other paper tubulars are as modern or reliable. Sealdtite tubulars are actually sealed tight against moisture by a distinctive Solar wax-molding process. This gives a more perfect seal than ever before attained for tubular paper capacitors.

Windings are non-inductive, with full-diameter hot-soldered leads 2 1/4" in length. Excellent r.f. characteristics.

"Sealdtite" means "Value sealed in—Moisture sealed out!" Reliable in every climate. In cartons of ten.

1600 V. D.C. WORKING

Catalog Number	Capacity Mfd.	Size, Inches Diam. Length
VIM-1	.005	1/16 1 5/8
VIM-3	.007	1/16 1 5/8
VIM-5	.01	1/8 1 5/8
VIM-7	.02	3/16 1 5/8
VIM-9	.05	5/8 2 1/8

1000 V. D.C. WORKING

VIM-11	.01	1/16 1 5/8
VIM-13	.02	1/16 1 5/8
VIM-15	.05	3/8 1 5/8

600 V. D.C. WORKING

S-0203	.00025	3/8 1 3/4
S-0204	.0005	3/8 1 3/4
S-0211	.001	3/8 1 3/4
S-0212	.002	3/8 1 3/4
S-0213	.003	3/8 1 3/4
S-0214	.004	3/8 1 3/4
S-0215	.005	3/8 1 3/4
S-0216	.006	3/8 1 3/4
S-0221	.01	1/4 1 3/4
S-0224	.02	1/4 1 5/8
S-0226	.03	1/4 1 5/8
S-0227	.04	1/2 1 5/8
S-0230	.05	3/8 1 5/8
S-0240	.1	1/2 2 1/8
S-0244	.2	1 2 3/8

(Listing continued at right)

"SEALDTITE" TUBULARS—continued

Catalog Number	Capacity Mfd.	Size, Inches Diam. Length
600 V. D.C. WORKING—continued		
S-0257	.25	3/4 2 3/8
S-0265	.5	1 2 3/8
S-0268	1.0	1 3

600 V. D.C. WORKING—SPECIAL SHORT UNITS

S-001	.001	3/8 1
S-002	.002	3/8 1
S-003	.003	3/8 1
S-004	.004	3/8 1
S-005	.005	3/8 1
S-006	.006	3/8 1

400 V. D.C. WORKING

S-01	.01	3/8 1
S-0219	.01	3/8 1 3/8
S-0223	.02	1/4 1 3/8
S-0228	.05	1/4 1 5/8
S-0238	.1	3/8 1 5/8
S-0243	.2	5/8 2 3/4
S-0256	.25	1 2 3/4
S-0263	.5	1 2 3/8
S-0267	1.0	1 2 5/8

200 V. D.C. WORKING

S-0235	.1	1/2 1 5/8
S-0245	.25	3/8 2 1/8
S-0261	.5	3/4 2 3/8
S-0266	1.0	1 2 3/8

"SEALDTITE" ASSORTMENTS

The Sealdtite assortments S-10 and S-25 are attractive, handy stock cartons of the most popular capacities and voltages in proportions as required for average service work.



S-10 ASSORTMENT

Consists of the following 10 Sealdtites attractively boxed:
Four .1 mfd. 600 V.W. Two .02 mfd. 600 V.W.
Two .05 mfd. 600 V.W. Two .01 mfd. 600 V.W.

List Price

Order by Number S-10

S-25 ASSORTMENT

Consists of the following 25 Sealdtites attractively boxed:
Two .5 mfd. 600 V.W. Five .05 mfd. 600 V.W.
Two .25 mfd. 600 V.W. Three .02 mfd. 600 V.W.
Nine .1 mfd. 600 V.W. Four .01 mfd. 600 V.W.

List Price

Order by Number S-25

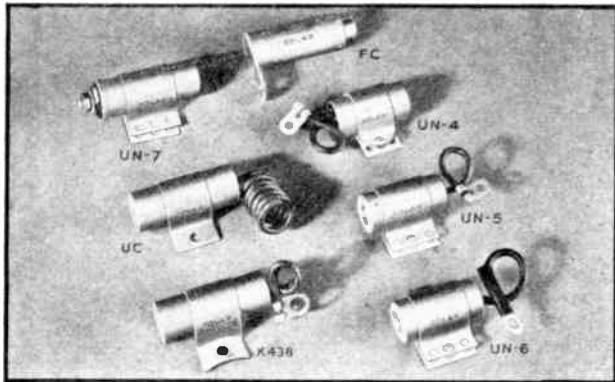

AUTO IGNITION CAPACITORS

These are standard replacement ignition condensers for automobile use under even extreme temperature conditions. For mechanical types, see illustration above.

Catalog Number	For design, see illustration
UN-4	" " " "
UN-5	" " " "
UN-6	" " " "
UN-7	" " " "
UC	" " " "
K-438	" " " "
FC	" " " "

HEARING-AID CAPACITORS

Modern vacuum tube type Hearing-Aid Devices require very special small capacitors. Several commonly used types are listed.

PAPER CAPACITORS—Miniature "Tom-Thumb" construction with bare wire leads, one out each end. Nominal voltage rating 100 V. D.C.

Catalog Number	Capacity Mfd.	Size, Inches (approx.)
TTH-001	.001	$\frac{1}{8} \times \frac{3}{8} \times \frac{1}{16}$
TTH-002	.002	$\frac{1}{8} \times \frac{3}{8} \times \frac{1}{16}$
TTH-005	.005	$\frac{1}{8} \times \frac{3}{8} \times \frac{1}{16}$
TTH-01	.01	$\frac{1}{11} \times \frac{3}{8} \times \frac{1}{16}$
TTH-02	.02	$\frac{1}{14} \times \frac{1}{16} \times \frac{1}{16}$
TTH-05	.05	$\frac{1}{16} \times \frac{1}{2} \times \frac{1}{16}$
TTH-1	.1	$\frac{3}{16} \times \frac{1}{2} \times \frac{1}{16}$

MICA CAPACITORS—Mica and foil sections, dipped for protection, with bare wire leads. Nominal voltage rating 100 V. D.C.

MMA-0002	.0002	$\frac{1}{16}$ wide x $\frac{9}{16}$ long
MMA-0005	.0005	$\frac{1}{16}$ wide x $\frac{9}{16}$ long
MMA-001	.001	$\frac{1}{16}$ wide x $\frac{9}{16}$ long

HIGH TEMPERATURE CAPACITORS

Special small capacitors, built to order, are available for continuous use over temperature ranges up to 250° F. These units are wound with synthetic film insulation, sealed in drawn cans or tubes. Especially designed for use with electric heating appliances, and other "hot-spot" installations.

PHT-1	.5 mfd. 600 v. d.c., 220 v. a.c. Special Hi-Temp Capacitor in 1" diam. x $2\frac{3}{8}$ " Generator type can with grounded bracket
PHT-2	1.0 mfd. 600 v. d.c., 220 v. a.c. Special Hi-Temp Capacitor in drawn can $1\frac{3}{4}$ " x $2\frac{1}{8}$ " x 1" high; one side grounded to can.



POWER FACTOR CAPACITORS

FOR FLUORESCENT LIGHTING

Oil-impregnated, oil-filled units for standard fluorescent lighting applications. Excellent over-voltage and high-temperature characteristics.

Built to order, including mounting arrangements if specified.

TYPES PFR & PF

Catalog Number	Capacity Mfd.	A.C. Volts	Dimensions, Inches
----------------	---------------	------------	--------------------

ROUND CANS

PFR-3-3	3.	330	2 diam. x $3\frac{1}{4}$
PFR-3.5-3	3.5	330	2 diam. x $3\frac{3}{4}$

CANS WITH OVAL SIDES

PF-4.75-12	4.75	118-236	$1 \times 2 \frac{1}{16} \times 4\frac{1}{2}$
PF-5.5-12	5.5	118-236	$1 \times 2 \frac{1}{16} \times 4\frac{1}{2}$
PF-6.5-1	6.5	118	$1 \times 2 \frac{1}{16} \times 4\frac{1}{2}$
PF-17-12	17.	118-236	$2\frac{1}{8} \times 2 \frac{1}{8} \times 5$
PF-19.5-12	19.5	118-236	$2\frac{1}{8} \times 2 \frac{1}{8} \times 5\frac{1}{2}$
PF-3-3	3.	330	$1 \times 2 \frac{1}{16} \times 3\frac{1}{4}$
PF-3.5-3	3.5	330	$1 \times 2 \frac{1}{16} \times 4\frac{1}{2}$

DOMINO

BAKELITE-MOLDED PAPER CAPACITORS

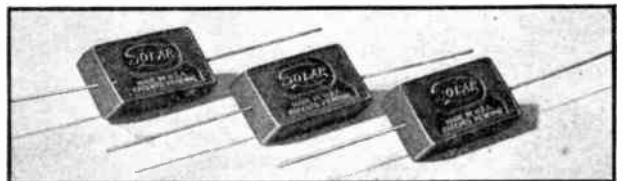

Molded in Bakelite, Domino capacitors meet Underwriters' requirements for units with a non-combustible case for use as a line bypass. Also used in instruments, electric fuel pumps and industrial applications. Dominoes are not designed for use as audio coupling capacitors or on A.C. voltages exceeding 250 volts. Bare leads are 2" long. Ten per carton.

DOMINO TYPE MPW

Catalog Number	Capacity Mfd.	D.C. Working Voltage	Dimensions, Inches
MPW-4103	.002	1000	$1 \frac{1}{16} \times \frac{3}{4} \times \frac{5}{16}$
MPW-4109	.005	1000	$1 \frac{1}{16} \times \frac{3}{4} \times \frac{3}{8}$
MPW-4115	.01	1000	$1 \frac{1}{16} \times \frac{3}{4} \times \frac{3}{8}$
MPW-4129	.005	600	$1 \frac{1}{16} \times \frac{5}{8} \times \frac{1}{4}$
MPW-4135	.01	600	$1 \frac{1}{16} \times \frac{3}{4} \times \frac{5}{16}$
MPW-4139	.05	600	$2 \times 1 \times \frac{9}{16}$
MPW-4140	.1	600	$2 \times 1 \times \frac{9}{16}$
MPW-4145	.05	400	$1 \frac{1}{16} \times \frac{3}{4} \times \frac{3}{8}$
MPW-4147	.1	400	$1 \frac{1}{16} \times \frac{3}{4} \times \frac{3}{8}$
MPW-4148	.25	400	$2 \times 1 \times \frac{9}{16}$
MPW-4157	.1	200	$1 \frac{1}{16} \times \frac{3}{4} \times \frac{3}{8}$
MPW-4163	.25	200	$2 \times 1 \times \frac{9}{16}$
MPW-4165	.5	200	$2 \times 1 \times \frac{9}{16}$
MPC-1	Clamp for rigid mounting of largest Domino size $2 \times 1 \times \frac{9}{16}$		



PAPER CAPACITORS TRANSMITTING CAPACITORS

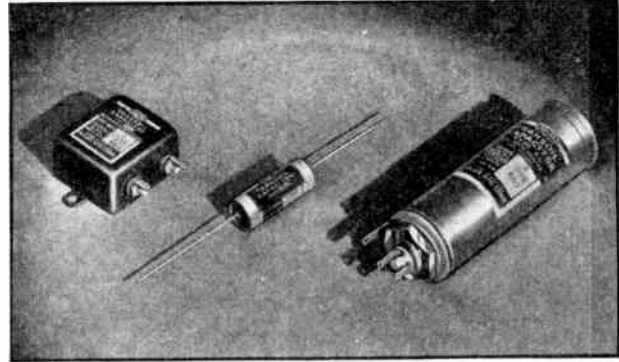
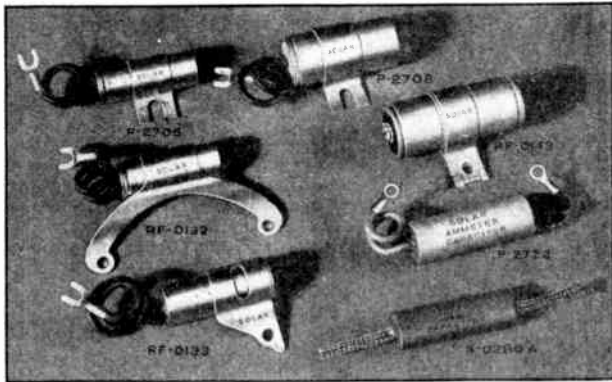

AUTO RADIO TYPES

• Built to satisfactorily withstand the difficult heat and vibration conditions encountered in auto usage.

AUTO GENERATOR CAPACITORS

Catalog Number	Capacity Mfd.	Size, Inches Diam.	Length
P-2702	.25	1 1/2	2
P-2705	.5	1 1/2	2
P-2708	1.	1 1/2	2 1/4

AUTO AMMETER CAPACITORS

P-2722	.5	3/4	2 1/4
P-2724	1.	1 1/2	2 1/2

DOME LIGHT FILTER

RF-0143	Cap. + Choke	1	2 5/8
---------	--------------	---	-------

SPECIAL FORD CAPACITORS

RF-0132	V-8 to 1936	1 1/2	2
RF-0133	1937, 1938, 1939	1 1/2	2

OVAL TUBULAR CAPACITOR

S-0286A	.5—120 V.	1 1/2 x 3/4 x 2 1/8
---------	-----------	---------------------

SPECIAL AUTO VIBRATOR UNIT

S-0286M	Dual .0008	1/4 x 1 1/4 x 1 1/8
---------	------------	---------------------

TYPE SDT HI-TEMP TUBULARS

Paper Tubulars Protected with High Temperature Wax for Use in Auto Radio Set "Hot Spots"

Catalog Number	Capacity Mfd.	D.C. Volts Working	Size, Inches Diam.	Length
SDT-0026	.002	600	3/8	1 1/4
SDT-0056	.005	600	7/8	1 1/4
SDT-016	.01	600	1/2	1 1/4
SDT-026	.02	600	7/8	1 3/8
SDT-056	.05	600	1 1/8	1 5/8
SDT-16	.1	600	3/8	2 1/4
SDT-014	.01	400	1 1/2	1 1/4
SDT-024	.02	400	1 1/2	1 5/8

VIBRATOR CAPACITORS

For high voltage paper tubulars, see VIM series on page K20. For special oil tubulars sealed in metal, see Type XTC at right.

TYPES XTC-XDC-XC

These hermetically-sealed units are popular for broadcast use, amateur transmitters, television and quality amplifiers. Transoil impregnation.

TYPE XTC—TUBULARS

Oil Impregnated—Metal Cases

Catalog Number	Capacity Mfd.	Operating Volts D.C.	Size, Inches Diam.	Length
XTC-16-.0005	.0005	1600	1 1/2	1 1/4
XTC-16-.001	.001	1600	1 1/2	1 1/4
XTC-16-.002	.002	1600	1 1/2	1 1/4
XTC-16-.003	.003	1600	1 1/2	1 1/4
XTC-16-.004	.004	1600	1 1/2	1 1/2
XTC-16-.005	.005	1600	1 1/2	1 1/2
XTC-16-.007	.007	1600	1 1/2	1 1/2
XTC-16-.01	.01	1600	1 1/2	1 3/8
XTC-16-.02	.02	1600	1 1/2	2
XTC-16-.05	.05	1600	1 1/2	2
XTC-16-.1	.1	1600	1 1/2	2
XTC-10-.01	.01	1000	1 1/2	1 1/2
XTC-10-.02	.02	1000	1 1/2	1 3/8
XTC-10-.05	.05	1000	1 1/2	2 1/8
XTC-10-.1	.1	1000	1 1/2	2 1/8

For still higher voltage metal-sealed tubulars, see Type XF on page K-24.

TYPE XDC—DRAWN SHELL CANS

Oil-impregnated—Oil-Filled

Catalog Number	Cap. Mfd.	Operating Volts D.C.	Can Size, Inches	Mtg. Ctrs. Inches
XDC-6-.1	.1	600	1 1/2 x 1 x 3/4	2 1/8
XDC-6-.25	.25	600	1 1/2 x 1 x 3/4	2 1/8
XDC-6-.5	.5	600	1 1/2 x 1 x 3/4	2 1/8
XDC-10-.1	.1	1000	1 1/2 x 1 x 3/4	2 1/8
XDC-10-.25	.25	1000	1 1/2 x 1 x 3/4	2 1/8

TYPE XC—ROUND INVERTED ALUMINUM CANS

3/4" Screwbase

Catalog Number	Capacity Mfd.	Operating Volts D.C.	Can Size, Inches Diam.	Height
XC-61	1	600	1 1/2	3
XC-62	2	600	1 1/2	3
XC-64	4	600	1 1/2	4 3/8
XC-11	1	1000	1 1/2	3
XC-12	2	1000	1 1/2	4 3/8
XC-155	.5	1500	1 1/2	3
XC-151	1	1500	1 1/2	4 3/8



TRANSMITTING CAPACITORS

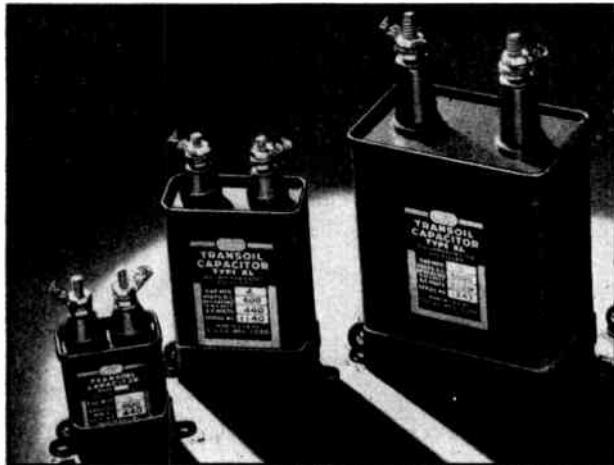

"TRANSOIL" TYPE XLC

Type XLC Transoil Filter Capacitors are oil-impregnated and oil-filled, sealed under vacuum to prevent ionization due to trapped air bubbles. Sections are rigid within sturdy metal containers. Every metal part is rust-proofed. The stand-off insulators are of the wet-process type. Unusual safety margins permit operation without injury even at 10% over-voltage. Separable clamps are arranged for mounting upright or inverted. Every Transoil capacitor is individually tested and guaranteed.

TYPE XLC—Rectangular Cans

Catalog Number	Capacity Mfd.	Can Size, Inches
----------------	---------------	------------------

600 D.C. OPER. VOLTS—440 R.M.S. RECT. A.C.

XLC-6-1	1	1 3/4 x 1 x 2 1/8
XLC-6-2	2	1 3/4 x 1 x 2 7/8
XLC-6-4	4	2 1/2 x 1 3/8 x 3 5/8

1000 D.C. OPER. VOLTS—660 R.M.S. RECT. A.C.

XLC-10-5	.5	1 3/4 x 1 x 2 1/8
XLC-10-1	1	1 3/4 x 1 x 2 7/8
XLC-10-2	2	1 3/4 x 1 x 4
XLC-10-4	4	2 1/2 x 1 3/8 x 4 3/4

XLC-10-5	5	3 3/4 x 1 1/4 x 3 3/4
XLC-10-6	6	3 3/4 x 1 1/4 x 4 3/4
XLC-10-8	8	3 3/4 x 1 1/4 x 4 3/4

(Listing continued at right)

"TRANSOIL" TYPE XLC—continued

Catalog Number	Capacity Mfd.	Can Size, Inches
----------------	---------------	------------------

1500 D.C. OPER. VOLTS—1000 R.M.S. RECT. A.C.

XLC-15-1	1	1 3/4 x 1 x 4
XLC-15-2	2	2 1/2 x 1 3/8 x 4 3/4
XLC-15-4	4	3 3/4 x 1 1/4 x 4 3/4

2000 D.C. OPER. VOLTS—1500 R.M.S. RECT. A.C.

XLC-20-.1	.1	1 3/4 x 1 x 2 1/8
XLC-20-.25	.25	1 3/4 x 1 x 2 7/8
XLC-20-.5	.5	1 3/4 x 1 x 2 7/8
XLC-20-1	1	2 1/2 x 1 3/8 x 3 5/8

XLC-20-2	2	3 3/4 x 1 1/4 x 4 3/4
XLC-20-4	4	3 3/4 x 2 1/4 x 4 3/4
XLC-20-5	5	3 3/4 x 2 1/4 x 4 3/4
XLC-20-6	6	3 3/4 x 3 1/8 x 4 3/4

2500 D.C. OPER. VOLTS—1800 R.M.S. RECT. A.C.

XLC-25-1	1	3 3/4 x 1 1/4 x 4 3/4
XLC-25-2	2	3 3/4 x 1 3/4 x 4 3/4
XLC-25-4	4	3 3/4 x 3 1/8 x 4 3/4

3000 D.C. OPER. VOLTS—2200 R.M.S. RECT. A.C.

XLC-30-.1	.1	1 3/4 x 1 x 2 7/8
XLC-30-.25	.25	2 1/2 x 1 3/8 x 3 5/8
XLC-30-.5	.5	2 1/2 x 1 3/8 x 3 5/8
XLC-30-1	1	3 3/4 x 2 1/4 x 4 3/4
XLC-30-2	2	3 3/4 x 3 1/8 x 4 3/4
XLC-30-4	4	3 3/4 x 4 1/8 x 5

4000 D.C. OPER. VOLTS—2800 R.M.S. RECT. A.C.

XLC-40-.1	.1	2 1/2 x 1 3/8 x 3 5/8
XLC-40-.25	.25	2 1/2 x 1 3/8 x 3 5/8
XLC-40-.5	.5	3 3/4 x 2 1/4 x 4 3/4
XLC-40-1	1	3 3/4 x 2 1/4 x 4 3/4
XLC-40-2	2	3 3/4 x 4 1/8 x 5 1/4
XLC-40-4	4	3 3/4 x 4 1/8 x 8 1/4

5000 D.C. OPER. VOLTS—3500 R.M.S. RECT. A.C.

XLC-50-.1	.1	2 1/2 x 1 3/8 x 4 3/4
XLC-50-.25	.25	3 3/4 x 1 1/2 x 4 3/4
XLC-50-.5	.5	3 3/4 x 2 1/4 x 4 3/4
XLC-50-1	1	3 3/4 x 4 1/8 x 4 3/4
XLC-50-2	2	3 3/4 x 4 1/8 x 6 1/4

6000 D.C. OPER. VOLTS—4400 R.M.S. RECT. A.C.

XLC-60-.1	.1	3 3/4 x 1 1/2 x 4 3/4
XLC-60-.25	.25	3 3/4 x 3 1/8 x 4 3/4



★ ★ ★ ★ ★ ★ ★ ★ ★ ★
TRANSMITTING CAPACITORS
TELEVISION CAPACITORS

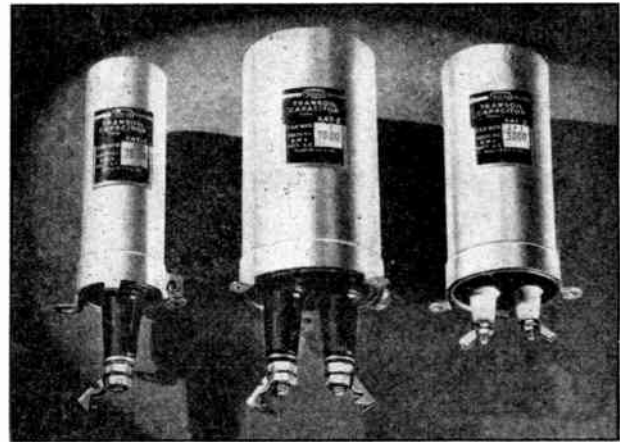

"SOLAREX" TYPE X

OIL-IMPREGNATED—OIL-FILLED

Solarex Filter Capacitors are the ideal type for advanced amateurs and general transmitting use where utmost value is a consideration. They are built of paper sections which are oil-impregnated under high vacuum; the carefully insulated assembly is rigidly held in round metal cans, oil-filled and hermetically sealed. Terminals are high quality porcelain stand-off insulators. Mounting is accomplished by detachable rings and the units may be used either upright or inverted. Each capacitor is individually tested and fully guaranteed.

600 D.C. or 440 R.M.S. Rect. A.C. W.V.—1200 Volts D.C. Test

Catalog Number	Capacity Mfd.	Dimensions, Inches	
		Diameter	Can Height
X-062	2	2	2 ³ / ₈
X-064	4	2	3 ³ / ₈

1000 D.C. or 660 R.M.S. Rect. A.C. W. V.—2000 Volts D.C. Test

X-11	1	2	1 ⁷ / ₈
X-12	2	2	2 ⁵ / ₈
X-14	4	2	4 ¹ / ₈

1500 D.C. or 1000 R.M.S. Rect. A.C. W.V.—3000 Volts D.C. Test

X-011	1	2	2 ⁵ / ₈
X-012	2	2	3 ³ / ₈
X-014	4	2 ¹ / ₂	4 ³ / ₈

2000 D.C. or 1500 R.M.S. Rect. A.C. W.V.—4000 Volts D.C. Test

X-21	1	2	3 ³ / ₈
X-22	2	2 ¹ / ₂	3 ⁵ / ₈
X-24	4	3	4 ¹ / ₄

3000 D.C. or 2200 R.M.S. Rect. A.C. W.V.—6000 Volts D.C. Test

X-31	1	2 ¹ / ₂	4 ⁵ / ₈
X-32	2	3	4 ¹ / ₄

Other types available on special quantity order.

HIGH VOLTAGE TYPES

FOR TELEVISION SERVICE

Built to special television specifications with adequate safety margins for the rigid requirements of television circuits. Oil-impregnated, oil-filled, in hermetically sealed cans with wet-process stand-off insulators and detachable mounting rings.

TYPE XAT—1

Single Section; Grounded Can; Single Insulator

Catalog Number	Capacity Mfd.	D.C. Volts Operating	Size, Inches	
			Diam.	Length
*XAT-1-01	.1	3000	1 ¹ / ₂	3
*XAT-1-025	.25	3000	2	2 ³ / ₄
XAT-1-71	.01	7500	1 ¹ / ₂	3 ¹ / ₂
XAT-1-12	.02	7500	1 ¹ / ₂	4 ¹ / ₂
XAT-1-75	.05	7500	2	4 ¹ / ₂

TYPE XAT—2

Single Section. Insulated from Can; Two Insulators

XAT-2-001	1.	2000	2 ¹ / ₂	4 ¹ / ₈
XAT-2-200	2.	2000	3	4 ¹ / ₂
*XAT-2-025	.25	3000	2 ¹ / ₂	2 ¹ / ₂
XAT-2-05	.5	3000	2 ¹ / ₂	3 ¹ / ₈
XAT-2-100	1.	3000	3	4 ¹ / ₂
*XAT-2-13	.03	7500	2 ¹ / ₂	3 ⁷ / ₈
XAT-2-75	.05	7500	2 ¹ / ₂	4 ¹ / ₈
XAT-2-71	.1	7500	3	4 ¹ / ₂

HIGH VOLTAGE TUBULARS

OIL-IMPREGNATED—OIL-FILLED—SEALED IN METAL OUTSIDE INSULATING TUBE



TYPE XF

XF-2-25	.005	2000	1 ¹ / ₈	1 ⁷ / ₈
XF-2-11	.01	2000	1 ¹ / ₈	1 ⁷ / ₈
*XF-2-01	.1	2000	1 ¹ / ₈	4
XF-3-25	.005	3000	1 ¹ / ₈	2 ¹ / ₈
XF-3-11	.01	3000	1 ¹ / ₈	2 ¹ / ₈
XF-3-12	.02	3000	1 ¹ / ₈	2 ⁵ / ₈
XF-3-13	.03	3000	1 ¹ / ₈	2 ⁷ / ₈
*XF-3-15	.05	3000	1 ¹ / ₈	4 ¹ / ₈
XF-3-01	.1	3000	1 ¹ / ₈	3 ³ / ₄

*Stock items. Other capacitors built to special order only.



★ ★ ★ ★ ★ ★ ★ ★ ★ ★ TRANSMITTING MICA CAPACITORS

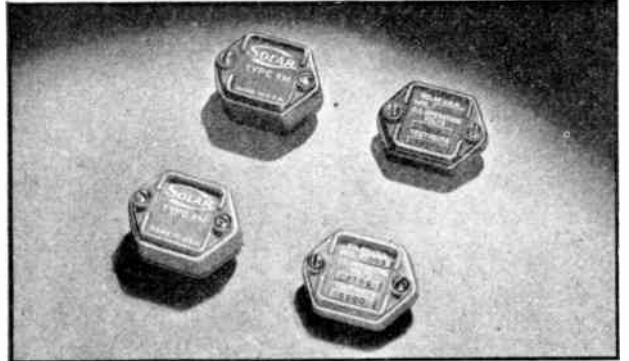
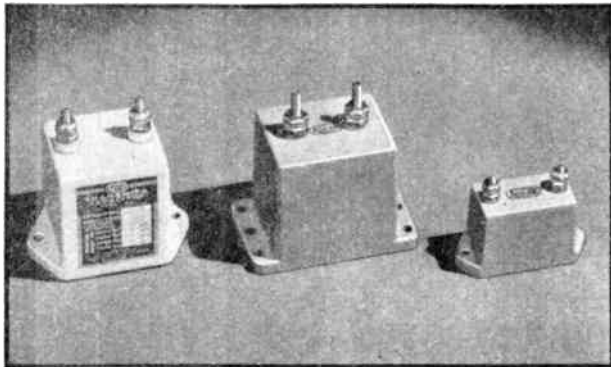

"TRANSMICA" TYPES

- High Q Characteristics
- Vacuum treated

Type XA is customarily employed in amateur equipment for intermittent use only; not designed for continuous duty.

For broadcast station use, and similar heavy-duty purposes, Types XR, XS and XH are highly recommended for complete dependability under the most difficult continuous operation.

TYPE XA—Porcelain Cases

Case Size $3\frac{1}{8}'' \times 2\frac{5}{8}'' \times 2\frac{1}{4}''$ — Mtg. Centers $3\frac{1}{4}''$

Catalog Number	Capacity Mfd.	Maximum D.C. Voltage		Maximum Amperes Operating		
		15000	7500	3750	1875	1875
XA-12-45	.00005	12500	3.5	2.5	1.7	1.
XA-12-21	.001	12500	10.	10.	11.	12.
XA-7-22	.002	7000	9.	9.	10.	10.
XA-7-25	.005	7000	10.	12.	14.	16.
XA-7-11	.01	7000	10.	12.	14.	16.
XA-2-01	.1	2000	12.	14.	16.	18.

TYPE XR—Low-loss Bakelite Cases*

Case Size— $2'' \times 1\frac{1}{2}'' \times \frac{3}{8}''$ — Mtg. Centers $2\frac{3}{8}''$

Catalog Number	Capacity Mfd.	Maximum D.C. Voltage		Maximum Amperes Operating		
		3000	1000	300	100	100
XR-3-31	.0001	3000	2.2	.8	.30	.10
XR-3-35	.0005	3000	4.	2.	1.	.55
XR-3-21	.001	3000	5.	3.	1.6	.80
XR-2-25	.005	2000	8.5	6.5	4.	2.
XR-1-11	.01	1000	10.	8.	5.	2.5
XR-25-01	.1	250	11.	12.	10.	6.

TYPE XS—Standard Bakelite Cases*

Case Size— $2\frac{1}{2}'' \times 1\frac{3}{4}'' \times 1\frac{1}{4}''$ — Mtg. Centers $2\frac{5}{8}''$

Catalog Number	Capacity Mfd.	Maximum D.C. Voltage		Maximum Amperes Operating		
		5000	1.5	.8	.2	.07
XS-5-45	.00005	5000	1.5	.8	.2	.07
XS-5-21	.001	5000	7.	4.	2.	1.
XS-6-22	.002	6000	9.	5.	3.	1.8
XS-2-11	.01	2000	10.	8.	5.	2.
XS-2-13	.03	2000	14.	20.	15.	7.
XS-5-01	.1	500	17.	20.	15.	8.

For low-loss Bakelite case for Type XS, add \$1.00 to list.

TYPE XH—Standard Bakelite Cases*

Case Size— $3'' \times 2\frac{7}{8}'' \times 2\frac{3}{8}''$ — Mtg. Centers $3\frac{1}{8}''$

Catalog Number	Capacity Mfd.	Maximum D.C. Voltage		Maximum Amperes Operating		
		8000	3.25	1.75	1.	.3
XH-8-31	.0001	8000	3.25	1.75	1.	.3
XH-8-35	.0005	8000	8.5	6.	3.	1.
XH-8-21	.001	8000	10.	8.5	4.5	1.5
XH-8-22	.002	8000	11.	11.	7.5	2.5
XH-8-11	.01	8000	16.	20.	15.	8.
XH-2-01	.1	2000	18.	25.	22.	12.

For low-loss Bakelite case for Type XH, add to list.

*Standard capacity tolerance for Types XR, XS and XH is $\pm 5\%$.

HIGH VOLTAGE MICAS

TYPE XM—BAKELITE-MOLDED

- High Q Characteristics
- Vacuum heat-treated
- Exceptional stability
- Cap'y tolerance $\pm 10\%$.

Closer tolerances available on special order. Available in either standard or low-loss Bakelite.*

Size A— $1\frac{3}{4}'' \times 1\frac{1}{16}'' \times \frac{9}{16}''$ thick — $1\frac{1}{4}''$ mtg. centers.
Size B— $1\frac{3}{4}'' \times 1\frac{1}{16}'' \times \frac{7}{8}''$ thick — $1\frac{1}{4}''$ mtg. centers

600 V. D.C. OPERATING—1000 V. D.C. TEST

Catalog Number	Capacity Mfd.	Size
XM-6-45	.00005	A
XM-6-31	.0001	A
XM-6-35	.0005	A
XM-6-21	.001	A
XM-6-22	.002	A
XM-6-25	.005	A
XM-6-11	.01	A
XM-6-12	.02	A
XM-6-125	.025	B
XM-6-15	.05	B

1200 V. D.C. OPERATING—2500 V. D.C. TEST

Catalog Number	Capacity Mfd.	Size
XM-12-45	.00005	A
XM-12-31	.0001	A
XM-12-32	.0002	A
XM-12-35	.0005	A
XM-12-21	.001	A
XM-12-22	.002	A
XM-12-25	.005	A
XM-12-11	.01	A
XM-12-115	.015	B
XM-12-12	.02	B
XM-12-13	.03	B

2500 V. D.C. OPERATING—5000 V. D.C. TEST

Catalog Number	Capacity Mfd.	Size
XM-25-45	.00005	A
XM-25-31	.0001	A
XM-25-32	.0002	A
XM-25-35	.0005	A
XM-25-21	.001	A
XM-25-22	.002	A
XM-25-25	.005	A
XM-25-11	.01	B
XM-25-115	.015	B

*For low-loss Bakelite case, add \$.25 to list.



★ ★ ★ ★ ★ ★ ★ ★ ★ ★

MICA CAPACITORS TRANSMITTING & BROADCAST

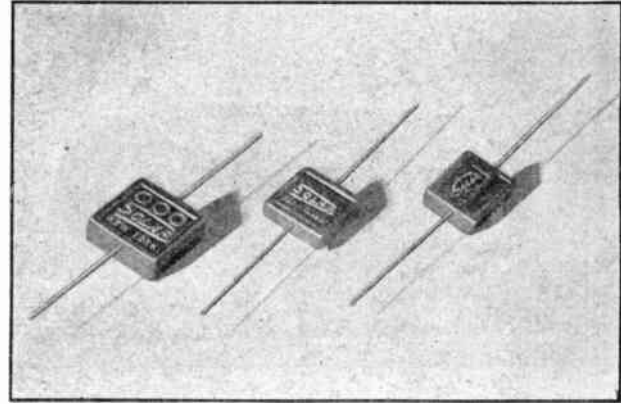
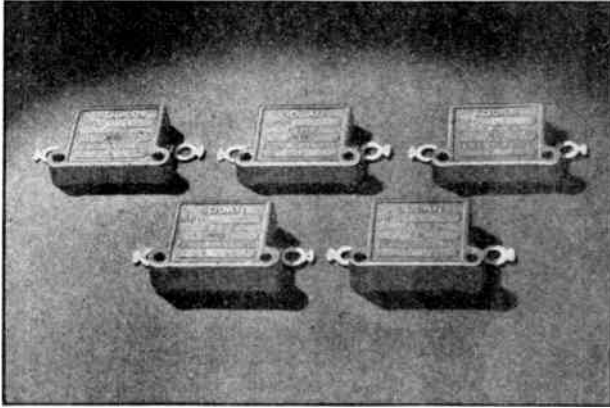

HIGH VOLTAGE MICAS

TYPE XQ

Type XQ molded mica capacitors are vacuum-treated for special stability and have high Q characteristics.

Size A— $1\frac{1}{4}$ " x $1\frac{1}{8}$ " x $\frac{11}{16}$ " thick.

Size B— $1\frac{1}{4}$ " x $1\frac{1}{8}$ " x $\frac{1}{16}$ " thick.

Insulated mounting centers, A or B— $1\frac{1}{16}$ ".

Terminal mounting centers, A or B— $1\frac{3}{4}$ ".

Available in either standard or low-loss Bakelite cases.*

Standard capacity tolerance is $\pm 10\%$. Closer tolerances available on special order.

600 V. D.C. OPERATING—1200 V. D.C. TEST

Catalog Number	Capacity Mfd.	Size
XQ-.6-45	.00005	A
XQ-.6-31	.0001	A
XQ-.6-35	.0005	A
XQ-.6-21	.001	A
XQ-.6-22	.002	A
XQ-.6-25	.005	A
XQ-.6-11	.01	A
XQ-.6-12	.02	B
XQ-.6-125	.025	B
XQ-.6-13	.03	B

1200 V. D.C. OPERATING—2500 V. D.C. TEST

Catalog Number	Capacity Mfd.	Size
XQ-1.2-45	.00005	A
XQ-1.2-31	.0001	A
XQ-1.2-32	.0002	A
XQ-1.2-325	.00025	A
XQ-1.2-35	.0005	A
XQ-1.2-21	.001	A
XQ-1.2-22	.002	A
XQ-1.2-23	.003	A
XQ-1.2-24	.004	B
XQ-1.2-25	.005	B
XQ-1.2-11	.01	B

2500 V. D.C. OPERATING—5000 V. D.C. TEST

Catalog Number	Capacity Mfd.	Size
XQ-2.5-45	.00005	A
XQ-2.5-31	.0001	A
XQ-2.5-32	.0002	A
XQ-2.5-35	.0005	A
XQ-2.5-21	.001	A
XQ-2.5-22	.002	B
XQ-2.5-23	.003	B
XQ-2.5-25	.005	B

*For low-loss Bakelite case, add \$.25 to list.

STANDARD MICAS

Standard molded mica units, 1000 volts D.C. test, $1\frac{1}{4}$ -inch leads.

TYPES MW—MT—MO

Capacity Mfd.	MW $\frac{3}{4}$ " sq.	MT $\frac{5}{8}$ " sq.	MO $\frac{1}{16}$ " x $1\frac{1}{16}$ "
	Catalog Number	Catalog Number	Catalog Number
.000025		MT-1306	MO-1406
.00003		MT-1307	MO-1407
.00004		MT-1308	MO-1408
.00005	MW-1210	MT-1310	MO-1410
.0001	MW-1216	MT-1316	MO-1416
.0002	MW-1218	MT-1318	MO-1418
.00025	MW-1219	MT-1319	MO-1419
.0003	MW-1220	MT-1320	MO-1420
.0004	MW-1221	MT-1321	
.0005	MW-1222	MT-1322	
.001	MW-1227	MT-1327	
.002	MW-1233		
.003	MW-1235		
.004	MW-1237		
.005	MW-1239		

SILVER-MICA

TYPES MWS—MOS

Silver-mica molded in low-loss Bakelite. Marked with silver dot. List prices are for standard $\pm 10\%$ tolerance. For $\pm 5\%$ tolerance, add 10% to prices. For $\pm 3\%$, add 30%. For $\pm 2\%$, add 50%. 1000 V. D.C. Test.

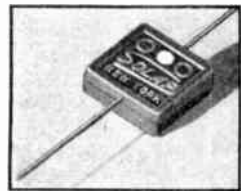

TYPE MWS— $\frac{3}{4}$ " SQ.

Catalog Number	Capacity Mfd.
MWS-100	.0001
MWS-250	.00025
MWS-500	.0005
MWS-700	.0007
MWS-1000	.001
MWS-1500	.0015
MWS-2000	.002
MWS-2500	.0025
MWS-3000	.003
MWS-4000	.004
MWS-5000	.005

TYPE MOS— $\frac{1}{16}$ " x $1\frac{1}{16}$ "

Catalog Number	Capacity Mfd.
MOS-5	.000005
MOS-10	.00001
MOS-20	.00002
MOS-30	.00003
MOS-40	.00004
MOS-50	.00005
MOS-70	.00007
MOS-100	.0001
MOS-150	.00015
MOS-200	.0002
MOS-250	.00025



CAPACITOR ANALYZERS

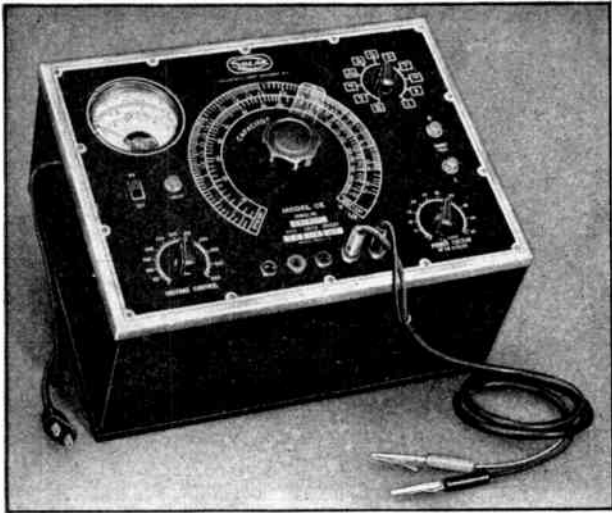

MODEL CE EXAM-ETER

Gives the whole condenser story at a glance! The only capacitor analyzer on the market having all these features—including Quick-Check dynamic testing.

- **QUICK-CHECK DYNAMIC TEST:** For Shorts, Opens, High R.F. Impedance, Intermittents. Tests can be made without the bother of removing capacitors from the receiver. Most defectives will be quickly located this way. The few exceptions can be readily checked upon removal from chassis.
- **CAPACITY BRIDGE:** Measures from 10 mmf. to 2000 mfd.
- **RESISTANCE BRIDGE:** Measures resistance from 50 ohms to 7.5 megohms.
- **MEGOHM METER:** Measures insulation resistance directly from 2 to 10,000 megohms.
- **MILLIAMMETER:** Measures leakage to 50 milliamperes at 0-550 V. D.C.
- **POWER FACTOR:** Measures to 50% P.F.
- **D.C. VACUUM TUBE VOLTMETER:** Measures D.C. Voltage 0-600 volts.
- **A.C. VACUUM TUBE VOLTMETER:** Measures A.C. Voltage 0-30 V. A.C.
- **CONTINUOUSLY VARIABLE D.C. VOLTAGE SUPPLY:** Provides 0 to 550 V. D.C.
- **CONTINUITY CHECKER.**
- **TESTS A.C. MOTOR STARTING CAPACITORS.**
- **TESTS FENCE CONTROL CAPACITORS TO 2000 MFD.** Size, 8 1/2" x 11 1/2" x 5 1/2" high. Weight 12 lbs.

CAPACITOR EXAM-ETERS

Catalog Number	Description
CE-1-60	CE Capacitor Exam-eter for 110 v., 60 cycles
CE-2-U	CE Capacitor Exam-eter for 110-220 v., 25-60 cycles

SPARE PARTS AND ACCESSORIES

Catalog Number	Description
CE-6L6	Tube type 6L6
QC-J5G	Tube type 6J5GT
QC-465	Test leads adjusted for oscillator circuit...
CE-300	Carrying case for either CE-1-60 or CE-2-U

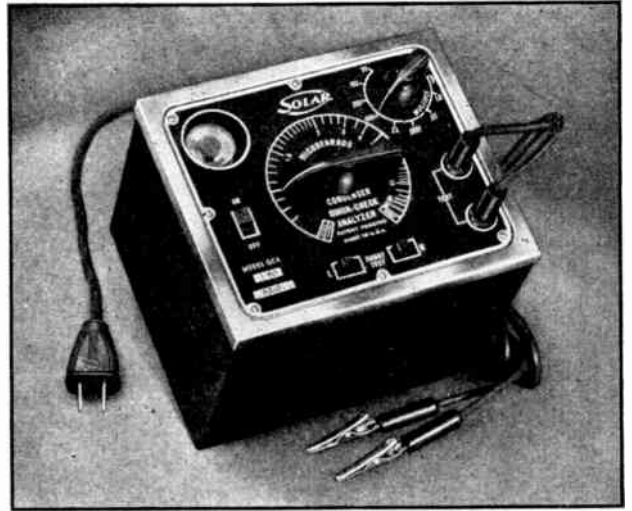

"QUICK-CHECK" MODEL QCA

Provides all usual tests—plus dynamic checking. A compact capacitor analyzer of unusual value.

- **QUICK-CHECK DYNAMIC TEST:** For Shorts, Opens, High R.F. Impedance, Intermittents. Tests can be made without the bother of removing capacitors from the receiver. Most defectives will be quickly located this way. The few exceptions can be readily checked upon removal from chassis.
- **CAPACITY BRIDGE:** Measures from .0002 to 70. mfd.
- **POWER FACTOR:** Indicates high and unsatisfactory P.F.
- **INSULATION RESISTANCE:** Tests made at 500 volts D.C. check insulation resistance of paper, mica and trimmers.
- **CONTINUITY METER:** Tests continuity of circuits, detecting opens in coils, transformers, etc. 5 1/2" x 6 1/2" x 4 3/4" high. 6 1/2 lbs.

Catalog Number

QCA-1-60	Quick-Check Analyzer for 110 v., 60 cycles
QCA-2-U	Quick-Check Analyzer for 110-220 v. 50-60 cycles

MODEL-QC

A valuable accessory where an older type capacitor analyzer is already in use. Incorporates the Quick-Check dynamic testing feature for detecting opens, shorts, intermittents, r.f. impedance and power factor—with capacitor in or out of circuit. Capacitance bridge and leakage test not included. Size, 5" x 6" x 4 1/2" high. Weight, 5 1/2 lbs.



QC-1-60	QC Quick-Check for 110 v., 60 cycles
QC-2-U	QC Quick-Check for 110-220 v., 50-60 cycles

SPARE PARTS AND ACCESSORIES

QC-301	Zipper Carrying Case for Model QCA
QC-300	Zipper Carrying Case for Model QC
QC-450	Test bench mounting rim, for Models QCA and QC
QC-465	Test leads for Models QCA, QC
QC-6G5	Tube type 6G5/6U5
QC-J5G	Tube type 6J5GT
QC-Z6G	Tube type 25Z6GT

SOLAR

★ ★ ★ ★ ★ ★ ★ ★ ★ ★

CAPACITOR ANALYZERS

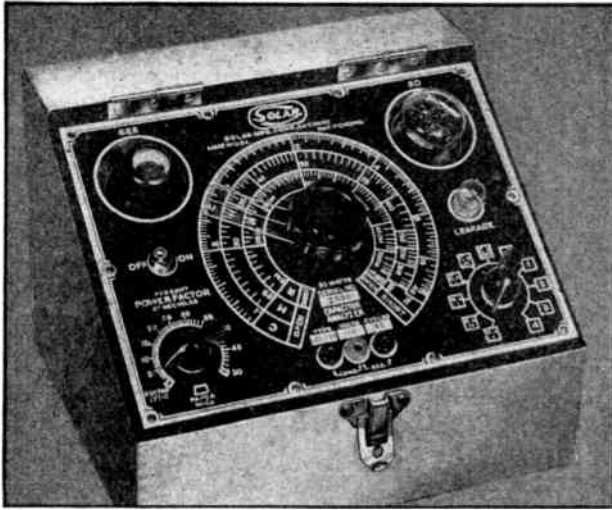

SPECIAL MODEL CC

Plus value! All features of Model CB—plus—

- High Capacity Scale
 - High Test Voltage
 - Simplified Scales
 - Sloping Panel
1. CAPACITY—measures capacity of electrolytic, paper, mica and air condensers including Motor Starting Condensers. Range .00001 to 800 mfd.
 2. POWER FACTOR—measures power factor of any standard electrolytic condenser, directly on a scale, in percentage. These measurements include those of A.C. Electrolytics.
 3. RESISTANCE—measures resistance directly in ohms. A long scale covering two ranges 50 to 2,000,000 ohms.
 4. INSULATION—measures insulation resistance of condensers and insulation. Tests are made at voltages up to 600 volts D.C. provided by built-in power supply.
 5. DETECTS DEFECTIVE CONDENSERS—directly indicates leaky, shorted, wrong capacity units, and "intermittents." Test voltages to 600 D.C. are available.
 6. IS A USEFUL CONTINUITY METER—for any circuits.
 7. COLOR-CODED SCALES—three unusually legible scales are provided, the outer (red) for capacity measurements to 70 mfd.; the center (black) for A.C. electrolytic capacities to 800 mfd.; the inner (blue) for resistance.
 8. SIMPLIFIED READING—the use of the open scales is quick and fool-proof, in connection with the multipliers marked on switch settings.
 9. CATHODE-RAY TUBE BALANCING—the magic 6E5 tube gives sensitive visual balance "quick as a wink."
 10. SELF-CONTAINED—COMPACT—PORTABLE—beautiful sloping panel. Size 9 $\frac{3}{4}$ " x 8 $\frac{1}{4}$ " x 6 $\frac{5}{8}$ ". Weight 8 pounds.

Catalog Number	Description
CC-1-60	CC Capacitor Analyzer for 110 v., 60 cycles
CC-2-U	CC Capacitor Analyzer for 110-220 v., 25-60 cycles

SPARE PARTS

Catalog Number	Description
CB-6E5	Tube type 6E5
CC-80	Tube type 80
CB-N	Leakage neon tube

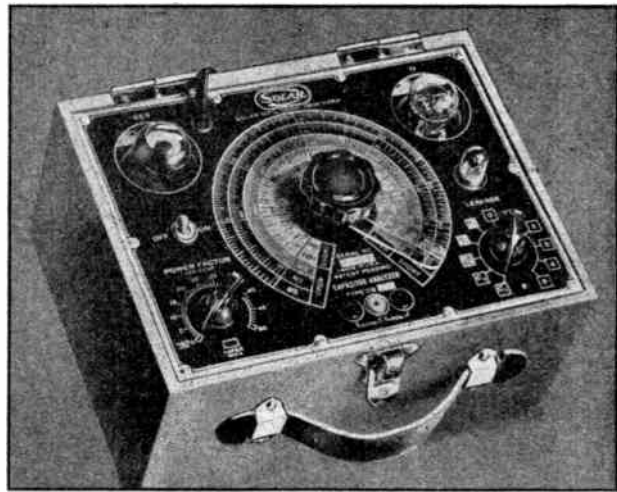

STANDARD MODEL CB

First in the field—still the standard! Capacity, power factor, leakage, resistance readings directly on the panel. For simplified measurements, dials are color-coded to match settings. Portable case with detachable lid.

FEATURES

1. MEASURES CAPACITY of electrolytic, paper, mica and air condensers. Range .00001 to 70. mfd.
2. MEASURES POWER FACTOR of any standard electrolytic condenser, directly on a scale, in percentage.
3. MEASURES RESISTANCE—directly in ohms, of resistors of all types. Range 50 to 2,000,000 ohms.
4. MEASURES INSULATION RESISTANCE of condensers and insulation. Tests are made at voltages up to 450 volts D.C., provided by built-in power supply.
5. DETECTS DEFECTIVE CONDENSERS—directly indicates leaky, shorted, wrong capacity units, and "intermittents."
6. IS A USEFUL CONTINUITY METER—for any circuits.
7. COLOR-CODED SCALES mean fool-proof operation. 45 linear inches of scales mean accuracy.
8. DIRECT READING of all measurements eliminates extra charts and annoyances.
9. CATHODE-RAY TUBE BALANCING—the magic 6E5 tube gives sensitive visual balance "quick as a wink."
10. SELF-CONTAINED—COMPACT—PORTABLE. Size 9 $\frac{1}{2}$ " x 7 $\frac{1}{8}$ " x 6 $\frac{1}{4}$ ". Weight 7 pounds.

Catalog Number

CB-1-60	CB Capacitor Analyzer for 110 v., 60 cycles
CB-2-U	CB Capacitor Analyzer for 110-220 v., 25-60 cycles

SPARE PARTS

Catalog Number	Description
CB-6E5	Tube type 6E5
CB-V	Tube type I-V
CB-N	Leakage neon tube



★ ★ ★ ★ ★ ★ ★ ★ ★ ★

RADIO-NOISE SUPPRESSORS TRIMMER CONDENSERS

ELIM-O-STATS

Solar maintains a complete interference laboratory where engineers solve radio-noise problems of all types. The Elim-o-stats listed below should take care of all ordinary cases of interference either at the appliance or at the radio receiver as noted. For exceptional cases write full details for engineering advice.



TYPE RA—Universal Elim-o-stat
To eliminate interference of low intensity. It slips over the prongs of the line cord plug.

TYPE RB—Universal Elim-o-stat
Plugs directly into the electrical outlet and the radio line cord plugs into the Elim-o-stat. Moderate price type for general use.

TYPE AD—Appliance Elim-o-stat
Similar to Type RB, but with ground connection binding post. Use with household appliances.

TYPE RN—Receiver Elim-o-stat
High efficiency capacitive-inductive type. Sectional band suppression construction with coils designed for both broadcast and short-wave bands.

JUMBO—Universal Elim-o-stat
Capacitive-inductive type for use either at the radio receiver or at the offending appliance. A popular merchandising leader.

TYPE AE—Shaver Elim-o-stat
Approved by the largest manufacturers of electric razors because of its superior effectiveness in suppressing radio noise. Capacitive-inductive type.

TYPE AR—Shaver Elim-o-stat
Carefully designed capacitive type which is very convenient to use.

TYPE AH—Appliance Elim-o-stat
Large capacitive-inductive type filter of the sectional band suppression type. Rated at 5 amperes 110 v. A.C., making it useful for larger appliances or with several at once.

TYPE AL—Appliance Elim-o-stat
Especially designed for application to oil-burners and similar permanent installations. Sectional band suppression capacitive-inductive construction, in metal cut-out box with facilities for connecting BX. Rated at 5 amperes, 110 volts A.C.-D.C.

TYPE AFL—Fluorescent Elim-o-stat
Capacitive-inductive type for fluorescent lighting application. Designed for channel mounting. Rated at 3 amperes, 110 v. A.C.-D.C. Dimensions, 6 1/2" x 2 1/4" x 1 1/4".



Additional types available, for special purposes, on quantity order.

TYPE T TRIMMERS

Solar engineering research and production care are reflected in the high quality and complete dependability of these trimmer capacitors. They are easily adjustable and feature excellent freedom from drift. Both Bakelite and ceramic base types are available.

Where quality is the prime consideration, use Solar trimmers for most satisfactory results.

TYPE TB—Ceramic Base; Body Size
5/8" x 3/4"

Catalog Number	Capacity Range Mmf.
TB-30	3-30
TB-90	4-90
TB-180	35-180

TYPE TC-D—Dual Ceramic Size 5/8" x 3/4"

TC-D-30	3-30
TC-D-70	5-70
TC-D-140	50-140

TYPE TP—Ceramic Base; Body Size
5/8" x 57/64"

TP-130	7-130
TP-260	15-260
TP-490	85-490
TP-750	160-750
TP-1140	330-1140
TP-1400	440-1400

TYPE TYM—Flanged Bakelite Base;
Size 3/2" x 3/2"

TYM-10	1.1-10
TYM-20	2-20
TYM-30	3-30

TYPE TR—Large Ceramic Base Size
1 1/8" x 1 3/4"

TR-70	4-70
TR-140	60-140
TR-220	90-220
TR-400	170-400
TR-600	300-600
TR-800	400-800
TR-1200	600-1200
TR-1600	1000-1600

TYPE TSS—Ceramic Base; M't'g Stud
1 1/8" x 1 1/8"

TSS-70	40-70
TSS-140	60-140
TSS-220	90-220
TSS-600	300-600

TYPE TD—Dual Ceramic Base
1 23/64" x 1 23/64"

TD-70	15-70
TD-220	35-220
TD-600	95-600



Most commonly used values are listed. Other ranges on special quantity orders.



SOLAR PRICE LIST

EFFECTIVE SEPTEMBER 26, 1941

Catalog Number	List Price	Catalog Number	List Price	Catalog Number	List Price	Catalog Number	List Price	Catalog Number	List Price	Catalog Number	List Price	Catalog Number	List Price
Page K-15				Page K-19									
"Red-Caps"				Type ZD									
R-020	\$.60	DT-859B	.90	LG5-16	1.75	D-813	1.90	TT-01	.50	S-0219	.20		
R-210	.60	DT-859C	1.10	LG5-44	1.45	D-8131	2.10	TT-025	.60	S-0223	.20		
R-215	.70	DT-859D	1.20	LG5-48	1.65	D-8132	2.40	TT-05	.75	S-0228	.20		
R-220	.75	DT-860A	.70	LG5-88	1.80	D-8133	2.85	TT-1	1.10	S-0238	.25		
R-230	.80	DT-860B	1.00	LG5-816	2.00	D-8134	3.45	TT-2	1.65	S-0243	.30		
R-240	.85	DT-866	.50	LG5-888A	2.65	D-820	1.95	TT-4	3.25	S-0256	.30		
R-310	.75	DT-868	.55	LG2-8	1.00	D-838	2.80	TT-22	.50	S-0263	.45		
R-320	1.05	DT-868B	.60	LG2-16	1.30							S-0267	.60
R-505	.75	DT-868A	.70	LG2-20	1.45							S-0235	.25
R-510	.80	DT-868C	.75	LG2-30	1.70							S-0245	.30
R-515	1.05	DT-869D	.80	LG2-88	1.50							S-0261	.45
R-520	1.20	DT-869E	.85	LG2-816	1.75							S-0266	.60
R-610	1.20	DT-869F	1.10	LG2-1616	2.00								
R-2205	1.00	DT-873	.50										
R-1010	1.05	DT-874	.55										
R-2020	1.30	DT-875	.70										
R-3030	1.50	DT-876	.85										
R-115	1.45	DT-877	1.20										
		DT-878	.50										
		DT-879	.50										
		DT-882	.60										
		DT-885	.85										
"Minicaps"				Type DH				Type DY					
M-010	\$.50	DH-201	\$.75	DY-10	\$.90								
M-025	.60	DH-82	.60	DY-20	1.35								
M-5010	.55	DH-162	.90	DY-30	1.65								
M-5025	.70	DH-83	.70	DY-40	1.95								
M-50100	1.20	DH-163	1.00	DY-41	1.20								
M-204	.50	DH-84	.75	DY-61	1.20								
M-208	.55	DH-164	1.10	DY-63	1.35								
M-212	.60	DH-85	1.10	DY-65	1.65								
M-216	.70	DH-2020	1.00	DY-66	1.35								
M-220	.75	DH-20201	1.30	DY-70	1.20								
M-224	.75	DH-30301	1.75	DY-71	1.80								
M-230	.80	DH-50501	2.00	DY-94	1.45								
M-240	.85	DH-882	1.05	DY-92	2.00								
M-258	.60	DH-883	1.15	DY-90	1.45								
M-2516	.90	DH-884	1.30	DY-97	1.60								
M-308	.70	DHS-20201	1.65	DY-98	1.90								
M-316	1.00	DHS-882	1.35	DY-99A	1.90								
M-404	.70	DHS-883	1.50	DY-105	1.90								
M-408	.75	DHS-16163	2.20	DY-106	2.10								
M-412	.90	DHS-884	1.65	DY-150	1.90								
M-416	1.10	DHS-8164	2.00	DY-144	2.00								
M-420	1.20	DHS-16164	2.40	DY-103	1.50								
M-508	1.10	DHTN-222	1.75	DY-103A	1.80								
M-011	.85	DHTN-422	1.80	DY-104	1.75								
M-288	1.00	DHTN-3211	1.80	DY-110	2.05								
M-816	1.05	DHTN-112	2.00	DY-111	1.35								
M-1616	1.15	DHTN-212	2.25	DY-133	1.50								
M-2020	1.30	DHTS-882	1.80	DY-134	1.90								
M-488	1.30	DHTS-16162	2.55	DY-141	1.65								
		DHTS-88422	2.00	DY-142	1.90								
		DHTS-		DY-145	2.70								
		816422	2.40	DY-1010	2.30								
		DHTS-8883	2.00	DY-1030	2.80								
		DHTS-8884	2.25	DY-1020	2.05								
				DYP-3	.06								
				DYP-4	.06								
				DYP-7	.09								
				DYP-8	.09								
Service Cartons				Page K-17				Page K-18					
M-3	\$3.75												
M-4	2.75												
M-5	3.50												
Page K-16				"Little Giants"									
Type DT				Type D									
DT-856	\$.70	LG5-2	\$.80	D-800	\$1.80								
DT-857	.70	LG5-4	.90	D-808	1.30								
DT-858	.70	LG5-8	1.15										
DT-859A	.75	LG5-10	1.40										
		LG5-12	1.60										
				Type DD									
				Type DM									
				Type DI									
				Type DO									
				Type DP									
				Type DQ									
				Type DZ									
				TYPE DGM									
				Type Z and ZV									
				Type ZK & ZM									
				Hardware									
				Mounting Straps									
				"Sealdtite" Tubulars									
				"Tom Thumb"									
				Types PFR & PF									
				High Temperature Types									
				Auto Ignition Types									
				Hearing-Aid Types									
				Page K-20									
				Page K-21									
				Page K-19									
				Page K-18									
				Page K-17									
				Page K-16									
				Page K-15									
				Page K-14									
				Page K-13									
				Page K-12									
				Page K-11									
				Page K-10									
				Page K-9									
				Page K-8									
				Page K-7									
				Page K-6									
				Page K-5									
				Page K-4									
				Page K-3									
				Page K-2									
				Page K-1									

Federal Excise Taxes, if any apply, are to be added to these prices.
SUBJECT TO CHANGE WITHOUT NOTICE

SOLAR PRICE LIST

EFFECTIVE SEPTEMBER 26, 1941

Catalog Number	List Price	Catalog Number	List Price	Catalog Number	List Price	Catalog Number	List Price	Catalog Number	List Price	Catalog Number	List Price	Catalog Number	List Price
Domino Type MPW		XDC-10-.1	2.20	X-011	4.20	Type XH*		XQ-1.2-22	1.65	MWS-1000	1.50	CB-6E5	1.45
MPW-4103	\$.45	XDC-10-.25	2.65	X-012	5.70	XH-8-31	\$21.60	XQ-1.2-23	1.90	MWS-1500	1.80	CB-V	.90
MPW-4109	.45	Type XC		X-014	7.50	XH-8-21	33.60	XQ-1.2-24	1.90	MWS-2000	1.80	CB-N	.75
MPW-4115	.55	XC-61	\$2.70	X-21	5.40	XH-8-35	30.00	XQ-1.2-25	2.10	MWS-2500	2.40	Page K-29	
MPW-4129	.40	XC-62	3.30	X-22	6.00	XH-8-21	33.60	XQ-1.2-11	3.40	MWS-3000	2.70	Elim-O-Stats	
MPW-4135	.45	XC-64	4.50	X-24	8.40	XH-8-22	33.60	XQ-2.5-45	1.10	MWS-4000	2.85	Type RA	\$.60
MPW-4139	.55	XC-11	3.00	X-31	10.80	XH-8-11	48.00	XQ-2.5-31	1.10	MWS-5000	3.00	Type RB	.90
MPW-4140	.60	XC-12	3.90	X-32	13.20	XH-2-01	42.00	XQ-2.5-32	1.30	Type MOS			
MPW-4145	.45	XC-155	3.60	Type XAT-1		*For low-loss Bake-lite case for Type XH, add \$1.80 to list.		XQ-2.5-35	1.50	MOS-5	\$.60	Type AD	1.50
MPW-4147	.50	XC-151	3.90	XAT-1-01	\$6.00	Type XM*		XQ-2.5-21	1.80	MOS-10	.50	Type Rn	7.20
MPW-4148	.55	Page K-23		XAT-1-025	7.80	XM-6-45	\$.75	XQ-2.5-22	2.70	MOS-20	.50	Jumbo	6.00
MPW-4157	.45	Type XLC		XAT-1-71	7.20	XM-6-31	.75	XQ-2.5-23	3.30	MOS-30	.50	Type AE	3.60
MPW-4163	.50	XLC-6-1	\$4.20	XAT-1-12	7.80	XM-6-35	.75	XQ-2.5-25	4.20	MOS-40	.50	Type AR	1.20
MPW-4165	.70	XLC-6-2	5.10	XAT-1-75	9.60	XM-6-21	.75	XQ, add \$.30 to list.		MOS-50	.50	Type AR	1.20
MPC-1	.09	XLC-6-4	6.60	Type XAT-2		XM-6-31	.75	Type MW		MOS-70	.50	Type AH	9.00
Page K-22		XLC-10-5	3.60	XAT-2-100	\$7.20	XM-6-22	.80	MW-1210	\$.20	MOS-100	.50	Type AL	9.60
Auto Radio Types		XLC-10-1	4.50	XAT-2-025	9.00	XM-6-25	1.05	MW-1216	.20	MOS-150	.60	Type AFL	6.60
P-2702	\$.50	XLC-10-2	6.00	XAT-2-05	10.80	XM-6-11	1.70	MW-1218	.20	MOS-200	.60	Trimmers Type TB	
P-2705	.60	XLC-10-4	7.50	XAT-2-100	14.40	XM-6-12	2.25	MW-1219	.25	MOS-250	.60	TB-30	\$.40
P-2708	.85	XLC-10-5	9.00	XAT-2-13	10.80	XM-6-125	2.80	MW-1220	.25	Page K-27†			
P-2722	.55	XLC-10-6	9.90	XAT-2-13	10.80	XM-6-15	4.65	MW-1221	.25	Model CE			
P-2724	.80	XLC-10-10	9.90	XAT-2-75	12.00	XM-12-45	.85	MW-1222	.25	Dealer Net Cost—			
RF-0143	1.00	XLC-10-8	10.80	XAT-2-71	15.00	XM-12-31	.85	MW-1227	.30	Catalog Complete Number with Tubes			
RF-0132	.75	XLC-15-1	5.40	Type XF		XM-12-32	.85	MW-1233	.40	CE-1-60	\$44.90*	TC-D-30	\$.75
RF-0133	.60	XLC-15-2	7.50	XF-2-25	\$1.80	XM-12-35	.85	MW-1235	.50	CE-2-U	49.90*	TC-D-70	.80
S-0286A	.55	XLC-20-1	6.60	XF-2-11	1.95	XM-12-21	1.10	MW-1237	.55	CE-6L6	\$1.60	TC-D-140	.90
S-0286M	.60	XLC-20-2	7.80	XF-2-01	2.10	XM-12-22	1.65	MW-1239	.60	QC-J5G	.90	Type TP	
Type SDT		XLC-20-5	5.10	XF-3-25	2.00	XM-12-11	3.40	Type MT		QC-465	.75	TP-130	\$.40
SDT-0026	\$.25	XLC-20-1	4.80	XF-3-11	2.05	XM-12-12	4.75	MT-1306	\$.25	CE-300	2.40	TP-260	.45
SDT-0056	.25	XLC-20-2	7.80	XF-3-12	2.10	XM-12-13	5.55	MT-1307	.25	Model QCA			
SDT-016	.25	XLC-20-4	10.80	XF-3-13	2.20	XM-25-45	1.10	MT-1308	.20	QCA-1-60	\$24.90*	TP-490	.60
SDT-026	.25	XLC-20-5	12.00	XF-3-15	2.30	XM-25-31	1.10	MT-1310	.20	QCA-2-U	29.60*	TP-750	.70
SDT-056	.30	XLC-20-6	14.10	XF-3-01	3.00	XM-25-32	1.30	MT-1316	.20	Model QC			
SDT-16	.40	XLC-25-1	9.60	Page K-25		XM-25-35	1.50	MT-1318	.20	QC-1-60	\$14.90*	TP-1140	.85
SDT-014	.25	XLC-25-2	15.60	Type XA		XM-25-21	1.80	MT-1319	.25	QC-2-U	18.75*	TP-1400	1.00
SDT-024	.25	XLC-25-4	21.60	XA-12-45	\$6.60	XM-25-22	2.70	MT-1320	.25	QC-301	1.65	Type TYM	
Type ZTC		XLC-30-1	10.20	XA-12-21	6.60	XM-25-25	4.10	MT-1321	.25	QC-300	1.50	TYM-10	\$.50
XTC-16-.0005	\$.75	XLC-30-25	10.80	XA-7-22	7.80	XM-25-11	4.95	MT-1322	.25	QC-450	.60	TYM-20	.45
XTC-16-.001	.75	XLC-30-5	12.00	XA-7-25	9.60	XM-25-115	5.40	MT-1327	.30	QC-465	.75	TYM-30	.45
XTC-16-.002	.75	XLC-30-1	14.40	XA-7-11	12.60	Type MO		MO-1406	\$.25	QC-6G5	1.10	Type TR	
XTC-16-.003	.75	XLC-30-2	18.00	XA-2-01	13.20	MO-1407	.25	MO-1408	.20	QC-J5G	.90	TR-70	\$.60
XTC-16-.004	.75	XLC-40-1	18.00	Type XR		MO-1409	.20	MO-1410	.20	QC-Z6G	.90	TR-140	.75
XTC-16-.005	.75	XLC-40-2	26.40	XR-3-31	\$10.80	MO-1416	.20	MO-1418	.20	Page K-28†			
XTC-16-.007	.75	XLC-40-4	48.00	XR-3-35	10.80	MO-1419	.25	MO-1420	.25	Model CC			
XTC-16-.005	.75	XLC-50-1	20.40	XR-3-21	10.80	Type XQ*		Silver-Mica		Dealer Net Cost—			
XTC-16-.007	.75	XLC-50-25	21.60	XR-2-25	10.80	XQ-.6-45	\$.60	List prices are standard ± 10% tolerance. For ± 5% tolerance, add 10% to prices. For ± 3%, add 30%. For ± 2%, add 50%.		Catalog Complete Number with Tubes			
XTC-16-.01	.75	XLC-50-5	24.00	XR-1-11	10.80	XQ-.6-31	.60	CC-1-60		\$32.50*	TSS-70	\$.75	
XTC-16-.02	.80	XLC-50-1	30.00	XR-25-01	12.00	XQ-.6-35	.60	CC-2-U		37.50*	TSS-140	.85	
XTC-16-.05	1.00	XLC-60-1	24.00	Type XS*		XQ-.6-22	.70	CC-6E5		1.45	TSS-220	1.00	
XTC-16-.1	1.10	XLC-60-.25	26.40	XS-5-45	\$14.40	XQ-.6-25	.85	CC-80		.90	TSS-600	1.20	
XTC-10-.01	.60	Page K-24		XS-5-21	14.40	XQ-.6-11	1.40	CB-N		.75	Type TSS		
XTC-10-.02	.70	Type X		XS-6-22	14.40	XQ-.6-12	1.90	Model CB		Prices \$1.00 higher on the West Coast, or west of Denver.			
XTC-10-.05	.80	X-062	\$3.90	XS-2-11	14.40	XQ-.6-15	2.30	CB-1-60	26.00*	Type TD			
XTC-10-.1	1.00	X-064	5.40	XS-2-13	15.60	XQ-1.2-45	.85	CB-2-U	30.75*	TD-70	\$.80		
Type XDC		X-11	3.30	XS-5-01	16.20	XQ-1.2-31	.85	Type MWS		TD-220	1.00		
XDC-6-1	\$1.75	*For low-loss Bake-lite case for Type XS, add \$1.20 to list.		XS, add \$1.20 to list.		XQ-1.2-32	.85	MWS-100	\$.60	TD-600	1.20		
XDC-6-.25	2.05	X-12	4.50	Page K-26		XQ-1.2-35	.85	MWS-250	.60				
XDC-6-.5	2.35	X-14	5.70	Type XQ*		XQ-1.2-21	1.10	MWS-500	.90				
				Type XQ*				MWS-700	1.20				

Federal Excise Taxes, if any apply, are to be added to these prices.

SUBJECT TO CHANGE WITHOUT NOTICE

Thank You!

When writing for additional
information or when ordering
from sources of supply listed
in this book, please mention

RADIO'S MASTER

Marlin

Pitts

5225

100 ft mi

Connecta

AEROVOX Electrolytic CONDENSERS

During the present emergency, we reserve the right to make mechanical changes without notice in order to produce equally suitable substitutes whenever and wherever necessary. Also, prices subject to change without notice.

CARDBOARD TUBE CONDENSERS

Single and Double Section Units
TYPE PR

Single and double-section dry electrolytic units encased in sturdy cardboard tube containers. Completely sealed in. Bare wire leads 2 1/2 inches long. Polarity-indicating markings on tubular case. Two leads single section; three leads double section. Used in preference to cardboard case type for point-to-point wiring jobs where unit is supported by own connections.

525v. Surge Pk.-450v. D.C. Work.

Cap. Mfd.s.	Size-Ins. Dia.-Ht.	List Price	Net Price
2	3/4 x 2 1/4	\$0.89	\$0.48
4	3/4 x 2 1/4	.90	.54
8	3/4 x 2 1/4	1.15	.69
10	3/4 x 2 1/4	1.40	.84
16	3/4 x 2 1/4	1.75	1.05

300v. Surge Pk.-250v. D.C. Work.

Cap. Mfd.s.	Size-Ins. Dia.-Ht.	List Price	Net Price
2	3/4 x 2 1/4	\$1.79	\$0.42
4	3/4 x 2 1/4	.81	.48
8	3/4 x 2 1/4	1.19	.63
10	3/4 x 2 1/4	1.11	.65

150v. Surge Pk.-100v. D.C. Work.

Cap. Mfd.s.	Size-Ins. Dia.-Ht.	List Price	Net Price
5	3/4 x 2 1/4	\$1.79	\$0.42
10	3/4 x 2 1/4	.81	.51
25	3/4 x 2 1/4	1.15	.69

75v. Surge Pk.-50v. D.C. Work.

Cap. Mfd.s.	Size-Ins. Dia.-Ht.	List Price	Net Price
5	3/4 x 2 1/4	\$0.69	\$0.35
10	3/4 x 2 1/4	.81	.48
20	3/4 x 2 1/4	.90	.54
25	3/4 x 2 1/4	1.00	.60
50	3/4 x 2 1/4	1.45	.87

40v. Surge Pk.-25v. D.C. Work.

Cap. Mfd.s.	Size-Ins. Dia.-Ht.	List Price	Net Price
5	3/4 x 2 1/4	\$0.60	\$0.36
10	3/4 x 2 1/4	.60	.36
20	3/4 x 2 1/4	.75	.45
25	3/4 x 2 1/4	.80	.48
50	3/4 x 2 1/4	1.15	.69

TYPE PR-25—Double Section

Cap. Mfd.s.	Size-Ins. Dia.-Ht.	List Price	Net Price
5-5	3/4 x 2 1/4	\$0.90	\$0.54

CARDBOARD CONTAINER CONDENSERS

TYPE PBM

Heavy-duty units similar to Type P but provided with cardboard mounting flanges for flat mounting. Made in double section, each section having two color-coded leads 8 inches long.

525v. Surge Pk.-450v. D.C. Work.

Cap. Mfd.s.	Size-Ins. Dia.-W.-L.	List Price	Net Price
4-4	1 1/4 x 1 3/4 x 4 1/2	\$1.45	\$0.87
4-8	1 1/4 x 1 3/4 x 4 1/2	1.65	.99
8-8	1 1/4 x 1 3/4 x 4 1/2	1.80	1.08

SPACE-SAVER MIDGET CONDENSERS

with Aerovox "ADJUSTMOUNT" Mounting Flanges

TYPE PBS—Single Section—2 Leads; Double Section—4 Leads
Triple Section—6 Leads



Single Section



Double Section

25 to 600v. D.C. Working, made possible in this small size by a tried, tested and perfected process, whereby far greater capacity is attained from a given bulk without impairing the working voltage or service life. Units encased in heavy cardboard containers, thoroughly impregnated and fully sealed. Wire leads color-coded for polarity.

The "Adjustmount" feature comprises a swivel mounting flange with slotted holes to fit any mounting hole spacings. The condenser may be mounted flat or upright depending on space. Also, two or three condensers may be stacked by overlapping the metal flanges.

800v. Surge Pk.-600v. D.C. Work.

Cap. Mfd.s.	Size-Ins. Dia.-W.-L.	List Price	Net Price
4	1 1/4 x 1 3/4 x 2 3/4	\$2.10	\$1.29
8	1 1/4 x 1 3/4 x 3 1/4	2.95	1.77

525v. Surge Pk.-450v. D.C. Work.

Cap. Mfd.s.	Size-Ins. Dia.-W.-L.	List Price	Net Price
2	1 1/4 x 1 3/4 x 2 3/4	\$0.89	\$0.48
4	1 1/4 x 1 3/4 x 2 3/4	.90	.54
6	1 1/4 x 1 3/4 x 2 3/4	1.10	.69
8	1 1/4 x 1 3/4 x 2 3/4	1.15	.69
10	1 1/4 x 1 3/4 x 2 3/4	1.40	.84
12	1 1/4 x 1 3/4 x 2 3/4	1.60	.96
16	1 1/4 x 1 3/4 x 2 3/4	1.75	1.05

TYPE PBS450—Double Section

Cap. Mfd.s.	Size-Ins. Dia.-W.-L.	List Price	Net Price
4-4	1 1/4 x 1 3/4 x 2 3/4	\$1.45	\$0.87
4-8	1 1/4 x 1 3/4 x 2 3/4	1.65	.99
8-8	1 1/4 x 1 3/4 x 2 3/4	1.89	1.08
8-16	1 1/4 x 1 3/4 x 3	2.30	1.38

PAPER-WOUND REPLACEMENTS FOR ELECTROLYTIC CONDENSERS

TYPE PWP



TYPE PWC



High-grade paper sections in standard inverted screw mounting aluminum can (PWC) or cardboard case (PWP) similar in appearance to electrolytics. Used as replacements for standard electrolytics indicated; applications subjected to high AC component or ripple particularly in first stage of filter circuit; or where excessive surges are encountered. No polarity to be observed. Actual capacity indicated in each case. Capacity is less than electrolytic being replaced but will be found adequate in most filter circuits since filtering capacity in electrolytics is more than generous. PWP has cardboard mounting flanges; PWC similar to the inverted dry electrolytic types.

800v. Surge Pk.-600v. D.C. Work.

TYPE PWC600—Single Section

Repl'g. Mfd.s.	Act. Mfd.s.	Size-Ins. D. L.	List Price	Net Price
1	2	1 3/8 x 4 1/2	\$1.65	\$0.99
8	2.75	1 3/8 x 4 1/2	2.10	1.26

TYPE PWC600—Double Section

Cap. Mfd.s.	Size-Ins. D.-W.-L.	List Price	Net Price
8-8	1.75-1.75 1 1/2 x 4 1/2	\$3.40	\$2.04

800v. Surge Pk.-600v. D.C. Work.

TYPE PWP600—Single Section

Repl'g. Mfd.s.	Act. Mfd.s.	Size-Ins. L. W. D.	List Price	Net Price
4	2	4 1/4 x 1 3/4 x 3/8	\$1.45	\$0.87
8	3	4 1/4 x 1 3/4 x 1/2	1.95	1.17

CARDBOARD CONTAINER CONDENSERS

TYPE P

Largest - sized cardboard - case dry electrolytic for heavy-duty service. Sections housed in wax-impregnated containers provided with Adjustmount Flanges to fit any mounting hole spacing. Polarity - indicating colored flexible leads, 8 inches long. Two leads - single section units; three leads double-section units, common negative.



600v. Surge Pk.-475v. D.C. Work.

Cap. Mfd.s.	Size-Ins. Dia.-W.-L.	List Price	Net Price
2	3 1/4 x 1 3/4 x 2 3/4	\$1.15	\$0.69
4	3 1/4 x 1 3/4 x 2 3/4	1.40	.84
8	3 1/4 x 1 3/4 x 2 3/4	1.65	.99

525v. Surge Pk.-450v. D.C. Work.

Cap. Mfd.s.	Size-Ins. Dia.-W.-L.	List Price	Net Price
1	3 1/4 x 1 3/4 x 2 3/4	\$0.70	\$0.42
2	3 1/4 x 1 3/4 x 2 3/4	.80	.48
6	3 1/4 x 1 3/4 x 2 3/4	1.10	.66
10	3 1/4 x 1 3/4 x 2 3/4	1.40	.84
12	3 1/4 x 1 3/4 x 2 3/4	1.60	.96
16	3 1/4 x 1 3/4 x 2 3/4	1.75	1.05

TYPE P450—Double Section

Cap. Mfd.s.	Size-Ins. Dia.-W.-L.	List Price	Net Price
4-4	3 1/4 x 1 3/4 x 2 3/4	\$1.45	\$0.87
4-8	3 1/4 x 1 3/4 x 2 3/4	1.65	.99
6-8	3 1/4 x 1 3/4 x 2 3/4	1.75	1.05
8-8	3 1/4 x 1 3/4 x 2 3/4	1.80	1.08

COMPACT CARDBOARD BOX CONDENSERS

TYPE PM—Single, Double and Triple Section Units



Convenient size dry electrolytic condensers. Double section units provided with three leads, common negative, and triple section units with four leads, common negative.

600v. Surge Pk.-475v. D.C. Work.

Cap. Mfd.s.	Size-Ins. Dia.-W.-L.	List Price	Net Price
1	3 1/4 x 1 3/4 x 2 1/4	\$1.05	\$0.63
2	3 1/4 x 1 3/4 x 2 1/4	1.15	.69
4	3 1/4 x 1 3/4 x 2 1/4	1.40	.84
6	3 1/4 x 1 3/4 x 2 1/4	1.60	.96
8	3 1/4 x 1 3/4 x 2 1/4	1.65	.99

525v. Surge Pk.-450v. D.C. Work.

Cap. Mfd.s.	Size-Ins. Dia.-W.-L.	List Price	Net Price
1	3 1/4 x 1 3/4 x 2 1/4	\$0.70	\$0.42
2	3 1/4 x 1 3/4 x 2 1/4	.80	.48
4	3 1/4 x 1 3/4 x 2 1/4	.90	.54
6	3 1/4 x 1 3/4 x 2 1/4	1.10	.66
8	3 1/4 x 1 3/4 x 2 1/4	1.15	.69

TYPE PM450—Double Section

Cap. Mfd.s.	Size-Ins. Dia.-W.-L.	List Price	Net Price
4-4	3 1/4 x 1 3/4 x 2 1/4	\$1.45	\$0.87
4-8	3 1/4 x 1 3/4 x 2 1/4	1.65	.99
8-8	3 1/4 x 1 3/4 x 2 1/4	1.80	1.08

TYPE PM450—Triple Section

Cap. Mfd.s.	Size-Ins. Dia.-W.-L.	List Price	Net Price
8-8-8	1 1/2 x 1 1/4 x 3	\$2.65	\$1.59

AEROVOX EXACT DUPLICATE Replacement CONDENSERS

During the present emergency, we reserve the right to make mechanical changes without notice in order to produce equally suitable substitutes whenever and wherever necessary. Also, prices subject to change without notice.

Having pioneered the Exact-Duplicate idea for years, AEROVOX is happy indeed to have it universally accepted today. And doubly so because, having refused to take the easier way of so-called general-utility types, and sometimes called "Universal" replacements, AEROVOX has built up a really complete line backed by the most extensive listings in use.

FIT Right! . . .

Because exact needs of standard sets in use have been critically studied, AEROVOX Exact-Replacement units readily fit in place of the original condensers. No jamming. No taping. No sloppy wiring. Saves time and trouble.

WORK Right! . . .

Because electrical as well as mechanical considerations have received thorough attention, AEROVOX replacements not only duplicate but usually excel the performance of the replaced units.

LOOK Right! . . .

Last but not least, an AEROVOX replacement restores the radio chassis to its original "new" status. Set owner is satisfied the job has been done right.



EXACT-DUPLICATE PAPER-WOUND REPLACEMENT CONDENSERS



Atwater-Kent



Spartan

These units are the finest replacement condensers obtainable, embodying AEROVOX high quality construction throughout.

They are carefully engineered and built to give long lasting service in the sets for which they are designed.

ATWATER-KENT	Cap. Mfda.	List Price	Net Price
37 Filter	.5	\$0.90	\$0.51
37 Bypass	.25-.25-.25	1.35	.21
37 Block		9.00	5.40

SPARTAN Part No.	Cap. Mfda.	D. C. W. V.	List Price	Net Price
5031	.5	400	\$0.97	\$0.54
5032	.1	290	.97	.51
5033	.25	600	.90	.51

CROSLEY Part No.	Cap. Mfda.	List Price	Net Price
W4013B	1.	\$0.85	\$0.51
W4232B	.5-.5	1.05	.63
W4233	.5	.65	.39
W4313B	.5	.65	.39
W4381	.06-.06	.75	.45
W4381B	.1-.1	.80	.48
W4919	.5	.80	.48
W4968	.5	.65	.39
W5862	1-.1	1.70	1.02
W5863	.5-.5	1.65	.99
W5943	.1	.60	.36
W6428	.5-.5	1.05	.63
W6471	.1	.55	.33
W7753B	.1-.5-.1	1.25	.75
W20186	.3-.25-.25	1.25	.75
W20187	.1	.60	.36
W20188	.1	.60	.36
W20446A	.1-.5-.1	1.25	.75
W20447	.1	.60	.36
W20448	.1	.55	.33
W20449	.5-.1	.85	.51
W22412	.1-.1-.1-.1	1.15	.69
W22315	.1-.5	.90	.54
W22995	.1-.5	.90	.54
W23736	.5-.25-.25	1.25	.75
W24333	.5-.5	1.05	.63
W27204	.02-.02	.35	.21

GENERAL MOTORS	Cap. Mfda.	List Price	Net Price
1204221	1.166	\$2.00	\$1.20
1204757	.1-.1-.1-.1	1.50	.90
1208156	1.0-3.0	4.00	2.40
1206397	.1-.1	.65	.39
1205834	.5-.1-.1	1.20	.72
1207239	1.0	.90	.54

TUBULAR CARDBOARD REPLACEMENTS

A line of handy universal replacement electrolytics in cardboard tubes, with two spade lug leads for mounting and separate wire leads for each section. Inexpensive. Attractive in appearance. Popular as general-utility replacements.



A-C D-C REPLACEMENTS

				List Price	Net Price
88	Spade Lug Type	8-8	450	⊙ 1 1/2 x 3 3/4	\$1.05 \$0.99
1216	Spade Lug Type	12-16	230	⊙ 1 1/2 x 2 3/4	1.90 1.14
816	Spade Lug Type	8-16	450	⊙ 1 1/2 x 3 3/4	2.00 1.20
148	Spade Lug Type	14-8x10-10	200x25	⊙ 1 3/4 x 4 1/4	2.50 1.50
138	Spade Lug Type	16-8x10-10	200x25	⊙ 1 3/4 x 3 3/4	2.50 1.50
1612	Spade Lug Type	16-12x10-10	200x25	⊙ 1 7/8 x 4 1/4	2.60 1.56
1212		12-12x5-5	200x25	⊙ 1 x 1 3/4 x 2 3/4	2.35 1.41
		(Same as Bosch Part CE-9520)			
88855		8-8x5-5	200x25	⊙ 1 1/4 x 1 1/2 x 3	3.00 1.90
1616R		16-16-Rx5-5	150x25	⊙ 1 1/4 x 1 1/4 x 3	2.95 1.77

Type Container—⊙ Cardboard Box; ⊙ Rectangular Can; ⊙ Universal Can; ⊙ Inverted Can; ⊙ Inverted Can (Wet); ⊙ Cartridge; ⊙ Inverted Can (Insulated Cover); ⊙ Cardboard Tube; ⊙ Cardboard Tube (Spade Lug Mounting); ⊙ Metal Can; ⊙ Round Can Special.

AEROVOX EXACT DUPLICATE Replacement CONDENSERS

During the present emergency, we reserve the right to make mechanical changes without notice in order to produce equally suitable substitutes whenever and wherever necessary. Also, prices subject to change without notice.

INSIST UPON GETTING GENUINE AEROVOX EXACT DUPLICATE ELECTROLYTIC REPLACEMENT CONDENSERS

When you MUST use identical replacements, simply remember to ask for AEROVOX EXACT DUPLICATE REPLACEMENTS. Designed specifically for most all standard sets . . . finest replacement units obtainable . . . embodying AEROVOX high-quality construction throughout.



Model of Set	Part No.	Cap. Mfd.	D.C. Work Voltage	Size—Inches	List Price	Net Price
AIR KING						
15, 16, 21, 22, 26, 29, 42, 48, 81, 221, 222, 251, 522, 699	10105	10-10-5	150	① 1x1 1/2x3	\$1.70	\$1.02

Model of Set	Part No.	Cap. Mfd.	D.C. Work Voltage	Size—Inches	List Price	Net Price
ATWATER KENT						
155 1 & 2	24602	S-S-S	150	① 1 1/8x1 1/2x3 1/4	1.65	.99
155 3	24955	S-S-S	150	① 1 1/4x1 1/2x3 1/4	1.65	.99
275, 825	26159	S-14-S	100	② 1 1/4x1 1/2x3 1/4	1.95	1.17
376	2'592	4-10	450-450-25	③ 1 1/2x4 1/4	1.99	1.14

Model of Set	Part No.	Cap. Mfd.	D.C. Work Voltage	Size—Inches	List Price	Net Price
ALL STAR JUNIOR						
PM5-444		4-4-4	450	① 1 1/8x1 1/2x4 1/4	1.75	1.05

Model of Set	Part No.	Cap. Mfd.	D.C. Work Voltage	Size—Inches	List Price	Net Price
BOSCH						
04	CE9527	12-12 3-3	200x25	① 1x1 1/2x2 1/4	1.95	1.17
350, 501, 501, 502	SA-105772	4-12-S-1	200x25	① 1 1/8x1 1/2x2 3/4	2.15	1.29
310 A	SA-104422	S-S-4	475x300	① 1 1/2x2 1/4x4 1/2	3.00	1.80
250, 251	SA-103950	S-S-4-4	450-450x450-300	① 1 1/2x2 1/4x4 1/2	2.75	1.65
139, Types II, I, HT, I.F., HC, I.C., HT, L.T.C.	CE-9510 early	4-4	350	② 1 1/2x1 1/2	1.15	.69
	CE-9510 later	4-4	350	② 1 1/2x2 1/4	1.15	.69

Model of Set	Part No.	Cap. Mfd.	D.C. Work Voltage	Size—Inches	List Price	Net Price
BELMONT						
103-4	S	16	500	⑤ 1 1/8x3 1/2	1.65	.99
	(Standard AeroVox Type PG500-16)					
103-6	S	500	⑥ 1 1/2x3 1/2	1.15	.69	
	(Standard AeroVox Type PG500-8)					
103-7	S	350	⑥ 1 1/2x3 1/2	1.10	.66	
	(Standard AeroVox Type PG350-S)					
103-8	S	16	500	⑥ 1 1/2x3 1/2	1.65	.99
	(Standard AeroVox Type PG500-16)					
425	A11093-1	5-25-5	200	① 7/8x2 1/2x2 1/2	1.95	1.17
	Same as Spartan part No. A11093-1 for Models 65, 65T, 66, 66T, 506					
650	C525C	5-25	100	① 1 1/2x1 1/2x2 1/2	1.25	.75

Model of Set	Part No.	Cap. Mfd.	D.C. Work Voltage	Size—Inches	List Price	Net Price
CLARION (TCA)						
G422	P4717	16-4	150	① 1 1/8x1 1/2x2 1/4	1.10	.66

Model of Set	Part No.	Cap. Mfd.	D.C. Work Voltage	Size—Inches	List Price	Net Price	
COLONIAL							
122, 125	R-8780-C	S-4	300-150	① 2 1/2x1 1/4x1 1/4	1.05	.63	
	D-4758-P	S	500	② 1 1/2x3 1/2	1.15	.69	
	(Standard AeroVox Type PG500-8)						
	R-7236	S	500	③ 1 1/2x3 1/2	1.65	.99	
	(Standard AeroVox Type PG500-16)						
	R-12451	S	350	④ 1 1/2x3 1/2	1.10	.66	
	(Standard AeroVox Type PG350-S)						
	R-12478	S	16	500	⑤ 1 1/2x3 1/2	1.65	.99
	(Standard AeroVox Type PG500-16)						
250	R-8053	S-S-S-S	200	① 1 1/8x1 1/2x2 1/2	1.90	1.14	
1850, 1851, 1862 (Sears Roebuck)	R-10673	6-6x25	150x25	① 1 1/2x1 1/2x2 1/2	1.50	.90	

Model of Set	Part No.	Cap. Mfd.	D.C. Work Voltage	Size—Inches	List Price	Net Price
CROSLLEY						
122, 1a2	W-23801	6-8	450	① 2 1/4x1 1/2x4 1/4	1.75	1.05
	(Standard AeroVox Type P450-6-S)					

Model of Set	Part No.	Cap. Mfd.	D.C. Work Voltage	Size—Inches	List Price	Net Price
CROSLLEY - Continued						
95, 163	W25857B	S-S	200-25	① 1 1/8x1 1/8x2 1/4	\$1.00	\$0.60
129-1, 130, 131-1, 132-1	W26119	S-4	150-300	① 1 1/8x1 1/2x2 3/8	1.05	.63
96, 150, 155, 163	W26870	10	25	① 3/8x2 3/8	.45	.27
146	W23093	12-6	300-25	① 4 1/8x1 1/2x1 1/2	1.35	.81
148, 167	W2'403A	S-6	25-300	① 1 1/8x1 1/2x2 1/4	.95	.57
147	W2767A	S-S	100	① 1x1x2 1/4	.75	.45
163, 400, 402	W28068	12	200	① 1 1/8x1 1/8x2 1/4	.80	.48
160	W23458	S-12	350-475	① 1 1/2x5 1/4	2.25	1.35
164, 170, 171	W29397B	S-S-S	450-450-250	① 1 1/2x5 1/4	2.15	1.23
169	W20150B	6-7-8	450-450-25	① 1 1/2x5 1/4	1.89	1.03
166, 172	W29234A	16-16-S	125-100-20	① 1 1/2x3 1/4	2.00	1.23
174	W29804A	S-16-16	150	① 1 1/2x5 1/4	1.85	1.11
102, 103	W29308	12	300	① 1 1/2x2 1/4	.95	.57
120, 134, 135, 137, 141, 150, 158	B30017	4-S	450	① 1 1/2x4 1/4	1.30	.78
129-1, 130-1, 132, 136-1, 157	B30013	S-S	450	① 1 1/2x5 1/4	1.40	.84
175	W30059A	S-S-S	450-250-450	① 1 1/2x6 1/2	1.95	1.17
173, 173-5	W30121	16-16-S	100-125-125	① 1 1/2x4 1/4	1.85	1.11
103	W33419	S-S	20-250	① 1 1/2x3 1/8	1.00	.60
182	W30932	S-25	125	① 1 1/2x1 1/2x3 1/4	1.45	.87
	(Same as United Motors condenser part A-44344 for model 4052)					
175	W32374	S-S-S	450-250-450	① 1 1/2x6 1/2	1.95	1.17
	Same as Crosley W-30059A					
555, 915, 1055, 1155, 6615, 6625	W36057	40	350	① 1 1/2x4 1/2	2.20	1.32
	Standard AeroVox Type PG350-40					
555, 715, 725, 855, 865, 915, 955, 1055, 6625	W36055	30	500	① 1 1/2x4 1/2	2.05	1.23
	Standard AeroVox Type PG500-30					

Model of Set	Part No.	Cap. Mfd.	D.C. Work Voltage	Size—Inches	List Price	Net Price
ERLA						
2272		S-20	150	① 1 1/8x1 1/8x2 1/4	1.20	.72
9442		4-10x7-7	150	① 1 1/2x1 1/2x3 1/2	2.00	1.20
9982		S-20-S	150	① 1 1/2x1 1/2x2 1/2	1.65	.99

Model of Set	Chassis No.	Part No.	Cap. Mfd.	D.C. Work Voltage	Size—Inches	List Price	Net Price
EMERSON							
20A, 25, 25A	C4	HC-31	4-4	200	① 1x1x2 1/2	\$0.90	\$0.54
20A, 25, 25A	G4	HC-32	5-5	200	① 7/8x1x1 1/8	.75	.45
250	H5	KC-51	S-S	200	① 1 1/2x3 1/2	1.15	.69
32	U5S	CCC-107	S-16x5-5	150-25	① 1x1 1/2x4	2.05	1.23
19	UV4	KKC-143	12-8	150	① 1 1/2x1 1/2x2 1/4	1.25	.75
31B5	UV5	UUC-179	12-8x5-5	150-25	① 1x1 1/2x4	1.95	1.17
	U6B	2CC-194	8-16	150	② 3/4x2 1/2x3 1/2	1.45	.87
106	U6B	2CC-222	12-12	150	③ 3/4x2 1/2x3 1/2	1.75	1.05
38	U6D-U6	GCC-125C	4-8-16	150	④ 1 1/2x3 1/4	1.90	1.14

Type Container—① Cardboard Box; ② Pectangular Can; ③ Universal Can; ④ Inverted Can; ⑤ Inverted Can (Wet); ⑥ Cartridge; ⑦ Inverted Can (Insulated Cover); ⑧ Cardboard Tube; ⑨ Cardboard Tube (Spade Lug Mounting); ⑩ Metal Can; ⑪ Round Can Special.

AEROVOX

EXACT DUPLICATE Replacement CONDENSERS

During the present emergency, we reserve the right to make mechanical changes without notice in order to produce equally suitable substitutes whenever and wherever necessary. Also, prices subject to change without notice.

EMERSON—Continued		Cap. Mfd.	D.C. Work. Voltage	Size—Inches	List Price	Net Price	
409, 410, 411 (Mickey Mouse)	U4B 2WC-239	8-5x5	150-25	① 1 1/4 x 3/4 x 2 3/8	\$1.45	\$0.87	
Mod. 45	6BD EEC-129	8-8-4	150	① 1 3/8 x 4 1/4	1.50	.90	
107	U6F 2LC-224	16-4-8	150	② 1 3/8 x 4	1.85	1.11	
965	ZC-123	6-10	350	① 1 1/8 x 1 1/8 x 2 1/8	1.40	.84	
BA-199	4DC-345	16-16	150	② 1 x 3 1/2	1.40	.84	
375	W6 TC-89	4x12x16	150	① 1 x 1 1/2 x 3	1.70	1.02	
36	TTC-159	6-8-12	450-450-25	① 1 1/2 x 4 1/2	2.25	1.35	
	AX-211 4HC-348B	20-20	150	② 3/8 x 2 1/4	1.15	.69	
Model of Set	Part No.	Cap. Mfd.	D.C. Work. Voltage	Size—Inches	List Price	Net Price	
FADA							
RN	4-1362-MS	8-16	200	② 1 3/8 x 3 1/4	\$1.45	\$0.87	
	4-1380-MS	8-8	250	② 1 x 4 3/8	1.20	.72	
RU	4-1450-MS	8-8-16	250-150-250	① 1 3/8 x 4 3/4	1.95	1.17	
	4-1461-MS	8	150	② 1 3/8 x 3 1/4	.65	.39	
GALVIN (See Motorola)							
GE Mods.	RCA Models	Part No.	Cap. Mfd.	D.C. Work. Voltage	Size—Inches	List Price	Net Price
G. E. and RCA-VICTOR							
K40	R27, R17M, R18W, M106, 330, 331	3536 (new) 66140-2(old)	5-5	35	② 7/8 x 2 3/8	.75	.45
K40A	R27, R17, R18W	3538 (new) 66140 (old)	4-4	200	② 3/8 x 3 1/8	.95	.57
K60, K65, K63	R37, R37P, R38P, 120	6487 (new) 66155 (old)	4-4-10-4	300-300-150-25	① 1 1/2 x 1 1/8 x 3 3/4	2.05	1.23
B52	M34, M106	6492 (new) 66140-4 (old)	3.6-1	100-200	② 7/8 x 2 3/8	.80	.48
L50	R22	6511 (new) 66160-2 (old)	8-4-10	150-100-25	① 1 1/8 x 1 1/8 x 3 3/4	1.30	.78
L50	R22	6518 (new) 66160 (old)	8-8	250-175	① 1 1/8 x 1 1/8 x 3 3/8	1.15	.69
K40A	R18W	6535	4-4	150-300	② 1 x 3 1/2	.90	.54
K78	330	6555 (new)	10-4	300-150	① 1 1/8 x 1 1/8 x 3 3/8	1.20	.72
K79	331	66143-2 (old)	10-4	300-150	① 1 1/8 x 1 1/8 x 3 3/8	1.20	.72
K66, K66N	220 222	6691 (new) 66189-2 (old)	8-4-4-4	350-150-300-25	① 1 1/8 x 1 1/8 x 3 3/4	2.05	1.23
L53	114	6783 (new) 66171-1 (old)	8x8x8 -4-8-10	200-200-250-25	① 1 1/8 x 2 1/8 x 3 3/4	3.60	2.16
K52, K53, K58	R28, R28P, R28BW, RE40, RE40P, T5-2, 110, 111, 115, 117, 118, 119, 128, 128E, 210, 211, 224E, 226, 310	7589 (new) 66143 (old)	4-4	150-450	① 1 x 1 1/2 x 3 3/4	1.05	.63
C6-2, C7-6, C8-15, C8-17, C9-4, C9-6, C11-1, C13-2, C15-3, D7-7, D9-19, D11-2, D22-1, T6-1, T6-9, T7-5, T8-14, T8-16, T9-9							
		5512(new) 68597-3(old)	20	350	① 1 3/8 x 3 1/2	1.70	1.02
(Standard Aerovox Type PG350-20)							

GE Mods.	RCA Models	Part No.	Cap. Mfd.	D.C. Work. Voltage	Size—Inches	List Price	Net Price
G. E. and RCA VICTOR—Continued							
		C6-2, C8-15, C8-17, C9-4, C9-6, D7-7, D9-19, T6-1, T6-9, T7-5, T8-14, T8-16, T9-9	11240(new) 68597-5(old)	12	500	① 1 3/8 x 3 1/2	\$1.40 .84
(Standard Aerovox Type PG150-12)							
		C11-1, C13-2, C14-3, D11-2, D22-1	11203(new) 68597-6(old)	12	500	① 1 3/8 x 3 1/2	1.40 .84
(Standard Aerovox Type PG150-12)							
			66122-2	4-4	250	① 1 1/8 x 1 1/8 x 2 3/8	.90 .54
Model of Set	Part No.	Cap. Mfd.	D.C. Work. Voltage	Size—Inches	List Price	Net Price	
GENERAL ELECTRIC (See also G. E. and RCA-VICTOR)							
F63-F65	K12J6	12-8	450	② 1 3/8 x 4 1/4	1.55	.93	
A63-A65	RC507	4-8x4	25-25x450	① 1 1/8 x 1 1/8 x 2 3/8	1.15	.69	
GENERAL MOTORS							
	1203346	4-4	450	① 1 3/8 x 5 3/8	1.40	.84	
GRUNOW							
501, 550	Chassis 5B	27151	4-8-20-4	25-150-150-150	① 1 3/8 x 2 7/8 x 1 3/8	2.20	1.32
625	34119-6	5-5x10-10	50-350	① 1 x 2 3/8 x 3 1/8	2.35	1.41	
	30326	8-8-12	350-350-25	① 1 3/8 x 1 1/8 x 2 3/8	1.80	1.08	
INTERNATIONAL							
	A-407	4-4	150	① 3/4 x 1 x 3	.85	.51	
ES19, ES20, ES25, ES30, 60, 65, 80, 85							
	A-412	8-30	150	① 3/4 x 1 3/8 x 3 1/8	1.55	.93	
40, 41	A-421	3.5-3.5-3.5	150-150-25	① 5/8 x 1 1/4 x 2 3/4	1.30	.78	
42, 46	A-424	4-10-10	150	① 1 x 1 1/4 x 3 3/8	1.65	.99	
Kadette A and B (A-430) (A-428)							
	A-425	2-7	100	① 5/8 x 1 1/8 x 2 1/4	.95	.57	
	A-427	3.5-3.5-3.5	100-100-25	① 5/8 x 1 1/4 x 2 1/4	1.20	.72	
A and B	A-425	10-10-4	150	① 1 1/4 x 7/8 x 2 3/4	1.55	.93	
66	A-422 (old)	8-30	150	① 1 3/8 x 3 3/4	1.15	.69	
66X	A-443(new)						
Kadette A and B (A-424) (A-428)							
	A-430	4-10-10	150	① 1 x 1 1/4 x 3 3/8	1.65	.99	
LE WOL							
LW4		25-10	150	(10) 1 x 2 x 3 1/4	1.40	.84	
		4-4-4	150	(10) 1 1/8 x 1 1/8 x 3 1/2	1.30	.78	
MAJESTIC							
151, 153, 154, 155, 156, 251, 253, 254	5414	8	450	① 1 1/4 x 1 1/8 x 4 1/8	.80	.48	
201, 203, 204	6277	8-4-4	450	① 1 3/8 x 2 3/8 x 4 1/2	2.00	1.20	
11	6433	4-8	450	① 1 3/8 x 1 1/8 x 4 3/8	1.25	.75	
56, 57, 58	6501	8-8	450	① 1 x 3 1/4 x 4	1.40	.84	
291, 293, 294	7173	8	450	① 7/8 x 1 1/8 x 4 1/8	.80	.48	
291, 293, 294	7278	7-10	150-6	① 1 1/8 x 1 1/4 x 2 1/4	1.00	.60	

Type Container—① Cardboard Box; ② Rectangular Can; ③ Universal Can; ④ Inverted Can; ⑤ Inverted Can (Wet); ⑥ Cartridge; ⑦ Inverted Can (Insulated Cover); ⑧ Cardboard Tube; ⑨ Cardboard Tube (Spade Lug Mounting); (10) Metal Can; (11) Round Can Special.

AEROVOX EXACT DUPLICATE Replacement CONDENSERS

During the present emergency, we reserve the right to make mechanical changes without notice in order to produce equally suitable substitutes whenever and wherever necessary. Also, prices subject to change without notice.

Model of Set	Part No.	Cap. Mfd.	D.C. Work Voltage	Size—Inches	List Price	Net Price
MAJESTIC—Continued						
324	7402	10	6	① $\frac{5}{8} \times 2\frac{1}{4}$	\$0.45	\$0.27
303, 304, 307, 324	7489	16	450	① $1\frac{1}{2} \times 1\frac{9}{16} \times 4\frac{1}{8}$	1.15	.69
311, 314, 315	7824	8-16	300-450	① $1\frac{1}{2} \times 1\frac{3}{4} \times 4\frac{1}{8}$	1.55	.93
324, 344, 363	7988	7	150	① $1\frac{1}{8} \times 1\frac{1}{8} \times 2\frac{3}{8}$.60	.36
311, 314, 315, 331, 336-77, 344, 363, 393	8118	20	30	① $1\frac{1}{8} \times 1\frac{1}{8} \times 2\frac{3}{8}$.60	.36
Chassis 114 Auto	8286	5	6	① $\frac{5}{8} \times 2\frac{1}{4}$.45	.27
15, 153, 154, 155, 156	6388	8-8	450	① $1\frac{1}{8} \times 1\frac{3}{8} \times 4\frac{1}{8}$	1.40	.84
77, 331, 336	8721	16	450	① $1\frac{3}{8} \times 3\frac{1}{2}$	1.25	.75
331, 336-77, 344, 393,	8722	8	450	① $1\frac{3}{8} \times 3\frac{1}{2}$.85	.51
381	8755	4-8	450	① $1\frac{1}{8} \times 1\frac{3}{8} \times 4\frac{1}{8}$	1.25	.75
381	8774	10	25	① $\frac{5}{8} \times 2\frac{1}{4}$.45	.27
344, 363	9019	10	25	① $1\frac{1}{8} \times 1\frac{1}{8} \times 2\frac{3}{8}$.45	.27
371, 373	9219	8-8	450	① $1\frac{1}{8} \times 1\frac{3}{8} \times 4\frac{1}{8}$	1.35	.81
411, 411A, 413, 413A	9661	8-10-16	150-25-150	① $1\frac{1}{2} \times 1\frac{1}{2} \times 4$	1.80	1.08
66X Chassis 116A Auto	9979	8-8	350	① $1\frac{1}{8} \times 1\frac{3}{8} \times 3\frac{1}{4}$	1.40	.84
118	10369	8-8	400	① $1\frac{1}{8} \times 1\frac{3}{8} \times 3\frac{1}{4}$	1.35	.81
40, 49, 194 Chassis 440	10536	10-4-8	25-300-350	① $1\frac{1}{4} \times 1\frac{3}{8} \times 4\frac{7}{8}$	1.70	1.02
55, 59, 75, 195, 560, 556	10827	10-8-8	25-350-350	① $1\frac{1}{2} \times 1\frac{1}{2} \times 5\frac{1}{2}$	1.85	1.11
77, 331, 336, Chassis 330	8721	16	450	① $1\frac{3}{8} \times 4\frac{1}{4}$	1.90	1.14
MONTGOMERY WARD (Air Line Radio)						
62-96,	80944-A (old)	4-12-16	150	① $1\frac{3}{8} \times 1\frac{3}{8} \times 2\frac{3}{4}$	1.65	.99
62-98	80944-E (new)	4-12-16	150	① $1\frac{3}{4} \times 1\frac{3}{8} \times 3$	1.65	.99
(Same as Wells Gardner condenser for Model 05A, 05B, 05AA, 05BA)						
MOTOROLA (Galvin)						
100	1388	8-8x25	350x25	① $1\frac{1}{8} \times 1\frac{1}{8} \times 2\frac{3}{8}$	2.00	1.20
75 (Early)	1465	6-6	350	① $1 \times 1\frac{1}{2} \times 2\frac{3}{4}$	1.15	.69
75 (Later)	1468	6-4x6	200x12	① $1 \times 1\frac{1}{2} \times 2\frac{3}{4}$	1.40	.84
34	34	3-6-10	200-200-12.5	① $1 \times 1\frac{1}{2} \times 4\frac{1}{2}$	1.40	.84
34	8428	4-8x5	350x200	① $1\frac{1}{8} \times 1\frac{1}{8} \times 2\frac{1}{2}$	1.70	1.02
44	8123	8-12	200	① $1\frac{1}{2} \times 2\frac{1}{2} \times 2\frac{3}{8}$	1.25	.75
44, 66, 77A	4-8200	4-8	200	① $1\frac{1}{8} \times 1\frac{1}{8} \times 2\frac{1}{4}$	1.05	.63
57 (Early)	1424	2-4	250	① $2 \times 1\frac{1}{2} \times 1\frac{1}{8}$	1.10	.66
57 (Later)	1540	3-5x6	200x25	① $1\frac{1}{8} \times 1\frac{1}{4} \times 1\frac{1}{8}$	1.35	.81
Dual 6 & Dual 8	8825	8-8-25	350-350-25	① $2 \times 2 \times 2\frac{1}{2}$	1.75	1.05
9-A, 6-2, 8-1, 10-1, 12-1	14-H37275	16-2-2-25	450-450-450-25	① $1\frac{1}{2} \times 4\frac{1}{2}$	2.30	1.38
PILOT						
63	71108TJ	8-8x2-2	475x475	① $1\frac{3}{4} \times 2\frac{1}{4} \times 3\frac{1}{4}$	3.45	2.07
PEERLESS E250						
		12-16-10	100	① $1\frac{1}{8} \times 2 \times 3$	1.70	1.02
RADIO KEG						
		5-8-12	25-150-150	① $1 \times 1\frac{1}{2} \times 3$	1.55	.93
RCA. (See G. E. and RCA-VICTOR)						
SILVERTONE						
7110	148	10-10x8-14	25x150	① $1\frac{3}{8} \times 4\frac{1}{2}$	1.95	1.17
SIMPLEX						
PR		4-4	450	① $1\frac{1}{8} \times 1\frac{1}{8} \times 4\frac{1}{8}$	1.45	.87
(Standard Aerovox Type PBM450-4-4)						
Model V		4-20	150	① $1 \times 1 \times 4\frac{1}{8}$	1.30	.84
Model 4Z		15-8x5-5	150x25	① $1 \times 1 \times 4\frac{1}{2}$	1.90	1.14

Model of Set	Part No.	Cap. Mfd.	D.C. Work Voltage	Size—Inches	List Price	Net Price
STEWART WARNER						
10-20	81698	5-5	25	① $\frac{3}{4} \times \frac{3}{4} \times 1\frac{1}{2}$	\$0.75	\$0.48
R-115, R-116	81959	4-13-7	150	① $3\frac{1}{8} \times 1\frac{3}{8} \times 1\frac{1}{8}$	1.65	.99
R-112	83111	8-8-5-5	250-250-25-25	① $1\frac{1}{2} \times 1\frac{1}{2} \times 3\frac{1}{8}$	1.95	1.17
	83394	12	150	① $1\frac{1}{8} \times 1\frac{1}{8} \times 2\frac{3}{8}$.65	.39
	85430	16	350	① $1\frac{3}{8} \times 3\frac{1}{2}$	1.35	.81
	(Standard Aerovox Type PG350-16)					
	85431	16	500	① $1\frac{3}{8} \times 3\frac{1}{2}$	1.65	.99
	85792	(Standard Aerovox Type PG500-16)				
	85793	(Standard Aerovox Type PG500-16)				
	83962	10-5	25-350	① $\frac{1}{2} \times 1\frac{1}{8} \times 2\frac{3}{8}$	1.35	.81
SPARTON						
71, 71B, 72-74	A-9754	8-8	450	① $1\frac{3}{8} \times 4\frac{1}{4}$	1.95	1.17
(Standard Aerovox Type 2G450-8-8)						
	A-9308	20	25	① $\frac{1}{8} \times \frac{1}{8} \times 2\frac{1}{4}$.55	.33
65, 65T, 66, 66T, 506	A-11093-1	5-25-5	200	① $\frac{3}{8} \times 2\frac{3}{8} \times 2\frac{1}{2}$	1.95	1.17
(Same as Belmont for Model 425)						
UNITED MOTORS (Delco)						
4038		10-10	300	① $1\frac{1}{2} \times 2\frac{1}{2} \times 2\frac{3}{8}$	1.55	.93
4052	A-443341	8-25	125	① $1\frac{1}{2} \times 1\frac{1}{2} \times 2\frac{1}{2}$	1.45	.87
(Same as Crosley part W-30962 for Model 182)						
982008 Oldsmobile 1936	R13183 (new)	8-8-12				
	1210514 (old)	250-250-20		① $1\frac{1}{2} \times 2 \times 2\frac{1}{4}$	1.80	1.08
980509 (Buick 1936)	1210885	8-8x12x5	350x25x50	① $1 \times 2\frac{3}{4} \times 3$	2.15	1.29
U. S. RADIO & TEL.						
Apex-5	6201	4-4-12	200	① $1\frac{1}{8} \times 1\frac{3}{8} \times 2\frac{3}{4}$	1.65	.99
(Same as United Motors (Delco) for Model 4048)						
Apex (1001 Chassis) 10H-200 President	2719	8	300	① $\frac{3}{4} \times 1\frac{3}{8} \times 4\frac{1}{4}$.75	.43
WARE						
S-76 (MB78)		4-4x4-8	450x450	① $1\frac{1}{2} \times 2 \times 4\frac{1}{8}$	2.50	1.80
WELLS-GARDNER						
05A, 05BA, 05AA	80944-A (old)	4-12-16	150	① $1\frac{3}{8} \times 1\frac{3}{8} \times 2\frac{3}{4}$	1.85	1.11
	80944-E (new)	4-12-16	150	① $1\frac{3}{8} \times 1\frac{3}{8} \times 3$	1.85	1.11
(Same as Montgomery Ward Air Line Models 62-96, 62-98)						
	81042	16	500	① $1\frac{3}{8} \times 3\frac{1}{2}$	1.65	.99
(Standard Aerovox Type PG500-16)						
	81043	20	350	① $1\frac{3}{8} \times 3\frac{1}{2}$	1.70	1.02
(Standard Aerovox Type PG350-20)						
WEBSTER S-3888						
		40	100	① $1 \times 4\frac{1}{4}$.95	.57
WURLITZER (Lyric)						
SA-5	35-3715	8-8-10	450-450-25	① $\frac{1}{8} \times 5\frac{1}{4}$	1.80	1.08
C4-M4	37-3773	4-8x10	250-25	① $\frac{7}{8} \times 1\frac{3}{8} \times 4$	1.50	.90
SU-5		12-16x10	150-25	① $1\frac{3}{8} \times 1\frac{3}{8} \times 2\frac{3}{8}$	1.70	1.02
ZENITH						
22-125		8	450	① $1\frac{3}{8} \times 3\frac{1}{4}$	1.30	.78
(Standard Aerovox Type G450-8)						
22-217		8-8	450	① $1\frac{3}{8} \times 4\frac{1}{4}$	1.95	1.17
(Standard Aerovox Type 2G450-8-8)						
22-230		8-8	450	① $1\frac{3}{8} \times 4\frac{1}{4}$	1.95	1.17
(Standard Aerovox Type 2E450-8-8)						
22-236		8-8-10	300-300-25	(11) $1\frac{3}{8} \times 2\frac{3}{4}$	1.70	1.02
22-125		8	500	① $1\frac{3}{8} \times 3\frac{1}{4}$	1.15	.69
22-331		(Standard Aerovox Type PG500-8)				
Chassis 5401, 4P26, 4T26	22-407B	2-4-8	450	① $1\frac{1}{2} \times 4\frac{1}{8}$	1.95	1.17
4P51, 4T51						
Chassis 5903, 9S30, 9S54, 9S55	22-412C	2-4-16	475	① $1\frac{1}{8} \times 4\frac{1}{4}$	2.50	1.80
5639, 8D-219	22-560	35-10-10	150-150-25	① $1\frac{1}{8} \times 4\frac{1}{8}$	1.50	.90

Type Container—① Cardboard Box; ② Rectangular Can; ③ Universal Can; ④ Inverted Can; ⑤ Inverted Can (Wet); ⑥ Cartridge; ⑦ Inverted Can (Insulated Cover); ⑧ Cardboard Tube; ⑨ Cardboard Tube (Spade Lug Mounting); (10) Metal Can; (11) Round Can Special.

AEROVOX *Interference Filters and Auto-Radio* CONDENSERS

During the present emergency, we reserve the right to make mechanical changes without notice in order to produce equally suitable substitutes whenever and wherever necessary. Also, prices subject to change without notice.

AEROVOX INTERFERENCE ANALYZER TYPE ANL-37

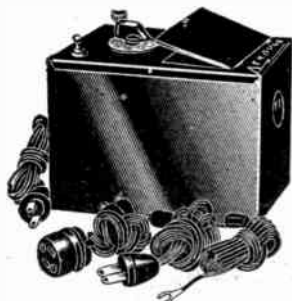

Plugs between interfering device and outlet. Selector switch adjusted until noise is eliminated or minimized. Dial indicates which type filter to use. Handsome. Sturdy metal cabinet. Compartment contains necessary test leads and attachment plugs and clips. Size 5 1/2 x 5 1/2 x 8 inches.

TYPE ANL-37
Dealers' and Servicemen's
Net Price \$8.40

AEROVOX Type IN-23



Especially for elimination of interference caused by fractional horsepower motors. Mounting bracket for attaching to frame of motor. Flexible leads for connecting across motors such as in hairdriers, fans, mixers, etc. .5-.5 mfd. 1 x 2 1/2 in.

TYPE IN-23.
List Price \$0.90...Net Price \$0.54

AEROVOX Type IN-24



Designed for use in the most serious cases of radio interference from power lines and appliances. Provided with inductance as well as capacitance for thorough filtering action. Plugs into electric outlet. Radio set or interference device plugs into receptacle of the filter. Especially desirable between device and line. Measures 4 x 2 1/4 x 3 1/2 in. 110-220v. A.C.

TYPE IN-24
List Price \$5.70...Net Price \$3.42

AEROVOX Type IN-27



Simple, inexpensive noise filter. Inserted between set and outlet when interference is slight. Also used with appliance causing low-intensity interference. Keeps troublesome noises out of house wiring and power line. Size 1 3/8 x 1 1/2 inches.

TYPE IN-27
List Price \$0.80 Net Price \$0.48

AEROVOX Type IN-28

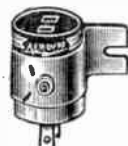

Intended for cases where ground is considerable distance from point of application. Most efficient when mounted directly on interfering device by bracket. Size 1 3/8 x 2 inches.

TYPE IN-28
List Price \$1.15...Net Price \$0.69

AEROVOX Type IN-29



Provides additional filtering action over IN-27 and IN-28. Especially effective for local sources of interference of variable character but strong intensity. Very effective for electric razor and other vibrating devices. Plugs between device and line. Size 1 3/8 x 3 inches.

TYPE IN-29
List Price \$0.90...Net Price \$0.54

AEROVOX Type IN-30



Similar to IN-29 but with additional inductance. Handles more severe interference. Plugs between set and outlet, or preferably between noisy appliance and outlet. Size 1 3/8 x 3 inches.

TYPE IN-30
List Price \$1.50...Net Price \$0.90

AEROVOX Type IN-31



Plugs in between attachment cord and electric outlet, either of set or preferably at appliance. Additional inductance for better filtering. Works best mounted by bracket directly on interfering appliance. Size 1 3/8 x 3 inches.

TYPE IN-31
List Price \$1.80 Net Price \$1.08

ANTENNA SUBSTITUTE



Plugs into outlet or light socket. Flexible lead connects with antenna post. Provides good aerial substitute under average wiring conditions. Size 1 3/8 x 2 inches.

TYPE ANT-32
List Price \$1.20...Net Price \$0.72

AUTO-RADIO CONDENSERS



Suppressor Condensers

Type 1120 — 1.0 Mfd.
List Price\$0.90
Net Price54
Type 1140 — 0.5 Mfd.
List Price\$0.60
Net Price36

Dual Section Suppressor Condenser

Type 1141 — .5-.5 Mfd.
List Price\$0.90
Net Price54

MOTOROLA Replacement Condenser

For Models 65 and 70 (Part No. 3321)

(2) Type 1466 — .0008 Mfd. 2500v. D.C. Test
List Price\$0.60
Net Price36

SUPPRESSOR CONDENSERS FOR FORD AUTO RADIOS

Type 1144-Cap. .5 Mfd.
List Price\$0.60
Net Price36

FOR 1936 MODELS

Type 1150-Cap. .5 Mfd.
List Price\$0.60
Net Price36

OIL-IMPREGNATED OIL-FILLED TUBULAR CONDENSERS



2000v. D.C. Working

Type 2089 oil-impregnated, oil-filled tubular condensers completely sealed from moisture or oil leakage and are ideal for vibrator applications, coupling condensers and transmitters, or high-voltage amplifiers and test equipment. All 2089 units are housed in a brass cadmium-plated can electrically insulated by special varnished-paper jacket. Ends of jacket spun over can rim eliminate possibility of shorts if leads are bent close to unit. Provided with mounting strap for additional connection.

Type No.	Cap. Mfd.	Size-Ins. D. L.	List Price	Net Price
2089	.0075	1 1/2 x 1 1/2	\$.90	\$.54
2089	.01	1 1/2 x 1 1/2	.90	.54
2089	.015	1 1/2 x 2 1/2	.90	.54
2039	.02	1 1/2 x 2 1/2	.90	.54
2089	.03	1 1/2 x 2 1/2	.95	.57
2089	.04	1 1/2 x 2 1/2	.95	.57
2089	.05	1 1/2 x 2 1/2	1.00	.60

Oil-impregnated Metal-Case VIBRATOR CONDENSERS



Type 1130 — One Lead Cap.	Type 1131- Two Leads Cap.
.007 Mfd.	.007 Mfd.
.01 Mfd.	.01 Mfd.
.02 Mfd.	.02 Mfd.
.03 Mfd.	.02 Mfd.

Any Capacity, Each
List Price \$0.65...Net Price \$0.33

Oil-impregnated Vibrator Condensers



Type	Cap.	List Price	Net Price
1135	.01	\$0.75	\$0.45
1135	.5	.80	.48

Tubular Paper Vibrator Condensers



Type 1684 — 1600 V.D.C.W.

Cap. Mfd.	List Price	Net Price	Cap. Mfd.	List Price	Net Price
.005	\$.45	\$.27	.03	\$.50	\$.30
.007	.45	.27	.04	.50	.30
.01	.45	.27	.05	.55	.33
.02	.45	.27			

Oil-impregnated Tubular Vibrator Condensers

Hermetically sealed oil condenser in metal tubes, with an outer cardboard tube as an insulating cover.

Type 1686 — 1600 V.D.C.W.

Cap. Mfd.	List Price	Net Price	Cap. Mfd.	List Price	Net Price
.005	\$.55	\$.33	.01	\$.75	\$.45
.006	.55	.33	.02	.75	.45
.007	.70	.42	.05	.80	.48
.008	.75	.45			

Gas-Gauge Filter Condenser

Type 1143-G
.95 mfd.

List Price\$0.60
Net Price36



"Hash" Condenser

Type 1122-Cap. .5 Mfd.
List \$0.50...Net \$0.30



Dome Light Filter Condenser

TYPE 1180

List Price\$1.00
Net Price60



Oil-Gauge Filter Condenser

Type 1142-O
.25 mfd.
List Price\$0.60
Net Price36



Ammeter Condensers

Type	Cap.	List Price	Net Price
1160	.6	\$0.65	\$0.33



AEROVOX Paper and Mica CONDENSERS

During the present emergency, we reserve the right to make mechanical changes without notice in order to produce equally suitable substitutes whenever and wherever necessary. Also, prices subject to change without notice.

TUBULAR PAPER CONDENSERS



Aerovox cartridge condensers are especially desirable for use where high grade units are required at low cost. They are compact, non-inductively wound and sealed in wax impregnated paper tubes with wax filled ends for longer life and protection against moisture.

Types and D.C.W. Voltages

484-400			684-600		
Cap. Mfd.	List Price	Net Price	List Price	Net Price	
.001		\$0.20	\$0.12		
.002			.12		
.003			.12		
.004			.12		
.005			.12		
.006			.12		
.01	\$0.20	\$0.12			
.015			.12		
.02	.20	.12	.12		
.03	.20	.12	.12		
.04	.20	.12	.15		
.05	.20	.12	.15		
.06	.25	.15	.18		
.1	.25	.15	.18		
.25	.30	.18	.45		
.5	.45	.27	.60		
1.0	.60	.36			
1084-1000			1684-1600		
.001	\$0.25	\$0.15			
.002	.25	.15			
.003	.25	.15			
.004	.25	.15	\$0.45	\$0.27	
.005	.25	.15			
.006	.25	.15			
.007		.45	.27		
.01	.40	.24	.45	.27	
.02	.40	.24	.45	.27	
.03			.50	.30	
.04			.50	.30	
.05	.45	.27	.55	.33	
.1	.60	.30			

STAMPED METAL CASE PAPER CONDENSERS



200 Volts D.C. Working

Type	Cap. Mfd.	List Price	Net Price
260	.05	\$0.60	\$0.36
260	.1	.70	.42
260	.25	.85	.51
260	.5	1.00	.60
260	1-1	.90	.54
260	.25-.25	1.15	.69
260	1-1-1	1.20	.72
261	1.0	1.30	.78
261	5-5	1.40	.84
261	25-25-25	1.50	.90

400 Volts D.C. Working

Type	Cap. Mfd.	List Price	Net Price
460	.05	\$0.70	\$0.42
460	.1	.80	.48
460	.25	.90	.54
460	.5	1.15	.69
460	1-1	1.00	.60
460	1-1-1	1.30	.78
461	.25	.90	.54
461	1.0	1.50	.90
461	.25-.25	1.20	.72
461	5-5	1.50	.90
461	25-25-25	1.60	.96

UNCASED PAPER CONDENSERS



TYPE UC200-200 V.D.C.W.

Cap. Mfd.	Size-In. L x W x D.	List Price	Net Price
.1	2 x 1/4 x 1/4	\$0.40	\$0.24
.25	2 x 1/4 x 3/8		.24
.5	2 x 1/4 x 1/2		.30
1.0	2 x 1/4 x 3/4		.45

TYPE UC400-400 V.D.C.W.

Cap. Mfd.	Size-In. L x W x D.	List Price	Net Price
.1	2 x 7/8 x 1/4	\$0.45	\$0.27
.25	2 x 1 x 3/4		.30
.5	2 x 1 1/8 x 3/4		.36
1.0	2 x 1 1/2 x 3/4		.54
2.0	3 1/4 x 1 1/2 x 3/4		.84
4.0	4 3/4 x 1 3/4 x 1 3/4		1.44

TYPE UC600-600 V.D.C.W.

Cap. Mfd.	Size-In. L x W x D.	List Price	Net Price
.25	2 x 1 1/8 x 3/4	\$0.60	\$0.26
.5	2 x 1 3/8 x 3/4		.75
1.0	3 1/4 x 1 1/2 x 3/4		1.10
2.0	3 1/4 x 1 3/4 x 1 1/4		1.65
4.0	4 3/4 x 1 3/4 x 1 3/4		3.25

TYPE UC1000-1000 V.D.C.W.

Cap. Mfd.	Size-In. L x W x D.	List Price	Net Price
5	4 3/4 x 1 7/8 x 1 3/4	\$1.20	\$0.72
1.0	4 3/4 x 1 3/4 x 1 1/4	1.40	1.08
2.0	4 3/4 x 2 1/4 x 1 3/4	3.00	1.80

DRAWN-CASE OIL FILLED CONDENSERS

TYPE 30



For applications requiring a compact superior-grade oil-impregnated, oil-filled capacitor. Non-inductive paper sections encased in a one-piece drawn metal case with soldered bottom plate for hermetic seal. Absolutely immersion-proof terminal assembly. Meets severe operating conditions encountered in aircraft, police, broadcast, p.a., and other types of communications equipment.

TYPE 430-400 V.D.C.W.

Cap. Mfd.	Size-In. L x W x H	List Price	Net Price
.1	1 1/2 x 1/2 x 1 1/2	\$2.05	\$1.23
.25	1 1/2 x 1/2 x 1 1/2		2.10
.5	1 1/2 x 1/2 x 1 1/2		2.30
1.0	2 1/8 x 1/2 x 1 1/2		2.75
2.0	2 x 2 x 1 1/2		3.30
1-1	1 1/2 x 1/2 x 1 1/2		2.75
25-25	1 1/2 x 1/2 x 1 1/2		2.80
5-5	2 1/8 x 1/2 x 1 1/2		2.95

TYPE 630-600 V.D.C.W.

Cap. Mfd.	Size-In. L x W x H	List Price	Net Price
.1	1 1/2 x 1/2 x 1 1/2	2.10	1.26
.25	1 1/2 x 1/2 x 1 1/2	2.20	1.32
.5	2 1/8 x 1/2 x 1 1/2	2.35	1.41
1.0	2 x 2 x 1 1/2	2.70	1.62
1-1	1 1/2 x 1/2 x 1 1/2	2.65	1.59
25-25	2 x 2 x 1 1/2	2.70	1.62
5-5	2 x 2 1/4 x 1 1/2	3.10	1.86

Other capacities and voltages available on special order.



A snappy, informative, practical engineering paper, issued monthly, the AEROVOX RESEARCH WORKER is free to servicemen, engineers, hams, and other interested radio workers. Ask your AEROVOX Jobber how you may subscribe, or write direct.

MICA CONDENSERS

Type 1450



High voltage, 1,000 volts D.C. test. *600v. D.C. test. Size 1 1/4 x 1 1/4 in.

Type 1467



Compact, size 1/2 in. square, provided with wire leads. Test volts 1000. *600v. D.C. test.

Cap. Mfd.	List Price	Net Price	Cap. Mfd.	List Price	Net Price
.0005	\$0.25	\$0.15	.003	\$0.50	\$0.30
.0015	.25	.15	.004	.50	.30
.0015	.30	.18	.005	.80	.36
.002	.40	.24	.006	.75	.45
.0025	.45	.27	.01	.90	.54

MIDGET MICA CONDENSERS

Type 1468 With Wire Leads



Midget size 3/8 x 3/8 in. provided with wire leads. Test volts 1000.

Cap. Mfd.	List Price	Net Price	Cap. Mfd.	List Price	Net Price
.00005	\$0.20	\$0.12	.00015	\$0.20	\$0.12
.00005	.20	.12	.0002	.20	.12
.0001	.20	.12	.00025	.25	.15
.00025	.20	.12	.0003	.25	.15
.0001	.20	.12	.00035	.25	.15
.0005	.20	.12	.0004	.25	.15
.0007	.20	.12	.0005	.25	.15
.00075	.20	.12	.00075	.25	.15
.0091	.20	.12	.001	.30	.18

Type 1460



Popular type mica condenser. Size 1 1/8 x 5/8 in. Two soldering lug terminals. Test volts 1000. *600v. D.C. test.

Cap. Mfd.	List Price	Net Price	Cap. Mfd.	List Price	Net Price
.00025	\$0.25	\$0.1	.0005	\$0.25	\$0.15
.0001	.20	.12	.00075	.25	.15
.00005	.20	.12	.001	.30	.18
.00007	.20	.12	.0015	.30	.18
.00015	.20	.12	.002	.40	.24
.00015	.20	.12	.0025	.45	.27
.0002	.20	.12	.003	.50	.30
.00025	.20	.12	.0035	.55	.33
.0003	.25	.15	.004	.60	.36
.00035	.25	.15	.0045	.65	.39
.0004	.25	.15	.005	.70	.42

SILVER MICA CONDENSERS



Type 1464

For most critical applications where precise capacity values must be attained and maintained, AEROVOX silver mica units are generally available. Encased in red molded AM bakelite. Similar in external appearance to standard bakelite-molded mica units.

Unique construction. Only plus .0022 per degree F.—a remarkably low temperature coefficient. Excellent retrace characteristics. Practically no capacity drift with time. Exceptionally high "Q". Mechanically protected against physical damage and changes in electrical characteristics due to varying atmospheric conditions. Wax impregnated externally. Ideal for use in circuits where inductance and capacity product must remain constant under all operating conditions. Specifically designed for use in push-button tuning where accuracy and stability are of prime importance.

Standard tolerance ±5%. For ±20% deduct 10% from price. For ±10% deduct 5%. For ±3% add 10%. For ±2% add 15%. For ±1% add 25%.

TYPE 1464—1000v. D.C. TEST

Cap. Mfd.	List Price	Net Price	Cap. Mfd.	List Price	Net Price
.00075	\$1.20	\$0.72	.002	\$1.80	\$1.08
.0008	1.20	.72	.0025	2.40	1.44
.0009	1.35	.81	.003	2.70	1.62
.001	1.50	.90	.004	2.85	1.71
.0015	1.80	1.08	.005	3.00	1.80

TYPE 1469—1000v. D.C. TEST

Cap. Mfd.	List Price	Net Price	Cap. Mfd.	List Price	Net Price
.00005	\$0.60	\$0.36	.00015	\$0.60	\$0.36
.00001	.50	.30	.0002	.60	.36
.000025	.50	.30	.00025	.60	.36
.00004	.50	.30	.0003	.90	.54
.00005	.50	.30	.00035	.90	.54
.00007	.50	.30	.0004	.90	.54
.000075	.50	.30	.0005	.90	.54
.0001	.50	.30			

TYPE 1479—1000v. D.C. TEST

Cap. Mfd.	List Price	Net Price	Cap. Mfd.	List Price	Net Price
.0001	\$0.50	\$0.30	.0005	\$0.90	\$0.54
.00015	.60	.36	.0007	1.20	.72
.0002	.60	.36	.00075	1.20	.72
.00025	.60	.36	.0008	1.20	.72
.0003	.90	.54	.0009	1.35	.81
.00035	.90	.54	.001	1.50	.90
.0004	.90	.54			

AEROVOX *Transmitting* CONDENSERS and RESISTORS

During the present emergency, we reserve the right to make mechanical changes without notice in order to produce equally suitable substitutes whenever and wherever necessary. Also, prices subject to change without notice.

HIGH-VOLTAGE MOLDED MICA TRANSMITTING CONDENSERS



Type 1450
Size 1 1/4" x 1 1/4"

One of the most popular of the AEROVOX mica transmitting line, intended for point-to-point wiring, being supported entirely by its soldered connections.

Type 1450
1000v. D.C. Test
*600v. D.C. Test

Cap. Mfd.	List Price	Net Price	Cap. Mfd.	List Price	Net Price
.0001	\$0.45	\$0.27	.002	\$0.55	\$0.33
.00015	.45	.27	.003	.70	.42
.0002	.45	.27	.004	.70	.42
.00025	.45	.27	.005	.70	.48
.0004	.45	.27	.006	.80	.60
.0005	.45	.27	.01	1.00	.60
.001	.50	.30	.02*	1.45	.87
			.05*	3.30	1.98



Types 1455-57
Size 1 1/4" x 1 1/2"

Types 1455-57, have insulated mounting holes, independent of soldering lugs, for connections. 1 1/2" spacing between mounting hole centers. If 1 3/8" spacing is preferred specify Types 1445-47. Large meter-mounting brackets permitting use of this type of unit for shunting meter windings may be obtained at 45c added to list price. Specify by adding suffix (A) to type number. Small brackets are also available at 25c additional. Specify by suffix (E). Both brackets have universal slots for either mounting hole spacing.

Types & D.C. Test Voltages

Cap. Mfd.	1455-1000		1456-2500		1457-5000	
	List Price	Net Price	List Price	Net Price	List Price	Net Price
.00005	\$0.60	\$0.38	\$0.85	\$0.51	\$1.10	\$0.68
.0001	.60	.38	.85	.51	1.10	.68
.00025	.60	.38	.85	.51	1.30	.78
.0005	.60	.38	.85	.51	1.50	.90
.001	.60	.38	1.10	.66	1.80	1.08
.002	.70	.42	1.65	.99	2.70	1.62
.006	1.05	.63	2.10	1.26		
.01	1.40	.84	3.40	2.04		
.02	1.90	1.14				
.03	2.55	1.53				

METAL-CASED ULTRA-COMPACT PAPER CONDENSERS

Ultra-compact heavy-duty condensers. Wax-impregnated, wax-filled. Used as replacements in sound equipment, high power radio receivers, electronic devices, and communication equipment. Housed in a rust-proof container with soldering terminals conveniently located.

Type 1080—1000v. D.C. Work.

Cap. Mfd.	Size-Ins. D. W. L.	List Price	Net Price
.5	1/2" x 1 1/4" x 2	\$1.80	\$1.09
1-0	1 1/4" x 1 1/4" x 2	2.50	1.50
2-0	2 1/4" x 1 1/4" x 2	3.85	2.31
4-0	2 3/4" x 2 3/4" x 2	6.20	3.72



Types 1650-54
Size 1 1/8" x 1 1/4"

Heaviest-duty molded bakelite mica condensers of the AEROVOX line. Provided with threaded holes taking the roundhead screw terminals. Also available with plain holes through which screws or rods may be slipped. Same price as 1650 series, but specify 1650A, etc. when latter is desired.

Types and D.C. Voltages

Cap. Mfd.	1650		1651		1652		1653		1654	
	Light-face	Bald-face	Light-face	Bald-face	Light-face	Bald-face	Light-face	Bald-face	Light-face	Bald-face
.00005	\$0.75	\$0.85	\$1.10	\$2.00	\$2.30					
.0001	.45	.51	.66	1.20	1.58					
.00015	.75	.95	1.10	2.35	2.90					
.0002	.45	.51	.66	1.41	1.74					
.00025	.75	.85	1.15	2.55	3.20					
.0002	.45	.51	.69	1.53	1.82					
.00025	.75	.85	1.20	2.70	4.05					
.00025	.45	.51	.72	1.62	2.43					
.00025	.75	.85	1.30	3.00	4.45					
.0005	.45	.51	.78	1.80	2.67					
.0005	.75	.85	1.50	4.20	6.60					
.001	.45	.51	.90	2.52	3.86					
.001	.75	1.10	1.80	5.05	8.40					
.002	.45	.66	1.08	3.03	5.04					
.002	.80	1.65	2.70	7.70						
.003	.48	.99	1.62	4.62						
.003	1.05	1.90	3.30	9.60						
.004	.63	1.14	1.98	5.76						
.004	1.05	1.90	3.80	12.00						
.005	.63	1.14	2.28	7.20						
.005	1.05	2.10	4.10							
.006	.63	1.26	2.46							
.006	1.20	2.10	4.20							
.01	.72	1.26	2.52							
.01	1.70	3.40	4.95							
.015	1.02	2.04	2.97							
.015	1.95	4.05	5.40							
.015	1.17	2.43	3.24							
.02	2.25	4.75								
.02	1.35	2.85								
.03	3.00	5.55								
.03	1.80	3.33								
.05	4.65									
.05	2.79									
.06	5.40									
.06	3.24									

"SLIDE-OHM" X-MITTING GRID LEAKS



Type 958—200 Watts
Size—1 1/2" x 10 1/2" inches
200-watt heavy-duty adjustable wire-wound vitreous-enamel resistors especially for use as a transmitting grid leak or in power units and other circuits where adjustable heavy-duty resistors or voltage dividers are required. Scale marked on each unit for setting to any desired resistance value. Provided with horizontal mounting brackets and one adjustable contact slider.

Resistance Ranges	List Price	Net Price
6-10,000	\$3.30	\$1.98
15,000-100,000	3.85	2.31
126,000-160,000	4.00	2.40



Commercial Grade

TRANSMITTING CAPACITORS

● The self-same extra-heavy-duty capacitors which Aerovox has been supplying to the Army and Navy, to commercial communication companies and broadcasters, and to builders of quality radio and electronic equipment, are now available to amateurs and experimenters as well.

Thus Aerovox is contributing its share towards narrowing still more the small remaining gap between professional and amateur radio practices.

Due to the necessarily limited demand for these extra-heavy-duty mica, paper, oil-filled and plug-in electrolytics, as well as the great diversity of items, this line is made to special order. However, your Authorized Aerovox Jobber is in a position to order these commercial-grade capacitors for you.

Let him know what applications you have that call for extra-heavy-duty capacitors, and he will gladly supply specifications and quotations, and take care of your orders.

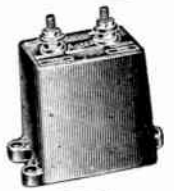

COMPACT HERMETICALLY-SEALED OIL-FILLED CONDENSERS

Type 16

Compact, oil-filled, hermetically-sealed units for use where least space and minimum weight are essential. Corrosion-proof metal container. Special immersion-proof terminals designed for equipment subjected to severe atmospheric and climatic conditions. Suitable for by-pass and filter applications in receivers and low-power transmitters. All 1 1/8" wide x 1 1/4" deep x 1 1/8" high except "units 1 1/4" high and 1 1/8" high.



Types and D.C.W. Voltages

Cap. Mfd.	216-200		416-400	
	List Price	Net Price	List Price	Net Price
.01	\$2.00	\$1.20	\$2.05	\$1.23
.05	2.05	1.23	2.10	1.26
.1	2.20	1.32	2.25	1.35
.25	2.25	1.35	2.30*	1.38*
.5	2.30*	1.38*	2.35†	1.41†
1.0	2.40†	1.44†		

PORCELAIN-CASED MICA CONDENSERS

Ideal for those higher-frequency applications. Encased and hermetically-sealed in glazed porcelain case. Heavy-duty terminals. Power loss due to dielectric absorption reduced to a minimum. Units operate at full load without heating up. Dimensions: 3 1/2" between mounting holes, 4" overall by 3" high.



Types 1991-96

Type 1991—2000v. Max. D.C.

Cap. Mfd.	List Price	Net Price	Cap. Mfd.	List Price	Net Price
.02	\$9.90	\$5.94	.1	\$13.20	\$7.92

Type 1992—3500v. Max. D.C.

Cap. Mfd.	List Price	Net Price	Cap. Mfd.	List Price	Net Price
.001	\$5.40	\$3.24	.005	\$9.00	\$5.40
.0015	5.40	3.24	.01	12.00	7.20
.002	6.60	3.96	.02	12.00	7.20
.003	7.20	4.32	.05	13.80	8.28

Type 1993—5000v. Max. D.C.

Cap. Mfd.	List Price	Net Price	Cap. Mfd.	List Price	Net Price
.002	\$7.20	\$4.30	.005	\$9.00	\$5.40
.003	7.80	4.68	.01	12.60	7.56

Type 1994—7000v. Max. D.C.

Cap. Mfd.	List Price	Net Price	Cap. Mfd.	List Price	Net Price
.0005	\$5.40	\$3.24	.003	\$8.40	\$5.04
.0015	6.00	3.60	.005	11.40	6.84
.0015	6.60	3.96	.01	12.60	7.56
.002	7.80	4.68			

Type 1995—10000v. Max. D.C.

Cap. Mfd.	List Price	Net Price	Cap. Mfd.	List Price	Net Price
.002	\$8.40	\$5.04	.005	\$12.00	\$7.20
.003	10.80	6.48			

Type 1996—12500v. Max. D.C.

Cap. Mfd.	List Price	Net Price	Cap. Mfd.	List Price	Net Price
.00005	\$6.60	\$3.96	.001	\$6.60	\$3.96
.0001	6.60	3.96	.0015	7.80	4.68
.00025	6.60	3.96	.002	9.00	5.40
.0005	6.60	3.96	.003	12.60	7.56

AEROVOX Vitreous-Enameled and Carbon RESISTORS

During the present emergency, we reserve the right to make mechanical changes without notice in order to produce equally suitable substitutes whenever and wherever necessary. Also, prices subject to change without notice.

"SLIDEOHM" Wire-Wound Vitreous-Enameled ADJUSTABLE RESISTORS

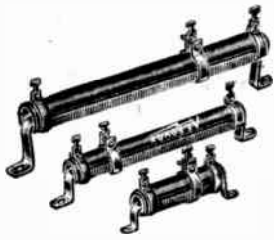

Adjustable resistors combining adjustment to any resistance value within unit's range, with positive, permanent, non-fluctuating qualities of wire-wound resistor. Each Slideohm Resistor is provided with horizontal mounting brackets and one adjustable contact slider.

Type 952—25 Watts Size $\frac{5}{8}$ x 2 inches

Ranges	List	Net
1-5000	\$0.95	\$0.57
6000-10,000	1.10	.66

Extra Slider Bands—10c ea., Net 6c

Type Resis. Ohms	952 Watts Cur. M.A.	954 50 Watts Cur. M.A.	956 75 Watts Cur. M.A.	957 100 Watts Cur. M.A.	958 200 Watts Cur. M.A.
1	5000				
8	2880				
5	2280	3160	3870	4470	6320
10	1680	2240	2740	3160	4470
15	1290		2240	2580	
20	1116				
25	1000	1410	1730	2000	2825
50	710	1000	1220	1410	2000
75	580	816	1000	1150	
100	600	706	866	1000	1400
150	410	576			
200	356	500	610		
250	316	446	550	630	900
300	290	406	500		
400	250	350	430		
500	225	316	386	446	630
750	180	260	316	366	
800		250	306		
850	170				
1000	160	225	275	316	450
1250	140	200	245		
1500	130	180	225	260	365
2000	110	160	195	225	315
2250	106	150			
2500	100	140	173	200	280
3000	90	130	158	180	260
3600	85	120	146	170	240
4000	80	110	137	160	225
4500	74	106	129	150	210
5000	70	100	122	140	200
6000	65	91	111	130	
7000	57	85	103		
7500	58		100	115	165
9000	50	79	97	110	
8500	47				
9000	44	75	91		
10,000	40	71	87	100	140
12,000		64			
15,000		58	71	90	115
20,000		48	61	70	100
25,000		40	55	60	90
30,000		33	50	50	82
35,000			43	43	71
40,000		25	37	37	62
50,000		20	30	30	50
60,000			25	25	42
70,000			21	21	
75,000					32
100,000					25
125,000					20
150,000					16

"PYROHM JUNIOR" Wire-Wound Vitreous-Enameled FIXED RESISTORS

Compact, genuine wire-wound units. Covered with vitreous-enamel. Highest quality materials used throughout. Correctly designed. Note these features:



- Crack-proof refractory tubing for the support. Adequate heat dissipation.
- Quality resistance wire precisely space wound under tension.
- Copper terminal band clamped to tubing. Wire ends wrapped about raised ear and brazed to same.

- Heavy vitreous-enamel coating for permanent seal against moisture, oxidation and mechanical damage.
- Pig-tail of stiff wire 2 in. long soldered to terminal band for positive, non-breakable connection.

Type 933—20 Watts Size—Ins. $\frac{1}{8}$ x 2

Ranges	List	Net
1-15,000	\$0.70	\$0.42
20,000-55,000	.85	.51
60,000-100,000	1.10	.66

25,000-100,000 ohms rated at 7 watts.

Type 931—10 Watts Size—Ins. $\frac{1}{8}$ x 1 $\frac{1}{2}$

Ranges	List	Net
1-10,000	\$0.45	\$0.27
12,000-50,000	.50	.30

30,000 to 50,000 ohms, rated at 5 watts.

Stock Resistance Ranges

1	200	1750	12,000
2	250	2000	12,500
3	300	2500	13,500
4	350	2750	14,300
5	400	3000	16,000
7.5	450	3500	18,000
10	500	4000	17,500
12	600	4500	18,000
15	650	5000	20,000
20	700	5500	22,500
25	750	6000	25,000
30	800	7000	30,000
35	850	7500	35,000
40	900	8000	40,000
50	1000	8500	45,000
75	1100	9000	50,000
100	1200	10,000	
125	1250		
150	1400		
175	1600		

Stock Resistance Ranges

1	650	3000	35,000
3	700	3500	40,000
6	750	4000	45,000
10	800	4500	50,000
15	850	5000	55,000
25	1000	6000	60,000
50	1200	7000	65,000
75	1250	7500	70,000
100	1500	8000	75,000
150	1750	10,000	80,000
175	1860	12,500	85,000
200	2000	13,000	90,000
250	2250	15,000	95,000
300	2400	20,000	100,000
350	2500	25,000	
400	2750	30,000	
500			

LACQUER COATED CARBON RESISTORS



Non-hygroscopic body of special composition, unaffected by temperature changes. Quiet in operation. Values permanently maintained at all loads. High mechanical and electrical strength. Pig-tail leads 2 in. long. Conservative ratings. RMA color-coded. Resistance values stamped thereon.

INSULATED MOLDED CARBON RESISTORS



Small, noiseless, vibration-proof. Crack-proof molded casing around molded carbon resistance element. Tinned copper pig-tail leads 2 in. long. Resists humidity effects. Ideal for AVC circuits, high-gain amplifiers. RMA color-coded; stamped with resistance value. Precision tested. Standard tolerance 10%. These types may come thru for some time in slightly larger sizes until complete changeover is achieved.

Types	Rating Watt	Size Ins.	List ea.	Net ea.
1096	$\frac{1}{2}$	$\frac{1}{8}$ x $\frac{1}{2}$	\$1.15	\$0.90
1095	1	$\frac{1}{4}$ x 1	.15	.09
1094	1	$\frac{1}{4}$ x $\frac{3}{4}$.18	.11

Stock Resistance Ranges—Ohms

1	500	7500	100000
2	600	8000	125000
3	700	9000	150000
5	750	10000	200000
7.5	800	11000	250000
10	850	12000	300000
15	900	12500	350000
20	1000	15000	400000
25	1200	17500	500000
30	1250	18000	600000
40	1400	20000	700000
50	1500	22500	750000
75	1750	25000	1 Meg.
100	2000	30000	1 $\frac{1}{2}$ Meg.
120	2250	35000	2 Meg.
150	2500	40000	2 $\frac{1}{2}$ Meg.
200	3000	45000	3 Meg.
250	3500	50000	4 Meg.
300	4000	60000	5 Meg.
350	5000	65000	6 Meg.
400	6000	70000	7 Meg.
450	7000	75000	10 Meg.
		80000	20 Meg.

Types	Rating Watt	Size Ins.	List ea.	Net ea.
1098	1	$1\frac{1}{4}$ x $\frac{5}{8}$	\$2.20	\$1.12
1097	$\frac{1}{2}$	$\frac{3}{8}$ x $\frac{3}{8}$.17	.10

Stock Resistance Ranges—Ohms

1	350	7500	100000
2	400	8000	125000
3	450	9000	150000
4	500	10000	175000
5	600	11000	200000
7.5	750	12000	250000
10	800	12500	300000
15	900	13000	400000
20	1000	14000	500000
25	1250	15000	600000
30	1500	17500	750000
40	1750	20000	1 Meg.
50	2000	22500	1 $\frac{1}{2}$ Meg.
60	2250	25000	2 Meg.
75	2500	30000	2 $\frac{1}{2}$ Meg.
100	3000	35000	3 Meg.
120	3500	40000	4 Meg.
150	4000	50000	5 Meg.
200	5000	60000	6 Meg.
250	6000	65000	7 Meg.
300	7000	70000	10 Meg.
		75000	20 Meg.

AEROVOX

CAPACITY and RESISTANCE

Bridge



● In the best interests of ALL users of condensers, AEROVOX engineers have developed this more critical checking means. Tests and readings, more than any claims and superlatives, best tell the true story of any and all condensers. Years of experience testing and checking condenser quality have been boiled down to provide this simple, portable, moderately-priced instrument. Do not confuse it with other bridges employing just an electric eye or neon lamps as indicators. Check the following features point by point with other type bridges, before you decide which one to buy. Remember, leading laboratories are using the AEROVOX Bridge, despite the fact that it is a serviceman's instrument, primarily.

What It Does .

● CAPACITY BRIDGE

Measures capacity, leakage, power factor, etc., of condensers under actual working conditions. 100 mmfd. (.0001) to 100 mfd. in 6 ranges.

● RESISTANCE BRIDGE

Measures resistance values of resistors and electrical equipment and circuits. 10 ohms to 1 megohm.

● INSULATION RESISTANCE

Measures this important factor in condensers and other devices. Meter calibrated directly in megohms. Reads up to 10,000 megohms at 500 volts.

● VACUUM-TUBE VOLTMETER

Consists of amplifier stage and grid-leak detector. Measures minute values.

● VOLTMETER

Available for voltage readings. 0-60 v., 0-300 v., 0-600 v., at 1000 ohms per volt. May be used externally.

● MILLIVOLTMETER

Meter terminals brought out directly. Range, 60 mv. at 60 ohms, or 1 m.a. Can be used with external shunts.

● MILLIAMMETER

Meter can be read in milliamperes. 0-5 ma., 0-60 ma. May be used externally.

● VARIABLE POWER SUPPLY

Available directly at terminals. Supplying between 15 and 600 volts continuously variable over entire range.

Specifications . . .

● Measures with sufficient practical accuracy all essential properties of condensers under actual working conditions. In addition, all components and circuits are utilized for other measurements and tests. ● Simple to operate. Neat layout of knobs and dials. Concise instructions for each control etched directly on panel. General directions on inside cover. ● Binding posts insulated with XXX Bakelite and accommodate banana plugs, spade terminals, phone tips and bare wires. ● Tubes mounted on shelf alongside panel. Space alongside -45 tube accommodates power cord. Tubes: 6C8G, 1V, -45. ● Red gumwood cabinet, Natural finish. Lock-corner construction. Leather handle. Heavy catch ● Two slip hinges permit removing cover. Rubber feet and bumpers, top and bottom. A fine instrument. ● Each instrument precisely calibrated and thoroughly factory tested. Serially numbered and registered in original owner's name for full protection. Elaborate manual supplied with each instrument. ● Dimensions: 10 $\frac{3}{4}$ x 7 $\frac{3}{4}$ x 8 inches. Weight: 11 lbs.

1. Meter Range Switch. "Brains" of the bridge. Provides external milliammeter first three positions; external voltmeter next three, ranging from 60, 300 and 600 v. at 1000 ohms per volt. "Bridge" indicates power on and balancing position. Also provides vacuum-tube voltmeter and insulation resistance test at "VTV"; leakage test through X terminals at "L 60 MA" and "L 6 MA" positions; and polarizing voltage readings on proper meter range at "PV" position.

2. Polarizing Voltage Control. Inner knob serves as transformer tap switch. Outer knob is vernier control indicating continuously variable voltage 15 to 600 volts in 3 steps. Voltmeter automatically switched to proper range 0-60, 0-300, 0-600. Variable voltage available between terminals X and Ground for meter calibration, load tests, amplifiers, etc.

3. Power Factor Control and Switch for insulation resistance test.

4. Bridge Range Control for reading capacity: .0001-.001 mfd.; .001-.01 mfd.; .01-.1 mfd.; 1-10 mfd.; 10-100 mfd. Multiplying factor for both capacity and resistance indicated on face of control.

5. Zero Adjustment for vacuum tube voltmeter and bridge detector.

6. Push Button for insulation resistance test.

7. Main Dial, linear calibration, for capacity and resistance readings.

Note the multiplicity of functions which this versatile instrument performs. High-grade meter movement is used in place of magic eyes and neon lamps generally found in bridges priced for the service trade. Resistors, tubes and other components are likewise of precision grade for accuracy first and last.



BRIDGE MANUAL: Covers theory and practice of all types of bridges. Covers all measurements and tests. Simply invaluable to radio and electrical worker. Supplied with Bridge. Available separately at 50c net.

AEROVOX

L-C CHECKER

Model 95

● Designed to test condensers and inductances in the radio-frequency range, under conditions that simulate actual working conditions. Determines effectiveness of capacity or inductance while actually connected in its circuit. Under such conditions the efficiency of testing is greatly increased. In addition to testing radio components singly, it is possible to test combinations of inductance (L) and capacitance (C), thereby determining the resonant frequency of combinations and, by such means, the operating effectiveness of the circuit. Also, this instrument can be employed to adjust circuit or systems to proper operating efficiency.

Unique, up-to-the-minute, simple, inexpensive, the L-C Checker is truly indispensable to the serious radio worker.

L - CHECKS INDUCTANCE

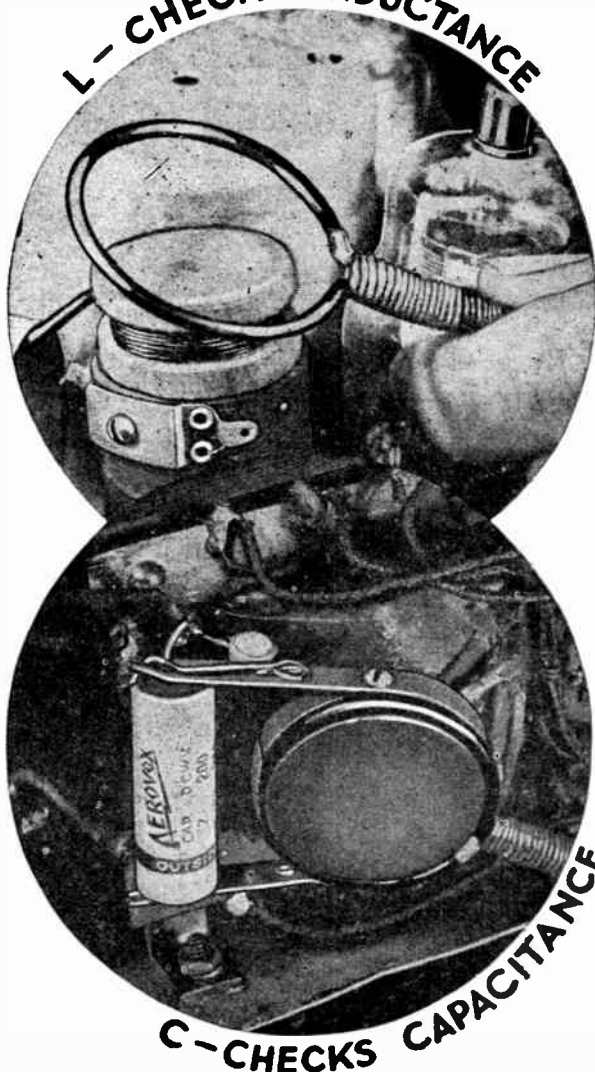

C - CHECKS CAPACITANCE

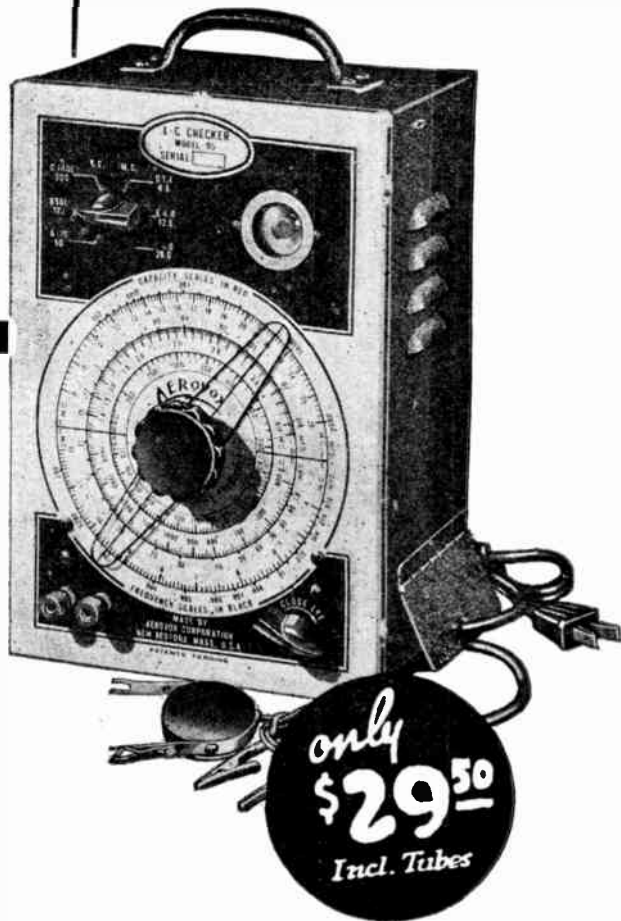

only
\$29⁵⁰
Incl. Tubes

What It Checks . . .

- ✓ Capacity of condensers at radio frequencies without removing them from circuit.
- ✓ Alignment of r.f. circuits. Tracking of super-het. oscillator.
- ✓ Alignment of both broad and narrow band u.f. amplifiers.
- ✓ Tuning of wave traps and of image-rejection circuits; frequency ranges of receivers; frequency ranges of signal generators; calibration of wave meters.
- ✓ Identifying harmonics of frequency standard in precision frequency calibration of radio equipment.
- ✓ Natural resonant points of r.f. chokes making sure they are beyond operating range.
- ✓ Tracing resonant absorption trouble in "all-wave" receiver circuits—locating dead spots, etc.
- ✓ Locating resonant points in shorted windings (unused coils in multi-range oscillators, etc.).
- ✓ Locating resonant frequency of r.f. coupling chokes, making sure of placement to secure enough gain balance over tuning range of r.f. stage.
- ✓ Checking natural period of antennae and transmission lines, to have resonant peaks at certain frequencies.
- ✓ Checking quartz crystals for frequency, false frequency, operation at harmonics, and for activity.
- ✓ Checking FM of i.f. transformers.
- ✓ Checking alignment of FM of i.f. channels.
- ✓ Checking many other functions when used with auxiliary equipment.

Specifications . . .

General: Completely self-contained. Sturdy steel case. Crackle-finished baked enamel. Handsome front panel. Side compartment holds power cord, test leads, coupling link. **Operation:** 115-volt 60-cycle A.C. Will operate on D.C. and frequencies other than specified. **Frequency range:** Oscillator has six coil ranges, selected by panel switch—60-170, 170-490, 490-1500 kc.; and 1.5-4.6, 4.5-15, and 13-26 mc. Indicator: Type 6E5 magic eye, indi-

ating energy in oscillator circuit by widening of shadow angle. Very critical. **Tube Complement:** 6J5G, 6E5, 25Z5, VR105. Accuracy: Checks capacitance and inductance values well within 10% depending upon conditions. Indicates frequencies within 1% under satisfactory conditions. Dimensions: 10 1/2 x 7 1/2 x 5 1/2 in. Weight: 6 lbs. Fully guaranteed. Serial numbered and registered in original buyer's name. Instruction manual included.

L-C CHECKER MODEL 95

Complete, including tubes, power cord, coupling unit and capacity clip (shown at left) and spring clip leads, together with explicit instructions on how to use instrument for widest variety of tests and checks.

Dealer's-Serviceman's Net Cost. . \$29.50

AEROVOX MOTOR-STARTING CAPACITOR SELECTOR AND EMERGENCY CAPACITORS

**FIRST AID FOR THAT AILING CAPACITOR-
START TYPE REFRIGERATOR MOTOR**

Refrigerator servicing is necessarily a rush job. Perishable food is at stake; more important still, the family's health. So if you're servicing electric refrigerators, by all means get them going promptly. Nine times out of ten, the trouble is a wornout capacitor. And here's the first-aid treatment:

WHAT CAPACITOR DO YOU NEED?

By referring to the motor name-plate and then to AEROVOX listings, you can readily determine what exact-duplicate capacitor is required. But—time is precious. Every minute counts. You may not have time to run down to the jobber's and pick up the required replacement. What to do?

USE THE CAPACITOR SELECTOR

Simple enough. Use the AEROVOX Capacitor Selector. Merely connect its clips in place of defunct capacitor. Try the various toggle switches starting with the 65 mfd. first. Note that each successive toggle throws in 17.5 mfd. more, for a wide range of capacities to 152½ mfd. Watch that the voltmeter reading doesn't exceed 138 volts. When adequate starting torque is obtained in less than three seconds, merely total the capacity from the "on" switches. That's the correct capacity required. Simple enough!

CLIP ON AN EMERGENCY CAPACITOR

Now, having determined required capacity with the Selector, simply take an AEROVOX Emergency Capacitor and make up the necessary capacity by plugging in the respective colored leads and plugs into the grouping connector, as per directions on the Emergency Capacitor. With the proper capacity now made up, simply clip the rubber-sleeved connectors in place of the discarded capacitor and leave the Emergency unit, with its grouping connector, inside the refrigerator motor compartment. The motor will now operate normally. You have safeguarded that family's food—and health.



FINALLY — INSTALL PERMANENT UNIT

But don't stop here. The Emergency Capacitor is not for permanent service. Such a unit necessarily costs more than an exact-duplicate unit. So at your convenience, pick up the right replacement at your AEROVOX jobber, and install it permanently in place of the Emergency unit. Thus you have our up-to-the-minute First Aid treatment for sick electric refrigerators. Likewise the means of gaining an outstanding reputation as the electric refrigerator serviceman who "gets 'em started in a jiffy."

These two aids . . . the Emergency Capacitor and the Capacitor Selector . . . permit prompt servicing of capacitor-type refrigerator motors. There's no guessing, fussing, stalling. You make the emergency replacement immediately, and install permanent replacement at your convenience. All of which spells greater good will, a growing reputation, and real servicing profits.

Ask . . .

Get further facts regarding this amazing first-aid technique. Ask to see these items. Better still, order a kit TODAY . . . and cash in on this sure-shot refrigerator servicing.



CAPACITOR SELECTOR

If in doubt regarding capacity required, use this simple instrument. Clip in place of discarded unit. Throw first toggle switch (65 mfd.), check starting time, and see that voltmeter reading doesn't exceed 138, red line on scale. Try other switches. When adequate starting torque, within 3 seconds' start, below 138 volt peak, is attained, total required capacity from "On" switches. Use capacitor of that value, for replacement.

EMERGENCY CAPACITOR

A truly universal capacitor. Any capacity from 17½ to 152½ mfd. Determine required capacity—from discarded unit's label, from motor name-plate, from AEROVOX listings—then plug in required sections (see above). Clip in place. Presto! Motor gets going. Later, when convenient, install permanent AEROVOX replacement.

Complete Kit

Model No. 87
Comprising Capacitor Selector
and two Emergency Capacitors,
with latest replacement listings.

\$18.00

DEALER'S
SERVICEMEN'S
NET COST

Capacitor Selector Model No. 85 \$10.00
Emergency Capacitor Model No. 86
\$4.00 each

AEROVOX MOTOR-STARTING CAPACITORS

FOR permanent replacements, AEROVOX offers the most extensive line of both standard and exact-duplicate capacitors now available.

These units are listed for ready identification and selection under motor manufacturer's name, including manufacturer's part number, Aerovox catalog number, capacity, AC voltage, dimensions, illustration, list price, and other essential data, in the AEROVOX INDUSTRIAL CAPACITOR CATALOG, copy of which will be sent to you on request, or given to you by your local jobber.

Also, for your convenience, these listings are available as a wall chart which you will find at your jobber's.

As pioneer of high-capacity electrolytics for motor-starting functions, and as the producer of the greater portion of the two million or more units in daily use, AEROVOX can best serve your replacement requirements with a thorough background of experience, the most extensive data available, and a product that is fully tried, tested and perfected. **ASK YOUR JOBBER FOR FURTHER DETAILS, OR WRITE AEROVOX DIRECT.**



EXACT DUPLICATE—UNIVERSAL ELECTROLYTIC CAPACITORS

For Replacement in Refrigerators, Oil Burners and Other
Motor Driven Equipment

During the present emergency, we reserve the right to make mechanical changes without notice in order to produce equally suitable substitutes whenever and wherever necessary. Also, prices subject to change without notice.

ELECTROLYTIC CAPACITOR REPLACEMENTS



A concise list of popular types of capacitors arranged according to name and original part number of manufacturers for whom the various units were originally made; also suggested Standard AeroVox Universal Replacement if exact duplicate unit is not immediately available. This listing is especially intended for those engaged in servicing electric refrigerators, oil burners and other fractional horsepower motor equipment employing capacitors.



Manufacturer and Mfrs. Part No.	A.C. Voltage	EXACT DUPLICATE REPLACEMENT					UNIVERSAL REPLACEMENT				
		AeroVox Cat. No.	Cap. Mfd.	List Price	Net Price	Dimensions	AeroVox Cat. No.	Cap. Mfd.	List Price	Net Price	Dimensions
APEX ELEC. MFG. CO.											
88021*	110	101	115	\$3.00	\$2.10	3 1/2 x 3 1/2 x 2					
88022*	110	208	150	3.60	2.52	3 1/2 x 3 1/2 x 2					
88023*	220	209	10	5.10	3.78	3 1/2 x 3 1/2 x 2					
88026**	110	160	124-138	1.80	1.26	1 3/8 x 3 1/4					
42480***	110	161	115	3.15	2.21	2 x 4 1/8	160	124-138	\$1.80	\$1.26	1 3/8 x 3 1/4
BALDOR ELEC. CO.											
.....	110	101	115	3.00	2.10	3 1/2 x 3 1/2 x 2					
.....	110	104	115	3.00	2.10	4 1/2 x 4 1/2 x 1 1/2					
.....	110	105	150	3.60	2.52	4 1/2 x 4 1/2 x 1 1/2					
.....	110	160	124-138	1.80	1.26	1 3/8 x 3 1/4					
.....	110	195	108-120	1.70	1.19	1 3/8 x 3 1/4					
.....	110	196	75-84	1.60	1.12	1 3/8 x 3 1/4					
BLACK & DECKER ELEC. CO.											
0-4270†	110	102	75	2.80	1.96	2 1/2 x 4 1/8	196	75-84	1.60	1.12	1 3/8 x 3 1/4
.....	110	105	150	3.60	2.52	4 1/2 x 4 1/2 x 1 1/2					
.....	110	196	75-84	1.60	1.12	1 3/8 x 3 1/4					
BROWN-BROCKMEYER CO., INC.											
.....	110	126	135	3.40	2.38	2 1/2 x 4 1/8	171	145-162	2.20	1.54	1 3/8 x 3 1/4
.....	110	146	80	2.85	2.00	2 x 4 1/8	180	86-96	1.65	1.16	1 3/8 x 3 1/4
.....	110	164	100	2.90	2.03	2 x 4 1/8	162	108-120	1.70	1.19	1 3/8 x 3 1/4
.....	110	166	50	2.70	1.89	2 x 4 1/8	193	53-60	1.50	1.05	1 3/8 x 3 1/4
.....	110	188	150	3.60	2.52	2 1/2 x 4 1/8	197	161-180	2.40	1.68	2 x 3 1/4
CENTURY ELEC. CO.											
110040**	110	168	43-48	1.45	1.02	1 3/8 x 3 1/4					
110050**	110	193	53-60	1.50	1.05	1 3/8 x 3 1/4					
110060**	110	167	64-72	1.50	1.05	1 3/8 x 3 1/4					
110070**	110	196	75-84	1.60	1.12	1 3/8 x 3 1/4					
110080**	110	180	86-96	1.65	1.16	1 3/8 x 3 1/4					
110100**	110	162	108-120	1.70	1.19	1 3/8 x 3 1/4					
110115**	110	160	124-138	1.80	1.26	1 3/8 x 3 1/4					
110135**	110	182	145-162	2.20	1.54	2 x 3 1/4					
110150**	110	197	161-180	2.40	1.68	2 x 3 1/4					
12018-2**	110	188	150	3.60	2.52	2 1/2 x 4 1/8	197	161-180	2.40	1.68	2 x 3 1/4
130050**	110	166	50	2.70	1.89	2 x 4 1/8	193	53-60	1.50	1.05	1 3/8 x 3 1/4
130080***	110	154	80	2.95	2.07	2 x 4 1/8	180	86-96	1.65	1.16	1 3/8 x 3 1/4
130100**	110	164	100	2.90	2.03	2 x 4 1/8	162	108-120	1.70	1.19	1 3/8 x 3 1/4
130115**	110	165	115	3.00	2.10	2 x 4 1/8	160	124-138	1.80	1.26	1 3/8 x 3 1/4
130135†	110	126	135	3.40	2.38	2 1/2 x 4 1/8	171	145-162	2.20	1.54	1 3/8 x 3 1/4
130150**	110	188	150	3.60	2.52	2 1/2 x 4 1/8	197	161-180	2.40	1.68	2 x 3 1/4
DELCO PROD. CORP.											
1056393**	110	160	124-138	1.80	1.26	1 3/8 x 3 1/4					
1056792**	110	171	145-162	2.20	1.54	1 3/8 x 3 1/4					
1057380**	110	180	86-96	1.65	1.16	1 3/8 x 3 1/4					
1057381**	110	171	145-162	2.20	1.54	1 3/8 x 3 1/4					
1057382**	110	197	161-180	2.40	1.68	2 x 3 1/4					
1057384**	220	202	26-30	2.65	1.86	1 3/8 x 3 1/4					
1057415**	110	160	124-138	1.80	1.26	1 3/8 x 3 1/4					
1061445†	110	106	115	3.00	2.10	2 1/2 x 4 1/8	160	124-138	1.80	1.26	1 3/8 x 3 1/4
1061447†	110	110	115	3.00	2.10	2 1/2 x 4 1/8	160	124-138	1.80	1.26	1 3/8 x 3 1/4
1062558	110	107	80	2.85	2.00	2 1/2 x 4 1/8	180	86-96	1.65	1.16	1 3/8 x 3 1/4
1062880	220	108	29	4.20	2.94	2 1/2 x 4 1/8					
1062882	110	107	80	2.85	2.00	2 1/2 x 4 1/8	180	86-96	1.65	1.16	1 3/8 x 3 1/4
1062883†	110	110	115	3.00	2.10	2 1/2 x 4 1/8	160	124-138	1.80	1.26	1 3/8 x 3 1/4
1062888†	110	111	95	2.90	2.03	2 1/2 x 4 1/8	162	108-120	1.70	1.19	1 3/8 x 3 1/4
1063855*	110	101	115	3.00	2.10	3 1/2 x 3 1/2 x 2					
1063856*	220	113	29	4.20	2.94	3 1/2 x 3 1/2 x 2					
1063868*	110	116	100	2.65	1.86	3 1/2 x 3 1/2 x 2					
1063990*	110	101	115	3.00	2.10	3 1/2 x 3 1/2 x 2					
1063991*	220	113	29	4.20	2.94	3 1/2 x 3 1/2 x 2					
1063993*	110	116	100	2.65	1.86	3 1/2 x 3 1/2 x 2					
1066300*	110	101	115	3.00	2.10	3 1/2 x 3 1/2 x 2					
1066301*	110	116	100	2.65	1.86	3 1/2 x 3 1/2 x 2					
1066302*	220	113	29	4.20	2.94	3 1/2 x 3 1/2 x 2					
1066303*	110	200	135	3.40	2.38	3 1/2 x 3 1/2 x 2					

* These units are furnished with insulating containers for insulating the capacitor from the motor.
 ** These units are furnished with outside insulating cardboard tube covers.
 *** These units are furnished with outside insulating cardboard tube covers and metal end caps.
 † Sections of these units are insulated from the can internally.

(Continued on next page)



During the present emergency, we reserve the right to make mechanical changes without notice in order to produce equally suitable substitutes whenever and wherever necessary. Also, prices subject to change without notice.

Manufacturer and Mfrs. Part No.	A.C. Voltage	EXACT DUPLICATE REPLACEMENT					UNIVERSAL REPLACEMENT				
		Aerovox Cat. No.	Cap. Mfds.	List Price	Net Price	Dimensions	Aerovox Cat. No.	Cap. Mfds.	List Price	Net Price	Dimensions
DELCO PROD. CORP.											
(Continued)											
1066307*	110	101	115	\$3.00	\$2.10	3 1/2 x 3 1/2 x 2					
1066308*	110	116	100	2.65	1.86	3 1/2 x 3 1/2 x 2					
1066309*	110	201	65	2.80	1.96	3 1/2 x 3 1/2 x 2					
1067224**	110	207	270-300	4.20	2.94	2 x 3 1/2					
1069526**	220	113	29	4.20	2.94	3 1/2 x 3 1/2 x 2					
1078253**	110	207	270-300	4.20	2.94	2 x 3 1/2					
1079111*	110	101	115	3.00	2.10	3 1/2 x 3 1/2 x 2					
1079113*	110	116	100	2.65	1.86	3 1/2 x 3 1/2 x 2					
5000690**	110	192	216-240	3.25	2.28	2 x 3 1/2					
5201729†	110	140	115	3.00	2.10	2 x 4 1/2	160	124-138	\$1.80	\$1.26	1 3/8 x 3 1/4
5201731†	110	107	80	2.85	2.00	2 1/2 x 4 1/2	180	86-96	1.65	1.16	1 3/8 x 3 1/4
5201733†	110	147	100	2.90	2.03	2 x 4 1/2	162	108-120	1.70	1.19	1 3/8 x 3 1/4
5201734†	110	148	135	3.40	2.38	2 1/2 x 4 1/2	171	145-162	2.20	1.54	1 3/8 x 3 1/4
5201882**	110	192	216-240	3.25	2.28	2 x 3 1/2					
5203421†	110	149	65	2.80	1.96	2 x 4 1/2	176	70-78	1.60	1.12	1 3/8 x 3 1/4
5204001†	110	150	20	2.30	1.61	2 x 4 1/2					
5204004†	220	174	37-41	3.40	2.38	2 1/2 x 4 1/2					
5204009†	220	151	15	2.20	1.54	2 x 4 1/2					
5205027†	110	181	70-78	1.60	1.12	3 1/2 x 3 1/2 x 1 1/2					
5205028†	110	175	124-138	1.80	1.26	1 7/8 x 3 3/4 x 1 1/2					
5205029†	110	204	86-96	1.65	1.16	1 7/8 x 3 3/4 x 1 1/2					
5205030†	110	183	145-162	2.20	1.54	1 7/8 x 3 3/4 x 1 1/2					
5205231**	110	176	70-78	1.60	1.12	1 3/8 x 3 1/4					
5205232**	110	167	64-72	1.50	1.05	1 3/8 x 3 1/4					
5205256**	110	160	124-138	1.80	1.26	1 3/8 x 3 1/4					
5205257**	110	162	108-120	1.70	1.19	1 3/8 x 3 1/4					
5205258**	110	180	86-96	1.65	1.16	1 3/8 x 3 1/4					
5205870**	110	171	145-162	2.20	1.54	1 3/8 x 3 1/4					
5206172**	110	182	145-162	2.20	1.54	2 x 3 1/2					
5208049†	110	204	86-96	1.65	1.16	1 7/8 x 3 3/4 x 1 1/2					
5208050†	110	175	124-138	1.80	1.26	1 7/8 x 3 3/4 x 1 1/2					
5208051†	110	183	145-162	2.20	1.54	1 7/8 x 3 3/4 x 1 1/2					
5201040†	110	147	100	2.90	2.03	2 x 4 1/2	162	108-120	1.70	1.19	1 3/8 x 3 1/4
5201042†	110	140	115	3.00	2.10	2 x 4 1/2	160	124-138	1.80	1.26	1 3/8 x 3 1/4
5201044†	110	107	80	2.85	2.00	2 1/2 x 4 1/2	180	86-96	1.65	1.16	1 3/8 x 3 1/4
5302187**	110	207	270-300	4.20	2.94	2 x 3 1/2					
5305947**	110	180	86-96	1.65	1.16	1 3/8 x 3 1/4					
5309410*	110	200	135	3.40	2.38	3 1/2 x 3 1/2 x 2					
5311150†	110	146	80	2.85	2.00	2 x 4 1/2	180	86-96	1.65	1.16	1 3/8 x 3 1/4
5311151†	110	147	100	2.90	2.03	2 x 4 1/2	162	108-120	1.70	1.19	1 3/8 x 3 1/4
5314420†	110	116	100	2.65	1.86	3 1/2 x 3 1/2 x 2					
5314421†	110	159B	80	2.55	1.79	3 1/2 x 3 1/2 x 2					
5314422†	110	200	135	3.40	2.38	3 1/2 x 3 1/2 x 2					
5317327**	110	162	108-120	1.70	1.19	1 3/8 x 3 1/4					
5324880**	110	162	108-120	1.70	1.19	1 3/8 x 3 1/4					
5325380**	220	202	26-30	2.65	1.86	1 3/8 x 3 1/4					
5327579†	110	140	115	3.00	2.10	2 x 4 1/2	160	124-138	1.80	1.26	1 3/8 x 3 1/4
5335417**	110	160	124-138	1.80	1.26	1 3/8 x 3 1/4					
5336320**	110	160	124-138	1.80	1.26	1 3/8 x 3 1/4					
5336321**	110	171	145-162	2.20	1.54	1 3/8 x 3 1/4					
5336323**	110	171	145-162	2.20	1.54	1 3/8 x 3 1/4					
5336324**	110	197	161-180	2.40	1.68	2 x 3 1/2					
5336325**	110	160	124-138	1.80	1.26	1 3/8 x 3 1/4					
5336362**	110	180	86-96	1.65	1.16	1 3/8 x 3 1/4					
5336364**	110	162	108-120	1.70	1.19	1 3/8 x 3 1/4					
5336365**	110	162	108-120	1.70	1.19	1 3/8 x 3 1/4					
5336366**	110	176	70-78	1.60	1.12	1 3/8 x 3 1/4					
5336368**	110	162	108-120	1.70	1.19	1 3/8 x 3 1/4					
5336900†	110	147	100	2.90	2.03	2 x 4 1/2	162	108-120	1.70	1.19	1 3/8 x 3 1/4
5336901†	110	140	115	3.00	2.10	2 x 4 1/2	160	124-138	1.80	1.26	1 3/8 x 3 1/4
5336902**	110	182	145-162	2.20	1.54	2 x 3 1/2					
5336907**	110	192	216-240	3.25	2.28	2 x 3 1/2					
5336908**	110	207	270-300	4.20	2.94	2 x 3 1/2					
17177†	110	136	115	3.00	2.10	2 x 4 1/2	160	124-138	1.80	1.26	1 3/8 x 3 1/4
49214**	110	162	108-120	1.70	1.19	1 3/8 x 3 1/4					
47433*	110	176	70-78	1.60	1.12	1 3/8 x 3 1/4					
45934**	110	162	108-120	1.70	1.19	1 3/8 x 3 1/4					
5205072**	110	182	145-162	2.20	1.54	2 x 3 1/2					
DE WALT PROD. CORP.											
.....	110	191	175	4.10	2.87	3 x 4 1/2					
ELEC. PROD. CO.											
.....	110	104	115	3.00	2.10	4 1/2 x 4 1/2 x 1 1/4					
EMERSON ELEC. MFG. CO.											
20-PE-100†	110	121	100	2.65	1.86	1 1/2 x 1 1/2 x 1 1/4					
25-PF-100†	110	142	100	2.90	2.03	2 1/2 x 1 1/2	162	108-120	1.70	1.19	1 3/8 x 3 1/4
34-PF-11**	110	165	115	3.00	2.10	2 x 4 1/2	160	124-138	1.80	1.26	1 3/8 x 3 1/4
34-P-10X**	110	164	100	2.90	2.03	2 x 4 1/2	162	108-120	1.70	1.19	1 3/8 x 3 1/4
42-P-10X†	110	140	115	3.00	2.10	2 x 4 1/2	160	124-138	1.80	1.26	1 3/8 x 3 1/4
42-P-GUN†	110	140	115	3.00	2.10	2 x 4 1/2	160	124-138	1.80	1.26	1 3/8 x 3 1/4
51-P-10X**	110	164	100	2.90	2.03	2 x 4 1/2	162	108-120	1.70	1.19	1 3/8 x 3 1/4
51-P-80†	110	146	80	2.85	2.00	2 x 4 1/2	180	86-96	1.65	1.16	1 3/8 x 3 1/4
52-PE-11E**	110	160	124-138	1.80	1.26	1 3/8 x 3 1/4					
52-PE-13E**	110	171	145-162	2.20	1.54	1 3/8 x 3 1/4					
52-PF-GUN**	110	160	124-138	1.80	1.26	1 3/8 x 3 1/4					
52-PF-STY**	110	171	145-162	2.20	1.54	1 3/8 x 3 1/4					
52-PF-065**	110	176	70-78	1.60	1.12	1 3/8 x 3 1/4					
55-P-040**	110	168	43-48	1.45	1.02	1 3/8 x 3 1/4					
60-PE-13E**	110	171	145-162	2.20	1.54	1 3/8 x 3 1/4					
60-PE-065**	110	176	70-78	1.60	1.12	1 3/8 x 3 1/4					
71-P-065†	110	199	65	2.80	1.96	2 x 2 1/2	176	70-78	1.60	1.12	1 3/8 x 3 1/4
D 1206†	110	122	115	3.00	2.10	2 1/2 x 1 1/2	160	124-138	1.80	1.26	1 3/8 x 3 1/4
KS-633-129†	110	121	100	2.65	1.86	4 1/2 x 4 1/2 x 1 1/4					
KS-60-BU**	110	158	115	4.80	3.36	2 x 4 1/2					
FAIRBANKS MORSE & CO.											
F-46981†	150	124	300	22.80	15.96	4 3/4 x 1 1/2 x 2 3/8					

* These units are furnished with insulating containers for insulating the capacitor from the motor.
 ** These units are furnished with outside insulating cardboard tube covers.
 *** These units are furnished with outside insulating cardboard tube covers and metal end caps.
 † Sections of these units are insulated from the can internally.



During the present emergency, we reserve the right to make mechanical changes without notice in order to produce equally suitable substitutes whenever and wherever necessary. Also, prices subject to change without notice.

Manufacturer and Mfrs. Part No.	A.C. Voltage	EXACT DUPLICATE REPLACEMENT					UNIVERSAL REPLACEMENT				
		Aerovox Cat. No.	Cap. Mfds.	List Price	Net Price	Dimensions	Aerovox Cat. No.	Cap. Mfds.	List Price	Net Price	Dimensions
GENERAL ELEC. CO.											
H4206674-GR5†	110	123	115	\$5.00	\$2.10	2 1/2 x 4 1/8	160	124-138	\$1.80	\$1.26	1 3/8 x 3 1/4
H4206673-GR7†	110	126	135	3.40	2.38	2 1/2 x 4 1/8	171	145-162	2.20	1.54	1 3/8 x 3 1/4
K3995073-12	110	206	378-420	5.40	3.78	2 x 3 1/8					
K3995073-15	110	182	145-162	2.20	1.54	2 x 3 1/8					
K4029710-AB1	110	182	145-162	2.20	1.54	2 x 3 1/8					
K5081778-AA2**	110	160	124-138	1.80	1.26	1 3/8 x 3 1/4					
K5081778-AA3**	110	162	108-120	1.70	1.19	1 3/8 x 3 1/4					
K5081778-AB1**	110	162	108-120	1.70	1.19	1 3/8 x 3 1/4					
K5081778-AB5	110	171	145-162	2.20	1.54	1 3/8 x 3 1/4					
K5081778-AF7**	110	180	86-96	1.65	1.16	1 3/8 x 3 1/4					
K5081778-AF3**	110	160	124-138	1.80	1.26	1 3/8 x 3 1/4					
K5081778-AD1**	110	197	161-180	2.40	1.68	2 x 3 1/8					
K5081778-AA4**	110	196	75-84	1.60	1.12	1 3/8 x 3 1/4					
K5081778-AA5**	110	180	86-96	1.65	1.16	1 3/8 x 3 1/4					
K5029710-AB1	110	182	145-162	2.20	1.54	2 x 3 1/8					
K5029710-AC2	110	206	378-420	5.40	3.78	2 x 4 1/8					
K5029710-AD2**	110	197	161-180	2.40	1.68	2 x 3 1/8					
K5029710-AD1**	110	192	216-240	3.25	2.28	2 x 3 1/8					
K5243119-1	110	160	124-138	1.80	1.26	1 3/8 x 3 1/4					
K5243119-2	110	171	145-162	2.20	1.54	1 3/8 x 3 1/4					
9CG-101S2	110	160	124-138	1.80	1.26	1 3/8 x 3 1/4					
9CG-101S10	110	162	108-120	1.70	1.19	1 3/8 x 3 1/4					
9CG-102F**	110	141	115	3.15	2.21	2 1/2 x 5 1/4	160	124-138	1.80	1.26	1 3/8 x 3 1/4
9CG-102S14	110	171	145-162	2.20	1.54	1 3/8 x 3 1/4					
9CG-102S16	110	171	145-162	2.20	1.54	1 3/8 x 3 1/4					
9CG-102S30	110	160	124-138	1.80	1.26	1 3/8 x 3 1/4					
9CG-102S31	110	160	124-138	1.80	1.26	1 3/8 x 3 1/4					
9CG-102S34	110	160	124-138	1.80	1.26	1 3/8 x 3 1/4					
9CG-102S47	110	171	145-162	2.20	1.54	1 3/8 x 3 1/4					
9CG-103S6	110	182	145-162	2.20	1.54	2 x 3 1/8					
9CG-104S36	110	149	65	2.80	1.96	2 x 4 1/8	176	70-78	1.60	1.12	1 3/8 x 3 1/4
46-2157**	110	188	150	5.60	2.52	2 1/2 x 4 1/8	197	161-180	2.40	1.68	2 x 3 1/8
GRIGSBY GRUNOW CO.											
22846†	110	127	115	3.00	2.10	3 x 4 1/8	160	124-138	1.80	1.26	1 3/8 x 3 1/4
23907†	110	122	115	3.00	2.10	2 1/2 x 4 1/8	160	124-138	1.80	1.26	1 3/8 x 3 1/4
GRUNOW (General Household Utilities Co.)											
5929-1 (6487)† For JK units	110	159A	53-60	2.40	1.68	3 1/2 x 3 1/2 x 2					
5929-1 (6487)† For D units	110	159B	80	2.55	1.79	3 1/2 x 3 1/2 x 2					
HOLTZER CABOT ELEC. CO.											
101535**	110	198	161-180	2.40	1.68	1 3/8 x 4 1/4					
102356**	110	193	53-60	1.50	1.05	1 3/8 x 3 1/4					
LELAND ELEC. CO.											
1172-1*	110	104	115	3.00	2.10	1 3/8 x 4 1/8 x 1 1/4					
1172-2*	110	105	150	3.60	2.52	1 3/8 x 4 1/8 x 1 1/4					
1172-4*	110	159B	80	2.55	1.79	3 1/2 x 3 1/2 x 2					
1172-5*	220	216	29	4.20	2.94	1 3/8 x 4 1/8 x 1 1/4					
1173-1†	110	110	115	3.00	2.10	2 1/2 x 4 1/8	160	124-138	1.80	1.26	1 3/8 x 3 1/4
1173-2**	110	166	50	2.70	1.89	2 x 4 1/8	193	53-60	1.50	1.05	1 3/8 x 3 1/4
1173-3†	110	107	80	2.85	2.00	2 1/2 x 4 1/8	180	86-96	1.65	1.16	1 3/8 x 3 1/4
1173-5†	110	142	100	2.90	2.03	2 1/2 x 4 1/8	162	108-120	1.70	1.19	1 3/8 x 3 1/4
1173-6*	110	188	150	3.60	2.52	2 1/2 x 4 1/8	197	161-180	2.40	1.68	2 x 3 1/8
1173-7†	110	142	100	2.90	2.03	2 1/2 x 4 1/8	162	108-120	1.70	1.19	1 3/8 x 3 1/4
1173-9†	220	108	29	4.20	2.94	2 1/2 x 4 1/8	162	108-120	1.70	1.19	1 3/8 x 3 1/4
1448-1†	110	142	100	2.90	2.03	2 1/2 x 4 1/8	162	108-120	1.70	1.19	1 3/8 x 3 1/4
1499-1†	110	146	80	2.85	2.00	2 x 4 1/8	180	86-96	1.65	1.16	1 3/8 x 3 1/4
1499-6*	220	216	29	4.20	2.94	1 3/8 x 4 1/8 x 1 1/4					
1589-6**	110	193	53-60	1.50	1.05	1 3/8 x 3 1/4					
1589-9**	110	196	75-84	1.60	1.12	1 3/8 x 3 1/4					
1589-10**	110	180	86-96	1.65	1.16	1 3/8 x 3 1/4					
1589-11**	110	194	97-107	1.70	1.19	1 3/8 x 3 1/4					
1589-12**	110	162	108-120	1.70	1.19	1 3/8 x 3 1/4					
1589-13**	110	160	124-138	1.80	1.26	1 3/8 x 3 1/4					
1589-14**	110	182	145-162	2.20	1.54	2 x 3 1/8					
LELAND, LTD.											
LC29009-3**	110	162	108-120	1.70	1.19	1 3/8 x 3 1/4					
LC29009-8**	110	198	161-180	2.40	1.68	1 3/8 x 4 1/4					
MARATHON ELEC. MFG. CO.											
.....	110	129	175	4.10	2.87	4 1/2 x 4 1/2 x 1 1/2					
.....	110	104	115	3.00	2.10	4 1/2 x 4 1/2 x 1 1/4					
.....	110	162	108-120	1.70	1.19	1 3/8 x 3 1/4					
2277*	110	105	150	3.60	2.52	4 1/2 x 4 1/2 x 1 1/2					
2754**	220	202	26-30	2.65	1.86	1 3/8 x 3 1/4					
2912**	110	207	270-300	4.20	2.94	2 x 3 1/8					
MASTER ELEC. CO.											
51474†	110	121	100	2.65	1.86	4 1/2 x 4 1/2 x 1 1/4					
52193**	110	195	108-120	1.70	1.19	1 3/8 x 3 1/4					
52378**	110	160	124-138	1.80	1.26	1 3/8 x 3 1/4					
52445**	110	198	161-180	2.40	1.68	1 3/8 x 4 1/4					
OHIO ELEC. MFG. CO.											
44-7-E**	110	168	43-48	1.45	1.02	1 3/8 x 3 1/4					
44E7-F**	110	193	53-60	1.50	1.05	1 3/8 x 3 1/4					
4457-G**	110	167	64-72	1.50	1.05	1 3/8 x 3 1/4					
4457-H**	110	176	70-78	1.60	1.12	1 3/8 x 3 1/4					
4457-I**	110	196	75-84	1.60	1.12	1 3/8 x 3 1/4					
4457-J**	110	180	86-96	1.65	1.16	1 3/8 x 3 1/4					
4457-L**	110	162	108-120	1.70	1.19	1 3/8 x 3 1/4					
4457-M**	110	160	124-138	1.80	1.26	1 3/8 x 3 1/4					
4457-N**	110	171	145-162	2.20	1.54	1 3/8 x 3 1/4					
4457-O**	110	198	161-180	2.40	1.68	1 3/8 x 4 1/4					

* These units are furnished with insulating containers for insulating the capacitor from the motor.

(Continued on next page)

** These units are furnished with outside insulating cardboard tube covers.

*** These units are furnished with outside insulating cardboard tube covers and metal end caps.

† Sections of these units are insulated from the can internally.

AEROVOX

During the present emergency, we reserve the right to make mechanical changes without notice in order to produce equally suitable substitutes whenever and wherever necessary. Also, prices subject to change without notice.

Manufacturer and Mfrs. Part No.	A.C. Voltage	EXACT DUPLICATE REPLACEMENT					UNIVERSAL REPLACEMENT				
		Aerovox Cat. No.	Cap. Mfcls.	List Price	Net Price	Dimensions	Aerovox Cat. No.	Cap. Mfcls.	List Price	Net Price	Dimensions
OHIO ELEC. MFG. CO. (Continued)											
4457-R**	110	192	216-240	\$3.25	\$2.28	2 x 3 1/8					
4457-T**	110	207	270-300	4.20	2.94	2 x 3 1/8					
4457-U**	110	210	324-360	4.80	3.36	2 x 4 1/8					
4457-YC**	220	202	26.30	2.65	1.80	1 1/2 x 3 1/4					
	110	123	115	3.00	2.10	2 1/2 x 4 1/8	160	124-138	\$1.80	\$1.26	1 3/8 x 3 1/4
	110	131	190	2.90	2.03	2 1/2 x 4 1/8	162	108-120	1.70	1.19	1 3/8 x 3 1/4
	220	133	25	3.30	2.32	2 1/2 x 4 1/8					
ROBBINS & MYERS, INC.											
C68175-1	110	210	324-360	4.80	3.36	2 x 4 1/8					
D20250-1**	110	193	53.60	1.70	1.05	1 1/2 x 3 1/4					
D20250-2**	110	176	70.78	1.60	1.12	1 1/2 x 3 1/4					
D20250-3**	110	180	84.96	1.65	1.16	1 1/2 x 3 1/4					
D20250-4**	110	132	138.12	1.70	1.19	1 1/2 x 3 1/4					
D20250-5**	110	160	124.138	1.80	1.26	1 1/2 x 3 1/4					
D20250-5**	110	171	145.162	2.20	1.54	1 1/2 x 3 1/4					
D20250-6**	110	198	161.180	2.40	1.68	1 1/2 x 4 1/8					
D20250-7**	110	192	216.240	3.25	2.28	2 x 3 1/8					
D20250-9	110	192	216.240	3.25	2.28	2 x 3 1/8					
D20250-11	110	226	270.300	5.40	3.78	2 x 4 1/8					
D20250-12	110	210	324.360	4.80	3.36	2 x 4 1/8					
D20251-1†	110	146	80	2.85	2.00	2 x 4 1/8	180	86-96	1.65	1.16	1 3/8 x 3 1/4
D20251-2	110	147	108-120	2.90	2.03	2 x 4 1/8	162	108-120	1.70	1.19	1 3/8 x 3 1/4
D20251-3†	110	140	115	3.00	2.10	2 x 4 1/8	160	124-138	1.80	1.26	1 3/8 x 3 1/4
D20251-4	110	148	145-162	3.40	2.38	2 1/2 x 4 1/8	171	145-162	2.20	1.54	1 3/8 x 3 1/4
D20252-6*	110	103	80	2.85	2.00	4 1/2 x 4 1/2 x 1 1/2					
D20252-8†	110	121	100	2.65	1.86	4 1/2 x 4 1/2 x 1 1/2					
D20252-9*	110	134	115	3.00	2.10	4 1/2 x 4 1/2 x 1 1/2					
D20252-10*	110	134	115	3.00	2.10	4 1/2 x 4 1/2 x 1 1/2					
D20252-12*	110	105	150	3.60	2.52	4 1/2 x 4 1/2 x 1 1/2					
D20253-1*	110	104	115	3.00	2.10	4 1/2 x 4 1/2 x 1 1/2					
D20253-2*	110	105	150	3.60	2.52	4 1/2 x 4 1/2 x 1 1/2					
D21481-1	110	160	124-138	1.80	1.26	1 3/8 x 3 1/4					
D21527-1	110	198	161-180	2.40	1.68	1 3/8 x 4 1/8					
D21527-2	110	206	378-420	5.40	3.78	2 x 4 1/8					
D21527-3	110	226	270-300	5.40	3.78	2 x 4 1/8					
SUNLIGHT ELEC. CO. (See Delco)											
WAGNER ELEC. CORP.											
HC-7482-E	110	162	108-120	1.70	1.19	1 3/8 x 3 1/4					
HC-7482-F**	110	162	108-120	1.70	1.19	1 3/8 x 3 1/4					
HC-7348-B**	110	160	124-138	1.80	1.26	1 3/8 x 3 1/4					
HC-7872**	110	210	324-360	4.80	3.36	2 x 4 1/8					
HC-7673-B**	110	237	270-300	4.20	2.94	2 x 3 1/8					
HC-7681-A**	110	137	161-180	2.40	1.68	2 x 3 1/8					
HC-7712-B**	110	207	270-300	4.20	2.94	2 x 3 1/8					
HC-7714-J**	220	202	26.30	2.65	1.86	1 3/8 x 3 1/4					
HC-7753-A**	110	182	115-162	2.20	1.54	2 x 3 1/8					
HC-7757**	110	212	216-240	3.25	2.28	2 1/2 x 3 1/8					
HC-7771**	220	202	26.30	2.65	1.86	1 3/8 x 3 1/4					
HC-7784**	110	162	108-120	1.70	1.19	1 3/8 x 3 1/4					
HC-7918**	110	214	161-180	2.40	1.68	2 1/2 x 3 1/8					
HC-8228-A**	110	196	75-84	1.60	1.12	1 3/8 x 3 1/4					
HD-4503-D1*	110	116	100	2.65	1.86	3 1/2 x 3 1/2 x 2					
HD-4500-D2*	110	101	115	3.00	2.10	3 1/2 x 3 1/2 x 2					
HD-4500-D3*	220	139	25	3.60	2.52	3 1/2 x 3 1/2 x 2					
HD-4892*	220	139	25	3.60	2.52	3 1/2 x 3 1/2 x 2					
HD-5223-D1*	110	116	100	2.65	1.86	3 1/2 x 3 1/2 x 2					
HD-5326-A1†	110	157	100	2.65	1.86	3 1/2 x 3 1/2 x 2					
HD-5400-A1*	110	101	115	3.00	2.10	3 1/2 x 3 1/2 x 2					
HD-5418*	220	215	25	3.60	2.52	3 1/2 x 3 1/2 x 2					
HD-5427*	220	113	20	4.20	2.94	3 1/2 x 3 1/2 x 2					
WESTINGHOUSE ELEC. & MFG. CO.											
SH-32291†	110	110	115	3.00	2.10	2 1/2 x 4 1/8	160	124-138	1.80	1.26	1 3/8 x 3 1/4
S-848578*	110	101	115	3.00	2.10	3 1/2 x 3 1/2 x 2					
S-857835*	220	113	20	4.20	2.94	3 1/2 x 3 1/2 x 2					
S-841011*	110	101	115	3.00	2.10	3 1/2 x 3 1/2 x 2					
S-857992*	110	208	150	3.60	2.52	3 1/2 x 3 1/2 x 2					
S-887696*	220	203	40	5.40	3.78	3 1/2 x 3 1/2 x 2					
987163*	110	137	115	3.00	2.10	3 1/2 x 3 1/2 x 2					
987252†	110	135	115	3.00	2.10	2 x 4 1/8	160	124-138	1.80	1.26	1 3/8 x 3 1/4
987450	110	147	108-120	2.90	2.03	2 x 4 1/8	162	108-120	1.70	1.19	1 3/8 x 3 1/4
987539	110	210	324-360	4.80	3.36	2 x 4 1/8					
987583	110	146	86-96	2.85	2.00	2 x 4 1/8	180	86-96	1.65	1.16	1 3/8 x 3 1/4
987591	110	188	161-180	3.60	2.52	2 1/2 x 4 1/8	197	161-180	2.40	1.68	2 x 3 1/8
1J25677	110	148	115-162	3.40	2.38	2 1/2 x 4 1/8	171	145-162	2.20	1.54	1 3/8 x 3 1/4
1030543**	110	192	216-240	3.25	2.28	2 x 3 1/8					
1030669*	110	213	243-270	3.60	2.52	2 x 3 1/8					
1030670**	110	206	378-420	5.40	3.78	2 x 4 1/8					
1030713**	110	197	161-180	2.40	1.68	2 x 3 1/8					
1030813**	110	160	124-138	1.80	1.26	1 3/8 x 3 1/4					
1030818	110	225	180-210	4.10	2.87	2 x 4 1/8					
1033825†	110	140	115	3.00	2.10	2 x 4 1/8	160	124-138	1.80	1.26	1 3/8 x 3 1/4
1124812	110	160	124-138	1.80	1.26	1 3/8 x 3 1/4					
1124813	110	198	161-180	2.40	1.68	1 3/8 x 4 1/8					
1124817	110	210	324-360	4.80	3.36	2 x 4 1/8					
1124818	110	206	378-420	5.40	3.78	2 x 4 1/8					
1127753	110	226	270-300	5.40	3.78	2 x 4 1/8					

* These units are furnished with insulating containers for insulating the capacitor from the motor.
 ** These units are furnished with outside insulating cardboard tube covers.
 *** These units are furnished with outside insulating cardboard tube covers and metal end caps.
 † Sections of these units are insulated from the can internally.



During the present emergency, we reserve the right to make mechanical changes without notice in order to produce equally suitable substitutes whenever and wherever necessary. Also, prices subject to change without notice.

Standard Universal Electrolytic Motor-Starting Replacement Capacitors

Many of these Standard Universal replacements are also Exact Duplicate replacements. They have the same AEROVOX catalog numbers shown in the foregoing Exact Duplicate-Universal Replacement electrolytic capacitor listing. This list is intended to simplify the selection of required capacitor when manufacturer's part number and AEROVOX catalog number are not known. Information given: capacity range, voltage rating, dimensions and type of container may help determine capacitor required in absence of original unit or name-plate data. This listing also ideal for use with Capacitor Selector described on Page K-51.

ULTRA-COMPACT 110 VOLTS A.C. IN 3/8" AND 2" ROUND CANS WITH INSULATING TUBES

AEROVOX Cat. No.	CAPACITY MFDS.		A.C. Voltage	DIMENSIONS D.H. or L.W.D.	Figure No.	List Price	Net Price
	Actual Range	Nominal Range					
217	20-24	20	110	1 1/2 x 3 1/4	18A	\$1.35	\$0.95
218	26-30	25	110	1 1/2 x 3 1/4	18A	1.35	.95
219	32-36	30	110	1 1/2 x 3 1/4	18A	1.45	1.02
220	38-42	35	110	1 1/2 x 3 1/4	18A	1.45	1.02
168	43-48	40	110	1 1/2 x 3 1/4	18A	1.45	1.02
193	53-60	50	110	1 1/2 x 3 1/4	18A	1.50	1.05
167	64-72	60	110	1 1/2 x 3 1/4	18A	1.50	1.05
176	70-78	65	110	1 1/2 x 3 1/4	18A	1.60	1.12
196	75-84	70	110	1 1/2 x 3 1/4	18A	1.60	1.12
180	86-96	80	110	1 1/2 x 3 1/4	18A	1.65	1.16
194	97-107	90	110	1 1/2 x 3 1/4	18A	1.70	1.19
162	108-120	100	110	1 1/2 x 3 1/4	18A	1.70	1.19
160	124-138	115	110	1 1/2 x 3 1/4	18A	1.80	1.26
171	145-162	135	110	1 1/2 x 3 1/4	18A	2.20	1.54
198	161-180	150	110	1 1/2 x 4 1/4	18A	2.40	1.68
192	216-240	200	110	2 x 3 1/2	18A	3.25	2.28
207	270-300	250	110	2 x 3 1/2	18A	4.20	2.94
210	324-360	300	110	2 x 4 1/2	18A	4.80	3.36
206	378-420	350	110	2 x 4 1/2	18A	5.40	3.78



Figure 18A

HEAVY-DUTY 110 VOLTS A.C. IN 2" AND 2 1/2" ROUND CANS

221	32-36	30	110	2 x 4 1/2	19D	\$2.65	\$1.86
166	53-60	50	110	2 x 4 1/2	19D	2.70	1.89
149	64-72	65	110	2 x 4 1/2	19D	2.80	1.96
146	86-96	80	110	2 x 4 1/2	19D	2.85	2.00
222	97-107	90	110	2 x 4 1/2	19D	2.90	2.03
147	108-120	100	110	2 x 4 1/2	19D	2.90	2.03
140	124-138	115	110	2 x 4 1/2	19D	3.00	2.10
223	145-162	135	110	2 x 4 1/2	19D	3.40	2.38
224	161-180	150	110	2 x 4 1/2	19D	3.60	2.52
225	189-210	175	110	2 x 4 1/2	19D	4.10	2.87
226	270-300	250	110	2 x 4 1/2	19D	5.40	3.78
227	32-36	30	110	2 1/2 x 4 1/2	19D	2.65	1.86
228	53-60	50	110	2 1/2 x 4 1/2	19D	2.70	1.89
229	64-72	60	110	2 1/2 x 4 1/2	19D	2.70	1.89
107	86-96	80	110	2 1/2 x 4 1/2	19D	2.85	2.00
230	97-107	90	110	2 1/2 x 4 1/2	19D	2.90	2.03
142	108-120	100	110	2 1/2 x 4 1/2	19D	2.90	2.03
110	124-138	115	110	2 1/2 x 4 1/2	19D	3.00	2.10
148	145-162	135	110	2 1/2 x 4 1/2	19D	3.40	2.38
188	161-180	150	110	2 1/2 x 4 1/2	19D	3.60	2.52
231	189-210	175	110	2 1/2 x 4 1/2	19D	4.10	2.87
232	270-300	250	110	2 1/2 x 4 1/2	19D	5.40	3.78



Figure 19D

ULTRA-COMPACT & HEAVY-DUTY 220 VOLTS A.C. IN 1 3/8" AND 2" ROUND CANS

246	23-24	20	220	1 3/8 x 3 1/4	18A	\$2.30	\$1.61
202	28-30	25	220	1 3/8 x 3 1/4	18A	2.65	1.86
248	32-36	30	220	2 x 4 1/2	19D	3.00	2.10
249	38-42	35	220	2 x 4 1/2	19D	3.40	2.38
230	43-48	40	220	2 x 4 1/2	19D	3.60	2.52
251	53-60	50	220	2 x 5 1/2	19D	4.10	2.87



Figure 12

HEAVY-DUTY 110 VOLTS A.C. IN RECTANGULAR CANS SUPPLIED WITH INSULATING COVERS

233	32-36	30	110	3 1/2 x 3 1/2 x 2	12	\$2.40	\$1.68
159A	53-60	50	110	3 1/2 x 3 1/2 x 2	12	2.40	1.68
234	64-72	60	110	3 1/2 x 3 1/2 x 2	12	2.55	1.79
159B	86-96	80	110	3 1/2 x 3 1/2 x 2	12	2.55	1.79
235	97-107	90	110	3 1/2 x 3 1/2 x 2	12	2.65	1.86
157	108-120	100	110	3 1/2 x 3 1/2 x 2	12	2.65	1.86
137	124-138	115	110	3 1/2 x 3 1/2 x 2	12	3.00	2.10
236	145-162	135	110	3 1/2 x 3 1/2 x 2	12	3.40	2.38
255	161-180	150	110	3 1/2 x 3 1/2 x 2	12	3.60	2.52
237	189-210	175	110	3 1/2 x 3 1/2 x 2	12	4.10	2.87
238	270-300	250	110	3 1/2 x 3 1/2 x 2	12	5.40	3.78

HEAVY-DUTY 110 VOLTS A.C. In Rectangular Cans With Terminal Board for Thermostat Connections

239	32-36	30	110	3 1/2 x 3 1/2 x 2	15A	\$2.40	\$1.68
240	53-60	50	110	3 1/2 x 3 1/2 x 2	15A	2.40	1.68
241	64-72	60	110	3 1/2 x 3 1/2 x 2	15A	2.55	1.79
242	86-96	80	110	3 1/2 x 3 1/2 x 2	15A	2.55	1.79
243	97-107	90	110	3 1/2 x 3 1/2 x 2	15A	2.65	1.86
116	108-120	100	110	3 1/2 x 3 1/2 x 2	15A	2.65	1.86
101	124-138	115	110	3 1/2 x 3 1/2 x 2	15A	3.00	2.10
200	145-162	135	110	3 1/2 x 3 1/2 x 2	15A	3.40	2.38
208	161-180	150	110	3 1/2 x 3 1/2 x 2	15A	3.60	2.52
244	189-210	175	110	3 1/2 x 3 1/2 x 2	15A	4.10	2.87
245	270-300	250	110	3 1/2 x 3 1/2 x 2	15A	5.40	3.78



Figure 15A

HEAVY-DUTY 220 VOLTS A.C. WITH INSULATING COVER

215	26-30	25	220	3 1/2 x 3 1/2 x 2	12	\$3.60	\$2.52
253	32-36	30	220	3 1/2 x 3 1/2 x 2	12	4.20	2.94
254	43-48	40	220	3 1/2 x 3 1/2 x 2	12	4.80	3.36



During the present emergency, we reserve the right to make mechanical changes without notice in order to produce equally suitable substitutes whenever and wherever necessary. Also, prices subject to change without notice.

Manufacturer & Mfrs. Part No.	A.C. Voltage	Cap. Mfcs.	Aerovox Cat. No.	Dimensions	List Price	Net Price
SUNLIGHT ELECTRIC CO.						
5000455	330	5	609	3 3/4 x 3 1/2 x 2	\$5.40	\$3.78
5000456	330	6	610	3 3/4 x 3 1/2 x 2 1/4	6.00	4.20
5205371	330	10	633	4 1/2 x 4 1/2 x 2 1/2	8.40	5.88
TIMKIN SILENT AUTO CO.						
3528Q17	330	3	612	3 1/8 x 4 1/8 x 1 1/2	4.40	3.08
WAGNER ELECTRIC CORP.						
HD-3444	330	5	615	3 3/4 x 3 1/2 x 1 1/2	5.40	3.78
HD-5742	220	8	634	2 1/2 x 5 1/4	6.15	4.31
HD-6089	220	12	635	2 1/2 x 5 1/4	8.20	5.74
HC-5902	220	6	636	2 1/2 x 5 1/4	5.10	3.57
HD-5869	220	10	637	2 1/2 x 5 1/4	7.20	5.04
HD-8135	220	4	638	2 x 4 1/2	4.45	3.12
WESTINGHOUSE ELECTRIC & MFG. CO.						
799966	330	5.2	613	3 1/2 x 4 1/2 x 2	5.55	3.89
WILLIAMS OIL-O-MATIC						
EM398A	375	4	572	4 1/2 x 3 1/2 x 2	5.60	3.92

STANDARD UNIVERSAL REPLACEMENT OIL CAPACITORS

Many of these Standard Universal replacements are also Exact Duplicate replacements. They have the same AEROVOX catalog numbers shown in the foregoing Exact Duplicate Replacement listing. This list is intended to simplify the selection of required capacitor by AEROVOX Catalog Number when manufacturer's part number is not known. Information given: capacity, voltage, dimensions and type of container may help determine AEROVOX replacement required in absence of original unit or name-plate data.

AEROVOX Cat. No.	A.C. Voltage	Cap. Mfcs.	Dimensions D.H. or L.W.D.	List Price	Net Price
984	220	8	2 1/2 x 5 1/4	\$6.15	\$4.31
635	220	12	2 1/2 x 5 1/4	8.20	5.74
636	220	6	2 1/2 x 5 1/4	5.10	3.57
637	220	10	2 1/2 x 5 1/4	7.20	5.04
638	220	4	2 x 4 1/2	4.45	3.12
639	330	1	1 3/8 x 4 1/8	3.30	2.31
640	330	2	2 x 4 1/2	4.10	2.87
641	330	3	2 x 4 1/2	4.40	3.08
642	330	4	2 x 5 1/4	4.95	3.47
643	330	5	2 1/2 x 4 1/2	5.40	3.78
644	330	6	2 1/2 x 5 1/4	6.00	4.20
645	440	1	2 x 3 1/2	3.60	2.52
646	440	2	2 x 4 1/2	4.15	3.26
647	440	3	2 1/2 x 4 1/2	5.30	3.71
648	440	4	2 1/2 x 5 1/4	5.60	3.92
538	330	1	1 1/8 x 3 1/8 x 1	3.30	2.31
509	330	2	1 1/8 x 3 1/8 x 1 1/4	4.10	2.87
510	330	3	1 1/8 x 3 1/8 x 1 3/8	4.40	3.08
511	330	4	1 1/8 x 3 1/8 x 1 7/8	4.95	3.47
649	330	5	1 1/8 x 3 1/8 x 1 7/8	5.40	3.78
512	330	6	1 1/8 x 3 1/8 x 2	6.00	4.20
558	330	7	1 1/8 x 3 1/8 x 2 1/4	6.70	4.69
513	330	8	1 1/8 x 3 1/8 x 2 1/2	7.35	5.15
561	330	10	1 1/8 x 3 1/8 x 2 3/4	8.40	5.88
562	330	12	1 1/8 x 3 1/8 x 3	9.60	6.72
650	440	1	1 1/8 x 3 1/8 x 1	3.60	2.52
651	440	2	1 1/8 x 3 1/8 x 1 1/4	4.15	3.26
584	440	3	1 1/8 x 3 1/8 x 1 3/4	5.30	3.71
652	440	4	1 1/8 x 3 1/8 x 1 7/8	5.60	3.92
653	440	5	1 1/8 x 3 1/8 x 2	6.50	4.55
654	440	6	1 1/8 x 3 1/8 x 2 1/4	7.20	5.04
655	440	8	1 1/8 x 3 1/8 x 2 1/2	8.40	5.88
600	440	10	1 1/8 x 3 1/8 x 2 3/4	10.20	7.14

NOTE: WRITE US FOR A COMPLETE AEROVOX INDUSTRIAL CAPACITOR REPLACEMENT CATALOG

Replacement capacitors not listed in the above and preceding pages can also be furnished on special order. When ordering units not listed, kindly send us a sample of the unit which has failed in service, together with all available data such as manufacturers' part number, capacity, voltage, ratings, etc.

GUARANTEE AEROVOX ELECTROLYTIC MOTOR-STARTING CAPACITORS

Aerovox Electrolytic A.C. capacitors are made for intermittent duty only, and are usually damaged by the failure of the associated equipment. It is important, therefore, to determine and eliminate the cause of capacitor failure before replacement. In addition, the replacement capacitor should be of proper capacity and voltage rating. The use of a wrong capacitor will usually result in rapid failure. For that reason, AC electrolytic capacitors are guaranteed as follows:

I. 110-VOLT CAPACITORS—

- STARTS**—Heavy-Duty Capacitors (standard foil and gauze), not more than 20 starts per hour, each start not over 3 seconds' duration (except that not over 100 times per year the capacitor may be on the line for periods not exceeding 10 seconds maximum). Ultra-Compact Capacitors (etched foil and reduced gauze) not more than 20 starts per hour, each start not over 1 second duration (except that not over 50 times per year the capacitor may be on line for periods not exceeding 10 seconds maximum).
- VOLTAGE**—not in excess of 125% of the rated voltage during any service period.
- AMBIENT TEMPERATURE**—not to exceed 130° Fahrenheit.
- DAMAGE**—Capacitor shall not have been damaged after shipment by manufacturer.
- MOTOR DEFECTS**—Capacitor shall not have been subjected to abnormal operating conditions resulting from motor and associated defects such as (1) defective or dry bearings; (2) sticky compressor; (3) tight belt; (4) defective centrifugal switch or relay; (5) improper adjustment of thermostat or refrigerator valves. Before applying capacitor, always check (a) centrifugal switch or relay; (b) easy turning of motor and compressor; (c) thermostat and valves, as a prerequisite of the guarantee.

II. ALL OTHER VOLTAGES—

Same as for 110-volt capacitors except that the voltage applied to the units during any service period may not exceed 110% of the rating.

It is recommended that the serviceman should check the following points before leaving the job:

- Measure the voltage across the capacitor during the starting period. It should not exceed 138 volts for 110-volt capacitors. For other voltage ratings, it should not exceed 110% of the nominal rating. If the voltage across the capacitor is higher than the limiting value given, it usually indicates a capacitor of too low capacity.
- Time the duration and frequency of the starting period. It should not exceed the limits given in the guarantee. If the start takes too long, either the capacity of the unit is incorrect—too high or too low—or the associated equipment is defective. Too frequent starts (over 20 per hour) should not be allowed. It usually indicates some defect in the control equipment.
- Measure the temperature of the capacitor motor compartment. It should not exceed 130° F.
- The container of the capacitor should be insulated from ground.

Attention to these factors will generally result in a satisfactory job.

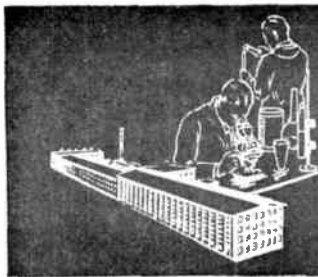

SPRAGUE CONDENSERS

SPRAGUE ATOMS . . . The Universal Condensers

Types AT, TA, TU, UT.

Unexcelled for almost any replacement use—even for replacing much larger condensers. They cost much less—are much smaller in size—yet are fully reliable. They have low leakage and

withstand exceptionally high surges. Hermetically sealed—yet absolutely protected against "blow-ups". Available in a full line of capacities, voltages and combinations for practically any radio need.

Use Atoms universally. Save time—save money—save space!

UNCONDITIONAL GUARANTEE

Extremely Low Leakage—High Surge Voltage—Exceptionally Good Shelf Life

Cat. No.	Cap. Mid.	Work. Volt.	Metal Diam.	Tube Length	List Price	Cat. No.	Cap. Mid.	Work. Volt.	Metal Diam.	Tube Length	List Price
TA-10	10	25	5/8"	1 1/2"	\$0.50	UT-12	12	150	5/8"	1 7/8"	\$0.90
TA-25	25	25	5/8"	1 1/2"	.60	UT-16	16	150	7/8"	2 1/8"	1.10
TA-55	5	50	5/8"	1 1/2"	.50	UT-20	20	150	7/8"	2 1/8"	1.20
TA-510	10	50	5/8"	1 1/2"	.55						
TA-525	25	50	5/8"	1 1/2"	.70						
TA-550	50	50	5/8"	1 1/2"	.85						
UT-41	4	150	5/8"	1 1/2"	.50						
UT-81	8	150	5/8"	1 1/2"	.55						
UT-121	12	150	5/8"	1 1/2"	.60						
UT-161	16	150	5/8"	1 1/2"	.70						
UT-201	20	150	5/8"	1 1/2"	.75						
UT-301	30	150	5/8"	1 1/2"	.8						
UT-401	40	150	5/8"	1 1/2"	.80						
UT-42	4	250	5/8"	1 1/2"	.55						
UT-82	8	250	5/8"	1 1/2"	.60						
UT-122	12	250	5/8"	1 1/2"	.80						
UT-162	16	250	5/8"	1 1/2"	.90						
UT-202	20	250	5/8"	2 1/2"	1.00						
UT-402	40	250	5/8"	2 1/2"	1.15						
UT-43	4	350	5/8"	1 1/2"	.60						
UT-83	8	350	5/8"	1 1/2"	.70						
UT-123	12	350	5/8"	1 1/2"	.85						
UT-4	4	150	5/8"	1 1/2"	.70						
UT-8	8	150	5/8"	1 1/2"	.75						

DUAL COMBINATION ATOMS											
Cat. No.	Cap. Mid.	Work. Volt.	Metal Diam.	Tube Length	List Price	Cat. No.	Cap. Mid.	Work. Volt.	Metal Diam.	Tube Length	List Price
TA-100	10-10	50	5/8"	2 1/2"	1.00	TA-88	8-8	150	1 1/8"	2 1/2"	1.00
TA-88	8-8	150	1 1/8"	2 1/2"	1.00	TA-122	12-20	150	1 1/8"	2 1/2"	1.15
TA-122	12-20	150	1 1/8"	2 1/2"	1.15	TA-220	20-20	150	1 1/8"	2 1/2"	1.30
TA-220	20-20	150	1 1/8"	2 1/2"	1.30	TA-212	12-12	200	1 1/8"	2 1/2"	1.15
TA-212	12-12	200	1 1/8"	2 1/2"	1.15	TA-216	16-16	200	7/8"	2 1/2"	1.30
TA-216	16-16	200	7/8"	2 1/2"	1.30	TA-816	8-16	200	3/4"	2 1/2"	1.15
TA-816	8-16	200	3/4"	2 1/2"	1.15	AT-816	8-16	250	3/4"	2 1/2"	1.30
AT-816	8-16	250	3/4"	2 1/2"	1.30	AT-261	16-16	250	1 1/8"	2 1/2"	1.50
AT-261	16-16	250	1 1/8"	2 1/2"	1.50	UT-88	8-8	450	1 1/8"	2 1/2"	1.30
UT-88	8-8	450	1 1/8"	2 1/2"	1.30	UT-816	8-16	450	1 1/8"	2 1/2"	1.65
UT-816	8-16	450	1 1/8"	2 1/2"	1.65						

SEPARATE POSITIVE AND NEGATIVE LEADS											
Cat. No.	Cap. Mid.	Work. Volt.	Metal Diam.	Tube Length	List Price	Cat. No.	Cap. Mid.	Work. Volt.	Metal Diam.	Tube Length	List Price
TU-220	20-20	150	1 1/8"	2 1/2"	\$1.65	TU-420	40-20	150	1 1/8"	2 1/2"	1.70
TU-420	40-20	150	1 1/8"	2 1/2"	1.70	TU-816	8-16	250	1 1/8"	2 1/2"	1.70
TU-816	8-16	250	1 1/8"	2 1/2"	1.70	TU-216	16-16	250	1 1/8"	2 1/2"	2.00
TU-216	16-16	250	1 1/8"	2 1/2"	2.00	TU-88	8-8	450	1 1/8"	3 1/2"	1.65
TU-88	8-8	450	1 1/8"	3 1/2"	1.65						

UNIVERSAL MOUNTING TYPE

Type LM

Equipped with rugged universal mounting lugs which can be soldered on top of chassis, anchored with screws, or be extended through holes in chassis and bent under. Mount in any position. All condenser sections have separate positive and separate negative

leads, which can be connected together to get common positive or negative replacements. Individual sections insure maximum convenience with safe performance. Lead ends are well sealed with high melting point compound, making units moisture proof.

Cat. No.	Cap. Mid.	Work. Volt.	Cardb'd Diam.	Tube Length	List Price	Cat. No.	Cap. Mid.	Work. Volt.	Cardb'd Diam.	Tube Length	List Price
LM-121	20	150	3 3/8"	2 1/2"	\$0.75	LM-88	8-8	450	1 1/8"	3"	1.65
LM-8	8	450	3 3/8"	2 1/2"	.75	LM-816	8-16	450	1 3/8"	3 1/2"	2.00
LM-16	16	450	7 3/8"	2 1/2"	1.10	LM-1616	16-16	450	1 3/8"	4 1/4"	2.40
LM-220	20-20	150	1 1/8"	2 1/2"	1.65	LM-2016	20-16	250 25	1 1/4"	3 1/2"	2.50
LM-28	8-8	250	7/8"	2 1/2"	1.35	LM-4020	40-20	250 25	1 1/4"	3 1/2"	2.85
LM-216	16-16	250	1 1/8"	3"	2.00						

HANDY ATOM KITS

For your convenience, we have packed ATOMS in these handy kits, a few of which will equip you for almost any dry electrolytic replacement you'll ever be called upon to make.

Remember: "You Can Always Get at 'Em With Sprague ATOMS!"

KIT No. AK-1

Contains six of the popular UTs (8 mfd.) 450-volt ATOMS List \$4.35

KIT No. AK-2

Twelve ATOMS as follows: Six UT-8; one UT-41; one UT-41; two UT-81 and two TA-10..... List \$7.50



CONDENSER REPLACEMENTS

Make Up Your Own Hard-to-Get Combinations

The larger, exact-duplicate replacement in this photo costs \$1.20. Three ATOMS combined with ST straps give the same hard-to-get capacities—in smaller size and for only 96c. ST straps are supplied free on request with your ATOM purchase. Thus you can make up almost any condenser combination using standard Sprague ATOMS obtainable from jobbers' stocks.

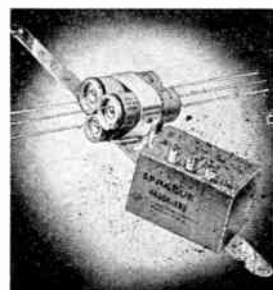

We reserve the right—during the present emergency—to change prices and mechanical specifications without notice.



SPRAGUE Condensers

Famous SPRAGUE TUBULARS Type TC (Cartridge By-Pass Type)

"Not a Failure in a Million" is more than a slogan for Sprague Tubulars. It is a matter of record—convincing proof of the efficiency of the most popular condensers ever presented to the radio profession.

Test Voltage 1200 Working Voltage 600

Catalog No.	Capacity Mfd.	Dimensions	List Price	Catalog No.	Capacity Mfd.	Dimensions	List Price
TC-31	.0001	1 1/4 x 1 1/2	.20	TC-11	.01	1 1/4 x 1 1/2	\$0.20
TC-325	.00025	1 1/4 x 1 1/2	.20	TC-12	.02	1 1/4 x 1 1/2	.20
TC-34	.0004	1 1/4 x 1 1/2	.20	TC-13	.03	1 1/4 x 1 1/2	.25
TC-35	.0005	1 1/4 x 1 1/2	.20	TC-14	.04	1 1/4 x 1 1/2	.25
TC-21	.001	1 1/4 x 1 1/2	.20	TC-15	.05	1 1/4 x 1 1/2	.25
TC-22	.002	1 1/4 x 1 1/2	.20	TC-16	.06	1 1/4 x 1 1/2	.30
TC-23	.003	1 1/4 x 1 1/2	.20	TC-1	1	2 1/4 x 1 1/2	.30
TC-24	.004	1 1/4 x 1 1/2	.20	TC-2	.25	2 1/4 x 1 1/2	.45
TC-25	.005	1 1/4 x 1 1/2	.20	TC-5	5	2 1/4 x 1 1/2	.60
TC-26	.005	1 1/4 x 1 1/2	.20	TC-10	10	2 1/4 x 1 1/2	1.00

BUY THEM IN THESE HANDY KITS

Save trips to your jobber and save money by buying these fast-moving paper tubular condensers in handy kit form.

Catalog No.	Each Kit Contains	List Price
TK-55	Five TC-5 (.5 mfd.)	\$3.00
TK-62	Six TC-2 (.25 mfd.)	2.55
TK-81	Eight TC-1 (.1 mfd.)	2.40
TK-1515	Fifteen TC-15 (.05 mfd.)	2.60
TK-1511	Fifteen TC-11 (.01 mfd.)	2.70
TK-1512	Fifteen TC-12 (.02 mfd.)	2.70

CATALOG No. TK-330

LIST PRICE \$8.05

Each Kit contains 33 TC Tubulars as follows:

2 TC-21 (.001)	5 TC-11 (.01)	8 TC-1 (.1)
3 TC-22 (.002)	5 TC-12 (.02)	2 TC-2 (.25)
3 TC-25 (.005)	4 TC-15 (.05)	1 TC-5 (.5)

SPRAGUE PINHEAD TINY MIKE

Type PTM. (Rectangular).

small size. Universal for a wide variety of replacements. Conservatively rated at 525 volts, but will stand surges as high as 560 to 580 volts, and come back for more!

Sprague offers a complete size range in dry elec-

tralytic replacements, each one affording the utmost in reliability and bringing you the additional convenience feature of quick, easy mounting with the Sprague special metal mounting feet. See cut at left.

Type PTM is a rectangular condenser of outstanding reliability in convenient

Working Voltage 450 Volts

Surge Voltage 525 Volts

Catalog No.	Capacity Mfd.	Working Voltage	Dimensions	List Price
PTM-1	1	450	3/4 x 3/4 x 2 1/2	\$0.70
PTM-2	2	450	3/4 x 3/4 x 2 1/2	.80
PTM-4	4	450	3/4 x 3/4 x 2 1/2	.90
PTM-8	8	450	3/4 x 3/4 x 2 1/2	1.15
PTM-10	10	450	3/4 x 3/4 x 2 1/2	1.40
PTM-12	12	450	3/4 x 3/4 x 2 1/2	1.60
PTM-16	16	450	3/4 x 3/4 x 2 1/2	1.75
PTM-4 (4 leads)	4	450	1 1/4 x 1 1/4 x 2 1/2	1.45
PTM-8 (4 leads)	8	450	1 1/4 x 1 1/4 x 2 1/2	1.65
PTM-8 (4 leads)	8	450	1 1/4 x 1 1/4 x 2 1/2	1.80

CARDBOARD DRY ELECTROLYTICS 450 VOLTS

Types LD, LT and LR.

Type LD

Working Voltage 450 Volts

Mox. Surge Voltage 525 Volts

Catalog No.	Capacity Mfd.	Working Voltage	Dimensions	List Price
LD-4 (2 leads)	4	450	1 1/2 x 1 3/8 x 3 1/4	\$0.90
LD-8 (2 leads)	8	450	1 1/2 x 1 3/8 x 3 1/4	1.15
LD-12 (2 leads)	12	450	1 1/2 x 1 3/8 x 3 1/4	1.60
LD-16 (2 leads)	16	450	1 1/2 x 1 3/8 x 3 1/4	1.75
LD-44 (com. neg.)	4-4	450	1 1/2 x 1 3/8 x 3 1/4	1.45
LD-88 (com. neg.)	8-8	450	1 1/2 x 1 3/8 x 3 1/4	1.80
LD-444 (com. neg.)	4-4-4	450	1 1/2 x 1 3/8 x 3 1/4	2.20
LD-888 (com. neg.)	8-8-8	450	1 1/2 x 1 3/8 x 3 1/4	2.65

Working Voltage 450 Volts

Mox. Surge Voltage 525 Volts

LT-4 (2 lugs)	4	450	4 1/2 x 1 3/8 x 3 1/4	\$0.90
LT-8 (2 lugs)	8	450	4 1/2 x 1 3/8 x 3 1/4	1.15
LT-16 (2 lugs)	16	450	4 1/2 x 1 3/8 x 3 1/4	1.75

Type LR

Working Voltage 450 Volts

Mox. Surge Voltage 525 Volts

LR-44 (4 leads)	4-4	450	4 1/2 x 1 3/8 x 1	\$1.45
LR-444 (6 leads)	1-4-4	450	4 1/2 x 1 3/8 x 1 1/4	2.20
LR-48 (4 leads)	4-8	450	4 1/2 x 1 3/8 x 1 1/4	1.65
LR-88 (4 leads)	8-8	450	4 1/2 x 1 3/8 x 1 1/4	1.80
LR-888 (6 leads)	8-8-8	450	4 1/2 x 2 x 1 1/4	2.65

We reserve the right—during the present emergency—to change prices and mechanical specifications without notice.

SPRAGUE Condensers

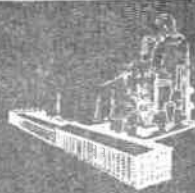

High Voltage CAN and CARDBOARD DRY ELECTROLYTICS

Sprague EC's are the finest, most reliable replacements on the market — designed for those who demand the very best it is possible to obtain, regardless of cost. Each condenser is DOUBLE TESTED. Each has a full 600-volt rating plus an EXTRA SAFETY FACTOR. Watch them build up to 650, 670 volts or even more without danger and with extremely low leakage. Double-seal, moisture-proof protection. When you use EC's you're sure the voltage is right—the highest for any job. Capacity is all you need consider.

Type EC

Double Tested—Shortproof—No Need to Check Surges

Continuous Working Voltage 475 Volts
Maximum Surge Voltage 600 Volts

Catalog No.	Capacity Mfd.	Dimensions	List Price
EC-2	2	2 1/2 x 5/8 x 5/8	\$1.15
EC-4	4	2 1/2 x 1 1/8 x 1 1/8	1.40
EC-8	8	2 1/2 x 1 3/8 x 1 3/8	1.65

Types DC and SR

Just the thing for public address and power amplifiers where the utmost reliability, quietness and ability to stand high surges are required. Also unexcelled for those exacting service jobs where you simply can't afford to have a failure. Extremely low power factor—low leakage—high voltage—no need to check surges.

Continuous Working Voltage 475 Volts
Maximum Surge Voltage 600 Volts

Catalog No.	Capacity Mfd.	Dimensions	List Price
DC-2	2	2 1/2 x 7/8 x 7/8	\$1.15
DC-4	4	4 1/8 x 1 1/8 x 7/8	1.40
DC-8	8	1 1/8 x 1 1/8 x 1 1/8	1.65
DC-44	4-4	4 1/8 x 1 1/8 x 1 1/8	2.20
DC-48	4-8	4 1/8 x 1 1/8 x 1 1/8	2.40
DC-88	8-8	4 1/8 x 1 1/8 x 1 1/8	2.65
SR-88 (4 leads)	8-8	4 1/8 x 1 1/8 x 1 1/8	2.65
SR-44 (4 leads)	4-4	4 1/8 x 1 1/8 x 1 1/8	2.20

Type RC — Surge Voltage 1000 Volts

For use with all public address and theater applications, where working voltage is high and surge voltages run well over 600 volts. These high capacity and high voltages are obtained by the use of Dry Electrolytic Condensers connected in series—giving long trouble free service. Full capacity—full working voltage—low leakage and low power factor are FULLY GUARANTEED.

Catalog No.	Capacity Mfd.	Working Voltage	Dimensions	List Price
RC-28	2	800V.	1 1/2 x 1 1/4 x 4 1/2	\$2.25
RC-48	4	800V.	1 1/2 x 1 1/4 x 4 1/2	2.40
RC-88	8	800V.	1 1/2 x 1 1/4 x 4 1/2	3.30

Type AP — Surge Voltage 800 Volts

AP-46	4	600V.	1 1/2 x 1 1/4	\$2.25
AP-86	8	600V.	1 1/2 x 1 1/4	3.15

Type AD — Surge Voltage 800 Volts

AD-46	4	600V.	1 1/2 x 1 1/4 x 2 1/2	\$2.10
AD-86	8	600V.	1 1/2 x 1 1/4 x 4 1/2	2.95

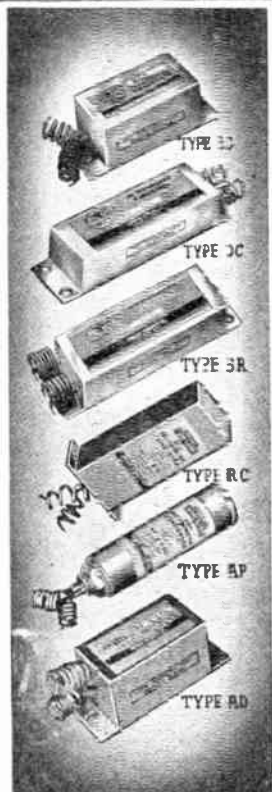

Miscellaneous PAPER CONDENSERS

Fully reliable and inexpensive, paper substitutes for dry electrolytics. The actual capacity is one-third to one-half that of a Dry Electrolytic in the same size container. Leakage and power factor are extremely low. No polarity has to be observed.

Types DR and RP are ideal for replacements in high voltage public address systems, power amplifiers and high voltage filter circuits.

Type DR

Catalog No.	Replacement Cap. Mfd.	Working Voltage	Dimensions	List Price
DR-4	4	600	1 3/8 x 1 3/8	\$1.65
DR-8	8	600	1 3/8 x 1 3/8	2.10
DR-44	4-4	600	4 3/8 x 1 3/8	2.70
DR-88	8-8	600	4 3/8 x 1 1/2	3.40

Type RP

RP-8	8	600	1 1/4 x 1 3/8 x 1 3/8	1.95
RP-88	8-8	600	4 3/8 x 1 1/8 x 1 3/8	3.20

Type UC

For Low Cost Xmitting Units and Many Other Uses Rugged, dependable yet truly economical high-voltage condensers for use up to 1000 volts. Oil impregnated—wax filled—fully cased and sealed. Mounting flanges may be cut off when not needed. Unconditionally guaranteed at rated voltages.

Catalog No.	Capacity Mfd.	D.C. Volt	Dimensions	List Price
UC-54	0.5	400	2 1/2 x 1 3/8 x 9/8	\$0.60
UC-14	1	400	2 1/2 x 1 5/8 x 9/8	.90
UC-24	2	400	2 1/2 x 1 5/8 x 1	1.40
UC-24	2	400	3 1/4 x 1 5/8 x 5/8	1.40
UC-16	1	600	2 1/2 x 1 1/2 x 1	1.10
UC-26	2	600	3 1/4 x 1 7/8 x 1 1/8	1.65
UC-46	4	600	4 1/4 x 1 7/8 x 1 1/4	3.00
UC-18	1	800	3 1/4 x 1 7/8 x 1 1/8	1.50
UC-28	2	800	4 1/4 x 2 1/4 x 1 1/8	2.40
UC-11	1	1000	4 1/4 x 1 7/8 x 1 1/4	1.80
UC-21	2	1000	4 1/4 x 2 1/8 x 1 3/4	3.00
UC-41	4	1000	4 1/4 x 2 1/8 x 3 1/4	5.40

Type BP

Enclosed in drawn metal case—proofed against heat and moisture by the special Sprague waxing process.

Test Voltage 1200 Working Voltage 400
Peak Voltage 600

Catalog No.	Capacity Mfd.	Dimensions	Mfg Dim.	List Price
BP-1	.1	1 3/4 x 1 x 3/4	2 1/8	\$0.85
BP-25	.25	1 3/4 x 1 1/8 x 3/4	2 1/8	.90
BP-50	.5	2 x 1 1/4 x 3/4	2 1/8	1.15
BP-10	1.0	2 x 1 1/4 x 1	2 1/8	1.50
BP-21	1-1	1 3/4 x 1 1/8 x 3/4	2 1/8	1.00
BP-225	.25-.25	2 x 1 1/4 x 3/4	2 1/8	1.20
BP-250	.5-.5	2 x 1 1/4 x 1	2 1/8	1.50
BP-31	1-1-1	2 x 1 x 3/4	2 1/8	1.30
BP-41	1-1-1-1	2 x 3/4 x 1 1/8	2 1/8	1.70

Type SW

High Voltage - Short Wave High Frequency
Oil Impregnated Condensers

Splendid mica substitutes when used as: (1) By-pass condensers; (2) Blocking condensers; (3) Antenna-coupling condensers; (4) Buffer condensers (Mercury Vapor Tubes); (5) in filter for phone use and (6) for grounding rotors.

Metal encased — non-inductive — extremely low power factor—oil impregnated—1500 V. and 1000 V.D.C. rating.

Guaranteed Unconditionally When Used as Specified

Catalog No.	Capacity	Working Voltage	Dimensions D. L.	List Price
SW-22	.002	1500	3/8 x 1 1/8	\$0.55
SW-25	.005	1500	3/8 x 1 1/8	.55
SW-11	.01	1500	3/8 x 1 1/8	.85
SW-12	.02	1500	7/8 x 1 1/8	1.00
SW-15	.05	1000	7/8 x 2 1/4	1.00
SW-1	0.1	1000	7/8 x 2 1/4	1.10

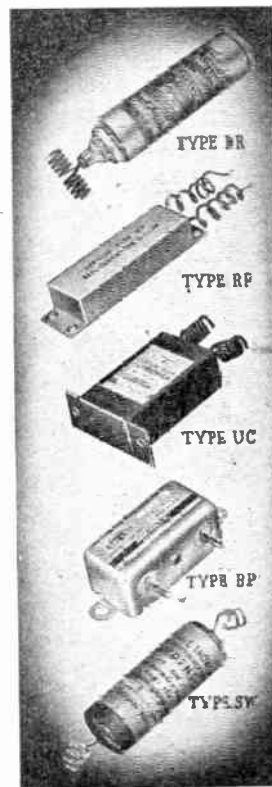

We reserve the right—during the present emergency—to change prices and mechanical specifications without notice.

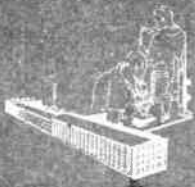

SPRAGUE Condensers

TYPE WC WET ELECTROLYTICS

Type WC. Perhaps not everyone realizes that Sprague has perfected more Wet Electrolytic developments, has pioneered and patented more features than any other manufacturer, BUT every serviceman and amateur who has used them plainly recognizes

Sprague superiority in EVERY electrical and mechanical characteristic. Chrome plated cans prevent corrosion and deterioration. Hidden vent is non-tamperable. Self-healing—long life—can withstand high peak voltages without injury.

D. C. Peak Voltage—500 Volts

Catalog No.	Capacity Mfd.	Dimensions	List Price
WC-4	4	1 x 3 3/8	\$1.00
WC-6	6	1 x 3 3/8	1.05
WC-8C	8	1 x 3 3/8	1.15
WC-8	8	1 x 3 3/8	1.15
WC-10	10	1 x 3 3/8	1.30
WC-12C	12	1 x 4 1/8	1.40
WC-12	12	1 x 3 3/8	1.40
WC-14C	14	1 1/8 x 4 1/8	1.65
WC-14	14	1 1/8 x 3 3/8	1.65
WC-16	16	1 1/8 x 3 3/8	1.75
WC-18	18	1 1/8 x 3 3/8	1.75

Catalog No.	Capacity Mfd.	Dimension	List Price
WC-25	25	1 1/2 x 4 1/8	\$2.00
WC-30	30	1 1/2 x 4 1/8	2.05
WC-83	18-300v. (Regulator)	1 1/2 x 3 3/8	1.40
WC-40	10-300v. (Regulator)	1 1/2 x 4 1/8	1.65

D. C. Peak Voltage—600 Volts

WC-46	4	1 1/2 x 3 3/8	\$1.60
WC-86	8	1 1/2 x 3 3/8	1.80
WC-166	16	1 1/2 x 4 1/8	2.40

TYPE EL SELF-MOUNTING DRY ELECTROLYTICS

Type EL. These condensers are assembled in un-insulated, aluminum cans that have a self-mounting feature, wherein the mounting ear is bent back under

the chassis. Connections are made to lug terminals. Each terminal is coded with a character, punched into the cover. For insulating the can, use a bakelite mounting plate that can be furnished at a list price of \$0.05 each. When ordering specify the diameter of the can. Metal mounting plates can also be furnished at a list price of \$0.05 each.

SINGLE SECTION

Catalog No.	Capacity Mfd.	D.C. Working Voltage	Dimensions D. L.	List Price
EL-1	10	150	1 x 2	\$0.90
EL-15	15	150	1 x 2	1.20
EL-2	20	150	1 x 2	1.35
EL-4	40	150	1 x 3	1.95
EL-5	50	350	1 x 3	1.75
EL-6	60	250	1 x 3	1.45
EL-14	10	200	1 x 3	1.10

DUAL SECTION

EL-210	10 10	150	1 x 2	\$1.45
EL-151	15 10	150	1 x 2	1.60
EL-220	20-20	150	1 x 3	2.00
EL-240	40-40	150	1 1/8 x 3	3.20
EL-32	30-20	350	1 x 3	1.75
EL-22	20 20	300/25	1 x 2	1.35
EL-120	20 20	250	1 x 2	1.35
EL-221	20 20	150	1 x 2	1.20
EL-35	30 50	150	1 x 3	1.50
EL-24	10-20	150	1 x 2	1.35
EL-25	50 50	150	1 x 3	1.60
EL-26	60-60	150	1 3/8 x 3	1.80

TRIPLE SECTION

Catalog No.	Capacity Mfd.	D.C. Working Voltage	Dimension D. L.	List Price
EL-202	10-10/20	150/25	1 x 3	\$1.60
EL-215	15-5/15	450/350	1 x 3	1.80
EL-205	20-15/20	450/25	1 1/8 x 2	2.05
EL-322	20-20/20	400/25	1 x 3	2.10
EL-102	10-10/20	350/25	1 x 2	1.35
EL-153	15-10/20	350/25	1 x 2	1.40
EL-212	20-10/20	350/25	1 x 3	1.60
EL-320	20-20-20	150	1 x 2	1.45
EL-224	40-20-40	150	1 x 3 1/2	1.65
EL-340	40 40-40	150	1 x 3	1.90
EL-222	20 20/20	150/25	1 x 3	1.35
EL-43	30-10/25	150/25	1 x 2	1.60

QUADRUPLE SECTION

EL-431	10 10-10/20	150/25	1 3/8 x 2	\$2.05
EL-415	20-10-5/10	350/25	1 1/8 x 2	1.80
EL-422	40 20-10 20	200 25	1 3/8 x 3	1.90

TYPES SB and HC CARDBOARD TUBE CONDENSERS

Type SB Cardboard Tube. For the past few years, we have found set manufacturers using types similar to our SB series shown below. The four capacities shown are popular and will serve as excellent universal replacements where this type of condenser is encountered.

Catalog No.	Capacity Mfd.	Working Voltage	Surge Voltage	Dimension	List Price
SB-88	8-8	450	525	1 1/2 x 3 1/8	\$1.65
SB-816	8-16	450	525	1 1/2 x 3 1/8	2.00
SB-216	16-16	450	425	1 1/2 x 4 1/8	2.40
SB-1216	12-16	200	225	1 1/2 x 3 1/8	1.90

Type HC. Cardboard tubular electrolytics with insulated covered wire leads out of each end. Note new high-capacity, low-voltage condensers that are highly recommended to serve as replacements for the HLV condensers listed at bottom of this page.

Catalog No.	Capacity Mfd.	D. C. Volt	Dimensions	List Price	Catalog No.	Capacity Mfd.	D. C. Volt	Dimensions	List Price
HC-5	5	25	2 1/2 x 1 1/8	\$0.60	HC-106	100	6	2 1/2 x 5/8	\$1.00
HC-10	10	25	2 1/2 x 1 1/8	.60	HC-102	100	25	2 1/2 x 5/8	1.10
HC-510	10	50	2 1/2 x 1 1/8	.80	HC-105	100	50	2 1/2 x 7/8	1.20
HC-25	25	25	2 1/2 x 1 1/8	.80	HC-1000	1000	6	3 1/2 x 5/8	2.40
HC-50	50	25	2 1/2 x 1 1/8	1.15	HC-1012	1000	12	3 3/8 x 1	3.00
HC-525	25	50	2 1/2 x 1 1/8	1.00	HC-2000	2000	6	3 3/8 x 1 3/8	3.30
HC-505	50	50	3 1/2 x 1	1.45	HC-2012	2000	12	4 1/2 x 1 1/2	3.90
HC-100	10-10	25	2 1/2 x 5/8	.90					

We reserve the right—during the present emergency—to change prices and mechanical specifications without notice.

SPRAGUE Condensers



Can Type DRY ELECTROLYTICS 450 VOLTS

Type PLS "Tiny Mike". Exceptional quality in extremely small size made possible by the use of the exclusive Sprague etched foil process. Mount in any position. Standard mounting by threaded bushing on can. Can is completely insulated. Working Voltage 450 V., Surge Voltage 525 V.

Catalog Number	Cap. Mfd.	Work. Volt.	Dimensions	List Price
PLS-4 (2 leads)	4	450	1 1/2 x 3 1/2	\$1.05
PLS-8 (2 leads)	8	450	1 1/2 x 3	1.30
PLS-12 (2 leads)	12	450	1 1/2 x 3	1.70
PLS-16 (2 leads)	16	450	1 1/2 x 3	1.90
PLS-48 (4 leads)	4-8	450	1 1/2 x 3	1.75
PLS-88 (4 leads)	8-8	450	1 1/2 x 3	1.90
PLS-888 (6 leads)	8-8-8	450	1 1/2 x 3	2.80
PLS-816 (4 leads)	8-16	450	1 1/2 x 3	2.50
PLS-216 (4 leads)	16-16	450	1 1/2 x 3	2.60

Type LS, LC and CT. Popular for replacing older can type capacitors. Mount in any position. Standard mounting through chassis by threaded bushing on can. Packed with mounting hardware and insulating washers. Special ring mounting clamps provided for upright mounting, or for mounting with can partly extending through panels or chassis.

Type LS units have the can as negative terminal, and lug terminals for anode connections. Type LC units have the can completely insulated from the sections. Separate positive and negative leads for each section are provided. Type CT units have can completely insulated from sections. Common negative and separate positive leads for the sections provided.

Working Voltage 450 Surge Voltage 525 V.

Catalog Number	Cap. Mfd.	Work. Volt.	Dimensions	List Price
LS-4	4	450	1 1/2 x 3 1/2	\$1.05
LS-8	8	450	1 1/2 x 1 1/2	1.30
LS-10	10	450	1 1/2 x 1 1/2	1.50
LS-12	12	450	1 1/2 x 1 1/2	1.70

Catalog Number	Cap. Mfd.	Work. Volt.	Dimensions	List Price
LS-16	16	450	1 1/2 x 1 1/2	\$1.90
LS-88 (2 lugs)	8-8	450	1 1/2 x 1 1/2	1.95
LC-8 (2 leads)	8	450	1 1/2 x 1 1/2	1.30
LC-12 (2 leads)	12	450	1 1/2 x 1 1/2	1.70
LC-16 (2 leads)	16	450	1 1/2 x 1 1/2	1.90
LC-44 (4 leads)	4-4	450	1 1/2 x 1 1/2	1.60
LC-88 (4 leads)	8-8	450	1 1/2 x 1 1/2	1.95
CT-216 (4 leads)	16-16	450	1 1/2 x 1 1/2	2.60
CT-44 (4 leads)	4-4	450	1 1/2 x 1 1/2	1.60
CT-88 (4 leads)	8-8	450	1 1/2 x 1 1/2	1.95

Type LA Upright Can Mounting. Standard mounting in upright position with a ring type mounting clamp permits these units to be placed anywhere on chassis without regard to old mounting holes or spacing. Mounting clamps included.

Type LA Single Section Units. Can is negative terminal. Positive terminal is a lug.

Type LA Multiple Section Units. Can is common negative terminal. Positive terminals are threaded studs provided with double nuts.

Working Voltage 450 Maximum Surge Voltage 525

Catalog Number	Cap. Mfd.	Work. Volt.	Dimensions	List Price
LA-4	4	450	1 1/2 x 3 1/2	\$1.05
LA-8	8	450	1 1/2 x 1 1/2	1.30
LA-16	16	450	1 1/2 x 1 1/2	1.90
LA-515	5-15	450	2 1/2 x 1 1/2	2.80
LA-88	8-8	450	2 1/2 x 1 1/2	2.20
LA-816	8-16	450	2 1/2 x 1 1/2	2.85
LA-444	4-4-4	450	2 1/2 x 1 1/2	2.60
LA-888	8-8-8	450	3 x 1 1/2	3.25
LA-9918	9-9-18	450	3 x 1 1/2	4.50
LA-8888	8-8-8-8	450	3 x 1 1/2	4.35
LA-8836	8-8-18-18	450	3 x 1 1/2	5.85
LA-9936	9-9-18-18	450	3 x 1 1/2	6.30

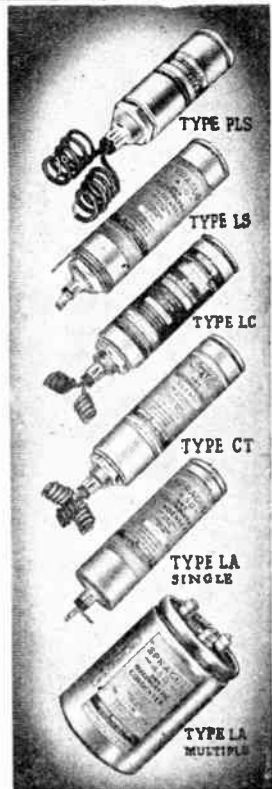

Can Type DRY ELECTROLYTICS 600 VOLTS

Extremely durable can type dry electrolytics especially designed for the exacting requirements of public address and power amplifier work. High surge voltage rating provides extra safety in high current power supplies where high peaks often occur. Unexcelled for those "extra tough" service replacement uses.

Type SC: Inverted Screw Can Mounting. Provided with threaded bushing for standard mounting in any position. Can is the negative terminal in all units. Positive terminal is lug connection. Supplied with mounting nuts, and insulating washers to insulate can from chassis. Special ring clamp for upright mounting supplied.

Continuous Working Voltage 475 Volts
Maximum Surge Voltage 600 Volts

Catalog Number	Capacity Mfd.	Dimensions	List Price
SC-4	4	1 1/2 x 3 1/2	\$1.50
SC-6	6	1 1/2 x 1 1/2	1.75
SC-8	8	1 1/2 x 1 1/2	1.80
SC-10	10	1 1/2 x 1 1/2	2.20
SC-12	12	1 1/2 x 1 1/2	2.50
SC-16	16	1 1/2 x 1 1/2	2.80
SC-88 (can neg)	8-8	1 1/2 x 1 1/2	2.90

Type CL: Inverted Screw Mounting. Can insulated from sections. Separate positive and negative terminal leads for each section.

Continuous Working Voltage 475 Volts
Maximum Surge Voltage 600 Volts

Catalog Number	Capacity Mfd.	Dimensions	List Price
CL-4 (2 leads)	4	1 1/2 x 3 1/2	\$1.50
CL-8 (2 leads)	8	1 1/2 x 1 1/2	1.80
CL-16 (2 leads)	16	1 1/2 x 1 1/2	2.80

Type AC: Aluminum Can—Upright Mounting. Standard mounting is by a ring clamp supplied with all units. Can be mounted in any position, without regard for old mounting holes or centers.

Can is common negative connection on all units. Extremely low power factor and low leakage.

Continuous Working Voltage 475 Volts
Maximum Surge Voltage 600 Volts

Catalog Number	Capacity Mfd.	Dimensions	List Price
AC-4	4	1 1/2 x 3 1/2	\$1.50
AC-8	8	1 1/2 x 1 1/2	1.80
AC-10	10	1 1/2 x 1 1/2	2.20
AC-12	12	1 1/2 x 1 1/2	2.50
AC-16	16	1 1/2 x 1 1/2	2.80

Type AC: Aluminum Can—Multiple Unit
Continuous Working Voltage 475 Volts
Maximum Surge Voltage 600 Volts

Catalog Number	Capacity Mfd.	Dimensions	List Price
CA-88 (4 leads)	8-8	1 1/2 x 1 1/2	\$2.90
SA-88	8-8	2 1/2 x 1 1/2	2.90
AC-88 (2 leads)	8-8	1 1/2 x 1 1/2	2.90
AC-888	8-8-8	3 x 1 1/2	4.80
AC-515	5-15	2 1/2 x 1 1/2	4.05
AC-9918	9-9-18	3 x 1 1/2	7.00
AC-9936	9-9-18-18	3 x 1 1/2	9.80

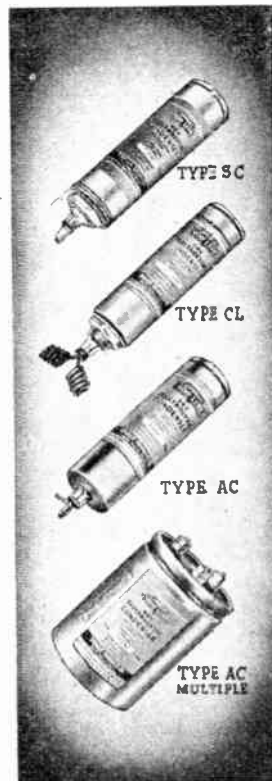

We reserve the right—during the present emergency—to change prices and mechanical specifications without notice.

SPRAGUE Condensers

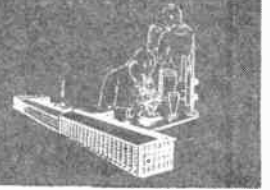

Auto RADIO CONDENSERS

Vibrator Condensers (Oil Impregnated). These sturdy new oil-impregnated units are your guarantee against troubles due to broken-down vibrator condensers. Fully sealed in durable metal cans.

Working Voltage 1600 Volts D. C.

Catalog Number	Capacity Mfd.	Dimensions	List Price
AR-11	.01	1 1/2 x 3/8 x 1 1/2	\$0.55
AR-12	.02	1 1/2 x 3/8 x 1 1/2	.55
AR-13	.03	1 1/2 x 3/8 x 1 1/2	.55
AR-14	.04	1 1/2 x 3/8 x 1 1/2	.55
AR-15	.05	1 1/2 x 3/8 x 1 1/2	.55
MV-11	.01	3 x 3/8 x 2 1/2	.55
FR-11	.01	1 x 7/8 x 1 1/2	.55
FR-12	.02	1 x 7/8 x 1 1/2	.55
LR-27	.007	1 1/2 x 2 1/2 x 1 1/2	.55
LR-11	.01	1 1/2 x 2 1/2 x 1 1/2	.55
LR-12	.02	1 1/2 x 2 1/2 x 1 1/2	.55

Type VT High Voltage—High Quality Tubulars

Catalog Number	Capacity Mfd.	Working Voltage	Dimensions	List Price
VT-27	.007	2000v	5/8 x 1 5/8	\$3.55
VT-11	.01	2000v	5/8 x 2 1/8	.55
VT-??	.02	2000v	1 x 2 1/8	.55

Type TR - High-Voltage Tubulars Oil Impregnated—Wax Filled
Designed for Buffer or other high-voltage uses.
Working Voltage 1600 Volts D. C.

Catalog Number	Capacity Mfd.	Mounting Dimensions	List Price
TR-25	.0005	3/4 x 1 1/2	\$0.45
TR-21	.001	3/4 x 1 1/2	.45
TR-22	.002	3/4 x 1 1/2	.45

Catalog Number	Capacity Mfd.	Mounting Dimensions	List Price
TR-23	.003	1 1/2 x 1 1/2	\$0.45
TR-24	.004	1 1/2 x 1 1/2	.45
TR-25	.005	1 1/2 x 1 1/2	.45
TR-26	.006	1 1/2 x 1 1/2	.45
TR-27	.007	1 1/2 x 1 1/2	.45
TR-28	.008	1 1/2 x 1 1/2	.45
TR-11	.01	1 1/2 x 2	.45
TR-12	.02	1 1/2 x 2	.45
TR-13	.03	1 1/2 x 2 1/2	.45
TR-14	.04	1 1/2 x 2 1/2	.50
TR-15	.05	1 1/2 x 2 1/2	.55

Specially designed to withstand intense vibration and heat. Full capacity—true voltage ratings.

TYPE List Price

DL-1	—Dome Light Filter	\$1.00
GG-5	—Gas Gauge Filter	.60
OG-50	—Oil Gauge Filter	.60
P-2077	—Ford Replacement Condenser	.60
P-2153	—Motorola Replacement Condenser, 2 x .0008 mfd.	.55
P-3402	—Ammeter Condenser, 5 mfd size 5/8 in. x 2 in.	.55

Type AR and FORD TYPE

Test Voltage—600 Working Voltage—400

Catalog Number	Capacity Mfd.	Dimensions Inches	List Price
AR-1	1 0	2 1/4 x 1 1/2 Dia	0.85
AR-2	5	2 1/4 x 1 1/2 Dia	.60
Ford Type	5	2 1/4 x 1 1/2 Dia	.60
AR-25	5 5	2 1/4 x 1 1/2 Dia	.90

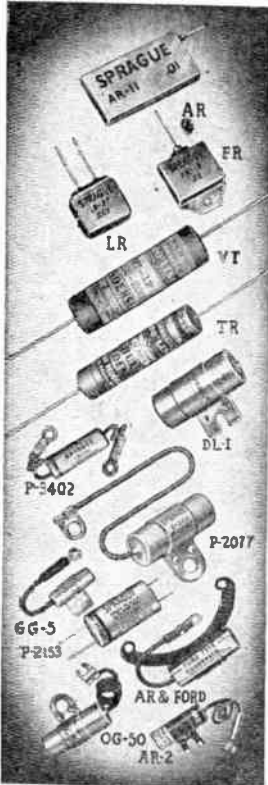

Transmitting CONDENSERS

Play safe on high voltages the practical way! Insist on Sprague... the only Transmitting Condensers equipped with the new "lifeguard" Terminal Insulation Caps.

Terminals are insulated from cans for at least twice the working voltage. Condensers are placed in complete metal cans which can be automatically grounded through the mounting clamps; and all condensers are oil impregnated—oil filled with SPRACOL, the famous Sprague 500 degree F. flash protection oil (not oil impregnated and wax filled)! Oil-FILLED units are essential for high voltage use.

New Type CR With Universal Mounting. To meet the demand for fully reliable, full quality Sprague Transmitting Condensers in small, rectangular size and with adjustable flanges for mounting in any position, we are pleased to announce the new Type CR. Like the famous Sprague Transmitting units of the past, they are oil impregnated and oil filled, cylindrically wound, perfectly sealed, and labelled with complete operating information based on A. R. R. L. standards. Ample safety factor is assured—no need to "play safe" by buying higher voltage units than required. Unconditionally guaranteed against breakdown when used as specified.

Catalog Number	Capacity Mfd.	D. C. Working Voltage	Can Size	List Price
CR-16	1	600	1 x 1 1/4 x 2 1/2	\$4.20
CR-26	2	600	1 x 1 1/4 x 2 1/2	5.10
CR-46	4	600	1 1/2 x 2 1/2 x 3 1/2	6.60
CR-11	1	1000	1 x 1 1/4 x 2 1/2	4.50
CR-21	2	1000	1 x 1 1/4 x 3 1/2	6.00
CR-41	4	1000	1 1/2 x 2 1/2 x 4 1/2	7.50
CR-115	1	1500	1 x 1 1/4 x 3 1/2	5.40
CR-215	2	1500	1 1/2 x 2 1/2 x 4 1/2	7.50
CR-415	4	1500	1 1/2 x 3 1/4 x 4 3/8	10.20
CR-12	1	2000	1 1/2 x 2 1/2 x 3 1/2	6.60
CR-22	2	2000	1 1/2 x 3 1/4 x 3 1/2	7.80
CR-42	4	2000	2 1/4 x 3 1/4 x 3 1/2	10.80

Catalog Number	Capacity Mfd.	D. C. Working Voltage	Can Size	List Price
CR-125	1	2500	1 1/4 x 3 1/4 x 3 1/4	\$9.60
CR-225	2	2500	1 1/4 x 3 1/4 x 3 1/4	15.60
CR-13	1	3000	2 1/4 x 3 3/4 x 4 1/4	14.40
CR-23	2	3000	3 1/2 x 3 3/4 x 4 1/2	18.00

Type PC. Inverted Screw Can Round Condensers for P. A. and Transmitter Work, Television and High Gain Amplifiers. Cans are grounded.

Catalog Number	Capacity Mfd.	D. C. Working Voltage	Can Size	List Price
PC-26	2	600	1 1/2 x 2 1/2	\$3.30
PC-46	4	600	1 1/2 x 4 1/2	4.50
PC-11	1	1000	1 1/2 x 2 1/2	3.00
PC-21	2	1000	1 1/2 x 4 1/2	3.90

Type OT (Round). Impregnated and filled with Spracol, rated to conform with tube and circuit design. Unconditionally guaranteed when used as specified.

Catalog Number	Capacity Mfd.	D. C. Working Voltage	Surge Voltage	List Price
OT-26	2	600	1000	\$3.90
OT-11	1	1000	1500	3.30
OT-21	2	1000	1500	4.50
OT-41	4	1000	1500	5.70
OT-515	0.5	1500	2000	3.30
OT-115	1	1500	2000	4.20
OT-215	2	1500	2000	5.70
OT-12	1	2000	3000	5.40
OT-22	2	2000	3000	6.00
OT-13	1	3000	3500	10.80

FREE! Lifeguard Protective Caps are now supplied at no extra cost with every Sprague Transmitting Condenser—or, you can buy them for your old condensers. **LG-1—List Price Per Pair 30c**

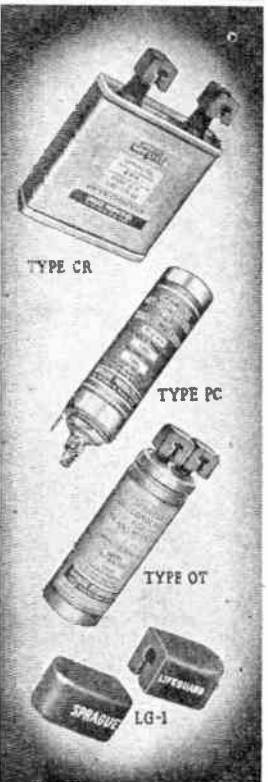

We reserve the right—during the present emergency—to change prices and mechanical specifications without notice.

SPRAGUE Condensers

Fixed MICA CONDENSERS Stamped With Capacity Ratings

Type 1FM - 2FM. Remarkably resistant to moisture. Power factor is extremely low and stable and voltage ratings are fully guaranteed. Wire leads can be looped for "eyelet" mounting.

Intermediate Capacities Available

Catalog Number	Capacity Mfd.	Working Voltage	List Price
1FM-45	0.0005	600	\$0.20
1FM-31	0.001	600	.20
1FM-315	0.0015	600	.25
1FM-32	0.002	600	.25
1FM-325	0.0025	600	.25
1FM-335	0.0035	600	.25
1FM-35	0.005	600	.25
1FM-37	0.007	600	.25
1FM-21	0.001	600	.30
1FM-215	0.0015	600	.30
1FM-22	0.002	600	.45
1FM-23	0.003	600	.50
1FM-24	0.004	600	.55
1FM-25	0.005	600	.70
1FM-26	0.006	600	.75
2FM-45	0.0005	300	.20
2FM-475	0.00075	300	.20
2FM-31	0.001	300	.20
2FM-315	0.0015	300	.25
2FM-32	0.002	300	.25
2FM-325	0.0025	300	.25
2FM-35	0.005	300	.25

Type 3FM. Molded in low loss bakelite. Moisture-proof. Tinned copper lugs are excellent for single hole mounting, and for mounting to screws or studs. Lug clearance hole for 6-32 machine screw.

Working Voltage—600 D.C. Test Voltage—1000

Catalog Number	Capacity Mfd.	List Price	Catalog Number	Capacity Mfd.	List Price
3FM-45	0.0005	\$0.30	3FM-215	0.0015	\$0.40
3FM-47	0.0007	.30	3FM-22	0.002	.45
3FM-475	0.00075	.30	3FM-225	0.0025	.45
3FM-31	0.001	.30	3FM-23	0.003	.50
3FM-32	0.002	.30	3FM-24	0.004	.55
3FM-325	0.0025	.30	3FM-25	0.005	.55
3FM-335	0.0035	.30	3FM-23	0.003	.70
3FM-35	0.005	.30	3FM-23	0.003	.75
3FM-21	0.001	.40	3FM-11	0.001	.85

ONLY
1 FM and 2 FM
DISCONTINUED

Type 4FM. Molded in low loss bakelite. Moisture-proof. Intended for mounting directly against chassis or panels by insertion of screws through the molded bakelite mounting ears. Heavy tinned copper lugs with hole clearance for 6-32 screw. Supplied in 1000 to 5000 DC volts test.

Working Voltage—600 D.C. Test Voltage—1000

Catalog Number	Capacity Mfd.	List Price	Catalog Number	Capacity Mfd.	List Price
4FM-45	0.0005	\$0.45	4FM-215	0.0015	\$0.55
4FM-47	0.0007	.45	4FM-22	0.002	.55
4FM-475	0.00075	.45	4FM-225	0.0025	.60
4FM-31	0.001	.45	4FM-23	0.003	.70
4FM-32	0.002	.45	4FM-24	0.004	.70
4FM-325	0.0025	.45	4FM-25	0.005	.70
4FM-335	0.0035	.45	4FM-26	0.006	.80
4FM-35	0.005	.45	4FM-28	0.008	.90
4FM-21	0.001	.50	4FM-11	0.001	1.00

Type 5FM

Working Voltage—1250 D.C. Test Voltage—2500

Catalog Number	Capacity Mfd.	List Price	Catalog Number	Capacity Mfd.	List Price
5FM-45	0.0005	\$0.60	5FM-325	0.0025	\$0.60
5FM-47	0.0007	.60	5FM-335	0.0035	.60
5FM-475	0.00075	.60	5FM-35	0.005	.60
5FM-31	0.001	.60	5FM-21	0.001	.70
5FM-32	0.002	.60	5FM-22	0.002	.90

Type 6FM

Working Voltage—2500 D.C. Test Voltage—5000

Catalog Number	Capacity Mfd.	List Price	Catalog Number	Capacity Mfd.	List Price
6FM-45	0.0005	\$0.75	6FM-35	0.005	\$1.05
6FM-31	0.001	.75	6FM-21	0.001	1.20
6FM-325	0.0025	.85	6FM-22	0.002	1.80

Type 7FM

Working Voltage—600 D.C. Test Voltage—1000

Catalog Number	Capacity Mfd.	List Price	Catalog Number	Capacity Mfd.	List Price
7FM-45	0.0005	\$0.75	7FM-24	0.004	\$1.05
7FM-31	0.001	.75	7FM-25	0.005	1.05
7FM-315	0.0015	.75	7FM-26	0.006	1.20
7FM-32	0.002	.75	7FM-28	0.008	1.45
7FM-325	0.0025	.75	7FM-11	0.001	1.70
7FM-35	0.005	.75	7FM-12	0.002	2.25
7FM-21	0.001	.75	7FM-125	0.025	2.80
7FM-215	0.0015	.80	7FM-13	0.003	3.00
7FM-22	0.002	.80	7FM-4	0.004	3.90
7FM-23	0.003	1.05	7FM-15	0.005	4.65

Type 8FM

Working Voltage—1250 D.C. Test Voltage—2500

Catalog Number	Capacity Mfd.	List Price	Catalog Number	Capacity Mfd.	List Price
8FM-45	0.0005	\$0.85	8FM-23	0.003	\$1.90
8FM-31	0.001	.85	8FM-24	0.004	1.90
8FM-315	0.0015	.85	8FM-25	0.005	2.10
8FM-32	0.002	.85	8FM-26	0.006	2.10
8FM-325	0.0025	.85	8FM-28	0.008	2.70
8FM-35	0.005	.85	8FM-11	0.001	3.40
8FM-21	0.001	1.10	8FM-115	0.015	4.05
8FM-215	0.0015	1.40	8FM-12	0.002	4.75
8FM-22	0.002	1.65	8FM-125	0.025	5.30

Type 9FM

Working Voltage—2500 D.C. Test Voltage—5000

Catalog Number	Capacity Mfd.	List Price	Catalog Number	Capacity Mfd.	List Price
9FM-45	0.0005	\$1.10	9FM-22	0.002	\$2.70
9FM-31	0.001	1.10	9FM-23	0.003	3.30
9FM-315	0.0015	1.20	9FM-24	0.004	3.80
9FM-32	0.002	1.30	9FM-25	0.005	4.00
9FM-325	0.0025	1.30	9FM-26	0.006	4.20
9FM-35	0.005	1.50	9FM-28	0.008	4.60
9FM-21	0.001	1.80	9FM-11	0.001	4.95
9FM-215	0.0015	2.35			

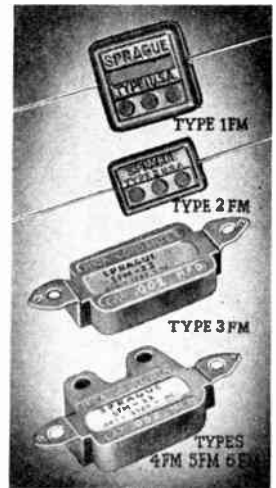

For Safety Selection of Mica Condenser Voltage Rating

NEW SPRAGUE COLOR CODE

- GREEN LABEL . . . 1000 Volts
- BLUE LABEL . . . 2500 Volts
- RED LABEL . . . 5000 Volts

Molded in low loss bakelite. Moisture-proof. Designed for mounting directly by the wiring or by screws on insulators or insulating panels. Threaded screw bushings on both sides tapped for 6-32 machine screw. Supplied in 1000, 2500, and 5000 DC v. test.

Cat. No.	Cap. Mfd.	Max. D.C. Volts	List Price
FMM-45	0.0005	7,000	\$5.40
FMM-45	0.0005	12,500	6.60
FMM-31	0.001	7,000	5.40
FMM-315	0.0015	12,500	6.60
FMM-32	0.002	7,000	5.40
FMM-325	0.0025	12,500	6.60
FMM-35	0.005	7,000	5.40
FMM-35	0.005	12,500	6.60
FML-21	0.001	3,500	5.40
FMM-21	0.001	7,000	6.00
FML-215	0.0015	12,500	6.60
FMM-215	0.0015	3,500	5.40
FML-22	0.002	12,500	7.80
FMM-22	0.002	3,500	6.60
FMM-22	0.002	7,000	7.80
FML-23	0.003	12,500	9.00
FMM-23	0.003	3,500	7.20
FMM-23	0.003	7,000	8.40
FML-24	0.004	10,000	10.80
FMM-24	0.004	3,500	8.40
FML-24	0.004	7,000	10.80
FML-25	0.005	10,000	11.40
FMM-25	0.005	3,500	7.80
FMM-25	0.005	7,000	11.40
FMM-25	0.005	10,000	12.00
FML-11	0.01	3,500	12.00
FMM-11	0.01	7,000	12.60
FML-12	0.02	3,500	12.00
FMM-12	0.02	7,000	9.90
FML-15	0.05	3,500	12.00
FMM-15	0.05	7,000	13.80
FML-1	0.1	2,000	13.80



Types FMH - FML - FMM. Condenser is sealed in a low loss, non hygroscopic, casing of glazed high voltage porcelain. The terminal seals are moisture proof and the entire condenser section is embedded in a low loss wax. The terminals are No. 10-32 machine screws, supplied with hex. nuts. Supplied in 2000 to 12,500 DC v. rating.

We reserve the right—during the present emergency—to change prices and mechanical specifications without notice.

SPRAGUE Condensers

INTERFERENCE ELIMINATION CONDENSERS and CHOKES

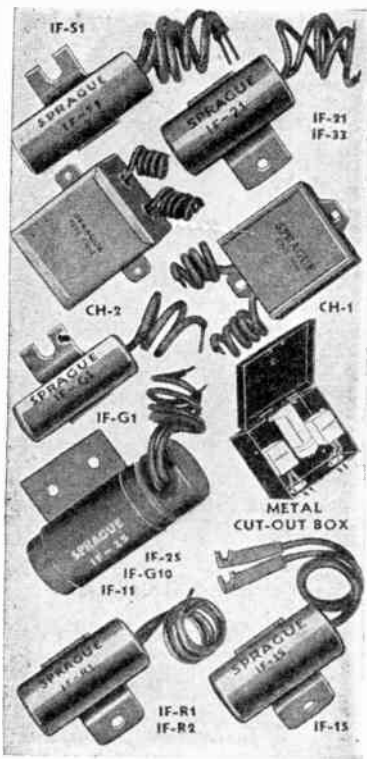

Type IF-15. A triple section filter for application to all small motors or motor operated devices. Specially designed to prevent accidental shocks from discharge of filter condensers, in accordance with RMA recommendations.

Type IF-25. A double section filter for medium sized motors, and 1 Horsepower motors. Condenser and terminals completely enveloped in metal shield for safety.

Type IF-G1. A compact, metal encased, single section filter for application to each brush of multiple brush generators, rotary converters, etc. Can and mounting bracket form one terminal of the filter.

Type IF-G10. A high capacity, single section filter, with completely enclosed terminal construction for safety. Used in combination with IF-11 condenser on 3 wire systems, etc.

Type IF-11. A dual high capacity filter, with completely enclosed safety construction. For application to large motors, over 1 Horsepower. Also used on high current arcing or sparking devices. Used with IF-G10 on 3 wire power systems.

Type IF-21 or IF-33. A dual, compact, metal encased tubular filter for use across the brushes of fractional horsepower motors with can grounded to the motor frame. Also used across the line terminals of motors in conjunction with chokes to form a "brute force" filter for stubborn cases of interference.

Type IF-S1. A single, 2 lead, filter section with can completely insulated. For use across make and break contacts.

Type IF-R1. A special resistor-capacitor filter combination for use across arcing, or make and break contacts in inductive circuits where prolonged sparking takes place.

Type IF-R2. Same construction and applications as IF-R1, except used in very highly inductive circuits, where suppression provided by IF-R1 is not sufficient.

Type CH-1, CH-2. High quality, completely metal encased chokes of adequate inductance to provide real filtering action at radio frequencies CH-1 carries up to 10 amps and CH-2 up to 20 amps. CH-1 Mounting centers 2 1/8", CH-2 Mounting centers 3 1/8". Both types provided with 8" Pigtail Leads.

Metal Cut-Out Boxes, Type CO-1. Sprague furnishes a standard metal cut-out box, size 8 1/4" x 6 1/2" x 3 1/2", to house various individual Sprague interference units used in a filter system—jobbers carry them in stock

List Price \$1.80

All condensers can be used at 110 volts AC or DC and 220 volts AC or DC.

All Leads 6 inches Long

Catalog Number	Can Size Diameter	List Price
IF-G1	1 7/8" x 1 3/8"	\$0.80
IF-S1	2" x 1 3/8"	.90
IF-33	3/8" x 5/8"	.90
IF-21	2 3/8" x 1"	1.20
IF-15	2 1/2" x 1"	1.50
IF-R1	2 1/2" x 1"	1.70
IF-R2	2 1/2" x 1"	1.70
IF-G10	3 1/2" x 1 3/8"	2.40
IF-25	3 1/2" x 1 3/8"	2.70
IF-11	4 1/2" x 1 1/2"	3.45
CH-1	3 3/8" x 1 7/8" x 1 1/2"	1.65
CH-2	3" x 2 1/2" x 2 1/4"	3.30

New SPRAGUE MICA Capacitors

TEST VOLTAGE—1000 VOLTS D. C.

Catalog Number	Capacity Mfd.	Working Voltage	List Price
XFM-45	.00005	600v	\$0.60
XFM-31	.0001	600v	.60
XFM-32	.0002	600v	.60
XFM-325	.00025	600v	.60
XFM-33	.0003	600v	.60
XFM-34	.0004	600v	.60
XFM-35	.0005	600v	.60
XFM-21	.001	600v	.60
XFM-215	.0015	600v	.60
XFM-22	.002	600v	.70
XFM-225	.0025	600v	.80
XFM-23	.003	600v	.85
XFM-24	.004	600v	.85
XFM-25	.005	600v	.85
XFM-26	.006	600v	1.05
XFM-28	.008	600v	1.20
XFM-11	.01	600v	1.40
XFM-115	.015	600v	1.65
XFM-12	.02	600v	1.90
XFM-125	.025	600v	2.30
XFM-13	.03	600v	2.55

TEST VOLTAGE—2500 VOLTS D. C.

Catalog Number	Capacity Mfd.	Working Voltage	List Price
YFM-45	.00005	1200v	\$0.85
YFM-31	.0001	1200v	.85
YFM-32	.0002	1200v	.85
YFM-325	.00025	1200v	.85
YFM-33	.0003	1200v	.85

TEST VOLTAGE—2500 VOLTS D. C.
(Continued)

Catalog Number	Capacity Mfd.	Working Voltage	List Price
YFM-35	.0005	1200v	\$0.85
YFM-21	.001	1200v	1.10
YFM-215	.0015	1200v	1.40
YFM-22	.002	1200v	1.65
YFM-225	.0025	1200v	1.75
YFM-23	.003	1200v	1.90
YFM-24	.004	1200v	1.90
YFM-25	.005	1200v	2.10
YFM-26	.006	1200v	2.10
YFM-28	.008	1200v	2.70
YFM-11	.01	1200v	3.40

TEST VOLTAGE—5000 VOLTS D. C.

Catalog Number	Capacity Mfd.	Working Voltage	List Price
ZFM-45	.00005	2500v	\$1.10
ZFM-31	.0001	2500v	1.10
ZFM-32	.0002	2500v	1.30
ZFM-325	.00025	2500v	1.30
ZFM-33	.0003	2500v	1.35
ZFM-35	.0005	2500v	1.50
ZFM-21	.001	2500v	1.80
ZFM-215	.0015	2500v	2.35
ZFM-22	.002	2500v	2.70
ZFM-225	.0025	2500v	3.00
ZFM-23	.003	2500v	3.30
ZFM-24	.004	2500v	3.80
ZFM-25	.005	2500v	4.00

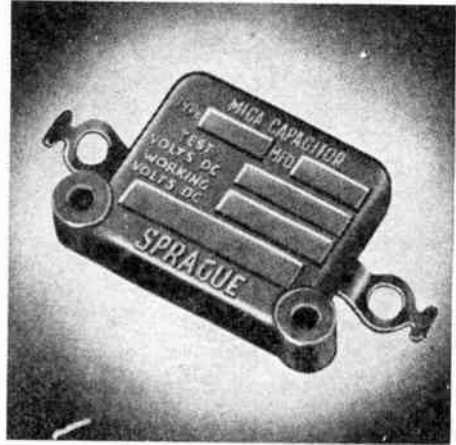

For several years past, Sprague Fixed Mica Capacitors have been meeting the most exacting demands as original equipment on the finest radio and electronic devices. They are now made generally available at standard prices and incorporating quality features unexcelled in the field. Units are carefully molded in low-loss phenolic and are scientifically protected against moisture. See page K-67 for listing of other types in ranges, sizes and mountings for practically any requirement.

We reserve the right—during the present emergency—to change prices and mechanical specifications without notice.

SPRAGUE

TEST EQUIPMENT

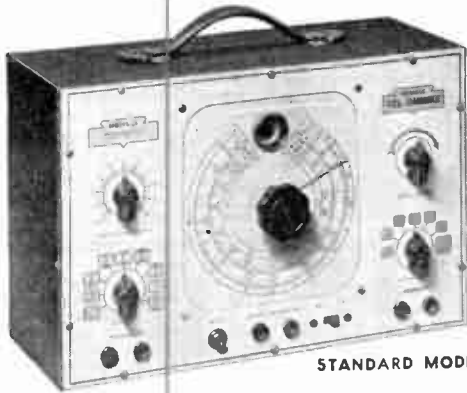
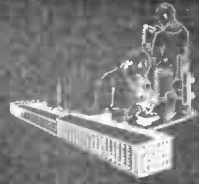

STANDARD MODEL

SPRAGUE TEL-OHMIKE CONDENSER-RESISTOR ANALYZER

DE LUXE TEL-OHMIKE—Similar to the Standard Model, but contains built-in DC volt-milliammeter. (See illustration below). Switch and pin-jacks provided so meter may be used on measurements external to the Tel-Ohmike. Meter ranges selected through an 8-position switch include 15, 150, 500, 1500 volts DC, and 1.5, 15 and 50 ma. DC. "Off" position is provided between the voltage and ma. ranges. Ranges graduated downward on either side for maximum meter safety. A rugged, double pivot meter movement and a broad, easily-read meter scale are used. Dimensions: **Cat. No. TO-2**
17½" x 9" x 6". Weight 14 lbs. **\$44.90 Net**

The handiest, most complete instrument of its kind. Permits a complete, easy check on EVERY basic characteristic of every type of condenser and resistor—on direct reading scales that eliminate guesswork. Measures capacity from .000010 to 2000 mfd. covering everything from minimum air condenser capacities to large motor-starting condensers. Measures DC resistance from .5 to 5,000,000 ohms and insulation resistance up to 10,000 megohms—the highest insulation resistance scale available on such an instrument. Thus, the insulation resistance of such components as Oil Condensers can be measured DIRECTLY on the Tel-Ohmike under high voltage up to 1000 volts! Power factor and leakage current of electrolytic condensers are also read directly. A built-in power supply permits measurement of ALL characteristics under DIRECT WORKING VOLTAGE CONDITIONS up to 1000 volts DC. A "magic eye" indicator shows bridge circuit balance. Condenser Characteristics Table included with complete instructions for use.

STANDARD TEL-OHMIKE does not include DC volt-milliammeter, but has jacks so that you can plug in your own, thus avoiding duplicating equipment you already have 13½" long x 8¾" high x 5¼" deep. Weighs 12¾ lbs. Metal container with durable black crackle finish. **Cat. No. TO-1**
\$34.50 Net

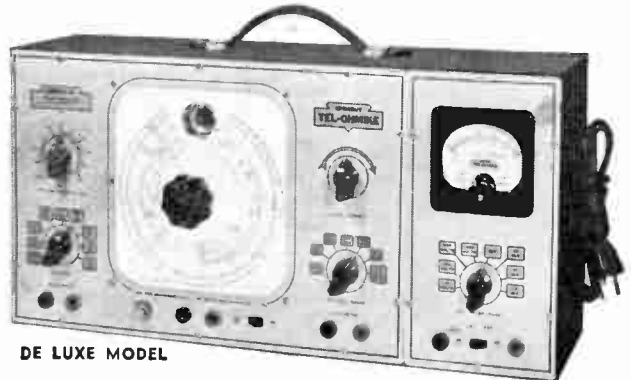

DE LUXE MODEL

STANDARD MODEL ONLY
DISCONTINUED

SPRAGUE MASTER INTERFERENCE ANALYZER MODEL MA-1

No more guess work! A compact, professional instrument for testing all types of equipment suspected of causing radio interference. Different filter circuits are automatically switched in until the correct combination is found which eliminates the noise. The Master Interference Analyzer tells you exactly what Sprague filter, filters and chokes, or filters and resistors are necessary for best results. In all, sixty filter combinations are possible from these various dial settings.

A chart is supplied showing recommended filter circuits. Opposite each circuit is given a list of Sprague parts necessary to make up the filter similar to the switch settings of the Analyzer.

Operates on 110 or 220 volts AC or DC. Chokes handle currents up to 20 amperes. A 24-page Interference Manual included free. Size: 7½" x 6" x 5½". Weight: 7½ lbs.

Price: \$27.90 Net

New SPRAGUE INTERFERENCE LOCATER MODEL IL-2

Designed by outstanding public utility engineers and radio interference specialists. Self-contained in a rugged metal case, equipped with detachable cover, and carrying handle. Circuits include a highly sensitive super-heterodyne receiver, audio amplifier, and loudspeaker. Directional loop antenna is mounted on top of the Locator in use, and carried within the cover recess when not in use. An extensible pole antenna is provided as standard equipment. Special antenna input circuit for latter provides very high sensitivity.

The sensitivity of the Locator is less than 1 microvolt for 10% output meter scale deflection. Tuning ranges, selected by a switch, are 500 to 1700 KC, 1.7 to 5 MC, and 15 to 32 MC. Operates from self-contained batteries, for portable operation, or directly from 115 volt AC or DC lines.

A sensitive two range output meter is provided. The calibrated volume control can be used with the output meter to measure interference levels and give the effectiveness of interference suppression devices. Loudspeaker, or headphone output through jacks, are selected by a switch.

Loop antenna can be switched to audio input as a search coil, for audio frequency interference pick up or for use as a pipe finder. Special coaxial cable, complete with connectors, can be supplied for remote use of pole antenna as a probe. Price, depending on cable length, given on request. Size: 15" x 11" x 8". Weight: 23 lbs.

Price: \$79.90 Net

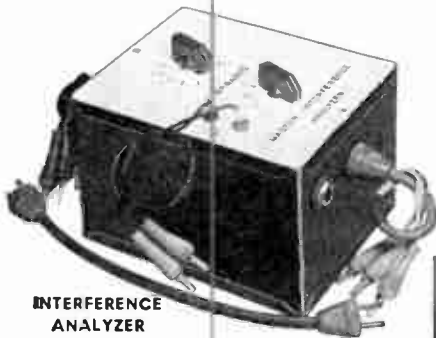

INTERFERENCE ANALYZER



INTERFERENCE LOCATOR

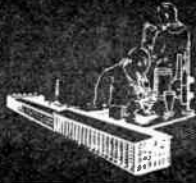

SPRAGUE KOOLOHM RESISTORS

Exclusive SPRAGUE KOOLOHM RESISTOR Features

★ **NEW RESISTANCE COATING—BEFORE WINDING**, every fractional inch of wire used is perfectly and uniformly insulated. The insulating material is hard, abrasion-resistant, and absolutely impervious to moisture! It conducts heat away from the wire more rapidly than any other material ever used for this purpose.

★ **NO SHORTED TURNS**—In KOOLOHMS the insulation on every bit of wire used completely eliminates the dangers of shorted or moving wire turns, even at highest operating temperatures.

★ **COOLER OPERATION**—The wire in KOOLOHM resistors operates far below the temperatures found in any other coated resistor, making for extra safety! No cements or enamels are used.

★ **LARGER WIRE SIZE**—The perfect insulation allows the resistance wire to be layer wound. This means higher resistances in a given space. The finest wire used in KOOLOHM resistors is 2 1/4 times greater in cross-sectional area than the wires used in other resistors, even for the highest resistance values!

★ **THE ONLY INSULATED POWER WIRE WOUND RESISTOR**—KOOLOHM windings need no overall insulation, but for extra mechanical protection they are electrically insulated in a cylindrical, ceramic shell—a complete insulator and a real lifeguard. No more frail cements or brittle enamels.

★ **TRULY NON-INDUCTIVE RESISTORS** — Non-Inductive KOOLOHM resistors have windings in

which each turn has its inductance cancelled by an immediately adjacent turn carrying current going in the opposite direction. The potential gradient between any two adjacent turns is so small as to be negligible. These resistors have the lowest residual inductance and distributed capacitance ever available in a power resistor. Non-Inductive KOOLOHMS are unsurpassed for such uses as plate circuit load resistors, transmission line terminating resistors, impedance matching circuits, etc., at high audio or radio frequencies up to 50 MC.

★ **TELEDOT WATTAGE INDICATOR**—The red dot above the terminal, on the end of each Sprague KOOLOHM resistor, is an automatic overload indicator! Think of it—no voltmeters, milliammeters, thermometers or other gadgets are necessary to tell if KOOLOHMS are being operated at rated wattage! The dot will retain a red shade until the resistor surface reaches a temperature corresponding to 25% overload in free air. When the resistor operates at 25% over rated wattage, the dot will change to brown. If you reduce the load, the brown dot will return to its original color, red. If you run the KOOLOHM resistor continually over its wattage rating, the red color of the spot will change permanently to brown. The "Teledot" indicator is intended only as an operating guide for your convenience—Sprague KOOLOHMS have the additional safety factor of withstanding overloads and excessive temperatures better than any competitive make of the same size and wattage rating.

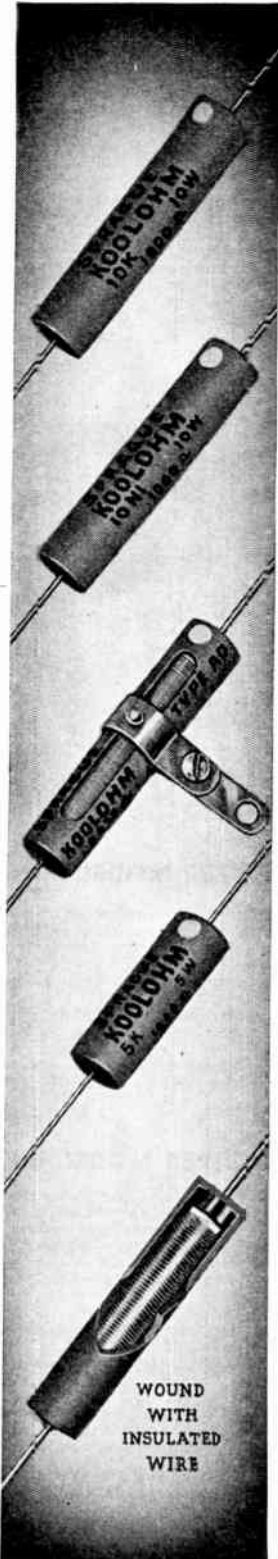

5 Watts 1 1/4" x 1/2" Dia. Catalog Type No. 5-K				10 Watts 1 3/4" x 1/2" Dia. Catalog Type No. 10-K				10 Watt Non-Inductive 1 3/4" x 1/2" Dia. Catalog Type No. 10-N1				10 Watt Adjustable 1 3/4" x 1/2" Dia. Catalog Type No. 10-AD			
Resistance in Ohms	Current in M.A.	Maximum Volts	List Price	Resistance in Ohms	Current in M.A.	Maximum Volts	List Price	Resistance in Ohms	Current in M.A.	Maximum Volts	List Price	Resistance in Ohms	Current in M.A.	Maximum Volts	List Price
5	1000	5.00	\$0.40	5	1414	7.07	\$0.45	10	1000	10	\$0.60	10	1000	10	\$0.75
10	707	7.07	.40	10	1000	10	.45	20	707	14	.60	25	630	15.8	.75
15	587	8.67	.40	15	830	12.3	.45	30	575	17	.60	50	447	22.4	.75
20	500	10	.40	20	707	14.1	.45	40	500	20	.60	100	316	31.6	.75
25	446	11	.40	25	630	15.8	.45	50	447	22	.60	150	259	38.7	.75
30	406	12	.40	30	575	17.4	.45	60	408	24	.60	200	223	44.6	.75
40	354	14	.40	40	500	20	.45	70	378	26	.60	250	200	50	.75
50	316	15	.40	50	447	22.4	.45	80	354	28	.60	300	182	54.7	.75
75	258	19	.40	75	365	27.4	.45	90	333	30	.60	400	158	63.3	.75
100	224	22	.40	100	316	31.6	.45	100	316	31	.60	500	141	70.7	.75
150	183	27	.40	150	259	38.7	.45	250	200	50	.60	750	115	86.9	.75
200	158	31	.40	200	223	44.6	.45	400	158	63	.60	1000	100	100	.75
250	141	35	.40	250	200	50	.45	500	141	70	.60	1500	81	123	.75
300	129	38	.40	300	182	54.7	.45	750	115	86	.60	2000	70	143	.75
400	112	44	.40	400	158	63.3	.45	1000	100	100	.60	2500	63	158	.75
500	100	50	.40	500	141	70.7	.45	1250	89	112	.70	3000	57	174	.75
600	91	54	.40	600	129	77.6	.45	1500	81	123	.70	4000	50	200	.75
700	84	59	.40	700	119	84	.45	2000	70	143	.70	5000	44	227	.75
800	79	63	.40	750	115	86.9	.45	2500	63	158	.75	7500	36	275	.75
900	74	67	.40	800	112	89.5	.45	3000	57	174	.75	10000	32	316	.75
1000	70	70	.40	900	105	95	.45	3500	53	188	.75				
1250	63	79	.40	1000	100	100	.45	4000	50	200	.75				
1500	57	86	.40	1250	89	112	.45	5000	44	227	.80				
1750	53	93	.40	1500	81	123	.45	7500	36	275	.90				
2000	50	100	.40	1750	75	133	.45	10000	32	316	1.15				
2500	44	112	.40	2000	70	143	.45								
3000	40	123	.40	2500	63	158	.45								
4000	35	141	.40	3000	57	174	.45								
5000	31	158	.40	4000	50	200	.45								
6000	28	173	.45	5000	44	227	.45								
7000	26	187	.45	6000	41	245	.45								
7500	25	194	.45	7500	36	275	.45								
8000	25	200	.45	8000	35	283	.45								
9000	23	212	.45	9000	33	300	.45								
10000	22	224	.45	10000	32	316	.45								
12500	20	250	.50	12000	29	346	.50								
14000	18	265	.50	14000	26	384	.50								
15000	18	274	.50	15000	25	400	.50								
20000	15	333	.55	17500	24	419	.60								
25000	14	354	.70	20000	21	475	.60								
30000	13	387	.75	25000	20	500	.70								
40000	11	447	.85	30000	18	555	.75								
				40000	16	632	.90								
				50000	14	700	1.00								
				60000	13	780	1.25								
				70000	12	840	1.40								

Resistance values up to 60,000 Ohms can be supplied in this size on special order—not carried in stock.

Tolerance guaranteed 5%.

Resistance values up to 100,000 Ohms can be supplied in this size on special order—not carried in stock.

Tolerance guaranteed 5%.

Extra Bands, \$0.10

You Can Use Sprague Koolohms at Their Full Wattage Ratings Regardless of Resistance Value

The same "Rubencote" insulation is used on all wire sizes. Therefore, KOOLOHMS will dissipate their rated wattage safely at any resistance value, even the highest! No asterisks or reservations are needed for KOOLOHMS to tell you that the high resistance values won't carry their rating because of fine wires or enamels used on wire. 10 full watts safely dissipated by even 70,000 ohms of resistance for 10-K units.

5% Resistance Accuracy Guaranteed

"Rubencote" is such perfect insulation that all possibility of shorted wire turns in manufacture is eliminated. This makes it easy to control resistance accuracy. KOOLOHMS are made to a standard resistance tolerance of 5%. Accuracy of 5% or better is guaranteed for all resistance values!



AMERICAN CONDENSER CORP.

HIGH GRADE ELECTROLYTIC & PAPER CAPACITORS

AMERICAN COMPLETE REPLACEMENT LINE

ELECTROLYTIC CAPACITORS



TYPE CB
CARDBOARD CONTAINER

Popular and widely used cardboard container electrolytics, available in a wide variety of capacities and voltages. Furnished with 6" leads and solder lug mounting. Triple sealed and built to the highest specifications, they can be depended upon for long, unflinching service.

WORKING VOLTAGE 450—P.V. 600

Cat. No.	Cap. Mfd.	Size	List Price
CB5-2	2	1x 5/8 x 2 3/8	\$0.65
CB5-4	4	1x 3/4 x 3 1/8	.75
CB5-8	8	1x 7/8 x 3 1/8	.95
CB5-12	12	1x1 1/8 x 3 1/8	1.30
CB5-16	16	1x1 3/8 x 3 1/8	1.45
CB5-44	4-4	1x1 3/8 x 3 1/8	1.20
CB5-48	4-8	1 1/4 x 1 1/2 x 3 1/8	1.35
CB5-88	8-8	1 1/4 x 1 1/2 x 3 1/8	1.50

AC-DC FILTER BLOCKS

CB2-101	16-12	1x1 1/4 x 2 1/8	2.15
	10-10		
CB2-102	16-8	1x1 1/4 x 2 1/8	2.00
	5-5		
CB2-103	20-10-10	1x1 1/4 x 2 1/8	2.15

WORKING VOLTAGE 25—P.V. 50

CB1-25	25	7/8 x 7/8 x 2 1/4	.65
CB1-50	50	7/8 x 7/8 x 2 1/4	.95



TYPE TC
TUBULAR TYPE

A triple sealed tubular electrolytic condenser characterized by extremely low leakage and power factor. Conservatively rated and thoroughly dependable, they are ideal for replacement work.

Cat. No.	Cap. Mfd.	Size	List Price
TC2-8	8	1 1/8 x 3	\$0.75
TC2-12	12	1 1/8 x 3	.75
TC2-16	16	1 1/8 x 3	.90
TC2-20	20	7/8 x 3	.95
TC2-40	40	7/8 x 3	1.25
TC1-5	5	5/8 x 2 1/4	.50
TC1-10	10	5/8 x 2 1/4	.50
TC1-25	25	5/8 x 2 1/4	.65
TC1-55	5-5	5/8 x 2 1/4	.75
TC1-1010	10x10	5/8 x 2 1/4	.75

TYPE C INVERTED PAPER TUBES

Type IC condensers are full sized condensers of the very highest quality designed for general use at moderate prices. Furnished in silvered cardboard tubes with 1 1/4" e-c spade bolt mounting.

WORKING VOLTAGE 450—P.V. 600

Cat. No.	Cap. Mfd.	Size	List Price
IC5-8	8	1 3/8 x 4	\$1.00
IC5-12	12	1 3/8 x 4	1.40
IC5-16	16	1 3/8 x 4	1.55
IC5-48	4-8	1 3/8 x 4	1.50
IC5-88	8-8	1 3/8 x 4	1.60
IC2-101	16-12	1 3/8 x 4	2.15
	10-10		
IC2-102	16-8	1 3/8 x 4	2.00
	5-5		

All AC-DC Filter Blocks have high voltage sections separate and low voltage sections common negative. High voltage sections rated at 150 V.W., 200 V.P., low voltage sections rated at 25 V.W., 50 V.P.

PAPER CAPACITORS



TYPE TP
TUBULAR BYPASS

Non-inductively wound with highest quality paper and tinfoil. Pig-tail leads hot soldered to sections. Vacuum sealed in thoroughly impregnated cardboard tubes, and fully protected against moisture. Full four papers between foils.

WORKING VOLTAGE 600V. D.C.

Cat. No.	Cap. Mfd.	Size	List Price
TP60T1	.0001	5/8 x 1	\$0.15
TP60T25	.00025	5/8 x 1	.15
TP60T50	.0005	5/8 x 1	.15
TP60B1	.001	5/8 x 1	.15
TP60B20	.002	5/8 x 1	.15
TP60B30	.003	5/8 x 1	.15
TP60B50	.005	5/8 x 1	.15
TP60B60	.006	5/8 x 1	.15
TP6001	.01	5/8 x 1 1/2	.15
TP6002	.02	5/8 x 1 1/2	.15
TP6005	.05	5/8 x 1 1/2	.20
TP6010	.1	5/8 x 1 1/2	.25
TP6025	.25	5/8 x 1 1/2	.30
TP6050	.5	5/8 x 2 3/8	.40
TP6100	1.	1 1/8 x 2 3/8	.50

VIBRATOR CAPACITORS

Sturdy, heavy duty units specifically designed to withstand the high voltages encountered in vibrator duty.

WORKING VOLTAGE 1600 V. D.C.

Cat. No.	Cap. Mfd.	Size	List Price
TPX005	.005	1 1/2 x 1 3/4	\$0.30
TPX01	.01	1 1/2 x 1 3/4	.35
TPX02	.02	5/8 x 1 3/4	.45

GENERATOR CONDENSER

TYPE GC



These generator condensers are characterized by painstaking mechanical construction to endure the severe duty encountered in auto service. Leads are hot soldered, and carefully swaged to the condenser section, and to the can. Section exceptionally well impregnated and sealed to give long, trouble-free life.

Type GC2050 List Price \$0.50

HIGH VOLTAGE PAPER CAPACITORS

They are sealed in steel cans with high-melting point wax, and due to the absence of free oil, there is no possibility of any annoying oil seepage. Furnished with stand-off insulators and heavy mounting feet. May be mounted in any position.

WORKING VOLTAGE 1000 D.C.

Cat. No.	Cap. Mfd.	Size	List Price
OC-1001	1	2 1/2 x 3 3/4 x 1 1/2	\$3.00
OC-1002	2	3 1/4 x 4 1/8 x 2 1/8	4.50
OC-1004	4	3 1/8 x 6 1/4 x 2 1/8	7.00

WORKING VOLTAGE 2000 D.C.

OC-2001	1	3 1/4 x 4 1/8 x 2 1/8	5.25
OC-2002	2	3 1/8 x 6 1/4 x 2 1/8	8.00

WORKING VOLTAGE 3000 D.C.

OC-3001	1	3 1/2 x 6 1/4 x 2 1/8	18.00
---------	---	-----------------------	-------

TYPE US—UNCASED SECTIONS

Type US condensers are especially recommended for replacement work in which reliability is the prime consideration. Made of the purest paper and foil, they are carefully impregnated and sealed and critically tested. Sealed with high melting point wax, and furnished with long, solidly anchored leads.

WORKING VOLTAGE 600 D.C.

Cat. No.	Cap. Mfd.	Size	List Price
US-601	1	1 1/2 x 2 1/4 x 1 3/4	\$0.90
US-602	2	7/8 x 2 1/2 x 2 1/4	1.35
US-604	4	1 3/8 x 2 1/2 x 2 1/2	2.70

WORKING VOLTAGE 1000 D.C.

US-1001	1	7/8 x 2 1/2 x 2 1/4	1.50
US-1002	2	1 3/8 x 2 1/2 x 2 1/4	2.50



Prices Subject to Change Without Notice



AMERICAN CONDENSER CORP.

HIGH GRADE ELECTROLYTIC & PAPER CAPACITORS

Little Americans

Dry Electrolytic Capacitors in all standard capacities and working voltages

Little Americans were designed to meet the popular demand for smaller and more compact capacitors. In life span and performance, they are comparable to standard units. Quality and performance ability have not been sacrificed to secure the smaller size. Literally, they are giants in the service they render. Their smaller size makes them ideal for replacement service—as they may readily be wired into the most inaccessible spots. . . . The specially prepared foil used in Little Americans has been subjected to the most exacting tests. It is guaranteed to stand up in service. . . . Perfect impregnation precludes the possibility of moisture absorption. Values remain constant. . . . Highest quality separation paper of uniform texture and thickness assures uniform electrical characteristics in all units. . . . Tinned leads, securely anchored to the foil will not pull out—are easily wired into the circuit. . . . Use Little Americans just as you would regular Americans—for long dependable service.

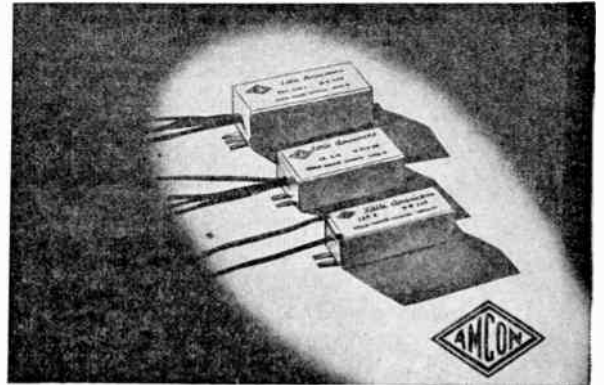
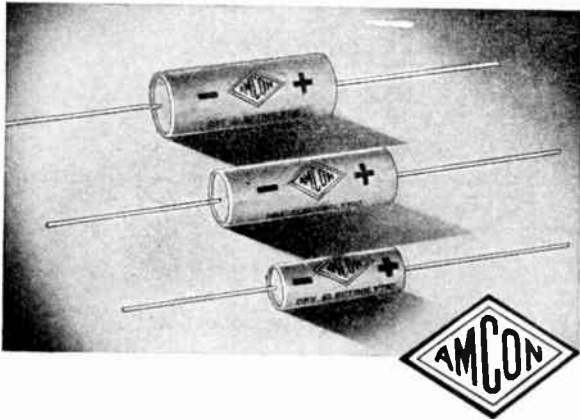

SMALLER AND MORE DEPENDABLE

STANDARD LISTINGS

	Mfd.	Size	List Price
25 VOLT D.C.	5	1 1/2" x 1 1/2"	\$0.40
	11	1 1/2" x 1 1/2"	
	25	1 1/2" x 1 1/2"	
50 VOLT D.C.	5	1 1/2" x 1 1/2"	.45
	11	1 1/2" x 1 1/2"	.50
	25	1 1/2" x 1 1/2"	.55
	5-5	2" x 1 1/2"	.65
	10-10	2" x 1 1/2"	.65
150 VOLT D.C.	4	2 1/8" x 2 1/8"	.40
	8	2 1/8" x 2 1/8"	.45
	12	2 1/8" x 2 1/8"	.50
	14	2 1/8" x 2 1/8"	.55
	20	2 1/8" x 2 1/8"	.60
	30	2 1/8" x 2 1/8"	.65
	40	2 1/8" x 2 1/8"	.70
	12-12	2 1/8" x 2 1/8"	.95
	16-16	2 1/8" x 2 1/8"	1.05
250 VOLT D.C.	4	2 1/8" x 2 1/8"	.45
	8	2 1/8" x 2 1/8"	.50
	12	2 1/8" x 2 1/8"	.65
	16	2 1/8" x 2 1/8"	.75
	20	2 1/8" x 2 1/8"	.80
	40	2 1/8" x 2 1/8"	.95
350 VOLT D.C.	4	2 1/8" x 2 1/8"	.50
	8	2 1/8" x 2 1/8"	.55
	12	2 1/8" x 2 1/8"	.70
	16	2 1/8" x 2 1/8"	.80
450 VOLT D.C.	4	2 1/8" x 2 1/8"	.55
	8	2 1/8" x 2 1/8"	.60
	12	2 1/8" x 2 1/8"	.75
	14	2 1/8" x 2 1/8"	.90
	8-8	1" x 2 1/4"	1.00

SMALL — COMPACT — STREAMLINED FOR EASY INSTALLATION

In response to the popular demand for a smaller and more compact cardboard container, dry electrolytic capacitor, these Little Americans have been produced. Requiring only the smallest of chassis space, they may be readily wired into the most inaccessible places. They are available in all standard sizes and multiple types. Dual and multiple type units are of separate sections.

Cat. No.	Capacity Mfd.	Dimensions L. - W. - D.	List Price
TYPE LP-2, 150 W.V. 200 P.V. DC			
LP2-8	8	2 3/8" x 3/4" x 3/4"	\$0.75
LP2-12	12	2 3/8" x 3/4" x 3/4"	.75
L 2-16	16	2 3/8" x 3/4" x 3/4"	.90
LP2-20	20	2 3/8" x 3/4" x 3/4"	.95
LP2-30	30	2 3/8" x 3/4" x 3/4"	1.10
LP2-40	40	2 3/8" x 1 1/4" x 3/4"	1.25
LP2-12-12	12-12	2 3/8" x 1 1/4" x 3/4"	1.35
LP2-12-16	12-16	2 3/8" x 1 1/4" x 3/4"	1.45
LP2-16-16	16-16	2 3/8" x 1 1/4" x 3/4"	1.50
LP2-16-10	16-10	2 3/8" x 1 1/4" x 3/4"	1.75
LP2-20-20 C.N.	20-20	2 3/8" x 1 1/4" x 3/4"	2.00
TYPE LP-3 250 W.V. 225 P.V. DC			
LP3-8	8	2 3/8" x 3/4" x 3/4"	.70
LP3-12	12	2 3/8" x 3/4" x 3/4"	.95
LP3-16	16	2 3/8" x 3/4" x 3/4"	1.05
LP3-20	20	2 3/8" x 1 1/4" x 3/4"	1.20
LP3-30	30	2 3/8" x 1 1/4" x 3/4"	1.15
LP3-40	40	2 3/8" x 1 1/4" x 3/4"	1.25
LP3-8-16	8-16	2 3/8" x 1 1/4" x 3/4"	1.45
LP3-16-16	16-16	2 3/8" x 1 1/4" x 3/4"	1.65
LP3-8-8 C.N.	8-8	2 3/8" x 1 1/4" x 3/4"	1.90
TYPE LP-5 450 W.V. 525 P.V. DC			
LP5-2	2	2 3/8" x 3/4" x 3/4"	.65
LP5-4	4	2 3/8" x 3/4" x 3/4"	.75
LP5-8	8	2 3/8" x 3/4" x 3/4"	.90
LP5-10	10	2 3/8" x 3/4" x 3/4"	1.15
LP5-12	12	2 3/8" x 1 1/4" x 3/4"	1.30
LP5-16	16	2 3/8" x 1 1/4" x 3/4"	1.45
LP5-4-4	4-4	2 3/8" x 1 1/4" x 3/4"	1.20
LP5-4-8	4-8	2 3/8" x 1 1/4" x 3/4"	1.35
LP5-8-8	8-8	2 3/8" x 1 1/4" x 3/4"	1.50
LP5-8-8-8	8-8-8	3" x 1 1/4" x 1"	2.20

Prices Subject to Change Without Notice

INDUSTRIAL



CONDENSER



THE INDUSTRIAL CONDENSER CORP. was formed in 1940 in order to answer a definite need for a midwestern manufacturer of oil, wax, electrolytic and motor starting capacitors. During this time INDUSTRIAL has grown to a leading place in the industry.

In addition to the standard types of paper and electrolytic capacitors covered in these pages (see Bulletin 1031A for complete line) and carried in distributors' stocks throughout the country, a wide variety of other types are available on special order.

The display shown at the left is on the counter of every INDUSTRIAL distributor. Reference to this will be of assistance in selecting the proper unit for each application.

Built to U. S. Signal Corps and Navy Specifications

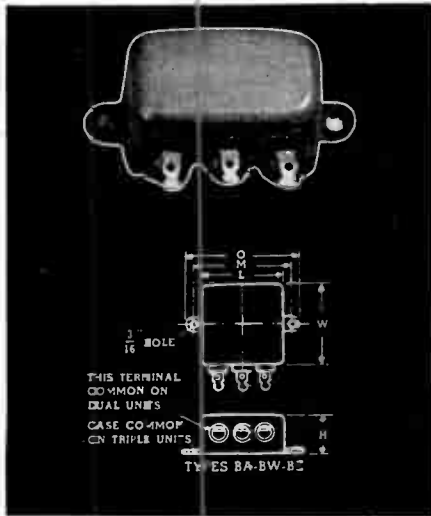

DRY ELECTROLYTICS

Type "BE" electrolytic capacitor is the first commercially available unit of this type with the reliability of the total submersion type, oil filled capacitors.

Wound with the highest purity aluminum foil and cellulose separators available; impregnated in electrolyte having excellent temperature characteristics, these units will outlive their associated equipment.

Cat. No.	Cap. in Mds.	Volts	Dimen. in In.				List Price
			L	W	H	M	
25BE10	10	25	1 1/8	1	1 1/4	2 1/2	\$1.75
25BE25	25	25	1 1/8	1	1 1/4	2 1/2	1.90
50BE10	10	50	1 1/8	1	1 1/4	2 1/2	1.80
50BE25	25	50	1 1/8	1	1 1/4	2 1/2	1.95

TYPE "BA" OIL FILLED

1. INCCO OIL "A" permits efficient operation of these compact units over the widest range of temperature.
2. The use of the HIGHEST GRADE CONDENSER TISSUE insures greater safety factor and longer life.
3. Specially PROCESSED RIVETED TERMINALS are designed to withstand total submersion in salt water and changes in temperature from 50° below zero Centigrade to 90° above zero Centigrade without loosening or losing their integrity.
4. CONDENSER MOUNTINGS form an integral part of these drawn shell containers insuring permanent and rigid fastenings.
5. All units are NON-INDUCTIVELY WOUND providing efficient operation over the widest range of frequencies.
6. HERMETICALLY SEALED, they are unaffected by time, temperature or humidity.
7. CONSERVATIVELY RATED for safe and continuous uninterrupted operation at 10% above rated voltage for the lifetime of associated equipment.
8. Tested at twice the rated voltage between terminals and twice the rated voltage plus 1000 from each terminal to case.

Cat. No.	Cap. in MFDS.	Dimensions in Inches				List Price
		L	W	H	M	
600 V. D. C. WORKING						
6BA05	.05	1 1/8	1	1 1/4	2 1/2	\$1.70
6BA10	.1	1 1/8	1	1 1/4	2 1/2	1.75
6BA25	.25	1 1/8	1	1 1/4	2 1/2	1.80
6BA50	.5	1 1/8	1	7/8	2 1/2	1.95
6BA100	1.0	2	1 3/4	7/8	2 3/4	2.25
6BA0505	.05-.05	1 1/8	1	1 1/4	2 1/2	2.15
6BA11	1-1	1 1/8	1	1 1/4	2 1/2	2.20
6BA22	.25-.25	2	1 3/4	7/8	2 3/4	2.25
6BA55	.5-.5	2	1 3/4	7/8	2 3/4	2.55
6BA111	1-1-1	1 1/8	1	1 1/4	2 1/2	2.50
6BA222	.25-.25-.25	2	1 3/4	7/8	2 3/4	2.80
6BA200	2	2	2	1 1/8	2 3/4	3.00
1000 V. D. C. WORKING						
10BA05	.05	1 1/8	1	1 1/4	2 1/2	1.75
10BA10	.1	1 1/8	1	1 1/4	2 1/2	1.85
10BA25	.25	1 1/8	1	1 1/4	2 1/2	1.90
10BA50	.5	2	1 3/4	7/8	2 3/4	2.05
10BA100	1.0	2	2	1 1/8	2 3/4	2.75
10BA0505	.05-.05	1 1/8	1	1 1/4	2 1/2	2.15
10BA11	1-1	1 1/8	1	1 1/4	2 1/2	2.30
10BA22	.25-.25	2	1 3/4	7/8	2 3/4	2.50

Above units also available in 200 V. D. C., 400 V. D. C. and 1500 V. D. C. on request.

NOTICE—Most units are available with TERMINALS ON TOP, BOTTOM OR ENDS. When ordering, add "T" for top terminals, "B" for terminals on bottom or "E" for end terminals, i.e., 6BAT100 for terminals on top. Type "B" also available in WAX FILLED. When ordering, change catalog number A to W, i.e., 6BW100. STANDARD CAPACITY tolerance of plus 20 per cent minus 10 per cent furnished on oil filled and wax filled units unless otherwise specified when ordering. Can be furnished in plus or minus 1 per cent capacity tolerance on special request.

INDUSTRIAL INCCO CONDENSER

TYPE "SA" OIL FILLED

1. INCCO OIL "A" IMPREGNATED AND FILLED—permitting efficient operation over widest range of temperature.
2. HERMETICALLY SEALED CASE—is unaffected by time, humidity, or operating temperatures.
3. Use of HIGHEST GRADE CONDENSER TISSUES insures a long uninterrupted life.
4. HIGH-GLAZE PORCELAIN INSULATORS—insure low moisture absorption and high terminal to case flash over.
5. CONSERVATIVELY RATED—SAFE FOR CONTINUOUS OPERATION AT 10 PER CENT OVERLOAD.
6. Use of "SPACE SAVER" UNIVERSAL MOUNTING BRACKETS provides adjustable capacitor heights.
7. LEAD COATED STEEL CASE—IS NON-CORROSIVE and lacquer finished.
8. TESTED FOUR TIMES BEFORE SHIPMENT—guarantees a 100 per cent perfect product electrically and mechanically.

If riveted terminal construction is wanted in place of porcelain stand-off insulators add "R" to catalog number. For example, 6SA50 changes to 6SAR50. Submersion proof terminal construction to meet Army and Navy specifications is optional; specify on order. Standard capacity tolerance plus or minus 10 per cent. Mounting brackets supplied in accordance with following catalog designations: TYPE SA—No mounting brackets. TYPE SAU—"Space Saver" universal bracket. TYPE SAJ—Soldered vertical mounting bracket. Type SAL—Reversible mounting foot bracket. TYPE SAH—Re-

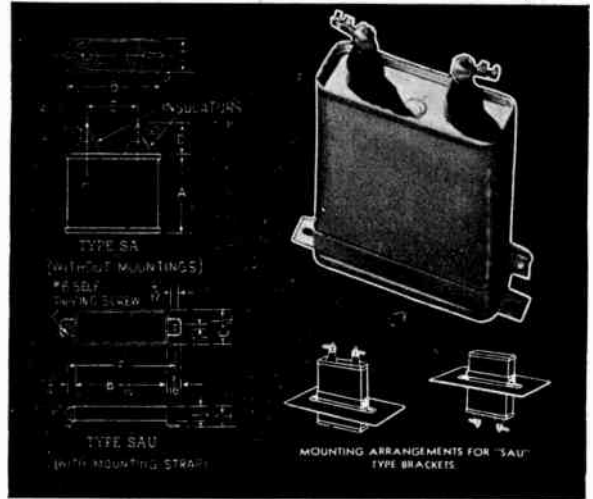

versible spade bolt bracket. For example: The 8mfd. 600V. type with "Space Saver" bracket has catalog number 6SAU800.

NOTE: Due to national emergency and to facilitate delivery we have standardized on container heights. In many cases units can be supplied in shorter containers if required.

Cat. No.	Cap. Mfd.	600 V.D.C. WORKING							List Price
		Dimensions in Inches							
		A	B	C	D	E	F	H	
6SA50	.5	2 3/4	1 1/4	1 1/4	3/4	1 1/4	2 1/4	2 1/4	\$2.75
6SA100	1.0	2 3/4	1 1/4	1 1/4	3/4	1 1/4	2 3/4	2 1/4	\$3.50
6SA200	2.0	2 3/4	1 1/4	1 1/4	3/4	1 1/4	2 3/4	2 1/4	4.25
6SA400	4.0	4 3/4	2 1/2	1 3/4	3/4	1 1/2	3	3	5.50
6SA600	6.0	4 3/4	2 1/2	1 3/4	3/4	1 1/2	3	3	6.75
6SA800	8.0	4 3/4	3 3/4	1 3/4	3/4	2	4 3/4	4 3/4	8.00
6SA1000	10.0	4 3/4	3 3/4	1 3/4	3/4	2	4 3/4	4 3/4	9.00

Cat. No.	Cap. Mfd.	1000 V.D.C. WORKING							List Price
		Dimensions in Inches							
		A	B	C	D	E	F	H	
10SA10	.1	2 3/4	1 1/4	1 1/4	3/4	1 1/4	2 1/4	2 1/4	2.50
10SA25	.25	2 3/4	1 1/4	1 1/4	3/4	1 1/4	2 1/4	2 1/4	2.75
10SA50	.5	2 3/4	1 1/4	1 1/4	3/4	1 1/4	2 1/4	2 1/4	3.00
10SA100	1.0	2 3/4	1 1/4	1 1/4	3/4	1 1/4	2 1/4	2 1/4	3.75
10SA200	2.0	4 3/4	2 1/4	1 3/4	3/4	1 1/2	3	3	5.00
10SA400	4.0	4 3/4	2 1/4	1 3/4	3/4	1 1/2	3	3	6.25
10SA600	6.0	4 3/4	3 3/4	1 3/4	3/4	2	4 3/4	4 3/4	8.25
10SA800	8.0	4 3/4	3 3/4	1 3/4	3/4	2	4 3/4	4 3/4	9.00
10SA1000	10.0	4 3/4	3 3/4	1 3/4	3/4	2	4 3/4	4 3/4	10.00

Cat. No.	Cap. Mfd.	1500 V.D.C. WORKING							List Price
		Dimensions in Inches							
		A	B	C	D	E	F	H	
15SA50	.5	2 3/4	1 1/4	1 1/4	3/4	1 1/4	2 1/4	2 1/4	4.00
15SA100	1.0	4 3/4	2 1/4	1 3/4	3/4	1 1/2	3	3	4.50
15SA200	2.0	4 3/4	2 1/4	1 3/4	3/4	1 1/2	3	3	6.25
15SA400	4.0	4 3/4	3 3/4	1 3/4	3/4	2	4 3/4	4 3/4	8.50
15SA600	6.0	4 3/4	3 3/4	1 3/4	3/4	2	4 3/4	4 3/4	10.25

Cat. No.	Cap. Mfd.	2000 V.D.C. WORKING							List Price
		Dimensions in Inches							
		A	B	C	D	E	F	H	
20SA10	.1	2 3/4	1 1/4	1 1/4	3/4	1 1/4	2 1/4	2 1/4	4.00
20SA25	.25	2 3/4	1 1/4	1 1/4	3/4	1 1/4	2 1/4	2 1/4	4.25

* Where G dimension is given, two spade lugs or mounting holes are supplied on each bracket.

Cat. No.	Cap. Mfd.	2000 V.D.C. WORKING							List Price	
		Dimensions in Inches								
		A	B	C	D	E	F	*G	H	
20SA50	.5	2 3/4	1 1/4	1 1/4	3/4	1 1/4	2 1/4		2 1/4	\$4.50
20SA100	1.0	4 3/4	2 1/4	1 3/4	3/4	1 1/2	3		3	5.50
20SA200	2.0	4 3/4	2 1/4	1 3/4	3/4	1 1/2	3		4 3/4	6.50
20SA400	4.0	4 3/4	3 3/4	1 3/4	3/4	2	4 3/4		4 3/4	9.00
20SA600	6.0	4 3/4	3 3/4	1 3/4	3/4	2	4 3/4	2	4 3/4	11.75

Cat. No.	Cap. Mfd.	2500 V.D.C. WORKING							List Price	
		Dimensions in Inches								
		A	B	C	D	E	F	*G	H	
25SA50	.5	4 3/4	3 3/4	1 3/4	1 3/4	2	4 3/4		4 3/4	7.00
25SA100	1.0	8 3/4	3 3/4	1 3/4	1 3/4	2	4 3/4		4 3/4	8.00
25SA200	2.0	4 3/4	3 3/4	1 3/4	1 3/4	2	4 3/4		4 3/4	13.00
25SA400	4.0	4 3/4	3 3/4	1 3/4	1 3/4	2	4 3/4	8 3/4	4 3/4	18.00

Cat. No.	Cap. Mfd.	3000 V.D.C. WORKING							List Price	
		Dimensions in Inches								
		A	B	C	D	E	F	*G	H	
30SA10	.1	2 3/4	1 1/4	1 1/4	3/4	1 1/4	1 1/4	3	3	8.50
30SA25	.25	3 3/4	2 1/4	1 1/4	3/4	1 1/4	1 1/4	3	3	9.00
30SA50	.5	4 3/4	2 1/4	1 1/4	3/4	1 1/4	1 1/4	3	3	10.00
30SA100	1.0	4 3/4	3 3/4	2 1/4	3/4	1 1/4	2	4 3/4	4 3/4	12.00
30SA200	2.0	4 3/4	3 3/4	3 3/4	3/4	1 1/4	2	4 3/4	2	15.00

Cat. No.	Cap. Mfd.	4000 V.D.C. WORKING							List Price	
		Dimensions in Inches								
		A	B	C	D	E	F	*G	H	
40SA10	.1	2 3/4	3 3/4	2 1/4	2	2	4 3/4		4 3/4	15.00
40SA25	.25	2 3/4	3 3/4	2 1/4	2	2	4 3/4		4 3/4	16.00
40SA50	.5	4 3/4	3 3/4	2 1/4	2	2	4 3/4		4 3/4	18.00
40SA100	1.0	5 3/4	3 3/4	2 1/4	2	2	4 3/4		4 3/4	22.00

Cat. No.	Cap. Mfd.	5000 V.D.C. WORKING							List Price	
		Dimensions in Inches								
		A	B	C	D	E	F	*G	H	
50SA50	.5	4 3/4	3 3/4	2 1/4	2	2	4 3/4		4 3/4	20.00
50SA100	1.0	4 3/4	3 3/4	4 3/4	2	2	4 3/4	3 3/4	4 3/4	25.00

Cat. No.	Cap. Mfd.	6000 V.D.C. WORKING							List Price	
		Dimensions in Inches								
		A	B	C	D	E	F	*G	H	
60SA50	.5	7 3/4	3 3/4	3 3/4	1 1/4	2	4 3/4	2	4 3/4	45.00
60SA100	1.0	8 3/4	3 3/4	4 3/4	2	2	4 3/4	3 3/4	4 3/4	50.00

TYPES "GA" and "HA" OIL FILLED

These inverted mounting capacitors fill a definite need where chassis space is the prime factor.

Types "GA" and "HA" are INCCO Oil "A" impregnated and filled.



The case is a one-piece metal extrusion with a "locked-in" molded neck. This construction meets and surpasses the Army and Navy requirements for a submersion-proof capacitor.

Type "GA" is available in the seven standard rating listed below, but can also be supplied in other capacities and/or voltages to manufacturers' specifications.

In the standard "GA" and "HA" types the container is insulated. A grounding lug can be supplied for connecting one terminal to the case. Fiber washers for insulating container from chassis, when case is grounded, and insulating cover for insulating the container from adjacent equipment, can also be supplied on special order.

Type "HA" differs from "GA" in container and mounting neck size, and also in the fact that it has three insulated terminals. Primarily, type "HA" is supplied to manufacturers' specifications, to meet special requirements of multiple-section and multiple-terminal capacitors, with either insulated or grounded container.

Cat. No.	Cap. Mfd.	Voltage D.C.	Case		List Price
			Working	Height	
6GA200	2	600	3"	3"	\$3.30
6GA300	3	600	4 1/2"	4 1/2"	4.00
6GA400	4	600	4 1/2"	4 1/2"	4.50
10GA100	1	1000	3"	3"	3.00
10GA200	2	1000	4 1/2"	4 1/2"	4.00
15GA50	.5	1500	8"	8"	3.60
15GA100	1	1500	4 1/2"	4 1/2"	4.00

Type	Case Diameter	Size of Mounting Neck
GA — GE — GW	1 1/2"	3/8" x 16 thread
HA — HE — HW	1 3/8"	3/8" x 16 thread

INDUSTRIAL



CONDENSER

CAPACITORS TO 100,000 V.D.C.W.

INCCO OIL "A" IMPREGNATED AND FILLED assures smaller size, low power factor, and widest range of operating temperatures.

ELECTRIC ARC WELDED HEAVY GAUGE HOT TINNED STEEL CASES are non-corrosive—finished in durable lacquer.

GLAZED WET-PROCESS PORCELAIN INSULATORS—low moisture absorption and high terminal to case flash over.

WOUND WITH HIGHEST GRADE CONDENSER TISSUES—insures a long, uninterrupted life.

CONSERVATIVELY RATED—Safe for continuous operation at 10 per cent overload.

HERMETICALLY SEALED STEEL CASE — unaffected by time, humidity or operating temperatures.

AVAILABLE TO MEET U. S. SIGNAL CORPS AND NAVY SALT WATER SUBMERSION REQUIREMENTS.

TYPE "WA" — HIGH VOLTAGE OIL FILLED CAPACITORS

Cat. No.	Cap. Mfd.	Case Dimensions in Inches			List Price
		Width	Length	Height	
6,000 V. D. C. WORKING					
60WA200	2.	4	8	11	\$108.00
60WA400	4.	4	12	11	132.00
60WA500	5.	4	12	11	150.00
60WA600	6.	4	12	13	168.00
60WA1000	10.	6	12	13	210.00
7,500 V. D. C. WORKING					
75WA50	.5	4	8	11	60.00
75WA100	1.	4	8	11	78.00
75WA200	2.	4	8	11	120.00
75WA400	4.	4	12	13	180.00
75WA600	6.	6	12	13	216.00
10,000 V. D. C. WORKING					
100WA100	1.	4	8	11	156.00
100WA200	2.	4	8	13	198.00
100WA400	4.	6	12	13	240.00
100WA500	5.	6	12	13	264.00
12,500 W. D. C. WORKING					
125WA50	.5	4	8	11	132.00
125WA100	1.	4	12	11	168.00
125WA200	2.	6	12	13	210.00
125WA500	5.	9 1/2	12	15	396.00

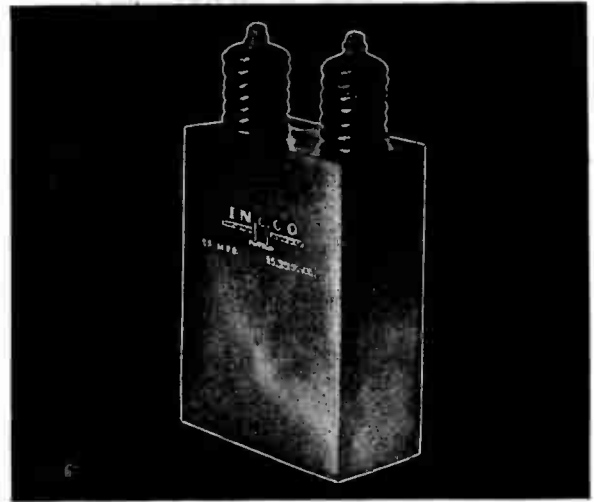

Cat. No.	Cap. Mfd.	Case Dimensions in Inches			List Price
		Width	Length	Height	
15,000 V. D. C. WORKING					
150WA25	.25	4	8	11	126.00
150WA50	.5	4	12	11	150.00
150WA100	1.	4	12	13	210.00
150WA200	2.	9 1/2	12	15	276.00
150WA300	3.	9 1/2	12	15	378.00
20,000 V. D. C. WORKING					
200WA25	.25	4	8	11	150.00
200WA50	.5	4	12	11	192.00
200WA100	1.	6	12	13	258.00
200WA150	1.5	9 1/2	12	15	348.00
200WA200	2.0	9 1/2	12	15	414.00
25,000 V. D. C. WORKING					
250WA20	.2	4	12	11	156.00
250WA25	.25	4	12	11	210.00
250WA50	.5	6	12	13	228.00
250WA100	1.	9 1/2	12	15	342.00
50,000 V. D. C. WORKING					
500WA25	.25	6	13 1/2	16 1/2	•
500WA50	.5	7 1/4	18	20	•
80,000 V. D. C. WORKING					
800WA25	.25	7 1/4	18	20	•
100,000 V. D. C. WORKING					
1000WA20	.2	7 1/4	18	20	•

* Prices on application.

For the duration of the war it is necessary that we reserve the right to make slight changes in case dimensions, in order to fabricate with available material. We will, however, notify you of any changes before entering your order.

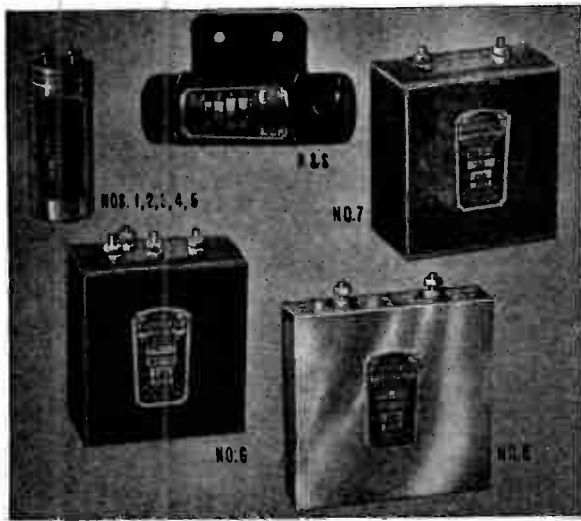

MOTOR STARTING CONDENSERS

These motor starting condensers are all heavy duty three second start. Built of the finest materials obtainable, these capacitors are engineered to the Nth degree of perfection. They are used by all the leading manufacturers of high quality motors.

The listings shown will take care of 90% of all your replacement requirements.

Number	Size, Inches	Capacity	List Price
1-A	1 1/2 Dia. x 3 1/4	45 - 70	\$1.40
1-B	1 1/2 Dia. x 3 1/4	85 - 115	1.55
1-C	1 1/2 Dia. x 3 1/4	120 - 150	1.65
1-T	1 1/2 Dia. x 3 1/4	145 - 162	2.00
2-D	1 1/2 Dia. x 3 3/4	85 - 115	1.60
2-E	1 1/2 Dia. x 3 3/4	120 - 150	1.70
3-F	2 Dia. x 4 1/4	90 - 115	2.60
3-P	2 Dia. x 4 1/4	120 - 150	2.75
3-U	2 Dia. x 4 1/4	245 - 300	3.60
3-W	2 Dia. x 4 1/4	161 - 190	3.00
4-G	2 1/2 Dia. x 4 1/4	85 - 115	2.60
4-H	2 1/2 Dia. x 4 1/4	120 - 150	2.75
5-I	3 Dia. x 4 1/4	100 - 115	2.65
6-J	3 1/2 x 4 x 2	90 - 115	2.60
6-K	3 1/2 x 4 x 2	124 - 138	2.75
6-L	3 1/2 x 4 x 2	145 - 162	2.90
7-M	3 1/2 x 4 x 2	80	2.30
7-Q	3 1/2 x 4 x 2	60 - 65	2.00
8-N	4 1/2 x 4 1/2 x 1 1/4	100 - 120	2.75
8-O	4 1/2 x 4 1/2 x 1 1/4	70 - 90	2.60
R	Mounting Bracket	for No. 1	.65
S	Mounting Bracket	for No. 3	.80

INDUSTRIAL INCCO CONDENSER

TUBULAR PAPER CONDENSERS



TYPE PT

Incco By-Pass Condensers are non-inductively wound and designed for maximum efficiency up to the highest radio frequencies. The units themselves are completely impregnated and sealed with a special non-hydroscopic sealing compound, thus preventing moisture penetration under the most humid conditions. The lead connected to the outside foil of the condenser is indicated by a black stripe around the end of the tube.

TESTED AT 3 TIMES RATED VOLTAGE

Catalog Number	Capacity Mfd.	Working Voltage	List Price
PT100	.0001	1000	\$0.20
PT101	.00025	1000	.20
PT102	.0005	1000	.20
PT103	.001	1000	.25
PT104	.002	1000	.25
PT105	.005	1000	.25
PT106	.006	1000	.25
PT107	.01	1000	.35
PT135	.01	600	.20
PT136	.02	600	.20
PT137	.03	600	.25
PT138	.05	600	.25
PT139	.1	600	.30
PT140	.25	600	.40
PT141	.5	600	.60
PT142	1.0	600	.95
PT170	.01	400	.20
PT171	.02	400	.20
PT172	.05	400	.20
PT173	.1	400	.25
PT174	.25	400	.30
PT175	.5	400	.40
PT176	1.0	400	.60
PT200	.02	200	.20
PT201	.05	200	.20
PT202	.1	200	.25
PT203	.25	200	.30
PT204	.5	200	.40
PT205	1.0	200	.60

VIBRATOR REPLACEMENTS

PT260	.005	2000	.40
PT261	.0075	2000	.40
PT262	.01	2000	.40
PT263	.02	2000	.40

INTERFERENCE ELIMINATOR



No. 7249

Designed for eliminating radio interference caused by fluorescent lights. By installing this unit directly in the fluorescent fixture, it eliminates all interference from the fixture. It is small enough to fit in any corner and is light enough so as not to require any special mounting. List Price.....\$1.00 each

DIRECT REPLACEMENT

For Aluminum Can Electrolytics—Wet and Dry Types
No Drilling — No Changes

Literally thousands have asked for a condenser which would directly replace the now almost extinct aluminum can screw neck type.

INDUSTRIAL now has the right answer—No fuss or worry as to whether or not it will fit. This new unit has the same mounting dimensions as the old condenser. It will slip into the same chassis hole without any drilling or enlarging. A heavy fibre washer and three nuts are the only mounting hardware—it's just as easy as the sketch shows.

Electrically and mechanically this condenser is designed for heavy duty service. It incorporates the exclusive INCCO etched foil process of construction. Each unit is first embedded in a high grade wax and then sealed in its inner case of heavy impregnated tubing. This entire condenser is then mounted in a heavy kraft tube thus relieving the condenser itself from any mechanical strain. Likewise, this construction provides an excellent seal against changes in characteristics and prevents moisture absorption. Whether it's a wet or a dry this new type "US" is the right condenser for replacement use. Supplied with Underwriters Approved rubber covered leads. Mounting washer and locking nuts included with each condenser. Individually boxed in attractive carton with instructions.



To replace 1 3/8" diameter screw neck type

Cat. No.	Cap. Mfd.	Work Volt	Peak Volt	Dimensions	Mtg. Neck	List Price	
US649	8	600	725	1 3/8" x 4"	3/4"	\$3.10	
US650	8	475	600	1 3/8" x 4"	3/4"	1.20	
US651	12	475	600	1 3/8" x 4"	3/4"	1.65	
US652	16	475	600	1 3/8" x 4"	3/4"	1.85	
US653	4 leads	8-8	475	600	1 3/8" x 4"	3/4"	1.90
US646	20	475	600	1 3/8" x 4"	3/4"	2.00	
US647	30	475	600	1 3/8" x 4"	3/4"	2.20	
US648	40	475	600	1 3/8" x 4"	3/4"	2.80	

AUTO GENERATOR CONDENSER

ALSO AVAILABLE IN HERMETICALLY SEALED SUBMERSION-PROOF CONSTRUCTION



TYPE F



TYPE G

Completely enclosed in a metal container to overcome severe operating conditions of temperature and humidity. Sturdily built to withstand constant vibration.

Cat. No.	Cap. Mfd.	List Price	Cat. No.	Cap. Mfd.	List Price
G325	.25	\$0.45	G328	1.0	\$0.90
G326	.5	.60	F330	.5	.60

DRY ELECTROLYTIC CONDENSERS

MIGHTY MIDGET METAL TUBULAR TYPE "MM"

Cat. No.	Cap. Mfd.	W.V.	Peak Volts	Dimen. Dia. L.	List Price
MM406	100	10	25	1 1/16 x 1 1/8	\$1.20
MM400	5	25	35	1 1/16 x 1 1/8	.40
MM401	10	25	35	1 1/16 x 1 1/8	.45
MM402	25	25	35	1 1/16 x 1 1/8	.60
MT403*†	10-10	25	35	1 1/16 x 2 3/8	.70
MM404	10	50	75	1 1/16 x 1 1/8	.50
MM405	25	50	75	1 1/16 x 1 1/8	.65
MM360	8	150	200	1 1/16 x 1 1/8	.50
MM368	12	150	200	1 1/16 x 1 1/8	.60
MM361	16	150	200	1 1/16 x 1 1/8	.65
MM362	20	150	200	1 1/16 x 2 3/8	.70
MM369	30	150	200	1 1/16 x 2 3/8	.75
MM363	40	150	200	1 1/16 x 2 3/8	.80
MM370†	20-20	150	200	1 1/16 x 2 3/8	1.25
MM364	4	475	600	1 1/16 x 1 1/8	.65
MM365	8	475	600	1 1/16 x 2 3/8	.70
MM366	16	475	600	1 1/16 x 2 3/8	1.05
MM367†	8-8	475	600	1 1/16 x 2 3/8	1.25

* In cardboard tube with wax filled ends. † 3 leads.

MIGHTY MIDGET CARTON TYPE "MC"

Cat. No.	Cap. Mfd.	W.V.	Peak Volts	Dimensions W. T. L.	List Price
MC450†	16-16	150	200	1 1/8 x 1 1/4 x 2 1/2	\$1.60
MC451†	20-20	150	200	1 1/8 x 1 1/4 x 2 1/2	1.70
MC452	8	475	600	3/4 x 1 1/8 x 2 1/2	1.10
MC453†	4-4	475	600	1 1/8 x 1 1/4 x 2 1/2	1.40
MC454†	8-8	475	600	1 x 1 1/4 x 3	1.80

† 4 leads.

LARGE CARTON TYPE "C"

C500	8	150	200	1 1/8 x 1 1/4 x 2 1/2	.95
C501†	16-16	150	200	1 x 1 1/4 x 3	1.95
C502*	{16-12	150	200	1 x 1 1/4 x 3 1/2	2.55
	{10-10	25	35		
C503†	{16-16-8	150	200	1 1/2 x 1 1/8 x 3 1/2	2.90
	{10-10	25	35		
C504	4	475	600	1 1/8 x 1 1/4 x 2 1/2	.90
C505	8	475	600	1 x 1 1/4 x 3	1.10
C506†	4-4	475	600	1 x 1 1/4 x 3 1/2	1.40
C507†	8-8	475	600	1 1/2 x 1 1/8 x 3 1/2	1.80

†C501, C506, C507—4 leads.

*C502—6 leads. †C503—7 leads.

Cat. No.	Cap. Mfd.	W.V.	Peak Volts	Dimen. Dia. L.	List Price
SB550†	16-12	150	200	1 3/8 x 3 3/4	\$1.80
SB551†	{16-12	150	200	1 3/8 x 3 3/4	2.40
	{10-10	25	35		
SB552†	8-8	475	600	1 3/8 x 3 3/4	1.80
SM660*	30-10	150	200	1 1/8 x 3	2.20
SM601*	30-30	150	200	1 1/8 x 3	2.20
SM607*	50-30	150	200	1 x 3	2.40
SM601†	{16-12	150	200	1 1/4 x 3	2.40
	{10-10	25	35		
SM605*	20-20	150	200	1 1/8 x 2 1/2	2.20
SM606†	20-20	150	200	1 x 2 1/2	2.30
SM603	8	475	600	1 1/8 x 3	1.10
SM604*	8-8	475	600	1 x 3	1.80

* SM600, SM601, SM607, SM605. SM604—3 leads.

† SB550, SB552, SB606—4 leads.

† SB551, SM602—6 leads.

An extremely popular type of condenser due to its exceptional high quality and midget size. Hermetic ally sealed in a small metal case and scientifically vented, to protect against adverse operating conditions of voltage, temperature and humidity. Container is insulated by a high grade tube which is spun over the ends of the can to eliminate shorts when wires are bent close to container. Easily mounted by their rigid wire leads.

All Type "MM" units are available with mounting strap. Recommended in cases of extreme vibration or when advisable to have unit solidly anchored. When ordering add the letter S before the catalog number.

Each unit is completely embedded in a high grade wax and then sealed in an impregnated carton to insure efficient operation under the most adverse conditions. New, high voltage protection against surges and high peak voltages. Supplied with color coded, Underwriters' Approved, rubber covered leads. Universal lugs permit easy mounting in any position.

Type "C" is similar to type "MC" above. It is designated, however, for older type sets where space is not limited.

Spade bolt type "SB" of mounting has been very popular due to its wide use in many radio sets. Each unit is embedded in a high temperature wax and then sealed in a thoroughly impregnated cardboard tube, affording complete immunity to moisture penetration. New high voltage protection gives complete protection against surges and high peak voltages.

Type "SM" has identical characteristics as "SB". The addition of the strap mounting bracket has proved favorable in its use due to its wide application in AC-DC and portable sets in the replacement field. The strap can be moved to the best mounting position and then bolted or soldered.

Supplied with color-coded, Underwriters' Approved, rubber covered leads.



Type MM



Type MMS



Type MC



Type C



Type SB



Type SM

Thank You!

When writing for additional
information or when ordering
from sources of supply listed
in this book, please mention

RADIO'S MASTER



PYRANOL CAPACITORS

*Cost Less because
They Last Longer*



COMPACT DEPENDABLE INDIVIDUALLY TESTED FIREPROOF
ROUND OR RECTANGULAR UPRIGHT OR INVERTED MOUNTING
CONTINUOUS OPERATION AT 10% OVERLOAD HERMETICALLY SEALED



Thousands of G-E Pyranol Capacitors are in service all over the world. Materials closely controlled as to quality, manufacturing processes under careful engineering and laboratory supervision, years of tested application experience—all these combine to give amateurs an unexcelled capacitor.

Pyranol Capacitors patented by General Electric Company contain non-inflammable dielectric developed by General Electric.* Its extraordinary insulating and dielectric properties make possible the unusual compactness of G-E capacitors.

Hermetical sealing assures permanence of the characteristics of Pyranol capacitors; contamination from air and moisture is impossible. G-E Pyranol capacitors are noted for their long life. For additional information ask for Bulletin GEA-2021C, General Electric, Schenectady, N. Y.

RATINGS AND PRICES Rectangular Cases

Volts D-C	Mfd	Base Mounting		Inverted Mounting	
		Cat. No.	Net Price	Cat. No.	Net Price
600	1	23F1	\$2.25	26F172	\$2.25
	2	23F2	2.76	26F167	2.76
	4	23F4	3.54	26F106	3.54
1000	1	23F10	2.40	26F156	2.40
	2	23F11	3.24	26F157	3.24
	4	23F13	4.05	26F93	4.05
	5	23F14	4.86	26F176	4.86
1500	1	23F20	2.91	26F181	2.91
	2	23F21	4.05	26F182	4.05
	4	23F23	5.52	26F184	5.52
	5	23F24	5.85	26F185	5.85
2000	1	23F30	3.57	26F190	3.57
	2	23F31	4.20	26F191	4.20
	4	23F33	5.85	26F193	5.85
	5	23F34	6.48	26F194	6.48
2500	1	23F39	5.16	26F199	5.16
	2	23F40	8.40	26F200	8.40
	4	23F41	11.64	26F201	11.64
3000	1	23F42	7.74	26F202	7.74
	2	23F43	9.72	26F203	9.72
	4	23F44	14.28	26F204	14.28
4000	0.5	23F45	11.70	26F205	11.70
	1	23F46	14.28	26F206	14.28
	2	23F47	18.00	26F207	18.00
5000	0.5	23F48	12.96	26F208	12.96
	1	23F49	16.20	26F209	16.20
	2	23F50	20.70	26F210	20.70

RATINGS AND PRICES Cylindrical Cases

Volts D-C	Mfd	Catalog No.	Net Price
600	2	23F60	\$2.10
	3	23F61	2.40
	4	23F62	2.91
1000	1	23F63	1.77
	2	23F64	2.40
	3	23F65	2.76
	4	23F66	3.06
1500	0.5	23F67	1.95
	1.0	23F68	2.25
	2.0	23F69	3.06
2000	1.0	23F70	2.91
	2.0	23F71	3.24

* Reg. U. S. Pat. Off.



LOW CAPACITY, SMALL SIZE UNITS

Volts D-C	Mfd	Catalog No.	Net Price
500	1.0	23F154	\$1.95
1000	0.01	23F155	1.29
1300	0.05	23F156	1.44
1000	0.1	23F157	1.62
1000	0.25	23F158	1.77
1000	0.5	23F159	1.95

Subject to Change Without Notice

K-83

SANGAMO CAPACITORS

TYPE K MICA CAPACITOR

COLOR CODE

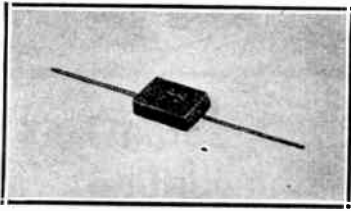

Type K: CM-20

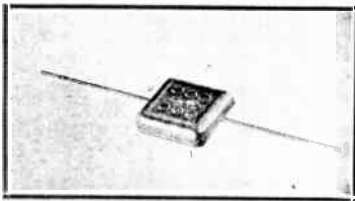
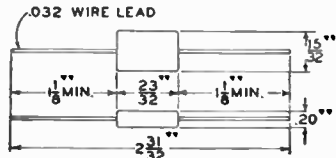

Type C: CM-30

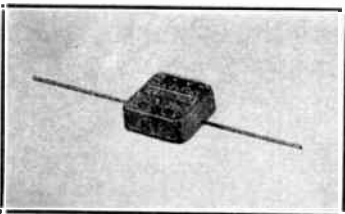
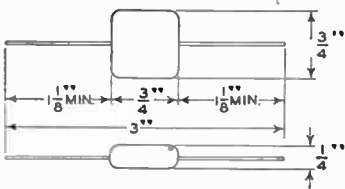

Type C: CM-35

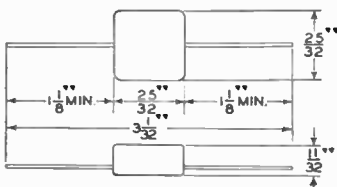

Cat. No.	A.S.A. Type Designation	Cap. mmf.	DC Wkg. Voltage	Upper Left Dot	Upper Center Dot	Upper Right Dot	Lower Right Dot	List Price
K-1550	CM20-050-	5	500	black	green	black	gold	.30
K-1410	CM20-100-	10	500	black	brown	black	black	.30
K-1412	CM20-120-	12	500	black	brown	red	black	.30
K-1415	CM20-150-	15	500	black	brown	green	black	.30
K-1418	CM20-180-	18	500	black	brown	gray	black	.30
K-1420	CM20-200-	20	500	black	red	black	black	.30
K-1422	CM20-220-	22	500	black	red	red	black	.30
K-1424	CM20-240-	24	500	black	red	yellow	black	.30
K-1427	CM20-270-	27	500	black	red	violet	black	.30
K-1430	CM20-300-	30	500	black	orange	black	black	.30
K-1433	CM20-330-	33	500	black	orange	orange	black	.30
K-1436	CM20-360-	36	500	black	orange	blue	black	.30
K-1439	CM20-390-	39	500	black	orange	white	black	.30
K-1443	CM20-430-	43	500	black	yellow	orange	black	.25
K-1447	CM20-470-	47	500	black	yellow	violet	black	.25
K-1451	CM20-510-	51	500	black	green	brown	black	.25
K-1456	CM20-560-	56	500	black	green	blue	black	.25
K-1462	CM20-620-	62	500	black	blue	red	black	.25
K-1468	CM20-680-	68	500	black	blue	gray	black	.25
K-1475	CM20-750-	75	500	black	violet	green	black	.25
K-1482	CM20-820-	82	500	black	gray	red	black	.25
K-1491	CM20-910-	91	500	black	white	brown	black	.25
K-1310	CM20-101-	100	500	black	brown	black	brown	.25
K-1311	CM20-111-	110	500	black	brown	brown	brown	.30
K-1312	CM20-121-	120	500	black	brown	red	brown	.30
K-1313	CM20-131-	130	500	black	brown	orange	brown	.30
K-1315	CM20-151-	150	500	black	brown	green	brown	.30
K-1316	CM20-161-	160	500	black	brown	blue	brown	.30
K-1318	CM20-181-	180	500	black	brown	gray	brown	.30
K-1320	CM20-201-	200	500	black	red	black	brown	.30
K-1322	CM20-221-	220	500	black	red	red	brown	.30
K-1324	CM20-241-	240	500	black	red	yellow	brown	.30
K-1327	CM20-271-	270	500	black	red	violet	brown	.30
K-1330	CM20-301-	300	500	black	orange	black	brown	.30
K-1333	CM20-331-	330	500	black	orange	orange	brown	.30
K-1336	CM20-361-	360	500	black	orange	blue	brown	.30
K-1339	CM20-391-	390	500	black	orange	white	brown	.30
K-1343	CM20-431-	430	500	black	yellow	orange	brown	.30
K-1347	CM20-471-	470	500	black	yellow	violet	brown	.30
K-1351	CM20-511-	510	500	black	green	brown	brown	.30
K-1210	CM20-102-	1000	500	black	brown	black	red	.35

For A characteristic use list price. For B characteristic use list price. For C characteristic (silvered mica) add 75% to list price. For D characteristic (silvered mica cycled) add 100% to list price. For ± 20% use list price. For ± 10% add 10% to the list price. For ± 5% add 20% to the list price. For ± 2% add 75% to the list price.

TYPE C MICA CAPACITOR

C-1347	CM30-471-	470	500	black	yellow	violet	brown	.25
C-1351	CM30-511-	510	500	black	green	brown	brown	.25
C-1356	CM30-561-	560	500	black	green	blue	brown	.25
C-1362	CM30-621-	620	500	black	blue	red	brown	.25
C-1368	CM30-681-	680	500	black	blue	gray	brown	.25
C-1375	CM30-751-	750	500	black	violet	green	brown	.25
C-1382	CM30-821-	820	500	black	gray	red	brown	.25
C-1391	CM30-911-	910	500	black	white	brown	brown	.25
C-1210	CM30-102-	1000	500	black	brown	black	red	.30
C-1211	CM30-112-	1100	500	black	brown	brown	red	.35
C-1212	CM30-122-	1200	500	black	brown	red	red	.35
C-1213	CM30-132-	1300	500	black	brown	orange	red	.35
C-1215	CM30-152-	1500	500	black	brown	green	red	.35
C-1216	CM30-162-	1600	500	black	brown	blue	red	.35
C-1218	CM30-182-	1800	500	black	brown	gray	red	.40
C-1220	CM30-202-	2000	500	black	red	black	red	.40
C-1222	CM30-222-	2200	500	black	red	red	red	.40
C-1224	CM30-242-	2400	500	black	red	yellow	red	.45
C-1227	CM30-272-	2700	500	black	red	violet	red	.45
C-1230	CM30-302-	3000	500	black	orange	black	red	.45
C-1233	CM30-332-	3300	500	black	orange	orange	red	.45

For A characteristic use list price. For B characteristic use list price. For C characteristic (silvered mica) add 75% to list price. For D characteristic (silvered mica cycled) add 100% to list price. For ± 20% use list price. For ± 10% add 10% to the list price. For ± 5% add 20% to the list price. For ± 2% add 75% to the list price.

C-1230*	CM35-302-	3000	500	black	orange	black	red	.45
C-1233*	CM35-332-	3300	500	black	orange	orange	red	.45
C-1236	CM35-362-	3600	500	black	orange	blue	red	.50
C-1239	CM35-392-	3900	500	black	orange	white	red	.50
C-1243	CM35-432-	4300	500	black	yellow	red	red	.55
C-1247	CM35-472-	4700	500	black	yellow	violet	red	.65
C-1251	CM35-512-	5100	500	black	green	brown	red	.65
C-1256	CM35-562-	5600	500	black	green	blue	red	.65
C-1262	CM35-622-	6200	500	black	blue	red	red	.70
C-06268	CM35-682-	6800	300	black	blue	gray	red	.80
C-06275	CM35-752-	7500	300	black	violet	green	red	.90
C-06282	CM35-822-	8200	300	black	gray	red	red	1.00
C-06110	CM35-102-	10000	300	black	brown	black	orange	1.15

For A characteristic use list price. For B characteristic use list price. For C characteristic add 75% to list price. For D characteristic add 100% to list price. *Preferable case size for these capacities. For ± 20% use list price. For ± 10% add 10% to list price. For ± 5% add 20% to list price.

SANGAMO CAPACITORS

GENERAL INFORMATION Relating to All Sangamo Capacitors

All list prices are subject to change without notice. When possible ample notice of price changes will be given, but due to uncertainties with regard to prices of raw materials it may not always be possible to do this.

When ordering be sure to give complete designation, including catalog number, capacity, and voltage ratings. Where special characteristics are desired, specify these by adding proper suffix letter or by complete description of the characteristics desired.

In many instances capacities in addition to those listed are available in various type units. Inquiry should be made to the factory in those cases where capacities other than those listed are required for information as to their availability.

The various characteristic designations used throughout this catalog are in accordance with those specified in the American War Standard for Fixed Mica Dielectric Capacitors, C75.3-1942. Details of these characteristics are indicated in the Characteristic Table below. Color code markings are also those specified in the above standard, and will be used where customer does not specify a different color code marking. Wherever possible case type designations as indicated by the War Standard have been shown.

Shipping instructions should accompany all orders. If no shipping instructions are furnished, the method of transportation considered to be most satisfactory will be used. All shipments are insured against non-delivery, unless otherwise instructed.

CHARACTERISTIC DESIGNATIONS

Characteristic	Q	Temperature Coefficient Parts/Million/Deg. C	Maximum Capacitance Drift (F-6)	Verification of Characteristics By Production Test
A	Not specified	Not specified	Not specified	Not required
B	(As specified in D-Sc(1))	Not specified	Not specified	Not required
C	"	-200 to +200	0.5 percent	Not required
D	"	-100 to +100	0.2 percent	Not required
E	"	0 to +100	0.05 percent	Not required
F	"	0 to + 50	0.025 percent	Required
G	"	0 to - 50	0.025 percent	Required

TYPE J MICA CAPACITOR

COLOR CODE

Cat. No.	A.S.A. Type Designation	Cap. nmf.	DC Wkg. Voltage	Upper Left Dot	Upper Center Dot	Upper Right Dot	Lower Right Dot	List Price
J-1310		100	500	black	brown	black	brown	.40
J-1325		250	500	black	red	green	brown	.40
J-1350		500	500	black	green	black	brown	.40
J-1210		1000	500	black	brown	black	red	.45
J-1220		2000	500	black	red	black	red	.50
J-1225		2500	500	black	red	green	red	.50
J-1230		3000	500	black	orange	black	red	.55
J-1233	CM40-332-	3300	500	black	orange	orange	red	.55
J-1236	CM40-362-	3600	500	black	orange	blue	red	.60
J-1239	CM40-392-	3900	500	black	orange	white	red	.60
J-1243	CM40-432-	4300	500	black	yellow	orange	red	.65
J-1247	CM40-472-	4700	500	black	yellow	violet	red	.65
J-1251	CM40-512-	5100	500	black	green	brown	red	.70
J-1256	CM40-562-	5600	500	black	green	blue	red	.75
J-1262	CM40-622-	6200	500	black	blue	red	red	.85
J-1268	CM40-682-	6800	500	black	blue	gray	red	.85
J-1275	CM40-752-	7500	500	black	violet	green	red	.90
J-1282	CM40-822-	8200	500	black	gray	red	red	.95
J-06291	CM40-912-	9100	300	black	white	brown	red	1.00
J-06110	CM40-103-	10000	300	black	brown	black	orange	1.10

For A characteristic use list price.

For B characteristic use list price.

For ± 20% use list price.

For ± 10% add 10% to list price.

For ± 5% add 20% to list price.

TYPE L MICA CAPACITOR

Cat. No.	Cap. mfd.	DC Test Voltage	DC Wkg. Voltage	List Price
L-1450	.00005	1000	500	\$0.50
L-1470	.00007	1000	500	.50
L-1475	.000075	1000	500	.50
L-1310	.0001	1000	500	.50
L-1320	.0002	1000	500	.50
L-1325	.00025	1000	500	.50
L-1335	.00035	1000	500	.50
L-1350	.0005	1000	500	.50
L-1210	.001	1000	500	.55
L-1215	.0015	1000	500	.60
L-1220	.002	1000	500	.65
L-1225	.0025	1000	500	.70
L-1230	.003	1000	500	.75
L-1240	.004	1000	500	.80
L-1250	.005	1000	500	.90
L-0626	.006	600	300	1.00
L-0628	.008	600	300	1.10
L-0611	.01	600	300	1.20

For A characteristic use list price.

For B characteristic use list price.

For ± 20% use list price.

For ± 10% add 10% to list price.

For ± 5% add 20% to list price.

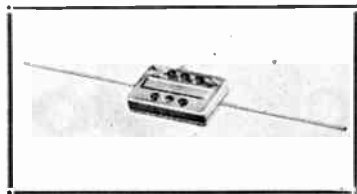

Type J (Thin)

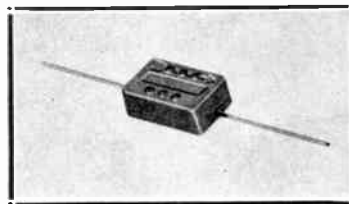
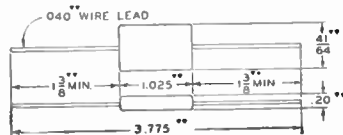

Type J: CM-40

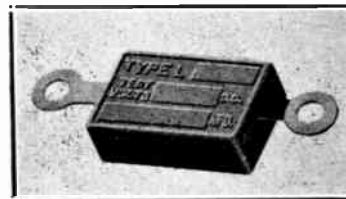
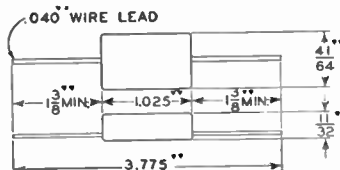

Type L

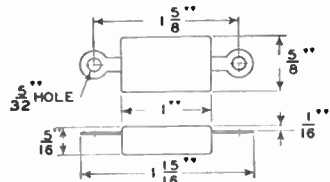

SANGAMO CAPACITORS



Type H: CM-45

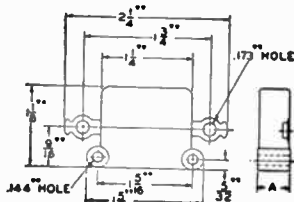

Type E

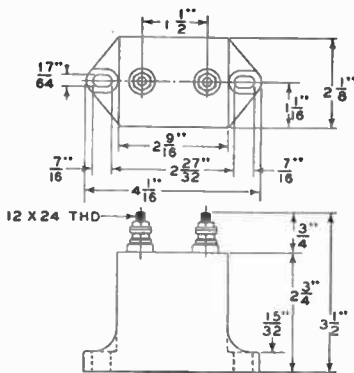

TYPE H MICA CAPACITOR

Cat. No.	ASA Case No.	Capacity	DC Test Volt.	DC Wkg. Volt.	List Price
H-1450	CM45	.00005	1000	600	\$0.50
H-1310	CM45	.0001	1000	600	.50
H-1320	CM45	.0002	1000	600	.50
H-1325	CM45	.00025	1000	600	.50
H-1330	CM45	.0003	1000	600	.50
H-1340	CM45	.0004	1000	600	.50
H-1350	CM45	.0005	1000	600	.50
H-1210	CM45	.001	1000	600	.50
H-1215	CM45	.0015	1000	600	.50
H-1220	CM45	.002	1000	600	.60
H-1225	CM45	.0025	1000	600	.70
H-1230	CM45	.003	1000	600	.70
H-1240	CM45	.004	1000	600	.70
H-1250	CM45	.005	1000	600	.70
H-1260	CM45	.006	1000	600	.85
H-1280	CM45	.008	1000	600	1.00
H-1110	CM45	.01	1000	600	1.20
H-1115	CM50	.015	1000	600	1.35
H-1120	CM50	.02	1000	600	1.60
H-1125	CM50	.025	1000	600	1.90
H-1130	CM50	.03	1000	600	2.10
H-2450	CM45	.00005	2500	1200	.70
H-2310	CM45	.0001	2500	1200	.70
H-2320	CM45	.0002	2500	1200	.70
H-2325	CM45	.00025	2500	1200	.70
H-2330	CM45	.0003	2500	1200	.70
H-2350	CM45	.0005	2500	1200	.70
H-2210	CM45	.001	2500	1200	.90
H-2215	CM45	.0015	2500	1200	1.20
H-2220	CM45	.002	2500	1200	1.35
H-2225	CM45	.0025	2500	1200	1.45
H-2230	CM45	.003	2500	1200	1.60
H-2240	CM50	.004	2500	1200	1.60
H-2250	CM50	.005	2500	1200	1.75
H-2260	CM50	.006	2500	1200	1.75
H-2280	CM50	.008	2500	1200	2.25
H-2110	CM50	.01	2500	1200	2.80
H-5450	CM45	.00005	5000	2500	.90
H-5310	CM45	.0001	5000	2500	.90
H-5320	CM45	.0002	5000	2500	1.10
H-5325	CM45	.00025	5000	2500	1.10
H-5330	CM45	.0003	5000	2500	1.15
H-5350	CM45	.0005	5000	2500	1.25
H-5210	CM45	.001	5000	2500	1.50
H-5215	CM45	.0015	5000	2500	1.95
H-5220	CM45	.002	5000	2500	2.25
H-5225	CM50	.0025	5000	2500	2.50
H-5230	CM50	.003	5000	2500	2.75
H-5240	CM50	.004	5000	2500	3.15
H-5250	CM50	.005	5000	2500	3.30

For A characteristic use list price. For B characteristic use list price. For ± 20% tolerance use list price. For ± 10% add 10% to the list price. For ± 5% add 20% to the list price. For ± 2% add 75% to the list price. For Meter mounting brackets (add letter E to type designation) add 30 cents to the list price when assembled on Condenser. For Meter mounting brackets add 20 cents to the list price not assembled on Condenser (specify case size).

TYPE E MICA CAPACITOR, For Amateur Transmitters

Catalog Number	Cap. mfd.	D.C. Test Volts	MAXIMUM OPERATING CURRENT IN AMPERES				List Price
			15,000 KC	7,500 KC	3,750 KC	1,875 KC	
E-1245	00005	12500	3.0	2.5	1.75	1.0	\$ 7.25
E-1231	0001	12500	5.0	4.0	3.0	2.0	7.25
E-12325	00025	12500	7.0	8.0	6.0	4.0	7.25
E-1235	0005	12500	8.0	9.0	8.0	7.0	7.25
E-721	001	7000	8.0	9.0	10.0	8.0	6.60
E-1221	001	12500	9.0	10.0	11.0	12.0	7.25
E-7215	0015	7000	9.0	9.0	10.0	8.0	7.25
E-12215	0015	12500	9.0	10.0	11.0	12.0	8.60
E-722	002	7000	8.0	9.0	10.0	10.0	8.60
E-1222	002	12500	9.0	12.0	13.0	15.0	9.90
E-723	003	7000	9.0	10.0	10.0	10.0	9.25
E-1023	003	10000	9.0	12.0	13.0	15.0	11.90
E-3524	004	3500	8.0	9.0	9.0	8.0	9.25
E-724	004	7000	9.0	10.0	10.0	10.0	11.90
E-1024	004	10000	10.0	11.0	13.0	14.0	12.55
E-3525	005	3500	9.0	11.0	11.0	10.0	8.60
E-725	005	7000	9.0	11.0	12.0	11.0	9.90
E-1025	005	10000	10.0	13.0	14.0	15.0	13.20
E-3511	01	3500	10.0	12.0	14.0	12.0	13.20
E-711	01	7000	10.0	13.0	15.0	15.0	13.85
E-212	02	2000	10.0	13.0	16.0	15.0	12.25
E-3512	02	3500	10.0	13.0	17.0	17.0	13.20
E-215	05	2000	10.0	15.0	16.0	17.0	13.20
E-3515	05	3500	11.0	14.0	16.0	18.0	15.20
E-201	0.1	2000	11.0	14.0	16.0	18.0	15.20

Standard tolerance ± 20%. For ± 10% add 50c to the list price. For ± 5% add \$1.00 to the list price. For ± 2% add \$2.00 to the list price. Recommended for amateur installations. Vacuum impregnated with special low loss wax.

SEE "GENERAL INFORMATION" ON PAGE K-85

SANGAMO CAPACITORS

TYPE A-2 MICA CAPACITOR

Cat. No.	ASA Case No.	Capacity	DC Test Volt.	DC Wkg. Volt.	List Price
A2-1450	CM55	.00005	1200	600	\$0.65
A2-1310	CM55	.0001	1200	600	.65
A2-1315	CM55	.00015	1200	600	.65
A2-1320	CM55	.0002	1200	600	.65
A2-1325	CM55	.00025	1200	600	.65
A2-1350	CM55	.0005	1200	600	.65
A2-1210	CM55	.001	1200	600	.65
A2-1215	CM55	.0015	1200	600	.70
A2-1220	CM55	.002	1200	600	.70
A2-1225	CM55	.0025	1200	600	.80
A2-1230	CM55	.003	1200	600	.85
A2-1240	CM55	.004	1200	600	.85
A2-1250	CM55	.005	1200	600	.85
A2-1250	CM55	.005	1200	600	1.00
A2-1280	CM55	.008	1200	600	1.20
A2-1110	CM55	.01	1200	600	1.40
A2-1120	CM55	.02	1200	600	1.85
A2-1125	CM50	.025	1200	600	2.30
A2-1130	CM50	.03	1200	600	2.50
A2-1140	CM50	.04	1200	600	3.25
A2-1150	CM50	.05	1200	600	3.80
A2-2450	CM55	.00005	2500	1200	.70
A2-2310	CM55	.0001	2500	1200	.70
A2-2315	CM55	.00015	2500	1200	.70
A2-2320	CM55	.0002	2500	1200	.70
A2-2325	CM55	.00025	2500	1200	.70
A2-2350	CM55	.0005	2500	1200	.70
A2-2210	CM55	.001	2500	1200	.90
A2-2215	CM55	.0015	2500	1200	1.20
A2-2220	CM55	.002	2500	1200	1.35
A2-2230	CM55	.003	2500	1200	1.60
A2-2240	CM55	.004	2500	1200	1.60
A2-2250	CM55	.005	2500	1200	1.75
A2-2260	CM55	.006	2500	1200	1.75
A2-2280	CM55	.008	2500	1200	2.25
A2-2110	CM55	.01	2500	1200	2.80
A2-2115	CM60	.015	2500	1200	3.35
A2-2120	CM60	.02	2500	1200	3.90
A2-2125	CM60	.025	2500	1200	4.35
A2-5450	CM55	.00005	5000	2500	.90
A2-5310	CM55	.0001	5000	2500	.90
A2-5315	CM55	.00015	5000	2500	1.00
A2-5320	CM55	.0002	5000	2500	1.05
A2-5325	CM55	.00025	5000	2500	1.05
A2-5350	CM55	.0005	5000	2500	1.25
A2-5210	CM55	.001	5000	2500	1.50
A2-5215	CM55	.0015	5000	2500	1.95
A2-5220	CM55	.002	5000	2500	2.25
A2-5230	CM55	.003	5000	2500	2.75
A2-5240	CM55	.004	5000	2500	3.15
A2-5250	CM55	.005	5000	2500	3.30
A2-5260	CM55	.006	5000	2500	3.45
A2-5280	CM60	.008	5000	2500	3.90
A2-5110	CM60	.01	5000	2500	4.10
A2-5115	CM60	.015	5000	2500	4.45

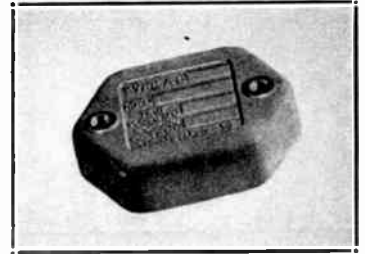

CM-55 Type A-2 *CM-56

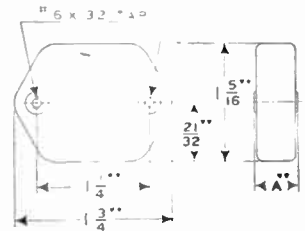

*CM56—Furnished with .144" clearance holes. Designate as Type A-2-A.



CM-61 Type A-2 *CM-61

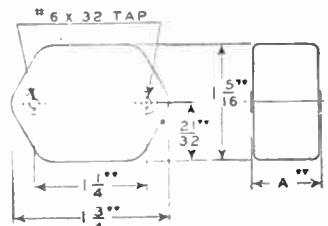

*CM61—Furnished with .144" clearance holes. Designate as Type A-2-A.

For B characteristic use list price. For C characteristic add 15c to the list price. For D characteristic add 75c to the list price. For $\pm 20\%$ tolerance use list price. For $\pm 10\%$ tolerance add 10% to the list price. For $\pm 5\%$ tolerance add 20% to the list price. For $\pm 2\%$ tolerance add 75% to the list price. The following characteristics in CM60 cases only: For E characteristic add \$1.00 to the list price. For F characteristic add \$1.25 to the list price.

SEE "GENERAL INFORMATION" ON PAGE K-85

SANGAMO CAPACITORS

TYPE F-1 MICA CAPACITOR

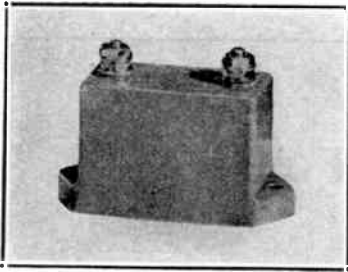

Type F-1 and F-2

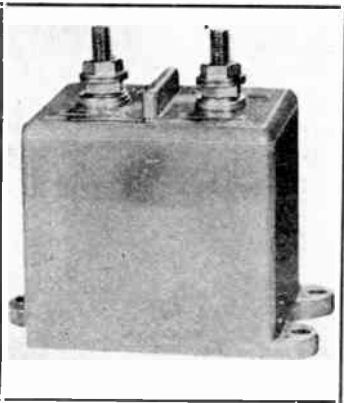
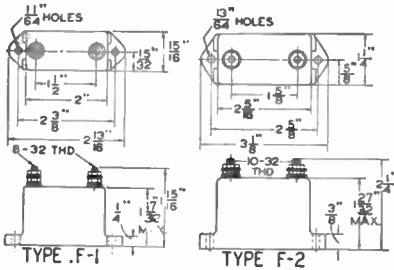

Type F-3

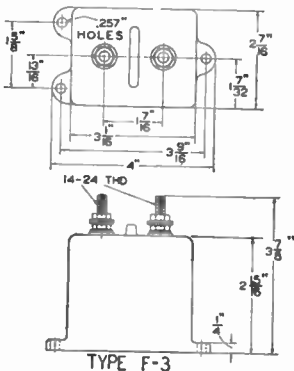

SEE "GENERAL INFORMATION"
ON PAGE K-85

Catalog Number	Cap. mfd.	Test Volts Effective Peak Wkg.	MAXIMUM OPERATING CURRENT IN AMPERES				List Price
			3,000 KC	1,000 KC	300 KC	100 KC	
FIL-341	00001	3000	.5	.2	.06	.02	\$ 9.90
FIL-342	00002	3000	.8	.3	.10	.03	9.90
FIL-345	00005	3000	1.3	.5	.18	.05	9.90
FIL-331	0001	3000	1.8	.75	.33	.10	9.90
FIL-3315	00015	3000	2.2	1.0	.47	.18	9.90
FIL-332	0002	3000	2.5	1.2	.62	.24	9.90
FIL-3325	00025	3000	2.8	1.0	.70	.30	9.90
FIL-333	0003	3000	3.0	1.5	.75	.36	9.90
FIL-334	0004	3000	3.5	1.8	.95	.45	9.90
FIL-335	0005	3000	3.6	2.0	1.10	.50	9.90
FIL-336	0006	3000	3.9	2.4	1.2	.56	9.90
FIL-3375	00075	3000	4.3	2.7	1.3	.62	9.90
FIL-338	0008	3000	4.4	2.7	1.5	.65	9.90
FIL-321	001	3000	4.7	3.0	1.6	.75	9.90
FIL-3215	0015	3000	5.6	3.9	2.0	.95	9.90
FIL-322	002	3000	6.2	4.3	2.4	1.1	9.90
FIL-3225	0025	3000	6.8	4.7	2.7	1.2	9.90
FIL-223	003	2000	7.5	5.1	3.0	1.4	9.90
FIL-224	004	2000	8.2	6.2	3.5	1.6	9.90
FIL-225	005	2000	8.5	6.8	3.8	1.8	9.90
FIL-226	006	2000	9.1	7.5	4.2	2.0	9.90
FIL-1528	008	1500	10.0	8.2	4.7	2.3	9.90
FIL-111	01	1000	10.0	9.1	5.1	2.5	9.90
FIL-112	02	1000	11.0	11.0	7.5	3.6	10.45
FIL-0215	05	250	11.0	11.0	9.1	4.7	10.45
FIL-0201	0.1	250	11.0	11.0	9.1	5.6	11.00

TYPE F-2 MICA CAPACITOR

F2L-545	00005	5000	1.6	.7	.30	.07	\$14.30
F2L-531	0001	5000	2.4	1.2	.47	.10	14.30
F2L-5315	00015	5000	3.3	1.8	.68	.24	14.30
F2L-532	0002	5000	3.6	2.0	.82	.33	14.30
F2L-5325	00025	5000	3.9	2.4	1.00	.43	14.30
F2L-533	0003	5000	4.1	2.7	1.1	.51	14.30
F2L-534	0004	5000	4.5	3.0	1.3	.65	14.30
F2L-535	0005	5000	4.8	3.3	1.6	.75	14.30
F2L-536	0006	5000	5.1	3.6	1.8	.82	14.30
F2L-5375	00075	5000	5.6	3.9	2.2	.91	14.30
F2L-538	0008	5000	5.7	4.0	2.3	1.0	14.30
F2L-521	001	5000	6.2	4.4	2.4	1.2	14.30
F2L-5215	0015	5000	6.8	5.2	3.3	1.5	14.30
F2L-522	002	5000	7.5	6.2	3.7	1.8	14.30
F2L-5225	0025	5000	8.2	6.5	4.3	2.1	14.30
F2L-523	003	5000	8.5	6.8	4.7	2.3	15.40
F2L-424	004	4000	9.1	7.5	5.6	2.7	15.40
F2L-325	005	3000	9.5	8.5	6.2	3.0	14.30
F2L-326	006	3000	10.0	9.1	6.2	3.0	14.30
F2L-328	008	3000	10.5	10.0	6.2	3.6	14.30
F2L-211	01	2000	11.0	11.0	7.5	3.9	14.30
F2L-2115	015	2000	12.0	12.0	8.2	4.3	14.30
F2L-212	02	2000	13.0	13.0	10.0	5.1	14.30
F2L-213	03	2000	14.0	15.0	12.0	6.8	15.40
F2L-1514	04	1500	15.0	16.0	13.0	7.5	14.30
F2L-1515	05	1500	15.0	16.0	15.0	7.8	14.85
F2L-0501	.1	500	15.0	18.0	15.0	8.2	15.95
F2L-0202	.2	250	16.0	18.0	15.0	9.0	20.90
F2L-02025	.25	250	16.0	18.0	15.0	9.0	23.10

Types F-1 and F-2 Mica Capacitors:

For B characteristic use list price. For C characteristic add \$.50 to the list price. For D characteristic add \$1.00 to the list price. For E characteristic add \$1.50 to the list price. For F characteristic add \$2.00 to the list price. For G characteristic add \$5.00 to the list price. For $\pm 2\%$ add \$1.50 to the list price. Characteristics D, E, & F require 50% reduction in current rating. Characteristic G requires 50% reduction in voltage and current rating.

TYPE F-3 MICA CAPACITOR

F3L-8325	00025	8000	7.5	5.0	1.5	.5	\$29.15
F3L-835	0005	8000	8.5	6.0	3.0	1.0	29.15
F3L-821	001	8000	10.0	8.5	4.5	1.5	32.45
F3L-822	002	8000	11.5	11.5	7.5	3.0	32.45
F3L-823	003	8000	12.5	13.5	9.5	4.0	34.65
F3L-824	004	8000	13.5	15.5	10.5	5.0	36.85
F3L-825	005	8000	14.0	16.0	11.5	6.0	40.15
F3L-826	006	8000	15.0	17.0	12.5	6.5	40.15
F3L-828	008	8000	16.0	19.0	14.0	7.5	42.90
F3L-811	01	8000	17.0	20.0	15.0	8.5	45.65
F3L-512	02	5000	18.0	23.0	18.0	10.5	45.65
F3L-413	03	4000	18.0	24.0	19.0	11.5	45.65
F3L-414	04	4000	18.0	24.0	20.0	12.0	48.95
F3L-415	05	4000	18.0	25.0	21.0	12.0	51.15
F3L-201	.1	2000	18.0	25.0	22.0	12.0	40.15
F3L-0602	.2	600	18.0	25.0	22.0	12.0	32.45
F3L-06025	.25	600	18.0	25.0	22.0	12.0	36.85
F3L-0603	.3	600	18.0	25.0	22.0	12.0	36.85
F3L-0604	.4	600	18.0	25.0	22.0	12.0	40.15
F3L-0605	.5	600	18.0	25.0	22.0	12.0	43.45
F3L-0606	.6	600	18.0	25.0	22.0	12.0	51.15
F3L-06075	.75	600	18.0	25.0	22.0	12.0	58.85
F3L-0610	1.0	600	18.0	25.0	22.0	12.0	67.65

For B characteristic use list price. For C characteristic add \$4.00 to the list price. For D characteristic add \$5.00 to the list price. For $\pm 2\%$ add \$2.00 to the list price. Characteristic D requires 50% reduction in current rating.

SANGAMO CAPACITORS

TYPE G-1 MICA CAPACITOR

Cat. No.	Cap. mfd.	Test Volts Effective.	MAXIMUM OPERATING CURRENT IN AMPERES				List Price
			3000 KC	1000 KC	300 KC	100 KC	
G1-641	00001	6000	.5	.3	.1	.05	\$22.00
G1-6425	000025	6000	1.0	.6	.2	.10	23.10
G1-645	00005	6000	2.0	1.3	.55	.18	24.20
G1-6475	000075	6000	2.5	1.7	.70	.23	25.30
G1-631	0001	6000	3.0	2.0	.91	.30	26.40
G1-63125	000125	6000	3.3	2.3	1.0	.35	27.50
G1-6315	00015	6000	3.7	2.5	1.2	.40	28.60
G1-632	0002	6000	4.4	3.1	1.5	.55	28.50
G1-6325	00025	6000	4.9	3.6	1.8	.60	28.60
G1-633	0003	6000	5.4	3.9	2.0	.65	29.70
G1-6335	00035	6000	6.0	4.3	2.4	.75	29.70
G1-634	0004	6000	6.5	4.7	2.7	.82	29.70
G1-635	0005	6000	7.2	5.3	3.0	1.00	29.70
G1-636	0006	6000	8.2	6.2	3.6	1.20	29.70
G1-637	0007	6000	8.5	6.5	3.9	1.40	29.70
G1-638	0008	6000	9.1	6.8	4.3	1.50	29.70
G1-621	001	6000	10.0	7.5	5.1	1.80	29.70
G1-6215	0015	6000	12.0	9.1	6.2	2.40	30.80
G1-622	002	6000	13.0	11.0	7.5	3.30	30.80
G1-6225	0025	6000	15.0	13.0	9.1	3.90	31.90
G1-623	003	6000	15.5	13.5	9.5	4.50	31.90
G1-624	004	6000	16.0	15.0	11.0	5.70	31.90
G1-625	005	6000	18.5	17.0	12.5	6.50	33.00
G1-526	006	5000	17.0	18.0	13.0	7.50	33.00
G1-527	007	5000	17.5	19.0	14.0	7.80	33.00
G1-528	008	5000	18.0	20.0	15.0	8.20	33.00
G1-511	01	5000	13.0	21.0	15.0	9.10	33.00
G1-4115	015	4000	13.0	21.0	15.0	10.00	33.00
G1-312	02	3000	13.0	22.0	16.0	11.00	33.00

TYPE G-2 MICA CAPACITOR

G2-1031	0001	10000	4.5	3.2	1.5	.50	\$41.80
G2-10315	00015	10000	5.5	4.0	2.0	.65	41.80
G2-1032	0002	10000	6.5	4.5	2.5	.85	41.80
G2-10325	00025	10000	7.2	5.1	2.7	1.00	41.80
G2-1035	0005	10000	9.1	7.0	4.0	1.60	41.80
G2-1036	0006	10000	11.0	8.2	4.7	1.80	41.80
G2-1038	0008	10000	11.5	9.1	5.1	2.20	41.80
G2-1021	001	10000	12.0	10.0	6.2	2.50	41.80
G2-10212	0012	10000	15.0	11.0	6.8	2.70	41.80
G2-10215	0015	10000	15.0	10.0	7.5	3.00	41.80
G2-1022	002	10000	16.0	13.0	8.2	3.60	41.80
G2-823	003	8000	18.0	16.0	10.0	4.70	41.80
G2-824	004	8000	20.0	18.0	12.0	5.60	41.80
G2-525	005	5000	20.0	20.0	13.0	6.50	41.80
G2-526	006	5000	20.0	22.0	15.0	6.80	44.00
G2-528	008	5000	20.0	24.0	16.0	8.20	44.00
G2-511	01	5000	20.0	24.0	18.0	9.10	44.00
G2-4115	015	4000	20.0	27.0	20.0	11.00	44.00
G2-312	02	3000	20.0	30.0	22.0	13.00	44.00

TYPE G-3 MICA CAPACITOR

Cat. No.	Cap. mfd.	Test Volts Effective.	MAXIMUM OPERATING CURRENT IN AMPERES				List Price
			3000 KC	1000 KC	300 KC	100 KC	
G3-2045	00005	20000	5.1	2.4	.51	.15	\$66.00
G3-2531	0001	25000	7.0	4.0	1.4	.50	66.00
G3-20315	00015	20000	8.2	5.0	2.1	.85	73.70
G3-2032	0002	20000	9.1	6.0	2.7	1.10	73.70
G3-20325	00025	20000	10.0	6.5	3.6	1.40	73.70
G3-2033	0003	20000	10.0	7.0	4.0	1.60	73.70
G3-2033a	0004	20000	12.0	8.2	4.5	2.10	73.70
G3-2035	0005	20000	12.5	9.1	5.3	2.50	73.70
G3-2036	0006	20000	13.0	11.0	6.2	2.70	73.70
G3-2038	0008	20000	15.0	12.0	6.8	3.30	73.70
G3-2021	001	20000	15.5	14.0	8.2	3.60	73.70
G3-20212	0012	20000	16.0	15.0	8.5	4.30	73.70
G3-20215	0015	20000	17.0	16.0	9.5	4.70	73.70
G3-1522	002	15000	19.0	20.0	11.0	5.60	77.00
G3-15225	0025	15000	20.0	22.0	13.0	6.20	77.00
G3-1523	003	15000	21.0	24.0	14.0	6.80	82.50
G3-1524	004	15000	22.0	27.0	16.0	8.20	82.50
G3-1025	005	10000	24.0	30.0	18.0	9.10	82.50
G3-1026	006	10000	24.0	33.0	20.0	10.00	87.50
G3-1028	008	10000	24.0	36.0	22.0	11.00	90.50
G3-1011	01	10000	25.0	39.0	24.0	12.00	93.50
G3-512	02	5000	25.0	47.0	30.0	18.00	88.00
G3-313	03	3000	25.0	51.0	33.0	20.00	77.00

TYPE G-4 MICA CAPACITOR

G4-3043	00003	30000	3.0	1.0	.3	.10	\$93.50
G4-3045	00005	30000	4.0	1.0	.3	.10	99.00
G4-3531	0001	35000	8.0	5.3	2.1	.70	104.50
G4-30315	00015	30000	9.5	6.5	3.0	1.30	121.00
G4-30325	00025	30000	11.0	9.1	4.7	2.20	121.00
G4-3034	0001	30000	13.0	11.0	6.2	3.00	121.00
G4-3035	0005	30000	13.0	12.0	7.0	3.50	121.00
G4-3035	0005	30000	15.0	13.0	8.2	4.00	126.50
G4-3038	0008	30000	16.0	15.0	9.1	4.70	126.50
G4-3021	001	30000	18.0	16.0	10.0	5.10	126.50
G4-25215	0015	25000	20.0	20.0	12.0	6.20	104.50
G4-2022	002	20000	22.0	22.0	15.0	7.50	104.50
G4-20225	0025	20000	22.0	24.0	15.0	8.50	110.00
G4-2023	003	20000	24.0	27.0	18.0	9.10	110.00
G4-2024	004	20000	25.0	30.0	20.0	11.00	110.00
G4-1525	005	15000	27.0	33.0	22.0	12.00	118.00
G4-1526	006	15000	27.0	36.0	24.0	15.00	126.50
G4-1228	008	12000	30.0	39.0	27.0	16.00	132.00
G4-1011	01	10000	30.0	43.0	30.0	18.00	132.00
G4-612	02	6000	30.0	51.0	36.0	23.00	132.00
G4-514	04	5000	30.0	56.0	39.0	30.00	121.00

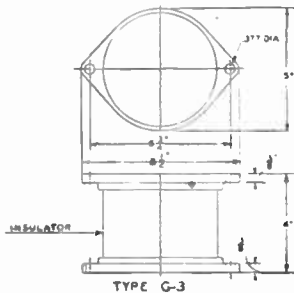
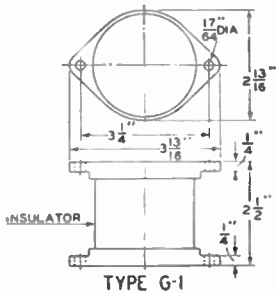

TYPES G-1, G-2, G-3:

For B characteristic use list price.
 For C characteristic add \$1.00 to the list price.
 For D characteristic add 2.50 to the list price.
 For E characteristic add 3.50 to the list price.
 For F characteristic add 5.00 to the list price.
 Characteristics D, E and F require 50% reduction in current rating.

TYPE G-4:

For B characteristic use list price.
 For C characteristic add \$2.50 to the list price.
 For D characteristic add 4.00 to the list price.
 For E characteristic add 7.50 to the list price.
 For F characteristic add 10.00 to the list price.
 Characteristics D, E and F require 50% reduction in current rating.

SEE "GENERAL INFORMATION" ON PAGE E-85

SANGAMO CAPACITORS



Type B



Type BE

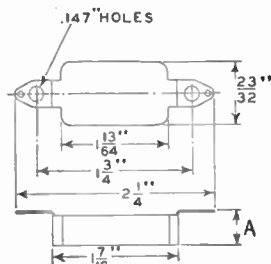

TYPE B

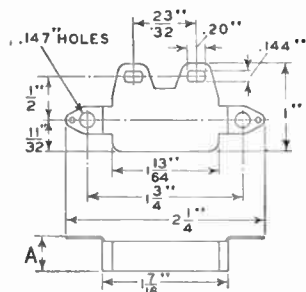

TYPE BE

TYPE B MICA CAPACITOR

TYPE B-10

Cat. No.	Cap. mfd.	DC Test	DC Wkg.	List Price
B-1450	.00005	1000V.	500V.	\$0.55
B-1470	.00007	1000V.	500V.	.55
B-1475	.000075	1000V.	500V.	.55
B-1310	.0001	1000V.	500V.	.55
B-1320	.0002	1000V.	500V.	.55
B-1325	.00025	1000V.	500V.	.55
B-1335	.00035	1000V.	500V.	.55
B-1350	.0005	1000V.	500V.	.55
B-1210	.001	1000V.	500V.	.60
B-1215	.0015	1000V.	500V.	.65
B-1220	.002	1000V.	500V.	.65
B-1225	.0025	1000V.	500V.	.70
B-1230	.003	1000V.	500V.	.75
B-1240	.004	1000V.	500V.	.80
B-1250	.005	1000V.	500V.	.85
B-1260	.006	1000V.	500V.	.95
B-1280	.008	1000V.	500V.	1.00
B-1110	.01	1000V.	500V.	1.10

TYPE B-25

B-2450	.00005	2500V.	1200V.	\$0.70
B-2470	.00007	2500V.	1200V.	.70
B-2475	.000075	2500V.	1200V.	.70
B-2310	.0001	2500V.	1200V.	.70
B-2320	.0002	2500V.	1200V.	.70
B-2325	.00025	2500V.	1200V.	.70
B-2335	.00035	2500V.	1200V.	.80
B-2350	.0005	2500V.	1200V.	.80
B-2210	.001	2500V.	1200V.	.90
B-2220	.002	2500V.	1200V.	1.05
B-2230	.003	2500V.	1200V.	1.30
B-2240	.004	2500V.	1200V.	1.50
B-2250	.005	2500V.	1200V.	1.70

TYPE B-50

B-5450	.00005	5000V.	2500V.	\$0.75
B-5310	.0001	5000V.	2500V.	.75
B-5325	.00025	5000V.	2500V.	.80
B-5350	.0005	5000V.	2500V.	.95
B-5210	.001	5000V.	2500V.	1.10
B-5220	.002	5000V.	2500V.	1.65

TYPES B AND BE:

Standard Tolerance plus or minus 20%.

For plus or minus 10% add 10% to the list price.

For plus or minus 5% add 20% to the list price.

For plus or minus 2% add 75% to the list price.

Mounting brackets for the Type BE condenser 20c list.

TYPE BE MICA CAPACITOR

TYPE BE-10

Cat. No.	Cap. mfd.	DC Test	DC Wkg.	List Price
BE-1450	.00005	1000V.	500V.	\$0.55
BE-1470	.00007	1000V.	500V.	.55
BE-1475	.000075	1000V.	500V.	.55
BE-1310	.0001	1000V.	500V.	.55
BE-1320	.0002	1000V.	500V.	.55
BE-1325	.00025	1000V.	500V.	.55
BE-1350	.0005	1000V.	500V.	.55
BE-1335	.00035	1000V.	500V.	.55
BE-1210	.001	1000V.	500V.	.60
BE-1215	.0015	1000V.	500V.	.65
BE-1220	.002	1000V.	500V.	.65
BE-1225	.0025	1000V.	500V.	.70
BE-1230	.003	1000V.	500V.	.75
BE-1240	.004	1000V.	500V.	.80
BE-1250	.005	1000V.	500V.	.85
BE-1260	.006	1000V.	500V.	.95
BE-1280	.008	1000V.	500V.	1.00
BE-1110	.01	1000V.	500V.	1.10

TYPE BE-15

BE-15450	.00005	1500V.	750V.	\$0.60
BE-15470	.00007	1500V.	750V.	.60
BE-15475	.000075	1500V.	750V.	.60
BE-15310	.0001	1500V.	750V.	.60
BE-15320	.0002	1500V.	750V.	.60
BE-15325	.00025	1500V.	750V.	.60
BE-15335	.00035	1500V.	750V.	.60
BE-15350	.0005	1500V.	750V.	.60
BE-15210	.001	1500V.	750V.	.70
BE-15215	.0015	1500V.	750V.	.75
BE-15220	.002	1500V.	750V.	.75
BE-15225	.0025	1500V.	750V.	.80
BE-15230	.003	1500V.	750V.	.85
BE-15240	.004	1500V.	750V.	.90
BE-15250	.005	1500V.	750V.	.95
BE-15260	.006	1500V.	750V.	1.05
BE-15280	.008	1500V.	750V.	1.10
BE-15110	.01	1500V.	750V.	1.25

TYPE BE-25

BE-2450	.00005	2500V.	1200V.	\$0.70
BE-2470	.00007	2500V.	1200V.	.70
BE-2475	.000075	2500V.	1200V.	.70
BE-2310	.0001	2500V.	1200V.	.70
BE-2320	.0002	2500V.	1200V.	.70
BE-2325	.00025	2500V.	1200V.	.70
BE-2335	.00035	2500V.	1200V.	.80
BE-2350	.0005	2500V.	1200V.	.80
BE-2210	.001	2500V.	1200V.	.90
BE-2220	.002	2500V.	1200V.	1.05
BE-2230	.003	2500V.	1200V.	1.30
BE-2240	.004	2500V.	1200V.	1.50
BE-2250	.005	2500V.	1200V.	1.70

TYPE BE-50

BE-5450	.00005	5000V.	2500V.	\$0.75
BE-5310	.0001	5000V.	2500V.	.75
BE-5325	.00025	5000V.	2500V.	.80
BE-5350	.0005	5000V.	2500V.	.95
BE-5210	.001	5000V.	2500V.	1.10
BE-5220	.002	5000V.	2500V.	1.65

SEE "GENERAL INFORMATION" ON PAGE K-85

Condensers

P.R. MALLORY & CO. Inc.
MALLORY

DRY ELECTROLYTIC TUBULAR ALUMINUM-CASED TYPES WB



• Type WB capacitors are supplied in hermetically sealed aluminum tubes with waxed cardboard outer sleeves. They are suitable for all general applications within the specifications shown below. Particularly noteworthy are their excellent low-temperature characteristics. They may be obtained with radial strap for mounting, if desired, by specifying type WBR.

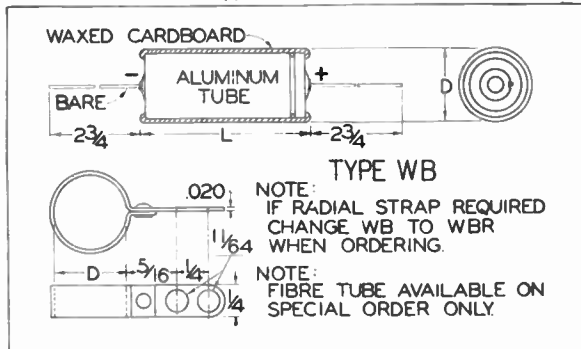

DRY ELECTROLYTIC TUBULAR "VICTORY LINE" TYPES VEC



• This standardized line, approved by the War Production Board and produced in conformance with American Standards Association specifications, is of dependable Mallory quality. You can use "Victory Line" condensers for radio service replacement with complete assurance that they will give long, trouble-free performance. Similar to former Mallory BR types, except fewer in number and no aluminum cases.

Capacity Mfd.	DC Working Volts	Catalog No.	List Price
100	25	VEC-1	\$0.85
10	50	VEC-2	.55
20	150	VEC-3	.75
20-20	150	VEC-4	1.30
50	150	VEC-5	1.10
20	250	VEC-6	1.00
10	450	VEC-7	.85
10-10	450	VEC-8	1.40
40	450	VEC-9	1.75
25	25	VEC-10	0.60

Cap. Mfd.	DC Wkg. Volts	SIZE		Max. Surge	120 Cycle Ohms	DC Ma.	Cap. Tol. -10%	RMS Ripple		Max. Temp.	Cat. No.	List Price
		D	L					Volts	Ma.			
10	25	1 1/16 x 1 1/2		40	27	.4	+200%	85° C.	WB22	\$3.60
25	25	1 1/16 x 1 1/2		40	11	.6	+200%	85° C.	WB26	.65
50	25	1 1/16 x 1 1/2		40	6	.8	+200%	85° C.	WB29	.75
10	50	1 1/16 x 1 1/2		70	27	.5	+200%	85° C.	WB32	.65
25	50	1 1/16 x 1 1/2		70	11	.8	+200%	3	45	85° C.	WB36	.70
50	50	1 1/16 x 1 1/2		70	6	1.0	+200%	3	90	85° C.	WB39	.85
8	150	1 1/16 x 1 1/2		200	25	.6	+100%	11	70	85° C.	WB41	.60
12	150	1 1/16 x 1 1/2		200	17	.8	+100%	11	100	85° C.	WB43	.65
16	150	1 1/16 x 1 1/2		200	13	.9	+100%	11	135	85° C.	WB44	.70
24	150	1 3/16 x 1 1/2		200	8	1.4	+100%	9.5	175	85° C.	WB46	.75
30	150	1 3/16 x 1 1/2		200	7	1.6	+100%	8.5	190	85° C.	WB47	.80
40	150	1 3/16 x 1 1/2		200	5	1.9	+100%	7	210	85° C.	WB48	.85
8	300	1 3/16 x 1 1/2		375	25	.7	+50%	14	85	85° C.	WB51	.75
12	300	1 3/16 x 1 1/2		375	17	.9	+50%	13	120	85° C.	WB53	.85
16	300	1 1/16 x 1 1/2		375	13	1.0	+50%	11.5	140	85° C.	WB54	1.00
24	300	1 1/16 x 1 1/2		375	8	1.6	+50%	10	140	85° C.	WB56	1.25
8	400	1 1/16 x 1 1/2		475	20	.8	+50%	16	100	85° C.	WB61	.85
12	400	1 1/16 x 1 1/2		475	14	1.0	+50%	14	130	85° C.	WB63	1.00
16	400	1 1/16 x 1 1/2		475	10	1.2	+50%	13	160	85° C.	WB64	1.25
8	450	1 1/16 x 1 1/2		525	20	.8	+50%	18	110	75° C.	WB71	.85
10	450	1 3/16 x 1 1/2		525	16	.9	+50%	16	125	75° C.	WB72	.90
12	450	1 1/16 x 1 1/2		525	14	1.0	+50%	15	140	75° C.	WB73	1.00
16	450	1 3/16 x 1 1/2		525	10	1.2	+50%	13	160	75° C.	WB74	1.25

P.R. MALLORY & CO. Inc. MALLORY

Condensers

Dry Electrolytic "Bathtub" Types

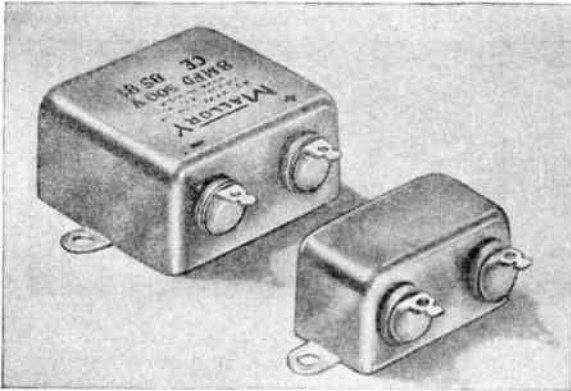

• Types BS and BT capacitors are WB tubulars encased in steel "bathtub" containers for double seal and mechanical strength. The added safety factor obtained by this construction makes these units ideal for the toughest type of service, including high altitudes, vibration, and extreme temperature. Normally supplied with two side terminals and unit internally insulated from case.

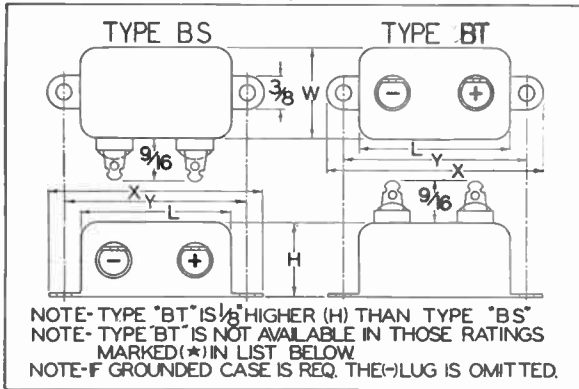

PAPER DIELECTRIC TUBULAR "VICTORY LINE" TYPES VPC

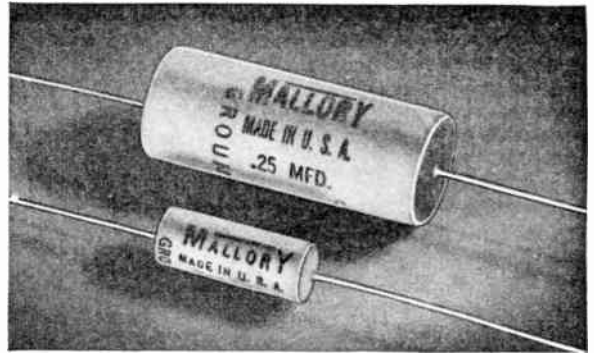

• Standardized paper by-pass line, resulting from the wartime necessity of reducing all lines of replacement parts to a minimum. Approved by the War Production Board, and produced in conformance with the American Standards Association specifications. Ratings have been reduced to a minimum, but Mallory quality and dependability remain the same.

Capacity Mfd.	DC Working Volts	Catalog No.	List Price
0.00025	600	VPC-1	.20
0.001	600	VPC-2	.20
0.002	600	VPC-3	.20
0.005	600	VPC-4	.20
0.01	600	VPC-5	.20
0.02	600	VPC-6	.20
0.05	600	VPC-7	.25
0.1	600	VPC-8	.30
0.25	600	VPC-9	.45

Cap. Mfd.	DC Wkg. Volts	Size					Max. Surge	120 Cycle Ohms	DC Ma.	Cap. Tol. -10°C	RMS Ripple		Max. Temp.	Cat. No.	List Price
		H	W	L	Y	X					Volts	Ma.			
10	25	$\frac{3}{8}$	1	$1\frac{1}{4}$	$2\frac{1}{8}$	$2\frac{1}{2}$	40	27	.4	+200%	85° C.	BS22	\$2.10
25	25	$\frac{3}{8}$	1	$1\frac{1}{4}$	$2\frac{1}{8}$	$2\frac{1}{2}$	40	11	.6	+200%	85° C.	BS26	2.20
50	25	$\frac{3}{8}$	1	$1\frac{1}{4}$	$2\frac{1}{8}$	$2\frac{1}{2}$	40	6	.8	+200%	85° C.	BS29	2.55
10	50	$\frac{3}{8}$	1	$1\frac{1}{4}$	$2\frac{1}{8}$	$2\frac{1}{2}$	70	27	.5	+200%	85° C.	BS32	2.25
25	50	$\frac{3}{8}$	1	$1\frac{1}{4}$	$2\frac{1}{8}$	$2\frac{1}{2}$	70	11	.8	+200%	3	45	85° C.	BS36	2.40
50	50	$\frac{3}{8}$	1	$1\frac{1}{4}$	$2\frac{1}{8}$	$2\frac{1}{2}$	70	6	1.0	+200%	3	90	85° C.	BS39	2.70
8	150	$\frac{3}{8}$	1	$1\frac{1}{4}$	$2\frac{1}{8}$	$2\frac{1}{2}$	200	25	.6	+100%	11	70	85° C.	BS41	2.10
12	150	$\frac{3}{8}$	1	$1\frac{1}{4}$	$2\frac{1}{8}$	$2\frac{1}{2}$	200	17	.8	+100%	11	100	85° C.	BS43	2.20
16	150	$\frac{3}{8}$	1	$1\frac{1}{4}$	$2\frac{1}{8}$	$2\frac{1}{2}$	200	13	.9	+100%	11	135	85° C.	BS44	2.40
24	150	$\frac{3}{8}$	1	$1\frac{1}{4}$	$2\frac{1}{8}$	$2\frac{1}{2}$	200	8	1.4	+100%	9.5	175	85° C.	BS46	2.55
30	150	$\frac{3}{8}$	1	$1\frac{1}{4}$	$2\frac{1}{8}$	$2\frac{1}{2}$	200	7	1.6	+100%	8.5	190	85° C.	BS47	2.65
40	150	1	$1\frac{1}{4}$	$1\frac{3}{4}$	$2\frac{1}{8}$	$2\frac{1}{2}$	200	5	1.9	+100%	7	210	85° C.	BS48*	2.75
8	300	$\frac{7}{8}$	1	$1\frac{1}{4}$	$2\frac{1}{8}$	$2\frac{1}{2}$	375	25	.7	+50%	14	85	85° C.	BS51	2.30
12	300	1	$1\frac{1}{4}$	$1\frac{3}{4}$	$2\frac{1}{8}$	$2\frac{1}{2}$	375	17	.9	+50%	13	120	85° C.	BS53*	2.75
16	300	1	$1\frac{1}{4}$	$1\frac{3}{4}$	$2\frac{1}{8}$	$2\frac{1}{2}$	375	13	1.0	+50%	11.5	140	85° C.	BS54*	2.90
24	300	$1\frac{1}{8}$	$1\frac{1}{4}$	$1\frac{3}{4}$	$2\frac{1}{8}$	$2\frac{1}{2}$	375	8	1.6	+50%	10	180	85° C.	BS56*	3.15
8	400	1	$1\frac{1}{4}$	$1\frac{3}{4}$	$2\frac{1}{8}$	$2\frac{1}{2}$	475	20	.8	+50%	16	100	85° C.	BS61*	2.75
12	400	$1\frac{1}{8}$	$1\frac{1}{4}$	$1\frac{3}{4}$	$2\frac{1}{8}$	$2\frac{1}{2}$	475	14	1.0	+50%	14	130	85° C.	BS63*	2.90
16	400	$1\frac{1}{8}$	$1\frac{1}{4}$	$1\frac{3}{4}$	$2\frac{1}{8}$	$2\frac{1}{2}$	475	10	1.2	+50%	13	160	85° C.	BS64*	3.15
8	450	1	$1\frac{1}{4}$	$1\frac{3}{4}$	$2\frac{1}{8}$	$2\frac{1}{2}$	525	20	.8	+50%	18	110	75° C.	BS71*	2.75
10	450	1	$1\frac{1}{4}$	$1\frac{3}{4}$	$2\frac{1}{8}$	$2\frac{1}{2}$	525	16	.9	+50%	16	125	75° C.	BS72*	2.85
12	450	$1\frac{1}{8}$	$1\frac{1}{4}$	$1\frac{3}{4}$	$2\frac{1}{8}$	$2\frac{1}{2}$	525	14	1.0	+50%	15	140	75° C.	BS73*	2.90
16	450	$1\frac{1}{8}$	$1\frac{1}{4}$	$1\frac{3}{4}$	$2\frac{1}{8}$	$2\frac{1}{2}$	525	10	1.2	+50%	13	160	75° C.	BS74*	3.15
4	500	$\frac{7}{8}$	$1\frac{3}{4}$	2	$2\frac{3}{8}$	$2\frac{1}{2}$	700	40	.5	+50%	25	80	85° C.	BS80*	3.90
8	500	1	$1\frac{3}{4}$	2	$2\frac{3}{8}$	$2\frac{1}{2}$	700	20	.8	+50%	22	140	85° C.	BS81*	4.25

Condensers

P. R. MALLORY & CO. Inc
MALLORY

PAPER DIELECTRIC TUBULAR TYPES TP AND OW

TP—Wax Impregnated Wax Filled.

OW—Oil Impregnated Wax Filled.

Cap. Mfd.	200 V. DC			400 V. DC			600 V. DC			1000 V. DC			1600 V. DC		
	Cat. No.	S	List Price	Cat. No.	S	List Price	Cat. No.	S	List Price	Cat. No.	S	List Price	Cat. No.	S	List Price
.0001							TP401	1	\$0.20						
.00025							TP402	1	.20				OW340	4	\$0.45
.0005							TP403	1	.20						
.001							TP404	1	.20	TP455	1	\$0.25	OW341	5	.45
.002							TP405	1	.20	TP456	2	.25	OW331	5	.45
.003							TP406	1	.20	TP457	4	.25	OW342	6	.45
.004							TP407	1	.20	TP458	4	.25	OW343	6	.45
.005							TP408	2	.20	TP459	4	.25	OW332	6	.45
.006							TP409	2	.20	TP460	4	.25	OW344	8	.45
.007							TP445	3	.20	TP461	5	.25	OW345	8	.45
.008							TP450	3	.20	TP462	5	.25	OW333	8	.45
.01				TP421	2	\$0.20	TP410	3	.20	TP434	8	.40	OW334	10	.45
.015				TP400	2	.20	TP411	4	.20	TP463	8	.40	OW335	11	.45
.02				TP423	4	.20	TP412	5	.20	TP435	9	.40	OW336	11	.45
.025							TP451	5	.25						
.03				TP424	6	.20	TP413	7	.25	TP464	9	.45	OW337	15	.45
.04				TP425	6	.20	TP414	8	.25	TP465	10	.45	OW338	19	.50
.05	TP436	7	\$0.20	TP426	8	.20	TP415	8	.25	TP437	13	.45	OW339	21	.55
.06				TP427	8	.25	TP416	8	.30	TP466	13	.45			
.075							TP452	9	.30	TP467	14	.50			
.1	TP438	9	.25	TP428	9	.25	TP418	12	.30	TP439	18	.60			
.15							TP417	14	.40						
.2				TP429	11	.30	TP419	15	.45						
.25	TP440	17	.30	TP430	14	.30	TP420	16	.45						
.3				TP444	14	.40	TP453	16	.55						
.4				TP442	15	.45	TP454	21	.60						
.5	TP441	18	.45	TP431	20	.45	TP432	22	.60						
1.0	TP443	22	.60	TP422	23	.60	TP433	24	.60						

TYPES TP AND OW

● Mallory tubular paper condensers are color coded for quick identification of voltage rating. Colored band at the "outside foil" or ground end tells the story.

- 200 volts—red
- 400 volts—yellow
- 600 volts—blue
- 1000 volts—gold
- 1600 volts—copper
- 2000 volts—silver

Mallory Type TP condensers are wax-impregnated and wax sealed at the ends, the accepted standard construction for maximum protection from atmospheric conditions.

Mallory Type OW condensers are oil-impregnated and wax sealed, providing extra safety factor for voltage applications higher than usually recommended for the wax impregnated type.

DUAL TP CONDENSERS

● Mallory Dual TP units are packed 5 to a carton. Outside foil is common and connected to mounting strap.

METAL CASED OIL-IMPREGNATED CONDENSERS TYPE OT

● Mallory OT tubular condensers represent the finest quality obtainable. Impregnated in oil and housed in hermetically sealed leak-proof metal tubes, they are ideal for vibrator buffers and high voltage coupling applications.

All OT units are externally insulated with cardboard tubes and supplied with a mounting strap which may be removed if not required. Wire leads 2 3/8 inches long. Packed in individual cartons.

SIZE CHART

S No.	Size	Box	S No.	Size	Box
1	1 x 5/16	10	13	1 7/8 x 3/4	10
2	1 x 3/8	10	14	1 7/8 x 11/16	10
3	1 1/16 x 7/16	10	15	1 7/8 x 3/4	10
4	1 1/4 x 3/8	10	16	1 7/8 x 13/16	10
5	1 1/4 x 7/16	10	17	2 x 3/4	10
6	1 1/4 x 9/16	10	18	2 x 7/8	5
7	1 1/4 x 7/8	10	19	2 1/8 x 13/16	5
8	1 1/2 x 1/2	10	20	2 1/8 x 7/8	5
9	1 1/2 x 9/16	10	21	2 1/8 x 1	5
10	1 1/2 x 5/8	10	22	2 1/8 x 1	5
11	1 3/8 x 3/4	10	23	2 1/8 x 1 1/4	5
12	1 11/16 x 5/8	10	24	2 1/8 x 1 1/4	5

All diameters are plus or minus .02"

Listing gives rating, catalog number and list price. Column S refers to size and standard package quantity as outlined above. Wire leads approximately 2 3/8 inches long.

Certain capacities in 200 and 400-volt ratings are not listed because they are too small in size for practical manufacture. If such ratings are required, always use the next higher voltage rating. There is no premium in price.

Capacity Mfd.	Volts DC	Size	Catalog Number	List Price
.01-.01	400	1 1/2 x 7/16	TP446	\$0.45
.05-.05	400	1 7/8 x 3/4	TP447	.50
.1-.1	400	2 1/4 x 11/16	TP448	.55
.25-.25	200	2 1/2 x 3/4	TP449	.60

Capacity Mfd.	Volts DC	Size	Catalog Number	List Price
.002	1600	1 1/4 x 5/8	OT370	\$0.55
.003	1600	1 1/4 x 5/8	OT377	.55
.005	1600	1 1/4 x 5/8	OT371	.55
.008	1600	1 1/4 x 5/8	OT372	.60
.01	1600	1 1/4 x 5/8	OT373	.70
.0125	1600	1 1/4 x 5/8	OT374	.75
.015	1600	1 3/4 x 5/8	OT375	.75
.02	1600	1 3/4 x 5/8	OT376	.75
.0025	2000	1 3/8 x 9/16	OT458	.75
.005	2000	1 11/16 x 11/16	OT459	.80
.0075	2000	1 7/8 x 11/16	OT460	.85
.01	2000	1 7/8 x 11/16	OT461	.90
.0125	2000	2 1/4 x 11/16	OT462	.90
.015	2000	2 1/4 x 11/16	OT363	.90
.02	2000	2 3/4 x 13/16	OT464	1.00
.03	2000	2 3/8 x 13/16	OT465	1.05
.04	2000	2 5/8 x 13/16	OT466	1.05
.05	2000	2 5/8 x 13/16	OT467	1.10



MALLORY

P. R. MALLORY & CO. Inc.

Condensers

DRY ELECTROLYTIC COMPACT VERTICAL TYPES FP* AND WP

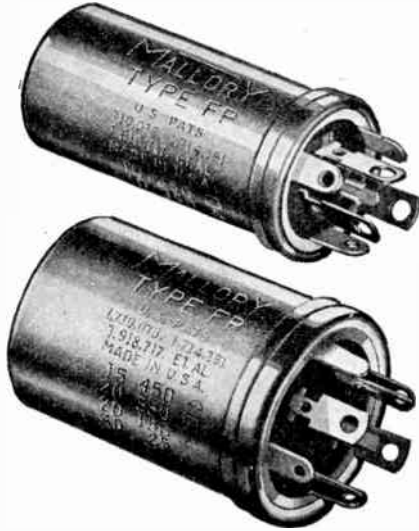

• These capacitors, long considered standard for metal encased units, are ideal for many types of service.

Light in weight, compact, and provided with an integral mounting feature, they save assembly space and time. Mounting brackets or accessories are not required where the chassis has been punched with the characteristic FP slotted design.

Reference to the chart below provides all characteristics needed for design requirements. While thousands of these units have given excellent service under extreme conditions of high altitudes and humidity, from an acceptance test standpoint, the hermetical seal provided may not prove as dependable as that used in the type BS. The test specification is the limiting factor rather than the service.

While other ratings are available, those listed were carefully selected to cover a maximum number of requirements with a minimum of units. Note the following examples:

1. The $\frac{3}{8}$ " size is not listed because the mounting feature is not as rigid as in the 1" size. Tubular type WB is best for these small sizes.
2. A dual 10 mfd. unit is listed in several instances rather than a single 20 mfd. unit, because of its greater flexibility—the dual sections to be paralleled when 20 mfd. is desired. The same procedure holds for triple units.
3. The dual and triple 50-volt units are listed in anticipation of 24-volt tube circuits. Physical dimension details are shown on the opposite page.

Special mounting wrench A-93436 is available for twisting the mounting ears when assembling to chassis or mounting wafers.

*Trade Mark Registered.

Capacity Mfd.	DC Wkg. Volts	Cat. No.	SIZE		Max. Surge	120 Cycle Ohms	DC Ma.	Cap. Tol. —10%	RMS RIPPLE (1st Section Only)		Max. Wkg. Temp.	List Price	
			D	L					Volts	Ma.			
3000	10	WP032	1 3/8	x 3	15	.4	3.0	+100%	.4	1200	85° C.	\$4.50	
1000	15	WP039	1	x 3	20	1.2	2.0	+100%	.9	600	85° C.		
2000	15	WP041	1 3/8	x 3	20	.6	2.5	+100%	.5	800	85° C.		4.50
500	25	WP057	1	x 3	40	1.4	1.5	+100%	1.0	500	85° C.		
1000	25	WP059	1 3/8	x 3	40	.7	2.5	+100%	1.0	750	85° C.		4.20
50-50	50	WP203	1	x 2	70	8.0	1.0	+200%	3.0	45	85° C.	1.45	
30-30-30	50	WP303	1	x 2	70	12.0	.9	+200%	3.0	90	85° C.		
150	50	WP062	1	x 2	70	2.0	1.8	+200%	2.3	250	85° C.	1.95	
500	50	WP065	1 3/8	x 3	70	1.4	2.5	+200%	1.5	700	85° C.		
50	150	WP115	1	x 2	200	6.0	2.3	+100%	6.0	230	85° C.	1.15	
30-30	150	WP211	1	x 2	200	10.0	1.6	+100%	9.0	200	85° C.		
20-20-20	150	WP354	1	x 2	200	15.0	1.2	+100%	12.0	180	85° C.	1.45	
(30-30-30) (40)	(150) (25)	WP408	1 3/8	x 2	200	10.0	1.6	+100%	9.0	200	85° C.		
40-40-40	150	WP357	1	x 3	200	7.5	1.9	+100%	7.0	220	85° C.	1.90	
10-10	300	WP222	1	x 2	375	24.0	.8	+50%	20.0	150	85° C.	1.20	
10-10-10	300	WP368	1	x 2	375	24.0	.8	+50%	20.0	150	85° C.		
(10-10-10) (20)	(300) (25)	WP411	1 3/8	x 2	375	24.0	.8	+50%	20.0	150	85° C.	1.90	
20-20	300	WP227	1	x 3	375	12.0	1.4	+50%	12.0	180	85° C.		
(20-20) (20)	(300) (25)	WP323	1	x 3	375	12.0	1.4	+50%	12.0	180	85° C.	1.65	
125	350	WP140	1 3/8	x 3	425	2.0	3.5	+50%	4.5	450	85° C.		
10	400	WP152	1	x 2	475	24.0	.9	+50%	20.0	150	85° C.	1.10	
20	400	WP154	1	x 2	475	12.0	1.6	+50%	12.0	180	85° C.		
15-15	400	WP254	1	x 3	475	16.0	1.2	+50%	15.0	170	85° C.	1.75	
(15-15) (40)	(400) (25)	WP349	1	x 3	475	16.0	1.2	+50%	15.0	170	85° C.		
10-10-10	400	WP399	1	x 3	475	24.0	.9	+50%	20.0	150	85° C.	2.00	
(20-20-20) (20)	(400) (25)	WP455	1 3/8	x 3	475	12.0	1.6	+50%	12.0	180	85° C.		
15	450	FP143	1	x 2	525	16.0	1.2	+50%	15.0	170	65° C.	1.20	
10-10	450	FP231	1	x 2	525	24.0	.9	+50%	20.0	150	65° C.		
(10-10) (20)	(450) (25)	FP332	1	x 2	525	24.0	.9	+50%	20.0	150	65° C.	1.60	
10-10-10	450	FP389	1	x 3	525	24.0	.9	+50%	20.0	150	65° C.		
20-20	450	FP234	1	x 3	525	12.0	1.6	+50%	12.0	180	65° C.	1.90	
(20-20) (20)	(450) (25)	FP339	1	x 3	525	12.0	1.6	+50%	12.0	180	65° C.		
20	25	(Where included with the above ratings)			40	35.0	.4	+200%	...		(Same as other included sections)		
40	25				40	17.0	.6	+200%	...				

Condensers

P. R. MALLORY & CO. Inc.
MALLORY

DRY ELECTROLYTIC COMPACT VERTICAL TYPES FP AND WP Hardware for Types FP and WP

Item	Description	Catalog Number	List Price	Item	Description	Catalog Number	List Price
Wrench	Special for FP Mounting	A-93436	\$0.75	Mounting Clip	For 3/4" FP	A-93434-1	\$0.10
Bakelite Washer	For 3/4" FP	A-93416-1	.05	Mounting Clip	For 1" FP	A-93443-1	.10
Bakelite Washer	For 1 1/8" FP	A-93410-1	.05	Mounting Clip	For 1 3/8" FP	A-93435-1	.10
Bakelite Washer	For 1 3/8" FP	A-93423-1	.05	Insulating Tube	For 3/4" x 2" FP	A-93280-6	.05
Metal Washer	For 3/4" FP	A-93431-1	.05	Insulating Tube	For 1" x 2" FP	A-93280-3	.05
Metal Washer	For 1 1/8" FP	A-91401-1	.05	Insulating Tube	For 1 1/8" x 2" FP	A-93280-2	.05
Metal Washer	For 1 3/8" FP	A-93421-1	.05	Insulating Tube	For 1 3/8" x 2" FP	A-93280-5	.05
				Insulating Tube	For 1 3/8" x 3" FP	A-93280-4	.05

DESCRIPTION	3/4" CONTAINER	1" CONTAINER	1 1/8" CONTAINER
Mounting End Detail and Important Dimensions See elsewhere on this page for terminal lug sequence.			
Perspective View of Container and Terminal Detail Mounting ring is negative terminal in all cases. All multiple units are common cathode construction. Black cardboard insulating tubes are available for all container sizes and may be secured assembled to container when required.			
Chassis Layout for Direct Mounting Drawings show simplified punch and die design for direct mounting to chassis. If greater clearance is required design punch and die in accordance with metal plate layout below.			
Metal Plate for Grounded Mounting These plates are cadmium plated, and serve as an alternative mounting to a directly punched chassis. Part A-93403-1 for 1" containers fits standard 1 1/4" tube socket holes.	Part A-93431-1 	Part A-93403-1 	Part A-93424-1
Bakelite Plate for Insulated Mounting (Similar to metal plates.)	Part A-93416-1 1/2" thick Punch Chassis 3/4" to 1"	Part A-93410-1 1/2" thick Punch Chassis 1" to 1 1/8"	Part A-93423-1 1/2" thick Punch Chassis 1 1/8"
Horizontal Mounting Clip These clips are similar to those used for cartridge fuses. They are cadmium plated and provided with a locating extrusion to prevent rotation.	 Part A-93434-1	 Part A-93443-1	 Part A-93435-1

TERMINAL LUG SEQUENCE

The location of terminals has been completely standardized. Unwanted terminals are deleted leaving a blank, though sealed, hole in the cover.

BLANK EAR

BLANK EAR

All 1" diameter containers have the following terminal lug sequence:

- Singles — lug (No. 3) (— Blank)
- Duals — lug (No. 1) highest V.
- lug (No. 2) lowest V.
- Triples — lug (No. 1) highest V.
- lug (No. 2) medium V.
- lug (No. 3) lowest V.

All 1 1/8" diameter containers have the following terminal lug sequence:

- Singles — lug (No. 4) (— Blank)
- Duals — lug (No. 1) highest V.
- lug (No. 3) lowest V.
- Triples — lug (No. 1) highest V.
- lug (No. 2) medium V.
- lug (No. 3) lowest V.
- lug (No. 4) highest V.
- lug (No. 2) near high V.
- lug (No. 3) near high V.
- lug (No. 4) lowest V.

For Identical Voltages the Above Sequence Will be Based on the Highest Capacity

CIRCULAR MOUNTING STRAPS

TANGENTIAL

RADIAL

3/4" Dia. Part A-91738-1 3/4" Dia. Part A-91737-1
 1" Dia. Part A-91738-2 1" Dia. Part A-91737-2

Tangential and Radial Mounting Straps
 Available assembled to the container for 3/4" and 1" diameter. The preferred location of the strap is against the bead as shown.

P.R. MALLORY & CO. Inc. MALLORY

Condensers

CARDBOARD TUBULAR WOODEN NECK TYPES RS, RM, HD, HS

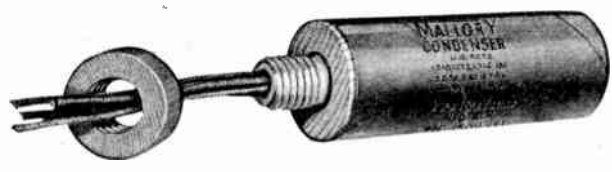

Mallory Wooden Neck dry electrolytics were designed to replace original aluminum can extruded neck condensers of both the dry and wet type. Using a minimum of raw materials vital for war production this new condenser employs an impregnated cardboard tube container and threaded wooden neck. An insulating washer and solid lug terminal are packed with each condenser for convenience in replacing original units equipped with lugs.

Capacity Mfd.	Working Volts DC	Size	Catalog No.	List Price
8	450	1 3/8 x 2 7/16	RS212	\$1.30
8	450	1 1/2 x 2 1/2	RS213	1.30
12	450	1 3/8 x 2 7/16	RS214	1.70
12	450	1 1/2 x 2 1/2	RS215	1.70
16	450	1 1/2 x 2 1/2	RS216	1.90
16	450	1 3/8 x 2 7/16	RS217	1.90
20	450	1 3/8 x 2 7/16	RS219	2.10
30	450	1 1/2 x 2 1/2	RS223	2.40
8	500	1 1/2 x 2 1/2	HD683	2.10
4	600	1 3/8 x 2 7/16	HS691	2.25
8	600	1 3/8 x 2 7/16	HS693	3.15
8-8	450	1 3/8 x 3 1/8	RM262	1.95
8-8-8	450	1 3/8 x 4 1/8	RM265	2.80

CARDBOARD CARTON TYPES CS, CM



Capacity Mfd.	Wkr. V. DC	Max. Surge V.	Size	Catalog No.	List Price
CS—SINGLE SECTION TYPE					
2	450	525	1/2 x 3/8 x 2 7/16	CS130	\$0.80
4	450	525	5/8 x 1/2 x 2 7/16	CS131	.90
8	450	525	3/4 x 1 x 2 7/16	CS133	1.15
16	450	525	1 x 1 1/4 x 2 7/16	CS136	1.75
CM—SEPARATE SECTION TYPE					
16-16	250	300	1 3/4 x 1 x 2 5/8	CM164	\$2.20
4-4	450	525	3/4 x 1 1/2 x 2 5/8	CM170	1.45
8-8	450	525	1 3/4 x 1 x 2 5/8	CM172	1.80
8-8-8	450	525	1 1/2 x 1 1/4 x 3	CM175	2.65

HEAVY DUTY TYPES HD AND HS

Type HD and HS condensers are ideal for all heavy-duty filter applications. Designed primarily for public address and theater applications, they may be used wherever extra safety factor is desirable.

Capacity Mfd.	Wkr. Volts DC	Max. Surge Volts	Size	Catalog Number	List Price
8	500	550	1 1/8 x 1 1/2 x 2 7/16	HD682	\$1.80
4	600	700	1 1/4 x 1 1/2 x 3	HS690	2.10
8	600	700	1 1/2 x 1 1/2 x 3	HS692	2.95

DRY ELECTROLYTIC HEAVY-DUTY TYPES HC AND EPB

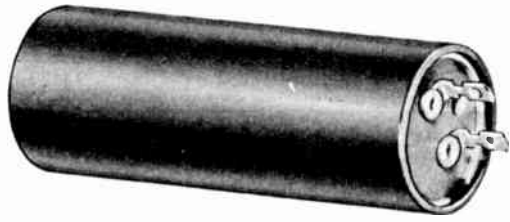

Type HC capacitors are high-capacity, low-voltage units supplied in round hermetically-sealed Bakelite containers. All units listed are stocked.

The Bakelite containers provide excellent insulation from bracket or ground.

Type EPB capacitors are supplied in Bakelite containers and are especially designed for high voltage applications where low temperatures will be encountered. These units are carried in stock for small quantity shipments.

Capacity Mfd.	DC Working Volts	Catalog Number	SIZE		Max. Surge	120 Cycle Ohms	DC Ma.	Cap. Tol. — 10%	RMS RIPPLE (1st Section Only)		Max. Working Temp.	List Price
			D	H					Volts	Ma.		
1000	12	HC1210	1 1/8	3 3/4	18	.8	2.0	+100%	.75	500	85° C.	\$3.00
2000	12	HC1220	1 1/8	3 3/4	18	.5	2.5	+100%	.65	750	85° C.	3.90
4000	12	HC1240	2 1/8	3 3/4	18	.3	3.5	+100%	.8	1500	85° C.	6.60
500	25	HC2505	1 1/8	3 3/4	40	1.0	2.0	+100%	1.0	750	85° C.	2.70
1000	25	HC2510	1 1/8	3 3/4	40	.6	2.5	+100%	1.0	1000	85° C.	4.20
2000	25	HC2520	2 1/8	3 3/4	40	.2	3.0	+100%	1.0	1500	85° C.	7.20
4000	25	HC2540	2 1/8	4 3/8	40	.4	4.0	+100%	1.0	2500	85° C.	10.00
8	500	EPB140	1 1/8	4 3/8	700	20.0	.8	+50%	22.0	140	85° C.	3.90
8	600	EPB141	1 1/8	4 3/8	800	20.0	.8	+50%	22.0	140	85° C.	4.50

HARDWARE and ACCESSORIES for all Types of Dry Electrolytic Condensers

Description	Catalog Number	List Price	Description	Catalog Number	List Price
Mallory Terminal Connector	A-016	\$0.05	Ring Clamp for 1 3/8" Round Unit	106-1	\$0.10
Washer for Clamp Mounting 1" Cans	A-017	.05	Ring Clamp for 1 1/2" Round Unit	107-1	.15
Washer for 3/8 Hole Mounting 1" Cans	015-1	.05	Ring Clamp for 2 1/2" Round Unit	108-1	.20
Washer for Spade Bolt Mounting 1" and 1 1/8" Cans	015-2	.05	Ring Clamp for 3" Round Unit	109-1	.20
Ring Clamp for 1" Round Unit	105-1	.10	Special Mounting Bracket	104-1	.15

Condensers

P. R. MALLORY & CO. Inc.
MALLORY

TRANSMITTING AND TELEVISION TYPES TZ AND TX

Capacity Mfd.	Working V. DC	Size			Catalog Number	List Price
		A	B	C		
SMALL ROUND CAN—TYPE TZ						
2	600	3	1 1/4		TZ332	\$3.30
4	600	4 1/4	1 1/4		TZ383	4.50
1	1000	2 1/4	1 1/4		TZ384	3.00
2	1000	4 1/4	1 1/4		TZ385	3.90
4	1000	3 7/8	2		TZ389	5.70
.5	1500	3 1/4	1 3/8		TZ386	3.60
1.0	1500	5 1/4	1 3/8		TZ387	3.90
2	1500	4 1/4	2		TZ388	5.70
RECTANGULAR CAN—TYPE TX						
1	600	2 1/4	1 3/4	1	TX801	\$4.20
2	600	2 1/4	1 3/4	1	TX802	5.10
4	600	4 1/4	1 3/4	1	TX803	6.60
.5	1000	2	1 3/4	1	TX822	3.60
1	1000	2 1/4	1 3/4	1	TX804	4.50
2	1000	3 1/4	1 3/4	1	TX805	6.00
4	1000	1 1/4	2 1/2	1 3/8	TX806	7.50
1	2000	4	1 3/4	1	TX810	6.60
2	2000	4 1/4	2 1/2	1 3/8	TX811	7.80
4	2000	4	3 1/4	1 1/4	TX823	10.80
1	2500	4	2 1/2	1 1/8	TX812	9.60
2	2500	4 1/4	2 1/2	1 1/8	TX813	15.60
1	3000	4 1/4	3 1/4	1 1/4	TX814	14.40
2	3000	4 1/4	3 3/4	1 3/8	TX815	18.00
2	4000	1 1/4	5 1/4	3 1/2	TX827	33.50
4	4000	8 1/4	5 1/4	3 1/2	TX828	48.00
1	5000	4 1/4	5 1/4	3 1/2	TX818	30.00
2	5000	8 1/4	5 1/4	3 1/2	TX819	39.40
.5	6000	4 1/4	5 1/4	3 1/2	TX820	48.00
1.0	6000	7	5 1/4	3 1/2	TX821	60.00

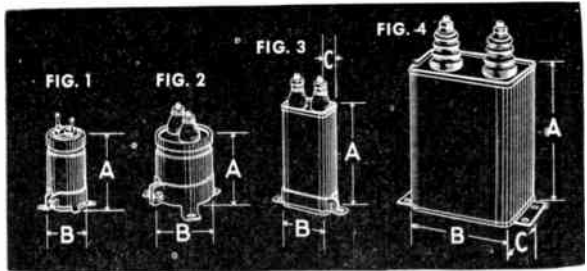
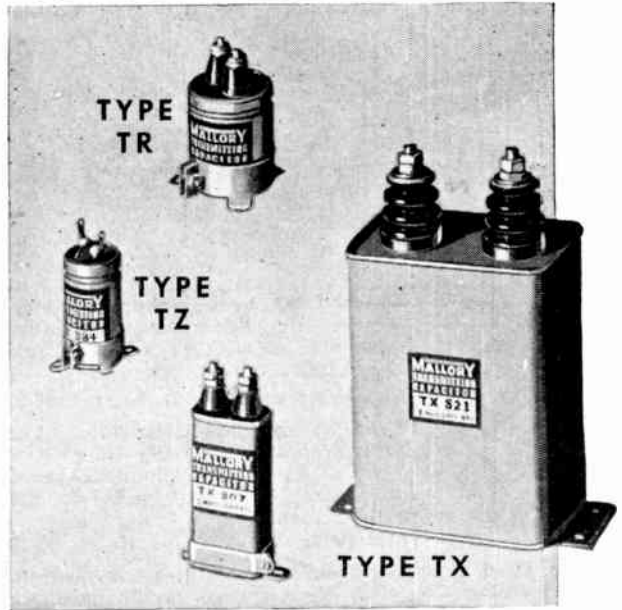

CASED BYPASS TYPES CB

Cap. Mfd.	Wkg. V. DC	Size				Fig.	Catalog Number	List Price
		A	B	C	D			
.1	400	1 1/4	7/8	3/4	2 1/8	1	CB301	\$0.80
.25	400	1 1/4	7/8	3/4	2 1/8	1	CB302	.90
.5	400	2	1 1/4	7/8	2 3/8	1	CB303	1.15
1.0	400	2	x 2	x 1	2 3/8	1	CB304	1.50
2 x .1	400	2	x 2	x 1 1/4	2 3/8	1	CB305	1.90
2 x .25	400	2	x 2	x 1 1/4	2 3/8	2	CB306	1.00
2 x .5	400	2	x 2	x 1	2 3/8	2	CB307	1.20
3 x .1	400	1 1/4	x 1 1/4	x 7/8	2 1/8	2	CB308	1.50
3 x .25	400	2	x 2	x 1	2 3/8	2	CB309	1.30
3 x .5	400	2	x 2	x 1 1/8	2 3/8	2	CB310	1.60
4 x .1	400	2	x 2	x 1 3/8	2 3/8	2	CB311	2.25
.1	600	2	x 1 3/4	x 7/8	2 3/8	3	CB312	1.70
.25	600	1 3/4	x 7/8	x 3/4	2 1/8	1	CB313	.90
.5	600	1 3/4	x 1	x 7/8	2 1/8	1	CB314	1.10
1	600	2	x 1 3/4	x 7/8	2 3/8	1	CB315	1.45
2 x .1	600	2	x 1 3/4	x 7/8	2 3/8	2	CB316	1.10
3 x .1	600	2	x 1 3/4	x 7/8	2 3/8	2	CB317	1.90

• Cased bypass single units (Fig. 1) have both terminals insulated from case. Dual units (Fig. 2) have center lug common and container insulated from all sections. Triple units (Fig. 2) have common grounded to case. Quad unit (Fig. 3) has common grounded to case.

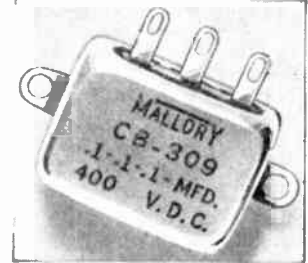

UNCASED TYPES UB

Capacity Mfd.	Wkg. V. DC	Size			Catalog Number	List Price
		A	B	C		
1	200	2 1/8	1 1/8	1/16	UB351	\$0.75
2	200	2 1/8	1 1/8	1/16	UB352	1.15
4	200	2 1/8	2 1/8	1 1/8	UB353	2.05
1	400	2 1/8	1 1/8	1/16	UB354	.90
2	400	2 1/8	1 1/8	1/16	UB355	1.40
4	400	4 1/8	1 1/8	1/16	UB356	2.40
.5	600	2 1/8	1 1/8	1/16	UB357	.75
1.0	600	2 1/8	1 1/8	1/16	UB358	1.10
2.0	600	2 1/8	2 1/8	1 1/8	UB359	1.65
1	800	4 1/8	1 1/8	1/16	UB360	1.50
2	800	4 1/8	2 1/8	1/16	UB361	2.40
1	1000	4 1/8	1 1/8	1/16	UB362	1.80
2	1000	4 1/8	2 1/8	1/16	UB363	3.00

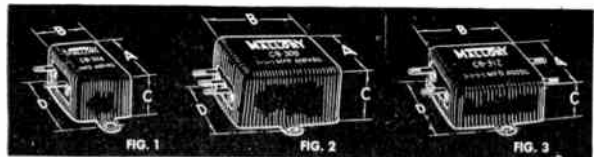

• Uncased condensers are convenient for replacing sections in paper condensers, filter blocks and for other applications requiring low-priced uncased units of this type. For long life, however, these units should be potted and not left unprotected from moisture.



P. R. MALLORY & CO. Inc. MALLORY

Condensers

NOISE FILTERS — FOR RADIO INTERFERENCE SUPPRESSION

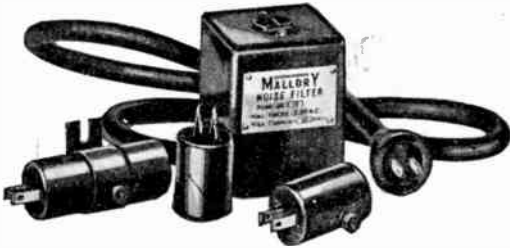

● Mallory Noise Filters are available in a number of specialized types, each type having its own field of application. For most effective noise elimination and for maximum economy, thought should be given to the selection of the correct Mallory Noise Filter type. The general application of Mallory filters is given in Form NF-100, available from your distributor. To assist you in securing the most effective and economical installation, the Engineering Department of P. R. Mallory & Co., Inc., will gladly analyze the essential facts covering your installation, and will recommend suitable equipment.

Some devices are particularly difficult to filter and it should also be understood that no type of noise filter is effective where the interference is entering through the antenna system if the source cannot be reached, nor the antenna location changed.



TYPES X1, X3, Z2, Z4

Type X1 is for relatively slight interference. Use at radio or appliance cord plug. Size $1\frac{1}{8}$ " x $1\frac{3}{4}$ ", rated 110 volts, 5 amps.

List Price each.....\$0.60

Type X3 is a capacitor type filter having greater efficiency than Type X1. Use at radio or appliance cord plug. Size $1\frac{1}{8}$ " x $2\frac{1}{4}$ ", rated 110-220 volts, 5 amps.

List Price each.....\$0.90

Type Z2 is a capacitor-inductance filter for medium interference. Use with electric razor, radio or appliance cord plugs. Most effective on grounded line systems where reversal of plug will affect operation. Size $1\frac{1}{8}$ " x $2\frac{3}{4}$ ", rated 110-220 volts, 3 amps.

List Price each.....\$1.40

Type Z4 is a dual inductance-capacity filter for severe interference on appliances where a return lead from the filter is inconvenient. Ideal for electric razor, vibrators and household appliances. Use at radio or appliance cord plug. Size $1\frac{1}{8}$ " x 3", rated 110-220 volts, 3 amps.

List Price each.....\$1.65



TYPE X5

Type X5 is a triple capacity filter with provision for return lead to appliance. Special safety feature prevents possibility of shock and makes this unit ideal for use with vacuum cleaners, food mixers, etc. Size $1\frac{1}{8}$ " x $2\frac{1}{2}$ ", rated 110-220 volts, 5 amps., and equipped with binding post for connection to appliance or motor frame.

List Price each.....\$1.50



TYPE ZA1

Type ZA1 is an antenna substitute using house wiring as antenna. Capacity and inductance combination, size $1\frac{1}{8}$ " x $1\frac{3}{4}$ ".

List Price each.....\$1.20



TYPES Z6 and Z8

Type Z6 is a dual inductance-capacity filter with provision for return lead to ground. Recommended for suppressing severe interference. Use at radio cord plug or motor and appliance plugs. Size $1\frac{1}{8}$ " x $3\frac{1}{8}$ ". Rated 110-220 volts, 3 amps.

List Price each.....\$2.10

Type Z8 is same as Z6 but with provision for return wire connection to motor or appliance frame rather than ground. An efficient filter equivalent to box type within 3 amp. rating.

List Price each.....\$2.10

Type Z8A is same as Z8 except provided with lead connections. Designed for mounting directly on appliance. Ideal for use with fluorescent lamps.

List Price each.....\$2.40

Type W7 is a dual capacity filter for use on motor brushes or rings and designed for mounting inside or on motor housing. For moderate interference. Size $\frac{7}{8}$ " x $1\frac{1}{2}$ ", rated 110-220 volts.

List Price each.....\$0.90



TYPES W7, W7A, W9, W11, W7SP, W9SP, W11SP

Type W7A is similar to W7, except smaller physical size. For 110-volt service only. Size $\frac{11}{16}$ " x $1\frac{1}{16}$ ".

List Price each.....\$0.75

Type W7SP is similar to W7 except provided with shock-proof feature to permit use with ungrounded appliances such as drink mixers, electric drills, etc. Size $\frac{7}{8}$ " x $1\frac{1}{16}$ ".

List Price each.....\$0.90

Type W9 is similar to Type W7 but for medium interference. Size 1" x 3". List Price each.....\$1.20

Type W9SP is similar to Type W7SP (except for medium interference, Size 1" x $2\frac{5}{8}$ ".

List Price each.....\$1.20

Type W11 is similar to Type W7, but for severe interference. Size $1\frac{1}{8}$ " x 3". List Price each.....\$1.50

Type W11SP is similar to Type W7SP, except for severe interference. Size $1\frac{1}{8}$ " x $3\frac{1}{4}$ ".

List Price each.....\$1.50

Type LC5 is an inductance-capacity filter for extremely severe interference. Has provision for return lead to frame of motor or appliance. Rated 110-220 volts, 5 amps., supplied in rectangular housing with mounting flanges. Size $2\frac{7}{8}$ " x 3" x $3\frac{1}{2}$ " high. List Price each.....\$6.00



TYPES LC-5 and LC-10

Type LC10 is identical in size to Type LC5, but is rated at 110-220 volts, 10 amps. List Price each \$9.60

HEAVY DUTY TYPES LB

● Mallory Type LB Noise Filters are for use with equipment that is permanently connected to the power line or which draws a minimum of 10 amperes or more.

Type LB Filters are furnished as complete units including capacity and inductance and supplied in standard type metal cut-out boxes. These units are available in various current ratings as listed below.



Type	Rating	Size	List Price Complete
LB-10	220V-10 Amps.	6 x 6 x 4	\$14.40
LB-20	220V-20 Amps.	10 x 10 x 6	\$33.60
LB-40	220V-40 Amps.	12 x 10 x 6	42.00

Condensers

P. R. MALLORY & CO. Inc.
MALLORY

AUTO RADIO TYPES VIBRATOR BUFFERS—TYPES VB, VD, VL, VO

Capacity	Wkg. V. DC	Size	Fig.	Cat. No.	List Price
.0075	1600	$\frac{7}{8}$ x $\frac{5}{8}$ x $\frac{1}{16}$	2	VB470	\$0.55
.01	1600	$\frac{7}{8}$ x $\frac{5}{8}$ x $\frac{1}{16}$	2	VB471	.55
.0125	1600	$\frac{5}{8}$ x 1 x $\frac{1}{16}$	1	VB472	.55
.015	1600	$\frac{7}{8}$ x $1\frac{1}{16}$ x $\frac{1}{16}$	2	VB473	.55
.02	1600	$\frac{7}{8}$ x $1\frac{1}{16}$ x $\frac{1}{16}$	2	VB474	.55
.03	1600	1 x $1\frac{15}{16}$ x $\frac{15}{32}$	2	VB475	.60
.04	1600	1 x $1\frac{15}{16}$ x $\frac{1}{16}$	2	VB476	.75
.05	1600	1 x 1 x $\frac{1}{2}$	2	VB477	.85
.01-.01	1600	$\frac{3}{4}$ x $\frac{7}{8}$ x $\frac{3}{4}$	14	VD490	1.05
.0005-.0005	1600	$1\frac{1}{16}$ x $\frac{5}{8}$ x $\frac{3}{16}$	3	VD491	.55
.01	2000	3 x $\frac{17}{32}$ x $\frac{3}{8}$	3	VL478	.90
.5	200	3 x $\frac{27}{32}$ x $\frac{3}{4}$	3	VL479	.80
.5	120	$2\frac{1}{4}$ x $\frac{3}{4}$ x $\frac{1}{16}$	4	VO480	.85

● Mallory types VB, VD and VL (478) condensers are oil-impregnated and designed especially for vibrator buffer applications.

This service requires extreme quality since high temperature conditions, excessive vibrations and unusually high peak voltages are encountered.

Types VL479 and VO480 are low voltage units and are of the wax-impregnated type.

MYE TECHNICAL MANUAL

● This simply written, practical book bridges the gap between radio theory and practice. Designed for the radio serviceman, engineer, amateur or experimenter who wants the latest technical information . . . presented so that he can easily apply it to everyday problems.

TABLE OF CONTENTS

1. Loud Speakers and Their Use
2. Superheterodyne First Detectors and Oscillators
3. Half-Wave and Voltage Doubler Power Supplies
4. Vibrator and Vibrator Power Supplies
5. Phono-Radio Service Data
6. Automatic Tuning operation and adjustment
7. Frequency Modulation
8. Television—suggestions for the postwar boom
9. Capacitors—how to overcome wartime shortages
10. Practical Radio Noise Suppression
11. Vacuum Tube Voltmeters
12. Useful Servicing Information
13. Receiving Tube Characteristics—of all American tube types

Contains 392 pages of information, beautifully bound, with hard cloth covers. It's worth far more than its price, \$2.00 net.

MISCELLANEOUS AUTO TYPES AG, AM, FM, DL, RF

Capacity	Wkg. V. DC	Size	Fig.	Cat. No.	List Price
.05	100	$\frac{7}{16}$ x $1\frac{1}{16}$	5	AG443	\$0.60
.25	200	$\frac{5}{8}$ x $1\frac{13}{16}$	5	AG444	.60
.5-.5	100	$\frac{7}{8}$ x 2	5	AG450	.90
.5	200	$\frac{4}{4}$ x 2	5	AG451	.60
1.0	200	1 x $2\frac{1}{16}$	5	AG452	.85
.5*	200	$\frac{3}{4}$ x $1\frac{3}{4}$	11	AG453	.90
.5	200	$\frac{5}{8}$ x 2	6	AM454	.55
.4	50	1 x 2 x 2	7	CA275X	2.00
.5	100	$\frac{11}{16}$ x $1\frac{7}{8}$	12	FM441	.60
.5	150	$\frac{11}{16}$ x 2	7	FM442	.60
.5	200	1 x $2\frac{3}{4}$	9	DL445	1.05
.5	100	$\frac{13}{16}$ x $1\frac{1}{16}$	13	RF480	.50
.5	50	$\frac{3}{4}$ x $1\frac{3}{4}$	8	RF481	.75
1.0	50	$\frac{13}{16}$ x $1\frac{5}{8}$	8	RF482	.90

● This group is designed for various car radio applications.

Types AG are for noise suppression at the generator, oil and gas gages, etc.

Type AM is for suppression at the ammeter and other instruments.

Types FM are especially designed for Ford generators.

Type DL is a dome light interference suppressor and includes an RF choke.

Types RF are for general vibrator hash and noise suppression and have a very low RF impedance.

RF CHOKES

Turns	Wire	Size	Fig.	Cat. No.	List Price
90	16	1 x $1\frac{1}{2}$	10	RF581	\$0.80
55	16	1 x $1\frac{1}{16}$	10	RF582	.60
55	12	$1\frac{1}{16}$ x $1\frac{1}{8}$	10	RF583	.90

● Mallory chokes, Type RF, are designed for use wherever RF chokes are needed for hash or other radio frequency suppression. Complete particulars and detailed instructions for their use will be found in the Mallory-Yaxley Radio Service Encyclopedia.

*Has shielded lead.

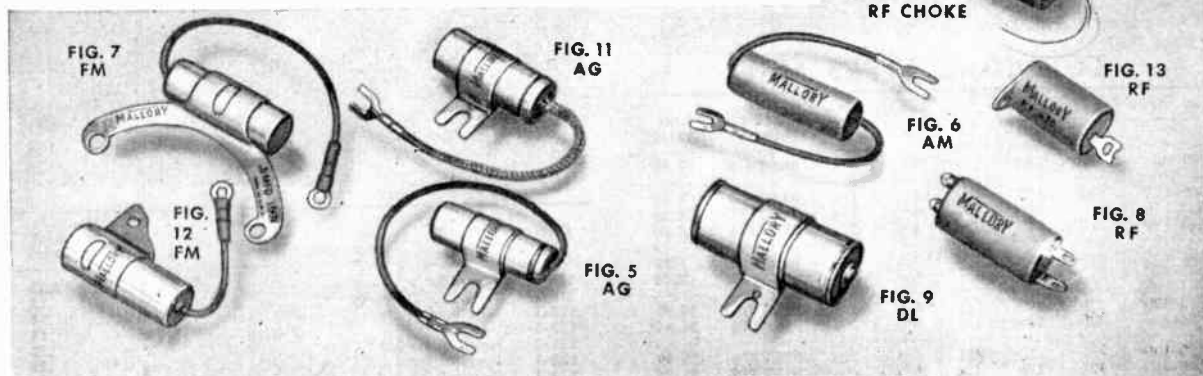

P.R. MALLORY & CO. Inc. MALLORY

Condensers

ROUND CAN TYPES MSU

Cap. Rating Mfd.		AC Volts	SIZE		Catalog Number	List Price
New	Old		Dia.	Height		
20-24	20	110	1 3/8	2 3/4	MSU120	\$1.35
26-30	25	110	1 3/8	2 3/4	MSU121	1.35
32-36	30	110	1 3/8	2 3/4	MSU122	1.45
38-42	35	110	1 3/8	2 3/4	MSU123	1.45
43-48	40	110	1 3/8	2 3/4	MSU124	1.45
53-60	50	110	1 3/8	2 3/4	MSU125	1.50
64-72	60	110	1 3/8	2 3/4	MSU126	1.50
70-78	65	110	1 3/8	2 3/4	MSU127	1.60
75-84	70	110	1 3/8	2 3/4	MSU128	1.60
86-96	80	110	1 3/8	2 3/4	MSU129	1.65
97-107	90	110	1 3/8	3 1/4	MSU130	1.70
108-120	100	110	1 3/8	3 1/4	MSU131	1.70
124-138	115	110	1 3/8	3 1/4	MSU132	1.80
145-162	135	110	1 3/8	3 1/4	MSU133	2.20
161-180	150	110	1 3/8	4 1/4	MSU134	2.40
161-180	150	110	1 3/8	3 1/4	MSU135	2.40
194-216	180	110	1 3/8	4 1/4	MSU136	2.90
194-216	180	110	1 3/8	3 1/4	MSU137	2.90
200-220	200	110	1 3/8	4 1/4	MSU138	3.15
216-240	230	110	2	4 1/4	MSU139	3.25
216-240	230	110	2	3 1/4	MSU140	3.25
243-270	225	110	1 3/4	4 1/4	MSU141	3.60
243-270	225	110	2	3 1/4	MSU142	3.60
270-300	250	110	2	3 1/4	MSU143	4.20
324-360	300	110	2	4 1/4	MSU144	4.80
378-420	350	110	2	4 1/4	MSU145	5.40
20-24	20	220	1 3/8	3 1/4	MSU175	2.30
26-30	25	220	1 3/8	3 1/4	MSU176	2.65
32-36	30	220	2	3 1/4	MSU177	3.00
38-42	35	220	2	3 1/4	MSU178	3.40
43-48	40	220	2	3 1/4	MSU179	3.60
53-60	50	220	2	3 1/4	MSU180	4.10

FOR A. C. MOTOR STARTING

• Mallory Motor Starting Capacitors incorporate the latest design improvements to provide long life and maximum efficiency in all motor starting applications. New universal mounting features reduce inventory—permit these modern compact capacitors to be used for replacing old-style large units. Complete instructions, replacement recommendations, test data and other valuable information given in Form M801 available without charge from your Mallory Distributor, or mailed on request.

RECTANGULAR TYPES MSF and MSG

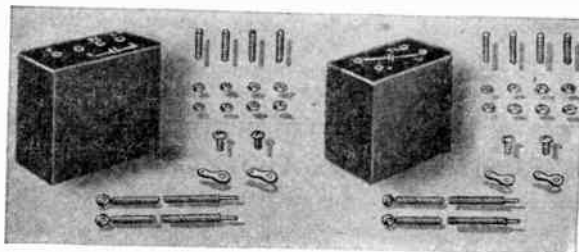

Cap. Rating Mfd.		AC Volts	SIZE			Cat. No.	List Price
New	Old		A	B	C		
32-36	30	110	3 1/2	3 1/2	2	MSG220	\$2.40
53-60	50	110	3 1/2	3 1/2	2	MSG221	2.40
64-72	60	110	3 1/2	3 1/2	2	MSG222	2.55
78-85	80	110	3 1/2	3 1/2	2	MSG223	2.55
86-96	80	110	4 1/2	4 1/2	1 1/2	MSF224	2.55
97-107	90	110	3 1/2	3 1/2	2	MSG225	2.65
108-120	100	110	3 1/2	3 1/2	2	MSG226	2.65
108-120	100	110	4 1/2	4 1/2	1 1/2	MSF227	2.65
124-138	115	110	3 1/2	3 1/2	2	MSG228	3.00
124-138	115	110	4 1/2	4 1/2	1 1/2	MSF229	3.00
145-162	135	110	3 1/2	3 1/2	2	MSG230	3.40
161-180	150	110	3 1/2	3 1/2	2	MSG231	3.60
161-180	150	110	4 1/2	4 1/2	1 1/2	MSF232	3.60
180-210	175	110	4 1/2	4 1/2	1 1/2	MSF233	4.10
270-300	250	110	3 1/2	3 1/2	2	MSG234	5.40
26-30	25	220	3 1/2	3 1/2	2	MSG250	3.60
32-36	30	220	3 1/2	3 1/2	2	MSG251	4.20
32-36	30	220	4 1/2	4 1/2	1 1/2	MSF252	4.20
43-48	40	220	3 1/2	3 1/2	2	MSG253	5.40

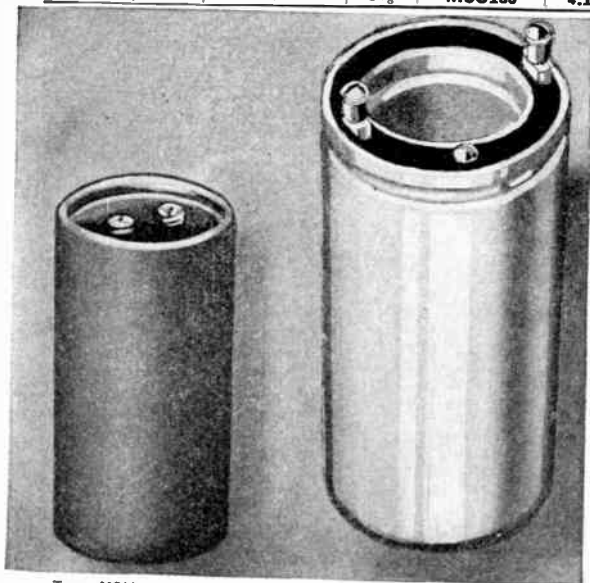

TOROIDAL TYPES MST

Cap. Rating Mfd.		AC Volts	SIZE			Catalog Number	List Price
New	Old		A	B	C		
86-96	80	110	2 1/2	4 1/2	1 1/8	MST970	\$3.60
108-120	100	110	2 1/2	4 1/2	1 1/8	MST971	4.20
124-138	115	110	2 1/2	4 1/2	1 1/8	MST972	4.50
161-180	175	110	3 1/4	5 3/8	2 1/8	MST973	6.00
230-255	225	110	3 1/4	5 3/8	2 1/8	MST975	7.80
243-270	225	110	3 1/4	6 3/8	2 1/8	MST976	8.40
324-330	300	110	3 1/4	5 3/8	2 1/8	MST977	10.80
324-330	300	110	3 1/4	6 3/8	2 1/8	MST978	11.40
400-450	375	110	3 1/4	6 3/8	2 1/8	MST979	12.00
460-510	425	110	3 1/4	6 3/8	2 1/8	MST980	13.20
540-600	500	110	3 1/4	6 3/8	2 1/8	MST981	15.60

STANDARD END CAPS and BRACKETS

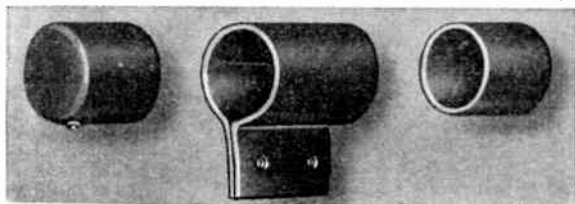

Cat. No.	Description	Dia.	List Price
115-1	Top Cap	1 3/8"	\$0.15
116-1	Top Cap	2"	.15
118-1	Bottom Cap	1 3/8"	.15
119-1	Bottom Cap	2"	.15
121-1	Bracket for 3 1/2" Can.	1 3/8"	.25
122-1	Bracket for 4 1/2" Can.	1 3/8"	.25
123-1	Bracket for 3 1/2" Can.	2"	.25
124-1	Bracket for 4 1/2" Can.	2"	.25

Centralab

Quality Controls • Resistors • Selector Switches

CENTRALAB STANDARD RADIOHM

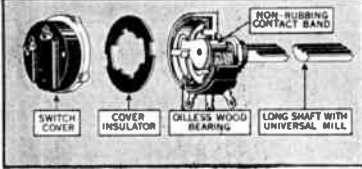

Wall Type Resistor hugs inner circumference of black molded bakelite case. Exclusive non-rubbing contact band assures quiet, smooth rotation and long life. Case dimensions 1 3/8" diameter x 1 1/2" deep. Metal shaft extends 3 3/8" from case; milled full length for push-on or set screw knob.

COMPANION TO THE STANDARD RADIOHM, the Midget is necessary to replace original controls in many current models using small controls for space savers. Molded bakelite case, 1 1/8" diameter. 1/4" metal shaft 3 3/8" long, milled for standard push-on or set screw knob.

STANDARD MIDGET RADIOHM

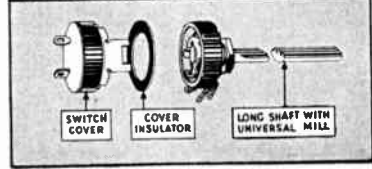

CENTRALAB STANDARD RADIOHM WITHOUT TAP LESS SWITCH \$1.00 WITH SWITCH \$1.50

Catalog Number				Usual Circuit Location	Resistance	
Without Switch	With Switch	Old #	New #		Ohms	Curve
72-118	A-100	62-118	B-100	Voltage Divider	500	1
72-107	A-101	62-107	B-101	Voltage Divider	1000	1
72-101	A-102	62-101	B-102	Voltage Divider	2000	1
72-108	A-103	62-108	B-103	Voltage Divider	3000	1
72-109	A-104	62-109	B-104	Voltage Divider	4000	1
72-110	AF-105	62-110	BF-105	Voltage Divider	5000	1
70-204	A-106	52-204	B-106	Antenna Shunt	5000	6
72-139	AF-107	62-139	BF-107	Voltage Divider	7500	1
72-114	AF-108	62-114	BF-108	Antenna, C-Bias	10000	1
72-113	AF-109	62-113	BF-109	Antenna, C-Bias	10000	3
70-205	AF-110	52-205	BF-110	Antenna, C-Bias	10000	4
72-100	A-111	62-100	B-111	Antenna Shunt	10000	6
72-115	AF-112	62-115	BF-112	Antenna, C-Bias	15000	3
79-006	AF-113	99-006	BF-113	Antenna, C-Bias	15000	4
72-119	AF-114	62-119	BF-114	Antenna, C-Bias	20000	3
72-111	AF-115	62-111	BF-115	Voltage Divider	25000	1
70-206	AF-116	52-206	BF-116	C-Bias	25000	4
72-102	AF-117	62-102	BF-117	Antenna Shunt	25000	3
72-103	A-118	62-103	B-118	Voltage Divider	50000	1
72-117	A-119	62-117	B-119	Tone Control	50000	6
72-123	A-120	62-123	B-120	Tone Control	75000	6
70-202	AF-121	52-202	BF-121	C-Bias	75000	4
72-104	A-122	62-104	B-122	Voltage Divider	100000	1
72-122	A-123	62-122	B-123	AF Grid or Tone	100000	6
72-136	A-124	62-136	B-124	AF Grid or Tone	150000	6
72-120	A-125	62-120	B-125	AF Grid or Tone	200000	1
72-131	AF-126	62-131	BF-126	C-Bias	200000	4
72-121	A-127	62-121	B-127	AF Grid or Tone	250000	6
72-105	A-128	62-105	B-128	Voltage Divider	500000	6
72-106	A-129	62-106	B-129	Series in RF Plate	500000	1
70-203	A-130	52-203	B-130	At Grid or Tone	500000	4
72-140	A-131	62-140	B-131	At Grid or Tone	750000	6
72-116	A-132	62-116	B-132	At Grid or Tone	1Meg	6
72-137	A-133	62-137	B-133	At Grid or Tone	2Mega	6
72-132	A-134	62-132	B-134	At Grid or Tone	3Mega	6

TAPPED STANDARD RADIOHM LESS SWITCH \$1.50 WITH SWITCH \$2.00

Cat. No.	Without Switch	With Switch	Maximum Resistance	Tap Resistance		
72-138	AT-135	62-138	BT-135	Tapped Audio Grid	250000	10
72-134	AT-136	62-134	BT-136	Tapped Audio Grid	500000	10
72-135	AT-137	62-135	BT-137	Tapped Audio Grid	1 Meg	10
72-142	AT-138	62-142	BT-138	Tapped Audio Grid	2 Meg	10

CENTRALAB MIDGET RADIOHM WITHOUT TAP LESS SWITCH \$1.00 WITH SWITCH \$1.50

Catalog Number		Usual Circuit Location	Resistance	
Without Switch	With Switch		Ohms	Curve
NF-106	PF-106	Voltage Divider	500	1
NF-107	PF-107	Antenna, C-bias	10000	1
NF-100	PF-100	Antenna, C-bias of One Tube	10000	3
NF-108	PF-108	Antenna, C-bias of Two Tubes	10000	4
N-109	P-109	Antenna Shunt	10000	6
NF-110	PF-110	Antenna, C-bias of One Tube	15000	3
NF-111	PF-111	Antenna, C-bias of Two Tubes	15000	4
NF-112	PF-112	Antenna, C-bias	20000	1
NF-113	PF-113	Voltage Divider	25000	3
NF-101	PF-101	Antenna, C-bias	25000	3
N-114	P-114	Voltage Divider	50000	1
N-115	P-115	Tone Control	50000	6
N-116	P-116	Voltage Divider	100000	1
N-117	P-117	Audio Grid or Tone	100000	6
N-102	P-102	Audio Grid or Tone	250000	6
N-118	P-118	Voltage Divider	500000	1
N-103	P-103	Audio Grid or Tone	500000	6
N-104	P-104	Audio Grid or Tone	1 Meg	6

TAPPED MIDGET RADIOHM LESS SWITCH \$1.50 WITH SWITCH \$2.00

Catalog Number		Maximum Resistance	Tap Resistance
Without Switch	With Switch		
NT-119	PT-119	250M	75M
NT-147	PT-147	250M	125M
NT-148	PT-148	350M	75M
NT-120	PT-120	500M	150M
NT-149	PT-149	500M	250M
NT-150	PT-150	1 Meg.	200M
NT-121	PT-121	1 Meg.	300M
NT-151	PT-151	2 Megs.	200M
NT-152	PT-152	2 Megs.	400M
NT-122	PT-122	2 Megs.	600M
NT-153	PT-153	2 Megs.	1 Meg.
NT-154	PT-154	2 Megs.	1 Meg.

ATTACHABLE SWITCH COVERS

FOR STANDARD AND WIRE WOUND RADIOHMS

Cat. No.	Circuit	Price	Cat. No.	Circuit	Price
K-10	S.P.S.T.	\$.50	K-16	S.P.D.T. (Operates at clockwise position)	.60
K-11	S.P.D.T.	.60	K-17	S.P.D.T. (With Dummy Lug)	.60
K-12	D.P.S.T.	.60			
K-15	Four Point	.60			

FOR MIDGET RADIOHMS

Cat. No.	Circuit	Price
K-155	S.P.S.T.	\$.50
K-156	S.P.D.T.	.60
K-157	D.P.S.T.	.60
K-158	Four Point	.60
K-169	S.P.S.T. (With Dummy Lug)	.60

STANDARD ROUND SHAFT RADIOHM

Shaft has no milled flat, so that a pointer type knob can be located in any desired relation to the slider. Useful for many commercial applications. Identical to Standard Radiohm except that shaft is 1/4" round steel cadmium plated length, 2 1/4" from face of unit with grooves every half inch for breakout purposes. These Radiohms may be converted into switch type by using any of the standard switches listed above.

Price All Types (Less Switch) \$1.00

STANDARD ROUND SHAFT RADIOHM

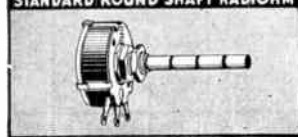

Cat. No.	Resistance	Curve
AS-139	10M	1
AS-140	25M	1
AS-141	50M	1
AS-142	100M	1
AS-143	100M	b
AS-144	250M	1
AS-145	250M	b
AS-146	500M	1
AS-147	500M	b
AS-148	1 Meg	1
AS-149	5 Megs	b
AS-150	10 Megs	b

STANDARD SUBMIDGET RADIOHM

A small diameter control with many of the characteristics of larger units. Ideal for use in small equipment and spaces where other controls will not fit. Especially adaptable in construction of hearing aids and to the requirements of experimenters, home set builders or "hams" for use in portable equipment. Case dimensions 3/8" depth by 3/4" diameter. Round steel shaft extends 2 3/8" beyond face of unit and is grooved every half inch from end of bushing. Features the wall type resistor which hugs the inner circumference of a metal case. The Standard Submidget Radiohm is not available with switch.

Price All Types \$1.00

Cat. No.	Resistance	Curve
NS-10	1M	1
NS-11	5M	1
NS-12	10M	1
NS-13	25M	1
NS-14	50M	1
NS-15	100M	b
NS-16	250M	b
NS-19	500M	1
NS-17	500M	b
NS-18	1 Meg	b

STANDARD SUB-MIDGET RADIOHM

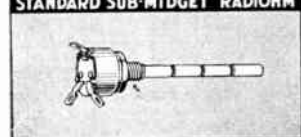

STANDARD ELF RADIOHM

A new control designed similar to the Standard Midget Radiohm but much smaller in diameter, features the Centralab wall type resistor. Bakelite case 57'64" diameter, 17/32" deep (less switch), 25 32" deep (with switch). Fully shielded with long skirt metal cover and metal back plate. Available with two shaft designs—one of the universal fluted mill, the other a universal

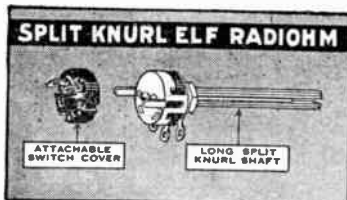
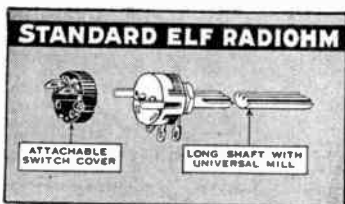

split knurl—either shaft 1/4" diameter, 3 3/8" long. Shafts easily cut to desired length. For switch type add Elf Radiohm switch covers K-150 or K-151.

This new control opens a new field of replacements by allowing installation in extremely

small spaces as found in present day battery portables, "personal" receivers and auto sets. Particularly adaptable to late model Motorola and Emerson auto sets and portables.

Centralab Standard Elf Radiohm Without Tap...\$1.00

Catalog Number		Usual Circuit Location	Resistance	
Fluted Mill Shaft	Split Knurl Shaft		Ohms	Curve
LF-100	LF-200	Antenna, C-bias	10M	4
LF-101	LF-201	Antenna, C-bias	25M	3
L-102	L-202	Antenna or Tone	50M	6
L-103	L-203	A.F. Grid or Tone	100M	6
L-104	L-204	A.F. Grid or Tone	250M	6
L-105	L-205	A.F. Grid or Tone	500M	6
L-106	L-206	A.F. Grid or Tone	1 Meg.	6
L-107	L-207	A.F. Grid or Tone	2 Megs.	6
L-108	L-208	A.F. Grid or Tone	3 Megs.	6

Centralab Standard Elf Radiohm With Tap...\$1.50

Catalog Number		Usual Circuit Location	Resistance	
Fluted Mill Shaft	Split Knurl Shaft		Maximum Resistance	Tap Resistance
LT-150	LT-250	Antenna, C-bias	250M	75M
LT-151	LT-251		500M	150M
LT-152	LT-252		1 Meg.	200M
LT-153	LT-253		1 Meg.	300M
LT-154	LT-254		2 Megs.	200M
LT-155	LT-255		2 Megs.	400M
LT-156	LT-256		2 Megs.	600M

Attachable Switch Covers

Catalog Number	Circuit	Price
K-150	Single Pole, Single Throw	\$0.50
K-151	Single Pole, Single Throw with Dummy Lug	.60

STANDARD RESISTANCE CURVES

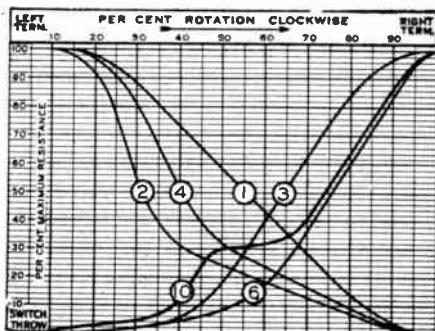

UNIVERSAL SPLIT-KNURL REPLACEMENT CONTROLS

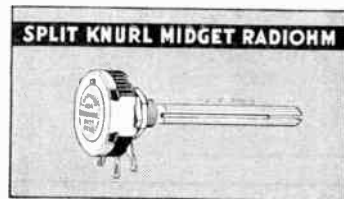

Pat. No. 2156067

Many late model radio sets use split-knurl shafts and the knobs will not fit the usual flatted shaft. These new Centralab replacements will fit simply by cutting the shaft to proper length and easily cut. For switch type, add Midget Radiohm switch covers K-155, K-156, K-157, K-158 or K-169.

Cat. No.	Ohms	Type	Price
NK-139	250M	Plain	\$1.00
NK-140	500M	Plain	1.00
NK-141	1 Meg.	Plain	1.00
NK-142	2 Meg.	Plain	1.00
NK-143	500M	Tapped	1.50
NK-144	1 Meg.	Tapped	1.50

WIRE WOUND RADIOHMS

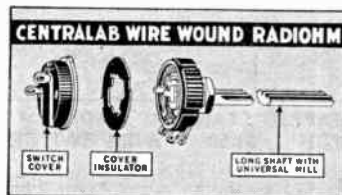

Wire wound resistance strip in brown molded bakelite case with dimensions identical to Standard Radiohm. Only plain controls are listed—converted to switch type with Standard Radiohm switch covers. Insulated metal shaft extends 3 3/8" from case, milled full lengths for push-on or set screw knob. Rated at 3 watts. All controls have linear relation of resistance to rotation.

Price—All Types \$1.00 (Less Switch)

Cat. No.	Ohms	Cat. No.	Ohms
V-100	2	V-121	100
V-102	4	V-123	200
V-104	6	V-125	300
V-106	8	V-126	400
V-108	10	V-127	500
V-109	15	V-128	750
V-110	20	VF-129	1000
V-111	25	VF-131	2000
V-112	30	VF-133	3000
V-114	40	VF-134	4000
V-116	50	VF-135	5000
V-117	60	VF-136	7500
V-118	75	VF-137	10000

Centralab

Quality Controls • Resistors • Selector Switches

● ADASHAFT MIDGET RADIOHM

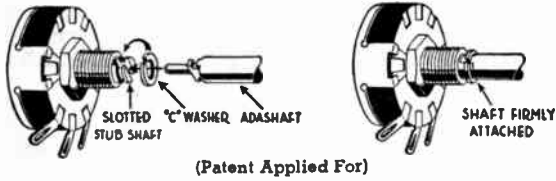

(Patent Applied For)

By merely adding any one of the shafts illustrated below the simple Adashaft construction permits a maximum of replacement possibilities with a minimum of stock. One K-185 shaft is included with each control listed in this group and additional parts are available upon request. The illustration above indicates the method of attaching the shaft to the control and by firmly clinching the "C" washer, the shaft is held in place without wobble or play.

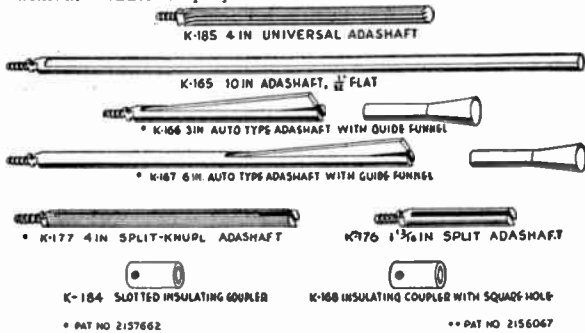

Adashaft Midget Radiohms are supplied without switch. To convert any control to switch type, use Midget switch covers listed on page L-5. Available resistance values and tapers are listed below.

Price, Less Tap, \$1.00

Catalog Number	Usual Circuit Location	Resistance Ohms	Curve
NF-126	Antenna, C-Bias	10M	3
NF-146	Antenna, C-Bias	25M	4
N-127	Tone Control	50M	6
N-128	Audio Grid or Tone	250M	6
N-129	Audio Grid or Tone	500M	6
N-130	Audio Grid or Tone	1 Meg.	6
N-131	Audio Grid or Tone	2 Meg.	6
N-145	Audio Grid or Tone	3 Meg.	8

● TAPPED ADASHAFT MIDGET RADIOHMS

Price, With Tap, \$1.50

Catalog Number	Usual Circuit Location	Resistance Ohms	Curve
NT-132	Tapped Audio Grid	250M	10
NT-133	Tapped Audio Grid	500M	10
NT-134	Tapped Audio Grid	2 Meg.	10
NT-135	Tapped Audio Grid	2 Meg.	10

● ADASHAFT FOR CONTROLS LISTED ABOVE

Catalog Number	Description	Price Each
K-163	4" Adashaft; 3/32" flat full length	.25
K-164	4" Adashaft; 3/32" flat full length	.25
K-165	10" Adashaft; 3/32" flat full length	.25
K-167	6" Auto Type Adashaft with Guide Funnel	.35
K-166	3" Auto Type Adashaft with Guide Funnel	.35
K-177	4" Split Knurl Adashaft	.25
K-176	1 1/8" Split Adashaft	.25

PORTABLE ADASHAFT KIT



Kit consists of twelve controls listed on this and previous page, an assortment of twelve shafts, five K-155 and one K-157 switches, and two couplers. An attractive and sturdy metal box finished in Centralab blue offers a handy method of carrying and maintaining a complete supply of adashaft controls and accessories.

Catalog No. 418 — Price \$17.60

UNIVERSAL AUTO REPLACEMENT

A universal unit to replace original controls with either slotted or tongue type shafts. 1/4" shaft 3" long slotted and furnished with hinged insert, complete with guide funnel, plain units furnished with slip clutch. Separate switches cannot be attached to plain controls. Order plain or switch type as required. Tone compensation tap on all controls can be omitted if desired. Switches are of D.P.S.T. type.

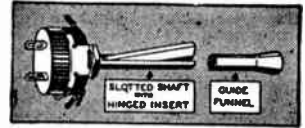

Pat. No. 2157662

LESS SWITCH.....\$1.50 WITH SWITCH.....\$2.00

NA-123	PA-123	Tapped Audio Grid	250000	10
NA-105	PA-105	Tapped Audio Grid	500000	10
NA-124	PA-124	Tapped Audio Grid	1 Meg.	10
NA-125	PA-125	Tapped Audio Grid	2 Megs.	10

TWIN REPLACEMENT RADIOHMS

Two resistance elements completely insulated from each other and from the shaft and bushing. Sections are Standard Radiohm bases, 1 3/8" diameter, both rotated by a single metal shaft 3" long.

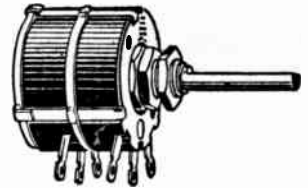

Cat. No.	Resistance		Price
	Front Base	Back Base	
C-100 (74-601)	10,000	25,000	\$2.50
C-101 (74-602)	10,000	50,000	2.50
C-102 (4010805)	100,000	100,000	2.50
C-103 (4010807)	250,000	250,000	2.50
C-104 (4010804)	500,000	500,000	2.50

EXTENSION SHAFTS

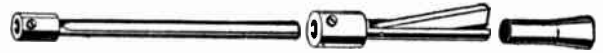

REGULAR Pat. No. 2157662 AUTO TYPE

Use with replacement controls or selector switches where long shafts are required. The auto type extension replaces any slotted or tongue type original auto control shaft.

- K-181 (1040089)—Extension shaft (4" x 1/4" dia. x 1/32" flat) \$.30
- K-182 (1040090)—Extension shaft (4" x 1/4" dia. x 3/32" flat) .30
- K-183 (1040091)—Extension shaft (4" x 3/16" dia. x 1/64" flat.) .30
- K-159—Auto type (3" x 1/4" dia.; 3/32 tongue and slot) .50

SHAFT COUPLERS

Price, any type, \$.25

- K-161 For coupling two 1/4" shafts or one 1/4" and one 3/16" shaft. Steel, 3/4" long, 7/16" diameter.
- K-194 (1040095)—Bakelite insulating auto control coupling, 1/4" diameter hole for control shaft; opposite end cone shaped and slotted to take most remote cable couplings.
- K-168—Same as K-184 but with square hole for Motorola receivers.

● CENTRALAB CERAMIC CAPACITORS

Centralab manufactures small special purpose capacitors for high frequency circuits and where temperature compensation, low power factor, or absolute permanence are important. They consist of a thin wall ceramic tube of special composition spacing two tubular condenser plates that remain permanent under all life and aging tests. The metal is actually electroplated on ceramic and no mechanical movement or warping that might change the distance between the plates is possible.

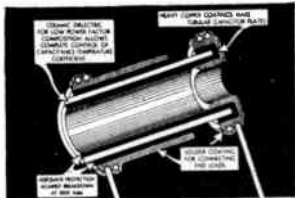

Standard capacitors are individually flash-tested at 1400 volts D.C. Recommended working voltage is 500 volts D.C. Power factor averages .05% with .1% the passing limit. Power factor does not increase with age. Leakage resistance is more than 10,000 megohms. Available in insulated and uninsulated types.

ZERO COEFFICIENT AND NEGATIVE TEMPERATURE COMPENSATING TYPES

Cap. MMF	CATALOG NUMBERS						Price
	Uninsulated		Insulated End Cap		Fully Insulated		
	ZTC*	NTC**	ZTC*	NTC**	ZTC*	NTC**	
1			920Z		931Z		\$0.60
2			920Z	920N	931Z	931N	.60
3			920Z	920N	931Z	931N	.60
4			920Z	920N	931Z	931N	.60
5	813Z		920Z	920N	931Z	931N	.60
10	813Z	813N	920Z	920N	931Z	931N	.60
20	813Z	813N	920Z	920N	931Z	931N	.60
25	813Z	813N	920Z	920N	931Z	931N	.60
40	813Z	813N		920N		931N	.60
50	813Z	813N		920N		931N	.60
75	810Z	813N					.60
100	810Z	813N					.60
125	814Z						.80
150	814Z						.80
150		810N					.60
175	814Z						.60
200		810N					.60
200	814Z						.80
250		810N					.60
250	816Z						1.00
300		814N					.80
300	816Z						1.00
350		814N					.80
350	816Z						1.00
400		814N					.80
450		814N					.80
500		816N					1.00
600		816N					1.00
700		816N					1.00
800		816N					1.00

* ZTC indicates zero temperature capacitor and is used where no change with temperature is desired.

** NTC indicates negative temperature compensating capacitor. NTC—.00075 mmi/mmi/°C.

DIMENSIONS—over-all length—Type 810, .860"; type 814, 1.300"; type 813, .460"; type 816, 1.800"; type 920, .760"; type 931, .760".

● CENTRALAB CERAMIC TRIMMERS

Centralab ceramic trimmers are interchangeable with air trimmers for most applications and have definite advantages in space requirements and mechanical stability.



Types 823 and 822 both have a base of strong, low dielectric stellite, and may be mounted on a metal panel with little increase in minimum capacity. The upper surface of this base is ground optically flat. Pure silver is fired on this flat surface to form the stationary capacitor plate.

The rotor is of high dielectric ceramic material with the lower surface ground optically flat to contact the stator with a uniform minimum air film. The top surface is silvered in a variable pattern to establish the desired capacity range. Since the rotor is of small mass and always in mechanical balance, with the weight evenly distributed around the bearing and under uniform spring pressure, no shaft lock is needed to maintain constant capacity under extreme vibration.

The type 820 trimmer has been successfully used on large production radio equipment since 1940. It is comparatively fragile, however, and not as desirable for laboratory or other small quantity applications as the types 823 or 822. The base is of thin high dielectric ceramic material, ground optically flat on the top side. The stator plate is silver fired to the under side of the base. The variable plate is a semi-circular piece of metal under constant spring pressure that rotates on the flat surface.

All three types may be continuously rotated, with the full capacity change in 180°. Type 823 only, is provided with a stop limiting rotation to 180° when so ordered. Types 823 and 822 are available with zero temperature coefficient, or with a negative temperature coefficient helpful in stabilizing many circuits. Those with negative coefficient have the largest capacity range because that ceramic material has the highest dielectric constant. Type 820 is only available with negative temperature coefficient. Power factor of all types is less than 0.2% measured at one megacycle. Voltage rating 500 volts D.C., flash tested at 1400 volts.

Type 823-N—\$2.50 each			Type 823-Z—\$2.50 each		
Temp. Coeff. .0005 mmi/mmi/°C			Zero Temperature Coefficient		
< 20mmf. to >	> 125mmf. 823-AN	< 12mmf. to >	> 62mmf. 823-AZ	< 10mmf. to >	> 50mmf. 823-BZ
< 10mmf. to >	> 100mmf. 823-BN	< 6mmf. to >	> 25mmf. 823-DZ	< 8mmf. to >	> 25mmf. 823-DN
< 8mmf. to >	> 50mmf. 823-DN	< 5mmf. to >	> 12mmf. 823-EZ		
< 8mmf. to >	> 25mmf. 823-EN				
Type 822-Z—\$1.50 each			Type 822-N—\$1.50 each		
Zero Temperature Coefficient			Temp. Coeff. .0005 mmi/mmi/°C		
< 4.5mmf. to >	> 25mmf. 822-AZ	< 7mmf. to >	> 45mmf. 822-BN	< 4.5mmf. to >	> 25mmf. 822-CN
< 2.5mmf. to >	> 13mmf. 822-BZ	< 2mmf. to >	> 6mmf. 822-DN	< 2mmf. to >	> 7.5mmf. 822-CZ
< 2mmf. to >	> 7.5mmf. 822-CZ				
Type 820—\$0.75 each					
Temperature Coefficient—.005 mmi/mmi/°C					
< 2.6mmf. to >	> 6mmf. 820-A	< 5mmf. to >	> 20mmf. 820-B	< 7mmf. to >	> 35mmf. 820-C

Centralab Power Rheostats

Work at High Temperatures Without Damage

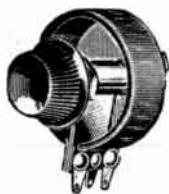

25 Watt Rheostat

Ideal for many commercial applications, such as small motor speed controls, charging rate adjusters, or soldering iron temperature regulators. Give maximum dissipation for size because of complete air circulation. All metal frame and core, insulated with treated asbestos. Practically indestructible. Made in three sizes, all two inches in diameter. Bushing 3/8" x 1/2" long. Shaft 1/4" x 1/2" long. Depth behind panel—25 watt, 3/4"; 50 watt, 1 1/4"; 75 watt, 1 3/4". All sizes furnished with Bakelite knob and panel insulating washers.

25 WATT RHEOSTATS

Part No.	Resistance, Ohms	Price
48-002	2	\$2.00
48-006	6	2.00
48-010	10	2.00
48-015	15	2.00
48-026	25	2.00
48-042	40	2.00
48-050	50	2.00
48-100	100	2.00
48-150	150	2.00
48-200	200	2.00
48-250	250	2.00
48-300	300	2.00
48-400	400	2.00
48-500	500	2.00
48-810	1000	2.00
48-815	1500	2.00
48-850	5000	2.00

50 WATT RHEOSTATS

Part No.	Resistance, Ohms	Price
48-003	2	\$2.50
48-025	25	2.50
48-060	60	2.50
48-151	150	2.50
48-201	200	2.50
40-301	300	2.50
48-501	500	2.50
48-811	1000	2.50
48-835	2500	2.50
48-851	5000	2.50

SOUND PROJECTION CONTROLS FOR EVERY APPLICATION

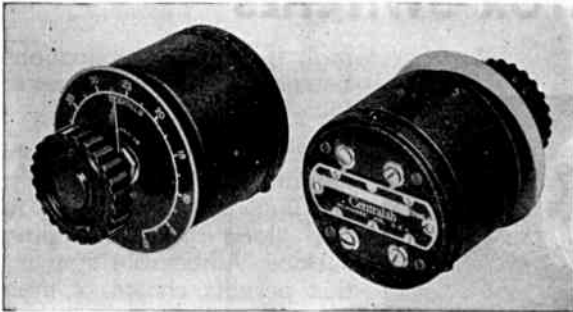

● CENTRALAB SERIES II

Controls are the finest for input circuits in broadcast stations, public address systems, and recording apparatus of new or old design. Will prove faultless in the most critical service.

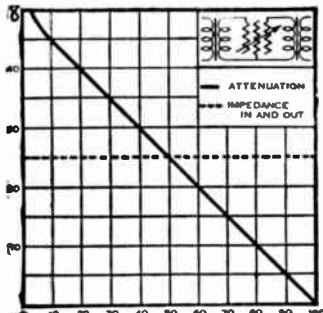

The curve chart shows the change in impedance and attenuation plotted against clockwise rotation for a "T" pad attenuator. The impedance characteristic (dotted line) is substantially the same at any setting. The attenuation curve (solid line) varies from infinity at zero rotation to zero Db. at full rotation. No insertion loss.

Electrostatic and electromagnetic shielding provided by a black finished steel case. Bakelite screw type terminal strip on back of case. All resistance elements insulated from shaft and bushing. Single hole mounting. Mounting bushing $\frac{3}{4}$ " long with 2 locknuts and lockwashers. Case diameter $2\frac{3}{4}$ ". Depth back of panel "T" Pad — $2\frac{3}{8}$ "; Gain Control — $1\frac{3}{8}$ ". Maximum load dissipation 1 watt.

For detailed information, write for technical booklet.

	Line Impedance	Resistance	Resistance Each Side of Center	Part Number	Price*
"T" Pad Attenuator	500 Ohms	Constant Impedance to Both Input and Output		7-010-852	\$10.00
	200 Ohms			7-010-851	10.00
	50 Ohms			7-010-850	10.00
"T" Pad Fader	500 Ohms	Two Constant Impedance Legs on Both Sides		7-210-852	\$15.00
	200 Ohms			7-210-851	15.00
	50 Ohms			7-210-850	15.00
"L" Pad Attenuator	500 Ohms	Constant Impedance to One Side Only		4-010-852	\$ 5.00
	200 Ohms			4-010-851	5.00
	50 Ohms			4-010-850	5.00
Gain Control	Attenuation 50 Decibels for Each Control	250MOhms	_____	1-010-852	\$ 4.00
		500MOhms	_____	1-010-851	4.00
		1 Megohm	_____	1-010-851	4.00
			_____	1-010-850	4.00
Straight Fader	For Crystal or High Impedance Pickups	500,000	_____	1-210-852	\$ 5.00
		100,000	_____	1-210-851	5.00
		50,000	_____	1-210-850	5.00
			_____	_____	_____

● KNOBS AND DIALS

All controls listed above are furnished with knobs and dials. When additional knobs and dials are required, order from list below:

K-112 Dial "T" and "L" Pad, Gain control.....	\$0.75
K-113 Dial "T" Pad Fader.....	.75
K-114 Knob All Series II Controls.....	.75

● ECONOMY P/A CONTROLS

These controls are intermediate to the Series II line and the older Series I types. As their name implies, they are economy controls, designed primarily for inexpensive sound equipment, where original cost is a limiting factor. They are designed for all types of fading and mixing systems.

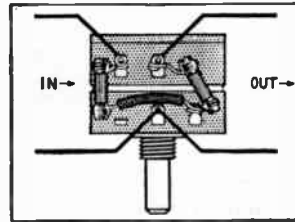

All units have $\frac{3}{8}$ " diam. brass bushing, $\frac{3}{8}$ " long, $\frac{1}{4}$ " aluminum shaft $2\frac{1}{4}$ " long — no mill. Two mounting nuts and lock-washers supplied on bushing. Small diameter bakelite case same dimensions as Standard Radiohm. Non-rubbing contact for smooth, quiet operation. Limited to input applications. Maximum

power rating for all units 1 watt.

Sketch illustrates connections to "Delta T" Pad. Resistance listed for these units is line impedance.

Catalog No.	Description	Resistance Ohms	Price Each
M-140	Gain Control	250M	\$1.75
M-141	Gain Control	500M	1.75
M-142	Gain Control	1 Meg.	1.75
M-143	Gain Control	2 Meg.	1.75
MT-144	Straight Fader	500M	2.00
MT-145	Straight Fader	1 Meg.	2.00
MX-146	"Delta-T" Pad	50	3.50
MX-147	"Delta-T" Pad	200	3.50
MX-148	"Delta-T" Pad	500	3.50

● KNOBS AND DIALS

For Economy P/A Controls:	
K-120 Bar Knob, all controls.....	\$0.15
K-117 Dial, Gain Controls and Attenuators.....	.15
K-160 Dial, Faders.....	.15

● CENTRALAB SERIES I

Constant impedance attenuators that are wire wound in the 10 watt or 50 watt "L" Pads, wire for the series and carbon for the shunt resistors in the 1 watt "T" Pad and C.I. Faders, also 4 watt "L" Pads. All carbon resistance in the 1 watt "L" Pad. Bakelite housing $3\frac{1}{2}$ " x $1\frac{3}{4}$ " deep single or 3 hole mounting for 10 watt "L" Pad, 1 watt "T" Pad, and C.I. Fader. 4 watt "L" Pad bakelite housing $2\frac{1}{4}$ " x $7\frac{1}{8}$ " deep. All furnished with insulating washers for bushings. One watt "L" Pad mounted in bakelite case $1\frac{3}{8}$ " x $1\frac{1}{16}$ " deep. Priced without knob or dial.

Impedance Matching Resistance	1 Watt "L" Pad Part No.	4 Watt "L" Pad Part No.	10 Watt "L" Pad Part No.	50 Watt "L" Pad Part No.	1 Watt "T" Pad Part No.	1 Watt C.I. Fader Part No.
10,000 Ohms	74-544	96-003	_____	_____	_____	_____
5,000 "	74-543	96-002	94-006	_____	93-008	83-006
1,500 "	_____	_____	_____	_____	93-001	83-002
500 "	_____	96-007	94-005	_____	93-002	83-003
200 "	_____	96-006	94-004	_____	93-003	83-004
100 "	_____	_____	94-003	_____	93-004	_____
50 "	_____	96-005	94-002	47-209	93-005	83-005
15 "	_____	96-001	94-001	47-208	93-006	_____
8 "	_____	_____	94-007	47-900	_____	_____

OVER 350 SPECIAL REPLACEMENT CONTROLS ARE LISTED IN THE CENTRALAB VOLUME CONTROL GUIDE

Centralab

Quality Controls • Resistors • Selector Switches

ASSEMBLED SELECTOR SWITCHES

Centralab switches employ a double jawed "biting" contact clip that maintains noiseless contact after standing for months in humidity or corrosive atmosphere as well as on original life test. Switch sections are available with Bakelite or Isolantite insulation. Bakelite is commonly used, but Isolantite is recommended for all

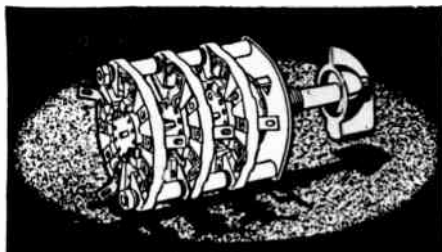

high frequency applications because of its low power factor.

Switches have single hole mounting on $\frac{3}{8}$ " diameter bushing. Aluminum shaft $2\frac{1}{4}$ " long from mounting surface. Adjustable stop index permits choice of from two to eleven positions. Each switch complete with bar knob.

WITH BAKELITE INSULATION

Part Number		Description			Price Each
Shorting	Non-Shorting	Gangs	Poles	Positions	
	1400	1	1	2 to 6	\$1.00
	1402	1	1	2 to 11	1.15
	1404	1	2	2 to 5	1.25
	1406	1	3	2 to 3	1.35
	1408	1	4	2	1.45
	1410	2	2	2 to 6	1.60
	1412	2	2	2 to 11	1.75
	1414	2	4	2 to 5	2.00
	1416	2	6	2 to 3	2.10
	1418	2	8	2	2.25
	1420	3	3	2 to 6	2.20
	1422	3	3	2 to 11	2.35
	1424	3	6	2 to 5	2.50
	1426	4	4	2 to 6	2.75
	1428	4	4	2 to 11	3.00
	1430	4	8	2 to 5	3.50

WITH ISOLANTITE INSULATION

Part No.	Gangs	Poles	Positions	Price Each
2501	1	1	2 to 6	\$1.70
2503	1	1	2 to 11	1.70
2505	1	2	2 to 5	1.70
2507	1	3	2 to 3	1.70
2511	2	2	2 to 6	2.70
2513	2	2	2 to 11	2.70
2515	2	4	2 to 5	2.70
2517	2	6	2 to 3	2.70
2521	3	3	2 to 6	3.90
2523	3	3	2 to 11	3.90
2525	3	6	2 to 5	3.90

Any bakelite or Isolantite selector switch can be assembled from SWITCHKIT PARTS. See page P-3 for complete list of parts to assemble these and similar switches.

TRANSMITTER SWITCHES FOR AMATEURS

Isolantite sections with four positions, 90 degrees apart for greater spacing between contacts. Adjustable stop will limit rotation to 2 or 3 positions if required. Contact will operate in transmitters rated up to 100 watts and at potentials up to 1000 volts D.C. One pole per section in all types, $\frac{1}{2}$ " spacing between sections. $2\frac{1}{4}$ " aluminum shaft can be easily cut to length required. Attractive bar knob included with each switch.

Cat. No.	Poles	Positions	Sections	List Price
2542	1	2 to 4	1	\$1.70
2543	2	2 to 4	2	2.70
2544	3	2 to 4	3	3.90
2545	4	2 to 4	4	4.90
2546	5	2 to 4	5	6.10

Dial Plate . . . Special, numbered 1 - 4 to agree with 90 degree index on switches listed above.

Cat. No. K-162.

Price each \$0.20

UNIVERSAL FLAT SWITCH



A compact inexpensive switch for many circuit applications. May be used as single pole single throw, single pole double throw, double pole single throw, double pole double throw, three pole single throw, three pole double throw, four pole single throw, four pole double throw. Non-shorting teeth. Flat construction requires only $\frac{5}{8}$ " overall back of mounting surface. Supplied with aluminum shaft $2\frac{1}{4}$ " overall. Standard bar knob included.

Catalog No. 1450

Price \$0.75

STONE SWITCHES

Catalog No. 1460—S.P.D.T. Price \$0.50

Catalog No. 1461—Single Pole, Three Pos. .60

Catalog No. 1462—D.P.D.T.60

Catalog No. 1465—Like 1461 plus snap switch 1.00

Catalog No. 1473—Two Pole, Three Pos.75

LOW CAPACITY LEVER ACTION SWITCHES

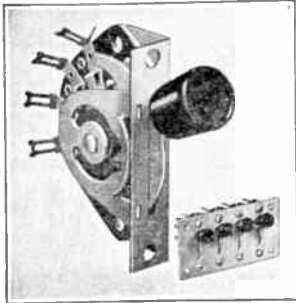

Used singly or in groups, these space saving switches are particularly adapted to broadcasting, receiving, public address, test instruments and industrial use. Available in ten different combinations including positive and spring return action with either shorting or non-shorting contacts. Use the shorting type contact for circuit switching where contacting the new circuit before breaking the old circuit will avoid noise. Further uses for this type of switch can be found in any application where multiple con-

tact low capacity switches are required to operate at low voltage and current. Dimensions of single switch are $\frac{3}{8}$ " width x $\frac{17}{8}$ " height x $1\frac{1}{2}$ " depth behind panel. Below are listed the various types, all furnished with black knob and nuts and bolts for panel mounting.

Price, All Types — \$1.00

Contacts		Description		Type of Index
Shorting	Non-Shorting	Poles	Positions	
1452	1454	2	3	Positive
1453	1455	2	3	Spring Return
1456	1457	4	2	Spring Return
1459	1458	4	2	Positive
1466	1467	2	3	Positive and Spring Return

LEVER ACTION SWITCHES WITH SNAP SWITCH

Similar in size and construction to the switches listed above, the two switches noted below differ in that the switch action consists of an underwriters approved snap switch either S.P.S.T. or D.P.S.T. Rated 1 amp. at 250 volts or 3 amp. at 125 volts. Can be mounted singly or in groups when used with mounting plates listed below.

Catalog No. 1468—S.P.S.T. Price \$0.60
 Catalog No. 1469—D.P.S.T. Price .75

MOUNTING PLATES

Part No.	No. of Switches	Mounting Holes	Price
P1755	1	Vertical	\$0.20
P1756	2	Vertical	.30
P1757	3	Vertical	.35
P1758	4	Vertical	.45
P1759	5	Vertical	.50
P1760	2	Horizontal	.30
P1761	3	Horizontal	.40
P1762	4	Horizontal	.50
P1763	5	Horizontal	.55

MOMENTARY PUSH SWITCHES

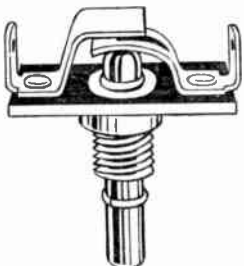

Centralab momentary open circuit switches may be used for many light duty applications such as meter insertion, record rejection or selection, test equipment, call bell, buzzer or annunciator systems, solenoid door check release, miniature lamp signals, small motor uses, and simple on-off switch. Rated 1 amp. at 110V A.C., contacts are phosphor bronze silver plated. Designed for panel mounting. Insulated $\frac{3}{8}$ " bushing, $\frac{3}{8}$ " long. Push button protrudes $\frac{3}{8}$ " from end of bushing.

Catalog No. 1470—Momentary opened.....Price \$0.50
 Catalog No. 1471—Momentary closedPrice \$.50

Copyright by U. C. P., Inc.

23 POSITION SELECTOR SWITCH

For test instruments and laboratory use. One common terminal contact twenty-three clips mounted on one section. Double wiping low capacity contact insures long life. Contact resistance averages .002 ohms. Furnished with shorting type contact only. Non-shorting contact cannot be supplied. $\frac{1}{4}$ " aluminum shaft $2\frac{1}{4}$ " long can easily be cut to required length. $\frac{3}{8}$ " brass bushing. Bar knob furnished with each switch. Switch cannot be supplied with adjustable stop.

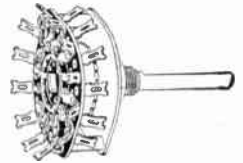

Catalog No. 1443 Price \$2.50
 Dial Plate numbered 1, 2, 3 for above switch.
 Catalog No. K-173 Price .20

SPRING RETURN SWITCHES

Replacements for intercommunicator talk-back switches. All are two positions. Shaft returns to original position when knob is released. Rotation against spring in clockwise position. Normal position is counter-clockwise. All have long shaft that can be cut to length.

Catalog Number Description Price
 Cat. No. 1463—1 Pole 2 Position.....\$0.65
 Cat. No. 1464—2 Pole 2 Position......75
 Cat. No. 1451—4 Pole 2 Position..... 1.00

METER INSERTION SWITCH

Twelve positions continuous rotation. Inserts millimeter in any one of twelve different circuits, keeping remaining eleven circuits closed. Aluminum shaft $2\frac{1}{4}$ " long. $\frac{3}{8}$ " brass bushing. Bar knob included with each switch. Complete wiring instructions included.

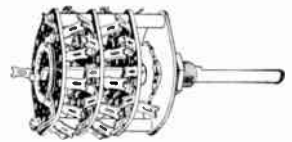

Catalog No. 1442.....Price \$4.50

ROTARY LINE AND TONE SWITCH

A compact and sturdy rotary type switch in a molded bakelite case, underwriters approved. Available in three types listed below, all furnished with long steel shaft milled for push-on knob.

No. 1447	SPST	Price \$0.50
No. 1448	DPST	.60
No. 1449	Tone Type	.60

KEY OPERATED SWITCH

Prevents unauthorized use or adjustment of equipment. Only key of proper shape will operate switch. Key furnished with each switch. Numerous uses include coin phonographs, electronic eye apparatus, power, timer or test recording equipment, electric door opener, temperature and humidity control regulators, laboratory setups, etc. Available in D.P.S.T. which can also be used as S.P.S.T. Rating of either switch 1 amp. at 250 volts A.C., 3 amp. at 125 volts A.C., or 15 amp. at 12 volts.

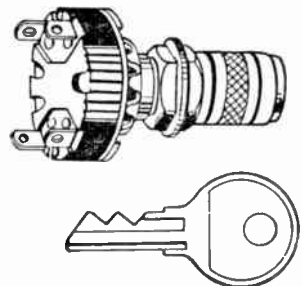

Catalog No. 1472—S.P.S.T. or D.P.S.T. Price \$1.00

THE CENTRALAB SWITCHKIT PROVIDES COUNTLESS SWITCH ASSEMBLIES

THE demand for selector switches includes so many different types that it is virtually impossible to maintain a complete stock of assembled switches. Selector switches are usually assembled with standard sections. The difficulty arises from the number of different ways that a small group of sections can be put together. To simplify stocking selector switches, Centralab has two switchkit assortments of sections, hardware, and accessories available. One of these includes bakelite sections and hardware; the other Iso-

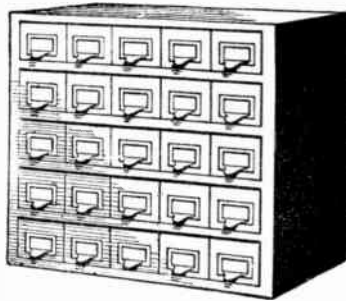

lantite sections and hardware. The parts included in each are tabulated below.

Each switchkit assortment is packed in an attractive sturdy steel cabinet identified with a Centralab decalcomania. Drawer pulls include identification

cards to show location of parts.

Cabinet contains 25 drawers, 3" x 2 1/2" x 8" inside. Cabinet 19" wide, 17 3/4" high, 9 1/4" deep overall. Finished in neutral green lacquer. Cabinet supplied FREE with either assortment listed below. Shipped F.O.B. Milwaukee, Wisconsin.

No. 414 KIT — includes assortment of bakelite sections, index assemblies and accessories listed below. Price: \$100.00.

No. 419 KIT — includes assortment of Isolantite sections, index assemblies and accessories listed below. Price \$100.00

PARTS INCLUDED IN BAKELITE SWITCHKIT

SECTIONS WITH BAKELITE INSULATION

Quantity	Catalog Number	Poles	Positions	Contact	Price Each
12	A	1	6	Shorting	\$.40
17	B	1	11	Shorting	.55
4	C	2	5	Shorting	.65
4	D	3	3	Shorting	.75
4	E	4	2	Shorting	.85
4	F*	1	5	Shorting	.60
4	G**	1	11	Shorting	.75
12	H	1	6	N. S.	.40
17	J	1	11	N. S.	.55
4	K	2	5	N. S.	.65
4	L	3	3	N. S.	.75
4	M	4	2	N. S.	.85
3	N	Use Together in			.50
3	P	Resistance Decade			.50
3	Q	Condenser Decade			.60
5	R***	2	5	Shorting	1.00
4	S***	3	3	Shorting	1.00

*Unused contacts shorted out on one side of common.
**All unused contacts shorted out.
***Isolantite Insulation.

INDEX ASSEMBLIES — COMPLETE WITH HARDWARE

Quantity	Catalog Number	Description	Price Each
20	K-121	To assemble 1 or 2 gang switches	\$.55
10	K-122	To assemble 3 or 4 gang switches	.75
5	K-123	To assemble 5 or 6 gang switches	.95

DIAL PLATES AND KNOBS

25	K-120	Bar Knob	\$.15
10	K-119	Arrow Knob	.15
10	K-115	Dial Plate: 1-5	.15
10	K-116	Dial Plate: 1-6	.15
10	K-117	Dial Plate: 1-10	.15
10	K-118	Dial Plate: 1-11	.15

PARTS INCLUDED IN ISOLANTITE SWITCHKIT

SECTIONS WITH ISOLANTITE INSULATION

Quantity	Catalog Number	Poles	Positions	Contact	Price Each
5	T	1	6	Shorting	\$1.00
10	U	1	11	Shorting	1.00
4	R	2	5	Shorting	1.00
4	S	3	3	Shorting	1.00
4	V	4	2	Shorting	1.00
4	X	1	6	N. S.	1.00
4	Y	1	11	N. S.	1.00
4	FR	2	5	N. S.	1.00
4	SS	3	3	N. S.	1.00
4	Z	4	2	N. S.	1.00
6	GC*	1	10	Shorting	1.00
15	XX**	1	4	N. S.	1.00

*All unused contacts shorted out.

**90 Degrees between positions—for transmitter switches.

INDEX ASSEMBLIES — COMPLETE WITH HARDWARE

Quantity	Catalog Number	Description	Price Each
10	K-121	For 1 or 2 Gang Selector Sw.	\$.55
10	K-170	For 1 or 2 Gang Trans. Sw.	.55
5	K-122	For 3 or 4 Gang Selector Sw.	.75
5	K-171	For 3 or 4 Gang Trans. Sw.	.75
3	K-123	For 5 or 6 Gang Selector Sw.	.95
3	K-172	For 5 or 6 Gang Trans. Sw.	.95

DIAL PLATES AND KNOBS

25	K-120	Bar Knob	\$.15
10	K-119	Bar Knob	.15
5	K-115	Dial Plate: 1-5	.15
10	K-117	Dial Plate: 1-10	.15
5	K-118	Dial Plate: 1-11	.15
12	K-162	1-4 Dial: 90 degree Index	.20

CLAROSTAT



Controls and Resistors

Composition-Element and
Wire-Wound Volume Controls.

Power Rheostats, Tandem
Rheostats, etc.

Power Resistors, Fixed
and Adjustable.

T-pads, L-pads, Faders,
Attenuators, etc.

Plug-In Resistors, Line-
Voltage Regulators, etc.

COMPOSITION—ELEMENT SERIES M CONTROLS

Compact—only 1 1/2" dia. by 1/2" (without switch) or 3/4" with switch. Permanent — negligible resistance change after cycling 10,000 times. Antenna and C-bias control still perfect after 28,000 cycles. CLAROSTAT Midget Controls are provided with the handy Ad-A-Switch feature. Plain metal cap readily slips off and switch member slips on in a jiffy. Choice of switches.

Series "M"	Ohms	Resist. Curve	Suggested Use of Unit
M-8	1,000	S	Std. Pot.
M-9	1,000	L	Untuned Ant.
M-10	1,000	V	C Bias Rheo.
M-11	2,000	S	Std. Pot.
M-12	2,000	L	Untuned Ant.
M-13	2,000	V	C Bias Rheo.
M-14	2,000	W	Sc. Grid & Phono.
M-15	3,000	S	Std. Pot.
M-16	3,000	U	Ant. & C—1 Tube
M-17	3,000	V	C Bias Rheo.
M-18	3,000	W	Sc. Grid & Phono.
M-19	5,000	S	Std. Pot.
M-20	5,000	U	Ant. & C—1 Tube
M-21	5,000	V	C Bias Rheo.
M-22	5,000	W	Sc. Grid & Phono.
M-23	7,500	S	Std. Pot.
M-24	7,500	U	Ant. & C—1 Tube
M-25	7,500	V	C Bias Rheo.
M-26	7,500	W	Sc. Grid & Phono.
M-27	10,000	S	Std. Pot.
M-28	10,000	N	Ant. or R.F. Coil
M-29	10,000	U	Ant. & C—1 Tube
M-30*	10,000	V	C Bias Rheo.
M-31	10,000	W	Sc. Grid & Phono.
M-32	15,000	S	Std. Pot.
M-33	15,000	U	Ant. & C—1 Tube
M-34	15,000	V	C Bias Rheo.
M-35	15,000	W	Sc. Grid & Phono.
M-36	20,000	S	Std. Pot.
M-37	20,000	U	Ant. & C—1 Tube
M-38	20,000	V	C Bias Rheo.
M-39	20,000	W	Sc. Grid & Phono.
M-40	25,000	S	Std. Pot.
M-41	25,000	W	Sc. Grid & Phono.
M-42	30,000	S	Std. Pot.
M-43	40,000	S	Std. Pot.
M-44	50,000	S	Std. Pot.
M-45	50,000	W	Sc. Grid & Phono.
M-46	50,000	Z	Audio Grid & Tone
M-47	75,000	S	Std. Pot.
M-48	75,000	V	C Bias Rheo.
M-49	100,000	N	Std. Pot.
M-50	100,000	Z	R.F. Shunt
M-51	100,000	Z	Audio & Tone
M-52	200,000	S	Std. Pot.
M-53	200,000	Z	Audio & Tone
M-54	200,000	V	C Bias Rheo.
M-55	250,000	S	Std. Pot.
M-56	250,000	Y	Audio Shunt
M-57	300,000	S	Std. Pot.
M-58	500,000	S	Std. Pot.
M-59	500,000	Y	Audio Shunt
M-60*	500,000	Z	Audio & Tone
M-61	1,000,000	S	Std. Pot.
M-62	1,000,000	Y	Audio Shunt
M-63*	1,000,000	Z	Audio & Tone
M-64*	250,000	Z	Audio & Tone
M-65	1,500,000	Z	Audio & Tone
M-66*	2,000,000	Z	Tone & AVC
M-67	3,000,000	Z	Tone & AVC
M-68	4,000,000	Z	Tone & AVC
M-69	5,000,000	Z	Tone & AVC
M-70	10,000	T	Ant. & C—2 Tubes
M-71	25,000	V	Ant. & C—1 Tube
M-72*	25,000	V	C Bias Rheo.
M-73	75,000	Z	Audio & Tone
M-74	500,000	No. 2 Spec.	Cathode Control
M-75	500,000	V	C Bias, Ser. Plate
M-76	100,000	V	C Bias Rheo.
M-77	150,000	Z	Audio & Tone
M-78	5,000,000	V	Series Screen
M-79	750,000	Z	Audio & Tone
M-80	4,000	S	Std. Pot.
M-81	10,000	Z	Ant. Shunt
M-82	1,000,000	Spec.	Bias Control

PRICE without switch..... \$1.00 Net \$0.60
Switch extra50 .30

WIRE WOUND SERIES W CONTROLS

● Selected alloy wire precisely wound on thin bakelite strip. Variable spacing of turns and also use of tapered strip for desired taper.
● Perfect sliding contact by means of special alloy contact shoe, together with use of exclusive winding lubricant.
● Linear resistance controls rated at 3 watts. "V" and "W" tapered controls rated at 2 watts. "L", "N" and "U" tapered controls rated at 1.5 watts. Ratings apply only to maximum resistance setting.

Series "W"	Ohms	Resist. Curve	Suggested Use of Unit
W-01	1	S	Std. Pot.
W-02	2	S	Std. Pot.
W-03	3	S	Std. Pot.
W-04	4	S	Std. Pot.
W-06	6	S	Std. Pot.
W-010	10	S	Std. Pot.
W-015	15	S	Std. Pot.
W-020	20	S	Std. Pot.
W-025	25	S	Std. Pot.
W-030	30	S	Std. Pot.
W-040	40	S	Std. Pot.
W-060	60	S	Std. Pot.
W-075	75	S	Std. Pot.
W-1	50	S	Std. Pot.
W-2	100	S	Std. Pot.
W-3	200	S	Std. Pot.
W-4	300	S	Std. Pot.
W-5	400	S	Std. Pot.
W-6	500	S	Std. Pot.
W-7	750	S	Std. Pot.
W-8	1,000	S	Std. Pot.
W-9	1,000	L	Untuned Ant.
W-10	1,000	V	C Bias Rheo.
W-11	2,000	S	Std. Pot.
W-12	2,000	L	Untuned Ant.
W-13	2,000	V	C Bias Rheo.
W-14	2,000	W	Sc. Grid & Phono.
W-15	3,000	S	Std. Pot.
W-16	3,000	U	Ant. & C—1 Tube
W-17	3,000	V	C Bias Rheo.
W-18	3,000	W	Sc. Grid & Phono.
W-19	5,000	S	Std. Pot.
W-20	5,000	L	Ant. & C—1 Tube
W-21	5,000	V	C Bias Rheo.
W-22	5,000	W	Sc. Grid & Phono.
W-23	7,500	S	Std. Pot.
W-24	7,500	U	Ant. & C—1 Tube
W-25	7,500	V	C Bias Rheo.
W-26	7,500	W	Sc. Grid & Phono.
W-27*	10,000	S	Std. Pot.
W-28	10,000	N	Ant. & R.F. Coil
W-29	10,000	U	Ant. & C—1 Tube
W-30	10,000	V	C Bias Rheo.
W-31	10,000	W	Sc. Grid & Phono.
W-32	15,000	S	Std. Pot.
W-33	15,000	U	Ant. & C—1 Tube
W-34	15,000	V	C Bias Rheo.
W-35	15,000	W	Sc. Grid & Phono.
W-36	20,000	S	Std. Pot.
W-37	20,000	U	Ant. & C—1 Tube
W-38	20,000	V	C Bias Rheo.
W-39	20,000	W	Sc. Grid & Phono.
W-40	25,000	S	Std. Pot.
W-41	25,000	W	Sc. Grid & Phono.
W-42	30,000	S	Std. Pot.
W-43	40,000	S	Std. Pot.
W-44	50,000	S	Std. Pot.
W-45	50,000	W	Sc. Grid & Phono.
W-47*	75,000	S	Std. Pot.
W-49*	100,000	S	Std. Pot.
W-80	4,000	S	Std. Pot.

All units except W-40 to W-49 \$1.00 Net \$0.60
W-40 to W-44 1.25 .75
W-45 1.50 .90
W-47 and W-49 2.00 1.20

SEPARATE SWITCHES FOR SERIES "M" & "W" CONTROLS

This original Ad-A-Switch feature, makes it easy to convert any of CLAROSTAT SERIES "M" & "W" controls to a switch type control.

TYPES AVAILABLE:	List	Net
SERIES "U", "A" Single Pole Single Throw	\$0.50	\$0.30
SERIES U-1, A-1* (3-Way) No-"Off"-Position. Single Pole Double Throw50	.30
SERIES U-2, A-2* Double Pole Single Throw50	.30
SERIES U-3, A-3* Three Wire (to control A, B and C voltage)50	.30
SERIES U-4, A-4* Four Wire (to control A, B and C voltage)50	.30
SERIES A-(REV) S.P.S.T. Switch (closes at full clockwise rotation)60	.36
SERIES A-(DL) S.P.S.T. Switch with Dummy Lug60	.36

MIDGET SERIES TCP TAPPED CONTROLS

Cat. No.	Total Resistance	Tapped at
TCP-10	6,000	2,500
TCP-20	30,000	6,000
TCP-22	44,000	7,000 & 14,000
TCP-23	44,000	7,000 & 14,000
TCP-25	50,000	25,000
TCP-29	60,000	10,000
TCP-30	60,000	3,000
TCP-31	63,000	3,000
TCP-37	200,000	25,000
TCP-38	200,000	100,000
TCP-39	250,000	25,000
TCP-40	250,000	50,000
TCP-41	250,000	100,000
TCP-42	250,000	125,000
TCP-43	250,000	50,000
TCP-44	250,000	60,000 & 125,000
TCP-45	250,000	30,000 & 60,000
TCP-50	250,000	150,000
TCP-51	300,000	150,000
TCP-60	350,000	25,000
TCP-69	350,000	75,000
TCP-70	350,000	75,000
TCP-75	500,000	15,000
TCP-78*	500,000	100,000
TCP-79	500,000	5,000
TCP-80	500,000	100,000
TCP-81	500,000	25,000
TCP-82	500,000	200,000
TCP-83	500,000	125,000
TCP-88	500,000	50,000
TCP-90	500,000	250,000
TCP-91	500,000	100,000 & 170,000
TCP-92	500,000	100,000 & 300,000
TCP-93	725,000	350,000
TCP-95	1,500,000	250,000 & 500,000
TCP-98	1,000,000	250,000
TCP-99	1,000,000	50,000
TCP-100	1,000,000	20,000
TCP-101	1,000,000	50,000
TCP-102	1,000,000	100,000 & 500,000
TCP-103	1,000,000	100,000
TCP-109*	1,000,000	225,000
TCP-110	1,000,000	170,000
TCP-111	1,000,000	200,000
TCP-112	1,000,000	500,000
TCP-113	2,000,000	25,000
TCP-114	2,000,000	100,000
TCP-115	2,000,000	500,000
TCP-116	2,000,000	1,000,000
TCP-117	2,000,000	40,000
TCP-118	2,000,000	20,000
TCP-119	2,000,000	200,000
TCP-120	2,000,000	400,000
TCP-121*	2,000,000	250,000 & 500,000
TCP-122	3,000,000	1,000,000
TCP-123*	2,500,000	250,000 & 500,000
TCP-124	2,000,000	5,000
TCP-125	1,500,000	350,000
TCP-126	2,000,000	200,000 & 400,000
TCP-127	2,000,000	5,000 & 500,000
TCP-128	4,000,000	500,000
TCP-129	2,000,000	15,000

LIST PRICE \$1.50 — NET, Each \$0.90

All controls are equipped with the original Ad-A-Switch features.

*"Victory" line for wartime replacements.

Note: Use Series "U" switch for Series "W" wire-wound controls. Use Series "A" switch for Series "M" composition controls.

CLAROSTAT



Controls and Resistors

- Composi-tion Element and Wire-Wound Volume Controls.
- Power Rheostats, Tandem Rheostats, etc.
- Power Resistors, Fixed and Adjustable.
- T-pads, L-pads, Faders, Attenuators, etc.
- Plug-in Resistors, Line-Voltage Regulators, etc.

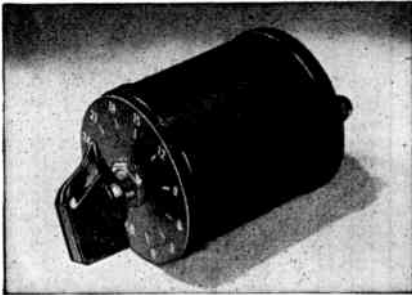

SERIES CIB—10 WATTS

The SERIES CIB, a constant impedance output attenuator, is a compact, inexpensive unit that will dissipate 10 watts at any position.

Recommended as an individual loud-speaker control without distortion.

Linear attenuation in 3 db steps up to 30 db and then final step to infinity. Insertion loss is zero.

Unit measures 2" in diameter and 2 3/4" long.

STOCK IMPEDANCES: 8, 15, 50, 200, 250 and 500 ohms.

Unit not equipped for switch, furnished with dial plate and knob.

MOUNTING: 1 hole mounting, 3/8" bushing, 1" shaft.

Dealer's Net price.....\$6.50

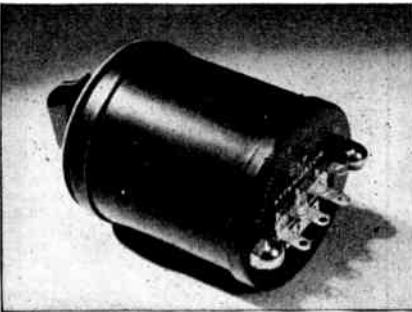

STANDARD and SPECIAL ITEMS

★ Items listed in these pages are the essential resistors and controls still available for civilian requirements under rigid wartime restrictions. The Clarostat standard line includes many more types and values as listed in jobber catalog pages, and obtainable on high priorities.

In addition to standard items meeting the widest range of unusual requirements, Clarostat also develops, designs and produces special resistors and controls for unusual needs, subject to highest priorities of course. Therefore, if your needs are unusual but vital to the war effort, and you do not find just the items you require listed herewith, ask for our more detailed listings, or submit your problem to us.

GLASOHMS*—FIBRE-GLASS RESISTORS AND HEATING UNITS

Glasohms, an exclusive Clarostat development and product, are miniature power resistors or heating elements so flexible that they can be fitted into tight places. The wire winding is on a fibre-glass core and is protected by an outer covering of braided fibre-glass.

In radio, electronic and electrical applications, these units can be used in point-to-

point wiring or again can be compacted into limited space. When used as miniature heating elements, Glasohms can be closely wrapped or packed about parts to be heated. Operating temperatures up to 750 degrees F.

In the absence of any materials that might char or burn, Glasohms are the ideal flexible resistors. Handy pigtail terminals and ferule ends that won't pull loose.

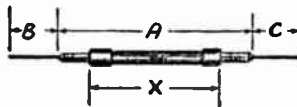

"X" directly proportional to watt dissipation.

TYPE "FXG" — Watts per inch = one. Core diameter 1/8 inch.

TYPE "FYG" — Watts per inch = two. Core diameter 1/8 inch.

"A" = "X" + 1/2 inch.

"B" = "C" = 2 inches. (Std.)

All linear measurements ± 1/8 inch.

* Trade Mark.

TYPE FXG—1 WATT

1" Body length with 2" Pigtails
1/8" Diameter Core

Type No.	Ohms	Type No.	Ohms
FXG5	5	FXG300	300
FXG10	10	FXG350	350
FXG15	15	FXG375	375
FXG25	25	FXG400	400
FXG40	40	FXG450	450
FXG50	50	FXG500	500
FXG60	60	FXG600	600
FXG75	75	FXG700	700
FXG100	100	FXG750	750
FXG125	125	FXG800	800
FXG150	150	FXG850	850
FXG200	200	FXG900	900
FXG225	225	FXG1000	1000
FXG250	250		

List Price \$0.20 — Net Price \$0.12

*Registered Trade Mark

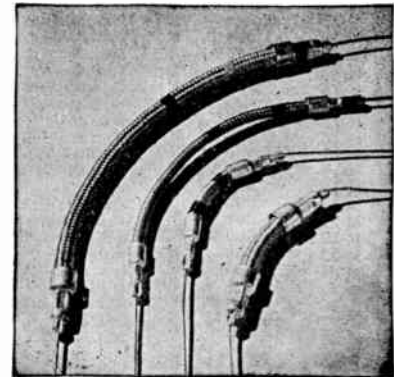

TYPE FYG—2 WATTS

1" Body length with 2" Pigtails
1/8" Diameter Core

Type No.	Ohms	Type No.	Ohms
FYG5	5	FYG375	375
FYG10	10	FYG400	400
FYG15	15	FYG500	500
FYG25	25	FYG600	600
FYG40	40	FYG700	700
FYG50	50	FYG750	750
FYG60	60	FYG800	800
FYG75	75	FYG850	850
FYG100	100	FYG900	900
FYG125	125	FYG1000	1000
FYG150	150	FYG1250	1250
FYG200	200	FYG1500	1500
FYG225	225	FYG1600	1600
FYG250	250	FYG1750	1750
FYG300	300	FYG2000	2000
FYG350	350		

List Price \$0.25 — Net Price \$0.15

ROTARY SWITCHES

Clarostat rotary switches are compact, positive-contact, bakelite-molded and Underwriter's Approved. Rated 1 amp. 250 v.; 3 amp. 125 v. Dimensions: 1-3/32" dia., 9/16" body depth; lug protrusion 1/4"; locking projection on a 17/32" radius; rotation for actuation, 30 degrees.

All standard stock numbers have a 3/8" bushing, 1 1/2" length shaft, and one locking projection. Other bushing length and shaft lengths available on special order. These rotary switches are of the same general design as the Clarostat Series M controls and therefore work nicely into any radio or electronic assembly. They take the standard radio knobs. Connections are made to the soldering lugs.

There is an adequate choice of switch types to meet all standard application requirements, beginning with the simple single-pole power switch and on to the two-pole three-position switch that can be used as a 2-pole 3-position tone switch, an AC line and 2-position tone switch, and as an amplifier and phonograph motor switch.

Switch Description	List	Net
Single Pole Single Throw.....	\$0.50	\$0.30
Single Pole Bussing Lug.....	.50	.30
Double Pole Single Throw.....	.60	.36
Single Pole, Double Throw.....	.60	.36
Single Pole Reversed Action.....	.50	.30
Four Wire Single Throw.....	.60	.36
2 Pole—3 Position.....	.60	.36

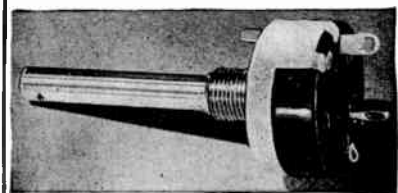

CLAROSTAT



Controls and Resistors

Composition-Element and Wire-Wound Volume Controls.
Power Rheostats, Tandem Rheostats, etc.
Power Resistors, Fixed and Adjustable.
T-pads, L-pads, Faders, Attenuators, etc.
Plug-In Resistors, Line Voltage Regulators, etc.

GREENOHMS*—WIRE-WOUND FIXED POWER RESISTORS Windings Protected by the CLAROSTAT Green Cement Coating



TYPE 10-C 10-WATT SIZE

Resis. Ohms	Resis. Ohms	Resis. Ohms	Resis. Ohms
1	200	2,000	9,000
2	250	2,250	10,000
3	300	2,500	11,000
5	350	3,000	12,000
7.5	400	3,500	12,500
10	500	4,000	14,300
15	600	4,500	15,000
20	750	5,000	20,000
25	800	6,000	25,000
50	1,000	7,000	30,000
75	1,250	7,500	35,000
100	1,450	8,000	40,000
150	1,500	8,500	50,000

Packed 10 to a box
List Price\$0.40 Net Price.....\$0.24

TYPE 20-C 20-WATT SIZE

Resis. Ohms	Resis. Ohms	Resis. Ohms	Resis. Ohms
1	500	2,500	11,000
5	750	2,750	12,000
10	800	3,000	12,500
25	850	3,500	15,000
50	1,000	4,000	20,000
75	1,200	4,500	25,000
100	1,250	5,000	30,000
150	1,500	6,000	35,000
200	1,750	7,000	40,000
250	1,850	7,500	50,000
300	2,000	8,000	60,000
350	2,250	9,000	70,000
400	2,400	10,000	80,000
			100,000

Packed 5 to a box.
Price List Price Net Price
Price—1 ohm to 15M ohms.....\$0.65 \$0.39
Price—20M ohms to 50M ohms .75 .45
Price—60M ohms to 100M ohms 1.00 .60

TYPE 25-C 25-WATT SIZE

Resis. Ohms	Resis. Ohms	Resis. Ohms	Resis. Ohms
1	400	6,000	50,000
3	500	7,500	60,000
5	750	8,000	70,000
10	800	9,000	80,000
15	1,000	10,000	90,000
25	1,250	12,000	100,000
50	1,500	15,000	
75	2,250	20,000	
100	2,500	25,000	
150	3,000	30,000	
200	3,500	35,000	
250	4,000	40,000	
300	5,000	45,000	

Price List Price Net Price
Price—1 ohm to 5M ohms.....\$0.75 \$0.45
Price—6M ohms to 15M ohms .85 .51
Price—20M ohms to 50M ohms 1.00 .60
Price—60M ohms 1.15 .69
Price—70M ohms 1.25 .75
Price—80M ohms 1.35 .81
Price—90M ohms 1.60 .96
Price—100M ohms 1.75 1.05

TYPE 40-C 40-WATT SIZE

Resis. Ohms	Resis. Ohms	Resis. Ohms	Resis. Ohms
25	500	6,000	50,000
50	750	7,500	60,000
75	1,000	10,000	70,000
100	1,500	12,500	80,000
125	2,000	15,000	90,000
150	2,500	20,000	100,000
200	3,000	25,000	125,000
300	4,000	35,000	150,000
400	5,000	40,000	200,000

Price—15 ohms to 5M ohms.....\$0.90 \$0.54
Price—6M ohms to 25M ohms 1.00 .60
Price—30M ohms to 100M ohms 1.20 .72
Price—125M ohms to 150M ohms 1.40 .84
Price—200M ohms 1.60 .96

TYPE 50-C 50-WATT SIZE

Resis. Ohms	Resis. Ohms	Resis. Ohms	Resis. Ohms
5	1,500	10,000	75,000
10	2,000	12,000	100,000
25	2,500	12,500	125,000
50	3,000	15,000	150,000
100	4,000	20,000	175,000
200	5,000	25,000	200,000
250	6,000	30,000	225,000
500	7,000	40,000	250,000
750	7,500	50,000	
1,000	8,000	60,000	

Price List Price Net Price
Price—5 ohms to 5M ohms.....\$1.10 \$0.66
Price—6M ohms to 25M ohms 1.25 .75
Price—30M ohms to 100M ohms 1.45 .87
Price—125M ohms 2.00 1.20
Price—150M ohms to 175M ohms 2.25 1.35
Price—200M ohms to 225M ohms 2.50 1.50
Price—250M ohms 2.75 1.65

TYPE 80-C 80-WATT SIZE

Resis. Ohms	Resis. Ohms	Resis. Ohms	Resis. Ohms
5	750	6,000	30,000
10	1,000	7,500	40,000
25	1,500	8,000	50,000
50	2,000	10,000	60,000
100	2,500	15,000	75,000
200	3,000	20,000	100,000
250	4,000	25,000	
500	5,000		

Price List Price Net Price
Price—5 ohms to 5M ohms.....\$1.25 \$0.75
Price—6M ohms to 25M ohms 1.50 .90
Price—30M ohms to 50M ohms 1.75 1.05
Price—60M ohms to 75M ohms 2.00 1.20
Price—100,000 ohms 2.25 1.35

TYPE 100-C 100-WATT SIZE

Resis. Ohms	Resis. Ohms	Resis. Ohms	Resis. Ohms
25	750	5,000	40,000
50	1,000	7,500	50,000
75	1,250	10,000	60,000
100	1,500	15,000	75,000
150	2,000	20,000	100,000
250	2,500	25,000	125,000
500	3,000	30,000	150,000
			200,000

Price List Price Net Price
Price—25 ohms to 3M ohms.....\$1.50 \$0.90
Price—5M ohms to 25M ohms 1.75 1.05
Price—30M ohms to 50M ohms 2.00 1.20
Price—60M ohms to 75M ohms 2.25 1.35
Price—100M ohms 2.50 1.50
Price—125M ohms 2.75 1.65
Price—150M ohms 3.00 1.80
Price—200M ohms 3.50 2.10

TYPE 160-C 160-WATT SIZE

Resis. Ohms	Resis. Ohms	Resis. Ohms	Resis. Ohms
100	3,000	15,000	60,000
200	3,500	20,000	70,000
500	4,000	25,000	80,000
1,000	4,500	30,000	100,000
1,500	5,000	35,000	125,000
2,000	7,500	40,000	150,000
2,500	10,000	50,000	

Price List Price Net Price
Price—100 ohms to 10M ohms.....\$2.00 \$1.20
Price—15M ohms to 50M ohms 2.40 1.44
Price—60M ohms to 100M ohms 2.70 1.65
Price—125M ohms 3.00 1.80
Price—150M ohms 3.25 1.95

TYPE 200-C 200-WATT SIZE

Resis. Ohms	Resis. Ohms	Resis. Ohms	Resis. Ohms
100	3,000	15,000	60,000
250	3,500	20,000	75,000
500	4,000	25,000	100,000
1,000	4,500	30,000	125,000
1,500	5,000	35,000	150,000
2,000	7,500	40,000	
2,500	10,000	50,000	

Price List Price Net Price
Price—100 ohms to 10M ohms.....\$2.50 \$1.50
Price—15M ohms to 100M ohms 3.00 1.80
Price—125M ohms to 150M ohms 3.50 2.10

CLAROSTAT Cement Coated Resistors

are available on Special Order with the following terminal connections.

Type "A"— $\frac{1}{4}$ inch terminal with an $\frac{1}{8}$ inch hole.

Type "C"—No. 18 B & S Hot Tinned Copper Wire, $1\frac{1}{2}$ inches long.

Type "D"—Fuse Clip terminal $\frac{9}{16}$ inch diameter.

Type "E"—Fuse Clip terminal $\frac{11}{16}$ inch diameter.

Type "F"—Fuse Clip terminal $\frac{13}{16}$ inch diameter.

Type "G"—Fuse Clip terminal $1\frac{1}{8}$ inch diameter.

Type "H"—Medium Edison Base.

Type "J"—Standard 6 inch flexible lead.

* Trade Mark. "Only Clarostat Makes Greenohms."

CLAROSTAT



Controls and Resistors

Composition-Element and Wire-Wound Volume Controls.

Power Rheostats, Tandem Rheostats, etc.

Power Resistors, Fixed and Adjustable.

T-pads, L-pads, Faders, Attenuators, etc.

Plug-in Resistors, Line-Voltage Regulators, etc.

GREENHOMS* — WIRE-WOUND POWER RESISTORS



* Trade Mark.
Only Clarostat Makes Greenhoms.

TYPE 10-CA		10-WATT SIZE	
Resis. Ohms	Resis. Ohms	Resis. Ohms	Resis. Ohms
1	75	750	3,500
2	100	800	4,000
3	150	1,000	4,500
5	200	1,250	5,000
7.5	250	1,450	6,000
10	300	1,500	7,000
15	350	2,000	8,000
20	400	2,250	9,000
25	500	2,500	10,000
50	600	3,000	

Packed in individual boxes
NO BRACKETS FURNISHED
EXTRA SLIDERS, LIST \$0.10 — NET \$0.06
LIST PRICE \$0.60 — NET PRICE \$0.36

TYPE 25-CA		25-WATT SIZE	
Resis. Ohms	Resis. Ohms	Resis. Ohms	Resis. Ohms
1	150	1,250	6,000
3	200	1,500	7,500
5	250	2,000	8,000
10	300	2,250	9,000
15	400	2,500	10,000
25	500	3,000	12,000
50	750	3,500	15,000
75	800	4,000	20,000
100	1,000	5,000	25,000
			50,000

Packed in individual boxes
BRACKETS FURNISHED
EXTRA SLIDERS, LIST \$0.10 — NET \$0.06

	List	Net
Price—1 ohm to 5M ohms.....	\$0.85	\$0.51
Price—6M ohms to 15M ohms....	.95	.57
Price—20M ohms to 25M ohms..	1.10	.66
Price—50M ohms	1.25	.75

Adjustable Type

Adjustment of the slider to the proper resistance is easily made by loosening the screw and setting to the proper point. The cement covering prevents mechanical injury to the wire and eliminates the possibility of the wire winding shifting. Mounting brackets are furnished with Adjustable Resistors except the small 10 watt size. Brackets for Power Resistors and extra sliders for the Adjustable Resistors are available.

TYPE 50-CA		50-WATT SIZE	
Resis. Ohms	Resis. Ohms	Resis. Ohms	Resis. Ohms
5	300	2,500	15,000
10	400	3,000	20,000
25	500	4,000	25,000
50	750	5,000	30,000
75	800	6,000	40,000
100	1,000	7,500	50,000
150	1,250	8,000	60,000
200	1,500	10,000	75,000
250	2,000	12,000	100,000

Packed in individual boxes
BRACKETS FURNISHED
EXTRA SLIDERS, LIST \$0.10 — NET \$0.06

	List	Net
Price—5 ohms to 5M ohms.....	\$1.35	\$0.81
Price—6M ohms to 25M ohms....	1.50	.90
Price—30M ohms to 50M ohms..	1.70	1.02
Price—60M ohms to 100M ohms	2.00	1.20

TYPE 80-CA		80-WATT SIZE	
Resis. Ohms	Resis. Ohms	Resis. Ohms	Resis. Ohms
5	400	3,500	25,000
10	500	4,000	30,000
15	750	5,000	35,000
25	800	6,000	40,000
50	1,000	7,500	45,000
100	1,500	8,000	50,000
200	2,000	10,000	60,000
250	2,500	15,000	80,000
300	3,000	20,000	100,000

Packed in individual boxes
BRACKETS FURNISHED
EXTRA SLIDERS, LIST \$0.15 — NET \$0.09

	List	Net
Price—5 ohms to 5M ohms	\$1.75	\$1.05
Price—6M ohms to 25M ohms....	2.00	1.20
Price—30M ohms to 50M ohms..	2.25	1.35
Price—60M ohms to 100M ohms	2.50	1.50

TYPE 100-CA		100-WATT SIZE	
Resis. Ohms	Resis. Ohms	Resis. Ohms	Resis. Ohms
100	2,000	8,000	50,000
200	2,500	10,000	60,000
400	3,000	15,000	75,000
500	4,000	20,000	100,000
750	5,000	25,000	125,000
1,000	6,000	30,000	150,000
1,500	7,500	40,000	

Packed in individual boxes
BRACKETS FURNISHED
EXTRA SLIDERS, LIST \$0.15 — NET \$0.09

	List	Net
Price—100 ohms to 5M ohms.....	\$2.00	\$1.20
Price—6M ohms to 25M ohms....	2.25	1.35
Price—30M ohms to 50M ohms....	2.50	1.50
Price—60M ohms to 100M ohms..	2.75	1.65
Price—125M ohms to 150M ohms	3.75	2.25

TYPE 160-CA		160-WATT SIZE	
Resis. Ohms	Resis. Ohms	Resis. Ohms	Resis. Ohms
100	2,500	10,000	50,000
200	3,000	15,000	60,000
250	3,500	20,000	70,000
500	4,000	25,000	80,000
1,000	4,500	30,000	100,000
1,500	5,000	35,000	125,000
2,000	7,500	40,000	150,000

Packed in individual boxes
BRACKETS FURNISHED
EXTRA SLIDERS, LIST \$0.15 — NET \$0.09

	List	Net
Price—100 ohms to 10M ohms....	\$2.50	\$1.50
Price—15M ohms to 50M ohms....	2.90	1.74
Price—60M ohms to 100M ohms..	3.25	1.95
Price—125M ohms to 150M ohms	3.75	2.25

TYPE 200-CA		200-WATT SIZE	
Resis. Ohms	Resis. Ohms	Resis. Ohms	Resis. Ohms
100	2,500	20,000	60,000
500	3,000	25,000	75,000
1,000	5,000	30,000	100,000
1,500	10,000	40,000	
2,000	15,000	50,000	

Packed in individual boxes
BRACKETS FURNISHED
EXTRA SLIDERS, LIST \$0.15 — NET \$0.09

	List	Net
Price—100 ohms to 10M ohms	\$3.00	\$1.80
Price—15M ohms to 100M ohms	3.50	2.10

AUTOMATIC LINE-VOLTAGE REGULATORS



The Clarostat Automatic Line Voltage Regulator illustrated is designed for use with 110-volt socket power radio sets not equipped for line ballasts.

At 110 volts, the resistance of the units is low and the voltage drop across them is negligible. As the line voltage increases, however, the resistance of the units increases with a consequent increase in voltage drop across them, keeping the voltage across the primary of the power transformer of the set prac-

tically constant, even though the line voltage increases up to 140

To install this unit, all that is necessary is to insert the usual attachment plug of the radio set into the slots provided in the top. Then insert the prongs of the unit into the slots of the usual screw type plug or convenience outlet of the electric light system.

The body dimensions of this units are only 1 1/4 in. in diameter and 1 3/4 in. in length. The prongs are 3/8 in. long.

Type Rating	For Use With	No. of
No. 50	Sets Consuming	Tubes Used
O	Up to 60 Watts.....	4
A	100..... 60 to 100 Watts.....	5, 6, 7
B	150..... 100 to 150 Watts.....	8, 9, 10
C	200..... 150 to 200 Watts.....	11, 12
D	250..... 200 to 250 Watts.....	2 Type 50
E*	100..... 60 to 100 Watts	

* Note: For use with 220 volt receivers. Available with "UX" Base. Add letters "UX" before tube number when ordering UX Base Tubes.

List Price, All Types, \$1.00
NET PRICE \$0.60



Controls and Resistors

Composition-Element and Wire-Wound Volume Controls.
 Power Rheostats, Tandem Rheostats, etc.
 Power Resistors, Fixed and Adjustable.
 T-pads, L-pads, Faders, Attenuators, etc.
 Plug-in Resistors, Line-Voltage Regulators, etc.

POWER RHEOSTAT

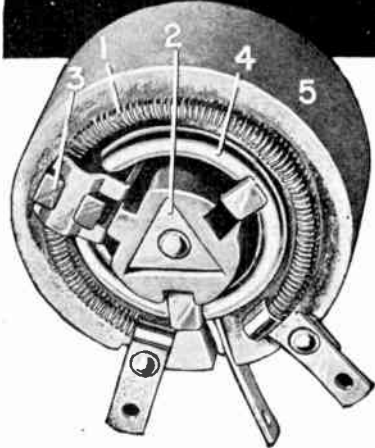

Due to the ability of these Clarostat power rheostats to withstand overload, there is provided a current rating for the first 1/3 rotation which is generally greater than the current rating of equivalent-resistance power rheostats of other designs. Besides giving the maximum current at total resistance (third column), Clarostat also gives you the maximum current up to 1/3 total resistance (fourth column).

Now available in both 25- and 50-watt sizes. Either provides for single-hole mounting. Adjustable projecting lug anchors unit against rotation of entire rheostat when mounted on panel. Shaft and bushing are insulated from contact carrier arm, allowing unit to be mounted directly on metal panel without use of insulating washer.

Note these exceptionally rugged details, as indicated in left-hand illustration: 1. Selected resistance wire on insulated metal core imbedded in cold-setting inorganic cement. Maximum heat conduction and radiation—no heat treatment. 2. Tripod-type rotor with helical spring. Smooth, easy, non-binding rotation. 3. Graphite-copper contact shoe rides third-rail ring and winding with positive, velvety contact. 4. Heavy brass third-rail contact ring which also serves as bearing rail for tripod rotor. 5. Heat-resistant

body forming continuous heat-conducting bond through inorganic cement with wire winding.

300 degrees rotation. All stock rheostats have 3/8" bushing and 1/2" shaft. 25-watt size is 1 1/8" dia. by 1 1/2" deep. 50-watt size is 2 1/4" diameter by 1 3/8" deep.

Other values than those listed can be supplied on special order. Also tandem units of two or more rheostats coupled together. Armored or enclosed types on special order. Also Army Air Force and Naval Air Force types.

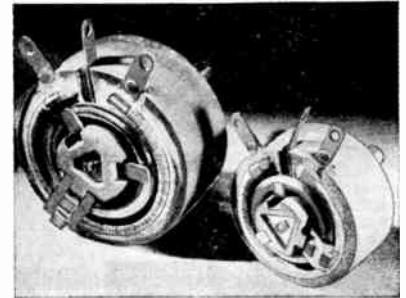

SERIES PW-25 (25-WATT)

Cat. No.	Total Resistance, Ohms	Max. Current at Total Resistance, Amps.	Max. Current up to 1/3 Resistance, Amps.	Net
PW-25-1	1	5.000	7.500	\$2.70
PW-25-2	2	3.450	5.175	2.40
PW-25-3	3	2.880	4.320	2.40
PW-25-6	6	2.040	3.060	2.40
PW-25-8	8	1.770	2.655	2.40
PW-25-10	10	1.580	2.370	2.40
PW-25-15	15	1.290	1.935	2.40
PW-25-25	25	1.000	1.500	2.40
PW-25-35	35	.845	1.317	2.40
PW-25-50	50	.707	1.060	2.40
PW-25-75	75	.575	.862	2.40
PW-25-100	100	.500	.750	2.40
PW-25-125	125	.445	.667	2.40
PW-25-175	175	.375	.562	2.40
PW-25-250	250	.316	.474	2.40
PW-25-350	350	.267	.400	2.40
PW-25-500	500	.222	.333	2.40
PW-25-750	750	.182	.273	2.40
PW-25-1000	1000	.155	.232	2.70
PW-25-1500	1500	.129	.193	2.70
PW-25-2500	2500	.100	.150	2.70
PW-25-3500	3500	.084	.126	2.85
PW-25-5000	5000	.070	.105	2.85

SERIES PW-50 (50-WATT)

Cat. No.	Total Resistance, Ohms	Max. Current at Total Resistance, Amps.	Max. Current up to 1/3 Resistance, Amps.	Net
PW-50-0.5	0.5	10.000	15.000	\$3.00
PW-50-1	1	7.070	10.605	3.00
PW-50-2	2	5.000	7.500	3.00
PW-50-4	4	3.530	5.295	2.70
PW-50-6	6	2.880	5.320	2.70
PW-50-8	8	2.500	3.750	2.70
PW-50-12	12	2.040	3.060	2.70
PW-50-16	16	1.760	2.640	2.70
PW-50-22	22	1.500	2.250	2.70
PW-50-35	35	1.190	1.785	2.70
PW-50-50	50	1.000	1.500	2.70
PW-50-80	80	.790	1.185	2.70
PW-50-125	125	.630	.945	2.70
PW-50-150	150	.575	.863	2.70
PW-50-225	225	.470	.705	2.70
PW-50-300	300	.408	.612	2.70
PW-50-500	500	.316	.474	2.70
PW-50-800	800	.250	.375	2.85
PW-50-1000	1000	.224	.346	2.85
PW-50-1600	1600	.176	.264	2.85
PW-50-2500	2500	.141	.212	2.85
PW-50-3500	3500	.119	.179	3.00
PW-50-5000	5000	.100	.150	3.00
PW-50-8000	8000	.079	.119	3.00
PW-50-10000	10000	.070	.105	3.00



UNIVERSAL METAL-TUBE RESISTORS

Universal Tube No.	Replaces AC-DC Tubes beginning with letters	Having numbers from	Ending in letter
10*23-A	BK, BL, K, L, M	10 to 23	A, B, C, D
10*23-E	BK, BL, K, L, M	10 to 23	E
10*23-F	BK, BL, K, L, M	10 to 23	F, G, H,
23*55-A	BK, BL, K, L, M	23 to 55	A, B, C, D
23*55-E	BK, BL, K, L, M	23 to 55	E
23*55-F	BK, BL, K, L, M	23 to 55	F, G, H,
60*92-A	BK, BL, K, L, M	60 to 92	A, B, C, D
60*92-E	BK, BL, K, L, M	60 to 92	E
60*92-F	BK, BL, K, L, M	60 to 92	F, G, H,
92*105-A	BK, BL, K, L, M	92 to 105	A, B, C, D

The Universal Resistor Tube will operate any AC-DC set within the voltage ranges specified on the tube, regardless of what pilot current is drawn or any pilot lamp combination.

The tube will operate regardless of pilot lamp or lamps burning out, operating well within the .3 ampere range required for the filaments of the tubes. Should pilot lamps burn out, the current will still be within range for efficient operation of tubes.

Regardless of line voltage variation, the tube will operate efficiently.

LIST PRICE \$1.00—NET PRICE \$0.60

CLAROSTAT



Controls and Resistors

Composition-Element and Wire-Wound Volume Controls.
 Power Rheostats, Tandem Rheostats, etc.
 Power Resistors, Fixed and Adjustable.
 T-pads, L-pads, Faders, Attenuators, etc.
 Plug-in Resistors, Line-Voltage Regulators, etc.

CONSTANT IMPEDANCE CONTROLS — "T" Pads, "L" Pads, and Other Types

When high quality reproduction of sound is required in public address, broadcast transmission, sound recording, projection and multiple outlet reproduction systems, care must be taken in the selection of volume controls or attenuators to eliminate distortion which arises from the mis-matching of impedances.

Volume controls or attenuators for this purpose must, therefore, be of the constant impedance type; that is, the input or output impedance, with the associated apparatus in the circuit, must remain within the limits of a required constant value.

For such requirements, Clarostat herewith lists three types of controls, each designed for a particular usage.

THE "T" PAD, the wiring diagram of which is shown in Fig. 1, and connections in Fig. 2, maintains a constant impedance both at the source and load terminals. It can therefore be used in any circuit requiring such characteristics. The "T" Pad is recommended for use as master level controls, mixer controls and output controls.

Although these controls have a theoretical attenuation of infinity, the practical range is 30 db in 80% rotation. For this range the attenuation in db is directly proportional to rotation. Care must be taken to limit the wattage across these units to a maximum of 2.5 watts.

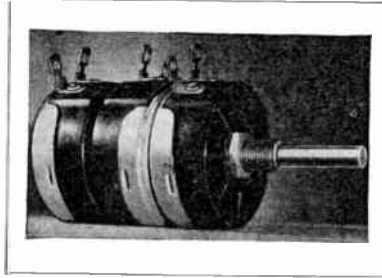

Figure 3 shows how to connect a multiplicity of sources to a common load while maintaining a constant impedance across each source and across the load.

THE "L" PAD, wiring diagram of which is shown in Fig. 4 and connections in Fig. 5, maintains a constant impedance only at the source terminals with the load terminals connected to associated apparatus.

This type of Pad is recommended for use as a volume control for individual speakers in multi-speaker installations. For this purpose care must be taken to limit the wattage across these units to a maximum of 2.5 watts.

Fig. 6 shows how to connect a multiplicity of loads (speakers) to a common source (output transformer) and at the same time maintain a constant impedance to the source.

THE TYPE "CISM" CONTROL, wiring diagram of which is shown in Fig. 7 and connections in Fig. 8, maintains a constant impedance at the load terminals only. This control is primarily intended for use as a mixer control in broadcasting and recording systems. For these purposes this control has been adopted after intensive tests, by one of the largest broadcasting systems in the country. Fig. 9 shows how to connect a multiplicity of sources (microphones, pick-ups, etc.) to a common load at the same time maintaining a constant impedance to the load.

Any of the above constant impedance controls are available for all line impedances up to 1000 ohms.

	List Price	Net Price
"T" Pad	\$3.50	\$2.10
"CISM"	3.00	1.80
"L" Pad	3.00	1.80

All controls are equipped with standard bushing, 3/8" dia. x 3/8" long, and with 1 1/2" long insulator shaft.

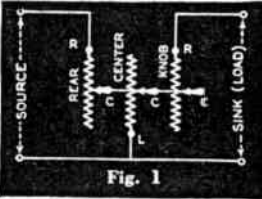

Fig. 1

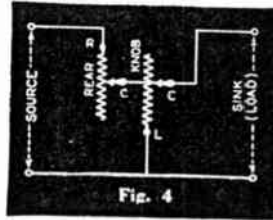

Fig. 4

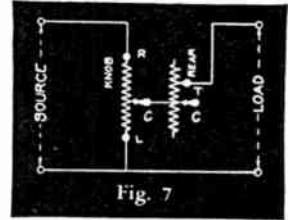

Fig. 7

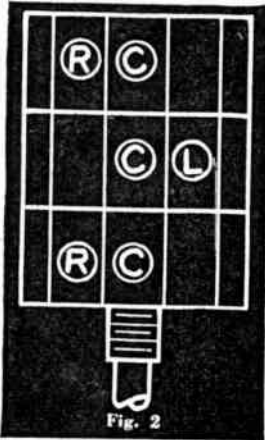

Fig. 2

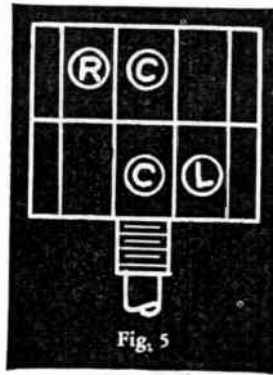

Fig. 5

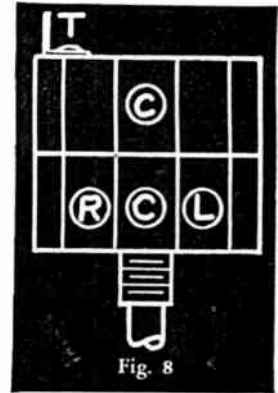

Fig. 8

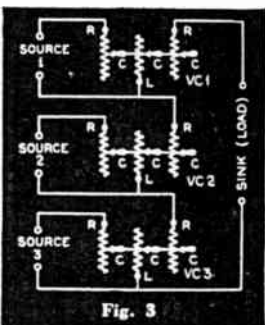

Fig. 3

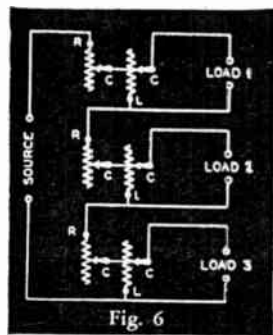

Fig. 6

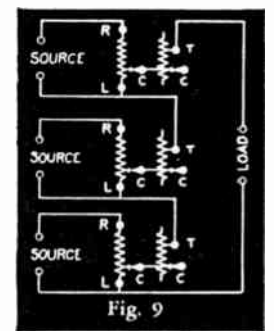

Fig. 9

"T" PAD AND "L" PAD WIREWOUND ATTENUATORS

For controlling volume in circuits and microphones, loudspeakers, phonograph pick-ups, mixers, audio and public address amplifiers and similar uses.

10-WATT "T" PADS OPEN FRAME TYPE

BODY: $2\frac{1}{4}$ " diameter, $\frac{3}{16}$ " deep.
BUSHING: $\frac{1}{16}$ " diameter, $\frac{3}{8}$ " long.
SHAFT: $\frac{1}{4}$ " diameter, $\frac{1}{16}$ " long, from bushing.

Mounts in single $\frac{1}{8}$ " hole.
Supplied with one mounting nut and two insulating washers for $\frac{3}{16}$ " hole.

10 watts (+32.2 DB level*) for average program material.
5 watts (+29.2 DB level*) steady tone, in infinite attenuation or "silent" position.

Effective rotation: 82 degrees.

Stock No.	Impedance	List	Net
TA-8	8 Ohms	\$3.75	\$2.25
TA-16	16 Ohms	3.75	2.25
TA-50	50 Ohms	3.75	2.25
TA-200	200 Ohms	3.75	2.25
TA-500	500 Ohms	3.75	2.25
TA-1000	1000 Ohms	3.75	2.25



Type TA

15-WATT "L" PADS OPEN FRAME TYPE

BODY: $2\frac{1}{4}$ " diameter, $\frac{3}{16}$ " deep.
BUSHING: $\frac{1}{16}$ " diameter, $\frac{3}{8}$ " long.
SHAFT: $\frac{1}{4}$ " diameter, $\frac{1}{16}$ " long, from bushing.

Mounts in single $\frac{1}{8}$ " hole.
Supplied with one mounting nut and two insulating washers for $\frac{3}{16}$ " hole.

15 watts (-34.0 DB level*) for average program material.
7 1/2 watts (+31.0 DB level*) steady tone, in infinite attenuation or "silent" position.

Effective rotation: 142 degrees.

Stock No.	Impedance	List	Net
LA-8	8 Ohms	\$3.25	\$1.95
LA-16	16 Ohms	3.25	1.95
LA-50	50 Ohms	3.25	1.95
LA-200	200 Ohms	3.25	1.95
LA-500	500 Ohms	3.25	1.95
LA-1000	1000 Ohms	3.25	1.95



Type LA

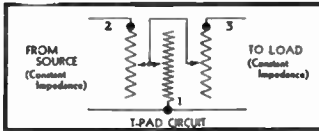
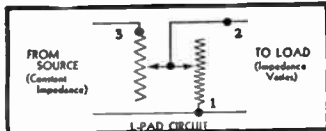

8-WATT "L" PADS ENCLOSED DUAL TYPE

BODY: $1\frac{1}{2}$ " diameter, $1\frac{1}{2}$ " deep.—BUSHING: $\frac{3}{8}$ " diameter, $\frac{3}{8}$ " long.—SHAFT: $\frac{1}{4}$ " diameter, $1\frac{1}{2}$ " long from bushing.—Mount in single $\frac{3}{8}$ " hole. Supplied with two hex. mounting nuts.—8 watts (+31.2 DB level*) for average program material.—4 watts (+28.2 DB level*) steady tone, in infinite attenuation or "silent" position.—Effective rotation: 276 degrees. All electrical parts insulated from housing.

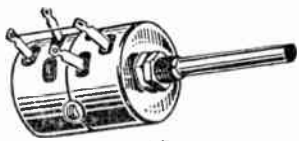

Type LE

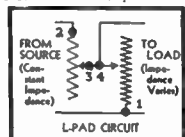

Stock No.	Impedance	List	Net
LE-8	8 Ohms	\$2.50	\$1.50
LE-16	16 Ohms	2.50	1.50
LE-50	50 Ohms	2.50	1.50
LE-200	200 Ohms	2.50	1.50
LE-500	500 Ohms	2.50	1.50
LE-1000	1000 Ohms	2.50	1.50

4-WATT "L" PADS ENCLOSED SINGLE TYPE

BODY: $1\frac{1}{8}$ " diameter, $\frac{1}{4}$ " deep.—BUSHING: $\frac{3}{8}$ " diameter, $\frac{3}{8}$ " long.—SHAFT: $\frac{1}{4}$ " diameter, $1\frac{1}{2}$ " long from bushing. Mount in single $\frac{3}{8}$ " hole.—Supplied with two brass hex mounting nuts. All electrical parts insulated from housing. Effective rotation 120 degrees. 4 watts (+28.2 DB level*) for average program material.

Stock No.	Impedance	List	Net
LW-8	8 Ohms	\$1.50	\$0.90
LW-16	16 Ohms	1.50	.90
LW-50	50 Ohms	1.50	.90
LW-200	200 Ohms	1.50	.90
LW-500	500 Ohms	1.50	.90
LW-1000	1000 Ohms	1.50	.90

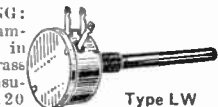

Type LW

* Using Zero level of 6 milliwatts.

WIREWOUND POTENTIOMETERS AND RHEOSTATS

The many years of continued preference for these pioneers of the small variable resistor field proves their dependability and high quality. Resistance elements clamped permanently in place, in one-piece cadmium-plated all-metal frame. Open construction gives the maximum heat dissipation for their size. Contact arm grounded to bushing and frame.

3-WATT POTENTIOMETERS & RHEOSTATS

BODY: $1\frac{1}{4}$ " diameter, $\frac{1}{4}$ " depth behind panel.

BUSHING: $\frac{3}{8}$ " diameter, $\frac{3}{8}$ " long.

SHAFT: $\frac{1}{4}$ " diameter, $1\frac{1}{2}$ " long from bushing.

Pots: Three terminals, no off position.

Rheostats: 2 terminals, with off position.

Effective rotation: 285 degrees.

Mounts in single $\frac{3}{8}$ " hole.

Supplied with one hex. mounting nut, one flat and one swdged insulating washer for $\frac{1}{8}$ " hole.

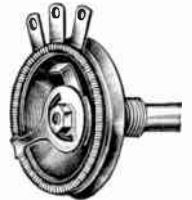

Type MP

STOCK VALUES IN OHMS

	6	25	75	500
$\frac{1}{2}$	10	30	100	1,000
1	15	40	200	1,500
3	20	50	400	

Stock No.	MP—Potentiometer, all sizes	LIST	NET
		\$0.50	\$0.30
Stock No.	MR—Rheostats, all sizes	.50	.30

15-WATT POTENTIOMETERS

BODY: $2\frac{1}{4}$ " diameter, $\frac{3}{16}$ " depth behind panel.

BUSHING: $\frac{1}{16}$ " diameter, $\frac{3}{8}$ " long.

SHAFT: $\frac{1}{4}$ " diameter, $\frac{1}{16}$ " long from bushing.

Three terminals; no off position.

Effective rotation: 300 degrees.

Wirewound on bakelite strip.

Mounts in single $\frac{1}{8}$ " hole.

Supplied with one hex. mounting nut, two extruded insulating washers for $\frac{3}{16}$ " hole.

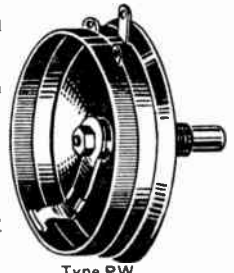

Type PW

Stock No.	Resist. in Ohms	Stock No.	Resist. in Ohms
PW-100	100	PW-1M	1000
PW-150	150	PW-2M	2000
PW-200	200	PW-3M	3000
PW-250	250	PW-5M	5000
PW-300	300	PW-7500	7500
PW-400	400	PW-10M	10000
PW-500	500	PW-20M	20000
PW-800	800	PW-50M	50000

Stock No.	PW—Potentiometers, all sizes	LIST	NET
		\$1.50	\$0.90

25-WATT RHEOSTATS

Same size as PW 15-Watt type, but resistance element wound on asbestos-covered steel strip for greater heat dissipation. Two terminals with off position.

Stock No.	Resist. in Ohms	Stock No.	Resist. in Ohms
SW-1	1	SW-60	60
SW-2	2	SW-75	75
SW-3	3	SW-100	100
SW-6	6	SW-150	150
SW-10	10	SW-200	200
SW-15	15	SW-250	250
SW-20	20	SW-300	300
SW-30	30	SW-400	400
SW-40	40	SW-500	500
SW-50	50		

Stock No.	SW—Rheostats, all sizes	LIST	NET
		\$1.75	\$1.05

TWO-CONDUCTOR PLUGS

Tip and sleeve circuits; fit standard 2-conductor jacks. New types now stocked for wide range of uses. For headphones, microphones, speakers, musical instruments, medical and test equipment, many others.

Molded Bakelite Handles: Now stocked in both red and black as listed. Metal Shield Handles: Bright nickel-plated, with internal 2-layer high-quality tubular insulators, preventing short-circuits in handle.

TU-WAY PHONE PLUGS

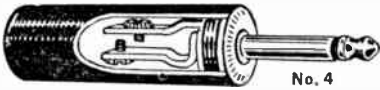

No. 4

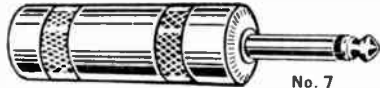

No. 7

A general-purpose type popular for years. Terminals flat with grooves for one or two phone tips, terminals or wires. Broad-headed knurled binding screws with screw driver slots. Handles $\frac{1}{2}$ " diameter, $2\frac{1}{2}$ " long.

	LIST	NET
No. 4—Black bakelite handle	\$0.60	\$0.36
No. 13—Red bakelite handle	.60	.36
No. 7—Shield handle	.90	.54

ONE-WAY PLUGS

Spring-grip terminals for one pair phone tips. No set screws. Stay-cord anchor. Handles $\frac{1}{2}$ " diameter, $1\frac{1}{2}$ " long.

	LIST	NET
No. 3—Black bakelite handle	\$0.70	\$0.42
No. 19—Red bakelite handle	.70	.42

No. 2 FLAT PLUG



Molded black bakelite body $\frac{1}{4}$ " thick, $1\frac{1}{2}$ " diameter. Ideal for panel or wall-plate. Phone tips gripped by set-screws. Stay-cord anchor.

	LIST	NET
No. 2 Flat Plug	\$0.85	\$0.51

No. 16 SHIELDED PLUG

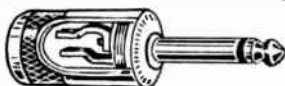

For plain or shielded cords. Broad flat tinned soldering terminals. Shield handle $\frac{1}{2}$ " diameter, 1" long.

	LIST	NET
No. 16 Shielded Plug	\$0.85	\$0.51

No. 17 SHIELDED PLUG

Designed for cords with center conductor and braided return-conductor shield. Perfect anchoring. Sleeve terminal bends to clamp shield braid after soldering in $\frac{3}{8}$ " hole. Shield handle $\frac{1}{2}$ " diameter, 1" long.

	LIST	NET
No. 17—Shielded Plug	\$0.85	\$0.51

No. 18 SHIELDED PLUG

Insulation $\frac{1}{8}$ " wide between tip and sleeve. Used with 3-conductor jack, other 2-conductor plugs short "ring" spring to sleeve; this plug leaves it open, for circuit switching. Also fits 2-conductor jacks. Shield handle $\frac{1}{2}$ " diameter, 1" long.

	LIST	NET
No. 18 Shielded Plug	\$0.90	\$0.54

THREE-CONDUCTOR PLUGS

Tip, ring, and sleeve circuits; fit standard 3-conductor jacks. For 2-button microphones, or circuits of 3 wires or 2 wires and separate shield. Bakelite handles $\frac{1}{2}$ " diameter, $1\frac{1}{2}$ " long. Shield handles $\frac{1}{2}$ " diameter, 1" long. Tubular insulator prevents short circuits.

	LIST	NET
No. 6—Black bakelite handle	\$0.85	\$0.51
No. 23—Red bakelite handle	.85	.51
No. 9—Shield handle	1.10	.66

IMP SHORT JACKS



No. 1—Open Circuit Jack



No. 2-A—Closed Circuit Jack



No. 2-B—Microphone Jack

Utah-Carter Imp Short Jacks are popular because they combine compact size, highest quality and economical price. Unique, patented design makes them the smallest jack fitting standard plugs. . . . The new No. 2-B Microphone Imp Short Jack now gives these same desirable features in a 3-conductor jack, having tip, ring and sleeve circuits. . . . These jacks all have finest grade bakelite insulators, tempered nickel-silver springs, and bright nickel-plated threaded brass bushing. . . . Mount in single $\frac{3}{8}$ " hole in panels up to $\frac{1}{8}$ " thick without insulating washers, or $\frac{1}{8}$ " with insulating washers. . . . Supplied with one $\frac{1}{2}$ " hexagonal nickel-plated mounting nut and washer, one flat and one swaged washer for $\frac{1}{16}$ " panel hole.

	LIST	NET
No. 1—Open Circuit Imp Short Jack—Has tip and sleeve circuits only. Electrical equivalent of Nos. 101 and 501	\$0.30	\$0.18
No. 2-A—Closed Circuit Imp Short Jack—Similar to No. 1, with an additional spring making contact with tip spring until plug is inserted. Electrical equivalent of Nos. 102-A and 502-A	.35	.21
No. 2-B—Microphone Imp Short Jack—A new 3-conductor jack, having tip, ring and sleeve circuits. Fits standard 3-circuit microphone plugs. Electrical equivalent of Nos. 102-B and 502-B	.45	.27

DUAL TIP JACKS

Utah-Carter Dual Tip Jacks are rugged simple units designed to receive two standard phone tips. It is these jacks which have been so widely used by large radio manufacturers to provide phone-television sound connections to today's radio, or to provide carbon connection on the popular portable radios.

Dimensions: Length $2\frac{1}{4}$ " overall; Width $\frac{5}{8}$ "; Depth $\frac{1}{2}$ " overall; Mounting Centers $1\frac{1}{4}$ ". Three circuit arrangements are available and are carried in stock.

Stock No.	Circuit Arrangement	List	Net
TU-11	Open circuit type; simple receptacles only.	\$0.25	\$0.15
TU-21	Automatic Shunt. (Receptacles normally short-circuited to each other; short circuit removed when tip inserted in receptacle A, by means of small fibre lifter.)	\$0.35	\$0.21
TU-31	Closed Circuit Type. Similar to TU-21 but automatic shunt spring is permanently insulated from receptacle B, making it similar to No. 2A Jack switching action.	\$0.40	\$0.24

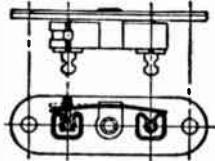

No. TU-21

PORTABLE JACKS

Used on end of extension cord. Fit 2-conductor plugs. Screw terminals take one pair phone tips, terminals or wires. Handles $\frac{1}{2}$ " diameter, $2\frac{1}{2}$ " long. Shield handles have tubular insulator to prevent short circuits.

	LIST	NET
No. 12—Black bakelite handle	\$0.60	\$0.36
No. 25—Red Bakelite handle	.60	.36
No. 8—Shield handle	1.10	.66

IMP TAP SWITCH

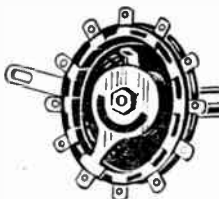

Positive snap action — strong wiping contact grounded to shaft and bushing. In operation contact breaks between makes.

Bushing length $\frac{3}{8}$ ". Shaft $\frac{1}{8}$ " from end of bushing.

Type	No. of Positions	List	Net
602	2 Points	\$0.50	\$0.30
603	3 Points	.50	.30
604	4 Points	.50	.30
605	5 Points	.50	.30
606	6 Points	.50	.30
607	7 Points	.50	.30
608	8 Points	.75	.45
609	9 Points	.75	.45
610	10 Points	.75	.45
611	11 Points	.75	.45
612	12 Points	.75	.45

2 1/2 WATT WIREWOUND RESISTORS

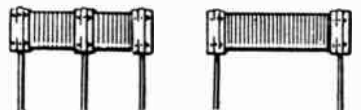

Precision Wound on Bakelite Forms. Size $1\frac{1}{2}$ " x $1\frac{1}{2}$ " with $2\frac{1}{2}$ " Flexible Leads.

Stock Values in Ohms			
1	5	12	25
2	6	15	30
3	8	18	40
4	10	20	50
			100
			200
			300
			400
			500
			750
			1,000

Type	LIST	NET
SH—Resistor	\$0.20	\$0.12
SHC—Resistor, Center-tapped	.25	.15



Type CU—Center Tapped. Mounting Centers End Terminals 1".

Stock Values in Ohms		
6	20	100
10	40	200
15	60	400

Type CU Resistor—
List Price \$0.20. Net Price \$0.12

LONG AND SHORT JACKS

SHORT JACKS



No. 103

The original long jacks adapted from telephone switchboard jacks. Long rugged phosphor-bronze springs parallel to the plug axis give precise action. These jacks take minimum panel mounting space, less than the short jacks.

Supplied with nickel-plated hex. shoulder mounting nut and nickel-plated washer.

Utah-Carter short jacks are small and compact, but do a full sized job. Depth behind panel is cut down by placing the tempered nickel-silver springs parallel to the panel. High quality sheet bakelite and tubular eponite insulators are used throughout: No paper or fibre used in Utah-Carter jacks. Supplied with nickel-plated hex. mounting nut and nickel-plated washer.



No. 502-B

LONG JACKS

Short and long jacks mount in single $\frac{3}{8}$ " hole in panels up to $\frac{3}{4}$ " thick. Fit of the plug in the jack is not affected by the thickness of the panel. Fit all standard plugs in two-and three-conductor types. Strong bright cadmium plated steel frame.

All contacts between springs are fine silver, giving minimum contact resistance.

For 2-Conductor Plugs, with Tip and Sleeve Only

Circuits	Stock Nos.	Contact Arrangement	Long Jacks			Short Jacks		
			Stock No.	List Price	Net Price	Stock No.	List Price	Net Price
	1-101 501	Open circuit	101	\$0.50	\$0.30	501	\$0.40	\$0.24
	502	Single closed circuit	102	.60	.36	502	.55	.33
	2A 102A 502A	Break contact on tip spring	102-A	.60	.36	502-A	.55	.33
	133 533	Sleeve spring; break contact on tip spring	133	.70	.42	533	.65	.39
	103 503	Separate make contact springs	103	.70	.42	503	.65	.39
	103A 503A	Break-make contacts on tip spring	103-A	.70	.42	503-A	.65	.39
	104 504	Sleeve spring; break contacts on tip and sleeve springs	104	.70	.42	504	.75	.45
	104A 504A	Break contact on tip spring; separate make contact springs	104-A	.80	.48	504-A	.75	.45
	105 505	Break contact on tip spring; separate break-make contact springs	105	.90	.54	505	.85	.51
	106 506	Sleeve spring; break contacts on tip and sleeve springs; separate break contact springs	106	1.00	.60	506	.95	.57

For 3-Conductor Plugs—With Tip, Ring and Sleeve—(2-Button Microphone, Etc.)

	2B 102B 502B	Open circuit	102-B	.60	.36	502-B	.55	.33
	103B 503B	Break contact on tip spring	103-B	.70	.42	503-B	.65	.39
	104B 504B	Break contacts on tip and ring springs	104-B	.80	.48	504-B	.75	.45

UTAH SENSITIVE D.C. RELAYS—PLUG-IN TYPE

low-priced, high quality plug-in relays. Dust-proof, tamperproof, accurately adjusted for reliable operation, sealed in vibrator-type zinc housing, $3\frac{1}{8}$ " x $1\frac{1}{2}$ ".

CAREFULLY ENGINEERED: Ratings overlap: For reliable operation from 1.2 to 120 volts or from 6 to 516 M.A., D.C., select relay from list.

CONTACTS: Fine silver for minimum contact resistance. 5 amperes, 115 volts A.C. non-inductive loads. For D.C. and inductive A.C. loads, arcing reduced by connecting 0.1 to 2 M.F. across contacts, with 10 to 500 ohms in series with condenser.



Types RA-A-
"Break" Con-
tacts (Normally
Closed)



Types RA-B-
"Make" Con-
tacts (Normally
Open)



Types RA-C-
"Break-Make"
Contacts (Single
Pole Double
Throw)

Stock No.	Contacts	List Price	Net Price
2-Volt Relays—15 Ohms—1.2 to 7.75 volts—80 to 516 M.A.			
RAA-2	Single Break, normally closed		
RAB-2	Single Make, normally open	\$2.25	\$1.35
RAC-2	Single Break-Make, S.P.D.T.		
6-Volt Relays—90 Ohms—3.15 to 19 Volts—35 to 210 M.A.			
RAA-6	Single Break, normally closed		
RAB-6	Single Make, normally open	2.25	1.35
RAC-6	Single Break-Make, S.P.D.T.		
32-Volt Relays—1000 Ohms—12 to 63 Volts—12 to 63 M.A.			
RAA-32	Single Break, normally closed		
RAB-32	Single Make, normally open	2.50	1.50
RAC-32	Single Break-Make, S.P.D.T.		
110-Volt Relays—3000 Ohms—18 to 120 Volts—6 to 40 M.A.			
RAA-110	Single Break, normally closed		
RAB-110	Single Make, normally open	3.00	1.80
RAC-110	Single Break-Make, S.P.D.T.		

IMP PUSHBUTTON SWITCHES

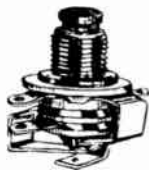

IS-30 Series

These switches are similar in general construction to the widely popular Utah-Carter Imp Short Jacks. Finest nickel-silver springs with integral contacts. High grade phenolic insulation. Body, nuts and washers bright nickel plated. Red or black Kolonite 1-piece shaft and button. Springs fully insulated from the mounting bushing and shaft. Made in three circuit arrangements:

IS-10 Series: "Make" contact, single circuit normally open.

IS-20 Series: "Break" contact, single circuit normally closed.

IS-30 Series: "Break-Make" contacts, single circuit, double-throw.

Description:—One-piece combined shaft and push-button. Mount in $\frac{3}{8}$ " hole in panel up to $\frac{1}{2}$ " thick. Supplied with one nickleplated hex nut and washer.

Circuit	Contact Arrangement	Red Pushbutton Stock No.	Black Pushbutton Stock No.	List Price	Net Price
	"Single Make"	IS-11	IS-13	\$0.75	\$0.45
	"Single Break"	IS-21	IS-23	\$0.75	\$0.45
	One "Break-Make"	IS-31	IS-33	\$0.75	\$0.45

UTAH-CARTER ROTARY LONG AND SHORT JACK SWITCHES

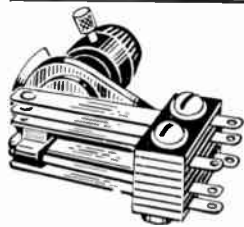

Rotary Two and Three Position—Long and Short Types.

SHORT JACK SWITCHES

Similar in design to Utah-Carter short jacks, these switches are small and compact.

LONG JACK SWITCHES

Similar in design to Utah-Carter long jacks, these are full-size switches, but take less panel space than the short jack switches.

All rotary jack switches supplied with knob and pointer screw, one nickel-plated hex. mounting nut and nickel-plated washer. Fit $\frac{3}{8}$ " hole in panels up to $\frac{1}{4}$ " thick. All electrical parts fully insulated from frame.

Two Position Switches

Circuits	Contact Arrangement	Long Jack Switches			Short Jack Switches		
		Stock No.	List Price	Net Price	Stock No.	List Price	Net Price
	Single make (SPST)	22	\$0.75	\$0.45	322	\$0.70	\$0.42
	Single break-make (SPDT)	33	.90	.54	333	.85	.51
	Two makes (DPST)	44	1.00	.60	344	.95	.57
	One break-make, one make (1-SPDT-1-SPST) (Normally Open)	55	1.15	.69	355	1.10	.66
	Two break-makes (2-SPDT)	66	1.25	.75	366	1.25	.75
	Three makes (3-SPST—Normally Open)	663	1.25	.75	306	1.25	.75
	Four makes (4-SPST—Normally Open)	880	1.60	.96	388	1.60	.96

Three Position Switches

	77	333-B	88	366-B	Single pole double throw, center off	77	\$0.90	\$0.54	333-B	\$0.85	\$0.51
	90	399-B	120	312-B	Two pole double throw, center off	88	1.25	.75	366-B	1.20	.72
					Three pole double throw, center off	90	1.60	.96	399-B	1.55	.93
					Four pole double throw, center off	120	2.00	1.20	312-B	1.95	1.17



SHORT PUSH-BUTTON SWITCHES—Non-Locking and Locking Types

Silver contacts for minimum resistance. High-quality nickel-silver springs. Bright cadmium-plated steel frame. Highest quality insulation used throughout. Mount in single $\frac{3}{8}$ " hole in panels up to $\frac{1}{2}$ ". Supplied with $\frac{1}{2}$ " polished black bakelite button and set-screw, one nickel-plated hexagonal mounting nut and washer.

Circuits	Contact Arrangement	Non-Locking Type	Locking Type	List Price	Net Price	Circuits	Contact Arrangement	Non-Locking Type	Locking Type	List Price	Net Price
	Single Make Contact	422-M	422-AM	\$0.90	\$0.54		Two Break Contacts	444-B	444-AB	\$1.20	\$0.72
	Single Break Contact	422-B	422-AB	\$0.90	\$0.54		Two Break-Make Contacts	666	666-A	\$1.50	\$0.90
	Single Break-Make Contact	433	433-A	\$1.00	\$0.60		Combination Break One and Make Two Contacts	555	555-A	\$1.50	\$0.78
	Two Make Contacts	444-M	444-AM	\$1.20	\$0.72		Two-Make Before-Break Contacts	676	676-A	\$1.65	\$0.99

Acro-Snap SWITCHES

FOR PRECISION CONTROL

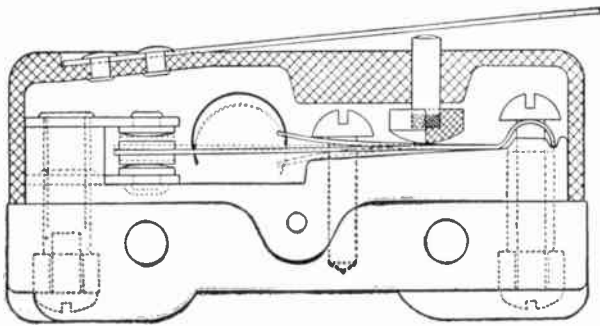

This improved type of snap-action switch operates on a new principle with a rolling spring providing frictionless action. Features of this switch are Precision Operation—Millions of Operations—Low Operating Pressure—High Contact Pressure—High Operating Frequency—Unaffected by ordinary Vibration—Small size—Easy installation.

SPECIFICATIONS—Size 1 15/16" x 1 1/16" x 27/32"
 Weight—Approximately 1 oz.
 Plastic case—drilled for two 6x32 screws
 Ratings—600 Volt 2 Amp. A.C.
 450 Volt 3 Amp. A.C.
 250 Volt 5 Amp. A.C.
 115 Volt 10 Amp. A.C.

TABLE OF PRESSURES AND TYPES

Type	Pressure Down to Actuation	Reduce Pressure for Release	Travel Distance
R	6 to 8 ozs.	4 to 6 ozs.	1/1000" apprx.
S	3 to 4 ozs.	2 to 3 ozs.	1/1000" apprx.
X	2 ozs. or less	1 oz. or less	3/1000" apprx.
T	3/4 to 1 oz.	1/2 to 3/4 oz.	3/1000" apprx.

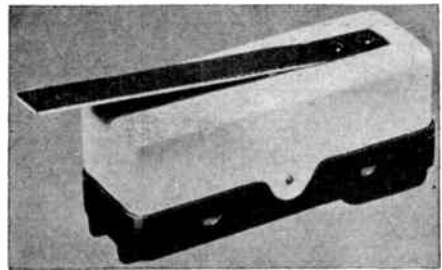

1L—LEAF ACTUATOR

Net Prices

Single Throw—Open	R \$1.10	X \$1.10	S \$1.30	T \$1.50
Single Throw—Closed	R 1.10	X 1.10	S 1.30	T 1.50
Double Throw	R 1.30	X 1.30	S 1.50	T 1.70

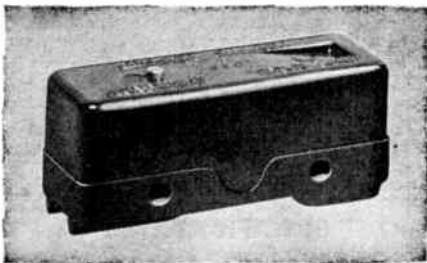

PIN PLUNGER TYPE—1A ACTUATOR

Net Prices

Single Throw—Open	R \$1.00	X \$1.00	S \$1.20	T \$1.40
Single Throw—Closed	R 1.00	X 1.00	S 1.20	T 1.40
Double Throw	R 1.20	X 1.20	S 1.40	T 1.60

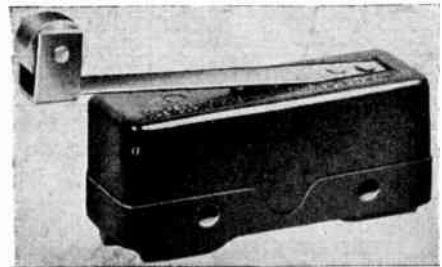

1M—ROLLER LEAF ACTUATOR

Net Prices

Single Throw—Open	R \$1.45	X \$1.45	S \$1.65	T \$1.85
Single Throw—Closed	R 1.45	X 1.45	S 1.65	T 1.85
Double Throw	R 1.65	X 1.65	S 1.85	T 2.05



These switches operate on same principle as the pin plunger type switches described above and have same features. Actuation is applied at end of blade.

Rated 1500 watts, 15 amperes, 125 volts A.C. or D.C., 7 1/2 Amps. 250 Volts and 4 amps. 460 volts.

Single Throw—Open	Net Price, each \$1.90
Single Throw—Closed	Net Price, each 1.90
Double Throw	Net Price, each 2.10



This type of open blade switch is designed for cam actuation. Switches weigh approximately 1 oz. Size is 3" x 1 1/16" x 1/2". Two 6-32 screws provide for mounting.

This type of switch can be supplied with modifications for specific purposes. Following prices apply to switch illustrated above.

Single Throw—Open	Net Price, each \$1.90
Single Throw—Closed	Net Price, each 1.90
Double Throw	Net Price, each 2.10



Dial and Jewel PILOT LIGHT ASSEMBLIES

WORLD'S LARGEST EXCLUSIVE MANUFACTURER

JEWEL LIGHT ASSEMBLIES

1/2" Polarized Pilot Light

No. 80 TYPE

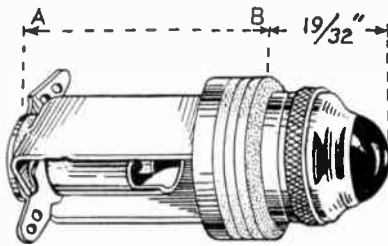

PATENT NO. 2220516
Net Wt. 0.080 lb.

The patented No. 80 incorporates the use of polarized discs to regulate light intensity. A partial turn of the jewel dims the light. Supplied with three fibre washers which compensate for different panel thicknesses.

Type Number	Style Socket	Length A to B	Panel Thickness	List Price
80	Miniature Bayonet	1 1/8"	0" to 1/4"	\$ 1.40
80S	Miniature Screw	1 3/8"	0" to 1/4"	1.40

SPECIFICATIONS

COLORS: Amber, Blue, Green Ruby, White, Yellow, Colorless. **TYPES OF JEWEL:** Regularly supplied with smooth glass, frosted on back only. Optional at no extra cost smooth glass frosted on face and back, symbol SFA; diamond cut (faceted) glass, symbol DC. Mounts in 1 1/8" hole. Lamp removable from front of panel. **LAMPS REQUIRED:** Any miniature bayonet or miniature screw based lamp with G 3 1/2 or T 3 1/4 bulb size. **PACKED** in bulk fully assembled. **FINISH:** Bright nickel. Extra charge for Chrome, Statuary bronze, or 200-hour salt spray protection.

PRICE LIST OF PARTS

Part Number	Description	List Price
35S-CSP	Socket assembly for No. 80	\$.12 Ea.
35SS-CSP	Socket assembly for No. 80S	.11 Ea.
50A	Round nut	.18 Ea.
50B	Vulcoid spacing washer	.03 Ea.
80AB-CSP	Jewel assembly including dimming mechanism	.78 Ea.
80C	Collar	.23 Ea.

1" Jewel—Horizontal Mounting
Double Contact Candelabra Bayonet Socket

No. 675 TYPE

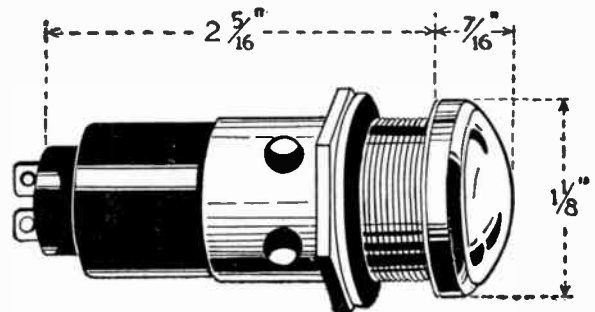

Net Wt. 0.137 lb.

The No. 675 has a "slip fit" bezel. It is exceedingly neat in appearance. Very substantial and easy to install. All parts are furnished cadmium plated except the bezel (jewel holder) which has a highly polished chrome finish.

Type Number	Style Socket	Panel Thickness	List Price
575	D.C. Candelabra Bayonet with screw terminals	0" to 1/2"	\$ 1.85
675	D.C. Candelabra Bayonet with solder terminals	0" to 1/2"	1.85

SPECIFICATIONS

COLORS: Amber, Blue, Green, Red, White, Yellow, Colorless. **TYPES OF JEWEL:** Regularly supplied with smooth, colorless, frosted on back only glass and removable color disc. Optional at no extra cost colored glass diamond cut (faceted) symbol DC; or smooth, frosted on back only, symbol SFB. Mounts in 1" hole. Lamp removable from front of panel. **LAMPS REQUIRED:** Any double contact, candelabra sized, bayonet base lamp with C7, C6, or T-4 1/2 bulb size. **PACKED** in bulk and fully assembled. Extra charge for 200-hour salt spray protection.

PRICE LIST OF PARTS

Part Number	Description	Price List
75A-CSP	Jewel	\$.62 Ea.
75C	Nut	.05 Ea.
75E	Color Disc	.03 Ea.
75F	Disc retaining ring	.02 Ea.
75G	Fibre washer—1 1/4" O.D.	.04 Ea.
3-14CSP	Socket assembly with screw terminals secured in tube	1.19 Ea.
3-17CSP	Socket assembly with solder terminals secured in tube	1.19 Ea.



Dial and Jewel PILOT LIGHT ASSEMBLIES

WORLD'S LARGEST EXCLUSIVE MANUFACTURER

JEWEL LIGHT ASSEMBLIES

1/2" Jewel . . Horizontal Mounting

1/2" Jewel . . Horizontal Mounting

No. 20 TYPE

No. 50 TYPE

The original Drake Horizontal Mounting Lamp Assembly, and still a fast seller. When ordering please be sure to select the correct part number for the thickness of panel on which to be installed; otherwise lamp may not extend far enough forward for easy removal, or if too far, prevent bezel screwing all the way on collar.

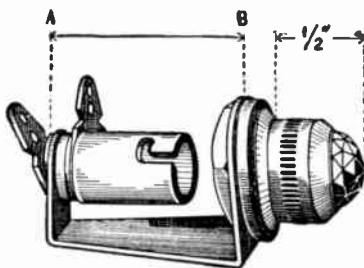

PATENT NO. 2220515
Net Wt. 0.036 lb.

This patented Drake Assembly is ideal for various applications. Specially designed for use on more than one thickness of panel. Supplied with three fibre washers which compensate for panel thicknesses. It is of sturdy construction, easy to mount, and requires little space.

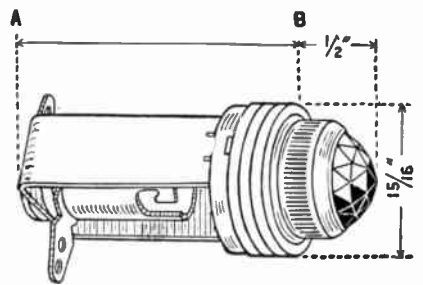

PATENT NO. 2220516
Net Wt. 0.05616 lb.

Type Number	Style Socket	Length A to B	Panel Thickness	List
20	Min. Bayonet	1 3/16"	1/16"	\$.50 EA.
30	Min. Bayonet	1"	1/4"	.50 EA.
40	Min. Bayonet	1 3/32"	3/8"	.50 EA.
20-S	Min. Screw	1"	1/16"	.50 EA.
30-S	Min. Screw	1 3/16"	1/4"	.50 EA.
40-S	Min. Screw	1 5/8"	3/8"	.50 EA.

Type Number	Style Socket	Length A to B	Panel Thickness	List Price
50	Min. Bayonet	1 1/8"	0" to 1/4"	\$.70 EA.
50 1/2	Min. Bayonet	1 1/8"	0" to 3/8"	.80 EA.
50-S	Min. Screw	7/8"	0" to 1/4"	.70 EA.
50 1/2-S	Min. Screw	7/8"	0" to 3/8"	.80 EA.

NOTE: Dimension A to B is overall length of mounting bracket.

NOTE: Dimension A to B is over-all length from front of panel.

SPECIFICATIONS

LAMPS REQUIRED: Miniature T 3/4 tubular, 6-8V, or other T 3/4 lamps of same over-all length. • Lamp removable from front of panel. • Mounts in 1 1/16" hole. • **JEWEL:** diamond cut (faceted); Amber, Blue, Crystal, Green, Ruby, White (Milk White) and Yellow. • **SPECIAL FINISHES:** Chrome, Black Nickel, Statuary Bronze. • **PACKED** in bulk with jewel, collar and nuts in bag. • **SPECIAL JEWELS:** SP—Smooth, plain; SFA—Smooth, frosted all over; SFB—Smooth, frosted back. • List Price SFA and SFB, 2c each extra.

PRICE LIST OF PARTS

Part No.	Description	List Price
20A-CSP	Socket Assembly for No. 20	\$.12*
21FB-CSP	Socket Assembly for No. 30	.12*
21V-CSP	Socket Assembly for No. 40	.12*
21FS-CSP	Socket Assembly for No. 20-S	.11*
22G-CSP	Socket Assembly for No. 30-S	.11*
22V-CSP	Socket Assembly for No. 40-S	.11*
25CSP	Jewel	.20*
27	Nut	6.40†
28	Collar for No. 0.1/4" panels	12.70†
30	Collar for 3/8" panel, 1/2" long	20.00†

*—Each. †—Per 100

SPECIFICATIONS

LAMPS REQUIRED: Miniature T 3/4 tubular, 6-8 V. or other T 3/4 lamps of same over-all length. • Lamp removable from front of panel. • Mounts in 11/16" hole. • **JEWEL:** diamond cut (faceted); Amber, Blue, Crystal, Green, Ruby, White (Milk White) and Yellow. • **SPECIAL FINISHES:** Chrome, Black Nickel, Statuary Bronze. • **PACKED** in individual boxes for jobbing trade; in bulk and fully assembled for manufacturing trade. • **SPECIAL JEWELS:** SP—Smooth, plain; SFA—Smooth, frosted all over; SFB—Smooth, frosted on back. • List price SFA and SFB, 2c each extra.

PRICE LIST OF PARTS

Part No.	Description	List Price
25CSP	Jewel	\$.20*
25A-CSP	Socket Assembly for No. 50 types	.12*
25B-CSP	Socket Assembly for No. 50-S types	.11*
28	Collar, 3/8" long	12.70†
30	Collar, 1/2" long for No. 50 1/2 types	23.00†
50A	Round nut	18.00†
50B	Fibre Washer, 15/16" O.D.	3.00†



Dial and Jewel PILOT LIGHT ASSEMBLIES

WORLD'S LARGEST EXCLUSIVE MANUFACTURER

JEWEL LIGHT ASSEMBLIES

3/4" Jewel . . Horizontal Mounting

No. 60 TYPE

This patented item is similar to the No. 50, but has a 3/4" Jewel in a "slip-fit" bezel. Supplied with three fibre washers which compensate for panel thickness. Its sturdy construction, ease of mounting, and small size make it an ideal assembly. When used with a neon glow lamp, a transparent jewel is supplied.

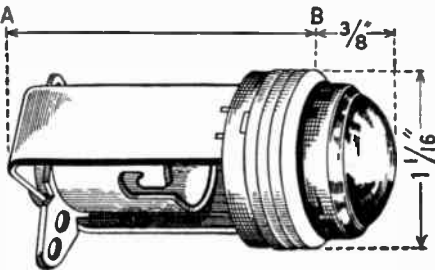

PATENT NO. 2220516

1" Jewel . . Horizontal Mounting

No. 75 TYPE

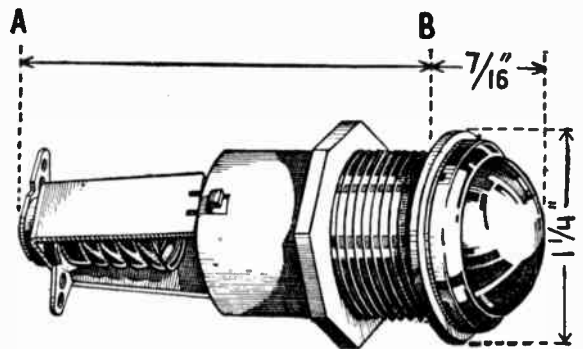

PATENT NO. 2192345

PRICE LIST

Type Number	Style Socket	Length A to B	Panel Thickness	List Price
60	Min. Bayonet	1 1/2"	0" to 1/4"	\$1.10 EA.
60 3/4	Min. Bayonet	1 1/2"	0" to 3/8"	1.65 EA.
60-S	Min. Screw	1 1/8"	0" to 1/4"	1.10 EA.
60 3/4-S	Min. Screw	1 1/8"	0" to 3/8"	1.65 EA.
60N	Candelabra	1 3/4"	0" to 1/4"	1.10 EA.
60 3/4-N	Candelabra	1 3/4"	0" to 3/8"	1.65 EA.

NOTE: Dimension A to B is over-all length from front of panel.

SPECIFICATIONS

LAMPS REQUIRED: For No. 60, 60 3/4, 60-S and 60 3/4-S, Miniature T 3/4 tubular, 6-8 V., or other T 3/4 lamps of same over-all length. For No. 60-N and 60 3/4-N, Neon glow T 4 1/2; and 4W, T4, Herzog lamps • Lamp removable from front of panel. • Removable color discs (color shows only when lamp is lighted). • Colored glass jewel, smooth, plain, or smooth frosted on back, furnished on request at no extra cost in Amber, Blue, Crystal, Green, Ruby, White (Milk White) and Yellow. • Mounts in 13/16" hole. • JEWEL regularly supplied: smooth crystal frosted on back. • Color discs: Amber, Blue, Green, Red, White, Yellow. • Bezel polished chrome. • PACKED in individual boxes for the jobbing trade; in bulk and fully assembled for the manufacturing trade.

PRICE LIST OF PARTS

Part No.	Description	List Price
28U-CSP	Socket Assembly for No. 60 Type	\$.12*
28V-CSP	Socket Assembly for No. 60-S Type	.11*
28W-CSP	Socket Assembly for No. 60-N Type	.14*
60A-CSP	Jewel	.50*
60B	Collar for No. 60 3/4 Types, 3/8" long	75.00†
60C	Collar for No. 60 Type, 1/2" long	20.00†
60D	Round nut	30.00†
60E	Color Disc	2.00†
60G	Retaining ring	2.00†
60I	Fibre Washer, 1 1/8" O.D.	4.00†

*—Each. †—Per 100

The patented No. 75 type has a "slip-fit" bezel. It is exceedingly neat in appearance. Very substantial and easy to install. All parts are burnished cadmium plated except the bezel which has a highly polished chrome finish.

Type No.	Style Socket	Length A to B	Panel Thickness	List Price
75	Candelabra	2 1/4"	0" to 1/2"	\$1.30 EA.
175	Min. Screw	1 3/4"	0" to 1/2"	1.30 EA.
275	Min. Bayonet	2 3/8"	0" to 1/2"	1.30 EA.
75AP	Cand. (Insul.)	2 1/4"	0" to 1/2"	1.40 EA.
375	S. C. Bayonet (Candelabra)	2 5/8"	0" to 1/2"	1.30 EA.

NOTE: Dimension A to B is over-all length from front of panel. Over-all diameter of mounting nut 1 1/8". The No. 75 AP is intended for use in apparatus requiring Board of Underwriters' approval.

SPECIFICATIONS

LAMPS REQUIRED: For No. 75 and 75AP, Candelabra base 6W (115 V.) S6; for No. 175 and 275 Miniature T 3/4 tubular, 6-8 V.; or other T 3/4 lamps of same over-all length. For No. 375, single contact, G6, bayonet lamp such as used for automobile headlights. • Lamp removable from front of panel. • Removable color discs (color shows only when lamp is lighted). • Mounts in 1" hole in panels up to 1/2" thick. • JEWEL regularly supplied: smooth crystal frosted on back. • Color discs Amber, Blue, Green, Red, White, Yellow. • Bezel polished chrome. • Colored glass jewels, smooth frosted on back or diamond cut (faceted) furnished on request at no extra cost in Amber, Blue, Crystal, Green, Ruby, White (Milk White) or Yellow. • PACKED in individual boxes for the jobbing trade; in bulk and fully assembled for the manufacturing trade.

PRICE LIST OF PARTS

Part No.	Description	List Price
19V CSP	Socket Assembly for No. 75	\$.18*
19V CSP-AP	Socket Assembly for No. 75AP	.28*
24H CSP	Socket Assembly for No. 275	.12*
24I CSP	Socket Assembly for No. 175	.11*
24J CSP	Socket Assembly for No. 375	.18*
75A CSP	Jewel	.62*
75B	Tube	.40*
75C	Nut	.05*
75E	Color Disc	3.00†
75F	Retaining ring	2.00†
75G	Fibre washer—1 1/4" O.D.	4.00†



Dial and Jewel PILOT LIGHT ASSEMBLIES

WORLD'S LARGEST EXCLUSIVE MANUFACTURER

JEWEL LIGHT ASSEMBLIES AND JEWELS

1/2" Jewel . . Vertical Mounting

No. 10 TYPE

NOTE:

Dimension A to B is from center of socket to outside of bracket. C to D from center of jewel to bottom of bracket. The No. 10B and 10C have brackets with oblong hole permitting adjustment to obtain best position for lamp filament back of jewel.

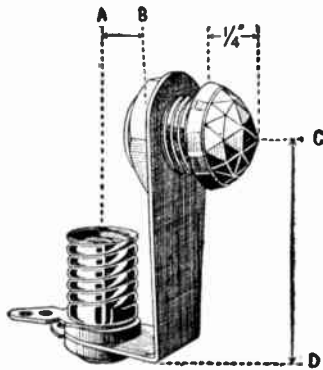

PRICE LIST

Type Number	Style Socket	A to B	C to D	List Price
10	Min. Screw	1/2"	1 1/4"	\$.32 EA.
10B	Min. Bayonet	3/4"	Adj. from 1 1/8"	.33 EA.
10C	Candelabra	3/4"	to 1 3/8"	.35 EA.
10G	Min. Bayonet	1/2"	1 1/4"	.33 EA.

SPECIFICATIONS

LAMPS REQUIRED: For No. 10 and 10B, miniature screw or bayonet base of any voltage (tubular preferred). For No. 10G, miniature bayonet, type G 3 1/2 bulb. For No. 10C any candelabra base lamp may be used. • Mounts in 7/16" hole on panels up to 1/4" thick. • **JEWEL:** diamond cut (faceted); Amber, Blue, Crystal, Green, Ruby, White (Milk White), and Yellow. • **SPECIAL FINISHES:** Chrome, Black Nickel, Statuary Bronze. • **PACKED** in bulk with jewels and nuts in bags. • **SPECIAL JEWELS:** SP—Smooth, plain; SFA—Smooth, frosted all over; SFB—Smooth, frosted on back. • List price SFA and SFB, 2c each extra.

PRICE LIST OF PARTS

Part No.	Description	List Price
15CSP	Socket Assembly for No. 10	\$.11*
15CSP-B	Socket Assembly for No. 10B	.12*
15CSP-G	Socket Assembly for No. 10G	.12*
15CSP-C	Socket Assembly for No. 10C	.14*
16CSP	Jewel and Nut	.21*
17	Nut	4.40†

*—Each. †—Per 100

1/2" Jewels



THREADED TYPE



SLOTTED TYPE

THREAD TYPE WITH NUTS

		LIST PRICE
16CSP	Shank 3/8" long, 7/8" O.D.	EA. \$.21
16 1/2CSP	Shank 1/2" long, 1 1/8" O.D.	EA. .34

SLOTTED TYPES

		LIST PRICE
22CSP	Shank 1/8" long, 3/8" O.D.	EA. \$.18
23CSP	Shank 3/8" long, 3/8" O.D.	EA. .18
31CSP	Shank .085" long, 3/8" O.D.	EA. .18
33CSP	Shank .065" long, .424" O.D.	EA. .18
34CSP	Shank .065" long, .436" O.D.	EA. .19

JEWELS: Diamond cut (faceted), Amber, Blue, Crystal, Green, Ruby, White (Milk White) and Yellow.

SPECIAL JEWELS: SP—Smooth, plain; SFA—Smooth, frosted all over; SFB—Smooth, frosted back. • List price SFA and SFB, 2c each extra. • **SPECIAL FINISHES:** Chrome, Black Nickel, Statuary Bronze.

11/32" JEWELS . . Slotted Types Only

JEWELS: Diamond cut (faceted), Amber, Crystal, Green, Ruby, White (Milk White). Also supplied with smooth plain glass (specify "SP") at same price.



FINISHES: Regular finish Statuary Bronze. Also supplied in nickel finish if so ordered, at same price.

21CSP, slotted type, Shank 3/8" long, 3/2" O.D.	
LIST PRICE EACH\$.15
24CSP, slotted type, Shank 1/4" long, 3/2" O.D.	
LIST PRICE EACH15

SELF LUMINOUS BULLS EYE

Per Navy Drawing No. 9S-5012-L parts 15 to 20 inclusive.

The No. 9S-5012-L self luminous bulls eye is for use on a Navy Jack box—W. T., type T-1M, for battery and sound powdered telephones, Navy drawing 9S-5012-L—Alt. 8.

The bulls eye is shipped fully assembled, individually wrapped in tissue paper and packed in bulk.

Orders for less than 1000 pieces not accepted.

List Price\$1.75 EA.





Dial and Jewel
PILOT LIGHT ASSEMBLIES

WORLD'S LARGEST EXCLUSIVE MANUFACTURER

DIAL LIGHT ASSEMBLIES
 FOR ALL STANDARD OR SPECIAL NEEDS

Clip Bracket Types With FLANGE Brackets

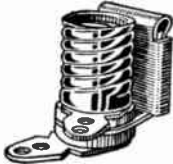

103 AE



103 AF

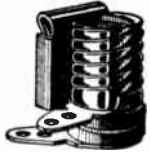

103 AG



103 AH

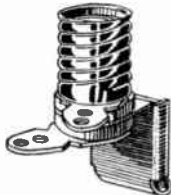

103 CE



103 CF



103 CG



103 CH



Clip Bracket Types With Flat Brackets



104 AE



104 AF



104 AG



104 AH



104 CE



104 CF



104 CG



104 CH

Bayonet Type Socket Assemblies



203 AH

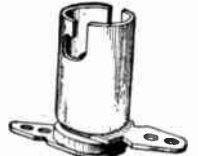

217 H

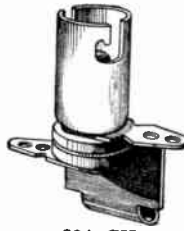

204 CH



203 CH



204 AH

MISCELLANEOUS TYPES . . SPECIAL SIZES



317 H



106 AE



106 CE



109 AH

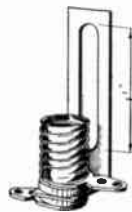

108 AH



108 CH

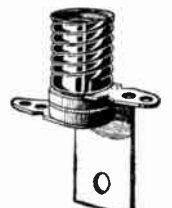

109 CH

PRICE LIST . . DIAL LIGHT ASSEMBLIES

Min. Screw Type		Min. Bayonet Type		Candelabra Type	
No.	List Price per 100	No.	List Price per 100	No.	List Price per 100
103	\$ 9.00	203	\$10.00	403	\$17.50
104		204		404	
106		206		406	
107		207		407	
108		208		408	
109		209		409	
156B		256B		456B	
119		219		419	
317H	\$ 6.50	217H	\$ 9.00	417H	\$15.00

CODE NUMBERS: Miniature Screw, 100 Series. Miniature Bayonet, 200 Series. Candelabra, 400 Series. (Except 317H).

MALLORY

P. R. MALLORY & CO. Inc.

Selector Switches

MULTI-GANG CIRCUIT SELECTOR AND ALL-WAVE SWITCHES Types 1200L Series and 1300L Series

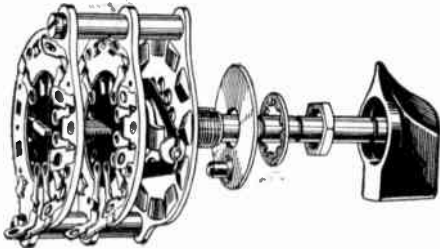

SINGLE-GANG CIRCUIT SELECTOR SWITCHES Types 3100J Series and 3200J Series

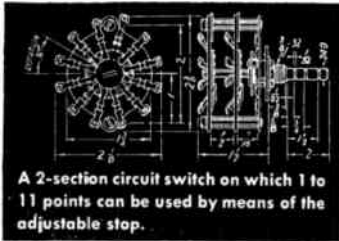
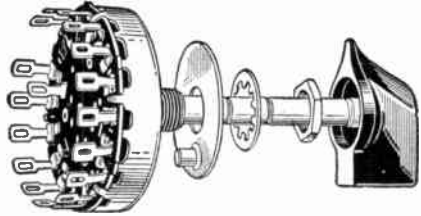

A 2-section circuit switch on which 1 to 11 points can be used by means of the adjustable stop.

● All contacting members of Mallory Circuit Selector Switches are heavily silver-plated with a hard finish that will withstand the wear throughout the life of the apparatus in which the switch is used. The high lift of the contact springs gives a wiping and self-cleaning contact.

The new adjustable stop feature provides for additional combinations in each switch and makes it possible to use a single switch for many different specifications. Provided with 3/8" diameter, 3/4" long brass bushing and 2" long shaft, grooved for easy cutting at popular lengths.

● For receiver band switching, tone control and tap switch applications. Available only in single gang and in two sizes—one with 1 1/4-inch diameter base, the other with 1 1/2-inch diameter base. The circuit combinations shown below indicate respective sizes. They are made in both shorting and non-shorting types. Adjustable stop features is available only in the 1 1/2-inch base size. Switches are equipped with universal shaft, 2 inches long and grooved to provide easy cutting at popular lengths.

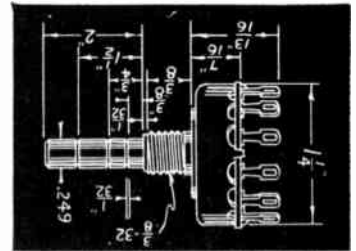

(Prices include one Mallory No. 366 Knob, one No. 232 Nut, and one No. 227 Lockwasher, but no Dial Plate. See page L-50 for special Dial Plates.)

Three and four-gang switches have one-inch spacing between sections, all others one-half inch. If necessary, these switches can be disassembled, the spacers cut down to meet the requirements as to length of the switch and the spacing of the sections.

(Prices include Mallory No. 366 Knob, one No. 232 Nut and one No. 227 Lockwasher, but do not include Dial Plates. See page L-50 for special Dial Plates.)

No. of Circuits per Section or Gang	Total No. of Circuits per Switch	No. of Points or Contacts per circuit	No. of Sections or Gangs per Switch	Shorting Type Catalog No.	Non-Shorting Type Cat. No.	List Price
1	1	6	1	1216L*	1316L*	\$1.20
1	1	11	1	1211L	1311L	1.40
2	2	5	1	1215L*	1315L*	1.50
2	2	3	1	1213L*	1313L*	1.65
4	4	2	1	1212L*	1312L*	1.75
4	4	6	2	1226L*	1326L*	1.95
1	2	11	2	1221L	1321L	2.10
2	4	5	2	1225L*	1325L*	2.40
3	6	3	3	1223L*	1323L*	2.55
4	8	2	4	1222L*	1322L*	2.70
1	3	6	3	1236L*	1336L*	2.65
1	3	11	3	1231L	1331L	2.85
2	6	5	3	1235L*	1335L*	3.00
1	4	6	4	1246L*	1346L*	3.30
1	4	11	4	1241L	1341L	3.60
2	8	5	4	1245L*	1345L*	4.20
2	8	11	4	1251L	1351L	4.50
2	10	6	5	1256L	1356L	5.55
1	6	11	6	1261L	1361L	5.30
2	12	6	6	1266L	1366L	6.75

*These switches are provided with an "off" position which is in addition to the number of positions listed in third column.

UNIVERSAL MOUNTING BRACKET RB254

● For baseboard or rear support mounting of all Mallory circuit selector switches, volume controls and jacks. Universal Mounting Bracket No. RB254 packed five to the carton. List price each.....\$0.25

HAMBAND SWITCHES—Series 160C

● For transmitter band switching. ● Hamband Switches are rated for use in transmitter plate circuits using up to 1000 Volts DC with power up to 100 watts inclusive.

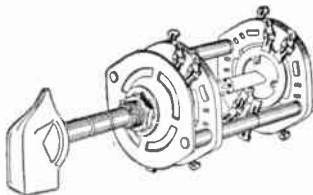

Impregnated magnesium silicate ceramic provides low losses at high frequencies. No stops; switch shaft is capable of continuous rotation. 90° Indexing. Technical data sheet, Form Y-648 available on request. Prices include 2" grooved shaft, 3/8" bushing and one each 366 Knob, No. 232 Nut and No. 227 Lockwasher.

Dial Plate for above, numbered 1 to 4.
No. 488. List price.....\$0.20

No. of Sections or Gangs	Circuits per Switch	Spacing between Sections	No. of Points or Contacts per Circuit	Cat. No.	List Price
1	1	2"	4	161C	\$2.85
2	2	3"	4	162C	3.25
3	3	1"	4	163C	4.70
4	4	1"	4	164C	5.90
5	5	1"	4	165C	7.35

*Replaces No. 2742. †Replaces No. 2762 by using adjustable stop. ‡Replaces No. 150J by using adjustable stop.

CIRCUIT OPENING SWITCH No. 1400L

● Mallory No. 1400L Switch will "open" any one of twelve "lines" for the insertion of a current reading meter and maintains a "through" circuit on the other eleven lines.

Special Circuit Opening Switch complete with Mallory Bar Type Knob No. 366, one No. 232 Nut, one No. 227 Lockwasher, and Mallory Etched Dial Plate No. 382.

No. 1400L. List price.....\$5.40

"HAMSWITCH" No. 151L

● Provides a method of using a single meter to measure currents or voltages up to and including five circuits of an Amateur Transmitter.

Two-gang construction with 2 1/4" spacing between sections, permitting multiplying resistors to be soldered directly to switch terminals. Has 2-inch grooved shaft, 3/8" bushing, one each No. 366 Knob, No. 232 Nut and No. 227 Lockwasher.

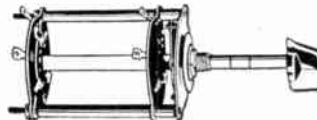

"Hamswitch" No. 151L. List price \$2.20. Dial Plate for above, numbered 1 to 5, with markings spaced 60°. No. 487. List price \$0.20.

"HAMSWITCH" No. 152L

● A two-gang unit, carrying two circuits through six positions, similar to 1326L, but with 330° shorting shoes which automatically connect together and short all unused terminals. Supplied with 3/8" bushing, 2" grooved shaft, one each No. 366 Knob, No. 232 Nut, and No. 227 Lockwasher.

"Hamswitch" No. 152L. List price.....\$2.70

24-POINT TAP SWITCH No. 13124L

● A special single circuit, 24-point non-shorting switch with 3/8" bushing and 2" grooved shaft, particularly useful in test equipment applications. No stops—switch is capable of continuous rotation.

Complete with Mallory Bar Type Knob No. 366, one No. 232 Nut, one No. 227 Lockwasher, and Mallory Dial Plate No. 394.
No. 13124L. List price.....\$3.20

MALLORY

P. R. MALLORY & CO. Inc.

Tip Jacks • Tip Plugs Twin Tip Jacks • Dial Plates

HEXAGON HEAD TIP JACKS

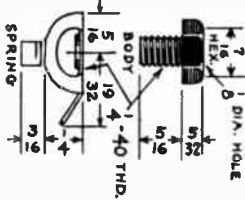

• (Supplied with one each Nos. 205 and 213 insulating washers.) With Hexagon Bakelite Top for mounting in $\frac{1}{4}$ " hole. When using insulating washers, mount in $\frac{3}{8}$ " hole. (U. S. Letters Patent No. 1,586,279—May 26, 1926.)

	Catalog No.	List Price
Red	420	\$0.20
Black	421	.20
Pair (1 Black, 1 Red) in envelope	422	.40

ROUND BAKELITE HEAD TIP JACKS

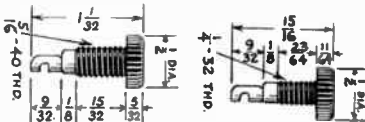

• (Supplied with one each Nos. 204 and 214 insulating washers, and one No. 233 nut.) Mount in $\frac{1}{4}$ " hole in panel up to $\frac{3}{8}$ " thick. When using insulating washers, mount in $\frac{3}{8}$ " hole.

	Catalog No.	List Price
Red	418	\$0.20
Black	419	.20

ROUND INSULATED HEAD TIP JACKS

• (Supplied with one each Nos. 205 and 213 insulating washers, and one No. 234 nut.) Mount in $\frac{1}{4}$ " hole in panel up to $\frac{3}{8}$ " thick. When using insulating washers, mount in $\frac{3}{8}$ " hole.

	Catalog No.	List Price
Red	520	\$0.20
Black	521	.20
Green	522	.20
Pair (1 Black—1 Red) in envelope	523	.40
Brown	524	.20
Light Blue	525	.20
Orange	526	.20
Yellow	527	.20
Light Green	528	.20
Dark Blue	529	.20

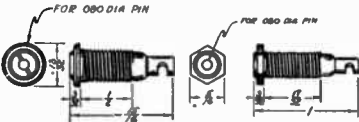
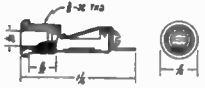
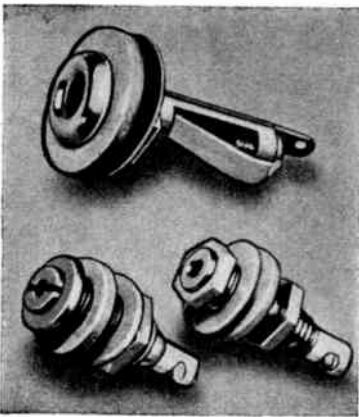

METAL TYPE TIP JACKS

• Round Head Type Tip Jack mounts in $\frac{3}{8}$ " hole. When using insulating washers, mount in $\frac{1}{2}$ " hole. Supplied with one each Nos. 208 and 212 washers and one No. 232 nut.

List Price
No. 16.....\$0.40

Round Head Type Tip Jack mounts in a $\frac{1}{2}$ " hole. When using insulating washers, mount in $\frac{3}{4}$ " hole. Supplied with one each Nos. 204 and 214 washers and one No. 233 nut.

No. 416.....\$0.15

Hexagon Head Type Tip Jack mounts in $\frac{1}{4}$ " hole. When using insulating washers, mount in $\frac{3}{8}$ " hole. Supplied with one each Nos. 205 and 213 washers and one No. 234 nut.

No. 417.....\$0.15

TIP PLUGS (SOLDERLESS TYPE)

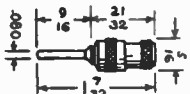
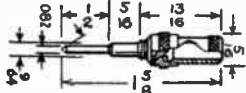
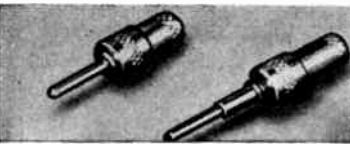

No. 15.....\$0.15
To be used with Mallory Tip Jacks Nos. 16, 420, 421, 432 and 401B.

No. 415.....\$0.10
For use with Mallory Tip Jacks Nos. 416, 417, 418, 419, 520 to 529 inclusive.

TWIN TIP JACKS

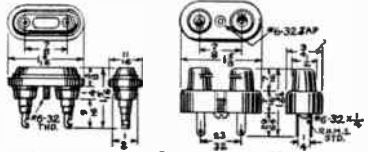
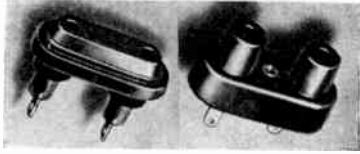

• Mounting Holes— $\frac{3}{8}$ "—Centers. No. 401 is a Twin Tip Jack. No. 432 is a circuit closing twin tip jack which closes circuit automatically when tips are removed.

	Catalog No.	List Price
Blank	401B	\$0.40
Blank	402P	.20
Shorting Type (Black)	432	.40
Shorting Type (Red)	433	.40

ETCHED DIAL PLATES

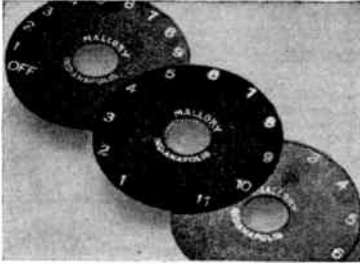

For Mallory Circuit Selector, Tap and All-Wave Switches.

Marking	For all Switch types 1200L, 1300L and $\frac{1}{4}$ " base 3100J, 3200J.		List Price
	Cat. No.	Cat. No.	
			\$0.20
1 to 2	372	453	.20
1 to 3	373	454	.20
1 to 4	374	455	.20
1 to 5	375	456	.20
1 to 6	376	457	.20
1 to 7	377	458	.20
1 to 8	378	459	.20
1 to 9	379	460	.20
1 to 10	380	461	.20
1 to 11	381	462	.20
1 to 12	382	463	.20
1 to 13	383	464	.20
1 to 14	384	465	.20
1 to 15	385	466	.20
1 to 16	386	467	.20
1 to 17	387	468	.20
1 to 18	388	472	.20
Off 1 to 2	389	473	.20
Off 1 to 3	390	474	.20
Off 1 to 4	391	475	.20
Off 1 to 5	392	476	.20
Off 1 to 6	393	477	.20
Off 1 to 7	394	478	.20
Off 1 to 8	395	479	.20
Off 1 to 9	396	480	.20
Off 1 to 10	397	481	.20
Off 1 to 11	398	482	.20
Off 1 to 12	399	483	.20
Off 1 to 13	400	484	.20
Off 1 to 14	401	485	.20
Off 1 to 15	402	486	.20
Off 1 to 16	403	487	.20
1 to 24	394 Special	15° Spacing Between Numerals	.20

Plugs and Jacks

P. R. MALLORY & CO. Inc.
MALLORY

Phone Plugs • Microphone Plugs • Extension Jacks

Description	Cat. No.	List Price
Two-Way Phone Plug with Tie-Cord Anchor (Bakelite Shell)	75	\$0.60
Two-Way Phone Plug with Tie-Cord Anchor (Shielded Nickel Shell)	75N	.90
Two-Way Phone Plug with Tie-Cord Anchor (Shielded Nickel Shell) (with Built-in Cable Clamp)	75A	1.50
Three-Way Microphone Plug (Bakelite Shell)	76	.90
Three-Way Microphone Plug (Shielded Nickel Shell) (with Built-in Cable Clamp)	76A	1.80
Two-Way Extension Jack (Fiber Shell) for No. 75 Phone Plug	100	1.20
Two-Way Extension Jack (Shielded Nickel Shell) for No. 75N Phone Plug	100N	1.50
Two-Way Extension Jack (Shielded Nickel Shell) for No. 75A Phone Plug (with Built-in Cable Clamp)	100A	2.10
Three-Way Extension Jack (Fiber Shell) for No. 76 Microphone Plug	101	1.80
Three-Way Extension Jack (Shielded Nickel Shell) for No. 76A Microphone Plug (with Built-in Cable Clamp)	101A	2.70

JACKS—Long Frame, Junior, Midget

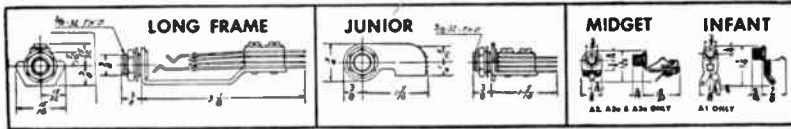

	LONG FRAME		JUNIOR		MIDGET and INFANT	
	Cat. No.	List Price	Cat. No.	List Price	Cat. No.	List Price
	1	\$0.60	701	\$0.50	*A1	\$0.30
	2	.75	702	.70	A2	.45
	2A	.75	702A	.70	A2A	.50
	2B	.75	702B	.70		
	3	.85	703	.80		
	3A	.85	703A	.80	A3A	.75
	3B	.85	703B	.80		
	3C	.85	703C	.80		
	4	1.00	704	.90		
	4A	1.00	704A	.90		
	4B	1.00	704B	.90		
	5	1.10	705	1.05		
	6	1.20	706	1.15		

Commonly referred to as "Infant" Jack.

"GROUNDING" JACK No. GJ-1

For "grounding" airplanes while refueling. Similar in construction to A1 Jack (above), except for insulation. List Price.....\$0.40

All Long Frame and Junior Jacks are supplied with one each No. 255 Nut and No. 226 Washer. All A1 (Infant) Jacks supplied with one each No. 232 Nut and No. 225 Washer. All Midget Jacks have two No. 232 Nuts and one No. 225 Washer.

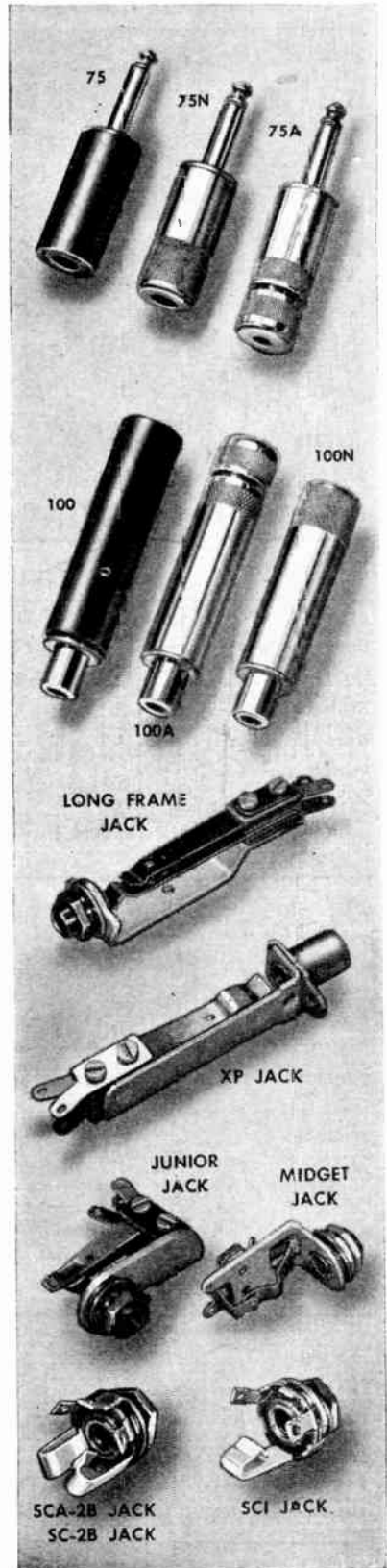

JACKS—"X" Type

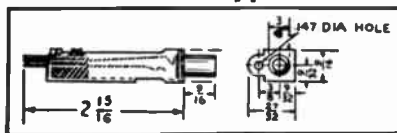

	Cat. No.	List Price
	XPI	\$0.80
	XP2B	.90
	XP3B	1.20

JACKS—Signal Corps

No. 8C-1A Phone Jack—Equivalent of Signal Corps Jack No. JK-34A. Same spring arrangement as No. 1 Long Frame Jack (see above). Designed to receive following plugs: Mallory No. 75, Western Electric Nos. 47A and 47B, Signal Corps Nos. PL-47, PL-48, PL-55, PL-148, PL-155. List Price\$0.60

No. 8CA-2B Microphone Jack—Equivalent of Signal Corps Jack No. JK-33A. Same spring arrangement as No. 2B Long Frame Jack (see above). Designed to receive following plugs: Western Electric No. 109 and Signal Corps Nos. PL-46, PL-68 and PL-168. List Price\$0.70

The two springs in the microphone jacks are located 120° apart, assuring definite pressure and positive electrical contact between the ground sleeve and bushing.

P. R. MALLORY & CO. Inc. MALLORY

Knobs • Nuts Washers • Screws

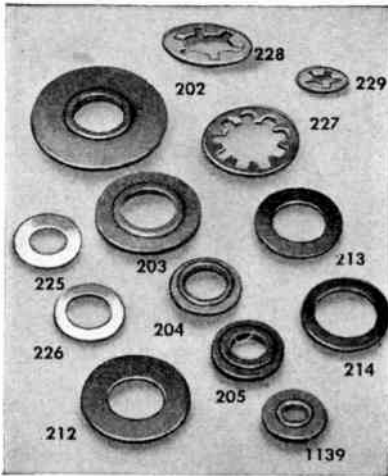

CAT. NO.	A	B	C	D
202	1	$\frac{3}{8}$	$\frac{1}{16}$	$\frac{1}{2}$
203	$\frac{3}{4}$	$\frac{3}{8}$	$\frac{1}{16}$	$\frac{1}{2}$
204	$\frac{1}{2}$	$\frac{5}{16}$	$\frac{3}{32}$	$\frac{3}{8}$
205	$\frac{1}{2}$	$\frac{1}{4}$	$\frac{3}{64}$	$\frac{3}{8}$
FIBRE 1139	$\frac{7}{16}$	$\frac{1}{8}$	$\frac{1}{16}$	$\frac{7}{32}$
BAKELITE				
212	$\frac{3}{4}$	$\frac{3}{8}$	$\frac{1}{32}$	$\frac{1}{2}$
213	$\frac{1}{2}$	$\frac{1}{4}$	$\frac{1}{64}$	$\frac{1}{2}$
214	$\frac{1}{2}$	$\frac{1}{8}$	$\frac{1}{16}$	$\frac{1}{2}$
BRASS				
225	$\frac{5}{8}$	$\frac{3}{8}$.040
226	$\frac{5}{8}$	$\frac{7}{16}$.040

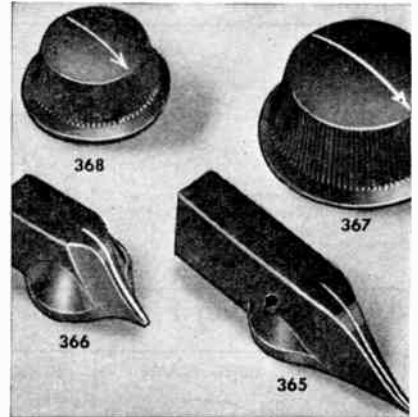

BAR AND ROUND BAKELITE KNOBS

Description	Catalog No.	List Price
$2\frac{1}{4}$ " Bar Type Knob, Black...	365-1	\$0.25
$2\frac{1}{4}$ " Bar Type Knob, Red...	365-R-1	.25
$1\frac{1}{2}$ " Bar Type Knob, Black...	366-1	.20
$1\frac{1}{2}$ " Bar Type Knob, Red...	366-R-1	.20
$1\frac{1}{4}$ " Dia. Round Knob, Black...	367-1	.25
$1\frac{1}{4}$ " Dia. Round Knob, Black...	368-1	.20

INSULATING WASHERS

Description and Dimensions	Catalog No.	List Price Per 10
Extruded Washer—Fiber—1 O. D. x $\frac{3}{8}$ I. D. x $\frac{1}{16}$; Extruded $\frac{1}{2}$ x $\frac{1}{16}$	202	\$0.30
For Set See No. 212 Flat Washer.....		
Extruded Washer—Fiber— $\frac{3}{4}$ O. D. x $\frac{3}{8}$ I. D. x $\frac{1}{16}$; Extruded $\frac{1}{2}$ x $\frac{1}{16}$	203	.30
For Set See No. 212 Flat Washer.....		
Extruded Washer—Fiber— $\frac{1}{2}$ O. D. x $\frac{5}{16}$ I. D. x $\frac{1}{16}$; Extruded $\frac{3}{8}$ x $\frac{1}{16}$	204	.30
For Set See No. 214 Flat Washer.....		
Extruded Washer—Fiber— $\frac{1}{2}$ O. D. x $\frac{1}{4}$ I. D. x $\frac{1}{16}$; Extruded $\frac{3}{8}$ x $\frac{1}{16}$	205	.30
For Set See No. 213 Flat Washer.....		
Extruded Washer—Fiber— $\frac{1}{2}$ O. D. x $\frac{1}{4}$ I. D. x $\frac{1}{16}$; Extruded $\frac{3}{8}$ x $\frac{1}{16}$	1139	.30
Flat Washer— $\frac{3}{4}$ O. D. x $\frac{3}{8}$ I. D. x $\frac{1}{16}$; Bakelite.....	212	.20
Flat Washer— $\frac{1}{2}$ O. D. x $\frac{1}{4}$ I. D. x $\frac{1}{16}$; Bakelite.....	213	.20
Flat Washer— $\frac{1}{2}$ O. D. x $\frac{1}{4}$ I. D. x $\frac{1}{16}$; Bakelite.....	214	.20
Metal Washer—Nickel Finish— $\frac{3}{4}$ O. D. x $\frac{3}{8}$ I. D. .040 Brass.....	225	.20
Metal Washer—Nickel Finish— $\frac{3}{4}$ O. D. x $\frac{3}{8}$ I. D. .040 Brass.....	226	.20
Lock Washer—Cadmium Plated Steel— $\frac{1}{16}$ O. D. x $\frac{1}{4}$ I. D.....	227	.20
Lock Washer—for No. 6 Screws.....	228	.10
Lock Washer—for No. 8 Screws.....	229	.10

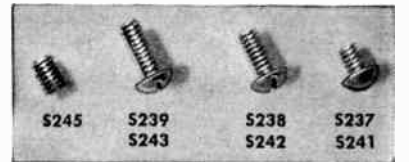

ROUND HEAD MACHINE SCREWS (Brass, Nickel-plated)

Description	Catalog No.	List Price Per 10
$\frac{1}{4}$ x 6-32.....	S237	\$0.15
$\frac{1}{4}$ x 6-32.....	S238	.15
$\frac{1}{4}$ x 6-32.....	S239	.15
$\frac{1}{4}$ x 6-32.....	S240	.20
$\frac{1}{4}$ x 6-32.....	S241	.15
$\frac{1}{4}$ x 6-32.....	S242	.20
$\frac{1}{4}$ x 6-32.....	S243	.20
$\frac{1}{4}$ x 6-32.....	S244	.25

HEADLESS STEEL CUP POINT SET SCREWS

Description	Catalog No.	List Price Per 10
$\frac{1}{4}$ x 6-32.....	S245	\$0.40
$\frac{1}{4}$ x 6-32.....	S246	.45
$\frac{1}{4}$ x 6-32.....	S247	.50
$\frac{1}{4}$ x 6-32.....	S248	.40
$\frac{1}{4}$ x 6-32.....	S249*	.45
$\frac{1}{4}$ x 6-32.....	S250	.50

*Used on knobs illustrated below.

TERMINAL STRIPS

Description	Catalog No.	List Price
2 terminal strip, plain, no marking.....	113	\$0.15
3 terminal strip, plain, no marking.....	114	.20

SOLDER LUG STRIPS

Description	Catalog No.	List Price
1 terminal strip.....	SL1	\$0.30 per 10
2 terminal strip.....	SL2	.45 per 10
3 terminal strip.....	SL3	.60 per 10
3 double terminal strip.....	A016	.05 ea.

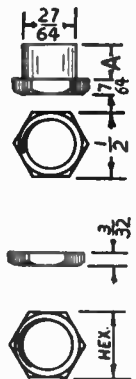
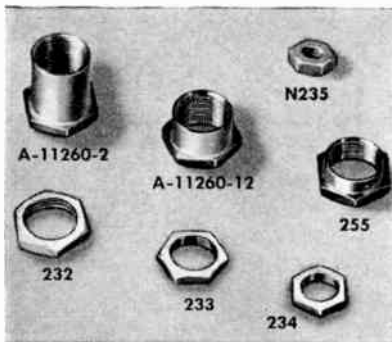

CAT. NO.	A	THREAD
255	$\frac{7}{64}$	$\frac{3}{8}$ -32
11260-2	$\frac{15}{32}$	$\frac{3}{8}$ -32
11260-12	$\frac{7}{32}$	$\frac{3}{8}$ -32

CAT. NO.	HEX	THD
232	$\frac{1}{2}$	$\frac{3}{8}$ -32
233	$\frac{7}{16}$	$\frac{5}{16}$ -40
234	$\frac{3}{8}$	$\frac{1}{4}$ -32

HEXAGON MOUNTING NUTS

Description	Thread	Dimension	Catalog No.	List Price
Flat Hex Mounting Nut.....	$\frac{3}{8}$ -32	$\frac{1}{2}$ x $\frac{3}{16}$	232	\$0.15 per 10
Flat Hex Mounting Nut.....	$\frac{7}{16}$ -40	$\frac{1}{2}$ x $\frac{1}{8}$	233	.15 per 10
Flat Hex Mounting Nut.....	$\frac{3}{4}$ -32	$\frac{3}{8}$ x $\frac{1}{8}$	234	.15 per 10
Flat Hex Mounting Nut.....	$\frac{3}{4}$ -32	$\frac{3}{8}$ x $\frac{1}{8}$	238	.15 per 10
Hex Mounting Nut.....	$\frac{3}{8}$ -32	$\frac{1}{2}$ x $\frac{1}{8}$	N235	.10 per 10
Hex Mounting Nut.....	6-32		N236	.15 per 10
Hex Mounting Nut.....	8-32		N236	.15 per 10
Hex Mounting Nut.....	$\frac{3}{8}$ -32		255	.15 each
Hex Mounting Nut.....	$\frac{3}{8}$ -32	$\frac{1}{2}$ x $\frac{1}{8}$ x $\frac{1}{8}$ shoulder nut	A-11260-2	.25 each
Hex Mounting Nut.....	$\frac{3}{8}$ -32	$\frac{1}{2}$ x $\frac{1}{8}$ x $\frac{1}{8}$ shoulder nut	A-11260-12	.20 each

Jack and Slide Switches Push-Button Switches

P. R. MALLORY & CO. Inc.
MALLORY

STANDARD AND JUNIOR JACK SWITCHES (Made under Patent No. 1,443,604)

Circuit Arrangement	Two Position			
	Standard		Junior	
	No.	List Price	No.	List Price
Single-Pole, Single-Throw	20	\$0.90	720	\$0.85
Single-Pole, Double-Throw	30	1.10	730	1.05
Double-Pole, Single-Throw	40	1.20	740	1.15
Five Springs, two break and one make	45	1.40	745	1.35
Double-Pole, Double-Throw	60	1.50	760	1.50
Three-Pole, Single-Throw	73	1.50	733	1.50
Four Pole, Single-Throw	74	1.95	744	1.95
Circuit Arrangement	Three Position			
	No.	List Price	No.	List Price
	Single-Pole, Double-Throw Center off Position	32	\$1.10	732
Double-Pole, Double-Throw Center off Position	62	1.50	762	1.45
Three-Pole, Double-Throw Center off Position	63	1.95	763	1.90
Four Pole, Double-Throw Center off Position	64	2.40	764	2.35

● Mallory Jack Switches and Junior Jack Switches are furnished complete with Black Knob, Pointer, and one each No. 255 Nut and No. 226 Washer. Two-position switches only are furnished with "Off-On" name plate. Mount in a single hole, $\frac{1}{16}$ " diameter, on panels up to $\frac{1}{4}$ " thick.

MIDGET JACK SWITCHES

● Same general construction as the Junior types but require less space. Furnished complete with one each No. 255 Nut, No. 226 Washer, Black Knob Pointer and "Off-On" name plate. Mount in single hole $\frac{1}{8}$ " diameter on panels up to $\frac{1}{4}$ " thick.

	List Price
Single-Pole, Single-Throw—No. 10	\$.60
Single-Pole, Double-Throw—No. 11	.80

SLIDE SWITCHES

● Positive snap action. Rated at .75 amperes, 125 volts.

	No.	List Price
Single-pole, single-throw	S1	\$0.40
Single pole, double-throw	S2	.45
Double-pole, double-throw	S3	.50

PUSH BUTTON SWITCHES (Single)

● Especially adapted for use in laboratories, test panels, meter circuits and where permanent or momentary contact is desired.

The non-locking switch operates only when the button is pushed in and releases on removal of the pressure. The locking type maintains its position when the button is pushed in and is released when button is pulled out.

Furnished with polished black Bakelite Knob, one each No. 255 Nut, No. 226 Washer and Set Screw. Mounts in single hole $\frac{1}{16}$ " diameter on panels up to $\frac{1}{4}$ " thick.

	Cat. No.	List Price
S. P. Make contact—Non-locking type	2001	\$1.10
S. P. Make contact—Locking type	2001-L	1.10
S. P. Break contact—Non-locking type	2002	1.10
S. P. Break contact—Locking type	2002-L	1.10
S. P. Double-Throw—Non-locking type	2003	1.20
S. P. Double-Throw—Locking type	2003-L	1.20
2-Pole—Make two contacts—Non-locking type	2004	1.45
2-Pole—Make two contacts—Locking type	2004-L	1.45
2-Pole—Break two contacts—Non-locking type	2005	1.45
2-Pole—Break two contacts—Locking type	2005-L	1.45
2-Pole—Double-Throw—Non-locking type	2006	1.80
2-Pole—Double-Throw—Locking type	2006-L	1.80
2-Pole—Make two—Break one—Non-locking type	2007	1.60
2-Pole—Make two—Break one—Locking type	2007-L	1.60
Double-Throw—Make before break—Non-locking type	2008	2.00
2-Pole—Double-Throw—Make before break—Locking type	2008-L	2.00

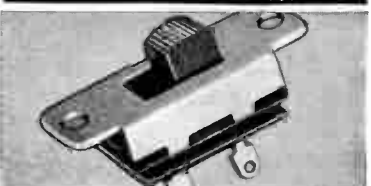
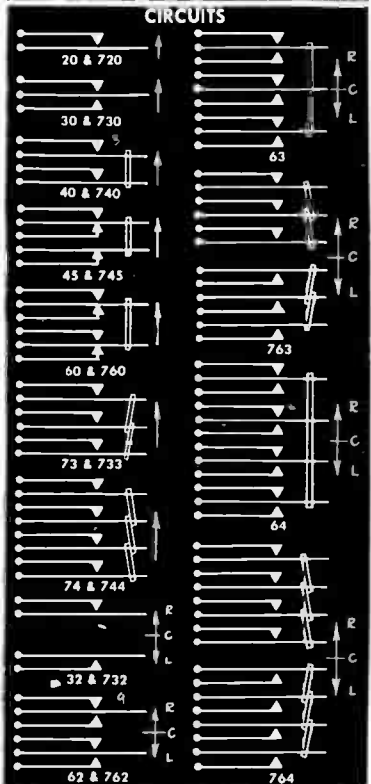
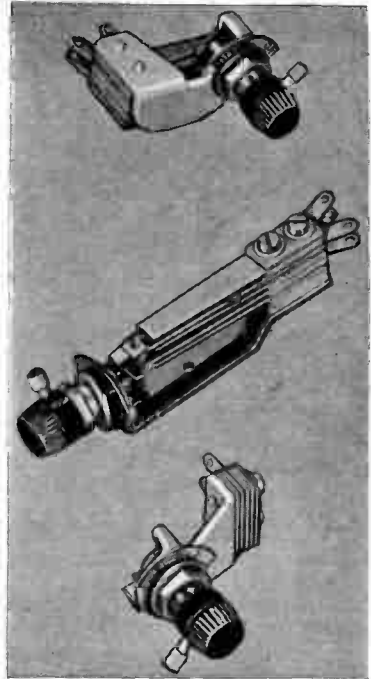
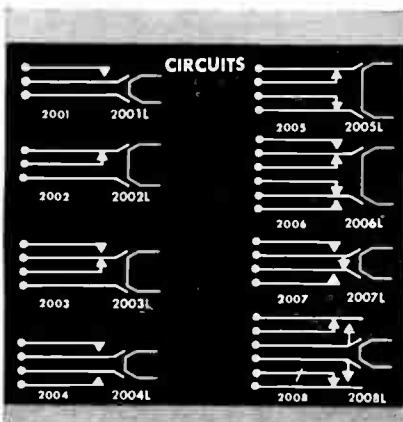
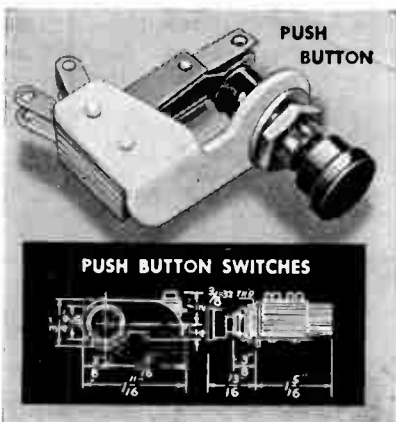

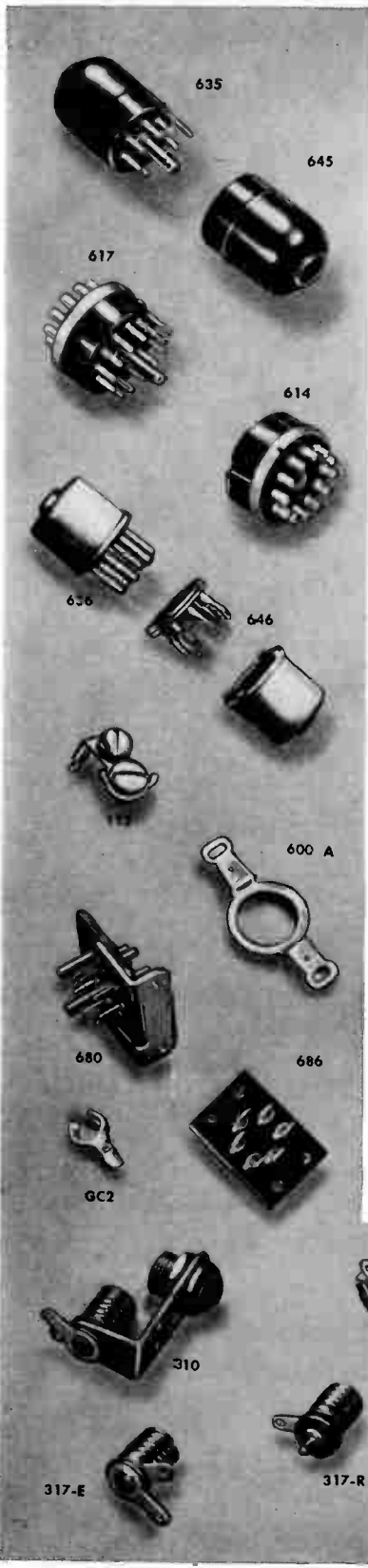

PIN PLUGS

	Catalog No.	List Price
*Pin Plug, with cover, 7 conductor	635	\$1.60
*Pin Plug, with cover, 12 conductor	625	2.10
*Pin Plug, with mounting ring, 7 conductor	631	1.40
*Pin Plug, with mounting ring, 12 conductor	617	1.80
Pin Plate, 7 conductor	680	.90
Pin Plate, 12 conductor	682	1.50
With cover, 2-conductor	632	.25
With cover, 3-conductor	633	.30
With cover, 4-conductor	634	.40
With cover, 6-conductor	636	.45

(Note—Covers are easily attached by crimping)
*For mounting on panels up to 1/8" thick.

RECEPTACLE PLUGS

	Catalog No.	List Price
Receptacle Plug, with cover, 7 conductor	645	\$1.60
Receptacle Plug, with cover, 12 conductor	615	2.10
Receptacle Plug, with mounting ring, 7 conductor	644	1.40
Receptacle Plug, with mounting ring, 12 conductor	614	1.80
With cover, 2-conductor	642	.20
With cover, 3-conductor	643	.25
With cover, 4-conductor	647	.30
With cover, 6-conductor	646	.40

For mounting on panels up to 1/8" thick.

PILOT AND DIAL LIGHT BRACKETS AND SOCKETS

DESCRIPTION Both terminals are insulated from bracket	Miniature Screw Base Types		Miniature Bayonet Base Types		List Price
	Catalog No.	Catalog No.	Catalog No.	Catalog No.	
Pilot Light Bracket only; no Jewel	310	B310			\$0.20
Pilot Light Bracket, 1/2" Amber Jewel	310A	B310A			.40
Pilot Light Bracket, 1/2" Clear Jewel	310C	B310C			.40
Pilot Light Bracket, 1/2" Green Jewel	310G	B310G			.40
Pilot Light Bracket, 1/2" Red Jewel	310R	B310R			.40
Pilot Light Bracket, 1/2" Blue Jewel	310B	B310B			.40
Pilot Light Bracket, 1/2" Opal Jewel	310F	B310F			.40
			With 1 Lug Terminal and 1 Rivet Terminal	With 1 Lug Terminal and 1 Rivet Terminal	List Price
Dial Light Slip-on Bracket	303AH		317R	B317R	\$0.15
Dial Light Slip-on Bracket (Inverted Type)	304CH			B304CR	.15
Shell Assemblies	317E			B317R	.15

JEWELS ONLY →

PANEL LIGHTS

A convenient reflector for panel mounting. Mounts in single 1/2" hole. Panel Light Catalog No. 330.

List Price\$0.80

MOUNTING BRACKETS

	Catalog No.	List Price
For use with types 631, 635, 644 and 645 7-conductor plugs	600A	\$0.30
For use with types 614, 615, 617 and 625 12-conductor plugs	600B	.30

Furnished complete with 2 screws and 4 washers.

MULTIPLE CABLE

	List Price
7 Conductor Insulated Cable	\$0.30 per ft.
12 Conductor Insulated Cable	.60 per ft.

CHASSIS MOUNTING RECEPTACLE PLATES

Useful for loud speaker connections and other applications.

	Catalog No.	List Price
2-conductor plates	681	\$0.15
3-conductor plates	683	.15
4-conductor plates	684	.20
6-conductor plates	686	.25

TERMINAL CLIPS

	Catalog No.	List Price
Terminal Clip	112B	\$0.05 ea.
Envelope of five	112E	.30

GRID CLIPS

	Catalog No.	List Price per 100
Small, for metal tubes	GC1	\$1.80
Large, for glass tubes	GC2	1.80

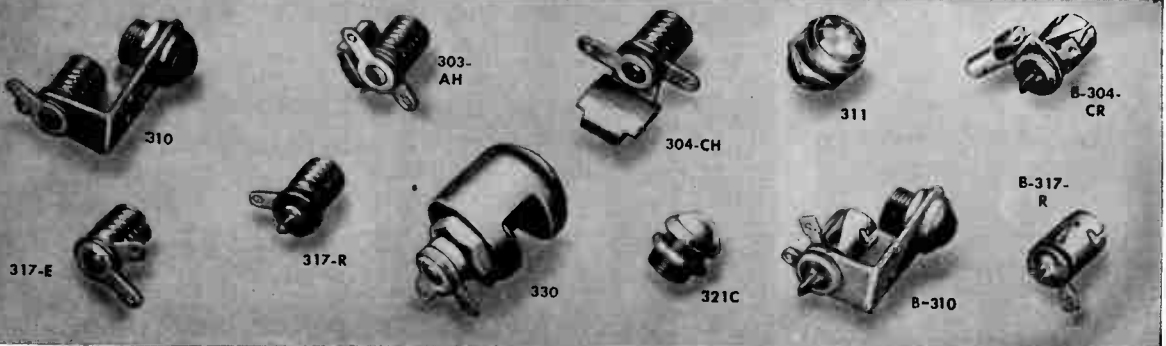

BE RIGHT WITH OHMITE

RHEOSTATS
RESISTORS
SWITCHES
CHOKES

OHMITE RHEOSTATS

All-Porcelain — Vitreous-Enamelled

The design and construction of these sturdy, compact Ohmite Rheostats insure permanently smooth, gradual, close control. The wire is wound over a porcelain core, bonded to porcelain base, and permanently locked in place by special Ohmite Vitreous Enamel. Nothing to smoke, char, shrink, or shift. Dissipates heat rapidly. Insulated shafts and bushings. Copper graphite contacts. Ratings are for "free air" use. Time-proved through long trouble-free service in countless installations the world over. Underwriters' Laboratories Listed.

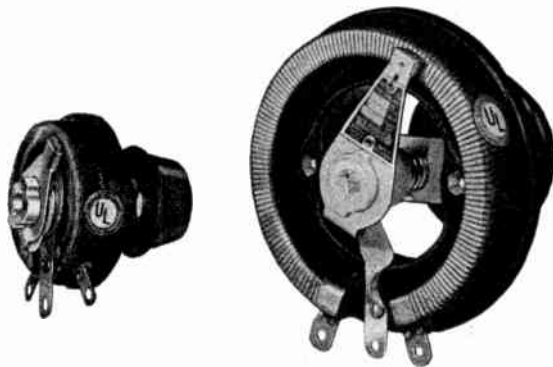

MODEL "H" 25 Watt Diameter 1 1/8". Depth behind panel 1 3/8"

Stock No.	Ohms	Max. Mils.	List Price	Stock No.	Ohms	Max. Mils.	List Price
0140	1	5,000	\$4.50	0152	125	445	\$4.00
0141	2	3,540	4.00	0153	175	375	4.00
0142	3	2,880	4.00	0154	250	318	4.00
0143	6	2,040	4.00	0155	350	267	4.00
0144	8	1,770	4.00	0156	500	222	4.00
0145	10	1,580	4.00	0157	750	182	4.00
0146	15	1,290	4.00	0158	1,000	155	4.50
0147	25	1,000	4.00	0159	1,500	129	4.50
0148	35	845	4.00	0160	2,500	100	4.50
0149	50	707	4.00	0161	3,500	84	4.75
0150	75	575	4.00	0162	5,000	70	4.75
0151	100	500	4.00				

MODEL "J" 50 Watt Diameter 2 1/8". Depth behind panel 1 3/8"

Stock No.	Ohms	Max. Mils.	List Price	Stock No.	Ohms	Max. Mils.	List Price
0308	0.5	10,000	\$5.00	0321	150	575	\$4.50
0309	1	7,070	5.00	0322	225	470	4.50
0310	2	5,000	5.00	0323	300	408	4.50
0311	4	3,530	4.50	0324	500	318	4.50
0312	6	2,880	4.50	0325	800	250	4.75
0313	8	2,500	4.50	0326	1,000	224	4.75
0314	12	2,040	4.50	0327	1,800	176	4.75
0315	16	1,760	4.50	0328	2,500	141	4.75
0316	22	1,500	4.50	0329	3,500	119	5.00
0317	35	1,190	4.50	0330	5,000	100	5.00
0318	50	1,000	4.50	0331	8,000	79	5.00
0319	80	790	4.50	0332	10,000	70	5.00
0320	125	630	4.50				



OHMITE SPECIAL RHEOSTATS for Soldering Iron Control

Adjusts heat of the soldering iron or melting pot for best work and economical operation.

Wattage of Soldering Iron or Pot to be Controlled	Rheostat Control Stock No.	Cage Dimensions	List Price Each
Watts	Volts	Diam. Hgt.	
40-65	115	SRC65 3 1/4" 2"	\$ 7.25
85-100	115	SRC100 3 1/4" 2"	7.25
120-150	115	SRC150 3 3/4" 2 3/4"	9.15
175-220	115	SRC220 3 3/4" 2 3/4"	10.00
300-350	115	SRC350 4 1/4" 2 3/4"	11.70
430-500	115	SRC500 7 1/2" 3 1/4"	17.00

For more complete information on OHMITE PRODUCTS, ask for Ohmite Catalog 18.

MODEL "K" 100 Watt Diameter 3 1/8". Depth behind panel 1 3/8"

Stock No.	Ohms	Max. Mils.	List Price	Stock No.	Ohms	Max. Mils.	List Price
0440	0.5	14,100	\$7.50	0452	200	707	\$7.00
0441	1	10,000	7.50	0453	300	575	7.00
0442	2	7,070	7.50	0454	400	500	7.00
0443	3	5,750	7.50	0455	500	447	7.00
0444	5	4,470	7.50	0456	750	365	7.00
0445	7.5	3,650	7.00	0457	1,000	318	7.50
0446	10	3,160	7.00	0458	1,500	258	7.50
0447	16	2,500	7.00	0459	2,000	224	7.50
0448	25	2,000	7.00	0460	2,500	200	7.50
0449	50	1,410	7.00	0461	5,000	141	8.00
0450	75	1,150	7.00	0462	7,500	115	8.50
0451	100	1,000	7.00	0463	10,000	100	9.00

MODEL "L" 150 Watt Diameter 4". Depth behind panel 2"

Stock No.	Ohms	Max. Mils.	List Price	Stock No.	Ohms	Max. Mils.	List Price
0524	0.5	17,300	\$9.50	0537	150	1,000	\$9.00
0525	1	12,300	9.50	0538	200	865	9.00
0526	2	8,650	9.50	0539	250	775	9.00
0527	3	7,070	9.50	0540	350	655	9.00
0528	5	5,480	9.50	0541	500	548	9.00
0529	7.5	4,470	9.50	0542	750	447	9.50
0530	10	3,880	9.00	0543	1,250	346	9.50
0531	15	3,163	9.00	0544	1,800	288	10.00
0532	25	2,450	9.00	0545	2,250	259	10.00
0533	35	2,070	9.00	0546	3,000	224	10.00
0534	50	1,735	9.00	0547	4,500	182	10.50
0535	75	1,415	9.00	0548	7,500	141	11.00
0536	100	1,225	9.00	0549	10,000	122	12.00

MODEL "N" 300 Watt Diameter 6". Depth behind panel 2 3/8"

Stock No.	Ohms	Max. Mils.	List Price	Stock No.	Ohms	Max. Mils.	List Price
0650	1	17,320	\$13.50	0661	100	1,730	\$13.50
0651	2	12,240	13.50	0662	150	1,410	13.50
0652	3	10,000	13.50	0663	200	1,220	13.50
0653	4	8,660	13.50	0664	300	1,000	13.50
0654	5	7,750	13.50	0665	400	868	13.50
0655	7.5	6,320	13.50	0666	700	655	13.50
0656	10	5,480	13.50	0667	900	578	13.50
0657	15	4,470	13.50	0668	1,200	500	13.50
0658	25	3,460	13.50	0669	1,500	447	13.50
0659	50	2,450	13.50	0670	1,750	414	13.50
0660	75	2,000	13.50	0671	2,500	346	13.50

OTHER OHMITE RHEOSTATS

Ohmite Rheostats are also available in Model G, 75 Watt; Model P, 225 Watt; Model R, 500 Watt; Model T, 750 Watt; and Model U, 1,000 Watt units, in many resistance values. Special Rheostats with tapered windings, etc., can be supplied; also Special Rheostats for Model Train Control. Cages and other accessories also available.

BE RIGHT WITH OHMITE*

RHEOSTATS
RESISTORS
SWITCHES
CHOKES

Popular OHMITE "BROWN DEVIL" RESISTORS

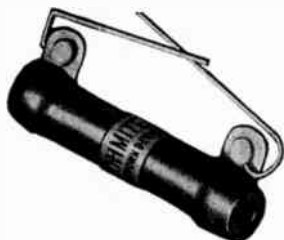

High quality, small size, wire wound resistors ideal for voltage dropping, bias units, bleeders, etc. They're extra-sturdy, all-porcelain, vitreous enameled. They give time-proved protection against shock, vibration, heat and humidity. Their long record of continuous trouble-free service—their wide use in all climates of the world—prove their complete reliability and economy. All units have 1½" tinned wire leads.

OHMITE "WIREWATT"



1 Watt wire-wound Resistor

Wire-wound on porcelain and insulated with low temperature enamel. Ends of the wire are mechanically locked and then brazed to terminal lugs to insure freedom from noise. 1½" tinned wire leads. RMA color coded, and labeled with the resistance. Size 1¼" x ¼".

10 Watt—1¼" x ⅞" Core Size					
Ohms	Mils.	Ohms	Mils.	Ohms	Mils.
1	3,160	150	258	1,500	79
2	2,235	200	223	1,750	74
3	1,825	225	217	2,000	69
4	1,580	250	200	2,250	64
5	1,414	300	182	2,500	63
7.5	1,155	350	169	3,000	56
10	1,000	400	158	3,500	51
12	910	450	149	4,000	47
15	816	500	141	4,500	45
20	707	600	129	5,000	43
25	632	700	119	6,000	38
30	575	750	115	7,000	34
35	535	800	111	7,500	32
40	500	900	105	8,000	31
50	447	1,000	100	8,500	29
75	365	1,100	95	10,000	26
100	316	1,200	91		
125	283	1,250	89		

20 Watt—2" x ⅞" Core Size					
Ohms	Mils.	Ohms	Mils.	Ohms	Mils.
5	2,000	700	189	2,750	85
10	1,414	750	183	3,000	81
25	894	800	158	3,500	75
50	632	850	153	4,000	70
75	516	1,000	141	4,500	66
100	447	1,200	129	5,000	63
150	365	1,250	126	6,000	57
200	316	1,500	115	7,000	53
250	283	1,750	107	7,500	51
300	258	1,850	104	8,000	50
350	239	2,000	100	10,000	43
400	223	2,250	94	12,500	35
500	200	2,400	91	15,000	30
650	175	2,500	89		

List Price, any 20 watt unit above \$0.70

20,000	24	35,000	15	45,000	13
25,000	20	40,000	14	50,000	12
30,000	17				

List Price, any 20 watt unit above \$0.85

*55,000	8.0	*75,000	7.0	*90,000	6.0
*60,000	8.0	*80,000	7.0	*95,000	6.0
*65,000	7.0	*85,000	6.0	*100,000	6.0
*70,000	7.0				

List Price, any 20 watt unit above \$1.10

Ohms	Mils.	Volts	Ohms	Mils.	Volts
100	100	10	2,250	21	47
125	89	11	2,500	20	50
150	81	12	3,000	18	54
200	70	14	3,500	16	59
250	63	15	4,000	15	63
300	57	17	4,500	14	67
350	53	18	5,000	14	70
400	50	20	6,000	12	77
500	44	22	7,000	11	83
600	40	24	7,500	11	86
700	37	26	8,000	11	89
750	36	27	9,000	10	95
800	35	28	10,000	10	100
900	33	30	12,500	9	112
1,000	31	31	15,000	8	122
1,100	30	33	16,000	7	126
1,200	28	34	17,500	7	132
1,250	28	35	18,000	7	134
1,500	25	38	20,000	7	141
1,750	23	41	22,500	6	150
2,000	22	44	25,000	6	158

List Price..... \$0.25

List Price, any 10 watt unit above \$0.45

11,000	24	16,000	18	*30,000	8
12,000	23	17,500	17	*35,000	7
12,500	22	18,000	17	*40,000	7
13,500	21	20,000	16	*45,000	6
14,300	20	22,500	15	*50,000	6
15,000	19	25,000	14		

List Price, any 10 watt unit above \$0.50

*The units marked with an asterisk are coated with a low temperature enamel.

OHMITE CENTER-TAPPED RESISTORS

Compact, Accurate, Convenient



"Wirewatt" and "Brown Devil" center-tapped resistors especially designed for use across radio transmitter tube filaments to provide an electrical center for the grid and plate returns. Should be connected as closely as possible to the tube socket. Center tap accurate to plus or minus 1%.



RITEOHM "81" Precision Resistors

High quality, 1% accurate, 1 watt, non-inductive, pie-wound Precision Resistors for voltmeter multipliers, laboratory equipment, radio and electrical test sets, attenuation pads, etc. Special Ohmite vacuum-type impregnation provides complete protection. Size ⅞" x 1¼". Equipped with soldering lugs and threaded stud terminals.

Available in many stock resistance values from 0.1 ohm to 2 megohms. For complete listing, see Ohmite Catalog 18. (Also available in closer tolerances.)

Riteohm "71" Vitreous-Enameled Precision Resistors and Riteohm Series "90" Hermetically-Glass-Sealed Precision Resistors are also available.

"WIREWATT" 1 Watt

Res. Ohms	For Heater or Filament Voltage up to	Max. Volts	List Price
10	2.5	3.15	\$0.35
15	2.5	3.85	.35
*20	2.5	4.4	.35
25	2.5	5.0	.35
30	2.5	5.4	.35
40	2.5	6.3	.35
*50	5.0	7.0	.35
75	5.0	8.6	.35
*100	6.3	10.0	.35
200	6.3	14.0	.35

"BROWN DEVIL" 10 Watt

Res. Ohms	For Heater or Filament Voltage up to	Max. Volts	List Price
10	6.3	10.0	\$0.55
15	6.3	12.2	.55
*20	7.5	14.0	.55
25	7.5	15.8	.55
30	7.5	17.3	.55
40	10.0	20.0	.55
*50	10.0	22.3	.55
75	10.0	27.3	.55
*100	12.0	31.5	.55
200	12.0	44.5	.55

*Shows most popular sizes.

For more complete information on OHMITE PRODUCTS, ask for Ohmite Catalog 18.

BE RIGHT WITH OHMITE*

**RHEOSTATS
RESISTORS
SWITCHES
CHOKES**

OHMITE DIVIDOHM RESISTORS

OHMITE FIXED RESISTORS



**All-Porcelain
Vitreous-Enameled**



You can adjust the resistance or secure odd resistance values quickly with these Dividohms; easily put on more taps where needed. Ideal voltage dividers. With one adjustable lug and with mounting brackets.

Extra-sturdy, wire-wound, all-porcelain resistors with the permanent protection of Ohmite Vitreous Enamel. Widely used for heavy duty applications to assure continuous trouble-free service. With mounting brackets.

10 WATTS

Core Size 1 1/4" x 1/2"			Mounting Centers 2 1/4"		
Adjustable Res.			Adjustable Res.		
Res. Ohms	Max. Mils.	Stock No.	Res. Ohms	Max. Mils.	Stock No.
1	3,150	1001	750	115	1021
2	2,235	1002	800	111	1022
3	1,825	1003	1,000	100	1023
5	1,415	1004	1,250	89	1024
7.5	1,155	1005	1,500	79	1025
10	1,000	1006	2,000	69	1026
15	816	1007	2,250	64	1027
20	707	1008	2,500	63	1028
25	632	1009	3,000	56	1029
50	447	1010	3,500	51	1030
75	365	1011	4,000	47	1031
100	316	1012	4,500	45	1032
150	258	1013	5,000	43	1033
200	223	1014	6,000	38	1034
250	200	1015	7,000	34	1035
300	182	1016	7,500	33	1036
350	169	1017	8,000	31	1037
400	158	1018	8,500	29	1038
500	141	1019	9,000	28	1039
600	129	1020	10,000	26	1040

List Price, any above unit.....\$0.75

75 WATTS

Core Size 6" x 1/2"			Mounting Centers 6 1/2"		
Adjustable Res.			Adjustable Res.		
Res. Ohms	Max. Mils.	Stock No.	Res. Ohms	Max. Mils.	Stock No.
5	3,870	0769	5,000	122	0783
10	2,735	0770	6,000	111	0783B
15	2,236	0771	7,000	103	0783C
25	1,732	0772	7,500	100	0784
50	1,224	0773	8,000	96	0784B
100	866	0774	9,000	91	0784C
200	612	0774B	10,000	86	0785
250	547	0775	12,000	79	0785B
300	500	0775B	15,000	70	0786
400	433	0775C	20,000	61	0787
500	387	0776	25,000	52	0788
750	316	0777	30,000	47	0789
1,000	273	0778	35,000	38	0790
1,250	245	0778B	40,000	33	0791
1,500	223	0779	45,000	28	0792
2,000	183	0780	50,000	25	0793
2,500	173	0781	60,000	19	0794
3,000	158	0781B	80,000	17	0795
3,500	146	0782	100,000	13	0796
4,000	136	0782B			

List Price, 5 to 5,000 ohms.....\$1.95
 List Price, 6,000 to 25,000 ohms..... 2.20
 List Price, 30,000 to 50,000 ohms..... 2.50
 List Price, 60,000 to 100,000 ohms 2.75

160 Watt Resistors—Core Size 8 1/2" x 1 1/2". Mounting Centers 9 1/2"—available in same resistances as the 200 Watt Resistors.

Ohms	Fixed Res. List Price	Adj. Res. List Price
5 to 10,000	\$2.20	\$2.75
15,000 to 50,000	2.65	3.20
60,000 to 100,000	3.00	3.50

ADJUSTABLE LUGS

Bakelite Knob			Screw Driver Type		
Res. Dia.	Stock No.	List Price	Res. Dia.	Stock No.	List Price
1/8"	0359	\$0.15	1/8"	1058	\$0.10
3/16"	1959	.25	3/16"	0358	.10
1/4"	2159	.25	1/4"	1958	.15
			3/8"	2158	.15

25 WATTS

Core Size 2" x 1/2"		Mounting Centers 2 1/2"	
		Fixed Resist.	Adj. Resist.
Res. Ohms	Max. Mils.	Stock No.	List Price
1	5,000	0360	\$0.95
2	3,535	0360B	.95
3	2,885	0361	.95
5	2,235	0200A	\$0.80
7.5	1,825	0362B	.95
10	1,580	0200B	.80
15	1,290	0364	.95
20	1,117	0364B	.95
25	1,000	0200C	.80
50	707	0200D	.80
75	577	0200E	.80
100	500	0200F	.80
150	408	0200G	.80
200	353	0200H	.80
250	316	0201	.80
300	288		
400	250		
500	223	0202	.80
750	182	0203	.80
800	176	0204	.80
1,000	158	0205	.80
1,250	141		
1,500	129	0206	.80
2,000	111	0207	.80
2,250	105		
2,500	100	0208	.80
3,000	91	0209	.80
3,500	84	0210	.80
4,000	79	0211	.80
4,500	74		
5,000	70	0212	.80
6,000	64	0213	.90
7,000	60		
7,200	59		
7,500	57	0214	.90
8,000	55		
9,000	52	0215	.90
10,000	50	0215	.90
12,000	42	0216	.90
15,000	34	0217	.90
20,000	26	0218	1.10
25,000	21	0219	1.10
40,000	14	0222	1.10
50,000	12	0224	1.10
100,000	7	0229	1.90

100 WATTS

Core Size 6 1/2" x 1/2"		Mounting Centers 7 1/2"	
5	4,470	0800A	\$1.65
10	3,160	0800B	1.65
25	2,000	0801	1.65
50	1,414	0802	1.65
75	1,153	0803	1.65
100	1,000	0804	1.65
150	816	0805	1.65
250	632	0806	1.65
500	447	0807	1.65
750	365	0808	1.65
1,000	316	0809	1.65
1,500	258	0810	1.65
2,000	223	0811	1.65
2,500	200	0812	1.65
3,000	182	0813	1.65
5,000	141	0814	1.65
7,500	115	0815	1.95
10,000	100	0815	1.95
15,000	81	0817	1.95
20,000	70	0818	1.95
25,000	53	0819	1.95
30,000	47	0820	2.20
40,000	36	0821	2.20
50,000	29	0822	2.20
60,000	24	0823	2.50
75,000	19	0824	2.50
100,000	15	0825	2.75

50 WATTS

Core Size 4" x 1/2"		Mounting Centers 4 1/2"	
		Fixed Resist.	Adj. Resist.
Res. Ohms	Max. Mils.	Stock No.	List Price
5	3,160	0400A	\$1.20
10	2,235	0400B	1.20
25	1,414	0400C	1.20
50	1,000	0400D	1.20
75	816	0400E	1.20
100	707	0400F	1.20
150	577	0400G	1.20
200	500	0400H	1.20
250	447	0401	1.20
300	408		
400	353		
500	316	0402	1.20
750	258	0403	1.20
1,000	223	0405	1.20
1,250	200		
1,500	182	0406	1.20
2,000	158	0407	1.20
2,500	141	0408	1.20
3,000	129	0409	1.20
3,500	119		
4,000	111	0410	1.20
4,500	105		
5,000	100	0411	1.20
6,000	91		
7,000	84		
7,500	81	0412	1.40
8,000	79	0413	1.40
9,000	74		
10,000	70	0414	1.40
12,000	64	0415	1.40
15,000	57	0416	1.40
20,000	48	0417	1.40
25,000	41	0418	1.40
30,000	41		
35,000	32	0419	1.60
40,000	35		
50,000	23	0420	1.60
60,000	20		
75,000	16	0421	1.60
80,000	15		
100,000	12	0422	1.60

200 WATTS

Core Size 10 1/2" x 1 1/2"		Mounting Centers 11 1/2"	
5	6,320	0900A	\$2.75
10	4,470	0900B	2.75
25	2,828	0901	2.75
50	2,000	0902	2.75
75	1,635	0903	2.75
100	1,414	0904	2.75
150	1,153	0905	2.75
250	894	0906	2.75
500	632	0907	2.75
750	516	0908	2.75
1,000	447	0909	2.75
1,500	365	0910	2.75
2,000	316	0911	2.75
2,500	283	0912	2.75
3,000	258	0913	2.75
5,000	200	0914	2.75
7,500	163	0915	2.75
10,000	141	0916	2.75
15,000	115	0917	3.30
20,000	100	0918	3.30
25,000	80	0919	3.30
30,000	81	0920	3.30
40,000	61	0921	3.30
50,000	49	0922	3.30
60,000	41	0923	3.30
75,000	33	0924	3.30
100,000	25	0925	3.30

For more complete information on OHMITE PRODUCTS, ask for Ohmite Catalog 18.

BE RIGHT WITH OHMITE

RHEOSTATS
RESISTORS
SWITCHES
CHOKES

OHMITE DUMMY ANTENNA

To Check R.F. Power and Tune Up to Peak Efficiency



For the first time, a compact, high-wattage resistor suitable for high radio-frequency measurements. Non-inductive, non-capacitive, constant in resistance. Provides a simple, accurate, direct means of measuring R. F. power in all transmitter stages for the purpose of tuning up to maximum efficiency. Used to determine transmission line losses—to check line to antenna impedance match—to keep signal off the air while tuning up—to eliminate unnecessary interference—and generally useful as a non-inductive resistor in other R. F. Circuits.

Space-wound resistance element of unusual design, mounted in a glass bulb, evacuated and gas filled. Four-prong steatite standard tube base. Several units can be connected in various ways for higher wattages.

Model D-100. 100 Watt rating. In popular 73 ohm and 600 ohm resistance values. Also in 13, 18, 34, 64, 100, 146, 219, 300, 400, 500 ohm values. Diameter $3\frac{1}{8}$ ". Height (from bottom of base) $4\frac{3}{8}$ ".

List Price.....\$6.50

Model D-250. 250 Watt rating. In 73 ohm and 600 ohm stock resistances. Diameter of bulb $2\frac{1}{2}$ ". Height $9\frac{1}{8}$ " (from bottom of base).

List Price.....\$13.00

Non-Inductive Vitreous-Enamelled Resistors also available. See Ohmite Catalog 18.

OHMITE OHM'S LAW CALCULATOR

This handy calculator, designed by Ohmite engineers, solves Ohm's Law problems with only one setting of the slide. No decimal points to cause confusion—all values are direct reading. Requires no slide rule knowledge. Scales on two sides



of the calculator cover both the range of currents, resistances, wattages, and voltages commonly used in the radio and electronic fields, and the higher current industrial range up to 100 amperes or 1000 watts. A convenient stock unit selector tells the stock number of the unit you may need. Size $4\frac{1}{8}$ " x 9".

Ohmite Ohm's Law Calculator.....NET Price \$0.10

OHMITE PARASITIC SUPPRESSOR



Designed to prevent unwanted ultra-high-frequency parasitic oscillations which occur in the plate and grid leads of push-pull and parallel tube circuits. The parasitics are suppressed, without loss of driving power.

The P-300 is an non-inductive, vitreous-enamelled resistor combined with a choke into one small integral unit. Only $1\frac{1}{4}$ " long overall and $\frac{5}{8}$ " diameter.

Model P-300. List Price.....\$1.50

OHMITE R.F. PLATE CHOKES

Built to Carry 1,000 M.A.



High frequency solenoid chokes designed to avoid fundamental or harmonic resonance in the amateur bands. Single-layer wound on low power factor steatite core—insulated and protected by moisture-proof coating. No portion can resonate independently of any other portion. Designed also to prohibit breakdown from high R. F. potentials. Ample space allowed at the ends to prevent flashover to ground. Non-magnetic mounting brackets furnished with the three larger sizes. Rated at 1,000 milliamperes. May be used in diathermy and therapeutic equipment as well as in radio transmitters.

Stock No.	Amateur Band, Meters	Micro-henries	Current Rating	D.C. Resistance Ohms	Lgth.	Tube Dia.	List Price
Z-0	$2\frac{1}{2}$	2.0	1,000 M.A.	0.19	$1\frac{3}{4}$ "	$\frac{1}{8}$ "	\$0.25
Z-1	5	5.5	1,000 M.A.	0.85	$1\frac{3}{4}$ "	$\frac{1}{4}$ "	.25
Z-2	10 and 20	30	1,000 M.A.	2	3"	$\frac{3}{8}$ "	.80
Z-3	20 and 40	90	1,000 M.A.	5	6"	$\frac{1}{2}$ "	1.20
Z-4	20, 40, 80 and 160	200	1,000 M.A.	9	$6\frac{1}{2}$ "	$\frac{3}{4}$ "	1.65

OHMITE POWER LINE CHOKES



Prevents high-frequency currents of radio transmitters, diathermy and therapeutic equipment from going out over the power lines and interfering with nearby radio receiving sets. Used as a filter in connection with two grounding condensers of 0.1 microfarad capacity each. The Z-20 Choke is also used at radio receivers to keep out interference. All chokes consist of two single-layer windings on a single ceramic core—insulated and protected by moisture-proof coating. Recommended for use in suppressing radio (not audio) frequency interference.

Stock No.	Micro-henries	Current Rating	Total D.C. Resistance Ohms	Lgth.	Tube Dia.	List Price
Z-20	14	5 Amperes	0.15	4"	$\frac{1}{8}$ "	\$1.65
Z-21	15	10 Amperes	0.07	$6\frac{1}{2}$ "	$\frac{3}{8}$ "	2.75
Z-22	18	20 Amperes	0.045	$8\frac{1}{2}$ "	$1\frac{1}{8}$ "	4.00

TRANSMITTER BAND CHANGE AND HIGH VOLTAGE SWITCH

For the rapid, convenient change of transmitter frequency by front-of-panel knob control. Suitable for circuits up to 1 K. W. rating. Adaptable for general use requiring high voltage insulation.

Model BC-3. Complete with Knob and Mounting Bracket.

List Price.....\$3.30

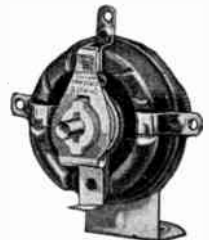

DEPENDABLE MUTER PRODUCTS

**MORE WATTS
PER DOLLAR**



**MORE WATTS
PER INCH**

5 WATT ZIPOHM WIRE WOUND REPLACEMENT RESISTORS



Size 1 1/2" x 1/2"

Zipohms are flat and fit into tight places easily. The 1/2" tinned leads are long enough for unusual installations. Accuracy is 5% and each unit is impregnated with a protective high temperature electric cement.

Number	Ohms	Number	Ohms	Number	Ohms	Number	Ohms
910	100	922	800	934	3500	944	12,500
911	125	923	900	935	4000	950	15,000
912	150	924	1000	936	4500	951	16,000
913	200	925	1100	937	5000	952	17,500
914	250	926	1200	938	6000	953	18,000
915	300	927	1250	939	7000	954	20,000
916	350	928	1500	940	7500	955	22,500
917	400	929	1750	941	8000	956	25,000
918	500	930	2000	942	9000		
919	600	931	2250	943	10,000		
920	700	932	2500				
921	750	933	3000				

NOTE

Size of the above 8 units is 1/2" x 2"

List Price of Above Units—25c

10 WATT ZIPOHM WIRE WOUND REPLACEMENT RESISTORS



Size 1 1/2" x 3/4"

Number	Ohms	Number	Ohms	Number	Ohms	Number	Ohms
1005	5	1033	200	1044	1000	1056	4500
1010	10	1034	250	1046	1200	1057	5000
1020	20	1035	300	1048	1500	1058	6000
1025	50	1036	350	1050	2000	1060	7500
1027	75	1037	400	1052	2500	1063	10,000
1030	100	1038	500	1053	3000	1064	12,000
1031	125	1039	600	1054	3500	1067	15,000
1032	150	1041	750	1055	4000	1071	20,000
						1073	25,000

List Price of Above Units—40c

ZIPOHM SPECIAL RESISTOR KIT FOR SERVICEMEN

\$15.45 Value for \$11.75

57 Zipohms in 27 different varieties



The large clearly marked aluminum tags make it possible to quickly select the desired resistor value. Kit assortment is supplied in the compact, convenient box shown above. Size of box, 8 3/4 x 3 3/4 x 2 1/2, weight, 1 lb.

5 Watt		5 Watt		5 Watt		10 Watt	
	Ohms		Ohms		Ohms		Ohms
2	100	4	750	4	5,000		
1	150	5	1,000	1	6,000	2	10,000
2	200	1	1,250	1	7,500		
1	250	3	1,500	2	10,000	2	15,000
2	300	4	2,000	1	15,000		
1	400	4	2,500	1	20,000	2	20,000
4	500	2	3,500	1	25,000	2	25,000
1	600	1	4,000				

The above units contained in the Zipohm Kit have been very carefully selected from frequency charts and will cover 80% of average replacement requirements for wire wound resistors. Other wire wound resistor values not contained in the Kit are listed above.

Stock No. 1075—Zipohm Resistor Kit

\$11.75

ORIGINAL EQUIPMENT CANDOHM REPLACEMENT RESISTORS



U. S. PATENT NO. 1,789,150

CANDOHM CASE, which makes it easy to order. We can supply any Candohm, give name of set and manufacturer's part number. Do not order by model. If unable to locate part number, send actual unit to be replaced.

Candohm patented wire-wound resistors and Voltage Dividers are found in practically all radio sets today. Make replacements with genuine Muter units exactly the same as supplied manufacturers originally. LOOK FOR THE SET MANUFACTURERS' PART NUMBER STAMPED IN THE METAL

DEPENDABLE MUTER PRODUCTS

MUTER PUSH BUTTON SWITCHES NON-LOCKING TYPE WITH BAKELITE BUTTON

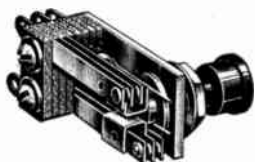

Size $1\frac{7}{8}$ " x $\frac{3}{4}$ " x $1\frac{5}{16}$ "
Bakelite buttons are removable
without loosening set screw.

Stock No.	Description	List
4500	Single Pole Make Contact	\$.90
4501	Single Pole Break Contact	.90
4502	Single Pole Double Throw	1.00
4503	2 Pole—Make 2 Contacts	1.20
4504	2 Pole—Break 2 Contacts	1.20
4505	2 Pole—Double Throw	1.50
4506	2 Pole—Make 2—Break 1	1.30
4507	Double Throw—Make Before Break	1.65

NOTE.—To remove the bakelite button, merely rotate through one-half a turn and at the same time pull. To re-assemble, push in and at the same time rotate 180°. The button remains locked in position, held by a new unique spring design.

NON-LOCKING TYPE WITH METAL BUTTON

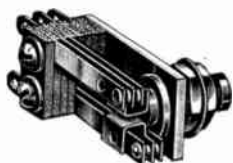

Size $1\frac{7}{8}$ " x $\frac{3}{4}$ " x $1\frac{1}{8}$ "
Switches have built-in lifters,
eliminating trouble from loose
parts.

Stock No.	Description	List
4520	Single Pole Make Contact	\$.90
4521	Single Pole Break Contact	.90
4522	Single Pole Double Throw	1.00
4523	2 Pole—Make 2 Contacts	1.20
4524	2 Pole—Break 2 Contacts	1.20
4525	2 Pole—Double Throw	1.50
4526	2 Pole—Make 2—Break 1	1.30
4527	Double Throw—Make Before Break	1.65

NOTE.—This series of Muter Push Button Switches are equipped with permanent lifters which are positive acting and cannot be removed. All metal parts are plated.



Size $1\frac{1}{8}$ " x $\frac{7}{8}$ " x $1\frac{1}{4}$ "
Compact switch which can be
used when back of panel space
is very limited.

SINGLE POLE PUSH BUTTON SWITCH

Stock No.	Description	List
4540	Single Pole Make Contact Non-Locking Type	70c

SPECIAL FEATURES.—A rugged compact switch using less space back of panel. Equipped with phosphor bronze springs, easily accessible solder lugs and metal push button insulated from contacts.

Midget Knife Throw Switches



Single Pole Single Throw
Base $1\frac{1}{4}$ " long, $\frac{1}{2}$ " wide.
Jobbers' standard quantity 50.
Weight per 100 is 2 lbs.

Stock No. 1900.....List Price \$0.20



Single Pole Double Throw
Base $1\frac{1}{4}$ " long, $\frac{1}{2}$ " wide.
Jobbers' standard quantity 50.
Weight per 100 is 2½ lbs.

Stock No. 1925.....List Price \$0.30



Double Pole Double Throw
Base $1\frac{1}{4}$ " long, 1" wide.
Jobbers' standard quantity 25.
Weight per 100 is 5 lbs.
Stock No. 1950.....List Price \$0.50

Candohmeter Resistance Indicators

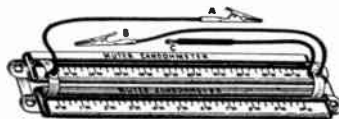

Description.—An accurate uniform wire-wound resistor insulated from and enclosed in metal housing with exposed slot permitting contact with resistor. Furnished with insulated handle test prods. Has two scales, the upper one to determine approximate value, the lower to permit more accurate reading within that range. Serves to determine proper resistance to replace a defective resistor; useful as a voltmeter multiplier to secure high voltage readings with low-range voltmeter; also serves as calibrated resistor for use in experimental work. Packed in individual boxes $1\frac{1}{4}$ " x 1" x $7\frac{1}{2}$ " with complete instructions for use. Approximate weight 7 oz. Jobbers' standard quantity 10.

Stock No.	Range in Ohms	List Price
1700	0 to 10,000 and 0 to 100,000	\$2.00
1701	0 to 100 and 0 to 1,000	1.75

ATLAS WIRE WOUND-TUBULAR RESISTORS



ATLAS HEAVY DUTY ADJUSTABLE VOLTAGE DIVIDERS S-I-X OUTSTANDING REASONS W-H-Y

YOU GET FAR MORE FOR YOUR MONEY WHEN YOU BUY ATLAS VARIABLE RESISTORS:

- 1—FULLY PACK WIRE-WOUND—NOT SPACE-WOUND.
- 2—HEAVIER WIRE AND MORE OF IT—FULL SAFE WATTAGE RATING.
- 3—HEAVY DUTY CHROME-OXIDE COATING—SAFELY DISSIPATING HIGH HEAT.
- 4—FROM ONE TO SIX BANDS SUPPLIED FREE WITH EVERY RESISTOR—EFFECTING A CONSIDERABLE SAVING.
- 5—ACCURATELY WOUND RESISTANCE VALUES—WELL WITHIN 5% TOLERANCE.
- 6—LARGE, OVERSIZE NON-HYGROSCOPIC TUBING—AFFORDING PLENTY OF AREA FOR HEAT DISSIPATION.

All Adjustable Resistors
are Supplied with
Mounting Brackets Attached



75 Watts—Size 5 1/4" x 3/4"
COATED ADJUSTABLE TYPE

IMPORTANT

Do not order values above
maximum ohmage listed

10 to 200 WATTS											
Type	Watts	Dimensions	Bands	Ohms	List	Type	Watts	Dimensions	Bands	Ohms	List
VA	10	2" x 1/2"	1	100 to 10M	\$0.45	VH	75	5 1/4" x 3/4"	6	50 to 25M	\$1.80
VB	20	2 1/2" x 3/8"	1	100 to 15M	.60	VH	75	5 1/4" x 3/4"	6	26M to 75M	1.95
VC	25	3" x 3/8"	1	100 to 20M	.75	VI	100	8" x 3/8"	6	50 to 25M	2.15
VD	30	4" x 3/8"	2	20 to 25M	.85	VI	100	8" x 3/8"	6	26M to 100M	2.30
VE	35	4" x 3/8"	3	20 to 30M	1.00	VJ	150	9 1/2" x 1"	6	50 to 25M	2.60
VF	40	4 1/2" x 3/8"	3	[20 to 40M	1.30	VJ	150	9 1/2" x 1"	6	26M to 100M	3.00
VG	50	5 1/4" x 3/4"	4	30 to 50M	1.50	VK	200	11" x 1 1/8"	6	100 to 25M	3.15
						VK	200	11" x 1 1/8"	6	26M to 50M	3.25
						VK	200	11" x 1 1/8"	6	51M to 100M	3.85

NOTE—Extra Bands—Add 10c each to cost

5 and 10-Watt Wire-Wound Resistors with PIGTAILS and LUGS

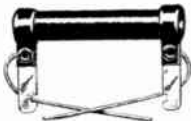

10
Resistors
of each
Ohmage in
Standard
Cartons

Moisture Proof—Triple Insulation
Tolerance within 2%—64 Standard Ohmage

Type SPT-5 (5 watts)—Size 1 1/4" x 3/8"
Type SPT-10 (10 watts)—Size 1 1/4" x 3/8"

Ohms	List Price		Ohms	List Price	
	5	10		5	10
5	\$0.30	\$0.35	1350	\$0.30	\$0.35
10	.30	.35	1400	.30	.35
15	.30	.35	1500	.30	.35
20	.30	.35	1750	.30	.35
25	.30	.35	2000	.30	.35
30	.30	.35	2250	.30	.35
40	.30	.35	2500	.30	.35
50	.30	.35	2750	.30	.35
75	.30	.35	3000	.30	.35
100	.30	.35	3500	.30	.35
125	.30	.35	4000	.30	.35
150	.30	.35	4500	.30	.35
175	.30	.35	5000	.30	.35
200	.30	.35	6000	.30	.35
225	.30	.35	7000	.30	.35
250	.30	.35	7500	.30	.35
275	.30	.35	8000	.30	.35
300	.30	.35	8500	.30	.35
350	.30	.35	9000	.30	.35
400	.30	.35	10000	.30	.35
450	.30	.35	12500	.30	.35
500	.30	.35	14000	.30	.35
600	.30	.35	15000	.30	.35
700	.30	.35	17500	.30	.35
750	.30	.35	20000	.30	.35
800	.30	.35	22500	.30	.35
850	.30	.35	25000	.30	.35
900	.30	.35	3000040
1000	.30	.35	3500040
1100	.30	.35	4000040
1200	.30	.35	4500040
1250	.30	.35	5000040

10-20-25 WATTS WIRE-WOUND RESISTORS Special Black Enamel—Fixed Resistors



Moisture Proof—Triple Insulation—Tolerance within 2%
64 Standard Ohmage—5 to 50000 Ohms

Type	Size	Watts	Ohms	List Price		
				10	20	25
SP-10	2" x 1 1/2"	10	5	\$0.35	\$0.45	\$0.50
SP-20	2" x 1 1/2"	20	10	.35	.45	.50
SP-25	2 1/2" x 1 1/2"	25	15	.35	.45	.50
			20	.35	.45	.50
			25	.35	.45	.50
			30	.35	.45	.50
			40	.35	.45	.50
			50	.35	.45	.50
			75	.35	.45	.50
			100	.35	.45	.50
			125	.35	.45	.50
			150	.35	.45	.50
			175	.35	.45	.50
			200	.35	.45	.50
			225	.35	.45	.50
			250	.35	.45	.50
			275	.35	.45	.50
			300	.35	.45	.50
			350	.35	.45	.50
			400	.35	.45	.50
			450	.35	.45	.50
			500	.35	.45	.50
			600	.35	.45	.50
			700	.35	.45	.50
			750	.35	.45	.50
			800	.35	.45	.50
			850	.35	.45	.50
			900	.35	.45	.50
			1000	.35	.45	.50
			1100	.35	.45	.50
			1200	.35	.45	.50
			1250	.35	.45	.50

NOTE.—For any other ohmage than those listed above—add 5c to cost.
BE SURE TO SPECIFY TYPE WHEN ORDERING



ATLAS VOLTAGE DIVIDERS

STANDARD REPLACEMENTS

The immediate choice of radio servicemen who know and appreciate honest quality.
 Atlas Voltage Dividers are built to entirely eliminate a major source of trouble—open-circuit dividers.

**FAST SERVICE
 PROMPT DELIVERY**

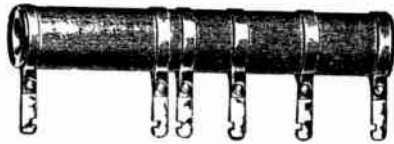

**PACK WIRE-WOUND
 CHROME-OXIDE COATED**

QUALITY RESISTORS THAT HAVE NO SUBSTITUTE

Type	Total Resistance	Sections	List Price
AIRLINE			
Model 2955	23973 Ohms	150-11250-9473-3100	\$1.35
ALL-AMERICAN MOHAWK	6200 "	900-300-1000-2000-2000	1.30
AMRAD			
Model 7 A.C.	4080 "	2175-1555-350	1.15
Model 70	8600 "	5000-3600	1.10
Model 82	2475 "	475-300-1000-700	1.15
APEX			
Model 7	4300 "	1100-3200	1.30
Model 7	3315 "	890-1800-225-290-200	1.40
Model 8	4450 "	500-1000-1200-600-600-550	1.40
Model 10	6825 "	2500-0-425-600-1800-1000-500	1.35
Model 27	23800 "	10700-8400-4700	1.30
Model 31	37600 "	10700-8400-3500-15000	1.40
Model 48	2970 "	70-2290-700	1.05
Gloritone 99A	24300 "	300-10000-11000-3000	1.35
Models 500-502	20950 "	10650-10000-300	1.35
Model 1009	17635 "	75-60-17500	1.35
ARGUS B195	5505 "	4000-0-460-700-0-65-280	2.60
BALKITE 180B	10800 "	6000-3000-1800	1.35
BOSCH			
Model Essex 4	21900 "	10000-11500-400	1.50
Model 48	4400 "	950-1450-2000	1.10
Model 49	4400 "	1950-800-1650	1.25
Model 54	20 "	20	1.10
Model 58	5130 "	950-180-1950-2050	1.30
Model 60	4790 "	1300-2380-160-950	1.30
Model 62	4250 "	1400-2600-250	1.30
Model 260R	7480 "	3700-2270-1510	1.25
Model 370E	27000 "	1000-12000-8000-6000	1.35
BRANDES			
Model B-10	8540 "	5600-0-10000-140-1800	1.30
Model B-16	2955 "	2500-45-410	1.25
BREMER-TULLY			
Model 640	16720 "	3008-560-6500-5000-1660	1.40
Model 820	13400 "	4900-5500-3000	1.25
BROWNING DRAKE			
Model 54	15300 "	850-4500-3450-3900-2600	1.40
BRUNSWICK			
Model DC	66 "	30-36	3.35
Model PR8-B17	9100 "	1900-200-2500-4000-500	1.30
Model 5KR7-3KR-2KR	3940 "	1600-0-1900-440	1.30
Model 3NC-8			
5NC-8	1290 "	400-350-350-190	1.35
Model 3NW8	7780 "	2200-300-4000-1280	1.30
Model 3NW8	3040 "	1500-1000-250-130-160	1.30
Model P.14	10700 "	300-100-700-2600-7000	1.20
COLONIAL			
Model 28 A.C.	7200 "	1000-4000-2200	1.25
Model 28 A.C.	15500 "	8500-7000	1.25
Model 28 A.C.	125000 "	50000-50000-25000	1.50
Model 31 A.C.	111000 "	37000-370000-37000	1.25
Model 31 D.C.	60 "	Large, filament resistor	2.50
Model 32 D.C.	34.9 "	31.9	2.50
Model 33	420 "	210-210	.55
Model 33 A.C.	121000 "	60000-50000-11000	1.50
Model 36 D.C.	176 "	4-36-136	1.70

Type	Total Resistance	Sections	List Price
COL. KOLSTER			
Model 300	2640 Ohms	2000-110-500	\$1.25
Model 500	2650 "	2100-120-430	1.25
Model 920	2060 "	1650-410	1.10
Model 931	9035 "	6000-2200-135-700	1.35
Model 940	2955 "	2500-15-410	1.25
Model 950	13110 "	9000-3290-140-70-700	1.30
Model 950	50000 "	30000-20000	1.40
Model 961C5	8050 "	7200-60-90-700	1.30
CROSLY			
Fiver	32400 "	24000-8400	.50
Model 158	25000 "	10000-15000	.50
Model 76 D.C.	52.7 "	5-47.7	1.62
Model 704	5000 "	1525-3475	.95
Model 705	140 "	95-45	.95
D. C. RESISTOR	360 "	45-315	.75
DAY FAN	8100 "	1000-3700-2050-100-50-1200	2.15
DAY FAN JR.	6300 "	2000-3000-1300	1.30
EARL			
Models 31-32	4750 "	4000-0-750	1.30
Models 31-32	5000 "	5000	1.25
EDISON			
Model D.C.	31 "	24-3 1/2-3 1/2	1.95
Model D.C.	32 "	20-6-6	1.95
Model R1	1500 "	750-750	.70
Model R2	12500 "	12500	1.30
ERLA	18100 "	100-14000-3400	1.30
FADA			
Model 18 D.C.	250 "	10-200-40	1.25
Model 82 D.C.	25 "	15-10	1.95
FEDERAL E	2685 "	135-2000-200-350	1.75
FREED			
Model 95S	4750 "	4000-0-750	1.30
Model 95S	5000 "	5000	1.25
FREED EISEMAN			
Model NR80	6350 "	2000-350-0-4000	1.40
Model NR80	3750 "	2000-1750	1.25
Model NR80	4350 "	4000-0-350	1.30
Model NR85	2350 "	2000-350	1.10
Model NR85	4250 "	1900-2000-0-350	1.35
FRESHMAN			
Model G	10950 "	300-1250-4300-3000-2100	1.30
Model G60S	11300 "	1800-1500-3000-2000	1.30
Model H60S	9300 "	4009-3899-1500	1.30
Model N	18100 "	2200-0900-3300-4500-1500	1.30
GENERAL MOTORS			
Model	5187 "	800-59-1863-2900-465	1.30
Model 251	19300 "	4800-7800-6900	1.10
Model S1A	40000 "	15000-25000	1.00
GOLDEN LEUTZ	41000 "	9000-3500-4000-4500-11000-9000	2.30
GREBE			
Model A.C. 6	2500 "	2500	.70
Model A.C. 6	7090 "	6300-95-495	1.30
Model A.C. 6	9450 "	5977-2897-750	1.30
Model S.K. 4	2930 "	677-2209-62	1.30
GULBRANSON			
Model 8 A.C.	24005 "	3100-9475-11250-189	1.40
HALSON			
	360 "	330-30	1.10
	425 "	375-50	1.10
HOWARD 135 A.C.	29600 "	1600-12000-16000	1.30
KENNEDY			
Model 20B	4250 "	2999-1590-750	1.25
Model 32	5750 "	2890-109-1890-750	1.30

ATLAS VOLTAGE DIVIDERS

EXACT DUPLICATES



ATLAS WIRE-WOUND TUBULAR RESISTORS have been generally acclaimed throughout the world as standard resistors designed especially to meet all radio requirements. They are used widely in service and replacement work.

**MOST COMPLETE LINE
PACKED IN INDIVIDUAL BOX**

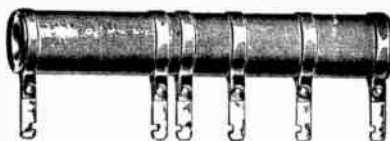

**PACK WIRE-WOUND
CHROME-OXIDE COATED**

MADE TO EXACT SPECIFICATIONS

Type	Total Resistance	Sections	List Price
KOLSTER			
Model 6H	6440 Ohms	940-5000-500	\$1.25
Model 6J	7120 "	3000-3000-220-900	1.30
Model 21K	1115 "	90-125-900	1.25
Model 22K	7120 "	3000-3000-220-60-840	1.30
Model 24K	7835 "	3400-3800-55-80-140-360	1.20
Model 38K	1430 "	3600-55-75-700	1.25
Model 42K	3580 "	840-140-2600	1.25
Model 43K	2980 "	1600-1000-380	1.30
Model 44K	2650 "	1450-650-200-350	1.35
Model 48K	5400 "	1500-2000-100-2000	1.30
Model 70K	8200 "	3000-3000-2000-200	1.30
Model 90K	16250 "	6000-7000-3000-250	1.30
Model 250K	8650 "	7800-60-90-700	1.10
LANG D.C.	233 "	30-27-27-27-15-80	1.40
MAJESTIC			
Model 20	12650 "	0-150-800-0-7500-4200	1.85
Model 25 D.C.	83 "	1½-20-60-0-1½	3.80
Model 30	10461 "	2350-3870-3460-0-101-750	1.85
Model 50	33620 "	140-250-0-23000-10000-230	1.85
Model 60	12700 "	6500-0-4300-600-0-500-800	1.85
Model 163	21400 "	4300-5700-4100-6000-500-800	1.85
Model 200	13790 "	7000-3500-3000-110-180	1.30
Model 250	82 "	45-15-2-0-20	3.80
Model 290	28610 "	230-0-6700-2400-18000-180-700-0-400	2.00
Model 300	25532 "	230-0-4900-72-20000-220-110	1.85
Model 360	29050 "	1500-9000-125-18000-200-225	1.85
Model 460	21778 "	10000-9000-364-1800-134-480	1.85
NORDEN HAUCK			
Model	755 "	775	.70
Model	6000 "	6000	.80
Model	14000 "	6500-6000-1500	1.40
Model 550	23000 "	8000-2500-3000-2500-7000	1.40
PEERLESS K70	19000 "	2500-8000-8500	1.40
PHILCO			
Model 20	5107 "	1400-187-75-0-2470-975	1.30
Models 30-76-77-77A	1050 "	250-800	.70
Model 70	3610 "	180-70-0-2300-1060	1.30
Model 86	4750 "	2100-1000-150-1500	1.30
Model 87	4582 "	3785-157-0-640	1.30
Model 511	20700 "	12500-5500-0-300-2400	1.40
R.C.A. RADIOLA			
Model 17	9100 "	1900-200-2500-4000-500	1.30
Model 18	3940 "	1600-0-1900-440	1.30
Model 28	2800 "	2000-300-500	1.30
Model 30A	6700 "	3000-2000-300-500-900	1.30
Models 31-33 D.C.	580 "	80-500	1.15
Model 41	25300 "	12300-8000-5000	1.30
Models 42-48	4865 "	3200-830-120-715	1.25
Models 44-46	2580 "	500-0-1460-540-0-80	1.30
Models 44-46	8400 "	2800-900-3600-1100	1.30
Models 46-47	2080 "	1460-540-0-80	1.30
Models 60-62	1290 "	400-350-350-190	1.35
Model 64	3040 "	1500-1000-250-130-160	1.30
Model 64	7780 "	1280-4000-300-2200	1.30
Model 64-67	4470 "	310-3850-310	1.00
Model 67	4030 "	2400-940-240-115-215-100	1.35
Model 67	8335 "	1430-3490-390-3200	1.30
SILVER MARSHAL			
Model 651	9720 "	3800-4200-730-990	1.30
SIMPLEX	1390 "	430-210-750	.80
SONORA			
A-36	21000 "	14000-7000	1.30
B-31	6950 "	750-1200-1500-3500	1.25

Type	Total Resistance	Sections	List Price
SPARTON D.C.	Ohms	54	\$1.38
SPLITDORF			
Model	1500 "	750-750	.70
Model	13210 "	650-150-4500-5400-2500	1.40
Model 171	11650 "	2000-3500-4000-150-2000	1.35
SPLITDORF ABBEY			
Model	11500 "	2500-3000-3000-3000	1.30
Model	13500 "	2500-3000-3000-3000-2000	1.40
STEINITE			
Model 26	16000 "	8000-8000	1.00
Model 40	20200 "	1190-1270-11740-3000	1.50
Model 50-102	25877 "	8100-11750-5200-827	1.40
Model 70	22140 "	10000-10000-2440	1.40
Model 991	2500 "	1000-1000-250-0-250	1.25
STERLING			
Model 41	5350 "	4000-450-900	1.30
Model 41	29000 "	20000-9000	1.30
STEWART WARNER			
Model 950	3250 "	850-2400	.95
Model 950	3330 "	1110-2220	.50
Model 950	15500 "	10000-5500	1.25
STROMBERG CARLSON			
Models 10-11	4500 "	400-100-4000	1.40
Models 10-11	10000 "	4570-3250-2000	1.40
Model 12	11025 "	4000-4000-3025	1.40
Model 12	6570 "	5000-100-1210-260	1.40
Model 20	3285 "	1575-900-0-60-0-750	1.40
Model 25	4900 "	4000-100-800	1.35
Model 25	9300 "	1800-3000-4500	1.35
Model 403 A.A.	5500 "	3000-2500	1.30
Model 523	3770 "	3000-70-700	1.35
Model 523	5500 "	3000-2500	1.30
Model 635	9270 "	2500-3000-3000-770	1.30
Model 638 D.C.	10 "	10	1.40
Model 638 D.C.	12 "	12	1.40
Model 638 D.C.	30 "	30	1.40
Model 638 D.C.	200 "	200	1.40
Model 638	9000 "	2500-6000-500	1.15
Models 641-651	19300 "	7800-4500-3000-4000	1.40
Model 642	9750 "	1450-4000-3000-1300	1.30
Model 642	11000 "	7800-3200	1.15
Model 846	9200 "	3200-6000	1.30
Model 846	6380 "	330-1700-4350	1.35
TEMPLE			
Model 7-60	21600 "	8000-1600-8000-1000	1.40
Model 8-60	6850 "	900-5200-750	1.30
TMORDARSON			
Model R171	13000 "	2000-3000-3000-3000-2000	1.40
VICTOR			
Models 9-18	3670 "	630-1500-1000-250-130-160	1.35
Model R925	3400 "	1400-2000	1.10
Models R32, 45, 52 & 75	4325 "	2000-1350-200-775	1.50
ZANEY GILL VITATONE			
Model 54	18450 "	2100-7500-7500-1350	1.30
ZENITH			
Model 10	24500 "	6000-7500-8500-2500	1.35
Model 10	22700 "	12000-5200-5500	1.40
Model 11	7200 "	3200-1200-1200-1600	1.35
Model 12	7500 "	1000-3500-1000-2000	1.40
Model 18	35390 "	13000-11000-9500-1800	1.55
Model 50	6000 "	850-2350-2800	1.30
Model 90	13000 "	3000-10000	.45
Model 91	6400 "	2800-3600	.60
Model 91	8000 "	3000-5000	.60



ATLAS RESISTORS

FOR SPECIAL REQUIREMENTS

We recommend Atlas Pack-Wound Heavy-Duty Chrome-Oxide Coated Resistors for Ship Instruments, Meters, Laboratory Equipment, Transmitting and Radio Receivers or any requirement where dependable resistors are essential

Every Mechanical Advantage to produce the Highest Efficiency Possible is represented in these Specially Designed Types.

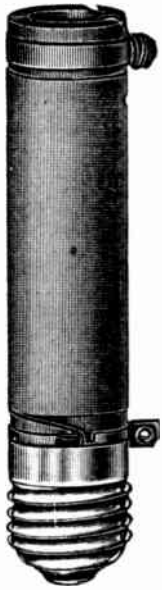

Edison Base Types are available only in 1/8" tube diameter. 50, 75, 100-Watt Ratings

ACCURATE
2% TOLERANCE

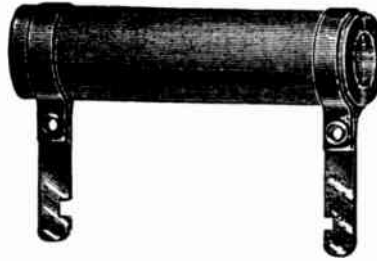

NON-POROUS
A QUALITY PRODUCT

SINGLE OR TAPPED UNITS

Type	Watts	Dimensions	Ohms	List	Type	Watts	Dimensions	Ohms	List
AB	5	1" x 1/8"	5 to 25M	\$0.30	HI	60	5" x 1"	20 to 25M	1.15
BC	5	2" x 1/8"	5 to 25M	.35	HI	60	5" x 1"	26M to 50M	1.20
CD	10	2" x 1/4"	5 to 25M	.40	IJ	75	6" x 1/8"	20 to 50M	1.35
CD	10	2" x 1/2"	26M to 50M	.45	IJ	75	6" x 3/8"	51M to 100M	1.45
DE	20	2" x 5/8"	5 to 25M	.55	JK	100	8" x 3/8"	20 to 50M	1.65
DE	20	2" x 3/4"	26M to 50M	.60	JK	100	8" x 1/2"	51M to 100M	1.80
EF	25	3" x 5/8"	5 to 25M	.70	KL	150	9 1/2" x 1"	20 to 50M	1.90
EF	25	3" x 3/4"	26M to 50M	.75	KL	150	9 1/2" x 1"	51M to 100M	2.15
FG	35	4" x 5/8"	10 to 25M	.90	LM	200	11" x 1 1/8"	20 to 100	2.20
FG	35	4" x 3/4"	26M to 50M	.95	LM	200	11" x 1 1/8"	150 to 25M	2.40
GH	50	4" x 3/4"	10 to 25M	1.00	LM	200	11" x 1 1/8"	26M to 100M	2.65
GH	50	4" x 1 1/8"	26M to 50M	1.10					

NOTE: ADD 10c TO COST FOR EACH ADDITIONAL TAP
ADD 20c TO COST FOR HEAVY MOUNTING BRACKETS
ADD 30c TO COST FOR EDISON BASE TYPE

ATLAS HEAVY-DUTY CHROME-OXIDE COATED TRANSMITTING BLEEDER RESISTORS WITH CENTER TAP

Ruggedly built, accurately made and procurable in a practical non-inductive winding. Atlas high voltage bleeder resistors are designed to improve the performance of your transmitter by functioning quietly, and effectively.

4 or 8 Sections.



Used for Grid Leaks as well as for Bleeders by AMATEUR SHORT-WAVE AND BROADCAST STATIONS
Specify whether you want Inductive or Non-Inductive Bleeders
EQUIPPED WITH HEAVY MOUNTING BRACKETS

A most important feature found only in Atlas heavy duty bleeder resistors is the non-inductive winding. Each side of the center tap has two to four oppositely wound sections of equal resistance. Therefore should only one section be used, that section will be purely non-inductive as well.

100 Watts—Size 8" x 1/2"			
Type	Ohmage	Resistance	List
SF	5000	2500-0-2500	\$1.95
SFA	10000	5000-0-5000	1.95
SFB	15000	7500-0-7500	1.95
SFC	20000	10000-0-10000	1.95
SFD	30000	15000-0-15000	1.95
SFE	40000	20000-0-20000	2.10
SFF	50000	25000-0-25000	2.10
SFG	100000	50000-0-50000	2.10

150 WATTS—Size 9 1/2" x 1"			
Type	Ohmage	Resistance	List
TG	5000	2500-0-2500	2.20
TGA	10000	5000-0-5000	2.20

150 WATTS—Size 9 1/2" x 1" (Continued)			
Type	Ohmage	Resistance	List
TGB	20000	10000-0-10000	\$2.20
TGC	50000	25000-0-25000	2.45
TGD	100000	50000-0-50000	2.45

200 WATTS—Size 11" x 1 1/2"			
Type	Ohmage	Resistance	List
UH	5000	2500-0-2500	2.50
UHA	10000	5000-0-5000	2.50
UHB	15000	7500-0-7500	2.50
UHC	20000	10000-0-10000	2.50
UHD	30000	15000-0-15000	2.50
UHE	40000	20000-0-20000	2.70
UHF	50000	25000-0-25000	2.70
UHG	100000	50000-0-50000	2.70

Add 40c to Cost for Non-Inductive Bleeders

AUTOMATIC

AMPERITE

REGULATOR

BALLAST TUBE FOR AUTOMATIC REGULATION OF CURRENT AND VOLTAGE



110 Volts—A.C. Sets

AMPERITE IS A REAL REGULATOR—Its resistance automatically varies to compensate for supply voltage variations. It should not be confused with ordinary resistors.

For 110-V. A.C. Sets—The proper Amperite is determined by the line current. A set drawing 0.7A requires Amperite 7A5, 1.2A requires Amperite 12A5, etc. Depending upon the line voltage, the voltage drop across an Amperite of —A5 series will vary from 8 to 30 volts and will control line voltages of 100 to 140 volts.

The line current drain of most 110 Volt A.C. Sets—except those using 6L6 or '50 tubes—average approximately 0.1 amp. per tube. A 7-tube set will draw 0.7A—use Amperite 7A5, etc. 220 Volt A.C. sets have half the current drain of similar 110 A.C. sets. For proper Amperite see Chart at left.

HOW TO DETERMINE PROPER AMPERITE FOR A.C. SETS

Line Voltage	110 V	220 V
No. of Tubes in Set	Use Amperite No.	Use Amperite No.
4 or 5	5-A-5	2H-5
6 or 7	7-A-5	3H-5
8, 9 or 10	9-A-5	4H-5
11 or 12	11-A-5	5H-5

A. C. - D. C. SETS

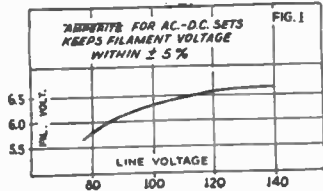

so-called ballasts or resistors used in A.C.-D.C. sets. No extra resistor required.

Pilot Lights—None, one or two of either 0.150A or 0.250A can be used with same Amperite. Should a pilot light burn out, the set will continue to operate properly without any damage to the Amperite, tubes or other parts. The patented starting resistor in the Amperite prevent overloading and premature burning-out of tubes and pilot lights. In some sets the ballast socket is purposely wired in such a way that the Pilot Light Resistors of standard ballasts would be burned out if inserted. In such sets special Amperites are required, as shown in table. Avoid burnouts—use proper Amperite.

BASE WIRING OF AMPERITES FOR A.C.-D.C. SETS

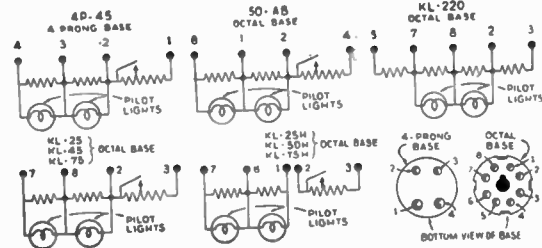

AMPERITES FOR 2-VOLT BATTERY SETS

Two-volt tube filaments are delicate and easily overloaded. Keeping the tube filaments at their proper voltage with a real regulator like Amperite invariably results in considerably more battery and tube life. The same Amperite can be used for dry cell, air cell, or 2 volt storage battery operation. The proper Amperite is determined by the total filament-current drain of the set. e.g.—for 0.5A use Amperite 5E1, etc.

REPLACEMENT REGULATORS—A.C.-D.C. SETS. List \$1.00

Amperite No.	Amperite Numbers Shown Replace All A.C.-D.C. Ballasts		Ending In
	Starting With Letter	With Numbers From	
KL 25 #	K, L, M or BK BL or BM	10 to 36	A, B, C, or D
KL 45		36 " 67	"
KL 75		67 " 105	"
KL 25H	K, L, M, or BK	11 to 26	F, G, or H
KL 50H		36 " 67	"
KL 75H		67 " 105	"
KL 50S1	K or L	40 to 100	S1
KL 50S2		"	S2
KL 50S3		"	S3
KL 50E	"	36 " 67	E

Except K18B, use Amperite K18B—4-Prong Base.

For	Use Amperite	For	Use Amperite	For	Use Amperite	For	Use Amperite
.0C2	a R300	3MZ-419	a 3MZ-419	9	a 4P45	33AG	a KL-25
.03G	a .03G	3MZ419A	a 3MZ419A	9-1	b 1Z1	33-310	a KL-25
.038	r 11-20			9A5	c 9A5	3,6D5	a 3,6D5
.042	b 5E1			4	d 9-10	36A	a KL-25
		4-1	b 1G1	9-20	r 9-20		
1-1	r 1-1	4A5	c 4A5	9-150	e 9-150	40	a 3-40
1A1	b 5E1	4-10	r 4-10	9-220	c 9-220	40W	a 3-40
1A2	b 30	4-20	r 4-20	9V10	e 8A5	40A2	a 4P45
1A5	c 1A5	4-150	e 4-150			40B2	a 4P45
1B1	b 3H1			10-1	b 10-1	40X300	a 4P45
1B2	b 31	4-220	c 4-220	10A5	c 10A5		
1C1	b 7H1	4H-1	b 4H-1	10AB	b 5H-1	42A	a 3-40
1C2	b 52	4H-5	c 4H-5	10-10	r 10-10	42A1	a 50AB
1D1	b 2H-1	4H-10	r 4H-10	10V10	c 10V10	42A2	a 50AB
1D2	b 1D2	4H-20	r 4H-20	10-20	r 10-20	42B2	a 50AB
1E1	b 6E1	4H-150	c 4H-150	10-23A	a KL-25	42HA	a 50AB
1E2	b 1E2	4H-220	c 4H-220	10-25	r 10-25		
1F1	b 7-1	4SR311	a 4SR311			45W	a 4P45
1G1	b 4-1	4-TU-9	a KL-45	10-150	c 10-150	46A1	a 46A1
1H-1	b 1H-1			10-220	c 10-220	46B1	a 46B1
1H-5	b 1H-5			10-610	a 10-610	49A	a 4P45
1J1	b 6-1	5	a 5	10-800	a 10-800	49A1	a 50AB
1K1	b 5H-1	5B	a 3-40			49A2	a 50AB
1L1	b 1L1	5A5	b 5E1			49B2	a 50AB
1M1	b 1N1	5-10	c 5A5	11A5	c 11A5	50MG	a KL-50S1
1P1	b 1P1	5-16	r 5-10	11-10	r 11-10		
1Q1	b 1Q1	5-20	r 5-16	11-20	r 11-20	50W	a 4P45
1R1	b 1R1	5-150	r 5-20	11-150	c 11-150	50A2	a 4P45
1S1	b 1S1	5-220	r 5-150	11-220	c 11-220	60A2MG	a KL-50S2
1T1	b 1T1	5E1	b 5E1			50B2	a 4P45
1U1	b 1U1	5H-1	b 5H-1	12A5	c 12A5	60B2MG	a KL-50S1
1V1	b 5H-1	5H-3	c 5H-3	12-10	r 12-10	60X3	a 4P45
1W1	b 1W1	5H-5	c 5H-5	12-20	r 12-20	50X3T	a 4P45
1Y1	b 1Y1	5H-10	c 5H-10	12-150	c 12-150	50X300	a 4P45
1Z1	b 0-1	5H-20	c 5H-20	12-220	c 12-220		
		5H-150	c 5H-150			52	b 1C2
		5H-220	c 5H-220	13A5	c 13A5	55A	a KL-45
2	a 2			13-10	r 13-10	55H	a KL-50H
2-1	r 2-1	6	r 1F1	13-20	r 13-20	55L8	a L55B
2A5	c 2A5	6-1	r 1J1			55KB	a KL-45
2-10	r 2-10	6A5	c 6A5	14A5	c 14A5		
2-20	r 2-20	6-10	c 6-10	14-10	r 14-10		
2CR-241	a KL-45	6-20	c 6-20	14-20	r 14-20	60-92A	a KL-75
2LR-212	a 50AB	6-150	c 6-150			60R30	a 60R30G
2M2	a 2M2	6-220	c 6-220	15A5	c 15A5	60R30G	a 60R30G
2UR-215	a KL-45	6A	b 5E1	15-10	r 15-10	64.23	a KL-45
2UR-224	a KL-45	6B	a 4P45	15-20	r 15-20	67A	a KL-45
2H-1	b 1D1	6.125	a KL-45J			69-2027	a 3-40
2H-2E	b 2H-2E	6.126	a KL-45J	16A5	c 16A5	69-2028	a 3-220
2H-5	c 2H-5					69-2033	a KL-45
2H-10	r 2H-10	6-128	a KL-45J	17-2	s 17-2	66-2037	a KL-45
2H-20	r 2H-20	6-129	a KL-45J	17A5	c 17A5		
3	a 4P45	6-130	a 6-130			70	r 70
3-1	b 3-1	6-133	a KL-45J	18	r 18-10	75	a KL-75
3A5	c 3A5	6-134	a KL-45J	18-10	r 18-10	80	a 4P45
3-10	r 3-10	6-135	a KL-45J	19A5	c 19A5	80R	a 80R
3-20	r 3-20					85L75CC	a 85L75CC
3-25	a 3-25	7	a 7	20-1	s 20-1	90	r 90
3-40	a 3-40	7-1	b 1F1	20A5	c 20A5	92A	a 4P45
3-150	c 3-150	7A5	c 7A5	20-10	r 20-10	95K2	a KL-45
3-220	a 3-220	7-10	r 7-10	22-10	r 22-10	98	r 9-20
3CR-241	a KL-45	7-20	r 7-20			100	r 9-20
3ER-248	a KL-45J	7-150	c 7-150	23-55A	a KL-45	100 R8	a 4P45
3ER-249	a 3ER-249	7-220	c 7-220	23-55F	a KL-50H	100-33	a 4P45
3H-1	b 1B1			23-3	s 23-3	100-37	a KL-45J
3H-2E	b 3H-2E	8	a 4P45	24-4	s 24-4	100-46	a 100-46
3H-5	c 3H-5	8-1	b 8-1			100-47	a 100-47
3H-10	c 3H-10	8A5	c 8A5				
3H-20	r 3H-20	8-10	r 8-10	30	b 1A2		
3H-150	c 3H-150	8-20	r 8-20	30A	a 3-25		
3H-220	c 3H-220	8-150	c 8-150	31	b 1B2		
3MR-253	a 3MR-253	8-220	c 8-220	32	a KL-50H		

(Continued on other side)

WIRT Resistors

CARBON COMPOSITION FIXED RESISTORS

RMA Color-Coded
Any Resistance

Watts	List Price
2	\$0.30
1	.20
1/2	.20
1/3	.20
1/4	.20

FIVE REASONS WHY WIRT FIXED RESISTORS ARE SPECIFIED BY BEST KNOWN RECEIVING SET MANUFACTURERS

- 1. Voltage coefficient:** Guaranteed well within 10%. By actual test 3% up to 500,000 ohms and not greater than 10% of any value.
- 2. Noise:** Less than one microvolt when measured on an amplifier having a gain of 65 dB.
- 3. Humidity:** After 100 hours in 90% relative humidity at 105° F. resistance change guaranteed under 10%—average of 1000 recorded tests under 3%.
- 4. Life:** Contrary to custom WIRT laboratory life tests are made at 100% overload instead of at a fraction of rated wattage. A batch of resistors recently removed from test after 4240 hours continuous 100% overload showed average resistance change of 2.81%.
- 5. Accuracy:** Resistors are individually tested by advanced methods to insure accuracy.

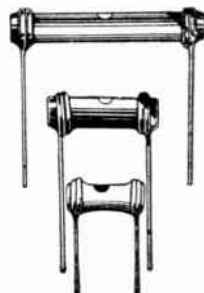

AUTO RADIO IGNITION SUPPRESSORS

All metal parts made of rugged unfinished brass. Ceramic casing is glazed wet process high-tension porcelain with internal threads to engage threaded terminals. Terminals are securely fastened in casings by special moisture and heat resisting dielectric cement. Resistor pills are sprayed with molten copper and tinned, then double impregnated with a special moisture-proofing compound. Resistance value

will not change more than 7% after being submerged in water for 100 hours. Test by sparking 1800 times per minute at 10,000 volts for 100 hours produces resistance change not more than 3%. WIRT Suppressors are impervious to heat, oil, moisture and mild acids, and will not change in resistance more than 10% in 50,000 miles of operation.

MADE IN TWO KINDS OF CASINGS — CERAMIC AND BAKELITE



Elbow Type—bakelite casing—with terminal attached to casing.
No. 901—List Price\$0.30



Bracket Type—ceramic casing—for all standard work.
No. 902—List Price \$0.40

Ford V8—ceramic casing—special resistance for Ford V8 cars.
No. 904—List Price \$0.40



Cable Type—ceramic casing—for splicing in cable.
No. 906—List Price \$0.40



Distributor Type—ceramic casing—standard for all distributors.
No. 910—List Price \$0.40



Bracket Type—bakelite casing—standard.
No. 914—List Price\$0.30
FV-8—Bakelite casing—for Ford V8 cars.
No. 916—List Price\$0.30



Distributor Type—bakelite casing—standard for all distributors.
No. 915—List Price \$0.40



FV-8 Brush Type—for Ford V8 1933, 1934 and 1935 cars.
No. 918—List Price\$0.30
FV-8 Brush Type—for Ford V8 1936 to 1940 cars.
No. 922—List Price\$0.30



Universal Screw Type—bakelite casing.
No. 921—List Price\$0.30
Universal Screw Type FV-8—bakelite casing.
No. 923—List Price\$0.30



Snap-on Type—bakelite casing.
No. 924—List Price \$0.30



Cable Type—bakelite casing—for splicing in cable.
No. 926—List Price\$0.30



Distributor Type—bakelite casing—with terminal molded in.
No. 927—List Price\$0.30

WIRT Resistors

WIRTHY FIXED RESISTORS

WIRTHY RESISTORS are wound on ceramic tubes and protected by either VITREOUS ENAMEL, PHENOCOTE, or BAKED ENAMEL.

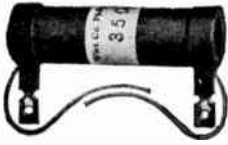

VITREOUS ENAMEL Units are made of the same material and in the same way as the standard WIRT Enameled Units, which have been adopted as standard by leading users of resistors.

PHENOCOTE—A special material developed in our laboratories, which is baked on the units at a high temperature, insuring resistance to moisture and heat.

BAKED ENAMEL Units are covered with a superior enamel which is baked on at a high temperature.

SIZE: 3/8" x 1" — RATING 5 WATTS

Equipped with Soldering Lugs and Wire Leads
Resistance 1 to 10,000 ohms..... List Price \$0.35 each

SIZE: 3/8" x 1 3/4" — RATING 10 WATTS

Equipped with Soldering Lugs and Wire Leads
Resistance 1 to 25,000 ohms..... List Price \$0.40 each

Stock Resistance Values

1	7.5	25	75	250	750	2500	7500
2	10	30	100	300	1000	3000	10000
3	12	35	125	400	1200	4000	12000
4	15	40	150	500	1500	5000	15000
5	20	50	200	600	2000	6000	20000

SIZE: 1/2" x 2" — RATING 20 WATTS

Equipped with Soldering Lugs and Wire Leads
Resistance 5 to 15000 ohms..... List Price \$0.65 each
16000 to 50000 ohms..... .75 each
51000 to 100000 ohms..... 1.00 each

Stock Resistance Values

5	100	400	800	1500	2500	5000	10000
10	150	500	850	1750	2750	6000	12500
25	200	650	1000	1850	3000	7000	16000
50	250	700	1100	2000	3500	7500	25000
75	300	750	1200	2250	4000	8000	35000

SIZE: 3/4" x 4" — RATING 50 WATTS

Equipped with Soldering Lugs and Mounting Brackets, 5" centers
Resistance 5 to 5000 ohms..... List Price \$1.10 each
5100 to 25000 ohms..... 1.25 each
26000 to 100000 ohms..... 1.45 each

SIZE: 1 1/8" x 6 1/2" — RATING 100 WATTS

Equipped with Soldering Lugs and Mounting Brackets, 7" centers
Resistance 5 to 5000 ohms..... List Price \$1.50 each
5100 to 25000 ohms..... 1.75 each
26000 to 50000 ohms..... 2.00 each
51000 to 75000 ohms..... 2.25 each
76000 to 100000 ohms..... 2.50 each

SIZE: 1 1/8" x 8 1/2" — RATING 160 WATTS

Equipped with Soldering Lugs and Mounting Brackets, 9" centers
Resistance 5 to 10000 ohms..... List Price \$2.00 each
11000 to 50000 ohms..... 2.40 each
51000 to 100000 ohms..... 2.70 each

SIZE: 1 1/8" x 10 1/2" — RATING 200 WATTS

Equipped with Soldering Lugs and Mounting Brackets, 11" centers
Resistance 5 to 10000 ohms..... List Price \$2.50 each
11000 to 100000 ohms..... 3.00 each

SIZE: 1 1/8" x 11 3/4" — RATING 300 WATTS

Resistance 5 to 10000 ohms..... List Price \$2.75 each
11000 to 100000 ohms..... 3.25 each

WIRT SEMI-VARIABLE RESISTORS

WIRT SEMI-VARIABLE RESISTORS are wound on ceramic tubing and are protected by Phenocote, the new tough, rugged, heat-resisting covering developed in the WIRT laboratories. Bands are made with small contact buttons so that a number of taps may be made without shorting out much resistance.

Standard Equipment: 2 Tab Terminals — 1 Sliding Band — 2 Mounting Brackets. (No mounting brackets furnished with 10-Watt size.)



SIZE: 1 3/4" x 3/8" — RATING 10 WATTS

Resistance 1 ohm to 10,000 ohms..... List Price each \$0.60

SIZE: 2" x 3/4" — RATING 25 WATTS

Resistance 1 ohm to 5000 ohms..... \$0.85
6M to 10M ohms..... .95
20M to 25M ohms..... 1.10

SIZE: 4" x 3/4" — RATING 50 WATTS

Resistance 5 ohms to 5M ohms..... \$1.35
1M to 25M ohms..... 1.50
10M to 50M ohms..... 1.70
60M to 100M ohms..... 2.00

SIZE: 6" x 3/4" — RATING 75 WATTS

Resistance 10 ohms to 5M ohms..... List Price each \$1.75
7500 to 25M ohms..... 2.00
30M to 50M ohms..... 2.25
60M to 100M ohms..... 2.50

SIZE: 8 1/2" x 1 1/8" — RATING 100 WATTS

Resistance 5 ohms to 10M ohms..... \$2.50
15M to 50M ohms..... 2.90
75M to 100M ohms..... 3.25

EXTRA SLIDING BANDS

10W, 25W, 50W..... \$0.10
75W, 100W..... .15

WHEN ORDERING BE SURE TO STATE TOTAL RESISTANCE OF UNITS

WIRT Variable Resistors

MINIATURE RHEOSTATS and POTENTIOMETERS

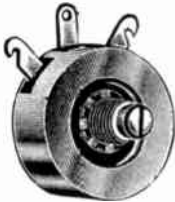

No. 802

Cat. No. 801 Rheostat—Resistance 5 to 15M ohms, diameter $1\frac{1}{8}$ " , thickness $\frac{1}{2}$ " , bushing $\frac{3}{8}$ " , $\frac{1}{4}$ " long, shaft 1 " from end of bushing, no flat, or $\frac{1}{8}$ " from end of bushing slotted for screw driver adjustment.

List Price \$0.75 each

Cat. No. 802 Potentiometer—Resistance 5 to 15M ohms, dimensions same as Cat. No. 801.

List Price \$1.00 each

SENSITIVITY CONTROL



No. 803

Cat. No. 803 Sensitivity Control — Resistance 5 to 15M ohms. Diameter $1\frac{1}{8}$ " , thickness $\frac{1}{2}$ " , no shaft or bushing, to be riveted to chassis. Slot in rotor mechanism for screw driver adjustment one side only.

List Price \$0.40 each

Cat. No. 804—Same as Cat. No. 803, except arranged for adjustment from both sides.

List Price \$0.45 each

VARIABLE VOLTAGE REGULATOR

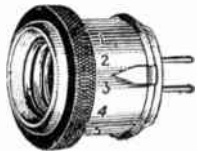

No. 211

Cat. No. 211 — A.C. Variable Voltage Regulator for use with A.C. sets having six tubes or less. Capacity of regulator 8 watts.

List Price \$2.45 each

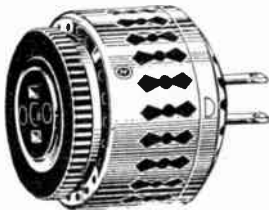

No. 211-B

Cat. No. 211-B—A.C. Variable Voltage Regulator for use with sets drawing not more than 150 watts. Capacity of regulator 21 watts.

List Price \$4.00 each

CORD CONNECTOR



No. 56A

Cat. No. 56A Cord Connector — Molded bakelite. $2\frac{3}{8}$ " x $1\frac{1}{8}$ " x $1\frac{1}{2}$ ". capacity 5 amps.

List Price \$0.40 each

SPECIAL CONTROLS

EXACT DUPLICATES OF ORIGINALS

Cat. No.	List Price
SW-1—RCA Victor: RE 32, RE 45, RE 52, RE 75.....	\$2.50
SW-3—Philco: 77, 77A, 20, 20A, 220, 220A, 21.....	2.40
SW-9—RCA Victor: R-15, 48, 92.....	2.75

STANDARD WIRE WOUND SINGLE VOLUME CONTROLS



Diameter $1\frac{3}{8}$ "
 Depth—without switch $1\frac{1}{8}$ "
 Depth—with switch $1\frac{1}{4}$ "

Cat. No.	Resistance, ohms	List Price
WI-75M	75,000	\$1.00
WI-50M	50,000	1.00
WI-40M	40,000	1.00
WI-32M	32,000	1.00
WI-30M	30,000	1.00
WI-30M-T	30,000	1.00
WG-25M	25,000	1.00
WI-25M	25,000	1.00
WI-25M-T	25,000	1.00
WI-20M	20,000	1.00
WI-15M	15,000	1.00
WI-15M-T	15,000	1.00
WG-15M	15,000	1.00
WI-12M-T	12,000	1.00
WI-10M-T	10,000	1.00
WI-10M	10,000	1.00
WI-7500	7,500	1.00
WI-7500-T	7,500	1.00
WI-5M-T	5,000	1.00
WI-5M	5,000	.95
WI-4M	4,000	.95
WI-3M	3,000	.95
WI-2M	2,000	.95
WI-2M-T	2,000	1.00
WI-1500	1,500	.95
WI-1000	1,000	.95
WI-800	800	.95
WI-750	750	.95
WI-600	600	.95
WI-500	500	.95
WI-400	400	.95
WI-300	300	.95
WI-200	200	.95
WI-100	100	.95
WI-20	20	.95
WI-10	10	.95

Symbol WG indicates grounded shaft
 Symbol WI indicates insulated shaft
 Letter "T" indicates tapered winding.

SWITCH and COVER PLATE

Cat. No. WR-711—Switch and Cover Plate. List Price.... \$0.40 each

STANDARD WIRE WOUND DUAL VOLUME CONTROLS

Diameter $1\frac{3}{8}$ "
 Depth—without switch $1\frac{1}{8}$ "
 Depth—with switch $1\frac{1}{4}$ "

Cat. No.	Resistance		List Price
	Upper Section	Lower Section	
WD-50-50	50,000	50,000	\$1.40
WD-15-50	50,000	15,000	1.40
WD-1-50	50,000	1,000	1.40
WD-4-4	4,000	4,000	1.40
WD-7500-10	10,000	7,500	1.40
WD-550-1	1,000	550	1.40
WD-645-10	10,000	645	1.40
WD-25-25	25,000	25,000	1.40
WD-15-500	500	15,000	1.40
WD-285-5	5,000	285	1.40
WD-1800-5	5,000	1,800	1.40
WD-225-5	5,000	225	1.40
WD-10-5	5,000	10,000	1.40
WD-10-25	25,000	10,000	1.40
WD-10-50	50,000	10,000	1.40

WIRT

Switches

ROTARY SNAP SWITCH

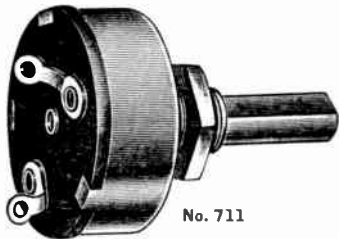

No. 711

Rotary Snap Switch, Underwriters Laboratories Inspected Rating 3 Amp. 125 V. O. D. $1\frac{1}{8}$ ", thickness $\frac{1}{2}$ ".

Cat. No. 711—Single Pole, Single Throw—List \$.40 ea.

Cat. No. 711A—Single Pole, Double Throw—List .45 ea.

WAFER SWITCH

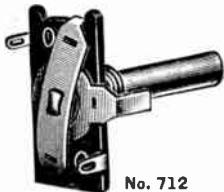

No. 712

Cat. No. 712—Wafer Switch. $1\frac{1}{4}$ " x $\frac{5}{8}$ ". Standard 2 terminals, $\frac{3}{8}$ " diameter bushing, threaded portion $\frac{1}{4}$ " long, shoulder $\frac{1}{8}$ " long, shaft $\frac{3}{8}$ " from end of bushing, shaft grounded. List Price\$0.30 each

Can be furnished with one to four terminals, any desired shaft length—Prices on request.

Cat. No. 717—Same as Cat. No. 712 except shaft insulated. List Price\$0.40 ea.

SNAP SWITCH

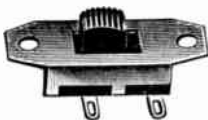

Cat. No. 719—Snap Switch. $\frac{1}{2}$ " wide, $1\frac{1}{8}$ " between center mounting holes.

Single Pole, Single Throw. List Price\$0.25 each



Escutcheon for No. 719 Switch. Steel Nickel Plated.

Cat. No. 501—List Price\$0.10 each

CIRCUIT SELECTOR SWITCH



Cat. No. 713—Circuit Selector Switch. $\frac{7}{8}$ " x $1\frac{1}{2}$ ". Bushing diameter $\frac{3}{8}$ ", length thread $\frac{3}{8}$ ", length shoulder $\frac{1}{4}$ ", length shaft beyond bushing $1\frac{1}{8}$ ", flat on shaft $\frac{5}{8}$ " x .218.

List Price

Cat. No. 713—Single Pole, Single Throw.....\$0.65 ea.

Cat. No. 713—Single Pole, Double Throw..... .70 ea.

Cat. No. 713—Double Pole, Single Throw..... .70 ea.

Cat. No. 713—Double Pole, Double Throw..... .75 ea.

SNAP SWITCHES

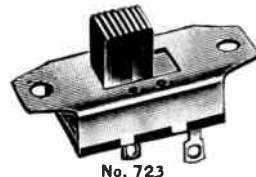

No. 723

Housings Steel Cadmium Plated $1\frac{1}{2}$ " x $\frac{3}{4}$ " overall. Mounting Holes .136" dia. on $1\frac{1}{8}$ " center. Buttons Bakelite $\frac{1}{4}$ " x $\frac{1}{16}$ " x $\frac{1}{12}$ " high. Contacts and Terminals Silver Plated.

Cat. No. 723—Single Pole, Single Throw, 2 terminals List Price \$0.25 ea.

Cat. No. 724—Single Pole, Double Throw, 3 terminals List Price .30 ea.

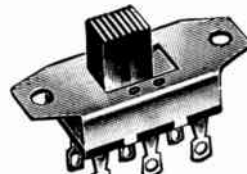

No. 726

Cat. No. 725—Two Pole, Single Throw, 4 terminals List Price \$0.35 ea.

Cat. No. 726—Two Pole, Double Throw, 6 terminals List Price .45 ea.

ADJUSTOHM RESISTORS

WITH BARE SIDE FOR ADJUSTMENT

WARD LEONARD 

ADJUSTOHM RESISTORS

Order by Type Number and Resistance Value



Mounting brackets are furnished with all Adjustohm Resistors except the 10 Watt size.
Price of resistor includes end brackets for mounting and one adjustable band.

TYPE 75A

75 WATT 6 1/2" x 3/4"

Resis. Ohms	Current m. a.	List Price
5	3870	\$1.75
10	2740	1.75
15	2230	1.75
25	1730	1.75
50	1220	1.75
75	1000	1.75
100	865	1.75
200	610	1.75
250	550	1.75
300	500	1.75
400	430	1.75
500	385	1.75
750	315	1.75
800	305	1.75
1,000	275	1.75
1,250	245	1.75
1,500	225	1.75
2,000	195	1.75
2,500	173	1.75
3,000	158	1.75
3,500	146	1.75
4,000	137	1.75
4,500	129	1.75
5,000	122	1.75
6,000	111	2.00
7,000	103	2.00
7,500	100	2.00
8,000	97	2.00
9,000	91	2.00
10,000	87	2.00
15,000	71	2.00
20,000	61	2.00
25,000	55	2.00
30,000	50	2.25
35,000	43	2.25
40,000	37	2.25
50,000	30	2.25
60,000	25	2.50
70,000	21	2.50
100,000	15	2.50

TYPE 25A

25 WATT 2" x 3/4"

Resis. Ohms	Current m. a.	List Price
5	2230	\$0.85
10	1580	.85
15	1290	.85
20	1115	.85
25	1000	.85
50	710	.85
75	580	.85
100	500	.85
150	410	.85
200	355	.85
250	315	.85
300	290	.85
400	250	.85
500	225	.85
750	180	.85
850	170	.85
1,000	160	.85
1,250	140	.85
1,500	130	.85
2,000	110	.85
2,250	105	.85
2,500	100	.85
3,000	90	.85
3,500	85	.85
4,000	80	.85
4,500	74	.85
5,000	70	.85
6,000	65	.95
7,000	57	.95
7,500	53	.95
8,000	50	.95
8,500	47	.95
9,000	44	.95
10,000	40	.95
12,000	33	.95
15,000	26	.95
25,000	16	1.10

TYPE 50A

50 WATT 4 1/2" x 3/4"

Resis. Ohms	Current m. a.	List Price
5	3160	\$1.35
10	2240	1.35
25	1410	1.35
50	1000	1.35
75	815	1.35
100	705	1.35
150	575	1.35
200	500	1.35
250	445	1.35
300	405	1.35
400	350	1.35
500	315	1.35
750	260	1.35
800	250	1.35
1,000	225	1.35
1,250	200	1.35
1,500	180	1.35
2,000	160	1.35
2,250	150	1.35
2,500	140	1.35
3,000	130	1.35
3,500	120	1.35
4,000	110	1.35
4,500	105	1.35
5,000	100	1.35
6,000	91	1.50
7,000	85	1.50
8,000	79	1.50
9,000	75	1.50
10,000	71	1.50
12,000	64	1.50
15,000	58	1.50
20,000	48	1.50
25,000	40	1.50
30,000	33	1.70
40,000	25	1.70
50,000	20	1.70

TYPE 10A

10 WATT 1 1/2" x 3/4"

Resis. Ohms	Current m. a.	List Price
1	3160	\$0.60
2	2240	.60
3	1825	.60
5	1415	.60
7.5	1155	.60
10	1000	.60
15	815	.60
20	705	.60
25	630	.60
50	450	.60
75	365	.60
100	315	.60
150	258	.60
200	225	.60
250	200	.60
300	183	.60
350	169	.60
400	158	.60
500	142	.60
600	129	.60
750	115	.60
800	111	.60
1,000	100	.60
1,250	89	.60
1,500	81	.60
2,000	70	.60
2,250	66	.60
2,500	63	.60
3,000	58	.60
3,500	53	.60
4,000	50	.60
5,000	45	.60
6,000	41	.60
7,000	38	.60
7,500	36	.60
8,000	35	.60
8,500	34	.60
9,000	33	.60
10,000	30	.60

No brackets furnished



SCREW DRIVER TYPE

BAKELITE KNOB TYPE

TYPE 100A

100 WATT 6 1/2" x 1 1/4"

Resis. Ohms	Current m. a.	List Price
5	4470	\$2.00
10	3160	2.00
25	2000	2.00
50	1410	2.00
100	1000	2.00
250	620	2.00
500	445	2.00
750	365	2.00
1,000	315	2.00
1,500	260	2.00
2,000	225	2.00
2,500	200	2.00
3,000	180	2.00
4,000	160	2.00
4,500	150	2.00
5,000	140	2.00
6,000	130	2.25
7,500	115	2.25
10,000	100	2.25
15,000	80	2.25
20,000	70	2.25
25,000	60	2.25
30,000	50	2.50
40,000	37	2.50
50,000	30	2.50
60,000	25	2.75
75,000	20	2.75
100,000	15	2.75

TYPE 160A

160 WATT 8 1/2" x 1 1/4"

Resis. Ohms	Current m. a.	List Price
5	5650	\$2.50
10	4000	2.50
15	3265	2.50
25	2525	2.50
50	1785	2.50
100	1260	2.50
200	900	2.50
500	570	2.50
1,000	400	2.50
1,500	330	2.50
2,000	280	2.50
2,500	250	2.50
3,000	230	2.50
3,500	215	2.50
4,000	200	2.50
4,500	185	2.50
5,000	180	2.50
7,500	145	2.50
10,000	125	2.50
15,000	105	2.90
20,000	90	2.90
25,000	80	2.90
30,000	67	2.90
40,000	50	2.90
50,000	40	2.90
60,000	33	3.25
75,000	26	3.25
80,000	25	3.25
100,000	20	3.25

TYPE 200A

200 WATT 10 1/2" x 1 1/4"

Resis. Ohms	Current m. a.	List Price
5	6320	\$3.00
10	4470	3.00
25	2825	3.00
50	2000	3.00
100	1400	3.00
250	900	3.00
500	630	3.00
1,000	450	3.00
1,500	365	3.00
2,000	315	3.00
2,500	280	3.00
3,000	260	3.00
3,500	240	3.00
4,000	225	3.00
4,500	210	3.00
5,000	200	3.00
7,500	165	3.00
10,000	140	3.50
15,000	115	3.50
20,000	100	3.50
25,000	90	3.50
30,000	82	3.50
40,000	62	3.50
50,000	50	3.50
60,000	42	3.50
75,000	33	3.50
100,000	25	3.75
125,000	20	3.75
150,000	16	3.75

LINE VOLTAGE REDUCERS



Catalog Number	Length Inches	Resis. Ohms	Load 115 volt Radio Set	List Price
507-109	1 1/2	25.	For 35-65 watt set on 115-140 volts	\$1.75
507-109A	1 1/2	10.	For 65-130 watt set on 115-140 volts	1.75
507-109B	2 1/4	4.5	For 130-285 watt set on 115-140 volts	2.10
507-109H	5 1/4	300.	For 60 watt set on 230 volts	2.75



**WARD
LEONARD**

FIXED RESISTORS

WIRE WOUND

Order by Type Number and Resistance Value.

10 WATT $1\frac{3}{4}'' \times \frac{5}{16}''$ **TYPE 10F**



Ward Leonard Resistors are known for their accuracy, dependability, and long life. No brackets furnished.

Resis. Ohms	Current m. a.	List Price	Resis. Ohms	Current m. a.	List Price
1	3160	\$0.40	1,750	75	\$0.40
3	1825	.40	2,000	70	.40
5	1415	.40	2,500	63	.40
10	1000	.40	3,000	53	.40
15	815	.40	4,000	50	.40
25	630	.40	5,000	45	.40
50	450	.40	7,500	36	.40
75	365	.40	10,000	30	.40
100	315	.40	12,500	24	.40
150	260	.40	15,000	20	.40
200	225	.40	20,000	15	.40
250	200	.40	25,000	12	.40
300	182	.40	30,000*	13	.40
400	158	.40	35,000*	12	.40
500	142	.40	40,000*	11	.40
600	129	.40	45,000*	10.5	.40
750	115	.40	50,000*	10	.40
800	110	.40			
900	105	.40			
1,000	100	.40			
1,250	89	.40			
1,500	81	.40			

*Low temperature. Rated at 5 watts

TYPE 20F $2'' \times \frac{9}{16}''$ **20 WATT**



Made with a high grade resistance wire, wound on a special refractory tube. No brackets furnished.

Resis. Ohms	Current m. a.	List Price	Resis. Ohms	Current m. a.	List Price
1	4480	\$0.65	1,750	107	\$0.65
3	2570	.65	2,000	100	.65
5	2000	.65	2,500	90	.65
10	1410	.65	2,750	85	.65
15	1150	.65	3,000	80	.65
25	900	.65	4,000	70	.65
50	630	.65	5,000	65	.65
75	510	.65	6,000	55	.65
100	450	.65	7,500	50	.65
150	365	.65	10,000	40	.65
175	340	.65	12,500	32	.65
200	320	.65	15,000	26	.65
250	285	.65	25,000	16	.75
350	240	.65	35,000	11	.75
400	220	.65	40,000	10	.75
500	200	.65	50,000	8	.75
750	160	.65	60,000*	10.5	1.00
800	155	.65	70,000*	10	1.00
1,000	140	.65	75,000*	9.5	1.00
1,200	130	.65	100,000*	8.5	1.00
1,250	125	.65			
1,500	115	.65			

*Low temperature. Rated at 7 watts

Mounting brackets are furnished with these sturdy wire wound heavy duty Vitrohm resistors.

HEAVY DUTY FIXED



TYPE 25F 25 WATT $2'' \times \frac{5}{8}''$			TYPE 50F 50 WATT $3\frac{1}{2}'' \times \frac{3}{4}''$			TYPE 100F 100 WATT $6\frac{1}{2}'' \times 1\frac{1}{8}''$			TYPE 160F 160 WATT $8\frac{1}{2}'' \times 1\frac{1}{8}''$			TYPE 200F 200 WATT $10\frac{1}{2}'' \times 1\frac{1}{8}''$		
Resis. Ohms	Current m. a.	List Price	Resis. Ohms	Current m. a.	List Price	Resis. Ohms	Current m. a.	List Price	Resis. Ohms	Current m. a.	List Price	Resis. Ohms	Current m. a.	List Price
15	1290	\$0.75	25	1415	\$1.10	5	4470	\$1.50	5	5650	\$2.00	5	6325	\$2.50
25	1000	.75	50	1000	1.10	10	3160	1.50	10	4000	2.00	10	4470	2.50
50	710	.75	75	815	1.10	25	2000	1.50	15	3260	2.00	25	2825	2.50
75	580	.75	100	705	1.10	50	1410	1.50	25	2525	2.00	50	2000	2.50
100	500	.75	150	575	1.10	75	1150	1.50	50	1785	2.00	75	1630	2.50
150	410	.75	200	500	1.10	100	1000	1.50	75	1460	2.00	100	1400	2.50
200	355	.75	250	445	1.10	150	815	1.50	100	1260	2.00	150	1150	2.50
250	315	.75	300	405	1.10	250	630	1.50	150	1035	2.00	250	900	2.50
300	290	.75	400	350	1.10	500	445	1.50	200	900	2.00	500	630	2.50
400	250	.75	500	315	1.10	750	365	1.50	250	800	2.00	750	515	2.50
500	225	.75	750	255	1.10	1,000	315	1.50	500	570	2.00	1,000	450	2.50
750	180	.75	1,000	225	1.10	1,250	285	1.50	750	460	2.00	1,500	365	2.50
850	170	.75	1,500	180	1.10	1,500	260	1.50	1,000	400	2.00	2,000	315	2.50
1,000	160	.75	2,000	160	1.10	2,000	225	1.50	1,500	330	2.00	2,500	280	2.50
1,250	140	.75	2,500	140	1.10	2,500	200	1.50	2,000	280	2.00	3,000	260	2.50
1,500	130	.75	3,000	130	1.10	3,000	180	1.50	2,500	250	2.00	3,500	240	2.50
2,000	110	.75	4,000	110	1.10	3,500	170	1.50	3,000	230	2.00	4,000	225	2.50
2,500	100	.75	5,000	100	1.10	4,000	160	1.50	3,500	215	2.00	4,500	210	2.50
3,000	90	.75	6,000	92	1.10	4,500	150	1.50	4,000	200	2.00	5,000	200	2.50
3,500	85	.75	7,500	82	1.25	5,000	140	1.50	4,500	185	2.00	7,500	165	2.50
4,000	80	.75	8,000	79	1.25	7,500	115	1.75	5,000	180	2.00	10,000	140	2.50
5,000	70	.75	10,000	70	1.25	10,000	100	1.75	7,500	145	2.00	15,000	115	3.00
6,000	65	.85	12,000	64	1.25	15,000	80	1.75	10,000	125	2.00	20,000	100	3.00
7,500	53	.85	12,500	56	1.25	20,000	70	1.75	15,000	105	2.40	25,000	90	3.00
8,500	47	.85	15,000	47	1.25	25,000	60	1.75	20,000	90	2.40	30,000	82	3.00
10,000	40	.85	20,000	35	1.25	30,000	50	2.00	25,000	80	2.40	35,000	71	3.00
15,000	27	.85	25,000	28	1.25	35,000	43	2.00	30,000	67	2.40	40,000	62	3.00
20,000	20	1.00	35,000	20	1.45	40,000	37	2.00	35,000	57	2.40	50,000	50	3.00
25,000	16	1.00	45,000	17	1.45	50,000	30	2.00	40,000	50	2.40	60,000	42	3.00
35,000	11	1.00	50,000	14	1.45	60,000	25	2.25	50,000	40	2.40	75,000	33	3.00
40,000	10	1.00	75,000	9	1.45	70,000	21	2.25	60,000	33	2.70	100,000	25	3.00
50,000	8	1.00	100,000	7	1.45	75,000	20	2.25	75,000	26	2.70	125,000	20	3.50
75,000	5	1.25	125,000	5	2.00	100,000	15	2.50	80,000	25	2.70	150,000	16	3.50
100,000	4	1.75							100,000	20	2.70			

CONTINENTAL RESISTORS

CONTINENTAL Bakelite and Ceramic Insulated Resistors

1000-Volt Insulation: Protects against Shorts to Sub-Panel and Wiring. Permanent Resistance Value.

M-Type Bakelite

M3	3 Watt	
2" x 1 1/4"		\$.30
M1	1 Watt	
1" x 3/4"		\$.20
M 1/2	1/2 Watt	
5/8" x 3/4"		\$.17
M 1/4	1/4 Watt	
3/8" x 5/8"		\$.15



Standard Stock Resistor Values

Available in Bakelite or Ceramic Insulation

50	17,500
100	20,000
150	25,000
200	30,000
250	35,000
300	40,000
400	50,000
500	55,000
600	60,000
750	70,000
	75,000
1,000	100,000
1,250	125,000
1,500	150,000
1,750	200,000
2,000	250,000
2,500	300,000
3,000	400,000
3,500	500,000
4,000	1,000,000
5,000	1,500,000
6,000	2,000,000
7,500	3,000,000
10,000	4,000,000
12,500	5,000,000
15,000	10,000,000

CONTINENTAL CARBON insulated resistors are now available in carbon and wire resistance elements, in bakelite, ceramic, glass, and vitreous enamel insulation according to their service requirements. Bakelite Insulated Type M resistors are recommended where space limits and insulation quality require a reliable, rugged, and small resistor capable of withstanding severe service as in auto, airplane, and marine radio equipment. Ceramic insulated Type D resistors are slightly larger than the bakelite units and dissipate heat over a wider area on overloads. In high gain amplifier circuits the large area of contact between the copper leads soldered to copper sprayed ends of the resistor assures permanent resistance value and absolute absence of molecular noise in the circuit.

D-Type Ceramic

D5	5 Watt	
3" x 1 1/4"		\$.50
D3	3 Watt	
2" x 3/4"		\$.30
D1	1 Watt	
1 3/8" x 3/4"		\$.20
D 1/2	1/2 Watt	
1" x 3/4"		\$.17

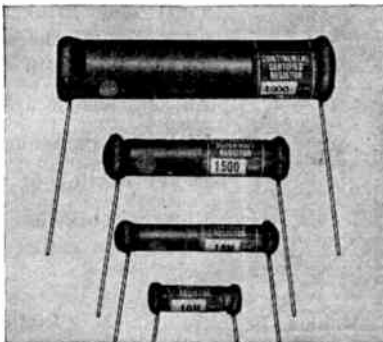

One Large Four Drawer Genuine Metal Cabinet and One Valuable Resistor Chart that tells what resistor to use with purchase of 70 Continental Certified Resistors **FREE**
TOTAL VALUE COMPLETE \$15.95—YOUR PRICE \$7.77

You get an all metal four drawer resistor cabinet 8" x 6" x 5 3/4" finished in olive green with a big stiff cardboard wall chart which solves every problem in Ohms Law at a glance. The chart is an invaluable aid in resistor service problems as are Continental Certified Resistors.

One each of these 35 resistors in 1 watt and 1 each in 1/2 watt—your choice of bakelite molded or ceramic insulated supplied in the following values:

150	1,000	2,500	5,000	10,000	20,000	50,000	150,000
250	1,500	3,000	6,000	12,500	25,000	60,000	250,000
400	1,750	3,500	7,500	15,000	30,000	75,000	300,000
500	2,000	4,000	8,500	17,500	40,000	100,000	500,000

1, 2, and 3 megohms

Code	List Price
777M—70 Bakelite molded resistors with Cabinet and Chart	\$12.95
777D—70 Ceramic insulated resistors with Cabinet and Chart	12.95

Lucky Sevens "777" Cabinet Deal

No Coupons Attached to Resistors on Cabinet Deals

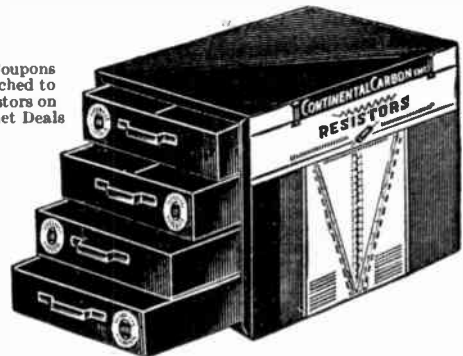

Type A - Precision Carbon Resistors

MADE IN ALL STANDARD STOCK RESISTOR VALUES



AVAILABLE IN: Type A 1/2—1/2 Watt—1" x 1/4" dia.
Type A1 — 1 Watt—1 1/2" x 1/4" dia.

A new type of carbon resistor, impregnated, hermetically sealed in glass, impervious to moisture, of the utmost stability, the A Type sets a new high standard of perfection for precision applications. Suitable for any 1-watt or 1/2-watt application, the A type is particularly recommended for high resistance voltmeter multipliers, critical photo-electric circuits which must be extremely stable, and in military and naval applications where the dependability of each component is most vital.

Types A1 and A 1/2—Tolerance ±2%	List Price \$0.50
Types A1 and A 1/2—Tolerance ±5%	List Price .30

Also made in

Type D1—1 Watt—Ceramic—Tolerance ±5%	List Price .30
--------------------------------------	----------------



Tool Box Resistor Kit

"Metal-Pac" resistor kits include: Choice of twenty-five 1/2 or 1-watt standard CONTINENTAL CARBON insulated resistors, dial color code indicator, and a lacquered steel carrying case suitable for rough usage in your tool box.

Purchase CONTINENTAL molded carbonite resistors in this convenient form. Any assortment with any duplication of values from the longer list of stock values will be furnished on request. Standard kits contain our selection of 25 certified resistors:

Code	Resistors	Insulation	List Price
125D1	25 1-watt	ceramic	\$5.00
125D1/2	25 1/2-watt	ceramic	4.25
125M1	25 1-watt	bakelite	5.00
125M1/2	25 1/2-watt	bakelite	4.25

CONTINENTAL RESISTORS

Type WV—Blue Vitreous Enamel Wire Wound Resistors

Tolerance Limits are $\pm 5\%$

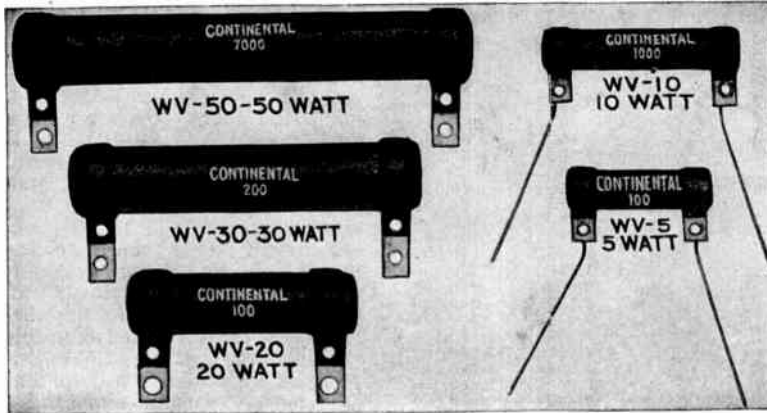

Vitreous enamelled resistors made by "Continental" are coated with crack-proof enamel fired on at red heat. The resistance wire is uniformly wound on the porcelain tube and held in exact position by preliminary hardening of the cemented enamel. This process does not allow the resistance wire to buckle and short when firing at the high temperature and, therefore, insures the highest degree of quality resistors.

All connections are silver soldered. Nichrome resistance wire.

Heavy coating of vitreous enamel.

Units will take overload up to 150% of wattage rating without failure.

Type	Wattage	Size	Values	List Price
WV5	5 watts	1 1/4" x 3/8"	1-10,000 ohms	\$.30
WV10	10 watts	1 3/4" x 3/8"	1-20,000 ohms	.35
WV20	20 watts	2" x 5/8"	1-30,000 ohms	.65
WV30	30 watts	3" x 5/8"	1-50,000 ohms	.80
WV50	50 watts	4" x 5/8"	1-75,000 ohms	1.00

Ceramic Tube Insulated Wire Wounds

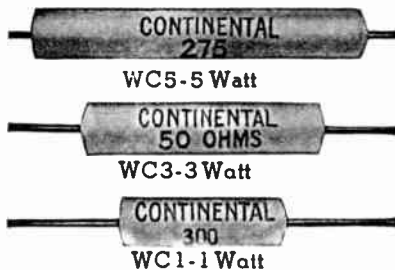

A new type of wire wound resistor has been developed with Nichrome resistance wire winding entirely on the inside diameter of a ceramic tube. The resistance wire is sealed in ceramic insulation. This unit can be mounted in close spaces or in contact with other parts. The heavy walled ceramic tube protects the winding from any outside shorts. Another feature is the overload rating of these units taking a 150% overload with ease. Standard Tolerance is $\pm 5\%$.

Type	Wattage	Size	Values	List Price
WC1	1 watt	7/8" x 3/32"	1 to 2500 ohms	\$0.20
WC3	3 watt	1 1/4" x 3/32"	1 to 4000 ohms	.30
WC5	5 watt	1 3/4" x 3/32"	1 to 6000 ohms	.30
WC10	10 watt	2" x 1/8"	1 to 10000 ohms	.35

Flexible Wire Wound Resistors

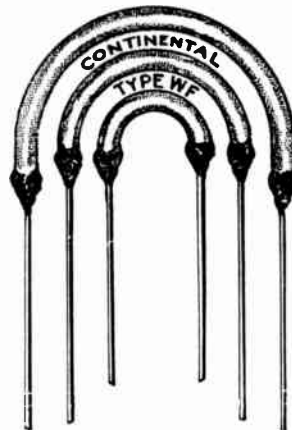

Continental type WF Flexible resistors are wound with Nichrome wire on an asbestos core and covered with Fiberglass sleeving. Fireproof and charproof throughout its construction this Flexible resistor will withstand enormous overloads in ratio of 2 to 3 times normal rating.

Terminals are fastened to wound resistance core by wrapping, compressing and braze soldering to give a permanent strong contact. The Fiberglass sleeving covers the terminal joints to make an entire insulated unit with no exposed metal end caps. These Flexible resistors can be used for heaters in contact with metal cans or chucked away in close positions.

Stock ratings are 1, 3, 5 and 10 watt sizes. A safe figure to use is 2 watts or less per inch of flexible wound resistance core. R.M.A. color coded for value. Standard Tolerance $\pm 10\%$.

Type	Wattage	Size	Values	List Price
WF1	1 watt	1 1/4" x 3/16" dia.	1 to 1500 ohms	\$0.20
WF3	3 watt	2 1/4" x 3/16" dia.	1 to 3500 ohms	.30
WF5	5 watt	3 1/4" x 3/16" dia.	1 to 5000 ohms	.30
WF10	10 watt	6 1/4" x 3/16" dia.	1 to 7500 ohms	.35

CONTINENTAL SUPPRESSORS

AUTO-RADIO SUPPRESSORS AND FILTER UNITS

CONTINENTAL Suppressors have been subjected to years of laboratory development and actual road service. They effectively remove noise interference from spark discharge at the plugs and high-tension distributor—yet do not in any way affect the motor car ignition system.

They have mechanical strength to stand the most severe service. The resistance value has been scientifically determined and is not changed after years of the most adverse conditions. Sparking across the terminals is eliminated by careful shaping of the electrodes and cases.

Spark Plug Suppressors and Distributor Suppressors Each — List Price \$0.30



Code S-21 Universal Spark Plug Suppressor—with "U" terminal. 5000 ohms.



Code S-27 Suppressor—Thread will fit all spark plugs. Most universal type yet devised. Ferrule nut is removable. 5000 ohms.



Code C-11 Cable Suppressor—meets requirements where it is necessary to cut ignition cable. 10,000 ohms.



Code T-13 Distributor Suppressor—fits all distributors. 10,000 ohms. Cable screws into housing making a watertight and non-loosening connection.



Code S-20A Spark Plug Suppressor—for Buick, Packard and Chrysler cars. Takes place of terminal on ignition cable. 5000 ohms.



Code S-19 Spark Plug Suppressor—Snaps on to spark plug. 5000 ohms. Vertical mounting.



Code T-20 Distributor Suppressor—Cable clip snaps into suppressor. 10,000 ohms. Not necessary to remove clip on cable and therefore suppressor can be quickly removed for ignition testing purposes.



Code S-23 Spark Plug Suppressor—Flexo-Terminal type. Can be bent to any angle, snaps on to spark plug.



Code T-22A Distributor Suppressor is the new Chrysler model with a bakelite umbrella cap which fits down around the distributor's risor. Inside the cap, around the suppressor, is a neoprene washer (a rubber substitute) which is not deteriorated by oil. This washer makes a water-proof seal between the risor, cap and suppressor. It also makes the suppressor very rigid in the distributor.

The ignition cable with its clip snaps into the suppressor similar to the T-20, which is illustrated at the left. This new T-22A suppressor is now very much in demand by the manufacturers.

"Oilac" Auto-Radio Vibrator Condensers

Buffer condensers rated for 1500 volts D.C. and flash tested at 3000 volts. Type V are rectangular in sealed metal containers.



VAE

Code	Capacity	Size	List Price
VAE11	.01	1" x 7/8" x 3/8"	.45
VAE12	.02	1" x 7/8" x 3/8"	.45
VAE13	.03	1" x 1 1/8" x 3/8"	.45
VAE14	.04	1" x 1 1/8" x 3/8"	.45

Ford Distributor Suppressors



T-15



T-17

Type	List Price
Type T-15—For Ford V8-1936 and 1937 models.....	.30
Type T-17 Universal type with insulating sleeve	
Type T-17 is T-15 slipped into a bakelite insulating tube of the same external diameter as T-14, to fit 1935 and previous models30

Continental Auto-Radio Filter Condensers

This line of equipment has been specially designed to give the serviceman a means of easily eliminating every cause of noise interference in auto-radio installation—at the actual source of interference.

Code	Application	Capacity	Size	List Price
GB025	Generator and coil	.25	2 1/2" x 3/4"	\$0.40
GB05	Generator and coil	.5	2 1/2" x 3/4"	.50
GB1	Generator and coil	1.0	2 1/2" x 1"	.70
GB05C	Ammeter to ground	.5	2" x 7/8"	.50
GB05H	Dome light filter	.5	3" x 1"	.80
GB05F	Ford V-8 coil	.5	2 1/2" x 3/4"	.60



GB025, GB05, GB1



GB05H



GB05F



GB05C

Continental "Voltacon"

LINE VOLTAGE REGULATOR FOR RADIOS



To protect radios from overvoltage Continental "Voltacon" in the line will reduce the voltage to a safe value. The "Voltacon" is a plug-in unit with three adjustments.

- No. 3 position for 125 to 130 volts.
- No. 2 position for 120 to 125 volts.
- No. 1 position for 115 to 120 volts.

Can be used on radios of 4 to 10 tubes or on any other electric device consuming 100 watts or less.

"VOLTACON" CODE V-20...List Price \$1.50

CONTINENTAL CONDENSERS

Paper Condensers for Replacing Electrolytics in Cardboard and Metal Cases



CONTINENTAL Carbon Mod-E condensers are high quality, paper dielectric capacitors built in shapes and sizes equivalent to electrolytic capacitors commonly found in radio receivers. They are flash tested at 3 times their d-c working voltage and have the advantage of low power factor at 60 cycles. They are non-inductive, non-polarized, and are of permanent capacity. No active chemicals are used which could cause corrosion of the foil or leakage. The tabulations below show the actual capacity in microfarads and the rated sizes of electrolytic condensers occupying the same dimensions. Recommended for use on d.c. and rectified a.c. only. Model E, d-c working volts, 600; peak volts, 1000.

Data and Prices on Model E Condensers, Cardboard Containers—Furnished with Six-Inch Wire Leads

Code	E-Type 600 Volts dc		Capacity in Mfds.	Equivalent Electrolytic	Size of E. Condensers in Inches
	List Price				
EE2	\$1.14		1.2	2	4 3/8 x 1 3/8 x 1 1/8
EE4	1.38		2.4	4	4 3/8 x 1 3/8 x 1 1/8
EE8	1.80		4.8	8	4 3/8 x 1 3/8 x 1 1/8
EE44	2.22		2.4-2.4	4-4	4 3/8 x 1 3/8 x 1 1/2
EE48	2.64		2.4-4.8	4-8	4 3/8 x 1 3/8 x 1 3/8
EE88	2.94		4.8-4.8	8-8	4 3/8 x 1 3/8 x 2 1/8

Condensers in Metal Cans, Inverted Stud Mounting, Six-Inch Leads Insulated from Can

IE4	\$1.68	2.4	4	3 3/8 x 1 3/8 Dia.
IE8	2.04	4.8	8	4 3/8 x 1 3/8 Dia.



"Oilacon" Tubular Condensers Oil Impregnated



Non-inductive tubular condensers in cardboard vacuum impregnated with moisture-proof wax. Bare flexible tinned leads. 2 3/8 in. long. Available in all standard sizes.

Code	Mfds.	Working Voltage	Size		List Price
			Len.	Dia.	
TF31	.0001	600	1 1/4	1 1/8	\$0.18
TF325	.00025	600	1 1/4	1 1/8	.18
TF21	.001	600	1 1/4	1 1/8	.18
TF22	.002	600	1 1/4	1 1/8	.18
TF25	.005	600	1 1/4	1 1/8	.18
TF11	.01	600	1 1/4	1 1/8	.18
TF12	.02	600	1 1/4	1 1/8	.18
TF15	.05	600	1 1/4	1 1/8	.24
TF01	.1	600	1 1/4	1 1/8	.30
TF025	.25	600	1 1/4	1 1/8	.42
TF05	.5	600	1 1/4	1 1/8	.60
TD25	.005	400	1 1/4	1 1/8	.18
TD11	.01	400	1 1/4	1 1/8	.18
TD12	.02	400	1 1/4	1 1/8	.18
TD15	.05	400	1 1/4	1 1/8	.18
TD01	.1	400	1 1/4	1 1/8	.24
TD025	.25	400	1 1/4	1 1/8	.30
TD05	.5	400	1 1/4	1 1/8	.42
TD1	1.0	400	1 1/4	1 1/8	.60

"Oilacon" Transmitting Condensers

ESPECIALLY DESIGNED FOR COMMERCIAL, POLICE AND AMATEUR TRANSMITTERS

The Continental Type W transmitting condensers are oil impregnated, non-inductive, conservatively rated and will stand severe service. Power factor is extremely low (1/2 of 1%) and reduces heating to a minimum. Enclosed in drawn metal containers. Glazed white porcelain stand-off type insulators. For continuous duty on A.C., restrict to not over 25% of D.C. working voltage.



Code	Capacity	D.C. Working Voltage	Size in Inches		List Price
			Len.	Dia.	
WAJ1	1	1000	5	x2 x2	\$2.10
WAJ2	2	1000	5	x2 1/2 x1 3/8	3.00
WAJ4	4	1000	5	x2 1/2 x2 1/4	5.40
WAE1	1	1500	5	x2 1/2 x1 3/8	2.70
WAE2	2	1500	5	x2 1/2 x2 1/4	3.90
WAE4	4	1500	5	x4 x3	6.00
WBJ1	1	2000	5	x2 1/2 x1 3/8	3.48
WBJ2	2	2000	5	x2 1/2 x2 1/4	4.80
WBJ4	4	2000	5	x4 x3	7.20

"OILACON" CONDENSERS

Oil Impregnated - Oil Filled - Hermetically Sealed

OILACON condensers have a very low power factor of .2% to .4%, a high insulation resistance, and are therefore ideal for continuous 110 to 440 volt A.C. applications. These condensers are particularly recommended for use in Condenser Type Motors, Neon Signs, Fluorescent Lighting, Filter Circuits and Power Factor Correction. Maximum operating temperature 175°F.

A.C. Volts 110 D.C. Volts 400				A.C. Volts 220, 330 & 440 D.C. Volts 800					
Code	Cap. Mfds.	Size		List Price	Code	Cap. Mfds.	Size		List Price
		D.	L.				D.	L.	
OD05	.5	1.0"	2 1/4"	\$.78	OH05	.5	1.0"	2 1/4"	\$.90
OD1	1	1 1/4"	2 3/8"	.96	OH1	1	1 1/4"	3"	1.50
OD2	2	1 1/4"	3"	1.38	OH2	2	1 1/4"	3 3/8"	2.22
OD3	3	1 1/4"	3 3/8"	1.80	OH3	3	1 1/2"	4 3/8"	3.00
OD4	4	1 1/2"	4 3/8"	2.10	OH4	4	1 3/4"	4 3/8"	3.60
OD5	5	1 3/4"	4 3/8"	2.40	OH5	5	1.975"	4 3/8"	4.20

Prices Subject to Change Without Notice

CONTINENTAL FILTERNOYS

For Elimination of Electrical Radio Interference

Filternoys units reduce or eliminate man-made static! With the development of ultra sensitive receivers, the problem of interference elimination has become a major factor in the sale and servicing of these radios. Vacuum sweepers, electric refrigerators, cake mixers, and other kitchen gadgets, electric shavers, sewing machines, and a host of other items all contribute their share to spoiling good reception. Every buzz, snap, or crackle heard on a new radio lessens the chances of a sale, but these same disturbances open the path for the alert dealer to sell "noise elimination service" along with the radio—and at a profit!

The offices of doctors, lawyers, dentists, and professional men—where radio provides entertainment and relaxation for waiting clientele—offer a lucrative market to radio servicemen who have the ability to locate man-made radio interference and quiet it with CONTINENTAL CARBON Filternoys devices. Filternoys are of three types: Suppression to block radiation of interference at its source; Rejectors to prevent noise from entering a receiver's power supply; and Diverters intended for use anywhere along a power line to divert interference to the ground. Filternoys are simple to install and profitable to sell. Never be without them in stock.

Filternoys F1005DH and F505DH Are Used at Electrical Devices to Eliminate Radio Interference

SUPPRESSION TYPE



Two chokes and two condensers are contained in this heavy duty unit intended for motors, neon signs, and on the individual circuits of a store or residence where it is necessary to exclude interference following the power lines. It may also be used on oil burner circuits in conjunction with OB15 oil burner ignition suppressors. 10-Ampere capacity. Size 4 3/8" by 3" diameter. 110 to 220 volts, a.c. or d.c.

Filternoys F1005DH List Price \$6.00

SUPPRESSION TYPE



Contains two medium size choke coils and two condensers suitable for suppression of noise from heater pads, flat-irons, domestic refrigerators, diathermy and dental machines, mangles, hair driers, etc. Handy plug-in type with soft rubber non-breakable plug on 36" cord. Suitable for devices on 110-120 volts drawing less than 550 watts. Size 4 3/8" by 2 1/2" diameter. With flexible ground wire, a.c. or d.c.

Filternoys F505DH List Price \$4.80

Filternoys F05D - Diverter Type Suitable for Across Brush Arms of Large KW Generators



Filternoys Diverter FO5D is a dual capacitor designed to resonate a power supply line to a point below broadcast frequencies and to divert interference to ground. For voltages up to 220 regardless of watts load. Size 4 3/8" x 2 1/2" diameter. Wire leads. Low power factor.

F05D List Price \$3.00

Filternoys G01DH

SUPPRESSION TYPE



A wire-in suppressor with dual chokes and two condensers with a grounded frame. Suitable for equipment having grounded frame or a connection to metal BX wiring conduit. For diathermy and dental machines where the G01DH unit may be mounted within the interfering device and for small motors of exhaust fans, pumps, and compressors. Size 3 3/8" by 1 1/4" diameter, 6-inch leads, 300 watts, a.c. or d.c., 110-130 v.

Filternoys G01DH List Price \$1.20

Filternoys R305DH and R01DH

Are Used at Radios to Block Incoming Line Interference

REJECTOR TYPE



Contains two chokes and two condensers properly connected to block noise from entering a radio receiver through its power line circuit. Supplements a noise rejecting aerial system for complete quieting. Intended for stores, hospitals, or homes where line interference is particularly severe. 660-Watt capacity on 110 to 220-volt a.c. or d.c. lines. Size 4 3/8" by 2 1/2" diameter. Plug-in type, with ground wire.

Filternoys R305DH List Price \$3.60

REJECTOR TYPE



A junior size line noise rejector with two chokes and two condensers for keeping moderate line interference out of a radio power line circuit. R01-DH helps particularly where traction line noise is picked up by house wiring and conducted to the radio outlet. Plug-in type for 110-120 v. a.c. or d.c. line. 5-Amp. capacity. Size 2 3/8" by 1 3/8" diam. Thoroughly insulated for safe handling.

Filternoys R01DH List Price \$1.20

Prices Subject to Change Without Notice



CONTINENTAL FILTERNOYS



Filternoys F01DH

Most Popular and Universal Plug-in Type

FOR ELECTRIC RAZORS

Counter Display Cards Available

SUPPRESSION TYPE

Handy plug-in type suppressor with two r-f chokes, two condensers, and a ground lead for use on electrical devices of 300 watts or less, creating interference of intermittent or temporary character, such as a sewing machine motor, small electric washing machines, electric shavers, drink mixers, cash registers, adding machines, or electric typewriters. Size 2 5/8" by 1 3/8" diameter. 300-Watt capacity on 120 volts, a.c. or d.c.



Filternoys F01DH List Price \$1.20

Fluorescent Light Filternoys

Fluorescent lighting creates a new source of radio interference which can be eliminated by the use of filternoys units. Continental has developed a new unit known as our LO2DH which is designed to make its installation universal on all types of fluorescent lighting fixtures. This unit is rated at 5 amperes—110-220 AC or DC.

In cases where a small size unit is required namely: floor lamp, table lamp, desk lamp or small ceiling fixtures, we recommend our GO1DH Filternoys with or without mounting brackets as shown on other page.

Filternoys LO2DH—1 1/8" high, 1 3/4" wide, 6 7/8" overall, 6 1/4" hole spacing.
List Price \$3.00



Filternoys G01D and G14T

Designed to Be Mounted directly on Small Electrical Devices

Filternoys Diverter G01D—Dual capacitors in a grounded container for any size electric motor operating on 120 volts or less. Through making use of the field coils as chokes, this is a most effective method to silence a noisy a.c. or d.c. motor. Size 2 1/8" by 3/4" diameter.



G01D List Price \$0.60

Filternoys Diverter G14T—Triple capacitors in a circuit which permits its use with all hand-operated motor driven devices without danger of shock. Particularly applicable to vacuum cleaners, flat-irons, etc. Size 1 1/2" by 5/8". Flexible leads for direct connection.

G14T List Price \$0.60

Oil Burner Suppressor

Filternoys Suppressor OB15, carbon element type, intended for use only with the high tension spark ignition of oil or gas burning heating systems. Must be connected in series with each line to the spark gap. Size of the suppressor 3 1/2" x 1 1/8" diameter. Universal connections at both ends for solderless contact.



OB15 List Price \$1.80

FREE! Attractive Counter Display Card with 24-F18 Filternoys

Code 24-F18—List Price \$12.00

Filternoys Diverter F18 is a compact 0.1 mfd capacitor in a conveniently small bakelite plug-in coupler for use across domestic power lines in which the neutral wire is grounded. The capacitor diverts interference from the high potential side of the power line to the grounded neutral side. Use on floor or table lamps, cigarette lighters, and the radio.



F18 List Price \$0.60

CONTINENTAL CARBON INTERFERENCE CHART

Cause	Filternoys Unit	Cause	Filternoys Unit	Cause	Filternoys Unit	Cause	Filternoys Unit
Adding Machines	F505DH or F01DH	Dish Washers	F505DH	Hair Driers	F01H	Printing Presses	G01D or F05D
Aerators	F01H	Door Bells	G01DH or F05D	Heating Pads	F505DH	Razors, Electric	F01DH
Barbers' Clippers	F01H	Drink Mixers	F01DH	Malted Milk Shakers	F01DH	Refrigerators	F505DH
Beer Pumps	F1005DH	Electric Typewriters	F01DH or F18	Mangles	F505DH	Sewing Machines	G14T
Cash Registers	F01H	Fans	G01D or F01DH	Massage Exercisers	F505DH	Sign Flashers	F1005DH
Compressors, Air	F1005DH	Flat-irons	F505DH	Motors, Repulsion	F05D	Stoker Motors	F1005DH
Dental Motors	G01DH or G01D	Food Mixers	F01H	Motors, Series Type	G01D or F05D	Vacuum Cleaners	G14T
Dental Lathes	G01DH or G01D	Fruit Juicers	F505DH	Neon Signs	F1005DH	Violet-rays	F505DH
Diathermy Machines	G01DH or G01D	Generators	F05D	Oil Burners	OB15 or OB14	Washing Machines	F505DH
Dictographs	G14T	Hand Drills	G01D or F01DH	Ozonators	F01H	X-rays	F1005DH

Prices Subject to Change Without Notice

UNIVERSAL SIZE



CONTROLS Type D

QUIET, ALL-PURPOSE CONTROLS

IRC Type D Universal Controls have an enviable reputation for quiet operation and continuous dependability. Small enough to fit almost anywhere, "husky" enough to replace larger controls, a small stock equips you for the great majority of jobs. They embody such outstanding exclusive features as the IRC Metallized Resistance Element—harder, smoother, moisture-proof and



Metallized Element



Spiral Connector



5-Finger Contactor



Coil Spring Washer

permanent; the IRC 5-Finger "Knee Action" Contactor—positive, more uniform contact; the famous IRC Silent Spiral Connector—a positive connection between contactor and its terminal—eliminating the most frequent source of noise in controls; and the IRC Steel Coil Spring Thrust Washer which eliminates end play and shaft wobble.

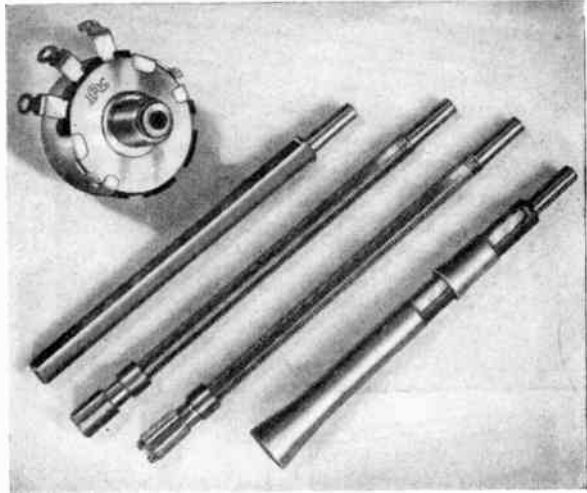

EASILY INSTALLED "TAP-IN" SHAFTS

Each D Control accommodates any of the four Tap-in Shaft types shown. The shaft socket is carefully gauged to a standard taper, and the shaft taper accurately machined to such a smooth fit, that the surfaces are practically bonded together when the shaft is driven in. Shaft flats may be located in any position. A few extra shafts greatly increase the utility of your D control stock at a small investment.

"DOUBLE-FLATTED" STANDARD SHAFT



Of unusual convenience is the "Double-Flatted" A shaft, included with each D control. Accommodates popular push-on knobs requiring either $\frac{1}{32}$ " or $\frac{3}{32}$ " flats and all set-screw knobs without filing of shaft or use of inserts. Illustration shows position of shaft for knobs requiring (a) $\frac{3}{32}$ " flat, (b) $\frac{1}{32}$ " flat, and (c) for set-screw knobs.

SPECIAL SHAFTS

Special shafts available:	List	Net
Shaft B—With tongued slot.....	\$0.35	\$0.21
Shaft C—Knurled slotted end.....	0.25	0.15
Shaft D—Plain slotted end.....	0.25	0.15

(Attached shaft lengths: B—3 $\frac{1}{2}$ ". C or D—4".)

QUICKLY ATTACHED SWITCHES

	List	Net
No. 41 S.P., S.T.	\$0.50	\$0.30
No. 42 D.P., S.T.	0.60	0.36
No. 43 S.P., D.T.	0.60	0.36
No. 45 Four Point	0.60	0.36
No. 47 S.P., S.T. with dummy lug.....	0.60	0.36

NEW SELLING AID!



The new IRC Control Tag, included with all D Controls, is of special value to servicemen in selling their services. Designed to be hung behind the control knob when a replacement has been made, it identifies to your customer the quality of the IRC Control used. Ample space for serviceman's name, address and phone number is provided.

UNIVERSAL Type "D" CONTROLS

Resistance	Tap	IRC No.	Taper	Usual Application
500 Ohms	D11-103	A	Potentiometer Voltage Divider
1 M "	D11-108	A	Potentiometer Voltage Divider
2 M "	D11-110	A	Potentiometer Voltage Divider
3 M "	D11-112	A	Potentiometer Voltage Divider
4 M "	D11-113	A	Potentiometer Voltage Divider
5 M "	D11-114	A	Potentiometer Voltage Divider
7500 "	D13-114	C	Antenna Control
10 M "	D11-115	A	Potentiometer Voltage Divider
10 M "	D11-116	A	*Antenna Grid Bias Control
10 M "	D13-116	C	Antenna Control
10 M "	D14-116	D	*Antenna Grid Bias of 2 tubes
10 M "	D16-116	F	*Antenna Grid Bias of 1 tube
15 M "	D14-118	D	*Antenna Grid Bias Control
15 M "	D16-118	F	*Antenna Grid Bias Control
20 M "	D16-119	F	*Antenna Grid Bias Control
25 M "	D11-120	A	Potentiometer Voltage Divider
25 M "	D14-120	A	*Grid Bias Control
25 M "	D16-120	F	Antenna Control
50 M "	D11-123	A	Potentiometer Voltage Divider
50 M "	D13-123	C	Tone Control
50 M "	D14-123	D	*Antenna Grid Bias Control
75 M "	D13-125	C	Tone Control
75 M "	D14-125	D	*Grid Bias Control
100 M "	D11-128	A	Potentiometer Voltage Divider
100 M "	D13-128	C	Tone or Audio Circuit Control
200 M "	D11-129	A	Potentiometer Voltage Divider
200 M "	D14-129	D	*Grid Bias Control
250 M "	D11-130	A	Potentiometer Voltage Divider
250 M "	D13-130	C	Tone or Audio Circuit Control
250 M "	125 M	†D13-130X	Spec. D	Audio Control with AVC Tap
250 M "	60 M	†D18-130X	H	*Grid Bias Control
350 M "	D13-132	C	Audio Control with Tone Tap
350 M "	75 M	†D18-132X	H	Tone or Audio Circuit Control
500 M "	D11-133	A	Audio Control with Tone Tap
500 M "	D13-133	C	Potentiometer Voltage Divider
500 M "	D13-133	H	Tone or Audio Circuit Control
500 M "	125 M	†D13-133X	H	Audio Control with Tone Tap
500 M "	D14-133	D	R. F. Plate Control
500 M "	50 M	†D18-133X	Spec. D	Audio Control with Tone Tap
1.0 Meg.	D11-137	A	Potentiometer Voltage Divider
1.0 "	D13-137	C	Tone or Audio Circuit Control
1.0 "	250 M	†D13-137X	H	Audio Control with Tone Tap
1.0 "	100 M	†D18-137X	Spec. H	Audio Control with Tone Tap
1.0 "	500 M	†D19-137X	Spec. C	Audio Control with Tone Tap
1.0 "	500 M	†DVC539X	Spec. C	Fader Control for fading one circuit into another
2.0 "	D13-139	C	Tone or Audio Circuit Control
2.0 "	500 M	†D13-139X	H	Audio Control with Tone Tap
2.0 "	1 meg.	†D18-139X	Spec. H	Audio Control with Tone Tap
3.0 "	D13-140	C	Audio Control with Tone Tap
5.0 "	D11-141	A	Potentiometer Voltage Divider
7.0 "	D11-142	A	Potentiometer Voltage Divider
10.0 "	D11-143	A	Potentiometer Voltage Divider

* Supplied with 300 ohm BT $\frac{1}{2}$ (½ watt) Insulated Metallized Resistor.
† Indicates Tapped Control.

PRICES

	List	Net
Single Controls, without switch.....	\$1.00	\$0.60
†Standard Tapped Controls, without switch	1.50	0.90

Prices include Shaft A packed with control.

VOLUME



CONTROLS

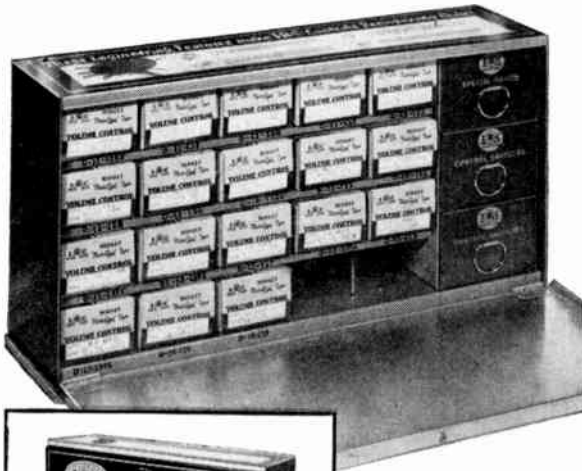

Attractive All-Metal Cabinet Included FREE

The IRC Control Cabinet is of sturdily-built all-metal construction and attractively finished in blue, yellow and silver. It provides individual compartments for 20 IRC Controls; 18 compartments indicate the control types included—you see at a glance what types should be reordered. Three handy drawers accommodate switches, special shafts, and spare parts. The hinged front cover snaps securely shut, so the cabinet may be carried in your car or truck, or may be removed entirely for shop use. Cabinet measures 14 1/2" long, 7 3/8" high, and 4 1/2" wide. Base is arranged for stacking where additional cabinets are required. This handsome cabinet is furnished FREE when packed with the IRC Type D Controls, Switches and Shafts indicated at the right.

MASTER RADIOTRICIAN'S CONTROL CABINET with Type D Universal Controls

The IRC Control Cabinet with its practical stock of Type D Controls, Switches and Shafts is the greatest step toward standardization of replacement controls ever introduced. Now popular among thousands of servicemen and dealers, it will save you time by furnishing required replacements when you need them. It saves you money by eliminating special trips for needed controls and often eliminates more costly exact duplicates. It enables you to reduce your inventory, step up your turnover, and increase your profits.

Specified for over 10,850 Models!

Definitely proved by IRC sales records to handle up to an average of 87% of all control replacements, you will find the control types included are recommended for over 10,850 models in the new IRC Volume Control Replacement Manual! The comprehensive replacement utility of this practical stock, together with the enviable reputation of Type D Controls for quiet, trouble-free operation and lasting dependable service, will definitely solve your control problems.

HERE IS WHAT YOU GET!

The IRC Master Radiotrician's Cabinet is factory-packed with the following 18 Type D Controls, switches and special shafts.

IRC Control Type No.	Resistance	Purpose	IRC Control Type No.	Resistance	Purpose
2-D13-133	500,000	A	1-D13-133X	500,000	F
1-D11-116	10,000	B	1-DC13-133X	500,000	G
1-D11-123	50,000	C	1-D13-137	1.0	A
1-D11-128	100,000	C	1-D13-137X	1.0	F
1-D11-133	500,000	C	1-D13-139	2.0	A
1-D13-123	50,000	D	1-D13-139X	2.0	F
1-D13-128	100,000	A	1-D14-116	10,000	H
1-D13-130	250,000	A	1-D16-119	20,000	B
1-D13-130X	250,000	E			

- A—Tone or Audio Circuit Control
- B—Antenna Grid Bias Control
- C—Potentiometer Voltage Divider
- D—Tone Control

- E—Tapped for A. V. C.
- F—Tapped for Tone Compensation
- G—Friction Clutch Auto Radio Type
- H—Antenna Grid Bias of 2 Tubes

Switches: 5 No. 41 S.P.S.T.; 1—No. 42 D.P.S.T.
Shafts: 1—Type B Auto Radio; 2—Type C with slotted, knurled terminals;
2—Type D with slotted, unknurled terminals.

List Price of 18 Controls, 6 Switches and 5 Special (Extra) Shafts, \$24.95. NET PRICE **\$14.97**
THE CABINET IS INCLUDED FREE!

12 IRC Controls Handle 29% of all Exact Duplicate Replacements!

IRC sales records show that these 12 most popular special controls will handle nearly one-third of your requirements for exact duplicate controls. The group includes low-capacity tapped controls, concentric duals, and special shaft units. For a more complete stock, carry at least one of each:

- J-127 3800/3800 ohms** List \$2.50 Net \$1.50
For RCA R32, RE45, R52, RE75, 145
- J-693 2 Meg (Tap 500M)** List \$1.50 Net \$0.90
For RCA 5T, 5T1, 5T4, 5T5, 5T6, 5T7, 5T8, 5U, C6-2, C6-8, 6K, 6K1, 6K2, 6K3, 6K10, 6T, T6-1, 6T2, 6T5, T6-7, 6T10, C7-6, C7-14, D7-7, 7K, 7K1, 7T, 7T1, T7-5, T7-12, 7U, 7U2, 7X, 7X1, C8-15, C8-17, C8-19, C8-20, D8-28, 8K, 8K1, 8K11, 8T, 8T2, 8T10, 8T11, T8-14, T8-16, T8-18, 8U, 8U2, C9-4, C9-6, D9-19, T9-7, T9-8, T9-9, T9-10, 811K, 811T
- J-699 2.5 Meg (Tap 250M & 500M)** List \$1.50 Net \$0.90
For RCA 9K, 9K2, 9K3, 9K10, 9T, 9U, 9U2, 10K, 10K1, 10K11, 10T, T10-1, 10T11, T10-3, C11-1, C11-3, D11-2, T11-8, C13-2, C13-3, 15U, 812K, 813K, 816K
- J-777 350M Ohms** List \$1.50 Net \$0.90
For Chrysler C1423; Ford T9-FT9, FT9X, F1440, F1442; Graham G1418, G1436; Lincoln L1420, L1424, L1425, L1427, L1429, L1460; Nash T12-NT12X, NT12X2, T15NT15, NT15X, N1418, N1433H, N1434H, N1514; Packard P1417, P1517; Philco 811PA, PB, PV, 816, 817, 818, 821P, 821PV, 826, 827, 827K, 828, 828K; Studebaker T12-ST12, T15-ST15, S1431, S1437, S1516; Willys W1419

- J-843 350M Ohms (Tap 75M)** List \$2.00 Net \$1.20
For Chrysler T10-CT10, T11-CT11, C1450, C1452; De Soto T10-CT10, T11-CT11; Dodge C11-CT11; Lincoln LT14X3; Packard T14-PT14, P1422, P1430, P1432H, P1439
 - J-958 2 Meg (Tap 1 Meg)** List \$1.50 Net \$0.90
For Philco 37-9, 37-10, 37-11, 37-116, 37-610, 37-611, 37-620, 37-623, 37-624, 37-630, 37-640, 37-641, 37-643, 37-650, 37-660, 37-665, 37-670, 37-675, 37-2620, 37-2650, 37-2670, 38-3, 38-116, 38-620
 - J-967 2 Meg (Tap 500M)** List \$2.00 Net \$1.20
For G. E. E61, E62, E68, E71, E72, E76, E79, E81, E86, E91, E95, E101, E105, E106, FD62, FD625
 - J-1043 2 Meg (Tap 500M)** List \$1.50 Net \$0.90
For RCA 8Q1, 8Q4, 10Q1, U30, M81, M82, M83, M84, 94BT6, 98K, 99K, U126, U128, U129, 910KG, 911K
 - J-1068 2.5 Meg (Tap 250M & 500M)** List \$2.00 Net \$1.20
For Zenith 7S323, 7S342, 7S343, 7S363, 7S364, 7S366, 8S359
 - DJ-4 2 Meg (Tap 500M/1 Meg)** List \$3.00 Net \$1.80
For RCA J26, 96K, 96K2, 96T2, 96T3, 97E, 97K, 97KG, 97T, 97Y, 97EY, 98X, 98YG, U119, U122E, UY122E, U124, U125
 - DJ-52 1 Meg (Tap 250M)** List \$2.00 Net \$1.20
For Buick 980534, 980535
 - DJ-85 220M** List \$2.00 Net \$1.20
For Zenith 6D302, 6D311, 6D326, 6D360
- List Price of 1 each of above controls . . . \$23.00
Year Net Cast **\$13.80**
(Order as "12-Group A, IRC Special Controls")

VOLUME



CONTROLS

Type CS VOLUME CONTROLS

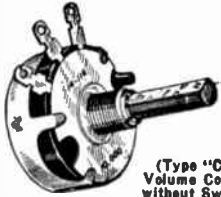

(Type "CS" Volume Control without Switch)

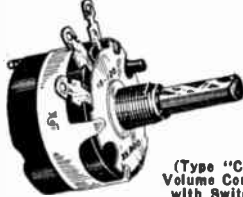

(Type "CS" Volume Control with Switch)

Type CS Controls are for use in most general requirements. The 45 standard values make it possible to secure from jobber stocks, at minimum prices, dependable units that are easily adapted for a large percentage of all replacements. Standard controls are recommended wherever resistance value and taper are essentially correct and the only thing needed to make them mechanically suitable is to cut the shaft or, in some cases, to ground a certain terminal or attach a switch. 3" shafts with flat the entire length.

Type CS CONTROL PRICES

Standard Single Controls—Without switch (plain cover), List \$1.00, Net \$0.60

†Standard Tapped Controls—Without switch (plain cover), List \$1.50, Net \$0.90

SWITCHES for CS CONTROLS

No.	Switch Type	List	Net
No. 21	S.P., S.T.	\$0.50	\$0.30
No. 22	D.P., S.T.	0.60	0.36
No. 23	S.P., D.T.	0.60	0.36
No. 24	Three point	0.60	0.36
No. 25	Four point	0.60	0.36
No. 26	S.P., D.T. at clockwise position	0.60	0.36
No. 27	S.P., S.T. with dummy lug	0.60	0.36

Type CS DUAL and TRIPLE CONTROLS

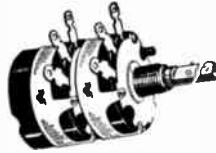

Type CS Dual Control

IRC Type CS Controls can be provided in any combination of two or three units operated from the same shaft. The following listing is of popular dual controls, but any combination of dual or triple controls, or of CS and type W Controls is available on special order. Standard switches can be attached. Dimensions are the same as for CS Controls, except that depth is 1 1/4" without switch; and 1 3/4" with switch.

IRC Type No.	Unit	Resistance	Curve	List Price	Net Price
35-1620	Panel	10,000 Ohms	C	\$2.50	\$1.50
	Rear	25,000 "	E		
61-1623	Panel	10,000 "	F	2.50	1.50
	Rear	50,000 "	A		
33-2828	Panel	100,000 "	C	2.50	1.50
	Rear	100,000 "	C		
33-3030	Panel	250,000 "	C	2.50	1.50
	Rear	250,000 "	C		
33-3333	Panel	500,000 "	C	2.50	1.50
	Rear	500,000 "	C		
33-3737	Panel	1 Meg.	C	2.50	1.50
	Rear	1 "	C		
33-3939	Panel	2 "	C	2.50	1.50
	Rear	2 "	C		

ATTENUATORS—For inexpensive L- and T-Pad Attenuators utilizing Type CS and Type W Wire Wound Dual and Triple Controls with special tapers and connections, see Page M-34.

Type CS CONTROLS

Resistance	Tap	Type No. No Switch	Taper	Usual Application
500 Ohms	11-103	A	Potentiometer Voltage Divider
1,000 "	11-108	A	Potentiometer Voltage Divider
2,000 "	11-110	A	Potentiometer Voltage Divider
3,000 "	11-112	A	Potentiometer Voltage Divider
4,000 "	11-113	A	Potentiometer Voltage Divider
5,000 "	11-114	A	Potentiometer Voltage Divider
5,000 "	13-114	C	Antenna Control
7,500 "	11-115	A	Potentiometer Voltage Divider
10,000 "	11-116	A	*Antenna Grid Bias Control
10,000 "	13-116	C	Antenna Control
10,000 "	14-116	D	*Antenna Grid Bias of 2 Tubes
10,000 "	16-116	F	*Antenna Grid Bias of 1 Tube
15,000 "	14-118	D	*Antenna Grid Bias Control
15,000 "	16-118	F	*Antenna Grid Bias Control
20,000 "	16-119	F	*Antenna Grid Bias Control
25,000 "	11-120	F	Potentiometer Voltage Divider
25,000 "	14-120	D	*Grid Bias Control
25,000 "	16-120	F	Antenna Control
50,000 "	11-123	A	Potentiometer Voltage Divider
50,000 "	13-123	C	Tone Control
75,000 "	13-125	C	Tone Control
75,000 "	14-125	D	*Grid Bias Control
100,000 "	11-128	A	Potentiometer Voltage Divider
100,000 "	13-128	C	Tone or Audio Circuit Control
200,000 "	11-129	A	Potentiometer Voltage Divider
200,000 "	14-129	D	*Grid Bias Control
250,000 "	13-130	C	Tone or Audio Circuit Tapped for A.V.C.
250,000 "	125M	†13-130X	A	*Grid Bias Control
250,000 "	14-130	D	*Grid Bias Control
250,000 "	60M	†18-130X	H	Tapped Tone Compensation
350,000 "	13-132	C	Tone or Audio Circuit Control
350,000 "	75M	†18-132X	H	Tapped Tone Compensation
500,000 "	11-133	A	Potentiometer Voltage Divider
500,000 "	13-133	C	Tone or Audio Circuit Control
500,000 "	125M	†13-133X	H	Tapped Tone Compensation
500,000 "	14-133	D	R. F. Plate Control
1.0 Meg.	13-137	C	Tone or Audio Circuit Control
1.0 "	250M	†13-137X	H	Tapped Tone Compensation
1.0 "	500M	†VC-539X	A	Fader Control for fading out of one circuit into another
2.0 "	13-139	C	Tone or Audio Circuit Control
2.0 "	500M	†13-139X	H	Tapped Tone Compensation
3.0 "	13-140	C	Tone or Audio Circuit Control
5.0 "	11-141	A	Potentiometer Voltage Divider
7.0 "	11-142	A	Potentiometer Voltage Divider
10.0 "	11-143	A	Potentiometer or Rheostat

† Indicates standard tapped controls without switch. * Includes 300 ohm BT-1/2 resistor.

8 STANDARD TAPERS

A—Used as potentiometer or rheostat in any circuit where uniform resistance change is required.

B—A semi-logarithmic curve used as tone control or audio circuit control.

C—A logarithmic curve. Used as audio circuit control or antenna shunt control.

D—Tapered at both ends to provide control of grid bias and antenna circuit. Used where control of grid bias is of prime importance in controlling volume.

E—Used as a rheostat in cathode circuit to control grid bias.

F—Tapered at both ends to provide control of grid bias and antenna circuit. Used where control of grid bias is essential in controlling volume. Generally used where the control changes the grid bias of only one or two tubes. Must not be used with heavy currents.

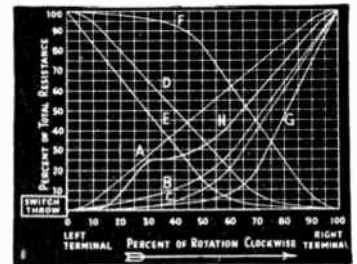

G—A logarithmic curve with very gradual change in resistance from left terminal. Used as audio circuit control or antenna shunt control.

H—A tapped logarithmic curve used as audio level control for automatic bass compensation. Standard Controls are made with Tapers A, C, D, F and H only. Special Replacements use all eight curves.

SPECIAL CONTROLS having resistances or tapers not listed as standard may be obtained by special order.

VOLUME CONTROLS

Type W WIRE WOUND CONTROLS



A dependable wire wound control of uniform resistance change for power requirements up to 2 watts. Tight, uniform windings assure utmost accuracy. Spiral Spring Connector between rotor arm and center terminal eliminates noise. Diameter, 1 1/4"; depth behind panel, 9/16"; shaft length 2 5/16" from control face. Illustration shows cover removed, although covers are supplied with controls. Includes new IRC Control Tag.

List Price without switch, \$1.00
Net \$0.60

IRC Control No.	Resistance Ohms	Max. Current (Amps.)	IRC Control No.	Resistance Ohms	Max. Current (Amps.)
W-2	2	1.000	W-100	100	.142
W-3	3	.815	W-200	200	.100
W-5	5	.630	W-300	300	.083
W-6	6	.560	W-400	400	.071
W-8	8	.500	W-500	500	.063
W-10	10	.450	W-750	750	.052
W-15	15	.370	W-1000	1000	.045
W-20	20	.320	W-2000	2000	.032
W-25	25	.285	W-3000	3000	.026
W-30	30	.260	W-4000	4000	.022
W-40	40	.225	W-5000	5000	.020
W-50	50	.200	W-7500	7500	.016
W-60	60	.183	W-10000	10000	.014
W-75	75	.164			

Type W SWITCHES

No.	Switch Type	List Price	Net Price	No.	Switch Type	List Price	Net Price
No. 51	S.P., S.T.	\$0.50	\$0.30	No. 55	Four Point	\$0.60	\$0.36
No. 52	D.P., S.T.	.60	.36	No. 56	S.P., D.T., at clockwise position	.60	.36
No. 53	S.P., D.T.	.60	.36	No. 57	S.P., S.T. with dummy lug.	.60	.36
No. 54	Three Point	.60	.36				

Type S SPECIAL STANDARD CONTROLS

Designed to accommodate the power requirements of plate circuit tone controls, the Type S Special Standard Controls should be used in such circuits where the audio output exceeds 2 watts. 1 1/4" in diameter, these controls employ the popular Tap-in Shaft feature of D Controls. Use switches indicated for Type CS Controls listed on preceding page. Includes new IRC Control Tag. Available only in the 100,000 ohm sizes as follows:

IRC No.	Resistance	Taper	List Price	Net Price
S11-128	100,000 Ohms	A	\$1.00	\$0.60
S13-128	100,000 Ohms	C	1.00	0.60

EXACT DUPLICATE CONTROLS

A large number of IRC Special or Exact Duplicate Controls are available for those replacements where electrical or mechanical requirements prevent the use of standard controls. Included are specially-tapped controls, dual and triple units, concentric duals, types with special switches, shafts, bushings, etc. Consult the IRC Volume Control Replacement Manual or send us complete details of required control with model, make and serial number of set involved.

Type D AUTO RADIO CONTROLS WITH FRICTION CLUTCH

Designed for practically any auto radio application. Controls have friction clutch drive-arm and are equipped with a special shaft for use where either a slotted or tongued type shaft is required. Instructions tell how to cut shaft for either application. **Switches cannot be used with friction clutch controls.** Sizes same as Type D Controls.

List Price complete, \$1.50.....Net \$0.90

IRC Control No.	Total Resistance	Resistance To Tap
DC13-130	250,000 Ohms	No Tap
DC18-130X	250,000 "	Tap 50M
DC13-133	500,000 "	No Tap
DC13-133X	500,000 "	Tap 125M
DC13-137	1.0 Meg.	No Tap
DC13-137X	1.0 "	Tap 250M
DC13-139	2.0 "	No Tap
DC13-139X	2.0 "	Tap 500M



"DE" CONTROLS with Built-in KNURLED SHAFT

Identical in size and construction to the Type D Control, the Type DE has a built-in split-knurled shaft measuring 3" from control face. 1/4" bushing to take care of crowded chassis installations. Uses Type D switches. Packaged with the new IRC Control Tag.

Resistance	Tap	IRC No.	Taper	List Price	Net Price
250,000	DE13-130	C	\$1.00	\$0.60
500,000	DE13-133	C	1.00	0.60
500,000	125 M	DE13-133X	H	1.50	0.90
1.0 Meg.	DE13-137	C	1.00	0.60
1.0 "	250 M	DE13-137X	H	1.50	0.90
2.0 "	DE13-139	C	1.00	0.60



EXTENSION SHAFTS



These shafts attach to regular shafts, thus extending length to any needed size, and frequently making it possible to use standard controls for "special" jobs.

Shaft No.	Dimensions	List Price	Net Price
Shaft No. 441	4" x 1/4" dia. x 1/32" flat....	\$0.30	\$0.18
Shaft No. 442	4" x 1/4" dia. x 3/32" flat....	0.30	0.18
Shaft No. 443	4" x 3/16" dia. x 3/64" flat....	0.30	0.18
Shaft No. 444	8" x 1/4" dia. x 3/32" flat for 4" length	0.30	0.18

SHAFT COUPLERS

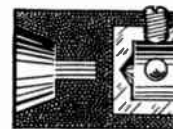

For use with standard controls to meet "special" shaft requirements.

Insulated Coupler No. C1 — for use with tongued type shaft.

Insulated Coupler No. C2 — for use with square type shaft used by Motorola.

Plain Shaft Coupler No. C3 — for coupling 1/4" shaft to 1/4" or 3/16" shaft.

Each coupler, list 25c, Net 15c

IRC Volume Control REPLACEMENT MANUAL

EDITION No. 3

New large 8 1/2" x 11" size with 136 pages lists one-third more models. Includes original manufacturers' part numbers, Rider's schematic reference and special shaft requirements. Trade and brand names in logical alphabetical order. Pages lettered for quick reference. The most comprehensive handbook of control replacement ever attempted.

PRICE 10c



INSULATED



RESISTORS



Type BT INSULATED *Metallized* RESISTORS

Completely insulated with bakelite to withstand 1,000 volts breakdown to ground, the BT Type Resistor employs the famous, time-tested Metallized resistance element. Unexcelled in such essential characteristics as stability, low noise level, low voltage coefficient, mechanical strength, moisture-proof protection and insulation. Standard tolerance $\pm 10\%$. **Special $\pm 5\%$ tolerance at 50% higher cost.**

Type BT-1/2—1/2 Watt

5/8" x 3/16". 250 ohms to 20.0 megohms. 350 volts maximum.
List \$0.17 Net \$0.10

Type BT-1—1 Watt

1 1/4" x 1/4". 350 ohms to 20.0 megohms. 500 volts maximum.
List \$0.20 Net \$0.12

Type BT-2—2 Watts

1 3/4" x 5/16". 500 ohms to 20.0 megohms. 500 volts maximum.
List \$0.30 Net \$0.18

Other BT Resistor ranges available on special order at above prices.

Type BW INSULATED WIRE WOUND RESISTORS

Same size and with same insulation as Insulated Metallized Resistors, but have wire resistance element wound tightly around special insulated core. Unexcelled for jobs such as meter shunts and multipliers (where precision is not a factor); cathode biasing, decoupling, series air cell battery use. Standard tolerance $\pm 10\%$. **Special $\pm 5\%$ tolerance available at 50% higher cost.**

Type BW-1/2—1/2 Watt

5/8" x 3/16". 0.5 ohm to 750 ohms.
List \$0.17 Net \$0.10

Type BW-1—1 Watt

1 1/4" x 1/4". 1.0 ohm to 4,000 ohms.
List \$0.20 Net \$0.12

Type BW-2—2 Watts

1 3/4" x 5/16". 1.0 ohm to 7,500 ohms.
List \$0.30 Net \$0.18

Other BW Resistor ranges available on special order at above prices.

STANDARD STOCK RANGES

Subject to the minimum and maximum values for each of the various types of BT and type F Resistors and BW Insulated Wire Wound Resistors.

Ohms	Ohms	Ohms	Ohms	Meg.
0.5	150	2,500	20,000	0.25
1	200	3,000	22,500	0.3
2	250	3,500	25,000	0.4
3	300	4,000	30,000	0.5
5	350	5,000	35,000	0.6
7.5	400	6,000	40,000	0.75
10	450	7,000	50,000	1.0
15	500	7,500	60,000	1.5
20	600	8,000	65,000	2.0
25	750	9,000	70,000	3.0
30	800	10,000	75,000	4.0
40	1,000	11,000	Meg.	5.0
50	1,250	12,000	0.1	6.0
75	1,500	12,500	0.125	7.0
100	2,000	15,000	0.15	10.0
120	2,250	17,500	0.2	20.0

ALL METAL RESIST-O-CABINET

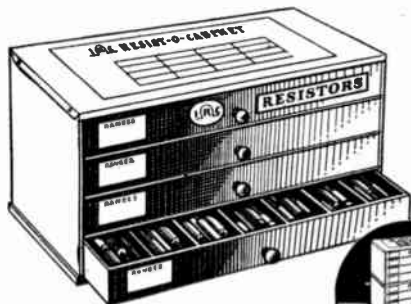

End Cigar Box Confusion—
Keep Your Resistors in Order!

The sturdy, all-metal IRC Resist-O-Cabinet is specifically designed to hold resistors systematically and safely without the bending of leads. It puts an end to "cigar box confusion"! Its four "non-spill" drawers have seven ample-sized compartments in each which readily accommodate resistor sizes from 1/2 to 10 watts.

Attractively finished in blue, yellow and silver. Ohm's Law formulas neatly and permanently lithographed on top of cabinet for handy reference. Cabinet measures 11" long, 5 1/2" high and 5 1/2" deep. Bases of Resist-O-Cabinets are arranged for stacking so that several cabinets may be used to increase stock capacity. This handy Resist-O-Cabinet is FREE with the purchase of any of the three well-balanced IRC resistor assortments listed. (Cabinet is not sold empty.)

RESISTOR ASSORTMENT NO. 1—59 Resistors in Types, Sizes and Ranges for Every Job.

Type BT-1/2 (1/2 Watt)—One each 1,000; 5,000; 10,000; 25,000; 50,000 ohms; 0.1; 0.25 and 0.5 meg.

Type BT-1 (1 Watt)—One each 40,000 and 75,000 ohms; 0.15 and 0.2 meg. Two each 1,000; 1,500; 2,000; 2,500; 5,000; 15,000; 25,000 ohms and 1.0 and 2.0 meg. Three each 10,000; 50,000 ohms; 0.1; 0.25 and 0.5 meg.

Type AB (10 Watts Fixed)—One each 1,000; 1,500; 2,500 and 5,000 ohms. Two each 10,000; 15,000 and 25,000 ohms.

Type ABA (10 Watts Adjustable)—One each 1,000; 2,500; 5,000 and 10,000 ohms.

Actual value of above 59 Resistors (Resist-O-Cabinet free),

List \$16.46, Net \$9.88

ASSORTMENT NO. 2—Contains 100 Type BT-1/2 (1/2 Watt) Insulated resistors as follows: Two each 50; 100; 3,000; 7,500; 30,000; 65,000; 75,000 ohms; 0.15; 0.2; 0.3 meg. Three each 250; 500; 1,500; 15,000; 20,000; 40,000 ohms; 1.0; 2.0 meg. Five each 2,000; 2,500; 25,000 ohms; 0.25 meg. Six each 1,000; 5,000; 10,000; 50,000 ohms; 0.1 and 0.5 meg.

List price of Resistors, \$17.00 **Net \$10.20**
(Cabinet Free)

ASSORTMENT NO. 3—Contains 83 Type BT-1 (1 Watt) Insulated Resistors as follows: Two each 50; 100; 250; 500; 1,500; 2,500; 3,000; 7,500; 30,000; 40,000; 65,000; 75,000 ohms; 0.15; 0.2; 0.3; 1.0; 2.0 meg. Three each 15,000; 20,000; 25,000 ohms. Five each 1,000; 2,000; 5,000; 10,000; 50,000 ohms; 0.1; 0.25 and 0.5 meg.

List price of Resistors, \$16.60 **Net \$9.96**
(Cabinet Free)

IRC RESISTOR COLOR CODE CHART

This new IRC Standard RMA Resistor Color Code Chart includes both old and new style codes, tolerance designation, ruler and the various Ohm's Law formulas—all on a handy, pocket-size, Pyrolin card. 5c Net or FREE with purchase of 5 IRC Resistors.

POWER



RESISTORS

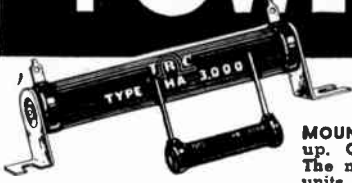

Not only do these famous resistors excel electrically, but their "climate-proofed" cement coating provides the most dependable protection yet devised for resistors for heavy duty work. Both fixed and adjustable types are available.

MOUNTING BRACKETS are packed with all resistors from 25 watts and up. ONE ADJUSTABLE BAND is furnished with each adjustable resistor. The new Type X Band (described below) is included as standard on units of 25 watts and above. Extra bands supplied at prices indicated.

FIXED TYPES

10 WATTS Type AB 1 3/4" x 5/16"		20 WATTS Type DG (Continued)		50 WATTS Type EP (Continued)		100 WATTS Type HA 6 1/2" x 1 1/8"	
Ohms	Max. m. a.	Ohms	Max. m. a.	Ohms	Max. m. a.	Ohms	Max. m. a.
1	3150	150	365	2,000	155	25	2000
2	2210	200	316	2,500	135	50	1414
3	1830	250	282	3,000	120	75	1155
5	1420	300	258	4,000	105	100	1000
7.5	1150	400	224	5,000	95	150	815
10	1000	500	200	List \$1.40		250	632
15	820	750	163	Net \$0.84		500	447
20	720	1,000	153	6,000	85	750	365
25	640	1,200	141	7,000	78	1,000	315
50	440	1,500	129	8,000	75	1,250	280
75	360	2,000	126	10,000	66	1,500	250
100	315	2,500	115	12,000	63	2,000	220
150	260	3,000	107	15,000	56	2,500	200
200	220	4,000	104	20,000	48	3,000	180
250	200	5,000	100	25,000	43	5,000	140
300	175	2,250	94	List \$1.60		List \$1.95	
350	169	2,400	91	Net \$0.96		Net \$1.17	
400	157	2,500	89	30,000	39	7,500	115
500	140	2,750	85	40,000	34	10,000	100
600	125	3,000	81	50,000	30	15,000	80
750	115	3,500	75	60,000	28	20,000	70
800	112	4,000	70	75,000	25	25,000	63
1,000	100	5,000	66	0.1 meg.		List \$2.20	
1,250	90	6,000	63	List \$1.60		Net \$1.32	
1,450	83	7,000	59	Net \$0.96		List \$2.50	
1,500	82	7,500	57	List \$1.40		Net \$1.50	
2,000	71	8,000	53	Net \$0.84		List \$2.75	
2,250	67	8,500	50	List \$1.20		Net \$1.65	
2,500	63	9,000	46	Net \$0.84		0.1 meg.	
3,000	57	10,000	43	60,000	41	List \$2.75	
3,500	53	11,000	41	75,000	36	Net \$1.65	
4,000	50	12,000	40	80,000	31	List \$2.75	
4,500	47	12,500	39	100,000	27	Net \$1.65	
5,000	45	15,000	35	List \$0.50		List \$2.75	
6,000	41	List \$0.85		List \$2.75		Net \$1.65	
7,000	37	Net \$0.51		0.1 meg.		List \$2.75	
7,500	36	20,000	30	List \$2.20		Net \$1.32	
8,000	35	25,000	28	List \$1.40		Net \$1.50	
8,500	34	30,000	25	Net \$0.84		List \$2.75	
9,000	33	35,000	23	List \$1.20		Net \$1.65	
10,000	31	40,000	22	Net \$0.84		List \$2.75	
List \$0.50		50,000	20	List \$1.60		Net \$1.32	
Net \$0.30		List \$1.10		List \$2.20		Net \$1.32	
11,000	30	60,000	13	List \$1.40		List \$2.50	
12,000	28	70,000	12	Net \$0.84		Net \$1.50	
12,500	28	80,000	11	List \$1.20		List \$2.75	
14,300	25	100,000	10	Net \$0.84		Net \$1.65	
15,000	25	List \$0.85		List \$2.20		Net \$1.32	
20,000	22	Net \$0.51		List \$1.40		List \$2.50	
25,000	20	Net \$0.66		List \$1.20		Net \$1.65	
30,000	19	List \$1.10		List \$2.20		List \$2.75	
35,000	12	Net \$0.66		List \$1.40		Net \$1.50	
40,000	11	List \$0.85		List \$2.20		List \$2.50	
50,000	10	Net \$0.66		List \$1.40		Net \$1.50	
List \$0.70		List \$1.10		List \$2.20		List \$2.50	
Net \$0.42		Net \$0.66		List \$1.40		Net \$1.50	
1	4400	List \$1.20		List \$2.20		List \$2.50	
5	2000	Net \$0.72		List \$1.40		Net \$1.50	
10	1415	List \$1.95		List \$2.20		List \$2.50	
25	895	Net \$1.17		List \$1.40		Net \$1.50	
50	633	List \$2.20		List \$2.20		List \$2.50	
75	517	Net \$1.32		List \$1.40		List \$2.50	
100	447	List \$2.50		List \$2.20		List \$2.50	
(Continued)		Net \$1.50		List \$2.20		List \$2.50	
(Continued)		0.1 meg.		List \$2.20		List \$2.50	
(Continued)		27		List \$2.20		List \$2.50	
(Continued)		0.1 meg.		List \$2.20		List \$2.50	

ADJUSTABLE TYPES

10 WATTS Type ABA 1 3/4" x 5/16"		25 WATTS Type DHA (Continued)		50 WATTS Type EPA (Continued)		100 WATTS Type HAA 6 1/2" x 1 1/8"	
Ohms	Max. m. a.	Ohms	Max. m. a.	Ohms	Max. m. a.	Ohms	Max. m. a.
1	3150	300	289	10,000	66	100	1000
2	2210	400	250	12,000	63	200	710
3	1830	500	224	15,000	56	400	500
5	1420	1,000	158	20,000	48	500	447
7.5	1150	1,250	141	25,000	43	750	365
10	1000	1,500	129	List \$1.90		1,000	315
15	820	2,000	112	Net \$1.14		1,500	250
20	720	2,250	105	30,000	39	2,000	220
25	640	2,500	100	40,000	34	2,500	200
50	440	3,000	91	50,000	30	3,000	180
75	360	3,500	84	List \$2.20		4,000	155
100	315	4,000	79	Net \$1.32		5,000	140
150	260	5,000	71	60,000	28	List \$2.50	
200	220	List \$1.10		75,000	25	Net \$1.50	
250	200	Net \$0.66		0.1 meg.	21	List \$2.50	
300	175	6,000	64	List \$1.95		Net \$1.50	
350	160	7,500	58	Net \$0.96		List \$2.50	
400	157	8,000	56	List \$1.40		Net \$1.50	
500	140	9,000	53	List \$2.20		List \$2.50	
600	125	10,000	50	Net \$0.84		List \$2.50	
750	115	12,000	45	List \$1.20		List \$2.50	
800	112	15,000	41	Net \$0.72		List \$2.50	
1,000	100	List \$1.20		List \$1.95		List \$2.50	
1,250	99	Net \$0.72		List \$2.20		List \$2.50	
1,450	83	20,000	35	List \$1.40		List \$2.50	
1,500	82	25,000	32	List \$1.20		List \$2.50	
2,000	71	List \$1.20		List \$1.40		List \$2.50	
2,250	67	Net \$0.72		List \$1.20		List \$2.50	
2,500	63	List \$1.40		List \$1.40		List \$2.50	
3,000	57	List \$1.20		List \$1.40		List \$2.50	
3,500	53	Net \$0.90		List \$1.40		List \$2.50	
4,000	50	List \$1.40		List \$1.40		List \$2.50	
4,500	47	List \$1.20		List \$1.40		List \$2.50	
5,000	45	List \$0.90		List \$1.40		List \$2.50	
6,000	41	3,165	31	List \$1.40		List \$2.50	
7,000	37	5	3165	List \$1.40		List \$2.50	
7,500	36	10	2230	List \$1.40		List \$2.50	
8,000	35	25	1390	List \$1.40		List \$2.50	
8,500	34	50	1000	List \$1.40		List \$2.50	
9,000	33	75	810	List \$1.40		List \$2.50	
10,000	31	100	700	List \$1.40		List \$2.50	
List \$0.50		150	550	List \$1.40		List \$2.50	
Net \$0.30		200	500	List \$1.40		List \$2.50	
List \$0.50		250	440	List \$1.40		List \$2.50	
Net \$0.30		300	375	List \$1.40		List \$2.50	
List \$0.50		400	350	List \$1.40		List \$2.50	
Net \$0.30		500	300	List \$1.40		List \$2.50	
List \$0.50		750	250	List \$1.40		List \$2.50	
Net \$0.30		800	248	List \$1.40		List \$2.50	
List \$0.50		1,000	215	List \$1.40		List \$2.50	
Net \$0.30		1,250	195	List \$1.40		List \$2.50	
List \$0.50		1,500	175	List \$1.40		List \$2.50	
Net \$0.30		2,000	155	List \$1.40		List \$2.50	
List \$0.50		2,500	135	List \$1.40		List \$2.50	
Net \$0.30		3,000	120	List \$1.40		List \$2.50	
List \$0.50		4,000	105	List \$1.40		List \$2.50	
Net \$0.30		5,000	95	List \$1.40		List \$2.50	
List \$0.50		List \$1.65		List \$1.40		List \$2.50	
Net \$0.30		Net \$0.99		List \$1.40		List \$2.50	
List \$0.50		6,000	85	List \$1.40		List \$2.50	
Net \$0.30		7,500	77	List \$1.40		List \$2.50	
List \$0.50		8,000	75	List \$1.40		List \$2.50	
Net \$0.30		List \$1.65		List \$1.40		List \$2.50	
List \$0.50		Net \$0.99		List \$1.40		List \$2.50	
Net \$0.30		List \$1.65		List \$1.40		List \$2.50	
List \$0.50		Net \$0.99		List \$1.40		List \$2.50	
Net \$0.30		List \$1.65		List \$1.40		List \$2.50	
List \$0.50		Net \$0.99		List \$1.40		List \$2.50	
Net \$0.30		List \$1.65		List \$1.40		List \$2.50	
List \$0.50		Net \$0.99		List \$1.40		List \$2.50	
Net \$0.30		List \$1.65		List \$1.40		List \$2.50	
List \$0.50		Net \$0.99		List \$1.40		List \$2.50	
Net \$0.30		List \$1.65		List \$1.40		List \$2.50	
List \$0.50		Net \$0.99		List \$1.40		List \$2.50	
Net \$0.30		List \$1.65		List \$1.40		List \$2.50	
List \$0.50		Net \$0.99		List \$1.40		List \$2.50	
Net \$0.30		List \$1.65		List \$1.40		List \$2.50	
List \$0.50		Net \$0.99		List \$1.40		List \$2.50	
Net \$0.30		List \$1.65		List \$1.40		List \$2.50	
List \$0.50		Net \$0.99		List \$1.40		List \$2.50	
Net \$0.30		List \$1.65		List \$1.40		List \$2.50	
List \$0.50		Net \$0.99		List \$1.40		List \$2.50	
Net \$0.30		List \$1.65		List \$1.40		List \$2.50	
List \$0.50		Net \$0.99		List \$1.40		List \$2.50	
Net \$0.30		List \$1.65		List \$1.40		List \$2.50	
List \$0.50		Net \$0.99		List \$1.40		List \$2.50	
Net \$0.30		List \$1.65		List \$1.40		List \$2.50	
List \$0.50		Net \$0.99		List \$1.40		List \$2.50	
Net \$0.30		List \$1.65		List \$1.40			

RHEOSTATS



RESISTORS

ALL-METAL RHEOSTATS



PR-25 (25 Watts) 1 1/2" diam. Depth behind panel, 3 1/2".
PR-50 (50 Watts) 2 3/8" diam. Depth behind panel, 1 3/8".

Operating temperatures are cut almost in half by the unique, all-metal aluminum construction of these new IRC Rheostats. They dissipate heat more rapidly—give ample safety factor. Ratings based on hottest spot temp. rise of only 140 degrees C. with max. load distributed over entire element. With full load applied to as little as 25% of element, rise is only 160 degrees C. Exclusive IRC Spiral Connector gives positive contact between rotor arm and center terminal.

NON-INDUCTIVE WIRE WOUNDS

Similar in size, style and construction to IRC fixed type Power Wire Wound Resistors except that interleaved windings in opposite directions result in negligible residual inductance and very low distributed capacity. No reduction in power ratings necessary when using these non-inductive resistors. IRC "Climate-Proof" cement coating.



	List Price	Net Price
50 Watts, Type NEP, 4 1/4" x 3/4", with brackets. All popular ranges from 5 ohms to 5,000 ohms.	\$3.00	\$1.80
100 Watts, Type NHA, 6 1/2" x 1 1/4", with brackets. All popular ranges from 5 ohms to 5,000 ohms.	4.00	2.40
200 Watts, Type NHO, 10 1/4" x 1 1/4", with brackets. 25, 50, 100, 250, 500, 750, 1,000, 1,500, 2,000, 2,500, 3,000 and 5,000 ohms.	5.00	3.00

HIGH FREQUENCY RESISTORS

Power Types

This new type Metallized Resistor is unexcelled as terminating resistor for Rhombic Antenna. Ratings represent maximum allowable dissipation in free air, based on maximum temperature of 140° C.



Type MPO — 800 ohms, 35 watts, 1 1/8" diam. x 10 1/2" long. Net \$3.00	Type MPR — 800 ohms, 100 watts, 2" diam. x 18 1/2" long. Net \$7.50	Type MPR — 400 ohms, 100 watts, 2" diam. x 18 1/2" long. Net \$7.50
--	---	---

Type NAB PARASITIC SUPPRESSOR

IRC Type NAB Non-Inductive Wire Wound Resistors are designed for use, one in each grid of audio driver or power amplifier tubes when paralleled, to prevent parasitic oscillations. 10 watts.



Type NAB—50 ohms; list \$0.90 each; Net 54c each

CENTER TAP INSULATED WIRE WOUNDS

Completely enclosed in molded bakelite and capable of standing high temperatures. Due to high power rating, these resistors may be used in balancing circuits for radio receivers or transmitters. They will carry up to five watts if mounted on chassis using the detachable mounting bracket and heat-dissipating metal strip; or two and one-half watts if mounted in open air. May be mounted anywhere without danger to units from heat or grounding.



Type MW-2J Center Tap Resistors — List Each 35c; Net 21c
DIMENSIONS: Length of molded unit 2". With bracket mounting centers 2 1/2". Six Standard Ranges: 10 ohms; 20 ohms; 50 ohms; 75 ohms; 100 ohms and 200 ohms.

BLEEDER RESISTOR

Type M-1034—25,000 ohms, over-all resistance, tapped at 7,500; 10,000; 12,500 and 15,000 ohms. 18 watts rating attached flat to chassis, 9 watts free air rating. Used as bleeder in any power supply up to 500 volts. Sealed in bakelite and insulated for 1,000 volts to ground. Bracket supplied.



M-1034—IRC Bleeder Resistor; List \$1.25; Net 75c each

METALLIZED MOTOR RADIO SUPPRESSORS

Constructed without springs, steel wool, rivets or other intermediate parts which might loosen or corrode under intense heat, motor vibration or climatic conditions.

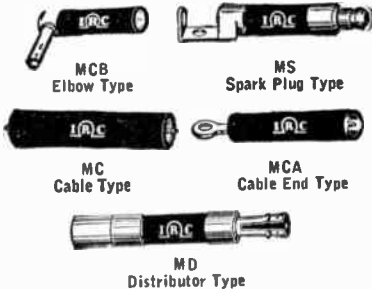

All Types List, 30c each
 Net, 18c each



MD Distributor Type

PR-25—25 Watts				PR-50—50 Watts			
Ohms	Max. m.a.	List Price	Net Price	Ohms	Max. m.a.	List Price	Net Price
0.5	7,000	\$4.50	\$2.70	0.5	10,000	\$5.00	\$3.00
1	5,000	4.50	2.70	1	7,070	5.00	3.00
2	3,450	4.00	2.40	2	5,000	5.00	3.00
3	2,880	4.00	2.40	4	3,520	4.50	2.70
6	2,040	4.00	2.40	6	2,880	4.50	2.70
8	1,770	4.00	2.40	8	2,880	4.50	2.70
10	1,580	4.00	2.40	12	2,040	4.50	2.70
15	1,290	4.00	2.40	16	1,770	4.50	2.70
25	1,000	4.00	2.40	22	1,500	4.50	2.70
35	845	4.00	2.40	35	1,190	4.50	2.70
50	709	4.00	2.40	50	1,000	4.50	2.70
75	575	4.00	2.40	80	790	4.50	2.70
100	500	4.00	2.40	125	630	4.50	2.70
125	445	4.00	2.40	150	575	4.50	2.70
175	375	4.00	2.40	225	470	4.50	2.70
250	315	4.00	2.40	300	407	4.50	2.70
350	267	4.00	2.40	500	315	4.50	2.70
500	222	4.00	2.40	800	250	4.75	2.85
750	173	4.00	2.40	1,000	223	4.75	2.85
1,000	155	4.50	2.70	1,600	177	4.75	2.85
1,500	129	4.50	2.70	2,500	140	4.75	2.85
2,500	100	4.50	2.70	3,500	120	5.00	3.00
3,500	84	4.75	2.85	5,000	100	5.00	3.00
5,000	70	4.75	2.85	8,000	79	5.00	3.00
				10,000	70	5.00	3.00

IRC TYPE F RESISTORS



Unexcelled for high frequency work when constant impedance over a wide frequency band is essential.

- 1/2 Watt (Type F-1/2)—50 ohms to 20 meg..... List 17c; Net 10c
- 1 Watt (Type F-1)—100 ohms to 20 meg..... List 20c; Net 12c
- 2 Watts (Type F-2)—50 ohms to 10 meg..... List 30c; Net 18c
- 3 Watts (Type F-3)—100 ohms to 5 meg..... List 30c; Net 18c



ULTRA HIGH RANGE Metallized RESISTORS

Available in sizes from 1 3/4" to 12" long in ranges from 100 meg. to 100,000 meg. Surface leakage problem solved by exclusive Metallized-type element and construction features. Complete description and record of other sizes on request. Std. tolerance ±10%. Closer tolerances available.

Available in sizes from 1 3/4" to 12" long in ranges from 100 meg. to 100,000 meg. Surface leakage problem solved by exclusive Metallized-type element and construction features. Complete description and record of other sizes on request. Std. tolerance ±10%. Closer tolerances available.

TYPE FH-1

1 3/16" x 1 1/2"—500 Volts Max.
 Each
 100, 250 or 500 Meg...Net \$1.00
 1,000 or 5,000 Meg...Net 1.50
 10,000 Meg.Net 2.00

TYPE MG-3

3" x 1 1/2"—1,000 Volts Max.
 Each
 100, 250 or 500 Meg...Net \$1.15
 1,000 or 5,000 Meg...Net 1.65
 10,000 or 20,000 Meg. Net 2.15

ATTENUATORS



RESISTORS

IRC Type A-21 ATTENUATORS

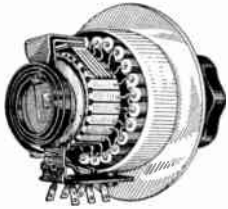

Type A-21

Molded Commutator
Switching Mechanism

4-Finger Beryllium
Copper Contact

"Silent Spiral" Clock
Spring Connector

The IRC Type A-21 Attenuator utilizes a unique molded commutator-type switching mechanism with conducting segments of polished, hard-drawn copper molded in phenolic. This, combined with a multi-finger beryllium copper contact and a flat clock-spring connector, assures an exceptionally low noise level which is maintained in actual service. Either potentiometer or ladder networks are available. Range from 0 to infinity in 21 steps; linear attenuation to 45 DB in 13 steps of 2.5 DB per step, tapering to infinity. Other values available. Standard units supplied with detent, although units without detent are available on special order at same prices. Unit is 2" long by 2" diameter. Dial plate, knob and mounting screws furnished.

STANDARD UNITS SUPPLIED WITH DETENT.

Type	Impedance	Network	Net
A-21L50	50 ohms	Ladder	\$7.00
A-21L200	200 ohms	Ladder	7.00
A-21L250	250 ohms	Ladder	7.00
A-21L500	500 ohms	Ladder	7.00
A-21-250M	250,000 ohms	Potent	6.75

IRC Type B-31 ATTENUATORS



Type B-31

Bridged T Network
with Zero Insertion Loss

Flat Frequency Characteristic
over Entire Audio Range

Unusually Low Noise Level
Maintained in Service

The IRC Type B-31 Attenuator employs spiral clock-spring connectors in each arm of the bridged "T" to eliminate wiping contacts and assure a maintained low noise level in service. Standard 30-step attenuation is linear for 24 steps; 1.5 DB per step up to 36 DB; tapering off to 65 DB on next to last, and to infinity on last step. Other values on special order. Bridged "T" circuit has constant impedance looking "in" and "out". The frequency response is substantially flat over the entire audio range. Supplied with or without detent. IRC Insulated Resistors are used for their inherent characteristics of stability and low noise level. 2" long x 2 1/8" diameter. Dial plate, knob and mounting screws furnished.

STANDARD UNITS SUPPLIED WITH DETENT.

Type	Impedance	Network	Net
B-31T50	50 ohms	Bridged T	\$17.50
B-31T200	200 ohms	Bridged T	17.50
B-31T250	250 ohms	Bridged T	17.50
B-31T500	500 ohms	Bridged T	17.50

PRECISION WIRE WOUND RESISTORS

IRC Precision Wire Wound Resistors are scientifically designed and constructed of highest quality materials to combine the utmost in accuracy with dependability. Winding forms are of a nonhygroscopic ceramic having high insulation qualities, high mechanical strength and low coefficient of expansion. Because of the special sectional construction which permits the winding of adjacent sections in opposite directions, a noninductive winding is made possible. This insures constant resistance at all frequencies up to 50,000 cycles.

These units are used by the leading instrument manufacturers for dependable precision meter multipliers and shunts, decade boxes and calibrated gain controls. 1% accuracy is standard. Closer tolerances available at slightly higher prices as follows: for 3/4% tolerance, add 10%; for 1/2% accuracy, add 15%; and for 1/10 of 1%, add 25% to list prices.



Types WW-4
9/16" x 1"
WW-5
3/4" x 1 1/4"



Types WW-1
9/16" x 2 1/8"
WW-2
3/8" x 2-15/16"

	WW-4		WW-1	
	List	Net	List	Net
0.1; 0.5; 1; 10; 25; 50; 100; 200; 250; 300 and 500 ohms	\$0.85	\$0.51	\$1.15	\$0.69
1,000; 1,500 and 2,000 ohms	.90	.54	1.15	.69
2,500 ohms	.90	.54	1.25	.75
4,000; 5,000; 7,500 and 10,000 ohms	1.00	.60	1.25	.75
12,500 and 15,000 ohms	1.10	.66	1.35	.81
20,000; 22,500; 25,000; 30,000; 40,000 and 50,000 ohms	1.35	.81	1.60	.96
60,000 and 75,000 ohms	1.60	.96	1.90	1.14
0.1 meg.	1.85	1.11	2.10	1.26
0.125 meg.	2.10	1.26	2.40	1.44
0.15; 0.175 and 0.2 meg.	2.35	1.41	2.65	1.59
0.225 and 0.25 meg.	2.60	1.56	2.90	1.74
0.3 meg	2.85	1.71	3.15	1.89
0.4 meg	3.00	1.80	3.15	1.89
0.5 meg	3.40	2.04	3.65	2.19
		WW-5	WW-2	
0.6 meg	4.25	2.55	4.25	2.55
0.75 meg	4.50	2.70	4.50	2.70
0.9 meg	4.75	2.85	4.75	2.85
1.0 meg	5.25	3.15	5.25	3.15
1.5 meg			7.50	4.50
2.0 meg			10.00	6.00
2.5 meg			12.50	7.50

For list prices of odd ranges not shown, use same price as given for next higher range. Type WW-3 (9/16" x 9/16") with wire leads or lug terminals obtainable on special order at same price as WW-4. Made in all ranges from 1 ohm to 0.15 meg. WW-4 and WW-5 with wire lead terminals instead of lugs are available on special order at no increase in cost.

Special Precision Resistor Types

In addition to those listed here, IRC offers a complete line of 14 Precision Resistor types in sizes, shapes and terminals for every need. See IRC General Catalog No. 48.

L- and T-PAD ATTENUATORS

By the use of special tapers and connections, the well-known IRC Type "CS" Dual and Triple Controls are now available as L-Pad and T-Pad Attenuators. Because of the extremely low noise level of these units resulting from the Silent Spiral Connector, the 5-Finger Silent Element Contactor and other IRC features, they are specially adapted to controlling low level input circuits in inexpensive sound equipment of all kinds.



L-Pads (dual)

Type I-1088	50 ohms*
Type I-1089	200 "
Type I-1090	250 "
Type I-976	500 "

List Price \$2.50, Net \$1.50

T-PADS (triple)

Type I-1091	50 ohms*
Type I-1092	200 "
Type I-1093	250 "
Type I-977	500 "

List Price \$3.50, Net \$2.10

* These controls are Wire Wound.

Utah

VITREOUS ENAMELED RESISTORS

UTAH Vitreous Enameled Resistors are perfectly protected against corrosion from salt spray, moisture, acids and alkalis, as their coating is genuine Vitreous Enamel, applied by a wet process, then fired in a furnace at a high temperature which fuses it into a hard glassy enamel which adheres permanently to the rugged porcelain tube core, resistance wire and terminals. To be doubly protected, all Utah Vitreous Enameled Resistors receive two generous coats, each of which is separately fired.

Utah terminals cannot tear loose, being securely eye-letted around the tube. Resistance wire joined to terminal on opposite side of tube from lug, so severe bending of soldering lugs cannot break the wire.

See reverse side for Adjustable Types.

10 WATT SIZES Type CC

RATING: 10 Watts up to 2000 ohms in free air. Higher resistance units rated as listed in table. $1\frac{3}{8}$ " long, $\frac{3}{8}$ " overall diameter. $\frac{1}{8}$ " long No. 18 Ga. tinned wire pigtail leads.

Ohms	Max. Current in Mils	Max. Voltage	List Price	Net Price	Ohms	Max. Current in Mils	Max. Voltage	List Price	Net Price
1	3,150	3	\$0.40	\$0.24	2,500	61	154	\$0.40	\$0.24
2	2,230	4.4	.40	.24	3,000	56	169	.40	.24
3	1,825	5.4	.40	.24	3,500	51	179	.40	.24
4	1,580	6.3	.40	.24	4,000	47	190	.40	.24
5	1,415	7	.40	.24	4,500	44	197	.40	.24
10	1,000	10	.40	.24	5,000	40	200	.40	.24
15	815	12	.40	.24	6,000	36	219	.40	.24
25	630	15	.40	.24	7,000	33	230	.40	.24
50	535	18	.40	.24	7,500	32	245	.40	.24
75	447	22	.40	.24	8,000	31	248	.40	.24
100	365	27	.40	.24	8,500	30	245	.40	.24
150	315	31	.40	.24	10,000	24	245	.40	.24
200	258	38	.40	.24	11,000	22	242	.40	.24
250	223	44	.40	.24	12,000	20	245	.40	.24
300	200	50	.40	.24	12,500	20	240	.40	.24
350	182	54	.40	.24	13,500	19	256	.40	.24
400	169	59	.40	.24	14,300	18	258	.40	.24
450	158	63	.40	.24	15,000	18	274	.40	.24
500	149	67	.40	.24	16,000	17	272	.40	.24
600	141	70	.40	.24	17,500	17	298	.40	.24
750	129	77	.40	.24	18,000	16	288	.40	.24
800	115	86	.40	.24	20,000	15	316	.40	.24
850	111	88	.40	.24	22,500	15	338	.40	.24
900	105	94	.40	.24	25,000	14	354	.40	.24
1,000	100	100	.40	.24	30,000	8	240	.40	.24
1,250	89	111	.40	.24	35,000	7	245	.40	.24
1,500	79	119	.40	.24	40,000	7	280	.40	.24
1,750	74	130	.40	.24	50,000	6	300	.40	.24
2,000	69	138	.40	.24					

20 WATT SIZES—Type EE

RATING: 20 Watts up to 10,000 ohms in free air. Higher resistance units rated as listed in table. 2" long, $\frac{1}{8}$ " overall diameter, $\frac{1}{8}$ " inside diameter. Supplied with mounting brackets, 2 $\frac{3}{8}$ " mounting centers. Has soldering lug terminals.

Ohms	Max. Current in Mils	Max. Voltage	List Price	Net Price	Ohms	Max. Current in Mils	Max. Voltage	List Price	Net Price
5	2,000	10	\$0.65	\$0.39	2,500	89	223	\$0.65	\$0.39
10	1,415	14	.65	.39	2,750	85	234	.65	.39
15	895	18	.65	.39	3,000	81	245	.65	.39
20	633	21	.65	.39	3,500	75	264	.65	.39
50	517	38	.65	.39	4,000	70	283	.65	.39
100	448	44	.65	.39	4,500	66	300	.65	.39
150	365	54	.65	.39	5,000	63	316	.65	.39
200	316	63	.65	.39	6,000	57	346	.65	.39
250	283	70	.65	.39	7,000	53	374	.65	.39
300	258	77	.65	.39	7,500	51	387	.65	.39
350	239	83	.65	.39	8,000	50	400	.65	.39
400	223	89	.65	.39	10,000	43	436	.65	.39
500	200	100	.65	.39	12,500	39	488	.65	.39
650	175	114	.65	.39	15,000	34	520	.65	.39
750	169	118	.65	.39	20,000	27	565	.75	.45
800	163	122	.65	.39	25,000	25	630	.75	.45
850	158	126	.65	.39	30,000	21	635	.75	.45
900	153	130	.65	.39	35,000	18	648	.75	.45
1,000	141	141	.65	.39	40,000	17	694	.75	.45
1,200	129	153	.65	.39	50,000	11	550	.75	.45
1,500	115	173	.65	.39	60,000	8	490	1.00	.60
1,750	107	187	.65	.39	75,000	7	547	1.00	.60
2,000	100	200	.65	.39	85,000	6.5	583	1.00	.60
2,250	94	212	.65	.39	100,000	6	633	1.00	.60

50 WATT SIZES—Type KK

RATING: 50 Watts up to 20,000 ohms in free air. Higher resistance units rated as listed in table. $4\frac{1}{2}$ " long, $\frac{1}{2}$ " overall diameter, $\frac{1}{2}$ " inside diameter. Supplied with mounting brackets, 5 $\frac{3}{8}$ " mounting centers. Has soldering lug terminals.

Ohms	Max. Current in Mils	Max. Voltage	List Price	Net Price	Ohms	Max. Current in Mils	Max. Voltage	List Price	Net Price
5	3,160	15	\$1.10	\$0.66	5,000	100	500	\$1.10	\$0.66
10	2,240	22	1.10	.66	7,500	81	600	1.25	.75
15	1,420	35	1.10	.66	8,000	79	632	1.25	.75
50	1,000	50	1.10	.66	10,000	70	700	1.25	.75
75	815	61	1.10	.66	12,000	64	768	1.25	.75
100	707	70	1.10	.66	15,000	57	850	1.25	.75
150	577	86	1.10	.66	20,000	48	960	1.25	.75
200	500	100	1.10	.66	25,000	43	1,070	1.25	.75
250	447	110	1.10	.66	35,000	33	1,150	1.45	.87
500	316	158	1.10	.66	50,000	25	1,250	1.45	.87
750	258	193	1.10	.66	75,000	18	1,200	1.45	.87
800	250	200	1.10	.66	100,000	12	1,200	1.45	.87
1,000	224	224	1.10	.66	125,000	11	1,375	2.00	1.20
1,500	183	274	1.10	.66	150,000	9	1,350	2.25	1.35
2,000	158	316	1.10	.66	175,000	7	1,225	2.25	1.35
2,500	142	354	1.10	.66	200,000	7	1,400	2.50	1.50
3,000	129	387	1.10	.66	250,000	6	1,500	2.75	1.65
4,000	112	448	1.10	.66					

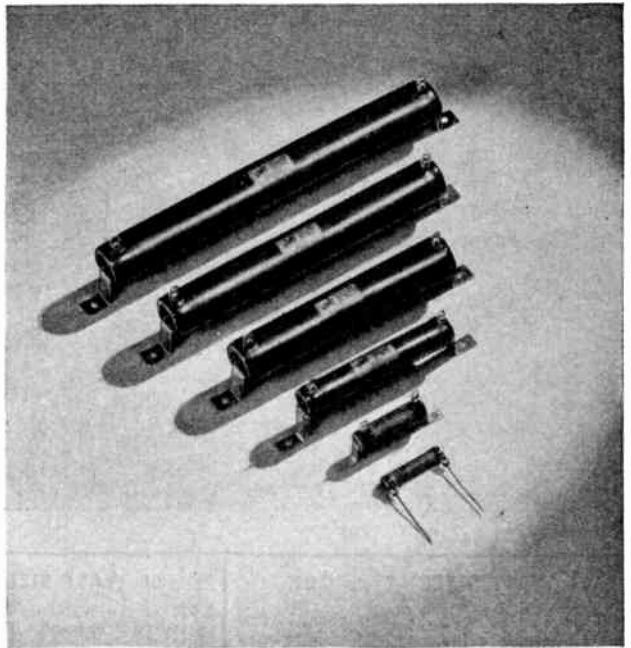

100 WATT SIZES—Type NN

RATING: 100 Watts up to 20,000 ohms in free air. Higher resistance units rated as listed in table. $6\frac{1}{2}$ " long, $1\frac{1}{4}$ " overall diameter, $\frac{3}{8}$ " inside diameter. Supplied with mounting brackets, 7 $\frac{3}{8}$ " mounting centers. Has soldering lug terminals.

Ohms	Max. Current in Mils	Max. Voltage	List Price	Net Price	Ohms	Max. Current in Mils	Max. Voltage	List Price	Net Price
5	4,470	23	\$1.50	\$0.90	2,500	200	500	1.50	.90
10	3,160	31	1.50	.90	3,000	182	545	1.50	.90
25	2,000	50	1.50	.90	5,000	141	700	1.50	.90
50	1,414	70	1.50	.90	7,500	115	860	1.75	1.05
75	1,155	85	1.50	.90	10,000	100	1,000	1.75	1.05
100	1,000	100	1.50	.90	15,000	81	1,200	1.75	1.05
150	815	120	1.50	.90	20,000	70	1,400	1.75	1.05
250	632	155	1.50	.90	25,000	56	1,400	1.75	1.05
500	447	220	1.50	.90	30,000	51	1,500	2.00	1.20
750	365	275	1.50	.90	40,000	38	1,520	2.00	1.20
1,000	316	315	1.50	.90	50,000	28	1,400	2.00	1.20
1,500	258	385	1.50	.90	75,000	16	1,200	2.25	1.35
2,000	223	445	1.50	.90	100,000	14	1,400	2.50	1.50

160 WATT SIZES—Type PP

RATING: 160 Watts up to 25,000 ohms in free air. Higher resistance units rated as listed in table. $8\frac{1}{2}$ " long, $1\frac{1}{4}$ " overall diameter, $\frac{3}{8}$ " inside diameter. Supplied with mounting brackets, 9 $\frac{3}{8}$ " mounting centers. Has soldering lug terminals.

Ohms	Max. Current in Mils	Max. Voltage	List Price	Net Price	Ohms	Max. Current in Mils	Max. Voltage	List Price	Net Price
5	5,660	33	\$2.00	\$1.20	2,500	253	632	\$2.00	\$1.20
10	4,000	40	2.00	1.20	3,000	231	692	2.00	1.20
25	2,530	63	2.00	1.20	5,000	179	895	2.00	1.20
50	1,788	89	2.00	1.20	7,500	146	1,090	2.00	1.20
75	1,460	108	2.00	1.20	10,000	126	1,260	2.00	1.20
100	1,266	126	2.00	1.20	15,000	103	1,545	2.40	1.44
150	1,035	150	2.00	1.20	20,000	89	1,780	2.40	1.44
250	800	200	2.00	1.20	25,000	80	2,000	2.40	1.44
500	566	282	2.00	1.20	30,000	73	2,190	2.40	1.44
750	462	346	2.00	1.20	40,000	55	2,200	2.40	1.44
1,000	400	400	2.00	1.20	50,000	43	2,150	2.40	1.44
1,500	328	490	2.00	1.20	75,000	27	2,020	2.70	1.62
2,000	283	566	2.00	1.20	100,000	18	1,800	2.70	1.62

200 WATT SIZES—Type UU

RATING: 200 Watts up to 30,000 ohms in free air. Higher resistance units rated as listed in table. $10\frac{1}{2}$ " long, $1\frac{1}{4}$ " overall diameter, $\frac{3}{8}$ " inside diameter. Supplied with mounting brackets, 11 $\frac{3}{8}$ " mounting centers. Has soldering lug terminals.

Ohms	Max. Current in Mils	Max. Voltage	List Price	Net Price	Ohms	Max. Current in Mils	Max. Voltage	List Price	Net Price
5	6,310	31	\$2.50	\$1.50	2,500	283	605	\$2.50	\$1.50
10	4,470	44	2.50	1.50	3,000	258	770	2.50	1.50
25	2,830	70	2.50	1.50	5,000	200	1,000	2.50	1.50
50	2,000	100	2.50	1.50	7,500	163	1,200	2.50	1.50
75	1,635	120	2.50	1.50	10,000	141	1,400	2.50	1.50
100	1,414	140	2.50	1.50	15,000	115	1,725	3.00	1.80
150	1,150	170	2.50	1.50	20,000	100	2,000	3.00	1.80
250	894	220	2.50	1.50	25,000	89	2,200	3.00	1.80
500	632	315	2.50	1.50	30,000	81	2,400	3.00	1.80
750	515	385	2.50	1.50	40,000	63	2,500	3.00	1.80
1,000	447	447	2.50	1.50	50,000	49	2,450	3.00	1.80
1,500	364	545	2.50	1.50	75,000	30	2,200	3.00	1.80
2,000	316	630	2.50	1.50	100,000	20	2,000	3.00	1.80

Utah

ADJUSTABLE VITREOUS ENAMEL RESISTORS

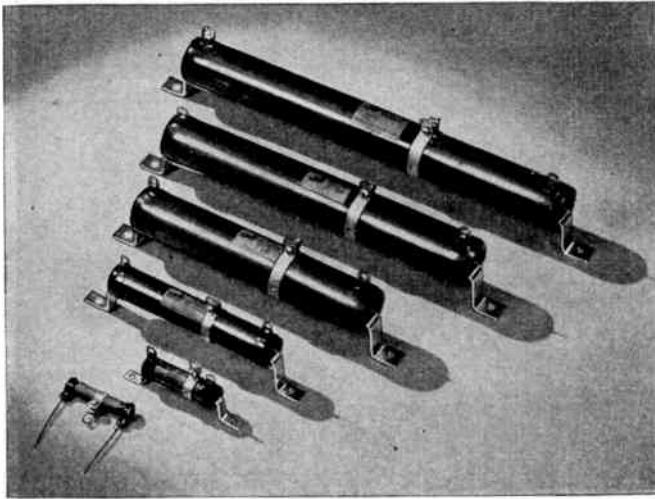

UTAH Adjustable Types have all the dependable features of the fixed units described on the reverse side; and in addition, the turns of the resistance wire are exposed in a narrow strip to make contact with the adjustable terminal band. Even in this partly exposed area, the wires are protected and anchored from shifting by an enamel which lies between the turns. The cadmium-plated steel adjustable terminal can be set at any desired value along the resistor, and clamped in place with a screw and nut. The wattage which may be safely dissipated at fractional settings is proportional to the effective length of the section being used. Thus an adjustable resistor rated at 50 watts overall, may safely take 25 watts over half of the winding.

10 WATT SIZES—Type CCX

RATING: 10 Watts up to 2000 ohms in free air, entire element. Higher resistance units rated as listed in table. 1 1/4" long, 3/8" overall diameter. Equipped with tinned lug type terminals at each end and one adjustable terminal.

Ohms	Max. Current in Mills	Max. Voltage	List Price	Net Price
10	1,000	10	\$0.60	\$0.36
25	630	15	.60	.36
50	447	22	.60	.36
100	315	31	.60	.36
250	200	50	.60	.36
500	141	70	.60	.36
750	115	86	.60	.36
1,000	100	100	.60	.36
1,500	79	119	.60	.36
2,500	61	154	.60	.36
4,000	47	190	.60	.36
5,000	40	200	.60	.36
7,500	32	245	.60	.36
10,000	24	245	.60	.36

20 WATT SIZES—Type EEX

RATING: 20 Watts up to 10,000 ohms in free air, entire element. Higher resistance units rated as listed in table. 2" long 5/8" overall diameter, 5/8" inside diameter. Supplied with mounting brackets, 2 3/4" mounting centers and one adjustable terminal. Has soldering lug terminals.

Ohms	Max. Current in Mills	Max. Voltage	List Price	Net Price
10	1,415	14	\$0.85	\$0.51
25	895	22	.85	.51
50	633	31	.85	.51
100	448	44	.85	.51
250	283	70	.85	.51
500	200	100	.85	.51
750	163	122	.85	.51
1,000	141	141	.85	.51
1,500	115	173	.85	.51
2,500	89	223	.85	.51
4,000	70	283	.85	.51
5,000	63	316	.85	.51
7,500	51	387	.95	.57
10,000	43	436	.95	.57
15,000	34	526	.95	.57
25,000	25	630	1.10	.66

50 WATT SIZES—Type KKK

RATING: 50 Watts up to 20,000 ohms in free air, entire element. Higher resistance units rated as listed in table. 4 1/2" long, 1 1/4" overall diameter, 1/2" inside diameter. Supplied with mounting brackets, 5 3/4" mounting centers, and one adjustable terminal. Has soldering lug terminals.

Ohms	Max. Current in Mills	Max. Voltage	List Price	Net Price
10	2,240	22	\$1.35	\$0.81
25	1,420	35	1.35	.81
50	1,000	50	1.35	.81
100	707	70	1.35	.81
250	447	110	1.35	.81
500	316	158	1.35	.81
750	258	193	1.35	.81
1,000	224	224	1.35	.81
1,500	183	274	1.35	.81
2,500	142	354	1.35	.81
4,000	112	448	1.35	.81
5,000	100	500	1.35	.81
7,500	81	600	1.50	.90
10,000	70	700	1.50	.90
15,000	57	850	1.50	.90
25,000	43	1,070	1.50	1.02
40,000	35	1,400	1.70	1.02
50,000	25	1,250	1.70	1.02
75,000	15	1,200	2.00	1.20
100,000	12	1,200	2.00	1.20

100 WATT SIZES—Type NNX

RATING: 100 Watts up to 20,000 ohms in free air, entire element. Higher resistance units rated as listed in table. 6 1/2" long, 1 1/4" overall diameter, 3/4" inside diameter. Supplied with mounting brackets, 7 3/4" mounting centers, and one adjustable terminal. Has soldering lug terminals.

Ohms	Max. Current in Mills	Max. Voltage	List Price	Net Price
25	2,000	50	\$2.00	\$1.20
50	1,414	70	2.00	1.20
100	1,000	100	2.00	1.20
500	447	220	2.00	1.20
1,000	316	315	2.00	1.20
2,500	200	500	2.00	1.20
5,000	141	700	2.00	1.35
10,000	100	1,000	2.25	1.35
15,000	81	1,200	2.25	1.35
20,000	70	1,400	2.25	1.35
25,000	56	1,400	2.25	1.35
40,000	38	1,520	2.50	1.50
50,000	28	1,400	2.50	1.50
75,000	16	1,200	2.75	1.65
100,000	14	1,400	2.75	1.65

160 WATT SIZES—Type PPX

RATING: 160 Watts up to 25,000 ohms in free air, entire element. Higher resistance units rated as listed in table. 8 1/2" long, 1 1/4" overall diameter, 3/4" inside diameter. Supplied with mounting brackets, 9 3/4" mounting centers, and one adjustable terminal. Has soldering lug terminals.

Ohms	Max. Current in Mills	Max. Voltage	List Price	Net Price
25	2,530	63	\$2.50	\$1.50
50	1,788	89	2.50	1.50
100	1,266	126	2.50	1.50
500	566	282	2.50	1.50
1,000	400	400	2.50	1.50
2,500	253	432	2.50	1.50
5,000	179	895	2.50	1.50
10,000	126	1,260	2.50	1.50
15,000	103	1,545	2.90	1.74
20,000	89	1,780	2.90	1.74
25,000	80	2,000	2.90	1.74
40,000	55	2,200	2.90	1.74
50,000	43	2,150	2.90	1.74
75,000	27	2,020	3.25	1.95
100,000	18	1,800	3.25	1.95

200 WATT SIZES—Type UUX

RATING: 200 Watts up to 30,000 ohms in free air, entire element. Higher resistance units rated as listed in table. 10 1/2" long, 1 1/4" overall diameter, 3/4" inside diameter. Supplied with mounting brackets, 11 3/4" mounting centers, and one adjustable terminal. Has soldering lug terminals.

Ohms	Max. Current in Mills	Max. Voltage	List Price	Net Price
25	2,830	70	\$3.00	\$1.80
50	2,000	100	3.00	1.80
100	1,414	140	3.00	1.80
500	632	315	3.00	1.80
1,000	447	447	3.00	1.80
2,500	283	705	3.00	1.80
5,000	200	1,000	3.00	1.80
10,000	141	1,400	3.00	1.80
15,000	115	1,725	3.50	2.10
20,000	100	2,000	3.50	2.10
25,000	89	2,200	3.50	2.10
40,000	63	2,500	3.50	2.10
50,000	49	2,450	3.50	2.10
75,000	30	2,200	3.50	2.10
100,000	20	2,200	3.50	2.10

EXTRA ADJUSTABLE TERMINALS

	List	Net
Type C—For model CCX	\$0.10	\$0.06
Type E—For model EEX	.10	.06
Type K—For model KKK	.10	.06
Type NPU—For models NNX-PPX-UUX	.10	.06

COMMERCIAL, INDUSTRIAL AND EQUIPMENT TYPE POTENTIOMETERS AND RHEOSTATS

"M" Type Variable Resistor and Potentiometer



Dissipates 4 Watts — Insulated Contact Arm. Use Dial Plate No. 395. 294° total rotation; 281° effective electrical rotation. Prices include one No. 232 Nut.

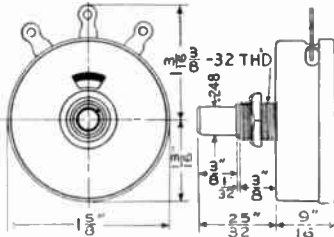

"C" Type Variable Resistor and Potentiometer

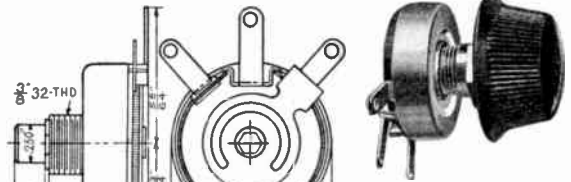

Dissipates 2 Watts—Grounded Contact Arm. Use Dial Plate No. 393. 284° total rotation; 266° effective electrical rotation. Prices include one No. 232 Nut.

Ohms Resistance	Carrying Capacity in Amps.	Poten-tiometer Cat. No.	List Price	Rheostat* Catalog Number	Price
1/4	2.80			M05R	\$0.75
1	2.00			M1R	.75
2	1.4			M2R	.75
3	1.15			M3R	.75
4	1.00			M4R	.75
6	.82			M6R	.75
10	.63			M10R	.75
15	.52	M15P	\$1.00	M15R	.75
20	.45	M20P	1.00	M20R	.75
25	.40	M25P	1.00	M25R	.75
30	.37	M30P	1.00	M30R	.75
40	.32	M40P	1.00	M40R	.75
50	.28	M50P	1.00	M50R	.75
60	.26	M60P	1.00	M60R	.75
75	.23	M75P	1.00	M75R	.75
100	.20	M100P	1.00	M100R	.75
200	.14	M200P	1.00		
400	.10	M400P	1.00		
500	.09	M500P	1.00		
600	.082	M600P	1.00		
1M	.063	M1MP	1.25		
2M	.045	M2MP	1.25		
3M	.037	M3MP	1.25		
4M	.032	M4MP	1.25		
5M	.028	M5MP	1.25		
10M	.020	M10MP	1.50		
15M	.016	M15MP	1.50		
20M	.014	M20MP	1.50		
25M	.013	M25MP	1.50		
50M	.009	M50MP	2.00		
70M	.0075	M70MP	2.00		

Ohms Resistance	Carrying Capacity in Amps.	Poten-tiometer Cat. No.	List Price	Rheostat* Catalog Number	List Price
6	.58	C6P	\$1.00	C6R	\$0.75
10	.45	C10P	1.00	C10R	.75
15	.37	C15P	1.00	C15R	.75
20	.32	C20P	1.00	C20R	.75
30	.26	C30P	1.00	C30R	.75
40	.22	C40P	1.00	C40R	.75
50	.2	C50P	1.00	C50R	.75
100	.14	C100P	1.00	C100R	.75
200	.1	C200P	1.00		
400	.07	C400P	1.00		
1M	.045	C1MP	1.25		
3M	.025	C3MP	1.25		
5M	.02	C5MP	1.50		
6M	.018	C6MP	1.50		
10M	.014	C10MP	1.50		
15M	.011	C15MP	1.50		

*"Open" or "off" position counter-clockwise.

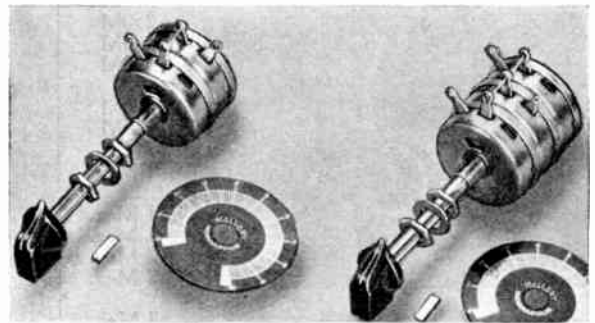

"E" Type Potentiometer

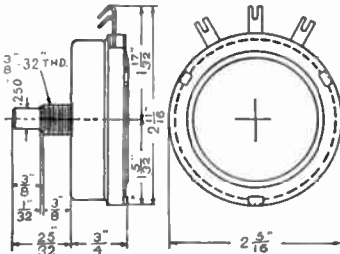

Dissipates 9 Watts—Contact Arm Grounded. Use Dial Plate No. 399. 318° total rotation; 304° effective electrical rotation. Prices include one No. 232 Nut.

Ohms Resistance	Carrying Capacity in Amps.	Catslog Number	List Price	Ohms Resistance	Carrying Capacity in Amps.	Catslog Number	List Price
5M	.042	E5MP	\$2.50	75M	.011	E75MP	\$2.75
10M	.03	E10MP	2.50	100M	.0095	E100MP	2.75
20M	.021	E20MP	2.50	125M	.0085	E125MP	2.75
25M	.019	E25MP	2.75	150M	.0078	E150MP	2.75
50M	.0135	E50MP	2.75				

"T" PAD ATTENUATORS

Ohms Impedance	Catalog Number	List Price
6	T6	\$5.00
8	T8	5.00
15	T15	5.00
50	T50	5.00
200	T200	5.00
250	T250	5.00
500	T500	5.00
2000	T2000	5.00

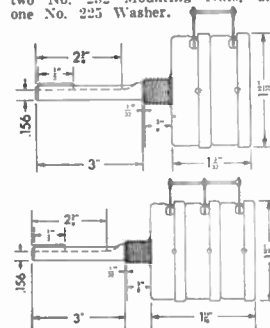

"L" PAD ATTENUATORS

Ohms Impedance	Catalog Number	List Price
6	L6	\$3.50
15	L15	3.50
50	L50	3.50
200	L200	3.50
250	L250	3.50
500	L500	3.50
2000	L2000	3.50

UNIVERSAL SINGLE REPLACEMENT CONTROLS (CARBON)

● Fixed Shaft types MR and Standard 1 1/2" diameter controls employ the channel shaft and insert to fit all type knobs. Type MK employs a 3" universal knurled shaft for use in replacing original controls of this construction. Plug-In Type UM is used with the proper type SS shaft selected for the individual application. Two No. 232 nuts, one No. 227 washer, and a ground terminal are included. See pages M-44 and M-45 for complete information on plug-in shafts, attachable switches, and accessories.

LIST PRICE **\$1.00** each (less attachable switch and accessories)
Plug-In Type UM is supplied less shaft.

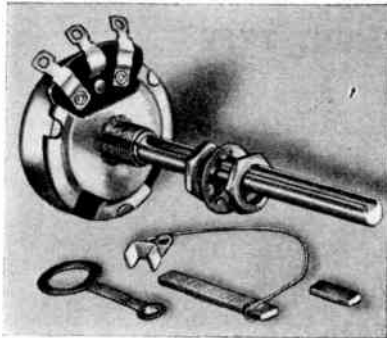

Standard 1 1/2" dia.

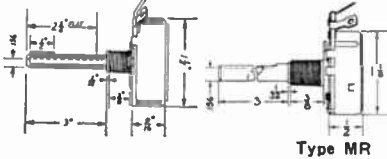

Type MR

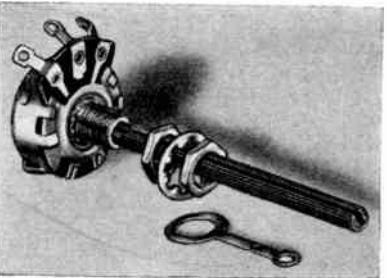
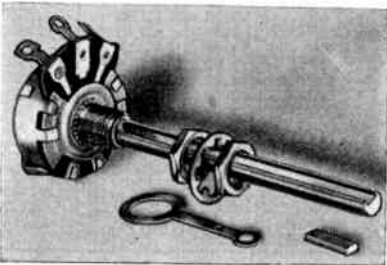

Type MK

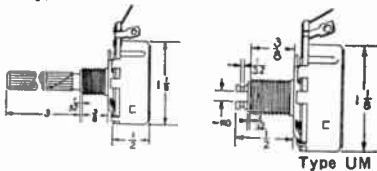

Type UM



Ohms Resistance	Taper	Standard 1 1/2" diameter	Types MR & MK 1 1/2" diameter (Fixed Shaft)	Type UM 1 1/2" diameter (Plug-In)
5M	1	E12§		
5M	4	Y5MP		
5M	4A		MR14§	UM114§
7500	1	F12§		
10M	1	G12§	MR18§	UM118§
10M	2	UC501§	MR19§	UM119§
10M	4	Y10MP	MR20§	UM120§
15M	1	H12§	MR21§	UM121§
15M	2		MR22§	UM122§
20M	1	Y§	MR24§	UM124§
25M	2	J§	MR28§	UM128§
25M	4	Y25MP	MR29§	UM129§
50M	1	K12	MR33	UM133
50M	2	K§	MR34§	UM134§
50M	4	Y50MP	MR35	UM135
75M	1	Z12	MR36	UM137
75M	2	Z§	MR37	UM138
100M	1	L	MR39	UM140
100M	2	UC510§	MR40	UM143*
100M	4	Y100MP	MR41	UM141
100M	Spec.			UM142
150M	1	UC502	MR42	UM180†
200M	4	Y200MP		UM144
250M	1	M	MR44	UM147
250M	2	UC511†	MK400	UM150*
250M	4	UC509§	MR45	
350M	1	Y250MP		UM149
500M	1	N	MR48	UM151
500M	2	UC512†	MK401	UM154
500M	4	UC513		UM157*
500M	4	Y500MP	MR50	UM156
750M	1	UC503	MR51	UM158
1 Meg.	1	O	MR53	UM161
1 Meg.	2	UC514†	MK402	UM162*
1 Meg.	4	Y1000MP		UM160
2 Meg.	Spec.			UM181‡
2 Meg.	1	P	MR55	UM163
3 Meg.	1	UC504	MR57	UM165
4 Meg.	1	UC505		
5 Meg.	1	UC506		
5 Meg.	2	UC507		
9 Meg.	1	UC508		

* Clutch type controls—no provision for attachable switch.

† Has slotted shaft for automobile receivers.

‡ Right hand switch action.

§ External adjustable resistor included.

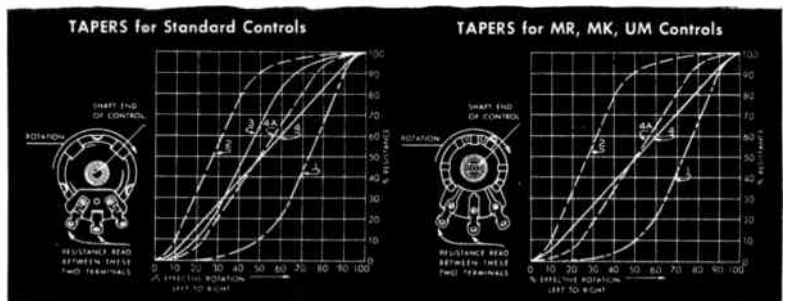

Standard Controls

P. R. MALLORY & CO. Inc.
MALLORY

UNIVERSAL SINGLE REPLACEMENT CONTROLS

(WIRE-WOUND)

● Mallory Universal Wire Wound Controls are supplied with the universal channel shaft and insert. Two No. 232 nuts, one No. 227 washer,

and a ground terminal are included. Nominal rating of wire wound types is 4 watts.

LIST PRICE **\$1.00** each (less attachable switch and accessories)

Ohms Resistance	Taper	Catalog Number	Ohms Resistance	Taper	Catalog Number
2	4	Q	2000	4	A2MP;
6	4	R	3000	1	D12;
10	4	S	3000	2	D1
20	4	T	3000	4	A3MP;
30	4	U	3000	7	D7;
60	4	V	5000	2	E;
100	4	W	5000	4	A5MP;
200	4	X	5000	7	E7;
400	4	A400P	7500	2	F1;
500	1	A	7500	7	F7;
550	4	A550P	10000	2	G;
1000	1	B	10000	4	A10MP;
1000	2	UC500	10000	7	G7;
1000	4	A1MP	15000	2	H1;
2000	1	C12;	15000	7	H7;
2000	2	C;	20000	4	A20MP;

‡ Have exclusive Mallory adjustable bias feature.

EXPLANATION OF TAPERS

Taper Number 1 is a modified logarithmic left hand taper in the carbon type of control and an approximation to this logarithmic taper in the wire wound type. This taper should always be used in shunt circuits as in usual antenna and audio circuits, or where only the center and left hand terminals are used.

Taper Number 2 is a right hand logarithmic taper in the carbon and an approximation in the wire wound type. Used in series circuits, as in cathode voltage controls, or where only the center and right hand terminals are used.

Taper Number 3 is a combination left and right hand taper. Has a limited use in circuits where the control must perform both as a shunt and as a series circuit control as in combination antenna shunt plus bias circuits. This is the most common use for such a taper.

Taper Number 4 is a linear taper. Strictly speaking it is not a "taper" although commonly referred to as such. A linear "taper" is used wherever a control should be such that voltage is proportional to the degree of rotation.

Taper Number 4A is a modification of the regular linear taper Number 4.

Taper Number 7 is made only in the wire wound type of control and is a form of left hand taper. This taper is desirable for the antenna shunt plus bias control, wherein greater attenuation is obtained by increasing the bias voltage. The slight left taper then suffices to gradually reduce the signal to zero volume by the shunting action in the antenna circuit.

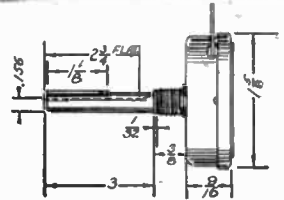
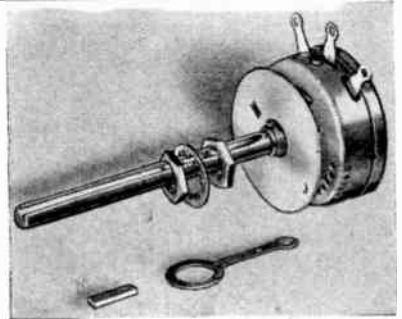

WIRE WOUND TAPERS

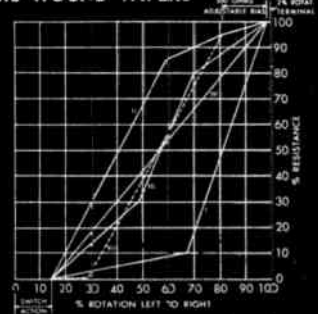

UNIVERSAL TAPPED REPLACEMENT CONTROLS

● Plug-In Tapped Controls types TM and DTM are used with the proper SS shaft selected for the individual application. The Standard 1 1/2" diameter Tapped Controls (type TRP) are supplied with the universal channel shaft and insert. See pages M-44 and M-45 for complete information on plug-in shafts, attachable

switches and accessories. Prices do not include switch or accessories. Two No. 232 nuts, one No. 227 washer and a ground terminal are included.

TM and DTM Types, List Price **\$1.25** TRP Type, List Price **\$1.50**

SINGLE TAP

Overall Resistance	Tap Resistance		Standard (1 1/2" dia.)	Type TM (1 1/2" dia.) Plug-in	Overall Resistance	Tap Resistance		Standard (1 1/2" dia.)	Type TM (1 1/2" dia.) Plug-in
	Tap 1	Tap 2				Tap 1	Tap 2		
40M	8M		TRP601		1 Meg.	200M		TRP608	TM240
60M	4M		TRP602		1 Meg.	300M			TM241*
60M	12M		TRP617						TM238
250M	50M		TRP623	TM229	1 Meg.	450M			TM239*
250M	110M		TRP603	TM221					TM242*
				TM222*					TM243
250M	20M		TRP604		1 Meg.	500M		TRP608†	
350M	70M		TRP605	TM225	1.5 Meg.	200M			TM244
			TRP614†	TM223*	2 Meg.	5M			TM245
500M	5M			TM228	2 Meg.	15M		TRP612	TM246
500M	15M			TM226	2 Meg.	60M			TM247
500M	60M		TRP616	TM233	2 Meg.	125M			TM250
500M	100M		TRP606	TM224*	2 Meg.	250M		TRP618	TM248
				TM227	2 Meg.	400M		TRP613	TM254
500M	150M			TM238	2 Meg.	600M			TM249
500M	225M		TRP607	TM231	2 Meg.	900M		TRP628	TM251
				TM232*					TM252
1 Meg.	30M		TRP610	TM234	2 Meg.	900M			TM259
1 Meg.	65M			TM236	3 Meg.	900M		TRP615	TM257
1 Meg.	125M								

* Clutch type controls—no provision for attachable switch. † Has slotted shaft for automobile receivers ‡ Special taper for ladder service.

DOUBLE TAP

Overall Resistance	Tap Resistance		Standard 1 1/2" dia.	Type DTM (1 1/2" dia.) Plug-in	Overall Resistance	Tap Resistance		Standard 1 1/2" dia.	Type DTM (1 1/2" dia.) Plug-in
	Tap 1	Tap 2				Tap 1	Tap 2		
44M	7M	14M	TRP622		2 Meg.	5M	500M	TRP621†	DTM293
250M.	50M	100M		DTM282	2.25 Meg.	250M	500M	TRP624†	DTM295
500M	100M	200M	TRP619		2.25 Meg.	500M	1 Meg.		DTM296
1 Meg.	50M	100M		DTM287	3 Meg.	100M	1.5 Meg.		DTM298
1 Meg.	250M	500M		DTM289					DTM298
1.5 Meg.	225M	500M		DTM291	‡No provision for switch.				

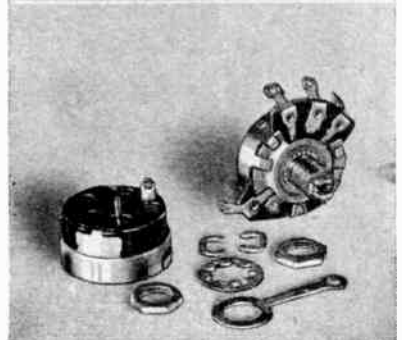
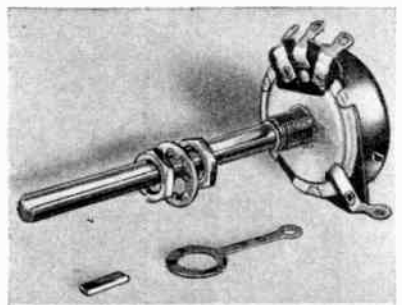

REPLACEMENT CONTROL ACCESSORIES

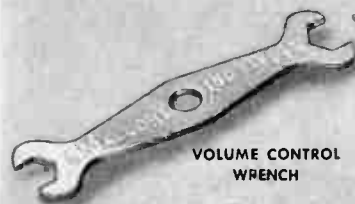
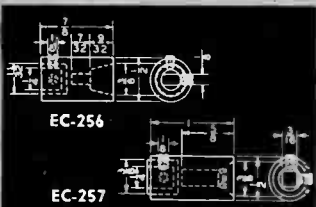
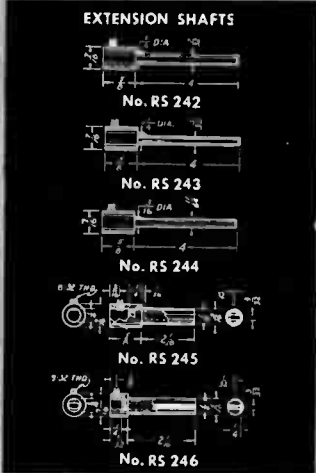

Marking	For Type of Control	Dia.	Cat. No.	List Price
Etched Dial Plates for Controls, Rheostats and Potentiometers				
0 to 10	For Standard Carbon Controls with switch type cover	2 1/4"	398	\$0.25
0 to 10	For Standard Carbon Controls with plain cover	2 1/4"	397	.25
0 to 10	For Standard Wire Wound Controls with switch type cover	2 1/4"	396	.25
0 to 10	For Standard Wire Wound Controls with plain cover; also "M" Type Rheostats and Potentiometers	2 1/4"	395	.25
0 to 10	For "C" Type Rheostats and Potentiometers	2 1/4"	393	.25
0 to 10	For "E" Type Potentiometers	2 1/4"	399	.25
0 to 100	All Rheostats and Potentiometers (compromise scale)	2 1/4"	360	.25
Increase Volume	All Rheostats and Potentiometers	1 1/4"	391	.15
Universal Extension Shafts:				
	4" long x 1/4" dia. x 1/8" flat		RS242*	.30 ea.
	4" long x 1/4" dia. x 3/32" flat		RS243*	.30 ea.
	4" long x 3/16" dia. x 1/8" flat		RS244*	.30 ea.
	2" long x 1/4" dia. with 1/8" slot (Enclosed in tight-fitting tube) For adapting Universal Controls to automobile receivers when slotted shaft is needed.		RS245*	.35 ea.
	2" long x 1/4" wide x 3/16" thick (Tongue shape and fitted with tube) For adapting Universal Controls to automobile receivers where tongue-shaped shaft is needed.		RS246*	.35 ea.
Universal Flexible Coupling Shafts:				
	For Universal replacement of all flexible wire shafts, coupling to 1/4" solid shafts		FS250	.60
	Shaft Coupling has 3/32" hole, 1/4" deep, with transverse pin, and is for use (with the correct Mallory control) as a replacement for Philco Models 805, 806, 808, 809 and PHD and PHXD, Studebaker AC266, Pierce-Arrow MT-3, Reo RT-3, etc.		FS251	.60
	Shaft Coupling has 5/16" hole, approximately 1/2" deep, and has 2 set screws opposite each other. It is used as a replacement for Philco Model D, Nash AC-989 (Code 122)		FS252	.60
	Shaft Coupling has 1/4" dia. hole, 1/2" deep, equipped with 2 screws at 90 degrees. This is to be used with the correct Mallory Control as a replacement for Chevrolet No. 36441.		FS253	.60
Universal Combination Extension Shaft Coupling and Reducer:				
	Will couple two 1/4" shafts or one 1/4" shaft and one 3/16" shaft		EC240	.25
Universal Insulated Shaft Couplers:				
	Designed to connect fixed shaft controls to remote drive couplings popular in automotive radio equipment.		EC256	.25
	Slotted Insacup		EC257	.25
	Square Insert Insacup (Motorola type)			
Universal Extension Bushing:				
	Designed to screw on the present bushing of Mallory controls and switches, so that the body of the control or switch will be held 5/8" away from the mounting surface. For example, it is used with the correct Universal Control to service Philco Models 28, 29, 45 and 45C.		EB247	.20
Universal Bushing and Nut:				
	Designed to accommodate 1/4" shaft wherever a panel bushing is desired. Includes one No. 252 nut		UB241	.75 for 10
			Packed 10 in Envelope	
Hexagon Shoulder Mounting Nuts:				
	For 1/8" Panels		255	.15
	For 1/2" Panels		A11260-12	.20
	For 3/4" Panels		A11260-2	.25
Volume Control Wrench:				
	For all standard Volume Control Hexagon Nuts		178	.20
Adjustable Mounting Brackets:				
	1 1/4" Mounting Centers		RB248†	.20 ea.
	2 1/2" Mounting Centers		RB249†	.20 ea.
			†Packed 5 to Box	

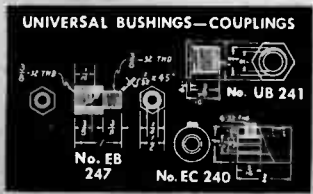
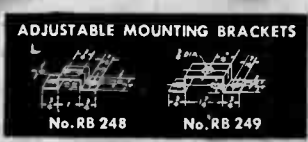

Standard Controls

P. R. MALLORY & CO. Inc.
MALLORY

Replacement Control Accessories

Plug-In Shafts for Use with Types UM, TM, and DTM Controls

Cat. No.	List Price	Cat. No.	List Price	Cat. No.	List Price
SS1	\$0.25	SS14	\$0.35	SS24	\$0.25
SS2	.25	SS15	.35	SS25	.25
SS3	.35	SS16	.25	SS26	.25
SS4	.25	SS17	.50	SS27	.25
SS5	.25	SS18	.25	SS28	.50
SS6	.25	SS19	.50	SS29	.25
SS10	.25	SS20	.50	SS30	.25
SS11	.35	SS21	.35	SS31	.25
SS12	.25	SS22	.25	SS32	.25
		SS23	.25		

Attachable Switches for 1/2" Dia. Controls

For use with standard Universal Controls, Carbon and Wire Wound types, TRP Tapped Controls, and Universal Dual Controls.

Cat. No.	Circuit Arrangement	List Price
6-9	Single-Pole—Single-Throw	\$0.50
6T	Single-Pole—Single-Throw	.60
7	Double-Pole—Single-Throw	.60
8	Single-Pole—Double-Throw	.60
13	Three-Pole—Single-Throw Shorting	.60
14	Four-Pole—Single-Throw Shorting	.60

*Has dummy terminal identified by copper rivet.

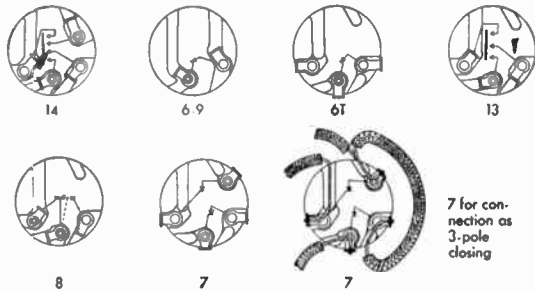

Attachable Switches for 1/8" Dia. Controls

For use with MR, MK, UM, TM and DTM controls.

Cat. No.	Circuit Arrangement	List Price
M-26	Single-Pole—Single-Throw	\$0.50
M-26T	Single-Pole—Single-Throw	.60
M-27	Double-Pole—Single-Throw	.60
M-28	Single-Pole—Double-Throw	.60
M-23-24	Four-Pole—Single-Throw, Shorting	.60

*Has dummy terminal identified by red dot.

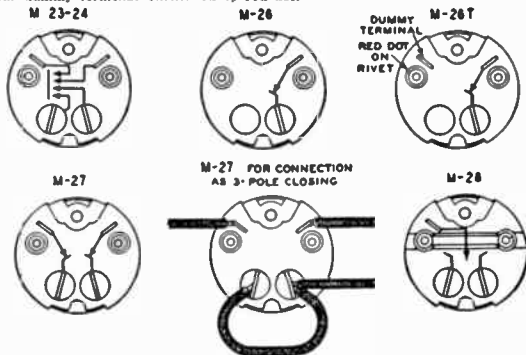

Universal Dual Replacement Controls

Ohms Resistance		Taper		Type Element		General Use		Cat. No.	List Price	Ohms Resistance		Taper		Type Element		General Use		Cat. No.	List Price
Front	Rear	Front	Rear	Front	Rear	Front	Rear	CE	\$2.50	100M	100M	I	I	Carbon	Carbon	Audio Shunt in Push Pull	LL	\$2.50	
2M	5M	I	VII	I	IV	W.W.	W.W.	GE	2.50	100M	250M	I	I	Carbon	Carbon	Audio Shunt, Tone Screen or RF Shunt	LM	2.50	
10M	10M	VII	IV	W.W.	W.W.	Ant. Shunt Bias or Screen	Ant. Shunt Bias or Screen	GG	2.50	250M	500M	I	I	Carbon	Carbon	Audio Shunt in Push Pull	MM	2.50	
10M	50M	I	IV	Carbon	Carbon	Ant. Shunt Bias or Screen	Ant. Shunt Bias or Screen	GK	2.50	500M	500M	I	I	Carbon	Carbon	Audio Shunt and Tone Compensation	MN	2.50	
50M	50M	IV	IV	Carbon	Carbon	Grid Shunt and Cathode Control	Grid Shunt and Cathode Control	DRP 388	2.50							Audio Shunt in Push Pull	NN	2.50	

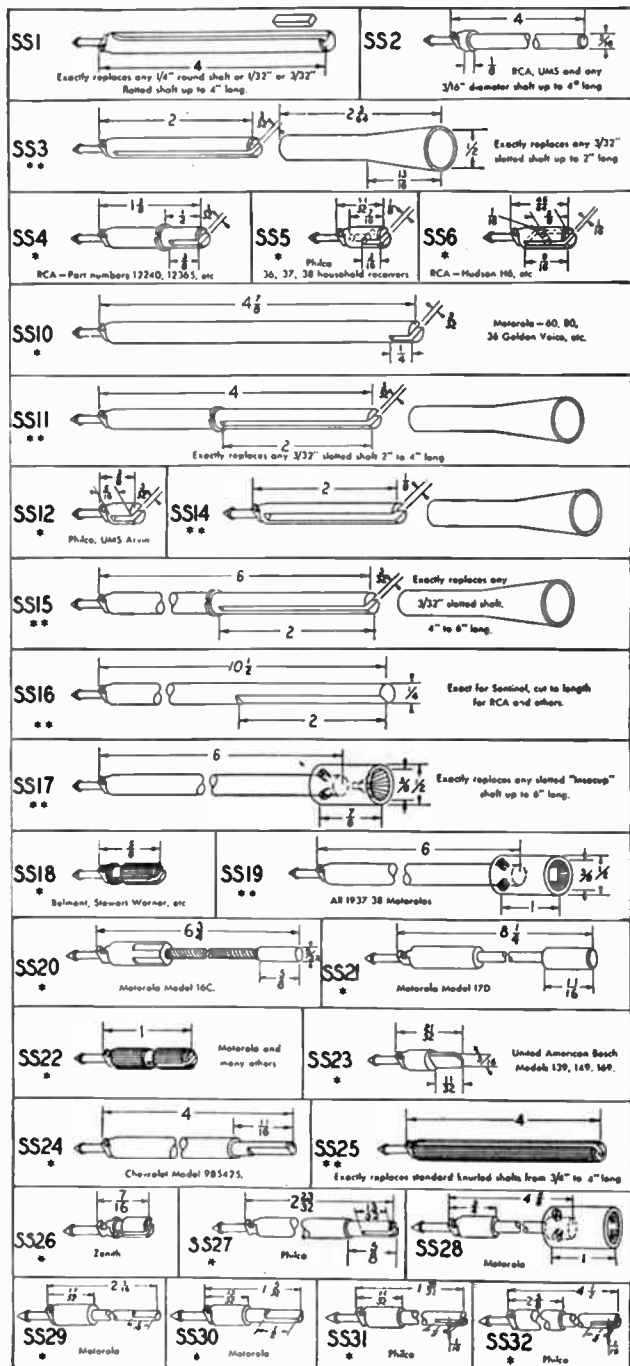

*These Plug-In Shafts are designed as exact replacements for applications requiring a given predetermined length with special coupling flats or tongue or an insulated coupler. None of these require any cutting or special adjustment.
*These Plug-In Shafts are of universal length and designed for many applications.

VITREOUS ENAMELED FIXED RESISTORS

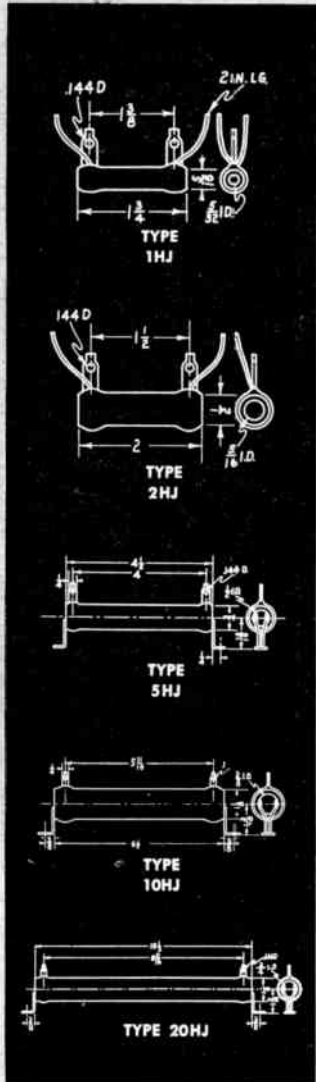
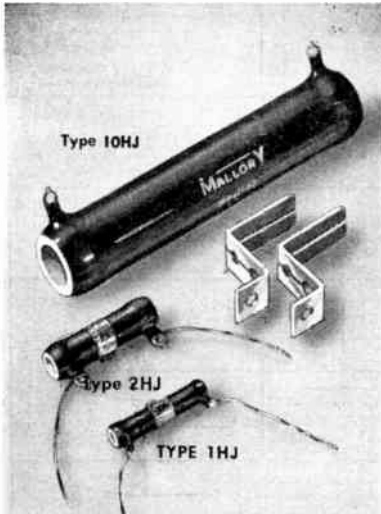

†10 Watt Rating
(10n Values to 10,000 Ohms) Size: 1/2 x 1 1/4 Tube

Resistance Ohms	Current Milli-amperes	Volts Max.	Catalog Number	List Price
1	3150	3	1HJ1	\$0.50
2	2200	4.5	1HJ2	.50
3	1800	5.5	1HJ3	.50
4	1580	6.3	1HJ4	.50
5	1400	7	1HJ5	.50
7.5	1150	8.5	1HJ7.5	.50
10	1000	10	1HJ10	.50
12	910	11	1HJ12	.50
15	812	12	1HJ15	.50
20	707	14	1HJ20	.50
25	630	16	1HJ25	.50
30	575	17.3	1HJ30	.50
35	550	18	1HJ35	.50
40	500	20	1HJ40	.50
50	447	22	1HJ50	.50
75	360	27	1HJ75	.50
100	315	31	1HJ100	.50
125	280	35	1HJ125	.50
150	260	39	1HJ150	.50
200	220	44	1HJ200	.50
225	210	47.5	1HJ225	.50
250	200	50	1HJ250	.50
300	180	55	1HJ300	.50
350	170	59	1HJ350	.50
400	158	63	1HJ400	.50
450	150	67	1HJ450	.50
500	141	70	1HJ500	.50
600	130	77	1HJ600	.50
700	120	83.5	1HJ700	.50
750	115	85	1HJ750	.50
800	112	89	1HJ800	.50
900	105	95	1HJ900	.50
1000	100	100	1HJ1000	.50
1100	95	105	1HJ1100	.50
1200	91	110	1HJ1200	.50
1250	89	111	1HJ1250	.50
1500*	81	122	1HJ1500*	.50
1750*	75	132	1HJ1750*	.50
2000*	70	141	1HJ2000*	.50
2250*	66.5	150	1HJ2250*	.50
2500*	63	158	1HJ2500*	.50
3000*	56	173	1HJ3000*	.50
3500*	53	185	1HJ3500*	.50
4000*	50	200	1HJ4000*	.50
4500*	47	212	1HJ4500*	.50
5000*	45	224	1HJ5000*	.50
6000*	40	240	1HJ6000*	.50
7000*	38	264	1HJ7000*	.50
7500*	36	270	1HJ7500*	.50
8000*	35	282	1HJ8000*	.50
8500*	34	291	1HJ8500*	.50
10000*	32	316	1HJ10000*	.50
11000*	18	195	1HJ11000*	.50
12500*	17	204	1HJ12500*	.50
13500*	16.5	210	1HJ13500*	.50
14300*	15.5	224	1HJ14300*	.50
15000*	15	225	1HJ15000*	.50
16000*	14.8	236	1HJ16000*	.50
17500*	14.3	246	1HJ17500*	.50
18000*	14	250	1HJ18000*	.50
20000*	13	260	1HJ20000*	.50
22500*	12.5	280	1HJ22500*	.50
25000*	12	300	1HJ25000*	.50
30000*	11	330	1HJ30000*	.50
35000*	10	350	1HJ35000*	.50
40000*	9	380	1HJ40000*	.50
45000*	8.8	385	1HJ45000*	.50
50000*	8	400	1HJ50000*	.50

†20 Watt Rating
(10n Values to 12,500 Ohms) Size: 1/2 x 2 Tube

Resistance Ohms	Current Milli-amperes	Volts Max.	Catalog Number	List Price
5	2000	10	2HJ5	\$0.80
10	1415	14	2HJ10	.80
15	1153	17	2HJ15	.80
25	895	22	2HJ25	.80
50	633	31	2HJ50	.80
75	517	38	2HJ75	.80
100	447	44	2HJ100	.80
150	365	54	2HJ150	.80
200	316	63	2HJ200	.80
250	283	72	2HJ250	.80
300	258	77	2HJ300	.80
400	224	90	2HJ400	.80
500	200	100	2HJ500	.80
750	163	122	2HJ750	.80
1000	141	141	2HJ1000	.80
1250	126	157	2HJ1250	.80
1500	115	173	2HJ1500	.80
1750	107	187	2HJ1750	.80
2000	100	200	2HJ2000	.80
2250	94	211	2HJ2250	.80
2500	89	222	2HJ2500	.80
2750	85	235	2HJ2750	.80
3000	81	243	2HJ3000	.80
3500	75	262	2HJ3500	.80
4000	71	284	2HJ4000	.80
4500	66	300	2HJ4500	.80
5000	63	315	2HJ5000	.80
6000	57	345	2HJ6000	.80
7500	51	387	2HJ7500	.80
10000	44	440	2HJ10000	.80
12500*	40	500	2HJ12500*	.80
15000*	23	446	2HJ15000*	.90
20000*	20	400	2HJ20000*	.90
25000*	18	417	2HJ25000*	.90
30000*	18	548	2HJ30000*	.90
35000*	15	528	2HJ35000*	.90
40000*	14	565	2HJ40000*	.90
50000*	13	632	2HJ50000*	.90
75000*	10	773	2HJ75000*	1.20
100000*	9	894	2HJ100000*	1.20

†100 Watt Rating
(10n Values to 50,000 Ohms) Size: 1 1/2 x 6 1/2 Tube

Resistance Ohms	Current Milli-amperes	Volts Max.	Catalog Number	List Price
25	2000	50	10HJ25	\$1.80
50	1414	70	10HJ50	1.80
75	1155	85	10HJ75	1.80
100	1000	100	10HJ100	1.80
150	815	120	10HJ150	1.80
250	632	158	10HJ250	1.80
500	447	220	10HJ500	1.80
750	365	275	10HJ750	1.80
1000	316	315	10HJ1000	1.80
1500	258	385	10HJ1500	1.80
2000	223	440	10HJ2000	1.80
2500	200	500	10HJ2500	1.80
5000	141	700	10HJ5000	1.80
7500	115	865	10HJ7500	2.10
10000	100	1000	10HJ10000	2.10
15000	81	1200	10HJ15000	2.10
20000	70	1400	10HJ20000	2.10
25000	63	1580	10HJ25000	2.10
30000	57	1724	10HJ30000	2.40
40000	50	2000	10HJ40000	2.40
50000*	44	2200	10HJ50000	2.40
75000*	23	1732	10HJ75000	2.70
100000*	20	2000	10HJ100000	2.70

†50 Watt Rating
(10n Values to 25,000 Ohms) Size: 3/4 x 4 1/2 Tube

Resistance Ohms	Current Milli-amperes	Volts Max.	Catalog Number	List Price
10	2240	22	5HJ10	\$1.35
25	1415	35.4	5HJ25	1.35
50	1000	50	5HJ50	1.35
100	707	70	5HJ100	1.35
250	447	111	5HJ250	1.35
500	316	158	5HJ500	1.35
750	258	192	5HJ750	1.35
1010	224	224	5HJ1000	1.35
1500	183	275	5HJ1500	1.35
2000	158	316	5HJ2000	1.35
2500	141	354	5HJ2500	1.35
5000	100	500	5HJ5000	1.50
7500	81	610	5HJ7500	1.50
10000	70	700	5HJ10000	1.50
12500	63	790	5HJ12500	1.50
15000	57	850	5HJ15000	1.50
20000	50	1000	5HJ20000	1.50
25000	44	1190	5HJ25000	1.50
30000*	26	774	5HJ30000*	1.75
40000*	22	894	5HJ40000*	1.75
50000*	20	1000	5HJ50000*	1.75
75000*	16	1223	5HJ75000*	1.75
100000*	14	1414	5HJ100000*	1.75

†200 Watt Rating
(10n Values to 75,000 Ohms) Size: 1 1/8 x 10 1/2 Tube

Resistance Ohms	Current Milli-amperes	Volts Max.	Catalog Number	List Price
25	2830	70	20HJ25	\$3.00
50	2000	100	20HJ50	3.00
75	1635	120	20HJ75	3.00
100	1414	140	20HJ100	3.00
250	894	220	20HJ250	3.00
500	632	315	20HJ500	3.00
750	515	385	20HJ750	3.00
1000	447	445	20HJ1000	3.00
1500	361	447	20HJ1500	3.00
2000	316	541	20HJ2000	3.00
2500	283	705	20HJ2500	3.00
3000	258	770	20HJ3000	3.00
5000	200	1030	20HJ5000	3.00
7500	163	1200	20HJ7500	3.00
10000	141	1400	20HJ10000	3.00
20000	81	2100	20HJ20000	3.00
30000	70	2800	20HJ30000	3.00
40000	63	3150	20HJ40000	3.00
50000	51	3820	20HJ50000	3.00
75000	28	2828	20HJ75000	3.00
100000*	28	2828	20HJ100000	3.00

Low temperature enamel is used on these sizes because it affords better protection to the small diameter wire that must be used to make the higher resistance values.

Power Resistors

P. R. MALLORY & CO. Inc.

MALLORY

VARIOHM ADJUSTABLE RESISTORS

†10 Watt Rating

(†On Values to 10,000 Ohms) Size: 1/4" x 1 3/4"

Resistance Ohms	Current Milli-amperes	Volts Max.	Catalog Number	List Price
1	3150	3	1AV1	\$0.75
2	2200	4.5	1AV2	.75
3	1800	5.5	1AV3	.75
5	1400	7	1AV5	.75
7.5	1150	8.5	1AV7.5	.75
10	1000	10	1AV10	.75
15	812	12	1AV15	.75
20	707	14	1AV20	.75
25	630	16	1AV25	.75
50	447	22	1AV50	.75
75	360	27	1AV75	.75
100	315	31	1AV100	.75
150	260	39	1AV150	.75
200	220	44	1AV200	.75
250	200	50	1AV250	.75
300	180	55	1AV300	.75
350	170	59	1AV350	.75
400	158	63	1AV400	.75
500	141	70	1AV500	.75
600	130	77	1AV600	.75
750	115	85	1AV750	.75
800	112	89	1AV800	.75
1000	100	100	1AV1000	.75
1250	89	111	1AV1250	.75
1500	81	122	1AV1500	.75
2000	70	141	1AV2000	.75
2250	66.5	150	1AV2250	.75
2500	63	158	1AV2500	.75
3000	56	173	1AV3000	.75
3500	53	185	1AV3500	.75
4000	50	200	1AV4000	.75
4500	47	212	1AV4500	.75
5000	45	224	1AV5000	.75
6000	40	240	1AV6000	.75
7000	38	264	1AV7000	.75
7500	36	270	1AV7500	.75
8000	35	282	1AV8000	.75
8500	34	291	1AV8500	.75
9000	33	303	1AV9000	.75
10000	32	318	1AV10000	.75

†50 Watt Rating

(†On Values to 40,000 Ohms) Size: 3/4" x 4 1/2" Tube

Resistance Ohms	Current Milli-amperes	Volts Max.	Catalog Number	List Price
5	3180	15	5AV5	\$1.65
10	2230	20	5AV10	1.65
25	1410	35	5AV25	1.65
50	1000	50	5AV50	1.65
75	816	61	5AV75	1.65
100	707	70	5AV100	1.65
150	577	85	5AV150	1.65
200	500	100	5AV200	1.65
250	447	111	5AV250	1.65
300	408	122	5AV300	1.65
400	354	140	5AV400	1.65
500	316	157	5AV500	1.65
750	258	192	5AV750	1.65
1000	224	224	5AV1000	1.65
1500	182	275	5AV1500	1.65
2000	158	315	5AV2000	1.65
2500	141	350	5AV2500	1.65
3000	129	387	5AV3000	1.65
4000	112	448	5AV4000	1.65
5000	100	500	5AV5000	1.65
7500	81	610	5AV7500	1.80
10000	70	700	5AV10000	1.80
12000	64	768	5AV12000	1.80
15000	57	855	5AV15000	1.80
20000	50	1030	5AV20000	1.80
25000	44	1100	5AV25000	1.80
30000	41	1240	5AV30000	2.05
40000*	35	1415	5AV40000	2.05
50000*	20	1000	5AV50000	2.05
60000*	18	1030	5AV60000	2.40
75000*	17	1275	5AV75000	2.40
80000*	16	1215	5AV80000	2.40
100000*	14	1414	5AV100000	2.40

†80 Watt Rating

(†On Values to 40,000 Ohms) Size: 3/4" x 6 1/2" Tube

Resistance Ohms	Current Milli-amperes	Volts Max.	Catalog Number	List Price
10	2830	28.3	8AV10	\$2.10
15	2310	34.6	8AV15	2.10
25	1790	44.8	8AV25	2.10
50	1285	63.2	8AV50	2.10
100	894	89.4	8AV100	2.10
250	566	141.5	8AV250	2.10
300	517	155	8AV300	2.10
400	495	178	8AV400	2.10
500	400	200	8AV500	2.10
750	327	245	8AV750	2.10
1000	283	283	8AV1000	2.10
1500	231	346	8AV1500	2.10
2000	200	400	8AV2000	2.10
2500	179	448	8AV2500	2.10
3000	152	530	8AV3000	2.10
3500	126	632	8AV5000	2.10
4000	103	775	8AV7500	2.40
5000	89	894	8AV10000	2.40
10000	73	1092	8AV15000	2.40
15000	63	1270	8AV20000	2.40
20000	57	1414	8AV25000	2.40
25000	51	1530	8AV30000	2.70
30000	44	1790	8AV40000	2.70
40000*	25	1265	8AV50000	2.70
50000*	23	1385	8AV60000	3.00
60000*	21	1575	8AV75000	3.00
75000*	20	1800	8AV100000	3.00
80000*	18	1789	8AV100000	3.00

200 Watt Rating

Size: 1 1/2" x 10 1/2" Tube

Resistance Ohms	Current Milli-amperes	Volts Max.	Catalog Number	List Price
50	2000	100	20AV50	\$3.60
100	1414	140	20AV100	3.60
500	632	315	20AV500	3.60
1000	447	447	20AV1000	3.60
1500	361	541	20AV1500	3.60
2000	316	632	20AV2000	3.60
2500	283	700	20AV2500	3.60
3000	200	1000	20AV5000	3.60
5000	141	1414	20AV10000	3.60
10000	100	2000	20AV20000	4.20
20000	89	2225	20AV25000	4.20
30000	81	2437	20AV30000	4.20
50000	63	3150	20AV50000	4.20
70000	51	3825	20AV75000	4.20
100000*	28	2828	20AV100000	4.20

*Low temperature enamel is used on these sizes because it affords better protection to the small diameter wire that must be used to make the higher resistance values.

Extra Adjustable Clips

Type No. 3V— List Price
For 25, 50, and 80-Watt Variohms...\$0.10 each
Type No. 6V—
For 100 and 200-Watt 1 1/2" Variohms .15 each

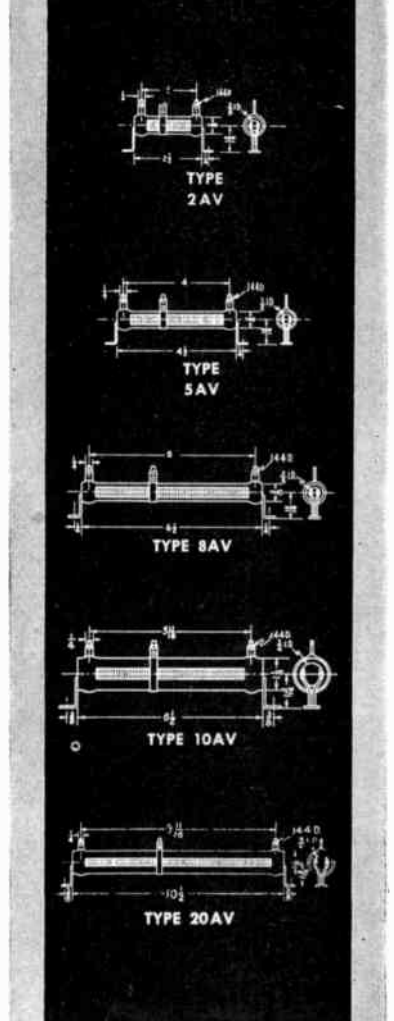
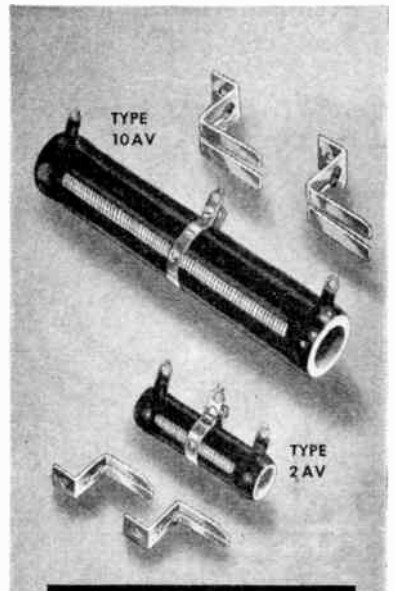

YARD-OHM RESISTANCE KITS

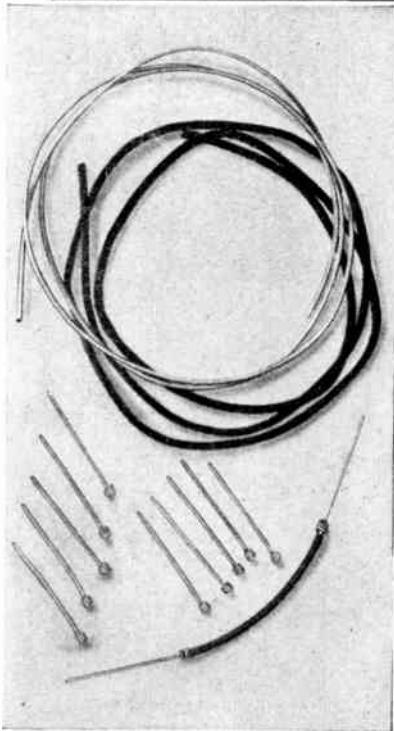

• Each Yard-Ohm Resistance Kit consists of an envelope containing all necessary materials to construct flexible resistors of a wide range of values. The Yard-Ohm Kit provides a real solution to the odd-value resistor problem. In addition to replacement applications, resistors made from the Yard-Ohm Kit are ideal for meter shunts, and for use wherever a high quality flexible resistor is desired.

Each Mallory Yard-Ohm Kit consists of an envelope containing the following:
1 yard spiral wound resistance wire
1 yard insulated braid
24 spiral wire leads

The kit is available in eight resistance values

Cat. No.	Resistance Value (Ohms per Inch)	Carrying Capacity in Amperes	List Price
YO-1	1	.707	\$0.75
YO-5	5	.315	.75
YO-10	10	.223	.75
YO-25	25	.141	.75
YO-50	50	.100	.75
YO-100	100	.071	.75
YO-250	250	.044	.75
YO-500	500	.031	.75

Dissipation—all types: ½ watt per inch.

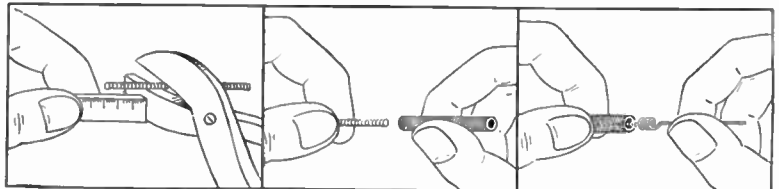

FIRST—Determine length by dividing "ohms per inch" into the resistance value desired. Add ¼ inch to this for terminals and cut.

SECOND — Cover element with the required length of insulating braid.

THIRD — Insert wire leads over ends of resistance elements and clinch tightly with pliers.

GRID BIAS CELL—An Exclusive Mallory Development

(U. S. Letters Patent 1,920,151; 2,063,524; 2,116,091; Des. 106,163; et al.)

• The Mallory Grid Bias Cell is a small acorn-shaped, self-contained device. The metal container or cup is the negative electrode. The black disc is the positive electrode. Various styles of holders are shown at left.

Mallory Bias Cells are available in two types—the original 1-volt cells and the new 1¼-volt cells. For new installations, the choice of Bias Cell types will depend on the voltage desired. Replacements should be made with the type of Bias Cell used as original equipment.

The 1¼-volt Bias Cells may be distinguished from the 1-volt unit by the concave depressions in both the upper electrode and bottom of the shell case.

Application

The principal use of Mallory Grid Bias Cells are in the biasing of the first audio amplifier tube in modern high-gain receivers. The bias cell does not need to be bypassed to ground.

Correspondence is invited regarding the application of Mallory Grid Bias Cells. Special Technical Bulletin No. B-303 may be obtained on request.

Characteristics

The no-current potential of Mallory Grid Bias Cells is: within plus or minus 10% of their rated voltage.

Current—The cell is strictly a potential or voltage cell for biasing class "A" amplifier tubes and should not be used for biasing power tubes or oscillators; or for

any circuit where an appreciable direct current may flow through the cell.

Temperature—The cells may be used in ambient temperatures from 40° below zero to 120° F. The voltage of the cell remains reasonably constant throughout this wide temperature range. It is recommended, however, that wherever possible the bias cell be placed in the coolest location.

Humidity—The cell exhibits no change in characteristics when exposed to a relative humidity of 90% at 120° F.

Impedance—Mallory Grid Bias Cells are non-reactive at audio frequencies. For the 1-volt cell, the DC resistance ranges between 11,000 and 50,000 ohms. The DC resistance of the 1¼-volt cell ranges between 10,000 and 40,000 ohms.

Noise—The cells do not cause the development of any noise.

PRICE LIST

Mallory Grid Bias Cells, 1-volt type (Packed 10 to the box).....	\$0.35 per cell
Mallory Grid Bias Cells, 1¼-volt type (Packed 10 to the box).....	.35 per cell
Mallory Grid Bias Cell Holder, Cat. No. GB11A, 1-cell capacity.....	.15 each
Mallory Grid Bias Cell Holder, Cat. No. GB11B, 1-cell capacity.....	.20 each
Mallory Grid Bias Cell Holder, Cat. No. GB12, 2-cell capacity.....	.25 each
Mallory Grid Bias Cell Holder, Cat. No. GB13, 3-cell capacity.....	.30 each
Mallory Grid Bias Cell Holder, Cat. No. GB14, 4-cell capacity.....	.40 each

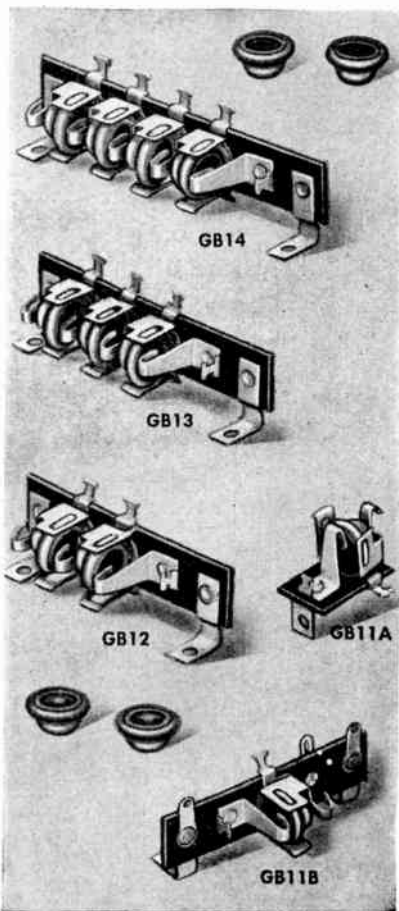

LECTROHM Enameled Vitreous RESISTORS

Quality—Accuracy—Dependability—Long Life

WIRE WOUND FIXED TYPES

LECTROHM Resistors are manufactured from the highest quality materials obtainable and are rated according to R.M.A. standards. LECTROHM Resistors are rugged—dependable—accurate—quality merchandise that will give long trouble-free service.

(Mounting brackets furnished with 20, 50, 80, 100, 160 and 200 watt units.)

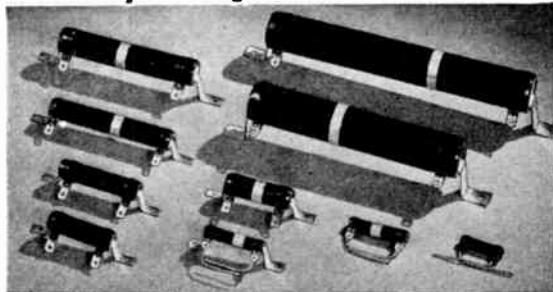

5-WATT

DIMENSIONS..... $\frac{1}{4}$ " x $\frac{3}{16}$ " x $\frac{1}{4}$ "
TERMINALS.....Solder Lug
MAXIMUM RESISTANCE.....10,000 ohms
No Mounting Brackets

Res. Ohms	Max. M.A.	List Price	Res. Ohms	Max. M.A.	List Price
1	2240	\$0.35	300	129	\$0.35
2	1580	.35	350	119	.35
3	1290	.35	400	111	.35
4	1110	.35	500	100	.35
5	1000	.35	600	91	.35
10	707	.35	700	84	.35
15	575	.35	750	81	.35
20	500	.35	800	79	.35
25	447	.35	900	74	.35
30	408	.35	1000	70	.35
35	374	.35	1100	64	.35
40	346	.35	1200	60	.35
50	316	.35	1250	59	.35
75	258	.35	1500	54	.35
100	222	.35	1750	50	.35
125	200	.35	2000	48	.35
150	182	.35	2500	46	.35
200	158	.35	3000	38	.35
225	149	.35	4000	31	.35
250	141	.35	5000	28	.35

10-WATT

DIMENSIONS..... $\frac{5}{16}$ " x $\frac{3}{16}$ " x $\frac{1}{4}$ "
TERMINALS.....Solder Lug
MAXIMUM RESISTANCE.....50,000 ohms
No Mounting Brackets

Res. Ohms	Max. M.A.	List Price	Res. Ohms	Max. M.A.	List Price
1	3150	\$0.40	1500	79	\$0.40
2	2230	.40	1750	74	.40
3	1825	.40	2000	69	.40
5	1415	.40	2250	61	.40
7.5	1155	.40	2500	61	.40
10	1000	.40	3000	56	.40
15	815	.40	3500	51	.40
20	707	.40	4000	47	.40
25	630	.40	4500	44	.40
30	575	.40	5000	40	.40
35	547	.40	6000	36	.40
40	514	.40	7000	33	.40
50	447	.40	7500	32	.40
75	365	.40	8000	31	.40
100	315	.40	8500	30	.40
150	258	.40	10000	24	.40
200	223	.40	15000	18	.40
250	200	.40	20000	15	.40
300	182	.40	25000	14	.40
350	169	.40	30000	14	.40
400	158	.40	40000	11	.40
500	141	.40	50000	8	.40
600	129	.40			
700	119	.40			
750	115	.40			
800	111	.40			
900	105	.40			
1000	100	.40			
1200	91	.40			
1250	89	.40			

LECTROHM R. F. PLATE CHOKES

(1000 Milliamps.)



Amateur Band	Micro-Henries	D C Ohms	Length overall	Diameter	List Price
5	5.4	0.85	1 3/4"	5/8"	\$0.25
10 and 20	3.5	2	3"	1 1/4"	1.80
20 and 40	95	5	6"	1 1/4"	1.20
20, 40, 80 and 160	220	0	6 1/2"	3/4"	1.65

20-WATT

DIMENSIONS..... $\frac{1}{2}$ " x $\frac{1}{8}$ " x $\frac{2}{16}$ "
TERMINALS.....Solder Lug
MAXIMUM RESISTANCE.....100,000 ohms
MOUNTING BRACKET.....Centers 2 1/2"

Res. Ohms	Max. M.A.	List Price	Res. Ohms	Max. M.A.	List Price
5	2000	\$0.70	3000	81	\$0.70
10	1414	.70	4000	70	.70
15	1153	.70	5000	63	.70
20	1000	.70	6000	57	.80
25	894	.70	7000	53	.80
40	707	.70	7500	51	.80
50	633	.70	8000	50	.80
60	574	.70	10000	43	.80
75	517	.70	12500	39	.85
100	448	.70	15000	36	.85
125	400	.70	20000	24	1.00
150	365	.70	25000	21	1.00
200	316	.70	30000	21	1.20
250	283	.70	35000	18	1.20
300	258	.70	40000	17	1.20
350	238	.70	45000	13	1.20
400	223	.70	50000	11	1.20
500	200	.70	55000	11	1.40
600	182	.70	60000	10	1.40
700	169	.70	65000	10	1.40
750	163	.70	70000	9	1.40
800	158	.70	75000	9	1.40
1000	141	.70	80000	8	1.50
1100	134	.70	85000	8	1.50
1250	126	.70	90000	6.5	1.90
1500	115	.70	95000	6	1.90
2000	100	.70	100000	6	1.90
2500	89	.70			

50-WATT

DIMENSIONS..... $\frac{3}{4}$ " x $\frac{1}{2}$ " x $\frac{4}{16}$ "
TERMINALS.....Solder Lugs
MAXIMUM RESISTANCE.....100,000 ohms
MOUNTING BRACKET.....Centers 5 1/2"

Res. Ohms	Max. M.A.	List Price	Res. Ohms	Max. M.A.	List Price
5	3165	\$1.10	6000	85	\$1.25
10	2230	1.10	7000	78	1.25
15	1825	1.10	7500	77	1.25
20	1600	1.10	8000	75	1.25
25	1415	1.10	10000	66	1.25
30	1290	1.10	12000	63	1.25
40	1110	1.10	12500	60	1.25
50	1000	1.10	15000	56	1.25
75	815	1.10	20000	48	1.25
100	707	1.10	25000	43	1.25
150	574	1.10	30000	39	1.45
200	500	1.10	40000	34	1.45
250	448	1.10	50000	30	1.45
300	400	1.10	60000	28	1.80
400	365	1.10	75000	25	1.80
500	316	1.10	100000	21	2.15

80-WATT

DIMENSIONS..... $\frac{3}{4}$ " x $\frac{1}{2}$ " x $\frac{6}{16}$ "
TERMINALS.....Solder Lugs
MAXIMUM RESISTANCE.....75,000 ohms
MOUNTING BRACKET.....Centers 7 1/2"

Res. Ohms	Max. M.A.	List Price	Res. Ohms	Max. M.A.	List Price
5	4000	\$1.50	1000	274	\$1.50
10	2730	1.50	1500	223	1.50
15	2230	1.50	2000	193	1.50
20	2000	1.50	2500	173	1.50
30	1665	1.50	3000	158	1.50
40	1415	1.50	4000	137	1.50
500	387	1.50	5000	122	1.50
750	316	1.50	6000	113	1.75
			7500	100	1.75

80-WATT (Con.)

8000	98	\$1.75	40000	43	\$2.00
10000	86	1.75	50000	39	2.00
15000	70	1.75	60000	35	2.25
20000	61	1.75	75000	31	2.25
25000	53	1.75	100000	27	2.25
30000	50	2.00			

100-WATT

DIMENSIONS..... $1\frac{1}{2}$ " x $\frac{3}{4}$ " x $\frac{6}{16}$ "
TERMINALS.....Solder Lugs
MAXIMUM RESISTANCE.....100,000 ohms
MOUNTING BRACKET.....Centers 7 1/2"

Res. Ohms	Max. M.A.	List Price	Res. Ohms	Max. M.A.	List Price
25	2000	\$1.60	3000	180	\$1.60
50	1414	1.60	5000	140	1.60
75	1153	1.60	7500	115	1.80
100	1000	1.60	10000	100	1.80
150	815	1.60	15000	80	1.80
200	707	1.60	20000	70	1.80
300	633	1.60	25000	63	1.80
400	574	1.60	30000	58	2.10
500	517	1.60	40000	50	2.10
750	448	1.60	50000	44	2.10
1000	400	1.60	60000	41	2.30
1500	365	1.60	75000	36	2.30
2000	316	1.60	100000	31	2.50
2500	283	1.60			

160-WATT

DIMENSIONS..... $1\frac{1}{2}$ " x $\frac{3}{4}$ " x $\frac{8}{16}$ "
TERMINALS.....Solder Lugs
MAXIMUM RESISTANCE.....100,000 ohms
MOUNTING BRACKET.....Centers 9 1/2"

Res. Ohms	Max. M.A.	List Price	Res. Ohms	Max. M.A.	List Price
5	5660	\$2.00	4500	185	\$2.00
10	4000	2.00	5000	180	2.00
15	3300	2.00	7500	145	2.00
20	2730	2.00	10000	125	2.00
25	2530	2.00	15000	105	2.40
30	2230	2.00	20000	90	2.40
40	2000	2.00	25000	80	2.40
50	1825	2.00	30000	67	2.40
75	1415	2.00	35000	57	2.40
100	1290	2.00	40000	50	2.40
150	1000	2.00	50000	40	2.40
200	900	2.00	60000	33	2.70
250	815	2.00	70000	28	2.70
300	707	2.00	80000	25	2.70
350	633	2.00	100000	20	2.70
400	600	2.00			

200-WATT

DIMENSIONS..... $1\frac{1}{2}$ " x $\frac{3}{4}$ " x $\frac{10}{16}$ "
TERMINALS.....Solder Lugs
MAXIMUM RESISTANCE.....100,000 ohms
MOUNTING BRACKET.....Centers 11 1/2"

Res. Ohms	Max. M.A.	List Price	Res. Ohms	Max. M.A.	List Price
5	6310	\$2.50	4500	210	\$2.50
10	4470	2.50	5000	200	2.50
15	3700	2.50	7500	165	2.50
20	3300	2.50	10000	140	2.50
25	3000	2.50	15000	115	3.00
30	2730	2.50	20000	100	3.00
40	2530	2.50	25000	90	3.00
50	2230	2.50	30000	82	3.00
75	1825	2.50	35000	71	3.00
100	1600	2.50	40000	61	3.00
150	1290	2.50	50000	50	3.00
200	1110	2.50	60000	42	3.00
250	1000	2.50	75000	33	3.00
300	900	2.50	100000	25	3.00
350	815	2.50			
400	707	2.50			

LECTROHM INSULATED WIRE-WOUND RESISTORS—1 WATT



Ohms	Current Milli.	Ohms	Current Milli.	Ohms	Current Milli.	Ohms	Current Milli.
100	100	250	38	5000	20	9000	10
125	89	3000	18	10000	18	10000	10
150	81	3500	16	12500	9	12500	9
200	70	4000	15	15000	8	15000	8
250	63	4500	14	16000	7	16000	7
300	57	5000	14	17500	7	17500	7
350	53	5500	12	18000	7	18000	7
400	50	6000	11	20000	6	20000	6
500	44	7500	11	22500	6	22500	6
600	40	8000	11	25000	6	25000	6
700	37	2250	21				

List Price, Each \$0.30

LECTROHM *Vitreous Enameled* RESISTORS

Quality—Accuracy—Dependability—Long Life

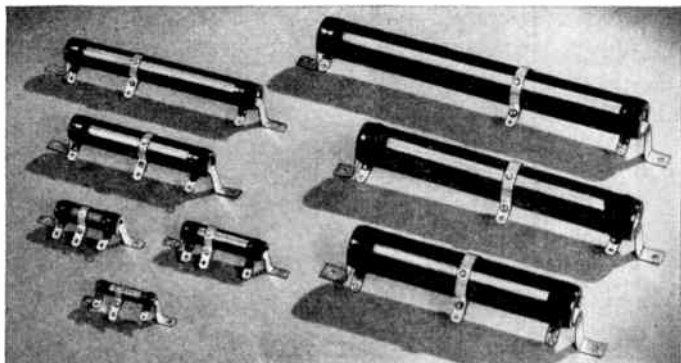

WIRE WOUND ADJUSTABLE TYPES

The same high quality and construction are used for LECTROHM Adjustable Resistors as are incorporated in LECTROHM fixed units.

These resistors are used for replacing voltage dividers in radio receivers, for radio transmitter power supply, and for general experimental work.

10-WATT

DIMENSIONS $1\frac{1}{2}'' \times 1\frac{1}{8}'' \times 1\frac{3}{4}''$
 TERMINALS Solder Lugs
 MAXIMUM RESISTANCE 10,000 ohms
 MOUNTING BRACKET Centers $2\frac{1}{4}''$

Res. Ohms	Max. M.A.	List Price	Res. Ohms	Max. M.A.	List Price
1	3150	\$0.60	750	115	\$0.60
2	2230	.60	800	111	.60
3	1825	.60	1000	100	.60
5	1415	.60	1250	89	.60
7.5	1155	.60	1500	79	.60
10	1000	.60	2000	69	.60
15	815	.60	2250	64	.60
20	707	.60	2500	61	.60
25	630	.60	3000	56	.60
50	447	.60	3500	51	.60
75	365	.60	4000	47	.60
100	315	.60	4500	44	.60
150	258	.60	5000	40	.60
200	223	.60	6000	36	.60
250	200	.60	7000	33	.60
300	182	.60	7500	32	.60
350	169	.60	8000	31	.60
400	158	.60	8500	30	.60
500	141	.60	10000	24	.60
600	129	.60			

25-WATT

DIMENSIONS $\frac{1}{2}'' \times \frac{1}{4}'' \times 2\frac{1}{2}''$
 TERMINALS Solder Lug
 MAXIMUM RESISTANCE 25,000 ohms
 MOUNTING BRACKET Centers $3\frac{3}{8}''$

Res. Ohms	Max. M.A.	List Price	Res. Ohms	Max. M.A.	List Price
1	5000	\$0.85	1000	158	\$0.85
3	2890	.85	1250	141	.85
5	2240	.85	1500	129	.85
10	1580	.85	2000	112	.85
15	1290	.85	2500	100	.85
25	1000	.85	3000	91	.85
50	707	.85	3500	84	.85
75	575	.85	4000	79	.85
100	500	.85	5000	71	.85
150	400	.85	6000	64	.95
200	353	.85	7500	57	.95
250	316	.85	10000	50	.95
300	288	.85	12000	44	.95
400	250	.85	15000	36	.95
500	224	.85	20000	22	1.10
750	182	.85	25000	20	1.10

50-WATT

DIMENSIONS $3\frac{1}{4}'' \times \frac{1}{2}'' \times 4\frac{1}{2}''$
 TERMINALS Solder Lugs
 MAXIMUM RESISTANCE 100,000 ohms
 MOUNTING BRACKET Centers $5\frac{1}{2}''$

Res. Ohms	Max. M.A.	List Price	Res. Ohms	Max. M.A.	List Price
5	3160	\$1.35	3000	129	\$1.35
10	2230	1.35	4000	112	1.35
25	1410	1.35	5000	100	1.35
50	1000	1.35	7500	81	1.50
75	816	1.35	10000	70	1.50
100	707	1.35	12000	64	1.50
150	577	1.35	15000	57	1.50
200	500	1.35	20000	50	1.50
250	447	1.35	25000	44	1.50
300	408	1.35	30000	41	1.70
400	354	1.35	40000	35	1.70
500	316	1.35	50000	20	1.70
750	258	1.35	60000	18	2.40
1000	224	1.35	75000	17	2.40
1500	182	1.35	80000	16	2.40
2000	158	1.35	100000	14	2.40
2500	141	1.35			

CO-WATT

DIMENSIONS $\frac{3}{4}'' \times \frac{1}{2}'' \times 6\frac{1}{2}''$
 TERMINALS Solder Lugs
 MAXIMUM RESISTANCE 100,000 ohms
 MOUNTING BRACKET Centers $7\frac{1}{2}''$

Res. Ohms	Max. M.A.	List Price	Res. Ohms	Max. M.A.	List Price
10	2830	\$1.75	3500	152	\$1.75
15	2310	1.75	5000	126	1.75
25	1790	1.75	7500	103	2.00
50	1265	1.75	10000	89	2.00
100	894	1.75	15000	73	2.00
250	566	1.75	20000	63	2.00
300	517	1.75	25000	57	2.00
400	495	1.75	30000	51	2.25
500	400	1.75	40000	44	2.25
750	327	1.75	50000	25	2.25
1000	283	1.75	60000	23	2.50
1500	231	1.75	75000	21	2.50
2000	200	1.75	80000	20	2.50
2500	179	1.75	100000	18	2.50

ADJUSTABLE LUGS

Screw-Driver Type	Diameter of Resistor	List Price
	$\frac{3}{8}''$	\$0.10
$\frac{1}{2}''$.10	
$\frac{5}{8}''$.15	
$1\frac{1}{4}''$.15	

100-WATT

DIMENSIONS $1\frac{1}{8}'' \times \frac{3}{4}'' \times 6\frac{1}{2}''$
 TERMINALS Solder Lugs
 MAXIMUM RESISTANCE 100,000 ohms
 MOUNTING BRACKET Centers $7\frac{1}{2}''$

Res. Ohms	Max. M.A.	List Price	Res. Ohms	Max. M.A.	List Price
50	1413	\$2.00	15000	81	\$2.25
100	1000	2.00	20000	70	2.25
500	447	2.00	25000	63	2.25
1000	316	2.00	30000	57	2.50
2000	223	2.00	35000	53	2.50
3000	182	2.00	40000	50	2.50
4000	158	2.00	50000	44	2.50
5000	141	2.00	75000	23	2.75
7500	115	2.25	100000	20	2.75
10000	100	2.25			

160-WATT

DIMENSIONS $1\frac{1}{8}'' \times \frac{3}{4}'' \times 8\frac{1}{2}''$
 TERMINALS Solder Lugs
 MAXIMUM RESISTANCE 100,000 ohms
 MOUNTING BRACKET Centers $9\frac{1}{2}''$

Res. Ohms	Max. M.A.	List Price	Res. Ohms	Max. M.A.	List Price
5	5660	\$2.50	10000	126	\$2.50
10	4000	2.50	15000	103	2.90
25	2530	2.50	20000	89	2.90
50	1788	2.50	25000	80	2.90
100	1266	2.50	30000	73	2.90
500	566	2.50	40000	55	2.90
1000	400	2.50	50000	43	2.90
2500	253	2.50	75000	27	3.25
5000	179	2.50	100000	18	3.25

200-WATT

DIMENSIONS $1\frac{1}{8}'' \times \frac{3}{4}'' \times 10\frac{1}{2}''$
 TERMINALS Solder Lugs
 MAXIMUM RESISTANCE 100,000 ohms
 MOUNTING BRACKET Centers $11\frac{1}{2}''$

Res. Ohms	Max. M.A.	List Price	Res. Ohms	Max. M.A.	List Price
50	2000	\$3.00	10000	141	\$3.00
100	1414	3.00	20000	100	3.50
500	632	3.00	25000	89	3.50
1000	447	3.00	30000	81	3.50
1500	361	3.00	50000	63	3.50
2000	316	3.00	75000	51	3.50
2500	283	3.00	100000	28	3.50
5000	200	3.00			

Mounting brackets and one band are furnished with all adjustable types.

**CABLES
CONNECTORS
SOCKETS**



**ADAPTERS
INSULATION
PLUGS**

ULTRA-LOW-LOSS TRANSMISSION LINES

TWINAX COPPER TUBING CABLE

Balanced 2-Conductor Shielded Line



No. 81-18C—Copper Tubing Twinax—80c per Ft.

New 2-conductor shielded cable. Specified by many engineers for ultra-high frequency use. Also used instead of single conductor concentric cable when a balanced line is required above ground. Used in broadcasting studios and laboratories for piping high frequencies from one source to another. Surge impedance of this cable is 150 ohms. Cable is constructed with two No. 18 solid tinned copper wires strung with No. 73-2 polystyrene beads described on next page. Has same copper tube outer conductor as used on the 72-12C cable. The ball and socket design permits bending the cable on wide radii without bending the conductors and keeps the wires parallel even around bends. Operates safely at temperatures to 190° F.

TWINAX FLEXIBLE CABLE



No. 81-18B — 80c per Ft.

A flexible two-conductor balanced line cable which can be bent and flexed on a 1" radius. Specifications are identical to those for Copper Tubing Twinax cable described above, but outer conductor is a braided shield of tinned copper wire. Outer covering is two separate cotton braids, each thoroughly impregnated against moisture.

CONNECTORS FOR TWINAX CABLES

For connecting two Copper Tubing Twinax Cables, two flexible twinax cables, a copper tubing cable to a flexible cable, or either type to a chassis or panel, use the MC3 microphone connectors described on page N-6. Use 3rd contact for cable shield.

SPECIAL CO-AXIAL CABLES

In addition to the cables listed on these pages, Amphenol manufactures a complete line of ultra-low-loss cables, having a wide range of impedances and capacities. Send in complete details of use to which cable is to be put and the correct cable will be recommended.

FOR TEST INSTRUMENTS AND RECEIVER LEAD-INS



- No. 76-22S—With No. 22 stranded center conductor.....50c per Ft.
- No. 76-20 —With No. 20 solid center conductor.....50c per Ft.

A small co-axial cable especially designed for test equipment leads. Also used for connecting other types of electronic apparatus where the larger diameter of other Amphenol cables is objectionable. Outside diameter of the cable is only 1/4". Ideal for leads inside transmitters and other apparatus.

Cable is constructed of No. 22 stranded or 20 solid tinned copper wire strung with No. 73-1 polystyrene beads described on next page. The beads are then shielded with a woven tinned copper braid. Over-all are two separate impregnated cotton braids. Cable beads on a 1" radius. Operates safely at temperatures to 190° F.

NOTE: No. 76-22S with No. 22 stranded center conductor is recommended for test instruments and other applications where cable is flexed a great deal. No. 76-20 with No. 20 solid center conductor, because of its lower capacity, is recommended for lead-ins, for television, frequency modulation, and even for straight a.m. receivers where a long lead-in is required.

RUBBER COVERED CABLE

- No. 76-228R—With No. 22 stranded center conductor.....90c per Ft.
 - No. 76-20R —With No. 20 solid center conductor.....90c per Ft.
- Identical to the polystyrene insulated cables No. 76-22S and No. 76-20 described above, but has a final outer cover of 1/16" live rubber. For use where absolute imperviousness to moisture is required.

HIGH TEMPERATURE CABLE

- No. 76-22ST—With No. 22 stranded center conductor.....82c per Ft.
 - No. 76-20T —With No. 20 solid center conductor.....82c per Ft.
- Cables are identical to Cotton Covered Cables No. 76-22S and 76-20 but insulating beads are molded from mica-filled bakelite. For use at temperatures to 285° F, as over the engines of marine craft, etc.

CO-AXIAL COPPER TUBING CABLE

Matches a Half Wave Antenna

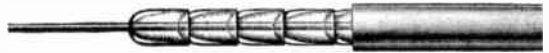

No. 72-12C — Copper Tubing Cable — 50c per Ft.

An exceptionally efficient co-axial cable for transmitting radio frequency current in broadcasting studios, test laboratories, and for amateur and broadcasting stations operating on power to one kilowatt. Recommended for long runs of cable that can be anchored to walls or other supports. Supplied in continuous lengths to 1000 feet.

Cable is constructed of No. 19 tinned solid copper wire, strung with 5/16" diameter polystyrene beads, finally covered with soft drawn copper tubing which forms the outer conductor and shield. Cable bends easily on a 4" radius. Surge impedance is 78 ohms, approximately matching a half wave antenna. Handles 1 kilowatt to 40 megacycles, 700 watts to 100 Mc. Operates safely at temperatures to 190° F.

No. 72-12CT—Identical to above but insulating beads are molded from mica-filled bakelite. For use where temperatures to 285° F. are encountered, as over engines in marine craft, geophysical field work, etc. List Price82c per Ft.



FLEXIBLE CO-AXIAL CABLE

No. 72-12 — 50c per Ft.

A flexible co-axial cable that can be bent and flexed on a 1" radius. Specifications are similar to above polystyrene insulated Copper Tubing Cable, but outer conductor is a braided shield of tinned copper wire. Outer covering is two separate cotton braids, each thoroughly impregnated against moisture. Surge impedance is 72 ohms. Handles 1 kilowatt to 40 megacycles, 700 watts to 100 Mc. at temperatures to 190° F.

Where a combination of flexible and semi-flexible cable is desired, as for an antenna feeder, No. 72-12 may be connected to No. 72-12C.

No. 72-12I—Identical to above but insulating beads are molded from mica-filled bakelite. For use at temperatures to 285° F. List Price82c per Ft.

No. 72-12R—Identical to No. 72-12 polystyrene insulated cable, but has a final outer 1/16" coating of pure flexible rubber. For use where absolute imperviousness to moisture is required. List Price90c per Ft.

CO-AXIAL CABLE CONNECTORS



93-M

93-F

93-C

Unbreakable, shielded cable connectors for any co-axial cable up to 13/32" in dia. May be reamed out to fit cables up to 9/16". Insulation is ultra-low-loss Amphenol "912-A" polystyrene. Screw type locking ring prevents accidental disconnections. Supplied with wiring instructions.

- 93M — Male with coupling ring 1.50 List
- 93M1 — Male with coupling threads 1.50 List
- 93F — Female with coupling threads 1.50 List
- 93F1 — Female with coupling ring 1.50 List
- 93C — Female chassis unit 1.25 List
- 93C1 — Male chassis unit 1.25 List

END TERMINAL CAP

Screws on to outer end of Cable End Terminal listed below. Umbrella-design cap is molded from Amphenol "912-A" polystyrene ultra-low-loss insulating material; 1-7/32" diameter, 1/4" high. For a positive, weather-proof seal, threads and wire opening should be coated with Liquid "912." 90-15—End Terminal Cap60c List



ANTENNA CABLE END TERMINAL

The ideal terminal for connecting any co-axial cable to open wires such as antenna, matching stubs, etc.; can be hung in the air or assembled to a bracket or insulator in a 25/32" hole, taking all strain off the center conductor. May be "sweated" on copper tubing cable. Body solder-lug is provided so that it can be used with di-pole and doublet receiving aerials.

93-MS—Antenna Cable End Terminal.....\$1.50 List



Comparison between Amphenol and other cables. Line Loss in Watts When 1000 Watts Are Fed Into 100 Feet

These Figures Represent Actual Wattage Loss

Wave Length	Light Rubber Co-Axial	Twisted Pair	Heavy Rubber Co-Axial	72-12 AMPHENOL COPPER CO-AXIAL TUBING	72-12C AMPHENOL COPPER CO-AXIAL TUBING
Meters					
2 1/2	820	800	700	320	210
5	800	645	563	249	162
10	637	463	411	186	121
20	460	324	308	133	88
40	324	206	206	110	65
80	206	133	135	60	49
160	143	83	92	45	39

CABLES CONNECTORS SOCKETS



ADAPTERS INSULATION PLUGS

5/16" POLYSTYRENE BEADS

No. 73 — Per Box of 250 Beads — \$2.50 List

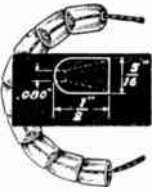

The most widely used of Amphénol insulating beads. Molded from pure, transparent polystyrene. Used for transmission lines and for insulating high voltage leads. Can be strung on wires up to No. 12 solid or No. 14 stranded. Hole diameter is .080"; length, 1/16"; over-all diameter is 5/16". When stringing cables figure 28 beads to the foot. Withstands temperatures to 190° F.

5/16" HIGH TEMPERATURE

No. 73-T — Per Box of 250 Beads
\$5.00 per box List

Identical to beads listed above but molded from mica-filled bakelite. For use where temperatures up to 285° F. are encountered, as for mounting transmission line over boilers on ships, etc. Mica-filled beads are superior to ceramic and are excelled in electrical characteristics only by Amphénol "912" polystyrene beads.

3/16" POLYSTYRENE INSULATING BEADS

No. 73-I — Per Box of 500 Beads — \$4.50 List

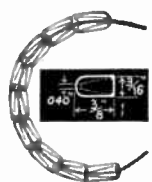

A transparent small bead molded from pure polystyrene, intended for use in small transmission lines to be used inside of electronic apparatus and as test instrument leads and for stringing on wires carrying high voltages.

Can be strung on wires up to No. 22 stranded or No. 20 solid wires. Hole diameter, .040"; length 3/16"; over-all diameter, 5/16". When stringing cables figure 35 beads to the foot. Withstands temperatures to 190° F.

3/16" MICA-FILLED BAKELITE BEADS

No. 73-IT — Per Box of 500 Beads — \$8.50 List

Identical to beads listed above but molded from mica-filled bakelite. Use where temperatures to 285° F. are encountered, as for mounting transmission line over boilers on ships, etc. Mica-filled beads are superior to ceramic and are excelled in electrical characteristics only by Amphénol "912" polystyrene beads.

TWO-WIRE BEADS

No. 73-2 — Per Box of 250 Beads — \$3.25 List



A new two hole bead molded from pure polystyrene for making balanced lines, especially for high frequency work.

Can be strung on wires up to No. 18 solid. Hole diameters, .050"; length, 1/4"; over-all diameter is 3/8". When stringing cables figure 28 beads to the foot. Rounded projections at each wire hole prevent the wire from shorting against the cable tubing when cable is bent.

Ultra-Low-Loss "912-B" Ribbon



A strong, water-clear, transparent, flexible insulating material to take the place of papers, treated fabrics, and other thin dielectrics used in winding condensers, transformers, etc. Used as a wrapped insulation for wires, bars, and cable terminals and splices.

100 Foot Rolls Individually Packaged

No.	Thickness	Width	List
65-001	.001"	3/4"	\$0.50
65-005	.005"	3/4"	2.50

On special order ribbon is available in widths to 27", in thicknesses from .001" to .010", in lengths to several thousand feet.

RIBBON CEMENT

Cement for above ribbon. Water-clear transparent. Supplied in 2 oz. bottles.

53-207-2	— 2 oz. Cement	50c List
53-207-2T	— 2 oz. Thinner	25c List

TRANSPARENT INSULATING MATERIALS

See Next Page for Electrical Characteristics

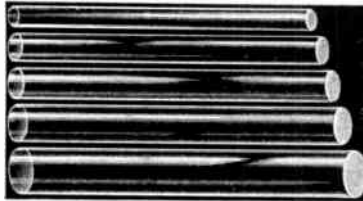

POLYSTYRENE "912-A" ROD

Nine sizes of rod are available in lengths up to 48". If no definite length is specified, 12" lengths will be shipped. There is a small cutting charge for pieces shorter than 12". Supplied in 1 ft. lengths unless otherwise specified.

1/8" diameter	\$0.15 per Ft.
3/16" diameter20 per Ft.
1/4" diameter40 per Ft.
5/16" diameter43 per Ft.
3/8" diameter45 per Ft.
1/2" diameter80 per Ft.
5/8" diameter	1.25 per Ft.
3/4" diameter	1.65 per Ft.
1" diameter	3.10 per Ft.

"912-B" ROD

There is a cutting charge for pieces less than 12" long. Available in lengths up to 48". Supplied in 1 ft. lengths unless otherwise specified.

No.	Dia.	List Price
65R250	1/4"	\$0.40 per Ft.
65R375	3/8"	.45 per Ft.
65R500	1/2"	.80 per Ft.
65R625	3/4"	1.25 per Ft.
65R750	1"	1.65 per Ft.
65R875	1 1/4"	2.40 per Ft.
65R1000	1 1/2"	3.10 per Ft.

Other sizes available up to 2 1/4" dia.

"912-B" TUBING

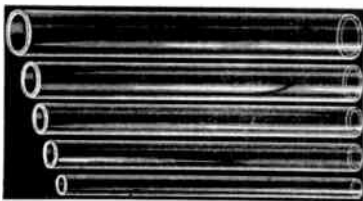

Tubing can be supplied in continuous lengths up to 48". No cutting charge is made for pieces 12" or over.

Cat. No. of 1 Ft. Lengths	Outside Diameter	Wall Thickness	List Price Per Foot
65T1-125	1 1/2"	1/8"	\$2.40
65T1-187	1 3/4"	3/8"	3.55
65T2-125	1 3/8"	1/8"	2.85
65T2-187	1 5/8"	3/8"	4.10
65T2-250	1 7/8"	1/2"	5.20
65T3-125	2"	1/8"	3.20
65T3-187	2 1/8"	3/8"	4.75
65T3-250	2 1/4"	1/2"	6.30
65T4-125	2 1/2"	1/8"	3.75
65T4-187	2 3/4"	3/8"	5.50
65T4-250	2 7/8"	1/2"	7.20
65T5-125	2 3/8"	1/8"	4.30
65T5-187	2 5/8"	3/8"	6.30
65T5-250	2 7/8"	1/2"	8.50
65T6-125	2 3/4"	1/8"	4.45
65T6-187	2 5/4"	3/8"	7.20
65T6-250	2 3/2"	1/2"	9.40
65T7-125	2 7/8"	1/8"	4.95
65T7-187	2 5/4"	3/8"	7.80
65T7-250	2 3/2"	1/2"	9.40
65T8-125	3"	1/8"	4.95
65T8-187	3 1/8"	3/8"	7.80
65T8-250	3 1/4"	1/2"	10.45

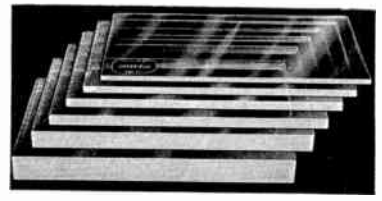

POLYSTYRENE "912-A" SHEETS

Five sizes of "912-A" sheet stock are available in 4" x 4" squares.

2" x 4" x .030" thick	\$0.20
4" x 4" square x 1/8" thick80
4" x 4" square x 3/16" thick80
4" x 4" square x 1/4" thick90
4" x 4" square x 5/16" thick90
4" x 4" square x 3/8" thick	1.00

"912-B" SHEET STOCK

Supplied in standard sheets, 12"x16". No additional charge is made for quarter or half sheets. Sheets available as large as 20"x25".

No.	Thickness	List Price
65-062	1/16"	\$ 4.00
65-125	1/8"	8.00
65-187	3/16"	12.00
65-250	1/4"	16.00
65-375	3/8"	24.00
65-500	1/2"	32.00

"912-B" THIN FLEXIBLE SHEETS

Thin flexible sheet stock available in sheets 20" x 50".

No.	Thickness	List Price
.001"	\$0.40	\$ 5.65
.002"	.80	7.60
.003"	1.20	12.50
.005"	2.00	14.75
.0075"	2.80	18.80
.010"	3.80	21.20
.0125"	5.10	23.00

"912-B" STRIPS



Recommended for making every type of low-loss insulator trimmer bases, terminal strips, bushings, open wire transmission line spreaders, mountings for binding posts and pin jacks, coil supports, etc.

ALL STRIPS ARE 12" LONG

No.	Size	List
65TS1-250	1/8" x 1/4"	\$0.26
65TS1-500	1/8" x 1/2"	.35
65TS1-750	1/8" x 3/4"	.42
65TS1-1000	1/8" x 1"	.52
65TS2-250	1/8" x 1/4"	.38
65TS2-500	1/8" x 1/2"	.57
65TS2-750	1/8" x 3/4"	.71
65TS2-1000	1/8" x 1"	.90
65TS3-250	3/16" x 1/4"	.57
65TS3-500	3/16" x 1/2"	.84
65TS3-750	3/16" x 3/4"	1.05
65TS3-1000	3/16" x 1"	1.34
65TS4-250	1/4" x 1/4"	.72
65TS4-500	1/4" x 1/2"	1.08
65TS4-750	1/4" x 3/4"	1.36
65TS4-1000	1/4" x 1"	1.75
65TS6-250	3/8" x 1/4"	1.06
65TS6-500	3/8" x 1/2"	1.60
65TS6-750	3/8" x 3/4"	2.00
65TS6-1000	3/8" x 1"	2.60
65TS8-250	1/2" x 1/4"	1.37
65TS8-500	1/2" x 1/2"	2.10
65TS8-750	1/2" x 3/4"	2.66
65TS8-1000	1/2" x 1"	3.45

CABLES CONNECTORS SOCKETS



ADAPTERS INSULATION PLUGS

"912-A" and "912-B" LOW-LOSS INSULATING MATERIALS

These are water-clear transparent insulating materials made famous for radio use by Amphenol in parts molded to shape, and in rod, sheet, and tubing for custom built parts. Amphenol "912-A" is pure polystyrene, the finest insulator available for U.F.H. use which can be formed into radio parts. Amphenol "912-B" is similar in appearance to "912-A" but is acrylic type of resin, slightly inferior to "912-A" for electrical purposes, but available in larger sizes. Following are the electrical characteristics of these superior materials:

	"912-A"	"912-B"
Power factor	1 Mc .0002	10 Mc .0002 ± .0004
Dielectric Constant	2.6	2.6
Loss Factor	.0005	.0005

ULTRA-LOW-LOSS COIL DOPE



Amphenol "912-A" polystyrene reduced to liquid form. The material is non-hygroscopic (will not absorb moisture), and has a very low-loss factor, making it ideal for high frequency use. It insures greater stability in receivers and other electronic devices, and allows more critical adjustments without the danger of drift due to leakage or moisture absorption.

Does not affect electrical characteristics of coil windings. Unequaled for sealing pores of fibre, cardboard, ceramics, paper, and other moisture absorbent materials. Used for cementing parts made of Amphenol "912-A." Supplied with brush.

No.	List
53-2 — 2 oz. Liquid "912"	50c
53-4 — 4 oz. Liquid "912"	85c
53-2T — 2 oz. Thinner	25c

U.H.F. OCTAL SOCKET



Body molded from transparent Amphenol "912-A" polystyrene. Remarkable low-loss properties which provides greater efficiency on high frequency work than has ever before been possible. The only caution to be

emphasized is that they should never be heated beyond 200° F. Requires 1/4" hole; mounting centers 1 1/2".

54-B—U.H.F. Octal Socket	40c List
--------------------------	----------

U.H.F. LOKTAL SOCKET

As above, but for the all-glass Loktal tubes. For use in U.H.F. apparatus.

54-8L—U.H.F. Loktal Socket	45c List
----------------------------	----------

U.H.F. TIP JACK OR BUSHING



Contact accommodates .080" phone tip. Contact may be removed and the transparent Amphenol "912-A" polystyrene body used as a high-frequency thru-panel bushing. Mounts in a plain round 3/8" hole, and is held in place with the No. 2-9 retainer ring, included.

54-1H—U.H.F. Tip Jack	25c List
-----------------------	----------

STAND-OFF INSULATORS



Ultra-low-loss. Formed from Amphenol "912-A" pure polystyrene. For indoor or outdoor use. Non-hygroscopic. Will not break when dropped or subjected to hard blows as do ceramics or glass. Type "A" has insulation 1/2" in diameter. Type "B" has insulation 3/8" in diameter. Wire is held in place by screw or solder-lug. Brass insert in top of insulator has "V" shaped slots so that wire can be securely clamped in place. Hex. screw head permits use of wrenches for binding wire in place.

No.	Length	List
66-1—(Type B)	1 1/2"	50c
66-2—(Type B)	2"	60c
66-3—(Type A)	2 1/2"	1.10
66-4—(Type A)	4"	1.35
66-5—(Type A)	6"	1.50

PLUG-IN COIL FORMS

Molded from Amphenol "912-A" pure polystyrene, the losses are practically zero. Coils wound on these forms superior to air wound coils because dirt cannot gather between windings and lower "Q" of coil. Frong spacing fits standard tube sockets. Use Amphenol mica-filled sockets at the receptacle. Diameter of coil 1 1/4"; length of body 2 1/4". Impregnate wound coils with Liquid "912-A."

24-4P—4-prong	50c List
24-5P—5-prong	55c List
24-6P—6-prong	60c List



MINIATURE COIL FORM

Ultra-low-loss; molded from Amphenol "912-A" pure polystyrene. Has raised hole in center of base to accept self-tapping screw. For mounting directly on wave band switch, tuning condenser or chassis. No holes for windings because it is easy to drill them where needed. 3/8" O.D., 1 1/8" long.

24—Coil Form	15c List
--------------	----------



MINIATURE PLUG-IN TYPES

Small plug-in coil forms, molded from Amphenol "912-A" polystyrene insulation. Only 3/8" in diameter. Especially designed for use in transmitters, low-power transmitters and receivers which work the ultra-high frequencies. No holes are provided for the ends of the coil windings because it is easy to drill holes exactly where they are wanted.

Use 54-5H and 54-6H Miniature sockets listed below on the coil form receptacles.

24-5H—5-prong	40c List
24-6H—6-prong	40c List



U.H.F. MINIATURE SOCKETS

Molded from Amphenol "912-A" polystyrene. 5 and 6-contact sockets designed for use with Miniature Coil Forms above, to keep coil and circuit losses in U.H.F. equipment at a minimum. Also fit Hytron Bantam Jr. tubes.

54-5H—5-contact Socket	35c List
54-6H—6-contact Socket	35c List



FOR R.C.A. MINIATURE TUBES

7-Contact U.H.F. socket for the tiny R.C.A. miniature tubes, such as 1R5, 1R5, 1R4, and 1T4, etc.; and 9000, 9001, 9002, and 9003.

54-7P—7-contact Socket	35c List
------------------------	----------

CRYSTAL HOLDER SOCKET

For plugging in standard quartz-crystal holders. Body molded of Amphenol "912-A" polystyrene. Contacts are of special phosphor bronze, silver plated to keep resistance at a minimum. Mounts above or below chassis.

54-2	30c List
------	----------



UNIVERSAL INSULATORS Stand-Off—Feed-Through—Lead-In

Sectional construction permits assembling insulator for below or above surface mounting, and with additional insulating tubes, can be used as an aerial lead-in through walls for antenna feeders. Following are the parts:

- A—Top Threaded Fitting with binding screw and soldering lug. When screw is removed, inside thread accommodates a banana plug.
- B—Insulator Tube, over-all length 2 1/4", diameter for 2" is 1/2", and is 1/2" for 1 1/2". Has 3/4" hole through center.
- C—Center Brass Rod, nickel plated, threaded at both ends.
- D—Insulator Base; described at bottom of page.
- E—Bottom Hex. Threaded Fitting with binding screw and soldering lug. When binding screw is removed, inside thread accommodates banana plug.

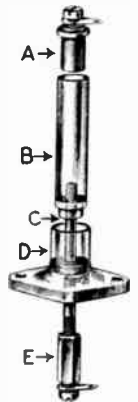

PRICES ON ABOVE HARDWARE

66-167—Center Rod 3/8" long, for stub insulator	15c ea. list
66-168—Center Rod 2 1/2" long, for standard insulator with 1 tube	18c ea. list
66-169—Center Rod 4 1/2" long, for insulator with 2 tubes	20c ea. list
66-170—Center Rod 6 1/2" long, for insulator with 3 tubes	25c ea. list
66-165—Top Brass Bushing with screw and solder-lug	20c ea. list
66-166—Bottom Hex. Fitting with screw and solder-lug	15c ea. list

Base and Tubes listed at bottom of page

COMPLETE INSULATOR

No. 66-60 — \$1.00 List
Universal insulator molded from Amphenol "912-A" pure polystyrene. Can be assembled as a feed-through insulator as illustrated here, or as a stand-off insulator as illustrated above. Center conductor is a brass rod. Both top and bottom fittings are equipped with binding screws and soldering lugs. Screws can be removed from either top or bottom and inside tapped hole will accommodate a banana plug. Over-all height of insulator is 3 1/4". With assembled hardware, 4". Mounting holes on 1 1/2" ctrs.



STUB INSULATOR

No. 66-61 — 80c List
Similar to above but length of insulator is only 1". For mounting coils, condensers, and other parts carrying high frequency or high voltage currents. Binding screws may be removed and tapped hole will accommodate banana plug mountings. Over-all length, 1 1/2".



INSULATOR BASE (Bushing)

No. 66-60B — 25c List
Affords an exceptionally versatile type of feed-through bushing for carrying high frequencies or high voltages through panels. Also for use with tubes listed below and hardware at top of column for assembling many types of insulators. Over-all length 1".



INSULATOR TUBE

No. 66-60T — 25c List
Insulating tube only as used on insulators described above. Molded from pure polystyrene Amphenol "912-A." Tubes are designed so that they can be fitted together, forming a tube as long as is required. Cement with Liquid "912-A" Coil Dope. Used extensively for feeding high frequency and high voltage lines through walls, etc. Also used in conjunction with other parts to assemble lead-in and other insulators. Ideal as forms for R.F., Ant., and I.F. coils for high frequency work.



CABLES CONNECTORS SOCKETS



ADAPTERS INSULATION PLUGS

REPLACEMENT SOCKETS



Regular "S" sockets and "CP" plugs (listed to the right) assembled with No. 4 retainer ring to nickel plated steel mounting plate with slotted mounting holes to fit riveting centers from 1 1/4" to 1 3/4". Extensively used by servicemen as replacements.

Socket	Plug	List
78-RS-4	86-RCP-4	4-contact 12c
78-RS-5	86-RCP-5	5-contact 12c
78-RS-6	86-RCP-6	6-contact 12c
78-RS-7S	86-RCP-7S	7-small 12c
78-RS-7L	86-RCP-7L	7-large 12c
78-RS-7C	86-RCP-7C	7-1 & S Comb. 15c
78-RS-8	86-RCP-8	8-octal 15c
78-RS-9	86-RCP-9	9-contact 19c
78-RS-11	86-RCP-11	11-contact 25c
78-RS-8L	10KTA	18c

*Fits both 7-large and 7-small.

VIBRATOR SOCKETS

List Price — 20c ea.

Molded black bakelite sockets for most vibrators. Supplied complete with mounting plate and No. 4 retainer ring; can be used for replacing wafer or single-hole mounting sockets. When ordering, forward old socket or diagram of vibrator pin spacings.

LOW-LOSS SOCKETS

Any socket listed on this page available molded from mica-filled bakelite. Provides 50% better power factor and 33% better dielectric constant. Especially recommended for high frequency use. When ordering, add the letter "T" to part number and 13c to list price.

STEATITE SOCKETS



Recommended for high frequency work where high temperatures are encountered such as in transmitters, amplifiers having high output, etc. Slotted mounting holes fit riveting centers from 1 1/4" to 1 3/4".

No.	List
20-RSS4	4-contact 40c
20-RSS5	5-contact 40c
20-RSS6	6-contact 40c
20-RSS7S	7-small 40c
20-RSS7L	7-large 50c
20-RSS8	8-contact 40c

PLUGS

20-RCPS3-4	6-prong plug 40c
------------	------------------

SOCKET PUNCHES



Special dies for punching keyed chassis holes for "S" type sockets, "CP" type plugs, and "61" power plugs. Used by laboratory men, amateurs and radio parts jobbers. Made of tool steel, properly hardened.

No.	List
25-LD-1	for small sockets \$10.00
25-LD-2	for large sockets 10.00
25-LD-3	mike connectors 3.00

Amphenol Sockets and Plug Assemblies are used in most of the better radio receivers, transmitters and test instruments throughout the world. Constructed of the best materials obtainable, molded from high dielectric black bakelite, designed perfectly for the purpose for which they are intended, yet priced so that they may be used by all servicemen, custom set builders, soundmen, and amateurs. There is an Amphenol Socket or Plug Assembly for every radio or sound job.

RETAINER RING MOUNTING

"S" TYPE SOCKETS and "CP" TYPE PLUGS



Extremely compact sockets and plugs, which are easily and quickly mounted to chassis or panels without screws or rivets. Held firmly in place by the patented Amphenol tempered steel retainer ring. Fits all chassis or panels from 19 gauge (.044") to 18 gauge (.062"). Insulating body of sockets and plugs is molded from high dielectric black bakelite.



SOCKET PRICES

(Price includes No. 4 Retainer Ring)

No.	List
78-S4	4-contact 11c
78-S5	5-contact 11c
78-S6	6-contact 11c
78-S7S	7-small 11c
78-S7L	7-large 11c
78-S7C	*7-combination 14c
78-S8	8-octal 14c
78-S9	9-contact 17c
78-S11	11-contact 23c
78-SL	LOKTA 18c

*Fits both 7-large and 7-small.

PLUG PRICES

(Price includes No. 4 Retainer Ring)

No.	List
86-CP4	4-prong 11c
86-CP5	5-prong 11c
86-CP6	6-prong 11c
86-CP7S	7-prong small 11c
86-CP7L	7-prong large 11c
86-CP8	8-prong (octal) 14c
86-CP9	9-prong (octal) 17c
86-CP11	11-prong (octal) 24c

FOR ABOVE SURFACE



"S" type sockets, "CP" type plugs, 110-250 volt plugs and receptacles are available mounted in a light weight steel shell which raises the unit 13/16" above or below surface. Four knockouts in side of shell for wire entrance. Ideal for mounting on work benches, breadboard radios, etc. Add 15c to list price of unit ordered. Specify "with ACS Shell". 23-1—Blank shell only 10c 23-1S—Punched Shell only 10c

FLUSH MOTOR SHELL



"S" type sockets, "CP" type plugs, 110-250 volt receptacles and plugs are supplied in this drawn steel shell, finished in burnished nickel. For below surface mounting on all types of radio and electrical apparatus. Add 15c to the list price of the unit selected. Specify "with 61-61 Shell." 61-61—Shell only 15c

ENDED TYPE



For extending a socket, plug, 110-250 volt receptacle or plug through a cabinet or wall. Supplied with any "S" type sockets, "CP" type plugs, 110-250 volt receptacle or plug. Add 20c to list price of unit selected. Specify "with 3-30A Cap." 3-30A—Cap only 20c

SIDE MOUNTING



A versatile outlet for radio and electrical work. Mounts on side of wall, work bench, etc. Supplied with any "S" type socket, "CP" type plug, 110-250 volt receptacle or plug. Add 20c to list price of unit selected. Specify "with 3-33A Cap." 3-33A—Cap only 20c

110-250 VOLT RECEPTACLES and PLUGS



Compact receptacles and plugs, molded from high dielectric black bakelite. Rated at 15 amps. for 110 volts, 10 amps. at 250 volts. Female type has both soldering lugs and binding screws; male has binding screws. 2-Pole type accepts any standard electric plug. For polarized cable connectors see next page.



RETAINER RING TYPE

As illustrated. No mounting screws or rivets required. Held firmly in place by patented Amphenol No. 4 retainer ring. Female accommodates either standard or polarized male.

RECEPTACLES	List
61-F—2-pole universal	25c
60-F—3-pole polarized	35c

PLUGS	List
61-M—2-pole standard	25c
61-MP—2-pole polarized	25c
60-M—3-pole polarized	35c

WITH MOUNTING PLATE

Receptacles and plugs assembled to a steel mounting plate as used with Replacement Sockets. Slotted mtg. centers fit riveting centers from 1 1/4" to 1 3/4".

RECEPTACLES	List
61-F1—2-pole universal	28c
60-F1—3-pole polarized	38c

PLUGS	List
61-M1—2-pole standard	28c
61-MP1—2-pole polarized	28c
60-M1—3-pole polarized	38c

MIP SOCKETS (Molded-in-Plate)



World's strongest socket. Sturdy steel mounting plate molded directly into bakelite body, cam-type loose or tight. 1 1/4" mounting centers. Mounts in 1 1/4" hole (MIP20 in 1-9/32" hole). Molded from high dielectric black bakelite.

77-MIP4	4-contact	10c
77-MIP5	5-contact	10c
77-MIP6	6-contact	10c
77-MIP7S	7-small	10c
77-MIP7L	7-large	12c
77-MIP8	8-contact	12c
77-MIP9	9-contact	15c
77-MIP11	11-contact	20c
77-MIP12	12-contact	25c
77-MIP20	20-contact	50c

MIP LOKTAL

Molded-in-plate socket for loktal tubes. Identical to standard MIP sockets but is smaller in size and has 1-5/16" mounting centers. Mounts in 1-1/16" hole.

88-8X—Loktal Socket 17c List

MIDGET OCTAL

Has all the features of the standard MIP sockets, but is smaller in size and fits building compact radios and as the companion socket for the above loktal Mtg. centers, 1-5/16". Mounts in 1 1/4" hole.

88-8—Midget Octal 12c List

U.H.F. SOCKETS

(Polystyrene)



Body molded from transparent Amphenol "912-A" (polystyrene). Remarkable LOW-LOSS properties provide greater efficiency for ultra-high frequency work than has ever before been possible. Castion—solder fast! Do not heat beyond 200° F. Requires 1 1/4" hole, 1 1/4" mounting centers.

54-8—Octal Socket	40c
54-8L—Loktal Socket	45c

TUBE SHIELD BASE

1-19/32" For standard tube shields. Mounts under "S" or "RS" type sockets, described at top of page, held firmly in place without screws or rivets. Has soldering lug for grounding.

No. 5-TSB-1 15c List Price 3/4c



Amphenol Radio Tube Sockets are patented under U. S. No. 2,087,784 — also foreign patents. Other patents pending.

CABLES CONNECTORS SOCKETS



ADAPTERS INSULATION PLUGS

MINIATURE SOCKETS

FOR RCA



For RCA miniature tubes, 184, 185, 1T4, and 11B; and 9001, 9001, 9002, and 9003. Mounts in a 3/8" hole, held firmly in place with the No. 2-9 retainer ring.

78-7P—7-contact17c List
As above but molded from Amphphenol "912-A" pure polystyrene. For U.I.F. applications.
54-7P35c List

RAYTHEON



For the tiny Raytheon hearing aid tubes, such as CK501, CK502, CK503, and CK504. Mounts in a 1/8" hole. Held firmly in place by the No. 2-10 retainer ring.

78-5P—5-contact17c List

BANTAM JR.



For Hytron Bantam Jr. tubes, HY113, HY-115, and HY125. Mounts in a 3/8" round hole. Held firmly in place with the No. 2-9 retainer ring. Extensively used in hearing aids.

78-5H—5-contact17c List
As above but molded from Amphphenol "912-A" pure polystyrene. For I.I.F. applications.
51-5H35c List

PHOTOCELL



For RCA Pee-Wee and Cetron CE-5BB and CE-20 photocells. Mounts in a 3/8" round hole. Held firmly in place by the No. 2-9 retainer ring.

78-S3S—3-contact14c List

BLANK SOCKET



Identical in size and appearance to regular "8" type sockets. Mounts in the standard 1-11/64" "8" type socket hole. Can be used as a bakelite bushing by drilling a hole in the center, but primarily designed as a dummy for spare socket. Supplied with a No. 4 retainer ring for mounting. No screws or rivets required.

78B—Blank Socket6c List

MINIATURE PLUGS

CABLE TYPE



Extremely compact plugs, used extensively for speaker connections in compact midsets. Also ideal for all plug-in connections where space is limited. Plated brass prongs are deeply recessed in individually molded pockets, preventing shorts due to insulation pulling back. With molded finger grip. Fit Miniature Sockets to right.

CHASSIS TYPE



Mounts in a plain round hole, 3/8" in diameter. No screws or rivets required. Held firmly in place by the No. 2-9 tempered steel retainer ring. Use with female Miniature Connectors (MPF types) at right.

Chassis	Prongs	List
86-CP-3S	71-3S	3 13c
86-CP-4S	71-4S	4 13c
86-CP-5S	71-5S	5 17c
86-CP-6S	71-6S	6 17c

SHIELDED CABLE CONNECTORS MULTI-WIRE CABLE CONNECTORS



The most practical of all plugs and cable connectors for use on power lines. Molded bakelite receptacles and plugs described on the preceding page, encased in drawn steel caps, making unbreakable cable terminals that are fully shielded. The cap snaps on and fits securely, but may be removed easily. Cable entrance accommodates cables up to 7/16" in diameter. Rubber grommet protects cables against abrasion. Cable clamp listed below may be used in place of rubber grommet to relieve all strain on connections.

No.	List
61-F4	2-Pole Receptacle35c
61-M4	2-Pole Standard Plug.....35c
61-MP4	2-Pole Polarized Plug.....35c
60-F4	3-Pole Receptacle45c
60-M4	3-Pole Polarized Plug.....45c



Made of regular Amphphenol "S" type tube sockets and "P" plugs, snugly covered by a steel cap that fits tightly but may be removed with an ordinary screw driver. Cover is 1" in height, black japanned. A rubber grommet protects cable from abrasions. Metal cover shields connections and provides an unbreakable cable terminal. Small and sturdy. Accommodates cables to 7/16".

Female	Male	List
78-PF4	86-PM4	4-contact 25c
78-PF5	86-PM5	5-contact 25c
78-PF6	86-PM6	6-contact 25c
78-PF7S	86-PM7S	7-small 25c
78-PF7L	86-PM7L	7-large 25c
78-PF8	86-PM8	8-contact 25c
78-PF9	86-PM9	9-contact 25c
78-PF11	86-PM11	11-contact 35c

ACCESSORIES FOR ABOVE CONNECTORS LOCKING SHELLS CABLE CLAMP



Cadmium-plated steel covers which can be slipped over "PF" and "PM" Connectors and 110-250 volt Connectors. Locks connectors firmly together, preventing accidental pull-aparts. Especially suited for public address work. Also used extensively in shops, etc., for connecting power cords. Set consists of one male and one female threaded shells.

15-CAB—Per Set25c List



Designed primarily for use with "PF" and "PM" connectors and 110-250 volt connectors described above. Simply remove rubber grommet of connector and slip this grip into place. Relieves soldered connections of all strain. Also used on panels and chassis to anchor cables firmly in place. Slips easily into any shape hole from 7/16" to 3/8". No screws or rivets required.

79-CC-4—Cable Clamp10c List

CHASSIS TYPE



Set consists of one threaded shell which fits under "S" type sockets or retainer ring mounting 110-250 volt receptacles listed on preceding page, and one shell which slips over the cable connector.

15-C-CHA—Per Set25c List

RUBBER PLUG HANDLE

"PF" or "PM" Connectors and 110-250 volt connectors snap into this rubber handle and are held securely in place by an inner molded shoulder. For easy removal of connectors plugged into recessed or hard-to-get-at places. Molded from black rubber. Illustration is cut away to show how connector is gripped by plug handle.

3-RPH—Rubber Plug Handle.....15c

SHIELDED PLUGS



For use where shielded plugs are desired. Male may also be used for making connection to miniature sockets described below. Cadmium-plated brass shells are 13/16" long, 5/8" in dia. Accepts cables up to 5/16" O.D.

Male	Female	Prongs	List
91-MPM3S	91-MPF3S	3	30c
91-MPM4S	91-MPF4S	4	33c
91-MPM5S	91-MPF5S	5	37c
91-MPM6S	91-MPF6S	6	37c

MINIATURE SOCKETS

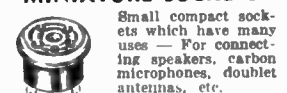

Small compact sockets which have many uses — For connecting speakers, carbon microphones, doublet antennas, etc.

Mount in a round hole 3/8" in diameter. No screws or rivets required.

78-S3S	3-contact socket	14c List
78-S4S	4-contact socket	14c List
78-S5S	5-contact socket	17c List
78-S6S	6-contact socket	17c List

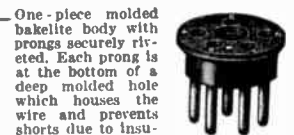

One-piece molded bakelite body with prongs securely riveted. Each prong is at the bottom of a deep molded hole which houses the wire and prevents shorts due to insulation pulling back. Also provides an economical cable connector for plugging multi-wire cables into amplifiers, remote controls, test instruments, etc.

71-4	4-prong	11c List
71-5	5-prong	11c List
71-6	6-prong	11c List
71-7	7-prong	14c List
70-8	8-prong	14c List
70-9	9-prong	17c List
70-12	12-prong	25c List
70-20	20-prong	50c List

20-CONTACT SOCKET AND SHIELDED PLUG



Molded bakelite plug encased in black japanned steel shell for connecting to cables having up to twenty No. 18 conductors. Rubber grommet accepts cables to 7/16" in diameter. Prongs molded directly into bakelite body, eliminating possibility of working loose or getting out of alignment. Molded octal type polarizing stud prevents incorrect insertions. Socket has molded-in steel mounting plate. Mounts in a 1-9/32" hole, with riveting centers of 1 1/4".

70-PM-20	20-prong plug	75c List
77-MIP-20	20-contact socket	50c

LOW-LOSS CONNECTORS

Any socket, plug, or connector listed on this page is available with the insulating body molded from mica-filled bakelite for better dielectric strength and loss factor. When ordering add the letter "M" to the part number and 13c to the list price.

MINIATURE CABLE CONNECTORS



Use female with flanged shell and male with straight shell for connecting two cables. For plugging cables into shielded chassis units listed to right, use male or female connector with straight shell.

Molded bakelite connectors housed in cadmium-plated brass shells. Only 1 1/4" long and 3/8" O.D. Bakelite element held in place by side set screw. Screw holes in two positions permits recessing male prongs when used as cable connectors. Accommodates cables up to 5/16". When used with shielded cables, shield can be soldered directly to the cadmium-plated shell.

Female	Male	List
91-MPF3L	91-MPM3L	3-contact 30c
91-MPF4L	91-MPM4L	4-contact 33c
91-MPF5L	91-MPM5L	5-contact 37c
91-MPF6L	91-MPM6L	6-contact 37c

Female	Male	List
91-MPF3	91-MPM3	3-contact 30c
91-MPF4	91-MPM4	4-contact 33c
91-MPF5	91-MPM5	5-contact 37c
91-MPF6	91-MPM6	6-contact 37c

CHASSIS UNITS



Use where a compact shielded connector is required. These chassis connectors are ruggedly built. High quality dielectric and low resistance contacts make it possible to use them in photocell circuits, etc., where minute currents are handled. For cable connector use Miniature Connectors with straight shell (MPM3L and MPP3L type) listed to left. Mtg. Ctrs. 1 1/4".

Male	Female	List
91-PCG3M	91-PCG3F	3-contact 30c
91-PCG4M	91-PCG4F	4-contact 30c
91-PCG5M	91-PCG5F	5-contact 34c
91-PCG6M	91-PCG6F	6-contact 34c

CABLES CONNECTORS SOCKETS



ADAPTERS INSULATION PLUGS

SINGLE CONTACT MICROPHONE CONNECTORS CABLE TYPE



75-MC1F 50c List
75-MC1M 40c List
 Completely shielded unbreakable connectors for use with single conductor microphone cable. Shell is chrome-plated machined brass. Coupling ring prevents accidental disconnections. Contact is made when soldered connections are pressed together by tightening the coupling ring. Spring cord protectors accommodate cables to 1/4" dia. **75-MC1F—Female** 50c List
75-MC1M—Male 40c List

PRESSURE CABLE CONNECTOR
 Identical to MC1M described at top of page, but center insulated contact is forced forward by a heavy coil spring for a more positive connection. Can be used for connecting to any unit where MC1M was formerly used. Supplied with coil spring cord protector for cables to 1/4".
75-SP-MC1M—Male 50c List

CHASSIS UNIT

Mount in .385" hole to ground to chassis. Mount in 1/4" hole when two circuits are desired independent of chassis. Supplied complete with extruded fibre washer, flat fibre washer, flat solder lug washer, and locking nut. Use MC1F or MC1F-A as the cable connector.
75-PC1M—Chassis Connector 30c List

PRESSURE CHASSIS UNIT

Identical to above PC1M Chassis Unit, but has heavy coil spring which pushes center contact forward. May be used wherever PC1M was formerly used.
75-SP-PC1M—Pressure Chassis Connector 40c List

CLOSED CIRCUIT CONNECTOR

Same as PC1M but circuit closes when cable connector is removed, eliminating open circuit grid howls. Same thread and hardware supplied as on PC1M. Contact is spring-actuated. Use MC1F or MC1F-A as the cable connector.
75-CL-PC1M 40c List

1 AND 2 CONTACT PLUG-IN CONNECTORS

CABLE TYPE



80-MC2F 65c List
80-MC2M 80c List
 For small co-axial cables, microphone cables, speakers, etc. Utilizes standard sleeve type contacts and male prongs for a more positive contact. Unbreakable brass shell, finished in polished chrome. Element is Amphenol molded from high dielectric black bakelite. Screw type coupling ring prevents accidental disconnections. Spring cord protector supplied as standard with single contact connectors accepts cables to 1/4". When ordering connectors for use with Amphenol 75 cable, request No. 8030 spring for 9/16" cables, as supplied with 2-contact type.

80-F* 1-contact Female 65c List
80-M* 1-contact Male 65c List
80-MC2F 2-contact Female 80c List
80-MC2M 2-contact Male 80c List

CONVENIENCE OUTLETS

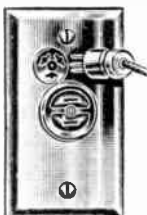

Antenna Outlet
 Wall plate described below, equipped with a 110-volt receptacle and a small 3-contact socket for a doublet or "T" type antenna. Supplied complete with the 3-prong plug for plugging the radio into the antenna outlet. This neat appearing assembly is being used in all modern homes.
84-AC—Complete \$1.45

Chrome plated wall plates, punched for any Amphenol receptacle, socket, or chassis connector. Mounting holes fit directly on standard outlet boxes. When ordering specify which Amphenol product is to be mounted on the wall plate.
84-2CH—Plate only 75c List

ANGLE CONNECTOR



A new convenient cable unit for connecting cables at right angles to chassis unit. For use on amplifiers, transmitters, and other apparatus which has the PC1M, SP-PC1M, or CL-PC1M installed. Eliminates unsightly long bends in cable and greatly reduces the breakage of cable shields and center conductors. Barred of connector is die cast and finished in polished chrome. Supplied with spring cord protector for cables 1/4".
75-MC1F-A—Angle Connector 60c List

MICROPHONE SWITCH



Compact, unbreakable microphone switch. Male threads fit the MC1F and MC1F-A. Coupling ring fits any other connector having coupling threads. No tools or wiring is required. May be connected directly to any mike which has the PC1M installed, between amplifier and mike cable, or between two cables connected with MC1M and MC1F. PUSH-TO-TALK, and release the button for stand-by; or SLIDE SWITCH forward for permanent connection. Switch short-circuits mike. Machined from solid brass, chrome plated.
75-MC1S—Switch Complete \$1.00

PHONE PLUG ADAPTER



Screws into coupling ring of MC1F and MC1F-A Connectors, permitting the cable to be plugged into any standard phone jack. There is no soldering or wiring. Since almost every microphone using single conductor shielded cable has the MC1F as the cable terminal, several of these adapters should always be on hand so that mikes can be plugged into amplifiers or recorders which use phone jacks for the input.
75-MC1P—(Plug Only) 45c List

CHASSIS UNITS

Lock Nut Mounting



Shielded chassis connectors. Supplied complete with metal washer and hex locking nut. 21/32" mounting hole.
80-C—1-contact Female 40c List
80-C1—1-Prong Male 40c List
80-PC2F—2-cont. Female 45c List
80-PC2M—2-Prong Male 45c List

With Riveting Plate

Chassis connectors for fast mounting with rivets or for replacement on apparatus that has a mounting hole too large for "Lock-Nut-Mounting" Amphenol Connectors. The 1 1/8" diameter round mounting plate is an integral part of shell, the entire unit being machined from solid brass, then chrome plated. Has 3/8" mounting hole centers.
80-CR—1-pole Female 50c List
80-PC2-CR—2-pole Female 55c List

CHASSIS UNIT WITH COUPLING RING



Connectors for mounting on chassis, panel, or may be screwed into microphone body having standard 3/8"-27 thread. Has coupling ring for engaging 80-F or MC2F Cable Connector. Brass shell is chrome plated. Supplied with hex. nut, lock washer, and flat washer. Requires 3/8" mounting hole.
80-MSP—1-pole Male 80c List
80-SP-MC2M—2-pole Male 90c List

CAP AND CHAIN



Chrome plated cap for sealing chassis units when not in use. Prevents dust entering, eliminating noisy connections. For use with any threaded single and 2-conductor chassis unit, such as PC1M, CL-PC1M, 80-C, 80-CR.
75-CCC-1—Cap and Chain 50c List

3 and 4 CONTACT MICROPHONE CONNECTORS



Molded bakelite elements encased in unbreakable chrome-plated polarized brass shells. Elements are interchangeable. By removing cap and spring cord protector, connector can be screwed into microphone having 3/8"-27 thread, standard for this industry. Screw type coupling ring prevents accidental disconnections. 3-contact connectors take cables up to 1/4" dia.; 4-contact to 3/8" dia.

Male	Female	List
91-MC3M	91-MC3F	3-contact \$1.00
91-MC3M1	91-MC3F1	3-contact 1.00
91-MC4M	91-MC4F	4-contact 1.10
91-MC4M1	91-MC4F1	4-contact 1.10

CHASSIS CONNECTORS



Mounts in 13/16" hole in any panel or chassis up to 1/4" in thickness. Bakelite element fixed permanently in plated-brass shell. Supplied complete with chrome-plated mounting ring, lock washer, and hex. lock nut.

91-PC3F—3-contact Female	50c List
91-PC3M—3-Prong Male	50c List
91-PC4F—4-contact Female	55c List
91-PC4M—4-Prong Male	55c List

SPECIAL CHASSIS CONNECTORS



Adjustable to panels up to 3/4" in thickness. Solder lugs recessed, protecting them from physical damage and eliminating danger of shock. Use MC3M or MC4M as cable connector.

91-SP-PC3—3-contact Female	\$1.00 List
91-SP-PC4—4-contact Female	1.10 List



Adjustable to panels up to 1/2" in thickness. Exceeds in front of panel 1/2". Shell is chrome plated and carries the coupling ring. Use MC3F or MC4F as the cable connector.

91-SP-PC3M—3-prong Male \$1.00 List
91-SP-PC4M—4-prong Male 1.10 List

STAND CONNECTOR



Screws on to top of any standard microphone stand. Female thread is 3/8"-27. Finished in polished chrome brass. Permits easy removal of mike.

91-SC3—3-contact \$1.00 List
91-SC4—4-contact 1.10 List

SIDE CABLE OUTLET



Designed to be placed between a microphone and stand having 3/8"-27 threads. Its purpose is to provide an outlet for the microphone cable where it is not desired to run it through the stand tubing. Efficient cable grip relieves strain. Heavy metal castings, finished in polished chrome.

57-SC03—Side Cable Outlet 75c List

CAP AND CHAIN



Chrome-plated cap for sealing chassis units when not in use. Prevents dust entering, eliminating noisy connections.

Fits any chassis unit in this column with coupling threads such as PC3F, SP-PC4F, etc.
91-CCC-3—Cap and Chain 50c List

LOW-LOSS CONNECTORS

Any connector listed on this page available molded from mica-filled bakelite. Provides 50% better power factor and 33% better dielectric constant. Especially recommended for high frequency use. When ordering add the letter "T" to part number and 13c to List Price.

CABLES CONNECTORS SOCKETS



ADAPTERS INSULATION PLUGS

COMPLETE CONDUIT AND CABLE ASSEMBLIES

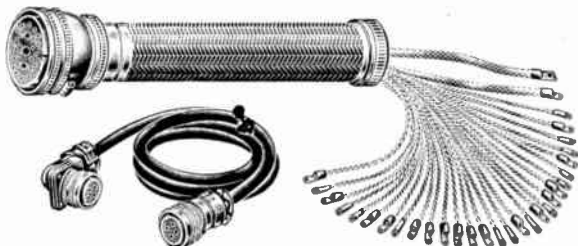

All types of conduit assemblies, cable assemblies, and wiring harnesses are produced complete by the Conduit Assembly Department of the American Phenolic Corporation. Experienced personnel with specially devised high-speed equipment are able to attach ferrules, fittings, connectors, and terminals quickly and accurately, usually with a substantial saving to customers. Every assembly is constructed to meet strict specifications and passes rigid inspection to assure complete satisfaction under the most severe conditions. Every order, large or small, given careful attention. For accurate estimates, blueprints should be supplied.

HEAVY-DUTY RADIO CONNECTORS For Cables Having up to 12 Conductors



With Coupling Ring With Coupling Thread Chassis Unit

Fully shielded, unbreakable polarized connectors which will withstand the rough usage of public address work. Drawn brass cadmium-plated shell houses a molded bakelite element. Cable type has a positive strain relief clamp which will accommodate cables up to 1/2" in diameter. Chassis type mounts in 1 1/4" hole and is supplied complete with lock washer, flat washer, and hex. locking nut.

No. of Contacts	Cable Connector With Coupling Ring		Cable Connector With Coupling Thread		Chassis Unit With Coupling Thread		List Price
	Male	Female	Male	Female	Male	Female	
4	79-04M	79-04F	79-04MI	79-04F	79-P04M	79-P04F	\$1.25
5	79-05M	79-05F	79-05MI	79-05F	79-P05M	79-P05F	1.25
6	79-06M	79-06F	79-06MI	79-06F	79-P06M	79-P06F	1.25
8	79-08M	79-08F	79-08MI	79-08F	79-P08M	79-P08F	1.25
12	79-012M	79-012F	79-012MI	79-012F	79-P012M	79-P012F	2.00



"AN" CONNECTORS

Amphenol "AN" connectors are now available for aircraft and industrial use, having 1 to 42 contacts, for carrying from 5 to 200 amperes. 106 Different elements are available, housed in every type of shell. Fittings for flexible and rigid conduit, portable cords or shielded cable can be supplied. Your jobber has complete information on this new line of connectors.

Heavy Duty POWER CONNECTORS



92M Male—\$2.50 List 92F Female—\$2.50 List
92FI Female—2.50 List 92MI Male—2.50 List

Has four flat blade prongs and phosphor bronze contacts more than heavy enough to carry 10 amps. at 250 volts, 15 amps. at 125 volts. Molded bakelite element completely encased in drawn brass, cadmium-plated shell. Listed by Underwriters' Laboratories.



SINGLE CONTACT SOCKETS

Molded bakelite single contact sockets. Mount in 5/16" hole. No screws or rivets required. Held firmly in place by Amphenol No. 2-11 retainer ring. Break-down voltage (with plug inserted) is in excess of 10,000 volts D.C. from contact to panel. Contacts are recessed 1/8" below the top of the tip jacks, preventing accidental shorts from the contact to the chassis. Contact may be removed and the bakelite body used as a feed-through bushing for wire leads.

Supplied in 7 different colors and 4 different prong diameters so that circuits can be easily and quickly identified, and high voltage plugs kept out of low voltage sockets. Colors available: black, red, green, blue, yellow, gray, and walnut. If no color is specified, black will be shipped.

- 78-1P—for .080" phone tip7/8c List
- 78-1S—for 3/32" plug7/8c List
- 78-1M—for 1/4" plug7/8c List
- 78-1L—for 5/32" plug7/8c List

SINGLE PRONG PLUGS

Smallest yet most practical plugs in the world. Supplied in 7 different colors: black, red, green, blue, yellow, gray, and walnut. If no color is specified black will be shipped.

- For use with above sockets.
- 71-1S—3/32" prong5c List
- 71-1M—1/4" prong5c List
- 71-1L—5/32" prong5c List

IMPEDANCE MATCHING SWITCH

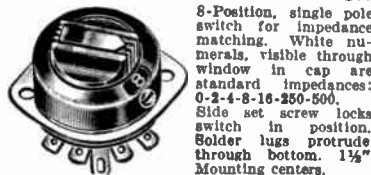

36-2—Impedance Matching Switch.....75c List

TAP CHANGE SWITCH

Same as above but white numerals are 1-2-3-4-5-6-7-8. Used for all switching purposes.
36-1—Tap Change Switch75c List

PREFOCUS LAMP SOCKET



Universally adaptable sockets for medium-base prefocused lamps as used in movie projectors. Ideal for experimenters' building apparatus using prefocused lamps for heat or high intensity light in flood lights, beacons, searchlights, etc. Can be installed in almost all movie projectors without drilling new holes. Molded from high-heat bakelite, withstanding temperatures to 450° F. Conservatively rated at 1000 watts, 110-250 volts. Listed by Underwriters' Laboratories. Heavy solid brass contacts for minimum resistance assuring maximum light intensity. Overall size, 1 1/4" dia. x 1-55/64" high.
98-8—Lamp Socket\$1.75



CHASSIS UNIT

Mounts in 1 1/4" hole in any panel or blank outlet cover up to 1/4" in thickness. Supplied with lock washer, flat washer, and hex. nut. Use with Male Cable Connector.
92C—Female\$2.50 List
92CI—Male 2.50 List



HEARING AID PLUGS

Especially suited for compact apparatus where plugs and sockets must use a minimum of space. Plugs are often used as supports for self sustaining coil forms.

- 70-27—2-prong plug10c List
 - 70-25—3-prong plug13c List
 - 70-26—4-prong plug18c List
 - 77-25—3-contact socket22c List
 - 77-26—4-contact socket25c List
- As above but have contacts adjusted to fit phone tips (.080"). Used to connect two pair of headphones in series or parallel.
- 77-25S—3-contact socket22c List
 - 77-26S—4-contact socket25c List

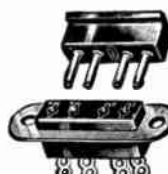

ELECTRICAL AND MECHANICAL CHARACTERISTICS OF AMPHENOL INSULATIONS

MATERIAL	Dielectric Strength V. per Mil.	Dielectric Constant		Power Factor		Loss Factor		Tensile Strength Lbs. per sq. in.	Softening Temperature Fahrenheit	Moisture Absorption
		1 Mc	10 Mc	1 Mc	10 Mc	1 Mc	10 Mc			
Black bakelite	400-500	5.9035178	...	8300	302°	.2%
Mica-Filled Bakelite	475-600	5008040	...	6500	275°	.07%
Ultra-Low-Loss Steatite	300-500	6.0	5.8	.0006	.0004	.0036	.0023	8500	1420°	.1%
Amphenol "912-A"	500-700	2.6	2.6	.0002	.0003	.0005	.00078	7000	190°	.05%

AMERICAN PHENOLIC CORPORATION • CHICAGO

CABLES CONNECTORS SOCKETS



ADAPTERS INSULATION PLUGS

UNWIRED ADAPTERS



A universal yet simple way for the serviceman or experimenter to make his own adapters. Finished adapter resembles a factory wired job in all respects. Required for modernizing tube checkers and analyzers; for adapting new tubes to old circuits; for bringing out leads to output meter, phono-pick-up, headphones, extra speaker, etc.

ADAPTER BASES

Bases supplied in 2 styles—with 5/32" side hole for bringing out leads or with a side stud that accommodates a metal tube grip cap. Bases and socket tops drilled for self tapping screws for holding assembly together. Screws supplied with Bases.

Bases are supplied in black only

Number of prongs	With Side Hole List 20c ea.	With Side Stud List 30c ea.
4-prong	50-4D	50-4G
5-prong	50-5D	50-5G
6-prong	50-6D	50-6G
7-small	50-7SD	50-7SG
8-octal	50-8SD	50-8SG
*7-large	50-7LD	50-7LG
*8-octal	50-8LD	50-8LG

*Fits 7-large and 7-comb. socket tops only.

ADAPTER SOCKET TOPS

List Price 20c Each

Socket tops available in black, red, green, blue, gray, yellow, and brown. Specify color.

FIT SMALL BASES ONLY

No. 44-4—4-contact	No. 44-7S—7-small
No. 44-5—5-contact	No. 44-8—8-octal
No. 44-6—6-contact	No. 44-L—Loktal

FITS LARGE BASES ONLY

No. 44-7L—7-large	No. 44-7C—7-comb.
-------------------	-------------------

With Center Locking Stud

7 Contact top with center stud for lock-type analyzer plugs. Fits any small base.

No. 44-7SS—Socket Top with Stud.....30c List

3-14 ADAPTER SHELL



Formed black-japanned steel tubing. Amphenol "S" type sockets or "UP" type plugs snap into either end and are held securely yet may be removed easily. Any combination possible from 4-prong or contact to 11-prong or contact. Supplied in two types. With blank sides or with rubber grommet in side for bringing out leads.

3-14—Shell, less side hole.....15c List
3-14D—Shell with side hole.....20c List

BULB TESTER SOCKET



A combination 7-contact tube socket (fits both large and small 7-prong tubes). Has a large center contact for testing dial lights, flashlight bulbs, etc., with either screw or bayonet base.

78-7CD—Retainer Ring Mounting.....44c List
78-RS7-CD—With Mounting Plate.....45c List



Compact socket for testing miniature bulbs such as are used in flashlights, dial lights, Christmas tree strings, etc. Accepts either screw or bayonet base. Mounts in a 3/8" round hole with a No. 2-9 retainer ring.

78-1DL.....30c List

UNIVERSAL GRID CAP



A new universal grid cap for tube checkers. Fits the grid stud of any receiving tube. Body is molded bakelite. A spring brass contact of unique design assures a positive connection at all times. Supplied wired with a flexible 15" lead, No. 20 stranded wire.

63-1W—Black Grid Cap.....20c List
63-1WR—Red Grid Cap.....20c List

Same as above but unwired. Contact is easily removed from bakelite body and soldered out in the open. No wire supplied.

63-1—Black Grid Cap.....15c List
63-1R—Red Grid Cap.....15c List

LOKTAL ADAPTERS



Adapters which will test any Loktal tube except the 7E7 and 7F7 in any tube checker, whether factory or custom built. Adapters convert loktals to exact counterparts in octal series.

Adapters are completely wired, ready for use. Socket tops are color coded for easy identification. Supplied with complete instructions.

44-11WK—Complete Wired Kit.....\$5.00 List

UNWIRED KIT

Same as above but adapters are unwired. Supplied with wiring and testing instructions.

44-11K—Complete Unwired Kit.....\$2.50 List

SPECIAL LOKTAL ADAPTERS

The 7E7 and 7F7 loktal tubes require special adapters because of their pin arrangement. Adapters are completely wired and are supplied with instructions.

44-11W7—for 7E7 tube.....\$1.00 List
44-11W8—for 7F7 tube.....1.00 List

LOKTAL ANALYZER PLUG

Completely Wired

Adapter bottom is loktal type plug. Same pin size and pin spacing as loktal tubes. Fits on end of analyzer plug.

No. 44-13-8—With Octal Top.....\$1.25 List
No. 44-13-7—7-contact Top.....1.25 List
No. 44-13-6—6-contact Top.....1.25 List

With Center Locking Stud

Same as above but 7-contact top has center stud for lock-type analyzer plugs.

No. 44-13-S7—Complete with Stud.....\$1.35 List

FOR SINGLE ENDED TUBES

Kit contains five wired adapters for testing the single ended tubes (without top grid stud) in any checker which has an octal socket. Supplied with complete instructions.

44-14WK—Complete Wired Kit.....\$5.00 List

UNWIRED KIT

Identical to the above but the adapters are unwired. Supplied with complete wiring and testing instructions.

44-14K—Complete Unwired Kit.....\$2.50 List

FOR MINIATURE TUBES



Unwired adapters for testing the new miniature tubes. No. 44-17-8 has a socket top to accommodate the RFA 1S4, 1S5, 1T4, and 1R5; and 9000, 9001, 9002, and 9003 series. No. 44-12-8 has a socket top to accommodate the Hytron Bantam Jr. tubes, HY113, HY115, and HY125. No. 44-26-8 is for Raytheon (CK501, CK502, CK503, etc.

Adapters have octal bases.

44-17-8—For RCA.....50c List
44-12-8—For Hytron.....50c List
44-26-8—For Raytheon.....50c List

U.H.F. ALIGNMENT TOOL



Molded from pure polystyrene Amphenol "912-A". The only alignment tool manufactured which has no capacity effect upon critical circuits. Necessary for radio servicemen, amateur and laboratory technicians who must align high and ultra-high frequency circuits. Supplied with a pencil-type clip so that it is convenient to carry in breast pockets.

55—Alignment Tool.....40c List

CRYSTAL HOLDER SOCKET



Black bakelite socket for standard crystal holders having two prongs on 3/8" centers. Easily mounted and requires minimum area on chassis or panel. Used extensively for crystal phasing in receivers, crystal control of transmitters and test equipment, and may be used as a dual tip jack on test panels. Accommodates 12" male prongs. (Amphenol No. 78-1M.)

33-2—Bakelite Crystal Holder Socket.....8c List

As above but molded from pure polystyrene for high frequency circuits.

54-2—Polystyrene Crystal Holder Socket 30c List

MAGIC EYE ASSEMBLY



For easily adapting Magic Eye tubes to any radio having automatic volume control, to F.M. receivers, and for constructing test instruments such as signal tracers, etc.

A spring clip grips tube base firmly yet permits rotation for proper focusing of eye movement. This spring clip is adjustable in slotted bracket, so tube will extend properly to any thickness panel. One-megohm target to plate resistor wired into socket. Five-wire color coded cable, 22" long. (All necessary hardware for assembling, with an attractive modernistically styled escutcheon.) With instructions.

58-MEA6—Complete Assembly.....\$1.25 List

FOR OCTAL MAGIC EYE

Similar to above Magic Eye Assembly but has an octal socket to accommodate 6AF64, 6AD60 and other electron tuning eyes having an octal base. Supplied with hardware and 10-2 escutcheon.

58-MEA8—Complete Assembly.....\$1.25 List

CATHODE RAY ASSEMBLY

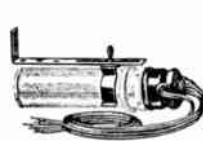

For mounting the 902 and 913 cathode ray tubes. Ideal foundation for test equipment. Consists of bakelite socket encased in a metal shell, adjustable mounting bracket and 22" 7-wire color

coded cable. Unit is completely wired.

58-913—Complete Assembly.....\$1.00 List

MAGIC EYE ESCUTCHEONS



10-1

10-2

For Magic Eyes. Modernistically designed to match the other component of your apparatus. Finished in antique bronze.

10-1—For 6-prong Single Eye tubes.....25c List
10-2—For 8-prong Double Eye tubes.....30c List

ANTI-MICROPHONIC SOCKET CUSHIONS

FLOATING SOCKET CUSHIONS
Reduce Microphonics



LIST PRICE 20c

All the parts necessary for converting Amphenol 3111 sockets to floating sockets are contained in an envelope on which are printed complete instructions. Consists of 1/2 live gum rubber cushions, metal washers, mounting screws, and nuts. To overcome tube microphonics, cushioned sockets are sometimes necessary, especially for photo-cell

work, ultra-sensitive circuits, and for some battery tubes.

11-3K—Kit less socket.....20c List

LIVE RUBBER CUSHIONS



Live rubber cushions for inserting in chassis or panel riveting holes to lessen vibration of an assembled part such as a tube socket. Molded from pure Para rubber.

No. 22-6—For 3/8" hole.....10 for 30c
No. 22-10—For 1/4" hole.....10 for 15c

BLACK RUBBER GROMMETS



For protecting cables from abrasions when passing through a chassis or panel hole.

No. 22-1—For 3/8" hole, 7/8" I.D.....10 for 13c
No. 22-2—For 1/2" hole, 7/8" I.D.....10 for 10c
No. 22-3—For 1/4" hole, 7/8" I.D.....10 for 9c

**CABLES
CONNECTORS
SOCKETS**



**ADAPTERS
INSULATION
PLUGS**

**COPELENE B SOLID DIELECTRIC
LOW-LOSS TRANSMISSION CABLES**

50-Ohm Coax Cables



A new flexible, solid dielectric, low-loss transmission line designed for high frequency operation. Also may be used advantageously for television, frequency modulation, test equipment, and many applications, as well as for "lead-in" or transmission lines of standard broadcast installations. Furnished on non-returnable wooden reels with a capacity up to 1200 ft. Conductor is constructed of seven strands of Size 21 A.W.G. bare copper wire. Diameter of solid Copolene B dielectric is .290". Over this are one or two closely braided copper shields with outer covering of cotton braid or vinyl. Cable bends easily on very short radius. Solid construction leaves no air spaces to collect moisture. Surge impedance is 52 ohms \pm 2 and capacitance per ft. is 32 mmf. High working temperatures are possible because cables have no sudden softening point.

U. S. Navy No.	British No.	Amphenol No.	Outside Covering	List Price per ft.
CASSF-50-1 (XA-8897A)	PT5M or C	21B-290-7/21-XB	Cotton Braid	\$.55
		21B-290-7/21-XXB	Cotton Braid	.70
		21B-290-7/21-XV	Vinyl	.60
		21B-290-7/21-XXV	Vinyl	.85

62-Ohm Coax Cables



This cable is made where exact equivalent of British PT7M or C cable is required. Has the same general characteristics of the 50-ohm cable. Conductor contains seven strands of Size 22 A.W.G. bare copper wire. Dielectric diameter is slightly larger, .335". Available with closely braided single or double shield copper and cotton braid, or vinyl outer covering. Surge impedance is 62 ohms \pm 4 and capacitance per ft., 26 mmf.

U. S. Navy No.	British No.	Amphenol No.	Outside Covering	List Price per ft.
	PT7M or C	21B-335-7/22-XB	Cotton Braid	\$.80
		21B-335-7/22-XXB	Cotton Braid	.95
		21B-335-7/22-XV	Vinyl	.75
		21B-335-7/22-XXV	Vinyl	.90

72-Ohm Coax Cable



A highly efficient solid dielectric coaxial cable made with solid center conductor for minimum loss in the microwave regions or with seven strands of Size 26 A.W.G. copper wire for high frequency transmission lines. Dielectric diameter on cables with stranded conductor and on cables with Size 16 copperweld center conductor is .290", and on cable with Size 15 copperweld center conductor is .335". Surge impedance is 72 ohms \pm 4 and capacitance per ft. is 22 mmf. Each type available with closely braided single or double copper shields with cotton braid or vinyl outer covering. Furnished on non-returnable wooden spools with a capacity of 1200 ft. Modifications in these standard constructions are made when quantity warrants.

U. S. Navy No.	British No.	Amphenol No.	Outside Covering	List Price per ft.
CASSF-70-1	PT4M or C	21B-290-7/26-XXV	Vinyl	\$.85
		21B-290-16CW-XB	Cotton Braid	.55
		21B-290-16CW-XV	Vinyl	.60
		21B-335-15CW-XV	Vinyl	.75

95-Ohm Twinx Cable



A small diameter, flexible, two conductor cable with solid Copolene B dielectric. Widely used for ultra-high frequency transmission, also where a balanced line is required above ground. Solid flexible dielectric permits bending on a small radius and keeps conductors parallel. The two conductors are each constructed of seven strands of Size 21 A.W.G. bare copper wire. Dielectric diameter is .475". Available with single or double shield braided copper and cotton braid, or vinyl outside covering. Surge impedance is 95 ohms \pm 5 and effective capacitance per ft. between conductors with outer shield grounded is 15 mmf. Furnished on non-returnable wooden reels with a capacity of 600 ft.

U. S. Navy No.	British No.	Amphenol No.	Outside Covering	List Price per ft.
TCSSF-95-1 (XA-8898A)	BA4M or C	31B-225/475-7/21-XB	Cotton Braid	\$1.00
		31B-225/475-7/21-XXB	Cotton Braid	1.15
		31B-225/475-7/21-XV	Vinyl	1.10
		31B-225/475-7/21-XXV	Vinyl	1.25

**LOW-LOSS CONNECTORS FOR SOLID
DIELECTRIC COAX and TWINAX CABLES**

Connector Plugs



These connector plugs are specially designed to accommodate coaxial and twinx cables. Low-loss, mica-filled bakelite and polystyrene insulations. All surfaces are heavily silver plated. The small size of these Amphenol connectors makes electrical discontinuity extremely slight—and with the dielectrics butted to each other and to the Copolene core of the cable, there is minimum air space so that constant characteristics are maintained.

Signal Corps No.	Navy No.	Amphenol No.	No. of Contacts	Cable O. D.	List Price
PL-259	CPH-49195	83-1 SP	Single	.410"	\$2.80
PL-284		83-22 SP	Twin	.410"	3.50
PL-295	CPH-49188	83-2 SP	Twin	.630"	4.65

Angle Plug Adapters



One-piece completely assembled units. High conductivity copper alloy pin contacts on one end, socket contacts on opposite end, assembled without solder. Pure polystyrene dielectric. No air spaces inside the unit. Rugged, die-cast zinc construction, heavily silver plated.

Signal Corps No.	Navy No.	Amphenol No.	No. of Contacts	Cable O. D.	List Price
M-359	CPH-49192	83-1 AP	Single	.410"	\$3.65
PL-293		83-22 AP	Twin	.410"	4.05
PL-325	CPH-49198	83-2 AP	Twin	.630"	4.80

Junctions



Straight junction connectors, completely assembled with socket contacts on both ends. It is used for joining two cables (with two No. 83-1SP, 83-22SP, or 83-2SP connector plugs) or for repairing damaged cable. Dielectric is pure polystyrene. There are no air spaces.

Signal Corps No.	Navy No.	Amphenol No.	No. of Contacts	Cable O. D.	List Price
PL-258	CPH-49191	83-1 J	Single	.410"	\$1.70
PL-285		83-22 J	Twin	.410"	2.15
PL-305	CPH-49189	83-2 J	Twin	.630"	2.78

"Tee" Connectors



One-piece completely assembled units used for providing leads to additional equipment by means of an additional pin contact at right angle to the socket contacts. Cast zinc silver plated. Polystyrene insulation assembled with liquid polystyrene to eliminate air spaces.

Signal Corps No.	Navy No.	Amphenol No.	No. of Contacts	Cable O. D.	List Price
M-358	CPH-99199	83-1 T	Single	.410"	\$3.90

**Chassis or Box Type
Receptacles**



These are complete units. One-piece construction makes for easy soldering to connectors within box or chassis. Die cast zinc shell silver plated for conducting high frequency current. Low-loss, mica-filled bakelite dielectric. High conductivity copper alloy socket contact.

Signal Corps No.	Navy No.	Amphenol No.	No. of Contacts	Cable O. D.	List Price
SO-239	CPH-49194	83-1 R	Single	.410"	\$2.20
SO-264		83-22 R	Twin	.410"	2.00
SO-265	CPH-49196	83-2 R	Twin	.630"	3.00

**Hoods for Box Type
Receptacles**



Silver plated brass hoods used with chassis or box type receptacles. Serve as shields for the wiring connection within the equipment. Provided with holes for easy soldering to shield.

Signal Corps No.	Navy No.	Amphenol No.	No. of Contacts	Cable O. D.	List Price
M-360	CPH-49193	83-1 H	Single	.410"	\$.55
M-365	CPH-49208	83-2 H	or Twin	.410" .630"	.75

AMERICAN PHENOLIC CORPORATION • CHICAGO

**CABLES
CONNECTORS
SOCKETS**



**ADAPTERS
INSULATION
PLUGS**

**ARMY-NAVY STANDARD (AN)
CONNECTORS**

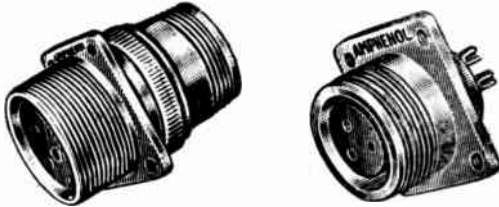

AN-3100 Receptacle wall mounting AN-3102 Receptacle box mounting



AN-3106 Straight plug AN-3108 Angle plug

Amphenol AN Connectors are made according to Army-Navy specifications specially for aircraft, tanks, ships, and wherever positive electrical connections must be maintained and electrical equipment must be quickly attached or removed. AN Connectors are available in a range of sizes and current carrying capacities sufficient for most connector requirements.

Each connector consists of a shell and an insert. The style of shell and type of insert used determine the kind of conductor.

Four different types of shells are provided: (1) wall mounting receptacle for use on conduit box, firewall, etc.; (2) box mounting receptacle for direct mounting on equipment; (3) straight plug; and (4) angle plug for any use requiring angle type connector. Any type of shell will accommodate any corresponding size insert. Receptacle shells are provided with external thread and are characterized by the internal polarizing key, while plugs have a knurled coupling ring and key slot. Where quick disconnects are desired, coupling ring may be eliminated. Inserts are held in the connector shell by two methods: (1) standard locking ring construction; and (2) the alternate construction of spun-in element for greater permanency.

INSERTS



Phantom Views

Inserts are made with a superior quality, high dielectric black bakelite insulation which holds the pin (male) or socket (female) contacts. Contacts are manufactured from carefully selected high conductivity alloys which combine superior electrical characteristics with great tensile strength. Both pin and socket connectors are provided in six sizes: 0, 4, 8, 12, 16, and 20, the numbers corresponding to wire sizes. Inserts are made in two styles, termed according to the type of contacts they accommodate—pin type (male) and socket type (female). These inserts are available for use with all possible wire combinations from 1 to 48 and the size of AN Connector Shell required.

Thermocouple Type Connector Inserts



Inserts with thermocouple metal contacts have been designed to provide more accurate readings on thermocouple type instruments. The contacts are made of iron and constantan instead of bronze. These inserts can be used in any shell of corresponding size.

SPECIAL MOUNTING ARRANGEMENTS

Amphenol Spacer Units are designed to mount fittings and connectors on curved or irregular shaped surfaces by building up the irregular surface to provide a flat area. Available in various shapes and sizes depending upon the size of the fitting or connector to be used. A number of standard units are provided, but special mountings will be designed to meet detailed requirements.

STANDARD AMPHENOL CONNECTORS



Amphenol "97" Series Connectors were developed under the same general specifications as the AN type. Slightly modified as illustrated, they are intended to supplement the standard AN type. For all purposes they offer the same dependable, weather-proof and vibration-proof service.

**SPECIAL CONNECTORS
Explosion-Proof Connectors**

Type 97-3102 EKP is an explosion-proof connector for use principally on electric motors and other equipment operating in the presence of explosive vapors or dusts. Amphenol Explosion-Proof Connectors have molded-in male prongs with barriers around each contact to provide a longer leakage path and minimize any possibility of arcing.



**ARMY-NAVY (AN) STANDARD
CONDUIT FITTINGS**



AN Conduit Fittings are designed to meet Army-Navy specifications for installations of electrical and radio equipment of aircraft, marine, and other motorized units. They also have widespread use in radio and electrical industries. Amphenol fittings properly join AN and "97" connectors to rigid or flexible conduit to provide for runs, turns, couplings, and other devices needed in a complete installation. Fittings are made of aluminum alloy of specified strength. All threads are accurately manufactured to specifications so that parts are completely interchangeable. Threads are coated with Permalub right down to the root to prevent binding of coupled parts. A wide variety of special finishes is provided for all Amphenol Connectors and Fittings, depending upon the use to be made of the various items.



**STANDARD AMPHENOL
FITTINGS**

Amphenol "97" series fittings have the same general specifications as the AN Fittings, and are intended for other than Army and Navy equipment. Typical examples are illustrated cap and chain assemblies made to fit all standard AN Electrical Connectors, both receptacle and plug types. They provide protection against live circuits, as well as protection from dirt and tampering while the connector is not in use. Complete listings are available upon request.





"300" SERIES PLUGS AND SOCKETS

General Specifications

2 Contacts to 33 Contacts. All plugs and sockets are polarized.
 2 Contact Plugs and Sockets are round, others rectangular.
 Plugs of one size cannot fit into sockets of another size.
 Phosphor bronze "knife-switch" type socket contacts engage both sides of flat plug contacts—double contact area.
 Molded Bakelite insulation.
 Formed metal caps. Formed fibre linings in caps.
 Small size, with good separation between contacts.
 Plug or socket for panel mounting.
 Plug or socket with cap.
 Simple, fool-proof assembly.
 Finish on caps—Black Crystal.
 Plug prongs— $\frac{1}{2}$ " wide by $\frac{3}{4}$ " thick.
 We suggest using the 300 series in circuits not exceeding 45 Volts and 5 Amps., although circuit characteristics may permit higher ratings.

Plug with Angle Brackets

No. Contacts	Ea.
P-302-AB (2)	\$.16
P-303-AB (3)	.19
P-304-AB (4)	.22
P-306-AB (6)	.27
P-308-AB (8)	.32
P-310-AB (10)	.37
P-312-AB (12)	.42

Socket with Angle Brackets

No. Contacts	Ea.
S-302-AB (2)	\$.17
S-303-AB (3)	.20
S-304-AB (4)	.23
S-306-AB (6)	.30
S-308-AB (8)	.37
S-310-AB (10)	.44
S-312-AB (12)	.51

Plug with Flush Plate

No. Contacts	Ea.
P-302-FP (2)	\$.27
P-303-FP (3)	.30
P-304-FP (4)	.33
P-306-FP (6)	.38
P-308-FP (8)	.43
P-310-FP (10)	.48
P-312-FP (12)	.53

Socket with Flush Plate

No. Contacts	Ea.
S-302-FP (2)	\$.28
S-303-FP (3)	.31
S-304-FP (4)	.34
S-306-FP (6)	.41
S-308-FP (8)	.48
S-310-FP (10)	.55
S-312-FP (12)	.62

Plug with Recessed Plate

No. Contacts	Ea.
P-302-RP (2)	\$.32
P-303-RP (3)	.35
P-304-RP (4)	.38
P-306-RP (6)	.45
P-308-RP (8)	.52
P-310-RP (10)	.59
P-312-RP (12)	.66

Socket with Recessed Plate

No. Contacts	Ea.
S-302-RP (2)	\$.33
S-303-RP (3)	.36
S-304-RP (4)	.39
S-306-RP (6)	.48
S-308-RP (8)	.57
S-310-RP (10)	.66
S-312-RP (12)	.75

Plug, Flared Hole in Cap

No. Contacts	Ea.
P-302-FHT-L (2)	\$.26
P-303-FHT (3)	.29
P-304-FHT (4)	.32
P-306-FHT (6)	.38
P-308-FHT (8)	.44
P-310-FHT (10)	.50
P-312-FHT (12)	.56

Socket, Flared Hole in Cap

No. Contacts	Ea.
S-302-FHT (2)	\$.27
S-303-FHT (3)	.30
S-304-FHT (4)	.33
S-306-FHT (6)	.41
S-308-FHT (8)	.49
S-310-FHT (10)	.57
S-312-FHT (12)	.65

Plug, Flared Hole in Cap and with Latches

No. Contacts	Ea.
P-302-FHT-L (2)	\$.36
P-303-FHT-L (3)	.39
P-304-FHT-L (4)	.42
P-306-FHT-L (6)	.48
P-308-FHT-L (8)	.54
P-310-FHT-L (10)	.60
P-312-FHT-L (12)	.66

Socket, Flared Hole in Cap and with Keepers

No. Contacts	Ea.
S-302-FHT-K (2)	\$.37
S-303-FHT-K (3)	.40
S-304-FHT-K (4)	.43
S-306-FHT-K (6)	.51
S-308-FHT-K (8)	.59
S-310-FHT-K (10)	.67
S-312-FHT-K (12)	.75

Plug, Cable Clamp in Cap

No. Contacts	Ea.
P-302-CCT (2)	\$.36
P-303-CCT (3)	.39
P-304-CCT (4)	.42
P-306-CCT (6)	.48
P-308-CCT (8)	.54
P-310-CCT (10)	.60
P-312-CCT (12)	.66

Socket, Cable Clamp in Cap

No. Contacts	Ea.
S-302-CCT (2)	\$.37
S-303-CCT (3)	.40
S-304-CCT (4)	.43
S-306-CCT (6)	.51
S-308-CCT (8)	.59
S-310-CCT (10)	.67
S-312-CCT (12)	.75

Plug, Cable Clamp in Cap and with Latches

No. Contacts	Ea.
P-302-CCT-L (2)	\$.46
P-303-CCT-L (3)	.49
P-304-CCT-L (4)	.52
P-306-CCT-L (6)	.58
P-308-CCT-L (8)	.64
P-310-CCT-L (10)	.70
P-312-CCT-L (12)	.76

Socket, Cable Clamp in Cap and with Keepers

No. Contacts	Ea.
S-302-CCT-K (2)	\$.47
S-303-CCT-K (3)	.50
S-304-CCT-K (4)	.53
S-306-CCT-K (6)	.61
S-308-CCT-K (8)	.69
S-310-CCT-K (10)	.77
S-312-CCT-K (12)	.85

Plug with Angle Brackets

No. Contacts	Ea.
P-315-AB (15)	\$.60
P-318-AB (18)	.75
P-321-AB (21)	.95
P-324-AB (24)	1.15
P-327-AB (27)	1.35
P-330-AB (30)	1.55
P-333-AB (33)	1.75

Socket with Angle Brackets

No. Contacts	Ea.
S-315-AB (15)	\$.70
S-318-AB (18)	.85
S-321-AB (21)	1.05
S-324-AB (24)	1.25
S-327-AB (27)	1.45
S-330-AB (30)	1.65
S-333-AB (33)	1.85

Plug with End Brackets

No. Contacts	Ea.
P-315-EB (15)	\$.60
P-318-EB (18)	.75
P-321-EB (21)	.95
P-324-EB (24)	1.15
P-327-EB (27)	1.35
P-330-EB (30)	1.55
P-333-EB (33)	1.75

Sockets with End Brackets

No. Contacts	Ea.
S-315-EB (15)	\$.70
S-318-EB (18)	.85
S-321-EB (21)	1.05
S-324-EB (24)	1.25
S-327-EB (27)	1.45
S-330-EB (30)	1.65
S-333-EB (33)	1.85

Plug with Shallow Brackets

No. Contacts	Ea.
P-315-SB (15)	\$.90
P-318-SB (18)	1.10
P-321-SB (21)	1.30
P-324-SB (24)	1.55
P-327-SB (27)	1.75
P-330-SB (30)	2.00
P-333-SB (33)	2.20

Sockets with Shallow Brackets

No. Contacts	Ea.
S-315-SB (15)	\$1.00
S-318-SB (18)	1.20
S-321-SB (21)	1.40
S-324-SB (24)	1.65
S-327-SB (27)	1.85
S-330-SB (30)	2.10
S-333-SB (33)	2.30

Plug with Deep Bracket

No. Contacts	Ea.
P-315-DB (15)	\$.90
P-318-DB (18)	1.10
P-321-DB (21)	1.30
P-324-DB (24)	1.55
P-327-DB (27)	1.75
P-330-DB (30)	2.00
P-333-DB (33)	2.20

Socket with Deep Bracket

No. Contacts	Ea.
S-315-DB (15)	\$1.00
S-318-DB (18)	1.20
S-321-DB (21)	1.40
S-324-DB (24)	1.65
S-327-DB (27)	1.85
S-330-DB (30)	2.10
S-333-DB (33)	2.30

Plug with Flared Hole in Top of Cap

No. Contacts	Ea.
P-315-FHT (15)	\$.80
P-318-FHT (18)	1.00
P-321-FHT (21)	1.20
P-324-FHT (24)	1.45
P-327-FHT (27)	1.65
P-330-FHT (30)	1.90
P-333-FHT (33)	2.10

Socket, Flared Hole in Top of Cap

No. Contacts	Ea.
S-315-FHT (15)	\$.90
S-318-FHT (18)	1.10
S-321-FHT (21)	1.30
S-324-FHT (24)	1.55
S-327-FHT (27)	1.75
S-330-FHT (30)	2.00
S-333-FHT (33)	2.20

Plug, Flared Hole in Top of Cap and with Latches

No. Contacts	Ea.
P-315-FHT-L (15)	\$.90
P-318-FHT-L (18)	1.10
P-321-FHT-L (21)	1.30
P-324-FHT-L (24)	1.55
P-327-FHT-L (27)	1.75
P-330-FHT-L (30)	2.00
P-333-FHT-L (33)	2.20

Socket, Flared Hole in Top of Cap and with Keepers

No. Contacts	Ea.
S-315-FHT-K (15)	\$1.00
S-318-FHT-K (18)	1.20
S-321-FHT-K (21)	1.40
S-324-FHT-K (24)	1.65
S-327-FHT-K (27)	1.85
S-330-FHT-K (30)	2.10
S-333-FHT-K (33)	2.30

Plug, Cable Clamp in Top of Cap

No. Contacts	Ea.
P-315-CCT (15)	\$.95
P-318-CCT (18)	1.15
P-321-CCT (21)	1.35
P-324-CCT (24)	1.60
P-327-CCT (27)	1.80
P-330-CCT (30)	2.10
P-333-CCT (33)	2.25

Socket, Cable Clamp in Top of Cap

No. Contacts	Ea.
S-315-CCT (15)	\$1.05
S-318-CCT (18)	1.25
S-321-CCT (21)	1.45
S-324-CCT (24)	1.70
S-327-CCT (27)	1.90
S-330-CCT (30)	2.20
S-333-CCT (33)	2.35

Plug, Cable Clamp in Top of Cap and with Latches

No. Contacts	Ea.
P-315-CCT-L (15)	\$1.05
P-318-CCT-L (18)	1.25
P-321-CCT-L (21)	1.45
P-324-CCT-L (24)	1.70
P-327-CCT-L (27)	1.90
P-330-CCT-L (30)	2.20
P-333-CCT-L (33)	2.35

Socket, Cable Clamp in Top of Cap and with Keepers

No. Contacts	Ea.
S-315-CCT-K (15)	\$1.15
S-318-CCT-K (18)	1.35
S-321-CCT-K (21)	1.55
S-324-CCT-K (24)	1.80
S-327-CCT-K (27)	2.00
S-330-CCT-K (30)	2.30
S-333-CCT-K (33)	2.45

"400" SERIES PLUGS AND SOCKETS (Formerly "Heavy Duty")

General Specifications

2, 4, 6, 8, 10 and 12 Contacts.
All plugs and sockets are polarized.
Phosphor bronze "knife switch" type socket contacts engage both sides of flat plug contacts—double contact area.
Molded Bakelite insulation.
Fibre linings in caps.
Plug or socket for panel mounting.
Plug or socket with caps.
Finish on caps—Black Crystal.
Plug prong cross section $\frac{1}{4}'' \times \frac{1}{16}''$.
Locking fittings available for panel types or extension cables as shown.
We recommend using the 400 series in circuits not exceeding 110 Volts and 10 Amperes, although circuit characteristics may permit higher ratings.

PLUG—Less Angle Brackets not Drilled or Tapped Unless Specified

No. Contacts	Ea.
P-402-LAB (2)	\$.25
P-404-LAB (4)	.35
P-406-LAB (6)	.45
P-408-LAB (8)	.55
P-410-LAB (10)	.65
P-412-LAB (12)	.75

SOCKET—Less Angle Brackets. Not Drilled or Tapped Unless Specified

No. Contacts	Ea.
S-402-LAB (2)	\$.30
S-404-LAB (4)	.45
S-406-LAB (6)	.60
S-408-LAB (8)	.75
S-410-LAB (10)	.90
S-412-LAB (12)	1.05

PLUG—with Angle Brackets for 1/16" Panel

No. Contacts	Ea.
P-402-AB (2)	\$.45
P-404-AB (4)	.55
P-406-AB (6)	.65
P-408-AB (8)	.75
P-410-AB (10)	.85
P-412-AB (12)	.95

SOCKET—with Angle Brackets

No. Contacts	Ea.
S-402-AB (2)	\$.50
S-404-AB (4)	.65
S-406-AB (6)	.80
S-408-AB (8)	.95
S-410-AB (10)	1.10
S-412-AB (12)	1.25

PLUG—with Shallow Brackets

No. Contacts	Ea.
P-402-SB (2)	\$.55
P-404-SB (4)	.70
P-406-SB (6)	.85
P-408-SB (8)	1.00
P-410-SB (10)	1.15
P-412-SB (12)	1.30

SOCKET—with Shallow Brackets

No. Contacts	Ea.
S-402-SB (2)	\$.60
S-404-SB (4)	.80
S-406-SB (6)	1.00
S-408-SB (8)	1.20
S-410-SB (10)	1.40
S-412-SB (12)	1.60

PLUG—with Deep Bracket

No. Contacts	Ea.
P-402-DB (2)	\$.55
P-404-DB (4)	.70
P-406-DB (6)	.85
P-408-DB (8)	1.00
P-410-DB (10)	1.15
P-412-DB (12)	1.30

SOCKET—with Deep Brackets

No. Contacts	Ea.
S-402-DB (2)	\$.60
S-404-DB (4)	.80
S-406-DB (6)	1.00
S-408-DB (8)	1.20
S-410-DB (10)	1.40
S-412-DB (12)	1.60

PLUGS

PLUG—Flared Hole in Top		PLUG—Flared Hole in End	
No. Contacts	Ea.	No. Contacts	Ea.
P-402-FHT (2)	\$.50	P-402-FHE (2)	\$.50
P-404-FHT (4)	.65	P-404-FHE (4)	.65
P-406-FHT (6)	.80	P-406-FHE (6)	.80
P-408-FHT (8)	.95	P-408-FHE (8)	.95
P-410-FHT (10)	1.10	P-410-FHE (10)	1.10
P-412-FHT (12)	1.25	P-412-FHE (12)	1.25

SOCKETS

SOCKET—Flared Hole in Top		SOCKET—Flared Hole in End	
No. Contacts	Ea.	No. Contacts	Ea.
S-402-FHT (2)	\$.55	S-402-FHE (2)	\$.55
S-404-FHT (4)	.75	S-404-FHE (4)	.75
S-406-FHT (6)	.95	S-406-FHE (6)	.95
S-408-FHT (8)	1.15	S-408-FHE (8)	1.15
S-410-FHT (10)	1.35	S-410-FHE (10)	1.35
S-412-FHT (12)	1.55	S-412-FHE (12)	1.55

PLUGS

PLUG—Cable Clamp in Top		PLUG—Cable Clamp in End	
No. Contacts	Ea.	No. Contacts	Ea.
P-402-CCT (2)	\$.70	P-402-CCE (2)	\$.70
P-404-CCT (4)	.85	P-404-CCE (4)	.85
P-406-CCT (6)	1.00	P-406-CCE (6)	1.00
P-408-CCT (8)	1.15	P-408-CCE (8)	1.15
P-410-CCT (10)	1.30	P-410-CCE (10)	1.30
P-412-CCT (12)	1.45	P-412-CCE (12)	1.45

SOCKETS

SOCKET—Cable Clamp in Top		SOCKET—Cable Clamp in End	
No. Contacts	Ea.	No. Contacts	Ea.
S-402-CCT (2)	\$.75	S-402-CCE (2)	\$.75
S-404-CCT (4)	.95	S-404-CCE (4)	.95
S-406-CCT (6)	1.15	S-406-CCE (6)	1.15
S-408-CCT (8)	1.35	S-408-CCE (8)	1.35
S-410-CCT (10)	1.55	S-410-CCE (10)	1.55
S-412-CCT (12)	1.75	S-412-CCE (12)	1.75

LOCKS FOR 400 SERIES PLUGS AND SOCKETS (Formerly Heavy Duty)

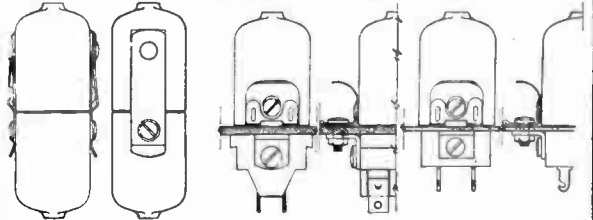

ILLUSTRATING No. 93 LOCK May be attached to any 400 Series plug for extension cables. If plugs are ordered with this lock, specify "with No. 93 locks."

ILLUSTRATING No. 63 LOCK. May be used on all panel mount 400 Series plugs and sockets when surface is flush with top of panel. Cannot be used on type DB plugs.

No. 93 Lock when attached to plug, add to list per pair \$.30
No. 93 Locks ONLY per pair .30

No. 63 Locks ONLY, per pair \$.30

Dimensions of 400 Series Plugs and Sockets

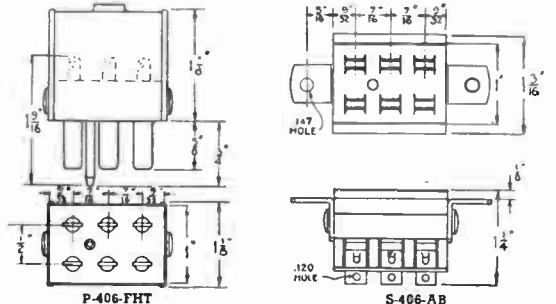



"500" SERIES PLUGS AND SOCKETS

For Complete Listing of 500 SERIES, Write for No. 500 Catalog

Designed for 5,000 volts and 25 amperes per contact. Circuit characteristics, however, may alter this rating one way or the other.

Long leakage path from terminal to terminal, and terminal to ground. Contacts are brass and phosphor bronze, silver plated. Metal parts of caps and brackets are steel, parkerized (rust-proofed). Plug and socket blocks are interchangeable in caps and brackets.

All sizes are polarized in a manner to prevent a smaller plug being inserted in a larger socket. Thus different sizes may be used on one installation without danger of making wrong connections.

Extreme care has been taken to make terminal connections under cap very accessible both for original wiring and subsequent inspection. The cap is insulated with canvas bakelite. Plug prong cross section $\frac{3}{16}'' \times \frac{3}{32}''$.

IMPORTANT: For safety with high voltages DEEP BRACKETS should always be used on one plug or socket, when the other plug or socket has a CAP. SHALLOW BRACKETS are for use only in connecting two units, each unit having plug or socket with SHALLOW BRACKET.

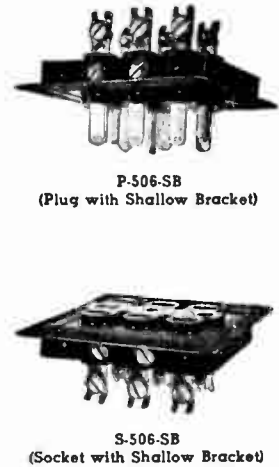

LOCKS FOR 500 SERIES PLUGS AND SOCKETS

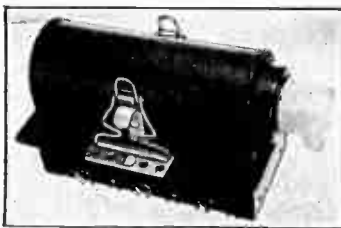

Locks shown above are used in connection with any DEEP BRACKET and cap combination.

The locks securely hold the units together, but they can be released instantly.

The mounting plates are made to fit all DEEP BRACKETS, and are fastened by the same screws or rivets that hold the deep brackets to the panel. Can not be used on shallow brackets. Sold in pairs only.

No. 500-L locks..... Per pair \$.75

PLUG

With Cap

Code	Price Ea.
P-502-CE	\$2.00
P-504-CE	2.85
P-506-CE	3.70
P-508-CE	4.55
P-510-CE	5.40
P-512-CE	6.25

PLUG

With Deep Bracket

Code	Price Ea.
P-502-DB	\$1.75
P-504-DB	2.50
P-506-DB	3.25
P-508-DB	4.00
P-510-DB	4.75
P-512-DB	5.50

PLUG

With Shallow Bracket

Code	Price Ea.
P-502-SB	\$1.75
P-504-SB	2.50
P-506-SB	3.25
P-508-SB	4.00
P-510-SB	4.75
P-512-SB	5.50

SOCKET

With Cap

Code	Price Ea.
S-502-CE	\$2.00
S-504-CE	2.85
S-506-CE	3.70
S-508-CE	4.55
S-510-CE	5.40
S-512-CE	6.25

SOCKET

With Deep Bracket

Code	Price Ea.
S-502-DB	\$1.75
S-504-DB	2.50
S-506-DB	3.25
S-508-DB	4.00
S-510-DB	4.75
S-512-DB	5.50

SOCKET

With Shallow Bracket

Code	Price Ea.
S-502-SB	\$1.75
S-504-SB	2.50
S-506-SB	3.25
S-508-SB	4.00
S-510-SB	4.75
S-512-SB	5.50



SERIES 101 PLUGS

The entire No. 101 Series of Plugs are identical with the exception of the cable ferrule which is furnished in four sizes as listed below. All metal parts are of brass. These Plugs fit all of the No. 101 Series Sockets. Assembly meets Navy Specifications. A low loss Plug and Socket ideal for high frequency connections.

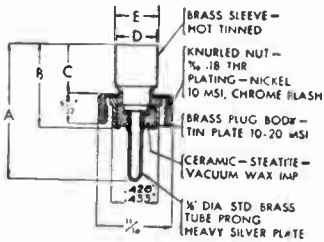

Code No.	A	B	C	D	E	Ea.
P-101-1/4"	1-1/4"	3/4"	7/16"	1/4"	9/32"	\$0.45
P-101-5/16"	1-3/8"	7/8"	9/16"	5/16"	11/32"	.55
P-101-3/8"	1-3/16"	11/16"	3/8"	3/8"	13/32"	.55
P-101-1/2"	1-7/8"	1-3/8"	1-1/16"	1/2"	9/16"	.60



P-101-1/4" P-101-5/16" P-101-3/8" P-101-1/2"

SERIES 101 SOCKETS

The No. 101 Series Sockets are furnished in three types as shown below. Base is of Brass, Nickel Plated with Chrome Flash. Brass contact is Silver Plated. Insulation is of low loss natural color XXX Bakelite. Meets Navy Specifications. The S-101-D is similar to the S-101 except that the Bakelite is recessed in the base. S-101-D Mod. is the same as S-101-D except that two sides of the base are milled as shown. Mounting Holes No. 101—No. 41 drill on 1/8" centers. Mounting holes No. 101-D and 101-D Mod. No. 30 drill on 1/2" centers.



S-101 S-101-D S-101-D Mod
 Price Each \$0.40 Price Each \$0.60 Price Each \$0.60
 (Above Illustrations are Actual Size)

SERIES 201

PLUGS

The No. 201 Series Plugs are of the same design as the No. 101 but are of heavier stock and larger. Made in one size only with 3/8" ferrule. All metal parts are of Brass, same finish as No. 101 Series and Wax Impregnated Ceramic Insulation. Overall length 1 1/8". Prong diameter 1/2". Fits only the 201 Socket.

SOCKETS

The 201 Socket is similar to the S-101-D except larger. Brass base is nickel plated with Chrome Flash. Brass contact is Silver Plated. Insulation is of low loss natural color XXX Bakelite. Both Plug and Socket meet Navy Specifications. Mounting holes—No. 30 drill on 1" centers.

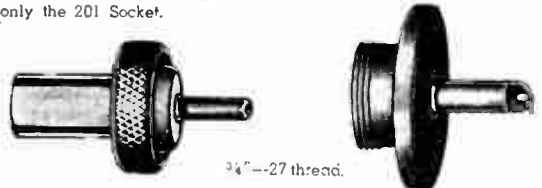

Code Ea. Code Ea.
 P-201-3/8" \$0.70 S-201 \$0.75

SERIES 202

PLUGS

The 202 Series Plugs and Sockets are made in two contacts only. Metal parts are of Brass with burnished Cadmium Plate. Insulation is of Molded Bakelite. Phosphor Bronze "Knife Switch" type Socket Contacts engage both sides of flat Plug Contacts—double contact area. Formed Fibre linings in caps. Polarized. Knurled nut has 3/4"-27 thread.

SOCKETS

Socket Mounting Holes, No. 30 drill on 1" centers.

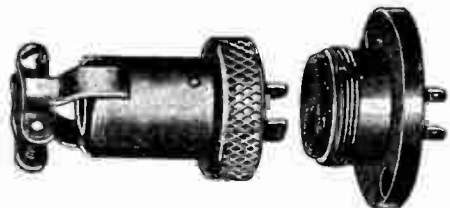

P-202-CCT \$0.55 P-202-FHT \$0.45 S-202-B \$0.65
 (as shown above) (without Cable Clamps)

1400 SERIES PLUGS AND SOCKETS

This series of "disconnect" plugs and sockets has the distinct advantage of low cost for a separable unit handling many circuits. Due to exposed metal parts, it is recommended for use when the complete unit is within a housing. Reduces costs of servicing units. Advantageous in shipping when it is desirable to pack units separately. Polarized—assures correct

coupling. Spring temper brass sockets assure perfect contact. Standard units are listed below from 5 to 16 contacts. However, we can supply units having as many as 30 or more contacts. On No. 1420 or larger we recommend the plug be divided into two or more units, as a single long plug is not mechanically strong. The socket will be made in one assembly.

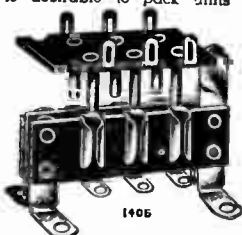

No.	(Contacts)	Ea.	No.	(Contacts)	Ea.
No. 1405	(5 Contacts)	\$0.20	No. 1411	(11 Contacts)	\$0.44
No. 1406	(6 Contacts)	.24	No. 1412	(12 Contacts)	.48
No. 1407	(7 Contacts)	.28	No. 1413	(13 Contacts)	.52
No. 1408	(8 Contacts)	.32	No. 1414	(14 Contacts)	.56
No. 1409	(9 Contacts)	.36	No. 1415	(15 Contacts)	.60
No. 1410	(10 Contacts)	.40	No. 1416	(16 Contacts)	.64

For units with more than 16 contacts, add 4c to the No. 1416 price for each additional contact.

Nos. 140 AND 150 SERIES SCREW TERMINAL BARRIER STRIPS

A new terminal strip that fills a long felt want. Has thousands of applications. Increased insulation is provided by having barriers placed between each terminal. These barriers follow around the edge of the strip and terminate with the base. The barriers not only make a long leakage path, but prevent direct shorts from frayed

wires at the terminals. Mounting holes are at the ends as illustrated. The terminals and binder screws are of brass, nickel plated. Insulation is molded Bakelite. White characters may be imprinted on the edges of the strip between the barriers and directly below the terminals. See page 18 for imprinting prices.



140

No. 140 TERMINAL STRIPS

$\frac{7}{8}$ " wide by $1\frac{1}{8}$ " high. Terminals are mounted on $\frac{3}{8}$ " centers. Screws: 5-40x $\frac{1}{2}$ " brass, burnished nickel plate. Metal to metal spacing over bakelite $\frac{1}{4}$ ".

MAXIMUM NUMBER OF TERMINALS—21
These terminal strips can be furnished with the W-140 solder terminals listed below, by adding the affix W to the code numbers at the right. Add price of W-140 terminals to the price of the terminal strip. For example: 4-140-W will cost \$3c plus 12c or 45c each.

Code	Ea.
No. 2-140..... (2 Terminals).....	\$ 3.19
No. 3-140..... (3 Terminals).....	.26
No. 4-140..... (4 Terminals).....	.33
No. 5-140..... (5 Terminals).....	.40
No. 6-140..... (6 Terminals).....	.47
No. 7-140..... (7 Terminals).....	.54
No. 8-140..... (8 Terminals).....	.61
No. 9-140..... (9 Terminals).....	.68
No. 10-140..... (10 Terminals).....	.75

For terminal strips with more than 10 terminals (maximum 21), add 7c to the No. 10-140 price for each additional terminal.



150

No. 150 TERMINAL STRIPS

$1\frac{1}{8}$ " wide by $1\frac{1}{8}$ " high. Terminals are mounted on $\frac{1}{2}$ " centers. Screws: 10-32 x $\frac{1}{8}$ " brass, burnished nickel plate. Fits standard 50 Amp. solder lug for 6 Ga. stranded wire. Metal to metal spacing over bakelite $\frac{3}{8}$ ".

These terminal strips can be furnished with the W-150 solder terminals listed below, by adding the affix W to the code numbers below. Add price of W-150 terminals to the price of the terminal strip. For example: 2-150-W will cost 75c plus 14c or 89c each.

Code	Ea.
No. 2-150..... (2 Terminals).....	\$ 3.75
No. 3-150..... (3 Terminals).....	1.05
No. 4-150..... (4 Terminals).....	1.35
No. 5-150..... (5 Terminals).....	1.65
No. 6-150..... (6 Terminals).....	1.95
No. 7-150..... (7 Terminals).....	2.25
No. 8-150..... (8 Terminals).....	2.55
No. 9-150..... (9 Terminals).....	2.85
No. 10-150..... (10 Terminals).....	3.15



141

No. 141 TERMINAL STRIPS

$1\frac{1}{8}$ " wide by $\frac{1}{2}$ " high. Terminals mounted on $\frac{1}{4}$ " centers. Screws: 6-32x $\frac{1}{4}$ " brass, nickel plated. Metal to metal spacing over bakelite $\frac{3}{8}$ ".

MAXIMUM NUMBER OF TERMINALS—20
These terminal strips can be furnished with the W-141 solder terminals listed below, by adding the affix W to the code numbers at the right. Add price of W-141 terminals to the price of the terminal strip. For example: 2-141-W will cost 24c plus 8c or 32c each.

Code	Ea.
No. 2-141..... (2 Terminals).....	\$ 2.24
No. 3-141..... (3 Terminals).....	.33
No. 4-141..... (4 Terminals).....	.42
No. 5-141..... (5 Terminals).....	.51
No. 6-141..... (6 Terminals).....	.60
No. 7-141..... (7 Terminals).....	.69
No. 8-141..... (8 Terminals).....	.78
No. 9-141..... (9 Terminals).....	.87
No. 10-141..... (10 Terminals).....	.96

For terminal strips with more than 10 terminals (maximum 20), add 9c to the No. 10-141 price for each additional terminal.



142

No. 142 TERMINAL STRIPS

$1\frac{1}{8}$ " wide by $\frac{3}{8}$ " high. Terminals are mounted on $\frac{1}{4}$ " centers. Screws: 8-32 x $\frac{1}{4}$ " brass, burnished nickel plate. Metal to metal spacing over bakelite $\frac{1}{4}$ ".

MAXIMUM NUMBER OF TERMINALS—17
These terminal strips can be furnished with the W-142 solder terminals listed below, by adding the affix W to the code numbers at the right. Add price of W-142 terminals to the price of the terminal strip. For example: 3-142-W will cost 40c plus 15c or 55c each.

Code	Ea.
No. 2-142..... (2 Terminals).....	\$ 2.29
No. 3-142..... (3 Terminals).....	.40
No. 4-142..... (4 Terminals).....	.51
No. 5-142..... (5 Terminals).....	.62
No. 6-142..... (6 Terminals).....	.73
No. 7-142..... (7 Terminals).....	.84
No. 8-142..... (8 Terminals).....	.95
No. 9-142..... (9 Terminals).....	1.06
No. 10-142..... (10 Terminals).....	1.17

For terminal strips with more than 10 terminals (maximum 17), add 11c to the No. 10-142 price for each additional terminal.

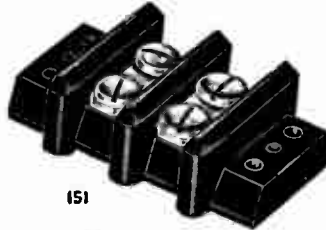

151

No. 151 TERMINAL STRIPS

2" wide by $1\frac{1}{8}$ " high. Terminals are mounted on $\frac{7}{8}$ " centers. Screws: 12-32 x $\frac{3}{8}$ " brass, burnished nickel plate. Fits standard 70 Amp. solder lug for 4 Ga. stranded wire. Metal to metal spacing over bakelite $\frac{3}{4}$ ".

These terminal strips can be furnished with the W-151 solder terminals listed below, by adding the affix W to the code numbers below. Add price of W-151 terminals to the price of the terminal strip. For example: 5-151-W will cost \$3.15 plus 60c or \$3.75 each.

Code	Ea.
No. 2-151..... (2 Terminals).....	\$1.35
No. 3-151..... (3 Terminals).....	1.95
No. 4-151..... (4 Terminals).....	2.55
No. 5-151..... (5 Terminals).....	3.15
No. 6-151..... (6 Terminals).....	3.75
No. 7-151..... (7 Terminals).....	4.35
No. 8-151..... (8 Terminals).....	4.95

No. 152 TERMINAL STRIPS

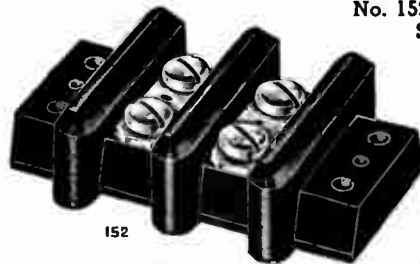

152

$2\frac{1}{4}$ " wide by $1\frac{1}{8}$ " high. Terminals are mounted on $1\frac{1}{2}$ " centers. Screws: $\frac{1}{4}$ "-28 x $\frac{1}{2}$ " brass, burnished nickel plate. Fits standard 90 Amp. solder lug for 2 Ga. stranded wire. Metal to metal spacing over bakelite 1".

These terminal strips can be furnished with the W-152 solder terminals listed at the left, by adding the affix W to the code numbers below. Add price of W-152 terminals to the price of the terminal strip. For example: 3-152-W will cost \$2.80 plus 54c or \$3.34 each.

Code	Ea.
No. 2-152..... (2 Terminals).....	\$1.90
No. 3-152..... (3 Terminals).....	2.80
No. 4-152..... (4 Terminals).....	3.70
No. 5-152..... (5 Terminals).....	4.60
No. 6-152..... (6 Terminals).....	5.50



SOLDER TERMINALS FOR BARRIER STRIPS

These solder terminals are for use only with our barrier strips where solder connections are desired on both sides of the terminal strip. The solder tip is designed to accommodate one or more wires. The binder screws of the barrier strip anchor these terminals securely in place.

Code	Stock	Overall Length	For use with Barrier Strip	Per 100
No. W-140	.036 Brass	$1\frac{1}{8}$ "	No. 140.....	\$ 3.00
No. W-141	.036 Brass	$1\frac{1}{8}$ "	No. 141.....	4.00
No. W-142	.036 Brass	$1\frac{1}{8}$ "	No. 142.....	5.00
No. W-150	.062 Brass	$2\frac{1}{8}$ "	No. 150.....	7.00
No. W-151	.062 Brass	$2\frac{1}{8}$ "	No. 151.....	12.00
No. W-152	.062 Brass	3"	No. 152.....	16.00



NO. 1 TERMINAL STRIPS

Terminal $\frac{1}{8}$ " Round Copper, Flattened at Ends, Tin Plated
A convenient and compact strip where solder connections are desired.

Insulation: Canvas Base Bakelite, $\frac{1}{2}$ " wide, $\frac{3}{8}$ " thick.
Terminals mounted on $\frac{1}{2}$ " centers. Mounting holes $\frac{1}{2}$ " from center of end terminals.

Code	Ea.	Code	Ea.
No. 2-1 (2 Terminals)	\$.07	No. 5-1 (5 Terminals)	\$.10
No. 3-1 (3 Terminals)	.08	No. 6-1 (6 Terminals)	.11
No. 4-1 (4 Terminals)	.09		

For terminal strips with more than 6 terminals, add 1c to the No. 6-1 price for each additional terminal.



NO. 3 TERMINAL STRIPS

Terminal $\frac{1}{8}$ " Round Copper, Flattened at Each End, Tin Plated

Similar to No. 1, except closer spacing and furnished with holes instead of hooks.

Insulation: Canvas base Bakelite, $\frac{1}{4}$ " wide, $\frac{3}{8}$ " thick.
Terminals mounted on $\frac{1}{4}$ " centers. Mounting holes $\frac{1}{4}$ " from center of end terminals.

Code	Ea.	Code	Ea.
No. 2-3 (2 Terminals)	\$.07	No. 5-3 (5 Terminals)	\$.10
No. 3-3 (3 Terminals)	.08	No. 6-3 (6 Terminals)	.11
No. 4-3 (4 Terminals)	.09		

For terminal strips with more than 6 terminals, add 1c to the No. 6-3 price for each additional terminal.



NO. 6 TERMINAL STRIPS

Terminal .046" Brass, Cadmium Plated

Screw and solder terminal. Substantial and reasonably priced.

Screw: 6-32 x $\frac{1}{4}$ " brass, binder head, burnished nickel plate. Insulation: XP Bakelite, $\frac{3}{4}$ " wide, $\frac{3}{8}$ " thick.
Terminals spaced on $\frac{1}{2}$ " centers. Mounting holes $\frac{1}{2}$ " from center of end terminals.

Code	Ea.	Code	Ea.
No. 2-6 (2 Terminals)	\$.11	No. 5-6 (5 Terminals)	\$.20
No. 3-6 (3 Terminals)	.14	No. 6-6 (6 Terminals)	.23
No. 4-6 (4 Terminals)	.17		

For terminal strips with more than 6 terminals, add 3c to the No. 6-6 price for each additional terminal.



NO. 7 TERMINAL STRIPS

Terminal .046" Brass, Burnished Nickel Plate

A two screw insulated terminal strip that can be mounted directly on metal surface.

Screws: 6-32 x $\frac{1}{4}$ " brass, binder head, burnished nickel plate. Insulation: XP Bakelite, $\frac{3}{8}$ " wide, $\frac{1}{4}$ " thick.
Terminals mounted on $\frac{1}{2}$ " centers. Mounting holes $\frac{1}{2}$ " from center of end terminals.

Code	Ea.	Code	Ea.
No. 2-7 (2 Terminals)	\$.16	No. 5-7 (5 Terminals)	\$.37
No. 3-7 (3 Terminals)	.23	No. 6-7 (6 Terminals)	.44
No. 4-7 (4 Terminals)	.30		

For terminal strips with more than 6 terminals, add 7c to the No. 6-7 price for each additional terminal.



NO. 10 TERMINAL STRIPS

Terminal 1/16" Brass, Tin Plated

Sturdy screw and solder terminal with both screw and solder connections on top of bakelite panel. Solder terminal turned up.

Screw: 6-32 x $\frac{1}{4}$ " brass, binder head, burnished nickel plate. Insulation: XP Bakelite, $\frac{3}{8}$ " wide, $\frac{3}{8}$ " thick. Terminals spaced on $\frac{3}{8}$ " centers. Mounting holes $\frac{3}{8}$ " from center of end terminals. Will take up to No. 15 B & S gauge wire (.057").

Code	Ea.	Code	Ea.
No. 2-10 (2 Terminals)	\$.16	No. 5-10 (5 Terminals)	\$.40
No. 3-10 (3 Terminals)	.24	No. 6-10 (6 Terminals)	.48
No. 4-10 (4 Terminals)	.32		

For terminal strips with more than 6 terminals, add 8c to the No. 6-10 price for each additional terminal.



NO. 11 TERMINAL STRIPS

Terminal 1/16" Brass, Tin Plated

Similar to No. 10, except larger in size and the solder tab is flat, but will be bent up, if specified.

Screws: 6-32 x $\frac{1}{4}$ " brass, binder head, burnished nickel plate. Insulation: XP Bakelite, $\frac{3}{8}$ " wide, $\frac{1}{4}$ " thick. Terminals mounted on $\frac{3}{4}$ " centers. Mounting holes $\frac{3}{4}$ " from center of end terminals. Will take up to No. 12 B & S gauge wire (.080").

Code	Ea.	Code	Ea.
No. 2-11 (2 Terminals)	\$.20	No. 5-11 (5 Terminals)	\$.47
No. 3-11 (3 Terminals)	.29	No. 6-11 (6 Terminals)	.56
No. 4-11 (4 Terminals)	.38		

For terminal strips with more than 6 terminals, add 9c to the No. 6-11 price for each additional terminal.



NO. 12 TERMINAL STRIPS

Terminal 1/16" Brass, Tin Plated

Similar to No. 11, except larger. Solder tab is flat, but will be bent up, if specified.

Screw: 10-32 x $\frac{3}{8}$ " brass, binder head, burnished nickel plate. Insulation: XP Bakelite, 1" wide, $\frac{1}{4}$ " thick. Terminals mounted on $\frac{3}{4}$ " centers. Mounting holes $\frac{3}{4}$ " from center of end terminals. Will take up to No. 9 B & S gauge wire (.114").

Code	Ea.	Code	Ea.
No. 2-12 (2 Terminals)	\$.29	No. 5-12 (5 Terminals)	\$.68
No. 3-12 (3 Terminals)	.42	No. 6-12 (6 Terminals)	.81
No. 4-12 (4 Terminals)	.55		

For terminal strips with more than 6 terminals, add 13c to the No. 6-12 price for each additional terminal.



NO. 16 TERMINAL STRIPS

Terminal .028" Brass, Cadmium Plated

A popular priced screw and solder terminal with many desirable features.

Screw: 6-32 x $\frac{1}{4}$ " brass, binder head, burnished nickel plate. Insulation: XP Bakelite, $\frac{3}{4}$ " wide, $\frac{1}{4}$ " thick. Terminals spaced on $\frac{1}{2}$ " centers. Mounting holes $\frac{1}{2}$ " from center of end terminals.

Code	Ea.	Code	Ea.
No. 2-16 (2 Terminals)	\$.10	No. 5-16 (5 Terminals)	\$.19
No. 3-16 (3 Terminals)	.13	No. 6-16 (6 Terminals)	.22
No. 4-16 (4 Terminals)	.16		

For terminal strips with more than 6 terminals, add 3c to the No. 6-16 price for each additional terminal.



NO. 20 TERMINAL STRIPS

Terminal 1/16" Brass, Burnished Nickel Plate

Strong two screw terminal with ears to hold wire securely under screw

Screws: 6-32 x $\frac{1}{4}$ " brass, binder head, burnished nickel plate. Insulation: XP Bakelite, $\frac{3}{4}$ " wide, $\frac{3}{8}$ " thick. Terminals mounted on $\frac{3}{8}$ " centers. Mounting holes $\frac{3}{8}$ " from center of end terminals. Will take up to No. 13 B & S gauge wire (.071").

Code	Ea.	Code	Ea.
No. 2-20 (2 Terminals)	\$.22	No. 5-20 (5 Terminals)	\$.55
No. 3-20 (3 Terminals)	.33	No. 6-20 (6 Terminals)	.66
No. 4-20 (4 Terminals)	.44		

For terminal strips with more than 6 terminals, add 11c to the No. 6-20 price for each additional terminal.



NO. 21 TERMINAL STRIPS

Terminal 1/16" Brass, Burnished Nickel Plate

Similar to No. 20, except larger

Screws: 8-32 x $\frac{1}{4}$ " brass, binder head, burnished nickel plate. Insulation: XP Bakelite, $\frac{1}{2}$ " wide, $\frac{1}{4}$ " thick. Terminals mounted on $\frac{3}{4}$ " centers. Mounting holes $\frac{3}{4}$ " from center of end terminals. Will take up to No. 11 B & S gauge wire (.090").

Code	Ea.	Code	Ea.
No. 2-21 (2 Terminals)	\$.29	No. 5-21 (5 Terminals)	\$.88
No. 3-21 (3 Terminals)	.42	No. 6-21 (6 Terminals)	.81
No. 4-21 (4 Terminals)	.55		

For terminal strips with more than 6 terminals, add 13c to the No. 6-21 price for each additional terminal.



NO. 22 TERMINAL STRIPS

Terminal 1/16" Brass, Burnished Nickel Plate

Similar to No. 21, except larger.

Screws: 10-32 x $\frac{3}{8}$ " brass, binder head, burnished nickel plate. Insulation: XP Bakelite, $\frac{1}{4}$ " wide, $\frac{1}{4}$ " thick. Terminals mounted on $\frac{3}{4}$ " centers. Mounting holes $\frac{3}{4}$ " from center of end terminals. Will take up to No. 8 B & S gauge wire (.128").

Code	Ea.	Code	Ea.
No. 2-22 (2 Terminals)	\$.40	No. 5-22 (5 Terminals)	\$.88
No. 3-22 (3 Terminals)	.56	No. 6-22 (6 Terminals)	1.04
No. 4-22 (4 Terminals)	.72		

For terminal strips with more than 6 terminals, add 16c to the No. 6-22 price for each additional terminal.



No. 32 TERMINAL STRIPS

Terminal .050" Brass, Tin Plated

An ideal terminal strip (solder type) for medium heavy wiring. One or more wires may be connected to this terminal.

Insulation: XX Bakelite, $\frac{3}{4}$ " wide, $\frac{1}{4}$ " thick. Terminals mounted on $\frac{1}{2}$ " centers. Mounting holes $\frac{1}{2}$ " from center of end terminals.

Code	Ea.	Code	Ea.
No. 2-32 (2 Terminals)	\$.16	No. 5-32 (5 Terminals)	\$.37
No. 3-32 (3 Terminals)	.23	No. 6-32 (6 Terminals)	.44
No. 4-32 (4 Terminals)	.30		

For terminal strips with more than 6 terminals add 7c to the No. 6-32 price for each additional terminal.



NO. 34 TERMINAL STRIPS

Terminal .062" Brass, Cadmium Plated

Very substantial and neat appearing terminal. Ample length solder terminal below panel, with screw connection above.

Screw: 6-32 x 3/4" brass, binder head, burnished nickel plate. Insulation: XP Bakelite, 3/8" wide, 1/8" thick. Terminals mounted on 1/2" centers. Mounting holes 1/2" from center of end terminals.

Terminals spaced on 1/2" centers. Mounting holes 1/2" from center of end terminals.

Code	Ea.	Code	Ea.
No. 2-34 (2 Terminals)	\$.15	No. 5-34 (5 Terminals)	\$.27
No. 3-34 (3 Terminals)	.19	No. 6-34 (6 Terminals)	.31
No. 4-34 (4 Terminals)	.23		

For terminal strips with more than 6 terminals, add 4c to the No. 6-34 price for each additional terminal.



NO. 53 TERMINAL STRIPS

Terminal, Spring Temper Brass, Cadmium Plated

A reliable socket type contact for many uses. Takes 3/32" prongs. May be used with No. 98 terminal strips (same terminal spacing), or with No. 40 pin tips. Insulation: XP Bakelite, 3/8" wide, 1/8" thick. Terminals mounted on 3/8" centers. Mounting holes 3/8" from center of end terminals.

Code	Ea.	Code	Ea.
No. 2-53 (2 Terminals)	\$.14	No. 5-53 (5 Terminals)	\$.20
No. 3-53 (3 Terminals)	.16	No. 6-53 (6 Terminals)	.22
No. 4-53 (4 Terminals)	.18		

For terminal strips with more than 6 terminals, add 2c to the No. 6-53 price for each additional terminal.



NO. 36 TERMINAL STRIPS

Terminal .031" Brass, Cadmium Plated

A popular priced screw and solder terminal with both screw and solder tab on same side of bakelite panel. Screw: 6-32 x 3/4" brass, binder head, burnished nickel plate. Insulation: XP Bakelite, 3/8" wide, 1/8" thick. Terminals spaced on 1/2" centers. Mounting holes 1/2" from center of end terminals.

Code	Ea.	Code	Ea.
No. 2-36 (2 Terminals)	\$.10	No. 5-36 (5 Terminals)	\$.19
No. 3-36 (3 Terminals)	.13	No. 6-36 (6 Terminals)	.22
No. 4-36 (4 Terminals)	.16		

For terminal strips with more than 6 terminals, add 3c to the No. 6-36 price for each additional terminal.

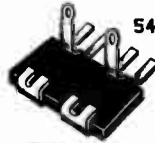

NO. 54 TERMINAL STRIPS

Terminal .032" Brass, Cadmium Plated

Spade terminal for cable harness. Convenient to use in connection with No. 2 or No. 6 terminal strips. Insulation: XP Bakelite, 1/2" wide, 1/8" thick. Terminals mounted on 1/2" centers.

Code	Ea.	Code	Ea.
No. 2-54 (2 Terminals)	\$.05	No. 5-54 (5 Terminals)	\$.11
No. 3-54 (3 Terminals)	.07	No. 6-54 (6 Terminals)	.13
No. 4-54 (4 Terminals)	.09		

For terminal strips with more than 6 terminals, add 2c to the No. 6-54 price for each additional terminal.



NO. 42 TERMINAL STRIPS

Terminal, Hard Brass, Silver Plated

Similar in construction to No. 53. Takes 1/8" prong. May be used with No. 99 terminal strips (same terminal spacing).

Insulation: XP Bakelite, 1/2" wide, 3/32" thick. Terminals mounted on 1/2" centers. Mounting holes 1/2" from center of end terminals.

Code	Ea.	Code	Ea.
No. 2-42 (2 Terminals)	\$.16	No. 5-42 (5 Terminals)	\$.28
No. 3-42 (3 Terminals)	.19	No. 6-42 (6 Terminals)	.35
No. 4-42 (4 Terminals)	.22		

For terminal strips with more than 6 terminals, add 3c to the No. 6-42 price for each additional terminal.



NO. 59 TERMINAL STRIPS

Terminal .028" Brass, Tin Plated

An inexpensive solder terminal. One wire may be brought up through hole and soldered, leaving vertical tab for other connection. Insulation: XP Bakelite, 3/8" wide, 1/8" thick. Terminals mounted on 3/8" centers. Mounting holes 3/8" from center of end terminals.

Code	Ea.	Code	Ea.
No. 2-59 (2 Terminals)	\$.06	No. 5-59 (5 Terminals)	\$.12
No. 3-59 (3 Terminals)	.08	No. 6-59 (6 Terminals)	.14
No. 4-59 (4 Terminals)	.10		

For terminal strips with more than 6 terminals, add 2c to the No. 6-59 price for each additional terminal.



NO. 43 TERMINAL STRIPS

Terminal, Hard Brass, Silver Plated

Same as No. 42, except that it takes 3/32" prongs. May be used with No. 100 terminal strips.

Insulation: XP Bakelite, 3/8" wide, 3/32" thick. Terminals mounted on 3/8" centers. Mounting holes 3/8" from center of end terminals.

Code	Ea.	Code	Ea.
No. 2-43 (2 Terminals)	\$.19	No. 5-43 (5 Terminals)	\$.31
No. 3-43 (3 Terminals)	.23	No. 6-43 (6 Terminals)	.35
No. 4-43 (4 Terminals)	.27		

For terminal strips with more than 6 terminals, add 4c to the No. 6-43 price for each additional terminal.



NO. 60 TERMINAL STRIPS

Terminal .050" Brass, Cadmium Plated

Screw terminal above panel—solder terminal below. Solder tab is notched. Screw: 6-32 x 3/4" brass, binder head, burnished nickel plate. Insulation: XP Bakelite, 3/8" wide, 1/8" thick. Terminals spaced on 3/8" centers. Mounting holes 3/8" from center of end terminals.

Code	Ea.	Code	Ea.
No. 2-60 (2 Terminals)	\$.13	No. 5-60 (5 Terminals)	\$.25
No. 3-60 (3 Terminals)	.17	No. 6-60 (6 Terminals)	.29
No. 4-60 (4 Terminals)	.21		

For terminal strips with more than 6 terminals, add 4c to the No. 6-60 price for each additional terminal.



NO. 48 TERMINAL STRIPS

Terminal .028" Brass, Tin Plated

A low priced double solder terminal. Insulation: XP Bakelite, 1/2" wide, 1/8" thick. Terminals mounted on 3/8" centers. Mounting holes 3/8" from center of end terminals.

Code	Ea.	Code	Ea.
No. 2-48 (2 Terminals)	\$.06	No. 5-48 (5 Terminals)	\$.12
No. 3-48 (3 Terminals)	.08	No. 6-48 (6 Terminals)	.14
No. 4-48 (4 Terminals)	.10		

For terminal strips with more than 6 terminals, add 2c to the No. 6-48 price for each additional terminal.



NO. 66-S TERMINAL STRIPS

Terminal .032" Hard Brass, Cadmium Plated

A heavy solder terminal with large oval hole for several wires. Insulation: XP Bakelite, 3/4" wide, 3/32" thick. Terminals mounted on 3/8" centers. Mounting holes 3/8" from center of end terminals.

Code	Ea.	Code	Ea.
No. 2-66-S (2 Terminals)	\$.07	No. 5-66-S (5 Terminals)	\$.13
No. 3-66-S (3 Terminals)	.09	No. 6-66-S (6 Terminals)	.15
No. 4-66-S (4 Terminals)	.11		

For terminal strips with more than 6 terminals, add 2c to the No. 6-66-S price for each additional terminal.



NO. 50 TERMINAL STRIPS

Terminal .062" Brass, Cadmium Plated

One of the most popular screw and solder terminals. Made of heavy stock with ears to firmly hold wires under screw. Screw: 6-32 x 3/4" brass, binder head, burnished nickel plate. Insulation: XP Bakelite, 3/8" wide, 1/8" thick. Terminals spaced on 1/2" centers. Mounting holes 1/2" from center of end terminals.

Code	Ea.	Code	Ea.
No. 2-50 (2 Terminals)	\$.15	No. 5-50 (5 Terminals)	\$.27
No. 3-50 (3 Terminals)	.19	No. 6-50 (6 Terminals)	.31
No. 4-50 (4 Terminals)	.23		

For terminal strips with more than 6 terminals, add 4c to the No. 6-50 price for each additional terminal.



NO. 66-D TERMINAL STRIPS

Terminal .032" Hard Brass, Cadmium Plated

Two No. 66 terminals mounted on opposite sides of panel and riveted together by solid rivet. Ideal strip for heavy work. Insulation: XP Bakelite, 3/4" wide, 1/8" thick. Terminals mounted on 3/8" centers. Mounting holes 3/8" from center of end terminals.

Code	Ea.	Code	Ea.
No. 2-66-D (2 Terminals)	\$.08	No. 5-66-D (5 Terminals)	\$.17
No. 3-66-D (3 Terminals)	.11	No. 6-66-D (6 Terminals)	.20
No. 4-66-D (4 Terminals)	.14		

For terminal strips with more than 6 terminals, add 3c to the No. 6-66-D price for each additional terminal.

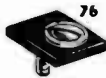

NO. 76 TERMINAL STRIPS

Terminal .028" Brass, Cadmium Plated

Cup shaped top holds wire securely under screw. A compact and good appearing terminal.
Screw: 6-32 x $\frac{1}{4}$ " brass, binder head, burnished nickel plate. Insulation: XP Bakelite, $\frac{3}{4}$ " wide, $\frac{1}{8}$ " thick. Terminals spaced on $\frac{1}{2}$ " centers. Mounting holes $\frac{1}{2}$ " from center of end terminals.

Code	Ea.	Code	Ea.
No. 2-76 (2 Terminals)	\$.11	No. 5-76 (5 Terminals)	\$.20
No. 3-76 (3 Terminals)	.14	No. 6-76 (6 Terminals)	.23
No. 4-76 (4 Terminals)	.17		

For terminal strips with more than 6 terminals, add 3c to the No. 6-76 price for each additional terminal.



AG 76

AG-76

Standard Antenna-Ground strip using No. 76 terminals. Insulation: $\frac{1}{2}$ " Bakelite, $\frac{1}{4}$ " wide. Mounting centers 1 $\frac{1}{2}$ ". Ends rounded. Letters A and G are filled in white.
No. AG-76 Ea. \$.09



NO. 96 TERMINAL STRIPS

Terminal, Spring Temper Brass, Cadmium Plated

Perhaps the most popular socket terminal ever sold. Takes standard tube prongs (No. 99 or No. 100). Furnished for No. 99 prongs ($\frac{1}{8}$ " unless otherwise specified). Insulation: XP Bakelite, $\frac{3}{4}$ " wide, $\frac{1}{8}$ " thick. Terminals mounted on $\frac{1}{2}$ " centers. Mounting holes $\frac{1}{4}$ " from center of end terminals.

Code	Ea.	Code	Ea.
No. 2-96 (2 Terminals)	\$.07	No. 5-96 (5 Terminals)	\$.13
No. 3-96 (3 Terminals)	.09	No. 6-96 (6 Terminals)	.15
No. 4-96 (4 Terminals)	.11		

For terminal strips with more than 6 terminals, add 2c to the No. 6-96 price for each additional terminal.



NO. 98 TERMINAL STRIPS

Terminal 3/32" Round, Brass, Silver Plated

Standard tube base prong of $\frac{1}{8}$ " diameter. To be used with No. 53 terminal strips. Insulation: XP Bakelite, $\frac{3}{4}$ " wide, $\frac{1}{8}$ " thick. Terminals mounted on $\frac{3}{4}$ " centers.

Code	Ea.	Code	Ea.
No. 2-98 (2 Terminals)	\$.06	No. 5-98 (5 Terminals)	\$.12
No. 3-98 (3 Terminals)	.08	No. 6-98 (6 Terminals)	.14
No. 4-98 (4 Terminals)	.10		

For terminal strips with more than 6 terminals, add 2c to the No. 6-98 price for each additional terminal.



NO. 99 TERMINAL STRIPS

Terminal $\frac{1}{4}$ " Round, Brass, Silver Plated

Similar to No. 98, except that it is $\frac{1}{4}$ " in diameter. To be used with No. 42 terminal strips, and also with No. 96 terminal strips. Insulation: XP Bakelite, $\frac{1}{2}$ " wide, $\frac{1}{8}$ " thick. Terminals mounted on $\frac{1}{2}$ " centers.

Code	Ea.	Code	Ea.
No. 2-99 (2 Terminals)	\$.08	No. 5-99 (5 Terminals)	\$.17
No. 3-99 (3 Terminals)	.11	No. 6-99 (6 Terminals)	.20
No. 4-99 (4 Terminals)	.14		

For terminal strips with more than 6 terminals, add 3c to the No. 6-99 Price for each additional terminal.



NO. 100 TERMINAL STRIPS

Terminal 5/32" Round, Brass, Silver Plated

Similar to No. 99, except $\frac{5}{32}$ " in diameter. To be used with No. 43 terminal strip, and No. 96 terminal strip. Insulation: XP Bakelite, $\frac{3}{8}$ " wide, $\frac{1}{8}$ " thick. Terminals mounted on $\frac{3}{8}$ " centers.

Code	Ea.	Code	Ea.
No. 2-100 (2 Terminals)	\$.12	No. 5-100 (5 Terminals)	\$.24
No. 3-100 (3 Terminals)	.16	No. 6-100 (6 Terminals)	.28
No. 4-100 (4 Terminals)	.20		

For terminal strips with more than 6 terminals, add 4c to the No. 6-100 price for each additional terminal.



NO. 130 TERMINAL STRIPS

Terminals Brass, Burnished Nickel Plate

An inexpensive terminal strip with two screw terminals. Screws: 5-40 x $\frac{1}{4}$ " brass, binder head, burnished nickel plate. Insulation: XP Bakelite, $\frac{1}{2}$ " wide, $\frac{1}{8}$ " thick. Terminals mounted on $\frac{1}{2}$ " centers. Mounting holes $\frac{1}{2}$ " from center of end terminals.

Code	Ea.	Code	Ea.
No. 2-130 (2 Terminals)	\$.12	No. 5-130 (5 Terminals)	\$.30
No. 3-130 (3 Terminals)	.18	No. 6-130 (6 Terminals)	.35
No. 4-130 (4 Terminals)	.24		

For terminal strips with more than 6 terminals, add 6c to the No. 6-130 price for each additional terminal.



NO. 131 TERMINAL STRIPS

Terminals Brass, Burnished Nickel Plate

Similar to No. 130, except larger. Screws: 6-32 x $\frac{1}{4}$ " brass, binder head, burnished nickel plate. Insulation: XP Bakelite, 1" wide, $\frac{1}{8}$ " thick. Terminals mounted on $\frac{3}{8}$ " centers. Mounting holes $\frac{3}{8}$ " from center of end terminals.

Code	Ea.	Code	Ea.
No. 2-131 (2 Terminals)	\$.15	No. 5-131 (5 Terminals)	\$.36
No. 3-131 (3 Terminals)	.22	No. 6-131 (6 Terminals)	.43
No. 4-131 (4 Terminals)	.29		

For terminal strips with more than 6 terminals, add 7c to the No. 6-131 price for each additional terminal.



NO. 132 TERMINAL STRIPS

Terminals Brass, Burnished Nickel Plate

Similar to No. 131, except larger. Screws: 8-32 x $\frac{1}{2}$ " brass, binder head, burnished nickel plate. Insulation: XP Bakelite, 1 $\frac{1}{2}$ " wide, $\frac{1}{8}$ " thick. Terminals mounted on $\frac{1}{2}$ " centers. Mounting holes $\frac{3}{4}$ " from center of end terminals.

Code	Ea.	Code	Ea.
No. 2-132 (2 Terminals)	\$.18	No. 5-132 (5 Terminals)	\$.42
No. 3-132 (3 Terminals)	.26	No. 6-132 (6 Terminals)	.50
No. 4-132 (4 Terminals)	.34		

For terminal strips with more than 6 terminals, add 8c to the No. 6-132 price for each additional terminal.



No. 143 TERMINAL STRIPS

Terminal .040" Brass, Tin Plated

A strong two-way solder terminal. Solder tabs lie flat. Crimps securely around edges of panel.

Special Strips

These strips can be made up special, with terminals mounted on any centers, from $\frac{3}{8}$ " up.

Standard Strips

Insulation: XP Bakelite, $\frac{3}{4}$ " wide, $\frac{1}{8}$ " thick. Terminals mounted on $\frac{1}{2}$ " centers. Mounting holes $\frac{1}{2}$ " from center of end terminals. Terminals may be numbered or lettered in white, as illustrated. (See page 18 for imprinting cost.)

Code	Ea.	Code	Ea.
No. 2-143 (2 Terminals)	\$.08	No. 5-143 (5 Terminals)	\$.14
No. 3-143 (3 Terminals)	.10	No. 6-143 (6 Terminals)	.16
No. 4-143 (4 Terminals)	.12		

For terminal strips with more than 6 terminals, add 2c to the No. 6-143 price for each additional terminal.



NO. 2000 TERMINAL STRIPS

Terminals .019" Brass, Tin Plated

Compact and sturdy junction terminal strip. Useful in assembling radio chassis, wiring, etc.
Insulation: Bakelite. Brackets: Steel, cadmium plated. Terminals spaced on $\frac{1}{4}$ " centers.

Code	Mounting Hole Centers:	Ea.
No. 2002 (2 Terminals)	1"	\$.05
No. 2003 (3 Terminals)	1-5/16"	.05
No. 2004 (4 Terminals)	1-5/8"	.06
No. 2005 (5 Terminals)	1-15/16"	.06
No. 2006 (6 Terminals)	2-1/4"	.07
No. 2007 (7 Terminals)	2-9/16"	.07
No. 2008 (8 Terminals)	2-7/8"	.08
No. 2009 (9 Terminals)	3-3/16"	.08
No. 2010 (10 Terminals)	3-1/2"	.09
No. 2011 (11 Terminals)	3-13/16"	.09
No. 2012 (12 Terminals)	4-1/8"	.10
No. 2013 (13 Terminals)	4-7/16"	.10



FUSE MOUNTS

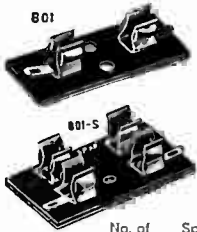

No. 800 SERIES

The 800 series fuse mounts provide solder tabs on the same side of the panel as the fuse clips. Mounts No. 3-AG fuses. An insulating strip of fibre, the same size as the bakelite panel, is furnished. Panels with clips for spare fuse have word "SPARE" imprinted on panel.

Code	No. of Fuses	Spare Fuse	Panel Size	Mounting Hole Centers	Price Each
No. 801	1	3/4"x1 1/8"	3/8"	\$.11
No. 802	2	1 1/4"x1 1/8"	3/8"	.18
No. 803	3	1 3/4"x1 1/8"	7/8"	.24
No. 801-S	1	1	1 1/4"x2 1/8"	3/8"	.18
No. 802-S	2	1	1 3/4"x2 1/8"	7/8"	.24
No. 803-S	3	1	2 1/4"x2 1/8"	7/8"	.31



No. 900 SERIES

The 900 series fuse mounts provide solder tab on the opposite side of panel to the fuse clips. Mounts No. 3-AG fuses. Panels with clips for spare fuse have word "SPARE" imprinted on panel.

Code	No. of Fuses	Spare Fuse	Panel Size	Mounting Hole Centers	Price Each
No. 901	1	3/4"x1 1/8"	3/8"	\$.10
No. 902	2	1 1/4"x1 1/8"	3/8"	.17
No. 903	3	1 3/4"x1 1/8"	7/8"	.23
No. 901-S	1	1	1 1/4"x2 1/8"	3/8"	.15
No. 902-S	2	1	1 3/4"x2 1/8"	7/8"	.22
No. 903-S	3	1	2 1/4"x2 1/8"	7/8"	.29

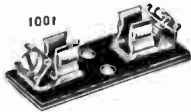

No. 1000 SERIES

The 1000 series fuse mounts provide screw terminals on the same side of panel as fuse clips. Clips are mounted so that screws face ends of panel. An insulating strip of fibre, the same size as the bakelite panel, is furnished. Panels with clips for spare fuse have the word "SPARE" imprinted on panel.

Code	No. of Fuses	Spare Fuse	Panel Size	Mounting Hole Centers	Price Each
No. 1001	1	3/4"x2 1/8"	3/8"	\$.17
No. 1002	2	1 1/4"x2 1/8"	3/8"	.30
No. 1003	3	1 3/4"x2 1/8"	7/8"	.42
No. 1001-S	1	1	1 1/4"x2 1/8"	3/8"	.23
No. 1002-S	2	1	1 3/4"x2 1/8"	7/8"	.36
No. 1003-S	3	1	2 1/4"x2 1/8"	7/8"	.49



No. 1100 SERIES

The 1100 series fuse mounts provide screw terminals on the same side of panel as the fuse clips. Clips are mounted so the screws face side of panel. Mount No. 3-AG fuses. An insulating strip of fibre, the same size as bakelite panel, is furnished. Panels with clips for spare fuse have word "SPARE" imprinted on panel.

Code	No. of Fuses	Spare Fuse	Panel Size	Mounting Hole Centers	Price Each
No. 1101	1	7/8"x1 1/2"	3/8"	\$.17
No. 1102	2	1 3/8"x1 1/2"	7/8"	.30
No. 1101-S	1	1	1 3/8"x1 1/2"	7/8"	.23
No. 1102-S	2	1	2 1/4"x1 1/2"	7/8"	.36

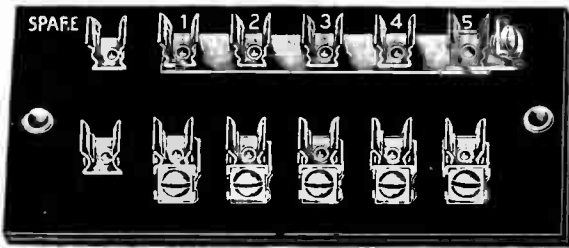

1200

No. 1200 SERIES MULTIPLE FUSE MOUNT PANELS

The No. 1200 series presents a very convenient fuse panel arrangement for multiple circuits. One side of all the fuse mounts is common, making it convenient for wiring. Screw terminals are provided on the same side of panel as fuse clips. Mounts No. 3-AG fuses. Each panel contains a pair of clips for mounting a spare fuse. The whole assembly has a bakelite insulating plate attached so that it can be mounted directly on metal.

Code	Fuse	Spare	Panel Size	Price Each
1201-S	1	1	2 1/4"x2 3/4"	\$.33
1202-S	2	1	2 1/4"x3"	.50
1203-S	3	1	2 1/4"x3 3/4"	.67
1204-S	4	1	2 1/4"x4 1/4"	.84
1205-S	5	1	2 1/4"x4 3/4"	1.01
1206-S	6	1	2 1/4"x5 1/4"	1.18
1207-S	7	1	2 1/4"x5 3/4"	1.35
1208-S	8	1	2 1/4"x6 1/4"	1.52

Code	Fuse	Spare	Panel Size	Price Each
1209-S	9	1	2 1/4"x7 3/4"	1.69
1210-S	10	1	2 1/4"x8"	1.86
1211-S	11	1	2 1/4"x8 3/4"	2.03
1212-S	12	1	2 1/4"x9 1/4"	2.20
1213-S	13	1	2 1/4"x9 3/4"	2.37
1214-S	14	1	2 1/4"x10 1/4"	2.54
1215-S	15	1	2 1/4"x11 1/4"	2.71

SPECIAL FUSE MOUNTS



Code No. 84 Single Fuse

No. 84

The No. 84 fuse mount provides solder tab on the same side of the panel as the fuse clips. Mounts No. 3-AG fuses. Similar in design to the No. 801 except that bakelite panel is of special size. Mounting hole in center of panel.

Panel Size	Price Each
3/4"x1 3/4"	\$.09

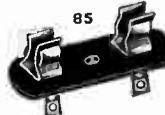

Code No. 85 Single Fuse

No. 85

The No. 85 fuse mount provides solder tab on the opposite side of panel to the fuse clips. Mounts No. 3-AG fuses. Similar to No. 901 except that bakelite panel is of special size and shape. Mounting hole in exact center of panel.

Panel Size	Price Each
3/4"x1 3/4"	\$.10



Code No. 86 Single Fuse

No. 86

The No. 86 fuse mount provides solder tabs on the same side of the panel as the fuse clips. Mounts No. 3-AG fuses. Bakelite strip is anchored to the terminal panel, enabling the fuse to be mounted direct on metal.

Panel Size	Price Each
3/4"x1 3/4"	\$.11

VOLTAGE REGULATOR TYPE

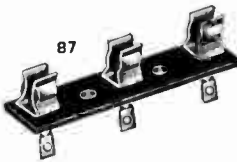

Code No. 87 Single Fuse

No. 87

The No. 87 fuse mount provides solder tabs on the opposite side of panel to the fuse clips. Mounts No. 3-AG fuses. Mounting holes are on 7/8" centers.

Panel Size	Price Each
3/4"x2 1/2"	\$.13



Code No. 88 Single Fuse

No. 88

The No. 88 fuse mount provides solder tabs on the same side of the panel as the fuse clips. Mounts No. 3-AG fuses. Mounting holes are on 7/8" centers.

Panel Size	Price Each
7/8"x2 1/2"	\$.14

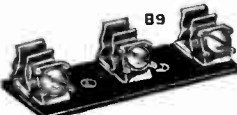

Code No. 89 Single Fuse

No. 89

The No. 89 fuse mount provides screw terminals on the same side of panel as fuse clips. Screws are mounted so that they face the side of panel. Mounting holes are on 7/8" centers.

Panel Size	Price Each
7/8"x2 1/2"	\$.23

CANNON CONNECTORS

CANNON ELECTRIC DEVELOPMENT COMPANY • 3209 HUMBOLDT STREET, LOS ANGELES, CALIFORNIA



TYPE DP FITTINGS

RACK & PANEL TYPES

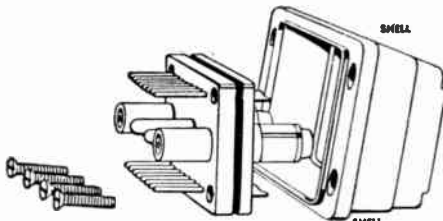

4 Machine Screws
No. 4-40x7/16
Oval Head.

PIN INSERT with co-axials, 40 and 10 AMP
Contacts. Molded pho-
enolic insulation. Shield
indicated covers sold-
er pot and internal
contact.

SHELL
With four mounting
holes.

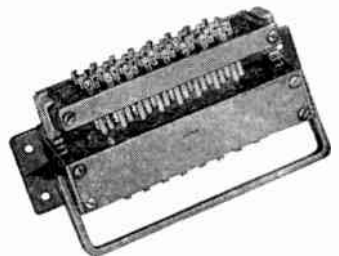

**TYPE DPR-40-33 and -34 Assembly
Rock Type—Single Unit**

Poles	Capacity	Wt. (lbs.)
40	15-amp.	.718 (total)

TYPE DPR-62-33 and -34 Assembly

Poles	Capacity	Wt. (lbs.)
62	{ (50) 10-amp. (12) 30-amp. }	.780



**"TYPE DP-D"
RECEPTACLE
(Socket Insert)**

Shell is 3 3/4" x 1 1/2" x 3/8" with max. coaxial contact extension of 3/8".

On standard shell mounting holes are .114 dia. Assembly uses #4-40 x 1 1/2 oval HD machine screws. #4-40 Elastic Stop Nuts are standard equipment, if available. Shell is aluminum or zinc. Weights in zinc only.

Poles	Capacity	Cat. No.	Wt. Lbs.
12	10-15-amp.	4500-31	.376
14	10-amp.	4500-61	.312
16	10-40-amp.	4500-13	.371
18	10-40-amp.	4500-53	.325
19	10-amp.	4500-59	.321
19	10-40-amp.	4500-55	.321
20	10-amp.	4500-29	.381
21	10-amp.	4500-57	.325
28	10-amp.	4500-34	.338
30	10-40-amp.	4500-1	.383
31	10-40-amp.	4500-3	.349
31	10-40-amp.	4500-7	.379
32	10-40-amp.	4500-5	.390
32	10-40-amp.	4500-9	.390
32	10-40-amp.	4500-11	.400
32	10-40-amp.	4500-32	.361

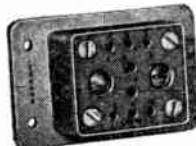

**"TYPE DP-B"
RECEPTACLE
(Socket Insert)**

Shell is 2 1/4" x 1 1/2" x 3/8" with max. coaxial contact extension of 5/8".

Type is a variation of DP-D with smaller shell. Mounting holes .144 dia, countersunk for No. 6 FH Machine Screws. 2 coaxials.

Type	Capacity	Wt. Zinc (lbs.)
Type DP-B10C2-33S	15-30-amp.	.268

Type	Capacity	Wt. Zinc (lbs.)
Type DP-B8-33S	15-amp.	.224

**"TYPE DP-B"
PLUG
(Pin Insert)**



Type	Capacity	Wt. Zinc (lbs.)
Type DP-B10C2-34P	15-30-amp.	.266

Type	Capacity	Wt. Zinc (lbs.)
Type DP-B8-34P	15-amp.	.176

**"TYPE DP-12" RECEPTACLE
(Socket Insert)
Panel Type—
No Shell**



Socket Panel Assembly is 2 7/8" x 2" x 5/8" with a solder pot extension of 1/4". 4 mounting holes .120 drill size for No. 4 FH screws.

Poles	Capacity	Cat. No.	Wt. (lbs.)
12	30-amp.	387-1	.135

**"TYPE DP-12"
PLUG
(Pin Insert)
Pin Panel
Assembly**

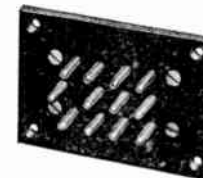

#4-40 Flat Head Machine Screws.	Inculcation, phenolic.	Cat. No.	Wt. (lbs.)
Poles	Capacity	387-2	.128
12	30-amp.		



**"TYPE DP-P"
RECEPTACLE
Socket Insert
No Shell**

4 holes No. 31 (.120) Drill size, countersunk to seat No. 4 Flat Head Machine Screws. Using No. 10 B & S Stranded Wire. 2 Guide Pins.

Poles	Capacity	Cat. No.	Wt. (lbs.)
10	30-amp.	11460	.109

**"TYPE DP-P"
PLUG
Pin Insert
Assembly
No Shell**



Poles	Capacity	Cat. No.	Wt. (lbs.)
10	30-amp.	11461	.069



**"TYPE DP-S"
RECEPTACLE
Socket Panel
Assembly—
No Shell**

Receptacle uses #4-40 x 1 1/2" Flat Head Machine Screws.

Poles	Capacity	Cat. No.	Wt. (lbs.)
12	30-amp.	1164	.083

**"TYPE DP-S"
PLUG**

**Pin Panel Assembly
No Shell**



Plug uses #4-40 x 5/8" Flat Head Machine Screws.

Poles	Capacity	Cat. No.	Wt. (lbs.)
12	30-amp.	1165	.121

Other types tooled: DP-30, DP-N26, DP-S10, DP-U60, DPL.

Other types tooled: DP-30, DP-N26, DP-S10, DP-U60, DPL, DP-D-33 Junction Shell.

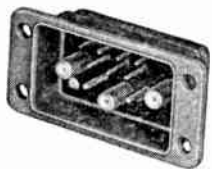

**"TYPE DP-D"
PLUG
(Pin Insert)**

Depth of shell on plug is 1 1/4" with a maximum coaxial contact extension of 3/8". Weights are in zinc only.

Poles	Capacity	Cat. No.	Wt. Lbs.
12	10-40-amp.	4500-36	.263
12	10-15-amp.	4500-30	.329
14	10-amp.	4500-60	.247
16	10-40-amp.	4500-14	.311
18	10-40-amp.	4500-62	.263
19	10-amp.	4500-58	.254
19	10-40-amp.	4500-54	.263
20	10-15-amp.	4500-28	.316
21	10-amp.	4500-56	.256
28	10-amp.	4500-35	.265
30	10-40-amp.	4500-2	.281
31	10-40-amp.	4500-4	.290
31	10-40-amp.	4500-8	.306
32	10-40-amp.	4500-6	.279
32	10-40-amp.	4500-10	.301
32	10-40-amp.	4500-12	.332
32	10-40-amp.	4500-33	.284

CANNON CONNECTORS

CANNON ELECTRIC DEVELOPMENT COMPANY • 3209 HUMBOLDT STREET, LOS ANGELES, CALIFORNIA



TYPE X FITTINGS

CANNON "TYPE X" PLUGS AND RECEPTACLES—The "Type X" Series of Midget Connectors offers inexpensive fittings of reliable quality for sound service, radio, public address systems and geophysical research. In addition to compactness, many exclusive Cannon features are embodied in this series, such as full floating contacts in all socket inserts. Solder pot cable connections are easily accessible. Cable glands are removable. Contacts are so positive that no latching device is needed for ordinary uses.

The arrow shows spring clip on full-floating socket contact which gives a positive pressure fit connection.

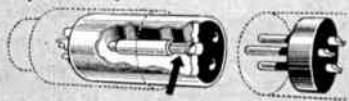

"TYPE X" STRAIGHT CORD PLUG (Socket Insert)



ONE-HALF ACTUAL SIZE

Sturdily built for dependable service. Light in weight. Shell is die-cast zinc. Finish is bright-dip nickel. Will take $\frac{1}{4}$ " to $\frac{3}{8}$ " cable. Used in conjunction with the following: X-14 Wall Receptacle, X-12 Straight Cord Plug, and X-42 Microphone Receptacle.

Poles	Capacity	Wt. Lbs.	Cat. No.	List Price
1	15-amp.	0.081	X-1-11	\$1.75
3	15-amp.	0.083	X-3-11	1.75
4	{ 3-10-amp. } { 1-15-amp. }	0.085	X-4-11	3.25

"TYPE X" STRAIGHT CORD PLUG (Pin Insert)

For use in conjunction with "Type X" Straight Cord Plug (Socket Insert) X-11 or "Type X" Wall Receptacle (Socket Insert) X-13. Shell is die-cast zinc, bright-dip nickel finish. Will take $\frac{1}{4}$ " to $\frac{3}{8}$ " cable.



ONE-HALF ACTUAL SIZE

Shell is of brass, bright-dip nickel finish. Equipped with quick-acting coupling ring. Solder pot connections are easily accessible. Takes $\frac{1}{4}$ " to $\frac{3}{8}$ " cable. Built for long, dependable service. Used in conjunction with XK-12, XK-14.

Poles	Capacity	Wt. Lbs.	Cat. No.	List Price
1	15-amp.	0.061	X-1-12	\$1.25
3	15-amp.	0.063	X-3-12	1.25
4	{ 3-10-amp. } { 1-15-amp. }	0.065	X-4-12	2.25

"TYPE X" WALL RECEPTACLE (Socket Insert)



ONE-HALF ACTUAL SIZE

Body fits in $\frac{3}{8}$ " hole and extends $\frac{1}{8}$ " behind flange, which is $1\frac{1}{2}$ " in diameter and drilled for three #4-40 oval-head screws on $\frac{1}{4}$ " radius. Die-cast zinc, bright-dip nickel finish. To be used in conjunction with the following straight cord plug (Pin Insert): X-12.

Poles	Capacity	Wt. Lbs.	Cat. No.	List Price
1	15-amp.	0.081	X-1-13	\$1.75
3	15-amp.	0.083	X-3-13	1.75
4	{ 3-10-amp. } { 1-15-amp. }	0.085	X-4-13	3.25

"TYPE X" WALL RECEPTACLE (Pin Insert)

Body fits in $\frac{3}{8}$ " hole and extends $\frac{3}{8}$ " behind the flange, which is $1\frac{1}{2}$ " in diameter and drilled for three #4-40 oval-head screws on $\frac{1}{4}$ " radius, 120° apart. Material used is DURAL, sand blast and clear lacquer finish. Used in conjunction with straight cord plug (Socket Insert) X-11. Solder pots extend $\frac{1}{4}$ " beyond rear of body.



ONE-HALF ACTUAL SIZE

Poles	Capacity	Wt. Lbs.	Cat. No.	List Price
1	15-amp.	0.040	X-1-14	\$1.25
3	15-amp.	0.042	X-3-14	1.25
4	{ 3-10-amp. } { 1-15-amp. }	0.044	X-4-14	2.25

"TYPE X" MICROPHONE RECEPTACLE (Pin Insert)

Has all the features of "Type X" Straight Cord Plugs and Wall Receptacles but it is mounted on a flat base, ready for mounting on equipment. Die-cast zinc, bright-dip nickel finish. Use with straight Cord Plug (Socket Insert) X-11. Mounting holes are $.144$ " in diameter and 1 " apart.



ONE-HALF ACTUAL SIZE

Poles	Capacity	Wt. Lbs.	Cat. No.	List Price
3	15-amp.	0.063	X-3-42	\$1.25

TYPE XK FITTINGS

CANNON "TYPE XK" PLUGS AND RECEPTACLES—A quality line of Connectors, similar in design and construction to the "Type X" Series, but equipped with the fast-acting, sturdy Acme Threaded Coupling Ring and, therefore, ideal for use on equipment which is subjected to considerable vibration and tension on cables, such as on sound trucks and other portable units.

"TYPE XK" WALL RECEPTACLE (Pin Insert)

Body fits in a $\frac{3}{8}$ " hole and extends $\frac{3}{8}$ " behind a $\frac{1}{8}$ " flange which is $1\frac{1}{2}$ " in diameter, drilled for four #4-40 oval-head mounting screws on a $\frac{5}{8}$ " radius, 90° apart. Made of brass, bright-dip nickel finish. Solder pots extend $\frac{3}{8}$ " beyond body. Has external acme thread on shell and is used in conjunction with straight cord plug XK-11.



ONE-THIRD ACTUAL SIZE

Poles	Capacity	Wt. Lbs.	Cat. No.	List Price
1	15-amp.	0.045	XK-1-14	\$2.00
3	15-amp.	0.047	XK-3-14	2.00
4	{ 3-10-amp. } { 1-15-amp. }	0.049	XK-4-14	3.00

"TYPE XK" WALL RECEPTACLE (Socket Insert)

Body fits in $1\frac{1}{8}$ " hole and extends $1\frac{1}{8}$ " behind flange which is $1\frac{1}{2}$ " in diameter and drilled for four #4-40 oval-head mounting screws on a $\frac{5}{8}$ " radius, 90° apart. Made of brass, bright-dip nickel finish. Solder pots on contacts extend $\frac{1}{8}$ " beyond body. Use in conjunction with a straight cord plug (Pin Insert) XK-12.



ONE-HALF ACTUAL SIZE

Poles	Capacity	Wt. Lbs.	Cat. No.	List Price
1	15-amp.	0.144	XK-1-13L	\$3.50
3	15-amp.	0.146	XK-3-13L	3.50
4	{ 3-10-amp. } { 1-15-amp. }	0.148	XK-4-13L	5.00

Quick-acting locking ring. Plugs and receptacles cannot be accidentally disconnected by jarring apart due to vibration or pulling on lines. 2 types of threaded coupling rings are shown below at A & C. Full-floating 'napkin ring' type socket contact. Pin and insert protected by shell. Built to withstand hard service. (B) Correct polarization governed by layout arrangement.

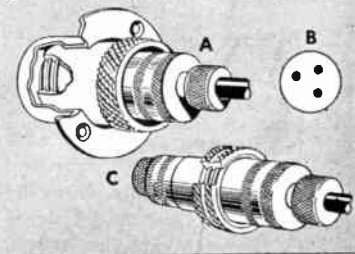

"TYPE XK" STRAIGHT CORD PLUG (Socket Insert)



ONE-HALF ACTUAL SIZE

Shell is of brass, bright-dip nickel finish. Equipped with quick-acting coupling ring. Solder pot connections are easily accessible. Takes $\frac{1}{4}$ " to $\frac{3}{8}$ " cable. Built for long, dependable service. Used in conjunction with XK-12, XK-14.

Poles	Capacity	Wt. Lbs.	Cat. No.	List Price
1	15-amp.	0.081	XK-1-11	\$3.50
3	15-amp.	0.083	XK-3-11	3.50
4	{ 3-10-amp. } { 1-15-amp. }	0.085	XK-4-11	5.00

"TYPE XK" STRAIGHT CORD PLUG (Pin Insert)

For use in conjunction with Straight Cord Plug (Socket Insert) or Wall Receptacle (Socket Insert) with Coupling Ring. Provided with threaded shell to take coupling ring. Made of brass, with bright-dip nickel finish. Takes $\frac{1}{4}$ " to $\frac{3}{8}$ " cable.



ONE-HALF ACTUAL SIZE

Poles	Capacity	Wt. Lbs.	Cat. No.	List Price
1	15-amp.	0.081	XK-1-12	\$2.00
3	15-amp.	0.083	XK-3-12	2.00
4	{ 3-10-amp. } { 1-15-amp. }	0.085	XK-4-12	3.00

"TYPE XK" WALL RECEPTACLE (Socket Insert)



ONE-HALF ACTUAL SIZE

Body fits in $\frac{1}{8}$ " hole and extends $\frac{1}{8}$ " behind flange which is $1\frac{1}{2}$ " in diameter and drilled for four #4-40 oval-head mounting screws on a $\frac{5}{8}$ " radius, 90° apart. Solder pots extend $\frac{3}{8}$ " beyond rear of body. Made of brass, with bright-dip nickel finish. Fitting has no coupling ring but will mate with a straight cord plug, XK-12. Whereas two cord connectors need a coupling ring, on a panel not subjected to vibration or hard wear it is not necessary.

Poles	Capacity	Wt. Lbs.	Cat. No.	List Price
1	15-amp.	0.081	XK-1-13	\$2.25
3	15-amp.	0.083	XK-3-13	2.25
4	{ 3-10-amp. } { 1-15-amp. }	0.085	XK-4-13	3.75

CANNON CONNECTORS

CANNON ELECTRIC DEVELOPMENT COMPANY • 3209 HUMBOLDT STREET, LOS ANGELES, CALIFORNIA



TYPE O FITTINGS

CANNON "TYPE O" PLUGS AND RECEPTACLES. This series consists of a line of 3-pole oval-shaped Plugs and Receptacles, equipped with Latch Locking Device. Contacts are silver-plated, full-floating, non-twisting. Solder terminals are tinned for ease of wiring.

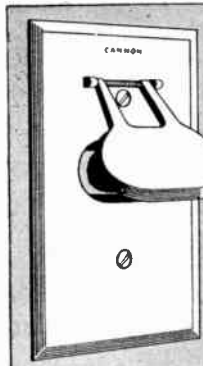

If "Type O" Fittings are to be installed in base-board or in panels, receptacles or plugs can be supplied with flush door and plate which fits standard single gang outlet box. Ideal for broadcasting studios.

"TYPE O" STRAIGHT CORD PLUG (Socket Insert)



Has Integral Clamp for $\frac{1}{8}$ " or smaller cable. Made of die-cast zinc, cadmium plated and finished with clear lacquer.

Poles	Capacity	Wt. Lbs.	Cat. No.	List Price
3	30-amp.	0.113	03-11	\$4.50

"TYPE O" STRAIGHT CORD PLUG (Pin Insert)

Corresponds with No. 03-11 "Type O" Straight Cord Plug (Socket Insert). Has integral cable clamp, for $\frac{1}{8}$ " or smaller cable. Made of die-cast zinc, cadmium plated, clear lacquer.



Poles	Capacity	Wt. Lbs.	Cat. No.	List Price
3	30-amp.	0.104	03-12	\$4.50

"TYPE O" FLUSH WALL RECEPTACLE (Socket Insert)



Flange is 2" in diameter, drilled with four holes to take #4-40 oval-head mounting screws, 90° apart on a radius of $\frac{1}{4}$ ". Made of die-cast zinc, cadmium plated and finished in clear lacquer. Latch Locking Device is operated from panel front.

Poles	Capacity	Wt. Lbs.	Cat. No.	List Price
3	30-amp.	0.148	03-13	\$4.50

"TYPE O" FLUSH WALL RECEPTACLE (Pin Insert)

The flange is 2" in diameter, drilled with four holes to take #4-40 oval-head mounting screws, 90° apart, on a radius of $\frac{1}{4}$ ". Made of cast aluminum, clear lacquer finish, or die-cast zinc, cadmium plated, clear lacquer finish.



Poles	Capacity	Wt. Lbs.	Cat. No.	List Price
3	30-amp.	0.107	03-14	\$4.50



ONE-FOURTH ACTUAL SIZE

"TYPE O" SINGLE GANG WALL RECEPTACLE (Socket Insert)

Plate is $4\frac{1}{2}$ " high and $2\frac{3}{4}$ " wide. Brackets furnished for standard switch box. Made of cast aluminum alloy, finished in clear lacquer.

Poles	Capacity
3	30-amp.

Wt. Lbs.	Cat. No.	List Price
0.10	03-35	\$5.50



ONE-FOURTH ACTUAL SIZE

"TYPE O" SINGLE GANG WALL RECEPTACLE (Socket Insert) DOOR TYPE

Plate is $4\frac{1}{2}$ " high and $2\frac{3}{4}$ " wide. Same as No. 03-35, except plate is provided with hinged door to keep out dust and dirt. Made of cast aluminum alloy, finished with clear lacquer.

Poles	Capacity	Wt. Lbs.	Cat. No.	List Price
3	30-amp.	0.296	03-35D	\$6.50

"TYPE O" SINGLE GANG WALL RECEPTACLE (Pin Insert)

Plate is $2\frac{3}{4}$ " wide and $4\frac{1}{2}$ " high. Brackets furnished for standard switch box. Made of cast aluminum alloy, finished with clear lacquer.

Poles	Capacity	Lbs.
3	30-amp.	0.904

Cat. No.	List Price
03-36	\$5.50

ONE-FOURTH ACTUAL SIZE

"TYPE O" SINGLE GANG WALL RECEPTACLE (Pin Insert) DOOR TYPE

Same as No. 03-36, except equipped with door to keep out dust and dirt. Made of cast aluminum alloy, finished with clear lacquer. Plate is $2\frac{3}{4}$ " wide and $4\frac{1}{2}$ " high.

Poles	Capacity	Wt. Lbs.	Cat. No.	List Price
3	30-amp.	0.328	03-36D	\$6.50

"TYPE O" MICROPHONE OR PANEL RECEPTACLE (Pin Insert)

Has flat base, with two lugs for mounting with #4-40 oval-head screws. Made of die-cast zinc, and cadmium plated.



ONE-THIRD ACTUAL SIZE

Poles	Capacity	Wt. Lbs.	Cat. No.	List Price
3	30-amp.	0.271	03-42D	\$4.50

"TYPE O" 90° MICROPHONE OR PANEL RECEPTACLE (Socket Insert)



ONE-THIRD ACTUAL SIZE

Flat base is flanged and is attached to microphone or panel by means of two #4-40 oval-head mounting screws. Made of die-cast zinc, cadmium plated and finished in clear lacquer.

Poles	Capacity	Wt. Lbs.	Cat. No.	List Price
3	30-amp.	0.274	03-41D	\$4.50

TYPE TQ FITTINGS

CANNON "TYPE TQ" COAXIAL FITTINGS. "Type TQ" Coaxial Fittings provide continuous shielding with constant impedance. Each fitting contains 1 standard Cannon style silver-plated contact, rated at 10-amp. and accommodating #16 stranded or #14 solid, or smaller, B&S gauge wire. Solder pots on rear of contacts are tinned for ease in wiring. Insulation discs are ISOLANTITE.

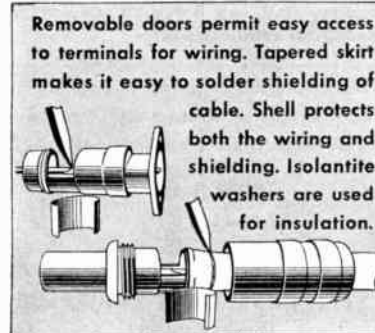

Removable doors permit easy access to terminals for wiring. Tapered skirt makes it easy to solder shielding of cable. Shell protects both the wiring and shielding. Isolantite washers are used for insulation.

CANNON "TYPE TQ" COAXIAL CORD PLUG (Socket Insert) For Continuous Shielding



ONE-HALF ACTUAL SIZE

A tapered skirt is provided on this Plug, to which the shielding is easily soldered. Accommodates $\frac{1}{2}$ " cable, but can be supplied for $\frac{3}{8}$ " cable if specified with order. Body machined from solid brass rod, cadmium plated.

Poles	Capacity	Wt. Lbs.	Cat. No.	List Price
1	10-amp.	0.106	TQ-1-12	\$2.00

"TYPE TQ" COAXIAL FLUSH PANEL RECEPTACLE (Pin Insert) For Continuous Shielding

Provided with a tapered skirt to which the shielding is easily soldered. Also has Inspection Door, which snaps into place. ISOLANTITE Insulation, as used in all "Type TQ" Fittings. Body is machined from solid brass rod, cadmium plated. Accommodates $\frac{1}{2}$ " cable, but can be supplied for $\frac{3}{8}$ " cable if specified with order. Two holes—.120 in diameter, 180° apart—on a $\frac{1}{4}$ " radius.



ONE-HALF ACTUAL SIZE

Poles	Capacity	Wt. Lbs.	Cat. No.	List Price
1	10-amp.	.043	TQ-1-13	\$2.00

"TYPE TQ" FLUSH RECEPTACLE (Pin Insert)

Similar to No. TQ-1-13, except that it is not provided with Inspection Door and is not designed for continuous shielding. Uses ISOLANTITE insulation. For mounting on front of panel. Body machined from solid brass rod, cadmium plated. Two holes—.120 in diameter, 180° apart—on a $\frac{1}{4}$ " radius.



ONE-HALF ACTUAL SIZE

Poles	Capacity	Wt. Lbs.	Cat. No.	List Price
1	10-amp.	0.037	TQ-1-13C	\$2.00

CANNON CONNECTORS

CANNON ELECTRIC DEVELOPMENT COMPANY • 3209 HUMBOLDT STREET, LOS ANGELES, CALIFORNIA



TYPE TQ FITTINGS

"TYPE TQ" FLUSH RECEPTACLE (Pin Insert)

For Mounting Behind Panel

Same construction as No. TQ-1-13C, except that the flange is mounted on back of panel. Body machined from solid brass rod, cadmium plated. Two holes—.120 diameter, 180° apart on a $\frac{1}{8}$ radius.



ONE-HALF ACTUAL SIZE

Poles Capacity Wt. Lbs. Cat. No. List Price
1 10-amp. 0.039 TQ-1-13BC \$2.00

"TYPE TQ" COAXIAL FLUSH RECEPTACLE (Pin Insert)

For Continuous Shielding

Designed for mounting behind panel, otherwise exactly the same as No. TQ-1-13. Accommodates $\frac{1}{8}$ " cable. Can be supplied to take $\frac{3}{16}$ " cable if specified on order. Body is machined from solid brass rod, cadmium plated. Two holes—.120 in diameter, 180° apart—on $\frac{1}{8}$ radius.



ONE-HALF ACTUAL SIZE

Poles Capacity Wt. Lbs. Cat. No. List Price
1 10-amp. 0.057 TQ-1-13B \$2.00

TYPE P FITTINGS

CANNON "TYPE P" FITTINGS. Universally used in sound and allied applications. "Type P" Fittings include a size and type for every requirement, all of a high standard of quality. All 90° Plugs, Pins and Sockets have split-shell construction for quick, easy access for wiring or inspection. Splosh-proof, but not weather-proof. Plug and receptacle dust caps are available for use under severe dust conditions. Laboratory tests show an average voltage-drop of not more than 10 millivolts, with current flowing at the rated capacity. Insulating material is Bokelite No. BM-6102 which has a .5% absorption in 24 hours of boiling water and a dielectric strength of 325 volts per mil at 60 cycles.

"TYPE P" STRAIGHT CORD PLUG (Socket Insert), ZINC



ONE-THIRD ACTUAL SIZE

Equipped with patented Latch which locks mating fitting when coupled. Instantly released by pressing with thumb. Made of die-cast zinc, cadmium plated and finished with clear lacquer. Compression gland for $\frac{1}{8}$ " or smaller cable.

Poles	Capacity	Wt. Lbs.	Cat. No.	List Price
2	30-amp.	0.183	P2-11	\$3.95
3	30-amp.	0.188	P3-11	4.25
4	30-amp.	0.193	P4-11	4.55
5	30-amp.	0.196	P5-11	4.85
6	30-amp.	0.200	P6-11	5.15
8	15-amp.	0.196	P8-11	5.15

"TYPE P" STRAIGHT CORD PLUG (Socket Insert), STEEL



ONE-THIRD ACTUAL SIZE

Same design and construction as the other "Type P" Straight Cord Plugs except it is made of steel, with a cadmium plated finish.

Poles	Capacity	Wt. Lbs.	Cat. No.	List Price
2	30-amp.	0.312	P2-11S	\$4.20
3	30-amp.	0.316	P3-11S	4.50
4	30-amp.	0.320	P4-11S	4.80
5	30-amp.	0.324	P5-11S	5.10
6	30-amp.	0.328	P6-11S	5.40
8	15-amp.	0.324	P8-11S	5.40

"TYPE P" STRAIGHT CORD PLUG (Socket Insert), STEEL



ONE-THIRD ACTUAL SIZE

Same design and construction as in other "Type P" Straight Cord Plugs except for split rubber wedge for cable. Supplied for $\frac{1}{8}$ " to $\frac{1}{2}$ " cable. Specify cable size when ordering. Made of steel, cadmium plated finish.

Poles	Capacity	Wt. Lbs.	Cat. No.	List Price
2	30-amp.	0.222	P2-11T	\$4.20
3	30-amp.	0.226	P3-11T	4.50
4	30-amp.	0.230	P4-11T	4.80
5	30-amp.	0.234	P5-11T	5.10
6	30-amp.	0.238	P6-11T	5.40
8	15-amp.	0.234	P8-11T	5.40

"TYPE P" STRAIGHT CORD PLUG (Socket Insert), ZINC



ONE-THIRD ACTUAL SIZE

Has all the usual "Type P" features except is equipped with Clamp Gland for $\frac{1}{8}$ " or smaller cable, insuring positive clamping with a waterproof gland. Made of die-cast zinc, cadmium plated and finished in clear lacquer.

Poles	Capacity	Wt. Lbs.	Cat. No.	List Price
2	30-amp.	0.213	P2-CG-11	\$3.95
3	30-amp.	0.217	P3-CG-11	4.25
4	30-amp.	0.221	P4-CG-11	4.55
5	30-amp.	0.225	P5-CG-11	4.85
6	30-amp.	0.229	P6-CG-11	5.15
8	15-amp.	0.225	P8-CG-11	5.15

STRAIGHT CORD PLUG (Socket Insert), STEEL



ONE-THIRD ACTUAL SIZE

Same as other "Type P" Straight Cord Plugs, except it is made of steel, with a cadmium plated finish.

Poles	Capacity	Wt. Lbs.	Cat. No.	List Price
2	30-amp.	0.242	P2-CG-11S	\$4.20
3	30-amp.	0.246	P3-CG-11S	4.50
4	30-amp.	0.250	P4-CG-11S	4.80
5	30-amp.	0.254	P5-CG-11S	5.10
6	30-amp.	0.258	P6-CG-11S	5.40
8	15-amp.	0.254	P8-CG-11S	5.40

"TYPE P" STRAIGHT CORD PLUG (Pin Insert), ZINC



ONE-THIRD ACTUAL SIZE

The corresponding Plug for use with "Type P" Straight Cord Plug (Socket Insert) No. P-11. It is equipped with a Compression Gland for $\frac{1}{8}$ " or smaller cable. Die-cast zinc, cadmium plated and finished in clear lacquer.

Poles	Capacity	Wt. Lbs.	Cat. No.	List Price
2	30-amp.	0.092	P2-12	\$2.50
3	30-amp.	0.095	P3-12	2.50
4	30-amp.	0.098	P4-12	2.50
5	30-amp.	0.101	P5-12	2.50
6	30-amp.	0.104	P6-12	2.75
8	15-amp.	0.101	P8-12	2.75

"TYPE P" STRAIGHT CORD PLUG, (Pin Insert), STEEL



ONE-THIRD ACTUAL SIZE

Corresponds with "Type P" Straight Cord Plug (Socket Insert) No. P-11S. Made of steel, cadmium plated finish. Has Compression Gland for $\frac{1}{8}$ " or smaller cable.

Poles	Capacity	Wt. Lbs.	Cat. No.	List Price
2	30-amp.	0.209	P2-12S	\$2.75
3	30-amp.	0.212	P3-12S	2.75
4	30-amp.	0.215	P4-12S	2.75
5	30-amp.	0.213	P5-12S	2.75
6	30-amp.	0.221	P6-12S	3.00
8	15-amp.	0.218	P8-12S	3.00

"TYPE P" STRAIGHT CORD PLUG (Pin Insert), STEEL



ONE-THIRD ACTUAL SIZE

Corresponds with the Straight Cord Plug (Socket Insert) No. P-11T. Has split rubber wedge for $\frac{3}{16}$ " to $\frac{1}{2}$ " cable. Specify cable diameter when ordering. Made of steel, cadmium plated finish.

Poles	Capacity	Wt. Lbs.	Cat. No.	List Price
2	30-amp.	0.109	P2-12T	\$2.75
3	30-amp.	0.112	P3-12T	2.75
4	30-amp.	0.115	P4-12T	2.75
5	30-amp.	0.118	P5-12T	2.75
6	30-amp.	0.121	P6-12T	3.00
8	15-amp.	0.118	P8-12T	3.00

"TYPE P" STRAIGHT CORD PLUG (Pin Insert), ZINC



ONE-THIRD ACTUAL SIZE

Corresponds with "Type P" Straight Cord Plug (Socket Insert) No. P-CG-11. Has Clamp Gland for $\frac{1}{8}$ " or smaller cable, insuring positive clamping with waterproof gland. Made of die-cast zinc, cadmium plated and finished in clear lacquer.

Poles	Capacity	Wt. Lbs.	Cat. No.	List Price
2	30-amp.	0.123	P2-CG-12	\$2.50
3	30-amp.	0.126	P3-CG-12	2.50
4	30-amp.	0.129	P4-CG-12	2.50
5	30-amp.	0.132	P5-CG-12	2.50
6	30-amp.	0.135	P6-CG-12	2.75
8	15-amp.	0.132	P8-CG-12	2.75

CANNON CONNECTORS

CANNON ELECTRIC DEVELOPMENT COMPANY • 3209 HUMBOLDT STREET, LOS ANGELES, CALIFORNIA



TYPE P FITTINGS

"TYPE P" STRAIGHT CORD PLUG (Pin Insert), STEEL

Corresponds with the "Type P" Straight Cord Plug (Socket Insert) No. P-CG-11S. Has Clamp Gland for 1/2" or smaller cable, insuring positive clamping with waterproof gland. Made of steel, cadmium plated finish.



ONE-THIRD ACTUAL SIZE

Poles	Capacity	Wt. Lbs.	Cat. No.	List Price
2	30-amp.	0.146	P2-CG-12S	\$2.75
3	30-amp.	0.149	P3-CG-12S	2.75
4	30-amp.	0.153	P4-CG-12S	2.75
5	30-amp.	0.156	P5-CG-12S	2.75
6	30-amp.	0.159	P6-CG-12S	3.00
8	15-amp.	0.156	P8-CG-12S	3.00

"TYPE P" STRAIGHT CORD PLUG (Socket Insert), HEAVY DUTY



ONE-THIRD ACTUAL SIZE

Built of cast aluminum alloy for severe service, but employing all features such as the latch type locking device which is standard on "Type P." It has integral clamp for 3/4" or smaller cable. Also made for 1/2" cable if specified. Clear lacquer finish.

Poles	Capacity	Wt. Lbs.	Cat. No.	List Price
2	30-amp.	0.166	P2-23	\$4.70
3	30-amp.	0.170	P3-23	5.00
4	30-amp.	0.174	P4-23	5.30
5	30-amp.	0.178	P5-23	5.60
6	30-amp.	0.182	P6-23	5.90

"TYPE P" STRAIGHT CORD PLUG (Socket Insert), LONG



ONE-THIRD ACTUAL SIZE

Same design as "Type P" Straight Cord Plug (Socket Insert) No. P-23 except shell is longer. Has Integral Clamp for 3/4" cable and can be drilled for 1/2" if specified. Made of die-cast zinc, cadmium plated and finished in clear lacquer.

Poles	Capacity	Wt. Lbs.	Cat. No.	List Price
2	30-amp.	0.295	P2-23L	\$4.70
3	30-amp.	0.299	P3-23L	5.00
4	30-amp.	0.303	P4-23L	5.30
5	30-amp.	0.307	P5-23L	5.60
6	30-amp.	0.309	P6-23L	5.90
8	15-amp.	0.307	P8-23L	5.90

"TYPE P" 90° CORD PLUG (Socket Insert)



ONE-THIRD ACTUAL SIZE

Has Split Shell for ease in wiring and inspection. It is supplied with Compression Gland for 1/2" or smaller cable. Made of cast aluminum alloy, clear lacquered.

Poles	Capacity	Wt. Lbs.	Cat. No.	List Price
2	30-amp.	0.190	P2-15	\$5.20
3	30-amp.	0.194	P3-15	5.50
4	30-amp.	0.198	P4-15	5.80
5	30-amp.	0.202	P5-15	6.10
6	30-amp.	0.206	P6-15	6.40
8	15-amp.	0.202	P8-15	6.40

"TYPE P" 90° CORD PLUG (Socket Insert)

Has Split Shell and all other "Type P" features used in Cord Plug (Socket Insert) No. P-15 except cable connection, which is an Integral Clamp for 1/2" or smaller cable. Made of cast aluminum alloy, finished in clear lacquer.



ONE-THIRD ACTUAL SIZE

Poles	Capacity	Wt. Lbs.	Cat. No.	List Price
2	30-amp.	0.220	P2-CG-15	\$5.20
3	30-amp.	0.224	P3-CG-15	5.50
4	30-amp.	0.228	P4-CG-15	5.80
5	30-amp.	0.232	P5-CG-15	6.10
6	30-amp.	0.236	P6-CG-15	6.40
8	15-amp.	0.232	P8-CG-15	6.40

"TYPE P" PANEL RECEPTACLE (Socket Insert), SURFACE MOUNTING



ONE-THIRD ACTUAL SIZE

Equipped with "Type P" Latching Locking Device and all other "Type P" features. Made of cast aluminum alloy, finished in clear lacquer. Flange is 2" in diameter, drilled with four .120" diameter holes for #4-40 oval-head mounting screws, 90° apart on a 1/8" radius. Body extends 1" out in front of 1/2" mounting flange.

Poles	Capacity	Wt. Lbs.	Cat. No.	List Price
2	30-amp.	0.125	P2-17	\$3.95
3	30-amp.	0.129	P3-17	4.25
4	30-amp.	0.133	P4-17	4.55
5	30-amp.	0.137	P5-17	4.85
6	30-amp.	0.141	P6-17	5.15
8	15-amp.	0.137	P8-17	5.15

"TYPE P" STRAIGHT CORD PLUG (Pin Insert), HEAVY DUTY

Corresponds with "Type P" Straight Cord Plug (Socket Insert) No. P-23. Built for hard service. The shell is of steel, cadmium plated finish. Has aluminum Integral Clamp for 3/4" or smaller cable. Made for 1/2" cable if specified.



ONE-THIRD ACTUAL SIZE

Poles	Capacity	Wt. Lbs.	Cat. No.	List Price
2	30-amp.	0.170	P2-24	\$3.25
3	30-amp.	0.173	P3-24	3.25
4	30-amp.	0.176	P4-24	3.25
5	30-amp.	0.179	P5-24	3.25
6	30-amp.	0.182	P6-24	3.50
8	15-amp.	0.179	P8-24	3.50

"TYPE P" STRAIGHT CORD PLUG (Pin Insert), LONG

Corresponds with "Type P" Straight Cord Plug (Socket Insert) No. P-23L. Skirt is of steel and body of die-cast zinc, cadmium plated and finished in clear lacquer. Integral clamp for 3/4" cable can be drilled 1/2" if specified.



ONE-THIRD ACTUAL SIZE

Poles	Capacity	Wt. Lbs.	Cat. No.	List Price
2	30-amp.	0.277	P2-24L	\$3.25
3	30-amp.	0.280	P3-24L	3.25
4	30-amp.	0.283	P4-24L	3.25
5	30-amp.	0.286	P5-24L	3.25
6	30-amp.	0.289	P6-24L	3.50
8	15-amp.	0.286	P8-24L	3.50

"TYPE P" 90° CORD PLUG (Pin Insert)

Has Split Shell, enabling easy access to terminals for wiring or inspection. Corresponds with "Type P" 90° Cord Plug (Socket Insert) No. P-15 and has Compression Gland for 1/2" or smaller cable. Skirt is of steel and body of aluminum alloy casting, finished in clear lacquer.



ONE-THIRD ACTUAL SIZE

Poles	Capacity	Wt. Lbs.	Cat. No.	List Price
2	30-amp.	0.168	P2-16	\$3.75
3	30-amp.	0.171	P3-16	3.75
4	30-amp.	0.174	P4-16	3.75
5	30-amp.	0.178	P5-16	3.75
6	30-amp.	0.181	P6-16	4.00
8	15-amp.	0.178	P8-16	4.00

"TYPE P" 90° CORD PLUG (Pin Insert)

Corresponds with "Type P" 90° Cord Plug (Socket Insert) No. P-CG-15, having Integral Clamp for 1/2" or smaller cable. Skirt is of steel and body of cast aluminum alloy, finished in clear lacquer. Split Shell enables easy access to terminals for wiring or inspection.



ONE-THIRD ACTUAL SIZE

Poles	Capacity	Wt. Lbs.	Cat. No.	List Price
2	30-amp.	0.195	P2-CG-16	\$3.75
3	30-amp.	0.198	P3-CG-16	3.75
4	30-amp.	0.201	P4-CG-16	3.75
5	30-amp.	0.204	P5-CG-16	3.75
6	30-amp.	0.207	P6-CG-16	4.00
8	15-amp.	0.204	P8-CG-16	4.00

"TYPE P" PANEL RECEPTACLE (Pin Insert) FOR SURFACE MOUNTING

Corresponds to "Type P" Panel Receptacle (Socket Insert) No. P-17. Shell is of brass, cadmium plated and finished in clear lacquer. Flange is 2" in diameter, drilled with four .120" diameter holes to take #4-40 oval-head mounting screws, 90° apart on a 1/8" radius.



ONE-THIRD ACTUAL SIZE

Poles	Capacity	Wt. Lbs.	Cat. No.	List Price
2	30-amp.	0.156	P2-18	\$2.50
3	30-amp.	0.159	P3-18	2.50
4	30-amp.	0.162	P4-18	2.50
5	30-amp.	0.165	P5-18	2.50
6	30-amp.	0.168	P6-18	2.75
8	15-amp.	0.165	P8-18	2.75

"TYPE P" PANEL RECEPTACLE (Socket Insert), FLUSH MOUNTING



ONE-THIRD ACTUAL SIZE

Has Latch Locking Device which operates from front of panel. Made of die-cast zinc, cadmium plated and finished in clear lacquer. Flange is 2" in diameter and drilled with four .120" diameter holes to take #4-40 oval-head mounting screws, located 90° apart on a radius of 1/8".

Poles	Capacity	Wt. Lbs.	Cat. No.	List Price
2	30-amp.	0.202	P2-13	\$3.95
3	30-amp.	0.206	P3-13	4.25
4	30-amp.	0.210	P4-13	4.55
5	30-amp.	0.214	P5-13	4.85
6	30-amp.	0.218	P6-13	5.15
8	15-amp.	0.214	P8-13	5.15

CANNON CONNECTORS

CANNON ELECTRIC DEVELOPMENT COMPANY • 3209 HUMBOLDT STREET, LOS ANGELES, CALIFORNIA



TYPE P FITTINGS

"TYPE P" TWO-GANG PANEL RECEPTACLE (Socket Insert), FLUSH MOUNTING



ONE-THIRD ACTUAL SIZE

Receptacles equipped with Latch Locking Device, operated from panel front. Flange is 3 3/4" wide and 2" high. Mounted with four #4-40 oval-head mounting screws. Shell is aluminum alloy casting, finished in clear lacquer.

Poles	Capacity	Wt. Lbs.	Cat. No.	List Price
2	30-amp.	0.300	P2-13-2G	\$9.40
3	30-amp.	0.308	P3-13-2G	10.00
4	30-amp.	0.316	P4-13-2G	10.60
5	30-amp.	0.324	P5-13-2G	11.20
6	30-amp.	0.332	P6-13-2G	11.80
8	15-amp.	0.324	P8-13-2G	11.80

"TYPE P" THREE-GANG PANEL RECEPTACLE (Socket Insert), FLUSH MOUNTING

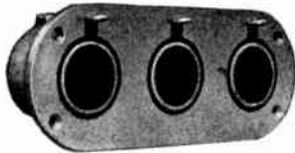

ONE-THIRD ACTUAL SIZE

Three Receptacles in a single unit, each being equipped with a Latch Locking Device, operated from panel front. Shell is of cast aluminum alloy, finished in clear lacquer. Flange is 5 1/4" wide and 2" high. Mounted with four #4-40 oval-head mounting screws.

Poles	Capacity	Wt. Lbs.	Cat. No.	List Price
2	30-amp.	0.495	P2-13-3G	\$14.10
3	30-amp.	0.507	P3-13-3G	15.00
4	30-amp.	0.519	P4-13-3G	15.90
5	30-amp.	0.531	P5-13-3G	16.80
6	30-amp.	0.543	P6-13-3G	17.70
8	15-amp.	0.531	P8-13-3G	17.70

"TYPE P" TWO-GANG PANEL RECEPTACLE (Pin Insert), FLUSH MOUNTING



ONE-THIRD ACTUAL SIZE

Flange is 3 3/4" wide and 2" high, drilled to take four #4-40 oval-head screws. Made of aluminum alloy, finished with clear lacquer.

Poles	Capacity	Wt. Lbs.	Cat. No.	List Price
2	30-amp.	0.176	P2-14-2G	\$6.50
3	30-amp.	0.182	P3-14-2G	6.50
4	30-amp.	0.188	P4-14-2G	6.50
5	30-amp.	0.194	P5-14-2G	6.50
6	30-amp.	0.200	P6-14-2G	7.00
8	15-amp.	0.194	P8-14-2G	7.00

"TYPE P" PANEL RECEPTACLE (Pin Insert), FLUSH MOUNTING

Flange is 2" in diameter, drilled with four .120" diameter holes to take four #4-40 oval-head mounting screws, arranged 90° apart on a radius of 1/4". Shell is die-cast zinc, cadmium plated and finished with clear lacquer.



ONE-THIRD ACTUAL SIZE

Poles	Capacity	Wt. Lbs.	Cat. No.	List Price
2	30-amp.	0.104	P2-14	\$2.50
3	30-amp.	0.107	P3-14	2.50
4	30-amp.	0.110	P4-14	2.50
5	30-amp.	0.113	P5-14	2.50
6	30-amp.	0.116	P6-14	2.75
8	15-amp.	0.113	P8-14	2.75

"TYPE P" THREE-GANG PANEL RECEPTACLE (Pin Inserts), FLUSH MOUNTING



ONE-THIRD ACTUAL SIZE

Flange is 5 1/4" wide, 2" high. It is drilled to take four #4-40 oval-head mounting screws. Made of aluminum alloy, and finished in clear lacquer.

Poles	Capacity	Wt. Lbs.	Cat. No.	List Price
2	30-amp.	0.288	P2-14-3G	\$9.75
3	30-amp.	0.300	P3-14-3G	9.75
4	30-amp.	0.312	P4-14-3G	9.75
5	30-amp.	0.324	P5-14-3G	9.75
6	30-amp.	0.336	P6-14-3G	10.50
8	15-amp.	0.324	P8-14-3G	10.50



ONE-FOURTH ACTUAL SIZE

"TYPE P" SINGLE GANG WALL RECEPTACLE (Socket Insert)

Furnished with brackets for standard switch box. Shell is die-cast zinc, cadmium plated and finished in clear lacquer. Plate is 4 1/2" high and 2 3/4" wide. Latch Locking Device operates from front of panel.

Poles	Capacity	Wt. Lbs.	Cat. No.	List Price
2	30-amp.	0.341	P2-35	\$4.95
3	30-amp.	0.345	P3-35	5.25
4	30-amp.	0.349	P4-35	5.55
5	30-amp.	0.353	P5-35	5.85
6	30-amp.	0.357	P6-35	6.15
8	15-amp.	0.353	P8-35	6.15



ONE-FOURTH ACTUAL SIZE

"TYPE P" TWO-GANG WALL RECEPTACLE (Socket Insert)

Furnished with brackets for standard switch box. Plate is 4 1/2" high and 4 3/4" wide. Both receptacles have Latch Locking Device, operated from front of panel. Shell is die-cast zinc, cadmium plated and finished with clear lacquer.

Poles	Capacity	Wt. Lbs.	Cat. No.	List Price
2	30-amp.	0.448	P2-35-2G	\$9.90
3	30-amp.	0.456	P3-35-2G	10.50
4	30-amp.	0.464	P4-35-2G	11.10
5	30-amp.	0.472	P5-35-2G	11.70
6	30-amp.	0.480	P6-35-2G	12.30
8	15-amp.	0.472	P8-35-2G	12.30

Excessive strain on contacts is eliminated by exclusive use of Cannon's FULL-FLOATING socket and RIGID pin inserts. Latch secures coupling.

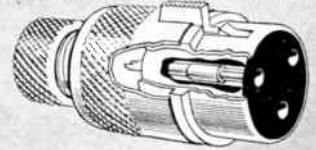

"TYPE P" SINGLE GANG WALL RECEPTACLE (Pin Insert)

Plate is 4 1/2" high and 2 3/4" wide. Furnished with brackets for standard switch box. Made of die-cast zinc, cadmium plated and finished with clear lacquer.



ONE-FOURTH ACTUAL SIZE

Poles	Capacity	Wt. Lbs.	Cat. No.	List Price
2	30-amp.	0.277	P2-36	\$3.50
3	30-amp.	0.280	P3-36	3.50
4	30-amp.	0.283	P4-36	3.50
5	30-amp.	0.286	P5-36	3.50
6	30-amp.	0.289	P6-36	3.75
8	15-amp.	0.286	P8-36	3.75

"TYPE P" TWO-GANG WALL RECEPTACLE (Pin Insert)

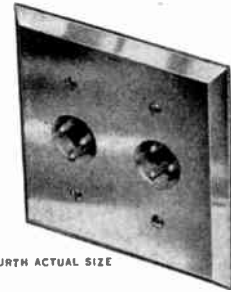

ONE-FOURTH ACTUAL SIZE

Plate is 4 1/2" high and 4 3/4" wide. Drilled to take four #4-40 oval-head mounting screws. Furnished with brackets for standard switch box. Made of die-cast zinc, cadmium plated and finished with clear lacquer.

Poles	Capacity	Wt. Lbs.	Cat. No.	List Price
2	30-amp.	0.554	P2-36-2G	\$7.00
3	30-amp.	0.563	P3-36-2G	7.00
4	30-amp.	0.572	P4-36-2G	7.00
5	30-amp.	0.579	P5-36-2G	7.00
6	30-amp.	0.588	P6-36-2G	7.50
8	15-amp.	0.579	P8-36-2G	7.50

SPECIAL TRIPLEX RECEPTACLE

Receptacle spacing prevents use of either adjacent receptacles simultaneously. Each receptacle is equipped with Latch Locking Device, operated from front of panel. Panel is 4 1/2" wide and 2" high. Made of cast aluminum alloy, clear lacquer finish.

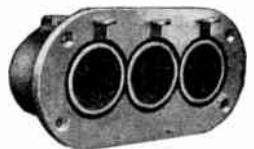

ONE-THIRD ACTUAL SIZE

Poles	Capacity	Wt. Lbs.	Cat. No.	List Price
6	30-amp.	0.470	P6-133	\$18.45

CANNON CONNECTORS

CANNON ELECTRIC DEVELOPMENT COMPANY • 3209 HUMBOLDT STREET, LOS ANGELES, CALIFORNIA



TYPE P FITTINGS

"TYPE P" THREE-GANG WALL RECEPTACLE (Socket Insert)

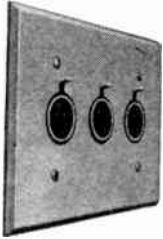

ONE-FOURTH ACTUAL SIZE

Plate is 4 1/2" high and 6 7/8" wide. It is drilled with four holes to take #4-40 oval-head mounting screws. Brackets are furnished for standard switch box. Made of cast aluminum alloy, finished with clear lacquer.

Poles	Capacity	Wt. Lbs.	Cat. No.	List Price
2	30-amp.	0.871	P2-35-3G	\$14.85
3	30-amp.	0.883	P3-35-3G	15.75
4	30-amp.	0.895	P4-35-3G	16.65
5	30-amp.	0.907	P5-35-3G	17.55
6	30-amp.	0.919	P6-35-3G	18.45
8	15-amp.	0.918	P8-35-3G	18.45

"TYPE P" SINGLE GANG RECEPTACLE (Pin Insert) DOOR TYPE



ONE-FOURTH ACTUAL SIZE

Plate is 4 1/2" high and 2 3/4" wide. Made of die-cast zinc, cadmium plated and finished in clear lacquer. Brackets are furnished for standard switch box. Equipped with spring door that covers insert opening, thereby protecting contacts from foreign matter.

Poles	Capacity	Wt. Lbs.	Cat. No.	List Price
2	30-amp.	0.350	P2-36D	\$4.00
3	30-amp.	0.353	P3-36D	4.00
4	30-amp.	0.356	P4-36D	4.00
5	30-amp.	0.359	P5-36D	4.00
6	30-amp.	0.362	P6-36D	4.25
8	15-amp.	0.359	P8-36D	4.25

DUST CAP

Fits all "Type P" fittings with pin contacts. Made of brass, cadmium plated, with nickel silver bead chain.



Lbs.	Cat. No	List
0.081	PPC	\$1.25
0.82	PCI*	1.75

ONE-THIRD ACTUAL SIZE

*No. PCI is insulated inside for application where prongs are hot.

DUST CAP

Fits all "Type P" fittings with socket contacts. Made of brass, cadmium plated, with nickel silver bead chain.



Lbs.	Cat. No	List
0.095	PRC	\$1.25

ONE-THIRD ACTUAL SIZE

"TYPE P" SINGLE GANG WALL RECEPTACLE (Socket Insert) DOOR TYPE



ONE-FOURTH ACTUAL SIZE

Plate is 4 1/2" high and 2 3/4" wide. Furnished with brackets for standard switch box. Made of die-cast zinc. Is equipped with Latch Locking Device, operated from panel front.

Poles	Capacity	Wt. Lbs.	Cat. No.	List Price
2	30-amp.	0.424	P2-35D	\$5.45
3	30-amp.	0.428	P3-35D	5.75
4	30-amp.	0.432	P4-35D	6.05
5	30-amp.	0.436	P5-35D	6.35
6	30-amp.	0.440	P6-35D	6.65
8	15-amp.	0.436	P8-35D	6.65

"TYPE P" 90° MICROPHONE OR PANEL RECEPTACLE (Pin Insert)



ONE-THIRD ACTUAL SIZE

For mounting on equipment or instrument panel. Back end is removable for easy wiring. Made of die-cast zinc with black wrinkle paint finish.

Poles	Capacity	Wt. Lbs.	Cat. No.	List Price
2	30-amp.	0.176	P2-42	\$3.25
3	30-amp.	0.179	P3-42	3.25
4	30-amp.	0.182	P4-42	3.25
5	30-amp.	0.185	P5-42	3.25
6	30-amp.	0.188	P6-42	3.50
8	15-amp.	0.185	P8-42	3.50

"TYPE P" 80° MICROPHONE OR PANEL RECEPTACLE (Pin Insert)



ONE-THIRD ACTUAL SIZE

Plug is at 10° angle to flat, flanged base. Back end removable for easy wiring. Made of cast brass with stately bronze finish.

Poles	Capacity	Wt. Lbs.	Cat. No.	List Price
2	30-amp.	0.311	P2-48	\$4.50
3	30-amp.	0.314	P3-48	4.50
4	30-amp.	0.317	P4-48	4.50
5	30-amp.	0.320	P5-48	4.50
6	30-amp.	0.323	P6-48	4.75
8	15-amp.	0.320	P8-48	4.75

"TYPE P" 90° MICROPHONE OR PANEL RECEPTACLE (Socket Insert)



ONE-THIRD ACTUAL SIZE

Can be mounted in equipment or instrument panel. Equipped with Latch Locking Device. Back end is removable for easy wiring. Shell is die-cast zinc, finished in black wrinkle paint.

Poles	Capacity	Wt. Lbs.	Cat. No.	List Price
2	30-amp.	0.249	P2-41	\$4.70
3	30-amp.	0.253	P3-41	5.00
4	30-amp.	0.257	P4-41	5.30
5	30-amp.	0.261	P5-41	5.60
6	30-amp.	0.265	P6-41	5.90
8	15-amp.	0.261	P8-41	5.90

CLAMP GLAND NUT

Made of die-cast zinc, cadmium plated and finished in clear lacquer. Complete with gasket.



ONE-THIRD ACTUAL SIZE

Wt. Lbs	Cat. No.	List Price
0.037	PCG	\$.75

PLAIN GLAND NUT

Made of Duralumin, finished in clear lacquer. Complete with gasket.



ONE-THIRD ACTUAL SIZE

Wt. Lbs	Cat. No.	List Price
0.008	PPG	\$.75

GLAND GASKET

As used in Straight Glands and Clamp Glands. Made of soft, white rubber.



ONE-THIRD ACTUAL SIZE

Cat. No.	List Price
P Gasket	\$.10

TAPER GLAND NUT

Made of Duralumin, finished with clear lacquer. Complete with gasket.



ONE-THIRD ACTUAL SIZE

Wt. Lbs	Cat. No.	List Price
0.009	PTG	\$.75

TAPER BUSHING

For cables from 1/8" to 7/8" diameter. Made of semi-hard rubber.



ONE-THIRD ACTUAL SIZE

Cat. No.	List Price
Put letter "T" after cable diameter: i.e. 1/8 T, etc.	\$.15

"TYPE P" THREE-GANG WALL RECEPTACLE (Pin Insert)

Plate is 4 1/2" high and 6 7/8" wide. Furnished with brackets for standard switch box. Made of cast brass, cadmium plated and finished with clear lacquer.

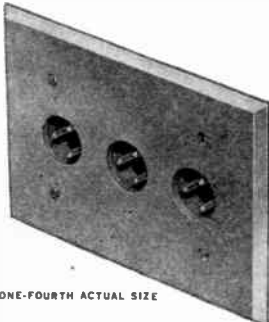

ONE-FOURTH ACTUAL SIZE

Poles	Capacity	Wt. Lbs.	Cat. No.	List Price
2	30-amp.	0.386	P2-36-3G	\$10.50
3	30-amp.	0.392	P3-36-3G	10.50
4	30-amp.	0.398	P4-36-3G	10.50
5	30-amp.	0.404	P5-36-3G	10.50
6	30-amp.	0.410	P6-36-3G	11.25
8	15-amp.	0.404	P8-36-3G	11.25

CANNON CONNECTORS

CANNON ELECTRIC DEVELOPMENT COMPANY • 3209 HUMBOLDT STREET, LOS ANGELES, CALIFORNIA



TYPE M1 FITTINGS

CANNON "TYPE M1" PLUGS AND RECEPTACLES. For Power, Heavy Duty Signal and Control Circuits Four-pole Plugs and Receptacles are approved for 440 volt AC 30 amp. service. All others are designed for heavy duty signal and control circuits. Cable fittings have a clamp for $\frac{1}{8}$ " or smaller cable. Standard shells are of cast aluminum. Illustration shows details of tongue-and-groove design as a means of polarizing which prevents any possibility of improperly connecting any Pin Insert with its corresponding Socket Insert. Pins and sockets cannot be forced out of alignment or broken by forcing together out of correct alignment. Pin contacts are of the split compression type insuring a positive electrical bond.



ONE-THIRD ACTUAL SIZE

Poles	Capacity	Wt. Lbs.	Cat. No.	List Price
4	30-amp.	.781	M1-4-23	\$5.00
5	30-amp.	.806	M1-5-23	6.00
6	30-amp.	.719	M1-6-23	7.00
7	30-amp.	.734	M1-7-23	8.00
8	30-amp.	.750	M1-8-23	9.00
9	30-amp.	.765	M1-9-23	10.00

"TYPE M1" 90° CORD PLUGS (Socket Insert)

Integral clamp for $\frac{1}{8}$ " cable or smaller. *Material:* Aluminum alloy. *Finish:* Clear Lacquer.

"TYPE M1" ROUND SURFACE WALL RECEPTACLES (Socket Inserts)



ONE-THIRD ACTUAL SIZE

Diameter flange, $3\frac{1}{8}$ ". Four mounting holes, 90° apart on a $1\frac{1}{2}$ " radius for four #6-32 flat head screws.

Poles	Capacity	Wt. Lbs.	Cat. No.	List Price
4	30-amp.	.422	M1-4-29	\$5.00
5	30-amp.	.447	M1-5-29	6.00
6	30-amp.	.360	M1-6-29	7.00
7	30-amp.	.375	M1-7-29	8.00
8	30-amp.	.391	M1-8-29	9.00
9	30-amp.	.406	M1-9-29	10.00

"TYPE M1" 90° CORD PLUGS (Pin Insert)

Integral clamp for $\frac{1}{8}$ " cable or smaller. *Material:* Aluminum alloy. *Finish:* Clear Lacquer.



ONE-THIRD ACTUAL SIZE

Poles	Capacity	Wt. Lbs.	Cat. No.	List Price
4	30-amp.	.782	M1-4-24	\$5.00
5	30-amp.	.734	M1-5-24	6.00
6	30-amp.	.750	M1-6-24	7.00
7	30-amp.	.869	M1-7-24	8.00
8	30-amp.	.782	M1-8-24	9.00
9	30-amp.	.797	M1-9-24	10.00

"TYPE M1" ROUND SURFACE WALL RECEPTACLES (Pin Inserts)

Diameter of flange $3\frac{1}{8}$ ". Four mounting holes, 90° apart on a $1\frac{1}{2}$ " radius for four #6-32 flat head screws.



ONE-THIRD ACTUAL SIZE

Poles	Capacity	Wt. Lbs.	Cat. No.	List Price
4	30-amp.	.532	M1-4-30	\$5.00
5	30-amp.	.484	M1-5-30	6.00
6	30-amp.	.500	M1-6-30	7.00
7	30-amp.	.619	M1-7-30	8.00
8	30-amp.	.532	M1-8-30	9.00
9	30-amp.	.547	M1-9-30	10.00

"TYPE M1" STRAIGHT CORD PLUGS (Socket Insert)



ONE-THIRD ACTUAL SIZE

Insulating medium is Bakelite. Shell has integral clamp gland and accommodates $\frac{1}{8}$ " cable or smaller. *Material:* Aluminum alloy die cast. *Finish:* Clear Lacquer.

Poles	Capacity	Wt. Lbs.	Cat. No.	List Price
4	30-amp.	.750	M1-4-21	\$5.00
5	30-amp.	.775	M1-5-21	6.00
6	30-amp.	.688	M1-6-21	7.00
7	30-amp.	.703	M1-7-21	8.00
8	30-amp.	.719	M1-8-21	9.00
9	30-amp.	.734	M1-9-21	10.00

"TYPE M1" 90° HANDLE TYPE CORD PLUGS (Socket Insert)

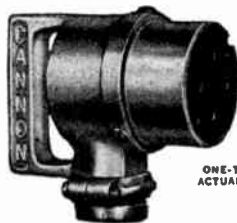

ONE-THIRD ACTUAL SIZE

Poles	Capacity	Wt. Lbs.	Cat. No.	List Price
4	30-amp.	.859	M1-4-25	\$6.00
5	30-amp.	.884	M1-5-25	7.00
6	30-amp.	.797	M1-6-25	8.00
7	30-amp.	.812	M1-7-25	9.00
8	30-amp.	.828	M1-8-25	10.00
9	30-amp.	.843	M1-9-25	11.00



ONE-THIRD ACTUAL SIZE

"TYPE M1" SQUARE SURFACE WALL RECEPTACLES (Socket Insert)

Flange $2\frac{1}{2}$ " square, four mounting holes, 90° apart on a $1\text{-}31/64$ " radius. For #6-32 flat head screws.

Poles	Capacity	Wt. Lbs.	Cat. No.	List Price
4	30-amp.	.406	M1-4-31	\$5.00
5	30-amp.	.431	M1-5-31	6.00
6	30-amp.	.344	M1-6-31	7.00
7	30-amp.	.359	M1-7-31	8.00
8	30-amp.	.375	M1-8-31	9.00
9	30-amp.	.390	M1-9-31	10.00

"TYPE M1" STRAIGHT CORD PLUGS (Pin Insert)



ONE-THIRD ACTUAL SIZE

Insulating medium is Bakelite. Shell has integral clamp gland and accommodates $\frac{1}{8}$ " cable or smaller. *Material:* Aluminum alloy die cast. *Finish:* Clear Lacquer.

Poles	Capacity	Wt. Lbs.	Cat. No.	List Price
4	30-amp.	.938	M1-4-22	\$5.00
5	30-amp.	.890	M1-5-22	6.00
6	30-amp.	.906	M1-6-22	7.00
7	30-amp.	1.025	M1-7-22	8.00
8	30-amp.	.938	M1-8-22	9.00
9	30-amp.	.953	M1-9-22	10.00

"TYPE M1" 90° HANDLE TYPE CORD PLUGS (Pin Insert)



ONE-THIRD ACTUAL SIZE

Poles	Capacity	Wt. Lbs.	Cat. No.	List Price
4	30-amp.	1.094	M1-4-26	\$6.00
5	30-amp.	1.046	M1-5-26	7.00
6	30-amp.	1.062	M1-6-26	8.00
7	30-amp.	1.181	M1-7-26	9.00
8	30-amp.	1.094	M1-8-26	10.00
9	30-amp.	1.109	M1-9-26	11.00

"TYPE M1" SQUARE SURFACE WALL RECEPTACLES (Pin Insert)

Flange is $2\frac{1}{2}$ " square, with four mounting holes, 90° apart on $1\text{-}31/64$ " radius. For #6-32 flat head screws.



ONE-THIRD ACTUAL SIZE

Poles	Capacity	Wt. Lbs.	Cat. No.	List Price
4	30-amp.	.438	M1-4-32	\$5.00
5	30-amp.	.390	M1-5-32	6.00
6	30-amp.	.406	M1-6-32	7.00
7	30-amp.	.525	M1-7-32	8.00
8	30-amp.	.438	M1-8-32	9.00
9	30-amp.	.453	M1-9-32	10.00

CANNON CONNECTORS

CANNON ELECTRIC DEVELOPMENT COMPANY • 3209 HUMBOLDT STREET, LOS ANGELES, CALIFORNIA



TYPE M1 FITTINGS



"TYPE M1" ROUND FLUSH WALL RECEPTACLES (Socket Insert)

Flange 3 1/2" diameter. Four mounting holes, 90° apart on a 1 1/8" radius for #6-32 flat head screws.

ONE-THIRD ACTUAL SIZE

Poles	Capacity	Wt. Lbs.	Cat. No.	List Price
4	30-amp.	.578	M1-4-33	\$6.50
5	30-amp.	.603	M1-5-33	7.50
6	30-amp.	.516	M1-6-33	8.50
7	30-amp.	.531	M1-7-33	9.50
8	30-amp.	.547	M1-8-33	10.50
9	30-amp.	.562	M1-9-33	11.50

"TYPE M1" ROUND FLUSH WALL RECEPTACLES (Pin Insert)



Flange 3 1/2" diameter. Four mounting holes, 90° apart on a 1 1/8" radius for #6-32 flat head screws.

ONE-THIRD ACTUAL SIZE

Poles	Capacity	Wt. Lbs.	Cat. No.	List Price
4	30-amp.	.438	M1-4-34	\$5.00
5	30-amp.	.390	M1-5-34	6.00
6	30-amp.	.406	M1-6-34	7.00
7	30-amp.	.525	M1-7-34	8.00
8	30-amp.	.438	M1-8-34	9.00
9	30-amp.	.453	M1-9-34	10.00

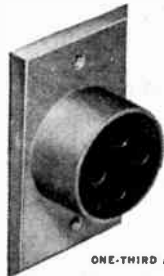

"TYPE M1" SINGLE GANG SURFACE RECEPTACLES (Socket Insert)

Designed to fit Single-Gang Switch Box. Plate 4 1/8" high and 2 1/8" wide.

ONE-THIRD ACTUAL SIZE

Poles	Capacity	Wt. Lbs.	Cat. No.	List Price
4	30-amp.	.468	M1-4-35	\$5.00
5	30-amp.	.493	M1-5-35	6.00
6	30-amp.	.406	M1-6-35	7.00
7	30-amp.	.421	M1-7-35	8.00
8	30-amp.	.437	M1-8-35	9.00
9	30-amp.	.451	M1-9-35	10.00

"TYPE M1" DUST CAPS (Socket Insert)

Lbs. .250 Cat. No. M1-59A List \$3.00

ONE-THIRD ACTUAL SIZE

"TYPE M1" DUST CAPS (Pin Insert)

Lbs. .250 Cat. No. M1-60A List \$3.00

ONE-THIRD ACTUAL SIZE

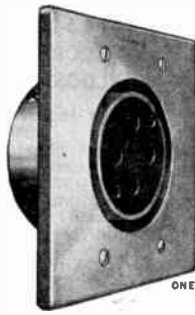

"TYPE M1" 2-GANG FLUSH WALL RECEPTACLES (Socket Insert)

Designed to fit Deep 2-Gang Switch Box.

ONE-THIRD ACTUAL SIZE

Poles	Capacity	Wt. Lbs.	Cat. No.	List Price
4	30-amp.	.781	M1-4-37	\$7.00
5	30-amp.	.806	M1-5-37	8.00
6	30-amp.	.719	M1-6-37	9.00
7	30-amp.	.734	M1-7-37	10.00
8	30-amp.	.750	M1-8-37	11.00
9	30-amp.	.765	M1-9-37	12.00

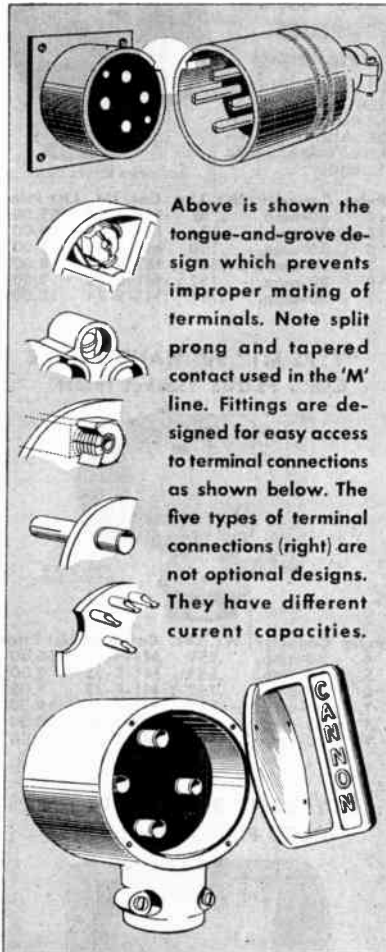

Above is shown the tongue-and-groove design which prevents improper mating of terminals. Note split prong and tapered contact used in the 'M' line. Fittings are designed for easy access to terminal connections as shown below. The five types of terminal connections (right) are not optional designs. They have different current capacities.

SURFACE BOX FOR M1-31 and M1-32 WALL RECEPTACLES

Tapped for 1/2" conduit.

Lbs. .563 Cat. No. M1-14 List \$1.50

ONE-THIRD ACTUAL SIZE



"TYPE M1" 2-GANG FLUSH DOOR RECEPTACLES (Socket Insert)

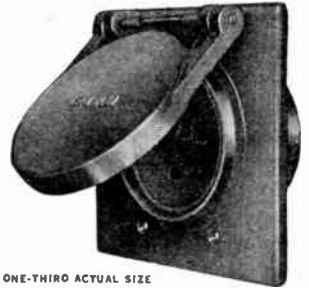

ONE-THIRD ACTUAL SIZE

Has hinged spring door to keep out foreign substances. Back plate is 4 1/2" high, 4 5/8" wide.

Poles	Capacity	Wt. Lbs.	Cat. No.	List Price
4	30-amp.	1.062	M1-4-39	\$7.50
5	30-amp.	1.087	M1-5-39	8.50
6	30-amp.	1.000	M1-6-39	9.50
7	30-amp.	1.015	M1-7-39	10.50
8	30-amp.	1.031	M1-8-39	11.50
9	30-amp.	1.047	M1-9-39	12.50

"TYPE M1" 2-GANG FLUSH DOOR RECEPTACLES (Pin Insert)



ONE-THIRD ACTUAL SIZE

Has hinged spring door to keep out foreign substances. Back plate is 4 1/2" high, 4 5/8" wide.

Poles	Capacity	Wt. Lbs.	Cat. No.	List Price
4	30-amp.	1.125	M1-4-40	\$7.50
5	30-amp.	1.077	M1-5-40	8.50
6	30-amp.	1.093	M1-6-40	9.50
7	30-amp.	1.212	M1-7-40	10.50
8	30-amp.	1.125	M1-8-40	11.50
9	30-amp.	1.140	M1-9-40	12.50

"TYPE M1" BRASS FLOOR RECEPTACLES (Socket Insert)



ONE-THIRD ACTUAL SIZE

Back plate is 5" square. Cap screws into face plate, covering socket contacts and preventing foreign substances from clogging contacts.

Poles	Capacity	Wt. Lbs.	Cat. No.	List Price
4	30-amp.	2.203	M1-4-70	\$15.00
5	30-amp.	2.155	M1-5-70	16.00
6	30-amp.	2.171	M1-6-70	17.00
7	30-amp.	2.290	M1-7-70	18.00
8	30-amp.	2.203	M1-8-70	19.00
9	30-amp.	2.218	M1-9-70	20.00

CANNON CONNECTORS



CANNON ELECTRIC DEVELOPMENT COMPANY • 3209 HUMBOLDT STREET, LOS ANGELES, CALIFORNIA

TYPE M2 FITTINGS

CANNON "TYPE M2" CONNECTORS.
 "Type M2" Fittings are adaptable to many special applications, ranging from television to all kinds of signal and control work. Similar in all details of design and construction to the "M1" Series except that fillers are of a large diameter to accommodate a greater number of poles. All socket inserts have Cannon style, full floating contacts. Solder terminals are tinned for ease of wiring. Cable types are available with clamps for cables from 3/4" to 1 3/4" in diameter. Unless otherwise specified, the M2-A4 items will be furnished with clamps for 3/4" cable. All others with clamp for 1 1/8" cable.

"TYPE M2" 90° PLUGS (Socket Insert)

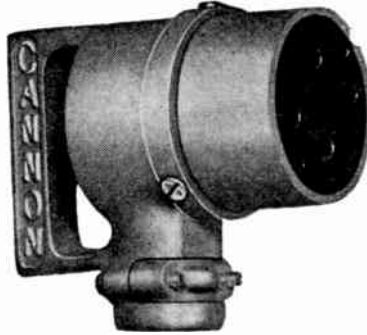

ONE-THIRD ACTUAL SIZE

Poles	Capacity	Wt. Lbs.	Cat. No.	List Price
4	30-amp.	1.625	M2-A4-25	\$12.25
4	60-amp.	1.650	M2-B4-25	12.25
15	30-amp.	1.563	M2-15-25	25.75
18	30-amp.	1.578	M2-18-25	28.75
24	30-amp.	1.594	M2-24-25	34.75
34	{ 33-30-amp. }	1.609	M2-34-25	38.75
	{ 1-40-amp. }			

"TYPE M2" WALL MOUNTING RECEPTACLES (Pin Insert)

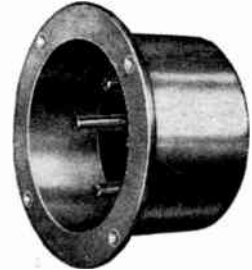

ONE-THIRD ACTUAL SIZE

Poles	Capacity	Wt. Lbs.	Cat. No.	List Price
4	30-amp.	.688	M2-A4-34	\$10.25
4	60-amp.	.640	M2-B4-34	10.25
15	30-amp.	.656	M2-15-34	18.25
18	30-amp.	.775	M2-18-34	19.75
24	30-amp.	.688	M2-24-34	22.75
34	{ 33-30-amp. }	.703	M2-34-34	24.45
	{ 1-40-amp. }			

"TYPE M2" STRAIGHT CORD PLUGS (Socket Insert)

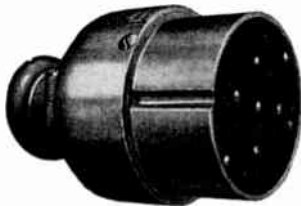

ONE-THIRD ACTUAL SIZE

Material: Cast aluminum alloy. Finish: Clear Lacquer.

Poles	Capacity	Wt. Lbs.	Cat. No.	List Price
4	30-amp.	1.287	M2-A4-21	\$12.25
4	60-amp.	1.334	M2-B4-21	12.25
15	30-amp.	1.042	M2-15-21	25.75
15	30-amp.	1.042	M2-15-21HD	29.35
18	30-amp.	1.427	M2-18-21	28.75
24	30-amp.	1.474	M2-24-21	34.75
34	{ 33-30-amp. }	1.568	M2-34-21	38.15
	{ 1-40-amp. }			

NOTE: The 21HD Connectors have heavy duty, double cable clamps.

"TYPE M2" 90° PLUGS (Pin Insert)

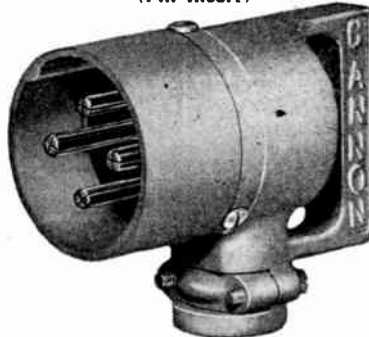

ONE-THIRD ACTUAL SIZE

Poles	Capacity	Wt. Lbs.	Cat. No.	List Price
4	30-amp.	1.281	M2-A4-26	\$10.25
4	60-amp.	1.313	M2-B4-26	10.25
15	30-amp.	1.328	M2-15-26	18.25
18	30-amp.	1.359	M2-18-26	19.75
24	30-amp.	1.422	M2-24-26	22.75
34	{ 33-30-amp. }	1.515	M2-34-26	24.45
	{ 1-40-amp. }			

"TYPE M2" FLUSH DOOR RECEPTACLES (Socket Insert)



ONE-FOURTH ACTUAL SIZE

Poles	Capacity	Wt. Lbs.	Cat. No.	List Price
4	30-amp.	1.694	M2-A4-39	\$16.00
4	60-amp.	1.741	M2-B4-39	16.00
15	30-amp.	1.773	M2-15-39	29.50
18	30-amp.	1.835	M2-18-39	32.50
24	30-amp.	1.881	M2-24-39	38.50
34	{ 33-30-amp. }	1.975	M2-34-39	41.90
	{ 1-40-amp. }			

"TYPE M2" STRAIGHT CORD PLUGS (Pin Insert)

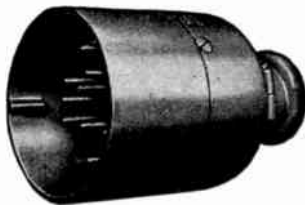

ONE-THIRD ACTUAL SIZE

Material: Cast aluminum alloy. Finish: Clear Lacquer.

Poles	Capacity	Wt. Lbs.	Cat. No.	List Price
4	30-amp.	.593	M2-A4-22	\$10.25
4	60-amp.	.625	M2-B4-22	10.25
15	30-amp.	.640	M2-15-22	18.25
15	30-amp.	.640	M2-15-22HD	21.85
18	30-amp.	.671	M2-18-22	19.75
24	30-amp.	.733	M2-24-22	22.75
34	{ 33-30-amp. }	.827	M2-34-22	24.45
	{ 1-40-amp. }			

NOTE: The 22HD Connectors have heavy duty, double cable clamps.

"TYPE M2" WALL MOUNTING RECEPTACLES (Socket Insert)

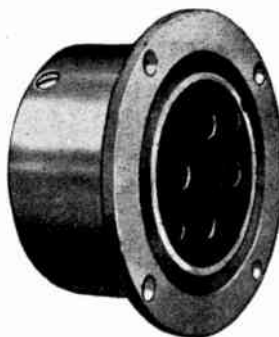

ONE-THIRD ACTUAL SIZE

Poles	Capacity	Wt. Lbs.	Cat. No.	List Price
4	30-amp.	.843	M2-A4-33	\$12.25
4	60-amp.	.890	M2-B4-33	12.25
15	30-amp.	.922	M2-15-33	25.75
18	30-amp.	.984	M2-18-33	28.75
24	30-amp.	1.030	M2-24-33	34.75
34	{ 33-30-amp. }	1.124	M2-34-33	38.15
	{ 1-40-amp. }			

"TYPE M2" FLUSH DOOR RECEPTACLES (Pin Insert)



ONE-FOURTH ACTUAL SIZE

Poles	Capacity	Wt. Lbs.	Cat. No.	List Price
4	30-amp.	1.376	M2-A4-40	\$14.00
4	60-amp.	1.328	M2-B4-40	14.00
15	30-amp.	1.344	M2-15-40	22.00
18	30-amp.	1.463	M2-18-40	23.50
24	30-amp.	1.376	M2-24-40	26.50
34	{ 33-30-amp. }	1.391	M2-34-40	28.20
	{ 1-40-amp. }			

CANNON CONNECTORS

CANNON ELECTRIC DEVELOPMENT COMPANY • 3209 HUMBOLDT STREET, LOS ANGELES, CALIFORNIA



TYPE M2 FITTINGS

"TYPE M2" SQUARE SURFACE RECEPTACLES (Socket Insert)
For 2-Gang Switch Box

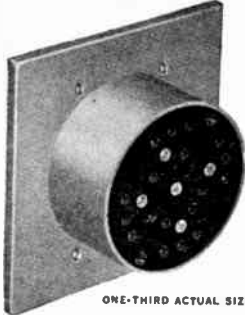

ONE-THIRD ACTUAL SIZE

Poles	Capacity	Wt. Lbs.	Cat. No.	List Price
4	30-amp.	.562	M2-A4-35	\$12.25
4	60-amp.	.609	M2-B4-35	12.25
15	30-amp.	.641	M2-15-35	25.75
18	30-amp.	.703	M2-18-35	28.75
24	30-amp.	.749	M2-24-35	34.75
34	{ 33-30-amp. 1-40-amp. }	.843	M2-34-35	38.15



ONE-THIRD ACTUAL SIZE

"TYPE M2" SQUARE SURFACE RECEPTACLES (Socket Insert)
Special Small Flange

Poles	Capacity	Wt. Lbs.	Cat. No.	List Price
4	30-amp.	.693	M2-A4-35R	\$12.25
4	60-amp.	.740	M2-B4-35R	12.25
15	30-amp.	.772	M2-15-35R	25.75
18	30-amp.	.834	M2-18-35R	28.75
24	30-amp.	.880	M2-24-35R	34.75
34	{ 33-30-amp. 1-40-amp. }	.974	M2-34-35R	38.15

"TYPE M2" FLOOR RECEPTACLES (Socket Insert)
(Brass with Screw Cover)



ONE-FOURTH ACTUAL SIZE

Poles	Capacity	Wt. Lbs.	Cat. No.	List Price
4	30-amp.	3.656	M2-A4-70	\$22.25
4	60-amp.	3.688	M2-B4-70	22.25
15	30-amp.	3.703	M2-15-70	35.75
18	30-amp.	3.734	M2-18-70	38.75
24	30-amp.	3.796	M2-24-70	44.75
34	{ 33-30-amp. 1-40-amp. }	3.890	M2-34-70	48.15



"TYPE M2" DUST CAPS (For Fittings with Socket Inserts)

ONE-THIRD ACTUAL SIZE

Wt. Lbs.	Cat. No.	List Price
.500	M2-59A	\$5.00



"TYPE M2" DUST CAPS (For Fittings with Pin Inserts)

ONE-THIRD ACTUAL SIZE

Wt. Lbs.	Cat. No.	List Price
.562	M2-60A	\$5.00

TYPE M3 FITTINGS

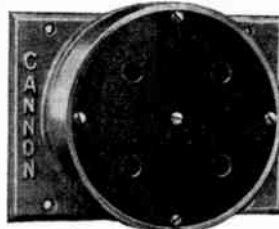

ONE-FOURTH ACTUAL SIZE



ONE-FOURTH ACTUAL SIZE

TYPE M-3 PLUGS AND RECEPTACLES

Type M-3 Plugs and Receptacles are identical with Types M-1 and M-2 in all features of design and construction except for the fact that M-3 Plugs and Receptacles are still larger in diameter and, therefore, handle a larger number of circuits.

TYPE M-3 RECEPTACLES

Poles	Capacity	Wt. Lbs.	Cat. No.	List Price
4	90 amps.	1.657	M3-4-35	\$30.00
30	30 amps.	2.281	M3-30-35	56.00

TYPE M-3 PLUGS

Poles	Capacity	Wt. Lbs.	Cat. No.	List Price
4	90 amps.	2.624	M3-4-26	\$30.00
30	30 amps.	2.937	M3-30-26	56.00

TYPE SS FITTINGS

CANNON "TYPE SS" SECTIONAL CABLE TERMINALS. Designed primarily to make standard telephone cable terminals of any desired size above 6 pairs in additional multiples of 5 pairs, using but 3 standard stock sections.

End sections have rounded corners on one end, while connecting sections have corresponding locking notches and tongues. Terminal posts are #8-32 cadmium plated brass screws with nuts and washers. Cable tips are cadmium plated brass, tinned at solder hook. Insulated medium is black malded Bakelite. Terminal pairs are 3/8" at centers.

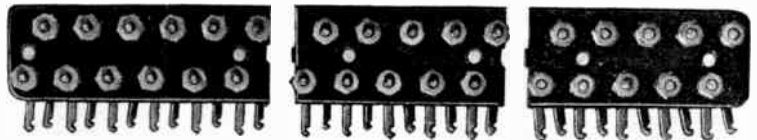

No. Terminals	Description	Wt. Lbs.	Cat. No.	List Price
12 (6 pairs)	End Section	.276	SSE-6	\$1.50
10 (5 pairs)	Center Section	.239	SSC-5	1.25
10 (5 pairs)	End Section	.242	SSE-5	1.25

CANNON "TYPE S" SECTIONAL CABLE TERMINALS. Same as "Type SS" except it is without solder lugs.



No. Terminals	Description	Wt. Lbs.	Cat. No.	List Price
12 (6 pairs)	End Section	.248	SE-6	\$1.50
10 (5 pairs)	Center Section	.216	SC-5	1.25
10 (5 pairs)	End Section	.219	SE-5	1.25



WK



GK



SK



NK

CANNON TYPES K & RK PLUGS FOR AIRCRAFT

SPLIT SHELL
CONSTRUCTION

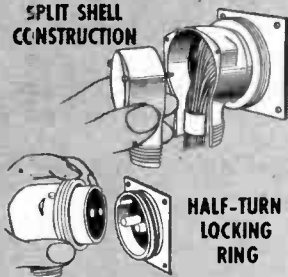

HALF-TURN
LOCKING
RING



RWK



RGK



RSK



RNK

The Type "K" Series was designed especially for use in the aircraft field and is used almost universally for aircraft radio, instrument and electrical circuits. Although light in weight, units are rugged and durable. The "K" Series is made in 3 basic types: (1) Straight Type, (2) 90° Type, (3) Wall Mounting Unit, for which either straight or right angle junction shells are provided. Inserts of laminated and molded Bakelite are removable.

The cable entry is regularly threaded for various sizes of aircraft flexible conduit, but there are fittings also available with cable clamp for special applications. The "K" Series is comprised of 8 diameters, with a great variety of contact arrangements covering a range of from 1 to 100 conductors, depending, of course, upon the diameter.

A pin-and-slot arrangement makes it possible to connect fittings easily and quickly without the necessity of fumbling to match pins and sockets. This eliminates any

possibility of forcing together in improper alignment and thus bending or breaking pins. Large terminals may be removed for soldering, thereby eliminating the possibility of damaging the insert with excessive heat.

Quick, easy access to solder pots at back of contact is made possible simply by removing either 3 or 4 Shake-proof Sems, depending upon the size of the fitting. Since these screws are equidistant, the barrel and insert may be rotated to accommodate 3 or 4 different positions. This is also true of the flanges on wall mounting units, making it easy to rotate these fittings to facilitate cable installation and avoid sharp bends in conduit.

Plugs and receptacles are locked together by means of a quick-acting threaded ring or collar which holds both members firmly together and prevents shaking or accidentally pulling them apart.

NOTE: Detailed Catalog Bulletin for K Connectors available on request.

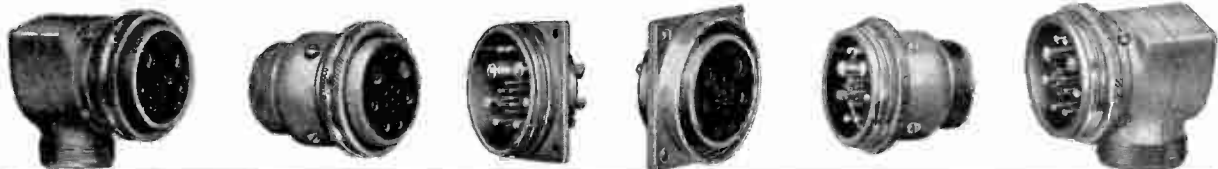

FK

RFK

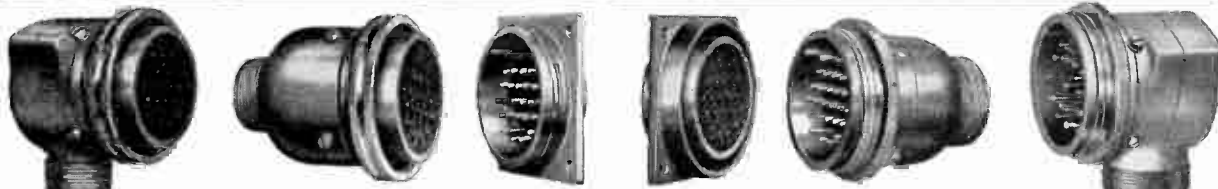

IK

RIK

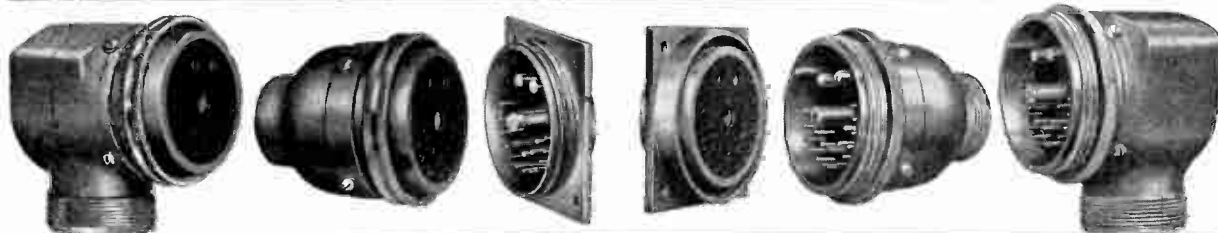

LK

RLK

ALL FITTINGS ON THIS PAGE ARE SLIGHTLY MORE THAN ONE-QUARTER ACTUAL SIZE



CANNON "Type AN" Series of plugs and receptacles was designed especially to meet Army-Navy Specifications for aircraft electrical connectors. While the AN Series retains all the basic features of the Type K Series—features which have established conclusive proof of their effectiveness as applied to aircraft—numerous changes in design and construction have been made to conform to Army-Navy Specifications AN 9534.

Type AN Plugs are made in three basic shapes or styles. These are: 1. Straight cord connectors, 2. Right angle or 90° cord connectors, 3. Flanged connectors for wall mounting. An almost unlimited combination of circuits and current capacities can be handled with AN connectors and their interchangeable inserts.

Removable and interchangeable inserts make it possible to change any fitting from a prong to a socket, or vice versa, and also to change the number of circuits

handled through any fitting provided the inserts are of the same diameter. The split shell, a feature pioneered by Cannon, makes it easy to install wiring or to solder terminals.

An important feature of the Type AN Series is the means provided for locking the members together. This consists of a locking ring which serves to draw the parts together and to release them, while it also prevents plugs and receptacles from being jarred apart by excessive vibration. No special tools are required to lock or unlock plugs and receptacles, to separate split shells or to remove inserts. This feature is invaluable since it eliminates delay in servicing in the field and also because there are so many combinations possible with Type AN Series.

NOTE: Detailed Catalog Bulletin for AN Connectors available on request.

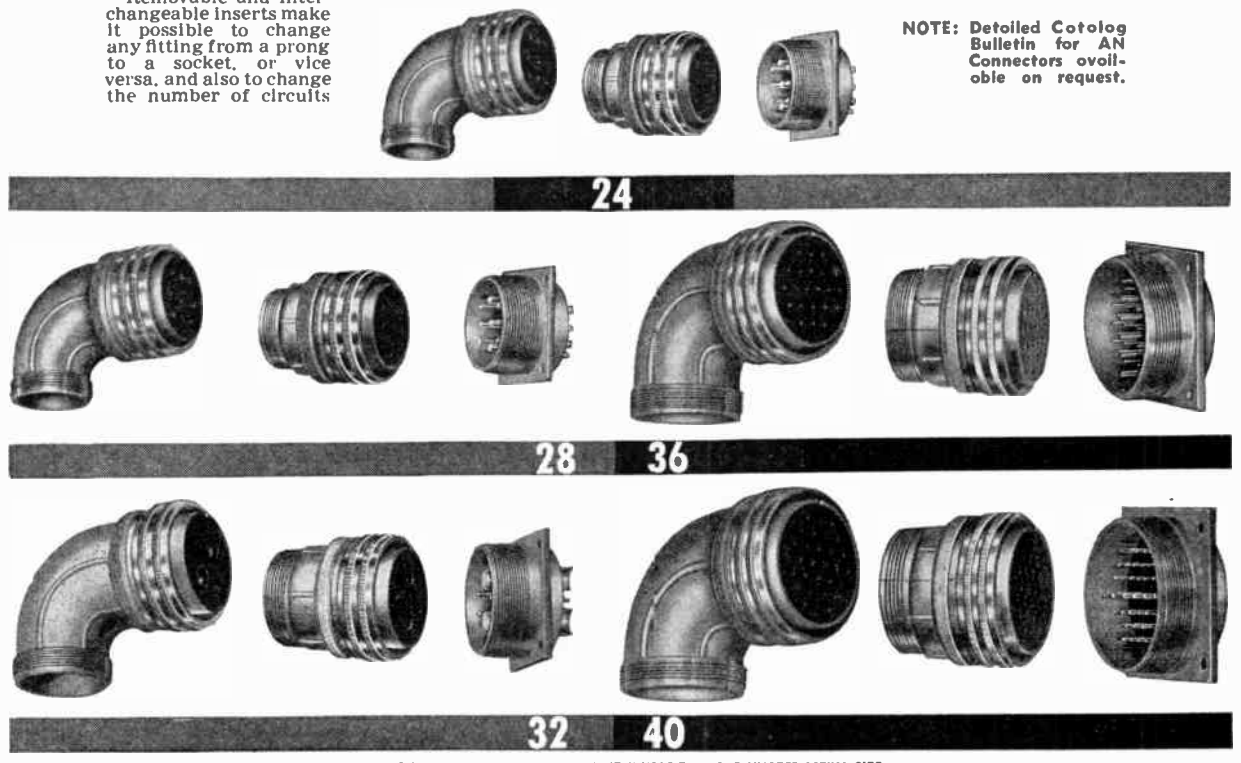

Meissner "Custom" Super Kits

12-TUBE CUSTOM SUPER RECEIVER KIT

Most all-wave home receiver in the Meissner Kit line—uses twelve latest type tubes, every one performing a vital function and contributing to the unequalled overall performance of this peer of radio receivers! High-gain "television" type tubes are used in the RF section for maximum sensitivity and stability; two-stage I-F channel with electrically-variable band-expanding transformers. Separate bass and treble tone controls permit tonal modification to suit the most fastidious ear; inverse feedback in the output stage eliminates distortion; full 15 watts of distortionless audio energy available at the speaker! Full frequency coverage between 540 kc and 42 mc in four bands plus an additional Longwave band covering 132 to 495 kc. Phono input jack permits

use of full audio system including tone and volume controls.

COMPLETE KIT

Anyone can build the Meissner 12-tube "Custom" Super with one of these Complete Kits. Everything is furnished, except tubes and speaker, down to the last nut and bolt—includes hook-up wire and solder. The only tools required are a screwdriver, pliers and soldering iron. Detailed instructions supplied with each kit, including famous Meissner Pictorial Wiring Diagram. A good 12" dynamic speaker is recommended, having a 2000-ohm field and output transformer to match 6L6's in push-pull. Tubes required are: 2-6AB7 (1853), 1-6SA7, 2-6K7, 1-6H6, 2-6C5, 2-6L6, 1-5X4G and 1-6X5.

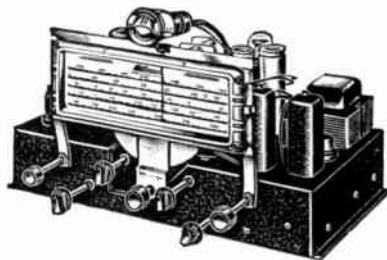

"ESSENTIAL" KIT

In addition to the Complete Kits, Meissner also offers the Essential parts required to build this quality receiver at a considerable saving in cost. "Essential" Kit includes the punched chassis, pre-aligned RF Tuning Assembly, dial, all I-F Transformers, Selectivity Switch and other special parts with complete instructions for assembly and wiring. Detailed Parts List describes other parts required which are all readily obtainable from general stock. No. 12-1028—"Essential" Kit...List Price \$65.50

- No. 10-1156—12-tube "Custom" Super, Complete Kit less Tubes and Speaker; without panel and cabinet; shipping weight, 25 lbs.....List Price \$109.50
 No. 10-1166—12-tube "Custom" Super, Complete Kit less Tubes and Speaker; with panel and cabinet; shipping weight, 43 lbs.....List Price \$121.00
 No. 11-8210—Front Panel for 12-tube "Custom", 19 1/4" x 10", black-crackle steel.....List Price \$3.85
 No. 11-8222—Steel Cabinet to match, 19 1/4" x 10" x 11 1/2", black-crack finish.....List Price \$8.25

9-TUBE CUSTOM SUPER RECEIVER KIT

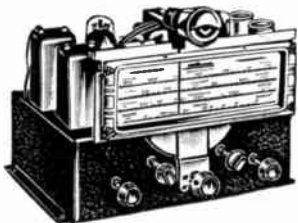

"Essential" Kit

For those who may have a supply of small parts on hand or who may wish to obtain them separately, this "Essential" Kit is available to provide all of the special Meissner parts required to build this excellent receiver. Contains completely punched steel chassis, pre-aligned RF Coil Assembly, dial, input and output I-F Transformers, and other special small parts with detailed assembly and wiring instructions, schematic and pictorial diagrams, same as supplied with the Complete Kit. Detailed Parts List included—"Essential" Kit...List Price \$47.50

Second only in performance to the 12-tube "Custom" Super and designed to include most of the quality features of the larger receiver. A considerable reduction in cost has been made possible, however, by judicious use of dual-purpose tubes and simplification of general arrangement of parts. Makes a very excellent replacement chassis for those who have a fine cabinet that they wish to keep or may be used in special Meissner steel cabinet, professionally finished in black crystal lacquer. Everything has been included to obtain maximum possible performance from a receiver of this size! High-gain RF stage on all bands; the four-band pre-aligned RF Coil Assembly provides full coverage from 540 kc to 42 mc. Ferric-iron-core I-F stage provides maximum selectivity consistent with good tonal quality. Diode second detector with transformer-coupled push-pull output stage; inverse feedback eliminates distortion; 6V6G output tubes

provide full 8 1/2 watts audio energy to the speaker. Phono pick-up jack is provided at input of audio system.

Easy to Build—Complete Kit

The construction of a complete receiver from one of these Complete Kits is extremely simple. The only parts not included are the tubes and speaker. A good 10" or 12" dynamic speaker should be obtained with a field resistance of 800 to 1250 ohms and output transformer to match 6V6's in push-pull. Tubes required are: 2-6AB7 (1853), 1-6SA7, 1-6K7, 1-6F6G, 2-6V6 or 6V6G, 1-5Y4G and 1-6G5. Detailed instructions with schematic and pictorial wiring diagrams are provided. The only tools required are a screwdriver, pliers and soldering iron; final alignment may be readily accomplished with standard service equipment.

- No. 10-1129—9-tube "Custom" Super, Complete Kit less Tubes and Speaker; without Panel and Cabinet; shipping weight, 22 lbs.....List Price \$83.75
 No. 10-1168—9-tube "Custom" Super, Complete Kit less Tubes and Speaker; with Panel and Cabinet; shipping weight, 38 lbs.....List Price \$94.50
 No. 11-8221—Front Panel for 9-tube "Custom", 19 1/4" x 10", black crystal lacquer.....List Price \$3.50
 No. 11-8222—Steel Cabinet to match, 19 1/4" x 10" x 11 1/2", black crystal lacquer.....List Price \$8.25

Student "Midget" Receiver Kits

BATTERY-OPERATED MODELS

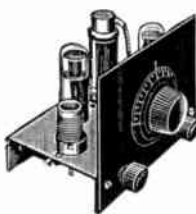

receiver. See listing below at right. All three models have a single large bakelite dial; Regeneration Control is provided on all three and a Volume Control is added when the Three-Tube set is built. All sets are designed for Headphone operation, although the Three-Tube set will operate a small magnetic or P-M dynamic speaker with excellent results.

Absolutely everything required for completion of the set is included. After it is all built it is only necessary to obtain a set of tubes and batteries and a pair of headphones and start listening! Detailed printed instructions are packed with each kit; Pictorial Wiring Diagrams show exactly where each part belongs and how it is connected. The only tools required are a screwdriver, pliers and a small soldering iron. All three sets use a single 1 1/2-volt "A" battery; the One-Tube set uses a single 45-volt "B" battery while the Two- and Three-Tube sets require two 45-volt "B" batteries and one 7 1/2 volt "C" battery. The One-Tube set uses a 1E4G tube; the Two-Tube set adds a 1C5G and the Three-Tube set uses an additional 1H5G tube.

BATTERY "MIDGET" KITS

- No. 10-1161—One-Tube Student "Midget" Battery Receiver Kit...List \$5.50
 No. 10-1162—Two-Tube Student "Midget" Battery Receiver Kit...List \$6.80
 No. 10-1163—Three-Tube Student "Midget" Battery Receiver Kit...List \$8.25

"ADD-ON" KITS

- Contain all parts and instructions necessary to make a Two-Tube set out of a One-Tube or a Three-Tube out of a Two-Tube.
 No. 10-1180—One- to Two-Tube "Midget" Add-On Kit, with instructions, List Price \$1.10
 No. 10-1181—Two to Three-Tube "Midget" Add-On Kit, with instructions, List Price \$2.00

AC-DC POWERED MODELS

In response to popular demand, the famous Meissner Student "Midget" receivers are now available for AC or DC operation—directly from any 110-volt power line! Practically identical in appearance and general circuit arrangement, their principal difference lies in the type of power supply only. The same progressive building idea has been maintained in making these new sets available in the form of two- and three-tube kits—with a special "Add-On" kit to convert the two-tube to the three-tube set! The circuit is of the regenerative type, providing remarkable sensitivity for a limited number of tubes; both sets are intended for headphone operation. The same plug-in coils as used in the battery models are used in these AC-DC models, the Broadcast band coil being furnished with the kit. Every student or beginning experimenter in radio will be able to gain a world of valuable practical information by building one of these efficient little receivers!

COMPLETE KIT—EVERYTHING FURNISHED

When you unpack one of these kits and start to assemble it according to the easy step-by-step instructions included, nothing need stop you until the job is done! Absolutely all parts are included except tubes and headphones. Two type—76 tubes are required for the two-tube set and three of the same type for the three-tube set. One of these serves as a rectifier in each set. They are inexpensive and available anywhere. Detailed instructions furnished include complete Pictorial and Schematic diagrams—every part and wire is shown just as it appears in the finished set!

AC-DC "MIDGET" KITS

- No. 10-1192—Two-tube Student "Midget" AC-DC Receiver Kit...List \$7.00
 No. 10-1193—Three-tube Student "Midget" AC-DC Receiver Kit...List 7.50

TWO- TO THREE-TUBE CONVERSION KIT

- Contains all of the extra parts required to make a three-tube receiver out of the two-tube set. Complete instructions included.
 No. 10-1194—Two- to three-tube "Midget" AC-DC Add-On Kit...List \$0.50

ACCESSORIES FOR STUDENT "MIDGETS"

- No. 18-2940—70 to 200 meter Plug-In Coil.....List Price \$0.70
 No. 18-2941—35 to 70 meter Plug-In Coil.....List Price .70
 No. 18-2942—17 to 35 meter Plug-In Coil.....List Price .70
 No. 18-2944—545 to 1500 meter Plug-In Coil.....List Price 1.65
 No. 28-1000—Single Headphone with Band.....List Price 1.65



Meissner Receiver Kits

4-TUBE AC-DC T.R.F. KIT

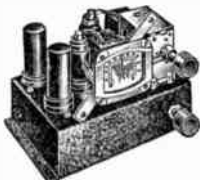

No. 10-1105A—4-Tube AC-DC T.R.F. Kit.....List Price \$18.00

A very small, compact receiver with surprising sensitivity and tone quality may be constructed from this complete kit. Covers regular Broadcast band from 530 to 1600 kc. Operates from 110-volt line, either AC or DC. Has one RF amplifier stage and two tuned circuits including the detector. All parts required for construction of this little receiver are furnished in the complete kit of parts. Tubes and speaker, however, are not supplied. Tubes required are: 1-6K7, 1-6J7, 1-25A6 and 1-25Z6; speaker should be a 5" magnetic or P-M dynamic with output transformer to match a single 25A6 output tube.

5-TUBE AC T.R.F. KIT



No. 10-1106—5-Tube AC T.R.F. Complete Kit.....List Price \$25.75

A low-cost, T.R.F. receiver that is surprisingly simple and easy to build and yet provides remarkable performance. Operates from 110-volt, 50- to 60-cycle lines and covers Broadcast band between 530 and 1600 kc (187 to 565 meters). Two stages of tuned Radio-frequency amplification; 3 tuned circuits including the detector stage, 3-gang, precision tuning condenser, 3" round vernier dial, manual volume and tone controls. Requires 2-6K7, 1-6J7, 1-6F6 and 1-5Y4G tubes; also requires a 6" dynamic speaker with field resistance of 1500 to 2000 ohms and output transformer to match a single 6F6. Complete Kit includes absolutely all parts except tubes and speaker. Even includes hook-up wire and solder. Clear, step-by-step printed instructions. Famous Meissner Pictorial Diagrams.

5-TUBE AC-DC SUPERHET KIT

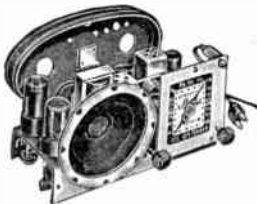

For real performance—with a minimum of tubes—this little set is an outstanding example of Meissner engineering! Unusually compact, but should not be confused with the average "midsize" receiver on the market. Covers entire broadcast band, 540 kc to 1600 kc; two-color metal dial plate is accurately calibrated. Left-hand control operates volume and power switch while the right-hand knob operates the tuning condenser. The I-F channel is peaked at 456 kc and uses two double-tuned transformers; special tuning condenser eliminates padding.

No. 10-1191—5-tube AC-DC Superhet Complete Kit.....List Price \$34.50

5-Tube AC-DC Essential Kit

Here's your chance to build this truly fine quality receiver at the very lowest cost! The Essential Kit contains all the "special" parts needed—the factory-wound loop antenna, oscillator coil, input I-F transformer, output I-F transformer, two-gang tuning condenser and detailed instructions. Rest of the parts can be obtained anywhere!

No. 12-1032—5-tube AC-DC Essential Kit.....List Price \$9.50

COMPLETE INSTRUCTION MANUAL

1941 Edition

Completely revised and brought up to date, this new edition of the Meissner Instruction Manual contains reprints of the actual constructional data and operating suggestions that are included with all of the Meissner Kits and wired units. Many new pages containing interesting and educational material on Frequency Modulation, Coil Design, Servicing Problems and Amateur Station operation! 168 pages—8 1/2 by 11 inches—sturdy two-color cover—indispensable to the experimenter!

1941 Instruction Manual.....Net Price \$5.50

MEISSNER KIT GUARANTEE

When you build a radio receiver from a Meissner kit of parts exactly in accordance with the Meissner Pictorial Diagram and Instructions, that receiver will either work satisfactorily or you have the privilege of shipping it (prepaid) to the Meissner plant for inspection and mechanical or electrical adjustment. If the fault is due to a defective part, or to an error in instructions or diagram, no charge whatsoever will be made for putting that receiver in perfect operating condition.

7-TUBE "UTILITY" SUPER KITS

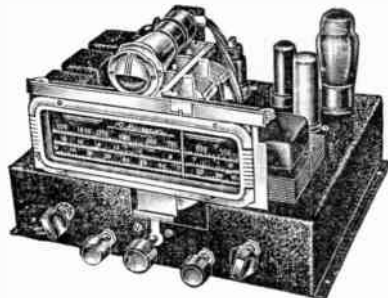

Four 7-tube "Utility" Super Kits have been designed for the easy construction of receivers having maximum performance for a set of this size. They will, in many cases, outperform sets having a greater number of tubes. Ideal replacement units to modernize old cabinets; all components are of highest quality although the kits are very moderate in price. Steel cabinets and panels are available for these sets, but are not furnished with kits. Kits also do not include tubes and speaker. An 8" dynamic speaker is recommended, having a field resistance of 1500 to 2000 ohms and equipped with an output transformer to match a single 6V6.

Easy to Build with Complete Kits

Anyone can build one of these fine 7-tube receivers. Complete Kit includes all parts required for completion of set, except tubes and speaker. Tubes required: 2-6K7, 1-6A8, 1-6Q7, 1-6V6, 1-6G5 and 1-5Y4G. Detailed instructions include famous Meissner Pictorial Wiring Diagrams.

	List Price
No. 10-1103—7-Tube "Utility" Super, Broadcast Model.....	\$38.75
No. 10-1104—7-Tube "Utility" Super, B-C and S-W Model.....	43.50
No. 10-1110—7-Tube "Utility" Super Broadcast, Police and Short-Wave Model.....	47.75
No. 10-1111—7-Tube "Utility" Super, Broadcast, Long-Wave and Short-Wave Model.....	47.75
No. 11-8215—Front Panel for Broadcast Model, 10" x 14", black crystal steel.....	2.00
No. 11-8217—Front Panel for all other Models, 10" x 14", black crystal steel.....	2.00
No. 11-8212—Cabinet for all Models, 10" x 14" x 11", black crystal steel.....	5.00

7-Tube Super "Essential" Kits

Include all Antenna, RF and Oscillator coils, I-F Transformers, band-switch, tuning condenser, dial, padding condensers and other special parts together with same detailed instructions as supplied with regular Complete Kits. All other necessary parts are clearly indicated on Parts List and are readily available from general stock.

No. 12-1022—Essential Kit for Broadcast Model.....	List Price \$18.25
No. 12-1023—Essential Kit for BC and SW Model.....	List Price 27.50
No. 12-1024—Essential Kit for BC-Pol-SW Model.....	List Price 30.50
No. 12-1025—Essential Kit for BC-LW-SW Model.....	List Price 30.50

8-TUBE "COMBINATION"

Semi-Communications Receiver

A complete kit that builds a real "Combination Receiver"—includes a beat-frequency oscillator for copying CW signals or to help in tuning weak short-wave stations. Frequency coverage begins with Broadcast band and extends down through 10-meter Amateur band to 7.1 meters! Continuous coverage from 540 kc to 42.3 mc in four bands; coil assembly completely wired with range switch and pre-aligned. Single I-F stage uses Ferrocart iron-core transformers. Diode second detector and high-mu triode first audio, resistance-coupled to single 6V6 output tube. Controls provided include manually adjustable Sensitivity, Tone and Volume. Tip jacks at rear of chassis provide connections for headphones; AVC-BFO and Stand-by Switches are also incorporated.

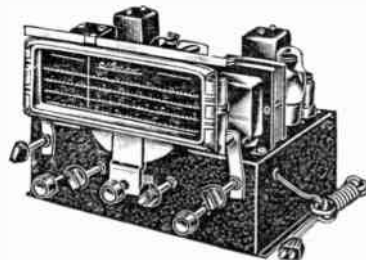

Complete Kit contains absolutely all parts necessary, except tubes and speaker. Speaker should be an 8" or 10" dynamic with 1500 to 2000-ohm field and output transformer to match a single 6V6. Tubes required: 2-6K7, 1-6J7, 1-6L7, 1-6G5, 1-6Q7, 1-6V6 or 6V6G and 1-5Y4G. Detailed instructions for assembly and wiring include Schematic and Pictorial Wiring Diagrams which show parts clearly in their exact location on chassis. Anyone with the ability to handle a soldering iron may easily build this versatile set!

No. 10-1116—8-tube "Combination" Super, Complete Kit less Tubes and Speaker; without Panel and Cabinet.....	\$67.50
No. 10-1164—8-tube "Combination" Super, Complete Kit less Tubes and Speaker; with Panel and Cabinet.....	78.50
No. 11-8228—Front Panel, Black crystal finish steel, 15" x 10 1/2" x 11 1/2".....	3.85
No. 11-8229—Cabinet, Black crystal finish steel, 15" x 10 1/2" x 11 1/2".....	8.25

8-Tube Super "Essential" Kit

In order to enable the Serviceman or Custom Set-Builder to construct this receiver at the lowest possible cost, this Essential Kit is offered in addition to the Complete Kits described above. Parts furnished include punched chassis, pre-aligned RF coil assembly, input and output I-F transformers, beat-frequency oscillator transformer, tuning condenser, dial, switches and other special parts. Detailed assembly and wiring instructions with schematic and pictorial wiring diagrams. Remaining parts necessary are available from general stock.

No. 12-1026—Essential Kit.....List Price \$47.50



Meissner P-A Tuners and Test Equipment

HIGH FIDELITY P-A TUNER



Specially designed for highest quality reception from local or semi-distant powerful Broadcast stations. Noise-free T.R.F. circuit with band-pass transformers provide true "high-fidelity" reproduction; audio response essentially flat from 40 to 10,000 cycles. Four tuned circuits provide ample selectivity; perfected automatic volume control holds output level constant. Tunes regular Broadcast band. Self-powered, operates on 110 volts, 50 to 60 cycles. Available either in Complete Kit form or as a complete wired and tested unit ready to operate. Kit does not include tubes; tubes are furnished with wired unit. Uses 2-6K7, 1-6H6, 1-6F8G and 1-5Z4. Complete Kit includes punched chassis, coils, tuning condenser, dial, power transformer, chokes, resistors, condensers, hardware, wire, solder and other miscellaneous parts. Detailed instructions with Pictorial Diagrams.

- No. 10-1152—High-Fidelity P-A Tuner Kit, without Panel and Cabinet, Less Tubes, List Price.....\$45.75
- No. 10-1172—High-Fidelity P-A Tuner Kit, with Panel and Cabinet, Less Tubes, List Price.....\$51.25
- No. 9-1034—High-Fidelity P-A Tuner, Fully Tested, in Cabinet, With Tubes, List Price.....\$77.50

"UTILITY" P-A TUNER

A general-purpose Tuner, identical in size and general construction to the High Fidelity model described above except for use of straight tuned radio-frequency circuits without band-pass coils. Ferrocast, iron-core, coils are used, however, providing an additional degree of sensitivity without material loss in selectivity. Four tuned circuits are employed and this Tuner may be used for distant as well as local reception. Frequency coverage 530 to 1600 kc; calibrated rectangular dial has linear scales 5 1/2" long. Full automatic volume control. Specially designed filter circuits in power supply keep hum level at absolute minimum. Operates on 110 volts, 50 to 60 cycles. Available either as a completely wired and tested unit, ready to operate, including tubes, or in a complete Kit containing all parts required for construction, less tubes. Tubes used: 3 6K7, 1 6H6, 1 6F8G and 1 5Z4. Detailed instructions and Diagrams.

- No. 10-1119—"Utility" P-A Tuner Kit, without Panel and Cabinet, Less Tubes, List Price.....\$38.50
- No. 10-1178—"Utility" P-A Tuner Kit, with Panel and Cabinet, Less Tubes, List Price.....\$44.00
- No. 9-1033—"Utility" P-A Tuner, Fully Tested, in Cabinet, With Tubes, List Price.....\$71.50

DUAL-BAND P-A TUNER



Where distant reception is a necessity or short-wave programs are desired. Covers 540 to 1600 kc and 5.8 to 18.8 mc; sensitive superheterodyne circuit with RF stage on both bands. Uses Ferrocast, iron-core, 1-F Transformers for extra gain and selectivity. Incorporates full AVC with diode second detector and dual triode output coupling tube. Output impedances same as High Fidelity model above. Complete unit, ready to operate, is furnished with a full set of tubes; Tuner in Kit form is supplied without tubes. Tubes used: 2 6K7, 1 6K8, 1 6H6, 1 6F8G, 1 6G5 and 1 5Z4.

- No. 10-1151—Dual-Band P-A Tuner Kit, less tubes; without Panel and Cabinet, List Price.....\$46.25
- No. 10-1171—Dual-Band P-A Tuner Kit, less tubes; with Panel and Cabinet, List Price.....\$52.00
- No. 9-1035—Dual-Band P-A Tuner, Complete Unit with Tubes, in Cabinet, List Price.....\$80.50

P-A TUNER PANELS AND CABINETS

- No. 11-8243—Front Panel for "Utility" or High-Fidelity Tuner, 8 1/2" x 8 1/2", List Price.....\$1.50
- No. 11-8200—Cabinet for "Utility" or High-Fidelity Tuner, 8 1/2" x 8 1/2" x 12 1/2", List Price.....\$5.25
- No. 11-8236—Front Panel for Dual-Band P-A Tuner, 10" x 14", List Price.....\$2.00
- No. 11-8212—Cabinet for Dual-Band P-A Tuner, black crystal steel, 10" x 14" x 11", List Price.....\$6.50

SPECIAL RACK-MOUNTING HI-FI TUNER

The same High-Fidelity Tuner described at top of page, arranged for rack-panel mounting. In many cases, individual tuners are mounted in a relay rack, with each tuner used to monitor a given station. Rack-panel mounted High-Fidelity P-A Tuners are provided with 500-ohm line coupling transformers, enabling operator to feed output of any tuner to the 500-ohm station bus lines. Special prices available on request covering assemblies of two or more tuners. High-Fidelity P-A Tuners are ideal for installation where a pre-tuned, multi-channel radio system is required. The necessary number of tuners may easily be mounted on a standard relay rack and coupled into individual or a common amplifier line.

No. 9-1036—Special High-Fidelity P-A Tuner, Completely Wired and Laboratory Tested; mounted on standard relay-rack panel, black crystal finish, 8 1/2" x 18". Enclosed in steel dust cover, arranged for easy removal. Complete with tubes. List Price.....\$102.50



AC-DC, BATTERY PORTABLE SUPER KIT

Here's absolutely the latest in a portable radio receiver—a real companion set, always ready in any location, under any circumstances, to bring you whatever is on the air! Covers the regular Broadcast band from 535 to 1600KC. Extremely compact, light in weight, contains its own power in the form of dry batteries and its own loop antenna. Equipped also to connect to regular 110-volt power line, either AC or DC, thus effecting a valuable saving in battery life. Also provided with connection for external antenna. Supplied in kit form for home construction, its initial cost is the lowest possible for a set of this quality. Uses latest type, low-drain battery operated tubes. Estimated battery life is approximately 70 hours for the "B" and 220 hours for the "A" battery during actual battery operation. The attractively finished, sturdy "airplane luggage" style case is only 6 1/2" x 8 1/2" x 13 1/2". Tubes required are one each types 1A7GT, 1H5GT, 3Q5GT, 11Z8GT and two type 1N5GT; tubes are not supplied with kit.

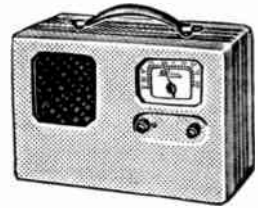

Build It Yourself—

Anyone can build this remarkable little receiver in a few hours—only tools required are pliers, screwdriver and soldering iron! Full instructions and Pictorial Diagrams. All parts are furnished (except tubes and batteries) including punched chassis, coils, sockets, resistors, condensers, dial, tuning condenser, speaker, etc. Loop antenna is ready built. Two 4 1/2-volt "A" batteries, and two 45-volt "B" batteries are required.

- No. 10-1190—Complete Kit for AC-DC, Battery Portable Super, less tubes, batteries and cabinet, List Price.....\$38.50
- No. 10-1189—Complete Kit for AC-DC, Battery Portable Super, including cabinet; less tubes and batteries, List Price.....\$45.00
- No. 11-8257—Portable Cabinet, 6 1/2" x 8 1/2" x 13 1/2", finished in brown airplane-luggage canvas, List Price.....\$7.75

"Essential" Kit

Contains all "special" parts such as tuning condenser, dial, punched chassis, coils, 1-F transformers and loop antenna. All other parts such as fixed condensers, resistors, sockets, speaker, etc. are readily obtainable from general stock. Complete detailed instructions and diagrams with parts list also furnished. Here's your chance to build a really fine, fully engineered portable receiver at very low cost!

- No. 12-1031—Essential Kit, List Price.....\$25.50

NEW MEISSNER "ANALYST"

THE MODERN SERVICE INSTRUMENT—Undoubtedly the most modern complete servicing instrument on the present day market. Handles the receivers of yesterday, today and tomorrow — with equal efficiency and facility! Entirely fundamental in its testing procedure. Will never become obsolete. SAVES TIME — SAVES MONEY—The use of the new Meissner ANALYST will not only permit you to make more money by handling a greater number of service jobs in a given time but it will give you additional assurance that these jobs will "stay sold." SERVICES BY "SIGNAL TRACING"—The new Meissner ANALYST tests receivers and locates faults by the "signal tracing" method — proven to be the fastest and most reliable method known at the present time. It is NOT, however, just another signal tracer! It is completely equipped with all devices that might be needed to make simultaneous checks on various parts of the receiver circuit.



Five separate and distinct "channels" provide as many different functions; all controls are accurately calibrated with functions clearly indicated.

Complete—Ready to Go to Work

The new Meissner ANALYST is completely wired, aligned and laboratory tested. Furnished complete with a full set of 12 tubes, it is all ready to be put into service the minute it is unpacked and connected to the 110-volt line! No alignment or adjustments are necessary—just read the instructions, hook it up and go to work!

- Complete Book of Instructions, supplied with the new Meissner ANALYST, gives detailed directions for use of this instrument in locating all kinds of radio troubles.
- No. 9-1040—New Meissner ANALYST, complete with tubes, prods, and Instruction Book; ready to operate, Net Price.....\$96.50

SIGNAL CALIBRATOR

The nearest to a primary frequency standard that can be built at a moderate price. Employs a very accurate 100-kc quartz crystal to control the initial oscillator and uses two sets of multi-vibrators to give frequencies of 50 kc and 10 kc. Better than a Signal Generator as it gives accurately known test signals modulated or unmodulated, in 100-kc, 50 kc or 10-kc divisions throughout the entire range from 100 kc to 60 mc! Has attenuator for controlling output and adjustable modulation control. Push-button selector switch determines frequency steps. Black crystal finish steel cabinet is 8" x 8" x 12". Operates directly from 110-volt, 60-cycle power lines; uses 2 6AC7, 2 6N7G, 1 6K8, 1 6SK7 and 1 6X5G tubes.

- No. 9-1006—Signal Calibrator, Complete with Tubes, Ready to Operate, Net Price.....\$44.00

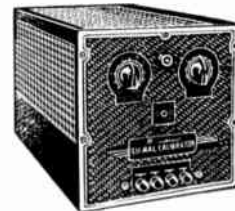

Meissner Tuning Units, F-M Parts, R-F Coils

ALL-WAVE TUNING UNITS

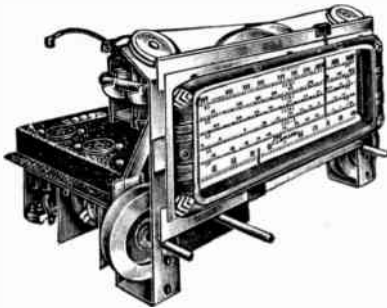

"Communications" type has five frequency-calibrated scales; additional 0-100 scale at bottom for band-spread pointer. Uses dual-control bandsread dial (23-8229) and ceramic-insulated tuning condenser (21-5143B). Incorporates coil assembly No. 13-7617 described below. Used in Meissner "Traffic Master." "Custom" type employs a single-speed vernier dial mechanism (23-8230) with five frequency calibrated scales. Uses three-gang tuning condenser (21-5141B) and coil assembly No. 13-7610, described below. Used in Meissner "Custom 12." Each unit includes complete RF, Mixer and Oscillator coils for all bands; shielded band switch, Align-Aire trimmers, tube sockets and associated resistors, condensers, etc., in addition to parts listed above. Entire assembly mounted on black crackle-finished steel chassis, 8 1/4" long and 5" wide, ready to be dropped into place. Just 7 connections to make to feed into any 450 kc I.F. channel, including plate and heater leads.

Communications Tuning Unit, 5-bands, 540 kc to 31.6 mc; uses 1853 (6AB7), 6K8 and 6J7G tubes. Completely wired, aligned and tested for sensitivity. Detailed instructions.

No. 13-7614—Less tubes. List Price.....\$63.25

"Custom" Broadcast Tuning Unit, 5-bands, 133 kc to 42 mc; uses two 1853 (6AB7) and one 6BA7 tubes. Furnished with complete instructions; wired, aligned and fully tested.

No. 13-7611—Less tubes. List Price.....\$53.25

MULTI-WAVE COIL ASSEMBLIES

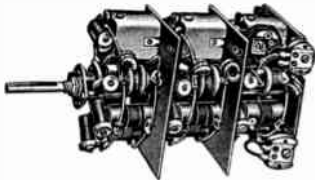

For use in construction of All-Wave receivers. Contain coils, range-switch, shunt trimmers, series padders, AVC by-pass condensers and all necessary shielding. Provides high-gain I.F. stage on all bands: complete primary and secondary switching on all coils. Align-Aire (air-dielectric) trimmers on all bands assure minimum frequency drift; extremely short leadwires—all coils exceed 133-406 kc range are soldered directly to switch terminals. All units are compact, approximately 4" x 5" x 8"; have simple three-point mounting. Factory-wired, tested, aligned and padded. Complete instructions and diagrams.

For 410-Mmf Condenser

No. 13-7610—5 Band Assembly, Tuning Ranges: 537 to 1754 kc, 1.68 to 5.96 mc, 5.85 to 18.2 mc, 17.6 to 42.0 mc and 133 to 406 kc. List Price, \$32.50

No. 13-7612—4-Band Assembly, Tuning Ranges: 537 to 1754 kc, 1.68 to 5.96 mc, 5.85 to 18.2 mc, and 17.6 to 42.0 mc. List Price.....\$28.00

For 280-Mmf Condenser

No. 13-7617—5-Band Assembly, Tuning Ranges: 540 to 1580 kc, 1.5 to 4.5 mc, 4.1 to 12.2 mc, 7.3 to 18.8 mc, and 11.2 to 31.6 mc. List Price, \$32.50

No. 13-7605—4-Band Assembly, Tuning Ranges: 1.5 to 4.5 mc, 4.1 to 12.2 mc, 7.3 to 18.8 mc, and 11.2 to 31.6 mc. List Price.....\$28.00

FREQUENCY-MODULATION COMPONENTS

F-M Tuning Assembly

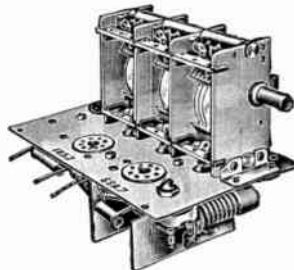

A complete front-end for any F-M receiver; covers 42 to 50 mc; designed for use with F-M dial below and to feed into 4.3-mc I-F system. Incorporates all components for antenna, mixer-oscillator and voltage regulator, wired, tested and aligned! Three gang special tuning condenser mounts on top of compact unit; fits chassis opening 3 3/4" by 7"; only 2 3/4" below chassis. Only five wires to connect to I-F channel and power supply.

No. 13-7621—List Price\$19.50

7" F-M Dial

Single-band linear scale dial mechanism designed especially for use with home-built F-M receivers. Calibrated to match F-M Tuning Assembly above; tuning ratio 11 to 1 in 180 degrees. Escutcheon is 3 3/4" by 8 3/4"; dull gold.

No. 23-8234—List Price\$6.00

F-M Antenna—R-F—Osc. Coils

Designed for the experimenter to use in construction of F-M receivers; antenna coil may be used with single or double antenna. (Cover the 42 to 50 mc F-M band with tuning condenser listed below. Coils are wound on moisture-resistant plastic forms, 1" long; have 3/4" diameter terminal base and single 4-36 stud for mounting to chassis.

No. 14-1034—Antenna Coil
No. 14-1035—Mixer Coil

No. 14-1036—Oscillator Coil
List. Each\$ 0.85



F-M Tuning Condenser



A special, extra-compact tuning condenser for use with coils described above. Only 2 1/2" long, 1 5/16" high and 1 3/4" wide! Ceramic-insulated trimmers; 3/4"-diameter shaft; 3 sections with 5 plates each; 7 to 22 1/2 mmfd. range with trimmers open.

No. 21-5201—F-M 3-gang Tuning Condenser. List Price...\$3.75

4.3-mc. F-M I-F Transformers

Illustrated herewith, these high-grade transformers are specially designed with broad response characteristics for F-M circuits. In metal shield can 1 3/4" square and 3" high; windings on molded plastic form; ceramic-base mica-dielectric trimmers; double-tuned.

No. 16-6664—List Price\$2.00

Discriminator Transformers

The real "heart" of the F-M circuit, the discriminator transformer fills a most important position between the limiter and detector. Accurately peaked at 4.3 mc. Rigid construction throughout, for maximum stability. Standard mica-trim type in metal shield can, 1 3/4" x 3"; coils on plastic form. Color-coded leads.

No. 17-3483—List Price\$2.75

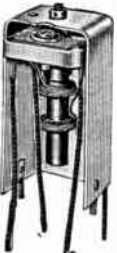

'TIME-SIGNAL' COIL KIT

A highly specialized kit, but one for which there is a definite demand among jewelers, watchmakers, manufacturers of automatic timing devices, physics laboratories in schools and universities—wherever there is any need for reception of the standard time signals transmitted by the Government station at Arlington. These transmissions from NAA are on a frequency of 113 kc, unmodulated.

No. 12-1033—Time-Signal Coil Kit. List Price.....\$27.50

The "Time-Signal" Coil Kit consists of five units including an antenna coupling transformer, antenna coil, R-F coil, combination detector and I-F-O transformer, and a 1.7-ke audio filter. The R-F units are provided with air trimmers and are fully shielded. Complete instructions are included for the construction of a high-quality, 6-tube TRF fixed frequency receiver for 110-volt AC-DC operation.

ANTENNA AND R.F. COILS

Standard Antenna—RF Coils



Standard type air-core coils of superior construction, designed to cover the broadcast band from 545 to 1580 kc (190 to 550 meters) with a 365-mmfd tuning condenser. Excellent for replacement use and are used as original parts by discriminating set-builders and experimenters in the design and construction of broadcast band receivers. All coils have high-impedance primaries, wound with Litz wire, fully protected against humidity. Shields are 1 1/4" x 2 1/4".

Unshielded coils are equal in construction and quality to the shielded units. Wound on heavy impregnated forms with sturdy mounting brackets.

Shielded, No.	Type	Unshielded, No.
14-1004	Antenna Coil	14-1010
14-1005	R-F Coil	14-1011

List Each, \$1.00 List Each, \$0.80

Universal-Adjustable Coils



These Adjustable-Inductance coils will replace broadcast-band coils in practically any receiver. No longer necessary to order hard-to-get "exact duplicates." Continuously variable in inductance over a wide range, these coils will accurately "track" with other coils in the set when properly adjusted. Exact inductance of the coil is easily matched by a simple screw-driver adjustment, regardless of the value of the tuning condenser! The oscillator may be used with any I-F from 175 to 520 kc. Shields are 1 3/4" square by 2 1/4" high. Furnished with complete instructions.

Shielded, No.	Type	Unshielded, No.
14-7413	Antenna Coil	14-1026
14-7558	R-F Coil	14-1027
14-7560	Oscillator Coil	14-1028

List Each, \$2.20 List Each, \$1.40

Compact Antenna—RF Coils



Highly efficient coils designed for use where space is at a premium. Cover the broadcast band, 545 to 1580 kc with a 365-mmfd tuning condenser. Ideal for replacement in midjet or auto radio sets as well as for new receiver construction. All have high-impedance primaries with Litz-wire "progressive-universal" secondaries. Windings are on 3/4" diameter forms, 1 1/4" long, fully impregnated. Black crackle shields are 1 1/4" diameter, 2" high.

Shielded, No.	Type	Unshielded, No.
14-1024	Antenna Coil	14-1022
14-1025	R-F Coil	14-1023

List Each, \$0.70 List Each, \$0.50

Iron-Core Antenna—RF Coils



The use of high-quality iron cores adds substantial gain and increases the selectivity of these radio-frequency transformers. Recommended for use in any circuit where highest quality components are required. Cover the broadcast band from 540 to 1600 kc with a 365-mmfd tuning condenser. Mounted in black crackle-finish shields, 1 3/4" square by 2 1/4" high. Will perform well with any of the standard types of RF amplifier tubes including battery types

Cat. No.	Type	List Price
14-1496—H-Imp. Pri. Ant. Coil	\$1.95
14-1497—Detector Stage R-F Coil	1.95
14-7860—Interstage R-F Coil	1.95



Meissner Coils — Noise Filters

MIDGET ANT. AND R. F. COILS



Entirely new design. Specially built for compact T.R.F. Super-Het and Auto Radio receivers. Wound on 1/2" bakelite form. Four bank windings with Litz wire. High impedance primaries. Shield cans 1 1/4" x 1 1/4" x 2". Spade bolt mountings. Power 190 to 550 meters with 365 mmf. condenser.

No. 14-2436—Antenna Coil
No. 14-2437—R. F. Coil
List Price, Each.....\$1.10

WEATHER-AIRCRAFT BAND COILS



Ultra-compact coils designed to provide highest possible efficiency for reception on the Weather-Aircraft band between 200 and 400 kc. Antenna coil has low-impedance winding for loop or other aircraft antenna in addition to regular high-impedance primary. For use with 365-mmfd condenser; in black crackle shields only 1 1/2" in diameter. 1 1/4" high.

- No. 14-1030—Aircraft Ant. Coil, List Price \$3.00
No. 14-1031—Aircraft R-F Coil, List Price 3.00
No. 14-1032—Aircraft Osc. Coil, List Price 2.20

DUAL-BAND COILS

Same as used in MEISSNER Kits; will give utmost in performance and stability. Both bands wound on same bakelite coil-form, 7/8" dia. Two mica-dielectric trimmers mounted in cans of shielded coils. All coils designed to be used with a 365 mmf, variable condenser and for operation with a 456 kc. I-F channel. Wound on bakelite forms 2 3/4" long. Shielded coils in cans 1 3/4" x 1 3/4" x 3". Broadcast-and-Police coils cover 530 to 1550 kc and 1.5 to 4.48 kc. Broadcast-and-Short-Wave coils covers 530 to 1680 kc and 5.8 to 19 mc.

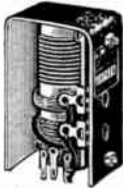

Broadcast and Police		Broadcast and SW	
Shielded	Unshielded	Type	Shielded Unshielded
14-7467	14-7482	Ant.	14-7467 14-7477
14-7471	14-7483	R-F	14-7478 14-7479
14-7475	14-7484	Osc.	14-7480 14-7481

List Price Each, Any Type, Shielded.....\$3.00
List Price Each, Any Type, Unshielded..... 2.00

- No. 22-5204—Padder Kit for BC-Pol., List \$1.40
No. 22-5203—Padder Kit for BC-SW, List 1.40
No. 24-8265—2-position Range Switch, List 1.65

TRIPLE-BAND COILS

Similar in design and construction to the shielded 2-band coils above; available in two combinations of frequency ranges: BC-Police and S-W bands and Long-Wave, Broadcast and Short-Wave bands. The BC-Pol-SW coils are for use with a 450-mmfd, tuning condenser and cover 540 to 1770 kc. 1.75 to 5.35 mc and 5.2 to 18.5 mc. LW-BC-SW coils are for use with a 385-mmfd, tuning condenser and cover 136 to 370 kc. 530 to 1580 kc and 5.8 to 18.6 mc. All coils are in black crackle shields with side-adjusted trimmers; for use with 456-kc I-F channel.

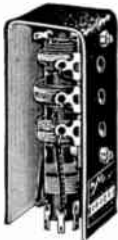

BC-Pol.-SW	Type	LW-BC-SW
No. 14-1012	Antenna	No. 14-1015
No. 14-1013	R-F	No. 14-1016
No. 14-1014	Oscillator	No. 14-1017

List Price Each, Any Type.....\$3.85

- No. 22-5201—Padder Kit for BC-Pol-SW, List \$1.40
No. 22-5202—Padder Kit for LW-BC-SW, List 1.65
No. 24-8264—3-position Range Switch, List 2.20

OSCILLATOR COILS

For the Broadcast band—190 to 550 meters. Tune with 365 mmf TRF type condenser. Will operate in all types of oscillator circuits.

Mounted on special bakelite base, with tinned soldering lugs. Unshielded coils mount by means of screw in one end of dowel. Shielded coils are in cans 1 1/4" diameter, 1 1/4" high, with spade bolt mountings. Proper value padder condensers must be used.



Shielded

No.	Int. Freq.	Padder	List Price
14-4242	175 kc	900 mmf.	\$1.05
14-4243	456 kc	350 mmf.	1.05

Unshielded

No.	Int. Freq.	Padder	List Price
14-3732	175 kc	900 mmf.	.85
14-6590	262 kc	686 mmf.	.85
14-6592	370 kc	500 mmf.	.85
14-4034	456 kc	350 mmf.	.85
14-1033	Special Unshielded Osc. for 6SA7	350 mmf.	.85

PHONO-OSCILLATOR COIL



Designed for the constructor and experimenter in building either wireless or direct-connected phonograph-oscillator units for record reproduction through the radio receiver. May be incorporated in the receiver or with the record-player. Knob adjustment permits selection of clear frequency in the broadcast band. Coil is in black crackle shield, 1 1/4" square by 3 1/2" high. Full instructions.

No. 17-9373—List Price\$2.20

PRESELECTOR COIL

Increases the selectivity of any Broadcast receiver not having an R. F. stage—without adding any tubes! Three separate windings, a primary and two tuned secondaries. Covers regular Broadcast band, 545 to 1580 kc, with a 365-mmfd, tuning condenser. Rigidly mounted in black-crackle-finished shield, 1 1/4" square, 3" high.

No. 14-6797—List Price.....\$2.20



DE LUXE LINE NOISE FILTER



For elimination of electrical interference entering receiver by means of power line. May be connected either to interfering device or to radio. For 110 or 220 volts, AC or DC; 200 watts maximum load. In black crackle case, 2" x 2" x 5".

No. 15-7519—List Price\$4.50

INTERFERENCE FILTERS

DE LUXE DUAL UNIVERSAL WAVE TRAP

Tunes 400-175 to eliminate code signals, etc., entering receiving at intermediate frequency. Also tunes 550 to 1950 kc for interfering signals in Broadcast and low-frequency Police bands. Knob makes adjustment easy. Has Ferrocoat (iron core) for greater efficiency.



No. 15-8048
List Price\$3.00

Dual Broadcast Model: a two-section trap designed for maximum efficiency on Broadcast band only, 550 to 1950 kc.

No. 15-8478—List Price\$3.00

DUAL AMATEUR BAND WAVE TRAP

Eliminates interference simultaneously from either 40 and 80, or 40 and 160 meter bands. Similar in construction to above dual unit, but without knob. Has screwdriver adjustment for both bands. Tunes 1.5 to 7.5 mc.

No. 15-8148—List Price\$3.00

STANDARD SINGLE WAVE TRAPS

Each trap designed for a specific frequency coverage; has screwdriver adjustment for easy setting to interfering signal. Air core design.

- No. 15-8479—For range 400 to 700 kc.
No. 15-8480—For range 650 to 1000 kc.
No. 15-8481—For range 950 to 1600 kc.
No. 15-8485—160 Meter and Police Band.
No. 15-8484—80 Meter Band.
No. 15-8483—40 Meter Band.
No. 15-8482—20 Meter Band.

Any Model—List Price\$1.40

456 I.F. WAVE TRAPS

Eliminate I.F. interference caused by code signals, etc.

- No. 15-7518—Fully shielded. List Price.....\$1.00
No. 15-8486—Similar to above, but unshielded.
List Price\$0.75

10-KC AUDIO FILTER

Eliminates the 10-kc squeals and whistles which spoil high-fidelity reproduction of programs. Two tuned filter circuits provide maximum attenuation of the 10-kc audio note. Complete instructions and diagrams. Operates with any of standard power output tubes—current carrying capacity 75 ma. Coils universal wound and fully protected. Accurately pretuned and mounted in black crackle-finished shield, 1 1/4" square by 2 1/4" high. Color-coded lead wires, spade lug mountings on shield.



No. 15-7520—List Price\$4.00

INDIVIDUAL ALL-WAVE COILS

The same high-grade antenna, R. F. and oscillator coils used in the Multi-Wave coil assemblies. Separately available for use in making up special combinations for any type of receiver. "Align-Aire" trimmer mounted on each coil; long-wave coils are shielded. Oscillators designed for 456-kc I-F.



For Use With 410 MMF Condensers

Frequency Coverage	Antenna Coil No.	R. F. Coil No.	Oscillator Coil No.	List Price	Padding Condenser	List Price
183-406 KC	14-7686	14-7688	14-7680	\$2.00	22-8037	.45
637-1754 KC	14-7682	14-7684	14-7682	1.40	22-8029	.45
1.88-18.8 MC	14-7684	14-7686	14-7684	1.40	122-5134	.50
5.8-18.2 MC	14-7674	14-7672	14-7870	1.40		

For Use With 280 MMF Condensers

Frequency Coverage	Antenna Coil No.	R. F. Coil No.	Oscillator Coil No.	List Price	Padding Condenser	List Price
540-1580 KC	14-7921	14-7920	14-7922	1.40	22-7981	.45
1.5-4.5 MC	14-7942	14-7940	14-7938	1.40	22-7733	.45
4.1-12.2 MC	14-7990	14-7992	14-7994	1.40	22-7731	.45
7.3-18.8 MC	14-7674	14-7672	14-1021	1.40	122-4137	.50
11.2-31.6 MC	14-1018	14-1019	14-1020	1.40	122-4137	.50

*Complete with padding condenser.

† Fixed mica padding condenser plus or minus 3%.



Meissner I-F Transformers

"ALIGN-AIRE I-F TRANSFORMERS"

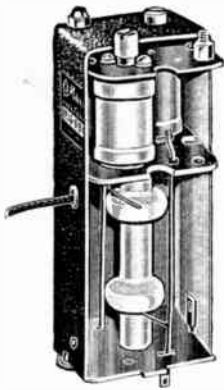

The result of years of engineering experience in designing high grade transformers for the finest commercial receivers! The exacting requirements of modern high-fidelity and communications type receivers demand units that can be depended upon under any and all conditions. They must be absolutely stable under temperature and humidity variation and unaffected by vibration. These requirements are all met by the "Align Aire" I-F Transformer!

Provides 3600 degrees of micrometer smooth trimmer adjustment instead of the usual 180 degree rotation! Accurate trimming can thus be readily accomplished. Available in either standard "Air-core" construction or with special "Iron-core" design for maximum gain and selectivity. Both types are double-tuned and offered in a complete range of frequencies for any application. Shield cans are black crackle finish, 2" x 2" x 3/4".

AIR CORE TYPES				Freq.	IRON-CORE TYPES			
Input	Intstage.	Output	CT-Out.	KC	Input	Intstage.	Output	CT-Out.
16-6630	16-5979	16-6C32	175	16-6631	16-5977	16-6633
16-6C34	16-CC36	262	16-5967	16-6637
16-CC39	16-C011	16-6640	370	16-6639	16-5993	16-6641
16-6C42	456	16-6C43	16-C123	16-CC45	16-6139
16-8090	16-8090	16-8C98	16-8102	1500	16-8089	16-8089	16-8097	16-8101
.....	3000	16-6241

Air-core types. List Each.....\$5.00 Iron-core types. List Each...\$5.50

"PLASTIC I-F TRANSFORMERS"

New type, one-piece molded plastic coil form and trimmer base makes possible this highly efficient transformer, unusually compact in size! Shield can is only 1 1/4" square and 2 1/2" high! Especially suitable for midget or portable receivers, their performance is second to none in any type of set. Made in a complete series of frequency ranges and set positions; windings are universal type with special Litz wire, fully protected against the effects of humidity and temperature variation. Double-tuned with mica-dielectric trimmers; RMA color-coded lead wires.



Frequency	Input	Intstage	Output	List
175	16-6649	16-6650	16-6651
262	16-6652	16-6653	16-6654	Any
370	16-6655	16-6656	16-6657	Type
456	16-6658	16-6659	16-6660	\$1.10

"STANDARD" I-F TRANSFORMERS

Meissner Air-core I-F Transformers have been accepted as "standard" for general replacement purposes. Gain characteristics have been designed to correspond closely with average values found in the majority of commercial receivers. Input and output units are high-gain, for use in single-stage amplifiers; inter-stage units have low gain to prevent oscillation in two-stage amplifiers.

All transformers are double-tuned, with ceramic-base, mica-dielectric trimmers. Windings of high-grade Litz wire are fully impregnated for protection from humidity. Well insulated, RMA color-coded lead wires. Mounted in "standard" size shield cans, 1 1/4" square by 3/4" high, finished in black crackle lacquer.



Frequency	Input	Intstage	Output	Output C-T
175	16-5700	16-5983	16-5702	16-3731
262	16-5704	16-5991	16-5706	16-6003
370	16-5708	16-6059	16-5710	16-6091
456	16-5712	16-6133	16-5714	16-3736
1500	16-8032	16-8092	16-8100	16-8104
3000	16-4260	16-4260	16-4261

Standard I-F Transformers, List Price, Each.....\$1.65

High-Gain Iron-Core Plastics

Same size and construction as above but with iron cores to provide high gain and selectivity.

No.	16-6662	456-ke	Input	Output	Either type, List, \$1.65
No.	16-6663	456-ke	Input	Output

PERMEABILITY-TUNED I-F TRANSF.

For perfect stability under all conditions; no trimmers; variable iron cores provide inductance adjustment. Fixed "silver mica" shunt condenser on each coil insures against drift. High-gain, low-loss universal windings are thoroughly protected from moisture and humidity. Peaked at 456 kc; shield is black crackle finish and is 1 1/4" square by 3/4" high.

No.	16-6664	16-6647	16-6648
No.	16-6664	16-6647	16-6648
Type	Input	Intstage	Output

List Price, Any Type, Each.....\$3.30



"FERROCART" I-F TRANSFORMERS



Designed primarily as original parts in high-gain receivers of superior quality, these transformers find consistent application in stepping up the performance of old receivers. Many sets with single I-F stage can be tremendously improved in sensitivity and selectivity by their use. Special powdered-iron "Ferrocart" cores used in the coils permits higher-"Q",

with resultant increase in gain and selectivity! The wide range of frequencies listed provides for a great variation in new receiver designs while also permitting almost universal application for replacement use. All are double-tuned, with ceramic-base, mica-dielectric trimmers; shields are 1 1/4" by 3/4".

Frequency	Input	Intstage	Output	Output C-T
175	16-5728	16-5981	16-5730
262	16-5732	16-5734
456	16-5740	16-6131	16-5742	16-6211
1500	16-8091	16-8091	16-8099
3000	16-6257

"Ferrocart" Iron Core I-F Transformers, List Price, Each.....\$2.20

BAND-EXPANDING I-F'S

Variable selectivity transformers to enable adjustment of the I-F channel band-width to meet the conditions of the moment! Coupling is variable electrically by means of a two or three position tap switch—no cams or levers. With the two-position units, normal and extra-selective response curves are provided. On the three-position units, an unusually broad response is added for high-fidelity reception. All are 456 kc, double-tuned; mica-trimmed units are 1 1/4" square by 3/4" high; air-trim: 2" by 4 1/2".

No.	17-7410	17-7412	17-7416	Trimmer Positions	Two	Three	6.75
No.	17-7410	17-7412	17-7416	Trimmer Positions	Two	Three	6.75
.....



TRIPLE-PIE I-F TRANSFORMERS

Highly efficient, supergain transformers designed particularly for use in single-stage I-F channels. Not recommended for use in two-stage amplifiers, since excessive gain tends to create instability and troublesome oscillation. These transformers are double-tuned with ceramic-base, mica-dielectric trimmers. Mounted in black crackle-finish shields, 1 1/4" square by 3/4" high.

Frequency	Input	Output
370	16-5720	16-5722
456	16-5724	16-5726

List Price, Each.....\$2.00



TRIPLE-TUNED I-F TRANSFORMERS

Especially designed for high-fidelity superhets, these transformers provide flat-top resonance characteristics with narrow, steep-sided skirts. Accordingly, they deliver the ultimate in tonal quality since there is no cutting of "sidebands". Triple-pie, universal windings are used to provide high gain. Provided with side-adjusted, ceramic-base trimmers. Shields are 2" square by 5" high.

Cat. No.	16-6858	16-6860	Frequency	456	456	Type	Input	Output
Cat. No.	16-6858	16-6860	Frequency	456	456	Type	Input	Output
.....

List Price, Each.....\$3.30

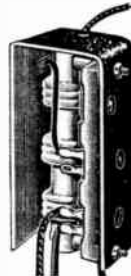

COMPOSITE I-F AND OSC.

Combined oscillator coil and input I-F transformer in one shield; for replacement use and new set construction. Designed to cover broadcast band from 190 to 550 meters with a 365-mmf tuning condenser. Double-tuned with ceramic-base trimmers; shield is 2" x 2" x 3".

No.	17-4031	17-7537	Frequency	175	456	Padder
No.	17-4031	17-7537	Frequency	175	456	Padder
.....

List Price, Each.....\$3.30



I-F TRANSFORMER REPLACEMENT MANUAL



A necessity to every serviceman! Tells what I-F transformer to use in any uperhet! Every super ever made, on which data could be obtained, is listed by manufacturer and model no., original

part numbers, original peak frequency AND the no. of the Meissner transformer recommended for replacement! Has 254 pages in handy pocket size! Lists 9,891 models!

I-F Transformer Replacement Manual, Net Price.....\$2

"CARTWHEEL" I-F TRANSFORMERS

Ultra-compact, unshielded I-F's complete with dual trimmers; fine for compact AC-DC or personal receivers! Also very useful as replacements in many sets using odd shapes and locations for their I-F's. Only 1 1/4" by 1-1/32" by 1 1/4"; one-piece plastic trimmer base; for 456 kc only, input or output.



No. 16-6661 "Cartwheel" I-F, List.....\$1.10



Meissner Replacement Coils

MAJESTIC COILS ONLY



Exact duplicates of original assemblies. Coils only, without cans or trimmers. Exactly replace defective burned-out units. Improved units, in cans with trimmers, are listed at right.

Meissner No.	Majestic No.	Use	Model	List Price
20-6070	4428	1st I.F.	15-15B-150	\$0.85
20-5310	8384	2nd I.F.	15-15B-150	.90
	4429			
20-5311	5326	1st I.F.	25	1.10
20-5312	5337	2nd I.F.	25	1.10
20-5317	5906	1st I.F.	55	1.10
20-5315	10589	1st I.F.	66	.80
	10078			
20-5316	10591	2nd I.F.	66	.80
	10098			
20-4065	379	Plate Choke	90-90B-100-100B	.85
20-4445	7643	2nd I.F.	114	1.10
20-5318	9355	1st I.F.	116	.95
20-5119	9361	2nd I.F.	116	.95
20-5321	6250	1st I.F.	200	1.10
20-6071	6119	1st I.F.	210	.85
20-5323	6123	2nd I.F.	210	.80
20-6072	6127	3rd I.F.	210	1.10
20-5324	6588	1st I.F.	220	1.10
20-5325	6572	2nd I.F.	220	.90
20-5326	6592	3rd I.F.	35-220	1.10
20-5327	7205	1st I.F.	290-300	1.10
20-5328	7300	2nd I.F.	290-300	1.10
20-5329	7821	1st I.F.	310A-310B-330-390	.95
20-3906	7812	2nd I.F.	310A-310B-330-390	1.10
20-4428	9094	2nd I.F.	360	1.10
20-4075	9229	2nd I.F.	370	1.10
	9568			
20-4075	9668	2nd I.F.	400	1.10
20-1491	10528	2nd I.F.	440	1.10
	10541			
20-3500	10148	1st I.F.	460	.80
	10149			
20-3457	10253	2nd I.F.	460	1.10
	11014			
20-5331	10843	1st I.F.	500	.90
20-8332	11705	2nd I.F.	600	.95
20-3457	10253	2nd I.F.	800	1.10
20-4204	7187	Primary coil used as R.F. Plate coil in Models 290-300-310-330-160-520 and 80B		.80

MAJESTIC EXACT DUPLICATE TRANSFORMERS

Manufactured from the original Majestic blue-prints, but Meissner-improved to eliminate the causes of failure. New construction insures satisfactory long life—mechanically and electrically perfect. Exactly replaces old units—requires practically no adjusting. Leads have original Majestic color-code.



Cat. No.	Application	List	Cat. No.	Application	List
Chassis No. 15-15B-150 Model 161-153-154-156					
20-2411	1st I.F. and Osc. Transf.	\$3.30	20-3915	1st I.F. Transformer	\$1.95
20-4051	1st R.F. Coll. less Can.	1.10	20-3944	2nd I.F. Transformer	2.20
20-4050	2nd R.F. Coll. less Can.	1.10	20-4454	Ant. Coll. less Can.	.85
Chassis 20—Model 21-22-23					
20-4052	1st I.F. Transformer	3.30	20-4432	1st I.F. Transformer	2.50
20-4053	2nd I.F. Transformer	5.50	20-4433	2nd I.F. Transformer	2.50
Chassis 25—Model 251-253-254					
20-4054	1st I.F. Transformer	1.65	Model 291-293-294-303-304-307		
Chassis 25-B—Model 251B-253B-254B					
20-4057	1st I.F. Transformer	1.65	20-4070	1st I.F. Transformer	2.50
20-4058	2nd I.F. Transformer	1.65	20-4071	2nd I.F. Transformer	2.75
			20-4069	Ant. Coll. less Can.	1.10
Chassis 35—Model 351-353					
20-4435	1st I.F. Transformer	2.50	20-4430	1st I.F. Transformer	2.20
20-4436	2nd I.F. Transformer	2.20	20-4431	2nd I.F. Transformer	2.50
20-4437	3rd I.F. Transformer	2.20	Chassis 340—Model 344		
Chassis 55—Model 56-57-58					
20-4051	1st R.F. Coll. less Can.	1.10	20-4429	2nd I.F. Transformer	2.20
20-4050	2nd R.F. Coll. less Can.	1.10	20-4427	Ant. Coll. less Can.	.85
Chassis 60 & 160—Model 61-62-163					
20-4372	2nd I.F. Transf. Tapped	3.85	Chassis 370—Model 371-373		
Model 66					
20-4062	1st I.F. Transformer	2.75	20-4074	1st I.F. & Osc. Transf.	2.75
20-4061	Osc. Coll. less Can.	.85	Chassis 400—Model 411-413		
20-4064	R.F. Choke less Can.	.85	20-4076	1st I.F. Transformer	3.85
			20-4064	R.F. Choke, less Can.	.85
Model 110					
20-4066	Broad Band Transformer	1.65	Chassis 440—Model 44-49-194		
Model 114					
20-4444	1st I.F. Transformer	2.20	20-1492	1st I.F. Transformer	1.65
Model 118					
20-4061	Osc. Coll. less Can.	.85	20-1489	Oscillator Coll. less Can.	.80
Model 120-121					
20-4439	1st I.F. Transformer	3.30	Chassis 460—Model 461-463		
20-4440	2nd I.F. Transformer	3.30	Chassis 520—Model 95		
Chassis 120B—Model 123					
20-4363	1st I.F. Transformer	2.20	Chassis 490—Model 491-493		
20-4369	2nd I.F. Transformer	2.20	20-3499	1st I.F. Transformer	2.20
Chassis 200—Model 201-203-204					
20-3816	2nd I.F. Transformer	2.20	20-4012	R.F. Coll. less Can.	1.10
20-4067	Ant. Coll. less Can.	1.10	20-4064	R.F. Choke, less Can.	.85
20-4319	Osc. Coll. less Can.	1.40	20-4078	Oscillator Coll. less Can.	1.10
20-3958	R.F. Coll. less Can.	1.65	Chassis 500		
			Model 55-59-75-195-560-566		
			20-4089	1st I.F. Transformer	2.75
			20-4081	2nd I.F. Transformer	2.75
			20-4090	3rd I.F. Transformer	3.85
			20-1619	Antenna Coll. less Can.	1.10
			20-4079	Oscillator Coll. Low Freq.	.55
			20-4080	Osc. Coll. High Freq.	.55
			Chassis 800—Model 85-86-898		
			20-4012	R.F. Coll. less Can.	1.10
			20-4064	R.F. Choke, less Can.	.85

CLARION Transformers and Coils

A carefully selected list of replacements for popular model Clarion sets. Exact duplicates with the addition of Meissner improvements to eliminate original defects.

No.	Model	Position	List
20-6938	480	Composite	\$2.75
20-6936	320	Composite	2.75
20-4284	260	2nd I.F.	2.00
20-4293	300	3rd I.F.	2.75
20-4286	300	1st or 2nd I.F.	2.20
Coil Sections Only			
20-3478	100	2nd I.F.	1.10
20-6909	140	2nd I.F.	1.10
20-3478	220	2nd I.F.	1.10
20-6309	260	2nd I.F.	1.10
20-3153	320	2nd I.F.	1.10
20-6313	360	1st I.F.	1.10
20-6317	360	2nd I.F.	1.10

RCA — RADIOLA Replacement I.F. Coils

Exact I.F. replacement coils for R.C.A.—Radiola—G. E.—Westinghouse and Graybar receivers.

No.	R.C.A.	Model	Position	List
20-6301	8567	80-82-86-RAE66	1st I.F.	\$1.10
20-6299	8565	80-82-86-RAE68	2nd I.F.	1.10
20-6297	8566	80-82-86-RAE68	3rd I.F.	1.10
20-6289	2991	R4-R5-R5DC-R5X R6-R7-R7A-R7DC R9DC-R9-RE-16-RE16A	1st I.F.	1.10
20-6281	2992	R4-R5-R5DC-R5X R6-R7-R7A-R7DC R9DC-R9-RE-16-RE16A	2nd I.F.	1.10
20-6273	8342	60-62-64	All I.F.	1.10

BELMONT Composite I.F. and Osc.

Exactly replaces first I.F.-Osc. coil in Belmont C-19, 50-C, 51-C. May also be used in many Sears-Roebuck sets. Complete exact duplicate in shield can.

No. 20-6792—List Price.....\$4.40

CROSLY Untuned I.F. Coil

Exact duplicate for Models 122, 123, 124, 125, 126. Every serviceman should have a supply of these efficient units.

No. 20-4297—List Price.....\$1.40

STEWART-WARNER Oscillator Coil

Exact duplicate for the oscillator coil used in Stewart Warner Model M3043. Same physical and electrical characteristics as original.

No. 20-1000—List Price.....\$0.85

"SLIP-OVER" REPLACEMENT PRIMARY WINDINGS

Economically replace burned out primaries on all types of Antenna and R.F. coils, where a new primary winding can be slipped over the secondary. High-impedance type for improved performance. Sizes are outside diameter of coil over which replacement primary will fit.



No.	Size	List
14-6850	For 1 1/4" O.D. Coil	\$0.35
14-6852	For 1" O.D. Coil	.30
14-6854	For 3/4" O.D. Coil	.30
14-6856	For 1/2" O.D. Coil	.30
14-8418	For 1/2" O.D. Coil	.25

REPLACEMENT I.F. WINDINGS

Designed particularly for replacement use in inexpensive midjet receivers. Coils are wound on wood dowels, 3/8" diameter and 1 1/4" long; coupling is adjustable by sliding primary coil.



STANDARD CENTER-TAPPED

No.	Freq.	List	No.	Freq.	List
16-6600	175	\$0.70	16-6602	175	\$0.90
16-6601	456	.70	16-6603	456	.90

"DOWEL" TYPE REPLACEMENT WINDINGS

For use in replacing burned out primaries, particularly where the "slip-over" type cannot be used due to mechanical difficulties. Fit inside the coil form. Antenna winding Type A is for use with sets having a regular antenna. Type B is for sets having a short "hank" or A.C.-D.C. type antenna; 3500 ohm R.F. winding Type C must be shunted with a 15 or 20 mfd condenser for best performance; 7500 ohm windings require no condenser.



No.	Type	Dimensions	Inductance
14-6865	A	3/8" dia. by 1 1/4" long	1700 uh
14-6866	A	3/8" dia. by 3/4" long	1700 uh
14-6867	A	3/8" dia. by 1 1/2" long	1700 uh
14-6868	B	3/8" dia. by 1 1/4" long	2250 uh
14-6869	B	3/8" dia. by 3/4" long	2250 uh
14-6870	B	3/8" dia. by 1 1/2" long	2250 uh
14-6871	C	3/8" dia. by 3/4" long	3500 uh
14-6872	C	3/8" dia. by 3/4" long	7500 uh
14-6873	C	3/8" dia. by 1 1/4" long	7500 uh

Dowel-Type Replacement Primaries, List Each.....\$0.35



Meissner Miscellaneous Parts

STANDARD R-F CHOKES

Accurately wound and individually tested; coils wound on specially treated forms, mounted on bakelite terminal base and thoroughly moisture proofed. Available in shields or without; both single-hole mounting. Shielded chokes have terminals thru top of can so unit may be mounted on inside wall of chassis. Shields are black crackle finish. 1 1/2" dia.



MIL Induct.	Shielded		Unshielded	
	No.	List	No.	List
2.5	19-5582	\$0.75	19-1994	\$0.50
5.0	19-5584	.75	19-4551	.50
8.0	19-5588	.80	19-2078	.55
10.0	19-1900	.85	19-8770	.65
16.0	19-5590	.90	19-1995	.70
30.0	19-5592	.95	19-2330	.75
80.0	19-5594	1.05	19-3247	.85
80.0	19-5596	1.10	19-2709	.90

IRON-CORE R-F CHOKES

Universal-wound on special powdered-iron cores, these chokes provide maximum efficiency—lower DC resistance per MIL. Coils are wax-impregnated; laminated bakelite terminal base; single-hole mounting; without shielding.



No.	MIL	List	No.	MIL	List
19-6834	2.5	\$0.80	19-6844	60.0	\$1.30
19-6840	10.0	.95	19-6846	80.0	1.45
19-1910	16.0	1.10	19-6848	125.0	1.85
19-6842	30.0	1.10			

FILAMENT CHOKE

A low-resistance choke wound with No. 14 PFC wire designed for use in the low voltage circuits of vibrator power supplies, auto radio sets, etc. Has an inductance of 4 uh. and a resistance of only .012 ohm. Single layer winding enclosed in a cardboard tube 3/4" diameter by 1 1/2" long, with wire leads.



No. 19-4215—Filament Choke. List Price....\$0.45

CERAMIC-BASE TRIMMERS

Low-loss ceramic base. Hot-tinned alloy plates. Cadmium-plated steel adjusting screw; extra-fine thread. Accurately threaded brass insert. Clear India Ruby mica dielectric.

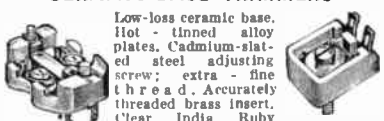

No.	Type	Capacity Range	List
22-7002	C	25-100 mmfd	\$0.30
22-7003	C	75-225 mmfd	.35
22-7004	C	125-350 mmfd	.40
22-7005	C	175-500 mmfd	.45
22-7006	C	225-650 mmfd	.50
22-7007	D	275-825 mmfd	.75
22-7008	D	325-1000 mmfd	.80
22-7009	D	400-1200 mmfd	.85
22-7010	D	500-1400 mmfd	.90
22-7011	D	600-1600 mmfd	.95
22-7012	D	700-1800 mmfd	1.00
22-5211	G (dual)	200-600 mmfd	.65

AIR-DIELECTRIC TRIMMERS

Metal-cased air trimmer as used in Align-Aire I-F transformers; absolutely stable under all conditions; dust-proof; moisture-proof.

Provides 3600 degrees rotation from minimum to maximum; ceramic insulated; 3/8" dia. by 1 1/2".
No. 22-5232—5 to 25 mmfd. List Price....\$1.00
No. 22-5240—25 to 50 mmfd. List Price.... 1.10
No. 22-5200—40 to 100 mmfd. List Price.... 1.40



MIDGET "ALIGN-AIRE"

Similar to above unit but in molded plastic case; only 7/16" diameter. 1 1/2" long; combination metal end plate and mounting bracket.

No. 22-5230—1 to 12 mmfd. List Price....\$0.40

SOCKET PUNCH

Hardened steel. Will cut right-sized hole in sheet metal up to 14 gauge to fit either Steatite or Bakelite Meissner sockets. Cuts clean; 1 1/4" hole; tempered to last.

No. 25-3558—Socket Punch. List Price....\$5.50

STANDARD "SLIDE-RULE" DIALS



9-INCH Used on larger Meissner receivers; single-speed vernier mechanism; fits 3/8" shaft; for right or left-hand closing condenser. 4-band scale calibrated 537-1754 kc, 1.68-5.96 mc, 5.85-18.2 mc and 17.6-62 mc. 5-band scale has 133-406 kc band additional.

Scale	Right-hand	Left-hand	List
4-band	No. 23-8233	No. 23-8232	\$7.75
5-band	No. 23-8231	No. 23-8230	7.75

7-INCH Used on Meissner 7-tube receivers; fit 3/8" shaft; for right- or left-hand closing condensers. Scales calibrated: A—530-1680 kc, 0-100; B—530-1660 kc, 5.85-18.8 mc, 0-100; C—537-1770 kc, 1.75-5.4 mc, 5.2-18.5 mc; D—135-370 kc, 530-1580 kc, 5.8-18.5 mc.

Scale	Right-hand	Left-hand	List
Type A	No. 23-8220	No. 23-8207	\$6.00
Type B	No. 23-8221	No. 23-8208	6.00
Type C	No. 23-8222	No. 23-8209	6.00
Type D	No. 23-8228	No. 23-8210	6.00

5-INCH Used on Meissner P-A Tuners; similar to above dials except for scale length. Fits 3/8" condenser shaft; for clock-wise closing condenser only; calibrated for broadcast band, 530 to 1600 kc; furnished with escutcheon.

No. 23-8227—5" Slide-Rule Dial. List Price....\$5.25

4-INCH ROUND DIAL

Used on Meissner 5-tube set; a handy mechanism for any application. Scale calibrated 0 to 100; fits 1/2" diameter shaft; dependable friction vernier drive; no cables; includes escutcheon.

No. 23-8257—4" Round Dial. List Price....\$3.30

SHIELD CANS

Meissner drawn zinc shield cans; black crackle finish. Furnished with spade-bolts for mounting.

No.	Shape	Dimensions	List
25-8271	Square	1 1/2" x 1 3/4" x 1 3/4"	\$0.30
25-8273	Square	1 3/4" x 1 3/4" x 2 1/2"	.35
25-8275	Square	1 3/4" x 1 3/4" x 3 1/2"	.40
25-8277	Square	1 3/4" x 1 3/4" x 2 1/2"	.35
25-8279	Square	1 3/4" x 1 3/4" x 3"	.45
25-8281	Square	2" x 2" x 1 1/2"	.70
25-8270	Round	1 1/2" dia. x 1"	.20
25-8272	Round	1 1/2" dia. x 1 1/2"	.25
25-8274	Round	1 1/2" dia. x 2 1/4"	.35

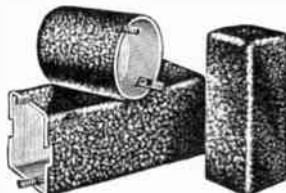

STANDARD VARIABLE CONDENSERS

Low-loss precision tuning condensers for any application; improved bakelite insulation; trimmers mounted on top; bushbar construction insures rigidity; 3/8" dia. shaft, 1 1/2" long; capacity increases clockwise; end plates are 1 1/2" x 3 1/4".

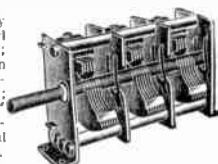

These are standard sized condensers for universal receiver use; sections are spaced 1 1/2" apart.

Cat. No.	21-5224	21-5221	21-5222	21-5223
Sections	One	Two	Three	Four
List Price	\$2.50	\$3.50	\$4.50	\$5.75

COMPACT VARIABLE CONDENSERS

Where space is an important factor these compact, reliable condensers are ideal. Each section is only 1" deep; end plates are 1 9/16" x 3 3/8"; rigid, bushbar construction; bakelite insulation; trimmers on top; 3/8" dia. shaft; capacity increases clockwise.



Capac.	One-Section	Two-Section	Three-Section
140	21-5200 \$1.80	21-5210 \$2.65	21-5211 \$3.65
365	21-5200 \$1.80	21-5214 2.75	21-5215 3.75
410		21-5216 2.75	21-5217 3.75

ROTARY TAP SWITCHES

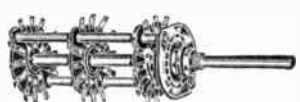

Shorting type contacts two adjacent points during rotation; circuit is never open. Non-shorting type opens circuit between each point; contacts only one point at a time. All have adjustable stops; any number of positions may be used. High-grade laminated bakelite insulation; positive silvered contacts. Overall diameter, 1 1/2"; mounts in 3/8" hole; flatted shaft 2" long, 3/8" diameter. Sections are spaced 1 1/2" apart; may be shortened by cutting spacers.

Circuits	Positions	Shorting		Non-Shorting	
		No.	List	No.	List
One	2 to 12	24-8251	\$1.30	24-8252	\$1.30
Two	2 to 5	24-8253	1.40	24-8254	1.40
Four	2 to 5	24-8256	1.95
Four	2 to 5	24-8258	2.20
Three	2 to 12	24-8259	2.60	24-8260	2.60
Six	2 to 5	24-8261	2.75	24-8262	2.75
Four	Two	24-8263	1.40

Coil-Shorting Rotary Switches

Designed for use in multi-band receivers; has separate wafers for complete switching of primary and secondary on each coil. Shorts out all lower-frequency coils to reduce absorption. Adjustable stop permits use of limited number of positions. High quality laminated bakelite insulation; positive silvered contacts; overall diameter, 1 1/2"; mounts in 3/8" hole. Flatted shaft is 2" long, 3/8" in diameter; sections are 1 1/2" apart; may be shortened by cutting spacers.

No.	Gangs	Circuits	Positions	List
24-9202	2	2	2 to 5	\$1.65
24-9204	6	6	2 to 5	3.85
24-9205	8	8	2 to 5	5.00

Molded Bakelite Socket—Octal Base

Has many points of superiority; accurately molded of highest grade bakelite; mounted in cadmium plated steel saddle; standard 1 1/2" mounting centers; requires 1 1/2" hole in chassis; has four ground lugs.



No. 25-8209—Bakelite Octal Socket. List....\$0.12
No. 25-8438—Carton of Six Sockets. List.... .70

Low-Loss Ceramic Octal Socket

Of same construction as above, this socket is made of highest quality ceramic insulation; low R-F losses make it ideal for high-frequency use. Phosphor-bronze contacts can't pull out with tube; standard mounting centers, 1 1/2".

No. 25-8437—Ceramic Octal Socket. List....\$0.40
No. 25-8439—Carton of Six Sockets. List.... 2.25



Meissner Amateur Equipment

14-tube "TRAFFIC MASTER" Communications Receiver

The answer to every Ham's ardent hope, the Traffic Master is the finest communications type receiver that could be designed with present tubes and circuit components! Available either in kit form, with complete instructions for assembling and wiring, or as a complete, laboratory-built receiver, ready for operation! Whether you build it yourself or buy the complete set—you get the same Meissner guaranteed quality—the most for your receiver dollar! The Traffic Master provides full coverage from 540 kc to 31.6 mc, in five bands, accurately calibrated on the big linear dual-control dial. Separate band-spread control, calibrated 0-100, makes tuning in

congested bands childishly simple! Heavy fly-wheels on both main and band-spread tuning controls for rapid coverage. In the kit the complete tuning unit is already assembled and aligned—the entire front end of the receiver up to the I-F channel—ready to drop into place on the chassis—only six wires to connect it to the rest of the set!

All parts are included in the Complete Kits, except tubes and speaker; punched chassis, 5-band tuning unit, band-spread dial, air-tuned I-F transformers, crystal-filter, B-F-Osc., illuminated "R" meter, controls, power transformer, condensers, resistors, sockets, etc

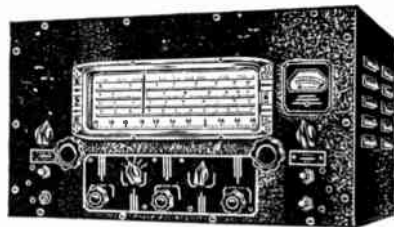

COMPLETE KITS

- 14-tube Traffic Master, less panel and cabinet, No. 10-1174—Amateur Net Price.....\$100.00
- 14-tube Traffic Master, with panel and cabinet, No. 10-1173—Amateur Net Price.....\$107.50
- No. 11-8219—Front Panel only, Net Price....\$2.75
- No. 11-8224—Cabinet only, Net Price..... 5.75

ESSENTIAL PARTS KIT

Contains all "special" parts not generally available in distributors stock; includes 5-band tuning unit, band-spread dial, punched chassis, crystal-filter and B-F-O units, and all I-F transformers, with complete instructions and parts lists. Save money by buying this economical kit as most of the remaining parts you may have on hand!

- No. 12-1030—Essential Parts Kit, Net Price,\$62.25

LABORATORY-BUILT RECEIVER

Built to match the finest commercial job on the market—the Traffic Master in complete form—ready for immediate operation! Assembled, wired, and accurately aligned in the Meissner Lab—thoroughly "air-tested" before shipment. A truly outstanding receiver at a moderate price! Complete with full set of tubes; less speaker.

- No. 9-1052—Traffic Master Receiver, Net \$136.75



9-tube "TRAFFIC SCOUT" Communications Receiver

Incorporating every feature you have always wanted in a "ham" set, this splendid receiver may be purchased either in "Kit" form or as a completely assembled and laboratory-wired instrument! Whether you build it yourself from the kit or buy the laboratory-built receiver, you are assured of the same eye-opening results that have made this set so popular! Full band-spread with dual-control fly-wheel tuning for rapid coverage; pre-aligned 5-band coil assembly, covers 540 kc to 31.6 mc; band-spread tuning condenser; punched steel chassis; crystal filter unit; B-F-O unit; 1-F transformers; sockets; resistors; condensers; controls; hardware—everything needed is included in the complete Kit! Anyone can build this fine receiver by following the detailed instructions and diagrams furnished with every kit.

COMPLETE KITS

All parts necessary to build the Traffic Scout are furnished with the exception of tubes and speaker. Detailed Schematic and Pictorial Diagrams and Instructions with every kit.

- 9-tube Traffic Scout, less panel and cabinet, No. 10-1170—Complete Kit, Net Price.....\$71.75
- 9-tube Traffic Scout, with panel and cabinet, No. 10-1169—Complete Kit, Net Price.....\$78.75
- No. 11-8246—Steel Front Panel, Net Price....\$2.30
- No. 11-8224—Steel Cabinet, Net Price..... 5.75

LABORATORY-BUILT RECEIVER

For the Ham who prefers a ready-built receiver, the Traffic Scout is offered completely assembled and wired; accurately aligned and "air-tested"; complete with full set of tubes; less speaker.

- No. 9-1051—Traffic Scout Complete Receiver, Net Price.....\$100.50

ESSENTIAL PARTS KIT

Contains all "special" parts required to build the Traffic Scout; includes chassis, dial, tuning condenser, 5-band, pre-aligned coil unit, I-F Transformers, X'tal filter and B-F-O; with instructions.

- No. 12-1029—Traffic Scout Essential Kit, Net Price.....\$56.75

ULTRA-HI FREQUENCY TRANSCEIVER

2 1/2-Meter Portable

A complete, combination transmitter and receiver for phone operation on the 2 1/2-meter band—covers 112 to 120 mc—battery operated. Steel case is only 12" square and 5 3/4" deep, finished in "battleship" gray with attractive panel design in ivory. Uses one each type 7A4, 6G6G and 6XJ7 tubes; distance range is 5 to 30 miles, depending on terrain. A perfected super-regenerative type receiver circuit is employed with separate quench oscillator to give absolutely stable operation. Vertical rod antenna telescopes into top of case when not in use; compartment in rear of case provides space for carrying phones and mike or combination handset. Either crystal or carbon type microphone may be used.



Easy to Operate

No re-adjustments necessary when changing from send to receive; constant antenna load—no ticklish coupling controls; light in weight—only 12 1/2 lbs., with batteries. Furnished complete with tubes, less batteries, phones and mike.

- No. 9-1081—Ultra-Hi Frequency Transceiver.....Price on Application

A Precision Type Instrument for Amateur, Commercial or Military Applications

CRYSTAL OVEN

For Positive Temperature Control

Designed especially to fit into the Signal Spotter but may be used with any Crystal Oscillator unit! Holds up to four mounted crystals; provides accurate temperature regulation within plus or minus 1 degree C. Steel outer shield is 4 1/2" square by 4 3/4" high; crystals in inner chamber of heavy cast aluminum with thick insulating material in walls; terminals on top for connection of 6.3-volt heater supply.

- No. 9-1046—Crystal Oven, Complete, (less crystals), Net Price.....\$15.25



SIGNAL SHIFTER

The "Time-Proven" E-C-O

Variable-frequency exciter delivering T9X output of 7 1/2 watts on any of five popular bands! Uses 6F6 oscillator, 6L6 doubler, 2 voltage regulators and a rectifier; tuned by new type vernier dial; no backlash or parallax; link-coupled to control frequency of any transmitter—directly from operating position; arranged for oscillator or doubler keying with built-in filter; relay provides automatic operation with transmitter; provides true CRYSTAL stability in an E-C-O!



COMPLETE—READY TO OPERATE

The Signal Shifter is complete with tubes and one set of coils for any band specified; 10-meter coils cover 14- to 15 mc, to be doubled in transmitter.

- No. 9-1058—Signal Shifter, 110-v. in black cabinet, Net Price.....\$52.25
- No. 9-1057—Signal Shifter, 110-v. in gray cabinet, Net Price.....\$52.25
- No. 9-1059—Signal Shifter, 220-v, black or gray, Net Price.....\$55.50
- No. 9-1060—Signal Shifter, 110-v. on rack panel, Net Price.....\$7.25

EXTRA COILS, SETS OF 3

Cat. No.	Band	Amateur
18-2915	160-meter	Net
18-2916	80-meter	Net
18-2917	40-meter	\$2.75
18-2918	20-meter	Per
18-2919	10-meter	Set

SIGNAL SPOTTER

Companion Unit to the Signal Shifter

A crystal-controlled, precision-built oscillator, with pre-tuned tank circuits to permit the use of four crystals! Desired crystal frequency instantly selected by switch on panel; power is derived from the Signal Shifter through a cable at the rear; control switch on the Shifter panel selects E-C-O or Crystal output as desired. The four crystal frequencies may all be on any one Amateur band or divided over any two bands; Indicator on panel for oven thermostat if Crystal Oven is used.



COMPLETE PRECISION CONTROL SYSTEM

The "Signal-Spotter, Signal-Shifter" COMBINATION provides the last word in a modern, precision-type frequency control system for the Amateur Transmitter! Use the Spotter for band-edge operation, traffic networks, etc.—the Shifter for general band operation on whatever frequency is best!

- Supplied complete with tubes and any two coils specified:
- No. 9-1043—Signal Spotter, in gray cabinet, Net Price.....\$24.75
- No. 9-1044—Signal Spotter, in black cabinet, Net Price..... 24.75

EXTRA COILS

Cat. No.	Band
18-2936	160-meter
18-2937	80-meter
18-2938	40-meter
18-2939	20-meter

Net Each.....\$0.95

Watch for these
NEW MEISSNER PRODUCTS!
High-Frequency Combination FM-AM Receptors
for Amateur and Commercial Use
Dual-Speed Portable Phono-Radio-Recorder
— SOON TO BE RELEASED —
Write for Complete Information

Meissner

Meissner Amateur Products

MC 28-56 CONVERTER

For 5- and 10-meter Bands

This precision-built instrument is responsible for many of the records established in recent years on the high-frequency bands! The popular choice of Amateurs and Experimenters everywhere. Designed for full coverage of the 28- to 30-mc and the 56- to 60-mc bands; tuning simplified by precision-type vernier dial, augmented by separate trimmer control. Incorporates a high-C oscillator circuit, fully stabilized by voltage-regulated power supply; insures complete signal stability! Uses an 18 2 R-F amplifier, 6P8 oscillator, and 18S2 mixer, with a 6X5 rectifier and VR-150 regulator. Average signal gain is 20 DB! Selector switch selects band or connects antenna directly to receiver; output frequency adjustable from 6.9 to 7.4 mc; manual gain control provided. Furnished complete with tubes, ready to operate, in black crackle cabinet 1 1/4" wide, 9" high and 1 1/2" deep.

No. 9-1032—MC 28-56 Converter, 110-v., 60-c., Complete. Net Price.....\$49.50



UNI-SIGNAL SELECTOR

For Noiseless C-W Reception

The most outstanding Amateur Radio development in recent years! Takes up where the X'tal Filter leaves off; provides super selectivity on ANY receiver! For use on CW only—too sharp for phone use—provides clear 1000-cycle note regardless of condition of signal. This unit is a combination electrical, mechanical and acoustical filter; connects in place of regular speaker; speaker connects to terminals on rear of Selector; switch on front of unit provides regular speaker output or Selector output. No internal connections to receiver—uses no power! Matches any 4,000 to 5,000 ohm output; installation is extremely simple. Special "Stethoscopic" headphones may be plugged into coupling "jack" in front of unit for private listening.

No. 9-1026—Uni-Signal Selector, Complete, less headphones. Net Price.....\$15.25

No. 26-1001—Special "Stethoscopic" Headphones. Net Price.....5.50



SIGNAL BOOSTER

Four-Band Preselector

Regardless of the type receiver you are using—regardless of the number of R-F stages you have—you will find the extra gain provided by the SIGNAL BOOSTER will make possible many solid 100% QSO's that would otherwise be missed. Has an average signal gain of 40 DB! Uses two high-gain R-F stages with type 18S2 amplifier tubes; three tuned circuits for maximum selectivity and image attenuation; complete coverage from 1600 to 31,000 kc in four bands; slide-rule dial with 7 1/4" linear scales, accurately calibrated! Antenna Compensator for accurate impedance match; connections for single or double antenna; switch connects antenna directly to receiver to cut out preselector without turning it off; includes manual gain control. Furnished complete with tubes for operation from 110 volts, 60 cycles; black crackle finish cabinet is 1 1/4" wide by 9" high by 1 1/2" deep.

No. 9-1031—Signal Booster, Complete with tubes. Net Price.....\$47.75



BEAT-FREQUENCY OSCILLATOR ADAPTER UNIT

For C-W on Any Receiver

The simplest method of adding a beat-frequency oscillator for reception of C-W signals or assistance in locating weak stations. May be used with any receiver having a 456- to 485-ke 1-F channel. Completely self-powered; operates on 110 volts, AC or DC. No internal connections to the receiver are required—just a coupling loop for the top grid of the I-F tube! Has output attenuator on end of chassis; pitch control on top of coil shield; clamp-on switch for "On-Off" control. Supplied either as a complete kit of parts or as wired unit—ready to operate—less tubes. Tubes used are one 6CS6 and one 25Z8G. Chassis is finished in black crackle; extra 110-volt receptacle located in end of chassis for radio or other attachments.

No. 10-6350—B-F-O Adapter Unit, Complete Kit. Net.....\$7.75

No. 9-1012—B-F-O Adapter, Wired Unit. Net.....10.00



NOISE-SILENCER ADAPTER UNIT

Eliminates 90% QRN on Any Set

A useful addition to any receiver with a 456- to 485-ke 1-F system. Using the famous "Lamb" principle, it effectively reduces static peaks and man-made noises to a very low level. Permits enjoyable short-wave reception in districts where the noise level is unusually high! Uses four tubes and operates on 110 volts, AC or DC. Very simple connections to any receiver are fully explained in detailed instructions and diagrams supplied with each unit. Available either as a complete kit of parts, less tubes, with detailed wiring instructions, or as a completely wired and tested unit, ready to operate. Tubes required are one each type 6K7, 6J7, 6I7 and 6H6. Has noise level control on one end of chassis and extra 110-volt receptacle on other end for radio or other appliance. Chassis finished in black crackle.

No. 10-7516—Noise Silencer Adapter, Complete Kit with Instructions. Net Price.....\$7.75

No. 9-1011—Noise Silencer Adapter, Complete Unit, ready to operate. Net Price.....10.00

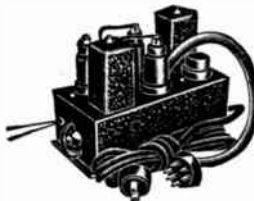

CRYSTAL FILTER UNIT

Mono-unit X'tal Filter as used in Traffic-Master receiver; complete and ready for installation in any communications type receiver. Only four connections to make; contains matched transformers with air-dielectric peak adjusters phasing condenser with crystal cut-out switch, no-drift coupling condenser and precision quality 456-ke mounted crystal in black crackle finished shield, 2 1/4" wide, 3 3/4" deep, 4 3/4" high.

No. 9-1042—Net \$15.00

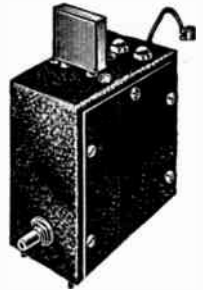

BEAT-FREQ. OSC. UNIT

For use with any receiver with 456-ke 1-F; has only four connections and includes 6BS7 socket; trimmer on top for rough adjustment; air condenser for panel-operated pitch control on front. In black crackle shield, 2 1/4" x 3 3/4" x 2 3/4".



No. 9-1049—Beat-Freq. Osc. Unit.....Net \$4.00

B-F-O TRANSFORMERS

For use with a separate triode oscillator to provide the necessary "beat-note" for reception of CW signals and to aid in locating weak stations; an absolute necessity on amateur communications type receivers. Knob on top controls pitch of beat note; separate trimmer to adjust the BFO frequency to match the 1-F. With air trimmers, 2" sq. x 4 1/2"; with mica trimmers, 1 1/2" sq. x 3 1/2".

Mica Trim	Air Trim		
Cat. No.	KC	Cat. No.	KC
.....	262	17-6773	370
.....	370	17-6772	458
.....	458	17-6770	1500
.....	1500	17-6793	3000
.....	3000	17-6794	
Net Price	Net Price	Net Price	Net Price
Each \$1.20	Each \$2.50	Each \$2.50	Each \$2.50



SIGNAL SPLICER

Accurately matches any antenna to any receiver; provides high signal gain without tubes! Reduces noise pickup and improves image rejection. One set of coils furnished for use on any band; full instructions included; extra coils available

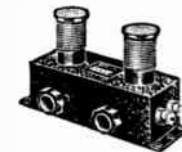

The Signal Splicer is a well-designed pi-network arranged to be connected between the antenna and the receiver. Dual air-electric capacitors provide adjustment for matching impedances.

No. 9-1022—Signal Splicer.....Complete, Net \$4.50
No. 18-2950—Extra Coils.....Per Pair, Net 1.10

WIRELESS PHONO OSCILLATOR

Provides reproduction of records through any radio set; acts as miniature broadcaster to transmit recording to the receiver without intervening wires; signal is tuned in on radio just as any other station! Operates in radius of 20 to 50 ft.; self-powered; operates on 110 volts AC or DC; has receptacle for phono motor. Uses a 6F7 and 25Z5; tubes not supplied.

Available as complete kit of parts or as factory-wired unit; both with detailed instructions.
No. 10-6380—Complete Kit.....Net \$5.70
No. 9-1010—Factory-wired.....Net 8.10

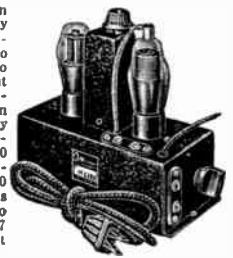

Meissner Amateur Accessories

NOISE SILENCER I-F TRANSF.



Special, close-coupled transformers for use in "Lamb" type noise-silencer circuits. Complete range of I-F frequencies available, with air or mica dielectric trimmers; air-tuned units are 2" sq. x 4 1/4", mica-tuned units 1 1/2" sq. x 3 3/4".

Mica Trim Cat. No.	KC	Air Trim Cat. No.
17-6849	175	17-6857
17-6851	262	17-6859
17-6853	370	17-6861
17-6855	458	17-6863
17-6857	546	17-6865
17-6859	634	17-6867
17-6861	722	17-6869
17-6863	810	17-6871
17-6865	898	17-6873
17-6867	986	17-6875
17-6869	1074	17-6877
17-6871	1162	17-6879
17-6873	1250	17-6881
17-6875	1338	
17-6877	1426	
17-6879	1514	
17-6881	1602	

Net Price, Mica-Trim...\$1.20; Air-Trim...\$2.50

CRYSTAL-FILTER I-F TRANSF.

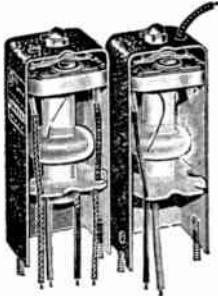

Supplied in matched pairs; designed to provide a low-impedance 11k-coupled filter circuit for superhet receivers. Input unit has tuned primary and low-impedance secondary; output unit has low-impedance primary and tuned, high-impedance secondary. Coupling is set to give optimum gain; selectivity provided by crystal in link circuit. In black crackle cans.

Mica Trimmers Cat. No.	Frequency KC	Align-Aire Trimmers Cat. No.
17-7450	175	17-7455
17-7451	262	17-7456
17-7452	370	17-7457
17-7453	458	17-7458
17-8183	1500	
17-7454	3000	17-7459

Net, Per Pair, \$2.65

Net, Per Pair, \$5.25

CONICAL STAND-OFF INSULATORS



High-density, glazed ceramic in four popular sizes for Amateur transmitters; both ends tapped for screws.

Cat. No.	Dia.	Ht.	Tap	Net
27-1001	1"	1"	8/32	\$0.17
27-1002	1"	1 1/4"	8/32	.17
27-1003	1 1/4"	2"	10/32	.30
27-1004	1 1/2"	3"	10/32	.50

2-PIECE FEED-THRU INSULATORS

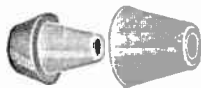

Designed to provide extra-long leakage path; glazed surface, high-density ceramic. Supplied with cork gaskets and hardware.

No. 27-1005	3/4" dia.	3/4" long	Net Price \$0.24
No. 27-1006	1" dia.	1" long	Net Price \$0.27

LEAD-IN INSULATORS



Glazed, with hardware.

No. 27-1010	1 1/4" Dia.	Net \$0.47	Glazed; 5 1/4" dia.; 2 1/2" H.
27-1011	1 1/2" Dia.	.57	No. 27-1012 Net \$4.30

"ALSIMAG 35" CYLINDERS



Unglazed cylindrical forms in several sizes; suitable for stand-off insulators for high-voltage circuits, mountings for condensers, tank coils, etc. Ends tapped.

No.	Dia.	Length	Tap	Net
27-1013	3/4"	3/4"	6-32	\$0.07
27-1014	3/4"	1 1/4"	6-32	.10
27-1015	3/4"	2"	6-32	.10
27-1016	1/2"	3/4"	6-32	.14
27-1017	1/2"	2"	6-32	.27
27-1018	1/2"	2 1/2"	6-32	.30
27-1019	1/2"	3 1/4"	6-32	.33

ANTENNA RELAY

Provides efficient, fast, and noiseless switching of the antenna from receiver to transmitter. Ceramic insulated; handles a full KW; metal parts chromium plated. Works on 110 volts AC; base is 3 1/4" by 4 1/4"; only 2 1/4" high!



No. 28-1004—Antenna Relay. Net Price....\$4.65

R-F RELAYS



Fully insulated with highest-grade ceramic; may be used in any R-F or power circuit, regardless of frequency. Large contacts and long-life phosphor-bronze springs insure efficient operation with minimum losses; for 110 v. AC.

No. 28-1001—D-P-D-T R-F Relay. Net.....\$3.65

No. 28-1002—S-P-D-T R-F Relay. Net.....2.65

POWER RELAY

Designed to handle 20 amperes, non-inductive load; has "double-break" contact system; heavy 5/16" silver contacts; operates on 110 volts AC; bakelite base.



No. 28-1003—Power Relay.....Net Price \$3.00

KEYING RELAY



Very compact; will break up to 1500 volts at contacts; operates on 5 to 15 volts AC; adjustable tension spring; single "make circuit" type; bakelite insulated.

No. 28-1000—Keying Relay.....Net Price \$2.35

TRANSMITTER CHOKES

Highly efficient for Amateur and Commercial use; six lateral wound sections provide effective action over wide frequency range. Windings on ceramic form w/h tapped ends; mounting brackets included.

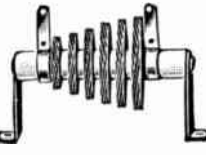

Cat. No.	Induct.	Current	Ohms	Net
19-3019	2.8 MH	1000 MA	5.0	\$1.35
19-3022	5.5 MH	500 MA	12.5	1.20
19-3025	5.9 MH	200 MA	34.9	1.20

UNIVERSAL R-F CHOKES



Pie-wound on ceramic cores with heavy tinned leads; cast metal ends; low DC resistance with high effective inductance; very low distributed capacity; maximum efficiency.

Cat. No.	Induct.	Current	Ohms	Net
19-1996	2.5 MH	125 MA	35	.18
19-1997	5.5 MH	125 MA	65	.45
19-1998	8.0 MH	125 MA	77	.54
19-1999	16.0 MH	100 MA	115	.66
19-1993	30.0 MH	75 MA	260	.75

CERAMIC OCTAL SOCKETS

For any high-frequency circuit; glazed ceramic insulation with heavy steel mounting saddle; fits standard 1 1/4" centers, uses 1 1/4" hole; four grounding lugs formed on saddle; bronze contacts.



No. 25-8437—Ceramic Socket.....Net, each \$0.24

No. 25-8439—Carton of Six.....Net \$1.35

INTERRUPTION-FREQ. OSC. COIL



Two high-impedance, universal-wound coils, mounted on a single form with iron cores to provide high inductance. Specially designed for use in super-regenerative receivers, operating on ultra-high frequencies, 30 to 120 mc. Bakelite terminal base.

No. 14-7832.....Net Price \$0.90

DUAL-CONTROL DIAL

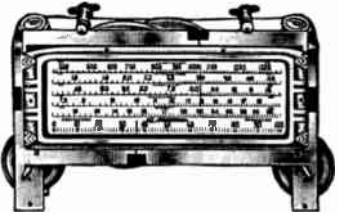

A super-smooth tuning mechanism of great precision, specially designed for use with the Hand-spread Condenser below. Used on Meissner Traffic Master and Traffic Scout receivers; has two 3/4" dia. operating shafts, both equipped with flywheels; dual drums have 3/8" and 3/16" hubs to fit condenser shafts. Translucent scale, rear illuminated, 5-bands calibrated 540 kc to 31.6 mc.

No. 23-8229—Dual Control Dial.....Net \$8.25

BANDSPREAD TUNING CONDENSER

Finest precision tuning condenser available; designed for Meissner Communications Receivers with dual-control dial above; fully ceramic insulated; rigid spacing bars and heavy end plates maintain perfect alignment; main tuning section closes clockwise and has 280 mmf max.; bandspread section closes counter clockwise; main shaft is 3/8"; bandspread shaft, 3/16".

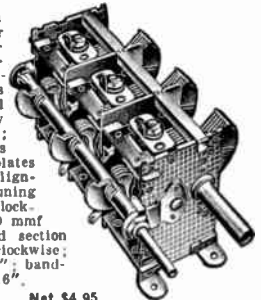

No. 21-5143B.....Net \$4.95

MIDGET VARIABLE CONDENSER

Standard type with low-loss bakelite insulation; excellent for general use in short-wave receivers; single-hole mounting, 1/4" diameter shaft; metal end-plate with long sleeve bearing and bronze rotor wiper; takes 3/8" hole in panel up to 1/4".



Cat. No.	Plates	MMf. Range	Net
21-5163	3	3.0 to 15	\$0.60
21-5164	5	3.2 to 30	.63
21-5168	14	4.3 to 100	.94
21-5170	20	5.0 to 140	.96

MIDGET CERAMIC VARIABLE

Exceptionally compact; ceramic plate is only 15/16" by 1 1/4"; fits in single 3/8" dia. hole in any panel up to 1/4" thick; long sleeve bearing eliminates wobble; ideal for all high-frequency work.



Cat. No.	Plates	MMf. Range	Net
21-5173	3	2.4 to 10	\$0.90
21-5174	7	3.0 to 25	.93
21-5175	14	3.5 to 50	.99
21-5176	20	4.5 to 75	1.05
21-5177	27	5.0 to 100	1.11
21-5178	37	6.5 to 140	1.17

CERAMIC ROTARY SWITCHES

A new type switch especially built for Amateur and commercial application in transmitters, U-I-F receivers, converters, etc. Switch wafers are of high-grade, low-loss ceramic, close-packed to reduce humidity effects to a minimum. Contacts are silver plated for lower resistance; adjustable stop permits use of as many positions as required; moving contact shorts adjacent points during rotation—circuit is never open. Arranged for mounting in single 3/8" diameter hole on any panel up to 1/4" in thickness; over-all diameter is 1 1/8"; wafers are 1 1/8" apart; may be shortened by cutting spacers; flatted, 3/4" dia. shaft extends 2" from front bushing.



Cat. No.	Gangs	Poles	Positions	Net
24-8270	One	One	2 to 12	\$1.85
24-8271	Two	Two	2 to 12	3.00
24-8272	Three	Three	2 to 12	4.15





EDWIN I. GUTHMAN & CO., INC.

15 SOUTH THROOP STREET ★ CHICAGO

PRECISION MANUFACTURERS AND ENGINEERS OF RADIO AND ELECTRICAL EQUIPMENT

GUTHMAN SUPER "Q" WIRE

Prior to the war the EDWIN I. GUTHMAN & CO., INC., Engineering Department realized there would be a need of a substitute for silk insulated wire. Our research resulted in a textile insulated wire, which qualifies electrically and has the same space factor as is found in silk covered wire. This wire is available in sizes No. 20 AWG and finer, in both Solid and Litzen-draht. GUTHMAN wire can be also purchased with any of the standard textile coverings now available.

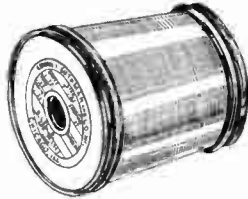

GUTHMAN MOLDED PAPER CONDENSERS

GUTHMAN paper condensers molded in type CMP 20 case for low voltage use are available up to 0.1 mmfd. capacity. This type condenser is best adapted for use in circuits where the D.C. voltage does not exceed 120 volts. Due to the compactness of this unit, it is being widely used for small battery equipment. This unit is built to meet the rigid specifications of the Signal Corps. In the manufacturing of this condenser the finest Kraft Paper and Aluminum Foil are used and the unit is given a transformer oil impregnation, which insures uniformity of quality. The unit is then molded in a high grade bakelite case, normalized and heat treated, then vacuum impregnated at high temperature. Samples upon request.



GUTHMAN COILS



R. F.

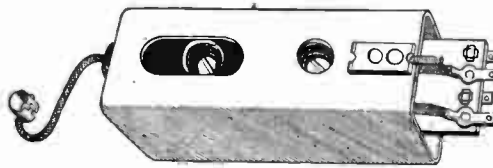

I. F.

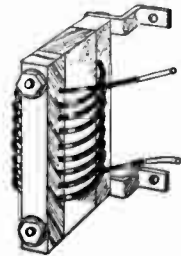

TRANSMITTING

GUTHMAN coils are available in any type of winding. Wound on winding machines of our own design to insure uniform production. Due to our part in the war effort, we have no standard coils available at this time, hence all are made to manufacturer's specification. We are making coils for all applications. Our engineering department is at the service of all manufacturers who at this time are making changes in their coil designs.

STANDARD CHOKES

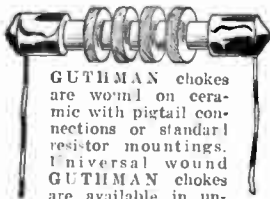

GUTHMAN chokes are wound on ceramic with pigtail connections or standard resistor mountings. Universal wound GUTHMAN chokes are available in unlimited ranges of inductances.

GUTHMAN TRIMMER CONDENSER



Clear India Ruby Mica and finest Ceramic are used. All capacities manufactured. Die-electric can be supplied plain or silver mica. Units are normalized and heat treated for minimum drift characteristics. Made to your specifications.

HARDWARE



Hardware for radio trade, such as small metal stampings and screw machine parts, are available to your specifications.

SHIELD CANS



GUTHMAN shields are made of the finest zinc and are supplied directly from mill to manufacturer. These shields can be had in any of the standard sizes. Special shields on request. Shields can be supplied perforated, spade bolt mountings, and in any finish desired.

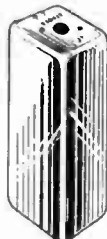

GUTHMAN MOLDED MICA CONDENSERS

CMP20 Type 20 mica condensers are now being manufactured by GUTHMAN. Capacitors are manufactured using India Ruby Mica die-electric, and a high grade bakelite molded case. Units are 100% normalized and vacuum impregnated. Are available in capacities from 2½ mmfd. to 470 mmfd. Any tolerances. Units are color coded to American War Standards Association.



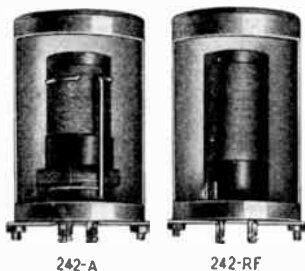

242-A 242-RF

Bank-Wound Litz Coils

For the designer or custom set builder who desires to employ the finest coils available, the bank-wound series coils are admirably suited.

Particular care has been taken in the design of these coils to produce the most efficient winding for use at broadcast frequencies. The coils are wound with Litzendraht wire in a two-layer bank, using a bakelite form as the winding base. Every precaution is taken to produce an excellent coil of consistently uniform quality, and with this end in view constant inspection during manufacturing and a final test upon completion assures the customer of a coil of unsurpassed quality. The RF coils provide uniform amplification over the broadcast band by the use of a combination of inductive and capacitive coupling in the primary circuit. Supplied with shields 1 7/8" x 3". For use with a .000365 mfd. variable condenser to cover the band from 540 to 1600 KC.

	List Price
No. 242-A Antenna Coil	\$.90
No. 242-BP Band-Pass Coil75
No. 242-RF RF Coil90
No. 277 Oscillator Coil (Available for all frequencies).....	.75

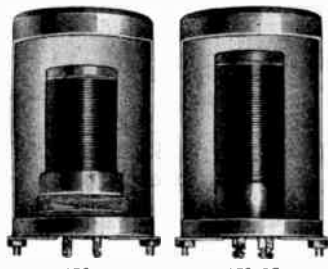

472-A 472-RF

Threaded Solenoid Coils

High impedance coupled type antenna and RF coils wound with solid enameled wire on threaded bakelite tubing.

Coupling turns are provided to prevent loss of energy at the high frequencies and to properly phase the antenna with the grid circuit. The RF coil primaries are also duo-lateral wound but are placed inside the secondary and are designed to match the impedance of the modern screen grid tubes. Adaptable for any TRF or super-heterodyne receiver. Supplied with shield 2 1/8" x 3 1/2" long. For use with .000365 mfd. variable condenser to cover the band from 540 to 1600 KC.

	List Price
No. 472-A Antenna Coil	\$.85
No. 472-RF RF Coil85
No. 472-BP Band-Pass Coil80

Untuned RF Coil

To be used in wide range TRF receivers and diode detector circuits. Maximum gain is obtained at the low frequency end of the band. Frequency range 540-1700 KC. Complete with aluminum shield 1 1/8" x 2 1/2" long.

	List Price
No. 472-UT Untuned RF Coil.....	\$1.50



277-477

Solenoid Oscillator Coils

These oscillator coils are designed for use with pentagrid converter tubes or the 6L7 mixer. The 277 series is particularly designed for use with the No. 242 antenna and RF coils, while the 477 type are recommended for use with the 472 type coils. However, these units will track with any of our standard coils when the proper oscillator padding condenser is incorporated in the circuit. All the above coils are available for use with any of the popular intermediate frequency amplifiers and may be obtained for use either shielded or unshielded. However, it is important that you specify whether the shielded or unshielded coil is desired upon ordering. If no specifications are given, the shielded type coil will be shipped. The shielded coils are supplied with the proper shields as listed below:

277 Type.....	1 7/8" x 3"	Shield
477 Type.....	2 1/8" x 3 1/2"	Shield

For use with standard .000365 mfd. variable condenser to cover the band from 540 to 1600 KC. Available for use with the following intermediate frequency amplifiers.

	List Price	
	Shielded	Unshielded
277 Series		
No. 277-M for 132 1/2 KC.....	\$.75	\$.50
Requires .0016 mfd. Series Pad.		
No. 277-K for 175 KC.....	.75	.50
Requires .001 mfd. Series Pad.		
No. 277-H for 262 1/2 KC.....	.75	.50
Requires .0006 mfd. Series Pad.		
No. 277-C for 465 KC.....	.75	.50
Requires .0004 mfd. Series Pad.		
477 Series		
No. 477-M for 132 1/2 KC.....	\$.85	\$.50
Requires .0016 mfd. Series Pad.		
No. 477-K for 175 KC.....	.85	.50
Requires .001 mfd. Series Pad.		
No. 477-H for 262 1/2 KC.....	.85	.50
Requires .0006 mfd. Series Pad.		
No. 477-C for 465 KC.....	.85	.50
Requires .0004 mfd. Series Pad.		

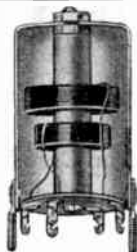

High Frequency Interrupter Coil

The ideal coil for super-regenerative 5 and 10 meter receivers. Carefully designed and tested to give the correct interrupter frequency. Assembled in aluminum shield 1 1/4" dia. x 2" long.

	List Price
No. 313 Interrupter Coil.....	\$1.00

Untuned Antenna Coil

Designed for use in high fidelity TRF and midget receivers. Antenna is connected through series condenser of approximately 100 uuf. to tap near ground end of coil. Complete with aluminum shield 1 1/8" diameter x 2 1/2" long.

	List Price
No. 472-UA—Untuned Antenna Coil....	\$1.25



EL-58

No. EL-58 10 KC Filter

(For Hi-Fidelity Receivers)

A shielded filter designed to eliminate the 10 KC whistle present in wide range broadcast receivers. It is a resonant filter to be used in the plate circuit of a triode A.F. amplifier or the diode load circuit. The attenuation to 10,000 cycles is approximately 30 db. The filter consists of a high inductance iron core winding shunted by a variable trimmer condenser operating at approximately 85 uuf.

The No. EL-58 filter is assembled in an aluminum shield 1 1/2" square x 2 1/2" long provided with spade bolts for mounting. This is an essential part for your high fidelity receiver.

No. EL-58 10 KC Filter.....	List Price
	\$2.25



EL-56

Negative Mutual Coupling Coils

These coils were designed for use in band-pass circuits of wide range receivers. They may also be used for high fidelity monitors and air-check receivers as well as for the general high fidelity broadcast receiver. They are identical with those supplied with our No. EL-570 coil kit and may be used with either the 242 or 472 type RF coils.

The coils are bifilar wound on a 7/8" diameter x 1 1/4" long bakelite form, which is provided with two "L" brackets for mounting. They are sold complete with an aluminum shield 1 7/8" diameter x 2" long.

	List Price
No. EL-56—Negative Mutual Coupling Coil	\$.75

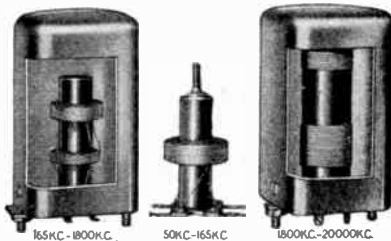

165KC-1800KC. 50KC-165KC. 1800KC-20000KC.

Test Oscillator Coils

Model 550 Test Oscillator Coils are for use in an electron coupled oscillator circuit of the high "C" type using a standard 2-gang variable condenser with the sections connected in parallel except for the highest frequency range. The frequency range is from 50 KC to 20,000 KC in five bands. Higher frequencies may be obtained by using the second harmonic.

	List Price
No. T-550 Test Oscillator Coils (Per Set)	\$3.75

Miller RADIO PRODUCTS

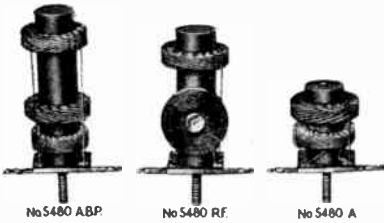

Duo-Lateral Wound Coils

When the space for mounting coils is restricted yet efficiency must not be sacrificed, the No. 5480 type coil is recommended. Secondaries are duo-lateral wound with multi-strand Litzendraht wire upon a 1/2" diameter dowel, offering the most efficient type of winding of any coil of equal size. Supplied in all types including an antenna-band-pass consisting of an antenna primary and secondary and an additional secondary inductively coupled, providing a complete pre-selector stage in one unit. Photographs are approximately one-third the actual size.

The 5480 series oscillator coils are recommended for use with these coils. For use with a .000365 mfd. variable condenser to cover the band from 540 to 1600 KC.

No. 5480-A	Antenna Coil	List Price
No. 5480-ABP	Ant.-Band-Pass Coil	\$.70
No. 5480-RF	RF Coil	1.00
		.80



**No. 5480 Duo-Lateral
Oscillator Coils**

The following oscillator coils are designed for use with the 2A7, 6A7, 6A8, 6L7-6C5 type oscillator circuits and are available for use with any of the popular intermediate frequency amplifiers. They may be employed with any of our RF or antenna coils. The photograph is approximately one-third actual size. For use unshielded with .000365 mfd. variable condenser to cover the band from 540 to 1600 KC. Available for the following intermediate frequencies:

No. 5480-K for 175 KC.	List Price
Requires .001 mfd. Series Pad.	\$.60
No. 5480-H for 262 1/2 KC.	.60
Requires .0006 mfd. Series Pad.	
No. 5480-C for 465 KC.	.60
Requires .0004 mfd. Series Pad.	

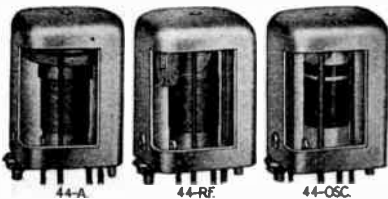

Four Bank Litz Coils

The Series 44 four-bank Litz wound broadcast band coils are especially recommended for use in auto receivers where a coil of maximum gain and small physical size is required. They may also be used in any broadcast band receiver. The RF coils are of the high impedance primary constant gain type. These coils are designed to be used with the standard .000365 mfd. variable condenser. The coils are supplied with aluminum shields 1 1/2" square x 2 1/2" long. Spade bolts are riveted to the shield for mounting to the chassis. Frequency range 540 to 1700 KC.

No. 44-A	Antenna Coil	List Price
No. 44-RF	RF Coil	\$.85
No. 44-BP	Band-Pass Coil	.85
No. 44-C	Oscillator Coil	.75
	(465 KC I.F.—.0004 Pad.)	
No. 44-H	Oscillator Coil	.75
	(262 KC I.F.—.0006 Pad.)	

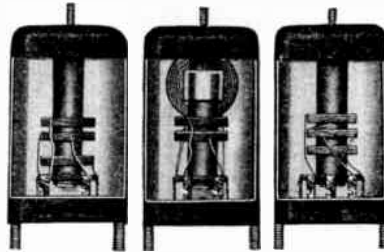

**No. 73 Universal Replacement
Coils**

(535-1700 KC)

To meet the long felt need of the serviceman and experimenter we have developed a series of compact iron core variable inductance broadcast band RF transformers. By means of the adjustable iron core, the inductance may be adjusted for use with any variable condenser whose maximum capacity is between 250 and 410 uuf. The oscillator coil may be adjusted for use with any intermediate frequency amplifier between 100 and 550 KC. May be used as replacement coils for almost all receivers and for experimental work. Save time and give better service by keeping a stock of these coils on hand at all times. The coils are housed in black Kem-Art finished aluminum shields. Dimensions 1 1/2" square x 2 1/2" long, spade bolt mounting center 1 7/16". Complete instructions included with each coil.

No. 73-A	Universal Antenna Coil	List Price
No. 73-RF	Universal RF Coil	\$2.00
No. 73-O	Universal Oscillator Coil	2.00

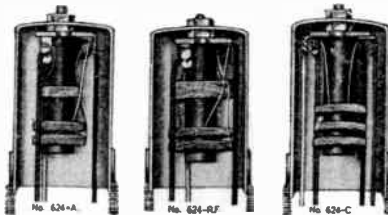

No. 624 Iron Core RF Coils

540 to 1700 KC

The No. 624 Series iron core coils are especially desirable for use in auto and other receivers where a high Q coil of small physical size is required. The secondaries are wound on Miller iron cores and No. 15/41 Litz wire is used. All coils are assembled in aluminum shields 1 1/4" x 2" long. Provided with spade bolts for mounting, 1 3/8" centers. For use with .000365 ufd. variable condenser. List Price

No. 624-A	Antenna Coil	\$1.50
No. 624-RF	RF Coil	1.50
No. 624-C	Oscillator Coil	1.50
	(Requires .0004 series pad.)	
No. 624-H	Oscillator Coil	1.50
	(Requires .0006 series pad.)	
No. 624-K	Oscillator Coil	1.50
	(Requires .001 series pad.)	

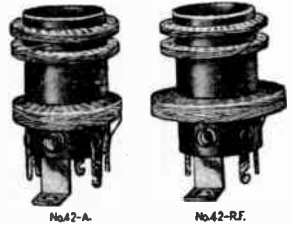

High-Gain Midget Coils

We believe the Miller type 42 coils to be the finest available for TRF receivers where it is desired to use unshielded coils. They are particularly designed for the popular 4-tube midget TRF receivers and will give performance comparable to many four and five tube superheterodynes. They provide uniform high gain and sensitivity throughout the entire broadcast band. The antenna coil is adjusted to give maximum results when using the short indoor aeriels generally used with this type of receiver. These coils use high impedance type coupling and are duo-lateral wound on 1/8" dia. x 1 1/2" long bakelite tubing. The secondaries are wound very narrow to reduce distributed capacity and to decrease RF resistance. To further reduce RF resistance, No. 15/41 silk covered Litz wire is used in the secondaries. The primaries are designed to work efficiently with the pentode type of RF tubes. The coils are for use with the standard .000365 mfd. variable condenser to cover the band from 540 to 1600 KC.

No. 42-A	Antenna Coil	List Price
No. 42-RF	RF Coil	\$.70
		.70

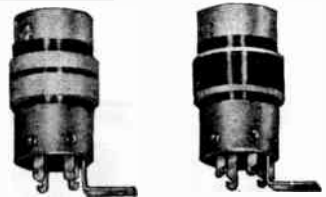

20-A 20-RF
Midget Type Solenoid Coils
on Cardboard Forms

Pictured above are our No. 20 Antenna and RF coils, which are universally accepted as the standard of comparison in 4-tube TRF receivers. Wound with enamelled wire on an especially impregnated Kraft tubing form, they offer a very inexpensive and efficient coil for use in receivers of this type where cost must be held to an absolute minimum. Both the antenna coupler and RF coil are of the transformer type, the primaries being wound on slip-over forms allowing easy adjustment of the coupling. The RF primaries have sufficient inductance to work efficiently with modern tubes. For use unshielded with .000365 mfd. variable condenser to cover the band from 550 to 1750 KC.

No. 20-A	Antenna Coil	List Price
No. 20-RF	RF Coil	\$.35
		.35
Tapped for 2400 KC Police		
No. 20-T-A	Antenna Coil	.40
No. 20-T-RF	RF Coils	.40

Peter Pan Type Coils

We can also supply coils in which the primary coupling is very tight, providing maximum gain at all frequencies. This is the same identical coil as used in the thousands of Peter Pan receivers marketed during the past few years.

No. PP-A	Peter Pan Antenna Coil	List Price
No. PP-RF	Peter Pan RF Coil	\$.40
		.40

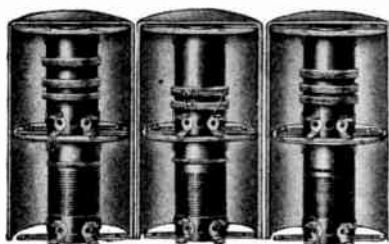

ALL WAVE COILS Miller "Select-Ur-Band" Coils

A new series and type of coil designed to meet the exacting demands of the experimenter and custom set builder for a high quality receiver covering one or more bands and using one or more RF stages or only a mixer stage. The Miller No. 727 "Select-Ur-Band" Coils are truly flexible in their application and may be assembled to suit your individual requirements. For a superheterodyne they are for use with a 465 KC intermediate frequency amplifier. Each coil of each band is a separate unit and all are so designed that any pair may be assembled in a single shield. All coils are wound on 7/8" dia. x 1 3/4" long bakelite tubing and are of correct form factor and of proper wire size to give maximum efficiency. The primaries are of the high impedance type designed for us with pentode type RF tubes. The use of the new Miller "Select-Ur-Band" Coils enables the experimenter or constructor to modernize old receivers by utilizing the 465 KC intermediate frequency amplifier and audio on the old receiver and installing an all wave or skip-band tuner.

The range of the individual bands is as follows:

Cat. No.	KC	Meters	Osc. Series Pad
X X-727	140-425	2100-700	.00012 uf.
A A-727	535-1500	560-200	.0004 uf.
B B-727	1500-4500	200-67	.001 uf.
C C-727	3750-11,000	80-27	.003 uf.
D D-727	8500-23,000	35-13	.01 uf.
E E-727	12,500-36,000	24-8	none
S S-727	5800-19,000	51-16	.003 uf.

Any two coils may be assembled—easily, using only a screw driver—to provide the bands required in a single coil shield and, of course, groups of two bands each may be used. Coils are not furnished assembled in shields.

Cat. No.	Purpose	List Price
BAND X		
X-727 A	—Antenna Coil	\$1.25
X-727 RF	—RF Coil	1.25
X-727 C	—Oscillator Coil—465 KC-I.F.	1.25
BAND A		
A-727 A	—Antenna Coil	1.00
A-727 RF	—RF Coil	1.00
A-727 C	—Oscillator Coil—465 KC-I.F.	1.00
BAND B		
B-727 A	—Antenna Coil	1.00
B-727 RF	—RF Coil	1.00
B-727 C	—Oscillator Coil—465 KC-I.F.	1.00
BAND C		
C-727 A	—Antenna Coil	1.00
C-727 RF	—RF Coil	1.00
C-727 C	—Oscillator Coil—465 KC-I.F.	1.00
BAND D		
D-727 A	—Antenna Coil	1.00
D-727 RF	—RF Coil	1.00
D-727 C	—Oscillator Coil—465 KC-I.F.	1.00
BAND E		
E-727 A	—Antenna Coil	1.00
E-727 RF	—RF Coil	1.00
E-727 C	—Oscillator Coil—465 KC-I.F.	1.00
BAND S		
S-727 A	—Antenna	1.00
S-727 RF	—RF Coil	1.00
S-727 C	—Oscillator Coil—465 KC-I.F.	1.00

COIL SHIELDS		
L-727 2 1/16"	Dia. x 4" Long	
Coil Shield		\$.40
S-727 2 1/16"	Dia. x 2 1/2" Long	
Coil Shield		.25

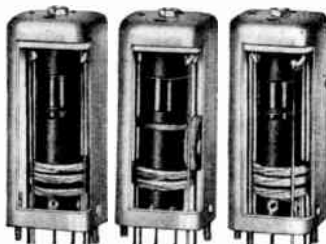

Two-Band Coils

The ideal coil for the constructor who wishes to build an inexpensive 2-band receiver covering both the standard broadcast band and either of two short wave bands.

The coils are wound on high grade bakelite tubing 3/4" in diameter and are approximately 3" long. Assembled in shields 1 3/8" sq. by 3 1/2" with trimmer condensers. The broadcast band coils are sectional duo-lateral wound and the short wave coils are solenoid wound. The coils are for use with a standard .000365 mfd. variable condenser. For 465 KC I.F.

Frequency range
540-1500 and 1500-4500 K.C.

	List Price
No. 3996-A 2-band Antenna Coil	\$2.50
No. 3996-RF2-band RF Coil	2.50
No. 3996-C 2-band Oscillator Coil	2.50
Oscillator Series Pad Condensers	
Broadcast band	.0004 mfd.
Short wave band	.001

Frequency Range
540-1500 and 5500-18000 KC

	List Price
No. 3997-A 2-band Antenna Coil	\$2.50
No. 3997-RF2-band RF Coil	2.50
No. 3997-C 2-band Oscillator Coil	2.50
Oscillator Series Pad Condensers	
Broadcast band	.0004 mfd.
Short wave band	.01

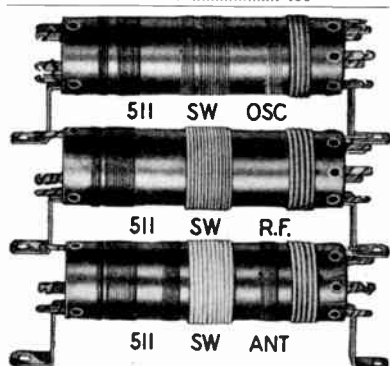

Three Band Short Wave Coils

(12 to 200 Meters.)

These coils are identical with those used in our No. 511 and No. 302 coil kits. The oscillator coil is designed for use with a 465 KC I.F. amplifier. Three separate coils are wound on a single high-grade bakelite form and the spacing between coils is great enough to prevent dead spots and excessive absorption effects. While not designed to be shielded, they may be used with partitions between coils providing that clearance of at least one inch from the partition or chassis to the coil is maintained. When used with a .000365 mfd. variable condenser the three bands are: 12 to 35 meters—35 to 75 meters—75 to 200 meters.

	List Price
No. 511-SW-ANT Antenna Coil	\$1.75
No. 511-SW-RF RF Coil	1.75
No. 511-SW-OSC Oscillator Coil	1.75

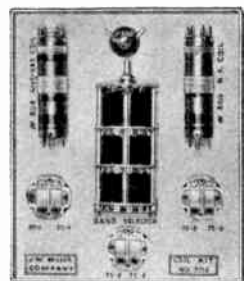

No. 302 Short Wave Pre-Selector Coil Kit

The Miller No. 302 Pre-Selector Coil Kit enables you to construct a highly efficient unit using two stages of tuned radio frequency amplification to be used ahead of any short-wave or all-wave receiver. The Miller Pre-Selector will give a tremendous increase in sensitivity, and it will actually bring in stations which you are now unable to receive with your present set. By increasing the signal voltage to the mixer tube of superheterodyne type receivers, the pre-selector will materially reduce background noise when receiving weak stations. Regardless of the number of tubes or the type of receiver you are now using, the Miller Pre-Selector will positively bring in more DX reception. Provision has been made for the incorporation of coils for the broadcast band.

A self-contained power supply and an extra position on the band switch for shunting the antenna around the pre-selector directly to the receiver are among the many conveniences offered by the new Miller Pre-Selector. Complete detailed data may be yours for the asking.

	List Price
The Miller No. 302 Pre-Selector Coil Kit contains the following parts	
1 No. 302 S.W. Antenna (12 to 200 Meters)	\$1.75
1 No. 302 S.W. RF Coil (12 to 200 Meters)	1.75
1 No. 302 Output Choke Coil	.50
1 No. 605 Band Selector Switch	2.40
3 No. 35 Dual Trimmer Condensers (@ .50)	1.50
1 Blue Print and Complete Instruction Data	.25
Miller No. 302 Pre-Selector Coil Kit, List Price	\$8.00



Complete Pre-Selector

The Miller No. 302 Pre-Selector described above is also available completely wired and factory tested, housed in an attractive metal cabinet with airplane type dial. Complete with tubes and power supply. If you would prefer to buy your equipment "tailor-made," here is a real opportunity.

	List Price
Model 302 Pre-Selector Complete—12 to 200 Meters	\$40.00
Model 302 Pre-Selector Complete—12 to 540 Meters	44.00
Model 302 Pre-Selector Complete—8 to 200 Meters	44.00

Miller

RADIO PRODUCTS



No. 711 All-Wave Superheterodyne Coil Kit

12 to 550 Meters

Many new features are to be found in this design, including the use of high impedance coupled antenna coils on the short-wave and broadcast bands.

If you have deferred the purchase of an All-Wave Kit because you have felt that construction of such a receiver would be too difficult or you have perhaps been prejudiced by the performance claims of cheap, inferior kits, using only three or four tubes in what is essentially a makeshift circuit, you need wait no longer. Just follow the simple, easy instructions included in the Miller No. 711 kit and you will be amazed at the remarkable performance of this all-wave receiver, which has been carefully designed and thoroughly tested to give the ultimate in short-wave reception.

The receiver you build, whether for yourself or for a customer, must be good, and such a receiver is easily constructed with the new, improved Miller Model 711 All-Wave Superheterodyne Coil Kit.

Additional information will gladly be supplied upon request. The following items are supplied in the Miller No. 711 Coil Kit:

- | | |
|-------------------------------------|--------|
| 1 B.C. Antenna Coil No. 711-Ant. | \$.80 |
| 1 B.C. Translocator Coil No. 711-A. | 1.75 |
| 1 75-200 Meter S.W. Coil No. 711-B. | 1.25 |
| 1 35-75 Meter S.W. Coil No. 711-C. | 1.50 |
| 1 12-35 Meter S.W. Coil No. 711-D. | 1.25 |
| 1 Input I.F. No. 711-1. | 1.60 |
| 1 Interstage I.F. No. 711-2. | 1.60 |
| 1 Output Stage I.F. No. 711-3. | 1.60 |
| 2 Dual Trimmers No. 35 (@ 50). | 1.00 |
| 4 Accurate Osc. Pad. Condensers. | 1.35 |
| 1 Rectifier Plate Choke No. 80-F. | 1.00 |
| 1 Osc. Coup. Condenser No. C-14. | .20 |
| 1 Band Selector Switch No. 404. | 1.60 |
| 1 Blue Print | .25 |

Complete Instructions and Data.

- | | |
|-------------------------------------|---------|
| Miller No. 711 All-Wave Kit | \$16.00 |
| Miller No. 711-B for 2 Volt Battery | 16.00 |
| Miller No. 711-M for Metal Tubes | 16.00 |

No. 724 7-Tube Superheterodyne Coil Kit

540 to 1600 KC

The signal frequency coils are of Litz bank-wound construction offering a most selective coil for use at broadcast frequencies. The two stage intermediate frequency amplifier is extremely selective and provides for a sensitivity of approximately one microvolt per meter in the completed receiver. All coils and I.F. transformers in this kit are supplied in shields 1 7/8" diameter x 3" long and are for 175 KC. Kit contains the following parts:

- | | |
|-------------------------------------|--------|
| 1 No. 242-A Antenna Coil | \$.90 |
| 1 No. 242-RF RF Coil | .90 |
| 1 No. 242-K Oscillator Coil | .75 |
| 1 No. 412-K-1 Input I.F. | 1.60 |
| 1 No. 412-K-2 Interstage I.F. | 1.60 |
| 1 No. 412-K-4 Half Wave Output I.F. | 1.60 |
| 1 .001 3% Mica Padding Condenser | .25 |
- Miller No. 724 7-Tube Superheterodyne Coil Kit.....\$7.50

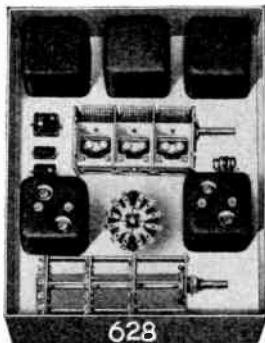

AIRCRAFT RADIO COIL KIT No. 628

A coil kit designed for constructing a highly efficient and compact 3-band receiver to meet the needs of the private flyer. Frequency range—140/425 KC—540/1600 KC—2.5/7.0 MC. 3-band signal frequency coils are assembled in 2" square by 4 1/4" long aluminum shields with built in high frequency trimmers. The antenna coil primaries are of the low impedance type for use with the short aircraft antenna. A single stage of iron-core air-tuned 465 KC I.F. is used. All windings are fully protected by a baked glyptal coating. The kit consists of the following parts:

- | | |
|--|---------|
| 1 No. 628-A 3-Band Ant. Coil | \$ 4.00 |
| 1 No. 628-RF 3-Band R.F. Coil | 4.00 |
| 1 No. 628-C 3-Band Osc. Coil | 4.00 |
| 1 No. 1112-C-2 Input I.F. | 5.50 |
| 1 No. 1112-C-4 Output I.F. | 5.50 |
| 1 No. 605 Band Switch | 2.40 |
| 1 No. 402 Switch | 1.00 |
| 1 No. 2103 3-Gang Var. Cond. | 3.75 |
| 1 .00012 3% Tol. Osc. Pad Cond | .25 |
| 1 .0004 3% Tol. Osc. Pad Cond | .25 |
| 1 .0016 3% Tol. Osc. Pad Cond | .25 |
| 1 Circuit Diagram and Chassis Layout Print | .25 |

No. 628 COIL KIT. LIST PRICE.....\$31.00
(parts may be purchased separately.)

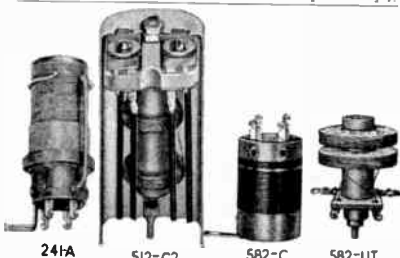

No. 582 Five Tube Economy Superheterodyne Coil Kit

(540 to 1700 KC.)

This coil kit may be utilized to construct a very economical and efficient five tube superheterodyne using the autodyne type oscillator circuit. The standard double tuned shielded I.F. transformer for the input stage and an untuned self-resonant I.F. transformer coil for the output stage provide maximum gain and selectivity. The intermediate frequency amplifier operates at 465 KC.

The coil kit consists of the following parts:

- | | |
|--------------------------------------|--------|
| 1 No. 241-A Antenna Coil | \$.70 |
| 1 No. 582-C Oscillator Coil | .25 |
| 1 No. 512-C-2 Input I.F. Transformer | 1.25 |
| 1 No. 582-UT Output I.F. Transformer | .75 |
| 1 .0004 3% Mica Padding Condenser | .25 |
| 1 No. 582 Blue Print | .25 |
- Miller No. 582 Economy Super Coil Kit. List Price.....\$3.25



No. EL-570 HIGH FIDELITY TUNER COIL KIT

The new Miller EL-570 High Fidelity Coil Kit is without doubt the finest set of coils available for constructing a true fidelity RF tuner. In order to obtain the lowest possible inherent set noise level, a tuned radio frequency circuit has been employed rather than the more commonly used superheterodyne. The circuit arrangement is as follows: An untuned antenna coil, two stages of negative mutual coupled band-pass circuits followed by an untuned RF coil feeding the detector tube. A 10 KC audio whistle filter is included with the kit and is to be used in the detector load circuit to prevent heterodyning from adjacent channels. Included with the kit is a 4-gang condenser of the latest bar type low minimum capacity construction.

The over-all RF circuit has a flat top response curve of between 20 and 23 KC. Due to the construction of the RF band-pass coils, which have an exceptionally high Q, the sides of the response curve are quite steep. The curve is approximately 32 KC wide at a voltage input ten times the resonant input.

This coil kit is particularly recommended for constructing a tuner to be used in making high quality air check recordings and for the discriminating experimenter.

Complete constructional data is available on request for the construction of either a tuner or the entire receiver, which uses fixed bias 2A3's in the output stage. The frequency range of the coils is from 540 to 1600 KC.

- | | |
|---|--------|
| 1 No. 472-UA Untuned Antenna Coil | \$1.25 |
| 2 No. 242-RF Bank-Wound RF Coils @ 90 | 1.80 |
| 2 No. 242-BP Bank Wound Band-Pass Coils @ .75 | 1.50 |
| 1 No. 472-UT Untuned Detector Coil | 1.50 |
| 2 EL-56 Negative Mutual Coupling Coils @ .75 | 1.50 |
| 1 EL-58 10 KC Audio Filter | 2.25 |
| 1 No. 2104 4-Gang Variable Condenser | 5.00 |
| 1 EL-570 Circuit Diagram Blue Print | .25 |

And Data Sheets
List Price
Miller No. EL-570 High Fidelity Coil Kit.....\$15.00

No. 924 9-Tube Superheterodyne Coil Kit

540 to 1600 KC

A coil kit for constructing a very fine broadcast band superheterodyne receiver using one stage of RF ahead of the mixer circuit and a two stage intermediate frequency amplifier followed by a push-pull Class AB pentode audio amplifier.

- | | |
|---|--------|
| 1 No. 242-A Antenna Coil | \$.90 |
| 1 No. 242-RF RF Coil | .90 |
| 1 No. 242-K Oscillator Coil | .75 |
| 1 No. 412-K-1 Input I.F. Transformer | 1.60 |
| 1 No. 412-K-2 Interstage I.F. Transformer | 1.60 |
| 1 No. 412-K-4 Output I.F. Transformer | 1.60 |
| 1 .001 3% Mica Padding Condenser | .25 |
| 1 No. 924 Blue Print | .25 |
- Miller No. 924 9-Tube Superheterodyne Coil Kit.....\$7.50

MILLER QUALITY PRODUCTS

Miller

RADIO PRODUCTS

INTERMEDIATE FREQUENCY TRANSFORMERS

CODE FOR ORDERING

We can supply from stock I.F. transformers in many popular intermediate frequencies and have adopted a code to facilitate ordering and identification of the various types as follows

Factory Adjusted to	Code Letter	Frequency Range
132½ KC	M	127 - 137 KC
175 KC	K	165 - 185 KC
262½ KC	H	250 - 275 KC
465 KC	C	450 - 475 KC
525 KC	O	500 - 550 KC
1500 KC	W	1400 - 1600 KC
3000 KC	X	2800 - 3200 KC
5000 KC	Y	4700 - 5300 KC
8000 KC	Z	7500 - 8500 KC

(Special frequencies can be supplied on order.)

Intermediate frequency transformers require different degrees of coupling for various circuit applications, and these are coded as follows:

No. 1 Input Stage—Has coupling adjusted for maximum selectivity and is for use between the mixer and the first I.F. amplifier tube when two or more stages are used.

No. 2 Interstage—Designed to be used as the interstage transformer in a two stage amplifier or as the input stage for a single stage amplifier. Coupling is adjusted to the optimum degree. May

also be used as the output transformer in an amplifier in which the second detector is a non-current consuming load, such as a bias detector of any type.

No. 3 Diode Transformer—For use as the output transformer to feed any full-wave diode detector circuit. The secondary is center tapped to provide equal voltage to both diode plates. Adjusted to provide over-coupling in order to prevent excessive selectivity, which would result in poor audio quality.

No. 4 Diode Transformer—This transformer is similar to the No. 3 type except that no center tap is provided.

No. 5 Beat Frequency Oscillator—An efficient electron-coupled type beat frequency oscillator transformer for CW use and for simplifying the logging of DX stations.

No. "CF" Crystal Filter Transformers—These transformers are sold in pairs for use in crystal filter circuits of amateur and commercial receivers. They replace the regular input transformer and are of the low impedance link coupled type.

Miller Intermediate Frequency Transformers are supplied in five standard shield sizes. Each size is available in types for use in any section of the intermediate frequency amplifier. Physical dimensions of the shields are as follows:

No. 212 Type—Outside dia. 2 1/8". Length 3 1/2". Spade bolt mounting centers 2".

No. 312—Outside dia. 1 3/8". Length 3". Spade bolt mounting centers 1 11/16".

No. 412 Type—Outside dia. 1 7/8". Length 3". Spade bolt mounting centers 1 11/8".

No. 512, 612, and 712 Types—1 1/2" square x 3 1/2" long. Spade bolt mounting centers 1 3/4".

No. 912, 1012 and 1112 Types—2" square x 4 1/2" long. Spade bolt mounting centers 1 7/8".

EXAMPLE OF THE USE OF PRECEDING

CODE: Suppose it is desired to order a set of intermediate frequency transformers to operate at 175 KC with a full-wave diode second detector. Should you desire to order the iron core air tuned type transformer, it is seen that the type number for this unit is No. 1112. As the frequency desired is 175 KC, by referring to the letter code you find 175 KC to be designated by the letter "K." As you desire three units, consisting of an input transformer, an interstage transformer, and an output transformer for a full-wave diode detector, you would order as follows:

- 1 Only No. 1112-K-1
- 1 Only No. 1112-K-2
- 1 Only No. 1112-K-3



Variable Selectivity I.F. Transformer

VARIABLE SELECTIVITY I.F. TRANSFORMERS

MILLER Variable Selectivity Intermediate Frequency Transformers have been designed to meet the combined demand for both the high degree of selectivity so necessary for good DX reception and for a band width great enough for the reception of high fidelity programs broadcast from nearby stations. This has been accomplished by a simple electrical method of changing coupling devised by Miller Engineers. It is the most simple and effective method available and does not require any form or type of mechanical adjusting control. A single pole double throw switch is all that is required with a single stage I.F. amplifier. The two positions of the switch provide for sharp and broad tuning. The "broad" position band width is approximately twice that of the "sharp" position for the particular type of I.F. transformer being used. Miller Variable Selectivity I.F. Transformers are available in several types and in all standard frequencies.

Type No.	Description	List Price
F#212	Air-Core Compression Trimmer. 2 1/8" dia. x 3 1/2" Shield.	\$2.00
F#312	Air-Core Compression Trimmer. 1 3/8" dia. x 3" Shield.	2.00
F#412	Air-Core Compression Trimmer. 1 7/8" dia. x 3" Shield.	2.00
F#512	Air-Core Compression Trimmer. 1 1/2" Sq. x 3 1/2" Shield.	2.00
F#612	Iron-Core Compression Trimmer. 1 1/2" Sq. x 3 1/2" Shield.	2.50
F#1012	Air-Core Air-Dielectric Trimmer. 2" Sq. x 4 1/4" Shield.	5.50
F#1112	Iron-Core Air-Dielectric Trimmer. 2" Sq. x 4 1/4" Shield.	6.00



No. 812

WAVE TRAPS

These units are designed to eliminate interference from amateur phone and CW stations and commercial transmitters in broadcast and short-wave receivers. They are also useful for reducing interference from powerful local broadcast stations. The Miller Wave Trap consists of a completely shielded high "Q" parallel resonant circuit and is compact and simple to install. The wave trap connects in series with the antenna, and if necessary several wave traps may be connected in series to eliminate interference from more than one station. Miller Wave Traps do not interfere with the normal operation of the receiver at frequencies other than that to which the wave trap is tuned. A screw driver adjustment is provided to tune the wave trap to the interfering frequency. Available for all standard frequencies and may be made on order for special frequencies. The dimensions of the unit are 1 3/8" diameter x 3" long.

Type No.	Description	List Price
812-X-1	425 to 525 KC	\$1.50
812-X-2	225 to 375 KC	1.50
812-X-3	150 to 225 KC	1.50
812-BC-1	1200 to 1800 KC (Standard)	1.50
812-BC-2	800 to 1200 KC (Broadcast)	1.50
812-BC-3	450 to 800 KC (Band)	1.50
812-A	160 Meter Amateur Band	1.50
812-B	80 Meter Amateur Band	1.50
812-C	40 Meter Amateur Band	1.50
812-D	20 Meter Amateur Band	1.50
812-E	10 Meter Amateur Band	1.50



DUAL WAVE TRAPS

While the ordinary single-circuit wave trap, such as our type 812, is satisfactory for most installations, quite often conditions are encountered making it necessary to provide a much higher degree of attenuation and a sharper resonance curve than can be obtained from either the series or parallel resonant circuit. To provide a satisfactory wave trap to be used under these extreme conditions we have developed a dual wave trap consisting of both a series resonant and a parallel resonant circuit separately shielded and assembled in a twin unit. This trap provides almost infinite attenuation at the resonant frequency and has a sufficiently sharp resonance curve to provide minimum attenuation at frequencies other than resonance. A separate tuning knob for each circuit is provided, and the entire wave trap is completely shielded. Mounting brackets enable the unit to be attached directly to the chassis of the receiver. Attractively finished in black "Kem-Art" baked enamel. Shield dimensions 1 3/8" wide x 2 3/4" long x 2" high.

List Price

- No. 813-BC-1 900-1600 KC Wave Trap..\$3.50
- No. 813-BC-2 500- 900 KC Wave Trap.. 3.50

MILLER QUALITY PRODUCTS

Miller

RADIO PRODUCTS

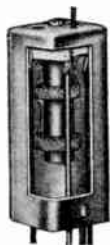

No. 512

Standard Replacement I.F. Transformers

The wise serviceman will carry a stock of these transformers at all times. They may be used for almost all makes of receivers. Constructed of the finest materials including aluminum shields, heat-treated low drift trimmers and a special winding impregnation which prevents electrolysis in warm, humid climate. Dimensions: 1 3/8" square x 3 1/2" high. Spade bolts are provided for mounting.

The actual frequency range of these replacement transformers is considerably greater than indicated below. However, most standard receivers use intermediate frequencies that are within the range given.

450 to 475 KC

	List Price
Input for 2-stage amplifiers	
No. 512-C-1	\$1.25
Interstage for 2-stage amplifiers	
No. 512-C-2	1.25
Input for single stage amplifiers	
No. 512-C-2	1.25
Output for full-wave diode	
No. 512-C-3	1.25
Output for half-wave diode	
No. 512-C-4	1.25

250 to 275 KC

Input for 2-stage amplifiers	
No. 512-H-1	1.25
Interstage for 2-stage amplifiers	
No. 512-H-2	1.25
Input for single stage amplifiers	
No. 512-H-2	1.25
Output for full-wave diode	
No. 512-H-3	1.25
Output for half-wave diode	
No. 512-H-4	1.25

165 to 185 KC

Input for 2-stage amplifiers	
No. 512-K-1	1.25
Interstage for 2-stage amplifiers	
No. 512-K-2	1.25
Input for single stage amplifiers	
No. 512-K-2	1.25
Output for full-wave diode	
No. 512-K-3	1.25
Output for half-wave diode	
No. 512-K-4	1.25

Beat Frequency Oscillators

For use in communications type receivers for CW signals and in short wave receivers to assist in tuning weak signals. An adjustment knob is provided on the top of the shield. The winding is of the tapped type for cathode feed-back in electron coupled circuits. May be used with either a triode or screen-grid tube. A circuit diagram is included with each transformer.

	Air Core Type	List Price
No. 512-K-5	165- 185 KC.....	\$1.75
No. 512-H-5	250- 275 KC.....	1.75
No. 512-C-5	450- 475 KC.....	1.75
No. 512-O-5	500- 550 KC.....	1.75
No. 512-W-5	1400-1600 KC.....	1.75
	Iron Core Type	
No. 612-K-5	165- 185 KC.....	\$2.25
No. 612-H-5	250- 275 KC.....	2.25
No. 612-C-5	450- 475 KC.....	2.25
No. 612-O-5	500- 550 KC.....	2.25
No. 612-W-5	1400-1600 KC.....	2.25

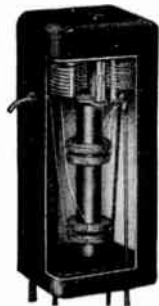

No. 1012

AIR TUNED TRANSFORMERS

Air Core and Iron Core

The air-dielectric condensers used in the MILLER Series 1012 and 1112 Intermediate Frequency Transformers are constructed on conventional time-proven principles and are not to be confused with some types using experimental and tricky designs. Soldered brass plates and ceramic construction is used throughout. A special tension shoe holds the rotor rigidly and permanently in adjustment when subjected to mechanical vibration and shocks. The condenser has an extremely low power factor and a "Q" approximately ten times as great as that of the ordinary mica compression type trimmer. In order to provide the utmost ease of adjustment the trimmer capacity is divided into two parts—approximately 70% of the total capacity being fixed and 30% variable. The entire capacity is, of course, air-dielectric. This method of construction gives the same effect as the use of parallel band spread used in Communication type receivers. Tuning adjustments are made from the top of the shield.

For UHF superheterodyne receivers our No. 1012 series high frequency I.F. transformers are the finest obtainable. The 1012 air-core series is available in the following stock frequencies: **K** type for 175 KC, **C** type for 465 KC, **W** type for 1500 KC, **X** type for 3000 KC, **Y** type for 5000 KC. The 1112 iron-core series is available in the following stock frequencies: **K** type for 175 KC, **H** type for 262 KC, **C** type for 465 KC.

Transformers for other frequencies are available on order.

MILLER Air-Tuned I.F. Transformers are assembled in attractive black "Kem-Art" finished aluminum shields 2" sq. x 4 1/4" long and are provided with 6/32 spade bolts for attaching to the chassis. The Series 1112 Transformers are the iron-core type.

Type No.	Description	List Price
(Air-Core Air-Dielectric Condenser Tuned I.F. Transformers)		
1012—Nos. 1, 2, 3, and 4		\$5.00
1012—No. 5 Beat Frequency Oscillator		5.25
F # 1012—Variable Selectivity		5.50
(Iron-Core Air-Dielectric Condenser Tuned I.F. Transformers)		
1112—Nos. 1, 2, 3, and 4		\$5.50
1112—No. 5 Beat Frequency Oscillator		5.75
F # 1112—Variable Selectivity		6.00



No. 612

Iron Core I.F. Transformers

Iron core intermediate frequency transformers give a great deal more gain and selectivity than can be obtained with the air core type. In many cases a single stage using iron core transformers will have the gain and selectivity of two stages of air core transformers and will have a lower noise level. In many cases an iron core transformer may be substituted for an air core unit in standard receivers to improve the performance.

1400 to 1600 KC

	List Price
Input for 2-stage amplifiers	
No. 612-W-1	\$2.00
Interstage for 2-stage amplifiers	
No. 612-W-2	2.00
Input for single stage amplifiers	
No. 612-W-2	2.00
Output for full-wave diode	
No. 612-W-3	2.00
Output for half-wave diode	
No. 612-W-4	2.00

450 to 475 KC

Input for 2-stage amplifiers	
No. 612-C-1	\$2.00
Interstage for 2-stage amplifiers	
No. 612-C-2	2.00
Input for single stage amplifiers	
No. 612-C-2	2.00
Output for full-wave diode	
No. 612-C-3	2.00
Output for half-wave diode	
No. 612-C-4	2.00

250 to 275 KC

Input for 2-stage amplifiers	
No. 612-H-1	2.00
Interstage for 2-stage amplifiers	
No. 612-H-2	2.00
Input for single stage amplifiers	
No. 612-H-2	2.00
Output for full-wave diode	
No. 612-H-3	2.00
Output for half-wave diode	
No. 612-H-4	2.00

165 to 185 KC

Input for 2-stage amplifiers	
No. 612-K-1	2.00
Interstage for 2-stage amplifiers	
No. 612-K-2	2.00
Input for single stage amplifiers	
No. 612-K-2	2.00
Output for full-wave diode	
No. 612-K-3	2.00
Output for half-wave diode	
No. 612-K-4	2.00

The mica compression trimmers used in Miller I.F. Transformers are treated with our exclusive automatic cycling heat treatment consisting of alternately heating to 200° F. and cooling to 90° F. through five complete cycles. This heat treatment results in a much higher degree of capacity stability, which in turn insures perfect alignment of the I.F. transformer under the conditions of varying temperatures encountered in the modern radio receiver.

MILLER QUALITY PRODUCTS

Miller

RADIO PRODUCTS

REPLACEMENT COILS

Miller replacement coils and windings are carefully constructed to duplicate as nearly as possible the original coil which they are designed to replace. All windings are thoroughly impregnated against moisture absorption. Replacement coils most commonly needed are listed below. However, we carry in stock and add to our stock from time to time new replacement units as the need arises. Special replacement coils which are not carried in stock may be made to order at a reasonable cost. Merely ship us the defective unit and we will make necessary repairs or a duplicate



Majestic Replacement I.F. Windings

Model	Winding Only for	Majestic No.	Miller No.	List Price
15-15B-55-150-200	1st I.F.	4428-6250-6506	4570	\$.80
15-15B-150 55	2nd I.F.	8384-4429	4571	.80
25	1st I.F.	5326	4574	.80
25	2nd I.F.	5337	4575	1.00
25B	1st I.F.	5601	4576	.80
25B	2nd I.F.	5602	4577	1.00
66	1st I.F.	10589-10078	4579	.80
66	2nd I.F.	10098-10591	4580	.80
116	2nd I.F.	9361	4581	.80
200	2nd I.F.	6254	4583	1.00
210	1st I.F.	6119	4584	.80
210	2nd I.F.	6123	4585	.80
210	3rd I.F.	6127	4572	.80
310-A, 310-B 330-340-360-390	1st I.F.	7821	4586	.80
310A-310B-330-340-390	2nd I.F.	7812	4587	1.00
360	2nd I.F.	9094	4588	.80
467	1st I.F.	10149	4589	.80
503	1st I.F.	10843	4590	.80
503	2nd I.F.	11705	4591	.80
500	3rd I.F.	10852	4592	.80
86-460-490-461-462-463-491-493-520-800-105-95	2nd I.F.	10253-11014-11361	4573	1.00
290-300-310-330-340-390-460-490-520-800-320-280	RF Choke Coil	7187	8412	.50

Stewart-Warner Replacement I.F. Coils

Model	Winding Only for	S-W No.	Miller No.	List Price
R-123 R-123-A	2nd I.F.	83953	8395	\$1.00

Zenith Replacement I.F. Coils

Chassis No.	Winding Only for	Zenith No.	Miller No.	List Price
1004-1203-5634-5635-5644-5709-5801	All I.F.		8396	\$1.25

Crosley Replacement I.F. Windings

Model	Winding Only for	Miller No.	List Price
124	Output I.F.	M-124	\$1.25



Radiola Replacement I.F. Windings

Model	Winding Only for	Radiola No.	Miller No.	List Price
R80-R82-R86-RAE68	1st I.F.	8567	8567	\$1.00
R80-R82-R86-RAE68	2nd I.F.	8565	8565	1.00
R80-R82-R86-RAE68	3rd I.F.	8566	8566	1.00



Model	Winding Only for	Radiola No.	Miller No.	List Price
R7A-R9DC-RE16A-R10DC-R7-R4-R6-RE18A-R21-R11-R18-RAE-26-R55	1st I.F.	7266	7266	1.00
R7A-R9DC-RE16A-R10DC-R7-R4-R6-RE18A-R21-R11-R18-RAE-26-R55	2nd I.F.	7267	7267	1.00



66-67	1st I.F.	8481	8481	1.00
66-67	2nd I.F.	8481	8481	1.00
66	3rd I.F.	8500	8500	1.00
67	3rd I.F.	8482	8482	1.00



RF Primary Choke	8197	8197	.50
------------------	------	------	-----

Antenna Coil Replacement Primaries

A high impedance type duo-lateral antenna primary for replacing burnt-out primaries. Wound on specially treated impregnated cardboard tubing. Available in four sizes. Dimensions given are for outside diameter of antenna coil secondary winding.

Model	List Price
No. 125—For 3/8" Coils	\$.25
No. 150—For 1/2" Coils	.25
No. 250—For 1" Coils	.25
No. 300—For 1 1/4" Coils	.25

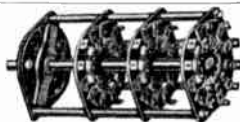

Band Selector Switches

The successful operation of a multi-band receiver depends to no little degree upon the excellence of the switch used. These switches are of a positive self-cleaning type with silver plated contacts. 3/8" single hole mounting.

Model	List Price
No. 402—4 Pole, 2 Position Switch	\$1.00
No. 205—2 Pole, 5 Position Switch	1.00
No. 404—4 Pole, 4 Position Switch	1.60
No. 405—4 Pole, 5 Position Switch	1.75
No. 605—6 Pole, 5 Position Switch	2.40
No. 806—8 Pole, 6 Position Switch	3.20



Tie Points

One of the handiest items the radio manufacturer or constructor can find for the termination of pigtail resistors and midget condensers and common leads in the receiver, amplifier, or transmitter. Extra heavy eyelet type terminal lugs are securely mounted in bakelite strips 1/8" thick, and are hot-dip tinned. The figure preceding the "0" indicates the number of insulated terminals.

Cat. No.	Lots of 100 Per 100	LIST PRICE	
		Less than 100—Each	100—Each
No. 1510—3/8" x 3/4"	2.00	\$.025	
No. 1520—3/8" x 1 1/8"	2.65	.030	
No. 1530—3/8" x 1 7/8"	4.15	.050	
No. 1540—3/8" x 2 1/4"	5.30	.060	
No. 1550—3/8" x 2 3/8"	6.00	.070	

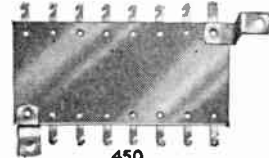

Bakelite Terminal Plates

These terminal plates, provided with solder lugs, are particularly adaptable for the assembly of groups of resistors and midget condensers. They will greatly facilitate assembly and wiring of the chassis.

No. 420—Has six terminal lugs on each side for 1/2 watt resistors, spaced 1/8" apart. Made of 1/8" bakelite 1" x 3".

No. 430—Has five terminal lugs on each side for 1 watt resistors and midget condensers, spaced 1/8" apart. Made of 1/8" bakelite 2" x 2 1/2".

No. 440—Has fourteen terminal lugs on each side for 1/2 watt resistors, spaced 1/8" apart. Made of 1/8" bakelite 1" x 5 3/4".

No. 450—Has seven terminal lugs on each side for 1 watt resistors and midget condensers, spaced 1/8" apart. Supplied with "Z" brackets for 3/8" stand-off from chassis. Made of 1/8" bakelite 1 3/4" x 3 3/4".

No. 470—Similar to No. 450 except has 19 terminal lugs on each side.

Model	List Price
No. 420 Terminal Plate	\$.20
No. 430 Terminal Plate	.25
No. 440 Terminal Plate	.35
No. 450 Terminal Plate	.30
No. 470 Terminal Plate	.75

On Quantity Orders we can make up special terminal strips to your specifications. Submit sketch for quotation.



Variable Condensers

High quality variable condensers furnished with spade bolts for mounting. Individual trimmers on each section. The latest design low-minimum capacity type. 1/4" shaft. Maximum capacity .000365 uf.

Model	List Price
No. 2102 2 Sections, 180° rotation	\$2.50
No. 2102-G 2 Sections, geared to 270° shaft rotation	2.75
No. 2103 3 Sections, 180° rotation	3.75
No. 2104 4 Sections, 180° rotation	5.00

(No. 2104 has mounting brackets)

MILLER QUALITY PRODUCTS MILLER QUALITY PRODUCTS

Miller

RADIO PRODUCTS



RESISTOR TYPE RF CHOKES Pi Wound on Ceramic Forms

MILLER Resistor Type Radio Frequency Chokes are the result of careful research and design and offer advantages found in no other similar type. The terminals will not come off! This is due to an entirely new method of fastening the leads as well as a unique design. Soldering temperatures and end strain will not loosen the leads. The terminals are made of a special cadmium plated soft, flexible brass. The windings are of the multiple-section duo-lateral type wound on high grade ceramic forms 1/4" diameter x 1 1/2" long. All of these chokes have extremely low distributed capacity, less than 1.5 uuf. for most types. Maximum safe current capacity is 125 MA. Inductance tolerance three percent plus or minus.

Cat. No.	Inductance (Millihenries)	DC Resistance (Ohms)	List Price
4531	.5	11.5	\$.55
4532	1.5	21.0	.55
4537	2.5	26.0	.55
4538	5.0	40.0	.75
4539	7.5	79.0	.85
4540	10.0	95.0	1.00
4541	25.0	160.0	1.20

2 1/2 and 5 Meter RF Chokes

Cat. No.	Inductance (Millihenries)	DC Resistance (Ohms)	List Price
4528	2.5	.27	\$.45
4529	5.0	1.00	.45

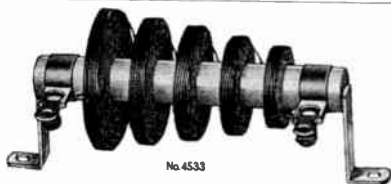

HEAVY DUTY NAVY TYPE CHOKES

The following Heavy Duty High Frequency Chokes are recommended for use in the high power transmitter. They are pi wound on Amsimag forms 1/2" in diameter x 3 1/2" long provided with snap-on brackets. Both ends of the form are tapped for 6/32 machine screws and the brackets may be removed for end mounting. All hardware is of cadmium plated brass.

Cat. No.	Inductance (Millihenries)	Current (Milli-amperes)	DC Resistance (Ohms)	List Price
4534	1.0	1000	2.50	\$1.50
4535	1.5	1000	3.65	1.60
4533	2.5	750	4.50	1.75
4536	4.0	750	5.50	2.00

High Frequency Chokes

3693	.40	1000	1.32	\$1.25
3694	.60	1000	2.00	1.50



2 1/2 and 5 Meter RF Chokes

Cat. No.	Inductance (Microhenries)	DC Resistance (Ohms)	List Price
3691	10	.36	\$.75
3692	20	.50	.75



Radio Frequency Chokes

The following Miller Radio Frequency Chokes are wound on specially treated wooden dowels with bakelite terminal plates and tinned soldering lugs. They are for single hole mounting and are duo-lateral wound. The low distributed capacity of these units makes them very efficient in radio frequency circuits wherever these inductance values are satisfactory. They are quite small and compact, the bakelite terminal plate being only 1 1/8" in diameter.

No.	Inductance (MH)	List Price
No. 610 RF Choke	.166	\$.75
No. 620 RF Choke	.675	.25
No. 630 RF Choke	1.540	.25
No. 640 RF Choke	2.742	.30
No. 650 RF Choke	4.450	.30
No. 660 RF Choke	6.500	.35
No. 670 RF Choke	9.300	.40
No. 680 RF Choke	12.200	.40
No. 690 RF Choke	16.000	.45
No. 1000 RF Choke	20.000	.50



Iron Core Shielded Chokes

Cat. No.	Inductance (Millihenries)	DC Resistance (Ohms)	List Price
851	.5	8.6	\$.85
852	1.0	11.5	.90
853	2.5	22.0	.95
854	5.0	31.0	1.00
855	7.5	42.0	1.00
856	10.0	47.0	1.05
857	25.0	100.0	1.20
858	50.0	160.0	1.35
859	75.0	222.0	1.45
860	100.0	348.0	1.85
861	150.0	520.0	2.45

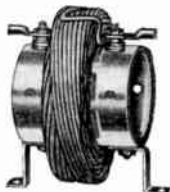

DUO-LATERAL LINE FILTER CHOKES

Miller Duo-Lateral Line Filter Chokes are recommended to manufacturers for use in farm lighting plants, sign flashers, signaling systems, oil burners, diathermy equipment, and all types of intermittent switching systems. Technicians and electrical contractors sometimes find it desirable to construct their own filters using Miller Chokes rather than to use the Miller Uni-Filter.

Single Chokes

Type No.	Max. Amps.	Inductance	DC Resistance	List Price
7825	2	.600	.75	\$1.00
7826	5	.570	.28	2.50
7827	10	.370	.15	3.25
7828	20	.200	.085	4.00
7829	30	.135	.05	5.00

Double Chokes

Type No.	Max. Amps.	Inductance	DC Resistance	List Price
D-7826	5	.570	.28	\$3.75
D-7827	10	.370	.15	5.00
D-7828	20	.200	.085	6.00
D-7829	30	.135	.05	7.50

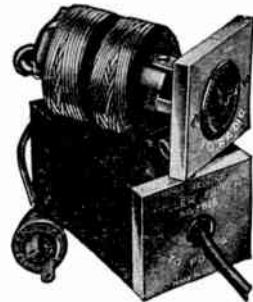

ALL-WAVE INTERFERENCE FILTERS

Underwriters' Laboratories Approved
The new Miller No. 7818 All-Wave Line Filter is an outstanding development for the elimination of radio interference from small electrical appliances, such as food mixers, juice extractors, hair dryers, drink mixers, vacuum cleaners, sewing machines, cash registers, small fans, dictating machines, comptometers, etc. When used in the supply cord of the radio receiver it will prevent unwanted signal pickup and direct line noise pick-up from the house wiring system.

The No. 7818 line filter may be used on either AC or DC voltages up to 220 volts. It is capable of filtering appliances and radios drawing up to 150 watts of power. Shipping weight approximately 1 pound.

List Price
No. 7818—All-Wave Line Filter.....\$4.00

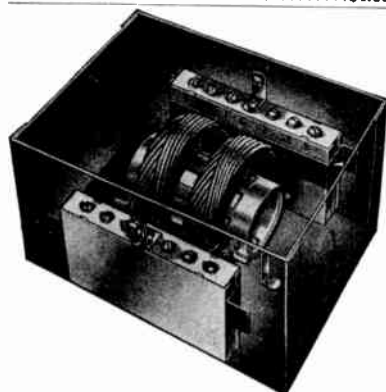

MILLER UNI-FILTER

As the name implies, the Miller Uni-Filter is a universal line filter. It may be used for any filter application by simply making the correct internal connections. It is no longer necessary to stock a special filter for each individual type of equipment—a Miller Uni-Filter will do the job!

The steel case with removable cover is finished in Kem-Art black baked "crackle" enamel. Knockouts are punched in each end for standard 1/2" or 3/4" conduit or flexible cable fittings. The dimensions of the Uni-Filter are 5" high x 8 3/4" long x 6 3/4" wide.

MILLER UNI-FILTERS

Uni-Filter No.	Current Capacity	List Price
7819	5 Amps.	\$15.50
7820	10 "	16.75
7821	20 "	17.75
7822	30 "	19.25

MILLER UNI-FILTER BASE KIT

Kit No.	List Price
7801—Uni-Filter Case	\$4.00
7802—Uni-Filter Capacitor Blocks @ \$3.75	7.50

7800—Uni-Filter Base Kit Complete... 11.50
Select a Dual Choke of suitable capacity for use with the Base Kit.



VARIABLE
LINK

AIR INDUCTORS

BARKER & WILLIAMSON • ARDMORE, PA.

SWINGING LINK ASSEMBLIES

TYPE BVL

100 WATTS RATING



A small, unusually compact, highly efficient Assembly designed for direct mounting on condenser. Ideal for low powered transmitters and exciter stages or in conjunction with B & W Type BL coils in interstage coupling. Six interchangeable plug-in coils provide a complete range, from 5 to 160 meters.

Type	*Capacity MMfd.	Inductance Microhenrys	Net Price
160BVL	150	55	\$2.10
80BVL	70	30	1.90
40BVL	40	13	1.65
20BVL	40	3.1	1.45
10BVL	35	1.0	1.40
5BVL	25	0.5	1.35

BVL ASSEMBLY—includes swinging link and jack bar. \$2.50

TYPE TVH

500 WATTS RATING

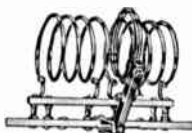

"Best yet" for those 500-watt rig! With TVH's you obtain the same high measure of efficiency at 10 meters as on the lower frequencies. Their novel plug arrangement permits easy capacity value selection. The time-tested B&W Variable Link design assures peak performance in ALL installations.

Type	Inductance Microhenrys	*Capacity MMfd.	Wire Size	Dia.	Outside Plug Centers	Net Price
160TVH	90	90	16	2½"	6"	\$2.85
80TVH	40	50	14	2½"	6"	2.85
40TVH	16	32	12	2½"	6"	2.85
20TVH	5.7	22	12	2½"	6"	2.85
10TVH	1.35	22	6	2½"	6"	2.85
TVH Base Assembly						3.75

TYPE TVL

250 WATTS RATING

The Type TVL AIR INDUCTOR is an outstanding example of the B & W policy—to design every AIR INDUCTOR to do a specific job . . . better than it was ever done before! You'll find Type TVL Coils and Assemblies practical . . . efficient . . . exceptionally dependable for medium power applications—even under extreme operating conditions.



Type	Inductance Microhenrys	*Capacity MMfd.	Wire Size	Dia.	Outside Plug Centers	Net Price
160TVL	130.0	65	18	2½"	5"	\$2.25
80TVL	38.0	55	14	2½"	5"	2.15
40TVL	15.0	34	12	2½"	5"	1.90
20TVL	4.6	28	12	2½"	5"	1.65
10TVL	1.5	22	6	2½"	5"	1.60
TV Base Assembly						4.00
TA Antenna Matching Coil						1.75

TYPE HDVL

1 K.W. RATING

Here is the "King of Swing"! For all around dependability and exceptional performance in high power transmitters the heavy duty Type HDVL Swinging Link Assembly is undeniably superior, both electrically and mechanically, to any other type of coil on the market. As in all B & W Swinging Link units, an independent link and base assembly permits panel control of coupling.



Type	Inductance Microhenrys	*Capacity MMfd.	Wire Size	Dia.	Outside Plug Centers	Net Price
160HDVL	94.0	90	14	3½"	7½"	\$5.25
80HDVL	47.0	44	10	3½"	7½"	4.50
40HDVL	18.0	28	8	3½"	7½"	4.00
20HDVL	5.2	25	8	3½"	7½"	3.75
10HDVL	1.3	25	4	2½"	7½"	3.25
HDV Base Assembly						5.00
HDA Antenna Matching Coil						4.00

* TOTAL EFFECTIVE CAPACITY REQUIRED TO EFFECT RESONANCE ON LOW FREQUENCY END OF SPECIFIED BAND



B&W "JUNIORS" 75 WATTS RATING

New! Huskier! . . . "Tops" for Most Limited-Space Applications!

These new B&W JUNIORS far surpass, in ruggedness and efficiency, most of the larger, more bulky coils of comparable rating. Designed for optimum performance in oscillator, buffer, or amplifier stages operating at input powers up to 75 watts and plate voltage to 850 volts.

All types may be used in capacity coupled circuits by omitting connections to the links. (Special Junior Coils or Junior Coil Assemblies quoted upon request.)

Type	Tuning Cap. Mmfd.
160 JEL	100
80 JEL	50
40 JEL	25
20 JEL	25
10 JEL	25
160 JCL	100
80 JCL	50
40 JCL	25
20 JCL	25
10 JCL	25
160 JVL	100
80 JVL	50
40 JVL	25
20 JVL	25
10 JVL	25

Amateur net Each \$1.00
Any type, less base85
5-prong Alsmag Base35



100 WATT 5-BAND TURRETS

TYPE BCL—Center Linked, Center Tapped Coils
TYPE BEL—End Linked Coils

These B&W 100-watt Turrets set new highs in fast, positive band switching on the commonly used amateur frequencies, 10 to 160 meters. Several new features, including a specially designed switch, make them equal in efficiency to the best individual plug-in coil systems.

They're extremely compact — 7½" high; 7½" wide; depth behind panel, 4½"; shaft extension, 1". They may be used with tubes operating at 1,000 to 1,250 volts and a maximum input power of 165 watts. Each unit comes complete with frequency-marked dial plate, lock washer and nut. It may be mounted directly on the panel in a single ¾" hole. You'll find the total cost of one of these turrets and suitable condensers is actually less than the cost of components for any comparative method now available.

Amateur Net Each \$8.50

B&W

FIXED LINK AIR INDUCTORS

BARKER & WILLIAMSON • ARDMORE, PA.

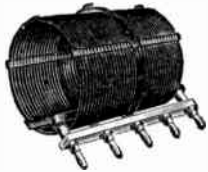

Type HDL (Fixed Link)

- Minimum Dielectric in the Field of the Coil
- Extremely Low Losses • Rugged Construction
- Excellent Appearance • Low Cost

Each AIR INDUCTOR is a completely finished unit in every respect. All coils are center tapped and equipped with three banana type plugs. . . . The "B" series is for use in oscillator and "buffer-doubler" stages developing up to 100 Watts of power. . . . The "BX" series is suitable for neutralized buffer and final tank stages with inputs up to 250 Watts. . . . The "T" line is especially well suited for high powered neutralized buffer and final tank stages where powers of 500 Watts are developed.

For the Amateur who wishes to use the maximum amount of power, our "HD" series of inductors are unquestionably the finest coils of their type on the market today. Sapable of handling a kilowatt with ease. Equipped with oversized plugs of ample current carrying capacity.

TYPE B and BL • 100 WATTS RATING

Std. Type	Net Price	Linked Type	Net Price	Ind. Mh.	*Cap. MMfd.	Wire Size	Diam.
160B	\$1.75	160BL	\$2.50	78.0	110	18	2 1/2"
80B	1.55	80BL	2.30	39.0	52	16	2 1/4"
40B	1.30	40BL	2.05	12.0	43	14	2"
20B	1.05	20BL	1.80	3.0	40	14	2"
10B	1.00	10BL	1.75	1.1	28	12	2"

Outside Plug Centers 3 1/4"

TYPE BX and BXL • 250 WATTS RATING

Std. Type	Net Price	Linked Type	Net Price	Ind. Mh.	*Cap. MMfd.	Wire Size	Diam.
160BX	\$1.80	160BXL	\$2.80	84.0	100	14	4"
80BX	1.60	80BXL	2.60	37.0	54	14	3"
40BX	1.35	40BXL	2.35	10.0	51	14	2 1/2"
20BX	1.10	20BXL	2.10	2.8	45	14	2 1/2"
10BX	1.05	10BXL	2.05	1.0	35	12	2"

Outside Plug Centers 4"

TYPE T and TL • 500 WATTS RATING

Std. Type	Net Price	Linked Type	Net Price	Ind. Mh.	*Cap. MMfd.	Wire Size	Diam.
160T	\$1.85	160TL	\$2.85	74.0	115	12	5"
80T	1.65	80TL	2.65	35.0	60	12	3 1/2"
40T	1.40	40TL	2.40	13.5	38	12	2 1/2"
20T	1.15	20TL	2.15	4.3	30	12	2 1/2"
10T	1.10	10TL	2.10	1.3	25	12	2"

Outside Plug Centers 5"

TYPE HD and RDL • 1 K.W. RATING

Std. Type	Net Price	Linked Type	Net Price	Ind. Mh.	*Cap. MMfd.	Wire Size	Diam.
160HD	\$4.25	160HDL	\$6.25	94.0	90	10	5"
80HD	3.50	80HDL	5.50	40.0	50	10	3 1/2"
40HD	3.00	40HDL	5.00	15.0	35	8	3 1/2"
20HD	2.75	20HDL	4.75	4.2	29	8	3"
10HD	2.25	10HDL	4.25	1.3	25	4	2"

Outside Plug Centers 7 1/2"

* Capacity required to effect resonance on low frequency end of specified band.

A68-P1—Network Coil—Complete with clip.....\$1.85

TYPE CX CONDENSER

An unusually high quality component, the B & W type CX variable condenser possesses features not found in units of conventional design. Integrally incorporated neutralizing plates eliminate mechanical mounting details and preserve circuit symmetry. B & W-type HDVL, HD, HDL, or TVH inductor assemblies may be mounted directly on the condenser, completely eliminating all closed circuit wiring and reducing total tuned circuit leads to an absolute minimum. Opposed stator sections provide short, high current RF paths so necessary in high powered transmitters.

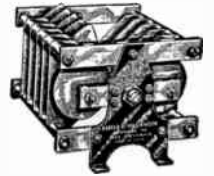

"A" TYPE - .500" AIRGAP

Type	Cap. per Section Max. Min.	Cap. Sections in Series Max. Min.	Mounting Length	Net Price
CX10A	12 6	7 3.5	4 1/2"	\$10.75
*CX20A	21 8	12 4.5	5 1/2"	13.15
*CX30A	32 12	17 6.6	6 1/2"	15.10
CX40A	41 15	23 8	7 1/2"	17.00
*CX50A	50 18	28 9	8 1/2"	18.95
CX60A	59 21	33 11	9 1/2"	20.85
*CX65A	67 24	37 13	10 1/2"	22.75
*CX75A	76 27	42 14.8	12 1/2"	24.70
CX85A	85 30	47 16.5	13 1/2"	26.60
CX95A	94 33	52 18	14 1/2"	28.50
*CX100A	102 36	56 19.8	15 1/2"	30.45
CX110A	110 39	61 21	16 1/2"	32.35
CX120A	119 42	66 23	17 1/2"	34.30

"C" TYPE - .250" AIRGAP

Type	Cap. per Section Max. Min.	Cap. Sections in Series Max. Min.	Mounting Length	Net Price
CX15C	15 5	8.3 2.8	3 1/2"	\$10.20
*CX25C	28 10	15.5 5.5	4 1/2"	12.50
CX40C	40 13	22 7	5 1/2"	14.35
*CX55C	56 15	31 8	6 1/2"	16.15
CX70C	72 18	40 10	7 1/2"	18.00
*CX85C	88 21	49 11.5	8 1/2"	19.85
*CX100C	108 24	60 13	9 1/2"	21.60
*CX120C	120 26	66 14.5	10 1/2"	23.45
*CX135C	136 29	75 15	11 1/2"	25.25
*CX150C	152 32	83 17	12 1/2"	27.00
CX170C	168 34	93 18.5	13 1/2"	28.95
CX185C	184 37	102 20	14 1/2"	30.75
*CX200C	200 40	112 22	15 1/2"	32.50

*Units thus marked are stock models. All other types available on order.

Standard plate thickness in all models, 1/16". Available on special order, 3/32" plates at 10% additional.

Special features—We are prepared to furnish quotations on gear drive, ball bearings, ganged units, or other types of special design.

Explanation: The type of each condenser designates its capacity and plate spacing as follows:

CX100 indicates 100 mmfd per section.

Letters A, B, C, or D denote plate spacing: A—.500", B—.375", C—.250", D—.187". Following N# denotes Neutralizing plates.

Type HDV assembly mounted on any type of condenser.....\$5.00 Net

Type HD or HDL Jack Bar mounted on condenser.....\$2.75 Net

Type TVH assembly mounted on condenser.....\$4.25 Net

B&W LOW-POWER COILS and BAND SWITCHING ASSEMBLIES



B&W "BAND-HOPPERS"

The Mighty Midgets of Band Switches!

Sturdy, unbelievably compact, low in price! These reliable practical units are now available in two completely redesigned units . . . improved throughout. Cover all five bands, yet require very little space. Panel control.

Model 2A—(25 Watt Rating)—For interstage coupling with beam power tubes. Net \$3.25

Model 2AB—(50 Watt Rating)—For interstage coupling between beam power tubes and triodes or high-powered beam tubes. Net \$3.50



"BABY" AIR INDUCTORS (25 Watt Rating)

Just the thing for crowded layouts, portables, field transmitters! The smallest, most efficient, most practical 25-Watt coils ever available to amateurs. "BABIES" measure only 1 1/2" x 1 1/2", are made

by a special B&W process which insures perfect air-spacing, maximum strength, fine appearance and ultra-high efficiency with an absolute minimum of insulating material. Available in five types, from 10 to 160 meters. Conservatively rated. Universal 5-prong Alsimag 198 bases.

Net, Any Type.....\$0.75

Straight Coil	Center Tapped	End Linked	Center Linked	Inductance	*Capacity
160M	MC	MEL	MCL	90	90
80M	MC	MEL	MCL	40	50
40M	MC	MEL	MCL	14	35
20M	MC	MEL	MCL	3.5	35
10M	MC	MEL	MCL	1.1	30

*Total effective capacity required to effect resonance on low frequency end of specified band.



"BABY" TURRETS

35-Watt Rating

These compact 5-band switching units cover amateur bands from 10 to 160 meters. They may be tuned in all types of service with any of the 100 mmfd. midjet condensers. Their sturdy construction and unique design assure permanent coil alignment and maximum efficiency with a minimum number of tubes. Four types — BTM, straight untapped; BTCL, center tapped; BTEL, end linked and BTCL, center linked—provide vastly improved band-switching efficiency in low-power transmitters and exciter stages. Net, Any Type.....\$5.25

Belden * AERIAL WIRE · LEAD-IN WIRE · ACCESSORIES

Belden Aerial Wire FULL GAUGE AND WEIGHT

Stranded Beldenamel

Number	Length in Foot	Size
8005	1000 spool	7 x 22
Solid Beldenamel		
*8008	1000 spool	12

All-Rubber Lead-in Wire



Easy stripping—easy soldering. All made of 7 strands of tinned copper wire with extra thick rubber sheath as indicated. (.031" = 1/32")

Number	Length in Foot on Spool	Size	Rubber Thickness	Outside Diameter of Wire
8200	1000	18	.040"	.126"

Belden Shielded Lead-in Wire



Size 16 stranded, rubber thickness indicated, tinned copper shield. For any audio or radio frequency circuits.

Number	Length in Foot on Spool	Rubber Wall	Frequency (Kc.)	Surge Impedance (Ohms)	Power Factor (Per Cent)	Maximum Capacity mmf. per Ft.
8206	250	1/32"	1500	33.5	1.78	63.0
			10000	33.8	1.52	62.0

Belden Arresters—Insulators



8896—Belden standard size bakelite resistor type arrester dissipates destructive charges induced in the aerial system. Listed as standard by Underwriters'. Furnished with \$100.00 guarantee.



8814—Glass insulators 3" over-all length.

Belden * TRANSMISSION LINE CABLES

These Transmission Cables will meet the requirements for all the frequencies in the audio to and including the television or frequency modulation range.



14 Stranded (19 x 28) tinned, low-loss rubber compound, tinned copper shield, tough vulcanized rubber sheath. O.D. = .460"



12 Solid tinned, low-loss insulating bead, tinned copper shield, cotton wrap, vulcanized rubber sheath. O.D. = .475"



EO1 Type, 12 solid, cellophane wrap, .035" rubber, twisted pair, over-all cotton braid, weather-proofed.



For the majority of all-wave receivers and of any half-wave di-pole antenna. 18 Stranded tinned, cotton wrap, low capacity rubber, color coded, twisted pair, over-all white cotton braid, weather-proofed.



Recommended for lead-ins where interference is great. 18 Stranded tinned, cotton wrap, rubber covered, color coded, twisted pair; paper wrap and tinned copper shield over twisted pair—over-all white cotton braid, weather-proofed.



22 Stranded tinned, paper wrap, rubber covered, color coded, twisted pair, over-all black cotton braid, weather-proofed.

72-Ohm Coaxial Cables

Designed for use as antenna receiving or transmitting cables; also for photoelectric or other circuits where characteristics fit the application.

Number	Length in Foot on Spool	Frequency (Kc.)	Surge Impedance (Ohms)	Power Factor (Per Ct.)	Capacity Det. Conds. (mmf. Per Ft.)	D. B. Loss Per 100 Ft.	Q Value	Min. Punct. Volt.	Max. Load Capacity (Watts)
8216	250c†	100	67.8	.69	28.0	.031	145.	40000	1000
		1500	69.3*	.68	26.8	.225	148.		
8217	100c†	10000	75.8*	.060	16.6	.377	1665.		
		40000	77.0*	.060	15.9	.620	1607.		
		100000	77.8*	.060	15.0	1.06	1607.		

Transmitting Line Cable

8210	500†	10000	73.7*	2.53	29.7	2.230	39.5
		40000	73.0*	1.12	29.7	6.300	89.0
		100000	73.0*	1.12	29.7	10.450	89.0

72-Ohm Twisted Pair

For Broadcast and Short Wave

8204	500†	100	66.4*	1.29	34.5	.062	10000	250
		1500	67.7*	1.42	33.5	.357		
		10000	68.4*	1.93	32.5	2.11		
		40000	68.9*	2.02	31.9	6.25		
		100000	69.6*	2.00	31.0	15.600		

Shielded Twisted Pair

8209	500†	100	75.5*	1.29	24.2	.052	10000	250
		1500	76.8*	1.42	23.4	.270		
		10000	77.7*	1.93	22.7	1.720		
		40000	77.7*	1.83	22.3	4.350		
		100000	79.2*	1.83	21.7	11.100		

Commercial Type Twisted Pair

8205	500†	100	92.5	5.74	23.8
		1500	95.8	3.88	22.3
		10000	96.0	3.63	21.3

*New put-up or color. *Value of surge impedance may vary ± 10% from the nominal 72-ohm or 100-ohm values.
†Length may vary ± 10%. c = Coils. All wires furnished on spools, except where indicated by letter "c", which indicates coils.

Belden Manufacturing Company, Chicago, U. S. A.

Belden ★ SOLDERING IRONS · CORDS · TERMINALS

Belden Head Phone Cords

5-Foot cords of extra flexible moisture-proof rubber covered tinsel cords, over-all durable mercerized brown cotton braid. "Y" arm sections additional 15", coupled in series.



8872—Head phone set pin tips all ends.



8873—Head phone set spade tips—4-phone ends, pin tips plug end.

Belden Terminal Assortment



8994—100 Assorted Belden Terminals in clear-view carton. Includes:

20—8995 25—8997
10—8996 10—8998
35—8999

Belden Terminals

Tinned—easy to solder—packed in clear-view cartons that are easy to stock and handle.



Screw Size 8 10 8 7 8
Number **8995** **8996** **8997** **8998** **8999**

Soldering Irons

Three Belden soldering irons provide a range of sizes to take care of practically all radio service and communications work. Sturdy construction throughout assures long service life.



8110—80-Watt iron with $\frac{3}{8}$ " tip. For light work. Complete with stand including tip cleaner.
8113—100-Watt iron with $\frac{3}{8}$ " tip. For medium light service. Complete with stand including tip cleaner.
8116—150-Watt iron with $\frac{1}{2}$ " tip. For medium heavy work, chassis spotting, etc. Complete with stand.

Soldering Iron Replacements

8111—80-Watt element for 8110.
8114—100-Watt element for 8113.
8117—150-Watt element for 8116.
8112—Tip ($\frac{3}{8}$ " for 8110 or 8113).
8118—Tip for 8116.
8119—Heater cord only. 6-Ft. Belden 3000-cycle heater cord with Belden Unbreakable Soft Rubber Plug. Opposite end stripped and tinned.

Belden ★ MICROPHONE CABLE



8401 For ribbon or crystal and single-button carbon microphones—or low impedance transmission lines. Belden developed low capacity rubber core and special stranding give extra flexibility plus unusual tensile strength.

8411 For lapel microphones.

8431 For phonograph pick-ups—(over-all cotton braid).

For double-button carbon microphone circuits using the shield as the grounded connection and for low impedance, 50- to 500-ohm transmission lines—or for coupling a pre-amplifier to a power amplifier, employing the shield as a ground.

For double-button carbon microphones feeding a mixer panel or circuits in which the diaphragm of the microphone must be above ground potential, yet shielded from transient fields.

For double-button carbon microphone circuits in which the attenuation control is located at the microphone and employs two of the four conductors of the cable.

For condenser microphone transmission line and power supply to microphone head amplifier.

For condenser microphone circuit with remote control switch or pilot light at microphone.

For auto-radio test instruments and acid resisting analyzer cable.

For temporary indoor installations of low impedance or carbon microphone transmission circuits. 20 (Stranded tinned), paper wrap, 1/64" rubber, color coded treated cotton braid, cabled, with tinned copper shield over-all.

Number	Length in Feet on Spool	Number of Conductors	MAXIMUM CAPACITY MMF. PER FT.		
			Between Conductor and Shield	Between Conductors	Outside Diameter
8401	500†	1	25	25	.245"
8411	100	1	25	35	.155"
8431	100	1	20	55	.160"

Two Conductor—Carbon Microphone

8422	100	2	20	70	37	.280"
8422	500†	2	20	70	37	.280"

Three to Seven Conductor

* 8423	250	3	20	65	37	.280"
* 8424	250	4	20	67	35	.325"
* 8425	250	5	20	58	30	.380"
8426	100	6	20	60	27	.410"
8427	100	7	20	56	26	.430"

Shielded—Without Rubber Sheath

* 8432	250	2	20	61	33	.215"
8433	100	3	20	55	30	.230"
8434	100	4	20	48	25	.270"

Belden ★ PA AND COMMUNICATING SYSTEM CABLES

Shielded Twisted Pair Type FOR INSIDE USE



19 Solid, double enameled, wrap cotton, color coded cotton braid, waxed, twisted pair, over-all bare copper shield. No. **8799**, 500 ft. spool, 2 conductors, .145" O.D.

Same construction as 8701, with over-all low-loss shield and cotton braid. No. **8702**, 500 ft. spool, 2 conductors, .165" O.D.

Armored Speaker Cable FOR INSIDE OR OUTSIDE USE



18 Stranded tinned, color coded cotton wrap, 2-conductors parallel, 1/64" rubber, paper wrap, over-all steel armor.

8212—500 Ft. spool, 2 conductors. **8204**—Unshielded Twisted Pair—see p. Q-1.

8209—Shielded Twisted Pair—see p. Q-1.

* New put-up or color. †Length may vary ± 10%.

Belden Manufacturing Company, Chicago, U. S. A.

Belden * MULTIPLE CONDUCTOR CABLE

Rubber Sheathed



For permanent magnet dynamic speakers and general power supply cable. 18 (41x34) Cotton wrap, 1/64" rubber, color coded, cabled with fillers, cotton wrap—over-all rubber sheath.

Number	Length in Ft. on Spool	No. Conductors	Thickness Rubber Sheath	Outside Diameter
8452	500†	2	.035"	.245"



For electro-dynamic speakers in which one audio circuit serves also as the return lead of the field supply and for speakers with a center-tapped input transformer requiring a three-conductor cable. Construction same as 8452.

8453	500†	3	.040"	.265"
------	------	---	-------	-------

For four-wire a-c or electro-dynamic speaker lines. Two 18 (41x34) balance 20 (26x34). Size 18—for lower resistance—for speaker field—heavy applications.

8454	500†	4	.040"	.260"
------	------	---	-------	-------

Over-all Glazed Cotton

Abrasion-proof "Basket-Weave" Braid



For permanent installation of speakers, remote control equipment, and multiple circuit, 500-ohm transmission lines.

Number	Length in Ft. on Spool	No. Conductors	Description	Outside Diameter
8443	500†	3	20 (Stranded tinned) paper wrap, .020"	.190"
8444	500†	4	rubber, color coded, cabled, over-all brown braid.	.210"
8445	500†	5		.230"

For use where high current must be carried with a low potential drop.

8446	100	6	2-16 (Stranded tinned),	.290"
8447	100	7	1/32" rubber balance, 20 (stranded tinned).	.310"
8448	100	8	Otherwise same as 8443.	.345"
8449	100	9		.360"

HOOK-UP WIRE

Size 20 special stranded tinned conductors have true concentric lay. Other stranded constructions are 18 (16 x 30); 14 (41 x 30).

Cellulose Acetate Push-Back "Basket-Weave" Rayon Braid

Tinned copper, heavy wrap cellulose acetate, "basket-weave" abrasion-proof rayon braid lacquered. Colors: green, blue, red, yellow, and black. 8938—500' Furnished in red and black only.

SOLID

*8941	500	20	1500	5.29	19.4
*8941	1000	20	10000	6.12	16.4
*8945	500	18	1500	5.29	19.4
*8945	1000	18	10000	6.12	16.4

STRANDED

*8943	500	20	1500	5.29	19.4
*8943	1000	20	10000	6.12	16.4
*8947	500	18	1500	5.29	19.4
*8947	1000	18	10000	6.12	16.4
*8938	500	14	10000	6.12	16.4

Punct. Voltage at 60 cycles 1550. Insulation* Resistance Megohms 280.

Rubber Push-Back

"Basket-Weave" Rayon Braid

Tinned copper, cotton wrap, .010" rubber, "basket-weave" abrasion-proof rayon braid lacquered. Colors: green, blue, red, yellow, and black. 8838—1000 Also made in white.

At Room Temperature and Humidity

Number	Length in Ft. on Spool	Size	Frequency (Kc.)	Power Factor (Per Cent)	Q Value
SOLID					
*8837	500	20	1500	5.00	20.0
*8837	1000	20	10000	5.40	18.5
STRANDED					
*8838	500	20	1500	5.00	20.0
*8838	1000	20	10000	5.40	18.5

R-F Hook-Up Wire

Tinned copper with two specially treated cellulose acetate braids. Colors: green, blue, red, yellow, black. 8861—Also made in white.

SOLID					
*8841	500	20	10000	2.71	34.0
*8861	500	18	After 24 hrs. at 100° F. and 90% relative humidity.		
			100	1.92	55.0
STRANDED					
*8839	500	20	1500	2.47	41.0
*8844	500	18	10000	3.07	33.0
			After 2 hrs. in water at 121° F.		
			9600.		

For 8839 Punct. Voltage at 60 cycles 3800. Insulation* Resistance Megohms 49000.

Shielded Grid Wire

Tinned copper, 1/64" rubber, rayon braid lacquered, over-all fine tinned copper shield of 85% coverage. O.D. = .105".

8885	500†		
------	------	--	--

High Tension Corona Resistant

Special rubber compound, heat and corona resisting Pyro-Glaze seal, and braid of Belden Fiberglass. Color: white. O.D. = .200".

Number	Length in Ft. on Spools	Size	Punct. Voltage at 60 Cycles
*8868	100	18	15000

AUTO-RADIO WIRE

Automotive Primary Wires

Stranded tinned copper, wrap colored cellophane, rubber wall, over-all glazed cotton braid lacquered. 100' Spools; color: 8650, 8651, 8652 blue only.



PLAIN			Rubber Thickness	SHIELDED	
Number	O. D.	Size		Number	O. D.
*8650	.195"	12	.031"	8654	.225"
*8651	.165"	14	.027"	8655	.195"
*8652	.140"	16	.022"	8656	.170"

Auto-Radio Shielded Low Capacitance Lead-In Wire



8663—100-Ft. 20 stranded tinned, cotton wrap, low capacity rubber, rayon braid, tinned copper shield over-all. Maximum capacity between conductor and shield 33 mmf. O.D. = .230".

8664—100-Ft. same as 8663 with rubber sheath over-all. O.D. = .290".

Spark Plug Wires—PLAIN

8667—7 mm. Belden Pyro-Glaze.

SHIELDED



8665—7 mm. Belden Pyro-Glaze spark plug wire with tinned copper shield.

Extra Flexible Test Prod Wire

The outstanding feature of this wire is its great flexibility. 18 Stranded (65 x 36, tinned), cotton wrap, 3/64" rubber wall. O.D. = .140".

*8899—500 Feet, red or black on spool.

High Voltage Test Prod Wire

8898—500 Feet, red or black on spool.

Tinned Copper Shielding



Tinned Copper—8661 fits 7 mm. spark plug wires.

Number	Length in Ft. on Spool	Inside Diameter
8661	50	3/8"
8661	250	3/8"
8660	50	13/64"
8660	250	13/64"
8662	50	25/62"
8662	250	25/62"

Beldenamel Magnet Wire on 1/2-Pound Spools

Size	Turns per Linear Inch	Turns per Square Inch	Approximate No. ft. on 1/2 Lb. Spool
14	14.7	217	39
16	18.6	345	60
18	23.2	540	100
20	29.2	851	160
22	36.5	1330	250
24	45.7	2090	400
26	57.8	3340	635
28	71.9	5170	1010
30	89.0	7920	1610

*New put-up or color. *D.C. Insulation per ft. Immersed in Mercury (Megohms). †Length may vary ± 10%.

Belden Manufacturing Company, Chicago, U. S. A.

Thank You!

When writing for additional
information or when ordering
from sources of supply listed
in this book, please mention

RADIO'S MASTER

LENZ

Wires *Quality Products* Cables

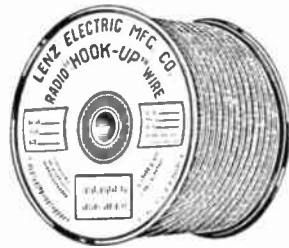

RADIO HOOK-UP WIRE

(PUSH-BACK TYPE)

Consists of push-back non-fraying insulation, thoroughly saturated in MOISTURE-PROOF compound effective in reducing leakage. Has high insulation resistance and other essential dielectric properties. Can be furnished in SOLID or STRANDED, WAXED or LACQUERED. Neatly packed in attractive cartons or supplied on spools. Colors: Blue, Orange, Green, Brown, Slate, Red, Yellow, White and Black. If color is not specified, BLACK will be furnished.



WAXED HOOK-UP WIRE (BRADAX) DOUBLE COTTON BRAIDS WAXED

No. 22 SOLID TINNED COPPER				No. 20 SOLID TINNED COPPER				No. 18 SOLID TINNED COPPER						
Cat. No.	Put-up	Std. Pkg.	Wt. Ea. in lbs.	Each List Price	Cat. No.	Put-up	Std. Pkg.	Wt. Ea. in lbs.	Each List Price	Cat. No.	Put-up	Std. Pkg.	Wt. Ea. in lbs.	Each List Price
1010	25' carton	20	.14	\$0.29	1022	25' carton	20	.17	\$0.32	1035	25' carton	20	.17	\$0.39
1011	50' carton	15	.24	.51	1023	50' carton	15	.31	.58	1036	50' carton	15	.35	.69
1012	100' spool	10	.45	1.04	1024	100' spool	10	.58	1.17	1037	100' spool	10	.7	1.40
1013	1000' spool	1	4.7	8.53	1025	1000' spool	1	6.1	9.85	1038	1000' spool	1	7.7	12.15
No. 22 STRANDED TINNED COPPER				No. 20 STRANDED TINNED COPPER				No. 18 STRANDED TINNED COPPER						
1016	25' carton	20	.14	\$0.31	1028	25' carton	20	.17	\$0.36	1041	25' carton	20	.17	\$0.44
1017	50' carton	15	.24	.56	1029	50' carton	15	.31	.65	1042	50' carton	15	.35	.79
1018	100' spool	10	.45	1.13	1030	100' spool	10	.58	1.32	1043	100' spool	10	.7	1.60
1019	1000' spool	1	4.7	9.48	1031	1000' spool	1	6.1	11.38	1044	1000' spool	1	7.7	14.13
No. 16 SOLID TINNED COPPER				No. 14 SOLID TINNED COPPER										
1710	25' carton	20	.25	\$0.46	1910	25' carton	20	.35	\$0.56					
1711	50' spool	15	.5	.83	1911	50' spool	15	.70	1.04					
1712	100' spool	10	1.0	1.68	1912	100' spool	10	1.4	2.09					
1713	1000' spool	1	11.0	14.93	1913	1000' spool	1	14.0	19.05					
No. 16 STRANDED TINNED COPPER				No. 14 STRANDED TINNED COPPER										
1816	25' carton	20	.25	\$0.54	1916	25' carton	20	.35	\$0.67					
1817	50' spool	15	.5	.98	1917	50' spool	15	.70	1.27					
1818	100' spool	10	1.0	1.98	1918	100' spool	10	1.4	2.54					
1819	1000' spool	1	11.0	17.98	1919	1000' spool	1	14.0	23.55					

LACQUERED FLAME-RESISTING HOOK-UP WIRE (BRALAC) DOUBLE COTTON BRAIDS LACQUERED

No. 22 SOLID TINNED COPPER				No. 20 SOLID TINNED COPPER				No. 18 SOLID TINNED COPPER						
Cat. No.	Put-up	Std. Pkg.	Wt. Ea. in lbs.	Each List Price	Cat. No.	Put-up	Std. Pkg.	Wt. Ea. in lbs.	Each List Price	Cat. No.	Put-up	Std. Pkg.	Wt. Ea. in lbs.	Each List Price
1050	25' carton	20	.14	\$0.31	1070	25' carton	20	.17	\$0.35	1220	25' carton	20	.17	\$0.41
1051	50' carton	15	.24	.54	1071	50' carton	15	.31	.62	1221	50' carton	15	.35	.74
1052	100' spool	10	.45	1.11	1072	100' spool	10	.58	1.25	1222	100' spool	10	.7	1.51
1053	1000' spool	1	4.7	9.18	1073	1000' spool	1	6.1	10.63	1223	1000' spool	1	7.7	13.20
No. 22 STRANDED TINNED COPPER				No. 20 STRANDED TINNED COPPER				No. 18 STRANDED TINNED COPPER						
1060	25' carton	20	.14	\$0.34	1080	25' carton	20	.17	\$0.39	1230	25' carton	20	.17	\$0.46
1061	50' carton	15	.24	.59	1081	50' carton	15	.31	.69	1231	50' carton	15	.35	.84
1062	100' spool	10	.45	1.20	1082	100' spool	10	.58	1.40	1232	100' spool	10	.7	1.70
1063	1000' spool	1	4.7	10.13	1083	1000' spool	1	6.1	12.15	1233	1000' spool	1	7.7	15.18

WAXED HOOK-UP WIRE (LENZITE)

TWO WRAPS CELLULOSE ACETATE TEXTILE PLUS ONE COTTON BRAID WAXED

No. 22 SOLID TINNED COPPER				No. 20 SOLID TINNED COPPER				No. 18 SOLID TINNED COPPER						
Cat. No.	Put-up	Std. Pkg.	Wt. Ea. in lbs.	Each List Price	Cat. No.	Put-up	Std. Pkg.	Wt. Ea. in lbs.	Each List Price	Cat. No.	Put-up	Std. Pkg.	Wt. Ea. in lbs.	Each List Price
1310	25' carton	20	.14	\$0.29	1322	25' carton	20	.17	\$0.32	1335	25' carton	20	.17	\$0.39
1311	50' carton	15	.24	.51	1323	50' carton	15	.31	.58	1336	50' carton	15	.35	.69
1312	100' spool	10	.45	1.04	1324	100' spool	10	.58	1.17	1337	100' spool	10	.7	1.40
1313	1000' spool	1	4.7	8.53	1325	1000' spool	1	6.1	9.85	1338	1000' spool	1	7.7	12.15
No. 22 STRANDED TINNED COPPER				No. 20 STRANDED TINNED COPPER				No. 18 STRANDED TINNED COPPER						
1316	25' carton	20	.14	\$0.31	1328	25' carton	20	.17	\$0.36	1341	25' carton	20	.17	\$0.44
1317	50' carton	15	.24	.56	1329	50' carton	15	.31	.65	1342	50' carton	15	.35	.79
1318	100' spool	10	.45	1.13	1330	100' spool	10	.58	1.32	1343	100' spool	10	.7	1.60
1319	1000' spool	1	4.7	9.48	1331	1000' spool	1	6.1	11.38	1344	1000' spool	1	7.7	14.13
No. 16 SOLID TINNED COPPER				No. 14 SOLID TINNED COPPER										
1825	25' carton	20	.25	\$0.46	1925	25' carton	20	.35	\$0.59					
1826	50' spool	15	.5	.83	1926	50' spool	15	.7	1.09					
1827	100' spool	10	1.0	1.68	1927	100' spool	10	1.4	2.19					
1828	1000' spool	1	10.0	14.93	1928	1000' spool	1	14.0	20.08					
No. 16 STRANDED TINNED COPPER				No. 14 STRANDED TINNED COPPER										
1831	25' carton	20	.25	\$0.54	1931	25' carton	20	.35	\$0.73					
1832	50' spool	15	.5	.98	1932	50' spool	15	.7	1.37					
1833	100' spool	10	1.0	1.98	1933	100' spool	10	1.4	2.77					
1834	1000' spool	1	10.0	17.98	1934	1000' spool	1	14.0	25.80					

Colls furnished without cartons—deduct two cents each from list price. All prices subject to change without notice.



LACQUERED FLAME RESISTING HOOK - UP WIRE (LENZAC)

Two Wraps Cellulose Acetate Textile Plus One Cotton Braid Lacquered

No. 22 SOLID TINNED COPPER				
Cat. No.	Put-up	Standard Package	Wt. Ea. in lbs.	List Price Each
1350	25-ft. carton	20	.14	\$0.31
1351	50-ft. carton	15	.24	.54
1352	100-ft. spool	10	.45	1.11
1353	1000-ft. spool	1	4.7	9.18

No. 20 SOLID TINNED COPPER				
Cat. No.	Put-up	Standard Package	Wt. Ea. in lbs.	List Price Each
1370	25-ft. carton	20	.17	\$0.35
1371	50-ft. carton	15	.31	.62
1372	100-ft. spool	10	.58	1.25
1373	1000-ft. spool	1	6.1	10.63

No. 18 SOLID TINNED COPPER				
Cat. No.	Put-up	Standard Package	Wt. Ea. in lbs.	List Price Each
1391	25-ft. carton	20	.17	\$0.41
1392	50-ft. carton	15	.35	.74
1393	100-ft. spool	10	.7	1.51
1394	1000-ft. spool	1	7.7	13.20

No. 22 STRANDED TINNED COPPER				
Cat. No.	Put-up	Standard Package	Wt. Ea. in lbs.	List Price Each
1360	25-ft. carton	20	.14	\$0.34
1361	50-ft. carton	15	.24	.59
1362	100-ft. spool	10	.45	1.20
1363	1000-ft. spool	1	4.7	10.13

No. 20 STRANDED TINNED COPPER				
Cat. No.	Put-up	Standard Package	Wt. Ea. in lbs.	List Price Each
1380	25-ft. carton	20	.17	\$0.39
1381	50-ft. carton	15	.31	.69
1382	100-ft. spool	10	.58	1.40
1383	1000-ft. spool	1	6.1	12.15

No. 18 STRANDED TINNED COPPER				
Cat. No.	Put-up	Standard Package	Wt. Ea. in lbs.	List Price Each
1395	25-ft. carton	20	.17	\$0.46
1396	50-ft. carton	15	.35	.84
1397	100-ft. spool	10	.7	1.70
1398	1000-ft. spool	1	7.7	15.18

Coils furnished without cartons — deduct two cents each from list price.

R.F. CIRCUIT HOOK - UP WIRE (PUSH - BACK TYPE)

A wire with insulation of extremely low losses at high frequencies. Designed especially for wiring the SWITCHING SYSTEM, AVC, PLATE and GRID of RF stages. Conductors supplied in several sizes either solid or stranded. Insulation pushes back freely without adhering to the conductor, and is mechanically strong enough to resist abrasion. A fine production wire with insulation impregnated in a high-resistant, low-loss, moisture-resisting compound.

No. 22 SOLID TINNED COPPER				
Cat. No.	Put-up	Standard Package	Wt. Ea. in lbs.	List Price Each
900	25-ft. carton	15	.16	\$0.42
901	50-ft. carton	10	.24	.75
902	100-ft. spool	4	.45	1.52
903	1000-ft. spool	1	4.7	13.30

No. 22 STRANDED TINNED COPPER				
Cat. No.	Put-up	Standard Package	Wt. Ea. in lbs.	List Price Each
910	25-ft. carton	15	.16	\$0.44
911	50-ft. carton	10	.24	.80
912	100-ft. spool	5	.45	1.62
913	1000-ft. spool	1	4.7	14.38

No. 20 SOLID TINNED COPPER				
Cat. No.	Put-up	Standard Package	Wt. Ea. in lbs.	List Price Each
920	25-ft. carton	15	.17	\$0.45
921	50-ft. carton	10	.31	.82
922	100-ft. spool	5	.58	1.67
923	1000-ft. spool	1	6.1	14.80

No. 20 STRANDED TINNED COPPER				
Cat. No.	Put-up	Standard Package	Wt. Ea. in lbs.	List Price Each
930	25-ft. carton	15	.17	\$0.49
931	50-ft. carton	10	.31	.89
932	100-ft. spool	5	.58	1.79
933	1000-ft. spool	1	6.1	16.05

No. 18 SOLID TINNED COPPER				
Cat. No.	Put-up	Standard Package	Wt. Ea. in lbs.	List Price Each
940	25-ft. carton	15	.19	\$0.49
941	50-ft. carton	10	.35	.90
942	100-ft. spool	5	.70	1.82
943	1000-ft. spool	1	7.7	16.30

No. 18 STRANDED TINNED COPPER				
Cat. No.	Put-up	Standard Package	Wt. Ea. in lbs.	List Price Each
950	25-ft. carton	15	.19	\$0.56
951	50-ft. carton	10	.35	1.03
952	100-ft. spool	5	.70	2.09
953	1000-ft. spool	1	7.7	19.02

No. 16 SOLID TINNED COPPER				
Cat. No.	Put-up	Standard Package	Wt. Ea. in lbs.	List Price Each
960	25-ft. carton	15	.28	\$0.59
961	50-ft. carton	10	.52	1.09
962	100-ft. spool	5	1.10	2.18
963	1000-ft. spool	1	11.25	20.08

No. 16 STRANDED TINNED COPPER				
Cat. No.	Put-up	Standard Package	Wt. Ea. in lbs.	List Price Each
970	25-ft. carton	15	.28	\$0.67
971	50-ft. carton	10	.52	1.26
972	100-ft. spool	5	1.10	2.53
973	1000-ft. spool	1	11.25	23.48

COLORS: White with red tracer; white—blue tracer; white—green tracer; white—yellow tracer; white—brown tracer; white—orange tracer; white—black tracer; and plain white.

Coils furnished without cartons — deduct two cents each from list price.

LACQUERED HI - VOLTAGE PLATE CIRCUIT TRANSMITTER HOOK - UP WIRE (DULAC)

Insulation Consists of Varnished Cambric Plus Lacquered Outer Braid

No. 18 STRANDED TINNED COPPER				
Cat. No.	Put-up	Standard Package	Wt. Ea. in lbs.	List Price Each
2000	25-ft. carton	15	.2	\$0.69
2014	50-ft. spool	10	.4	1.29
2015	100-ft. spool	5	.8	2.59
2016	1000-ft. spool	1	8.0	24.03

No. 16 STRANDED TINNED COPPER				
Cat. No.	Put-up	Standard Package	Wt. Ea. in lbs.	List Price Each
2020	25-ft. carton	15	1.0	\$0.83
2021	50-ft. spool	10	2.0	1.57
2022	100-ft. spool	5	5.5	3.16
2023	1000-ft. spool	1	11.0	29.75

COLORS: Blue, Orange, Green, Brown, Slate, Red, Yellow, White, or Black. Coils furnished without cartons — deduct two cents each from list price.

All prices subject to change without notice

LENZ

WIRES *Quality Products* CABLES

SHIELDED LEAD-IN AND GROUND WIRE

FREE STRIPPING RUBBER

Consists of FLEXIBLE tinned copper conductors, heavy wall of FREE STRIP rubber and CLOSELY WOVEN tinned copper shield. Shield can be grounded, reducing interference, resulting in better reception.



No. 18 FLEXIBLE 1/32' R.C.				No. 16 FLEXIBLE 1/32' R.C.				No. 14 FLEXIBLE 1/32' R.C.			
Cat. No.	Put-up	Std. Wt. Pkg. in lbs.	Price Each	Cat. No.	Put-up	Std. Wt. Pkg. in lbs.	Price Each	Cat. No.	Put-up	Std. Wt. Pkg. in lbs.	Price Each
1100	50-ft. carton	5 1.1	\$1.52	1102	50-ft. carton	5 1.4	\$1.75	1104	50-ft. carton	5 1.8	\$2.02
1101	250-ft. spool	1 5.9	7.60	1103	250-ft. spool	1 7.2	8.78	1105	250-ft. spool	1 9.0	10.13
1101A	500-ft. spool	1 11.8	14.98	1103A	500-ft. spool	1 14.4	17.33	1105A	500-ft. spool	1 18.0	20.00

SHIELDED LEAD-IN AND GROUND WIRE

WITH WAXED COTTON BRAID UNDER-SHIELD

Consists of FLEXIBLE tinned copper conductors, heavy wall of FREE STRIP rubber, plus WAXED COTTON BRAID and CLOSELY WOVEN tinned copper shield.

No. 18 FLEXIBLE 1/32' R.C.				No. 16 FLEXIBLE 1/32' R.C.				No. 14 FLEXIBLE 1/32' R.C.			
Cat. No.	Put-up	Std. Wt. Pkg. in lbs.	Price Each	Cat. No.	Put-up	Std. Wt. Pkg. in lbs.	Price Each	Cat. No.	Put-up	Std. Wt. Pkg. in lbs.	Price Each
118	50-ft. carton	5 1	\$1.77	116	50-ft. carton	5 1.3	\$2.15	114	50-ft. carton	5 1.6	\$2.43
118A	250-ft. spool	1 5.5	8.83	116A	250-ft. spool	1 7	10.75	114A	250-ft. spool	1 8.5	12.13
118B	500-ft. spool	1 11.0	17.40	116B	500-ft. spool	1 14.0	21.25	114B	500-ft. spool	1 17.0	24.02

BLACK POLISHED RUBBER COVERED LEAD-IN AND GROUND WIRE

Conductor consists of stranded clean tinned copper wire. Insulation—high quality live rubber, easily stripped. Put up in attractive CARTONS and on SPOOLS.

No. 18 FLEXIBLE 1/32' R.C.				No. 16 FLEXIBLE 1/32' R.C.				No. 14 FLEXIBLE 1/32' R.C.			
Cat. No.	Put-up	Std. Wt. Pkg. in lbs.	Price Each	Cat. No.	Put-up	Std. Wt. Pkg. in lbs.	Price Each	Cat. No.	Put-up	Std. Wt. Pkg. in lbs.	Price Each
1094	50-ft. carton	15 45	\$0.58	1097	50-ft. carton	15 90	\$0.85	1510	50-ft. carton	15 10	\$1.00
1095	100-ft. spool	10 95	1.13	1098	100-ft. spool	10 1.75	1.60	1511	100-ft. spool	10 2.0	1.95
1095B	500-ft. spool	2 2.5	5.75	1098B	500-ft. spool	2 9.0	7.85	1511B	500-ft. spool	2 11.0	9.42
1096	1000-ft. spool	1 5.0	10.83	1099	1000-ft. spool	1 17.8	15.45	1512	1000-ft. spool	1 21.0	18.83

TINNED COPPER SHIELDING AND BONDING BRAIDS

Conveniently furnished on spools in complete range of various widths. Used for general shielding purposes, especially auto radio. Wider widths used for bonding purposes, especially where automotive floating power exists.



1/8" Wide—Opens to 7/32"				1/4" Wide—Opens to 3/8"				9/16" Wide—Opens to 15/16"			
Cat. No.	Put-up	Std. Wt. Pkg. in lbs.	Price Each	Cat. No.	Put-up	Std. Wt. Pkg. in lbs.	Price Each	Cat. No.	Put-up	Std. Wt. Pkg. in lbs.	Price Each
1208	50-ft. spool	5 4	\$1.05	1212	50-ft. spool	5 1.4	\$1.95	1216	50-ft. spool	5 2.4	\$3.85
1208A	100-ft. spool	3 1.0	2.03	1212A	100-ft. spool	3 2.8	3.83	1216A	100-ft. spool	3 4.8	7.63
1209	250-ft. spool	1 2.5	5.08	1213	250-ft. spool	1 4.7	9.60	1217	250-ft. spool	1 9.6	19.05
1209B	500-ft. spool	1 5.0	9.95	1213B	500-ft. spool	1 9.4	18.98	1217B	500-ft. spool	1 19.2	37.87
3/16" Wide—Opens to 1/4"				3/8" Wide—Opens to 7/16"				1 1/16" Wide—Opens to 1 1/4"			
Cat. No.	Put-up	Std. Wt. Pkg. in lbs.	Price Each	Cat. No.	Put-up	Std. Wt. Pkg. in lbs.	Price Each	Cat. No.	Put-up	Std. Wt. Pkg. in lbs.	Price Each
1210	50-ft. spool	5 1.1	\$1.48	1214	50-ft. spool	5 1.7	\$2.52	1218	50-ft. spool	5 3.2	\$5.45
1210A	100-ft. spool	3 2.2	2.88	1214A	100-ft. spool	3 3.4	4.95	1218A	100-ft. spool	3 6.4	10.83
1211	250-ft. spool	1 3.7	7.17	1215	250-ft. spool	1 6.7	12.40	1219	250-ft. spool	1 13.3	27.15
1211B	500-ft. spool	1 7.4	14.15	1215B	500-ft. spool	1 13.4	24.60	1219B	500-ft. spool	1 26.6	53.95

All prices subject to change without notice.

LENZ

WIRES *Quality Products* **CABLES**

Shielded Rubber Jacketed Microphone Cables



Conductors all color-coded. Braided with tinned copper shield. Heavy Jacket Tough Black Polished Rubber applied overall. Will withstand severe service. Adaptable to carbon, condenser, and moving coil microphones. **POSITIVELY WATERPROOF**—excellent for field microphones.

Cat. No.	Put-up	Approx. O.D.	Std. Pkg.	Wt. Ea. Lbs.	List Price Each
1185	100-ft. spool, 2-conductor	1/8"	1	7.5	\$8.28
1186	250-ft. spool, 2-conductor	1/8"	1	20.7	21.10
1186A	500-ft. spool, 2-conductor	1/8"	1	39.4	41.20
1187	100-ft. spool, 3-conductor	1/8"	1	9.5	\$9.08
1188	250-ft. spool, 3-conductor	1/8"	1	25.7	27.13
1188A	500-ft. spool, 3-conductor	1/8"	1	49.4	45.28
1180	100-ft. spool, 4-conductor	3/8"	1	10.0	\$10.42
1181	250-ft. spool, 4-conductor	3/8"	1	27.0	27.08
1181A	500-ft. spool, 4-conductor	3/8"	1	52.0	51.95
1182	100-ft. spool, 5-conductor	3/8"	1	10.5	\$12.80
1183	250-ft. spool, 5-conductor	3/8"	1	28.0	32.58
1183A	500-ft. spool, 5-conductor	3/8"	1	54.0	64.03
1189	100-ft. spool, 6-conductor	3/8"	1	15.0	\$14.85
1190	250-ft. spool, 6-conductor	3/8"	1	39.0	37.70
1190A	500-ft. spool, 6-conductor	3/8"	1	76.0	74.25

Shielded Rubber Jacketed Microphone Cables Light Weight

Cat. No.	Put-up	Approx. O.D.	Std. Pkg.	Wt. Ea. Lbs.	List Price Each
1800	100-ft. spool, 2-conductor	1/8"	1	3.6	\$7.30
1801	250-ft. spool, 2-conductor	1/8"	1	9.5	17.85
1802	500-ft. spool, 2-conductor	1/8"	1	17.0	36.35
1810	100-ft. spool, 3-conductor	1/8"	1	5.0	\$8.43
1811	250-ft. spool, 3-conductor	1/8"	1	14.5	20.72
1812	500-ft. spool, 3-conductor	1/8"	1	22.0	42.00

Special Extra Flexible Shielded Rubber Jacketed Microphone Cable

Conductors of EXTRA FLEXIBLE CONSTRUCTION. Closely woven tinned copper shield, heavy Jacket Tough Black Polished Rubber overall.

Cat. No.	Put-up	Approx. O.D.	Std. Pkg.	Wt. Ea. Lbs.	List Price Each
1192	100-ft. spool, 3-conductor	1/8"	1	6.4	\$11.13
1193	250-ft. spool, 3-conductor	1/8"	1	18.0	27.46
1193A	500-ft. spool, 3-conductor	1/8"	1	34.0	55.49

Crystal Microphone Cable Shielded—Rubber Jacketed

The conductor is extremely flexible. Insulation is of low loss, high dielectric characteristics. A closely-woven tinned copper shield is applied, over which is placed a durable, high-quality rubber jacket.

SINGLE CONDUCTOR

Cat. No.	Put-up	Approx. O.D.	Std. Pkg.	Wt. Ea. Lbs.	List Price Each
1252	100-ft. spool	1/8"	3	3.0	\$7.02
1253	250-ft. spool	1/8"	1	0.75	17.23
1253A	500-ft. spool	1/8"	1	13.5	35.00

TWO-CONDUCTOR

Cat. No.	Put-up	Approx. O.D.	Std. Pkg.	Wt. Ea. Lbs.	List Price Each
1254	100-ft. spool	1/8"	1	3.55	\$8.98
1255	250-ft. spool	1/8"	1	8.80	22.98
1255A	500-ft. spool	1/8"	1	17.6	42.58

Shielded Cables



Flexible tinned copper conductors plus good grade of rubber insulation. Each conductor braided with color-coded cotton braid, thoroughly saturated in MOISTURE-PROOF compound, CLOSELY WOVEN tinned copper shield overall. Especially adaptable to AUTO RADIO, PUBLIC ADDRESS SYSTEMS and SOUND RECORDING EQUIPMENT.

NO. 20 FLEXIBLE R.C. COTTON BRAID CONDS.

Cat. No.	Put-up	Std. Pkg.	Wt. Ea. Lbs.	List Price Each
1110	100-ft. spool, 2-conductor No. 20	3	3.3	\$5.28
1111	250-ft. spool, 2-conductor No. 20	1	7.4	12.23
1111A	500-ft. spool, 2-conductor No. 20	1	16.8	23.83
1112	100-ft. spool, 3-conductor No. 20	3	4.7	7.10
1113	250-ft. spool, 3-conductor No. 20	1	10.7	16.59
1113A	500-ft. spool, 3-conductor No. 20	1	23.4	32.15
1114	100-ft. spool, 4-conductor No. 20	3	5.6	7.80
1115	250-ft. spool, 4-conductor No. 20	1	15.1	19.20
1115A	500-ft. spool, 4-conductor No. 20	1	28.2	38.93
1116	100-ft. spool, 5-conductor No. 20	3	6.5	10.32
1117	250-ft. spool, 5-conductor No. 20	1	16.8	24.26
1117A	500-ft. spool, 5-conductor No. 20	1	31.6	46.73
1118	100-ft. spool, 6-conductor No. 20	3	7.5	12.85
1119	250-ft. spool, 6-conductor No. 20	1	18.6	29.12
1119A	500-ft. spool, 6-conductor No. 20	1	35.2	56.00

NO. 18 FLEXIBLE R.C. COTTON BRAID CONDS.

Cat. No.	Put-up	Std. Pkg.	Wt. Ea. Lbs.	List Price Each
1120	100-ft. spool, 2-conductor No. 18	3	3.8	\$6.05
1121	250-ft. spool, 2-conductor No. 18	1	8.6	14.12
1121A	500-ft. spool, 2-conductor No. 18	1	19.2	27.43
1122	100-ft. spool, 3-conductor No. 18	3	5.4	7.92
1123	250-ft. spool, 3-conductor No. 18	1	14.7	19.42
1123A	500-ft. spool, 3-conductor No. 18	1	27.4	35.83
1124	100-ft. spool, 4-conductor No. 18	3	7.0	10.12
1125	250-ft. spool, 4-conductor No. 18	1	18.2	23.78
1125A	500-ft. spool, 4-conductor No. 18	1	34.4	45.85
1126	100-ft. spool, 5-conductor No. 18	3	8.2	11.64
1127	250-ft. spool, 5-conductor No. 18	1	21.6	27.41
1127A	500-ft. spool, 5-conductor No. 18	1	41.2	52.77
1128	100-ft. spool, 6-conductor No. 18	3	9.8	13.72
1129	250-ft. spool, 6-conductor No. 18	1	25.0	32.37
1129A	500-ft. spool, 6-conductor No. 18	1	48.0	62.20

Shielded Cables Cotton Braid Overall

NO. 20 FLEXIBLE R.C. COTTON BRAID CONDS.

Cat. No.	Put-up	Std. Pkg.	Wt. Ea. Lbs.	List Price Each
1160	100-ft. spool, 2-conductor No. 20	3	3.5	\$6.52
1161	250-ft. spool, 2-conductor No. 20	1	8.0	15.41
1161A	500-ft. spool, 2-conductor No. 20	1	18.0	29.45
1162	100-ft. spool, 3-conductor No. 20	3	4.9	8.50
1163	250-ft. spool, 3-conductor No. 20	1	11.1	19.97
1163A	500-ft. spool, 3-conductor No. 20	1	24.2	38.58
1164	100-ft. spool, 4-conductor No. 20	3	6.0	9.28
1165	250-ft. spool, 4-conductor No. 20	1	16.0	22.83
1165A	500-ft. spool, 4-conductor No. 20	1	30.0	46.20
1166	100-ft. spool, 5-conductor No. 20	3	7.3	12.00
1167	250-ft. spool, 5-conductor No. 20	1	12.5	28.27
1167A	500-ft. spool, 5-conductor No. 20	1	33.0	54.38
1168	100-ft. spool, 6-conductor No. 20	3	8.0	14.13
1169	250-ft. spool, 6-conductor No. 20	1	20.0	33.37
1169A	500-ft. spool, 6-conductor No. 20	1	38.0	64.10

NO. 18 FLEXIBLE R.C. COTTON BRAID CONDS.

Cat. No.	Put-up	Std. Pkg.	Wt. Ea. Lbs.	List Price Each
1170	100-ft. spool, 2-conductor No. 18	3	4.2	\$7.59
1171	250-ft. spool, 2-conductor No. 18	1	11.5	20.40
1171A	500-ft. spool, 2-conductor No. 18	1	21.0	34.40
1172	100-ft. spool, 3-conductor No. 18	3	6.2	9.52
1173	250-ft. spool, 3-conductor No. 18	1	15.0	22.40
1173A	500-ft. spool, 3-conductor No. 18	1	28.0	43.18
1174	100-ft. spool, 4-conductor No. 18	3	7.4	11.92
1175	250-ft. spool, 4-conductor No. 18	1	19.2	28.03
1175A	500-ft. spool, 4-conductor No. 18	1	36.4	53.95
1176	100-ft. spool, 5-conductor No. 18	3	8.7	13.56
1177	250-ft. spool, 5-conductor No. 18	1	22.0	32.00
1177A	500-ft. spool, 5-conductor No. 18	1	42.0	61.50
1178	100-ft. spool, 6-conductor No. 18	3	10.4	15.65
1179	250-ft. spool, 6-conductor No. 18	1	26.5	37.00
1179A	500-ft. spool, 6-conductor No. 18	1	51.0	71.05

All prices subject to change without notice.

LENZ

WIRES *Quality Products* CABLES

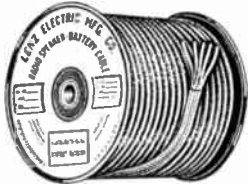

DYNAMIC SPEAKER EXTENSION CABLE

Individual conductors consist of flexible tinned copper, rubber insulation and color-coded cotton braid. Brown cotton braid applied overall. Suitable for either permanent or portable PUBLIC ADDRESS systems.

No. 20 STRANDED CONDUCTORS

Cat. No.	Put-up	Std. Pkg.	Wt. Ea. in lbs.	List Price Each
1139	100-ft. spool, 2 conductor, No. 20	3	2.0	\$3.55
5139	500-ft. spool, 2 conductor, No. 20	1	12.0	17.65
1140	100-ft. spool, 3 conductor, No. 20	3	2.7	4.65
5140	500-ft. spool, 3 conductor, No. 20	1	15.5	23.10
1141	100-ft. spool, 4 conductor, No. 20	3	3.5	5.83
1141	100-ft. spool, 4 conductor, No. 20	1	19.5	29.05
5141	500-ft. spool, 4 conductor, No. 20	3	4.0	6.80
5142	100-ft. spool, 5 conductor, No. 20	1	22.0	33.90
5142	500-ft. spool, 5 conductor, No. 20	3	5.0	7.85
1143	100-ft. spool, 6 conductor, No. 20	1	27.0	39.15
5143	500-ft. spool, 6 conductor, No. 20	3	6.0	9.15
1144	100-ft. spool, 7 conductor, No. 20	1	32.0	45.67
5144	500-ft. spool, 7 conductor, No. 20	1	32.0	45.67

No. 16 & No. 20 STRANDED CONDUCTORS

Cable consists of two heavy conductors for voice-coil circuit.

Cat. No.	Put-up	Std. Pkg.	Wt. Ea. in lbs.	List Price Each
1141A	100-ft. spl., 4 cond., 2 No. 16 and 2 No. 20	3	4.5	\$7.67
1141B	500-ft. spl., 4 cond., 2 No. 16 and 2 No. 20	1	24.5	38.28
1142A	100-ft. spl., 5 cond., 2 No. 16 and 3 No. 20	3	5.6	8.85
1142B	500-ft. spl., 5 cond., 2 No. 16 and 3 No. 20	1	30.0	44.30
1143A	100-ft. spl., 6 cond., 2 No. 16 and 4 No. 20	3	6.6	10.07
1143B	500-ft. spl., 6 cond., 2 No. 16 and 4 No. 20	1	35.0	50.23
1144A	100-ft. spl., 7 cond., 2 No. 16 and 5 No. 20	3	7.6	11.25
1144B	500-ft. spl., 7 cond., 2 No. 16 and 5 No. 20	1	40.0	56.13

RUBBER JACKETED DYNAMIC SPEAKER EXTENSION CABLE

Heavy Tough Rubber Jacket Applied Overall—Suitable for Portable Public Address Systems
(Not Shielded)

No. 20 STRANDED CONDUCTORS

Cat. No.	Put-up	Approx. O.D.	Std. Pkg.	Wt. Ea. in lbs.	List Price Each
1700	100-ft. spool, 4 conductor	5/16"	1	6.5	\$7.65
1701	500-ft. spool, 4 conductor	5/16"	1	34.5	38.05

No. 16 & No. 20 STRANDED CONDUCTORS

Cat. No.	Put-up	Approx. O.D.	Std. Pkg.	Wt. Ea. in lbs.	List Price Each
1700A	100-ft. spool, 4 conductor	13/32"	1	8.0	\$10.35
1700B	500-ft. spool, 4 conductor	13/32"	1	42.0	51.60

HEAD SET CORDS

DOUBLE HEAD-SET CORDS

Trim A has pin tips on all ends. Trim B has loop tips on head-set end and pin tips opposite end. Mercerized cotton braid.

CAT. No. 1225A

5-Ft. Lengths—Trim A



Trim A

Quantity	Weight in lbs.	List Price Per Cord
Lots of 12	.6	\$0.58
Lots of 25	1.3	.55
Lots of 100	5.2	.49

CAT. No. 1225B

5-Ft. Lengths—Trim B

Quantity	Weight in lbs.	List Price Per Cord
Lots of 12	.6	\$0.58
Lots of 25	1.3	.55
Lots of 100	5.2	.49

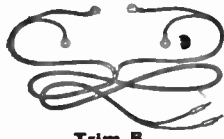

Trim B

SINGLE PHONE CORDS

Also Used on Magnetic Speakers and Electric Pickups

Construction — Good grade tinsel conductor, well insulated. Overall braid mercerized cotton.

CAT. No. 1235A

5-Ft. Lengths—Trim A

Quantity	Weight in lbs.	List Price Per Cord
Lots of 12	.5	\$0.42
Lots of 25	1.2	.38
Lots of 100	4.8	.35

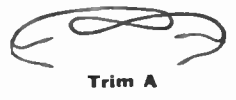

Trim A

CAT. No. 1235B

5-Ft. Lengths—Trim B

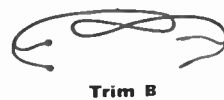

Trim B

Quantity	Weight in lbs.	List Price Per Cord
Lots of 12	.5	\$0.42
Lots of 25	1.2	.38
Lots of 100	4.8	.35

EXTENSION CORDS

20-FOOT LENGTHS

Extra flexible tinsel conductor, well insulated. Overall mercerized cotton braid. Can be used on auxiliary speaker or phono pick-up extension.

CAT. No. 1245

Put-up	Weight Per Lot	List Price Per Cord
Lots of 12—20-ft. length	2.2	\$0.75
Lots of 25—20-ft. length	4.5	.72
Lots of 100—20-ft. length	18.0	.67

RADIO BATTERY CABLE

Consists of two heavy conductors for "A" battery supply. All conductors color-coded. Durable brown cotton braid overall.

Cat. No.	Put-up	Std. Pkg.	Wt. Ea. in lbs.	List Price Each
1150	100-ft. spool, 5 conductor	3	5.0	\$7.55
1150A	500-ft. spool, 5 conductor	1	27.0	37.55
1151	100-ft. spool, 7 conductor	2	7.0	9.85
1151A	500-ft. spool, 7 conductor	1	37.0	49.17
1152	100-ft. spool, 9 conductor	1	10.0	12.33
1152A	500-ft. spool, 9 conductor	1	52.0	61.55

All prices subject to change without notice.

LENZ

WIRES *Quality Products* CABLES

TRANSMISSION LINE FOR ALL-WAVE DOUBLET ANTENNA SYSTEM

NOT SHIELDED



Excellent for short-wave reception. Conductors are of solid copper, insulated with a heavy coating of enamel, and weatherproof cotton braid, color coded.

Cat. No.	Put-up	Standard Package	Wt. Ea. in lbs.	List Price Each
1260	100-ft. spool	5	1	\$1.88
1261	500-ft. spool	1	5	8.48

SHIELDED



Ideal for short-wave reception. Conductors are of solid copper, insulated with a heavy coating of enamel over which is placed a weatherproof cotton braid, color coded. A

closely woven bare copper shield is placed over all for grounding purposes.

Cat. No.	Put-up	Standard Package	Wt. Ea. in lbs.	List Price Each
1262	100-ft. spool	5	2.25	\$3.65
1263	500-ft. spool	1	11.25	17.35

TWISTED PAIR BRAID OVERALL DOUBLET TRANSMISSION CABLE



BLACK weatherproof braid overall suitable as transmission line for DOUBLET ANTENNA SYSTEM required on "ALL WAVE" RADIO RECEIVERS.

Cat. No.	Put-up	Standard Package	Weight Ea. in lbs.	List Price Each
1264	100' spool	5	2.45	\$3.55
1265	500' spool	1	11.90	16.88

SHIELDED LOW CAPACITY CABLE



permits shielding without excessive loss signal.

For auto antenna lead-in and short-wave converters. Extremely low capacity between conductor and shield

Cat. No.	Put-up	Std. Pkg. in lbs.	Wt. Ea. in lbs.	List Price Each
1194	50-ft. coil $\frac{1}{4}$ " O.D.	3	4.0	\$7.10
1195	100-ft. spool $\frac{1}{4}$ " O.D.	1	10.0	14.75
1195B	500-ft. spool $\frac{1}{4}$ " O.D.	1	50.0	69.85
1196	50-ft. spool $\frac{1}{2}$ " O.D.	3	2.5	3.48
1197	100-ft. spool $\frac{1}{2}$ " O.D.	1	7.0	7.50
1197B	500-ft. spool $\frac{1}{2}$ " O.D.	1	37.0	33.60

Shielded Low Capacity Weatherproof Tubing

LOOM

$\frac{1}{4}$ " I.D. Shielded low capacity weatherproof tubing, approximately $\frac{1}{4}$ " O.D.

Small outside diameter permits easy assembly in corner post of auto as shield for antennae lead-in. Excellent for shielding output of signal generators. Used by many prominent manufacturers of auto radio.



Cat. No.	Put-up	Std. Pkg. in lbs.	Wt. Ea. in lbs.	List Price Each
1203	50-ft. spool $\frac{1}{4}$ " I.D.	3	2.0	\$4.50
1204	100-ft. spool $\frac{1}{4}$ " I.D.	1	4.0	8.77
1296	500-ft. spool $\frac{1}{2}$ " I.D.	1	20.0	43.83

RUBBER JACKETED SHIELDED LOW CAPACITY CABLE

SINGLE CONDUCTOR



Outer rubber jacket insures **Positive Weatherproofing**. Excellent interference eliminator on broadcast band. Suggest ends be sealed after installation to prevent moisture absorption.

Cat. No.	Put-up	Std. Pkg. in lbs.	Wt. Ea. in lbs.	List Price Each
1400	50-ft. coil $\frac{1}{8}$ " O.D.	1	4.0	\$5.47
1400A	100-ft. spool $\frac{1}{8}$ " O.D.	1	5.0	10.73
1400B	500-ft. spool $\frac{1}{8}$ " O.D.	1	40.0	53.50
1405	50-ft. coil $\frac{1}{4}$ " O.D.	1	12.0	11.60
1405A	100-ft. spool $\frac{1}{4}$ " O.D.	1	22.0	24.20
1405B	500-ft. spool $\frac{1}{4}$ " O.D.	1	111.0	117.00

INDOOR AERIAL

EXTREMELY FLEXIBLE conductor, tightly woven brown cotton braid. Will not kink and can be easily concealed. Also suitable for loop aeriels.

Cat. No.	Put-up	Std. Pkg. in lbs.	Wt. Ea. in lbs.	List Price Each
1089	20-ft. carton	20	.05	\$0.18
1090	60-ft. carton	5	.16	.42
1091	125-ft. carton	5	.30	.74
1092	1000-ft. spool	1	2.75	5.55

NEW! SUPER-FLEXIBLE MICROPHONE CABLE



Cat. No.	Put up in	approx. O.D.	standard package	wt.	List Price Each
1240	100' spool	$\frac{1}{32}$ "	3	3 lbs.	\$7.88
1240A	250' spool	$\frac{1}{32}$ "	1	6 $\frac{1}{2}$ lbs.	20.00
1240B	500' spool	$\frac{1}{32}$ "	1	13 $\frac{1}{2}$ lbs.	39.27

All prices subject to change without notice.

ALPHA-WIRE-PRODUCTS

LACQUERED HOOK-UP AND LEAD-IN WIRE High Gloss Lacquered Braid

GENERAL PURPOSE: For point to point soldering connections on transformers, amplifiers, panel hook-up, etc., where a low loss dielectric is required. It is not a pushback wire but will strip easily.

CONSTRUCTION: Stranded tinned conductor, free stripping rubber, silk braid highly lacquered.

No.	Length Feet	Size	Tinned Strand	Rubber Thickness	Voltage Breakdown (60 Cycles)	D.C. Resistance Per Foot (Megohms)	O.D.	List Price
1511	25 Spool	20	10/30	1/64"	7000	290	.090"	\$0.30
1513	100 Spool	20	10/30	1/64"	7000	290	.090"	1.25
1515	500 Spool	20	10/30	1/64"	7000	290	.090"	5.65
1521	25 Spool	18	16/30	1/64"	7000	300	.110"	.45
1523	100 Spool	18	16/30	1/64"	7000	300	.110"	1.65
1525	500 Spool	18	16/30	1/64"	7000	300	.110"	7.50
1531	25 Spool	18	16/30	1/32"	8500	460	.135"	.45
1533	100 Spool	18	16/30	1/32"	8500	460	.135"	1.70
1535	500 Spool	18	16/30	1/32"	8500	460	.135"	8.00
1541	25 Spool	16	26/30	1/32"	8500	460	.150"	2.25
1543	100 Spool	16	26/30	1/32"	8500	460	.150"	8.55
1545	500 Spool	16	26/30	1/32"	8500	460	.150"	10.25

Size #18 Stranded 1/32" Stock Colors: Black, Red, Green, Yellow, Blue, Brown, White. Other sizes Stock Colors: Black and Red.

"LACTIV" WIRE (Pushback)

GENERAL PURPOSE: Pushback hook-up wire in various colors for circuit identification.

CONSTRUCTION: Single conductor, solid or stranded tinned copper, served, .010" special rubber compound, colored cotton braid waxed.

No.	Length	Size	Strand	Voltage Breakdown (60 Cycles)	D.C. Resistance Per Foot (Megohms)	O.D.	List Price
1411	25 Ft. Spool	22	Solid	2500	16	.080"	\$0.22
1413	100 Ft. Spool	22	Solid	2500	16	.080"	.85
1415	500 Ft. Spool	22	Solid	2500	16	.080"	4.25
1421	25 Ft. Spool	20	Solid	2400	15.5	.090"	.30
1423	100 Ft. Spool	20	Solid	2400	15.5	.090"	1.00
1425	500 Ft. Spool	20	Solid	2400	15.5	.090"	4.50
1431	25 Ft. Spool	18	Solid	2450	16	.097"	.45
1433	100 Ft. Spool	18	Solid	2450	16	.097"	1.65
1435	500 Ft. Spool	18	Solid	2450	16	.097"	7.50
1441	25 Ft. Spool	16	Solid	2200	15	.105"	.40
1443	100 Ft. Spool	16	Solid	2200	15	.105"	1.45
1445	500 Ft. Spool	16	Solid	2200	15	.105"	6.55
1451	25 Ft. Spool	14	Solid	2150	14.8	.130"	1.95
1453	100 Ft. Spool	14	Solid	2150	14.8	.130"	7.25
1455	500 Ft. Spool	14	Solid	2150	14.8	.130"	18.75
1301	25 Ft. Spool	22	7/30	2500	16	.080"	.25
1303	100 Ft. Spool	22	7/30	2500	16	.080"	.95
1305	500 Ft. Spool	22	7/30	2500	16	.080"	4.50
1311	25 Ft. Spool	20	10/30	2300	15.5	.090"	.30
1313	100 Ft. Spool	20	10/30	2300	15.5	.090"	1.05
1315	500 Ft. Spool	20	10/30	2300	15.5	.090"	4.75
1321	25 Ft. Spool	18	16/30	2400	16	.097"	.45
1323	100 Ft. Spool	18	16/30	2400	16	.097"	1.65
1325	500 Ft. Spool	18	16/30	2400	16	.097"	7.50
1331	25 Ft. Spool	16	26/30	2200	15	.105"	.45
1333	100 Ft. Spool	16	26/30	2200	15	.105"	1.75
1335	500 Ft. Spool	16	26/30	2200	15	.105"	7.75
1341	25 Ft. Spool	14	41/30	2150	14.8	.130"	2.20
1343	100 Ft. Spool	14	41/30	2150	14.8	.130"	8.50
1345	500 Ft. Spool	14	41/30	2150	14.8	.130"	21.00

22-20-18—Stranded and Solid Stock Colors: Black, Red, Green, Yellow, Blue, Brown, White.
16-14—Stranded and Solid Colors: Black and Red.

SHIELDED LEAD-IN AND GROUND WIRE

GENERAL PURPOSE: Eliminates interference caused by motors, high tension wires, X-Ray machines or other apparatus that radiate electrical impulses. Can also be used for grid and plate leads.

CONSTRUCTION: Stranded tinned conductor, free strip rubber, braided tinned copper shield overall. Frequency: 3000 K.C.

No.	Length Feet	Size	Strand	Thickness Rubber	Maximum Capacity Per Foot	Surge Impedance (Ohms)	Power Factor Percent	O. D.	List Price
1201	250 Spool	14	41/30	3/64"	84 mmf.	27.7	1.98	.180"	\$10.00
1205	50 Carton	14	41/30	3/64"	84 mmf.	27.7	1.98	.180"	2.15
1211	250 Spool	16	26/30	1/32"	66 mmf.	33.7	1.83	.150"	7.50
1215	50 Carton	16	26/30	1/32"	66 mmf.	33.7	1.83	.150"	1.55
1221	500 Spool	18	16/30	1/64"	97 mmf.	23.1	1.90	.115"	11.65
1225	500 Spool	20	10/30	1/64"	92 mmf.	29.3	2.10	.107"	9.40

LACQUERED PRIMARY WIRE

GENERAL PURPOSE: For automobile head, tail, side, dashboard lamps, horn, spotlight, instrument leads and general primary voltage applications.

CONSTRUCTION: Stranded soft annealed tinned copper, insulated with rubber, over which is a highly lacquered braid. Oil, heat, and moisture-resistant.

No.	Spool	Size	Strand	Rubber	O.D.	List	No.	Spool	Size	Strand	Rubber	O.D.	List
1983	100'	10	19/23	1/32"	.208"	\$6.25	1995	100'	16	26/30	1/32"	.155"	\$2.15
1989	100'	18	16/30	1/64"	.110"	1.60	1996	500'	16	26/30	1/32"	.155"	9.75
1990	500'	18	16/30	1/64"	.110"	7.25	1997	100'	14	41/30	1/32"	.170"	2.50
1991	100'	18	16/30	1/32"	.147"	1.45	1998	500'	14	41/30	1/32"	.170"	11.50
1992	500'	18	16/30	1/32"	.147"	7.50	1999	100'	12	19/25	1/32"	.180"	3.75

BRAIDED SHIELDING

GENERAL PURPOSE: For shielding speaker leads, lead-ins, amplifier wires, auto radio installations. Also for bonding.

CONSTRUCTION: Composed of very fine soft annealed copper wire braided and rolled flat.

BARE COPPER				TINNED COPPER			
No.	Spool	I.D.	List	No.	Spool	I.D.	List
1226	50 Ft.	1/4"	\$1.65	1230	50 Ft.	3/16"	\$1.50
1227	50 Ft.	3/8"	1.90	1231	50 Ft.	1/4"	1.90
1228	50 Ft.	5/8"	3.90	1232	50 Ft.	3/8"	2.25
				1232D	250 Ft.	3/8"	10.00
				1233	50 Ft.	5/8"	4.00

"SUPER HI-TENSION" KINKLESS TEST LEAD WIRE

GENERAL PURPOSE: As test leads in analyzers, oscillators and all other types of testing apparatus or wherever an EXTRA FLEX-IBLE insulated wire is required.

CONSTRUCTION: #20-41/36 tinned soft annealed copper, concentric strand, cotton wrap, 3/64" "Super Hi-Tension" rubber, satin finish.

No.	Spool Feet	Voltage (60 Cycles)	D.C. Resistance Per Foot (Megohms)	O.D.	List Price
1633	100	10,000 V.	710	.140"	\$1.70
1635	500	10,000 V.	710	.140"	8.00

STOCK COLORS: RED and BLACK

Heavy Duty Type

GENERAL PURPOSE: For television therapeutic equipment, analyzers, oscillators, etc. or wherever a heavy duty high voltage line is required.

CONSTRUCTION: #18-66 36 tinned soft annealed copper wire, concentric strand, cotton wrap, heavy "Super Hi-Tension" rubber, satin finish.

No.	Spool	Voltage	D.C. Resistance	O.D.	List
1637	100	22,000 V.	Over 1,000	.248"	\$5.00
1638	500	22,000 V.	Over 1,000	.248"	22.50

STOCK COLORS: RED and BLACK

AUTO RADIO SHIELDED LEAD-IN

GENERAL PURPOSE: As an antenna lead-in to reduce interference of ignition pick-up.

CONSTRUCTION: Single conductor, stranded tinned copper, insulated with rubber, jute filters, close tinned copper shield overall.

No.	Spool	Max. Capacity	Per Foot	O.D.	List
1239	100'	27.6 mmf.		.250"	\$7.50
1240	100'	9.7 mmf.		.500"	11.25

SHIELDED LOW LOSS CABLE

GENERAL PURPOSE: For auto radios, lead-ins, phonograph pick-ups, short wave receivers and for grid leads in the input stages of PA amplifiers.

CONSTRUCTION: Single conductor #20-10/30 stranded tinned copper, insulated with low loss rubber compound, white silk braid, tinned copper shield overall.

No.	Spool	Capacity	Per Foot	O.D.	List
1241	100 Ft.	22.6 mmf.		.225"	\$4.90

7 MM SHIELDED IGNITION CABLE

GENERAL PURPOSE: For automotive and aircraft ignition systems requiring grounding to overcome interference.

CONSTRUCTION: Single conductor #16-19/29 stranded tinned copper, rubber insulated, cotton braid highly lacquered, braided tinned copper shield overall.

No.	Spool	O.D.	List
1193	100 Ft.	.300"	\$8.00

SHIELDED LOOM

GENERAL PURPOSE: For shielding auto antenna lead-ins. Shields the output of signal generators.

CONSTRUCTION: Made of heavy braided loom, weatherproofed and covered with a closely woven tinned copper shield.

No.	Spool	I.D.	List
1236	50 Ft.	3/8"	\$6.25
1237	50 Ft.	5/16"	5.00
1238	50 Ft.	3/16"	3.65

7 MM LACQUERED IGNITION WIRE

GENERAL PURPOSE: For automotive ignition systems.

CONSTRUCTION: Single conductor #16-19/29 stranded tinned copper, rubber insulated, cotton braid highly lacquered.

No.	Spool	O.D.	List
1981	100 Ft.	.275"	\$4.40

ALPHA-WIRE-PRODUCTS

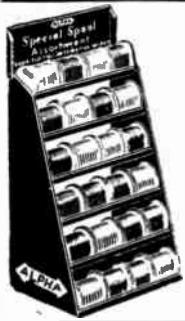

ALPHA SPECIAL SPOOL ASSORTMENT
On Attractive Metal Spools
... Including ...

PUSHBACK HOOK-UP RUBBER COVERED AUTOMOTIVE PRIMARY SHIELDED LEAD-IN FIXTURE LAMP WIRE

LIST 63c EACH

Catalog No.	Description	Approximate Quantity per Spool
9801	#22 Solid Pushback Wire-Assorted Colors	85 Ft.
9802	#20 Solid Pushback Wire-Assorted Colors	70 Ft.
9804	#18 Solid Pushback Wire-Assorted Colors	60 Ft.
9805	#16 Solid Pushback Wire-Assorted Colors	40 Ft.
9806	#14 Solid Pushback Wire-Assorted Colors	35 Ft.
9811	#22 Stranded Pushback Wire-Assorted Colors	70 Ft.
9812	#20 Stranded Pushback Wire-Assorted Colors	60 Ft.
9814	#18 Stranded Pushback Wire-Assorted Colors	50 Ft.
9815	#16 Stranded Pushback Wire-Assorted Colors	35 Ft.
9816	#14 Stranded Pushback Wire-Assorted Colors	25 Ft.
9820	#20 Stranded 1/32" R. C. Wire-Black	100 Ft.
9822	#18 Stranded 1/32" R. C. Wire-Black	75 Ft.
9824	#16 Stranded 1/32" R. C. Wire-Black	45 Ft.
9827	#14 Stranded 3/64" R. C. Wire-Black	35 Ft.
9828	#18 Solid 3/64" R. C. Lead-In Wire-Black	70 Ft.
9829	#20 Solid 3/64" R. C. Lead-In Wire-Black	100 Ft.
9830	#18 Stranded 1/32" R. C. Lacquered Braid-Assorted Colors	40 Ft.
9834	#20 Stranded 1/64" R. C. Shielded Lead-In	35 Ft.
9837	"Super Hi-Tension" Test Prod. Colored Rubber Wire-Black and Red	35 Ft.
9838	Heavy Duty "Super Hi-Tension" Test Prod. Colored Rubber Wire-Black and Red	12 Ft.
9840	A. C. - D. C. Indoor Aerial Wire	100 Ft.
9848	#18 E-Z Strip All Rubber Parallel Lamp Cord-Approved Assorted Colors	25 Ft.
9870	#18 Plain Tinned Copper	100 Ft.
9875	#18 Annunciator (Bell) Wire	100 Ft.

MAGNET WIRE

Plain Enameled

Size B & S	384 Special Footage Spool	List Price	1/2 Lb. Spool	List Price	1/2 Lb. Spool	List Price
14	27	\$0.38	19	\$0.28	39	\$0.53
16	45	.38	30	.30	60	.53
18	60	.38	50	.30	100	.53
20	95	.38	80	.33	180	.53
22	150	.38	125	.35	250	.55
24	220	.38	200	.35	400	.60
26	310	.38	315	.43	635	.63
28	460	.38	505	.45	1010	.75
30	610	.38	805	.48	1610	.83
32	820	.38	1275	.53	2550	.90
34	1220	.38	2030	.63	4060	1.05
36	1620	.38	3220	.73	6440	1.20
38	2000	.38	5120	.90	10240	1.43
40	2500	.38	8140	1.38	16280	2.10

Double Cotton Covered

Size B & S	384 Special Footage Spool	List Price	1/2 Lb. Spool	List Price	1/2 Lb. Spool	List Price
14	27	\$0.38	19	\$0.31	39	\$0.58
16	37	.38	30	.35	60	.58
18	53	.38	50	.35	95	.63
20	65	.38	75	.40	150	.68
22	90	.38	115	.45	235	.78
24	120	.38	180	.48	360	.93
26	180	.38	280	.60	560	1.10
28	190	.38	430	.70	860	1.33
30	290	.38	645	.85	1290	1.58
32	240	.38	965	1.05	1930	1.95
34	260	.38	1350	1.45	2700	2.80
36	280	.38	1875	2.04	3350	3.85

Double Silk Covered

Size B & S	384 Special Footage Spool	List Price	1/2 Lb. Spool	List Price	1/2 Lb. Spool	List Price
18	32	\$0.30	50	\$0.55	100	\$1.05
20	44	.30	80	.65	150	1.25
22	62	.30	125	.73	250	1.43
24	87	.30	195	.85	395	1.65
26	105	.30	310	1.04	620	2.00
28	125	.30	490	1.15	980	2.25
30	145	.30	765	1.30	1530	2.50
32	170	.30	1190	1.75	2380	3.40
34	200	.30	1785	2.25	3570	4.40
36	230	.30	2685	3.50	5370	6.75

FLEXIBLE VARNISHED TUBING



RADIO TUBING—(Spaghetti). A sleeving with a heavy coat of varnish, in high gloss vivid colors. Average dielectric strength: 5,000 volts.

SATURATED SLEEVING—A fibre yarn sleeving saturated with high grade insulating varnish. Cuts clean and has a smooth interior wall. Average dielectric strength: 1,200 volts.

MAGNETO TUBING—The production of this type of tubing is under rigid control so as to insure a maximum in quality. It is thoroughly impregnated with a varnish of maximum insulating value. It is resistant to heat, oil, gas and acids. Colors are bright and vivid. Average dielectric strength: 7,000 volts.

Note: Sizes follow the B & S System of gauging wires. For instance, a #10 tubing will fit over a #10 bare wire or any wire with an insulation of which the O.D. is equivalent to #10 B & S gauge. If in doubt, it is best to submit a sample of the wire or product to be covered.

List Prices Per 100 Feet			List Prices Per 100 Feet						
No.	App. I.D.	Radio Tubing	Sat. Sleevings	Magneto Tubing	No.	App. I.D.	Radio Tubing	Sat. Sleevings	Magneto Tubing
20	.034	\$4.15	\$2.75	\$6.25	8	.133	\$6.25	\$4.50	\$9.40
19	.038	4.15	2.75	6.25	7	.148	6.90	4.75	10.00
10	.042	4.15	2.75	6.25	6	.160	7.65	5.15	10.75
17	.047	4.15	2.75	6.25	5	.186	8.25	5.65	11.50
16	.053	4.25	2.90	6.50	4	.208	9.00	6.15	12.25
15	.059	4.25	2.90	6.75	3	.234	9.75	6.65	13.00
*14	.066	4.70	3.25	7.00	2	.263	10.40	7.15	14.50
*13	.076	4.75	3.40	7.15	1	.294	10.75	7.65	16.00
*12	.085	4.90	3.50	7.25	0	.330	12.25	8.25	18.75
11	.095	5.15	3.65	8.00	3/8	.375	14.75	8.90	21.25
10	.106	5.25	3.75	8.50	7/16	.438	17.25	9.50	23.75
9	.118	5.65	4.25	9.00	1/2	.500	19.75	10.15	26.25
					5/8	.625	22.25	10.75	31.25

Tolerances: Sizes 0 to 2—plus or minus .005"
3 to 15—plus or minus .004"
14 to 20—plus or minus .002"

Lengths—Standard 36"
"30"

AC-DC ANTENNA WIRE



GENERAL PURPOSE: Ideal replacement wire for universal midsets, indoor aerials and loop antennas.

CONSTRUCTION: Single conductor #23-20/36 stranded bare copper, extra flexible, covered with a dark brown cotton braid overall.

Number	Length	Put-Up	List
1281	25 Ft.	Disc	\$0.18
1282	100 Ft.	Spool	.65
1283	500 Ft.	Spool	2.75
1284	1000 Ft.	Spool	5.25

AC-DC RESISTANCE LINE CORDS

These line cords are built with a third element voltage drop resistor to take care of reducing line voltage and also increase life of coils and condensers as well as eliminate heat generated by the receiver. Equipped with a soft rubber unbreakable attachment plug.

INDIVIDUALLY BOXED FOR SETS WITH FOLLOWING TUBES

No.	Ohms	For Tubes
1174	135	4-6.3 Volt Tubes, 1-43, 1-25Z5
1175	180	3-6.3 Volt Tubes, 1-43, 1-25Z5
1175B	180	4-6.3 Volt Tubes, 1-43, 1-12Z3
		2-6.3 Volt Tubes, 1-43, 1-25Z5
1176	220	3-6.3 Volt Tubes, 1-43, 1-12Z3
1176B	250	2-6.3 Volt Tubes, 1-43, 1-12Z3
		3-6.3 Volt Tubes, 1-25Z5
1177	290	3-6.3 Volt Tubes, 1-12Z3
1178	330	4-6.3 Volt Tubes, 1-12Z3
		2-6.3 Volt Tubes, 1-12Z3
1179	360	1-6.3 Volt Tube, 1-12Z3
		3-6.3 Volt Tubes

List Price, each.....\$0.60

HEAVY DUTY RUBBER EXTENSION CORD SET



Best for extending power lines of motors, refrigerators, washing machines, electric drills, vacuum cleaners, etc. Construction 18-2 SJ service cord, rubber connector one end, other end rubber plug.

Number	Length	List
4139	9 Ft.	Extension Cord \$0.80
4142	12 Ft.	Extension Cord .93

E-Z STRIP POWER CORDS



Ideal power supply cord for replacement on radios, lamps, fans, etc. Made of E-Z strip all rubber parallel cord (UNDERWRITERS APPROVED).

No.	Lgth.	List	No.	Lgth.	List
2196	8'	\$0.23	2109	9'	\$0.28
			2112	12'	\$0.35

GUY WIRE

GENERAL PURPOSE: Extensively used on transmitter and receiver poles and towers.

CONSTRUCTION: Galvanized steel wire having extremely high tension strength.

Number	Length	List
2195	25 Ft. Coil	\$0.25
2196	50 Ft. Coil	.50



CUBE TAP EXTENSION CORD

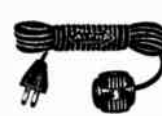

Constructed of ALPHA E-Z Strip rubber cord. A three outlet Bakelite tap is at one end and an unbreakable rubber attachment plug on the other end. (UNDERWRITERS APPROVAL.)

INDIVIDUALLY BOXED

No.	Lgth.	List	No.	Lgth.	List	No.	Lgth.	List
4196	8'	\$0.40	4110	10'	\$0.48	4115	15'	\$0.60
4198	9'	.45	4112	12'	.55	4120	20'	.70

ANNUNCIATOR (BELL) WIRE

Pure copper, two cotton serves reversed and heavy paraffin impregnation are the components used in our wire. Supplied in assorted colors.



Single	
No.	List
1970	25 Ft. Carton... \$0.15
1971	1/2 Lb. Carton... .22
1972	1/4 Lb. Carton... .40
1974	7 Lb. Spool... 5.25

Twisted Pair

1975	7 Lb. Spool.... 5.80
------	----------------------

SPAGHETTI TUBING

Takes' up to a No. 14 wire. Black, Yellow, Red, Green and Brown.

List Price, each.....\$0.09 1/2

ALPHA-WIRE-PRODUCTS

SHIELDED DUPLEX SPEAKER CABLE

GENERAL PURPOSE: For PA systems, photo-electric cell circuits, master control sound systems, etc.
CONSTRUCTION: Two conductors twisted, each #18-16/30 stranded tinned copper, 1/32" "Hi-Tension" rubber, color coded, paper wrap over both conductors, close tinned copper shield overall.



No.	Ft. per Spool	Conductors	Maximum Capacity per Ft.		O. D.	List Price
			Cond. to Shield	Bet. Cond.		
1265	500	2	65 mmf.	23 mmf.	.250"	\$27.50

ARMORED DUPLEX SPEAKER CABLE Varnished Cambric Type

GENERAL PURPOSE: For PA systems, oil burner installations, automotive wiring, etc.
CONSTRUCTION: Two conductors parallel, each #18-16/30 stranded tinned copper, varnished cambric wrapped, color coded waxed cotton braid, galvanized steel armor overall.



Number	Spool	O. D.	List Price
1272	500 Ft.	.132" x .182"	\$21.40

Rubber Insulated Type

GENERAL PURPOSE: Loud speaker wiring in master control sound systems.
CONSTRUCTION: Two conductors parallel, each #18-16/30 stranded tinned copper, color coded cotton serve, 1/64" 40% rubber, paper wrap over both conductors, galvanized steel armor overall.



Number	Spool	O. D.	List Price
1273	500 Ft.	.190" x .245"	\$21.40

COMMUNICATION SYSTEM CABLE

GENERAL PURPOSE: For interior use designed for connecting inter-communication systems, annunciators, telephones, etc.
CONSTRUCTION: Each conductor solid tinned copper wire, two cotton reverse serves paraffined, color coded, conductors twisted into pairs, then covered with an impregnated double paper wrap, and overall a cotton braid saturated with a moisture-proof, slow-burning, rodent-proof compound.



Number	Spool	Size	No. of Pairs	O. D.	List
1276	100 Ft.	22	6 (12 Conductors)	.310"	\$10.00
1277	100 Ft.	22	10 (20 Conductors)	.375"	16.25

SHIELDED MULTIPLE CONDUCTOR CABLE

GENERAL PURPOSE: For indoor permanent or portable P.A. systems, photo electric cell circuits, sound recording and auto radios.
CONSTRUCTION: Each conductor #20-10/30 stranded tinned copper, 1/64" rubber, color coded cotton braid, conductors twisted, tinned copper shield overall. #1262, #1263, #1264 same specifications except with glazed brown cotton braid over shield.



TINNED SHIELD OVERALL

No.	Ft. per Spool	Conductors	Maximum Capacity per Ft.		O. D.	List Price
			Cond. to Shield	Bet. Cond.		
1256	100	2	60.5 mmf.	32 mmf.	.215"	\$4.65
1257	100	3	54.0 mmf.	29 mmf.	.240"	5.75
1258	100	4	48.0 mmf.	26 mmf.	.270"	7.15

COTTON BRAID DYER SHIELD

1262	100	2	60.5 mmf.	32 mmf.	.225"	\$5.25
1263	100	3	54.0 mmf.	29 mmf.	.245"	8.00
1264	100	4	48.0 mmf.	26 mmf.	.275"	9.40

SHIELDED TRANSMISSION LINE

GENERAL PURPOSE: For inter-communication, short wave, PA systems, etc.
CONSTRUCTION: Two conductors twisted, each #19 solid copper, heavy enamel coated, cotton serve, cotton braid waxed, color coded, bare copper shield overall.



No.	Spool	Maximum Capacity Per Foot	Frequency (KC)	Surge Impedance (Ohms)	Power Factor (Percent)	O. D.	List Price
1267	500 Ft.	27.3 mmf.	3,000	69.6	1.41	.145"	\$14.40

Surge impedance is one-half the above when using shield as common conductor in dual transmission line.

UNSHIELDED TRANSMISSION LINE

GENERAL PURPOSE: For short wave, inter-communication, annunciator systems, etc. where shielding is not required.
CONSTRUCTION: Two conductors twisted, each #19 solid copper, heavy enamel coated, cotton serve, cotton braid waxed, color coded, conductors twisted.

No.	Spool	O. D.	List	Length		O. D.	List
				No.	Length		
1269	500 Ft.	.135"	\$7.50	1270	100 Ft. Spool	.325"	\$11.25
				1271	1000 Ft. Reel	.325"	\$100.00

LEAD SHEATHED CABLE

GENERAL PURPOSE: For PA systems, communication, traffic control, mines, railroads and many other uses where severe moisture conditions are encountered.
CONSTRUCTION: Two conductors twisted, each #19 solid tinned copper, 1/32" "Hi-Tension" rubber, coded, overall is a pure lead sheath.



No.	Length	O. D.	List
1270	100 Ft. Spool	.325"	\$11.25
1271	1000 Ft. Reel	.325"	\$100.00

SPEAKER AND BATTERY CABLE

GENERAL PURPOSE: For connecting speakers, analyzers, remote control units. PA systems or wherever a multiple 500 ohm circuit hook-up is required.



CONSTRUCTION: Each conductor #20-10/30 stranded tinned copper, 1/64" rubber, color coded cotton braid, conductors twisted, glazed brown cotton braid overall.

Number	Spool	Conductors	Capacity Between Conductors	O. D.	List Price
1182	100 Ft.	2	31.5 mmf.	.200"	\$3.00
1183	100 Ft.	3	31.0 mmf.	.205"	3.50
1184	100 Ft.	4	30.0 mmf.	.260"	5.00
1185	100 Ft.	5	29.5 mmf.	.300"	6.00
1186	100 Ft.	6	29.2 mmf.	.320"	7.25
1187	100 Ft.	7	28.8 mmf.	.340"	8.25
1188	100 Ft.	8	28.5 mmf.	.370"	9.50
1189	100 Ft.	9	27.9 mmf.	.400"	11.50
1190	100 Ft.	10	27.6 mmf.	.410"	13.15
1192	100 Ft.	12	27.0 mmf.	.430"	15.00

INTER-COMMUNICATION CABLE Braided Type

GENERAL PURPOSE: Designed for interior use for connecting inter-communication systems, annunciators, thermostat controls of oil burners, air conditioners, etc.



CONSTRUCTION: Each conductor solid bare copper wire, two cotton reverse serves paraffined, color coded, conductors twisted then an overall cotton braid waxed.

Number	Spool	Size	No. of Conductors	O. D.	List
1274	500 Ft.	18	2	.150"	\$10.65
1275	500 Ft.	18	3	.175"	12.50

Armored Type

GENERAL PURPOSE: Same as braided type but armored for heavy duty and grounding.
CONSTRUCTION: Same specifications as braided type except galvanized steel armor overall.



Number	Spool	Size	No. of Conductors	O. D.	List
1278/2	500 Ft.	18	2	.150"	\$23.00
1278/3	500 Ft.	18	3	.175"	27.75
1278/4	500 Ft.	18	4	.185"	32.90

CRYSTAL MICROPHONE CABLE

GENERAL PURPOSE: Low loss design for use with crystal, ribbon, dynamic and velocity microphones, photo-electric cells. Use #1248 for lapel microphones and phonograph pick-ups.



CONSTRUCTION: Single conductor, extra flexible stranded tinned copper, cotton serve, insulated with special low loss SIC rubber compound, braided tinned copper shield, cotton serve, tough black rubber jacket overall.

No.	Spool	Size	Strand	Max. Capacity per Ft. Between Cond. and Shield		O. D.	List Price
				Cond. & Shield	Conds.		
1248	100 Ft.	20	26/34	45 mmf.	.175"	\$4.65	
1249	100 Ft.	20	26/34	36 mmf.	.255"	5.65	

SHIELDED MICROPHONE CABLE

GENERAL PURPOSE: Adaptable for all indoor and outdoor crystal, carbon and condenser microphones as well as public address systems.



CONSTRUCTION: Each conductor #20-26/34 stranded tinned copper, cotton wrap, 1/64" "Hi-Tension" low capacity rubber, color coded, conductors twisted, cushioned with cotton fillers, braided tinned copper shield, cotton wrap, tough black rubber jacket overall.

Number	Spool	Number of Conductors	Max. Capacity per Ft. Between		O. D.	List Price
			Cond. & Shield	Conds.		
1250	100 Ft.	2	70 mmf.	38 mmf.	.270"	\$7.15
1251	100 Ft.	3	65 mmf.	38 mmf.	.280"	8.00
1252	100 Ft.	4	65 mmf.	38 mmf.	.300"	9.40
1253	100 Ft.	5	60 mmf.	32 mmf.	.315"	11.75
1254	100 Ft.	6	60 mmf.	30 mmf.	.330"	13.75

UNSHIELDED MICROPHONE CABLE

GENERAL PURPOSE: For indoor and outdoor speakers, permanent or portable PA systems, sound recording and auto radios.



CONSTRUCTION: Each conductor #20-26/34 stranded tinned copper, cotton wrap, 1/32" "Hi-Tension" rubber, color coded, conductors twisted, cushioned with cotton fillers, cotton wrap, tough black rubber jacket overall.

Number	Spool	Number of Conductors	Capacity per Ft. Between Conductors	O. D.	List Price
1244	100 Ft.	2	22 mmf.	.250"	\$4.15
1245	100 Ft.	3	20 mmf.	.300"	5.25
1246	100 Ft.	4	18 mmf.	.315"	6.25
1247	100 Ft.	5	17 mmf.	.330"	8.40

ALPHA - WIRE - PRODUCTS

GENUINE EO1 TRANSMISSION CABLE



GENERAL PURPOSE: Standard feeder system for transmitter, frequency modulation, television, short wave, police, aircraft receivers, etc.
CONSTRUCTION: Two conductors #12 solid bare soft annealed copper, paper separator, insulated to .177" low loss moisture resisting rubber compound, twisted, soft cotton braid overall, saturated pitch and mica finish.

No.	Length Feet	Capacity Between Condensers Per Foot	Frequency (K.C.)	Surge Impedance (Ohms)	Power Factor Percent	D. B. Loss Per 100 Feet	List Price
1153	100 Spool	23 mmf.	3,500	72	1	.36	\$10.00
1154	250 Reel	23 mmf.	3,500	72	1	.36	23.75
1155	500 Reel	23 mmf.	3,500	72	1	.36	47.50
1156	1000 Reel	23 mmf.	3,500	72	1	.36	95.00

LO-Q CABLE (ULTRA HI-FREQUENCY)



GENERAL PURPOSE: An extremely low loss cable as feeder system for frequency modulation (F.M.) and television.
CONSTRUCTION: 2 conductors #14 solid tinned copper, 1/32" moisture-resisting rubber, both conductors twisted under 3/64" 60% rubber jacket, cotton braid saturated with black flame-resisting finish overall.

No.	Ft. per Spool	Capacity Bet. Conds. Per Foot	Frequency (K.C.)	Surge Impedance (Ohms)	Power Factor	D. B. Loss Per 100 Ft.	Instantaneous Puncture Voltage	Maximum Load Cap. (Watts)	List Price
1152	100	17 mmf.	1,000	100	.03	.04 at 1000 K.C.	35,000 V.	500	\$18.25

TRANSMITTING LINE CABLE



GENERAL PURPOSE: Standard feeder system for transmitter, short wave, etc.
CONSTRUCTION: 2 conductors twisted #12 solid bare copper, paper serve, 3/64" code rubber, overall soft cotton braid, weatherproofed.

No.	Ft. per Spool	Maximum Capacity Per Foot	Frequency (K.C.)	Surge Impedance (Ohms)	Power Factor	D. B. Loss Per 100 Feet	List Price
1157	100	28.5	3,500	72	2.34	.725	\$8.65

SHIELDED PRIMARY HOOK-UP WIRE



GENERAL PURPOSE: To reduce interference caused by motors, high tension wire, X-Ray machines or other apparatus that radiates electrical impulses.

CONSTRUCTION: Stranded tinned copper, free strip rubber, highly lacquered braid, close tinned copper shield overall.

No.	Ft. per Spool	Size	Strand	Rubber Thickness	O.D.	List Price
1194	100	20	10/30	1/64"	.123"	\$2.75
1196	100	18	16/30	1/32"	.157"	3.25
1197	100	16	26/30	1/32"	.172"	3.65

RUBBER SHEATHED SERVICE CORD

(UNDERWRITERS APPROVED)



GENERAL PURPOSE: For use on vacuum cleaners, electric tools, washing machines, refrigerators, appliances, trouble lights, garage lamps or wherever a rough power line is required.

CONSTRUCTION: Each conductor stranded bare copper, cotton separator, 1/32" "Hi-Tension" rubber, color coded, conductors twisted, cushioned with jute fillers, 40% tough rubber jacket overall.

No.	Length Feet	Size	Conductors	Type	Current Carrying Capacity	Voltage Rating	O.D.	List Price
1951	250 Spool	18	2	SV	5 amps	300	.250"	\$10.00
1952	250 Spool	18	2	SJ	5 amps	300	.310"	11.90
1953	250 Spool	16	2	SJ	7 amps	300	.340"	15.00
1954	250 Coil	18	2	S	5 amps	600	.390"	22.50
1955	250 Coil	16	2	S	7 amps	600	.410"	26.50
1956	250 Coil	14	2	S	15 amps	600	.540"	51.00

FILAMENT AND HOOK-UP WIRE



GENERAL PURPOSE: Point to point wiring for all radio and electrical uses.

CONSTRUCTION: Single conductor #14-#1/30 stranded tinned copper, served, rubber insulation and braid overall, wax impregnated.

No.	Length—Feet	Voltage Breakdown (60 Cycles)	D.C. Resistance Per Foot (Megohms)	O.D.	List Price
1641	25 Spool	2150	14.8	.130"	\$8.00
1645	500 Spool	2150	14.8	.130"	38.65

SUPER "HI-TENSION" TEST LEADS



Can readily be connected for testing circuit defects and all devices such as meters, batteries, transformers, etc. An insulation of Alpha "Super Hi-Tension" heavy rubber is over an extremely flexible tinned copper wire (Alpha #1635 Test Prod Wire). Constructed to withstand rough usage and repeated bendings. Handles are of sturdy fibre. Overall length 50". Red and Black leads for easy identification.

INDIVIDUALLY BOXED

No.	List Price
2171 — Needle Point Prods with Spade Terminals	\$8.60
2172 — Needle Point Prods with Phone Tip Terminals	.60
2173 — Needle Point Prods with Alligator Clips	.75
2175 — Solderless Prods with Spade Terminals	.60
2176 — Solderless Prods with Phone Tip Terminals	.60
2177 — Solderless Prods with Alligator Clips	.75

TYPE POSJ

E-Z STRIP LAMP CORD

(UNDERWRITERS APPROVED)



GENERAL PURPOSE: For line cord on radios, lamps, electric clocks, food mixers and other small appliances.

CONSTRUCTION: Two conductors parallel, each conductor #18-#2/34 extra flexible bare copper, color coded cotton serve, 40% tough rubber jacket overall. Slit in jacket to permit "E-Z" separation.

No.	Spool	O.D.	List
1966	100 Ft.	.235" x .130"	\$2.50
1967	250 Ft.	.235" x .130"	5.00

FLEXIBLE LAMP CORD AND FIXTURE WIRE



For use on lamps, radio AC or DC lines, ground, aerial connections, etc.

No.	Ft. per Spool	Size	Type	List
1930	1000	18 1/64"	Single Conductor	\$8.25
1931	500	18 1/64"	Single Conductor	4.25
1935	500	18 1/64"	Twisted Pair	9.40
1 37	250	18 1/32"	Twisted Pair (Approved)	6.50
1940	1000	20 1/64"	Single Conductor	7.75
1941	500	20 1/64"	Single Conductor	4.00

TELEPHONE WIRE—INSIDE



GENERAL PURPOSE: For interior use in dry locations. Designed for connecting inter-communication systems, annunciators, interior telephones, etc. Also used for ground and aerial connections.

CONSTRUCTION: Each conductor solid tinned copper, 1/64" telephone compound rubber, hard glazed cotton braid color coded, conductors twisted.

No.	Coil	Size	Conductors	O.D.	List
1279	500 Ft.	19	2	.250"	\$15.00
1280	500 Ft.	19	3	.375"	\$22.50

DIAL CABLE

Phosphor Bronze



CONSTRUCTION: Made of 42 strands genuine phosphor bronze wire with a linen center for extra flexibility. Is guaranteed not to warp or stretch.

No.	Ft. per Spool	Tensile Strength	List Price
1689	25	50 lbs.	\$1.05
1690	50	50 lbs.	2.05
1691	100	50 lbs.	3.65
1692	500	50 lbs.	16.90

Braided Linen

CONSTRUCTION: Made of the finest linen obtainable. Composed of a very strong linen center over which is a black braid.

No.	Ft. per Spool	Tensile Strength	List Price
1694	25	40 lbs.	\$1.40
1695	100	40 lbs.	4.75
1696	500	40 lbs.	19.50
1697	25	22.5 lbs.	1.25
1698	100	22.5 lbs.	4.40
1699	500	22.5 lbs.	16.90
1700	25	18 lbs.	.70

ALPHA - WIRE - PRODUCTS

SPRING AERIAL ADJUSTER



Prevents sagging and swaying. Powerful springs, cadmium plated and corrosion proof.

List Price
No. 1285 Individually Boxed \$0.45

RADIO LIGHTNING ARRESTER



Made of high quality glazed porcelain with nickeled screws and nuts. For indoor or outdoor use.

Furnished with two wood screws.

List Price
No. 2001 Individually Boxed \$0.19

DOUBLET LIGHTNING ARRESTER



Made of high quality glazed porcelain with nickeled screws and nuts. For complete protection on doublet antenna systems. For indoor or outdoor use.

Furnished with two wood screws.

List Price
No. 2000 Individually Boxed \$0.30

BATTERY AND TEST CLIPS

For protection against rust and corrosion, these clips are completely cadmium plated. Strong spring jaw for permanent contact.



No.	Type	Amps.	Per Box	List Price
2071	Midget	5	50	\$6.25
2072	Pee-Wee	10	50	6.25
2073	Medium	25	50	9.00
2074	Large	50	30	15.00

ALLIGATOR CLIP

These clips are nickel plated as protection against rust and corrosion. Strong spring jaw for firm contact.



Number	Per Box	List Price
2075	50	\$6.25

UNBREAKABLE SOFT RUBBER PLUG

Made of sturdy live soft rubber. Brass blades. Unbreakable, easy to attach.



No.	Per Carton	List Price
1964	100	\$8.00

BUS-BAR WIRE

This copper wire is tinned and receives several wipings to insure cleanliness and brightness. Is cut in uniform 2 ft. lengths.



Number	Size	List Price
2078	10 Round	\$5.00
2080	12 Round	3.40
2081	14 Square	2.90
2082	14 Round	2.50

LEAD-IN AND GROUND WIRE

GENERAL PURPOSE: Lead-in, ground, hook-up, all purpose wire. CONSTRUCTION: Stranded tinned or solid tinned copper conductor, insulated with live free stripping rubber, jet black waxed finish overall.



No.	Length Feet	Put-Up	Size	Tinned Strand	Rubber Thickness	O. D.	List Price
1114	1000	Spool	20	10/30	1/32"	.105"	\$5.25
1114E	500	Spool	20	10/30	1/32"	.105"	2.75
1115	500	Spool	14	41/30	3/64"	.175"	7.00
1117	100	Spool	14	41/30	3/64"	.175"	1.50
1118	50	Carton	14	41/30	3/64"	.175"	.75
1121	500	Spool	16	26/30	1/32"	.130"	4.75
1124	100	Spool	16	26/30	1/32"	.130"	1.05
1125	50	Carton	16	26/30	1/32"	.130"	.60
1130	100	Spool	18	16/30	1/32"	.125"	.80
1131	500	Spool	18	16/30	1/32"	.125"	3.70
1132	50	Carton	18	16/30	1/32"	.125"	.40
1133	25	Carton	18	16/30	1/32"	.125"	.24
1134	1000	Spool	18	16/30	1/64"	.110"	6.50
1101	500	Spool	16	Solid	3/64"	.135"	4.25
1105	50	Carton	16	Solid	3/64"	.135"	.45
1111	500	Spool	18	Solid	3/64"	.133"	3.50
1112	50	Carton	18	Solid	3/64"	.133"	.40
1117	1000	Spool	20	Solid	3/64"	.130"	5.50

GLASS INSULATORS



Crystal clear, of great tensile strength, moistureproof, waterproof and weatherproof.

Number	Length	Per Carton	List Price
2020	3"	100	\$5.00
2021	3 1/2"	100	7.50

PORCELAIN INSULATOR



Made of glazed porcelain. Will withstand great strain.

Number	Per Carton	List Price
2022	100	\$3.75

SCREW EYES



A cadmium plated sharply pointed #6 gauge screw with glazed porcelain eye.

Number	Length	Per Carton	List Price
2052	3"	100	\$4.15
2056	7"	100	5.00
2058	12"	100	17.50

NAIL KNOB



A 2-piece knob of glazed porcelain and a heavy nail for secure holding.

Number	Per Carton	List Price
2031	100	\$3.50

STAPLES

Made of coppered steel with sharply pointed tips for easy tacking. Properly insulated. Furnished in standard construction and also in brown, white and buff.



No.	Per Box	List Price
2041	Standard Type	50
2043	Colors	40
		\$0.12
		.12

LEAD-STRIP—CLIP TYPE



(SOLDERED)

Weatherproofed and fully covered with a heavily lacquered braid. Fahnestock clips riveted and soldered to strap for firm contact.

Number	Length	Per Carton	List Price
2002	12"	50	\$6.00

(UNSOLDERED)

Constructed exactly like our No. 2002 but the clips are unsoldered.

Number	Length	Per Carton	List Price
2003	12"	250	\$5.00

LEAD-STRIP—SCREW TYPE



A heavily lacquered braid makes this strip weatherproof. The screws, nuts and washers are nicked brass. Makes positive contact.

Number	Length	Per Carton	List Price
2005	12"	50	\$8.75

LEAD-STRIP—DOUBLET TYPE



Same construction as No. 2005 but 2 strips laid parallel and staggered to prevent contact, held apart by riveted fibre pieces. Especially adaptable to doublet antennas.

Number	Length	Per Carton	List Price
2004	12"	50	\$16.75

GROUND CLAMP



Heavy gauge strap, Fahnestock terminal and brass screw and nut. Makes a quick and positive connection. Fits 3/8" to 2" pipe.

Number	Per Carton	List Price
2012	Strap Type 50	\$5.00

PIPE CLAMP

Cadmium plated. Is of neat appearance. Attaches the ground wire to the pipe easily and securely. Will last indefinitely.



No.	Per Carton	List Price
2011	"C" Type 50	\$6.25

ALPHA-WIRE-PRODUCTS



Alpha Aerial Kits are designed to meet the requirements of the various types of radio installations. Each kit is complete and boxed attractively.

No. 300
35 Ft. 7 Strand Copper Aerial Wire
20 Ft. R. C. Lead-In Wire
2 #2022 Porcelain Insulators
2 #2031 Porcelain Nail Knobs
1 #2012 Copper Ground Clamp
1 #2002 Weatherproof Lead-In Strip
List Price, Complete Kit.....\$0.58

No. 301
50 Ft. 7 Strand Copper Aerial Wire
25 Ft. R. C. Lead-In Wire
2 #2022 Porcelain Insulators
2 #2031 Porcelain Nail Knobs
1 #2012 Copper Ground Clamp
1 #2002 Weatherproof Lead-In Strip
List Price, Complete Kit.....\$0.65

AERIAL KITS

No. 307
75 Ft. 7/23 Copper Aerial Wire
35 Ft. #18 Solid R.C. Lead-In Wire
15 Ft. Indoor Wire
2 #2021 Glass Insulators
1 #2001 Lightning Arrester
1 #2002 Weatherproof Lead-In Strip
1 #2012 Copper Ground Clamp
6 #2041 Insulated Staples
2 #2031 Porcelain Nail Knobs
2 Galvanized Screw Eyes
2 Wood Screws
List Price, Complete Kit.....\$1.45

No. 314
100 Ft. 7/22 Copper Aerial Wire
50 Ft. #18 Stranded R.C. Lead-In Wire
25 Ft. Indoor Wire
1 #2001 Lightning Arrester
2 #2021 Glass Insulators
1 #2005 Screw Type Lead-In Strip
1 #2011 "C" Type Ground Clamp
2 #2052 Porcelain Screw Eyes
2 #2031 Porcelain Nail Knobs
6 #2041 Insulated Staples
2 Wood Screws
List Price, Complete Kit.....\$2.25

No. 304
75 Ft. 7/24 Copper Aerial Wire
25 Ft. R.C. Lead-In Wire
1 #2001 Lightning Arrester
1 #2002 Weatherproof Lead-In Strip
2 #2031 Porcelain Nail Knobs
1 #2012 Copper Ground Clamp
2 #2020 Glass Insulators
2 Galvanized Screw Eyes
2 Wood Screws
List Price, Complete Kit.....\$1.10

No. 303
75 Ft. 7/27 Copper Aerial Wire
25 Ft. R.C. Lead-In Wire
1 #2012 Copper Ground Clamp
2 #2022 Porcelain Insulators
2 #2031 Porcelain Nail Knobs
1 #2002 Weatherproof Lead-In Strip
2 Galvanized Screw Eyes
List Price, Complete Kit.....\$0.75

No. 310
75 Ft. 7/22 Copper Aerial Wire
35 Ft. #18 Stranded R.C. Lead-In Wire
25 Ft. Indoor Wire
1 #2011 "C" Type Ground Clamp
1 #2001 Lightning Arrester
2 #2021 Glass Insulators
1 #2005 Screw Type Lead-In Strip
2 #2031 Porcelain Nail Knobs
2 #2052 Porcelain Screw Eyes
6 #2041 Insulated Staples
2 Wood Screws
List Price, Complete Kit.....\$1.80

DOUBLET AERIAL KITS



Soldered For Immediate Installation

KIT No. 25
1—All Wave Antenna Coupler
2—30 Ft. Coils Stranded Tinned Aerial Wire
1—50 Ft. Coil Transmission Cable #1149
3—Glass Insulators #2020
2—Glazed Porcelain Nail Knobs #2031
1—"C" Type Pipe Clamp #2011
2—Weatherproofed Lead-In Strips #2002
1—"C" Porcelain Screw Eye #2056
1—Instruction Sheet.
List Price, Complete Kit.....\$2.65

KIT No. 24
Same as Kit No. 25 Except without All Wave Antenna Coupler.
List Price, Complete Kit.....\$1.75

KIT No. 31
1—All Wave Antenna Coupler
2—48 Ft. Coils Stranded Aerial Wire
1—75 Ft. Coil Transmission Cable #1146
1—Triangular Antenna Block
1—Double Screw Type Lead-In Strip #2004
4—Glass Insulators #2020
1—25 Ft. Coil Heavy Flexible R.C. Wire
2—7" Porcelain Screw Eyes #2056
2—Glazed Porcelain Nail Knobs #2031
1—"C" Type Pipe Clamp #2011
6—Insulated Staples #2041
1—Instruction Sheet.
List Price, Complete Kit.....\$3.90

KIT No. 30
Same as Kit No. 31 except without All Wave Antenna Coupler.
List Price, Complete Kit.....\$3.90

AERIAL WIRE

All Alpha Aerial Wire is properly annealed to assure required flexibility and tensile strength.

STRANDED—BARE			STRANDED—TINNED		
No.	Length	List Price	No.	Length	List Price
104	7/20 100 Ft. Coil	\$1.25	173	7/23 100 Ft. Coil	.69
104	7/20 75 Ft. Coil	.95	176	7/23 75 Ft. Coil	.53
105	7/20 50 Ft. Coil	.64	177	7/23 50 Ft. Coil	.37
106	7/20 1000 Ft. Spool	12.25	178	7/23 1000 Ft. Spool	6.90
107	7/22 100 Ft. Coil	.75	185	7/24 100 Ft. Coil	.58
110	7/22 75 Ft. Coil	.58	188	7/24 75 Ft. Coil	.44
111	7/22 50 Ft. Coil	.40	189	7/24 50 Ft. Coil	.32
112	7/22 1000 Ft. Spool	7.50	190	7/24 1000 Ft. Spool	5.75
119	7/23 100 Ft. Coil	.62			
122	7/23 75 Ft. Coil	.47			
123	7/23 50 Ft. Coil	.33			
124	7/23 1000 Ft. Spool	6.15			
131	7/24 100 Ft. Coil	.50	269	14 100 Ft. Coil	\$0.75
134	7/24 75 Ft. Coil	.39	272	14 75 Ft. Coil	.58
135	7/24 50 Ft. Coil	.27	273	14 50 Ft. Coil	.40
136	7/24 1000 Ft. Spool	5.00	274	14 1000 Ft. Spool	7.50
143	7/25 100 Ft. Coil	.43	275	12 100 Ft. Coil	1.15
146	7/25 75 Ft. Coil	.33	278	12 75 Ft. Coil	.88
147	7/25 50 Ft. Coil	.23	279	12 50 Ft. Coil	.60
148	7/25 1000 Ft. Spool	4.25	280	12 1000 Ft. Spool	11.40
149	7/26 100 Ft. Coil	.37	281	10 100 Ft. Coil	1.80
152	7/26 75 Ft. Coil	.29	282	10 50 Ft. Coil	.94
153	7/26 50 Ft. Coil	.20	283	10 1000 Ft. Spool	18.00
154	7/26 1000 Ft. Spool	3.65			
155	7/27 100 Ft. Coil	.31	284	14 100 Ft. Coil	.75
158	7/27 75 Ft. Coil	.24	285	14 50 Ft. Coil	.40
159	7/27 50 Ft. Coil	.17	286	14 1000 Ft. Spool	7.50
160	7/27 1000 Ft. Spool	3.10	287	12 100 Ft. Coil	1.08
			288	12 50 Ft. Coil	.58
			289	12 1000 Ft. Spool	10.75
			290	10 100 Ft. Coil	2.00
			291	10 50 Ft. Coil	1.07
			292	10 1000 Ft. Spool	20.00
STRANDED—TINNED			SOLID—ENAMEL		
No.	Length	List Price	No.	Length	List Price
161	7/22 100 Ft. Coil	\$0.84	269	14 100 Ft. Coil	\$0.75
164	7/22 75 Ft. Coil	.64	272	14 75 Ft. Coil	.58
165	7/22 50 Ft. Coil	.44	273	14 50 Ft. Coil	.40
166	7/22 1000 Ft. Spool	8.40	274	14 1000 Ft. Spool	7.50
167	7/23 100 Ft. Coil	.75	275	12 100 Ft. Coil	1.15
170	7/23 75 Ft. Coil	.58	278	12 75 Ft. Coil	.88
171	7/23 50 Ft. Coil	.40	279	12 50 Ft. Coil	.60
172	7/23 1000 Ft. Spool	7.50	280	12 1000 Ft. Spool	11.40
173	7/24 100 Ft. Coil	.69	281	10 100 Ft. Coil	1.80
176	7/24 75 Ft. Coil	.53	282	10 50 Ft. Coil	.94
177	7/24 50 Ft. Coil	.37	283	10 1000 Ft. Spool	18.00
178	7/24 1000 Ft. Spool	6.90			
185	7/24 100 Ft. Coil	.58			
188	7/24 75 Ft. Coil	.44			
189	7/24 50 Ft. Coil	.32			
190	7/24 1000 Ft. Spool	5.75			
STRANDED—TINNED			SOLID—ENAMEL		
No.	Length	List Price	No.	Length	List Price
161	7/22 100 Ft. Coil	\$0.84	269	14 100 Ft. Coil	\$0.75
164	7/22 75 Ft. Coil	.64	272	14 75 Ft. Coil	.58
165	7/22 50 Ft. Coil	.44	273	14 50 Ft. Coil	.40
166	7/22 1000 Ft. Spool	8.40	274	14 1000 Ft. Spool	7.50
167	7/23 100 Ft. Coil	.75	275	12 100 Ft. Coil	1.15
170	7/23 75 Ft. Coil	.58	278	12 75 Ft. Coil	.88
171	7/23 50 Ft. Coil	.40	279	12 50 Ft. Coil	.60
172	7/23 1000 Ft. Spool	7.50	280	12 1000 Ft. Spool	11.40
173	7/24 100 Ft. Coil	.69	281	10 100 Ft. Coil	1.80
176	7/24 75 Ft. Coil	.53	282	10 50 Ft. Coil	.94
177	7/24 50 Ft. Coil	.37	283	10 1000 Ft. Spool	18.00
178	7/24 1000 Ft. Spool	6.90			
185	7/24 100 Ft. Coil	.58			
188	7/24 75 Ft. Coil	.44			
189	7/24 50 Ft. Coil	.32			
190	7/24 1000 Ft. Spool	5.75			
STRANDED—TINNED			SOLID—ENAMEL		
No.	Length	List Price	No.	Length	List Price
161	7/22 100 Ft. Coil	\$0.84	269	14 100 Ft. Coil	\$0.75
164	7/22 75 Ft. Coil	.64	272	14 75 Ft. Coil	.58
165	7/22 50 Ft. Coil	.44	273	14 50 Ft. Coil	.40
166	7/22 1000 Ft. Spool	8.40	274	14 1000 Ft. Spool	7.50
167	7/23 100 Ft. Coil	.75	275	12 100 Ft. Coil	1.15
170	7/23 75 Ft. Coil	.58	278	12 75 Ft. Coil	.88
171	7/23 50 Ft. Coil	.40	279	12 50 Ft. Coil	.60
172	7/23 1000 Ft. Spool	7.50	280	12 1000 Ft. Spool	11.40
173	7/24 100 Ft. Coil	.69	281	10 100 Ft. Coil	1.80
176	7/24 75 Ft. Coil	.53	282	10 50 Ft. Coil	.94
177	7/24 50 Ft. Coil	.37	283	10 1000 Ft. Spool	18.00
178	7/24 1000 Ft. Spool	6.90			
185	7/24 100 Ft. Coil	.58			
188	7/24 75 Ft. Coil	.44			
189	7/24 50 Ft. Coil	.32			
190	7/24 1000 Ft. Spool	5.75			

STRANDED—BOXED

No.	Length	Material	List Price
1015	7/22 Tinned	100 Ft.	\$0.80
1019	7/22 Tinned	75 Ft.	.68
1020	7/20 Bare	100 Ft.	1.28
1025	7/22 Bare	100 Ft.	.80
1029	7/22 Bare	75 Ft.	.63
1035	7/23 Bare	100 Ft.	.65
1039	7/23 Bare	75 Ft.	.50

SOLID—BOXED

No.	Length	Material	List Price
1040	10 Enamel	100 Ft.	\$1.05
1045	12 Enamel	100 Ft.	1.18
1055	14 Enamel	100 Ft.	.80
1060	10 Tinned	100 Ft.	2.05
1064	10 Tinned	25 Ft.	.55
1065	12 Tinned	100 Ft.	1.13
1069	12 Tinned	25 Ft.	.33
1070	14 Tinned	100 Ft.	.80
1074	14 Tinned	25 Ft.	.25
1075	16 Tinned	100 Ft.	.58
1079	16 Tinned	25 Ft.	.18

COPPERWELD ENAMEL AERIAL WIRE

GENERAL PURPOSE: Ideal for short wave and marine antennas, directional and doublet systems. Will not sag or stretch.
CONSTRUCTION: A solid steel core, heavily covered with pure electrolytic copper over which is baked black insulating enamel.

Number	Size	Carton	Tensile Strength	O. D.	List Price
1158	10	100 Ft.	1050 Lbs.	.103"	\$2.50
1159	12	100 Ft.	670 Lbs.	.083"	1.65
1160	14	100 Ft.	420 Lbs.	.066"	1.15

PHOSPHOR BRONZE AERIAL WIRE

GENERAL PURPOSE: Recommended especially for ship, short wave, and transmitting aeriels where high tensile strength is required.
CONSTRUCTION: 7 strands #18 Phosphor Bronze.

Number	Length	Tensile Strength	O. D.	List Price
1162	100 Ft. Carton	1000 Lbs.	.122"	\$4.40
1163	500 Ft. Spool	1000 Lbs.	.122"	22.00



DOUBLET TRANSMISSION LINE

GENERAL PURPOSE: Doublet style twisted lead-in designed for low loss coupling between antenna and receiver.
CONSTRUCTION—Braided Type: Two conductors #22-7/30 stranded tinned copper, 1/32" "Hi-Tension" Rubber, color coded, conductors twisted, cotton braid overall, saturated weather-proof finish.

No.	Length Feet	Capacity Bet. Conds. Per Foot	Frequency (KC)	Surge Impedance (Ohms)	Power Factor Percent	List Price
1146	500 Spool	21.8 mmf.	3,500	90.2	3.75	\$8.00
1148	100 Coil	21.8 mmf.	3,500	90.2	3.75	1.60
1149	50 Coil	21.8 mmf.	3,500	90.2	3.75	.80

CONSTRUCTION—All Rubber Type: Two conductors #22-7/30 stranded tinned copper, 1/32" "Hi-Tension" Rubber, color coded, conductors twisted, rubber jacket overall, black satin finish.

No.	Length Feet	Capacity Bet. Conds. Per Foot	Frequency (KC)	Surge Impedance (Ohms)	Power Factor Percent	List Price
1135	500 Spool	21.8 mmf.	3,500	90.2	3.75	\$12.50
1137	100 Coil	21.8 mmf.	3,500	90.2	3.75	2.50
1138	50 Coil	21.8 mmf.	3,500	90.2	3.75	1.25



NOISE-MASTER

ALL-WAVE ANTENNA

FOR EVERY SET AND LOCATION

Eliminates "man-made" static on broadcast as well as short wave bands.

There is a correct "NOISE-MASTER" antenna for every set and location. Radio reception is enjoyed to its fullest extent by installing one of these competent units. "NOISE-MASTER" is scientifically engineered to filter out the innumerable nuisance noises caused by electrical devices . . . assuring perfect reception over broadcast as well as short-wave frequency.

No. 14 "NOISE-MASTER"

\$6.75 LIST. Code: CORAL, Wt. 2 lbs. 12 oz.

Recommended where there are sufficient "man-made" noises to interfere with radio reception over both the short-wave and broadcast bands. Licensed under Amy, Aceves & King patent No. Re. 19864. A highly engineered product which makes one aerial act electrically as two perfect

antennas. Two or more sets (preferably not more than 4) can be operated at the same time on the same antenna by using an additional lower transformer unit on each additional set. Assures highest efficiency over the entire receiving band.

CONTENTS:

- | | |
|--|------------------------------|
| 2—30 foot coils of stranded copper antenna wire | 3—6" screw eye insulators |
| 1 upper transformer assembly | 1 No. 755 dual lead-in strip |
| 2 glass insulators | 1 lower transformer unit |
| 75 feet twisted pair down lead | 1—4" porcelain tube |
| No. 14a (Code: CUTAT)—Kit containing upper and lower transformers only..... | 1 instruction sheet |
| No. 127 (Code: CYTAT)—Extra lower transformers, each..... | List \$5.00 |
| No. 14b (Code: CATAW)—"EUROPEAN NOISE-MASTER." Same as No. 14 except that transformers are designed to operate on 15 to 2100 meters..... | List 2.25 |
| No. 128 (Code: CYTAR)—European type lower transformer..... | List 7.00 |
| | List 2.50 |

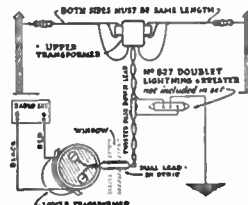

No. 14

No. 19 "NOISE-MASTER" . . \$4.95 LIST.

This antenna is a deluxe doublet employing an Amy, Aceves & King licensed Self-Selecting matching transformer and a junction box in the antenna line. Easy to install and factory fabricated. When properly erected it assures excellent all-wave reception.

CONTENTS:

- | | |
|---------------------------------------|--------------------------------------|
| 2—30 ft. coils 7/23 aerial wire | 1 No. 755 dual lead-in strip |
| 2—No. 1 porcelain insulators | 1—4" porcelain tube |
| 1 junction-box assembly | 1 No. 129 Self-Selecting transformer |
| 75 ft. No. 123 twisted pair down lead | 1 instruction sheet. |
| 3—6" screw eye insulators | |

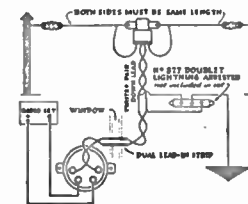

No. 19

No. 18 "NOISE-MASTER" . . \$3.75 LIST.

A licensed Amy, Aceves & King antenna at a popular price! Simple doublet type, featuring a high-grade Self-Selecting licensed matching transformer. Easy to install and completely factory fabricated. Recommended for locations where "man-made" static interferes with short-wave but not with ordinary broadcast reception.

CONTENTS:

- | | |
|---|---|
| 2—30 ft. coils 7/24 "TRI-COR" all-wave aerial wire. | 10 ft. coil stranded twisted pair brown inside lead-in wire |
| 2 No. 2 glass insulators | 3—6" screw eye insulators |
| 1 triangular porcelain center insulator | 1 No. 755 dual lead-in strip |
| 50 ft. No. 117 stranded twisted "TU KOLOR" down lead (connected at our factory to the two coils of aerial wire at center insulator) | 1—4" porcelain tube |
| | 1 No. 129 Self-Selecting transformer |
| | 1 instruction sheet |

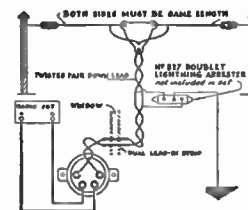

No. 18

BROADCAST ANTENNA KITS

These are popular priced broadcast kits of the "L" type. Each kit contains the necessary parts for the installation of the complete antenna. They are furnished in an attractive two-color box.

Kit No. 3
THE MAJOR
Code: CYTAM. Wt. 3 lbs.
CONTENTS:

- 75 ft. No. 15 stranded aerial wire; 35 ft. rubber-covered lead-in wire; 1 No. 825 lightning arrester; 2 glass insulators; 2 glazed porcelain nail knobs; 1—3" screw eye stand-off insulator; 1 No. 760 high gloss lead-in strip; 1 No. 710 "C" type ground clamp; 15 ft. flexible rubber-covered wire; 6 insulated staples; 2 wood screws.

\$1.55 List

Kit No. 4
THE CAPTAIN
Code: CYTON. Wt. 2 1/2 lbs.
CONTENTS:

- 75 ft. 7/24 stranded aerial wire; 25 ft. rubber-covered lead-in wire; 1 No. 825 lightning arrester; 2 porcelain insulators; 2 glazed porcelain nail knobs; 1 No. 760 high gloss lead-in strip; 1 No. 712 "C" type ground clamp; 15 ft. flexible rubber-covered wire; 2 wood screws.

\$1.25 List

Kit No. 5
THE LIEUTENANT
Code: CYTAL. Wt. 2 lbs.
CONTENTS:

- 75 ft. 7/27 stranded aerial wire; 25 ft. rubber-covered lead in wire; 1 No. 825 lightning arrester; 2 porcelain insulators; 2 nail knobs; 1 No. 707 strap type ground clamp; 1 No. 770 lead-in strip; 2 wood screws.

95c List





RADIO WIRE products

AERIAL WIRE

The most careful attention has been given to those properties which make CORWICO aerial wire the most suitable for radio reception; viz., large surface area, high electric conductivity, and tensile strength.

STRANDED BARE WIRE

No.	7/20	List Price
64	100-ft. coil	\$1.38

No.	7/22	List Price
40A	75-ft. coil	.63
40	100-ft. coil	.84
40B	1000-ft. spool	8.40

No.	7/22 (14 B&S)	List Price
51A	75-ft. coil	.59
51	100-ft. coil	.78
51B	1000-ft. spool	7.80

No.	7/23	List Price
41A	75-ft. coil	.53
41	100-ft. coil	.70
41B	1000-ft. spool	7.00

No.	7/23 (15 B&S)	List Price
31A	75-ft. coil	.49
31	100-ft. coil	.62
31B	1000-ft. spool	6.20

No.	7/24	List Price
42A	75-ft. coil	.44
42	100-ft. coil	.57
42B	1000-ft. spool	5.70

No.	7/24 (16 B&S)	List Price
50A	75-ft. coil	.41
50	100-ft. coil	.54
50B	1000-ft. spool	5.40

No.	7/26	List Price
30A	75-ft. coil	.30
30	100-ft. coil	.39
30B	1000-ft. spool	3.90

SOLID BARE WIRE

No.	No. 14	List Price
57	100-ft. coil	.67
57B	1000-ft. spool	6.70

No.	No. 15	List Price
55	100-ft. coil	.54

STRANDED TINNED WIRE

No.	7/22	List Price
45A	75-ft. coil	.73
45	100-ft. coil	.95
45B	1000-ft. spool	9.50

LEAD-IN WIRE

STRANDED

No.	Ft.	Size	List Price	No.	Ft.	Size	List Price
300	50	coil 18- $\frac{1}{16}$ "	.43	310	50	coil 16- $\frac{1}{16}$ "	.56
301	100	spool 18- $\frac{1}{16}$ "	.85	311	250	spool 16- $\frac{1}{16}$ "	2.80
302	500	spool 18- $\frac{1}{16}$ "	4.00	312	500	spool 16- $\frac{1}{16}$ "	5.40
303	1000	spool 18- $\frac{1}{16}$ "	7.80	313	1000	spool 16- $\frac{1}{16}$ "	10.50

SOLID

320	25	coil 18- $\frac{1}{16}$ "	.20	330	25	coil 20- $\frac{1}{16}$ "	.17
321	50	coil 18- $\frac{1}{16}$ "	.38	331	50	coil 20- $\frac{1}{16}$ "	.33
322	500	spool 18- $\frac{1}{16}$ "	3.60	332	500	spool 20- $\frac{1}{16}$ "	3.10
323	1000	spool 18- $\frac{1}{16}$ "	7.00	333	1000	spool 20- $\frac{1}{16}$ "	5.90

COLORS RUBBER LEAD-IN AND GROUND WIRE

Colors: Red, Black, Green, White

No.	List Price, Each	No.	List Price, Each
215—No. 16 str., 25-ft.	.35	217—No. 16 str., 100-ft.	1.25
216—No. 16 str., 50-ft.	.68	218—No. 16 str., 1000-ft.	12.50

TWISTED PAIR DOWNLEADS

No. 122—List Mft. \$18.00

This is a popular-priced twisted pair down lead consisting of two conductors, each No. 22 stranded copper, 1/32" and rubber-covered (one black, one red), twisted and covered with overall black weatherproof braid.

No. 116—List Mft. \$35.00

This is a heavy twisted pair down lead especially designed for use in doublet type antennas. Each conductor consists of No. 16 (26/30) stranded tinned copper wire with a 1/32" rubber covering and a single white weatherproof braid. The two conductors are then twisted together.

No. 120—List Mft. \$20.00

This is a cheaper twisted pair down lead consisting of two conductors each No. 20 (10/30) stranded copper, 1/32" rubber covered twisted and covered with an overall black weatherproof braid.

ANTENNA ACCESSORIES

LIGHTNING ARRESTERS

Extreme care has been given to the design of these arresters to produce low-priced products of greatest possible value.

No.	List Price
No. 825—2 Pole	25c
No. 827—3 Pole (Doublet)	35c



LEAD-IN STRIPS

All Strips 12" Long—Packed 50 to a Carton

No.	List per C
760— $\frac{1}{2}$ " Zinc, High Gloss, Soldered Terminals	\$5.85
761— $\frac{1}{2}$ " Zinc, High Gloss, not Soldered Terminals	5.35
770— $\frac{1}{2}$ " Zinc, Dull Finish, not Soldered Terminals	4.50
771— $\frac{1}{2}$ " Zinc, Dull Finish, Soldered Terminals	5.00
750— $\frac{1}{2}$ " Copper, High Gloss, Soldered Terminals	6.75
751— $\frac{1}{2}$ " Copper, High Gloss, not Soldered Terminals	6.25

SCREW END LEAD-IN STRIPS

Equipped with screw-type terminals, insuring positive and lasting contact. Length 12"—Packed 50 to a Carton.

No. 780—Copper, High Gloss	List per C \$7.00
No. 781—Zinc, High Gloss	List per C 6.40
No. 755—Doublet, Copper, High Gloss	List per C 18.00



SCREW EYE INSULATORS

Packed 50 to a Carton

No.	List per C
795—Porcelain Eye, 8"	\$3.90
796—Porcelain Eye, 6"	4.50
797—Bakelite Eye, 8"	4.70
798—Bakelite Eye, 6"	5.70



BATTERY CLIPS

Spring jaw clips for instant connection to wet or dry batteries. Packed 80 to carton.

No.	List per C
1—50 amp	\$15.00
2—25 amp	8.75
3—10 amp	5.00
4—5 amp	5.00

GROUND CLAMPS



710



707

We manufacture a complete line of ground clamps of all types, for every purpose.

"C" TYPE GROUND CLAMP.

Hardened steel point, assures positive ground connection. Opening 1 $\frac{1}{4}$ ". Packed 50 to a carton.

No. 710—Cadmium Plated	List per C \$6.00
No. 713—Plain Finish	List per C 4.80

SADDLE TYPE GROUND CLAMP. Hardened steel point assures positive contact. Easily applied to any pipe or rod from $\frac{1}{2}$ " to 2 $\frac{1}{2}$ " in diameter. Cadmium Plated. Packed 50 to a carton.

No. 700—Saddle Type	List per C \$5.50
---------------------	-------------------

STRAP TYPE GROUND CLAMP. Packed 50 to a carton. The No. 708 Clamps have a copper finish.

No. 707—Copper Strap Clamp	List per C \$4.25
No. 708—Steel Strap Clamp	List per C 3.80



GROUND RODS No. 785 Made of $\frac{3}{8}$ " coppered steel, 4 ft. long. Has adjustable saddle with pointed screw for positive ground connection. Packed—12. Weight 20 lbs. Each.....50c



GLASS INSULATORS

Substantially made of non-brittle crystal glass.

No. 1—8" length, 100 per carton	List per C \$6.00
No. 2—3 $\frac{3}{4}$ " length, 25 per carton	List per C 6.50

PORCELAIN INSULATORS

Made of high grade glazed porcelain for long and short wave antennas.

No. 790	List per C \$3.90
---------	-------------------



RADIO WIRE *products*

P-A WIRES and CABLES

HOLLYWOOD MICROPHONE CABLES

(Shielded—Rubber Jacketed)

Substantially made to withstand rough usage. Special low capacity color coded rubber used on conductors. Braided with tinned copper shield. Tough weatherproof polished rubber jacket overall. Single conductor—unusually low capacity. Can be used up to 100 ft. with high impedance ribbon microphones and up to 50 ft. with crystal microphones.

Cat. No.	Conductors	Feet on Spool	Approx. Outside Diam.	List Price
1105	1	100	1/16"	\$ 7.00
2104	1	500	1/16"	27.00
2101	1	1000	1/16"	53.00
Two conductor, for low impedance microphones and transmission lines.				
1152	2	100	1/16"	7.60
1153	2	250	1/16"	18.50
2152	2	500	1/16"	36.00
1154	3	100	1/16"	10.25
1155	3	250	1/16"	20.75
2153	3	500	1/16"	41.50
1156	4	100	1/16"	13.00
1157	4	250	1/16"	26.25
2154	4	500	1/16"	52.50
1158	5	100	1/16"	16.50
1159	5	250	1/16"	33.50
1160	6	100	1/16"	18.75
1161	6	250	1/16"	38.00

MULTI-CONDUCTOR RUBBER JACKETED CABLES

(Not Shielded)

Principally Used as Speaker Extension Cables

Cat. No.	Conductors	Feet on Spool	Approx. Outside Diam.	List Price
2160	2	100	1/4"	5.00
2161	2	250	1/4"	12.00
2162	2	500	1/4"	24.00
2163	3	100	1/4"	6.80
2164	3	250	1/4"	16.75
2165	3	500	1/4"	33.50
2166	4	100	1/4"	8.65
2167	4	250	1/4"	21.00
2168	4	500	1/4"	42.00

SHIELDED CABLES

These cables are recommended for sound recording equipment and P.A. systems where a flexible shielded cable is necessary. Each conductor consists of multi-strand copper wire cotton served, rubber covered and braided with color-coded cotton.

Cat. No.	Put-Up	Conductor	List Price
1114	100 spool	2 Conductor	\$ 5.30
1115	250 spool	2 Conductor	12.00
1116	100 spool	3 Conductor	7.50
1117	250 spool	3 Conductor	17.50
1118	100 spool	4 Conductor	9.15
1119	250 spool	4 Conductor	21.60
1120	100 spool	5 Conductor	10.80
1121	250 spool	5 Conductor	25.75
1122	100 spool	6 Conductor	12.20
1123	250 spool	6 Conductor	29.25

SHIELDED CABLES—COTTON BRAID OVERALL

Cat. No.	Put-Up	Conductor	List Price
1124	100 spool	2 Conductor	\$ 6.60
1125	250 spool	2 Conductor	15.25
1126	100 spool	3 Conductor	9.00
1127	250 spool	3 Conductor	21.25
1128	100 spool	4 Conductor	10.30
1129	250 spool	4 Conductor	24.50
1130	100 spool	5 Conductor	12.50
1131	250 spool	5 Conductor	30.00
1132	100 spool	6 Conductor	14.10
1133	250 spool	6 Conductor	34.00

RADIO BATTERY CABLE AND DYNAMIC SPEAKER EXTENSION CABLE

Made of multi-conductor cable. Flexible conductors with over-all heavy cotton braid. Individual conductor consists of stranded copper, rubber covered with color-coded cotton braid. Suitable to all types of P.A. systems.

Cat. No.	Put-Up	List Price
228	3 wire-100 Ft. Spool	4.00
219	4 wire-100 Ft. Spool	5.00
221	5 wire-100 Ft. Spool	6.00
231	6 wire-100 Ft. Spool	7.00
241	7 wire-100 Ft. Spool	8.00
222	8 wire-100 Ft. Spool	9.00
223	9 wire-100 Ft. Spool	10.00
224	10 wire-100 Ft. Spool	11.00
227	12 wire-100 Ft. Spool	13.00

SHIELDED LEAD-IN AND GROUND WIRE

These products are made of flexible stranded copper conductors insulated with a substantial wall of high grade rubber with an overall of close tinned copper shield. They are most frequently used as a shielded down lead to ground out interference noise.

Cat. No.	Put-Up	List Price
No. 20 FLEXIBLE 1/32" R.C.		
1143	50 Ft. Coil	\$ 1.35
1144	250 Ft. Spool	5.35
1145	1000 Ft. Spool	20.00
No. 18 FLEXIBLE 1/32" R.C.		
Cat. No.	Put-Up	List Price
1146	50 Ft. Coil	\$ 1.30
1147	250 Ft. Spool	6.20
1148	1000 Ft. Spool	22.50
No. 16 FLEXIBLE 1/32" R.C.		
Cat. No.	Put-Up	List Price
1149	50 Ft. Coil	\$ 1.60
1150	250 Ft. Spool	7.75
1151	500 Ft. Spool	15.00

AUTO RADIO WIRES and CABLES



SHIELDED LOW CAPACITY CABLE

Extremely low capacity between conductor and shield used in auto radio for antenna lead-in and elsewhere where a low capacity wire is required.

Cat. No.	Put-Up	List Price
1100	50' Coil 1/4" O.D.	\$5.65
1101	100' Coil 1/4" O.D.	10.70
1102	50' Coil 1/2" O.D.	4.20
1103	100' Coil 1/2" O.D.	7.95

BRAIDED TINNED COPPER TUBULAR SHIELDING

Convenient shielding for auto radio installations. We recommend the 1/4" width for wires up to 1/8" O.D. and the 1/2" width for larger wires.

Cat. No.	Put-Up	Width	List Price
1108	50 Ft. Spool	1/4"	\$2.70
1109	100 Ft. Spool	1/4"	4.60
1110	250 Ft. Spool	1/4"	10.50
1111	50 Ft. Spool	1/2"	4.55
1112	100 Ft. Spool	1/2"	8.65
1113	250 Ft. Spool	1/2"	21.00

SHIELDED LOW CAPACITY LOOM

Frequently used in auto radio as a shield for the antenna lead-in. Inside Diameter 1/8" (Approx.). Outside Diameter 1/4" (Approx.).

Cat. No.	Put-Up	List Price
1106	50' Coil 1/8" I.D.	\$5.50
1007	100' Coil 1/8" I.D.	10.00

SHIELDED IGNITION CABLE

Consists of a No. 16 Stranded Conductor with high grade rubber wall with a lacquered braid and overall tinned copper shield. This wire is effectively used in secondary circuits in auto radio and also in photo electric cell leads.

Cat. No.	Type	Spool	List Price
1134	7MM R.W.—100'		\$ 9.80
1136	7MM R.W.—250'		24.00
1137	1/2" R.W.—100'		4.30
1139	1/2" R.W.—500'		18.50



FLEXIBLE CORDS

(Fixture Wires—Lamp Cords)

Fixture wires often used as all-purpose radio and lead-in wire. Lamp cords used for power supply and extension cords. Colors: Brown, Black, Ivory.

Cat. No.	Put-up	List Price
133	No. 20 Single, Type F, Cotton	1000 ft. \$ 8.50
136	No. 18 Single, Type F, Cotton	1000 ft. 10.50
*138	No. 18 Parallel, Type PO, Rayon	250 ft. 24.00
*139	No. 18 Parallel, Type POSJ, All Rubber	250 ft. 21.00
*132	No. 18 All Rubber Service Cord, Type SJ	250 ft. 40.00

TEST LEAD WIRE

A super flexible conductor covered with heavy live rubber. Will not wear, kink or crack. Made in Black and Red. Mention color when ordering.

Cat. No.	Put-Up	List Price
1140	100 Ft. Spools	\$ 2.75
1141	500 Ft. Spools	12.50
1142	1000 Ft. Spools	24.00

AC-DC Antenna Lead Wire

A replacement antenna wire for Universal Sets at a minimum cost. The type of wire used incorporates the well-known Corlac Insulation between the copper conductor and the outside brown cotton braid which not only assures a moisture-proof product but also greatly tends to make the wire non-kinkable.

Cat. No.	Put-Up	List Price
660A	25 Ft. on Fibre	\$0.30
660B	100 Ft. on Spools	.90
660C	500 Ft. on Spools	4.00
660	1000 Ft. on Spools	17.50
Same Wire Without Corlac Insulation		
661	on 1000 Ft. Spools	5.90



RADIO WIRE products

RADIO HOOK-UP WIRES



"BRAIDITE" PUSH-BACK WIRE

These Hook-Up wires are the standard type of push back wires. They have a cotton serve and an impregnated braid which slides back easily from the tinned copper conductor, thus making it easy to solder.

Plain			Lacquered		
Cat. No.	Put-Up	List Each	Cat. No.	Put-Up	List Each
No. 22 SOLID					
398	25 Ft. Cartons	\$0.28	416	25 Ft. Cartons	\$0.31
399	100 Ft. Spools	0.94	417	100 Ft. Spools	1.05
400	1000 Ft. Spools	5.90	418	1000 Ft. Spools	6.80
No. 20 SOLID					
401	25 Ft. Cartons	\$0.30	419	25 Ft. Cartons	\$0.34
402	100 Ft. Spools	1.05	420	100 Ft. Spools	1.22
403	1000 Ft. Spools	6.75	421	1000 Ft. Spools	8.00
No. 18 SOLID					
404	25 Ft. Cartons	\$0.36	422	25 Ft. Cartons	\$0.39
405	100 Ft. Spools	1.33	423	100 Ft. Spools	1.54
406	1000 Ft. Spools	8.70	424	1000 Ft. Spools	10.00
No. 22 STRANDED					
407	25 Ft. Cartons	\$0.32	425	25 Ft. Cartons	\$0.36
408	100 Ft. Spools	1.12	426	100 Ft. Spools	1.23
409	1000 Ft. Spools	6.40	427	1000 Ft. Spools	7.40
No. 20 STRANDED					
410	25 Ft. Cartons	\$0.36	428	25 Ft. Cartons	\$0.40
411	100 Ft. Spools	1.23	429	100 Ft. Spools	1.38
412	1000 Ft. Spools	7.50	430	1000 Ft. Spools	8.70
No. 18 STRANDED					
413	25 Ft. Cartons	\$0.41	431	25 Ft. Cartons	\$0.46
414	100 Ft. Spools	1.56	432	100 Ft. Spools	1.77
415	1000 Ft. Spools	10.00	433	1000 Ft. Spools	11.75

"CORLAC" HOOK-UP WIRE

For the discriminating service man who knows the importance of voltage break down and insulation resistance. Special under-insulation makes this hook-up wire moisture-proof and gives voltage break-down of 3100 volts (as per certified report of Electrical Testing Laboratory, N. Y. C.). Excellent push-back. Tinned copper conductors.



Plain			Lacquered		
Cat. No.	Put-Up	List Each	Cat. No.	Put-Up	List Each
No. 22 SOLID					
434	25 Ft. Cartons	\$0.33	452	25 Ft. Cartons	\$0.37
435	100 Ft. Spools	1.14	453	100 Ft. Spools	1.32
436	1000 Ft. Spools	7.00	454	1000 Ft. Spools	8.30
No. 20 SOLID					
437	25 Ft. Cartons	\$0.37	455	25 Ft. Cartons	\$0.44
438	100 Ft. Spools	1.34	456	100 Ft. Spools	1.56
439	1000 Ft. Spools	8.50	457	1000 Ft. Spools	10.30
No. 18 SOLID					
440	25 Ft. Cartons	\$0.43	458	25 Ft. Cartons	\$0.48
441	100 Ft. Spools	1.66	459	100 Ft. Spools	1.80
442	1000 Ft. Spools	10.75	460	1000 Ft. Spools	13.20
No. 22 STRANDED					
443	25 Ft. Cartons	\$0.37	461	25 Ft. Cartons	\$0.42
444	100 Ft. Spools	1.32	462	100 Ft. Spools	1.44
445	1000 Ft. Spools	8.00	463	1000 Ft. Spools	9.50
No. 20 STRANDED					
446	25 Ft. Cartons	\$0.44	464	25 Ft. Cartons	\$0.49
447	100 Ft. Spools	1.54	465	100 Ft. Spools	1.71
448	1000 Ft. Spools	9.60	466	1000 Ft. Spools	11.40
No. 18 STRANDED					
449	25 Ft. Cartons	\$0.51	467	25 Ft. Cartons	\$0.59
450	100 Ft. Spools	1.88	468	100 Ft. Spools	2.05
451	1000 Ft. Spools	12.80	469	1000 Ft. Spools	15.00

COLORS RUBBER HOOK-UP WIRE



When a rubber covered hook-up wire is necessary the following products are recommended. They are made of Stranded Tinned Copper Wire covered with live rubber sufficient to withstand any voltage ordinarily used in radio. For circuit distinction these products are covered with colored rubber in Red, Green, Black and White.

No. 515	25 Ft. Cartons	No. 18—1/64" R.C.	\$0.37
No. 515B	1000 Ft. Spools	No. 18—1/64" R.C.	9.25
No. 215	25 Ft. Coils	No. 16—1/32" R.C.	.35
No. 218	1000 Ft. Coils	No. 16—1/32" R.C.	12.50

ALL PRICES SUBJECT TO CHANGE WITHOUT NOTICE

"NUCOR" HOOK-UP WIRE

By using a special soft rubber insulation this wire has the highest possible electrical properties of insulation resistance and voltage break-down for a push back wire (13,000 volts as per certified report of Electrical Testing Laboratory of New York City). Tinned Copper conductors.



Plain			Lacquered		
Cat. No.	Put-Up	List Price Each	Cat. No.	Put-Up	List Price Each
No. 22 SOLID					
470	25 Ft. Cartons	\$0.40	485	25 Ft. Cartons	\$0.45
471	100 Ft. Spools	1.48	486	100 Ft. Spools	1.70
472	1000 Ft. Spools	8.40	487	1000 Ft. Spools	9.90
No. 20 SOLID					
473	25 Ft. Cartons	\$0.43	488	25 Ft. Cartons	\$0.49
474	100 Ft. Spools	1.55	489	100 Ft. Spools	1.75
475	1000 Ft. Spools	9.75	490	1000 Ft. Spools	10.85
No. 22 STRANDED					
476	25 Ft. Cartons	\$0.435	491	25 Ft. Cartons	\$0.49
477	100 Ft. Spools	1.55	492	100 Ft. Spools	1.70
478	1000 Ft. Spools	9.60	493	1000 Ft. Spools	10.65
No. 20 STRANDED					
479	25 Ft. Cartons	\$0.52	494	25 Ft. Cartons	\$0.58
480	100 Ft. Spools	1.82	495	100 Ft. Spools	2.02
481	1000 Ft. Spools	11.40	496	1000 Ft. Spools	12.65
No. 18 STRANDED					
482	25 Ft. Cartons	\$0.62	497	25 Ft. Cartons	\$0.72
483	100 Ft. Spools	2.40	498	100 Ft. Spools	2.90
484	1000 Ft. Spools	14.90	499	1000 Ft. Spools	16.50

"HANDY" SPOOL ASSORTMENT

(One Price Spools)

This "Silent Sam" works day and night. An easy, attractive way to sell the fast moving kinds of wire. . . All one price.



FREE DISPLAY WITH INITIAL

ORDER FOR 100 SPOOLS

Extra Display Racks \$1.50

LIST PRICE, per spool . 65c

Cat. No.	Approx. ft.
1250—No. 22 Solid Push Back	80
1251—No. 20 Solid Push Back	70
1252—No. 18 Solid Push Back	60
1253—No. 16 Solid Push Back	40
1254—No. 22 Stranded Push Back	70
1255—No. 20 Stranded Push Back	60
1256—No. 18 Stranded Push Back	50
1257—No. 16 Stranded Push Back	35
1258—No. 18 Stranded Colored Rubber	60
1259—No. 16 Stranded Colored Rubber	40
1260—AC-DC Aerial Wire	100
1261—No. 18 Solid Lead-in Wire	70
1262—No. 18 Stranded Lead-in Wire	75
1263—No. 20 Single Fixture Wire	65
1264—No. 18 Single Fixture Wire	55
1265—No. 18 Stranded 1/2" R.C. Lacquered	40
1266—No. 18 White Bell Wire	100
1267—No. 18 Solid Tinned Copper (Bare)	100
1268—No. 18 Parallel Silk Lamp Cord	30
1269—No. 18 Parallel All Rubber Lamp Cord	30
1270—No. 18 Twisted Lamp Cord	25
1271—Test Lead Wire	35
1272—No. 18 Stranded Shielded	20

MAGNET WIRE DISPLAY

The best way to sell magnet wire. Supplied in even gauges from 16 to 36, on one price spools in plain enamel, double cotton and double silk.

LIST PRICE, per spool 40c

Free display rack with initial orders for 100 spools.

EXTRA RACKS, \$1.50

TACO

ALL-WAVE
SELF-SELECTING

MASTER

ANTENNA
SYSTEM

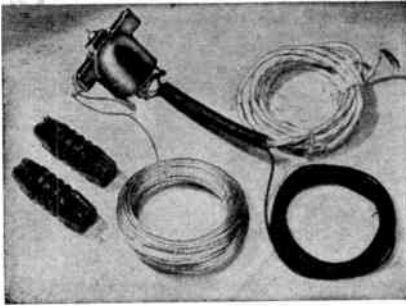

TACO MASTER ROOF KIT

*Cat. No. 340—For 1-25 outlets..... **\$7.50**

Consisting of:

- | | |
|--|---|
| 1 Transformer Unit (341) | 1 Sleeving 100-ft. 7/20 tinned copper aerial wire |
| 1 15-ft. coil transmission cable (305) | 1 25-ft. coil ground wire |
| 2 4" Navy Insulators | |

TACO HOME ROOF KIT

For a small apartment house or an individual home where a span of 65 feet is available. The antennae may be fully concealed in attic for maximum neatness of installation.

*Cat. No. 342—For 1-8 outlets..... **\$7.50**

Consisting of:

- | | |
|--|--|
| 1 Transformer Unit (341) | 2 50-ft. coils No. 14 tinned aerial wire |
| 1 15-ft. coil transmission cable (305) | 1 25-ft. coil ground wire |
| | 2 4" Navy Insulators |

*No. 341—Transformer Unit only, incorporating the Underwriter's approved Lightning Arrestor..... **\$3.50**

The sensible and economical solution of the radio problem facing apartment houses, hotels, club houses, hospitals or private homes. One efficient aerial and transmission line carried down inconspicuously outside of building serves up to 25 sets. Each set connected through a coupler to the aerial. Eliminates usual jungle of unsightly poles, aerials and downleads constituting menace to life and property as well as an unsightly mess.

EFFICIENCY — TACO Master Antenna provides excellent broadcast, amateur and short-wave reception with modern all-wave sets. Matches all sets. Minimum background noise. The system covers all bands including the new FM band by the use of the proper coupler.

SIMPLICITY—All mysteries taken out of

installation work. Components available through the distributor in kit form. The Foundation Kit contains all parts necessary for the roof installation. Erect the TACO aerial as high as possible for best results and follow the instructions given in the specification booklet for a durable, successful installation. If additional information is desired we will gladly assist.

LOW COST—As inexpensive as efficient. Inconspicuous neutral tone transmission cable and neat exposed wiring outlets permit wiring any existing building. No objectionable wires. Nothing to mar inside or outside walls.

SPECIFICATION DATA—Complete specification data available in printed form giving full details both for layout as well as cost estimating.

RECEIVER COUPLERS

The choice of Coupler depends on the frequency bands to be covered, the space available and the preference in Coupler finish. If only the Broadcast and S-W bands are required either Coupler may be used. If the new FM band is also desired use No. 343 Coupler.



*No. 343 Coupler, FM and AM bands, for exposed wiring..... **\$3.00**



*No. 344 Coupler, for exposed wiring..... **\$2.50**

Coupler finished in baked IVORY. Bakelite terminal panel with screw posts for easy connections to radio set. Single hole mounting.

Small, Neat, Finished in satin aluminum. Bakelite terminal panel with ANT. & GND. screw posts for radio set connections.

ESSENTIAL TACO WIRING PARTS

Cat. No. 304—Aerial Wire 7/20 Tinned Copper Wire, per 80 ft..... **\$2.25**

Cat. No. 305—Transmission Line No. 18 Twisted-Pair Neutral Buff-Covered, per 500-ft. roll..... **20.00**

Cat. No. 306—Transmission Line No. 18 Twisted-Pair Black-Covered, per 500-ft. roll..... **20.00**

Cat. No. 307—Solid knobs, white or brown, for supporting transmission cable. 100 to a carton. Per carton..... **4.00**

Cat. No. 309—Double Lightning Arrestor, Underwriters Approved..... **.75**

Cat. No. 319—Heavy Duty, low-loss glazed porcelain insulators, 4" long, each..... **.20**

Cat. No. 330—Bracket for mounting Antenna Transformer..... **1.00**

Cat. No. 186—Mast Bracket, for mounting 1" pipe mast. Complete with lag bolts, expansion shields, U-bolts, per pair..... **3.75**

TELEVISION AND FREQUENCY-MODULATION ANTENNAE

For the sure interception of F-M signals, a di-pole antenna similar to a television antenna is recommended. The installation of an F-M antenna is comparatively simple as reflections do not as a rule cause any noticeable interference with the reception.

For this reason, Reflectors are not required except in rare instances. However, the majority of the F-M receivers are also equipped for the reception of amplitude-modulated signals and therefore a transformer system is incorporated in some of our models to assure noise-free reception in the standard broadcast and short-wave bands.

The short rigid di-pole has the advantage over the longer wire antennae mentioned on the front page of this catalog in that it can more readily be erected much higher. A single mast is all that is required. It also has the advantage of being easily directed to intercept the favorite stations. With a long-wire antenna this cannot readily be accomplished, often resulting in a low signal strength on some weak station. Always erect the antenna as high as possible for best results.

The choice of the Antenna and the Transmission Line depends on the signal level in the area. If signal strength is low, use a rigid di-pole type antenna. If the length of the transmission line is over 60 ft. use the special No. 336 U-H-F transmission line.

TELEVISION ANTENNAE

For the selection of the most suitable television antenna-reflector combination and for

No. 425—Featherweight Television Antenna complete with universal mounting brackets and 60-ft. transmission line..... **\$8.75**

No. 450—Featherweight Television Reflector for No. 425 or 426 Antenna, complete with crossarm..... **8.50**

full detailed installation instructions see our special television catalog sheet.

No. 428—Double Di-pole Television Antenna complete with Reflectors and 60 ft. No. 152 transmission line..... **\$33.00**

FM AND TELEVISION STORE DEMONSTRATION SYSTEM

The TACO Store Demonstration Antenna handles all wave bands from the Standard Broadcast band to the U-H-F bands with one antenna without any interaction between the sets. Full noise-reduction for all bands. No switching or fussing with connections after the set is once connected to the system. Each set requires its own No. 343 Master Coupler and six to eight sets may be operated from one antenna.

*No. 481-FM — Di-pole Antenna, with No. 480 Transformer, 8-ft. mast, less wire..... **\$13.50**

*No. 343 — Master Coupler, one used for each set connected to the system, each..... **\$3.00**

F-M ANTENNA SYSTEMS

*No. 476-FM—Rigid di-pole Antenna using No. 480 and No. 218-FM transformers for coverage of broadcast and short wave bands in addition to the FM band. Complete with 60-ft. No. 152 transmission line..... **\$14.50**

*No. 486-FM—Same as above, plus one 8-ft. wooden mast in two sections..... **17.50**

*No. 477-FM—Rigid di-pole Antenna, same as No. 476-FM, except using 60-ft. No. 336 U-H-F transmission line..... **17.50**

*No. 487-FM—Same as above, plus one 8-ft. wooden mast in two sections..... **17.50**

*No. 480—Antenna coupler with mounting bracket..... **3.50**

*No. 218-FM — Receiver Coupler, for connection of one additional receiver..... **3.25**

*No. 215-FM—Antenna, see front page..... **8.25**

*No. 225-FM—Antenna, see front page..... **8.00**

ACCESSORIES

No. 185—Television Mast, 10-ft. wood mast in two sections..... **2.75**

No. 188—Galvanized 10-ft. iron mast in two sections..... **2.75**

No. 186—Pipe Mast bracket, complete with expansion shields, lag bolts and "U" bolts, per pair..... **3.75**

No. 152—Transmission line, 500-ft. rolls..... **30.00/M**

COMBINATIONS AND DETAILS OF FM AND TELEVISION ANTENNAE SHOWN IN SEPARATE CATALOGUE

TACO DeLuxe Self-Selecting Antenna

The function of an efficient antenna is to bring to the receiver a clear signal free from all interference. This problem has taken on new importance with the introduction of the FM super-high-fidelity receivers as the antenna kits now have to cover a much wider frequency range without loss of fidelity. TACO engineers have solved this problem by introducing special iron dust core transformers into the circuits.

Each kit is designed to meet special requirements and each design is based on TACO's long experience in building high fidelity antennae with unexcelled noise reduction. Determine which type kit is needed to cover the range of the set and regardless of the kit selected you will get the finest instrument of its kind to feed the set the strongest and clearest signals even in locations heretofore considered hopeless for radio reception.

*Cat. No. 215 TACO DeLuxe Antenna System. Uses No. 217 Set Transformer. Covers 150 kc - 25 mc

*Cat. No. 215-FM Antenna, covers FM and AM bands. Uses No. 218-FM Set transformer; 150 kc - 75 mc

*Cat. No. 200-V Antenna, especially designed for the short wave and broadcast bands

*Cat. No. 215L—DeLuxe Antenna, less Set Transformer. **\$5.50**

*Cat. No. 216—TACO Antenna Transformer only **2.75**

The array of electrically interconnected transformers automatically select the most efficient path for the signals and assure a perfect match to any radio set. A porcelain shell gives perfect weather-proofing and mechanical protection for the transformers. A 30-ft. - 30 ft. doublet aerial makes this kit easy to erect anywhere.

Separate terminals are available on the No. 218-FM set transformer for connection to the FM binding posts on the receiver.

The DeLuxe Antenna is complete, factory wired, soldered and tested under laboratory conditions, ready to be erected.

TACO DeLuxe Antenna is self-selecting and fully automatic and comparative tests indicate the greatest signal-to-noise ratio of any system on the market. Let your own test substantiate our claim.

*Cat. No. 217—TACO Set Transformer only **3.00**

*Cat. No. 218-FM Set Transformer. Separate leads for the AM and FM bands. **3.25**

*Cat. No. 217—TACO Set Transformer only **3.00**

*Cat. No. 218-FM Set Transformer. Separate leads for the AM and FM bands. **3.25**

For installations where a doublet is difficult to erect, this L-type kit with the transformer attached at one end of a 50-ft. aerial is the ideal solution. It covers the same frequency range as the kit above and has the same type iron core transformers guaranteeing the highest obtainable noise reduction.

Extensively used for homes where the transmission line must be inconspicuously arranged. The construction facilitates the grounding of the transformer unit for maximum noise reduction.

This TACO kit is Self-Selecting and with its durable porcelain shell assures a satisfactory trouble-free installation.

*No. 225 Antenna, using 50-ft. aerial and 60-ft. trans. line. 150 kc - 25 mc. Uses No. 217 Set Transformer **\$7.75**

*No. 225-FM Antenna, covers FM and AM bands 150 kc - 75 mc. Uses No. 218-FM Set Transformer **8.00**

*No. 225L Antenna, less Set Transformer **5.25**

*No. 226 Antenna Transformer only **2.75**

*No. 217 Set Transformer only **3.00**

*No. 218-FM Set Transformer only. Separate leads for the AM and FM bands **3.25**

Modern all-wave receivers are capable of reproducing the faintest radio signals brought to the receivers but to furnish an enjoyable program the signal must be free of outside interference.

The TACO Standard Antenna is designed to fulfill these requirements for the standard broadcast band as well as for the short-wave bands and the FM band.

This Antenna System with its weather-proof porcelain antenna unit housing matches all sets regardless of make or design. It is fully automatic, selecting the path of maximum efficiency for the different wave-bands. Iron cores assure the maximum signal transfer in all bands.

The simplicity of construction makes an installation possible where very limited space is available. For the best result the antenna proper should be erected on the roof out of the noise area.



TACO No. 515 STANDARD ANTENNA
For the noise-free reception of standard broadcast and short wave bands.

TACO No. 515-FM STANDARD ANTENNA
Covers all bands including the FM band with excellent clarity and fidelity.



● **CONTENTS OF No. 215 KIT** ●
No. 216 Antenna Transformer; No. 217 Set Transformer; 2-30 ft. coils Tinned Aerial Wire; 60 ft. Transmission Cable; 1 Screw Eye; 2 Nail Knobs; 2 Porcelain Aerial Insulators; Packed in Display Box with complete instructions.

● **CONTENTS OF No. 215-FM KIT** ●
Same as above except using No. 218-FM Set Transformer. Separate leads for the FM and AM bands makes this kit adaptable to any type radio receiver.



● **CONTENTS OF No. 515 KIT** ●
No. 516 Antenna Transformer; No. 517 Set Transformer; 2-30 ft. coils Aerial Wire; 60 ft. Transmission Cable; 1 Screw Eye; 2 Nail Knobs; 2 TACO Insulators; Attractively boxed complete with instructions.

● **CONTENTS OF No. 515-FM KIT** ●
Same as above except using No. 518-FM Set Transformer. Separate leads available for the AM and FM bands.

*No. 515 Antenna, 150 kc - 25 mc. Broadcast and short wave bands **\$5.25**

*No. 515-FM Antenna, FM and AM bands 150 kc - 75 mc **5.50**

*No. 515L Antenna, less set transformer **4.25**

No. 516 Antenna Transformer only **1.75**

*No. 517 Set Transformer, broadcast and short wave bands only **1.75**

*No. 518-FM Set Transformer, FM and AM bands, separate leads for FM and AM **2.25**



CAT. No. 400 ALL-WAVE ANTENNA

The importance of a good antenna system for a modern radio set is generally underestimated. It is an integral part of a radio set and must be treated as such. For best results an antenna must be installed with the utmost care and the TACO No. 400 Antenna improves the all-wave reception in all locations.

This antenna is Self-Selecting, same as the higher priced TACO models. Easily erected in a very limited space on the roof. It is fool-proof and trouble-free—once erected—always functioning.

● **CONTENTS OF No. 400 KIT** ●
No. 401 Transfer Unit; No. 402 Set Transformer; 2 30-ft. Coils Antenna Wire; 50-ft. Coil Transmission Cable; 1 Screw Eye; 2 Nail Knobs; 2 Porcelain Insulators. Attractively boxed with complete instructions.

*Cat. No. 400 Kit **\$4.50**

Cat. No. 400L Kit Less Set Coupler **3.50**

*Cat. No. 402 Set Transformer **1.50**



TELESCOPING VERTICAL RADIATORS

Aluminum Radiators

Meeting every demand for light weight combined with corrosion resistance and adequate strength for the most exacting conditions, Premax Aluminum Antennas are in popular use for mobile installations, such as pick-up trucks, etc., where light weight, convenience in extending and collapsing and attractive appearance are important considerations. They are ideal for radio telephone use on fresh water craft or inland locations, as well as for commercial installations.

For commercial use, for police, fire, forestry, public utility and similar services, as well as for amateur installations or home receiving sets, Premax Aluminum Antennas are convenient, dependable, attractive and extremely reasonable in cost. The solid taper rod (No. AM-106) makes an ideal element for FM or television di-poles.

The tubing is special drawn bright finish seamless aluminum, with diameters, gauges and temper engineered to withstand wind velocities up to 60 miles per hour without failure or permanent damage. Guying is not essential under normal conditions, but is recommended as an extra precaution against unexpected stresses.

The locking device between sections is of the clutch type, comprising a specially formed hexagon cap nut, engaging a tapered split compression sleeve. This construction is simple in operation and provides an efficient, low-resistance contact between sections.

A group of six different units is available, all excepting the tapered top section (No. AM-106) being fully telescoping and adjustable between the minimum and maximum lengths shown.

HEAVY DUTY NON-ADJUSTABLE MASTS

To meet demands from various commercial services, Premax has designed Special Duty Non-Adjustable Masts (not illustrated), which can be depended upon for enduring performance under the most extreme conditions. In either the 17 1/2' or 35' lengths, this special aluminum alloy mast is designed to withstand wind velocities up to 100 M. P. H. The tubing is graduated in steps from a base diameter of 2" to a top of 1/2" on the 35' mast and a base diameter of 1 1/4" to a top of 1/2" on the 17 1/2' mast, and has a smooth, polished finish to resist corrosion or a collection of dirt. The joint on the 35' mast is ground to a fine fit for positive contact and maximum strength throughout.

Several masts of this type were in use without guying at W2USA on the Communications Building for the two years of the New York World's Fair and withstood extremely high gales and severe sleet storms with no evidence of damage in any respect.

SPECIFICATIONS AND LIST PRICES

No.	Ext. Length	Col. Length	Base O.D.	Top O.D.	Base I.D.	Weight Each	List Price
AM-106	6'3"	6'3"	.343"	.125"	...	1/4 lb.	\$ 5.00
AM-312	12'2 1/2"	6'3"	.500"	.320"	.334"	1 1/2 lbs.	10.00
AM-518	18' 1/2"	6'3"	.750"	.320"	.584"	3 lbs.	20.00
AM-124	23'8 1/2"	6'3"	1.000"	.320"	.810"	5 lbs.	30.00
AM-230	29'2"	6'3"	1.312"	.320"	1.112"	7 1/4 lbs.	45.00
AM-336	34'8"	6'3"	1.625"	.320"	1.425"	11 lbs.	60.00
AM-017	17'6"	17'6"	.969"	.500"	.689"	5 1/2 lbs.	40.00
AM-035	34'9"	18'0"	2.000"	.500"	1.732"	19 lbs.	100.00

(For Base Insulators and Mountings see page Q-49)

Monel Radiators

Outstanding for marine installations and those other commercial uses where high strength and unusual resistance to corrosion are prime considerations, Premax Monel Antennas have satisfactorily stood up under the most severe wind and shock strains, even when installed on the speedy boats of the navy and coast guard. Monel antennas have proven their ability to resist the action of sea air, salt spray and other corrosive agents.

The monel masts are built up of multiple sections of hard-drawn monel tubing which is a product of Superior Tube Company of Norristown, Pa. They are fully telescoping and adjustable. Their rich, highly polished appearance conforms perfectly with the equipment of even the finest craft, yet their cost is not excessive for the more modest installations when their indefinite life and operating efficiency is considered.

Monel is without doubt the perfect material for radio antennas, far more resistant toward more corrosives than either the nickels or coppers which are used in the formulation of monel. It has both the corrosion resistance and mechanical properties which enable it to withstand weather conditions, low temperatures and sudden shocks without affecting its toughness.

Monel is stronger and tougher than common steels and its fatigue strength exceeds the limits of mild steel or all brasses and bronzes. This means freedom from internal structural failures, season cracking and other weaknesses, which, in ordinary metals, result in poor contacts, increased resistance or mechanical breakdowns. The endurance of monel is well shown by the fact that a monel roof on the Pennsylvania Terminal in New York City is still practically perfect after more than 25 years of exposure.

Rigid tests by both government and private ship-builders have shown Premax Monel Antennas as the most dependable unit available for high efficiency and completely satisfactory service under the most exacting conditions.

Two types of Monel Antenna are offered, the MM which is standard for most installations and the USM which is a heavy duty antenna in 25-foot length only, developed especially for navy use. The MM type and the USM-525 are telescoping and fully adjustable within the maximum and minimum lengths shown. The USM-325 is a jointed non-adjustable antenna.

SPECIFICATIONS AND LIST PRICES

No.	Old No.	Ext. Length	Col. Length	Base O.D.	Top O.D.	Base I.D.	Wgt. Each	List Price
MM-313	MM-213	13'1"	6'9"	.625"	.489"	.555"	2 3/4 lbs.	\$65.00
MM-419	MM-119	19'1 1/2"	6'9"	.750"	.489"	.666"	5 lbs.	90.00
MM-425	MM-225	24'10 1/2"	6'9"	.875"	.489"	.777"	8 lbs.	120.00
MM-430	MM-330	30'0"	6'9"	1.063"	.489"	.935"	13 lbs.	150.00
MM-435	MM-335	35'0 1/2"	7'8"	1.063"	.489"	.935"	15 lbs.	160.00
USM-525	USM-225	25'0"	7'6"	1.063"	.625"	.932"	12 lbs.	145.00
USM-325		25'0"	9'0"	1.312"	.750"	1.146"	30 lbs.	225.00

(For Base Mountings and Insulators see Page Q-49)



Steel Radiators

VERTICAL TYPE

Probably the most enviable reputation for dependable, efficient performance under the most severe conditions has been earned by Premax Tubular Steel Antennas which are in wide use for vertical radiators, home receiving antennas and countless commercial and public installations.

Premax Telescoping Steel Antennas are made of a high tensile, copper-nickel steel tubing, heavily plated in bright cadmium. They are not only highly resistant to corrosion but are extremely strong both in material and design.

Diameters and wall thicknesses have been engineered to provide ample strength against all ordinary stresses in the services to which they are adapted. While no positive guarantee can be offered against abnormal wind strains above 60 miles per hour, or extreme conditions encountered in heavy sleet storms and other unusual circumstances, many actual instances have been reported where Premax Telescoping Steel Antennas have weathered such punishment with perfect performance. Guying, while not generally considered necessary, is suggested as a reasonable precaution where possible.

Hundreds of amateur, public and commercial users are recommending Premax Telescoping Steel Antennas as dependable, low-cost equipment for a wide variety of radio services.

Premax Telescoping Steel Antennas are available in a range of sizes as shown below, for many different amateur and commercial services. All units are fully telescoping and adjustable between the maximum and minimum lengths shown. The locking device is simple in operation, positive in action and provides a secure, efficient contact between sections.

METHODS OF MOUNTING VERTICAL ANTENNAS

There are several commonly used methods of mounting Vertical Antennas, of which the most popular is with Premax Type 1 Heavy Duty Base. Lighter antennas up to about 18 feet in height can be satisfactorily mounted on the Type 2 Base. Type IX Base is similar to the Type 1 excepting that it has a socket instead of a post, and is generally used as footing insulators for towers or where the entire weight is downward. Type 6 is used where the connections are made through a flat roof or deck. In some instances, a wall bracket is desirable in order to secure proper location, and for this purpose the Wall Bracket WB-1 is used with a type 1 or 2 Base. Complete details of the various base mountings and insulators will be found on page Q-49.

SPECIFICATIONS AND LIST PRICES

No.	Description	Ext. Lgth.	Col. Lgth.	Base O.D.	Top O.D.	Base I.D.	Wgt. Each	List Price Each
112-M	2-sec. telscpg.	11'8"	6'1"	.656"	.500"	.556"	4 lbs.	5.50
318-M	3-sec. telscpg.	17'3"	6'2"	.875"	.500"	.775"	7 lbs.	8.00
224-M	4-sec. telscpg.	22'9"	6'3"	1.063"	.500"	.963"	11 lbs.	11.00
130-M	5-sec. telscpg.	28'3"	6'4"	1.250"	.500"	1.150"	15 lbs.	14.00
136-M	6-sec. telscpg.	33'9"	6'5"	1.500"	.500"	1.400"	20 lbs.	17.00

(Prices do not include base mountings. See page Q-49)

Corulite Elements

OF STEEL

For efficient performance in horizontal arrays and similar applications, the Premax Corulite Elements have a wide acceptance. These elements are exceptionally light in weight, yet provide the necessary extreme strength and rigidity so essential in the horizontal type of construction—and at a surprisingly low cost.

This Corulite type of steel tubing was developed by Premax in order to insure a metal structure which would possess unusual stiffness and strength in combination with light wall thickness and consequent low weight—all features essential in this type of array. Although many attempts have been made to imitate this construction, no other type has been able to equal Premax Corulite. A positive clamp, simple in its operation, insures rigid joints and perfect electrical contact between sections.

All Corulite Elements listed below (excepting No. 104-M) are fully telescoping and adjustable between the minimum and maximum lengths shown. These elements meet all requirements for the various 5, 10 and 20-meter arrays in general use, and will also be found ideal equipment for the experimenter on new combinations in the amateur, commercial, television or F. M. bands.

PREMAX PROVIDES A SPECIAL "HAIRPIN" TUNING BAR

The performance of a definite antenna can, to a large extent, be improved or ruined by the adjustments. This difficulty is completely eliminated by the use of the Premax "Hairpin" Tuning Bar. This bar is inserted between the two halves of the element, and may be slid up or down so as to provide a variation in the overall length from tip to tip of the element without making any adjustment in the two halves of the element itself. In other words, the electrical length is measured from the outside end of one element through that portion of the "hairpin" that is in use to the outside end of the other half of the element. By this method it is possible to have all of the elements set at a single physical length and the variation in their electrical length may be provided by the "hairpin". Similarly, the variation from one end of a given band to another may be obtained by a similar adjustment.



SPECIFICATIONS AND LIST PRICES

No.	Description	Ext. Lgth.	Col. Lgth.	Base O.D.	Top O.D.	Recom. For	Wgt. Per Pair	List Price
104-M	1-sec., non-adj.	4'0"	4'0"	.625"	.625"	5-meter	1 lb.	3.00
108-M	2-sec., telscpg.	8'2"	4'7"	.750"	.625"	10-meter	2 lbs.	6.00
113-M	3-sec., telscpg.	12'4"	4'8"	.875"	.625"	Dbl. Zep	3 1/2 lbs.	10.00
618-M	4-sec., telscpg.	17'0"	5'3"	1.000"	.625"	20-meter	5 1/2 lbs.	14.00

(Premax Corulite Elements sold only in pairs, complete with Premax "Hairpin" Tuning Bar) (For Insulators and Mountings, see page Q-49)

BRONZE MOUNTING CLIPS

Formed bronze clips or clamps for mounting horizontal elements or vertical antennas on standard stand-off insulators. Also used for connecting feed wires and transmission lines to antenna or elements. 3/4" wide, cadmium plated.



No.	Description	List Price
218-C	Fits 1" tube	\$0.30
418-C	Fits 1 1/2" tube	0.30



INSULATORS AND ACCESSORIES

BASE INSULATOR TYPE 1



Heavy duty type, of heavy wet-process brown-glaze porcelain held in compression between hot galvanized malleable iron castings. A Lapp design with compression rating up to 10,000 pounds. Height to top of cone 7". Bolt circle 5 1/4". Weight 7 lbs. Complete with mounting bolts and nuts.

SPECIFICATIONS AND PRICES

No.	Diameter Top Post	Fits Antennas	List Each
1P-24*	3/4"	318-M, MM-425	\$20.00
1P-26	1 1/8"	AM-124	20.00
1P-30	1 3/8"	224-M, MM-430, MM-435	20.00
1P-44*	1 3/8"	136-M	20.00
1P-45	1 1/2"	AM-336	20.00

*—Can be used with adapters to fit other sizes of masts.

BASE INSULATOR TYPE 2



Light design for up to 18' masts or longer lengths if guyed or supported with stand-off insulators. Brown-glazed porcelain with galvanized malleable iron top post and base support cemented into insulator. Porcelain diameter 3 1/4". Height to top of porcelain 6". Flange diameter 3 1/4". Weight 4 pounds. Furnished complete with necessary mounting bolts and nuts.

SPECIFICATIONS AND PRICES

No.	Diameter Top Post	Fits Antennas	List Each
2P-24*	3/4"	318-M, MM-425	\$5.50

*—Can be used with adapters to fit other sizes of masts.

BASE INSULATOR TYPE 6



For marine, mobile unit, tower platform, roof-top, etc. Simple to install, neat and compact. Lead-thru construction permits antenna connections below deck. General construction similar to Type 1. Flanges are 6" diameter with six bolt holes on 5" circle. Furnished with center stud and flange bolts for deck 1/2" to 3/4" thick. Total height above deck to base of post 4 1/2". Weight 11 1/2 lbs.

SPECIFICATIONS AND PRICES

No.	Diameter Top Post	Fits Antenna	Galvanized	Brass
6P-24*	3/4"	318-M, MM-425	\$25.00	\$45.00
6P-26	1 1/8"	AM-124	25.00	45.00
6P-30	1 3/8"	224-M, MM-430, MM-435	25.00	45.00
6P-44*	1 3/8"	136-M	25.00	45.00
6P-45	1 1/2"	AM-336	25.00	45.00

*—Can be used with adapters to fit other sizes of masts.

ADAPTORS FOR BASE INSULATORS TYPES 1 AND 2



Short lengths of cadmium plated steel tubing fitted with connection clamp to permit use of standard Type 1, 2 or 6 Base Insulators with other sizes of tubular masts.

SPECIFICATIONS AND PRICES

No.	Used with Insulator No.	To Fit Antennas	Weight Each	List Each
A-20	1P-24, 2P-24, 6P-24	MM-313 or 5/8" O.D.	1/2 lb.	\$6.50
A-21	1P-24, 2P-24, 6P-24	112-M or 3/4" O.D.	1/2 lb.	0.50
A-24	1P-24, 2P-24, 6P-24	AM-518, MM-419, or 3/4" O.D.	1/2 lb.	0.50
A-40	1P-44, 6P-44	130-M or 1 1/4" O.D.	3/4 lb.	0.50
A-42	1P-44, 6P-44	AM-230, or 1 1/4" O.D.	3/4 lb.	0.50



DECK BUSHING

Of brown-glazed porcelain cemented into hot galvanized malleable flange which bolts through rubber gasket to the deck or other surface. Provides additional support for antenna in lieu of guying.

SPECIFICATIONS AND PRICES

No.	I.D.	Total Length	Above Deck	Flange Diameter	Weight Each	List Each
5D-24	3/4"	6"	3"	4"	2 lbs.	\$8.00
5D-40	1 1/2"	8"	4 1/2"	4 1/2"	3 1/2 lbs.	11.00
5D-56	1 3/4"	8 1/2"	4 1/2"	5 3/8"	4 1/2 lbs.	14.00

WALL BRACKET



A heavy steel bracket designed for mounting Vertical Radiators on side walls, parapets or posts. Drilled to fit Premax Type 1 and Type 2 Base Insulators. Cadmium plated. Stand-off Type 3 or 4 suggested for use with this mounting, in order to give additional support.

No.	Weight	List Each
WB-1	7 lbs.	\$4.50

Insulator not included.

WALL MOUNT INSULATOR

Firm, serviceable side mounting which fastens securely to wall or post. Brown-glaze porcelain insulator similar to Type 2. Metal parts hot galvanized malleable iron. Stand-off Insulator Type 3 or 4 suggested for use with this mounting.

No.	Post Diameter	Weight	List Each
2-WP	3/4"	5 lbs.	\$8.00



Type 3

TYPE 3 INSULATORS

Heavy duty design for stand-off support of vertical antennas, etc., or for use in pairs as complete mounting of vertical or horizontal elements. Galvanized or brass fittings attached to threaded studs cemented in brown-glazed porcelain body. Porcelain 3" diameter. Height to top of porcelain 3". Weight 2 pounds each.



SPECIFICATIONS AND PRICES

No.	Fits Tube O. D.	List Price Each Galvanized	Type 4 Polished Brass
3S-16	1/2"	\$5.00	\$ 7.50
3S-20	3/4"	5.00	7.50
3S-24	1"	5.00	7.50
3S-28	1 1/8"	5.00	7.50
3S-32	1 1/4"	5.00	8.00
3S-34	1 1/2"	5.00	8.00
3S-40	1 3/4"	5.00	9.00
3S-42	1 7/8"	5.00	9.00
3S-48	1 3/4"	5.00	10.00
3S-52	1 7/8"	5.00	10.00

TYPE 4 INSULATORS

Similar in design to Type 3 but with double clamp. Top clamp sizes available in same range as Type 3. Bottom clamp made to fit all standard pipe sizes from 1/4" to 3". Available in galvanized or polished brass. Prices on request. State size of clamps desired, both top and bottom.

TYPE 7 INSULATORS

A low-priced but substantial stand-off mounting with wide application. Galvanized malleable iron frame enclosing white porcelain split bushing. Height 6". Weight, each, 2 1/2 pounds.



SPECIFICATIONS AND PRICES

No.	Fits Tube O. D.	List Price
7S-20	3/4"	\$3.00
7S-24	1"	3.00
7S-28	1 1/8"	3.00
7S-32	1 1/4"	3.00

INSULATED MOUNTING CLAMP TYPE 8

A better-than-ordinary insulated mounting support for horizontal elements, verticals, etc., in many of the new arrays. Galvanized malleable iron frame with white porcelain split bushing. Overall width 3 1/2". Weight each, 1 pound.



No.	Fits Tube O. D.	List Price
8C-20	3/4"	\$2.00
8C-24	1"	2.00
8C-28	1 1/8"	2.00
8C-32	1 1/4"	2.00

(Other sizes available to order)



INSULATED MOUNTING CLAMP TYPE 9

A simple, more compact mounting for horizontal elements, verticals, etc., as suggested for Type 8. Gray iron galvanized frame with white porcelain split bushing. Height to center 2". Weight each, 1 pound.

No.	Fits Tube O. D.	List Price
9C-20	3/4"	\$1.75
9C-24	1"	1.75
9C-28	1 1/8"	1.75
9C-32	1 1/4"	1.75



POLICE ANTENNA — Receiving and Sending

Premax Police Antennas for police and commercial applications are of solid steel of extremely high carbon content, heat-treated and oil-tempered to carefully develop physical properties. Rods of varying diameters, cold-drawn to rigidly held tolerances, are joined securely and permanently into a single graduated length which provides high flexibility, minimum wind resistance and indefinite life. A cadmium plate finish of .001" minimum gives adequate protection against corrosion in all ordinary atmospheres, including marine or salt air exposures.

Where ordinary antennas bend or break under stress of striking tree branches, bridges, garage doors and similar obstructions, Premax Police Antennas merely flex under the stress and return immediately to normal position when the obstruction is passed. This eliminates the usual replacement costs and Premax Police Antennas may easily save their initial cost in a few months.

Premax Police Antennas are available with two styles of bases. Style A has a plain 1/4" end and fits Premax Mountings K, L, T, R and NA. Style B has a 7/16" threaded stud complete with hexagon nuts and lock washer and fits Premax Mountings G or N.

Due to the single piece construction, Premax Police Antenna Rods should be purchased in the nearest standard length for the desired frequency and then cut, if necessary, to the exact length required. Specific lengths can be supplied to order in reasonable quantities.

Premax Police Antenna Rods are also available in polished, hard-drawn Stainless Steel.



TYPE N

Bumper Mount is of heavy gauge steel with 1 1/4" high tension cone insulators. Fits Style B Rod. List, each . . . \$4.50



TYPE NA

Adjustable Bumper Mount, otherwise similar to Type N but for Style A Rod. List, each \$5.50



TYPE R

Universal Adjustable Mount. Fits Style A Rod. List, each



TYPE L

Is similar to Type K in adjusting feature. Has 6" spacing between insulators giving extra base support. Fits Style A Rod. List, each \$10.00

ANTENNA MOUNTINGS

TYPE TA

For attaching Type A Rod to trunk or car body. Lower support is solid brass rod securely jointed to 12" brass tube carrying antenna. Upper support is 24" brass rod and has adjustable lock permitting proper fitting to contour of car. All insulators are high-tension, white-glazed ceramic cones 1 1/4" high. Antenna tube provides maximum 10" adjustment in antenna height. All metal parts heavily cadmium plated List, each \$15.00

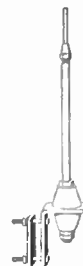
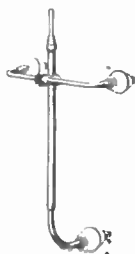

TYPE K

Adjustable Bumper Mount, similar in design to Type NA but with longer socket tube which permits 10" adjustment in height of Style A Rod. List, each \$6.50



TYPE G

Grounded Bumper Mount for Style B Rod for use on shunted or grounded systems. List each \$1.50

ANTENNA RODS ONLY—LIST PRICES WITHOUT MOUNTINGS

CADMIUM PLATED STEEL

Lgth	Style A No.	List Price	Style B No.	List Price
72"	AC-172	\$2.50	BC-172	\$3.25
78"	AC-178	2.75	BC-178	3.50
84"	AC-184	3.00	BC-184	3.75
90"	AC-190	3.25	BC-190	4.00
96"	AC-196	3.50	BC-196	4.25

STAINLESS STEEL

Style A No.	List Price	Style B No.	List Price
AS-172	\$5.50	BS-172	\$6.25
AS-178	6.00	BS-178	6.75
AS-184	6.50	BS-184	7.25
AS-190	7.00	BS-190	7.75
AS-196	7.50	BS-196	8.25

PREMAX GROUND RODS FOR RADIO

Premax Ground Rods are made of copper plated or cadmium plated steel or copper-headed with bright steel shaft, in 3/8", 1/2", 5/8" and 3/4" diameters, and in 4', 5', 6' and 8' lengths. All rods have one end pointed for easy driving.

They are made in four styles as illustrated: Style D with spring clamp; Style G with screw clamp; Style P with securely attached pigtail wire; Style H with drilled hole.

CADMIUM PLATED GROUND RODS

Size	Style D Spring Clamp	Style G Screw Clamp	List Each
4' x 3/8"	No. CD-4	No. CG-4	\$0.45
5' x 3/8"	No. CD-5	No. CG-5	0.60
6' x 3/8"	No. CD-6	No. CG-6	0.70

COPPER PLATED GROUND RODS

Size	Style D Spring Clamp	Style G Screw Clamp	List each
4' x 3/8"	No. RD-4	No. RG-4	\$0.45
5' x 3/8"	No. RD-5	No. RG-5	0.60
6' x 3/8"	No. RD-6	No. RG-6	0.70

COPPER HEADED GROUND RODS

Size	Style D Spring Clamp	Style G Screw Clamp	List each
4' x 3/8"	No. SD-4	No. SG-4	\$0.40

HEAVY DUTY GROUND RODS

Size	Style G	Style H	Style P	List
5' x 3/8"	G-85	H-85	P-85	\$1.20
6' x 3/8"	G-86	H-86	P-86	1.30
8' x 3/8"	G-88	H-88	P-88	1.60
6' x 5/8"		H-106	P-106	1.90
8' x 5/8"		H-108	P-108	2.30
8' x 3/4"		H-128	P-128	3.25

Above prices apply on either cadmium plated or copper plated rods. Please specify on order.

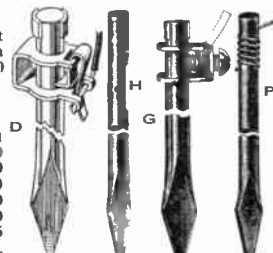



RADIO INSULATORS

for

BETTER RECEPTION - BETTER PROTECTION - BETTER TRANSMISSION

The isolation of radio frequency currents and their confinement within definite circuits demand the use of non-conducting materials possessing an unusual combination of electrical and physical characteristics. Radio frequency currents tend to leak over to adjacent conductors, and materials which may offer a fairly effective barrier to the passage of currents of low frequency sometimes prove to be conductors, or at least inefficient insulators, at radio frequencies.

Essential properties for satisfactory radio insulation are low power loss, low surface conductivity, high electrical resistance, a hard smooth surface, stability against corrosive influences, and a high strength-to-weight ratio. These properties must remain permanent and unchanged by age, exposure to the elements, and the continued impact of radio energy.

Performance, which alone has won for PYREX Radio Insulators their present day supremacy, is the direct result of the inherent properties of the glass composition from which they are made. PYREX Radio Insulators are made of a material whose dielectric constant is 4.7 at 740,000 cycles, and whose power factor is 0.42% at 740,000 cycles. The surface conductivity is so low as to be practically negligible. The specific gravity is 2.23, so that in PYREX Radio Insulators the dual advantages of light weight and high electrical strength are combined.

The stability of PYREX Radio Insulators against corrosive influences renders them immune to the attack of acid fumes, smoke, fog and salt sprays. For this last reason, PYREX Insulators are widely used for marine communication systems.

PYREX Radio Insulators, because of their coefficient of expansion of 0.0000032 between 19 deg. C. and 350 deg. C., are indifferent to heat shock and abrupt temperature changes. Tropical sunshine does not create strains within them. The sudden chill of a summer hailstorm does not affect them.

PYREX Insulators have played their part in many spectacular examples of extreme service. They have been with Commander Byrd at the North and South Poles. They were an important part of the radio equipment of the Louise A. Boyd and the MacGregor Arctic expeditions. The Atlantic Ice Patrol sends warnings of icebergs over antennae equipped with PYREX Radio Insulators. They are used by the United States Army Signal Corps, the Coast Guard, the Navy, and the Lighthouse Service. On your own equipment they will perform the same duties and provide the same unflinching service.

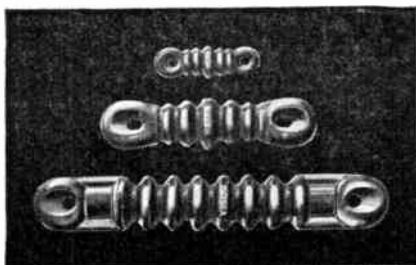

Top 67007—Center 67017—Bottom 67021

PYREX ANTENNA INSULATORS

For Superior Sending and Reception. For Longer Life and Trouble-Free Service.

No.	Description	Length Over-all	Developed Leakage Path	Average Flashover Value (KV)		Minimum Ultimate Strength	Price Each, List
				Wet	Dry		
67007	Broadcast Reception Insulator	3 5/8"	2 1/8"	28	42	500 lbs.	\$.25
67017	Amateur Transmitting Insulator	7 1/2"	6 1/8"	54	70	800 lbs.	1.00
67021	Strain Insulator	12 1/4"	11 3/8"	87	121	1000 lbs.	3.00
67003	Galvanized Shackles for installing 67017 or 67021; one pair per insulator; price per pair						1.00

PYREX ENTERING INSULATORS



67104-67105

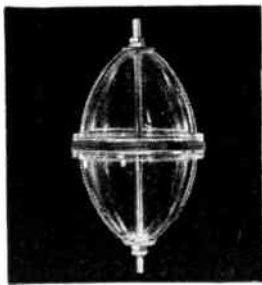

67115-67116



67079

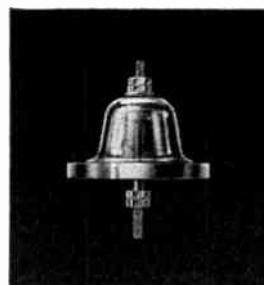

67080

Amateur Type

Here are practical, convenient lead-in Insulators designed specifically for amateur use. The bowls are made of PYREX brand Electrical Glass which possesses high dielectric strength and low power loss. They will give clearer signals and better operation, particularly under adverse conditions. The flanges on these bowls are wide and flat, bringing a large enough surface in contact with the wall to minimize slipping. The ruggedness of the bowls together with the rubber gaskets permits a water-tight, permanent installation. The rods are threaded except for 2 1/2" in the center. All sizes are supplied with four brass jamb nuts, two brass washers, two rubber washers and two rubber gaskets.

No.	Bowl	Length Center Pin	Outside Diameter	Price Each, List
67104	67056	15"	2 1/2"	\$2.00
67105	67056	20"	2 1/2"	2.20
67115	67009	15"	6 1/8"	3.50
67116	67009	20"	6 1/8"	3.60

Airplane Type

67056—Glass Bowl only, clear or opaque.*
 67075—Two 67056 Bowls with Brass Fittings but no guides. Has solid brass rod 1/4" diameter, 5 3/4" long.
 67079—Two 67056 Bowls with Brass Fittings and guides, as illustrated. Has hollow brass rod 3/8" diameter, 5 1/2" long.
 67080—One 67056 Bowl with Brass Fittings, as illustrated.

No.	Outside Diameter	Over-all Length	Price Each, List
67056	2 1/2"	1 5/8"	\$.20
67075	2 1/2"	5 3/4"	1.20
67079	3 1/2"	6 3/4"	4.50
67080	3 1/4"	4"	3.00

Opaque bowls can be furnished at extra cost.

Navy Type — Bowls Only



No.	Glass	Outside Height Overall at Base	Outside Diam.	Price Each, List
67009	Clear or opaque*	4 3/8"	6 1/8"	\$1.00
67037	Clear or opaque*	4 3/8"	6 1/8"	1.00

* Opaque bowls can be furnished at extra cost.

67009-67037



RADIO INSULATORS

for

BETTER RECEPTION • BETTER PROTECTION • BETTER TRANSMISSION



67106-67107 67108-67109

67027

PYREX STAND OFF INSULATORS

No.	Height Over-all	Type of Base	Size of Base	Diameter of Glass Part	Developed Leakage Path	Average Flashover Value (KV)		Price Each, List
						Wet	Dry	
67106	3"	Oval	3 1/8" x 1 1/8"	1 1/4"	1 3/8"	13.5	22.5	\$2.25
67107	7"	Oval	3 1/8" x 1 1/8"	1 1/4"	5 1/8"	32.5	58.0	2.50
67108	3"	Rectangular	2 7/8" x 1 1/8"	1 1/4"	1 1/8"	13.5	22.5	2.25
67109	7"	Rectangular	2 7/8" x 1 1/8"	1 1/4"	5 1/8"	32.5	58.0	2.50
67027	12 1/4"	Round	4 3/4" diameter	2 1/2"	10 1/2"	73.0	96.5	7.00

All types are furnished with cap screw and washer, and brass wood screws for fastening base.

PYREX ENTERING INSULATORS

Navy Type



B-67071

Both types have flanges 3 3/4" in diameter with six 1/2" studs equidistantly spaced on 7 3/4" bolt circle and are approximately 6" high from bottom of lower flange to top of center pin. Center pin is 3/8" in diameter with 16 threads per inch at the ends.

Style B has studs 1 1/4" long and in the bottom flange three equidistantly spaced countersunk 1/8" holes on 7 3/4" center circle.

Style C is furnished with a template ring 1/8" thick for locating mounting holes for the 2 1/8" studs. This template can also be used as a backing ring or washer.

Both styles have two 3/8" jamb nuts for the lower end of the center pin and Style C has two 1/2" jamb nuts for each stud.

The 11 1/2" center pin is standard for both assemblies but any other length rod can be furnished at extra cost.



C-67076

No.	Bowl	Glass	Length Center Pin	Outside Diameter at Base	Price Each, List
67071	67037	Clear or opaque*	11 1/2"	8 3/4"	\$20.00
67076	67037	Clear or opaque*	11 1/2"	8 3/4"	21.00

* Opaque bowls can be furnished at extra cost.

PYREX STRAIN INSULATORS

Navy Type

Each PYREX Navy Type Strain Insulator is actually tested to 3,500 pounds pull strain for one minute. The minimum ultimate is 5,000 pounds.

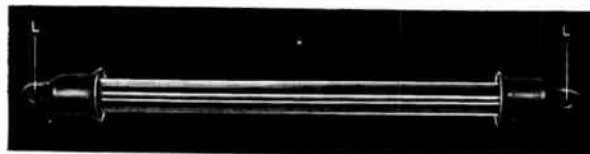

67045-67043-67046

No.	Average Length (L to L)	Outside Diameter of Glass Part	Developed Leakage Path	Price Each, List
67045	12"	1 7/8"	3 3/8"	\$9.00
67043	18"	1 7/8"	9 3/8"	9.50
67046	24"	1 7/8"	15 3/8"	10.00

Birnbach

F-N and TELEVISION ANTENNAS



F-M and TELEVISION DOUBLET ANTENNAS

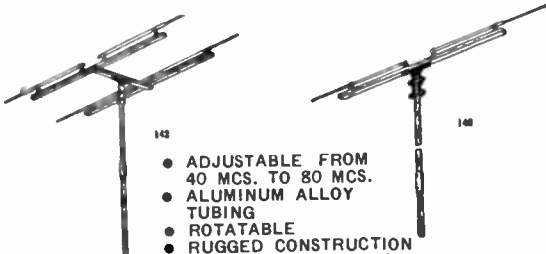

- ADJUSTABLE FROM 40 MCS. TO 80 MCS.
- ALUMINUM ALLOY TUBING
- ROTATABLE
- RUGGED CONSTRUCTION
- CERAMIC INSULATORS

A superior antenna construction for television reception. Consist of corrosion proof aluminum alloy tubes adjustable to all frequencies between 80 mcs. and 40 mcs. mounted on high grade low absorption glazed porcelain standoff insulators which maintains its efficiency under all weather conditions. Strong wooden supports. Adjustments can be made in the horizontal planes. This will permit the antenna to be properly adjusted in respect to the transmitted wave and the signal strength. There are two types available: No. 140 Doublet and the No. 142 Doublet with reflector to eliminate interference. Complete with mounting poles and steel coupling.

No.	List Price
140—Doublet	\$12.50
142—Doublet with reflector	22.50

ULTRA HIGH FREQUENCY ANTENNAS (VERTICAL RODS)

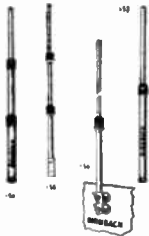

They are constructed of hard drawn aluminum alloy tubing, telescoped together and adjusted by forcing down with a turning motion a specially designed brass nickel-plated taper lock bushing. They cover all requirements for stationary or portable use. Two types of mountings are available: stand-off mounting having $\frac{1}{4}$ " - 20 threaded bushing on No. 154 and 10-32 threaded bushing on No. 157, and binding post mounting consisting of a reinforced flattened end with two holes drilled $1\frac{1}{2}$ " between centers. The frequency range listed is for $\frac{1}{4}$ wave-length antenna.

No.	Sections	Frequency Range in Mcs.		List Price
		Open	Telescoped	
154	3	55	145	\$3.30
155	3	55	145	3.30
156	2	112	200	2.00
157	2	112	200	2.00
161	2	40	75	2.20
164		Taper Lock Bushings $\frac{1}{8}$ and $\frac{3}{8}$.15

MAST AERIAL

The Birnbach Mast Aerial is made of four tempered carbon steel tube sections which will instantly go back to an erect position when flexed by the wind. They make an actual height of 12 ft. and are treated to prevent corrosion. Two heavy duty ceramic mounting insulators permit every type of installation to be made with ease. The Safety Lightning Arrestor protects the antenna from excessive static charges of atmospheric electricity. The accumulating charges bypasses the receiver and discharges to the ground. No. 169—Includes: 1 12 ft. 1 section Mast Aerial and Clamps; 2 porcelain mounting insulators; and securing clamps; 1 nailt knobs; 1 safety lightning arrester; 35 ft. leadin wire; 1—6" insulated screw eye; 1 ground clamp; mounting charges and directions. List \$5.00 No. 170 — Includes: Everything contained in the No. 169 with the exception of 1 Safety lightning arrester. List ... \$4.75

BASE INSULATOR



Ideal for replacement and well suited as a base insulator for ultra high frequency antennas as it permits a connection to be at the bottom of the insulator. Made of highly vitrified low absorption glazed porcelain. No. 146—Base Insulator, Std. Pkg. 10.....List, \$0.60

SEE PAGE Q-58 for complete line of TRANSMISSION CABLE suitable for FM and TELEVISION

ADJUSTABLE DIPOLE ANTENNA

For Television or Frequency Modulation



An adjustable antenna that can be used as a vertical or horizontal doublet. Can be rotated to any angle for any degree of polarization. Impedance at center 72 ohms, matched by E01 Cable. Aluminum alloy tubing permits outdoor mountings. Special tapered lock bushings hold each section in place simply by turning and pushing down. The center mounting insulator is $4\frac{1}{2}$ " high.

No.	Frequency Range in Mcs.		List Price
	Open	Telescoped	
158	82	155	\$5.50
160	40	75	6.60

Wooden Mounting Poles

Made of straight grain ash and finished with a weatherproof varnish. With the use of the couplings, several poles can be joined together. The couplings are made of steel tubing and are cadmium plated.

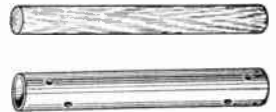

No.	Std. Pkg.	List
144—Coupling	10	\$1.00
145—4 ft. Wooden pole	10	1.00

MOUNTING STRAP

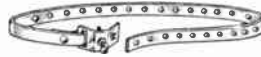

A very useful aid in securing poles of Television or mast antennas to vent pipes. It is made of cadmium plated steel and is 24" long.

No. 626—Mounting Strap	Std. Pkg. 25	\$0.30 List
------------------------	--------------	-------------

GUY WIRE

Constructed of high tensile strength galvanized steel wires. Ideal for guying up transmitter and receiver towers and poles.



No. 19—Guy Wire, 25 ft. Coil	each	\$0.30 List
No. 20—Guy Wire, 50 ft. Coil	each	.60 List

No. 150 ALL WAVE ANTENNA

An efficient and low cost all wave antenna with noise reducing features. It will give efficient reception on both broadcast and short waves on every type of receiver. It has the newly designed all ceramic transfer unit. With this unit the antenna wire and the transmission line are firmly and securely anchored. There are no wire leads from the transfer unit to collect ice in the winter and to deteriorate in the summer. Comes complete with everything necessary for installation.

LIST OF PARTS

2—30 ft. coils 7-21 Bare Aerial Wire	2—Porcelain Insulators	List Price
1—50 ft. coil Stranded Transmission Cable	2—All Wave Lead-in Strips	
1—All Wave Coupler	1—Ground Clamp	\$4.00
1—Transfer Unit	2—Glazed Nailt Knobs	
Complete Instructions		3.00
No.		
150—Birnbach All Wave Antenna		\$4.00
152—Special All Wave Antenna		3.00

No. 148 UNIVERSAL WAVE ANTENNA (FOR EVERY TYPE OF RECEIVER)

The No. 148 All Wave Antenna is the same as the No. 150, but is packed in a special attractive two color box imprinted to customer's specifications. This kit is designed for efficient operation with all types of receivers. Standard cartons of 20 kits.



No.	List Price
148—All Wave Kit with Receiver Coupler	each \$4.00
149—All Wave Kit without Receiver Coupler	each 3.50



Birnbach

AERIAL ACCESSORIES

LEADIN STRIPS



Covered with a heavy cotton braid, weather-proofed, with numerous coats of lacquer. The Clips are riveted and soldered at both ends.

No.	Lgth.	Std. Pkg.	Each	List Price
611—Black	12"	50	\$0.07 1/2
612—Black	16"	2515
613—White	12"	5008

DOUBLET LEADIN STRIPS

Two strips held parallel to each other by a piece of bakelite prevents them from moving back and forth. Available in black or white.



No. 2611—Std. pkg. 25. Ea. \$0.17 List

Screw Terminal Leadin Strip



Locks the wire together with the strip in a secure connection assuring perfect contact. Has weather-proof covering over a copper strip with cadmium plated terminals. Available in white or black.

No.	Std. Pkg.	List Price
617—Leadin Strip	50\$0.14
2617—Doublet Leadin Strip	2525

COPPER STRAP CLAMP



Will take 3/8" to 2" Pipe. Made of copper with Birnbach clip riveted and soldered to strap, complete with nut and bolt.

No. 600—Std. pkg. 50. Ea. \$0.07 List

C-CLAMP



Attaches easily to a water or radiator pipe. The cone-pointed screw cuts through and makes positive contact. Cadmium finish prevents rusting.

No. 615—Std. pkg. 25. Ea. \$0.10 List

SADDLE GROUND CLAMPS

These ground clamps have a hard pointed screw which digs through rust and makes a positive contact. Fits a 3/8" to 2" pipe.



No.	Std. Pkg.	List Price
625—Heavy Saddle Clamp	50\$0.12
630—Light Saddle Clamp	5008

SOLID TINNED WIRE

SOFT DRAWN		No. 18	
No. 10	List Price	No. 18	List Price
1400—25 ft. coil	\$0.72	1416—25 ft. coil	\$0.22
1401—50 ft. coil	1.40	1417—50 ft. coil	.40
1402—100 ft. coil	2.70	1418—100 ft. coil	.72
1403—1000 ft. spool	27.00	1419—1000 ft. spool	7.20
No. 12		No. 20	
1404—25 ft. coil	.45	1410—25 ft. coil	.20
1405—50 ft. coil	.80	1421—50 ft. coil	.33
1406—100 ft. coil	1.50	1422—100 ft. coil	.66
1407—1000 ft. spool	15.00	1423—1000 ft. spool	6.60
No. 14		No. 22	
1408—25 ft. coil	.33	1424—1 lb. spool	.50
1409—50 ft. coil	.55	1425—1 lb. spool	.90
1410—100 ft. coil	1.00	1426—1 lb. spool	1.50
1411—1000 ft. spool	10.00	No. 24	
No. 16		1427—1 lb. spool	.55
1412—25 ft. coil	.28	1428—1 lb. spool	1.00
1413—50 ft. coil	.45	1429—1 lb. spool	1.75
1414—100 ft. coil	.77	No. 26	
1415—1000 ft. spool	7.70	1430—1 lb. spool	.60
		1431—1 lb. spool	1.10
		1432—1 lb. spool	2.00

GLASS INSULATORS



Made of crystal clear glass and have a smooth surface which prevents dirt or ice to collect.

No.	Std. Pkg.	List Price
00—3"	100C \$5.50
660—3 3/4"	100C 8.25
661—3 3/4" Flat Type	100C 8.80
662—3 3/4"	100C 9.50
659—4 1/2"	100C 14.30

PORCELAIN INSULATORS AND NAIL-IT KNOBS



No.	Porcelain Insulators	Std. Pkg.	List Price
666—Brown or White	100	C \$4.40
669—Glazed Nail-It Knobs	100	C 3.85

GROUND RODS



The Ground Rod when driven into the ground will afford a highly efficient ground.

No.	Std. Pkg.	List Price
616—4 Ft.	12ea. \$0.85
818—6 Ft.	12ea. 1.25

AERIAL SPRING ADJUSTER



Prevents swinging and swaying of antennas and eliminates the resultant fading of signals. Consists of two books with porcelain rings interconnecting with a powerful compression spring. Cadmium plated throughout.

No.	Std. Pkg.	List Price
765—Birnbach Aerial Spring Adjuster	each \$0.55

PORCELAIN TUBES



To bring a leadin into a building, we advise our Porcelain Tubes, which require a 3/8" dia. hole.

No.	Std. Pkg.	List Price
42—2"	100C \$3.25
43—3"	100C 4.00
44—4"	100C 5.25
46—6"	100C 7.00
48—8"	100C 10.00

PHOSPHOR BRONZE

It has about twice the strength of copper. It is used extensively on Master Antenna Systems where strength and reliability are demanded.

No.	Ft.	Size	List Price
499	1007/18	\$6.00
574	1007/32	3.50
526	1007/32	3.25

SOLID ENAMEL WIRE

No. 10		No. 12	
No.	List Price	No.	List Price
597—25 ft. coil	\$0.65	192—25 ft. coil	.45
697—50 ft. coil	1.30	292—50 ft. coil	.85
497—100 ft. coil	2.50	492—100 ft. coil	1.60
1497—1000 ft. spool	24.50	492A—150 ft. coil	2.40
No. 12		No. 14	
192—25 ft. coil	.45	190—25 ft. coil	.30
292—50 ft. coil	.85	290—50 ft. coil	.60
492—100 ft. coil	1.60	490—100 ft. coil	1.18
492A—150 ft. coil	2.40	490A—150 ft. coil	1.65
1492—1000 ft. spool	16.00	490B—200 ft. coil	2.20
No. 15		No. 16	
498—100 ft. coil	.85		



ANTENNA KITS

No. 536—Aerial Kit... Each \$0.75
 35 ft. 7-Strand Copper Wire
 20 ft. R.C. Lead-In Wire
 2—No. 666 Porcelain Insulators
 2—No. 669 Glazed Nailit Knobs
 1—No. 600 Ground Clamp
 1—No. 611 Lead-in Strip
 Std. Pkg. 24 Weight 36 lbs.

No. 555—Aerial Kit... Each \$0.85
 50 ft. 7-Strand Copper Wire
 25 ft. R.C. Lead-in Wire
 2—No. 666 Porcelain Insulators
 2—No. 669 Glazed Nailit Knobs
 1—No. 600 Ground Clamp
 1—No. 611 Lead-in Strip
 Std. Pkg. 24 Weight 38 lbs.

No. 505—Aerial Kit... Each \$1.10
 75 ft. 7-Strand Copper Wire
 25 ft. R.C. Lead-in Wire
 1—No. 65 Lightning Arrester
 2—No. 666 Porcelain Insulators
 2—No. 669 Glazed Nailit Knobs
 1—No. 600 Ground Clamp
 1—No. 611 Lead-in Strip
 Std. Pkg. 24 Weight 48 lbs.

No. 500—Aerial Kit... Each \$1.35
 75 ft. 7-26 Copper Wire
 25 ft. R.C. Lead-in Wire
 1—650 Lightning Arrester
 1—No. 611 Lead-in Strip
 1—No. 600 Ground Clamp
 2—No. 666 Porcelain Insulators
 2—No. 669 Glazed Nailit Knobs
 2—No. 665 Galvanized Screw Eyes
 Std. Pkg. 24 Weight 50 lbs.

No. 501—Aerial Kit... Each \$2.00
 75 ft. 7-24 Copper Wire
 40 ft. R.C. Lead-in Wire
 15 ft. Flexible R.C. Wire
 1—No. 611 Lead-in Strip
 1—No. 650 Lightning Arrester
 1—No. 630 Ground Clamp
 2—No. 666 Porcelain Insulators
 2—No. 669 Glazed Nailit Knobs
 2—No. 665 Galvanized Screw Eyes
 6 Insulated Staples
 Std. Pkg. 24 Weight 61 lbs.

LIGHTNING ARRESTERS

Made of a brown glazed porcelain body with nickel-plated hardware. Suitable for outdoor or indoor use. Complete with mounting screws and instructions.



No.	Std. Pkg.	List Price
650—Lightning Arrester	50\$0.30
65—Lightning Arrester	10018



DOUBLET LIGHTNING ARRESTERS



This Arrester is of the air gap type which is the accepted means of protecting doublet antennas from lightning. Installation instructions are printed on the box.

No.	Std. Pkg.	List Price
2650—Doublet Lightning Arrester	25List \$0.35

SCREW EYES

Heavy rustproof cadmium plated steel screws hold the blue glaze porcelain eyes firmly. The bakelite insulated eye is specially molded for outdoor use.



No.	Std. Pkg.	List Price
666—3 3/4 in.	100\$5.50
664—7 in.	506.50
667—12 in.	2521.00

No.	Std. Pkg.	List Price
963—3 in.	100\$5.50
964—7 in.	506.60
967—12 in.	2521.00

COPPERWELD ANTENNA WIRE (STRETCHLESS)



Has a steel core covered with copper and heavily enameled. It will not elongate because of its high tensile strength which is several times that of enameled copper wire. It has low R.F. resistance and is ideal for transmitting doublet and directional antenna systems as it will maintain the frequency characteristics of the antenna because of its stretchless qualities.

Feet	LIST PRICES		
	No. 10	No. 12	No. 14
100\$3.25	\$2.25	\$1.55
2508.00	5.50	3.75
50016.00	11.00	7.25
100031.25	22.00	14.25
250077.50	54.50	35.50

TENSILE STRENGTH

No. 101130 lbs.
No. 12720 lbs.
No. 14400 lbs.

SPECIAL LENGTHS AVAILABLE ON ORDER

Birnback HOOK-UP WIRE



SPECIAL SPOOL ASSORTMENT \$.80 LIST PRICE

No.	Ft.	Size	Type	No.	Ft.	Size	Type
3000	.80	.22	Solid Pushback	3013	.70	.18	Solid Leadin
3001	.70	.20	Solid Pushback	3014	.75	.18	Stranded Leadin
3002	.60	.18	Solid Pushback	3015	.40	.18	Stranded Lacquered
3003	.40	.16	Solid Pushback	3016	.100		Brown & White AC-DC Wire
3004	.35	.14	Solid Pushback	3017	.35		Kinkless Wire
3005	.70	.22	Stranded Pushback	3018	.25	.18	Twisted Lamp Cord
3006	.60	.20	Stranded Pushback	3019	.55	.18	Single Fix. Wire
3007	.50	.18	Stranded Pushback	3020	.30	.18	Parallel Silk
3008	.35	.16	Stranded Pushback	3021	.20	.18	Blk., Wht., Brn. Zip Cord
3009	.25	.14	Stranded Pushback	3022	.100	.18	Solid Tinned
3010	.60	.18	Colored Rubber	3023	.100	.18	Bell Wire
3011	.40	.16	Colored Rubber	3024	.20	.18	Shielded Wire
3012	.35	.14	Stranded Leadin				

FREE DISPLAY

One Display is given with each initial order for 100 spools. Each Display made of strong, re-inforced steel, mahogany crackle finish with attractive 3 color Display at top. Space provided to indicate YOU'r resale price.

EXTRA DISPLAY RACKS AVAILABLE AT \$1.25 EACH, NET

Height — 24" Width — 12½"

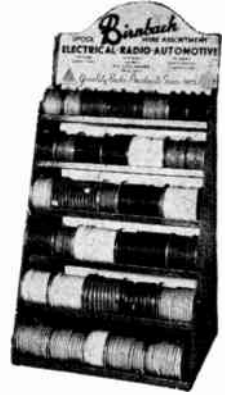

RUBBER COVERED LEAD-IN WIRE



Constructed of tinned conductor with a special grade of live rubber compound for outdoor use. Rubber strips easily and leaves the wire clean and bright, ready for splicing and soldering.

clean and bright, ready for splicing and soldering.

SOLID CONDUCTOR 3/64" WALL			
No.	Ft.	Size	O.D. List Price
1517	25	.20	.125 \$0.25
1518	50	.20	.125 \$0.48
1519	100	.20	.125 .95
1520	500	.20	.125 4.25
1521	25	.19	.130 .28
1522	50	.19	.130 .50
1523	100	.19	.130 1.00
1524	500	.19	.130 4.60
1525	25	.18	.135 .30
1526	50	.18	.135 .55
1527	100	.18	.135 1.10
1528	500	.18	.135 5.25
1529	25	.17	.140 .30
1530	50	.17	.140 .65
1531	100	.17	.140 1.25
1532	500	.17	.140 5.90
517	25	.16	.145 .45
516	50	.16	.145 .85
519	100	.16	.145 1.65
518	500	.16	.145 7.50
521	25	.15	.154 .50
520	50	.15	.154 .95
522	100	.15	.154 1.90
523	500	.15	.154 9.50
STRANDED CONDUCTOR 1/32" WALL			
2331	100	.18	.111 1.10
2330	500	.18	.111 4.75
1541	50	.16	.125 .85
1543	250	.18	.125 4.25
1544	500	.16	.125 7.50
1542	500	.20	.103 3.75
1545	1000	.20	.103 7.00
STRANDED CONDUCTOR 3/64" WALL			
1552	25	.18	.141 .40
1551	50	.18	.141 .75
1550	100	.18	.141 1.35
1549	500	.18	.141 6.00
1548	500	.16	.153 8.00
1553	500	.14	.175 10.75

SHIELDED LEAD-IN WIRE

Used to prevent the pickup of interference or man-made static. Consists of a stranded tinned copper conductor with a wall of live rubber over which a tinned copper braid is woven.

No. 20—1/64"				No. 16—1/32"			
No.	Ft.	Cap. mmfd. per Ft.	List O.D. Price	No.	Ft.	Cap. mmfd. per Ft.	List O.D. Price
810	500	.105	.090 \$15.00	825	25	.90	.145 \$1.10
				851	100	.90	.145 4.25
				802	250	.90	.145 10.00
No. 18—1/64"				No. 14—3/64"			
807	25	.125	.100 \$0.90	804	25	.95	.185 \$1.55
809	100	.125	.100 3.50	806	100	.95	.185 6.00
803	250	.125	.100 8.50	801	250	.95	.185 14.50

RADEX SLIPBACK HOOKUP WIRES

It has a covering of rubber over a cotton wrap and is then covered with a bright color cotton braid and dipped into paraffin. This construction will not cause the cotton insulation to fray or bunch up when pushed back. It has a high dielectric strength and will withstand all climatic changes without breakdown.

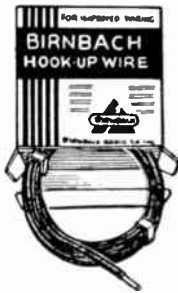

25 FT. COILS				100 FT. SPOOLS				500 FT. SPOOLS						
Size	Solid		Stranded		No.	Solid		Stranded		No.	Solid		Stranded	
	No.	List Price	No.	List Price		No.	List Price	No.	List Price		No.	List Price	No.	List Price
20	280	\$0.40	281	\$0.45	380	\$1.60	381	\$1.80	480	\$8.00	481	\$9.00		
18	282	.45	283	.50	382	1.80	383	2.00	482	9.00	483	10.00		
16	284	.55	285	.60	384	2.20	385	2.40	484	11.00	485	12.00		
14	286	.75	287	.90	386	3.00	387	3.60	486	13.50	487	16.00		
12	288	1.15	289	1.25	388	4.60	389	5.00	488	23.00	489	25.00		
1000 FT. SPOOLS				SOLID WIRE PUNCTURE VOLTAGE										
Size	Solid		Stranded		60 Cycle A.C.									
	No.	List Price	No.	List Price	No. 16	No. 2000	No. 18	No. 2100						
20	580	\$15.00	581	\$16.50										
18	582	17.50	583	18.50	No. 14	2100	No. 12	2200						
16	584	20.00	585	22.50										
14	586	25.00	587	28.00	STRANDED WIRE PUNCTURE VOLTAGE									
12	588	45.00	589	50.00	60 Cycle A.C.									
					No. 20	2200	No. 14	2300						
					No. 16	2200	No. 12	2300						

COLORS—Black, Red, Blue, Yellow, Green, White, Brown

BIRNTEX SLIPBACK WIRE

This wire is constructed of quality materials and carefully insulated with a cotton wrap over which a cotton braid is closely woven, and then saturated with paraffin.

SOLID COLORS:—Red, Black, Green, Blue, Yellow, White.
TRACER COLORS:—Red, Black, Green, Blue, Yellow, Brown.



25 FT. COILS				100 FT. COILS					
Size	Solid		Stranded		No.	Solid		Stranded	
	No.	List Price	No.	List Price		No.	List Price	No.	List Price
20	70	\$0.30	71	\$0.35	72	\$1.20	73	\$1.40	
20	80	.35	81	.40	84	1.40	85	1.60	
18	82	.40	83	.45	86	1.60	87	1.80	
500 FT. SPOOLS				1000 FT. SPOOLS					
Size	Solid		Stranded		No.	Solid		Stranded	
	No.	List Price	No.	List Price		No.	List Price	No.	List Price
22	74	\$6.00	75	\$7.00	76	\$11.00	77	\$12.50	
20	88	7.00	89	8.00	92	12.50	93	14.00	
18	90	8.00	91	9.00	94	15.00	95	17.00	

STRANDED COLORED RUBBER WIRE

It is constructed of carefully annealed stranded tin-copper conductors with a cotton wrap, insulated with a special grade of non-cracking live colored rubber compound. It strips readily and is available in various colors for easy identification.

No.	Ft.	Size	Current Carrying Capacity	Puncture Volts A.C. 60 Cycle	O.D.	Wire Stranding	List Price
225	25	Coil					\$0.40
1225	1000	Spool	18, 1/4	3 Amps	5,500	.087 16-30's	13.00
COLORS:—Red, Black, Yellow, Green, Brown, White.							
425	25	Coil					\$0.65
440	50	Coil	16, 1/2	6 Amps	8,000	.135 26-30's	1.20
1440	100	Spool					2.25
2440	500	Spool					10.50
COLORS:—Red, Black, White, Brown, Green.							
FILAMENT WIRE (HIGH AMPERAGE)							
782	25	Coil					\$8.90
786	500	Spool	14, 1/2	17 Amps	8,500	.145 26-28's	18.00
784	25	Coil					1.25
787	500	Spool	12, 3/4	20 Amps	12,000	.190 41-28's	25.00
COLORS:—Red and Black.							



Birnbach

CABLE and TRANSMISSION LINE

PA and COMMUNICATING SYSTEM CABLES



Shielded Twisted Pair

Constructed of solid enameled wire with a cotton braid twisted pair waxed, and bare copper braid woven overall.

No.	Size	O.D.	List Price
821—100 Ft.	.22	.125	\$ 4.00
822—500 Ft.	.22	.125	17.50
823—100 Ft.	.19	.145	4.25
824—500 Ft.	.19	.145	19.50



Armored Speaker Cable

Constructed of 2 No. 18 stranded parallel conductors of rubber color coded cotton braid waxed, paper wrap and closely armored.

No.	Size	O.D.	List Price
1110—100 Ft.	.18 $\frac{1}{2}$.155 x .260"	\$ 6.75
1111—250 Ft.	.18 $\frac{1}{2}$.155 x .260"	16.00
1112—500 Ft.	.18 $\frac{1}{2}$.155 x .260"	29.00
1113—1000 Ft.	.18 $\frac{1}{2}$.155 x .260"	55.00

Rubber Shielded Microphone Cable



Consists of individual flexible tinned copper conductors, each insulated with a heavy wall of colored rubber for easy identification. A tinned copper shield is woven over all conductors, and then cotton wrapped. A 1/32 wall of tough rubber is placed overall. It is a weatherproof cable, ideal for outdoor use, and will withstand hard and rough usage.

No.	Conds.	Ft.	Size	Cap. bet. Shield & Conds. mmds.	Cap. bet. Conds. mmds.	O.D.	List Price
772	2	100	20	.55	.31	.310	\$11.50
1772	2	250	20	.55	.31	.310	28.25
773	3	100	20	.58	.33	.317	13.00
1773	3	250	20	.58	.33	.325	32.25
774	4	100	20	.48	.28	.350	17.50
1774	4	250	20	.48	.28	.370	43.25
775	5	100	20	.51	.29	.395	20.00
1775	5	250	20	.51	.29	.395	49.50
776	6	100	20	.45	.27	.430	23.00
1776	6	250	20	.45	.27	.430	57.50
777	7	100	20	.49	.27	.430	27.50
1777	7	250	20	.49	.27	.430	68.50
SMALL DIAMETER CABLE							
702	2	100	20 $\frac{1}{2}$.107	.57	.270	11.50
1702	2	250	20 $\frac{1}{2}$.107	.57	.270	28.25



RUBBER S. J. CABLE

Consists of individual flexible tinned copper conductors, each insulated with a heavy wall of colored rubber for easy identification. A 1/32 wall of tough polished rubber is placed overall. It is a weatherproof cable, ideal for outdoor use, and will withstand hard and rough usage.

No.	Spool	O.D.	List Price each
788—2 Conductor Cable,	100 Ft.	.280	\$ 7.50
789—2 Conductor Cable,	250 Ft.	.280	18.25
790—3 Conductor Cable,	100 Ft.	.300	9.00
791—3 Conductor Cable,	250 Ft.	.300	22.00
792—4 Conductor Cable,	100 Ft.	.325	11.00
793—4 Conductor Cable,	250 Ft.	.325	27.00
794—5 Conductor Cable,	100 Ft.	.370	18.75
795—5 Conductor Cable,	250 Ft.	.370	46.50
796—6 Conductor Cable,	100 Ft.	.400	21.50
797—6 Conductor Cable,	250 Ft.	.400	53.25
798—7 Conductor Cable,	100 Ft.	.400	25.00
749—8 Conductor Cable,	100 Ft.	.460	30.00



EO1 Transmission Cable (GENUINE)

This cable has a surge impedance of 72 ohms which accurately matches the impedance at the center of the half wave Hertz Antenna. It is constructed of 2 No. 12 Bare Copper conductors having a paper wrap. A special high frequency rubber insulates each side of the line and accurately maintains the impedance. It has a special weatherproof cotton braid overall with a mica finish.

No.	Ft.	List Price	Freq. (Ohms)	Surge Imp. (Ohms)	Loss per 100'
956	100 Spool	\$17.00	10 Mcs.	73	1.8
955	250 Reel	39.00	20 Mcs.	73.7	3.2
954	500 Reel	75.00	40 Mcs.	73.7	5.9
953	1000 Coil	150.00			



No. 12 Solid Twisted For Television or Frequency Modulation (100 ohm)

Designed for use with television and Frequency Modulation (F.M.) receivers. It is constructed of 2 No. 12 bare conductors insulated with a paper wrap with a special grade of rubber insulation which separates and insulates the conductors and helps maintain the correct impedance. Over this is placed a cotton braid impregnated with a weatherproof finish.

No.	Ft.	List Price	Freq. (Ohms)	Surge Imp. (Ohms)	Loss per 100'
980	100 Spool	\$11.00	10 Mcs.	98	2.4
959	250 Reel	26.50	20 Mcs.	101	3.5
958	500 Reel	52.50	40 Mcs.	101	6.2
957	1000 Coil	100.00			



72 OHM No. 14 SOLID

Constructed of 2 No. 14 Solid tinned conductors with a special grade of low loss rubber covered with a weatherproof cotton braid overall. Reasonably priced having many desirable characteristics of the more expensive cable.

No.	Ft.	List Price	Freq. (Ohms)	Surge Imp. (Ohms)	Loss per 100'
906	50 Spool	\$10.00	10 Mcs.	73	1.8
907	100 Spool	19.00	20 Mcs.	73.8	3.3
908	250 Spool	45.00	40 Mcs.	74.1	5.8
909	500 Spool	85.00			
910	1000 Reel	175.00			



Crystal Microphone Cable

For use with crystal and ribbon microphones. They are designed for low capacity and low losses. Constructed of tinned stranded conductor with a wall of low capacity rubber and closely woven shield and tough rubber wall overall.

No.	Ft.	Size	Cap. bet. Shield & Conds. mmds.	O.D.	List Price
872	100 Crystal	20	37	.270	\$10.00
1872	250 Crystal	20	37	.270	23.00
870	100 Lapel	20	60	.175	6.50
1870	250 Lapel	20	60	.175	16.00
871	100 Lapel	20	50	.155	6.50
1871	250 Lapel	20	50	.155	16.00



Shielded Battery Cable

Constructed of flexible stranded conductors covered with quality rubber compound and tinned copper shield is woven overall. Used to prevent interference from being picked up.

No.	No.	Ft.	Size	Cap. bet. Shield & Conds. mmds.	Cap. bet. Conds. mmds.	O.D.	List Price
972	2	100	20	.76	.61	.205	\$ 6.50
973	3	100	20	.90	.50	.230	8.00
974	4	100	20	.62	.37	.250	10.00
975	5	100	20	.61	.45	.265	12.50
976	6	100	20	.95	.48	.335	15.00
977	7	100	20	.87	.41	.345	19.00
978	8	100	20	1.03	.61	.395	21.00
979	9	100	20	1.00	.57	.380	23.50
980	10	100	20	1.07	.80	.400	26.50

HEAVY DUTY S. J. CABLE

No.	Spool	O.D.	List Price each
574	500 ft. 2 Conductors, No. 18 Gauge	.310	\$37.50
578	500 ft. 2 Conductors, No. 16 Gauge	.330	50.00
576	100 ft. 4 Conductors, 2 No. 16 and 2 No. 20	.375	15.00
577	250 ft. 4 Conductors, 2 No. 16 and 2 No. 20	.375	37.50

Commercial Type Twisted Pair (No. 22 STRANDED)



This cable is used extensively for replacement on all antenna systems. Consists of 2 No. 22 tinned stranded conductors rubber covered and weatherproof braid overall. Available in black or white.

No.	Ft.	List Price	Freq. (Ohms)	Surge Imp. (Ohms)	Loss per 100'
950	50 Coil	\$1.80			
951	100 Coil	3.50			
952	500 Spool	16.00			



72 Ohm Rubber Jacket (No. 16 Stranded)

A very good transmission line designed for long satisfactory use with Television F.M. and Master Antenna Systems. Constructed with 2 No. 16 linned stranded conductors insulated with a special non aging low loss rubber compound covered with a tough abrasion resisting 40% rubber jacket.

No.	Ft.	List Price	Freq. (Ohms)	Surge Imp. (Ohms)	Loss per 100'
911	50 Spool	\$ 5.50			
912	100 Spool	10.50	10 Mcs.	103	1.9
913	250 Spool	20.00	20 Mcs.	104	3.4
914	500 Spool	39.00	40 Mcs.	104.5	5.7
915	1000 Spool	75.00			

Commercial Type Twisted Pair (No. 18 STRANDED)



This cable is used extensively as original equipment of master antenna systems. It is constructed of 2 No. 18 tinned stranded conductors insulated with a special grade of rubber color coded and covered with a white weatherproof cotton braid.

No.	Ft.	List Price	Freq. (Ohms)	Surge Imp. (Ohms)	Loss per 100'
916	50 Spool	\$ 3.10			
917	100 Spool	6.00	10 Mcs.	82	2.1
918	250 Spool	12.00	20 Mcs.	82.5	3.9
919	500 Spool	23.00	40 Mcs.	82.3	6.3
920	1000 Spool	45.00			

BATTERY CABLE



Constructed of individual rubber insulated stranded conductors, cotton braided and color coded. A closely woven cotton braid overall.

No.	Conds.	Ft.	Size	O.D.	List Price
172	2	100	20	.175	\$ 4.00
173	3	100	20	.195	5.00
174	4	100	20	.245	6.25
175	5	100	20	.255	7.25
176	6	100	20	.280	9.50
177	7	100	20	.320	10.50
178	8	100	20	.335	12.00
179	9	100	20	.350	15.00
180	10	100	20	.360	18.50
182	12	100	20	.375	19.00

With 2 No. 16 Conductors and Balance No. 20	No.	Ft.	Size	O.D.	List Price
186	6	100	2 No. 16—4 No. 20	.290	10.50
187	7	100	2 No. 16—5 No. 20	.310	11.50
188	8	100	2 No. 16—6 No. 20	.370	13.50
189	9	100	2 No. 16—7 No. 20	.400	15.50

All Cables Available in Special Lengths



Shielded Battery Cable (Cotton Braid Overall)

Constructed of individual tinned stranded copper with a wall of rubber and covered with a colored cotton braid.

No.	Conds.	Ft.	Size	Cap. bet. Shield & Conds. mmds.	Cap. bet. Conds. mmds.	O.D.	List Price
1922	2	100	20	120	.65	.215	\$ 7.75
1923	3	100	20	96	.49	.210	11.00
1924	4	100	20	103	.46	.295	13.00
1925	5	100	20	73	.38	.312	15.00
1926	6	100	20	70	.36	.330	18.00
1927	7	100	20	68	.35	.350	20.00



Diathermy Cable

Specially designed for use with electrotherapy apparatus. It is extremely flexible with a special grade of tough live flexible jacket to withstand the exacting service required.

No.	Ft.	Spool	O.D.	List Price
756	100	Spool	20,000	.300
757	1000	Reel	20,000	.300

Birnbach

BIRACO TUBING DIAL and MAGNET WIRE



DIAL CABLE

42 Strand Phosphor Cable

Constructed of the finest phosphor bronze wire over a linen thread center. Due to its high tensile strength, it will not stretch.

No. 1025—25'	Spool	List Price	\$1.20	each
No. 1050—50'	Spool	List Price	2.25	each
No. 1051—100'	Spool	List Price	4.00	each
No. 1052—1000'	Spool	List Price	33.00	each

Phosphor Bronze (Light Cable)

A lower quality cable than No. 1025, but a cable that will give good service. This is a braided Phosphor Bronze cable.

No. 1053—25'	Spool	List Price	\$0.66	each
No. 1054—50'	Spool	List Price	1.25	each
No. 1055—100'	Spool	List Price	2.50	each
No. 1056—1000'	Spool	List Price	18.50	each

Extra Heavy Linen Dial Cable

Made of the finest linen for replacement on all receivers, same as used for Philco. It is extra heavy for exceptional long service.

No. 1057—25'	Spool	List Price	\$1.30	each
No. 1058—50'	Spool	List Price	2.50	each
No. 1059—100'	Spool	List Price	4.50	each
No. 1060—1000'	Spool	List Price	36.00	each

Heavy Linen Cable

This braided cable is used for replacement for all Philco Receivers.

No. 2025—25'	Spool	List Price	\$1.30	each
No. 2050—50'	Spool	List Price	2.50	each
No. 2051—100'	Spool	List Price	4.50	each
No. 2052—1000'	Spool	List Price	36.00	each

Light Linen Dial Cable (Silk Core)

High quality linen cable used on many receivers specially treated to prevent slipping.

No. 3025—25'	Spool	List Price	\$1.20	each
No. 3050—50'	Spool	List Price	2.25	each
No. 3051—100'	Spool	List Price	4.00	each
No. 3052—1000'	Spool	List Price	25.00	each

Extra Light Linen Cable

It is a strong extra thin linen cable for replacement. Braided of the finest black linen.

No. 4025—25'	Spool	List Price	\$0.75	each
No. 4050—50'	Spool	List Price	1.40	each
No. 4051—100'	Spool	List Price	2.50	each
No. 4052—1000'	Spool	List Price	18.50	each



SPRING WIRE CLIPS

They will hold a wire up to No. 10 B&S Gauge, in a secure contact. All clips are brass nickel-plated.

No.	Ft.	Size	List Price
32	Spring Clip	1"	\$1.50
33	Twin Clip	1 1/4"	100.....6.00

ALL RUBBER LAMP CORD

This cord is an all Underwriters Approved rubber covered insulated parallel cord which can be separated by starting with a knife. Connects easily and cannot fray. Sanitary and heat.

COLORS: Black, White, Brown APPROVED

No.	Ft.	Size	List Price
570	100 Spool	18	\$4.10
572	250 Spool	18	9.35
573	500 Spool	18	16.00

UNAPPROVED

590	100 Spool	20	3.00
591	250 Spool	20	6.75

BUS BAR WIRE

Used to hook up all types of transmitters, especially ultra short wave equipment. Made of hard drawn copper, tinned, straightened, and cut 2 ft. lengths.

No.	List Price per 100 lengths
2010—No. 10 Round Tinned	\$6.05
2012—No. 12 Square Tinned	4.70
2013—No. 12 Round Tinned	4.45
2014—No. 11 Square Tinned	3.60
2015—No. 11 Round Tinned	3.05

MAGNET WIRE

Special Spools—\$4.00 List Price

On attractive spools, even sizes from 14 to 40 inclusive, in Double Cotton, Plain Enamel, and Double Silk. Here is a really sensational seller for the dealer who will put this display on the counter. It is a Silent Salesman which will bring you real profit the year around! **FREE DISPLAY!** One Display is given with each initial order for 100 spools. Each Display made of strong, re-infused steel, mahogany crackle finish with attractive 3 color Display at top. Space provided to indicate YOUR resale price.

Extra Display Packs available at \$1.25 each, Net.

LENGTH OF WIRE OF SPECIAL SPOOLS

Size B&S	Plain Enamel	Double Cotton	Double Silk	Size B&S	Plain Enamel	Double Cotton	Double Silk	Size B&S	Plain Enamel	Double Cotton	Double Silk
12	15 ft.	9 ft.	9 ft.	22	112 ft.	75 ft.	75 ft.	32	675 ft.	180 ft.	124 ft.
14	26 ft.	20 ft.	11 ft.	24	184 ft.	97 ft.	97 ft.	34	900 ft.	195 ft.	131 ft.
16	34 ft.	34 ft.	19 ft.	26	211 ft.	116 ft.	116 ft.	36	1275 ft.	206 ft.	142 ft.
18	56 ft.	11 ft.	23 ft.	28	301 ft.	131 ft.	131 ft.	38	1725 ft.	240 ft.	166 ft.
20	86 ft.	56 ft.	29 ft.	30	325 ft.	158 ft.	158 ft.	40	1970 ft.	265 ft.	185 ft.

1/4 LB., 1/2 LB., 1 LB.,

MAGNET WIRE—Approximate Feet and List Prices

Double Cotton (White)				Plain Enamel				Double Silk (Green)			
1/4 lb Spool	1/2 lb Spool	1 lb Spool	List	1/4 lb Spool	1/2 lb Spool	1 lb Spool	List	1/4 lb Spool	1/2 lb Spool	1 lb Spool	List
12	12	12	\$0.40	12	12	12	\$0.33	12	12	12	\$1.08
14	19	14	39 .71	14	20	14	35 .40	14	19	14	.60
16	31	16	44 .62	16	32	16	37 .63	16	31	16	.62
18	48	18	45 .97	18	50	18	37 .100	18	49	18	.72
20	78	20	49 .157	20	80	20	40 .160	20	78	20	.83
22	119	22	55 .238	22	127	22	41 .251	22	123	22	.96
24	131	24	64 .289	24	201	24	43 .403	24	195	24	1.06
26	281	26	77 .368	26	320	26	52 .640	26	303	26	1.20
28	335	28	91 .451	28	507	28	55 .1015	28	178	28	1.43
30	611	30	109 .1284	30	805	30	60 .1610	30	739	30	1.72
32	976	32	135 .1953	32	1282	32	66 .2564	32	1136	32	2.18
34	1365	34	190 .2735	34	2037	34	75 .4075	34	1712	34	2.81
36	1827	36	260 .3654	36	3221	36	87 .6432	36	2551	36	3.57
38	2738	38	500 .5476	38	5132	38	100 .10246	38	3770	38	6.25
40	3405	40	681 .1400	40	8133	40	150 .16286	40	5040	40	9.35

ELECTRIC EXTENSION CORDS



Constructed of Underwriters Approved P.O.S.J. All Rubber. Has a bakelite three outlet tap on one end of the cord and is equipped with a cap for insertion into the nearest wall outlet. Is easily installed and brings three convenient outlets where they are needed. Available only in brown.

No.	Ft.	List Price
508	6	\$0.65
509	9	.75
514	12	.85
515	15	.90
511	20	1.00

BIRACO TUBING (Extruded)



It is an extruded tubing made of the new synthetic plastic material. Extremely flexible and when stretched returns to its original form. Withstands the effects of heat and will not support combustion. Will only soften at 300°F and will not flow at 125°F. Its dielectric strength—750 volts per mil, when dry and 350 volts when wet. It is not affected by oil and is resistant to most coal tar solvents and petroleum solvents. Resists acids, alkalis in concentrations up to 30% by weight. Available in continuous lengths. Dielectric strength—10,000 volts.

COLORS: Black, Red, Green, White and Yellow

No.	Size	I.D.	List Price per 36" lengths
313	20	.034	\$0.14
314	18	.042	.14
315	16	.053	.15
316	14	.066	.16
317	12	.085	.16
318	8	.135	.40
319	4	.208	.45
320	2	.263	.50
321	1 1/2	.3125	.55
322	1	.375	.60
323	1/2	.400	1.00
324	5/8	.625	1.10

Write for prices in long lengths



FIXTURE WIRE

A flexible stranded rubber insulated wire with a closely woven cotton braid overall. Useful for interior wiring and as indoor aerials. A popular wire for connecting ground and aerial connection of radio receivers.

COLORS: White or Brown

No.	Ft.	List Price
565	1000 ft.	No. 20-1/64 Single Conductor... each \$17.50
566	1000 ft.	No. 18-1/64 Single Conductor... each 18.50
568	500 ft.	No. 17-1/64 Twisted Pair... each 15.00
569	500 ft.	No. 20-1/64 Twisted Pair... each 14.00



SERVICE CORDS

Constructed of all rubber Underwriters Approved lamp cord and plug on one end and with the other end stripped and tinned all ready for use.

COLORS: Black or Brown

No.	Ft.	List Price
817	7 1/2	\$0.50
819	10	.55

VARNISHED TUBING



Provides quality insulation for wires used on radio sets, small electrical equipment and instruments. The outside is impervious to oil, acid and water. It is highly flexible and will not crack after aging. Average dielectric strength—5000 volts.

COLORS: Black, Red, Green, White and Yellow

No.	Size	I.D.	List Price per 30" lengths
291	20	.034	\$0.14
293	18	.042	.14
294	16	.053	.15
295	14	.066	.16
300	12	.085	.16
301	8	.133	.40
297	3 1/2	.208	.40
2 8	1	.263	.50
294	1 1/2	.3125	.55
294	1	.375	.60
299	1/2	.400	1.10
296	5/8	.625	1.15

Write for prices in long lengths



Birnbach

TEST LEADS and ACCESSORIES

High Voltage Test Leads

The high dielectric strength and low leakage resistance of these test leads recommend them for testing high voltage high sensitivity devices such as Meggers and Megohmmeters. They are particularly well suited for use in testing breakdown voltages up to 1200 volts. The prods and the tip handles are made of black and red bakelite with special designed tips for application. The prods are 6" long and 1/2" dia. and have a guard ring near the metal tip to prevent accidental touching of the exposed metal part. Extra heavy kinkless test lead wire 7/32" dia. is used throughout. The leads are 60" long.

No. 562—High Voltage Test Leads \$4.50

DeLuxe Test Leads

Constructed with 5" long cast phenolic red and black handles with removable needlepoint chucks or solderless tips. Black and red heavy kinkless instrument 48" long is used to connect the prods with the insulated red and black cast phenolic solderless tips. Either needlepoint or solderless tip available.

No. 560—Solderless prod test leads... \$1.35
561—Needlepoint prod test leads... 1.35

Bakelite Pencil Type Test Leads

Red and black bakelite handles, 6" long and 5/16" in dia. and red and black bakelite insulated phone tips. Heavy kinkless wire is used together with the Birnbach Scrulok system of solderless wire connection. The Universal needle and phone tip prod have the same dimensions as the standard phone tip and are useful for piercing insulation without damage. The needlepoint is extra heavy to prevent breakage and should it become broken can be readily replaced. Available only in combination of needlepoint prods and insulated phone tips. Length overall 60".

No. 408—Bakelite Pencil Type Test Lead \$2.00
439—Needlepoint Prod Tip for Replacement .17

Needlepoint Test Leads

Have 4" red and black insulated handles. Needles can be replaced when broken simply by loosening the knurled collar. Available with either phone tips or spade lugs. Length overall 50".

No. 420—Phone Tip Test Leads \$.85
421—Spade Lug Test Leads .85

Same as above with a Sr. solderless phone tip.
No. 422—Phone Tip Test Leads... \$0.85
423—Spade Lug Test Leads... .85

Insulated Solderless Phone Tips

Insulated handles 5/8" dia. by 1" long fitted to solderless phone tips. The wire can be easily attached by threading through the hole in the handle and tightening the knurled nut. Colors:—red, black, green, and yellow.

No. 409—Insulated Sr. Solderless Tip—2 1/4" Long... each \$0.15
415—Insulated Jr. Solderless Tip—1 1/8" Long... each .14

Insulated Phone Tip

The insulated handle is 1" long, 3/8" dia. Connection is made by threading the wire through the Scrulok threaded bushing (see drawing). Colors: red, black, green and yellow.
412—Scrulok Pin Tip, 1 1/8" Long... each \$0.17
419—Scrulok Pin Tip, 1 1/8" Long... each .22

Phone Tip

Ideal for replacement on headset, speaker and extension cords.
No. 402—Std. Pkg. 100
List Price \$1.90 per C.

Solderless Phone Tips

Milled of solid brass and nickel-plated. Designed for easy insertion of the wire into the tip.
No. 24—Junior... \$8.00 per C
24—Senior... 9.00
Std. Pkg. 100.

No. 26 Phone Tip Jack

Milled of brass and nickel plated. The bronze springs are specially made to hold the phone tip tight and straight. Mounts in a 1/4" dia. hole.
No. 26—Std. Pkg. 100.
List Price \$9.00 per C.

No. 407 Insulated Tip Jack

Has a 1/2" insulated top and mounts in a 3/8" dia. hole. The specially designed bronze springs hold the phone tip tight and straight. Colors:—red, black, yellow, and green. Std. Pkg. 100.
No. 407—Insulated Phone Tip Jack... \$0.13

Kinkless Test Lead Wire

Abrasion resisting live rubber that will not kink or break down in service. No. 20 has 41 strands and No. 18 has 66 strands of No. 36 tinned annealed copper wire.

No.	Ft.	Price	Size	Rubber Wall Thicknesses	Puncture Voltage 60 Cycle A.C.	O.D.
60	25	\$0.60	20 $\frac{3}{4}$			
61	100	2.25		0.45	12,000	.140
62	500	10.50				
64	25	.95	18 $\frac{3}{4}$.045	12,000	.155
66	100	3.25				
67	500	15.00				
HIGH VOLTAGE TEST LEAD WIRE						
63	25	1.85	18 $\frac{3}{4}$.076	16,500	.218
68	100	6.50				
69	500	30.00				

COLORS:—Red and Black.

No. 411 Bakelite Pencil Test Prods

These prods have the Birnbach Scrulok solderless needlepoint tips. They are made of bakelite and are 6" long and 3/8" dia. The connection is made by threading the wire through the handle and securing to the needlepoint tip by locking the Scrulok. The tip is then screwed into the handle. Available in red or black only.

No. 411—Bakelite Pencil Test Prods... \$0.75

Solderless Tip Prod

Made of highly polished cast phenolic resin. A solderless phone tip is threaded at end permitting replacement of tip. Available in red or black.
No. 410... 1" Handle... \$0.33
343... 5" Handle... .40

Needlepoint Test Prod

A threaded shank needlepoint chuck is threaded into the end of handle. Made of highly polished cast phenolic handle. Available in red or black.
No. 344—Needlepoint Test Prod, 4" Handle... \$0.35
345—Needlepoint Test Prod, 5" Handle... .40

SCRULOCK Needlepoint Test Prods

These insulated prods have the Scrulok solderless system of wire connection. Wire is easily attached without soldering. An extra heavy needle is fitted into the tip. Colors:—black or red.
No. 417... 4" Handle... \$0.35
418—Needlepoint Test Prod, 5" Handle... .40

Headset Phone Cords

These cords are closely woven and are very durable and strong. They are used for replacement of worn headset cords. Standard cords are listed which will match practically all headsets manufactured. We will be glad to quote on cords having special terminal requirements.
No. 105—5 ft. ends... \$0.75
105—5 ft. Pin & Spade Tips... .75
107—5 ft. Pin & Eye Tips... .75
108—8 ft. Pin & Eye Tips... .95
109—10 ft. Pin & Eye Tips... 1.40

AC-DC Resistance Cords



Designed for replacement of the internal voltage dropping resistor on the present and older type of AC-DC sets. It consists of a line cord into which a third element has been incorporated. The voltage dropping resistor reduces the voltage to that needed for the filament of the tubes.

No.	Cord Rating	Sets Having Following Tubes	List Price
35	135 ohm	25Z5-43-4"	\$0.85
36	160 ohm	25Z5-43-3"	.85
34	180 ohm	12Z3-43-4"	.85
49	200 ohm	25Z5-43-2"	.85
37	220 ohm	12Z3-43-3"	.85
41	250 ohm	12Z3-43-2"	.85
38	290 ohm	25Z5	.85
45	300 ohm	25Z5	.85
39	330 ohm	12Z3	.85
40	350 ohm	12Z3	.85
47	390 ohm		.85
125	220-110 Volt Voltage reducing cord		1.50
126	280 ohm	4 Wire	1.25
127	190 ohm	4 Wire	1.25
128	165 ohm	4 Wire	1.25

* 6.3 volt tubes. † For Emerson Radio.

Speaker Extension Cords

Constructed of stranded annealed copper wire insulated with rubber over which a brown mercerized cotton braid is closely woven. Complete with easily attached bakelite connector.

No.	Length	Std.	List Price
186	10 ft. Cord		\$1.00
120	50 ft. Cord		1.35
121	30 ft. Cord		1.80
122	40 ft. Cord		2.05
123	50 ft. Cord		2.35
124	100 ft. Cord		4.50
151	Bakelite Extension Cord connector only		.40

Alligator Clips

Made of steel nickel plated. The jaws match accurately permitting them to grip all kinds of wire securely. The insulated handle is 3/4" dia. and 3/4" long and comes in red or black.

No.	Length	Std.	List Price
31	Alligator clip 2"		\$0.08 1/2
310	Insulated Alligator clip 2 1/4"		.17

Test Clips



The teeth mesh correctly permitting good contact to be made. The No. 27-S is a solid copper clip with a brass screw designed for high frequency work. Sturdily constructed. Standard Package 50.

No.	Length	Std.	List Price
27	1-1/2" Wee		\$0.08
28	1-1/2" Wee		.08
29	Medium		.11
30	Large		.20
27C	1-1/2" Wee		.17
27R	1-1/2" Wee		.16

Birnbach

AUTO CABLE and ACCESSORIES



SHIELDED FABRIC LOOM



Is made of a tinned copper braid over a weather-proof loom. Used to shield auto antenna lead-in and grouped leads against interference, also in shielding the output of signal generators.

No.	Inside Dia.	List Price
1316—100 ft. Spool	3/8"	\$ 9.35
1516—100 ft. Spool	1/2"	13.50
1038—100 ft. Spool	3/8"	15.50
1716—100 ft. Spool	1/2"	19.00
1012—100 ft. Spool	1/2"	22.00

Ford V-8 Distributor Suppressor



Designed to be inserted in the distributor of Ford V-8. Unit consists of a resistor brush which replaces the regular brush.

No. 365 List Price \$.28

AUTO ANTENNA CONNECTOR

Permits quick connection of the auto antenna lead-in to the receiver.



No. 366—Auto Connector.....per C \$7.50

FUSED ANTENNA CONNECTOR



This connector takes a standard 3 AG automobile fuse. Used in auto radio power supply cables.

No. 367—Fused Connector.....per C \$11.00

HIGH VOLTAGE LACQUERED WIRE

Recommended for use as leads for wiring high voltage



devices, and transmitter power supplies. Constructed of tinned stranded copper conductor with a wall of rubber covered with a highly lacquered cotton braid.

No.	Ft.	Size	Puncture Voltage	O.D.	List Price
2810—100	10 3/32	9500	.225		\$7.40
2812—100	12 3/32	9500	.192		4.40
2814—100	14 3/32	9500	.167		3.05
2816—100	16 3/32	9500	.153		2.65
2818—100	18 3/32	9500	.145		2.05

Shielded Varnished Cambric Wire

Used where an oil and water resistant wire with a shielded



covering is required. Constructed of tinned stranded conductor with 2 layers of varnished cambric and a lacquered cotton braid with a tinned copper shield overall.

No.	Ft.	Size	Capacity per Ft. mmfds.	O.D.	List Price
1800—100	16	142	.145		\$7.00
1818—100	18	102	.131		6.25
1820—100	20	100	.125		5.75

SHIELDED GRID LEAD WIRE



High insulation of this wire will reduce the loss in shielded grid circuits.

Constructed of tinned stranded conductor with a rubber insulation, waxed cotton braid with closely woven shield overall.

No.	Ft.	Size	Capacity per Ft. mmfds.	O.D.	List Price
818—100	18 3/32	.75	.180		\$4.75
820—100	20 3/32	.70	.150		4.25

AUTO RADIO SHIELDED LEAD-IN



Consists of a stranded tipped copper conductor, insulated with rubber and filled with hemp and a tinned copper braid overall.

No.	Ft.	Capacity mmfd per ft.	O.D.	List Price
799—100	49	.275		\$10.00
800—100	54	.300		14.00

7 MM HIGH TENSION CABLE



Useful in reducing interference from auto secondary circuits. Also used as photo electric cell leads and wherever a low loss shielded lead is required.

No.	Description	List Price Per 100'
1600—7 MM. High Tension Cable		\$6.50
781—7 MM. Shielded Secondary Wire		10.00

REPLACEMENT PARTS



No.	Description	List Price per C
368—Female Sleeve for Fuse Connector		\$5.50
369—Female Sleeve of Antenna Connector		4.40
370—Male Part of Antenna Connector		3.30
371—Spring for Antenna and Fuse Connector		1.10
372—Fibre Insulator for Fuse Holder		.80
373—Bakelite Eyelet Bushing		1.35

RAYON BRAID LACQUERED WIRE

Constructed of stranded tinned copper conductor for easy soldering, with heavy wall of live rubber over which a rayon braid is woven. A high gloss lacquered finish over braid. Conductor consists of 16 strands of No. 30.



No.	Ft.	Puncture Voltage	Size	List Price
3425—25 Coil	9000	18 3/32		\$.55
3450—50 Coil	9000	18 3/32		1.05
3460—100 Coil	9000	18 3/32		2.10
3600—500 Spool	9000	18 3/32		10.00

Colors: Black, red, green, yellow, brown, blue

VARNISHED CAMBRIC WIRE

Widely used in automotive wiring because of oil and waterproof construction. Consists of tinned stranded conductor with two layers of varnished cambric over which a lacquered cotton braid is woven.



No.	Ft.	Size	Puncture Voltage	O.D.	List Price
3416—100	16	1000	.108		\$4.50
3418—100	18	1000	.107		3.75
3420—100	20	1000	.094		3.00

No. 340 Wheel Static Eliminator

An effective means of reducing static created by the front wheels. Installation is made by placing the broad base of the spring against the hub and the cone point into the hole of the axle.



No. 340—Std. Pkg. 50 List Price..... \$8.50 per 100

AUTO RADIO SHIELDING



Used for shielding leads of interference creating circuits; and for bonding motor block and other parts of the automobile to the chassis.

TINNED

No.	Inside Dia.	List Price
858—50 ft. Spool	1/8"	\$1.75
859—50 ft. Spool	3/16"	1.90
863—50 ft. Spool	1/4"	2.35
864—50 ft. Spool	5/8"	2.75
865—50 ft. Spool	3/8"	5.50
857—50 ft. Spool	3/32"	8.80

BAR E

860—50 ft. Spool	1/4"	2.00
861—50 ft. Spool	3/8"	2.30
862—50 ft. Spool	5/8"	5.00

AVAILABLE IN SPECIAL LENGTHS



BIRNBACH IGNITION FILTERS

These Ignition Filters completely eliminate all ignition and high tension circuit interference, making clear auto radio reception a certainty. The only ignition filters having a copper wound inductance, which accounts for the low resistance of 120 ohms for the Ignition Filter. Less gasoline is consumed than when high resistance filters are used.

No.	Description	List Price each
350—Ignition Filter—Bracket Type		\$.60
351—Ignition Filter—Cable Type		.60
352—Distributor Filter		.60
353—Ignition Filter—Screw Type		.60
359—Ignition Filter—Slip-on Type		.60

BIRNBACH MASTER FILTER

Eliminates all ignition interference and does away with the necessity of having a separate filter for each spark plug. Available in two types, namely, the Distributor type for easy insertion into distributor head, and the Cable type to be placed into the distributor lead where it is impossible to insert it into the distributor head.



No.	Description	List Price each
354—Cable or Distributor Type		\$2.50

AUTO NOISE FILTER

These are especially designed for the elimination of noise created by generator commutator, electrical windshield wiper, horn, and especially dome, tail, and stop light cables. Connections made by bolting down the flange of container to chassis. The long insulated lead with a convenient screw lug is connected to the source of interference.

No.	Description	List Price
355—Auto Noise Filter—1/2 Mfd.		ea. \$.55
356—Auto Noise Filter—1 Mfd.		ea. .65



Birnbach PLUGS and JACKS



GIANT PLUGS

Used for heavy current, they are rated at 25 amps. The long life nickel silver alloy spring is secured over a pin preventing a collapse of the spring and also maintaining the full action of the spring when inserted into the jack. The No. 398A plug has a hole in the threaded shank to permit soldering to it. It is used extensively on diathermy electrode pad cables. Standard Package 25.

No.	A	B	C	List Price
396 Plug	1 1/2"	—	10-32	each \$0.25
397 Plug	1 1/4"	—	3/4-20	each .30
398 Plug	1 3/8"	5/8"	1/4-28	each .25
398A Plug	1 5/8"	5/8"	1/4-28	each .25

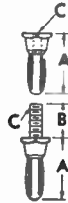

GIANT JACKS

Milled with the central hole being reamed to size to insure a tight fit with all Giant Plugs. The No. 394 and No. 399A have a 10-32 thread tapped at the end permitting connection to be made. They are all made of brass and nickel-plated and come complete with nut and lug.



No.	Std. Pkg.	A	B	C	List Price
394 Jack	25	1 1/8"	1/2"	3/8-21	each \$0.25
395 Jack	25	1 1/8"	1/2"	3/8-21	each .20
399 Jack	25	7/8"	5/8"	1/2-20	each .25
399A Jack	25	1 3/8"	—	—	each .30



BANANA PLUGS

Large area of contact is one of the outstanding features of these jacks and plugs. The No. 400 series of packages have a nickel silver contact spring secured over a full length central pin, making these plugs non-collapsible and assuring a low resistance contact. Capacity 5 amperes. Standard Package 100.

No.	A	B	C	List Price
400 Plug	3/4"	1/2"	6-32	each \$0.09
401 Plug	3/8"	—	6-32	each .10
404A Plug	3/4"	3/8"	1/4-28	each .14

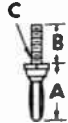

No. 392 INSULATED GIANT PLUG

Made so that no projecting edges are exposed, thereby protecting the user from unnecessary contact. Connection is made by soldering into the hole at the end of the threaded shank of the plug. Handle is 1 1/2" long by 5/8" dia.; length overall 3". Colors: red or black.

No. 392—Insulated Giant Plug	List Price \$0.45
------------------------------	-------------------



No. 393 INSULATED GIANT JACK

Designed to leave no metal part exposed on the panel. The 3/4-21 brass nickel plated sleeve has a 10-32 threaded hole at the end permitting a connection at the end of the jack or to the lug under the head. Either assembly available complete with nut, insulating shoulder washer, lock-washer and lug. Length overall 1 3/4". Colors: red or black.

No. 393—Insulated Giant Jack under head lug	List Price \$0.40
393A—Insulated Giant Jack end lug	each .40



No. 403 BANANA JACK

Accurately milled and has a precision reamed hole to help maintain the tight and smooth action of the plug. It is made of brass nickel plated and comes complete with nut and lug. Standard Package 100.

No.	A	B	C	List Price
403 Jack	1/2"	3/8"	1/4-28	\$0.09



INSULATED BANANA JACKS

The No. 391 Jack is very popular with the electric therapeutic manufacturers. The 1/2" dia. insulated head admits all of the exposed metal part of the metal plug when inserted. Mounts in a 1/8" dia. hole on a panel up to 3/8" thick. The No. 406 Jack has a 7/16" dia. insulated top. It fits into a 3/8" dia. hole and takes up to a 3/8" panel. Both come complete with insulating shoulder washer, nut and lug.



No.	Std. Pkg.	List Price
391—Insulated Jack—red or black	50	\$0.14
406—Insulated Jack—red, black, yellow, or green	50	.13

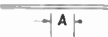

SHAFT COUPLINGS, REDUCERS AND EXTENDERS

By the use of these units all 1/4" and 3/8" dia. shafts and knobs can be assembled together. The insulated units are for use where electrical isolation is desired. Furnished complete with set screws shown. Be sure to specify whether Brass or Insulated is desired.

Brass No.	Insulated No.	Shaft A	Hole B	List Price
534	634	1/4"	1/4"	each \$0.18
535	635	1/4"	3/8"	each .18
536	636	3/8"	3/8"	each .18
537—Reducer for 3/8" Dia. Hole to 1/4" Dia. Shaft				each .12

COUPLINGS

Brass No.	Insulated No.	Shaft A	Hole B	List Price
531	631	1/4"	1/4"	each \$0.18
532	632	1/4"	3/8"	each .18
533	633	3/8"	3/8"	each .18

EXTENDERS

No.	Length	Hole I.D.	Shaft O.D.	List Price
538—Brass	1 3/8"	1/4"	1/4"	each \$0.25
539—Insulated	1 3/8"	1/4"	1/4"	each .25

BRASS SHAFTING

No.	Dia.	Length	List Price
540—1/4"	6"	each \$0.18	
541—3/8"	12"	each .36	
542—3/8"	8"	each .36	

FIBRE SHAFTING

No.	Dia.	Length	List Price
543—1/4"	6"	each \$0.25	
544—3/8"	12"	each .50	
545—3/8"	8"	each .50	



HARD RUBBER INSULATED GIANT PLUG

Especially designed for use with diathermy cables. It has a 5/8" dia. hole in the handle to take the largest cable. It is made of polished black hard rubber. The handle is 3" long by 3/8" dia. Overall length is 1 1/8".

No. 342—Hard Rubber Insulated Plug	List Price \$1.25
------------------------------------	-------------------



No. 341 Insulated Banana Plug

This plug consists of our No. 401A plug with a larger handle 1 1/2" long by 1/2" dia. Used on a therapeutic apparatus and test equipment. Overall length 2 1/2". Colors: red or black.

No. 341—Insulated Banana Plug	List Price \$0.35
-------------------------------	-------------------



No. 404 Insulated Banana Plug

The plug is for experimental test leads because of its Serulok solderless connection and the non-collapsible special alloy springs assembled on a pin preventing collapse of the plug spring. The handle is made of phenolic resin and is 3/4" by 1" long. Colors: red, black, yellow and green.

No. 404—Insulated Banana Plug	Std. Pkg. 50	List Price \$0.18
-------------------------------	--------------	-------------------



No. 604 BANANA PLUG

Made of solid brass nickel-plated, with the end being slotted. The cast phenolic handle is 1" long by 3/4" dia. and is held on by the screw that secures the wire to the plug. Colors: red, black, yellow and green.

No. 604—Plug	Std. Pkg. 50	List Price \$0.14
--------------	--------------	-------------------



No. 605 HANDLE JACK

Consists of a banana jack inside an insulated sleeve. Connection is made by soldering to the end of the jack. Handle is made of cast phenolic resin 3/8" dia. by 1 1/2" long. Colors: red, black, yellow and green.

No. 605—Handle Jack	Std. Pkg. 50	List Price \$0.18
---------------------	--------------	-------------------

TINNED LUGS



No.	Hole for Screw	Length	List Price Per M
201	1/4"	1/2"	\$ 3.25
1	1/4"	3/4"	3.25
2	1/4"	5/8"	3.25
3	1/4"	3/4"	19.25
4	1/4"	1"	24.50
5	1/4"	1 1/4"	6.00
21	1/4"	1"	6.00
22	1/4"	1 1/4"	15.00
201	3/8"	1"	6.00
96	3/8"	1 1/4"	5.00
97	3/8"	1 1/2"	5.00
98	3/8"	1 3/4"	6.00
99	3/8"	1 3/4"	6.00

Birnbach

INSULATORS



CONE STANDOFF INSULATORS



Made of low absorption high tensile strength porcelain with a smooth glaze. All heights except the No. 430 are available with a Jack or a threaded hole top. Range of sizes are adequate for all needs. They are available only in a white glaze and come complete with screws, metal and cork washers.

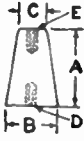

No.	Height		Std. Pkg.	Mounting		Threaded Holes		List Price
	A	B		Hole	D	E	each	
430	5/8"	100	5/8"	1 1/4"		6-32	6-32	\$.12
431	1"	50	1 1/8"	1 1/2"		8-32	8-32	.15
431J	1"	50	1 1/8"	1 1/2"		8-32	No. 430 Jack	.21
432	1 1/2"	50	7/8"	1 3/4"		10-32	10-32	.19
432J	1 1/2"	50	7/8"	1 3/4"		10-32	No. 403 Jack	.24
433	2 3/4"	25	1 1/4"	2 1/4"		1 1/4-20	1 1/4-20	.30
433J	2 3/4"	25	1 1/4"	2 1/4"		1 1/4-20	No. 395 Jack	.45

CORRUGATED FEEDTHRU INSULATORS



The six new corrugated type feedthru insulators have more than twice the leakage path of the straight type because of increased surface of the corrugations and recommends itself where a straight side insulator of equal height is not satisfactory because of its shorter leakage path. Brass nickel-plated hardware and cork mounting washers supplied.

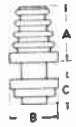

No.	Height		Std. Pkg.	Mounting		Hardware	List Price
	A	B		Hole	D		
479	1 3/8"	25	1 1/4"	1 1/8"	3/8"	10-32	ea. \$.38
479J	1 3/8"	25	1 1/4"	1 1/8"	3/8"	No. 403 Jack	ea. .44
4276	2 3/4"	10	1 3/4"	1 1/2"	3/4"	1/4-20	ea. .65
4276J	2 3/4"	10	1 3/4"	1 1/2"	3/4"	No. 394 Jack	ea. .80
4452	4 1/2"	5	2 3/8"	1 1/2"	1"	1/4-20	ea. 1.00
4452J	4 1/2"	5	2 3/8"	1 1/2"	1"	No. 394 Jack	ea. 1.20

HIGH VOLTAGE FEEDTHRU INSULATOR



This insulator has been designed to meet the demand for an insulator having high dielectric and mechanical strength. The extra long leakage path is made possible by the corrugations on the top insulator. The bottom sleeve taper from a base dia. of 1 1/4" where the electric stress is greatest.

Height 1 1/2" ... Base Dia. 2" ... Mounting Hole 1 1/4" Hardware 1/4-20 No. 4233 List Price \$0.55

METAL BASE INSULATORS



Designed to replace conventional porcelain insulators where failure of the base is due to cracking when fastened down. Extremely long leakage paths due to the corrugated surface is one of the important characteristics. They are made from high tensile strength low absorption porcelain smoothly glazed all over. Supplied with nickel-plated brass screws and nuts and cadmium plated drawn steel bases.

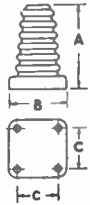

Cat. No.	Height		Std. Pkg.	Base Dimen.		Mounting Screw		Hardware	List Price
	A	B		B	C	D	each		
867	1 3/8"	25	1 1/4"	1 1/8"	1 1/2"	2 No. 8	10-32	ea. \$0.22	
867J	1 3/8"	25	1 1/4"	1 1/8"	1 1/2"	2 No. 8	No. 403 Jack	ea. .27	
4176	2 3/4"	10	1 3/4"	1 1/2"	1 3/4"	4 No. 10	1/4-20	ea. .38	
4176J	2 3/4"	10	1 3/4"	1 1/2"	1 3/4"	4 No. 10	No. 395 Jack	ea. .50	
4451	4 1/2"	5	2 3/8"	1 1/2"	1 3/4"	4 No. 10	1/4-20	ea. .55	
4451J	4 1/2"	5	2 3/8"	1 1/2"	1 3/4"	4 No. 10	No. 395 Jack	ea. .75	

"LUCITE" FEEDTHRU INSULATORS

These feedthru insulators are ideal for bringing high frequency leads thru a panel. They are made of genuine Dupont Lucite. Because of its low loss at high frequency, it is well adapted to insulated elements of high frequency circuits. The 1/2" dia. insulators have brass nickel plated 6-32 hardware and the 3/4" have 10-32 hardware.

No.	Height above Panel		Dia.	Hole	Bottom Height	List Price
	Insulator	Mtg.				
377	1/4"	1/2"	1/2"	1/8"	3/4"	\$.22
378	1/2"	1"	1/2"	1/8"	3/4"	.25
379	1"	1 1/2"	1/2"	1/8"	3/4"	.33
475	1 1/2"	2"	3/4"	1/8"	1 1/2"	.60
476	2"	2 1/2"	3/4"	1/8"	1 1/2"	.70



STANDOFF INSULATORS

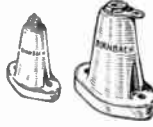

The sizes range from 5/8" to 4 1/2" high in five properly graduated heights. Made of highly vitrified low absorption glazed porcelain. No washers are necessary for mounting as the mounting surface is ground flat; but for the No. 405 and No. 966 Standoff Insulators, it is advisable to use cork washers which are available as they will permit mounting securely without breakage. All brass nickel-plated hardware is supplied. Available in white or brown glaze.

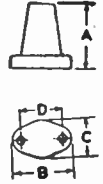

No.	Height		Std. Pkg.	Mounting		Hardware	List Price
	A	B		Hole	D		
405	5/8"	100	1"	1 1/4"	1 1/4"	6-32	\$0.07
965	1"	50	1 1/4"	1 3/4"	1 3/4"	8-32	.09
966	1"	50	1 1/4"	1 3/4"	1 3/4"	8-32	.09
966J	1"	50	1 1/4"	1 3/4"	1 3/4"	No. 403 Jack	.12
866	1 1/2"	25	1 3/4"	1 3/4"	1 3/4"	10-32	.13
866J	1 1/2"	25	1 3/4"	1 3/4"	1 3/4"	No. 403 Jack	.17
866SJ	1 1/2"	10	1 3/4"	1 3/4"	1 3/4"	No. 395 Jack	.40
4275	2 3/4"	10	2 3/4"	2 3/4"	2 3/4"	1/4-20	.35
4275J	2 3/4"	10	2 3/4"	2 3/4"	2 3/4"	No. 399 Jack	.60
4450	4 1/2"	5	3 3/8"	2 1/2"	2 5/8"	1/4-20	.95
4450J	4 1/2"	5	3 3/8"	2 1/2"	2 5/8"	No. 399 Jack	.90

FEEDTHRU INSULATORS



Made of highly vitrified, low absorption porcelain smoothly glazed to prevent accumulation of dust or dirt. Maximum strength is achieved by the proper proportions and flat mounting surfaces. Long insulating sleeves on the lower part of the insulator contribute much to their performance on high voltages. Brass nickel-plated hardware.

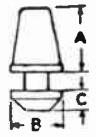

No.	Height		Std. Pkg.	Mounting		Hardware	List Price
	A	B		Hole	D		
458	5/8"	50	1 1/4"	1 1/4"	1 1/4"	6-32	ea. \$.14
478	1"	25	1 1/4"	1 1/4"	1 1/4"	10-32	ea. .22
478J	1"	25	1 1/4"	1 1/4"	1 1/4"	No. 403 Jack	ea. .28
4125	1 1/4"	25	1 3/4"	1 3/4"	1 3/4"	10-32	ea. .28
4125J	1 1/4"	25	1 3/4"	1 3/4"	1 3/4"	No. 403 Jack	ea. .33
4234	2 3/4"	10	2 3/4"	2 3/4"	2 3/4"	1/4-20	ea. .60
4175	2 3/4"	10	1 1/4"	1 1/4"	1 1/4"	1/4-20	ea. .55
4175J	2 3/4"	10	1 1/4"	1 1/4"	1 1/4"	No. 394 Jack	ea. .85

BEE-HIVE STANDOFF



Base measures 2" dia. with 3 holes on a 1 5/8" circle, for No. 6 screws. Supplied complete with 12-24 nickel-plated brass screw and nuts. The No. 766J has a No. 403 Jack. Available white or brown glaze.

No.	Hardware	Std. Pkg.	List Price
766	12-24 Screw	10	\$0.17
766J	Jack Type	10	.22

FRONT PANEL BEARING

The No. 550 Front Panel Bearing is cadmium plated brass for panels up to 3/8" in thickness and for 1/4" dia. shafts. The No. 551 and No. 552 are complete assemblies of the No. 550 and 1/4" dia. brass shaft cadmium plated.

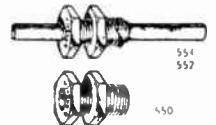

Cat. No.	Hardware	Std. Pkg.	List Price
550	Front Panel Bearing	10	each \$.18
551	Front Panel Bearing, 1/4" shaft, 3" long	10	each .36
552	Front Panel Bearing, 1/4" shaft, 6" long	10	each .50

FLEXIBLE COUPLINGS

These flexible couplings cover all needs of the constructor. Tandem operation of two or more units is possible without having the shafts in exact alignment. Flexibility without back-lash is obtained by the cadmium plated phosphor bronze springs, which are rigidly riveted to the insulation. All units fit 1/4" dia. shafts.



No.	Dia.	Insulation	List Price
360	1 1/4"	Fibro	each \$.35
361	1 3/4"	Bakelite	each .50
362	1 1/8"	Steatite	each .60



Birnbach INSULATORS

STEATITE PILLARS



These (steatite) pillar insulators have great tensile strength with extremely low losses at very high frequencies and are glazed on the outside to decrease surface leakage. They are tapped on both ends and are supplied complete with nickel-plated mounting base and top hardware.

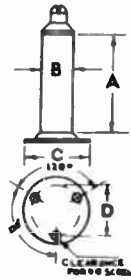

No.	Height		Std. Pkg.	B	Hardware	Base Dia. C	D	List Price each
	A	B						
450	1"	10	1/2"		No. 6-32	1 1/8"	7/8"	\$.35
450J	1"	10	1/2"		No. 403 Jack	1 1/8"	7/8"	\$.40
451	1 1/2"	10	1/2"		6-32	1 1/8"	7/8"	\$.40
451J	1 1/2"	10	1/2"		No. 403 Jack	1 1/8"	7/8"	\$.45
452	2 1/2"	10	1/2"		6-32	1 1/8"	7/8"	\$.45
452J	2 1/2"	10	1/2"		No. 403 Jack	1 1/8"	7/8"	\$.55
453	2 1/2"	5	3/4"		1/4-20	1 1/8"	1 1/8"	\$.75
453J	2 1/2"	5	3/4"		No. 395 Jack	1 1/8"	1 1/8"	\$.90
454	4"	5	3/4"		1/4-20	1 1/8"	1 1/8"	1.00
454J	4"	5	3/4"		No. 395 Jack	1 1/8"	1 1/8"	1.10



LUCITE SPREADERS

They are made of Dupont Lucite rod which has a very low loss at radio frequencies. It is water clear and has very low water absorption. The holes are drilled to take a No. 12 wire. A screw at the end of the spreader locks the wire in position.

LUCITE SPREADERS

No.	Wire-Spacing	Std. Pkg.	List Price Each
436	2"	25	\$0.28
437	4"	25	.33
438	6"	25	.40

LUCITE RODS

No.	Dia.	List Price per Ft.
455	1/4"	\$0.50
459	3/8"	.60
460	1/2"	1.00
461	3/4"	1.80

Available in lengths up to 48 inches

FEEDER SPREADERS

They have a cross section of 3/8" x 1/2". Made of highly vitrified, low absorption, high tensile strength porcelain with a smooth white glaze overall.

No.	Std. Pkg.	List Price
462—Spreader, 2" long	25	each \$0.14
464—Spreader, 4" long	25	each .19
469—Spreader, 6" long	25	each .24

ANTENNA INSULATORS

These Antenna Insulators have exceptional low moisture absorption. The leakage path is long and the cross section is small and is consistent with the strength required. A smooth white glaze overall prevents the accumulation of dirt or ice.

No.	Std. Pkg.	List Price
668—1 1/4" long	25	each \$.17
470—7" long	10	each .68
471—12" long	5	each .85
468—1 1/2" long Center Insulator	10	each .30

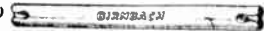

LEADIN INSULATORS

Each cone is 2 3/4" high and made of low absorption, highly vitrified glazed porcelain. The Nos. 4237 and 4238 Leadin Insulators have sufficient insulating bushings to insulate the rod that goes through the wall. In addition, 2 bushings are included, 1/4" and 1/2" long, allowing complete insulation of the threaded rod of any length in multiples of 1/4". They come complete with brass nickel-plated hardware and lead and cork washers to permit a water-tight seal.



No.	Description	List Price
4235—10" Rod		\$1.15
4236—15" Rod		1.30
4237—10" Rod with bushings		1.50
4238—15" Rod with bushings		1.90

STEATITE BUTTON



These specially designed steatite buttons are intended for use to simplify wiring and to be used as a binding post or a binding post insulator, or as a standoff insulator. Attention is called to the uniqueness of the design which prevents either section of the insulator from turning in respect to the special screw. The specially designed screw locks both sections.



A 1 1/8"	B 1/2"	C 3/4"	D 1/2"	E 6-32
No. 457	Std. Pkg. 25			List Price \$.25

STEATITE PILLARS (Without Hardware)

In many constructions, these unmounted threaded steatite pillars will facilitate assembly because of the one hole mounting and parallel mounting surfaces. They are made of glazed Steatite with threaded holes on both sides.



No.	Height	Dia.	Threaded Hole	List Price
445	1"	1/2"	6-32	\$0.25
446	1 1/2"	3/4"	6-32	.30
447	2"	1/2"	6-32	.35
448	2 1/2"	3/4"	1/4-20	.55
449	4"	3/4"	1/4-20	.90

AIRPLANE INSULATORS

Used on mobile antenna installations, particularly on aircraft, as they are shaped for the least air resistance. They are made of white glazed low absorption porcelain.



No.	Length	Std. Pkg.	List Price
473	2"	100	each \$0.08
474	1 1/2"	100	each .07

STEATITE AIRPLANE INSULATORS

A very small compression type insulator with small wind resistance. It is 1 1/2" long and 1/2" dia.

No. 463—Std. Pkg. 25, List Price \$3.00 ea.



TUBE CLAMPS

These tube clips will be found extremely desirable when mounting resonant lines or elements of directive beam antennas. They are made of hard drawn aluminum and are available for 1/8", 3/8", 1/2", 3/4" and 1" dia. tubes. The 1/8", 3/8", and 1/2" have a clearance hole for No. 10 screw and the 3/4" and 1" dia. clamps have holes for 1/4" bolts.



Cat. No.	To Fit Tube	List Price
51—Clamp	1/4" Dia.	each \$0.15
52—Clamp	3/8" Dia.	each .15
53—Clamp	1/2" Dia.	each .15
54—Clamp	3/4" Dia.	each .15
55—Clamp	1" Dia.	each .25
56—Clamp	1 1/4" Dia.	each .25
57—Clamp	1 1/2" Dia.	each .30



FLEXIBLE SHAFTS

At times there is difficulty getting the controls to the proper position on the panel. With couplings and these flexible shafts, locations can be made with ease on an offset and angles up to 90 degrees. The flexible shafts are made of phosphor bronze and fitted into 1/4" dia. hubs.

Cat. No.	List Price
553—Flexible Shaft, 3" long	each \$0.45
554—Flexible Shaft, 6" long	each .60

TRANSMITTING TUBE SOCKETS

Improved design and additional features of the Birnbach transmitting sockets has increased their popularity and are accepted as standard. The 50 watt socket has extra heavy side-wiping phosphor bronze contact spring with the filament spring having a double contact to safely carry the heavy current. The tube base is supported by the highly polished nickel-plated brass shell set in a highly vitrified low absorption porcelain base which is ground flat to prevent breakage. All brass nickel-plated screw and milled nuts are used.



Cat. No.	List Price
434—50 Watt Socket	each \$1.40
435—10 Watt Socket	each .95



INSULATED PHONE TIP JACK

The head is made of insulated material and is supplied with a shoulder washer for a complete insulation. Supplied in three different size heads and available in all colors.

No. 1866 3/8" Head\$1.00 each
No. 138 7/16" Head10 each
No. 1860 9/16" Head15 each

BANANA PLUG OR TIP JACK



Made to take standard phone tips in banana type plugs. Plugs will fit interchangeably. Mounts in a 1/4" hole in panels up to 1/2" thick. Overall length 1 3/8". Supplied complete with shoulder washer and nut.

No. 148\$1.50 each



HEXAGON HEAD TIP JACK

The head is made of hexagon material and is forced into the tip jack to prevent the head from turning loose. Size of head is 7/16" across the flats and is available in all colors.

No. 1828\$1.12 each



COMBINATION INSULATED BINDING POSTS

This insulated binding post is of new design which accommodate standard banana plugs through the top of the post, a standard phone tip through the side, or as more ordinarily used with a wire through the side. The non removable head is heavily knurled for a firm grip.

No. 143-All colors\$1.50 each



MIDGET JACKS

ARHCO Midget Phone Jacks are made of the finest quality brass and are nickel plated with an enduring nickel finish. Noiseless contact is provided by phosphor bronze spring contacts. Mounts in 3/8" diameter hole, in panels up to 5/16" thick.

No. 89 Open Circuit Jack\$2.50 each
No. 1789 Closed Circuit Jack30 each

BABY PLUGS AND JACKS

These plugs and jacks are excellent for use in all high frequency transmitters and receivers. Their small size allows them a wide range of uses. The No. 392 plug has a 10/32 threaded shank, a 3/16" hexagon shank and is 7/8" overall. Also available with 7/8" Ameroid Handle in any standard color. The mate to this plug is the No. 394 Jack. It has a hexagon head and a 10/32 threaded shank which will fit in panels up to 1/4" in thickness. Also available with an insulated ameroid head in any standard color.



Per 100
No. 392 Threaded Shank Plug\$ 6.50
No. 393 Plug and Ameroid Handle10.00
No. 394 Non-Insulated Jack6.00
No. 395 Insulated Jack10.00



Banana Type Plugs

This type Plug is extensively used on coils and on other plug-in transmitting and laboratory equipment.

No. 1764-6/32 Thread 1" Long\$9.50 per 100
No. 120-6/32 Thread 1/2" Long\$7.00 per 100
No. 122-8/32 Thread 1/2" Long\$7.00 per 100



Split Type Banana Plug

The strong action of the contact prongs eliminates faulty electrical continuity. The hexagonal shape of the body between the tip and the threaded shank facilitates holding of plug while tightening. The plug fits our jacks Nos. 136, 125, 148, and 336. The overall length is 1 1/4".

No. 124\$7.00 per 100

Sr. Solderless Phone Tip



May be used with all our standard type phone tip jacks. Entirely constructed of high grade brass with nickel plated finish. Overall length is 1 5/8".

No. 10 Tip \$6.00 per 100

Jr. Solderless Phone Tip



Fits all standard phone tip jacks such as our No. 137 and No. 138. Made entirely of brass with nickel plated finish. Length overall is 1 1/4". The tip is 3/8".

No. 9 Tip \$5.00 per 100



Insulated Solderless Phone Tip

This type Phone Tip is highly recommended on set analyzers, tube testers and all types of laboratory test equipment. Fits all standard tip jacks. A knurled collar is provided which when tightened after inserting the wire through the barrel, securely clamps the wire and makes soldering unnecessary. The overall length of the plug is 2". The sleeve is 1" Long.

No. 141 12c each



INSULATED BANANA PLUG JACK

Will fit all our standard banana size plugs. Mounts in a 5/16" diameter hole and can be used up to panels 3/8" thick. Overall length 7/8". Available in all colors.

No. 336\$1.15 each

INSULATED BINDING POST



This type binding post is available in two sizes. Easy identification is made possible by the bright colored head.

Ea.
146 1/2" Head\$1.10
147 3/4" Head08

HEAVY DUTY METAL BINDING POST

This type of binding post is especially designed for high amperage work or for use on test equipment where low resistance connections are imperative.

No. 32\$10.00 per C

Solderless Insulated Banana Plug



A completely insulated Banana Type Plug to fit all standard Banana Jacks. A one-piece Phosphor Bronze Spring and full length center pin assure good contact and long life. Ameroid barrel is 3/4" long, 3/8" diameter. Available in all colors.

No. 33212c each

Split Type Banana Plug



Designed to snugly fit a standard type banana jack. Spring action is positive and durable. A set screw is provided in the side of the barrel to secure the wire to the plug without soldering. Length 1-7/16". The plug is 1/2" long. Available in all colors.

No. 331\$1.15 each

Insulated Banana Plug



A set screw in the side of the barrel secures the wire within the plug without the necessity of soldering. A full length center pin prevents the spring from collapsing. Ameroid sleeves are available in all colors.

No. 131-7/8" Sleeve Overall Length 1 5/8"12 1/2c ea.
No. 131A-1 1/2" Sleeve Overall Length 2 1/4"15c ea.

PHONE TIP PLUG



This solderless phone tip is made to fit our No. 137, and No. 138 Jacks and No. 143 Binding Posts. Tightening the knurled collar produces a perfect electrical connection without the necessity of soldering. The Ameroid sleeve is available in all colors. Length is 1 1/2".

No. 142 Plug\$1.12 each



INSULATED BANANA JACK

This insulated Banana Jack is used with the Banana Type Plugs 3/8" long and mounts in a 1/4" hole in panels up to 3/8" thick. Available in all colors.

No. 136\$1.10 each

NEW BANANA JACK



Recommended for use with No. 1150 Banana Plug. Countersunk to fit tapered portion of plug shank. Will fit panels up to 7/16" thick.

No. 1151\$0.06 each

PHONE TIP JACKS



The outstanding feature of this jack is the specially designed springs within the body that hold the phone tips straight and grip firmly at all times. Mounts in a 1/4" hole in panels up to 3/8" thick.

No. 137 \$6.00 per 100



NEW BANANA TYPE PLUG

Equipped with a 6/32 Female thread and supplied with a 6/32 screw and soldering lug. A one piece phosphor bronze spring assures positive and long lasting contact. The full length center pin prevents the plug from collapsing when misaligned with the jack.

No. 1150\$0.07 each



Streamlined Phone Tip Plug

The highly polished ameroid handles are made so that they will fit a standard non-insulated or insulated phone tip jack. By inserting the wire in the hole and screwing the tip in securely, a solid, solderless connection is made. Available in all colors. Plug 1 3/8" long, 1/2" high.

No. 185525c each

PHONE PLUGS



The AHRCO Phone Plug designed for use with all standard size jacks, is available in a variety of colors, and a brass nickel polished sleeve. A shielded sleeve of this type is imperative in many microphone circuits. Overall length is 2 3/4".

No. 128 Plug with Ameroid Sleeve\$0.40 each
No. 218 Plug with Pol Nickel Sleeve75 each

Midget Phone Plugs

This Midget Phone Plug fulfills a pressing need for a small but practical plug to fit all standard phone jacks.

No. 1786 2 1/4" Plug\$0.35 each



AMERICAN RADIO HARDWARE CO., Inc.,

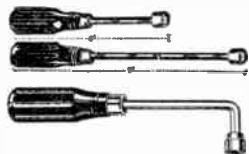

SPIN TYPE SOCKET WRENCHES STRAIGHT AND OFFSET TYPES

Wrenches are made with a deep hollow hole in ends of shanks that will take long screws up to No. 10 Straight Types six and nine inches long; offset type seven inches long.

6" LONG			9" LONG			7" OFFSET		
No.	for	Ea.	No.	for	Ea.	No.	for	Ea.
46	3/16" Hex Nut	\$.25	58	3/16" Hex Nut	\$.39	106	3/16" Hex Nut	\$.30
50	1/4" Hex Nut	.25	54	1/4" Hex Nut	.30	107	1/4" Hex Nut	.30
51	5/16" Hex Nut	.25	55	5/16" Hex Nut	.30	108	5/16" Hex Nut	.30
52	3/8" Hex Nut	.25	56	3/8" Hex Nut	.30	109	3/8" Hex Nut	.30
53	7/16" Hex Nut	.25	57	7/16" Hex Nut	.30	110	7/16" Hex Nut	.30
49	1/2" Hex Nut	.25	59	1/2" Hex Nut	.30	111	1/2" Hex Nut	.30
660 box of six 6" long wrenches 1.50			690 box of six 9" long wrenches 1.80			670 box of six 7" long wrenches 1.80		



Unbreakable Handle Spin Type Socket Wrenches

The ARHCO Amber Handle Socket Wrenches are made with amber color plastic unbreakable handles which are absolutely shockproof and unbreakable. The socket wrenches are constructed with a deep hollow hole in the end of the socket and will take a screw up to a No. 10 diameter. The shank is made of steel and cadmium plated. The socket is made of fine steel and case hardened for service and durability. The handle is 1" in diameter and is ribbed for a tight and firm grip and can easily be spun around. The overall length is 7 1/2".

No.	for	Ea.	No.	for	Ea.
3100	3/16" Hex Nut	\$.60	3104	3/8" Hex Nut	\$.60
3101	1/4" Hex Nut	.60	3105	7/16" Hex Nut	.60
3102	5/16" Hex Nut	.60	3106	1/2" Hex Nut	.60
3103	11/32" Hex Nut	.60	3107	Complete set of seven wrenches	4.20

PARKER KALON TYPE SOCKET WRENCHES

3110	for No. 4 Screw	\$2.00 each
3111	for No. 6 Screw	2.00 each
3112	for No. 8 Screw	2.00 each
3113	for No. 10 Screw	2.00 each
3114	for No. 12 Screw	2.00 each

DUAL GRID CAP



This cap may be used with the standard glass tube cap or the small metal tube grid cap. Furnished with a 12" wire and standard phone tip. Cap is made of ameroind and is available in various colors.

No. 412 20c each

Insulated Grid Caps

The 418 fits the standard glass tube cap and the 419 fits the 866 tube cap, as well as many types of transmitting tubes. Cap is provided with a 12" wire.

No. 418 Glass Tube Cap \$2.00 each
No. 419 866 Type Cap30 each

Beaded Edge Grid Caps



A beaded edge is formed around the lower edge of the cap to produce a wiping grip and ease of soldering is assured by a bridge in the tail.

No. 102 \$4.00 per M
202 (Metal Tube Caps) 2.50 per M

New Metal Tube Grid Caps



Made in two types—one without a hole and one with a hole in the tail of the cap to facilitate the soldering of the wire.

No. 114 \$4.00 per M
No. 121 with Hole 4.00 per M
Metal Tube Grid Cap to fit inside of Grid Shield.
No. 115 \$4.00 per M

Candelabra Bulb Socket



These candelabra type sockets are designed to be used wherever a heavy duty intermediate base socket is required. Two finned eyelets provide easy soldering connections.

No. 1542 (Up Bracket) \$7.00 per C
No. 1543 (Down Brkt.) 7.00 per C

Clip-on Bracket Type Sockets



Will accommodate all standard miniature base bulbs. The height of the shell and washer is 1/2" and the length of the bracket is 3/4".

No. 34 UP Clip type 3/4" long \$7.00 per C
No. 35 DOWN Clip type 1 1/8" long 7.00 per C

Horizontal Panel Indicator Assembly



This departure in design of panel indicators has many outstanding features. The bulb fits into the jewel so the maximum light is concentrated thru the jewel. The bulb is instantly removable. Due to its design this indicator requires less space than ordinary types. The jewels are supplied in Red, Green, Amber, Blue, and White.

No. 88 50c each

Grid Cap Shield



Cadmium plated or black finish.
92 Cad. Plated \$1.00 ea.
94 Black15 ea.

ANTENNA AND FUSE CONNECTORS



These Connectors are made in two types; one that is plain and the second with a reinforced ring around the connecting part of the Connector. The Connectors

are made for automobile quick connections either on the antenna or ground line as well as for the standard 3AG automobile fuses.

In addition to being available completely assembled, they are also available in individual parts.

No. 221 Overall length 1 1/4" 7c each
No. 222 Overall length 3 1/2" 10c each

REINFORCED RING TYPE

No. 231 Overall length 1 1/4" 12c each
No. 232 Overall length 3 1/2" 15c each



Volume Control Wrench

The handles of the volume control wrench are made of amber color plastic unbreakable material which will withstand the severest sledge hammer blows. The handle is 1" diameter 3 1/2" long and is ribbed so that a firm and secure grip necessary to tighten the nuts is assured. The shank is made of fine steel, cadmium plated and will take shafts up to 4 1/4" long x 1/4" O. D. The socket is of case hardened steel accurately turned and broached and securely fastened to the shank.

No. 3116 \$1.00

Alligator Clips



These alligator clips are available in two sizes and can be supplied either in cadmium or bright nickel.

45AT 2" Long \$7.00 C
742 2 3/4" Long 8.00 C

Insulated Alligator Clips



Insulated Alligator Clips Nos. 129 and 130 consist of the No. 45AT clip with Ameroid Handle attached. The No. 152 Insulated Alligator Clip utilizes the No. 242 size clip. All clips are furnished with a loop around which the connecting wire can be twisted for soldering.

129 Clip, Overall 2 3/4", Handle 1 1/4" long \$.15 each
130 Clip, Overall 2 1/4", Handle 1 1/2" long15 each
152 Clip, Overall 3 1/4", Handle 1 1/4" long17 1/2 each

Approved Type Bayonet Dial Sockets



These sockets are completely insulated and made in four types, all meeting the Underwriters Laboratories' approval.

1721 Straight UP Bracket \$15.00 C
1722 Straight DOWN br. 15.00 C
1723 UP clip-on bracket 15.00 C
1724 DOWN clip-on br. 15.00 C

Bayonet Type Dial Sockets

The shell is securely eyeleted to the bracket proper. The center contact is of new design permitting a constant and positive pressure on the bulb contact.

1539 Straight UP bracket \$7.00 C
1539 Straight DOWN br. 7.00 C
1540 UP clip-on bracket 7.00 C
1541 DOWN clip-on br. 7.00 C

Approved Type Panel Indicator Bayonet Type

This socket conforms to Underwriters Laboratories' specifications. Constructed so that accidental short circuits are prevented. Each socket furnished with a red, green, amber, blue or white glass "Bull's eye." Mounts in panels up to 5/16" thick.

No. 1725 \$3.00

Panel Indicator Bracket

The indicator mounts in a single hole 7/16" in diameter and can be used on panels up to 5/16" in thickness. The jewels are translucent Ameroid in various colors. Available in Red, Blue, White, Green, and Amber jewels.

No. 39 Miniature Socket .25 each
No. 93 Candelabra Type Socket40 each

Approved Type Clip-In Sockets



A Pilot Light Socket that meets the rigid requirements of the Underwriters Laboratories. Connection to the shell is made by a lug which is lanced directly from the shell body and connection to the center of the contact of the bulb is made with a specially moulded rubber sleeve which embodies a spring and contact.

No. 1718 18c each

Clip-In Sockets

It is so constructed that it may be clipped into a dial directly. It requires a mounting slot 3/4" long and 1/2" wide.

No. 1753 Clip-in socket screw shell type \$8.00 per C
No. 1760 Clip-in socket bayonet type 8.50 per C

Giant Panel Indicators



Each pilot light indicator can be individually marked, by writing in the desired copy one requires

on the card disc which is supplied with each unit. Mounts in 3/4" hole in panels up to 3/8" thickness. Indicator 1" in diameter and extends 1 3/8" behind the panel. Available in green, red, blue.
1872 Bayonet Type \$.75 ea.
1873 Miniature Screw Shell .75 ea.



Fibre Neutralizing Tools



Made of hard fibre and are a 3 in 1 combination. A 1/4" diameter screw driver on the inside and 1/4" and 5/16" sockets at each end of the tool. A completely insulated neutralizing tool for servicemen.
No. 2501. Each. \$0.50

Ameroid Neutralizing Tools

Made of ameroid and are a 3 in 1 combination 1/4" diameter screw driver on the inside and 1/4" and 5/16" sockets at each end of the tool.
700 Neutralizing Tool \$.45 each
720 Majestic Attachments .15 each
730 Crosley Attachments .15 each

Fibre Neutralizing Tubes



These tubes are ideal, for when the hexagon wears out it can be cut off and used again. It may be had in the 1/4" or 5/16" hexagon nut size as listed.

2502 6" Long	\$.20 each
2503 8" Long	.25 each
2504 10" Long	.30 each
2505 12" Long	.35 each
2505 28" Long	.75 each

TUNING WANDS



This is a soft rubber Tuning Wand. Made of soft rubber so that it can be bent into any desired shape. These rubber tuning wands have a pulverized iron core at one end and a brass insert at the other. Wand is 6" Long. Straight tuning Wand also available.

840 Flexible Tuning Wands	\$1.00 each
825 Straight Tuning Wand	.70 each

PROD HANDLES



Prod Handles and Banana Test Prods to fit all needs. Available in all standard colors.

SOLDERLESS TEST PRODS:

145 Handle 5 1/2"	\$.25 each
149 Handle 7"	.30 each

PHONO NEEDLE PROD HANDLES:

153 Handle 4 1/2"	.25 each
155 Handle 5 1/2"	.30 each

BANANA TEST PRODS

151 Handle 5"	.40 each
134 Handle 3"	.30 each
135 Handle 1 1/2"	.25 each

Alligator Alignment Wrench



Made to fit various sizes both knurled and hexagon nuts up to 3/8" diameter. The alligator jaws are fastened to the insulating rod with a rivet to prevent turning. Overall length is 6" and diameter of shaft is 1/4". Available in assorted colors.

No. 805	\$.35 each
---------	------------

ARHCO HARDWARE MERCHANDISER

An attractive display consisting of seventy-two transparent cellophane envelopes—eighteen different items and four envelopes of each item. Replacement envelopes of all the items may be ordered separately from catalog numbers listed below.



2330 Display Card of Hardware \$7.20

The contents are easily identified as each envelope is stamped as to the item it contains. The following articles are furnished as an integral part of the display.

2331 RHICPMS 6/32" x 1/4"	\$.10
2332 RHICPMS 6/32" x 3/8"	.10
2333 RHICPMS 6/32" x 1/2"	.10
2334 RHICPMS 6/32" x 3/4"	.10
2335 RHICPMS 6/32" x 1"	.10
2336 RHICPMS 8/32" x 1/4"	.10
2337 RHICPMS 8/32" x 3/8"	.10
2338 RHICPMS 8/32" x 1/2"	.10
2339 RHICPMS 8/32" x 3/4"	.10
2340 RHICPMS 8/32" x 1"	.10
2341 Steel Hex Nuts C.P. 6/32" x 1/8"	.10
2342 Steel Hex Nuts C. P. 6/32" x 5/16"	.10
2343 Steel Hex Nuts C. P. 8/32" x 5/16"	.10
2344 No. 6 Nickel Plated Washers	.10
2345 No. 8 Nickel Plated Washers	.10
2346 No. 6 Shakeproof Lock Washers	.10
2347 No. 8 Shakeproof Lock Washers	.10
2348 No. 6 Kantlink Washers	.10

AMBER BAKELITE HANDLE SCREW DRIVERS



The ARHCO No. 2356 Display Card consists of twelve Handle Screw Drivers. The top of the handles are machined out of Amber Colored Bakelite in both convex and concave shapes—and ribbed for solid grip.

The different styles and sizes of screw drivers shown on the Display Card are also supplied separately.

2350 Convex Handle 2 1/4" Blade	\$.15
2351 Convex Handle 3 1/2" Blade	.20
2352 Convex Handle 4 1/2" Blade	.25
2353 Concave Handle 2 1/4" Blade	.15
2354 Concave Handle 3 1/2" Blade	.20
2355 Concave Handle 4 1/2" Blade	.25
2356 Display Card	2.40

Low Capacity Alignment Screw Driver

The screw driver is made of 1/4" Ameroid Rod Silver Finish, provided with two screw driver knibs. The knob extending from the lower end of the handle extends 1/2" and can be used for ordinary padding condensers. There is another recessed screw driver knob in the upper end of the handle which may be used for aligning permeability tuned circuits.

No. 2370	\$.50
----------	-------

Dual Duty Alignment Tool

Handle is 3/8" diameter 2 1/2" long. From one end of the handle there is a sturdy 1 3/4" screw driver blade. This screw driver blade may be used for aligning padding condensers. From the opposite end a socket screw driver projects which may be used for adjustable iron core tuning systems. Overall size of screw driver is 6".

No. 2371	\$.50
----------	-------

Fuse Mounting Bases



These fuse bases are designed for the auto type fuse. Available in two types, one for breadboard mounting and the other for panel mounting.

103 Single, Baseboard Mount	\$.15
127 Double, Baseboard Mount	.25
104 Single, Panel Mount	.15
125 Double, Panel Mount	.25

Alignment Screw Driver



This screw driver is made of ANEROID, 6" long and 7/32" in diameter, and is so fabricated that the amount of metal in the screw driver nib will negligibly affect the inductance of the coil. This is of prime importance in the alignment of modern all-wave receivers. Available in various colors.

No. 860	\$.25 each
---------	------------

Push Button Tuner Aligning Tool



Specially adaptable for aligning Push Button Tuning units of the variable permeability type. Handle is 3/8" diameter and 1 1/8" long. The shank is 4/2" long and permanently fixed in the handle. The socket is 7/32" diameter and contains a screw driver knob recessed in the socket.

No. 2372	\$.50
----------	-------

Compensating Screw Driver



Made of ameroid. The compensating screw driver has a special shape blade at one end for adjusting trimmer screws. The other end is knurled for a non-slip grip. Supplied with pocket clip. 6" overall.

No. 710	\$.20 each
---------	------------

Pencil Type Test Prods With Interchangeable Tips Ends



Spring prongs located at flexible end of test prods allows to interchange spade lugs, phone tips, and alligator spring clips. New type needle point phone tip for piercing through insulated wire for a good contact. Equipped with black and red flexible wires measuring 5 feet and same colored handles. Each set complete with two Alligator Clips, two Needle Point Phone Tips, and two American Type Tapered Lugs.
500 \$1.50 Set

Socket Head Alignment Wrench



This is an Alignment Tool 6" long with a brass 1/4" socket head that fits over trimmer screws on various types of receivers. Outside diameter of this Hexagon Wrench is 3/8". An insulating shaft is forced into wrench and riveted to prevent shaft from turning. The other end has a hardened screw driver bit for adjusting trimmer screws. Diameter of the insulation is 7/32" and will fit into a 1/4" hole where the wrench has to go thru the top of a coil available in assorted colors.

No. 820	\$.50 each
---------	------------

Heavy Duty Test Prods

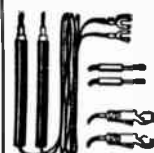

Ameroid prod handles are 7/16" diameter and 5" long. Prods equipped with 60" long heavy duty flexible wire. Prod tips are sharp, suitable for scraping and piercing corrosion. Handles and leads are colored red and black.

300 with Taper Lugs	\$.80 pair
310 with Phone Tips	.90 pair
320 with Alligator Clips	.90 pair

TEST LEADS

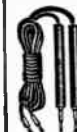

SOLDERLESS TIP TEST LEADS	
200 with Phone tips	\$.60 pr.
210 with Spade Lugs	.60 pr.
260 with Alligator Clips	.70 pr.

PHONO NEEDLE TEST LEADS

230 with Phone Tips	\$.60 pr.
240 with Spade Lugs	.60 pr.
259 with Alligator Clips	.70 pr.

TEST LEAD SPECIAL

Ameroid Handles with 3 feet of kinkless rubber covered wire. Standard Phone Tip on one end; spade lugs on the other end.
No. 439 Price \$4.50



AMERICAN RADIO HARDWARE CO., Inc.

SHAFT COUPLINGS EXTENDERS & REDUCERS

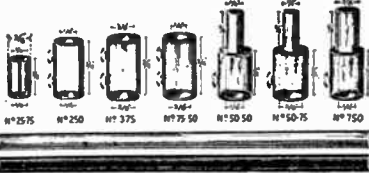

These accurately machined brass fittings can be used for coupling shafts of the same or different diameter, for straight extension, or for extension with smaller or larger shaft diameter.

NO.	LENGTH	Hole I.D.	O.D.	EA.
25-75	7/16"	1/4"	3/8"	7c
250	3/4"	1/4"	1/2"	15c
375	3/4"	3/8"	3/8"	15c
75-50	3/4"	3/8"	9/16"	15c
50-50	1 1/8"	1/4"	1/2"	15c
50-75	1 1/8"	3/8"	9/16"	15c
750	1 1/8"	1/4"	1/2"	15c
5250	6"	1/4"	1/2"	15c
12250	12"	1/4"	1/2"	30c
388	8"	3/8"	3/8"	30c
250 C	3/4"	1/4"	1/2"	15c
375 C	3/4"	3/8"	9/16"	15c
75-50 C	3/4"	3/8"	9/16"	15c
50-50 C	1 1/8"	1/4"	1/2"	15c
50-75 C	1 1/8"	3/8"	9/16"	15c
750 C	1 1/8"	1/4"	1/2"	15c
637 C	6"	1/4"	1/2"	10c
1237 C	12"	1/4"	1/2"	20c
388 C	12"	3/8"	3/8"	30c

ANGLE AND BRACKET ASSORTMENT



No. 10 ANGLE AND BRACKET ASSORTMENT

28 popular size angles and brackets made of brass and nickel plated. A choice selection of "Z" brackets and perforated strips are included. Indispensable for mounting radio parts.

No. 488-10 \$.50



Self-Tapping Screw Assortment

Parker Kalon self-tapping screw assortment of most popular sizes. Genuine replacements for ALL standard brand receivers.

No. 1078 \$.50

ANGLES AND BRACKETS

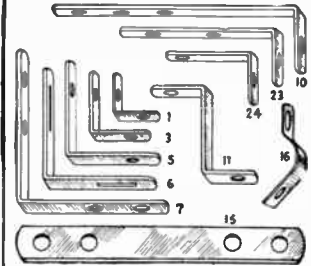

No.	Length	Hole Size	Per 100
1	1/2" x 1/2"	6 or 8	\$.90
3	3/4" x 3/4"	8	1.60
5	1" x 1"	8	2.50
6	1 1/8" x 1 1/8"	8	3.25
7	1 1/2" x 1 1/2"	8	4.00
10	3/4" x 2 1/4"	8	4.00
11	1 3/16" high	8	1.60
15	2 1/4" long	8	3.50
23	1/2" x 1 1/2"	8	2.00
21	1/2" x 7/8"	8	1.60

TINNED BRASS LUGS



No.	Length	Hole Size	1000
1	3/8"	6 or 8	\$2.50
2	3/8"	8	2.50
3	3/4"	8	2.50
4	3/8"	6 or 8	2.50
5	7/8"	6 or 8	2.50

Twin Phone Tip Jacks

Jacks in this assembly are our No. 138 type, mounted on a bakelite strip 1/2" wide and 2" long. Coded red and black for identification. Mounting strips may be had unmarked or with the following identification: SPEAKER, INPUT, OUTPUT, I-2, and A-G. No. 40E Marked \$.25 each
No. 40J Unmarked20 each

Bracket Type Lug Strips

No.	Price per 100
1620	3 lug \$10.00
1621	4 lug 12.00
1622	5 lug 15.00
1623	6 lug 18.00
1841	Special Mounting Bkt. 1.25
1839	Mounting Bracket and Lug Combination 1.50

Available with No. 1841 Bracket as illustrated or with No. 1837 Bracket, which is a combination bracket and mounting lug or with No. 1847 Bracket which is similar to No. 1839 but with a tapped 6/32 hole.

No.	Price
1660	3 Lug with 1839 Br. \$12.00
1661	4 Lug with 1839 Br. 14.00
1662	5 Lug with 1839 Br. 17.00
1663	6 Lug with 1839 Br. 20.00
1664	3 Lug with 1847 Br. 14.00
1665	4 Lug with 1847 Br. 16.00
1666	5 Lug with 1847 Br. 19.00
1667	6 Lug with 1847 Br. 22.00
1847	Bracket and Lug with tapped 6/32 Hole. 3.00

Rubber Grommet Ass'm't

An assortment of 5 sizes of pure gum and black rubber grommets.

No.	Assortment	Price
No. 63	Assortment of 12 Rubber Grommets	\$.25
No. 69	Assortment of 30 Rubber Grommets	.50
No. 70	Assortment of 100 Rubber Grommets	1.60

Special Angle Brackets with Tapped Holes



No.	Size	Per 100
No. 1627	1/2" x 1/2" Bracket	\$3.00
No. 1628	1/2" x 3/8" Bracket	3.50
No. 1629	1/2" x 3/4" Bracket	4.00
Z Bracket	Type with no clearance hole—one tapped hole, 1/2" x 3/8" Bend x 7/16" long.	2363 4.00

RACK SCREWS



Particularly suitable for mounting panels in racks and cabinets. Enhances appearance of any panel. Screws, steel nickel plated.

NO.	SIZE	Per 100
1641	1/4" x 6/32	\$.30
1642	1/2" x 6/32	.31
1643	3/8" x 6/32	.40
1644	1" x 6/32	.41
1637	1/4" x 8/32	.31
1638	1/2" x 8/32	.40
1639	3/8" x 8/32	.45
1640	1" x 8/32	.5
1630	1/4" x 10/32	.45
1631	1/2" x 10/32	.50
1632	3/8" x 10/32	.55
1633	1" x 10/32	.60

WASHERS



No.	Price
1634	6/32 Cup Washer .80
1635	8/32 Cup Washer .80
1636	10/32 Cup Washer .80

TERMINAL BOARDS

PLUG-IN TYPE



Where connections must be changed quickly and easily and yet maintain a firm contact.

No.	Price
1701	1 Clip Strips.....\$1.00 Each
1702	2 Clip Strips......12 each
1703	3 Clip Strips......15 Each
1704	4 Clip Strips......20 Each
1705	5 Clip Strips......25 Each
1706	6 Clip Strips......30 Each
1707	7 Clip Strips......35 Each
1708	8 Clip Strips......40 Each
2391	Contacts Only1.25 per C
1715	Pin Plug08 Each

Round Head Steel Cadmium Plated Machine Screws

PRICE PER 1000

1/4" x 6/32	\$2.80	1 1/4" x 8/32	\$6.00
3/8" x 6/32	3.05	1 1/2" x 8/32	6.50
1/2" x 6/32	3.35	2" x 8/32	7.50
3/8" x 8/32	3.60	2 1/2" x 8/32	9.00
3/4" x 6/32	3.90	3" x 8/32	11.00
1/4" x 8/32	4.45	1" x 10/32	\$4.15
3/8" x 8/32	\$3.35	3/8" x 10/32	4.45
1/2" x 8/32	3.65	1/2" x 10/32	4.75
3/4" x 8/32	3.90	3/4" x 10/32	5.00
1" x 8/32	4.15	5/8" x 10/32	5.30
1 1/8" x 8/32	4.45	1" x 10/32	5.85
1 1/4" x 8/32	5.00		

Terminal Lug Strips

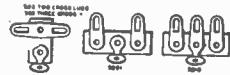

No.	Per C	No.	Per C
5101	\$2.00	5201	3.00
5110	2.25	5210	3.25
512	2.25	5202	4.00
501	2.25	5211	4.25

RUBBER GROMMETS

Ideal for use on all types of electrical and radio purposes.



No.	Panel Hole	I.D.	O.D.	Panel Thickness	Per 100
1113	13/32	21/64	5/8	1/16	\$2.35
1114	1/4	1/8	11/32	1/16	1.50
1115	3/8	1/4	9/16	7/32	2.50
1118	5/16	3/16	7/16	1/16	2.00
1119	13/32	17/64	9/16	1/16	2.00
1120	7/16	19/64	5/8	1/16	2.25
1121	1/2	3/8	11/16	1/16	2.25
1122	11/32	1/4	1/2	1/32	2.00

When ordering Gum Rubber add G to Number and add \$1.00 per C to list price of Black.

ESICO

Green Label Electric Soldering Irons

GENERAL INFORMATION: These irons are extraordinarily high-quality tools. They are packed in green label boxes to differentiate from Esico Industrial Irons, which have orange labels. They have one-piece blued steel cases. Rich



dark mahogany handles. Replaceable forged copper tips. They are wound in voltages ranging from 32 to 250 volts and can be used on both A.C. or D.C. current. (Nick Nacks 105-120 volts only.)

55 WATTS "NICK NACK"



CAT. No. 15

No. 15 Tip $\frac{3}{8}$ " Diameter

Weight 6 Oz.

Length $11\frac{3}{4}$ "

List Prices — Iron Complete \$1.25 Extra Tip 25c Element 60c

65 WATTS "MIDGET"

Screw Tip — Cat. No. 16
Plug Tip — Cat. No. 16P



No. 16 Tip $\frac{3}{8}$ " Diameter
No. 16P Tip $\frac{3}{8}$ " Diameter

Weight 7 Oz.

Length $11\frac{1}{4}$ "

List Prices — Iron Complete \$1.95 Extra Tip 35c Element \$1.35



100 WATTS "JUNIOR"

Screw Tip — Cat. No. 17
Plug Tip — Cat. No. 17P

No. 17 Tip $\frac{3}{8}$ " Diameter
No. 17P Tip $\frac{3}{8}$ " Diameter

Weight 9 Oz.

Length $12\frac{1}{4}$ "

List Prices — Iron Complete \$2.95 Extra Tip 35c Element \$1.45



150 WATTS "TROPHY"

Screw Tip — Cat. No. 18
Plug Tip — Cat. No. 18P

No. 18 Tip $\frac{7}{8}$ " Diameter
No. 18P Tip $\frac{1}{2}$ " Diameter

Weight 18 Oz.

Length $12\frac{1}{2}$ "

List Prices — Iron Complete \$5.00 Extra Tip 45c Element \$2.50

COPPER TIPS FOR MIDGET OR JUNIOR IRONS

CAT. No.

JM 2

Tip $\frac{3}{8}$ " in Diameter

Fits either

No. 16 or 17 Irons



Price

40c



CAT. No.

JM 3

Tip $\frac{5}{8}$ " in Diameter

Fits either

No. 16 or 17 Irons



Price

40c

JM2 and JM3 Tips Not Available for Plug Tip Irons

ESICO

Industrial Electric Soldering Irons

GENERAL INFORMATION FOR PLUG TIP IRONS:

These irons can be used on both A.C. or D.C. current and are wound in voltages ranging from 105 to 240 volts. The tips are the plug type, held by a set screw, which is easily removed for making tip replacements. It is not necessary to return these irons to the factory for repairs. Elements and other parts are easily replaced. For soldering,



these irons cannot be surpassed as ample heat is delivered to the tip for fastest work. For durability, their construction is such, with a one-piece heavy-gauge steel case, mounted element and a positive grip handle, that through use, the parts cannot fail to give unlimited service, regardless of the hardest use imposed upon them. Each iron is equipped with a 6' cord and attachment plug. A metal stand is supplied with every tool.



List Prices—Iron Complete \$5.00
Extra Tip 25c Element \$2.25

No. 54—65 WATTS
Tip $\frac{3}{8}$ " in Diameter

Equal to copper of $\frac{1}{2}$ lb. Length overall 10". Weight exclusive of cord, 8 oz. For light work, such as soldering fine wires, radio factory use, tool kits, and especially suitable for use of operators where a light short tool is required.



List Prices—Iron Complete \$5.50
Extra Tip 32c Element \$2.75

No. 96—110 WATTS
Tip $\frac{3}{8}$ " in Diameter

Equal to copper of $\frac{3}{4}$ lb. Length overall, 12". Weight exclusive of cord, 10 oz. For electrical and radio factories, telephone switchboards, telephone repair work, fuses, tool kits, light manufacturing, delicate instruments, radio and electrical experimental laboratories.



List Prices—Iron Complete \$7.75
Extra Tip 65c Element \$3.50

No. 126—130 WATTS
Tip $\frac{1}{2}$ " in Diameter

Equal to copper of 1 lb. Length overall, 12 $\frac{1}{2}$ ". Weight exclusive of cord, 16 oz. For light tin work, automobile repairs and general factory soldering. A very handy tool because of its shortness.



List Prices—Iron Complete \$8.75
Extra Tip 70c Element \$3.75

No. 206—200 WATTS
Tip $\frac{1}{2}$ " in Diameter

Equal to copper of 1 $\frac{1}{2}$ lbs. Length overall, 14". Weight exclusive of cord, 24 oz. For medium tin work, automobile repairs, patterns and general factory work. Suitable for small branders.



List Prices—Iron Complete \$10.25
Extra Tip \$1.25 Element \$5.00

No. 355—310 WATTS
Tip $\frac{3}{8}$ " in Diameter

Equal to copper of 3 lbs. Length overall, 14 $\frac{1}{2}$ ". Weight exclusive of cord, 41 oz. For heavy sheet metal work, tinsmiths, automobile radiators, refrigerators and branding purposes.



List Prices—Iron Complete \$12.25
Extra Tip \$1.75 Element \$6.00

No. 505—500 WATTS
Tip 1 $\frac{1}{8}$ " in Diameter

Equal to copper of 5 lbs. Length overall, 14 $\frac{1}{2}$ ". Weight exclusive of cord, 54 oz. For very heavy soldering, large tanks or cans, roofs and objects of large area. Very large branders.

ESICO THERMOSTATIC CONTROL STAND

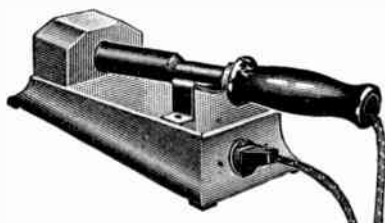

Patent Pending

TEMPERATURE: Iron can be maintained at any desired temperature while in the stand. Efficient control of the tip temperature is attained.

Years of experimental work in attempting to incorporate a thermostat in the iron itself have failed to obtain the fine degree of temperature regulation secured with this stand. When removed from the control, full current is instantly applied to the iron.

POSITIVELY IMPOSSIBLE FOR IRON TO OVERHEAT OR TO BURN OFF ITS TIN!

PROLONG: Element and tip life.

SAVE: Cost of electric current.

Permits the use of high wattage elements in small irons as they cannot overheat.

Cat. No. 5—Irons up to 1" Diameter tip.
Cat. No. 6—Irons 1" to 1 $\frac{1}{8}$ " Diameter tip.

List Price — \$6.50



KRAEUTER

The choice of skilled mechanics



"GRIPTITE" COMBINATION PLIERS

New Pattern

These are of new design with slightly tapered nose, and are fitted with special non-slipping serrated edge wire cutters. The two larger sizes have three slip-joint adjustments which give a wider range of parallel grips on large nuts. No. 356 is furnished with the famous "Don't Slip" handle design. No. 355 is furnished with smooth handles.

No.	Length	Finish	Wt. per doz.	Price	
				per doz.	Each
356	5½ in.	Full Nickel	3½ lbs.	\$1.00	
356	6 in.	" "	5¼ lbs.	1.25	
356	8 in.	" "	8¾ lbs.	1.50	
356	10 in.	" "	14 lbs.	2.00	
355	5½ in.	Blue Temper	3½ lbs.	1.00	
355	6 in.	" "	5¼ lbs.	1.25	
355	8 in.	" "	8¾ lbs.	1.50	
355	10 in.	" "	14 lbs.	2.00	



COMBINATION SIDE CUTTING PLIERS

A very popular automotive combination slip-joint plier. Has side cutter suitable for cutting insulated or bare wire. Small groove in nose for holding cotter pins. No. 1973 is furnished with the famous "Don't Slip" handle design. No. 1972 is furnished with smooth handles.

No.	Length	Finish	Wt. per doz.	Price	
				per doz.	Each
1973	5½ in.	Full Nickel	3½ lbs.	1.90	
1973	7 in.	" "	7¼ lbs.	2.20	
1972	5½ in.	Blue Temper	3½ lbs.	1.55	
1972	7 in.	" "	7¼ lbs.	1.80	



RADIO PLIERS

Diagonal cutting pliers specially developed for close cutting in radio and radio tube work.

No.	Length	Finish	Wt. per doz.	Price	
				per doz.	Each
2612	6 in.	Blue Temper	3 lbs.	2.00	

This is only a partial listing of Kraeuter Pliers. Send for Catalog.



COMBINATION PLIERS

These well-made sturdy pliers are designed to meet the demand for medium priced good quality pliers that will give good service.

No.	Length	Finish	Wt. per doz.	Price	
				per doz.	Each
36	6 in.	Dull Nickel	6 lbs.	\$1.40	
38	8 in.	" "	7 lbs.	.55	
310	10 in.	" "	12¾ lbs.	.85	
46	6 in.	Full Nickel	6 lbs.	.55	
48	8 in.	" "	7 lbs.	.85	



ELECTRICIANS' DIAGONAL CUTTING PLIERS

Longer jaws and made especially for close cutting. Forged from special plier steel and finely fitted for exact work.

No.	Length	Finish	Wt. per doz.	Price	
				per doz.	Each
4601	4½ in.	Full Polished	1½ lbs.	1.85	
4601	5 in.	" "	2¼ lbs.	2.00	
4601	5½ in.	" "	3¼ lbs.	2.20	
4601	6 in.	" "	3¾ lbs.	2.30	
4601	7½ in.	" "	6 lbs.	2.65	
4501	4½ in.	Blue Temper	1½ lbs.	1.50	
4501	5 in.	" "	2¼ lbs.	1.65	
4501	5½ in.	" "	3¼ lbs.	1.75	
4501	6 in.	" "	3¾ lbs.	1.90	
4501	7½ in.	" "	6 lbs.	2.20	

Also Furnished in K Brand.



EXTRA HEAVY DIAGONAL CUTTING PLIERS

Designed to meet the demand for a larger and more powerful diagonal cutter. Is practically unbreakable. Joint is extra heavy and rigid.

No.	Length	Finish	Wt. per doz.	Price	
				per doz.	Each
4611	7 in.	Full Polished	5¼ lbs.	2.25	
4610	7 in.	Blue Temper	5¼ lbs.	1.95	

Also Furnished in K Brand.



KRAEUTER

The choice of skilled mechanics



HY-POWER SIDE CUTTING PLIERS

Useful for heavy duty jobs of wire cutting and twisting. Very strongly constructed and have extra tough jaws.

No.	Length	Finish	Wt. per doz.	Price Each
1801	6 in.	Blue Temper	5¼ lbs.	\$1.90
1801	7 in.	" "	7½ lbs.	2.20
1801	8½ in.	" "	11¼ lbs.	2.50

Also Furnished in K Brand.



"SURE-GRIP" IGNITION PLIERS New Pattern

A handy little plier to replace 10- or 12-piece sets of ignition wrenches. Has bulldog grip, slip joint adjustment, serrated teeth, narrow nose, and thin, strong, shaped handles.

Can be used to advantage on distributor, generator, magneto, carburetor, dash panel connections, and on any small or awkwardly placed nuts. Instantly adjustable and a marvelous time saver.

No.	Length	Finish	Wt. per doz.	Price Each
643	5 in.	Blue Temper	1 lb.	1.10



END CUTTING NIPPERS

A strong, easy-cutting single joint nipper. The jaw is compact and the rivet lies close to the edge, affording maximum leverage. A quick-action tool, forged of high-grade tool steel with sharp, enduring cutters.

No.	Length	Finish	Wt. per doz.	Price Each
1851	5 in.	Full Polished	4½ lbs.	1.60
1851	6 in.	" "	6 lbs.	1.80
1851	7 in.	" "	8 lbs.	2.20
1851	8 in.	" "	10½ lbs.	2.50

Spring in Handle35



No. 4206



SIDE CUTTING PLIERS

Used extensively for electrical and general wiring work. Strongly constructed with sturdy wire cutters. A very popular style.

No.	Length	Finish	Wt. per doz.	Price Each
1831	4 in.	Full Polished	1½ lbs.	\$1.55
1881	5 in.	" "	2¼ lbs.	1.75
1831	6½ in.	" "	4¾ lbs.	2.00
1831	7 in.	" "	6¾ lbs.	2.25
1831	8 in.	" "	8¾ lbs.	2.50
1830	4 in.	Blue Temper	1½ lbs.	1.25
1830	5 in.	" "	2¼ lbs.	1.40
1830	6½ in.	" "	4¾ lbs.	1.60
1830	7 in.	" "	6¾ lbs.	1.75
1830	8 in.	" "	8¾ lbs.	1.90

Also Furnished in K Brand.



"DREADNOUGHT" LINEMEN'S PLIERS Heavy Duty—Lap Jointed

Powerful and durable—wonderful strength and cutting power. Drop forged—perfectly hardened, accurately fitted.

No.	Length	Finish	Wt. per doz.	Price Each
2801	6 in.	Full Polished	5¼ lbs.	2.50
2801	7 in.	" "	7½ lbs.	2.75
2801	8½ in.	" "	11¼ lbs.	3.25



WITH STRIPPING NOTCH

Extensively used on electrical outside lighting fixtures, for cutting and stripping the asbestos insulation on 14 gauge wire without injury to the wire.

No.	Length	Finish	Wt. per doz.	Price Each
S2801	6 in.	Full Polished	5¼ lbs.	2.75
S2801	7 in.	" "	7½ lbs.	3.00
S2801	8½ in.	" "	11¼ lbs.	3.50

DIAGONAL HARD WIRE CUTTERS

This tool was designed for cutting hardened wire. Will cut up to 1/8" diameter. Also suitable for general use.

No.	Length	Finish	Wt. per doz.	Price Each
4206	6 in.	Blue Temper	4½ lbs.	2.00

THIS IS ONLY A PARTIAL LISTING OF KRAEUTER TOOLS SEND FOR CATALOG



KRAEUTER

The choice of skilled mechanics



NEEDLE NOSE SIDE CUTTING PLIERS

A fine slender nosed, tapered point plier. Handy on all ignition work and on generators, starters, switch work, etc.

No.	Length	Finish	Wt. per doz.	Price Each
1661	6 in.	Blue Temper	3½ lbs.	\$1.70
1671	Same without cutter		3½ lbs.	1.50
1662	6 in.	Polished Steel	3½ lbs.	1.90
1672	Same without cutter		3½ lbs.	1.65

Also Furnished in K Brand.



LONG NOSE SIDE-CUTTING CHAIN PLIERS

The long slender jaws are milled inside, and the side-cutters are built to cut. An easy operating plier with sturdy joint.

No.	Length	Finish	Wt. per doz.	Price Each
1681	6 in.	Blue Temper	3¾ lbs.	1.75



EXTRA LONG REACH FLAT NOSE PLIERS

The long, flat nose is nicely tapered and beveled. No cutter. Adaptable to all the uses of a flat nose plier with the added feature of an extremely long nose.

No.	Length	Finish	Wt. per doz.	Price Each
1741	6 in.	Blue Temper	3 lbs.	1.60
1751	Same with Cutter		3 lbs.	1.80



FINE ROUND NOSE—EXTRA LONG PLIERS

Specially developed for radio and radio tube work. Long round nose jaws milled on the end. Extensively used by leading manufacturers.

No.	Length	Finish	Wt. per doz.	Price Each
2631	6 in.	Blue Temper	2¾ lbs.	\$1.65



EXTRA LONG NOSE PLIERS

Very popular with auto mechanics and repair men. Especially good for radiator repair work and in places difficult to reach. Used on auto ignition work on generators, starters, switch work, etc., and on speedometer repair work. Length of jaw 2¾ in.

No.	Length	Finish	Wt. per doz.	Price Each
1781	7 in.	Blue Temper	3 lbs.	\$1.90
1771	Same without Cutter		3 lbs.	1.60
1782	7 in.	Polished Steel	3 lbs.	2.20
1772	Same without cutter		3 lbs.	1.80



LONG NOSE CHAIN PLIERS

Designed for use as a half-round nose, chain nose and flat nose plier. Made without cutter.

No.	Length	Finish	Wt. per doz.	Price Each
1691	6 in.	Blue Temper	2¾ lbs.	1.65

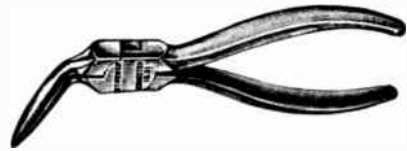

CURVED NEEDLE NOSE PLIERS

Spring tempered, long curved nose pliers for unusual jobs. Used for any awkward job.

No.	Length	Finish	Wt. per doz.	Price Each
1631	5½ in.	Blue Temper	2¼ lbs.	1.85
1632	5½ in.	Polished Steel	2¼ lbs.	2.10



LONG FINE NEEDLE NOSE PLIERS

This pattern is especially made for difficult and odd jobs where no other plier will answer. Especially useful for auto mechanics and vulcanizers. Its capacity for fine work is unusual. The long, fine nose is very carefully tempered.

No.	Length	Finish	Wt. per doz.	Price Each
1621	6 in.	Blue Temper	2¼ lbs.	1.75
1622	6 in.	Polished Steel	2¼ lbs.	1.90

THIS IS ONLY A PARTIAL LISTING OF KRAEUTER TOOLS . . . SEND FOR CATALOG



KRAUTER

The choice of skilled mechanics

Professional Line

SPECIAL NEEDLE-POINT PLIERS

FOR RADIO - ELECTRICAL - OPTICAL AND JEWELRY WORK

These extra fine needle-point pliers are specially designed for light professional use in the radio, electrical, optical and jewelry field. They are invaluable where delicate adjustments have to be made. (Nose of these Pliers Not Guaranteed.)

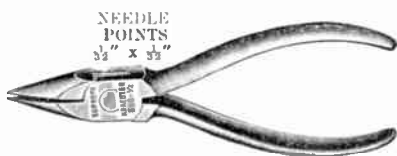

Short Nose Extra-fine Needlepoints—without cutter.

No.	Length	Finish	Wt. per doz.	Price Each
800	4 in.	Full Polished	1½ lbs.	\$1.50
803	4½ in.	" "	1¾ lbs.	1.60
800	5 in.	" "	2¼ lbs.	1.70
800	5½ in.	" "	3 lbs.	1.80
800	6 in.	" "	3¾ lbs.	1.90

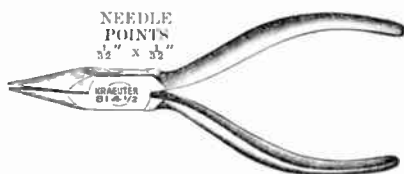

Extra fine points and narrow jaw—fine nose—without cutter.

No.	Length	Finish	Wt. per doz.	Price Each
814	4½ in.	Full Polished	1½ lbs.	\$1.60

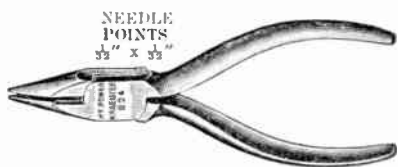

Short-Nose extra fine needlepoint—with side cutter.

No.	Length	Finish	Wt. per doz.	Price Each
824	4½ in.	Full Polished	1½ lbs.	\$1.80

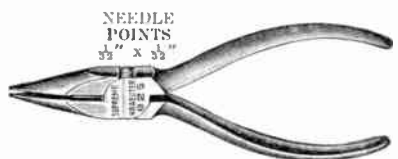

Short-Nose extra fine needlepoint—with side cutter.

No.	Length	Finish	Wt. per doz.	Price Each
825	5 in.	Full Polished	2¼ lbs.	\$1.90

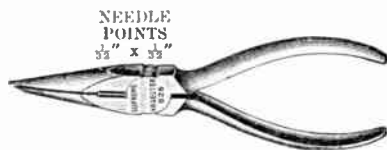

Medium-Nose extra fine needlepoint—with side cutter.

No.	Length	Finish	Wt. per doz.	Price Each
826	6 in.	Full Polished	3 lbs.	\$2.00

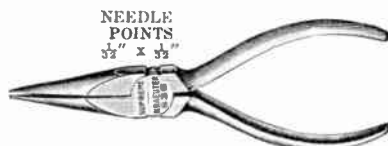

Medium-Nose extra fine needle points—without cutter.

No.	Length	Finish	Wt. per doz.	Price Each
836	6 in.	Full Polished	2¾ lbs.	\$1.75

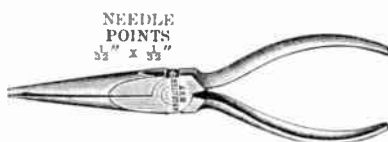

Long-Nose extra fine needlepoints—without cutter.

No.	Length	Finish	Wt. per doz.	Price Each
837	7 in.	Full Polished	3¾ lbs.	\$1.90
827	Same with Cutter		3¾ lbs.	2.20

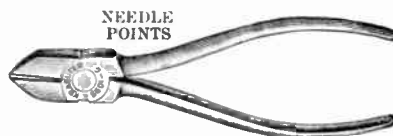

Radio and Electrical Fine Nose Diagonal.

No.	Length	Finish	Wt. per doz.	Price Each
5601	4½ in.	Full Polished	2 lbs.	\$2.00
5601	5 in.	" "	2¾ lbs.	2.25
5601	5½ in.	" "	3¼ lbs.	2.45
5601	6 in.	" "	3¾ lbs.	2.60



KRAEUTER

The choice of skilled mechanics

KRAEUTER "COHARDITE" INSULATED PLIERS

SAFETY TESTED FROM 10,000 TO 20,000 VOLTS

Invaluable to television and radio mechanics, linemen, metermen and all electrical workers
— INCREASED FACTOR OF SAFETY —

KRAEUTER "COHARDITE" INSULATED HANDLES

1. Resist extreme temperatures, moisture, oil and acid fumes.
2. Will not peel or crack.
3. Tough, rugged, and will stand abuse.
4. Tested to full di-electric test before leaving factory.
5. Approved by safety engineers wherever used.



KRAEUTER "COHARDITE" INSULATED LINEMEN'S PLIERS Heavy Duty-Lap Jointed

Powerful and durable—wonderful strength and cutting power. Drop-forged, perfectly hardened, accurately fitted.

No.
1N-2801

Length
8 1/2"

Wt. per Doz.
13 lbs.

Price Each
\$4.95



KRAEUTER "COHARDITE" INSULATED NEEDLE NOSE SIDE CUTTING PLIERS
A fine, slender nosed, taper point plier. Handy on all ignition work and on generators, starters, switch work, etc.

No.
1N-1661

Length
6"

Wt. per Doz.
4 lbs., 10 oz.

Price Each
\$3.25



KRAEUTER "COHARDITE" INSULATED DIAGONAL CUTTING PLIERS

Longer jaws and made especially for close cutting. Forged from special plier steel and finely fitted for exact work.

No.
1N-4501

Length
5"

Wt. per Doz.
4 lbs.

Price Each
\$3.30



KRAEUTER

The choice of skilled mechanics



OFFSET SCREW DRIVERS

Invaluable for reaching screws in difficult places.

No.	Stock	Length	Wt. per doz.	Price Each
497	1/4 in.	4 1/2 in.	1 lb.	\$.55
	3/8 in.	8 in.	3 1/4 lbs.	.65
97	1/8 in.	6 in.	2 3/4 lbs.	.55



STEEL WOOD CHISELS

An exclusive Kraeuter design, with beveled edges and bit, making it easier to operate in heavy wood. The handle is slightly raised to clear the hand when using.

Forged from special chisel steel, perfect temper, highly polished face, side of grip, bevels and bit. Number and size stamped on shank.

No.	Cut	Stock	Length	Weight per Doz.	Price Each
403	3/8 in.	1/2 in.	11 in.	6 lbs.	.70
	1/2 in.	3/4 in.	11 in.	7 lbs.	.77
	1 in.	1 in.	11 in.	10 1/2 lbs.	.90
	1 1/4 in.	1 1/4 in.	11 in.	11 1/2 lbs.	1.00
	1 1/2 in.	3/4 in.	11 in.	15 lbs.	1.10
	2 in.	7/8 in.	12 in.	23 lbs.	1.35



COLD CHISELS

(Sold by Cutting Size)

No. 430—A lower priced trip hammer forged chisel—fine quality steel—well tempered—black finish—polished blade.

Cut	Stock	Length	Weight per Doz.	Price Each
3/8 in.	3/8 in.	5 in.	1 1/2 lb.	\$.24
1/2 in.	1/2 in.	5 in.	2 lb.	.24
3/4 in.	3/4 in.	5 in.	1 1/4 lbs.	.24
1 in.	1 in.	5 in.	1 3/4 lbs.	.28
1 1/2 in.	1 1/2 in.	6 in.	2 1/4 lbs.	.35
2 in.	1 1/2 in.	6 1/2 in.	4 lbs.	.40
3 in.	3/8 in.	7 in.	6 lbs.	.50
4 in.	3/8 in.	8 in.	11 1/2 lbs.	.65
5 in.	3/8 in.	8 1/2 in.	15 lbs.	.85
6 in.	1 in.	9 in.	21 lbs.	1.20
7 in.	1 1/8 in.	9 1/2 in.	30 lbs.	1.50
8 in.	1 1/8 in.	12 in.	6 lbs.	.50
9 in.	1 1/2 in.	12 in.	7 1/4 lbs.	.55
10 in.	1 1/2 in.	12 in.	12 lbs.	.65
11 in.	1 1/2 in.	12 in.	16 1/2 lbs.	.90
12 in.	1 in.	12 in.	24 lbs.	1.10
14 in.	3/4 in.	18 in.	12 lbs.	.70
16 in.	3/4 in.	18 in.	18 lbs.	.90
18 in.	3/4 in.	18 in.	26 1/4 lbs.	1.25
20 in.	3/4 in.	18 in.	34 1/4 lbs.	1.65
22 in.	1/2 in.	24 in.	16 1/2 lbs.	1.00
24 in.	3/8 in.	24 in.	24 lbs.	1.20
26 in.	3/8 in.	24 in.	36 lbs.	1.65
28 in.	3/8 in.	24 in.	48 lbs.	2.10
30 in.	3/8 in.	30 in.	54 lbs.	1.95
32 in.	3/8 in.	30 in.	63 lbs.	2.40
34 in.	3/8 in.	36 in.	73 1/2 lbs.	2.10
36 in.	3/8 in.	36 in.	75 lbs.	2.75



STAR DRILLS

These tools are drop forged from high-carbon steel, oil hardened and oil tempered on both cutting and striking end. The size and number are plainly marked on each drill. The blades have a rounded bevel which gives support to the cutting edge, and permits fast work without splintering or cracking the edge. The flutes are large enough to prevent clogging, and the blades are specially designed for ease in rotating the drill in the hole.

No.	Size Hole	Length	Wt. per Doz.	Price Each
342	1/4 x	8 in.	1 lb.	\$.28
	3/8 x	8 in.	1 1/2 lbs.	.31
	1/2 x	8 in.	2 1/4 lbs.	.33
	5/8 x	8 in.	2 3/4 lbs.	.35
	3/4 x	8 in.	3 1/4 lbs.	.37
	7/8 x	8 in.	4 lbs.	.40
	1 x	8 in.	4 lbs.	.42
	1 1/8 x	8 in.	5 1/2 lbs.	.50
	1 1/4 x	8 in.	8 lbs.	.57
	1 1/2 x	8 in.	11 1/2 lbs.	.70
	1/4 x	12 in.	1 1/2 lbs.	.35
	3/8 x	12 in.	2 1/4 lbs.	.35
	1/2 x	12 in.	3 1/4 lbs.	.37
	5/8 x	12 in.	3 3/4 lbs.	.40
	3/4 x	12 in.	5 lbs.	.45
	7/8 x	12 in.	6 1/2 lbs.	.50
	1 x	12 in.	6 1/2 lbs.	.50
	1 1/8 x	12 in.	8 1/4 lbs.	.60
	1 1/4 x	12 in.	12 3/4 lbs.	.77
	1 1/2 x	12 in.	17 lbs.	.85
	1 3/4 x	12 in.	23 lbs.	1.10
	2 x	12 in.	29 lbs.	1.30
	2 1/2 x	12 in.	30 1/2 lbs.	2.10
	3/8 x	18 in.	5 1/4 lbs.	.44
	1/2 x	18 in.	5 1/4 lbs.	.55
	5/8 x	18 in.	7 1/4 lbs.	.50
	3/4 x	18 in.	9 1/4 lbs.	.65
	7/8 x	18 in.	9 1/4 lbs.	.65
	1 x	18 in.	12 3/4 lbs.	.75
	1 1/8 x	18 in.	19 lbs.	.90
	1 1/4 x	18 in.	26 lbs.	1.10
	1 1/2 x	18 in.	36 lbs.	1.30
	1 3/4 x	18 in.	46 lbs.	1.60
	2 x	18 in.	47 lbs.	2.35
	1/2 x	24 in.	9 3/4 lbs.	.70
	3/4 x	24 in.	13 lbs.	.75
	5/8 x	24 in.	13 lbs.	.75
	3/4 x	24 in.	16 1/2 lbs.	.85
	7/8 x	24 in.	25 1/2 lbs.	1.00
	1 x	24 in.	36 lbs.	1.20
	1 1/8 x	24 in.	51 lbs.	1.55
	1 1/4 x	24 in.	64 lbs.	1.75
	1 1/2 x	24 in.	66 lbs.	2.65



PIN PUNCHES

(Sold by Point and Length Size)

Accurately machined precision tools made by an improved method which insures perfectly square ends. Number and size stamped on each tool.

No. 291	Number	Point Size	Length	Price Each							
	0	1	2	3	4	5	6	7	8	9	
	1/16	1/8	3/16	1/4	5/16	3/8	7/16	1/2	5/8	3/4	
	7/8	1	1 1/8	1 1/4	1 1/2	1 3/4	1 7/8	2	2 1/8	2 1/4	
	2 1/2	3	3 1/2	4	4 1/2	5	5 1/2	6	6 1/2	7	
	8	9	10	10 1/2	11	12	13	14	15	16	
	17	18	19	20	22	24	26	28	30	32	
	34	36	38	40	42	44	46	48	50	52	
	54	56	58	60	62	64	66	68	70	72	
	74	76	78	80	82	84	86	88	90	92	
	94	96	98	100	102	104	106	108	110	112	
	114	116	118	120	122	124	126	128	130	132	
	134	136	138	140	142	144	146	148	150	152	
	154	156	158	160	162	164	166	168	170	172	
	174	176	178	180	182	184	186	188	190	192	
	194	196	198	200	202	204	206	208	210	212	
	214	216	218	220	222	224	226	228	230	232	
	234	236	238	240	242	244	246	248	250	252	
	254	256	258	260	262	264	266	268	270	272	
	274	276	278	280	282	284	286	288	290	292	
	294	296	298	300	302	304	306	308	310	312	
	314	316	318	320	322	324	326	328	330	332	
	334	336	338	340	342	344	346	348	350	352	
	354	356	358	360	362	364	366	368	370	372	
	374	376	378	380	382	384	386	388	390	392	
	394	396	398	400	402	404	406	408	410	412	
	414	416	418	420	422	424	426	428	430	432	
	434	436	438	440	442	444	446	448	450	452	
	454	456	458	460	462	464	466	468	470	472	
	474	476	478	480	482	484	486	488	490	492	
	494	496	498	500	502	504	506	508	510	512	
	514	516	518	520	522	524	526	528	530	532	
	534	536	538	540	542	544	546	548	550	552	
	554	556	558	560	562	564	566	568	570	572	
	574	576	578	580	582	584	586	588	590	592	
	594	596	598	600	602	604	606	608	610	612	
	614	616	618	620	622	624	626	628	630	632	
	634	636	638	640	642	644	646	648	650	652	
	654	656	658	660	662	664	666	668	670	672	
	674	676	678	680	682	684	686	688	690	692	
	694	696	698	700	702	704	706	708	710	712	
	714	716	718	720	722	724	726	728	730	732	
	734	736	738	740	742	744	746	748	750	752	
	754	756	758	760	762	764	766	768	770	772	
	774	776	778	780	782	784	786	788	790	792	
	794	796	798	800	802	804	806	808	810	812	
	814	816	818	820	822	824	826	828	830	832	
	834	836	838	840	842	844	846	848	850	852	
	854	856	858	860	862	864	866	868	870	872	
	874	876	878	880	882	884	886	888	890	892	
	894	896	898	900	902	904	906	908	910	912	
	914	916	918	920	922	924	926	928	930	932	
	934	936	938	940	942	944	946	948	950	952	
	954	956	958	960	962	964	966	968	970	972	
	974	976	978	980	982	984	986	988	990	992	
	994	996	998	1000	1002	1004	1006	1008	1010	1012	

* Due to extremely fine points—these sizes are not guaranteed.



OCTAGON CENTER PUNCHES

Black Enamelled Body with Polished Bit.

No.	Stock	Length	Wt. per doz.	Price Each
23	1/8 in.	4 1/2 in.	1 lb.	\$.28
	3/8 in.	4 1/2 in.	1 3/8 lbs.	.33
	1/2 in.	4 1/2 in.	2 1/8 lbs.	.38
	5/8 in.	4 1/2 in.	2 3/8 lbs.	.45
	3/4 in.	6 in.	1 3/8 lbs.	.33
	7/8 in.	6 in.	2 lbs.	.38
	1 in.	6 in.	2 3/4 lbs.	.45
	1 1/2 in.	6 in.	3 1/2 lbs.	.50

DRAKE



RADIO IRONS



60 WATT IRON WITH 3/8" TIP

An excellent iron for light work. Highest quality Nichrome wire used in porcelain element. Equipped with 6 ft. heater cord, rubber plug and small stand. Gun metal finish.

No. 315 List \$1.20 Net Price \$.72
Element — List \$0.50 Tip — List \$0.50
 Net \$.30 Net \$.30

Net Weight 1 lb.



65 WATT IRON WITH 1/4" TIP

An excellent iron for light work and tight corners. Highest quality Nichrome wire wound on amber mica. Complete with 6 ft. heater cord, rubber plug and small stand. Gun metal finish.

No. 317 List \$2.25 Net Price \$1.35
Element — List \$1.30 Tip — List \$0.40
 Net \$.78 Net \$0.24

Net Weight 1 lb.

100 WATT IRON WITH 3/8" TIP

SAME DESIGN AS No. 317

Recommended for the radio amateur. Highest quality Nichrome wire wound on amber mica. Complete with 6 ft. heater cord, rubber plug and small stand. Gun metal finish.

No. 320 List \$3.00 Net Price \$1.80
Element — List \$1.50 Tip — List \$0.50
 Net \$.90 Net \$.30

Net Weight 1 1/2 lbs.



125 WATT IRON WITH 3/8" TIP

Recommended for the experimenter who desires an extra hot iron. Highest quality Nichrom wire wound on amber mica. Complete with 6 ft. heater cord, rubber plug and small stand. Gun metal finish.

No. 321 List \$4.15 Net Price \$2.49
Element — List \$1.50 Tip — List \$0.50
 Net \$0.90 Net \$.30

Net Weight 2 lbs.

150 WATT IRON WITH 1/2" TIP

SAME DESIGN AS No. 321

Recommended for light medium work such as chassis spotting. Highest quality Nichrome wire wound on amber mica. Complete with 6 ft. heater cord, rubber plug and small stand. Gun metal finish.

No. 322 List \$5.00 Net Price \$3.00
Element — List \$2.50 Tip — List \$0.60
 Net \$1.50 Net \$0.36

Net Weight 2 lbs.



60 WATT IRON WITH 1/4" TIP

An Extra Small Iron for Midget Sets

Highest quality Nichrome wire wound on amber mica. Complete with 6 ft. heater cord, rubber plug and No. 12 "Magic Cup" stand. Fully nickel plated.

No. 400 List \$4.50 Net Price \$2.70
Element — List \$2.00 Tip — List \$0.40
 Net \$1.20 Net \$.24

Net Weight 2 lbs.

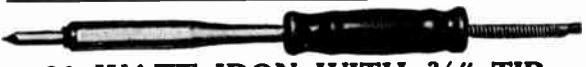

80 WATT IRON WITH 3/8" TIP

Recommended for light radio work. Highest quality Nichrome wire wound on amber mica. Complete with 6 ft. heater cord, rubber plug and No. 12 "Magic Cup" Stand. Fully nickel plated.

No. 225 List \$3.50 Net Price \$2.10
Element — List \$2.00 Tip — List \$0.50
 Net \$1.20 Net \$.30

Net Weight 1 1/2 lbs.

100 WATT IRON WITH 3/8" TIP

SAME DESIGN AS No. 225

Recommended for general radio work. Highest quality Nichrome wire wound on amber mica. Complete with 6 ft. heater cord, rubber plug and No. 12 "Magic Cup" Stand. Fully nickel plated.

No. 325 List \$4.15 Net Price \$2.49
Element — List \$2.50 Tip — List \$0.50
 Net \$1.50 Net \$.30

Net Weight 1 1/2 lbs.



125 WATT IRON WITH 3/8" TIP

AN EXTRA HOT IRON FOR SERVICE MEN. Highest quality Nichrome wire wound on amber mica. Complete with 6 ft. heater cord, rubber plug and No. 12 "Magic Cup" Stand. Fully nickel plated.

No. 325 Special List \$5.00 Net \$3.00
Element — List \$2.50 Tip — List \$0.50
 Net \$1.50 Net \$.30

Net Weight 2 lbs.

200 WATT IRON WITH 5/8" TIP

SAME DESIGN AS No. 325 SPECIAL

Recommended for medium heavy work. Highest quality Nichrome wire wound on amber mica. Complete with 6 ft. heater cord, rubber plug and No. 10 Stand. Fully nickel plated.

No. 425 List \$8.25 Net Price \$4.95
Element — List \$3.50 Tip — List \$0.80
 Net \$2.10 Net \$.48

Net Weight 2 lbs.

DRAKE



Industrial IRONS



80 WATT IRON WITH 3/8" TIP

Recommended for fine instruments, light telephone and other light soldering.

No. 450	List \$4.50	Net Price \$3.17
Element	List \$2.50	Tip List \$0.50
	Net \$1.87	Net \$.37

Net Weight 1 1/2 lbs.

100 WATT IRON WITH 3/8" TIP

Same design as No. 450

For switchboards, radio and other light soldering.

No. 600	List \$6.00	Net Price \$4.50
Element	List \$2.75	Tip List \$0.50
	Net \$2.06	Net \$.37

Net Weight 2 lbs.



100 WATT IRON WITH 3/8" TIP

ONLY 10" OVERALL

Designed for same class of work as our No. 600.

No. 600-10	List \$6.50	Net Price \$4.87
Element	List \$2.75	Tip List \$0.50
	Net \$2.06	Net \$.37

Net Weight 2 lbs.

Speed up production with the

No. 600 SPECIAL

Same design as our No. 600-10

A 140 WATT IRON WITH 3/8" TIP

Recommended for high speed work on radio sets.

No. 600 SPECIAL, List \$7.00; Net Price \$5.25

Element	List \$3.00	Tip List \$0.50
	Net \$2.25	Net \$.37

Net Weight 2 lbs.

The elements of all Drake Industrial Soldering Irons are wound on high grade amber mica with Driver Harris Nichrome 5 and come complete with 10,000 cycle heater cord, rubber plug and "Magic Cup" stand.

You Carry a Spare Tire—

WHY NOT A SPARE SOLDERING IRON?

DRAKE No. 3 "MIDGET"



A 40 watt iron with 1/2" tip complete with container for convenient storage in your tool kit.

No. 3 Midget YOUR PRICE \$0.75



DRAKE "MAGIC CUP" SOLDERING STAND

The most practical soldering stand ever devised. A twist of the wrist and all oxide disappears. Furnished with all Drake Irons shown on this catalog sheet, with the exception of Nos. 3, 315, 317, 320, 321, 322 and 425 irons.

No. 12 List \$0.50 Net Price \$0.38

DOUBLE THE LIFE OF YOUR IRON
with the

DRAKE VARIABLE HEAT CONTROL

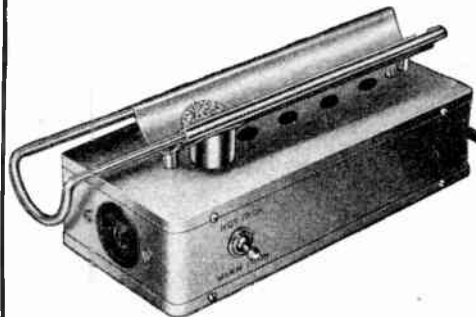

KEEPS YOUR TIP PROPERLY TINNED
• PAYS FOR ITSELF WITHIN A SHORT TIME

With this control you can keep your iron warm at low cost. A flip of the switch and the iron is ready for use in a few moments. For use with any Soldering Iron not exceeding 150 Watts Input. 115 Volts A. C. or D. C. only.

No. 300, without hood List \$4.00 Net \$2.40

No. 300-H, with hood List 4.50 Net 2.70

Net weight 3 lbs.

GENERAL



CEMENT

Radio Cements - Paints

RADIO SERVICE SOLVENT

"Cleans and Dissolves"

Specially prepared for loosening cement on speaker cones, etc. Is also used as a thinner for G-C Service Cement.

No.	Net Price
312—2 oz. bottle	\$.021
314—4 oz. bottle	.30
316—6 oz. economy bottle	.39
318—8 oz. economy bottle	.45
311E—1 pt. economy bottle	.75



RADIO SERVICE CEMENT

The Best Cement for Speaker and Radio Work. Especially suitable for cementing replacement cones and repairing rattling and torn cones. Also used on glass, to seal adjustments, hold wires in place, etc. Dependable, Vibration-Proof, Waterproof, and Fast-Drying.

No.	Net Price
302—2 oz. bottle, brush attached to cap	\$.030
304—4 oz. economy bottle	.54
306—6 oz. economy bottle	.75
308—8 oz. economy bottle	.98
301E—1 pt. bottle	1.80



FILM SPICING CEMENT

High quality fast drying Cement specially prepared for splicing movie camera film.



No.	Net Price
331—1 oz. size	\$0.15
332—2 oz. size	.27

BAKELITE CEMENT

Prepared for cementing Bakelite to Bakelite or Bakelite to other materials. Useful for broken knobs, molded cabinets, etc.



No.	Net Price
322—2 oz. bot.	\$.21
328—Half Pint	.66
321E—Pint	1.20

CEMENT & SOLVENT KIT

Kit consists of 1 bottle of our famous Service Cement and 1 bottle of Service Solvent. Handy Kit to carry with you.



No.	Net Price
343	\$0.30

SPEAKER REPAIR CEMENT IN TUBES

This is our regular service cement put up in a handy tube. Makes a good, general-purpose, waterproof glue. Also useful for speakers, cones, coils, etc.



No.	Net Price
342	\$0.25

TOUCH-UP COLOR CODING KIT

Kit of brilliant enamels for coding parts, resistors, coils, etc. Also for touching up and improving appearance of equipment. Colors: Red, Green, Blue, and Yellow. Solvent and brushes included.



No.	Net Price
675	\$0.30

R.M.A. COLOR CODING KIT

Complete Kit of all of the standard RMA colors: Black, Brown, Red, Orange, Yellow, Green, Blue, Purple, Grey and White. All colors are brilliantly alive. Brushes furnished and RMA color chart is on box. Kit is necessary for complete color coding of parts.



No.	Net Price
677	\$0.54

FROST-X

Provides a frost-like finish that is used for covering window-glass for privacy and to eliminate sun glare. Also is a desirable decorative finish for test equipment, mirrors, vases, etc. Easy to apply.



No.	Net Price
682—1/2 pt. bottle	\$.021
684—1/2 pt. can	.39
688—1/2 pt. can	.63
681E—Pint can	1.20
683E—Quart can	1.80

KRYSTAL KOAT CRYSTALLIZING LACQUER

The famous GC Krystal Koat lacquer. Strictly Air-Drying; forms beautiful floral pattern when dry. For chassis, panels, etc. Can be used on metal, wood or paper. Colors: Black, Gray, Brown, Green, Blue, Red. Specify color.



No.	Net Price
632—1/2 pt.	\$.021
634—1/2 pt.	.39
638—1/2 pt.	.63
631E—Pint	1.20

NOTE: Impenetro Sealer must be used for undercoat when Krystal Koat is applied over other finishes. Same price as black.

DIAL LITE COLORING

Long lasting coloring for multicolored dials. Instant drying. Bright colors of Red, Green, Blue, Amber, Purple, and Solvent. Earn extra money by selling colored dial lites. Dress up those old sets.



No.	Net Price
666—6 bts.	.36
665—5 bts. no purple	.30
661—Bot. of any color	.06
661E—Pint of any color	.90

KROME KOAT ALUMINUM PAINT

Fast drying ready mixed Aluminum Paint. Leaves Chrome-like finish. For P. A. equipment, speakers, poles, chassis, towers, etc.



No.	Net Price
612—1/2 pt.	\$.18
614—1/2 pt.	.27
618—1/2 pt.	.48
611E—Pint	.90
613E—Quart	1.35
61-G—Gallon	3.90

DECORATIVE ENAMELS

High quality Enamels for all purposes. High Gloss. Supplied in Black, Red, Brown, Green, Blue, Yellow, Ivory and White. Specify color desired.



No.	Net Price
652—1/2 pt. All colors	\$0.15
654—1/2 pt. All colors	.27
658—1/2 pt. All colors	.51
651E—Pint. All colors	.96
653E—Quart. All colors	1.80

HANDY POCKET TOOL CASE



Wallet type pocket tool case; fits in the hip pocket. Will hold necessary tools required on job. Saves your pockets and the tools. Made of Genuine Leather.

No.	Net Price
703	\$0.60

FIBRELOID SPEAKER SHIMS



Handy tool for centering voice coils. Kit consists of 5 sizes of specially flexible and tough celluloid shims put up in gold-lettered snap case. Sizes marked — 20 shims to kit.

No.	Net Price
702	\$0.36

TELEPHONE BLACK & GRAY

High grade enamel that covers well and dries fast. Black will produce an ebony black finish that is so familiar on telephone devices. Gray is a pleasing shade. Excellent for panel work and parts. Specify color.



No.	Net Price
622—1/2 pt.	\$.21
628—1/2 pt.	.63
621E—Pint	1.20

SWEDISH STEEL SPEAKER SHIMS



The best shims for centering voice coils. With steel shims adjustments can be made in a few minutes. Made of Swedish Steel, these are very flexible — a permanent tool. Kit consists of 4 sizes, put up in gold-lettered snap case. 16 shims to kit.

No.	Net Price
701	\$0.39

Sky-Ranger Indoor Aerial



A New Aerial Eliminator that really works. Can be used with any radio. Very high grade in appearance and performance. Sells on sight. Improves reception. It can be quickly installed by anyone.

No.	Net Price
1400	\$0.60
(Selling Price \$1.00)	

RADIO REPAIR LITE



Light where you want it—110v. AC or DC

Just the light for Service work in the field. Lights up those hard-to-see corners in Chassis and Refrigerators. Handy for coloring dial lite bulbs. Dip bulb in coloring and job is done.

No.	Net Price
705	\$0.75

NE-O-LITE TESTER

Handy, inexpensive Ne-O-Lite tester that every Radio Man should have for testing A.C. Lines, polarity of A.C. or D.C., testing for blown fuses, tracing ground line in A.C., as a R.F. indicator Spark Plug tester and 101 other uses. Can be used on 60 V. A.C. to 500 V. A.C. or D.C.

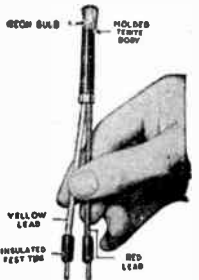

No.	Net Price
706	\$0.60

RADIO CLAMP LAMP

Good light is important and the Clamp Lamp is just the thing. You can clamp it onto chassis or radio cabinet and get light where you want it. Handy to carry with you.



No.	Net Price
708	\$0.99

RADIO BENCH LAMP

Practical Bench Lamp specially made for Radio Work. Flexible arm can be adjusted to any position. Lamp is high enough so it can be used over radio chassis. Base has compartments for screws, knobs, and parts—a special feature in itself! This lamp will save your light bill and your eyes. Eliminates glare—a 25-watt lamp will give better light than a 100-watt over head.



No.	Net Price
707	\$1.95

RUBR-SHIM



Made of Sponge Rubber, adhesive one side, sticks to anything. For rims of radio speakers, chassis, vibrators, condensers, refrigerators, etc. Prevents rattles and vibration.

No.	Net Price
1080— $\frac{3}{8}$ " 10 ft. roll	\$0.27
1081— $\frac{1}{2}$ " 10 ft. roll	.30
1082— $\frac{3}{4}$ " 10 ft. roll	.39
1083— $\frac{1}{2}$ " 50 ft. roll	1.20
1084— $\frac{3}{8}$ " 50 ft. roll	1.35
1085— $\frac{1}{4}$ " 50 ft. roll	1.50

11-PIECE RADIO SOCKET SET

Eleven pieces, $\frac{1}{4}$ " hexagon drive, put up in convenient crystal enameled steel case, as follows: 6 $\frac{1}{2}$ " Wood Grip Screw Driver Handle, 4" L Handle, 3 $\frac{3}{8}$ " Extension adapter, $\frac{1}{4}$ " $\frac{1}{8}$ " $\frac{3}{16}$ " $\frac{1}{4}$ " Hex. Sockets, $\frac{3}{8}$ " Round Knurled Socket, and $\frac{1}{4}$ " and $\frac{3}{8}$ " Square Sockets.



No.	Net Price
713	\$1.05

8-PIECE VEST POCKET SOCKET SET



The smallest, though most complete, and practical 8-Piece Socket Wrench set on the market. An outstanding value. Seven sockets, $\frac{1}{4}$ " $\frac{3}{16}$ " $\frac{1}{8}$ " $\frac{3}{8}$ " $\frac{1}{2}$ " Hex., $\frac{3}{8}$ " Round Knurled, $\frac{1}{4}$ " Square and 4" L Handle with two friction balls, in Baked Enamel Box.

No.	Net Price
712	\$0.45

No-Metal Hex-Wrench



Hard, black fibre trimmer wrench with $\frac{1}{4}$ " hex broaching through it. If ends wear, they can be easily cut to provide a good-as-new wrench.

No.	Net Price
730—6" long	\$0.12
731—8" long	.15
732—12" long	.21

Escutcheon Plate Screws



Bronze plated wood screws such as are used for attaching escutcheon plates to cabinets.

No.	Net Price
1090—Assortment of 100 in a jar.	\$0.27
1091—No. 1— $\frac{1}{4}$ " length, per doz. in envelope	.06
1092—No. 1— $\frac{3}{8}$ " length, per doz. in envelope	.06
1093—No. 2— $\frac{3}{8}$ " length, per doz. in envelope	.06

Insulated Bell Staples

Saddle type insulated staples for holding wires in place and out of the way.

No.	Net Price
1701—No. 1 size (3/16" x 1/2"). Box of 50.	\$0.09
1702—No. 1 size (3/16" x 3/8"). Box of 100.	.15
1703—No. 5 size (1/4" x 3/8"). Box of 50.	.09
1704—No. 5 size (1/4" x 1/2"). Box of 100.	.15

INSULATED HEX WRENCH & SCREW DRIVER



Combination hex wrench and insulated screw driver. The screwdriver may be extended from handle to provide extra long length.

No.	Net Price
735 extends from 7-13"	\$0.39
736 extends from 11-17"	.51

Ornamental Head Screws

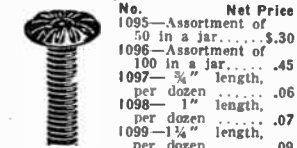

A Rosette head, statuary Bronze head screw, $\frac{1}{8}$ " head with a 6-32 thread.

No.	Net Price
1095—Assortment of 50 in a jar.	\$0.30
1096—Assortment of 100 in a jar.	.45
1097— $\frac{3}{8}$ " length, per dozen	.06
1098— $\frac{1}{2}$ " length, per dozen	.07
1099— $\frac{3}{4}$ " length, per dozen	.09

Solder Lug Assortment

An assortment of 100 of the most necessary soldering lugs needed by the Radio Man. "Ham", or e x p e r i m e n t e r. Lugs are tinued, and neatly stamped.

No.	Net Price
1020	\$0.27

SERVICE BENCH STOOLS

Comfortable Chairs for Radio Repairs. A practical chair or stool has a definite place in the service shop. Every bench should have a good stool for comfortable seating. Stools are made extra strong and will last a life time. They are all double riveted, have wood seats, and 403 Series have wood back rests.



No.	Net Price
401—Steel Stool—wood seat, 24" high	\$4.05
401-A—Steel Stool—wood seat, 26" high	4.35
401-C—Steel Stool—wood seat, 30" high	4.75
403—Chair same as 401 but with back rest, 24" high	6.05
403-A—Chair same as 402 but with back rest, 2h" high	6.35
403-C—Chair same as 401 but with back rest, 30" high (30" stools have turned out foot rest)	6.75

Brass & Fibre Shafting Rods

No.	Net Price
715— $\frac{1}{4}$ " x 6" Fibre	\$0.12
716— $\frac{1}{4}$ " x 1" Fibre	.24
717— $\frac{3}{8}$ " x 6" Fibre	.15
718— $\frac{3}{8}$ " x 1" Fibre	.30
719— $\frac{1}{2}$ " x 6" Brass	.09
720— $\frac{1}{2}$ " x 1" Brass	.18
721— $\frac{3}{8}$ " x 6" Brass	.15
722— $\frac{3}{8}$ " x 1" Brass	.30

Screw Type Chassis Felt Feet



No.	Diam.	Net Price per doz.
1086— $\frac{1}{2}$ "	wood screw	\$0.27
1087— $\frac{3}{8}$ "	6-32 screw	.27
1088— $\frac{3}{4}$ "	wood screw	.30
1089— $\frac{1}{2}$ "	10-32 screw	.30

No-metal Insul. Adjust-ment Screw Driver



Made of Black Bone fibre. Indispensable for aligning all-wave sets. Will give long service. Ends can be re-ground.

No.	Net Price
714—7" long	\$0.21

Felt & Rubber Bumpers

Used on the bottoms of radios and appliances.

Felt Pads

No.	Net Price
1070—50 in env.	\$1.18
1071—100 in env.	.30

Rubber Tack Bumpers

No.	Net Price
1075—10 in env.	.09
1076—25 in env.	.21
1077—Per hund.	.66

Snap Button Hole Plugs

The plug so popular on many sets to seal adjustments, cover holes, etc. Will fit in any material up to $\frac{1}{16}$ " thick.

No.	Net Price
1710—50 assorted plugs in box	\$1.20
1711— $\frac{3}{8}$ " hole dia., per 10	.15
1712— $\frac{1}{2}$ " hole dia., per 10	.21
1713— $\frac{5}{8}$ " hole dia., per 10	.24
1714— $\frac{3}{4}$ " hole dia., per 10	.24
1715— $\frac{1}{2}$ " hole dia., per 10	.42

Snap-in Trimounts

"Take the Place of Screws" The new fastener used on all of the latest sets. Trimounts are used to fasten dial scales, etc. to the radio chassis and also to hold the new built in antennas to the chassis or plastic cabinet. These are often lost while working on the set. Have a stock of replacements on hand.

No.	Net Price
1720—100 assorted types (4 sizes)	\$1.45
1721—100 Small	.42
1722—100 Medium	.42
1723—100 Large	.45
1724—100 Extra Large	.45

GENERAL



CEMENT

Radio Chemicals

LUBE-REX

"Prevents Corrosion"

The best contact cleaner on the market. Fine for attenuators, push button switches, all wave switches, contacts, etc. Cleans contacts and prevents corrosion. The only acceptable lubricant for Philco Mystery controls. Moisture repellent and and rust preventing—fine for



use on locks, fishing reels, guns, dial mechanisms, phonograph equipment, etc. Is especially desirable since it clings to the metal.
No. Net Price
1209 \$0.21
2 oz. bottle

Radio Chassis Cleaner

Make extra money by returning your customer's set thoroughly cleaned from dirt, grease and grime. Chassis Cleaner cleans Radio Chassis, Panels, Test Equipment, etc., without injuring the surface. Buy in gallon quantities and save.

No. Net Price
1238 \$0.30
8 oz. bottle
1231645
16 oz. bottle
123 1/2 G90
1/2 gallon can
123-1G 1.35
gallon can



KRAK FILLER

Fills holes and cracks in wood. Use on cabinets, panels, floors, furniture, etc. Easy to mix and apply. Dries very hard.

No. Net Price
1215 \$0.15

Plastic Iron Cement

New filling compound for use in metals. Fills holes, patches, broken and cracked metal articles.

No. Net Price
1217 \$0.15



Cabinet Repair Glue

A glue specially for use in cabinet repair work. This glue will not cut the finish on the cabinet. A high quality, fast drying glue. Non-better.



No. Net Price
394 \$0.21
4 oz. bottle
39839
1/2 pint can

PARA WAX

A clear moisture-free paraffine-type wax especially suitable for radio parts. Is used to fill in and seal condensers, transformers, parts, etc. that must be protected from moisture. Simply melt and apply.
No. Net Price
5816 \$0.27
Pint can



MICROPHONE CARBON GRANULES



Finest grade, polished carbon. No ash content, so can stand high currents without burning. Enough for several double button Microphones. 3 types.
No. Net Price
1281—No. 100 size—highest sensitivity, best quality reproduction, but packs easily.....\$.45
1282—No. 80 size—Best for general purpose work. Good quality reproduction and does not easily pack..... .45
1283—No. 60 size—Best for hard use—sound trucks, etc. Fair quality reproduction less packing..... .45

NON-STICK IRON TIP COMPOUND

A new development. Prevents iron tips from burning into soldering irons. Saves tips and irons.

No. Net Price
1201—2 oz. bottle..... \$0.21



GC SOLDERING PASTE



High quality non-corrosive paste for radio work.

No. Net Price
1207—2 oz. can..... \$0.09

Cabinet Sound Deadener
Eliminates undesirable cabinet resonance. Product easily applied, simply paint on the inside of the tone chamber or cabinet. Try this on your sound equipment or to improve the tone quality for that fussy customer.

No. Net Price
574 \$0.21
1/4 pint
57839
1/2 pint
571672
Pint
5732 1.20
Quart



PLASTIC SOLDER

A high grade solder compound you can melt with a match. Contains everything necessary to solder. Merely apply on the joint and heat. Especially desirable for antenna work, etc., where soldering has previously been difficult because you could not use your electric iron. Goes further than solder. Strong and non-corrosive.



No. Net Price
428 \$0.60
1/2 pound jar
4216 1.05
Pound can
4232 1.95
2 pound can

Insulating & Dipping Varnish

Clear Amber Insulating Varnish for noisy or buzzing transformers, chokes, field coils, etc. Requires no baking—air dries.

No. Net Price
562 \$0.15
2 oz. bottle
56427
4 oz. can
56845
1/2 Pint can
561875
Pint can



CONTACT & ATTENUATOR SERVICE KIT

"Eliminates Noise . . . Prevents Corrosion"
Ideal kit for cleaning noisy attenuators, tuners, all-wave switches, variable contacts, etc. Consists of special contact cleaner and special corrosion-resistant lubricant. With this



Kit you can easily clean those noisy controls and 9 times out of 10 without dismantling the chassis or control unit. It will pay to use this Kit.

No. Net Price
777—Kit \$0.60

Contact & Crystal Cleaner
Specially prepared for cleaning contacts and crystals. Cleans easily and will not injure delicate parts, crystals, etc. "Hams" and Radio Men will appreciate this item.



No. Net Price
1272—2 oz. bott. \$12
1274—4 oz. bott. .21
1278—8 oz. bott. .36
12716—Pint bott. .66

RADIO DIAL OIL

Special oil for lubricating dial mechanisms. Treated with graphite to assure effective lubrication. You need this for the new complicated dials.



No. Net Price
1245—4 oz. Can with Spout \$1.15

GRAFOLINE

Specially made for noisy controls, switches, and wire wound controls. Will eliminate noises on controls and contacts and on tube prongs.



No. Net Price
1202—2 oz. bottle..... \$0.15

CARBON-X

"For Noisy Carbon Controls"
Here is an item every Service Man has been looking for. A practical method to touch up those worn and noisy spots on carbon volume controls. You simply apply CARBON-X over the bad spots and the job is done. When you cannot sell a replacement control you can do the job with Carbon-X.



CARBON-X is an electrical conductor

No. Net Price
1204—1 oz. bottle..... \$0.24
1205—2 oz. bottle..... .36

Q-DOPE

"Made from Polystyrene"

New Ultra Low Loss Compound that is recommended for high frequency work. Absolutely no loss in Q—fast-drying—maintains coil characteristics.

No. Net Price
372—2 oz. bot. \$0.21
378—1/2 pt. can... .63
3716—Pint can ... 1.20
Special Thinner
412—2 oz. bot.15



LIQUIDOPE

"Genuine All-Wave Coil Dope"

Ideal coil dope for all-wave coil windings. Clear and fast-drying. Gives coils a tough protective film that insures firmness and prevents characteristic changes due to weather.



No. Net Price
362—2 oz. bot. \$0.21
368—1/2 pt. can... .63
3616—Pint can ... 1.20

RADIO CHASSIS JACKS

A practical tool for the Radio Bench. Have you ever tried to prop up a set with boxes, old parts, etc.? If you have, then you will appreciate these jacks. They are quickly adjustable to fit any set, and can be used in any place. Made of metal, they will find a permanent place on your bench and will more than pay for themselves in time saved.

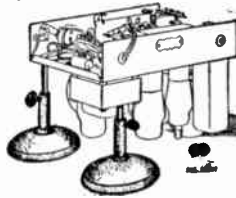

No. Net Price
711—Per pair \$0.75

RADIO CHEMICAL KIT

A complete kit of 8 chemical necessities in a neat leatherette pocket case. The kit makes it easy for the Serviceman to always have his chemical needs with him on the job. Includes the following 8 necessities: Service Cement, Rubber Drive Cement, Carbon-X, Grafoline, Scratch Polish, Non Slip Compound, Dial Oil, and Contact Cleaner. A handy applicator is attached to the cap of each container to make it easy to use. Servicemen should have this kit with them for every outside call.



No. Net Price
999—Radio Chemical Kit..... \$1.05
Any type refill for Kit..... .12

GENERAL



CEMENT

Switches - Insulation - Tape Plugs - Grommets - Tubing

GC Toggle Switches

High grade switches specially made for controlling Radio Sets, Small Motors, etc. The best switches made for the purpose. Underwriters approved. Rated at 3 amps, 125 volts. Made by II & H for G-C. Available in statutory bronze or nickel plated finish.



No.	Description	Shank Length	Net Price
1300	S.P.S.T.	1/2"	\$0.24
1301	S.P.S.T.	1/2"	.27
1302	S.P.D.T.	1/2"	.33
1303	S.P.D.T.	1/2"	.36
1304	D.P.S.T.	1/2"	.45
1305	D.P.S.T.	1/2"	.48
1306	D.P.D.T.	1/2"	.51
1307	D.P.D.T.	1/2"	.54

Toggle Switch Off-On Plate
Fits toggle type switches
Nickel or Bronze
No. 1329 Net Price \$0.02

GC Rotary Switches

Best grade rotary switches specially made for replacements, or construction of new apparatus. Underwriters approved. Rated at 3 amps, 125 volts. Made by II & H for G-C. Shafts 1 1/2" long.



No.	Description	Shank Length	Net Price
1320	S.P.S.T.	3/4"	\$0.27
1321	S.P.S.T.	1"	.33
1322	S.P.D.T.	3/4"	.33
1323	S.P.D.T.	1"	.42
1324	D.P.S.T.	1"	.60
1325	D.P.D.T.	3/4"	.63
1326	D.P.D.T.	1"	.66

Bat Handle Toggle Switches

Same as our regular toggle switch except that the handle is bat shaped. Is specially attractive for panel and instrument boards. 1/2" shank. Nickel Plated only. Made for G-C by II & H.



No.	Description	Net Price
No. 1330	S.P.S.T.	\$0.24
No. 1331	S.P.D.T.	\$0.33
No. 1332	D.P.S.T.	\$0.45
No. 1333	D.P.D.T.	\$0.57

Push Button Switch

A two circuit slow make and quick break momentary contact switch. One circuit is normally on and the other is off. Pushing the button reverses the circuits in use.



Used on many testers and analyzers. Made by II & H for G-C. Shaft 3/8" long.
No. 1340 Net Price \$0.35

Heavy Duty Power Switch

D. P. S. T. power switch. Capacity 12 amps. at 125 volts. Available in both toggle and push-button type. The push-button type is especially adaptable as a safety switch for transformers, high frequency work, etc. Made by II & H for G-C.



No.	Description	Net Price
1350	Toggle type	\$0.69
1351	Push-button type	1.05

Handy Snap Switch

The same switch that is used on many of the new sets. Used as a tone control, phono switch, circuit switch, etc. 1/2" wide—1 1/4" between center mounting holes.
No. 1355—S.P.S.T.... Net Price \$0.12
Plate for above switch
No. 1356..... Net Price \$0.05



Radio Friction Tape

High quality friction tape specially made for Radio Work. Narrow cut eliminates tearing and waste.

No.	Net Price
870—3/8" narrow—65 ft.	\$.15
871—3/4" regular—1/2 lb.	.27

SCOTCH RADIO TAPE

Well known scotch tape for Radio Work. General purpose tape for coils, wires, etc.

No.	Net Price
875—1/2" x 10 yds.	\$0.30
876—1/2" x 72 yds.	1.35

Genflex Adhesive Tape

Clonk back tape specially made for Radio and Electrical work. Excellent insulation. Waterproof, eliminates corrosion.

No.	Net Price
880—1/2" x 10 yds.	\$0.30
881—1/2" x 60 yds.	1.35

INSIDE ANTENNA and LOOP WIRE

Extra flexible brown indoor antenna wire, such as used on Loop and on AC-DC sets. Will take a lot of bending.

No.	Spools	Net
840	25 ft.	\$.15
841	100 ft.	.51
842	500 ft.	2.40
843	1000 ft.	4.50

SPRING ACTION BAKELITE PLUG

Flat Handle grip approved plug. Spring contacts.

No.	Net Price
860—Brown	\$.06

SPRING ACTION CUBE TAP

Bakelite cube tap that will stay in place because of Spring action features.

No.	Net Price
862—Brown	\$.09

GC SOLDER IRON TIPS

Made of best grade hard drawn copper; will fit all makes Irons.

No.	diam.	long	Net
725	3/8"	4 1/2"	\$.27
726	1/2"	4 1/2"	.27
727	3/8"	4"	.36

Circuit Selector Switches

A high quality selector type switch. Used on analyzers, tube testers, and for general radio use. All single hole 1/8" mounting. Thread length and the shaft length is 15/16". Shaft is flat on one end.

No.	Description	Net Price
1360	S.P.S.T.	\$0.33
1361	S.P.D.T.	.33
1362	D.P.S.T.	.33
1363	D.P.D.T.	.33
1364	3 P.S.T.	.39
1365	3 P.D.T.	.45
1366	4 P.S.T.	.45
1367	4 P.D.T.	.54
1368	5 P.S.T.	.51
1369	5 P.D.T.	.60
1370	6 P.S.T.	.57
1371	6 P.D.T.	.66

Insulating Cambric

"Breakdown Voltage—10,000 volts"
Dry yellow varnished cambric for field coils, transformers, chokes, resistors, etc.

No.	Net Price
549—Roll, over 210 sq. in.	\$.30

FYBEROID

"Paraffined" fish paper.

No.	Net Price
560—.010"—240 sq. in.	\$.24

Extension Cord Sets

Brown Rubber cord with Bakelite Cube Tap and Spring action plug.

No.	Net Price
890—6 ft. cord.	\$.24
891—9 ft. cord.	.28
892—12 ft. cord.	.30
893—15 ft. cord.	.34
894—20 ft. cord.	.41

RADIO CORD SETS

Handy replacement cord sets ready to attach to Radio Sets and appliances. Made of approved Brown Rubber cord, with spring action bakelite plug attached. Wires are tinned ready for use.

No.	Net Price
886—7 1/2 ft. cord.	\$.17
887—12 ft. cord.	.21

Spring Action Rubber Plug

Handle Grip approved plug. Spring contacts.

No.	Net Price
861—Black	\$.06

Cube Cord Connection

Bakelite cord connection to fit on end of cord. Make your own extensions.

No.	Net Price
863	\$.09

RUBBER GROMMETS

Live Rubber Grommets for protecting wires when passing through chassis or panel hole. Also make ideal cushions for condensers, sockets, etc.

No.	Net Price
1040—Kit of 50 asst. Grommets.	\$0.45
1041—For 1/4" hole, 3/16" I.D.	.90
Per C	.90
1042—For 3/8" hole, 9/32" I.D.	1.05
Per C	1.05
1043—For 1/2" hole, 5/8" I.D.	1.20
Per C	1.20

Black Rubber Grommets

Suitable for protecting cables and wire from abrasion when passing through a panel hole where strain is not present.

No.	Net Price
1045—Kit of 50 asst. Grommets.	\$0.30
1046—For 1/4" hole, 3/16" I.D.	.54
Per C	.54
1047—For 3/8" hole, 9/32" I.D.	.63
Per C	.63
1048—For 1/2" hole, 5/8" I.D.	.75
Per C	.75



RADIO SPAGHETTI

High grade spaghetti for Radio-Television work. Average dielectric strength—5,000 volts. Very flexible.
Colors: Black, Brown, Red, Green, Yellow.

No.	Net Price
503—No. 17—fit 18 wire.	\$.07
506—No. 14—fit 14 wire.	.07
508—No. 12—fit 12 wire.	.07
512—1/2" I.D.	.15
515—1/2" I.D.	.21
518—1/2" I.D.	.27
521—1/2" I.D. (resistor size)	.33
522—1/2" I.D.	.45
523—1/2" I.D.	.54

(All in 30" Lengths)

COATED SLEEVING



Improved Saturated Sleeveing, lower price than regular spaghetti. Dielectric strength 2,000 volts.

No.	Net Price
528—No. 17—fit 18 wire.	\$.05
531—No. 14—fit 14 wire.	.06
533—No. 12—fit 12 wire.	.06
537—1/4"	.09
540	.12
543	.15
546	.21
547	.24

(All in 30" Lengths)

Resistor Sleeveing



A special-size sleeveing to fit over resistors to insulate them from chassis, parts, etc. 3/8" diam. 30-inch length. Black.
No. 556—Sleeveing..... Net Price \$0.15

Asst. Saturated Sleeveing Kit



An assortment of 7 1/2" lengths of saturated sleeveing. 26 lengths to the kit. Sizes include from No. 17 wire to 3/8" I.D.
No. 550—26 lengths.... Net Price \$0.30

Laminated Bakelite

Genuine laminated Bakelite. Needed by all experimenters, amateurs and Radio men for insulating parts, terminal strips, building sets, etc. 1/16" stock in black.

No.	Net Price
590—6" x 6" x 1/16"	\$.25
591—6" x 12" x 1/16"	.48
592—12" x 14" x 1/16"	1.11

Rubber Chassis Mounts



Live rubber mounts for floating chassis and speakers, to prevent microphonic noises.

No.	Net Price
1030—Kit of 25 assorted	\$.90
Wide High	
1031—1/4" x 3/8", per C.	2.10
1032—1/2" x 3/8", per C.	2.70
1033—1/2" x 1/2", per C.	3.90
1034—1/2" x 3/4", per C.	3.00
1035—1 1/4" x 1 1/2", per C.	6.00
1036—1 1/4" x 3/4", Zenith discs, per C.	4.80

GENERAL



CEMENT

Radio Dial Cables Woven Fabric Dial Belts

General Cement Dial Cables are all Best Quality, Specially made for Radio use.



42 STRAND PHOSPHOR BRONZE CABLE

Highest Grade cable made of 42 strands and constructed over a linen thread center.

No.	Spool Net
71-25	25 ft. \$.69
71-50	50 ft. 1.35
71-1C	100 ft. 2.40

*BRAIDED BRONZE CABLE

A lower quality cable than the No. 71, but a cable that will give good service. Braided Phosphor Bronze Cable.

No.	Spool Net
72-25	25 ft. \$.39
72-50	50 ft. .75
71-1C	100 ft. 1.47

HEAVY LINEN CABLE

Best Quality cord, same as used in Philco, Silver Marshall, Brunswick and others. Made of finest Black Linen Braided.

No.	Spool Net
73-25	25 ft. \$.78
73-50	50 ft. 1.50
73-1C	100 ft. 2.70

EXTRA HEAVY LINEN CABLE

"Same as Used On Philco" A heavier cable than our No. 73. This is the same type and weight of cable used on Philco receivers.

No.	Spool Net
73X-25	25 ft. \$.78
73X-50	50 ft. 1.50
73X-1C	100 ft. 2.70

LIGHT LINEN CABLE

Black Silk Core Highest quality Light Cord, exactly as used in RCA, Wells-Gardner, Majestic, Sonora and others. Made of finest Black Silk Braided. The strongest cable available.

No.	Spool Net
74-25	25 ft. \$.69
74-50	50 ft. 1.35
74-1C	100 ft. 2.40

LIGHT LINEN CABLE

Linen Core A very high grade linen cable. Used for original equipment on many of the older type sets. Has a strong linen core with a closely braided and treated covering to minimize wear.

No.	Net Price
74L-25	25 ft. spool...\$.69
74L-50	50 ft. spool...1.35
74L-1C	100 ft. spool...2.40

SPECIAL THIN-LINEN CABLE

A strong, extra-thin linen cable for replacement where a very thin cord must be used. Braided of finest black linen.

No.	Net Price
75-25	25 ft. spool...\$.45
75-50	50 ft. spool...\$.84
75-1C	100 ft. spool...1.56

SPECIAL LIGHT BRONZE CABLE

A High Quality Special Thin Phosphor Bronze Braided Cable exactly the same as used on RCA and GE sets.

No.	Net Price
76-25	25 ft. spool...\$.45
76-50	50 ft. spool...\$.84
76-1C	100 ft. spool...1.56

SPECIAL-HEAVY GREY CORD

For Kolster and Grebe Sets An extra heavy and extra strong cable, not to be confused with the regular heavy cords.

No.	Net Price
77-25	25 ft. spool...\$1.20
77-50	50 ft. spool...2.10
77-100	100 ft. spool...4.05

PHOSPHOR BRONZE BELTING

Same belting as used on Atwater Kents, Colonial, Steelite, Crosley and others. 3/16" wide x .005" thick.

No.	Net Price
61-25	25 ft. spool...\$.75
61-50	50 ft. spool...1.35
61-1C	100 ft. spool...\$1.11

WHITE BRAIDED LINEN CORD

Same type of cable as used on Emersons. A light colored tightly braided linen cable. Very strong and durable.

No.	Net Price
78-25	25 ft. spool...\$.45
78-50	50 ft. spool...\$.84
78-1C	100 ft. spool...1.56

MONEL METAL DIAL CABLE

A very high grade monel metal cable. It will not ravel, is very strong, won't stretch, and solders very easily. Preferred by many to the popular phosphor bronze cables.

No.	Net Price
79-25	25 ft. spools...\$.45
79-50	50 ft. spools...\$.84
79-1C	100 ft. spools...1.56

EXTRA-THIN METAL CABLE

A strong extra-thin metal cable, now becoming popular. Used especially in the foreign market. Thinner than our No. 76 cable.

No.	Net Price
80-25	25 ft. spool...\$.69
80-50	50 ft. spool...1.35
80-1C	100 ft. spool...2.40

LATEX RUBBER TREATED MEDIUM HEAVY CABLE

A new type dial cord, treated with rubber for extra friction and strength. Will not stretch or ravel. Should be used on dials to prevent slipping on troublesome dials.

No.	Net Price
81-25	25 ft. spool...\$.60
81-50	50 ft. spool...1.14
81-1C	100 ft. spool...2.10

READY MADE DIAL CABLES

Make of Set and Model No.	Net Price
Atwater Kent, 35, 37.....	\$.15
Atwater Kent, 44.....	\$.24
Atwater Kent, 46.....	\$.15
Atwater Kent, 55.....	\$.15
Bosch, 48A.....	\$.15
Bosch, 58, 60.....	\$.15
Brunswick, 15, 22 Front.....	\$.24
Brunswick, 15, 22 Rear.....	\$.24
Gen. Elec., A88, A82, A87, 12	\$.12
Majestic, 70, 71, 72.....	\$.15
Majestic, 15B Lazy Boy.....	\$.15
Majestic, 52, 60.....	\$.15
New Majestic, 60, 620.....	\$.15
Philco, 71.....	\$.15
Philco, 91.....	\$.15
RCA, 44, 46, 47.....	\$.18
RCA, 16, 17, 18, 33.....	\$.18

Cables available for other models also; state Make and Model when ordering or send in old cable.

DIAL DRIVE SPRING ASSORTMENT

Kit of Dial Drive Tension Springs. Six sizes supplied to handle all sets.



No. 1055 — Kit of 25 assorted springs. Net Price...\$.60

No. 1056 — Kit of 100 assorted springs. Net Price...\$2.10

No. 1057 — Any size. Each...\$.03

GC RUBBER DRIVES

Specially made for Atwater Kent, RCA, Stewart Warner, Olsen, Kennedy, Emerson and others. Best quality live rubber drives.



No.	Net Pr.
1025	25 asstd....\$.90
1026	100 asstd....3.30
Each,	any type.....06
All numbers,	per 100.....3.30

No. 15 Philco No. 42-2346...15

DIAL DRIVE CEMENT

Specially prepared for cementing Rubber dial drives to metal shafts, rubber mountings to chassis, or for cementing any rubber material to metal.



No.	Net Price
351—Dial Drive Cement in tube.	\$.27
352—Dial Drive Cement, 2 oz. bottle with brush.	\$.30

SERVICE MEN'S DIAL CABLE KIT No. 1

Kit contains: Four 25 ft. spools of popular type Dial Cable—42 strand Dial Cable—Special thin GE—RCA Cable—Light and Heavy Linen Cable. FREE assortment of Eyelets and Clamps with Kit.

No. 77-SK—Cable Kit..... Net Price \$2.35

SERVICE MEN'S CABLE KIT No. 2

A handy combination Kit of all 12 G-C dial cables listed above. Each type in a separate envelope, and all packed in a leatherette box. No. 78-SK—Complete Kit..... Net Price \$2.55



NON-SLIP COMPOUND FOR RADIO DIALS

Powder Compound for treating friction type dial drives, such as cords, cables, and belts. Easy to use. Just apply freely to slipping parts. No. 1210 Net Price \$1.18



EYELET AND CLAMP ASSORTMENT

The same eyelets and clamps as are used on R E A D Y M A D E CABLES. Make your own cables and belts—AND SAVE! No. Net Price 1028—50 asstd. pieces...\$.15



WOVEN FABRIC RADIO DIAL BELTS

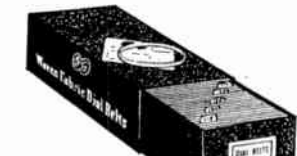

FREE STEEL BOXES SUPPLIED WITH KITS

General Cement Belts are approved replacements for all sets. They are made of best quality material and will not stretch. They are specially treated to prevent slipping. Buy the G-C Red Belt! Net Price Each... \$1.15



SERVICEMEN'S KITS

Servicemen Have an assortment of belts on hand for prompt replacement. Kits contain only the more popular belts used. FREE! WITH EACH KIT—ATTRACTIVE STEEL BOX—BELT SCALE AND COMPLETE LISTING OF OVER 1100 MODELS.

No. G-25	—Kit of 25 popular belts.....	Net 3.75
No. G-50	—Kit of 50 popular belts.....	Net 7.00
No. G-100	—Kit of 100 (Includes every size) Net	13.50

CABLE EYELET TOOL

Inexpensive riveting tool for riveting parts to chassis and for turning eyelets on dial cables and assemblies. Kit consists of a base which can be inserted in a vise and a clincher punch for turning the rivets. No. 740..... Net Price \$3.30



When determining the size of belt required, stretch a thin thread or cord around the belt pulleys. (A thick cord will provide an inaccurate reading.) When taking stretched out measurement of old belts, subtract 3/16" from over all length of stretched out belt to arrive at the correct circumference of belt. Note the stretched out length is not the accurate circumference of belts.

INSTRUCTIONS — FOR MEASURING BELTS

GC Belt Size		GC Belt No.		GC Belt Size		GC Belt No.		GC Belt Size		GC Belt No.		GC Belt Size		GC Belt No.	
6-23/32"	101	7-15/16"	111	9-13/64"	115	10-11/64"	120	11-25/64"	136	12-7/16"	193	13-1/64"	149	17-13/32"	169
6-55/64"	161	8-1/64"	104	9-19/64"	113	10-11/16"	121	11-7/16"	173	12-13/16"	168	13-1/8"	187	17-37/64"	179
6-57/64"	102	8-1/32"	159	9-5/16"	116	10-45/64"	120	11-21/32"	194	12-15/32"	144	13-1/2"	183	17-5/8"	190
6-15/16"	158	8-15/64"	114	9-17/32"	119	10-29/32"	180	11-3/4"	141	12-1/2"	178	13-13/16"	182	18-1/2"	189
7-1/4"	157	8-9/32"	108	9-7/8"	123	10-61/64"	133	11-13/16"	143	12-39/64"	145	13-61/64"	186	18-21/32"	191
7-1/4"	106	8-19/64"	172	9-59/64"	127	10-31/32"	132	12-1/32"	154	13-3/16"	146	16"	192	19-7/16"	166
7-9/32"	156	8-5/16"	162	9-61/64"	126	11"	135	12-1/16"	138	14-27/64"	147	16-19/64"	170	19-47/64"	188
7-13/32"	177	8-29/64"	109	10-1/4"	164	11-5/64"	139	12-3/32"	142	14-7/32"	180	16-11/16"	184	21-5/16"	175
7-15/32"	103	8-1/2"	110	10-17/64"	128	11-9/64"	131	12-7/32"	140	14-11/16"	148	16-15/16"	185	22-35/64"	176
7-1/2"	105	8-5/8"	112	10-19/64"	128	11-9/64"	131	12-9/32"	139	14-57/64"	151	17-1/16"	185	22-49/64"	191
7-19/32"	155	8-39/64"	153	10-23/64"	118	11-5/32"	137								
7-11/16"	107	8-11/16"	180	10-3/8"	122	11-9/32"	x								
7-3/4"	174	8-13/16"	167	10-25/64"	125	5/16"	131V								
7-57/64"	113	9-1/16"	117	10-1/2"	125	11-3/8"	134								

Ask Your Jobber for Complete Belt Listing of Over 1100 Models.



Record Compounds and Accessories Belts - Wire - Glass Crystals

REK-O-DOPE

"New All-Purpose Record Compound"

Cleans - Lubricates - Hardens -
Renews old records and preserves new records and recordings. It improves reproduction as it removes all dirt and loose particles, lubricates the surface and hardens the grooves. Records treated with G-C REK-O-DOPE will give better tone, and will last longer.



No.	Net Price
1261—1 oz. bottle.....	\$.15
1262—2 oz. bottle.....	.21
1264—4 oz. bottle.....	.30
1266—6 oz. bottle.....	.39

RECORD-TURNTABLE FELT



"Ready Cut Pieces"
Replace worn out and "friction-less" felt on record turntables. You or your customers cannot obtain good recordings or reproductions unless the record is held firmly in place on the turntable. Keep a supply of this special felt on hand for that extra-profit job. Pieces cut round, center hole punched.

No.	Net Price
1292—7 7/8" diam.	\$.21
1293—9 7/8" diam.30
1294—11 7/8" diam.39

(Use grille cloth cement as an adhesive.)

RECORD LUBRICANT

Reduces the surface noise and prevents excessive wear on the record or needles. Can also be used for a pre-recording lubricant. Records will last longer when you use a lubricant.



No.	Net Price
1252—2 oz. bottle.....	\$.21
1254—4 oz. bottle.....	.30
1256—6 oz. bottle.....	.45

RECORD CLEANING PAD



For all who use records, this specially treated pad is necessary to clean and remove dust and accumulation from records, without harming them. You can sell record users one of these pads.

No.	Net Price
1290—Size 4" x 4".....	\$.12
1290—Size 6" x 6".....	.18

TEN TIME PHONOGRAPH NEEDLES

Better quality needles that will play 10 records. Specially heat-treated to give better service and last longer. Good needles save your records. Available in extra loud, loud, medium and soft tones.

1421—50 to pkg., specify tone.....	\$.09
1422—100 to pkg., specify tone.....	.15
1423—Carton of 50 pkgs. of 100, assorted tones	7.20
1424—Carton of 50 pkgs. of 100, specify tone..	7.20
1425—Carton of 50 pkgs. of 50, assorted tones	4.35
1426—Carton of 50 pkgs. of 50, specify tone..	4.35

Phono-Turntable Lubricant

"A Stainless Lubricant"

A new special lubricant for phonographs. Other lubricants will thin and run to the lowest point of gravity on the mechanism, but this is specially formulated so that the lubricant clings to the surface of the parts. Eliminate trouble on phono repairs by using the best.



No.	Net Price
1222—2 oz. bottle.....	\$.21

Play Back Phonograph Needles

G-C Phonograph needles are made of the very finest grade tool steel. The points are precision ground, and are accurately cut. They are specially heat treated to give good service. Good needles save the cost of record replacements.



Available in extra loud, loud, medium and soft tones.

No.	Net Price
1401—50 to pkg.—specify tone.....	\$.06
1402—100 to pkg.—specify tone.....	.09
1403—Carton of 50 pkgs. of 100—ass'd. tones	4.35
1404—Carton of 50 pkgs. of 100—specify tone	4.35
1405—Carton of 50 pkgs. of 50—ass'd. tones	2.85
1406—Carton of 50 pkgs. of 50—specify tone	2.85

G-C RADIO HOOK-UP WIRE

G-C Hook-up Wire is constructed of quality material and is particularly intended for Radio Repair and Constructive Work. Available in either Solid or Stranded tinned copper conductors. Colors — Red, Black, Green, Blue, and Yellow.



SOLID PUSH BACK

Cat. No.	Size	Length	Net Price
801	22	25 ft.	\$.15
802	22	100 ft.	.51
805	20	25 ft.	.17
806	20	100 ft.	.57
810	18	25 ft.	.20
811	18	100 ft.	.72



STRANDED PUSH BACK

Cat. No.	Size	Length	Net Price
825	22	25 ft.	\$.17
826	22	100 ft.	.60
830	20	25 ft.	.20
831	20	100 ft.	.66
835	18	25 ft.	.23
836	18	100 ft.	.84

AC RUBBER CORD

"Approved by Underwriters' Labs"

This high grade cord is one of the most popular items in the Electrical and Radio field for a general purpose cord. It can be used on radios, clocks, lamps, and appliances. No. 18 conductors completely covered with rubber.



No.	Net Price
845—Brown color, 100 ft. spool, per C ft.....	\$1.80
846—Brown color, 250 ft. spool, per C ft.....	1.74

GLASS DIAL CRYSTALS

Round Convex dial crystals. Now you can replace those cracked or broken dial crystals and Profit! Can also be used for clock crystals, instrument panels, etc. Available in all different sizes.

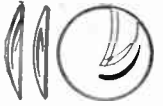

Diam. Net No. (") Price	Diam. Net No. (") Price	Diam. Net No. (") Price	Diam. Net No. (") Price
25 1 3/4 \$.21	35 3 1/4 \$.21	46 4 1/4 \$.27	57 5 7/8 \$.27
26 1 7/8 .21	36 3 1/4 .21	47 4 1/2 .27	58 6 .27
26A 2 .21	37 3 3/4 .21	48 4 3/4 .27	59 6 1/2 .27
27 2 1/8 .21	38 3 1/2 .21	49 4 7/8 .27	60 6 3/4 .27
28 2 1/4 .21	39 3 3/4 .21	50 5 .27	61 6 1/2 .27
29 2 3/8 .21	40 3 3/4 .21	51 5 1/8 .27	62 6 1/2 .27
30 2 1/2 .21	41 3 3/8 .21	52 5 1/4 .27	63 6 3/8 .27
31 2 5/8 .21	42 4 .27	53 5 3/8 .27	64 6 3/8 .27
32 2 3/4 .21	43 4 1/8 .27	54 5 1/2 .27	66 7 .30
33 2 7/8 .21	44 4 1/4 .27	55 5 3/4 .27	74 8 .30
34 3 .21	45 4 3/4 .27	56 5 3/4 .27	

SHELLAC STIKS

For permanently filling in holes and nicks in cabinets and fine furniture. All shades.

No.	Net Price
929—Light Walnut, 7" stick....	\$.15
930—Dark Walnut, 7" stick....	.15
931—Light Oak, 7" stick.....	.15
932—Dark Oak, 7" stick.....	.15
933—Black, 7" stick.....	.15
934—White, 7" stick.....	.15
935—Maple, 7" stick.....	.15
936—Special Spatula.....	.30
937—Alcohol Lamp.....	.15
938—Alcohol Lamp Fuel per pt..	.45

Porcelain Patch Stick

Specially made for white Porcelain Refrigerators. Simply melt into nick and smooth off. Makes a perfect patch.



No.	Net Price
908.....	\$.15

DIAL GLASS KIT

DC-50—Kit of 50 dial crystals complete in handy Free Box. \$11.10

VACUUM CLEANER BELTS



Profit by displaying a card of Vacuum Cleaner Belts. Every Home is a potential customer. Belts made of the very finest grade of live rubber.

No.	Net Price
1010—24 assorted belts on a wire display.....	\$.95
1011—Hamilton Beach Belt, G.E., Premier, etc.....	.06
1012—Hoover Flat Belt.....	.08
1013—Hoover Rubber round type ..	.15

Window Cleaner Concentrate

"Make your own window cleaner and save"

Here's exactly the same compound as is used in the popular window cleaners — make your own and save. You simply add the concentrate to water and have a first grade window cleaner. Concentrate is colored blue. Regular size bottle will make a quart of cleaner.



No. 1225—6 oz bottle.....	Net Price \$1.15
---------------------------	------------------

ALUMINUM FOIL



The ideal shielding material now available in straight lengths. Can be used to form your own shields. Suitable for use as an inside aerial — can be tacked on the back or connected to the aerial post. Has a 100-1 various uses for the Radio Experimenter or Serviceman. Aluminum .0025" thick and supplied in roll lengths.

No.	Net Price
1410—12" x 24".....	\$.24
1411—12" x 48".....	.36

DELUXE CABINET REPAIR KIT



Comes in handy Black Leatherette finish box. Contains nine shades of shellac sticks, bottles of light and dark oil stain, bottles of metal shading varnish, polish, General Scratch Stik, alcohol lamp (with alcohol), spatula, small brushes, steel wool, sand paper, and wiping cloth. Everything necessary for a practical repair job. No special skill required. Directions included.

No. 901 Net Price \$1.95

REFRIGERATOR PATCH KIT

Supplies everything necessary to repair porcelain or Duco nicks, dents, or scratches. Kit contains bottle of pure white lacquer enamel and bottles of yellow, blue, brown, and black tinting colors, a bottle of porcelain glazing compound, solvent, spatula, sandpaper, mixing tins and brushes. Useful on refrigerators, washers, ranges, table tops, etc. Directions included.



No. 902 Net Price \$1.50

RADIO-REFRIGERATOR CABINET PATCH KIT

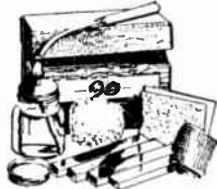

A Kit of the Shellac Patch Sticks to fill all needs. Patches wood, plastics, bakelite and porcelain. Nine shellac sticks for the light and dark shades of wood, and black and white, alcohol lamp (with alcohol), spatula, steel wool, sand paper, and wiping cloth. Directions included.

No. 903 Net Price \$1.35

CABINET TOUCH-UP KIT



A practical Kit for scratches and dents. Includes light and dark stains and light and dark varnish stains that dry almost immediately, brushes, wiping cloth, and a scratch filler.

No. 905 Net Price \$3.60

PLASTIC CABINET TOUCH-UP KIT

"For Plastic and Colored Cabinets"



contains Walnut, Ivory, Black, Red, Blue and Green colors. Brushes furnished.

No. 910 Net Price \$4.45



SCRATCH STIK

Handy Pocket scratch remover. The stick has both a filler and a scratch polish in it. It's hard to avoid making scratches, but they are easy to take out with this stick. The most popular Scratch Stik on the market. Thousands in use. Makes excellent premium for customers. Your name imprinted in Gross logo.

No. 909—Scratch Stik Net Price \$3.30

FRENCH VARNISH



For blending repaired surfaces with the original. Merely apply over the repaired part and it will blend into the original finish and conceal the repair. Dries Fast.

No. Net Price
1602—1/4 pt. bot. ... \$21
1604—1/2 pt. can. ... 39
1608—1/2 pt. can. ... 63
16016—1 Pint can ... 1.20

RUBBING OIL



For rubbing down newly finished cabinets and furniture. Takes the high gloss off newly lacquered and varnished surfaces. Produces a satin-like finish.

No. Net Price
16316—1 Pint \$30
16332—Quart 45
1686—Gallon 1.20

VARNISH STAIN

The same stains that are used in our cabinet touch-up Kits. A durable fast drying varnish with the finishing stains in it. Available in light and dark walnut shades. Specify shade.



No. Net Price
1612—1/2 pt. ... \$15
1614—1/4 pt. ... 21
1618—1/2 pt. ... 39
16116—1 Pint 75
16132—Quart 1.35

PENETRATING STAIN



The stain that is used to cover scratches and nicks on Radio Cabinets, Pianos, Furniture, etc. Specially formulated to penetrate into wood. Fine for darkening the corners on cabinets. Use on all wood. Walnut finish.

No. Net Price
1622—1/4 pt. \$12
1624—1/4 pt. 21
1628—1/2 pt. 39
16216—1 Pint 75

TOPS SPOT CLEANER

A High Grade dry cleaner with a special applicator. The applicator is in the cap—no extra cloth needed. Non-explosive. Sell your customers for extra profits.

No. Net Price
1241—Regular Size bottle \$15
10A—Deal—Includes 36 bottles of Tops Spot Cleaner and display \$4.86
1242—5 oz. bottle \$24
1248—8 oz. bottle 30
12416—16 oz. bottle 45



TOPS SCRATCH REMOVER POLISH

Our famous Scratch Remover Polish put up in a special bottle with an applicator in the cap. Merely rub the applicator over the scratch and the job is done. Display in your shop for extra sales.

No. Net Price
921—Regular Size bottle \$15
9A—Deal—Includes 36 bottles of Tops Scratch Polish and display \$5.10
920—5 oz. bottle 30



MAGIC SCRATCH REMOVER POLISH

Something new! Polish contains the proper stains, etc., to eliminate scratches on cabinets while polishing the cabinet to a gloss! You can sell this to Housewives.

No. Net Price
922—2 oz. bottle... \$12
928—8 oz. bottle... 27
9212—12 oz. bottle... 36
9216—16 oz. bottle... 45



CREME-O-WAX POLISH

The best polish for furniture, radio cabinets, pianos, etc. Truly a wax finish; contains no oil. Dries hard and glossy. Is not sticky. Demonstrate on the job and sell your customer. Easily applied.

No. Net Price
952—2 oz. bottle... \$12
958—8 oz. bottle... 27
9512—12 oz. bottle... 36
9516—16 oz. bottle... 45



CABINET SPEAKER GRILLE CLOTH

High quality cloth that will blend with any cabinet.

No. Net Price
940—18 x 20" \$45
941—9 x 18" 30
942—12 x 12" 27
943—14 x 18" 36
944—24 x 13" 42
945—18 x 13" 33
946—8 x 8" 12
947—9 1/2 x 10" 15
948—6 x 6" 12
949—50" wide. Any length, per yd. 1.80



Special light color Grille Cloth for Plaskon and Ivory Cabinets can be supplied at above prices. Specify "Ivory" when wanted.

LEMON OIL POLISH



A high grade inexpensive lemon oil polish. Polish those sets after repairing for customer good-will. Fast working—Inexpensive.

No. Net Price
918—8 oz. bot. \$15
9112—12 oz. bot. 21
9116—16 oz. bot. 27

PORCELAIN GLAZE

"For Refrigerators & Washers" Easily fills in those nicks in porcelain. Used on refrigerators and washing machines and all porcelain. Merely fill in the nick and smooth over the top.



No. Net Price
911 \$21

SCRATCH CRAYONS

Handy package of Six Shades of Crayon Fillers to match practically all shades of wood.

These are special Stain Fillers. Merely select the filler of the proper shade and run it over the scratch or dent. Works fast.



No. Net Price
912—Per Package \$3.30

MAGIC SCRATCH REMOVER KIT

A combination kit of Scratch Crayons and Scratch Fluid. Handy to have for emergency jobs. Put up in convenient box.



No. Net Price
913 \$3.39

TOPS SELF-POLISH LIQUID FLOOR WAX

Durable no-rub self-polishing Floor Wax. Very Best Quality. Merely apply to the floor and dries to a durable gloss finish. Profit by selling.



No. Net Price
C716—1 Pint \$36
9732—Quart 60
97G—Gallon 1.95

Knobs - Springs - Fabric Ignition Suppressors

BAKELITE KNOBS



MAJESTIC BAKELITE KNOBS
Popular pattern, walnut finish. Set screw, 1/4" shaft.
No. Size Net
1100-3/4" \$.08



ROYAL BAKELITE KNOBS
Beautiful pattern, walnut finish. Set screw, 3/8" shaft.
No. Size Net
1105-3/4" \$.08



YANKEE BAKELITE KNOBS
Modern pattern, walnut finish. Set screw, 1/4" shaft.
No. Size Net
1109-3/4" \$.08
1110-1" .09

POINTER KNOBS



MODERN POINTER KNOBS
Attractive pattern, black finish. Set screw, 1/4" shaft.
No. Size Net
1130-2 1/4" \$.14
1131-1 1/4" .11



STREAMLINE POINTER KNOBS
Popular design, black finish. Set screw, 1/4" shaft.
No. Size Net
1135-2 1/4" \$.09
1136-1 1/4" .08

MIDGET KNOBS



MIDGET BAKELITE KNOBS
Popular knobs for small sets, 1 1/16" diam. Set screw, 1/4" shaft.
Pointer Type
No. Color
1115-Walnut
1116-Ivory
1117-Red
1118-Black
Net \$.06 each

Non-Pointer
Type
No. Color
1111-Walnut
1112-Ivory
1113-Red
1114-Black
Net \$.06 each

WOOD KNOBS



MODERN WOOD KNOBS
Modern pattern, walnut finish. Set screw, 3/8" shaft.
No. Size Net
1120-1" \$.09
1121-1 1/4" .10
1122-1 1/4" .10



ROYAL WOOD KNOBS
Popular pattern, black finish. Set screw, 3/8" shaft.
No. Size Net
1125-3/4" \$.10
1126-1" .11
1127-1 1/4" .11

KNURL SHAFT BAKELITE KNOBS



Bakelite—15/16" diam. spring type to fit 1/4" flat shaft. Has 7/16" extension shank.
No. Net Price
1151-Walnut \$.06
1152-Ivory .06



Bakelite—15/16" diam. knurled shaft with a 7/16" extension shank.
No. Net Price
1153-Walnut \$.08
1154-Ivory .06



Bakelite—15/16" diam. to fit the new style knurled shaft.
No. Net Price
1155-Walnut \$.06
1156-Ivory .06



Midget Bakelite 3/4" diam. knurled type — with 5/16" extension shaft.
No. Net Price
1157-Walnut \$.06
1158-Ivory .06



Midget Bakelite 3/4" diam. knurled type shaft.
No. Net Price
1159-Walnut \$.06
1160-Ivory .06

Radio Push-on Knob Springs

Here's what you've been looking for. An assortment of types of springs used in radio knobs. Will fit in all knobs, such as on Majestic, RCA, Philco, General Electric, etc. You need a Kit.

No. Net Price
1050—Kit of 35 Springs \$.36
1051—Kit of 100 Springs75



RADIO SOCKETS

High quality molded bakelite sockets. High Dielectric. Sockets have plated bronze contacts and will not corrode. Three grounding lugs are on metal base of each socket, and are automatically grounded when the socket is installed. 1 1/8" mounting centers. 1-3/82" mounting hole.



Standard R.M.A. Contact Spacings

No.	Net Price
1524—4 prong	\$.06
1525—5 prong	.06
1526—6 prong	.06
1527—7 prong, standard small	.06
1528—8 prong octal base	.08

RADIO KNOB FELTS

Same as are used behind radio knobs on the latest sets. Prevent scratching and rubbing.



No. Net Price
1065—Box of 25 Felts. \$.15

RADIO KNOB SET SCREWS

Replacement Screws for Knobs. Assortment of 50. Contains various lengths of 6/32, 8/32, 10/32 screws.



No. Net Price
1060 — 50 assorted set screws \$.45
1061 — Any size per 10075

LUGGAGE FABRIC

Aeroplane type—same as used in new portable radios. Necessary to re-cover or repair damaged cases, modernize your old test equipment cases, etc. The logical covering for worn out instrument cases.

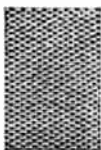

No.	Net Price
960—18" x 18"	\$.27
961—86" x 18"	.51
962—Any length (per yd.) 36" wide	.90

LEATHERETTE INSTRUMENT FABRIC

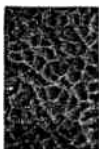

A black leatherette finish fabric for re-covering instrument cases. Same as used by manufacturers. Keep your instruments looking new.

No.	Net Price
965—18" x 20"	\$.27
966—18" x 40"	.51
967—Any length (per yd.) 40" wide	.90

Grille Cloth Fabric Cement

"For Cementing Cloth, Fabric, to Wood"

For cementing grille cloth to radio cabinets and also to adhere the new aeroplane type fabric to the new portable radios, cases, or to wood of any kind. This cement dries quickly and evenly.

No.	Net Price
384—1/4 pt. can	\$.21
386—1/2 pt. can	.36
3816—1 pint can	.66



HUB CAP STATIC ELIMINATOR

Eliminates static noises in front wheels of car. Spring is made with metal point for sure contact.



No. Net Price
1058 Each \$.06
1059—Box of 24 1.35

G-C CALL LETTER TAB SHEET

"General Replacement for Assorted Tabs"

The G-C Tab sheet will enable you to replace or change the call letters with a minimum expense. You merely cut out the proper size letters and paste them on the proper shape tabs. Tabs may be covered with a coating of Service Cement after they are inserted in place to provide a good protective coating and to hold them in place. Enough letters are provided to make up from 150 to 200 individual tabs. Sheet is brown, with white letters.
No. 1181 Net Price \$.09

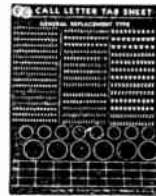

RADIO CHASSIS GUARDS

"The Answer to the Radio Man's Problem!"

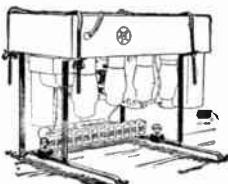

Inexpensive set of guards that will protect the chassis and tubes. When working on set, chassis can be turned in any position without damage to set or tubes. Adjustable to fit all sets. Easily applied

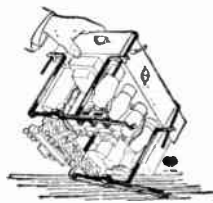

No. 709—Chassis Guards complete, per pair Net Price \$1.25

Quality

Xcelite

Tools

Xcelite NUT DRIVERS

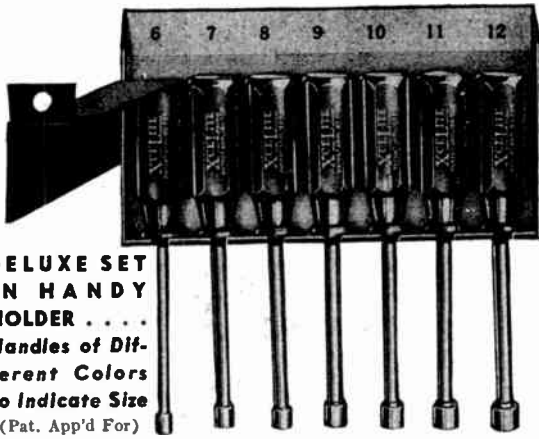

DELUXE SET IN HANDY HOLDER
Handles of Different Colors to Indicate Size
 (Pat. App'd For)

● A great set of tools—and a great time-saver. Each nut driver has a different colored handle to show at a glance its size—no fumbling—no squinting to read printed sizes. Handles are made of special plastic which is shatter-proof, shock-proof, fire proof. Shafts and sockets of high carbon steel, case hardened by special process insuring extreme depth of case. Sockets are precision formed, deep enough to handle two nuts.

Attractive, green finished, metal tool holder (Pat. App'd For) has two screw holes for attaching, and lock bar which covers the nut holders (and the attachment screws) and has eyelets for padlock. Over-all size of tool holder and nut drivers, 7 1/2" x 7 1/4" x 1 1/4". Finish of Deluxe Nut Drivers subject to government decree. List, complete set with holder \$6.10

Color of Handles	Number	Nut Size	List Price	Net Price
Black	6	3/8"	\$0.80	\$0.53
Brown	7	7/16"	.80	.53
Red	8	1/2"	.80	.53
Orange	9	5/8"	.80	.53
Yellow	10	3/4"	.80	.53
Green	11	7/8"	.80	.53
Blue	12	1"	.80	.53

SCREW-HOLDING SCREWDRIVER

The Xcelite Screw-Holding Screw Driver is a tool for which electricians, radio men and mechanics everywhere have long searched. It is a genuine Xcelite product with a unique attachment that instantly and rigidly holds and starts any screw, even one without a head. Spring holder remains in place either above, below or exactly at the driver point. Grasps the screw at the head or 3/8" below giving three point suspension for greater rigidity. Can also be used for removing screws. Comes in 1/2" square blade, 3", 4" and 5". Packed 12 assorted lengths on metal display.

	List	Net
Display, complete	\$6.00	\$4.00
Each50	.33

Xcelite Shockless SCREWDRIVERS

COMPLETE Xcelite SCREWDRIVER PRICE LIST

Number	SQUARE BLADES		Number	ROUND BLADES	
	Description	Net Price		Description	Net Price
SM-183	1/4" x 3"	\$0.50	R-3322	3/8" x 2"	\$0.25
SM-184	1/4" x 4"	.50	R-3323	3/8" x 3"	.25
SM-185	1/4" x 5"	.50	R-3324	3/8" x 4"	.25
S-183	1/4" x 3"	.45	R-181	1/4" x 2"	.30
S-184	1/4" x 4"	.45	R-183	1/4" x 3"	.30
S-185	1/4" x 5"	.45	R-184 1/2	1/4" x 4"	.30
†S-3161	3/8" x 1 1/2"	.55	R-182	1/4" x 2 1/2"	.45
S-3163	3/8" x 3"	.70	R-184	1/4" x 4"	.45
S-3164	3/8" x 4"	.75	R-186	1/4" x 6"	.50
S-3166	3/8" x 6"	.80	R-188	1/4" x 8"	.55
S-3168	3/8" x 8"	.85	R-1810	1/4" x 10"	.60
S-31610	3/8" x 10"	.95	R-5323	5/16" x 3"	.55
†S-141	1/2" x 1"	.65	R-5324	5/16" x 4"	.55
S-142	1/2" x 2"	.80	R-5325	5/16" x 5"	.55
S-144	1/2" x 4"	.85	R-5328	5/16" x 8"	.66
S-146	1/2" x 6"	.90	R-3163	3/8" x 3"	.66
S-148	1/2" x 8"	1.00	R-3164	3/8" x 4"	.70
†S-5161	5/8" x 1"	.65	R-3166	3/8" x 6"	.75
S-5162	5/8" x 2"	.85	R-3168	3/8" x 8"	.80
S-5166	5/8" x 6"	1.10	R-31610	3/8" x 10"	.90
S-5168	5/8" x 8"	1.20	R-142	1/2" x 2"	.75
S-51610	5/8" x 10"	1.30	R-144	1/2" x 4"	.80
S-51612	5/8" x 12"	1.40	R-146	1/2" x 6"	.85
S-388	3/4" x 8"	1.60	R-148	1/2" x 8"	.95
*S-3812	3/4" x 12"	2.25	R-5166	5/8" x 6"	1.05
*S-3818	3/4" x 18"	2.50	R-5168	5/8" x 8"	1.15
*S-7166	7/8" x 6"	1.90	1/2" handles		
*S-71612	7/8" x 12"	2.35	3/4" handles		
*S-71618	7/8" x 18"	2.60			

* Stubby Type. † Double Grip Handles.

For blades insulated full length any size 8 in. or less, add \$0.30 to list. Over 8 in. up to 12 in., add \$0.40 to list.

No. 10 DISPLAY — This Display consists of 10 screwdrivers with 5/32" chrome plated blades in assorted lengths of 3", 4" and 5" all mounted on a very attractive metal display.

List Price, Complete \$5.66
 Net Price, Complete 3.43
 List Price, ea. S.D. .50
 Net Price, ea. S.D. .33

No. 12 DISPLAY — Radio and Ignition Screwdrivers come complete with Pocket Clips assorted with 2", 3" and 4" chrome plated blades in the popular 1/4" diameter size. Packed 12 on an attractive metal display.

List Price, Complete \$3.75
 Net Price, Complete \$2.50
 List Price, ea. S.D. .25
 Net Price, ea. S.D. .17

No. 332 Display — Same as No. 12 except diameter of blades is 3/32". Fits screws on knobs of mid-gut sets; also for fine instrument work. List Price, Complete \$3.15 List Price, ea. S.D. .25
 Net Price, Complete \$2.10 Net Price, each \$0.17

No. 24 DISPLAY — The popular Xcelite pocket screwdriver (another original Xcelite introduction) has a 1/8" diameter chrome plated blade 2" in length. Comes 24 on an attractive metal display.
 List Price, Complete \$7.20 List Price, ea. S.D. \$0.25
 Net Price, Complete 4.80 Net Price, ea. S.D. .17

PHILLIPS SCREWDRIVERS

Xcelite Handles — Alloy Steel Blades

Cat. No.	Description Blade	No. in Box	Weight per box	List Price	Net Price
X-101	3/8" diam., 3" length	6	3/8 lb.	\$0.85	\$0.57
X-102	1/2" diam., 3" length	6	1 1/4 lb.	1.25	.83
X-103	3/8" diam., 6" length	6	2 1/4 lb.	1.75	1.17
X-104	1/2" diam., 8" length	6	3 1/2 lb.	1.95	1.30
SSX-101	3/8" diam., Stubby	6	5/8 lb.	.80	.53
SSX-102	1/2" diam., Stubby	6	1 1/4 lb.	.90	.60

PHILLIPS SCREWDRIVERS — Wooden Handles

P 01	3/8" diam., 3" length	6	1/2 lb.	\$0.60	\$0.40
P-02	1/2" diam., 4" length	6	1 1/4 lb.	.80	.50
P-10	3/8" diam., 6" length	6	2 lb.	.75	.50
P-104	3/8" diam., 8" length	6	3 1/2 lb.	1.00	.67
SP-101	3/8" diam., Stubby	12	5/8 lb.	.60	.40
SP-102	1/2" diam., Stubby	12	1 1/4 lb.	.60	.40

Quality

XCELITE

Tools

XCELITE NUT DRIVERS

Deep hex. sockets capable of handling two nuts are truly formed and entirely free from burrs—tempered and finished, handles of genuine amber XceLite are shockproof, breakproof and comfortable. Can be furnished with fully insulated shank if desired. Display stand holds 7 popular sizes either 6" or 9" long overall. Can also be furnished with 5 wrenches.

Nut Size	No. and Length	List Price	Net Price	No. and Length	List Price	Net Price
3/16"	No. 6—6"	\$0.70	\$0.42	No. A 6—9"	\$0.80	\$0.48
7/32"	No. 7—6"	.70	.42	No. A 7—9"	.80	.48
1/4"	No. 8—6"	.70	.42	No. A 8—9"	.80	.48
9/32"	No. 9—6"	.70	.42	No. A 9—9"	.80	.48
5/16"	No. 10—6"	.70	.42	No. A10—9"	.80	.48
11/32"	No. 11—6"	.70	.42	No. A11—9"	.80	.48
3/8"	No. 12—6"	.70	.42	No. A12—9"	.80	.48
7/16"	No. 14—6 1/2"	.90	.54	No. A14—9"	.95	.57
1/2"	No. 16—6 1/2"	.90	.54	No. A16—9"	.95	.57

Average weight 2 lbs. per dozen

NOTE

For insulated shanks on No. 6 thru 16.....\$0.20 list extra
 For insulated shanks on A6 thru A16..... .25 list extra

NUT DRIVER DISPLAYS

No.	List Price	Net Price
15—Nut Driver Display complete with 5 wrenches Nos. 6, 8, 10, 11, 12.....	\$3.80	\$2.28
17—Nut Driver Display complete with 7 wrenches No. 6 to No. 12.....	5.25	3.15
15—Display Rack only (holds 5 wrenches).....	.30	.18
17—Display Rack only (holds 7 wrenches).....	.35	.21

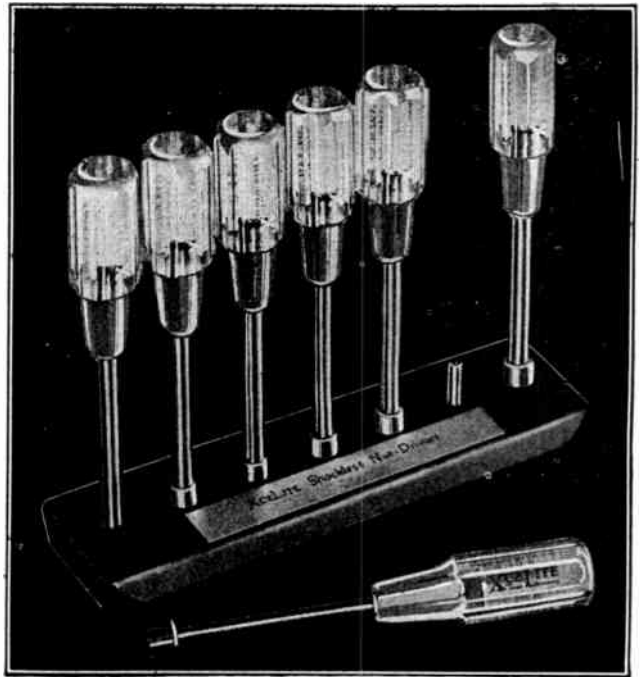

No. 17—Nut Driver Display

HOLLOW SHAFT NUT DRIVERS



This unique, time-saving tool was especially designed for general electrical and radio work. In radio, it is primarily useful in installing and removing volume control and other panel equipment. The nut is readily tightened or loosened without damage to the panel. On telephone or power switchboards, the Hollow Shaft Nut Driver is especially useful where nuts must be installed or removed over long protruding bolts or studs — made with or without insulated shafts. The former for use with high voltage work. Shafts insulated for protection up to 1000 volts; handles to 5000 volts.

Nut Size	Depth of Hole	No. and Length Overall	Weight per Box			Insulated	
				List	Net	List	Net
3/8"	2 1/4"	HS-10 6"	1 lbs.	\$0.90	\$0.54	\$1.10	\$0.66
1/2"	2 1/4"	HS-11 6"	1 lbs.	.90	.54	1.10	.66
5/8"	5"	HS-12 6"	1 lbs.	1.05	.63	1.25	.75
3/4"	5"	HS-14 6"	1 1/4 lbs.	1.10	.66	1.30	.78
7/8"	5"	HS-16 6"	1 1/2 lbs.	1.15	.69	1.35	.81
1"	5"	HS-18 6"	1 3/4 lbs.	1.30	.78	1.50	.90
1 1/8"	5"	HS-20 7"	1 7/8 lbs.	1.50	.90	1.70	1.02

STUBBY NUT DRIVERS

These tools have all the features of the regular XCELITE Nut Drivers, plus the advantage of a short shank for working in close or difficult quarters where a powerful grip is required. The Stubby Nut Driver is a mighty practical tool for installing car radios, working around carburetors, fuel pumps, shock absorbers, etc. Made in 1/4", 5/16", and 3/8" sizes, with extra-deep hexagon sockets to handle two nuts at once.

Sockets are truly formed and free of burrs. They are tempered and fully finished. Handles are genuine shockproof XceLite.

Handle, 1 1/4" diameter
 Overall Length 3 1/4"
 Shaft, 1 1/4" hollow
 Weight per doz., 1 1/2 lbs.

List Price
 \$0.70
 Net Price
 \$0.42

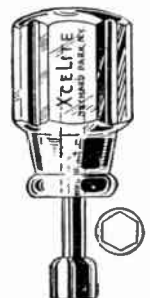

Quality

XCELITE

Tools

XCELITE "Combination Detachable" SCREWDRIVER

Here's convenience—and saving—combined in a mighty unique and useful tool. The XCELITE Combination Detachable Screwdriver has a genuine XceLite Shockless Handle, hollow to receive the dual-blade screwdriver units listed below. With this practical XceLite handle and, for example, a No. 2 Phillips blade on one end and a 1/4" XceLite blade on the other, you have two screwdrivers for just about the price of one! What's more, you can buy blades of other sizes to fit the same handle. Note the unique ball fastener on the blade. This holds the screwdriver unit securely in place—yet readily slips out when desired.

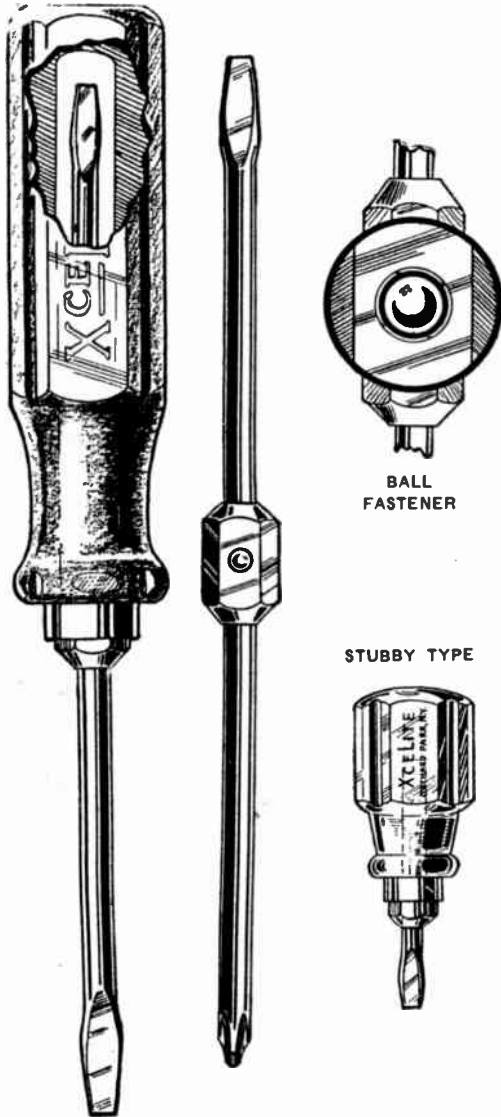

BLADE COMBINATIONS

(Order by Number)

- No. 1 — No. 1 Phillips and 1/8" XceLite
- No. 2 — No. 2 Phillips and 1/4" XceLite
- No. 3 — No. 3 Phillips and 3/8" XceLite

STUBBY TYPE (overall length 3")

- No. S-1 Stubby — No. 1 Phillips and 1/8" XceLite
- No. S-2 Stubby — No. 2 Phillips and 1/4" XceLite
- No. S-3 Stubby — 3/8" XceLite and 1/4" XceLite

PRICES

	Regular		Stubby	
	List	Net	List	Net
Complete	\$1.45	\$0.97	\$1.10	\$0.73
Extra Handles75	.50	.65	.43
Extra Blades75	.50	.50	.33

6" XCEL Adjustable SOCKET WRENCH (with Attachments)

A whole set of tools in one! Easy, light-weight tool to handle; yet super tough due to its drop-forged construction of special chrome nickel steel. Chrome finished. Fits any size nut, hexagon or square, round or odd shaped, from 1/4" to 1". Has two mighty useful attachments—hammer head of unbreakable XCELITE and an alloy steel screwdriver to insert in small end of wrench to form offset screwdriver.

List Price, complete, \$1.75

Special Dealer Price \$0.98

Individually boxed, packed 6 to a self-selling display carton.

Weight, 6 lbs.

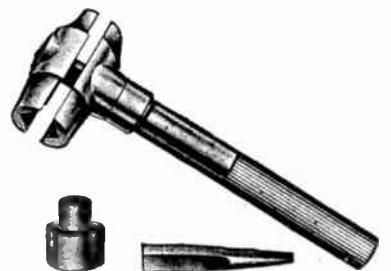

Quality

XCELITE

Tools

XCEL PLIERS

XCEL pliers are made for radio and electrical work. They embody in their design suggestions from radio and electrical engineers and technicians. Recent advances in the manufacture of alloy steel have enabled us to still further improve the quality. From drop forging to final inspection, the best methods and highest standards prevail. Xcel pliers are fully guaranteed against defects of material or workmanship

and any plier showing such defects will be cheerfully replaced if returned to us.

Please do not ask us to replace cutting pliers which have been abused by attempting to cut metal which has been case hardened or otherwise hardened. Pliers which have been filed or reground or burnt from a live wire are not replaceable. If pliers break, return ALL broken parts. Remember, pliers wear out. When they do, don't expect free replacement.



No. 60—Xcel Side Cutting Plier 6" List, \$1.90 Net, \$1.33

The handles of this plier are designed to afford the greatest leverage. The plier is lighter in weight than the regular lineman's side cutter and is designed for radio and light electrical work. Drop forged from finest alloy steel and skillfully tempered, its cutting qualities are unsurpassed by any side cutting plier. Knives are hand honed.



No. 58—Xcel Radio Special 7" List, \$2.90 Net, \$2.03

This plier must be seen to be appreciated. It combines the usefulness of a diagonal and needle nose. Excellent for crushing and stripping insulated wire. Knives are hand honed and useful in the "hard to get at" places.

NOTE: Not guaranteed against breakage.



No. 59—Xcel Chain Nose Electricians Plier 7 3/4" List, \$2.50 Net, \$1.75

A plier that should be in every Radio and Electrical worker's kit. It has literally a dozen special uses. It is of very sturdy construction yet is so streamlined that it easily gets into places no other plier can. A very popular number. Drop forged from finest alloy steel.



No. 55—Xcel Diagonal 5" List, \$2.20 Net, \$1.54

This plier has special features not found in any other diagonal on the market and embodies suggestions made by Radio and Electrical engineers. The throat of the jaws is flattened for crushing insulation on wires before removal and for taking out "kinks" in the wire. These pliers are drop forged from a special analysis alloy steel and the most exacting care is used in their heat treatment. The jaws are hand honed and will cut clean and stand up. This is a special diagonal plier designed for Radio Electrical use exclusively. Not recommended for general use.



No. 57—Xcel extra Long Duck Bill 7" List, \$2.20 Net, \$1.54

This duck bill plier has that extra long reach for the "hard to get at place." It is sturdy, being made from a special alloy steel. Made to fit the hand. A superior plier of this type.



No. 56—Xcel Wrench Plier 6" List, \$1.10 Net, \$0.77

Here is the handiest battery plier you ever used. It is so designed that gripping the handle forces the object in against the jaws instead of out and away. Will handle anything round, square or hexagon, a wonderful all around general purpose plier. Has jaws milled with pipe wrench teeth. Drop forged from tough nickel molybdenum steel, expertly heat treated. Range of jaws 3/8". Three adjustments.



No. 51—Xcel Long Needle Nose and Side Cutter Plier 7" List, \$2.20 Net, \$1.54

Xcel long needle nose side cutting plier is drop forged from the finest alloy steel. The nose is spring tempered and the cutting knives are hand honed. Every radio repair man knows how handy this plier is.

No. 62—Xcel Ignition Plier 5" List, \$0.90 Net \$0.63

This plier is of the same general construction as the No. 56 except it is much smaller, being 5" long. Extremely useful both for Radio and ignition work.

JACKSON SOLDERING IRONS

No. 121 55 WATTS



Tip $\frac{3}{8}$ dia. Length 11 in. Weight 8 oz. Highly polished nickel plated tube. 6 ft. Heater Cord with Rubber Cap. Mahogany Handle. Removable Copper Tip.

Model 121	List Price	\$1.50
Extra Tips, each	List Price	.25
Elements, each	List Price	.65

No. 216 55 WATTS



Tip $\frac{3}{8}$ dia. Length 12 in. Weight 8 oz. Highly polished nickel plated tube. 6 ft. Heater Cord with Rubber Cap. Mahogany Handle. Adjustable Copper Tip with set screw.

Model 216	List Price	\$1.50
Extra Tips, each	List Price	.25
Elements, each	List Price	.65

SOLDERING IRON KIT



Complete with 55 watt iron and stand. Gun Metal Finish. Removable Tip. Solder and Paste, Emery Cloth.

Model 121K	List Price	\$1.50
------------------	------------	--------

No. 217 75 WATTS



Tip $\frac{3}{8}$ dia. Length 12 in. Weight 10 oz. Highly polished nickel plated tube. 6 ft. Heater Cord with Rubber Cap. Mahogany Handle. Adjustable Copper Tip with set screw.

Model 217	List Price	\$2.15
Extra Tips, each	List Price	.40
Elements, each	List Price	.95

No. 218 100 WATTS



Tip $\frac{1}{2}$ dia. Length 12 in. Weight 14 oz. Highly polished nickel plated tube. 6 ft. Heater Cord with Rubber Cap. Mahogany Handle. Adjustable Copper Tip with set screw.

Model 218	List Price	\$2.50
Extra Tips, each	List Price	.55
Elements, each	List Price	1.75

SOLDERING PENCIL



The Tool You've Been Waiting For! A 25-watt, $\frac{1}{4}$ inch soldering pencil that does the work of any 100-watt iron. The result of extensive research. Extremely economical. Brass wound, mica covered element guarantees durability. 6-ft. approved rubber cord and plug. Model 230, complete with 3 tips and stand.

Model 230	List Price	\$1.50
Model 231 ($\frac{3}{8}$ " tips—40 Watts)	List Price	\$2.00

BATTERY CLIPS—Heavy Spring Jaw Clips for Instant Connection

No. 206—Midget Size, 5 Amp.

Electro-Plated—1½ in. Long

List Price.....\$5.00 C

No. 123B—Small Size, 10 Amp.

Electro-Plated—2 in. Long

List Price.....\$5.00 C

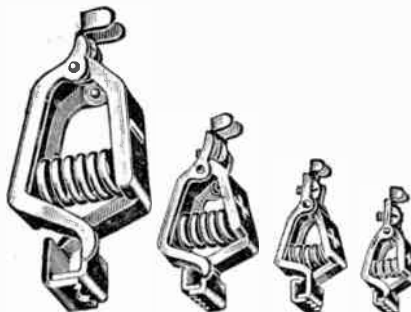

No. 123—Medium Size, 25 Amp.

Electro-Plated—2¾ in. Long

List Price.....\$8.00 C

No. 124—Large Size, 50 Amp.

Electro-Plated—3¾ in. Long

All above packed 50 to Carton.

List Price.....\$12.00 C



No. 117
AUTOMATIC VOLTAGE CONTROL

For all standard Sets. Individual Box
List Price..... Each \$0.68

No. 125
HEAVY GRIP TITE GROUND CLAMP

With Set Screws—Electro-Plated
Packed 50 to Carton
List Price.....\$5.50 C



JACKSON SOLDERING IRONS

FEATURES

The sturdy construction of JACKSON Irons guarantees long usage and hard wear. Every part is carefully manufactured, and tested in our fac-

tory before shipping. Standard Soldering Irons are individually packed in orange and black cartons, plainly marked as to type and voltage.

No. 141 75 WATTS



Tip $\frac{1}{8}$ dia. Length 12 in. Weight 12 oz. Highly polished nickel plated tube. 6 ft. Heater Cord with Rubber Cap. Removable Mahogany Handle. Removable Copper Tip.

Model 141	List Price	\$3.00
Extra Tips, each	List Price	.40
Elements, each	List Price	1.35

No. 142 100 WATTS



Tip $\frac{1}{2}$ dia. Length 12 in. Weight 16 oz. Highly polished nickel plated tube. 6 ft. Heater Cord with Rubber Cap. Removable Mahogany Handle. Removable Copper Tip.

Model 142	List Price	\$3.75
Extra Tips, each	List Price	.55
Elements, each	List Price	1.75

No. 144 150 WATTS

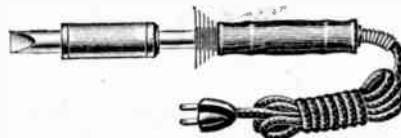

Tip $\frac{3}{8}$ dia. Length 12 in. Weight 20 oz. Highly polished nickel plated tube. 6 ft. Heater Cord with Rubber Cap. Removable Mahogany Handle. Removable Copper Tip.

Model 144	List Price	\$6.00
Extra Tips, each	List Price	.80
Elements, each	List Price	2.75

No. 143 200 WATTS

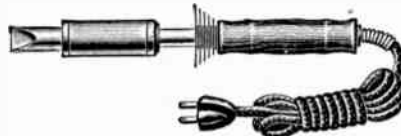

Tip $\frac{3}{4}$ dia. Length 13 in. Weight 24 oz. Highly polished nickel plated tube. 6 ft. Heater Cord with Rubber Cap. Removable Mahogany Handle. Removable Copper Tip.

Model 143	List Price	\$8.00
Extra Tips, each	List Price	.95
Elements, each	List Price	3.75

No. 149 75 WATTS



Tip $\frac{3}{16}$ dia. Length 12 in. Weight 12 oz. Highly polished nickel plated tube. 6 ft. Heater Cord with Rubber Cap. Removable Black Handle. Adjustable Copper Tip with set screw.

Model 149	List Price	\$3.25
Extra Tips, each	List Price	.55
Elements, each	List Price	1.20

No. 145 100 WATTS



Tip $\frac{3}{8}$ dia. Length 12½ in. Weight 16 oz. Highly polished nickel plated tube. 6 ft. Heater Cord with Rubber Cap. Removable Black Handle. Adjustable Copper Tip with set screw.

Model 145	List Price	\$4.50
Extra Tips, each	List Price	.65
Elements, each	List Price	1.85

No. 146 150 WATTS

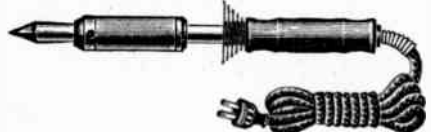

Tip $\frac{1}{2}$ dia. Length 12½ in. Weight 20 oz. Highly polished nickel plated tube. 6 ft. Heater Cord with Rubber Cap. Removable Black Handle. Adjustable Copper Tip with set screw.

Model 146	List Price	\$7.00
Extra Tips, each	List Price	.80
Elements, each	List Price	2.75

No. 147 200 WATTS

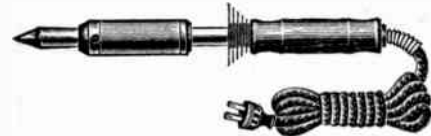

Tip $\frac{5}{8}$ dia. Length 12½ in. Weight 24 oz. Highly polished nickel plated tube. 6 ft. Heater Cord with Rubber Cap. Removable Black Handle. Adjustable Copper Tip with set screw.

Model 147	List Price	\$10.00
Extra Tips, each	List Price	1.10
Elements, each	List Price	3.75

Approved by Underwriters Laboratories

VASCO

TRADE-MARK REG. U. S. PAT. OFF.

ELECTRIC SOLDERING IRONS

(APPROVED BY UNDERWRITERS' LABORATORIES)

No. 85—A brand new iron in the VASCO line for high speed soldering on wiring and other light electrical work.



Cat. No.	Diameter of Tip	Watts	Net Weight	Length Over All	Diameter Over All	Shipping Weight Approximate	List Price	Extra Element No. 85E	Extra Tip No. 10038
85	3/8 in.	85	14 oz.	12 ins.	3/8 in.	2 lbs.	\$5.50	\$2.35	\$0.40

No. 100—Used exclusively by radio factories, telephone switch-board work and other light duty production jobs.



Cat. No.	Diameter of Tip	Watts	Net Weight	Length Over All	Diameter Over All	Approximate Shipping Weight	List Price	Extra Element No. 100E	Extra Tip No. 10038
100	3/8 in.	100	16 oz.	12 1/2 ins.	3/8 in.	2 lbs.	\$7.20	\$3.60	\$0.40

No. 150—A medium weight iron for chassis spotting, radio work, small metal parts. Provides the extra heat needed for many jobs.



Cat. No.	Diameter of Tip	Watts	Net Weight	Length Over All	Diameter Over All	Approximate Shipping Weight	List Price	Extra Element No. 150E	Extra Tip No. 15012
150	1/2 in.	130	19 oz.	12 3/4 ins.	1 in.	2 lbs.	\$8.50	\$4.75	\$0.80

No. 180—An excellent iron for general shop and garage use. Large enough for light sheet metal work, and auto electricians.



Cat. No.	Diameter of Tip	Watts	Net Weight	Length Over All	Diameter Over All	Approximate Shipping Weight	List Price	Extra Element No. 180E	Extra Tip No. 20058
180	5/8 in.	200	28 oz.	13 3/8 ins.	1 1/4 ins.	3 lbs.	\$9.60	\$5.25	\$1.25

No. 300—Used extensively for sheet metal work, small motor factories, general service, and production work.



Cat. No.	Diameter of Tip	Watts	Net Weight	Length Over All	Diameter Over All	Approximate Shipping Weight	List Price	Extra Element No. 300E	Extra Tip No. 30078
300	7/8 in.	300	42 oz.	14 3/8 ins.	1-9/16"	4 lbs.	\$11.50	\$6.50	\$1.75

No. 500—A heavy duty industrial iron for hard service. Used by tin shops, copper-smiths and other production jobs requiring a heavy iron.



Cat. No.	Diameter of Tip	Watts	Net Weight	Length Over All	Diameter Over All	Approximate Shipping Weight	List Price	Extra Element No. 500E	Extra Tip No. 55098
500	1 1/8 ins.	500	60 oz.	15 ins.	1 3/4 ins.	5 1/2 lbs.	\$15.00	\$10.00	\$2.50

All irons furnished for 105-120 volts, A.C. or D.C., also 215-230 volts A.C. or D.C. Special voltages can be furnished upon request.

HOTSPOT

TRADE-MARK

ELECTRIC SOLDERING IRONS

(APPROVED BY UNDERWRITERS' LABORATORIES)

THE 1941 Series HOTSPOT IRONS are the finest popular priced iron on the American market. HOTSPOT irons are furnished with the NEW bakelite handle, which incorporates terminal connector, strain relief, and handle all in one (except No. 75). New also is the highly efficient nested heat retarding union—keeps the handle cool at all times. These are exclusive HOTSPOT features. (Patents pending.) HOTSPOT IRONS all have "Compression-Type" elements, wound on genuine amber mica, insuring the maximum thermal efficiency and electrical strength. Chromel "A" resistance alloy used exclusively in winding HOTSPOT IRONS. Although designed primarily for intermittent duty, thousands of HOTSPOT IRONS are used in industrial plants and shops.



Cat. No. 75—60 Watts— $\frac{1}{4}$ " Tip.
Weight 8 oz.

LIST PRICE\$3.75
Extra tip, No. 75T..... .25
Extra element, No. 75E..... 1.45

The NEW "BABY" HOTSPOT Iron—For Tool Kit or Bench

FEATURES { LIGHT WEIGHT (Only 8 ounces)
SMALL TIP for close places ($\frac{1}{4}$ ")
SHORT LENGTH—Just 8 $\frac{1}{2}$ inches
HANDY SIZE—Plus plenty of heat.



Cat. No. 850—85 Watts— $\frac{3}{8}$ " Tip.
Weight 12 oz.

LIST PRICE\$4.50
Extra tip, No. 10038..... .40
Extra element, No. 850E..... 1.50

This is an efficient, quick-heating iron for wire connections and other light soldering jobs. Equipped with plunger tip and indestructible element, same as used in higher-priced irons.



Cat. No. 10—100 Watts— $\frac{3}{8}$ " Tip.
Weight 1 lb.

LIST PRICE\$5.00
Extra tip, No. 10038..... .40
Extra element, No. 10E..... 1.75

An ideal iron for radio assembly and other light soldering. Plunger tip completely surrounded by element, thereby utilizing maximum heat.



Cat. No. 15—150 Watts— $\frac{1}{2}$ " Tip.
Weight 1 lb. 4 oz.

LIST PRICE\$5.75
Extra tip, No. 15012..... .80
Extra element, No. 15E..... 2.50

Has the extra heat necessary for chassis spotting. An excellent iron for the shop, radio work, etc.



Cat. No. 18—200 Watts— $\frac{5}{8}$ " Tip.
Weight 2 lbs.

LIST PRICE\$7.50
Extra tip, No. 20058..... 1.00
Extra element, No. 18E..... 3.75

A general purpose iron for shop, garage and light sheet metal work. Also used by radio factories.

(See other side)

American Beauty

ELECTRIC SOLDERING IRONS

Durable • Dependable • Efficient

"American Beauty" Electric Soldering Irons embody those features of design and construction that 46 years of specialized experience in the exclusive manufacture of electric heating appliances have demonstrated to be desirable for efficient and lasting service.

RELATIVE SIZES AND SPECIFICATIONS

Nos. 3138 to 3198 are typical in design and construction, varying only in sizes and capacities. All are built with baffle-plate to prevent free conduction of heat from heating unit to wood handle. Baffle-plate of No. 3138 is of such dimensions as not to interfere with the use of the iron in limited spaces. Can be supplied in special wattages to meet particular conditions. Made for use on all standard voltages and for 32 volts. No. 3138 also made for use on 12 volts. Nos. 3138 to 3198 can be equipped with 3-conductor cord, one wire grounded, at slight additional charge.



S-76

No. S-76 is a small iron designed and intended for very light work. Its wattage consumption is but 50 watts. It differs from the Nos. 3138 to 3198 in design and construction. Its tip is of the screw-on type, with tapered fit, and screws on to aluminum head of heating element.

Cat. No.	Watts	Diam. of Tip	Length Over All	Net Weight
S-76	50	$\frac{1}{8}$ in.	11 $\frac{1}{8}$ in.	6 oz.
3138	100	$\frac{3}{8}$ in.	12 $\frac{1}{8}$ in.	16 oz.
3158	200	$\frac{5}{8}$ in.	13 $\frac{1}{8}$ in.	28 oz.
3178	300	$\frac{7}{8}$ in.	14 $\frac{1}{8}$ in.	42 oz.
3198	550	1 $\frac{1}{8}$ in.	15 in.	60 oz.

S-76—List Price.....\$4.50 Net Price.....\$2.98

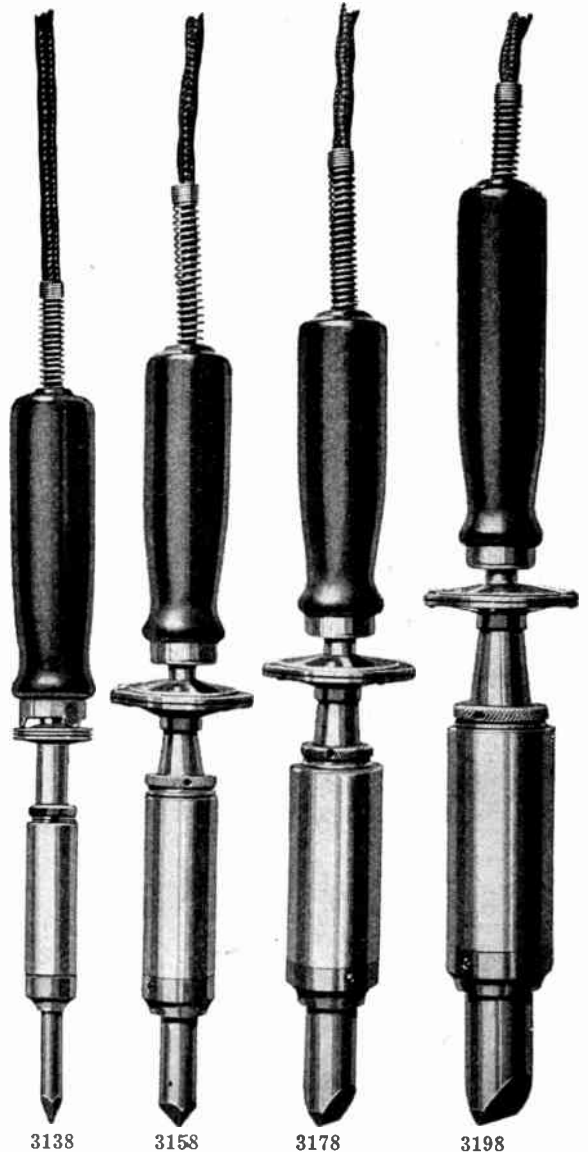

3138

3158

3178

3198

TEMPERATURE REGULATING STAND

No. 475

List	\$7.20	\$8.60	\$11.50	\$15.00
Net	4.79	5.72	7.67	9.98

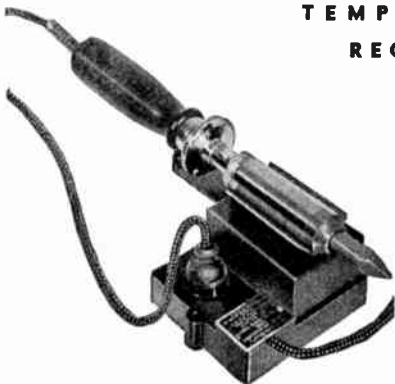

List Price

\$4.95

Net Price

\$3.46

← This is a thermostatically controlled device for the regulation of the temperature of electric soldering irons. When placed on this stand, the soldering iron is maintained at working temperature, ready for instant use, or if desired, at a lower temperature. Through an adjustment on bottom of stand, thermostat may be set for maintenance of any desired temperature from very low, or warm, to full working temperature. Body of stand is of molded plastic. Soldering iron holder proper is of copper. Stand is provided with cord and attachment-plug cap for connection to current and with a receptacle for connection of the electric soldering iron. It is designed for use with electric soldering irons up to 660 watts capacity and on circuits up to 240 volts, AC only.

ELECTRIC • SIGNAL • DRILLS

1/4" Light Duty

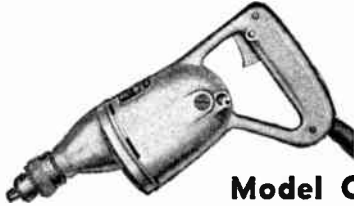

Model OB-8

\$22.50 List

The OB-8 light duty drill is designed for intermittent service. It is a good, high quality product, properly balanced, with an air-cooled handle having a comfortable grip. Light in weight, it is especially adaptable for radio repair work, wood and metal assembly, airplane construction, boat building and kindred applications.

1/2" Standard Duty

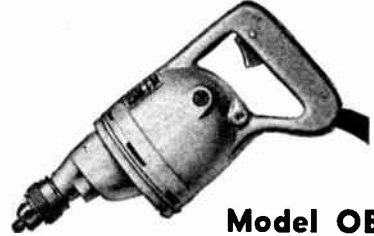

Model OB-4

\$26.50 List

For general maintenance, construction and building work the OB-4 standard duty drill will give dependable service. It is popular with electricians, carpenters, machinists and repairmen. It has an abundance of power developed by a smooth-running universal motor. It is well balanced, has a comfortable grip and air-cooled handle.

Inside Views

of

SIGNAL DRILLS

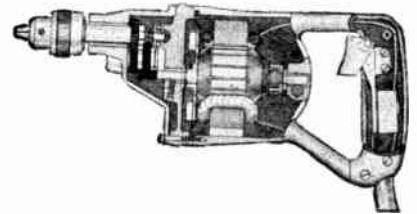
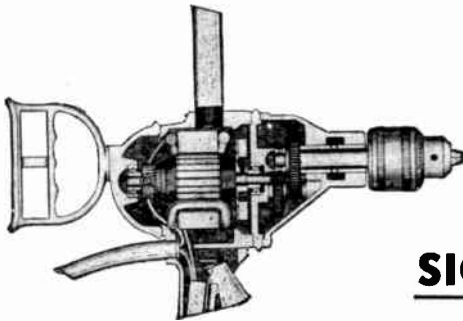

1/2" Standard Duty

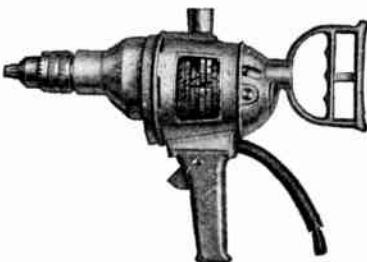

Model OB-5

\$47.50 List

To cooperate with the War Effort we reserve the privilege of altering specifications or materials, without notice.

This standard duty half-inch drill has everything a good drill should possess—lots of power, proper speed, light weight, durability, high quality construction and correct balance. For general production, garage, machine shop and maintenance work where a drill receives hard use, it is recommended. Contractors, plumbers, electricians, and others will find it can be depended upon to give efficient service at all times. Attractively priced, this drill has established for itself a fine reputation that is recognized by users and distributors alike.

SPECIFICATIONS

Motor: Universal for direct or alternating current, 110-120 volts, 25-60 cycles.

	OB-8	OB-4	OB-5
Code Word	SEMED	SEMEB	SEMEC
List Prices (110-120 volts)	\$22.50	\$26.50	\$47.50
Special Voltages	10 percent addition list.		
Overall Length	12"	12 3/8"	16 1/2"
Bearings	Bronze wool packed with thrust ball spindle bearing.		Armature and spindle thrust high grade ball.
Capacity	1/4"	1/4"	1/2"
Speed (No load R.P.M.)	2950	1700	400
Ampere (No load)	1.0	.9	1.8
Switch	Trigger type with lock for continuous operation.		
Cord Length	Not to exceed 7 feet.		
Net Weight	5 1/4 lbs.	7 1/4 lbs.	14 lbs.
Shipping Weight	7 lbs.	8 lbs.	16 lbs.
Pipe Handle	Detachable		
Cord	Heavy duty, rubber covered with rubber cord protector. 3 conductor.		
Plug	Rubber		
Brushes	Accessible from outside.		
Gears	Special alloy, heat treated.		
Housing	Durable aluminum alloy.		
Chuck	Jacobs, 3-jaw, with key.		

V A C O

AMBERYL SHOCK & BREAK PROOF HANDLE SCREW DRIVERS
DEEP GROOVE SURE GRIP HANDLES — ALLOY STEEL BLADES — FULLY GUARANTEED

AMBERYL "Lifetime" TOOL STEEL SCREW DRIVERS

The finest tool steel blades, heat treated to give long hard service—FULLY GUARANTEED.

Stock No.	Blade Size	Style	List each	Dealer each
A116	2"- .0925x2	Pocket Clip	\$.35	\$.23
A116	3"- .0925x3	Pocket Clip	.35	.23
A116	4"- .0925x4	Pocket Clip	.35	.23
A130	2"- 1/8x2	Pocket Clip	.95	.17
A130	3"- 1/8x2	Pocket Clip	.25	.17
A130	4"- 1/8x3	Pocket Clip	.25	.17
A132	1 1/4"- 1/8x1 1/2	Stub	.60	.40
A216R	4"- 1/8x4	Narrow Bit	.50	.33
A216R	6"- 1/8x6	Narrow Bit	.53	.35
A216R	8"- 1/8x6	Narrow Bit	.55	.37
A216R	10"- 1/8x10	Narrow Bit	.60	.40
A316R	3"- 3/16x3	Round Blade	.60	.40
A316R	4"- 3/16x1	Round Blade	.65	.43
A316R	5"- 3/16x5	Round Blade	.70	.45
A316R	6"- 3/16x6	Round Blade	.70	.46
A316R	8"- 3/16x8	Round Blade	.75	.50
A316S	4"- 3/16x4	Square	.80	.50
A316S	6"- 3/16x6	Square	..	.85 .65
A316S	8"- 3/16x8	Square	..	.90 .57
A416R	4"- 1/4x4	Round Blade	.80	.53
A416R	5"- 1/4x5	Round Blade	.85	.57
A416R	6"- 1/4x6	Round Blade	.90	.60
A416R	8"- 1/4x8	Round Blade	.95	.62
A416S	4"- 1/4x4	Square	..	.95 .62
A416S	6"- 1/4x6	Square	..	1.05 .69
A-16S	8"- 1/4x8	Square	..	1.15 .77
A516R	6"- 5/16x6	Round Blade	1.05	.69
A516R	8"- 5/16x8	Round Blade	1.10	.75
A516R	10"- 5/16x10	Round Blade	1.15	.77
A516S	6"- 5/16x6	Square	..	1.20 .80
A516S	8"- 5/16x8	Square	..	1.30 .87
A516S	10"- 5/16x10	Square	..	1.40 .94

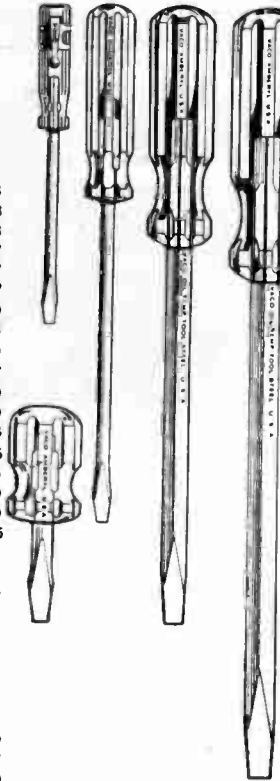

AMBERYL PHILLIPS — HIGH CARBON STEEL BLADE

The increasing use of Phillips self-centering screws in radio assembly make a full kit of Vaco Phillips screw drivers a necessity.



Stock No.	Size Blade (")	Point No.	Overall Length (")	List Each	Dealer Each
P10	5/32x3	1	5 1/2	\$.80	\$.53
P20	1/4x1 1/4	2	8 1/2	.95	.63
P30	5/16x6	3	10	1.25	.83
P40	3/8x8	4	12	1.70	1.13
P50	1/2x1 1/2	2	3	.90	.60
P60	5/32x1 1/2	1	3	.85	.57
P111	5/32x1 1/2	1	3 1/2	.70	.47
P122	5/32x3 1/4	1	5 1/2	.75	.50

AMBERYL SPIN - HEX NUT DRIVERS

Deep drilled shafts—Thin wall Hex. Flat faced for close work.

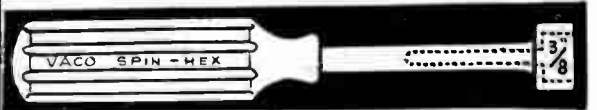

Stock No.	Size (")	Overall Length (")	List Each	Dealer Each
S6	3/16	6	\$.75	\$.50
S8	1/4	6	.75	.50
S9	9/32	6	.75	.50
S10	5/16	6	.75	.50
S11	11/32	6	.75	.50
S12	3/8	6	.75	.50
S14	7/16	6	.75	.50
S16	1/2	6	.75	.50

VOLUME CONTROL SIZES—Hollow Shaft Throughout

S160	1/4	7	1.40	.93
S180	9/16	7	1.50	1.00

FOR 3/32" SQUARE SET SCREWS

S3	3/32 Square	6	.75	.50
----	-------------	---	-----	-----

VACO CARDED DISPLAY UNITS

No. S90
SPIN-HEX NUT DRIVER
DISPLAY UNIT



Contains One Each
SPIN-HEX
 3/16", 1/4", 5/16", 11/32",
 3/8", 7/16", 1/2"
 and one each Volume Control
 7/16" and 1/2"
 Heavy easel back board keeps
 each size in its place.
 List each \$8.65
 Dealer each 5.50

No. PC260
PHILLIPS CARBON
STEEL DISPLAY UNIT



Contains One Each
PHILLIPS High Carbon
 Nos. P10, P20, P30, P50,
 P60, P111, P122
 Display these to your cus-
 tomers. Also keep one unit
 on your bench.
 List each \$6.65
 Dealer each 4.22

No. A1116
EXTRA THIN BLADE
POCKET CLIP
SCREW DRIVERS

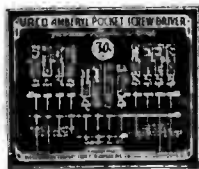

Contains One Dozen
 Assorted Lengths
 No. 116 Radio Pocket Clip
 Screw Drivers. Blade Dia.
 .0925. Bit Width .0825.
 Extra long Amberyl Handle
 clipped at top, very popular
 and useful. Contains 4 each
 2", 3" and 4" lengths on
 display board.
 List per unit of 12...\$4.20
 Dealer per unit of 12... 2.65

No. A238
1/8" SQUARE BLADE HEX
VACOLITE HANDLE,
POCKET CLIP SCREW DRIVER



Contains One Dozen
 2" square blade Shock and Break
 Proof hexagon Vacolite handle with
 pocket clip. A tough strong rust
 proofed blade. A very popular driv-
 er—low in price but high in qual-
 ity.
 List per card.....\$2.40
 Dealer per card..... 1.50

No. A138
1/8" ROUND BLADE
NARROW BIT
AMBERYL HANDLE
POCKET SCREW DRIVER



Contains One Dozen
 Assorted Lengths
 1/8" blade, narrow cabinet
 point. Board holds 4 each:
 2", 3" and 4" lengths. 1/2"
 grooved handle, Shock and
 Break Proof, Rust Proofed
 Blades.
 List per card.....\$3.60
 Dealer per card..... 2.16

V A C O

AMBERYL SHOCK & BREAK PROOF HANDLE SCREW DRIVERS
DEEP GROOVE SURE GRIP HANDLES — ALLOY STEEL BLADES — FULLY GUARANTEED

VACO HAND FORGED—CHROME VANADIUM STEEL SCREW DRIVERS

Large Size AMBERYL HANDLES, Long Tapered Hand Shaped Bits
 "The Finest Screw Driver Money Can Buy"

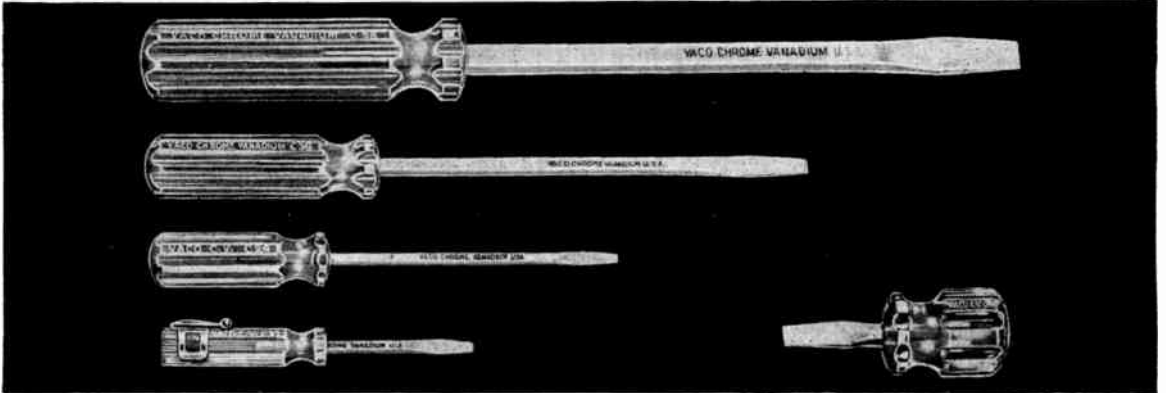

MADE WITH SQUARE BLADES ONLY

THIN BLADE RADIO STOCK SIZES				HEAVY DUTY LARGE SIZES			
Stock No.	Size of Blade (")	List each	Dealer each	Stock No.	Size of Blade (")	List each	Dealer each
C22	3/8x2 Pocket Clip	\$.60	\$.40	C410	1/4x10 Regular Style	\$1.40	\$.93
C23	3/8x3 Regular Style	.65	.43	C54	5/16x4 Regular Style	1.50	1.00
C24	3/8x4 Regular Style	.70	.46	C55	5/16x5 Regular Style	1.55	1.03
C26	3/8x6 Regular Style	.75	.50	C56	5/16x6 Regular Style	1.60	1.06
C33	3/16x3 Regular Style	.90	.60	C58	5/16x8 Regular Style	1.70	1.12
C34	3/16x4 Regular Style	.95	.63	C510	5/16x10 Regular Style	1.80	1.20
C35	3/16x5 Regular Style	1.00	.66	C66	3/8x8 Regular Style	2.00	1.33
C36	3/16x6 Regular Style	1.05	.70	C68	3/8x8 Regular Style	2.10	1.39
C38	3/16x8 Regular Style	1.10	.73	C610	3/8x10 Regular Style	2.20	1.47
C41	1/4x1 1/2 Stubby	.85	.57	C614	3/8x14 Regular Style	2.75	1.83
C44	1/4x4 Regular Style	1.10	.73				
C46	1/4x6 Regular Style	1.25	.83				
C48	1/4x8 Regular Style	1.35	.90				

VACO PHILLIPS CHROME ALLOY SCREW DRIVERS

Cadmium Plated, Rust Proofed Blades

Built for Long Hard Service—Highest Quality—Longest Life



Stock No.	Size and Length (")	Point No.	Overall Length	Takes Screws Numbers	List each	Dealer each
P1	5/32x3	1	5 1/2"	4 and smaller	\$.95	\$.63
P2	1/4x4 1/4	2		5 to 9	1.30	.87
P3	5/16x6	3		10 to 16	1.50	1.00
P4	3/8x8	4		18 and larger	2.10	1.40
P5	1/4x1 1/4 Stub	2		5 to 9	1.10	.73
P6	5/32x1 1/4 Stub	1		4 and smaller	1.00	.66
P11	5/32x1 1/4 Pocket Clip			4 and smaller	.95	.63
P12	5/32x3 1/4 Pocket Clip	1		4 and smaller	1.00	.66

VACO PHILLIPS OFFSET CHROME ALLOY SCREW DRIVER
 Combination No. 1 Point One End
 No. 2 Point Other End



No. P120 Offset Phillips should be in every tool kit. Very handy for those hard to get at places. Length 4 1/4". Bit length 1". No. 1 and No. 2 points.

List, Each \$0.60
 Dealer, Each40

No. C80 CHROME VANADIUM RADIO SIZES

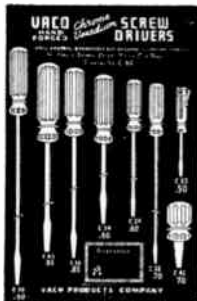

This attractive display unit contains 8 popular radio sizes — one each, C45, C38, C36, C34, C24, C26, C22, C41.
 List, Each \$7.85
 Dealer, Each 5.00

No. PC16 CHROME ALLOY PHILLIPS DISPLAY UNIT



Contains one each P1, P2, P3, P5, P6, P11, P12. Chrome alloy Ambery Phillips. Handy for both bench use and display.
 List, Each \$8.20
 Dealer, Each 5.10

No. AN12 NEON ELECTRICAL TESTING SCREW DRIVER DISPLAY



Contains — One dozen No. AN4, 3/16 x 4" neon tube testers. Handles colored red in center, shows a bright red flash when leaks are encountered.
 List, per Card.....\$11.40
 Dealer, per Card.... 7.00

V A C O

AMBERYL SHOCK & BREAK PROOF HANDLE SCREW DRIVERS
DEEP GROOVE SURE GRIP HANDLES—ALLOY STEEL BLADES—FULLY GUARANTEED

VACO GRIP-POINT SCREW HOLDING SCREW DRIVERS

"The Perfect Screw Holding Screw Driver"

- HOLDS SCREW SECURELY TO DRIVER
- NO DROPPED OR LOST SCREWS
- HOLDS SCREW UNTIL FULLY SET

- NO INTERFERENCE WITH SCREW HEAD
- OPERATES WITH ONE HAND
- SPEEDY — POSITIVE — SURE
- NON-MAGNETIC



- NO INTERFERENCE WITH SCREW HEAD
- OPERATES WITH ONE HAND
- NON MAGNETIC

Stock No.	Sizes	Overall Length	Weight Doz.	List Each	Dealer Each
No. G2	$\frac{3}{8}$ " x $4\frac{1}{4}$ " Takes Screws 1 to 6	7 $\frac{1}{4}$ "	2 lbs.	\$1.60	\$1.10
No. G3	$\frac{1}{4}$ " x $4\frac{1}{4}$ " Takes Screws 4 to 14	8"	2 $\frac{1}{4}$ lbs.	1.70	1.13
No. G4	$\frac{5}{8}$ " x $4\frac{1}{4}$ " Takes Screws 8 to 20	8 $\frac{1}{4}$ "	2 $\frac{1}{2}$ lbs.	1.75	1.16

VACO RUBBER COVERED BLADE ALL INSULATED SCREW DRIVERS

Long slim blades coated all but the tip with rubber by a new plating process. Handles are shock and break proof amberyl.

Prices are for Each One

- VR241 — $\frac{1}{8}$ " x 4"
List, \$.65 . Dealer, \$.43
- VR261 — $\frac{1}{8}$ " x 6"
List, \$.70 . Dealer, \$.46
- VR281 — $\frac{1}{8}$ " x 8"
List, \$.75 . Dealer, \$.50
- VR361 — $\frac{3}{16}$ " x 6"
List, \$.90 . Dealer, \$.60
- VR381 — $\frac{3}{16}$ " x 8"
List, \$.95 . Dealer, \$.63



DISPLAY UNIT
 No. VR1200
 CONTAINS ONE DOZEN ASSORTED

VACO ALL AMBERYL, COMPLETELY INSULATED $\frac{1}{4}$ " SPIN-HEX NUT DRIVER



No. S40

Radio Servicemen will welcome this solid amberyl all insulated nut driver in the popular $\frac{1}{4}$ " size.
 List, ea. \$1.00 Dealer, ea. \$.66

No. A86 All AMBERYL SCREW DRIVER



A full six inches of solid amberyl all insulated radio screw driver. $\frac{1}{8}$ " x 1" bit. Pocket clip attached. Handy, useful, safe.
 List, ea. \$.65 Dealer, ea. \$.43

AMBERYL HANDLE ELECTROLYTIC NUT WRENCH



The quick way to service PAL nuts used on electrolytic condensers. Deep sockets to clear leads.

TWO SIZES

- No. S32 for $\frac{3}{32}$ " nuts, list, ea. \$1.50 . Dealer, ea. \$1.00
- No. S36 for $1\frac{3}{32}$ " nuts, list, ea. 1.50 . Dealer, ea. 1.00

Thank You!

When writing for additional
information or when ordering
from sources of supply listed
in this book, please mention

RADIO'S MASTER

Blue Wizard Adjustable Circle Cutters

Rugged improved circle cutters for making holes from 1" to 10" in diameter. Designed to cut accurately and quickly any materials listed below. May be used in slow-speed drill press or ordinary hand-brace. A practical tool priced so low that no shop can afford to be without it. Ideal for all kinds of radio construction work. All cutting bits are made of special high speed steel and are easily replaced with new ones or removed for sharpening.

THE SILENT SALESMAN

A Display Board for the Dealer's store consisting of 10 different sizes and types of circle cutters with samples of materials that the tool is capable of cutting, will greatly stimulate sales in the store. See photograph of Display Board to the right.

PRICES—ROUND SHANK

	List Price	Net Price
No. 100—"Single Blade" Circle Cutter.....	\$1.70	\$1.28
No. 700—"Dual Blade" Circle Cutter.....	2.80	2.10
Cuts 1" to 6½" Circle—¾" Round Shank		

"STANDARD" MODELS

No. 200—"Single Blade" Circle Cutter.....	\$2.50	\$1.88
No. 800—"Dual Blade" Circle Cutter.....	3.30	2.48
Cuts 1" to 6½" Circle—¾" Round Shank		

"JUMBO" MODELS (HEAVY DUTY)

No. 300—"Single Blade" Circle Cutter.....	\$4.20	\$3.15
No. 900—"Dual Blade" Circle Cutter.....	5.80	4.35
Cuts 1¼" to 10½" Circle—½" Round Shank		

SQUARE TAPERED SHANK

"JUNIOR" MODEL

No. 500—"Single Blade" Circle Cutter.....	\$2.50	\$1.88
No. 1100—"Dual Blade" Circle Cutter.....	3.30	2.48
Cuts 1" to 5" Circle		

"STANDARD" MODEL

No. 600—"Single Blade" Circle Cutter.....	\$3.30	\$2.48
No. 1200—"Dual Blade" Circle Cutter.....	4.20	3.15
Cuts 1" to 6½" Circle		

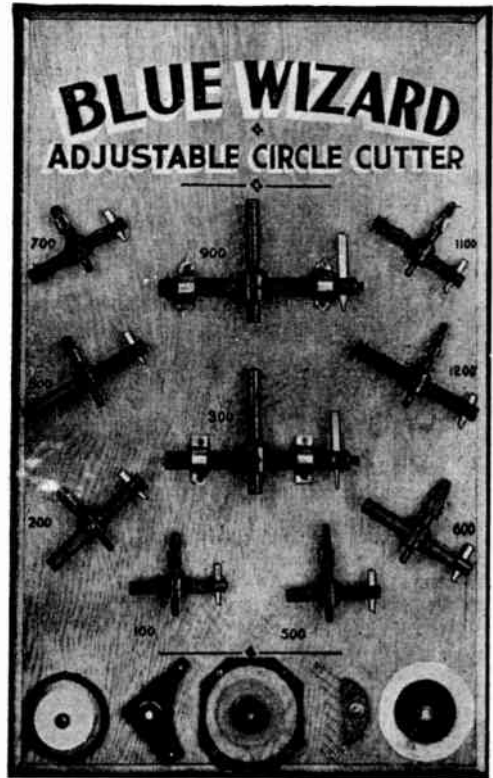

No. (10) "Blue Wizard" Display Board complete with 10 Tools as shown.....\$35.60 List \$26.70 Net

F.O.B. Los Angeles, Calif.

Cut SHARP and CLEAN CIRCLES — DISCS — WASHERS GASKETS

in

- Wood or Cork
- Bakelite or Fibre
- Leather or Rubber
- Stainless Steel
- Thin Shim Material
- Galvanized Sheet Iron
- Cold Roll Steel

Gardiner

RADIO SOLDER



Gardiner

ROSIN-CORE SOLDER

CHICAGO



Custom set builders, servicemen and radio fans must have Rosin-Core Solder. This small package of Rosin-Core Solder catches their eye and the sale is easily made. Packed same as Repair-All. Stock it—display it, you'll sell it.

Here is just the combination solder and flux for delicate electrical and radio work. Used and recommended by the largest manufacturers of telephone, electrical and radio equipment. Quality alloy of tin and lead solder with pure rosin flux inside it, makes absolutely non-corrosive joints. No other flux is needed nor recommended. Only heat is necessary.



Gardiner Rosin-Core Solder melts quickly, flows freely and makes high tensile strength bonds. You are money ahead when you buy Gardiner Solder—it costs less!

Put up on 1 - 5 - 20 lb. spools.

ENGLISH WIRE GAUGES

Gauge No.	Decimal Inch Equivalent	Approximate Fractional Inch Equivalent	Approximate Millimeter Equivalent
1.....	.300"	19/64"	7.62 mm
2.....	.284"	9/32"	7.21 mm
3.....	.259"	17/64"	6.58 mm
4.....	.238"	15/64"	6.05 mm
5.....	.220"	7/32"	5.59 mm
6.....	.203"	13/64"	5.16 mm
7.....	.180"	3/16"	4.57 mm
8.....	.165"	11/64"	4.19 mm
9.....	.148"	5/32"	3.76 mm
10.....	.134"	9/64"	3.40 mm
11.....	.120"	1/8"	3.05 mm
12.....	.109"	7/64"	2.77 mm
13.....	.095"	3/32"	2.41 mm
14.....	.083"	21/256"	2.11 mm
15.....	.072"	9/128"	1.83 mm
16.....	.065"	1/16"	1.65 mm
17.....	.058"	7/128"	1.47 mm
18.....	.049"	3/64"	1.24 mm
19.....	.042"	5/128"	1.07 mm
20.....	.035"	9/256"	.89 mm
21.....	.032"	1/32"	.81 mm

MELTING POINTS of METALS and SOLDERS

Metals	Degrees Fahrenheit	Degrees Centigrade
Aluminum	1216	658
Antimony	1166	630
Bismuth	518	270
Copper	1981	1083
Gold	1945	1063
Lead	621	327
Silver	1762	961
Tin	450	232
Zinc	786	419

ALLOYS OF SOLDER

Melting Points only approximate
Tin Content mentioned first

Alloys	Degrees Fahrenheit	Degrees Centigrade
25/75	500	260
30/70	480	249
35/65	470	243
40/60	460	238
45/55	440	227
50/50	415	213
55/45	390	199
60/40	370	188
63/37	358	181

Solid Wire Solders are supplied in gauges from No. 1 to No. 21 inclusive.

Acid-Core, Rosin-Core, and Special Core Solders are supplied in gauges from No. 6 to No. 20 inclusive.

Flux-Filled Solders are made in core sizes to contain from 1% to 5% Flux, the percentage based on weight. Standard core size contains 3% Flux.

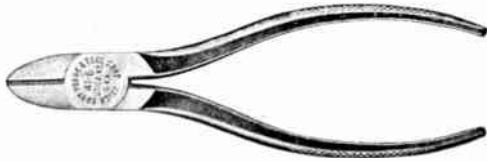

No. 41 • Electricians' Diagonal Pliers—

Drop forged. Hardened and tempered in oil. Special narrow nose for radio work.

No. 41	5"	6"
Price	1.00	1.90

Can be furnished with insulation stripper.



No. 654 • Utica Long Needle Nose Side Cutting Plier

This is a long fine spring-tempered nose side cutting plier, drop forged, with hand-honed cutting knives.

Utica Finish Size	6"
Price	1.65



No. 1033 • Utica Long Chain Needle Nose Plier

This is a long needle nose type of plier without a side cutter. It has a spring-tempered needle nose with a fine balance for delicate work.

Utica Finish Size	6"
Price	1.40



No. 622 • Utica Short Chain Nose Mechanic's Plier

This plier is a Short Chain Nose Side Cutting Plier, hand-honed cutting knives. It makes an all around Electrical Mechanic's plier.

Utica Finish Size	5"
Price	1.25



No. 65 • Utica Jeweler's End Cutting Nipper

This Nipper is forged from a fine grade of steel, carefully tempered. A light, strong End Cutting Nipper, used by Electricians and Machinists. The keen cutting edges and "Perfect Fit" handles make this a very popular tool (Lap joint).

Utica Finish Size	5"
Price	1.60



No. 50 • Utica Standard Side Cutting Plier

An ideal too for electrical work. Its cutting qualities are unsurpassed by any side cutting plier.

Utica Finish Size	5"	6"	7"	8"
Price	1.20	1.30	1.50	1.60



No. 777 • Utica Long Needle Nose Plier

This plier has a long, half-round, spring-tempered nose for very fine work in assembling small electrical apparatus.

Utica Finish Size	6"
Price	1.75



No. 888 • Curved Needle Nose Pliers

This is a long curved spring-tempered Needle Nose Plier and used in deep and narrow places. It may be used without turning or twisting the hand in the assembling of small fixtures, electrical apparatus, etc.

Utica Finish Size	6"
Price	2.00



No. 22
Utica Chain Nose Plier

This is a Short Chain Nose Plier forged from a fine quality of steel with fine points particularly adapted for the use of Jewelers, Opticians, Telephone Installers, Electricians and Radio Assemblers.

Utica Finish Size 6"
Price 1.10



No. 82
Utica Chain Nose Wiring Plier

This is a Special Radio Repair Man's Plier, new in design, having a chain nose for those who prefer this type of construction.

Utica Finish Size 7³/₄"
Price 1.75

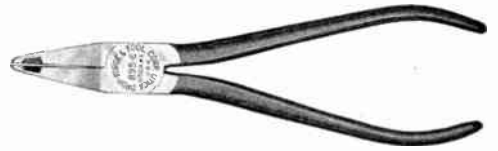

No. 895
Utica Radio Plier

This is a General Radio Repair Man's Plier. It has a center cutter and flat scored nose for looping and bending.

Utica Finish Size 6"
Price 2.10



No. 517
Utica Ignition Plier

This ignition Plier with its unique design will fit all ignition units. A great little tool for the hard to get at adjustments.

No. 517 5"
Price 1.15

No. 91 • Thin Adjustable Angle Wrenches, 22¹/₂°

Size	4"	6"	8"	10"	12"
Price	1.00	1.00	1.20	1.55	2.10



This new Utica Thin Pattern Wrench is not just another wrench; it's different in that the jaws are designed to get at places inaccessible with the ordinary wrench of this type.

Both the handle and jaw are drop forged, hardened and tempered in oil and will not break or wear in the gear teeth and allow play in the wrench, permitting the jaw to slip off the nut.

Note the full deep throat for either square or hexagon nuts. It will give better service and last longer than any other wrench.

WALSCO

AIDS TO THE SERVICEMAN

RADIO DIAL DRIVE CABLES AND CORD ASSORTMENT

Walsco Cords are among the finest. They are put up most attractively and conveniently, and priced low.



PHOSPHOR BRONZE CABLE—42-Strand— Highest grade phosphor bronze wound over linen center.

No. 30—25 ft. Spool.....Net \$0.72
No. 30-5C—500 ft. Spool.....Net 11.10

PHOSPHOR BRONZE CABLE—16-Braided— A low priced cable of good quality to be used as a substitute for No. 30, 33 or 34 cables. Has strong linen center.

No. 31—25 ft. Spool.....Net \$0.51
No. 31-5C—500 ft. Spool.....Net 8.10

THIN PHOSPHOR BRONZE CABLE—As used in previous years on some RCA and GE sets.

No. 32—25 ft. Spool.....Net \$0.51

HEAVY LINEN CORD—Finest grade, as used on many sets such as Philco, Majestic, etc.

No. 33—25 ft. Spool.....Net \$0.78
No. 33-5C—500 ft. Spool.....Net 12.00

MEDIUM LINEN CORD—Same quality as heavy, but thinner. As used on many newer models of RCA, Sonora, etc.

No. 34—25 ft. Spool.....Net \$0.69
No. 34-1C—100 ft. Spool.....Net 2.40
No. 34-5C—500 ft. Spool.....Net 9.00

SPECIAL THIN CORD—Same kind as used on many of the latest models. Very light, but exceptionally strong and durable. Specially treated.

No. 35—25 ft. Spool.....Net \$0.45
No. 35-1C—100 ft. Spool.....Net 1.56
No. 35-5C—500 ft. Spool.....Net 6.00



THRIFTI-SPOOL

The most economical and practical small assortment of popular numbers of Dial Cables.

15 feet each of #33 Heavy Cord, #34 Medium Cord, and #35 Special Thin Cord.

Cat. No. 36—45 ft. asstd.....Net \$0.99

15 feet each of #31 Bronze Cable, #34 Medium Cord, and #35 Special Thin Cord.

Cat. No. 37—45 ft. asstd.....Net \$0.99

MULTI-SPOOL

This is a very handy item for the shop and tool kit, consisting of 4 different types of dial cables and cords, total 70 feet. 15 feet #31 Bronze Cable, 15 feet #33 Heavy Cord, 15 feet #34 Medium Cord, and 25 feet #35 Special Thin Cord.

Cat. No. 38—70 ft. asstd.....Net \$1.59

"NO SLIP"

This newly developed chemical makes slipping dials work instantly. Its application is very easy, only a small quantity brushed on the slipping cord or fabric belt will provide friction and also slightly shrink the cord. WALSCO NO SLIP has a penetrating, lasting effect. Comes with built-in brush.



Cat. No. 401—½ oz. bottleNet \$0.21
Cat. No. 402—2 oz. bottleNet .45

WALSCO UNIBELT - - ADJUSTABLE DIAL BELT

A Great Timesaver for Radiomen

OUTSTANDING, EXCLUSIVE FEATURES FOUND ONLY IN THE WALSCO UNIBELTS:

- **ADJUSTABLE** to fit any dial; all popular replacements can be made with only 3 sizes. Each belt can be cut to measure within range specified, by using a diagonal cutter, pair of scissors, etc.

- **COMES OPEN!** Can usually be installed without taking dial mechanism apart. Zipper-like fastening gives instant, strong, and durable connection. As a result, an hour's job can now be done in a couple of minutes.

- **CAN'T SLIP.** Special latex covering prevents any possible slipping.

- **CAN'T STRETCH.** The core of the WALSCO UNIBELT is made of specially tempered, highly flexible clock-spring steel. **STRETCHING**, therefore, is absolutely impossible!

Each belt or kit comes with exact instructions how to measure and cut the belt. Also included is a paper ruler to make exact measurements.

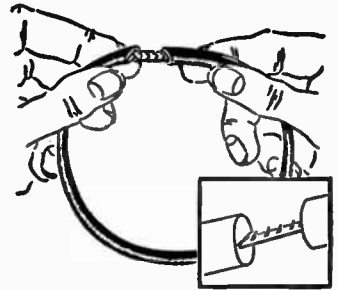

A job that used to take an hour or more can now be done in a couple of minutes; and better too! PATENTS PENDING.

Standard Packages 10, 50 or 100 Belts.
Cat. No. Adjustable From Net Price
300-A (brown box) 6 ½" to 10 ¼" \$0.29*
300-B (blue box) 10 ¼" to 13 ¾" .29*
300-C (green box) 14 ¾" to 17 ¾" .33*
300-D (red box) 19" to 23 ¾" .33*

UNIBELT KIT

Contains three No. 300A, four No. 300B, two No. 300C, one No. 300D.
Cat. No. 305.....Net Price \$2.80*
*Federal Rubber Excise Tax included.
Ask jobber for Reference Chart Form A-9.

WALSCO STAPLE DRIVER

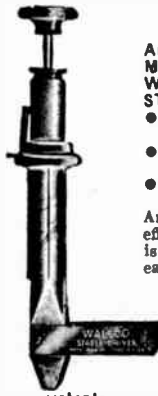

Patents Pending

An indispensable tool for Radio, Public Address, and Inter-Communication Men. Officially adopted by the largest Alarm System, Telephone and Wiring Companies all over the world. **VERY USEFUL FOR GENERAL STAPLING, SIGN-POSTING, REFRIGERATION GASKET WORK, ETC.**

- Makes all wire and cable installations twice as easy—much neater—saves half the time.
- Wires can be stapled down in corners, behind pipes, into moldings and other places never before accessible with hammer and ordinary staples.
- Wires can also be attached to hard surfaces such as plaster, mortar and even soft concrete.

Amazing tool! Automatically sets the staples in place with a minimum of effort. It feeds its own staples, it is jam-proof as the flow of the staples is regulated with the "trigger." The staples are extremely hard and very easy to drive even into hard surfaces. The depth to which the staples can be driven is adjustable to fit any wire or cable up to ¼" in diameter. Damage to wire is impossible and no special insulation for the staple is required. Magazine holds 23 staples which come in strips and can be loaded in a few seconds. The tool will pay for itself on the first installation job you do.

Dealer's Net
*Cat. No. 500—Tool Finish\$3.70
*Cat. No. 501—De Luxe Chromium Finish..... 4.65
*Including one box Walsco staples.

SHIPPING WEIGHT 1 ½ LBS.

ACCESSORIES FOR WALSCO STAPLE DRIVER

CARRYING CASE



For the WALSCO STAPLE DRIVER to carry the tool in the pocket or on the belt. Genuine leather.

Cat. No. 505
Dealer's Net \$1.25

CARBON STEEL STAPLES



Made of tool steel, come in strips and are especially made for the WALSCO STAPLE DRIVER. Inside coated with special clear insulating lacquer, patented process. Available in Ivory, Brown. Specify color. (Cat. No. 553 is available in assorted colors.)

Net
Cat. No. 550—250 staples\$0.29
Cat. No. 552—1000 Staples 1.10
Cat. No. 553—5000 Staples 5.00

RUBBER CAP



Covers the plunger head of Staple Driver and makes it easier on the hand to drive staples into hard surfaces.
No. 507.....Net \$0.19

WALSCO

AIDS TO THE SERVICEMAN

WALSCO GRILLE CLOTH

This cloth of highest quality and finest pattern harmonizes with most any set. A piece should always be on hand for repair work, dressing up trade-ins, and P.A. speakers. Use non-penetrating WALSCO FABRIC CEMENT, Cat. No. 21, for quick attaching.

	Net
No. 360—12"x12"	\$0.30
No. 361—18"x24"57
No. 362—50" wide, any length, per yard (Specify length)	2.10

RADIO DIAL OIL

A light bodied lubricating oil, absolutely free from acids or gummy substances. For use on radio dials, band switches, and on all electrical appliances. To prevent rust on radio-chassis, tools and machinery—cover thinly with Dial Oil.

No. 70—½-oz. Bottle	Net \$0.09
No. 72—2-oz. Bottle15
No. 74—4-oz. Bottle24

WALSCOLUB B

A new chemical that eliminates noise on band switches, push button tuners, controls, and other air-exposed electrical contacts. Superior to any graphite compound for this purpose. Also makes an excellent lubricant. Tube with special opening permits economical dispensing.

No. 22—Tube	Net \$0.27
-------------------	------------

MOTOR AND GEAR LUBRICANT

This is the latest development in chemicals for lubricating purposes. Much superior to greases because of its higher lubricating power. — Does not change consistency with temperature. Used on phonograph motors, record changers, and appliances that require a grease-type lubricant, it will practically last indefinitely.

No. 23—Tube (1 ¼ oz.)	Net \$0.27
-----------------------------	------------

SERVICEMEN'S WALL RACK

Here is the solution for the always crowded work-bench in the service shop. This display hangs on the wall and holds all the Chemicals, Dial Cables and Belts the serviceman needs.

IT'S FREE — with the purchase of the material that it holds. The assortment contains one 2-ounce bottle each of Radio Cement, Cement Solvent, Dial Oil, Contact Cleaner; 60 feet assorted Dial Cables (Catalog No. 38) and 6 Unibelts (2 No. 300-A; 2 No. 300-B; 2 No. 300-C).

No. 1006	Dealer's Net (incl. Federal Excise Tax) \$4.25
----------------	--

WALSCO TUBE ASSORTMENT AN ASSORTMENT OF RADIO NECESSITIES

Here is a convenient kit of WALSCO chemicals put up in tubes. The sturdy box makes this assortment very handy to carry in the tool-kit. Contains Radio Cement, Fabric Cement, Multi-use Cement, Walscolub B, and Motor and Gear Lubricant.

No. 115	Net \$1.17
---------------	------------

CONTACT CLEANING FLUID

CONTACT CLEANING FLUID is especially prepared for cleaning tuning-condenser-springs, volume controls, band switches, etc. It contains liquefied "WALSCOLUB B" to prevent future corrosion of the contacts.

No. 80—½-oz. Bottle	Net \$0.09
No. 82—2-oz. Bottle21
No. 84—4-oz. Bottle30
No. 88—8-oz. Bottle45
No. 89—16-oz. Bottle81

(Each Bottles Comes with a Brush)



COIL DOPE KIT

This coil dope has a polystyrene base and its power factor loss is negligible, even if used for high frequency work. Will render articles moisture proof. May also be used for cementing parts which are made of polystyrene. Kit contains 2 oz. bottle of coil dope, 1 oz. bottle of special thinner, and two brushes.

No. K-21	Net \$0.39
----------------	------------

(Special price on larger quantities)



RECORDENE

FOR RECORDS AND RECORDINGS

Recordene will remove dirt, dust or grease accumulated in the grooves, and will leave a plastic film which will reduce surface noise and prolong the life of the record. Special wool felt dauber makes application very easy and effective. Comes in attractive displays of 12 bottles. (Use it on any recording except those made of Ethyl Cellulose.)

No. 92—2-oz. Bottle	Net \$0.27
---------------------------	------------



RECORD-EASE

RECORDING—WITH THE GREATEST OF EASE!

Record-Ease should be applied to all home recording and transcription blanks BEFORE the cutting. It makes the shavings "fluffy" and prevents their interfering with the cutting point, as they pile up automatically in the center of the record. It also lessens the cutting point friction, thereby increasing the life of the stylus considerably. REDUCES SURFACE NOISE CONSIDERABLY.

No. 95—2-oz. Bottle	Net \$0.36
---------------------------	------------

FRICTION POWDER

For repairing dial drives with slipping cords or belts. Should be applied freely to the slipping parts, and it will often make the replacement of slipping cords and belts unnecessary.

No. F1—Small Bottle	Net \$0.09
No. F2—2-oz. Jar15



CHROME LUSTRE PAINT

An aluminum paint which leaves a satin chrome finish. Can be brushed or sprayed on. May be used indoors or outside and will adhere to practically anything. Will leave no brush marks and dries in about an hour.

No. CP-2—2-oz. Jar	Net \$0.18
No. CP-16—1 pt. Can	Net 1.05



CRYSTALLIZING LACQUER

Standard Colors: Black, Green, Gray, Brown, Clear. This lacquer can be used on metal, wood, cardboard, etc. Brushed on, it will dry in about 30 minutes, and will leave an absolutely professional finish. No spraying equipment or baking oven is necessary, and its application does not require experience. The finish obtained is the same as that on many chassis, panels, speakers, and transformers. Walsco Lacquer Sealer should be used as undercoat if this lacquer is to be applied on porous materials, or over other finishes.

No. CL-2—2-oz. Jar	Net \$0.24
No. CL-16—1 pt. Can	Net 1.35

(If no color is specified, we ship Black)



LACQUER SEALER

No. LS-2—2-oz. Jar	Net \$0.21
No. LS-16—1 pt. Can	Net 1.20

WALSCO

AIDS TO THE SERVICEMAN

WALSCO RADIO CEMENT

- **Fast Drying**
- **Vibration Proof**
- **Unsurpassed Adhesive Power**

An elastic cement especially prepared for repairing speakers. It is not affected by vibration, dries fast and will never become brittle with age. The latest developments in synthetic resins and gums are incorporated in WALSCO RADIO CEMENT, which is one of the strongest adhesives ever developed.



Bottles are equipped with built-in brush (1/2, 2 and 4 oz. sizes)

In addition to speaker repair work, WALSCO RADIO CEMENT can also be used for repairing cabinets, loose tube bases, and grid caps. It will provide a strong bond between almost any articles and is not affected by high temperature, moisture, oil, etc. All bottles have an evaporation-preventing cap liner.



	Net		Net
No. 50—1/2 oz. bottle.....	\$0.15	No. 58— 8 oz. bottle.....	\$0.96
No. 52— 2 oz. bottle.....	.30	No. 59— 1 pint.....	1.80
No. 54— 4 oz. bottle.....	.54	No. 51—Tube (1 1/4 oz.).....	.25

SCRATCH REMOVER



One of the most valuable items for Repair Men, Salesmen and Delivery Men. Made of Unbreakable Plastic and has the shape of a Fountain Pen. A handy clip makes it convenient to carry in the pocket.

The WalSCO Scratch Remover makes instantly disappear minor scratches on radios, furniture, etc., when brushed over with the felt wick on the one end. If the finish is off, or the scratch is deep, the damage can be stained and filled with the special filler on the other end.

The WalSCO Scratch Remover is indispensable to any shop or store and can be sold also to housewives, to whom it will prove to be a very helpful gadget. Comes also on display card, holding six.

No.		
700—Each	Net	\$0.30

SCRATCH REMOVING POLISH



This product is a blend of polishing and staining ingredients. Removes scratches on cabinets, radios, furniture, etc., and polishes at the same time. Very easy to apply. Will not change shade of finish.

No. 414—4 oz. bottle.....	Net	\$0.21
No. 416—8 oz. bottle.....	Net	.30

"SUPER POLISH" CONCENTRATED



This is a new article that works differently. It first removes any old polish, grease or dirt that may be on the cabinet. Then it forms a hard, dry and durable film that will protect the cabinet for a long time and give it a new-like appearance. This product requires very little rubbing. Dealers use it on their stock sets and recommend it to customers. A demonstration will convince and a sale will ensue. Sample bottle free upon request.

No. 412— 4 oz.	Net	\$0.21
No. 418— 8 oz.	Net	.30

CEMENT SOLVENT & THINNER

A universal thinner for all lacquer-type cements, such as radio, speaker, fabric and similar adhesives. Acts quickly as solvent on speaker cones, voice coils, etc.

No. 62—2 oz. bottle.....	Net	\$0.21
No. 64—4 oz. bottle.....	Net	.30
No. 68—8 oz. bottle.....	Net	.45
No. 69—16 oz. bottle.....	Net.	.75

CEMENT & SOLVENT KIT

A handy kit which is easy to carry in the tool box. It contains one 2-ounce bottle of Radio Cement and one 1-ounce bottle of Thinner. A brush is built in the cement bottle cap. Another brush is included.



No. K-19	Net	\$0.39
----------------	-----	--------

MULTI-USE CEMENT

IDEAL FOR PLASTIC CABINETS



One of the finest adhesives made. Heavier in body than our Radio Cement and unexcelled for repairing broken plastic cabinets, knobs, grid caps, etc. Waterproof and heat-resisting.

No.		Net
No. 42—2 oz bottle.....	Net	\$0.30
No. 41—Tube	Net	.25



FABRIC CEMENT



Specially made for attaching GRILL CLOTH, Turntable Felt, Covering of Portable Radios, etc. Dries very fast; is unaffected by moisture and high temperature and does not become brittle. DOES NOT PENETRATE THE FABRIC.

No. 21—Tube (1 1/4 oz.)	Net	\$0.25
-------------------------------	-----	--------

RUBBER CEMENT

For cementing rubber parts such as chassis mounts, drive rubbers, etc., to metal or wood. Brush is attached to cap of each bottle.

No. R-2—2 oz. bottle	Net	\$0.30
----------------------------	-----	--------

WALSCO

AIDS TO THE SERVICEMAN

RADIO CABINET PATCHING OUTFIT



Designed especially for Radio Men. Will last for approximately 120 repair jobs and contains everything necessary to repair satisfactorily over 95% of all cabinet damage. The best Kit on the market with all Lacquers, Stains, and Enamels, specially prepared, ready mixed and soluble in alcohol. This has four advantages:

1. Drying time is reduced to about half that of ordinary materials.
2. Original finish of cabinet can in no way be burned or lifted, as would be the case with ordinary lacquers if improperly applied.
3. An unsatisfactory patch can be washed off completely, and the work started all over again.
4. No special thinners required. Thinning, washing-out brushes, etc., can be done with alcohol, which is obtainable anywhere.

Kit contains two shades of Spirit Walnut Stain (1 oz. each), which will match practically any radio cabinet. Dark Brown Lacquer (1 oz.) will cover injuries to bases and moldings. Holes or broken edges can be filled with the Plastic Wood. For the new ivory sets, there are two shades of Ivory Spirit Enamel—(1 oz. each). "Walco Patching Lacquer" (4 oz.) is one of the most important items in the Kit—brushed on. It will heal cracked finishes and "French Polished," it will build up a spray-like finish without the use of costly equipment. "Walco Polish Renewer" (4 oz.) gives the cabinet a new appearance.

Also included are alcohol (4 oz.), three brushes, eight sheets of Garnet Finishing Paper, French Polishing Pad, Steel Wool and an instruction booklet explaining the different kinds of cabinet damages, and how to repair them.

No. K-10—In strong leatherette finish box—Shipping Weight 4 1/2 lbs. \$2.85
 K-10-W—In beautiful wooden case with hinged lid—Shipping Weight 5 lbs. 3.21

MASTER DE LUXE REFINISHING KIT

Made for the Radio Dealer to refinish completely or patch up old radios, trade-ins, etc. (can be used by both SKILLED and INEXPERIENCED) REFINISHERS. The kit contains all items of the Radio Cabinet Patching Outfit #K-10 (see above) plus Shellac Rubbing Fluid (4 oz.); Scratch Removing Polish (a combination of polish and stain) (4 oz.); Felt; 8 shades of Stick Shellac; 1 oz. bottles each of Spirit Stain in Mahogany and Maple; and 1 oz. bottles each of Blending Stains Dark Brown, Medium Brown, and Light Brown; and 1 large Polishing Cloth.

This outstanding 100% complete refinishing kit is a necessity to every radio dealer, and will pay for itself many times.

No. K-12—Shipping Weight 8 lbs. Net \$7.90

RADIO CHEMO KIT



An assortment of those chemicals every Radio Man must have. Costs no more than the individual chemicals bought separately, makes a more professional appearance, and is easy to carry. Kit contains one 2-oz. bottle of each: Walco Radio Cement, Walco Cement-Solvent, Walco Radio Dial Oil, Walco Contact Cleaning Fluid, 3 Brushes.

No. K-20—Shipping Weight 1 1/2 lbs. \$0.81

RADIO KNOB SPRINGS

A handy assortment of Knob Springs of all sizes needed by repair men and radio stores. Indispensable for every radio shop.

Cat. No. 345—Kit of 10 Assorted Springs. Net \$0.24



RADIO SET SCREWS

A new assortment of precision made hardened steel Set Screws of all popular sizes to fit radio knobs, record changers, and to be used wherever Set Screws are needed for home or automobile radios.

Cat. No. 348—Kit of 20 Assorted Screws. Net \$0.24



DIAL DRIVE SPRINGS

Made of high grade steel wire and rustproof. Five sizes will take care of any replacement job and will give excellent service.

Cat. No. 340—Kit of 10 Assorted Springs. Net \$0.24

Cat. No. 341—Kit Asst. (small sizes only) Net .24



SNAP-IN TRIMOUNTS

This new fastener is used in all modern radio sets, on back covers, dial scales, chassis, built-in

antennas, etc. Is faster than a screw.
 Cat. No. 346—Kit of 30 Fasteners. Net \$0.24

RADIO CABINET REPAIR KIT



A handy compact kit made for quick patching of damaged cabinets. Small brushes are built in the caps of all Stain and Enamel bottles. Contents are of same high quality as in Walco Radio Cabinet Patching Outfit at left. However, this kit is designed for the smaller shop or store which has only occasional cabinet repairs, and is especially suitable for the outside man, to be carried on the delivery truck, etc.

Kit contains 1 bottle of each: Ivory Spirit Enamel, light (1/2 oz.), Ivory Spirit Enamel, dark (1/2 oz.), Lacquer Enamel, dark brown (1/2 oz.), Spirit Stain, walnut (1/2 oz.), Polish Renewer (4 oz.), French Varnish (2 oz.), 3 sheets Garnet Finishing Paper, Steel Wool, and Polishing Cloth. Instruction Booklet is enclosed.

No. K-9—Shipping Weight 2 1/2 lbs. Net Price \$1.17

UTILITY RADIO SERVICE KIT



Radio Servicemen: Here is an article that next to the screwdriver is the most useful thing in radio repairing. Put up in a compact genuine leather pocket kit are those things that the serviceman always needs on the job and which are so often missing from his tool case because they are not available in handy form. Fits any pocket and closes with snaps.

Kit contains: One bottle of Walco Concentrated Polish Renewer, 1 bottle of Walco Radio Cement for Speaker Repair and General Radio Work, 1 bottle of Friction Powder for repair of slipping

dial-drives, 1 bottle of Walco Contact Cleaner for contact springs, wavy volume-controls, etc., 1 bottle of Special Cabinet Stain to remove scratches on cabinets, Bottle of Dial Oil and 2 sheets of fine Sandpaper. Bottle-caps of cement, Cleaning fluid and Stain have brush attached. The oil-bottle comes with an applicator.

No. K-25—Shipping Weight 1 1/2 lbs. Net Price \$1.35

FURNITURE REFINISHING KIT



A very complete kit containing all ingredients for real professional work on furniture, pianos, radios, etc. Scratches, nicks, dents, broken edges may be repaired quickly and without experience in cabinet refinishing. Also, anybody who wants to do his own refinishing will find this the most handy kit. It will pay for itself, often on the first job.

Kit contains: Polish Renewer, Patching Lacquer, Alcohol, Spirit Stains in Walnut, Mahogany, Maple and Black, Shellac-Rubbing-Fluid, Plastic Wood, 6 colors Stick Shellac, Alcohol Lamp, Spatula, 3 brushes and 8 sheets Garnet Finishing Paper. Comes in a strong, hinged, wooden case. Complete Instruction Book enclosed.

No. K-15—Shipping Weight 5 lbs. Net Price \$3.75

HOUSEHOLD APPLIANCE PATCHING KIT

The finest kit for touching up Refrigerators, Stoves, Washing Machines, Table Tops and all lacquered, enameled or porcelain Appliances. Dents, nicks, chipped porcelain, etc., can be repaired to such an extent that the patch is practically invisible. Stick-Shellac combination included makes emergency repairs possible in a few minutes.

Kit includes: Pure White Lacquer Enamel, Filling Compound, Tinting Colors in Red, Blue, Black and Yellow, 4 Shellac Sticks in White and Black, 2 Thinners, 2 Brushes, Alcohol Lamp, Spatula, Steel Wool, Sandpaper and Instruction Book. Comes in a strong wooden case with hinged lid.

No. K-17—Shipping Weight 4 1/2 lbs. Net Price \$3.75

LIGHT & BULB COLORING



This transparent, heat and moisture resisting dipping lacquer is specially made for coloring bulbs such as used in radio dials, signal systems, model trains, and fancy illumination. Big jars permit dipping of even larger bulbs.

Cat. No. 116—Neon-Red, 2-oz. jar \$0.15
 Cat. No. 117—Blue, 2-oz. jar15
 Cat. No. 118—Green, 2-oz. jar15
 Cat. No. 119—Kit of three assorted42

Vibrapacks*

P. R. MALLORY & CO. Inc.
MALLORY

*Reg. U. S. Pat. Off.

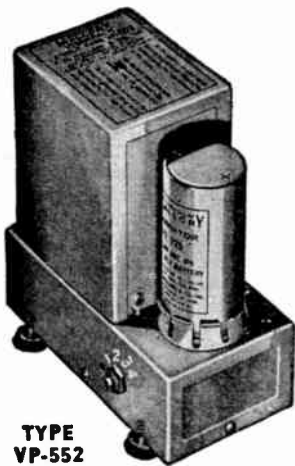

**TYPE
VP-552**



**TYPE
VP-554**

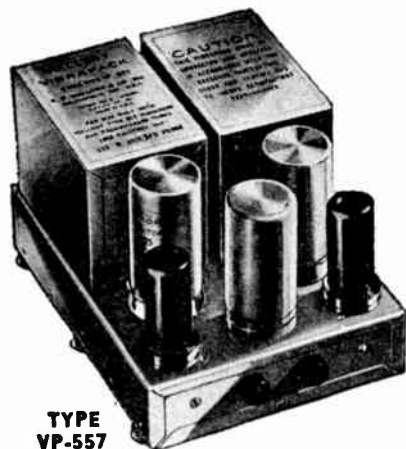

**TYPE
VP-557**

Vibrapacks are equipped with complete, built-in noise suppression equipment. Type VP-555 also includes an efficient low-frequency hum filter. Type VP-557 incorporates the first input filter condenser only. Other Vibrapacks do not include the high voltage hum filter. High voltage filter requirements are similar to equivalent AC power packs.

Manufactured and sold under one or more of the following United States Letters Patent:

No. 1,943,240
No. 2,049,310
No. 2,190,685
No. 2,223,573 et al.

No. 2,032,424
No. 2,186,638
No. 2,197,607

No. 2,039,957
No. 2,187,959
No. 2,223,516

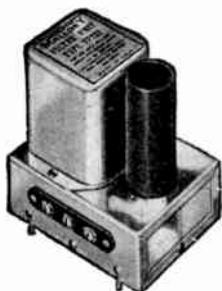

VF-223 Filter

• A complete audio filter system for use with all single-unit Vibrapacks. Designed to give maximum suppression of hum with minimum voltage drop. Especially recommended for applications which are sensitive to hum, or where voltage regulation is important as in Class "B" audio amplifiers.

No. VF-223 Filter. List price.....\$8.00

• Vibrapacks are flexible, HEAVY-DUTY vibrator power supplies designed for providing dependable and low cost high voltage direct current from a low voltage storage battery. Proved efficient and dependable by more than seven years of actual field service. Available in various types and sizes, with outputs up to 60 watts at 300 and 400 volts.

Outstanding Advantages:

1. High efficiency—low battery drain.
2. Dependable—trouble free—time-tested in thousands of installations.
3. Low cost—low maintenance.
4. Compact—light in weight.
5. Ease of installation.
6. Flexibility. Single unit Vibrapacks can be adjusted to give 4 output voltage ranges each.

Applications

Vibrapacks are widely used for furnishing "B" power in the following applications:

Automobile receivers—police, sheriff, amateur short wave, etc.

Aircraft and marine receivers and transmitters.

Farm receivers.

Police mobile two-way equipment.

Automobile P. A. systems.

Military, lighthouse, and forestry service radio communication apparatus.

Miscellaneous electronic applications where commercial power is unavailable.

Catalog Number	Nominal Operating Voltage	Nominal Output Voltage	Maximum Output Current	Type	List Price
VP-551	6.3	125-150-175-200	100 ma.	Self-Rectifying	\$16.00
VP-552	6.3	225-250-275-300	100 ma.	Self-Rectifying	19.50
VP-553	6.3	125-150-175-200	100 ma.	Tube Rectifier	17.00
VP-554	6.3	225-250-275-300	100 ma.	Tube Rectifier	20.50
VP-555*	6.3	300	200 ma.	Tube Rectifier	40.00
VP-557*	6.3	400	150 ma.	Tube Rectifier	40.00
VP-G556	12.6	225-250-275-300	100 ma.	Self-Rectifying	20.50
VP-F558	32.	225-250-275-300	100 ma.	Tube-Rectifying	21.50

*Special Dual Packs for high output. Tube rectifier types permit "B—" to be isolated from ground if desired. Output voltages indicated are nominal. Actual average output voltages at various loads will be found in the graphs of our Form No. E-555C, when operated at rated terminal voltage. Vibrapacks are supplied complete with special Mallory vibrator. Rectifier tubes included in the interrupter types.

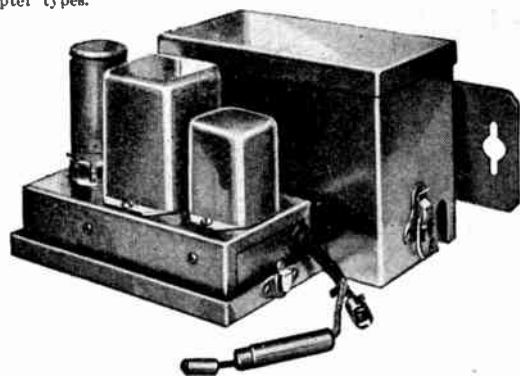

VP-540 Vibrapack—Completely filtered

• Designed for use as a complete "B" power unit for automobile, airplane, and marine service. May be used to operate long wave, broadcast-band, and short wave receivers, or any electronic device within its load capabilities. Rigid anchorage of components permits satisfactory operation under conditions of considerable vibration. Completely filtered for both RF and audio so that the hum and hash level is extremely low.

Universal mounting, any position, with horizontal preferred. VP-540 is of the synchronous, or self-rectifying type. Nominal output, 250 volts at 60 m.a. Nominal input, 6.3 volts. Size 7½ x 3½ x 5¼" high, exclusive of mounting brackets and leads. Weight, 7 lbs., 14 oz.

No. VP-540 Vibrapack. List price.....\$22.50

P. R. MALLORY & CO. Inc.
MALLORY

Vibrators

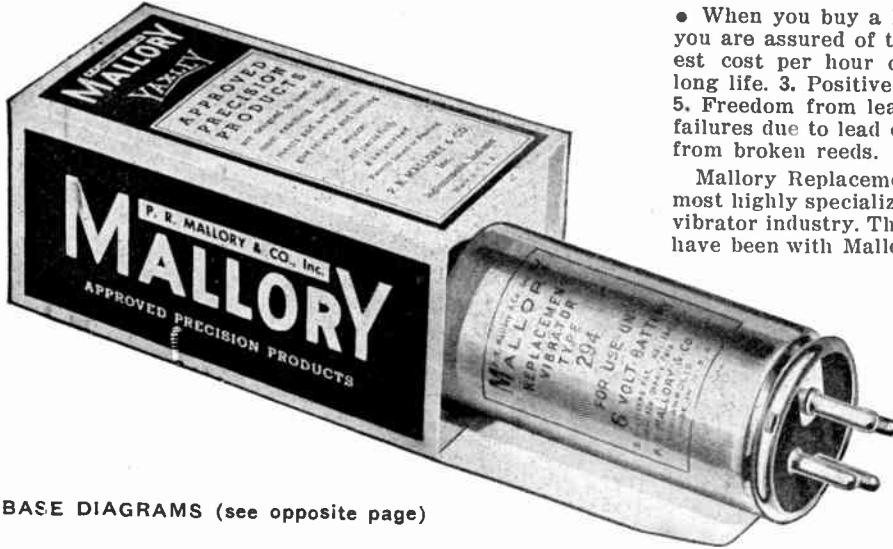

• When you buy a Mallory Replacement Vibrator you are assured of the following benefits: 1. Lowest cost per hour of actual use. 2. Trouble-free long life. 3. Positive starting. 4. Easy installation. 5. Freedom from lead breakage. 6. Freedom from failures due to lead corrosion. 7. Absolute freedom from broken reeds.

Mallory Replacement Vibrators are built by the most highly specialized group of technicians in the vibrator industry. The majority of these employees have been with Mallory since the beginning of the vibrator industry. Such a highly trained personnel can only assure the highest quality of workmanship possible.

For recommendations by receiver make and model number, see your distributor for the Mallory Vibrator Guide or consult the Mallory Radio Service Encyclopedia.

BASE DIAGRAMS (see opposite page)

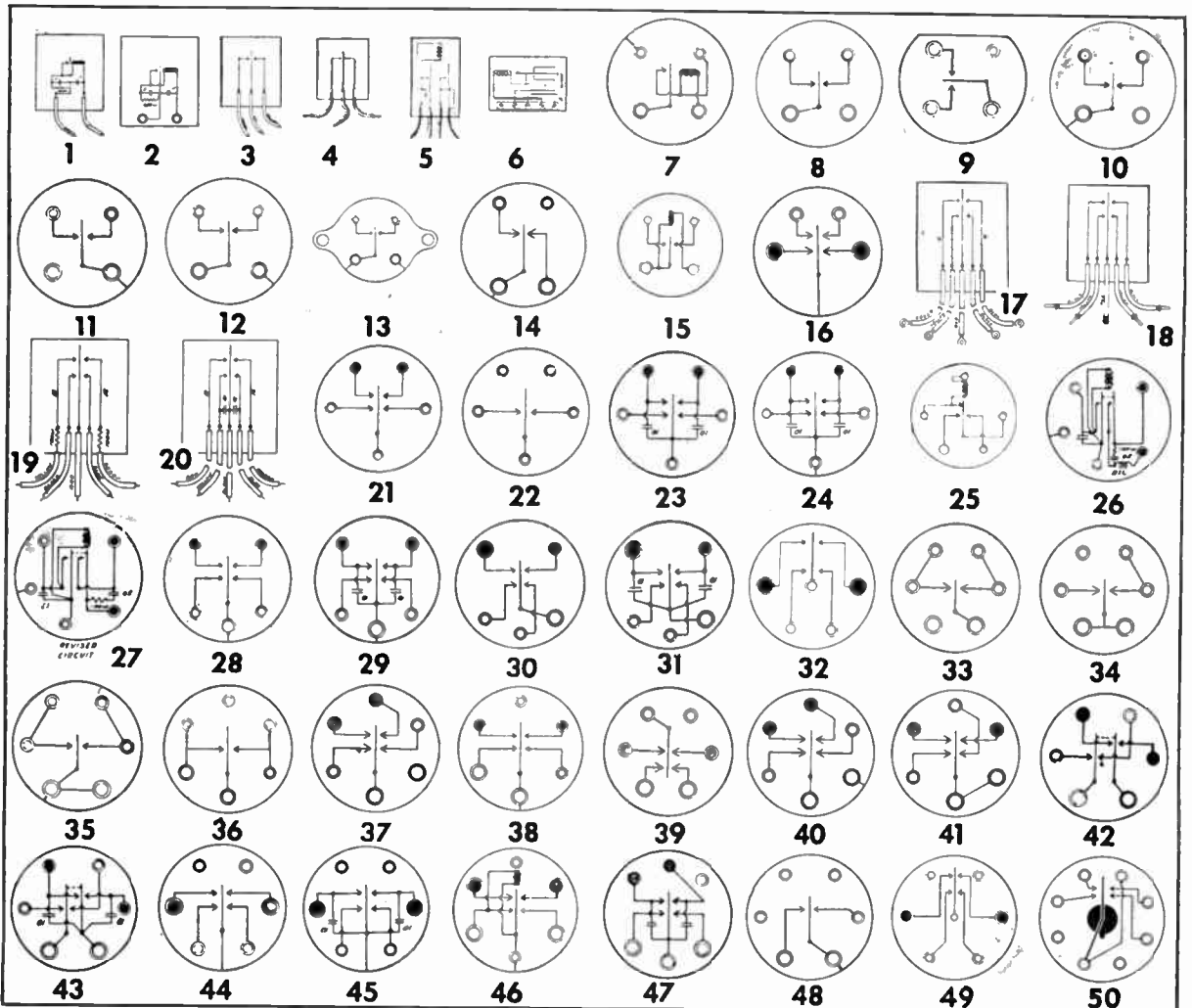

Vibrators

P. R. MALLORY & CO. Inc.
MALLORY

MALLORY REPLACEMENT VIBRATOR SPECIFICATIONS

Int.— Interrupter Syn.— Synchronous

Type No.	Volt.	Type	Base Dia.	Size*	List Price	Type No.	Volt.	Type	Base Dia.	Size*	List Price
201	6	Int.	7	2 1/16 x 2 7/8 x 5 5/8	\$7.80	294SW	6	Int.	11	1 1/2 dia. x 3 1/4	\$3.55
F204	32	Int.	7	2 1/16 x 2 7/8 x 5 5/8	8.10	F294	32	Int.	10	1 1/2 dia. x 3 1/4	5.35
205	6	Int.	7	2 1/16 x 2 7/8 x 5 5/8	7.80	296	6	Int.	35	1 1/2 dia. x 3 1/4	3.55
210	6	Syn.	26	2 7/16 x 2 1/4 x 5 5/16	9.00	297	6	Int.	33	1 1/2 dia. x 3 1/4	4.75
F211	32	Syn.	26	2 7/16 x 2 1/4 x 5 5/16	9.00	F297	32	Int.	33	1 1/2 dia. x 3 1/4	5.95
220B	6	Int.	6	3 3/16 x 2 x 1	4.80	299	6	Int.	34	1 1/2 dia. x 3 1/4	4.75
F220C	32	Int.	6	3 3/16 x 2 x 1	6.00	302S	6	Int.	2	2 15/16 x 2 13/16 x 6 5/16	7.80
221	6	Int.	3	4 1/2 x 1 9/16 x 1 9/16	4.75	311S	6	Int.	1	2 3/4 x 2 5/8 x 6 1/8	9.00
F221	32	Int.	4	2 7/16 x 1 1/2 x 1 3/8	5.35	F312	32	Int.	2	2 15/16 x 2 13/16 x 6 5/16	9.00
222	6	Syn.	20	4 7/8 x 1 7/8 x 1 13/16	6.60	500P	6	Int.	10	2 3/8 dia. x 4 3/4	3.00
223	6	Syn.	17	4 7/8 x 1 3/4 x 1 13/16	7.15	501P	6	Int.	10	1 5/8 dia. x 3 5/8	3.00
F223	32	Syn.	17	4 7/8 x 1 3/4 x 1 13/16	7.15	F502P	32	Int.	9	1 5/8 dia. x 3 5/8	7.15
224	6	Syn.	47	2 3/8 dia. x 4 3/4	8.40	503	6	Int.	3	1 1/2 dia. x 2 3/4	4.75
226	6	Syn.	19	4 1/2 x 1 9/16 x 1 9/16	7.15	504	6	Int.	48	1 1/2 dia. x 3 1/4	4.75
230	6	Syn.	27	2 7/16 x 2 1/4 x 5 5/16	9.00	505P	6	Int.	8	1 15/16 dia. x 3 1/2	3.00
231	6	Syn.	5	2 5/16 x 2 1/8 x 5 5/16	8.70	506P	6	Int.	36	1 15/16 dia. x 3 1/2	4.75
235	6	Syn.	5	2 5/16 x 2 1/8 x 5 5/16	7.15	507P	6	Int.	10	1 5/8 dia. x 4 3/4	3.00
245	6	Syn.	21	1 1/2 dia. x 3 1/4	5.95	508P	6	Int.	10	1 1/2 dia. x 3 1/4	3.00
245A	6	Syn.	21	1 15/16 dia. x 3 1/2	5.95	509P	6	Int.	8	1 1/2 dia. x 2 7/8	3.00
245C	6	Syn.	28	1 1/2 dia. x 3 1/4	5.95	510P	6	Int.	8	1 1/2 dia. x 3 1/4	3.60
245SSW	6	Syn.	21	1 1/2 dia. x 3 1/4	5.95	514	6	Syn.	30	1 15/16 dia. x 3 1/2	5.95
F245	32	Syn.	21	1 1/2 dia. x 3 1/4	7.15	716	6	Syn.	30	1 15/16 dia. x 3 1/2	5.95
G245	12	Syn.	21	1 1/2 dia. x 3 1/4	7.15	722A	6	Syn.	40	1 15/16 dia. x 3 1/2	5.95
W245	4	Syn.	21	1 1/2 dia. x 3 1/4	5.95	725	6	Syn.	49	1 1/2 dia. x 3 1/4	6.60
W245A	4	Syn.	21	1 15/16 dia. x 3 1/2	5.95	G725	12	Syn.	49	1 1/2 dia. x 3 1/4	7.80
246	6	Syn.	38	1 1/2 dia. x 3 1/4	5.95	728A	6	Syn.	37	1 15/16 dia. x 3 1/2	5.95
246A	6	Syn.	38	1 15/16 dia. x 3 1/2	5.95	742	6	Syn.	32	1 1/2 dia. x 2 7/8	5.95
W246	4	Syn.	38	1 1/2 dia. x 3 1/4	5.95	743	6	Syn.	38	1 1/4 dia. x 3 1/8	5.95
247	6	Syn.	46	1 1/2 dia. x 3 1/4	5.95	744	6	Int.	22	1 1/4 dia. x 3 1/8	4.75
F247	32	Syn.	46	1 1/2 dia. x 3 1/4	6.60	748	6	Syn.	44	1 1/4 dia. x 2 7/8	5.95
248	6	Syn.	44	1 1/2 dia. x 3 1/4	5.95	825	6	Int.	8	1 1/2 dia. x 3 1/4	5.40
249	6	Syn.	49	1 1/2 dia. x 3 1/4	5.95	826	6	Int.	8	1 1/2 dia. x 3 1/4	4.75
G249	12	Syn.	49	1 1/2 dia. x 3 1/4	7.15	F826	32	Int.	8	1 1/2 dia. x 3 1/4	5.95
F251	32	Int.	12	2 dia. x 4 1/2	5.35	G826	12	Int.	8	1 1/2 dia. x 3 1/4	5.95
253	6	Int.	12	2 dia. x 4 1/2	4.75	839	6	Int.	8	1 1/2 dia. x 3 1/4	4.15
253T	6	Int.	13	2 dia. x 4 5/8	4.75	850	6	Int.	8	1 1/2 dia. x 3 1/4	3.55
253Y	6	Int.	8	1 3/4 dia. x 4 1/4	3.55	G850	12	Int.	8	1 1/2 dia. x 3 1/4	4.75
G253	12	Int.	12	2 dia. x 4 1/2	7.20	852	6	Int.	14	1 5/8 dia. x 3 5/8	3.55
264	6	Syn.	38	1 1/2 dia. x 2 29/32	5.95	853	6	Int.	10	1 5/8 dia. x 3 5/8	3.55
270B	6	Syn.	23	2 dia. x 4 1/2	7.15	854	6	Int.	11	1 1/2 dia. x 3 1/4	3.55
271	6	Syn.	24	2 dia. x 4 1/2	7.15	859	6	Int.	8	1 1/2 dia. x 2 7/8	3.55
Adapter					1.20	860	6	Int.	14	1 1/2 dia. x 3 1/4	3.55
271HD	6	Syn.	24	2 dia. x 4 1/2	7.15	866	6	Int.	10	1 1/2 dia. x 3	3.55
273C	6	Syn.	29	2 dia. x 4 1/2	6.60	868	6	Int.	14	1 1/2 dia. x 3 1/4	3.55
273D	6	Syn.	31	2 dia. x 4 1/2	6.60	869	6	Int.	10	1 1/2 dia. x 3 1/4	3.55
275XS	6	Syn.	43	2 dia. x 4 1/2	9.00	870	6	Int.	14	1 1/2 dia. x 3	3.55
277S	6	Syn.	45	2 dia. x 4 1/2	7.15	901M	6	Int.	8	1 1/2 dia. x 3 1/4	3.00
285XS	6	Syn.	42	2 dia. x 4 1/2	8.40	902M	6	Int.	8	1 1/2 dia. x 3 1/4	3.00
P285Y	6	Syn.	41	1 3/4 dia. x 4 1/2	5.95	903M	6	Int.	8	1 1/2 dia. x 2 7/8	3.00
286S	6	Syn.	44	2 dia. x 4 1/2	6.60	951P	6	Syn.	38	1 1/2 dia. x 3 1/4	6.30
G286S	12	Syn.	44	2 dia. x 4 1/2	9.00	952W	6	Syn.	16	1 3/8 dia. x 2 7/8	5.95
289Y	6	Syn.	49	1 3/4 dia. x 4 1/4	5.95	953W	6	Syn.	16	1 1/2 dia. x 3 5/16	5.95
292	6	Int.	3	1 1/2 x 1 13/8 x 2 7/16	4.15	954	6	Syn.	39	1 1/2 dia. x 3 5/16	5.95
294	6	Int.	10	1 1/2 dia. x 3 1/4	3.55	1100	6	Int.	8	1 1/2 dia. x 2 3/8	3.55

Vibrators

MALLORY

P. R. MALLORY & CO. Inc.

MALLORY REPLACEMENT VIBRATOR CHART

for Auto Radio and Battery-Operated Household Receivers—Continued

Models	Re-placement	Models	Re-placement	Models	Re-placement	Models	Re-placement
CROSLY—Cont'nued		EMERSON		FORD—Continued		GOODYEAR—Continued	
A267, A268	850	AS179	294	6F1D	850	010219 (Runs 3, 4,	246
A355	273C	E128	294	CM29J (Zenith)	853	Ch. 489A)	246
A368	850	F7 (Chassis)	222	CMF490	850	010221 (Ch. 804)	246
A368, A455	273C	U164, V164, V155	294	GMF690	1100	015110	246
A459	850	1A	290	FORDSON		015130	850
A555	273C	5A	2773	FP 32 V. (250001 and up)	F221	100502 (Double Eagle)	294
4A1	247	6A	255Y	FREED		101500, 101501	850
5A1	223	3477, 101F7	222	A7, A9	210	GRAHAM—(Also see Philco)	
6B1 (68A4 Synchrotube)	247	687	299	GALVIN—See Motorola		A255, A355, A455	273C
98, 99	223	678 (Types 1 and 2)	222	GAMBLE-SKOGMO		G1418, G1436, G1528	505P
102	223	965	290	5C8 (Cb)	952W	G1628	508P
103	223	EMPIRE		5Y (25Y1)	2869	CRAYBAR	
117 Power Pack	W246	60	292	5Y (25Y1)—12 Volt	G286S	150 Chassis	271
119, 159	F223	ERLA (Erie-Sentinel)		CC1	294	GREBE	
146, 435, 546	246	10M, 10MF	294	CC7	248	61R	292
557	W246	11M	294	CC9	248	GRIGSBY-GRUNOW—	
587	850	31B, 34B, 49B, 50B	245A	6J	248	See Majestic	
636	246	63B, 60B, 60BE, 68,	245A	OK	248	GRUNOW (General Household Utilities)	
687	850	68B, 68BE	245A	6L, 6R	294	4NB	245
588	850	73B, 78B, 78BE, 88BE,	245A	OS, 6U	290	5AB	294
6615	246	96BE	245A	25Y1	286S	7NB, 410, 411	245
DEFOREST (Canada)		100X	294	25Y1 (12-Volt)	G286S	508, 509	294
510, 510A	223	119B, 130B, 130BE,	245A	26B5	F251	614, 618	294
513A, 513B, 513C, 513D	223	140B, 140BE	245A	26R1	294	C25	273D
DELCO		144X, 144XE	294	26S1	294	711	245
66	220B	185B, 186BE	245A	31B7, 34BT	245A	GULBRANSEN—(Also see Wells-Gardner)	
2035, 4036	221	191B, 191BE	245A	489, 504	246	V822, 20Z1	292†
4037, 4038	222	197X	294	568	294	06W	210
626, 627, 628, 629	222	236, 256	245A	577A, B, C, D	294†	062A	205
630, 631, 631A, 632, 633	273C	237, 257	294	680	290	HALLICRAFTERS	
634, 635	853	600, 602	294	C66, 667B	294	S30 (Radio Compass)	725
R640, R641, R642, R643, R644	273C	603	292	C70, 670A	299	HALSON	
R663, R664, R665, R666, R667	852	5500	294	C77A, 677B	294	loadmaster, 199	220B
R669, R669, R673	852	5600	F251	C78A, B, C	248	HARLEY-DAVIDSON	
R675, R676, R677, R678	860	6100, 6101, 6102	F221	C80 Auto	294	All Models Prior to 1937	271HD
R685, R686, R687, R688, R689, R696, R697	868	FADA		803A, 803B	299	AVR10A, EG45A	743
R700, R701	868	101 (RK), 102 (RP), 104,	221	6100	F221	M1-7b15, M1-7b15A	294
3203, 3204	F247	104B (RV)	221	CAROD		HERBERT H. HORN	
4049, 4050, 4051	F223	126, 127, 128 (NK)	245A	2B6, 2B6-1, 3B6, 3B6-3	W245	535, 536, 537, 538	294
R6010	245A	163	245	37B, 37D	W245	HOWARD	
R6011, R6012, R6015	245A	166 (Motoret)	255Y	1739	246	Auto (Series 1)	249
DESOTO—		246	W245	GENERAL ELECTRIC		HA1 (670A)	299
(Also see Philco)		266, 266SD, 266SG	294	4SR1A2 (M1-7630)	743	HA2 (52, 502)	292
G (CGD), G (CGDU),		267 Series	294	B40, B52	271*	HA3, HA4	294
G-122 (CGD-122), G-122		1246	W245	C41	292	HA6	249
(CGDU-122), R (CRD),		FAIRBANKS-MORSE		C61	273	HA7	294
T-2 (CT-2), T-5 (CT-5)	500P	36	297	D50, D51, D52	286S	HA8	294
T-10 (CT-10)	507P	4B, 6C (6CC-2B),	294	D72	294	HA9	294
T-11 (CT-11)	500P	6C (6CT-4B)	246	FA60, FA61, FA60	248	Highwayman	299
C1550, C1452	505P	2387 (1st)	3029	FB52, FB53, FB56, FB57	W246	6B-A, 6B-T	245C
C1560	505P	2387 (2nd)	3029	FB72, FB73, FB76, FB77	W246	7B-T	245C
C1606	508P	33A6	3029	GA62	854	52, 502	292
C1808	505P	3356 (2nd)	292	JA64	854	505 (6-Volt)	850
C1708	509P	3387 (1st)	292	JB72, JB372	245A	505 (12-Volt)	(850)
C1808	509P	3387 (2nd)	292	M58, M60	294	765 (6-Volt)	850
	509P	3388 (1st)	292	N51	248	765 (12-Volt)	(850)
	509P	3388 (2nd)	292	N60	294		(850)
	509P	3398 (1st)	294	U51, U55	246	HUDSON-TERRAFLANE	
	509P	3398 (2nd)	294	X127	246	CB6, DB37, DB38	249
	509P	43 Auto	294	GENERAL MOTORS		DB39	854
	509P	67 (6717, 6746)	240	(Canada)		DB41	854
	509P	346, 347	245	134, 134B	223	DB42	1100
	509P	67 (6717, 6746)	240	135	223	116, JA40	294
	509P	73 (73CCB, 73T3B)	245	136, 137, 138	273C	JA41	854
	509P	74 Auto	294	GILFILLAN		SA37	249
	509P	77 (77CCB, 77T3B)	294	Z	202	SA38	294
	509P	78 (78CCB, 78T3B)	294	7A	291	SA39	854
	509P	79 (79CCB, 79T3B)	294	8A	294	SA40	854
	509P	80 (80CCB, 80T3B)	294	C7A, 67R, 77R, 87R	294	SA41	854
	509P	81 (81CCB, 81T3B)	294	700, All 1933, 34, 35,	296	653HD, 651HE, 660TD,	292
	509P	82 (82CCB, 82T3B)	294	and 36 Models		601TE	294
	509P	83 (83CCB, 83T3B)	294	GOLDENTONE AND GOLD MEDAL		696, 698, 690	294
	509P	84 (84CCB, 84T3B)	294	L7, 24, 25, X6	245C	Majestic Head	220B
	509P	85 (85CCB, 85T3B)	294	U6	294	HUPMOBILE—(Also see Philco)	
	509P	86 (86CCB, 86T3B)	294	GOODRICH—(Also see Motorola)		G (HGD), G-122 (HGD),	
	509P	87 (87CCB, 87T3B)	294	R420, R421	245C	H (HHD), H-122	
	509P	88 (88CCB, 88T3B)	294	R422	850	(HHD), R (HRD),	
	509P	89 (89CCB, 89T3B)	294	GOODYEAR		T-2 (HT-2)	500P
	509P	90 (90CCB, 90T3B)	294	566	246	T-11 (HT-11), T-11X	507P
	509P	91 (91CCB, 91T3B)	294	568	294	INTERNATIONAL—	
	509P	92 (92CCB, 92T3B)	294	580	299	(Kadette)	
	509P	93 (93CCB, 93T3B)	294	660	220B	K6 (K60-St. Regis)	296
	509P	94 (94CCB, 94T3B)	294	661, 666 (1 and 2), 667	294	JACOBS	
	509P	95 (95CCB, 95T3B)	294	670	294	Nine	246
	509P	96 (96CCB, 96T3B)	294	680, 690	299	KADETTE—See International	
	509P	97 (97CCB, 97T3B)	294	680	299		
	509P	98 (98CCB, 98T3B)	294	01018 (Runs 1, 2, Ch. 880)	299		
	509P	99 (99CCB, 99T3B)	294	01020 (Ch. 881)	294		
	509P	100 (100CCB, 100T3B)	294	01584 (Ch. 505)	850		
	509P	101 (101CCB, 101T3B)	294	010219 (Ch. 415A, Ch. 415B)	246		
	509P	102 (102CCB, 102T3B)	294				
	509P	103 (103CCB, 103T3B)	294				
	509P	104 (104CCB, 104T3B)	294				
	509P	105 (105CCB, 105T3B)	294				
	509P	106 (106CCB, 106T3B)	294				
	509P	107 (107CCB, 107T3B)	294				
	509P	108 (108CCB, 108T3B)	294				
	509P	109 (109CCB, 109T3B)	294				
	509P	110 (110CCB, 110T3B)	294				
	509P	111 (111CCB, 111T3B)	294				
	509P	112 (112CCB, 112T3B)	294				
	509P	113 (113CCB, 113T3B)	294				
	509P	114 (114CCB, 114T3B)	294				
	509P	115 (115CCB, 115T3B)	294				
	509P	116 (116CCB, 116T3B)	294				
	509P	117 (117CCB, 117T3B)	294				
	509P	118 (118CCB, 118T3B)	294				
	509P	119 (119CCB, 119T3B)	294				
	509P	120 (120CCB, 120T3B)	294				
	509P	121 (121CCB, 121T3B)	294				
	509P	122 (122CCB, 122T3B)	294				
	509P	123 (123CCB, 123T3B)	294				
	509P	124 (124CCB, 124T3B)	294				
	509P	125 (125CCB, 125T3B)	294				
	509P	126 (126CCB, 126T3B)	294				
	509P	127 (127CCB, 127T3B)	294				
	509P	128 (128CCB, 128T3B)	294				
	509P	129 (129CCB, 129T3B)	294				
	509P	130 (130CCB, 130T3B)	294				
	509P	131 (131CCB, 131T3B)	294				
	509P	132 (132CCB, 132T3B)	294				
	509P	133 (133CCB, 133T3B)	294				
	509P	134 (134CCB, 134T3B)	294				
	509P	135 (135CCB, 135T3B)	294				
	509P	136 (136CCB, 136T3B)	294				
	509P	137 (137CCB, 137T3B)	294				
	509P	138 (138CCB, 138T3B)	294				
	509P	139 (139CCB, 139T3B)	294				
	509P	140 (140CCB, 140T3B)	294				
	509P	141 (141CCB, 141T3B)	294				
	509P	142 (142CCB, 142T3B)	294				
	509P	143 (143CCB, 143T3B)	294				
	509P	144 (144CCB, 144T3B)	294				
	509P	145 (145CCB, 145T3B)	294				
	509P	146 (146CCB, 146T3B)	294				
	509P	147 (147CCB, 147T3B)	294				
	509P	148 (148CCB, 148T3B)	294				
	509P	149 (149CCB, 149T3B)	294				
	509P						

Vibrators

MALLORY

P. R. MALLORY & CO. INC.

MALLORY REPLACEMENT VIBRATOR CHART

for Auto Radio and Battery-Operated Household Receivers—Continued

Models	Re- place- ment	Models	Re- place- ment	Models	Re- place- ment	Models	Re- place- ment
KARADIO		MALLORY—Vibrapacks		MOTOROLA (Galvin)—		NASH—Continued	
57, 57B, 63, 65, 66	296	—Continued		9-24, 9-24A	903M	N1418, N1433, N1433H,	
88, 150, 160, 180	296	12A200	G725	9-29, 9-39, 9-44, 9-49	902M	N1434, N1434H, N1514,	505P
KNIGHT—See Allied Radio		12A325	G725	9-69	901M	N1524	
LAFAYETTE (Radio Wire		12A35J	G725	15P (Ford-Mercury)	902M	NOBLITT-SPARKS—See	
Tels., Wholesale Radio)		6B200	826	16G (Chevrolet)	902M	Arvin	
AM20	296	6B250	826	17D (Plymouth)	902M	NORTHERN ELECTRIC	
B62	286S	12B200	G826	180 (Oldsmobile)	902M	(Canada)	
B64	F251	12B250	G826	19B (Buick), 20P, 21L	901M	33, 40 (Auto)	271*
B90 (N Late)		12B300	G826	22S	902M	61 (Auto)	296
B90 (R Early)	294	32B225	F826	24K (Packard)	901M	OLDSMOBILE	
B92	248	32B250	F826	25-P (Ford), 25-N (Nash		393884, 393885, 405045	273C
BB75	248	MARCONI (Canada)		and Lafayette), 26-C6		405046, 405047, 405057	273C
C60	294	5, 6	W245	(Chev., 6-Tube), 26-C7		405062, 405063	273C
J50, J60	285XS	42	271*	(Chev., 7-Tube), 27-D,		980393	221
L22, L23	292P	48	292	27-D6, 27-D6-1		980441, 980455, 980459	273C
L30	253	69 Auto	294	(Chrysler Cars), 28-O	902M	982006, 982007, 982008	273C
LW10	294	95, 103, 165, 291, 294	294	(Oldsmobile)	901M	982043, 982044, 982045	852
M44	285XS	MIDWEST		29-B (Buick), 30-P (Pon-		982083, 982084, 982085	852
S17762	210	5-36, 6-37 (Auto)	294	tiac), 34-K6 (Packard		982126	852
062, 062A	205	7-36 (Batt.), 7-37 (Batt.)	294	6-Tube), 34-K7 (Packard	902M	982127	868
685, 2681	253	7-38 (Batt.-Export)	245	7-Tube)	901M	982153	852
LARKIN		7-39 (Batt.)	245	34F	902M	982160	870
91	292	8-38 (Batt.), 12-38 (Batt.)	245	35N	903M	982161	868
LaSALLE—(Also see		62B	550	36C1, 36C2	902M	982215	870
Cadillac)		MISSION BELL		37D1	901M	982216	838
5X, 6XB	248	10A, 11, 12, 14, 16	292	37D2	902M	982282	870
612, 68	294	17, 18	294	38B1	902M	982283	868
1425470, 1425471	248	25A	292	39B1	901M	PACIFIC	
1939 Master	248	638, 638A, 3716	294	39B2	902M	H6-37, H7-37	291
LEWOL		3817, 3817A, 3818	294	40P	902M	M7-38	291
9101, 9102	292	MOHAWK (Canada)	245	42S	902M	6V	291
0682	285XS	568B	245	43H	902M	21, 22, 23, 25	245
LINCOLN (Also see		MONARCH		44A	901M	80-37 Series	245
Ford-Lincoln)		L7, Z4, Z5	245C	44	901M	101	292
L1420, L1424	505P	17, 24, Z5	294	45	91M	101B, 101C	291
L1425, L1427	505P	54, 64	294	45N	903M	102 (Knkht 6-Tube)	292
(Lin.-Zephyr)	505P	MONTGOMERY-WARD		46C	902M	301	291
L1429, L1460, L1560	505P	(Airlime)		47D1, 47D1A, 47D2,	902M	682	285XS
(Lin.-Zephyr), L1660	505P	Auto Radio, 62, 062	205	47D2A	902M	PACIFIC RADIO	
T-14 (T-14X3, L7-14X4)	500P	37	292	4802	901M	EXCHANGE	
8N1.692	850	102	299	49B, 49BU	901M	Spero-Autodyne	292
L. TATRO		62-118	253	50P, 52S	902M	PACKARD BELL	
AQ69, BQ69	744	62-130	220B	55, 55A	901M	25 (2 Types), 65, 67, 75	294
C625, D625	F251	62-136, 62-138	F251	56T, 56Y	901M	76 (Auto)	850
E53 (Commander)	F294	62-166	253	57	901M	78	294
E293 (Admiral)	F294	62-202, 62-236, 62-242	294	60	902M	PACKARD MOTOR CAR	
EN64, EN84	246	62-258	294	61	270B	B (PBD), H-122 (PH-122)	
EQ39	F294	62-261	294	62	901M	T5 (PT-5), T-14 (PT-14)	500P
F725	F251	62-281, 62-289	246	63	270B	P1417, P1421, P1422	
F913 (Captain)	F204	62-283 (Series B)	246	64	270B	P1427, P1430, P1432	
FQ39	F294	62-284, 62-284	246	65	270B	P1432H, P1439, P1451,	
G63 (Pilot)	F294	62-292, 62-294	246	66	270B	P1451, P1535, P1617,	
H465, 1465	271	62-334	246	67	901M	P1630, P1635	505P
IN25	F251	62-345, 62-356	246	68	902M	P1835	509P
J5 (Pilot)	F204	62-364	246	69 (Golden Voice)	901M	PA333915 (Early),	
J665, K665	271	62-384	246	109, 110	253T	PA333915 (Late "R"),	
L54 (Lt. Governor)	F294	62-394	248	251, 300	903M	PA351099, PA351100,	
L74 (Lt. Governor)	F251	62-373, 62-374	246	301, 302	902M	PA351101, PA351102,	
M4616 (1st)	275XS	62-376	246	350	902M	PA353832	854
M4616 (2nd)	285XS	62-425	246	351	902M	PACKARD RADIO	
N54 (Governor)	F211	62-445	246	352	903M	6-Tube Auto	294
N74 (Governor)	F251	62-459A	246	353	902M	PARMAK (Parker-	
N065, 0065	246	62-465, 62-466	246	392A	902M	McCroly)	
O84 (President)	F211	(2-48)	245	401, 402	902M	6C, 6D	850
O94 (President)	F251	62-522	246	496HT1	246A	BA41	245C
O4626 (1st)	275XS	62-553	294	509	902M	76	246
O4626 (2nd)	285XS	62-591	953W	511	901M	PATTERSON	
P54 (Recorder), P64	F251	62-650	246	550, 550A	902M	77B, 77BA, 78B, 79B	245
P4626 (1st)	275XS	62-651, 62-652	246	551	901M	80B, 168, 268	245
P4626 (2nd)	285XS	62-653	246	552	902M	PHILCO (U. S. and	
Q5630, R5636, S5636 (1st)	275XS	62-751, 62-751	850	700	901M	C)	
Q5636, R5636, S5636 (2nd)	285XS	04BR557A	294	701	901M	Custom-Built Auto	
SP67	744	04BR570A	850	Motorola Police	902M	Receivers—Chrysler	
T6216	F251	04BR675A	850	P-69-12	902M	D (CDS), G (CGD),	
TP67	F294	04BR676A	850	P-69-13	902M	G (CGDU), G-122	
U5226, V5226	F251	04BR678C	248	T-69-20	901M	(CGU-122), R (CRD),	
W6236, X6236, Y6236	F251	04BR679A	294	MOTOSET—See Fada		T-2 (CT-2), T-5 (CT-5)	500P
6A	271	14BR-681A	294	MUSIC MASTER		T-10 (CT-10)	507P
MAJESTIC		14BR-682A	748	Ten-Ten	292	T-11 (CT-11)	500P
(Grigsby-Grunow)		14BR-688A	850	NASH		C1423, C1450, C1452,	
66, 116, 116A, 118, 118P,		14BR-689A	850	AC3689	249	C1550	505P
40-18805	220B	93BR1393A	246A	AC3789	249	C1635	508P
490, 491, 493 (Trans. Type)	F220C	93BR1564A	850	AC4289	246	C1708	509P
490, 491, 493 (Plug-In)	F204	93BR1696A	248	AC4389	850	C1808	509P
MALLORY		5U (25Y1)	288S	AC8001	850	DeSoto	
"B" Eliminators		MOTOMASTER		AC8011	850	G (CGD), G (CGDU),	
Types 1 through 4	201	611 DeLuxe	504	6MN585	850	G-122 (CG-122), G-122	
Types 5 and 6	205	MOTOROLA (Galvin)		6MN695	1100	(CGDU-122), R (CRD),	
Types 10 through 14	210	Dual 6	253	7MN586	850	T-2 (CT-2), T-5 (CT-5)	500P
(1933-34)		Super 6	270B	C (NCD), D (NDD),		T10 (CT-10)	507P
Vibrapacks		Twin 8	253	D (NDD), D (NDD),		T-11 (CT-11)	500P
VP551, VP552	725	Golden Voice		Q (NQD), T-7 (NT-7),		C1450, C1452	505P
VP553, VP554, VP555	825	Golden Voice 1937	901M	T-8 (NT-8), T-12 (NT-	901M	C1551	508P
VP-556	G725	8-30, 8-40	902M	12X, NT-12X2, T-15		C1691	508P
VP557	825	8-50, 8-60	902M	(NT-15, NT-15X2),		C1608	505P
VP-F558	F256	8-70, 8-80	902M	AC-989, AC-1089,		C1708	509P
VP600	620	8-70, 8-80	901M	AC-1289	500P	C1808	509P
6A225	725						
6A300	725						
6A325	725						

Vibrators

P. R. MALLORY & CO. Inc.

MALLORY

MALLORY REPLACEMENT VIBRATOR CHART

for Auto Radio and Battery-Operated Household Receivers—Continued

Models	Re- place- ment	Models	Re- place- ment	Models	Re- place- ment	Models	Re- place- ment
PHILCO—Continued		PHILCO—Continued		RAOINETTE		SEARS-ROEBUCK	
Dodge		AR-10, AR-40, AR-45, AR-50, AR-55, AR-75, 509P		54, 64..... 294		<i>(Silvertone)—Continued</i>	
G (CGD), G-122 (CGD-122), R (CRD), T-2 (CT-2), T-11 (CT-11)..... 500P		Transitone, 2, 3, 5, 6, 7, 9, 10-12, 10-122, 11-121, 11-122, 12..... 500P		RCA		4643..... 246A	
C1450, C1452..... 505P		70J, 800, 800 (122), 802, 805, 806, 808, 809, 816, 818B..... 500P		5M..... 249		4650..... 246	
C1500..... 505P		817, 818, 818K, 819, 819H, 823, 827, 827K, 828, 828K, 920, 921, 922, 928, 927, 928, 928K..... 508P		6BK6, 6BT6..... W245A		4651..... 291	
C1808..... 505P		931, 912, 933..... 539P		6M, 6M2..... 249		4700..... 294	
C1809..... 509P		936, 937, 938K..... 508P		HC8-6, BT6-5..... 215A		4722, 4723..... 246A	
Ford		Police Receivers		I1-6 (Hudson)..... 249		4740..... 246	
N (Center Control), N-FND..... 500P		810PA, 810PB, 810PV..... 500P		AVR7, AVR-7A, AVR-7B (C2933)..... 249		4750..... 246	
F1440, F1440X, F1442, F1442X, F1540..... 505P		821P, 821PV..... 506P		AVR8A, AVR8B..... C219		600J, 600I..... 852	
F1640..... 508P		Household Receivers		W215A..... W215A		6005..... 213	
F1740..... 500P		F502P		W215A..... W215A		6071, 6072..... 213A	
F1840..... 509P		32..... 951P		8M, 8M1, 8M2..... 85J		6073, 6074..... 243	
FT-6, FT-9, FT-9X..... 500P		37-34, 37-624, 38-34..... 510P		8M3, 8M4..... 213		6376, 6077..... 243	
Graham		28-35 (121)..... 510P		8YB, 8YBK..... W245A		6079..... 291	
G1418, G1436, G1528..... 505P		28-39 (121)..... 510P		9M1, 9M2..... 85J		6103, 6101..... 852	
Hupmobile		28-40 (121)..... 510P		RC-9 (Mobile Trans.)..... 725		6104..... 85J	
G (HGD), G-122 (HGD-122), H (HHD), H-122 (HHD-122)..... 500P		38-024..... 951P		AVR10, AVR10A (6-Volt)..... 743		6170..... 213A	
R (HRD), T-2 (HT-2), T-11 (HT-11), T-11X (HT-11X)..... 507P		39-744..... 951P		AVR15 (9-Volt)..... 745		6171, 6172..... 246	
Lincoln, Lincoln-Zephyr		43-748..... 951P		AVT15 (12-Volt)..... 271*		6176..... 243	
L1420, L1424, L1425, L1427, L1429, L1460, L1560, L1680..... 505P		P285Y		AVT15A (6-Volt)..... 85J		6193 (123.200)..... 85J	
T-14 (LT-14X3, LT-14X4)..... 500P		Canadian Models Only		M34..... 85J		6210..... 213A	
Nash		37-324, 38-C624..... 951P		M5J (RC3571)..... 85J		6214..... 213	
C (NCD), D-122 (CND), D-122J (NJD), Q (NQD), T-7 (NT-7), T-8 (NT-8), T-12 (NT-12X, NT-12X2), T-15 (NT-15, NT-15X2), N1418, N1433, N1433H, N1434, N1434H, N1514, N1524..... 505P		3818..... 509P		M7M1, 67M2, 67M3..... 85J		6218..... 291	
Packard		3911..... 501P		M70 (RC391)..... 85J		6273..... 246	
P (PHD), H-122 (PHD-122), T-5 (PT-5), T-14 (PT-14)..... 500P		3827..... 505P		R379V..... 729A		6271, 6272..... 291	
P1417, P1421, P1422, P1426, P1430, P1432, P1432H, P1436, P1517, P1530, P1535, P1617, P1630, P1635..... 505P		PHONOLA (Dominion Electrohome)		R379V..... 729A		6311 (123, 211)..... 85J	
P1835..... 509P		062..... 205		RS79 I, 81BT6..... 722A		6311 (126.223)..... 742	
Pierce-Arrow		3491, 3492..... 223B		85B F3..... 729A		6319-3G..... 85J	
E (MED), E-122 (MED-122), T-3 (MT-3), T-14 (MT-14X4)..... 500P		6V82E, 6V92D..... 215		91BT6, 91BT31..... 722A		6173 (101.582)..... 291	
M1412, M1435..... 505P		6V92P, 6V92S..... 245		93BK6, 93BT3..... 722A		6382 (101.594)..... 294	
Plymouth		7V41E..... 271		M101 (9-Volt)..... C2933		7353..... 294	
G (CGD), G-122 (CGD-122), R (CRD), T-2 (CT-2), T-11 (CT-11)..... 500P		7V51M, 7V51P, 7V52E..... 246		M104 (6-Volt)..... 291		7358..... 292	
C1450, C1452..... 505P		7V62P, 7V8 S, 8V41E..... 246		M104 (12-Volt)..... C2933		7383..... 222B	
C1808..... 505P		8V51M, 8V51P..... 246		M105..... 271*		7391, 7093, 7094..... 87J	
C1708..... 509P		9A041P..... 248		M107 (6-Volt)..... 231		7117..... 291	
C1808..... 509P		40V52V, 40V52E-1, 40V52P..... 245A		M108 (9-Volt)..... 293		7149..... 222B	
Reo		PIERCE-AIRO—(Also see Pierce-Arrow)		M108 (12-Volt)..... 291		7149 (2nd)..... 293	
T-3 (RT-3), T-14 (RT-14X)..... 500P		517 Auto..... 294		M116..... 271*		7153..... 291	
R1415..... 500P		617 Auto..... 294		M123..... 221		7157..... 291	
Studebaker		PIERCE-ARROW (Motor Car)		AC3569 (Nash)..... 219		7187..... 294	
C (SCD), C-122 (SCD-122), D (SDD), J (SJD), Q (SQD), T-3 (ST-3), T-7 (ST-7X), T-12 (ST-12), T-15 (ST-15)..... 500P		E (MED), E-122 (MED-122), T-3 (MT-3), T-14 (MT-14X4)..... 500P		AC3789 (Nash)..... 85J		7233..... 245C	
S1416, S1431, S1437, S1516, S1528..... 505P		M1412, M1435..... 505P		MI-7814..... 743		SENTINEL	
S1616, S1622..... 508P		PILOT		MI-7815, EQ45A, 81310-3, AR4229..... 271*		<i>(Eria-Sentinel)</i>	
S1722..... 509P		G50, G57 (G50 Series)..... 245A		REG MOTOR CAR—See Philco		10M, 10MF..... 294	
S1825..... 509P		1164..... 850		RADOLEK		11M..... 294	
S1826..... 509P		91..... 294		1098..... F221		31B, 34B, 49B, 50B..... 245A	
Willys		253, 255 (Type 1)..... 285XS		K16743, K16746..... 215C		63B, 66B, 66BE, 68, 68B, 68BE..... 245A	
W1419..... 505P		253, 255 (Type 2)..... 215		K16749..... 245A		73B, 78B, 78BE, 88BE, 99BE..... 215A	
Universal Auto Receivers		517, 527, 617, 702..... 294		K16781..... 245A		109X, 130B, 130B 3, 140B, 140BE..... 245A	
AR-1, AR-2, AR-3, AR-4, AR-5..... 509P		X2253, X2255..... F245		K16825..... 291		144X, 144XE..... 245A	
AR-6, AR-7, AR-8, AR-9..... 509P		G5206, CG5206, TG5206, G5207, TG5207 (G5200 Series)..... F245		N16704..... 245C		181B, 181BE..... 215A	
		H6204 (H6200 Series)..... 850		REMLER		191B, 191BE..... 215A	
		PLYMOUTH (Motor Car)		27 Scouty, 35 Auto..... 292		191X..... 215A	
		<i>(Also see Philco)</i>		SEARS-ROEBUCK		236..... 215A	
		G (CGD), G-122 (CGD-122), R (CRD), T-2 (CT-2), T-11 (CT-11)..... 500P		<i>(Silvertone)</i>		237..... 291	
		C1450, C1452..... 505P		107HA62..... 219		257..... 291	
		C1550..... 505P		598, 666..... 294		633, 602..... 292	
		C1808..... 505P		1855, 1853 (4-Prong)..... F294		653J..... 291	
		C1708..... 509P		1856, 1853 (6-Prong)..... F297		5100..... F251	
		C1808..... 509P		1859, 1859A..... 271		6100, 6101, 6102..... F221	
		PONTIAC		1880..... F251		SETCHELL-CARLSON	
		544245, 544246, 544267, 544268, 544289, 544290, 544291, 544297, 544298, 980393..... 273C		1871..... 291		<i>(Setco)</i>	
		980441, 980455, 980459, 983506, 983507..... 222		1899X..... 291		47, 41, 50, 51, 52, 410, 510, 44, 8J, 61, 62, 77, 81, 61J, 620, 622, 630, Sheriff..... 744	
		983526, 983527, 983534, 983569, 983570, 983616, 983617..... 852		1924, 1934..... 215A		SILVERTONE—See Sears-Roebuck	
		983667..... 249		1919, 1949A..... 291		SIMPLEX	
		983679..... 898		2061..... 213		DB, DF (500,001 and up)..... 245C	
		983680..... 870		2421..... 213		GB, GBE..... 245C	
		983705..... 249		4400, 4400A..... 219		P, P (32-Volt)..... F221	
		983775..... 870		4405..... 294		PB, PF (352,001 and up)..... 215C	
		983776..... 868		4407..... 291		Q (378,001 and up)..... 291	
		983777..... 870		4418..... 213		T (Early)..... 292	
		983910..... 870		4419..... 213		T (Late)..... 245C	
		983911..... 868		4421..... 213		TA..... 248	
		983912..... 859		4428..... 213		SONORA	
		723253..... 852		4430..... 213		AU12..... 264	
				4433..... 213		KU9..... 264	
				4441..... 213		LU170..... 85J	
				4448..... 294		M, Q, QA..... 246	
				4450..... 291		SM..... 850	
				4451, 4453, 4459, 4519..... 213		TM..... 246	
				4521..... 243		SPARTON (U. S. and Canada)	
				4523..... 294		33, 33A, 33B, 33C, ER33..... 292	
				4548..... 294		36..... 222	
				4548A..... 294		332-A, 838-B..... 292	
				4518V..... 291		649-6L..... 850	
				4550..... 213		649-6S..... 850	
				4559..... 246		670-6L..... 850	
				4600, 4601..... 852			
				4617..... 294			
				4814..... 294			
				4622, 4623..... 246A			
				4640..... 246			

P. R. MALLORY & CO. Inc.

MALLORY

Vibrators

MALLORY REPLACEMENT VIBRATOR CHART

for Auto Radio and Battery-Operated Household Receivers

Models	Re- place- ment	Models	Re- place- ment	Models	Re- place- ment	Models	Re- place- ment
SPARTON (U. S. and Canada)—Continued		STEWART-WARNER (U. S.)—Continued		TRUETONE (Western Auto)—Continued		WELLS-GARDNER—Continued	
670-68.....	850	1601, 1602, 1603, 1604,		8743.....	294	6-Tube (32-Volt).....	F251
676, 677, 678.....	204	1605, 1606, 1607, 1608,	294SW	V622, Z6Z1.....	292†	7C15-771.....	850
686, D686, H686.....	294	1609.....		1.7, X6, Z4, Z5.....	245C	C8, C6A, C6B.....	205
687-6, 688-6.....	245	1781.....	294SW	5H Series.....	246	062, 062A.....	205
699.....	294	1911, 1912, 1913, 1914,		5Y (25Y1).....	286S	06V, 06X.....	210
SPIEGEL		1915, 1916, 1917, 1918,	245	6C1.....	294	06Z.....	292†
A2200.....	245A	1919.....		6D.....	248	V622, Z6Z1.....	205
A2204.....	245A	1921, 1922, 1923, 1924,	245	6K.....	248	072.....	210
A2260.....	245A	1925, 1926, 1927, 1928,		6P.....	245C	C11, C13, C14.....	248
A245A, A2456, A2462.....	850	1929.....		6R, 6U.....	253	15C6.....	952W
L7.....	245C	R3271, R3271C, R3291,	854	062, 062A.....	205	25Y1.....	286S
U6.....	294	R3291C, 3341, 3371.....	294	06V.....	210	25Y1 (12-Volt).....	(286S)
V1148.....	850			072.....	292†	2611, 2615.....	F251
W216.....	246	STEWART-WARNER (Canadian)		R131 (J312).....	204	2981, 2611.....	253
W408.....	294	CR112.....	292	180, 184.....	245	36C7, 36C11.....	248
Z4, Z5.....	245C	R117.....	294	577.....	294†	461.1.....	294
Z7208.....	245A	R184, R187, R189.....	285XNS	670.....	299	651I.....	246
Z7460, Z7462.....	245C	R195 (1955).....	245	677.....	294		
6J.....	248	R198, R199.....	245	ULTRAMAR			
6P.....	245C	R402.....	245SW	327.....	246	WESTERN AIR PATROL	
14-129.....	245	1415.....	246A	337.....	246	708 (W832).....	246
25Y1 (5Y).....	296S	R4061.....	294SW	345, 355.....	246	WESTINGHOUSE (U.S.)	
102, 104, 112, 124 (Z4)	245C			856, 877.....	850	WR25.....	294
144.....	245C	STROMBERG-CARLSON (U. S. and Canada)				WR125 (6-Prong).....	296
145E.....	245	33, 33A, 33X.....	210	UNITED AMERICAN BOSCH—See Bosch		WR26 (6-Prong).....	294
152, 167, 178, 182, 183,	245C	115.....	245A	UNITED MOTORS SERVICE—See Buick, Chevrolet, Delco, Oldsmobile, and Pontiac		WR500, WR501, WR502, WR503.....	253Y
186.....	294	STUDEBAKER—(Also see Philco)		UNITED SCIENTIFIC LABS.—See Dewald		WR603, WR606.....	294
651.....	246	C (8CD), C-122 (8CD-122), D (8DD), J (8JD), Q (8JD), T-3 (8T-3), T-7 (8T-7X), T-12 (8T-12), T-15 (8T-15).....	500P	UNIVERSAL BATTERY		WR610.....	245
1108, 1109, 1110, 1111 (211).....	294	S1416, S1431, S1437, S1516, S1526.....	805P	50A9.....	246	WESTINGHOUSE (Canada)	
1142, V1142, 1143.....	294	S1618, S1622.....	808P	50A9.....	294	A43, A44.....	271*
1801, 1907, 1911, 1921 (X6).....	245C	S1825.....	509P	61A6 (1936).....	245C	B718A, B718X.....	W245A
1932, 1955, 1957 (X6), 1981, 1981 (X6).....	245C	S1825.....	509P	61A6 (1937).....	246	B719A, B819X.....	W245A
2006.....	850	S1826.....	509P	70.....	294	H40192.....	W245A
2007.....	850	TERRAPLANE—See Hudson-Terraplane		72A6.....	245C	WILCOX-GAY	
2212, 2213, 2214, 2215.....	245	TRANSITONE—See Philco		80, 802, 803.....	294	A5, A6 (5F8).....	
2222.....	245	5-Tube Batt. Rec.....	246	7232 (32V).....	F251	3R6, 4B6 (Roadmate).....	
2223.....	245	6-Tube Batt. or AC.....	850	7332 (32 V.), 8232 (32 V.), 8332 (32 V.).....	F204		
2224.....	245	7-Tube Auto.....	850	8432.....	294	WILLIS	
2225.....	245	8-Tube Batt. or AC.....	850	VICTOR (Canadian)		W1419.....	505P
2222-2220 (73B).....	245A	6, 6A.....	246	5M, 6M, 6M-2.....	240	61W693.....	1100
2254-2257.....	245	6, 6A.....	246	V6-1.....	W245A		
2280, 2281.....	245	6, 6A.....	246	8M, 8M1.....	850	4F133.....	W246
2300, 2301, T2300.....	294	6, 6A.....	246	8M3.....	240	4V31, 4V59.....	246
2302, 2303 (78).....	850	6, 6A.....	246	CV3 (Pak-O-Power).....	W245A	5F134, 5F166.....	W246
4040.....	950	6, 6A.....	246	A134.....	271*	5J217, 5J217T, 5J247, 5J255.....	850
4210 (66), 4212 (88).....	870	6, 6A.....	246	67M1.....	249	5M190.....	294SW
4215.....	294	6, 6A.....	246	67M2.....	249	5M191.....	294
4400.....	245C	6, 6A.....	246	95BK6, 95BT6, 97BK6.....	722A	5M291, 5M294.....	853
4402.....	246	6, 6A.....	246	M108.....	286S	6B107, 6B129, 6B164, 6B331.....	246
4404.....	245C	6, 6A.....	246	M108 (12-Volt).....	G286S	6J325, 6J325T, 6J357, 6J436, 6J463.....	850
4410.....	246	6, 6A.....	246	N1123.....	271*	6M190D, 6M190S, 6M191D, 6M191B, 6M192.....	294
4420, 4452.....	245C	6, 6A.....	246	WARWICK		6M192, 6M193, 6M194, 6M195.....	294
4519 (603).....	252	6, 6A.....	246	6-Tube Auto.....	504	6M292, 6M293, 6M295.....	853
4534.....	294	6, 6A.....	246	9-4.....	246A	6M390 (Ford).....	853
5200, 5210, 5214, 5216.....	246	6, 6A.....	246	9-59.....	850	6MF490 (Ford).....	850
5218.....	245	6, 6A.....	246	0-627.....	850	6MF590, 6MF591.....	850
5258, 5260 (700).....	246A	6, 6A.....	246	406.....	246A	6MF690.....	1100
5300.....	294	6, 6A.....	246	453.....	246	6M1495.....	850
6708 (M5).....	245A	6, 6A.....	246	511, 550C.....	504	6M1496.....	246
6712.....	245	6, 6A.....	246	553, 562, 600.....	246	6M1505.....	246
6714.....	246	6, 6A.....	246	646.....	294	6M1595.....	850
6716.....	245	6, 6A.....	246	651.....	246	6M1805.....	1100
6750, 6752 (Z4).....	245C	6, 6A.....	246	652B.....	246A	6M1W693.....	1100
6754 (M5).....	245C	6, 6A.....	246	654, 700.....	246	6V27, 6V62.....	246
6758.....	246	6, 6A.....	246	746.....	294	6VA27, 6VA62.....	246
6760 (700).....	246A	6, 6A.....	246	847.....	246	7J232, 7J232T, 7J259, 7J259T, 7J323, 7J368.....	296
6766.....	245	6, 6A.....	246	751, 761.....	246	7M191D, 7M191S.....	850
6770 (700).....	246A	6, 6A.....	246	846.....	294	7M1592.....	294
6772.....	245	6, 6A.....	246	WELLS-GARDNER		7M1596.....	850
6800.....	204	6, 6A.....	246	B2A, 82 Series.....	246	8M106.....	294
6805, 6806, 6807, 6808,		6, 6A.....	246	C5.....	248	8M1092.....	850
6815, 6816, 6817, 6818,		6, 6A.....	246	C7.....	248	S1 (Series).....	246
6836 (14-1128).....	294	6, 6A.....	246	3C6.....	952W	3C6.....	952W
9930.....	286S	6, 6A.....	246	6C1.....	953W	6B.....	952W
STEWART-WARNER (U. S.)		6, 6A.....	246	6C7, 6C9.....	248	5H Series.....	286S
R112.....	292	6, 6A.....	246	5Y.....	286S	5Y (12-Volt).....	G286S
R117, R118.....	294	6, 6A.....	246	5Y.....	286S	6B.....	F251
R131.....	294	6, 6A.....	246	6C1.....	294	6B.....	294
R132.....	289Y	6, 6A.....	246	6C7, 6C9.....	248	6C1.....	248
R133.....	294	6, 6A.....	246	6G.....	248	6G.....	248
R143, R160.....	294SW	6, 6A.....	246	6J.....	248	6K.....	248
R178.....	294SW	6, 6A.....	246	6L, 6N, 6R.....	294	6L, 6N, 6R.....	294
R189.....	285XS	6, 6A.....	246	6S, 6U.....	253	6S, 6U.....	253
R191D, R192D.....	245	6, 6A.....	246				
R318, R319.....	854	6, 6A.....	246				
1121, 1122, 1123.....	292	6, 6A.....	246				
1171, 1172, 1181, 1182, 1183.....	294	6, 6A.....	246				
1311, 1312, 1313, 1314, 1315, 1316, 1317, 1318, 1319.....	294	6, 6A.....	246				
1322.....	289Y	6, 6A.....	246				
1332.....	294	6, 6A.....	246				
1431.....	294SW	6, 6A.....	246				

*Requires Special Cup Adapter. Supplied at \$1.20 list.
 †CAUTION! If the vibrator being replaced in one of these radio sets is a DeVry Carbon Point Vibrator, it will be necessary to replace the power transformer with one of a later type. This transformer is available from the Radio Set Manufacturer.
 ‡Buffer capacity value must be changed to .015 mfd.
 †Transfer pins from original vibrator.
 The prefix letter "F" designates Vibrator designed for 32-volt Service.
 The prefix letter "G" designates Vibrator designed for 12-volt Service.



REPLACEMENT VIBRATORS

COMPARISON CHART

Radiart	Utah	Radiart	Utah	Radiart	Utah	Radiart	Utah	Mallory	Utah	Mallory	Utah	Delco	Utah
2742	NL3	3463	32SP2M	4402	SP5	5335	NP487	220B	NL3M	292	NL3	1206048	NL3
2743	NL3	3481	32NP61	4403	SP56	5339	NP480	F220C	32NL3M	F292	32NL3	1207758	NL3
2747	NL3	3503	32NP6	4404	32SP6	5340M	NP484	221	NL3	294	NP42	1208000	SL5
2819	NL3	3588	32NL3	4414	SP72	5341M	NP484	F221	32NL3	294C	NP480	1208116	32SL5
2819-32	32NL3	3607	32SL5	4415	SP61	5342M	NP485	222	SL5	F294	32NP42	1208182	SL5
2864	NL3	3608	32NL3	4415-12	12SP61	5365	NP65	223	SL5	294SW	NP43	1208239	SL5
2867	NL3	3651	32SP56	4416	SP66	5400	SP62	F223	32SL5	296	NP6	1208920	32SP6
3200	NL3	3679	SP55	4417	4SP56	5404	SP63	224	SP61	297	NP61	1209282	SP51
3223	NP6	3741	NP40	4500	SL5	5405	SP55	225	SL5	F297	32NP61	1211375	SP56
3225	32NL3	3782	NP42	4501	SP63	5406	SP71	226	SL5	299	NP63	5035120	SL5
3227	NL3	3786	NP51	4502	SP50	5406-12	12SP71	230	SP5H	500P	NP41	5037400	SP51
3260	NP4	3806	NP42	4504	SP52	5407	SP641	231	SL4H	501P	NP44	5038055	SP51
3261	NP6	3815	NP481	4505	SP50	5409	SP5	234	SL4H	503	NL3	5039661	SP51
3282	NP40	3842	NP481	4607	SL4H	5409-32	32SP5	235	SL4H	504	NP62	5039757	SP51
3283	NP6	3848	SL5	4608	SP68	5409-4	4SP5	245	SP5	505P	NP49	5040000	NP44
3284	NP482	3850	SP63	4610	SP5H	5410	SP55	245A	SP56	507P	NP483	5040700	SP51
3283	SP50	3865	NP44	4611	SP52	5411	SP66	F245	32SP5	508P	NP484	5041125	SP56
3290	SL4H	3880	NL3	4612	SP66	5413	SP66	G245	12SP5	509P	NP476	5041245	SP51
3293	NP6	3883	SP69	4613	SP51	5415	4SP56	W245	4SP5	510P	NP48	5041376	NP42
3300	NL3	3888	NP40	4614	SP51	5420P	SP66	W245A	4SP56	514	SP54	5042240	SP51
3302	NP6	3883-12	12SP69	5300	NP42	5421	SP66	245C	SP55	715	SP54	5042703	NP49
3308	SL5	3989	SP6	5301	NP485	5422	SP7	246	SP66	716	SP54	5043853	SP52
3313	NL3	4253	NP42	5303	NP480	5426	SP54	246A	SP646	722A	SP64	5050498	SP54
3315	SL5	4253-12	12NP42	5304	NP50	5427	4SP66	W246	4SP66	725	SP71	5050651	SP56
3317	SL5	4253-32	32NP42	5305	NP42g	5428	SP60	247	SP6	G725	12SP71	5050673	NP480
3318	SP5H	4264	SL52	5306	NP6	5430	SP64	F247	32SP6	728A	SP64	5052370	SL51
3319	SL51	4254-12	12SL52	5310	NP42	5431	4SP65	248	SP62	743	SP644	5052374	NP6
3320	NP41	4254-32	32SL52	5312	NP6	5434	SP64	249	SP71	825	NP48	5052378	NP42
3356	NP61	4255	SP71	5313	NP48	5435	SP66	F251	32NP489	F826	32NP48	5052525	SP66
3375	NL3	4255-12	12SP71	5320	NP49	5437	SP645	253T	NP481	839	NP48	5052538	NP481
3395	32NP48	4255-32	32SP71	5321	NP44	5438	SP640	253Y	NP44	850	NP48	5052869	SP69
3397	32NP61	4257	SP72	5322	NP41	5439	SP66	253	NP489	G850	12NP48	5053141	SP53
3398	NL3	4257-12	12SP72	5323	NP483	5439-12	12SP66	F253	32NP489	852	NP480	5053179	SP6
3399	NP482	4257-32	32SP72	5325P	NP484	210	NP484	G253	12NP489	853	NP44	5053181	SP55
3417	NP482	4260	NP4	5326P	NP485	211	SP5H	270B	SP50	854	NP43	5053183	SP71
3417-12	12NP482	4301	NP482	5327P	NP48	212	SP5H	271	SP50	860	NP45	5053185	SP5
3442	NL3M	4313	NP482	5330	NP4	213	SP5H	271HD	SP50	863	NP487	5053501	SP62
3445	SP5H	4314	32NP61	5331	NP43	214	SP5H	273C	SP51	868	NP45	5053696	NL3
3460	32NL3M	4318	NP62	5333	NP45	F211	32SP5H	273D	SP52	869	NP42		
3461	PS15	4320	NP63	5334	NP45	219	SP5H	275XS	SP68	901M	NP484		
								277S	SP63	902M	NP48		
								P285Y	SP60	903M	NP485		
								W285	4SP56	591P	SP66		
								285XS	SP67	592W	SP645		
								286S	SP69	953W	SP640		
								G286S	12SP69	954	SP633		
								289Y	SP72				

PRICE LIST — HOOK-UP — DIMENSIONS OF UTAH VIBRATORS

Stock Number	Size	Base Code Letter	List Price	Stock Number	Size	Base Code Letter	List Price	Stock Number	Size	Base Code Letter	List Price
NL3	1 1/4 x 1 1/2 x 2 H	A	\$4.15	NP51	2 x 3 3/8	O	\$4.15	SP60	1 1/4 x 3 1/2	AA	\$5.95
NL3M	1 1/2 x 1 1/2 x 3 1/2	B	4.75	NP6	1 1/4 x 3 1/2	P	3.55	SP61	2 1/4 x 3 1/2	AB	6.50
NP4	1 1/4 x 3 1/2	I	3.55	NP61	1 1/4 x 3 1/2	Q	4.75	SP62	1 1/2 x 3 1/2	AC	5.95
NP40	1 1/2 x 3 3/8	I	4.15	NP62	1 1/4 x 3 1/2	R	4.75	SP63	2 x 4 1/2	AD	7.15
NP41	2 1/4 x 4 1/4	J	3.00	NP63	1 1/4 x 3 1/2	R	4.75	SP64	2 x 3 3/8	AE	5.95
NP42	1 1/2 x 3 1/2	J	3.55	NP64	2 x 3 3/8	S	4.75	SP65	1 1/4 x 3 1/2	AG	6.60
NP43	1 1/2 x 3 1/2	K	3.55	SL5	1 1/4 x 1 1/2 x 2 H	C	6.60	SP66	1 1/2 x 3 1/2	AH	5.95
NP44	1 1/2 x 3 1/2	J	3.55	SL51	2 x 4 1/2	D	7.15	SP67	2 x 4 1/2	AJ	8.50
NP45	1 1/2 x 3 1/2	M	3.55	SLM (see SL4H)				SP68	2 x 4 1/2	AK	9.00
NP46	1 1/2 x 3 1/2	L	3.55	SL4H	1 1/4 x 1 1/2 x 2 H	F	7.15	SP69	2 x 4 1/2	AC	6.60
NP47	1 1/2 x 3 1/2	J	3.55	SL52	1 1/4 x 3 1/2	E	5.95	SP633	1 1/2 x 3 1/2	AF	5.95
NP47b	1 1/2 x 2 1/2	L	3.55	SP5H	2 1/4 x 2 1/2 x 5 1/2	G	9.00	SP640	1 1/2 x 3 1/2	AC	5.95
NP48	1 1/2 x 3 1/2	L	3.55	SP5	1 1/4 x 3 1/2	T	5.95	SP641	1 1/2 x 2 1/2	AC	5.95
NP49	2 x 3 3/8	J	3.55	SP5H	1 1/4 x 3 1/2	U	5.95	SP644	1 1/2 x 3 1/2	AH	5.95
NP480	1 1/2 x 3 3/8	M	3.55	SP50	2 x 4 1/2	V	7.15	SP645	1 1/2 x 2 1/2	AC	5.95
NP481	2 x 4 1/2	I	4.75	SP51	2 x 4 1/2	U	6.60	SP646	1 1/2 x 3 1/2	AH	5.95
NP482	2 x 4 1/2	I	4.75	SP52	2 x 4 1/2	W	6.60	SP7	1 1/2 x 3 1/2	AL	6.60
NP483	1 1/4 x 3 1/2	J	3.00	SP53	2 x 3 3/8	U	7.15	SP71	1 1/2 x 3 1/2	AN	5.95
NP484	1 1/2 x 3 1/2	J	3.00	SP54	1 1/4 x 3 1/2	X	5.95	SP72	1 1/2 x 3 1/2	AN	5.95
NP485	1 1/2 x 3 1/2	J	3.00	SP55	1 1/4 x 3 1/2	Y	5.95	4SP5	1 1/2 x 3 1/2	T	5.95
NP487	1 1/2 x 2 1/2	M	3.55	SP56	2 x 3 3/8	T	5.95	4SP56	2 x 3 3/8	T	5.95
NP489	2 x 4 1/2	H	4.75	SP57	1 1/4 x 3 1/2	T	5.95	4SP65	1 1/2 x 3 1/2	AG	6.60
NP50	1 1/2 x 3 1/2	N	4.15	SP6	1 1/2 x 3 1/2	Z	5.95	4SP66	1 1/2 x 3 1/2	AH	5.95

BASE DIAGRAMS

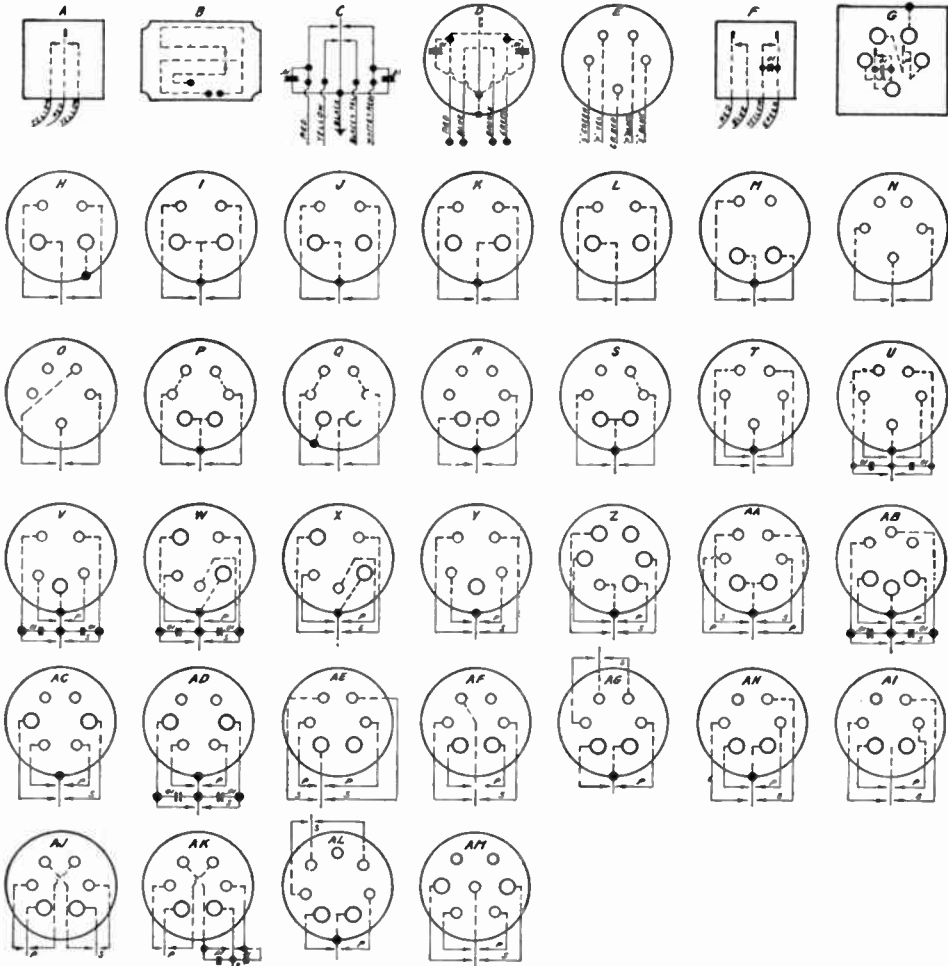

VIBRATOR TESTER CIRCUIT

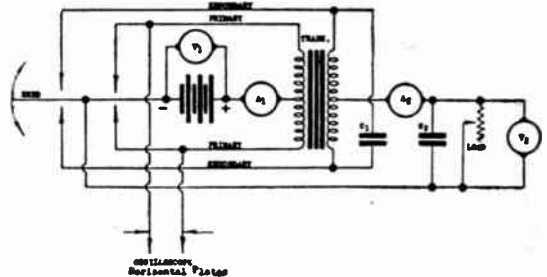
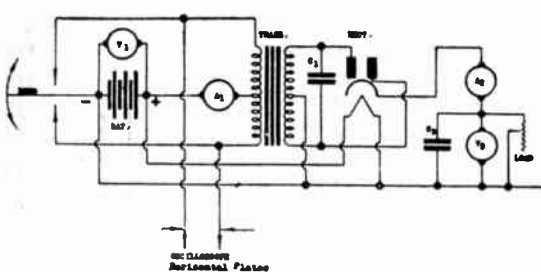

NON-SYNCHRONOUS

- | | |
|---|---|
| Trans.—Utah No. 2460 Vibrator Transformer | C ₁ —8 M. F. 450 V. Electrolytic Condenser |
| Rect.—6X5G Rectifier Tube | A ₁ —0-10 Ammeter, D.C. |
| Load—5000 Ohm 25 Watt Rheostat | A ₂ —0-100 Milliammeter, D.C. |
| C ₁ —.008 M. F. 1600 V. Buffer Condenser | V ₁ —0-10 Voltmeter, D.C. |
| | V ₂ —0-500 Voltmeter, D.C. |

SYNCHRONOUS

- | | |
|--|---|
| Trans.—Utah No. 2460 Vibrator Transformer | C ₁ —8 M. F. 450 V. Electrolytic Condenser |
| Load—5000 Ohm 25 Watt Rheostat | A ₁ —0-10 Ammeter, D.C. |
| C ₁ —.01 M. F. 1600 V. Buffer Condenser | A ₂ —0-100 Milliammeter, D.C. |
| | V ₁ —0-10 Voltmeter, D.C. |
| | V ₂ —0-500 Voltmeter, D.C. |

Thank You!

When writing for additional
information or when ordering
from sources of supply listed
in this book, please mention

RADIO'S MASTER

Mueller Electric Co.

CLEVELAND, OHIO

MUELLER BATTERY AND TEST CLIPS

U.S. PATENTS: 1,521,903; 1,686,842; 1,779,442; 1,965,151; 1,994,251; 1,999,613

For use in making quick, temporary electrical connections. Packed 10 in a box, half marked + half plain to indicate polarity. Screw connections



No. 45 PEE WEE
A very small test clip for radio, ignition, meter and similar work. 1 1/2" long. Jaw spread 3/8". Steel, bright finish.
EACH NET.....\$0.05 LOTS OF 10.....\$0.033
Use No. 47 Insulator



No. 48-B TEST AND BATTERY CLIP
A small test and battery clip for radio use and general testing purposes. 2" long. Jaw spread 1/2". Steel, bright finish.
EACH NET.....\$0.05 LOTS OF 10.....\$0.035
No. 48C—Solid Copper. Same size as 48-B.
EACH NET.....\$0.10 LOTS OF 10.....\$0.07
Use No. 49 Insulator for Clips 48-B and 48-C.



No. 27
A high grade test clip with meshing teeth on three sides of jaws. For laboratory and shop test work. 2 1/2" long. Jaw spread 5/8". Steel, bright finish.
EACH NET.....\$0.10 LOTS OF 10.....\$0.07
EACH NET.....\$0.17 LOTS OF 10.....\$0.12
No. 27-C—Solid copper. Same size as No. 27.
Use No. 29 Insulator for clips 27 and 27-C.



No. 24-A
A medium sized battery clip. Stands erect on battery post. Lead coated, copper shunt protects spring. 2 3/4" long. Jaw spread 1". Steel, lead plated.
EACH NET.....\$0.10 LOTS OF 10.....\$0.07
EACH NET.....\$0.20 LOTS OF 10.....\$0.14
No. 24—Solid copper. Same size as No. 24-A.
Use No. 26 Insulator for Clips 24-A and 24.

LARGER SIZES OF CLIPS

	Each Net	Lots of 10
No. 21-A—Heavy Duty Steel, lead plated, 4" long	\$0.17	\$0.12
No. 11A—100 Amp. Steel, lead plated, 6" long	0.60	0.42
No. 11—200 Amp. Solid copper, 6" long	1.00	0.70
No. 33—300 Amp. Solid copper, 7 3/4" long	1.80	1.25

(Above furnished with lug connections.)

RUBBER INSULATORS FOR CLIPS



A packaged protection against short circuit and electric shock. Packed 10 in a box, 5 red and 5 black to indicate polarity. Long tail prevents breakage of wire. Constructed so that clip is held in firmly.

Insulator No.	For Use with Clip No.	Each Net	Lots of 10
13	11, 11-A	\$0.52	\$0.36
23	21, 21-A	0.33	0.23
26	24, 24-A	0.19	0.13
29	27, 27-C	0.12	0.084
35	33	0.82	0.58
47	45, 45-C	0.08	0.056
49	48-B, 48-C	0.09	0.06
87	85	0.06	0.037
93	88	0.05	0.035

CROCODILE CLIPS

U.S. Patent No. 1,999,613



No. 85 Clip with No. 87 Insulator
No. 85—A very small clip with slender, elongated jaws for getting into tight places in radio or electrical test work. Teeth really mesh. Screw connection. 2" long.
EACH NET.....\$0.07 LOTS OF 10.....\$0.045
No. 85-T—New Crocodile "Tip-Clip"—equipped with standard phone tip on one jaw, otherwise same as No. 85. Ideal for use as a prod, for ordinary clip connections and for connections to insulated binding posts having non-removable heads.
EACH NET.....\$0.14 LOTS OF 10.....\$0.095
Use No. 87 Insulators for either clip. Red and Black. Cover entire clip except nose. Protects against short and shock. Helps to distinguish leads.

ALLIGATOR CLIPS

No. 60—CONVENTIONAL TYPE
Accurately made, slim jaws, fine meshing teeth. Convenient, round thumb grip, barrel connection for banana plug. Equipped with small soldering lip. Strong spring with a hard bite. Bright, non-corrosive finish. 2" long.
EACH NET.....\$0.05 LOTS OF 10.....\$0.35

No. 60-S—SCREW CONNECTION
Eliminates necessity for soldering. Otherwise same as No. 60.
EACH NET.....\$0.06 LOTS OF 10.....\$0.04

No. 60-CS—NEW COPPER R.F. ALLIGATOR CLIP
Same as No. 60 except made of solid copper. Has phosphor bronze spring and brass screw connection. Ideal for R.F. work. Will not heat up in H.F. circuits. Bright, natural copper finish. 2" long.
EACH NET.....\$0.10 LOTS OF 10.....\$0.07

No. 60-HS—STEEL ALLIGATOR CLIP WITH INSULATED HANDLE
Same as No. 60 except equipped with red and black insulating sleeves on end. Very convenient for distinguishing leads. Has screw connection also. Bright, attractive finish. 2 1/4" long.
EACH NET.....\$0.12 LOTS OF 10.....\$0.085

No. 60-CHS—COPPER ALLIGATOR CLIP WITH INSULATED HANDLE
Same as No. 60-CS except equipped with red and black insulating sleeves on end. Entirely non-ferrous with brass screw connection, for R.F. work. 2 1/4" long.
EACH NET.....\$0.17 LOTS OF 10.....\$0.12

WEE-PEE-WEE No. 88

Entirely Non-ferrous. Smaller Than Ever!
An extremely small clip for fine testing in radio and electrical work. Light-Weight; thin-nosed; spring-temper phosphor bronze. Ideal for close-wound coils. 1 1/8" long; jaw spread 1/4".
EACH NET.....\$0.09 LOTS OF 10.....\$0.06
No. 93—Fiber-glas Insulators for No. 88 Clip.
EACH NET.....\$0.05 LOTS OF 10.....\$0.035

No. 45-C SOLID COPPER TEST CLIP

Solid copper radio frequency test clip. Phosphor bronze spring, brass screw. Will not heat up in high frequency test work, entirely non-ferrous.
EACH NET.....\$0.08 LOTS OF 10.....\$0.055
Use No. 47 Insulator.

CLAMPIPE GROUND CLAMP

The exclusive patented feature of a U-shaped cross section in combination with a U-shaped clamp gives a rigidity and effectiveness to the ClamPipe that cannot be found in any other make.

The ClamPipe will not bend or lop over when applied to a pipe. The point of the large case hardened screw, cuts through rust, paint or corrosion into clean, fresh metal, insuring a good contact. The Clamp may be installed on a pipe lying flush against a wall. Will not spread open.

The best ground clamp value on the market. Applicable to pipe 3/8" to 1 1/2" outside diameter.

Packed 10 in a box
EACH NET.....\$0.09 LOTS OF 10.....\$0.06

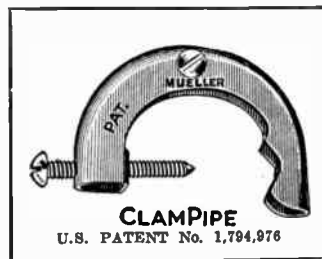

No. 58

Mueller Electric Co.

THE SNAPPER

A Long Insulated Test Clip and
A "Triple Threat" Radio Tool

U. S. Patent No. 2,074,324
No. 99—7" Long Insulated



The long tube is of insulating material and is fitted with spring contact jaws on the far end. The jaws are operated by a push of the thumb on the near end. Wire is quickly and easily connected in a hole in the insulator knob binding post on the near end.

May be used as (1) A "Deep Sea" Electric Test Clip—test contacts with ease, deep in the recesses of radio chassis with no danger of short circuits; (2) An Electric Contact Prod—clip jaws may be used to make quick prod contacts, or clip one Snapper on ground circuit and prod with another; (3) A Retriever—start small screws and nuts or pick up odds and ends that may accidentally be dropped into inaccessible places.

PRICE...\$0.65 EACH Dealers Wholesale Price, each...\$0.39 Net
Snappers are generally used in pairs—1 red and 1 black.

INSULATED GRID CLIP ASSEMBLY

One Universal Clip That Fits Them All
This assembly is made up of a Pee-Wee Clip with jaws specially constructed to give a firm grip on all sizes of grid caps, a rubber insulator over the clip, 10 inches of flexible, rubber-covered wire and a standard phone tip.

FEATURES: ● Will Never Weaken or Break ● Bull-Dog Grip—in either vertical or horizontal position, will not come off cap no matter how hard tube is pounded. ● Will Not Injure or Break Grid Cap—if clip itself is struck accidentally it will pull loose without damaging cap. ● Wire Will Not Pull Loose from Clip—soldered connection at both ends. ● Quick and Easy Application—fits all sizes of grid caps. No. 106—Insulated Grid Clip Assembly
EACH NET \$0.20 LOTS OF 10 \$0.13



U. S. Patents Nos.
1,779,442-1,965,151

RADIO CLIP KIT



No. 104

A handy and useful assortment of clips, ground clamps, insulators, etc. for the radio shop.

Have what you want when you want it. A real value in a convenient package. The 77 items cost much less when purchased in this kit
PRICE PER KIT.....\$6.67
Dealers wholesale price.....\$4.00 Net
than they would separately.

BATTERY POST ADAPTER

For Making Non-Corrosive, Semi-Permanent
Connections to Storage Batteries

No. 103—Is simply pressed, not burned, on to battery post. The wire is quickly and easily connected under the thumb nut.

Made of non-corrosive antimonial lead. Ideal for use on battery operated home appliances.



No. 103

Packed 10 in a box

EACH NET.....\$0.15 LOTS OF 10.....\$0.10

BATTERY CHARGING JUMPERS



No. 89—MUELLER CLIP JUMPER

A complete jumper, ready to use. Two No. 24-A clips and 14" of rubber covered copper wire.

EACH NET.....\$0.25 Packed 10 in a box
LOTS OF 10.....\$0.18



No. 57—MUELLER TAP-TITE SPIKE JUMPER

Hard, pointed steel pins soldered to ends of wire and held firmly in lead coated steel jackets. Drive into battery posts.

EACH NET.....\$0.20 Packed 10 in a box
LOTS OF 10.....\$0.15



No. 38—MUELLER PRES-TITE JUMPER

Is simply pressed over battery posts. Made of non-corrosive, antimonial lead.

EACH NET.....\$0.20 Packed 10 in a box
LOTS OF 10.....\$0.15

BATTERY CARRIERS



No. 73—MUELLER "COCKEYED CARRIER"

No. 73—A rugged carrier with heavy, rubber covered strap which will stand plenty of abuse. To use, drop the end pieces over the battery posts and lift up. This cocks the eyes and they grah hold. The heavier the battery the tighter the grip. 12" long. Packed 10 in a box.

EACH NET.....\$0.40 LOTS OF 10.....\$0.27

NEW EXTRA LONG CARRIER

No. 73-EL—19" long. Ample length to take the new long batteries in some latest model cars. Same construction as No. 73. Packed 10 in a carton.

EACH NET.....\$0.50 LOTS OF 10.....\$0.35

PRICES SUBJECT TO CHANGE WITHOUT NOTICE

Copyright by U. C. P., Inc.

Pioneer

POWER SUPPLY DEVICES

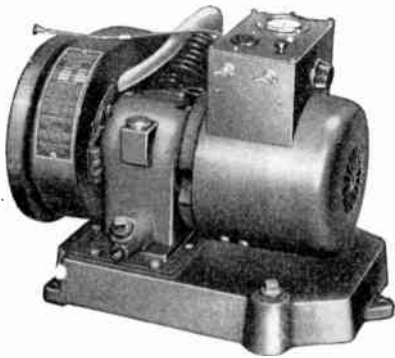

THE NEW BLUE DIAMOND A.C. - D.C. GAS - ELECTRIC PLANT

Same as "Power Co." Electricity — Also Charges Batteries

Thousands of Blue Diamond Plants are now in use throughout the world. The NEW Blue Diamond portable TWO in ONE Electric Plant is the outstanding value in A.C. plants, yet, this unit will also furnish an adequate supply of D.C. for charging batteries. The A.C. is 110 volts, 60 cycles, without a flicker, the same as furnished by power companies.

FEATURES—Capacity—300 watts, 110 volts A.C. 60 cycles, without a flicker, and from the same plant 200 watts, 6 volts D.C.; 250 watts, 12 volts D.C., or 325 watts, 32 volts D.C.—Generator—4-pole—direct connected on to crankshaft of engine (no coupling)—steel shell—all parts easily accessible by merely removing end cover.—Engine—4 cycle, single cylinder, air-cooled, 5/8 H.P. engine with mechanical governor to maintain constant speed of 1800 R.P.M.—cast-iron fuel tank base—ignition shielding. Starting—All Models—push-button starting—also auxiliary rope-puller starter (except type DD110). Filter—If the plant is used to operate a radio, the filter is recommended.—Fuel Consumption—Operates 12 to 16 hours on one gallon of gasoline—base tank one gallon capacity.—Compact Design—Overall dimensions, 19 1/2" long, 14" high, 14" wide, making the Blue Diamond the ideal plant where space is valuable.—Remote Control Type—Push-button starting and stopping from a remote point—built into the plant, not furnished separately.

NEW BLUE DIAMOND A.C. - D.C. PLANT

Type	Description	Output Watts A.C.* or D.C.	Approx. Net Weight	Code	List Price
BD6	110 Volts A.C.; or D.C. for charging 6-volt batteries.	300 200	106 lbs.	BLAZE	\$ 87.95
BDR6	110 Volts A.C. or D.C. for charging 6-volt batteries, with remote control, ammeter and voltmeter in control box.	300 200	110 lbs.	BLAST	115.45
BD12	110 Volts A.C.; or D.C. for charging 12-volt batteries.	300 250	106 lbs.	BLURB	96.20
BDR12	110 Volts A.C.; or D.C. for charging 12-volt batteries, with remote control, ammeter and voltmeter in control box.	300 250	110 lbs.	BLOOM	123.70
BD32	110 Volts A.C.; or D.C. for charging 32-volt batteries.	300 325	106 lbs.	BLACH	101.15
BDR32	110 Volts A.C.; or D.C. for charging 32-volt batteries, with remote control, ammeter and voltmeter in control box.	300 325	110 lbs.	BLINT	128.65

*At 1.0 power factor.

Rheostat shown in illustration furnished only on type DD6-12.

These A.C.-D.C. Plants furnish either A.C. or D.C. (not designed to develop full rating of both at same time).

NEW BLUE DIAMOND D.C. PLANT

DD6-12	6 or 12 Volts D.C.—6 volts 175 watts, 12 volts 350 watts.	108 lbs.	BLETH	\$64.45
DD32	32 Volts D.C.—350 watts.	108 lbs.	BLEAK	76.95
DD-110	110 Volts D.C.; 350 watts; rope starter only.	108 lbs.	BLEEN	81.35
BDF	Filter (for either "BD" or "DD" series)	2 lbs.	BLIGE	6.60

The "Pincor" Champion Gas-Electric Plant S-6 (NACRE) for charging 6-volt batteries; S-12 (NAMAZ) for charging 12-volt batteries; 175 watts; 51 lbs. List Price \$54.95

ANNOUNCING THE NEW "PINCOR" GOLD CROWN HEAVY DUTY GAS - ELECTRIC PLANTS



The NEW "Pincor" GOLD CROWN Gas-Electric Plants provide a full line of units that fill every heavy-duty requirement. They answer the ever-increasing demand for generators of greater output with attending low first cost, economical operation and minimum space requirements. The NEW "Gold Crown" is the result of many years of developmental work and tests by pioneer Gen-E-Motor Corporation engineers.

Features—Capacity—600, 1000 or 1500 watts.—All voltages: 32 volts, 110 volts A.C. or D.C. or 220 volts A.C. or D.C. The 32-volt D.C. plants are designed for use with 32-volt storage batteries, the average charging rate (depending on condition of battery) 600-watt plant, 18 amperes; 1000-watt plant, 25 amperes; 1500-watt plant, 38 amperes. The 110-volt D.C. and A.C. plants are for direct connection to load. Generator—4-pole—self-excited—mounted on the crankshaft of engine (NO COUPLING)—Large fan mounted on the armature assures cool operation and prevents the accumulation of dust or dirt.—All windings thoroughly impregnated with insulating compound.—Large commutator and collector rings—Accurately balanced armature.—1800 R.P.M.—All parts easily accessible by merely removing end cover.—Engine—4-cycle, single cylinder L head, air cooled—High-tension moisture-proof flywheel Magneto.—Pump and splash lubrication.—Float feed, adjustable Carburetor.—Flyball type, adjustable, full-enclosed Governor, operating in oil.—S.A.E. babbit-lined Bearings.—One-piece, special alloy Cam and Cam Gear.—1045 S.A.E. steel, heat-treated crankshaft, counter-weights drop-forged integral with shaft.—Alloy steel, completely enclosed Valves.—Aluminum alloy Connecting Rod, large split bearing on crank pin.—Aluminum alloy Piston, fitted with two compression rings and one oil control ring.—Oil bath Air Cleaner.—Heat resisting enamel finish.—600-Watt Plant Engine—1 h.p.; bore 2 1/4"; stroke 2 1/4"; fuel tank capacity 1 gallon for approximately 7 hours' operation at rated load.—1000-Watt Plant Engine.—2 h.p.; bore 2 5/8"; stroke 2 3/4"; fuel tank capacity 1 gallon for approximately 4 to 5 hours' operation at rated load.—1500-Watt Plant Engine—3 h.p.; bore 3 1/4"; stroke 3 1/4"; fuel tank capacity 1 1/2 gallon, approximately 3 hours operation on 1 gallon at rated load.—Starting—Push-button electric starting is standard on the 32-volt D.C. and 110-volt A.C. plants (12-volt battery required for electric starting of 110-volt A.C. plant) also auxiliary rope-pull starter. The 110-volt D.C. type has rope-pull starter in 600 and 1000 watt and hand-crank starter in 1500 watt.—Remote Control Type—Push-button starting and stopping from a remote point an optional extra feature available on the 110-volt A.C. plants. The Remote Control feature is built into the plant—not furnished separately. Operates from a 12-volt battery which is included in the price of the Remote Control feature.—Filter and Shielding—For operating a radio, the filter and ignition shielding should be used. (Optional extra equipment.)

NEW "GOLD CROWN" AIR COOLED PLANTS

Type No.	Code	Voltage	Capacity	DIMENSIONS			Approx. Net Weight	List Price
				Length	Width	Height		
BA-6	BAAND	110 Volts A.C.	600 Watts	27"	22 1/4"	21"	142 lbs.	\$397.50
BA-10	BABCO	110 Volts A.C.	1000 Watts	27"	22 1/2"	21"	175 lbs.	285.50
BA-15	BACUS	110 Volts A.C.	1500 Watts	40"	26"	32"	365 lbs.	375.50
BC-6	BEARY	for 32-volt batteries	600 Watts	27"	22 1/4"	21"	135 lbs.	173.25
BC-10	BEBTO	for 32-volt batteries	1000 Watts	27"	22 1/2"	21"	170 lbs.	203.50
BC-15	BECCA	for 32-volt batteries	1500 Watts	40"	26"	32"	360 lbs.	316.25
DC-6	SAHIB	110 Volts D.C.	600 Watts	20 3/4"	18 3/4"	20"	140 lbs.	173.25
DC-10	SABAN	110 Volts D.C.	1000 Watts	24 1/4"	19 1/4"	21 1/4"	170 lbs.	203.50
DC-15	SALIS	110 Volts D.C.	1500 Watts	29 1/4"	20"	24 1/4"	275 lbs.	316.25
BT-12	STATT	12-Volt Starting Battery for 110-Volt A.C. Plants ("BA" Series)					60 lbs.	15.95

Remote Control Feature—for 600 and 1000-watt plant add \$48.20 to list price of standard plant. For 1500-watt plant add \$52.25 to list price of standard plant. This includes a 12-volt starting battery. For REMOTE CONTROL, use code word "GOMAT" in addition to code word for standard plant. **Filter and Shielding**—\$11.50 list—use code word "GORAD" in addition to code word for standard plant. For 220 volts D.C. or A.C. (60 cycles) add 5% to the list price of 110-volt plant.—For 220 volts D.C. use code word "DID0Z" in addition to code word for 110-volt plant.—For 220 volts A.C. (60 cycles) use code word "ACTTO" in addition to code word for 110-volt plant. For 110-volt 50-cycle output add 15% to the list price of 60-cycle plant.—Use code word "FPCY" in addition to code word for 110-volt, 60-cycle unit. NOTE: The maximum wattage for 50 cycles of 1500-watt plant (BA-150) is 1200 watts—BA-100 is 700 watts—BA-60 is 400 watts.

"PINCOR" PRODUCTS Manufactured by Pioneer Gen-E-Motor Corporation

Pioneer

POWER SUPPLY DEVICES

PIONEER ROTARY CONVERTERS



Converts 6, 12, 32, 110, 220 Volts
Direct Current to 110 Volts
Alternating Current

Rotary converters with and without filters for operation of: Public Address Systems, Power Amplifiers, Radio Receivers, Electric Phonographs, A. C. Motors, Neon Signs, and any other similar apparatus requiring a reliable source of A. C.

Here's a PIONEER double-wound rotary converter of dynamotor construction with separate D. C. and A. C. windings. Less heating and longer brush life result from the engineered PIONEER converter design! The double-wound converter results in more efficient commutation than is obtainable with "tapped" winding.

Converters are rated in volt amperes—the Power Factor of the load determines the size of converter to be used—all PIONEER converters are engineered for the apparatus with which they are to be used.

Code	Type No.	INPUT		OUTPUT		LIST PRICE	
		D.C. Volt	D.C. Current	A.C. Volt	Volt Amps.	Less Filter	With Filter
Kadex	6K4	6	14. amps.	110	40	\$53.35	\$62.42
Karax	6K6	6	20. "	110	60	69.02	78.10
Keap	12K4	12	8.0 "	110	40	40.15	48.40
Kenus	12K5	12	13.5 "	110	80	53.35	56.92
Kempe	12K11	12	17.5 "	110	90	61.60	66.00
Kelly	12K16	12	24. "	110	160	79.75	93.32
Kidel	3K4	32	2.8 "	110	40	39.60	46.20
Kirst	3K8	32	4.8 "	110	80	41.25	47.30
Kilty	3K11	32	6.2 "	110	90	42.35	50.32
Kinky	3K20	32	10.4 "	110	200	52.40	61.60
Kigaw	3K30	32	14.5 "	110	300	67.10	78.10
Kouse	1K4	115	.8 "	110	40	39.30	46.75
Koony	1K8	115	1.4 "	110	80	41.25	47.30
Koise	1K11	115	1.8 "	110	110	42.35	50.32
Kobno	1K20	115	3.0 "	110	200	52.80	61.60
Koxy	1K30	115	4.2 "	110	300	67.10	78.10

All Pioneer 6 and 12-volt converters operate on ball bearings. Can be supplied on other units—add \$3.85 to the list price.

PIONEER GEN-E-MOTOR Auto "B" Eliminators

New Compact Models

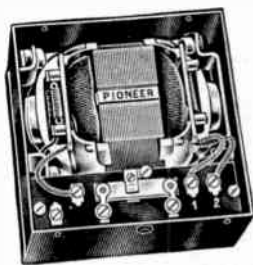

Complete with built-in filter units, for use as battery eliminators for auto receivers using "B" batteries, and for installation in auto sets where it is desired to remove the filter system used with the old vibrator unit. The entire unit is housed in a sturdy metal case measuring 2 7/8" x 5 1/4" x 5 1/4". The Gen-E-Motor is floated in rubber, assuring complete freedom from vibration. The armature is supported by two sets of ball bearings. Shpg. Wt. 7 1/4 lbs.

Code	No.	Output		Battery Drain	List Price
		Volts	M.A.		
Baggy	5135-A	135	30	1.80	\$21.45
Balmy	5180-A	180	30	2.50	21.45
Balsa	5200-A	200	40	3.15	21.45
Bandy	5226	225	50	4.3	21.45
Banjo	5250	250	50	4.7	21.45

The above units may be furnished with intermediate tap for 50c additional. Use code word "TAPPO" in addition to code word for standard unit. Shipping weight 7 1/4 lbs.

Model "H" For Amplifiers and Sound Trucks

Code	No.	Output		Battery Drain	List Price
		Volts	M.A.		
Basic	7565	265	75	7.75	\$37.50
Baste	7300	300	100	9.5	41.25

PIONEER DYNAMOTORS

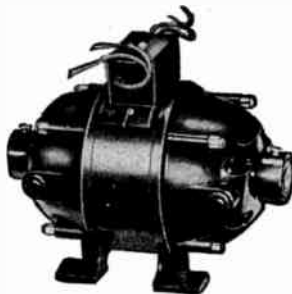

Use Pioneer "Silver Band" Dynamotors for Better Performance in Sound Systems, Police Units, Aircraft, Marine and Broadcast Service.

FEATURES

No ripple or voltage variation.
Nothing to adjust!
Compact, light weight, and completely enclosed in dust-tight case.
Welded steel ring construction—end brackets of tough, high quality malleable iron.
Armature, dynamically balanced, runs on grease-sealed bearings insures quiet, smooth operation.

Code	Type No.	Output		Input		Wt. Lbs.	SIZE			List Price
		Volts	M.A.	Volts	A.		Lgth. Ina.	Width Ins.	Hgr. Ins.	
Gavel	E1W272	250	50	6	4.7	7 1/2	5 1/2	4 1/2	4 1/2	\$38.50
Gayal	E2W353	250	50	6	4.8	9 1/2	6 1/2	4 1/2	4 1/2	44.00
Galea	E1W339	250	100	6	7.5	7 1/2	5 1/2	4 1/2	4 1/2	38.50
Gecko	E2W397	250	150	6	13.2	9 1/2	6 1/2	4 1/2	4 1/2	44.00
Genet	E2W351	300	100	6	9.7	9 1/2	6 1/2	4 1/2	4 1/2	44.00
Gatch	E2W243	300	150	6	14.0	9 1/2	6 1/2	4 1/2	4 1/2	44.00
Genus	E2W256	350	150	6	15.2	9 1/2	6 1/2	4 1/2	4 1/2	46.20
Giant	E2W438	400	125	6	14.2	9 1/2	6 1/2	4 1/2	4 1/2	46.20
Gaily	E3W413	500	100	6	15.0	11	6 1/2	4 1/2	4 1/2	52.25
Girth	RA0W188	300	200	6	18.0	16	8	5 1/2	5 1/2	82.50
Given	RA1W201	400	225	6	25.0	17 1/2	8 1/2	5 1/2	5 1/2	90.75
Glade	RA1W189	500	200	6	27.0	17 1/2	8 1/2	5 1/2	5 1/2	93.50
Glair	RA1W331	600	200	6	31.0	17 1/2	8 1/2	5 1/2	5 1/2	98.25
Grate	RA1W549	750	125	6	25.0	17 1/2	8 1/2	5 1/2	5 1/2	96.00
Glint	RA3W550	750	250	12	24.0	23 1/2	9 1/2	5 1/2	5 1/2	107.25
Gonad	RA2W475	1000	150	12	20.0	19 1/2	8 1/2	5 1/2	5 1/2	115.50
Grist	RA3W534	1000	250	12	32.0	23 1/2	9 1/2	5 1/2	5 1/2	126.50

All units may be furnished for any D.C. input other than listed above at an addition of 15% to list price. Add "X" to code word and follow with input voltage required.

List Price

Standard Filter for "E" units. \$21.45
Transient Filter for "RA" units. \$27.50
"EA" units, using aluminum wherever possible to reduce weight \$11.00 additional to list price of corresponding "E" unit.

Most "RA" units may be furnished in "DA" frame at 15% less than "RA" list.
Prices Slightly Higher in West and South

List Price

TYPE T ROTARY CONVERTER

FEATURES

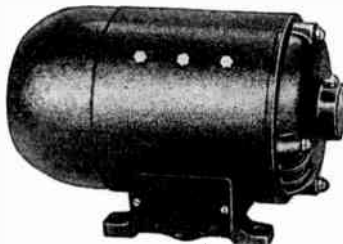

4-pole construction, 1800 R.P.M., ball bearings, cast-iron end brackets, windings thoroughly impregnated with insulating compound, large D.C. commutator, specially designed brush holders assuring correct commutation. Cool operation. Quiet. Available with or without filter. Prices on request.

MODEL JW-GEN-E-MOTOR • WITHOUT FILTER

It is being used with remarkable success to replace vibrators in auto radio receivers—as it can be easily installed usually within the set itself. It is excellent for this service because it is extremely compact (4 1/8" x 5 1/2" x 2 7/8") and can be used without circuit alterations—complete instructions included.

Supplies a uniform voltage output, eliminating noisy or weak reception.



Code	No.	Output		Battery Drain	List Price
		Volts	M.A.		
Abate	JW-18	180	30	2.5	\$15.95
Abbey	JW-20	200	40	3.15	15.95
Abhor	JW-25	225	50	4.3	15.95
Abide	JW-50	250	50	4.7	15.95

For 32-Volt Radios

About	JW-32	210	45	.7	\$19.80
-------	-------	-----	----	----	---------

Shipping weight, each 6 lbs.



Illustrating all type ATR Shaverpacks except Types 6 and 12.

● ATR SHAVERPACKS

Model
SPA

Specially Designed for Operating A. C. Razors from 6, 12, 32, 110, and 220 volt D. C. Lines. May Also be Used for Other Small A. C. Devices.

ATR Shaverpacks are midget D.C.-A.C. Inverters designed especially for the operation of A. C. razors in the car (6-volt type), on buses or aeroplanes (12-volt type), on trains (32-volt type), on boats, in hotels, and D. C. districts (110- and 220-volt types). They are ideally suitable for traveling salesmen, sportsmen, and all owners of electric shavers. By the use of ATR Shaverpacks with standard A. C. razors, electric razor operation can be had anywhere! ATR Shaverpacks deliver 60 cycle A. C. current so necessary for electric razor operation and utilize a new ATR type of six contact Vibrator construction having four 3/16" diameter tungsten power contacts and two silver alloy driver contacts, which unit will give many years of satisfactory service and outlast the electric razor.

TYPE	Input D. C. volts	A.C. Output 60 cycles	Wattage Output	Code Word	List Price
6	6	110 volts	15 watts	ASPAC	\$8.95
12	12	110	15	BSPAD	8.95
32	32	110	15	CSPA E	10.95
110	110	110	15	DSPAF	9.95
220	220	110	15	ESPAG	9.95

Radio frequency interference not suppressed.

The above Shaverpack types are also available with an output voltage of 220 volts A. C. at prices 10% higher. In ordering, specify "S" after the type number and substitute for the last letter in the code word "T"; that is, if a 110 volt D. C. Shaverpack having a 220 volt A. C. output is desired, this would be ordered as Type 110S covered by code word, "DSPAT". ATR Shaverpacks are housed in metal cabinets having an attractive black-wrinkled finish, which is standard. Ivory finishes are available on special order at 30c additional; all chromium-plated cabinets are available at a charge of \$1.00 additional. Dimensions, 4 1/4"x3 5/8"x2 3/8"; shipping weight, 3 lbs.

Replacement Vibrators for any of the above Shaverpack types. List Price, \$3.50; Exchange List Price, \$2.95. Be sure to mention the type number as well as model number when ordering.



Illustrating Types 6 and 12 ATR Shaverpacks, fitted with receptacle (for dash mounting), which attaches direct to battery.



Illustrating all ATR Low Power Inverters except Types 6 and 12.

● ATR Low Power INVERTERS

Model
LIA

For Operating Small A. C. Motors and Devices of Approximately 35 watts Consumption from 6, 12, 32, 110, and 220 volt D. C. Lines.

This line of ATR Low Power Inverters was specially brought out to meet the insistent demand for a good, low power, inexpensive portable Inverter for operating phonograph and other A. C. motors and a host of small A. C. devices from D. C. voltage sources. These Inverters operate at an efficiency in excess of 90% and are designed for operation of loads having a power factor as low as 60%. They are ruggedly built and powered by a special ATR six-contact plug-in Inverter Vibrator utilizing four 1/4" diameter tungsten power contacts and two silver alloy driver contacts.

Type	Input D. C. volts	A.C. Output 60 cycles	Wattage		Code Word	List Price
			Maximum	Continuous		
6	6	110 volts	50	35	ALIAM	\$12.95
12	12	110	50	35	BLIAN	12.95
32	32	110	50	35	CLIAO	14.95
110	110	110	75	35	DLIAP	13.95
220	220	110	75	35	ELIAQ	13.95

Radio frequency interference not suppressed. Filter built-in, \$4.50 additional.

Any of the above type Low Power Inverters are available with 220 volt A. C. output at prices 10% higher. In ordering, specify "S" after the type number and substitute for the last letter in the code word "T"; that is, if a 110 volt D. C. Low Power Inverter having a 220 volt A. C. output is desired, this would be ordered as Type 110S covered by code word, "DLIAT". ATR Low Power Inverters are housed in a black-wrinkled finished metal cabinet.

Dimensions, 5 3/8"x4-3/16"x5 5/8"; shipping weight, 5 1/2 lbs.

Replacement Vibrators for any of the above Low Power Inverters. List Price, \$4.95; Exchange List Price, \$4.50. Be sure to mention the type number as well as model number when ordering.



Illustrating Types 6 and 12 Low Power Inverters only.

● ATR STANDARD AND HEAVY DUTY

RADIO INVERTERS

Model RSA (Standard)
Model RHA (Heavy Duty)



Illustrating all Standard Type ATR Radio Inverters except Types 6 and 12. For Heavy Duty Styles—see cut below.

Specially Designed for Operating Standard A. C. Radios, Radio-Phonograph Combinations, Public Address Systems, Television Sets, Amplifiers, Intercall Systems, and Radio Test Equipment from D. C. Voltages in Cars, on Farms, Trains, Boats, and in D. C. Districts.

This group of ATR Inverters is especially recommended for use with standard A. C. radios, television sets, and radio equipment, being exceptionally well filtered to insure interference-free all-wave radio reception. With ATR Inverters, the need for special equipment is eliminated. They are designed for quiet, long-life radio operation. The standard models are equipped with an ATR ten-contact plug-in Inverter Vibrator of new design and construction having dual arms and utilizing eight 1/4" diameter tungsten power contacts and two silver alloy driver contacts, whereas, the heavy duty models are equipped with ATR twenty-contact plug-in Inverter Vibrators having sixteen 1/4" diameter tungsten power contacts and four silver alloy driver contacts, insuring increased long life and reliable service. These Inverters also come equipped

with four point voltage regulators, which make possible the correct output voltage for minimum to maximum loads and also help compensate for input voltages which are lower or higher than normal; the operating efficiency is in excess of 85%.

Type	Model	Input D.C. Volts	A.C. Output 60 Cycles	Output Wattage		Code Word	List Price
				Intermittent	Continuous		
6	RSA	6	110 volts	100	75	ARSAD	\$25.95
12	RSA	12	110	125	100	BRSAE	25.95
32	RSA	32	110	150	100	CRSAF	26.95
32B	RHA	32	110	200	180	DRHAG	37.50
50	RSA	50	110	150	100	ERSAH	28.00
90	RSA	90	110	200	150	FRSAI	28.00
110	RSA	110	110	250	150	GRSAJ	26.95
110A	RHA	110	110	325	225	HRHAK	35.00
110B	RHA	110	110	500	350	IRHAL	45.00
110C	RSA	110	110/220	250	150	JRSAM	32.50
110D	RSA	110/220	110/220	250	150	KRSAN	38.50
220	RSA	220	110	250	150	LRSAP	26.95
220A	RSA	220	110/220	250	150	MRSAP	35.00



Illustrating Types 6 and 12 Standard Radio and Industrial Inverters only.

Radio frequency interference completely suppressed. Any of the above type Inverters are available with 220 volt A. C. output at prices 10% higher. In ordering, specify "S" after the type number and substitute for the last letter in the code word "T"; that is, if a 110 volt D. C. Inverter having a 220 volt A. C. output is desired, this would be ordered as Type 110S covered by code word, "GRSAT".

ATR Standard and Heavy Duty Radio Inverters are housed in at-

tractively finished brown-wrinkled metal cabinets. Dimensions of Standard Model Radio Inverters, 7 1/8"x8-3/16"x4 1/2"; Shipping weight, 16 lbs. Dimensions of Heavy Duty Model Radio Inverters, 7 1/8"x9"x6 1/4"; Shipping weight, 26 lbs.

For correct replacement vibrator, consult Inverter Vibrator Guide.

● ATR STANDARD AND HEAVY DUTY

INDUSTRIAL INVERTERS

Model ISM (Standard)
Model IHM (Heavy)



Illustrating Heavy Duty Models Radio and Industrial Inverters except types 6 and 12. Types 6 and 12 Industrial Inverters are illustrated by center cut above. Another style of Heavy Duty Industrial Inverter is that illustrated in the cut on page 5 covering ATR Custom Built Power Supplies.

Radio frequency interference not suppressed. Any of the above type Inverters are available with 220 volt A. C. output at prices 10% higher. In ordering, follow similar directions given above.

ATR Standard and Heavy Duty Industrial Inverters are housed in attractively finished brown-wrinkled metal cabinets.

Dimensions of Standard Model Industrial Inverters, 7 1/8"x8-3/16"x4 1/2". Shipping weight, 17 lbs.

For Operating A. C. Motors, Pin Ball Games, Electrical Testing Equipment, Coin Phonographs, and A. C. Electrical Appliances from D. C. Lines.

These units are specially designed for all industrial and pin ball game applications as indicated, permitting the use of standard A. C. equipment on D. C. lines. These Inverters operate at an efficiency in excess of 80% and are carefully built and equipped to give the longest possible life and operating satisfaction. The Standard and Heavy Duty Industrial Inverters utilize ATR ten and twenty contact plug-in vibrators, respectively, and are also equipped with four point voltage regulators as fully described above. These Industrial Inverters are recommended for use with loads having power factors as low as 60%, and as low as 50% for the pin ball Inverters indicated. These Inverters should not be used with Neon signs.

Type	Model	Input D.C. volts	A.C. Output 60 cycles	Output Wattage		Code Word	List Price
				Intermittent	Continuous		
6	ISM	6	110 volts	100	75	AISMD	\$25.00
12	ISM	12	110	125	100	BISME	25.00
32	ISM	32	110	150	100	CISME	26.50
32P*	ISM	32	110	150	125	ISMF	29.95
32B	IHM	32	110	200	180	EIHMG	37.50
110	ISM	110	110	250	150	FISMH	26.50
110P*	ISM	110	110	250	150	GISMI	29.95
110A	IHM	110	110	325	225	HIHMJ	35.00
110B	IHM	110	110	500	350	IHMK	45.00
220	ISM	220	110	250	150	JISML	26.50
220P*	ISM	220	110	300	150	KISMM	29.95

Dimensions of Heavy Duty Industrial Inverters, 7 1/8"x9"x6 1/4"; shipping weight, 26 lbs. For correct replacement vibrator, consult Inverter Vibrator Guide.

*"P" Inverters are corrected for loads having power factors as low as 50% and are especially designed for pin ball games.

Built-in Filter, \$4.50 additional.

● ATR HEAVY DUTY VIBRATOR PACKS

Model
VPM

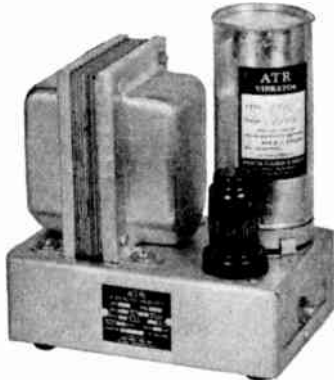

Illustrating ATR Vibrator Pack complete without audio filter, Style A.

For Inverting Low Voltage D. C. to High Voltage D. C. for Operation of Portable Receivers and Transmitters, for Police, Aircraft, Amateur, and Commercial Uses, Public Address Systems, Amplifiers, and Scientific Apparatus.

Here is a complete line of Heavy Duty Vibrator Packs for operation on 6, 12, 32, 110, and 220 volts D. C. inverting same to an output of 325 volts D. C. at 125 milliamperes, adjustable in four steps as low as 250 volts D. C. at 50 milliamperes. ATR Vibrator Packs are available in two models: complete with audio filter and without audio filter. All models have built-in RF filters and come complete with rectifying tube and Vibrator. The Vibrator used is an ATR ten contact Inverter type having eight 1/4" diameter tungsten power contacts and two silver alloy driver contacts for longest life and utmost reliability. The efficiency is in excess of 55%.

Type	Input Volts D.C.	Output		Without Audio Filter		With Audio Filter	
		Volts D.C.	Current ma.	Code Word	List Price	Code Word	List Price
6	6	325-250	125-50	AVPMD	\$22.00	FVPMI	\$29.50
12	12	325-250	125-50	BVPME	22.00	GVPMJ	29.50
32	32	325-250	125-50	CVPMF	30.00	HVPMK	37.50
110	110	325-250	125-50	DVPMG	30.00	IVPML	37.50
220	220	325-250	125-50	EVPMH	30.00	JVPMM	37.50

Style A—Attractively cadmium-plated finished as shown; dimensions 5 3/8" x 3 3/8" x 6 1/2"; shipping weight, 7 lbs.

Style B—Housed in an attractive black-wrinkled metal cabinet; dimensions, 7 3/8" x 4" x 6 3/8"; shipping weight 11 1/2 lbs.

ATR Vibrator Pack Replacement Vibrators, any type, List Price, \$6.50; Exchange List Price, \$5.50. Be sure to mention the type number as well as model number when ordering.

Special Vibrator Packs are available for television and other purposes—your inquiries are invited.



Illustrating ATR Vibrator Pack complete with audio filter, Style B.

● ATR Polarity Changer INVERTERS

Model
PCA



Illustrating ATR Polarity Changer Inverter.

For Operating Fractional Horsepower Motors, A. C. Radios, Amplifiers, and Other A. C. Devices from 110 and 220 Volt D. C. Lines.

The Polarity Changer Inverter really consists of nothing more than a polarity changer Vibrator with associated condensers. The Polarity Changer Inverter is unique in the respect that generally no transformer is made use of and its chief advantages are light weight and small size. The polarity changer Vibrator used is in effect a double-pole double-throw switch which causes the D. C. input voltage to be applied across any given load in first one direction and then reversed, the frequency of operation being determined by the frequency of the vibrating reed. The Polarity Changer Inverter is of especially high efficiency and generally in excess of 95%. These units are corrected for operation with loads having power factors not lower than 75%.

Type	Input D.C. Voltage	A.C. Output		Maximum Output Capacity	List Price	Code Word	R. F. Suppressed	Application
		Voltage	Frequency					
110	110	110	60 cycles	150 watts	\$25.00	DPCAJ	Yes	Radios, Amplifiers
110A	110	110	60 cycles Adjustable to	150 watts	24.00	EPCAK	No	Industrial
220	220	220	60 cycles	150 watts	25.00	GPCAM	Yes	Radios, Amplifiers

ATR Polarity Changer Inverters are attractively housed in a black-wrinkled finished metal cabinet; dimensions, 7 3/8" x 4 1/2" x 3-3/16"; Shipping weight, 6 lbs.

ATR Replacement Polarity Changer Vibrators, any type, List

Price, \$8.00; Exchange List Price, \$7.00. Be sure to mention the type number as well as model number when ordering.

Special Polarity Changer Inverters can be supplied—your inquiries are invited.



Illustrating Standard Model "A" Battery Eliminator.

● ATR "A" BATTERY ELIMINATORS

Specially Designed for Demonstrating and Testing Auto Radio Sets on Regular A. C. Lines, 105-125 Volts 50-60 Cycles.

- Eliminates Storage Batteries and Battery Chargers.
- Prevents the Possibility of Spiling a Sale Because of a Run-Down Battery.
- Operates the Set at Maximum Efficiency at All Times.
- Delivers Pure Direct Current at the Correct Voltage for the Proper Operation of Any Auto Radio Set.
- Fully Automatic and Fool-Proof.

Other Suggested Uses:

As a power supply for field coils, exciter lamps, and relays.
In the laboratory, for supplying various low D. C. voltages by simply using rheostat in one side of the A. C. cord.

Equipped with Full-Wave Dry-Disc Type Rectifier, Assuring Noiseless, Interference-Free Operation and Extreme Long Life and Reliability.

ATR STANDARD MODEL—Rated output 6.3 volts at 6.5 amperes.
Size 7 $\frac{1}{2}$ "x7 $\frac{1}{4}$ "x5-3/16"; Shipping weight, 18 $\frac{1}{4}$ lbs.;
code word "SELIM." List Price..... **\$25.95**

ATR HEAVY DUTY MODEL—Rated output 6.3 volts at 14 amperes.
Uses dual rectifiers. Size 8 $\frac{3}{8}$ "x13"x5 $\frac{1}{4}$ "; Shipping weight,
32 lbs.; code word "HELM." List Price..... **\$42.50**

Any of the above model "A" Battery Eliminators can be supplied for 220-240 volt A. C. input operation at 15% higher prices. If a 220-240 volt input "A" Battery Eliminator is desired, specify Type "B" and substitute "T" for the last letter in the cord word.

All ATR Eliminators have as standard equipment: On-Off Switch, Pilot Light Indicator, 10-Ampere Fuse, Rubber Mounting Feet, 6-ft. All-Rubber Cord Set, and Cabinet of heavy gauge metal having attractive black-wrinkled finish.



Illustrating Heavy Duty Model "A" Battery Eliminator.



Illustrating Model 600.

● ATR AUTOMATIC TAPERING BATTERY CHARGERS

For Keeping Auto Batteries Fully Charged Right in the Car! An Automotive Necessity—Needed More Now Than Ever Before—Makes Cold Weather Starting Easy.

The additional appliances—such as auto radios, spot lights, heaters, fans, cigarette lighters, etc.—operated from the battery of the modern automobile impose a severe drain on the battery, making the normal "hard starting" in cold weather still more difficult.

The ATR Automatic Tapering CHARGER solves this problem by boosting or charging the battery right in the car conveniently and economically. No need to remove the battery! Simply attach plug to dash receptacle which connects to ammeter and frame of car and flip the charger toggle switch "ON." Cannot overcharge battery due to automatic tapering charge feature.

Operates from any 110-120 volt 50-60 cycle A. C. line. Utilizes a full-wave dry-disc type rectifier, assuring extreme long life and reliability.

- Noiseless
- Efficient
- Long Life
- No Radio Interference
- Economical

ATR STANDARD CHARGER—Model 400—Charging rate 4 to 2 amperes.
Complete as illustrated with polarized dash receptacle and plug, fuse, 6-foot D. C. cord, 6-foot A. C. cord, and complete instructions. Dimensions 5 $\frac{1}{2}$ "x3-5/16"x3 $\frac{1}{4}$ "; Shipping weight, 5 lbs.; code word "FCHAR" Price List **\$8.95**

ATR DELUXE CHARGER—Model 600—Charging rate 6 to 3 amperes. Complete as illustrated with polarized dash receptacle and plug, fuses, 9-foot D. C. cord, and 12-foot A. C. cord, on-off toggle switch, and complete instructions. Dimensions 8"x4"x3-5/16"; Shipping weight, 8 lbs.; code word "DCHAL" List Price **\$12.95**

Any of the above model Battery Chargers can be supplied for 220-240 volt A. C. input operation at 15% higher prices. If a 220-240 volt input Battery Charger is desired, specify Type "B" and substitute "T" for the last letter in the code word.



Illustrating Model 400.

Janette Rotary Converters

FOR CHANGING DIRECT CURRENT TO ALTERNATING CURRENT]

For Use with Radio Receivers, Amplifiers, Phonographs, Gaseous Electric Signs, Sound Pictures, Electric Organs, Public Address Systems, Musical Instruments, Etc.

*Capacity in Volt Amperes When Wound For		DEALER PRICES FOR CONVERTERS F.O.B. CHICAGO, ILL.				** D.C. Amperes Input (60 Cycle Output)	Price Additions for Manual D.C. Starter
60 Cycles	50 Cycles	Frame Size	With Filters	Frame Size	Without Filters		
115 VOLTS DIRECT CURRENT TO SINGLE PHASE—							
110 VOLTS—A.C. (‡) 3600 R.P.M.—SLEEVE BEARINGS							
230 Volts—Add \$1.35 net for converters wound for 230 volt D.C. primary.**							
						115 Volts	115 Volts
							230 Volts
110	90	CA-19-F	\$30.30	CA-19	\$25.50	1.9	
150	120	CA-18-F	33.30	CA-18	28.80	2.4	
225	175	CA-16-F	38.85	CA-16	32.10	3.0	
300	250	CS-13-F	46.95	CS-13	40.20	4.0	
500	400	CS-12-F	61.80	CS-12	54.60	6.1	
†750	600	CE-12-F	91.95	CE-12	79.80	8.5	\$15.00
1000	800	CE-10-F	114.00	CE-10	98.10	13.0	22.20
115 OR 230 VOLTS DIRECT CURRENT TO SINGLE PHASE—							
110 VOLTS—A.C. (‡) 1800 R.P.M.—BALL BEARINGS							
600	500	CF-12-F	\$144.60	CF-12	\$128.70	8.2	\$15.00
800	650	CF-34-F	154.20	CF-34	138.00	10.0	15.00
1200	950	CF-1-F	167.10	CF-1	151.20	14.0	22.20
1500	1200	CF-15-F	204.90	CF-15	189.00	16.5	22.20
2500	2090	CF-2-F	277.50	CF-2	261.60	25.5	22.20
3250	2600	CF-35-F	324.60	CF-35	309.00	33.0	27.60
6 VOLTS DIRECT CURRENT TO SINGLE PHASE—							
110 VOLTS—A.C. (‡) 3600 R.P.M.—BALL BEARINGS							
40	40	CA-19-F	\$37.50			15.0	
60	60	CA-18-F	46.95			24.0	
12 VOLTS DIRECT CURRENT TO SINGLE PHASE—							
110 VOLTS—A.C. (‡) 3600 R.P.M.—BALL BEARINGS							
80	80	CA-19-F	\$34.20			15.0	
120	120	CA-18-F	39.60			18.0	
160	130	CA-16-F	55.95			24.0	
225	160	CS-13-F	62.55			32.0	
32 VOLTS DIRECT CURRENT TO SINGLE PHASE—							
110 VOLTS—A.C. (‡) 3600 R.P.M.—SLEEVE BEARINGS							
110	90	CA-19-F	\$30.30	CA-19	\$25.50	6.5	
150	120	CA-18-F	33.30	CA-18	28.80	8.5	
225	175	CA-16-F	38.85	CA-16	32.10	11.5	
300	250	CS-13-F	46.95	CS-13	40.20	15.0	
500	400	CS-12-F	61.80	CS-12	54.60	18.0	
650	600	CE-12-F	91.95	CE-12	79.80	27.0	\$22.20
850	750	CE-10-F	126.90	CE-10	98.10	36.0	22.20

THE ORIGINAL CONVERTER For Converting D.C. to A.C.

Built especially for radio and sound apparatus—capacities 110 to 3250 volt amperes—with or without all-wave filters. Dynamotor construction—economical to operate—ruggedly built for years of trouble-free service—used or recommended by the largest manufacturers of radio and sound apparatus throughout the world.

WHY EXPERIMENT?
INSIST ON A JANETTE

ALL PRICES ARE SUBJECT TO
CHANGE WITHOUT NOTICE

*CAUTION: Voltamperes and watts are the same ONLY on a load of 100% power factor. For a load of 85% P. F. the watts will be 15% less than the voltampere capacities shown. All converters are furnished for 60-cycle output unless otherwise specified.

** Ampere ratings are based on 85% P. F. and may vary plus or minus 10% from the figures shown. The amperes for 230 volt D.C. converters will be half the amperes shown for 115 volt input.

‡ Converters wound for 50 cycles will run about 5/6 of speeds shown for 60 cycles.

* The special type of filter is designed for both short and standard broadcasting bands from 500 to 30,000 kilocycles (10 to 547 meters). Exceptionally quiet reception results on all bands.

† No starter is required for CE-12-F converter WITH filter but must be used with CE-12 converter WITHOUT filter.

PRICES FOR SPECIAL VOLTAGE FREQUENCY OR BOTH: For building converters wound for a direct or alternating current voltage on frequency not listed as standard or for converters wound for operating from 28 to 36 volts D.C. for railroad radio service, an extra charge is made. Any converter can be wound with 220 volts alternating current secondary, for the same capacity as shown for 110 volts. For these special windings ADD 10%.

FREQUENCY CONTROL: For converters with manual frequency control add \$6.00 net. For automatic frequency control add \$16.20 net. Not built for 6 volts D.C.

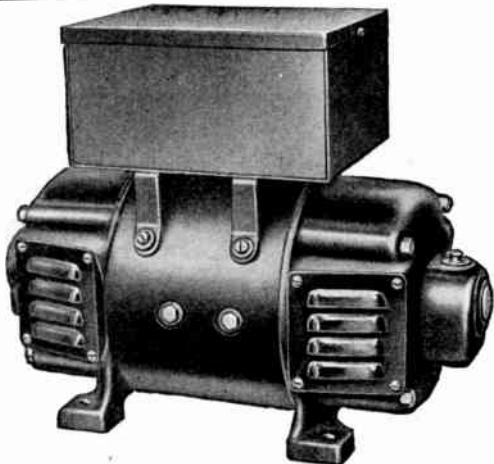

Fig. 1. CS12F.

Janette
Machines
are Sold
on a Quality
Basis — Not
on Price

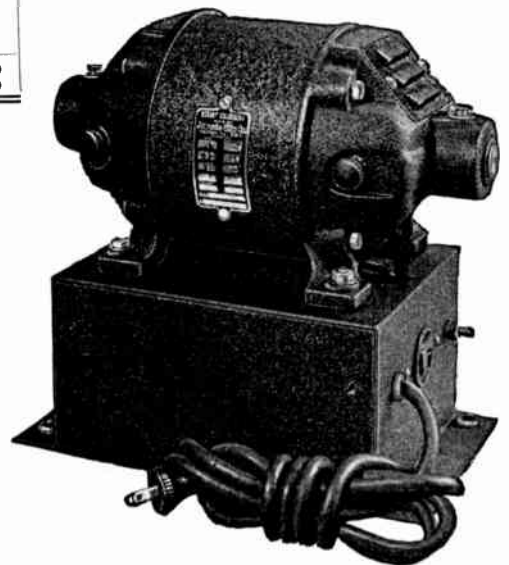

Fig. 2. CA18F.

Janette Rotary Converters

DYNAMOTORS

For Converting Direct Current from One Voltage to Another
 ★Continuous Service 50°C. — 30 Minutes Intermittent Service 55°C.

CAPACITY IN WATTS		VOLTS OUTPUT	FRAME SIZES	DEALER PRICES F.O.B. CHICAGO, ILL.		D.C. Amperes Approx. ★★★	APPROX. WEIGHTS IN POUNDS BOXED
Contin-uous Service ★	Inter-mittent Service ★			DYNAMOTORS			
		One Voltage Only		Without Filters	With Filters		
FOR 32, 115 or 230 VOLTS D.C. PRIMARY — SLEEVE BEARINGS ★ ★							
20‡	35‡	6 to 350	CU30‡	\$30.60	\$36.60	.75	16
75	120	6 to 600	CA18	36.00	42.60	1.8	27
95	180	6 to 600	CA16	42.60	49.20	2.5	30
150	240	8 to 600	CS13	49.80	56.40	3.3	50
		601 to 750	CS13H	58.80	67.20	3.3	
250	400	10 to 600	CS12	68.40	76.20	5.6	64
		601 to 750	CS12H	79.80	89.40	5.6	
350	600	15 to 600	CE12	99.60	108.00	7.6	79
		601 to 750	CE12H	117.00	126.00	7.6	
500	800	21 to 600	CE10	122.40	130.80	10.	118
		601 to 750	CE10H	144.00	153.60	10.	
FOR 115 or 230 VOLTS D.C. PRIMARY — BALL BEARINGS							
270	400	6 to 500	CF12	\$160.80	\$176.40	6.6	148
360	600	8 to 500	CF34	172.80	188.40	9.6	154
600	850	18 to 500	CF1	189.60	205.80	13.0	178
FOR 6 VOLTS D.C. PRIMARY — BALL BEARINGS							
20	35	6 to 350	CU30	\$36.00	\$42.60	14.0	16
60	75	6 to 500	CA18	40.20	46.80	22.0	27
100	100	6 to 600	CS13	72.00	78.60	34.0	50
FOR 12 VOLTS D.C. PRIMARY — BALL BEARINGS							
20	35	6 to 350	CU30	\$36.00	\$42.60	7.	16
80	120	6 to 600	CA18	40.20	46.80	16.	27
175	250	6 to 600	CS13	60.00	66.60	33.	50

★ Specify continuous or intermittent duty when ordering.

★★★ The amperes shown are for intermittent rated dynamotors wound for 115 volts D.C. primary; for 32 volt machines multiply by 3.7; for 230 volt machines divide by 2.

★★ For ball bearings ADD \$6.50 list to dynamotor prices shown for sleeve bearing machines.

‡ Wound for 32 and 115 volts only.

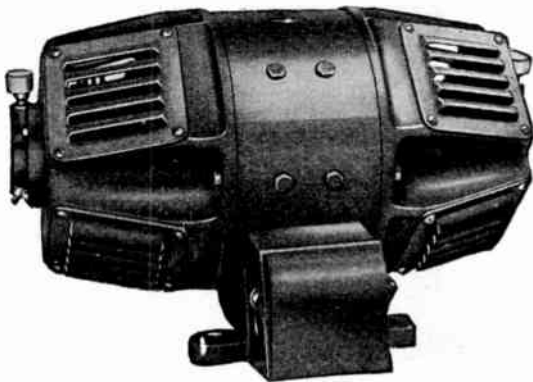

Fig. 3.—CF1

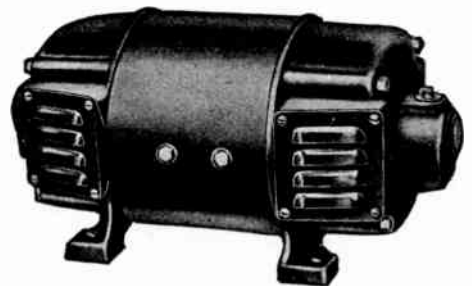

Fig. 4.—CS12

ALL PRICES SUBJECT TO CHANGE WITHOUT NOTICE



AUTO RADIO DEMONSTRATION PACKS

STANCOR MASTER DELUXE PACK

A heavy duty auto radio demonstration and radio service pack.

An all-purpose heavy duty, well filtered unit with a multiplicity of applications. Delivers 16 amperes @ 6 volts continuously or 22 amperes @ 2.7 — 6.4 volts intermittently. Will power complete auto radio display boards and operate the largest push button tuning unit. It eliminates several smaller packs or the messy storage batteries. Because of its reserve power it will permit the operation of two or more radios simultaneously for comparison purposes (output will drop, momentarily when push buttons are operated.)

Provides 8 volts @ 9 amperes for testing vibrators by duplicating extreme conditions encountered in actual use. May also be used as a battery charger.

General laboratory, production or other industrial users will find this pack very handy to have around, as it will deliver a variety of voltages for tests and many other applications.

Excellent filtering reduces ripple to less than 5%. A fuse in the primary circuit, together with overload relay, protects the pack and the equipment it is operating.

All controls are mounted on front panel. Voltage is controlled by means of a tap switch in approximately one half volt steps. A high grade voltmeter indicates the output voltage



SPECIFICATIONS

D. C. OUTPUT

No load 11 to 15 volts
 Cont. load . . 16 A., 3 to 6 volts
 Max. inst. 22 A., 2.7 to 6.4 volts
 Rectifier (2 used) BRIDGE Type
 29 radiating 3½" fins.
 Filter — heavy current choke —
 4000 mfd. condenser
 Ripple less than 5%.

POWER SOURCE

115 volts 50-60 cycles A.C.
 Input 420 V. A. @ Max. Cont.
 load
 Electrostatic shield
 Rotary tap switch
 Overload relay protection
 Six ft. cord and plug
 Size H. 7" x W. 18½" x D. 11"
 Weight in carton 50 lbs.

Stancor No. 133 Net Price **\$69.00**

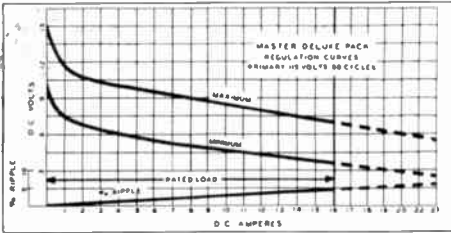

STANCOR MASTER PACK

Provides 6 Volts D.C. for Auto Radio and Accessories.



A compact power unit designed to meet numerous requirements for obtaining low voltage heavy duty D.C. from 115 volt A.C. lines.

Ideal for Auto Radio Sales demonstration, and service test work, effectively operating most push button tuning auto radios. Useful for industrial or laboratory purposes. May also be used as a battery charger, a magnetic field exciter, or for electroplating.

Delivers from 3 to 6 volts (see curve) of well filtered D.C. at 12.5 amperes on continuous duty, or 5 volts at 16 amperes instantaneous load.

Exceptionally well designed filter minimizes ripple to six percent. A fuse in the primary circuit, together with an overload relay, protects the pack and your equipment.

All controls and terminals easily accessible on an inclined front panel. Control switch varies the output voltage in approximately one-half volt steps.

Useful for industrial or laboratory purposes. May also be used as a battery charger, a magnetic field exciter, or for electroplating.

Delivers from 3 to 6 volts (see curve) of well filtered D.C. at 12.5 amperes on continuous duty, or 5 volts at 16 amperes instantaneous load.

Exceptionally well designed filter minimizes ripple to six percent. A fuse in the primary circuit, together with an overload relay, protects the pack and your equipment.

All controls and terminals easily accessible on an inclined front panel. Control switch varies the output voltage in approximately one-half volt steps.

Delivers from 3 to 6 volts (see curve) of well filtered D.C. at 12.5 amperes on continuous duty, or 5 volts at 16 amperes instantaneous load.

Exceptionally well designed filter minimizes ripple to six percent. A fuse in the primary circuit, together with an overload relay, protects the pack and your equipment.

All controls and terminals easily accessible on an inclined front panel. Control switch varies the output voltage in approximately one-half volt steps.

SPECIFICATIONS

D. C. OUTPUT

No load 8 to 12 volts
 Cont. load 12.5 A. . . 3 to 6 V.
 Max. inst. load 16 A. 2 to 5 V.
 Rectifier — full wave with
 twenty-five 3½" radiating
 fins.
 Filter — heavy current choke
 with 4,000 mfd. condenser.
 Ripple less than 6%

POWER SOURCE

115 volts 50-60 cycles A.C.
 325 watts at continuous load.
 Overload relay adjusted to 20
 amperes.
 Electrostatic shielded trans-
 former.
 Dimensions L. 13½"; W. 8¾";
 H. 6".
 Weight in carton 26 lbs.

Stancor No. 132 Net Price **\$31.00**

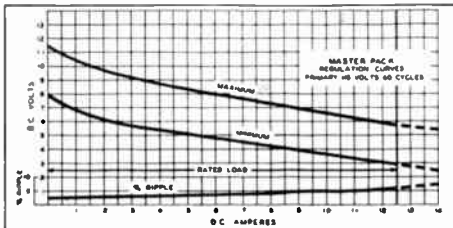

STANCOR ECONOMY PACK

Provides Well Filtered 6 Volts D.C. from Power Line

The Economy 131 Pack is one of the lowest priced and most compact units having well filtered D.C. output. The output current is rated lower than the 132 Master Pack, but the quality of the output is the same.

Here is a powerful little pack without extra controls that will furnish plenty of amperes for most requirements.

Output terminals are conveniently located for connections. Protection from damage is assured by the easily replaced fuse. "On-off" toggle switch is within easy reach. A bright jeweled pilot light indicates whether power is "on" or "off".

The unit can be used wherever the adjustment of voltage is not necessary. It is well adapted to radio, auto and industrial use. The pack will normally operate one auto radio with remote control.



SPECIFICATIONS

D. C. OUTPUT

No load 11 volts
 Continuous load 7A. . . 6.5 V.
 Max. inst. load 12A. . 4.5 V.
 Rectifier—full wave with thir-
 teen 2½" radiating fins.
 Filter — heavy current choke
 with 4000 mfd. condenser.
 Ripple less than 4.5%

POWER SOURCE

115 volts 50-60 cycles A.C.
 175 watts at continuous load
 Electrostatic shielded trans-
 former
 Fuse connected in primary
 Jeweled pilot light
 Six foot cord and plug
 Dimensions L. 8", W. 6¼", H.
 7¼"
 Weight in carton 16½ lbs.

Stancor No. 131 Net Price **\$20.40**

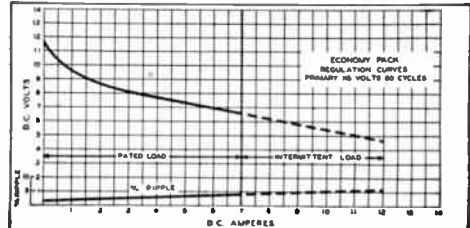

Power Plants * Converters * Dynamotors

"Utilite" Gas-Electric Plants famous for dependability and economy!

Ideal power supply for portable or standby use—for farms, camps, sound trucks, fire departments, boats, trailers, construction work. AC or DC models for all standard voltages. Push button starting standard on AC and Battery Charging units. Built-in remote control available on AC types. All plants have rope pull. Easily installed—simple, safe and economical to operate. Plenty of power—with ample reserve for overload. World-famous engine. Each plant complete with ignition shielding and radio filter.

TYPE	OUTPUT				METERS	NET WT.	CODE	LIST PRICE
	AC		DC					
	VOLTS	WATTS	VOLTS	WATTS				
3AP6	110	300	6	200	AC Voltmeter	97 lbs.	GIANT	\$89.50
3AR6	110	300	6	200	AC Voltmeter DC Ammeter	100 lbs.	GAVEL	111.75
3DP2			6 12	200 350	DC Ammeter	87 lbs.	GLOBE	71.95
3DP3			32	350	DC Ammeter	87 lbs.	GUIDE	79.75
3DM1			110	350	DC Voltmeter	87 lbs.	GRACE	83.50
4AP6	110	450	6	200	AC Voltmeter	107 lbs.	GABLE	135.50
4AR6	110	450	6	200	AC Voltmeter DC Ammeter	110 lbs.	GAUNT	160.25
6AP1	110	600	12	250	AC Voltmeter	122 lbs.	GUEST	190.00
6AR1	110	600	12	250	AC Voltmeter DC Ammeter	125 lbs.	GORGE	220.00
10AP1	110	1000	12	250	AC Voltmeter	175 lbs.	GAUGE	264.95
10AR1	110	1000	12	250	AC Voltmeter DC Ammeter	178 lbs.	GALOP	294.50

Others also available. For complete details and listing write for Bulletin G2.

Eicor Rotary Converters

Convert direct current to alternating current for amplifiers, projectors, phonographs, radio receivers, transmitters, medical equipment, musical instruments, and other applications. Available for operation on any DC voltage—and have standard AC output. With or without filter. All-equipped with ball bearings. You get highest efficiency, quiet operation, long life—more economically than ever before!

3600 RPM TWO POLE

TYPE No.	INPUT		OUTPUT		WITHOUT FILTER		WITH FILTER	
	VOLTS	AMPS.	VOLTS	AMPS.	LIST	CODE	LIST	CODE
131	32	7.6	150		\$43.50	CAULK	\$50.50	CYNIC
132	32	11.	225		48.50	CAROL	58.75	CRIMP
133	32	14.2	300		61.00	CATER	71.00	CROCK
134	32	21.	450		77.50	CAUSE	88.50	CLEAR
136	115	2.2	150		43.50	CHASM	50.50	CRAPE
137	115	3.1	225		48.50	CHECK	58.75	COZEN
138	115	3.7	300		61.00	CHILD	71.00	COUPE
139	115	5.9	450		77.50	CHIEF	88.50	CABOT

Other standard Eicor Converters available including types for 6, 12, and 230 Volts DC Input. For complete listing—send for Bulletin C2.

Eicor Dynamotors

Widely used in important Aircraft, Police, Amateur, Broadcast and Marine radio equipment. Smooth, continuous, trouble-free performance even under severe operating conditions! Practically no filtering necessary. AC ripple reduced to absolute minimum. Eicor Dynamotors are the lightest in weight per watt output—and are available from the smallest in size to the largest in output. There's a size for every need!

TYPE NO.	OUTPUT		INPUT		DUTY	NET WT.	CODE	LIST PRICE
	VOLTS	MA	VOLTS	AMPS.				
108	350	150	6	16.0	Con.	5½ lbs.	BOATS	\$52.00
109	400	150	6	17.0	Con.	7½ lbs.	BLUMA	52.00
161	500	200	12	13.5	Int.	7½ lbs.	BRAND	64.00
163	500	400	12	26.0	Int.	13 lbs.	BLISS	108.00
170	1050	400	12	56.0	Int.	31 lbs.	BELGA	275.00

For complete listing of Eicor Dynamotors send for Bulletin D2.



EICOR POWER PLANTS

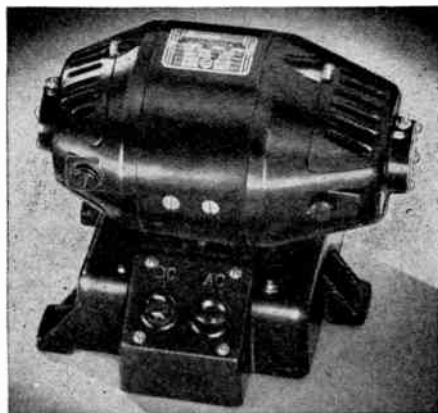

EICOR CONVERTERS



EICOR DYNAMOTORS

ELECTRONIC CONVERTERS

ELECTRIC LOW POWER CONVERTERS

To Operate Electric Razors and Small AC Devices Requiring 35 Watts or Less

- Electronic Model 851— 6 Volts DC to 110 Volts AC—35 Watts
- Electronic Model 861— 12 Volts DC to 110 Volts AC—35 Watts
- Electronic Model 871— 32 Volts DC to 110 Volts AC—35 Watts
- Electronic Model 951—110 Volts DC to 110 Volts AC—35 Watts
- Electronic Model 891—220 Volts DC to 110 Volts AC—35 Watts

As the answer to the problem of operating standard electric razors in rural localities, on camping trips, and on Pullman cars, this series of converters was designed to provide 60 cycles alternating current from 6, 12, 32, 110 or 220 volts direct current. Only a pure 60 cycle alternating current will operate all makes and all models of electric razors and it was for this reason that Electronic uses their heavy duty converter type vibrator in this low wattage converter.

This series of converters has been found exceedingly useful for operating small electric signs, low power motors, and various other equipment where a light and portable converter is required.

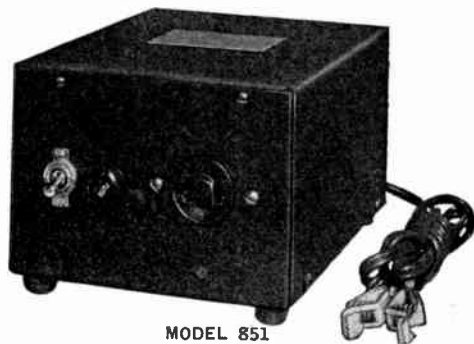

MODEL 851

ELECTRONIC CONVERTERS OPERATING FROM 6- TO 12-VOLT STORAGE BATTERIES

- Electronic Model 302— 6 Volts DC to 110 Volts AC— 75 Watts
- Electronic Model 306— 6 Volts DC to 110 Volts AC— 95 Watts
- Electronic Model 502—12 Volts DC to 110 Volts AC—125 Watts

Ideal for operating 110 volt AC equipment from storage batteries, these three units perform perfect service for:

1. The operation of small 110 volt AC radio sets and amplifiers from 6 volt batteries (Model 302).
2. Exactly the same type of job in the conversion of 12 volts from DC to AC by Model 502, which is used extensively as a power supply for radio and public address systems mounted in trucks that have 12 volt storage batteries.
3. The Model 306 is the same as Model 302 but having a high wattage ratio.

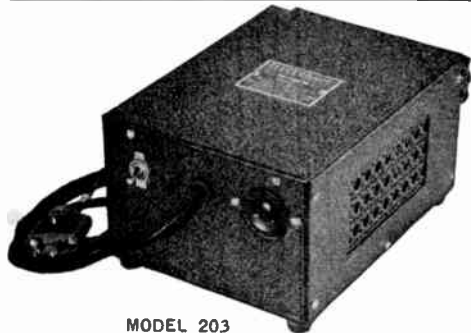

MODEL 203

ELECTRONIC CONVERTERS FOR 110 DC TO AC

To Operate 110 Volt AC Radios, Public Address Systems, Electrical Appliances, Intercall Systems, Phonographs, Radio Test Equipment, Etc.

- Electronic Model 203—110 Volts DC to 110 Volts AC—150 Watts
- Electronic Model 223—110 Volts DC to 110 Volts AC—200 Watts

These two Electronic models are designed especially for conversion of direct current to AC in the large areas so frequently found in most big cities. They are also used on Kohler systems and marine power plants where 110 volt AC equipment is required.

The Model 203 Electronic converter is recommended for the operation of AC radios from direct current, while the Model 223 is a more powerful unit for large radios and electrical appliances and devices with synchronous motors having low power factors (with the exception of electric clocks and neon signs) that come within its wattage rating. Ideal for demonstrating AC appliances in stores wired with DC.

ELECTRONIC CONVERTERS FOR 32-VOLT SYSTEMS

To Operate 110 AC Radios, Amplifiers, Public Address Systems

- Electronic Model 102—32 Volts DC to 110 Volts AC—100 to 125 Watts
- Electronic Model 143—32 Volts DC to 110 Volts AC—180 to 200 Watts

Wherever the operation of 32 volt power plants is prevalent—rural districts, trains, yachts—these two converters make possible the operation of standard 110 volt AC equipment. The converters operate on a voltage from 24 to 45 volts and have an 85 per cent efficiency at full load.

The Model 102 converter is used primarily for operating radios—thus giving listeners the opportunity to select any make or model 110 volt AC radio rather than be limited to battery sets or a few 32 volt models that have low trade-in value.

The Model 143 converter is a more powerful unit designed for operating 110 volt AC radios, amplifiers and P. A. systems from 32 volt power plants.

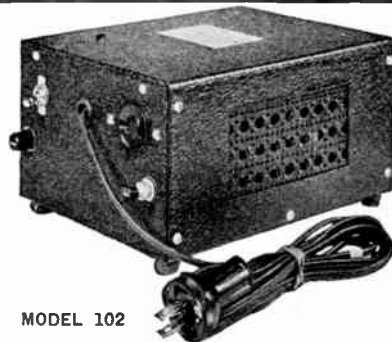

MODEL 102

ELECTRONIC CONVERTERS FOR COIN PHONOGRAPHS

Electronic Model 233—110 Volts DC to 110 Volts AC—350 Watts

Electronic Model 346—220 Volts DC to 110 Volts AC—350 Watts

Possessing many exclusive advantages over rotary type converters, this Model eliminates necessity of purchasing expensive DC coin phonograph machines which may be obsolete at any time by change to AC location. Universal operation, with either old or new AC phonographs, is made possible at less expense by these easy-to-attach Electronic converters. Small size enables it to fit in phonograph cabinet. Quiet in operation. Will give long, trouble-free performance, and is fool proof in operation. Designed for direct current operation of standard AC machines made by Rock-Ola, Wurlitzer, Seeburg, Mills Novelty, Capehart, A.M.I., etc.

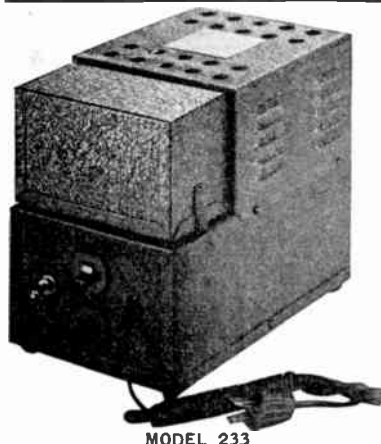

MODEL 233

ELECTRONIC SPECIALIZED ENGINEERING SERVICE

★ You'll find answers to your electrical designing and manufacturing problems at Electronic Laboratories. There, a highly-trained, thoroughly-experienced and amazingly-resourceful engineering staff is at your service. To it have come—already—many of America's key defense-producing companies as well as important civilian supply manufacturers. Not only have they found that Electronic could develop what was needed, but could manufacture it as well. A glance at a few of Electronic's important products described above will convince you, we believe, that you can get what you need from Electronic engineers. Their full facilities are always at your disposal.

SEE OTHER SIDE FOR CONVERTER VALUOGRAPH CHART



MODEL 883

ELECTRONIC POLARITY CHANGER CONVERTER

For the Operation of Electric Clock Motors, Amplifiers, Fractional Horsepower Motors, and Other AC Apparatus

Electronic Model 849—110 Volts DC to 110 Volts AC—20 Watts

Electronic Model 883—110 Volts DC to 110 Volts AC—100 Watts

Electronic Model 97—220 Volts DC to 220 Volts AC—100 Watts

Electronic Model 850—110 Volts DC to 110 Volts AC—20 Watts

Polarity Changer Converters deliver the same output voltage as the input and differ from standard converters in that they do not use a transformer in the conversion process. The Polarity Changer is essentially a vibrating double pole double throw switch whereby the input direct current is reversed across any given load at the frequency of the vibrating reed.

Various models are supplied, the Model 883 being designed for industrial application, the Model 849 being designed essentially for synchronous clock motors due to the fact that it has a variable frequency adjustment by means of which the frequency may be varied between 58½ and 61½ cycles. Model 97 is designed for 220 volt operation and is the equivalent of Model 883.

Polarity Changers are the most economical method of supplying direct current conversion, they are light in weight and very high in efficiency—the actual value being over 95 per cent.

THE Electronic CONVERTER VALUGRAPH CHART

Model No.	D. C. Input Voltage	Output Voltage	Output Frequency	Rated Continuous Wattage	Rated Inter-mittent Wattage	% Efficiency at Full Load	% Regulation	Current Drain Full Load	% Minimum Load Power Factor	Radio Freq. Interference Suppressed	Vibrator No.	Shipping Wt.	Dimensions in Inches	Best Adapted For	Price List
851	6	110	60	35	50	90	75	6.0	75	No	431	5	6 x 5½ x 3½	Electric Razors Small A. C. Motors	\$ 17.50
302	6	110	60	75	75	85	84	14.7	60	Yes	431	14	8¾ x 6¼ x 4½	Radio, P. A.	33.00
306	6	110	60	100	100	85	80	2.2	75	Yes	432	14	8¾ x 6¼ x 4½	Radio, P. A.	37.00
861	12	110	60	35	50	90	75	3.0	75	No	330	5	6 x 5½ x 3½	Electric Razors Small A. C. Motors	17.50
502	12	110	60	100	125	85	94	10.	60	Yes	330	14	8¾ x 6¼ x 4½	Radio, P. A.	33.00
102	32	110	60	100	125	85	80	3.7	85	Yes	3238	15	8¾ x 6¼ x 4½	Radio	27.00
891	32	110	60	35	50	90	75	1.3	75	No	3238	5	6 x 5½ x 3½	Electric Razors Small A. C. Motors	17.50
143	32	110	60	180	200	85	80	5.5	60	Yes	3239	19	9¾ x 7½ x 6	Amplifiers, P. A., Radio	39.00
152	32	110	60	100	125	78	77	4.0	60	No	3238	18	12¼ x 5 7/8 x 4 1/8	Sound on Film Amplifiers	35.00
382	110	110	60	200	250	90	95	3.2	50	No	11030	15	8¾ x 6¼ x 4½	Pin Ball Games	30.00
383	110	110	60	200	250	90	95	3.2	50	No	11030	15	8¾ x 6¼ x 4½	Pin Ball Games	31.00
S-404	110 A.C.	110	60	150	...	30	70	...	70	No	11030H	29	19½ x 9½ x 8	Frequency Changer	175.00
951	110	110	60	50	70	90	85	.5	60	No	11030	5	6 x 5½ x 3½	Small A. C. Apparatus	25.00
93	110	110	60	20	50	85	90	.25	100	No	11033	6	10 ½ x 8 ¾ x 6	Ozonators	20.00
203	110	110	60	150	200	85	91	1.6	85	Yes	11031	15	10 ½ x 8 ¾ x 6	Radio	38.50
212	110	110	60	100	125	80	80	1.1	50	Yes	11031	14	8¾ x 6¼ x 4½	Radio, Small Syn. Motors, Etc.	34.00
223	110	110	60	200	300	87	85	3.2	80	Yes	11032	19	9¾ x 7½ x 6	Radio, P. A.	40.00
233	110	110	60	350	500	87	83	5.3	60	No	11032	21	9¾ x 7½ x 6	Coin Operated Phonographs	50.00
242	110	110	60	125	150	80	80	1.1	60	No	11031	19	12¼ x 5 ½ x 4 ¼	Sound on Film Amplifiers	37.50
849	110	110	Var.	20	20	95	90	.2	80	No	801	4	7½ x 4½ x 3½	Electric Clocks	25.00
883	110	110	60	100	100	95	90	2.4	80	Yes	801	4	7½ x 4½ x 3½	Amplifiers	25.00
850	110	110	60	20	20	90	50	.2	50	No	802	2	2¼ x 2¼ x 8½	Miscellaneous	17.50
351	110 220	110 220	60	150	250	90	95	1.6	75	No	11031	17	13 ¾ x 5 ¾ x 4 ¾	Amplifiers Foreign Use	50.00
323	220	110 220	60	150	250	90	95	.76	75	Yes	11031	17	12¼ x 5 ¾ x 4 ¾	Radio, P. A., Foreign Use	47.00
332	220	110	60	300	300	90	95	1.6	50	No	11030	16	8¾ x 6¼ x 4½	Pin Ball Games	35.00
871	220	110	60	35	50	90	75	.22	75	No	11030	5	6 x 5½ x 3½	Electric Razors Small A. C. Motors	25.00
97	220	220	60	100	109	95	90	1.3	80	Yes	22097	4	7½ x 4½ x 3½	Amplifiers	25.00
320	...	110	60	75	75	..	85	...	60	Yes	495	25	12 x 9½ x 9½	Portapak	125.00
346	220	110	60	350	500	85	80	2.7	50	No	11032	21	9¾ x 7½ x 6	Coin Phonographs	50.00

For 50 Cycle Output Mark (X) After Type No. and Add 10% to Price.

For Accurate AC Frequency to ± .2% Mark (H) After Type No. and Add 10% to Price.

For Variable Output Frequency ± 5% Mark (HO) After Type No. and Add 15% to Price.

Prices 50% Higher F. O. B. TORONTO, CANADA.

Prices 10% Higher F. O. B. WEST OF ROCKIES.

Copyright by U. C. P., Inc.

ELECTRONIC PORTAPOWER UNITS

1. All Electronic power packs delivering over 30 watts use Electronic converter or Electronic tandem type vibrators.
2. Electronic heavy duty power packs are now available with capacity as high as 80 watts DC output, plus 20 watts AC output.
3. Variable output is available; 325 volts at 125 milliamperes to 400 volts at 200 milliamperes. Input power requirements vary almost directly with output power requirements. An efficiency over 60% is obtained with all Electronic power packs.
4. Heavy duty units, besides delivering DC output, also deliver 110 volts AC at 60 cycles for operating turntable motors, relays, etc.
5. All heavy duty power packs are universal, designed for operating on the DC voltage specified or on 110 AC.
6. All heavy duty units are equipped with switch terminals for stand-by operation on DC. (No heavy duty switch is necessary.)
7. In order to take care of rectifier requirements under various load conditions, all heavy duty packs are designed to use either two 0Z4 rectifier tubes or one 5T4 rectifier with no change of wiring.
8. It is unnecessary to use two vibrators and two transformers to obtain high DC output. One Electronic vibrator has ample capacity and will give longer life than any other two vibrators on the market.
9. Average life of an Electronic vibrator when used in a heavy duty power pack is 2500 hours (five times the life of an auto radio type vibrator).
10. Electronic vibrators are standard equipment in practically 100% of all portable and mobile public address systems now produced in the country.
11. Since 1932 Electronic has produced more vibrator power supplies than any other manufacturer.

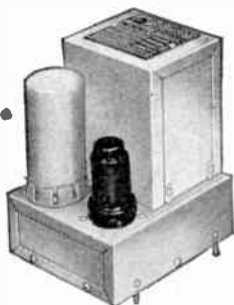

TYPES 601, 602, 603

The types 601, 602 and 603 are designed for operation on 6, 12 and 32 volts DC respectively. The 601 is adapted to use the 0Z4 or the 6W5 rectifier. The 602 and 603 are designed to use the 0Z4 rectifier tube. All three units have variable output by means of a four step tap switch ranging from 225 volts at 50 ma. to 300 volts at 100 ma. No output filter is included.

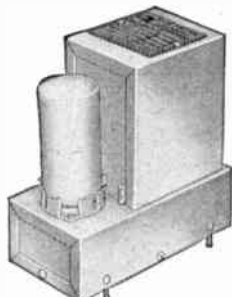

TYPES 604 AND 605

The types 604 and 605 are 6 volt power supplies using synchronous rectifiers. The 604 having an output rating ranging from 225 at 50 ma. to 300 at 100 ma. and the 605 is designed particularly for farm radios having an output rating ranging from 150 volts at 35 ma. to 275 volts at 65 ma.

These five power supplies utilize auto radio type vibrators.

The efficiency of all of these power supplies is in excess of 60%. These power supplies are designed particularly for mounting directly on the chassis of transmitters, public address systems, receivers, or test equipment and should have their output connected to a condenser fed filter where the first condenser is 8 mfd. or over. All Electronic vibrator power supplies have a unique switching arrangement to vary the high voltage output inasmuch as the tap switch is continually at ground potential. This eliminates possibility of high voltage short circuits or other conditions due to leakage that might impair the operation of the unit.

All power supplies using an 0Z4 rectifier tube must have a minimum current of 35 milliamperes output but may run as high as 125 milliamperes output.

Input connections leading to the vibrator power supply should be as heavy as possible and a minimum wire size of No. 14 is recommended. The power unit can be mounted in any position but should if possible, be at the farthest point from the RF and IF stages of a radio or from the input stages of an amplifier.

The output rating as indicated in the characteristic chart of these various power units should not be exceeded and if higher outputs are required, a selection should be made from the Electronic heavy duty power supplies listed herein.

RECTIFIER TUBES

In the heavy duty power supplies an opportunity for the use of two types of rectifiers has been provided. Where instantaneous operation of the power supply is desired, it is desirable to use a gaseous type of rectifier tube such as the 0Z4 or the 0Z4Q. By using these tubes the output rating of the power supply will be reduced approximately 10%. These tubes should only be used to deliver an output not in excess of 375 volts at 150 ma. The 0Z4 rectifiers are used each as half wave rectifiers both being in a full wave circuit in order to provide current carrying capacity.

Characteristic charts shown in this circular, have been taken using a 5T4 rectifier throughout. The 5T4 rectifier is a filament tube requiring approximately ten seconds to heat. The 5T4 is a more efficient tube than the 0Z4, consequently, the efficiency of the power supply is higher using the 5T4 on all except the first tap and on this tap the efficiency is approximately 4% less than when the 0Z4 tubes are used.

It is suggested that for dependability of operation the 5T4 rectifier be used wherever possible although the 0Z4 will give instantaneous response upon the closing of the primary switch.

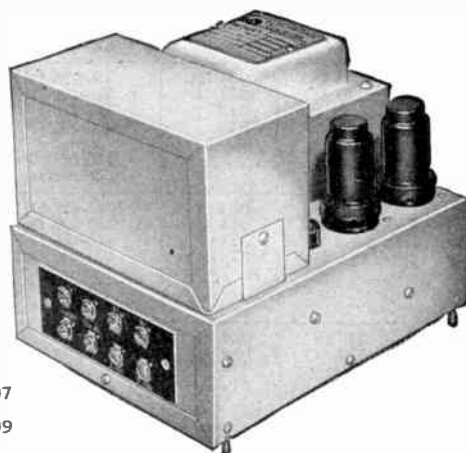

TYPES 606-607 and 608-609

HEAVY DUTY PORTAPOWER UNITS

Electronic heavy duty power supplies have been designed with an aim to supplying every requirement necessary in a portable pack. These power supplies are adapted for use directly on a chassis for mobile public address systems, portable transmitters, marine and air craft transmitters and two-way communication systems such as used by Police and the Coast Guard and have many applications where it is desired to have a source of high voltage and alternating current both from a low voltage DC source.

The following features have been combined in the Electronic heavy duty pack which are exclusive and can be found in no other type of power supply:

1. A variable source of high voltage DC power is obtainable ranging from 40 to 80 watts. The output can be varied by means of a tap switch on the unit. In order to take care of the exceedingly high power, provision has been made for the use of two types of rectifier tubes both the 0Z4 and the 5T4. On low voltage output taps 0Z4 tubes may be used and particularly when instantaneous output is required, but on the high output a 5T4 should be used in order to take care of the high output current delivered by the No. 2 of the power supply and socket No. 1 should be left vacant.
 2. A source of alternating current is available from these power supplies for the operation of phonograph turntable motors, relays, etc. The AC output is 110 volts and the frequency is 60 cycles.
 3. The power supply is universal inasmuch as it can be operated either from a 6 volt, 12 volt, 32 volt, or 110 volt source for which it is designed and also 110 volts AC. This is of great advantage in public address systems, transmitters, etc., where it is desired to have a universal power unit.
 4. These heavy duty power supplies utilize the Electronic tandem or converter type vibrator which are internationally accepted as the finest vibrator equipment that can be produced.
 5. The Electronic heavy duty power supplies are also equipped on their terminal strips with terminals for stand-by operation. On the 6 and 12 volt types the input current which ranges between 10 and 25 amperes can be controlled by means of a small inexpensive toggle switch due to the fact that the stand-by switch controls the operation of the vibrating unit and it is unnecessary to break the main power line. Electronic heavy duty power supplies have no input polarity, consequently it is unnecessary to connect the battery or the line in any particular manner.
- The expected life of the vibrator in the heavy duty power supply depends naturally somewhat upon the cycle of duty but ordinarily is between 1000 and 5000 hours of operation, depending upon the output of the unit.

SEE OTHER SIDE FOR PORTAPOWER VALUGRAPH CHART

Electronic PORTAPOWER Valugraph

Trade Mark

Model	Input	Rectifier	Output	Vibrator	DC High Volt. Filter	Dimensions	Holes	List Price
601	6 DC	0Z4 or 6W5	225-50 250-65 275-80 300-100	R-20	No	4 1/8 x 3 3/8 x 5 3/8	3 x 3 3/8" 4 holes	\$17.00
602	12 DC	0Z4	225-50 250-65 275-80 300-100	R-22	No	4 1/8 x 3 3/8 x 5 3/8	3 x 3 3/8" 4 holes	18.00
603	32 DC	0Z4	225-50 250-65 275-80 300-100	R-23	No	4 1/8 x 3 3/8 x 5 3/8	3 x 3 3/8" 4 holes	19.00
604	6 DC	Syn.	225-50 250-65 275-80 300-100	R-21	No	2 3/8 x 5 3/8 x 5 3/8	3 3/4 x 2 3/8" 4 holes	16.00
605	6 DC	Syn.	150-35 200-40 250-50 275-65	R-21	No	2 3/8 x 5 3/8 x 5 3/8	3 3/4 x 2 3/8" 4 holes	16.00
606 Heavy Duty	6 DC or 110 AC	0Z4 (2) 0Z4 (2) 5T4 5T4	325-125 DC 350-150 DC 375-175 DC 400-200 DC and 110 AC 60 cyc. 20 watts	490C	8 mfd.	6 x 7 1/2 x 6	6 3/4 x 5 3/8" 4 holes	32.00 without rectifier
607 Heavy Duty	12 DC or 110 AC	0Z4 (2) 0Z4 (2) 5T4 5T4	325-125 DC 350-150 DC 375-175 DC 400-200 DC and 110 AC 60 cyc. 20 watts	390C	8 mfd.	6 x 7 1/2 x 6	6 3/4 x 5 3/8" 4 holes	33.00 without rectifier
608 Heavy Duty	32 DC or 110 AC	0Z4 (2) 0Z4 (2) 5T4 5T4	325-125 DC 350-150 DC 375-175 DC 400-200 DC and 110 AC 60 cyc. 20 watts	3240	8 mfd.	6 x 7 1/2 x 6	6 3/4 x 5 3/8" 4 holes	33.00 without rectifier
609 Heavy Duty	110 DC or 110 AC	0Z4 (2) 0Z4 (2) 5T4 5T4	325-125 DC 350-150 DC 375-175 DC 400-200 DC and 110 AC 60 cyc. 20 watts	11028	8 mfd.	6 x 7 1/2 x 6	6 3/4 x 5 3/8" 4 holes	32.00 without rectifier
251	6 DC	0Z4 6W5	300-100	425	Yes	8 3/8 x 5 3/4 x 3 3/4	8 1/2 x 3 1/2" 4 holes	25.00
311	6 DC	0Z4 or 6W5	250-50 300-100 325-125	425	Yes	8 3/4 x 5 1/2 x 3 1/2	7 5/8 x 1 1/8" 4 holes	30.00
551	12 DC	0Z4	300-100	325	Yes	8 3/8 x 5 3/4 x 3 3/4	8 1/2 x 3 1/2" 4 holes	25.00
511	12 DC	0Z4	250-50 275-75 300-100 325-125	325	Yes	8 3/4 x 5 1/2 x 3 1/2	7 5/8 x 1 1/8" 4 holes	30.00

• Aircraft units supplied in aluminum cases at additional cost. • Prices are 40% higher in Canada. • For custom built power supplies to meet special conditions, write ELECTRONIC LABORATORIES, INC.

ELECTRONIC HEAVY DUTY VIBRATORS

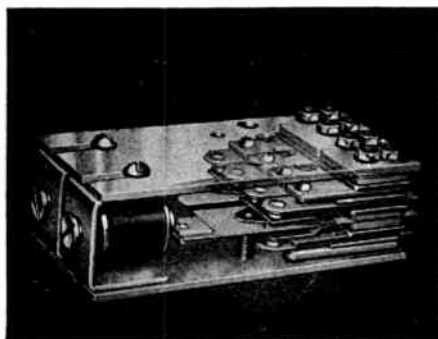

Electronic Laboratories is the sole manufacturer of vibrators for heavy duty applications. For many years Electronic Laboratories was one of the largest manufacturers of auto radio type vibrators but found that this business was not compatible with the production of heavy duty units and precision built equipment. Today Electronic Laboratories produces only converters and heavy duty vibrators and these large vibrators should not be compared with their earlier and more fragile predecessors.

Six volt vibrators capable of carrying as high as 25 to 30 amperes are manufactured for mobile public address systems. 110 volt vibrators are produced for railway applications capable of carrying as high as 750 Watts. Electronic Vibrators are constant in frequency, being accurate enough to operate electric clocks.

Electronic standard converter vibrators and tandem vibrators are sturdy in construction and are built to carry heavy current for long periods of time. Contact points almost 1/4-inch in diameter are used sometimes singly, other times in multiple parallel. Each individual reed has its own separate adjustment so that accurate alignment can be made.

Electronic Vibrators are manufactured under rigid engineering inspection and have been designed to incorporate essential merits of symmetry and balance. All Electronic Vibrators have incorporated in their design a wiping action of the contact points which precludes the possibility of rapid wear due to pitting or burning. Erosion of the contact points is minimized by the use of fine grain hard tungsten as a contact material. The vibrating reed is fabricated from a special alloy spring steel rolled only for this company. Fatigue and change in adjustment of the semi-stationary reeds

is minimized by the use of spring temper Monel metal which from long experience, has proven itself to be the finest material for this application. Only Mica insulation is used in the stack assembly and even Mica bushings are used in order to provide high dielectric insulation and permanent characteristics.

Electronic Vibrators are the standard throughout the world where precision and performance are requisites.

P·L·U·G All GTC Porta-Power

Take advantage of the high lines — A necessity wherever rural electrification has come, or portable radios are owned.

Convert Battery Radios to 105-125 volt, 50-60 cycle lines

Supply all needed power to convert radios to ALL-ELECTRIC operation. Provide constant peak source of completely filtered, hum-free power at a small fraction of the cost of batteries

Model "P"

FOR 6 VOLT RADIOS
"TWIN-POWERED"



CONVERTS 98% OF ALL 6 VOLT RADIOS

Vibrator disturbance is eliminated and high fidelity performance assured by sensational new design having two separate sources; one for the vibrator and one for the filaments.

Provides two sources of 6 volts at 1½ amps. or connected in parallel 3 amps—Screw type terminals.

\$1675

List.....

Shipping weight approximately 8 lbs. (Size: 3¾" x 6½" x 5½")

Model "U"

FOR 1½ VOLT PORTABLE OR FARM RADIOS
of 4 or 5 TUBES



Universal sockets for all types of battery plugs. May be used in any position. Will fit the battery compartment of 99% of all portables.

Small enough to be installed permanently in many, in addition to the batteries.

Light weight for portable operation. Great economy for home use.

PROVIDES:

"A"—1.5v at 200 m.a.
"B"—90v at 13 m.a.

\$950

List.....

Shipping weight approximately 4 lbs. (Size: 2" x 3½" x 6")

Model "L"

for 2 VOLT RADIOS

Supplies "A", "B" and "C" Power to 4 to 8 tube sets designed for 3 volt Dry Battery, 2.5 volt Air Cell, or 2 volt Storage Cell "A" Power.

PROVIDES:

"A"—2v, D.C.
"B"—67½, 90, 112½, 135v (Can be adapted for 45 volts)
"C"—1½ to 22½v, (2 or 3 "C" voltages if necessary.)

Screw Type Terminals

Shipping weight approximately 6 lbs. (Size: 6 1/16" x 4" x 5½")

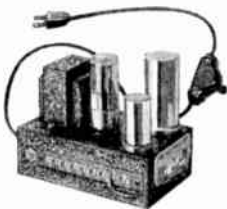

\$1225

List.....

Model "G"

for 1½ volt radios of 4, 5 or 6 tubes requiring more power than model "U" provides.

PROVIDES:

"A"—1.5v at 200 m.a.
1.35v at 250 m.a.
1.55v at 300 m.a.
1.35v at 350 m.a.
"B"—90v at 13 m.a.
101v at 8.5 m.a.

List..... **\$1150**

Shipping weight approx. 5 lbs. (Size: 3 9/16" x 6 1/16" x 4 13/16")



OPERATE 1½ VOLT BATTERY RADIOS FROM 6 VOLT STORAGE BATTERY

Model "C"



SUPPLIES 1.4 VOLTS "A" AND 90 VOLTS "B" FROM 6 VOLTS D. C. INPUT

- Replaces "A" and "B" batteries in 1.4 volt portable or farm radios having 4, 5, or 6 tubes.
- Hum and hash free operation.

PROVIDES:

"A"—1.4v at 200, 250 and 300 m.a.
"B"—90v at 10 m.a.

Six Battery Type Sockets

\$1500

List.....



Shipping weight approximately 5½ lbs. (Size 3¾" x 6¼" x 6")

110 VOLT AC ANYWHERE WITH KATOLIGHT!

CONTINUOUS DUTY RUGGEDLY CONSTRUCTED ECONOMICAL PORTABLE

Designed for sound trucks, homes, cottages, trailers, farms or any place where plant is desired for running many hours daily and expected to give years of trouble-free service.

KATOLIGHT PLANTS are the result of years of actual experience in the light plant field; the result of much laboratory and actual field tests. The engine that will give the best performance is selected for each model. Engine manufacturers are known internationally and maintain service stations in key cities in U.S., Canada and foreign countries. The user is assured of service and parts from authorized service stations.

NOTE: All Katolight plants are completely filtered and shielded for radio operation.

KATOLIGHT PLANTS are already to go by simply adding a little gasoline and oil and connecting to the lines; complete with engine, generator, base, fuel tank, instruction manual, hand crank (with exception of 19A & 23A which come furnished with push button start on plant and convenient rope crank), nothing else required.

BATTERY CHARGERS

JR32, JDS12 & JDS6—Ideal for hooking on to automobile, truck, radio or tractor battery. A completely discharged battery in good condition can be charged up about 4 to 6 hours. A battery may be restored to usefulness in from ½ to 1 hour's time. Furnished with starting switch, cutout, ammeter, cables, clips, carrying handle and emergency rope crank. Have Battery Ignition engines but can be equipped with Magneto Ignition Engine at \$6.00 list extra.

6-12 AND 12 VOLT BATTERY CHARGERS

Watts Capacity	MODEL No.	Type of Cooling	Make of Engine	No. Cyl.	Engine H.P.	Cranking Volts	Shp. Wgt.	CODE WORD	Speed	LIST PRICE
300	JR32	Air	Lauson	1	¾	32	60	KODE	3600	\$80.00
250	JDS12	Air	Lauson	1	¾	12	60	KARE	3600	60.00
240	JDS6	Air	Lauson	1	¾	6	60	KARS	3600	60.00

CONTROLS & ACCESSORIES FOR KATOLIGHT PLANTS

IMPORTANT FEATURE:—Any of the standard controls can be attached or changed on Katolight Plants up to and including 5000 watts capacity—do not have to be ordered with plant. Each control includes battery, cutout, DC ammeter showing amount of battery charge, battery charge control resistor which permits adjusting charging current to suit needs, 25-ft. wire and one push button control station furnished with remote control.

19A & 23A & Battery Chargers only furnished complete with push button starter right on plant including cutout, battery charge control resistor, start push button and battery cables, but no electric choke. If remote or full automatic control is desired on these models, extra must be added as shown.

Write for information on sizes up through 15,000 watts capacity. Available for 32, and 110-volts D.C.

110 VOLTS A.C. — 1800 R.P.M.

Watts Capacity	MODEL No.	Type of Cooling	Make of Engine	No. Cyl.	Engine H.P.	Cranking Volts	Shp. Wgt.	CODE WORD	Speed	LIST PRICE
350	19A	Air	Johnson	1	5/8	6	140	ABOBE	1800	\$102.00
500	23A	Air	Johnson	1	1.4	6	150	ABTOL	1800	158.00
600	14A	Air	**B&S	1	1.4	12	220	ALERT	1800	210.00
1000	26A	Air	**B&S	1	2.4	12	295	ABBOT	1800	298.00
1500	28A	Air	**B&S	1	4.5	18	340	ABEAR	1800	365.00
2000	30A	Air	**B&S	1	6	18	360	ABIDE	1800	450.00
4000	44A	Air	LeIrol	4	13.8	24	800	ACTIN	1800	750.00
3500	43A	Water	LeIrol	2	9	24	800	ALAS	1800	775.00
5000	45A	Water	LeIrol	4	16	24	910	ALBION	1800	850.00
*7500	47A	Water	LeIrol	4	25	6	1300	ALBON	1800	1350.00
*10000	49A	Water	LeIrol	4	25	6	1300	ALBUN	1800	1460.00
*15000	51A	Water	LeIrol	4	38	6	1500	ACTIV	1800	1630.00
*3500	43AG	Water	LeIrol	4	16	6	1100	ALBERTA	1200	850.00
*5000	45AG	Water	LeIrol	4	19	6	1300	ALBERT	1200	1100.00
*7500	47AG	Water	LeIrol	4	27	6	1300	ALBOX	1200	1460.00
*10000	49AG	Water	LeIrol	4	27	6	1500	ALBUS	1200	1630.00

*Regularly furnished with separately excited generators on which better delivery can usually be made. Can be furnished with self-excited generators upon specification.

**Briggs & Stratton. WATTS RATING AT 100% POWER FACTOR (LAMP LOAD)

CONTROLS AND ACCESSORIES

40-FT. REMOTE CONTROL for stopping and starting 40-ft. or less away from plant.....	\$20.00
500-FT. REMOTE CONTROL for stopping and starting 500-ft. or less away from plant.....	35 0
NOTE: No control cable is furnished with 40-ft. control. About 15 ft. three-wire control cable is furnished with the 500-ft. Remote Control. Use ordinary No. 18 3-wire control cable.	
FULL AUTOMATIC CONTROL (for sizes to 30A).....	\$100.00
FULL AUTOMATIC CONTROL (for sizes 43A and larger).....	150.00
Full automatic control starts and stops plant automatically as load is turned on and off.	
SPECIAL MUFFLER for sound truck application.....	9.00
START AND STOP CONTROL STATIONS—Each.....	1.10
SPECIAL THREE-WIRE CONDUCTOR CABLE—Per Foot.....	.03½
TWO-COMPARTMENT TANK for starting on gasoline and running on kerosene.....	8.00

KATO ROTARY CONVERTERS-3600 R.P.M.—Ball Bearing For changing 32v. or 110v. D.C. to 110v. A.C.

Output Watts	MODEL No.		Shp. Wgt.	CODE		LIST *L.F.	LIST *W.F.
	32v.	110v.		32v.	110v.		
80	10	20	30	RABAT	RAVEN	\$46.20	\$52.80
110	131	221	30	RAIN	RUN	48.40	55.00
150	181	261	30	RANT	RAMP	53.90	61.60
200	231	311	44	RAN	RUNT	59.40	68.20
250	281	361	44	RAY	RAID	66.00	74.80

1800 R.P.M.—Ball Bearing

350	341	471	105	RINK	RAOE	99.00	107.80
500	611	S611	130	RICE	RACE	148.50	176.00
750	861	S861	140	RIFE	RATE	170.50	198.00
1000	1110	S1110	150	RICK	RACK	214.50	231.00
1500	1610	S1610	220	RIFT	RAFT	317.90	344.30

* Filter necessary for radio operation only SPECIFY if wanted when ordering.

If desired for special voltages or cycles, add 10% to the cost.

APPLY FOR DISCOUNTS

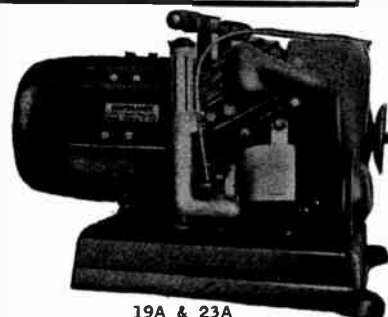

19A & 23A

The 19A is a combination 350 watt 110-volt 60-cycle A.C. or 200 watt 6-volt battery charger. Complete with start and stop push button, battery cables, D.C. ammeter, charge control resistor, cutout, cast aluminum one gallon gas tank base, convenient carrying handle, four cycle aircooled ½ h.p. Johnson engine, 1800 r.p.m. aircleaner, ignition shielded and generator filtered. Runs 8 to 12 hours on a gallon of gasoline. Requires 6-volt battery only if self-cranking is desired. The 23A, 500 watts A.C. or 200 watts at 6-volts D.C., has same specifications as the 19A and is powered with a Johnson 1 h.p. engine.

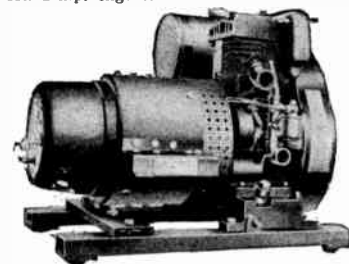

14A

Similar appearance of 600, 1000, 1500 and 2000 watt models. The 14A has a capacity of 600 watts, 110-volts, 60-cycles A.C. It is approximately 19" wide by 21" high by 22½" long and weighs approximately 161-pounds. These are very ruggedly constructed, continuous duty models, ideal for home lighting, sound trucks, farms, cabin camps, resorts, filling stations, and for innumerable other purposes. These models will give many years of trouble-free service.

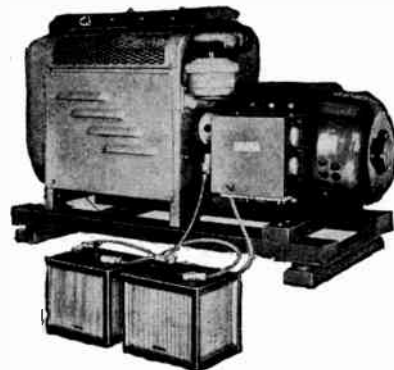

44A (with weatherproof housing)

4,000 watt, four cylinder, aircooled, powered with 14 h.p. engine, 2½" bore; 3" stroke. Enclosed flyball type governor. Full pressure lubrication. Oil bath type aircleaner. Spark plugs, ignition cables and switch shielded for radio operation generator filtered. Complete ready to go by simply adding gas and oil and connecting up to lines. Can be equipped with any of the controls described.

Copyright by U. C. P., Inc.

MALLORY

P. R. MALLORY & CO. Inc.

Dry Disc Rectifiers Battery Chargers

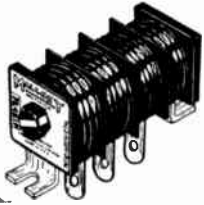

REPLACEMENT RECTIFIERS

• Ask your distributor, or write for technical bulletin Form R-615 on copper sulphide rectifiers.

Catalog Number	Replacement for Type Number	List Price
B8C3M IB12C1M	8A3, 4A3, WSA3 12C1, F12C1, IF12C1B, 12C1F, F12C1K, IB12C1X, X112, X12, U12, 3C Booster	\$3.85
F16C3M	16C3, F16CB3, 16CD3, X116, X16, ME16, 16C3B*, XB16*, M16*	5.30
F16H1P IS16CB7M IF16CB7M IS16B7M	W16A1, F16G1 For 5535 B Charger For 5535 A Charger	6.15 3.60 7.65 7.80
F20H1P F24H1P F28H1PM F32H1PM	For 107 Charger F20G1, W20A1, 20A1, X20 F24G1, W24A1 F28G1, F28H1P F32H1P	9.60 4.30 5.10 5.80 6.55

*Use base from o.d. rectifier.

BATTERY CHARGERS AND BOOSTERS

• Mallory Chargers and Boosters provide a simple, economical and dependable method of charging 6-volt storage batteries. They are designed to operate from 115 volts, 50-60 cycles, and to automatically provide a tapering charge; that is, a high charging rate into a discharged battery, the rate gradually decreasing as the battery becomes charged and a safe charging rate when the battery is fully charged.

Although designed especially for battery charging, Mallory Chargers and Boosters may be used for a wide variety of other applications, such as: electroplating, toy and model train operation, with or without a Mallory dry electrolytic condenser in shunt with the D.C. terminals of the rectifiers, in combination with a filter for operating loud speaker fields, as a dry battery substitute for operating coin machines, relays, solenoids, door bells, scientific apparatus, small generator and alternator fields and other applications requiring a low voltage direct current. Supplied complete with dash receptacle for easy attachment.



TYPE 3C

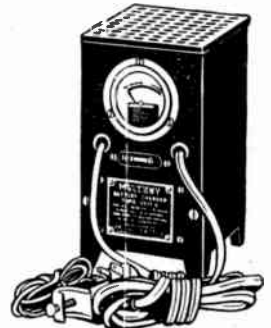

TYPE 5535B

Type Charger	Max. Charg. Rate	Tapered Rate	Charging Meter	Height	Width	Depth	Approx. Shipping Weight	Length A.C. Cord	Length D.C. Cord	List Price
3C	4	2	No	6	3 3/8	3 3/8	4 3/4	6	4	\$9.55
5535B	6	4	Yes	7 1/2	4 1/2	4 1/2	7 1/4	6	6	13.80
107	10	7	Yes	9 1/2	6 1/2	5 3/4	11	6	6	18.00
125†	5	3	Yes	9 1/2	6 1/2	5 3/4	11	6	6	27.00

†For charging 12-volt storage batteries in aircraft, boats, buses and fire trucks. Types 3C, 5535B and 107 are for charging batteries of 6 volts or less.

All chargers are equipped with one No. 652 dash receptacle.

CHARGER ACCESSORIES

No. 652—Extra dash receptacle and plug for Mallory 3C, No. 5535A, No. 5535B and 107 charger...\$1.80

AVIATION BATTERY CHARGERS

• Mallory aviation rectifier battery chargers have been designed and developed to answer the need for a practical and economical unit to charge 12 and 24 volt aircraft batteries and battery carts.

Featuring a tapering charge, these units supply a high charging rate for a discharged battery with a gradually decreasing rate as the battery becomes charged.

Mallory aircraft battery chargers employ the "tried and proven" Mallory magnesium-copper sulfide dry disc method of rectification. This method eliminates all moving parts and assures long life and dependability.

Write for catalog sheet R-662.



TYPE 5C12



TYPE 5AC24D



TYPE 10AC24

Type Charger	Battery Volts	No. of Cells	Charg. Initial	Amps. Tapered	DC Output		Length	Width	Height	Appr. Shp. Weight	AC Cord Length	Net Price
					Connection	Type						
5AC24D	12* 24*	6 12	7 1/2 5	4 1/2 3	Parallel Series	4 Studs	10	5 1/2	9	20	8	\$37.50
5C12	12	6	5	3	Straight	6' Cord, Plug, Receptacle	6 1/4	5 3/4	9 1/4	11	6	15.00
10AC24	24	12	10	6	Straight	Studs	12	10	14	85	8	72.50

*Two 12-volt batteries may be charged simultaneously from independent circuits or connected in series and charged from 24-volt output.

P. R. MALLORY & CO. Inc.
MALLORY

Battery Chargers DC Power Supplies

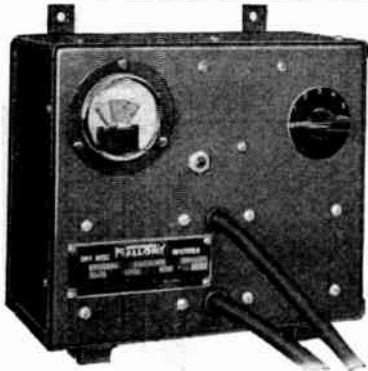

SINGLE CELL CHARGER

No. 3RPS2

● Built with the same outstanding characteristics that have distinguished other Mallory Magnesium-Copper Sulphide Rectifiers, this rectifier charger is designed for charging and maintaining a full current output with single cell lead batteries.

It is especially adaptable in maintaining the charge of single cell batteries used in portable radios and transmitters.

In the laboratory, this handy charger has many uses. In addition to full charging duty, it can also be used for a "trickle" charge or a "floating" charge across the battery, while in use. Send for catalog sheet R-661.

Net price, FOB Indianapolis.....\$29.00

MULTI-CIRCUIT BATTERY CHARGER No. 85C30M

● For the charging of several airplane, tank or bus batteries simultaneously, Mallory has designed an efficient Multi-Circuit magnesium-copper sulphide dry disc rectifier battery charger. Ten separate, individually-controlled, charging stations assure the proper charge for each battery. Installed in

airplane hangar, tank or bus depot, this versatile charger will give economical and dependable service in the charging of 6, 12 and 24 volt batteries. Send for catalog sheet R-660.

Net price, FOB Indianapolis.....\$450.00

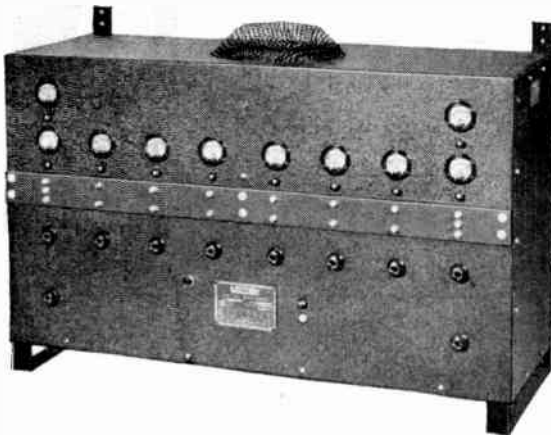

GENERAL UTILITY DC POWER SUPPLY

● A compact, heavy-duty, mobile DC power unit to replace batteries or battery carts on assembly lines, in laboratories and maintenance departments. Provides adequate and dependable DC power for manufacturing, testing and repairing all electrical communications and electronic equipment in aircraft and other mobile units employing 12 or 24 volt systems. The Mallory General Utility DC Power Supply may also be used to taper charge batteries or battery carts of similar voltages.

Quiet operation—no moving parts to wear out or break down. Made in two types, both designed to operate from a 230 volt (Operating range 210-250 volts), 3 phase, 50-60 cycle source. Units to operate from 480 volt source are available on special quotation. Send for catalog sheet R-631.

Type VA1500—Furnishes 10 to 16 volts at 100 amps, 20 to 32 volts at 50 amps. Net price, F.O.B. Indianapolis.....\$400.00

Type VA3000—Furnishes 10 to 16 volts at 200 amps, 20 to 32 volts at 100 amps. Net price, F. O. B. Indianapolis.....\$500.00

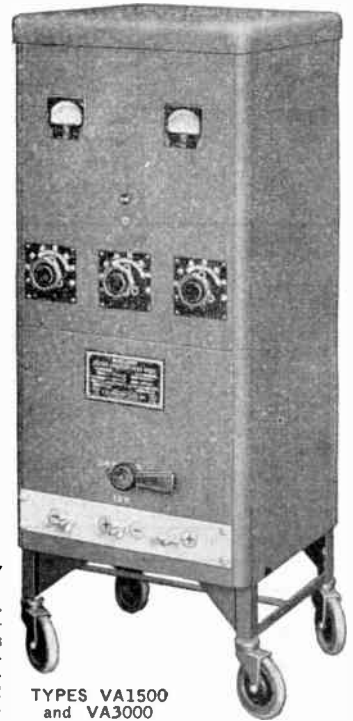

TYPES VA1500
and VA3000

GENERAL UTILITY RECTOPOWER SUPPLY

● A compact, heavy-duty Mallory Dry Disc Rectifier that furnishes a constant and adequate DC power. The unit is particularly suited for testing and repairing electrical communications and electronic equipment in all applications employing voltage within specified ranges.

May also be used for the economical and efficient taper charging of batteries.

Requires no special foundation; may be quickly and easily mounted on wall or bench for the most convenient location.

Featuring a variable voltage output to simulate actual operation under different conditions, the power supply has low ripple characteristics—3% at full load, lower at light load. Send for catalog sheet R-659.



Type	Volts	Amps.	AC Input		Dimensions				Approx. Weight	Net Price
			Volts	Phase/Cycle	Width	Depth	Height			
							Unit Only	Overall		
6VA10	6	10	115	1/60	9	7	10	13	20	\$65.00
12VA10†	12	10	115	1/60	10	10	12	15	32	95.00
24VA10†	24	10	115	1/60	18	10	14	18	60	145.00
32VA10†	32	10	115	1/60	18	12	15	20	75	180.00
6VA25*	6	25	115	1/60	12	8	12	15	45	125.00
12VA25*	12	25	115	1/60	12	12	14	17	72	180.00
24VA25+*	24	25	115	1/60	18	12	16	20	140	265.00
32VA25+*	32	25	115	1/60	18	14	18	22	175	335.00
12VA50*	12	50	230	3/60	15	10	14	18	90	260.00
24VA50*	24	50	230	3/60	15	13	16	20	175	390.00
32VA50*	32	50	230	3/60	17	15	18	22	220	420.00

*Fan cooled. †Can be furnished for dual operation, i.e., half voltage, double current.



How You Can Profit

By the Use of

ELECTRONICS

War-born production speed and precision now makes "automatic operation control" vital to post-war competition.

Consider how Worner Fotoelectric Units can see more accurately than the human eye; respond more quickly, more surely than the human hand . . . continuously, unfalteringly, night and day! With untiring accuracy, with unerring precision they see and act instantaneously . . . they stop, start, sort, grade, count, signal, etc. more quickly than human mental processes can begin to function.

Today, Worner Fotoelectric Units are controlling hitherto unconquerable uncertainties in an amazing variety of unrelated problems. Suggestive applications are listed here. Translate them to your problems and let us help you plan opportunities for you to capitalize at once.

Synchronizing Conveyor Operations

Controlling Smoke for Proper Combustion

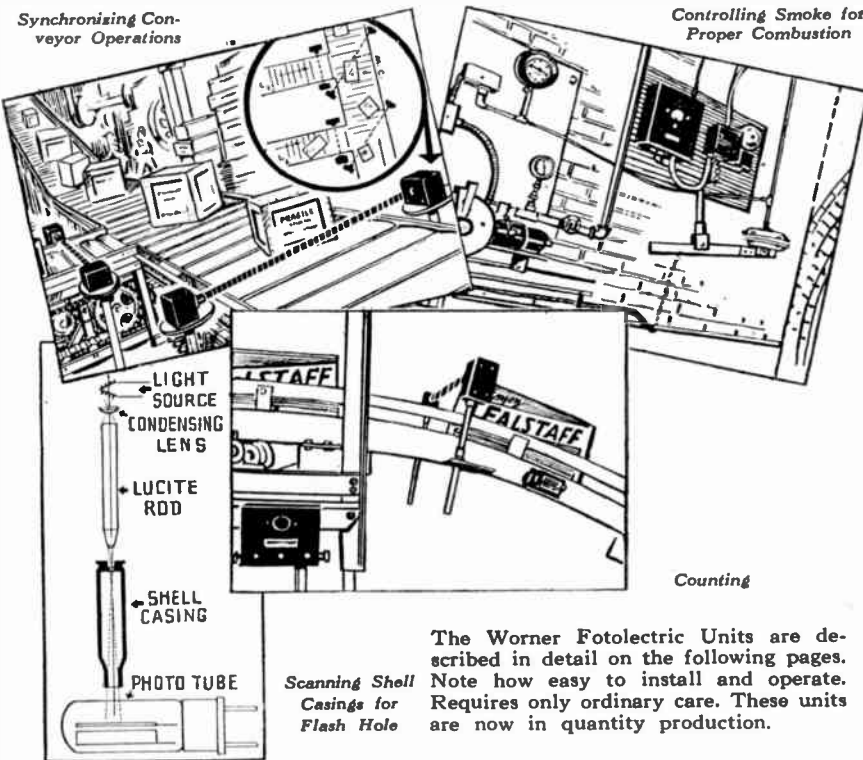

Scanning Shell Casings for Flash Hole

The Worner Fotoelectric Units are described in detail on the following pages. Note how easy to install and operate. Requires only ordinary care. These units are now in quantity production.

How FOTOELECTRIC Units Now Serve Industry

In addition to the many common uses described at the left, Worner Units have been adapted to handle the following and many other problems.

Control machinery by interruption of light by objects too light in weight to operate mechanical switches!

Control of water valves by radiant energy from hot billets that are to be descaled.

Shutting off boiler feed water and giving alarm when creosote is prominent in condensate thus arresting damage to boiler tubes.

Control for automatically wrapping bread, candy and many other packages so that the printed matter is in desired position.

Inspection and rejection of lightweight and empty cans that have been through cooker and are enroute to cooler. This is to prevent these cans from clogging cooler.

Counting of sheets in tin plate mills.

Pin hole detection.

Detecting breaks in belts, paper, wire, etc.

Automatically controls amount of artificial illumination according to change in natural light.

Control of tower street beacon signs, etc. Turns lights on and off at a predetermined intensity.

Flame control in oil or gas burners to prevent explosion by preventing flow of combustibles after flame is extinguished.

Automatic control of flow of materials on conveyors or belts.

Control of humidity in room where shoe soles are conditioned before going into production.

NOTE: What is your problem? Let Worner Electronics Engineers solve it for you.

See Page U-3 for Worner Anti-Sabotage Equipment, the invisible ray that protects life and property.
See Page U-4 for Worner Combustion Supervisor that maintains boiler operation at correct combustion level for maximum efficiency and lower fuel consumption.

WORNER Fotoelectric PRODUCTS

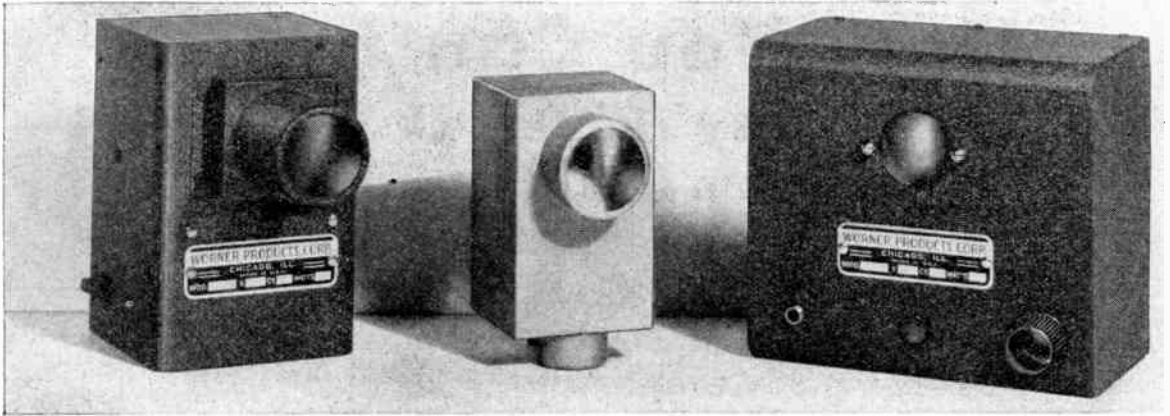

Light Source for 2-Unit Set

Extension Photocell for 3-Unit Set
Extension Light Source for 3-Unit Set

Amplifier and Relay for 2-Unit
and 3-Unit Sets

Two and Three-Unit Sets

The Two-Unit Set consists of a Light Source and a Photo-Electric Receiver equipped with a sensitivity control and an on-off switch. The Three-Unit Set consists of an Amplifier, an Extension Photo-Cell and an Extension Light Source. The Amplifier contains relay, sensitivity regulator, power supply and output terminal. The Extension Photocell Unit is available in three sizes for convenient installation where space limitations are a factor.

Operation

The sets will operate upon interruption of the light beam or on a change of light intensity. Response is sufficiently fast to open and close built-in relays up to 500 times per minute.

Lamp Life

Lamp life in either two or three-unit-system is approximately 2000 hours.

Relays

Relays are double pole, double throw types rated at 3 amperes non-inductive, 1 ampere inductive at 110 volts, 60 cycles AC.

Construction

Each unit is carefully engineered and accurately constructed of finest parts. Cases are sturdily made of 19 gauge steel, finished in gray crackle. Light Source measures 6" x 7" x 4 1/8"; Receiver 7" x 6 1/4" x 4 1/4". Wall brackets are included. Extension Photocell Units are available in the following three sizes: The standard Extension Photocell Unit for both the Light Source and the Photo Cell has cast iron weatherproof housing for 1/2" conduit, size 4 1/2" x 3" x 2 3/4". Where applications require a smaller extension unit, order our 18 gauge size 6 1/4" x 1 5/8" x 1 5/8" or 18 gauge, size 3 3/4" x 1 1/8" x 1 1/8".

Installation

The installation will vary to meet the requirements of the particular job. We shall be glad to supply detailed information on request. Both models are for use from 110 volts, 60 cycles AC.

List Prices

MODEL 2801-RL—Amplifier and Relay.....	\$55.00	{ For distances under 4 feet.
MODEL 2801-LL—Extension Light Source.....	\$12.00	
MODEL 2801-R—Amplifier and Relay.....	\$55.00	{ For distances over 4 feet
MODEL 2801-L—Extension Light Source.....	\$12.00	
MODEL 2104—Amplifier and Relay.....	\$60.00	
MODEL 2304—Extension Light Source.....	\$ 8.50	
MODEL 2204—Standard Extension Photocell.....	\$ 8.50	

(For smaller size Extension Photocell, write for quotation.)

We will gladly furnish you with details pertaining to our experience in the following applications or any other application not listed here.

- Remote control of machines, doors.
- Ventilation control.
- Operation of valves & switches.
- Detecting paper breaks (printing).
- Production inspection and counting, sorting, sizing, and weighing.
- Conveyor Control.
- Reversing steel mill rolls.
- Automatic package wrapping.
- Spray control for painting.
- Registering control (printing).
- Operation of safety doors.
- Auto speed indicators.
- Remote control of dangerous processes.
- Safety protection of oil burners, gas burners and stokers.
- Safeguards expensive dies on punch and forming presses.
- Elevator safeguards.
- Control and inspection.
- Turbidity control in water supply.
- Titration of chemicals.
- Detecting flaws in materials.
- Color Analysis—matching and comparison
- Sorting Foods.
- Control of cut-off saws.
- Measuring liquids, tanks, bottles, cans, barrels, etc.
- Automatic control of paper trimming.
- Calipering small parts.
- Room illumination and window display control.
- Airport, aviation and lighthouse beacons.

WORNER Fotoelectric PRODUCTS



Light Source

Weatherproof Case for Each Unit

Robot

ANTI-SABOTAGE EQUIPMENT

For The Plant That is NOT EXPENDABLE . . .

THE INVISIBLE RAY THAT PROTECTS LIFE AND PROPERTY

The Worner Anti-Sabotage system is an extremely flexible photocell sentinel. Provides protection that cannot be bribed. For the war plant, warehouse, shipyard, light plant, railroad yard anywhere! Carefully engineered, incorporating most practical features to assure utmost protection. Projects a beam of infra-red (invisible) rays which, when interrupted, actuate a relay which, in turn, operates an alarm or series of alarms. The alarm may be Visible or Audible, it may be local and may also be hooked up to the closest police headquarters.

Worner Anti-Sabotage systems are protecting vital plants throughout the country. In shipbuilding yards, in factories, in power plants, Worner systems serve as ever vigilant sentinels to protect the increasing flow of materials so necessary to the successful conduct of the war.

Operates Indoors or Outdoors

Indoor installation shows exact room in which trespass occurs; Outdoor installation locates trespasser within 500 feet. Can also be connected to turn on floodlights in the area where the trespass occurs. The entire installation may be invisible if desired. The units comprising the system are small and readily hidden from view. The projected infra-red rays are invisible, and so the intruder—even if he suspects the presence of a photo-cell system—is not aware of its location.

Two Standard Models

Available with ranges of 250 feet and 500 feet respectively. Where greater coverage is required, send detailed information and sketches showing areas to be protected. Quotations will be promptly supplied, covering a system engineered to that particular job. Installation is simple and can be made by anyone with a little electrical knowledge.

Specifications

The Worner Anti-Sabotage Equipment consists of the Robot and Light Source illustrated above. A weatherproof metal case covers each unit. The visor protects lenses against rain or snow.

Lamp Life

The life of the lamp in the Light Source is approximately 1000 hours.

Relays

Relays are all double pole, double throw types. Maximum current capacity is 3 amperes at 110 volts, 60 cycles AC non-inductive and 1 ampere inductive load.

Construction

The cases are built of sturdy 14 gauge steel, and all joints are carefully welded for complete weatherproofing. Case size is 7" high, 5¾" wide and 1¾" deep. Finished in brown wrinkle enamel. Equipped with mounting flanges which accommodate 1½" pipe. For operation from 110 volts, 60 cycles AC. Complete with tubes.

Model No.	List Price	Slip. Wt.
2250 250 foot range*	\$170.00	33 lbs.
2500 500 foot range*	265.00	33 lbs.

* Both models are equipped with a scientifically engineered device for limiting the unwanted-light. The Worner unwanted-light rejector materially increases the daylight range of the unit if equipment is installed so that 90% of the light reaching the Photo-Cell is that generated by the Light Source.

Burglary Protection

For burglary protection, ranges are available from 100 to 500 lineal feet. Write for Engineering Bulletins on Burglary Protection.

WORNER Fotoelectric PRODUCTS

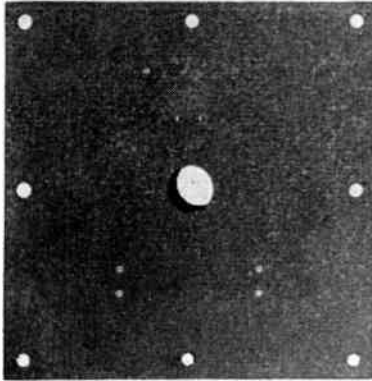

Light Source



Control Cabinet

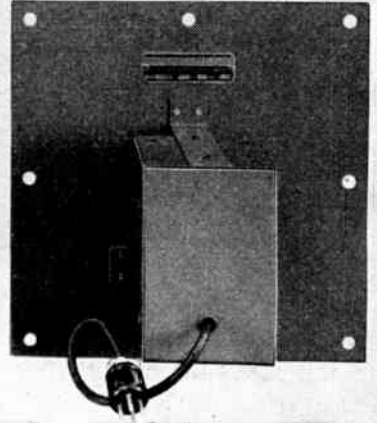

Photocell Receiver

COMBUSTION SUPERVISOR

Maintain Boiler Operation at Correct Combustion Level
Get Maximum Efficiency • Reduce Fuel Consumption

Essential wherever a boiler is used. It is of greater-than-ever importance under today's conditions of high-speed performance. It is a photo-cell system which accurately and dependably operates combustion controls to maintain boiler operation at maximum efficiency, and accuracy. It works on a "smoke detection" principle. A more-than-normal increase in the density of smoke passing through a boiler breeching means a reduction in heat, loss of efficiency, increase in fuel consumption and operating costs, and a violation of ordinances directed at control of the smoke nuisance.

Entirely Automatic

The Combustion Supervisor is easily installed (requires only two small openings) across the breeching leading from a boiler. Provides dependable warning when smoke density increases beyond a permissible level. It is entirely automatic, eliminates possibility of errors from the "human element" and provides control of amazing accuracy and flexibility.

Flexibility

As easy to regulate as a pressure gauge. Responds to any magnitude of smoke density to assure a maximum efficiency and economy in boiler performance. Condition of smoke density is shown at all times by the meter and the colored jewels on the front of the Control Cabinet. If a permanent and continuous record of boiler behavior is desired, a recording meter may be used. Built-in relays can be connected to operate any Audible or Visible alarm and any combustion control mechanism. To avoid "false alarms" resulting from an excess smoke density of momentary duration, the Combustion Supervisor is equipped with a variable time-delay which may be adjusted to control operation for any interval, from instant to one minute. We have designed a triple method of air flow with removable glass baffle for easy cleaning.

Complete, Compact, Convenient

The system consists of three units: a Light Source which projects a beam across the area to be protected; a Receiver which contains a sensitive Photocell; a Control Cabinet which contains Amplifiers, Relays, Terminals for Power, Control and Alarm, Light Intensity Regulator, Photocell Sensitivity Regulator, Time-delay Regulator, Operating Signals, Smoke Density Meter and Restoration Control Button.

Lamp Life

Average life ranges from 2000 to 3000 hours depending upon brilliance of beam required.

Relays

Relays are double pole, double throw types rated at 3 amperes non-inductive, 1 ampere inductive at 110 volts, 60 cycles AC. If more current must be handled, auxiliary relays may be connected to terminals on control panel.

Construction

Cases are built of 14 gauge steel and are equipped with standard outlet boxes. Light Source if built on a 12" x 12", 14 gauge steel flange which is provided with 8 holes for easy mounting. Control Cabinet is 11³/₄" high, 9" wide and 5" deep. Fifteen feet coaxial cable supplied as standard. For greater length, please specify. For operation from 110 volts, 60 cycles AC.

Model	Description	List Price	Shipping Wt.
MODEL 2101-A	For use where no time delay is necessary. Usually used as an alarm device, not to control automatic combustion correcting equipment.	\$100.00	33 lbs.
MODEL 2101-B	For use with combustion control equipment. Equipped with time delay to arrest operation of control equipment from voltage drop and short puffs of smoke.	\$150.00	33 lbs.
MODEL 2101-C	For use with combustion control equipment. Equipped with time delay to arrest operation of control equipment from voltage drop and short puffs of smoke. An additional time delay holding control to continue operation of combustion correcting equipment for a predetermined period of time. Prevents cycling of equipment.	\$175.00	35 lbs.



Westinghouse

TYPE RQ PHOTO-TROLLER



A LOW COST PHOTO - ELECTRIC RELAY FOR AUTOMATIC "ELECTRIC-EYE" CONTROL

Westinghouse Photo-trollers give automatic control with heavy-duty dependability, accuracy and efficiency up to 28 feet. They have countless uses in Industry, Commercial installations, and in the Home. Standard accessories such as counters, signals, solenoid valves, etc. are available at slight additional cost. For details, consult your Westinghouse representative.

USE THE PHOTO-TROLLER FOR:

COUNTING—You'll find Photo-troller an extremely accurate, easily installed photo-electric switch for tripping counting circuits.

PROTECTING—Injuries to machine operators are prevented and lost time due to accidents is cut down by installing Photo-troller as a safety switch on hazardous machines. Instantly the Photo-troller relay will cause the protective electrical circuit on machines to lock them against operation for as long as the danger to the operator exists.

CONTROLLING—Users are successfully applying Photo-troller to such varied applications as operating drinking fountains, limit switches, announcing customers, and conveyor control.

OPENING DOORS—Restaurant service is speeded up and accidental spilling of heavily loaded trays is eliminated when a Photo-troller is used to control an automatic door opener.

EXPERIMENTATION—Radio experimenters and home workshop enthusiasts find literally hundreds of uses for a Photo-troller.



- INEXPENSIVE
- RUGGEDLY BUILT
- OPERATES DIRECTLY FROM 115 VOLT 50/60 CYCLE AC CURRENT
- LOW CURRENT CONSUMPTION
- MAXIMUM FLEXIBILITY
- EASY INSTALLATION

ACCESSORIES

Style No. 1183185—Infra-Red Filter
To make Photo-troller beam invisible. Supplied with holder to fit any type F-1 Light Source. List Price \$2.25

Style No. 1190347—Solenoid Valve
For drinking fountain and other water line applications. For 3/8" pipe, 110 volts, 60 cycles, 75 lbs. pressure. . . List Price \$9.20

Style No. 1190348—Magnetic Counter
5 digit, 110 volt, 60 cycle magnetic counter with hand reset, to be operated by relay in Type RQ Photo-troller. . . List Price \$25.00

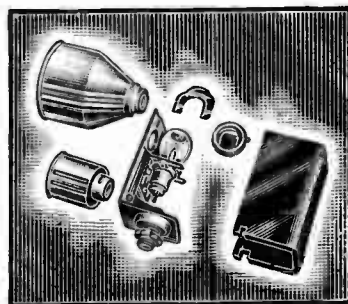
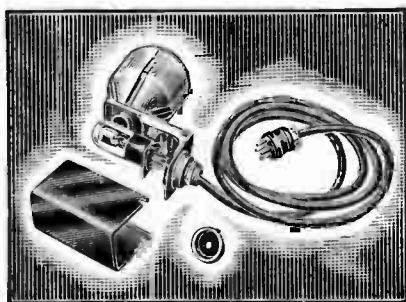

When Using Your Own Light Source . . . Measure the Light . . . then Select Your Control Here

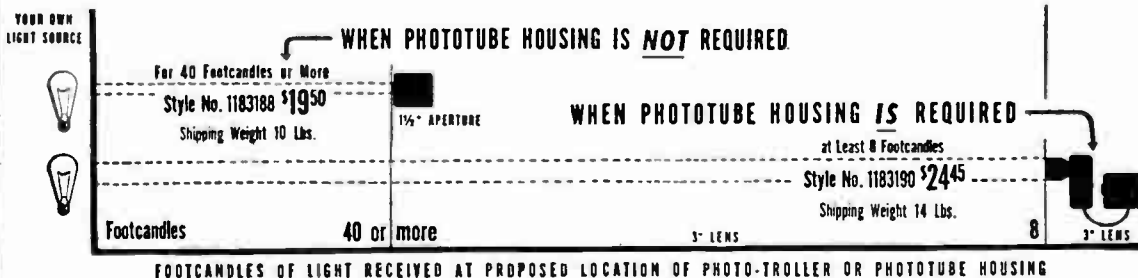

When Selecting Complete Equipment Including Light Source . . . Measure the Distance . . . then Select Your Control Here

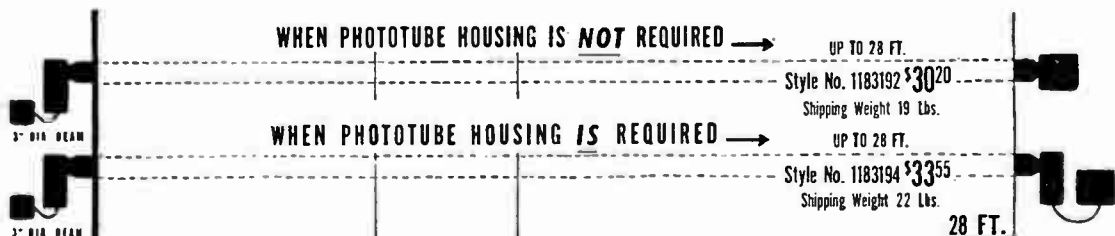

Thank You!

When writing for additional
information or when ordering
from sources of supply listed
in this book, please mention

RADIO'S MASTER

RADIO'S MASTER

GENERAL INDEX

- A -

	Page
ABBOTT INSTRUMENTS, INC.	H-24
ACRO ELECTRIC CO.	L-27
ADVANCE ELECTRIC CO.	H-85 to 88
AEROVOX CORPORATION	K-37 to 58
Aircraft Battery Chargers	T-31
Aircraft Connectors, Plugs	N-7, 9, 35, 36
Aircraft Fuses	F-22
Aircraft Horns	D-7
Alarms, Burglar, Photo Electric	U-3
Alignment & Neutralizing Tools	H-108, 119, 120; N-8; R-3, 16
ALLIANCE MFG. CO.	E-27, 28
ALLIED CONTROL CO., INC.	H-91 to 93
Alligator Clips	H-115; Q-29, 60; R-2; T-5
ALPHA WIRE CORP.	Q-25 to 30
"American Beauty" Soldering Irons	R-41
AMERICAN CONDENSER CORP. ("Amcont")	K-73, 74
AMERICAN ELECTRICAL HEATER CO.	R-41
AMERICAN MICROPHONE CO., INC.	E-31 to 34
AMERICAN PHENOLIC CORP. ("Amphenol")	N-1 to 10
AMERICAN RADIO HARDWARE CO., INC.	R-1 to 4
AMERICAN RADIO RELAY LEAGUE ("ARRL")	G-11, 12
AMERICAN TELEVISION & RADIO CORP. ("ATR")	T-9 to 12
Ammeters	F-2, 5, 8, 26, 27, 28, 61, 62, 70, 78
AMPEREX ELECTRONIC PRODUCTS CO.	B-35, 36
AMPERITE COMPANY	E-7, 8; M-13, 14
"Amplical" Intercommunicating Systems	C-27, 28
Amplifiers and Systems	Section C
Cases, Cabinets	C-13, 14; H-99, 104, 111
Foundation Chassis	H-99, 104, 111
Kits, P.A., Amateur	H-106
Phono Amplifiers	C-12, 36, 71, 72
Pre-amplifiers	C-12, 28, 36
Remote Control for Amplifier Operation	C-14
Tuners	H-48; O-3
Xmitter Speech Amplifiers	H-14, 31, 106
Analyzers (See also "Testers")	Section F
Condenser	F-14; K-14c, K-27, 28, 50
Condenser-Resistor	K-27, 28, 69
Interference	K-44, 69
Resistance	K-69; M-6
Set	Section F; O-3
Angles and Brackets	H-118; R-4
Annunciator (Bell) Wire	Q-26, 38, 57
Antenna Accessories	Section Q; E-38; H-64 to 66
Coils	Section O
Insulators	H-47, 64; Q-1, 29, 36, 49 to 56, 64
Lead-in Strips, Ground Clamps, etc.	Q-29, 36, 50, 56;
Lightning Arresters	Q-1, 29, 36, 56
Loops	R-18
Spring Adjusters	Q-29, 56
Spring Wire Clips	H-118; Q-59
Transformers	H-66; Q-42
Wire and Cable	Section Q; H-64, 66
Antennas and Systems	H-64, 66; Q-30, 35, 41 to 55
Auto Antennas	H-122; Q-50
F-M Antennas	Q-41, 42, 55
Ihome Antennas	H-121; Q-30, 35, 42, 55, 56
Indoor Aerials, Eliminators	R-16
Kits	Q-30, 35, 41, 42, 55, 56
Kits, Doublet	Q-30, 35
Masts, Radiators	Q-41, 47, 48, 55
Rotary Beam Antennas	H-66
Telescoping Antennas	Q-47, 48
Television Antennas	H-66; Q-41, 55
Appliance Testers	F-4, 6, 86
"Areturus" Tubes and Lamps	B-23
ASTATIC CORPORATION	E-21 to 24
ATLAS RESISTOR CO.	M-9 to 12
ATLAS SOUND CORP.	D-31, 32
Attenuators	L-9, 14, 18, 21; M-34, 41
AUDAK CO., INC. ("Audax")	E-85, 86
Audio Chokes	Section J
AUDIO DEVICES, INC.	E-57, 58
Audio Oscillators	F-16, 19
Audio Reactors	J-3, 54, 64, 76
Audio Transformers	Section J; D-25, 48, 44, 60; E-8, 88
Auto Radio Accessories:	
Aerials	H-122; Q-50
Antenna Accessories	H-122; Q-61
Battery Eliminators	T-8, 12, 17
Condensers	H-122; K-12, 21, 22, 44, 66, 73, 78, 99; M-23
Fuse Connectors, Retainers	F-28; H-122; Q-61; R-2, 3

	Page
Auto Radio Accessories (Con.)	
Panel Lamps	B-8, 10, 14, 15, 23
Power Packs	S-5, T-17
Shielding	Q-3, 21, 24, 25, 37, 61
Suppressors, Ignition, Noise	H-122; M-15, 23, 25, 33;
Vibrators	Q-61; R-22
Volume and Tone Controls	Section S
Wire and Cable	L-7; M-30, 42, 43
	Q-3, 21 to 26, 37, 61

- B -

Baffles and Enclosures for Speakers	C-14; D-21, 24, 31, 32,
	42, 51, 60
Bakelite Panels	H-112; R-18
Bakelite Rods, Tubing, etc.	H-113
Ballast (Resistor) Tubes	B-5, 10, 38; L-17; M-13, 14
Band Expanders	H-21, 125; O-9
Band Switches and Assemblies	H-108; L-49; M-4; O-55, 56
BARKER & WILLIAMSON ("B & W")	O-65, 56
Bases & Bottom Plates for Metal Chassis	H-98, 104, 106, 112
Batteries	B-15, T-1
Adapters, Cables	T-6
Cable	Q-23, 27, 37, 58
Carriers	T-6
Clips	Q-29, 36; R-31; T-5, 6
Jumpers	T-6
Battery Chargers, Boosters	T-12, 26, 31, 32
Battery Eliminators	T-8, 12, 17
Battery Receivers	O-3
Battery Testers	F-2, 19, 27, 62, 65, 67, 75, 76
Beat Frequency Oscillators, Units	O-10, 26
BELDEN MFG. CO.	Q-1 to 3
BELL SOUND SYSTEMS, INC. ("Belfone")	C-35 to 42
Bell Wire	Q-26, 38, 57
Bench Chassis Jacks	R-17
Bench Lamps	R-16
Bench Stools	R-16
Binding Posts	H-47, 115, 127; R-1
BIRNBACH RADIO CO.	Q-55 to 64
BILEY ELECTRIC CO.	H-131, 132
"Blue Wizard" Circle Cutters	R-51
BOGEN COMPANY, INC., DAVID	C-1 to 17
Books and Manuals	Section G
Brackets and Angles	H-118; R-4
Bridges, Capacitor	K-14c
Bridges, Capacitor-Resistor	K-49
BRUSH DEVELOPMENT CO.	E-25, 26; H-136
BUD RADIO, INC.	H-101 to 110
Bumpers and Feet, Felt, Rubber	R-16, 18
BUNNELL & CO., J. H.	H-67, 68
BURGESS BATTERY CO.	T-1
Burglar Alarms, Photo Electric	U-3
Bus Bar Wire	Q-29, 59
Buzzers for Telegraph Keys	H-67, 76, 94

- C -

Cabinet Mouldings, Handles, etc.	H-113
Cabinet Patching and Refinishing Kits	R-21, 58
Cabinet Patching Materials	R-17, 20, 21, 57, 58
Cabinet Sound-Deadener and Sealer	R-17
Cabinets, Metal	H-49, 97, 98, 99, 103, 104, 111, 113
Cabinets, Utility	H-97, 113
Cable	See "Wire"
Cable Clamps	H-118; N-5, 30
Cable Connectors and Assemblies	Section N; D-32, 68; L-54
Calculators	G-4, 12; N-4
Calibrators, Signal	H-8, 106, 128; O-3
Call and Paging Systems	C-15 to 28, C-41, 42
Call Letter Tab Sheet	R-22
CANNON CO., C. F.	H-135
CANNON ELECTRIC DEVELOPMENT CO.	N-24 to 36
Capacitors	See "Condensers"
Capacitor Selectors, Motor-Starting	K-51
Carbon Granules, Microphone	H-110; R-17
CARDWELL MFG. CO., ALLEN D.	H-55 to 60
Carrying Cases	C-13, 14; H-104, 113
Cathode Ray Oscillographs	Section F
Cathode Ray Tube Mounting Assemblies	N-8
Cathode Ray Tubes	B-2, 17, 38; F-60
Cements, Repair, Coil, Speaker, etc.	H-44, 127; N-2; O-8;
	R-15, 17, 22, 57

GENERAL INDEX (Continued)

	Page
CENTRALAB (Globe-Union, Inc.)	L-5 to 12
Ceramic Condensers	L-8
"Cetron" Phototubes, Rectifiers	B-39, 40
Chart Frames	H-49
Chassis Mounts, Rubber, Felt	R-16, 18
Chassis, Panels, etc., Metal	H-98, 105, 106, 112
Chassis Punches	H-120
Chassis Supports and Guards for Bench	R-17, 22
Chemical Kits and Chemicals	R-17, 56, 58
Chisels	R-12
CHISHOLM-RYDER CO., INC., Premax Division	Q-47 to 50
Chokes, Audio, Filter, etc.	Section J
Chokes, R. F.	H-49, 53, 64, 107, 117, 127; K-99; M-4, 51; O-8, 11, 12, 28
Chokes, Xmitting, Diathermy, etc.	H-49, 53, 107, 117, 127; M-4; O-11, 28
CINAUDAGRAPH SPEAKERS, INC.	D-43 to 46
Circle-Cutting Tools	H-120; R-51
CLAROSTAT MFG. CO., INC.	L-13 to 18
Cleaning Fluids, Materials	R-15, 17, 20, 21, 56
Clips:	
Alligator	H-115; Q-29, 60; R-2; T-5
Battery	Q-29, 36; R-31; T-5, 6
Fuse	F-22 to 24; H-118; N-19; Q-61; R-2, 3
Test	H-115; Q-29, 60; T-5, 6
Tube	H-46, 63, 110, 118, 116, 117, 127; L-54; N-8; Q-64; R-2; T-6
Wire and Cable Spring Clips	H-118; Q-59
Co-axial Cable, Antenna	H-66; N-1, 10; Q-1
Co-axial Speakers	D-20, 46
Code Practice Oscillators	H-48, 79, 106, 121
Code Practice Sets	H-67 to 80, H-94, H-121
Coil Assemblies	H-44, 45, 108; O-4, 55, 56
Coil Chart Frames	H-49
Coil Dope	H-44, 127; N-3; O-8; R-17, 56
Coil Forms	H-44, 45, 48, 54, 109, 117, 127; N-3
Coil Kits	Section O; H-54, 109, 117
Coil Plugs and Sockets	H-127; N-3
Coil Replacement Windings	O-7, 27
Coil Shields	H-48, 49, 118
Coils	Section O
Antenna	Section O; H-108
Exact Duplicate	O-7, 27
I. F.	Section O; H-48, 127
Link (Inductor)	H-45, 62, 63, 108, 109, 127; O-55, 56
Oscillator	Section O; H-48, 109, 127
Plug-in	H-109, 117, 127
Preselector	O-5, 10, 23
R. F.	Section O; H-117
Color Coding Kits	R-15
Communicating Systems	C-15 to 28, O-41, 42
Cable	Q-2, 27, 28, 58
Communication Receivers	H-1 to 36; O-9
"Communophone" Intercommunicating Systems	C-15 to 17
Compass, Marine Radio	H-9
Condenser Analyzers	F-14; K-14c, K-27, 28, 50
Condenser Decades	K-14c
Condensers (Capacitors)	Section K; B-15; L-8; M-23, 24
Auto	H-122; K-12, 21, 22, 44, 66, 73, 78, 99; M-23
Ceramic	L-8
Electrolytic, Dry	Section K
Electrolytic, Wet	K-8, 19, 37, 64
Exact Duplicate	K-11, K-40 to 48, K-52 to 58
Fluorescent Lighting	K-21; M-24
Mica	K-14a, 14b, 25, 26, 45, 47, 67, 68, 84 to 90; O-12
Molded Paper	K-21; O-12
Motor-Starting	K-51 to 58, 77, 100; M-24
Neutralizing, Padding	H-41, 51 to 62, 102, 121, 126
Plug-in and Prong Base Electrolytic	K-4, 17, 37, 38, 94, 95
Television	K-22, 24, 46, 97
Transmitting, Fixed	Section K; M-24
Transmitting Variable	H-39 to 43, H-51 to 62, H-101, 126
Trimmer, Tuning, etc.	H-51 to 62, H-102, 126; K-29; L-8; O-8, 11, 12, 27
Variable Receiving	H-39, 40, 41, 51 to 62, 102, 121, 126; O-4, 8, 11, 27, 56
Connector Plug Handle	N-6
Connectors	Section N
Army-Navy, Aircraft	N-7, 9, 35, 36
Cable, etc.	Section N; D-32, 68; L-54
Chassis	D-68; N-5, 6, 7
Cord	Section N; M-17; R-18
Heavy Duty	N-7, 28, 31, 32
Microphone	D-32, 68; E-12, 17, 22, 34; H-110; N-6, 26, 30
Contact and Vibration Microphones	C-73; E-8, 22, 25, 44
CONTINENTAL CARBON, INC.	M-21 to 26
CONTINENTAL ELECTRIC CO. ("Cetron")	B-39, 40
Converters, Power Packs	S-5; T-9 to 30
Converters, Rotary	T-8, 13, 14, 18, 26
Converters, 5 and 10 Meter	O-10
CORNELL-DUBILIER ELECTRIC CORP. ("C-D")	K-1 to 14
CORNING GLASS WORKS ("Pyrex")	Q-51, 52
CORNISH WIRE CO., INC. ("Corwico")	Q-35 to 38

	Page
Couplings, Flexible, Insulated	H-44, 53, 107, 117; Q-63
Crystals	H-131 to 133
Filters	H-132; O-10
Holders	H-32, 133
Ovens	O-9
Sockets	H-53, 127; N-3, 8
Cutting Heads, Recording	E-4, 18, 24, 26, 36
Cutting Needles, Recording	E-36, 48, 58, 69 to 74
Cutting Pliers	R-7 to 11, R-30, 53
Cutting Tools, Circle	H-120; R-51

— D —

Decades, Capacitor	K-14c
Dial Cable, Belts	Q-28, 59; R-19, 55
Dial Crystals, Replacement	R-20
Dial Drive Accessories	R-19, 55, 58
Dial Drive Friction Cements, Compounds	R-19, 55, 56, 57
Dial Drive Friction Rubbers	R-19
Dial Knobs, Pointers	H-38, 108, 114; L-52; R-22
Dial Lamps	B-7, 8, 10, 14, 15, 23
Dial Light Assemblies, Jewels	F-24; H-108; L-42 to 46, L-54; R-2
Dial Light Coloring Lacquers, Kits	R-15, 58
Dial Oil	R-17, 56
Dial Plates	H-106, 114; L-50
Dials, Tuning, etc.	H-38, 106, 114, 126; O-8, 11
Diaphragm Replacements, Horn	D-1
Diathermy Tubes	B-27 to 38
DRAKE ELECTRIC WORKS, INC.	R-13, 14
DRAKE MANUFACTURING CO.	L-42 to 46
Drills, Portable	R-42
Drills, Steel, Refills	R-12
DUMONT LABORATORIES, ALLEN B.	F-59, 60
DUOTONE CO., INC.	E-69, 70
"Dykanol" Capacitors	K-13, 14
Dynamotors	T-8, 14, 18

— E —

Earphones	H-121, 134 to 136
EASTERN MIKE-STAND CO.	E-9 to 12
ECHOPHONE RADIO CO.	H-19, 20
"Economy" Speakers	D-67
EDITORS & ENGINEERS, LTD. (Radio Handbook)	Q-7
ELCOR, INC.	T-18
EITEL-McCULLOUGH, INC. ("Eimac")	B-29, 30
Electrical Connecting Devices, Section N; H-115; L-50; M-17; R-18	Section U
"Electric Eye" Equipment, Units	B-2, B-38 to 40
Photocells	Q-26, 59; R-18
Electrical Extension Cords, Sets	T-7, 18, 26
Electric Power Plants	R-5, 6
ELECTRIC SOLDERING IRON CO. ("Esico")	Section K
Electrolytic Condensers	T-19 to 22
ELECTRONIC LABORATORIES, INC.	R-15, 21, 56
Enamels, Lacquers, Paints, Varnishes	T-7, 18, 26
Engines, Gas-Electric	C-45 to 47
ERWOOD CO.	Q-26, 59; R-18
Extension Cord Sets	H-118; R-19
Eyelets, Rivets	H-120; R-19
Punches, Tools	H-120; R-19

— F —

Fabric for Instrument Covers, etc.	R-22
Feeder Line Spreader Insulators	H-47, 64; Q-64
Felt Bumpers, Feet, Pads	R-16, 22
Fence Controller Transformers	J-63
Fenoline Tubing	H-113
Field Supplies, Speaker	D-24, 55
Filament Transformers	Section J
Filter Chokes	Section J
Filters, Crystal	H-132; O-10
Filters, Interference, Noise	H-121, 122, 127; K-14d, 29, K-44, 68, 77, 98; M-4, 25, 26; O-5, 10, 21, 25, 28
Filter Selectors	K-44, 69
Fixture Wire	Q-26, 28, 37, 38, 57, 59; R-20
Flashlight Batteries	T-1
Flashlight Lamps	B-15
Flexible Couplings	H-44, 53, 107, 117; Q-63
Flexible Resistors	L-14; M-22
Flexible Screw Drivers	H-119
Flexible Shafts	H-44, 65, 107; M-44; Q-84
Flexible Tubing, Varnished (Spaghetti)	H-113; Q-26, 59; R-18
Floor Wax	R-21
Fluorescent Lighting Capacitors, Suppressors	K-21; M-24, 26
FM-AM Tuners	H-13; O-4
F-M Antennas	Q-41, 42, 55
F-M Books, Manuals	Section G
Foundation Chassis for Amplifiers	H-99, 104, 111
Foundation Units, Transmitter	H-37

GENERAL INDEX (Continued)

Record Players	Page
Parts, Accessories	U-12, 46
Rectifiers, Dry Disc	E-37, 38, 70; R-20, 56
Rectifiers, Replacement	T-32
Refrigerator Cabinet Patching Kits	R-21, 58
REGAL ELECTRONICS CORP. ("Tokfone")	C-23 to 26
Regulators, Automatic Line Voltage	L-16; M-17, 19, 23; R-31
REK-O-KUT CORP.	E-49, 60
Relays:	
Antenna Changeover (for Amateur Xmitters, etc.)	H-82, 86, 88, 89; O-11
Band-Switching	H-82
Break-In	H-82, 90; L-23
Circuit Control	H-85, 87, 88
Electronic	H-87
High Frequency	H-89, 92
Impulse	H-88, 89
Industrial Control	H-88
Keying	H-82, 86, 90, 91, 94; O-11
Latching	H-82, 86, 88, 93
Midget	H-82, 87, 88, 89, 91, 92, 93
Overload and Underload	H-82, 87, 90
Photo Electric	U-1 to 5
Plug-in Type	L-23
Power	H-92, 93; O-11
Remote Control	H-82, 89
Safety	H-82
Sensitive	H-82, 92
Starting	H-87
Time Delay	H-82, 86, 89
Remote Control Unit for Amplifier Operation	C-14
Remote Control Switch for Intercom. Spkr. Operation	C-23
Resistance Analyzers, Indicators	K-69; M-6
Resistance Meters	F-61
Resistors	Sections L and M
Adjustable	Section M; K-47, 48, 70; L-16, 21
Fixed	Section M; H-81; K-48, 70; L-8, 14, 15, 22
Flexible	L-14; M-22
Line Cord	Q-26, 60
Precision	M-2, 21, 34
Tube	B-5, 10, 38; L-17; M-18, 14
R. F. Chokes	H-49, 53, 64, 107, 117, 127; K-99; M-4, 51; O-8, 11, 12, 28
R. F. Coils	Section O; H-117
Rheostats	H-81; L-8, 17, 21; M-1, 4, 17, 33, 41
RIDER PUBLISHER, INC., JOHN F.	G-3 to 6
Rivets, Eyelets	H-118, R-19
Punches, Tools	H-120; R-19
"RME" Receivers	H-21, 22
ROESCH & SPEARS ("Blue Wizard" Tools)	R-51
Rotary Converters	T-8, 13, 14, 18, 26
Rotary Switches	H-107, 114; L-11, 14, 22, 24, 49; M-18; O-8, 11; R-18

— S —

SANGAMO ELECTRIC CO.	K-84 to 90
SCHOTT CO., WALTER L. ("Walsco")	R-55 to 58
Scotch Tape	R-18
Scratch Removers, Polishes	R-21, 57
Screen Grid Detector Coupler	H-48
Screw Drivers	H-119, 120; R-27, 29, 47, 48, 49
Neutralizing, Alignment	H-108, 119; R-3, 16
Offset	R-12, 48
Screw-Eye Insulators	Q-29, 36, 56
Screws, Nuts, Washers	H-118; L-52; R-3, 4, 16
SELECTAR MFG. CORP.	D-68
Selector Switches	F-8; L-10, 11, 12, 49; M-18; O-27; R-18
Sensitivity Controls	M-17
Service Aids, Miscellaneous	Section R
Service Manuals	Section G; E-38; H-53, 66; K-99
Set Analyzers	Section F; O-3
Shaft Couplings, Extenders, Reducers	H-44, 65, 107, 117, 118; M-44; Q-62; R-4, 16
Shafts, Flexible	H-44, 65, 107; M-44; Q-64
Shelves for Cabinet Jacks, Metal	H-98
Shielding, Copper, Braid	Q-3, 21, 24, 25, 37, 61
Shields and Shield Cans	H-48, 49, 104, 105, 127; O-8, 12; R-20
Coil Shields	H-48, 49, 113
Jack Shields	H-48
Tube Shields	H-49, 113, 127
Shims, Speaker	R-15, 16
SHURE BROTHERS	E-13 to 18
Signal Boosters, Amateur	H-21; O-10, 23
Signal Calibrators	H-8, 106, 128; O-3
SIGNAL ELECTRIC MFG. CO.	H-94; R-42
Signal Generators	Section F; O-9
Signal Indicators	F-24; H-108; L-42 to 46; L-54; R-2
SIMPSON ELECTRIC CO.	F-25 to 28
SIMPSON MFG. CO., MARK ("Masco")	C-71 to 74
Sleeving, Coated, Saturated	H-113; Q-26; R-18
Slide-Type Switches	H-116; L-27, 53; M-18; R-18
Sockets and Plugs	Section N
For coils	H-127; N-3
For crystal holders	H-53, 127; N-3, 6
For dial lights, miniature lamps	L-46; N-8; R-2
For prefocused lamps	N-7

Sockets and Plugs (Con.)	Page
For transmitting tubes	H-46, 63, 107, 117, 127; N-4; O-11; Q-64
For vibrators	N-4
Panel, Sub-panel	H-47, 107, 117, 127; N-4, 5; O-8; R-23
Wafer	H-46, 54, 63, 117
Socket Punches	N-4; O-8
Socket Selectors	F-69
Socket Wrenches	H-120; R-2, 16, 29
SOLAR MFG. CORP.	K-15 to 31
Solder	R-17, 52
Soldering Irons	H-120; Q-2; R-5, 6, 13, 14, 31 to 41
Non-stick Compounds	R-17
Rheostats, Control	M-1
Stands, Heat Controls	R-6, 14, 41
Tips, Replacement	H-120; Q-2; R-18
Soldering and Terminal Lugs	H-63, 115, 118; L-52; Q-2, 62; R-4, 16
Solvents, Thinners	R-15, 57
Sound Systems	Section C
Spade Lugs	H-63, 115
Spaghetti Tubing	H-113; Q-26, 59; R-13
Spark Plug Suppressors	H-122; M-15, 23, 25, 33; Q-61; R-22
Speakers	Section D
Baffles, Cabinets, Enclosures	Section D; C-14, 73; H-82
Cable	Q-2, 3, 23, 27, 37, 58
Carrying Cases	C-14; H-99, 104, 111
Cement, Repair	R-15, 57
Extension Cords	Q-23, 60
Field Supplies	D-24, 55
Grille Cloth	R-21, 56
Horns and Trumpets	Section D; C-23
Marine Speakers	D-3, 31
Networks	D-20, 46
Plugs	N-5
Projectors	Section D
Reproducers	D-21, 26, 51, 53, 60
Shims	R-15, 16
Stands	D-19, 31, 44
Volume Control, Power	D-32
"Speed-X" Keys	H-75, 76
SPRAGUE PRODUCTS CO.	K-61 to 70
Springs for Knobs	R-22
STANDARD ARCTURUS CORP.	B-23
STANDARD TRANSFORMER CORP. ("Stancor")	J-57 to 74; T-17
Stands, Microphone	Section E; C-13, 74; D-32; H-110
Stands, Speaker	D-19, 31, 44
Staple Driver	R-55
Staples and Tacks, Insulated	Q-29; R-16, 55
Stepdown Transformers	J-40, 63, 64, 82
STERLING MFG. CO.	F-61, 62
Student Midget Receiver Kits	O-1, 16
Suppressors, Noise	H-121, 122, 127; K-14d, 29, 44, 68, 77, 98; M-4, 25, 26; O-5, 10, 21, 26, 28
Auto Ignition	H-122; M-15, 23, 25, 33; Q-61; R-22
Parasitic	M-4, 33
SUPREME INSTRUMENTS CORP.	F-19 to 21
SUPREME PUBLICATIONS	G-8
Switches	Section L
Band	H-108; L-49; M-4; O-55, 56
Circuit-Opening	L-11, 49
Electronic (for Oscillographs)	F-60
Jack	L-24, 53
Key-Operated	L-11
Knife-Throw	H-116; M-6
Lever Action (Low Capacity)	L-11
Meter Insertion	L-11, 49
Microphone	E-10, 17, 21, 48; N-6
Power	H-107, 114; R-18
Push, Push-Button	H-32, 107, 114; L-11, 24, 53; M-6; R-18
Record Player	E-38; H-121
Relay	H-91
Rotary	H-107, 114; L-11, 14, 22, 24, 49; M-18; O-8; O-11; R-18
Selector	F-8; L-10, 11, 12, 49; M-18; O-27; R-18
Slide-Type, Snap	H-116; L-27, 53; M-18; R-18
Spring-Return	L-11
Tap	L-22, 49; N-7; O-8
Toggle	H-107, 114; R-18
Tone	L-10, 11
Transmitter (Amateur)	L-10, 49
Universal	L-10
Wafer	M-18
SYLVANIA ELECTRIC PRODUCTS, INC.	B-5 to 8

— T —

Tacks and Staples, Insulated	Q-29; R-16, 55
"Taco" Antenna Equipment	Q-41, 42
TALK-A-PHONE MFG. CO.	C-13 to 22
Tape, Friction, Scotch, Adhesive	R-18
TAYLOR TUBES, INC.	B-33, 34
TECHNICAL APPLIANCE CORP. ("Taco")	Q-41, 42
TELEGRAPH APPARATUS CO. ("Tac")	H-79, 80

GENERAL INDEX (Concluded)

Telegraph Keys and Practice Sets.....	H-67 to 80, H-94, H-121
Buzzers.....	H-67, 76, 94
Cord and Wedge.....	H-68
Keying Units, Radio Beam & Electronic.....	H-72
Oscillators, Code Practice.....	H-48, 79, 106, 121
Recorders.....	H-71
Relays.....	H-82, 86, 90, 91, 94; O-11
Tape Perforator.....	H-70
Tape Pullers, Pulleys.....	H-71, 72
Television Antennas.....	H-66; Q-41, 55
Television Capacitors.....	K-22, 24, 46, 97
Television Testers.....	F-3, 38, 66, 78
Television Tubes.....	B-2, 10
Terminal Clips, Plates, Strips... H-47, 116, 127; L-52; N-15 to 18, N-34; O-27; R-4	
Terminal Lugs.....	H-63, 115, 118, L-52; Q-2, 62; R-4, 16
Test Adapters and Plugs.....	N-8
Test Clips.....	H-115; Q-29, 60; T-5, 6
Test Leads.....	H-108, 119; Q-28, 60; R-3
Test Oscillators.....	Section F
Test Prods, Handles.....	H-116; Q-60; R-3
Test Prod Wire.....	Q-3, 25, 26, 37, 38, 57, 60
Testing Instruments, Analyzers	Section F
Appliance Testers.....	F-4, 6, 36
Battery Testers.....	F-2, 19, 27, 62, 65, 67, 75, 76
Condenser (Capacitor) Analyzers.....	F-14; K14c, 27, 28, 50
Condenser-Resistor Analyzers.....	K-27, 28, 69
Free-Point Testers.....	F-3, 4, 7, 8
Industrial Circuit Testers.....	F-16, 67, 68, 76, 77, 78
Multimeters, Multitesters.....	Section F
Oscillators, Signal Generators.....	Section F
Oscillographs, Oscilloscopes.....	Section F; H-82
Pocket "Tattletales," etc.....	F-24; R-16
Set Analyzers.....	Section F; O-3
Socket Selectors.....	F-69
Television Testers.....	F-3, 38, 66, 78
Tube Checkers, Testers.....	Section F
Vibrator Testers.....	F-2
Thermo Ammeters.....	F-6, 70
THORDARSON ELECTRIC MFG. CO.	J-75 to 82
"Time Signal" Coil Kit.....	O-4
Toggle Switches.....	H-107, 114; R-18
"Tokfone" Call Systems, Amplifiers.....	C-23 to 26
Tone Controls.....	L-5, 6, 7, 13; M-27, 28, 29, 41
Auto Tone Controls.....	L-7
Tone Control Unit.....	J-62
Tone Switches.....	L-10, 11
Tone Cases, Pocket.....	R-15
Tools	Section R; H-120; Q-2
Neutralizing, Alignment.....	H-108, 119, 120; N-8; R-3, 16
T-Pads.....	L-9, 18, 21; M-34, 41
Transceivers, 2 1/2 Meter.....	H-6, 24; O-9
Transceiver Transformers.....	J-64
Transcription Players.....	C-12; E-47
Transformers	Section J
Universal Replacement, for Radios.....	J-39, 40, 46
Transmission Line Cable.....	Section Q; N-1, 10
Transmitters	H-6 to 12; H-31, 37
Accessories, Foundation Units.....	H-37, 125
Marine Radiophone Units.....	H-10 to 12
Modulator Units.....	H-32
Speech Amplifiers.....	H-14, 31, 106
Transceivers, 2 1/2 Meter.....	H-6, 24; O-9
Trim for Cabinets.....	H-113
TRIM, INC.	H-134
Trimmer Condensers.....	H-51 to 62, H-102, 126; K-29; L-8; O-8, 11, 12, 27
TRIPLETT ELECTRICAL INSTRUMENT CO.	F-1 to 6
Trumpets and Horns.....	Section D; C-23
Tube Adapters, Plugs.....	N-8
Tube Clips and Caps.....	H-46, 63, 110, 113, 116, 117, 127; L-54; N-8; Q-64; R-2; T-6
Tube Shields.....	H-49, 113, 127
Tube Sockets... H-46, 47, 54, 63, 107, 117, 127; N-4, 5; O-8; R-22	
Xmitting Tube Sockets.....	H-46, 63, 107, 117, 127; N-4; O-11; Q-64
Tube Testers.....	Section F
Tube Tester Transformers.....	J-63
Tubes	Section B
Cathode Ray.....	B-2, 17, 38; F-60
Diathermy.....	B-27 to 38
Hearing Aid.....	B-11
Industrial & Special Purpose.....	B-2, 12, 16, 28 to 30
Phototubes.....	B-2, B-38 to 40
Receiving.....	Section B
Resistor (Ballast).....	B-5, 10, 38; L-17; M-13, 14
Television.....	B-2, 10
Transmitting, Power, Amateur.....	B-2, 11, 12, 16, 24 to 40
Voltage Regulating.....	L-16; M-17, 19, 23; R-31
Tubing, Flexible Varnished.....	H-113; Q-26, 59; R-18
Tuner Kits, P. A.....	H-48; O-3, 24
Tuners, FM-AM.....	H-13; O-4
TUNG-SOL LAMP WORKS, INC.	B-13, 14
Tuning Diodes.....	H-38, 106, 114, 126; O-8, 11
Tuning Units, Assemblies.....	H-48, 53; O-4
Tuning Wands.....	R-3
TURNER CO., THE	E-43, 44
Turntables and Motors, Phono.....	E-27, 28, 37

Page

— U —

UNITED ELECTRONICS CO.	B-31, 32
UNITED TRANSFORMER CO. ("UTC")	J-31 to 42
Universal Adapters.....	N-8
UNIVERSAL MICROPHONE CO., LTD.	E-3, 4
Universal Replacement Transformers, Radio.....	J-39, 40, 46
UNIVERSITY LABORATORIES	D-61, 62
UTAH RADIO PRODUCTS CO.	D-51 to 55; J-1 to 4; L-21 to 24; M-37, 38; S-35, 36
UTICA DROP FORGE & TOOL CORP.	R-53, 54

— V —

VACO PRODUCTS CO.	R-47 to 49
Vacuum Cleaner Belts.....	R-20
Variable Condensers.....	H-39 to 43, 51 to 62, 101, 102, 121, H-126; O-4, 8, 11, 27, 56
Varnishes, Lacquers, Paints, Enamels.....	R-15, 21, 56
Varnished Tubing, Flexible (Spaghetti).....	H-113; Q-26, 59; R-18
VASCO ELECTRICAL MFG. CO.	R-39, 40
Vernier Dials.....	H-3E, 114
Vibration Pickups, Microphone.....	E-22, 25, 44
Vibrator Power Packs.....	S-5; T-11 to 30
Vibrators.....	Section S; T-22
Vibrator Testers.....	F-2
Vibrator Transformers.....	J-3, 58, 80
VIBROPLEX CO., INC.	H-77, 78
"Vidiotrons" (tubes).....	B-17
Voltage Regulators, Reducers.....	L-16; M-17, 19, 23; R-31
Voltage Regulator-Transformers.....	J-35, 38, 40, 63, 64, 82
Voltmeters.....	Section F
Voltohmeters.....	F-7, 31, 63, 69
Volt-ohm-milliammeters.....	F-2 to 8, F-25, 31, 35, 38, 69
Volume Controls	Section L; B-15; M-17, 27 to 30, 41 to 45
Auto.....	L-7; M-30, 42, 43
P.A., etc.....	L-9, 14, 18, 21; M-27, 28, 29, 34, 41
Volume Control Wrenches.....	H-120; M-44; R-2, 47

— W —

Water Sockets.....	H-46, 54, 63, 117
Wall Plates, Receptacles, Assemblies.....	Section N
"Walsco" Service Aids.....	R-55 to 58
WARD LEONARD ELECTRIC CO.	H-81, 82; M-19, 20
Wattmeters.....	F-6, 36
Wave Traps.....	E-38; H-127; O-5, 25
Wax Filler.....	R-17
Wax, Floor.....	R-21
WESTINGHOUSE ELECTRIC MFG. CO.	B-37, 38; U-5
WESTON ELECTRICAL INSTRUMENT CORP.	F-65 to 70
Wheel Static Eliminators, Auto.....	H-122; Q-61
Window Antennas.....	H-121
Window Cleaner Compound.....	R-20
Wire and Cable	Section Q
Antenna Wire and Cable.....	Section Q; H-64, 66
Antenna Wire for AC-DC Sets.....	Q-26, 37, 38, 57; R-18
Auto Radio Wire and Cable.....	Q-3, 21 to 26, 37, 61
Battery Cable.....	Q-23, 27, 37, 58
Bell Wire.....	Q-26, 38, 57
Bus-Bar Wire.....	Q-29, 59
Communicating System Cable.....	Q-2, 27, 28, 58
Coaxial Cable.....	H-66; N-1, 10, Q-1
Copper Tubing Cable.....	N-1
Dial Cable, Belts.....	Q-28, 59; R-19, 55
Electrical Extension Cords, Sets.....	Q-26, 59; R-15
Fixture, Service Wire.....	Q-26, 28, 37, 38, 57, 59; R-20
Guy Wire.....	Q-26, 55
Headphone Cords.....	Q-2, 23, 60
High Temperature Cable.....	N-1; Q-3
Hookup Wire.....	Q-3, 19 to 28, 38, 57; R-20
Indoor Aerial Wire.....	Q-24, 26; R-18
Lead-in and Ground Wire.....	Q-1, 3, 21 to 29, 36 to 38, 57
Magnet Wire.....	Q-3, 26, 38, 59
Microphone Cable.....	Q-2, 22, 24, 27, 37, 58; E-15
Multiple-Conductor Cable.....	Q-3, 22, 27, 37; L-54
Phosphor Bronze Aerial Wire.....	Q-30, 56
Resistance Cords.....	Q-26, 60
Shielding, Copper, Braid.....	Q-3, 21, 24, 25, 37, 61
Speaker Cable.....	Q-2, 3, 23, 27, 37, 58
Speaker Cords.....	Q-23, 60
Telephone Wire, Inside.....	Q-28
Test Prod Wire.....	Q-3, 25, 26, 37, 38, 57, 60
Transmission Line Cable.....	Section Q; N-1, 10
Tubing, Flexible Varnished (Spaghetti).....	H-113; Q-26, Q-59; R-15
WIRT CO.	M-15 to 18
World Time Indicators.....	G-2
WORNER ELECTRONIC DEVICES	U-1 to 4
Wrenches:	
Neutralizing, Alignment.....	H-108, 119; R-3, 16
Socket.....	H-120; R-2, 16, 29
Steel.....	R-54
Volume Control.....	H-120; M-44; R-2, 47

— X —

"Xcelite" Tools.....	R-27 to 30
----------------------	------------

GENERAL INDEX (Continued)

	Page
Record Players	C-12, 46
Parts, Accessories	E-37, 38, 70; R-20, 56
Rectifiers, Dry Disc	T-32
Rectifiers, Replacement	T-32
Refrigerator Cabinet Patching Kits	R-21, 58
REGAL ELECTRONICS CORP. ("Toktone")	C-23 to 26
Regulators, Automatic Line Voltage	L-10; M-17, 19, 23; R-31
REK-O-KUT CORP.	E-49, 50

Relays:	
Antenna Changeover (for Amateur Xmitters, etc.)	H-82, 86, 88, 89; O-11
Band-Switching	H-82
Break-In	H-82, 90; L-23
Circuit Control	H-85, 87, 88
Electronic	H-87
High Frequency	H-89, 92
Impulse	H-88, 89
Industrial Control	H-88
Keying	H-82, 86, 90, 91, 94; O-11
Latching	H-82, 86, 88, 93
Midget	H-82, 87, 88, 89, 91, 92, 93
Overload and Underload	H-82, 87, 90
Photo Electric	U-1 to 5
Plug-in Type	L-23
Power	H-92, 93; O-11
Remote Control	H-82, 89
Safety	H-82
Sensitive	H-82, 92
Starting	H-87
Time Delay	H-82, 86, 89
Remote Control Unit for Amplifier Operation	C-14
Remote Control Switch for Intercom. Spkr. Operation	C-23
Resistance Analyzers, Indicators	K-69; M-6
Resistance Meters	F-61
Resistors	
Adjustable	Sections L and M
Fixed	Section M; K-47, 48, 70; L-16, 21
Flexible	Section M; H-81; K-48, 70; L-8, 14, 15, 22
Line Cord	L-14; M-22
Precision	Q-26, 60
Tube	M-2, 21, 34
R. F. Chokes	B-5, 10, 38; L-17; M-13, 14
R. F. Coils	H-49, 53, 64, 107, 117, 127; K-99; M-4, 51; O-8, 11, 12, 28
Rheostats	Section O; H-117
RIDER PUBLISHER, INC., JOHN F.	H-81; L-8, 17, 21; M-1, 4, 17, 33, 41
Rivets, Eyelets	G-3 to 6
Punches, Tools	H-118, R-19
"RME" Receivers	H-120; R-19
ROESCH & SPEARS ("Blue Wizard" Tools)	H-21, 22
Rotary Converters	R-51
Rotary Switches	T-8, 13, 14, 18, 26
	H-107, 114; L-11, 14, 22, 24, 49; M-18; O-8, 11; R-18

— S —

SANGAMO ELECTRIC CO.	K-84 to 90
SCHOTT CO., WALTER L. ("Walsco")	R-55 to 58
Scotch Tape	R-18
Scratch Removers, Polishes	R-21, 57
Screen Grid Detector Coupler	H-48
Screw Drivers	
Neutralizing, Alignment	H-119, 120; R-27, 29, 47, 48, 49
Offset	H-108, 119; R-3, 16
Screw-Eye Insulators	R-12, 48
Screws, Nuts, Washers	Q-29, 36, 56
SELECTAR MFG. CORP.	H-118; L-52; R-3, 4, 16
Selector Switches	D-68
Sensitivity Controls	F-8; L-10, 11, 12, 49; M-18; O-27; R-18
Service Aids, Miscellaneous	M-17
Service Manuals	Section R
Set Analyzers	Section G; E-38; H-53, 66; K-99
Shaft Couplings, Extenders, Reducers	Section F; O-3
	H-44, 65, 107, 117, 118; M-44; Q-62; R-4, 16
Shafts, Flexible	H-44, 65, 107; M-44; Q-64
Shelves for Cabinet Racks, Metal	H-98
Shielding, Copper, Braid	Q-3, 21, 24, 25, 37, 61
Shields and Shield Cans	H-48, 49, 104, 105, 127; O-8, 12; R-20
Coil Shields	H-48, 49, 113
Jack Shields	H-48
Tube Shields	H-49, 113, 127
Shims, Speaker	R-15, 16
SHURE BROTHERS	E-13 to 13
Signal Boosters, Amateur	H-21; O-10, 23
Signal Calibrators	H-8, 106, 128; O-3
SIGNAL ELECTRIC MFG. CO.	H-94; R-42
Signal Generators	Section F; O-9
Signal Indicators	F-24; H-108; L-42 to 46; L-54; R-2
SIMPSON ELECTRIC CO.	F-25 to 28
SIMPSON MFG. CO., MARK ("Masco")	C-71 to 74
Sleeving, Coated, Saturated	H-113; Q-26; R-18
Slide-Type Switches	H-116; L-27, 53; M-18; R-18
Sockets and Plugs	
For coils	Section X
For crystal holders	H-127; N-3
For dial lights, miniature lamps	H-53, 127; N-3, 8
For prefocused lamps	L-46; N-8; R-2

Sockets and Plugs (Con.)	
For transmitting tubes	H-46, 63, 107, 117, 127; N-4; O-11; Q-64
For vibrators	N-4
Panel, Sub-panel	H-47, 107, 117, 127; N-4, 5; O-8; R-22
Wafer	H-46, 54, 63, 117
Socket Punches	N-4; O-8
Socket Selectors	F-69
Socket Wrenches	H-120; R-2, 16, 29
SOLAR MFG. CORP.	K-15 to 31
Solder	R-17, 52
Soldering Irons	
Non-stick Compounds	H-120; Q-2; R-5, 6, 13, 14, 31 to 41
Rheostats, Control	R-17
Stands, Heat Controls	M-1
Tips, Replacement	R-6, 14, 41
Soldering and Terminal Lugs	H-120; Q-2; R-18
	H-63, 115, 118; L-52; Q-2, 62; R-4, 16
Solvents, Thinners	R-15, 57
Sound Systems	Section C
Spade Lugs	H-63, 115
Spaghetti Tubing	H-113; Q-26, 59; R-18
Spark Plug Suppressors	H-122; M-15, 23, 25, 33; Q-61; R-22
Speakers	
Baffles, Cabinets, Enclosures	Section D; C-14, 73; R-32
Cable	Q-2, 3, 23, 27, 37, 58
Carrying Cases	C-14; H-99, 104, 111
Cement, Repair	R-15, 57
Extension Cords	Q-23, 60
Field Supplies	D-24, 55
Grille Cloth	R-21, 56
Horns and Trumpets	Section D; C-23
Marine Speakers	D-3, 31
Networks	D-20, 46
Plugs	N-5
Projectors	Section D
Reproducers	I-21, 26, 51, 63, 60
Shims	R-15, 16
Stands	D-19, 31, 44
Volume Control, Power	D-32
"Speed-X" Keys	H-75, 76
SPRAGUE PRODUCTS CO.	K-61 to 70
Springs for Knobs	R-22
STANDARD ARCTURUS CORP.	B-23
STANDARD TRANSFORMER CORP. ("Stancor")	J-57 to 74; T-17
Stands, Microphone	Section E; C-13, 74; D-32; H-110
Stands, Speaker	D-19, 31, 44
Staple Driver	R-55
Staples and Tacks, Insulated	Q-29; R-16, 55
Stepdown Transformers	J-40, 63, 64, 82
STERLING MFG. CO.	F-61, 62
Student Midget Receiver Kits	O-1, 16
Suppressors, Noise	H-121, 122, 127; K-14d, 29, 44, 68, 77, 98; M-4, 25, 26; O-5, 10, 21, 25, 28
Auto Ignition	H-122; M-15, 23, 25, 33; Q-61; R-22
Parasitic	M-4, 33
SUPREME INSTRUMENTS CORP.	F-19 to 21
SUPREME PUBLICATIONS	G-8
Switches	
Band	Section L
Circuit-Opening	H-108; L-49; M-4; O-55, 56
Electronic (for Oscillographs)	L-11, 49
Jack	F-60
Key-Operated	L-24, 53
Knife-Throw	L-11
Lever Action (Low Capacity)	H-116; M-6
Meter Insertion	L-11
Microphone	E-10, 17, 21, 43; N-6
Power	H-107, 114; R-18
Push, Push-Button	H-82, 107, 114; L-11, 24, 53; M-6; R-18
Record Player	E-38; H-121
Relay	H-91
Rotary	H-107, 114; L-11, 14, 22, 24, 49; M-18; O-8; O-11; R-18
Selector	F-8; L-10, 11, 12, 49; M-18; O-27; R-18
Slide-Type, Snap	H-116; L-27, 53; M-18; R-18
Spring-Return	L-11
Tap	L-22, 49; N-7; O-6
Toggle	H-107, 114; R-18
Tone	L-10, 11
Transmitter (Amateur)	L-10, 49
Universal	L-10
Wafer	M-18
SYLVANIA ELECTRIC PRODUCTS, INC.	R-5 to 8

— T —

Tacks and Staples, Insulated	Q-29; R-16, 55
"Taco" Antenna Equipment	Q-41, 42
TALK-A-PHONE MFG. CO.	C-18 to 22
Tape, Friction, Scotch, Adhesive	R-18
TAYLOR TUBES, INC.	B-33, 34
TECHNICAL APPLIANCE CORP. ("Taco")	Q-41, 42
TELEGRAPH APPARATUS CO. ("Tac")	H-79, 80

GENERAL INDEX (Concluded)

	Page	
Telegraph Keys and Practice Sets.....	H-67 to 80, H-94, H-121	
Buzzers.....	H-67, 76, 94	
Cord and Wedge.....	H-68	
Keying Units, Radio Beam & Electronic.....	H-72	
Oscillators, Code Practice.....	H-48, 79, 106, 121	
Recorders.....	H-71	
Relays.....	H-82, 86, 90, 91, 94; O-11	
Tape Perforator.....	H-70	
Tape Pullers, Pulleys.....	H-71, 72	
Television Antennas.....	H-66; Q-41, 55	
Television Capacitors.....	K-22, 24, 46, 97	
Television Testers.....	F-3, 38, 66, 78	
Television Tubes.....	B-2, 10	
Terminal Clips, Plates, Strips.....	H-47, 116, 127; L-52; N-15 to 18, N-34; O-27; R-4	
Terminal Lugs.....	H-63, 115, 118, L-52; Q-2, 62; R-4, 16	
Test Adapters and Plugs.....	N-8	
Test Clips.....	H-115; Q-29, 60; T-5, 6	
Test Leads.....	H-108, 119; Q-28, 60; R-3	
Test Oscillators.....	Section F	
Test Prods, Handles.....	H-116; Q-60; R-3	
Test Prod Wire.....	Q-3, 25, 26, 37, 38, 57, 60	
Testing Instruments, Analyzers.....	Section F	
Appliance Testers.....	F-4, 6, 36	
Battery Testers.....	F-2, 19, 27, 62, 65, 67, 75, 76	
Condenser (Capacitor) Analyzers.....	F-14; K14c, 27, 28, 50	
Condenser-Resistor Analyzers.....	K-27, 28, 69	
Free-Point Testers.....	F-3, 4, 7, 8	
Industrial Circuit Testers.....	F-16, 67, 68, 76, 77, 78	
Multimeters, Multitesters.....	Section F	
Oscillators, Signal Generators.....	Section F	
Oscillographs, Oscilloscopes.....	Section F; H-82	
Pocket "Tattletites," etc.....	F-24; R-16	
Set Analyzers.....	Section F; O-3	
Socket Selectors.....	F-69	
Television Testers.....	F-3, 38, 66, 78	
Tube Checkers, Testers.....	Section F	
Vibrator Testers.....	F-2	
Thermo Ammeters.....	F-6, 70	
THORDARSON ELECTRIC MFG. CO. "Time Signal" Coil Kit.....	J-75 to 82 O-4	
Toggle Switches.....	H-107, 114; R-18	
"Tokfone" Call Systems, Amplifiers.....	C-23 to 26	
Tone Controls.....	L-5, 6, 7, 18; M-27, 28, 29, 41	
Auto Tone Controls.....	L-7	
Tone Control Unit.....	J-62	
Tone Switches.....	L-10, 11	
Tool Cases, Pocket.....	R-15	
Tools.....	Section R; H-120; Q-2	
Neutralizing, Alignment.....	H-108, 119, 120; N-8; R-3, 16	
T-Pads.....	L-9, 18, 21; M-34, 41	
Transceivers, 2 1/2 Meter.....	H-6, 24; O-9	
Transceiver Transformers.....	J-64	
Transcription Players.....	C-12; E-47	
Transformers.....	Section J	
Universal Replacement, for Radios.....	J-39, 40, 46	
Transmission Line Cable.....	Section Q; N-1, 10	
Transmitters.....	H-6 to 12; H-31, 37	
Accessories, Foundation Units.....	H-37, 125	
Marine Radiophone Units.....	H-10 to 12	
Modulator Units.....	H-32	
Speech Amplifiers.....	H-14, 31, 106	
Transceivers, 2 1/2 Meter.....	H-6, 24; O-9	
Trim for Cabinets.....	H-113	
TRIMM, INC.....	H-134	
Trimmer Condensers.....	H-51 to 62, H-102, 126; K-29; L-8; O-8, 11, 12, 27	
TRIPLETT ELECTRICAL INSTRUMENT CO. Trumpets and Horns.....	F-1 to 6	
Tube Adapters, Plugs.....	Section D; C-23	
Tube Clips and Caps.....	N-8	
H-46, 63, 110, 113, 116, 117, 127; L-54; N-8; Q-64; R-2; T-6		
H-49, 113, 127		
Tube Shields.....	H-49, 113, 127	
Tube Sockets.....	H-46, 47, 54, 63, 107, 117, 127; N-4, 5; O-8; R-22	
Xmitting Tube Sockets.....	H-46, 63, 107, 117, 127; N-4; O-11; Q-64	
Tube Testers.....	Section F	
Tube Tester Transformers.....	J-63	
Tubes.....	Section B	
Cathode Ray.....	B-2, 17, 38; F-60	
Diathermy.....	B-27 to 38	
Hearing Aid.....	R-11	
Industrial & Special Purpose.....	B-2, 12, 16, 28 to 40	
Phototubes.....	B-2, B-38 to 40	
Receiving.....	Section B	
Resistor (Ballast).....	B-5, 10, 88; L-17; M-13, 14	
Television.....	B-2, 10	
Transmitting, Power, Amateur.....	B-2, 11, 12, 16, 24 to 40	
Voltage Regulating.....	L-16; M-17, 19, 23; R-31	
H-113; Q-26, 59; R-18		
H-48; O-3, 24		
H-18; O-4		
B-13, 14		
H-38, 106, 114, 126; O-8, 11		
H-48, 58; O-4		
R-3		
E-43, 44		
E-27, 28, 37		
Turntables and Motors, Phono.....	E-27, 28, 37	

— U —

UNITED ELECTRONICS CO.....	B-31, 32
UNITED TRANSFORMER CO. ("UT").....	J-31 to 42
Universal Adapters.....	N-8
UNIVERSAL MICROPHONE CO., LTD.....	E-3, 4
Universal Replacement Transformers, Radio.....	J-39, 40, 46
UNIVERSITY LABORATORIES.....	D-61, 62
UTAH RADIO PRODUCTS CO.....	D-51 to 55; J-1 to 4;
	L-21 to 24; M-37, 38; S-85, 86
UTICA DROP FORGE & TOOL CORP.....	R-53, 54

— V —

VACO PRODUCTS CO.....	R-47 to 49
Vacuum Cleaner Belts.....	R-20
Variable Condensers.....	H-39 to 43, 51 to 62, 101, 102, 121, H-126; O-4, 8, 11, 27, 56
Varnishes, Lacquers, Paints, Enamels.....	R-15, 21, 56
Varnished Tubing, Flexible (Spaghetti).....	H-118; Q-26, 59; R-18
VASCO ELECTRICAL MFG. CO.....	R-39, 40
Vernier Dials.....	H-38, 114
Vibration Pickups, Microphone.....	F-22, 25, 44
Vibrator Power Packs.....	S-5; T-11 to 30
Vibrators.....	Section S; T-22
Vibrator Testers.....	F-2
Vibrator Transformers.....	J-8, 58, 80
VIBROPLEX CO., INC. "Videotrons" (tubes).....	H-77, 78 B-17
Voltage Regulators, Reducers.....	L-16; M-17, 19, 23; R-31
Voltage Regulator-Transformers.....	J-35, 38, 40, 63, 64, 82
Voltmeters.....	Section F
Voltmeters.....	F-7, 31, 68, 69
Volt-ohm-milliammeters.....	F-2 to 8, F-25, 31, 35, 38, 69
Volume Controls.....	Section L; B-15; M-17, 27 to 30, 41 to 45
Auto.....	L-7; M-30, 42, 43
P.A., etc.....	L-9, 14, 18, 21; M-27, 28, 29, 34, 41
Volume Control Wrenches.....	H-120; M-44; R-2, 47

— W —

Wafer Sockets.....	H-46, 54, 63, 117
Wall Plates, Receptacles, Assemblies.....	Section N
"Walsco" Service Aids.....	R-55 to 58
WARD LEONARD ELECTRIC CO.....	H-81, 82; M-19, 20
Wattmeters.....	F-6, 36
Wave Traps.....	E-38; H-127; O-5, 25
Wax Filler.....	R-17
Wax, Floor.....	R-21
WESTINGHOUSE ELECTRIC MFG. CO.....	B-37, 38; U-5
WESTON ELECTRICAL INSTRUMENT CORP.....	F-65 to 70
Wheel Static Eliminators, Auto.....	H-122; Q-61
Window Antennas.....	H-131
Window Cleaner Compound.....	R-20
Wire and Cable.....	Section Q
Antenna Wire and Cable.....	Section Q; H-64, 66
Antenna Wire for AC-DC Sets.....	Q-26, 37, 38, 57; R-18
Auto Radio Wire and Cable.....	Q-3, 21 to 26, 37, 61
Battery Cable.....	Q-23, 27, 37, 53
Bell Wire.....	Q-26, 38, 57
Bus-Bar Wire.....	Q-29, 59
Communicating System Cable.....	Q-2, 27, 28, 58
Coaxial Cable.....	H-66; N-1, 10; Q-1
Copper Tubing Cable.....	N-1
Dial Cable, Belts.....	Q-28, 59; R-19, 55
Electrical Extension Cords, Sets.....	Q-26, 59; R-18
Fixture, Service Wire.....	Q-26, 28, 37, 38, 57, 59; R-20
Guy Wire.....	Q-26, 55
Headphone Cords.....	Q-2, 23, 60
High Temperature Cable.....	N-1; Q-8
Hookup Wire.....	Q-3, 19 to 28, 38, 57; R-20
Indoor Aerial Wire.....	Q-24, 26; R-18
Lead-in and Ground Wire.....	Q-1, 3, 21 to 29, 36 to 38, 57
Magnet Wire.....	Q-3, 26, 88, 59
Microphone Cable.....	Q-2, 22, 24, 27, 37, 58; E-15
Multiple-Conductor Cable.....	Q-3, 22, 27, 37; L-54
Phosphor Bronze Aerial Wire.....	Q-30, 56
Resistance Cords.....	Q-26, 60
Shielding, Copper, Braid.....	Q-3, 21, 24, 25, 37, 61
Speaker Cable.....	Q-2, 3, 23, 27, 37, 58
Speaker Cords.....	Q-23, 60
Telephone Wire, Inside.....	Q-28
Test Prod Wire.....	Q-3, 25, 26, 37, 38, 57, 60
Transmission Line Cable.....	Section Q; N-1, 10
Tubing, Flexible Varnished (Spaghetti).....	H-118; Q-26, Q-59; R-18
WIRT CO.....	M-15 to 18
World Time Indicators.....	G-2
WORNOR ELECTRONIC DEVICES.....	U-1 to 4
Wrenches:	
Neutralizing, Alignment.....	H-108, 119; R-3, 16
Socket.....	H-120; R-2, 16, 29
Steel.....	R-54
Volume Control.....	H-120; M-44; R-2, 47

— X —

"Xcelite" Tools.....	R-27 to 30
----------------------	------------

SAY YOU SAW IT IN "Radio's Master"



